

PIPE FITTINGS



Pipe Size	1/16	1/8	1/4	3/8	1/2	3/4	1
Thread Size	1/16-27	1/8-27	1/4-18	3/8-18	1/2-14	3/4-14	1-11/2
Working Pressure	1200	1200	1200	1200	1200	1000	1000
Thread OD	1/4	3/8	1/2	5/8	3/4	1	1-1/4

Typical Application: Grease, Fuels, LP and Natural Gas (available on special order), Refrigeration, Instrumentation and Hydraulic Systems.

Pressure: Operating pressure up to 1200 PSI.

Vibration: Fair resistance.

Temperature Range:

-65°F to +250°F (-53°C to +121°C).

Used With: Brass, Bronze, Copper, Steel, Aluminum And Iron Pipe.

Tolerance : +/- .02 on all dimensions. Dimension Data can change without notice. Please call us when dimensions are critical.

Conformance: Meets specifications and standards of ASA, ASME and SAE

• Not lead free

Assembly Instructions

1 - Tighten approximately 2 turns past hand tight.

2 - Fittings with thread sealant tighten two turns past hand tight. Brittle materials require special cautions.

MIDLAND	MIDLAND INDUSTRIES PRODUCT NUMBER
AMC	ANDERSON METALS CORPORATION CROSSOVER NUMBERS
CHAMPION	CHAMPION CROSSOVER NUMBERS
MAF	MID-AMERICA FITTINGS PART NUMBERS

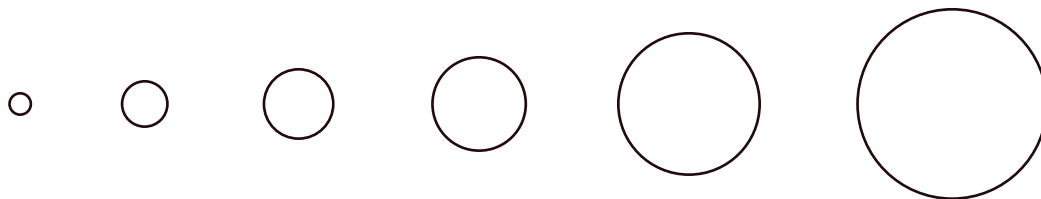

Actual outside diameters of pipe threads



Actual Male Thread Profiles

WARNING: This product can expose you to chemicals, including lead, which are known to the State of California to cause cancer and birth defects or other reproductive harm. For more information, visit www.P65Warnings.ca.gov

PIPE**BRASS FITTINGS****90° FEMALE ELBOW**

SAE# 130238

06100
100

MIDLAND	AMC	CHAMPION	LIST	THREAD SIZE NPTF	MAF #	MAF PRICE
				1/16"	23500X1	...
28001	06100-02	100A-A	----	1/8"	23500X2	...
28002	06100-04	100A-B	----	1/4"	23500X4	...
28003	06100-06	100A-C	----	3/8"	23500X6	...
28004	06100-08	100A-D	----	1/2"	23500X8	...
28005	06100-12	100A-E	----	3/4"	23500X12	...
				1/8 x 1/16	23502X1	...
				1/4 x 1/8	23504X2	...
				3/8 x 1/8	23506X2	...
28015B			----	3/8" x 1/4"	23506X4	...
28053B			----	1/2" x 1/4"	23508X4	...
28016B			----	1/2" x 3/8"	23508X6	...
				3/4 x 1/4	23512X4	...
				3/4" x 3/8"	23512X6	...
				3/4 x 1/2	23512X8	...

100 2200P 3500 302 200

90° FORGED FEMALE ELBOW06200
100F

MIDLAND	AMC	CHAMPION	LIST	THREAD SIZE NPTF	MAF #	MAF PRICE
28009	06200-02	100AF-A	----	1/8"	100F-2	...
28010	06200-04	100AF-B	----	1/4"	100F-4	...
28011	06200-06	100AF-C	----	3/8"	100F-6	...
28012	06200-08	100AF-D	----	1/2"	100F-8	...
28013	06200-12	100AF-E	----	3/4"	100F-12	...
28014	06205-0402	100AF-BA	----	1/4" x 1/8"	100FR-42	...
28015	06205-0604	100AF-CB	----	3/8" x 1/4"	100FR-64	...
28016	06205-0806	100A-DC	----	1/2" x 3/8"	100FR-86	...
28017			----	1"		

1200P E7 100AF 100B

45° FEMALE ELBOW06107
10045

MIDLAND	AMC	CHAMPION	LIST	THREAD SIZE NPTF	MAF #	MAF PRICE
28018	06107-02	100-45A-A	----	1/8"	10045-2	...
28019	06107-04	100-45A-B	----	1/4"	10045-4	...
28020			----	3/8"	10045-6	...
28021B		100X-45-D	----	1/2"	10045-8	...

129 2201P 205 23355 45EZ 105 100-45A

DIMENSION DATA CAN CHANGE WITHOUT NOTICE. PLEASE CALL WHEN DIMENSIONS ARE CRITICAL.

PIPE
BRASS FITTINGS

UNION TEE

SAE# 130438



06101
101

MIDLAND	AMC	CHAMPION	LIST	THREAD SIZE NPTF	MAF #	MAF PRICE
28022			----	1/16"	23700X1	...
28024	06101-02	101A-A	----	1/8"	23700X2	...
28025	06101-04	101A-B	----	1/4"	23700X4	...
28026	06101-06	101A-C	----	3/8"	23700X6	...
28027	06101-08	101A-D	----	1/2"	23700X8	...
28028	06101-12	101A-E	----	3/4"	23700X12	...
				1/8 x 1/16	23700X2X1	...
				1/4 x 1/8	23700X4X2	...
				3/8 x 1/4	23700X6X4	...
				1/2 x 3/8	23700X8X6	...
				3/4 x 1/2	23700X12X8	...

311 101A 322 2203P 3700 203

UNION FORGED TEE



06201
101F

MIDLAND	AMC	CHAMPION	LIST	THREAD SIZE NPTF	MAF #	MAF PRICE
28032	06201-02	101AF-A	----	1/8"	101F-2	...
28033	06201-04	101AF-B	----	1/4"	101F-4	...
28034	06201-06	101AF-C	----	3/8"	101F-6	...
28035	06201-08	101AF-D	----	1/2"	101F-8	...
28036	06201-12	101AF-E	----	3/4"	101F-12	...
28023		101AF-F	----	1"		

1203P LT7 101AF 101B

REDUCING FORGED TEES



06206
101FR

MI	AMC	LIST	1 NPT	2 NPT	3 NPT	BODY WIDTH	MAF #	MAF PRICE
28029	06206-020204	----	1/8"	1/8"	1/4"	0.69	101FR-224	...
28030	06206-040402	----	1/4"	1/4"	1/8"	0.69	101FR-442	...
28031		----	1/4"	1/4"	3/8"	0.81	101FR-446	...
28038		----	3/8"	1/4"	3/8"	0.81	101FR-646	...
28039	06206-060604	----	3/8"	3/8"	1/4"	0.81	101FR-664	...
28046	06206-080806	----	1/2"	1/2"	3/8"	1.00	101FR-886	...
28047		----	3/4"	1/2"	3/4"	1.25	101FR-12812	...
28048	06206-121208	----	3/4"	3/4"	1/2"	1.25	101FR-12128	...

CROSS



06102
102

MIDLAND	AMC	CHAMPION	LIST	THREAD SIZE NPTF	MAF #	MAF PRICE
				1/16"	23950X1	22.94
28041	06102-02	102A-A	----	1/8"	23950X2	...
28042	06102-04	102A-B	----	1/4"	23950X4	...
28043	06102-06	102A-C	----	3/8"	23950X6	...
28044	06102-08	102A-D	----	1/2"	23950X8	...
28045	06102-12	102A-E	----	3/4"	23950X12	...

2205P 3950 228 102A 102BE

WARNING: This product can expose you to chemicals, including lead, which are known to the State of California to cause cancer and birth defects or other reproductive harm. For more information, visit www.P65Warnings.ca.gov

PIPE**BRASS FITTINGS****FORGED CROSS**06202
102F

MIDLAND	AMC	CHAMPION	LIST	THREAD SIZE NPTF	MAF #	MAF PRICE
28049	06202-02	102AF-A	----	1/8"	102F-2	...
28050	06202-04	102AF-B	----	1/4"	102F-4	...
28051	06202-06	102AF-C	----	3/8"	102F-6	...
28052	06202-08	102AF-D	----	1/2"	102F-8	...

C7 105 102AF 102

COUPLING

SAE# 130138



23300 = SAE Pattern

06103
103

MIDLAND	AMC	CHAMPION	LIST	THREAD SIZE NPTF	MAF #	MAF PRICE
28057			----	1/16"	23300X1	...
28058L	06103-02	103A-A	----	1/8"	103-2	...
28058	06303-02	103AH-A	----	1/8"	23300X2	...
28059L	06103-04	103A-B	----	1/4"	103-4	...
28059	06303-04	103AH-B	----	1/4"	23300X4	...
28060L	06103-06	103A-C	----	3/8"	103-6	...
28060	06303-06	103AH-C	----	3/8"	23300X6	...
28061L	06103-08	103A-D	----	1/2"	103-8	...
28061	06303-08	103AH-D	----	1/2"	23300X8	...
28062L	06103-12	103A-E	----	3/4"	103-12	...
28062	06303-12	103AH-E	----	3/4"	23300X12	...
				1"	103-16	...
28063		103AH-F	----	1"	23300X16	...
				2"	23300X32	...

207P 371 3300 103AH 103

WARNING: This product can expose you to chemicals, including lead, which are known to the State of California to cause cancer and birth defects or other reproductive harm. For more information, visit www.P65Warnings.ca.gov



PIPE

BRASS FITTINGS

REDUCING COUPLING

SAE# 130138



06119
119

MIDLAND	AMC	CHAMPION	LIST	THREAD SIZE NPTF	MAF #	MAF PRICE
				1/8" x 1/16"	23302X1	...
28181L	06119-0402	119A-BA	----	1/4" x 1/8"	119-42	...
28181		119AH-BA	----	1/4" x 1/8"	23304X2	...
				3/8" x 1/8"	119-62	...
28182	06119-0602		----	3/8" x 1/8"	23306X2	...
28183L	06119-0604	119A-CB	----	3/8" x 1/4"	119-64	...
28183		119AH-CB	----	3/8" x 1/4"	23306X4	...
28180	06119-0802	119A-DA	----	1/2" x 1/8"	119-82	...
28184L	06119-0804	119A-DB	----	1/2" x 1/4"	119-84	...
28184		119AH-DB	----	1/2" x 1/4"	23308X4	...
28185L	06119-0806	119A-DC	----	1/2" x 3/8"	119-86	...
28185		119AH-DC	----	1/2" x 3/8"	23308X6	...
28187	06119-1204		----	3/4" x 1/4"	119-124	...
				3/4" x 1/4"	23312X4	...
28188*	706119-1206	119A-EC	----	3/4" x 3/8"	119-126	...
				3/4" x 3/8"	23312X6	...
28189*	706119-1208	119A-ED	----	3/4" x 1/2"	119-128	...
				3/4" x 1/2"	23312X8	...
				1 x 1/4"	119-164	...
				1 x 3/8"	119-166	...
28178	06119-1608		----	1" x 1/2"	119-168	...
28179	06119-1612		----	1" x 3/4"	119-1612	...
				2 x 1"	23332X16	...

10 377 3300 208P 108 119B 119AH

UNION



06104
104

MIDLAND	AMC	CHAMPION	LIST	THREAD SIZE NPTF	MAF #	MAF PRICE
28067	06104-02	104A-A	----	1/8"	104-2	...
28068	06104-04	104A-B	----	1/4"	104-4	...
28069	06104-06	104A-C	----	3/8"	104-6	...
28070	06104-08	104A-D	----	1/2"	104-8	...
28071	06104-12		----	3/4"	104-12	...

3250 212P 104A 104B

PIPE**BRASS FITTINGS****CAP**06108
108

MIDLAND	AMC	CHAMPION	LIST	THREAD SIZE NPTF	MAF #	MAF PRICE
28075	06108-02	108A-A	----	1/8"	108-2	...
28076	06108-04	108A-B	----	1/4"	108-4	...
28077	06108-06	108A-C	----	3/8"	108-6	...
28078	06108-08	108A-D	----	1/2"	108-8	...
28079	06108-12	108A-E	----	3/4"	108-12	...
28080	06108-16	108A-F	----	1"	108-16	...
				1-1/4"	108-20	...
				1-1/2"	108-24	...
				2"	108-32	...

3129 213P 23129 108A 108B

90° STREET ELBOW

SAE# 130239

SHORT 06116
116
LONG 06118

MIDLAND	AMC	CHAMPION	LIST	THREAD SIZE NPTF	MAF #	MAF PRICE
28161			----	1/16"	23400X1	...
28156	06118-02	116A-A	----	1/8"	23400X2	...
28156S	06116-02		----	1/8" short	23401X2	...
28157	06118-04	116A-B	----	1/4"	23400X4	...
28157S	06116-04	116A-AMB	----	1/4" short	23401X4	...
28158	06118-06	116AH-C	----	3/8"	23400X6	...
		116A-C		3/8" short	23401X6	...
28159	06116-08	116AH-D	----	1/2"	23400X8	...
28160	06116-12	116A-E	----	3/4"	23400X12	...
				1/8 x 1/16"	23402X1	...
				1/8 x 1/4"	23402X4	...
				1/4 x 1/8"	23404X2	...
				3/8 x 1/8"	23406X2	...
				3/8 x 1/4"	23406X4	...
				1/2 x 1/4"	23408X4	...
				1/2 x 3/8"	23408X6	...
				1/2 x 3/4"	23400X8X12	...

2202P 304 115 202 3400 116A

FORGED 90° STREET ELBOW

116F

MIDLAND	AMC	CHAMPION	LIST	THREAD SIZE NPTF	MAF #	MAF PRICE
28165	06216-02	116AF-A	----	1/8"	116F-2	...
28166	06216-04	116AF-B	----	1/4"	116F-4	...
28167	06216-06	116AF-C	----	3/8"	116F-6	...
28168	06216-08	116AF-D	----	1/2"	116F-8	...
28169	06216-12	116AF-E	----	3/4"	116F-12	...

5E8 1202P 116AF 116B

WARNING: This product can expose you to chemicals, including lead, which are known to the State of California to cause cancer and birth defects or other reproductive harm. For more information, visit www.P65Warnings.ca.gov

PIPE

BRASS FITTINGS

REDUCING 90° STREET ELBOW

Barstock & Forged



128

*Barstock (B)

MIDLAND	AMC	CHAMPION	LIST	THREAD SIZE NPTF FXM	MAF #	MAF PRICE
28259*			----	1/8" x 1/16"	23402X1*	...
28260	06228-0204		----	1/8" x 1/4"	23402X4*	...
28261B	06228-0402	128A-BA	----	1/4" x 1/8"	23404X2*	...
28261			----	1/4" x 1/8"	128F-42	...
				1/4 x 3/8"	23404X6*	...
28262	06228-0406		----	1/4" x 3/8"	128F-46	...
				3/8" x 1/4"	23406X4*	...
28263	06228-0604	128A-CB	----	3/8" x 1/4"	128F-64	...
				3/8" x 1/2"	23406X8*	...
28264	06228-0608		----	3/8" x 1/2"	128F-68	...
28265	06228-0806		----	1/2" x 3/8"	128F-86	...
				1/2" X 1/4"	23408X4*	...
28265B*			----	1/2" x 3/8"	23408X6*	...

FACE BUSHING



06140
110F

MIDLAND	AMC	CHAMPION	LIST	THREAD SIZE NPTF MXF	MAF #	MAF PRICE
28121	06140-0402		----	1/4" x 1/8"	110F-42	...
28122	06140-0602		----	3/8" x 1/8"	110F-62	...
28116	06140-0604	110FB-CB	----	3/8" x 1/4"	110F-64	...
28090			----	1/2" x 1/8"	110F-82	...
28128			----	1/2" x 1/4"	110F-84	...
28117	06140-0806	110FB-DC	----	1/2" x 3/8"	110F-86	...
28129			----	3/4" x 1/4"	110F-124	...
28130			----	3/4" x 3/8"	110F-126	...
28118	06140-1208	110FB-ED	----	3/4" x 1/2"	110F-128	...
28120	06140-1608		----	1" x 1/2"	110F-168	...
28119	06140-1612		----	1" x 3/4"	110F-1612	...

120AH-BW HEAVY ADAPTER BREAKAWAY



116F

MIDLAND	AMC	CHAMPION	LIST	THREAD SIZE NPTF	MAF #	MAF PRICE
		120AH-BB-BW		1/4"		
		120AH-CC-BW		3/8"		

5E8 1202P 116AF 116B

WARNING: This product can expose you to chemicals, including lead, which are known to the State of California to cause cancer and birth defects or other reproductive harm. For more information, visit www.P65Warnings.ca.gov

BRASS

PIPE**BRASS FITTINGS****HEX BUSHING**

SAE# 130140



232 = SAE Pattern

06110
110

MIDLAND	AMC	CHAMPION	LIST	THREAD SIZE NPTF MXF	MAF #	MAF PRICE
28101	06110-0201		----	1/8" x 1/16"	110-21	...
28102L	06110-0402	110A-BA	----	1/4" x 1/8"	110-42	...
28102		110AH-BA	----	1/4" x 1/8"	23224X2	...
				3/8 x 1/8	110-62	...
28103	06110-0602	110A-CA	----	3/8" x 1/8"	23226X2	...
28104L	06110-0604	110A-CB	----	3/8" x 1/4"	110-64	...
28104		110AH-CB	----	3/8" x 1/4"	23226X4	...
28105L	06110-0802	110A-DA	----	1/2" x 1/8"	110-82	...
28105		110AH-DA	----	1/2" x 1/8"	23228X2	...
28106L	06110-0804	110A-DB	----	1/2" x 1/4"	110-84	...
28106		110AH-DB	----	1/2" x 1/4"	23228X4	...
28107L	06110-0806	110A-DC	----	1/2" x 3/8"	110-86	...
28107		110AH-DC	----	1/2" x 3/8"	23228X6	...
				3/4 x 1/8	110-122	...
28108	06110-1202	110A-EA	----	3/4" x 1/8"	23232X2	...
28109L	06110-1204	110A-EB	----	3/4" x 1/4"	110-124	...
				3/4 x 1/4	23232X4	...
28110L	06110-1206	110A-EC	----	3/4" x 3/8"	110-126	...
				3/4 x 3/8	23232X6	...
28111L	06110-1208	110A-ED	----	3/4" x 1/2"	110-128	...
28111		110AH-ED	----	3/4" x 1/2"	23232X8	...
28091	06110-1602		----	1" x 1/8"	110-162	...
28112	06110-1604	110A-FB	----	1" x 1/4"	110-164	...
28113	06110-1606	110A-FC	----	1" x 3/8"	110-166	...
				1 x 1/2	110-168	...
28114	06110-1608	110A-FD	----	1" x 1/2"	23236X8	...
				1 x 3/4	110-1612	...
28115	06110-1612	110A-FE	----	1" x 3/4"	23236X12	...
				2 x 1/2	110-328	...
				2 x 3/4	110-3212	...
				2 x 1	110-3216	...
				2 X 1-1/4	110-3220	...
				2 x 1-1/2	110-3224	...

PRB 373 3220 209P 110A 110B

WARNING: This product can expose you to chemicals, including lead, which are known to the State of California to cause cancer and birth defects or other reproductive harm. For more information, visit www.P65Warnings.ca.gov



PIPE

BRASS FITTINGS

SQUARE HEAD CORED PLUG



06109
109

MIDLAND	AMC	CHAMPION	LIST	THREAD SIZE NPTF	MAF #	MAF PRICE
				1/8"	109-2	...
				1/4"	109-4	...
				3/8"	109-6	...
		109A-D		1/2"	109-8	...
28088	06109-12	109A-E	----	3/4"	109-12	...
28089	06109-16	109A-F	----	1"	109-16	...

3151 211P 109A 109B

SQUARE HEAD SOLID PLUG



06114

MIDLAND	AMC	CHAMPION	LIST	THREAD SIZE NPTF	MAF #	MAF PRICE
28084	06114-02	109A-A	----	1/8"	109SD-2	...
28085	06114-04	109A-B	----	1/4"	109SD-4	...
28086	06114-06	109A-C	----	3/8"	109SD-6	...
28087	06114-08	109AS-D	----	1/2"	109SD-8	...
		109AS-E		3/4"	109SD-12	...
				1"	109SD-16	...

COUNTERSUNK HEX PLUG

3/4" taper thread



06115
109AL

MIDLAND	AMC	CHAMPION	LIST	THREAD SIZE NPTF	MAF #	MAF PRICE
28092			----	1/16"	109AL-1	...
28093	06115-02	109CS-A	----	1/8"	109AL-2	...
28094	06115-04	109CS-B	----	1/4"	109AL-4	...
28095	06115-06	109CS-C	----	3/8"	109AL-6	...
28096	06115-08	109CS-D	----	1/2"	109AL-8	...
28097			----	3/4"	109AL-12	...
				1"	109AL-16	...

3153 219P 109CS 118

SLOTTED-HEAD PLUG



06117
117

MIDLAND	AMC	CHAMPION	LIST	THREAD SIZE NPTF	MAF #	MAF PRICE
28174	06117-02	117A-A	----	1/8"	117-2	...
28175	06117-04	117A-B	----	1/4"	117-4	...
28176	06117-06	117A-C	----	3/8"	117-6	...
				1/2"	117-8	...

220P 3150 117A 117B

WARNING: This product can expose you to chemicals, including lead, which are known to the State of California to cause cancer and birth defects or other reproductive harm. For more information, visit www.P65Warnings.ca.gov

BRASS

PIPE**BRASS FITTINGS****CORED HEX PLUGS**

23152 = SAE Pattern

06121
121

MIDLAND	AMC	CHAMPION	LIST	THREAD SIZE NPTF	MAF #	MAF PRICE
28200			----	1/16"	121-1	...
28201	06121-02	121A-A	----	1/8"	121-2	...
				1/8"	23152X2	...
28202	06121-04	121A-B	----	1/4"	121-4	...
				1/4"	23152X4	...
28203	06121-06	121A-C	----	3/8"	121-6	...
				3/8"	23152X6	...
28204	06121-08	121A-D	----	1/2"	121-8	...
				1/2"	23152X8	...
28205	06121-12	121A-E	----	3/4"	121-12	...
				3/4"	23152X12	...
28206			----	1"	121-16	...
				1-1/4"	121-20	...
				1-1/2"	121-24	...
				2"	121-32	...

218P 3152 121A 103 121B PPH 218P

SOLID HEX HEAD PLUGS06125
121S

MIDLAND	AMC	CHAMPION	LIST	THREAD SIZE NPTF	MAF #	MAF PRICE
28201S	06125-02	121AS-A	----	1/8"	121S-2	...
28202S	06125-04	121AS-B	----	1/4"	121S-4	...
28203S	06125-06	121AS-C	----	3/8"	121S-6	...
28204S	06125-08	121AS-D	----	1/2"	121S-8	...
28205S	06125-12	121AS-E	----	3/4"	121S-12	...
28206S			----	1"	121S-16	...

121AS

LOCKNUT

- Jam Nuts
- Straight pipe thread

06111
111

MIDLAND	AMC	CHAMPION	LIST	THREAD SIZE NPTF	MAF #	MAF PRICE
28123	06111-02	111A-A	----	1/8"	111-2	...
28124	06111-04	111A-B	----	1/4"	111-4	...
28125	06111-06	111A-C	----	3/8"	111-6	...
28126	06111-08	111A-D	----	1/2"	111-8	...
28127	06111-12		----	3/4"	111-12	...

210P 21102 111A 111B

WARNING: This product can expose you to chemicals, including lead, which are known to the State of California to cause cancer and birth defects or other reproductive harm. For more information, visit www.P65Warnings.ca.gov



PIPE

BRASS FITTINGS

CLOSE NIPPLE



06112
112

MIDLAND	AMC	CHAMPION	LIST	THREAD SIZE NPTF	MAF #	MAF PRICE
28131	06112-02	112A-A	----	1/8"	112-2	...
28132	06112-04	112A-B	----	1/4"	112-4	...
28133	06112-06	112A-C	----	3/8"	112-6	...
28134	06112-08	112A-D	----	1/2"	112-8	...
28135	06112-12	112A-E	----	3/4"	112-12	...

165 215PN 3326 112A 112B

LONG NIPPLE



06113
113

MIDLAND	AMC	CHAMPION	LIST	THREAD SIZE NPTF	LENGTH	MAF #	MAF PRICE
28140	06113-0224	113A-A15	----	1/8"	1.5	113-224	...
28141	06113-0232	113A-A2	----	1/8"	2.0	113-232	...
28142	06113-0240	113A-A25	----	1/8"	2.5	113-240	...
28143	06113-0248	113A-A3	----	1/8"	3	113-248	...
28475			----	1/8"	3.5	113-256	...
28144	06113-0424	113A-B15	----	1/4"	1.5	113-424	...
28145	06113-0432	113A-B2	----	1/4"	2	113-432	...
28146	06113-0440	113A-B25	----	1/4"	2.5	113-440	...
28147	06113-0448	113A-B3	----	1/4"	3	113-448	...
28481			----	1/4"	3.5	113-456	...
28148	06113-0624	113A-C15	----	3/8"	1.5	113-624	...
28149	06113-0632	113A-C2	----	3/8"	2	113-632	...
28150	06113-0640		----	3/8"	2.5	113-640	...
28151	06113-0648	113A-C3	----	3/8"	3	113-648	...
28487			----	3/8"	3.5	113-656	...
28152	06113-0824	113A-D15	----	1/2"	1.5	113-824	...
28153	06113-0832	113A-D2	----	1/2"	2	113-832	...
28154	06113-0840	113A-D25	----	1/2"	2.5	113-840	...
28155	06113-0848		----	1/2"	3	113-848	...
28493			----	1/2"	3.5	113-856	...
28136	06113-1224	113A-E15	----	3/4"	1.5	113-1224	...
28497		113A-E2	----	3/4"	2	113-1232	...
28498			----	3/4"	2.5	113-1240	...
28499			----	3/4"	3	113-1248	...

113B 113A 166 3327, 3328, 3329, 3330 3331 215PNL

WARNING: This product can expose you to chemicals, including lead, which are known to the State of California to cause cancer and birth defects or other reproductive harm. For more information, visit www.P65Warnings.ca.gov

BRASS

PIPE**BRASS FITTINGS****HEX NIPPLE**

SAE# 130137



06122
06322 (LONG)
122

MIDLAND	AMC	CHAMPION	LIST	THREAD SIZE NPTF	MAF #	MAF PRICE
28210			----	1/16"	23325X1	...
28211L	06122-02	122A-A	----	1/8"	122-2	...
28211		122AH-A	----	1/8"	23325X2	...
28212L	06122-04	122A-B	----	1/4"	122-4	...
28212	06322-04	122AH-B	----	1/4"	23325X4	...
				1/4" BSPT	122-4BSPT	...
28213L	06122-06	122A-C	----	3/8"	122-6	...
28213		122AH-C	----	3/8"	23325X6	...
28214L	06122-08	122A-D	----	1/2"	122-8	...
28214		122AH-D	----	1/2"	23325X8	...
28215L	06122-12	122A-E	----	3/4"	122-12	...
28215		122AH-E	----	3/4"	23325X12	...
				3/4 3800 PSI	HPHN-12	...
28216L	06122-16		----	1"	122-16	...
28-216				1"	23325X16	...
				1-1/4	122-20	...
				1-1/2	122-24	...
				2"	122-32	...

PHN 216P 3325 379 122AH 122B

WARNING: This product can expose you to chemicals, including lead, which are known to the State of California to cause cancer and birth defects or other reproductive harm. For more information, visit www.P65Warnings.ca.gov



PIPE

BRASS FITTINGS

REDUCING HEX NIPPLE

SAE# 130137



23325 = SAE Pattern

06123
123

MIDLAND	AMC	CHAMPION	LIST	THREAD SIZE NPTF	MAF #	MAF PRICE
28218			----	1/8" x 1/16"	23325X2X1	...
28220L	06123-0402	123A-BA	----	1/4" x 1/8"	123-42	...
28220		123AH-BA	----	1/4" x 1/8"	23325X4X2	...
28221L	06123-0602	123A-CA	----	3/8" x 1/8"	123-62	...
28221		123AH-CA	----	3/8" x 1/8"	23325X6X2	...
28222L	06123-0604	123A-CB	----	3/8" x 1/4"	123-64	...
28222		123AH-CB	----	3/8" x 1/4"	23325X6X4	...
				1/2" x 1/8"	123-82	...
28223L	06123-0804	123A-DB	----	1/2" x 1/4"	123-84	...
28223		123AH-DB	----	1/2" x 1/4"	23325X8X4	...
28224L	06123-0806	123A-DC	----	1/2" x 3/8"	123-86	...
28224		123AH-DC	----	1/2" x 3/8"	23325X8X6	...
				1/2" x 3/8"	23325X8X6TP*	...
				3/4" x 1/8"	123-122	...
				3/4" x 1/4"	123-124	...
				3/4" x 3/8"	123-126	...
28225L	06123-1208		----	3/4" x 1/2"	123-128	...
28225		123A-ED	----	3/4" x 1/2"	23325X12X8	...
				1" x 1/4"	123-164	...
				1" x 3/8"	123-166	...
				1" x 1/2"	123-168	...
28227	06123-1612		----	1" x 3/4"	123-1612	...
				1" x 3/4"	23325X16X12	...
				2" x 1/2"	123-328	...
				2" x 3/4"	123-3212	...
				2" x 1"	123-3216	...
				2" x 1-1/4"	123-3220	...
				2" x 1-1/2"	123-3224	...

*Tapped 3/8 NPTF on 1/2 NPTF

PHN 216P 3325 379 122AH 122B

PIPE SWIVEL ADAPTER

*300 PSI all sizes

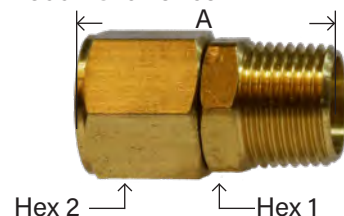

MIDLAND	THREAD SIZE NPTF FXM	A	HEX 1	HEX 2	APPROX. WT. LBS.	
28424	1/8"	1.10	0.43	0.50	0.05	----
28425	1/4"	1.34	0.56	0.62	0.06	----
28426	3/8"	1.36	0.68	0.75	0.08	----
28427	1/2"	1.87	0.87	0.95	0.10	----

MALE NPT X FEMALE NPT

- 360° Turning
- Swivels



MIDLAND	SIZE	
320061	1/4	----

344R 3183

WARNING: This product can expose you to chemicals, including lead, which are known to the State of California to cause cancer and birth defects or other reproductive harm. For more information, visit www.P65Warnings.ca.gov

PIPE**BRASS FITTINGS****45° STREET ELBOW**

SAE# 130339

06124
124

MIDLAND	AMC	CHAMPION	LIST	1 X 2 THREAD SIZE NPTF	MAF #	MAF PRICE
				1/16"	23350X1	...
28230	06124-02	124A-A	----	1/8"	23350X2	...
28231	06124-04	124A-B	----	1/4"	23350X4	...
28232	06124-06	124A-C	----	3/8"	23350X6	...
28233	06124-08	124A-D	----	1/2"	23350X8	...
28234	06124-12	124A-E	----	3/4"	23350X12	...
				1/8" x 1/16"	23350X2X1	...
				1/4" x 1/16"	23350X4X1	...
				1/4" x 1/8"	23350X4X2	...
				1/4" x 3/8"	23350X4X6	...
				3/8" x 1/8"	23350X6X2	...
				3/8" x 1/4"	23350X6X4	...
				3/8" x 1/2"	23350X6X8	...
				1/2" x 1/8"	23350X8X2	...
				1/2" x 1/4"	23350X8X4	...
				1/2" x 3/8"	23350X8X6	...
				3/4" x 3/8"	23350X12X6	...
				3/4" x 1/2"	23350X12X8	...

306 3350 2214P 224

45° FORGED STREET ELBOW06224
124F

MIDLAND	AMC	CHAMPION	LIST	THREAD SIZE NPTF	MAF #	MAF PRICE
28238	06224-02		----	1/8"	124F-2	...
28239	06224-04		----	1/4"	124F-4	...
28240	06224-06	124AF-C	----	3/8"	124F-6	...

45E8 124B

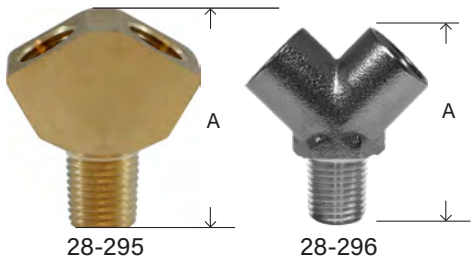
PIPE WYE FIP X MIP

28-295

28-296

MIDLAND	LIST	THREAD SIZE NPT	A	APPROX. WT. LBS.	MAF #	MAF PRICE
28295	----	1/4"	1.56	.15	137yb-4fm	
28296	----	1/4 N/P	1.4	.12		

PIPE WYE FIP X FIP - NICKEL PLATED

MIDLAND	THREAD SIZE NPT	A	APPROX. WT. LBS.	MAF PRICE
28298	1/4	1.4	.12	----

SEE OUR WEBSITE FOR BSPT, BSPP & BSP FITTINGS

PIPE

BRASS FITTINGS

STREET TEE/ SERVICE TEE/ MALE RUN TEE

SAE# 130424



06127
127

MIDLAND	AMC	CHAMPION	LIST	1 X 2 X 3 THREAD SIZE NPTF	MAF #	MAF PRICE
28245	06127-02	127A-A	----	1/8"	23750X2	...
				1/8"	127-2	...
28246	06127-04	127A-B	----	1/4"	23750X4	...
				1/4"	127-4	...
28247	06127-06	127A-C	----	3/8"	23750X6	...
				3/8"	127-6	...
28248	06127-08	127A-D	----	1/2"	23750X8	...
				1/2"	127-8	...
28249	06127-12	127A-E	----	3/4"	23750X12	...
				3/4"	127-12	...
				1/8 X 1/16 X 1/8"	127R-212	...
				1/4 X 1/8 X 1/4"	127R-424	...
				3/8 X 1/4 X 3/8"	127R-646	...
				1/2 X 3/8 X 1/2"	127R-868	...
				1/2 x 1/2 x 1/4"	127R-884	...

225 2225P 3750 326 225 127A

FORGED STREET TEE



06227
127F

MIDLAND	AMC	CHAMPION	LIST	THREAD SIZE NPTF	MAF #	MAF PRICE
28253	06227-02	127AF-A	----	1/8"	127F-2	...
28254	06227-04		----	1/4"	127F-4	...
28255	06227-06	127AF-C	----	3/8"	127F-6	...
28256	06227-08		----	1/2"	127F-8	...
28257	06227-12			3/4"	127F-12	...

107 T8 127B

127A TAP TAPPED STREET TEE



PICTURE NO.	PART NO.	EPT	MPT	TAP	TAP LOCATION	THREAD SEALANT	LIST
1	CVS127A-D-1/8TAPX2*	1/2	1/2	1/8	TOP & SIDE	YES	
2	CVS127A-D-1/8TAPX1*	1/2	1/2	1/8	TOP	YES	
3	NE-127A-B-1/8TAP	1/4	1/4	1/8	SIDE	NO	
3	NE-127A-C-1/8TAP	3/8	3/8	1/8	SIDE	NO	
3	NE-127A-D-1/8TAP	1/2	1/2	1/8	SIDE	NO	

WARNING: This product can expose you to chemicals, including lead, which are known to the State of California to cause cancer and birth defects or other reproductive harm. For more information, visit www.P65Warnings.ca.gov

BRASS

PIPE**BRASS FITTINGS****EXTENDER ADAPTER**

SAE# 130139

06120
120

MIDLAND	AMC	CHAMPION	LIST	THREAD SIZE NPTF FXM	MAF #	MAF PRICE
				1/8 x 1/6	23200X2X1	...
				1/8" x 10/32"	120-20	...
28190L	06120-0202	120A-AA	----	1/8" x 1/8"	120-22	...
28190		120AH-AA	----	1/8" x 1/8"	23200X2	...
				1/4" x 1/16"	120-41	...
28191L	06120-0402	120A-BA	----	1/4" x 1/8"	120-42	...
28191		120AH-BA	----	1/4" x 1/8"	23404X2	...
28192L	06120-0404	120A-BB	----	1/4" x 1/4"	120-44	...
28192		120AH-BB	----	1/4" x 1/4"	23200X4	...
				1/4 X 1/2	120-48	...
28198	06120-0602	120A-CA	----	3/8" x 1/8"	120-62	...
				3/8" x 1/8"	23206X2	...
28193L	06120-0604	120A-CB	----	3/8" x 1/4"	120-64	...
28193		120AH-CB	----	3/8" x 1/4"	23206X4	...
28194L	06120-0606	120A-CC	----	3/8" x 3/8"	120-66	...
28194		120AH-CC	----	3/8" x 3/8"	23200X6	...
				3/8 X 1/2	120-68	...
28197	06120-0802		----	1/2" x 1/8"	120-82	...
				1/2 x 1/4	120-84	...
28199	06120-0804	120A-DB	----	1/2" x 1/4"	23208X4	...
28195L	06120-0806	120A-DC	----	1/2" x 3/8"	120-86	...
28195		120AH-DC	----	1/2" x 3/8"	23208X6	...
28196L	06120-0808	120A-DD	----	1/2" x 1/2"	120-88	...
28196		120AH-DD	----	1/2" x 1/2"	23200X8	...
				3/4 x 1/4	120-124	...
				3/4 x 3/8	120-126	...
28207			----	3/4" x 3/8"	23212X6	...
28208		120A-ED	----	3/4" x 1/2"	23212X8	...
28208L			----	3/4" x 1/2"	120-128	...
28209	06120-1212		----	3/4" x 3/4"	23200X12	...
				1" x 1/4"	120-164	...
				1" x 3/8"	120-166	...
				1" x 1/2"	120-168	...
				1" x 3/4"	120-1612	...
				1" x 1"	120-1616	...
				2" X 1/2"	120-328	...
				2" x 3/4"	120-3212	...
				2" x 1-1/2"	120-3224	...
				2" X 2"	120-3232	...

375 222P 3200 R1 120AH 120B

WARNING: This product can expose you to chemicals, including lead, which are known to the State of California to cause cancer and birth defects or other reproductive harm. For more information, visit www.P65Warnings.ca.gov



PIPE

BRASS FITTINGS

FORGED 90° MALE ELBOW



06230
130

MIDLAND	AMC	CHAMPION	LIST	THREAD SIZE NPTF	MAF #	MAF PRICE
28266	06230-02	116AM-A	----	1/8"	130F-2	...
28267	06230-04	116AM-B	----	1/4"	130F-4	...
28268	06230-06	116AM-C	----	3/8"	130F-6	...
28269	06230-08	116AM-D	----	1/2"	130F-8	...

1204P LE5 3455 116AMF

BARSTOCK 90° MALE ELBOW



06130
130R

MIDLAND	AMC	CHAMPION	LIST	THREAD SIZE NPTF	MAF #	MAF PRICE
28266B	06130-02		----	1/8"	23455X2	...
28267B	06130-04		----	1/4"	23455X4	...
				1/4 MPT X BSPT	23455X4X4B-SPT	...
28268B	06130-06		----	3/8"	23455X6	...
28269B	06130-08		----	1/2"	23455X8	...
28270B			----	3/4"	23455X12	...
28276B			----	1/2" x 3/8"	23455X8X6	...

FORGED 90° MALE REDUCING ELBOW



06235
130F

MIDLAND	AMC	CHAMPION	LIST	THREAD SIZE NPTF	MAF #	MAF PRICE
28274	06235-0402	116AM-BA	----	1/4" x 1/8"	130FR-42	...
				3/8" x 1/8"	130FR-62	...
28275	06235-0604	116AM-CB	----	3/8" x 1/4"	130FR-64	...
28276	06235-0806	116AM-DC	----	1/2" x 3/8"	130FR-86	...

SAE# 130425

MALE BRANCH TEE



06131
131

MIDLAND	AMC	CHAMPION	LIST	THREAD SIZE NPTF	MAF #	MAF PRICE
28281	06131-02	T9-222	----	1/8"	23600X2	...
				1/8"	131-2	...
28282	06131-04	T9-444	----	1/4"	23600X4	...
				1/4"	131-4	...
28283	06131-06	T9-666	----	3/8"	23600X6	...
				3/8"	131-6	...
28284	06131-08	T9-888	----	1/2"	23600X8	...
				1/2"	131-8	...
28285	06131-12	T9-121212	----	3/4"	23600X12	...
				3/4"	131-12	...
				1/8 X 1/16	131R-21	...
				1/4 X 1/8	131R-42	...
				3/8 X 1/4	131R-64	...
				1/2 X 3/8	131R-86	...
				3/4 X 1/2	131R-128	...

				(1"x2") x 3"		
--	--	--	--	--------------	--	--

WARNING: This product can expose you to chemicals, including lead, which are known to the State of California to cause cancer and birth defects or other reproductive harm. For more information, visit www.P65Warnings.ca.gov



PIPE**BRASS FITTINGS****FORGED MALE BRANCH TEE**06231
131F

MIDLAND	AMC	CHAMPION	LIST	THREAD SIZE NPTF	MAF #	MAF PRICE
28281F			----	1/8"	131F-2	...
28282F			----	1/4"	131F-4	...
				3/8"	131F-6	...
				1/2"	131F-8	...

T9

FORGED ALL MALE TEE06232
132F

MIDLAND	AMC	CHAMPION	LIST	THREAD SIZE NPTF	MAF #	MAF PRICE
28290	06232-02		----	1/8"	132F-2	...
28291	06232-04		----	1/4"	132F-4	...
28292	06232-06		----	3/8"	132F-6	...
28293	06232-08		----	1/2"	132F-8	...
28294	06232-12		----	3/4"	132F-12	...

T12 M101

LONG STREET ELLS

D.O.T. Approved



MIDLAND	AMC	CHAMPION	LIST	THREAD SIZE NPTF	LENGTH	MAF #	MAF PRICE
28440			----	1/8"	1"-3/16"	116XL-219	...
28441			----	1/8"	1"-7/16"	116XL-223	...
28442			----	1/8"	1"-11/16"	116XL-227	...
28443			----	1/8"	1"-7/8"	116XL-230	...
28328			----	1/4"	1"-3/16"	116XL-419	...
28329			----	1/4"	1"-7/16"	116XL-423	...
28330			----	1/4"	1"-11/16"	116XL-427	...
28331			----	1/4"	1"-7/8"	116XL-430	...
28332			----	1/4"	2"-1/4"	116XL-436	...
28333			----	3/8"	1"-3/4"	116XL-628	...

LONG EXTENSION ADAPTERS

D.O.T. Approved



MIDLAND	AMC	CHAMPION	LIST	THREAD SIZE NPTF	LENGTH	MAF #	MAF PRICE
28335			----	1/8"	1"-1/4"	120XL-220	...
28336			----	1/8"	1"-3/4"	120XL-228	...
28337			----	1/8"	3"	120XL-248	...
28338			----	1/4"	1"-9/16"	120XL-425	...
28339			----	1/4"	1"-13/16"	120XL-429	...
28340			----	1/4"	2"-1/16"	120XL-433	...

WARNING: This product can expose you to chemicals, including lead, which are known to the State of California to cause cancer and birth defects or other reproductive harm. For more information, visit www.P65Warnings.ca.gov



BULKHEAD FITTINGS

BRASS FITTINGS

BULKHEAD SUFFIX DESCRIPTIONS:

129FC-#	All Brass Fitting
129C-#-SN	Brass Fitting with Steel Nut
129FC-#-STL	All Steel Fitting
129FC-#-STL-XL	All Steel Fitting, Long Body

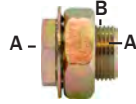
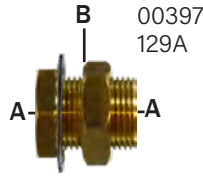

BULKHEAD / ANCHOR / FRAME COUPLINGS FEMALE PIPE X FEMALE PIPE

MIDLAND	CHAMPION	LIST	FEMALE NPTF	STRAIGHT THREAD	HOLE SIZE	LENGTH (IN.)	MAF #	MAF PRICE
28299	129AS-A	----	1/8	5/8-18 UNS	5/8	0.96	207ACBH-2S	...
28300	129A-A	----	1/8	5/8-18 UNS	5/8	1-1/2	207ACBH-2	...
28301	129AS-B	----	1/4	3/4-16 UNS	3/4	15/16	207ACBH-45	
28301SN	129AS-B-SN		Brass body/Steel Nut					
28306	129AS-B-STL		All Steel					
28302	129A-B	----	1/4	3/4-16 UNS	3/4	1-1/2	207ACBH-4	...
28302SN	129A-B-SN		Brass Body/Steel Nut					
28307	129A-B-STL		All Steel					
28315		----	with Large Mounting Nut				207ACBHLH-4	...
28303	129A-C	----	3/8	1-14 UNS	1	1-5/16	207ACBH-6	...
28303SN	129A-C-SN		Brass Body/Steel Nut					
28308	129A-C-STL		All Steel					
28304	129A-D	----	1/2	1-1/8-14 UNS	1-1/8	1-1/2	207ACBH-8	...
28311	129A-E	----	3/4	1-5/16-12	1-5/16	1-1/2	207ACBH-12	...
28316**	129A-F	----	1	1-5/8-14	1-5/8	1.68	207ACBH-16	...

**Without washer

344R 3183

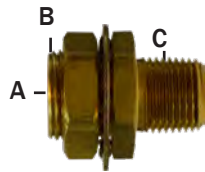

FEMALE PIPE X MALE PIPE

MIDLAND	CHAMPION	LIST	FEMALE NPTF	STRAIGHT THREAD	C	LENGTH (IN.)	MAF #	MAF PRICE
28317	129FC-1	----	1/4	1-14 UNS	1/2-14 NPTF	2-1/8	MA1317	...
28317SN	129FC-1-SN		Brass Body/Steel Nut					
28318	129FC-4	----	3/8	1-14 UNS	1/2-14 NPTF	1-11/16	MA1318	...
28318SN	129FC-4-SN		Brass Body/Steel Nut					
28318STL	129FC-4-STL		All Steel					
28319	129FC-4-XL	----	3/8	1-14 UNS	1/2-14 NPTF	1-29/32	MA1319	...
28319SNXL	129FC-4-SN-XL		Long Brass Body/Steel Nut					
28319STLXL	129FC-4-STL-XL		All Steel					

BULKHEAD FITTINGS

BRASS FITTINGS



FEMALE PIPE X MALE PIPE

MIDLAND	CHAMPION	LIST	FEMALE NPTF	STRAIGHT THREAD	MALE PIPE	LENGTH (IN.)	MAF #	MAF PRICE
28313	129FC-3-SN	----	1/4	1-14 UNS	1/2-14 NPTF	2.88	MA1342	...
28313BN	129FC-3		Brass Body/Brass Nut			2.88		
28312	129FC-3-STL		All Steel			2.94		
28320	129FC-3-STL-XL		All Steel			3.94		

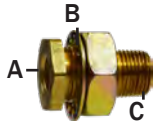

FEMALE PIPE X MALE PIPE

MIDLAND	CHAMPION	LIST	FEMALE NPTF	STRAIGHT THREAD	MALE PIPE	LENGTH (IN.)	MAF #	MAF PRICE
28346	129FC-7-SN	----	3/8	1-14 UNS	1/2	1-7/8	207BH-6FML	...
28346BN	129FC-7		Brass Body/Brass Nut					
28347	129FC-8	----	1/2	1-14 UNS	1/2	2-3/8	207BH-8FML	...
28347SN	129FC-8-SN		Brass Body/Brass Nut					

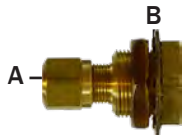

NYLON AIR BRAKE X FEMALE PIPE

MIDLAND	CHAMPION	LIST	OD TUBE	STRAIGHT THREAD	FIP	LENGTH (IN.)	MAF #	MAF PRICE
28321		----	1/2	7/8-20 UNCF	3/8	1-5/16	NT207BH-8	...
28322		----	3/8	7/8-20 UNCF	3/8	1-3/8	NT207BH-6	...

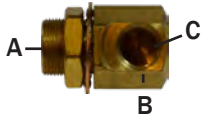

FEMALE PIPE X CLAMPING STUD ELBOW

MIDLAND	CHAMPION	LIST	OD TUBE	STRAIGHT THREAD	FIP	LENGTH (IN.)	MAF #	MAF PRICE
28348	129FC-6	----	3/8	7/8-20 UNEF	3/8-18 NPTF	2-5/16	MA1348	...



BRASS MARINE BULKHEAD

MIDLAND	CHAMPION	LIST	OD TUBE	STRAIGHT THREAD	FIP	LENGTH (IN.)	MAF #	MAF PRICE
46540		----	5/16 Hose ID	----	----	2.37	29SBBHS-5	...
46541		----	3/8 Hose ID	----	----	2.37	29SBBHS-6	...

WARNING: This product can expose you to chemicals, including lead, which are known to the State of California to cause cancer and birth defects or other reproductive harm. For more information, visit www.P65Warnings.ca.gov



BULKHEAD FITTINGS

BRASS FITTINGS

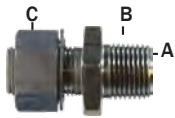

FEMALE PIPE X MALE PIPE - ALL STEEL

MIDLAND	CHAMPION	LIST	FEMALE	STRAIGHT THREAD	MIP	LENGTH (IN.)	MAF #	MAF PRICE
28345	129FC-2	----	1/4-18 NPTF	3/4 - 16 UNS	1/2-14 NPTF	2.16	MA1345	
28309	129FC-2-STL		28345 w/ Large				MA1309	

28310		----	Long Pattern			2.53	MA1310	

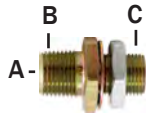

FEMALE PIPE X MALE PIPE - ALL STEEL

MIDLAND	CHAMPION	LIST	FEMALE NPTF	STRAIGHT THREAD	MALE PIPE	LENGTH (IN.)	MAF #	MAF PRICE
28325	129FC-5-STL	----	1/4	3/4 - 16 UNS	1/2-14 NPTF	1-11/16	MA1325	

STAINLESS STEEL BULKHEAD FITTINGS

- Temperature range: -20F° - 360F°
- Working pressure: 1450 - 2175PSI
- Washers are PA6 (Nylon)

BULKHEAD FITTINGS - STAINLESS STEEL 316L NPT (1/8-1/2")



MIDLAND	LIST	SIZE	HOLE SIZE	HEX	LENGTH
28300SS	----	1/8"	0.701	0.866	0.748
28301SS	----	1/4"	0.858	1.063	0.748
28303SS	----	3/8"	1.055	1.260	1.102
28304SS	----	1/2"	1.173	1.417	1.378

BULKHEAD FITTINGS - STAINLESS STEEL 316 NPT (3/4-2")



63214	----	3/4"	1-5/8"	2-15/32"	1-13/16"
63215	----	1"	2-1/4"	3-1/16"	2-7/8"
63216	----	1-1/4"	2-1/4"	3-1/16"	2-3/8"
63217	----	1-1/2"	3"	4-1/4"	2-5/8"
63218	----	2"	3"	4-1/4"	2-5/8"

WARNING: This product can expose you to chemicals, including lead, which are known to the State of California to cause cancer and birth defects or other reproductive harm. For more information, visit www.P65Warnings.ca.gov

BRASS

BULKHEAD FITTINGS

BRASS FITTINGS

INDUSTRY CROSSOVERS

CHAMPION BRASS PART NO.	CHAMPION	INDUSTRY	MIDLAND	MID-AMERICA
129A-A	129A-A	55207	28300	207ACBH-2
129A-B	129A-B	55661-BN	28302	207ACBH-4
129A-B-SN		55661	28302SN	
129A-B-STL	129A-55661STL	55661STL	28307	
129A-C	129A-C	55607-BN	28303	207ACBH-6
129A-C-SN		55607	28303SN	
129A-C-STL	129ASTL-C	55607STL	28308	
129A-D	129A-D	55807	28304	207ACBH-8
129A-E	129A-E		28311	207ACBH-12
129A-F	129A-F		28316	207ACBH-16
129AS-A			28299	207ACBH-25
129AS-B	129AS-B	55611	28301	207ACBH-45
129AS-B-SN		55611-SN	28301SN	
129AS-B-STL	129A-55611STL	55611STL	28306	
129FC-1		55615-BN	28317	MA1317
129FC-1-SN	129A-391FC1	55615	28317SN	
129FC-2	129A-391FC2		28345	MA1345
129FC-2-STL	129A-391FC2STL	55689STL	28309	MA1309
129FC-3	129A-391FC3-BN	55600-BN	28313	MA1342
129FC-3-SN	129A-391FC3	55600	28313SN	
129FC-3-STL	129A-55600STL	55600STL	28312	
129FC-3-STL-XL	129A-55664	55664	28320	
129FC-4	129A-391FC4	55620	28318	MA1318
129FC-4-SN		55620-SN6	28318SN	
129FC-4-STL		55620STL	28318STL	
129FC-4-XL	129A-55646	55646-BN	28319	MA1319
129FC-4-SN-XL		55646	28319SN	
129FC-4-STL-XL	129A-55646STL	55646STL	28319STLXL	
129FC-5-STL		55612STL	28325	MA1325
129FC-6	129A-55616	55616	28348	MA1348
129FC-7		55613-BN	28346BN	
129FC-7-SN	129A-55613	55613	28346	207BH-6FML
129FC-8	129A-55629-BN	55629-BN	28347	207BH-8FML
129FC-8-SN	129A-55629	55629	28347SN	
			28321	NT207BH-8
			28322	NT207BH-6
			46540	29BBHS-5
			46541	29BBHS-6
			28310	MA1310

WARNING: This product can expose you to chemicals, including lead, which are known to the State of California to cause cancer and birth defects or other reproductive harm. For more information, visit www.P65Warnings.ca.gov

HOSE BARB FITTINGS



Temperature and Working Pressure Ranges

From -40°F to + 160°F at 150 PSI maximum.

Tolerance

+/- .02 on all dimensions. Dimension Data can change without notice. Please call us when dimensions are critical.

Note: These fittings are intended for use with hose clamp, similar type clamp or a crimped ferrule.

Assembly Instructions

- 1- Cut hose cleanly and squarely to length.
- 2- Slide clamp on hose.
- 3- Lubricate hose. Push hose on fitting until hose bottoms against stop ring or hex.
- 4- Position hose clamp as shown and secure with a screwdriver or wrench. Maintain "A" dimension noted below for proper clamp positioning. (Diagram/Reference is to the right)

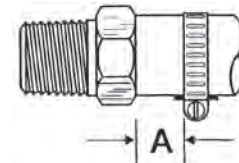

HOSE SIZE	A
3/16"	1/4"
1/4"	1/4"
5/16"	1/4"
3/8"	1/8"
1/2"	1/8"
5/8"	1/8"
3/4"	1/8"

Actual Profile of Hose Barbs

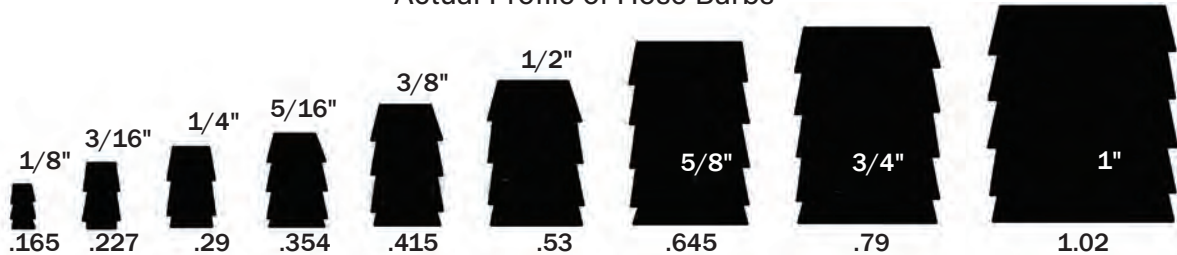

WARNING: This product can expose you to chemicals, including lead, which are known to the State of California to cause cancer and birth defects or other reproductive harm. For more information, visit www.P65Warnings.ca.gov

BRASS

HOSE BARB

BRASS FITTINGS

RIGID MALE ADAPTER

- These are not Lead Free



PGH = SAE Pattern

07001
29
129

MIDLAND	AMC	CHAMPION	LIST	HOSE I.D. X MALE NPTF	MAF #	MAF PRICE
32950			----	1/16" x 10/32"	29-10	...
32951			----	1/16" x 1/16"	29-11	...
32912			----	1/8" x 10/32"	29-20	...
32300			----	1/8" x 1/16"	29-21	...
32001	07001-0202	201A-2A	----	1/8" x 1/8"	29-22	...
32027	07001-0204	201A-2B	----	1/8" x 1/4"	29-24	...
32952			----	3/16" x 1/16"	29-31	...
32002	07001-0302	201A-3A	----	3/16" x 1/8"	29-32	...
32003	07001-0304	201A-3B	----	3/16" x 1/4"	29-34	...
32953			----	3/16" x 3/8"	29-36	...
32301		201A-4X	----	1/4" x 1/16"	29-41	...
32004	07001-0402	201A-4A	----	1/4" x 1/8"	29-42	...
				1/4" x 1/8"	PGH4X2	...
32005	07001-0404	201A-4B	----	1/4" x 1/4"	29-44	...
				1/4" x 1/4"	PGH4X4	...
32006	07001-0406	201A-4C	----	1/4" x 3/8"	29-46	...
32007	07001-0408	201A-4D	----	1/4" x 1/2"	29-48	...
32954			----	1/4" x 3/4"	29-412	...
32008	07001-0502	201A-5A	----	5/16" x 1/8"	29-52	...
32009	07001-0504	201A-5B	----	5/16" x 1/4"	29-54	...
				5/16" x 1/4"	PGH5X4	...
32010	07001-0506	201A-5C	----	5/16" x 3/8"	29-56	...
		201A-5D		5/16" x 1/2"	29-58	...
				5/16" x 3/4"	29-512	...
32011	07001-0602	201A-6A	----	3/8" x 1/8"	29-62	...
	07001-0604	201A-6B	----	3/8" x 1/4"	29-64	...
32012				3/8" x 1/4"	PGH6X4	...
32013	07001-0606	201A-6C	----	3/8" x 3/8"	29-66	...
				3/8" x 3/8"	PGH6X6	...
32014	07001-0608	201A-6D	----	3/8" x 1/2"	29-68	...
				3/8" x 1/2"	PGH6X8	...
32026	07001-0612	201A-6E	----	3/8" x 3/4"	29-612	...
32956	07001-0704	201A-7B	----	7/16" x 1/4"	29-74	...
32957	07001-0706		----	7/16" x 3/8"	29-76	...
32958			----	7/16" x 1/2"	29-78	...
32302		201A-8A	----	1/2" x 1/8"	29-82	...

CONTINUED ON NEXT PAGE

WARNING: This product can expose you to chemicals, including lead, which are known to the State of California to cause cancer and birth defects or other reproductive harm. For more information, visit www.P65Warnings.ca.gov

HOSE BARB

BRASS FITTINGS

RIGID MALE ADAPTER - CONTINUED

• These are not Lead Free



PGH = SAE Pattern

07001
29
129

MIDLAND	AMC	CHAMPION	LIST	HOSE I.D. X MALE NPTF	MAF #	MAF PRICE
32015	07001-0804	201A-8B	----	1/2" x 1/4"	29-84	...
				1/2" x 1/4"	PGH8X4	...
32016	07001-0806	201A-8C	----	1/2" x 3/8"	29-86	...
				1/2" x 3/8"	PGH8X6	...
32017	07001-0808	201A-8D	----	1/2" x 1/2"	29-88	...
				1/2" x 1/2"	PGH8X8	...
32018	07001-0812	201A-8E	----	1/2" x 3/4"	29-812	...
32303			----	1/2" x 1"	29-816	...
32304			----	5/8" x 1/4"	29-104	...
32019	07001-1006	201A-10C	----	5/8" x 3/8"	29-106	...
				5/8" x 3/8"	PGH10X6	...
32020	07001-1008	201A-10D	----	5/8" x 1/2"	29-108	...
				5/8" x 1/2"	PGH10X8	...
32021	07001-1012	201A-10E	----	5/8" x 3/4"	29-1012	...
				5/8" x 3/4"	PGH10X12	...
32305			----	5/8" x 1"	29-1016	...
32915			----	3/4" x 1/4"	29-124	...
32306	07001-1206	201A-12C	----	3/4" x 3/8"	29-126	...
32022	07001-1208	201A-12D	----	3/4" x 1/2"	29-128	...
				3/4" x 1/2"	PGH12X8	...
32023	07001-1212	201A-12E	----	3/4" x 3/4"	29-1212	...
				3/4" x 3/4"	PGH12X12	...
32316	07001-1216	201A-12F	----	3/4" x 1"	29-1216	...
				1" x 3/8"	29-166	...
32307		201A-16D	----	1" x 1/2"	29-168	...
32024	07001-1612	201A-16E	----	1" x 3/4"	29-1612	...
32025	07001-1616	201A-16F	----	1" x 1"	29-1616	...
				1" x 1-1/4"	29-1620	...
32029		201A-20E	----	1-1/4" x 3/4"	29-2012	...
32028	07001-2016	201A-20F	----	1-1/4" x 1"	29-2016	...
				1-1/4" x 1-1/4"	29-2020	...

4244 PGH 101 102 201A 125HBL 105B-1 KF-PS MPB

WARNING: This product can expose you to chemicals, including lead, which are known to the State of California to cause cancer and birth defects or other reproductive harm. For more information, visit www.P65Warnings.ca.gov

BRASS

HOSE BARB

BRASS FITTINGS

BRASS RIGID MALE BSPT BARB ADAPTER

29SWV
29MS

MIDLAND	AMC	CHAMPION	LIST	HOSE I.D. X MALE BSPT	MAF #	MAF PRICE
32450			----	1/4" x 1/8"	29BSPT-42	...
32451			----	1/4" x 1/4"	29BSPT-44	...
32452			----	3/8" x 1/4"	29BSPT-64	...
32453			----	3/8" x 3/8"	29BSPT-66	...
32454			----	3/8" x 1/2"	29BSPT-68	...
32455			----	1/2" x 3/8"	29BSPT-86	...
32456			----	1/2" x 1/2"	29BSPT-88	...
32457			----	3/4" x 3/4"	29BSPT-1212	...
32458			----	1" x 1"	29BSPT-1616	...

SWIVEL MALE ADAPTER

Rotation 360°

07003

MIDLAND	AMC	CHAMPION	LIST	HOSE I.D. X MALE NPTF	MAF #	MAF PRICE
32329		201AS-3A	----	3/16" x 1/8"	29MS-32	...
32331		201AS-3B	----	3/16" x 1/4"	29MS-34	...
32332		201AS-4A	----	1/4" x 1/8"	29MS-42	...
32349		201AS-4B	----	1/4" x 1/4"	29MS-44	...
				1/4" x 3/8"	29MS-46	...
32351	07003-0602		----	3/8" x 1/8"	29MS-62	...
32201	07003-0604	201AS-6B	----	3/8" x 1/4"	29MS-64	...
32360		201AS-6C	----	3/8" x 3/8"	29MS-66	...
				3/8" x 1/2"	29MS-68	...
32355	07003-0806	201AS-8C	----	1/2" x 3/8"	29MS-86	...
32356	07003-0808	201AS-8D	----	1/2" x 1/2"	29MS-88	...
32357	07003-1212	201AS-12E	----	3/4" x 3/4"	29MS-1212	...
32386		201AS-16F	----	1" x 1"	29MS-1616	...

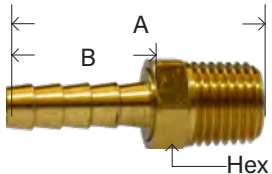
SWIVEL MALE ADAPTER

MIDLAND	AMC	CHAMPION	LIST	HOSE I.D. X MALE NPTF	MAF #	MAF PRICE
32200	07003-0404		----	1/4" x 1/4"		
32202	07003-0606		----	3/8" x 3/8"		

WARNING: This product can expose you to chemicals, including lead, which are known to the State of California to cause cancer and birth defects or other reproductive harm. For more information, visit www.P65Warnings.ca.gov



HOSE BARB

BRASS FITTINGS

MENDER/ SPLICER



07014
29S
129S

MIDLAND	AMC	CHAMPION	LIST	HOSE I.D. X HOSE I.D.	MAF #	MAF PRICE
32091	07014-02	HM-2	----	1/8"	29S-2	...
32092	07014-03	HM-3	----	3/16"	29S-3	...
32093	07014-04	HM-4	----	1/4"	29S-4	...
32079		HM-42	----	1/4" x 1/8"	29SR-42	...
32094	07014-05	HM-5	----	5/16"	29S-5	...
32090		HM-54	----	5/16" x 1/4"	29SR-54	...
32095	07014-06	HM-6	----	3/8"	29S-6	...
32960			----	3/8 x 1/8	29SR-62	...
32961			----	3/8 x 3/16	29SR-63	...
32080		HM-64	----	3/8" x 1/4"	29SR-64	...
32375		HM-65	----	3/8" x 5/16"	29SR-65	...
32096	07014-08	HM-8	----	1/2"	29S-8	...
				1/2" x 1/4"	29SR-84	...
32087		HM-86	----	1/2" x 3/8"	29SR-86	...
32097	07014-10	HM-10	----	5/8"	29S-10	...
				5/8" x 1/4"	29SR-104	...
32088		HM-106	----	5/8" x 3/8"	29SR-106	...
32376		HM-108	----	5/8" x 1/2"	29SR-108	...
32098	07014-12	HM-12	----	3/4"	29S-12	...
				3/4" x 3/8"	29SR-126	...
32089		HM-128	----	3/4" x 1/2"	29SR-128	...
32379		HM-1210	----	3/4" x 5/8"	29SR-1210	...
				1" x 1/2"	29SR-168	...
				1" x 5/8"	29SR-1610	...
32380		HM-1612	----	1" x 3/4"	29SR-1612	...
32099	07014-16	HM-16	----	1"	29S-16	...
				1-1/4"	29S-20	...

HIGH VOLUME MALE SWIVEL

- 300 PSI
- Nitrile Buna (NBR) O-Ring



29MS-64HF



29HPS

MIDLAND	AMC	CHAMPION	LIST	HOSE I.D. X MALE NPTF	MAF #	MAF PRICE
32781			----	3/8" x 1/4"	29MS-64HF	...
28415			----	1/4" x 1/4"	29HPS-44	...
28417				3/8" x 1/4"	29HPS-64	...

WARNING: This product can expose you to chemicals, including lead, which are known to the State of California to cause cancer and birth defects or other reproductive harm. For more information, visit www.P65Warnings.ca.gov

BRASS

HOSE BARB

BRASS FITTINGS

RIGID FEMALE ADAPTER

07002
29F
129F

MIDLAND	AMC	CHAMPION	LIST	HOSE I.D. X FEMALE NPTF	MAF #	MAF PRICE
32050	07002-0202	209A-2A	----	1/8" x 1/8"	29F-22	...
32317	07002-0204	209A-2B	----	1/8" x 1/4"	29F-24	...
32051	07002-0302	209A-3A	----	3/16" x 1/8"	29F-32	...
32062	07002-0304	209A-3B	----	3/16" x 1/4"	29F-34	...
32052	07002-0402	209A-4A	----	1/4" x 1/8"	29F-42	...
32053	07002-0404	209A-4B	----	1/4" x 1/4"	29F-44	...
32054	07002-0406	209A-4C	----	1/4" x 3/8"	29F-46	...
32441	07002-0408	209A-4D	----	1/4" x 1/2"	29F-48	...
32055	07002-0502	209A-5A	----	5/16" x 1/8"	29F-52	...
32056	07002-0504	209A-5B	----	5/16" x 1/4"	29F-54	...
32318	07002-0506	209A-5C	----	5/16" x 3/8"	29F-56	...
32320			----	5/16" x 1/2"	29F-58	...
32057	07002-0602	209A-6A	----	3/8" x 1/8"	29F-62	...
32058	07002-0604	209A-6B	----	3/8" x 1/4"	29F-64	...
32059	07002-0606	209A-6C	----	3/8" x 3/8"	29F-66	...
32063	07002-0608	209A-6D	----	3/8" x 1/2"	29F-68	...
		209A-6E		3/8" X 3/4"	29F-612	
32449				1/2" x 1/8"	29F-82	...
32064	07002-0804	209A-8B		1/2" x 1/4"	29F-84	...
32060	07002-0806	209A-8C		1/2" x 3/8"	29F-86	...
32061	07002-0808	209A-8D		1/2" x 1/2"	29F-88	...
32443		209A-8E		1/2" x 3/4"	29F-812	...
32444		209A-10C		5/8" x 3/8"	29F-106	...
32445		209A-10D		5/8" x 1/2"	29F-108	...
32446		209A-10E		5/8" x 3/4"	29F-1012	...
32447		209A-12D		3/4" x 1/2"	29F-128	...
32065	07002-1212	209A-12E		3/4" x 3/4"	29F-1212	...
32049	07002-1612	209A-16E		1" x 3/4"	29F-1612	...
32321	07002-1616	209A-16F		1" x 1"	29F-1616	...
32448				1-1/4" x 1"	29F-2016	...

209A 128 29A 29F 126HB 126 FPB 105B-2 KF-RS 104 144

SWIVEL FEMALE ADAPTER NPTF

MIDLAND	AMC	CHAMPION	LIST	HOSE I.D. X FEMALE NPTF	MAF #	MAF PRICE
32470		209AF-4B	----	1/4" x 1/4"		
32472		209AF-6B	----	3/8" x 1/4"		
32473		209AF-6C	----	3/8" x 3/8"		
32475		209AF-8C	----	1/2" x 3/8"		
32476		209AF-8D	----	1/2" x 1/2"		

WARNING: This product can expose you to chemicals, including lead, which are known to the State of California to cause cancer and birth defects or other reproductive harm. For more information, visit www.P65Warnings.ca.gov



HOSE BARB

BRASS FITTINGS

SWIVEL FEMALE ADAPTER - WITH GASKET

National Pipe Straight Gasket Seal Swivel

- NPSM Thread



07009
29UFS
129UFS

- Not recommend for water due to fiber gasket - for air service only.

MIDLAND	AMC	CHAMPION	LIST	HOSE I.D. X FEMALE NPSM	MAF #	MAF PRICE
32131	07009-0202	209AFSG-2A		1/8" x 1/8"	29UFS-22	...
32132	07009-0302	209AFSG-3A		3/16" x 1/8"	29UFS-32	...
32133	07009-0304	209AFSG-3B		3/16" x 1/4"	29UFS-34	...
32120	07009-0402	209AFSG-4A		1/4" x 1/8"	29UFS-42	...
32121	07009-0404	209AFSG-4B		1/4" x 1/4"	29UFS-44	...
32129	07009-0406	209AFSG-4C		1/4" x 3/8"	29UFS-46	...
32130	07009-0504	209AFSG-5B		5/16" x 1/4"	29UFS-54	...
32122	07009-0604	209AFSG-6B		3/8" x 1/4"	29UFS-64	...
32123	07009-0606	209AFSG-6C		3/8" x 3/8"	29UFS-66	...
32354	07009-0608	209AFSG-6D		3/8" x 1/2"	29UFS-68	...
32124	07009-0806	209AFSG-8C		1/2" x 3/8"	29UFS-86	...
32125	07009-0808	209AFSG-8D		1/2" x 1/2"	29UFS-88	...
32117		209AFSG-8E		1/2" x 3/4"	29UFS-812	...
32118		209AFSG-10E		5/8" x 3/4"	29UFS-1012	...
32119		209AFSG-12E		3/4" x 3/4"	29UFS-1212	...

130 126 29FSG KF-RN NPSM Gasket Seal

FORGED HOSE BARB 90° ELBOW



07020
29E
129E

MIDLAND	AMC	CHAMPION	LIST	HOSE I.D. X MALE NPTF	MAF #	MAF PRICE
32308	07020-0302	HE1-3A		3/16" x 1/8"		
32391		HE1-3B		3/16" x 1/4"		
32038	07020-0402	HE1-4A		1/4" x 1/8"	29E-42	...
32039	07020-0404	HE1-4B		1/4" x 1/4"	29E-44	...
32309		HE1-4C		1/4" x 3/8"	29E-46	...
32036	07020-0502	HE1-5A		5/16" x 1/8"	29E-52	...
32040	07020-0504	HE1-5B		5/16" x 1/4"	29E-54	...
32310	07020-0506	HE1-5C		5/16" x 3/8"	29E-56	...
32046	07020-0602	HE1-6A		3/8" x 1/8"	29E-62	...
32041	07020-0604	HE1-6B		3/8" x 1/4"	29E-64	...
32042	07020-0606	HE1-6C		3/8" x 3/8"	29E-66	...
32047	07020-0608	HE1-6D		3/8" x 1/2"	29E-68	...
32048	07020-0804	HE1-8B		1/2" x 1/4"	29E-84	...
32043	07020-0806	HE1-8C		1/2" x 3/8"	29E-86	...
32311	07020-0808	HE1-8D		1/2" x 1/2"	29E-88	...
32044	07020-1006	HE1-10C		5/8" x 3/8"	29E-106	...
32045	07020-1008	HE1-10D		5/8" x 1/2"	29E-108	...
32312		HE1-10E		5/8" x 3/4"		
32313		HE1-12D		3/4" x 1/2"		
32314 *		HE1F-12E		3/4" x 3/4"		
32330 **				3/4" x 1"		
32315		HE1-16E		1" x 3/4"		
32319		HE1-16F		1" x 1"		

DIMENSION DATA CAN CHANGE WITHOUT NOTICE. PLEASE CALL WHEN DIMENSIONS ARE CRITICAL.

WARNING: This product can expose you to chemicals, including lead, which are known to the State of California to cause cancer and birth defects or other reproductive harm. For more information, visit www.P65Warnings.ca.gov



129 HBEI KF-PS90 HE-1 29E 146

HOSE BARB

BRASS FITTINGS

BARSTOCK HOSE BARB 90° ELBOW

29EBS

MIDLAND	AMC	CHAMPION	LIST	HOSE I.D. X MALE NPTF	MAF #	MAF PRICE
32038B				1/4" X 1/8"	29E-42BS	...
32039B				1/4" X 1/4"	29E-44BS	...
32309B				1/4" X 3/8"	29E-46BS	...
32036B				5/16" X 1/8"	29E-52BS	...
32040B				5/16" X 1/4"	29E-54BS	...
32310B				5/16" X 3/8"	29E-56BS	...
32046B				3/8" X 1/8"	29E-62BS	...
32041B				3/8" X 1/4"	29E-64BS	...
32042B				3/8" X 3/8"	29E-66BS	...
32047B				3/8" X 1/2"	29E-68BS	...
32048B				1/2" X 1/4"	29E-84BS	...
32043B				1/2" X 3/8"	29E-86BS	...
32311B				1/2" X 1/2"	29E-88BS	...
32314B				3/4" X 3/4"	29E-1212BS	...

HOSE BARB TEES

07024

* Barstock

MIDLAND	AMC	CHAMPION	LIST	HOSE BARB SIZE (1 & 2) X 3	MAF #	MAF PRICE
32367 *		HBT2-2		1/8"		
32368		HBT2-3		3/16"		
32365 **	07024-04	HBT2-4		1/4"	29T-4	...
32350 *		HBT2-442		(1/4") x 1/8"		
32366	07024-05	HBT2-5		5/16"	29T-5	...
32126 **	07024-06	HBT2-6		3/8"	29T-6	...
		HBT2-664		3/8" x 1/4"		
32400 *		HBT2-8		1/2"		
32352 *		HBT2-886		(1/2") x 3/8"		
32361		HBT2-10		5/8"		
32363		HBT2-12		3/4"		
32353		HBT2-12128		(3/4") x 1/2"		
32128 *		HBT2-6B		3/8"HB x 1/4" MIP	29TRM-664	...

90° FEMALE HOSE BARB ELBOW

129HB

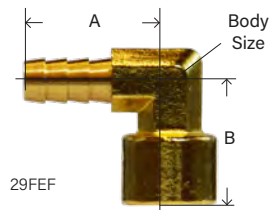

29FEF

MIDLAND	AMC	CHAMPION	LIST	HOSE I.D. X FEMALE NPTF	MAF #	MAF PRICE
32401		HE3-4A	----	1/4" x 1/8"		
32402		HE3-4B	----	1/4" x 1/4"		
32403		HE3-6A	----	3/8" x 1/8"		
32404		HE3-6B	----	3/8" x 1/4"		
32405		HE3-6C	----	3/8" x 3/8"		
32406			----	3/8" x 1/2"		
32407		HE3-8B	----	1/2" x 1/4"		
32410		HE3-8C	----	1/2" x 3/8"		
32411		HE3-8D	----	1/2" x 1/2"		
32409		HE3-12E	----	3/4" x 3/4"		

WARNING: This product can expose you to chemicals, including lead, which are known to the State of California to cause cancer and birth defects or other reproductive harm. For more information, visit www.P65Warnings.ca.gov

BRASS FITTINGS

90° HOSE BARB ELBOW

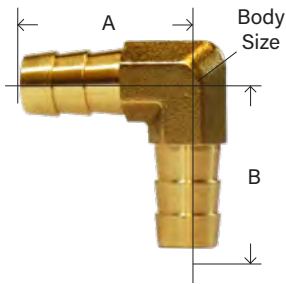

MIDLAND	AMC	CHAMPION	LIST	HOSE I.D. X HOSE I.D.	MAF #	MAF PRICE
32429		HM-90-2	----	1/8" x 1/8"		
32433		HM-90-3	----	3/16" x 3/16"		
32412			----	1/4" x 1/8"		
32413 *		HM-90-4	----	1/4" x 1/4"		
32425		HM-90-5	----	5/16" x 5/16"		
32414			----	3/8" x 1/8"		
32415			----	3/8" x 1/4"		
32416 *		HM-90-6	----	3/8" x 3/8"		
32417			----	3/8" x 1/2"		
32418			----	1/2" x 1/4"		
32419			----	1/2" x 3/8"		
32420 *		HM-90-8	----	1/2" x 1/2"		
32434		HM-90-10	----	5/8" x 5/8"		
32435			----	3/4" x 1/2"		
32436		HM-90-12	----	3/4" x 3/4"		

45° ELBOW



07045
294S
1294S

* Barstock

MIDLAND	AMC	CHAMPION	LIST	HOSE I.D. X MALE NPTF	MAF #	MAF PRICE
32110	07045-0402	HE1-45-4A		1/4" x 1/8"	2945F-42	...
				1/4" x 1/8"	2945-42BS*	...
32109*	07045-0404	HE1-45-4B		1/4" x 1/4"	2945-44BS*	...
	07045-0002	HE1-45-5A		5/16" x 1/8"	2945F-52	
	07045-0504	HE1-45-5B		5/16" x 1/4"	2945F-54	...
32111	07045-0602	HE1-45-6A		3/8" x 1/8"	2945F-62	...
32112	07045-0604	HE1-45-6B		3/8" x 1/4"	2945F-64	...
32113	07045-0606	HE1-45-6C		3/8" x 3/8"	2945F-66	...
32346	07045-0804	HE1-45-8B		1/2" x 1/4"	2945F-84	...
32114	07045-0806	HE1-45-8C		1/2" x 3/8"	2945F-86	...
32116		HE1-45-8D		1/2" x 1/2"	2945F-88	...
32115	07045-1006	HE1-45-10C		5/8" x 3/8"	2945F-106	...
32345		HE1-45-12D		3/4" x 1/2"		

140 HE145 139HB KF-PS45 13945

CROSSES



MIDLAND	AMC	CHAMPION	LIST	HOSE ID	MAF #	MAF PRICE
32608			----	1/4"		
32609			----	5/16"		
32610			----	3/8"		

Hose Wyes available with extended lead time.

DIMENSION DATA CAN CHANGE WITHOUT NOTICE. PLEASE CALL WHEN DIMENSIONS ARE CRITICAL.

HOSE BARB

BRASS FITTINGS

BALL END SWIVEL

NPSM - Ball seat type

07008
29FS
129FS

MIDLAND	AMC	CHAMPION	LIST	HOSE I.D. X NPSM	MAF #	MAF PRICE
32066	07008-0202	209AS-2A		1/8" x 1/8"	29FS-22	...
32067	07008-0302	209AS-3A		3/16" x 1/8"	29FS-32	...
32068	07008-0304	209AS-3B		3/16" x 1/4"	29FS-34	...
32962				3/16" x 3/8"	29FS-36	...
32069	07008-0402	209AS-4A		1/4" x 1/8"	29FS-42	...
32070	07008-0404	209AS-4B		1/4" x 1/4"	29FS-44	...
32078	07008-0406	209AS-4C		1/4" x 3/8"	29FS-46	...
32071	07008-0504	209AS-5B		5/16" x 1/4"	29FS-54	...
32389		209AS-5C		5/16" x 3/8"	29FS-56	...
32072	07008-0604	209AS-6B		3/8" x 1/4"	29FS-64	...
32073	07008-0606	209AS-6C		3/8" x 3/8"	29FS-66	...
32074	07008-0608	209AS-6D		3/8" x 1/2"	29FS-68	...
32075	07008-0806	209AS-8C		1/2" x 3/8"	29FS-86	...
32076	07008-0808	209AS-8D		1/2" x 1/2"	29FS-88	...
32077	07008-1212	209AS-12E		3/4" x 3/4"	29FS-1212	...

128HBLSV 29FS 209AS 124 131

BALLSEAT MALE ADAPTER

Beveled Seat



07654

MIDLAND	AMC	CHAMPION	LIST	NPSM X MALE NPTF	MAF #	MAF PRICE
32359	07654-0202	122AS-2A		1/8" x 1/8"	WH48-22	...
32034	07654-0402	122AS-4A		1/4" x 1/8"	WH48-42	...
32030	07654-0404	122AS-4B		1/4" x 1/4"	WH48-44	...
32362	07654-0604	122AS-6B		3/8" x 1/4"	WH48-64	...
32031	07654-0606	122AS-6C		3/8" x 3/8"	WH48-66	...
32392		122AS-6D		3/8" x 1/2"	WH48-68	...
32364	07654-0806	122AS-8C		1/2" x 3/8"	WH48-86	...
32032	07654-0808	122AS-8D		1/2" x 1/2"	WH48-88	...
32033	07654-1212	122AS-12E		3/4" x 3/4"	WH48-1212	...

172 134 127HB 122AS

BALLSEAT UNION30° Seat
07656

MIDLAND	AMC	CHAMPION	LIST	NPSM X NPSM	MAF #	MAF PRICE
32460		122AS-22UN		1/8"	WH42-2	...
32461	07656-0404	122AS-44UN		1/4"	WH42-4	...
32462				3/8"	WH42-6	...
32463	07656-0808			1/2"	WH42-8	...

WARNING: This product can expose you to chemicals, including lead, which are known to the State of California to cause cancer and birth defects or other reproductive harm. For more information, visit www.P65Warnings.ca.gov



HOSE BARB

BRASS FITTINGS

45° FLARE ADAPTER



07004
29SAE
129SAE

MIDLAND	AMC	CHAMPION	LIST	HOSE I.D. X 45° FLARE	MAF #	MAF PRICE
32322	07004-0304	201BF-34		3/16" x 1/4"	29MSAE-34	...
32081	07004-0404	201BF-44		1/4" x 1/4"	29MSAE-44	...
32082	07004-0406	201BF-46		1/4" x 3/8"	29MSAE-46	...
32083	07004-0505	201BF-55		5/16" x 5/16"	29MSAE-55	...
32084	07004-0606	201BF-66		3/8" x 3/8"	29MSAE-66	...
32085	07004-0608	201BF-68		3/8" x 1/2"	29MSAE-68	...
32086	07004-0808	201BF-88		1/2" x 1/2"	29MSAE-88	...

142 201BF KF-MS KDS

COMPRESSION ADAPTER - BARB X MALE COMPRESSION THREAD



MIDLAND	AMC	CHAMPION	LIST	SIZE	MAF #	MAF PRICE
				1/8" x 1/4"	29CT-24	...
				3/16" x 3/16"	29CT-33	...
				3/16" x 1/4"	29CT-34	...
				1/4" x 3/16"	29CT-43	...
				1/4" x 1/4"	29CT-44	...
				1/4" x 5/16"	29CT-45	...
				1/4" x 3/8"	29CT-46	...
				5/16" x 1/4"	29CT-54	...
				5/16" x 5/16"	29CT-55	...
				3/8" x 3/16"	29CT-63	...
				3/8" x 1/4"	29CT-64	...
				3/8" x 3/8"	29CT-66	...
				1/2" x 1/2"	29CT-88	...

WARNING: This product can expose you to chemicals, including lead, which are known to the State of California to cause cancer and birth defects or other reproductive harm. For more information, visit www.P65Warnings.ca.gov

BRASS

HOSE BARB

BRASS FITTINGS

DUAL 45°/ 37° FLARE SWIVEL

MIDLAND	AMC	CHAMPION	LIST	HOSE ID X DUAL SEAT	MAF #	MAF PRICE
32107	07010-0304			3/16" x 1/4"	29DS-34	...
32107C**				3/16 X 1/4		
32337				1/4" x 1/4"	29DS-44	...
32337C**				1/4" X 1/4"	29CSAE-44	
32102	07010-0405			1/4" x 5/16"	29DS-45	...
32339				5/16" x 5/16"	29DS-55	...
32340				3/8" x 1/2"	29DS-68	...
				3/8" x 3/8"	29CSAE-66	
32341				1/2" x 1/2"	29DS-88	...
32341C**				1/2" X 1/2"	29CSAE-88	
32342	07010-0810			1/2" x 5/8"	29DS-810	...
32394**				5/8" x 5/8"		
				5/8" x 5/8"	29CSAE-1010	
				3/4" x 3/4"	29CSAE-122	

** Swivel crimp style

KDS

FEMALE 45° FLARE SWIVEL07010
29SAE
129SAE* CRIMP STYLE
29CSAE

MIDLAND	AMC	CHAMPION	LIST	HOSE I.D. X FEMALE 45° FLARE	MAF #	MAF PRICE
32326	07010-0303	209ASF-33		3/16" x 3/16"	29SAE-33	...
	07010-0304			3/16" x 1/4"	29SAE-34	...
				3/16" x 1/4"	29CSAE-34	...
				3/16" x 3/8"	29SAE-36	...
30295	07215-0310			3/16" x 3/8"	29CSAE-36	...
32101	07010-0404	209ASF-44		1/4" x 1/4"	29SAE-44	...
				1/4" x 1/4"	29CSAE-44	...
	07010-0405			1/4" x 5/16"	29SAE-45	...
32103	07010-0406	209ASF-46		1/4" x 3/8"	29SAE-46	...
32104	07010-0505	209ASF-55		5/16" x 5/16"	29SAE-55	...
32327	07010-0506	209ASF-56		5/16" x 3/8"	29SAE-56	...
32105	07010-0606	209ASF-66		3/8" x 3/8"	29SAE-66	...
32105C				3/8" x 3/8"	29CSAE-66	...
32106	07010-0608	209ASF-68		3/8" x 1/2"	29SAE-68	...
32100	07010-0808	209ASF-88		1/2" x 1/2"	29SAE-88	...
32341C				1/2" x 1/2"	29CSAE-88	...
32394				5/8" x 5/8"	29SAE-1010	...
32328	07010-1212	209ASF-1212		3/4" x 3/4"	29CSAE-1212	...

29SAE 209ASF 146HBLFSV KF-NS 128 FSS 146 144

WARNING: This product can expose you to chemicals, including lead, which are known to the State of California to cause cancer and birth defects or other reproductive harm. For more information, visit www.P65Warnings.ca.gov



HOSE BARB

BRASS FITTINGS

FEMALE 37° J.I.C. FLARE SWIVEL



* CRIMP STYLE
**STAINLESS

MIDLAND	AMC	CHAMPION	LIST	HOSE ID X FEMALE 37° FLARE	MAF #	MAF PRICE
32334		209ASJ-46		1/4" x 3/8"	29JIC-46	...
32335		209ASJ-56		5/16" x 3/8"	29JIC-56	...
				3/8" x 3/8"	29CJIC-66	
32336C				3/8" X 3/8"	29CJIC-66*	...
32338		209ASJ-1212		3/4" x 3/4"	29JIC-1212	
32338C				3/4" x 3/4"	29CJIC-1212*	
32338SS**				3/4" x 3/4"		

KJS

* swivel crimp style - (100 piece minimum)

BARB X SWT

MIDLAND	AMC	CHAMPION	LIST	HOSE ID	MAF #	MAF PRICE
				1/2" x 1/2"	29SWT-88	...
				3/4" x 1/2"	29SWT-128	...
				3/4" x 5/8"	29SWT-1210	...
				3/4" x 7/8"	29SWT-1214	...
				1" x 1"	29SWT-1616	...

REUSABLE MALE FITTINGS



07216
29RU17

MIDLAND	AMC	LIST	HOSE ID	HOSE OD	MALE NPTF	MAF #	MAF PRICE
32727	07217-040804		1/4"	1/2"	1/4"	29RU17-484	...
32728	07217-040904		1/4"	9/16"	1/4"	29RU17-494	...
32726	07217-041004		1/4"	5/8"	1/4"	29RU17-4104	...
32741			5/16"	5/8"	1/4"	29RU17-5104	...
32742	07217-061004		3/8"	5/8"	1/4"	29RU17-6104	...
32744	07217-061104		3/8"	11/16"	1/4"	29RU17-6114	...
32725	07217-061204		3/8"	3/4"	1/4"	29RU17-6124	...
32747	07217-061006		3/8"	5/8"	3/8"	29RU17-6106	...
32750	07217-061106		3/8"	11/16"	3/8"	29RU17-6116	...
32746	07217-081408		1/2"	7/8"	1/2"	29RU17-8148	...

WARNING: This product can expose you to chemicals, including lead, which are known to the State of California to cause cancer and birth defects or other reproductive harm. For more information, visit www.P65Warnings.ca.gov

BRASS

HOSE BARB

BRASS FITTINGS

REUSABLE FEMALE SWIVEL STEMS



MIDLAND	AMC	CHAMPION	LIST	HOSE ID	FEMALE NPSM
32770			----	1/4"	1/4"-18
32771			----	3/8"	3/8"-18

REUSABLE FEMALE SWIVELS



29RU16

MIDLAND	AMC	CHAMPION	LIST	HOSE ID	HOSE OD	FEMALE NPSM
32772			----	1/4"	1/2"	1/4"
32773			----	3/8"	5/8"	3/8"
32774			----	3/8"	11/16"	3/8"
32775			----	1/2"	7/8"	1/2"

REUSABLE FERRULES



MIDLAND	AMC	CHAMPION	LIST	HOSE ID	HOSE OD
32749			----	1/4"	1/2"
32751			----	1/4"	9/16"
32752			----	1/4"	5/8"
32753			----	3/8"	5/8"
32754			----	3/8"	11/16"
32755			----	3/8"	3/4"
32756			----	1/2"	7/8"

REUSABLE MALE STEMS

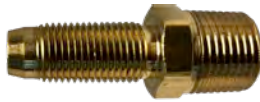

MIDLAND	AMC	CHAMPION	LIST	HOSE ID	MALE NPT THREAD
32758			----	1/4"	1/4"
32759			----	3/8"	1/4"
32760			----	3/8"	3/8"
32761			----	1/2"	1/2"

WARNING: This product can expose you to chemicals, including lead, which are known to the State of California to cause cancer and birth defects or other reproductive harm. For more information, visit www.P65Warnings.ca.gov



HOSE BARB

BRASS FITTINGS

BRASS FUEL HOSE BARBS

Typical Application: Low pressure air, fuel and oil applications. Generally used for automotive, light truck, and small engine fuel lines. Use with fuel hose SAE 30R7 & SAE 30R9.

Advantages: Easy to assemble, just push the fitting into the hose & clamp. Good selection of configurations at reasonable cost.

BEADED BARB X MALE PIPE



08701
159
29SB

MIDLAND	AMC	CHAMPION	LIST	HOSE ID	MAF #	MAF PRICE
38800	08701-0302	201AB-3A		3/16" x 1/8"	29SB-32	...
38802	08701-0402	201AB-4A		1/4" x 1/8"	29SB-42	...
32377	08701-0404	201AB-4B		1/4" x 1/4"	29SB-44	...
38806	08701-0502	201AB-5A		5/16" x 1/8"	29SB-52	...
38808	08701-0504	201AB-5B		5/16" x 1/4"	29SB-54	...
38810	08701-0602	201AB-6A		3/8" x 1/8"	29SB-62	...
32381	08701-0604	201AB-6B		3/8" x 1/4"	29SB-64	...
32382	08701-0606	201AB-6C		3/8" x 3/8"	29SB-66	...
		201AB-8B		1/2" x 1/4"	29SB-84	...
32383	08701-0806	201AB-8C		1/2" x 3/8"	29SB-86	...
32384	08701-0808	201AB-8D		1/2" x 1/2"	29SB-88	...
				1/2" x 3/4"	29SB-812	...
	08701-1006	201AB-10C		5/8" x 3/8"	29SB-106	...
32385	08701-1008	201AB-10D		5/8" x 1/2"	29SB-108	...
	08701-1012			5/8" x 3/4"	29SB-1012	...
32387	08701-1208	201AB-12D		3/4" x 1/2"	29SB-128	...
32388	08701-1212	201AB-12E		3/4" x 3/4"	29SB-1212	...
				1" x 1/2"	29SB-168	...
		201AB-16E		1" x 3/4"	29SB-1612	...
				1" x 1"	29SB-1616	...
				1"-1/8" x 1"	29SB-1816	...

68HB

BUBBLE BARB MALE ADAPTER

BUBBLE X MIP



MIDLAND	AMC	CHAMPION	LIST	BUBBLE X MIP	MAF #	MAF PRICE
32176				3/8" x 3/8"		
32177				1/2" x 1/4"	29BB-84	...
32178				1/2" x 3/8"	29BB-86	...
32179				1/2" x 1/2"	29BB-88	...
32182				5/8" x 3/8"	29BB-106	...
32183				5/8" x 1/2"	29BB-108	...
32184				3/4" x 1/2"	29BB-128	...
32180				3/4" x 3/4"	29BB-1212	...
32185				1" x 3/4"	29BB-1612	...
32181				1" x 1"	29SB-1616	...

WARNING: This product can expose you to chemicals, including lead, which are known to the State of California to cause cancer and birth defects or other reproductive harm. For more information, visit www.P65Warnings.ca.gov

BRASS

HOSE BARB

BRASS FITTINGS

INVERTED FLARE MALE CONNECTOR

BEADED BARB X INVERTED FLARE

08706
159IN
29IFSB

MIDLAND	AMC	CHAMPION	LIST	HOSE ID	MAF #	MAF PRICE
	08706-0404			1/4" x 1/4"	29IFSB-44	...
	08706-0405			1/4" x 5/16"	29IFSB-45	...
38828	08706-0504	205AB-54		5/16" x 1/4"	29IFSB-54	...
38830	08706-0505	205AB-55		5/16" x 5/16"	29IFSB-55	...
38832	08706-0506	205AB-56		5/16" x 3/8"	29IFSB-56	...
38834	08706-0605			3/8" x 5/16"	29IFSB-65	...
38836	08706-0606	205AB-66		3/8" x 3/8"	29IFSB-66	...

90° MALE ELBOW

BEADED BARB X MALE PIPE

08720
29ESB

MIDLAND	AMC	CHAMPION	LIST	HOSE ID	MAF #	MAF PRICE
38860	08720-0402	HE1B-4A		1/4" x 1/8"	29ESB-42	...
38862	08720-0502	HE1B-5A		5/16" x 1/8"	29ESB-52	...
38864	08720-0504	HE1B-5B		5/16" x 1/4"	29ESB-54	...
38866	08720-0602	HE1B-6A		3/8" x 1/8"	29ESB-62	...
38868	08720-0604	HE1B-6B		3/8" x 1/4"	29ESB-64	...

269HB

BUBBLE BARB

159E

MIDLAND	AMC	CHAMPION	LIST	HOSE ID	MAF #	MAF PRICE
32186	08720-0606	HE1B-6C		3/8" x 3/8"	29ESB-66	...
32194		HE1B-8B		1/2" x 1/4"		
32187	08720-0806	HE1B-8C		1/2" x 3/8"	29ESB-86	...
32191	08720-0808			1/2" x 1/2"	29ESB-88	...
32195		HE1B-10B		5/8" x 1/4"		
32188	08720-1006	HE1B-10C		5/8" x 3/8"	29ESB-106	...
32189	08720-1008	HE1B-10D		5/8" x 1/2"	29ESB-108	...
32190	08720-1208	HE1B-12D		3/4" x 1/2"	29ESB-128	...
32192		HE1B-12E		3/4" x 3/4"	29ESB-1212	...
				1" x 3/4"	29ESB-1612	...

INVERTED FLARE MALE SWIVEL 90° ELBOW

BEADED BARB X TUBE O.D.

08722
159ELS
29IMES

MIDLAND	AMC	CHAMPION	LIST	HOSE ID	MAF #	MAF PRICE
38861	08722-0404	205AB-90-44		1/4" x 1/4"	29IMES-44	...
	08722-0405	205AB-90-45		1/4" x 5/16"	29IMES-45	...
38873	08722-0505	205AB-90-55		5/16" x 5/16"	29IMES-55	...
38869	08722-0605			3/8" x 5/16"	29IMES-65	...
38874	08722-0606	205AB-90-66		3/8" x 3/8"	29IMES-66	...

WARNING: This product can expose you to chemicals, including lead, which are known to the State of California to cause cancer and birth defects or other reproductive harm. For more information, visit www.P65Warnings.ca.gov



WELD HOSE FITTINGS

BRASS FITTINGS

WELDING HOSE ASSEMBLIES

OXYGEN LINE HOSE BARB X RIGHT HAND THREAD (9-16-18) ASSEMBLIES



MIDLAND	AMC	CHAMPION	LIST	WELDING HOSE	MAF #	MAF PRICE
30408	07629-0309	209RWA-3		3/16"	29FWE3-9	
30409	07629-0409	209RWA-4		1/4"	29FWE4-9	
	07629-0509	209RWA-5		5/16"	29FWE5-6	
30415	07629-0609	209RWA-6		3/8"	29FWE6-9	
30407	07629-0306			3/16"	29FWE3-6	

ACETYLENE LINE HOSE BARB X LEFT HAND THREAD (9/16-18) ASSEMBLY



MIDLAND	AMC	CHAMPION	LIST	HOSE SIZE	MAF #	MAF PRICE
30417	07639-0309	209LWA-3		3/16"	29FWL3-9	
30431	07639-0409	209LWA-4		1/4"	29FWL4-9	
	07639-0509	209LWA-5		5/16"	29FWL5-9	
30433	07639-0609	209LWA-6		3/8"	29FWL6-9	
	07639-0306*			3/16"	29FWL3-6	

* 3/8-24 thread

WARNING: This product can expose you to chemicals, including lead, which are known to the State of California to cause cancer and birth defects or other reproductive harm. For more information, visit www.P65Warnings.ca.gov

BRASS

WELD HOSE FITTINGS

BRASS FITTINGS

WELDING HOSE FITTINGS**STEM ONLY - WELDING HOSE CONNECTOR**

MIDLAND	AMC	CHAMPION	LIST	HOSE ID	MAF #	MAF PRICE
30410		209WA-3		3/16"	29FW-3	...
30411		209WA-4		1/4"	29FW-4	...
		209WA-5		5/16"	29FW-5	...
30413		209WA-6		3/8"	29FW-6	...

Assemble with nuts below.

201RWA WRS WLS

RIGHT HAND 9/16 - 18 FOR OXYGEN LINE - WELDING HOSE NUT

MIDLAND	AMC	CHAMPION	LIST	SIZE	MAF #	MAF PRICE
30420		209RWA-NUT		R.H. Nut only	29FVN-9R	...

Assemble with stem above.

201RWA WRS KF-PE 152

07629
(WITH STEM)**LEFT HAND 9/16 - 18 FOR ACETYLENE LINE - WELDING HOSE NUT**

MIDLAND	AMC	CHAMPION	LIST	SIZE	MAF #	MAF PRICE
30421		209LWA-NUT		L.H. Nut only	29FVN-9L	...

Assemble with stem above.

209LWA WLS 154 KF-RE

07639
(WITH STEM)**RIGHT HAND 9/16 - 18 #122RWA - WELDING HOSE CONNECTOR**

MIDLAND	AMC	CHAMPION	LIST	SIZE	MAF #	MAF PRICE
		122RWA-A		1/8"-27		
30401	07651-0904	122RWA-B		1/4"-18	122RWA-92	...
32437	07651-0906	122RWA-C		3/8"-18	122RWA-96	...
32438*	07651-0909	122RWA-UNION		9/16"-18	122RWA-99	...

* Right UNF thread

156

07651
651
WH42R**LEFT HAND 9/16 - 18 #122LWA - WELDING HOSE CONNECTOR**

MIDLAND	AMC	CHAMPION	LIST	SIZE	MAF #	MAF PRICE
30406	07652-0904	122LWA-B		1/4"-18	122LWA-94	...
32439	07652-0906	122LWA-C		3/8"-18	122LWA-96	...
32440*	07652-0909			9/16"-18	122LWA-99	...

* Left UNF thread

158

07652
652
WH42L

WARNING: This product can expose you to chemicals, including lead, which are known to the State of California to cause cancer and birth defects or other reproductive harm. For more information, visit www.P65Warnings.ca.gov

BARBED FOR PLASTIC TUBING

BRASS FITTINGS

UNION

07062
29MBS



TUBE O.D. (TUBE I.D.) X TUBE O.D. (TUBE I.D.)

MIDLAND	AMC	LIST	SIZE	MAF #	MAF PRICE
21003	07062-02		1/4(1/8) x 1/4(1/8)	29MBS-2	...
			1/4(1/8) Long	29MBS-2L	...
			1/4(1/8) x 10/32(5/32)	29MBS-250	...
21007			3/8(1/4) x 1/4(1/8)	29MBS-42	...
			3/8(1/4) x 5/16(3/16)	29MBS-43	...
21009	07062-04		3/8(1/4) x 3/8(1/4)	29MBS-4	...
			1/2(3/8) x 1/4(1/8)	29MBS-62	...
			1/2(3/8) x 3/8(1/4)	29MBS-64	...
21084	07062-06		1/2(3/8) x 1/2(3/8)	29MBS-6	...

1062 962

MALE ADAPTER

07068



TUBE O.D. (TUBE I.D.) X MALE PIPE

MIDLAND	AMC	CHAMPION	LIST	SIZE	MAF #	MAF PRICE
				1/8(1/16) x 1/8	29MB-12	...
21021				1/4(1/8) x 1/16	29MB-21	...
21023	07068-0202			1/4(1/8) x 1/8	29MB-22	...
21025	07068-0204			1/4(1/8) x 1/4	29MB-24	...
21027	07068-0402	68MB-4A		3/8(1/4) x 1/8	29MB-42	...
20128	02082-06	68MB-4B		3/8(1/4) x 1/4	29MB-44	...
				3/8(1/4) x 1/2	29MB-48	...
21033	07068-0806			1/2(3/8) x 3/8	29MB-66	...
				1/2(3/8) x 1/2	29MB-68	...

1068 968 688

FEMALE ADAPTER



TUBE O.D. (TUBE I.D.) X FEMALE PIPE

MIDLAND	AMC	CHAMPION	LIST	SIZE	MAF #	MAF PRICE
21043				1/4(1/8) x 1/8	29FMB-22	...
21044				1/4(1/8) x 1/4	29FMB-24	...
21046				3/8(1/4) x 1/4	29FMB-44	...
21049				3/8(1/4) x 3/8	29FMB-46	...
				1/2(3/8) x 3/8	29FMB-66	...

1066 966 26 668

BULKHEAD UNION

29MBHS



MIDLAND	AMC	CHAMPION	LIST	SIZE	MAF #	MAF PRICE
21082				1/4(1/8)	29MBHS-2	...
21083		62MBH-4		3/8(1/4)	29MBHS-4	...
21084				1/2(3/8)	29MBHS-6	...

WARNING: This product can expose you to chemicals, including lead, which are known to the State of California to cause cancer and birth defects or other reproductive harm. For more information, visit www.P65Warnings.ca.gov



BARBED FOR PLASTIC TUBING

BRASS FITTINGS

MINI BARB ELBOW

1065
965
07065

MIDLAND	AMC	CHAMPION	LIST	SIZE	MAF #	MAF PRICE
21095	07065-02			1/4(1/8)	29BEMB-2	...
21097	07065-04			3/8(1/4)	29BEMB-4	...
21099	07065-06			1/2(3/8)	29BEMB-6	...

MALE 90° ELBOW

07069

MIDLAND	AMC	CHAMPION	LIST	SIZE	MAF #	MAF PRICE
21111				1/4(1/8) x 1/16	29MBE-21	...
21113	07069-0202			1/4(1/8) x 1/8	29MBE-22	...
21115	07069-0204			1/4(1/8) x 1/4	29MBE-24	...
21117	07069-0402			3/8(1/4) x 1/8	29MBE-42	...
21119	07069-0404			3/8(1/4) x 1/4	29MBE-44	...
21121	07069-0606			1/2(3/8) x 3/8	29MBE-66	...

1069 969 229

FEMALE 90° ELBOW

MIDLAND	AMC	CHAMPION	LIST	SIZE	MAF #	MAF PRICE
21133				1/4(1/8) x 1/8	29MBFE-22	...
21134				3/8(1/4) x 1/4	29MBFE-44	...

1070 970 230

UNION TEE

07064

MIDLAND	AMC	LIST	1 X 2 X 3 SIZE	MAF #	MAF PRICE
21151	07064-02		1/4(1/8)	29MBT-2	...
21153			3/8(1/4)X 3/8(1/4)X1/4(1/8)	29MBTR-442	...
			3/8(1/4) x 1/2(3/8) x 3/8(1/4)	29MBTR-464	...
21155	07064-04		3/8(1/4)	29MBT-4	...
			1/2(3/8) x 1/2(3/8) x 1/4(1/8)	29MBTR-662	...
21159			1/2(3/8)X1/2(3/8)X3/8(1/4)	29MBTR-664	...
21161	07064-06		1/2(3/8)	29MBT-6	...

1064 964 224

WARNING: This product can expose you to chemicals, including lead, which are known to the State of California to cause cancer and birth defects or other reproductive harm. For more information, visit www.P65Warnings.ca.gov

BARBED FOR PLASTIC TUBING

BRASS FITTINGS

MALE BRANCH TEE



29MRMT
07072

MIDLAND	AMC	LIST	SIZE	MAF #	MAF PRICE
21193	07072-0202		1/4(1/8) x 1/4(1/8) x 1/8	29MBMT-22	...
21195			3/8(1/4) x 3/8(1/4) x 1/8	29MBMT-42	...
			3/8(1/4) x 3/8(1/4) x 1/4	29MBMT-44	...

1072 972 232

FEMALE BRANCH TEE



29MBPT

MIDLAND	AMC	LIST	SIZE	MAF #	MAF PRICE
21207			1/4(1/8) x 1/4(1/8) x 1/8	29MBFT-22	...

1077 978

MALE RUN TEE



07071

MIDLAND	AMC	CHAMPION	LIST	SIZE	MAF #	MAF PRICE
				1/4(1/8) x 1/8	29MBMRT-22	...
				3/8 (1/4) x 1/8	29MBMRT-42	...

PLUGS



MIDLAND	AMC	CHAMPION	LIST	SIZE	MAF #	MAF PRICE
				1/4(1/8)	29MBP-2	...
				3/8(1/4)	29MBP-4	...
				1/2(3/8)	29MBP-6	...

DOUBLE BARB ADAPTERS



MIDLAND	AMC	CHAMPION	LIST	SIZE	MAF #	MAF PRICE
				1/4(1/8) x 10/32	29DB-20	...
32150				1/4(1/8) x 1/8	29MDB-22	...
32151				1/4(1/8) x 1/4	29MDB-24	...
32153				3/8(1/4) x 1/4	29MDB-44	...

UNION TEE



MIDLAND	AMC	CHAMPION	LIST	SIZE	MAF #	MAF PRICE
32159				1/4(1/8)	29DBT-2	...
32160				3/8(1/4)	29DBT-4	...

WARNING: This product can expose you to chemicals, including lead, which are known to the State of California to cause cancer and birth defects or other reproductive harm. For more information, visit www.P65Warnings.ca.gov

BRASS

BARBED FOR PLASTIC TUBING

BRASS FITTINGS

90° ELBOW

MIDLAND	AMC	CHAMPION	LIST	SIZE	MAF #	MAF PRICE
32170				1/4(1/8 ID)	29DBBE-2	...
32171				3/8(1/4 ID)	29DBBE-4	...
				10/32 (5/32 ID)	29DBBE-532	...

DB X MIP ELBOW

MIDLAND	AMC	CHAMPION	LIST	SIZE	MAF #	MAF PRICE
				1/4 (1/8) x 1/8	29DBE-22	...
				1/4 (1/8) x 1/4	29DBE-24	...
				3/8(1/4) x 1/8	29DBE-42	...
				3/8(1/4) x 1/4	29DBE-44	...

REDUCING DB SPLICER

MIDLAND	AMC	CHAMPION	LIST	SIZE	MAF #	MAF PRICE
				1/2(3/8) x 1/8	29SDB-62	...

WARNING: This product can expose you to chemicals, including lead, which are known to the State of California to cause cancer and birth defects or other reproductive harm. For more information, visit www.P65Warnings.ca.gov

BARSTOCK/ CAST SS HOSE BARB

BRASS FITTINGS

316 STAINLESS STEEL MACHINED RIGID MALE ADAPTER



PART #	HOSE I.D. X NPT	
32001SS	1/8" x 1/8"	----
32002SS	3/16" x 1/8"	----
32003SS	3/16" x 1/4"	----
32004SS	1/4" x 1/8"	----
32005SS	1/4" x 1/4"	----
32006SS	1/4" x 3/8"	----
32008SS	5/16" x 1/8"	----
32009SS	5/16" x 1/4"	----
32010SS	5/16" x 3/8"	----
32011SS	3/8" x 1/8"	----
32012SS	3/8" x 1/4"	----
32013SS	3/8" x 3/8"	----
32014SS	3/8" x 1/2"	----
32015SS	1/2" x 1/4"	----
32016SS	1/2" x 3/8"	----
32017SS	1/2" x 1/2"	----
32018SS	1/2" x 3/4"	----
32019SS	5/8" x 3/8"	----
32020SS	5/8" x 1/2"	----
32021SS	5/8" x 3/4"	----
32022SS	3/4" x 1/2"	----
32023SS	3/4" x 3/4"	----
32024SS	1" x 3/4"	----

316 STAINLESS STEEL SPLICER

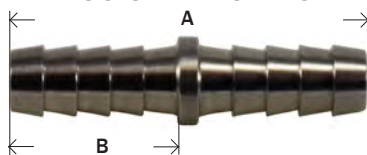

PART #	HOSE I.D. X HOSE I.D.	A	B	
32091SS	1/8"			----
32093SS	1/4"	2.03	0.97	----
32094SS	5/16"			----
32095SS	3/8"	2.06	0.97	----
32096SS	1/2"	2.06	0.97	----
32098SS	3/4"	2.50	1.19	----

316 STAINLESS STEEL BARB ELBOW



PART #	HOSE I.D. X NPT	
32038SS	1/4" x 1/8"	----
32039SS	1/4" x 1/4"	----
32041SS	3/8" x 1/4"	----
32042SS	3/8" x 3/8"	----
32043SS	1/2" x 3/8"	----
32311SS	1/2" x 1/2"	----
32314SS	3/4" x 3/4"	----

304 STAINLESS STEEL HOSE NIPPLES



• Cast

PART #	HOSE I.D. X MALE PIPE	
73951	1/4"	----
73952	3/8"	----
73953	1/2"	----
73954	3/4"	----
73955	1"	----
73956	1-1/4"	----
73957	1-1/2"	----
73958	2"	----
73959	2-1/2"	----
73960	3"	----

304 STAINLESS STEEL REDUCING HOSE NIPPLES



• Cast

PART #	HOSE I.D. X MALE PIPE	
73970	1/4" X 1/8"	----
73971	3/8" X 1/4"	----
73972	1/2" X 3/8"	----
73973	1/2" X 1/4"	----
73974	3/4" X 1/2"	----
73975	1" X 3/4"	----
73976	1" X 1/2"	----
73977	1-1/4" X 1"	----
73979	1-1/2" X 1-1/4"	----
73980	1-1/2" X 1"	----
73981	2" X 1-1/2"	----
73982	2" X 1-1/4"	----

316 STAINLESS STEEL HOSE NIPPLES



• Cast

PART #	HOSE I.D. X MALE PIPE	
973951	1/4"	----
973952	3/8"	----
973953	1/2"	----
973954	3/4"	----
973955	1"	----
973956	1-1/4"	----
973957	1-1/2"	----
973958	2"	----
973959	2-1/2"	----
973990	3"	----
973991	4"	----

• See King nipples on page 359

WARNING: This product can expose you to chemicals, including lead, which are known to the State of California to cause cancer and birth defects or other reproductive harm. For more information, visit www.P65Warnings.ca.gov

BRASS

BEVERAGE FITTINGS

BRASS FITTINGS

BARB TO MALE PIPE ADAPTERSTAINLESS
STEEL

PART #	SIZE	
34587	1/4" x 1/8"	----
34588	1/4" x 1/4"	----
34589	1/4" x 3/8"	----
34590	3/8" x 1/8"	----
34591	3/8" x 1/4"	----
34592	3/8" x 3/8"	----
34595	3/8" x 1/2"	----
34597	1/2" x 3/4"	----

BARB TO MALE FLARE ADAPTERSTAINLESS
STEEL**HOSE ID X 45° FLARE**

PART #	SIZE	
34579	1/4" x 1/4"	----
34586	1/4" x 5/16"	----
34584	1/4" x 3/8"	----
34580	1/4" x 1/2-16"	----
34583	3/8" x 1/4"	----
34585	3/8" x 3/8"	----
34581	3/8" x 1/2-16"	----

FEMALE FLARE SWIVEL SETSSTAINLESS
STEEL

BARB X FEMALE FLARE - TWO PIECE

PART #	SIZE	
34501	1/4" x 1/4"	----
34502	5/16" x 1/4"	----
34504	3/8" x 3/8"	----

ONE PIECE SWIVEL BARB X FE.STAINLESS
STEEL

BARB X FE-FLARE

PART #	SIZE	
34510	3/8" x 1/4"	----

HOSE SPLICER (STRAIGHT)STAINLESS
STEEL**ID HOSE**

PART #	SIZE	
34532	3/16"	----
34533	1/4"	----
34534	1/4" x 3/16"	----
34536	5/16"	----
34537	5/16" x 1/4"	----
34535	3/8"	----
34538	3/8" x 3/16"	----
34543	3/8" x 1/4"	----
34539	3/8" x 5/16"	----
34540	1/2" x 3/8"	----

THINWALL SPLICERSSTAINLESS
STEEL

PART #	SIZE	
34533T	1/4"	----
34535T	3/8"	----
34541T	1/2"	----
34540T	1/2" x 3/8"	----
34543T	3/8" x 1/4"	----

PLUGSTAINLESS
STEEL

PART #	SIZE	
34572	1/4"	----
34574	3/8"	----

THINWALL

PART #	SIZE	
34572T	1/4"	----
34574T	3/8"	----

BARB X COMPRESSIONSTAINLESS
STEEL

PART #	SIZE	
34624	1/4" x 1/4"	----
34625	1/4" x 3/8"	----
34626	3/8" x 3/8"	----

PLATED BRASS SPLICERS

ID SIZES

VINYL TUBE ID/ PL. TUBE ID



PART #	SIZE	
34725	3/16"/1/4"	----
34726	1/4" x 3/16"	----
	5/16" x 1/4"	----
34728	5/16"/3/8"	----
34727	5/16" x 3/16"	----
	3/8"/1/4"	----

TAILPIECES**SS BARB X SWIVEL SHANK**

PART #	SIZE	
34711	-/ 3/16"	----
34713	3/16"/ 1/4"	----
34715	1/4"/ 5/16"	----
34717	3/8"/-	----
34719	1/2"/ 3/8"	----

**N/P BRASS**

PART #	SIZE	
34710	3/16"/1/4"	----
34712	1/4"/5/16"	----
34714	5/16"/3/8"	----
34716	3/8"/-	----
34718	1/2"/-	----

**#304 SS 90° ELBOW**

PART #	SIZE	
34720	3/16"/-	----
34721	1/4"/1/4"	----
34722	5/16"/5/16"	----
34723	3/8"/3/8"	----
34724	1/2"/1/2"	----

WARNING: This product can expose you to chemicals, including lead, which are known to the State of California to cause cancer and birth defects or other reproductive harm. For more information, visit www.P65Warnings.ca.gov

BEVERAGE FITTINGS

BRASS FITTINGS

90° SWIVEL ELBOW



HOSE ID X FEMALE 45°

PART #	SIZE	
34525	1/4" x 1/4"	----
34526	3/8" x 1/4"	----
34529	3/8" x 3/8"	----
34531	1/2" x 1/2"	----

BARB TO SWIVEL ELBOW



HOSE ID X FEMALE 45° FLARE

PART #	SIZE	
34600	1/4" x 1/4"	----
34601	3/8" x 1/4"	----

MALE ELBOWS



HOSE ID X MALE NPTF

PART #	SIZE	
34610	1/4" x 1/8"	----
34611	3/8" x 1/4"	----
34612	3/8" x 3/8"	----
34613	1/2" x 1/2"	----

FEMALE ADAPTERS



BARB X FEMALE PIPE

PART #	SIZE	
34661	1/4"	----
34658	1/2"	----

U-BEND

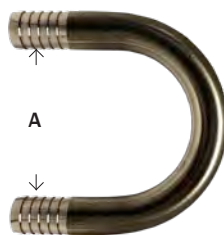

PART #	SIZE	A	
34633	3/8"	2	----

THINWALL U-BEND

Part #	Size	A	
34633T	3/8"	1-1/2	----

U-BEND W/MANIFOLD



THINWALL

PART #	SIZE	
34621T	1/4"	----
34622T	3/8"	----

CROSS



PART #	SIZE	
34635T	1/4"	----
34638T	3/8"	----

Y TEES

T= LIGHT PATTERN



PART #	SIZE	A	
34826	1/4"		
34650T	1/4"	1-1/8	----
34652T	3/8"	1-1/4	----
34854	3/8"		

BARB HOSE TEES



ID HOSE

PART #	SIZE	
34561	1/8"	----
34562	1/4"	----
34565	5/16"	----
34563	3/8"	----

REDUCING TEES

PART #	1&2	3	
34567	1/4"	3/8"	----
34568	3/8"	1/4"	----

THINWALL TEES



PART #	SIZE	
34562T	1/4"	----
34565T	5/16"	----
34563T	3/8"	----
34564T	1/2"	----

REDUCING THINWALL TEES

PART #	1&2	3	
34567T	1/4"	3/8"	----
34568T	3/8"	1/4"	----

90° BARB SPLICER



ID HOSE

PART #	SIZE	
34551	1/4"	----
34550	5/16"	----
34552	3/8"	----

THINWALL 90° BARB SPLICERS



PART #	SIZE	
34551T	1/4"	----
34552T	3/8"	----
34553T	1/2"	----

PUSH ON HOSE BARB

BRASS FITTINGS

PUSH ON BARB FITTINGS

Typical Application: Low Pressure Air, Fuel, Lube, and Oil Lines

- Pressure determined by tube material and hardness. Midland Parts have been tested to max 150 PSI.

Advantages: Easy assembly. No clamps needed!!

• **Assembly Instructions**

- 1- Lubricate insert.
- 2- Hold hose at angle to insert over first barb.
- 3- Continue to push straight on until hose is seated under protective plastic cap. Keep hands back from hose end area so that hose can expand.

• **Disassembling Instructions**

- 1- Split hose. Do not cut completely through hose. Sealing edge of barb could be damaged.
- 2- Bend hose and remove with a quick pull.

See lead free section for lead free push-on barb fittings. **Stainless steel available at the end of this section.**

Actual Profile of Push On Barbs



USE OUR APP WITH YOUR FREE BIN LABELS TO MANAGE YOUR CUSTOMERS INVENTORY MORE EFFICIENTLY

WARNING: This product can expose you to chemicals, including lead, which are known to the State of California to cause cancer and birth defects or other reproductive harm. For more information, visit www.P65Warnings.ca.gov

PUSH-ON FITTINGS

BRASS FITTINGS

MALE ADAPTERS

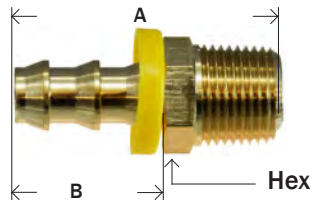

07201
29PO1
129PO1

MIDLAND	AMC	CHAMPION	LIST	HOSE I.D. X MALE NPTF	MAF #	MAF PRICE
30200	07201-0402	301-42		1/4" x 1/8"	29PO1-42	
30201	07201-0404	301-44		1/4" x 1/4"	29PO1-44	
30211	07201-0406	301-46		1/4" x 3/8"	29PO1-46	
30208				1/4" x 1/2"	29PO1-48	
30212	07201-0502	301-52		5/16" x 1/8"	29PO1-52	
30213	07201-0504	301-54		5/16" x 1/4"	29PO1-54	
30202	07201-0602	301-62		3/8" x 1/8"	29PO1-62	
30203	07201-0604	301-64		3/8" x 1/4"	29PO1-64	
30204	07201-0606	301-66		3/8" x 3/8"	29PO1-66	
30205	07201-0608	301-68		3/8" x 1/2"	29PO1-68	
30392	07201-0612	301-612		3/8" x 3/4"	29PO1-612	
30216	07201-0804	301-84		1/2" x 1/4"	29PO1-84	
30206	07201-0806	301-86		1/2" x 3/8"	29PO1-86	
30207	07201-0808	301-88		1/2" x 1/2"	29PO1-88	
30217	07201-0812	301-812		1/2" x 3/4"	29PO1-812	
30218				1/2" x 1"	29PO1-816	
30219	07201-1006	301-106		5/8" x 3/8"	29PO1-106	
30209	07201-1008	301-108		5/8" x 1/2"	29PO1-108	
30214	07201-1012	301-1012		5/8" x 3/4"	29PO1-1012	
30215	07201-1208	301-128		3/4" x 1/2"	29PO1-128	
30210	07201-1212	301-1212		3/4" x 3/4"	29PO1-1212	
				3/4" x 1"	29PO1-1216	
30238	07201-1612	301-1612		1" x 3/4"	29PO1-1612	
30239	07201-1616	301-1616		1" x 1"	29PO1-1616	

301 P990A HLM 100B-1 KA-MB 272 29PO 725 625 BPN 941 30182

MALE ELBOW

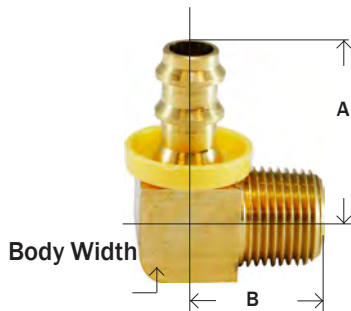

29POE
129PO20

MIDLAND	AMC	CHAMPION	LIST	HOSE I.D. X MALE NPTF	MAF #	MAF PRICE
30372	07220-0402	311-42	----	1/4" x 1/8"		
30373	07220-0404	311-44	----	1/4" x 1/4"		
30374	07220-0502	311-52	----	5/16" x 1/8"		
30375	07220-0504	311-54	----	5/16" x 1/4"		
30370	07220-0602	311-62	----	3/8" x 1/8"		
30371	07220-0604	311-64	----	3/8" x 1/4"		
30376	07220-0606	311-66	----	3/8" x 3/8"		
30377	07220-0608	311-68	----	3/8" x 1/2"		
30382	07220-0806	311-86	----	1/2" x 3/8"		
30378	07220-0808	311-88	----	1/2" x 1/2"		
30379	07220-1008	311-108	----	5/8" x 1/2"		
30383	07220-1208	311-128	----	3/4" x 1/2"		
30381	07220-1212	311-1212	----	3/4" x 3/4"		

WARNING: This product can expose you to chemicals, including lead, which are known to the State of California to cause cancer and birth defects or other reproductive harm. For more information, visit www.P65Warnings.ca.gov

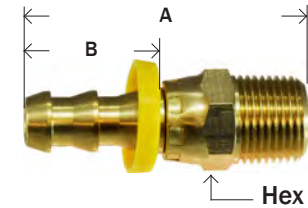

100-C 29EPO 273

PUSH-ON FITTINGS**BRASS FITTINGS****MALE SWIVEL**

07202
29PO9
129PO2

MIDLAND	AMC	CHAMPION	LIST	HOSE I.D. X MALE NPTF	MAF #	MAF PRICE
30422		301S-42		1/4" x 1/8"	29PO9-42	
30385	07202-0404	301S-44		1/4" x 1/4"	29PO9-44	
30423				3/8" x 1/8"	29PO9-62	
30386	07202-0604	301S-64		3/8" x 1/4"	29PO9-64	
30387	07202-0606	301S-66		3/8" x 3/8"	29PO9-66	
30388	07202-0806	301S-86		1/2" x 3/8"	29PO9-86	
30389	07202-0808	301S-88		1/2" x 1/2"	29PO9-88	
30424		301S-108		5/8" x 1/2"	29PO9-108	
30390	07202-1212	301S-1212		3/4" x 3/4"	29PO9-1212	

921 HMS 285 31382

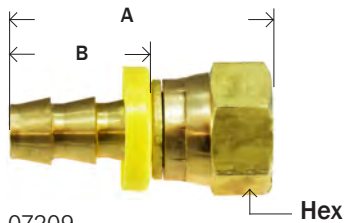
FEMALE GASKET SEAL SWIVEL - NPSM

07209
129PO9

MIDLAND	AMC	CHAMPION	LIST	HOSE I.D. X MALE NPTF	MAF #	MAF PRICE
30359	07209-0402	312-42		1/4" x 1/8"	29PO12-42	
30358	07209-0404	312-44		1/4" x 1/4"	29PO12-44	
	07209-0406			1/4" x 3/8"		
30360	07209-0604	312-64		3/8" x 1/4"	29PO12-64	
30361	07209-0606	312-66		3/8" x 3/8"	29PO12-66	
30362	07209-0608	312-68		3/8" x 1/2"	29PO12-68	
30363	07209-0808	312-88		1/2" x 1/2"	29PO12-88	
	07209-0812	312-108		1/2" x 3/4"		
	07209-1012			5/8" x 3/4"	29PO12-1012	
30366	07209-1212	312-1212		3/4" x 3/4"	29PO12-1212	

280

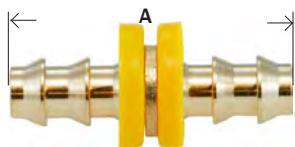
HOSE SPLICER

07214
29P08
129PO14

MIDLAND	AMC	CHAMPION	LIST	HOSE I.D.	MAF #	MAF PRICE
30300	07214-04	304-44		1/4"	29PO8-4	
30305	07214-05	304-55		5/16"	29PO8-5	
30301	07214-06	304-66		3/8"	29PO8-6	
30302	07214-08	304-88		1/2"	29PO8-8	
30303	07214-10	304-1010		5/8"	29PO8-10	
30304	07214-12	304-1212		3/4"	29PO8-12	

BPM 696 29SPO 296 915 729 100B-Y KA-RM MHL 296 38282

WARNING: This product can expose you to chemicals, including lead, which are known to the State of California to cause cancer and birth defects or other reproductive harm. For more information, visit www.P65Warnings.ca.gov



PUSH ON HOSE BARB

BRASS FITTINGS

RIGID FEMALE ADAPTER

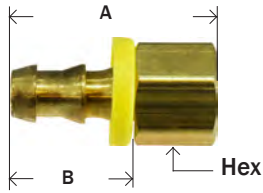

07207
29PO2
129PO7

MIDLAND	AMC	CHAMPION	LIST	HOSE I.D. X FEMALE NPTF	MAF #	MAF PRICE
30220	07207-0402	3099-42		1/4" x 1/8"	29PO2-42	
30221	07207-0404	3099-44		1/4" x 1/4"	29PO2-44	
30384	07207-0406	3099-46		1/4" x 3/8"	29PO2-46	
30391	07207-0502	3099-52		5/16" x 1/8"	29PO2-52	
30222	07207-0504	3099-54		5/16" x 1/4"	29PO2-54	
30393	07207-0602	3099-62		3/8" x 1/8"	29PO2-62	
30224	07207-0604	3099-64		3/8" x 1/4"	29PO2-64	
30225	07207-0606	3099-66		3/8" x 3/8"	29PO2-66	
30394	07207-0608	3099-68		3/8" x 1/2"	29PO2-68	
30397	07207-0612			3/8" x 3/4"	29PO2-612	
30223	07207-0804	3099-84		1/2" x 1/4"	29PO2-84	
30226	07207-0806	3099-86		1/2" x 3/8"	29PO2-86	
30227	07207-0808	3099-88		1/2" x 1/2"	29PO2-88	
30396	07207-0812	3099-812		1/2" x 3/4"	29PO2-812	
30398	07207-1006			5/8" x 3/8"	29PO2-106	
30229	07207-1008	3099-108		5/8" x 1/2"	29PO2-108	
30403	07207-1012			5/8" x 3/4"	29PO2-1012	
30399	07207-1208	3099-128		3/4" x 1/2"	29PO2-128	
30395	07207-1212	3099-1212		3/4" x 3/4"	29PO2-1212	
30400	07207-1612			1" x 3/4"	29PO2-1612	
30402	07207-1616	3099-1616		1" x 1"	29PO2-1616	

30282 29FPO HLF 626 274 726 940

45° MALE SAE FLARE ADAPTER

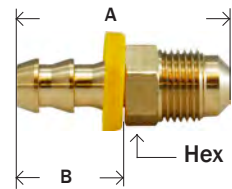

07204
29PO3
129PO4

MIDLAND	AMC	CHAMPION	LIST	HOSE I.D. X 45° MALE FLARE	MAF #	MAF PRICE
30240	07204-0404	302-44		1/4" x 1/4"	29PO3-44	
30241	07204-0405	302-45		1/4" x 5/16"	29PO3-45	
	07204-0406			1/4" x 3/8"	29PO3-46	
30249	07204-0505	302-55		5/16" x 5/16"	29PO3-55	
	07204-0604			3/8" x 1/4"	29PO3-64	
30271	07204-0605	302-65		3/8" x 5/16"	29PO3-65	
30243	07204-0606	302-66		3/8" x 3/8"	29PO3-66	
	07204-0608			3/8" x 1/2"	29PO3-68	
30245	07204-0808	302-88		1/2" x 1/2"	29PO3-88	
	07204-0810			1/2" x 5/8"	29PO3-810	
				5/8" x 3/8"	29PO3-106	
	07204-1008			5/8" x 1/2"	29PO3-108	
30246	07204-1010	302-1010		5/8" x 5/8"	29PO3-1010	
	07204-1210			3/4" x 5/8"	29PO3-1210	
30247	07204-1212	302-1212		3/4" x 3/4"	29PO3-1212	

100B-3 KA-MS 727 945 682 302 282

PUSH ON HOSE BARB

BRASS FITTINGS

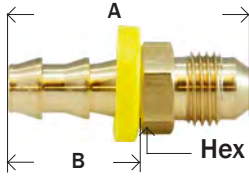
37° MALE JIC FLARE ADAPTER

07205
29PO11
129PO5

MIDLAND	AMC	CHAMPION	LIST	HOSE I.D. X MALE JIC	MAF #	MAF PRICE
32900	07205-0404	310-44		1/4" x 1/4"	29PO11-44	
32901	07205-0405			1/4" x 5/16"	29PO11-45	
32906	07205-0406	310-46		1/4" x 3/8"	29PO11-46	
	07205-0604			3/8" x 1/4"	29PO11-64	
	07205-0605			3/8" x 5/16"	29PO11-65	
32902	07205-0606	310-66		3/8" x 3/8"	29PO11-66	
	07205-0608			3/8" x 1/2"	29PO11-68	
32903	07205-0808	310-88		1/2" x 1/2"	29PO11-88	
	07205-0810			1/2" x 5/8"	29PO11-810	
	07205-1008			5/8" x 1/2"	29PO11-108	
32907	07205-1010	310-1010		5/8" x 5/8"	29PO11-1010	
	07205-1210			3/4" x 5/8"	29PO11-1210	
32905	07205-1212	310-1212		3/4" x 3/4"	29PO11-1212	
				1" x 3/4"	29PO11-1612	
				1" x 1"	29PO11-1616	

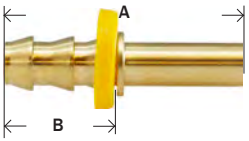
RIGID TUBE ADAPTER

07215
29PO10
129PO15

MIDLAND	AMC	CHAMPION	LIST	HOSE I.D. X O.D TUBE	MAF #	MAF PRICE
30290	07215-0403	303-43		1/4" x 3/16"	29PO10-43	
30291	07215-0404	303-44		1/4" x 1/4"	29PO10-44	
30292	07215-0405	303-45		1/4" x 5/16"	20PO10-45	
30293	07215-0505	303-55		5/16" x 5/16"	29PO10-55	
30294	07215-0606	303-66		3/8" x 3/8"	29PO10-66	
30426		303-68		3/8" x 1/2"	29PO10-68	
30297	07215-0808	303-88		1/2" x 1/2"	29PO10-88	
30298	07215-1010	303-1010		5/8" x 5/8"	29PO10-1010	
30299	07215-1212	303-1212		3/4" x 3/4"	29PO10-1212	

294 100B-X KA-RL 303 732 694

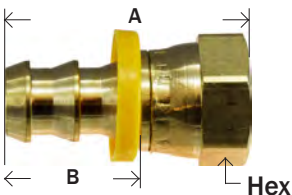
SAE/JIC DUAL 45°/37° FEMALE SWIVEL

07210
29PO5
129PO10

MIDLAND	AMC	CHAMPION	LIST	HOSE I.D. X DUAL SEAT	MAF #	MAF PRICE
30230	07210-0404	309-44		1/4" x 1/4"	29PO5-44	
30231	07210-0405	309-45		1/4" x 5/16"	29PO5-45	
30232	07210-0505	309-55		5/16" x 5/16"	29PO5-55	
30427		309-65		3/8" x 5/16"	29PO5-65	
30233	07210-0608	309-68		3/8" x 1/2"	29PO5-68	
30234	07210-0808	309-88		1/2" x 1/2"	29PO5-88	
30235	07210-0810	309-810		1/2" x 5/8"	29PO5-810	
30236	07210-1008	309-108		5/8" x 1/2"	29PO5-108	
30237	07210-1010	309-1010		5/8" x 5/8"	29PO5-1010	
30428	07210-1210			3/4" x 5/8"	29PO5-1210	

DIMENSION DATA CAN
CHANGE WITHOUT NOTICE.
PLEASE CALL WHEN
DIMENSIONS ARE CRITICAL.

29FD5 287 HDF 309 735 690 P990-K 305 935/934

PUSH ON HOSE BARB

BRASS FITTINGS

45° SAE FLARE FEMALE SWIVEL

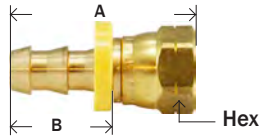

07211
29P06
129PO14

MIDLAND	AMC	CHAMPION	LIST	HOSE I.D. X 45° FEMALE FLARE	MAF #	MAF PRICE
30250	07211-0404			1/4" x 1/4"	29PO6-44	
30251	07211-0405			1/4" x 5/16"	29PO6-45	
30253	07211-0406	307-46		1/4" x 3/8"	29PO6-46	
30254	07211-0505			5/16" x 5/16"	29PO6-55	
30260	07211-0506	307-56		5/16" x 3/8"	29PO6-56	
				3/8" x 5/16"	29PO6-65	
30252	07211-0606	307-66		3/8" x 3/8"	29PO6-66	
30257	07204-0608			3/8" x 1/2"	29PO6-68	
30261	07211-0806	307-86		1/2" x 3/8"	29PO6-86	
30255	07211-0808			1/2" x 1/2"	29PO6-88	
30258	07211-1010			5/8" x 5/8"	29PO6-1010	
30259	07211-1212	307-1212		3/4" x 3/4"	29PO6-1212	...

30882 728 P990-H 29AEPO 307 284 100S-4 KA-NS HSF 684 934

FEMALE 37° JIC FLARE SWIVEL

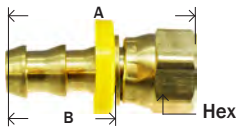

07212
29P07
129PO12

MIDLAND	AMC	CHAMPION	LIST	HOSE I.D. X FEMALE JIC	MAF #	MAF PRICE
30265	07212-0404			1/4" x 1/4"	29PO7-44	
30264	07212-0406	308-46		1/4" x 3/8"	29PO7-46	
30270	07212-0506	308-56		5/16" x 3/8"	29PO7-56	
30266	07212-0606	308-66		3/8" x 3/8"	29PO7-66	
		308-86		1/2" x 3/8"	29PO7-86	
30267	07212-0808	308-88		1/2" x 1/2"	29PO7-88	
30268	07212-1010			5/8" x 5/8"	29PO7-1010	
30269	07212-1212	308-1212		3/4" x 3/4"	29PO7-1212	
30429		308-1616		1" x 1"	29PO7-1616	...

JF 944/934 29J1CPO HJF 688 738 288 100B-6 308 P990-F 30682 KA-NJ

INVERTED FLARE MALE SWIVEL

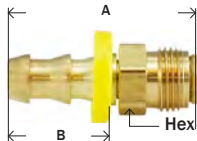

07206
29P016
129PO6

MIDLAND	AMC	CHAMPION	LIST	HOSE I.D. X MALE INV FLARE	MAF #	MAF PRICE
30275	07206-0403	305-43		1/4" x 3/16"	29PO16-43	
30276	07206-0404	305-44		1/4" x 1/4"	29PO16-44	
30277	07206-0405	305-45		1/4" x 5/16"	29PO16-45	
	07206-0504			5/16" x 1/4"	29PO16-54	
30280	07206-0505	305-55		5/16" x 5/16"	29PO16-55	
30283	07206-0506	305-56		5/16" x 3/8"	29PO16-56	
30284	07206-0605	305-65		3/8" x 5/16"	29PO16-65	
30279	07206-0606	305-66		3/8" x 3/8"	29PO16-66	...
	07206-0608			3/8" x 1/2"	29PO16-68	
	07206-0806			1/2" x 3/8"	29PO16-86	
30282	07206-0808	305-88		1/2" x 1/2"	29PO16-88	
30286	07206-1010	305-1010		5/8" x 5/8"	29PO16-1010	...

290 100B-B KA-MF 1MS 947

PUSH ON HOSE BARB

BRASS FITTINGS

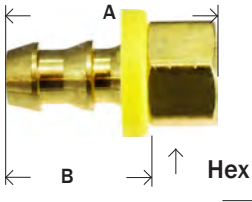
INVERTED FLARE FEMALE ADAPTER-RIGID

07213
29P013
129PO13

MIDLAND	AMC	CHAMPION	LIST	HOSE I.D. X FEMALE INV FLARE	MAF #	MAF PRICE
30310	07213-0403	306-43		1/4" x 3/16"	29PO13-43	
30311	07213-0404	306-44		1/4" x 1/4"	29PO13-44	
30312	07213-0405	306-45		1/4" x 5/16"	29PO13-45	
30316	07213-0505	306-55		5/16" x 5/16"	29PO13-55	
30313	07213-0605	306-65		3/8" x 5/16"	29PO13-65	
30314	07213-0606	306-66		3/8" x 3/8"	29PO13-66	
30315	07213-0808	306-88		1/2" x 1/2"	29PO13-88	...

306 100B-A KA-NG 292 P990-J 736 692 946

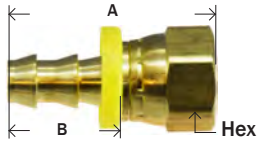
FEMALE BALLSEAT SWIVEL

07208
29P04
129PO8

MIDLAND	AMC	CHAMPION	LIST	HOSE I.D. X FEMALE NPSM	MAF #	MAF PRICE
30340	07208-0402	3099S-42		1/4" X 1/8"	29PO4-42	
30341	07208-0404	3099S-44		1/4" X 1/4"	29PO4-44	
30342	07208-0406	3099S-46		1/4" x 3/8"	29PO4-46	
30343	07208-0604	3099S-64		3/8" X 1/4"	29PO4-64	
30344	07208-0606	3099S-66		3/8" X 3/8"	29PO4-66	
30430	07208-0608	3099S-68		3/8" x 1/2"	29PO4-68	
30346	07208-0808	3099S-88		1/2" X 1/2"	29PO4-88	
30345	07208-0812	3099S-812		1/2" x 3/4"	29PO4-812	
				5/8" x 1/2"	29PO4-108	
	07208-1012			5/8" x 3/4"	29PO4-1012	
30349	07208-1212	3099S-1212		3/4" X 3/4"	29PO4-1212	...

628 278 29SPO 731 NPSM

PUSH ON MALE BRANCH TEE

MIDLAND	AMC	CHAMPION	LIST	BRB X BRB X MPT	MAF #	MAF PRICE
				1/4HID X 1/4HID X 1/8MPT	29PO19-442	
				1/4HID X 1/4HID X 1/4MPT	29PO19-444	
				3/8HID X 3/8HID X 1/4MPT	29PO19-664	
				3/8HID X 3/8HID X 3/8MPT	29PO19-666	...

WARNING: This product can expose you to chemicals, including lead, which are known to the State of California to cause cancer and birth defects or other reproductive harm. For more information, visit www.P65Warnings.ca.gov

PUSH ON HOSE BARB

BRASS FITTINGS

SAE/ JIC 37°/ 45° FEMALE SWIVEL 90° ZINC PLATED STEEL

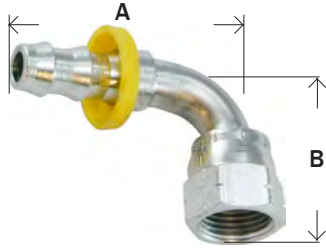

MIDLAND	AMC	CHAMPION	LIST	HOSE I.D. X FEMALE 37°/45°	MAF #	MAF PRICE
30480		318S-44		1/4"		
30482		318S-66		3/8"		
30483*				3/8"		
30484		318S-88		1/2"		
30486		318S-1212	----	3/4"		

* SAE

317S 45° FEMALE SAE SWIVEL STEEL FITTING



MIDLAND	AMC	CHAMPION	LIST	HOSE I.D.	MAF #	MAF PRICE
		317S-44	----	1/4"		
		317S-66	----	3/8"		

WARNING: This product can expose you to chemicals, including lead, which are known to the State of California to cause cancer and birth defects or other reproductive harm. For more information, visit www.P65Warnings.ca.gov

BRASS

STAINLESS STEEL PUSH ON 316 HOSE BARB

BRASS FITTINGS

316 STAINLESS STEEL MALE ADAPTERS

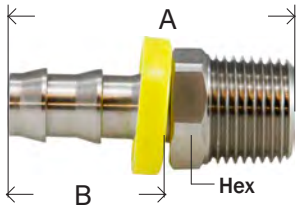

MIDLAND	AMC	CHAMPION	LIST	HOSE I.D. X NPT	MAF #	MAF PRICE
30200SS				1/4" x 1/8"		
30201SS				1/4" x 1/4"		
30203SS				3/8" x 1/4"		
30204SS				3/8" x 3/8"		
30206SS				1/2" x 3/8"		
30207SS				1/2" x 1/2"		
30215SS				3/4" x 1/2"		
30210SS				3/4" x 3/4"		

316 STAINLESS STEEL SAE/ JIC 45°/ 37° FEMALE SWIVEL

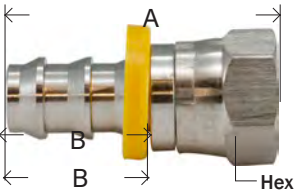

MIDLAND	AMC	CHAMPION	LIST	HOSE I.D. X FEMALE 45°/37°	MAF #	MAF PRICE
30230SS				1/4" x 1/4"		
30234SS				1/2" x 1/2"		

316 STAINLESS STEEL FEMALE 37° JIC FLARE SWIVEL

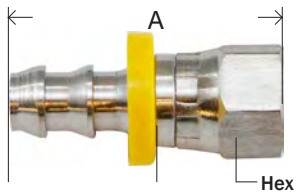

MIDLAND	AMC	CHAMPION	LIST	HOSE I.D. X FEMALE 37°	MAF #	MAF PRICE
30266SS				3/8" x 3/8"		
30269SS				3/4" x 3/4"		

WARNING: This product can expose you to chemicals, including lead, which are known to the State of California to cause cancer and birth defects or other reproductive harm. For more information, visit www.P65Warnings.ca.gov

GARDEN HOSE FITTINGS



• **Temperature and Working Pressure Ranges**

From +35°F to +100°F at 75 PSI maximum or the recommended working pressure of the garden hose. (Not to exceed 150 PSI.)

Note: All female connector ends should have a rubber washer inserted prior to usage.

FGH = Female Garden Hose threads

MGH = Male Garden Hose threads

Male garden hose threads are all 3/4" with an outside diameter of 1.0625 and 11-1/2" threads per inch.



Male Garden Hose Profile



See Plastic section for Plastic Garden Hose Fittings



See Lead Free Section for lead free Garden Hose

Washers included are #30150B black rubber washers.

Actual Profile of Garden Hose Barbs

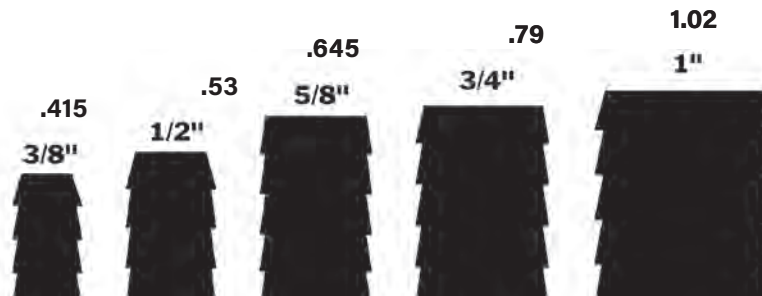

WARNING: This product can expose you to chemicals, including lead, which are known to the State of California to cause cancer and birth defects or other reproductive harm. For more information, visit www.P65Warnings.ca.gov

BRASS

GARDEN HOSE**BRASS FITTINGS****SWIVEL - MGH X FGH**

•WASHER INCLUDED
•NOT A LIVE SWIVEL

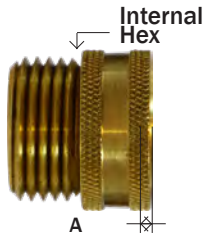

MIDLAND	AMC	CHAMPION	LIST	MGH X FGH	MAF #	MAF PRICE
30000**		24AS-12		3/4" x 3/4"	106GH	
				1" x 3/4"	16GH	
				1" x 3/4"	16KNGH*	

** available in swivel crimp style | * Knurled Nut

SWIVEL - FGH X FGH

•WASHER INCLUDED

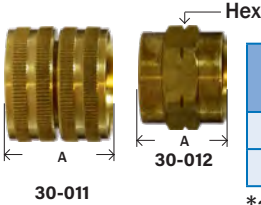

MIDLAND	AMC	CHAMPION	LIST	FGH X FGH	MAF #	MAF PRICE
30011	07403-12	22AS-12E		3/4" x 3/4"	S3*	
30012	07402-12	22A-12		No Swivel	13GH	

*add w for washer

HUS 91 203W GSU 101GHSV 22AS 506 FS66

SWIVEL - FGH X FEMALE PIPE

PART #	AMC	CHAMPION	LIST	FGH X FEMALE NPTF	MAF #	MAF PRICE
30001	07401-1208	5AS-12D		3/4" x 1/2"	S1*	
30006	07401-1212	5AS-12E		3/4" x 3/4"	S2*	
				1" x 1"	S5	

*add w for washer

S1 HSU11 91Z 197S 98GHSV 5AS 21517 502 FS65

EVAPORATIVE COOLER FITTINGS

MIDLAND	AMC	CHAMPION	LIST	SIZE	MAF #	MAF PRICE
50016	07487-1208			MGH x 1/2" FIP	ECD-12*	
30013	07492-0808			1/2 MIP x 1/2 FIP x 1/8	ECF8	
30019	07492-1212			3/4 MIP x 3/4 FIP x 1/8	ECF12	
30020	07493-1212			MGH x FGH x 1/8	ECF12H	

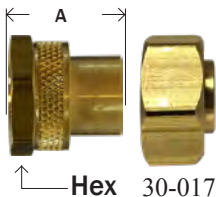
RIGID - FGH X FEMALE PIPE

MIDLAND	AMC	CHAMPION	LIST	FGH X FEMALE NPTF	MAF #	MAF PRICE
30016	07411-1202	5A-12A		3/4" x 1/8"	73GH	
30017	07411-1204	5A-12B		3/4" x 1/4"	74GH	
30018		5A-12C		3/4" x 3/8"	75GH	

95GH 501



SEE WEBSITE TO DOWNLOAD YOUR MOST UPDATED PRICING

WARNING: This product can expose you to chemicals, including lead, which are known to the State of California to cause cancer and birth defects or other reproductive harm. For more information, visit www.P65Warnings.ca.gov



GARDEN HOSE

BRASS FITTINGS

RIGID - FGH X FEMALE PIPE

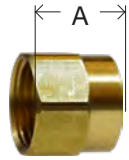

Hex

MIDLAND	AMC	CHAMPION	LIST	FGH X FEMALE NPTF	MAF #	MAF PRICE
30078	07482-1208	5A-12D		3/4" x 1/2"	82GH	
30083	07482-1212	5A-12E		3/4" x 3/4"	83GH	

FS67 198 HU11 21507 501 99GH 5A H15PP

SWIVEL - FGH X MALE PIPE

• WASHER INCLUDED

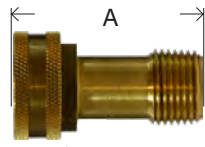

Hex

MIDLAND	AMC	CHAMPION	LIST	FGH X MALE NPTF	MAF #	MAF PRICE
30047	07420-1204			3/4" x 1/4"	102GH-LNG	
30048	07420-1206	W1-CX		3/4" x 3/8"	103GH-LNG	
30049	07420-1208			3/4" x 1/2"	104GH-LNG	

504 89GH W1 62H4 88GH W1

3/8" COMP 3/4" FGH DISHWASHER 90° ELBOW

• WASHER INCLUDED

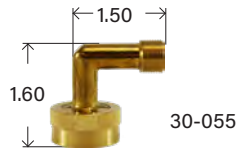
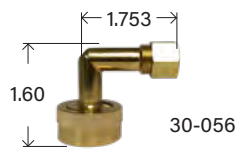

MIDLAND	LIST	3/4 FEMALE GARDEN HOSE THREAD X 3/8 COMPRESSION
30055		3/4" x 3/8" Body Only
30056		3/4" x 3/8" w/ nut & sleeve

SWIVEL - FGH X MALE PIPE

• WASHER INCLUDED

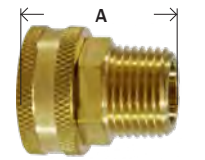

MIDLAND	AMC	CHAMPION	LIST	FGH X MALE NPTF	MAF #	MAF PRICE
30181*		W1-B	----	3/4" x 1/4"	102GH	
30184*	07420-1206	W1-C	----	3/4" x 3/8"	103GH	
30183		W1-D	----	3/4" x 1/2"	104GH	
30182*		W1-E	----	3/4" x 3/4"	105GHXD	
				3/4" x 1/2"	104GHHN	
				3/4" x 3/4"	105GH	

RIGID - FGH X MALE PIPE

• WASHER INCLUDED

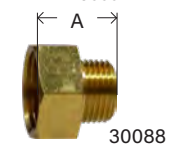

MIDLAND	AMC	CHAMPION	LIST	FGH X MALE NPTF	MAF #	MAF PRICE
30087		20A-12C	----	3/4" x 3/8"	84GH-126	
30088	07484-1208	20A-12D	----	3/4" x 1/2"	84GH	
30088S				3/4" x 1/2"(1/2"SWT)	84GHS	
30093	07484-1212	20A-12E	----	3/4" x 3/4"	85GH	
30094	07484-121208	20A-12ED	----	3/4" x 3/4"(1/2" FIP)	85GHT	
30093L*			----	3/4" x 3/4"	85GHL	

* Long pattern | ** 1/2 Swt = 5/8 O.D.

21505 503 83GH 20A HU21 199 H7

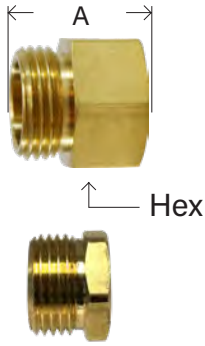
GARDEN HOSE**BRASS FITTINGS****RIGID - MGH X FEMALE PIPE**

MIDLAND	AMC	CHAMPION	LIST	MGH X FEMALE NPTF	MAF #	MAF PRICE
30066	07480-1204	18A-12B	----	3/4" x 1/4"	110GH-124	
30067	07480-1206	18A-12C	----	3/4" x 3/8"	110GH-126	
30068	07480-1208	18A-12D	----	3/4" x 1/2"	80GH	
30073	07480-1212	18A-12E	----	3/4" x 3/4"	81GH	
30074				3/4" x 1"	66GH-1216	
30075				1" x 1"	66GH-1616	

197 18R HU12 H11PP 18A 507 18H 81GH 21503 MF67

30-068

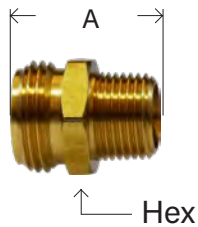
RIGID - MGH X MALE PIPE

MIDLAND	AMC	CHAMPION	LIST	MGH X MALE NPTF	MAF #	MAF PRICE
30054				3/4" x 1/4"	76GH	
30053	07478-1206	19A-12C	----	3/4" x 3/8"	77GH	
30058	07478-1208	19A-12D	----	3/4" x 1/2"	78GH	
30058S*	07478-1208			3/4" x 1/2" SWT	78GHS	
30063**	07478-121208	19AF-12DE	----	3/4" x 3/4" x 1/2"	79GHT	
30063BE***			----	3/4" x 3/4"	79GHTS	
30063S		19AF-12E	----	3/4" x 3/4" Short	79GH	
30064		19A-12F	----	3/4" x 1"	68GH-1216	
30065				1" x 1"	68GH-1616	

19R 196 H530 21501 508 HU22 514 71GH 19A

No Tap

* (1/2 Swt = 5/8 O.D.)

** (Tapped 1/2 FIP)

*** (Tapped 1/2 FIP

Both ends)

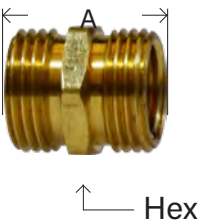
RIGID - MGH X MGH

MIDLAND	AMC	CHAMPION	LIST	MGH X MGH	MAF #	MAF PRICE
30098	07486-121208		----	3/4" x 3/4" (1/2" FIP)	86GHT	
30099	07486-1212	23A-12	----	3/4" x 3/4"	86GH	
30100*		23A-16	----	1" x 3/4"	86GH-1612H	
30101				1" x 1"	86GH-16H	

21500 509 75GH 23A H8 19R

* 1-11/2

GARDEN HOSE NUT

MIDLAND	AMC	CHAMPION	LIST	SIZE	MAF #	MAF PRICE
30021	07407-12	GHN1	----	Knurled	GHNK	
30022	07406-12	GHN1-HC	----	Cut Hex Nut	GHNH	
		GHN1-H		Hex Nut		

94GH GHN1 HNR 21514

Dimension data can change without notice. Please see our website when dimensions are critical.

WARNING: This product can expose you to chemicals, including lead, which are known to the State of California to cause cancer and birth defects or other reproductive harm. For more information, visit www.P65Warnings.ca.gov

GARDEN HOSE

BRASS FITTINGS

GARDEN HOSE WASHERS

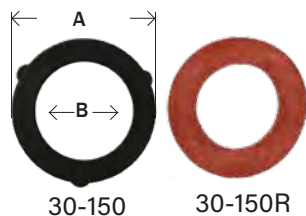

MIDLAND	AMC	CHAMPION	LIST	SIZE	MAF #	MAF PRICE
30150	07405-12	GH-W	----	black*	GHW	
30150R		GH-W-RED	----	red	GHW-12R	
				white	GHW-12-PE	
30151			----	1"	GHW-16	

* plasticized rubber

GHW 901GH

GARDEN HOSE FILTER WASHER

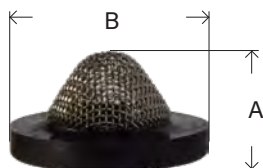

MIDLAND	AMC	CHAMPION	LIST	SIZE	MAF #	MAF PRICE
30180		GH-W-SCREEN	----	30 Mesh	GHFW	
30180F			----	60 Mesh	GHFW-60	

▪ 300 Series Stainless Steel Screen

LA662

GARDEN HOSE CAP

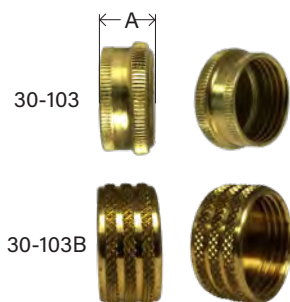

MIDLAND	AMC	CHAMPION	LIST	SIZE	MAF #	MAF PRICE
30103	07408-12	GHN5-DC	----	3/4" Die Cast		
30103B		GHN5	----	3/4" Barstock	HC-12BS	
				w/ washer	HC12BSW	

▪ Garden hose washers sold separately

513 96GH GHN5 HC1 LA215 21518 200-W

GARDEN HOSE CAP WITH CHAIN

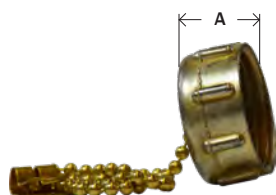

MIDLAND	AMC	CHAMPION	LIST	SIZE	MAF #	MAF PRICE
30142		GHN5-CHAIN	----	3/4" w/ 12" Chain	HC-12WC	

* Zinc die cast

GARDEN HOSE PLUG

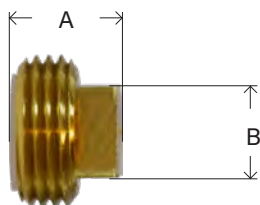

MIDLAND	AMC	CHAMPION	LIST	SIZE	MAF #	MAF PRICE
30026	07412-12	GHP1	----	3/4" Square	GHP	
				3/4 Hex	GHPH	

WARNING: This product can expose you to chemicals, including lead, which are known to the State of California to cause cancer and birth defects or other reproductive harm. For more information, visit www.P65Warnings.ca.gov

BRASS

GARDEN HOSE

BRASS FITTINGS

HOSE MENDERS - SOLID BARB X BARB



MIDLAND	AMC	CHAMPION	LIST	HOSE I.D. X HOSE I.D.	MAF #	MAF PRICE
32096			----	1/2"	29S-8	
32097	07014-10	HM-10	----	5/8"	29S-10	
32098	07014-12	HM-12	----	3/4"	29S-12	
32099			----	1"	29S-16	

QUICK DISCONNECT GARDEN HOSE COUPLERS

.WASHER INCLUDED

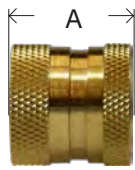
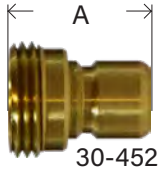

30-451

MIDLAND	AMC	CHAMPION	LIST	SIZE	MAF #	MAF PRICE
30450			----	Complete		
30451			----	Female end		
30452			----	Male end		
30149				Recessed Washer		

- Unvalved construction allows maximum Flow
- 150 PSI
- NBR Seals

LA73C

MALE FLARE X FGH RIGID

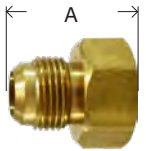

Hex

MIDLAND	AMC	CHAMPION	LIST	MALE FLARE X FGH	MAF #	MAF PRICE
30123	07495-0612	46WH-612	----	3/8" x 3/4"	94GH	
30128	07495-0812		----	1/2" x 3/4"	95GH	
30133	07495-1012		----	5/8" x 3/4"	96GH	

190 46WH HFU21

MALE FLARE X FGH SWIVEL

.WASHER INCLUDED

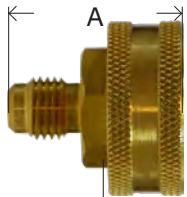

Hex

MIDLAND	AMC	CHAMPION	LIST	MALE FLARE X FGH	MAF #	MAF PRICE
30052			----	1/4" x 3/4"	98GH	
30138	07499-0612	W1-6	----	3/8" x 3/4"	99GH	
30139	07499-0812		----	1/2" x 3/4"	100GH	

* Internal Hex

50GHSV 51GHSV W1 68H 191

COMPRESSION X FGH

.WASHER INCLUDED

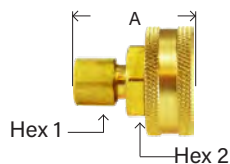

Hex 1

Hex 2

MIDLAND	AMC	CHAMPION	LIST	SWIVEL COMPRESSION X FGH	MAF #	MAF PRICE
30050			----	1/4" x 3/4"	124GH-412	
30051			----	3/8" x 3/4"	125GH-612	
				1/2" x 3/4"	129GH-812	



MIDLAND	AMC	CHAMPION	LIST	NO SWIVEL COMPRESSION X MGH	MAF #	MAF PRICE
30135			----	1/4" x 3/4"	126GH	
30136			----	3/8" x 3/4"	127GH	
30137			----	1/2" x 3/4"	128GH	

Male Flare X Garden Hose Available

WARNING: This product can expose you to chemicals, including lead, which are known to the State of California to cause cancer and birth defects or other reproductive harm. For more information, visit www.P65Warnings.ca.gov

GARDEN HOSE

BRASS FITTINGS

BARSTOCK BRASS GARDEN HOSE COUPLINGS

FEMALE SWIVEL ONLY

•WASHER INCLUDED

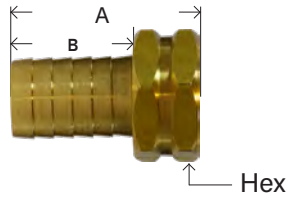

29FGH
329F

BRASS					
MIDLAND	CHAMPION	LIST	HOSE BARB X FGH	MAF #	MAF PRICE
30031	209GHS-6EH	----	3/8" x 3/4"	29FGH-612H	
30032	209GHS-8EH	----	1/2" x 3/4"	29FGH-812H	
30033	209GHS-10EH	----	5/8" x 3/4"	29FGH1012H	
30034	209GHS-12EH	----	3/4" x 3/4"	29FGH-1212H	
30044	209GHS-16EH	----	1" x 3/4"	29FGH-1612H	
30035	209GHS-16FH	----	1" x 1"	29FGH-1616H	



STAINLESS STEEL 316					
30032SS		----	1/2" x 3/4"		
30033SS		----	5/8" x 3/4"		
30034SS		----	3/4" x 3/4"		

MALE END ONLY

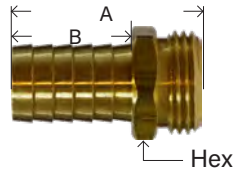

29MGH
329M

BRASS					
MIDLAND	CHAMPION	LIST	HOSE BARB X MGH	MAF #	MAF PRICE
30039	201GH-6EX	----	3/8" x 3/4"	29MGH-612	
30040	201GH-8EX	----	1/2" x 3/4"	29MGH-812	
30041	201GH-10EX	----	5/8" x 3/4"	29MGH-1012	
30042	201GH-12EX	----	3/4" x 3/4"	29MGH-1212	
30045	201GH-16EX	----	1" x 3/4"	29MGH-1612	
30043	201GH-16FX	----	1" x 1"	29MGH-1616	



STAINLESS STEEL 316					
30040SS		----	1/2" x 3/4"		
30041SS		----	5/8" x 3/4"		
30042SS		----	3/4" x 3/4"		

GARDEN HOSE COUPLING



BRASS					
MIDLAND	CHAMPION	LIST	HOSE BARB	MAF #	MAF PRICE
30025	202GHSH-66	----	3/8"	29GHS-65H	
30027	202GHSH-88	----	1/2"	29GHS-8H	
30028	202GHSH-1010	----	5/8"	29GHS-10H	
30029	202GHSH-1212	----	3/4"	29GHS-12H	
30046		----	1"(3/4" threads)	29GHS-16H	
30030	202GHSH-1616	----	1"		



STAINLESS STEEL 316					
30027SS		----	1/2"		
30028SS		----	5/8"		
30029SS		----	3/4"		

WARNING: This product can expose you to chemicals, including lead, which are known to the State of California to cause cancer and birth defects or other reproductive harm. For more information, visit www.P65Warnings.ca.gov

BRASS

GARDEN HOSE

BRASS FITTINGS

FEMALE SWIVEL ONLY - SHORT SHANK KNURLED NUT

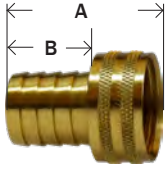

MIDLAND	AMC	CHAMPION	LIST	HOSE BARB X FGH	MAF #	MAF PRICE
30464		209GHS-4E		1/4" x 3/4"	29FGH-412	
		209GHS-6E		3/8" x 3/4"	29FGH-0612	
30466	07046-0812	209GHS-8E	----	1/2" x 3/4"	29FGH-812	
30467	07046-1012	209GHS-10E	----	5/8" x 3/4"	209GHS-1012	
30468	07046-1212	209GHS-12E	----	3/4" x 3/4"	209GHS-1212	

FEMALE END ONLY - SHORT SHANK W/ HEX



MIDLAND	AMC	CHAMPION	LIST	HOSE X FGH	MAF #	MAF PRICE
30453			----	1/2" x 3/4"	29FGH-812MHK	
30454			----	5/8" x 3/4"	29FGH-1012MHK	
30455			----	3/4" x 3/4"	29FGH-1212MHK	

MALE END ONLY - SHORT SHANK

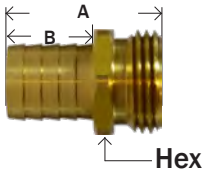

MIDLAND	AMC	CHAMPION	LIST	HOSE BARB X MGH	MAF #	MAF PRICE
30469				1/4" x 3/4"	29MGH-412	
	07048-0612	201GH-6E			29MGH-0612	
30471	07048-0812	201GH-8E	----	1/2" x 3/4"	29MGH-812	
30472	07048-1012	201GH-10E	----	5/8" x 3/4"	29MGH-1012	
30473	07048-1212	201GH-12E	----	3/4" x 3/4"	29MGH-1212	

GARDEN HOSE COUPLING SETS - SHORT SHANK W/ HEX NUT



MIDLAND	AMC	CHAMPION	LIST	HOSE BARB	MAF #	MAF PRICE
30457	07042-08	202GHS-88	----	1/2"	29GHS-8MHK	
30458	07042-10	202GHS-1010	----	5/8"	29GHS-10MHK	
30459	07042-12	202GHS-1212	----	3/4"	29GHS-12MHK	

FEMALE SWIVEL ONLY - 2" SHANK

-WASHER INCLUDED

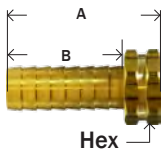

GHFL 594

MIDLAND	AMC	CHAMPION	LIST	HOSE BARB X FGH	MAF #	MAF PRICE
30505		209GHS-8EHXL	----	1/2" x 3/4"	29FGH-8LGH	
30506		209GHS-10EHXL	----	5/8" x 3/4"	29FGH-10LGH	
30507		209GHS-12EHXL	----	3/4" x 3/4"	29FGH-12LGH	
30508		209GHS-16FHXL	----	1" x 1"	29FGH-16LGH	

MALE END ONLY - 2" SHANK

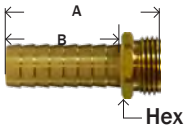

MIDLAND	AMC	CHAMPION	LIST	HOSE BARB X MGH	MAF #	MAF PRICE
30510		201GH-8EXL	----	1/2" x 3/4"	29MGH-8LG	
30511		201GH-10EXL	----	5/8" x 3/4"	29MGH-10LG	
30512		201GH-12EXL	----	3/4" x 3/4"	29MGH-12LG	
30513		201GH-16FXL	----	1" x 1"	29MGH-16LG	

GARDEN HOSE COUPLING SETS - 2" SHANK



GHML 593

MIDLAND	AMC	CHAMPION	LIST	HOSE X FGH	MAF #	MAF PRICE
30516		202GHSH-8XL	----	1/2"	29GHS-8LGH	
30517		202GHSH-10XL	----	5/8"	29GHS-10LGH	
30518		202GHSH-12XL	----	3/4"	29GHS-12LGH	

WARNING: This product can expose you to chemicals, including lead, which are known to the State of California to cause cancer and birth defects or other reproductive harm. For more information, visit www.P65Warnings.ca.gov

NPSM GARDEN HOSE

BRASS FITTINGS

NPSM FEMALE SHORT SHANK

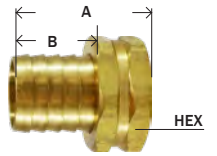

329NPSM

MIDLAND	AMC	CHAMPION	HOSE ID	LIST
30545	07040-812	209NPSM-8EH	1/2	----
30546	07040-1012		5/8	----
30547	07040-1212	209NPSM-12EH	3/4	----
30548			1	----

NPSM MALE SHORT SHANK

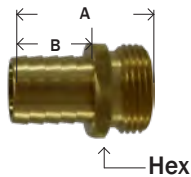

MIDLAND	AMC	CHAMPION	HOSE ID	LIST
30550			1/2	----
30551			5/8	----
30552			3/4	----
30553			1	----

NPSM SHORT SHANK SETS



MIDLAND	AMC	CHAMPION	SIZE	LIST
30540			1/2"	----
30541			5/8"	----
30542			3/4"	----
30543			1"	----

NPSM FEMALE LONG SHANK

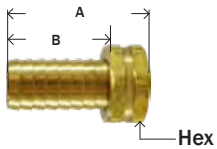

MIDLAND	AMC	CHAMPION	HOSE ID	LIST
30565			1/2	----
30566			5/8	----
30567			3/4	----
30568			1	----

NPSM MALE LONG SHANK

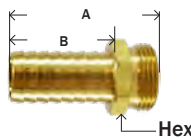

MIDLAND	AMC	CHAMPION	HOSE ID	LIST
30570			1/2	----
30571			5/8	----
30572			3/4	----
30573			1	----

NPSM LONG SHANK SETS



MIDLAND	AMC	CHAMPION	SIZE	LIST
30560			1/2"	----
30561			5/8"	----
30562			3/4"	----
30563			1"	----

WARNING: This product can expose you to chemicals, including lead, which are known to the State of California to cause cancer and birth defects or other reproductive harm. For more information, visit www.P65Warnings.ca.gov

BRASS

GARDEN HOSE VALVES/ FITTINGS

BRASS FITTINGS

GARDEN HOSE VALVES**ONE WAY BRASS BALL VALVE - FGH X MGH**

• 500 PSI • 180°F

• WASHER INCLUDED

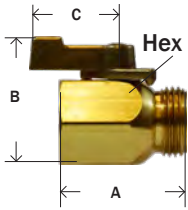

MIDLAND	AMC	CHAMPION	LIST	FGH X MGH	MAF #	MAF PRICE
30161		24AV-12	----	3/4" x 3/4"		

ONE WAY BRASS BALL VALVE - FEMALE PIPE X MGH

• 500 PSI • 180°F

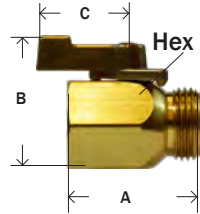

MIDLAND	AMC	CHAMPION	LIST	FEMALE NPTF X MGH	MAF #	MAF PRICE
30162		18AV-12E	----	3/4" x 3/4"		

ZINC ALLOY HOSE SHUT-OFF W/ ONE LEVER

• WASHER INCLUDED



MIDLAND	AMC	CHAMPION	LIST	FGH X MGH	MAF #	MAF PRICE
30631			----	3/4" x 3/4"		

PLASTIC GARDEN HOSE VALVE • CYCOLAC BODY & BALL

• WASHER INCLUDED

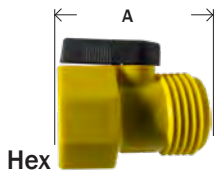

MIDLAND	AMC	CHAMPION	LIST	FGH X MGH	MAF #	MAF PRICE
30163			----	3/4" x 3/4"		

LA450C



VIEW PRICING AND AVAILABLE STOCK ONLINE

WARNING: This product can expose you to chemicals, including lead, which are known to the State of California to cause cancer and birth defects or other reproductive harm. For more information, visit www.P65Warnings.ca.gov



GARDEN HOSE VALVES

BRASS FITTINGS

ZINC ALLOY HOSE - "Y" CONNECTOR

• WASHER INCLUDED

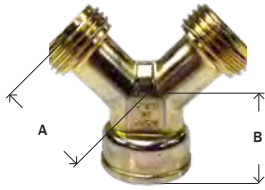

MIDLAND	AMC	CHAMPION	LIST	SIZE FGH X MGH(2)	MAF #	MAF PRICE
30141	07460-12			3/4"		

86Y 21A

CAST BRASS HOSE - "Y" CONNECTOR

• WASHER INCLUDED

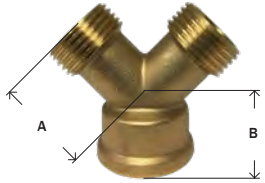

MIDLAND	AMC	CHAMPION	LIST	SIZE FGH X MGH(2)	MAF #	MAF PRICE
30140	07461-12		----	3/4"		

86Y 21A

86YRB
HY12

PLASTIC, NON-CORROSIVE, 2-WAY HOSE SHUT-OFF "Y"

• WASHER INCLUDED

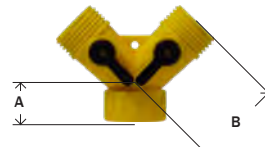

No Swivel ✓

MIDLAND	AMC	CHAMPION	LIST	SIZE FGH X MGH(2)	MAF #	MAF PRICE
30160			----	3/4"		

"Y" SHAPE ZINC ALLOY CONNECTOR W/ TWO LEVERS

• WASHER INCLUDED

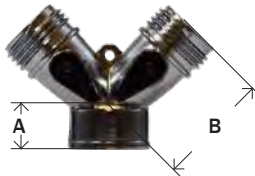

No Swivel

MIDLAND	AMC	CHAMPION	LIST	SIZE FGH X MGH(2)	MAF #	MAF PRICE
30626		21AVNI-12	----	3/4"		

"Y" SHAPE BRASS CONNECTOR W/ 2-WAY SHUT OFF

• WASHER INCLUDED



• Brass Levers

MIDLAND	AMC	CHAMPION	LIST	SIZE	MAF #	MAF PRICE
30627		21AV-12	----	3/4"		

ZINC ALLOY SWIVEL HOSE CONNECTOR

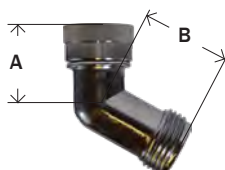

MIDLAND	AMC	CHAMPION	LIST	SIZE FGH X MGH	MAF #	MAF PRICE
30629			----	3/4"		

WARNING: This product can expose you to chemicals, including lead, which are known to the State of California to cause cancer and birth defects or other reproductive harm. For more information, visit www.P65Warnings.ca.gov



GARDEN HOSE NOZZLES

BRASS FITTINGS

2-1/2" BRASS NOZZLE

• WASHER INCLUDED

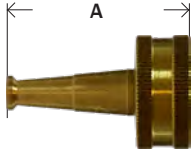

MIDLAND	AMC	CHAMPION	LIST	SIZE	MAF #	MAF PRICE
30637		PSN76	----	3/4"		

3" CROSSED PATTERN BRASS NOZZLE

• WASHER INCLUDED

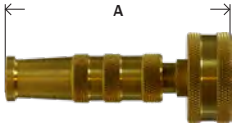

MIDLAND	AMC	CHAMPION	LIST	SIZE	MAF #	MAF PRICE
30640		500AM4-3	----	3/4"		

4" CROSSED PATTERN BRASS NOZZLE

• WASHER INCLUDED

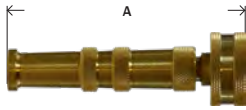

MIDLAND	AMC	CHAMPION	LIST	SIZE	MAF #	MAF PRICE
30638			----	3/4"		

ADJUSTABLE SPRAY

• WASHER INCLUDED



MIDLAND	AMC	CHAMPION	LIST	SIZE	MAF #	MAF PRICE
30600			----	5-1/2"		

Zinc Alloy spray nozzle with insulated handle soft grip and front thread protector

LEAD FREE

• WASHER INCLUDED



MIDLAND	AMC	CHAMPION	LIST	SIZE	MAF #	MAF PRICE
30620			----	4-1/4"		

Zinc Alloy spray nozzle

ADJUSTABLE SPRAY - LEAD FREE

• WASHER INCLUDED



MIDLAND	AMC	CHAMPION	LIST	SIZE	MAF #	MAF PRICE
30609			----	5-1/4"		

Zinc Alloy spray nozzle with easily adjustable brass head and plastic grip

PLASTIC SPRAY NOZZLE

• WASHER INCLUDED

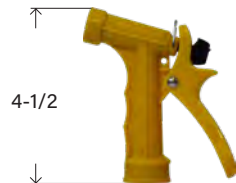

MIDLAND	AMC	CHAMPION	LIST	SIZE	MAF #	MAF PRICE
30630			----	4-1/2"		

Plastic spray nozzle

WARNING: This product can expose you to chemicals, including lead, which are known to the State of California to cause cancer and birth defects or other reproductive harm. For more information, visit www.P65Warnings.ca.gov



SAE 45° FLARE

BRASS FITTINGS

SAE 45° FLARE



Tube O.D.	1/8	3/16	1/4	5/16	3/8	7/16	1/2	5/8	3/4
Thread Size-B	5/16-24	3/8-24	7/16-20	1/2-20	5/8-18	11/16-16	3/4-16	7/8-14	1-1/16-14

•Typical Application

LP and natural gas, flammable liquids, instrumentation, refrigeration, power steering, hydraulic and pneumatic systems.

•Working Pressure Ranges

Temperature and type of tubing used are important factors. However, the following table is a good guide for proper selection. Temperature 73°F with copper tubing:

PSI	Tube O.D. (in.)	Tube Wall (in.)
2800	1/8	.030
1900	3/16	.030
1400	1/4	.030
1200	5/16	.032
1000	3/8	.032
750	1/2	.032
650	5/8	.035
550	3/4	.035
450	7/8	.035

•Vibration

Good resistance - use long nut when greater vibration resistance is required.

•Temperature Range

-65°F to +250°F (-53°C to +121°C) range at maximum operating pressures.

•Used With

Copper, brass, aluminum and steel hydraulic tubing that can be flared.

Actual O.D. of Flare Fittings

• Tolerance

+/- .03 on all dimensions. Dimension data can change without notice. Please call us when dimensions are critical.

•Conformance

Meets specifications and standards of ASA, ASME, SAE and MS (Military standards).

Assembly Instructions

- 1- Cut tubing to desired length. Make sure all burrs are removed and ends are cut square.
- 2- Slide nut on tube. Threaded end "A" of nut must face out.
- 3- Flare end of tube with a 45° flaring tool.
 - a- Measure flare diameter.
 - b- Examine flare for excessive thin out.
- 4- Lubricate threads and assemble to fitting body. Nut should be turned hand tight.
- 5- Tighten assembly with wrench until a solid feeling is encountered. From that point, apply a one-sixth turn.

Note: Do not over-torque as it may damage the fitting or split the tubing at the flare.

PRICING FILE AVAILABLE ONLINE



WARNING: This product can expose you to chemicals, including lead, which are known to the State of California to cause cancer and birth defects or other reproductive harm. For more information, visit www.P65Warnings.ca.gov

BRASS

SAE 45° FLARE

BRASS FITTINGS

SAE# 010110

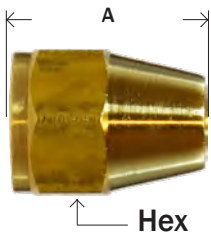
SHORT ROD NUT

41S
411S
04014

MIDLAND	AMC	CHAMPION	LIST	THREAD SIZE UNF	MAF #	MAF PRICE
10013	04014-02	N1-2		1/8"	21110X2	...
				1/8"	41S-2	...
10014	04014-03	N1-3		3/16"	21110X3	...
				3/16"	41S-3	...
10015				1/4"	21110X4	...
10015L	04014-04	N1-4		1/4"	41S-4	...
				1/4"	21010X4	...
10016	04014-05	N1-5		5/16"	21110X5	...
				5/16"	41S-5	...
10017L	04014-06	N1-6		3/8"	41S-6	...
				3/8"	21010X6	...
10017		41AS-6		3/8"	21110X6	...
10018	04014-07	N1-7		7/16"	21110X7	...
				7/16"	41S-7	...
10019L	04014-08	N1-8		1/2"	41S-8	...
10019		41AS-8		1/2"	21110X8	...
10020L	04014-10	N1-10		5/8"	41S-10	...
10020		41AS-10		5/8"	21110X10	...
10021	04014-12	N1-12		3/4"	41S-12	...
				3/4"	21110X12	...
10022	04014-14	N1-14		7/8"	41S-14	...
				7/8"	21110X14	...
10026	04014-16	N1-16		1"	41S-16	...

20910 41FS 1110 N1 41FX 441S 'L'

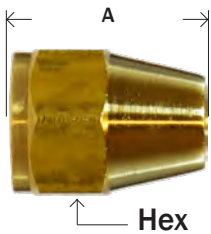
REDUCING SHORT ROD NUT

MIDLAND	AMC	CHAMPION	LIST	THREAD SIZE UNF	MAF #	MAF PRICE
10023		N1-64		3/8" x 1/4"	41SR-64	...
10024		N1-86		1/2" x 3/8"	41SR-86	...
10025		N1-108		5/8" x 1/2"	41SR-108	...

WARNING: This product can expose you to chemicals, including lead, which are known to the State of California to cause cancer and birth defects or other reproductive harm. For more information, visit www.P65Warnings.ca.gov



SAE 45° FLARE

BRASS FITTINGS

LONG ROD NUT

SAE# 010111

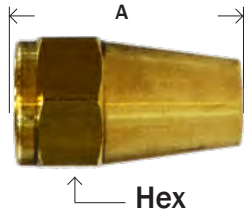

41L
04041

MIDLAND	AMC	CHAMPION	LIST	THREAD SIZE UNF	MAF #	MAF PRICE
10001	04041-02	N2-2		1/8"	41L-2	...
10002	04041-03	N2-3		3/16"	41L-3	...
10003	04041-04	N2-4		1/4"	41L-4	...
10004	04041-05	N2-5		5/16"	41L-5	...
10005	04041-06	N2-6		3/8"	41L-6	...
10006	04041-08	N2-8		1/2"	41L-8	...
10007	04041-10	N2-10		5/8"	41L-10	...
10008	04041-12	N2-12		3/4"	41L-12	...

41FL N2 241 441 41

LONG FORGED NUT

SAE# 010167

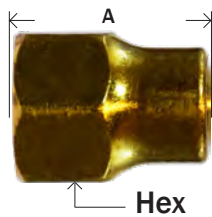

640L
641L
04016

MIDLAND	AMC	CHAMPION	LIST	THREAD SIZE UNF	MAF #	MAF PRICE
10028	04016-04	N4-4		1/4"	641L-4	...
	04016-05	N4-5		5/16"	641L-5	...
10030	04016-06	N4-6		3/8"	641L-6	...
10031	04016-08	N4-8		1/2"	641L-8	...
10032	04016-10	N4-10		5/8"	641L-10	...
10033	04016-12	N4-12		3/4"	641L-12	...

41FF 39 N4 14FL 641

SHORT FORGED NUT

SAE# 010166

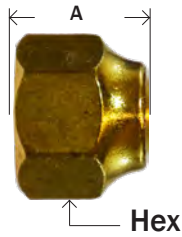

641S
6401S
04018

MIDLAND	AMC	CHAMPION	LIST	THREAD SIZE UNF	MAF #	MAF PRICE
10038	04018-03	NS4-3		3/16"	641S-3	...
10039	04018-04	NS4-4		1/4"	641S-4	...
10040	04018-05	NS4-5		5/16"	641S-5	...
10041	04018-06	NS4-6		3/8"	641S-6	...
10042	04018-08	NS4-8		1/2"	641S-8	...
10043	04018-10	NS4-10		5/8"	641S-10	...
10044	04018-12	NS4-12		3/4"	641S-12	...
10045	04018-14	NS4-14		7/8"	641S-14	...

14FS 41FFS 40 641-S 1116 NS4

FROST PROOF

MIDLAND	AMC	CHAMPION	LIST	THREAD SIZE UNF	MAF #	MAF PRICE
				1/4"	641SFP-4	...
				3/8"	641SFP-6	...
				1/2"	641SFP-8	...
				5/8"	641SFP-10	...

WARNING: This product can expose you to chemicals, including lead, which are known to the State of California to cause cancer and birth defects or other reproductive harm. For more information, visit www.P65Warnings.ca.gov

BRASS

SAE 45° FLARE

BRASS FITTINGS

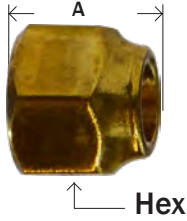
EXTRA HEAVY SHORT FORGED NUT

641SH
6401SXH
04019

MIDLAND	AMC	CHAMPION	LIST	THREAD SIZE UNF	MAF #	MAF PRICE
10046	04019-04			1/4"	641SH-4	...
				5/16"	641SH-5	...
10047	04019-06			3/8"	641SH-6	...
10048	04019-08			1/2"	641SH-8	...
10049	04019-10			5/8"	641SH-10	...
				3/4"	641SH-12	...
				7/8"	641SH-14	...

NSA

FORGED REDUCING NUT

660
662S
04020

MIDLAND	AMC	CHAMPION	LIST	FEMALE FLARE X OD	MAF #	MAF PRICE
10051	04020-0504	NSR4-54		5/16" x 1/4"	662S-54	...
10052	04020-0604	NSR4-64		3/8" x 1/4"	662S-64	...
10053	04020-0605	NSR4-65		3/8" x 5/16"	662S-65	...
10054	04020-0806	NSR4-86		1/2" x 3/8"	662S-86	...
10055	04020-1006	NSR4-106		5/8" x 3/8"	662S-106	...
10056	04020-1008	NSR4-108		5/8" x 1/2"	662S-108	...
	04020-1208	NSR4-128		3/4" x 1/2"	662S-128	...
10058	04020-1210	NSR4-1210		3/4" x 5/8"	662S-1210	...

NSR4 14FS 41FRS 40R 662-S

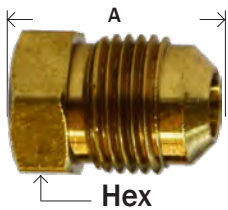
FLARED PLUG

39
439
04039

MIDLAND	AMC	CHAMPION	LIST	THREAD SIZE UNF	MAF #	MAF PRICE
10062	04039-02			1/8"	39-2	...
10063	04039-03	P2-3		3/16"	39-3	...
10064	04039-04	P2-4		1/4"	39-4	...
10065	04039-05	P2-5		5/16"	39-5	...
10066	04039-06	P2-6		3/8"	39-6	...
10067	04039-08	P2-8		1/2"	39-8	...
10068	04039-10	P2-10		5/8"	39-10	...
10069	04039-12	P2-12		3/4"	39-12	...
				7/8"	39-14	...

58 639F PF 57 P2 2229 439

WARNING: This product can expose you to chemicals, including lead, which are known to the State of California to cause cancer and birth defects or other reproductive harm. For more information, visit www.P65Warnings.ca.gov



SAE 45° FLARE

BRASS FITTINGS

FLARED CAP



Hex
40
440
04040

MIDLAND	AMC	CHAMPION	LIST	THREAD SIZE UNF	MAF #	MAF PRICE
10073	04040-02			1/8"	40-2	...
10074	04040-03	N5-3		3/16"	40-3	...
10075 *	04040-04	N5-4		1/4"	40-4	...
10075EH				1/4"	2139X4	...
10076	04040-05	N5-5		5/16"	40-5	...
10077 *	04040-06	N5-6		3/8"	40-6	...
10078	04040-08	N5-8		1/2"	40-8	...
10079	04040-10	N5-10		5/8"	40-10	...
10080	04040-12	N5-12		3/4"	40-12	...
				7/8"	40-14	...

640F 41FC 56 N5 2129 54 440

FINGER TIGHTENING CAP



NFTS
FTC5
04099

MIDLAND	AMC	CHAMPION	LIST	THREAD SIZE UNF	MAF #	MAF PRICE
10081	04099-04			1/4"	FTC5-4	...
10082	04099-06			3/8"	FTC5-6	...

• Neoprene | • O-Ring Included

NFT5

COPPER GASKET

SAE# 010113



463
04063

MIDLAND	AMC	CHAMPION	LIST	SIZE	MAF #	MAF PRICE
10084	04063-03			3/16"	463-3	...
10085	04063-04	B2-4		1/4"	463-4	...
10086	04063-05	B2-5		5/16"	463-5	...
10087	04063-06	B2-6		3/8"	463-6	...
10088	04063-08	B2-8		1/2"	463-8	...
10089	04063-10	B2-10		5/8"	463-10	...
10090	04063-12	B2-12		3/4"	463-12	...

B2 2GF 6251 FG 157 59 46

COPPER BONNET

SAE# 010114

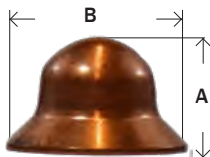

464
04064

MIDLAND	AMC	CHAMPION	LIST	SIZE	MAF #	MAF PRICE
10094	04064-03			3/16"	464-3	...
10095	04064-04	B1-4		1/4"	464-4	...
	04064-05			5/16"	464-5	...
10097	04064-06	B1-6		3/8"	464-6	...
10098	04064-08	B1-8		1/2"	464-8	...
10099	04064-10	B1-10		5/8"	464-10	...
10100	04064-12			3/4"	464-12	...

B1 3GF 64C 57 156 FB 695 464

SAE 45° FLARE

BRASS FITTINGS

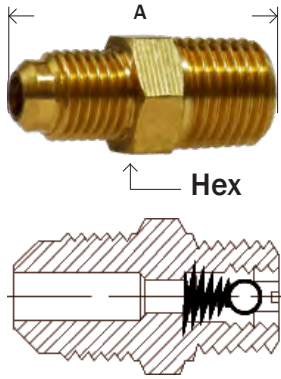
MALE BALL CHECK CONNECTOR

MIDLAND	AMC	CHAMPION	LIST	MALE FLARE X MALE NPTF	MAF #	LIST
10131*	04043-0402			1/4" x 1/8"	43-42	...
10256WC				1/4" x 1/4"	43-44	...
10132				5/16" x 1/8"	43-52	...
10133*	04043-0604			3/8" x 1/4"	43-64	...

43A

43
403
04043

* Note: Ball & Spring position may be reversed to change flow/check position. Min working pressure 3 PSI.

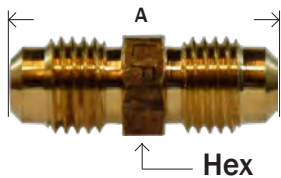
UNION**SAE# 010101**

42 - LIGHT
242 - SAE
04042

MIDLAND	AMC	CHAMPION	LIST	THREAD SIZE UNF	MAF #	MAF PRICE
10104	04042-02	U2-2		1/8"	242X2	...
				1/8"	42-2	...
10105	04042-03	U2-3		3/16"	242X3	...
				3/16"	42-3	...
10106L	04042-04	U2-4		1/4"	42-4	...
10106				1/4"	242X4	...
10106EH				1/4"	R42XH-4	...
10107	04042-05	U2-5		5/16"	242X5	...
				5/16"	42-5	...
10108L	04042-06			3/8"	42-6	...
10108		U2-6		3/8"	242X6	...
				7/16"	242X7	...
10109L	04042-08	U2-8		1/2"	42-8	...
10109				1/2"	242X8	...
10110L	04042-10			5/8"	42-10	...
10110		U2-10		5/8"	242X10	...
				3/4"	42-12	...
10111	04042-12	U2-12		3/4"	242X12	...
10112	04042-14	U2-14		7/8"	42-14	...

42F U2

WARNING: This product can expose you to chemicals, including lead, which are known to the State of California to cause cancer and birth defects or other reproductive harm. For more information, visit www.P65Warnings.ca.gov

SAE 45° FLARE

BRASS FITTINGS

REDUCING UNION



42R
506
04056

MIDLAND	AMC	CHAMPION	LIST	THREAD SIZE UNF	MAF #	MAF PRICE
10115	04056-0402			1/4" x 1/8"	42R-42	...
10116	04056-0403			1/4" x 3/16"	42R-43	...
10117	04056-0504	UR2-54		5/16" x 1/4"	42R-54	...
10118	04056-0604	UR2-64		3/8" x 1/4"	42R-64	...
				3/8" x 1/4"	242RX6X4	...
10119	04056-0605	UR2-65		3/8" x 5/16"	42R-65	...
10120	04056-0804	UR2-84		1/2" x 1/4"	42R-84	...
				1/2" x 1/4"	242RX8X4	...
10121	04056-0806	UR2-86		1/2" x 3/8"	42R-86	...
				1/2" x 3/8"	242RX8X6	...
10122	04056-1006	UR2-106		5/8" x 3/8"	42R-106	...
				5/8" x 3/8"	242RX10X6	...
10123	04056-1008	UR2-108		5/8" x 1/2"	42R-108	...
				5/8" x 1/2"	242RX10X8	...
10126	04056-1208	UR2-128		3/4" x 1/2"	42R-128	...
10127	04056-1210	UR2-1210		3/4" x 5/8"	42R-1210	...

656F UR2 42-R

BULKHEAD UNION

MIDLAND	AMC	CHAMPION	LIST	THREAD SIZE UNF	MAF #	MAF PRICE
				1/4"	42BH-4	...
				3/8"	42BH-6	...
				1/2"	42BH-8	...
				5/8"	42BH-10	...
				3/4"	42BH-12	...
				3/8" x 1/2"	42RBH-68	...
				1/2" x 3/8"	42RBH-86	...

LOCKNUT ONLY

				1/4"	41LN-4	...
				3/8"	41LN-6	...
				1/2"	41LN-8	...

244F T2 144F

UNION TEE



44F - FORGED
404
244 - BARSTOCK
04044

MIDLAND	AMC	CHAMPION	LIST	THREAD SIZE UNF	MAF #	MAF PRICE
10157	04044-02	T2-2		1/8"	44F-2	...
10158	04044-03	T2-3		3/16"	44F-3	...
10159	04044-04	T2F-4		1/4"	44F-4	...
		T2-4		1/4"	244X4	...
10160	04044-05	T2-5		5/16"	44F-5	...
				5/16"	244X5	...
10161	04044-06	T2-6		3/8"	44F-6	...
				3/8"	244X6	...
10162	04044-08	T2-8		1/2"	44F-8	...
				1/2"	244X8	...
10163	04044-10	T2-10		5/8"	44F-10	...
				5/8"	244X10	...
10164	04044-12	T2-12		3/4"	44F-12	...
10165	04044-14			7/8"	44F-14	...

244F T2 144F

SAE 45° FLARE

BRASS FITTINGS

REDUCING TEE 1 X 2 X 3

144F TR2 659F 684F 44R

44FR
509
04059

MIDLAND	AMC	CHAMPION	LIST	THREAD SIZE UNF 1X2X3	MAF #	MAF PRICE
10170	04059-040406	TR2-446		1/4" x 1/4" x 3/8"	44FR-446	...
10171	04059-050504			5/16" x 5/16" x 1/4"	44FR-554	...
10172	04059-060404			3/8" x 1/4" x 1/4"	44FR-644	...
10173	04059-060406			3/8" x 1/4" x 3/8"	44FR-646	...
10174	04059-060604	TR2-664		3/8" x 3/8" x 1/4"	44FR-664	...
10175	04059-060608	TR2-668		3/8" x 3/8" x 1/2"	44FR-668	...
10176	04059-060610	TR2-6610		3/8" x 3/8" x 5/8"	44FR-6610	...
	04059-080408			1/2" x 1/4" x 1/2"	44FR-848	...
10178	04059-080606	TR2-686		1/2" x 3/8" x 3/8"	44FR-866	...
10179	04059-080608	TR2-868		1/2" x 3/8" x 1/2"	44FR-868	...
10180	04059-080804	TR2-884		1/2" x 1/2" x 1/4"	44FR-884	...
10181	04059-080806	TR2-886		1/2" x 1/2" x 3/8"	44FR-886	...
10182	04059-080810	TR2-8810		1/2" x 1/2" x 5/8"	44FR-8810	...
	04059-080812	TR2-8812		1/2" x 1/2" x 3/4"		
	04059-100608	TR2-1068		5/8" x 3/8" x 1/2"		
	04059-100610	TR2-10610		5/8" x 3/8" 5/8"		
	04059-100808	TR2-1088		5/8" x 1/2" x 1/2"		
	04059-100606			5/8" x 3/8" x 3/8"	44FR-1066	...
10187	04059-100810	TR2-10810		5/8" x 1/2" x 5/8"	44FR-10810	...
	04059-101006	TR2-10106		5/8" x 5/8" x 1/4"	44FR-10104	...
10188	04059-101008	TR2-10108		5/8" x 5/8" x 3/8"	44FR-10106	...
10189	04059-121210			5/8" x 5/8" x 1/2"	44FR-10108	...
				3/4" x 5/8" x 3/4"	44FR-121012	...
				3/4" x 3/4" x 5/8"	44FR-121210	...

**MALE BRANCH
TEE**

SAE# 010425

45R
245
405

MIDLAND	AMC	CHAMPION	LIST	MALE FLARE X MALE NPT (1&2)X3	MAF #	MAF PRICE
	04045-0202	T1-2A		1/8" x 1/8"		
10203	04045-0302	T1-3A		3/16" x 1/8"		
10204	04045-0402	T1F-4A		1/4" x 1/8"		
10205	04045-0404	T1-4B		1/4" x 1/4"		
10206	04045-0406			1/4" x 3/8"		
	04045-0408	T1-4D		1/4" x 1/2"		
10207	04045-0502	T1-5A		5/16" x 1/8"		
10208	04045-0504	T1-5B		5/16" x 1/4"		
10209	04045-0602	T1-6A		3/8" x 1/8"		
10210	04045-0604	T1-6B		3/8" x 1/4"		
10211	04045-0606	T1-6C		3/8" x 3/8"		
10212	04045-0608	T1-6D		3/8" x 1/2"		
10213	04045-0804	T1-8B		1/2" x 1/4"		
10214	04045-0806	T1-8C		1/2" x 3/8"		
10215	04045-0808	T1-8D		1/2" x 1/2"		
10216	04045-0812	T1-8E		1/2" x 3/4"		
10217	04045-1006	T1-10C		5/8" x 3/8"		
10218	04045-1008	T1-10D		5/8" x 1/2"		
10219	04045-1012	T1-10E		5/8" x 3/4"		
10220	04045-1208	T1-12D		3/4" x 1/2"		
	04045-1212	T1-12E		3/4" x 3/4"		

WARNING: This product can expose you to chemicals, including lead, which are known to the State of California to cause cancer and birth defects or other reproductive harm. For more information, visit www.P65Warnings.ca.gov

SAE 45° FLARE

BRASS FITTINGS

FEMALE ADAPTER

SAE# 010103



46 - LIGHT
246 - SAE
406
04046

MIDLAND	AMC	CHAMPION	LIST	MALE FLARE X FEMALE NPTF	MAF #	MAF PRICE
	04046-0202	u3-2a		1/8" x 1/8"	46-22	...
10227	04046-0302	U3-3A		3/16" x 1/8"	246X3	...
				3/16" x 1/8"	46-32	...
10228L	04046-0402	U3-4A		1/4" x 1/8"	46-42	...
10228		RU3-4A		1/4" x 1/8"	246X4	...
10229L	04046-0404	U3-4B		1/4" x 1/4"	46-44	...
10229				1/4" x 1/4"	246X4X4	...
10230	04046-0406	U3-4C		1/4" x 3/8"	46-46	...
				1/4" x 3/8"	246X4X6	...
10231	04046-0408	U3-4D		1/4" x 1/2"	46-48	...
10232	04046-0502	U3-5A		5/16" x 1/8"	246X5	...
				5/16" x 1/8"	46-52	...
				5/16" x 1/4"	246X5X4	...
10233	04046-0504	U3-5B		5/16" x 1/4"	46-54	...
	04046-0506	u3-5c		5/16" x 3/8"		
				3/8" x 1/8"	246X6X2	...
10234	04046-0602	U3-6A		3/8" x 1/8"	46-62	...
10235L	04046-0604	U3-6B		3/8" x 1/4"	46-64	...
10235		RU3-6B		3/8" x 1/4"	246X6	...
10236L	04046-0606			3/8" x 3/8"	46-66	...
10236		U3-6C		3/8" x 3/8"	246X6X6	...
10237L	04046-0608	U3-6D		3/8" x 1/2"	46-68	...
10237		RU3-6D		3/8" x 1/2"	246X6X8	...
10238	04046-0612	U3-6E		3/8" x 3/4"	46-612	...
10239	04046-0804	U3-8B		1/2" x 1/4"	46-84	...
10240L	04046-0806	U3-8C		1/2" x 3/8"	46-86	...
10240		RU3-8C		1/2" x 3/8"	246x8	...
10241L	04046-0808			1/2" x 1/2"	46-88	...
10241		RU3-8D		1/2" x 1/2"	246x8x8	...
10242L	04046-0812	U3-8E		1/2" x 3/4"	46-812	...
10242				1/2" x 3/4"	246X8X12	...
10243	04046-1006	U3-10C		5/8" x 3/8"	46-106	...
10244L	04046-1008	U3-10D		5/8" x 1/2"	46-108	...
10244				5/8" x 1/2"	246X10	...
10245	04046-1012	U3-10E		5/8" x 3/4"	46-1012	...
10246	04046-1208	U3-12D		3/4" x 1/2"	46-128	...
10247	04046-1212	U3-12E		3/4" x 3/4"	46-1212	...
				7/8" x 1/2"	46-148	...
10248	04046-1412	U3-14E		7/8" x 3/4"	46-1412	...

46 U3

WARNING: This product can expose you to chemicals, including lead, which are known to the State of California to cause cancer and birth defects or other reproductive harm. For more information, visit www.P65Warnings.ca.gov

BRASS

SAE 45° FLARE

BRASS FITTINGS

MALE ADAPTER

SAE# 010102



48
248 - LIGHT
408 - SAE
04048

MIDLAND	AMC	CHAMPION	LIST	MALE FLARE X MALE NPTF	MAF #	MAF PRICE
10253	04048-0202	U1-2A		1/8" x 1/8"	248X2	...
				1/8" x 1/8"	48-22	...
10254	04048-0302	U1-3A		3/16" x 1/8"	248X3	...
				3/16" x 1/8"	48-32	...
	04048-0302	U1-3B		3/16" x 1/4"	48-34	...
10255L	04048-0402	U1-4A		1/4" x 1/8"	48-42	...
10255		RU1-4A		1/4" x 1/8"	248X4	...
10255EH				1/4" x 1/8"	R48XH-42	...
				1/4" x 1/4"	AV48-44	...
10256L	04048-0404	U1-4B		1/4" x 1/4"	48-44	...
10256	04448-0404	RU1-4B		1/4" x 1/4"	248X4X4	...
10257	04048-0406	U1-4C		1/4" x 3/8"	48-46	...
				1/4" x 3/8"	248X4X6	...
10258	04048-0408	U1-4D		1/4" x 1/2"	48-48	...
				1/4" x 1/2"	248X4X8	...
10259L	04048-0502	U1-5A		5/16" x 1/8"	48-52	...
10259				5/16" x 1/8"	248X5	...
10260L	04048-0504	U1-5B		5/16" x 1/4"	48-54	...
10260		RU1-5B		5/16" x 1/4"	248X5X4	...
10261	04048-0506	U1-5C		5/16" x 3/8"	48-56	...
				5/16" x 1/2"	48-58	...
10262	04048-0602	U1-6A		3/8" x 1/8"	248X6X2	...
				3/8" x 1/8"	48-62	...
10263L	04048-0604	U1-6B		3/8" x 1/4"	48-64	...
10263		RU1-6B		3/8" x 1/4"	248X6	...
10264L	04048-0606	U1-6C		3/8" x 3/8"	48-66	...
10264	04448-0606	RU1-6C		3/8" x 3/8"	248X6X6	...
10265L		U1-6D		3/8" x 1/2"	48-68	...
10265	04048-0608	RU1-6D		3/8" x 1/2"	248X6X8	...
10266	04448-0612	RU1-6E		3/8" x 3/4"	248X6X12	...
				7/16" x 1/4"	248X7	...
				1/2" x 1/8"	248X8X2	...
10267	04048-0804	U1-8B		1/2" x 1/4"	48-84	...
				1/2" x 1/4"	248X8X4	...
10268L	04048-0806	U1-8C		1/2" x 3/8"	48-86	...
10268	04448-0806	RU1-8C		1/2" x 3/8"	248X8	...
10269L		U1-8D		1/2" x 1/2"	48-88	...
10269	04048-0808	RU1-8D		1/2" x 1/2"	248X8X8	...
10270	04048-0812	U1-8E		1/2" x 3/4"	248X8X12	...
				1/2" x 3/4"	48-812	...
10271	04048-1004	U1-10B		5/8" x 1/4"	48-104	...
				5/8" x 1/4"	248X10X4	...

CONTINUED ON NEXT PAGE

U1 48

WARNING: This product can expose you to chemicals, including lead, which are known to the State of California to cause cancer and birth defects or other reproductive harm. For more information, visit www.P65Warnings.ca.gov



SAE 45° FLARE

BRASS FITTINGS

MALE ADAPTER - CONTINUED

MIDLAND	AMC	CHAMPION	LIST	MALE FLARE X MALE NPTF	MAF #	MAF PRICE
10272L	04048-1006	U1-10C		5/8" x 3/8"	48-106	...
10272		RU1-10C		5/8" x 3/8"	248X10X6	...
10273L		U1-10D		5/8" x 1/2"	48-108	...
10273	04048-1008	RU1-10D		5/8" x 1/2"	248X10	...
10274	04448-1012	RU1-10E		5/8" x 3/4"	248X10X12	...
				5/8" x 3/4"	48-1012	...
10275	04048-1208	U1-12D		3/4" x 1/2"	248X12	...
				3/4" x 1/2"	48-128	...
10276	04048-1212	U1-12E		3/4" x 3/4"	248X12X12	...
				3/4" x 3/4"	48-1212	...
10277	04048-1408	U1-14D		7/8" x 1/2"	48-148	...
10278	04048-1412	U1-14E		7/8" x 3/4"	48-1412	...
				1" x 1/2"	48-168	...
10279	04048-1612	U1-16E		1" x 3/4"	48-1612	...
10280	04048-1616	U1-16F		1" x 1"	48-1616	...

WARNING: This product can expose you to chemicals, including lead, which are known to the State of California to cause cancer and birth defects or other reproductive harm. For more information, visit www.P65Warnings.ca.gov

BRASS

SAE 45° FLARE

BRASS FITTINGS

**90° MALE ELBOW
SAE# 010202**49F
E1F

Forged Elbow

249
E1

Barstock Elbow

*Barstock
**Available in
stainless steel add
SS to part #

Dimension data
can change without
notice. Please call
when dimensions
are critical.

MIDLAND	AMC	CHAMPION	LIST	MALE FLARE X MALE NPTF	MAF #	MAF PRICE
10283	04049-0202	E1-2A		1/8" x 1/8"	49F-22	...
10283B*				1/8" x 1/8"	249X2	...
10284	04049-0302	E1F-3A		3/16" x 1/8"	49F-32	...
10284B*		E1-3A		3/16" x 1/8"	249X3	...
10285	04049-0304	E1-3B		3/16" x 1/4"	49F-34	...
10286	04049-0402	E1F-4A		1/4" x 1/8"	49F-42	...
10286B*		E1-4A		1/4" x 1/8"	249X4	...
10287	04049-0404	E1F-4B		1/4" x 1/4"	49F-44	...
10287B*		E1-4B		1/4" x 1/4"	249X4X4	...
10288 **	04049-0406	E1-4C		1/4" x 3/8"	49F-46	...
				1/4" x 3/8"	249X4X6	...
10289	04049-0408	E1-4D		1/4" x 1/2"	49F-48	...
10290	04049-0502	E1F-5A		5/16" x 1/8"	49F-52	...
10290B*		E1-5A		5/16" x 1/8"	249X5	...
10291	04049-0504	E1-5B		5/16" x 1/4"	49F-54	...
10291B*				5/16" x 1/4"	249X5X4	...
10292	04049-0506	E1-5C		5/16" x 3/8"	49F-56	...
	04049-0508	E1-5D		5/16" x 1/2"		
10293	04049-0602	E1F-6A		3/8" x 1/8"	49F-62	...
10293B*		E1-6A		3/8" x 1/8"	249X6X2	...
10294	04049-0604	E1-6B		3/8" x 1/4"	49F-64	...
10294B*	04049-0604B	E1F-6B		3/8" x 1/4"	249X6	...
10295 **	04049-0606	E1F-6C		3/8" x 3/8"	49F-66	...
10295B*		E1-6C		3/8" x 3/8"	R49F-66	...
10295L				3/8" x 3/8"	249X6X6	...
10296 **	04049-0608	E1-6D		3/8" x 1/2"	249X6X8	...
				3/8" x 1/2"	49F-68	...
10297	04049-0612	E1-6E		3/8" x 3/4"	249X6X12	...
				3/8" x 3/4"	49F-612	...
				7/16" x 1/4"	249X7	...
	04049-0802	E1-8A		1/2" x 1/8"		
10298	04049-0804	E1F-8B		1/2" x 1/4"	49F-84	...
10298B*		E1-8B		1/2" x 1/4"	249X8X4	...
10299	04049-0806	E1F-8C		1/2" x 3/8"	49F-86	...
10299B*	04049-0806B	E1-8C		1/2" x 3/8"	249X8	...
10300	04049-0808	E1F-8D		1/2" x 1/2"	49F-88	...
10300B*	04049-0808B	E1-8D		1/2" x 1/2"	249X8X8	...
				1/2" x 1/2"	R49F-88	...
				1/2" x 1/2"	R49F-88L	...
10301	04049-0812	E1-8E		1/2" x 3/4"	49F-812	...
				1/2" x 3/4"	249X8X12	...
10311	04049-1004	E1-10B		5/8" x 1/4"	49F-104	...
10302	04049-1006	E1-10C		5/8" x 3/8"	49F-106	...
10302B*				5/8" x 3/8"	249X10X6	...
10303	04049-1008	E1-10D		5/8" x 1/2"	249X10	----

CONTINUED ON NEXT PAGE

249F 49 E1 149F

WARNING: This product can expose you to chemicals, including lead, which are known to the State of California to cause cancer and birth defects or other reproductive harm. For more information, visit www.P65Warnings.ca.gov

SAE 45° FLARE

BRASS FITTINGS

90° MALE ELBOW - CONTINUED



*1/8 TAP.
MIP Threads have
threaded sealant

MIDLAND	AMC	CHAMPION	LIST	MALE FLARE X MALE NPTF	MAF #	MAF PRICE
10303B*				5/8" x 1/2"	249X10	...
10304	04049-1012	E1-10E		5/8" x 3/4"	49F-1012	...
				5/8" x 3/4"	249X10X12	...
	04049-1206	E1-12C		3/4" x 3/8"	49F-126	...
10305	04049-1208	E1-12D		3/4" x 1/2"	49F-128	...
				3/4" x 1/2"	249X12	...
		CVSE1F-12D-1/8TAP*		3/4" x 1/2" x 1/8"		
10306	04049-1212	E1-12E		3/4" x 3/4"	49F-1212	...
10306B*				3/4" x 3/4"	249X12X12	...
	04049-1216	E1-12F		3/4" x 1		
10307	04049-1412	E1-14E		7/8" x 3/4"	49F-1412	...
10308	04049-1612	E1-16E		1" x 3/4"	49F-1612	...
10309	04049-1616			1" x 1"	49F-1616	...

90° FEMALE ELBOW

SAE# 010203



Forged Elbow

50F



Barstock Elbow

50F
250
500
04050

* Barstock

MIDLAND	AMC	CHAMPION	LIST	MALE FLARE X FEMALE NPTF	MAF #	MAF PRICE
10312	04050-0302	E3-3A		3/16" x 1/8"	50F-32	...
10313	04050-0402	E3-4A		1/4" x 1/8"	50F-42	...
10313B*				1/4" x 1/8"	250X4	...
10314	04050-0404	E3-4B		1/4" x 1/4"	50F-44	...
10314B*				1/4" x 1/4"	250X4X4	...
10315	04050-0406	E3-4C		1/4" x 3/8"	50F-46	...
10333	04050-0408			1/4" x 1/2"	50F-48	...
10316	04050-0502	E3-5A		5/16" x 1/8"	50F-52	...
10316B*				5/16" x 1/8"	250X5	...
10317	04050-0504	E3-5B		5/16" x 1/4"	50F-54	...
10318	04050-0602	E3-6A		3/8" x 1/8"	50F-62	...
10319	04050-0604	E3-6B		3/8" x 1/4"	50F-64	...
10319B*				3/8" x 1/4"	250X6	...
10320	04050-0606	E3F-6C		3/8" x 3/8"	50F-66	...
10320B*		E3-6C		3/8" x 3/8"	250X6X6	...
10321		E3-6D		3/8" x 1/2"	50F-68	...
				3/8" x 1/2"	250X6X8	...
10321L	04050-0608			3/8" x 1/2"		...
10322	04050-0612	E3-6E		3/8" x 3/4"	50F-612	...
10323	04050-0804	E3-8B		1/2" x 1/4"	50F-84	...
10324	04050-0806	E3-8C		1/2" x 3/8"	50F-86	...
10324B*				1/2" x 3/8"	250X8	...
10325		E3-8D		1/2" x 1/2"	50F-88	...
10325L	04050-0808			1/2" x 1/2"		...
10326	04050-0812	E3-8E		1/2" x 3/4"	50F-812	...
10327	04050-1006	E3-10C		1/2" x 3/4"	50F-106	...
10328	04050-1008	E3-10D		5/8" x 3/8"	50F-108	...
				5/8" x 1/2"	250X10	...
10329	04050-1012	E3-10E		5/8" x 3/4"	50F-1012	...
10-330	04050-1208	E3-12D		3/4" x 1/2"	50F-128	...
10-331	04050-1212	E3-12E		3/4" x 3/4"	50F-1212	...
	04050-1412	E3-14E		7/8" x 3/4"	50F-1412	...

E3 50 150F

SAE 45° FLARE

BRASS FITTINGS

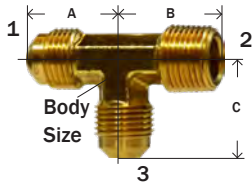
FORGED MALE RUN TEE

51F
501
04051

MIDLAND	AMC	CHAMPION	LIST	MALE FLARE X MALE NPTF (1&3) X 2	MAF #	MAF PRICE
10343	04051-0302	T3-3A		3/16" x 1/8"	51F-32	...
10344	04051-0402	T3-4A		1/4" x 1/8"	51F-42	...
10344B				1/4" x 1/8"	251X4	...
10345	04051-0404	T3-4B		1/4" x 1/4"	51F-44	...
	04051-0406	T3-4C		1/4" x 3/8"	51F-46	...
10347	04051-0502	T3-5A		5/16" x 1/8"	51F-52	...
10348	04051-0504	T3-5B		5/16" x 1/4"	51F-54	...
	04051-0602	T3-6A		3/8" x 1/8"	51F-62	...
10350	04051-0604	T3-6B		3/8" x 1/4"	51F-64	...
10351	04051-0606	T3-6C		3/8" x 3/8"	51F-66	...
10340				3/8" x 1/2" x 3/8"	51F-668	...
10352	04051-0608	T3-6D		3/8" x 1/2"	51F-68	...
10353				1/2" x 3/8" x 1/2"	51F-886	...
	04051-0804			1/2" x 1/4"	51F-84	...
10354	04051-0806	T3-8C		1/2" x 3/8"	51F-86	...
10355	04051-0808	T3-8D		1/2" x 1/2"	51F-88	...
	04051-0806	T3-10C		5/8" x 3/8"	51F-106	...
10357	04051-1008	T3-10D		5/8" x 1/2"	51F-108	...
10359	04051-1208	T3-12D		3/4" x 1/2"	51F-128	...
10360	04051-1212	T3-12E		3/4" x 3/4"	51F-1212	...

FORGED FLARE CROSS

SAE# 010501

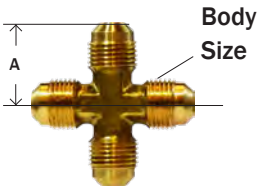

52
502
04052

MIDLAND	AMC	CHAMPION	LIST	THREAD SIZE UNF	MAF #	MAF PRICE
10373	04052-04	C1-4444		1/4"	52F-4	...
10374	04052-05	C1-5555		5/16"	52F-5	...
10375	04052-06	C1-6666		3/8"	52F-6	...
10376	04052-08	C1-8888		1/2"	52F-8	...
	04052-10	C1-101010		5/8"	52F-10	...

455 C1 147F 52

FEMALE RUN TEE

04091

MIDLAND	AMC	CHAMPION	LIST	THREAD SIZE UNF	MAF #	MAF PRICE
	04091-040404			1/4" x 1/4"	51FP-44	...
	04091-060606			3/8" x 3/8"	51FP-66	...
	04091-060608			3/8" x 1/2"	51FP-68	...
	04091-060808					
	04091-080806					

Dimension data can change without notice. Please call when dimensions are critical.

T3 151F 51

SAE 45° FLARE

BRASS FITTINGS

FORGED ADAPTER TEE / SERVICE TEE

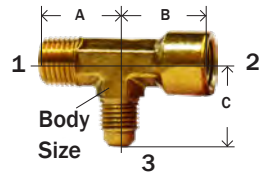

04053
53
503

MIDLAND	AMC	CHAMPION	LIST	SIZE 1 X 2 X 3	MAF #	MAF PRICE
				1/8"x1/8"x3/16"	253X3	...
10382	04053-020204	T4-4A		1/8"x1/8"x1/4"	53F-42	...
	04053-040404	T4-4B		1/4"x1/4"x1/4"	53F-44	...
				3/8"x3/8"x1/4"	53F-64	...
	04053-040406	T4-6B				

T17 53

MIP X MIP X FL

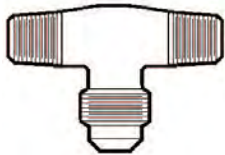

MIDLAND	AMC	CHAMPION	LIST	MIP X MIP ON RUN X MALE FLARE	MAF #	MAF PRICE
		T13-4A		1/8" x 1/4"	53FM-224	...
		T13-4B		1/4" x 1/4"	53FM-444	...
				3/8" x 3/8"	53FM-666	...

FL X FL X FIP FEMALE TEE



040

MIDLAND	AMC	CHAMPION	LIST	FLARE X FLARE X FIP	MAF #	MAF PRICE
	04058-040402			1/4" x 1/8"	58FP-42	...
	04058-040404			1/4" x 1/4"	58FP-44	...
	04058-060604			3/8" x 1/4"	58FP-64	...
	04058-060606			3/8" x 3/8"	58FP-66	...
	04058-080806			1/2" x 3/8"	58FP-86	...
	04058-080808			1/2" x 1/2"	58FP-88	...
	04093-06060608			3/8" x 1/2"	53FP-6668*	...
	04096-040404			1/4"x 1/4"	T6-444**	...

* Flare x flare x flare x FIP cross ** fe. flare on branch

UNION ELBOW

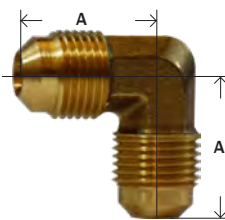

55F Forged
505
255 Barstock

* Barstock

MIDLAND	AMC	CHAMPION	LIST	THREAD SIZE UNF	MAF #	MAF PRICE
10404	04055-02	E2-2		1/8"	55F-2	...
10405	04055-03	E2-3		3/16"	55F-3	...
10406	04055-04	E2-4		1/4"	55F-4	...
10406B*				1/4"	255X4*	...
10407	04055-05	E2-5		5/16"	55F-5	...
				5/16"	255X5*	...
10408	04055-06	E2F-6		3/8"	55F-6	...
				3/8"	255X6*	...
10409	04055-08	E2-8		1/2"	55F-8	...
10409B*				1/2"	255X8*	...
10410	04055-10	E2-10		5/8"	55F-10	...
				5/8"	255X10*	...
10411	04055-12	E2-12		3/4"	55F-12	...
10412	04055-14	E2-14		7/8"	55F-14	...

E2 155F

SAE 45° FLARE

BRASS FITTINGS

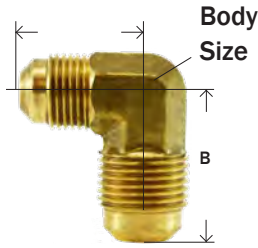
FORGED REDUCING ELBOW

55R
507
04057

MIDLAND	AMC	CHAMPION	LIST	MALE FLARE X MALE FLARE	MAF #	MAF PRICE
10416	04057-0604	ER2-64		3/8" x 1/4"	55FR-64	...
	04057-0804	ER2-84		1/2" x 1/4"	55FR-84	...
10419	04057-0806	ER2-86		1/2" x 3/8"	55FR-86	...
	04057-1006	ER2-106		5/8" x 3/8"	55FR-106	...
10421	04057-1008	ER2-108		5/8" x 1/2"	55FR-108	...
	04057-1208			3/4" x 1/2"	55FR-128	...
	04057-1210	ER2-1210		3/4" x 5/8"	55FR-1210	...

ER2 657F 55R

45° ELBOW

SAE# 010302



10151
254

54
4945
40945
04095

MIDLAND	AMC	CHAMPION	LIST	MALE FLARE X MALE NPTF	MAF #	MAF PRICE
	04095-0302	E1-4S-3A		3/16" x 1/8"	4945F-32	...
10448	04095-0402			1/4" x 1/8"	4945F-42	...
10448B*		E1-45-4A		1/4" x 1/8"	254X4*	...
10449	04095-0404	E1-45-4B		1/4" x 1/4"	4945F-44	...
				1/4" x 1/4"	254X4X4	...
10450	04095-0502	E1-45-5A		5/16" x 1/8"	4945F-52	...
				5/16" x 1/8"	254X5*	...
10451	04095-0504	E1-45-5B		5/16" x 1/4"	4945F-54	...
10452	04095-0604	E1F-45-6B		3/8" x 1/4"	4945F-64	...
10452B*		E1-45-6B		3/8" x 1/4"	254X6*	...
10453	04095-0606	E1-45-6C		3/8" x 3/8"	4945F-66	...
				3/8" x 3/8"	254X6X6*	...
10454	04095-0608	E1-45-6D		3/8" x 1/2"	4945F-68	...
				1/2" x 1/4"	4945F-84	...
10455	04095-0806	E1-45-8C		1/2" x 3/8"	4945F-86	...
10455B*				1/2" x 3/8"	254X8*	...
10456	04095-0808	E1-45-8D		1/2" x 1/2"	4945F-88	...
				1/2" x 1/2"	254X8X8*	...
10460	04095-1006	E1-45-10C		5/8" x 3/8"	4945F-106	...
				5/8" x 3/8"	254X10X6*	...
10457	04095-1008	E1-45-10D		5/8" x 1/2"	4945F-108	...
				5/8" x 1/2"	254X10*	...
10458	04095-1208	E1-45-12D		3/4" x 1/2"	4945F-128	...

* Barstock

E145 54 159F 654F 59FF 254 47 4945

FEMALE 45° FLARE FITTINGS**UNION**

SAE# 010107

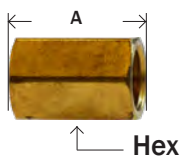

600
600F
04060

MIDLAND	AMC	CHAMPION	LIST	FEMALE FLARE X FEMALE FLARE	MAF #	MAF PRICE
10135	04060-04	U4-4		1/4"	600F-4	...
10136	04060-06	U4-6		3/8"	600F-6	...
10137	04060-08	U4-8		1/2"	600F-8	...
10138	04060-10			5/8"	600F-10	...
10139	04060-12			3/4"	600F-12	...

• Use with Copper Gasket

2310 U4 660HD 32

WARNING: This product can expose you to chemicals, including lead, which are known to the State of California to cause cancer and birth defects or other reproductive harm. For more information, visit www.P65Warnings.ca.gov

SAE 45° FLARE

BRASS FITTINGS

FEMALE FLARE X MALE PIPE

SAE# 010106

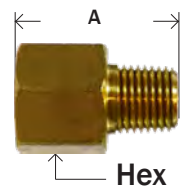

664
04066

* Swivel

MIDLAND	AMC	CHAMPION	LIST	FEMALE FLARE X MALE NPTF	MAF #	MAF PRICE
10440	04066-0402	U5-4A		1/4" x 1/8"	664-42	...
10441	04066-0404	U5-4B		1/4" x 1/4"	664-44	...
10442	04066-0604	U5-6B		3/8" x 1/4"	664-64	...
				3/8" x 1/4"	664S-64*	...
10438				3/8" x 1/2"	664-68	...
10443	04066-0806	U5-8C		1/2" x 3/8"	664-86	...
10444	04066-0808	U5-8D		1/2" x 1/2"	664-88	...

U5 664FHD 33 48-FF

FEMALE FLARE X MALE FLARE

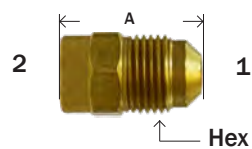

601
04061

WG=WITH GASKET

MIDLAND	AMC	CHAMPION	LIST	FEMALE FLARE X MALE FLARE	MAF #	MAF PRICE
				3/16" x 1/4"	601-34	...
	04061-0403			1/4" x 3/16"	601-43	...
				1/4" x 5/16"	601-45	...
	04061-0406			1/4" x 3/8"	601WG-46	...
10463	04061-0406	UR3-46		1/4" x 3/8"	601-46	...
	04061-0408			1/4" x 1/2"	601-48	...
				1/4" x 3/4"	601-412	...
				5/16" x 1/4"	601WG-54	...
				5/16" x 1/4"	601-54	...
				5/16" x 3/8"	601-56	...
10462	04061-0604	UR3-64		3/8" x 1/4"	601-64	...
				3/8" x 1/4"	601WG-64	...
10467	04061-0608	UR3-68		3/8" x 1/2"	601-68	...
				3/8" x 1/2"	601WG-68	...
	04061-0610	UR3-610		3/8" x 5/8"	601-610	...
				3/8" x 3/4"	601-612	...
10461	04061-0804	UR3-84		1/2" x 1/4"	601-84	...
10464	04061-0806	UR3-86		1/2" x 3/8"	601-86	...
				1/2" x 3/8"	601WG-86	...
				1/2" x 5/8"	601WG-810	...
10469	04061-0810	UR3-810		1/2" x 5/8"	601-810	...
				1/2" x 3/4"	601-812	...
				5/8" x 1/4"	601-104	...
10473	04061-1006	UR3-106		5/8" x 3/8"	601-106	...
				5/8" x 1/2"	601WG-108	...
10468	04061-1008	UR3-108		5/8" x 1/2"	601-108	...
				5/8" x 3/4"	601-1012	...
				5/8" x 3/4"	601WG-1012	...
				5/8" x 15/16"	601RG-1015	...
				3/4" x 3/8"	601-126	...
10471	04061-1012	UR3-1012		3/4" x 1/2"	601-128	...
10470	04061-1210	UR3-1210		3/4" x 5/8"	601-1210	...

UR3 661FHD 227 46-FF

WARNING: This product can expose you to chemicals, including lead, which are known to the State of California to cause cancer and birth defects or other reproductive harm. For more information, visit www.P65Warnings.ca.gov

BRASS

SAE 45° FLARE

BRASS FITTINGS

BRASS FLARE SWIVEL FITTINGS

FORGED SWIVEL

SAE# 010108

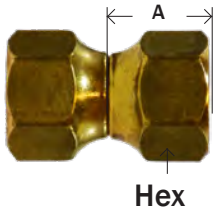
700
04070

MIDLAND	AMC	CHAMPION	LIST	FEMALE FLARE UNF	MAF #	MAF PRICE
10481	04070-04	US4-4		1/4"	700-4	...
10482	04070-05	US4-5		5/16"	700-5	...
10483		US4-6		3/8"	700-6	...
10483L	04070-06			3/8"	700SH-6	...
10484		US4-8		1/2"	700-8	...
10484L	04070-08			1/2"	700SH-8	...
10485	04070-10	US4-10		5/8"	700-10	...
				5/8"	700SH-10	...
10486	04070-12	US4-12		3/4"	700-12	...

1350 US4 14FSV 34

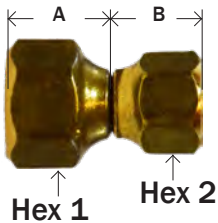
REDUCING SWIVELS700R
04075

MIDLAND	AMC	CHAMPION	LIST	FEMALE FLARE UNF	MAF #	MAF PRICE
10487	04075-0604	US4-64		3/8" x 1/4"	700R-64	...
10488	04075-0806	US4-86		1/2" x 3/8"	700R-86	...
10489	04075-1008	US4-108		5/8" x 1/2"	700R-108	...

FORGED SWIVEL ELBOWS701
04071

MIDLAND	AMC	CHAMPION	LIST	MALE FLARE X FEMALE FLARE	MAF #	MAF PRICE
10493	04071-0404	ES4-44		1/4"	ES4-44	...
10494	04071-0606	ES4-66		3/8"	ES4-66	...
				3/8" x 1/2"	ES4-68	...
10495	04071-0808	ES4-88		1/2"	ES4-88	...
10496	04071-1010	ES4-1010		5/8"	ES4-1010	...
10497	04071-1212	ES4-1212		3/4"	ES4-1212	...

ES4

DRUM ADAPTERS

SAE# 010165

K1
04030

MIDLAND	AMC	CHAMPION	LIST	MALE FLARE X FIP	MAF #	MAF PRICE
50011	04030-0804	K1-8		1/4" x 1/2"	K1-48	...
50001	04030-1204			1/4" x 3/4"	K1-412	...
	04030-1206			3/8" x 3/4"	K1-612	...
	04030-1208			1/2" x 3/4"	K1-812	...
GASKET						
	04032-08			1/2"	KG-8	...
	04032-12			3/4"	KG-12	...

• Straight Thread

WARNING: This product can expose you to chemicals, including lead, which are known to the State of California to cause cancer and birth defects or other reproductive harm. For more information, visit www.P65Warnings.ca.gov



45° FLARE

BRASS FITTINGS

FLARE SWEAT FITTINGS-SOLDER CONNECTORS



04082

MIDLAND	AMC	CHAMPION	LIST	FLARE X SWEAT	MAF #	MAF PRICE
10600	04082-0404	US3-44		1/4" x 1/4"	48S-44	...
10602	04082-0406	US3-46		1/4" x 3/8"	48S-46	...
10620				3/8" x 1/4"	48S-64	...
10612	04082-0606	US3-66		3/8" x 3/8"	48S-66	...
10613	04082-0608			3/8" x 1/2"	48S-68	...
10621	04082-0808			1/2" x 1/2"	48S-88	...
10611				1/2" x 5/8"	48S-810	...
10614	04082-1010	US3-1010		5/8" x 5/8"	48S-1010	...
10622				5/8" x 7/8"	48S-1014	...
10615	04082-1212	US3-1212		3/4" x 3/4"	48S-1212	...
10616				3/4" x 7/8"	48S-1214	...
10617				7/8" x 7/8"	48S-1414	...
10618				1" x 1-1/8"	48S-1618	...
10619				1-1/8" x 1-1/8"	48S-1818	...

FL X SWT ELBOW



04089

MIDLAND	AMC	CHAMPION	LIST	FLARE X SOLDER OD FEMALE FLARE UNF	MAF #	MAF PRICE
				1/4" x 1/4"	49S-44	...
				3/8" x 3/8"	49S-66	...
				1/2" x 1/2"	49S-88	...

SPACE HEATER FITTINGS

9/16-24 FINE THREAD FLARE NUT/CAP



#M-82SH
04800
04840
41FT
800

MIDLAND	AMC	CHAMPION	LIST	SIZE	MAF #	MAF PRICE
14001	04800-06			3/8	41FT-6	...
				3/8 CAP	40FT-6	...

FEMALE ADAPTER



#M-80SH
04806
46FT
805

MIDLAND	AMC	CHAMPION	LIST	SIZE	MAF #	MAF PRICE
14018	04806-0606			3/8 x 3/8	46FT-66	...
14025	04806-0608			3/8 x 1/2	46FT-68	...
	04806-0612			3/8 x 3/4	46FT-612	...

WARNING: This product can expose you to chemicals, including lead, which are known to the State of California to cause cancer and birth defects or other reproductive harm. For more information, visit www.P65Warnings.ca.gov

BRASS

SPACE HEATER/ GAS RANGE FITTINGS**BRASS FITTINGS****SPACE HEATER UNION/TEE**

MIDLAND	AMC	CHAMPION	LIST	SIZE	MAF #	MAF PRICE
14011	04802-06			3/8	42FT-6	...
	04844-06			3/8 TEE	44FT-6	...

04802

SPACE HEATER MALE ADAPTER/ ELBOWS

MIDLAND	AMC	CHAMPION	LIST	SIZE	MAF #	MAF PRICE
14016	04808-0606			3/8 x 3/8	48FT-66	...
14017	04808-0608			3/8 x 1/2	48FT-68	...
	04809-0608			3/8 x 1/2 *	49FT-68	...
	04850-0608			3/8 x 1/2**	50FT-68	...

#M-83SH

*MALE ELBOW || ** FEMALE ELBOW

BRASS GAS RANGE FITTINGS**BRASS MALE ADAPTERS - 15/16-16 FLARE THREAD**45RG
408RC
04748

MIDLAND	AMC	CHAMPION	LIST	MALE FLARE X MALE NPTF	MAF #	MAF PRICE
35130				3/8" x 3/8"(1/8 TAP)	48WT-662	...
35133				3/8" x 3/8"(1/4 TAP)	48WT-664	...
35131				3/8" x 1/2"(3/8 TAP)	48WT-66-820	...
35132	04088-080806			1/2" x 1/2" (3/8" FIP TAP)	48WT-686	...
35134	04748-1508			15/16" x 1/2"	48WT-886	...
35135		U1GA- 10DE		15/16" x 1/2" (3/8" FIP TAP)	48RGT-158	...
	04748-151208			15/16" x 3/4" (1/2" FIP TAP)	48RGT-1512	...

CAP & NUT

04741

MIDLAND	AMC	CHAMPION	LIST	SIZE	MAF #	MAF PRICE
35186				15/16"	40RG-15	...
	04741-15			15/16-16"*	41SRG	...

*NUT

BRASS FEMALE ADAPTERS

MIDLAND	AMC	CHAMPION	LIST	SIZE	MAF #	MAF PRICE
35136	04746-1508			15/16" x 1/2"	46RG-158	...
35142	04746-1512			15/16" x 3/4"	46RG-1512	...

WARNING: This product can expose you to chemicals, including lead, which are known to the State of California to cause cancer and birth defects or other reproductive harm. For more information, visit www.P65Warnings.ca.gov



POL FITTINGS

BRASS FITTINGS

TEE CONNECTION



2000
05200

MIDLAND	AMC	CHAMPION	LIST	PIPE SIZE	MAF #	MAF PRICE
34001	05200	POL-T1		1/4" Inverted flare x 1/4" MPT	2000	...
				2000 + 200IAB	2001	...

41-1-390-0014 2000

TAILPIECE WITH FLATS



2001A
05220

1/4 NPT

MIDLAND	AMC	CHAMPION	LIST	PIPE SIZE	MAF #	MAF PRICE
34011	05220	POL-LTP		2.34 w/ wrench Flats	2001A	...
34012		POL-LTPH		2.13 w/ Hex	2001AHN	...

1001AUL 21605 M-2001-A 2002A 2001AHN

STANDARD NUT



2001B
05221

MIDLAND	AMC	CHAMPION	LIST	PIPE SIZE	MAF #	MAF PRICE
34016	05221	POL-N		.880-14 LH	2001B	...
				Large hex	2001BLH	...

7/8" Hex

2001B

TAILPIECE & NUT ASSEMBLY



MANIFOLD
BLOCK TEE
ASSEMBLY

2002AB
05225

MIDLAND	AMC	CHAMPION	LIST	PIPE SIZE	MAF #	MAF PRICE
34022	05225	POL-NLTP		1/4	2001AB	...
					2001AHB	...
					200IS	...

2002AB

POL CAP



2004
05204

MIDLAND	AMC	CHAMPION	LIST	PIPE SIZE	MAF #	MAF PRICE
34031	05204	POL-N5		.880-14LH	2004	...

ME1699 POL2004 1004A M-2004

WARNING: This product can expose you to chemicals, including lead, which are known to the State of California to cause cancer and birth defects or other reproductive harm. For more information, visit www.P65Warnings.ca.gov

BRASS

POL FITTINGS

BRASS FITTINGS

POL PLUG WITH CHAIN

2014
2014

MIDLAND	AMC	CHAMPION	LIST	DESCRIPTION	MAF #	MAF PRICE
34141				POL PLUG WITH CHAIN	2014	...

ME1691-1

SINGLE PIECE POL ADAPTER

2008
05208

MIDLAND	AMC	CHAMPION	LIST	DESCRIPTION	MAF #	MAF PRICE
34130	05208			MALE POL X 1/4 FPT	2008	...
34131				MALE POL X 1/2 FPT	2009	

ME351 ME357

ADAPTERS

35792
35810
05205

MIDLAND	AMC	CHAMPION	LIST	PIPE SIZE	MAF #	MAF PRICE
34041	05205	POL-U2-6		3/8 Flare x .880-14LH	2005	...
34046	05206	POL-U2-8		1/2 Flare x .880-14LH	2006	...
34051	05207	POL-U2-10		5/8 Flare x .880-14LH	2007	...

ME3510 2906E 2007

WARNING: This product can expose you to chemicals, including lead, which are known to the State of California to cause cancer and birth defects or other reproductive harm. For more information, visit www.P65Warnings.ca.gov



POL FITTINGS

BRASS FITTINGS

TAILPIECE ASSEMBLY W/HEX HEAD NUT & STEM



PART #	LENGTH	
34080	1/4 NPT X POL 2 LONG HARD NOSE 2 OAL	----
34082	MALE POL X 3/8 NPT	----

2906D ME352



PART #	LENGTH	
34088	MPOL HARD NOSE 9/16- 18 FE LH THREAD	----

ME1650



PART #	LENGTH	
34084	MPOL X 1/4 HOSE BARB 7/8 HEX	----

ME5930 970JR

SOFT NOSE TAILPIECE ASSEMBLY



PART #	LENGTH	
34060	1/4 NPT X POL 2.1 LONG #60 ORIFICE	----
34061	1/4 MPT X POL SOFT NOSE 2-1/2	----
34062	1/4 NPT POL SOFT NOSE #60 ORIFICE 2.3 LONG	----
34063	POL X 9/16-18 LH TAIL- PIECE SOFT NOSE	----
34064	1/4 NPT X POL SOFT NOSE 2 3/8 LONG	----

ME1638 2003-T-GH-60 2002 2018-L 2003-T 970S

HAND WHEEL POL ADAPTERS



PART #	LENGTH	
34065	MPOL SOFT NOSE X 1/4 HOSE BARB BR.WHEEL	----

ME1656AR



PART #	LENGTH	
34072	1/4 MPT POL SOFT NOSE W/PLASTIC WHEEL	----

ME1654



PART #	LENGTH	
34073	1/4 MPT POL SOFT NOSE WITH BRASS WHEEL	----

ME1654AR



PART #	LENGTH	
34074	MPOL SOFT NOSE X 1/4 HB W/PLASTIC WHEEL	----

ME1656

VISIT MIDLANDINDUSTRIES.COM/LPGAS TO
SEE OUR COMPLETE OFFERING OF LP GAS
PRODUCTS

WARNING: This product can expose you to chemicals, including lead, which are known to the State of California to cause cancer and birth defects or other reproductive harm. For more information, visit www.P65Warnings.ca.gov

BRASS

POL FITTINGS

BRASS FITTINGS

PROPANE MOTOR FUEL FILL ADAPTER

- Allows a standard POL fitting to be adapted to fill an engine fuel tank.

PART #	LENGTH	
34079	FE POL X 1 3/4 ACME FUEL FILL ADPT	----

ME458 2017

FEMALE POL X MIP ADAPTER

PART #	LENGTH	
34111	1/4 MPT X FE POL ADAPTER	----
34112	3/8 MPT X FE POL ADAPTER	----
34113	1/2 MPT X FE POL ADAPTER	----
34114	3/4 MPT X FE POL ADAPTER	----

2011-B ME285 2011-D 2011-E

FEMALE FPT X FEMALE POL ADAPTER

PART #	LENGTH	
34120	1/4 FPT X FE POL	----
34121	3/8 FPT X FE POL	----
34122	1/2 FPT X FE POL	----
34123	3/4 FPT X FE POL	----

2016-B ME302 2016-D ME304

POL O-RING ONLY

PART #	LENGTH	
34143	POL O-RING ONLY	----

C5-OR-POL 568-110-01

POL PLASTIC DUST PLUG

PART #	LENGTH	
34160	POL PLASTIC DUST PLUG	----

ME970P

APPLIANCE TEE

- Tap & Add

PART #	LENGTH	
34170	M.POLXF.POL W/1-20M CYL AND 1/4 INV FLAR	----

2090



- With QCC1 connection

PART #	LENGTH	
34174	QCC1 X F. POL W/1-20 MALE CYLINDER THD	----

2013

DUAL APPLIANCE TEE

PART #	LENGTH	
34176	M.POL X (2) OF 1-20 MALE CYLINDER THREAD	----

2099

WARNING: This product can expose you to chemicals, including lead, which are known to the State of California to cause cancer and birth defects or other reproductive harm. For more information, visit www.P65Warnings.ca.gov



JIC 37° FLARE STRAIGHTS

BRASS FITTINGS

STRAIGHT TUBE UNION



PART #	TUBE OD	TUBE THREAD	L	HEX	WORKING PRESSURE	
28966	1/4	7/16-20	1.35	0.49	3250 psi	----
28969	3/8	9/16-18	1.41	0.63	3250 psi	----
28970	1/2	3/4-16	1.62	0.81	3250 psi	----
28971	3/4	1-1/16-12	2.14	1.13	3250 psi	----
28972	1"	1-5/16-12	2.25	1.38	2600 psi	----

SBC 132403 HTXB

FEMALE STRAIGHT ADAPTER



PART #	TUBE OD	PIPE	TUBE THREAD	L	HEX	WORKING PRESSURE	
28957	1/4	1/8-27	7/16-20	1.19	0.56	3250 psi	----
28958	1/4	1/4-18	7/16-20	1.40	0.75	3250 psi	----
28959	3/8	1/4-18	9/16-18	1.40	0.75	3250 psi	----
28960	3/8	3/8-18	9/16-18	1.40	0.88	3250 psi	----
28961	1/2	3/8-18	3/4-16	1.56	0.88	3250 psi	----
28962	1/2	1/2-14	3/4-16	1.79	1.13	3250 psi	----
28963	5/8	1/2-14	7/8-14	1.87	1.13	3250 psi	----
28964	3/4	3/4-1/4	1-1/16-12	2.06	1.38	2600 psi	----

STRAIGHT



PART #	TUBE OD	A NPTF	TUBE THREAD	L	HEX	WORKING PRESSURE	
28701	1/4	1/8-27	7/16-20	1.22	0.45	3250 psi	----
28702	1/4	1/4-18	7/16-20	1.37	0.56	3250 psi	----
28703	1/4	3/8-18	7/16-20	1.42	0.75	3250 psi	----
28704	5/16	1/8-27	1/2-20	1.41	0.56	3250 psi	----
28705	5/16	1/4-18	1/2-20	1.42	0.56	3250 psi	----
28706	3/8	1/8-27	9/16-18	1.24	0.63	3250 psi	----
28707	3/8	1/4-18	9/16-18	1.43	0.63	3250 psi	----
28708	3/8	3/8-18	9/16-18	1.38	0.75	3250 psi	----
28709	3/8	1/2-14	9/16-18	1.69	0.88	3250 psi	----
28710	1/2	1/4-18	3/4-16	1.53	0.81	3250 psi	----
28711	1/2	3/8-18	3/4-16	1.53	0.81	3250 psi	----
28712	1/2	1/2-14	3/4-16	1.79	0.88	3250 psi	----
28713	1/2	3/4-14	3/4-16	1.85	1.13	2600 psi	----
28714	5/8	3/8	7/8-14	1.84	0.94	3250 psi	----
28715	5/8	1/2-14	7/8-14	1.89	0.94	3250 psi	----
28716	5/8	3/4-14	7/8-14	1.95	1.13	2600 psi	----
28748	3/4	1/2-14	1 1/16-12	2.06	1.13	2925 psi	----
28717	3/4	3/4-14	1 1/16-12	2.06	1.13	2600 psi	----
28749	3/4	1-11 1/2	1 1/16-12	2.25	1.38	1950 psi	----
28719	1	3/4-14	1 5/16-12	2.06	1.13	2275 psi	----
28718	1	1-11 1/2	1 5/16-12	2.3	1.38	1950 psi	----

B2404 SB FTXB

STRAIGHT SWIVEL ADAPTER



PART #	TUBE OD	A NPTF	TUBE THREAD	L	HEX	WORKING PRESSURE	
28752	1/4	1/4-18	7/16-20	1.389	.563	3250 psi	----
28753	3/8	1/4-18	9/16-18	1.6	.563	3250 psi	----
28754	3/8	3/8-18	9/16-18	1.574	.690	2925 psi	----
28756	1/2	1/2-14	3/4-16	1.706	.875	2600 psi	----

B6505 SJS

JIC 37° SHAPES

BRASS FITTINGS

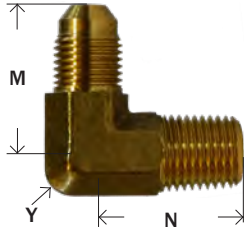
90° FORGED ELBOW

• Swivel available

PART #	TUBE OD	TUBE THREAD	A NPTF	M	N	Y	WORKING PRESSURE	
28760F	1/4	7/16-20	1/8-27	0.89	0.78	0.5	2160 psi	----
28762F	1/4	7/16-20	1/4-18	1.05	1.03	0.53	1846 psi	----
28766F	5/16	1/2-20	1/4-18	1.10	1.10	0.55	3905 psi	----
28768F	3/8	9/16-18	1/8-27	1.06	1.00	0.56	3128 psi	----
28770F	3/8	9/16-18	1/4-18	1.06	1.09	0.54	1564 psi	----
28772F	3/8	9/16-18	3/8-18	1.15	1.22	0.74	1464 psi	----
28773F	3/8	9/16-18	1/2-14	1.22	1.47	0.90	1265 psi	----
28774F	1/2	3/4-16	3/8-18	1.25	1.22	0.81	1467 psi	----
28777F	1/2	3/4-16	1/2-14	1.31	1.47	0.90	1265 psi	----
28778F	1/2	3/4-16	3/4-14	1.4	1.59	0.89	2061 psi	----
28780F	5/8	7/8-14	1/2-14	1.45	1.47	0.88	1265 psi	----
28781F	3/4	1 1/16-12	1/2-14	1.66	1.56	1.08	1265 psi	----
28783F	3/4	1 1/16-12	3/4-14	1.66	1.59	1.06	1084 psi	----
28784F	1	1 5/16-12	3/4-14	1.88	1.77	1.32	1802 psi	----
28786F	1	1 5/16-12	1-11 1/2	1.81	1.97	1.3	2361 psi	----

DL3B2 3F69CL GGL6A1 F23L2 EE48D3 EE46B2 FF45A2 F48C3 FF22C3 D49B1 D25B1 3F47C1

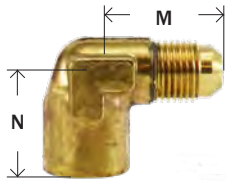
FEMALE ELBOW FORGED BODY

PART #	TUBE OD	TUBE THREAD	A NPTF	M	N	WORKING PRESSURE	
28973	1/4	7/16-20	1/8-27	1.08	0.66	2797 psi	----
28974	1/4	7/16-20	1/4-18	1.25	0.55	3066 psi	----
28975	3/8	9/16-18	1/4-18	1.23	0.88	2842 psi	----

B2502 EBF DTXB

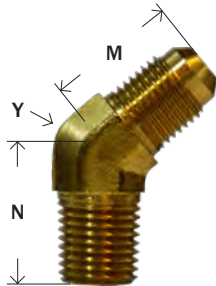
45° FORGED ELBOW

• Swivel available

PART #	TUBE OD	TUBE THREAD	A NPTF	M	N	Y	WORKING PRESSURE	
28722F	1/4	7/16-20	1/8-27	0.72	0.64	0.5	4367 psi	----
28724F	1/4	7/16-20	1/4-18	0.81	0.84	0.53	3750 psi	----
28728F	5/16	1/2-20	1/4-18	0.88	0.86	0.54		
28729F	3/8	9/16-18	1/8-27	0.83	0.65	0.63	3128 psi	----
28731F	3/8	9/16-18	1/4-18	0.83	0.86	0.63	3128 psi	----
28733F	3/8	9/16-18	3/8-18	0.91	0.95	0.81	3100 psi	----
28734F	3/8	9/16-18	1/2-14	1.03	1.17	0.94	2826 psi	----
28736F	1/2	3/4-16	3/8-18	0.98	0.95	0.75	2938 psi	----
28738F	1/2	3/4-16	1/2-14	1.13	1.17	0.86	2826 psi	----
28740F	5/8	7/8-14	1/2-14	1.13	1.08	0.88		
28742F	3/4	1 1/16-12	3/4-14	1.28	1.2	1.13	2442 psi	----

B2503 FBC-F VTXB

THREAD CHART

SIZE	JIC THREAD
1/8	5/16-24
3/16	3/8-24
1/4	7/16-20
5/16	1/2-20
3/8	9/16-18
1/2	3/4-16
5/8	7/8-14
3/4	1-1/16-12
1	1-5/16-12

WARNING: This product can expose you to chemicals, including lead, which are known to the State of California to cause cancer and birth defects or other reproductive harm. For more information, visit www.P65Warnings.ca.gov



INVERTED FLARE

BRASS FITTINGS

INVERTED FLARE FITTINGS



Tube O.D.	1/8	3/16	1/4	5/16	3/8	7/16	1/2	5/8	3/4	7/8	1
Thread O.D. threads per inch	5/16-28	3/8-24	7/16-24	1/2-20	5/8-18	11/16-18	3/4-18	7/8-18	1-1/16-16	1-3/16-16	1-5/16-16

•Typical Application

Hydraulic brake, power steering, fuel lines and transmission cooler lines, LP and natural gas.

•Working Pressure Ranges

Temperature and type of tubing used are important factors. However, the following table is a

PSI	Tube O.D. (in.)	Tube Wall (in.)
2800	1/8	.030
1900	3/16	.030
1400	1/4	.030
1200	5/16	.032
1000	3/8	.032
750	1/2	.032
650	5/8	.035
550	3/4	.035

good guide for proper selection. Temperature 73°F with copper tubing:

•Vibration

Excellent resistance.

•Temperature Range

-65°F to +250°F (-53°C to +121°C) range at maximum operating pressures.

•Used With

Copper, brass, aluminum and steel hydraulic tubing that can be flared.

•Advantages

Very low cost and reusable. Seats and threads are internal and protected. Compact, excellent vibration life. Short nut affords very close tube bends. Steel or brass

tube nut.

•Tolerance

+/- .03 on all dimensions.

•Conformance

Meets specifications and standards of ASA, ASME, SAE and MS (Military Standards).

•Assembly Instructions

- 1-Cut tubing to desired length. Make sure all burrs are removed and the ends are cut square.
- 2- Slide nut on tube. Threaded end "A" of nut must face out.
- 3- Flare end of tube with a 45° flaring tool.
 - a- Measure flare diameter.
 - b- Examine flare for excessive thin out.
 - c- On thin wall, welded or brazed tubing, use double flare to prevent pinch-off and cracked flares.
- 4- Lubricate threads and assemble to fitting body. Nut should be turned hand tight.

STANDARD METRIC THREADS

Description Tube Size	Thread O.D.	Crest (Pitch)	Thread Description
Japanese 3/16"	10mm	1.0mm	M10 x 1.0
European 3/16"	10mm	1.0mm	M10 x 1.0
GM 6mm	12mm	1.0mm	M12 x 1.0
Fuel 5/16"	14mm	1.5mm	M14 x 1.5
Fuel 3/8"	16mm	1.5mm	M16 x 1.5

Measuring Metric Threads: Measure the O.D. of the threads and the crest to crest distance (pitch) in millimeters between threads.

Actual O.D. of male inverted flare threads

5/16"-28 2800 PSI 3/8"-24 1900 PSI 7/16"-24 1400 PSI 1/2"-20 1200 PSI 5/8"-18 1000 PSI

3/4"-18 750 PSI

7/8"-18 650 PSI

1-1/16"-16 550 PSI

1/8"

3/16"

1/4"

5/16"

3/8"

1/2"

5/8"

3/4"

WARNING: This product can expose you to chemicals, including lead, which are known to the State of California to cause cancer and birth defects or other reproductive harm. For more information, visit www.P65Warnings.ca.gov

BRASS

INVERTED FLARE

BRASS FITTINGS

ZINC CHROMATE STEEL NUT

SAE# 040110

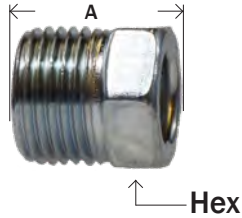

41IFS
41INS
04340

MIDLAND	AMC	CHAMPION	LIST	SIZE	MAF #	MAF PRICE
12001	04340-02	41IS-2		1/8"	41IFS-2	...
12002	04340-03	41IS-3		3/16"	41IFS-3	...
12018	04335-0304			3/16"	MA105X3X4	...
12003	04340-04	41IS-4		1/4"	41IFS-4	...
12004	04340-05	41IS-5		5/16"	41IFS-5	...
12005	04340-06	41IS-6		3/8"	41IFS-6	...
12000		41IS-7		7/16"	41IFS-7	...
12011		41IS-67		3/8"	MA105X6X7	...
12006	04340-08	41IS-8		1/2"	41IFS-8	...
12007	04340-10	41IS-10		5/8"	41IFS-10	...
12008	04340-12	41IS-12		3/4"	41IFS-12	...
12083				7/8"	41IFS-14	...
12084				1"	41IFS-16	...

121XXX 2105 411FS 105 41W

LONG STEEL NUT

FOR DOMESTIC LINES

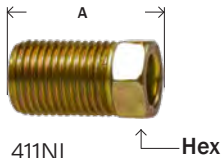

411NL
04330

MIDLAND	AMC	CHAMPION	LIST	SIZE	MAF #	MAF PRICE
12009	04330-03	41ISL-3		3/16"	41IFS-3L	...
12010	04330-04	41ISL-4		1/4"	41IFS-4L	...

7896

INVERTED FLARE BRASS NUT

SAE# 040110

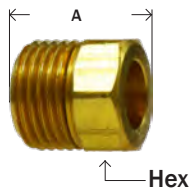

411FB
411NB
04341

MIDLAND	AMC	CHAMPION	LIST	SIZE	MAF #	MAF PRICE
12012	04341-02	411B-2		1/8"	411FB-2	
12013	04341-03	411B-3		3/16"	411FB-3	...
12014	04341-04	411B-4		1/4"	411FB-4	...
12015	04341-05	411B-5		5/16"	411FB-5	...
12016	04341-06	411B-6		3/8"	411FB-6	...
12017	04341-08	411B-8		1/2"	411FB-8	...
12019	04341-10	411B-10		5/8"	411FB-10	...
				3/4"	411FB-12	...
				1"	411FB-16	...

WARNING: This product can expose you to chemicals, including lead, which are known to the State of California to cause cancer and birth defects or other reproductive harm. For more information, visit www.P65Warnings.ca.gov



INVERTED FLARE

BRASS FITTINGS

ZINC STEEL METRIC TUBE NUTS - SEE OUR WEBSITE FOR BRAKE LINES AND TUBING



PART #	TUBESIZE	THREAD	REF#	
12260	3/16 British	3/8-24 Bubble	---	----
12261	3/16 European	M10 x 1.0 Bubble	276110	----
12262	3/16 Japanese	M10 x 1.0 Inv.	121050	----
12263	3/16 Domestic	1/2 x 20 Inv.	---	----
12264	3/16 Domestic	9/16 - 18 Inv.	121039	----
12266	3/16 Imported	M12 x 1.0 Bubble	276012	----
12268	1/4 Domestic	9/16 x 18 Inv.	121049	----
12269	1/4 Domestic	1/2 x 20 Inv.	121045	----
12270	6mm Imported	M12 x 1.0 Bubble		----
12274	5/16 Domestic	M14 x 1.5 Surface Seal	121069	----
12275	3/8 Domestic	M16 x 1.5 Surface Seal	121070	----

2100 411F 100 411B

UNION INTERNAL

SAE# 040101

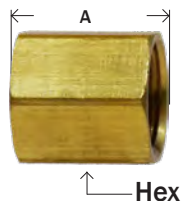

421F
421N
04342

MIDLAND	AMC	CHAMPION	LIST	INV. FLARE X INV. FLARE	MAF #	MAF PRICE
12022	04342-02	421-2		1/8"	2302X2	
				1/8"	421F-2	
12023	04342-03	421-3		3/16"	2302X3	...
				3/16"	421F-3	...
12024	04342-04	421-4		1/4"	2302X4	...
				1/4"	421F-4	...
12025	04342-05	421-5		5/16"	2302X5	...
				5/16"	421F-5	...
12026	04342-06	421-6		3/8"	2302X6	...
				3/8"	421F-6	...
12027	04342-08	421-8		1/2"	2302X8	...
				1/2"	421F-8	...
12028				5/8"	2302X10	...
				3/16" X 1/8"	421FR-32	...
				1/4" X 3/16"	421FR-43	...
				5/16" X 3/16"	421FR-53	...
				5/16" X 1/4"	421FR-54	...
				3/8" X 1/4"	421FR-64	...
				3/8" X 5/16"	421FR-65	...

302 2300 421FHD

WARNING: This product can expose you to chemicals, including lead, which are known to the State of California to cause cancer and birth defects or other reproductive harm. For more information, visit www.P65Warnings.ca.gov

BRASS

INVERTED FLARE

BRASS FITTINGS

FEMALE ADAPTER

SAE# 040103

46IFHD 252 46W

46IN
46IN
04346

MIDLAND	AMC	CHAMPION	LIST	INV. FLARE X FEMALE NPTF	MAF #	MAF PRICE
12029				1/8" x 1/8"	46IF-22	...
12032	04346-0302	46I-3A		3/16" x 1/8"	46IF-32	...
12033	04346-0402	46I-4A		1/4" x 1/8"	46IF-42	...
12030	04346-0404			1/4" x 1/4"	46IF-44	...
12034	04346-0502	46I-5A		5/16" x 1/8"	46IF-52	...
12035	04346-0604	46I-6B		3/8" x 1/4"	46IF-64	...
				3/8" x 3/8"	46IF-66	...
12031	04346-0704			7/16" x 1/4"	46IF-74	...
12037				1/2" x 1/4"	46IF-84	...
12036	04346-0806	46I-8C		1/2" x 3/8"	46IF-86	...
12039	04346-1008			5/8" x 1/2"	46IF-108	...
12099	04346-1212			3/4" x 3/4"	46IF-1212	...

MALE ADAPTER

SAE# 040102

481N
481F
04348

MIDLAND	AMC	CHAMPION	LIST	INV. FLARE X MALE NPTF	MAF #	MAF PRICE
12041	04348-0202	48I-2A		1/8" x 1/8"	48IF-22	
12042	04348-0302	48I-3A		3/16" x 1/8"	48IF-32	...
12053	04348-0304			3/16" x 1/4"	48IF-34	...
12043	04348-0402	48I-4A		1/4" x 1/8"	2202X4	...
				1/4" x 1/8"	48IF-42	...
12044	04348-0404	48I-4B		1/4" x 1/4"	2234X4	...
				1/4" x 1/4"	48IF-44	...
				1/4" x 3/8"	48IF-46	...
12045	04348-0502	48I-5A		5/16" x 1/8"	2200X5	...
				5/16" x 1/8"	2202X5	...
				5/16" x 1/8"	48IF-52	...
12046	04348-0504	48I-5B		5/16" x 1/4"	48IF-54	...
12055	04348-0506			5/16" x 3/8"	48IF-56	...
12047	04348-0602	48I-6A		3/8" x 1/8"	48IF-62	...
12048	04348-0604	48I-6B		3/8" x 1/4"	2202X6	...
				3/8" x 1/4"	48IF-64	...
12049	04348-0606	48I-6C		3/8" x 3/8"	2236X6	...
				3/8" x 3/8"	48IF-66	...
12104	04348-0704			7/16" x 1/4"	48IF-74	...
12038	04348-0804	48I-8B		1/2" x 1/4"	48IF-84	...
12050	04348-0806	48I-8C		1/2" x 3/8"	2202X8	...
				1/2" x 3/8"	48IF-86	...
				1/2" x 1/2"	2202X8X8	...
12051	04348-0808	48I-8D		1/2" x 1/2"	48IF-88	...
12052	04348-1008	48I-10D		5/8" x 1/2"	48IF-108	...
				5/8" x 3/4"	48IF-1012	...
12105	04348-1208			3/4" x 1/2"	48IF-128	...
12040	04348-1212	48I-12E		3/4" x 3/4"	48IF-1212	...
12107	04348-1608			7/8" x 3/4"	48IF-1412	...
12108	04348-1616			1" x 3/4"	48IF-1612	...
				1" x 1"	48IF-1616	...

Dimension data can change without notice. Please call when dimensions are critical.

WARNING: This product can expose you to chemicals, including lead, which are known to the State of California to cause cancer and birth defects or other reproductive harm. For more information, visit www.P65Warnings.ca.gov

2200 48IFHD 202 48W 200

INVERTED FLARE

BRASS FITTINGS

MALE INVERTED FLARE UNIONS



MIDLAND	AMC	CHAMPION	LIST	SIZE	MAF #	MAF PRICE
				1/4" x 3/16"	22IFS-43	
				5/16" x 3/16"	22IFS-53	...
				5/16" x 1/4"	22IFS-54	...
				3/8" x 1/4"	22IFS-64	...
				3/8" x 5/16"	22IFS-65	...

ELBOW

SAE# 040202



491N
491F
04349

MIDLAND	AMC	CHAMPION	LIST	INV. FLARE X MALE NPTF	MAF #	MAF PRICE
12057	04349-0202	49I-2A		1/8" x 1/8"	49IF-22	
12058	04349-0302	49I-3A		3/16" x 1/8"	49IF-32	...
12059	04349-0402	49I-4A		1/4" x 1/8"	2402X4	...
				1/4" x 1/8"	49IF-42	...
12054*				1/4" x 1/8"	49IFRH-42	...
12060	04349-0404	49I-4B		1/4" x 1/4"	49IF-44	...
12061	04349-0502	49I-5A		5/16" x 1/8"	49IF-52	...
12062	04349-0504	49I-5B		5/16" x 1/4"	49IF-54	...
12082	04394-0506			5/16" x 3/8"	49IF-56	...
12063	04349-0602	49I-6A		3/8" x 1/8"	49IF-62	...
12064	04349-0604	49I-6B		3/8" x 1/4"	2402X6	...
				3/8" x 1/4"	49IF-64	...
12065	04349-0606	49I-6C		3/8" x 3/8"	49IF-66	...
12114	04349-0804	49I-8B		1/2" x 1/4"	49IF-84	...
12066	04349-0806	49I-8C		1/2" x 3/8"	49IF-86	...
12067	04349-0808	49I-8D		1/2" x 1/2"	49IF-88	...
12056	04349-1006	49I-10C		5/8" x 3/8"	49IF-106	...
12068	04349-1008	49I-10D		5/8" x 1/2"	49IF-108	...
12069	04349-1208			3/4" x 1/2"	49IF-128	...
				3/4" x 3/4"	49IF-1212	...
12080	04394-1412			7/8" x 3/4"	49IF-1412	...
12081	04394-1616			1" x 1"	49IF-1616	...

*Restricted pipe end .062

400 2400 2491FHD 402 2491F 49W

WARNING: This product can expose you to chemicals, including lead, which are known to the State of California to cause cancer and birth defects or other reproductive harm. For more information, visit www.P65Warnings.ca.gov

BRASS

INVERTED FLARE

BRASS FITTINGS

45° ELBOW

SAE# 040302

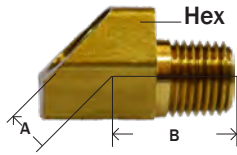

591F
941N
04394

MIDLAND	AMC	CHAMPION	LIST	INV. FLARE X MALE NPTF	MAF #	MAF PRICE
12070	04394-0202			1/8" x 1/8"	591F-22	...
12072	04394-0302	94I-3A		3/16" x 1/8"	591F-32	...
12073	04394-0402	94I-4A		1/4" x 1/8"	591F-42	...
12074	04394-0502	94I-5A		5/16" x 1/8"	591F-52	...
12075	04394-0504	94I-5B		5/16" x 1/4"	591F-54	...
12115	04394-0602			3/8" x 1/8"	591F-62	...
12076	04394-0604	94I-6B		3/8" x 1/4"	591F-64	...
12077	04394-0806	94I-8C		1/2" x 3/8"	591F-86	...
12079	04394-1008	94I-10D		5/8" x 1/2"	591F-108	...

154 2352 2591FHD 352 94W

UNION TEE

SAE# 040401



441F
441N
04344

MIDLAND	AMC	CHAMPION	LIST	SIZE	MAF #	MAF PRICE
12085	04344-02			1/8"	441F-2	
12086	04344-03	44I-3		3/16"	441F-3	...
12087	04344-04	44I-4		1/4"	441F-4	...
12088	04344-05	44I-5		5/16"	441F-5	...
12089	04344-06	44I-6		3/8"	441F-6	...
12090	04344-08	44I-8		1/2"	441F-8	...
				7/8"	441F-14	...

2441FHD 702 44I

STEEL PLUG

SAE# 040109

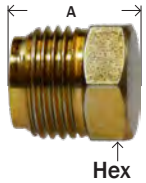

391N
391F
04399



STEEL						
MIDLAND	AMC	CHAMPION	LIST	SIZE	MAF #	MAF PRICE
12091	04339-03	41IP-3		3/16"	391F-3	...
12092	04339-04	41IP-4		1/4"	391F-4	...
12093	04339-05	41IP-5		5/16"	391F-5	...
12094	04339-06	41IP-6		3/8"	391F-6	...
BRASS						
12095				3/8"	391FB-6	...
12096				1/2"	391FB-8	...
12097				5/8"	391FB-10	...
12098				3/4"	391FB-12	...

▪ cored

106 41IP 131 2131

FEMALE ELBOW

SAE# 040203

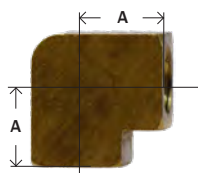

501F
501N
04350

MIDLAND	AMC	CHAMPION	LIST	INV. FLARE X FEMALE NPTF	MAF #	MAF PRICE
	04350-0320	50I-3A		3/16" x 1/8"	501F-32	
12110	04350-0402	50I-4A		1/4" x 1/8"	501F-42	
12111	04350-0502	50I-5A		5/16" x 1/8"	501F-52	...
12112	04350-0604	50I-6B		3/8" x 1/4"	501F-64	...
				1/2" x 3/8"	501F-86	...

450

WARNING: This product can expose you to chemicals, including lead, which are known to the State of California to cause cancer and birth defects or other reproductive harm. For more information, visit www.P65Warnings.ca.gov

INVERTED FLARE

BRASS FITTINGS

UNION ELBOW INV. FL X INV. FL

SAE# 040203

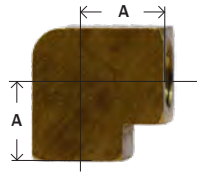

MIDLAND	AMC	CHAMPION	LIST	INV. FLARE X FEMALE NPTF	MAF #	MAF PRICE
12415	04355-04			1/4	55IF-4	
				5/16	55IF-5	
	04355-06			3/8	55IF-6	
				1/2	55IF-8	

MALE BRANCH TEE

SAE# 040425

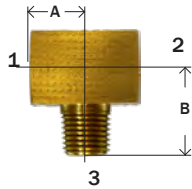

451F
451N
04345

MIDLAND	AMC	CHAMPION	LIST	INV. FLARE X MALE NPTF (1&2)X3	MAF #	MAF PRICE
12100	04345-0302	54I-3A		3/16" x 1/8"	451F-32	...
12101	04345-0402	54I-4A		1/4" x 1/8"	451F-42	...
12102	04345-0502	54I-5A		5/16" x 1/8"	451F-52	...
12103	04345-0604	54I-6B		3/8" x 1/4"	451F-64	...

145 245IFHD 602 2600 600

MALE RUN TEE

SAE# 040424

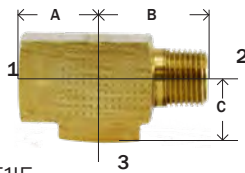

511F
511N
04351

MIDLAND	AMC	CHAMPION	LIST	INV. FLARE X MALE NPTF (1&3)X2	MAF #	MAF PRICE
12118	04351-0302	51I-3A		3/16" x 1/8"	511F-32	...
12119	04351-0402	51I-4A		1/4" x 1/8"	511F-42	...
12120	04351-0502	51I-5A		5/16" x 1/8"	511F-52	...
12121	04351-0604	51I-6B		3/8" x 1/4"	511F-64	...
				1/2" x 3/8"	511F-86	...

251IFHD 752 550 151

FEMALE BRANCH TEE

SAE# 040427

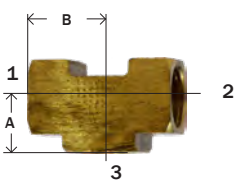

521F
521N
04352

MIDLAND	AMC	CHAMPION	LIST	INV. FLARE X FEMALE NPTF (1&2)X3	MAF #	MAF PRICE
12127		52I-3A		3/16" x 1/8"	521F-32	
12128				1/4" x 1/8"	521F-42	
12129	04352-0502			5/16" x 1/8"	521F-52	...
12130	04352-0604			3/8" x 1/4"	521F-64	...
				1/2" x 3/8"	521F-86	...
				1/2" x 1/2"	521F-88	...

252IFHD 652 136

FIPXMIPXINV FL TEE

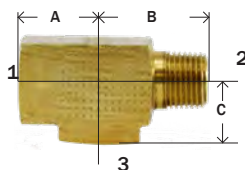

MIDLAND	AMC	CHAMPION	LIST	FIP X MIP X INV FL. SIZE	MAF #	MAF PRICE
				1/8" x 1/8" x 3/16"	53IF-32	
				1/8" x 1/8" x 1/4"	53IF-42	

WARNING: This product can expose you to chemicals, including lead, which are known to the State of California to cause cancer and birth defects or other reproductive harm. For more information, visit www.P65Warnings.ca.gov



INVERTED FLARE

BRASS FITTINGS

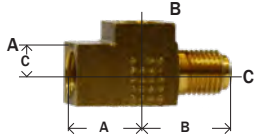
TOWED TRAILER BRAKE TEE

127BT

MIDLAND	AMC	CHAMPION	REF #	LIST	INVERTED SEAT	INV SEAT	MALE THREAD	MAF #	MAF PRICE
12147	08603	127BT-3	7900		3/16" 0.57	3/16" 0.76	3/16" 0.42	MA7900	...
12145	08608		7906		3/16" (1/2-20) 0.68	3/16" (3/8-24) 0.94	3/16" (1/2-20) 0.47	MA7906	...
12148	08605		7933		3/16" (9/16-18)	3/16" (3/8-24)	3/16" (9/16/18)	MA7933	...
12144	08607		7905		3/16" (9/16-20) 0.82	3/16" (3/8-24) 0.94	3/16" (9/16-20) 0.47	MA7905	...
12146	08609		7914		3/16" (7/16-24) 0.54	3/16" (3/8-24) 0.78	1/4" (7/16-24) 0.42	MA7914	...
12150	08604	127BT-4	7901		1/4" 0.56	3/16" 0.77	1/4" 0.43	MA7901	...
12149	08606		7904		1/4" (9/16-18) 0.81	3/16" (3/8-24) 0.93	1/4" (9/16-18) 0.50	MA7904	...
12151	08601	127BT-1	7898		1/4" 0.56	1/4" 0.77	1/4" 0.43	MA7898	...

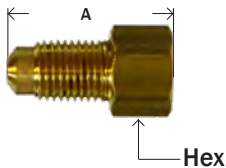
INVERTED FLARE AUTO FITTINGS**DUAL MASTER CYLINDER ADAPTER**

MIDLAND	AMC	CHAMPION	LIST	MALE FLARE X FEMALE INV.	MAF #	MAF PRICE
12200				3/16" x 3/16"	MA1441	...
12202				5/16" x 3/16"	MA7897	...

WARNING: This product can expose you to chemicals, including lead, which are known to the State of California to cause cancer and birth defects or other reproductive harm. For more information, visit www.P65Warnings.ca.gov

INVERTED FLARE

BRASS FITTINGS

DUAL MASTER CYLINDER ADAPTER

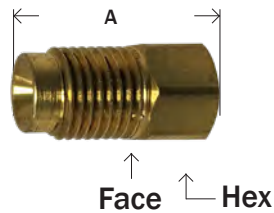

48STA
6641N
6011N

* Seals on hex face

MIDLAND	AMC	CHAMPION	REF#	LIST	MALE INVERTED THREAD	FEMALE INVERTED THREAD	MAF #	MAF PRICE
12206	08664-090918		7911		3/16(9/16-18)	3/16	MA7911	...
12209	08664-0809		7913		3/16(9/16-18)	3/16(1/2-20)	MA7913	...
12207	08664-030920		7910		3/16(9/16-20)	3/16	MA7910	...
12210	08661-0403	47I-43	7828		3/16	1/4	MA7828	...
12212	08661-0304	47I-34	7818		1/4	3/16	MA7818	...
12214*	08683	47I-47-HEX	7732		7/16-20	1/4	MA7732	...
12211	08664-0409		7908		1/4(9/16-18)	1/4	MA7908	...
12215	08661-0504		7917		1/4	5/16	MA7917	...
12213*	08681		7817		5/16	3/16	MA7817	...
12216	08661-0305	47I-35	7909		5/16	3/16	MA7909	...
12208	08664-0908	7912	7912		5/16	3/16(9/16-18)	MA7912	...
12218*	08684	47I-45-HEX	7727		5/16	1/4	MA7727	...
12220	08661-0405	47I-45	7829		5/16	1/4	MA7829	...
12222*	08685	47I-55-HEX	1074		5/16	5/16	MA1074	...
12221	08661-0506	47I-65	7915		5/16	3/8	MA7915	...
12224			7771		3/8" NPTF	5/16	MA7771	...
12217	08661-0605	47I-56	7916		3/8	5/16	MA7916	...

47W

CARBURETOR TO FUEL LINE ADAPTER - FORD

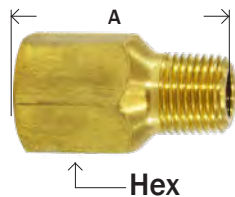

MIDLAND	AMC	CHAMPION	LIST	FEMALE TUBE OD X MALE NPTF	MAF #	MAF PRICE
12230				1/4"(1/2-20) x 1/8"	MA1513	

RESTRICTION PIPE ADAPTER (.0625 ORIFICE)

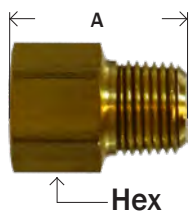

MIDLAND	AMC	CHAMPION	REF#	LIST	SIZE FIP X MIP	MAF #	MAF PRICE
12310			1512		1/8"	MA1512	

Dimension data can change without notice. Please call when dimensions are critical.

INVERTED FLARE

BRASS FITTINGS

SAE FLARE X INVERTED FLARE

4205

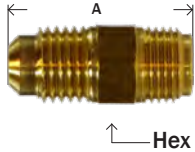

MIDLAND	AMC	CHAMPION	REF #	LIST	SAE FLARE X INV. FLARE	MAF #	MAF PRICE
12250		04MF-04MI	1518		1/4" x 3/16"	MA1518	----
12252			1522		1/4" x 1/4"	MA1522	----
12254		06MF-06MI	1553		3/8" x 5/16"	MA1553	----
12256			1563		3/8" x 3/8"	MA1563	----
12257			1554		3/8" x 7/16"	MA1554	----

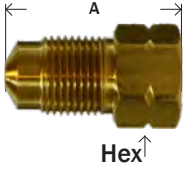
METRIC HYDRAULIC BRAKE FITTINGS**METRIC ADAPTER**

MIDLAND	AMC	CHAMPION	REF #	LIST	TUBE O.D./ FEMALE THREAD	MAF #	MAF PRICE
12335			1442		3/16"(3/8-24)	MA1442	...
12326			7935		3/16"(M10x1.0)	MA7935	...
12327			7936		3/16"(M10x1.0)	MA7936	...
12328			7937		3/16"(M10x1.0)	MA7937	...

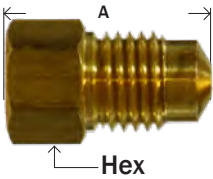
ADAPTER STANDARD TO METRIC BUBBLE

MIDLAND	AMC	CHAMPION	REF #	LIST	FEMALE INV. FLARE SEAT	MALE METRIC BUBBLE FLARE	MAF #	MAF PRICE
12336			7973		3/16" (3/8-24)	11x1.5	MA7973	...
12337			7970		3/16" (3/8-24)	(3/16") (10x1.25)	MA7970	...
12339			7972		3/16" (3/8-24)	13x1.5	MA7972	...
12341			7974		3/16" (3/8-24)	12x1.0	MA7974	...

FEMALE X MALE ADAPTERS

MIDLAND	LIST	FEMALE STANDARD FLARE SEAT	MALE BUBBLE FLARE	MAF #	MAF PRICE
12330		3/8-24 (3/16)	7/16-20	MA1330	...



MIDLAND	REF #	LIST	TUBE OD/ FEMALE THREAD	INVERTED MALE THREAD	MAF #	MAF PRICE
12205	1443		3/16 (3/8-24)	M10 x 1.0	MA1443	

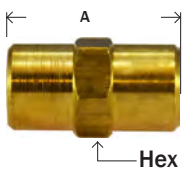

MIDLAND	LIST	FEMALE STANDARD FLARE	INVERTED MALE THREAD	MAF #	MAF PRICE
12329		3/8-24 (3/16)	M9 x 1.0	MA1329	

METRIC UNION

MIDLAND	REF #	LIST	SIZE	MAF #	LIST
12342	1594		British Brake Lines 3/16 (3/8-24 Bubble)	MA1594	
12343	7975		European Brake Lines 3/16"(10.0MM)	MA7975	...
12344	7934A		Japanese Brake Lines 3/16 (M10 x 1.0) Inverted	MA7934A	...
12345			GM Brake Lines 6mm M12 x 1.0 Bubble	MA2345	...

WARNING: This product can expose you to chemicals, including lead, which are known to the State of California to cause cancer and birth defects or other reproductive harm. For more information, visit www.P65Warnings.ca.gov

COMPRESSION

BRASS FITTINGS

COMPRESSION FITTINGS



These are NOT Lead Free
See Lead Free section for Lead Free products

Tube O.D.	1/8	3/16	1/4	5/16	3/8	7/16	1/2	5/8	3/4	7/8
Thread Size-B	5/16-24	3/8-24	7/16-24	1/2-24	9/16-24	5/8-24	11/16-20	13/16-18	1-18	1-1/8-18
Working Pressure	400	400	300	300	200	200	200	150	100	75

• Typical Application

Use with copper, aluminum and thermoplastic tubing. Not recommended for steel tubing. Manufactured for low and medium pressure tubing connection work where excessive vibration or tube movement is not involved. Not recommended for application using gaseous media.

• Pressure

See table above for working pressures at 73°F.

• Vibration

Fair resistance - use long nut when greater vibration resistance is needed.

• Temperature Range

-65°F to +250°F (-53°C to +121°C) range at maximum operating pressures. (Refer to tubing temperature range.)

• Used With

Aluminum, copper, brass and plastic tubing. Plastic tubing requires insert. Not recommended for steel tubing.

• Tolerance

+/- .02 on all dimensions. Dimension data can change without notice. Please call us when dimensions are critical.

• Conformance

Meets specifications and standards of ASA, ASME and SAE.

• Assembly Instructions

- 1- Cut tubing to desired length.
- 2- Slide nut and then sleeve on tube. Threaded end "A" of nut must face toward fitting.
- 3- Insert tubing into fitting body. Be sure tubing is bottomed on fitting shoulder.
- 4- Lubricate threads and assemble nut to fitting body.
- 5- Tighten nut hand tight. From that point, tighten with a wrench the number of turns indicated in the chart below.

Tube Size	Additional Turns from Hand Tight
1/8" thru 1/4"	1-1/4"
5/16"	1-3/4"
3/8" thru 1"	2-1/4"

• "L" at the end of a Part# means Light Pattern

-These fittings are completely interchangeable with full pattern fittings, but have been modified in some way. This modification is usually in the length of the pipe threads. Used in plumbing and light industrial applications.

WARNING: This product can expose you to chemicals, including lead, which are known to the State of California to cause cancer and birth defects or other reproductive harm. For more information, visit www.P65Warnings.ca.gov

Actual Profile of Compression Threads

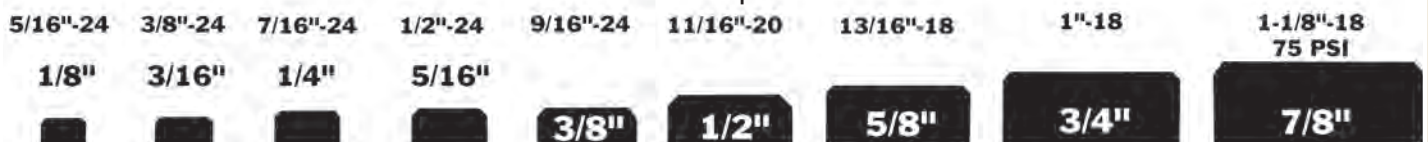

COMPRESSION**BRASS FITTINGS****BRASS SLEEVE**

• FERRULES
SAE# 060115

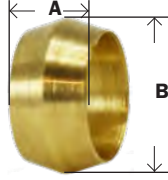

60
00060

MIDLAND	AMC	CHAMPION	LIST	SIZE	MAF #	MAF PRICE
18001	00060-02	60A-2	----	1/8"	60-2	----
				1/8"	260X2	----
18002	00060-03	60A-3	----	3/16"	60-3	----
				3/16"	260X3	----
18003	00060-04	60A-4	----	1/4"	60-4	----
				1/4"	260X4	----
18004	00060-05	60A-5	----	5/16"	60-5	----
				5/16"	260X5	----
18005	00060-06	60A-6	----	3/8"	60-6	----
				3/8"	260X6	----
18006	00060-07	60A-7	----	7/16"	60-7	----
				7/16"	260X7	----
18007	00060-08	60A-8	----	1/2"	60-8	----
				1/2"	260X8	----
18008	00060-10	60A-10	----	5/8"	60-10	----
				5/8"	260X10	----
18009	00060-12	60A-12	----	3/4"	60-12	----
				3/4"	260X12	----
18010	00060-14	60A-14	----	7/8"	60-14	----
18011			----	1"	260X16	----
					260X16	

60 260

BRASS NUT

SAE# 060110

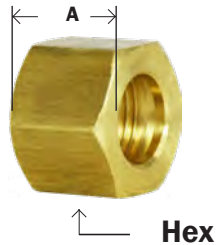

61
00061

MIDLAND	AMC	CHAMPION	LIST	SIZE	MAF #	MAF PRICE
				1/8"	61-2	----
18033	00061-02	61A-2	----	1/8"	261X2	----
				3/16"	61X3	----
18034	00061-03	61A-3	----	3/16"	261X3	----
18035L			----	1/4"	61-4	----
18035	00061-04	61A-4	----	1/4"	261X4	----
				5/16"	61-5	----
18036	00061-05	61A-5	----	5/16"	261X5	----
18037L	00061-06		----	3/8"	61-6	----
18037		61A-6	----	3/8"	261X6	----
				7/16"	61-7	----
18038	00061-07	61A-7	----	7/16"	261X7	----
18039L	00061-08		----	1/2"	61-8	----
18039		61AH-8	----	1/2"	261X8	----
18040L	00061-10		----	5/8"	61-10	----
18040		61AH-10	----	5/8"	261X10	----
				3/4"	61-12	----
18041	00061-12	61A-12	----	3/4"	261X12	----
				7/8"	61-14	----
18042	00061-14	61A-14	----	7/8"	261X14	----
18043			----	1"	261X16	----

61 261

WARNING: This product can expose you to chemicals, including lead, which are known to the State of California to cause cancer and birth defects or other reproductive harm. For more information, visit www.P65Warnings.ca.gov

COMPRESSION

BRASS FITTINGS

UNION

SAE# 060101BA

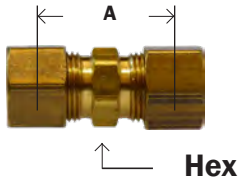

62
262
00062

MIDLAND	AMC	CHAMPION	LIST	SIZE	MAF #	MAF PRICE
				1/8"	62-2	----
18062	00062-02	62A-22	----	1/8"	262X2	----
				3/16"	62-3	----
18063	00062-03	62A-33	----	3/16"	262X3	----
18064L	00062-04		----	1/4"	62-4	----
18064		62A-44	----	1/4"	262X4	----
				5/16"	62-5	----
18065	00062-05	62A-55	----	5/16"	262X5	----
18066L	00062-06		----	3/8"	62-6	----
18066		62A-66	----	3/8"	262X6	----
				3/8"	62FC-6	----
18067	00062-07	62A-77	----	7/16"	62-7	----
18068L	00062-08		----	1/2"	62-8	----
18068		62A-88	----	1/2"	262X8	----
18069L	00062-10		----	5/8"	62-10	----
18069		62A-1010	----	5/8"	262X10	----
18070	00062-12	62A-1212	----	3/4"	262X12	----
18071L	00062-14		----	7/8"	62-14	----
18071		62A-1414	----	7/8"	262X14	----
18072	00062-16		----	1"	262X16	----

M-62

REDUCING UNION

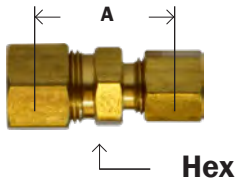

62R
00082

MIDLAND	AMC	CHAMPION	LIST	SIZE	MAF #	MAF PRICE
				3/16" x 1/8"	62R-32	----
18076	00082-0402	62A-42	----	1/4" x 1/8"	62R-42	----
18077	00082-0403	62A-43	----	1/4" x 3/16"	62R-43	----
18078	00082-0504	62A-54	----	5/16" x 1/4"	62R-54	----
18079	00082-0604	62A-64	----	3/8" x 1/4"	62R-64	----
				3/8" x 1/4"	262RX6X4	----
18080	00082-0605	62A-65	----	3/8" x 5/16"	62R-65	----
				1/2" x 1/4"	262RX8X4	----
18081	00082-0806	62A-86	----	1/2" x 3/8"	262RX8X6	----
18082	00082-1006	62A-106	----	5/8" x 3/8"	62R-106	----
18083	00082-1008	62A-108	----	5/8" x 1/2"	62R-108	----
				5/8" x 1/2"	262RX10X8	----
18085	00082-1406		----	7/8" x 3/8"	62R-146	----
18086	00082-1408		----	7/8" x 1/2"	262RX14X8	----
18084	00082-1410		----	7/8" x 5/8"	262RX14X10	----
				7/8" x 3/4"	262RX14X12	----

62-R

DRILLED THRU TANK UNION

00092

MIDLAND	AMC	CHAMPION	LIST	SIZE	MAF #	MAF PRICE
				1/8"	62T-2	----
				1/4"	62T-4	----
				3/8"	62T-6	----
				1/2"	62T-8	----
				5/8"	62T-10	----
				7/8"	62T-14	----

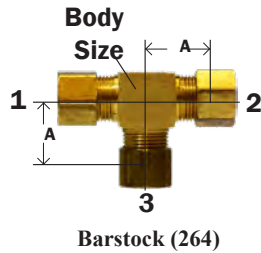
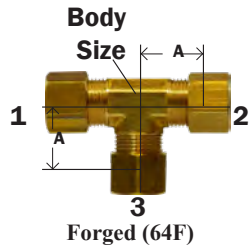
COMPRESSION**BRASS FITTINGS****TEE**
SAE# 06040164
00064

MIDLAND	AMC	CHAMPION	LIST	SIZE	MAF #	MAF PRICE
18101	00064-02		----	1/8"	64F-2	----
18101B		64A-22	----	1/8"	264X2	----
18102	00064-03		----	3/16"	64F-3	----
18102B		64A-33	----	3/16"	264X3	----
18103	00064-04	64AF-44	----	1/4"	64F-4	----
18103B		64A-44	----	1/4"	264X4	----
18104	00064-05	64A-55	----	5/16"	64F-5	----
18104B			----	5/16"	264X5	----
18105		64AF-66	----	3/8"	64F-6	----
18105B	00064-06	64A-66	----	3/8"	264X6	----
	00064-07	64A-77		7/16"	64F-7	----
				7/16"	264X7	----
18106	00064-08	64A-88	----	1/2"	64F-8	----
				1/2"	264X8	----
18107	00064-10		----	5/8"	64F-10	----
				5/8"	264X10	----
18108	00064-12	64A-1212	----	3/4"	64F-12	----
				3/4"	264X12	----
18109	00064-14	64A-1414	----	7/8"	64F-14	----
				7/8"	264X14	----
				1"	264X16	----

64 264C

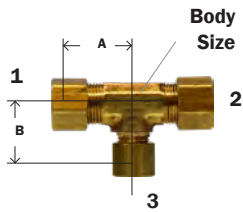
FORGED REDUCING TEE64R
00084

MIDLAND	AMC	CHAMPION	LIST	SIZE 1 X 2 X 3	MAF #	MAF PRICE
18114	00084-040402	64A-442	----	1/4" x 1/4" x 1/8"	64FR-442	----
18110	00084-040406	64A-446	----	1/4" x 1/4" x 3/8"	64FR-446	----
	00084-050504	64A-554		5/16" x 5/16" x 1/4"	64FR-554	----
18111	00084-060404	64A-644	----	3/8" x 1/4" x 1/4"	64FR-644	----
18115	00084-060604	64A-664	----	3/8" x 3/8" x 1/4"	64FR-664	----
18116	00084-080804	64A-884	----	1/2" x 1/2" x 1/4"	64FR-884	----
18117	00084-080806	64A-886	----	1/2" x 1/2" x 3/8"	64FR-886	----
18118	00084-101006	64A-10106	----	5/8" x 5/8" x 3/8"	64FR-10106	----
18119	00084-101008	64A-10108	----	5/8" x 5/8" x 1/2"	64FR-10108	----

64-R

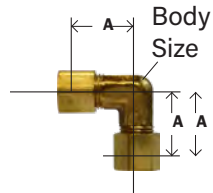
UNION ELBOW SAE# 06020165
00065

MIDLAND	AMC	CHAMPION	LIST	SIZE	MAF #	MAF PRICE
18122B	00065-02	65A-22	----	1/8"	265X2	----
18123	00065-03	65A-33	----	3/16"	265X3	----
18124	00065-04	65AF-44	----	1/4"	265X4	----
18125	00065-05	65A-55	----	5/16"	265X5	----
18126	00065-06	65A-66	----	3/8"	265X6	----
18127	00065-08	65A-88	----	1/2"	265X8	----
18128	00065-10	65A-1010	----	5/8"	65F-10	----
18129	00065-12	65A-1212	----	3/4"	65F-12	----
18130	00065-14	65A-1414	----	7/8"	65F-14	----

65 BSE2 165C 265C

COMPRESSION

BRASS FITTINGS

REDUCING ELBOW - FORGED

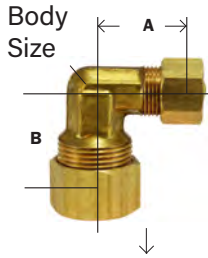

00085
65R

MIDLAND	AMC	CHAMPION	LIST		MAF #	MAF PRICE
18135	00085-0604	65A-64	----	3/8" x 1/4"	65FR-64	----
18136	00085-0806	65A-86	----	1/2" x 3/8"	65FR-86	----
18137	00085-1006	65A-106	----	5/8" x 3/8"	65R-106	----
	00085-1008	65A-108		5/8" x 1/2"	65R-108	

65-R

FEMALE ADAPTER

SAE# 060103

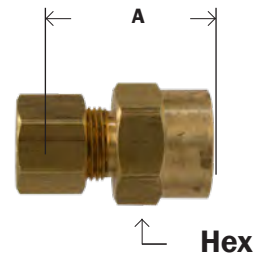

66

MIDLAND	AMC	CHAMPION	LIST	COMP. X FEMALE NPTF	MAF #	MAF PRICE
18142	00066-0202	66A-2A	----	1/8" x 1/8"	66-22	----
18143	00066-0302	66A-3A	----	3/16" x 1/8"	66-32	----
18144	00066-0304	66A-3B	----	3/16" x 1/4"	66-34	----
18145L	00066-0402		----	1/4" x 1/8"	66-42	----
18145		66A-4A	----	1/4" x 1/8"	266X4	----
18146L	00066-0404		----	1/4" x 1/4"	66-44	----
18146		66A-4B	----	1/4" x 1/4"	266X4X4	----
	00066-0406	66A-4C		1/4" x 3/8"	66-46	----
18148	00066-0408	66A-4D	----	1/4" x 1/2"	66-48	----
				1/4" x 5/8"	66S-410*	----
18149	00066-0502	66A-5A	----	5/16" x 1/8"	66-52	----
18150	00066-0504	66A-5B	----	5/16" x 1/4"	66-54	----
	00066-0506	66A-5C		5/16" x 3/8"	66-56	----
18152	00066-0602	66A-6A	----	3/8" x 1/8"	66-62	----
18153L	00066-0604		----	3/8" x 1/4"	66-64	----
18153		66A-6B	----	3/8" x 1/4"	266X6	----
18154L	00066-0606		----	3/8" x 3/8"	66-66	----
18154		66A-6C	----	3/8" x 3/8"	266X6X6	----
18155	00066-0608	66A-6D	----	3/8" x 1/2"	66-68	----
	00086-0610	66AS-610		3/8" x 5/8"	66S-610*	----
18156	00066-0612	66A-6E	----	3/8" x 3/4"	66-612	----
18157	00066-0804	66A-8B	----	1/2" x 1/4"	66-84	----
18158L	00066-0806		----	1/2" x 3/8"	66-86	----
18158		66A-8C	----	1/2" x 3/8"	266X8	----
18159L	00066-0808		----	1/2" x 1/2"	66-88	----
18159		66A-8D	----	1/2" x 1/2"	266X8X8	----
	00096-0808			1/2"	66T-88**	----
				1/2" x 5/8"	66S-810*	----
18160	00066-0812	66A-8E	----	1/2" x 3/4"	66-812	----
	00096-1006	66A-10C		5/8" x 3/8"	66-106	----
18162L	00066-1008		----	5/8" x 1/2"	66-108	----
18162		66A-10D	----	5/8" x 1/2"	266X10	----
18163	00066-1012	66A-10E	----	5/8" x 3/4"	66-1012	----
18164	00066-1208	66A-12D	----	3/4" x 1/2"	66-128	----
18165	00066-1212	66A-12E	----	3/4" x 3/4"	66-1212	----
18167	00066-1408		----	7/8" x 1/2"	66-148	----
18166	00066-1412	66A-14E	----	7/8" x 3/4"	66-1412	----

** Drilled thru

* Comp x SWT

• More sizes available online

WARNING: This product can expose you to chemicals, including lead, which are known to the State of California to cause cancer and birth defects or other reproductive harm. For more information, visit www.P65Warnings.ca.gov

BRASS

COMPRESSION

BRASS FITTINGS

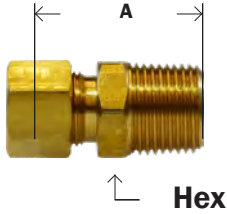
MALE ADAPTER
SAE# 06010268
00068

MIDLAND	AMC	CHAMPION	LIST	COMP. X MALE NPTF	MAF #	MAF PRICE
18175		68A-2X	----	1/8" x 1/16"	68-21	----
18176	00068-0202	68A-2A	----	1/8" x 1/8"	268X2	----
				3/16" x 1/8"	68-32	----
18177	00068-0302	68A-3A	----	3/16" x 1/8"	268X3	----
18178	00068-0304	68A-3B	----	3/16" x 1/4"	68-34	----
18179L			----	1/4" x 1/8"	68-42	----
18179	00068-0402	68A-4A	----	1/4" x 1/8"	268X4	----
18180L	00068-0404		----	1/4" x 1/4"	68-44	----
18180		68A-4B	----	1/4" x 1/4"	268X4X4	----
18181	00068-0406	68A-4C	----	1/4" x 3/8"	268X4X6	----
18182	00068-0408	68A-4D	----	1/4" x 1/2"	268X4X8	----
	00068-0502			5/16" x 1/8"	68-52	----
18183		68A-5A	----	5/16" x 1/8"	268X5	----
18184L	00068-0504		----	5/16" x 1/4"	68-54	----
18184		68A-5B	----	5/16" x 1/4"	268X5X4	----
18185	00068-0506	68A-5C	----	5/16" x 3/8"	68-56	----
18186	00068-0508	68A-5D	----	5/16" x 1/2"	68-58	----
18187L	00068-0602		----	3/8" x 1/8"	68-62	----
18187		68A-6A	----	3/8" x 1/8"	268X6X2	----
18188L	00068-0604		----	3/8" x 1/4"	68-64	----
18188		68A-6B	----	3/8" x 1/4"	268X6X4	----
18189L	00068-0606		----	3/8" x 3/8"	68-66	----
18189		68A-6C	----	3/8" x 3/8"	268X6X6	----
18190L	00068-0608		----	3/8" x 1/2"	68-68	----
18190		68A-6D	----	3/8" x 1/2"	268X6X8	----
				3/8" x 1/2"	68LP-68	----
18191	00068-0612	68A-6E	----	3/8" x 3/4"	68-612	----
18192	00068-0704	68A-7B	----	7/16" x 1/4"	268X7	----
18204	00068-0706	68A-7C	----	7/16" x 3/8"	68-76	----
18193L	00068-0804		----	1/2" x 1/4"	68-84	----
18193		68A-8B	----	1/2" x 1/4"	268X8X4	----
18194L	00068-0806		----	1/2" x 3/8"	68-86	----
18194		68A-8C	----	1/2" x 3/8"	268X8	----
18195L	00068-0808		----	1/2" x 1/2"	68-88	----
18195		68A-8D	----	1/2" x 1/2"	268X8X8	----
18196	00068-0812	68A-8E	----	1/2" x 3/4"	68-812	----
18216	00068-1004		----	5/8" x 1/4"	68-104	----
18197	00068-1006	68A-10C	----	5/8" x 3/8"	268X10X6	----
18198	00068-1008	68A-10D	----	5/8" x 1/2"	68-108	----
				5/8" x 1/2"	268X10	----
18199	00068-1012	68A-10E	----	5/8" x 3/4"	68-1012	----
18200	00068-1208	68A-12D	----	3/4" x 1/2"	68-128	----
18201	00068-1212	68A-12E	----	3/4" x 3/4"	68-1212	----
18202	00068-1408	68A-14D	----	7/8" x 1/2"	68-148	----
18203	00068-1412	68A-14E	----	7/8" x 3/4"	68-1412	----
18205	00068-1416		----	7/8" x 1"	68-1416	----
18206	00068-1612		----	1" x 3/4"	68-1612	----
18207	00068-1616		----	1" x 1"	68-1616	----

68

WARNING: This product can expose you to chemicals, including lead, which are known to the State of California to cause cancer and birth defects or other reproductive harm. For more information, visit www.P65Warnings.ca.gov

COMPRESSION

BRASS FITTINGS

MALE ELBOW SAE# 060202

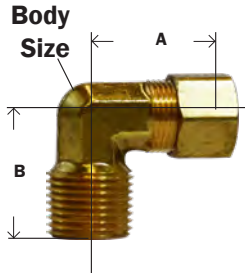

Forged (69F)

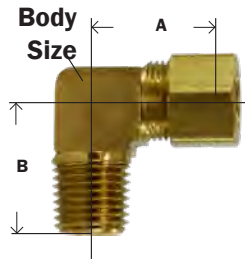

Barstock (269)

69
00069

* Barstock

** Compression x SWT

MIDLAND	AMC	CHAMPION	LIST	COMP. X MALE NPTF	MAF #	MAF PRICE
18219		69A-2X	----	1/8" x 1/16"	269X2X1	----
18220	00069-0202		----	1/8" x 1/8"	69F-22	----
18220B*		69A-2A	----	1/8" x 1/8"	269X2	----
18221	00069-0302		----	3/16" x 1/8"	69F-32	----
18221B*		69AF-3A	----	3/16" x 1/8"	269X3	----
18223	00069-0304	69A-3B	----	3/16" x 1/4"	69F-34	----
18223B*			----	3/16" x 1/4"	269X3X4	----
18224	00069-0402		----	1/4" x 1/8"	69F-42	----
				1/4" x 1/8"	69-42	----
18224B*	00069-0402B	69AF-4A	----	1/4" x 1/8"	269X4	----
18225	00069-0404	69AF-4B	----	1/4" x 1/4"	69F-44	----
18225B*		69A-4B	----	1/4" x 1/4"	269X4X4	----
18226	00069-0406	69A-4C	----	1/4" x 3/8"	69F-46	----
18226B			----	1/4" x 3/8"	269X4X6	----
18227	00069-0408	69A-4D	----	1/4" x 1/2"	69F-48	----
18228	00069-0502	69AF-5A	----	5/16" x 1/8"	69F-52	----
18228B*		69A-5A	----	5/16" x 1/8"	269X5	----
18229	00069-0504	69AF-5B	----	5/16" x 1/4"	69F-54	----
18229B*		69A-5B	----	5/16" x 1/4"	269X5X4	----
18230	00069-0506	69A-5C	----	5/16" x 3/8"	69F-56	----
18231	00069-0508		----	5/16" x 1/2"	69F-58	----
18232	00069-0602		----	3/8" x 1/8"	69F-62	----
18232B*		69A-6A	----	3/8" x 1/8"	269X6X2	----
18233	00069-0604	69AF-6B	----	3/8" x 1/4"	69F-64	----
18233B*		69A-6B	----	3/8" x 1/4"	269X6	----
18234	00069-0606	69AF-6C	----	3/8" x 3/8"	69-66	----
18234B*	00069-0606B	69A-6C	----	3/8" x 3/8"	269X6X6	----
18235	00069-0608	69A-6D	----	3/8" x 1/2"	69F-68	----
18235B*			----	3/8" x 1/2"	269X6X8	----
	00089-0610			3/8" x 5/8"	69S-610**	----
18248	00069-0612		----	3/8" x 3/4"	69F-612	----
18248B*		69A-6E	----	3/8" x 3/4"	269X6X12	----
18247	00069-0704	69A-7B	----	7/16" x 1/4"	69F-74	----
	00069-0706			7/16" x 3/8"	69F-76	----
18236	00069-0804	69A-8B	----	1/2" x 1/4"	69F-84	----
18236B*			----	1/2" x 1/4"	269X8X4	----
18237	00069-0806		----	1/2" x 3/8"	69F-86	----
18237B*		69A-8C	----	1/2" x 3/8"	269X8	----
18238	00069-0808		----	1/2" x 1/2"	69F-88	----
18238B*		69A-8D	----	1/2" x 1/2"	269X8X8	----
18239	00069-0812	69A-8E	----	1/2" x 3/4"	69F-812	----
18240	00069-1006	69A-10C	----	5/8" x 3/8"	69F-106	----
				5/8" x 3/8"	269X10X6	----

(Continued On Next Page)

69 269C BSE1 169C

WARNING: This product can expose you to chemicals, including lead, which are known to the State of California to cause cancer and birth defects or other reproductive harm. For more information, visit www.P65Warnings.ca.gov

BRASS

COMPRESSION

BRASS FITTINGS

MALE ELBOW-CONTINUED

SAE# 060202

MIDLAND	AMC	CHAMPION	LIST	COMP. X MALE NPTF	MAF #	MAF PRICE
18241	00069-1008		----	5/8" x 1/2"	69F-108	----
18241B*		69A-10D	----	5/8" x 1/2"	269X10	----
18242	00069-1012	69A-10E	----	5/8" x 3/4"	69F-1012	----
18243	00069-1208	69A-12D	----	3/4" x 1/2"	69F-128	----
18245	00069-1212	69A-12E	----	3/4" x 3/4"	69F-1212	----
	00069-1408			7/8" x 1/2"	69F-148	----
18246	00069-1412	69A-14E	----	7/8" x 3/4"	69F-1412	----

FEMALE ELBOW

SAE# 060203

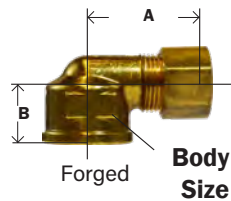

Barstock

70

* Barstock

** Drop ear elbow

MIDLAND	AMC	CHAMPION	LIST	COMP. X FEMALE NPTF	MAF #	MAF PRICE
18251	00070-0202		----	1/8" x 1/8"	70F-22	----
18251B*		70A-2A	----	1/8" x 1/8"	270X2*	----
18252	00070-0302		----	3/16" x 1/8"	70F-32	----
18252B*		70A-3A	----	3/16" x 1/8"	270X3*	----
18253	00070-0402	70A-4A	----	1/4" x 1/8"	70F-42	----
18253B*			----	1/4" x 1/8"	270X4*	----
18254	00070-0404	70A-4B	----	1/4" x 1/4"	70F-44	----
18254B*			----	1/4" x 1/4"	270X4X4*	----
18267	00070-0406	70A-4C	----	1/4" x 3/8"	70F-46	----
18268	00070-0408		----	1/4" x 1/2"	70F-48	----
18255	00070-0502	70A-5A	----	5/16" x 1/8"	70F-52	----
18256	00070-0504		----	5/16" x 1/4"	70F-54	----
18257	00070-0602	70A-6A	----	3/8" x 1/8"	70F-62	----
18258	00070-0604	70A-6B	----	3/8" x 1/4"	70F-64	----
				3/8" x 1/4"	270X6*	----
18259	00070-0606	70A-6C	----	3/8" x 3/8"	70F-66	----
18260	00070-0608	70A-6D	----	3/8" x 1/2"	70F-68	----
18250	00070-0612		----	3/8" x 3/4"	70F-612	----
18261	00070-0804	70A-8B	----	1/2" x 1/4"	70F-84	----
18262	00070-0806	70A-8C	----	1/2" x 3/8"	70F-86	----
18262B				1/2" x 3/8"	270X8*	----
18263	00070-0808	70A-8D	----	1/2" x 1/2"	70F-88	----
18270	00070-0812	70A-8E	----	1/2" x 3/4"	70F-812	----
18269	00070-1006	70A-10C	----	5/8" x 3/8"	70F-106	----
18264	00070-1008	70A-10D	----	5/8" x 1/2"	70F-108	----
				5/8" x 1/2"	270X10	----
				5/8" x 1/2"	70DE-108**	----
18265	00070-1012	70A-10E	----	5/8" x 3/4"	70F-1012	----
18266	00070-1208	70A-12D	----	3/4" x 1/2"	70F-128	----
		70A-12E		3/4" x 3/4"		

70 270C BSE3 170C

COMPRESSION

BRASS FITTINGS

FORGED MALE RUN TEE

SAE# 060424BA

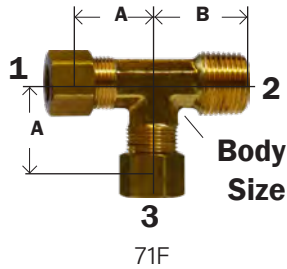

71
00071

* Barstock

MIDLAND	AMC	CHAMPION	LIST	COMP. X MALE NPTF (1&3) X 2	MAF #	MAF PRICE
18272	00071-0202	71A-2A	----	1/8" x 1/8"	71F-22	----
				1/8" x 1/8"	271X2*	----
18273	00071-0302		----	3/16" x 1/8"	71F-32	----
18273B*		71A-3A	----	3/16" x 1/8"	271X3*	----
18274	00071-0402	71A-4A	----	1/4" x 1/8"	71F-42	----
18274B*			----	1/4" x 1/8"	271X4*	----
18275	00071-0404	71A-4B	----	1/4" x 1/4"	71F-44	----
18276	00071-0502	71A-5A	----	5/16" x 1/8"	71F-52	----
				5/16" x 1/8"	271X5*	----
18277	00071-0504	71A-5B	----	5/16" x 1/4"	71F-54	----
18278	00071-0602	71A-6A	----	3/8" x 1/8"	71F-62	----
18279	00071-0604	71A-6B	----	3/8" x 1/4"	71F-64*	----
18279B				3/8" x 1/4"	271X6*	----
18280	00071-0606	71A-6C	----	3/8" x 3/8"	71F-66	----
18281	00071-0806	71A-8C	----	1/2" x 3/8"	71F-86	----
18282	00071-0808	71A-10D	----	1/2" x 1/2"	71F-88	----
18283	00071-1008	71A-10D	----	5/8" x 1/2"	71F-108	----
18284	00071-1208	71A-12D	----	3/4" x 1/2"	71F-128	----
	00071-1212			3/4" x 3/4"	71F-1212	----

71 171C BST3

WARNING: This product can expose you to chemicals, including lead, which are known to the State of California to cause cancer and birth defects or other reproductive harm. For more information, visit www.P65Warnings.ca.gov

BRASS

COMPRESSION

BRASS FITTINGS

MALE BRANCH TEE

SAE# 060425

72
00072

MIDLAND	AMC	CHAMPION	LIST	COMP. X MALE NPTF (1&2) X 3	MAF #	MAF PRICE
18289	00072-0202	72A-22	----	1/8" x 1/8"	72F-22	----
18289B				1/8" x 1/8"	272X2*	----
18290	00072-0302	72A-3A	----	3/16" x 1/8"	272X3	----
18291	00072-0402	72A-4A	----	1/4" x 1/8"	72F-42	----
18291B*				1/4" x 1/8"	272X4*	----
18292	00072-0404		----	1/4" x 1/4"	72F-44	----
18292B		72A-4B		1/4" x 1/4"	272X4X4*	----
18293	00072-0502	72A-5A	----	5/16" x 1/8"	72F-52	----
18294	00072-0504	72A-5B	----	5/16" x 1/4"	72F-54	----
18294B				5/16" x 1/4"	272X5*	----
18295	00072-0602	72A-6A	----	3/8" x 1/8"	72F-62	----
18296	00072-0604	72A-6B	----	3/8" x 1/4"	72F-64	----
18296B				3/8" x 1/4"	272X6*	----
18297	00072-0606	72A-6C	----	3/8" x 3/8"	72F-66	----
18298	00072-0608		----	3/8" x 1/2"	72F-68	----
18304	00072-0804		----	1/2" x 1/4"	72F-84	----
18299B*				1/2" x 3/8"	272X8*	----
18299	00072-0806	72A-8C	----	1/2" x 3/8"	72F-86	----
18300	00072-0808	72A-8D	----	1/2" x 1/2"	72F-88	----
18301	00072-1008	72A-10D	----	5/8" x 1/2"	72F-108	----
18302	00072-1208	72A-12D	----	3/4" x 1/2"	72F-128	----
18303	00072-1212	72A-12E	----	3/4" x 3/4"	72F-1212	----

* Barstock

72 BST1 172C

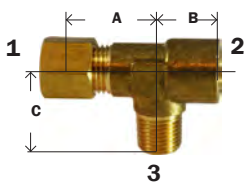
TEE - COMP X FIP X MIP

* Barstock

MIDLAND	AMC	CHAMPION	LIST	COMP. X FEMALE NPTF X MALE NPTF 1X(2&3)	MAF #	MAF PRICE
				1/4" x 1/8"	273X4*	----
				3/8" x 1/4"	273X6*	----
18307	00075-040202		----	1/4" x 1/8"	75F-42	----

75
273 BARSTOCK
00075

BST3

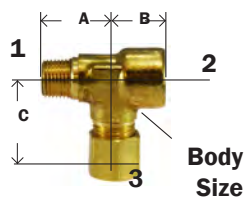
ADAPTER TEE & GAUGE TEE* Barstock
** Gauge tee

MIDLAND	AMC	CHAMPION	LIST	MALE NPTF X FEMALE NPTF X COMP. 3 X (1&2)	MAF #	MAF PRICE
	00076-0202			1/8" x 1/8"	276X2*	----
	00076-0302			3/16" x 1/8"	276X3*	----
18314	00076-0402	76A-4A	----	1/4" x 1/8"	76F-42	----
		76A-4B		1/4" x 1/8"	276X4*	----
				5/16" x 1/4"	2905X4**	----
18316	00076-0604	76A-6B	----	3/8" x 1/4"	76F-64	----

76
00076

76 176C

COMPRESSION

BRASS FITTINGS

FEMALE BRANCH FORGED TEE

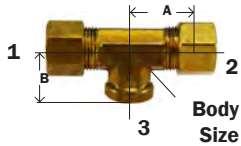

78
00078

MIDLAND	AMC	CHAMPION	LIST	COMP. X FEMALE NPTF (1&2)X3	MAF #	MAF PRICE
18321	00078-0402	77A-4A	----	1/4" x 1/8"	78-42	----
18328	00078-0404		----	1/4" x 1/4"	78-44	----
18325	00078-0602		----	3/8" x 1/8"	78-62	----
18322	00078-0604		----	3/8" x 1/4"	78-64	----
18323	00078-0606		----	3/8" x 3/8"	78-66	----
18326	00078-0802		----	1/2" x 1/8"	78-82	----
18324	00078-0806		----	1/2" x 3/8"	78-86	----
18327	00078-1002		----	5/8" x 1/8"	78-102	----

78 **BST4 77 177C 2908**

45° ELBOW

SAE# 060302

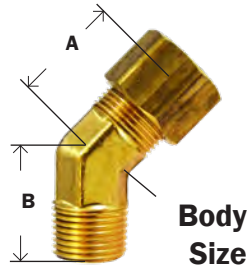

6945
00095

* Barstock

MIDLAND	AMC	CHAMPION	LIST	COMP. X MALE NPTF	MAF #	MAF PRICE
18329	00095-0302	6945A-3A	----	3/16" x 1/8"	6945F-32	----
18330	00095-0402	6945A-4A	----	1/4" x 1/8"	6945F-42	----
18330B				1/4" x 1/8"	273X4*	----
18336	00095-0404	6945A-4B	----	1/4" x 1/4"	6945F-44	----
18331	00095-0502	6945A-5A	----	5/16" x 1/8"	6945F-52	----
18332	00095-0504	6945A-5B	----	5/16" x 1/4"	6945F-54	----
18333	00095-0604	6945A-6B	----	3/8" x 1/4"	6945F-64	----
18333B				3/8" x 1/4"	273X6*	----
18338	00095-0606	6945A-6C	----	3/8" x 3/8"	6945F-66	----
18334	00095-0806	6945A-8C	----	1/2" x 3/8"	6945F-86	----
18339	00095-0808	6945A-8D	----	1/2" x 1/2"	6945F-88	----
18335	00095-1008	6945A-10D	----	5/8" x 1/2"	6945F-108	----

6945 **45BSE1 74 179C 273 77**

COMPRESSION PLUG

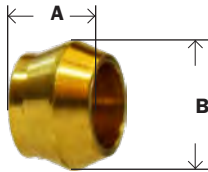

60CP
60CSP
00039

MIDLAND	AMC	CHAMPION	LIST	SIZE	MAF #	MAF PRICE
18028	00039-04		----	1/4"	60CSP-4	----
18029	00039-06		----	3/8"	60CSP-6	----
18032			----	5/16"	60CSP-5	----
18030	00039-08		----	1/2"	60CSP-8	----
18031	00039-10		----	5/8"	60CSP-10	----

CSP

CAP

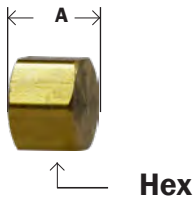

61CC
61CX
00081

MIDLAND	AMC	CHAMPION	LIST	SIZE	MAF #	MAF PRICE
				1/8"	61CC-2	----
				3/16"	61CC-3	----
18047	00081-04	N5CT-4	----	1/4"	61CC-4	----
18048	00081-06	N5CT-6	----	3/8"	61CC-6	----
18049	00081-08	N5CT-8	----	1/2"	61CC-8	----
18050	00081-10	N5CT-10	----	5/8"	61CC-10	----
				3/4"	61CC-12	----

61-CC N5CT

WARNING: This product can expose you to chemicals, including lead, which are known to the State of California to cause cancer and birth defects or other reproductive harm. For more information, visit www.P65Warnings.ca.gov

COMPRESSION

BRASS FITTINGS

BULKHEAD UNIONS

SAE# 060101

62BH
00083

MIDLAND	AMC	CHAMPION	LIST	SIZE	MAF #	MAF PRICE
				3/16"	62BH-3	----
18088	00083-04	62BH-4	----	1/4"	62BH-4	----
				5/16"	62BH-5	----
18090	00083-06	62BH-6	----	3/8"	62BH-6	----
18093	00083-10		----	1/2"	62BH-8	----
				5/8"	62BH-10	----

62BH 75 274

BULKHEAD LOCKNUT

MIDLAND	AMC	CHAMPION	LIST	SIZE	MAF #	MAF PRICE
				1/8"	61LN-2	----
				3/16"	61LN-3	----
				1/4"	61LN-4	----
				5/16"	61LN-5	----
				3/8"	61LN-6	----
				1/2"	61LN-8	----
				5/8"	61LN-10	----

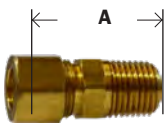
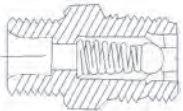
BALL CHECK VALVE - MIN. WORKING PRESSURE 3 PSI.

Hex

63
00063

MIDLAND	AMC	CHAMPION	LIST	TUBE OD X MALE NPTF	MAF #	MAF PRICE
18092	00063-0202	63A-2A	----	1/8" x 1/8"	63-22	----
18093	00063-0302		----	3/16" x 1/8"	63-32	----
18094	00063-0402	63A-4A	----	1/4" x 1/8"	63-42	----
18095	00063-0502			5/16" x 1/8"	63-52	----
18096	00063-0604	63A-6B	----	3/8" x 1/4"	63-64	----

63 263 63A

WARNING: This product can expose you to chemicals, including lead, which are known to the State of California to cause cancer and birth defects or other reproductive harm. For more information, visit www.P65Warnings.ca.gov

COMPRESSION

BRASS FITTINGS

TANK ADAPTER DRILLED THRU (NO STOP)

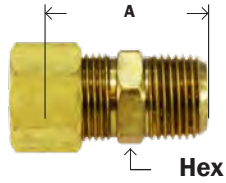

68T
00088

MIDLAND	AMC	CHAMPION	LIST	COMP. X MALE NPTF	MAF #	MAF PRICE
				1/8" x 1/8"	68T-22	----
	00088-0302			3/16" x 1/8"	68T-32	----
				3/16" x 1/4"	68T-34	----
18208	00088-0402	68ATS-4A	----	1/4" x 1/8"	68T-42	----
18209	00088-0404	68ATS-4B	----	1/4" x 1/4"	68T-44	----
				1/4" x 3/8"	68T-46	----
				1/4" x 1/2"	68T-48	----
				5/16" x 1/4"	68T-54	----
				5/16" x 3/8"	68T-56	----
18210	00088-0604	68ATS-6B	----	3/8" x 1/4"	68T-64	----
18211	00088-0606	68ATS-6C	----	3/8" x 3/8"	68T-66	----
18212	00088-0608		----	3/8" x 1/2"	68T-68	----
				7/16" x 3/8"	68T-76	----
18213	00088-0806	68ATS-8C	----	1/2" x 3/8"	68T-86	----
18214	00088-0808	68ATS-8D	----	1/2" x 1/2"	68T-88	----
18215	00088-1008		----	5/8" x 1/2"	68T-108	----
	00088-1012			5/8" x 3/4"	68T-1012	----
				3/4" x 3/4"	68T-1212	----
				7/8" x 1"	68T-1416	----

68-T 682C 80F

COMP X FLARE

MIDLAND	AMC	CHAMPION	LIST	COMP X FLARE	MAF #	MAF PRICE
				1/4" x 1/4"	6242CF-44	----
				1/4" x 3/8"	6242CF-46	----
				3/8" x 3/8"	6242CF-66	----
				3/8" x 1/2"	6242CF-68	----
				1/2" x 1/2"	6242CF-88	----

WARNING: This product can expose you to chemicals, including lead, which are known to the State of California to cause cancer and birth defects or other reproductive harm. For more information, visit www.P65Warnings.ca.gov

BRASS

DOUBLE COMPRESSION

BRASS FITTINGS

DOUBLE COMPRESSION THREADED SLEEVE FITTINGS

▪ Use with aluminum and copper tubing or plastic tubing with internal tube support. Not recommended for steel tubing.

▪ Easy to assemble, no flaring, two piece construction.

▪ For use on oil, air, water and grease lubrication systems.

▪ When design makes a dimension critical, contact us for information.

Tube OD	1/8	3/16	1/4	5/16	3/8
Thread	5/16-24	3/8-24	7/16-24	1/2-20	9/16-20
Working Pressure	500	500	500	250	250

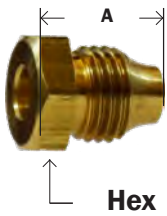
NUT

Hex

MIDLAND	AMC	CHAMPION	LIST	SIZE	MAF #	MAF PRICE
16001	00881-02	181A-2	----	1/8"	26100X2	----
16002	00881-03	181A-3	----	3/16"	26100X3	----
16003	00881-04	181A-4	----	1/4"	26100X4	----
16004	00881-05	181A-5	----	5/16"	26100X5	----
16005	00881-06		----	3/8"	26100X6	----
16006	00881-08		----	1/2"	26100X8	----
16007	00881-10		----	5/8"	26100X10	----

181

181 6100 11

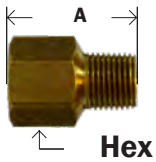
MALE ADAPTER

Hex

MIDLAND	AMC	CHAMPION	LIST	THRD SLEEVE X MALE NPTF	MAF #	MAF PRICE
16117			----	1/8" x *	26200X2X21	----
16118	00888-0202	188A-2A	----	1/8" x 1/8"	26200X2	----
16119	00888-0302	188A-3A	----	3/16" x 1/8"	26200X3	----
16121	00888-0402	188A-4A	----	1/4" x 1/8"	26200X4	----
16120	00888-0404		----	1/4" x 1/4"	26200X4X4	----
16122	00888-0502	188A-5A	----	5/16" x 1/8"	26200X5	----
16125	00888-0504		----	5/16" x 1/4"	26200X5X4	----
16123	00888-0604		----	3/8" x 1/4"	26200X6	----

188

26200

* 1/4 - 28 Male Thread Tapered.

188 6200 12

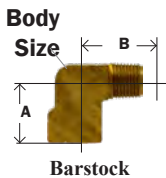
90° ELBOW

Barstock

MIDLAND	AMC	CHAMPION	LIST	THRD SLEEVE X MALE NPTF	MAF #	MAF PRICE
16127			----	1/8" x *	26400X2X21	----
16128	00889-0202	189A-2A	----	1/8" x 1/8"	26400X2	----
16129	00889-0302	189A-3A	----	3/16" x 1/8"	26400X3	----
16130	00889-0402	189A-4A	----	1/4" x 1/8"	26400X4	----
16131	00889-0502		----	5/16" x 1/8"	26400X5	----
16133	00889-0604		----	3/8" x 1/4"	26400X6	----

189

26400

* 1/4 - 28 Male Thread Tapered

189 6400 15

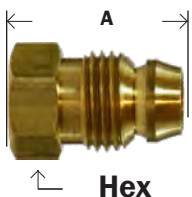
BREAK-AWAY NUT

Hex

MIDLAND	AMC	CHAMPION	LIST	SIZE	MAF #	MAF PRICE
16009	00880-02		----	1/8"	26104X2	----
16090	00880-03		----	3/16"	26104X3	----
16010	00880-04	81LB-4	----	1/4"	26104X4	----
16011			----	5/16"	26104X5	----
16012	00880-06		----	3/8"	26104X6	----

181SP
21604

181-BA 21604 99LB 81LB

SPLIT SLEEVE FITTINGS

BRASS FITTINGS

BRASS SPLIT SLEEVE D.O.T. FITTINGS (5/32 O.D.)

TRANSMISSION BRASS FITTINGS

APPLICATIONS: Used with SAE J844 Type A nylon tube in pressure protected air transmission applications.
 TECHNICAL DATA: Maximum working pressure up to 150 PSI. Fittings will withstand variations from -40°F to +220°F (-40°C to + 104°C)

Ideally suited for use in passive protected air transmission applications. A specially designed slotted sleeve helps eliminate notch stress related to over torque. **25 prefix parts do not have a stake, use 38 part # with white sealant only.**

COLLET



MIDLAND	AMC	CHAMPION	LIST	TUBE O.D.	MAF #	MAF PRICE
38711	00840-53	60TF-2.5	----	5/32"	280X50	----
25001		60TF-2	----	1/8"	280X2	----
25002		60TF-3	----	3/16"	280X3	----
25003			----	1/4"	280X4	----

1460 90791 280 90946

NUT



MIDLAND	AMC	CHAMPION	LIST	TUBE O.D.	MAF #	MAF PRICE
38732		61TF-2.5	----	5/32"	281X50	----
25033		61TF-2	----	1/8"	281X2	----
					281X3	----
					281X4	----

1461 90790 281 90885

DOUBLE END UNION



MIDLAND	AMC	CHAMPION	LIST	TUBE O.D.	MAF #	MAF PRICE
38761		62TF-2.5	----	5/32"	283X50S	----
25062		62TF-2	----	1/8"	283X2	----
25064				1/4"	283X4	----

1462 90792 283 90891

CONNECTOR WITH NUT AND SLEEVE



MIDLAND	AMC	CHAMPION	LIST	TUBE O.D.	MAF #	MAF PRICE
38769		68TF-2.5X	----	5/32" x 1/6"	282X51S	----
38770	00848-5302	68TF-2.5A	----	5/32" x 1/8"	282X52S	----
25175		68TF-2X	----	1/8" x 1/16"	282X2X1N	----
25176		68TF-2A	----	1/8" x 1/8"	282X2N	----
25177				3/16" x 1/8"	282X3	----
25179				1/4" x 1/8"	282X4	----

• Shipped with nut and split sleeve, picture shows insert

1468 90794 282 90985

ELBOW



MIDLAND	AMC	CHAMPION	LIST	TUBE O.D.	MAF #	MAF PRICE
38715		69TF-2X	----	5/32"	284X51SN	----
38718	00849-5302	69TF-2.5A	----	5/32"	284X52S	----
25219	00849-0202	69TF-2A	----	1/8"	284X2	----
25220			----	1/8"	284X2X1N	----
25221			----	3/16"	284X3	----
25224			----	1/4"	284X4	----

284

WARNING: This product can expose you to chemicals, including lead, which are known to the State of California to cause cancer and birth defects or other reproductive harm. For more information, visit www.P65Warnings.ca.gov

BRASS

SPECIAL COMPRESSION ASSEMBLIES**BRASS FITTINGS**

To purchase special compression assemblies, delete the 18 prefix on part# and add the prefix of the type of special assembly you desire. Pricing and availability upon request.

22 - Plastic sleeve (inserts should be ordered separately) | 24 - Long nut compression | 26 - Captive sleeve (parts listed on following pages) | 27 - Self align sleeve

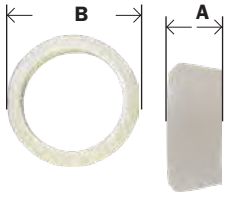
DELTRIN SLEEVE

MIDLAND	AMC	CHAMPION	LIST	SIZE	MAF #	MAF PRICE
18015	00560-04	60AP-4	----	1/4"	60P-4	----
18016	00560-05	60AP-5	----	5/16"	60P-5	----
18017	00560-06	60AP-6	----	3/8"	60P-6	----
18018	00560-08	60AP-8	----	1/2"	60P-8	----
18019	00560-10	60AP-10	----	5/8"	60P-10	----

60P

60-P

BRASS INSERT

• SLEEVE

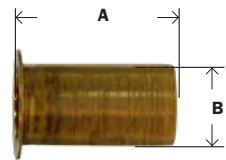

MIDLAND	AMC	CHAMPION	LIST	SIZE	MAF #	MAF PRICE
22008	00561-02	60AE-2	----	1/8"	63P-2	----
22008A			----	1/8"	295X2	----
22009	00561-03	60AE-3	----	3/16"	63P-3	----
22009A			----	3/16"	295X3	----
22010	00561-04	60AE-4	----	1/4"	63P-4	----
22010A			----	1/4"		
22010B			----	1/4"		
22011A			----	5/16"	295X5	----
22011	00561-05	60AE-5	----	5/16"	63P-5	----
22012	00561-06	60AE-6	----	3/8"	63P-6	----
22013	00561-08	60AE-8	----	1/2"	63P-8	----
22014	00561-10	60AE-10	----	5/8"	63P-10	----
22015	00561-12	60AE-12	----	3/4"	63P-12	----

61P
63P

63-BI 60AE 2030 63PT

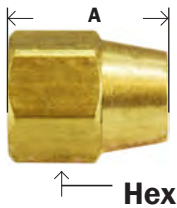
LONG NUT COMPRESSION - CAN BE ASSEMBLED ON ANY COMPRESSION FITTING

161

MIDLAND	AMC	CHAMPION	LIST	SIZE	MAF #	MAF PRICE
10013	04014-02	N1-2	----	1/8"	21110X2	----
24002	00161-03	161A-3	----	3/16"		
24003	00161-04	161A-4	----	1/4"	21611-4	----
24004	00161-05	161A-5	----	5/16"	21611X5	----
24005	00161-06	161A-6	----	3/8"	21611X6	----
24006	00161-08	161A-8	----	1/2"	21611X8	----
24007	00161-10	161A-10	----	5/8"	21611X10	----
24008	00161-12	161A-12	----	3/4"	21611X12	----

161

SELF-ALIGN SLEEVES

MIDLAND	AMC	CHAMPION	LIST	SIZE	MAF #	MAF PRICE
27001	00260-02	60SA-2	----	1/8"	260-2M	----
27002	00260-03	60SA-3	----	3/16"	260-3M	----
27003	00260-04	60SA-4	----	1/4"	260-4M	----
27005	00260-06	60SA-6	----	3/8"	260X6M	----
27006	00260-08	60SA-8	----	1/2"	260-8M	----

• More sizes available online

860 601

WARNING: This product can expose you to chemicals, including lead, which are known to the State of California to cause cancer and birth defects or other reproductive harm. For more information, visit www.P65Warnings.ca.gov

CAPTIVE SLEEVE COMPRESSION

BRASS FITTINGS

CAPTIVE SLEEVE NUT



61SA
61CS

MIDLAND	AMC	CHAMPION	LIST	SIZE	MAF #	MAF PRICE
26001	00261-02	961A-2	----	1/8"	261CAX2	----
26002	00261-03	961A-3	----	3/16"	261CAX3	----
26003	00261-04	961A-4	----	1/4"	261CAX4	----
26004	00261-05	961A-5	----	5/16"	261CAX5	----
26005	00261-06	961A-6	----	3/8"	261CAX6	----
26007	00261-08	961A-8	----	1/2"	261CAX8	----
26008	00261-10	961A-10	----	5/8"	261CAX10	----
	00261-12	961A-12		3/4"		
	00261-14	961A-14		7/8"		

CS61 61CA

UNION



62SA

MIDLAND	AMC	CHAMPION	LIST	SIZE	MAF #	MAF PRICE
26062	00262-02	962A-22	----	1/8"	62CS-2	----
26063	00262-03	962A-33	----	3/16"	62CS-3	----
26064	00262-04	962A-44	----	1/4"	62CS-4	----
26065	00262-05	962A-55	----	5/16"	62CS-5	----
26066	00262-06	962A-66	----	3/8"	62CS-6	----
26079	00282-0604	962A-64	----	3/8" x 1/4"	62CS-64	----
26068	00262-08	962A-88	----	1/2"	62CS-8	----
26069	00262-10	962A-1010	----	5/8"	62CS-10	----

CS62 62CA

TEE



64SA

MIDLAND	AMC	CHAMPION	LIST	SIZE	MAF #	MAF PRICE
	00264-02	964A-22				
26102	00264-03	964A-33	----	3/16"	64FCS-3	----
26103	00264-04	964A-44	----	1/4"	64FCS-4	----
26105	00264-06	964A-66	----	3/8"	64FCS-6	----
	00264-08	964A-88				

CS64 164CA

FEMALE ADAPTER



66SA

MIDLAND	AMC	CHAMPION	LIST	COMP. X FEMALE NPTF	MAF #	MAF PRICE
26142	00266-0202	966A-2A	----	1/8" x 1/8"		
26145	00266-0402	966A-4A	----	1/4" x 1/8"		
26146	00266-0404	966A-4B	----	1/4" x 1/4"		
26153	00266-0604	966A-6B	----	3/8" x 1/4"		
	00266-0606	966A-6C		3/8" x 3/8"		
	00266-0608	966A-6D		3/8" x 1/2"		
	00266-0806	966A-8C		1/2" x 3/8"		
	00266-0808	966A-8D		1/2" x 1/2"		
	00266-1008	966A-10D		5/8" x 1/2"		

CS66 66CA

Any compression fitting can be used for captive sleeve by simply changing out the nuts.



WARNING: This product can expose you to chemicals, including lead, which are known to the State of California to cause cancer and birth defects or other reproductive harm. For more information, visit www.P65Warnings.ca.gov

BRASS

CAPTIVE SLEEVE COMPRESSION

BRASS FITTINGS

MALE ADAPTER

68SA

MIDLAND	AMC	CHAMPION	LIST	COMP. X MALE NPTF	MAF #	MAF PRICE
26175		968A-2X	----	1/8" x 1/16"	68CS-21	----
26176	00268-0202	968A-2A	----	1/8" x 1/8"	68CS-22	----
26177	00268-0302	968A-3A	----	3/16" x 1/8"	68CS-32	----
26178	00268-0304	968A-3B	----	3/16" x 1/4"	68CS-34	----
26179	00268-0402	968A-4A	----	1/4" x 1/8"	68CS-42	----
26180		968A-4B	----	1/4" x 1/4"	268CS-44	----
26180L	00268-0404		----	1/4" x 1/4"	68CS-44	----
26181	00268-0406	968A-4C	----	1/4" x 3/8"	68CS-46	----
26182	00268-0408	968A-4D	----	1/4" x 1/2"	68CS-48	----
26183	00268-0502	968A-5A	----	5/16" x 1/8"	68CS-52	----
26184	00268-0504	968A-5B	----	5/16" x 1/4"	68CS-54	----
26188	00268-0604	968A-6B	----	3/8" x 1/4"	68CS-64	----
26189	00268-0606	968A-6C	----	3/8" x 3/8"	68CS-66	----
26190	00268-0608	968A-6D	----	3/8" x 1/2"	68CS-68	----
26193	00268-0804	968A-8B	----	1/2" x 1/4"	68CS-84	----
26194	00268-0806	968A-8C	----	1/2" x 3/8"	68CS-86	----
26195	00268-0808	968A-8D	----	1/2" x 1/2"	68CS-88	----
26198	00268-1008	968A-10D	----	5/8" x 1/2"	68CS-108	----
	00268-1212	968A-12E		3/4" x 3/4"		
	00268-1412	968A-14E		7/8" x 3/4"		

CS68 68CA

MALE ELBOW

69SA

MIDLAND	AMC	CHAMPION	LIST	COMP. X MALE NPTF	MAF #	MAF PRICE
26220	00269-0202	969A-2A	----	1/8" x 1/8"	69FCS-22	----
26220B			----	1/8" x 1/8"	269CS-22	----
26221B			----	3/16" x 1/8"	269CS-32	----
26221	00269-0302	969A-3A	----	3/16" x 1/8"	69FCS-32	----
26223	00269-0304		----	3/16" x 1/4"	69FCS-34	----
26224B			----	1/4" x 1/8"	269CS-42	----
26224	00269-0402	969A-4A	----	1/4" x 1/8"	69FCS-42	----
26225	00269-0404	969A-4B	----	1/4" x 1/4"	69FCS-44	----
26225B			----	1/4" x 1/4"	269CS-44	----
26226	00269-0406		----	1/4" x 3/8"	69FCS-46	----
26228	00269-0502	969A-5A	----	5/16" x 1/8"	69FCS-52	----
26229	00269-0504	969A-5B	----	5/16" x 1/4"	69FCS-54	----
26232	00269-0602	969A-6A	----	3/8" x 1/8"	69FCS-62	----
26233	00269-0604	969A-6B	----	3/8" x 1/4"	69FCS-64	----
26233B			----	3/8" x 1/4"	269CS-64	----
26234	00269-0606	969A-6C	----	3/8" x 3/8"	69FCS-66	----
26235	00269-0608		----	3/8" x 1/2"	69FCS-68	----
26237	00269-0806	969A-8C	----	1/2" x 3/8"	69FCS-86	----
26238	00269-0808	969A-8D	----	1/2" x 1/2"	69FCS-88	----
	00269-1008	969A-10D		5/8" x 1/2"		
	00269-1212	969A-12E		3/4" x 3/4"		

CS69 169CA

WARNING: This product can expose you to chemicals, including lead, which are known to the State of California to cause cancer and birth defects or other reproductive harm. For more information, visit www.P65Warnings.ca.gov



CAPTIVE SLEEVE COMPRESSION

BRASS FITTINGS

MALE BRANCH TEE



72SA

MIDLAND	AMC	CHAMPION	LIST	COMP. X MALE NPTF (1&2) X 3	MAF #	MAF PRICE
26291	00272-0402	972A-4A	----	1/4" x 1/8"	72FCS-42	----
26292	00272-0404	972A-4B	----	1/4" x 1/4"	72FCS-44	----
26293	00272-0502		----	5/16" x 1/8"	72FCS-52	----
26296	00272-0604	972A-6B	----	3/8" x 1/4"	72FCS-64	----

CS72 172CA

CAPTIVE SLEEVE X MALE PIPE ANGLE NEEDLE VALVE



MIDLAND	AMC	CHAMPION	LIST	COMP X MALE PIPE	MAF #	MAF PRICE
26011	09603-0402		----	1/4" x 1/8"	103CCS	----
26014	09603-0504		----	5/16" x 1/4"	1102CCS	----

CAPTIVE SLEEVE X CAPTIVE SLEEVE NEEDLE VALVE

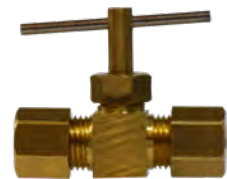

MIDLAND	AMC	CHAMPION	LIST	COMP X COMP	MAF #	MAF PRICE
26021	09606-04		----	1/4"	106CCS	----
26023	09606-06		----	3/8"	113CCS	----

Interchangeable with compress-align fittings.

These are NOT Lead Free

- More sizes available
- Lead Free - add LF to part #

Lead Free products available upon request

WARNING: This product can expose you to chemicals, including lead, which are known to the State of California to cause cancer and birth defects or other reproductive harm. For more information, visit www.P65Warnings.ca.gov

BRASS

FLARELESS BRASS FITTINGS

Flareless FITTINGS

Flareless Brass Tube Fittings are Interchangeable with Poly-Flo®, Poly-Tite® and Poly-Line® and Poly-Fit®



Built-in SS
Tube Support

Tube O.D.	1/8	3/16	1/4	5/16	3/8	1/2
Thread Size-B	5/16-24	3/8-24	3/8-24	7/16-24	1/2-24	1 1/16-20

•Typical Application

Pneumatic instrumentation circuits, lubricant and cooling lines.

•Working Pressure and Temperature Ranges

Up to 150 PSI from 0°F to + 150°F with thermoplastic tubing. Up to 300 PSI from 0°F to + 175°F with soft metal tubing.

•Maximum allowable metal tube wall thickness for use with Poly-Tite fittings:

1/8", 3/16" O.D. --no limitation,
1/4" O.D.--.035 5/16", 3/8", 1/2" O.D.--.049

•Vibration

Excellent Resistance.

•Temperature Range

Depends on tubing used. -65°F to +250°F (-53°C to +121°C) with brass sleeve, -40°F to +150°F (-40°C to +66°C) with plastic sleeve. (Refer to tubing temperature range.)

•Used With

Aluminum & copper tubing. Hard plastic tubing requires brass sleeve. Not recommended for steel tubing.

• Tolerance

+/- .02 on all dimensions. Dimension data can change without notice. Please call us when dimen-

sions are critical.

•Advantages

No flaring of tubing required. Easy installation, captive sleeve, pre-assembled for installation and can be reassembled. Nuts rotate around the sleeve during tightening, preventing twisting of tubing.

•Assembly Instructions

- 1- Cut tubing to desired length.
- 2- Slide nut/sleeve assembly on tube. Threaded end "A" of nut must face toward fitting.
- 3- Bottom tubing into fitting.
- 4- Plastic sleeve - Tighten nut hand tight.
Brass Sleeve - Tighten nut hand tight, then an additional 3/4 turn.

* Note: 1/8 and 3/16 sizes have brass sleeves

Save 5% by ordering online at
www.midlandindustries.com

WARNING: This product can expose you to chemicals, including lead, which are known to the State of California to cause cancer and birth defects or other reproductive harm. For more information, visit www.P65Warnings.ca.gov

FLARELESS

BRASS FITTINGS

NUT AND PLASTIC SLEEVE ASSEMBLY - WHITE SLEEVE



MP61P
261PF

MIDLAND	AMC	CHAMPION	LIST	TUBE O.D.	MAF #	MAF PRICE
20211	022661-04	261PF-4	----	1/4"	MP61P-4	----
20212	022661-05	261PF-5	----	5/16"	MP61P-5	----
20213	022661-06	261PF-6	----	3/8"	MP61P-6	----

261PF 1261 61PN

NUT AND PLASTIC SLEEVE ASSEMBLY - BLACK SLEEVE



MIDLAND	AMC	CHAMPION	LIST	TUBE O.D.	MAF #	MAF PRICE
				1/4"	MP61P-4BLK	----
				5/16"	MP61P-5BLK	----
				3/8"	MP61P-6BLK	----
				1/2"	MP61P-8BLK	----

NUT/BLACK SLEEVE ASSEMBLY

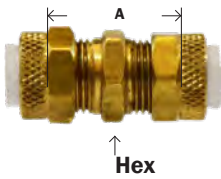

MP62
262PF

MIDLAND	AMC	CHAMPION	LIST	TUBE O.D.	MAF #	MAF PRICE
20240	02662-02	262PF-2	----	1/8"	MP62-2	----
20241	02662-03	262PF-3	----	3/16"	MP62-3	----
20242	02662-04	262PF-4	----	1/4"	MP62-4	----
20243	02662-05	262PF-5	----	5/16"	MP62-5	----
20244	02662-06	262PF-6	----	3/8"	MP62-6	----
20200	02656-0604	256PF-64	----	3/8" x 1/4"	MP56-64	----
20245	02662-08	262PF-8	----	1/2"	MP62-8	----
				1/2" x 3/8"	MP56-86	----

262PF 1262 62P 262P

BULKHEAD UNION

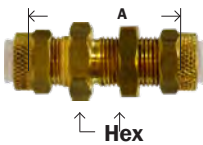

MP82
282PF

MIDLAND	AMC	CHAMPION	LIST	TUBE O.D.	MAF #	MAF PRICE
20337	02682-04	282PF-4	----	1/4"	MP82-4	----
20338	02682-05	282PF-5	----	5/16"	MP82-5	----
20339	02682-06	282PF-6	----	3/8"	MP82-6	----
	02682-08	282PF-8		1/2"	MP82-8	----

62PBH 329P 282P

UNION TUBE #M62C - FLARELESS X STANDARD COMPRESSION

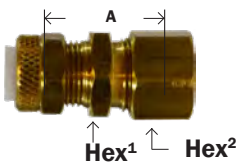

MP62C
262PFC

MIDLAND	AMC	CHAMPION	LIST	TUBE O.D.	MAF #	MAF PRICE
20235	02642-04		----	1/4"	MP62C-4	----
				5/16"	MP62C-5	----
20237	02642-06		----	3/8"	MP62C-6	----

262S 62PCA 262PC

WARNING: This product can expose you to chemicals, including lead, which are known to the State of California to cause cancer and birth defects or other reproductive harm. For more information, visit www.P65Warnings.ca.gov

BRASS

FLARELESS

BRASS FITTINGS

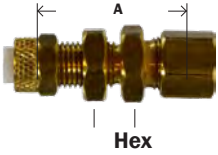
BULKHEAD UNION - FLARELESS X COMPRESSION

MP827
282PFC

MIDLAND	AMC	CHAMPION	LIST	TUBE O.D.	MAF #	MAF PRICE
20333	02648-04			1/4"	MP82C-4	----
20334	02648-06			3/8"	MP82C-6	----

1274

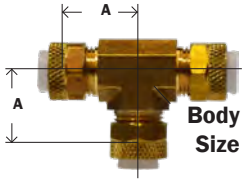
UNION TEE

* Reducing Branch

MP6A
264PF

MIDLAND	AMC	CHAMPION	LIST	TUBE O.D.	MAF #	MAF PRICE
20248	02664-02	264PF-2		1/8"	MP64-2	----
20249				3/16"	MP64-3	----
20250	02664-04	264PF-4		1/4"	MP64-4	----
20251	02664-05	264PF-5		5/16"	MP64-5	----
20252	02664-06	264PF-6		3/8"	MP64-6	----
20330*	02679-0604	264PF-664		3/8" x 1/4"	MP79-64	----
20253	02664-08	264PF-8		1/2"	MP64-8	----

1264 164P 264P

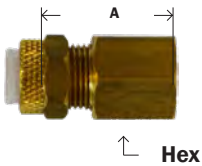
FEMALE CONNECTOR

MP66
266PF

MIDLAND	AMC	CHAMPION	LIST	TUBE O.D. X FEMALE NPTF	MAF #	MAF PRICE
20256	02666-0202	266PF-2A		1/8" x 1/8"	MP66-22	----
20257	02666-0302			3/16" x 1/8"	MP66-32	----
				3/16" x 1/4"	MP66-34	----
20259	02666-0402	266PF-4A		1/4" x 1/8"	MP66-42	----
20260	02666-0404	266PF-4B		1/4" x 1/4"	MP66-44	----
20261	02666-0502	266PF-5A		5/16" x 1/8"	MP66-52	----
				5/16" x 1/4"	MP66-54	----
20265	02666-0602			3/8" x 1/8"	MP66-62	----
20262	02666-0604	266PF-6B		3/8" x 1/4"	MP66-64	----
20263	02666-0806	266PF-8C		1/2" x 3/8"	MP66-86	----
				1/2" x 1/2"	MP66-88	----

1266 66P 266P

WARNING: This product can expose you to chemicals, including lead, which are known to the State of California to cause cancer and birth defects or other reproductive harm. For more information, visit www.P65Warnings.ca.gov

FLARELESS

BRASS FITTINGS

MALE CONNECTOR

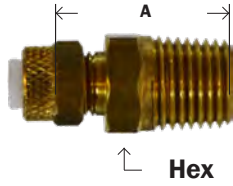

MP68
268PF

MIDLAND	AMC	CHAMPION	LIST	TUBE O.D. X MALE NPTF	MAF #	MAF PRICE
		268PF-2X1032		1/8" x 10/32"	MP68-20	----
				1/8" x 1/16"	MP68-21	----
20268	02668-0202	268PF-2A		1/8" x 1/8"	MP68-22	----
20269	02668-0302	268PF-3A		3/16" x 1/8"	MP68-32	----
20270	02668-0400	268PF-4X1032		1/4" x 10/32"	MP68-40	----
	02668-0401			1/4" x 1/16"	MP68-41	----
20271	02668-0402	268PF-4A		1/4" x 1/8"	MP68-42	----
20272	02668-0404	268PF-4B		1/4" x 1/4"	MP68-44	----
20273	02668-0406	268PF-4C		1/4" x 3/8"	MP68-46	----
				1/4" x 1/2"	MP68-48	----
20274	02668-0502	268PF-5A		5/16" x 1/8"	MP68-52	----
20275	02668-0504	268PF-5B		5/16" x 1/4"	MP68-54	----
20276	02668-0602	268PF-6A		3/8" x 1/8"	MP68-62	----
20277	02668-0604	268PF-6B		3/8" x 1/4"	MP68-64	----
20278	02668-0606	268PF-6C		3/8" x 3/8"	MP68-66	----
				3/8" x 1/2"	MP68-68	----
	02668-0804	268PF-8B		1/2" x 1/4"	MP68-84	----
20279	02668-0806	268PF-8C		1/2" x 3/8"	MP68-86	----
20282	02668-0808	268PF-8D		1/2" x 1/2"	MP68-88	----

1268 68P 268P

MALE ELBOW

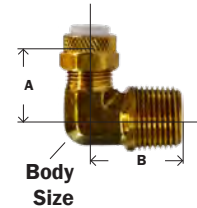

* Barstock

MP69
269PF

MIDLAND	AMC	CHAMPION	LIST	TUBE O.D. X MALE NPTF	MAF #	MAF PRICE
				1/8" x 1/16"	MP69-21	----
20287	02669-0202	269PF-2A		1/8" x 1/8"	MP69-22	----
20288	02669-0302	269PF-3A		3/16" x 1/8"	MP69-32	----
20289*	02669-0402	269PF-4A		1/4" x 1/8"	MP69-42	----
20290	02669-0404	269PF-4B		1/4" x 1/4"	MP69-44	----
20291	02669-0406	269PF-4C		1/4" x 3/8"	MP69-46	----
20292	02669-0502	269PF-5A		5/16" x 1/8"	MP69-52	----
20293	02669-0602	269PF-6A		3/8" x 1/8"	MP69-62	----
20294	02669-0604	269PF-6B		3/8" x 1/4"	MP69-64	----
20295	02669-0606	269PF-6C		3/8" x 3/8"	MP69-66	----
20296	02669-0806	269PF-8C		1/2" x 3/8"	MP69-86	----
	02669-0808	269PF-8D		1/2" x 1/2"	MP69-88	----

1269 169P 269P

FEMALE ELBOW

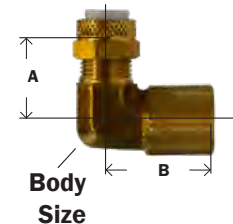

MP70
270PF

MIDLAND	AMC	CHAMPION	LIST	TUBE O.D. X FEMALE NPTF	MAF #	MAF PRICE
20300	02670-0202			1/8" x 1/8"	MP70-22	----
20301	02670-0302			3/16" x 1/8"	MP70-32	----
20302	02670-0402	270PF-4A		1/4" x 1/8"	MP70-42	----
20303	02670-0404	270PF-4B		1/4" x 1/4"	MP70-44	----
20304	02670-0604	270PF-6B		3/8" x 1/4"	MP70-64	----
20305	02670-0806	270PF-8C		1/2" x 3/8"	MP70-86	----

1270 170P

FLARELESS

BRASS FITTINGS

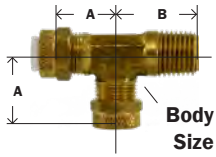
MALE RUN TEEMP71
271PF

MIDLAND	AMC	CHAMPION	LIST	TUBE O.D. X MALE NPTF	MAF #	MAF PRICE
20308	02671-0202			1/8" x 1/8"	MP71-22	----
20309	02671-0302			3/16" x 1/8"	MP71-32	----
20310	02671-0402	271PF-4A		1/4" x 1/8"	MP71-42	----
20311	02671-0404	271PF-4B		1/4" x 1/4"	MP71-44	----
20312	02671-0502			5/16" x 1/8"	MP71-52	----
20313	02671-0604	271PF-6B		3/8" x 1/4"	MP71-64	----
20314	02671-0806	271PF-8C		1/2" x 3/8"	MP71-86	----

1271 171P

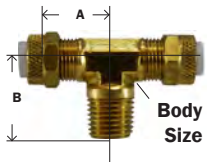
MALE BRANCH TEEMP72
272PF

MIDLAND	AMC	CHAMPION	LIST	TUBE O.D. X MALE NPTF	MAF #	MAF PRICE
20317	02672-0202	272PF-2A		1/8" x 1/8"	MP72-22	----
20318	02672-0302			3/16" x 1/8"	MP72-32	----
20319	02672-0402	272PF-4A		1/4" x 1/8"	MP72-42	----
20320	02672-0404	272PF-4B		1/4" x 1/4"	MP72-44	----
20321	02672-0502	272PF-5A		5/16" x 1/8"	MP72-52	----
20322	02672-0602	272PF-6A		3/8" x 1/8"	MP72-62	----
20323	02672-0604	272PF-6B		3/8" x 1/4"	MP72-64	----
20324	02672-0806	272PF-8C		1/2" x 3/8"	MP72-86	----

1272 172P 272P

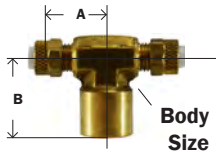
FEMALE BRANCH TEEMP77
277PF

MIDLAND	AMC	CHAMPION	LIST	TUBE O.D. X FEMALE NPTF	MAF #	MAF PRICE
20327	02677-0402			1/4" x 1/8"	MP77-42	----
20328	02677-0404	277PF-4B		1/4" x 1/4"	MP77-44	----
	02677-0406	277PF-4C		1/4" x 3/8"	MP77-46	----

1277 177P 277P

UNIVERSAL NUT AND BRASS SLEEVE ASSEMBLYMP61B
261PFB

MIDLAND	AMC	CHAMPION	LIST	TUBE O.D.	MAF #	MAF PRICE
20227	02761-02	261PFB-2		1/8"	MP61B-2	----
20228	02761-03	261PFB-3		3/16"	MP61B-3	----
20229	02761-04	261PFB-4		1/4"	MP61B-4	----
20230	02761-05	261PFB-5		5/16"	MP61B-5	----
20231	02761-06	261PFB-6		3/8"	MP61B-6	----
20232	02761-08	261PFB-8		1/2"	MP61B-8	----

261PFB 1261B 61PB 261UB

C/P NUT PLASTIC SLEEVE ASSEMBLY

MIDLAND	AMC	CHAMPION	LIST	TUBE O.D.	MAF #	MAF PRICE
		02621-04		1/4"	MP61PCP-4	----
		02621-06		3/8"	MP61PCP-6	----

WARNING: This product can expose you to chemicals, including lead, which are known to the State of California to cause cancer and birth defects or other reproductive harm. For more information, visit www.P65Warnings.ca.gov



FLARELESS

BRASS FITTINGS

NUT



MP61
261PFN

MIDLAND	AMC	CHAMPION	LIST	TUBE O.D.	MAF #	MAF PRICE
20218	02961-02	261PFN-2		1/8"	MP61-2	----
20219				3/16"	MP61-3	----
20220	02961-04	261PFN-4		1/4"	MP61-4	----
20221	02961-05	261PFN-5		5/16"	MP61-5	----
20222	02961-06	261PFN-6		3/8"	MP61-6	----
20223	02961-08	261PFN-8		1/2"	MP61-8	----

61PN 1261 261FPN

PLASTIC SLEEVE

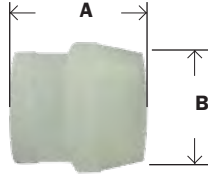

MP60
260PF

MIDLAND	AMC	CHAMPION	LIST	TUBE O.D.	MAF #	MAF PRICE
20205	02660-04	260PF-4		1/4"	MP60-4W	----
20206	02660-05	260PF-5		5/16"	MP60-5	----
20207	02660-06	260PF-6		3/8"	MP60-6W	----
20208	02660-08	260PF-8		1/2"	MP60-8	----

260FF 1260 60P 260P

BLACK PLASTIC SLEEVE



MIDLAND	AMC	CHAMPION	LIST	TUBE O.D.	MAF #	MAF PRICE
				1/4"	MP60-4BLK	----
				3/8"	MP60-6BLK	----

BRASS SLEEVE ONLY



MIDLAND	AMC	CHAMPION	LIST	TUBE O.D.	MAF #	MAF PRICE
	02760-02	260PFB-2		1/8"	MP60B-2	----
		260PFB-3		3/16"	MP60B-3	----
	02760-04	260PFB-4		1/4"	MP60B-4	----
	02760-06	260PFB-6		3/8"	MP60B-6	----

PLASTIC CAP

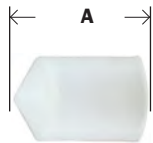

MP59
269PF

MIDLAND	AMC	CHAMPION	LIST	TUBE O.D.	MAF #	MAF PRICE
20201	02659-04			1/4"	MP59-4	----
20203	02659-06			3/8"	MP59-6	----
20204	02659-08			1/2"	MP59-8	----

1229 59P 259P

WARNING: This product can expose you to chemicals, including lead, which are known to the State of California to cause cancer and birth defects or other reproductive harm. For more information, visit www.P65Warnings.ca.gov

BRASS

BRASS PUSH-IN FITTINGS

BRASS FITTINGS

PUSH-IN/ PUSH-TO-CONNECT FITTINGS

BRASS PUSH-IN



NICKEL PLATED BRASS PUSH-IN



BALL VALVES FOR N/P PUSH-IN



METRIC N/P BRASS PUSH-IN



COMPOSITE BODY PUSH-IN



COMPOSITE BODY METRIC PUSH-IN



FDA PLASTIC PUSH-IN



DOT BRASS PUSH-IN



DOT COMPOSITE PUSH-IN



WARNING: This product can expose you to chemicals, including lead, which are known to the State of California to cause cancer and birth defects or other reproductive harm. For more information, visit www.P65Warnings.ca.gov

BRASS PUSH-IN FITTINGS



ENGINEERING AND DESIGN

- **QUICK CONNECT**, simply push tubing in, no tools. Saves up to 75% of assembly time of standard compression fittings.
- **QUICK DISCONNECT**, hold two fingers on insert and pull tubing out, no tools required.
- **REUSEABLE**, connect and disconnect numerous times.
- **FULL FLOW DESIGN**, provides up to 60% more flow area than conventional fittings with internal tube supports.
- **POSITIVE SEAL**, no leaks. After tubing is inserted, seal is made.
- **VERSATILE**, BunaN "O" rings standard. Other materials of "O" rings available.
- **SECURE TUBE RETENTION**, pulling on tubing only serves to tighten the connection.
- **SELF CONTAINED ASSEMBLY**, no loose parts, brass body and insert.
- **BRASS CONSTRUCTION**, elbows and tees are forged brass.
- **CHOICE** of convenient swivel or economical stationary elbows and tees.
- **STRAIGHT CONNECTORS** have interior hex for Allen key tightening where space is limited...no need to use a wrench.
- **PRE-APPLIED POLYTETRAFLUOROETHYLENE**® based pipe sealant on all male pipe threads, saving customer additional labor.
- **METRIC SIZES AVAILABLE**: Metric tube sizes from 2mm through 12mm in both standard NPT and metric pipe sizes are available on a special order basis.
- **WORKING TEMPERATURE**:
-10°F to 200°F (other ranges available on request).
- **PIPE THREAD**: NPTF with Polytetrafluoroethylene® based sealant pre-applied.

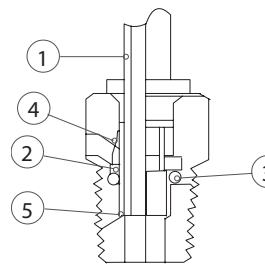

When tubing (1) is inserted into the fitting, it first passes through the gripping teeth (2). Just beyond the gripping teeth is the o-ring (3) which provides the leak proof seal against the OD of the tube. The gripping teeth grab the tube, which

expands the insert. Pulling back on the tube only tightens the grip as the insert moves onto the camming surface (4). Pressure through the tube also serves to tighten the grip. The tube bottoms against a positive tube stop (5) in a cavity providing tube support to prevent leakage.

• Tolerance

+/- .02 on all dimensions. Dimension data can change without notice. Please call us when dimensions are critical

WARNING: This product can expose you to chemicals, including lead, which are known to the State of California to cause cancer and birth defects or other reproductive harm. For more information, visit www.P65Warnings.ca.gov

BRASS

BRASS PUSH-IN FITTINGS

BRASS FITTINGS

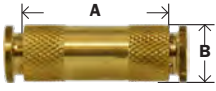
UNION CONNECTOR

MIDLAND	AMC	CHAMPION	LIST	TUBE O.D.	MAF #	MAF PRICE
20017	02062-02	262PP-2		1/8"	MQ62-2	----
20018	02062-53	262PP-2.5		5/32"	MQ62-532	----
20019	02062-04	262PP-4		1/4"	MQ62-4	----
20022		262PP-64		3/8" x 1/4"	MQ62-64	----
20020	02062-06	262PP-6		3/8"	MQ62-6	----
20021	02062-08	262PP-8		1/2"	MQ62-8	----

AQ62P
MQ62

AQ62 6580 3106 62PL KQH 12-020 50-562 262-OF 1162 262PP

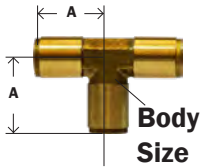
UNION TEE

MIDLAND	AMC	CHAMPION	LIST	TUBE O.D.	MAF #	MAF PRICE
20025	02064-02	264PP-2		1/8"	MQ64-2	----
20026	02064-53	264PP-2.5		5/32"	MQ64-532	----
20027	02064-03	264PP-3		3/16"	MQ64-3	----
20028	02064-04	264PP-4		1/4"	MQ64-4	----
20031*		264PPNIC-5		5/16"	MQ64-5	----
20029	02064-06	264PP-6		3/8"	MQ64-6	----
20030	02064-08	264PP-8		1/2"	MQ64-8	----

AQ64P
MQ64

* Nickel Plated

KQT 12-060 50-564 264OF 264PP 1164 AQ64 6540 3140 164PL

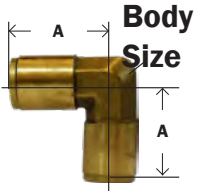
UNION ELBOW

MIDLAND	AMC	CHAMPION	LIST	TUBE O.D.	MAF #	MAF PRICE
20150	02065-02	265PP-2		1/8"	MQ65-2	----
20151	02065-53	265PP-2.5		5/32"	MQ65-532	----
20152	02065-04	265PP-4		1/4"	MQ65-4	----
20155				5/16"	MQ65-5	----
20153	02065-06	265PP-6		3/8"	MQ65-6	----
20154	02065-08	265PP-8		1/2"	MQ65-8	----

AQ65P
MQ65

AQ65 6550 3102 165PL KQL 12-040 50-565 265-OF

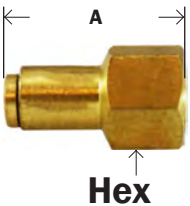
FEMALE CONNECTOR

MIDLAND	AMC	CHAMPION	LIST	TUBE O.D. X FEMALE NPTF	MAF #	MAF PRICE
20032	02066-0202	266PP-2A		1/8" x 1/8"	MQ66-22	----
20038				1/8" x 1/4"	MQ66-24	----
20012	02066-5302	266PP25A		5/32" x 1/8"	MQ66-5322	----
20034	02066-0402	266PP-4A		1/4" x 1/8"	MQ66-42	----
20035	02066-0404	266PP-4B		1/4" x 1/4"	MQ66-44	----
20036	02066-0604	266PP-6B		3/8" x 1/4"	MQ66-64	----
20037	02066-0606	266PP-6C		3/8" x 3/8"	MQ66-66	----

AQ66P

266PP AQ66 6463 3114 66PL 12-426 50-566 266-OF 1166

WARNING: This product can expose you to chemicals, including lead, which are known to the State of California to cause cancer and birth defects or other reproductive harm. For more information, visit www.P65Warnings.ca.gov



BRASS PUSH-IN FITTINGS

BRASS FITTINGS

MALE CONNECTOR

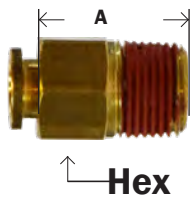

AQ68P
MQ68

MIDLAND	AMC	CHAMPION	LIST	TUBE O.D. X MALE NPTF	MAF #	MAF PRICE
20047*	02068-0200	268PP-2X1032		1/8" x 10-32"*	MQ68-20	----
20045	02068-0201	268PP-2X		1/8" x 1/16"	MQ68-21	----
20048	02068-0202	268PP-2A		1/8" x 1/8"	MQ68-22	----
20023	02068-0204	268PP-2B		1/8" x 1/4"	MQ68-24	----
20049*	02068-5300	268PP-2.5X1032		5/32" x 10-32"*	MQ68-5320	----
20050	02068-5302	268PP-2.5A		5/32" x 1/8"	MQ68-5322	----
20046	02068-5304	268PP-2.5B		5/32" x 1/4"	MQ68-5324	----
20051*	02068-0300	268PP-3X1032		3/16" x 10-32"*	MQ68-30	----
20052	02068-0302	268PP-3A		3/16" x 1/8"	MQ68-32	----
20053*	02068-0400	268PP-4X1032		1/4" x 10-32"*	MQ68-40	----
20039		268PP-4X		1/4" x 1/16"		----
20054	02068-0402	268PP-4A		1/4" x 1/8"	MQ68-42	----
20055	02068-0404	268PP-4B		1/4" x 1/4"	MQ68-44	----
20056	02068-0406	268PP-4C		1/4" x 3/8"	MQ68-46	----
20530	02068-0502			5/16" x 1/8"	MQ68-52	----
20531	02068-0504			5/16" x 1/4"	MQ68-54	----
20532				5/16" x 3/8"	MQ68-56	----
20057	02068-0602	268PP-6A		3/8" x 1/8"	MQ68-62	----
20058	02068-0604	268PP-6B		3/8" x 1/4"	MQ68-64	----
20059	02068-0606	268PP-6C		3/8" x 3/8"	MQ68-66	----
20062	02068-0608	268PP-6D		3/8" x 1/2"	MQ68-68	----
20060	02068-0804	268PP-8B		1/2" x 1/4"	MQ68-84	----
20061	02068-0806	268PP-8C		1/2" x 3/8"	MQ68-86	----
20063	02068-0808	268PP-8D		1/2" x 1/2"	MQ68-88	----

* Furnished with gaskets

268PP AQ68 6510 3115 68PL KQH 12-425 50-568 268-OF 1168

SWIVEL MALE ELBOW

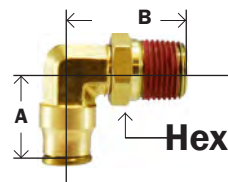

AQ69PS
MQ69S

MIDLAND	AMC	CHAMPION	LIST	TUBE O.D. X MALE NPTF	MAF #	MAF PRICE
20079	02169-0202	269PPS-2A		1/8" x 1/8"	MQ69S-22	----
20535*				1/8" x 1/4"	MQ69S-24	----
20076**	02169-5300	269PPS-2.5X1032		5/32" x 10-32"	MQ69S-5320	----
20080	02169-5302	269PPS-2.5A		5/32" x 1/8"	MQ69S-5322	----
20077	02169-5304	269PPS-2.5B		5/32" x 1/4"	MQ69S-5324	----
20078**	02169-0400	269PPS-4X1032		1/4" x 10-32"	MQ69S-40	----
20081	02169-0402	269PPS-4A		1/4" x 1/8"	MQ69S-42	----
20082	02169-0404	269PPS-4B		1/4" x 1/4"	MQ69S-44	----
20086	02169-0406	269PPS-4C		1/4" x 3/8"	MQ69S-46	----
20538*				5/16" x 1/4"	MQ69S-54	----
20539*				5/16" x 3/8"	MQ69S-56	----
20087	02169-0602	269PPS-6A		3/8" x 1/8"	MQ69S-62	----
20083	02169-0604	269PPS-6B		3/8" x 1/4"	MQ69S-64	----
20084	02169-0606	269PPS-6C		3/8" x 3/8"	MQ69S-66	----
20088	02169-0608	269PPS-6D		3/8" x 1/2"	MQ69S-68	----
20085	02169-0806	269PPS-8C		1/2" x 3/8"	MQ69S-86	----
20092	02169-0808	269PPS-8D		1/2" x 1/2"	MQ69S-88	----

* Nickel Plated

** Furnished with gaskets

aq69-ps 56520 3109 169pl kql 12-447 50-579 269-OF5 11695

WARNING: This product can expose you to chemicals, including lead, which are known to the State of California to cause cancer and birth defects or other reproductive harm. For more information, visit www.P65Warnings.ca.gov

BRASS PUSH-IN FITTINGS

BRASS FITTINGS

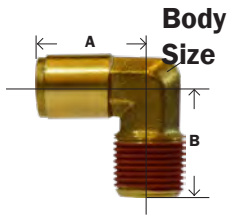
FIXED MALE ELBOWAQ69P
MQ69

MIDLAND	AMC	CHAMPION	LIST	TUBE O.D. X MALE NPTF	MAF #	MAF PRICE
20065	02069-0202	269PP-2A		1/8" x 1/8"	MQ69-22	----
20066	02069-5302	269PP-2.5A		5/32" x 1/8"	MQ69-5322	----
20067	02069-0302	269PP-3A		3/16" x 1/8"	MQ69-32	----
20068	02069-0402	269PP-4A		1/4" x 1/8"	MQ69-42	----
20069	02069-0404	269PP-4B		1/4" x 1/4"	MQ69-44	----
20070	02069-0406	269PP-4C		1/4" x 3/8"	MQ69-46	----
20071	02069-0602	269PP-6A		3/8" x 1/8"	MQ69-62	----
20072	02069-0604	269PP-6B		3/8" x 1/4"	MQ69-64	----
20073	02069-0606	269PP-6C		3/8" x 3/8"	MQ69-66	----
20074	02069-0804	269PP-8B		1/2" x 1/4"	MQ69-84	----
20075	02069-0806	269PP-8C		1/2" x 3/8"	MQ69-86	----
20064	02069-0808	269PP-8D		1/2" x 1/2"	MQ69-88	----

269PP AQ69-P 6500 169PLNS 12-445 1169

Dimension data can change without notice. Please see our website when dimensions are critical.

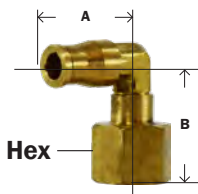
FEMALE SWIVEL ELBOWAQ70PS
MQ70S

MIDLAND	AMC	CHAMPION	LIST	TUBE O.D. X FEMALE NPTF	MAF #	MAF PRICE
20094S		270PPS-25A		5/32" x 1/8"	MQ70S-5322	----
20089S	02170-0402	270PPS-4A		1/4" x 1/8"	MQ70S-42	----
20090S	02170-0404	270PPS-4B		1/4" x 1/4"	MQ70S-44	----
20091S	02170-0604	270PPS-6B		3/8" x 1/4"	MQ70S-64	----
	02170-0606			3/8" x 3/8"	MQ70S-66	
	02170-0806	270PPS-8C		1/2" x 3/8"	MQ70S-86	

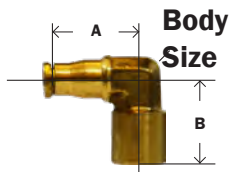
FEMALE ELBOWAQ70P
MQ70

MIDLAND	AMC	CHAMPION	LIST	TUBE O.D. X FEMALE NPTF	MAF #	MAF PRICE
20192	02070-0202	270PP-2A		1/8" x 1/8"	MQ70-22	----
20094	02070-5302	270PP-2.5A		5/32" x 1/8"	MQ70-5322	----
20089	02070-0402	270PP-4A		1/4" x 1/8"	MQ70-42	----
20090	02070-0404	270PP-4B		1/4" x 1/4"	MQ70-44	----
20091	02070-0604	270PP-6B		3/8" x 1/4"	MQ70-64	----

AQ70-P 3009

WARNING: This product can expose you to chemicals, including lead, which are known to the State of California to cause cancer and birth defects or other reproductive harm. For more information, visit www.P65Warnings.ca.gov

BRASS PUSH-IN FITTINGS

BRASS FITTINGS

SWIVEL MALE RUN TEE

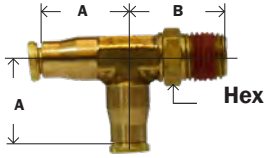

AQ71PS
MQ71S

MIDLAND	AMC	CHAMPION	LIST	TUBE O.D. X MALE NPTF	MAF #	MAF PRICE
20160	02171-0202	271PPS-2A		1/8" x 1/8"	MQ71S-22	----
20161	02171-5302	271PPS-2.5A		5/32" x 1/8"	MQ71S-5322	----
20162	02171-0402	271PPS-4A		1/4" x 1/8"	MQ71S-42	----
20163	02171-0404	271PPS-4B		1/4" x 1/4"	MQ71S-44	----
20164	02171-0604	271PPS-6B		3/8" x 1/4"	MQ71S-64	----
20165	02171-0606	271PPS-6C		3/8" x 3/8"	MQ71S-66	----
20174				1/2" x 1/4"		
20166	02171-0806	271PPS-8C		1/2" x 3/8"	MQ71S-86	----
20167	02171-0808	271PPS-8D		1/2" x 1/2"	MQ71S-88	----

AQ71-PS 56440 3103 171PL KQY 12-468 50-571 271-OFS 11715

FIXED MALE RUN TEE

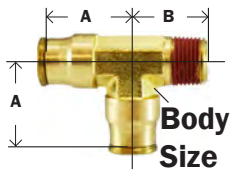

AQ71P
MQ71

MIDLAND	AMC	CHAMPION	LIST	TUBE O.D. X MALE NPTF	MAF #	MAF PRICE
20095	02071-0202	271PP-2A		1/8" x 1/8"	MQ71-22	----
20097	02071-0302			3/16" x 1/8"		
20098	02071-0402	271PP-4A		1/4" x 1/8"	MQ71-42	----
20093	02071-0404	271PP-4B		1/4" x 1/4"	MQ71-44	----
20099	02071-0602			3/8" x 1/8"		
20100	02071-0604	271PP-6B		3/8" x 1/4"	MQ71-64	----
20101	02071-0606	271PP-6C		3/8" x 3/8"	MQ71-66	----
20102	02071-0806			1/2" x 3/8"	MQ71-86	----

AQ71-P

SWIVEL MALE BRANCH TEE

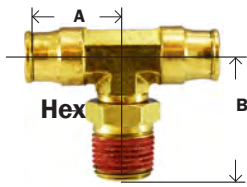

AQ72PS
MQ72S

* Furnished with gaskets

MIDLAND	AMC	CHAMPION	LIST	TUBE O.D. X MALE NPTF	MAF #	MAF PRICE
20103	02172-0202	272PPS-2A		1/8" x 1/8"	MQ72S-22	----
20104*	02172-5300	272PPS-2.5A x 10.32		5/32" x 10-32"	MQ72S-5320	----
20109	02172-5302	272PPS-2.5A		5/32" x 1/8"	MQ72S-5322	----
20105	02172-0402	272PPS-4A		1/4" x 1/8"	MQ72S-42	----
20106	02172-0404	272PPS-4B		1/4" x 1/4"	MQ72S-44	----
20107	02172-0604	272PPS-6B		3/8" x 1/4"	MQ72S-64	----
20108	02172-0606	272PPS-6C		3/8" x 3/8"	MQ72S-64	----
20110	02172-0806	272PPS-8C		1/2" x 3/8"	MQ72S-86	----
20111	02172-0808	272PPS-8D		1/2" x 1/2"	MQ72S-88	----

FIXED MALE BRANCH TEE

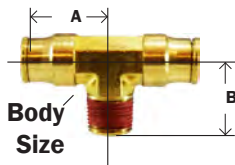

AQ72P
MQ72

MIDLAND	AMC	CHAMPION	LIST	TUBE O.D. X MALE NPTF	MAF #	MAF PRICE
20112	02072-0202			1/8" x 1/8"	MQ72-22	----
20113	02072-5302	272PP-2.5A		5/32" x 1/8"	MQ72-532	----
20115	02072-0402	272PP-4A		1/4" x 1/8"	MQ72-42	----
20116	02072-0404	272PP-4B		1/4" x 1/4"	MQ72-44	----
20117	02072-0602	272PP-6A		3/8" x 1/8"	MQ72-62	----
20118	02072-0604	272PP-6B		3/8" x 1/4"	MQ72-64	----
20119	02072-0606	272PP-6C		3/8" x 3/8"	MQ72-66	----
20120	02072-0806	272PP-8C		1/2" x 3/8"	MQ72-86	----

AQ72-P

BRASS PUSH-IN FITTINGS

BRASS FITTINGS

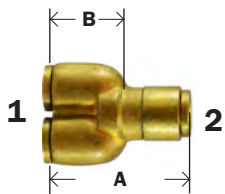
UNION "Y"

AQ89P

MIDLAND	AMC	CHAMPION	LIST	TUBE O.D. 1 X 2	MAF #	MAF PRICE
20551	02089-5353	289PP-2.5		5/32" x 5/32"	MQ89-532	----
20552	02089-0402			1/4" x 1/8"	MQ89-42	----
20553	02089-0404	289PP-4		1/4" x 1/4"	MQ89-44	----

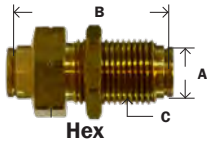
BULKHEAD UNIONAQ82P
MQ82

MIDLAND	AMC	CHAMPION	LIST	TUBE O.D. A	MAF #	MAF PRICE
20124	02082-02	283PP-2		1/8"	MQ82-2	----
20125	02082-53	283PP-2.5		5/32"	MQ82-532	----
20126	02082-03			3/16"	MQ82-3	----
20127	02082-04	283PP-4		1/4"	MQ82-4	----
20128	02082-06	283PP-6		3/8"	MQ82-6	----
20129	02082-08	283PP-8		1/2"	MQ82-8	----

AQ82-P 6590 62PLBH KQE 12-029 50-582 282-OF 1174

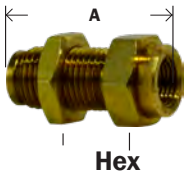
FEMALE BULKHEAD UNIONAQ86P
MQ86

MIDLAND	AMC	CHAMPION	LIST	TUBE O.D. X FEMALE NPTF	MAF #	MAF PRICE
20170	02086-0402	287PP-4A		1/4" x 1/8"	MQ86-42	----
20171	02086-0404	287PP-4B		1/4" x 1/4"	MQ86-44	----
20172	02086-0604	287PP-6B		3/8" x 1/4"	MQ86-64	----

AQ86-P 1166BH

Dimension data can change without notice. Please call us when dimensions are critical.

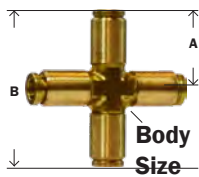
CROSS

MIDLAND	AMC	CHAMPION	LIST	SIZE	MAF #	MAF PRICE
20142		252PP-4		1/4"	MQ52-4	----
20143		252PP-6		3/8"	MQ52-6	----

REDUCER - NICKEL PLATED - TUBE OD X STUD

MQ97

MIDLAND	AMC	CHAMPION	LIST	TUBE O.D. 1 X 2	MAF #	MAF PRICE
20510		286PP-42		1/8" x 1/4"	MQ97-24	----
20511		286PP-42.5		5/32" x 1/4"	MQ97-5324	----
20512		286PP-64		1/4" x 3/8"	MQ97-46	----

67PPL 286PP

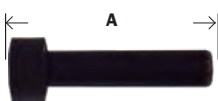
PLASTIC PLUGAQ59P
MQ59

MIDLAND	AMC	CHAMPION	LIST	TUBE O.D.	MAF #	MAF PRICE
20009	02059-53	284PP-2.5		5/32"	MQ59-532	----
20010	02059-04	284PP-4		1/4"	MQ59-4	----
20011	02059-06	284PP-6		3/8"	MQ59-6	----
20013	02059-08	284PP-8		1/2"	MQ59-8	----

• Cored

284PP AQ59 209-OF 1129 6900 639PL 12-004 50-526

NICKEL PLATED PUSH-IN FITTINGS

BRASS FITTINGS

NICKEL PLATED PUSH-IN FITTINGS WITH GLOBAL THREAD

• NPTF • BSPP • BSPT • ISO 7 • ISO 228 • G THREAD • J THREAD



- Saves time and money
- No stripped threads
- No stripped parts
- Reduce inventory

- Completely reusable
- Quick installation
- No pitch identification

Component Parts and Materials	
Body	Brass - Nickel Plated
Thrust Ring	Acetalic Resin/ Glass filled Nylon
Sleeve	Brass - Nickel Plated
Gripper Collet	Stainless Steel
Safety Ring	PA66
Lip Seal (1/8 O-Ring Seal)	NBR 70
Thread Seal	NBR 70

Max Operating Pressure: Vacuum to 290PSI.
Min Temperature: -4°F
Max Temperature: 176°F
Tubing: Nylon, Polyethylene, Polyurethane.
- For best results use 95 Durometer
Media: Compressed air, water, vacuum

• Tolerance

+/- .02 on all dimensions. Dimension data can change without notice. Please call us when dimensions are critical.

GLOBAL THREAD

WORKS WITH INCH OR METRIC THREADS



“Global Thread” fittings can be assembled with female threads produced to the following standards:

Tapered NPTF
Parallel (BSPP, BSP, ISO 7)
Tapered (BSPT, PT, ISO 7, ISO 228)

WARNING: This product can expose you to chemicals, including lead, which are known to the State of California to cause cancer and birth defects or other reproductive harm. For more information, visit www.P65Warnings.ca.gov

BRASS

NICKEL PLATED PUSH-IN FITTINGS

BRASS FITTINGS

UNION CONNECTOR

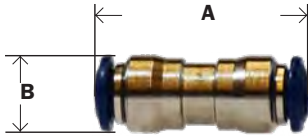

*w/ plastic collet

MIDLAND	CHAMPION	TUBE O.D.	LIST
20017N	262PPNI-2	1/8"	
20018N*	262PPNI-2.5	5/32"	
20016N	262PPNI-42.5	5/32" x 1/4"	
20019N*	262PPNI-4	1/4"	
20015N*	262PPNI-5	5/16"	
20020N*	262PPNI-6	3/8"	
20022N	262PPNI-64	3/8" x 1/4"	
20021N*	262PPNI-8	1/2"	
20024N	262PPNI-86	1/2" x 3/8"	

62PL 88040

UNION TEE

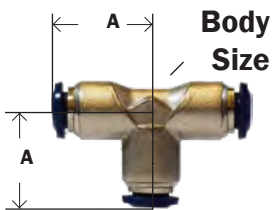

MIDLAND	CHAMPION	TUBE O.D.	LIST
20025N	264PPNI-2	1/8"	
20026N*	264PPNI-2.5	5/32"	
20028N*	264PPNI-4	1/4"	
20031N*	264PPNI-5	5/16"	
20029N*	264PPNI-6	3/8"	
20030N*	264PPNI-8	1/2"	

164PL 88230

UNION ELBOW

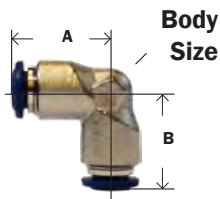

MIDLAND	CHAMPION	TUBE O.D.	LIST
20150N	265PPNI-2	1/8"	
20151N*	265PPNI-2.5	5/32"	
20152N*	265PPNI-4	1/4"	
20155N*	265PPNI-5	5/16"	
20153N*	265PPNI-6	3/8"	
20154N*	265PPNI-8	1/2"	

165PL 88130

FEMALE CONNECTOR

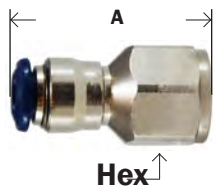

MIDLAND	CHAMPION	TUBE O.D. X FEMALE NPTF	LIST
20032N	266PPNI-2A	1/8" x 1/8"	
20038N	266PPNI-2B	1/8" x 1/4"	
20034N	266PPNI-4A	1/4" x 1/8"	
20035N	266PPNI-4B	1/4" x 1/4"	
20036N	266PPNI-6B	3/8" x 1/4"	
20037N	266PPNI-6C	3/8" x 3/8"	

66PL 88030

WARNING: This product can expose you to chemicals, including lead, which are known to the State of California to cause cancer and birth defects or other reproductive harm. For more information, visit www.P65Warnings.ca.gov



NICKEL PLATED PUSH-IN FITTINGS

BRASS FITTINGS

MALE CONNECTOR

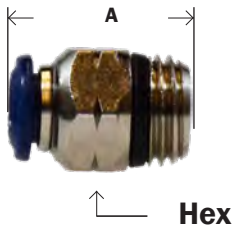

• Can be purchased with NPTF threads upon request

* Available in stainless steel

MIDLAND	CHAMPION	TUBE O.D. X MALE GLOBAL THREAD	LIST
20047N	268PPNI-2X1032	1/8" x 10-32"	
20048N	268PPNI-2A	1/8" x 1/8"	
20023N	268PPNI-2B	1/8" x 1/4"	
20049N*	268PPNI-2.5X1032	5/32" x 10-32"	
20050N*	268PPNI-2.5A	5/32" x 1/8"	
20046N*	268PPNI-2.5B	5/32" x 1/4"	
20053N*	268PPNI-4X1032	1/4" x 10-32"	
20054N*	268PPNI-4A	1/4" x 1/8"	
20055N*	268PPNI-4B	1/4" x 1/4"	
20056N	268PPNI-4C	1/4" x 3/8"	
20530N*	268PPNI-5A	5/16" x 1/8"	
20531N*	268PPNI-5B	5/16" x 1/4"	
20532N	268PPNI-5C	5/16" x 3/8"	
20057N	268PPNI-6A	3/8" x 1/8"	
20058N*	268PPNI-6B	3/8" x 1/4"	
20059N*	268PPNI-6C	3/8" x 3/8"	
20062N	268PPNI-6D	3/8" x 1/2"	
20841N		1/2" x 1/8"	
20060N	268PPNI-8B	1/2" x 1/4"	
20061N*	268PPNI-8C	1/2" x 3/8"	
20063N*	268PPNI-8D	1/2" x 1/2"	

MALE CONNECTOR WITH INTERNAL HEX

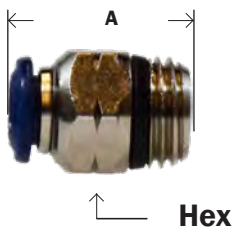

MIDLAND	CHAMPION	TUBE O.D. X MALE GLOBAL THREAD	LIST
20842N		1/8" x 10-32" UNF	
20847N		5/32" x 10-32 UNF	
20846N		5/32" x 1/8"	
20845N		1/4" x 10-32" UNF	
20843N		1/4" x 1/8"	
20844N		1/4" x 1/4"	

68PL 87000

FIXED MALE ELBOW

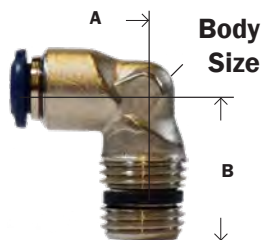

MIDLAND	CHAMPION	TUBE O.D. X MALE NPTF	LIST
20068N	269PPNI-4A	1/4" x 1/8"	
20069N	269PPNI-4B	1/4" x 1/4"	
20072N	269PPNI-6B	3/8" x 1/4"	
20073N	269PPNI-6C	3/8" x 3/8"	

W169PLNS 8100

NICKEL PLATED PUSH-IN FITTINGS

BRASS FITTINGS

SWIVEL MALE ELBOW

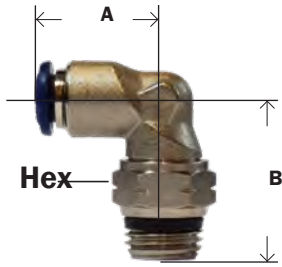

• Can be purchased with NPTF threads upon request

* Available in stainless steel

MIDLAND	CHAMPION	TUBE O.D. X MALE GLOBAL THREAD	LIST
20079N	269PPSNI-2A	1/8" x 1/8"	
20535N	269PPSNI-2B	1/8" x 1/4"	
20076N*	269PPSNI-2.5X1032	5/32" x 10-32"	
20080N*	269PPSNI-2.5A	5/32" x 1/8"	
20848N*	269PPSNI-2.5B	5/32" x 1/4"	
20081N*	269PPSNI-4A	1/4" x 1/8"	
20082N*	269PPSNI-4B	1/4" x 1/4"	
20086N	269PPSNI-4C	1/4" x 3/8"	
20537N*	269PPSNI-5A	5/16" x 1/8"	
20538N*	269PPSNI-5B	5/16" x 1/4"	
20539N	269PPSNI-5C	5/16" x 3/8"	
20087N	269PPSNI-6A	3/8" x 1/8"	
20083N*	269PPSNI-6B	3/8" x 1/4"	
20084N*	269PPSNI-6C	3/8" x 3/8"	
20088N*	269PPSNI-6D	3/8" x 1/2"	
20184N	269PPSNI-8B	1/2" x 1/4"	
20085N*	269PPSNI-8C	1/2" x 3/8"	
20092N*	269PPSNI-8D	1/2" x 1/2"	

W169PL 87110

FEMALE SWIVEL ELBOW

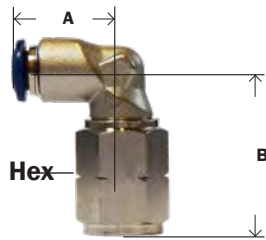

MIDLAND	CHAMPION	TUBE O.D. X FEMALE NPTF	LIST
20094N	270PPSNI-2.5A	5/32" x 1/8"	
20089N	270PPSNI-4A	1/4" x 1/8"	
20090N	270PPSNI-4B	1/4" x 1/4"	
20762N	270PPSNI-6A	3/8" x 1/8"	
20091N	270PPSNI-6B	3/8" x 1/4"	

SWIVEL MALE RUN TEE

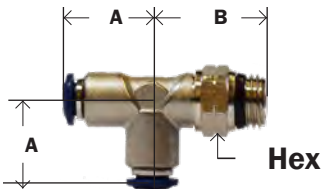

• Can be purchased with NPTF threads upon request

MIDLAND	CHAMPION	TUBE O.D. X MALE GLOBAL THREAD	LIST
20095N	271PPSNI-2A	1/8" x 1/8"	
20851N	271PPSNI-2B	1/8" x 1/4"	
20852N	271PPSNI-2.5A	5/32" x 1/8"	
20853N	271PPSNI-2.5B	5/32" x 1/4"	
20162N	271PPSNI-4A	1/4" x 1/8"	
20163N	271PPSNI-4B	1/4" x 1/4"	
20164N		1/4" x 3/8"	
20159N		3/8" x 1/8"	
20168N	271PPSNI-6B	3/8" x 1/4"	
20165N	271PPSNI-6C	3/8" x 3/8"	
20181N	271PPSNI-6D	3/8" x 1/2"	
20174N	271PPSNI-8B	1/2" x 1/4"	
20166N	271PPSNI-8C	1/2" x 3/8"	
20167N	271PPSNI-8D	1/2" x 1/2"	

W171PL 87222

NICKEL PLATED PUSH-IN FITTINGS

BRASS FITTINGS

SWIVEL MALE BRANCH TEE

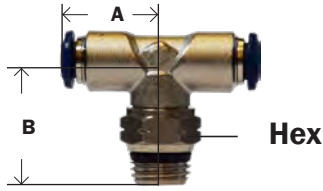

• Can be purchased with NPTF threads upon request

* with plastic collet

MIDLAND	CHAMPION	TUBE O.D. X MALE GLOBAL THREAD	LIST
20103N	272PPSNI-2A	1/8" x 1/8"	
20104N		5/32" x 10-32"	
20109N	272PPSNI-2.5A	5/32" x 1/8"	
20850N	272PPSNI-2.5B	5/32" x 1/4"	
20105N	272PPSNI-4A	1/4" x 1/8"	
20106N	272PPSNI-4B	1/4" x 1/4"	
20156N	272PPSNI-4C	1/4" x 3/8"	
20157N		3/8" x 1/8"	
20107N	272PPSNI-6B	3/8" x 1/4"	
20108N	272PPSNI-6C	3/8" x 3/8"	
20158N	272PPSNI-6D	3/8" x 1/2"	
20112N	272PPSNI-8B	1/2" x 1/4"	
20110N	272PPSNI-8C	1/2" x 3/8"	
20111N	272PPSNI-8D	1/2" x 1/2"	

W172PL 87210

BULKHEAD UNION

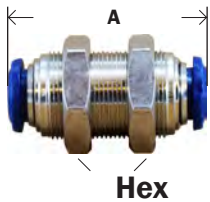

MIDLAND	CHAMPION	TUBE O.D.	LIST
20124N	283PPNI-2	1/8"	
20125N*	283PPNI-2.5	5/32"	
20127N*	283PPNI-4	1/4"	
20123N*	283PPNI-5	5/16"	
20128N*	283PPNI-6	3/8"	
20129N*	283PPNI-8	1/2"	

62PLBH 88050

UNION "Y"

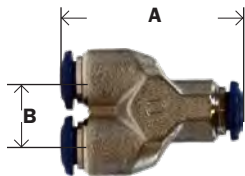

MIDLAND	CHAMPION	TUBE O.D.	LIST
20553N	289PPNI-4	1/4" x 1/4"	

662PL 88310

REDUCER



MIDLAND	CHAMPION	TUBE O.D. 2	LIST
20510N	286PPNI-42	1/4"	
20511N	286PPNI-42.5	1/4"	
20512N	286PPNI-64	3/8"	
20513N	286PPNI-84	1/2"	
20514N	286PPNI-86	1/2"	

67PPL 88700

Also available:

- Nylon plug
- Single banjo
- Double banjo
- Push fit cartridges and tools

NICKEL PLATED PUSH-IN FITTINGS

BRASS FITTINGS

CHROME PLATED BRASS MINI BALL VALVES

- Compact Design
- Max Working Pressure 250 psi

**PUSH-IN X PUSH-IN**

PART #	SIZE	BOX/CASE	WGT.	
28400	1/8	30/300	.07	----
28401	1/4	30/300	.10	----
28402	3/8	20/200	.21	----

**PUSH-IN X MALE PIPE**

PART #	SIZE TUBE X MIP	BOX/ CASE	WGT.	
28403	5/32 x 1/8	30/300	.08	----
28407	1/4 x 1/8	30/300	.08	----
28404	1/4 x 1/4	30/300	.10	----
28405	3/8 x 3/8	20/200	.17	----

**FIP X FIP**

PART #	SIZE	BOX/CASE	WGT.	
46650	1/8	30/300	.11	----
46651	1/4	30/300	.10	----
46652	3/8	20/200	.14	----
46653	1/2	15/150	.25	----

**MIP X FIP**

PART #	SIZE	BOX/CASE	WGT.	
46660	1/8	30/300	.11	----
46661	1/4	30/300	.10	----
46662	3/8	20/200	.14	----
46663	1/2	15/150	.25	----

- Optional colors of handle plate for identification

PANEL MOUNT DESIGN**FIP X FIP ANGLE**

PART #	SIZE	BOX/CASE	WGT.	
46670	1/8	20/200	.19	----
46671	1/4	20/200	.20	----
46672	3/8	25/250	.11	----

**3-WAY FIP - OPEN CENTER**

PART #	SIZE	BOX/CASE	WGT.	
466900	1/8	25/250	.13	----
466901	1/4	20/200	.21	----
466902	3/8	20/200	.21	----

**3-WAY FIP - CLOSED CENTER**

PART #	SIZE	BOX/CASE	WGT.	
46680	1/8	25/250	.13	----
46681	1/4	20/200	.21	----
46682	3/8	20/200	.21	----

WARNING: This product can expose you to chemicals, including lead, which are known to the State of California to cause cancer and birth defects or other reproductive harm. For more information, visit www.P65Warnings.ca.gov

NICKEL PLATED METRIC PUSH-IN FITTINGS

BRASS FITTINGS

UNION

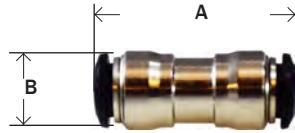

* Available in SS

MIDLAND	CHAMPION	TUBE O.D. (MM)	LIST
20723N	262PPNI-3MM	3	
20600N*	262PPNI-4MM	4	
20724N	262PPNI-5MM	5	
20725N	262PPNI-6MMX4MM	6 x 4	
20601N*	262PPNI-6MM	6	
20726N	262PPNI-8MMX6MM	8 x 6	
20727N*	262PPNI-8MM	8	
20728N	262PPNI-10MMX8MM	10 x 8	
20603N*	262PPNI-10MM	10	
20729N	262PPNI-12MMX10MM	12 x 10	
20604N*	262PPNI-12MM	12	
20730N	262PPNI-14MM	14	

UNION TEE

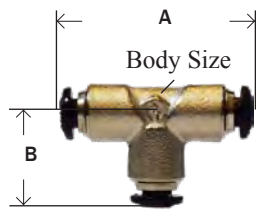

* Available in SS

MIDLAND	CHAMPION	TUBE O.D. (MM)	LIST
20741N	264PPNI-3MM	3	
20610N*	264PPNI-4MM	4	
20742N	264PPNI-5MM	5	
20611N*	264PPNI-6MM	6	
20612N*	264PPNI-8MM	8	
20613N*	264PPNI-10MM	10	
20614N*	264PPNI-12MM	12	
20743N	264PPNI-14MM	14	

UNION ELBOW

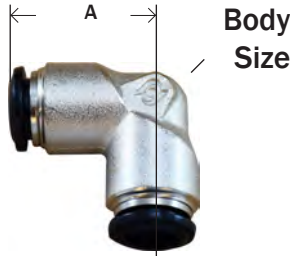

* Available in SS

MIDLAND	CHAMPION	TUBE O.D. (MM)	LIST
20738N	265PPNI-3MM	3	
20206N*	265PPNI-4MM	4	
20739N	265PPNI-5MM	5	
20660N*	265PPNI-6MM	6	
20661N*	265PPNI-8MM	8	
20807N*	265PPNI-10MM	10	
20808N*	265PPNI-12MM	12	
20740N	265PPNI-14MM	14	

UNION Y

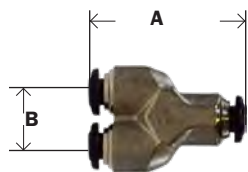

MIDLAND	CHAMPION	TUBE O.D. (MM)	LIST
20744N		3	
20813N		4	
20745N		5	
20814N	289PPNI-6MM	6	
20815N		8	
20746N		10	

PLUG

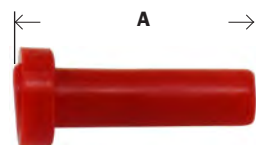

MIDLAND	CHAMPION	TUBE O.D. (MM)	LIST
20748N		4	
20749N		5	
20750N		6	
20751N		8	
20752N		10	
20753N		12	

NICKEL PLATED METRIC PUSH-IN FITTINGS

BRASS FITTINGS

METRIC TUBE STRAIGHT MALE

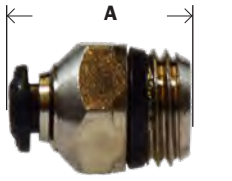

Hex



• Can be purchased with BSPP or BSPT Threads

* Available in SS

MIDLAND	CHAMPION	TUBE O.D. (MM) X GLOBAL THREAD	LIST
20630N*	268PPNI-4MMX1/8	4 x 1/8	
20631N*	268PPNI-4MMX1/4	4 x 1/4	
20700N	268PPNI-5MMX1/8	5 x 1/8	
20701N	268PPNI-5MMX1/4	5 x 1/4	
20632N*	268PPNI-6MMX1/8	6 x 1/8	
20633N*	268PPNI-6MMX1/4	6 x 1/4	
20628N	268PPNI-6MMX3/8	6 x 3/8	
20629N	268PPNI-6MMX1/2	6 x 1/2	
20702N*	268PPNI-8MMX1/8	8 x 1/8	
20634N*	268PPNI-8MMX1/4	8 x 1/4	
20635N	268PPNI-8MMX3/8	8 x 3/8	
20703N	268PPNI-8MMX1/2	8 x 1/2	
20636N*	268PPNI-10MMX1/4	10 x 1/4	
20637N*	268PPNI-10MMX3/8	10 x 3/8	
20704N*	268PPNI-10MMX1/2	10 x 1/2	
20801N	268PPNI-12MMX1/4	12 x 1/4	
20638N*	268PPNI-12MMX3/8	12 x 3/8	
20705N*	268PPNI-12MMX1/2	12 x 1/2	
20706N	268PPNI-14MMX3/8	14 x 3/8	
20707N	268PPNI-14MMX1/2	14 x 1/2	

METRIC TUBE INTERNAL HEX

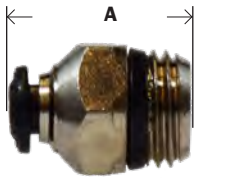

Hex

MIDLAND	CHAMPION	TUBE O.D. (MM) X GLOBAL THREAD	LIST
20619N		3 x M5	
20620N		4 x 1/8	
20621N*		4 x M5	
20622N		4 x M7 x 1	
20623N		6 x 1/4	
20624N		6 x 1/8	
20625N*		6 x M5	
20626N		8 x 1/4	
20627N		8 x 1/8	

METRIC TUBE SWIVEL MALE ELBOW

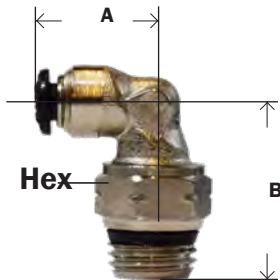

Hex



• Can be purchased with BSPP or BSPT Threads

* Available in SS w BSPP or BSPT Threads

MIDLAND	CHAMPION	TUBE O.D. (MM) X GLOBAL THREAD	LIST
20708N*	269PPSNI-4MMX1/8	4 x 1/8	
20709N*	269PPSNI-4MMX1/4	4 x 1/4	
20710N	269PPSNI-5MMX1/8	5 x 1/8	
20642N*	269PPSNI-6MMX1/8	6 x 1/8	
20803N*	269PPSNI-6MMX1/4	6 x 1/4	
20711N*	269PPSNI-8MMX1/8	8 x 1/8	
20805N*	269PPSNI-8MMX1/4	8 x 1/4	
20655N	269PPSNI-8MMX3/8	8 x 3/8	
20712N	269PPSNI-8MMX1/2	8 x 1/2	
20656N*	269PPSNI-10MMX1/4	10 x 1/4	
20657N*	269PPSNI-10MMX3/8	10 x 3/8	
20713N*	269PPSNI-10MMX1/2	10 x 1/2	
20658N*	269PPSNI-12MMX3/8	12 x 3/8	
20659N*	269PPSNI-12MMX1/2	12 x 1/2	
20714N	269PPSNI-14MMX3/8	14 x 3/8	
20715N	269PPSNI-14MMX1/2	14 x 1/2	

WARNING: This product can expose you to chemicals, including lead, which are known to the State of California to cause cancer and birth defects or other reproductive harm. For more information, visit www.P65Warnings.ca.gov

NICKEL PLATED METRIC PUSH-IN FITTINGS

BRASS FITTINGS

METRIC TUBE SWIVEL MALE BRANCH TEE

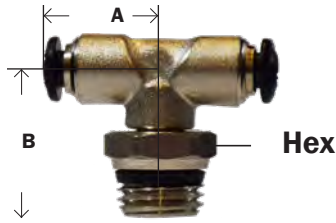

• Can be purchased with BSPP or BSPT threads

* Available in SS w/BSPP or BSPT threads

MIDLAND	CHAMPION	TUBE O.D. (MM) X GLOBAL THREAD	LIST
20680N*	272PPSNI-4MMX1/8	4 x 1/8	
20716N*	272PPSNI-4MMX1/4	4 x 1/4	
20717N	272PPSNI-5MMX1/8	5 x 1/8	
20682N*	272PPSNI-6MMX1/8	6 x 1/8	
20683N*	272PPSNI-6MMX1/4	6 x 1/4	
20809N*	272PPSNI-8MMX1/8	8 x 1/8	
20684N*	272PPSNI-8MMX1/4	8 x 1/4	
20690N	272PPSNI-8MMX3/8	8 x 3/8	
20691N	272PPSNI-8MMX1/2	8 x 1/2	
20686N*	272PPSNI-10MMX1/4	10 x 1/4	
20687N*	272PPSNI-10MMX3/8	10 x 3/8	
20810N*	272PPSNI-10MMX1/2	10 x 1/2	
20688N*	272PPSNI-12MMX3/8	12 x 3/8	
20689N*	272PPSNI-12MMX1/2	12 x 1/2	
20718N	272PPSNI-14MMX3/8	14 x 3/8	
20719N	272PPSNI-14MMX1/2	14 x 1/2	

METRIC TUBE SWIVEL MALE RUN TEE

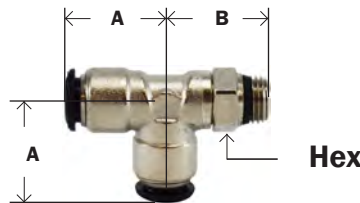

• Can be purchased with BSPP threads

* Available in SS w/BSPP or BSPT threads

MIDLAND	CHAMPION	TUBE O.D. (MM) X GLOBAL THREAD	LIST
20670N	271PPSNI-4MMX1/8	4 x 1/8	
20720N	271PPSNI-4MMX1/4	4 x 1/4	
20721N	271PPSNI-5MMX1/8	5 x 1/8	
20672N	271PPSNI-6MMX1/8	6 x 1/8	
20673N	271PPSNI-6MMX1/4	6 x 1/4	
20811N	271PPSNI-8MMX1/8	8 x 1/8	
20674N	271PPSNI-8MMX1/4	8 x 1/4	
20668N	271PPSNI-8MMX3/8	8 x 3/8	
20669N	271PPSNI-8MMX1/2	8 x 1/2	
20676N	271PPSNI-10MMX1/4	10 x 1/4	
20677N	271PPSNI-10MMX3/8	10 x 3/8	
20722N	271PPSNI-10MMX1/2	10 x 1/2	
20678N	271PPSNI-12MMX3/8	12 x 3/8	
20679N	271PPSNI-12MMX1/2	12 x 1/2	

BULKHEAD

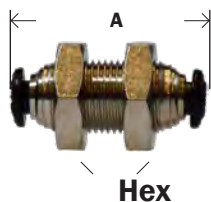

MIDLAND	CHAMPION	TUBE O.D. (MM)	LIST
20731N	283PPNI-3MM	3	
20732N*	283PPNI-4MM	4	
20733N	283PPNI-5MM	5	
20734N*	283PPNI-6MM	6	
20735N*	283PPNI-8MM	8	
20736N*	283PPNI-10MM	10	
20737N*	283PPNI-12MM	12	

* Available in SS

NICKEL PLATED WITH NICKEL COLLET

BRASS FITTINGS

UNION W/ NICKEL COLLET



CHAMPION	LIST	PTC	MAF #	MAF PRICE
262PPNIC-2		1/8	MQ62-2	----
262PPNIC-2.5		5/32	MQ62-532	
262PPNIC-4		1/4	MQ62-4	----
262PPNIC-5		5/16		
262PPNIC-6		3/8	MQ62-6	----
262PPNIC-8		1/2	MQ62-8	----

UNION TEE W/ NICKEL COLLET



CHAMPION	LIST	PTC X FPT	MAF #	MAF PRICE
264PPNIC-2		1/8	MQ64-2	----
264PPNIC-2.5		5/32	MQ64-532	
264PPNIC-4		1/4	MQ64-4	----
264PPNIC-5		5/16		
264PPNIC-6		3/8	MQ64-6	----
264PPNIC-8		1/2	MQ64-8	----

90° UNION ELBOW W/ NICKEL COLLET



CHAMPION	LIST	PTC	MAF #	MAF PRICE
265PPNIC-2		1/8	MQ65-2	----
265PPNIC-2.5		5/32	MQ65-532	
265PPNIC-4		1/4	MQ65-4	----
265PPNIC-5		5/16	MQ65-5	
265PPNIC-6		3/8	MQ65-6	----
265PPNIC-8		1/2	MQ65-8	----

FEMALE ADAPTER W/ NICKEL COLLET



CHAMPION	LIST	PTC X FPT	MAF #	MAF PRICE
266PPNIC-2X1032		1/8 x 10-32		
266PPNIC-2A		1/8 x 1/8	MQ66-22	----
266PPNIC-2.5X1032		5/32 x 10-32		
266PPNIC-2.5A		5/32 x 1/8	MQ65-5322	
266PPNIC-4A		1/4 x 1/8	MQ65-42	
266PPNIC-4B		1/4 x 1/4	MQ65-44	
266PPNIC-4C		1/4 x 3/8		
266PPNIC-5B		5/16 x 1/4		
266PPNIC-5C		5/16 x 3/8		
266PPNIC-6B		3/8 x 1/4	MQ65-64	
266PPNIC-6C		3/8 x 3/8	MQ65-66	
266PPNIC-6D		3/8 x 1/2		
266PPNIC-8C		1/2 x 3/8		
266PPNIC-8D		1/2 x 1/2		

WARNING: This product can expose you to chemicals, including lead, which are known to the State of California to cause cancer and birth defects or other reproductive harm. For more information, visit www.P65Warnings.ca.gov



NICKEL PLATED WITH NICKEL COLLET

BRASS FITTINGS

MALE ADAPTER W/ NICKEL COLLET



CHAMPION	LIST	PTC X MPT	MAF #	MAF PRICE
268PPNIC-2X1032		1/8 x 10-32	MQ68-20	
268PPNIC-2A		1/8 x 1/8	MQ6-22	
268PPNIC-2B		1/8 x 1/4	MQ6-24	
268PPNIC-2.5X1032		5/32 x 10-32	MQ6-5320	
268PPNIC-2.5A		5/32 x 1/8	MQ6-5322	
268PPNIC-2.5B		5/32 x 1/4	MQ6-5324	
268PPNIC-4X1032		1/4 x 10-32	MQ6-40	
268PPNIC-4A		1/4 x 1/8	MQ6-42	
268PPNIC-4B		1/4 x 1/4	MQ6-44	
268PPNIC-4C		1/4 x 3/8	MQ6-46	
268PPNIC-5A		5/16 x 1/8	MQ6-52	
268PPNIC-5B		5/16 x 1/4	MQ6-54	
268PPNIC-5C		5/16 x 3/8	MQ6-56	
268PPNIC-6A		3/8 x 1/8	MQ6-62	
268PPNIC-6B		3/8 x 1/4	MQ6-64	
268PPNIC-6C		3/8 x 3/8	MQ6-66	
268PPNIC-6D		3/8 x 1/2	MQ6-68	
268PPNIC-8B		1/2 x 1/4	MQ6-84	
268PPNIC-8C		1/2 x 3/8	MQ6-86	
268PPNIC-8D		1/2 x 1/2	MQ6-88	

90° MALE ELBOW SWIVEL W/ NICKEL COLLET



CHAMPION	LIST	PTC X MPT	MAF #	MAF PRICE
269PPSNIC-2X1032		1/8 x 10-32		
269PPSNIC-2A		1/8 x 1/8	MQ69S-22	----
269PPSNIC-2B		1/8 x 1/4	MQ69S-24	----
269PPSNIC-2.5X1032		5/32 x 10-32	MQ69S-5320	----
269PPSNIC-2.5A		5/32 x 1/8	MQ69S-5322	
269PPSNIC-4A		1/4 x 1/8	MQ69S-42	----
269PPSNIC-4B		1/4 x 1/4	MQ69S-44	----
269PPSNIC-4C		1/4 x 3/8	MQ69S-46	----
269PPSNIC-5B		5/16 x 1/4	MQ69S-54	
269PPSNIC-5C		5/16 x 3/8	MQ69S-56	
269PPSNIC-6A		3/8 x 1/8	MQ69S-62	----
269PPSNIC-6B		3/8 x 1/4	MQ69S-64	----
269PPSNIC-6C		3/8 x 3/8	MQ69S-66	----
269PPSNIC-6D		3/8 x 1/2	MQ69S-68	----
269PPSNIC-8B		1/2 x 1/4	MQ69S-84	
269PPSNIC-8C		1/2 x 3/8	MQ69S-86	----
269PPSNIC-8D		1/2 x 1/2	MQ69S-88	----

WARNING: This product can expose you to chemicals, including lead, which are known to the State of California to cause cancer and birth defects or other reproductive harm. For more information, visit www.P65Warnings.ca.gov

BRASS

NICKEL PLATED WITH NICKEL COLLET

BRASS FITTINGS

MALE RUN TEE SWIVEL W/ NICKEL COLLET

CHAMPION	LIST	PTC X MPT	MAF #	MAF PRICE
271PPSNIC-2X1032		1/8 x 10-32		
271PPSNIC-2A		1/8 x 1/8		
271PPSNIC-4A		1/4 x 1/8		
271PPSNIC-4B		1/4 x 1/4		
271PPSNIC-4C		1/4 x 3/8		
271PPSNIC-6B		3/8 x 1/4		
271PPSNIC-6C		3/8 x 3/8		
271PPSNIC-6D		3/8 x 1/2		
271PPSNIC-8C		1/2 x 3/8		
271PPSNIC-8D		1/2 x 1/2		

MALE BRANCH TEE SWIVEL W/ NICKEL COLLET

CHAMPION	LIST	PTC X MPT	MAF #	MAF PRICE
272PPSNIC-2X1032		1/8 x 10-32	MQ72-20	
272PPSNIC-2A		1/8 x 1/8	MQ72-22	----
272PPSNIC-4A		1/4 x 1/8	MQ72-42	----
272PPSNIC-4B		1/4 x 1/4	MQ72-44	----
272PPSNIC-4C		1/4 x 3/8		
272PPSNIC-5A		5/16 x 1/8		
272PPSNIC-5B		5/16 x 1/4		
272PPSNIC-5C		5/16 x 3/8		
272PPSNIC-6B		3/8 x 1/4	MQ72-64	----
272PPSNIC-6C		3/8 x 3/8	MQ72-66	----
272PPSNIC-6D		3/8 x 1/2	MQ72-68	
272PPSNIC-8B		1/2 x 1/4	MQ72-84	
272PPSNIC-8C		1/2 x 3/8	MQ72-86	----
272PPSNIC-8D		1/2 x 1/2	MQ72-88	

BULKHEAD UNION W/ NICKEL COLLET

CHAMPION	LIST	PTC	MAF #	MAF PRICE
283PPNIC-2.5		5/32	MQ82-532	
283PPNIC-4		1/4	MQ82-4	----
283PPNIC-5		5/16	MQ82-5	
283PPNIC-6		3/8	MQ82-6	----
283PPNIC-8		1/2	MQ82-8	----

METRIC UNION W/ NICKEL COLLET

CHAMPION	LIST	PTC	MAF #	MAF PRICE
262PPNIC-4MM		4MM		
262PPNIC-6MM		6MM		
262PPNIC-8MM		8MM		
262PPNIC-10MM		10MM		
262PPNIC-12MM		12MM		

METRIC UNION TEE W/ NICKEL COLLET

CHAMPION	LIST	PTC	MAF #	MAF PRICE
264PPNIC-4MM		4MM		
264PPNIC-6MM		6MM		
264PPNIC-8MM		8MM		
264PPNIC-10MM		10MM		
264PPNIC-12MM		12MM		

WARNING: This product can expose you to chemicals, including lead, which are known to the State of California to cause cancer and birth defects or other reproductive harm. For more information, visit www.P65Warnings.ca.gov

NICKEL PLATED WITH NICKEL COLLET

BRASS FITTINGS

METRIC 90° UNION ELBOW W/ NICKEL COLLET



CHAMPION	LIST	PTC	MAF #	MAF PRICE
265PPNIC-4MM		4MM		
265PPNIC-6MM		6MM		
265PPNIC-8MM		8MM		

METRIC FEMALE ADAPTER W/ NICKEL COLLET



CHAMPION	LIST	PTC X FEMALE BSPP	MAF #	MAF PRICE
266PPNIC-4MMX1/8		4MM x 1/8		
266PPNIC-6MMX1/8		6MM x 1/8		
266PPNIC-6MMX1/4		6MM x 1/4		
266PPNIC-8MMX1/8		8MM x 1/8		
266PPNIC-8MMX1/4		8MM x 1/4		
266PPNIC-10MMX1/4		10MM x 1/4		
266PPNIC-10MMX3/8		10MM x 3/8		

METRIC MALE CONNECTOR W/ NICKEL COLLET



CHAMPION	LIST	PTC X MALE BSPT	MAF #	MAF PRICE
268PPNIC-4MMX1/8		4MM x 1/8		
268PPNIC-4MMX1/4		4MM x 1/4		
268PPNIC-6MMX1/8		6MM x 1/8		
268PPNIC-6MMX1/4		6MM x 1/4		
268PPNIC-8MMX1/8		8MM x 1/8		
268PPNIC-8MMX1/4		8MM x 1/4		
268PPNIC-8MMX3/8		8MM x 3/8		
268PPNIC-10MMX1/4		10MM x 1/4		
268PPNIC-10MMX3/8		10MM x 3/8		
268PPNIC-12MMX1/4		12MM x 1/4		

METRIC 90° MALE ELBOW SWIVEL W/ NICKEL COLLET



CHAMPION	LIST	PTC X MALE BSPT	MAF #	MAF PRICE
269PPSNIC-4MMX1/8		4MM x 1/8		
269PPSNIC-4MMX1/4		4MM x 1/4		
269PPSNIC-6MMXM5		6MM x M5		
269PPSNIC-6MMX1/8		6MM x 1/8		
269PPSNIC-6MMX1/4		6MM x 1/4		
269PPSNIC-8MMX1/8		8MM x 1/8		
269PPSNIC-8MMX1/4		8MM x 1/4		
269PPSNIC-8MMX3/8		8MM x 3/8		
269PPSNIC-10MMX1/4		10MM x 1/4		
269PPSNIC-10MMX3/8		10MM x 3/8		

METRIC BULKHEAD UNION W/ NICKEL COLLET



CHAMPION	LIST	PTC	MAF #	MAF PRICE
283PPNIC-4MM		4MM		
283PPNIC-8MM		8MM		

WARNING: This product can expose you to chemicals, including lead, which are known to the State of California to cause cancer and birth defects or other reproductive harm. For more information, visit www.P65Warnings.ca.gov



STAINLESS STEEL PUSH IN FITTINGS

BRASS FITTINGS

UNION STAINLESS STEEL



CHAMPION	PTC	LIST
262PP-SS-2.5	5/32	
262PP-SS-3	3/16	
262PP-SS-4	1/4	
262PP-SS-5	5/16	
262PP-SS-6	3/8	
262PP-SS-8	1/2	

UNION TEE STAINLESS STEEL



CHAMPION	PTC	LIST
264PP-SS-2.5	5/32	
264PP-SS-4	1/4	
264PP-SS-5	5/16	
264PP-SS-6	3/8	
264PP-SS-8	1/2	

90° UNION ELBOW STAINLESS STEEL



CHAMPION	PTC	LIST
265PP-SS-2.5	5/32	
265PP-SS-4	1/4	
265PP-SS-5	5/16	
265PP-SS-6	3/8	
265PP-SS-8	1/2	

FEMALE ADAPTER STAINLESS STEEL



CHAMPION	PTC X FPT	LIST
266PP-SS-2.5X1032	5/32 x 10-32	
266PP-SS-2.5A	5/32 x 1/8	
266PP-SS-2.5B	5/32 x 1/4	
266PP-SS-4X1032	1/4 x 10-32	
266PP-SS-4A	1/4 x 1/8	
266PP-SS-4B	1/4 x 1/4	
266PP-SS-4C	1/4 x 3/8	
266PP-SS-4D	1/4 x 1/2	
266PP-SS-5A	5/16 x 1/8	
266PP-SS-5B	5/16 x 1/4	
266PP-SS-5C	5/16 x 3/8	
266PP-SS-5D	5/16 x 1/2	
266PP-SS-6B	3/8 x 1/4	
266PP-SS-6C	3/8 x 3/8	
266PP-SS-6D	3/8 x 1/2	
266PP-SS-8B	1/2 x 1/4	
266PP-SS-8C	1/2 x 3/8	
266PP-SS-8D	1/2 x 1/2	

WARNING: This product can expose you to chemicals, including lead, which are known to the State of California to cause cancer and birth defects or other reproductive harm. For more information, visit www.P65Warnings.ca.gov



STAINLESS STEEL PUSH IN FITTINGS

BRASS FITTINGS

MALE CONNECTOR STAINLESS STEEL



CHAMPION	PTC X MPT	LIST
268PP-SS-2X1032	1/8 x 10-32	
268PP-SS-2.5X1032	5/32 x 10-32	
268PP-SS-2.5A	5/32 x 1/8	
268PP-SS-2.5B	5/32 x 1/4	
268PP-SS-4X1032	1/4 x 10-32	
268PP-SS-4A	1/4 x 1/8	
268PP-SS-4B	1/4 x 1/4	
268PP-SS-4C	1/4 x 3/8	
268PP-SS-4D	1/4 x 1/2	
268PP-SS-5A	5/16 x 1/8	
268PP-SS-5B	5/16 x 1/4	
268PP-SS-5C	5/16 x 3/8	
268PP-SS-5D	5/16 x 1/2	
268PP-SS-6B	3/8 x 1/4	
268PP-SS-6C	3/8 x 3/8	
268PP-SS-6D	3/8 x 1/2	
268PP-SS-8B	1/2 x 1/4	
268PP-SS-8C	1/2 x 3/8	
268PP-SS-8D	1/2 x 1/2	

90° MALE ELBOW SWIVEL STAINLESS STEEL



CHAMPION	PTC X MPT	LIST
269PPS-SS-2.5X1032	5/32 x 10-32	
269PPS-SS-2.5A	5/32 x 1/8	
269PPS-SS-2.5B	5/32 x 1/4	
269PPS-SS-4X1032	1/4 x 10-32	
269PPS-SS-4A	1/4 x 1/8	
269PPS-SS-4B	1/4 x 1/4	
269PPS-SS-4C	1/4 x 3/8	
269PPS-SS-4D	1/4 x 1/2	
269PPS-SS-5A	5/16 x 1/8	
269PPS-SS-5B	5/16 x 1/4	
269PPS-SS-5C	5/16 x 3/8	
269PPS-SS-5D	5/16 x 1/2	
269PPS-SS-6A	3/8 x 1/8	
269PPS-SS-6B	3/8 x 1/4	
269PPS-SS-6C	3/8 x 3/8	
269PPS-SS-6D	3/8 x 1/2	
269PPS-SS-8B	1/2 x 1/4	
269PPS-SS-8C	1/2 x 3/8	
269PPS-SS-8D	1/2 x 1/2	

WARNING: This product can expose you to chemicals, including lead, which are known to the State of California to cause cancer and birth defects or other reproductive harm. For more information, visit www.P65Warnings.ca.gov

BRASS

STAINLESS STEEL PUSH IN FITTINGS

BRASS FITTINGS

MALE RUN TEE SWIVEL STAINLESS STEEL

CHAMPION	PTC X MPT	LIST
271PPS-SS-2.5X1032	5/32 x 10-32	
271PPS-SS-2.5A	5/32 x 1/8	
271PPS-SS-2.5B	5/32 x 1/4	
271PPS-SS-4X1032	1/4 x 10-32	
271PPS-SS-4A	1/4 x 1/8	
271PPS-SS-4B	1/4 x 1/4	
271PPS-SS-4C	1/4 x 3/8	
271PPS-SS-4D	1/4 x 1/2	
271PPS-SS-5A	5/16 x 1/8	
271PPS-SS-5B	5/16 x 1/4	
271PPS-SS-5C	5/16 x 3/8	
271PPS-SS-5D	5/16 x 1/2	
271PPS-SS-6B	3/8 x 1/4	
271PPS-SS-6C	3/8 x 3/8	
271PPS-SS-6D	3/8 x 1/2	
271PPS-SS-8B	1/2 x 1/4	
271PPS-SS-8C	1/2 x 3/8	
271PPS-SS-8D	1/2 x 1/2	

MALE BRANCH TEE SWIVEL STAINLESS STEEL

CHAMPION	PTC X MPT	LIST
272PPS-SS-2.5X1032	5/32 x 10-32	
272PPS-SS-2.5A	5/32 x 1/8	
272PPS-SS-2.5B	5/32 x 1/4	
272PPS-SS-4X1032	1/4 x 10-32	
272PPS-SS-4A	1/4 x 1/8	
272PPS-SS-4B	1/4 x 1/4	
272PPS-SS-4C	1/4 x 3/8	
272PPS-SS-4D	1/4 x 1/2	
272PPS-SS-5A	5/16 x 1/8	
272PPS-SS-5B	5/16 x 1/4	
272PPS-SS-5C	5/16 x 3/8	
272PPS-SS-5D	5/16 x 1/2	
272PPS-SS-6A	3/8 x 1/8	
272PPS-SS-6B	3/8 x 1/4	
272PPS-SS-6C	3/8 x 3/8	
272PPS-SS-6D	3/8 x 1/2	
272PPS-SS-8B	1/2 x 1/4	
272PPS-SS-8C	1/2 x 3/8	
272PPS-SS-8D	1/2 x 1/2	

WARNING: This product can expose you to chemicals, including lead, which are known to the State of California to cause cancer and birth defects or other reproductive harm. For more information, visit www.P65Warnings.ca.gov

STAINLESS STEEL PUSH IN FITTINGS

BRASS FITTINGS

FEMALE BULKHEAD ADAPTER STAINLESS STEEL



CHAMPION	PTC X FPT	LIST
287PP-SS-2.5X1032	5/32 x 10.32	
287PP-SS-2.5A	5/32 x 1/8	
287PP-SS-2.5B	5/32 x 1/4	
287PP-SS-4X1032	1/4 x 10.32	
287PP-SS-4A	1/4 x 1/8	
287PP-SS-4B	1/4 x 1/4	
287PP-SS-4C	1/4 x 3/8	
287PP-SS-4D	1/4 x 1/2	
287PP-SS-5A	5/16 x 1/8	
287PP-SS-5B	5/16 x 1/4	
287PP-SS-5C	5/16 x 3/8	
287PP-SS-5D	5/16 x 1/2	
287PP-SS-6B	3/8 x 1/4	
287PP-SS-6C	3/8 x 3/8	
287PP-SS-6D	3/8 x 1/2	
287PP-SS-8B	1/2 x 1/4	
287PP-SS-8C	1/2 x 3/8	
287PP-SS-8D	1/2 x 1/2	

BULKHEAD UNION STAINLESS STEEL

CHAMPION	PTC	LIST
262BHPP-SS-6	3/8	

BULKHEAD UNION STAINLESS STEEL



CHAMPION	PTC	LIST
283PP-SS-2.5	5/32	
283PP-SS-4	1/4	
283PP-SS-5	5/16	
283PP-SS-6	3/8	
283PP-SS-8	1/2	

Y-CONNECTOR UNION STAINLESS STEEL



CHAMPION	PTC	LIST
289PP-SS-2.5	5/32	
289PP-SS-4	1/4	
289PP-SS-5	5/16	
289PP-SS-6	3/8	
289PP-SS-8	1/2	

WARNING: This product can expose you to chemicals, including lead, which are known to the State of California to cause cancer and birth defects or other reproductive harm. For more information, visit www.P65Warnings.ca.gov

BRASS

COMPOSITE BODY PUSH-IN FITTINGS

BRASS FITTINGS

Composite Body Push-In Fittings

- For Food Grade, see page 340-343

Specifications

Fluid admitted	Air
Working pressure range	0-150 PSI (10BAR)
Min. Burst pressure	340PSI (23BAR)
Working Temperature range	0°F ~160°F

Materials of Construction:

1	Body	Composite Polyacetal (hemopolymer, copolymer)
2	Body	Brass
3	Tube Release	Acetal Resin
4	Retainer	Brass
5	Gripper Ring	Stainless Steel
6	Spacer	Brass
7	O-Ring	NBR 70
8	Threads	Brass w/ white sealant

The latest generation of composite material is used in the body construction in addition to brass on threaded components and stainless steel on the tube gripper.

• Tolerance

+/- .02 on all dimensions. Dimension data can change without notice. Please call us when dimensions are critical.

May you live all the
days of your life.

- Jonathan Swift



GO ONLINE TO VIEW OPEN ORDERS, ORDER HISTORY, AND TRACKING INFORMATION ON ALL SHIPMENTS

WARNING: This product can expose you to chemicals, including lead, which are known to the State of California to cause cancer and birth defects or other reproductive harm. For more information, visit www.P65Warnings.ca.gov

COMPOSITE BODY PUSH-IN FITTINGS

BRASS FITTINGS

UNION



MIDLAND	CHAMPION	TUBE O.D.	LIST
20017C	262PPC-2	1/8"	
20018C	262PPC-2.5	5/32"	
20001C	262PPC-3	3/16"	
20019C	262PPC-4	1/4"	
20015C	262PPC-5	5/16"	
20020C	262PPC-6	3/8"	
20021C	262PPC-8	1/2"	
	262PPC-42	1/4" x 1/8"	
20016C	262PPC-42.5	1/4" x 5/32"	
20515C	262PPC-54	5/16" x 1/4"	
20022C	262PPC-64	3/8" x 1/4"	
20516C	262PPC-65	3/8" x 5/16"	
20024C	262PPC-86	1/2" x 3/8"	

PQ62P

UNION TEE



MIDLAND	CHAMPION	TUBE O.D.	LIST
20025C	264PPC-2	1/8"	
20026C	264PPC-2.5	5/32"	
20027C	264PPC-3	3/16"	
20028C	264PPC-4	1/4"	
20031C	264PPC-5	5/16"	
20029C	264PPC-6	3/8"	
20030C	264PPC-8	1/2"	
	264PPC-2.54	5/32" x 1/4"	
	264PPC-42.5	1/4" x 5/32"	
	264PPC-46	1/4" x 3/8"	
	264PPC-54	5/16" x 1/4"	
	264PPC-64	3/8" x 1/4"	
	264PPC-65	3/8" x 5/16"	
	264PPC-86	1/2" x 3/8"	

PQ64P

90° UNION ELBOW



MIDLAND	CHAMPION	TUBE O.D.	LIST
20150C	265PPC-2	1/8"	
20151C	265PPC-2.5	5/32"	
20149C	265PPC-3	3/16"	
20152C	265PPC-4	1/4"	
20155C	265PPC-5	5/16"	
20153C	265PPC-6	3/8"	
20154C	265PPC-8	1/2"	

PQ65P

UNION "Y" CONNECTOR



MIDLAND	CHAMPION	TUBE O.D.	LIST
	289PPC-2	1/8"	
20551C	289PPC-2.5	5/32"	
20553C	289PPC-4	1/4"	
20182C	289PPC-5	5/16"	
20555C	289PPC-6	3/8"	
20185C	289PPC-8	1/2"	
	289PPC-46	1/4" x 3/8"	
	289PPC-64	3/8" x 1/4"	

PQ89P

WARNING: This product can expose you to chemicals, including lead, which are known to the State of California to cause cancer and birth defects or other reproductive harm. For more information, visit www.P65Warnings.ca.gov

BRASS

COMPOSITE BODY PUSH-IN FITTINGS

BRASS FITTINGS

FEMALE CONNECTOR

• Brass

MIDLAND	CHAMPION	TUBE O.D. X FEMALE NPT	LIST
	266PPC-2X1032	1/8" x 10-32	
	266PPC-2A	1/8" x 1/8"	
	266PPC-2.5A	5/32" x 1/8"	
	266PPC-2.5B	5/32" x 1/4"	
	266PPC-3A	3/16" x 1/8"	
20034C	266PPC-4A	1/4" x 1/8"	
20035C	266PPC-4B	1/4" x 1/4"	
	266PPC-5A	5/16" x 1/8"	
	266PPC-5B	5/16" x 1/4"	
	266PPC-5C	5/16" x 3/8"	
	266PPC-6A	3/8" x 1/8"	
20036C	266PPC-6B	3/8" x 1/4"	
20037C	266PPC-6C	3/8" x 3/8"	
	266PPC-6D	3/8" x 1/2"	
	266PPC-8B	1/2" x 1/4"	
	266PPC-8C	1/2" x 3/8"	

PQ66P

MALE CONNECTOR

• Nickel Plated

MIDLAND	CHAMPION	TUBE O.D. X MALE NPT	LIST
	268PPC-2X1032	1/8" x 10-32	
	268PPC-2X	1/8" x 1/16"	
	268PPC-2A	1/8" x 1/8"	
	268PPC-2B	1/8" x 1/4"	
	268PPC-2.5X1032	5/32" x 10-32	
20050C	268PPC-2.5A	5/32" x 1/8"	
	268PPC-2.5B	5/32" x 1/4"	
	268PPC-3A	3/16" x 1/8"	
	268PPC-3B	3/16" x 1/4"	
20053C	268PPC-4X1032	1/4" x 10-32"	
20054C	268PPC-4A	1/4" x 1/8"	
20055C	268PPC-4B	1/4" x 1/4"	
20056C	268PPC-4C	1/4" x 3/8"	
	268PPC-4D	1/4" x 1/2"	
20530C	268PPC-5A	5/16" x 1/8"	
20531C	268PPC-5B	5/16" x 1/4"	
	268PPC-5C	5/16" x 3/8"	
20057C	268PPC-6A	3/8" x 1/8"	
20058C	268PPC-6B	3/8" x 1/4"	
20059C	268PPC-6C	3/8" x 3/8"	
20062C	268PPC-6D	3/8" x 1/2"	
20060C	268PPC-8B	1/2" x 1/4"	
20061C	268PPC-8C	1/2" x 3/8"	
20063C	268PPC-8D	1/2" x 1/2"	

PQ68P

WARNING: This product can expose you to chemicals, including lead, which are known to the State of California to cause cancer and birth defects or other reproductive harm. For more information, visit www.P65Warnings.ca.gov

COMPOSITE BODY PUSH-IN FITTINGS

BRASS FITTINGS

SWIVEL MALE ELBOW



- Swivels for installation only.
- Not a live swivel
- * Global Thread

MIDLAND	CHAMPION	TUBE O.D. X MALE NPT	LIST
	269PPSC-2X1032	1/8" x 10-32	
	269PPSC-2X	1/8" x 1/16"	
20079C	269PPSC-2A	1/8" x 1/8"	
20535C*	269PPSC-2B	1/8" x 1/4"	
20049C*	269PPSC-2.5X1032	5/32" x 10/32	
20080C*	269PPSC-2.5A	5/32" x 1/8"	
20077C*	269PPSC-2.5B	5/32" x 1/4"	
	269PPSC-3A	3/16" x 1/8"	
20517C*		3/16" x 1/4"	
20078C	269PPSC-4X1032	1/4" x 10-32	
20081C	269PPSC-4A	1/4" x 1/8"	
20082C	269PPSC-4B	1/4" x 1/4"	
20086C	269PPSC-4C	1/4" x 3/8"	
20518C*	269PPSC-4D	1/4" x 1/2"	
20537C	269PPSC-5A	5/16" x 1/8"	
20538C	269PPSC-5B	5/16" x 1/4"	
20539C*	269PPSC-5C	5/16" x 3/8"	
20087C	269PPSC-6A	3/8" x 1/8"	
20083C	269PPSC-6B	3/8" x 1/4"	
20084C	269PPSC-6C	3/8" x 3/8"	
20088C	269PPSC-6D	3/8" x 1/2"	
20184C	269PPSC-8B	1/2" x 1/4"	
20085C	269PPSC-8C	1/2" x 3/8"	
20092C*	269PPSC-8D	1/2" x 1/2"	

PQ69PS

LONG PATTERN MALE ELBOWS



MIDLAND	CHAMPION	TUBE O.D. X THREAD	LIST
20572C	269EXTPPSC-4A	1/4" x 1/8"	
20573C	269EXTPPSC-4B	1/4" x 1/4"	
20574C	269EXTPPSC-4C	1/4" x 3/8"	
20579C	269EXTPPSC-6B	3/8" x 1/4"	
20580C	269EXTPPSC-6C	3/8" x 3/8"	
20581C	269EXTPPSC-6D	3/8" x 1/2"	
20582C	269EXTPPSC-8B	1/2" x 1/4"	
20583C	269EXTPPSC-8C	1/2" x 3/8"	
20584C	269EXTPPSC-8D	1/2" x 1/2"	

FEMALE SWIVEL ELBOWS



MIDLAND	CHAMPION	TUBE O.D. X FEMALE NPT	LIST
	270PPSC-2A	1/8" x 1/8"	
	270PPSC-2.5A	5/32" x 1/8"	
	270PPSC-2.5B	5/32" x 1/4"	
	270PPSC-4X1032	1/4" x 10-32	
20089C	270PPSC-4A	1/4" x 1/8"	
20090C	270PPSC-4B	1/4" x 1/4"	
20591C	270PPSC-4C	1/4" x 3/8"	
	270PPSC-5A	5/16" x 1/8"	
	270PPSC-6A	3/8" x 1/8"	
20091C	270PPSC-6B	3/8" x 1/4"	
20595C	270PPSC-6C	3/8" x 3/8"	
20596C		3/8" x 1/2"	
20597C	270PPSC-8C	1/2" x 3/8"	
20598C		1/2" x 1/2"	

WARNING: This product can expose you to chemicals, including lead, which are known to the State of California to cause cancer and birth defects or other reproductive harm. For more information, visit www.P65Warnings.ca.gov

BRASS

COMPOSITE BODY PUSH-IN FITTINGS

BRASS FITTINGS

45° SWIVELS



MIDLAND	CHAMPION	TUBE O.D. X MALE NPT	LIST
20139C	279PPSC-4A	1/4" x 1/8"	
20140C	279PPSC-4B	1/4" x 1/4"	

SWIVEL MALE RUN TEE



- Swivels for installation only.
- Not a live swivel
- * Global Thread

MIDLAND	CHAMPION	TUBE O.D. X MALE NPT	LIST
	271PPSC-2X1032	1/8" x 10-32	
20160C*	271PPSC-2A	1/8" x 1/8"	
20833C*		1/8" x 1/4"	
20835C*	271PPSC-2.5X1032	5/32" x 10-32	
	271PPSC-2.5A	5/32" x 1/8"	
	271PPSC-2.5B	5/32" x 1/4"	
20834C*	271PPSC-4X1032	1/4" x 10-32	
20162C	271PPSC-4A	1/4" x 1/8"	
20163C	271PPSC-4B	1/4" x 1/4"	
	271PPSC-4C	1/4" x 3/8"	
	271PPSC-5A	5/16" x 1/8"	
	271PPSC-5B	5/16" x 1/4"	
	271PPSC-5C	5/16" x 3/8"	
20099C	271PPSC-6A	3/8" x 1/8"	
20100C	271PPSC-6B	3/8" x 1/4"	
20165C	271PPSC-6C	3/8" x 3/8"	
20181C	271PPSC-6D	3/8" x 1/2"	
20174C	271PPSC-8B	1/2" x 1/4"	
20166C	271PPSC-8C	1/2" x 3/8"	
20167C	271PPSC-8D	1/2" x 1/2"	

PQ71PS

SWIVEL MALE BRANCH TEE



- Swivels for installation only.
- Not a live swivel
- * Global Thread

MIDLAND	CHAMPION	TUBE O.D. X MALE NPT	LIST
	272PPSC-2X1032	1/8" x 10-32	
	272PPSC-2X	1/8" x 1/16"	
20103C*	272PPSC-2A	1/8" x 1/8"	
20519C*	272PPSC-2B	1/8" x 1/4"	
20104C*	272PPSC-2.5X1032	5/32" x 10-32	
20109C*	272PPSC-2.5A	5/32" x 1/8"	
20135C*	272PPSC-2.5B	5/32" x 1/4"	
20830C*		3/16" x 1/8"	
20831C*	272PPSC-4X1032	1/4" x 10-32	
20105C	272PPSC-4A	1/4" x 1/8"	
20106C	272PPSC-4B	1/4" x 1/4"	
20121C	272PPSC-4C	1/4" x 3/8"	
20136C*	272PPSC-5A	5/16" x 1/8"	
20137C*	272PPSC-5B	5/16" x 1/4"	
20832C*	272PPSC-5C	5/16" x 3/8"	
	272PPSC-6A	3/8" x 1/8"	
20107C	272PPSC-6B	3/8" x 1/4"	
20108C	272PPSC-6C	3/8" x 3/8"	
20158C*	272PPSC-6D	3/8" x 1/2"	
20138C*	272PPSC-8B	1/2" x 1/4"	
20110C	272PPSC-8C	1/2" x 3/8"	
20111C	272PPSC-8D	1/2" x 1/2"	

PQ72PS

BULKHEAD UNION



MIDLAND	CHAMPION	TUBE O.D.	LIST
	283PPC-2	1/8"	
	283PPC-2.5	5/32"	
20127C	283PPC-4	1/4"	
	283PPC-5	5/16"	
20128C	283PPC-6	3/8"	
20129C	283PPC-8	1/2"	

PQ82P

WARNING: This product can expose you to chemicals, including lead, which are known to the State of California to cause cancer and birth defects or other reproductive harm. For more information, visit www.P65Warnings.ca.gov



COMPOSITE BODY PUSH-IN FITTINGS

BRASS FITTINGS

BULKHEAD FEMALES



MIDLAND	CHAMPION	TUBE O.D. X THREAD	LIST
20170C	287PPC-4A	1/4" x 1/8"	
20171C	287PPC-4B	1/4" x 1/4"	
20172C	287PPC-6B	3/8" x 1/4"	
20173C	287PPC-6C	3/8" x 3/8"	
20175C		1/2" x 1/4"	
20176C		1/2" x 3/8"	
20179C		1/2" x 1/2"	

SWIVEL "Y" CONNECTOR



- Swivels for installation only.
- Not a live swivel

MIDLAND	CHAMPION	TUBE O.D. X MALE NPT	LIST
20187C	288PPSC-4A	1/4" x 1/8"	
20557C	288PPSC-4B	1/4" x 1/4"	
20188C	288PPSC-6B	3/8" x 1/4"	
20189C	288PPSC-6C	3/8" x 3/8"	
20193C	288PPSC-6D	3/8" x 1/2"	
20194C	288PPSC-8C	1/2" x 3/8"	
20195C	288PPSC-8D	1/2" x 1/2"	

PQ88PS

IN-LINE NEEDLE VALVE



MIDLAND	CHAMPION	TUBE O.D.	LIST
	959PPC-2	1/8"	
	959PPC-2.5	5/32"	
20487C	959PPC-4	1/4"	
20488C	959PPC-5	5/16"	
20489C	959PPC-6	3/8"	
	959PPC-8	1/2"	

PQ310C

RIGHT ANGLE FLOW CONTROL METER IN



- Marked w/V
- Free flow out

← Metered

→ Free Flow

MIDLAND	CHAMPION	TUBE O.D. X MALE NPT	LIST
20727C		1/4" x 1/8"	
20728C		1/4" x 1/4"	
20780C		3/8" x 1/4"	
20781C		3/8" x 3/8"	
20782C		1/2" x 1/2"	

JPQ

RIGHT ANGLE FLOW CONTROL METER OUT



- Marked w/C
- Free flow in

→ Metered

← Free Flow



MIDLAND	CHAMPION	TUBE O.D. X MALE NPT	LIST
20785C	958PPC-4A	1/4" x 1/8"	
20786C	958PPC-4B	1/4" x 1/4"	
20787C		3/8" x 1/4"	
20788C	958PPC-6C	3/8" x 3/8"	
20789C	958PPC-8D	1/2" x 1/2"	

WARNING: This product can expose you to chemicals, including lead, which are known to the State of California to cause cancer and birth defects or other reproductive harm. For more information, visit www.P65Warnings.ca.gov

BRASS

METRIC COMPOSITE BODY PUSH-IN FITTINGS

BRASS FITTINGS

Technical Characteristics

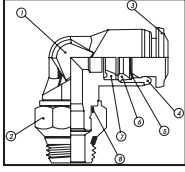

PART 1	BODY	COMPOSITE
PART 2	BODY	NICKEL PLATED BRASS
PART 3	TUBE RELEASE	ACETAL RESIN
PART 4	RETAINER	NICKEL PLATED BRASS
PART 5	GRIPPER RING	STAINLESS STEEL
PART 6	SPACER	COMPOSITE
PART 7	THREAD PACKING	NBR 70
PART 8	O-RING	NBR 70
PART 9	THREAD SEAL	NBR70

Operating Range

Pressure: 0 to 220 PSI (15 bar)

Vacuum: 0 to 29hg (-.99 bar)

Temperature

-5° F to + 175° F (-20° C to + 80° C)

Media

Compressed air.

Non-toxic fluids (water)

Materials

The latest generation of composite material is used in the body construction in addition to nickel-plated brass on threaded components and stainless steel on the tube gripper.

UNION



MIDLAND	CHAMPION	TUBE O.D. (MM)	LIST
20600	262PPC-4MM	4	
20601	262PPC-6MM	6	
20602	262PPC-8MM	8	
20603	262PPC-10MM	10	
20604	262PPC-12MM	12	
	262PPC-14MM	14	
	262PPC-16MM	16	
	262PPC-6MMX4MM	6 x 4	
	262PPC-8MMX6MM	8 x 6	
	262PPC-10MMX8MM	10 x 8	
	262PPC-12MMX10MM	12 x 10	

UNION ELBOW



MIDLAND	CHAMPION	TUBE O.D. (MM)	LIST
20806	265PPC-4MM	4	
20660	265PPC-6MM	6	
20661	265PPC-8MM	8	
20807	265PPC-10MM	10	
20808	265PPC-12MM	12	
20740	265PPC-14MM	14	
	265PPC-16MM	16	

3102

UNION TEE



MIDLAND	CHAMPION	TUBE O.D. (MM)	LIST
20610	264PPC-4MM	4	
20862		5	
20611	264PPC-6MM	6	
20612	264PPC-8MM	8	
20613	264PPC-10MM	10	
20614	264PPC-12MM	12	
20861	264PPC-14MM	14	
	264PPC-16MM	16	

3104

FEMALE ADAPTER



MIDLAND	CHAMPION	TUBE O.D. (MM) X FEMALE BSPT	LIST
	266PPC-4MMX1/8	4 x 1/8	
	266PPC-4MMX1/4	4 x 1/4	
	266PPC-6MMX1/8	6 x 1/8	
	266PPC-6MMX1/4	6 x 1/4	
	266PPC-8MMX1/8	8 x 1/8	
	266PPC-8MMX1/4	8 x 1/4	
	266PPC-10MMX3/8	10 x 3/8	
	266PPC-12MMX3/8	12 x 3/8	
	266PPC-12MMX1/2	12 x 1/2	

WARNING: This product can expose you to chemicals, including lead, which are known to the State of California to cause cancer and birth defects or other reproductive harm. For more information, visit www.P65Warnings.ca.gov



METRIC COMPOSITE BODY PUSH-IN FITTINGS

BRASS FITTINGS

MALE ADAPTER



MIDLAND	CHAMPION	TUBE OD (MM) X MALE BSPT	LIST
	268PPC-4MMXM5	4 x M5	
20630	268PPC-4MMX1/8	4 x 1/8	
20631	268PPC-4MMX1/4	4 x 1/4	
	268PPC-6MMXM5	6 x M5	
20632	268PPC-6MMX1/8	6 x 1/8	
20633	268PPC-6MMX1/4	6 x 1/4	
	268PPC-6MMX3/8	6 x 3/8	
	268PPC-6MMX1/2	6 x 1/2	
	268PPC-8MMX1/8	8 x 1/8	
20634	268PPC-8MMX1/4	8 x 1/4	
20635	268PPC-8MMX3/8	8 x 3/8	
	268PPC-8MMX1/2	8 x 1/2	
	268PPC-10MMX1/8	10 x 1/8	
20636	268PPC-10MMX1/4	10 x 1/4	
20637	268PPC-10MMX3/8	10 x 3/8	
	268PPC-10MMX1/2	10 x 1/2	
20801	268PPC-12MMX1/4	12 x 1/4	
20638	268PPC-12MMX3/8	12 x 3/8	
	268PPC-12MMX1/2	12 x 1/2	
	268PPC-14MMX3/8	14 x 3/8	
	268PPC-14MMX1/2	14 x 1/2	

3175

SWIVEL RUN TEE



MIDLAND	CHAMPION	TUBE OD (MM) X BSPT	LIST
20670		4 x 1/8	
20720*	271PPSNI-4MMX1/4	4 x 1/4	
20721*	271PPSNI-5MMX1/8	5 x 1/8	
20672		6 x 1/8	
20673		6 x 1/4	
20811		8 x 1/8	
20674		8 x 1/4	
20675		8 x 3/8	
20676		10 x 1/4	
20677		10 x 3/8	
20678		12 x 3/8	
20679		12 x 1/2	

- * Global Thread
- BSPP Available

SWIVEL ELBOW



MIDLAND	CHAMPION	TUBE OD (MM) X MALE BSPT	LIST
20690*		4 x M5	
20856*	269PPSC-4MMX1/8	4 x 1/8	
20855*	269PPSC-4MMX1/4	4 x 1/4	
20692*		5 x M5	
20857*		5 x 1/8	
20859*		6 x M5	
20642	269PPSC-6MMX1/8	6 x 1/8	
20803	269PPSC-6MMX1/4	6 x 1/4	
20698*	269PPSC-6MMX3/8	6 x 3/8	
20699*	269PPSC-6MMX1/2	6 x 1/2	
20711*	269PPSC-8MMX1/8	8 x 1/8	
20805	269PPSC-8MMX1/4	8 x 1/4	
20655	269PPSC-8MMX3/8	8 x 3/8	
20712*	269PPSC-8MMX1/2	8 x 1/2	
	269PPSC-10MMX1/8	10 x 1/8	
20656	269PPSC-10MMX1/4	10 x 1/4	
20657	269PPSC-10MMX3/8	10 x 3/8	
20713*	269PPSC-10MMX1/2	10 x 1/2	
20790	269PPSC-12MMX1/4	12 x 1/4	
20658	269PPSC-12MMX3/8	12 x 3/8	
20659	269PPSC-12MMX1/2	12 x 1/2	
20714*	269PPSC-14MMX3/8	14 x 3/8	
20854*	269PPSC-14MMX1/2	14 x 1/2	

- BSPP Available
- * Global Thread

WARNING: This product can expose you to chemicals, including lead, which are known to the State of California to cause cancer and birth defects or other reproductive harm. For more information, visit www.P65Warnings.ca.gov

BRASS

METRIC COMPOSITE BODY PUSH-IN FITTINGS

BRASS FITTINGS

SWIVEL BRANCH TEE



- BSPP Available
- * Global Thread

MIDLAND	CHAMPION	TUBE OD (MM) X MALE BSPT	LIST
20680*	272PPSC-4MMX1/8	4 x 1/8	
20860*	272 PPSC-4MMX1/4	4 x 1/4	
20717*		5 x 1/8	
20682	272PPSC-6MMX1/8	6 x 1/8	
20683	272PPSC-6MMX1/4	6 x 1/4	
20809	272PPSC-8MMX1/8	8 x 1/8	
20684	272PPSC-8MMX1/4	8 x 1/4	
20685	272PPSC-8MMX3/8	8 x 3/8	
20686	272PPSC-10MMX1/4	10 x 1/4	
20687	272PPSC-10MMX3/8	10 x 3/8	
20810	272PPSC-10MMX1/2	10 x 1/2	
	272PPSC-12MMX1/4	12 x 1/4	
20688	272PPSC-12MMX3/8	12 x 3/8	
20689	272PPSC-12MMX1/2	12 x 1/2	
20718*	272PPSC-14MMX3/8	14 x 3/8	

CAP



MIDLAND	CHAMPION	TUBE O.D. (MM)	LIST
20610	285PPC-4MM	4	
20862	285PPC-6MM	6	
20611	285PPC-8MM	8	
20612	285PPC-10MM	10	
20613	285PPC-12MM	12	

UNION WYE



MIDLAND	CHAMPION	TUBE OD (MM)	LIST
20813	289PPC-4MM	4	
20814	289PPC-6MM	6	
20815	289PPC-8MM	8	
20746	289PPC-10MM	10	
20802	289PPC-12MM	12	
	289PPC-4MMX6MM	4 x 6	
	289PPC-6MMX8MM	6 x 8	
	289PPC-8MMX10MM	8 x 10	

SWIVEL MALE WYE



- * Global Thread
- BSPP Available

MIDLAND	CHAMPION	TUBE OD (MM)	LIST
20816		4	
20821*		4	
20817*		6	
20818		6	
20819*		8	
20820*		8	
20822*		8	
20823*		10	
20824*		10	
20825*		10	
20826*		12	
20827*		12	

Also available:

- 45° elbow swivel
- 4 position Y
- Manifolds
- Extended swivel elbows
- Bulkhead union
- Plug-in elbows and tees

WARNING: This product can expose you to chemicals, including lead, which are known to the State of California to cause cancer and birth defects or other reproductive harm. For more information, visit www.P65Warnings.ca.gov



D.O.T. PUSH-IN TUBE FITTINGS

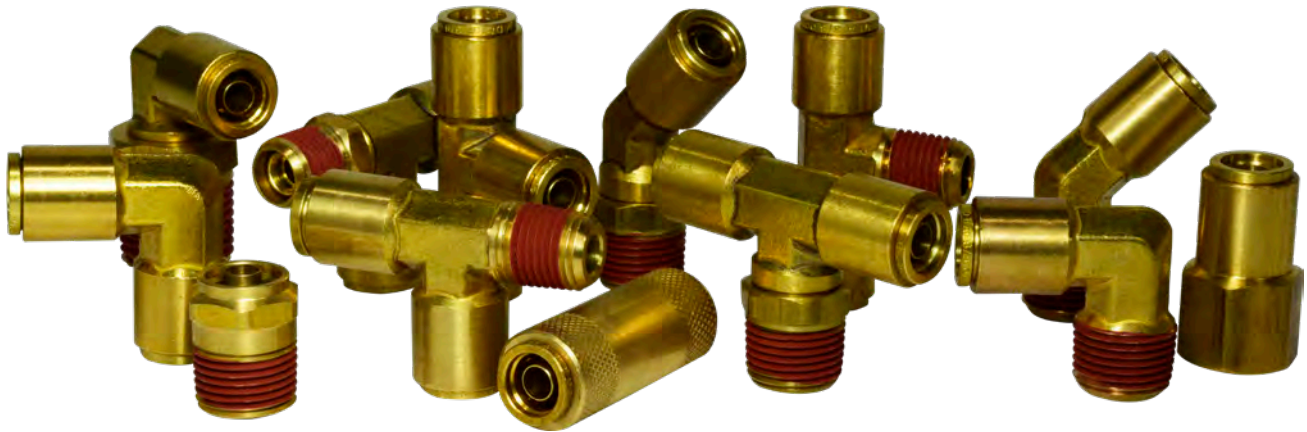

Meets D.O.T. FMVSS 571.106 SAE J1131 Air Brake System Require-

Benefits for Cost Savings & Engineering Project

- **Fast assembly:** No tools required. Simply push tubing in. Saves up to 75% of assembly time compared to standard air compression fittings. No loose parts to handle.
- **Fast disconnect:** Hold the collet collar with two fingers and pull out tube. No tools required.
- **Reusable:** Can be connected and disconnected several times.
- **Reliable sealing:** Using recommended tubing, full sealing is guaranteed.
- **Versatility:** Buna N O'ring standard. Fluoroelastomer and others available per request. Secure tube retention. Pulling on tubing only serves to tighten the connection.
- **Pre-Applied Polytetrafluoroethylene®** based pipe sealant on all male pipe threads, saving customer additional labor.
- **Full Flow Design,** provides more flow area than conventional fittings with internal tube supports even in the swivels.

DOT Fittings are constructed with an all brass captive eyelet which allows for maximum flow. The brass captive eyelet with extended length is floating and has a machined top end radius for easy installation of tubing. All male threads have a pre-applied Polytetrafluoroethylene® based pipe sealant to provide for easy assembly and leak proof seal.

▪ Materials:

Brass

"O" Ring: Buna - Nitrile (90 Durometer)

EP (Ethylene Propylene)

▪ Working Pressures & Temperature Ranges

Vacuum to 150 PSI

-40°F to 200° F (-40°C to +93°C)

PRICING FILE AVAILABLE ONLINE

Dimension data can change without notice. Please see our website when dimensions are critical.

D.O.T. PUSH-IN

BRASS FITTINGS

PLUG

AQ59DOT

MIDLAND	AMC	CHAMPION	TUBE O.D.	LIST
595320	02459-53		5/32"	
590400	02459-04		1/4"	
590600	02459-06		3/8"	
590800	02459-08		1/2"	

1829 **DQ59DOT** 639PMT**UNION**AQ62DOT
DQ62

MIDLAND	AMC	CHAMPION	TUBE O.D.	LIST
		262PPDOT-2	1/8"	
620532	02462-53	262PPDOT-2.5	5/32"	
620300		262PPDOT-3	3/16"	
620400	02462-04	262PPDOT-4	1/4"	
		262PPDOT-5	5/16"	
620600	02462-06	262PPDOT-6	3/8"	
620604			3/8" x 1/4"	
620800	02462-08	262PPDOT-8	1/2"	
621000	02462-10	262PPDOT-10	5/8"	
621200	02462-12	262PPDOT-12	3/4"	

AQ62DOT **62PMT** 1862 **DQ62DOT****UNION TEE**AQ64DOT
DQ64

MIDLAND	AMC	CHAMPION	TUBE O.D.	LIST
		264PPDOT-2.5	5/32"	
640400	02464-04	264PPDOT-4	1/4"	
640600	02464-06	264PPDOT-6	3/8"	
640800	02464-08	264PPDOT-8	1/2"	
641000		264PPDOT-10	5/8"	
641200	02464-12	264PPDOT-12	3/4"	
640604		264PPDOT-664	3/8" x 1/4"	
640804		264PPDOT-884	1/2" x 1/4"	

AQ64DOT **164 PMT** 1864 **DQ64DOT****UNION ELBOW**AQ65DOT
DQ65

MIDLAND	AMC	CHAMPION	TUBE O.D.	LIST
655320	02465-53		5/32"	
		265PPDOT-3	3/16"	
650400	02465-04	265PPDOT-4	1/4"	
650600	02465-06	265PPDOT-6	3/8"	
650800	02465-08	265PPDOT-8	1/2"	

WARNING: This product can expose you to chemicals, including lead, which are known to the State of California to cause cancer and birth defects or other reproductive harm. For more information, visit www.P65Warnings.ca.gov



D.O.T. PUSH-IN

BRASS FITTINGS

FEMALE CONNECTOR



AQ66DOT
DQ66

MIDLAND	AMC	CHAMPION	TUBE O.D. X FEMALE NPTF	LIST
		266PPDOT-2.5A	5/32" x 1/8"	
660402	02466-0402	266PPDOT-4A	1/4" x 1/8"	
660404	02466-0404	266PPDOT-4B	1/4" x 1/4"	
660602		266PPDOT-6A	3/8" x 1/8"	
660604	02466-0604	266PPDOT-6B	3/8" x 1/4"	
660606	02466-0606	266PPDOT-6C	3/8" x 3/8"	
660804	02466-0804	266PPDOT-8B	1/2" x 1/4"	
660806	02466-0806	266PPDOT-8C	1/2" x 3/8"	
660808	02466-0808	266PPDOT-8D	1/2" x 1/2"	

AQ66DOT 66PMT 1866 DQ66DOT

MALE CONNECTOR



AQ68DOT
DQ68

MIDLAND	AMC	CHAMPION	TUBE O.D. X MALE NPTF	LIST
			1/8" x 1/8"	
685320	02468-5300		5/32" x 10/32"	
685321	02468-5301	268PPDOT-2.5X	5/32" x 1/16"	
685322	02468-5302	268PPDOT-2.5A	5/32" x 1/8"	
		268PPDOT-3 x 10/32	3/16" x 10-32"	
680302		268PPDOT-3A	3/16" x 1/8"	
		268PPDOT-3B	3/16" x 1/4"	
		268PPDOT-3X	3/16" x 1/16"	
680421		268PPDOT-4X	1/4" x 1/16"	
680402	02468-0402	268PPDOT-4A	1/4" x 1/8"	
680404	02468-0404	268PPDOT-4B	1/4" x 1/4"	
680406	02468-0406	268PPDOT-4C	1/4" x 3/8"	
680602	02468-0602	268PPDOT-6A	3/8" x 1/8"	
680604	02468-0604	268PPDOT-6B	3/8" x 1/4"	
680606	02468-0606	268PPDOT-6C	3/8" x 3/8"	
680608	02468-0608	268PPDOT-6D	3/8" x 1/2"	
680804	02468-0804	268PPDOT-8B	1/2" x 1/4"	
680806	02468-0806	268PPDOT-8C	1/2" x 3/8"	
680808	02468-0808	268PPDOT-8D	1/2" x 1/2"	
		268PPDOT-8E	1/2" x 3/4"	
681006	02468-1006	268PPDOT-10C	5/8" x 3/8"	
681008	02468-1008	268PPDOT-10D	5/8" x 1/2"	
		268PPDOT-10E	5/8" x 3/4"	
681208	02468-1208	268PPDOT-12D	3/4" x 1/2"	
681212	02468-1212	268PPDOT-12E	3/4" x 3/4"	

AQ68DOT 68PM 1868 DQ68DOT 68PMT

Dimension data can change without notice.
Please see our website when dimensions are critical.

D.O.T. PUSH-IN

BRASS FITTINGS

MALE ELBOW

Forged

AQ69DOT
DQ69

MIDLAND	AMC	CHAMPION	TUBE O.D. X MALE NPTF	LIST
695302		269PPDOT-2.5X	5/32" x 1/16"	
695322	02469-5302	269PPDOT-2.5A	5/32" x 1/8"	
690302		269PPDOT-3A	3/16" x 1/8"	
690402	02469-0402	269PPDOT-4A	1/4" x 1/8"	
690404	02469-0404	269PPDOT-4B	1/4" x 1/4"	
690406	02469-0406	269PPDOT-4C	1/4" x 3/8"	
690602	02469-0602	269PPDOT-6A	3/8" x 1/8"	
690604	02469-0604	269PPDOT-6B	3/8" x 1/4"	
690606	02469-0606	269PPDOT-6C	3/8" x 3/8"	
690608	02469-0608	269PPDOT-6D	3/8" x 1/2"	
690804	02469-0804	269PPDOT-8B	1/2" x 1/4"	
690806	02469-0806	269PPDOT-8C	1/2" x 3/8"	
690808	02469-0808	269PPDOT-8D	1/2" x 1/2"	
691006	02469-1006	269PPDOT-10C	5/8" x 3/8"	
691008	02469-1008	269PPDOT-10D	5/8" x 1/2"	
691208	02469-1208	269PPDOT-12D	3/4" x 1/2"	
691212	02469-1212	269PPDOT-12E	3/4" x 3/4"	

AQ69DOT 169PMTNS 1869 DQ69DOT

MALE SWIVEL ELBOW

Forged

AQ62DOTS
DQ69S

MIDLAND	AMC	CHAMPION	TUBE O.D. X MALE NPTF	LIST
695322S	02569-5302	269PPSDOT-2.5A	5/32" x 1/8"	
		269PPSDOT-2.5B	5/32" x 1/4"	
690402S	02569-0402	269PPSDOT-4A	1/4" x 1/8"	
690404S	02569-0404	269PPSDOT-4B	1/4" x 1/4"	
690406S	02569-0406	269PPSDOT-4C	1/4" x 3/8"	
690602S	02569-0602	269PPSDOT-6A	3/8" x 1/8"	
690604S	02569-0604	269PPSDOT-6B	3/8" x 1/4"	
690606S	02569-0606	269PPSDOT-6C	3/8" x 3/8"	
690608S	02569-0608	269PPSDOT-6D	3/8" x 1/2"	
		269PPSDOT-6E	3/8" x 3/4"	
690804S	02569-0804	269PPSDOT-8B	1/2" x 1/4"	
690806S	02569-0806	269PPSDOT-8C	1/2" x 3/8"	
690808S	02569-0808	269PPSDOT-8D	1/2" x 1/2"	
691006S	02569-1006	269PPSDOT-10C	5/8" x 3/8"	
691008S	02569-1008	269PPSDOT-10D	5/8" x 1/2"	
		269PPSDOT-10E	5/8" x 3/4"	
		269PPSDOT-12C	3/4" x 3/8"	
691208S	02569-1208	269PPSDOT-12D	3/4" x 1/2"	
691212S	02569-1212	269PPSDOT-12E	3/4" x 3/4"	

AQ69DOTS 169PMT 1869 DQ69DOTS

WARNING: This product can expose you to chemicals, including lead, which are known to the State of California to cause cancer and birth defects or other reproductive harm. For more information, visit www.P65Warnings.ca.gov

D.O.T. PUSH-IN

BRASS FITTINGS

FEMALE ELBOW



Forged

AQ70DOTS
DQ70

MIDLAND	AMC	CHAMPION	TUBE O.D. X FEMALE NPTF	LIST
700402	02470-0402	270PPDOT-4A	1/4" x 1/8"	
700404	02470-0404	270PPDOT-4B	1/4" x 1/4"	
700406	02470-0406	270PPDOT-4C	1/4" x 3/8"	
700602			3/8" x 1/8"	
700604	02470-0604	270PPDOT-6B	3/8" x 1/4"	
700606	02470-0606	270PPDOT-6C	3/8" x 3/8"	
700806		270PPDOT-8C	1/2" x 3/8"	
700808	02470-0808	270PPDOT-8D	1/2" x 1/2"	

AQ70DOTS 1870 DQ70DOTS 170PMTNS

FEMALE SWIVEL ELBOW



AQ70DOTS

MIDLAND	AMC	CHAMPION	TUBE O.D. X FEMALE NPTF	LIST
	02570-0402	270PPSDOT-4A	1/4" x 1/8"	
700404S	02570-0404	270PPSDOT-4B	1/4" x 1/4"	
		270PPSDOT-6B	3/8" x 1/4"	

MALE RUN TEE



Forged

AQ71DOT
DQ71

MIDLAND	AMC	CHAMPION	TUBE O.D. X MALE NPTF (1 X 3) X 2	LIST
710402	02471-0402	271PPDOT-4A	1/4" x 1/8"	
			(1/4" x 3/8") x 1/4"	
710404	02471-0404	271PPDOT-4B	1/4" x 1/4"	
710604	02471-0604	271PPDOT-6B	3/8" x 1/4"	
71060404		271PPDOT-64B	(3/8" x 1/4") x 1/4"	
710606	02471-0606	271PPDOT-6C	3/8" x 3/8"	
71060406		271PPDOT-64C	(3/8" x 1/4") x 3/8"	
710608			3/8" x 1/2"	
710806	02471-0806	271PPDOT-8C	1/2" x 3/8"	

AQ71DOT 171PMTNS 1871 DQ71DOT

MALE SWIVEL RUN TEE



Forged

AQ71DOTS
DQ71S

MIDLAND	AMC	CHAMPION	TUBE O.D. X MALE NPTF	LIST
710402S	02571-0402	271PPSDOT-4A	1/4" x 1/8"	
710404S	02571-0404	271PPSDOT-4B	1/4" x 1/4"	
710604S	02571-0604	271PPSDOT-6B	3/8" x 1/4"	
710606S	02571-0606	271PPSDOT-6C	3/8" x 3/8"	
710804S		271PPSDOT-8B	1/2" x 1/4"	
710806S	02571-0806	271PPSDOT-8C	1/2" x 3/8"	
710808S	02571-0808	271PPSDOT-8D	1/2" x 1/2"	

AQ71DOTS 171PMT 1871 DQ71DOTS

WARNING: This product can expose you to chemicals, including lead, which are known to the State of California to cause cancer and birth defects or other reproductive harm. For more information, visit www.P65Warnings.ca.gov

BRASS

D.O.T. PUSH-IN

BRASS FITTINGS

MALE 45° ELBOW

Forged
AQ54DOT
DQ54

MIDLAND	AMC	CHAMPION	TUBE O.D. X MALE NPTF	LIST
540402	02454-0402	279PPDOT-4A	1/4" x 1/8"	
540404	02454-0404	279PPDOT-4B	1/4" x 1/4"	
540602	02454-0602	279PPDOT-6A	3/8" x 1/8"	
540604	02454-0604	279PPDOT-6B	3/8" x 1/4"	
540606	02454-0606	279PPDOT-6C	3/8" x 3/8"	
540608	02454-0608	279PPDOT-6D	3/8" x 1/2"	
540804	02454-0804	279PPDOT-8B	1/2" x 1/4"	
540806	02454-0806	279PPDOT-8C	1/2" x 3/8"	
540808		279PPDOT-8D	1/2" x 1/2"	
541006		279PPDOT-10C	5/8" x 3/8"	
541008	02454-1008	279PPDOT-10D	5/8" x 1/2"	
541208		279PPDOT-12D	3/4" x 1/2"	
541212		279PPDOT-12E	3/4" x 3/4"	

AQ54DOT 179MTNS 1880 DQ54DOT

MALE 45° SWIVEL ELBOW

AQ54DOTS
DQ54S

MIDLAND	AMC	CHAMPION	TUBE O.D. X MALE NPTF	LIST
540402S	02554-0402	279PPSDOT-4A	1/4" x 1/8"	
540404S	02554-0404	279PPSDOT-4B	1/4" x 1/4"	
540602S	02554-0602	279PPSDOT-6A	3/8" x 1/8"	
540604S	02554-0604	279PPSDOT-6B	3/8" x 1/4"	
540606S	02554-0606	279PPSDOT-6C	3/8" x 3/8"	
		279PPSDOT-6D	3/8" x 1/2"	
540804S	02554-0804	279PPSDOT-8B	1/2" x 1/4"	
540806S	02554-0806	279PPSDOT-8C	1/2" x 3/8"	
540808S	02554-0808	279PPSDOT-8D	1/2" x 1/2"	
		279PPSDOT-10C	5/8" x 3/8"	
541008S	02554-1008	279PPSDOT-10D	5/8" x 1/2"	
		279PPSDOT-12E	3/4" x 3/4"	

AQ54DOTS 179PMT 1880 DQ54DOTS

MALE BRANCH TEE

Forged
AQ72DOT
DQ72

MIDLAND	AMC	CHAMPION	TUBE O.D. X MALE NPTF (1 X 2) X 3	LIST
		272PPDOT-2.5A	5/32" x 1/8"	
720302			3/16" x 1/8"	
720402	02472-0402	272PPDOT-4A	1/4" x 1/8"	
720404	02472-0404	272PPDOT-4B	1/4" x 1/4"	
720604	02472-0604	272PPDOT-6B	3/8" x 1/4"	
72060404			(3/8" x 1/4") x 1/4"	
720606	02472-0606	272PPDOT-6C	3/8" x 3/8"	
		272PPDOT-6D	3/8" x 1/2"	
720804	02472-0804		1/2" x 1/4"	
720806	02472-0806	272PPDOT-8C	1/2" x 3/8"	
720808			1/2" x 1/2"	

AQ72DOT 172PMTNS 1872 DQ72DOT

WARNING: This product can expose you to chemicals, including lead, which are known to the State of California to cause cancer and birth defects or other reproductive harm. For more information, visit www.P65Warnings.ca.gov



D.O.T. PUSH-IN

BRASS FITTINGS

MALE SWIVEL BRANCH TEE



AQ72DOTS
DQ72S

MIDLAND	AMC	CHAMPION	TUBE O.D. X MALE NPTF	LIST
720402S	02572-0402	272PPSDOT-4A	1/4" x 1/8"	
720404S	02572-0404	272PPSDOT-4B	1/4" x 1/4"	
720602S		272PPSDOT-6A	3/8" x 1/8"	
720604S	02572-0604	272PPSDOT-6B	3/8" x 1/4"	
720606S	02572-0606	272PPSDOT-6C	3/8" x 3/8"	
		272PPSDOT-6D	3/8" x 1/2"	
720804S	02572-0804	272PPSDOT-8B	1/2" x 1/4"	
720806S	02572-0806	272PPSDOT-8C	1/2" x 3/8"	
720808S	02572-0808	272PPSDOT-8D	1/2" x 1/2"	

AQ72DOTS 172PMT 1872 DQ72DOTS

FEMALE BRANCH TEE



AQ77DOT
DQ77

(RUN) BRANCH				
MIDLAND	AMC	CHAMPION	(1 & 2) X 3	LIST
770402	02477-0402	277PPDOT-4A	1/4" x 1/8"	
770404		277PPDOT-4B	1/4" x 1/4"	
770604		277PPDOT-6B	3/8" x 1/4"	
		277PPDOT-6C	3/8" x 3/8"	

GLADHAND BULKHEAD CONNECTOR



TUBE OD X MALE NPTF				
MIDLAND	AMC	CHAMPION	SIZE	LIST
830808			1/2" x 1/2"	

BULKHEAD UNION

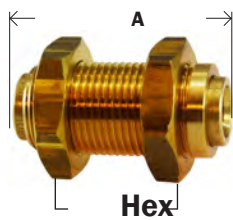

AQ82DOT
DQ82

MIDLAND	AMC	CHAMPION	TUBE O.D.	LIST
820400	02482-04	262BHPPDOT-4	1/4"	
820600	02482-06	262BHPPDOT-6	3/8"	
820800	02482-08	262BHPPDOT-8	1/2"	
821000	02482-10	262BHPPDOT-10	5/8"	

AQ82DOT 62PMTBH 1874 DQ82DOTS

FEMALE BULKHEAD UNION



AQ86DOT
DQ86

• Jam nuts not available separately

MIDLAND	AMC	CHAMPION	TUBE O.D. X FEMALE NPTF	LIST
860402	02486-0402	266BHPPDOT-4A	1/4" x 1/8"	
860404	02486-0404	266BHPPDOT-4B	1/4" x 1/4"	
860604	02486-0604	266BHPPDOT-6B	3/8" x 1/4"	
860606		266BHPPDOT-6C	3/8" x 3/8"	
		266BHPPDOT-8C	1/2" x 3/8"	
860808			1/2" x 1/2"	

AQ86DOT 1873 DQ86DOT 66PMTBH

COMPOSITE BODY D.O.T. PUSH-IN

BRASS FITTINGS

COMPOSITE BODY DOT AIRBRAKE FITTINGS

WARNING

- Composite DOT push-to-connect fittings are designed only for use in applications where air is utilized as an operating fluid.
 - Fittings must be used in accordance with manufacturer and industry specifications.
 - They are not intended for use in environments exceeding 145psi or 140 degrees F.
 - The Department of Transportation FMVSS 49CFR571-106 prohibits use of this type of fitting for connections between towed and towing vehicles or between a driveshaft and chassis.
 - Using Composite DOT fittings in a manner inconsistent with manufacturer specifications may result in serious injury or property damage.
 - Under no circumstances shall the supplier be liable to buyer for any consequential or incidental damages of any nature whatsoever arising from nonconformity of goods, defective goods, or delay in shipment or any other breach by seller.
- Please feel free to email warning@compdotfitting.com with any questions or concerns.



- One touch connection reduces installation time and cost.
- Rugged ultraviolet and vibration resistant composite body.
- Various shapes and configurations to meet vehicle applications and make installations easier.

SPECIFICATIONS FOR FMVSS (D.O.T.) AND SAE COMPLIANT FITTINGS

PRICING FILE AVAILABLE ONLINE

Operating Fluid	Air						
Max. Operating Pressure	145psi (1.0MPa)						
Proof Pressure	Size	5/32"	1/4"	3/8"	1/2"	5/8"	3/4"
	At 75°F (24°C)	1200psi	1200psi	1400psi	950psi	900psi	800psi
	At 200 °F (93°C)	450psi (3.1MPa)					
Recommended Fluid and Ambient Temperature*	-40°F to 140°F (-40°C to 60°C)						
Leak Rate at -40°F (-40°C)	7 Ncm ³ /min. or less						
Thread	Thread Portion	ANSI/ASME B1.20.1, 1983 R1992					
	Nut	JIS B 0208 (Unified fine thread) ISO 263					
Thread Sealant	Fluorine/ Acrylic						
Applicable Standards	D.O.T. FMVSS 49 CFR 571.106, SAE J2494-3						
Applicable Tubing	Tubing conforming to both SAE J844 and D.O.T. FMVSS 49 CFR 571.106. Material: Nylon12						
Tube O.D.	5/32", 1/4", 3/8", 1/2", 5/8", 3/4"						

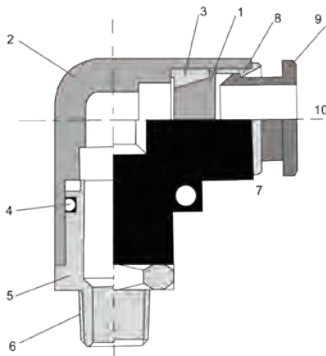

1. Chuck	Stainless steel or Brass
2. Body	Polybutylene Terephthalate (PBT), Brass
3/4. Tube seal, O-Ring	Buna-N, Nitrile Rubber
5. Stud	Brass
6. Sealant	Flourine/ Acrylic
7. Guide	Stainless Steel or Polyacetal (Acetal)
8. Stabilization Ring	Stainless Steel
9. Release Button	Polyacetal, POM (Acetal)
10. Tube support	Stainless Steel/ Brass

WARNING: This product can expose you to chemicals, including lead, which are known to the State of California to cause cancer and birth defects or other reproductive harm. For more information, visit www.P65Warnings.ca.gov



COMPOSITE BODY D.O.T. PUSH-IN

BRASS FITTINGS

STRAIGHT UNION



MIDLAND	CHAMPION	TUBE OD (INCH)	LIST
620532C	262PPCDOT-2.5	5/32	
620300C	262PPCDOT-3	3/16	
620400C	262PPCDOT-4	1/4	
620600C	262PPCDOT-6	3/8	
620800C	262PPCDOT-8	1/2	
621000C	262PPCDOT-10	5/8	
621200C	262PPCDOT-12	3/4	
620453C	262PPCDOT-42.5	1/4 x 5/32	
640604C	262PPCDOT-64	3/8 x 1/4	
620806CC	262PPCDOT-86	1/2 x 3/8	

UNION TEE



MIDLAND	CHAMPION	TUBE OD (INCH)	LIST
645320C	264PPCDOT-2.5	5/32	
640300C	264PPCDOT-3	3/16	
640400C	264PPCDOT-4	1/4	
640600C	264PPCDOT-6	3/8	
640800C	264PPCDOT-8	1/2	
641000C	264PPCDOT-10	5/8	
640406C	264PPCDOT-446	1/4 x 3/8	
64060604C	264PPCDOT-664	3/8 x 1/4	
640806C	264PPCDOT-886	1/2 x 3/8	

UNION 90° ELBOW



MIDLAND	CHAMPION	TUBE OD (INCH)	LIST
655320C	265PPCDOT-2.5	5/32	
650400C	265PPCDOT-4	1/4	
650600C	265PPCDOT-6	3/8	
650800C	265PPCDOT-8	1/2	
651000C	265PPCDOT-10	5/8	

FEMALE CONNECTOR



MIDLAND	CHAMPION	TUBE OD (INCH)	LIST
665302C	266PPCDOT-2.5A	5/32 x 1/8	
665304C	266PPCDOT-2.5B	5/32 x 1/4	
660302C	266PPCDOT-3	3/16 x 1/8	
660402C	266PPCDOT-4A	1/4 x 1/8	
660404C	266PPCDOT-4B	1/4 x 1/4	
660406C	266PPCDOT-4C	1/4 x 3/8	
660602C	266PPCDOT-6A	3/8 x 1/8	
660604C	266PPCDOT-6B	3/8 x 1/4	
660606C	266PPCDOT-6C	3/8 x 3/8	
660608C	266PPCDOT-6D	3/8 x 1/2	
660802C	266PPCDOT-8A	1/2 x 1/8	
660804C	266PPCDOT-8B	1/2 x 1/4	
660806C	266PPCDOT-8C	1/2 x 3/8	
660808C	266PPCDOT-8D	1/2 x 1/2	
661008C	266PPCDOT-10D	5/8 x 1/2	

COMPOSITE BODY D.O.T. PUSH-IN

BRASS FITTINGS

STRAIGHT MALE CONNECTOR

MIDLAND	CHAMPION	APP. TUBE OD (INCH)	LIST
685301C	268PPCDOT-2.5X	5/32 x 1/16	
685302C	268PPCDOT-2.5A	5/32 x 1/8	
685304C	268PPCDOT-2.5B	5/32 x 1/4	
680302C	268PPCDOT-3A	3/16 x 1/8	
680304C	268PPCDOT-3B	3/16 x 1/4	
680402C	268PPCDOT-4A	1/4 x 1/8	
680404C	268PPCDOT-4B	1/4 x 1/4	
680406C	268PPCDOT-4C	1/4 x 3/8	
680408C	268PPCDOT-4D	1/4 x 1/2	
680602C	268PPCDOT-6A	3/8 x 1/8	
680604C	268PPCDOT-6B	3/8 x 1/4	
680606C	268PPCDOT-6C	3/8 x 3/8	
680608C	268PPCDOT-6D	3/8 x 1/2	
680804C	268PPCDOT-8B	1/2 x 1/4	
680806C	268PPCDOT-8C	1/2 x 3/8	
680808C	268PPCDOT-8D	1/2 x 1/2	
681006C	268PPCDOT-10C	5/8 x 3/8	
681008C	268PPCDOT-10D	5/8 x 1/2	
681012C	268PPCDOT-10E	5/8 x 3/4	
681206C	268PPCDOT-12C	3/4 x 3/8	
681208C	268PPCDOT-12D	3/4 x 1/2	
681212C	268PPCDOT-12E	3/4 x 3/4	

90° MALE ELBOW

• Positional Swivel

MIDLAND	CHAMPION	TUBE OD (INCH)	LIST
695322SC	269PPSCDOT-2.5A	5/32 x 1/8	
695304SC	269PPSCDOT-2.5B	5/32 x 1/4	
690302SC	269PPSCDOT-3A	3/16 x 1/8	
690402SC	269PPSCDOT-4A	1/4 x 1/8	
690404SC	269PPSCDOT-4B	1/4 x 1/4	
690406SC	269PPSCDOT-4C	1/4 x 3/8	
690408SC	269PPSCDOT-4D	1/4 x 1/2	
690602SC	269PPSCDOT-6A	3/8 x 1/8	
690604SC	269PPSCDOT-6B	3/8 x 1/4	
690606SC	269PPSCDOT-6C	3/8 x 3/8	
690608SC	269PPSCDOT-6D	3/8 x 1/2	
690804SC	269PPSCDOT-8B	1/2 x 1/4	
690806SC	269PPSCDOT-8C	1/2 x 3/8	
690808SC	269PPSCDOT-8D	1/2 x 1/2	
690812SC	269PPSCDOT-8E	1/2 x 3/4	
691006SC	269PPSCDOT-10C	5/8 x 3/8	
691008SC	269PPSCDOT-10D	5/8 x 1/2	
691012SC	269PPSCDOT-10E	5/8 x 3/4	
691208SC	269PPSCDOT-12D	3/4 x 1/2	
691212SC	269PPSCDOT-12E	3/4 x 3/4	

WARNING: This product can expose you to chemicals, including lead, which are known to the State of California to cause cancer and birth defects or other reproductive harm. For more information, visit www.P65Warnings.ca.gov

COMPOSITE BODY D.O.T. PUSH-IN

BRASS FITTINGS

90° FEMALE ELBOW



• Positional Swivel

MIDLAND	CHAMPION	TUBE OD (INCH)	LIST
705302C	270PPSCDOT-2.5A	5/32 x 1/8	
705304C	270PPSCDOT-2.5B	5/32 x 1/4	
700402SC	270PPSCDOT-4A	1/4 x 1/8	
700404SC	270PPSCDOT-4B	1/4 x 1/4	
700406SC	270PPSCDOT-4C	1/4 x 3/8	
700602C	270PPSCDOT-6A	3/8 x 1/8	
700604SC	270PPSCDOT-6B	3/8 x 1/4	
700606SC	270PPSCDOT-6C	3/8 x 3/8	
700608SC	270PPSCDOT-6D	3/8 x 1/2	
700804C	270PPSCDOT-8B	1/2 x 1/4	
700806SC	270PPSCDOT-8C	1/2 x 3/8	
700808SC	270PPSCDOT-8D	1/2 x 1/2	

MALE RUN TEE



• Positional Swivel

MIDLAND	CHAMPION	TUBE OD (INCH)	LIST
715301C	271PPSCDOT-2.5X	5/32 x 1/16	
715302C	271PPSCDOT-2.5A	5/32 x 1/8	
715304C	271PPSCDOT-2.5B	5/32 x 1/4	
710402SC	271PPSCDOT-4A	1/4 x 1/8	
710404SC	271PPSCDOT-4B	1/4 x 1/4	
710604SC	271PPSCDOT-6B	3/8 x 1/4	
710606SC	271PPSCDOT-6C	3/8 x 3/8	
710608SC	271PPSCDOT-6D	3/8 x 1/2	
710804C	271PPSCDOT-8B	1/2 x 1/4	
710806SC	271PPSCDOT-8C	1/2 x 3/8	
710808C	271PPSCDOT-8D	1/2 x 1/2	
711008C	271PPSCDOT-10D	5/8 x 1/2	

REDUCING MALE RUN TEE			
MIDLAND	CHAMPION	TUBE OD (INCH) 1 X 2 X 3	LIST
71060404C	271PPSCDOT-64B	3/8 x 1/4 x 1/4	
71060406C	271PPSCDOT-64C	3/8 x 1/4 x 3/8	
71080408C	271PPSCDOT-84D	1/2 x 1/4 x 1/2	
71080608C	271PPSCDOT-86D	1/2 x 3/8 x 1/2	

WARNING: This product can expose you to chemicals, including lead, which are known to the State of California to cause cancer and birth defects or other reproductive harm. For more information, visit www.P65Warnings.ca.gov

BRASS

COMPOSITE BODY D.O.T. PUSH-IN

BRASS FITTINGS

MALE BRANCH TEE

• Positional Swivel

MIDLAND	CHAMPION	TUBE OD (INCH)	LIST
725301C	272PPSCDOT-2.5X	5/32 x 1/16	
725302C	272PPSCDOT-2.5A	5/32 x 1/8	
725304C	272PPSCDOT-2.5B	5/32 x 1/4	
720402SC	272PPSCDOT-4A	1/4 x 1/8	
720404SC	272PPSCDOT-4B	1/4 x 1/4	
720406SC	272PPSCDOT-4C	1/4 x 3/8	
720602SC	272PPSCDOT-6A	3/8 x 1/8	
720604SC	272PPSCDOT-6B	3/8 x 1/4	
720606SC	272PPSCDOT-6C	3/8 x 3/8	
720608C	272PPSCDOT-6D	3/8 x 1/2	
720804C	272PPSCDOT-8B	1/2 x 1/4	
720806SC	272PPSCDOT-8C	1/2 x 3/8	
720808SC	272PPSCDOT-8D	1/2 x 1/2	
721006C	272PPSCDOT-10C	5/8 x 3/8	
721008C	272PPSCDOT-10D	5/8 x 1/2	

FEMALE BRANCH TEE

• Positional Swivel

MIDLAND	CHAMPION	TUBE OD (INCH)	LIST
770402C	277PPSCDOT-4A	1/4 x 1/8	
770404C	277PPSCDOT-4B	1/4 x 1/4	
770604C	277PPSCDOT-6B	3/8 x 1/4	
770806C	277PPSCDOT-8C	1/2 x 3/8	
771004C	277PPSCDOT-10B	5/8 x 1/4	

45° MALE ELBOW

• Positional Swivel

MIDLAND	CHAMPION	TUBE OD (INCH)	LIST
545302C	279PPSCDOT-2.5A	5/32 x 1/8	
540402SC	279PPSCDOT-4A	1/4 x 1/8	
540404SC	279PPSCDOT-4B	1/4 x 1/4	
540406SC	279PPSCDOT-4C	1/4 x 3/8	
540602SC	279PPSCDOT-6A	3/8 x 1/8	
540604SC	279PPSCDOT-6B	3/8 x 1/4	
540606SC	279PPSCDOT-6C	3/8 x 3/8	
540608SC	279PPSCDOT-6D	3/8 x 1/2	
540802C	279PPSCDOT-8A	1/2 x 1/8	
540804SC	279PPSCDOT-8B	1/2 x 1/4	
540806SC	279PPSCDOT-8C	1/2 x 3/8	
540808SC	279PPSCDOT-8D	1/2 x 1/2	
541006SC	279PPSCDOT-10C	5/8 x 3/8	
541008SC	279PPSCDOT-10D	5/8 x 1/2	
541206C	279PPSCDOT-12C	3/4 x 3/8	
541208SC	279PPSCDOT-12D	3/4 x 1/2	

WARNING: This product can expose you to chemicals, including lead, which are known to the State of California to cause cancer and birth defects or other reproductive harm. For more information, visit www.P65Warnings.ca.gov

Dimension data can change without notice. Please see our website when dimensions are critical.

COMPOSITE BODY D.O.T. PUSH-IN

BRASS FITTINGS

UNION "Y"



MIDLAND	CHAMPION	A&B TUBE OD (INCH)	LIST
620553C	289PPCDOT-4	1/4	
620409C	289PPCDOT-46	1/4 x 3/8	
620555C	289PPCDOT-6	3/8	
620559C	289PPCDOT-64	3/8 x 1/4	
620557C	289PPCDOT-8	1/2	
620558C	289PPCDOT-10	5/8	

MALE BRANCH "Y"



• Positional Swivel

MIDLAND	CHAMPION	TUBE OD (INCH) X MIP	LIST
880402C	288PPSCDOT-4A	1/4 x 1/8	
880404C	288PPSCDOT-4B	1/4 x 1/4	
880406C	288PPSCDOT-4C	1/4 x 3/8	
620604C	288PPSCDOT-6B	3/8 x 1/4	
620606C	288PPSCDOT-6C	3/8 x 3/8	
620806C	288PPSCDOT-8C	1/2 x 3/8	
620808C	288PPSCDOT-8D	1/2 x 1/2	

BULKHEAD UNION



MIDLAND	CHAMPION	TUBE OD (INCH)	LIST
825320C	262BHPPCDOT-2.5	5/32	
820400C	262BHPPCDOT-4	1/4	
820600C	262BHPPCDOT-6	3/8	
820800C	262BHPPCDOT-8	1/2	
821000C	262BHPPCDOT-10	5/8	

FEMALE BULKHEAD CONNECTOR



MIDLAND	CHAMPION	TUBE OD (INCH) X FIP	LIST
865304C	266BHPPCDOT-2.5B	5/32 x 1/4	
860402C	266BHPPCDOT-4A	1/4 x 1/8	
860404C	266BHPPCDOT-4B	1/4 x 1/4	
860604C	266BHPPCDOT-6B	3/8 x 1/4	
860606C	266BHPPCDOT-6C	3/8 x 3/8	
860806C	266BHPPCDOT-8C	1/2 x 3/8	
860808C	266BHPPCDOT-8D	1/2 x 1/2	

Available on
MidlandIndustries.com



WARNING: This product can expose you to chemicals, including lead, which are known to the State of California to cause cancer and birth defects or other reproductive harm. For more information, visit www.P65Warnings.ca.gov

BRASS

D.O.T. AIR BRAKE - NYLON TUBING

BRASS FITTINGS

D.O.T. AIR BRAKE - NYLON TUBING

Tube O.D	1/4	3/8	1/2	5/8	3/4
Thread Size-B	7/16-24	17/32-24	11/16-20	13/16-18	1-18

-Typical Application

Air brake systems except where temperatures exceed +200°F or where battery acid can drip on tubing.

-Pressure

Maximum operating pressure of 150 PSI.

-Vibration

Fair resistance.

-Temperature Range

-40°F to +200°F (-40°C to +93°C).

-Material

Brass

-Used With

NT Nylon Tubing - SAE J844 Type A and B.

- Tolerance

+/- .02 on all dimensions. Dimension data can change without notice. Please call us when dimensions are critical

-Advantages

Easy to assemble (no tube preparation or flaring required.) Built in tube support. Fittings utilize a ribbed sleeve for compression and positive grip. May be used with copper tubing by replacing nut, sleeve and insert with long nut and spherical sleeve. Insert should be removed for copper tubing use.

-Conformance

Meets specifications and standards of SAE and DOT FMVSS 571,106.

-Assembly Instructions

- 1- Cut tubing to desired length.
- 2-Slide nut and then sleeve on tubing. Threaded end of nut "A" must face toward fitting body.
- 3-Insert tubing into the preassembled fitting. Be sure tubing is bottomed in fitting.
- 4- Tighten nut to required torque as indicated on chart.

Disassembling: Remove nut and pull tubing out of fitting body. Insert will remain in tubing.

Reassembly: Push tubing and insert into fitting body until it bottoms. Thread nut onto fitting body

Tube Size	Additional Number of Turns from Hand-Tight
1/4	3
3/8, 1/2	4
5/8, 3/4	3-1/2

WARNING: This product can expose you to chemicals, including lead, which are known to the State of California to cause cancer and birth defects or other reproductive harm. For more information, visit www.P65Warnings.ca.gov

D.O.T. AIR BRAKE - NYLON TUBING

BRASS FITTINGS

SLEEVE



SAE# 100115
60NA
NT60

MIDLAND	AMC	CHAMPION	LIST	TUBE O.D.	MAF #	MAF PRICE
38000		60NAB-3		3/16"	NT60-3	----
38001	00460-04	60NAB-4		1/4"	NT60-4	----
38002	00460-06	60NAB-6		3/8"	NT60-6	----
38003	00460-08	60NAB-8		1/2"	NT60-8	----
38004	00460-10	60NAB-10		5/8"	NT60-10	----
38005	00460-12	60NAB-12		3/4"	NT60-12	----

60NAB 60NTA 1460

NUT



SAE# 100110
62NA
NT61

MIDLAND	AMC	CHAMPION	LIST	TUBE O.D.	MAF #	MAF PRICE
38009	00461-03	61NAB-3		3/16"	NT61-3	----
38010	00461-04	61NAB-4		1/4"	NT61-4	----
38011	00461-06	61NAB-6		3/8"	NT61-6	----
38012	00461-08	61NAB-8		1/2"	NT61-8	----
38013	00461-10	61NAB-10		5/8"	NT61-10	----
38014	00461-12	61NAB-12		3/4"	NT61-12	----

61NAB 61NTA 1461

UNION



SAE# 100101BA
62NA
NT62

MIDLAND	AMC	CHAMPION	LIST	TUBE O.D.	MAF #	MAF PRICE
38018	00462-03			3/16"	NT62-3	----
38019	00462-04	62NAB-4		1/4"	NT62-4	----
38020	00462-06	62NAB-6		3/8"	NT62-6	----
38021	00462-08	62NAB-8		1/2"	NT62-8	----
38022	00462-10	62NAB-10		5/8"	NT62-10	----
38023	00462-12	62NAB-12		3/4"	NT62-12	----

62NAB 62NTA 1462

BULKHEAD UNION



62NABH
NT62BH

MIDLAND	AMC	CHAMPION	LIST	TUBE O.D.	MAF #	MAF PRICE
		62NABH-3		3/16"	NT62BH-3	----
38028	00483-04	62NABH-4		1/4"	NT62BH-4	----
38029	00483-06	62NABH-6		3/8"	NT62BH-6	----
38030	00483-08	62NABH-8		1/2"	NT62BH-8	----
	00483-10	62NABH-10		5/8"	NT62BH-10	----

62NBH 1474 47

STAINLESS STEEL INSERT



• 300 SERIES
STAINLESS
• For SAE# J844
TUBING
AQ71DOTS
DQ71S

MIDLAND	AMC	CHAMPION	LIST	TUBE O.D.	MAF #	MAF PRICE
					NT63SS1-3	
38035	00463-04	63NAB-4		1/4"	NT63SS1-4	
38036	00463-06	63NAB-6		3/8"	NT63SS1-6	
38037	00463-08	59A-8		1/2"	NT63SS1-8	
38038	00463-10	59A-10		5/8"	NT63SS1-10	
38039	00463-12	59A-12		3/4"	NT63SS1-12	

* STEEL INSERTS AVAILABLE FROM MAF

59A 63NTA

BRASS INSERT



AQ71DOTS
DQ71S

MIDLAND	AMC	CHAMPION	LIST	TUBE O.D.	MAF #	MAF PRICE
38040	00473-04	1484X4		1/4"	NT63B-4	----
38041	00473-06	1484X6		3/8"	NT63B-6	----
38042	00473-08	1484X8		1/2"	NT63B-8	----
38043	00473-10	1484X10		5/8"	NT63B-10	----
38048	00473-12	1484X12		3/4"	NT63B-12	----

D.O.T. AIR BRAKE - NYLON TUBING**BRASS FITTINGS****TEE**

MIDLAND	AMC	CHAMPION	LIST	TUBE O.D.	MAF #	MAF PRICE
38044	00464-04	64NAB-4		1/4"	NT464-4	
38045	00464-06	64NAB-6		3/8"	NT264X6	----
38046	00464-08	64NAB-8		1/2"	NT64-8	----
38047	00464-10	64NAB-10		5/8"	NT64-10	----
				3/4"	NT64-12	----

SAE# 100401BA

64NA

NT64

64NAB 264NTA 1464

REDUCING BRANCH TEE

MIDLAND	AMC	CHAMPION	LIST	TUBE O.D. (1&2) X 3	MAF #	MAF PRICE
				(3/8" x 1/4") x 3/8"	NT64R-466	----
38049		64NAB-664		3/8" x 1/4"	NT64FR-664	----
				(1/2" X 3/8") X 1/2	NT64R-868	----
38057		64NAB-886		1/2" x 3/8"		
				3/8" X 1/2"	NT64R-668	----

ELBOW

MIDLAND	AMC	CHAMPION	LIST	TUBE O.D.	MAF #	MAF PRICE
38052	00465-04	65NAB-4		1/4"	NT65-4	----
38053	00465-06	65NAB-6		3/8"	NT265X6	----
38054	00465-08	65NAB-8		1/2"	NT65-8	----
38055	00465-10	65NAB-10		5/8"	NT65-10	----

SAE# 100201BA

65NA

NT65

65NAB 265NTA 1465

FEMALE ADAPTER

MIDLAND	AMC	CHAMPION	LIST	TUBE O.D. X FEMALE NPT	MAF #	MAF PRICE
38060	00466-0402	66NAB-4A		1/4" x 1/8"	NT66-42	----
38061	00466-0404	66NAB-4B		1/4" x 1/4"	NT66-44	----
38062	00466-0602	66NAB-6A		3/8" x 1/8"	NT66-62	----
38063	00466-0604	66NAB-6B		3/8" x 1/4"	NT66-64	----
38064	00466-0606	66NAB-6C		3/8" x 3/8"	NT66-66	----
38065	00466-0806	66NAB-8C		1/2" x 3/8"	NT66-86	----
38066	00466-0808	66NAB-8D		1/2" x 1/2"	NT66-88	----
38067	00466-1006	66NAB-10C		5/8" x 3/8"	NT66-106	----
38068	00466-1008	66NAB-10D		5/8" x 1/2"	NT66-108	----
38059	00466-1208			3/4" x 1/2"	NT66-128	----
				1/2" X 3/4"	NT66-812	----

SAE# 100103BA

66NA

NT66

66NAB 66NTA 1466 66NBH

Dimension data can change without notice. Please see our website when dimensions are critical.

D.O.T. AIR BRAKE - NYLON TUBING

BRASS FITTINGS

MALE ADAPTER

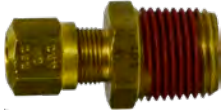

SAE# 100102BA
68NA
NT68VS

• More sizes
available online

MIDLAND	AMC	CHAMPION	LIST	TUBE O.D. X MALE NPTF	MAF #	MAF PRICE
38069		68NAB-3X		3/16" X 1/16"	NT68-31VS	----
38070		68NAB-3A		3/16" X 1/8"	NT68-32VS	----
		68NAB-3B		5/16 X 1/4		
38072		68NAB-4X		1/4" x 1/16"	NT68-41VS	----
38073	00468-0402	68NAB-4A		1/4" x 1/8"	NT68-42VS	----
38074	00468-0404	68NAB-4B		1/4" x 1/4"	NT68-44VS	----
38075	00468-0406	68NAB-4C		1/4" x 3/8"	NT68-46VS	----
38076	00468-0602	68NAB-6A		3/8" x 1/8"	NT68-62VS	----
38077	00468-0604	68NAB-6B		3/8" x 1/4"	NT68-64VS	----
38078	00468-0606	68NAB-6C		3/8" x 3/8"	NT68-66VS	----
38079	00468-0608	68NAB-6D		3/8" x 1/2"	NT68-68VS	----
38080	00468-0804	68NAB-8B		1/2" x 1/4"	NT68-84VS	----
38081	00468-0806	68NAB-8C		1/2" x 3/8"	NT68-86VS	----
38082	00468-0808	68NAB-8D		1/2" x 1/2"	NT68-88VS	----
38087	00468-0812	68NAB-8E		1/2" x 3/4"	NT68-812VS	----
38083	00468-1006	68NAB-10C		5/8" x 3/8"	NT68-106VS	----
38084	00468-1008	68NAB-10D		5/8" x 1/2"	NT68-108VS	----
38088	00468-1012	68NAB-10E		5/8" x 3/4"	NT68-1012VS	----
		68NAB-12C		5/8" x 3/8"	NT68-126VS	----
38085	00468-1208	68NAB-12D		3/4" x 1/2"	NT68-1218VS	
38086	00468-1212	68NAB-12E		3/4" x 3/4"	NT68-1212VS	----

68NAB 68NTA 1468

SWIVEL MALE ADAPTER



MIDLAND	AMC	CHAMPION	LIST	TUBE O.D. X MALE NPTF	MAF #	MAF PRICE
38078S				3/8" x 3/8"	NT68SWW-66VS	
38081S				1/2" x 3/8"	NT68SWW-86VS	

MALE ELBOW



SAE# 100202BA
69NA
NT69VS

• More sizes
available online

MIDLAND	AMC	CHAMPION	LIST	TUBE O.D. X MALE NPTF	MAF #	MAF PRICE
		69NAB-3A		3/16" X 1/8"	NT69-32VS	----
		69NAB-3B		3/16" X 1/4"	NT69-34VS	----
38091	00469-0402	69NAB-4A		1/4" x 1/8"	NT69-42VS	----
38092	00469-0404	69NAB-4B		1/4" x 1/4"	NT69-44VS	----
38093	00469-0406	69NAB-4C		1/4" x 3/8"	NT69-46VS	----
38094	00469-0602	69NAB-6A		3/8" x 1/8"	NT69-62VS	----
38095	00469-0604	69NAB-6B		3/8" x 1/4"	NT69-64VS	----
38090				3/8" x 1/4" LONG	NT69L-64VS	----
38101	00469-0606	69NAB-6C		3/8" x 3/8"	NT69-66VS	----
38102	00469-0608	69NAB-6D		3/8" x 1/2"	NT69-68VS	----
38103	00469-0804	69NAB-8B		1/2" x 1/4"	NT69-84VS	----
38104	00469-0806	69NAB-8C		1/2" x 3/8"	NT69-86VS	----
38109				1/2" x 3/8" LONG	NT69L-86VS	----
38105	00469-0808	69NAB-8D		1/2" x 1/2"	NT69-88VS	----
38106	00469-1006	69NAB-10C		5/8" x 3/8"	NT69-106VS	----
38107	00469-1008	69NAB-10D		5/8" x 1/2"	NT69-108VS	----
38110	00469-1012	69NAB-10E		5/8" x 3/4"	NT69-1012VS	----
				3/4" X 3/8"	NT69-126VS	----
38108	00469-1208	69NAB-12D		3/4" x 1/2"	NT69-128VS	----
38111	00469-1212	69NAB-12E		3/4" x 3/4"	NT69-1212VS	----

D.O.T. AIR BRAKE - NYLON TUBING

BRASS FITTINGS

SWIVEL MALE ELBOW

MIDLAND	AMC	CHAMPION	LIST	TUBE O.D. X MALE NPTF	MAF #	MAF PRICE
38101S				3/8" x 3/8"	NT69SWV-66VS	----
38104S				1/2" x 3/8"	NT69SWV-86VS	----

FEMALE ELBOW

SAE# 100203BA

70NA
NT70

MIDLAND	AMC	CHAMPION	LIST	TUBE O.D. X FEMALE NPTF	MAF #	MAF PRICE
		70NAB-3A		3/16" X 1/8"	nt270x3	----
38113	00470-0402	70NAB-4A		1/4" x 1/8"	NT70-42	----
38114	00470-0404	70NAB-4B		1/4" x 1/4"	NT70-44	----
38115	00470-0602	70NAB-6A		3/8" x 1/8"	NT70F-62	----
38116	00470-0604	70NAB-6B		3/8" x 1/4"	NT70F-64	----
38117	00470-0606	70NAB-6C		3/8" x 3/8"	NT70F-66	----
38118	00470-0806	70NAB-8C		1/2" x 3/8"	NT70F-86	----
38119	00470-0808	70NAB-8D		1/2" x 1/2"	NT70F-88	----
38120	00470-1008	70NAB-10D		5/8" x 1/2"	NT70F-108	----

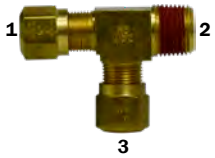
MALE RUN TEE

SAE# 100424BA

71NA
NT71VS

MIDLAND	AMC	CHAMPION	LIST	TUBE O.D. X MALE NPTF X TUBE O.D. 1X2X3	MAF #	MAF PRICE
38125	00471-0402	71NAB-4A		1/4" x 1/8" x 1/4"	NT71-42VS	----
38126	00471-0404	71NAB-4B		1/4" x 1/4" x 1/4"	NT71-44VS	----
38124		71NAB-64B		3/8" x 1/4" x 1/4"	NT71-644VS	----
38127	00471-0604	71NAB-6B		3/8" x 1/4" x 3/8"	NT71-646VS	----
38128	00471-0606	71NAB-6C		3/8" x 3/8" x 3/8"	NT271X6X6VS	----
38129	00471-0806	71NAB-8C		1/2" x 3/8" x 1/2"	NT71-86VS	----
		71NAB-8D		1/2" x 1/2" x 1/2"	NT71-88VS	----
		71NAB-10D		5/8" x 1/2" x 5/8"	NT71-108VS	----

71NAB 271NTA 1471

MALE BRANCH TEE

SAE# 100425BA

72NA
NT72VS

MIDLAND	AMC	CHAMPION	LIST	TUBE O.D. X TUBE O.D. X MALE NPTF 1X2X3	MAF #	MAF PRICE
		72nab-3a		3/16" x 3/16" x 1/8"		
38136	00472-0402	72NAB-4A		1/4" x 1/4" x 1/8"	NT72-42VS	----
38137	00472-0404	72NAB-4B		1/4" x 1/4" x 1/4"	NT72-44VS	----
38138	00472-0602	72NAB-6A		3/8" x 3/8" x 1/8"	NT72-62VS	----
38132		72NAB-64B		3/8" x 1/4" x 1/4"	NT72-644VS	----
38139	00472-0604	72NAB-6B		3/8" x 3/8" x 1/4"	NT272X6VS	----
38140	00472-0606	72NAB-6C		3/8" x 3/8" x 3/8"	NT272X6X6VS	----
38134	00472-080606	72NAB-86C		1/2" x 3/8" x 3/8"	NT72-866VS	----
38133		72NAB-8B		1/2" x 1/2" x 1/4"	NT7272X8X4VS	----
38141	00472-0806	72NAB-8C		1/2" x 1/2" x 3/8"	NT72-86VS	----
38142	00472-0808	72NAB-8D		1/2" x 1/2" x 1/2"	NT72-88VS	----
38143	00472-1008	72NAB-10D		5/8" x 5/8" x 1/2"	NT72-108VS	----

72NAB 272NTA 1472

WARNING: This product can expose you to chemicals, including lead, which are known to the State of California to cause cancer and birth defects or other reproductive harm. For more information, visit www.P65Warnings.ca.gov



D.O.T. AIR BRAKE - NYLON TUBING

BRASS FITTINGS

FEMALE BRANCH TEE

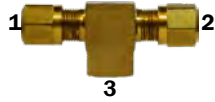

MIDLAND	AMC	CHAMPION	LIST	TUBE O.D. X TUBE O.D. X FEMALE NPTF 1X2X3	MAF #	MAF PRICE
38144				3/8" x 3/8" x 1/4"	NT-78-64	
				1/2" x 1/2" x 1/4"	NT-78-104	
38146				5/8" x 5/8" x 1/4"	NT-78-84	

45° ELBOW



SAE# 100302BA
6945NA
NT6945VS

MIDLAND	AMC	CHAMPION	LIST	TUBE O.D. X MALE NPTF	MAF #	MAF PRICE
38148	00495-0402	79NAB-4A		1/4" x 1/8"	NT6945-42VS	----
38149	00495-0404	79NAB-4B		1/4" x 1/4"	NT6945-44VS	----
38150	00495-0602	79NAB-6A		3/8" x 1/8"	NT6945-62VS	----
38151	00495-0604	79NAB-6B		3/8" x 1/4"	NT6945-64VS	----
38152	00495-0606	79NAB-6C		3/8" x 3/8"	NT6945-66VS	----
38153	00495-0608	79NAB-6D		3/8" x 1/2"	NT6945-68VS	----
38157	00495-0804	79NAB-8B		1/2" x 1/4"	NT6945-84VS	----
38154	00495-0806	79NAB-8C		1/2" x 3/8"	NT6945-86VS	----
38155	00495-0808	79NAB-8D		1/2" x 1/2"	NT6945-88VS	----
		79NAB-10C		5/8" x 3/8"	NT6945-106VS	----
38156	00495-1008	79NAB-10D		5/8" x 1/2"	NT6945-108VS	----
38158	00495-1208	79NAB-12D		3/4" x 1/2"	NT6945-128VS	----

6945NAB 279NTA 1480

SWIVEL 45° ELBOW



MIDLAND	AMC	CHAMPION	LIST	TUBE O.D. X MALE NPTF	MAF #	MAF PRICE
38152S				3/8" x 3/8"	NT6945SWV-66VS	----
38154S				1/2" x 3/8"	NT6945SWV-86VS	----

WARNING: This product can expose you to chemicals, including lead, which are known to the State of California to cause cancer and birth defects or other reproductive harm. For more information, visit www.P65Warnings.ca.gov

BRASS

D.O.T. AIR BRAKE - COPPER TUBING

BRASS FITTINGS

SLEEVE

SAE# 120115BA

60AB
AB60

MIDLAND	AMC	CHAMPION	LIST	TUBE O.D.	MAF #	MAF PRICE
38161	00360-04	260A-4		1/4"	AB60-4	----
				5/16"	AB60-5	----
38162	00360-06	260A-6		3/8"	AB60-6	----
38163	00360-08	260A-8		1/2"	AB60-8	----
38164	00360-10	260A-10		5/8"	AB60-10	----
38165	00360-12	260A-12		3/4"	AB60-12	----
				1"	AB60-16	----

60AB 1360

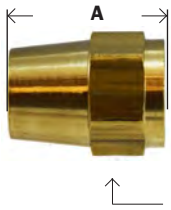
NUT

Hex

SAE# 120111BA

61AB
AB61

MIDLAND	AMC	CHAMPION	LIST	TUBE O.D.	MAF #	MAF PRICE
38170	00361-04	261A-4		1/4"	AB61-4	----
				5/16"	AB61-5	----
38171	00361-06	261A-6		3/8"	AB61-6	----
38172	00361-08	261A-8		1/2"	AB61-8	----
38173	00361-10	261A-10		5/8"	AB61-10	----
38174	00361-12	261A-12		3/4"	AB61-12	----

20961 61AB 1361

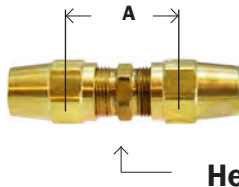
UNION

Hex

SAE# 120101BA

62AB
AB62

MIDLAND	AMC	CHAMPION	LIST	TUBE O.D.	MAF #	MAF PRICE
38179	00362-04	262A-4		1/4"	AB62-4	----
38180	00362-06	262A-6		3/8"	AB62-6	----
38181	00362-08	262A-8		1/2"	AB62-8	----
38182	00362-10	262A-10		5/8"	AB62-10	----
38183	00362-12	262A-12		3/4"	AB62-12	----

BULKHEAD UNIONS AVAILABLE UPON REQUEST

62AB 1362

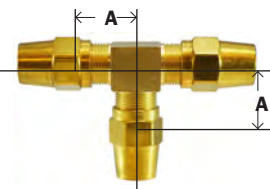
TEE

SAE# 120401BA

64AB
AB64

MIDLAND	AMC	CHAMPION	LIST	TUBE O.D.	MAF #	MAF PRICE
38188	00364-04	264A-44		1/4"	AB64-4	----
38189	00364-06	264A-66		3/8"	AB64-6	----
38190	00364-08	264A-88		1/2"	AB64-8	----
38191	00364-10	264A-1010		5/8"	AB64-10	----

264AB 1364

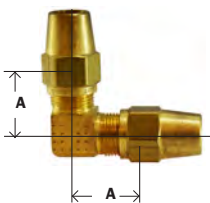
ELBOW

SAE# 120201BA

65AB
A65

MIDLAND	AMC	CHAMPION	LIST	TUBE O.D.	MAF #	MAF PRICE
38196	00365-04	265A-44		1/4"	AB65-4	----
38197	00365-06			3/8"	AB65-6	----
38198	00365-08			1/2"	AB65-8	----
38199	00365-10			5/8"	AB65-10	----

265AB 1365

WARNING: This product can expose you to chemicals, including lead, which are known to the State of California to cause cancer and birth defects or other reproductive harm. For more information, visit www.P65Warnings.ca.gov



D.O.T. AIR BRAKE - COPPER TUBING

BRASS FITTINGS

FEMALE ADAPTER

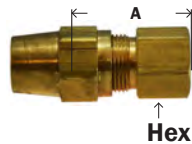

SAE# 120103BA
66AB
AB66

MIDLAND	AMC	CHAMPION	LIST	TUBE O.D. X FEMALE NPTF	MAF #	MAF PRICE
38204	00366-0402	266A-4A		1/4" x 1/8"	AB66-42	----
38205	00366-0404	266A-4B		1/4" x 1/4"	AB66-44	----
38206	00366-0602	266A-6A		3/8" x 1/8"	AB66-62	----
38207	00366-0604	266A-6B		3/8" x 1/4"	AB66-64	----
38208	00366-0606	266A-6C		3/8" x 3/8"	AB66-66	----
38209	00366-0806	266A-8C		1/2" x 3/8"	AB66-86	----
38210	00366-0808	266A-8D		1/2" x 1/2"	AB66-88	----
38211	00366-1006			5/8" x 3/8"	AB66-106	----
38212	00366-1008	266A-10D		5/8" x 1/2"	AB66-108	----
38213	00366-1208			3/4" x 1/2"	NT66-128	----

66AB 1366

MALE ADAPTER

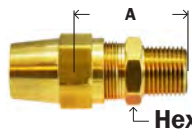

SAE# 120102BA
68AB
AB68

MIDLAND	AMC	CHAMPION	LIST	TUBE O.D. X MALE NPTF	MAF #	MAF PRICE
38217	00368-0402	268A-4A		1/4" x 1/8"	AB68-42	----
38218	00368-0404	268A-4B		1/4" x 1/4"	AB68-44	----
		268A-4C		1/4" x 3/8"		
		268A-6A		3/8" x 1/8"	AB68-62	----
38221	00368-0604	268A-6B		3/8" x 1/4"	AB68-64	----
38222	00368-0606	268A-6C		3/8" x 3/8"	AB68-66	----
38223	00368-0608	268A-6D		3/8" x 1/2"	AB68-68	----
38224	00368-0804	268A-8B		1/2" x 1/4"	AB68-84	----
38225	00368-0806	268A-8C		1/2" x 3/8"	AB68-86	----
38226	00368-0808	268A-8D		1/2" x 1/2"	AB68-88	----
38227	00368-1006	268A-10C		5/8" x 3/8"	AB68-106	----
38228	00368-1008	268A-10D		5/8" x 1/2"	AB68-108	----
38229	00368-1208	268A-12D		3/4" x 1/2"	AB68-128	----
		268A-12E		3/4" x 3/4"		

68AB 368

90° MALE ELBOW

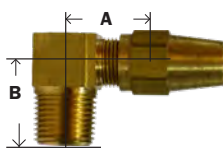

SAE# 120202BA
69AB
AB69

MIDLAND	AMC	CHAMPION	LIST	TUBE O.D. X MALE NPTF	MAF #	MAF PRICE
38235	00369-0402	269A-4A		1/4" x 1/8"	AB69-42	----
38236	00369-0404	269A-4B		1/4" x 1/4"	AB69-44	----
38237	00369-0406	269A-4C		1/4" x 3/8"	AB69-46	----
		269A-6A		3/8" x 1/8"		
38239	00369-0604	269A-6B		3/8" x 1/4"	AB69-64	----
38240	00369-0606	269A-6C		3/8" x 3/8"	AB69-66	----
38241	00369-0608	269A-6D		3/8" x 1/2"	AB69-68	----
		269A-8B		1/2" x 1/4"		
38243	00369-0806	269A-8C		1/2" x 3/8"	AB69-86	----
38244	00369-0808	269A-8D		1/2" x 1/2"	AB69-88	----
	00369-1006			5/8" x 3/8"	AB69-106	----
38246	00369-1008	269A-10D		5/8" x 1/2"	AB69-108	----
38247	00369-1208	269A-12D		3/4" x 1/2"	AB69-128	----

269AB 1369

D.O.T. AIR BRAKE - COPPER TUBING

BRASS FITTINGS

90 DEGREE FEMALE ELBOW

MIDLAND	AMC	CHAMPION	LIST	TUBE O.D. X MALE NPTF (1&2)X3	MAF #	MAF PRICE
38252	00370-0402	270A-4A		1/4 X 1/8	AB70-42	
38253	00370-0404	270A-4B		1/4 X 1/4	AB70-44	
	00370-0602	270A-6A		3/8 x 1/8	AB70-62	
38255	00370-0604	270A-6B		3/8 X 1/4	AB70-64	
38256	00370-0606	270A-6C		3/8 X 3/8	AB70-66	
38257	00370-0806	270A-8C		1/2 X 3/8	AB70-86	
38259	00370-1008	270A-10D		5/8 x 1/2	AB70-108	

MALE RUN TEE

MIDLAND	AMC	CHAMPION	LIST	TUBE O.D. X MALE NPTF (1&2)X3	MAF #	MAF PRICE
38264	00371-0402	271A-4A		1/4" x 1/8"	AB71-42	----
38265	00371-0404	271A-4B		1/4" x 1/4"	AB71-44	----
				3/8" x 1/4"	AB271X6	----
38266	00371-0604	271A-6B		3/8" x 1/4"	AB71F-64	----
38267	00371-0606	271A-6C		3/8" x 3/8"	AB71-66	----
	00371-0806			1/2" x 3/8"	AB71-86	----
38269	00371-0808			1/2" x 1/2"	AB71-88	----
	00371-1008			5/8" x 1/2"	AB71-108	----

271AB 1371

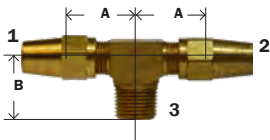
MALE BRANCH TEE

SAE# 120425BA

72AB

AB72

MIDLAND	AMC	CHAMPION	LIST	TUBE O.D. X MALE NPTF (1&2)X3	MAF #	MAF PRICE
	00372-0402			1/4" x 1/8"	AB72-42	----
	00372-0404			1/4" x 1/4"	AB72-44	----
38278	00372-0604			3/8" x 1/4"	AB72-64	----
38279	00372-0606			3/8" x 3/8"	AB72-66	----
				1/2" x 1/4"	AB72-84	----
38280	00372-0806			1/2" x 3/8"	AB72-86	----
38281	00372-0808			1/2" x 1/2"	AB72-88	----
	00372-1008			5/8" x 1/2"	AB72-108	----

272AB 1372

45° ELBOW

MIDLAND	AMC	CHAMPION	LIST	TUBE O.D. X MALE NPTF (1&2)X3	MAF #	MAF PRICE
38287	00395-0402			1/4" x 1/8"	AB6945-42	----
38288	00395-0404			1/4" x 1/4"	AB6945-44	----
	00395-0602			3/8" x 1/8"	AB6945-62	----
38290	00395-0604			3/8" x 1/4"	AB6945-64	----
38291	00395-0606			3/8" x 3/8"	AB6945-66	----
38292	00395-0608			3/8" x 1/2"	AB6945-68	----
				1/2" x 1/4"	AB6945-84	----
	00395-0806					
38294	00395-0808			1/2" x 1/2	AB6945-88	----
				5/8" x 3/8"	AB6945-106	----
	00395-1008			5/8" x 1/2"	AB6945-108	----

279AB 1380

D.O.T. AIR BRAKE - HOSE/ ENDS

BRASS FITTINGS

D.O.T. AIR BRAKE REUSABLE HOSE/ FITTINGS



•Typical Application

Air Brake hose connections.
Meets SAE & DOT specifications
(FMVCS 10 GAL)

•Pressure

Determined by maximum working pressure for hose size. Up to 125 psi

Temperature: -40°F to + 120° F (-40°C to +48°C)

•Advantages

Can be used for nearly any brake line. Easy to assemble with a good selection of hose end configurations. Brass material offers excellent resistance against corrosion.

• Tolerance

+/- .02 on all dimensions. Dimension data can change without notice. Please call us when dimensions are critical.

•Assembly Instructions

- 1- Slide nut and sleeve onto hose. Make sure bevel edge of sleeve faces out toward fitting.
- 2- Push hose into fitting until it bottoms.
- 3- Screw nut until contact is made with body hex.

NOTE: When reassembling fitting, body and nut should be inspected. Only reuse if in proper condition. Sleeves should never be reused.

SLEEVE

FERRULE

60HE
HE60



MIDLAND	AMC	CHAMPION	LIST	HOSE I.D. SIZE	MAF #	MAF PRICE
38300	08060-06	360A-6		3/8"	HE60-6	----
38301	08060-08	360A-8		1/2"	HE60-8	----

#60HC 3380-A 0903610 367 60RB

NUT

61HE
HE61



MIDLAND	AMC	CHAMPION	LIST	HOSE I.D. SIZE	MAF #	MAF PRICE
38306	08061-06	361A-6		3/8"	HE61-6	----
38307	08061-08	361A-8		1/2"	HE61-8	----

61RB #61HC 369 3380-B 0903624

NUT FOR USE WITH SPRING

61HES
HE61N



MIDLAND	AMC	CHAMPION	LIST	HOSE I.D. SIZE	MAF #	MAF PRICE
38312	08071-06	361A-6G		3/8"	HE61N-6	----
38313	08071-08	361A-8G		1/2"	HE61N-8	----

WARNING: This product can expose you to chemicals, including lead, which are known to the State of California to cause cancer and birth defects or other reproductive harm. For more information, visit www.P65Warnings.ca.gov

BRASS

D.O.T. AIR BRAKE - HOSE/ ENDS

BRASS FITTINGS

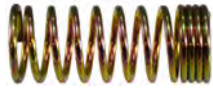
SPRING61HSG
HE61G

MIDLAND	AMC	CHAMPION	LIST	HOSE I.D.	MAF #	MAF PRICE
38351	08070-06	371AS-6		3/8"	HE61G-6	----
38352	08070-08	371AS-8		1/2"	HE61G-8	----

#60SG 0901045 3380-C 377

NUT & SPRING ASSEMBLY

HE61NG

MIDLAND	AMC	CHAMPION	LIST	HOSE I.D. SIZE	MAF #	MAF PRICE
38015		371A-6		3/8"	HE61NG-6	----
38016		371A-8		1/2"	HE61NG-8	----

379 67RBSG 0999999

UNION62HE
HE62

MIDLAND	AMC	CHAMPION	LIST	HOSE I.D.	MAF #	MAF PRICE
38318	08062-06	362A-6		3/8"	HE62-6	----
38319	08062-08	362A-8		1/2"	HE62-8	----

#62HC 3380B-Y0 362

**BODY ONLY**

MIDLAND	AMC	CHAMPION	LIST	HOSE I.D.	MAF #	MAF PRICE
39318		B362A-6		3/8"	HE62B-6	----
39319		B362A-8		1/2"	HE62B-8	----

FEMALE CONNECTOR HOSE

66HEA

MIDLAND	AMC	CHAMPION	LIST	HOSE I.D. X FEMALE ABS	MAF #	MAF PRICE
38357	08066-0612	366A-6		3/8" x 3/4-20	HE68SB-6	----
38358	08066-0814	366A-8		1/2" x 7/8-20	HE68SB-8	----

#66ABS 66RBSV 3380B-Y7 386

**BODY ONLY**

MIDLAND	AMC	CHAMPION	LIST	HOSE I.D. X FEMALE ABS	MAF #	MAF PRICE
39357				3/8" x 3/4-20	HE685B-6B0	
39358				1/2" x 7/8-20	HE685B-8B0	

MALE CONNECTOR68HEA
HE68S

MIDLAND	AMC	CHAMPION	LIST	HOSE I.D. X MALE PIPE	MAF #	MAF PRICE
38363	08086-0604	389A-6B		3/8" x 1/4"	HE68S-64	----
	08086-0606	389A-6C		3/8" X 3/8"	HE68S-66	----
		389A-6D		3/8" X 1/2"	HE68S-68	----
38364	08086-0806	389A-8C		1/2" x 3/8"	HE68S-86	----
		389A-8D		1/2" x 1/2"	HE68S-88	----

#68ABS 09155 3380B-Y8 387

WARNING: This product can expose you to chemicals, including lead, which are known to the State of California to cause cancer and birth defects or other reproductive harm. For more information, visit www.P65Warnings.ca.gov



D.O.T. AIR BRAKE - HOSE/ENDS

BRASS FITTINGS

ADAPTER FOR SWIVEL TYPE REUSABLE AND CRIMPED ON



68HEAB
1390

MIDLAND	AMC	CHAMPION	LIST	MALE ABS X MALE PIPE	MAF #	MAF PRICE
38369	08088-0604	388A-12B		3/8" x 1/4"	1390-64	----
38368	08088-0606	388A-12C		3/8" x 3/8"	1390-66	----
38372		388A-12D		3/8" x 1/2"	1390-68	----
38370	08088-0806	388A-14C		1/2" x 3/8"	1390-86	----
38371	08088-0808	388A-14D		1/2" x 1/2"	1390-88	----

#68ABS 1390 76RB 388

MALE ADAPTER



68HE
HE68

MIDLAND	AMC	CHAMPION	LIST	HOSE I.D. X MALE PIPE	MAF #	MAF PRICE
38333	08068-0604	368A-6B		3/8" x 1/4"	HE68-64	----
38334	08068-0606	368A-6C		3/8" x 3/8"	HE68-66	----
38335	08068-0608	368A-6D		3/8" x 1/2"	HE68-68	----
38336	08068-0806	368A-8C		1/2" x 3/8"	HE68-86	----
38337	08068-0808	368A-8D		1/2" x 1/2"	HE68-88	----

#68HC 368 3380B-Y2 68RB

ADAPTER BODY



68HEB
HE68B

MIDLAND	AMC	CHAMPION	LIST	HOSE I.D. X MALE PIPE	MAF #	MAF PRICE
38324	08098-0604	B368A-6B		3/8" x 1/4"	HE68B-64	----
38325	08098-0606	B368A-6C		3/8" x 3/8"	HE68B-66	----
38326	08098-0608	B368A-6D		3/8" x 1/2"	HE68B-68	----
38327	08098-0806	B368A-8C		1/2" x 3/8"	HE68B-86	----
38328	08098-0808	B368A-8D		1/2" x 1/2"	HE68B-88	----

#68B W1391Z

MALE ADAPTER



68HES
HE68G

MIDLAND	AMC	CHAMPION	LIST	HOSE I.D. X MALE PIPE	MAF #	MAF PRICE
38342	08078-0604	378A-6B		3/8" x 1/4"	HE68G-64	----
38343	08078-0606	378A-6C		3/8" x 3/8"	HE68G-66	----
38344	08078-0608	378A-6D		3/8" x 1/2"	HE68G-68	----
38345	08078-0806	378A-8C		1/2" x 3/8"	HE68G-86	----
38346	08078-0808	378A-8D		1/2" x 1/2"	HE68G-88	----

#68HCS 3380B-Y3 68RBSG 378

BLACK RUBBER AIR BRAKE HOSE



MIDLAND	AMC	CHAMPION	LIST	HOSE O.D. X HOSE I.D.	MAF #	MAF PRICE
38910		RAB6-50		3/4 x 3/8		
		RAB6-250		3/4 x 3/8		
38915		RAB8-50		7/8 x 1/2		
		RAB8-250		7/8 x 1/2		

WARNING: This product can expose you to chemicals, including lead, which are known to the State of California to cause cancer and birth defects or other reproductive harm. For more information, visit www.P65Warnings.ca.gov

BRASS

STEEL GREASE FITTINGS

BRASS FITTINGS

- 8000 PSI MAX. PRESSURE
- EXCEEDS 12HR SALT SPRAY
- ASSORTMENTS ALSO AVAILABLE
- Meets SAE #J-534C
- SEE WEBSITE FOR GREASE ACCESSORIES

BALL CHECK - 1/8"-27 NPTF

Many types available on special order.

PIPE THREAD

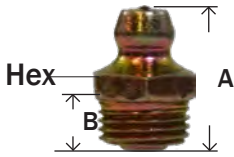

MIDLAND	AMC	CHAMPION	LIST	SIZE	MAF #	MAF PRICE
36110	08310			1/8" -27 NPTF	610	
36110SS				303 SS		
36111				Thread Forming		

#610 1610 2800 1720 5000

PIPE THREAD

BALL CHECK

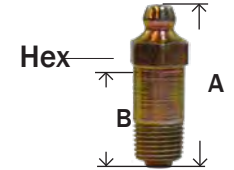

MIDLAND	AMC	CHAMPION	LIST	SIZE	MAF #	MAF PRICE
36112	08311			1/8" -27 NPTF	607	
36113				1/8" -27 NPTF		

#607 1607 2800 1669 5003

PIPE THREAD

30° ANGLE BALL CHECK

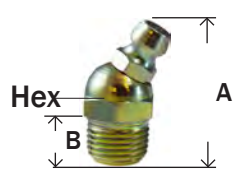

MIDLAND	AMC	CHAMPION	LIST	SIZE	MAF #	MAF PRICE
36114	08313			1/8" -27 NPTF	611	

#611 1611 2830 5100

PIPE THREAD

45° ANGLE BALL CHECK

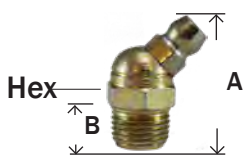

MIDLAND	AMC	CHAMPION	LIST	SIZE	MAF #	MAF PRICE
36116	08314			1/8" -27 NPTF	688	
36116SS				303 SS		

#688 1688 2845 5200

PIPE THREAD

65° ANGLE BALL CHECK

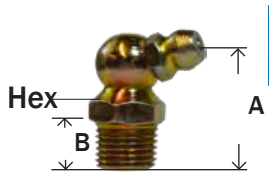

MIDLAND	AMC	CHAMPION	LIST	SIZE	MAF #	MAF PRICE
36118	08315			1/8" -27 NPTF	612	

#612 1612 2865 5300

PIPE THREAD

90° ANGLE BALL CHECK

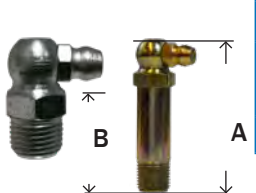

MIDLAND	AMC	CHAMPION	LIST	SIZE	MAF #	MAF PRICE
36120	08316			1/8" -27 NPTF	613	
36120SS				303 SS		
36121				1/8" -27 NPTF		

#613 1613 2890 5400 5407

PIPE THREAD

BALL CHECK - 1/4"-18 NPTF

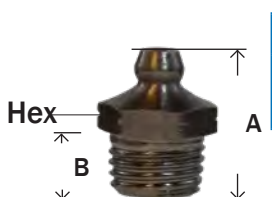

MIDLAND	AMC	CHAMPION	LIST	SIZE	MAF #	MAF PRICE
36130	08321			1/4" -18 NPTF	627	
36130SS				303 SS		

#627 1627 2900K 5050

WARNING: This product can expose you to chemicals, including lead, which are known to the State of California to cause cancer and birth defects or other reproductive harm. For more information, visit www.P65Warnings.ca.gov



STEEL GREASE FITTINGS

BRASS FITTINGS

PIPE THREAD 65° ANGLE BALL CHECK

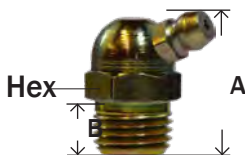

MIDLAND	AMC	CHAMPION	LIST	SIZE	MAF #	MAF PRICE
36132	08324			1/4"-18 NPTF	629	

#629 1629 2965 5350

1/4-28 TAPER THREAD SHORT BALL CHECK - 1/4-28 NPTF

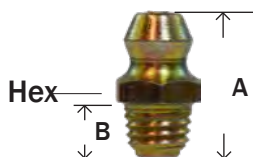

MIDLAND	AMC	CHAMPION	LIST	SIZE	MAF #	MAF PRICE
36140	08341			1/4"-28 NPTF	641	
36140SS				303 SS		
36141				Thread Forming		

#641 1641 2400 3038 5010

1/4-28 TAPER THREAD LONG BALL CHECK

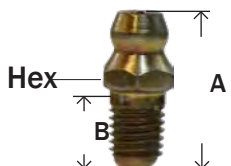

MIDLAND	AMC	CHAMPION	LIST	SIZE	MAF #	MAF PRICE
36142	08342			1/4"-28 Taper Thread	652	0.34

#652 1652 2400 5013

1/4-28 TAPER THREAD EXTRA LONG BALL CHECK

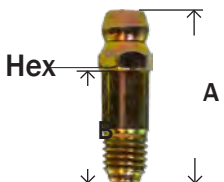

MIDLAND	AMC	CHAMPION	LIST	SIZE	MAF #	MAF PRICE
36144	08343			1/4"-28 Taper Thread	680	

#680 1680 2400 5014

1/4-28 TAPER THREAD SHORT 45° BALL CHECK

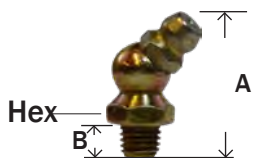

MIDLAND	AMC	CHAMPION	LIST	SIZE	MAF #	MAF PRICE
36146	08346			1/4"-28 Taper Thread	637	
36146SS				303 SS		
36147				1/4"-28 Taper Thread		

#637 1637 2445 1665 2465 3010 5210

1/4-28 TAPER THREAD LONG 45° BALL CHECK



MIDLAND	AMC	CHAMPION	LIST	SIZE	MAF #	MAF PRICE
36148	08347			1/4"-28 Taper Thread	636	

#636 1630 2445

1/4-28 TAPER THREAD 90° ANGLE BALL CHECK

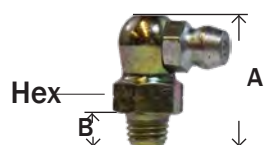

MIDLAND	AMC	CHAMPION	LIST	SIZE	MAF #	MAF PRICE
36150	08349			1/4"-28 Taper Thread	911	
36150SS				303 SS		
36152				Thread Forming		

SAE# A515002

#911 1911 2490 3054 5410

WARNING: This product can expose you to chemicals, including lead, which are known to the State of California to cause cancer and birth defects or other reproductive harm. For more information, visit www.P65Warnings.ca.gov

BRASS

STEEL GREASE FITTINGS

BRASS FITTINGS

DRIVE TYPE BALL CHECK Drive Type

MIDLAND	AMC	CHAMPION	LIST	SIZE	MAF #	MAF PRICE
36160	08375			5/16"	608	

#608 1608 5021

DRIVE TYPE BALL CHECK

MIDLAND	AMC	CHAMPION	LIST	SIZE	MAF #	MAF PRICE
36164	08373			3/16"	728	
36164SS				303 SS		

#728 1728 2316 5033

DRIVE TYPE BALL CHECK

MIDLAND	AMC	CHAMPION	LIST	SIZE	MAF #	MAF PRICE
36166	08374			1/4"	743	
36166SS				303 SS		

#743 1743 214 5029

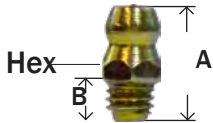
METRIC

MIDLAND	AMC	CHAMPION	LIST	SIZE	MAF #	MAF PRICE
36168	08391			6MM x 1	710	

(Diameter x Pitch)

#711 6000 2106 2M6 5175

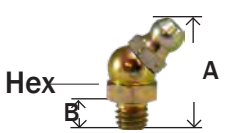
METRIC 45° ANGLE

MIDLAND	AMC	CHAMPION	LIST	SIZE	MAF #	MAF PRICE
36170	08392			6MM x 1	712	

#712 6045 2107 5176

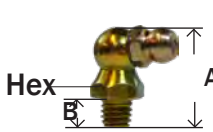
METRIC 90° ANGLE

MIDLAND	AMC	CHAMPION	LIST	SIZE	MAF #	MAF PRICE
36172	08393			6MM x 1	713	

#713 6090 2108 ZM906 5177

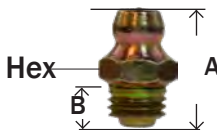
METRIC

MIDLAND	AMC	CHAMPION	LIST	SIZE	MAF #	MAF PRICE
36174	08394			8MM x 1	810	

#811 8000 2103 ZM58 5178

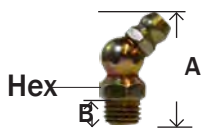
METRIC 45° ANGLE

MIDLAND	AMC	CHAMPION	LIST	SIZE	MAF #	MAF PRICE
36176	08395			8MM x 1	812	

#812 8045 2104 ZM458 5179

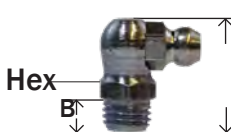
METRIC 90° ANGLE

MIDLAND	AMC	CHAMPION	LIST	SIZE	MAF #	MAF PRICE
36178	08396			8MM x 1	813	

#813 8090 2105 ZM908 5180

WARNING: This product can expose you to chemicals, including lead, which are known to the State of California to cause cancer and birth defects or other reproductive harm. For more information, visit www.P65Warnings.ca.gov



STEEL GREASE FITTINGS

BRASS FITTINGS

METRIC

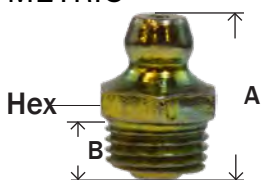

MIDLAND	AMC	CHAMPION	LIST	SIZE	MAF #	MAF PRICE
36180	08397			10MM x 1	910	

• DIAMETER X PITCH (EXTRA FINE)

#911 9000 2109 ZM510 5181

METRIC

45° ANGLE

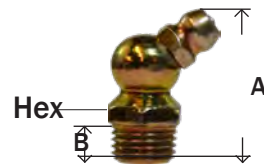

MIDLAND	AMC	CHAMPION	LIST	SIZE	MAF #	MAF PRICE
36182	08398			10MM x 1	912	

#912 9045 2110 ZM4510 5182

METRIC

90° ANGLE



MIDLAND	AMC	CHAMPION	LIST	SIZE	MAF #	MAF PRICE
36184	08399			10MM x 1	913	

#913 9090 2111 ZM9010 5183

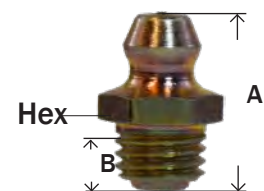

MIDLAND	AMC	CHAMPION	LIST	SIZE	MAF #	MAF PRICE
36186	08351			5/16"-24		

#711-B 1711 2500

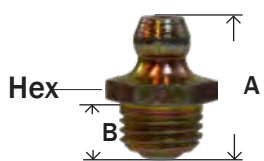

MIDLAND	AMC	CHAMPION	LIST	SIZE	MAF #	MAF PRICE
36188	08352			3/8"-24		

#710-B 1710 2600

BUTTON HEAD

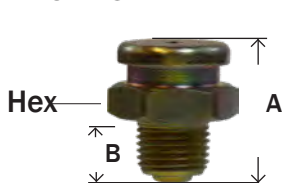

MIDLAND	AMC	CHAMPION	LIST	SIZE	MAF #	MAF PRICE
36200	08302			1/8"-27 PTF		
36205	08304			1/4"-18 NPT		

1184 1186

WHIP HOSE - EXCEEDS SAE 100R1-AT - USE WITH HAND GREASE GUNS ONLY

10,000 PSI BURST PRESSURE RUBBER

3,000 PSI WORKING PRESSURE

3/16" ID

1/8" NPT SOLID BASE



MIDLAND	AMC	CHAMPION	LIST	LENGTH	MAF #	MAF PRICE
36210				12" RUBBER		
36212				18" RUBBER		
36214				24" RUBBER		
36216				36" RUBBER		

4 JAW GREASE GUN COUPLER

PROVIDES QUICK, POSITIVE, LEAKPROOF CONNECTION W/ GREASE

1/8" NPTF

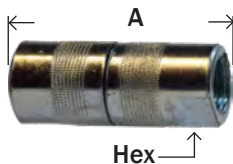

MIDLAND	AMC	CHAMPION	LIST	LENGTH	MAF #	MAF PRICE
36220				1.50		

STEEL GREASE FITTINGS

BRASS FITTINGS

Adapters for Grease Fittings

ADAPTERS

• CARBON STEEL, ZINC COATED



MIDLAND	AMC	CHAMPION	LIST	FEMALE	MALE	MAF #	MAF PRICE
36300				1/8"-27 NPTF	1/4"-28" SAE-LT		
36301				1/8"-27 NPTF	1/4"-28" SAE-LT		



MIDLAND	AMC	CHAMPION	LIST	FEMALE ENGLISH TO MALE ENGLISH		MAF #	MAF PRICE
36304				1/4"-28 UNF	M6 x 1.0		
36305				1/4"-28 UNF	M8 x 1.0		
36306				1/4"-28 UNF	M10 x 1.0		

EXTENSIONS

MIDLAND	AMC	CHAMPION	LIST	FEMALE ENGLISH TO MALE ENGLISH		MAF #	MAF PRICE
36307				1/4"-28 UNF	1/4"-28 SAE-LT		
36308				1/8"-27 NPTF	1/8"-27 NPTF		
36309*				1/8"-27 NPTF	1/8"-27 NPTF		
36310				1/8"-27 NPTF	1/8"-27 NPTF		
36311				1/8"-27 NPTF	1/8"-27 NPTF		

*BRASS PLATED

45° ANGLE ELBOWS

MIDLAND	AMC	CHAMPION	LIST	FEMALE	MALE	MAF #	MAF PRICE
36360				1/8"-27 NPTF	1/4"-28 SAE-LT		
36362				1/8"-27 NPTF	1/8"-27 PTF SAE Short		

90° ANGLE ELBOWS

MIDLAND	AMC	CHAMPION	LIST	FEMALE	MALE	MAF #	MAF PRICE
36370				1/8"-27 NPTF	1/4"-28 SAE-LT		
36371				1/8"-27 NPTF	1/4"-28 SAE-LT		
36372				1/8"-27 NPTF	1/4"-18 PTF SAE Short		
36374				1/8"-27 NPTF	1/8"-27 PTF SAE Short		
36375				1/8"-27 NPTF	1/8"-27 NPTF		
36377				1/4"-18 NPTF	1/4"-18 NPTF		
36376				1/8"-27 NPTF	1/8"-27 NPTF		
36373				1/8"-27 PTF SPL Extra Short	1/8"-27 PTF SPL Extra Short		

COUPLING

MIDLAND	AMC	CHAMPION	LIST	FEMALE	FEMALE	MAF #	MAF PRICE
36340				1/4"-28 UNF	1/8"-27 NPTF		

BULKHEAD CONNECTOR

MIDLAND	AMC	CHAMPION	LIST	FEMALE	MALE (FEMALE)	MAF #	MAF PRICE
36350				1/8"-27 NPTF	1/8"-27 NPSM (1/4"-28 UNF)		

WARNING: This product can expose you to chemicals, including lead, which are known to the State of California to cause cancer and birth defects or other reproductive harm. For more information, visit www.P65Warnings.ca.gov

SPECIALTY VALVES AND COCKS



DRAIN COCKS



AIR VALVES



3, 4 AND 6 WAY

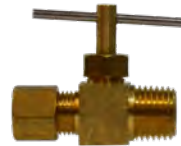

NEEDLE



MARINE & ANTI-SIPHON



PANEL MOUNT BALL VALVES



TRUCK



MINI BALL



SOLID BOTTOM SHUT-OFF



CHECK

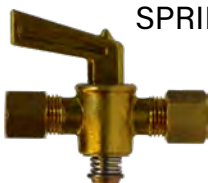

SPRING BOTTOM SHUT-OFF

MORE VALVES ON OUR WEBSITE
See our valve section for much, much more!

WARNING: This product can expose you to chemicals, including lead, which are known to the State of California to cause cancer and birth defects or other reproductive harm. For more information, visit www.P65Warnings.ca.gov

DRAIN COCKS

BRASS FITTINGS

DRAIN COCKS

- For use with low pressure air, water and fluids.
- Designed for a working pressure of 150 psi @ 250°.
- Hand-tightening provides a metal-to-metal seal.
- Not intended for natural gas, LPG, nuclear or aircraft applications.

Install on your tank for easy draining

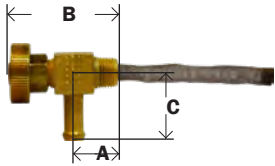
GASOLINE SHUT OFF W/ SCREEN FILTER

MIDLAND	AMC	CHAMPION	LIST	BARB X MALE PIPE	MAF #	MAF PRICE
46064				1/4" x 1/8"	MA6600	----

827

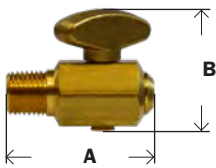
DRAIN COCK 150 PSI - TRUNK AIR TANK

MIDLAND	AMC	CHAMPION	LIST	MALE PIPE	MAF #	MAF PRICE
46066		40D		1/4"	PRC601-4	

DCR601-4

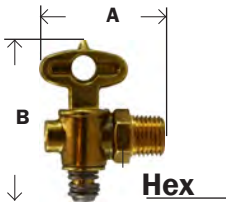
TRUCK DRAIN - 125 P.S.I.G

MIDLAND	AMC	CHAMPION	LIST	MALE PIPE	MAF #	MAF PRICE
46067	09403-02	37D		1/8"	H37P	----
46-068	09403-04	38D		1/4"	H38P	

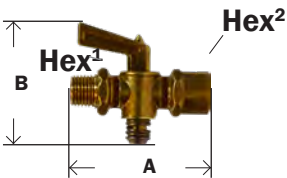
SHUT OFF - 150 P.S.I MAX.

MIDLAND	AMC	CHAMPION	LIST	MALE PIPE X FEMALE PIPE	INDUSTRY NUMBER	MAF #	MAF PRICE
46069		H130C-L		1/4"	W20332	H49P	----

#60HC 3380-A 0903610 367

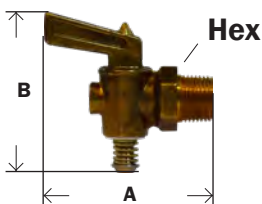
LEVER HANDLE

MIDLAND	AMC	CHAMPION	LIST	MALE PIPE	INDUSTRY NUMBER	MAF #	MAF PRICE
46070	09404-02	41D		1/8"	41P		
46071	09404-04	42D		1/4"	42P		
46072	09404-06	43D		3/8"	43P		
46073	09404-08	44D		1/2"	44P		

- 30 psi

840 41D DC601

*Valve is closed when handle is in the position of the picture

AIR TANK DRAIN PULL VALVE - 1/4 MALE

MIDLAND	AMC	CHAMPION	LIST	LENGTH OF CABLE	MAF #	MAF PRICE
39595		327-5		5'	MA595-60	----
39596		327-4		4'	MA595-68	
39597				3'	MA595-36	----
39600				AIR VALVE	MA595	----

DRAIN COCKS

BRASS FITTINGS

INTERNAL SEAT

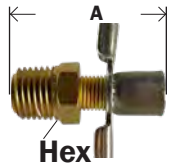

MIDLAND	AMC	CHAMPION	LIST	MALE PIPE	MAF #	MAF PRICE
46079				1/8"	MA6783	----

DC602 808 400A 1800A

INTERNAL SEAT - WING NUT HANDLE

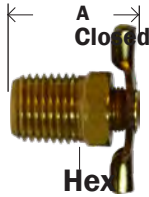

MIDLAND	AMC	CHAMPION	LIST	MALE PIPE	MAF #	MAF PRICE
46074	09440-02	300D		1/8"	MA130	
46075	09440-04	301D		1/4"	MA140	
46077		302D		3/8"	MA230	

HB - 5/16 803 305A

LONG INTERNAL SEAT

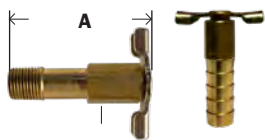

MIDLAND	AMC	CHAMPION	LIST	SIZE	MAF #	MAF PRICE
46078				1/8 MIP	MA185	----
46076				3/8" Hose I.D.		

46-078 46-076

809

PIN HANDLE - INTERNAL SEAT

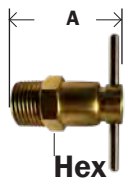

MIDLAND	AMC	CHAMPION	LIST	MALE PIPE	MAF #	MAF PRICE
46080	09420-02	200D		1/8"	200P	----
46081	09420-04	201D		1/4"	201P	----
46082	09420-06	202D		3/8"	202P	----

DC603 802

EXTERNAL SEAT W/ SPOUT

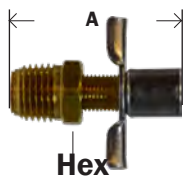

MIDLAND	AMC	CHAMPION	LIST	MALE PIPE	INDUSTRY NUMBER	MAF #	MAF PRICE
	09442-02	420D		1/8"		420P	
46084*	09442-04	421D		1/4"	6788	421P	

* Replaces GM # 511771 & Chrysler #836015

200A 239 DC606 807

BIBB VALVE



MIDLAND	AMC	CHAMPION	LIST	MALE PIPE	INDUSTRY NUMBER	MAF #	MAF PRICE
46088	09430-02	200DH		1/8"	150	302P	----
46089	09430-04	201DH		1/4"	120	303P	----
46089A				1/4"	6660	MA6660	----

* With valve closed

804 DC607 2019 201DH

RADIATOR TYPE - EXTERNAL SEAT

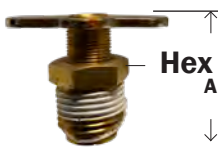

MIDLAND	AMC	CHAMPION	LIST	MALE PIPE	IND #	MAF #	MAF PRICE
46085	09432-02	320D		1/8"	135	320P	
46086	09432-04	321D		1/4"	145	321P	
46087	09432-06	322D		3/8"	270	322P	
46083	09432-08	323D		1/2"	108	323P	

320D 240 DC604 801

SHUT-OFF COCKS

BRASS FITTINGS

- Designed for working pressure of 30 PSI.
- Forged brass bodies and brass handles.
- Instantaneous off-on operation with 360° rotation.
- Not good for gasoline.

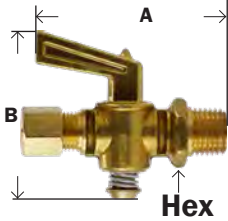
COMPRESSION X MALE PIPE

MIDLAND	AMC	CHAMPION	LIST	COMP X MALE PIPE	MAF #	MAF PRICE
46130	09201-0402	27CC		1/4" x 1/8"	27C	----
46131	09201-0404	227CC		1/4" x 1/4"	227C	----
46132	09201-0502	133C-5J		5/16" x 1/8"	29C	
	09201-0504			5/16" x 1/4"	229C	----
46134	09201-0604	57CC		3/8" x 1/4"	57C	----
46-135	09201-0606			3/8" x 3/8"	557C	----

868 V304C 2068 133C VC206

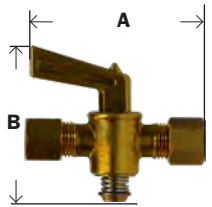
COMPRESSION X COMPRESSION

MIDLAND	AMC	CHAMPION	LIST	COMP X COMP	MAF #	MAF PRICE
46140	09206-04	28CC		1/4"	28C	----
46141	09206-05	30CC		5/16"	30C	----
46142	09206-06	58CC		3/8"	58C	----
46143	09206-08	68CC		1/2"	68C	

V3030F 2062 134C

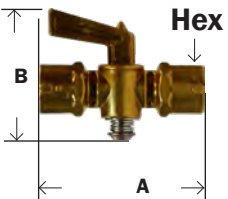
FEMALE X FEMALE PIPE

MIDLAND	AMC	CHAMPION	LIST	FEMALE PIPE X FEMALE PIPE	MAF #	MAF PRICE
46151	09234-02	31PC		1/8"	31P	
46152	09234-04	32PC		1/4"	32P	
46152T*				1/4"	H32P	----
46153	09234-06	40PC		3/8"	40P	

* 150 PSI

V403P 132C 875

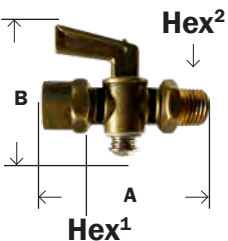
MALE PIPE X FEMALE

MIDLAND	AMC	CHAMPION	LIST	MALE PIPE X FEMALE PIPE	MAF #	MAF PRICE
46160	09235-02	48PC		1/8"	48P	
46161	09235-04	49PC		1/4"	49P	
46161T*				1/4"	H49P	----
46162	09235-06	50PC		3/8"	50P	

* 150 PSI

880 V402P 130C

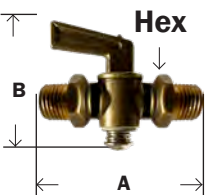
MALE PIPE X MALE PIPE

MIDLAND	AMC	CHAMPION	LIST	MALE PIPE X MALE PIPE	IND. #	MAF #	MAF PRICE
46165	09208-02	76PC		1/8"	76-P	76P	
46166	09208-04	77PC		1/4"	77-P	77P	
46166T*				1/4"		H77P	----
46167	09208-06	78PC		3/8"	78-P	78P	

* 150 PSI

1V401P 890

SHUT-OFF COCKS

BRASS FITTINGS

MALE FLARE X MALE PIPE



MIDLAND	AMC	CHAMPION	LIST	MALE FLARE X MALE PIPE	MAF #	MAF PRICE
46100	09204-0402	27SAE		1/4" x 1/8"	27SAE	----
46101	09204-0404	227SAE		1/4" x 1/4"	227SAE	----
46102	09204-0502			5/16" x 1/8"	295SAE	
46103	09204-0504			5/16" x 1/4"	229SAE	----
46104	09204-0604	57SAE		3/8" x 1/4"	57SAE	----
	09204-0606			3/8" x 3/8"		
	09204-0608			3/8" x 1/2"	577SAE	
46107	09204-0806	67SAE		1/2" x 3/8"	67SAE	----
	09204-0808			1/2" x 1/2"	77SAE	----

MALE FLARE X MALE FLARE



MIDLAND	AMC	CHAMPION	LIST	MALE FLARE	IND. #	MAF #	MAF PRICE
46115	09210-04	28SAE		1/4"		28SAE	----
	09210-05			5/16"		30SAE	----
46117	09210-06	58SAE		3/8"		58SAE	----
46118	09210-08	68SAE		1/2"		68SAE	----
	09210-10			5/8"		1010SAE	----

MALE FLARE X FEMALE PIPE



MIDLAND	AMC	CHAMPION	LIST	MALE FLARE X FEMALE PIPE	IND. #	MAF #	MAF PRICE
46125	09205-0608	161SAE		3/8" x 1/2"		161SAE	----
46127	09205-0606	163SAE		3/8" x 3/8"		163SAE	----
46128	09205-0808	164SAE		1/2" x 1/2"		164SAE	----
46126				3/8" x 9/16-24		161SAE	----
	09205-1012			5/8" x 3/4"		167SAE	----

WARNING: This product can expose you to chemicals, including lead, which are known to the State of California to cause cancer and birth defects or other reproductive harm. For more information, visit www.P65Warnings.ca.gov

BRASS

NEEDLE VALVES

BRASS FITTINGS

NEEDLE VALVES

THESE ARE NOT LEAD FREE SEE PAGES 169 FOR LEAD FREE PRODUCTS

Made with either pin handle or pressed on handle.

Please specify if you have a preference.

metal

- Used on instrumentation, hydraulic, and pneumatic systems.
- Designed for a maximum working pressure of 150 PSI. or

- Provided with steel handles and metal-to-seats with fine-thread screwdown.
- Not designed for natural gas, LPG, nuclear aircraft applications.
- Always install with pressure against the seat.

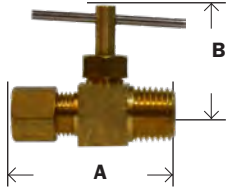
COMP X MALE PIPE

MIDLAND	AMC	CHAMPION	LIST	COMP X MALE PIPE	MAF #	MAF PRICE
46001	09101-0302			3/16" x 1/8"	133C	----
46002	09101-0402	101CP		1/4" x 1/8"	101C	----
46003	09101-0404	101CP-4		1/4" x 1/4"	1101C	----
46004	09101-0502	102-C		5/16" x 1/8"	102C	----
46005	09101-0604	143CP		3/8" x 1/4"	143C	----

NV106C 2205 820 3068

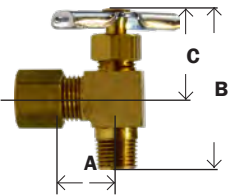
COMP X MALE PIPE-ANGLE

MIDLAND	AMC	CHAMPION	LIST	COMP X MALE PIPE	MAF #	MAF PRICE
46011	09103-0402	103CC		1/4" x 1/8"	103C	----
46011X				Heavy Pattern		
46012	09103-0404	103-4CC		1/4" x 1/4"	104C	----
46013	09103-0502	203CC		5/16" x 1/8"	203C	----
	09103-0602	303ACC		3/8" x 1/8"	302C	
46016	09103-0604	303CC		3/8" x 1/4"	303C	----

NV104C 2203 821 3069

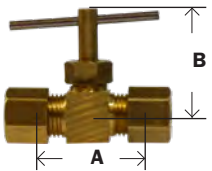
COMP X COMP

MIDLAND	AMC	CHAMPION	LIST	COMP X COMP	MAF #	MAF PRICE
46020				3/16"	105C	----
46021	09106-04	106CC		1/4"	106C	----
46022	09106-05	107CC		5/16"	107C	----
46023	09106-06	113CC		3/8"	113C	----

NV105C 3062 2201 822

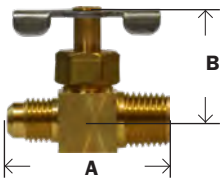
FLARE X MALE PIPE

MIDLAND	AMC	CHAMPION	LIST	MALE FLARE X MALE PIPE	MAF #	MAF PRICE
46028	09104-0402	104SAE		1/4" x 1/8"	104SAE	----
46029	09104-0404	105SAE		1/4" x 1/4"	1104SAE	----
	09104-0502			5/16" x 1/8"	106SAE	----
46031	09104-0604	108SAE		3/8" x 1/4"	108SAE	----

NV103F 2405 823 3048

WARNING: This product can expose you to chemicals, including lead, which are known to the State of California to cause cancer and birth defects or other reproductive harm. For more information, visit www.P65Warnings.ca.gov

NEEDLE VALVES

BRASS FITTINGS

FLARE X MALE PIPE

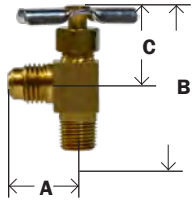

MIDLAND	AMC	CHAMPION	LIST	MALE FLARE X MALE PIPE	MAF #	MAF PRICE
46036	09102-0402	103SAE		1/4" x 1/8"	103SAE	----
46038		203SAE		5/16" x 1/8"	203SAE	----
46039		204SAE		5/16" x 1/4"	204SAE	----
46040	09102-0604	303SAE		3/8" x 1/4"	303SAE	----

NV101F 2403 824 3049

FLARE X FLARE

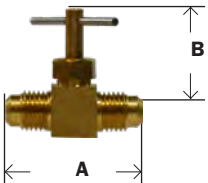

MIDLAND	AMC	CHAMPION	LIST	MALE FLARE X MALE FLARE	MAF #	MAF PRICE
46045	09110-04	110SAE		1/4"	110SAE	----
46046	09110-06	115SAE		3/8"	115SAE	----

NV102F 3042 825 2401

MULTI-PURPOSE AIR VENT

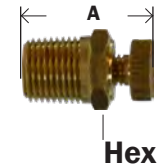

Hex

MIDLAND	AMC	CHAMPION	LIST	MALE PIPE	MAF #	MAF PRICE
46048		340AV		1/8"	AV-2S	----
46048S*				1/8"		

* #303 Stainless Steel

705

MALE PIPE TO MALE PIPE

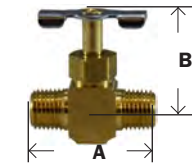

MIDLAND	AMC	CHAMPION	LIST	MALE PIPE X MALE PIPE	MAF #	MAF PRICE
46050	09108-02	108MP		1/8"	108P	----
46051	09108-04	110MP		1/4"	110P	----
				3/8"	202P	----

NV107P 2301 826 3122

FEMALE PIPE X FEMALE PIPE

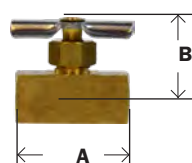

MIDLAND	AMC	CHAMPION	LIST	FEMALE PIPE X FEMALE PIPE	MAF #	MAF PRICE
46055*	09134-02	31NV		1/8"	304P	----
46056	09134-04	32NV		1/4"		
46056P*				1/4" Heavy	3044PFH	----

* Pressed on handle

6800 NV109P 2304 817 3103

MALE X FEMALE PIPE NBR seals -30°C to 120°C

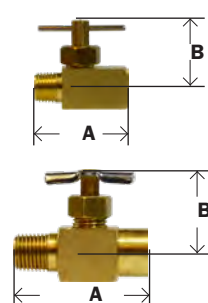

MIDLAND	AMC	CHAMPION	LIST	MALE PIPE X FEMALE PIPE	MAF #	MAF PRICE
46060	09135-02	48NV		1/8"	305P	----
46061	09135-04	49NV		1/4"	3055P	----
46061L				1/4" Light Pattern	3055PFH	----

NV108P 2305 818 3120

SPECIALTY VALVES

BRASS FITTINGS

BRASS TRUCK VALVES

- Used in heavy duty truck, trailer and mobile markets.
- Used on water, oil and coolant lines.
- Forged brass construction with steel handle.
- Temperature range -40° - 250°
- Max pressure 250 psi
- Metal to metal seats for high heat/fluid compatibility
- Fine thread screw down to afford flow control ability and a positive seal.
- Not intended for natural gas, LPG, Nuclear or aircraft applications

BARB TO MALE PIPE

MIDLAND	AMC	CHAMPION	LIST	SIZE	MAF #	MAF PRICE
46450	08944-0606	HV1-6C		3/8 x 3/8	TV44-66	----
	08944-0806	HV1-8C		1/2 x 3/8	TV44-86	----
46451	08944-1006	HV1-10C		5/8 x 3/8	TV44-106	----
46455	08944-1008	HV1-10D		5/8 x 1/2	TV44-108	----
46457	08944-1206	HV1-12C		3/4 x 3/8	TV44-126	----
46456	08944-1208	HV1-12D		3/4 x 1/2	TV44-128	----

404V

BARB TO MALE PIPE SPECIAL- PIN HANDLE

MIDLAND	AMC	CHAMPION	LIST	SIZE	MAF #	MAF PRICE
	08947-0606			3/8 x 3/8	TV44PH-66	----
	08947-1006	HV1-PH-10C		5/8 x 3/8	TV44PH-106	----



WITH ROUND SILVER HANDLE						
MIDLAND	AMC	CHAMPION	LIST	SIZE	MAF #	MAF PRICE
		97V-10P		5/8 x 1/2		

FEMALE TO MALE PIPE

MIDLAND	AMC	CHAMPION	LIST	SIZE	MAF #	MAF PRICE
46465	08945-0606	1W-66		3/8 x 3/8	TV45-66	----
46466	08945-0608	1W-86		3/8 x 1/2	TV45-68	----
46467	08945-0808	1W-88		1/2 x 1/2	TV45-88	----

405V

HOSE BARB TO MALE PIPE - ROUND HANDLE

MIDLAND	AMC	CHAMPION	LIST	SIZE	MAF #	MAF PRICE
		HBV-6C		3/8 x 3/8		

WARNING: This product can expose you to chemicals, including lead, which are known to the State of California to cause cancer and birth defects or other reproductive harm. For more information, visit www.P65Warnings.ca.gov

SPECIALTY VALVES

BRASS FITTINGS

BRASS TRUCK VALVES

- Used in heavy duty truck, trailer and mobile markets.
- Used on water, oil and coolant lines.
- Forged brass construction with steel handle.
- Temperature range -40° - 250°
- Max pressure 250 psi
- Metal to metal seats for high heat/fluid compatibility
- Fine thread screw down to afford flow control ability and a positive seal.
- Not intended for natural gas, LPG, Nuclear or aircraft applications

FLARE TO MALE PIPE



TV49

MIDLAND	AMC	CHAMPION	LIST	SIZE	MAF #	MAF PRICE
	08949-0604			3/8 x 1/4	TV49-64	----
	08949-0606			3/8 x 3/8	TV49-66	----
	08949-0608			3/8 x 1/2	TV49-68	----
	08949-0806			1/2 x 3/8	TV49-86	----
46475	08949-0808	7814X8X8X90		1/2 x 1/2	TV49-88	----
46476	08949-1008	7814X8X90		5/8 x 1/2	TV49-108	----

409V

MIP X FLARE



TV412

MIDLAND	AMC	CHAMPION	LIST	SIZE	MAF #	MAF PRICE
46485	08942-1008	7814X8X90X1		1/2 x 5/8	TV412-108	

KANTLEAK 90° BALL VALVE - PIN HANDLE



MIDLAND	AMC	CHAMPION	LIST	SIZE	MAF #	MAF PRICE
		ABV1-B		1/4 x 1/4	190BV-4	
		ABV1-C		3/8 x 3/8	190BV-6	----
		ABV1-D		1/2 x 1/2	190BV-8	----

OIL DRUM AND TANK VALVES

FLARE TUBE O.D. TO MALE PIPE 45° ELBOW

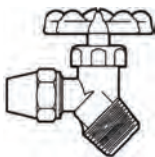

MIDLAND	AMC	CHAMPION	LIST	SIZE	MAF #	MAF PRICE
	09540-0606			3/8 x 3/8		
	09540-0608	5818X8		3/8 x 1/2	60V	
	09540-0612	5818X12		3/8 x 3/4	70V	
	09540-0808			1/2 x 1/2		
	09540-0812			1/2 x 3/4		

PLASTIC DRUM FAUCETS

- Pipe threads to ANSI B1.20.1
- Hose threads to ANSI B

The FLO-RITE faucet has been engineered to meet the demand for greater chemical resistance, using linear polyethylene for the stem.



"FLO-RITE" DRUM FAUCET

PART #	SIZE	MAF PRICE
46277	3/4"	----

WARNING: This product can expose you to chemicals, including lead, which are known to the State of California to cause cancer and birth defects or other reproductive harm. For more information, visit www.P65Warnings.ca.gov

BRASS

SPECIALTY VALVES

BRASS FITTINGS

DRUM & BARREL FAUCET VALVE

- Die cast body w/ nylon seat and steel spring.
- For use with all petroleum products except trichlorethylene.



G261N

Not suitable for potable water

SELF-CLOSING DRUM & BARREL FAUCET

PART #	SIZE	
46270	3/4"	----

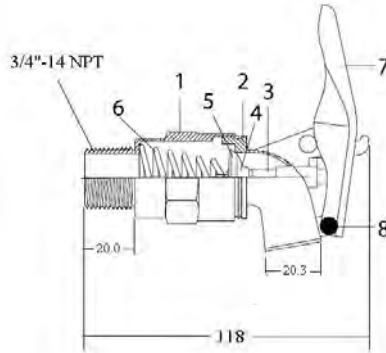

Part #	Part Name	Material
1	Body	Zinc
2	Bonnet	Zinc
3	Stem	Steel
4	Disc	Plastic
5	Seal	Rubber
6	Spring	Zinc plated steel
7	Handle	Aluminum
8	Rivet	Aluminum

SOLID BOTTOM VALVES

- Designed for instantaneous on-off operation.
- 360° rotation standard.
- 30 PSI
- Packed with grease.

O-RING SEALED MIP X FIP

MIDLAND	AMC	CHAMPION	LIST	SIZE	MAF #	MAF PRICE
46400		103SD-2		1/8	170C-2	----
46401		103SD-4		1/4	170C-4	----
46402		103SD-6		3/8	170C-6	----

- Good for Propane

1035D M-70-SBV

#M-72-SBV FIP X FIP

MIDLAND	AMC	CHAMPION	LIST	SIZE	MAF #	MAF PRICE
46411		32SD		1/4	172C-4	----

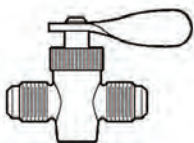
MALE FLARE X MALE FLARE

MIDLAND	AMC	CHAMPION	LIST	SIZE	MAF #	MAF PRICE
		58SD		3/8	176C-6	----

WARNING: This product can expose you to chemicals, including lead, which are known to the State of California to cause cancer and birth defects or other reproductive harm. For more information, visit www.P65Warnings.ca.gov



SPECIALTY VALVES

BRASS FITTINGS

SOLID BOTTOM FUEL VALVES

- Approved for use on Motorcraft fuel lines.
- Pointer lever.
- 90° turn stop mechanism to assure positive location of the on and off positions.
- Corrosion proofed internal construction assures maximum salt atmosphere protection.
- Port hole is 1/4 (.250) diameter.
- UL listed for use in fuel oils no. 1 & no. 2, LP gas and utility gas.

MALE PIPE X FEMALE PIPE



MIDLAND	AMC	CHAMPION	LIST	SIZE	MAF #	MAF PRICE
46400M	09500-02	670C-J		1/8 x 1/8	M670C-2	----
46401M	09500-04	670C-L		1/4 x 1/4	M670C-4	----
46402M	09500-06	670C-N		3/8 x 3/8	M670C-6	----

8980

MALE PIPE X MALE PIPE



MIDLAND	AMC	CHAMPION	LIST	SIZE	MAF #	MAF PRICE
46406M	09501-04	77SD		1/4 x 1/4	M671C-4	----

- Good for Propane

8990

FEMALE PIPE X FEMALE PIPE



MIDLAND	AMC	CHAMPION	LIST	SIZE	MAF #	MAF PRICE
46411M	09502-04	672C-L		1/4 x 1/4	M672C-4	----

8975

MALE FLARE X MALE PIPE



MIDLAND	AMC	CHAMPION	LIST	SIZE	MAF #	MAF PRICE
	09505-0402			1/4 x 1/8	M675C-42	
	09505-0404			1/4 x 1/4	M675C-44	
46429M	09505-0604	675C-6L		3/8 x 1/4	M675C-64	----
46430M	09505-0606	675C-6N		3/8 x 3/8	M675C-66	----
	09505-0608			3/8 x 1/2		
	09505-0806			1/2 x 3/8		

8948

WARNING: This product can expose you to chemicals, including lead, which are known to the State of California to cause cancer and birth defects or other reproductive harm. For more information, visit www.P65Warnings.ca.gov

BRASS

SPECIALTY VALVES

BRASS FITTINGS

GROUND PLUG SHUT-OFF COCKS

NON-LUBRICATED PLUG VALVES are designed to operate in systems where INSTANTANEOUS PORT SELECTION is desired. Since LUBRICANTS ARE NOT USED, relubrication is not required. There is no lubricant to freeze and lock the valve or to contaminate fine fluids. The O-RING SEALED CAP and STEM eliminate leakage to atmosphere. The mating BRASS BODY and CELCON PLUG produce a fine seal that WILL NOT SEIZE OR GALL.

Designed for PANEL or BRACKET MOUNTING. They are generally recommended for operation in GASOLINE, OIL, AIR, WATER and DETERGENT systems from minus 40° to 180°F, at a maximum operating pressure of 30 p.s.i.g. The fluid port size is 9/32 (.281) diameter for 1/8 and 1/4 sizes, 5/16 (.312) diameter for the 3/8 size. **(Consult factory for applications requiring a higher pressure).**

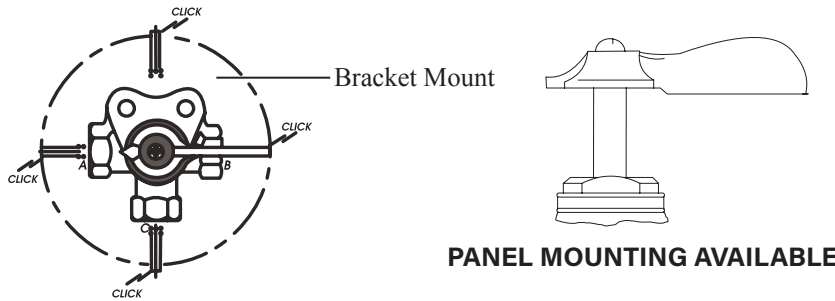

Type 1 (Standard)

A pronounced "click" may be felt at each position.
Handle travel is not restricted.

THREE-WAY VALVES (Side Outlet)

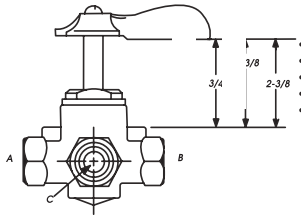

- 1-3/8" Stem
- Side Outlet
- Bracket Mounting
- O-Ring Sealed
- 4-way celcon roter standard

LESS CLICK

MIDLAND	AMC	CHAMPION	LIST	A-B-C FEMALE PIPE THREAD	LENGTH OF STEM	MAF #	MAF PRICE
46247		110C-J		1/4	1-3/8"		
46248		110C-N		3/8	1-3/8"		

M-108-MID WITH CLICK 360°

MIDLAND	AMC	CHAMPION	LIST	A-B-C FEMALE PIPE THREAD	LENGTH OF STEM	MAF #	MAF PRICE
46250	09508-02	108SD-2		1/8	1-3/8"	210C-2	----
46251	09508-04	108SD-4		1/4	1-3/8"	210C-4	----
46252	09508-06	108SD-6		3/8	1-3/8"	210C-6	----

V406P 6749

Openings:

Handle Pointer over A.....Valve Open A-C

Handle Pointer over C.....Valve Open B-C

Handle Pointer over B.....Valve "OFF"

Handle Pointer over Bracket.....Valve "OFF"

WARNING: This product can expose you to chemicals, including lead, which are known to the State of California to cause cancer and birth defects or other reproductive harm. For more information, visit www.P65Warnings.ca.gov



SPECIALTY VALVES

BRASS FITTINGS

GROUND PLUG SHUT-OFF COCKS

THREE-WAY VALVES (Bottom Outlet)

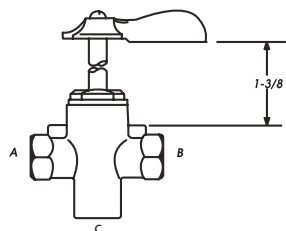

- 1-3/8" Stem
- Side Outlet
- Bracket Mounting
- O-Ring Sealed
- 4-way celcon roter standard

Openings:

Handle *Pointer* over A.....Valve Open A-C
 Handle *Pointer* over B.....Valve Open B-C
 Handle *Pointer* over Bracket.....Valve "OFF"

LESS CLICK

MIDLAND	AMC	CHAMPION	LIST	A-B-C FEMALE PIPE THREAD	LENGTH OF STEM	MAF #	MAF PRICE
46241		120C-L		1/4	1-3/8"	120C-4	----

WITH CLICK 360°

MIDLAND	AMC	CHAMPION	LIST	A-B-C FEMALE PIPE THREAD	LENGTH OF STEM	MAF #	MAF PRICE
46243		220C-J		1/8	1-3/8"	220C-2	----
46244		220C-L		1/4	1-3/8"	220C-4	----

FOUR-WAY VALVES

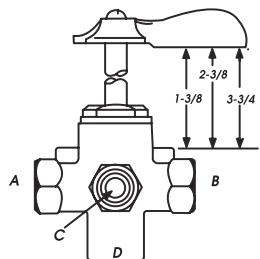

- Side Outlet
- Bracket Mounting
- O-Ring Sealed
- 4-way celcon roter standard

Openings:

Handle *Pointer* over A.....Valve Open A-D
 Handle *Pointer* over C.....Valve Open C-D
 Handle *Pointer* over B.....Valve Open B-D
 Handle *Pointer* over Bracket.....Valve "OFF"

LESS CLICK

MIDLAND	AMC	CHAMPION	LIST	A-B-C-D FEMALE PIPE THREAD	LENGTH OF STEM	MAF #	MAF PRICE
46257		100C-L		1/4	1-3/8"	220C-4LC	----

M-114-MID WITH CLICK (360°)

MIDLAND	AMC	CHAMPION	LIST	A-B-C-D FEMALE PIPE THREAD	LENGTH OF STEM	MAF #	MAF PRICE
46255	09514-04	114SD		1/4	1-3/8"	200C-4	----
46256	09514-06	200C-N		3/8	1-3/8"	200C-6	----

WITH 2-3/8" LONG STEM M-115-MID

MIDLAND	AMC	CHAMPION	LIST	A-B-C-D FEMALE PIPE THREAD	LENGTH OF STEM	MAF #	MAF PRICE
46260	09515-04	105C-L		1/4	2-3/8"	215C-4	----
	09515-06			3/8		215C-6	----

WARNING: This product can expose you to chemicals, including lead, which are known to the State of California to cause cancer and birth defects or other reproductive harm. For more information, visit www.P65Warnings.ca.gov

BRASS

V407P

MINIATURE BALL VALVES

BRASS FITTINGS

BRASS MINIATURE BALL VALVES

- Working Pressure up to 1000 P.S.I.G.
- ASTM B-16 Corrosion Resistant Brass Body.
- Non-Adjusting Fluoroelastomer O-Ring Stem Seal Design Never Needs Tightening.
- Highly Inert Polytetrafluoroethylene Seats.
- Long Life Nickel Plated Brass Ball.
- Blow-Out Proof Stem for Safety.
- Temperature: -40°F to 300°F
- 1/4 Turn Instantaneous On-Off Operation.
- Quarter Turn Handle Design.
- Water, Oil, and Air Pressure Systems.
- Ideal for tight, confined areas, or when routing aesthetics are desired. Applications include instrumentation, gas sampling systems, high pressure gauges, test stands, hydraulic and pneumatic service lines on capital equipment.
- Not good for steam.
- Good for propane, gas and diesel.

MALE X FEMALE

MIDLAND	AMC	CHAMPION	LIST	SIZE	MAF #	MAF PRICE
46900		350BV-J		1/8 x 1/8	350BV-22	----
46903		350BV-L		1/4 x 1/4	350BV-44	----

MALE X FEMALE

MIDLAND	AMC	CHAMPION	LIST	SIZE	MAF #	MAF PRICE
		350BVR-J		1/8 x 1/8		
		350BVR-L		1/4 x 1/4		

MALE X MALE

MIDLAND	AMC	CHAMPION	LIST	SIZE	MAF #	MAF PRICE
46910		351BV-J		1/8 x 1/8	351BV-22	----
46912		351BV-L		1/4 x 1/4	351BV-44	----

HOSE BARB X MALE PIPE

MIDLAND	AMC	CHAMPION	LIST	SIZE	MAF #	MAF PRICE
47042		357BV-4J		1/4 X 1/8	357BV-42	----
46980		357BV-4L		1/4 x 1/4	357BV-44	----
				5/16 X 1/4	357BV-54	----
46981		357BV-6L		3/8 X 1/4	357BV-64	----
				3/8 X 3/8	357BV-66	----
				1/2 X 1/2	357BV-88	----

FEMALE X FEMALE

MIDLAND	AMC	CHAMPION	LIST	SIZE	MAF #	MAF PRICE
46920		352BV-J		1/8 x 1/8	352BV-22	----
46921		352BV-JXL		1/8 x 1/4	352BV-24	----
46922		352BV-L		1/4 x 1/4	352BV-44	



MIDLAND	AMC	CHAMPION	LIST	SIZE	MAF #	MAF PRICE
46922A				1/4 x 1/4		
46923				3/8 x 3/8		



MIDLAND	AMC	CHAMPION	LIST	SIZE	MAF #	MAF PRICE
46924				1/2 x 1/2		
46925				3/4 x 3/4		

WARNING: This product can expose you to chemicals, including lead, which are known to the State of California to cause cancer and birth defects or other reproductive harm. For more information, visit www.P65Warnings.ca.gov

MINIATURE BALL VALVES

BRASS FITTINGS

U.L. TWO WAY VALVES

- Buna-N Seal, Polytetrafluoroethylene Seat Plated metal handle, plated brass ball.
- 250 PSI Working Pressure

U.L. TWO WAY VALVES FNPT X FNPT



MIDLAND	AMC	CHAMPION	LIST	SIZE	MAF #	MAF PRICE
46440				1/4 x 1/4		

U.L. TWO WAY VALVES MNPT X FNPT



MIDLAND	AMC	CHAMPION	LIST	SIZE	MAF #	MAF PRICE
46443				1/4 x 1/4		

PANEL MOUNT BRASS BALL VALVES

- Working pressure: 1500 psi wog for 1/8" to 1/4", 1000 psi wog for 3/8" to 1/2"
- Vacuum rating: 29.92" Hg
- Working temp: -40°F to +300°F
- Panel mount hole is 9/16" Dia.
- Brass body cap, PTFE ball seats, Fluoro-elastomer stem sealing, Brass chrome plated ball

FEMALE X FEMALE



MIDLAND	AMC	CHAMPION	LIST	SIZE	MAF #	MAF PRICE
46830		362BV-J		1/8 x 1/8	352BV-22	----
46832		362BV-L		1/4 x 1/4	352BV-44	
46833		362BV-N		3/8 x 3/8	352BV-66	
46834		362BV-P		1/2 x 1/2	352BV-88	



MIDLAND	AMC	CHAMPION	LIST	SIZE	MAF #	MAF PRICE
46875		392BV-JXJ		1/8 x 1/8	392BV-22	----
46878				1/4 x 1/4	392BV-44	----

FEMALE X FEMALE X FEMALE



MIDLAND	AMC	CHAMPION	LIST	SIZE	MAF #	MAF PRICE
46951		3222BV-JJXJ		1/8 FPT		
46956		3222BV-LLXL		1/4 FPT		

FEMALE X FEMALE X FEMALE X FEMALE



MIDLAND	AMC	CHAMPION	LIST	SIZE	MAF #	MAF PRICE
		4122BV-LL		1/4 FPT		

WARNING: This product can expose you to chemicals, including lead, which are known to the State of California to cause cancer and birth defects or other reproductive harm. For more information, visit www.P65Warnings.ca.gov

BRASS

CHECK VALVES

BRASS FITTINGS

BRASS CHECK VALVES

• 500 PSI • 1 PSI Cracking Pressure • Buna-N Seal for water, air & inert gas • **Fluoroelastomer Seal for oil, gas & diesel fuel**

FIP X FIP BUNA-N

• 180° temp rating

MIDLAND	AMC	CHAMPION	LIST	SIZE	MAF #	MAF PRICE
46560				1/8"		
46561				1/4"		
46562				3/8"		
46563				1/2"		
46564				3/4"		

FIP X FIP FLUOROELASTOMER

• 180° temp rating

MIDLAND	AMC	CHAMPION	LIST	SIZE	MAF #	MAF PRICE
46560V				1/8"		
46561V				1/4"		
46562V				3/8"		
46563V				1/2"		
46564V				3/4"		

FEMALE X MALE BUNA-N

MIDLAND	AMC	CHAMPION	LIST	SIZE	MAF #	MAF PRICE
46565				1/8"		
46566				1/4"		
46567		750CV2-NXN		3/8"		
46568				1/2"		
46569				3/4"		

MALE X MALE

MIDLAND	AMC	CHAMPION	LIST	SIZE	MAF #	MAF PRICE
46570				1/8"		
46571				1/4"		
46572				3/8"		
46573				1/2"		

MALE X FEMALE

MIDLAND	AMC	CHAMPION	LIST	SIZE	MAF #	MAF PRICE
46575				1/8"		
46576				1/4"		
46577				3/8"		
46578				1/2"		

PNEUMATIC CHECK VALVES

• Max Operating Pressure: 220 psi • Working Pressure: 14.5-145 psi • Cracking Pressure: 2.8 psi
 • Maximum Temperatures: 140° F

Body	Chrome plated Brass
Spring	Steel
O-Ring	NBR Rubber

NPT- Inlet NPSM - Outlet



MIDLAND	AMC	CHAMPION	LIST	SIZE	MAF #	MAF PRICE
46200				1/4		
46201				3/8		
46202				1/2		

CHECK VALVES

BRASS FITTINGS

HIGH PRESSURE CHECK VALVES

MNPT X MNPT MAX. 2500 PSI Cracking Pressure 1 PSI



MIDLAND	AMC	CHAMPION	LIST	SIZE	MAF #	MAF PRICE
46500				1/4 x 1/4		

•SS ball and spring • Opening diameter .187 • 180° max operating temp. CV = 0.4

MNPT X FNPT MAX. 2500 PSI



MIDLAND	AMC	CHAMPION	LIST	SIZE	MAF #	MAF PRICE
46505				1/4 x 1/4		

•SS ball and spring • Flo direction -> • Opening diameter .187 • 180° max operating temp. • Buna Seal

FNPT X FNPT MAX. 1200 PSI



MIDLAND	AMC	CHAMPION	LIST	SIZE	MAF #	MAF PRICE
46510				1/4 x 1/4		
46511		650-6F6F-B		3/8 x 3/8		
46512		850-8F8F-B		1/2 x 1/2		

• O-Ring poppet seal Bubble tight operation • 180°F max operating temp.

HIGH PRESSURE CHECK VALVES

- Operates in any position, and is available in mixed or matched end combinations.
- Standard cracking pressure 1 p.s.i. with a maximum operating pressure of 3000 p.s.i. and a maximum operating temperature of 180°F using Buna-N seals.
- Buna-N seals standard, other seals available.
- Guided 316 stainless steel ball + spring.
- Fixed ringed seat prevents extrusion of seal.
- Opening diameter .28
- Approximate CV 1.2
- Water G.P.M. @ 10 p.s.i. is 4.0
- Good for air

FEMALE X FEMALE



MIDLAND	AMC	CHAMPION	LIST	SIZE	MAF #	MAF PRICE
46513				1/4		
46517				3/8		

FEMALE X MALE



MIDLAND	AMC	CHAMPION	LIST	SIZE	MAF #	MAF PRICE
46514				1/4		
46518				3/8		

MALE X FEMALE



MIDLAND	AMC	CHAMPION	LIST	SIZE	MAF #	MAF PRICE
46516				1/4		
46539				3/8		

MALE X MALE



MIDLAND	AMC	CHAMPION	LIST	SIZE	MAF #	MAF PRICE
46515				1/4		
46519				3/8		

WARNING: This product can expose you to chemicals, including lead, which are known to the State of California to cause cancer and birth defects or other reproductive harm. For more information, visit www.P65Warnings.ca.gov

BRASS

MARINE FITTINGS

BRASS FITTINGS

MARINE FITTINGS

• Calibrated to support 30" column of gasoline.

• Flo direction <-



BRASS ANTI-SIPHON VALVES

PART #	SIZE
46520	1/4 x 1/4
46521	3/8 x 3/8
46522	1/2 x 1/2



**BRASS ANTI-SIPHON VALVES
BARB X NPT**

PART #	SIZE
46529	1/4 x 1/4
46530	5/16 x 1/4
46531	3/8 x 1/4
46532	3/8 x 3/8
46533	1/2 x 3/8



**MINI BALL VALVE - BRASS
W/ SS HANDLE AND NUT**

PART #	BARB X MIP
46986	5/6 x 1/4
46987	3/8 x 1/4
46988	3/8 x 3/8
46989	1/2 x 1/2



ALUMINUM

PART #	SIZE
46520A	1/4 x 1/4
46521A	3/8 x 3/8



ALUMINUM

PART #	SIZE
46530A	5/16 x 1/4
46531A	3/8 x 1/4
46532A	3/8 x 3/8
46533A	1/2 x 3/8

- NBR O-Ring
- Working temp 180°F
- 3,000 PSI
- Brass or Aluminum
- #316 Ball & Spring



MALE MIP X FEMALE FIP BRASS

PART #	SIZE
46523	1/4
46524	3/8



ALUMINUM

PART #	SIZE
46523A	1/4
46524A	3/8



FLARE X MIP - BRASS

PART #	SIZE
46526	3/8 x 1/4

SIX-WAY VALVES

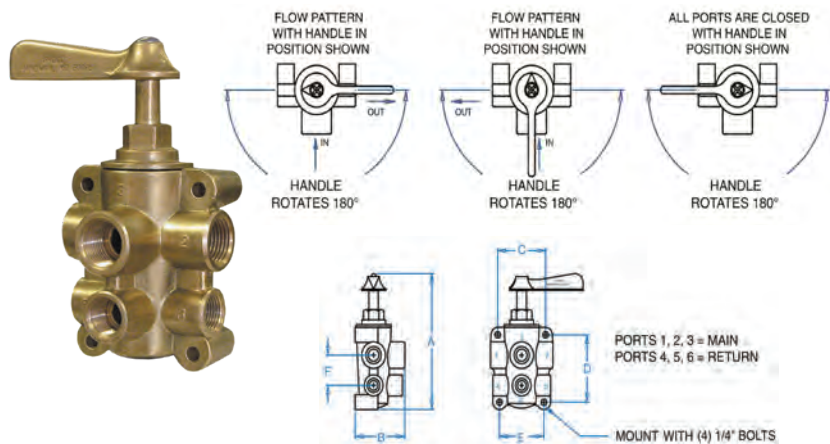

MIDLAND	CHAMPION	LIST	FEMALE PIPE THREAD OF 1-2-3 4-5-6	STEM	IND. #
46237	SP2483-CM		1/2 x 3/8	13/16	SK-1036

Six port fuel valves are used where 2 tanks supply a single engine, and a return to each supply tank is required.

ABYC H33.9.2 states that fuel system valves must have an independent means of support, so in-line valves are not suitable for fuel system applications.

WARNING: This product can expose you to chemicals, including lead, which are known to the State of California to cause cancer and birth defects or other reproductive harm. For more information, visit www.P65Warnings.ca.gov