

# List Price Book PVC Fittings



DWV Fittings - Prices Effective February 1, 2023  
Sewer Fittings - Prices Effective February 1, 2023  
Electrical Fittings - Prices Effective October 27, 2021

**Westlake**  
Pipe & Fittings





# List Price Book

## PVC Fittings

DWV Fittings - Prices Effective February 1, 2023

Sewer Fittings - Prices Effective February 1, 2023

Electrical Fittings - Prices Effective October 27, 2021

Westlake Pipe & Fittings injection molded and fabricated fittings are recognized for the highest quality standards in the industry. Westlake Pipe & Fittings offers fittings with triple certification listing.

**Please Note:**

- Parts listed with a single asterisk are injection molded fittings.
- Parts listed with a † are fittings that are assembled from molded components.
- Parts with no asterisk are fabricated fittings.

**Gasketed CIOD Pressure Fittings DR18 (C-Series)** **C** C1 - C3

**Gasketed CIOD Pressure Fittings DR25 (C-Series)** **C** C4 - C6

**Solvent Weld DWV Fittings (D-Series)** **D** D2 - D14

**Rigid PVC Conduit Fittings & Accessories (E-Series)** **E** E1 - E6

**ENT Fittings (E-Series)** **E** E7 - E10

**Gasketed Sewer Fittings SDR 35 (G-Series)** **G** G1 - G12

**Gasketed Sewer Fittings SDR 26/PS 115 (H-Series)** **H** H1 - H12

**PVC Profile Fittings (K-Series)** **K** K1 - K6

**Gasketed CIOD Non-Pressure Fittings (N-Series)** **N** N1 - N8

**Solvent Weld Sewer Fittings SDR 35 (P-Series/S-Series)** **P/S** P/S1 - P/S12

**Gasketed IPS Drainage Fittings (T-Series)** **T** T1 - T6

# Westlake

## Pipe & Fittings

### Policy and Terms

#### Claims Policy

Discrepancy claims must be reported within two business days of receipt of order.

#### Freight Policy

Freight is prepaid for orders totaling \$2,000 net or greater. Some items are special order and may not qualify for prepaid freight. Prepaid freight applies to a single shipment to one destination within the continental United States.

#### Minimum Order Policy

A minimum order of \$100 net is required.

#### Non-Stock Product Policy

Non-stock product is considered special order and is non-cancelable and non-returnable.

#### Standard Payment Terms

Payment terms are 2% 30 net 45 days.

#### Return Goods Policy

All returns must be approved by Westlake Pipe & Fittings and accompanied by a return goods authorization number also issued by Westlake Pipe & Fittings. A minimum restocking fee of 25% will apply to all returned goods. The shipper is responsible for return freight.

**For the most up to date Terms & Conditions, please visit:**  
[www.westlake.com/purchasing-terms](http://www.westlake.com/purchasing-terms)

## C.I.O.D. Gasketed Pressure Fittings (C-Series)

DR 18 (Class 150)

Fabricated in Sizes 10" – 36"



### Applications

C.I.O.D. DR 18 PVC Gasketed Pressure fittings are thermoformed, glued and fiberglass reinforced. This eliminates the threat of rust or corrosion, providing better flow and cleaner water quality. C900 PVC pressure fittings can be used in both higher pressure water systems and low pressure sewer force main systems.

Westlake Pipe & Fittings offers a standard bell OD to facilitate joint restraint installation, while allowing all fittings to have fiberglass reinforced plastic where required. Bends of 45 degrees or less, are manufactured of one-piece construction where possible. This provides a lightweight, compact fitting, which can be easily handled in the field.

Westlake Pipe & Fittings C900 PVC fittings are designed to be used with engineered joint restraints or concrete thrust blocking. C900 PVC fittings are a tough alternative to cast iron fittings offering the added benefit of corrosion resistance.

### Certification

Our Pressure C.I.O.D. Gasketed Sewer fittings conform to AWWA C900.

**Attention:** Westlake Pipe & Fittings are not to be used with compressed air or gases. Westlake Pipe & Fittings does not recommend that piping systems that include its products be tested with compressed air or gases.

Item	Size In Inches	Part Number	List Price
<b>Straight Tee GxGxG (DR18)</b>			
	10 x 4	C18-1010-4	6,626.50
	10 x 6	C18-1010-6	6,721.17
	10 x 8	C18-1010-8	6,816.06
	10 x 10	C18-1010	6,910.56
	12 x 4	C18-1012-4	7,004.92
	12 x 6	C18-1012-6	7,099.78
	12 x 8	C18-1012-8	7,193.04
	12 x 10	C18-1012-10	7,289.12
	12 x 12	C18-1012	7,383.93
	14 x 4	C18-1014-4	11,332.74
	14 x 6	C18-1014-6	11,803.54
	14 x 8	C18-1014-8	12,274.25
	14 x 10	C18-1014-10	12,745.14
	14 x 12	C18-1014-12	13,215.85
	14 x 14	C18-1014	13,686.60
	16 x 4	C18-1016-4	14,157.55
	16 x 6	C18-1016-6	14,628.24
	16 x 8	C18-1016-8	15,098.99
	16 x 10	C18-1016-10	15,569.88
	16 x 12	C18-1016-12	16,040.57
	16 x 14	C18-1016-14	16,511.27
	16 x 16	C18-1016	16,982.20
	18 x 4	C18-1018-4	17,449.65
	18 x 6	C18-1018-6	17,923.80
18 x 8	C18-1018-8	18,394.59	
18 x 10	C18-1018-10	18,865.40	
18 x 12	C18-1018-12	19,336.02	
18 x 14	C18-1018-14	19,803.62	
18 x 16	C18-1018-16	20,388.18	
18 x 18	C18-1018	21,360.07	
20 x 4	C18-1020-4	22,163.92	
20 x 6	C18-1020-6	22,967.91	
20 x 8	C18-1020-8	23,279.49	
20 x 10	C18-1020-10	23,591.56	
20 x 12	C18-1020-12	23,903.41	
20 x 14	C18-1020-14	24,408.84	
20 x 16	C18-1020-16	24,914.43	
20 x 18	C18-1020-18	25,251.50	
20 x 20	C18-1020	25,588.67	
24 x 4	C18-1024-4	25,925.76	
24 x 6	C18-1024-6	26,263.02	
24 x 8	C18-1024-8	26,600.22	
24 x 10	C18-1024-10	27,971.53	
24 x 12	C18-1024-12	29,342.80	
24 x 14	C18-1024-14	30,714.06	
24 x 16	C18-1024-16	32,085.40	
24 x 18	C18-1024-18	33,456.67	
24 x 20	C18-1024-20	34,828.00	
24 x 24	C18-1024	36,199.32	

Item	Size In Inches	Part Number	List Price
<b>Tee Cross GxGxGxG (DR18)</b>			
	10 x 10	C18-17910	8,022.53
	12 x 12	C18-17912	9,125.68
	14 x 14	C18-17914	15,834.37
	16 x 16	C18-17916	19,223.02
	18 x 18	C18-17918	25,466.38
	20 x 20	C18-17920	33,684.32
24 x 24	C18-17924	46,473.26	

Item	Size In Inches	Part Number	List Price
<b>Cap (G) (DR18)</b>			
	10	C18-16010	2,648.78
	12	C18-16012	3,169.46
	14	C18-16014	3,422.94
	16	C18-16016	4,181.82
	18	C18-16018	6,551.60
	20	C18-16020	7,622.33
24	C18-16024	9,685.32	

Item	Size In Inches	Part Number	List Price
<b>Stop Coupling GxG (DR18)</b>			
	10	C18-6010	1,239.63
	12	C18-6012	1,708.57
	14	C18-6014	3,471.77
	16	C18-6016	4,178.07
	18	C18-6018	11,062.14
	20	C18-6020	12,315.65
24	C18-6024	17,388.93	

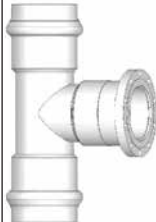
Item	Size In Inches	Part Number	List Price
<b>Straight Tee with Flange Branch GxGxF (DR18)</b>			
	10 x 4	C18-10310-4	9,939.95
	10 x 6	C18-10310-6	10,081.98
	10 x 8	C18-10310-8	10,223.87
	10 x 10	C18-10310	10,365.97
	12 x 4	C18-10312-4	10,507.91
	12 x 6	C18-10312-6	10,649.68
	12 x 8	C18-10312-8	10,782.10
	12 x 10	C18-10312-10	10,933.74
	12 x 12	C18-10312	11,075.72
	14 x 4	C18-10314-4	16,999.28
	14 x 6	C18-10314-6	17,705.29
	14 x 8	C18-10314-8	18,411.57
	14 x 10	C18-10314-10	19,117.66
	14 x 12	C18-10314-12	19,823.80
	14 x 14	C18-10314	20,530.05
	16 x 4	C18-10316-4	21,236.38
	16 x 6	C18-10316-6	21,942.17
	16 x 8	C18-10316-8	22,648.62
	16 x 10	C18-10316-10	23,354.79
	16 x 12	C18-10316-12	24,060.78
	16 x 14	C18-10316-14	24,767.09
	16 x 16	C18-10316	25,473.17
	18 x 4	C18-10318-4	26,179.59
	18 x 6	C18-10318-6	27,024.38
18 x 8	C18-10318-8	27,591.91	
18 x 10	C18-10318-10	28,298.12	
18 x 12	C18-10318-12	29,004.09	
18 x 14	C18-10318-14	29,705.41	
18 x 16	C18-10318-16	30,582.21	
18 x 18	C18-10318	32,040.19	
20 x 4	C18-10320-4	33,246.04	
20 x 6	C18-10320-6	34,451.70	
20 x 8	C18-10320-8	34,918.81	
20 x 10	C18-10320-10	35,387.25	
20 x 12	C18-10320-12	35,855.05	
20 x 14	C18-10320-14	36,613.38	
20 x 16	C18-10320-16	37,371.57	
20 x 18	C18-10320-18	37,877.30	
20 x 20	C18-10320	38,383.19	
24 x 4	C18-10324-4	38,888.72	
24 x 6	C18-10324-6	39,394.60	
24 x 8	C18-10324-8	39,900.29	
24 x 10	C18-10324-10	41,957.33	
24 x 12	C18-10324-12	44,014.22	
24 x 14	C18-10324-14	46,071.15	
24 x 16	C18-10324-16	48,128.13	
24 x 18	C18-10324-18	50,185.18	
24 x 20	C18-10324-20	52,241.87	
24 x 24	C18-10324	54,299.14	

Item	Size In Inches	Part Number	List Price
<b>Flange Adapter GxF (DR18)</b>			
	10	C18-9210	2,405.35
	12	C18-9212	2,742.81
	14	C18-9214	5,238.33
	16	C18-9216	7,112.92
	18	C18-9218	7,425.86
	20	C18-9220	9,323.63
	24	C18-9224	13,269.00

Item	Size In Inches	Part Number	List Price
<b>Spigot Plug (S) (DR18)</b>			
	10	C18-11610	2,584.18
	12	C18-11612	3,092.16
	14	C18-11614	3,339.48
	16	C18-11616	3,636.33
	18	C18-11618	6,391.81
	20	C18-11620	7,436.43
24	C18-11624	9,449.09	

Item	Size In Inches	Part Number	List Price
<b>Repair Coupling GxG (DR18)</b>			
	10	C18-6210	1,487.54
	12	C18-6212	2,050.30
	14	C18-6214	4,168.17
	16	C18-6216	5,013.67
	18	C18-6218	13,274.60
	20	C18-6220	14,882.14
24	C18-6224	20,866.72	

- Fabricated from DR18 Class 150 pipe for pressure applications
- Conforms to AWWA C900
- Additional Sizes Available Upon Request

Item	Size In Inches	Part Number	List Price
<b>Concentric Increaser Coupling GxG (DR18)</b>			
	10 x 4	C18-6010-4	1,203.62
	10 x 6	C18-6010-6	1,313.16
	10 x 8	C18-6010-8	1,452.46
	12 x 4	C18-6012-4	1,581.70
	12 x 6	C18-6012-6	1,651.46
	12 x 8	C18-6012-8	1,770.72
	12 x 10	C18-6012-10	1,949.89
	14 x 4	C18-6014-4	3,282.84
	14 x 6	C18-6014-6	3,382.68
	14 x 8	C18-6014-8	3,481.85
	14 x 10	C18-6014-10	3,620.97
	14 x 12	C18-6014-12	3,700.62
	16 x 4	C18-6016-4	4,009.46
	16 x 6	C18-6016-6	4,128.46
	16 x 8	C18-6016-8	4,227.84
	16 x 10	C18-6016-10	4,566.04
	16 x 12	C18-6016-12	4,624.27
	16 x 14	C18-6016-14	5,381.91
	18 x 4	C18-6018-4	7,425.04
	18 x 6	C18-6018-6	7,641.90
	18 x 8	C18-6018-8	7,878.80
	18 x 10	C18-6018-10	8,684.47
	18 x 12	C18-6018-12	8,823.81
	18 x 14	C18-6018-14	9,380.87
	18 x 16	C18-6018-16	9,967.89
	20 x 4	C18-6020-4	8,893.90
	20 x 6	C18-6020-6	9,172.56
	20 x 8	C18-6020-8	9,450.51
	20 x 10	C18-6020-10	9,738.99
	20 x 12	C18-6020-12	9,838.41
20 x 14	C18-6020-14	11,519.60	
20 x 16	C18-6020-16	11,868.16	
20 x 18	C18-6020-18	12,942.21	
24 x 4	C18-6024-4	11,609.84	
24 x 6	C18-6024-6	11,968.22	
24 x 8	C18-6024-8	12,336.43	
24 x 10	C18-6024-10	12,713.53	
24 x 12	C18-6024-12	13,111.40	
24 x 14	C18-6024-14	14,314.96	
24 x 16	C18-6024-16	15,160.48	
24 x 18	C18-6024-18	15,906.50	
24 x 20	C18-6024-20	16,921.53	

<b>1/4 Bend (90) GxG (DR18)</b>			
	10	C18-2510	3,336.44
	12	C18-2512	4,400.50
	14	C18-2514	6,496.12
	16	C18-2516	7,749.38
	18	C18-2518	13,479.38
	20	C18-2520	16,583.11
	24	C18-2524	27,774.68

<b>1/8 Bend (45) GxG (DR18)</b>			
	10	C18-5010	1,870.17
	12	C18-5012	2,437.38
	14	C18-5014	5,133.16
	16	C18-5016	6,237.40
	18	C18-5018	10,952.70
	20	C18-5020	13,598.73
	24	C18-5024	19,239.18

<b>1/16 Bend (22.5) GxG (DR18)</b>			
	10	C18-17010	1,907.80
	12	C18-17012	2,486.36
	14	C18-17014	5,236.34
	16	C18-17016	6,362.81
	18	C18-17018	11,172.85
	20	C18-17020	13,872.09
	24	C18-17024	19,625.89

<b>1/32 Bend (11.25) GxG (DR18)</b>			
	10	C18-19310	1,926.90
	12	C18-19312	2,511.22
	14	C18-19314	5,288.74
	16	C18-19316	6,426.44
	18	C18-19318	11,284.57
	20	C18-19320	14,010.77
	24	C18-19324	19,822.17

Item	Size In Inches	Part Number	List Price
<b>Concentric Increaser Bushing SxG (DR18)</b>			
	10 x 4	C18-1210-4	925.21
	10 x 6	C18-1210-6	1,054.58
	10 x 8	C18-1210-8	1,191.89
	12 x 4	C18-1212-4	1,233.46
	12 x 6	C18-1212-6	1,353.08
	12 x 8	C18-1212-8	1,482.12
	12 x 10	C18-1212-10	1,611.52
	14 x 4	C18-1214-4	2,735.73
	14 x 6	C18-1214-6	2,825.16
	14 x 8	C18-1214-8	2,914.80
	14 x 10	C18-1214-10	3,054.05
	14 x 12	C18-1214-12	3,163.55
	16 x 4	C18-1216-4	3,284.73
	16 x 6	C18-1216-6	3,382.27
	16 x 8	C18-1216-8	3,461.89
	16 x 10	C18-1216-10	3,909.51
	16 x 12	C18-1216-12	4,048.75
	16 x 14	C18-1216-14	4,675.54
	18 x 4	C18-1218-4	6,131.07
	18 x 6	C18-1218-6	6,310.10
	18 x 8	C18-1218-8	6,505.92
	18 x 10	C18-1218-10	7,281.79
	18 x 12	C18-1218-12	7,640.06
	18 x 14	C18-1218-14	8,028.02
	18 x 16	C18-1218-16	8,366.24
	20 x 4	C18-1220-4	7,545.47
	20 x 6	C18-1220-6	7,781.90
	20 x 8	C18-1220-8	8,018.01
	20 x 10	C18-1220-10	8,266.73
	20 x 12	C18-1220-12	8,329.59
20 x 14	C18-1220-14	8,893.46	
20 x 16	C18-1220-16	9,410.75	
20 x 18	C18-1220-18	10,793.44	
24 x 4	C18-1224-4	10,202.90	
24 x 6	C18-1224-6	10,521.59	
24 x 8	C18-1224-8	10,849.86	
24 x 10	C18-1224-10	11,181.41	
24 x 12	C18-1224-12	11,529.59	
24 x 14	C18-1224-14	12,723.26	
24 x 16	C18-1224-16	13,618.65	
24 x 18	C18-1224-18	14,921.77	
24 x 20	C18-1224-20	15,160.61	

<b>1/4 Bend (90) SxG (DR18)</b>			
	10	C18-2710	3,253.01
	12	C18-2712	4,290.46
	14	C18-2714	6,333.72
	16	C18-2716	7,555.69
	18	C18-2718	13,142.38
	20	C18-2720	16,168.51
	24	C18-2724	27,080.33

<b>1/8 Bend (45) SxG (DR18)</b>			
	10	C18-4010	1,823.45
	12	C18-4012	2,376.42
	14	C18-4014	5,004.85
	16	C18-4016	6,081.46
	18	C18-4018	10,678.90
	20	C18-4020	13,258.72
	24	C18-4024	18,758.20

<b>1/16 Bend (22.5) SxG (DR18)</b>			
	10	C18-17110	1,860.12
	12	C18-17112	2,424.19
	14	C18-17114	5,105.44
	16	C18-17116	6,203.72
	18	C18-17118	10,893.50
	20	C18-17120	13,525.24
	24	C18-17124	19,135.24

<b>1/32 Bend (11.25) SxG (DR18)</b>			
	10	C18-18310	1,878.73
	12	C18-18312	2,448.46
	14	C18-18314	5,156.51
	16	C18-18316	6,265.79
	18	C18-18318	11,002.47
	20	C18-18320	13,660.51
	24	C18-18324	19,326.61

- Fabricated from DR18 Class 150 pipe for pressure applications
- Conforms to AWWA C900
- Additional Sizes Available Upon Request

## C.I.O.D. Gasketed Pressure Fittings (C-Series)

DR 25 (Class 100)  
Fabricated in Sizes 10" – 36"



### Applications

C.I.O.D. DR 25 PVC Gasketed Pressure fittings are thermoformed, glued and fiberglass reinforced. This eliminates the threat of rust or corrosion, providing better flow and cleaner water quality. C900 PVC pressure fittings can be used in both higher pressure water systems and low pressure sewer force main systems.

Westlake Pipe & Fittings offers a standard bell OD to facilitate joint restraint installation, while allowing all fittings to have fiberglass reinforced plastic where required. Bends of 45 degrees or less, are manufactured of one-piece construction where possible. This provides a lightweight, compact fitting, which can be easily handled in the field.

Westlake Pipe & Fittings C900 PVC fittings are designed to be used with engineered joint restraints or concrete thrust blocking. C900 PVC fittings are a tough alternative to cast iron fittings offering the added benefit of corrosion resistance.

### Certification

Fittings conform to AWWA C900.

**Attention:** Westlake Pipe & Fittings are not to be used with compressed air or gases. Westlake Pipe & Fittings does not recommend that piping systems that include its products be tested with compressed air or gases.





Item	Size In Inches	Part Number	List Price
<b>Straight Tee GxGxG (DR25)</b>			
	10 x 4	C25-1010-4	6,023.53
	10 x 6	C25-1010-6	6,109.67
	10 x 8	C25-1010-8	6,195.74
	10 x 10	C25-1010	6,281.64
	12 x 4	C25-1012-4	6,367.78
	12 x 6	C25-1012-6	6,453.75
	12 x 8	C25-1012-8	6,539.84
	12 x 10	C25-1012-10	6,625.78
	12 x 12	C25-1012	6,712.02
	14 x 4	C25-1014-4	10,301.39
	14 x 6	C25-1014-6	10,729.44
	14 x 8	C25-1014-8	11,157.32
	14 x 10	C25-1014-10	11,585.26
	14 x 12	C25-1014-12	12,013.15
	14 x 14	C25-1014	12,441.19
	16 x 4	C25-1016-4	12,869.16
	16 x 6	C25-1016-6	13,297.03
	16 x 8	C25-1016-8	13,724.99
	16 x 10	C25-1016-10	14,152.98
	16 x 12	C25-1016-12	14,580.83
	16 x 14	C25-1016-14	15,008.86
	16 x 16	C25-1016	15,436.80
	18 x 4	C25-1018-4	15,864.82
	18 x 6	C25-1018-6	16,292.68
	18 x 8	C25-1018-8	16,720.57
	18 x 10	C25-1018-10	17,148.67
	18 x 12	C25-1018-12	17,576.43
	18 x 14	C25-1018-14	18,004.49
18 x 16	C25-1018-16	18,532.79	
18 x 18	C25-1018	19,416.33	
20 x 4	C25-1020-4	20,147.12	
20 x 6	C25-1020-6	20,877.70	
20 x 8	C25-1020-8	21,161.14	
20 x 10	C25-1020-10	21,444.64	
20 x 12	C25-1020-12	21,706.54	
20 x 14	C25-1020-14	22,187.62	
20 x 16	C25-1020-16	22,647.15	
20 x 18	C25-1020-18	22,953.56	
20 x 20	C25-1020	23,260.26	
24 x 4	C25-1024-4	23,566.59	
24 x 6	C25-1024-6	23,873.01	
24 x 8	C25-1024-8	24,179.47	
24 x 10	C25-1024-10	25,426.13	
24 x 12	C25-1024-12	26,672.66	
24 x 14	C25-1024-14	27,919.25	
24 x 16	C25-1024-16	29,165.62	
24 x 18	C25-1024-18	30,412.25	
24 x 20	C25-1024-20	31,658.62	
24 x 24	C25-1024	32,905.21	

<b>Series 160 IPS Adapter Coupling GxG (IPS Gasket Hub x C900 DR25 Gasket Hub)</b>			
	10 x 10	C25-8010	1,669.03
	12 x 12	C25-8012	2,126.30
	14 x 14	C25-8014	3,264.22
	16 x 16	C25-8016	3,973.40
	18 x 18	C25-8018	9,490.97
	20 x 20	C25-8020	10,566.44
	24 x 24	C25-8024	13,427.50

<b>Series 160 IPS Adapter Bushing SxG (IPS Gasket Hub x C900 DR25 Spigot)</b>			
	10 x 10	C25-9010	2,253.23
	12 x 12	C25-9012	2,870.51
	14 x 14	C25-9014	4,681.64
	16 x 16	C25-9016	5,600.39
	18 x 18	C25-9018	15,314.42
	20 x 20	C25-9020	17,962.75
	24 x 24	C25-9024	20,835.38

Item	Size In Inches	Part Number	List Price
<b>1/4 Bend (90) GxG (DR25)</b>			
	10	C25-2510	3,169.67
	12	C25-2512	4,180.45
	14	C25-2514	6,171.24
	16	C25-2516	7,361.86
	18	C25-2518	13,098.58
	20	C25-2520	15,753.92
	24	C25-2524	26,385.80

<b>1/4 Bend (90) SxG (DR25)</b>			
	10	C25-2710	3,090.40
	12	C25-2712	4,075.95
	14	C25-2714	6,016.95
	16	C25-2716	7,177.78
	18	C25-2718	12,771.11
	20	C25-2720	15,360.06
	24	C25-2724	25,726.16

<b>1/8 Bend (45) GxG (DR25)</b>			
	10	C25-5010	1,776.16
	12	C25-5012	2,314.51
	14	C25-5014	4,753.08
	16	C25-5016	5,775.37
	18	C25-5018	10,141.49
	20	C25-5020	12,591.69
24	C25-5024	17,814.40	

<b>1/8 Bend (45) SxG (DR25)</b>			
	10	C25-4010	1,732.39
	12	C25-4012	2,256.63
	14	C25-4014	4,634.22
	16	C25-4016	5,630.98
	18	C25-4018	9,887.95
	20	C25-4020	12,276.89
24	C25-4024	17,369.02	

<b>1/16 Bend (22.5) GxG (DR25)</b>			
	10	C25-17010	1,811.84
	12	C25-17012	2,361.04
	14	C25-17014	4,848.58
	16	C25-17016	5,891.50
	18	C25-17018	10,345.33
	20	C25-17020	12,844.77
	24	C25-17024	18,172.49

<b>1/16 Bend (22.5) SxG (DR25)</b>			
	10	C25-17110	1,766.55
	12	C25-17112	2,302.02
	14	C25-17114	4,727.34
	16	C25-17116	5,744.21
	18	C25-17118	10,086.69
	20	C25-17120	12,523.65
	24	C25-17124	17,718.16

<b>1/32 Bend (11.25) GxG (DR25)</b>			
	10	C25-19310	1,829.96
	12	C25-19312	2,384.66
	14	C25-19314	4,897.05
	16	C25-19316	5,950.38
	18	C25-19318	10,448.76
	20	C25-19320	12,973.22
	24	C25-19324	18,354.20

<b>1/32 Bend (11.25) SxG (DR25)</b>			
	10	C25-18310	1,784.23
	12	C25-18312	2,325.04
	14	C25-18314	4,774.68
	16	C25-18316	5,801.62
	18	C25-18318	10,187.55
	20	C25-18320	12,648.88
	24	C25-18324	17,895.38

- Fabricated from DR25 Class 100 pipe for pressure applications
- Conforms to AWWA C900
- Additional Sizes Available Upon Request

Item	Size In Inches	Part Number	List Price
<b>Cap (G) (DR25)</b>			
	10 x 10	C25-16010	2,582.61
	12 x 12	C25-16012	3,090.22
	14 x 14	C25-16014	3,337.42
	16 x 16	C25-16016	3,634.05
	18 x 18	C25-16018	6,387.84
	20 x 20	C25-16020	7,431.80
	24 x 24	C25-16024	10,478.61

Item	Size In Inches	Part Number	List Price
<b>Stop Coupling GxG (DR25)</b>			
	10 x 10	C25-6010	1,208.64
	12 x 12	C25-6012	1,665.91
	14 x 14	C25-6014	3,385.00
	16 x 16	C25-6016	4,073.62
	18 x 18	C25-6018	10,785.63
	20 x 20	C25-6020	12,007.74
	24 x 24	C25-6024	16,954.23

Item	Size In Inches	Part Number	List Price
<b>Concentric In increaser Coupling GxG (DR25)</b>			
	10 x 4	C25-6010-4	1,143.18
	10 x 6	C25-6010-6	1,246.89
	10 x 8	C25-6010-8	1,379.33
	12 x 4	C25-6012-4	1,502.20
	12 x 6	C25-6012-6	1,568.25
	12 x 8	C25-6012-8	1,681.67
	12 x 10	C25-6012-10	1,851.68
	14 x 4	C25-6014-4	3,117.69
	14 x 6	C25-6014-6	3,212.15
	14 x 8	C25-6014-8	3,306.62
	14 x 10	C25-6014-10	3,438.81
	14 x 12	C25-6014-12	3,514.40
	16 x 4	C25-6016-4	3,807.75
	16 x 6	C25-6016-6	3,920.56
	16 x 8	C25-6016-8	4,015.06
	16 x 10	C25-6016-10	4,336.39
	16 x 12	C25-6016-12	4,421.45
	16 x 14	C25-6016-14	5,110.95
	18 x 4	C25-6018-4	7,051.53
	18 x 6	C25-6018-6	7,257.52
	18 x 8	C25-6018-8	7,482.37
	18 x 10	C25-6018-10	8,247.55
	18 x 12	C25-6018-12	8,379.87
	18 x 14	C25-6018-14	8,908.86
	18 x 16	C25-6018-16	9,466.19
	20 x 4	C25-6020-4	8,446.64
	20 x 6	C25-6020-6	8,711.20
	20 x 8	C25-6020-8	8,974.97
	20 x 10	C25-6020-10	9,248.93
	20 x 12	C25-6020-12	9,345.37
	20 x 14	C25-6020-14	10,940.09
	20 x 16	C25-6020-16	11,270.68
	20 x 18	C25-6020-18	12,291.00
24 x 4	C25-6024-4	11,025.88	
24 x 6	C25-6024-6	11,366.26	
24 x 8	C25-6024-8	11,715.77	
24 x 10	C25-6024-10	12,073.69	
24 x 12	C25-6024-12	12,451.59	
24 x 14	C25-6024-14	13,594.74	
24 x 16	C25-6024-16	14,398.56	
24 x 18	C25-6024-18	15,105.69	
24 x 20	C25-6024-20	16,069.88	

Item	Size In Inches	Part Number	List Price
<b>Spigot Plug (S) (DR25)</b>			
	10 x 10	C25-11610	2,584.18
	12 x 12	C25-11612	3,092.16
	14 x 14	C25-11614	3,339.48
	16 x 16	C25-11616	3,636.33
	18 x 18	C25-11618	6,391.81
	20 x 20	C25-11620	7,436.43
	24 x 24	C25-11624	10,485.12

Item	Size In Inches	Part Number	List Price
<b>Repair Coupling GxG (DR25)</b>			
	10 x 10	C25-6210	1,450.37
	12 x 12	C25-6212	1,943.99
	14 x 14	C25-6214	4,063.97
	16 x 16	C25-6216	4,888.35
	18 x 18	C25-6218	12,942.74
	20 x 20	C25-6220	14,510.07
	24 x 24	C25-6224	20,345.04

Item	Size In Inches	Part Number	List Price
<b>Concentric In creaser Bushing SxG (DR25)</b>			
	10 x 4	C25-1210-4	878.61
	10 x 6	C25-1210-6	1,001.43
	10 x 8	C25-1210-8	1,114.81
	12 x 4	C25-1212-4	1,171.50
	12 x 6	C25-1212-6	1,284.76
	12 x 8	C25-1212-8	1,407.69
	12 x 10	C25-1212-10	1,530.45
	14 x 4	C25-1214-4	2,598.10
	14 x 6	C25-1214-6	2,683.12
	14 x 8	C25-1214-8	2,768.19
	14 x 10	C25-1214-10	2,900.29
	14 x 12	C25-1214-12	3,004.28
	16 x 4	C25-1216-4	3,119.42
	16 x 6	C25-1216-6	3,212.15
	16 x 8	C25-1216-8	3,287.80
	16 x 10	C25-1216-10	3,712.82
	16 x 12	C25-1216-12	3,844.97
	16 x 14	C25-1216-14	4,440.19
	18 x 4	C25-1218-4	5,822.61
	18 x 6	C25-1218-6	5,992.78
	18 x 8	C25-1218-8	6,178.62
	18 x 10	C25-1218-10	6,879.23
	18 x 12	C25-1218-12	7,255.63
	18 x 14	C25-1218-14	7,624.09
	18 x 16	C25-1218-16	7,945.12
	20 x 4	C25-1220-4	7,165.86
	20 x 6	C25-1220-6	7,390.31
	20 x 8	C25-1220-8	7,614.91
	20 x 10	C25-1220-10	7,850.67
	20 x 12	C25-1220-12	7,907.54
	20 x 14	C25-1220-14	8,445.92
	20 x 16	C25-1220-16	8,937.15
	20 x 18	C25-1220-18	10,250.35
24 x 4	C25-1224-4	9,689.72	
24 x 6	C25-1224-6	9,992.28	
24 x 8	C25-1224-8	10,304.04	
24 x 10	C25-1224-10	10,618.80	
24 x 12	C25-1224-12	10,949.51	
24 x 14	C25-1224-14	12,083.09	
24 x 16	C25-1224-16	12,933.31	
24 x 18	C25-1224-18	14,171.01	
24 x 20	C25-1224-20	14,397.69	

- Fabricated from DR25 Class 100 pipe for pressure applications
- Conforms to AWWA C900
- Additional Sizes Available Upon Request

## Solvent Weld DWV Fittings (D-Series)

Injection Molded in Sizes 1 1/2" – 12"  
Fabricated in Sizes 10" – 24"



### Applications

The most complex installations require the most advanced fittings. Injection molded DWV fittings from Westlake Pipe & Fittings eliminate typical problems resulting from installing a DWV system with inconsistent, inaccurate, or non-certified fittings. When installing or specifying DWV you can count on a 45° bend being exactly that, a 45° bend. Literally from every angle, Westlake Pipe & Fittings understands the importance of accuracy and consistency on the job site and provides you with a perfect fit from roof to grade.

Our DWV fittings make installation of the system quicker, easier and less costly. Productivity gains are significant when our DWV fittings are specified and installed. Combine with our fabricated fittings to ensure a trouble-free installation.

### Certification

Westlake Pipe & Fittings PVC Solvent Weld DWV Molded Fittings are third party tested and listed by NSF, UPC, and CSA to meet specifications defined in ASTM D2665, F1866, and CSA B181.2, where applicable. Fabricated fittings conform to ASTM F1866.

1 1/2" – 12" molded fittings are NSF certified to ASTM D2665.

**Note:** Please contact Westlake Pipe & Fittings Technical Services regarding certifications for specific fittings.

**Attention:** Westlake Pipe & Fittings are not to be used with compressed air or gases. Westlake Pipe & Fittings does not recommend that piping systems that include its products be tested with compressed air or gases.

DWV systems may be air tested at no more than 5 psi. To ensure safe testing, apply proper pressure regulation, relief devices and procedures.

Third Party Tested



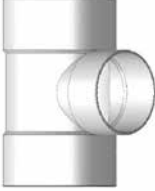

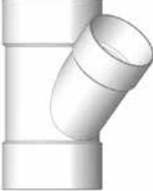
Item	Size In Inches	Alt Part Number	Part Number	Box Qty	Crate Qty	List Price
<b>Straight Tee HxHxH</b>						
	*1 1/2 x 1 1/2	D101	D441015	25	2000	165.18
	*2 x 2	D102	D441020	25	1000	123.70
	*3 x 3	D103	D441030	10	360	372.38
	*4 x 4	D104	D441040	7	120	532.81
	*6 x 4	D106-4	D441532	5	50	456.96
	*6 x 6	D106	D441060	4	48	1,020.58
	*8 x 4	D108-4	D441582	4	-	3,284.92
	*8 x 6	D108-6	D441585	2	-	3,434.00
	*8 x 8	D108	D441080	2	24	2,583.67
	*10 x 4	D1010-4	D441624	1	12	1,146.35
	*10 x 6	D1010-6	D441626	1	10	1,410.47
	*10 x 8	D1010-8	D441628	1	10	1,582.45
	*10 x 10	D1010	D441100	1	10	1,785.52
	*12 x 4	D1012-4	D441664	1	8	1,550.00
	*12 x 6	D1012-6	D441666	1	8	1,769.82
	*12 x 8	D1012-8	D441668	1	8	2,024.32
	*12 x 10	D1012-10	D441670	1	7	2,415.40
	*12 x 12	D1012	D441120	1	6	2,968.39
	14 x 4	D1014-4	Special Order	1	-	Priced on Demand
	14 x 6	D1014-6	TBD	1	-	4,009.24
	14 x 8	D1014-8	TBD	1	-	4,223.81
	14 x 10	D1014-10	Special Order	1	-	Priced on Demand
	14 x 12	D1014-12	TBD	1	-	5,789.59
	14 x 14	D1014	D441140	1	-	6,339.31
	16 x 4	D1016-4	TBD	1	-	4,330.32
	16 x 6	D1016-6	TBD	1	-	4,836.39
	16 x 8	D1016-8	TBD	1	-	5,152.09
	16 x 10	D1016-10	Special Order	1	-	Priced on Demand
	16 x 12	D1016-12	Special Order	1	-	Priced on Demand
	16 x 14	D1016-14	Special Order	1	-	Priced on Demand
	16 x 16	D1016	TBD	1	-	7,387.87
	18 x 4	D1018-4	Special Order	1	-	Priced on Demand
	18 x 6	D1018-6	Special Order	1	-	Priced on Demand
	18 x 8	D1018-8	Special Order	1	-	Priced on Demand
	18 x 10	D1018-10	Special Order	1	-	Priced on Demand
	18 x 12	D1018-12	Special Order	1	-	Priced on Demand
	18 x 14	D1018-14	Special Order	1	-	Priced on Demand
	18 x 16	D1018-16	Special Order	1	-	Priced on Demand
	18 x 18	D1018	TBD	1	-	8,398.91
	20 x 4	D1020-4	Special Order	1	-	Priced on Demand
	20 x 6	D1020-6	Special Order	1	-	Priced on Demand
	20 x 8	D1020-8	Special Order	1	-	Priced on Demand
	20 x 10	D1020-10	Special Order	1	-	Priced on Demand
	20 x 12	D1020-12	Special Order	1	-	Priced on Demand
	20 x 14	D1020-14	TBD	1	-	7,604.86
	20 x 16	D1020-16	Special Order	1	-	Priced on Demand
	20 x 18	D1020-18	Special Order	1	-	Priced on Demand
	20 x 20	D1020	Special Order	1	-	Priced on Demand
24 x 4	D1024-4	Special Order	1	-	Priced on Demand	
24 x 6	D1024-6	TBD	1	-	13,416.68	
24 x 8	D1024-8	Special Order	1	-	Priced on Demand	
24 x 10	D1024-10	Special Order	1	-	Priced on Demand	
24 x 12	D1024-12	Special Order	1	-	Priced on Demand	
24 x 14	D1024-14	Special Order	1	-	Priced on Demand	
24 x 16	D1024-16	Special Order	1	-	Priced on Demand	
24 x 18	D1024-18	Special Order	1	-	Priced on Demand	
24 x 20	D1024-20	Special Order	1	-	Priced on Demand	
24 x 24	D1024	Special Order	1	-	Priced on Demand	

Item	Size In Inches	Alt Part Number	Part Number	Box Qty	Crate Qty	List Price
<b>45 Degree Wye HxHxH</b>						
	*1 1/2 x 1 1/2	D301	D600015	50	1200	70.72
	*2 x 1 1/2 x 1 1/2	D302-1-1	D601241	25	1000	97.37
	*2 x 1 1/2 x 2	D302-1-2	D601242	10	800	150.74
	*2 x 1 1/2	D302-1	D601251	25	800	85.16
	*2 x 2	D302	D600020	25	600	69.72
	*3 x 1 1/2	D303-1	D601337	15	360	125.96
	*3 x 2	D303-2	D601338	25	300	139.32
	*3 x 3	D303	D600030	25	200	188.33
	*4 x 1 1/2	D304-1	Special Order	1	-	Priced on Demand
	*4 x 2	D304-2	D601420	10	200	204.52
	*4 x 3	D304-3	D601422	10	160	277.42
	*4 x 4	D304	D600040	5	90	341.73
	*6 x 4	D306-4	D601532	4	60	796.49
	*6 x 6	D306	D600060	2	48	986.45
	*8 x 4	D308-4	D601582	3	18	1,679.43
	*8 x 6	D308-6	D601585	2	18	1,731.62
	*8 x 8	D308	D600080	2	4	1,739.18
	*10 x 4	D3010-4	D601624	1	4	1,259.61
	*10 x 6	D3010-6	D601626	1	4	1,633.91
	*10 x 8	D3010-8	D601628	1	4	1,933.45
	*10 x 10	D3010	D600100	1	4	2,211.30
	*12 x 4	D3012-4	D601664	1	3	1,950.92
	*12 x 6	D3012-6	D601666	1	3	2,130.03
	*12 x 8	D3012-8	D601668	1	3	2,529.63
	*12 x 10	D3012-10	D601670	1	3	2,832.84
	*12 x 12	D3012	D600120	1	3	3,592.17
	14 x 4	D3014-4	TBD	1	-	4,173.95
	14 x 6	D3014-6	D601696	1	-	4,555.52
	14 x 8	D3014-8	TBD	1	-	4,769.17
	14 x 10	D3014-10	D601700	1	-	5,240.25
	14 x 12	D3014-12	D601702	1	-	6,332.69
	14 x 14	D3014	D600140	1	-	6,886.99
	16 x 4	D3016-4	TBD	1	-	5,098.56
	16 x 6	D3016-6	D60116X6	1	-	5,611.13
	16 x 8	D3016-8	TBD	1	-	5,954.14
	16 x 10	D3016-10	TBD	1	-	6,939.22
	16 x 12	D3016-12	TBD	1	-	7,172.81
	16 x 14	D3016-14	TBD	1	-	7,354.08
	16 x 16	D3016	TBD	1	-	8,289.38
	18 x 4	D3018-4	TBD	1	-	5,734.99
	18 x 6	D3018-6	TBD	1	-	5,976.37
	18 x 8	D3018-8	TBD	1	-	6,217.49
	18 x 10	D3018-10	TBD	1	-	6,699.40
	18 x 12	D3018-12	TBD	1	-	6,939.91
	18 x 14	D3018-14	TBD	1	-	7,181.12
	18 x 16	D3018-16	TBD	1	-	7,807.92
	18 x 18	D3018	TBD	1	-	8,241.36
	20 x 4	D3020-4	Special Order	1	-	Priced on Demand
20 x 6	D3020-6	TBD	1	-	7,171.67	
20 x 8	D3020-8	Special Order	1	-	Priced on Demand	
20 x 10	D3020-10	TBD	1	-	8,038.74	
20 x 12	D3020-12	TBD	1	-	8,328.16	
20 x 14	D3020-14	Special Order	1	-	Priced on Demand	
20 x 16	D3020-16	TBD	1	-	9,369.24	
20 x 18	D3020-18	TBD	1	-	9,889.86	
20 x 20	D3020	TBD	1	-	10,193.31	
24 x 4	D3024-4	TBD	1	-	12,043.54	
24 x 6	D3024-6	TBD	1	-	14,087.48	
24 x 8	D3024-8	TBD	1	-	15,244.44	
24 x 10	D3024-10	TBD	1	-	15,417.57	
24 x 12	D3024-12	TBD	1	-	15,756.74	
24 x 14	D3024-14	Special Order	1	-	Priced on Demand	
24 x 16	D3024-16	TBD	1	-	15,906.93	
24 x 18	D3024-18	Special Order	1	-	Priced on Demand	
24 x 20	D3024-20	Special Order	1	-	Priced on Demand	
24 x 24	D3024	Special Order	1	-	Priced on Demand	

\* Denotes Molded Fitting  
† Denotes Assembled from Molded Components

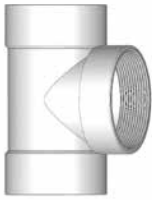
• Additional Sizes Available Upon Request  
• Non-Stock items are non-cancelable, non-returnable

Item	Size In Inches	Alt Part Number	Part Number	Box Qty	Crate Qty	List Price
<b>Test Tee without Plug HxHxFIPT</b>						
	*1 1/2 x 1 1/2	D1101	D445015	20	1600	79.97
	*2 x 2	D1102	D445020	20	960	93.40
	*3 x 3	D1103	D445030	10	360	181.15
	*4 x 4	D1104	D445040	8	180	322.25
	*6 x 4	D1106-4	D445532	3	-	965.10
	*6 x 6	D1106	D445060	4	25	1,629.02
	†8 x 4	D1108-4	Special Order	1	-	Priced on Demand
	*8 x 6	D1108-6	D445585	2	26	3,428.22
	*8 x 8	D1108	D445080	2	24	2,766.85
	*10 x 4	D11010-4	D445624	1	12	2,061.62
	*10 x 6	D11010-6	D445626	1	11	2,505.42
	*10 x 8	D11010-8	D445628	1	11	3,559.20
	*10 x 10	D11010	D445100	1	11	3,461.44
	*12 x 4	D11012-4	D445664	1	8	2,678.44
	*12 x 6	D11012-6	D445666	1	8	3,343.13
	*12 x 8	D11012-8	D445668	1	8	3,993.27
	*12 x 10	D11012-10	D445670	1	8	4,156.12
	*12 x 12	D11012	D445120	1	7	3,430.43
	14 x 4	D11014-4	Special Order	1	-	Priced on Demand
	14 x 6	D11014-6	Special Order	1	-	Priced on Demand
	14 x 8	D11014-8	Special Order	1	-	Priced on Demand
	16 x 4	D11016-4	Special Order	1	-	Priced on Demand
	16 x 6	D11016-6	Special Order	1	-	Priced on Demand
	16 x 8	D11016-8	TBD	1	-	11,897.96

Item	Size In Inches	Alt Part Number	Part Number	Box Qty	Crate Qty	List Price
<b>Test Tee with Raised Plug HxHxFIPT</b>						
	*1 1/2 x 1 1/2	D12901	D443015	10	1250	98.69
	*2 x 2	D12902	D443020	1	1000	114.47
	*3 x 3	D12903	D443030	1	360	218.75
	*4 x 4	D12904	D443040	7	160	377.78
	*6 x 4	D12906-4	D443532	1	12	2,925.66
	*6 x 6	D12906	D443060	1	24	1,805.38
	†8 x 4	D12908-4	TBD	1	-	3,138.53
	*8 x 6	D12908-6	D443585	1	26	3,054.59
	*8 x 8	D12908	D443080	1	10	3,568.72
	*10 x 4	D12910-4	D443624	1	12	1,948.08
	*10 x 6	D12910-6	D443626	1	9	2,643.55
	*10 x 8	D12910-8	D443628	1	8	4,116.47
	*10 x 10	D12910	D443100	1	11	4,199.43
	*12 x 4	D12912-4	D443664	1	8	2,519.75
	*12 x 6	D12912-6	D443666	1	7	3,235.61
	*12 x 8	D12912-8	D443668	1	6	4,510.11
	*12 x 10	D12912-10	D443670	1	8	4,719.66
	*12 x 12	D12912	D443120	1	7	4,986.68
	14 x 4	D12914-4	Special Order	1	-	Priced on Demand
	14 x 6	D12914-6	Special Order	1	-	Priced on Demand
	14 x 8	D12914-8	Special Order	1	-	Priced on Demand
	16 x 4	D12916-4	TBD	1	-	4,439.84
	16 x 6	D12916-6	TBD	1	-	5,385.96
	16 x 8	D12916-8	TBD	1	-	6,890.37

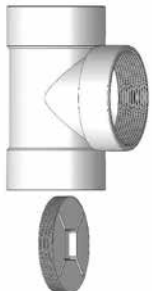
Item	Size In Inches	Alt Part Number	Part Number	Box Qty	Crate Qty	List Price
<b>Test Tee with Countersunk Plug HxHxFIPT</b>						
	*2 x 2	D12802	D445020X	10	960	161.43
	*3 x 3	D12803	D445030X	10	360	260.32
	*4 x 4	D12804	D445040X	8	180	414.67
	*6 x 4	D12806-4	D445532X	1	12	520.99
	*6 x 6	D12806	D445060X	1	15	966.58
	†8 x 4	D12808-4	Special Order	1	-	Priced on Demand
	*8 x 6	D12808-6	D445585X	1	13	1,312.36
	*8 x 8	D12808	D445080X	1	10	3,753.64
	*10 x 4	D12810-4	D445624X	1	12	2,322.52
	*10 x 6	D12810-6	D445626X	1	9	3,216.34
	*10 x 8	D12810-8	D445628X	1	8	5,320.10
	*10 x 10	D12810	D445100X	1	11	5,686.67
	*12 x 4	D12812-4	Special Order	1	-	Priced on Demand
	*12 x 6	D12812-6	Special Order	1	-	Priced on Demand
	*12 x 8	D12812-8	TBD	1	-	5,776.92
	*12 x 10	D12812-10	Special Order	1	-	Priced on Demand
	*12 x 12	D12812	Special Order	1	-	Priced on Demand
	14 x 4	D12814-4	Special Order	1	-	Priced on Demand
	14 x 6	D12814-6	Special Order	1	-	Priced on Demand
	14 x 8	D12814-8	Special Order	1	-	Priced on Demand
	16 x 4	D12816-4	Special Order	1	-	Priced on Demand
	16 x 6	D12816-6	Special Order	1	-	Priced on Demand
	16 x 8	D12816-8	Special Order	1	-	Priced on Demand

Item	Size In Inches	Alt Part Number	Part Number	Box Qty	Crate Qty	List Price
<b>Tee Cross HxHxHxH</b>						
	4 x 4	D1794	TBD	1	-	545.49
	6 x 4	D1796-4	TBD	1	-	3,012.19
	6 x 6	D1796	TBD	1	-	3,403.66
	8 x 4	D1798-4	TBD	1	-	4,098.31
	8 x 6	D1798-6	TBD	1	-	4,438.86
	*8 x 8	D1798	D179800	1	-	5,494.03
	10 x 4	D17910-4	TBD	1	-	1,930.20
	10 x 6	D17910-6	TBD	1	-	2,111.40
	10 x 8	D17910-8	TBD	1	-	2,758.78
	10 x 10	D17910	TBD	1	-	3,284.57
	12 x 4	D17912-4	Special Order	1	-	Priced on Demand
	12 x 6	D17912-6	Special Order	1	-	Priced on Demand
	12 x 8	D17912-8	Special Order	1	-	Priced on Demand
	12 x 10	D17912-10	Special Order	1	-	Priced on Demand
	12 x 12	D17912	Special Order	1	-	Priced on Demand
	14 x 4	D17914-4	Special Order	1	-	Priced on Demand
	14 x 6	D17914-6	Special Order	1	-	Priced on Demand
	14 x 8	D17914-8	Special Order	1	-	Priced on Demand
	14 x 10	D17914-10	Special Order	1	-	Priced on Demand
	14 x 12	D17914-12	Special Order	1	-	Priced on Demand
	14 x 14	D17914	Special Order	1	-	Priced on Demand
	16 x 4	D17916-4	Special Order	1	-	Priced on Demand
	16 x 6	D17916-6	Special Order	1	-	Priced on Demand
	16 x 8	D17916-8	Special Order	1	-	Priced on Demand
	16 x 10	D17916-10	Special Order	1	-	Priced on Demand
	16 x 12	D17916-12	Special Order	1	-	Priced on Demand
	16 x 14	D17916-14	Special Order	1	-	Priced on Demand
	16 x 16	D17916	Special Order	1	-	Priced on Demand
	18 x 4	D17918-4	Special Order	1	-	Priced on Demand
	18 x 6	D17918-6	Special Order	1	-	Priced on Demand
	18 x 8	D17918-8	Special Order	1	-	Priced on Demand
	18 x 10	D17918-10	Special Order	1	-	Priced on Demand
18 x 12	D17918-12	Special Order	1	-	Priced on Demand	
18 x 14	D17918-14	Special Order	1	-	Priced on Demand	
18 x 16	D17918-16	Special Order	1	-	Priced on Demand	
18 x 18	D17918	Special Order	1	-	Priced on Demand	
20 x 4	D17920-4	Special Order	1	-	Priced on Demand	
20 x 6	D17920-6	Special Order	1	-	Priced on Demand	
20 x 8	D17920-8	Special Order	1	-	Priced on Demand	
20 x 10	D17920-10	Special Order	1	-	Priced on Demand	
20 x 12	D17920-12	Special Order	1	-	Priced on Demand	
20 x 14	D17920-14	Special Order	1	-	Priced on Demand	
20 x 16	D17920-16	Special Order	1	-	Priced on Demand	
20 x 18	D17920-18	Special Order	1	-	Priced on Demand	
20 x 20	D17920	Special Order	1	-	Priced on Demand	
24 x 4	D17924-4	Special Order	1	-	Priced on Demand	
24 x 6	D17924-6	Special Order	1	-	Priced on Demand	
24 x 8	D17924-8	Special Order	1	-	Priced on Demand	
24 x 10	D17924-10	Special Order	1	-	Priced on Demand	
24 x 12	D17924-12	Special Order	1	-	Priced on Demand	
24 x 14	D17924-14	Special Order	1	-	Priced on Demand	
24 x 16	D17924-16	Special Order	1	-	Priced on Demand	
24 x 18	D17924-18	Special Order	1	-	Priced on Demand	
24 x 20	D17924-20	Special Order	1	-	Priced on Demand	
24 x 24	D17924	Special Order	1	-	Priced on Demand	

Item	Size In Inches	Alt Part Number	Part Number	Box Qty	Crate Qty	List Price
<b>Test Tee with Raised Gasketed Plug HxHxFIPT</b>						
	*1 1/2 x 1 1/2	D12901G	Special Order	1	-	Priced on Demand
	*2 x 2	D12902G	Special Order	1	-	Priced on Demand
	*3 x 3	D12903G	Special Order	1	-	Priced on Demand
	*4 x 3	D12904-3G	Special Order	1	-	Priced on Demand
	*4 x 4	D12904G	Special Order	1	-	Priced on Demand

\* Denotes Molded Fitting  
† Denotes Assembled from Molded Components

• Additional Sizes Available Upon Request  
• Non-Stock items are non-cancelable, non-returnable

Item	Size In Inches	Alt Part Number	Part Number	Box Qty	Crate Qty	List Price
<b>45 Degree Wye SxHxH</b>						
	*1 1/2 x 1 1/2	D321	D602015	50	1200	131.14
	*2 x 2	D322	D602020	30	720	125.73
	*3 x 1 1/2	D323-1	D603337	20	400	317.32
	*3 x 2	D323-2	D603338	30	360	215.06
	*3 x 3	D323	D602030	10	240	273.62
	*4 x 2	D324-2	D603420	10	200	639.56
	*4 x 3	D324-3	D603422	10	160	595.99
	*4 x 4	D324	D602040	10	120	560.25

Item	Size In Inches	Alt Part Number	Part Number	Box Qty	Crate Qty	List Price
<b>Cottage Wye with 2" Left Side Inlet HxHxHxH</b>						
	*3 x 3 x 3 x 2	D363-2CL	D625030	5	180	932.94
	*4 x 4 x 4 x 2	D364-2CL	D625040	5	90	1,207.14

Item	Size In Inches	Alt Part Number	Part Number	Box Qty	Crate Qty	List Price
<b>Cottage Wye with 2" Right Side Inlet HxHxHxH</b>						
	*3 x 3 x 3 x 2	D363-2CR	D626030	5	180	932.94
	*4 x 4 x 4 x 2	D364-2CR	D626040	5	90	1,207.14

Item	Size In Inches	Alt Part Number	Part Number	Box Qty	Crate Qty	List Price
<b>Combo Wye &amp; 1/8 Bend HxHxH (2 Piece)</b>						
	†4 x 4	D1654	D503040	4	60	686.67
	†6 x 4	D1656-4	D504532	1	20	1,765.03
	†6 x 6	D1656	D503060	1	16	1,962.40
	†8 x 4	D1658-4	D504582	1	14	1,789.81
	†8 x 6	D1658-6	D504585	1	10	2,940.01
	†8 x 8	D1658	D503080	1	10	2,961.29
	†10 x 4	D16510-4	D504624	1	10	1,651.17
	†10 x 6	D16510-6	D504626	1	8	2,122.53
	†10 x 8	D16510-8	D504628	1	8	2,768.05
	†10 x 10	D16510	D503100	1	6	4,700.17
	†12 x 4	D16512-4	D504664	1	8	2,567.90
	†12 x 6	D16512-6	D504666	1	6	2,667.51
	†12 x 8	D16512-8	D504668	1	6	3,364.23
	†12 x 10	D16512-10	D504670	1	4	4,819.24
	†12 x 12	D16512	D503120	1	3	5,542.27
	14 x 4	D16514-4	Special Order	1	-	Priced on Demand
	14 x 6	D16514-6	TBD	1	-	5,044.16
	14 x 8	D16514-8	TBD	1	-	5,603.80
	14 x 10	D16514-10	Special Order	1	-	Priced on Demand
	14 x 12	D16514-12	Special Order	1	-	Priced on Demand
	14 x 14	D16514	TBD	1	-	10,785.39
	16 x 4	D16516-4	TBD	1	-	5,719.43
	16 x 6	D16516-6	TBD	1	-	5,855.81
	16 x 8	D16516-8	TBD	1	-	6,398.02
	16 x 10	D16516-10	TBD	1	-	7,934.20
	16 x 12	D16516-12	TBD	1	-	8,811.08
	16 x 14	D16516-14	Special Order	1	-	Priced on Demand
	16 x 16	D16516	TBD	1	-	12,325.87
18 x 4	D16518-4	Special Order	1	-	Priced on Demand	
18 x 6	D16518-6	TBD	1	-	6,940.59	
18 x 8	D16518-8	TBD	1	-	7,298.03	
20 x 4	D16520-4	Special Order	1	-	Priced on Demand	
20 x 6	D16520-6	Special Order	1	-	Priced on Demand	
20 x 8	D16520-8	TBD	1	-	8,757.90	
24 x 4	D16524-4	Special Order	1	-	Priced on Demand	
24 x 6	D16524-6	Special Order	1	-	Priced on Demand	
24 x 8	D16524-8	Special Order	1	-	Priced on Demand	

Item	Size In Inches	Alt Part Number	Part Number	Box Qty	Crate Qty	List Price
<b>2-Way Cleanout HxHxH</b>						
	*3	D1003	D448030	10	200	346.19
	*4	D1004	D448040	6	80	448.10
	*6	D1006	D448060	3	-	3,715.34

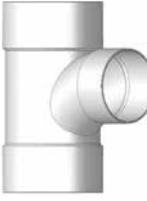
Item	Size In Inches	Alt Part Number	Part Number	Box Qty	Crate Qty	List Price
<b>Sanitary Tee HxHxH (formerly T-Y)</b>						
	*1 1/2 x 1 1/2	D151	D400015	100	1800	38.85
	*2 x 1 1/2	D152-1	D401251	50	1000	50.58
	*2 x 1 1/2 x 1 1/2	D152-1-1	D401241	25	1000	50.37
	*2 x 1 1/2 x 2	D152-1-2	D401242	25	900	60.69
	*2 x 2	D152	D400020	35	840	57.25
	*3 x 1 1/2	D153-1	D401337	20	480	109.27
	*3 x 2	D153-2	D401338	10	360	113.40
	*3 x 3	D153	D400030	30	240	150.43
	*4 x 1 1/2	D154-1	D401419	5	280	288.00
	*4 x 2	D154-2	D401420	10	240	236.40
	*4 x 3	D154-3	D401422	10	200	321.23
	*4 x 4	D156	D400040	25	120	274.71
	*6 x 4	D157-4	D401532	30	72	1,066.74
	*6 x 6	D157	D400060	20	48	1,103.04
	*8 x 4	D158-4	D401582	2	-	3,358.65
	*8 x 6	D158-6	D401585	2	-	3,667.13
	*8 x 8	D158	D400080	2	16	2,444.03
	10 x 4	D1510-4	TBD	1	-	1,639.04
	10 x 6	D1510-6	TBD	1	-	2,005.86
	10 x 8	D1510-8	TBD	1	-	2,707.34
	10 x 10	D1510	TBD	1	-	3,987.40
	12 x 4	D1512-4	TBD	1	-	2,082.41
	12 x 6	D1512-6	TBD	1	-	2,163.33
	12 x 8	D1512-8	TBD	1	-	3,002.73
	12 x 10	D1512-10	TBD	1	-	3,631.58
	12 x 12	D1512	TBD	1	-	4,800.16
	14 x 4	D1514-4	Special Order	1	-	Priced on Demand
	14 x 6	D1514-6	TBD	1	-	4,533.66
	14 x 8	D1514-8	Special Order	1	-	Priced on Demand
	14 x 10	D1514-10	Special Order	1	-	Priced on Demand
	14 x 12	D1514-12	Special Order	1	-	Priced on Demand
	14 x 14	D1514	Special Order	1	-	Priced on Demand
16 x 4	D1516-4	Special Order	1	-	Priced on Demand	
16 x 6	D1516-6	TBD	1	-	4,865.79	
16 x 8	D1516-8	TBD	1	-	5,919.47	
16 x 10	D1516-10	D4011610	1	-	7,453.36	
16 x 12	D1516-12	Special Order	1	-	Priced on Demand	
16 x 14	D1516-14	Special Order	1	-	Priced on Demand	
16 x 16	D1516	Special Order	1	-	Priced on Demand	
18 x 4	D1518-4	Special Order	1	-	Priced on Demand	
18 x 6	D1518-6	Special Order	1	-	Priced on Demand	
18 x 8	D1518-8	Special Order	1	-	Priced on Demand	
20 x 4	D1520-4	Special Order	1	-	Priced on Demand	
20 x 6	D1520-6	Special Order	1	-	Priced on Demand	
20 x 8	D1520-8	Special Order	1	-	Priced on Demand	
24 x 4	D1524-4	Special Order	1	-	Priced on Demand	
24 x 6	D1524-6	Special Order	1	-	Priced on Demand	
24 x 8	D1524-8	Special Order	1	-	Priced on Demand	

Item	Size In Inches	Alt Part Number	Part Number	Box Qty	Crate Qty	List Price
<b>Sanitary Tee (T-Y) SxHxH</b>						
	*1 1/2 x 1 1/2	D171	D403015	20	1600	116.37
	*2 x 1 1/2 x 1 1/2	D172-1-1	D404241	25	1200	104.10
	*2 x 1 1/2	D172-1	D404251	50	1000	99.49
	*2 x 2	D172	D403020	25	800	112.87
	*3 x 1 1/2	D173-1	D404337	10	480	216.47
	*3 x 2	D173-2	D404338	20	480	185.90
	*3 x 3	D173	D403030	30	240	188.16
	*4 x 2	D174-2	D404420	5	240	353.19
	4	D174	D403040	6	160	475.13

Item	Size In Inches	Alt Part Number	Part Number	Box Qty	Crate Qty	List Price
<b>Combo Wye &amp; 1/8 Bend HxHxH (One Piece) (formerly Long Radius Sanitary Tee)</b>						
	*1 1/2 x 1 1/2	D1641	D501015	50	1000	94.13
	*2 x 1 1/2 x 1 1/2	D1642-1-1	D502241	5	320	186.34
	*2 x 1 1/2	D1642-1	D502251	20	640	132.27
	*2 x 2	D1642	D501020	10	480	117.52
	*3 x 1 1/2	D1643-1	D502337	15	360	235.90
	*3 x 2	D1643-2	D502338	10	320	176.77
	*3 x 3	D1643	D501030	10	180	258.76
	*4 x 2	D1644-2	D502420	5	180	266.25
	*4 x 3	D1644-3	D502422	4	120	343.45
	*4	D1644	D501040	4	80	509.67

\* Denotes Molded Fitting  
† Denotes Assembled from Molded Components









• Additional Sizes Available Upon Request  
• Non-Stock items are non-cancelable, non-returnable

Item	Size In Inches	Alt Part Number	Part Number	Box Qty	Crate Qty	List Price
<b>Double Sanitary Tee (T-Y) HxHxHxH</b>						
	*1 1/2 x 1 1/2	D151D	D428015	20	1200	85.54
	*2 x 1 1/2	D152-1D	D429252	20	720	90.73
	*2 x 2	D152D	D428020	20	640	115.58
	*3 x 1 1/2	D153-1D	D429337	20	400	210.42
	*3 x 2	D153-2D	D429338	10	240	228.75
	*3 x 3	D153D	D428030	20	200	323.12
	†4 x 1 1/2	D154-1D	Special Order	1	-	Priced on Demand
	*4 x 2	D154-2D	D429420	5	200	429.86
	*4 x 3	D154-3D	D429422	5	135	446.02
	4 x 4	D154D	D428040	4	96	519.72
	6 x 4	D1536-4D	TBD	1	-	2,369.38
	6 x 6	D1536D	TBD	1	-	4,017.19
	8 x 4	D1538-4D	TBD	1	-	2,435.07
	8 x 6	D1538-6D	TBD	1	-	4,659.11
	8 x 8	D1538D	TBD	1	-	6,873.44
	10 x 4	D15310-4D	Special Order	1	-	Priced on Demand
	10 x 6	D15310-6D	Special Order	1	-	Priced on Demand
	10 x 8	D15310-8D	Special Order	1	-	Priced on Demand
	10 x 10	D15310D	Special Order	1	-	Priced on Demand
	12 x 4	D15312-4D	Special Order	1	-	Priced on Demand
	12 x 6	D15312-6D	Special Order	1	-	Priced on Demand
	12 x 8	D15312-8D	Special Order	1	-	Priced on Demand
	12 x 10	D15312-10D	Special Order	1	-	Priced on Demand
	12 x 12	D15312D	Special Order	1	-	Priced on Demand
	14 x 4	D15314-4D	Special Order	1	-	Priced on Demand
	14 x 6	D15314-6D	Special Order	1	-	Priced on Demand
	14 x 8	D15314-8D	Special Order	1	-	Priced on Demand
	14 x 10	D15314-10D	Special Order	1	-	Priced on Demand
	14 x 12	D15314-12D	Special Order	1	-	Priced on Demand
	14 x 14	D15314D	Special Order	1	-	Priced on Demand
	16 x 4	D15316-4D	Special Order	1	-	Priced on Demand
	16 x 6	D15316-6D	Special Order	1	-	Priced on Demand
	16 x 8	D15316-8D	Special Order	1	-	Priced on Demand
	16 x 10	D15316-10D	Special Order	1	-	Priced on Demand
	16 x 12	D15316-12D	Special Order	1	-	Priced on Demand
	16 x 14	D15316-14D	Special Order	1	-	Priced on Demand
	16 x 16	D15316D	Special Order	1	-	Priced on Demand
	18 x 4	D15318-4D	Special Order	1	-	Priced on Demand
	18 x 6	D15318-6D	Special Order	1	-	Priced on Demand
	18 x 8	D15318-8D	Special Order	1	-	Priced on Demand
	18 x 10	D15318-10D	Special Order	1	-	Priced on Demand
	18 x 12	D15318-12D	Special Order	1	-	Priced on Demand
	18 x 14	D15318-14D	Special Order	1	-	Priced on Demand
	18 x 16	D15318-16D	Special Order	1	-	Priced on Demand
	18 x 18	D15318D	Special Order	1	-	Priced on Demand
	20 x 4	D15320-4D	Special Order	1	-	Priced on Demand
	20 x 6	D15320-6D	Special Order	1	-	Priced on Demand
	20 x 8	D15320-8D	Special Order	1	-	Priced on Demand
	20 x 10	D15320-10D	Special Order	1	-	Priced on Demand
	20 x 12	D15320-12D	Special Order	1	-	Priced on Demand
	20 x 14	D15320-14D	Special Order	1	-	Priced on Demand
	20 x 16	D15320-16D	Special Order	1	-	Priced on Demand
	20 x 18	D15320-18D	Special Order	1	-	Priced on Demand
	20 x 20	D15320D	Special Order	1	-	Priced on Demand
	24 x 4	D15324-4D	Special Order	1	-	Priced on Demand
	24 x 6	D15324-6D	Special Order	1	-	Priced on Demand
	24 x 8	D15324-8D	Special Order	1	-	Priced on Demand
	24 x 10	D15324-10D	Special Order	1	-	Priced on Demand
	24 x 12	D15324-12D	Special Order	1	-	Priced on Demand
	24 x 14	D15324-14D	Special Order	1	-	Priced on Demand
	24 x 16	D15324-16D	Special Order	1	-	Priced on Demand
	24 x 18	D15324-18D	Special Order	1	-	Priced on Demand
	24 x 20	D15324-20D	Special Order	1	-	Priced on Demand
	24 x 24	D15324D	Special Order	1	-	Priced on Demand

Item	Size In Inches	Alt Part Number	Part Number	Box Qty	Crate Qty	List Price
<b>Double 45 Degree Wye HxHxHxH</b>						
	*1 1/2 x 1 1/2	D361	D611015	40	800	159.15
	*2 x 1 1/2	D362-1	D612252	10	500	162.24
	*2 x 2	D362	D611020	20	540	188.90
	*3 x 1 1/2	D363-1	D612337	10	240	338.08
	*3 x 2	D363-2	D612338	10	200	275.29
	*3 x 3	D363	D611030	15	120	369.34
	*4 x 2	D364-2	D612420	5	120	449.31
	*4 x 3	D364-3	D612422	5	80	593.34
	*4 x 4	D364	D611040	1	60	796.02
	*6 x 4	D366-4	D612532	2	36	2,081.98
	*6 x 6	D366-6	D611060	2	24	1,487.97
	8 x 4	D368-4	TBD	1	-	3,933.77
	8 x 6	D368-6	TBD	1	-	4,701.06
	8 x 8	D368-8	TBD	1	-	6,642.16
	10 x 4	D3610-4	TBD	1	-	1,818.20
	10 x 6	D3610-6	TBD	1	-	2,445.81
	10 x 8	D3610-8	TBD	1	-	2,997.54
	10 x 10	D3610	TBD	1	-	3,467.73
	12 x 4	D3612-4	TBD	1	-	2,816.05
	12 x 6	D3612-6	TBD	1	-	3,117.55
	12 x 8	D3612-8	TBD	1	-	3,834.76
	12 x 10	D3612-10	TBD	1	-	4,480.24
	12 x 12	D3612	TBD	1	-	5,820.99
	14 x 4	D3614-4	Special Order	1	-	Priced on Demand
	14 x 6	D3614-6	TBD	1	-	6,377.77
	14 x 8	D3614-8	Special Order	1	-	Priced on Demand
	14 x 10	D3614-10	Special Order	1	-	Priced on Demand
	14 x 12	D3614-12	Special Order	1	-	Priced on Demand
	14 x 14	D3614	Special Order	1	-	Priced on Demand
	16 x 4	D3616-4	Special Order	1	-	Priced on Demand
	16 x 6	D3616-6	TBD	1	-	7,513.98
	16 x 8	D3616-8	Special Order	1	-	Priced on Demand
	16 x 10	D3616-10	Special Order	1	-	Priced on Demand
	16 x 12	D3616-12	Special Order	1	-	Priced on Demand
	16 x 14	D3616-14	Special Order	1	-	Priced on Demand
	16 x 16	D3616	Special Order	1	-	Priced on Demand
	18 x 4	D3618-4	Special Order	1	-	Priced on Demand
	18 x 6	D3618-6	TBD	1	-	8,366.84
	18 x 8	D3618-8	Special Order	1	-	Priced on Demand
	18 x 10	D3618-10	Special Order	1	-	Priced on Demand
	18 x 12	D3618-12	Special Order	1	-	Priced on Demand
	18 x 14	D3618-14	Special Order	1	-	Priced on Demand
	18 x 16	D3618-16	Special Order	1	-	Priced on Demand
	18 x 18	D3618	Special Order	1	-	Priced on Demand
	20 x 4	D3620-4	Special Order	1	-	Priced on Demand
	20 x 6	D3620-6	Special Order	1	-	Priced on Demand
	20 x 8	D3620-8	Special Order	1	-	Priced on Demand
	20 x 10	D3620-10	Special Order	1	-	Priced on Demand
	20 x 12	D3620-12	Special Order	1	-	Priced on Demand
	20 x 14	D3620-14	Special Order	1	-	Priced on Demand
	20 x 16	D3620-16	Special Order	1	-	Priced on Demand
	20 x 18	D3620-18	Special Order	1	-	Priced on Demand
	20 x 20	D3620	Special Order	1	-	Priced on Demand
	24 x 4	D3624-4	TBD	1	-	15,470.08
	24 x 6	D3624-6	Special Order	1	-	Priced on Demand
	24 x 8	D3624-8	Special Order	1	-	Priced on Demand
	24 x 10	D3624-10	Special Order	1	-	Priced on Demand
	24 x 12	D3624-12	Special Order	1	-	Priced on Demand
	24 x 14	D3624-14	Special Order	1	-	Priced on Demand
	24 x 16	D3624-16	Special Order	1	-	Priced on Demand
	24 x 18	D3624-18	Special Order	1	-	Priced on Demand
	24 x 20	D3624-20	Special Order	1	-	Priced on Demand
	24 x 24	D3624	Special Order	1	-	Priced on Demand









\* Denotes Molded Fitting  
 † Denotes Assembled from Molded Components

• Additional Sizes Available Upon Request  
 • Non-Stock items are non-cancelable, non-returnable

Item	Size In Inches	Alt Part Number	Part Number	Box Qty	Crate Qty	List Price
<b>Combo Wye &amp; 1/8 Bend With Left Side Inlet HxHxH</b>						
	*3 x 2	D1643-2L	Special Order	1	-	Priced on Demand
<b>Combo Wye &amp; 1/8 Bend With Right Side Inlet HxHxH</b>						
	*3 x 2	D1643-2R	Special Order	1	-	Priced on Demand
<b>Sanitary Tee with Left Side Inlet HxHxH</b>						
	*3 x 1 1/2	D153-1L	D416337	10	240	424.05
	*3 x 2	D153-2L	D416338	10	240	292.88
	*4 x 2	D154-2L	D416420	5	120	682.23
<b>Sanitary Tee with Right Side Inlet HxHxH</b>						
	*3 x 1 1/2	D153-1R	D417337	10	240	424.05
	*3 x 2	D153-2R	D417338	5	240	292.88
	*4 x 2	D154-2R	D417420	5	120	682.23
<b>Sanitary Tee with Two Side Inlets HxHxH</b>						
	*3 x 2	D153-2LR	D418338	5	160	429.34
	*4 x 2	D154-2LR	D418420	5	100	893.83
<b>Double Fixture Fitting (All Hub)</b>						
	†2x1 1/2x1 1/2	D1642-1-IDF	D510251	20	640	242.09
	*3 x 3	D1643DF	D510030	10	135	424.61
<b>U-Bend HxH</b>						
	*1 1/2 x 1 1/2	D1811	D700015	30	1280	70.55
	*2 x 2	D1822	D700020	30	700	134.16
	*3 x 3	D1833	D700030	3	240	376.35
	*4 x 4	D1844	D700040	3	80	683.51
	*6 x 6	D1866	D700060	3	-	1,723.69
<b>P-Trap HXH</b>						
	†1 1/2 x 1 1/2	D1811P	D706015	25	1000	82.55
	†2 x 2	D1822P	D706020	20	480	100.58
	†3 x 3	D1833P	D706030	10	160	339.54
	†4 x 4	D1844P	D706040	4	64	817.72
	†6 x 6	D1866P	TBD	1	-	2,326.90

\* Denotes Molded Fitting

† Denotes Assembled from Molded Components

Item	Size In Inches	Alt Part Number	Part Number	Box Qty	Crate Qty	List Price
<b>Double Cottage Wye with 2" Side Inlet (All Hub)</b>						
	*3x3x3x3x2	D363-2C	D610030	10	120	2,268.05
<b>Double Sanitary Tee SxHxHxH (One Piece)</b>						
	*3 x 1 1/2	D173-1D	Special Order	1	-	Priced on Demand
<b>Double Sanitary Tee with Side Inlet (All Hub)</b>						
	*3 x 2	D153-2DS	D438338	10	120	475.57
	*4 x 2	D154-2DS	Special Order	1	-	Priced on Demand
<b>Double Sanitary Tee with Two Side Inlets (All Hub)</b>						
	*3 x 2	D153-2DLR	D439338	10	120	738.15
	*4 x 2	D154-2DLR	D439420	5	60	1,199.14
<b>Double Combination Wye &amp; 1/8 Bend All Hub (Three Piece)</b>						
	†2 x 1 1/2	D1652-1D	TBD	1	-	460.74
	†3 x 2	D1653-2D	TBD	1	-	755.09
	†3 x 3	D1653D	D507030	5	80	731.01
	†4 x 2	D1654-2D	D507420	5	80	1,454.45
	†4 x 3	D1654-3D	D507422	5	60	1,231.78
†4 x 4	D1654D	D507040	5	40	1,335.01	
<b>P-Trap with Cleanout (HxHxFIPT)</b>						
	†1 1/2 x 1 1/2	D1811PC	D707015	10	1000	126.17
	†2 x 2	D1822PC	D707020	10	480	219.61
<b>P-Trap with Union (HxH)</b>						
	†1 1/2 x 1 1/2	D1811PU	D708015	25	800	98.35
	†2 x 2	D1822PU	D708020	20	400	226.62
<b>P-Trap with Union and Cleanout (HxHxFIPT)</b>						
	†1 1/2 x 1 1/2	D1811PUC	Special Order	1	-	Priced on Demand
	†2 x 2	D1822PUC	Special Order	1	-	Priced on Demand

• Additional Sizes Available Upon Request

• Non-Stock items are non-cancelable, non-returnable



Item	Size In Inches	Alt Part Number	Part Number	Box Qty	Crate Qty	List Price
<b>1/4 Bend (90 Degree) Vent HxH</b>						
	*1 1/2 x 1 1/2	D201	D331015	-	2500	45.84
	*2 x 2	D202	D331020	30	1440	59.45
	*3	D203	D331030	25	500	154.10
	*4	D204	D331040	8	240	395.38
	*6	D206	D331060	4	64	1,246.51
	*8	D208	D331080	2	24	1,947.67
	*10	D2010	D331100	1	9	1,461.63
	*12	D2012	D331120	1	6	2,250.78

Item	Size In Inches	Alt Part Number	Part Number	Box Qty	Crate Qty	List Price
<b>1/4 Bend (90) HxH (formerly Long Sweep)</b>						
	*1 1/2 x 1 1/2	D251	D300015	100	2400	22.26
	*2 x 2	D252	D300020	50	1200	35.14
	*3	D253	D300030	25	400	103.22
	*4	D256	D300040	10	200	203.86
	*6	D257	D300060	4	60	713.76
	*8	D258	D300080	2	32	922.24
	†10	D2510	D300100	1	8	1,610.09
	†12	D2512	D300120	1	6	2,479.77
	14	D2514	TBD	1	-	4,178.20
	16	D2516	D300160	1	-	5,718.53
	18	D2518	TBD	1	-	6,037.87
	20	D2520	TBD	1	-	8,771.49
	24	D2524	TBD	1	-	12,148.01

Item	Size In Inches	Alt Part Number	Part Number	Box Qty	Crate Qty	List Price
<b>1/4 Bend (90) HxH Long Sweep</b>						
	*1 1/2 x 1 1/2	D261	D304015	50	1800	51.63
	*2 x 2	D262	D304020	25	1000	57.59
	*3	D263	D304030	10	320	132.70
	*4	D264	D304040	5	120	250.38

Item	Size In Inches	Alt Part Number	Part Number	Box Qty	Crate Qty	List Price
<b>Closet Bend (90) HXH Reducing</b>						
	*4 x 3	D254-3CB	D329422	1	300	165.99

Item	Size In Inches	Alt Part Number	Part Number	Box Qty	Crate Qty	List Price
<b>1/4 Bend (90) HxH Long Sweep</b>						
	†6	D266	D304060	5	36	976.22

Item	Size In Inches	Alt Part Number	Part Number	Box Qty	Crate Qty	List Price
<b>1/4 Bend (90) HxHxH Long Sweep with Low Heel Inlet</b>						
	*3 x 2	D263-2LH	D307338	25	300	397.97

Item	Size In Inches	Alt Part Number	Part Number	Box Qty	Crate Qty	List Price
<b>1/4 Bend (90) HxHxH with Low Heel Inlet</b>						
	*3 x 1 1/2	D253-1LH	D303337	25	320	221.80
	*3 x 2	D253-2LH	D303338	-	400	177.74
	*4 x 2	D254-2LH	D303420	15	180	350.97

Item	Size In Inches	Alt Part Number	Part Number	Box Qty	Crate Qty	List Price
<b>1/4 Bend (90) HxHxH with Side Inlet</b>						
	*3 x 1 1/2	D253-1SI	D301337	10	400	299.88
	*3 x 2	D253-2SI	D301338	10	320	201.60

Item	Size In Inches	Alt Part Number	Part Number	Box Qty	Crate Qty	List Price
<b>1/4 Bend (90 Degree) Vent SxH</b>						
	*1 1/2 x 1 1/2	D221	D333015	25	3125	46.22
	*2 x 2	D222	D333020	-	1600	68.84
	*3	D223	D333030	5	400	184.45
	*4	D224	D333040	1	200	593.42
	*6	D226	D333060	1	64	988.42
	*8	D228	D333080	2	24	2,897.02
	*10	D2210	D333100	1	9	1,611.46
	*12	D2212	D333120	1	6	2,393.91

Item	Size In Inches	Alt Part Number	Part Number	Box Qty	Crate Qty	List Price
<b>1/4 Bend (90) SxH (formerly Long Sweep)</b>						
	*1 1/2 x 1 1/2	D271	D302015	100	3200	28.78
	*2 x 2	D272	D302020	50	1600	44.32
	*3	D273	D302030	20	400	123.17
	*4	D274	D302040	10	200	205.91
	*6	D277	D302060	4	60	920.67
	*8	D278	D302080	2	32	1,786.23
	†10	D2710	TBD	1	-	2,698.73
	†12	D2712	TBD	1	-	3,850.88
	14	D2714	Special Order	1	-	Priced on Demand
	16	D2716	Special Order	1	-	Priced on Demand
	18	D2718	Special Order	1	-	Priced on Demand
	20	D2720	TBD	1	-	8,771.49
	24	D2724	TBD	1	-	12,148.01

Item	Size In Inches	Alt Part Number	Part Number	Box Qty	Crate Qty	List Price
<b>1/4 Bend (90) SxH Long Sweep (formerly Extra Long Sweep)</b>						
	*1 1/2 x 1 1/2	D281	D309015	50	1000	79.17
	*2 x 2	D282	D309020	-	1000	94.80
	*3	D283	D309030	20	360	235.90
	*4	D284	D309040	-	120	363.37

Item	Size In Inches	Alt Part Number	Part Number	Box Qty	Crate Qty	List Price
<b>Closet Bend (90) SxH Reducing</b>						
	*3 x 4	D253-4CB	D330341	10	240	323.29

Item	Size In Inches	Alt Part Number	Part Number	Box Qty	Crate Qty	List Price
<b>1/4 Bend (90) SxHxH with Low Heel Inlet</b>						
	*3 x 2	D273-2LH	D293338	15	400	508.37

Item	Size In Inches	Alt Part Number	Part Number	Box Qty	Crate Qty	List Price
<b>1/4 Bend (90) HxH Reducing</b>						
	*2 x 1 1/2	D252-1	D300251	10	1440	128.00

Item	Size In Inches	Alt Part Number	Part Number	Box Qty	Crate Qty	List Price
<b>Double 1/4 Bend (90) HXHXH</b>						
	*1 1/2	D251D	D327015	20	1350	87.65
	*2 x 1 1/2	D252-1D	D327241	25	960	110.05
	*2	D252D	D327020	25	900	119.57
	*3	D253D	D327030	10	270	312.43

\* Denotes Molded Fitting  
 † Denotes Assembled from Molded Components

• Additional Sizes Available Upon Request  
 • Non-Stock items are non-cancelable, non-returnable

Item	Size In Inches	Alt Part Number	Part Number	Box Qty	Crate Qty	List Price
<b>1/6 Bend (60) HxH</b>						
	*1 1/2 x 1 1/2	D161	D319015	40	2560	51.82
	*2 x 2	D162	D319020	-	1600	60.35
	*3	D163	D319030	20	480	222.80
	*4	D164	D319040	10	240	296.95
	6	D1356.60	TBD	1	-	1,159.43
	8	D1358.60	TBD	1	-	1,922.21
	10	D13510.60	TBD	1	-	3,263.07
	12	D13512.60	Special Order	1	-	Priced on Demand
	14	D13514.60	Special Order	1	-	Priced on Demand
	16	D13516.60	Special Order	1	-	Priced on Demand
	18	D13518.60	Special Order	1	-	Priced on Demand
	20	D13520.60	Special Order	1	-	Priced on Demand
	24	D13524.60	Special Order	1	-	Priced on Demand

Item	Size In Inches	Alt Part Number	Part Number	Box Qty	Crate Qty	List Price
<b>1/8 Bend (45) HxH</b>						
	*1 1/2 x 1 1/2	D501LS	D321015	100	3200	21.82
	*2 x 2	D502LS	D321020	50	1600	32.55
	*3	D503LS	D321030	20	400	92.42
	*4	D504LS	D321040	8	200	169.28
	*6	D506LS	D321060	5	72	625.53
	*8	D508SS	D321080	2	32	818.98
	*10	D5010SS	D321100	1	12	1,229.01
	*12	D5012SS	D321120	1	8	1,860.22
	14	D5014	D321140	1	-	3,598.31
	16	D5016	D321160	1	-	3,891.65
	18	D5018	TBD	1	-	4,521.13
	20	D5020	TBD	1	-	6,934.98
	24	D5024	TBD	1	-	9,963.92

Item	Size In Inches	Alt Part Number	Part Number	Box Qty	Crate Qty	List Price
<b>1/12 Bend (30) HxH</b>						
	4	D1354.30	TBD	1	-	224.10
	6	D1356.30	TBD	1	-	450.56
	8	D1358.30	Special Order	1	-	Priced on Demand
	10	D13510.30	Special Order	1	-	Priced on Demand
	12	D13512.30	Special Order	1	-	Priced on Demand
	14	D13514.30	Special Order	1	-	Priced on Demand
	16	D13516.30	Special Order	1	-	Priced on Demand
	18	D13518.30	Special Order	1	-	Priced on Demand
	20	D13520.30	Special Order	1	-	Priced on Demand
	24	D13524.30	Special Order	1	-	Priced on Demand

Item	Size In Inches	Alt Part Number	Part Number	Box Qty	Crate Qty	List Price
<b>1/16 Bend (22.5) HxH</b>						
	*1 1/2 x 1 1/2	D1701	D324015	100	4000	30.97
	*2 x 2	D1702	D324020	25	2000	36.71
	*3	D1703	D324030	-	640	90.51
	*4	D1704	D324040	8	360	142.98
	*6	D1706	D324060	6	72	825.84
	*8	D1708	D324080	3	56	1,366.97
	*10	D17010	D324100	1	24	1,174.98
	*12	D17012	D324120	1	8	1,879.99
	14	D17014	TBD	1	-	3,145.87
	16	D17016	TBD	1	-	3,722.46
	18	D17018	TBD	1	-	3,961.60
	20	D17020	TBD	1	-	7,164.70
	24	D17024	TBD	1	-	10,316.03

Item	Size In Inches	Alt Part Number	Part Number	Box Qty	Crate Qty	List Price
<b>1/32 Bend (11.25) HxH</b>						
	4	D1934	TBD	1	-	220.79
	6	D1936	TBD	1	-	443.81
	8	D1938	TBD	1	-	3,593.05
	10	D19310	TBD	1	-	1,788.81
	12	D19312	TBD	1	-	2,429.76
	14	D19314	Special Order	1	-	Priced on Demand
	16	D19316	Special Order	1	-	Priced on Demand
	18	D19318	Special Order	1	-	Priced on Demand
	20	D19320	Special Order	1	-	Priced on Demand
	24	D19324	Special Order	1	-	Priced on Demand

Item	Size In Inches	Alt Part Number	Part Number	Box Qty	Crate Qty	List Price
<b>1/6 Bend (60) SxH</b>						
	*1 1/2 x 1 1/2	D181	D320015	40	4000	94.06
	*2 x 2	D182	D320020	25	2500	121.19
	*3	D183	D320030	20	700	261.37
	*4	D184	D320040	10	240	406.46
	6	D1346.60	Special Order	1	-	Priced on Demand
	8	D1348.60	Special Order	1	-	Priced on Demand
	10	D13410.60	Special Order	1	-	Priced on Demand
	12	D13412.60	Special Order	1	-	Priced on Demand
	14	D13414.60	Special Order	1	-	Priced on Demand
	16	D13416.60	Special Order	1	-	Priced on Demand
	18	D13418.60	Special Order	1	-	Priced on Demand
	20	D13420.60	Special Order	1	-	Priced on Demand
	24	D13424.60	Special Order	1	-	Priced on Demand

Item	Size In Inches	Alt Part Number	Part Number	Box Qty	Crate Qty	List Price
<b>1/8 Bend (45) SxH</b>						
	*1 1/2 x 1 1/2	D401LS	D323015	100	3200	20.94
	*2 x 2	D402LS	D323020	50	1800	33.20
	*3	D403LS	D323030	20	480	87.63
	*4	D404LS	D323040	8	240	150.23
	*6	D406LS	D323060	5	72	740.88
	*8	D408SS	D323080	2	32	888.87
	*10	D4010SS	D323100	1	12	1,227.38
	*12	D4012SS	D323120	1	8	1,880.77
	14	D4014	D323140	1	-	3,360.19
	16	D4016	D323160	1	-	3,891.65
	18	D4018	TBD	1	-	4,471.78
	20	D4020	Special Order	1	-	Priced on Demand
	24	D4024	Special Order	1	-	Priced on Demand

Item	Size In Inches	Alt Part Number	Part Number	Box Qty	Crate Qty	List Price
<b>1/12 Bend (30) SxH</b>						
	4	D1344.30	Special Order	1	-	Priced on Demand
	6	D1346.30	Special Order	1	-	Priced on Demand
	8	D1348.30	Special Order	1	-	Priced on Demand
	10	D13410.30	Special Order	1	-	Priced on Demand
	12	D13412.30	Special Order	1	-	Priced on Demand
	14	D13414.30	Special Order	1	-	Priced on Demand
	16	D13416.30	Special Order	1	-	Priced on Demand
	18	D13418.30	Special Order	1	-	Priced on Demand
	20	D13420.30	Special Order	1	-	Priced on Demand
	24	D13424.30	Special Order	1	-	Priced on Demand

Item	Size In Inches	Alt Part Number	Part Number	Box Qty	Crate Qty	List Price
<b>1/16 Bend (22.5) SxH</b>						
	*1 1/2 x 1 1/2	D1711	D326015	50	4000	83.85
	*2 x 2	D1712	D326020	25	2000	89.91
	*3	D1713	D326030	-	720	140.13
	*4	D1714	D326040	8	360	203.33
	*6	D1716	D326060	6	72	800.08
	*8	D1718	D326080	3	56	3,389.76
	*10	D17110	D326100	1	24	1,362.02
	*12	D17112	D326120	1	8	1,879.98
	14	D17114	Special Order	1	-	Priced on Demand
	16	D17116	TBD	1	-	3,722.46
	18	D17118	Special Order	1	-	Priced on Demand
	20	D17120	Special Order	1	-	Priced on Demand
	24	D17124	TBD	1	-	10,316.03

Item	Size In Inches	Alt Part Number	Part Number	Box Qty	Crate Qty	List Price
<b>1/32 Bend (11.25) SxH</b>						
	4	D1834	TBD	1	-	226.32
	6	D1836	TBD	1	-	454.97
	8	D1838	TBD	1	-	775.10
	10	D18310	D328100	1	20	1,787.03
	12	D18312	D328120	1	15	2,427.41
	14	D18314	Special Order	1	-	Priced on Demand
	16	D18316	Special Order	1	-	Priced on Demand
	18	D18318	Special Order	1	-	Priced on Demand
	20	D18320	Special Order	1	-	Priced on Demand
	24	D18324	Special Order	1	-	Priced on Demand

\* Denotes Molded Fitting  
† Denotes Assembled from Molded Components

• Additional Sizes Available Upon Request  
• Non-Stock items are non-cancelable, non-returnable

Item	Size In Inches	Alt Part Number	Part Number	Box Qty	Crate Qty	List Price
<b>Cap (H)</b>						
	*1 1/2 x 1 1/2	D1601	D447015	10	-	42.15
	*2 x 2	D1602	D447020	5	-	70.41
	*3	D1603	D447030	10	-	117.67
	*4	D1604	D447040	27	-	167.91
	*6	D1606	D447060	8	-	424.06
	*8	D1608	D447080	6	-	1,139.99
	*10	D16010	D116100	2	27	787.20
	*12	D16012	D116120	2	27	995.81
	14	D16014	TBD	1	-	1,661.55
	16	D16016	TBD	1	-	2,223.73
	18	D16018	TBD	1	-	2,193.91
	20	D16020	TBD	1	-	4,814.46
	24	D16024	TBD	1	-	5,495.34

Item	Size In Inches	Alt Part Number	Part Number	Box Qty	Crate Qty	List Price
<b>Drain Grate (S)</b>						
	*4	D911	D191040	25	-	169.38
	*6	D916	D191060	10	-	366.52

Item	Size In Inches	Alt Part Number	Part Number	Box Qty	Crate Qty	List Price
<b>Stop Coupling HxH</b>						
	*1 1/2 x 1 1/2	D601	D100015	100	6400	10.44
	*2 x 2	D602	D100020	100	3600	14.35
	*3	D603	D100030	60	960	50.10
	*4	D604	D100040	12	500	85.06
	*6	D606	D100060	10	180	278.35
	*8	D608	D100080	3	64	462.53
	*10	D6010	D100100	2	24	540.54
	*12	D6012	D100120	1	18	920.67
	14	D6014	D100140	1	-	1,416.24
	16	D6016	D100160	1	-	1,579.71
	18	D6018	TBD	1	-	2,309.84
	20	D6020	TBD	1	-	3,470.04
	24	D6024	TBD	1	-	3,904.00

Item	Size In Inches	Alt Part Number	Part Number	Box Qty	Crate Qty	List Price
<b>Male Trap Adapter - SxSLIP</b>						
	*1 1/2 x 1 1/4	D1351-0	D103212	100	8000	43.11
	*1 1/2 x 1 1/2	D1351	D103015	50	6250	38.56
	*2 x 2	D1352	D103020	25	3600	140.09

Item	Size In Inches	Alt Part Number	Part Number	Box Qty	Crate Qty	List Price
<b>Female Trap Adapter HxSLIP</b>						
	*1 1/2 x 1 1/4	D1451-0	D114212	50	6000	42.15
	*1 1/2 x 1 1/2	D1451	D114015	50	6250	32.92
	*2 x 2	D1452	D114020	50	6250	63.69

Item	Size In Inches	Alt Part Number	Part Number	Box Qty	Crate Qty	List Price
<b>Flush Threaded Reducer Bushing SxFIPT</b>						
	*2 x 1 1/2	D12502-1T	D108251	50	7200	112.59

Item	Size In Inches	Alt Part Number	Part Number	Box Qty	Crate Qty	List Price
<b>Spigot Plug (S)</b>						
	*4	T1164	-	18	-	102.52
	*6	T1166	-	12	-	321.38
	*8	T1168	-	6	-	363.77
	*10	D11610	D161100	2	36	697.26
	*12	D11612	D161120	2	27	874.18
	14	D11614	Special Order	1	-	Priced on Demand
	16	D11616	Special Order	1	-	Priced on Demand
	18	D11618	Special Order	1	-	Priced on Demand
	20	D11620	Special Order	1	-	Priced on Demand
	24	D11624	Special Order	1	-	Priced on Demand

Item	Size In Inches	Alt Part Number	Part Number	Box Qty	Crate Qty	List Price
<b>Male Adapter HxMPT</b>						
	*1 1/2 x 1 1/2	D1301	D109015	50	6250	19.88
	*1 1/2 x 1 1/4	D1301-0	D109212	25	7000	28.78
	*2 x 2	D1302	D109020	50	6250	26.74
	*3	D1303	D109030	25	1600	74.66
	*4	D1304	D109040	4	800	169.11
	*6	D1306	D109060	8	-	1,086.56

Item	Size In Inches	Alt Part Number	Part Number	Box Qty	Crate Qty	List Price
<b>Repair Coupling HxH</b>						
	*1 1/2 x 1 1/2	D621	D130015	25	6000	57.46
	*2 x 2	D622	D130020	25	3125	40.08
	*3	D623	D130030	10	800	101.40
	*4	D624	D130040	12	495	195.02
	*6	D626	D130060	10	-	871.98
	*8	D628	D130080	3	-	1,625.03
	*10	D6210	D130100	2	24	720.94
	*12	D6212	D130120	1	18	1,148.38
	14	D6214	Special Order	1	-	Priced on Demand
	16	D6216	Special Order	1	-	Priced on Demand
	18	D6218	Special Order	1	-	Priced on Demand
	20	D6220	Special Order	1	-	Priced on Demand
	24	D6224	Special Order	1	-	Priced on Demand

Item	Size In Inches	Alt Part Number	Part Number	Box Qty	Crate Qty	List Price
<b>Male Trap Adapter with One Piece Plastic Nut - SxSLIP</b>						
	*1 1/2 x 1 1/4	D1351-0N	D113212	1	6000	44.53
	*1 1/2 x 1 1/2	D1351N	D113015	50	5000	41.00
	*2 x 2	D1352N	D113020	25	3125	196.90

Item	Size In Inches	Alt Part Number	Part Number	Box Qty	Crate Qty	List Price
<b>Female Trap Adapter with One Piece Plastic Nut HxSlip</b>						
	*1 1/2 x 1 1/4	D1451-0N	D104212	50	5000	39.28
	*1 1/2 x 1 1/2	D1451N	D104015	50	4000	38.99
	*2 x 2	D1452N	D104020	60	2500	87.64

\* Denotes Molded Fitting  
 † Denotes Assembled from Molded Components

• Additional Sizes Available Upon Request  
 • Non-Stock items are non-cancelable, non-returnable

Item	Size In Inches	Alt Part Number	Part Number	Box Qty	Crate Qty	List Price
<b>Concentric Reducer Coupling HxH</b>						
	*2 x 1 1/2	D602-1	D102251	25	3125	31.84
	*3 x 1 1/2	D603-1	D102337	25	1200	93.17
	*3 x 2	D603-2	D102338	20	1280	72.58
	*4 x 1 1/2	D604-1	D102419	25	-	160.37
	*4 x 2	D604-2	D102420	10	640	142.23
	*4 x 3	D604-3	D102422	30	640	151.97
	*6 x 4	D606-4	D102532	8	192	591.22
	*8 x 4	D608-4	D102582	5	96	822.88
	*8 x 6	D608-6	D102585	6	96	661.62
	*10 x 4	D6010-4	D102624	2	-	865.34
	*10 x 6	D6010-6	D102626	2	27	892.69
	*10 x 8	D6010-8	D102628	2	27	920.01
	*12 x 4	D6012-4	D102664	2	-	1,311.06
	*12 x 6	D6012-6	D102666	2	-	1,533.05
	*12 x 8	D6012-8	D102668	2	27	1,609.72
	*12 x 10	D6012-10	D102670	2	27	1,690.15
	14 x 4	D6014-4	TBD	1	-	2,116.23
	14 x 6	D6014-6	Special Order	1	-	Priced on Demand
	14 x 8	D6014-8	Special Order	1	-	Priced on Demand
	14 x 10	D6014-10	TBD	1	-	2,857.62
	14 x 12	D6014-12	TBD	1	-	3,000.56
	16 x 4	D6016-4	TBD	1	-	2,524.06
	16 x 6	D6016-6	TBD	1	-	2,999.09
	16 x 8	D6016-8	TBD	1	-	2,599.06
	16 x 10	D6016-10	TBD	1	-	3,368.13
	16 x 12	D6016-12	D1001612	1	-	3,184.24
	16 x 14	D6016-14	TBD	1	-	3,302.99
	18 x 4	D6018-4	TBD	1	-	3,590.62
	18 x 6	D6018-6	TBD	1	-	3,783.26
	18 x 8	D6018-8	TBD	1	-	4,074.77
	18 x 10	D6018-10	TBD	1	-	4,361.59
	18 x 12	D6018-12	TBD	1	-	4,433.78
	18 x 14	D6018-14	TBD	1	-	4,819.74
	18 x 16	D6018-16	TBD	1	-	5,060.76
	20 x 4	D6020-4	Special Order	1	-	Priced on Demand
	20 x 6	D6020-6	Special Order	1	-	Priced on Demand
	20 x 8	D6020-8	Special Order	1	-	Priced on Demand
	20 x 10	D6020-10	Special Order	1	-	Priced on Demand
	20 x 12	D6020-12	Special Order	1	-	Priced on Demand
	20 x 14	D6020-14	Special Order	1	-	Priced on Demand
20 x 16	D6020-16	TBD	1	-	5,214.80	
20 x 18	D6020-18	TBD	1	-	5,569.58	
24 x 4	D6024-4	Special Order	1	-	Priced on Demand	
24 x 6	D6024-6	Special Order	1	-	Priced on Demand	
24 x 8	D6024-8	Special Order	1	-	Priced on Demand	
24 x 10	D6024-10	Special Order	1	-	Priced on Demand	
24 x 12	D6024-12	Special Order	1	-	Priced on Demand	
24 x 14	D6024-14	Special Order	1	-	Priced on Demand	
24 x 16	D6024-16	Special Order	1	-	Priced on Demand	
24 x 18	D6024-18	TBD	1	-	8,972.36	
24 x 20	D6024-20	TBD	1	-	10,495.09	

<b>Cast Iron Soil Pipe Spigot Adapter HxH</b>						
	*2 x 2	D702	D122020	10	1250	205.77
	*3 x 3	D703	D122030	10	480	350.15
	*4 x 4	D704	D122040	15	320	308.31

<b>No Hub Cast Iron Pipe Adapter (MJ) MJSxH</b>						
	*2 x 2	D6522	D119020	25	2500	55.06
	*3 x 3	D6523	D119030	20	960	79.95
	*4 x 3	D6524-3	D119422	10	-	197.32
	*4	D6524	D119040	20	600	102.61

Item	Size In Inches	Alt Part Number	Part Number	Box Qty	Crate Qty	List Price
<b>Concentric Reducer Bushing SxH</b>						
	*6 x 4	D1216	D121532	10	-	292.80
	*8 x 4	D1217	D121582	5	-	506.57
	*8 x 6	D1218	D121585	4	-	518.84
	*10 x 4	D1210-4	D121624	2	-	735.09
	*10 x 6	D1210-6	D121626	2	-	850.17
	*10 x 8	D1210-8	D121628	2	-	1,015.63
	*12 x 4	D1212-4	D121664	2	-	1,113.67
	*12 x 6	D1212-6	D121666	2	-	1,362.99
	*12 x 8	D1212-8	D121668	2	-	1,402.51
	*12 x 10	D1212-10	D121670	2	-	1,431.60
	14 x 4	D1214-4	TBD	1	-	2,015.43
	14 x 6	D1214-6	TBD	1	-	2,039.73
	14 x 8	D1214-8	TBD	1	-	2,302.18
	14 x 10	D1214-10	TBD	1	-	2,721.58
	14 x 12	D1214-12	TBD	1	-	2,857.70
	16 x 4	D1216-4	TBD	1	-	2,403.87
	16 x 6	D1216-6	TBD	1	-	2,475.32
	16 x 8	D1216-8	TBD	1	-	2,856.25
	16 x 10	D1216-10	TBD	1	-	3,207.75
	16 x 12	D1216-12	TBD	1	-	3,170.44
	16 x 14	D1216-14	TBD	1	-	3,145.68
	18 x 4	D1218-4	TBD	1	-	3,419.64
	18 x 6	D1218-6	TBD	1	-	3,603.10
	18 x 8	D1218-8	TBD	1	-	3,880.73
	18 x 10	D1218-10	TBD	1	-	4,153.91
	18 x 12	D1218-12	TBD	1	-	4,222.63
	18 x 14	D1218-14	TBD	1	-	4,590.22
	18 x 16	D1218-16	TBD	1	-	4,819.74
	20 x 4	D1220-4	Special Order	1	-	Priced on Demand
	20 x 6	D1220-6	TBD	1	-	4,323.53
	20 x 8	D1220-8	Special Order	1	-	Priced on Demand
	20 x 10	D1220-10	TBD	1	-	4,544.08
	20 x 12	D1220-12	TBD	1	-	4,606.00
	20 x 14	D1220-14	TBD	1	-	4,901.46
	20 x 16	D1220-16	TBD	1	-	4,966.44
	20 x 18	D1220-18	TBD	1	-	5,304.33
	24 x 4	D1224-4	Special Order	1	-	Priced on Demand
	24 x 6	D1224-6	Special Order	1	-	Priced on Demand
	24 x 8	D1224-8	TBD	1	-	7,634.97
	24 x 10	D1224-10	Special Order	1	-	Priced on Demand
24 x 12	D1224-12	Special Order	1	-	Priced on Demand	
24 x 14	D1224-14	Special Order	1	-	Priced on Demand	
24 x 16	D1224-16	Special Order	1	-	Priced on Demand	
24 x 18	D1224-18	TBD	1	-	8,545.11	
24 x 20	D1224-20	TBD	1	-	9,995.32	

<b>Cast Iron Soil Pipe Hub Adapter HxS</b>						
	*2 x 2	D802	D123020	20	1280	104.32
	*3 x 3	D803	D123030	20	640	197.87
	*4 x 4	D804	D123040	20	360	297.59

<b>Copper to DWV Adapter with Plastic Nut (Hxslip)</b>						
	*1 1/2 x 1 1/4	D7551-0N	Special Order	1	-	Priced on Demand
	*1 1/2 x 1 1/2	D7551N	Special Order	1	-	Priced on Demand
	*2 x 2	D7552N	Special Order	1	-	Priced on Demand

\* Denotes Molded Fitting  
† Denotes Assembled from Molded Components

• Additional Sizes Available Upon Request  
• Non-Stock items are non-cancelable, non-returnable

Item	Size In Inches	Alt Part Number	Part Number	Box Qty	Crate Qty	List Price
<b>Eccentric Reducer Coupling HxH</b>						
	6 x 4	D6106-4	TBD	1	-	290.12
	8 x 4	D6108-4	TBD	1	-	500.47
	8 x 6	D6108-6	TBD	1	-	543.64
	10 x 4	D6110-4	TBD	1	-	814.16
	10 x 6	D6110-6	TBD	1	-	1,229.32
	10 x 8	D6110-8	TBD	1	-	865.57
	12 x 4	D6112-4	Special Order	1	-	Priced on Demand
	12 x 6	D6112-6	TBD	1	-	1,442.37
	12 x 8	D6112-8	TBD	1	-	1,514.52
	12 x 10	D6112-10	Special Order	1	-	Priced on Demand
	14 x 4	D6114-4	Special Order	1	-	Priced on Demand
	14 x 6	D6114-6	Special Order	1	-	Priced on Demand
	14 x 8	D6114-8	Special Order	1	-	Priced on Demand
	14 x 10	D6114-10	Special Order	1	-	Priced on Demand
	14 x 12	D6114-12	Special Order	1	-	Priced on Demand
	16 x 4	D6116-4	Special Order	1	-	Priced on Demand
	16 x 6	D6116-6	Special Order	1	-	Priced on Demand
	16 x 8	D6116-8	Special Order	1	-	Priced on Demand
	16 x 10	D6116-10	Special Order	1	-	Priced on Demand
	16 x 12	D6116-12	TBD	1	-	2,995.96
	16 x 14	D6116-14	Special Order	1	-	Priced on Demand
	18 x 4	D6118-4	Special Order	1	-	Priced on Demand
	18 x 6	D6118-6	Special Order	1	-	Priced on Demand
	18 x 8	D6118-8	Special Order	1	-	Priced on Demand
	18 x 10	D6118-10	Special Order	1	-	Priced on Demand
	18 x 12	D6118-12	Special Order	1	-	Priced on Demand
	18 x 14	D6118-14	Special Order	1	-	Priced on Demand
	18 x 16	D6118-16	Special Order	1	-	Priced on Demand
	20 x 4	D6120-4	Special Order	1	-	Priced on Demand
	20 x 6	D6120-6	Special Order	1	-	Priced on Demand
	20 x 8	D6120-8	Special Order	1	-	Priced on Demand
	20 x 10	D6120-10	Special Order	1	-	Priced on Demand
	20 x 12	D6120-12	Special Order	1	-	Priced on Demand
20 x 14	D6120-14	Special Order	1	-	Priced on Demand	
20 x 16	D6120-16	Special Order	1	-	Priced on Demand	
20 x 18	D6120-18	Special Order	1	-	Priced on Demand	
24 x 4	D6124-4	Special Order	1	-	Priced on Demand	
24 x 6	D6124-6	Special Order	1	-	Priced on Demand	
24 x 8	D6124-8	Special Order	1	-	Priced on Demand	
24 x 10	D6124-10	Special Order	1	-	Priced on Demand	
24 x 12	D6124-12	Special Order	1	-	Priced on Demand	
24 x 14	D6124-14	Special Order	1	-	Priced on Demand	
24 x 16	D6124-16	Special Order	1	-	Priced on Demand	
24 x 18	D6124-18	Special Order	1	-	Priced on Demand	
24 x 20	D6124-20	Special Order	1	-	Priced on Demand	

<b>Expansion Joint Coupling HxH Gray PVC</b>						
	*2	D632	D133020	10	1000	959.60
	*3	D633	D133030	9	360	1,182.38
	*4	D634	D133040	5	160	2,579.21

<b>DWV Adapter Coupling HxH (SDR 35) Solvent Sewer Hub x Solvent DWV Hub</b>						
	*3 x 3	P653-3	S650030	12	-	19.63
	*4 x 3	P655	S650422	45	-	23.24
	*4 x 4	P657	S650040	15	-	32.77
	*6 x 4	P658	S650532	10	-	90.22
	*6 x 6	P659	S650060	12	-	112.74
	†8 x 8	P6508	S650080	1	-	344.28
	10 x 8	P6510-8	S650628	2	-	789.46
	10 x 10	P6510	S650100	1	-	839.30
12 x 12	P6512	S650120	1	-	1,235.56	

<b>Gasketed DWV Adapter Coupling GxDWV G SDR 26 Gasket Sewer Hub x Gasket DWV Hub</b>						
	*4 x 4	H657	-	6	-	173.05
	*6 x 4	H658	-	4	-	232.14
	*6 x 6	H659	-	3	-	254.05
	8 x 8	H6508	-	1	-	606.45
	10 x 10	H6510	-	1	-	839.30
	12 x 12	H6512	-	1	-	1,235.58

<b>Gasketed DWV Adapter Bushing SxDWV G SDR 26 Chamfer Sewer Spigot x Gasket DWV Hub</b>						
	*4 x 4	H1213	-	6	-	160.25
	*6 x 4	H1214	-	5	-	219.21
	*6 x 6	H1215	-	4	-	241.00
	8 x 8	H9208	-	1	-	591.25
	10 x 10	H9210	-	1	-	818.29
	12 x 12	H9212	-	1	-	1,204.55

\* Denotes Molded Fitting  
† Denotes Assembled from Molded Components

Item	Size In Inches	Alt Part Number	Part Number	Box Qty	Crate Qty	List Price
<b>Eccentric Reducer Bushing SxH</b>						
	6 x 4	D1306-4	TBD	1	-	378.02
	8 x 4	D1308-4	TBD	1	-	544.78
	8 x 6	D1308-6	TBD	1	-	547.33
	10 x 4	D13010-4	Special Order	1	-	Priced on Demand
	10 x 6	D13010-6	TBD	1	-	1,008.27
	10 x 8	D13010-8	TBD	1	-	1,071.40
	12 x 4	D13012-4	Special Order	1	-	Priced on Demand
	12 x 6	D13012-6	TBD	1	-	1,437.90
	12 x 8	D13012-8	Special Order	1	-	Priced on Demand
	12 x 10	D13012-10	Special Order	1	-	Priced on Demand
	14 x 4	D13014-4	Special Order	1	-	Priced on Demand
	14 x 6	D13014-6	Special Order	1	-	Priced on Demand
	14 x 8	D13014-8	Special Order	1	-	Priced on Demand
	14 x 10	D13014-10	Special Order	1	-	Priced on Demand
	14 x 12	D13014-12	Special Order	1	-	Priced on Demand
	16 x 4	D13016-4	Special Order	1	-	Priced on Demand
	16 x 6	D13016-6	Special Order	1	-	Priced on Demand
	16 x 8	D13016-8	Special Order	1	-	Priced on Demand
	16 x 10	D13016-10	Special Order	1	-	Priced on Demand
	16 x 12	D13016-12	Special Order	1	-	Priced on Demand
	16 x 14	D13016-14	Special Order	1	-	Priced on Demand
	18 x 4	D13018-4	Special Order	1	-	Priced on Demand
	18 x 6	D13018-6	Special Order	1	-	Priced on Demand
	18 x 8	D13018-8	Special Order	1	-	Priced on Demand
	18 x 10	D13018-10	Special Order	1	-	Priced on Demand
	18 x 12	D13018-12	Special Order	1	-	Priced on Demand
	18 x 14	D13018-14	Special Order	1	-	Priced on Demand
	18 x 16	D13018-16	Special Order	1	-	Priced on Demand
	20 x 4	D13020-4	Special Order	1	-	Priced on Demand
	20 x 6	D13020-6	Special Order	1	-	Priced on Demand
	20 x 8	D13020-8	Special Order	1	-	Priced on Demand
	20 x 10	D13020-10	Special Order	1	-	Priced on Demand
	20 x 12	D13020-12	Special Order	1	-	Priced on Demand
20 x 14	D13020-14	Special Order	1	-	Priced on Demand	
20 x 16	D13020-16	Special Order	1	-	Priced on Demand	
20 x 18	D13020-18	Special Order	1	-	Priced on Demand	
24 x 4	D13024-4	Special Order	1	-	Priced on Demand	
24 x 6	D13024-6	Special Order	1	-	Priced on Demand	
24 x 8	D13024-8	Special Order	1	-	Priced on Demand	
24 x 10	D13024-10	Special Order	1	-	Priced on Demand	
24 x 12	D13024-12	Special Order	1	-	Priced on Demand	
24 x 14	D13024-14	Special Order	1	-	Priced on Demand	
24 x 16	D13024-16	Special Order	1	-	Priced on Demand	
24 x 18	D13024-18	Special Order	1	-	Priced on Demand	
24 x 20	D13024-20	Special Order	1	-	Priced on Demand	

<b>Flush Reducer Bushing SxH</b>						
	*1 1/2 x 1 1/4	D12501-0	D107212	100	9900	41.71
	*2 x 1 1/4	D12502-0	D107250	50	6250	49.97
	*2 x 1 1/2	D12502-1	D107251	50	6250	18.20
	*3 x 1 1/2	D12503-1	D107337	30	1920	87.30
	*3 x 2	D12503-2	D107338	30	1920	46.08
	*4 x 2	D12504-2	D107420	30	1200	151.76
	*4 x 3	D12504-3	D107422	30	1080	78.39
	*6 x 3	D12506-3	D107530	10	-	611.46
	*6 x 4	D12506-4	D107532	10	320	389.76
	*8 x 4	D12508-4	D107582	5	90	703.19
	*8 x 6	D12508-6	D107585	5	90	763.04
	*10 x 3	D12510-3	D107623	1	54	824.23
	*10 x 4	D12510-4	D107624	1	27	824.23
	*10 x 6	D12510-6	D107626	1	63	850.17
	*10 x 8	D12510-8	D107628	2	63	878.05
	*12 x 3	D12512-3	D107661	1	36	1,248.59
	*12 x 4	D12512-4	D107664	1	36	1,248.59
*12 x 6	D12512-6	D107666	1	63	1,460.09	
*12 x 8	D12512-8	D107668	1	54	1,533.05	
*12 x 10	D12512-10	D107670	1	54	1,609.72	

<b>DWV Adapter Bushing SxH (SDR 35) Solvent (Short) Sewer Spigot x Solvent DWV Hub</b>						
	*3 x 1 1/2	P1202	S649337	15	-	47.50
	*3 x 2	P1203	S649338	15	-	42.86
	*4 x 1 1/2	P1204	S649149	8	-	44.13
	*4 x 2	P1205	S649420	8	-	44.75
	*4 x 3	P1211	S649422	15	-	97.72
	*4 x 4	P1213	S649040	20	-	62.59
	*6 x 4	P1214	S649532	15	-	108.03
*6 x 6	P1215	S649060	12	-	142.95	

\* Additional Sizes Available Upon Request  
\* Non-Stock items are non-cancelable, non-returnable

Item	Size In Inches	Alt Part Number	Part Number	Box Qty	Crate Qty	List Price
<b>Gasketed DWV Adapter Coupling HxDWV G SDR 26 Solvent Sewer Hub x Gasket DWV Hub</b>						
	*4 x 4	H954	-	6	-	154.19
	*6 x 4	H956-4	-	4	-	197.66
	*6 x 6	H956	-	4	-	235.07
	8 x 8	H958	-	1	-	565.76
	10 x 10	H9510	-	1	-	963.09
	12 x 12	H9512	-	1	-	1,409.35

Item	Size In Inches	Alt Part Number	Part Number	Box Qty	Crate Qty	List Price
<b>DWV Adapter Bushing SxH (SDR 35) Chamfer (Long) Sewer Spigot x Solvent DWV Hub</b>						
	*4 x 4	G944	-	8	-	62.59
	*6 x 4	G946-4	-	5	-	110.48
	*6 x 6	G946	-	4	-	142.97
	*8 x 8	G948	-	4	-	271.01
	10 x 10	L9410	-	1	-	351.10
	12 x 12	L9412	-	1	-	482.89

Item	Size In Inches	Alt Part Number	Part Number	Box Qty	Crate Qty	List Price
<b>DWV Adapter Sleeve DWV SxG Solvent DWV Spigot x SDR 35 Gasket Sewer Hub</b>						
	*4 x 4	G1208	-	16	-	125.68
	*6 x 6	G1209	-	8	-	240.56
	8 x 8	L12008	-	1	-	625.38
	10 x 10	L12010	-	1	-	839.21
	12 x 12	L12012	-	1	-	1,235.46

Item	Size In Inches	Alt Part Number	Part Number	Box Qty	Crate Qty	List Price
<b>DWV Adapter Sleeve DWV SxH Solvent DWV Spigot x SDR 35 Solvent Sewer Hub</b>						
	*3 x 3	P1207	S651030	1	-	27.20
	*4 x 4	P1208	S651040	36	-	24.56
	*6 x 6	P1209	S651060	20	-	105.95
	8 x 8	P12008	S651080	1	-	288.41
	10 x 10	P12010	S651100	1	-	357.16
	12 x 12	P12012	S651120	1	-	562.87

Item	Size In Inches	Alt Part Number	Part Number	Box Qty	Crate Qty	List Price
<b>Temporary Plug Polypropylene (S)</b>						
	*4	G1184	-	36	-	23.24
	*6	G1186	-	40	-	34.53
	8	G1188	-	8	-	71.23

Item	Size In Inches	Alt Part Number	Part Number	Box Qty	Crate Qty	List Price
<b>In-Line Backwater Valve HxH</b>						
	*4 x 4	D0104	D010040	1	-	893.29
	*6 x 6	D0106	D010060	1	-	2,157.84
	8 x 8	D0108	TBD	1	-	14,384.64
	10 x 10	D0110	TBD	1	-	16,244.09
	12 x 12	D0112	TBD	1	-	17,088.53

8" size and larger are fabricated from SDR 35 sewer pipe

Item	Size In Inches	Alt Part Number	Part Number	Box Qty	Crate Qty	List Price
<b>Downspout Adapter (H) Downspout x Solvent DWV Hub</b>						
	*2 x 3 x 4	D1904	D190259	35	-	56.46
	*3 x 4 x 3	D1905	D190347	65	-	88.51
	*3 x 4 x 4	D1906	D190348	60	-	89.41

Item	Size In Inches	Alt Part Number	Part Number	Box Qty	Crate Qty	List Price
<b>Gasketed DWV Adapter Bushing SxDWV G SDR 26 Solvent Sewer Spigot x Gasket DWV Hub</b>						
	4 x 4	H924	-	6	-	160.27
	6 x 4	H926-4	-	4	-	219.21
	6 x 6	H926	-	4	-	241.00
	8 x 8	H928	-	1	-	591.32
	10 x 10	H92210	-	1	-	818.37
	12 x 12	H92212	-	1	-	1,204.68

Item	Size In Inches	Alt Part Number	Part Number	Box Qty	Crate Qty	List Price
<b>DWV Adapter Bushing SxH (SDR 26) Chamfer (Long) Sewer Spigot x Solvent DWV Hub</b>						
	4 x 4	H944	-	1	-	116.48
	6 x 4	H946-4	-	1	-	178.44
	6 x 6	H946	-	1	-	187.83
	8 x 8	H948	-	1	-	441.98
	10 x 10	H9410	-	1	-	755.29
	12 x 12	H9412	-	1	-	1,111.89

Item	Size In Inches	Alt Part Number	Part Number	Box Qty	Crate Qty	List Price
<b>DWV Adapter Sleeve DWV SxG Solvent DWV Spigot x SDR 26 Gasket Sewer Hub</b>						
	*4 x 4	H1208	-	4	-	125.70
	*6 x 6	H1209	-	4	-	240.58
	8 x 8	H12008	-	1	-	625.45
	10 x 10	H12010	-	1	-	839.30
	12 x 12	H12012	-	1	-	1,235.58

Item	Size In Inches	Alt Part Number	Part Number	Box Qty	Crate Qty	List Price
<b>Gasketed DWV Hub Adapter SxG Solvent DWV Spigot x Gasket DWV Hub</b>						
	*4 x 4	D904	D901040	6	-	265.46
	*6 x 6	D906	D901060	4	-	552.22
	*8 x 8	D908	D901080	4	-	914.69
	10 x 10	D9010	Special Order	1	-	Priced on Demand
	12 x 12	D9012	Special Order	1	-	Priced on Demand

Item	Size In Inches	Alt Part Number	Part Number	Box Qty	Crate Qty	List Price
<b>Vertical Riser Adapter SxS</b>						
	*4 x 4	T984	-	6	-	181.93
	*6 x 6	T986	-	4	-	322.05
	*8 x 8	T988	-	4	-	705.85

Item	Size In Inches	Alt Part Number	Part Number	Box Qty	Crate Qty	List Price
<b>Terminal Backwater Valve (H)</b>						
	4	D0204	TBD	1	-	2,391.13
	6	D0206	Special Order	1	-	Priced on Demand
	8	D0208	Special Order	1	-	Priced on Demand
	10	D0210	Special Order	1	-	Priced on Demand
	12	D0212	Special Order	1	-	Priced on Demand









Item	Size In Inches	Alt Part Number	Part Number	Box Qty	Crate Qty	List Price
<b>Flushmount Downspout Adapter (H) Flushmount Downspout x Solvent DWV Hub</b>						
	*4 x 6 x 6	D1928	D192532	4	-	311.40

\* Denotes Molded Fitting

† Denotes Assembled from Molded Components









• Additional Sizes Available Upon Request

• Non-Stock items are non-cancelable, non-returnable

Item	Size In Inches	Alt Part Number	Part Number	Box Qty	Crate Qty	List Price
<b>Female Adapter HxFIPT</b>						
	*1 1/2 x 1 1/2	D1401	D101015	100	6400	19.75
	*2 x 2	D1402	D101020	100	3600	33.80
	*3	D1403	D101030	60	1080	90.17
	*4	D1404	D101040	18	480	117.11
	*6	D1406	D101060	4	180	375.65
	*8	D1408	D101080	4	72	859.19
	*10	D14010	D101100	2	-	2,342.32
	*12	D14012	D101120	2	-	3,398.13
<b>Female Adapter with Countersunk Plug HxFIPT</b>						
	†4 x 4	D8404	TBD	1	-	225.43
	†6 x 6	D8406	TBD	1	-	658.32
	†8 x 8	D8408	TBD	1	-	1,807.38
	†10 x 10	D84010	TBD	1	-	4,074.19
	†12 x 12	D84012	TBD	1	-	5,893.56
<b>Female Adapter with Raised Plug HxFIPT</b>						
	†4 x 4	D9404	TBD	1	-	192.24
	†6 x 6	D9406	TBD	1	-	602.98
	†8 x 8	D9408	TBD	1	-	1,661.12
	†10 x 10	D94010	TBD	1	-	3,388.23
	†12 x 12	D94012	TBD	1	-	4,950.97
<b>Threaded Plug - Raised</b>						
	*1 1/2 x 1 1/2	D1151	D106015	50	14000	18.72
	*2	D1152	D106020	50	9000	21.06
	*3	D1153	D106030	25	3125	37.47
	*4	D1154	D106040	36	1920	55.57
	*6	D1156	D106060	20	480	176.37
	*8	D1158	D106080	9	400	801.94
	*10	D11510	D106100	2	-	737.97
	*12	D11512	D106120	2	-	1,102.95
<b>Threaded Plug - Raised with Gasket</b>						
	*1 1/2 x 1 1/2	D1151G	Special Order	1	-	Priced on Demand
	*2 x 2	D1152G	Special Order	1	-	Priced on Demand
	*3	D1153G	Special Order	1	-	Priced on Demand
	*4	D1154G	Special Order	1	-	Priced on Demand
<b>Closest Flange (One Piece) Hub</b>						
	*4 x 3	D1803	D800422	25	500	93.11
	*4 x 4	D1804	D800040	25	600	130.69
<b>Closest Flange Flush (1 pc) Hub</b>						
	*4 x 3	D1803F	Special Order	1	-	Priced on Demand
	(Fits Over 3" pipe or Inside 4" pipe)					
<b>Closest Flange Flush with Knockout (1 pc) Hub</b>						
	*4 x 3	D1803FKO	D815422	25	500	171.32
	(Fits Over 3" pipe or Inside 4" pipe)					
<b>Closest Flange with 45 Degree Discharge Adjustable with Plastic Ring (Hub)</b>						
	*4 x 3	D1803-45PR	Special Order	1	-	Priced on Demand

\* Denotes Molded Fitting

† Denotes Assembled from Molded Components

Item	Size In Inches	Alt Part Number	Part Number	Box Qty	Crate Qty	List Price
<b>Fitting Cleanout (SxFIPT)</b>						
	*1 1/2 x 1 1/2	D1501	D105015	50	6250	25.29
	*2 x 2	D1502	D105020	50	4000	33.80
	*3	D1503	D105030	50	900	90.73
	*4	D1504	D105040	18	480	149.10
	*6	D1506	D105060	5	200	424.54
	*8	D1508	D105080	4	-	1,570.49
	*10	D15010	D105100	2	-	2,185.31
	*12	D15012	D105120	2	-	3,174.49
<b>Fitting Cleanout with Countersunk Plug (SxFIPT)</b>						
	†4 x 4	D8504	Special Order	1	-	Priced on Demand
	†6 x 6	D8506	Special Order	1	-	Priced on Demand
	†8 x 8	D8508	TBD	1	-	3,766.10
	†10 x 10	D85010	Special Order	1	-	Priced on Demand
	†12 x 12	D85012	TBD	1	-	6,037.46
<b>Fitting Cleanout with Raised Plug (SxFIPT)</b>						
	†1 1/2 x 1 1/2	D9501	D112015	50	5000	44.01
	†2 x 2	D9502	D112020	50	2500	54.86
	†3 x 3	D9503	D112030	25	900	128.24
	†4 x 4	D9504	D112040	10	480	204.62
	†6 x 6	D9506	D112060	4	180	600.94
	†8 x 8	D9508	TBD	1	-	3,203.20
	†10 x 10	D95010	TBD	1	-	3,473.18
	†12 x 12	D95012	TBD	1	-	5,075.05
<b>Threaded Plug - Countersunk</b>						
	*2	D1142	D110020	25	6000	68.05
	*3	D1143	D110030	50	3125	79.17
	*4	D1144	D110040	20	1800	92.45
	*6	D1146	D110060	20	-	127.62
	*8	D1148	D110080	8	-	905.64
	*10	D11410	D110100	2	-	1,396.74
	*12	D11412	D110120	3	-	1,426.30
	<b>Fit-Rite Adjustable Closet Flange</b>					
	*4	D1864	Special Order	1	-	Priced on Demand
	Supplied without gasketed closet flange shown					
<b>Closest Flange (One Piece) Spigot</b>						
	*4 x 3	D1823	D801422	25	600	125.85
	*4 x 4	D1824	D801040	25	600	207.42
<b>Closest Flange with Knockout (One Piece) Hub</b>						
	*4 x 3	D1803KO	D810422	25	500	107.10
	*4 x 4	D1804KO	Special Order	1	-	Priced on Demand
<b>Closest Flange Adjustable with Plastic Ring (Hub)</b>						
	*4 x 3	D1803PR	Special Order	1	-	Priced on Demand
<b>Closest Flange Adjustable with Plastic Ring and Knockout (Hub)</b>						
	*4 x 3	D1803KOPR	Special Order	1	-	Priced on Demand

• Additional Sizes Available Upon Request

• Non-Stock items are non-cancelable, non-returnable

Item	Size In Inches	Alt Part Number	Part Number	Box Qty	Crate Qty	List Price
<b>Saddle Tee with Stainless Steel Clamps</b>						
<b>Solvent Skirt x Solvent DWV Inlet</b>						
	6 x 4	D2106-4	TBD	1	-	248.47
	8 x 4	D2108-4	TBD	1	-	351.16
	8 x 6	D2108-6	TBD	1	-	361.53
	10 x 4	D2110-4	Special Order	1	-	Priced on Demand
	10 x 6	D2110-6	Special Order	1	-	Priced on Demand
	10 x 8	D2110-8	Special Order	1	-	Priced on Demand
	12 x 4	D2112-4	TBD	1	-	533.93
	12 x 6	D2112-6	TBD	1	-	620.57
	12 x 8	D2112-8	Special Order	1	-	Priced on Demand
	12 x 10	D2112-10	Special Order	1	-	Priced on Demand
	14 x 4	D2114-4	Special Order	1	-	Priced on Demand
	14 x 6	D2114-6	Special Order	1	-	Priced on Demand
	14 x 8	D2114-8	Special Order	1	-	Priced on Demand
	14 x 10	D2114-10	Special Order	1	-	Priced on Demand
	14 x 12	D2114-12	Special Order	1	-	Priced on Demand
	16 x 4	D2116-4	Special Order	1	-	Priced on Demand
	16 x 6	D2116-6	Special Order	1	-	Priced on Demand
	16 x 8	D2116-8	Special Order	1	-	Priced on Demand
	16 x 10	D2116-10	Special Order	1	-	Priced on Demand
	16 x 12	D2116-12	Special Order	1	-	Priced on Demand
	16 x 14	D2116-14	Special Order	1	-	Priced on Demand
	18 x 4	D2118-4	TBD	1	-	942.00
	18 x 6	D2118-6	Special Order	1	-	Priced on Demand
	18 x 8	D2118-8	Special Order	1	-	Priced on Demand
	18 x 10	D2118-10	TBD	1	-	2,488.73
	18 x 12	D2118-12	Special Order	1	-	Priced on Demand
	18 x 14	D2118-14	Special Order	1	-	Priced on Demand
	18 x 16	D2118-16	Special Order	1	-	Priced on Demand
	20 x 4	D2120-4	Special Order	1	-	Priced on Demand
	20 x 6	D2120-6	Special Order	1	-	Priced on Demand
	20 x 8	D2120-8	Special Order	1	-	Priced on Demand
	20 x 10	D2120-10	Special Order	1	-	Priced on Demand
	20 x 12	D2120-12	Special Order	1	-	Priced on Demand
	20 x 14	D2120-14	Special Order	1	-	Priced on Demand
20 x 16	D2120-16	Special Order	1	-	Priced on Demand	
20 x 18	D2120-18	Special Order	1	-	Priced on Demand	
24 x 4	D2124-4	Special Order	1	-	Priced on Demand	
24 x 6	D2124-6	Special Order	1	-	Priced on Demand	
24 x 8	D2124-8	Special Order	1	-	Priced on Demand	
24 x 10	D2124-10	Special Order	1	-	Priced on Demand	
24 x 12	D2124-12	Special Order	1	-	Priced on Demand	
24 x 14	D2124-14	Special Order	1	-	Priced on Demand	
24 x 16	D2124-16	Special Order	1	-	Priced on Demand	
24 x 18	D2124-18	Special Order	1	-	Priced on Demand	
24 x 20	D2124-20	Special Order	1	-	Priced on Demand	

Item	Size In Inches	Alt Part Number	Part Number	Box Qty	Crate Qty	List Price
<b>Saddle Wye with Stainless Steel Clamps</b>						
<b>Solvent Skirt x Solvent DWV Inlet</b>						
	6 x 4	D2306-4	TBD	1	-	267.02
	8 x 4	D2308-4	TBD	1	-	377.42
	8 x 6	D2308-6	TBD	1	-	388.69
	10 x 4	D2310-4	TBD	1	-	475.71
	10 x 6	D2310-6	TBD	1	-	554.33
	10 x 8	D2310-8	Special Order	1	-	Priced on Demand
	12 x 4	D2312-4	TBD	1	-	574.02
	12 x 6	D2312-6	TBD	1	-	667.41
	12 x 8	D2312-8	TBD	1	-	1,753.44
	12 x 10	D2312-10	Special Order	1	-	Priced on Demand
	14 x 4	D2314-4	Special Order	1	-	Priced on Demand
	14 x 6	D2314-6	TBD	1	-	729.18
	14 x 8	D2314-8	TBD	1	-	1,794.87
	14 x 10	D2314-10	Special Order	1	-	Priced on Demand
	14 x 12	D2314-12	Special Order	1	-	Priced on Demand
	16 x 4	D2316-4	Special Order	1	-	Priced on Demand
	16 x 6	D2316-6	TBD	1	-	778.22
	16 x 8	D2316-8	TBD	1	-	1,835.82
	16 x 10	D2316-10	TBD	1	-	2,183.74
	16 x 12	D2316-12	TBD	1	-	2,222.53
	16 x 14	D2316-14	Special Order	1	-	Priced on Demand
	18 x 4	D2318-4	Special Order	1	-	Priced on Demand
	18 x 6	D2318-6	TBD	1	-	1,081.02
	18 x 8	D2318-8	TBD	1	-	2,397.60
	18 x 10	D2318-10	Special Order	1	-	Priced on Demand
	18 x 12	D2318-12	TBD	1	-	3,208.87
	18 x 14	D2318-14	Special Order	1	-	Priced on Demand
	18 x 16	D2318-16	Special Order	1	-	Priced on Demand
	20 x 4	D2320-4	Special Order	1	-	Priced on Demand
	20 x 6	D2320-6	Special Order	1	-	Priced on Demand
	20 x 8	D2320-8	Special Order	1	-	Priced on Demand
	20 x 10	D2320-10	Special Order	1	-	Priced on Demand
	20 x 12	D2320-12	Special Order	1	-	Priced on Demand
	20 x 14	D2320-14	Special Order	1	-	Priced on Demand
20 x 16	D2320-16	Special Order	1	-	Priced on Demand	
20 x 18	D2320-18	Special Order	1	-	Priced on Demand	
24 x 4	D2324-4	Special Order	1	-	Priced on Demand	
24 x 6	D2324-6	Special Order	1	-	Priced on Demand	
24 x 8	D2324-8	Special Order	1	-	Priced on Demand	
24 x 10	D2324-10	Special Order	1	-	Priced on Demand	
24 x 12	D2324-12	Special Order	1	-	Priced on Demand	
24 x 14	D2324-14	Special Order	1	-	Priced on Demand	
24 x 16	D2324-16	Special Order	1	-	Priced on Demand	
24 x 18	D2324-18	Special Order	1	-	Priced on Demand	
24 x 20	D2324-20	Special Order	1	-	Priced on Demand	

<b>Skirt Gasket for Saddle Tee</b>						
	4" Inlet	G5004	-	6	-	43.02
	6" Inlet	G5006	-	4	-	56.37

<b>Skirt Gasket for Saddle Wye</b>						
	4" Inlet	G5054	-	6	-	48.03
	6" Inlet	G5056	-	4	-	64.52

<b>Stainless Steel Clamp (Standard) 9/16" Width</b>						
	6-8	100-140-9	-	1	-	50.35
	10-12	100-230-9	-	1	-	69.48

Not to exceed 100 in/lb torque

\* Denotes Molded Fitting  
† Denotes Assembled from Molded Components

• Additional Sizes Available Upon Request  
• Non-Stock items are non-cancelable, non-returnable



## Rigid PVC Conduit Fittings and Accessories (E-Series)

Injection Molded in Sizes 1/2" - 6"





Westlake Pipe & Fittings offers a complete line of rigid PVC conduit fittings. Westlake Pipe & Fittings non-metallic conduit and fittings are certified by the CSA and UL where applicable, for use in above and below ground applications.





Westlake Pipe & Fittings rigid PVC conduit systems are used in non-burial applications, encased in concrete, concealed in walls and direct burial applications:

- Utilities
- Cable, data and communication lines
- Institutional, commercial, industrial buildings
- Residential applications, including service entrances
- Street and highway underground feeds
- Transportation systems - subways, bridges, tunnels, airports
- Water and wastewater treatment plants
- Marinas
- Mines and mills

Item	Size In Inches	Part Number	Box Qty	List Price
<b>Coupling HxH</b>				
	1/2	E010050	200	98.81
	3/4	E010075	125	121.93
	1	E010100	70	187.82
	1 1/4	E010125	40	250.43
	1 1/2	E010150	30	349.47
	2	E010200	40	454.83
	2 1/2	E010250	20	801.10
	3	E010300	40	1,324.91
	3 1/2	E010350	30	1,464.83
	4	E010400	20	2,043.71
5	E010500	10	5,172.40	
6	E010600	8	6,613.19	
8	E010800	3	21,647.71	

Item	Size In Inches	Part Number	Box Qty	List Price
<b>Bell End Coupling HxS</b>				
	1/2	E070050	100	1,170.66
	3/4	E070075	100	1,301.34
	1	E070100	50	1,539.02
	1 1/4	E070125	50	1,880.20
	1 1/2	E070150	50	1,973.24
	2	E070200	40	2,815.13
	2 1/2	E070250	30	3,049.66
	3	E070300	50	3,282.04
	3 1/2	E070350	50	3,619.07
	4	E070400	50	3,905.36
5	E070500	25	6,149.27	
6	E070600	15	6,742.73	

Item	Size In Inches	Part Number	Box Qty	List Price
<b>Terminal Adapter HxMIPT</b>				
	1/2	E011050	200	131.43
	3/4	E011075	125	232.60
	1	E011100	70	293.46
	1 1/4	E011125	40	377.43
	1 1/2	E011150	30	455.16
	2	E011200	40	654.23
	2 1/2	E011250	20	1,112.29
	3	E011300	40	1,629.61
	3 1/2	E011350	30	2,103.53
	4	E011400	20	2,797.07
5	E011500	10	5,505.10	
6	E011600	8	6,617.71	

Item	Size In Inches	Part Number	Box Qty	List Price
<b>Service Entrance Fitting H</b>				
	1/2	E025050	10	3,367.19
	3/4	E025075	10	3,531.68
	1	E025100	20	4,162.60
	1 1/4	E025125	20	5,597.42
	1 1/2	E025150	20	6,759.71
	2	E025200	5	11,255.70
	2 1/2	E025250	5	57,168.43
	3	E025300	5	55,273.24
	3 1/2	E025350	5	155,252.14
	4	E025400	1	170,075.18

Item	Size In Inches	Part Number	Box Qty	List Price
<b>Solvent Weld End Cap H</b>				
	1/2	E026050	100	847.04
	3/4	E026075	100	930.14
	1	E026100	50	1,058.87
	1 1/4	E026125	25	1,346.94
	1 1/2	E026150	25	1,520.44
	2	E026200	50	2,600.20
	2 1/2	E026250	25	5,672.42
	3	E026300	25	5,926.02
	3 1/2	E026350	25	9,052.62
	4	E026400	25	12,347.96
5	E026500	25	14,334.31	
6	E026600	10	15,447.90	
8	E026800	6	82,378.68	









Item	Size In Inches	Part Number	Box Qty	List Price
<b>Expansion Joint Coupling HxH</b>				
	1/2	E016050	25	16,956.90
	3/4	E016075	10	17,579.02
	1	E016100	10	17,480.17
	1 1/4	E016125	5	17,657.49
	1 1/2	E016150	5	17,919.87
	2	E016200	25	19,218.40
	2 1/2	E016250	12	26,654.90
	3	E016300	12	33,740.30
	3 1/2	E016350	6	41,650.51
	4	E016400	6	49,421.38
5	E016500	1	75,603.92	
6	E016600	1	102,246.72	







Item	Size In Inches	Part Number	Box Qty	List Price
<b>Expansion Joint w/Terminal Adapter HxFIPT</b>				
	2	E016200TA	4	64,864.44
	2 1/2	E016250TA	8	98,971.96
	3	E016300TA	8	101,224.66
	4	E016400TA	8	152,331.58

Item	Size In Inches	Part Number	Box Qty	List Price
<b>Female Adapter (NPT Tapered Thread) HxFIPT</b>				
	1/2	E012050	200	149.61
	3/4	E012075	125	247.78
	1	E012100	70	335.01
	1 1/4	E012125	40	448.17
	1 1/2	E012150	30	476.59
	2	E012200	40	649.17
	2 1/2	E012250	20	1,440.44
	3	E012300	40	1,797.51
	3 1/2	E012350	30	2,352.20
	4	E012400	20	2,410.06
5	E012500	10	5,994.36	
6	E012600	8	7,913.11	

Item	Size In Inches	Part Number	Box Qty	List Price
<b>Junction Box Adapters HxFlange</b>				
	1/2	E059050	100	547.18
	3/4	E059075	100	543.02
	1	E059100	100	587.82
	1 1/4	E059125	50	628.29
	1 1/2	E059150	50	641.87
	2	E059200	25	704.07
	2 1/2	E059250	10	2,916.32
	3	E059300	10	2,930.40
	3 1/2	E059350	10	3,217.03
	4	E059400	10	3,374.43

• List Price per 100 Units  
• Tested and Listed by CSA and UL

Item	Size In Inches	Part Number	Box Qty	List Price
<b>5 Degree Coupling HxH</b>				
	2	E013200	20	10,396.00
	2 1/2	E013250	12	10,054.38
	3	E013300	25	11,908.81
	3 1/2	E013350	15	12,630.47
	4	E013400	15	13,137.27
	5	E013500	8	15,587.26
	6	E013600	4	21,692.42
<b>5 Degree Coupling SxH</b>				
	2	E013200S	20	10,396.00
	2 1/2	E013250S	12	10,054.38
	3	E013300S	25	11,908.81
	3 1/2	E013350S	15	12,630.47
	4	E013400S	15	13,137.27
	5	E013500S	8	15,587.26
	6	E013600S	4	21,692.42
<b>Universal Plug w/Pull Tab Polyethylene</b>				
	2	E091200	70	1,006.12
	3	E091300	45	1,481.94
	4	E091400	80	1,565.02
	5	E091500	45	2,090.23
	6	E091600	35	2,587.88
<b>Strain Relief Connector</b>				
	3/4	E030075	25	7,264.49
<b>Pull Elbow HxH</b>				
	1/2	E027050	75	4,164.44
	3/4	E027075	50	4,609.92
<b>Meter Offset HxMIPT</b>				
	1 1/4	E024125	15	4,681.91
	2	E024200	8	4,985.33
<b>Octagonal Box with Cover and Knockout Plugs</b>				
	4 x 1 1/2 (3/4 x 1/2)	E028150	20	8,932.47
	4 x 2 (1)	E028200	12	9,147.17
<b>Octagonal Box Extension Ring</b>				
	1	E029100	20	3,326.66
	2	E029200	20	3,893.26
<b>Junction Box with Gasket (Self-Tapping Screws)</b>				
	4 x 4 x 2	E051442	10	6,716.42
	4 x 4 x 4	E051444	10	11,079.34
	4 x 4 x 6	E051446	10	12,580.32
	5 x 5 x 2	E051552	10	13,305.63
	6 x 6 x 4	E051664	10	13,563.11
	6 x 6 x 6	E051666	5	15,826.60
	8 x 8 x 4	E051884	5	25,588.90
	8 x 8 x 7	E051887	4	37,695.88
	12 x 12 x 4	E05112124	2	38,699.02
	12 x 12 x 6	E05112126	2	39,998.37
	12 x 12 x 8	E05112128	3	61,732.72

Item	Size In Inches	Part Number	Box Qty	List Price
<b>Reducer Bushing SxH</b>				
	3/4 x 1/2	E0140705	100	673.31
	1 x 1/2	E0141005	300 †	1,518.30
	1 x 3/4	E0141007	100	1,551.96
	1 1/4 x 3/4	E0141207	50 ^	1,989.33
	1 1/4 x 1	E0141210	50	2,020.30
	1 1/2 x 1	E0141510	50	2,158.10
	1 1/2 x 1 1/4	E0141512	50	2,056.97
	2 x 1	E0142010	50	2,458.87
	2 x 1 1/4	E0142012	25	2,512.79
	2 x 1 1/2	E0142015	25	2,506.28
	2 1/2 x 2	E0142520	25	8,260.21
	3 x 2	E0143020	25	9,290.18
	3 x 2 1/2	E0143025	25	9,949.49
	4 x 2	E0144020	15	10,961.16
	4 x 3	E0144030	20	11,043.64
4 3/4	E0144035	20	11,782.49	
† = 20/bag    ^ = 5/bag				
<b>Threaded Reducer Bushing SxFIPT</b>				
	3/4 x 1/2	E0150705	200	2,470.59
	1 x 1/2	E0151005	200	3,688.28
	1 x 3/4	E0151007	200	2,969.87
<b>Threaded Strain Relief Connector</b>				
	1/2	E031050	25	7,264.49
	3/4	E031075	25	7,264.49
<b>Pipe Strap PVC - 2 Hole</b>				
	1/2	E039050	300	185.42
	3/4	E039075	200	219.61
	1	E039100	200	279.98
	1 1/4	E039125	200	303.01
	1 1/2	E039150	200	355.90
	2	E039200	200	447.49
<b>Duplex Floor Box</b>				
	3/4 (4)	E068004	9	14,061.58
	3/4 (2) x 1 (2)	E068001	9	14,061.58
Includes Reducer Bushings, Leveling Ring and Pour Cover				
<b>Duplex Floor Box Cover</b>				
	Poly Bronze Cover	E068003	10	17,570.82
<b>Junction Box with Gasket (Brass Screws and Inserts)</b>				
	4 x 4 x 2	E551442	15	7,786.60
	4 x 4 x 4	E551444	10	12,593.32
	4 x 4 x 6	E551446	8	12,783.40
	5 x 5 x 2	E551552	12	14,528.50
	6 x 6 x 4	E551664	15	23,345.34
	6 x 6 x 6	E551666	4	27,576.38
	8 x 8 x 4	E551884	4	36,417.40
	8 x 8 x 7	E551887	4	48,244.38
	12 x 12 x 4	E55112124	2	71,135.93
	12 x 12 x 6	E55112126	4	82,533.43
	12 x 12 x 8	E55112128	3	91,695.93

• List Price per 100 Units  
• Tested and Listed by CSA and UL

Item	Size In Inches	Part Number	Box Qty	List Price
<b>Access Fitting Type C (Self-Tapping Screws)</b>				
	1/2	E032050	25	2,085.20
	3/4	E032075	15	3,036.39
	1	E032100	10	3,299.64
	1 1/4	E032125	10	5,020.40
	1 1/2	E032150	10	5,384.82
	2	E032200	5	9,528.01
	2 1/2	E032250	5	39,767.47
	3	E032300	5	44,300.59
	3 1/2	E032350	4	45,443.90
4	E032400	4	47,710.53	

Item	Size In Inches	Part Number	Box Qty	List Price
<b>Access Fitting Type LB (Self-Tapping Screws)</b>				
	1/2	E033050	25	2,007.58
	3/4	E033075	15	2,576.47
	1	E033100	10	2,836.20
	1 1/4	E033125	10	4,311.36
	1 1/2	E033150	10	5,185.29
	2	E033200	5	9,175.07
	2 1/2	E033250	5	33,321.16
	3	E033300	5	34,425.94
	3 1/2	E033350	4	36,903.73
4	E033400	4	37,765.72	

Item	Size In Inches	Part Number	Box Qty	List Price
<b>Access Fitting Type LL (Self-Tapping Screws)</b>				
	1/2	E034050	25	2,056.00
	3/4	E034075	15	2,894.76
	1	E034100	10	3,130.93
	1 1/4	E034125	10	4,588.53
	1 1/2	E034150	10	5,384.82
	2	E034200	5	9,245.23
	2 1/2	E034250	5	39,767.47
	3	E034300	5	44,307.26
	3 1/2	E034350	4	45,443.90
4	E034400	4	47,710.53	

Item	Size In Inches	Part Number	Box Qty	List Price
<b>Access Fitting Type LR (Self-Tapping Screws)</b>				
	1/2	E035050	25	2,056.00
	3/4	E035075	15	2,894.77
	1	E035100	10	3,130.96
	1 1/4	E035125	10	4,588.53
	1 1/2	E035150	10	5,384.82
	2	E035200	5	9,245.21
	2 1/2	E035250	5	39,767.50
	3	E035300	5	44,307.26
	3 1/2	E035350	4	45,443.87
4	E035400	4	47,710.53	

Item	Size In Inches	Part Number	Box Qty	List Price
<b>Access Fitting Type E (Self-Tapping Screws)</b>				
	1/2	E036050	25	2,098.62
	3/4	E036075	15	3,050.00
	1	E036100	10	3,194.64
	1 1/4	E036125	10	4,507.60
	1 1/2	E036150	10	5,384.82
	2	E036200	5	9,528.01
	2 1/2	E036250	5	34,769.48
	3	E036300	5	35,806.24
	3 1/2	E036350	4	40,784.07
4	E036400	4	42,246.53	

Item	Size In Inches	Part Number	Box Qty	List Price
<b>Access Fitting Type T (Self-Tapping Screws)</b>				
	1/2	E037050	25	2,589.58
	3/4	E037075	15	3,171.10
	1	E037100	10	3,304.77
	1 1/4	E037125	10	5,384.82
	1 1/2	E037150	10	7,092.02
	2	E037200	5	10,073.34
	2 1/2	E037250	2	39,767.47
	3	E037300	2	44,307.26
	3 1/2	E037350	1	45,443.90
4	E037400	1	47,710.53	

Item	Size In Inches	Part Number	Box Qty	List Price
<b>Access Fitting Type C (Brass Screws and Inserts)</b>				
	1/2	E532050	30	2,576.00
	3/4	E532075	20	3,536.13
	1	E532100	15	3,756.14
	1 1/4	E532125	15	6,221.03
	1 1/2	E532150	10	7,548.08
	2	E532200	15	12,921.21
	2 1/2	E532250	4	42,478.62
	3	E532300	4	47,253.16
	3 1/2	E532350	4	48,706.67
4	E532400	4	50,160.24	

Item	Size In Inches	Part Number	Box Qty	List Price
<b>Access Fitting Type LB (Brass Screws and Inserts)</b>				
	1/2	E533050	25	2,576.00
	3/4	E533075	25	3,536.13
	1	E533100	15	3,756.14
	1 1/4	E533125	20	6,221.03
	1 1/2	E533150	10	7,548.08
	2	E533200	15	12,921.21
	2 1/2	E533250	5	42,478.62
	3	E533300	5	47,253.16
	3 1/2	E533350	5	48,706.67
4	E533400	5	50,160.24	

Item	Size In Inches	Part Number	Box Qty	List Price
<b>Access Fitting Type LL (Brass Screws and Inserts)</b>				
	1/2	E534050	25	2,576.00
	3/4	E534075	20	3,536.13
	1	E534100	15	3,756.14
	1 1/4	E534125	10	6,221.03
	1 1/2	E534150	10	7,548.08
	2	E534200	10	12,921.21
	2 1/2	E534250	4	42,478.62
	3	E534300	4	47,253.16
	3 1/2	E534350	5	48,706.67
4	E534400	5	50,160.24	

Item	Size In Inches	Part Number	Box Qty	List Price
<b>Access Fitting Type LR (Brass Screws and Inserts)</b>				
	1/2	E535050	25	2,576.00
	3/4	E535075	20	3,536.13
	1	E535100	15	3,756.14
	1 1/4	E535125	10	6,221.03
	1 1/2	E535150	10	7,548.08
	2	E535200	10	12,921.21
	2 1/2	E535250	4	42,478.62
	3	E535300	4	47,253.16
	3 1/2	E535350	5	48,706.67
4	E535400	5	50,160.24	

Item	Size In Inches	Part Number	Box Qty	List Price
<b>Access Fitting Type E (Brass Screws and Inserts)</b>				
	1/2	E536050	30	2,743.46
	3/4	E536075	20	3,766.01
	1	E536100	15	4,000.31
	1 1/4	E536125	20	6,625.40
	1 1/2	E536150	10	8,038.71
	2	E536200	15	14,206.18
	2 1/2	E536250	4	45,239.73
	3	E536300	4	50,324.59
	3 1/2	E536350	4	51,872.61
4	E536400	4	53,420.71	

Item	Size In Inches	Part Number	Box Qty	List Price
<b>Access Fitting Type T (Brass Screws and Inserts)</b>				
	1/2	E537050	30	3,025.57
	3/4	E537075	20	4,083.91
	1	E537100	25	4,340.32
	1 1/4	E537125	15	7,188.57
	1 1/2	E537150	10	8,722.02
	2	E537200	10	15,413.73
	2 1/2	E537250	4	49,085.11
	3	E537300	4	54,602.16
	3 1/2	E537350	4	56,281.78
4	E537400	4	57,961.46	

• List Price per 100 Units  
• Tested and Listed by CSA and UL

Item	Size In Inches	Part Number	Box Qty	List Price
<b>Access Fitting Type TB (Self-Tapping Screws)</b>				
	1/2	E069050	30	4,220.27
	3/4	E069075	20	4,713.92
	1	E069100	10	4,894.54
	1 1/4	E069125	10	6,413.64
	1 1/2	E069150	15	9,072.66
	2	E069200	10	11,805.87
	2 1/2	E069250	10	28,123.96
	3	E069300	4	29,121.43
3 1/2	E069350	4	38,909.03	
4	E069400	4	39,665.38	

<b>Single Gang Cover Plate F Series (Self-Tapping Screws)</b>				
	A. Toggle	E046002	100	2,346.60
	B. Duplex	E046001	100	2,346.60
	C. 15 Amp	E046004	100	2,346.60
	D. 20 Amp	E046003	100	2,346.60
	E. 30 Amp	E046005	100	2,346.60
	F. Blank w/ Gasket	E046006	50	4,536.08

<b>Single Gang Weatherproof Cover Plate (Self-Tapping Screws)</b>				
	A. Toggle w/ Cover	E047002	10	5,897.76
	B. Plunger w/ Cover	E047008	10	7,676.46
	C. Toggle	E047009	10	6,721.58
	D. Duplex	E047001	10	6,422.01
	D. Duplex White	E047010	20	6,422.01
	E. Ground Fault	E047007	10	6,871.36
	E. Ground Fault White	E047011	20	6,871.36
	F. 15 Amp	E047003	10	7,929.21
	F. 20 Amp	E047004	10	11,320.47
F. 30 Amp	E047005	10	11,320.47	
F. 50 Amp	E047006	10	13,311.12	

<b>Double Gang Weatherproof Cover Plate (Self-Tapping Screws)</b>				
	B. GFI & Toggle	E049005	10	9,408.36
	C. Duplex & Toggle	E049006	10	9,592.81
	D. Double Duplex	E049007	10	9,134.97
	E. Double Toggle	E049008	10	10,957.78
	F. Blank w/ Gasket	E049009	25	5,194.77

<b>Single Gang Box F Series (For Self-Tapping Screws)</b>				
	A. 1/2 FS	E042001	10	5,403.40
	A. 3/4 FS	E042002	10	5,678.23
	B. 1/2 FSS	E042003	10	5,787.38
	B. 3/4 FSS	E042004	10	6,209.33
	C. 1/2 FSC	E042005	10	5,678.23
	C. 3/4 FSC	E042006	10	6,209.33
	D. 1/2 FSCC	E042007	10	6,211.80
	D. 3/4 FSCC	E042008	10	7,032.98

Item	Size In Inches	Part Number	Box Qty	List Price
<b>Access Fitting Type TB (Brass Screws and Inserts)</b>				
	1/2	E569050	30	4,747.79
	3/4	E569075	20	5,303.18
	1	E569100	10	5,506.36
	1 1/4	E569125	10	13,243.70
	1 1/2	E569150	15	14,081.12
	2	E569200	10	17,857.39
	2 1/2	E569250	10	31,639.47
	3	E569300	4	32,761.62
3 1/2	E569350	4	43,770.82	
4	E569400	4	44,623.57	

<b>Single Gang Cover Plate F Series (Brass Screws)</b>				
	A. Toggle	E546002	100	2,522.61
	B. Duplex	E546001	100	2,522.61
	C. 15 Amp	E546004	100	2,522.61
	D. 20 Amp	E546003	100	2,522.61
	E. 30 Amp	E546005	100	2,522.61
	F. Blank w/ Gasket	E546006	100	4,876.32

<b>Single Gang Weatherproof Cover Plate (Brass Screws)</b>				
	A. Toggle w/ Cover	E547002	20	6,340.10
	B. Plunger w/ Cover	E547008	20	8,252.20
	C. Toggle	E547009	20	7,225.69
	D. Duplex	E547001	20	6,903.66
	D. Duplex White	E547010	20	6,903.66
	E. Ground Fault	E547007	20	7,386.73
	E. Ground Fault White	E547011	20	7,386.73
	F. 15 Amp	E547003	20	8,523.90
	F. 20 Amp	E547004	20	12,169.53
F. 30 Amp	E547005	20	12,169.53	
F. 50 Amp	E547006	20	14,309.47	

<b>Double Gang Weatherproof Cover Plate (Brass Screws)</b>				
	B. GFI & Toggle	E549005	10	10,113.96
	C. Duplex & Toggle	E549006	10	10,312.29
	D. Double Duplex	E549007	10	9,820.08
	E. Double Toggle	E549008	10	11,779.61
	F. Blank w/ Gasket	E549009	25	5,584.38

<b>Single Gang Box with Gasket F Series (With Brass Inserts)</b>				
	A. 1/2 FS	E542001	10	6,078.82
	A. 3/4 FS	E542002	10	6,388.01
	B. 1/2 FSS	E542003	10	6,510.77
	B. 3/4 FSS	E542004	10	6,985.49
	C. 1/2 FSC	E542005	10	6,388.01
	C. 3/4 FSC	E542006	10	6,985.50
	D. 1/2 FSCC	E542007	10	6,988.28
	D. 3/4 FSCC	E542008	10	7,912.10

Item	Size In Inches	Part Number	Box Qty	List Price	
<b>Single Gang Deep Box FD Series (For Self-Tapping Screws)</b>					
A.	B.	A. 1/2 FDS	E043001	10	5,673.13
	A. 3/4 FDS	E043002	10	5,673.13	
C.	A. 1 FDS	E043003	10	5,673.13	
	B. 1/2 FDC	E043004	10	5,759.34	
	B. 3/4 FDC	E043005	10	5,759.34	
	B. 1 FDC	E043006	10	5,759.34	
	C. Blank	E043007	10	5,736.93	

Item	Size In Inches	Part Number	Box Qty	List Price	
<b>Double Gang Box F Series (For Self-Tapping Screws)</b>					
A.	B.	A. 1/2 FS	E041001	5	7,712.66
	A. 3/4 FS	E041002	5	7,712.66	
C.	A. 1 FS	E041003	5	7,712.66	
	B. 1/2 FSS	E041004	5	9,258.71	
D.	B. 3/4 FSS	E041005	5	9,258.71	
	B. 1 FSS	E041006	5	9,258.71	
E.	C. 1/2 FSC	E041007	5	7,858.04	
	C. 3/4 FSC	E041008	5	7,858.04	
	C. 1 FSC	E041009	5	7,858.04	
	D. 1/2 FSCC	E041011	5	9,258.71	
	D. 3/4 FSCC	E041012	5	9,258.71	
	D. 1 FSCC	E041013	5	9,258.71	
	E. Blank	E041010	5	8,127.57	

Item	Size In Inches	Part Number	Box Qty	List Price
<b>Duct Spacer Intermediate Vertical Lock Spacer</b>				
	2 x 1 1/2	IS2015	350	816.81
	2 x 2	IS2020	300	842.88
	2 x 3	IS2030	200	921.46
	3 x 1 1/2	IS3015	225	870.89
	3 x 2	IS3020	200	989.51
	3 x 3	IS3030	125	1,065.23
	4 x 1	IS4010	200	817.47
	4 x 1 1/2	IS4015	150	943.26
	4 x 2	IS4020	125	1,024.07
	4 x 3	IS4030	90	1,187.27
	5 x 1 1/2	IS5015	100	1,090.77
	5 x 2	IS5020	100	1,195.94
	5 x 3	IS5030	80	1,349.76
	6 x 1 1/2	IS6015	100	1,202.94
	6 x 2	IS6020	90	1,494.89
	6 x 3	IS6030	70	2,046.53
8 x 1 1/2	IS8015	60	3,447.86	
8 x 2	IS8020	60	3,648.50	

Item	Size In Inches	Part Number	Box Qty	List Price	
<b>Single Gang Deep Box with Gasket FD Series (With Brass Inserts)</b>					
A.	B.	A. 1/2 FDS	E543001	10	6,524.16
	A. 3/4 FDS	E543002	10	6,524.16	
C.	A. 1 FDS	E543003	10	6,524.16	
	B. 1/2 FDC	E543004	10	6,623.24	
	B. 3/4 FDC	E543005	10	6,623.24	
	B. 1 FDC	E543006	10	6,623.24	
	C. Blank	E543007	10	7,615.76	
	C. 3/4 Volt	E543008	10	7,615.76	

Item	Size In Inches	Part Number	Box Qty	List Price	
<b>Double Gang Box with Gasket F Series (With Brass Inserts)</b>					
A.	B.	A. 1/2 FS	E541001	10	8,869.53
	A. 3/4 FS	E541002	10	8,869.53	
C.	A. 1 FS	E541003	10	8,869.53	
	B. 1/2 FSS	E541004	10	10,647.50	
D.	B. 3/4 FSS	E541005	10	10,647.50	
	B. 1 FSS	E541006	10	10,647.50	
E.	C. 1/2 FSC	E541007	10	9,036.72	
	C. 3/4 FSC	E541008	10	9,036.72	
	C. 1 FSC	E541009	10	9,036.72	
	D. 1/2 FSCC	E541011	10	10,647.50	
	D. 3/4 FSCC	E541012	10	10,647.50	
	D. 1 FSCC	E541013	10	10,647.50	
	E. Blank	E541010	10	9,346.67	

Item	Size In Inches	Part Number	Box Qty	List Price
<b>Duct Spacer Base Vertical Lock Spacer</b>				
	2 x 1 1/2	BS2015	250	850.87
	2 x 2	BS2020	225	877.90
	2 x 3	BS2030	225	959.82
	3 x 1 1/2	BS3015	175	907.10
	3 x 2	BS3020	155	1,030.66
	3 x 3	BS3030	150	1,109.61
	4 x 1	BS4010	175	851.54
	4 x 1 1/2	BS4015	140	982.39
	4 x 2	BS4020	140	1,066.66
	4 x 3	BS4030	120	1,236.64
	5 x 1 1/2	BS5015	120	1,136.31
	5 x 2	BS5020	120	1,245.94
	5 x 3	BS5030	100	1,406.00
	6 x 1 1/2	BS6015	100	1,253.07
	6 x 2	BS6020	100	1,557.10
	6 x 3	BS6030	95	2,093.18
8 x 1 1/2	BS8015	50	3,626.53	
8 x 2	BS8020	50	3,837.60	

- List Price per 100 Units
- Tested and Listed by CSA and UL

## ENT Fittings (E-Series)

Injection Molded in Sizes 1/2" - 6"

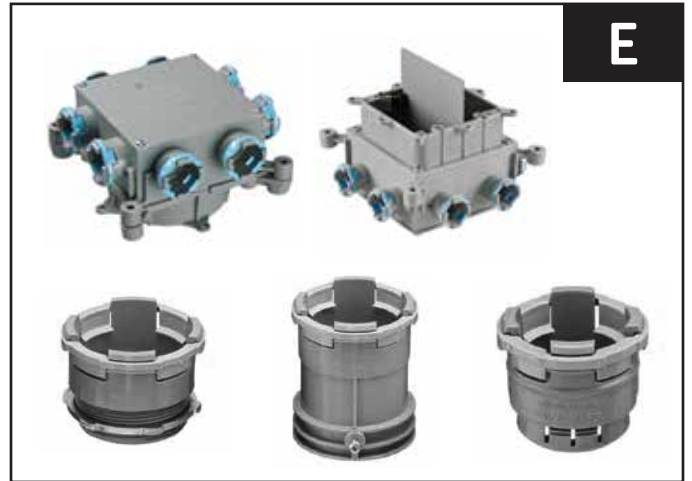



Westlake Pipe & Fittings offers a complete line of ENT fittings. Westlake Pipe & Fittings non-metallic flexible tubing and fittings are certified by the CSA and UL.





Westlake Pipe & Fittings ENT systems are used in walls, floors, non-plenum ceilings and other general purpose applications.

- Residential dwellings
- Commercial buildings
- Industrial buildings
- Fire alarm systems
- Recreational vehicles
- Marinas and boat yards
- Institutions
- Solar voltaic systems

Item	Size In Inches	Part Number	Box Qty	List Price
<b>ENT Shallow Slab Box</b>				
	1/2 (8)	RSMB-S-H-10	25	11,842.69
	1/2 (4) 3/4 (4)	RSMB-S-H-10-15	25	12,251.04
	1/2 (4) 3/4 (2) 1 (2)	RSMB-S-H-10-15-20	25	13,067.83
	1/2 (4) 1 (4)	RSMB-S-H-10-20	25	12,856.94
	3/4 (8)	RSMB-S-H-15	25	12,659.48
	3/4 (4) 1 (4)	RSMB-S-H-15-20	25	13,067.83

Item	Size In Inches	Part Number	Box Qty	List Price
<b>ENT Shallow Single Gang Concrete Wall Box</b>				
	1/2	RSVSB-H-10	70	6,494.00
	3/4	RSVSB-H-15	70	6,594.59
	1	RSVSB-H-20	70	7,194.20

Item	Size In Inches	Part Number	Box Qty	List Price
<b>ENT Square Slab Box</b>				
	1/2 (8)	RSSB-H-10	25	14,393.26
	1/2 (4) 3/4 (4)	RSSB-H-10-15	25	14,889.62
	1/2 (4) 3/4 (2) 1 (2)	RSSB-H-10-15-20	25	15,882.10
	1/2 (4) 1 (4)	RSSB-H-10-20	25	15,795.33
	3/4 (8)	RSSB-H-15	25	15,708.57
	3/4 (4) 1 (4)	RSSB-H-15-20	25	15,882.17
	Divider Plate Sold separately		RSSB-H-DC	10

Item	Size In Inches	Part Number	Box Qty	List Price
<b>ENT Slab Box with Hub Extensions and Grey Lid</b>				
	1/2 (8)	RSMB-H-10	25	11,842.69
	1/2 (4) 3/4 (4)	RSMB-H-10-15	25	12,251.04
	1/2 (4) 3/4 (2) 1 (2)	RSMB-H-10-15-20	25	12,859.41
	1/2 (4) 1 (4)	RSMB-H-10-20	25	13,067.83
	3/4 (8)	RSMB-H-15	25	12,659.48
	3/4 (4) 1 (4)	RSMB-H-15-20	25	13,067.83

Lids may be color coded for service identification:  
Add Suffix: G (green), W (white), B (blue), Y (yellow), R (red)

Item	Size In Inches	Part Number	Box Qty	List Price
<b>ENT Coupling</b>				
	1/2	RKC10	150	580.47
	3/4	RKC15	100	669.84
	1	RKC20	50	1,361.48
	1 1/4	RKC25	50	3,757.99
	1 1/2	RKC30	40	4,175.49
	2	RKC35	25	4,639.53

Item	Size In Inches	Part Number	Box Qty	List Price
<b>EMT Adapter with Set Screw</b>				
	1/2	RKTC10	125	1,775.07
	3/4	RKTC15	100	2,141.98
	1	RKTC20	50	2,723.68
	1 1/4	RKTC25	50	3,648.06
	1 1/2	RKTC30	40	4,175.10
	2	RKTC35	15	5,366.79

Item	Size In Inches	Part Number	Box Qty	List Price
<b>ENT Clip Ring</b>				
	1/2	RKR10	200†	220.77
	3/4	RKR15	200†	239.19
	1	RKR20	200†	284.18
	1 1/4	RKR25	100*	463.28
	1 1/2	RKR30	100*	480.84
	2	RKR35	50^	709.12

† = 20/bag \* = 10/bag ^ = 5/bag

Item	Size In Inches	Part Number	Box Qty	List Price
<b>ENT Isolator Module Slab Box</b>				
	1/2 (8)	RSMB-10-IMB	20	13,619.07
	1/2 (4) 3/4 (4)	RSMB-10-15-IMB	20	14,088.68
	1/2 (4) 3/4 (2) 1 (2)	RSMB-10-15-20-IMB	20	15,027.98
	1/2 (4) 1 (4)	RSMB-10-20-IMB	20	14,785.49
	3/4 (8)	RSMB-15-IMB	20	14,558.38
	3/4 (4) 1 (4)	RSMB-15-20-IMB	20	15,027.98

Item	Size In Inches	Part Number	Box Qty	List Price
<b>ENT Deep Single Gang Concrete Wall Box</b>				
	1/2 (8)	RSVDB-H-10	25	16,516.12
	1/2 (4) 3/4 (4)	RSVDB-H-10-15	25	16,516.12
	1/2 (4) 3/4 (2) 1 (2)	RSVDB-H-10-15-20	25	16,516.12
	1/2 (4) 1 (4)	RSVDB-H-10-20	25	16,516.12
	3/4 (8)	RSVDB-H-15	25	16,516.12
	3/4 (4) 1 (4)	RSVDB-H-15-20	25	16,516.12

Item	Size In Inches	Part Number	Box Qty	List Price
<b>ENT Slab Box with Knockouts and Grey Lid</b>				
	1/2 (8)	RSMB-10	25	8,546.72
	1/2 (4) 3/4 (4)	RSMB-10-15	25	11,577.24
	1/2 (4) 3/4 (2) 1 (2)	RSMB-10-15-20	25	8,546.72
	1/2 (2) 3/4 (4) 1 (2)	RSMB-15-20-10	25	12,156.14
	3/4 (8)	RSMB-15	25	11,963.19
	3/4 (4) 1 (4)	RSMB-15-20	25	12,349.09

Lids may be color coded for service identification:  
Add Suffix: G (green), W (white), B (blue), Y (yellow), R (red)

Item	Size In Inches	Part Number	Box Qty	List Price
<b>ENT Threaded Terminal Adapter with Lock Nut</b>				
	1/2	RKTA10	150	620.28
	3/4	RKTA15	100	987.88
	1	RKTA20	50	2,285.50
	1 1/4	RKTA25	50	6,663.20
	1 1/2	RKTA30	50	7,403.46
	2	RKTA35	25	8,226.16

Item	Size In Inches	Part Number	Box Qty	List Price
<b>ENT Quick-Snap Terminal Adapter</b>				
	1/2	RKTS10	150	505.77
	3/4	RKTS15	100	1,117.79
	1	RKTS20	50	1,770.58

Item	Size In Inches	Part Number	Box Qty	List Price
<b>Heavy Duty Lock Nut</b>				
	1/2	RLN10	200	232.42
	3/4	RLN15	200	314.44
	1	RLN20	200	615.69
	1 1/4	RLN25	200	1,492.47
	1 1/2	RLN30	200	1,895.13
	2	RLN35	200	2,021.71

- List Price per 100 Units
- Tested and Listed by CSA and UL



Item	Size In Inches	Part Number	Box Qty	List Price
<b>Straight Stubby (Polyethylene)</b>				
	1/2	RECM10	150	2,161.77
	3/4	RECM15	150	2,330.10
	1	RECM20	200	2,401.78
	1 1/4	RECM25	200	2,713.07

Item	Size In Inches	Part Number	Box Qty	List Price
<b>Tapered Plug (Polyethylene)</b>				
	1/2	RTP10	250	456.14
	3/4	RTP15	100	476.81
	1	RTP20	100	704.88

Item	Size In Inches	Part Number	Box Qty	List Price
<b>45 Degree Angled Form Stubby (Polyethylene)</b>				
	1/2	RKASTB10	50	2,702.37
	3/4	RKASTB15	50	2,913.01
	1	RKASTB20	50	3,003.46
	1 1/4	RKASTB25	50	3,391.29
	1 1/2	RKASTB30	50	3,601.10
	2	RKASTB35	50	4,129.66

Item	Size In Inches	Part Number	Box Qty	List Price
<b>ENT Slab Box Extension Ring</b>				
	1 Extension	RSMBXTENSION	20	5,678.40





## Gasketed Sewer Fittings SDR 35 (G-Series)

Injection Molded in Sizes 4" – 12"  
Fabricated in Sizes 15" – 36"



Gasketed SDR 35 fittings feature a one-piece integral bell and an extended pre-alignment entrance that aids in proper alignment of pipe and fittings. In addition to scientifically formulated resins, square pipe stops resist pipe push-through while extra heavy support is provided under the pipe stop at branch intersections for added strength. Where available, reducing branches on injection molded 8", 10", and 12" tees, wyes, and tee-wyes shall be minimum DR18 wall thickness in the reducing branch body and reducing branch hub area below the gasket race.

### Applications

Gasketed Sewer fittings are intended for non-pressure drainage of sewage and surface water.

### Certification

Westlake Pipe & Fittings Gasketed Sewer fittings are third party tested and listed by NSF, UPC and CSA to meet specifications defined in ASTM D3034, ASTM F1336 and CSA B182.2, where applicable.

**Attention:** Westlake Pipe & Fittings are not to be used with compressed air or gases. Westlake Pipe & Fittings does not recommend that piping systems that include its products be tested with compressed air or gases.

Third Party Tested





Item	Size In Inches	Part Number	Box Qty	Crate Qty	List Price
<b>Straight Tee GxGxG</b>					
	*4 x 4	G104	12	-	86.74
	*6 x 4	G106-4	4	54	181.71
	*6 x 6	G106	4	50	185.75
	*8 x 4	G108-4	2	30	280.70
	*8 x 5	G108-5	2	30	348.74
	*8 x 6	G108-6	2	30	290.43
	*8 x 8	G108	2	13	412.16
	*10 x 4	G1010-4	2	12	912.01
	*10 x 5	G1010-5	1	11	919.59
	*10 x 6	G1010-6	1	10	927.41
	*10 x 8	G1010-8	1	10	1,467.53
	*10 x 10	G1010	1	10	1,506.53
	*12 x 4	G1012-4	1	8	1,115.13
	*12 x 5	G1012-5	1	8	1,145.10
	*12 x 6	G1012-6	1	8	1,175.27
	*12 x 8	G1012-8	1	7	1,612.93
	*12 x 10	G1012-10	1	7	1,891.19
	*12 x 12	G1012	1	6	2,164.72
	15 x 4	L1015-4	1	-	1,810.29
	15 x 6	L1015-6	1	-	1,949.74
	15 x 8	L1015-8	1	-	2,099.14
	15 x 10	L1015-10	1	-	2,336.88
	15 x 12	L1015-12	1	-	2,757.59
	15 x 15	L1015	1	-	3,581.56
	18 x 4	L1018-4	1	-	4,568.49
	18 x 6	L1018-6	1	-	4,723.31
	18 x 8	L1018-8	1	-	4,934.82
	18 x 10	L1018-10	1	-	5,124.72
	18 x 12	L1018-12	1	-	5,264.85
	18 x 15	L1018-15	1	-	5,606.94
	18 x 18	L1018	1	-	5,921.00
	21 x 4	L1021-4	1	-	6,426.67
	21 x 6	L1021-6	1	-	6,894.00
	21 x 8	L1021-8	1	-	7,405.31
	21 x 10	L1021-10	1	-	7,956.86
	21 x 12	L1021-12	1	-	8,528.66
	21 x 15	L1021-15	1	-	9,519.15
	21 x 18	L1021-18	1	-	10,801.78
	21 x 21	L1021	1	-	14,317.61
	24 x 4	L1024-4	1	-	10,140.53
	24 x 6	L1024-6	1	-	12,296.04
	24 x 8	L1024-8	1	-	12,490.73
	24 x 10	L1024-10	1	-	13,042.73
	24 x 12	L1024-12	1	-	13,280.95
24 x 15	L1024-15	1	-	13,801.43	
24 x 18	L1024-18	1	-	19,099.14	
24 x 21	L1024-21	1	-	20,662.53	
24 x 24	L1024	1	-	25,388.95	
27 x 4	L1027-4	1	-	13,266.95	
27 x 6	L1027-6	1	-	13,346.31	
27 x 8	L1027-8	1	-	15,235.56	
27 x 10	L1027-10	1	-	16,024.17	
27 x 12	L1027-12	1	-	17,522.08	
27 x 15	L1027-15	1	-	19,780.68	
27 x 18	L1027-18	1	-	20,269.08	
27 x 21	L1027-21	1	-	20,876.16	
27 x 24	L1027-24	1	-	25,829.65	
27 x 27	L1027	1	-	26,560.23	
30 x 4	L1030-4	1	-	17,730.48	
30 x 6	L1030-6	1	-	17,836.76	
30 x 8	L1030-8	1	-	20,361.24	
30 x 10	L1030-10	1	-	21,415.34	
30 x 12	L1030-12	1	-	23,417.44	
30 x 15	L1030-15	1	-	26,435.71	
30 x 18	L1030-18	1	-	27,088.89	
30 x 21	L1030-21	1	-	27,900.05	
30 x 24	L1030-24	1	-	34,520.16	
30 x 27	L1030-27	1	-	35,496.11	
30 x 30	L1030	1	-	44,370.26	
36 x 4	L1036-4	1	-	22,195.03	
36 x 6	L1036-6	1	-	23,190.24	
36 x 8	L1036-8	1	-	27,264.91	
36 x 10	L1036-10	1	-	27,610.43	
36 x 12	L1036-12	1	-	29,172.72	
36 x 15	L1036-15	1	-	31,801.58	
36 x 18	L1036-18	1	-	34,246.40	
36 x 21	L1036-21	1	-	38,925.78	
36 x 24	L1036-24	1	-	43,563.82	
36 x 27	L1036-27	1	-	47,251.74	
36 x 30	L1036-30	1	-	59,066.54	
36 x 36	L1036	1	-	73,833.13	

Item	Size In Inches	Part Number	Box Qty	Crate Qty	List Price
<b>45 Degree Wye GxGxG</b>					
	*4 x 4	G304	10	-	92.28
	*6 x 4	G306-4	4	50	187.13
	*6 x 6	G306	4	20	211.86
	*8 x 4	G308-4	3	32	279.19
	*8 x 6	G308-6	2	28	332.92
	*8 x 8	G308	2	12	580.47
	*10 x 4	G3010-4	1	12	849.22
	*10 x 6	G3010-6	1	10	863.28
	*10 x 8	G3010-8	1	8	1,364.58
	*10 x 10	G3010	1	8	1,714.05
	*12 x 4	G3012-4	1	8	1,222.77
	*12 x 6	G3012-6	1	6	1,260.90
	*12 x 8	G3012-8	1	6	1,883.60
	*12 x 10	G3012-10	1	5	2,302.31
	*12 x 12	G3012	1	5	2,396.85
	15 x 4	L3015-4	1	-	1,844.55
	15 x 6	L3015-6	1	-	2,209.19
	15 x 8	L3015-8	1	-	2,463.56
	15 x 10	L3015-10	1	-	2,960.67
	15 x 12	L3015-12	1	-	3,298.10
	15 x 15	L3015	1	-	4,164.46
	18 x 4	L3018-4	1	-	4,236.91
	18 x 6	L3018-6	1	-	4,291.85
	18 x 8	L3018-8	1	-	4,443.97
	18 x 10	L3018-10	1	-	4,992.75
	18 x 12	L3018-12	1	-	5,364.89
	18 x 15	L3018-15	1	-	5,741.32
	18 x 18	L3018	1	-	7,457.71
	21 x 4	L3021-4	1	-	6,824.32
	21 x 6	L3021-6	1	-	7,315.02
	21 x 8	L3021-8	1	-	8,249.70
	21 x 10	L3021-10	1	-	9,298.88
	21 x 12	L3021-12	1	-	10,056.71
	21 x 15	L3021-15	1	-	11,647.46
	21 x 18	L3021-18	1	-	13,715.93
	21 x 21	L3021	1	-	17,947.77
	24 x 4	L3024-4	1	-	10,293.31
	24 x 6	L3024-6	1	-	11,781.87
	24 x 8	L3024-8	1	-	12,706.38
	24 x 10	L3024-10	1	-	12,843.85
	24 x 12	L3024-12	1	-	13,114.34
	24 x 15	L3024-15	1	-	13,210.62
	24 x 18	L3024-18	1	-	18,555.45
	24 x 21	L3024-21	1	-	20,348.36
24 x 24	L3024	1	-	22,373.31	
27 x 4	L3027-4	1	-	13,273.41	
27 x 6	L3027-6	1	-	13,886.03	
27 x 8	L3027-8	1	-	16,337.88	
27 x 10	L3027-10	1	-	16,573.96	
27 x 12	L3027-12	1	-	17,463.06	
27 x 15	L3027-15	1	-	19,037.15	
27 x 18	L3027-18	1	-	20,501.13	
27 x 21	L3027-21	1	-	23,302.26	
27 x 24	L3027-24	1	-	26,079.17	
27 x 27	L3027	1	-	28,286.36	
30 x 4	L3030-4	1	-	18,616.98	
30 x 6	L3030-6	1	-	18,728.63	
30 x 8	L3030-8	1	-	21,834.56	
30 x 10	L3030-10	1	-	22,486.12	
30 x 12	L3030-12	1	-	25,759.20	
30 x 15	L3030-15	1	-	29,079.29	
30 x 18	L3030-18	1	-	29,797.78	
30 x 21	L3030-21	1	-	31,142.32	
30 x 24	L3030-24	1	-	36,246.13	
30 x 27	L3030-27	1	-	37,803.44	
30 x 30	L3030	1	-	47,254.26	
36 x 4	L3036-4	1	-	24,760.58	
36 x 6	L3036-6	1	-	24,909.07	
36 x 8	L3036-8	1	-	28,628.22	
36 x 10	L3036-10	1	-	29,906.53	
36 x 12	L3036-12	1	-	32,702.44	
36 x 15	L3036-15	1	-	36,917.45	
36 x 18	L3036-18	1	-	37,829.63	
36 x 21	L3036-21	1	-	40,872.07	
36 x 24	L3036-24	1	-	48,207.46	
36 x 27	L3036-27	1	-	49,614.32	
36 x 30	L3036-30	1	-	65,928.45	
36 x 36	L3036	1	-	87,684.91	

\* Denotes Molded Fitting      • Items in **Bold** feature Heavy Duty Branches (SDR 18)  
 † Denotes Assembled from Molded Components  
 • Specifications: ASTM D3034, F1336, CSA B182.2

• Third party tested and listed by CSA, NSF and UPC  
 • Additional Sizes Available Upon Request  
 • Non-Stock items are non-cancelable, non-returnable

Item	Size In Inches	Part Number	Box Qty	Crate Qty	List Price
<b>Straight Tee SxGxG</b>					
	*4 x 4	G124	15	-	100.25
	*6 x 4	G126-4	4	28	206.29
	*6 x 6	G126	4	-	229.04
	*8 x 4	G128-4	2	-	277.78
	†8 x 6	G128-6	2	18	287.47
	8 x 8	G128	2	-	442.95
	10 x 4	L12710-4	1	-	902.02
	10 x 6	L12710-6	1	-	935.94
	10 x 8	L12710-8	1	-	1,461.54
	10 x 10	L12710	1	-	1,506.53
	12 x 4	L12712-4	1	-	1,103.83
	12 x 6	L12712-6	1	-	1,124.74
	12 x 8	L12712-8	1	-	1,552.84
	12 x 10	L12712-10	1	-	1,866.98
	12 x 12	L12712	1	-	1,981.45
	15 x 4	L12715-4	1	-	1,786.04
	15 x 6	L12715-6	1	-	1,896.40
	15 x 8	L12715-8	1	-	1,930.50
	15 x 10	L12715-10	1	-	2,283.68
	15 x 12	L12715-12	1	-	2,467.52
	15 x 15	L12715	1	-	3,118.75
	18 x 4	L12718-4	1	-	4,522.98
	18 x 6	L12718-6	1	-	4,678.17
	18 x 8	L12718-8	1	-	4,889.05
	18 x 10	L12718-10	1	-	5,079.07
	18 x 12	L12718-12	1	-	5,219.02
	18 x 15	L12718-15	1	-	5,562.05
	18 x 18	L12718	1	-	5,875.29
	21 x 4	L12721-4	1	-	6,112.33
	21 x 6	L12721-6	1	-	6,579.68
	21 x 8	L12721-8	1	-	7,090.88
	21 x 10	L12721-10	1	-	7,642.31
	21 x 12	L12721-12	1	-	8,213.88
	21 x 15	L12721-15	1	-	9,204.80
	21 x 18	L12721-18	1	-	10,484.77
	21 x 21	L12721	1	-	13,992.56
	24 x 4	L12724-4	1	-	9,911.46
	24 x 6	L12724-6	1	-	12,163.72
	24 x 8	L12724-8	1	-	12,491.17
	24 x 10	L12724-10	1	-	12,614.80
24 x 12	L12724-12	1	-	13,114.34	
24 x 15	L12724-15	1	-	13,280.08	
24 x 18	L12724-18	1	-	19,099.21	
24 x 21	L12724-21	1	-	20,662.69	
24 x 24	L12724	1	-	25,389.65	
27 x 4	L12727-4	1	-	11,381.59	
27 x 6	L12727-6	1	-	12,243.11	
27 x 8	L12727-8	1	-	14,320.24	
27 x 10	L12727-10	1	-	14,635.41	
27 x 12	L12727-12	1	-	16,256.25	
27 x 15	L12727-15	1	-	18,562.08	
27 x 18	L12727-18	1	-	20,270.42	
27 x 21	L12727-21	1	-	20,876.16	
27 x 24	L12727-24	1	-	25,829.65	
27 x 27	L12727	1	-	26,058.75	
30 x 4	L12730-4	1	-	19,603.80	
30 x 6	L12730-6	1	-	19,721.36	
30 x 8	L12730-8	1	-	22,512.58	
30 x 10	L12730-10	1	-	23,678.01	
30 x 12	L12730-12	1	-	25,891.67	
30 x 15	L12730-15	1	-	29,228.81	
30 x 18	L12730-18	1	-	29,950.99	
30 x 21	L12730-21	1	-	30,847.87	
30 x 24	L12730-24	1	-	38,167.41	
30 x 27	L12730-27	1	-	39,246.47	
30 x 30	L12730	1	-	49,058.28	
36 x 4	L12736-4	1	-	24,540.08	
36 x 6	L12736-6	1	-	25,640.42	
36 x 8	L12736-8	1	-	30,145.64	
36 x 10	L12736-10	1	-	30,527.67	
36 x 12	L12736-12	1	-	32,255.03	
36 x 15	L12736-15	1	-	35,161.62	
36 x 18	L12736-18	1	-	37,864.78	
36 x 21	L12736-21	1	-	43,038.50	
36 x 24	L12736-24	1	-	48,166.61	
36 x 27	L12736-27	1	-	52,244.17	
36 x 30	L12736-30	1	-	65,307.28	
36 x 36	L12736	1	-	81,634.10	

Item	Size In Inches	Part Number	Box Qty	Crate Qty	List Price
<b>45 Degree Wye SxGxG</b>					
	*4 x 4	G324	8	-	119.70
	*6 x 4	G326-4	4	50	187.13
	*6 x 6	G326	4	20	226.92
	*8 x 4	G328-4	3	32	277.78
	†8 x 6	G328-6	2	28	332.92
	*8 x 8	G328	2	12	881.73
	10 x 4	L3210-4	1	-	898.99
	10 x 6	L3210-6	1	-	946.04
	10 x 8	L3210-8	1	-	1,403.40
	10 x 10	L3210	1	-	1,684.06
	12 x 4	L3212-4	1	-	1,240.17
	12 x 6	L3212-6	1	-	1,270.93
	12 x 8	L3212-8	1	-	1,859.23
	12 x 10	L3212-10	1	-	2,277.78
	12 x 12	L3212	1	-	2,382.40
	15 x 4	L3215-4	1	-	1,915.03
	15 x 6	L3215-6	1	-	2,154.77
	15 x 8	L3215-8	1	-	2,506.48
	15 x 10	L3215-10	1	-	2,891.05
	15 x 12	L3215-12	1	-	3,336.40
	15 x 15	L3215	1	-	3,866.98
	18 x 4	L3218-4	1	-	4,814.19
	18 x 6	L3218-6	1	-	5,703.41
	18 x 8	L3218-8	1	-	5,958.78
	18 x 10	L3218-10	1	-	6,188.09
	18 x 12	L3218-12	1	-	6,357.33
	18 x 15	L3218-15	1	-	6,602.59
	18 x 18	L3218	1	-	8,579.52
	21 x 4	L3221-4	1	-	7,847.98
	21 x 6	L3221-6	1	-	8,412.31
	21 x 8	L3221-8	1	-	9,487.20
	21 x 10	L3221-10	1	-	10,693.73
	21 x 12	L3221-12	1	-	11,565.22
	21 x 15	L3221-15	1	-	13,594.55
	21 x 18	L3221-18	1	-	15,773.32
	21 x 21	L3221	1	-	20,639.92
	24 x 4	L3224-4	1	-	12,244.72
	24 x 6	L3224-6	1	-	15,554.50
	24 x 8	L3224-8	1	-	15,912.31
	24 x 10	L3224-10	1	-	16,498.99
24 x 12	L3224-12	1	-	16,800.40	
24 x 15	L3224-15	1	-	17,458.80	
24 x 18	L3224-18	1	-	24,160.53	
24 x 21	L3224-21	1	-	26,138.07	
24 x 24	L3224	1	-	32,117.04	
27 x 4	L3227-4	1	-	16,782.68	
27 x 6	L3227-6	1	-	16,883.10	
27 x 8	L3227-8	1	-	19,272.98	
27 x 10	L3227-10	1	-	20,270.59	
27 x 12	L3227-12	1	-	22,165.45	
27 x 15	L3227-15	1	-	25,022.84	
27 x 18	L3227-18	1	-	25,640.41	
27 x 21	L3227-21	1	-	26,750.09	
27 x 24	L3227-24	1	-	32,674.44	
27 x 27	L3227	1	-	33,598.68	
30 x 4	L3230-4	1	-	21,564.22	
30 x 6	L3230-6	1	-	21,693.49	
30 x 8	L3230-8	1	-	24,763.82	
30 x 10	L3230-10	1	-	26,045.77	
30 x 12	L3230-12	1	-	28,480.80	
30 x 15	L3230-15	1	-	32,151.73	
30 x 18	L3230-18	1	-	32,946.11	
30 x 21	L3230-21	1	-	34,432.66	
30 x 24	L3230-24	1	-	41,984.18	
30 x 27	L3230-27	1	-	43,171.16	
30 x 30	L3230	1	-	53,964.09	
36 x 4	L3236-4	1	-	27,376.69	
36 x 6	L3236-6	1	-	28,204.44	
36 x 8	L3236-8	1	-	33,160.25	
36 x 10	L3236-10	1	-	33,580.42	
36 x 12	L3236-12	1	-	36,157.63	
36 x 15	L3236-15	1	-	40,818.05	
36 x 18	L3236-18	1	-	41,826.54	
36 x 21	L3236-21	1	-	47,342.35	
36 x 24	L3236-24	1	-	55,391.60	
36 x 27	L3236-27	1	-	57,468.60	
36 x 30	L3236-30	1	-	72,894.23	
36 x 36	L3236	1	-	96,949.35	

\* Denotes Molded Fitting • Items in Bold feature Heavy Duty Branches (SDR 18)  
 † Denotes Assembled from Molded Components  
 • Specifications: ASTM D3034, F1336, CSA B182.2

• Third party tested and listed by CSA, NSF and UPC  
 • Additional Sizes Available Upon Request  
 • Non-Stock items are non-cancelable, non-returnable

Item	Size In Inches	Part Number	Box Qty	Crate Qty	List Price
<b>Straight Tee with DWV Branch GxGxDWV G</b>					
	*8 x 4	H118-4	2	28	462.23
	*8 x 6	H118-6	2	26	514.88
	†10 x 4	G1110-4	1	-	949.97
	†10 x 6	G1110-6	1	-	969.29
	†12 x 4	G1112-4	1	-	1,153.12
	†12 x 6	G1112-6	1	-	1,217.25
	15 x 4	L1115-4	1	-	1,848.22
	15 x 6	L1115-6	1	-	1,991.70
	18 x 4	L1118-4	1	-	4,606.23
	18 x 6	L1118-6	1	-	4,765.41
	21 x 4	L1121-4	1	-	6,464.51
	21 x 6	L1121-6	1	-	7,141.66
	24 x 4	L1124-4	1	-	10,178.32
	24 x 6	L1124-6	1	-	12,338.07
	27 x 4	L1127-4	1	-	13,304.82
27 x 6	L1127-6	1	-	13,388.54	

For fabricated Tees - use "L" Prefix

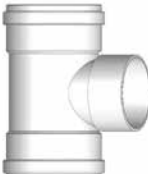
Item	Size In Inches	Part Number	Box Qty	Crate Qty	List Price
<b>Straight Tee with DWV Branch GxGxDWV H</b>					
	*8 x 4	G138-4	2	16	440.23
	*8 x 6	H138-6	2	28	490.36
	†10 x 4	G1310-4	1	-	912.01
	†10 x 6	G1310-6	1	-	927.39
	†12 x 4	G1312-4	1	-	1,115.13
	†12 x 6	G1312-6	1	-	1,175.24
	15 x 4	L1315-4	1	-	1,810.29
	15 x 6	L1315-6	1	-	1,949.62
	18 x 4	L1318-4	1	-	4,568.21
	18 x 6	L1318-6	1	-	4,723.24
	21 x 4	L1321-4	1	-	6,426.56
	21 x 6	L1321-6	1	-	6,893.74
	24 x 4	L1324-4	1	-	10,140.33
	24 x 6	L1324-6	1	-	12,295.97
	27 x 4	L1327-4	1	-	13,266.95
27 x 6	L1327-6	1	-	13,346.31	

For fabricated Tees - use "L" Prefix

Item	Size In Inches	Part Number	Box Qty	Crate Qty	List Price
<b>Combo Wye &amp; 1/8 Bend GxGxG (2 Piece)</b>					
	†4 x 4	G1654	1	-	163.92
	†6 x 4	G1656-4	1	20	258.75
	†6 x 6	G1656	1	16	406.62
	†8 x 4	G1658-4	1	14	433.46
	†8 x 6	G1658-6	1	10	590.72
	†8 x 8	G1658	1	8	895.04
	†10 x 4	G16510-4	1	10	1,062.57
	†10 x 6	G16510-6	1	8	1,217.55
	†10 x 8	G16510-8	1	8	1,868.79
	†10 x 10	G16510	1	4	2,538.30
	†12 x 4	G16512-4	1	8	1,309.29
	†12 x 6	G16512-6	1	6	1,395.38
	†12 x 8	G16512-8	1	5	2,197.37
	†12 x 10	G16512-10	1	4	3,126.48
	†12 x 12	G16512	1	-	3,554.56
	15 x 4	L16515-4	1	4	2,112.58
	15 x 6	L16515-6	1	4	2,336.67
	15 x 8	L16515-8	1	4	2,777.23
	15 x 10	L16515-10	1	-	3,784.75
	15 x 12	L16515-12	1	-	4,455.70
	15 x 15	L16515	1	-	6,776.23
	18 x 4	L16518-4	1	3	4,675.11
	18 x 6	L16518-6	1	2	5,078.72
	18 x 8	L16518-8	1	2	5,494.95
	21 x 4	L16521-4	1	-	6,895.31
	21 x 6	L16521-6	1	-	7,434.06
	21 x 8	L16521-8	1	-	9,026.21
	24 x 4	L16524-4	1	-	11,359.83
	24 x 6	L16524-6	1	-	13,644.04
	24 x 8	L16524-8	1	-	14,149.32
	27 x 4	L16527-4	1	-	14,006.30
	27 x 6	L16527-6	1	-	14,371.09
	27 x 8	L16527-8	1	-	16,650.16
	30 x 4	L16530-4	1	-	17,998.58
	30 x 6	L16530-6	1	-	18,467.68
	30 x 8	L16530-8	1	-	21,306.57
36 x 4	L16536-4	1	-	23,877.50	
36 x 6	L16536-6	1	-	24,068.37	
36 x 8	L16536-8	1	-	27,838.24	

Item	Size In Inches	Part Number	Box Qty	Crate Qty	List Price
<b>45 Degree Wye with DWV Branch GxGxDWV G</b>					
	*8 x 4	H318-4	2	14	450.57
	*8 x 6	H318-6	2	12	541.16
	†10 x 4	G3110-4	1	-	886.56
	†10 x 6	G3110-6	1	-	905.42
	†12 x 4	G3112-4	1	-	1,406.59
	†12 x 6	G3112-6	1	-	1,338.28
	15 x 4	L3115-4	1	-	1,882.25
	15 x 6	L3115-6	1	-	2,282.01
	18 x 4	L3118-4	1	-	4,274.91
	18 x 6	L3118-6	1	-	4,333.77
	21 x 4	L3121-4	1	-	6,862.25
	21 x 6	L3121-6	1	-	7,356.99
	24 x 4	L3124-4	1	-	10,331.34
	24 x 6	L3124-6	1	-	11,823.83
	27 x 4	L3127-4	1	-	13,311.42
27 x 6	L3127-6	1	-	13,927.97	

For fabricated Wyes - use "L" Prefix

Item	Size In Inches	Part Number	Box Qty	Crate Qty	List Price
<b>45 Degree Wye with DWV Branch GxGxDWV H</b>					
	*8 x 4	G338-4	3	32	381.17
	*8 x 6	H338-6	2	12	481.10
	†10 x 4	G3310-4	1	-	1,043.91
	†10 x 6	G3310-6	1	-	1,177.70
	†12 x 4	G3312-4	1	-	1,309.07
	†12 x 6	G3312-6	1	-	1,464.80
	15 x 4	L3315-4	1	-	2,028.97
	15 x 6	L3315-6	1	-	2,430.13
	18 x 4	L3318-4	1	-	5,276.56
	18 x 6	L3318-6	1	-	5,455.41
	21 x 4	L3321-4	1	-	7,506.74
	21 x 6	L3321-6	1	-	8,046.53
	24 x 4	L3324-4	1	-	11,712.35
	24 x 6	L3324-6	1	-	14,878.23
	27 x 4	L3327-4	1	-	15,273.41
27 x 6	L3327-6	1	-	13,885.88	

For fabricated Wyes - use "L" Prefix

Item	Size In Inches	Part Number	Box Qty	Crate Qty	List Price
<b>Double 45 Degree Wye GxGxGxG</b>					
	†4 x 4	G364	1	-	377.91
	*6 x 4	G366-4	3	15	260.65
	*6 x 6	G366-6	2	15	504.39
	8 x 4	L368-4	1	12	545.96
	8 x 6	L368-6	1	10	788.76
	8 x 8	L368-8	1	-	1,625.82
	10 x 4	L3610-4	1	-	1,566.72
	10 x 6	L3610-6	1	-	1,622.29
	10 x 8	L3610-8	1	-	2,328.71
	10 x 10	L3610	1	-	2,775.37
	12 x 4	L3612-4	1	-	1,981.61
	12 x 6	L3612-6	1	-	2,082.11
	12 x 8	L3612-8	1	-	2,846.57
	12 x 10	L3612-10	1	-	3,222.32
	12 x 12	L3612	1	-	3,384.50
	15 x 4	L3615-4	1	-	2,930.35
	15 x 6	L3615-6	1	-	3,340.37
	15 x 8	L3615-8	1	-	3,503.83
	15 x 10	L3615-10	1	-	4,014.58
	15 x 12	L3615-12	1	-	4,743.07
	15 x 15	L3615	1	-	5,186.42
	18 x 4	L3618-4	1	-	5,477.76
	18 x 6	L3618-6	1	-	5,750.42
	18 x 8	L3618-8	1	-	6,284.97
	21 x 4	L3621-4	1	-	7,072.69
	21 x 6	L3621-6	1	-	7,650.87
	21 x 8	L3621-8	1	-	8,765.06
	24 x 4	L3624-4	1	-	10,843.24
	24 x 6	L3624-6	1	-	12,117.01
	24 x 8	L3624-8	1	-	12,422.44
	27 x 4	L3627-4	1	-	13,744.84
	27 x 6	L3627-6	1	-	14,315.28
	27 x 8	L3627-8	1	-	14,620.86
	30 x 4	L3630-4	1	-	23,268.91
	30 x 6	L3630-6	1	-	24,308.71
	30 x 8	L3630-8	1	-	29,389.69
36 x 4	L3636-4	1	-	30,947.56	
36 x 6	L3636-6	1	-	32,330.60	
36 x 8	L3636-8	1	-	38,534.00	

\* Denotes Molded Fitting • Items in **Bold** feature Heavy Duty Branches (SDR 18)  
† Denotes Assembled from Molded Components  
• Specifications: ASTM D3034, F1336, CSA B182.2

• Third party tested and listed by CSA, NSF and UPC  
• Additional Sizes Available Upon Request  
• Non-Stock items are non-cancelable, non-returnable

Item	Size In Inches	Part Number	Box Qty	Crate Qty	List Price
<b>Sanitary Tee (T-Y) GxGxG</b>					
	*4 x 4	G156	10	-	103.00
	*6 x 4	G157-4	5	56	222.93
	*6 x 6	G157	2	24	259.92
	*8 x 4	G158-4	3	30	282.32
	*8 x 6	G158-6	2	30	324.72
	*8 x 8	G158	2	12	799.23
	10 x 4	L1510-4	1	-	1,062.55
	10 x 6	L1510-6	1	-	1,217.65
	10 x 8	L1510-8	1	-	1,868.98
	10 x 10	L1510	1	-	2,478.36
	12 x 4	L1512-4	1	-	1,309.41
	12 x 6	L1512-6	1	-	1,395.47
	12 x 8	L1512-8	1	-	2,068.11
	12 x 10	L1512-10	1	-	3,063.37
	12 x 12	L1512	1	-	3,462.44
	15 x 4	L1515-4	1	-	2,112.80
	15 x 6	L1515-6	1	-	2,336.88
	15 x 8	L1515-8	1	-	2,522.51
	18 x 4	L1518-4	1	-	4,814.19
	18 x 6	L1518-6	1	-	4,902.68
	18 x 8	L1518-8	1	-	5,196.80
	21 x 4	L1521-4	1	-	6,822.83
	21 x 6	L1521-6	1	-	7,381.96
	21 x 8	L1521-8	1	-	9,027.15
	24 x 4	L1524-4	1	-	11,360.98
	24 x 6	L1524-6	1	-	14,269.55
	24 x 8	L1524-8	1	-	14,597.81
	27 x 4	L1527-4	1	-	15,396.28
	27 x 6	L1527-6	1	-	15,489.23
	27 x 8	L1527-8	1	-	17,236.47
	30 x 4	L1530-4	1	-	19,640.95
	30 x 6	L1530-6	1	-	19,759.50
	30 x 8	L1530-8	1	-	23,035.46
	36 x 4	L1536-4	1	-	25,115.15
	36 x 6	L1536-6	1	-	26,279.10
	36 x 8	L1536-8	1	-	30,202.76

Item	Size In Inches	Part Number	Box Qty	Crate Qty	List Price
<b>Sanitary Tee (T-Y) SxGxG</b>					
	*4 x 4	G174	10	-	113.32
	*6 x 4	G177-4	5	-	217.04
	*6 x 6	G177	2	-	259.92
	*8 x 4	G178-4	3	30	282.32
	*8 x 6	G178-6	2	30	324.72
	*8 x 8	G178	2	-	839.10
	10 x 4	L1710-4	1	-	1,213.64
	10 x 6	L1710-6	1	-	1,264.90
	10 x 8	L1710-8	1	-	1,848.85
	10 x 10	L1710	1	-	2,329.86
	12 x 4	L1712-4	1	-	1,309.41
	12 x 6	L1712-6	1	-	1,395.47
	12 x 8	L1712-8	1	-	2,571.35
	12 x 10	L1712-10	1	-	2,879.50
	12 x 12	L1712	1	-	3,254.70
	15 x 4	L1715-4	1	-	2,266.34
	15 x 6	L1715-6	1	-	2,337.63
	15 x 8	L1715-8	1	-	2,523.16
	18 x 4	L1718-4	1	-	4,816.37
	18 x 6	L1718-6	1	-	4,902.68
	18 x 8	L1718-8	1	-	5,196.80
	21 x 4	L1721-4	1	-	6,824.32
	21 x 6	L1721-6	1	-	7,381.97
	21 x 8	L1721-8	1	-	9,027.40
	24 x 4	L1724-4	1	-	11,360.98
	24 x 6	L1724-6	1	-	12,037.42
	24 x 8	L1724-8	1	-	12,283.14
	27 x 4	L1727-4	1	-	14,007.73
27 x 6	L1727-6	1	-	14,372.57	
27 x 8	L1727-8	1	-	14,708.85	

Item	Size In Inches	Part Number	Box Qty	Crate Qty	List Price
<b>2-Way Cleanout GxGxG</b>					
	*4 x 4	G1004	6	-	217.04
	*6 x 6	G1006	3	21	1,232.40

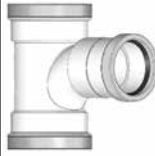
Item	Size In Inches	Part Number	Box Qty	Crate Qty	List Price
<b>Sanitary Tee with DWV Branch (T-Y) GxGxDWV G</b>					
	†8 x 4	H188-4	2	14	450.57
	†8 x 6	H188-6	2	10	586.48
	10 x 4	L1810-4	1	-	1,100.44
	10 x 6	L1810-6	1	-	1,259.73
	12 x 4	L1812-4	1	-	1,347.24
	12 x 6	L1812-6	1	-	1,437.63
	15 x 4	L1815-4	1	-	2,150.81
	15 x 6	L1815-6	1	-	2,378.93
	18 x 4	L1818-4	1	-	4,852.08
	18 x 6	L1818-6	1	-	4,944.75
	21 x 4	L1821-4	1	-	6,861.38
	21 x 6	L1821-6	1	-	7,424.02
	24 x 4	L1824-4	1	-	11,399.05
	24 x 6	L1824-6	1	-	12,079.41
	27 x 4	L1827-4	1	-	14,045.65
	27 x 6	L1827-6	1	-	14,414.71

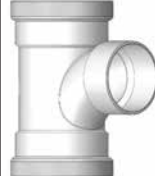
Item	Size In Inches	Part Number	Box Qty	Crate Qty	List Price
<b>Sanitary Tee with DWV Branch (T-Y) GxGxDWV H</b>					
	*8 x 4	H198-4	2	15	381.17
	*8 x 6	H198-6	2	14	481.10
	10 x 4	L1910-4	1	-	1,062.46
	10 x 6	L1910-6	1	-	1,217.65
	12 x 4	L1912-4	1	-	1,309.34
	12 x 6	L1912-6	1	-	1,395.47
	15 x 4	L1915-4	1	-	2,112.80
	15 x 6	L1915-6	1	-	2,336.77
	18 x 4	L1918-4	1	-	4,814.06
	18 x 6	L1918-6	1	-	4,902.50
	21 x 4	L1921-4	1	-	6,823.52
	21 x 6	L1921-6	1	-	7,381.96
	24 x 4	L1924-4	1	-	11,360.98
	24 x 6	L1924-6	1	-	12,037.39
	27 x 4	L1927-4	1	-	14,007.73
	27 x 6	L1927-6	1	-	14,372.57

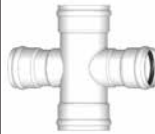
Item	Size In Inches	Part Number	Box Qty	Crate Qty	List Price
<b>Tee Cross GxGxGxG</b>					
	4 x 4	L1794	1	-	331.23
	6 x 4	L1796-4	1	-	357.90
	6 x 6	L1796	1	-	432.92
	8 x 4	L1798-4	1	-	558.50
	8 x 6	L1798-6	1	-	702.80
	8 x 8	L1798	1	-	1,046.77
	10 x 4	L17910-4	1	-	1,414.95
	10 x 6	L17910-6	1	-	1,469.51
	10 x 8	L17910-8	1	-	2,023.13
	10 x 10	L17910	1	-	2,408.03
	12 x 4	L17912-4	1	-	1,538.64
	12 x 6	L17912-6	1	-	1,807.20
	12 x 8	L17912-8	1	-	2,099.67
	12 x 10	L17912-10	1	-	2,437.49
	12 x 12	L17912	1	-	2,837.32
	15 x 4	L17915-4	1	-	2,645.17
	15 x 6	L17915-6	1	-	3,056.32
	15 x 8	L17915-8	1	-	3,212.66
	15 x 10	L17915-10	1	-	3,298.75
	15 x 12	L17915-12	1	-	3,527.29
	15 x 15	L17915	1	-	4,233.55
	18 x 4	L17918-4	1	-	5,314.60
	18 x 6	L17918-6	1	-	6,066.04
	18 x 8	L17918-8	1	-	6,337.93
	18 x 10	L17918-10	1	-	7,702.45
	18 x 12	L17918-12	1	-	8,438.05
	18 x 15	L17918-15	1	-	9,609.45
	18 x 18	L17918	1	-	13,042.94
	21 x 4	L17921-4	1	-	6,975.11
	21 x 6	L17921-6	1	-	7,608.08
21 x 8	L17921-8	1	-	8,715.89	
24 x 4	L17924-4	1	-	10,782.44	
24 x 6	L17924-6	1	-	12,049.98	
24 x 8	L17924-8	1	-	12,352.53	
27 x 4	L17927-4	1	-	12,845.69	
27 x 6	L17927-6	1	-	13,378.73	
27 x 8	L17927-8	1	-	13,664.33	

\* Denotes Molded Fitting • Items in Bold feature Heavy Duty Branches (SDR 18)  
 † Denotes Assembled from Molded Components  
 • Specifications: ASTM D3034, F1336, CSA B182.2

• Third party tested and listed by CSA, NSF and UPC  
 • Additional Sizes Available Upon Request  
 • Non-Stock items are non-cancelable, non-returnable

Item	Size In Inches	Part Number	Box Qty	Crate Qty	List Price
<b>1/4 Bend (90) GxG</b>					
	*4	G204	10	-	67.33
	*6	G206	4	48	123.89
	*8	G208	2	14	342.64
	*10	G2010	1	9	1,152.35
	*12	G2012	1	6	1,491.17

Item	Size In Inches	Part Number	Box Qty	Crate Qty	List Price
<b>1/4 Bend (90) GxG Long Sweep</b>					
	*4	G256	6	-	67.32
	*6	G257	4	24	289.95
	*8	G258	2	12	654.03
	†10	G2510	1	8	1,601.69
	†12	G2512	1	6	2,268.82
	15	L18015	1	-	3,147.93
	18	L18018	1	-	5,324.95
	21	L18021	1	-	9,145.97
	24	L18024	1	-	12,228.87
	27	L18027	1	-	13,965.08
	30	L18030	1	-	20,298.55
	36	L18036	1	-	25,559.95

Item	Size In Inches	Part Number	Box Qty	Crate Qty	List Price
<b>Deep Socket 1/4 Bend (90) GxG (2-Piece)</b>					
	†4	H2566	1	-	699.05
	†6	H2577	1	18	778.52
	†8	H2588	1	-	1,337.44

Item	Size In Inches	Part Number	Box Qty	Crate Qty	List Price
<b>1/8 Bend (45) GxG</b>					
	*4	G504	8	168	53.50
	*6	G506	6	50	108.61
	*8	G508	4	32	304.03
	*10	G5010	1	12	788.76
	*12	G5012	1	7	1,145.66
	15	L5015	1	-	2,565.39
	18	L5018	1	-	4,106.00
	21	L5021	1	-	6,953.89
	24	L5024	1	-	9,493.65
	27	L5027	1	-	10,315.86
30	L5030	1	-	15,904.97	
36	L5036	1	-	19,834.82	

Item	Size In Inches	Part Number	Box Qty	Crate Qty	List Price
<b>Deep Socket 1/8 Bend (45) GxG</b>					
	†4	H5044	1	-	381.03
	*6	H5066	1	25	394.72
	†8	H5088	1	-	769.88

Item	Size In Inches	Part Number	Box Qty	Crate Qty	List Price
<b>1/8 Bend (45) GxG (Extra Long Sweep Radius)</b>					
	4	L4804	1	-	510.83
	6	L4806	1	-	725.09
	8	L4808	1	-	2,202.61
	10	L48010	1	-	3,524.26
	12	L48012	1	-	6,607.92
	15	L48015	1	-	8,259.97

Item	Size In Inches	Part Number	Box Qty	Crate Qty	List Price
<b>1/12 Bend (30) GxG</b>					
	4	L1354.30	1	-	145.23
	6	L1356.30	1	-	263.75
	8	L1358.30	1	-	306.93
	10	L13510.30	1	-	859.63
	12	L13512.30	1	-	1,094.90
	15	L13515.30	1	-	2,895.90
	18	L13518.30	1	-	4,232.44
	21	L13521.30	1	-	6,005.98
	24	L13524.30	1	-	8,647.10
	27	L13527.30	1	-	10,316.30
30	L13530.30	1	-	13,786.50	
36	L13536.30	1	-	17,643.37	

Item	Size In Inches	Part Number	Box Qty	Crate Qty	List Price
<b>1/4 Bend (90) SxG</b>					
	*4	G224	12	-	61.92
	*6	G226	4	50	130.93
	*8	G228	2	14	353.58
	*10	G2210	1	10	1,144.56
	*12	G2212	1	6	1,457.06

Item	Size In Inches	Part Number	Box Qty	Crate Qty	List Price
<b>1/4 Bend (90) SxG Long Sweep</b>					
	*4	G274	6	-	61.92
	*6	G277	4	24	323.04
	*8	G278	2	12	718.44
	†10	G2710	1	8	1,533.63
	†12	G2712	1	6	2,190.31
	15	L18215	1	-	2,872.13
	18	L18218	1	-	4,921.58
	21	L18221	1	-	8,269.35
	24	L18224	1	-	10,210.61
	27	L18227	1	-	14,184.81
	30	L18230	1	-	17,934.16
	36	L18236	1	-	25,176.56

Item	Size In Inches	Part Number	Box Qty	Crate Qty	List Price
<b>Deep Socket 1/4 Bend (90) SxG (2-Piece)</b>					
	†4	H2744	1	-	699.05
	†6	H2777	1	18	778.52
	†8	H2788	1	-	1,337.44

Item	Size In Inches	Part Number	Box Qty	Crate Qty	List Price
<b>1/8 Bend (45) SxG</b>					
	*4	G404	12	168	48.15
	*6	G406	6	60	96.24
	*8	G408	4	16	290.43
	*10	G4010	1	12	777.34
	*12	G4012	1	8	1,110.98
	15	L4015	1	-	2,009.81
	18	L4018	1	-	3,383.62
	21	L4021	1	-	6,006.56
	24	L4024	1	-	8,647.46
	27	L4027	1	-	10,314.80
30	L4030	1	-	15,099.44	
36	L4036	1	-	19,038.98	

Item	Size In Inches	Part Number	Box Qty	Crate Qty	List Price
<b>Deep Socket 1/8 Bend (45) SxG</b>					
	†4	H4044	1	-	380.99
	*6	H4066	1	25	375.89
	†8	H4088	1	-	769.80

Item	Size In Inches	Part Number	Box Qty	Crate Qty	List Price
<b>1/8 Bend (45) SxG (Extra Long Sweep Radius)</b>					
	4	L4904	1	-	510.82
	6	L4906	1	-	725.09
	8	L4908	1	-	2,202.61
	10	L49010	1	-	3,524.26
	12	L49012	1	-	6,607.92
	15	L49015	1	-	8,259.97

Item	Size In Inches	Part Number	Box Qty	Crate Qty	List Price
<b>1/12 Bend (30) SxG</b>					
	4	L1344.30	1	-	148.14
	6	L1346.30	1	-	269.02
	8	L1348.30	1	-	320.52
	10	L13410.30	1	-	816.66
	12	L13412.30	1	-	1,071.43
	15	L13415.30	1	-	2,313.81
	18	L13418.30	1	-	3,531.85
	21	L13421.30	1	-	6,005.36
	24	L13424.30	1	-	8,647.10
	27	L13427.30	1	-	10,315.24
30	L13430.30	1	-	13,689.97	
36	L13436.30	1	-	17,519.85	

\* Denotes Molded Fitting • Items in **Bold** feature Heavy Duty Branches (SDR 18)  
† Denotes Assembled from Molded Components  
• Specifications: ASTM D3034, F1336, CSA B182.2

• Third party tested and listed by CSA, NSF and UPC  
• Additional Sizes Available Upon Request  
• Non-Stock items are non-cancelable, non-returnable





Item	Size In Inches	Part Number	Box Qty	Crate Qty	List Price
<b>1/16 Bend (22.5) GxG</b>					
	*4	G1704	12	-	53.46
	*6	G1706	6	60	105.28
	*8	G1708	3	38	306.71
	*10	G17010	1	24	839.63
	*12	G17012	1	8	1,094.90
	15	L17015	1	-	2,895.90
	18	L17018	1	-	4,232.44
	21	L17021	1	-	6,006.12
	24	L17024	1	-	8,647.98
	27	L17027	1	-	10,316.30
	30	L17030	1	-	13,786.98
	36	L17036	1	-	17,643.37

Item	Size In Inches	Part Number	Box Qty	Crate Qty	List Price
<b>Deep Socket 1/16 Bend (22.5) GxG</b>					
	†4	H17044	1	-	381.03
	*6	H17066	1	60	394.72
	†8	H17088	1	-	769.80

Item	Size In Inches	Part Number	Box Qty	Crate Qty	List Price
<b>1/16 Bend (22.5) GxG (Extra Long Sweep Radius)</b>					
	4	L14904	1	-	510.83
	6	L14906	1	-	725.09
	8	L14908	1	-	2,202.61
	10	L14910	1	-	3,524.26
	12	L14912	1	-	6,607.92
	15	L14915	1	-	8,259.97

Item	Size In Inches	Part Number	Box Qty	Crate Qty	List Price
<b>1/32 Bend (11.25) GxG</b>					
	4	L1934	1	-	145.23
	6	L1936	1	-	257.29
	8	L1938	1	-	306.93
	10	L19310	1	-	839.63
	12	L19312	1	-	1,094.90
	15	L19315	1	-	2,895.90
	18	L19318	1	-	4,232.44
	21	L19321	1	-	6,005.98
	24	L19324	1	-	8,647.98
	27	L19327	1	-	10,316.30
	30	L19330	1	-	13,786.50
	36	L19336	1	-	17,643.37

Item	Size In Inches	Part Number	Box Qty	Crate Qty	List Price
<b>Cap (G)</b>					
	*4	G1604	27	-	34.51
	*6	G1606	8	140	64.77
	*8	G1608	8	80	174.77
	*10	G16010	2	36	546.78
	*12	G16012	2	27	821.34
	15	L16015	1	-	1,328.25
	18	L16018	1	-	1,930.98
	21	L16021	1	-	4,188.43
	24	L16024	1	-	4,837.12
	27	L16027	1	-	6,100.78
	30	L16030	1	-	7,839.81
	36	L16036	1	-	14,520.89

Item	Size In Inches	Part Number	Box Qty	Crate Qty	List Price
<b>Stop Coupling GxG</b>					
	*4	G604	16	-	66.13
	*6	G606	4	60	132.02
	*8	G608	4	38	224.26
	*10	G6010	2	24	497.71
	*12	G6012	1	16	723.21
	15	L6015	1	-	1,496.26
	18	L6018	1	-	2,912.61
	21	L6021	1	-	4,963.78
	24	L6024	1	-	7,231.17
	27	L6027	1	-	8,154.54
	30	L6030	1	-	10,478.96
	36	L6036	1	-	13,413.02

Item	Size In Inches	Part Number	Box Qty	Crate Qty	List Price
<b>1/16 Bend (22.5) SxG</b>					
	*4	G1714	15	-	50.82
	*6	G1716	6	60	99.94
	*8	G1718	4	38	320.52
	*10	G17110	1	24	816.66
	*12	G17112	1	8	1,071.43
	15	L17115	1	-	2,313.81
	18	L17118	1	-	3,531.85
	21	L17121	1	-	6,005.52
	24	L17124	1	-	8,646.96
	27	L17127	1	-	10,315.24
	30	L17130	1	-	13,580.18
	36	L17136	1	-	17,378.72

Item	Size In Inches	Part Number	Box Qty	Crate Qty	List Price
<b>Deep Socket 1/16 Bend (22.5) SxG</b>					
	†4	H17144	1	-	380.99
	*6	H17166	1	60	394.68
	†8	H17188	1	-	769.80

Item	Size In Inches	Part Number	Box Qty	Crate Qty	List Price
<b>1/16 Bend (22.5) SxG (Extra Long Sweep Radius)</b>					
	4	L14904S	1	-	510.87
	6	L14906S	1	-	725.16
	8	L14908S	1	-	2,202.61
	10	L14910S	1	-	3,524.26
	12	L14912S	1	-	6,607.92
	15	L14915S	1	-	8,259.97

Item	Size In Inches	Part Number	Box Qty	Crate Qty	List Price
<b>1/32 Bend (11.25) SxG</b>					
	4	L1834	1	-	138.83
	6	L1836	1	-	190.30
	8	L1838	1	-	320.48
	10	L18310	1	-	816.92
	12	L18312	1	-	1,071.43
	15	L18315	1	-	2,313.81
	18	L18318	1	-	3,531.85
	21	L18321	1	-	5,999.98
	24	L18324	1	-	8,639.32
	27	L18327	1	-	10,305.97
	30	L18330	1	-	13,772.69
	36	L18336	1	-	17,625.72

Item	Size In Inches	Part Number	Box Qty	Crate Qty	List Price
<b>Spigot Plug (S)</b>					
	*4	G1164	24	-	26.10
	*6	G1166	15	168	40.01
	*8	G1168	8	-	141.79
	*10	G11610	2	-	472.41
	*12	G11612	2	-	564.59
	15	L11615	1	-	1,111.10
	18	L11618	1	-	1,564.40
	21	L11621	1	-	3,094.38
	24	L11624	1	-	4,652.90
	27	L11627	1	-	5,689.34
	30	L11630	1	-	10,172.27
	36	L11636	1	-	13,017.87

Item	Size In Inches	Part Number	Box Qty	Crate Qty	List Price
<b>Repair Coupling GxG</b>					
	*4	G624	16	-	66.13
	*6	G626	4	60	132.02
	*8	G628	4	38	224.26
	*10	G6210	2	24	497.71
	*12	G6212	1	16	723.21
	15	L6215	1	-	1,496.26
	18	L6218	1	-	2,912.61
	21	L6221	1	-	4,963.66
	24	L6224	1	-	7,231.17
	27	L6227	1	-	8,154.54
	30	L6230	1	-	10,478.96
	36	L6236	1	-	13,413.02

\* Denotes Molded Fitting • Items in Bold feature Heavy Duty Branches (SDR 18)  
 † Denotes Assembled from Molded Components  
 • Specifications: ASTM D3034, F1336, CSA B182.2

• Third party tested and listed by CSA, NSF and UPC  
 • Additional Sizes Available Upon Request  
 • Non-Stock items are non-cancelable, non-returnable

Item	Size In Inches	Part Number	Box Qty	Crate Qty	List Price
<b>Concentric Inserter Coupling GxG</b>					
	*6 x 4	G606-4	8	-	189.83
	*8 x 4	G608-4	8	-	301.31
	*8 x 6	G608-6	4	-	316.40
	*10 x 4	G6010-4	2	36	694.42
	*10 x 6	G6010-6	2	36	822.60
	*10 x 8	G6010-8	2	36	954.61
	*12 x 4	G6012-4	2	27	1,010.85
	*12 x 6	G6012-6	2	27	1,069.43
	*12 x 8	G6012-8	2	27	1,238.86
	*12 x 10	G6012-10	2	18	1,430.26
	15 x 4	L6015-4	1	-	1,592.92
	15 x 6	L6015-6	1	-	1,673.42
	15 x 8	L6015-8	1	-	1,814.73
	15 x 10	L6015-10	1	-	1,999.39
	15 x 12	L6015-12	1	-	2,173.96
	18 x 4	L6018-4	1	-	2,095.16
	18 x 6	L6018-6	1	-	2,131.28
	18 x 8	L6018-8	1	-	2,162.78
	18 x 10	L6018-10	1	-	2,238.93
	18 x 12	L6018-12	1	-	2,286.60
	18 x 15	L6018-15	1	-	2,381.65
	21 x 4	L6021-4	1	-	3,022.09
	21 x 6	L6021-6	1	-	3,053.42
	21 x 8	L6021-8	1	-	3,096.79
	21 x 10	L6021-10	1	-	3,137.78
	21 x 12	L6021-12	1	-	3,300.46
	21 x 15	L6021-15	1	-	3,812.25
	21 x 18	L6021-18	1	-	4,107.79
	24 x 4	L6024-4	1	-	6,299.08
	24 x 6	L6024-6	1	-	6,360.43
	24 x 8	L6024-8	1	-	6,433.68
	24 x 10	L6024-10	1	-	6,466.61
	24 x 12	L6024-12	1	-	6,667.63
	24 x 15	L6024-15	1	-	6,833.64
	24 x 18	L6024-18	1	-	7,200.53
	24 x 21	L6024-21	1	-	7,810.03
	27 x 4	L6027-4	1	-	6,466.24
	27 x 6	L6027-6	1	-	6,495.49
	27 x 8	L6027-8	1	-	6,565.02
	27 x 10	L6027-10	1	-	6,639.92
27 x 12	L6027-12	1	-	6,980.39	
27 x 15	L6027-15	1	-	7,018.09	
27 x 18	L6027-18	1	-	7,307.30	
27 x 21	L6027-21	1	-	8,421.22	
27 x 24	L6027-24	1	-	9,122.51	
30 x 4	L6030-4	1	-	8,278.96	
30 x 6	L6030-6	1	-	8,594.30	
30 x 8	L6030-8	1	-	10,641.80	
30 x 10	L6030-10	1	-	13,620.93	
30 x 12	L6030-12	1	-	17,434.19	
30 x 15	L6030-15	1	-	19,680.29	
30 x 18	L6030-18	1	-	25,190.74	
30 x 21	L6030-21	1	-	26,360.72	
30 x 24	L6030-24	1	-	29,610.72	
30 x 27	L6030-27	1	-	30,332.91	
36 x 4	L6036-4	1	-	10,591.22	
36 x 6	L6036-6	1	-	10,641.80	
36 x 8	L6036-8	1	-	13,620.93	
36 x 10	L6036-10	1	-	17,434.19	
36 x 12	L6036-12	1	-	22,316.35	
36 x 15	L6036-15	1	-	25,158.27	
36 x 18	L6036-18	1	-	26,360.72	
36 x 21	L6036-21	1	-	27,805.15	
36 x 24	L6036-24	1	-	30,694.03	
36 x 27	L6036-27	1	-	32,138.44	
36 x 30	L6036-30	1	-	36,905.02	

**Controlled Settlement Joint GxG**

	4 x 4	H6004	1	-	417.54
	6 x 6	H6006	1	-	533.27
	8 x 8	H6008	1	-	913.29

Fabricated from SDR 28 pipe

Item	Size In Inches	Part Number	Box Qty	Crate Qty	List Price
<b>Concentric Inserter Bushing SxG</b>					
	*6 x 4	G1216	10	-	96.24
	*8 x 4	G1219	5	-	262.90
	*8 x 6	G1220	5	-	294.47
	*10 x 4	G1210-4	2	36	689.02
	*10 x 6	G1210-6	2	36	715.79
	*10 x 8	G1210-8	2	36	851.30
	*12 x 4	G1212-4	2	18	919.36
	*12 x 6	G1212-6	2	18	939.33
	*12 x 8	G1212-8	2	18	1,076.81
	*12 x 10	G1212-10	2	18	1,194.13
	15 x 4	L1215-4	1	-	1,531.42
	15 x 6	L1215-6	1	-	1,588.32
	15 x 8	L1215-8	1	-	1,797.88
	15 x 10	L1215-10	1	-	1,812.04
	15 x 12	L1215-12	1	-	2,078.26
	18 x 4	L1218-4	1	-	2,168.07
	18 x 6	L1218-6	1	-	2,197.16
	18 x 8	L1218-8	1	-	2,220.80
	18 x 10	L1218-10	1	-	2,252.05
	18 x 12	L1218-12	1	-	2,283.80
	18 x 15	L1218-15	1	-	2,302.47
	21 x 4	L1221-4	1	-	2,509.33
	21 x 6	L1221-6	1	-	2,746.34
	21 x 8	L1221-8	1	-	2,762.76
	21 x 10	L1221-10	1	-	2,795.68
	21 x 12	L1221-12	1	-	2,862.56
	21 x 15	L1221-15	1	-	2,972.86
	21 x 18	L1221-18	1	-	3,223.58
	24 x 4	L1224-4	1	-	5,568.29
	24 x 6	L1224-6	1	-	5,634.44
	24 x 8	L1224-8	1	-	5,704.61
	24 x 10	L1224-10	1	-	5,837.80
	24 x 12	L1224-12	1	-	5,913.67
	24 x 15	L1224-15	1	-	6,082.05
	24 x 18	L1224-18	1	-	6,347.56
	24 x 21	L1224-21	1	-	7,460.78
	27 x 4	L1227-4	1	-	5,685.37
	27 x 6	L1227-6	1	-	5,728.05
	27 x 8	L1227-8	1	-	5,806.86
	27 x 10	L1227-10	1	-	5,883.24
27 x 12	L1227-12	1	-	5,893.23	
27 x 15	L1227-15	1	-	6,222.34	
27 x 18	L1227-18	1	-	6,549.99	
27 x 21	L1227-21	1	-	7,636.02	
27 x 24	L1227-24	1	-	9,122.51	
30 x 4	L1230-4	1	-	7,279.89	
30 x 6	L1230-6	1	-	7,330.47	
30 x 8	L1230-8	1	-	9,381.58	
30 x 10	L1230-10	1	-	12,010.42	
30 x 12	L1230-12	1	-	15,375.90	
30 x 15	L1230-15	1	-	19,680.29	
30 x 18	L1230-18	1	-	25,190.74	
30 x 21	L1230-21	1	-	26,360.72	
30 x 24	L1230-24	1	-	29,610.72	
30 x 27	L1230-27	1	-	30,332.91	
36 x 4	L1236-4	1	-	9,312.92	
36 x 6	L1236-6	1	-	9,381.58	
36 x 8	L1236-8	1	-	12,010.42	
36 x 10	L1236-10	1	-	15,375.90	
36 x 12	L1236-12	1	-	19,680.29	
36 x 15	L1236-15	1	-	25,158.27	
36 x 18	L1236-18	1	-	26,360.72	
36 x 21	L1236-21	1	-	27,805.15	
36 x 24	L1236-24	1	-	30,694.03	
36 x 27	L1236-27	1	-	32,138.44	
36 x 30	L1236-30	1	-	36,905.02	

**Controlled Settlement Joint SxG**

	4 x 4	H6304	1	-	380.88
	6 x 6	H6306	1	-	517.39
	8 x 8	H6308	1	-	885.93

Fabricated from SDR 28 pipe

\* Denotes Molded Fitting • Items in **Bold** feature Heavy Duty Branches (SDR 18)  
 † Denotes Assembled from Molded Components  
 • Specifications: ASTM D3034, F1336, CSA B182.2

• Third party tested and listed by CSA, NSF and UPC  
 • Additional Sizes Available Upon Request  
 • Non-Stock items are non-cancelable, non-returnable

Item	Size In Inches	Part Number	Box Qty	Crate Qty	List Price
<b>Eccentric In increaser Coupling GxG</b>					
	*6 x 4	G616-4	12	-	189.83
	8 x 4	L618-4	1	-	301.31
	*8 x 6	G618-6	8	-	288.44
	10 x 4	L6110-4	1	-	694.42
	10 x 6	L6110-6	1	-	822.60
	10 x 8	L6110-8	1	-	954.61
	12 x 4	L6112-4	1	-	1,010.85
	12 x 6	L6112-6	1	-	1,069.43
	12 x 8	L6112-8	1	-	1,238.86
	12 x 10	L6112-10	1	-	1,430.26
	15 x 4	L6115-4	1	-	1,592.92
	15 x 6	L6115-6	1	-	1,673.42
	15 x 8	L6115-8	1	-	1,814.73
	15 x 10	L6115-10	1	-	1,999.39
	15 x 12	L6115-12	1	-	2,173.96
	18 x 4	L6118-4	1	-	2,095.16
	18 x 6	L6118-6	1	-	2,131.28
	18 x 8	L6118-8	1	-	2,162.78
	18 x 10	L6118-10	1	-	2,238.93
	18 x 12	L6118-12	1	-	2,286.60
	18 x 15	L6118-15	1	-	2,381.65
	21 x 4	L6121-4	1	-	3,022.09
	21 x 6	L6121-6	1	-	3,053.42
	21 x 8	L6121-8	1	-	3,096.79
	21 x 10	L6121-10	1	-	3,137.78
	21 x 12	L6121-12	1	-	3,300.46
	21 x 15	L6121-15	1	-	3,812.25
	21 x 18	L6121-18	1	-	4,107.79
	24 x 4	L6124-4	1	-	6,299.08
	24 x 6	L6124-6	1	-	6,360.43
	24 x 8	L6124-8	1	-	6,433.68
	24 x 10	L6124-10	1	-	6,466.61
	24 x 12	L6124-12	1	-	6,667.63
	24 x 15	L6124-15	1	-	6,833.64
24 x 18	L6124-18	1	-	7,200.53	
24 x 21	L6124-21	1	-	7,810.03	
27 x 4	L6127-4	1	-	6,466.24	
27 x 6	L6127-6	1	-	6,495.49	
27 x 8	L6127-8	1	-	6,565.02	
27 x 10	L6127-10	1	-	6,639.92	
27 x 12	L6127-12	1	-	6,980.39	
27 x 15	L6127-15	1	-	7,018.09	
27 x 18	L6127-18	1	-	7,307.30	
27 x 21	L6127-21	1	-	8,421.22	
27 x 24	L6127-24	1	-	9,122.51	

<b>Gasketed C900 Adapter Coupling GxG</b> Gasket SDR 26 Sewer Hub x Gasket C900 Hub					
	4 x 4	H7204	1	-	301.94
	6 x 6	H7206	1	-	363.44
	8 x 8	H7208	1	-	1,169.09
	10 x 10	H7210	1	-	1,432.23
	12 x 12	H7212	1	-	1,715.66
	15 x 16	H7215	1	-	4,759.57
	18 x 18	H7218	1	-	5,472.74
	21 x 20	H7221	1	-	7,538.94
24 x 24	H7224	1	-	7,749.85	

<b>Gasketed C900 Adapter Bushing SxG</b> Chamfer SDR 26 Sewer Spigot x Gasket C900 Hub					
	4 x 4	H7404	1	-	301.94
	6 x 6	H7406	1	-	363.44
	8 x 8	H7408	1	-	1,000.66
	10 x 10	H7410	1	-	1,432.23
	12 x 12	H7412	1	-	1,715.66
	15 x 16	H7415	1	-	4,688.19
	18 x 18	H7418	1	-	5,472.74
	21 x 20	H7421	1	-	7,425.86
24 x 24	H7424	1	-	7,749.85	

Item	Size In Inches	Part Number	Box Qty	Crate Qty	List Price
<b>Eccentric In increaser Bushing SxG</b>					
	*6 x 4	G1306-4	10	-	101.15
	*8 x 4	G1308-4	5	-	262.90
	*8 x 6	G1308-6	8	-	288.44
	10 x 4	L13010-4	1	-	689.02
	10 x 6	L13010-6	1	-	715.79
	10 x 8	L13010-8	1	-	851.30
	12 x 4	L13012-4	1	-	919.36
	12 x 6	L13012-6	1	-	939.33
	12 x 8	L13012-8	1	-	1,076.81
	12 x 10	L13012-10	1	-	1,194.13
	15 x 4	L13015-4	1	-	1,531.42
	15 x 6	L13015-6	1	-	1,588.32
	15 x 8	L13015-8	1	-	1,797.88
	15 x 10	L13015-10	1	-	1,812.04
	15 x 12	L13015-12	1	-	2,078.26
	18 x 4	L13018-4	1	-	2,168.07
	18 x 6	L13018-6	1	-	2,197.16
	18 x 8	L13018-8	1	-	2,220.80
	18 x 10	L13018-10	1	-	2,254.56
	18 x 12	L13018-12	1	-	2,283.80
	18 x 15	L13018-15	1	-	2,302.47
	21 x 4	L13021-4	1	-	2,509.33
	21 x 6	L13021-6	1	-	2,746.34
	21 x 8	L13021-8	1	-	2,762.76
	21 x 10	L13021-10	1	-	2,795.68
	21 x 12	L13021-12	1	-	2,862.56
	21 x 15	L13021-15	1	-	2,972.86
	21 x 18	L13021-18	1	-	3,223.58
	24 x 4	L13024-4	1	-	5,568.29
	24 x 6	L13024-6	1	-	5,634.44
	24 x 8	L13024-8	1	-	5,704.61
	24 x 10	L13024-10	1	-	5,837.80
	24 x 12	L13024-12	1	-	5,913.67
	24 x 15	L13024-15	1	-	6,082.05
24 x 18	L13024-18	1	-	6,347.56	
24 x 21	L13024-21	1	-	7,460.78	
27 x 4	L13027-4	1	-	5,685.37	
27 x 6	L13027-6	1	-	5,728.05	
27 x 8	L13027-8	1	-	5,806.86	
27 x 10	L13027-10	1	-	5,883.24	
27 x 12	L13027-12	1	-	5,893.23	
27 x 15	L13027-15	1	-	6,222.34	
27 x 18	L13027-18	1	-	6,549.99	
27 x 21	L13027-21	1	-	7,636.02	
27 x 24	L13027-24	1	-	9,122.51	

<b>Manhole Adapter without Pipe Stop SxG</b> Sand Finish					
	4 x 4	L8904	1	-	118.70
	6 x 6	L8906	1	-	221.00
	8 x 8	L8908	1	-	223.80
	10 x 10	L89010	1	-	406.90
	12 x 12	L89012	1	-	596.61
	15 x 15	L89015	1	-	763.59
	18 x 18	L89018	1	-	1,555.92
	21 x 21	L89021	1	-	2,171.68
	24 x 24	L89024	1	-	3,616.47
	27 x 27	L89027	1	-	4,200.05
	30 x 30	L89030	1	-	5,962.59
	36 x 36	L89036	1	-	6,706.51

<b>Gasketed C900 Adapter Bushing SxG</b> C900 Spigot x SDR 26 Gasket Hub					
	4 x 4	H9004	1	-	301.94
	6 x 6	H9006	1	-	363.44
	8 x 8	H9008	1	-	1,169.09
	10 x 10	H90010	1	-	1,432.23
	12 x 12	H90012	1	-	1,715.66
	16 x 15	H90015	1	-	4,574.02
	18 x 18	H90018	1	-	5,472.74
	20 x 21	H90021	1	-	7,245.04
	24 x 24	H90024	1	-	7,749.85

\* Denotes Molded Fitting • Items in Bold feature Heavy Duty Branches (SDR 18)  
 † Denotes Assembled from Molded Components  
 • Specifications: ASTM D3034, F1336, CSA B182.2

• Third party tested and listed by CSA, NSF and UPC  
 • Additional Sizes Available Upon Request  
 • Non-Stock items are non-cancelable, non-returnable

Item	Size In Inches	Part Number	Box Qty	Crate Qty	List Price
<b>Gasketed Sewer Adapter HxG Solvent Sewer Hub x Gasket Sewer Hub</b>					
	*4 x 4	G644	6	-	66.36
	*6 x 4	G646-4	8	-	114.00
	*6 x 6	G646	4	-	145.36
	*8 x 8	H648	4	-	376.42

Item	Size In Inches	Part Number	Box Qty	Crate Qty	List Price
<b>Gasketed DWV Adapter Coupling GxDWV G Gasket Sewer Hub x Gasket DWV Hub</b>					
	*4 x 4	H657	6	-	173.05
	*6 x 4	H658	4	-	232.14
	*6 x 6	H659	3	-	254.05
	8 x 8	H6508	1	-	606.45
	10 x 10	H6510	1	-	839.30
	12 x 12	H6512	1	-	1,235.58

Item	Size In Inches	Part Number	Box Qty	Crate Qty	List Price
<b>Solvent Sewer to DWV Adapter Coupling HxDWV G Solvent Sewer Hub x Gasket DWV Hub</b>					
	*4 x 4	H954	6	-	154.19
	*6 x 4	H956-4	10	-	197.66
	*6 x 6	H956	4	-	235.07
	8 x 8	H958	1	-	565.76
	10 x 10	H9510	1	-	963.09
	12 x 12	H9512	1	-	1,409.35

Item	Size In Inches	Part Number	Box Qty	Crate Qty	List Price
<b>Solvent DWV Adapter Bushing SxDWV H Chamfer Sewer Spigot x Solvent DWV Hub</b>					
	*4 x 4	G944	8	-	62.59
	*6 x 4	G946-4	5	-	110.48
	*6 x 6	G946	4	-	142.97
	*8 x 8	G948	4	-	271.01
	10 x 10	L9410	1	-	351.10
	12 x 12	L9412	1	-	482.89

Item	Size In Inches	Part Number	Box Qty	Crate Qty	List Price
<b>Temporary Plug Polypropylene (S)</b>					
	*4	G1184	36	-	22.78
	*6	G1186	40	-	33.84
	8	G1188	8	-	69.81

Item	Size In Inches	Part Number	Box Qty	Crate Qty	List Price
<b>In-Line Backwater Valve GxG (SDR 35)</b>					
	†4	G0104	1	-	660.74
	†6	G0106	1	-	1,426.96
	8	L0108	1	-	4,686.18
	10	L0110	1	-	5,902.55
	12	L0112	1	-	7,888.09

Item	Size In Inches	Part Number	Box Qty	Crate Qty	List Price
<b>Skirt Gasket for Saddle Tee</b>					
	4" Inlet	G5004	6	-	43.02
	6" Inlet	G5006	4	-	56.37

Item	Size In Inches	Part Number	Box Qty	Crate Qty	List Price
<b>Gasketed Sewer Adapter SxG Solvent Sewer Spigot x Gasket Sewer Hub</b>					
	*4 x 4	G904	6	-	74.43
	*6 x 6	G906	4	-	139.22
	*8 x 8	G908	4	-	322.33
	10 x 10	L9010	1	-	333.66
	12 x 12	L9012	1	-	507.67
	15 x 15	L9015	1	-	767.45
	18 x 18	L9018	1	-	1,686.66
	21 x 21	L9021	1	-	1,855.41
	24 x 24	L9024	1	-	3,354.20
	27 x 27	L9027	1	-	3,908.91

Item	Size In Inches	Part Number	Box Qty	Crate Qty	List Price
<b>Gasketed DWV Adapter Bushing SxDWV G Chamfer Sewer Spigot x Gasket DWV Hub</b>					
	*4 x 4	H1213	6	-	160.25
	*6 x 4	H1214	5	-	219.21
	*6 x 6	H1215	4	-	241.00
	8 x 8	H9208	1	-	591.25
	10 x 10	H9210	1	-	818.29
	12 x 12	H9212	1	-	1,204.55

Item	Size In Inches	Part Number	Box Qty	Crate Qty	List Price
<b>Solvent Weld Sewer Adapter SxH Chamfer Sewer Spigot x Solvent Sewer Hub</b>					
	*4 x 4	G964	8	-	99.16
	6 x 6	G966	1	-	122.48
	8 x 8	G968	1	-	283.62

Item	Size In Inches	Part Number	Box Qty	Crate Qty	List Price
<b>DWV Adapter Sleeve DWV SxSewer G DWV Spigot x Gasket Sewer Hub</b>					
	*4 x 4	G1208	16	-	125.68
	*6 x 6	G1209	8	-	240.56
	8 x 8	L12008	1	-	625.38
	10 x 10	L12010	1	-	839.21
	12 x 12	L12012	1	-	1,235.46

Item	Size In Inches	Part Number	Box Qty	Crate Qty	List Price
<b>Vertical Riser Adapter SxS</b>					
	*4 x 4	G984	9	-	114.00
	*6 x 6	G986	4	-	197.66
	*8 x 8	G988	4	-	442.35



Item	Size In Inches	Part Number	Box Qty	Crate Qty	List Price
<b>Terminal Backwater Valve G (SDR 35)</b>					
	4	L0204	1	-	564.69
	6	L0206	1	-	852.14
	8	L0208	1	-	1,346.97
	10	L0210	1	-	1,558.12
	12	L0212	1	-	1,689.01



Item	Size In Inches	Part Number	Box Qty	Crate Qty	List Price
<b>Stainless Steel Clamp (Standard) 9/16" Width</b>					
	6-8	100-140-9	1	-	50.35
	10-12	100-230-9	1	-	69.48
	Not to exceed 100 in/lb torque				

Item	Size In Inches	Part Number	Box Qty	Crate Qty	List Price
<b>Skirt Gasket for Saddle Wye</b>					
	4" Inlet	G5054	6	-	48.03
	6" Inlet	G5056	4	-	64.52

\* Denotes Molded Fitting • Items in **Bold** feature Heavy Duty Branches (SDR 18)  
 † Denotes Assembled from Molded Components  
 • Specifications: ASTM D3034, F1336, CSA B182.2



• Third party tested and listed by CSA, NSF and UPC  
 • Additional Sizes Available Upon Request  
 • Non-Stock items are non-cancelable, non-returnable

Item	Size In Inches	Part Number	Box Qty	Crate Qty	List Price
<b>Saddle Tee with Stainless Steel Clamps (SDR 26)</b> Short Gasket Skirt x Gasket Inlet					
	*6 x 4	H2106-4R	5	-	152.20
	*8 x 4	H2108-4R	6	-	191.23
	*8 x 6	H2108-6R	3	-	219.02
	*10 x 4	H2110-4R	5	-	338.02
	*10 x 6	H2110-6R	4	-	403.60
	*12 x 4	H2112-4R	6	-	419.30
	*12 x 6	H2112-6R	5	-	471.51
Skirt gasket included					
<b>Saddle Tee with Stainless Steel Clamps (SDR 26)</b> Short Gasket Skirt x Gasket Inlet w/ Locator Ring					
	*6 x 4	H4106-4R	5	-	167.40
	*8 x 4	H4108-4R	6	-	210.31
	*8 x 6	H4108-6R	3	-	240.87
	*10 x 4	H4110-4R	5	-	371.82
	*10 x 6	H4110-6R	4	-	443.95
	*12 x 4	H4112-4R	6	-	461.25
	*12 x 6	H4112-6R	5	-	518.64
Skirt gasket included					
<b>Saddle Tee with Stainless Steel Clamps (SDR 35)</b> Extended Solvent Skirt x Gasket Inlet					
	6 x 4	L2106-4	4	-	152.22
	8 x 4	L2108-4	4	-	191.23
	8 x 6	L2108-6	3	-	219.04
	10 x 4	L2110-4	4	-	338.06
	10 x 6	L2110-6	4	-	403.65
	10 x 8	L2110-8	1	-	677.20
	12 x 4	L2112-4	3	-	419.34
	12 x 6	L2112-6	2	-	471.56
	12 x 8	L2112-8	1	-	781.52
	12 x 10	L2112-10	1	-	983.86
	15 x 4	L2115-4	1	-	443.36
	15 x 6	L2115-6	1	-	475.41
	15 x 8	L2115-8	1	-	933.79
	15 x 10	L2115-10	1	-	1,055.85
	15 x 12	L2115-12	1	-	1,580.58
	18 x 4	L2118-4	4	-	781.52
	18 x 6	L2118-6	2	-	860.96
	18 x 8	L2118-8	1	-	1,114.32
	18 x 10	L2118-10	1	-	1,236.38
	18 x 12	L2118-12	1	-	1,767.51
	18 x 15	L2118-15	1	-	1,929.57
	21 x 4	L2121-4	1	-	813.43
	21 x 6	L2121-6	1	-	895.47
	21 x 8	L2121-8	1	-	1,158.85
	21 x 10	L2121-10	1	-	1,285.85
	21 x 12	L2121-12	1	-	1,838.21
	21 x 15	L2121-15	1	-	2,006.75
	21 x 18	L2121-18	1	-	2,865.49
	24 x 4	L2124-4	1	-	845.93
	24 x 6	L2124-6	1	-	931.22
	24 x 8	L2124-8	1	-	1,205.19
	24 x 10	L2124-10	1	-	1,337.28
	24 x 12	L2124-12	1	-	1,911.70
	24 x 15	L2124-15	1	-	2,087.02
	24 x 18	L2124-18	1	-	3,010.67
24 x 21	L2124-21	1	-	3,389.18	
27 x 4	L2127-4	1	-	888.26	
27 x 6	L2127-6	1	-	977.83	
27 x 8	L2127-8	1	-	1,265.52	
27 x 10	L2127-10	1	-	1,404.16	
27 x 12	L2127-12	1	-	2,007.29	
27 x 15	L2127-15	1	-	2,191.39	
27 x 18	L2127-18	1	-	3,161.21	
27 x 21	L2127-21	1	-	3,558.64	
27 x 24	L2127-24	1	-	4,185.47	
30 x 4	L2130-4	1	-	1,263.97	
30 x 6	L2130-6	1	-	1,383.35	

Item	Size In Inches	Part Number	Box Qty	Crate Qty	List Price
<b>Saddle Wye with Stainless Steel Clamps (SDR 26)</b> Short Gasket Skirt x Gasket Inlet					
	*6 x 4	H2306-4R	4	-	182.63
	*8 x 4	H2308-4R	4	-	229.50
	*8 x 6	H2308-6R	3	-	322.24
	*10 x 4	H2310-4R	3	-	379.19
	*10 x 6	H2310-6R	4	-	406.94
	*12 x 4	H2312-4R	4	-	422.62
	*12 x 6	H2312-6R	4	-	474.62
Skirt gasket included					
<b>Saddle Wye with Stainless Steel Clamps (SDR 26)</b> Short Gasket Skirt x Gasket Inlet w/ Locator Ring					
	*6 x 4	H4306-4R	4	-	205.01
	*8 x 4	H4308-4R	4	-	245.32
	*8 x 6	H4308-6R	3	-	289.06
	*10 x 4	H4310-4R	3	-	568.84
	*10 x 6	H4310-6R	4	-	610.48
	*12 x 4	H4312-4R	4	-	633.91
	*12 x 6	H4312-6R	4	-	711.95
Skirt gasket included					
<b>Saddle Wye with Stainless Steel Clamps (SDR 35)</b> Extended Solvent Skirt x Gasket Inlet					
	6 x 4	L2306-4	3	-	182.66
	8 x 4	L2308-4	3	-	229.50
	8 x 6	L2308-6	2	-	262.79
	10 x 4	L2310-4	3	-	379.24
	10 x 6	L2310-6	1	-	406.99
	10 x 8	L2310-8	1	-	884.49
	12 x 4	L2312-4	4	-	422.66
	12 x 6	L2312-6	4	-	474.68
	12 x 8	L2312-8	1	-	1,245.57
	12 x 10	L2312-10	1	-	1,496.08
	15 x 4	L2315-4	1	-	445.40
	15 x 6	L2315-6	1	-	490.82
	15 x 8	L2315-8	1	-	1,519.72
	15 x 10	L2315-10	1	-	1,716.61
	15 x 12	L2315-12	1	-	2,094.63
	18 x 4	L2318-4	3	-	794.20
	18 x 6	L2318-6	2	-	865.98
	18 x 8	L2318-8	1	-	1,700.18
	18 x 10	L2318-10	1	-	1,897.15
	18 x 12	L2318-12	1	-	2,275.47
	18 x 15	L2318-15	1	-	2,443.67
	21 x 4	L2321-4	1	-	824.71
	21 x 6	L2321-6	1	-	900.60
	21 x 8	L2321-8	1	-	1,768.20
	21 x 10	L2321-10	1	-	1,973.05
	21 x 12	L2321-12	1	-	2,366.51
	21 x 15	L2321-15	1	-	2,541.45
	21 x 18	L2321-18	1	-	3,066.05
	24 x 4	L2324-4	1	-	840.14
	24 x 6	L2324-6	1	-	936.63
	24 x 8	L2324-8	1	-	1,838.93
	24 x 10	L2324-10	1	-	2,051.96
	24 x 12	L2324-12	1	-	2,461.18
	24 x 15	L2324-15	1	-	2,643.08
	24 x 18	L2324-18	1	-	3,188.71
24 x 21	L2324-21	1	-	3,626.44	
27 x 4	L2327-4	1	-	900.60	
27 x 6	L2327-6	1	-	983.43	
27 x 8	L2327-8	1	-	1,930.84	
27 x 10	L2327-10	1	-	2,154.54	
27 x 12	L2327-12	1	-	2,584.22	
27 x 15	L2327-15	1	-	2,775.25	
27 x 18	L2327-18	1	-	3,348.17	
27 x 21	L2327-21	1	-	3,771.48	
27 x 24	L2327-24	1	-	4,336.75	
30 x 4	L2330-4	1	-	1,259.98	
30 x 6	L2330-6	1	-	1,357.17	

\* Denotes Molded Fitting • Items in Bold feature Heavy Duty Branches (SDR 18)  
 † Denotes Assembled from Molded Components  
 • Specifications: ASTM D3034, F1336, CSA B182.2

• Third party tested and listed by CSA, NSF and UPC  
 • Additional Sizes Available Upon Request  
 • Non-Stock items are non-cancelable, non-returnable

Item	Size In Inches	Part Number	Box Qty	Crate Qty	List Price
<b>Reducing Tee Vertical Riser Kit</b>					
	8 x 4	HDB108-4	1	-	1,750.60
	8 x 6	HDB108-6	1	-	1,941.97
<b>Reducing Sanitary Tee (T-Y) Vertical Riser Kit</b>					
	8 x 4	HDB158-4	1	-	1,768.94
	8 x 6	HDB158-6	1	-	1,982.99

Item	Size In Inches	Part Number	Box Qty	Crate Qty	List Price
<b>Reducing 45 Degree Wye Vertical Riser Kit</b>					
	8 x 4	HDB308-4	1	-	1,818.41
	8 x 6	HDB308-6	1	-	2,105.22

## Heavy Wall Gasketed Sewer Fittings SDR 26/PS 115 (H-Series)

Injection Molded in Sizes 4" – 12"  
Fabricated in Sizes 15" – 36"

With a 34.5% thicker wall than SDR 35 and high impact retention ring, Westlake Pipe & Fittings PVC Heavy Wall Gasketed Sewer fittings are manufactured to last. The distinctive green gasket is also heavy duty and engineered to make assembly fast and easy. Just push the pipe in until it hits the square stop for a solid, positive seal.

SDR 26/PS 115 Heavy Wall Gasketed Sewer fittings also feature distinctive green high impact gasket retention rings for easy identification in the field. The deep lead into the gasket reduces the possibility of gasket damage or rolling. In addition, the shock absorbing ring inhibits fittings from breaking under impact.

### Applications

Heavy Wall Gasketed Sewer fittings can be used where extra heavy wall (SDR 26) is specified by your local jurisdiction. SDR 26/PS 115 fittings are intended for non-pressure drainage of sewage and surface water.



### Certifications

Heavy Wall Gasketed Sewer fittings are third party tested and listed by NSF to meet specifications defined in ASTM D3034 and F1336 and CSA to meet specifications defined in CSA B182.2, where applicable.

4" - 12" SDR 26 molded, certified to CSA B182.2 (CSA) ASTM D3034/ F1336 (NSF).

15" SDR 26 fabricated, certified to CSA B182.2 (Intertek), manufactured as per ASTM D3034/F1136.

18" and over, PS 115 fabricated, manufactured as per ASTM F679/ F1336.

**Attention:** Westlake Pipe & Fittings are not to be used with compressed air or gases. Westlake Pipe & Fittings does not recommend that piping systems that include its products be tested with compressed air or gases.

Third Party Tested



Item	Size In Inches	Part Number	Box Qty	Crate Qty	List Price
<b>Straight Tee GxGxG</b>					
	*4 x 4	H104	12	-	243.01
	*6 x 4	H106-4	4	54	309.19
	*6 x 6	H106	4	50	333.04
	*8 x 4	H108-4	2	30	419.27
	*8 x 6	H108-6	2	30	466.98
	*8 x 8	H108	2	13	691.02
	*10 x 4	H1010-4	1	12	<b>1,048.33</b>
	*10 x 6	H1010-6	1	10	<b>1,068.65</b>
	*10 x 8	H1010-8	1	8	1,623.56
	*10 x 10	H1010	1	10	1,769.67
	*12 x 4	H1012-4	1	8	1,337.91
	*12 x 6	H1012-6	1	7	1,401.17
	*12 x 8	H1012-8	1	6	1,902.11
	*12 x 10	H1012-10	1	6	2,271.90
	*12 x 12	H1012	1	5	2,452.20
	15 x 4	H1015-4	1	-	1,987.45
	15 x 6	H1015-6	1	-	2,190.11
	15 x 8	H1015-8	1	-	2,306.29
	15 x 10	H1015-10	1	-	2,629.07
	15 x 12	H1015-12	1	-	3,098.01
	15 x 15	H1015	1	-	4,023.97
	18 x 4	H1018-4	1	-	5,719.13
	18 x 6	H1018-6	1	-	5,913.17
	18 x 8	H1018-8	1	-	6,177.78
	18 x 10	H1018-10	1	-	6,415.32
	18 x 12	H1018-12	1	-	6,590.97
	18 x 15	H1018-15	1	-	7,019.25
	18 x 18	H1018	1	-	7,412.53
	21 x 4	H1021-4	1	-	8,675.87
	21 x 6	H1021-6	1	-	9,306.75
	21 x 8	H1021-8	1	-	9,997.04
	21 x 10	H1021-10	1	-	10,741.70
	21 x 12	H1021-12	1	-	11,513.59
	21 x 15	H1021-15	1	-	12,850.79
	21 x 18	H1021-18	1	-	14,582.33
	21 x 21	H1021	1	-	19,328.93
	24 x 4	H1024-4	1	-	13,689.52
	24 x 6	H1024-6	1	-	16,599.74
	24 x 8	H1024-8	1	-	16,862.53
	24 x 10	H1024-10	1	-	17,607.58
	24 x 12	H1024-12	1	-	17,929.29
	24 x 15	H1024-15	1	-	18,632.05
	24 x 18	H1024-18	1	-	25,783.87
	24 x 21	H1024-21	1	-	27,894.39
	24 x 24	H1024	1	-	34,275.14
	27 x 4	H1027-4	1	-	17,825.43
	27 x 6	H1027-6	1	-	18,516.53
	27 x 8	H1027-8	1	-	20,470.65
27 x 10	H1027-10	1	-	21,530.30	
27 x 12	H1027-12	1	-	23,543.01	
27 x 15	H1027-15	1	-	26,577.52	
27 x 18	H1027-18	1	-	27,234.13	
27 x 21	H1027-21	1	-	19,393.36	
27 x 24	H1027-24	1	-	36,715.15	
27 x 27	H1027	1	-	41,286.95	
30 x 4	H1030-4	1	-	22,906.62	
30 x 6	H1030-6	1	-	23,686.85	
30 x 8	H1030-8	1	-	26,305.45	
30 x 10	H1030-10	1	-	27,667.24	
30 x 12	H1030-12	1	-	30,253.79	
30 x 15	H1030-15	1	-	34,153.24	
30 x 18	H1030-18	1	-	34,997.09	
30 x 21	H1030-21	1	-	36,045.09	
30 x 24	H1030-24	1	-	44,597.87	
30 x 27	H1030-27	1	-	45,858.69	
30 x 30	H1030	1	-	57,323.55	
36 x 4	H1036-4	1	-	30,465.84	
36 x 6	H1036-6	1	-	31,291.32	
36 x 8	H1036-8	1	-	34,986.23	
36 x 10	H1036-10	1	-	36,797.44	
36 x 12	H1036-12	1	-	40,237.57	
36 x 15	H1036-15	1	-	45,423.82	
36 x 18	H1036-18	1	-	46,546.17	
36 x 21	H1036-21	1	-	47,939.95	
36 x 24	H1036-24	1	-	59,315.13	
36 x 27	H1036-27	1	-	60,992.04	
36 x 30	H1036-30	1	-	81,119.46	
36 x 36	H1036	1	-	107,888.82	

Item	Size In Inches	Part Number	Box Qty	Crate Qty	List Price
<b>45 Degree Wye GxGxG</b>					
	*4 x 4	H304	10	-	232.76
	*6 x 4	H306-4	4	50	305.51
	*6 x 6	H306	4	20	377.86
	*8 x 4	H308-4	3	30	427.80
	*8 x 6	H308-6	2	28	490.86
	*8 x 8	H308	2	10	860.71
	*10 x 4	H3010-4	1	11	1,082.15
	*10 x 6	H3010-6	1	10	1,099.65
	10 x 8	H3010-8	1	-	1,699.06
	10 x 10	H3010	1	-	2,052.93
	*12 x 4	H3012-4	1	7	1,478.36
	*12 x 6	H3012-6	1	7	1,497.78
	12 x 8	H3012-8	1	-	2,226.85
	12 x 10	H3012-10	1	-	2,735.23
	12 x 12	H3012	1	-	2,908.52
	15 x 4	H3015-4	1	-	2,111.23
	15 x 6	H3015-6	1	-	2,529.18
	15 x 8	H3015-8	1	-	2,820.40
	15 x 10	H3015-10	1	-	3,389.74
	15 x 12	H3015-12	1	-	3,776.18
	15 x 15	H3015	1	-	4,767.95
	18 x 4	H3018-4	1	-	5,304.20
	18 x 6	H3018-6	1	-	5,373.02
	18 x 8	H3018-8	1	-	5,563.31
	18 x 10	H3018-10	1	-	6,250.35
	18 x 12	H3018-12	1	-	6,716.31
	18 x 15	H3018-15	1	-	7,187.20
	18 x 18	H3018	1	-	9,336.34
	21 x 4	H3021-4	1	-	9,212.86
	21 x 6	H3021-6	1	-	10,713.74
	21 x 8	H3021-8	1	-	11,137.06
	21 x 10	H3021-10	1	-	12,553.50
	21 x 12	H3021-12	1	-	13,576.54
	21 x 15	H3021-15	1	-	15,723.93
	21 x 18	H3021-18	1	-	18,516.72
	21 x 21	H3021	1	-	24,229.38
	24 x 4	H3024-4	1	-	14,397.78
	24 x 6	H3024-6	1	-	17,429.75
	24 x 8	H3024-8	1	-	17,705.66
	24 x 10	H3024-10	1	-	18,487.99
	24 x 12	H3024-12	1	-	18,825.74
	24 x 15	H3024-15	1	-	19,563.64
	24 x 18	H3024-18	1	-	27,073.06
	24 x 21	H3024-21	1	-	29,289.14
	24 x 24	H3024	1	-	35,988.89
	27 x 4	H3027-4	1	-	18,716.70
	27 x 6	H3027-6	1	-	19,442.35
	27 x 8	H3027-8	1	-	21,494.20
27 x 10	H3027-10	1	-	22,606.84	
27 x 12	H3027-12	1	-	24,720.19	
27 x 15	H3027-15	1	-	27,906.44	
27 x 18	H3027-18	1	-	28,595.82	
27 x 21	H3027-21	1	-	32,518.05	
27 x 24	H3027-24	1	-	38,550.95	
27 x 27	H3027	1	-	43,351.30	
30 x 4	H3030-4	1	-	24,051.98	
30 x 6	H3030-6	1	-	24,871.20	
30 x 8	H3030-8	1	-	27,620.73	
30 x 10	H3030-10	1	-	29,050.61	
30 x 12	H3030-12	1	-	31,766.47	
30 x 15	H3030-15	1	-	35,860.89	
30 x 18	H3030-18	1	-	36,746.99	
30 x 21	H3030-21	1	-	37,847.36	
30 x 24	H3030-24	1	-	46,827.75	
30 x 27	H3030-27	1	-	48,151.62	
30 x 30	H3030	1	-	60,189.75	
36 x 4	H3036-4	1	-	31,989.13	
36 x 6	H3036-6	1	-	32,855.91	
36 x 8	H3036-8	1	-	36,735.53	
36 x 10	H3036-10	1	-	38,637.29	
36 x 12	H3036-12	1	-	42,249.40	
36 x 15	H3036-15	1	-	53,483.11	
36 x 18	H3036-18	1	-	48,873.46	
36 x 21	H3036-21	1	-	50,336.96	
36 x 24	H3036-24	1	-	62,280.88	
36 x 27	H3036-27	1	-	64,041.63	
36 x 30	H3036-30	1	-	85,175.43	
36 x 36	H3036	1	-	113,283.24	

\* Denotes Molded Fitting • Items in **Bold** feature Heavy Duty Branches (SDR 18)  
† Denotes Assembled from Molded Components  
• Specifications: ASTM D3034, F1336, CSA B182.2, F679

• 4"-12" Third party tested and listed by CSA and NSF  
• Additional Sizes Available Upon Request  
• Non-Stock items are non-cancelable, non-returnable





Item	Size In Inches	Part Number	Box Qty	Crate Qty	List Price
<b>Straight Tee SxGxG</b>					
	*4 x 4	H124	12	-	306.11
	*6 x 4	H126-4	4	28	321.46
	*6 x 6	H126	4	50	349.47
	*8 x 4	H128-4	2	18	598.27
	*8 x 6	H128-6	2	18	700.41
	*8 x 8	H128	2	13	743.35
	10 x 4	H12710-4	1	-	1,048.33
	10 x 6	H12710-6	1	-	1,068.65
	10 x 8	H12710-8	1	-	1,623.56
	10 x 10	H12710	1	-	1,769.67
	12 x 4	H12712-4	1	-	1,337.91
	12 x 6	H12712-6	1	-	1,401.17
	12 x 8	H12712-8	1	-	1,902.11
	12 x 10	H12712-10	1	-	2,271.90
	12 x 12	H12712	1	-	2,452.20
	15 x 4	H12715-4	1	-	1,987.45
	15 x 6	H12715-6	1	-	2,190.11
	15 x 8	H12715-8	1	-	2,306.29
	15 x 10	H12715-10	1	-	2,629.07
	15 x 12	H12715-12	1	-	3,098.01
	15 x 15	H12715	1	-	4,023.97
	18 x 4	H12718-4	1	-	5,719.13
	18 x 6	H12718-6	1	-	5,913.17
	18 x 8	H12718-8	1	-	6,177.78
	18 x 10	H12718-10	1	-	6,415.32
	18 x 12	H12718-12	1	-	6,590.97
	18 x 15	H12718-15	1	-	7,019.25
	18 x 18	H12718	1	-	7,412.53
	21 x 4	H12721-4	1	-	8,675.87
	21 x 6	H12721-6	1	-	9,306.75
	21 x 8	H12721-8	1	-	9,997.04
	21 x 10	H12721-10	1	-	10,741.70
	21 x 12	H12721-12	1	-	11,513.59
	21 x 15	H12721-15	1	-	12,850.79
	21 x 18	H12721-18	1	-	14,582.33
	21 x 21	H12721	1	-	19,328.93
	24 x 4	H12724-4	1	-	13,689.52
	24 x 6	H12724-6	1	-	16,599.74
	24 x 8	H12724-8	1	-	16,862.53
	24 x 10	H12724-10	1	-	17,607.58
	24 x 12	H12724-12	1	-	17,929.29
	24 x 15	H12724-15	1	-	18,632.05
	24 x 18	H12724-18	1	-	25,783.87
	24 x 21	H12724-21	1	-	27,894.39
	24 x 24	H12724	1	-	34,275.14
27 x 4	H12727-4	1	-	20,499.24	
27 x 6	H12727-6	1	-	21,293.99	
27 x 8	H12727-8	1	-	23,541.28	
27 x 10	H12727-10	1	-	24,759.88	
27 x 12	H12727-12	1	-	27,074.46	
27 x 15	H12727-15	1	-	30,564.21	
27 x 18	H12727-18	1	-	31,319.24	
27 x 21	H12727-21	1	-	35,614.97	
27 x 24	H12727-24	1	-	42,222.45	
27 x 27	H12727	1	-	47,480.02	
30 x 4	H12730-4	1	-	26,342.64	
30 x 6	H12730-6	1	-	27,239.86	
30 x 8	H12730-8	1	-	30,251.29	
30 x 10	H12730-10	1	-	31,817.33	
30 x 12	H12730-12	1	-	34,791.85	
30 x 15	H12730-15	1	-	39,276.20	
30 x 18	H12730-18	1	-	40,246.65	
30 x 21	H12730-21	1	-	41,451.86	
30 x 24	H12730-24	1	-	51,287.55	
30 x 27	H12730-27	1	-	52,737.49	
30 x 30	H12730	1	-	65,922.11	
36 x 4	H12736-4	1	-	35,035.69	
36 x 6	H12736-6	1	-	35,985.05	
36 x 8	H12736-8	1	-	40,234.15	
36 x 10	H12736-10	1	-	42,317.06	
36 x 12	H12736-12	1	-	46,273.17	
36 x 15	H12736-15	1	-	52,237.35	
36 x 18	H12736-18	1	-	53,528.10	
36 x 21	H12736-21	1	-	55,130.95	
36 x 24	H12736-24	1	-	68,212.42	
36 x 27	H12736-27	1	-	70,140.82	
36 x 30	H12736-30	1	-	93,287.34	
36 x 36	H12736	1	-	124,072.16	

Item	Size In Inches	Part Number	Box Qty	Crate Qty	List Price
<b>45 Degree Wye SxGxG</b>					
	14 x 4	H324	10	-	286.43
	16 x 4	H326-4	4	50	354.61
	6 x 6	H326	4	20	434.96
	8 x 4	H328-4	3	30	491.78
	8 x 6	H328-6	2	28	564.49
	8 x 8	H328	2	10	988.96
	10 x 4	H3210-4	1	-	1,244.46
	10 x 6	H3210-6	1	-	1,264.60
	10 x 8	H3210-8	1	-	1,960.41
	10 x 10	H3210	1	-	2,360.88
	12 x 4	H3212-4	1	-	1,700.22
	12 x 6	H3212-6	1	-	1,722.39
	12 x 8	H3212-8	1	-	2,560.81
	12 x 10	H3212-10	1	-	3,145.51
	12 x 12	H3212	1	-	3,340.05
	15 x 4	H3215-4	1	-	2,428.18
	15 x 6	H3215-6	1	-	2,908.58
	15 x 8	H3215-8	1	-	3,243.49
	15 x 10	H3215-10	1	-	3,898.18
	15 x 12	H3215-12	1	-	4,342.60
	15 x 15	H3215	1	-	5,483.18
	18 x 4	H3218-4	1	-	6,905.87
	18 x 6	H3218-6	1	-	7,140.20
	18 x 8	H3218-8	1	-	7,459.60
	18 x 10	H3218-10	1	-	7,746.45
	18 x 12	H3218-12	1	-	7,958.60
	18 x 15	H3218-15	1	-	8,475.70
	18 x 18	H3218	1	-	10,736.67
	21 x 4	H3221-4	1	-	10,594.77
	21 x 6	H3221-6	1	-	12,320.78
	21 x 8	H3221-8	1	-	12,807.62
	21 x 10	H3221-10	1	-	14,436.52
	21 x 12	H3221-12	1	-	15,613.03
	21 x 15	H3221-15	1	-	18,082.48
	21 x 18	H3221-18	1	-	21,294.22
	21 x 21	H3221	1	-	27,863.80
	24 x 4	H3224-4	1	-	16,530.09
	24 x 6	H3224-6	1	-	20,044.23
	24 x 8	H3224-8	1	-	20,361.52
	24 x 10	H3224-10	1	-	21,261.22
	24 x 12	H3224-12	1	-	21,649.60
	24 x 15	H3224-15	1	-	22,498.18
	24 x 18	H3224-18	1	-	31,134.00
	24 x 21	H3224-21	1	-	33,682.50
	24 x 24	H3224	1	-	41,387.23
27 x 4	H3227-4	1	-	21,524.20	
27 x 6	H3227-6	1	-	22,358.68	
27 x 8	H3227-8	1	-	24,718.30	
27 x 10	H3227-10	1	-	25,997.86	
27 x 12	H3227-12	1	-	28,428.20	
27 x 15	H3227-15	1	-	32,092.37	
27 x 18	H3227-18	1	-	32,885.21	
27 x 21	H3227-21	1	-	37,395.78	
27 x 24	H3227-24	1	-	44,333.57	
27 x 27	H3227	1	-	49,854.01	
30 x 4	H3230-4	1	-	27,659.76	
30 x 6	H3230-6	1	-	28,601.87	
30 x 8	H3230-8	1	-	31,763.80	
30 x 10	H3230-10	1	-	33,408.19	
30 x 12	H3230-12	1	-	36,551.47	
30 x 15	H3230-15	1	-	41,240.04	
30 x 18	H3230-18	1	-	42,259.03	
30 x 21	H3230-21	1	-	43,524.45	
30 x 24	H3230-24	1	-	53,851.96	
30 x 27	H3230-27	1	-	55,374.37	
30 x 30	H3230	1	-	69,218.19	
36 x 4	H3236-4	1	-	36,787.48	
36 x 6	H3236-6	1	-	37,784.26	
36 x 8	H3236-8	1	-	42,245.83	
36 x 10	H3236-10	1	-	44,432.91	
36 x 12	H3236-12	1	-	48,586.84	
36 x 15	H3236-15	1	-	54,849.26	
36 x 18	H3236-18	1	-	56,204.49	
36 x 21	H3236-21	1	-	57,887.51	
36 x 24	H3236-24	1	-	71,623.06	
36 x 27	H3236-27	1	-	73,647.87	
36 x 30	H3236-30	1	-	97,951.72	
36 x 36	H3236	1	-	130,275.73	

\* Denotes Molded Fitting • Items in Bold feature Heavy Duty Branches (SDR 18)  
 † Denotes Assembled from Molded Components  
 • Specifications: ASTM D3034, F1336, CSA B182.2, F679

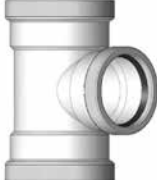
• 4"-12" Third party tested and listed by CSA and NSF  
 • Additional Sizes Available Upon Request  
 • Non-Stock items are non-cancelable, non-returnable

Item	Size In Inches	Part Number	Box Qty	Crate Qty	List Price
<b>Straight Tee with DWV Branch GxGxDWV G</b>					
	16 x 4	H116-4	1	-	358.25
	*8 x 4	H118-4	2	28	462.23
	*8 x 6	H118-6	2	26	514.88
	110 x 4	H1110-4	1	-	1,309.86
	110 x 6	H1110-6	1	-	1,333.24
	112 x 4	H1112-4	1	-	1,627.93
	112 x 6	H1112-6	1	-	1,723.73
	15 x 4	H1115-4	1	-	2,295.52
	15 x 6	H1115-6	1	-	2,529.67
	18 x 4	H1118-4	1	-	6,605.61
	18 x 6	H1118-6	1	-	6,829.74
	21 x 4	H1121-4	1	-	10,020.60
	21 x 6	H1121-6	1	-	10,749.28
	24 x 4	H1124-4	1	-	15,811.44
	24 x 6	H1124-6	1	-	19,172.70
	27 x 4	H1127-4	1	-	20,588.32
27 x 6	H1127-6	1	-	21,386.62	

Item	Size In Inches	Part Number	Box Qty	Crate Qty	List Price
<b>Straight Tee with DWV Branch GxGxDWV H</b>					
	16 x 4	H136-4	1	-	302.75
	*8 x 4	H138-4	2	30	440.23
	*8 x 6	H138-6	2	28	490.36
	110 x 4	H1310-4	1	-	1,188.42
	110 x 6	H1310-6	1	-	1,280.06
	112 x 4	H1312-4	1	-	1,477.94
	112 x 6	H1312-6	1	-	1,612.58
	15 x 4	H1315-4	1	-	2,186.18
	15 x 6	H1315-6	1	-	2,409.20
	18 x 4	H1318-4	1	-	6,291.07
	18 x 6	H1318-6	1	-	6,504.54
	21 x 4	H1321-4	1	-	9,543.42
	21 x 6	H1321-6	1	-	10,237.43
	24 x 4	H1324-4	1	-	15,058.52
	24 x 6	H1324-6	1	-	18,259.74
	27 x 4	H1327-4	1	-	19,607.96
27 x 6	H1327-6	1	-	20,368.18	

Item	Size In Inches	Part Number	Box Qty	Crate Qty	List Price
<b>Combo Wye &amp; 1/8 Bend GxGxG (2 Piece)</b>					
	14 x 4	H1654	4	-	433.51
	16 x 4	H1656-4	1	20	437.08
	16 x 6	H1656	1	16	569.46
	18 x 4	H1658-4	1	12	574.79
	18 x 6	H1658-6	1	12	693.38
	18 x 8	H1658	1	8	1,447.47
	110 x 4	H16510-4	1	8	1,236.60
	110 x 6	H16510-6	1	9	1,389.11
	10 x 8	H16510-8	1	-	2,183.92
	10 x 10	H16510	1	-	3,024.09
	112 x 4	H16512-4	1	6	1,596.74
	112 x 6	H16512-6	1	6	1,679.13
	12 x 8	H16512-8	1	5	2,705.96
	12 x 10	H16512-10	1	-	3,706.29
	12 x 12	H16512	1	-	4,390.97
	15 x 4	H16515-4	1	5	2,429.56
	15 x 6	H16515-6	1	3	2,691.90
	15 x 8	H16515-8	1	3	3,299.52
	15 x 10	H16515-10	1	-	4,360.74
	15 x 12	H16515-12	1	-	5,258.55
	15 x 15	H16515	1	-	7,696.53
	18 x 4	H16518-4	1	3	6,122.95
	18 x 6	H16518-6	1	3	6,371.17
	18 x 8	H16518-8	1	-	6,965.32
	21 x 4	H16521-4	1	-	9,330.37
	21 x 6	H16521-6	1	-	10,875.61
	21 x 8	H16521-8	1	-	11,615.32
	24 x 4	H16524-4	1	-	14,491.00
	24 x 6	H16524-6	1	-	17,590.92
	24 x 8	H16524-8	1	-	18,183.21
	27 x 4	H16527-4	1	-	18,835.15
	27 x 6	H16527-6	1	-	19,605.30
	27 x 8	H16527-8	1	-	21,973.55
	30 x 4	H16530-4	1	-	24,170.47
	30 x 6	H16530-6	1	-	25,034.13
	30 x 8	H16530-8	1	-	28,100.10
36 x 4	H16536-4	1	-	32,107.60	
36 x 6	H16536-6	1	-	33,018.88	
36 x 8	H16536-8	1	-	37,214.85	

Item	Size In Inches	Part Number	Box Qty	Crate Qty	List Price
<b>45 Degree Wye with DWV Branch GxGxDWV G</b>					
	6 x 4	H316-4	4	-	454.62
	*8 x 4	H318-4	2	14	450.57
	*8 x 6	H318-6	2	12	541.16
	110 x 4	H3110-4	1	-	1,265.97
	110 x 6	H3110-6	1	-	1,364.23
	112 x 4	H3112-4	1	-	1,662.30
	112 x 6	H3112-6	1	-	1,762.27
	15 x 4	H3115-4	1	-	2,438.76
	15 x 6	H3115-6	1	-	2,924.37
	18 x 4	H3118-4	1	-	6,935.92
	18 x 6	H3118-6	1	-	7,171.25
	21 x 4	H3121-4	1	-	10,640.84
	21 x 6	H3121-6	1	-	12,374.33
	24 x 4	H3124-4	1	-	16,601.97
	24 x 6	H3124-6	1	-	20,131.35
	27 x 4	H3127-4	1	-	21,617.75
27 x 6	H3127-6	1	-	22,455.92	

Item	Size In Inches	Part Number	Box Qty	Crate Qty	List Price
<b>45 Degree Wye with DWV Branch GxGxDWV H</b>					
	6 x 4	H336-4	1	-	432.19
	*8 x 4	H338-4	2	16	381.17
	*8 x 6	H338-6	2	12	481.10
	110 x 4	H3310-4	1	-	1,222.18
	110 x 6	H3310-6	1	30	1,311.04
	112 x 4	H3312-4	1	-	1,618.47
	112 x 6	H3312-6	1	-	1,709.09
	15 x 4	H3315-4	1	-	2,322.61
	15 x 6	H3315-6	1	-	2,761.41
	18 x 4	H3318-4	1	-	6,605.61
	18 x 6	H3318-6	1	-	6,829.74
	21 x 4	H3321-4	1	-	10,134.12
	21 x 6	H3321-6	1	-	11,785.11
	24 x 4	H3324-4	1	-	15,811.39
	24 x 6	H3324-6	1	-	19,172.70
	27 x 4	H3327-4	1	-	20,588.32
27 x 6	H3327-6	1	-	21,386.62	

Item	Size In Inches	Part Number	Box Qty	Crate Qty	List Price
<b>Double 45 Degree Wye GxGxGxG</b>					
	14 x 4	H364-4	1	-	331.65
	*6 x 4	H366-4	3	15	363.23
	*6 x 6	H366-6	2	12	706.30
	8 x 4	H368-4	1	-	725.78
	8 x 6	H368-6	1	-	868.53
	8 x 8	H368-8	1	-	1,429.78
	10 x 4	H3610-4	1	-	1,800.69
	10 x 6	H3610-6	1	-	1,893.25
	10 x 8	H3610-8	1	-	2,672.19
	10 x 10	H3610-10	1	-	3,024.71
	12 x 4	H3612-4	1	-	2,281.74
	12 x 6	H3612-6	1	-	2,426.33
	12 x 8	H3612-8	1	-	3,274.73
	12 x 10	H3612-10	1	-	3,784.34
	12 x 12	H3612-12	1	-	4,099.58
	15 x 4	H3615-4	1	-	3,292.04
	15 x 6	H3615-6	1	-	3,753.02
	15 x 8	H3615-8	1	-	4,021.09
	15 x 10	H3615-10	1	-	4,681.61
	15 x 12	H3615-12	1	-	5,865.08
	15 x 15	H3615-15	1	-	6,509.27
	18 x 4	H3618-4	1	-	6,858.05
	18 x 6	H3618-6	1	-	7,198.84
	18 x 8	H3618-8	1	-	7,867.95
	21 x 4	H3621-4	1	-	11,976.70
	21 x 6	H3621-6	1	-	14,463.56
	21 x 8	H3621-8	1	-	15,591.91
	24 x 4	H3624-4	1	-	18,686.17
	24 x 6	H3624-6	1	-	23,530.11
	24 x 8	H3624-8	1	-	24,787.91
	27 x 4	H3627-4	1	-	24,331.68
	27 x 6	H3627-6	1	-	26,247.15
	27 x 8	H3627-8	1	-	30,091.87
	30 x 4	H3630-4	1	-	31,267.59
	30 x 6	H3630-6	1	-	33,576.09
	30 x 8	H3630-8	1	-	38,669.00
36 x 4	H3636-4	1	-	41,585.87	
36 x 6	H3636-6	1	-	44,355.46	
36 x 8	H3636-8	1	-	51,429.72	

\* Denotes Molded Fitting • Items in **Bold** feature Heavy Duty Branches (SDR 18)  
† Denotes Assembled from Molded Components  
• Specifications: ASTM D3034, F1336, CSA B182.2, F679

• 4"-12" Third party tested and listed by CSA and NSF  
• Additional Sizes Available Upon Request  
• Non-Stock items are non-cancelable, non-returnable

Item	Size In Inches	Part Number	Box Qty	Crate Qty	List Price
<b>Sanitary Tee (T-Y) GxGxG</b>					
	*4 x 4	H156	10	-	282.77
	*6 x 4	H157-4	5	56	331.64
	*6 x 6	H157	2	24	434.46
	*8 x 4	H158-4	3	30	418.89
	*8 x 6	H158-6	2	28	478.60
	*8 x 8	H158	2	13	1,078.33
	10 x 4	H1510-4	1	-	1,236.73
	10 x 6	H1510-6	1	-	1,389.25
	10 x 8	H1510-8	1	-	2,152.23
	10 x 10	H1510	1	-	2,664.42
	12 x 4	H1512-4	1	-	1,542.17
	12 x 6	H1512-6	1	-	1,679.30
	12 x 8	H1512-8	1	-	2,351.55
	12 x 10	H1512-10	1	-	3,256.25
	12 x 12	H1512	1	-	3,701.29
	15 x 4	H1515-4	1	-	2,429.79
	15 x 6	H1515-6	1	-	2,642.87
	15 x 8	H1515-8	1	-	2,833.81
	18 x 4	H1518-4	1	-	6,028.47
	18 x 6	H1518-6	1	-	6,138.15
	18 x 8	H1518-8	1	-	6,510.71
	21 x 4	H1521-4	1	-	9,719.55
	21 x 6	H1521-6	1	-	11,303.01
	21 x 8	H1521-8	1	-	12,186.76
	24 x 4	H1524-4	1	-	15,337.28
	24 x 6	H1524-6	1	-	18,388.35
	24 x 8	H1524-8	1	-	18,679.47
	27 x 4	H1527-4	1	-	19,746.13
	27 x 6	H1527-6	1	-	20,511.12
	27 x 8	H1527-8	1	-	22,676.36
	30 x 4	H1530-4	1	-	25,374.82
	30 x 6	H1530-6	1	-	26,239.09
	30 x 8	H1530-8	1	-	29,139.84
	36 x 4	H1536-4	1	-	33,748.54
	36 x 6	H1536-6	1	-	34,662.97
	36 x 8	H1536-8	1	-	38,755.97

Item	Size In Inches	Part Number	Box Qty	Crate Qty	List Price
<b>Sanitary Tee (T-Y) SxGxG</b>					
	*4 x 4	H174	10	-	295.98
	*6 x 4	H177-4	5	40	331.64
	*6 x 6	H177	2	24	434.46
	*8 x 4	H178-4	3	15	418.89
	*8 x 6	H178-6	2	28	478.60
	*8 x 8	H178	2	12	1,132.20
	10 x 4	H1710-4	1	-	1,422.22
	10 x 6	H1710-6	1	-	1,597.67
	10 x 8	H1710-8	1	-	2,475.03
	10 x 10	H1710	1	-	4,100.90
	12 x 4	H1712-4	1	-	1,793.77
	12 x 6	H1712-6	1	-	1,679.30
	12 x 8	H1712-8	1	-	3,274.40
	12 x 10	H1712-10	1	-	5,077.31
	12 x 12	H1712	1	-	5,751.90
	15 x 4	H1715-4	1	-	2,794.28
	15 x 6	H1715-6	1	-	3,068.54
	15 x 8	H1715-8	1	-	3,421.88
	18 x 4	H1718-4	1	-	7,284.96
	18 x 6	H1718-6	1	-	7,532.12
	18 x 8	H1718-8	1	-	7,869.08
	21 x 4	H1721-4	1	-	11,176.33
	21 x 6	H1721-6	1	-	12,997.08
	21 x 8	H1721-8	1	-	14,013.33
	24 x 4	H1724-4	1	-	17,636.08
	24 x 6	H1724-6	1	-	21,144.46
	24 x 8	H1724-8	1	-	21,479.22
	27 x 4	H1727-4	1	-	22,708.05
	27 x 6	H1727-6	1	-	23,588.41
	27 x 8	H1727-8	1	-	26,077.83

Item	Size In Inches	Part Number	Box Qty	Crate Qty	List Price
<b>Long Radius Sanitary Tee GxGxG</b>					
	†4 x 4	H1644	1	28	619.69

Item	Size In Inches	Part Number	Box Qty	Crate Qty	List Price
<b>Sanitary Tee (T-Y) with DWV Branch GxGxDWV G</b>					
	†8 x 4	H188-4	2	14	450.57
	†8 x 6	H188-6	2	10	586.48
	10 x 4	H1810-4	1	-	1,400.30
	10 x 6	H1810-6	1	-	1,431.31
	12 x 4	H1812-4	1	-	1,801.58
	12 x 6	H1812-6	1	-	1,939.61
	15 x 4	H1815-4	1	-	2,806.42
	15 x 6	H1815-6	1	-	3,081.85
	18 x 4	H1818-4	1	-	7,317.35
	18 x 6	H1818-6	1	-	7,518.14
	21 x 4	H1821-4	1	-	11,226.09
	21 x 6	H1821-6	1	-	13,054.97
	24 x 4	H1824-4	1	-	17,714.55
	24 x 6	H1824-6	1	-	21,238.55
	27 x 4	H1827-4	1	-	22,809.90
	27 x 6	H1827-6	1	-	23,691.00

Item	Size In Inches	Part Number	Box Qty	Crate Qty	List Price
<b>Sanitary Tee (T-Y) with DWV Branch GxGxDWV H</b>					
	*8 x 4	H198-4	2	15	381.17
	*8 x 6	H198-6	2	14	481.10
	10 x 4	H1910-4	1	-	1,352.66
	10 x 6	H1910-6	1	-	1,528.02
	12 x 4	H1912-4	1	-	1,848.08
	12 x 6	H1912-6	1	-	1,872.21
	15 x 4	H1915-4	1	-	2,903.25
	15 x 6	H1915-6	1	-	2,761.41
	18 x 4	H1918-4	1	-	6,968.94
	18 x 6	H1918-6	1	-	7,205.39
	21 x 4	H1921-4	1	-	10,691.54
	21 x 6	H1921-6	1	-	12,433.27
	24 x 4	H1924-4	1	-	16,871.03
	24 x 6	H1924-6	1	-	20,227.21
	27 x 4	H1927-4	1	-	21,720.73
27 x 6	H1927-6	1	-	22,562.83	

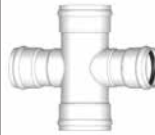
Item	Size In Inches	Part Number	Box Qty	Crate Qty	List Price
<b>Tee Cross GxGxGxG</b>					
	4 x 4	H1794	1	-	380.92
	6 x 4	H1796-4	1	-	515.28
	6 x 6	H1796	1	-	707.41
	8 x 4	H1798-4	1	-	863.93
	8 x 6	H1798-6	1	-	1,067.61
	8 x 8	H1798	1	-	1,583.25
	10 x 4	H17910-4	1	-	2,028.61
	10 x 6	H17910-6	1	-	2,130.61
	10 x 8	H17910-8	1	-	2,885.47
	10 x 10	H17910	1	-	3,502.00
	12 x 4	H17912-4	1	-	2,268.39
	12 x 6	H17912-6	1	-	2,631.99
	12 x 8	H17912-8	1	-	3,049.10
	12 x 10	H17912-10	1	-	3,577.27
	12 x 12	H17912	1	-	4,189.47
	15 x 4	H17915-4	1	-	3,749.75
	15 x 6	H17915-6	1	-	4,329.63
	15 x 8	H17915-8	1	-	4,577.28
	15 x 10	H17915-10	1	-	4,776.96
	15 x 12	H17915-12	1	-	5,161.43
	15 x 15	H17915	1	-	6,217.75
	18 x 4	H17918-4	1	-	8,316.67
	18 x 6	H17918-6	1	-	9,492.69
	18 x 8	H17918-8	1	-	9,918.10
18 x 10	H17918-10	1	-	12,053.07	
18 x 12	H17918-12	1	-	13,204.28	
18 x 15	H17918-15	1	-	15,037.62	
18 x 18	H17918	1	-	20,369.50	
21 x 4	H17921-4	1	-	11,582.65	
21 x 6	H17921-6	1	-	12,650.26	
21 x 8	H17921-8	1	-	14,482.84	

Item	Size In Inches	Part Number	Box Qty	Crate Qty	List Price
<b>2-Way Cleanout GxGxG</b>					
	*4 x 4	H1004	6	-	217.04
	*6 x 6	H1006	2	21	1,232.40

\* Denotes Molded Fitting • Items in Bold feature Heavy Duty Branches (SDR 18)  
 † Denotes Assembled from Molded Components  
 • Specifications: ASTM D3034, F1336, CSA B182.2, F679

• 4"-12" Third party tested and listed by CSA and NSF  
 • Additional Sizes Available Upon Request  
 • Non-Stock items are non-cancelable, non-returnable

Item	Size In Inches	Part Number	Box Qty	Crate Qty	List Price
<b>1/4 Bend (90) GxG</b>					
	*4	H204	10	-	182.70
	*6	H206	4	50	200.48
	*8	H208	2	14	874.32
	*10	H2010	1	9	1,449.22
	*12	H2012	1	6	1,914.78

Item	Size In Inches	Part Number	Box Qty	Crate Qty	List Price
<b>1/4 Bend (90) GxG Long Sweep</b>					
	*4	H256	6	-	182.68
	*6	H257	4	24	436.49
	*8	H258	2	12	873.61
	†10	H2510	1	8	1,895.65
	†12	H2512	1	6	2,918.43
	15	H2515	1	-	3,536.46
	18	H2518	1	-	6,666.29
	21	H2521	1	-	12,347.18
	24	H2524	1	-	16,509.00
	27	H2527	1	-	18,763.61
	30	H2530	1	-	23,530.39
	36	H2536	1	-	30,109.16

Item	Size In Inches	Part Number	Box Qty	Crate Qty	List Price
<b>Deep Socket 1/4 Bend (90) GxG (2 Piece Assembly)</b>					
	†4	H2566	1	-	699.05
	†6	H2577	1	18	778.52
	†8	H2588	1	-	1,337.44

Item	Size In Inches	Part Number	Box Qty	Crate Qty	List Price
<b>1/8 Bend (45) GxG</b>					
	*4	H504	8	168	102.83
	*6	H506	6	50	188.77
	*8	H508	4	32	469.04
	*10	H5010	1	12	924.36
	*12	H5012	1	8	1,435.83
	15	H5015	1	-	2,882.14
	18	H5018	1	-	5,140.29
	21	H5021	1	-	9,387.68
	24	H5024	1	-	12,816.44
	27	H5027	1	-	14,747.37
	30	H5030	1	-	18,951.23
	36	H5036	1	-	24,257.54

Item	Size In Inches	Part Number	Box Qty	Crate Qty	List Price
<b>Deep Socket 1/8 Bend (45) GxG</b>					
	†4	H5044	1	-	381.03
	*6	H5066	1	25	394.72
	†8	H5088	1	-	769.88

Item	Size In Inches	Part Number	Box Qty	Crate Qty	List Price
<b>1/8 Bend (45) GxG (Extra Long Sweep Radius)</b>					
	4	H4804	1	-	510.88
	6	H4806	1	-	725.16
	8	H4808	1	-	2,259.11
	10	H48010	1	-	3,614.61
	12	H48012	1	-	6,777.33
15	H48015	1	-	8,471.78	

Item	Size In Inches	Part Number	Box Qty	Crate Qty	List Price
<b>1/12 Bend (30) GxG</b>					
	4	H1354.30	1	-	145.23
	6	H1356.30	1	-	263.75
	8	H1358.30	1	-	484.73
	10	H13510.30	1	-	1,064.38
	12	H13512.30	1	-	1,430.42
	15	H13515.30	1	-	3,416.09
	18	H13518.30	1	-	5,563.69
	21	H13521.30	1	-	8,513.68
	24	H13524.30	1	-	12,258.65
	27	H13527.30	1	-	15,852.08
	30	H13530.30	1	-	20,370.58
	36	H13536.30	1	-	26,074.28

Item	Size In Inches	Part Number	Box Qty	Crate Qty	List Price
<b>1/4 Bend (90) SxG</b>					
	*4	H224	10	-	182.70
	*6	H226	4	50	190.31
	*8	H228	2	14	852.64
	*10	H2210	1	9	1,449.22
	*12	H2212	1	6	1,914.78

Item	Size In Inches	Part Number	Box Qty	Crate Qty	List Price
<b>1/4 Bend (90) SxG Long Sweep</b>					
	*4	H274	6	-	182.68
	*6	H277	4	24	494.78
	†8	H278	2	12	1,017.86
	†10	H2710	1	8	1,895.65
	†12	H2712	1	6	2,918.43
	15	H2715	1	-	3,536.46
	18	H2718	1	-	6,161.45
	21	H2721	1	-	11,163.46
	24	H2724	1	-	13,784.18
	27	H2727	1	-	19,058.86
	30	H2730	1	-	29,403.33
	36	H2736	1	-	37,636.25

Item	Size In Inches	Part Number	Box Qty	Crate Qty	List Price
<b>Deep Socket 1/4 Bend (90) SxG (2 Piece Assembly)</b>					
	†4	H2744	1	-	699.05
	†6	H2777	1	18	778.52
	†8	H2788	1	-	1,337.44

Item	Size In Inches	Part Number	Box Qty	Crate Qty	List Price
<b>1/8 Bend (45) SxG</b>					
	*4	H404	12	168	94.93
	*6	H406	6	60	139.44
	*8	H408	4	16	469.04
	*10	H4010	1	12	924.36
	*12	H4012	1	8	1,435.83
	15	H4015	1	-	2,882.14
	18	H4018	1	-	4,235.96
	21	H4021	1	-	9,387.68
	24	H4024	1	-	12,816.44
	27	H4027	1	-	15,097.23
	30	H4030	1	-	23,688.92
	36	H4036	1	-	30,321.77

Item	Size In Inches	Part Number	Box Qty	Crate Qty	List Price
<b>Deep Socket 1/8 Bend (45) SxG</b>					
	†4	H4044	1	-	380.99
	*6	H4066	1	25	375.89
	†8	H4088	1	-	769.80

Item	Size In Inches	Part Number	Box Qty	Crate Qty	List Price
<b>1/8 Bend (45) SxG (Extra Long Sweep Radius)</b>					
	4	H4904	1	-	510.87
	6	H4906	1	-	725.16
	8	H4908	1	-	2,259.11
	10	H49010	1	-	3,614.61
	12	H49012	1	-	6,777.33
15	H49015	1	-	8,471.78	

Item	Size In Inches	Part Number	Box Qty	Crate Qty	List Price
<b>1/12 Bend (30) SxG</b>					
	4	H1344.30	1	-	148.15
	6	H1346.30	1	-	269.02
	8	H1348.30	1	-	494.45
	10	H13410.30	1	-	1,085.68
	12	H13412.30	1	-	1,459.02
	15	H13415.30	1	-	3,484.44
	18	H13418.30	1	-	5,674.98
	21	H13421.30	1	-	8,683.94
	24	H13424.30	1	-	12,503.82
	27	H13427.30	1	-	16,169.16
	30	H13430.30	1	-	20,778.03
	36	H13436.30	1	-	26,595.75

\* Denotes Molded Fitting • Items in **Bold** feature Heavy Duty Branches (SDR 18)  
† Denotes Assembled from Molded Components  
• Specifications: ASTM D3034, F1336, CSA B182.2, F679

• 4"-12" Third party tested and listed by CSA and NSF  
• Additional Sizes Available Upon Request  
• Non-Stock items are non-cancelable, non-returnable

Item	Size In Inches	Part Number	Box Qty	Crate Qty	List Price
<b>1/16 Bend (22.5) GxG</b>					
	*4	H1704	12	-	136.48
	*6	H1706	6	60	257.29
	*8	H1708	3	38	472.79
	*10	H17010	1	12	1,013.68
	*12	H17012	1	8	1,362.30
	15	H17015	1	-	3,253.45
	18	H17018	1	-	5,298.76
	21	H17021	1	-	8,108.23
	24	H17024	1	-	11,674.95
	27	H17027	1	-	14,405.18
	30	H17030	1	-	18,511.14
	36	H17036	1	-	23,694.30

Item	Size In Inches	Part Number	Box Qty	Crate Qty	List Price
<b>Deep Socket 1/16 Bend (22.5) GxG</b>					
	†4	H17044	1	-	381.03
	*6	H17066	1	60	394.72
	†8	H17088	1	-	769.80

Item	Size In Inches	Part Number	Box Qty	Crate Qty	List Price
<b>1/16 Bend (22.5) GxG (Extra Long Sweep Radius)</b>					
	4	H14904	1	-	510.88
	6	H14906	1	-	725.16
	8	H14908	1	-	2,259.11
	10	H14910	1	-	3,614.61
	12	H14912	1	-	6,777.33
	15	H14915	1	-	8,471.78

Item	Size In Inches	Part Number	Box Qty	Crate Qty	List Price
<b>1/32 Bend (11.25) GxG</b>					
	4	H1934	1	-	145.23
	6	H1936	1	-	257.29
	8	H1938	1	-	484.77
	10	H19310	1	-	1,013.68
	12	H19312	1	-	1,362.30
	15	H19315	1	-	3,253.45
	18	H19318	1	-	5,298.76
	21	H19321	1	-	8,108.23
	24	H19324	1	-	11,674.95
	27	H19327	1	-	16,089.87
	30	H19330	1	-	20,676.16
	36	H19336	1	-	26,465.38

Item	Size In Inches	Part Number	Box Qty	Crate Qty	List Price
<b>Cap (G)</b>					
	*4	H1604	18	-	93.07
	*6	H1606	8	140	215.00
	*8	H1608	8	80	318.76
	10	H16010	1	-	614.14
	12	H16012	1	-	966.08
	15	H16015	1	-	1,607.35
	18	H16018	1	-	2,417.71
	21	H16021	1	-	5,654.56
	24	H16024	1	-	6,530.85
	27	H16027	1	-	10,956.58
	30	H16030	1	-	14,079.66
	36	H16036	1	-	18,021.92

Item	Size In Inches	Part Number	Box Qty	Crate Qty	List Price
<b>Stop Coupling GxG</b>					
	*4	H604	8	-	113.32
	*6	H606	4	60	320.31
	*8	H608	4	38	388.45
	10	H6010	1	-	570.42
	12	H6012	1	-	828.04
	15	H6015	1	-	1,713.02
	18	H6018	1	-	3,646.10
	21	H6021	1	-	6,700.87
	24	H6024	1	-	9,762.14
	27	H6027	1	-	10,956.58
	30	H6030	1	-	14,079.66
	36	H6036	1	-	18,860.89

Item	Size In Inches	Part Number	Box Qty	Crate Qty	List Price
<b>1/16 Bend (22.5) SxG</b>					
	*4	H1714	15	-	130.67
	*6	H1716	6	60	246.47
	*8	H1718	4	38	472.79
	*10	H17110	1	12	1,013.68
	*12	H17112	1	8	1,362.30
	15	H17115	1	-	3,253.45
	18	H17118	1	-	5,298.76
	21	H17121	1	-	8,108.23
	24	H17124	1	-	11,674.73
	27	H17127	1	-	14,405.18
	30	H17130	1	-	23,138.91
	36	H17136	1	-	29,617.77

Item	Size In Inches	Part Number	Box Qty	Crate Qty	List Price
<b>Deep Socket 1/16 Bend (22.5) SxG</b>					
	†4	H17144	1	-	380.99
	*6	H17166	1	60	394.68
	†8	H17188	1	-	769.80

Item	Size In Inches	Part Number	Box Qty	Crate Qty	List Price
<b>1/16 Bend (22.5) SxG (Extra Long Sweep Radius)</b>					
	4	H14904S	1	-	510.87
	6	H14906S	1	-	725.16
	8	H14908S	1	-	2,259.11
	10	H14910S	1	-	3,614.61
	12	H14912S	1	-	6,777.33
	15	H14915S	1	-	8,471.78

Item	Size In Inches	Part Number	Box Qty	Crate Qty	List Price
<b>1/32 Bend (11.25) SxG</b>					
	4	H1834	1	-	138.83
	6	H1836	1	-	190.31
	8	H1838	1	-	484.77
	10	H18310	1	-	1,013.68
	12	H18312	1	-	1,362.30
	15	H18315	1	-	3,253.45
	18	H18318	1	-	5,298.76
	21	H18321	1	-	8,108.23
	24	H18324	1	-	11,674.73
	27	H18327	1	-	16,411.66
	30	H18330	1	-	25,462.10
	36	H18336	1	-	32,591.43

Item	Size In Inches	Part Number	Box Qty	Crate Qty	List Price
<b>Spigot Plug (S)</b>					
	*4	H1164	24	495	72.38
	*6	H1166	15	168	167.70
	*8	H1168	8	80	296.66
	10	H11610	1	-	569.25
	12	H11612	1	-	678.63
	15	H11615	1	-	1,248.43
	18	H11618	1	-	1,958.73
	21	H11621	1	-	4,177.45
	24	H11624	1	-	6,281.31
	27	H11627	1	-	7,644.23
	30	H11630	1	-	13,667.56
	36	H11636	1	-	17,494.45

Item	Size In Inches	Part Number	Box Qty	Crate Qty	List Price
<b>Repair Coupling GxG</b>					
	*4	H624	8	-	113.32
	*6	H626	4	60	226.99
	*8	H628	4	38	372.85
	10	H6210	1	-	570.42
	12	H6212	1	-	828.04
	15	H6215	1	-	1,713.02
	18	H6218	1	-	3,646.10
	21	H6221	1	-	6,701.00
	24	H6224	1	-	9,762.14
	27	H6227	1	-	10,956.58
	30	H6230	1	-	14,079.66
	36	H6236	1	-	18,860.89

\* Denotes Molded Fitting • Items in Bold feature Heavy Duty Branches (SDR 18)  
 † Denotes Assembled from Molded Components  
 • Specifications: ASTM D3034, F1336, CSA B182.2, F679

• 4"-12" Third party tested and listed by CSA and NSF  
 • Additional Sizes Available Upon Request  
 • Non-Stock items are non-cancelable, non-returnable

Item	Size In Inches	Part Number	Box Qty	Crate Qty	List Price
<b>Concentric Inserter Coupling GxG</b>					
	*6 x 4	H606-4	4	-	217.12
	*8 x 4	H608-4	4	-	415.51
	*8 x 6	H608-6	4	-	430.40
	10 x 4	H6010-4	1	-	780.68
	10 x 6	H6010-6	1	-	924.36
	10 x 8	H6010-8	1	-	1,072.29
	12 x 4	H6012-4	1	-	1,181.05
	12 x 6	H6012-6	1	-	2,012.84
	12 x 8	H6012-8	1	-	1,430.19
	12 x 10	H6012-10	1	-	1,657.78
	15 x 4	H6015-4	1	-	1,983.77
	15 x 6	H6015-6	1	-	2,571.03
	15 x 8	H6015-8	1	-	2,182.59
	15 x 10	H6015-10	1	-	2,405.61
	15 x 12	H6015-12	1	-	2,615.84
	18 x 4	H6018-4	1	-	2,622.75
	18 x 6	H6018-6	1	-	2,668.28
	18 x 8	H6018-8	1	-	2,707.56
	18 x 10	H6018-10	1	-	2,802.72
	18 x 12	H6018-12	1	-	2,862.56
	18 x 15	H6018-15	1	-	2,981.39
	21 x 4	H6021-4	1	-	4,079.74
	21 x 6	H6021-6	1	-	4,122.11
	21 x 8	H6021-8	1	-	4,180.58
	21 x 10	H6021-10	1	-	4,234.03
	21 x 12	H6021-12	1	-	4,455.70
	21 x 15	H6021-15	1	-	5,146.78
	21 x 18	H6021-18	1	-	5,545.46
	24 x 4	H6024-4	1	-	8,502.29
	24 x 6	H6024-6	1	-	8,586.55
	24 x 8	H6024-8	1	-	8,685.34
	24 x 10	H6024-10	1	-	8,729.90
	24 x 12	H6024-12	1	-	9,001.18
	24 x 15	H6024-15	1	-	9,225.32
	24 x 18	H6024-18	1	-	9,720.67
	24 x 21	H6024-21	1	-	10,542.74
	27 x 4	H6027-4	1	-	8,926.51
	27 x 6	H6027-6	1	-	9,015.00
	27 x 8	H6027-8	1	-	9,118.67
	27 x 10	H6027-10	1	-	9,165.47
27 x 12	H6027-12	1	-	9,450.27	
27 x 15	H6027-15	1	-	9,685.60	
27 x 18	H6027-18	1	-	10,205.61	
27 x 21	H6027-21	1	-	11,069.86	
27 x 24	H6027-24	1	-	12,563.57	
30 x 4	H6030-4	1	-	11,120.80	
30 x 6	H6030-6	1	-	11,171.14	
30 x 8	H6030-8	1	-	14,299.07	
30 x 10	H6030-10	1	-	18,302.78	
30 x 12	H6030-12	1	-	23,427.56	
30 x 15	H6030-15	1	-	29,987.26	
30 x 18	H6030-18	1	-	38,383.73	
30 x 21	H6030-21	1	-	49,131.11	
30 x 24	H6030-24	1	-	62,887.84	
30 x 27	H6030-27	1	-	80,496.42	
36 x 4	H6036-4	1	-	14,234.58	
36 x 6	H6036-6	1	-	14,299.07	
36 x 8	H6036-8	1	-	18,302.78	
36 x 10	H6036-10	1	-	23,427.56	
36 x 12	H6036-12	1	-	29,987.26	
36 x 15	H6036-15	1	-	38,383.73	
36 x 18	H6036-18	1	-	49,131.11	
36 x 21	H6036-21	1	-	62,887.84	
36 x 24	H6036-24	1	-	80,496.42	
36 x 27	H6036-27	1	-	103,035.43	
36 x 30	H6036-30	1	-	131,885.32	

<b>Controlled Settlement Joint GxG</b>					
	4 x 4	H6004	1	-	417.54
	6 x 6	H6006	1	-	533.27
	8 x 8	H6008	1	-	913.29

Fabricated from SDR 28 pipe

Item	Size In Inches	Part Number	Box Qty	Crate Qty	List Price
<b>Concentric Inserter Bushing SxG</b>					
	*6 x 4	H1216	5	-	195.70
	*8 x 4	H1219	5	-	374.02
	*8 x 6	H1220	5	-	392.59
	10 x 4	H1210-4	1	-	779.88
	10 x 6	H1210-6	1	-	924.36
	10 x 8	H1210-8	1	-	1,072.29
	12 x 4	H1212-4	1	-	1,181.05
	12 x 6	H1212-6	1	-	1,241.59
	12 x 8	H1212-8	1	-	1,430.19
	12 x 10	H1212-10	1	-	1,657.78
	15 x 4	H1215-4	1	-	1,983.77
	15 x 6	H1215-6	1	-	2,012.84
	15 x 8	H1215-8	1	-	2,182.61
	15 x 10	H1215-10	1	-	2,405.61
	15 x 12	H1215-12	1	-	2,615.84
	18 x 4	H1218-4	1	-	2,450.49
	18 x 6	H1218-6	1	-	2,714.05
	18 x 8	H1218-8	1	-	2,780.16
	18 x 10	H1218-10	1	-	2,819.21
	18 x 12	H1218-12	1	-	2,858.99
	18 x 15	H1218-15	1	-	2,882.58
	21 x 4	H1221-4	1	-	3,387.65
	21 x 6	H1221-6	1	-	3,707.58
	21 x 8	H1221-8	1	-	3,729.89
	21 x 10	H1221-10	1	-	3,774.21
	21 x 12	H1221-12	1	-	3,864.50
	21 x 15	H1221-15	1	-	4,013.44
	21 x 18	H1221-18	1	-	4,351.78
	24 x 4	H1224-4	1	-	7,517.24
	24 x 6	H1224-6	1	-	7,606.40
	24 x 8	H1224-8	1	-	7,983.95
	24 x 10	H1224-10	1	-	7,881.14
	24 x 12	H1224-12	1	-	7,983.43
	24 x 15	H1224-15	1	-	8,210.76
	24 x 18	H1224-18	1	-	8,569.37
	24 x 21	H1224-21	1	-	10,072.19
	27 x 4	H1227-4	1	-	7,892.31
	27 x 6	H1227-6	1	-	7,985.89
	27 x 8	H1227-8	1	-	8,085.66
	27 x 10	H1227-10	1	-	8,274.43
27 x 12	H1227-12	1	-	8,381.70	
27 x 15	H1227-15	1	-	8,620.41	
27 x 18	H1227-18	1	-	8,996.91	
27 x 21	H1227-21	1	-	10,574.67	
27 x 24	H1227-24	1	-	12,257.11	
30 x 4	H1230-4	1	-	9,777.75	
30 x 6	H1230-6	1	-	9,851.24	
30 x 8	H1230-8	1	-	12,609.58	
30 x 10	H1230-10	1	-	16,140.29	
30 x 12	H1230-12	1	-	20,659.52	
30 x 15	H1230-15	1	-	26,444.16	
30 x 18	H1230-18	1	-	33,848.57	
30 x 21	H1230-21	1	-	43,326.15	
30 x 24	H1230-24	1	-	55,457.47	
30 x 27	H1230-27	1	-	70,985.57	
36 x 4	H1236-4	1	-	12,515.51	
36 x 6	H1236-6	1	-	12,609.58	
36 x 8	H1236-8	1	-	16,140.29	
36 x 10	H1236-10	1	-	20,659.52	
36 x 12	H1236-12	1	-	26,444.16	
36 x 15	H1236-15	1	-	33,848.57	
36 x 18	H1236-18	1	-	43,326.15	
36 x 21	H1236-21	1	-	55,457.47	
36 x 24	H1236-24	1	-	71,483.98	
36 x 27	H1236-27	1	-	90,861.56	
36 x 30	H1236-30	1	-	116,302.78	

<b>Controlled Settlement Joint SxG</b>					
	4 x 4	H6304	1	-	380.88
	6 x 6	H6306	1	-	517.39
	8 x 8	H6308	1	-	885.93

Fabricated from SDR 28 pipe

\* Denotes Molded Fitting • Items in **Bold** feature Heavy Duty Branches (SDR 18)  
 † Denotes Assembled from Molded Components  
 • Specifications: ASTM D3034, F1336, CSA B182.2, F679

• 4"-12" Third party tested and listed by CSA and NSF  
 • Additional Sizes Available Upon Request  
 • Non-Stock items are non-cancelable, non-returnable

Item	Size In Inches	Part Number	Box Qty	Crate Qty	List Price
<b>Eccentric Increaser Coupling GxG</b>					
	*6 x 4	H616-4	6	-	217.12
	8 x 4	H618-4	1	-	415.51
	8 x 6	H618-6	1	-	468.34
	10 x 4	H6110-4	1	-	800.25
	10 x 6	H6110-6	1	-	947.47
	10 x 8	H6110-8	1	-	1,099.11
	12 x 4	H6112-4	1	-	1,210.64
	12 x 6	H6112-6	1	-	2,012.84
	12 x 8	H6112-8	1	-	1,466.04
	12 x 10	H6112-10	1	-	1,699.20
	15 x 4	H6115-4	1	-	2,033.48
	15 x 6	H6115-6	1	-	2,571.03
	15 x 8	H6115-8	1	-	2,237.26
	15 x 10	H6115-10	1	-	2,465.72
	15 x 12	H6115-12	1	-	2,681.20
	18 x 4	H6118-4	1	-	2,748.25
	18 x 6	H6118-6	1	-	2,781.88
	18 x 8	H6118-8	1	-	2,849.52
	18 x 10	H6118-10	1	-	2,889.72
	18 x 12	H6118-12	1	-	2,930.44
	18 x 15	H6118-15	1	-	2,981.39
	21 x 4	H6121-4	1	-	4,079.74
	21 x 6	H6121-6	1	-	4,122.11
	21 x 8	H6121-8	1	-	4,180.58
	21 x 10	H6121-10	1	-	4,234.03
	21 x 12	H6121-12	1	-	4,455.70
	21 x 15	H6121-15	1	-	5,146.78
	21 x 18	H6121-18	1	-	5,545.46
	24 x 4	H6124-4	1	-	8,502.29
	24 x 6	H6124-6	1	-	8,586.55
	24 x 8	H6124-8	1	-	8,685.34
	24 x 10	H6124-10	1	-	8,729.90
24 x 12	H6124-12	1	-	9,001.18	
24 x 15	H6124-15	1	-	9,225.32	
24 x 18	H6124-18	1	-	9,720.67	
24 x 21	H6124-21	1	-	10,542.74	
27 x 4	H6127-4	1	-	8,926.51	
27 x 6	H6127-6	1	-	9,015.00	
27 x 8	H6127-8	1	-	9,118.67	
27 x 10	H6127-10	1	-	9,165.47	
27 x 12	H6127-12	1	-	9,450.27	
27 x 15	H6127-15	1	-	9,685.60	
27 x 18	H6127-18	1	-	10,205.61	
27 x 21	H6127-21	1	-	11,069.86	
27 x 24	H6127-24	1	-	12,563.57	

<b>Gasketed C900 Adapter Coupling GxG</b> Gasket SDR 26 Sewer Hub x Gasket C900 Hub					
	4 x 4	H7204	1	-	301.94
	6 x 6	H7206	1	-	363.44
	8 x 8	H7208	1	-	1,169.09
	10 x 10	H7210	1	-	1,432.23
	12 x 12	H7212	1	-	1,715.66
	15 x 16	H7215	1	-	4,759.57
	18 x 18	H7218	1	-	5,472.74
	21 x 20	H7221	1	-	7,538.94
	24 x 24	H7224	1	-	7,749.85

<b>Gasketed C900 Adapter Bushing SxG</b> Chamfer SDR 26 Sewer Spigot x Gasket C900 Hub					
	4 x 4	H7404	1	-	301.94
	6 x 6	H7406	1	-	363.44
	8 x 8	H7408	1	-	1,000.66
	10 x 10	H7410	1	-	1,432.23
	12 x 12	H7412	1	-	1,715.66
	15 x 16	H7415	1	-	4,688.19
	18 x 18	H7418	1	-	5,472.74
	21 x 20	H7421	1	-	7,425.86
	24 x 24	H7424	1	-	7,749.85







Item	Size In Inches	Part Number	Box Qty	Crate Qty	List Price
<b>Eccentric Increaser Bushing SxG</b>					
	*6 x 4	H1306-4	10	-	195.70
	8 x 4	H1308-4	1	-	374.02
	8 x 6	H1308-6	1	-	392.59
	10 x 4	H13010-4	1	-	779.88
	10 x 6	H13010-6	1	-	924.36
	10 x 8	H13010-8	1	-	1,072.29
	12 x 4	H13012-4	1	-	1,181.05
	12 x 6	H13012-6	1	-	1,241.59
	12 x 8	H13012-8	1	-	1,430.19
	12 x 10	H13012-10	1	-	1,657.78
	15 x 4	H13015-4	1	-	1,983.77
	15 x 6	H13015-6	1	-	2,012.84
	15 x 8	H13015-8	1	-	2,182.61
	15 x 10	H13015-10	1	-	2,405.61
	15 x 12	H13015-12	1	-	2,615.84
	18 x 4	H13018-4	1	-	2,450.49
	18 x 6	H13018-6	1	-	2,714.05
	18 x 8	H13018-8	1	-	2,780.16
	18 x 10	H13018-10	1	-	2,819.21
	18 x 12	H13018-12	1	-	2,858.99
	18 x 15	H13018-15	1	-	2,882.58
	21 x 4	H13021-4	1	-	3,587.65
	21 x 6	H13021-6	1	-	3,707.58
	21 x 8	H13021-8	1	-	3,729.89
	21 x 10	H13021-10	1	-	3,774.21
	21 x 12	H13021-12	1	-	3,864.50
	21 x 15	H13021-15	1	-	4,013.44
	21 x 18	H13021-18	1	-	4,351.78
	24 x 4	H13024-4	1	-	7,517.24
	24 x 6	H13024-6	1	-	7,606.40
	24 x 8	H13024-8	1	-	7,983.95
	24 x 10	H13024-10	1	-	7,881.14
24 x 12	H13024-12	1	-	7,983.43	
24 x 15	H13024-15	1	-	8,210.76	
24 x 18	H13024-18	1	-	8,569.37	
24 x 21	H13024-21	1	-	10,072.19	
27 x 4	H13027-4	1	-	7,892.31	
27 x 6	H13027-6	1	-	7,985.89	
27 x 8	H13027-8	1	-	8,085.66	
27 x 10	H13027-10	1	-	8,274.43	
27 x 12	H13027-12	1	-	8,381.70	
27 x 15	H13027-15	1	-	8,620.41	
27 x 18	H13027-18	1	-	8,996.91	
27 x 21	H13027-21	1	-	10,574.67	
27 x 24	H13027-24	1	-	12,257.11	









<b>Manhole Adapter without Pipe Stop SxG</b> Sand Finish					
	4 x 4	H9904	1	-	118.71
	6 x 6	H9906	1	-	221.02
	8 x 8	H9908	1	-	244.28
	10 x 10	H9910	1	-	457.25
	12 x 12	H9912	1	-	670.37
	15 x 15	H9915	1	-	857.87
	18 x 18	H9918	1	-	1,860.68
	21 x 21	H9921	1	-	2,931.73
	24 x 24	H9924	1	-	4,882.13
	27 x 27	H9927	1	-	6,094.90
	30 x 30	H9930	1	-	7,801.20
	36 x 36	H9936	1	-	9,985.52

<b>Gasketed C900 Adapter Bushing SxG</b> C900 DR25 Spigot x Gasket SDR 26 Sewer Hub					
	4 x 4	H9004	1	-	301.94
	6 x 6	H9006	1	-	363.44
	8 x 8	H9008	1	-	1,169.09
	10 x 10	H90010	1	-	1,432.23
	12 x 12	H90012	1	-	1,715.66
	16 x 15	H90015	1	-	4,574.02
	18 x 18	H90018	1	-	5,472.74
	20 x 21	H90021	1	-	7,245.04
	24 x 24	H90024	1	-	7,749.85

\* Denotes Molded Fitting • Items in Bold feature Heavy Duty Branches (SDR 18)  
 † Denotes Assembled from Molded Components  
 • Specifications: ASTM D3034, F1336, CSA B182.2, F679

• 4"-12" Third party tested and listed by CSA and NSF  
 • Additional Sizes Available Upon Request  
 • Non-Stock items are non-cancelable, non-returnable



Item	Size In Inches	Part Number	Box Qty	Crate Qty	List Price
<b>Gasketed Sewer Adapter HxG (SDR 26) Solvent Sewer Hub x Gasket Sewer Hub</b>					
	*4 x 4	H644	6	-	93.92
	*6 x 4	H646-4	4	-	133.00
	*6 x 6	H646	4	-	172.03
	*8 x 8	H648	4	-	376.42
<b>Gasketed DWV Adapter Coupling GxDWV G SDR 26 Gasket Sewer Hub x Gasket DWV Hub</b>					
	*4 x 4	H657	6	-	173.05
	*6 x 4	H658	4	-	232.14
	*6 x 6	H659	3	-	254.05
	8 x 8	H6508	1	-	606.45
	10 x 10	H6510	1	-	839.30
	12 x 12	H6512	1	-	1,235.58
<b>Solvent Sewer to DWV Adapter Coupling HxDWV G SDR 26 Solvent Sewer Hub x Gasket DWV Hub</b>					
	*4 x 4	H954	6	-	154.19
	*6 x 4	H956-4	10	-	197.66
	*6 x 6	H956	4	-	235.07
	8 x 8	H958	1	-	565.76
	10 x 10	H9510	1	-	963.09
	12 x 12	H9512	1	-	1,409.35
<b>Solvent DWV Adapter Bushing SxDWV H SDR 26 Chamfer Sewer Spigot x Solvent DWV Hub</b>					
	4 x 4	H944	1	-	116.48
	6 x 4	H946-4	1	-	178.44
	6 x 6	H946	1	-	187.83
	8 x 8	H948	1	-	441.98
	10 x 10	H9410	1	-	755.29
	12 x 12	H9412	1	-	1,111.89
<b>Temporary Plug Polypropylene (S)</b>					
	*4	G1184	36	-	22.78
	*6	G1186	40	-	33.84
	8	G1188	8	-	69.81
<b>In-Line Backwater Valve GxG (SDR 35)</b>					
	†4	G0104	1	-	660.74
	†6	G0106	1	-	1,426.96
	8	L0108	1	-	4,686.18
	10	L0110	1	-	5,902.55
	12	L0112	1	-	7,888.09
<b>Skirt Gasket for Saddle Tee</b>					
	4" Inlet	G5004	6	-	43.02
	6" Inlet	G5006	4	-	56.37

Item	Size In Inches	Part Number	Box Qty	Crate Qty	List Price
<b>Gasketed Sewer Adapter SxG (SDR 26) Solvent Sewer Spigot x Gasket Sewer Hub</b>					
	*4 x 4	H904	6	-	100.25
	*6 x 6	H906	4	-	167.13
	8 x 8	H908	1	-	354.56
	10 x 10	H9010	1	-	420.83
	12 x 12	H9012	1	-	630.08
	15 x 15	H9015	1	-	951.47
	18 x 18	H9018	1	-	2,364.00
	21 x 21	H9021	1	-	2,504.94
	24 x 24	H9024	1	-	4,528.10
	27 x 27	H9027	1	-	5,276.35
	<b>Gasketed DWV Adapter Bushing SxDWV G SDR 26 Chamfer Sewer Spigot x Gasket DWV Hub</b>				
	*4 x 4	H1213	6	-	160.25
	*6 x 4	H1214	5	-	219.21
	*6 x 6	H1215	4	-	241.00
	8 x 8	H9208	1	-	591.25
	10 x 10	H9210	1	-	818.29
	12 x 12	H9212	1	-	1,204.55
<b>Solvent Weld Sewer Adapter SxH (SDR 26) Chamfer Sewer Spigot x Solvent Sewer Hub SDR 26</b>					
	4 x 4	H964	1	-	162.09
	6 x 6	H966	1	-	182.98
	8 x 8	H968	1	-	390.06
<b>DWV Adapter Sleeve DWV SxG Solvent DWV Spigot x SDR 26 Gasket Sewer Hub</b>					
	*4 x 4	H1208	4	-	125.70
	*6 x 6	H1209	4	-	240.58
	8 x 8	H12008	1	-	625.45
	10 x 10	H12010	1	-	839.30
	12 x 12	H12012	1	-	1,235.58
<b>Vertical Riser Adapter SxS</b>					
	*4 x 4	G984	9	-	114.00
	*6 x 6	G986	4	-	197.66
	*8 x 8	G988	4	-	442.35
<b>Terminal Backwater Valve (G) (SDR 35)</b>					
	4	L0204	1	-	564.69
	6	L0206	1	-	852.14
	8	L0208	1	-	1,346.97
	10	L0210	1	-	1,558.12
	12	L0212	1	-	1,689.01
<b>Stainless Steel Clamp (Standard) 9/16" Width</b>					
	6-8	100-140-9	1	-	50.35
	10-12	100-230-9	1	-	69.48
Not to exceed 100 in/lb torque					
<b>Skirt Gasket for Saddle Wye</b>					
	4" Inlet	G5054	6	-	48.03
	6" Inlet	G5056	4	-	64.52

\* Denotes Molded Fitting • Items in **Bold** feature Heavy Duty Branches (SDR 18)  
 † Denotes Assembled from Molded Components  
 • Specifications: ASTM D3034, F1336, CSA B182.2, F679

• 4"-12" Third party tested and listed by CSA and NSF  
 • Additional Sizes Available Upon Request  
 • Non-Stock items are non-cancelable, non-returnable



Item	Size In Inches	Part Number	Box Qty	Crate Qty	List Price
<b>Saddle Tee with Stainless Steel Clamps Solvent Skirt x Gasket Inlet</b>					
	*6 x 4	H2106-4R	5	-	152.20
	*8 x 4	H2108-4R	6	-	191.23
	*8 x 6	H2108-6R	3	-	219.02
	*10 x 4	H2110-4R	5	-	338.02
	*10 x 6	H2110-6R	4	-	403.60
	10 x 8	H2110-8	1	-	946.45
	*12 x 4	H2112-4R	6	-	419.30
	*12 x 6	H2112-6R	5	-	471.51
	12 x 8	H2112-8	1	-	1,099.54
	12 x 10	H2112-10	1	-	1,377.95
	15 x 4	H2115-4	1	-	770.02
	15 x 6	H2115-6	1	-	909.19
	15 x 8	H2115-8	1	-	1,127.37
	15 x 10	H2115-10	1	-	1,604.45
	15 x 12	H2115-12	1	-	1,753.68
	18 x 4	H2118-4	1	-	1,050.10
	18 x 6	H2118-6	1	-	1,157.08
	18 x 8	H2118-8	1	-	1,497.08
	18 x 10	H2118-10	1	-	1,661.31
	18 x 12	H2118-12	1	-	2,374.95
	18 x 15	H2118-15	1	-	2,592.62
	21 x 4	H2121-4	1	-	1,108.08
	21 x 6	H2121-6	1	-	1,194.19
	21 x 8	H2121-8	1	-	1,571.92
	21 x 10	H2121-10	1	-	1,744.38
	21 x 12	H2121-12	1	-	2,493.64
	21 x 15	H2121-15	1	-	2,722.26
	21 x 18	H2121-18	1	-	3,848.81
	24 x 4	H2124-4	1	-	1,163.46
	24 x 6	H2124-6	1	-	1,253.89
24 x 8	H2124-8	1	-	1,650.54	
24 x 10	H2124-10	1	-	1,831.62	
24 x 12	H2124-12	1	-	2,618.36	
24 x 15	H2124-15	1	-	2,858.41	
24 x 18	H2124-18	1	-	4,045.24	
24 x 21	H2124-21	1	-	4,554.25	
27 x 4	H2127-4	1	-	1,221.64	
27 x 6	H2127-6	1	-	1,316.60	
27 x 8	H2127-8	1	-	1,733.01	
27 x 10	H2127-10	1	-	1,923.22	
27 x 12	H2127-12	1	-	2,749.27	
27 x 15	H2127-15	1	-	3,001.33	
27 x 18	H2127-18	1	-	4,247.45	
27 x 21	H2127-21	1	-	4,782.05	
27 x 24	H2127-24	1	-	5,020.52	
30 x 4	H2130-4	1	-	1,411.01	
30 x 6	H2130-6	1	-	1,518.65	



Skirt Gasket included with 4" and 6" Inlets

Item	Size In Inches	Part Number	Box Qty	Crate Qty	List Price
<b>Saddle Tee with Stainless Steel Clamps w/Locator Ring Solvent Skirt x Gasket Inlet</b>					
	*6 x 4	H4106-4R	5	-	167.40
	*8 x 4	H4108-4R	6	-	210.31
	*8 x 6	H4108-6R	3	-	240.87
	*10 x 4	H4110-4R	5	-	371.82
	*10 x 6	H4110-6R	4	-	443.95
	*12 x 4	H4112-4R	6	-	461.25
	*12 x 6	H4112-6R	5	-	518.64

Skirt Gasket Included

Item	Size In Inches	Part Number	Box Qty	Crate Qty	List Price
<b>Reducing Tee Vertical Riser Kit</b>					
	8 x 4	HDB108-4	1	-	1,750.60
	8 x 6	HDB108-6	1	-	1,941.97

Item	Size In Inches	Part Number	Box Qty	Crate Qty	List Price
<b>Reducing Sanitary Tee (T-Y) Vertical Riser Kit</b>					
	8 x 4	HDB158-4	1	-	1,768.94
	8 x 6	HDB158-6	1	-	1,982.99

Item	Size In Inches	Part Number	Box Qty	Crate Qty	List Price
<b>Saddle Wye with Stainless Steel Clamps Solvent Skirt x Gasket Inlet</b>					
	*6 x 4	H2306-4R	4	-	182.63
	*8 x 4	H2308-4R	4	-	229.50
	*8 x 6	H2308-6R	3	-	322.24
	*10 x 4	H2310-4R	3	-	379.19
	*10 x 6	H2310-6R	4	-	406.94
	10 x 8	H2310-8	1	-	1,155.17
	*12 x 4	H2312-4R	4	-	422.62
	*12 x 6	H2312-6R	4	-	474.62
	12 x 8	H2312-8	1	-	1,614.41
	12 x 10	H2312-10	1	-	1,948.54
	15 x 4	H2315-4	1	-	863.63
	15 x 6	H2315-6	1	-	985.19
	15 x 8	H2315-8	1	-	1,990.28
	15 x 10	H2315-10	1	-	2,226.84
	15 x 12	H2315-12	1	-	2,727.95
	18 x 4	H2318-4	1	-	1,181.36
	18 x 6	H2318-6	1	-	1,301.72
	18 x 8	H2318-8	1	-	2,212.96
	18 x 10	H2318-10	1	-	2,505.13
	18 x 12	H2318-12	1	-	3,131.56
	18 x 15	H2318-15	1	-	3,910.90
	21 x 4	H2321-4	1	-	1,246.60
	21 x 6	H2321-6	1	-	1,343.46
	21 x 8	H2321-8	1	-	2,435.65
	21 x 10	H2321-10	1	-	3,006.25
	21 x 12	H2321-12	1	-	3,757.82
	21 x 15	H2321-15	1	-	5,622.79
	21 x 18	H2321-18	1	-	8,454.23
	24 x 4	H2324-4	1	-	1,308.95
	24 x 6	H2324-6	1	-	1,410.63
24 x 8	H2324-8	1	-	2,557.44	
24 x 10	H2324-10	1	-	3,064.28	
24 x 12	H2324-12	1	-	4,578.96	
24 x 15	H2324-15	1	-	6,875.39	
24 x 18	H2324-18	1	-	9,297.06	
24 x 21	H2324-21	1	-	13,931.67	
27 x 4	H2327-4	1	-	1,374.35	
27 x 6	H2327-6	1	-	1,481.14	
27 x 8	H2327-8	1	-	2,685.29	
27 x 10	H2327-10	1	-	3,217.53	
27 x 12	H2327-12	1	-	4,807.96	
27 x 15	H2327-15	1	-	7,219.15	
27 x 18	H2327-18	1	-	9,761.89	
27 x 21	H2327-21	1	-	14,628.59	
27 x 24	H2327-24	1	-	17,335.70	
30 x 4	H2330-4	1	-	1,587.42	
30 x 6	H2330-6	1	-	1,708.46	

Skirt Gasket included with 4" and 6" Inlets

Item	Size In Inches	Part Number	Box Qty	Crate Qty	List Price
<b>Saddle Wye with Stainless Steel Clamps w/Locator Ring Solvent Skirt x Gasket Inlet</b>					
	*6 x 4	H4306-4R	4	-	205.01
	*8 x 4	H4308-4R	4	-	245.32
	*8 x 6	H4308-6R	3	-	289.06
	*10 x 4	H4310-4R	3	-	568.84
	*10 x 6	H4310-6R	4	-	610.48
	*12 x 4	H4312-4R	4	-	633.91
	*12 x 6	H4312-6R	4	-	711.95

Skirt Gasket Included

Item	Size In Inches	Part Number	Box Qty	Crate Qty	List Price
<b>Reducing 45 Degree Wye Vertical Riser Kit</b>					
	8 x 4	HDB308-4	1	-	1,818.41
	8 x 6	HDB308-6	1	-	2,105.22

\* Denotes Molded Fitting • Items in Bold feature Heavy Duty Branches (SDR 18)  
 † Denotes Assembled from Molded Components  
 • Specifications: ASTM D3034, F1336, CSA B182.2, F679

• 4"-12" Third party tested and listed by CSA and NSF  
 • Additional Sizes Available Upon Request  
 • Non-Stock items are non-cancelable, non-returnable



## Profile Fittings (K- Series)

Fabricated in Sizes 8" – 36"



### Applications

PVC Profile fittings are for use with Ultra Rib, KOR FLO, Ultra Corr, and many other types of PVC and poly ribbed pipe. They are constructed from smooth wall SDR 35 pipe. Adapters are available to connect to sewer or other types of pipe.

### Features

- Gaskets are supplied with every fitting purchased.
- Water tight joints - virtually no risk of infiltration or leakage.
- Smooth Interior walls of our PVC Profile fittings allow for high flow rate

### Certifications

Profile fittings conform to ASTM F794.

**Attention:** Westlake Pipe & Fittings are not to be used with compressed air or gases. Westlake Pipe & Fittings does not recommend that piping systems that include its products be tested with compressed air or gases.

Item	Size In Inches	Part Number	List Price
<b>Straight Tee HxHxH</b>			
	8 x 8	K108	400.10
	10 x 8	K1010-8	1,310.22
	10 x 10	K1010	1,344.85
	12 x 8	K1012-8	1,440.01
	12 x 10	K1012-10	1,688.32
	12 x 12	K1012	1,932.59
	15 x 8	K1015-8	1,874.00
	15 x 10	K1015-10	2,086.31
	15 x 12	K1015-12	2,471.25
	15 x 15	K1015	3,197.52
	18 x 8	K1018-8	4,405.66
	18 x 10	K1018-10	4,575.11
	18 x 12	K1018-12	4,700.21
	18 x 15	K1018-15	5,005.65
	18 x 18	K1018	5,286.10
	21 x 8	K1021-8	6,611.18
	21 x 10	K1021-10	7,103.66
	21 x 12	K1021-12	7,614.13
	21 x 15	K1021-15	8,498.31
	21 x 18	K1021-18	9,643.42
	21 x 21	K1021	12,782.36
	24 x 8	K1024-8	11,151.31
	24 x 10	K1024-10	11,644.14
	24 x 12	K1024-12	11,856.77
	24 x 15	K1024-15	12,321.43
	24 x 18	K1024-18	17,051.02
	24 x 21	K1024-21	18,446.80
	24 x 24	K1024	22,666.46
	27 x 8	K1027-8	13,601.81
	27 x 10	K1027-10	14,305.82
	27 x 12	K1027-12	15,643.09
	27 x 15	K1027-15	17,659.48
	27 x 18	K1027-18	18,095.51
	27 x 21	K1027-21	18,637.51
	27 x 24	K1027-24	23,059.85
	27 x 27	K1027	23,712.05
30 x 8	K1030-8	17,478.67	
30 x 10	K1030-10	18,383.47	
30 x 12	K1030-12	20,102.18	
30 x 15	K1030-15	22,693.19	
30 x 18	K1030-18	23,253.90	
30 x 21	K1030-21	23,950.20	
30 x 24	K1030-24	29,633.11	
30 x 27	K1030-27	30,470.89	
30 x 30	K1030	38,088.70	
36 x 8	K1036-8	18,972.03	
36 x 10	K1036-10	22,026.89	
36 x 12	K1036-12	22,708.60	
36 x 15	K1036-15	24,583.02	
36 x 18	K1036-18	26,905.13	
36 x 21	K1036-21	29,189.30	
36 x 24	K1036-24	30,629.02	
36 x 27	K1036-27	35,853.65	
36 x 30	K1036-30	41,308.18	
36 x 36	K1036	59,514.60	



<b>Cap (H)</b>			
	*8	K1608	156.07
	10	K16010	488.13
	12	K16012	733.26
	15	K16015	1,185.80
	18	K16018	1,723.95
	21	K16021	3,739.33
	24	K16024	4,318.43
	27	K16027	5,446.59
	30	K16030	6,999.15
	36	K16036	15,002.21

<b>Spigot Plug (S)</b>			
	8	K1168	126.58
	10	K11610	421.76
	12	K11612	504.11
	15	K11615	991.89
	18	K11618	1,396.64
	21	K11621	2,762.55
	24	K11624	4,153.94
	27	K11627	5,079.27
	30	K11630	6,522.87
	36	K11636	13,864.25

Item	Size In Inches	Part Number	List Price
<b>Straight Tee with Gasket SDR 35 Branch HxHxG</b>			
	8 x 4	K1038-4	251.30
	8 x 6	K1038-6	260.13
	8 x 8	K1038	412.07
	10 x 4	K10310-4	816.66
	10 x 6	K10310-6	830.46
	10 x 8	K10310-8	1,349.48
	10 x 10	K10310	1,385.21
	12 x 4	K10312-4	998.64
	12 x 6	K10312-6	1,052.49
	12 x 8	K10312-8	1,483.21
	12 x 10	K10312-10	1,738.95
	12 x 12	K10312	1,990.60
	15 x 4	K10315-4	1,621.15
	15 x 6	K10315-6	1,746.11
	15 x 8	K10315-8	1,930.24
	15 x 10	K10315-10	2,148.93
	15 x 12	K10315-12	2,535.68
	15 x 15	K10315	3,293.46
	18 x 4	K10318-4	4,091.09
	18 x 6	K10318-6	4,230.00
	18 x 8	K10318-8	4,537.90
	18 x 10	K10318-10	4,712.40
	18 x 12	K10318-12	4,841.23
	18 x 15	K10318-15	5,155.80
	18 x 18	K10318	5,444.67
	21 x 4	K10321-4	5,755.40
	21 x 6	K10321-6	6,173.98
	21 x 8	K10321-8	6,809.51
	21 x 10	K10321-10	7,316.79
	21 x 12	K10321-12	7,842.54
	21 x 15	K10321-15	8,753.24
	21 x 18	K10321-18	9,932.69
	21 x 21	K10321	13,165.84
	24 x 4	K10324-4	9,081.38
	24 x 6	K10324-6	11,011.83
	24 x 8	K10324-8	11,485.85
	24 x 10	K10324-10	11,993.46
	24 x 12	K10324-12	12,212.46
	24 x 15	K10324-15	12,691.09
	24 x 18	K10324-18	17,562.56
	24 x 21	K10324-21	19,000.20
	24 x 24	K10324	23,349.60
	27 x 4	K10327-4	11,881.26
	27 x 6	K10327-6	11,952.60
	27 x 8	K10327-8	14,009.86
	27 x 10	K10327-10	14,735.02
	27 x 12	K10327-12	16,112.42
	27 x 15	K10327-15	18,189.27
27 x 18	K10327-18	18,638.39	
27 x 21	K10327-21	19,196.63	
27 x 24	K10327-24	23,751.63	
27 x 27	K10327	24,423.44	
30 x 4	K10330-4	15,267.99	
30 x 6	K10330-6	15,359.68	
30 x 8	K10330-8	18,003.03	
30 x 10	K10330-10	18,934.95	
30 x 12	K10330-12	20,705.26	
30 x 15	K10330-15	23,373.99	
30 x 18	K10330-18	23,951.51	
30 x 21	K10330-21	24,668.67	
30 x 24	K10330-24	30,522.09	
30 x 27	K10330-27	31,385.01	
30 x 30	K10330	39,231.43	
36 x 4	K10336-4	17,480.73	
36 x 6	K10336-6	18,913.14	
36 x 8	K10336-8	19,541.22	
36 x 10	K10336-10	22,687.74	
36 x 12	K10336-12	23,389.85	
36 x 15	K10336-15	25,320.50	
36 x 18	K10336-18	27,712.28	
36 x 21	K10336-21	30,065.00	
36 x 24	K10336-24	31,861.86	
36 x 27	K10336-27	36,929.25	
36 x 30	K10336-30	42,547.45	
36 x 36	K10336	61,300.00	

- Fittings are supplied with gaskets
- Fittings conform to ASTM F794

- Specify pipe manufacturer for gaskets required
- All items are non-cancelable, non-returnable

Item	Size In Inches	Part Number	List Price
<b>45 Degree Wye HxHxH</b>			
	8 x 8	K308	518.20
	10 x 8	K3010-8	1,375.71
	10 x 10	K3010	1,530.28
	12 x 8	K3012-8	1,681.61
	12 x 10	K3012-10	2,055.41
	12 x 12	K3012	2,139.90
	15 x 8	K3015-8	2,199.38
	15 x 10	K3015-10	2,643.10
	15 x 12	K3015-12	2,944.45
	15 x 15	K3015	3,717.89
	18 x 8	K3018-8	4,625.97
	18 x 10	K3018-10	4,803.88
	18 x 12	K3018-12	4,935.21
	18 x 15	K3018-15	5,255.96
	18 x 18	K3018	6,658.01
	21 x 8	K3021-8	7,365.05
	21 x 10	K3021-10	8,301.71
	21 x 12	K3021-12	8,978.28
	21 x 15	K3021-15	10,398.46
	21 x 18	K3021-18	12,245.12
	21 x 21	K3021	16,023.18
	24 x 8	K3024-8	11,708.88
	24 x 10	K3024-10	12,226.35
	24 x 12	K3024-12	12,449.61
	24 x 15	K3024-15	12,937.51
	24 x 18	K3024-18	17,903.61
	24 x 21	K3024-21	19,369.12
	24 x 24	K3024	23,799.81
	27 x 8	K3027-8	14,585.91
	27 x 10	K3027-10	15,021.14
	27 x 12	K3027-12	16,425.27
	27 x 15	K3027-15	18,542.45
	27 x 18	K3027-18	19,000.32
	27 x 21	K3027-21	20,803.52
	27 x 24	K3027-24	24,212.83
	27 x 27	K3027	25,253.00
30 x 8	K3030-8	18,743.40	
30 x 10	K3030-10	19,302.67	
30 x 12	K3030-12	21,105.65	
30 x 15	K3030-15	23,827.88	
30 x 18	K3030-18	24,416.59	
30 x 21	K3030-21	26,733.41	
30 x 24	K3030-24	31,114.77	
30 x 27	K3030-27	32,451.63	
30 x 30	K3030	40,564.41	
36 x 8	K3036-8	19,920.67	
36 x 10	K3036-10	23,128.25	
36 x 12	K3036-12	23,844.01	
36 x 15	K3036-15	25,812.19	
36 x 18	K3036-18	28,250.39	
36 x 21	K3036-21	30,648.77	
36 x 24	K3036-24	32,160.46	
36 x 27	K3036-27	39,293.35	
36 x 30	K3036-30	44,723.98	
36 x 36	K3036	59,921.14	
<b>Manhole Adapter with stop (SxH) sanded</b>			
	8 x 8	K99108	315.31
	10 x 10	K99110	461.36
	12 x 12	K99112	650.40
	15 x 15	K99115	970.96
	18 x 18	K99118	1,528.17
	21 x 21	K99121	2,466.04
	24 x 24	K99124	3,610.23
	27 x 27	K99127	5,930.49
	30 x 30	K99130	6,915.44
36 x 36	K99136	9,476.07	
<b>Manhole Adapter with stop (SxH) no sand</b>			
	8 x 8	K89108	217.16
	10 x 10	K89110	363.27
	12 x 12	K89112	532.66
	15 x 15	K89115	853.25
	18 x 18	K89118	1,371.18
	21 x 21	K89121	2,309.08
	24 x 24	K89124	3,414.03
	27 x 27	K89127	5,734.26
	30 x 30	K89130	6,653.81
36 x 36	K89136	9,214.46	

Item	Size In Inches	Part Number	List Price
<b>45 Degree Wye with SDR 35 Branch HxHxG</b>			
	8 x 4	K338-4	263.85
	8 x 6	K338-6	298.20
	8 x 8	K338	533.71
	10 x 4	K3310-4	857.52
	10 x 6	K3310-6	871.99
	10 x 8	K3310-8	1,416.96
	10 x 10	K3310	1,576.16
	12 x 4	K3312-4	1,095.07
	12 x 6	K3312-6	1,129.20
	12 x 8	K3312-8	1,732.07
	12 x 10	K3312-10	2,117.10
	12 x 12	K3312	2,204.12
	15 x 4	K3315-4	1,702.19
	15 x 6	K3315-6	1,978.21
	15 x 8	K3315-8	2,265.37
	15 x 10	K3315-10	2,722.42
	15 x 12	K3315-12	3,032.75
	15 x 15	K3315	3,829.41
	18 x 4	K3318-4	4,295.64
	18 x 6	K3318-6	4,441.49
	18 x 8	K3318-8	4,764.77
	18 x 10	K3318-10	4,948.03
	18 x 12	K3318-12	5,083.27
	18 x 15	K3318-15	5,413.61
	18 x 18	K3318	6,857.78
	21 x 4	K3321-4	6,111.46
	21 x 6	K3321-6	6,551.11
	21 x 8	K3321-8	7,585.99
	21 x 10	K3321-10	8,550.78
	21 x 12	K3321-12	9,247.64
	21 x 15	K3321-15	10,710.41
	21 x 18	K3321-18	12,612.47
	21 x 21	K3321	16,503.87
	24 x 4	K3324-4	9,535.47
	24 x 6	K3324-6	11,562.43
	24 x 8	K3324-8	12,060.14
	24 x 10	K3324-10	12,593.18
	24 x 12	K3324-12	12,823.06
	24 x 15	K3324-15	13,325.64
	24 x 18	K3324-18	18,440.67
	24 x 21	K3324-21	19,950.22
	24 x 24	K3324	24,513.81
	27 x 4	K3327-4	12,475.30
	27 x 6	K3327-6	12,550.19
	27 x 8	K3327-8	15,306.04
	27 x 10	K3327-10	15,471.73
	27 x 12	K3327-12	16,918.04
	27 x 15	K3327-15	19,098.74
27 x 18	K3327-18	19,570.34	
27 x 21	K3327-21	21,427.61	
27 x 24	K3327-24	24,939.18	
27 x 27	K3327	26,010.61	
30 x 4	K3330-4	16,031.41	
30 x 6	K3330-6	16,127.66	
30 x 8	K3330-8	19,305.72	
30 x 10	K3330-10	19,881.69	
30 x 12	K3330-12	21,740.52	
30 x 15	K3330-15	24,542.70	
30 x 18	K3330-18	25,149.08	
30 x 21	K3330-21	27,535.41	
30 x 24	K3330-24	32,048.19	
30 x 27	K3330-27	33,425.17	
30 x 30	K3330	41,781.33	
36 x 4	K3336-4	18,354.78	
36 x 6	K3336-6	19,858.80	
36 x 8	K3336-8	20,518.27	
36 x 10	K3336-10	23,822.10	
36 x 12	K3336-12	24,559.31	
36 x 15	K3336-15	26,586.53	
36 x 18	K3336-18	29,097.93	
36 x 21	K3336-21	31,568.22	
36 x 24	K3336-24	33,125.29	
36 x 27	K3336-27	40,471.24	
36 x 30	K3336-30	46,065.74	
36 x 36	K3336	64,365.02	

- Fittings are supplied with gaskets
- Fittings conform to ASTM F794

- Specify pipe manufacturer for gaskets required
- All items are non-cancelable, non-returnable

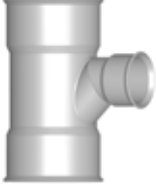
Item	Size In Inches	Part Number	List Price
<b>T-Y HxHxH</b>			
	8 x 8	K158	713.46
	10 x 8	K1510-8	1,668.59
	10 x 10	K1510	1,757.40
	12 x 8	K1512-8	1,846.30
	12 x 10	K1512-10	2,158.20
	12 x 12	K1512	2,246.89
	15 x 8	K1515-8	2,309.40
	15 x 10	K1515-10	2,775.25
	15 x 12	K1515-12	3,091.67
	15 x 15	K1515	3,903.79
	18 x 8	K1518-8	4,857.27
	18 x 10	K1518-10	5,044.07
	18 x 12	K1518-12	5,181.99
	18 x 15	K1518-15	5,518.74
	18 x 18	K1518	6,990.93
	21 x 8	K1521-8	8,059.05
	21 x 10	K1521-10	8,743.14
	21 x 12	K1521-12	9,427.20
	21 x 15	K1521-15	10,918.39
	21 x 18	K1521-18	12,857.35
	21 x 21	K1521	16,824.35
	24 x 8	K1524-8	12,294.30
	24 x 10	K1524-10	12,837.67
	24 x 12	K1524-12	13,072.06
	24 x 15	K1524-15	13,584.40
	24 x 18	K1524-18	18,798.75
	24 x 21	K1524-21	20,337.57
	24 x 24	K1524	24,989.77
	27 x 8	K1527-8	15,315.20
	27 x 10	K1527-10	15,772.19
	27 x 12	K1527-12	17,246.55
	27 x 15	K1527-15	19,469.59
	27 x 18	K1527-18	19,950.33
	27 x 21	K1527-21	21,843.72
	27 x 24	K1527-24	25,423.47
	27 x 27	K1527	26,515.64
30 x 8	K1530-8	19,680.58	
30 x 10	K1530-10	20,267.75	
30 x 12	K1530-12	22,160.97	
30 x 15	K1530-15	25,019.26	
30 x 18	K1530-18	25,637.39	
30 x 21	K1530-21	28,070.07	
30 x 24	K1530-24	32,670.50	
30 x 27	K1530-27	34,074.23	
30 x 30	K1530	42,592.65	
36 x 8	K1536-8	20,916.71	
36 x 10	K1536-10	24,284.68	
36 x 12	K1536-12	25,036.18	
36 x 15	K1536-15	27,102.80	
36 x 18	K1536-18	29,662.92	
36 x 21	K1536-21	32,181.21	
36 x 24	K1536-24	33,768.52	
36 x 27	K1536-27	41,258.01	
36 x 30	K1536-30	46,960.22	
36 x 36	K1536	62,917.21	

<b>Profile Adapter Coupling HxSDR 35 G</b>			
	8	K648	289.47
	10	K6410	574.48
	12	K6412	805.87
	15	K6415	1,645.90
	18	K6418	3,027.41
	21	K6421	5,315.88
	24	K6424	7,561.13
	27	K6427	8,990.63
	30	K6430	11,694.15
	36	K6436	15,259.39

<b>Profile Adapter Bushing SxH (SDR 35 Spigot x Profile Hub)</b>			
	8	K978	284.39
	10	K9710	560.11
	12	K9712	826.04
	15	K9715	1,604.77
	18	K9718	2,951.74
	21	K9721	5,448.79
	24	K9724	7,750.16
	27	K9727	8,765.86
	30	K9730	11,401.83
	36	K9736	14,877.95

Item	Size In Inches	Part Number	List Price
<b>T-Y with SDR 35 Branch HxHxG</b>			
	8 x 4	K1588-4	277.04
	8 x 6	K1588-6	313.14
	8 x 8	K1588	734.89
	10 x 4	K15810-4	977.09
	10 x 6	K15810-6	1,119.69
	10 x 8	K15810-8	1,718.64
	10 x 10	K15810	1,810.15
	12 x 4	K15812-4	1,204.17
	12 x 6	K15812-6	1,283.24
	12 x 8	K15812-8	1,901.65
	12 x 10	K15812-10	2,222.95
	12 x 12	K15812	2,314.31
	15 x 4	K15815-4	1,942.83
	15 x 6	K15815-6	2,148.93
	15 x 8	K15815-8	2,378.64
	15 x 10	K15815-10	2,858.55
	15 x 12	K15815-12	3,184.43
	15 x 15	K15815	4,020.90
	18 x 4	K15818-4	4,510.41
	18 x 6	K15818-6	4,663.59
	18 x 8	K15818-8	5,002.97
	18 x 10	K15818-10	5,195.41
	18 x 12	K15818-12	5,337.43
	18 x 15	K15818-15	5,684.28
	18 x 18	K15818	7,200.65
	21 x 4	K15821-4	6,417.04
	21 x 6	K15821-6	6,878.69
	21 x 8	K15821-8	8,300.81
	21 x 10	K15821-10	9,005.43
	21 x 12	K15821-12	9,710.02
	21 x 15	K15821-15	11,245.97
	21 x 18	K15821-18	13,243.06
	21 x 21	K15821	17,329.09
	24 x 4	K15824-4	10,446.91
	24 x 6	K15824-6	12,140.53
	24 x 8	K15824-8	12,663.15
	24 x 10	K15824-10	13,222.77
	24 x 12	K15824-12	13,464.23
	24 x 15	K15824-15	13,991.91
	24 x 18	K15824-18	19,362.74
	24 x 21	K15824-21	20,947.71
	24 x 24	K15824	25,739.49
	27 x 4	K15827-4	13,099.08
	27 x 6	K15827-6	13,177.70
	27 x 8	K15827-8	15,774.67
	27 x 10	K15827-10	16,245.33
	27 x 12	K15827-12	17,763.94
	27 x 15	K15827-15	20,053.70
27 x 18	K15827-18	20,548.85	
27 x 21	K15827-21	22,499.02	
27 x 24	K15827-24	26,186.17	
27 x 27	K15827	27,311.14	
30 x 4	K15830-4	16,832.98	
30 x 6	K15830-6	16,983.65	
30 x 8	K15830-8	20,271.01	
30 x 10	K15830-10	20,875.82	
30 x 12	K15830-12	22,825.80	
30 x 15	K15830-15	25,769.84	
30 x 18	K15830-18	26,406.52	
30 x 21	K15830-21	28,912.18	
30 x 24	K15830-24	33,650.65	
30 x 27	K15830-27	35,096.45	
30 x 30	K15830	43,870.44	
36 x 4	K15836-4	19,272.52	
36 x 6	K15836-6	20,851.74	
36 x 8	K15836-8	21,544.21	
36 x 10	K15836-10	25,013.22	
36 x 12	K15836-12	25,787.30	
36 x 15	K15836-15	27,915.91	
36 x 18	K15836-18	30,552.83	
36 x 21	K15836-21	33,146.65	
36 x 24	K15836-24	34,781.57	
36 x 27	K15836-27	42,495.76	
36 x 30	K15836-30	48,369.01	
36 x 36	K15836	64,804.71	

- Fittings are supplied with gaskets
- Fittings conform to ASTM F794

- Specify pipe manufacturer for gaskets required
- All items are non-cancelable, non-returnable

Item	Size In Inches	Part Number	List Price
<b>Stop Coupling HxH</b>			
	8	K608	216.15
	10	K6010	444.33
	12	K6012	645.62
	15	K6015	1,335.88
	18	K6018	2,600.27
	21	K6021	4,431.52
	24	K6024	6,455.69
	27	K6027	7,280.13
	30	K6030	9,355.32
	36	K6036	11,737.99

Item	Size In Inches	Part Number	List Price
<b>Concentric Increaser Coupling HxH</b>			
	10 x 8	K6010-8	852.29
	12 x 8	K6012-8	1,106.00
	12 x 10	K6012-10	1,276.94
	15 x 8	K6015-8	1,620.19
	15 x 10	K6015-10	1,784.95
	15 x 12	K6015-12	1,940.77
	18 x 8	K6018-8	1,930.91
	18 x 10	K6018-10	1,998.84
	18 x 12	K6018-12	2,041.46
	18 x 15	K6018-15	2,126.19
	21 x 8	K6021-8	2,764.74
	21 x 10	K6021-10	2,801.35
	21 x 12	K6021-12	2,946.55
	21 x 15	K6021-15	3,403.45
	21 x 18	K6021-18	3,667.29
	24 x 8	K6024-8	5,743.71
	24 x 10	K6024-10	5,773.14
	24 x 12	K6024-12	5,952.63
	24 x 15	K6024-15	6,100.86
	24 x 18	K6024-18	6,428.39
	24 x 21	K6024-21	6,972.48
	27 x 8	K6027-8	6,564.36
	27 x 10	K6027-10	6,639.25
	27 x 12	K6027-12	6,979.69
	27 x 15	K6027-15	7,017.38
	27 x 18	K6027-18	7,306.56
	27 x 21	K6027-21	8,420.36
	27 x 24	K6027-24	9,121.58
	30 x 8	K6030-8	8,437.23
	30 x 10	K6030-10	8,531.76
	30 x 12	K6030-12	8,969.33
	30 x 15	K6030-15	9,017.76
	30 x 18	K6030-18	9,389.24
	30 x 21	K6030-21	10,820.37
	30 x 24	K6030-24	11,721.69
	30 x 27	K6030-27	14,652.26
	36 x 8	K6036-8	18,564.79
	36 x 10	K6036-10	18,794.02
	36 x 12	K6036-12	19,048.45
	36 x 15	K6036-15	19,500.89
36 x 18	K6036-18	19,998.57	
36 x 21	K6036-21	20,535.38	
36 x 24	K6036-24	22,854.45	
36 x 27	K6036-27	23,505.10	
36 x 30	K6036-30	24,905.09	

Item	Size In Inches	Part Number	List Price
<b>Repair Coupling HxH</b>			
	8	K628	216.15
	10	K6210	444.33
	12	K6212	645.62
	15	K6215	1,335.88
	18	K6218	2,600.27
	21	K6221	4,431.52
	24	K6224	6,455.69
	27	K6227	7,280.13
	30	K6230	9,355.32
	36	K6236	11,737.99

Item	Size In Inches	Part Number	List Price
<b>Concentric Increaser Coupling with SDR 35 Hub HxG</b>			
	8 x 4	K6058-4	269.87
	8 x 6	K6058-6	283.38
	10 x 4	K60510-4	621.06
	10 x 6	K60510-6	736.76
	10 x 8	K60510-8	877.84
	12 x 4	K60512-4	905.33
	12 x 6	K60512-6	957.78
	12 x 8	K60512-8	1,139.19
	12 x 10	K60512-10	1,315.25
	15 x 4	K60515-4	1,426.70
	15 x 6	K60515-6	1,498.72
	15 x 8	K60515-8	1,668.82
	15 x 10	K60515-10	1,839.48
	15 x 12	K60515-12	1,998.99
	18 x 4	K60518-4	1,876.29
	18 x 6	K60518-6	1,908.88
	18 x 8	K60518-8	1,988.84
	18 x 10	K60518-10	2,058.82
	18 x 12	K60518-12	2,102.73
	18 x 15	K60518-15	2,190.02
	21 x 4	K60521-4	2,706.47
	21 x 6	K60521-6	2,734.46
	21 x 8	K60521-8	2,847.67
	21 x 10	K60521-10	2,885.40
	21 x 12	K60521-12	3,034.93
	21 x 15	K60521-15	3,505.59
	21 x 18	K60521-18	3,777.33
	24 x 4	K60524-4	5,641.21
	24 x 6	K60524-6	5,696.21
	24 x 8	K60524-8	5,916.00
	24 x 10	K60524-10	5,946.35
	24 x 12	K60524-12	6,131.20
	24 x 15	K60524-15	6,283.86
	24 x 18	K60524-18	6,621.21
	24 x 21	K60524-21	7,181.65
	27 x 4	K60527-4	6,659.56
	27 x 6	K60527-6	6,689.68
	27 x 8	K60527-8	6,761.31
	27 x 10	K60527-10	6,838.45
	27 x 12	K60527-12	7,189.08
	27 x 15	K60527-15	7,227.92
	27 x 18	K60527-18	7,525.75
	27 x 21	K60527-21	8,672.98
	27 x 24	K60527-24	9,395.24
	30 x 4	K60530-4	8,409.09
	30 x 6	K60530-6	8,596.36
	30 x 8	K60530-8	8,690.33
	30 x 10	K60530-10	8,787.74
	30 x 12	K60530-12	9,238.39
	30 x 15	K60530-15	9,288.24
	30 x 18	K60530-18	9,670.89
	30 x 21	K60530-21	11,144.96
	30 x 24	K60530-24	12,073.35
	30 x 27	K60530-27	15,091.81
	36 x 4	K60536-4	18,847.81
	36 x 6	K60536-6	18,976.39
	36 x 8	K60536-8	19,121.76
	36 x 10	K60536-10	19,357.83
	36 x 12	K60536-12	19,619.93
	36 x 15	K60536-15	20,085.92
36 x 18	K60536-18	20,598.54	
36 x 21	K60536-21	21,151.45	
36 x 24	K60536-24	23,540.06	
36 x 27	K60536-27	24,210.25	
36 x 30	K60536-30	25,652.24	

- Fittings are supplied with gaskets
- Fittings conform to ASTM F794

- Specify pipe manufacturer for gaskets required
- All items are non-cancelable, non-returnable

Item	Size In Inches	Part Number	List Price
<b>Ultra Rib Gasket</b>			
	8	K8908	56.59
	10	K8910	87.40
	12	K8912	141.22
	15	K8915	225.95
	18	K8918	351.84
	21	K8921	531.45
	24	K8924	557.21
	27	K8927	1,101.92
	30	K8930	1,540.35
	36	K8936	1,859.75

Item	Size In Inches	Part Number	List Price
<b>1/4 Bend (90) HxH</b>			
	8	K208	305.87
	10	K2010	1,028.76
	12	K2012	1,331.34
	15	K2015	2,810.35
	18	K2018	4,753.88
	21	K2021	8,165.25
	24	K2024	10,917.50
	27	K2027	12,467.48
	30	K2030	15,629.72
	36	K2036	24,552.85

Item	Size In Inches	Part Number	List Price
<b>1/8 Bend (45) HxH</b>			
	8	K508	271.37
	10	K5010	704.19
	12	K5012	1,022.80
	15	K5015	2,290.36
	18	K5018	3,665.67
	21	K5021	6,208.16
	24	K5024	8,475.65
	27	K5027	9,209.63
	30	K5030	11,834.70
	36	K5036	16,963.04

Item	Size In Inches	Part Number	List Price
<b>1/16 Bend (22.5) HxH</b>			
	8	K1708	273.87
	10	K17010	749.57
	12	K17012	1,086.73
	15	K17015	2,585.33
	18	K17018	3,894.78
	21	K17021	6,596.16
	24	K17024	9,005.40
	27	K17027	9,785.26
	30	K17030	12,574.36
	36	K17036	18,023.25

Item	Size In Inches	Part Number	List Price
<b>Kor Flo Gasket</b>			
	8	K8808	73.54
	10	K8810	113.60
	12	K8812	183.61
	15	K8815	293.70
	18	K8818	457.31
	21	K8821	690.92
	24	K8824	724.36
	27	K8827	1,432.48
	30	K8830	2,002.42
	36	K8836	2,417.69

Item	Size In Inches	Part Number	List Price
<b>1/6 Bend (60) HxH</b>			
	8	K1358.60	286.36
	10	K13510.60	783.81
	12	K13512.60	1,136.37
	15	K13515.60	2,703.42
	18	K13518.60	4,072.70
	21	K13521.60	6,897.49
	24	K13524.60	9,416.71
	27	K13527.60	10,232.19
	30	K13530.60	13,148.73
	36	K13536.60	18,846.52

Item	Size In Inches	Part Number	List Price
<b>1/12 Bend (30) HxH</b>			
	8	K1358.30	282.12
	10	K13510.30	772.22
	12	K13512.30	1,119.56
	15	K13515.30	2,663.44
	18	K13518.30	4,012.53
	21	K13521.30	6,795.55
	24	K13524.30	9,277.55
	27	K13527.30	10,081.00
	30	K13530.30	12,954.39
	36	K13536.30	18,567.98

Item	Size In Inches	Part Number	List Price
<b>1/32 Bend (11.25) HxH</b>			
	8	K1938	277.91
	10	K19310	760.77
	12	K19312	1,103.02
	15	K19315	2,624.11
	18	K19318	3,953.20
	21	K19321	6,695.10
	24	K19324	9,140.46
	27	K19327	9,932.02
	30	K19330	12,762.96
	36	K19336	18,293.57

- Fittings are supplied with gaskets
- Fittings conform to ASTM F794

- Specify pipe manufacturer for gaskets required
- All items are non-cancelable, non-returnable



## C.I.O.D. Gasketed Non-Pressure (N-Series)

Fittings DR 25

Fabricated in Sizes 4" – 36"



### Applications

C.I.O.D. DR 25 Gasketed Non-Pressure fittings are for sewer and drain applications. C.I.O.D. Non-Pressure fittings are not fiberglass reinforced and they are most commonly installed in either areas of high water tables or extremely deep burials. Bends of 45 degrees or less, are manufactured of one-piece construction. This provides a lightweight, compact fitting, which can be easily handled in the field.

### Certifications

Our Non-pressure C.I.O.D. Gasketed Sewer fittings conform to portions of AWWA C900.

**Attention:** Westlake Pipe & Fittings are not to be used with compressed air or gases. Westlake Pipe & Fittings does not recommend that piping systems that include its products be tested with compressed air or gases.

Item	Size In Inches	Part Number	List Price
<b>Straight Tee GxGxG (C900xC900)</b>			
	6 x 4	N25-106-4	496.02
	8 x 4	N25-108-4	1,293.28
	8 x 6	N25-108-6	1,453.57
	10 x 4	N25-1010-4	1,633.05
	10 x 6	N25-1010-6	1,678.19
	10 x 8	N25-1010-8	1,796.89
	12 x 4	N25-1012-4	2,107.24
	12 x 6	N25-1012-6	2,255.95
	12 x 8	N25-1012-8	2,499.41
	12 x 10	N25-1012-10	2,837.61
	14 x 4	N25-1014-4	4,882.23
	14 x 6	N25-1014-6	5,030.37
	14 x 8	N25-1014-8	6,254.73
	14 x 10	N25-1014-10	6,528.41
	14 x 12	N25-1014-12	6,894.41
	16 x 4	N25-1016-4	6,636.91
	16 x 6	N25-1016-6	6,839.68
	16 x 8	N25-1016-8	7,003.53
	16 x 10	N25-1016-10	7,136.08
	16 x 12	N25-1016-12	7,206.24
	16 x 14	N25-1016-14	8,165.52
	18 x 4	N25-1018-4	11,222.75
	18 x 6	N25-1018-6	11,565.83
	18 x 8	N25-1018-8	11,753.01
	18 x 10	N25-1018-10	12,439.27
	18 x 12	N25-1018-12	13,164.63
	18 x 14	N25-1018-14	14,888.16
	18 x 16	N25-1018-16	15,878.72
20 x 4	N25-1020-4	12,907.30	
20 x 6	N25-1020-6	13,299.33	
20 x 8	N25-1020-8	13,632.58	
20 x 10	N25-1020-10	14,061.65	
20 x 12	N25-1020-12	14,849.16	
20 x 14	N25-1020-14	15,855.33	
20 x 16	N25-1020-16	16,627.40	
20 x 18	N25-1020-18	18,803.36	
24 x 4	N25-1024-4	18,522.58	
24 x 6	N25-1024-6	19,091.91	
24 x 8	N25-1024-8	19,325.91	

Item	Size In Inches	Part Number	List Price
<b>Straight Tee with SDR 26 Sewer Branch GxGxG</b>			
	6 x 4	N25-106-4GGSB	496.02
	8 x 4	N25-108-4GGSB	1,293.28
	8 x 6	N25-108-6GGSB	1,453.57
	10 x 4	N25-1010-4GGSB	1,633.05
	10 x 6	N25-1010-6GGSB	1,678.19
	10 x 8	N25-1010-8GGSB	1,796.89
	12 x 4	N25-1012-4GGSB	2,107.24
	12 x 6	N25-1012-6GGSB	2,255.95
	12 x 8	N25-1012-8GGSB	2,499.41
	12 x 10	N25-1012-10GGSB	2,837.61
	14 x 4	N25-1014-4GGSB	4,882.23
	14 x 6	N25-1014-6GGSB	5,030.37
	14 x 8	N25-1014-8GGSB	6,254.73
	14 x 10	N25-1014-10GGSB	6,528.41
	14 x 12	N25-1014-12GGSB	6,894.41
	16 x 4	N25-1016-4GGSB	6,636.91
	16 x 6	N25-1016-6GGSB	6,839.68
	16 x 8	N25-1016-8GGSB	7,003.53
	16 x 10	N25-1016-10GGSB	7,136.08
	16 x 12	N25-1016-12GGSB	7,206.24
	18 x 4	N25-1018-4GGSB	11,222.75
	18 x 6	N25-1018-6GGSB	11,565.83
	18 x 8	N25-1018-8GGSB	11,753.01
	18 x 10	N25-1018-10GGSB	12,439.27
	18 x 12	N25-1018-12GGSB	13,164.63
	20 x 4	N25-1020-4GGSB	12,907.30
	20 x 6	N25-1020-6GGSB	13,299.33
	20 x 8	N25-1020-8GGSB	13,632.58
20 x 10	N25-1020-10GGSB	14,061.65	
20 x 12	N25-1020-12GGSB	14,849.16	
20 x 18	N25-1020-18GGSB	18,803.36	
24 x 4	N25-1024-4GGSB	18,522.58	
24 x 6	N25-1024-6GGSB	19,091.91	
24 x 8	N25-1024-8GGSB	19,325.91	
24 x 10	N25-1024-10GGSB	19,583.22	
24 x 12	N25-1024-12GGSB	19,723.57	
24 x 18	N25-1024-18GGSB	20,480.14	

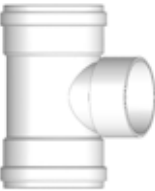
Item	Size In Inches	Part Number	List Price
<b>Straight Tee with Schedule 40 Branch GxGxH</b>			
	6 x 4	N25-136-4	473.36
	8 x 4	N25-138-4	1,241.07
	8 x 6	N25-138-6	1,401.27
	10 x 4	N25-1310-4	1,464.03
	10 x 6	N25-1310-6	1,594.86
	10 x 8	N25-1310-8	1,718.46
	12 x 4	N25-1312-4	2,041.20
	12 x 6	N25-1312-6	2,156.97
	12 x 8	N25-1312-8	2,367.17
	12 x 10	N25-1312-10	2,731.59
	14 x 4	N25-1314-4	4,882.23
	14 x 6	N25-1314-6	5,030.37
	14 x 8	N25-1314-8	6,254.73
	14 x 10	N25-1314-10	6,528.41
	14 x 12	N25-1314-12	6,894.41
	16 x 4	N25-1316-4	6,636.91
	16 x 6	N25-1316-6	6,839.68
	16 x 8	N25-1316-8	7,003.53
	16 x 10	N25-1316-10	7,136.08
	16 x 12	N25-1316-12	7,206.24
	16 x 14	N25-1316-14	8,165.52
	18 x 4	N25-1318-4	11,222.75
	18 x 6	N25-1318-6	11,565.83
	18 x 8	N25-1318-8	11,753.01
	18 x 10	N25-1318-10	12,439.27
	18 x 12	N25-1318-12	13,164.63
	18 x 14	N25-1318-14	14,888.16
	18 x 16	N25-1318-16	15,878.72
20 x 4	N25-1320-4	12,907.30	
20 x 6	N25-1320-6	13,299.33	
20 x 8	N25-1320-8	13,632.58	
20 x 10	N25-1320-10	14,061.65	
20 x 12	N25-1320-12	14,849.16	
20 x 14	N25-1320-14	15,855.33	
20 x 16	N25-1320-16	16,627.40	
20 x 18	N25-1320-18	18,803.36	
24 x 4	N25-1324-4	18,522.58	
24 x 6	N25-1324-6	19,091.91	
24 x 8	N25-1324-8	19,325.91	

Item	Size In Inches	Part Number	List Price
<b>Straight Tee with Schedule 40 Branch GxGxG</b>			
	6 x 4	N25-116-4	496.02
	8 x 4	N25-118-4	1,293.28
	8 x 6	N25-118-6	1,453.57
	10 x 4	N25-1110-4	1,633.05
	10 x 6	N25-1110-6	1,678.19
	10 x 8	N25-1110-8	1,796.89
	12 x 4	N25-1112-4	2,107.24
	12 x 6	N25-1112-6	2,255.95
	12 x 8	N25-1112-8	2,499.41
	12 x 10	N25-1112-10	2,837.61
	14 x 4	N25-1114-4	4,882.23
	14 x 6	N25-1114-6	5,030.37
	14 x 8	N25-1114-8	6,254.73
	14 x 10	N25-1114-10	6,528.41
	14 x 12	N25-1114-12	6,894.41
	16 x 4	N25-1116-4	6,636.91
	16 x 6	N25-1116-6	6,839.68
	16 x 8	N25-1116-8	7,003.53
	16 x 10	N25-1116-10	7,136.08
	16 x 12	N25-1116-12	7,206.24
	18 x 4	N25-1118-4	11,222.75
	18 x 6	N25-1118-6	11,565.83
	18 x 8	N25-1118-8	11,753.01
	18 x 10	N25-1118-10	12,439.27
	18 x 12	N25-1118-12	13,164.63
	20 x 4	N25-1120-4	12,907.30
	20 x 6	N25-1120-6	13,299.33
	20 x 8	N25-1120-8	13,632.58
20 x 10	N25-1120-10	14,061.65	
20 x 12	N25-1120-12	14,849.16	
20 x 16	N25-1120-16	16,627.40	
24 x 4	N25-1124-4	18,522.58	
24 x 6	N25-1124-6	19,091.91	
24 x 8	N25-1124-8	19,325.91	
24 x 10	N25-1124-10	19,583.22	
24 x 12	N25-1124-12	19,723.57	
24 x 16	N25-1124-16	20,877.79	

- For C900 Pipe - Sewer and Drain Use - Non-Pressure applications only
- Additional Sizes Available Upon Request

- Conforms to AWWA C900
- Fabricated from DR25 Pipe

Item	Size In Inches	Part Number	List Price
<b>45 Degree Wye GxGxG (C900xC900)</b>			
	6 x 4	N25-306-4	582.47
	8 x 4	N25-308-4	1,413.51
	8 x 6	N25-308-6	1,499.71
	10 x 4	N25-3010-4	1,680.83
	10 x 6	N25-3010-6	1,791.30
	10 x 8	N25-3010-8	1,904.28
	12 x 4	N25-3012-4	2,210.97
	12 x 6	N25-3012-6	2,368.79
	12 x 8	N25-3012-8	2,627.22
	12 x 10	N25-3012-10	3,100.88
	14 x 4	N25-3014-4	4,955.45
	14 x 6	N25-3014-6	5,105.81
	14 x 8	N25-3014-8	6,348.52
	14 x 10	N25-3014-10	6,626.35
	14 x 12	N25-3014-12	6,997.85
	16 x 4	N25-3016-4	6,736.49
	16 x 6	N25-3016-6	6,942.30
	16 x 8	N25-3016-8	7,108.59
	16 x 10	N25-3016-10	7,243.10
	16 x 12	N25-3016-12	7,314.31
	16 x 14	N25-3016-14	8,288.00
	18 x 4	N25-3018-4	11,391.09
	18 x 6	N25-3018-6	11,739.33
	18 x 8	N25-3018-8	11,929.31
	18 x 10	N25-3018-10	12,625.87
	18 x 12	N25-3018-12	13,362.09
	18 x 14	N25-3018-14	15,111.51
	18 x 16	N25-3018-16	16,116.94
	20 x 4	N25-3020-4	13,100.90
	20 x 6	N25-3020-6	13,498.85
20 x 8	N25-3020-8	13,837.07	
20 x 10	N25-3020-10	14,272.58	
20 x 12	N25-3020-12	15,071.90	
20 x 14	N25-3020-14	16,093.15	
20 x 16	N25-3020-16	16,876.80	
20 x 18	N25-3020-18	19,085.39	
24 x 4	N25-3024-4	18,800.40	
24 x 6	N25-3024-6	19,378.29	
24 x 8	N25-3024-8	19,615.79	

Item	Size In Inches	Part Number	List Price
<b>45 Degree Wye with SDR 26 Sewer Branch GxGxG</b>			
	6 x 4	N25-306-4GSB	582.47
	8 x 4	N25-308-4GSB	1,413.51
	8 x 6	N25-308-6GSB	1,499.71
	10 x 4	N25-3010-4GSB	1,680.83
	10 x 6	N25-3010-6GSB	1,791.30
	10 x 8	N25-3010-8GSB	1,904.28
	12 x 4	N25-3012-4GSB	2,210.97
	12 x 6	N25-3012-6GSB	2,368.79
	12 x 8	N25-3012-8GSB	2,627.22
	12 x 10	N25-3012-10GSB	3,100.88
	14 x 4	N25-3014-4GSB	4,955.45
	14 x 6	N25-3014-6GSB	5,105.81
	14 x 8	N25-3014-8GSB	6,348.52
	14 x 10	N25-3014-10GSB	6,626.35
	14 x 12	N25-3014-12GSB	6,997.85
	16 x 4	N25-3016-4GSB	6,736.49
	16 x 6	N25-3016-6GSB	6,942.30
	16 x 8	N25-3016-8GSB	7,108.59
	16 x 10	N25-3016-10GSB	7,243.10
	16 x 12	N25-3016-12GSB	7,314.31
	18 x 4	N25-3018-4GSB	11,391.09
	18 x 6	N25-3018-6GSB	11,739.33
	18 x 8	N25-3018-8GSB	11,929.31
	18 x 10	N25-3018-10GSB	12,625.87
	18 x 12	N25-3018-12GSB	13,362.09
	20 x 4	N25-3020-4GSB	13,100.90
	20 x 6	N25-3020-6GSB	13,498.85
	20 x 8	N25-3020-8GSB	13,837.07
	20 x 10	N25-3020-10GSB	14,272.58
	20 x 12	N25-3020-12GSB	15,071.90
20 x 18	N25-3020-18GSB	19,085.39	
24 x 4	N25-3024-4GSB	18,800.40	
24 x 6	N25-3024-6GSB	19,378.29	
24 x 8	N25-3024-8GSB	19,615.79	
24 x 10	N25-3024-10GSB	20,221.52	
24 x 12	N25-3024-12GSB	20,844.02	
24 x 18	N25-3024-18GSB	24,349.50	

Item	Size In Inches	Part Number	List Price
<b>45 Degree Wye with Schedule 40 Branch GxGxH</b>			
	6 x 4	N25-336-4	562.64
	8 x 4	N25-338-4	1,361.33
	8 x 6	N25-338-6	1,469.30
	10 x 4	N25-3310-4	1,652.63
	10 x 6	N25-3310-6	1,704.34
	10 x 8	N25-3310-8	1,851.29
	12 x 4	N25-3312-4	2,158.49
	12 x 6	N25-3312-6	2,324.37
	12 x 8	N25-3312-8	2,566.14
	12 x 10	N25-3312-10	3,025.26
	14 x 4	N25-3314-4	4,955.45
	14 x 6	N25-3314-6	5,105.81
	14 x 8	N25-3314-8	6,348.52
	14 x 10	N25-3314-10	6,626.35
	14 x 12	N25-3314-12	6,997.85
	16 x 4	N25-3316-4	6,736.49
	16 x 6	N25-3316-6	6,942.30
	16 x 8	N25-3316-8	7,108.59
	16 x 10	N25-3316-10	7,243.10
	16 x 12	N25-3316-12	7,314.31
	16 x 14	N25-3316-14	8,288.00
	18 x 4	N25-3318-4	11,391.09
	18 x 6	N25-3318-6	11,739.33
	18 x 8	N25-3318-8	11,929.31
	18 x 10	N25-3318-10	12,625.87
	18 x 12	N25-3318-12	13,362.09
	18 x 14	N25-3318-14	15,111.51
	18 x 16	N25-3318-16	16,116.94
	20 x 4	N25-3320-4	13,100.90
	20 x 6	N25-3320-6	13,498.85
20 x 8	N25-3320-8	13,837.07	
20 x 10	N25-3320-10	14,272.58	
20 x 12	N25-3320-12	15,071.90	
20 x 14	N25-3320-14	16,093.15	
20 x 16	N25-3320-16	16,876.80	
20 x 18	N25-3320-18	19,085.39	
24 x 4	N25-3324-4	18,800.40	
24 x 6	N25-3324-6	19,378.29	
24 x 8	N25-3324-8	19,615.79	

Item	Size In Inches	Part Number	List Price
<b>45 Degree Wye with Schedule 40 Branch GxGxG</b>			
	6 x 4	N25-316-4	582.47
	8 x 4	N25-318-4	1,413.51
	8 x 6	N25-318-6	1,499.71
	10 x 4	N25-3110-4	1,680.83
	10 x 6	N25-3110-6	1,791.30
	10 x 8	N25-3110-8	1,904.28
	12 x 4	N25-3112-4	2,210.97
	12 x 6	N25-3112-6	2,368.79
	12 x 8	N25-3112-8	2,627.22
	12 x 10	N25-3112-10	3,100.88
	14 x 4	N25-3114-4	4,955.45
	14 x 6	N25-3114-6	5,105.81
	14 x 8	N25-3114-8	6,348.52
	14 x 10	N25-3114-10	6,626.35
	14 x 12	N25-3114-12	6,997.85
	16 x 4	N25-3116-4	6,736.49
	16 x 6	N25-3116-6	6,942.30
	16 x 8	N25-3116-8	7,108.59
	16 x 10	N25-3116-10	7,243.10
	16 x 12	N25-3116-12	7,314.31
	18 x 4	N25-3118-4	11,391.09
	18 x 6	N25-3118-6	11,739.33
	18 x 8	N25-3118-8	11,929.31
	18 x 10	N25-3118-10	12,625.87
	18 x 12	N25-3118-12	13,362.09
	20 x 4	N25-3120-4	13,100.90
	20 x 6	N25-3120-6	13,498.85
	20 x 8	N25-3120-8	13,837.07
	20 x 10	N25-3120-10	14,272.58
	20 x 12	N25-3120-12	15,071.90
20 x 16	N25-3120-16	16,876.80	
24 x 4	N25-3124-4	18,800.40	
24 x 6	N25-3124-6	19,378.29	
24 x 8	N25-3124-8	19,615.79	
24 x 10	N25-3124-10	20,221.52	
24 x 12	N25-3124-12	20,844.02	
24 x 16	N25-3124-16	21,190.97	

- For C900 Pipe - Sewer and Drain Use - Non-Pressure applications only
- Additional Sizes Available Upon Request

- Conforms to AWWA C900
- Fabricated from DR25 Pipe

Item	Size In Inches	Part Number	List Price
<b>T-Y GxGxG (C900xC900)</b>			
	6 x 4	N25-157-4	591.22
	8 x 4	N25-158-4	1,434.70
	8 x 6	N25-158-6	1,522.20
	10 x 4	N25-1510-4	1,706.06
	10 x 6	N25-1510-6	1,818.18
	10 x 8	N25-1510-8	1,932.86
	12 x 4	N25-1512-4	2,244.12
	12 x 6	N25-1512-6	2,404.35
	12 x 8	N25-1512-8	2,666.65
	12 x 10	N25-1512-10	3,147.40
	14 x 4	N25-1514-4	5,029.76
	14 x 6	N25-1514-6	5,182.37
	14 x 8	N25-1514-8	6,443.76
	14 x 10	N25-1514-10	6,725.76
	14 x 12	N25-1514-12	7,102.80
	16 x 4	N25-1516-4	6,837.49
	16 x 6	N25-1516-6	7,046.43
	16 x 8	N25-1516-8	7,215.22
	16 x 10	N25-1516-10	7,351.74
	16 x 12	N25-1516-12	7,424.03
	18 x 4	N25-1518-4	11,561.93
	18 x 6	N25-1518-6	11,915.40
	18 x 8	N25-1518-8	12,108.22
	18 x 10	N25-1518-10	12,815.25
	18 x 12	N25-1518-12	13,562.55
	20 x 4	N25-1520-4	13,297.43
	20 x 6	N25-1520-6	13,701.31
	20 x 8	N25-1520-8	14,044.64
20 x 10	N25-1520-10	14,486.68	
20 x 12	N25-1520-12	15,298.01	
20 x 16	N25-1520-16	17,129.98	
24 x 4	N25-1524-4	19,082.37	
24 x 6	N25-1524-6	19,668.96	
24 x 8	N25-1524-8	19,910.00	
24 x 10	N25-1524-10	20,832.70	
24 x 12	N25-1524-12	21,474.06	
24 x 16	N25-1524-16	21,831.46	

Item	Size In Inches	Part Number	List Price
<b>T-Y with SDR 26 Sewer Branch GxGxG</b>			
	6 x 4	N25-157-4GGSB	591.22
	8 x 4	N25-158-4GGSB	1,434.70
	8 x 6	N25-158-6GGSB	1,522.20
	10 x 4	N25-1510-4GGSB	1,706.06
	10 x 6	N25-1510-6GGSB	1,818.18
	10 x 8	N25-1510-8GGSB	1,932.86
	12 x 4	N25-1512-4GGSB	2,244.12
	12 x 6	N25-1512-6GGSB	2,404.35
	12 x 8	N25-1512-8GGSB	2,666.65
	12 x 10	N25-1512-10GGSB	3,147.40
	14 x 4	N25-1514-4GGSB	5,029.76
	14 x 6	N25-1514-6GGSB	5,182.37
	14 x 8	N25-1514-8GGSB	6,443.76
	14 x 10	N25-1514-10GGSB	6,725.76
	14 x 12	N25-1514-12GGSB	7,102.80
	16 x 4	N25-1516-4GGSB	6,837.49
	16 x 6	N25-1516-6GGSB	7,046.43
	16 x 8	N25-1516-8GGSB	7,215.22
	16 x 10	N25-1516-10GGSB	7,351.74
	16 x 12	N25-1516-12GGSB	7,424.03
	18 x 4	N25-1518-4GGSB	11,561.93
	18 x 6	N25-1518-6GGSB	11,915.40
	18 x 8	N25-1518-8GGSB	12,108.22
	18 x 10	N25-1518-10GGSB	12,815.25
	18 x 12	N25-1518-12GGSB	13,562.55
	20 x 4	N25-1520-4GGSB	13,297.43
	20 x 6	N25-1520-6GGSB	13,701.31
	20 x 8	N25-1520-8GGSB	14,044.64
20 x 10	N25-1520-10GGSB	14,486.68	
20 x 12	N25-1520-12GGSB	15,298.01	
20 x 18	N25-1520-18GGSB	19,371.68	
24 x 4	N25-1524-4GGSB	19,082.37	
24 x 6	N25-1524-6GGSB	19,668.96	
24 x 8	N25-1524-8GGSB	19,910.00	
24 x 10	N25-1524-10GGSB	20,832.70	
24 x 12	N25-1524-12GGSB	21,474.06	
24 x 18	N25-1524-18GGSB	24,714.72	

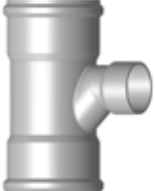
Item	Size In Inches	Part Number	List Price
<b>T-Y with Schedule 40 Branch GxGxH</b>			
	6 x 4	N25-196-4	571.08
	8 x 4	N25-198-4	1,381.73
	8 x 6	N25-198-6	1,491.35
	10 x 4	N25-1910-4	1,677.44
	10 x 6	N25-1910-6	1,729.91
	10 x 8	N25-1910-8	1,879.03
	12 x 4	N25-1912-4	2,190.86
	12 x 6	N25-1912-6	2,359.23
	12 x 8	N25-1912-8	2,604.63
	12 x 10	N25-1912-10	3,070.64
	14 x 4	N25-1914-4	5,029.76
	14 x 6	N25-1914-6	5,182.37
	14 x 8	N25-1914-8	6,443.76
	14 x 10	N25-1914-10	6,725.76
	14 x 12	N25-1914-12	7,102.80
	16 x 4	N25-1916-4	6,837.49
	16 x 6	N25-1916-6	7,046.43
	16 x 8	N25-1916-8	7,215.22
	16 x 10	N25-1916-10	7,351.74
	16 x 12	N25-1916-12	7,424.03
	18 x 4	N25-1918-4	11,561.93
	18 x 6	N25-1918-6	11,915.40
	18 x 8	N25-1918-8	12,108.22
	18 x 10	N25-1918-10	12,815.25
	18 x 12	N25-1918-12	13,562.55
	20 x 4	N25-1920-4	13,297.43
	20 x 6	N25-1920-6	13,701.31
	20 x 8	N25-1920-8	14,044.64
20 x 10	N25-1920-10	14,486.68	
20 x 12	N25-1920-12	15,298.01	
20 x 16	N25-1920-16	17,129.98	
24 x 4	N25-1924-4	19,082.37	
24 x 6	N25-1924-6	19,668.96	
24 x 8	N25-1924-8	19,910.00	
24 x 10	N25-1924-10	20,832.70	
24 x 12	N25-1924-12	21,474.06	
24 x 16	N25-1924-16	21,831.46	

Item	Size In Inches	Part Number	List Price
<b>T-Y with Schedule 40 Branch GxGxG</b>			
	6 x 4	N25-186-4	591.22
	8 x 4	N25-188-4	1,434.70
	8 x 6	N25-188-6	1,522.20
	10 x 4	N25-1810-4	1,706.06
	10 x 6	N25-1810-6	1,818.18
	10 x 8	N25-1810-8	1,932.86
	12 x 4	N25-1812-4	2,244.12
	12 x 6	N25-1812-6	2,404.35
	12 x 8	N25-1812-8	2,666.65
	12 x 10	N25-1812-10	3,147.40
	14 x 4	N25-1814-4	5,029.76
	14 x 6	N25-1814-6	5,182.37
	14 x 8	N25-1814-8	6,443.76
	14 x 10	N25-1814-10	6,725.76
	14 x 12	N25-1814-12	7,102.80
	16 x 4	N25-1816-4	6,837.49
	16 x 6	N25-1816-6	7,046.43
	16 x 8	N25-1816-8	7,215.22
	16 x 10	N25-1816-10	7,351.74
	16 x 12	N25-1816-12	7,424.03
	18 x 4	N25-1818-4	11,561.93
	18 x 6	N25-1818-6	11,915.40
	18 x 8	N25-1818-8	12,108.22
	18 x 10	N25-1818-10	12,815.25
	18 x 12	N25-1818-12	13,562.55
	20 x 4	N25-1820-4	13,297.43
	20 x 6	N25-1820-6	13,701.31
	20 x 8	N25-1820-8	14,044.64
20 x 10	N25-1820-10	14,486.68	
20 x 12	N25-1820-12	15,298.01	
20 x 16	N25-1820-16	17,129.98	
24 x 4	N25-1824-4	19,082.37	
24 x 6	N25-1824-6	19,668.96	
24 x 8	N25-1824-8	19,910.00	
24 x 10	N25-1824-10	20,832.70	
24 x 12	N25-1824-12	21,474.06	
24 x 16	N25-1824-16	21,831.46	

- For C900 Pipe - Sewer and Drain Use - Non-Pressure applications only
- Additional Sizes Available Upon Request

- Conforms to AWWA C900
- Fabricated from DR25 Pipe

Item	Size In Inches	Part Number	List Price
<b>Tee Cross GxGxGxG</b>			
	6 x 4	N25-1796-4	809.79
	8 x 4	N25-1798-4	1,681.27
	8 x 6	N25-1798-6	1,962.36
	10 x 4	N25-17910-4	2,122.94
	10 x 6	N25-17910-6	2,265.56
	10 x 8	N25-17910-8	2,515.63
	12 x 4	N25-17912-4	2,739.41
	12 x 6	N25-17912-6	3,045.55
	12 x 8	N25-17912-8	3,499.15
	12 x 10	N25-17912-10	4,114.52
	14 x 4	N25-17914-4	6,591.00
	14 x 6	N25-17914-6	7,042.49
	14 x 8	N25-17914-8	9,069.32
	14 x 10	N25-17914-10	9,792.64
	14 x 12	N25-17914-12	10,686.33
	16 x 4	N25-17916-4	8,959.86
	16 x 6	N25-17916-6	9,575.56
	16 x 8	N25-17916-8	10,155.12
	16 x 10	N25-17916-10	10,704.13
	16 x 12	N25-17916-12	11,169.64
	16 x 14	N25-17916-14	13,064.85
	18 x 4	N25-17918-4	15,150.70
	18 x 6	N25-17918-6	16,192.17
	18 x 8	N25-17918-8	17,041.87
	18 x 10	N25-17918-10	18,658.94
	18 x 12	N25-17918-12	20,405.20
	18 x 14	N25-17918-14	23,821.09
	18 x 16	N25-17918-16	26,199.91
	20 x 4	N25-17920-4	17,424.88
	20 x 6	N25-17920-6	18,619.09
	20 x 8	N25-17920-8	19,767.25
	20 x 10	N25-17920-10	21,092.46
20 x 12	N25-17920-12	23,016.21	
20 x 14	N25-17920-14	25,368.52	
20 x 16	N25-17920-16	27,435.20	
20 x 18	N25-17920-18	31,965.67	
24 x 4	N25-17924-4	25,005.46	
24 x 6	N25-17924-6	26,728.68	
24 x 8	N25-17924-8	28,022.53	
24 x 10	N25-17924-10	29,374.87	
24 x 12	N25-17924-12	30,571.51	

Item	Size In Inches	Part Number	List Price
<b>Manhole Adapter without pipe stop (SxG) Sanded</b>			
	4	N25-9604	249.44
	6	N25-9606	351.00
	8	N25-9608	600.32
	10	N25-9610	916.10
	12	N25-9612	1,338.15
	14	N25-9614	1,872.91
	16	N25-9616	2,656.54
	18	N25-9618	3,440.39
	20	N25-9620	8,335.51
24	N25-9624	10,175.10	

Item	Size In Inches	Part Number	List Price
<b>Cap (G)</b>			
	4	N25-1604	284.50
	6	N25-1606	478.76
	8	N25-1608	1,060.56
	10	N25-16010	1,521.08
	12	N25-16012	1,770.16
	14	N25-16014	1,838.95
	16	N25-16016	2,074.89
	18	N25-16018	3,455.87
	20	N25-16020	3,976.37
24	N25-16024	5,732.09	

Item	Size In Inches	Part Number	List Price
<b>Stop Coupling GxG</b>			
	4	N25-604	157.20
	6	N25-606	241.06
	8	N25-608	545.77
	10	N25-6010	832.87
	12	N25-6012	1,216.55
	14	N25-6014	3,061.71
	16	N25-6016	3,653.69
	18	N25-6018	9,740.53
	20	N25-6020	10,931.59
24	N25-6024	13,795.96	

Item	Size In Inches	Part Number	List Price
<b>45 Degree Double Wye GxGxGxG</b>			
	6 x 4	N25-366-4	809.79
	8 x 4	N25-368-4	1,837.58
	8 x 6	N25-368-6	2,024.61
	10 x 4	N25-3610-4	2,185.09
	10 x 6	N25-3610-6	2,418.32
	10 x 8	N25-3610-8	2,665.99
	12 x 4	N25-3612-4	2,874.26
	12 x 6	N25-3612-6	3,197.87
	12 x 8	N25-3612-8	3,678.14
	12 x 10	N25-3612-10	4,496.28
	14 x 4	N25-3614-4	6,788.71
	14 x 6	N25-3614-6	7,253.74
	14 x 8	N25-3614-8	9,341.44
	14 x 10	N25-3614-10	10,086.44
	14 x 12	N25-3614-12	11,006.94
	16 x 4	N25-3616-4	9,228.64
	16 x 6	N25-3616-6	9,862.82
	16 x 8	N25-3616-8	10,459.76
	16 x 10	N25-3616-10	11,025.26
	16 x 12	N25-3616-12	11,504.74
	16 x 14	N25-3616-14	13,456.78
	18 x 4	N25-3618-4	15,605.20
	18 x 6	N25-3618-6	16,677.96
	18 x 8	N25-3618-8	17,553.10
	18 x 10	N25-3618-10	19,218.69
	18 x 12	N25-3618-12	21,017.38
	18 x 14	N25-3618-14	24,535.70
	18 x 16	N25-3618-16	26,985.93
	20 x 4	N25-3620-4	17,947.61
	20 x 6	N25-3620-6	19,177.66
	20 x 8	N25-3620-8	20,360.27
	20 x 10	N25-3620-10	21,725.25
20 x 12	N25-3620-12	23,706.70	
20 x 14	N25-3620-14	26,129.62	
20 x 16	N25-3620-16	28,261.40	
20 x 18	N25-3620-18	32,924.64	
24 x 4	N25-3624-4	25,755.29	
24 x 6	N25-3624-6	27,530.53	
24 x 8	N25-3624-8	28,863.22	
24 x 10	N25-3624-10	30,256.11	
24 x 12	N25-3624-12	31,488.67	

Item	Size In Inches	Part Number	List Price
<b>C900 Adapter Bushing SxG (C900xC900)</b>			
	4 x 4	N25-9094	153.29
	6 x 6	N25-9096	235.01
	8 x 8	N25-9098	552.12
	10 x 10	N25-90910	812.07
	12 x 12	N25-90912	1,186.13
	14 x 14	N25-90914	2,985.16
	16 x 16	N25-90916	3,562.32
	18 x 18	N25-90918	9,496.99
	20 x 20	N25-90920	10,658.29
	24 x 24	N25-90924	13,451.03

Item	Size In Inches	Part Number	List Price
<b>Spigot Plug (S)</b>			
	4	N25-1164	271.54
	6	N25-1166	471.50
	8	N25-1168	1,018.23
	10	N25-11610	1,225.69
	12	N25-11612	1,547.65
	14	N25-11614	1,651.06
	16	N25-11616	1,824.86
	18	N25-11618	2,990.95
	20	N25-11620	3,511.36
	24	N25-11624	5,523.79

Item	Size In Inches	Part Number	List Price
<b>Repair Coupling GxG</b>			
	4	N25-624	161.14
	6	N25-626	247.06
	8	N25-628	559.46
	10	N25-6210	853.71
	12	N25-6212	1,246.97
	14	N25-6214	3,138.25
	16	N25-6216	3,744.99
	18	N25-6218	9,984.02
	20	N25-6220	11,204.86
	24	N25-6224	14,140.84

- For C900 Pipe - Sewer and Drain Use - Non-Pressure applications only
- Additional Sizes Available Upon Request

- Conforms to AWWA C900
- Fabricated from DR25 Pipe

Item	Size In Inches	Part Number	List Price
<b>Concentric Increaser Coupling GxG</b>			
	10 x 4	N25-6010-4	839.60
	10 x 6	N25-6010-6	915.99
	10 x 8	N25-6010-8	1,013.16
	12 x 4	N25-6012-4	1,103.47
	12 x 6	N25-6012-6	1,152.02
	12 x 8	N25-6012-8	1,235.35
	12 x 10	N25-6012-10	1,360.11
	14 x 4	N25-6014-4	2,290.06
	14 x 6	N25-6014-6	2,359.44
	14 x 8	N25-6014-8	2,428.81
	14 x 10	N25-6014-10	2,525.98
	14 x 12	N25-6014-12	2,581.43
	16 x 4	N25-6016-4	2,796.96
	16 x 6	N25-6016-6	2,879.83
	16 x 8	N25-6016-8	2,949.21
	16 x 10	N25-6016-10	3,185.31
	16 x 12	N25-6016-12	3,247.68
	16 x 14	N25-6016-14	3,754.19
	18 x 4	N25-6018-4	3,513.11
	18 x 6	N25-6018-6	3,615.83
	18 x 8	N25-6018-8	3,727.73
	18 x 10	N25-6018-10	4,109.14
	18 x 12	N25-6018-12	4,174.98
	18 x 14	N25-6018-14	4,438.52
	18 x 16	N25-6018-16	4,716.22
	20 x 4	N25-6020-4	6,204.47
	20 x 6	N25-6020-6	6,398.67
	20 x 8	N25-6020-8	6,592.56
20 x 10	N25-6020-10	6,793.78	
20 x 12	N25-6020-12	6,863.14	
20 x 14	N25-6020-14	7,110.11	
20 x 16	N25-6020-16	7,324.95	
20 x 18	N25-6020-18	8,112.12	
24 x 4	N25-6024-4	6,408.77	
24 x 6	N25-6024-6	6,606.58	
24 x 8	N25-6024-8	6,809.74	
24 x 10	N25-6024-10	7,017.81	
24 x 12	N25-6024-12	7,237.46	
24 x 14	N25-6024-14	7,901.93	
24 x 16	N25-6024-16	8,368.63	
24 x 18	N25-6024-18	8,780.61	
24 x 20	N25-6024-20	9,340.67	

<b>Gasketed SDR 26 Sewer Adapter Coupling GxG Gasket C900 Hub x Gasket SDR26 Sewer Hub</b>			
	4 x 4	H7204	301.94
	6 x 6	H7206	363.44
	8 x 8	H7208	1,169.09
	10 x 10	H7210	1,432.23
	12 x 12	H7212	1,715.66
	18 x 18	H7218	5,472.74
	24 x 24	H7224	7,749.85

<b>Gasketed Schedule 40 Adapter Bushing SxG C900 Spigot x Gasket Schedule 40 Hub</b>			
	4 x 4	N25-7504	306.45
	6 x 6	N25-7506	368.85
	8 x 8	N25-7508	1,186.50
	10 x 10	N25-7510	1,453.55
	12 x 12	N25-7512	1,741.20

<b>Gasketed Schedule 40 Adapter Coupling GxG Gasket C900 Hub x Gasket Schedule 40 Hub</b>			
	4 x 4	N25-7804	321.77
	6 x 6	N25-7806	387.29
	8 x 8	N25-7808	1,245.81
	10 x 10	N25-7810	1,526.23
	12 x 12	N25-7812	1,828.26
	14 x 14	N25-7814	3,875.02
	16 x 16	N25-7816	5,083.17
	18 x 18	N25-7818	5,831.96
	20 x 20	N25-7820	7,045.29
	24 x 24	N25-7824	8,258.57

Item	Size In Inches	Part Number	List Price
<b>Concentric Increaser Bushing SxG</b>			
	10 x 4	N25-1210-4	645.34
	10 x 6	N25-1210-6	735.57
	10 x 8	N25-1210-8	818.91
	12 x 4	N25-1212-4	860.53
	12 x 6	N25-1212-6	943.76
	12 x 8	N25-1212-8	1,034.04
	12 x 10	N25-1212-10	1,124.20
	14 x 4	N25-1214-4	1,908.36
	14 x 6	N25-1214-6	1,970.88
	14 x 8	N25-1214-8	2,033.38
	14 x 10	N25-1214-10	2,130.36
	14 x 12	N25-1214-12	2,206.70
	16 x 4	N25-1216-4	2,291.43
	16 x 6	N25-1216-6	2,359.44
	16 x 8	N25-1216-8	2,414.98
	16 x 10	N25-1216-10	2,727.27
	16 x 12	N25-1216-12	2,824.32
	16 x 14	N25-1216-14	3,261.54
	18 x 4	N25-1218-4	2,900.90
	18 x 6	N25-1218-6	2,985.63
	18 x 8	N25-1218-8	3,078.27
	18 x 10	N25-1218-10	3,445.31
	18 x 12	N25-1218-12	3,614.80
	18 x 14	N25-1218-14	3,798.44
	18 x 16	N25-1218-16	3,958.33
	20 x 4	N25-1220-4	4,657.17
	20 x 6	N25-1220-6	4,803.02
	20 x 8	N25-1220-8	4,948.80
20 x 10	N25-1220-10	5,102.24	
20 x 12	N25-1220-12	5,139.25	
20 x 14	N25-1220-14	5,489.06	
20 x 16	N25-1220-16	5,808.32	
20 x 18	N25-1220-18	6,765.36	
24 x 4	N25-1224-4	5,632.13	
24 x 6	N25-1224-6	5,808.06	
24 x 8	N25-1224-8	5,989.23	
24 x 10	N25-1224-10	6,172.15	
24 x 12	N25-1224-12	6,364.40	
24 x 14	N25-1224-14	7,023.26	
24 x 16	N25-1224-16	7,517.51	
24 x 18	N25-1224-18	8,236.86	
24 x 20	N25-1224-20	8,368.63	

<b>Gasketed SDR 26 Sewer Adapter Bushing SxG C900 Spigot x Gasket SDR26 Sewer Hub</b>			
	4 x 4	H9004	301.94
	6 x 6	H9006	363.44
	8 x 8	H9008	1,169.09
	10 x 10	H90010	1,432.23
	12 x 12	H90012	1,715.66
	18 x 18	H90018	5,472.74
	24 x 24	H90024	7,749.85

<b>Gasketed SDR 26 Sewer Adapter Bushing SxG SDR26 Chamfer Sewer Spigot x Gasket C900 Hub</b>			
	4 x 4	H7404	301.94
	6 x 6	H7406	363.44
	8 x 8	H7408	1,000.66
	10 x 10	H7410	1,432.23
	12 x 12	H7412	1,715.66
	18 x 18	H7418	5,472.74
	24 x 24	H7424	7,749.85

<b>Gasketed Schedule 40 Adapter Bushing SxG Schedule 40 Chamfer Spigot x Gasket C900 Hub</b>			
	4 x 4	N25-7604	317.01
	6 x 6	N25-7606	381.55
	8 x 8	N25-7608	1,227.42
	10 x 10	N25-7610	1,503.69
	12 x 12	N25-7612	1,801.23
	14 x 14	N25-7614	3,817.76
	16 x 16	N25-7616	5,008.04
	18 x 18	N25-7618	5,745.76
	20 x 20	N25-7620	6,941.14
	24 x 24	N25-7624	8,136.53

- For C900 Pipe - Sewer and Drain Use - Non-Pressure applications only
- Additional Sizes Available Upon Request

- Conforms to AWWA C900
- Fabricated from DR25 Pipe

Item	Size In Inches	Part Number	List Price
<b>1/4 Bend (90) GxG</b>			
	4	N25-204	356.53
	6	N25-206	840.31
	8	N25-208	1,577.32
	10	N25-2010	2,407.04
	12	N25-2012	3,174.54
	14	N25-2014	4,771.54
	16	N25-2016	5,692.29
	18	N25-2018	10,719.65
	20	N25-2020	12,181.04
	24	N25-2024	20,401.71

Item	Size In Inches	Part Number	List Price
<b>1/8 Bend (45) GxG</b>			
	4	N25-504	304.22
	6	N25-506	465.57
	8	N25-508	884.15
	10	N25-5010	1,349.20
	12	N25-5012	2,051.84
	14	N25-5014	3,770.51
	16	N25-5016	4,581.62
	18	N25-5018	8,045.24
	20	N25-5020	9,988.92
	24	N25-5024	14,132.02

Item	Size In Inches	Part Number	List Price
<b>1/12 Bend (30) GxG</b>			
	4	N25-1354.30	307.26
	6	N25-1356.30	470.20
	8	N25-1358.30	893.01
	10	N25-13510.30	1,362.86
	12	N25-13512.30	2,072.40
	14	N25-13514.30	3,808.21
	16	N25-13516.30	4,627.43
	18	N25-13518.30	8,125.68
	20	N25-13520.30	10,088.85
	24	N25-13524.30	14,273.37

Item	Size In Inches	Part Number	List Price
<b>1/16 Bend (22.5) GxG</b>			
	4	N25-1704	310.33
	6	N25-1706	474.90
	8	N25-1708	901.92
	10	N25-17010	1,376.49
	12	N25-17012	2,093.15
	14	N25-17014	3,846.29
	16	N25-17016	4,673.72
	18	N25-17018	8,206.98
	20	N25-17020	10,189.73
	24	N25-17024	14,416.09

Item	Size In Inches	Part Number	List Price
<b>1/32 Bend (11.25) GxG</b>			
	4	N25-1934	313.44
	6	N25-1936	479.64
	8	N25-1938	910.94
	10	N25-19310	1,390.23
	12	N25-19312	2,114.10
	14	N25-19314	3,884.73
	16	N25-19316	4,720.44
	18	N25-19318	8,289.06
	20	N25-19320	10,291.61
	24	N25-19324	14,560.27

Item	Size In Inches	Part Number	List Price
<b>1/4 Bend (90) SxG</b>			
	4	N25-224	365.43
	6	N25-226	861.33
	8	N25-228	1,616.75
	10	N25-2210	2,467.24
	12	N25-2212	3,253.93
	14	N25-2214	4,890.87
	16	N25-2216	5,834.63
	18	N25-2218	10,987.65
	20	N25-2220	12,485.57
	24	N25-2224	20,911.76

Item	Size In Inches	Part Number	List Price
<b>1/8 Bend (45) SxG</b>			
	4	N25-404	311.80
	6	N25-406	477.23
	8	N25-408	906.27
	10	N25-4010	1,382.89
	12	N25-4012	2,103.17
	14	N25-4014	3,864.80
	16	N25-4016	4,696.16
	18	N25-4018	8,246.40
	20	N25-4020	10,238.97
	24	N25-4024	14,485.36

Item	Size In Inches	Part Number	List Price
<b>1/12 Bend (30) SxG</b>			
	4	N25-1344.30	314.93
	6	N25-1346.30	481.97
	8	N25-1348.30	915.33
	10	N25-13410.30	1,396.75
	12	N25-13412.30	2,124.22
	14	N25-13414.30	3,903.42
	16	N25-13416.30	4,743.16
	18	N25-13418.30	8,328.86
	20	N25-13420.30	10,341.06
	24	N25-13424.30	14,630.20

Item	Size In Inches	Part Number	List Price
<b>1/16 Bend (22.5) SxG</b>			
	4	N25-1714	318.10
	6	N25-1716	486.82
	8	N25-1718	924.49
	10	N25-17110	1,410.67
	12	N25-17112	2,145.45
	14	N25-17114	3,942.43
	16	N25-17116	4,790.55
	18	N25-17118	8,412.11
	20	N25-17120	10,444.49
	24	N25-17124	14,785.92

Item	Size In Inches	Part Number	List Price
<b>1/32 Bend (11.25) SxG</b>			
	4	N25-1834	321.26
	6	N25-1836	491.67
	8	N25-1838	933.72
	10	N25-18310	1,424.80
	12	N25-18312	2,166.94
	14	N25-18314	3,981.88
	16	N25-18316	4,838.47
	18	N25-18318	8,496.24
	20	N25-18320	10,548.92
	24	N25-18324	14,924.28

- For C900 Pipe - Sewer and Drain Use - Non-Pressure applications only
- Additional Sizes Available Upon Request

- Conforms to AWWA C900
- Fabricated from DR25 Pipe





# Solvent Weld Sewer Fittings SDR 35 (P-Series/S-Series)

Injection Molded in Sizes 3" – 12"  
Fabricated in Sizes 10" – 36"



## Applications

Westlake Pipe & Fittings has the broadest product offering of Solvent Weld Sewer fittings in the industry. They conform to all municipal, federal, and military requirements. They are tested for joint tightness, internal stress and dimensional stability. The P Series and S Series are engineered for the harsh environment of construction, shipping, handling and installation.

Listed below are some of the uses of Solvent Weld Sewer fittings:

- Onsite Disposal
- Closed loop septic fields
- Open system septic fields
- Engineered systems
- Laterals to Municipal Sewers (sanitary & storm)
- Surface Drainage
- Foundation Drains
- Radon Gas Venting
- Yard Drainage
- Downspouts
- Pool Drainage
- Area Drainage
- Landscape Drainage

## Certifications

Westlake Pipe & Fittings Solvent Weld Sewer fittings are third party tested and listed by NSF, UPC, and CSA to meet specifications defined in ASTM D3034 and CSA B182.2.

**Attention:** Westlake Pipe & Fittings are not to be used with compressed air or gases. Westlake Pipe & Fittings does not recommend that piping systems that include its products be tested with compressed air or gases.

### Third Party Tested





































Item	Size In Inches	Part Number P	Part Number S	Box Qty	Crate Qty	List Price
<b>DWV Adapter Coupling HxH Solvent Sewer Hub x Solvent DWV Hub</b>						
	*3 x 3	P653-3	S650030	12	-	19.63
	*4 x 3	P655	S650422	45	-	23.24
	*4 x 4	P657	S650040	15	-	32.77
	*6 x 4	P658	S650532	10	-	90.22
	*6 x 6	P659	S650060	12	-	112.74
	†8 x 8	P6508	S650080	1	-	344.28
	10 x 8	P6510-8	S650628	2	-	789.46
	10 x 10	P6510	S650100	1	-	839.30
12 x 12	P6512	S650120	1	-	1,235.56	
<b>DWV Adapter Sleeve SxH DWV Spigot x Solvent Sewer Hub</b>						
	*3 x 3	P1207	S651030	10	-	27.20
	*4 x 4	P1208	S651040	36	-	24.56
	*6 x 6	P1209	S651060	20	-	105.95
	8 x 8	P12008	S651080	1	-	288.41
	10 x 10	P12010	S651100	1	-	357.16
	12 x 12	P12012	S651120	1	-	562.87
<b>Gasketed Sewer Adapter HxG Solvent Sewer Hub x Gasket Sewer Hub</b>						
	*4 x 4	G644	-	6	-	66.36
	*6 x 4	G646-4	-	8	-	114.00
	*6 x 6	G646	-	4	-	145.36
	*8 x 8	H648	-	4	-	376.42
<b>Gasketed DWV Adapter Coupling GxDWV G SDR 26 Gasket Sewer Hub x Gasket DWV Hub</b>						
	*4 x 4	H657	-	6	-	173.05
	*6 x 4	H658	-	4	-	232.14
	*6 x 6	H659	-	3	-	254.05
<b>Gasketed DWV Adapter Coupling HxDWV G SDR 26 Solvent Sewer Hub x Gasket DWV Hub</b>						
	*4 x 4	H954	-	6	-	154.19
	*6 x 4	H956-4	-	4	-	197.66
	*6 x 6	H956	-	4	-	235.07
<b>Corrugated Pipe Adapter SxH Corrugated Spigot x Solvent Sewer Hub</b>						
	*4 x 4	P674	-	24	-	78.55
<b>In-Line Backwater Valve HxH (SDR 35)</b>						
	†4 x 4	P0104	S010040	1	-	470.56
	†6 x 6	P0106	S010060	1	-	1,229.64
	8 x 8	P0108	S010080	1	-	4,216.33
	10 x 10	P0110	S010100	1	-	5,406.64
	12 x 12	P0112	S010120	1	-	6,070.59
	15 x 15	P0115	-	-	1	-
<b>Downspout Adapter (H) Downspout x Solvent Sewer Hub</b>						
	*2 x 3 x 3	P1903	S190338	40	-	22.90
	*2 x 3 x 4	P1904	S190259	35	-	26.63
	*3 x 4 x 3	P1905	S190347	65	-	38.09
	*3 x 4 x 4	P1906	S190348	60	-	42.08
Note: Last dimension is pipe dimension						
<b>Flushmount Downspout Adapter (H) Flushmount Downspout x Solvent Sewer Hub</b>						
	*2 x 3 x 3	P1923	S192338	36	-	18.92
	*2 x 3 x 4	P1924	S192259	22	-	20.05
	*3 x 4 x 4	P1926	S192348	24	-	35.93
	*4 x 6 x 6	P1928	S192532	8	-	115.27
Note: Last dimension is pipe dimension						

\* Denotes Molded Fitting

† Denotes Assembled from Molded Components

• Additional Sizes Available Upon Request

Item	Size In Inches	Part Number P	Part Number S	Box Qty	Crate Qty	List Price
<b>DWV Adapter Bushing SxH Solvent Sewer Spigot x Solvent DWV Hub</b>						
	*3 x 1 1/2	P1202	S649337	15	-	47.50
	*3 x 2	P1203	S649338	15	-	42.86
	*4 x 1 1/2	P1204	S649149	8	-	44.13
	*4 x 2	P1205	S649420	8	-	44.75
	*4 x 3	P1211	S649422	15	-	97.72
	*4 x 4	P1213	S649040	20	-	62.59
*6 x 4	P1214	S649532	15	-	108.03	
*6 x 6	P1215	S649060	12	-	142.95	
<b>DWV Adapter Bushing SxH Chamfer (Long) Sewer Spigot x Solvent DWV Hub</b>						
	*4 x 4	G944	-	8	-	62.59
	*6 x 4	G946-4	-	5	-	110.48
	*6 x 6	G946	-	4	-	142.97
	*8 x 8	G948	-	4	-	271.01
	10 x 10	L9410	-	1	-	351.10
	12 x 12	L9412	-	1	-	482.89
<b>Solvent DWV Adapter Bushing Solvent Sewer Spigot x Gasket DWV Hub</b>						
	*4 x 4	G924	-	6	-	-
	*6 x 4	G926-4	-	4	-	-
	*6 x 6	G926	-	4	-	-
<b>Gasketed Sewer Adapter SxG Solvent Sewer Spigot x Gasket Sewer Hub</b>						
	*4 x 4	G904	-	6	-	74.43
	*6 x 6	G906	-	4	-	139.22
	*8 x 8	G908	-	4	-	322.33
<b>Gasketed DWV Adapter Bushing SxDWV G SDR 26 Chamfer Sewer Spigot x Gasket DWV Hub</b>						
	*4 x 4	G1213	-	8	-	-
	*6 x 4	G1214	-	5	-	-
	*6 x 6	G1215	-	4	-	-
<b>DWV Adapter Sleeve SxH Solvent DWV Spigot x SDR 26 Gasket Sewer Hub</b>						
	*4 x 4	H1208	-	4	-	125.70
	*6 x 6	H1209	-	4	-	240.58
	8 x 8	H12008	-	1	-	625.45
<b>Solvent Sewer Hub Adapter SxH Chamfer Sewer Spigot x Solvent Sewer Hub</b>						
	*4 x 4	G964	-	8	-	99.16
	6 x 6	G966	-	1	-	122.48
	8 x 8	G968	-	1	-	283.62
<b>Terminal Backwater Valve H (SDR 35)</b>						
	4 x 4	P0204	S020040	1	-	534.09
	6 x 6	P0206	S020060	1	-	624.40
	8 x 8	P0208	S020080	1	-	1,248.23
<b>Corrugated Flushmount Downspout Adapter (S) Flushmount Downspout x Corrugated Spigot</b>						
	*2 x 3 x 4	P1944	S194259	32	-	24.09
	*3 x 4 x 4	P1946	S194422	24	-	38.23
	*4 x 6 x 6	P1948	S194532	6	-	149.71
Note: Last dimension is pipe dimension						
<b>Male Adapter Solvent Sewer Hub x Male Pipe Thread</b>						
	*3	P1303	S109030	40	-	74.24
	*4	P1304	S109040	30	-	76.77
	*6	P1306	S109060	3	-	360.52

• Third party tested and listed by CSA, NSF and UPC

• Specifications: ASTM D3034, F679, CSA B182.2

• Non-Stock items are non-cancelable, non-returnable







## I.P.S. Gasketed Drainage (T-Series)

Injection Molded in Sizes 4" – 8"  
Fabricated in Sizes 10" – 24"

Westlake Pipe & Fittings is one of the only manufacturers to supply 4" – 8" Gasketed Drainage fittings in molded components. These Gasketed Drainage fittings feature distinctive blue rings and gaskets for easy field identification.

### Applications





Gasketed Drainage fittings are intended for non-pressure drainage of sewage and surface water where IPS pipe is specified.





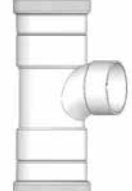

### Certifications

Westlake Pipe & Fittings Gasketed Drainage fittings are made to accept ASTM D2241 pipe or ASTM D2665 DWV pipe.

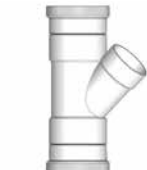





**Attention:** Westlake Pipe & Fittings are not to be used with compressed air or gases. Westlake Pipe & Fittings does not recommend that piping systems that include its products be tested with compressed air or gases.







Item	Size In Inches	Part Number	Box Qty	Crate Qty	List Price
<b>Straight Tee GxGxG</b>					
	1/4 x 4	T104	6	-	376.24
	1/2 x 4	T106-4	1	-	409.98
	1/2 x 6	T106	1	-	432.19
	1/2 x 8	T108-4	1	-	649.28
	*8 x 6	T108-6	2	14	809.22
	1/2 x 8	T108	1	-	1,309.95
	10 x 4	T1010-4	1	-	1,130.65
	10 x 6	T1010-6	1	-	1,353.10
	10 x 8	T1010-8	1	-	1,747.68
	10 x 10	T1010	1	-	1,816.60
	12 x 4	T1012-4	1	-	1,487.34
	12 x 6	T1012-6	1	-	1,697.76
	12 x 8	T1012-8	1	-	1,949.53
	12 x 10	T1012-10	1	-	2,345.44
	12 x 12	T1012	1	-	2,845.54
<b>Straight Tee with DWV Branch GxGxH</b>					
	1/4 x 4	T134	1	-	415.74
	1/2 x 4	T136-4	1	-	453.46
	1/2 x 6	T136	1	-	472.18
	1/2 x 8	T138-4	1	-	727.07
	*8 x 6	T138-6	1	-	906.20
	1/2 x 8	T138	1	-	1,466.97
<b>Sanitary Tee (T-Y) GxGxG</b>					
	1/4 x 4	T156	5	-	403.51
	1/2 x 4	T157-4	1	-	700.79
	1/2 x 6	T157	1	-	936.09
	1/2 x 8	T158-4	1	-	1,025.92
	1/2 x 6	T158-6	1	-	1,266.10
	1/2 x 8	T158	1	-	1,816.60
	10 x 4	T1510-4	1	-	1,631.96
	10 x 6	T1510-6	1	-	1,997.26
	10 x 8	T1510-8	1	-	2,695.55
	12 x 4	T1512-4	1	-	2,073.47
	12 x 6	T1512-6	1	-	2,153.94
	12 x 8	T1512-8	1	-	3,511.01
<b>Sanitary Tee (T-Y) with DWV Branch GxGxH</b>					
	1/4 x 4	T194	1	-	413.59
	1/2 x 4	T196-4	1	-	718.24
	1/2 x 6	T196	1	-	959.40
	1/2 x 8	T198-4	1	-	1,051.61
	1/2 x 6	T198-6	1	-	1,297.75
	1/2 x 8	T198	1	-	1,862.10
<b>Combo Wye &amp; 1/8 Bend GxGxG (One Piece)</b>					
	1/4 x 4	T1644	1	-	743.59
<b>Tee Cross GxGxGxG</b>					
	4 x 4	T1794	1	-	489.12
	6 x 4	T1796-4	1	-	533.02
	6 x 6	T1796	1	-	583.45
	8 x 4	T1798-4	1	-	844.06
	8 x 6	T1798-6	1	-	1,092.45
	1/2 x 8	T1798	1	-	1,833.94
	10 x 4	T17910-4	1	-	1,730.59
	10 x 6	T17910-6	1	-	1,826.66
	10 x 8	T17910-8	1	-	2,475.46
	10 x 10	T17910	1	-	2,945.87
	12 x 4	T17912-4	1	-	1,933.49
	12 x 6	T17912-6	1	-	2,291.98
	12 x 8	T17912-8	1	-	2,729.35
	12 x 10	T17912-10	1	-	3,283.60
	12 x 12	T17912	1	-	4,268.36

Item	Size In Inches	Part Number	Box Qty	Crate Qty	List Price
<b>45 Degree Wye GxGxG</b>					
	1/4 x 4	T304	1	-	429.50
	1/2 x 4	T306-4	1	-	481.46
	*6 x 6	T306	1	16	544.21
	*8 x 4	T308-4	2	14	705.05
	*8 x 6	T308-6	2	12	934.35
	1/2 x 8	T308	1	-	1,506.44
	10 x 4	T3010-4	1	-	1,208.69
	10 x 6	T3010-6	1	-	1,566.15
	10 x 8	T3010-8	1	-	1,858.73
	10 x 10	T3010	1	-	2,118.69
	12 x 4	T3012-4	1	-	1,870.20
	12 x 6	T3012-6	1	-	2,040.09
	12 x 8	T3012-8	1	-	2,425.76
	12 x 10	T3012-10	1	-	2,716.66
	12 x 12	T3012	1	-	3,445.93
<b>45 Degree Wye with DWV Branch GxGxH</b>					
	1/4 x 4	T334	1	-	474.56
	1/2 x 4	T336-4	1	-	531.94
	1/2 x 6	T336	1	-	601.36
	1/2 x 8	T338-4	1	-	789.57
	1/2 x 6	T338-6	1	-	1,046.36
	1/2 x 8	T338	1	-	1,687.04
<b>Combo Wye &amp; 1/8 Bend GxGxG (2 Piece)</b>					
	1/4 x 4	T1654	1	-	718.56
	1/2 x 4	T1656-4	1	-	770.55
	1/2 x 6	T1656	1	-	936.09
	1/2 x 8	T1658-4	1	-	1,025.92
	1/2 x 6	T1658-6	1	-	1,319.24
	1/2 x 8	T1658	1	-	2,144.27
	10 x 4	T16510-4	1	-	1,631.96
	10 x 6	T16510-6	1	-	1,997.26
	10 x 8	T16510-8	1	-	2,695.55
	12 x 4	T16512-4	1	-	2,159.31
	12 x 6	T16512-6	1	-	2,424.96
	12 x 8	T16512-8	1	-	3,511.01
<b>Combo Wye &amp; 1/8 Bend with DWV Branch GxGxH (2 Piece)</b>					
	1/4 x 4	T1754	1	-	736.51
	1/2 x 4	T1756-4	1	-	789.76
	1/2 x 6	T1756	1	-	959.40
	1/2 x 8	T1758-4	1	-	1,051.46
	1/2 x 6	T1758-6	1	-	1,352.05
	1/2 x 8	T1758	1	-	2,197.62
<b>2-Way Cleanout GxGxG</b>					
	1/4	T1004	1	20	510.48
	1/2	T1006	1	14	2,187.78
<b>Double 45 Degree Wye GxGxGxG</b>					
	4 x 4	T364-4	1	-	558.30
	1/2 x 4	T366-4	1	-	625.89
	1/2 x 6	T366-6	1	-	755.91
	8 x 4	T368-4	1	-	916.53
	8 x 6	T368-6	1	-	1,261.40
	8 x 8	T368-8	1	-	2,109.02
	10 x 4	T3610-4	1	-	1,864.40
	10 x 6	T3610-6	1	-	2,114.28
	10 x 8	T3610-8	1	-	2,767.28
	10 x 10	T3610-10	1	-	3,126.17
	12 x 4	T3612-4	1	-	2,431.24
	12 x 6	T3612-6	1	-	2,754.10
	12 x 8	T3612-8	1	-	3,446.76
	12 x 10	T3612-10	1	-	4,101.98
	12 x 12	T3612-12	1	-	5,168.90

\* Denotes Molded Fitting  
 • Molded fittings are third party tested and listed by NSF at 200 PSI  
 † Denotes Assembled from Molded Components

• Specifications: ASTM D2241, D3139  
 • Made for SDR 26 and ASTM D2665 pipe  
 • Additional Sizes Available Upon Request

Item	Size In Inches	Part Number	Box Qty	Crate Qty	List Price
<b>1/4 Bend (90) GxG</b>					
	†4	T204	6	-	308.86
	†6	T206	1	-	738.05
	†8	T208	1	-	921.96
	10	T2010	1	-	1,605.02
	12	T2012	1	-	2,469.01
<b>1/4 Bend (90) GxG Long Sweep</b>					
	†4	T256	1	30	324.19
	†6	T257	1	20	791.59
	†8	T258	1	-	958.56
	10	T2510	1	-	1,689.69
	12	T2512	1	-	2,599.19
<b>1/8 Bend (45) GxG</b>					
	*4	T504	5	42	289.14
	*6	T506	5	48	384.89
	†8	T508	2	-	715.67
	10	T5010	1	-	1,250.32
	12	T5012	1	-	1,759.19
<b>1/12 Bend (30) GxG</b>					
	4	T1354.30	1	-	299.33
	6	T1356.30	1	-	405.47
	8	T1358.30	1	-	740.91
	10	T13510.30	1	-	1,294.40
	12	T13512.30	1	-	1,800.80
<b>1/16 Bend (22.5) GxG</b>					
	†4	T1704	10	-	296.35
	†6	T1706	1	-	401.43
	†8	T1708	1	-	733.55
	10	T17010	1	-	1,281.60
	12	T17012	1	-	1,782.96
<b>1/32 Bend (11.25) GxG</b>					
	4	T1934	1	-	302.29
	6	T1936	1	-	409.51
	8	T1938	1	-	740.91
	10	T19310	1	-	1,307.33
	12	T19312	1	-	1,818.82

Item	Size In Inches	Part Number	Box Qty	Crate Qty	List Price
<b>1/4 Bend (90) SxG</b>					
	†4	T224	6	-	468.18
	†6	T226	1	-	1,006.58
	†8	T228	1	-	1,216.16
	10	T2210	1	-	1,637.11
	12	T2212	1	-	2,518.37
<b>1/4 Bend (90) SxG Long Sweep</b>					
	†4	T274	6	30	330.67
	†6	T277	1	25	840.39
	†8	T278	1	-	1,114.66
	10	T2710	1	-	1,764.38
	12	T2712	1	-	2,651.21
<b>1/8 Bend (45) SxG</b>					
	*4	T404	6	-	294.92
	*6	T406	5	48	392.56
	†8	T408	1	-	729.97
	10	T4010	1	-	1,275.32
	12	T4012	1	-	1,803.21
<b>1/12 Bend (30) SxG</b>					
	4	T1344.30	1	-	306.78
	6	T1346.30	1	-	415.64
	8	T1348.30	1	-	768.33
	10	T13410.30	1	-	1,325.92
	12	T13412.30	1	-	1,845.83
<b>1/16 Bend (22.5) SxG</b>					
	†4	T1714	8	-	303.79
	†6	T1716	1	-	411.51
	†8	T1718	1	-	760.71
	10	T17110	1	-	1,313.60
	12	T17112	1	-	1,827.55
<b>1/32 Bend (11.25) SxG</b>					
	4	T1834	1	-	309.86
	6	T1836	1	-	419.82
	8	T1838	1	-	775.98
	10	T18310	1	-	1,340.03
	12	T18312	1	-	1,864.28

\* Denotes Molded Fitting  
 • Molded fittings are third party tested and listed by NSF at 200 PSI  
 † Denotes Assembled from Molded Components

• Specifications: ASTM D2241, D3139  
 • Made for SDR 26 and ASTM D2665 pipe  
 • Additional Sizes Available Upon Request

Item	Size In Inches	Part Number	Box Qty	Crate Qty	List Price
<b>Cap (G)</b>					
	*4	T1604	12	-	181.36
	*6	T1606	12	-	284.71
	†8	T1608	8	-	467.06
	10	T16010	1	-	750.89
	12	T16012	1	-	990.62
<b>Vertical Riser Adapter SxS</b>					
	*4	T984	6	-	181.93
	*6	T986	4	-	322.05
	*8	T988	4	-	705.85
<b>Stop Coupling GxG</b>					
	*4	T604	6	-	108.87
	*6	T606	5	-	226.50
	*8	T608	4	-	400.04
	10	T6010	1	-	599.56
	12	T6012	1	-	882.57
<b>Concentric Increaser Coupling GxG</b>					
	†6 x 4	T606-4	1	-	297.74
	†8 x 4	T608-4	1	-	571.23
	†8 x 6	T608-6	2	-	578.24
	10 x 4	T6010-4	1	-	844.95
	10 x 6	T6010-6	1	-	1,032.69
	10 x 8	T6010-8	1	-	1,159.32
	12 x 4	T6012-4	1	-	1,292.84
	12 x 6	T6012-6	1	-	1,604.44
	12 x 8	T6012-8	1	-	1,604.44
	12 x 10	T6012-10	1	-	1,818.98
<b>Eccentric Increaser Coupling GxG</b>					
	6 x 4	T616-4	1	-	312.63
	8 x 4	T618-4	1	-	595.18
	8 x 6	T618-6	1	-	607.19
	10 x 4	T6110-4	1	-	887.22
	10 x 6	T6110-6	1	-	1,320.35
	10 x 8	T6110-8	1	-	1,217.27
	12 x 4	T6112-4	1	-	1,357.51
	12 x 6	T6112-6	1	-	1,637.82
	12 x 8	T6112-8	1	-	1,684.67
	12 x 10	T6112-10	1	-	1,909.90
<b>Gasketed DWV Adapter Coupling GxDWV G SDR 26 Gasket Sewer Hub x Gasket DWV Hub</b>					
	*4 x 4	H657	6	-	173.05
	*6 x 4	H658	4	-	232.14
	*6 x 6	H659	3	-	254.05
	8 x 8	H6508	1	-	606.45
	10x10	H6510	1	-	839.30
	12x12	H6512	1	-	1,235.58
<b>Gasketed DWV Adapter Coupling HxDWV G SDR 26 Solvent Sewer Hub x Gasket DWV Hub</b>					
	*4 x 4	H954	6	-	154.19
	*6 x 4	H956-4	4	-	197.66
	*6 x 6	H956	4	-	235.07
	8 x 8	H958	1	-	565.76
	10 x 10	H9510	1	-	963.09
	12 x 12	H9512	1	-	1,409.35
<b>Gasketed DWV Hub Adapter SxG Solvent DWV Spigot x Gasket DWV Hub</b>					
	*4 x 4	D904	6	-	265.46
	*6 x 6	D906	4	-	552.22
	*8 x 8	D908	4	-	914.69
	10 x 10	D9010	1	-	Priced on Demand
	12 x 12	D9012	1	-	Priced on Demand

Item	Size In Inches	Part Number	Box Qty	Crate Qty	List Price
<b>Spigot Plug (S)</b>					
	*4	T1164	18	-	102.52
	*6	T1166	12	-	321.38
	*8	T1168	6	-	363.77
	*10	D11610	2	36	697.26
	*12	D11612	2	27	874.18
<b>Temporary Plug Polypropylene (S)</b>					
	*4	G1184	36	-	22.78
	*6	G1186	40	-	33.84
	8	G1188	8	-	69.81
<b>Repair Coupling GxG</b>					
	*4	T624	6	-	108.87
	*6	T626	5	-	226.49
	*8	T628	4	-	400.04
	10	T6210	1	-	599.56
	12	T6212	1	-	882.57
<b>Concentric Increaser Bushing SxG</b>					
	†6 x 4	T1216	5	-	283.53
	†8 x 4	T1217	1	-	539.81
	†8 x 6	T1218	1	-	550.70
	†10 x 4	T1210-4	1	-	804.72
	†10 x 6	T1210-6	1	-	983.60
	†10 x 8	T1210-8	1	-	1,103.44
	†12 x 4	T1212-4	1	-	1,213.96
	†12 x 6	T1212-6	1	-	1,464.62
	†12 x 8	T1212-8	1	-	1,506.53
	12 x 10	T1212-10	1	-	1,707.95
<b>Eccentric Increaser Bushing SxG</b>					
	6 x 4	T1306-4	1	-	297.74
	8 x 4	T1308-4	1	-	566.81
	8 x 6	T1308-6	1	-	578.24
	10 x 4	T13010-4	1	-	844.87
	10 x 6	T13010-6	1	-	1,032.80
	10 x 8	T13010-8	1	-	1,159.32
	12 x 4	T13012-4	1	-	1,274.65
	12 x 6	T13012-6	1	-	1,537.83
	12 x 8	T13012-8	1	-	1,581.81
	12 x 10	T13012-10	1	-	1,793.36
<b>Gasketed DWV Adapter Bushing SxDWV G SDR 26 Chamfer Sewer Spigot x Gasket DWV Hub</b>					
	*4 x 4	H1213	6	-	160.25
	*6 x 4	H1214	5	-	219.21
	*6 x 6	H1215	4	-	241.00
	8 x 8	H9208	1	-	591.25
	10 x 10	H9210	1	-	818.29
	12 x 12	H9212	1	-	1,204.55
<b>Gasketed DWV Adapter Bushing SxDWV G SDR 26 Solvent Sewer Spigot x Gasket DWV Hub</b>					
	4 x 4	H924	6	-	160.27
	6 x 4	H926-4	4	-	219.21
	6 x 6	H926	4	-	241.00
	8 x 8	H928	1	-	591.32
	10 x 10	H92210	1	-	818.37
	12 x 12	H92212	1	-	1,204.68
<b>DWV Adapter Bushing SxH SDR 26 Chamfer Sewer Spigot x Solvent DWV Hub</b>					
	4 x 4	H944	1	-	116.48
	6 x 4	H946-4	1	-	178.44
	6 x 6	H946	1	-	187.83
	8 x 8	H948	1	-	441.98
	10 x 10	H9410	1	-	755.29
	12 x 12	H9412	1	-	1,111.89

\* Denotes Molded Fitting

• Molded fittings are third party tested and listed by NSF at 200 PSI





† Denotes Assembled from Molded Components





• Specifications: ASTM D2241, D3139

• Made for SDR 26 and ASTM D2665 pipe

• Additional Sizes Available Upon Request









Item	Size In Inches	Part Number	Box Qty	Crate Qty	List Price
<b>DWV Adapter Sleeve DWV SxG</b>					
<b>Solvent DWV Spigot x SDR 35 Gasket Sewer Hub</b>					
	*4 x 4	G1208	16	-	125.68
	*6 x 6	G1209	8	-	240.56
	8 x 8	L12008	1	-	625.38
	10 x 10	L12010	1	-	839.21
	12 x 12	L12012	1	-	1,235.46
<b>Controlled Settlement Joint GxG</b>					
	4	T6004	1	-	488.13
	6	T6006	1	-	663.05
<b>Saddle Tee with Stainless Steel Clamps</b>					
<b>Solvent Skirt x Gasket Inlet</b>					
	6 x 4	T2106-4	1	-	313.21
	8 x 4	T2108-4	1	-	395.49
	8 x 6	T2108-6	1	-	527.29
	10 x 4	T2110-4	1	-	468.63
	10 x 6	T2110-6	1	-	650.66
	10 x 8	T2110-8	1	-	1,122.25
	12 x 4	T2112-4	1	-	630.93
	12 x 6	T2112-6	1	-	733.52
	12 x 8	T2112-8	1	-	1,802.94
	12 x 10	T2112-10	1	-	2,158.75
<b>Saddle Tee with Stainless Steel Clamps</b>					
<b>Solvent Skirt x Solvent Inlet</b>					
	6 x 4	D2106-4	1	-	248.47
	8 x 4	D2108-4	1	-	351.16
	8 x 6	D2108-6	1	-	361.53
	12 x 4	D2112-4	1	-	533.93
	12 x 6	D2112-6	1	-	620.57
	18 x 4	D2118-4	1	-	942.00
	18 x 10	D2118-10	1	-	2,488.73

Item	Size In Inches	Part Number	Box Qty	Crate Qty	List Price
<b>DWV Adapter Sleeve SxG</b>					
<b>Solvent DWV Spigot x SDR 26 Gasket Sewer Hub</b>					
	*4 x 4	H1208	4	-	125.70
	*6 x 6	H1209	4	-	240.58
	8 x 8	H12008	1	-	625.45
	10 x 10	H12010	1	-	839.30
	12 x 12	H12012	1	-	1,235.58
<b>Controlled Settlement Joint SxG</b>					
	4	T6304	1	-	473.56
	6	T6306	1	-	607.91
<b>Saddle Wye with Stainless Steel Clamps</b>					
<b>Solvent Skirt x Gasket Inlet</b>					
	6 x 4	T2306-4	1	-	323.17
	8 x 4	T2308-4	1	-	409.51
	8 x 6	T2308-6	1	-	541.73
	10 x 4	T2310-4	1	-	486.32
	10 x 6	T2310-6	1	-	671.23
	10 x 8	T2310-8	1	-	1,321.18
	12 x 4	T2312-4	1	-	818.66
	12 x 6	T2312-6	1	-	865.58
	12 x 8	T2312-8	1	-	2,127.44
	12 x 10	T2312-10	1	-	2,547.34
<b>Saddle Wye with Stainless Steel Clamps</b>					
<b>Solvent Skirt x Solvent Inlet</b>					
	6 x 4	D2306-4	1	-	267.02
	8 x 4	D2308-4	1	-	377.42
	8 x 6	D2308-6	1	-	388.69
	10 x 4	D2310-4	1	-	475.71
	10 x 6	D2310-6	1	-	554.33
	12 x 4	D2312-4	1	-	574.02
	12 x 6	D2312-6	1	-	667.41
	12 x 8	D2312-8	1	-	1,753.44
	14 x 6	D2314-6	1	-	729.18
	14 x 8	D2314-8	1	-	1,794.87
	16 x 6	D2316-6	1	-	778.22
	16 x 8	D2316-8	1	-	1,835.82
	16 x 10	D2316-10	1	-	2,183.74
	16 x 12	D2316-12	1	-	2,222.53
	18 x 6	D2318-6	1	-	1,081.02
	18 x 8	D2318-8	1	-	2,397.60
	18 x 12	D2318-12	1	-	3,208.87

\* Denotes Molded Fitting  
 • Molded fittings are third party tested and listed by NSF at 200 PSI  
 † Denotes Assembled from Molded Components

• Specifications: ASTM D2241, D3139  
 • Made for SDR 26 and ASTM D2665 pipe  
 • Additional Sizes Available Upon Request

Item	Size In Inches	Part Number	Box Qty	Crate Qty	List Price
<b>Skirt Gasket for Saddle Tee</b>					
	4" Inlet	G5004	6	-	43.02
	6" Inlet	G5006	4	-	56.37
<b>In-Line Backwater Valve HxH</b>					
	*4 x 4	D0104	1	-	70.55
	*6 x 6	D0106	1	-	134.16
	8 x 8	D0108	1	-	376.35
	10 x 10	D0110	1	-	683.51
	12 x 12	D0112	1	-	1,723.69
8" size and larger are fabricated from SDR 35 sewer pipe					

Item	Size In Inches	Part Number	Box Qty	Crate Qty	List Price
<b>Skirt Gasket for Saddle Wye</b>					
	4" Inlet	G5054	6	-	48.03
	6" Inlet	G5056	4	-	64.52
<b>Stainless Steel Clamp (Standard) 9/16" Width</b>					
	6-8	100-140-9	1	-	50.35
	10-12	100-230-9	1	-	69.48
Not to exceed 100 in/lb torque					
<b>Manhole Adapter SxG</b>					
	4 x 4	T9904	1	-	206.21
	6 x 6	T9906	1	-	284.93
	8 x 8	T9908	1	-	327.64
	10 x 10	T9910	1	-	517.03
	12 x 12	T9912	1	-	758.52
(Sanded)					
<b>Terminal Backwater Valve HxH</b>					
	4 x 4	D0204	1	-	2,391.13
	6 x 6	D0206	1	-	Priced on Demand
	8 x 8	D0208	1	-	Priced on Demand
	10 x 10	D0210	1	-	Priced on Demand
	12 x 12	D0212	1	-	Priced on Demand



The logo for Westlake Pipe & Fittings. It features the word "Westlake" in a bold, blue, sans-serif font, with a stylized blue 'W' that has a white negative space. Below "Westlake" is the text "Pipe & Fittings" in a smaller, blue, sans-serif font.

**Westlake**  
Pipe & Fittings

[www.westlakepipe.com](http://www.westlakepipe.com)

©2023 Westlake Pipe & Fittings All rights reserved GE-PL-023-US-EN-0223.1