

Webstone[®]

a brand of **NIBCO[®]**

PRODUCT CATALOG

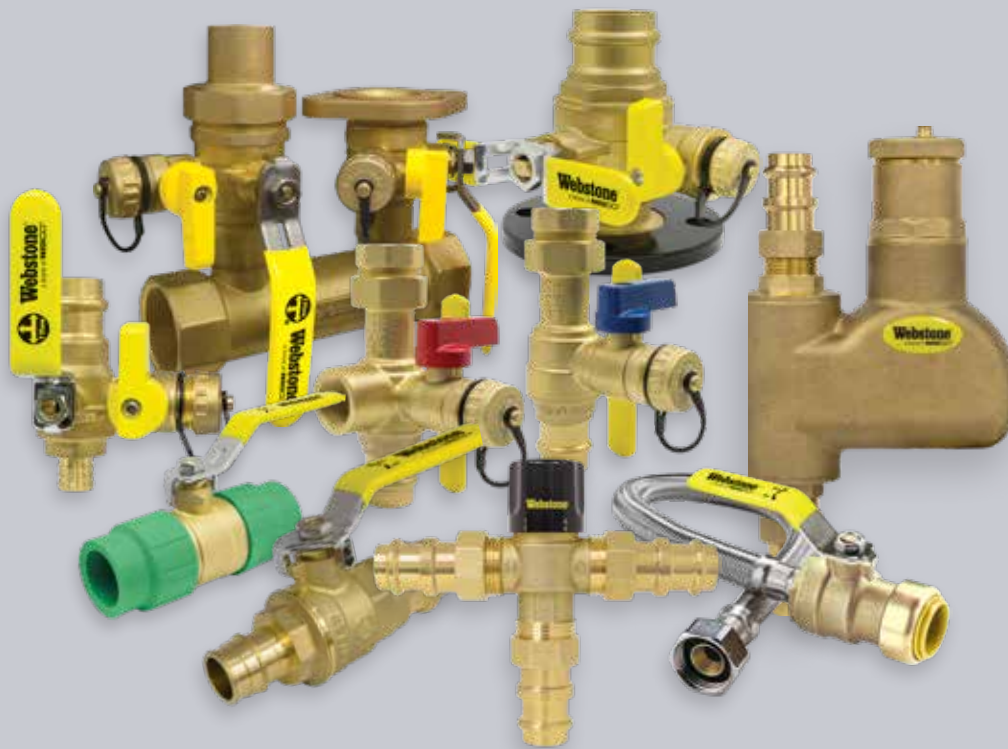

The ISOLATOR[®]
E·X·P
TWH SERVICE VALVES

**TEMPERATURE
CONTROL
VALVES**

HYDRO-CORE[™]

**AIR
SEPARATORS**

**PRO-PAL
SERIES**

The ISOLATOR[®]
UNI-FLANGE BALL VALVE[®]

PEX PRODUCTS

**PRO-CONNECT
PRESS**

**PRO-CONNECT
PPRPRO**

**PRO-CONNECT
PROPUSH**

BALL VALVES

**VALVE INNOVATION
GUARANTEED FOR LIFE**

CONDITIONS APPLY. SEE WEBSTONEVALVES.COM FOR FULL DETAILS.

WORK SMARTER

THE ISOLATOR® E-X-P™ TANKLESS WATER HEATER KITS	4-5
E-X-P™	4
E2™	4
E3™	4
Complete Tankless Water Heater Service Valve Kit	5
Accessories	5
ADD-A-GAUGE TOOL	5
THERMOSTATIC MIXING VALVES	6-9
Thermostatic Mixing Valve	8
G1 Union Accessories	9
Isolation Kits	9
WATER HEATER TEMPERING VALVE	10
CHECK VALVES	11
SILCOCKS	11
HOSE BIBBS	11
UNIONS	11
HYDRO-CORE™	12-15
Manifold Kits	13
Complete Near Boiler Piping Kits	14
Accessories	15
THE ISOLATOR® E-X-P™ WALL HUNG & COMBI BOILER KITS	15
AIR SEPARATORS	16-17
Vertical Air Separator	16
G1 Union Accessories	17
Horizontal Air Separator	17
PRO-PAL® SERIES	18-19
Ball Drain™	18
Union Ball Drain™	18
T-Drain™	19
Purge & Fill™	19
Purge-Tee™	19
Expansion Tank Pro Service Valve™	19
THE ISOLATOR®	20-22
w/ Rotating Flange	20
w/ Rotating Flange & Multi-Function Drain	20
Uni-Flange Ball Valve	21
w/ Drain	21
Circulator Pump Installation Kit	21
Double Flanged Check	21
w/ Round Flange	22
Select	22
F1960 PEX PRODUCTS	24
PEX Transition Valves	24
F1807 PEX PRODUCTS	25
PEX/PE-RT Transition Valves	25
PRO-CONNECT PRESS™	26-27
PRO-CONNECT PP-R PRO™	28-29
PP-R	28
PP-RCT	29
PRO-CONNECT PRO PUSH™	30-31
Valves	30
Tools & Accessories	30
Kits	30-31
Fittings	31
BALL VALVES	32-34
Brass Ball Valves	32-33
Transition Valves	33
Stainless Steel Ball Valves	34
Gas Ball Valves	34
Mini Ball Valves	34
GATE VALVES	34
RADIATOR VALVES	35
BOILER DRAINS	35
GLOBE VALVES	35
INDEX	36-39

SAVE TIME, SAVE SPACE & SAVE LABOR

REPLACES
220
COMPONENTS

SAVES OVER
26
HOURS

ELIMINATES
177
LEAK PATHS

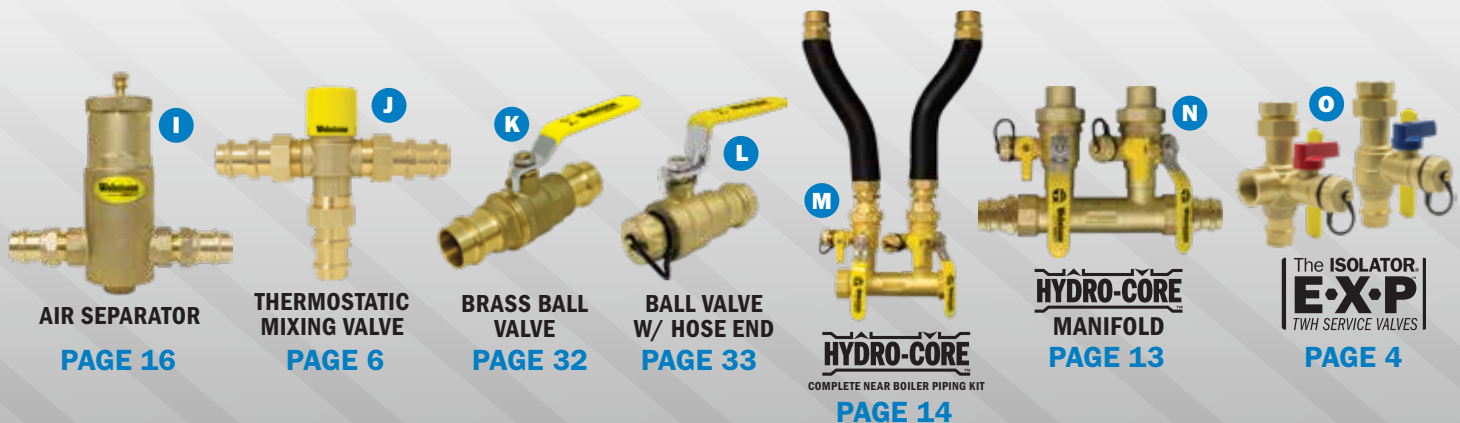
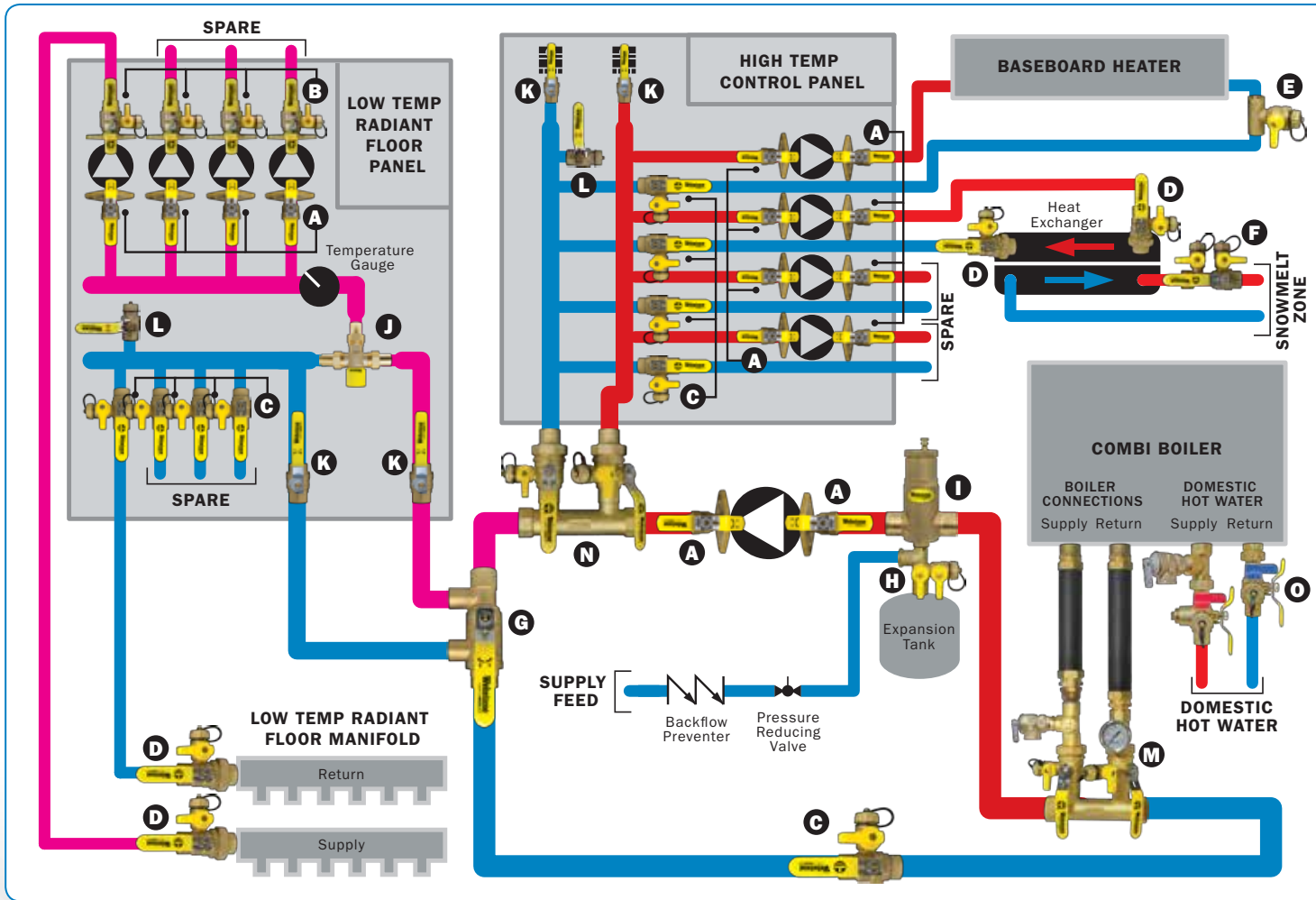

The ISOLATOR[®] E·X·P[™] TWH SERVICE VALVES

THE ONLY WAY TO INSTALL ANY TANKLESS WATER HEATER

PATENTED TECHNOLOGY

ADVANTAGES

- Quicker, consistent quality installations
- Fewer leak paths
- Allows for easy cleaning or flushing of system
- Allows for one person diagnostic testing
- Also for use with wall hung and combi boilers - see page 15

NORMAL OPERATION

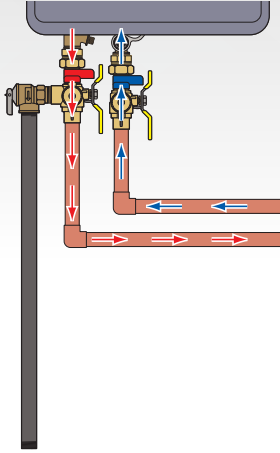

CLEANING

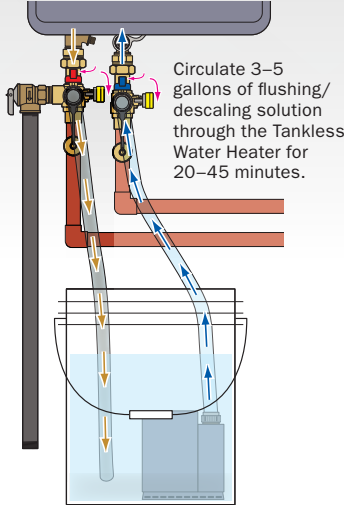

FLUSHING

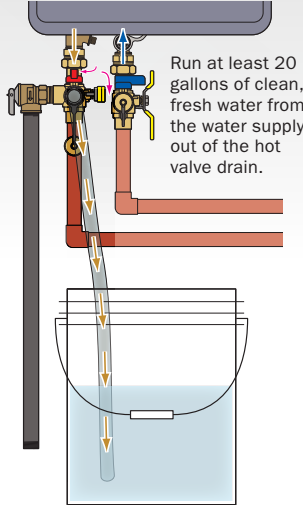

THE OLD WAY

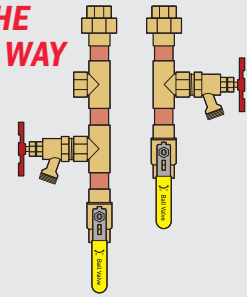

REPLACES 14 COMPONENTS
ELIMINATES 12 LEAK PATHS
SAVES 108 MINUTES OF LABOR

THE ISOLATOR E-X-P TANKLESS WATER HEATER SERVICE VALVE KIT

Hot & Cold Set of Full Port Forged Brass Ball Valves w/ Hi-Flow Hose Drains, Pressure Relief Valve Outlet, Choice of Pressure Relief Valve & Adjustable Packing Glands

LEAD-FREE BRASS
Certified to NSF/ANSI 61 & 372

SIZE	ITEM#	PR ITEM#	CTN/CASE	CASE WT
FIP Union × FIP				
3/4"	H-40443W	H-40443WPR	1/8	600 CWP
1"	H-50443W	H-50443WPR	1/8	51
SWT × FIP Union				
3/4"	H-50443W	H-50443WPR	1/8	600 CWP
1"	H-50443W	H-50443WPR	1/8	51

THREE SERVICE VALVE STYLES



The ISOLATOR[®]
E·X·P[™]
TWH SERVICE VALVES
**PREMIUM
DESIGN**

THE ISOLATOR E-X-P E2 TANKLESS WATER HEATER SERVICE VALVE KIT

Hot & Cold Set of Full Port Forged Brass Ball Valves w/ Hi-Flow Hose Drains, Pressure Relief Valve Outlet, Choice of Pressure Relief Valve & Adjustable Packing Glands

LEAD-FREE BRASS
Certified to NSF/ANSI 61 & 372

SIZE	ITEM#	PR ITEM#	PR-LF ITEM#	CTN/CASE	CASE WT
FIP Union × FIP					
3/4"	H-44443W	H-44443WPR	H-44443WPR-LF	1/10	37
1"	H-44444W	H-44444WPR	H-44444WPR-LF	1/10	65
FIP Union × SWT					
3/4"	H-54443W	H-54443WPR	H-54443WPR-LF	1/10	42
1"	H-54444W	H-54444WPR	H-54444WPR-LF	1/10	65
FIP Union × Press					
3/4"	H-84443W	H-84443WPR	H-84443WPR-LF	1/10	36
1"	H-84444W	H-84444WPR	H-84444WPR-LF	1/10	65
FIP Union × Push*					
3/4"	H-64443W	H-64443WPR	-	1/10	36
FIP Union × ASTM F1807 PEX†					
3/4"	H-14443W	H-14443WPR	-	1/10	33
FIP Union × ASTM F1960 PEX†					
3/4"	H-34443W	H-34443WPR	-	1/10	34

*SERVICE VALVES CERTIFIED TO NSF/ANSI 14 & IAPMO ANSI Z1157
†SERVICE VALVES ALSO CERTIFIED TO NSF/ANSI 14 & IAPMO ANSI Z1157

The ISOLATOR[®]
E·X·P[™]
E2
TWH SERVICE VALVES

**SPACE
SAVING**



The ISOLATOR[®]
E·X·P[™]
E3
TWH SERVICE VALVES
**RECESSED
BOXES**



PR-LH Kits include lever handles for tight combi boiler installations

THE ISOLATOR E-X-P E3 TANKLESS WATER HEATER SERVICE VALVE KIT

Hot & Cold Set of Full Port Forged Brass Ball Valves w/ Hi-Flow Hose Drains, Adjustable Pressure Relief Valve Outlet, Choice of Pressure Relief Valve & Adjustable Packing Glands

LEAD-FREE BRASS
Certified to NSF/ANSI 61 & 372

SIZE	PR ITEM#	PR-LF ITEM#	PR-LH ITEM#	CTN/CASE	CASE WT
FIP Union × FIP					
3/4"	H-45443WPR	H-45443WPR-LF	H-45443WPR-LH	1/10	33
FIP Union × SWT					
3/4"	H-55443WPR	H-55443WPR-LF	H-55443WPR-LH	1/10	32
Press × FIP Union					
3/4"	H-85443WPR	H-85443WPR-LF	H-85443WPR-LH	1/10	48

W/ CHOICE OF PRESSURE RELIEF VALVE



COMMERCIAL PRV
150 PSI/2.7M BTU/HR
w/ Close Nipple
(see next page)



The **ISOLATOR**
E·X·P
TWH SERVICE VALVES
COMPLETE

COM KIT
3/4" CGA
Gas Ball Valve
(175 WOG)

COM-FP KIT
3/4" CSA Full Port
Forged Brass Ball
Valve (600 WOG)

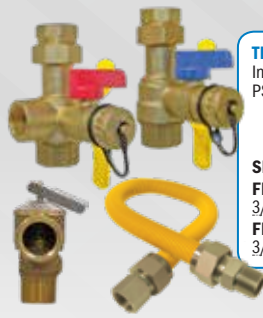

THE ISOLATOR E-X-P COMPLETE TANKLESS WATER HEATER INSTALLATION KIT
Includes E-X-P E2 Service Valves w/ Residential Pressure Relief Valve (150 PSI/500,000 BTU/HR), 24" x 3/4" Gas Flex Line, & Choice of Gas Ball Valve

LEAD-FREE BRASS

Certified to NSF/ANSI 61 & 372

SIZE	COM KIT	COM-FP KIT	CTN/CASE	CASE WT
FIP Union x FIP				
3/4"	H-44443WCOM	H-44443WCOM-FP	1/4	500 CWP 29
FIP Union x SWT				
3/4"	H-54443WCOM	H-54443WCOM-FP	1/4	500 CWP 30

E-X-P ACCESSORIES

Add an Installation Kit to the E-X-P of your choice, or customize your installation with individual accessories.



TANKLESS WATER HEATER INSTALLATION KIT
3/4 CGA Gas Ball Valve (175 WOG) & 24" x 3/4" Gas Flex Line

SIZE	ITEM #	CTN/CASE	CASE WT
FIP"	H-22563-24	1/10	20
W/ LEAD-FREE PRESSURE RELIEF VALVE RELOCATION ADAPTER (FOR USE WITH E-X-P E2)			
3/4"	H-22563-24-ADPT	1/10	26



TANKLESS WATER HEATER INSTALLATION KIT
3/4 CSA Full Port Forged Brass Ball Valve (600 WOG) & 24" x 3/4" Gas Flex Line

SIZE	ITEM #	CTN/CASE	CASE WT
FIP"	H-41703T-24	1/10	21
W/ LEAD-FREE PRESSURE RELIEF VALVE RELOCATION ADAPTER (FOR USE WITH E-X-P E2)			
3/4"	H-41703T-24-ADPT	1/10	27



PRESSURE RELIEF VALVES

STANDARD BRASS

SIZE	ITEM #	CTN/CASE	CASE WT
RESIDENTIAL PRESSURE RELIEF VALVE 150 PSI/500,000 BTU/HR			
3/4"	H-20713	1/100	46
COMMERCIAL GRADE PRESSURE RELIEF VALVE & CLOSE NIPPLE 150 PSI/2.7M BTU/HR			
3/4"	H-20723-CN	1/10	15
BOILER PRESSURE RELIEF VALVE 30 PSI/510,000 BTU/HR			
3/4"	H-20733	1/100	46

LEAD-FREE BRASS

AB 1953 (CA), S.152 (VT), 372 (MD)

SIZE	ITEM #	CTN/CASE	CASE WT
RESIDENTIAL PRESSURE RELIEF VALVE 150 PSI/500,000 BTU/HR			
3/4"	H-20713W	1/100	46



THE ISOLATOR E-X-P PRESSURE RELIEF VALVE RELOCATION ADAPTER

For Recessed Boxes, Tight or Unique Installations

LEAD-FREE BRASS

Certified to NSF/ANSI 61-G

SIZE	ITEM #	CTN/CASE	CASE WT
Fits E-X-P E2			
3/4"	H-28023W	10/100	58



ADD-A-GAUGE

TO ANY STANDARD HOSE CONNECTION IN JUST MINUTES

PATENT PENDING

- Utilize any hose connection as a gauge port
- Suitable for temporary or permanent gauge installation
- Works with temperature and/or pressure gauges



ADD-A-GAUGE TOOL

Forged Brass Hose Fitting

LEAD-FREE BRASS

SIZE	ITEM #	CTN/CASE	CASE WT
W/ 1/8" BLEEDER (CAPPED) FOR CONNECTION TO PRESSURE GAUGE			
Hose x FIP Union			
3/4" x 1/4"	H-30000W-P	10/100	250 PSI 27
W/ 1/8" BLEEDER (CAPPED) FOR CONNECTION TO TEMPERATURE/PRESSURE GAUGE			
Hose x FIP Union			
3/4" x 1/2"	H-30000W-TP	10/100	250 PSI 27

THERMOSTATIC MIXING VALVES

RIGHT TEMPERATURE RIGHT CONNECTION

- Mixes hot and cold water to pre-set output temperature
- Heavy duty lead-free forged brass construction
- Integral check valves on inlets
- Temperature locking handle on select models
- Sizes 3/8" - 1"
- Wide range of G1 Union Accessories and Kits offer a solution for most installation needs

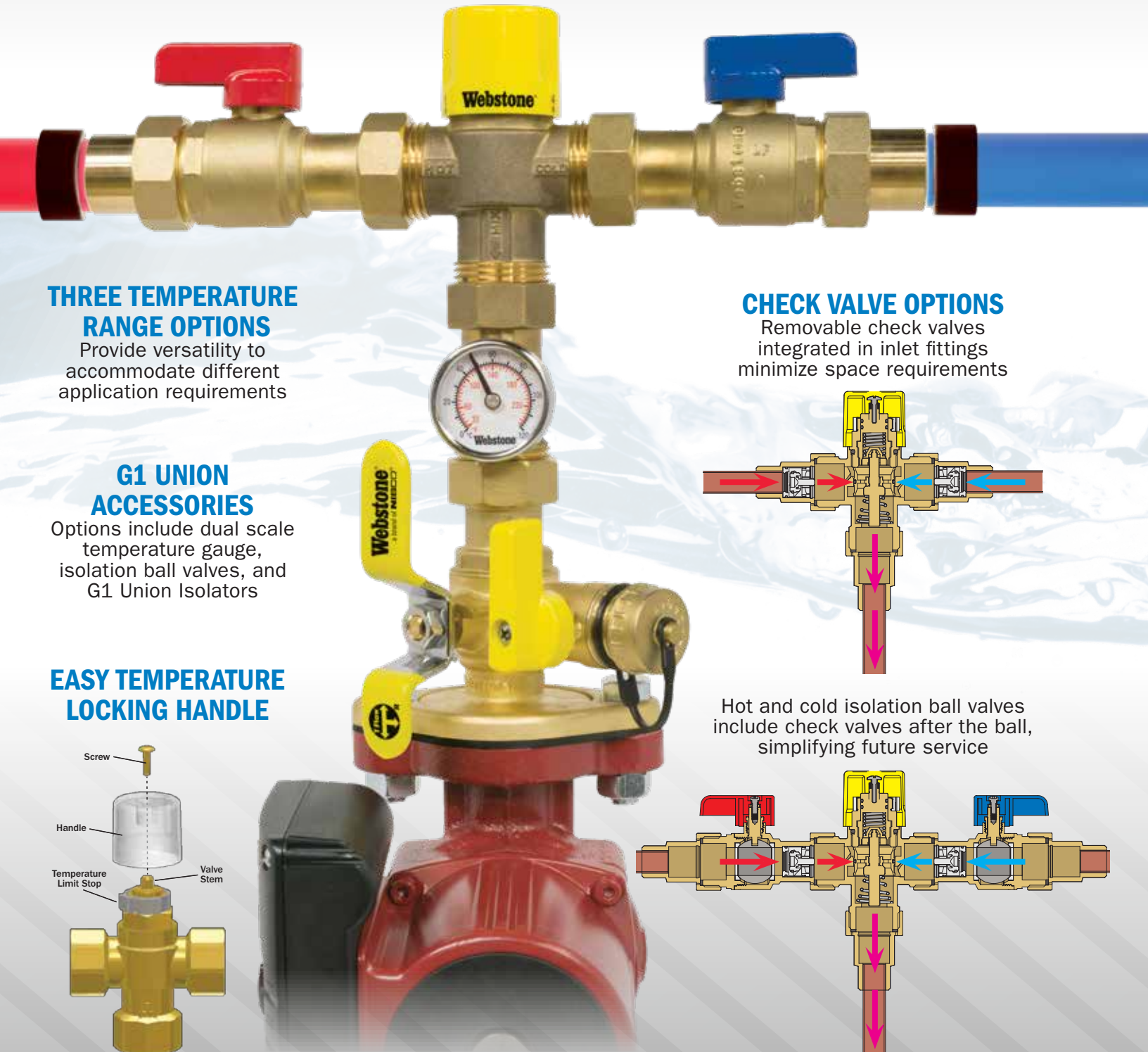

THREE TEMPERATURE RANGE OPTIONS

Provide versatility to accommodate different application requirements

G1 UNION ACCESSORIES

Options include dual scale temperature gauge, isolation ball valves, and G1 Union Isolators

EASY TEMPERATURE LOCKING HANDLE

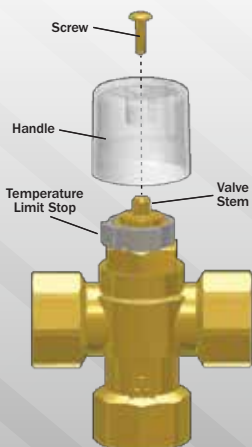

CHECK VALVE OPTIONS

Removable check valves integrated in inlet fittings minimize space requirements

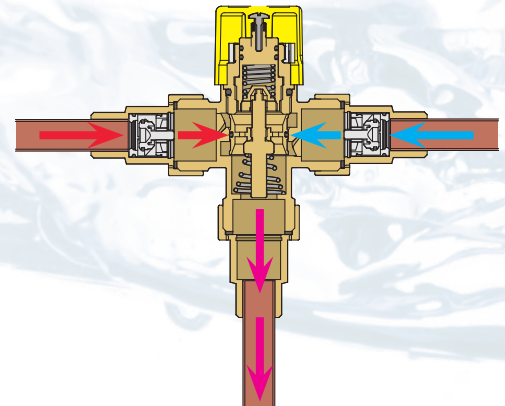

Hot and cold isolation ball valves include check valves after the ball, simplifying future service

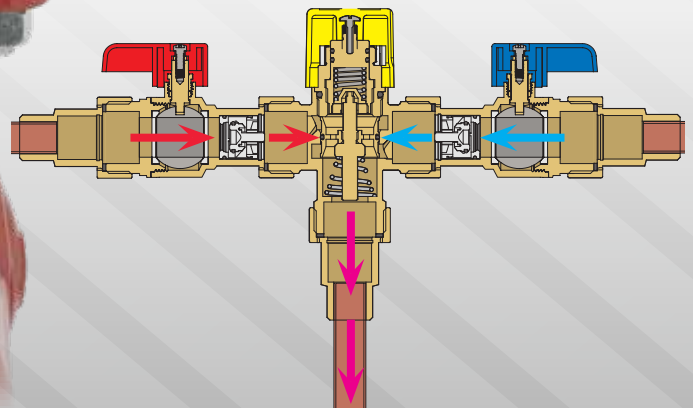

APPLICATIONS

WATER DISTRIBUTION SYSTEMS

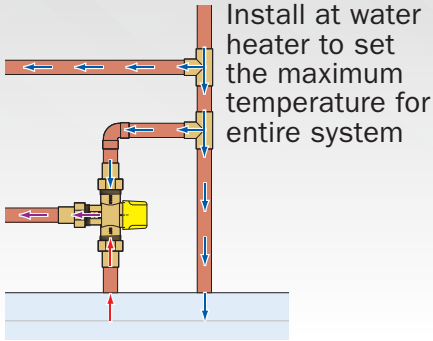

LOW TEMP HYDRONIC

Set a maximum temperature up to 131°F for radiant floor or other low temp heating application

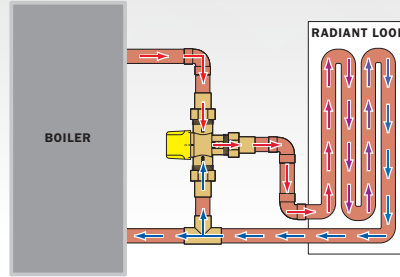

HIGH TEMP HYDRONIC

Set a maximum temperature up to 176°F for radiant floor, baseboard heat, radiators, or other high temp heating application

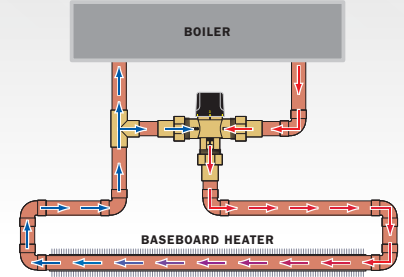

POINT OF USE - MULTI FIXTURE

Set the maximum temperature for a group of fixtures

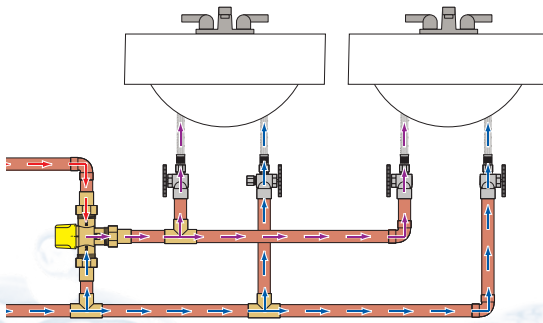

POINT OF USE - SINGLE FIXTURE

Set the maximum temperature of each fixture individually

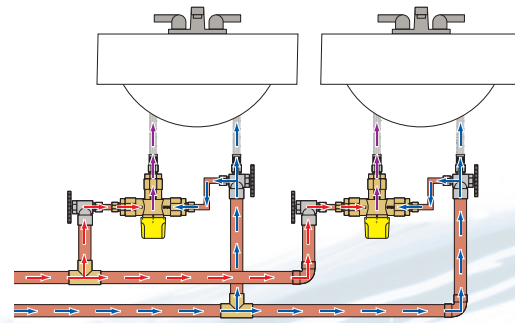

THREE TEMPERATURE RANGES

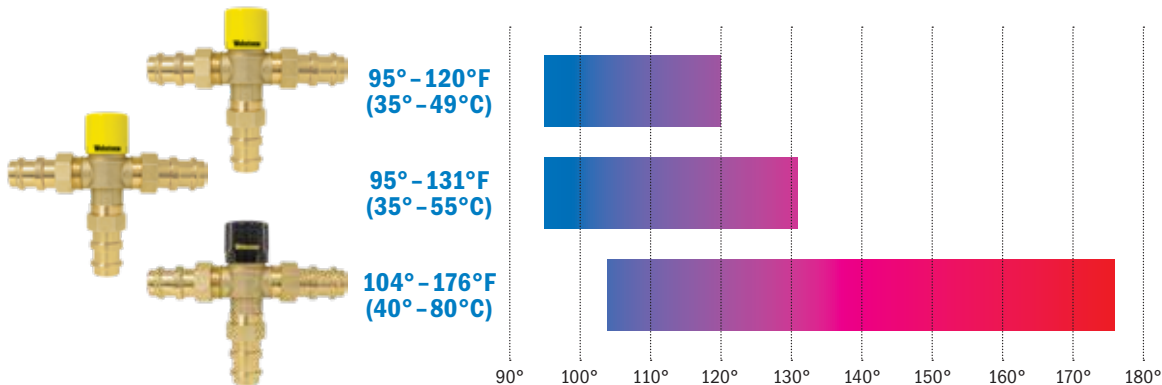

Customize your installation and simplify future service with a full selection of

G1 UNION ACCESSORIES & ISOLATION KITS

SEE PAGE 9 FOR DETAILS



THERMOSTATIC MIXING VALVES

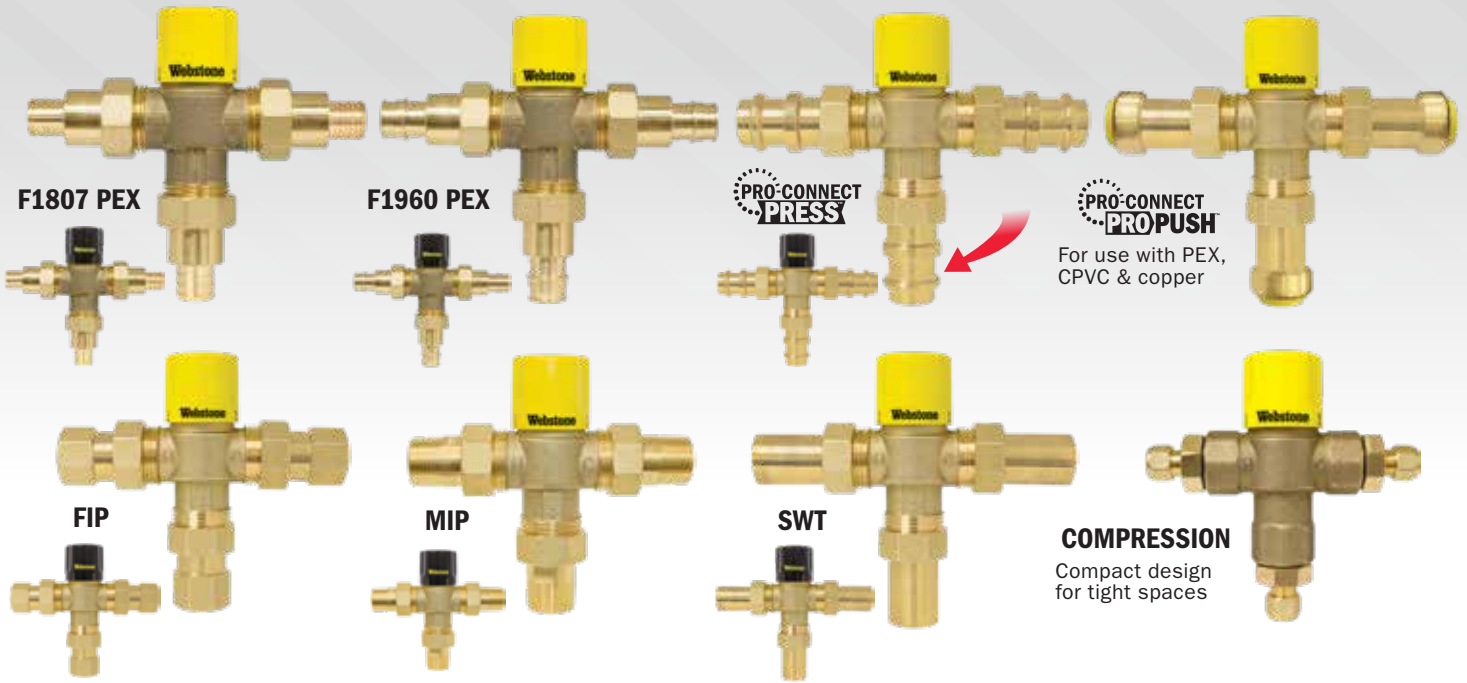

APPLICATION	WATER DISTRIBUTION SYSTEMS Certified to NSF/ANSI 61 & 372, Body (H-7000W) Certified to ASSE 1017, CSA B125.3				POINT OF USE Certified to NSF/ANSI 61 & 372, ASSE 1070, ASSE 1017, CSA B125.3		
	LOW TEMPERATURE HYDRONIC		HIGH TEMPERATURE HYDRONIC		SINGLE OR MULTI FIXTURE		SINGLE ONLY
	TEMP RANGE	95° - 120°F (35° - 49°C)	95° - 131°F (35° - 55°C)	95° - 131°F (35° - 55°C)	104° - 176°F (40° - 80°C)	95° - 120°F (35° - 49°C)	95° - 131°F (35° - 55°C)
F1807 PEX	7120W-CAN	7120W	7120W	7127W	-	-	-
F1960 PEX	7320W-CE-CAN	7320W-CE	7320W-CE	7327W	-	-	-
PRESS	7820W-CAN	7820W	7820W	7827W	-	-	-
PUSH	7620W-CAN	7620W	7620W	-	-	-	-
FIP	7220W-CAN	7220W	7220W	7227W	-	-	-
MIP	7420W-CAN	7420W	7420W	7427W	7420W-CAN	7420W	-
SWT	7520W-CAN	7520W	7520W	7527W	7520W-CAN	7520W	-
COMPRESSION	-	-	-	-	-	-	7440W

THERMOSTATIC MIXING VALVE W/ INTEGRAL CHECK VALVES

Forged Brass Valve w/ Dezincification Resistant Brass Fittings & G1 Union Connections · Outlet Temperature Range 95° - 120°F

LEAD-FREE BRASS

SIZE	ITEM #	CTN/CASE	CASE WT
ASTM F1807 PEX			
1/2"	H-71202W-CAN*	1/10	18
3/4"	H-71203W-CAN*	1/10	18
ASTM F1960 PEX			
1/2"	H-73202W-CE-CAN	1/10	18
3/4"	H-73203W-CE-CAN	1/10	18
Press			
1/2"	H-78202W-CAN	1/10	19
3/4"	H-78203W-CAN	1/10	21
1"	H-78204W-CAN	1/10	22
Push			
1/2"	H-76202W-CAN†	1/10	21
3/4"	H-76203W-CAN†	1/10	22
FIP			
1/2"	H-72202W-CAN	1/10	21
3/4"	H-72203W-CAN	1/10	22
1"	H-72204W-CAN	1/10	24
MIP			
1/2"	H-74202W-CAN	1/10	19
3/4"	H-74203W-CAN	1/10	19
1"	H-74204W-CAN	1/10	22
SWT			
1/2"	H-75202W-CAN	1/10	19
3/4"	H-75203W-CAN	1/10	19
1"	H-75204W-CAN	1/10	20

*NEW ITEM NUMBER - FORMERLY H-7320W-CAN SERIES
†PUSH FITTINGS CERTIFIED TO ASSE 1061

THERMOSTATIC MIXING VALVE W/ INTEGRAL CHECK VALVES

Forged Brass Valve w/ Dezincification Resistant Brass Fittings, w/ Temperature Locking Handle & G1 Union Connections · Outlet Temperature Range 95° - 131°F

LEAD-FREE BRASS

SIZE	ITEM #	CTN/CASE	CASE WT
ASTM F1807 PEX			
1/2"	H-71202W*	1/10	18
3/4"	H-71203W*	1/10	18
ASTM F1960 PEX			
1/2"	H-73202W-CE	1/10	18
3/4"	H-73203W-CE	1/10	18
Press			
1/2"	H-78202W	1/10	20
3/4"	H-78203W	1/10	21
1"	H-78204W	1/10	22
Push			
1/2"	H-76202W†	1/10	21
3/4"	H-76203W†	1/10	22
FIP			
1/2"	H-72202W	1/10	21
3/4"	H-72203W	1/10	22
1"	H-72204W	1/10	24
MIP			
1/2"	H-74202W	1/10	19
3/4"	H-74203W	1/10	19
1"	H-74204W	1/10	23
SWT			
1/2"	H-75202W	1/10	17
3/4"	H-75203W	1/10	19
1"	H-75204W	1/10	22

*NEW ITEM NUMBER - FORMERLY H-7320W SERIES
†PUSH FITTINGS CERTIFIED TO ASSE 1061

THERMOSTATIC MIXING VALVE W/ INTEGRAL CHECK VALVES

Forged Brass Valve w/ Temperature Locking Handle · For Point of Use (Single Fixture)

LEAD-FREE BRASS

SIZE	ITEM #	CTN/CASE	CASE WT
Compression			
3/8"	H-74401W	1/10	150 PSI 17

THERMOSTATIC MIXING VALVE W/ INTEGRAL CHECK VALVES

Forged Brass Valve w/ Temperature Locking Handle & G1 Union Connections · Outlet Temperature Range 104° - 176°F

LEAD-FREE BRASS

SIZE	ITEM #	CTN/CASE	CASE WT
ASTM F1807 PEX			
1/2"	H-71272W	1/10	18
3/4"	H-71273W	1/10	18
ASTM F1960 PEX			
1/2"	H-73272W	1/10	18
3/4"	H-73273W	1/10	18
Press			
1/2"	H-78272W	1/10	20
3/4"	H-78273W	1/10	21
1"	H-78274W	1/10	22
FIP			
1/2"	H-72272W	1/10	21
3/4"	H-72273W	1/10	22
1"	H-72274W	1/10	24
MIP			
1/2"	H-74272W	1/10	19
3/4"	H-74273W	1/10	19
1"	H-74274W	1/10	23
SWT			
1/2"	H-75272W	1/10	17
3/4"	H-75273W	1/10	19
1"	H-75274W	1/10	22

THERMOSTATIC MIXING VALVES

G1 UNION ACCESSORIES

ISOLATION BALL VALVE

Full Port Forged Brass Valve

LEAD-FREE BRASS

Certified to NSF/ANSI 61 & 372

SIZE	ITEM #	CTN/CASE	CASE WT
G1 Union x G1 Thread			
YELLOW HANDLE			
1"	H-7-G134WY	10/60	51
RED HANDLE W/ INTEGRAL CHECK VALVE			
1"	H-7-G234WR	10/60	51
BLUE HANDLE W/ INTEGRAL CHECK VALVE			
1"	H-7-G234WB	10/60	51

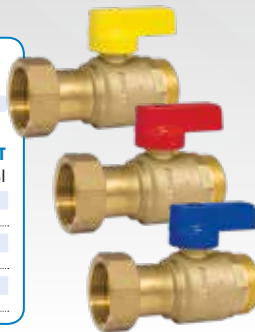

DUAL SCALE TEMPERATURE GAUGE

w/ Integrated Forged Brass Fitting · 1½" Dial · Temperature Range 32° - 248°F

LEAD-FREE BRASS

Certified to NSF/ANSI 61 & 372

SIZE	ITEM #	CTN/CASE	CASE WT
G1 Union x G1 Thread			
1"	H-32000W	10/100	50



THE ISOLATOR W/ ROTATING FLANGE

Full Port Forged Brass Uni-Flange Ball Valve · w/ Detachable Rotating Flange, Adjustable Packing Gland, Nuts & Bolts

LEAD-FREE BRASS

Certified to NSF/ANSI 61 & 372

SIZE	ITEM#	HV ITEM#	CTN/CASE	CASE WT
G1 Union x Rotating Flange				
1"	H-G1404W	H-G1404WHV	1/20	600 CWP 34

HV ITEMS FIT HIGH VELOCITY & STANDARD SIZE PUMPS.



THE ISOLATOR W/ ROTATING FLANGE & MULTI-FUNCTION DRAIN

Full Port Forged Brass Uni-Flange Ball Valve w/ Detachable Rotating Flange, Multi-Function Hi-Flow Hose Drain, Adjustable Packing Glands, Nuts & Bolts

LEAD-FREE BRASS

Certified to NSF/ANSI 61 & 372

SIZE	ITEM#	HV ITEM#	CTN/CASE	CASE WT
G1 Union x Rotating Flange				
1"	H-G1414W	H-G1414WHV	1/20	600 CWP 42

HV ITEMS FIT HIGH VELOCITY & STANDARD SIZE PUMPS.



ISOLATION KITS

HOT AND COLD ISOLATION KIT FOR THERMOSTATIC MIXING VALVE

Set of 2 Lead Free Brass Ball Valves (Red & Blue Handles) w/ Integral Check Valves

LEAD-FREE BRASS

Certified to NSF/ANSI 61 & 372

SIZE	ITEM #	CTN/CASE	CASE WT
G1 Union x G1 Thread			
1"	H-7-G234W-KITA	1/10	18



3-WAY ISOLATION KIT FOR THERMOSTATIC MIXING VALVE

Set of 3 Lead Free Brass Ball Valves (Red, Blue & Yellow Handles) w/ Integral Check Valves on Inlets

LEAD-FREE BRASS

Certified to NSF/ANSI 61 & 372

SIZE	ITEM #	CTN/CASE	CASE WT
G1 Union x G1 Thread			
1"	H-7-G234W-KITB	1/10	26



3-WAY ISOLATION KIT FOR THERMOSTATIC MIXING VALVE

Set of 2 Lead Free Brass Ball Valves (Red & Blue Handles) w/ Integral Check Valves & G1 Isolator w/ Rotating Flange

LEAD-FREE BRASS

Certified to NSF/ANSI 61 & 372

SIZE	ITEM #	CTN/CASE	CASE WT
G1 Union x Rotating Flange			
1"	H-G1404W-KITB	1/10	35



3-WAY ISOLATION KIT FOR THERMOSTATIC MIXING VALVE

Set of 2 Lead Free Brass Ball Valves (Red & Blue Handles) w/ Integral Check Valves & G1 Isolator w/ Multi-Function Drain & Rotating Flange

LEAD-FREE BRASS

Certified to NSF/ANSI 61 & 372

SIZE	ITEM #	CTN/CASE	CASE WT
G1 Union x Rotating Flange			
1"	H-G1414W-KITB	1/10	39



WATER HEATER TEMPERING VALVE

HOT WATER MADE BETTER

GREATER & SAFER HOT WATER OUTPUT PER GALLON STORED

- Allows water heater to be set at 140°F, minimizing risk of Legionella bacteria in the tank
- Mixes hot output with cold supply for greater effective hot water storage
- Adjustable temperature control limits output to 120°F to prevent risk of scalding
- Integrated recirculation port simplifies installation

WATER HEATER TEMPERING VALVE

Forged Brass Valve w/ 18" Flex Hose Connector & Integral Check Valve · Outlet Temperature Range 86° - 120°F

LEAD-FREE BRASS

Certified to NSF/ANSI 61 & 372, ASSE 1017, ASSE 1070

SIZE	ITEM #	CTN/CASE	CASE WT
MIP × FIP			150 PSI
3/4"	H-74303W	1/9	22
W/ TEMPERATURE GAUGE			
3/4"	H-74313W	1/9	26

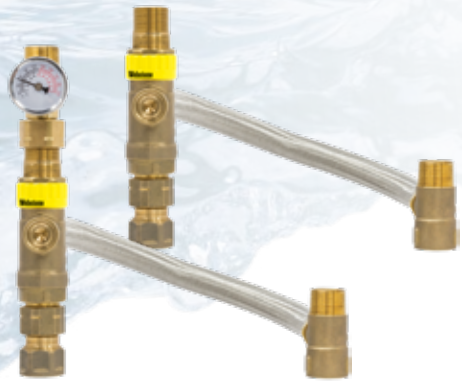

SIMPLIFY THE JOB

Tempering Valve Installation Kits include everything to connect to Copper, CPVC or PEX



WATER HEATER TEMPERING VALVE INSTALLATION KIT

Forged Brass Valve w/ 18" Flex Hose Connector & Integral Check Valve · Outlet Temperature Range 86° - 120°F

LEAD-FREE BRASS

Certified to NSF/ANSI 61 & 372, ASSE 1017, ASSE 1070

SIZE	ITEM #	CTN/CASE	CASE WT
INCLUDES (2) 3/4" PRO-PUSH ITEM# 26033W-18 FLEXIBLE WATER HEATER CONNECTORS			
3/4"	H-74303W-KITA	1/4	14
w/ Outlet Temperature Gauge			
3/4"	H-74313W-KITA	1/4	19
<small>*SUPPLY LINES CERTIFIED TO NSF/ANSI 61-G, ASSE 1061 & ASME A112.18.6/CSA B125.6</small>			
INCLUDES (2) 3/4" PRO-PUSH ITEM# 62033W-18 FLEXIBLE WATER HEATER CONNECTORS W/ BALL VALVES			
3/4"	H-74303W-KITB	1/4	16
w/ Outlet Temperature Gauge			
3/4"	H-74313W-KITB	1/4	21
<small>*SUPPLY LINES CERTIFIED TO NSF/ANSI 61-G, ASSE 1061, ASME A112.18.6/CSA B125.6, IAPMO/ANSI Z1157</small>			

CHECK VALVES



PRO-CONNECT PRO-PUSH IN-LINE SPRING CHECK VALVE
Forged Dezincification Resistant Brass Fitting - For Connection to Copper, CPVC or PEX - **Lead-Free**

SIZE	INDIVIDUALLY PACKED			BULK PACKED		
	ITEM #	CTN/CASE	CASE WT	ITEM #	BOX/CASE	CASE WT
1/2"	-	-	-	H-26992W-B	6/120	20
3/4"	H-26993W	12/120	39	H-26993W-B	6/72	24
1"	-	-	-	H-26994W-B	3/45	25

200 PSI/200 F
Certified to NSF/ANSI 61-G, ASSE 1061



FORGED BRASS SWING CHECK VALVE

Hard Seat

SIZE	ITEM #	LEAD-FREE BRASS	
		CTN/CASE	CASE WT
FIP			200 CWP/125 WSP
1/4"	H-10540W	12/120	27
3/8"	H-10541W	10/120	35
1/2"	H-10542W	10/120	49
3/4"	H-10543W	10/80	49
1"	H-10544W	5/60	51
1 1/4"	H-10545W	5/40	56
1 1/2"	H-10546W	5/30	60
2"	H-10547W	2/12	34
2 1/2"	H-10548W	2/8	38
3"	H-10549W	1/8	61
4"	H-10550W	1/4	47
SWT			200 CWP/125 WSP
1/2"	H-10622W	10/120	50
3/4"	H-10623W	10/80	51
1"	H-10624W	5/60	54
1 1/4"	H-10625W	5/40	59
1 1/2"	H-10626W	5/30	63
2"	H-10627W	2/10	31

Certified to NSF/ANSI 61

BRASS IN-LINE SPRING CHECK VALVE

316 Stainless Steel Spring - Soft Seat

SIZE	ITEM #	LEAD-FREE BRASS	
		CTN/CASE	CASE WT
FIP			300 PSI
3/8"	H-10701W	60/240	42
1/2"	H-10702W	10/100	29
3/4"	H-10703W	7/70	30
1"	H-10704W	5/50	31
1 1/4"	H-10705W	5/40	40
1 1/2"	H-10706W	5/30	36
2"	H-10707W	2/20	38



B62 BRONZE (85-5-5-5) SWING CHECK VALVE

Hard Seat

SIZE	ITEM #	CTN/CASE	CASE WT
3/8"	H-10501	10/120	53
1/2"	H-10502	10/120	54
3/4"	H-10503	10/80	51
1"	H-10504	5/60	49
1 1/4"	H-10505	5/40	59
1 1/2"	H-10506	5/30	56
2"	H-10507	2/24	68
2 1/2"	H-10508	1/12	56
3"	H-10509	1/8	59
4"	H-10510	1/4	43

300 CWP/150 WSP



FORGED BRASS SWING CHECK VALVE

Soft Seat

SIZE	ITEM #	STANDARD BRASS	
		CTN/CASE	CASE WT
FIP			200 CWP/125 WSP
1/2"	H-10522	12/120	50
3/4"	H-10523	10/80	47
1"	H-10524	5/60	47
1 1/4"	H-10525	5/40	55
1 1/2"	H-10526	5/30	56
2"	H-10527	2/24	64

SILCOCKS

FULL FLOW FORGED NICKEL PLATED BRASS SILCOCK

1/4 Turn Action w/ Stainless Steel Lever Handle

SIZE	ITEM #	LEAD-FREE BRASS	
		CTN/CASE	CASE WT
ASTM F1960 PEX Flange x MIP Hose			125 CWP
1/2"	H-33202WSSL	12/72	58



FORGED BRASS SILCOCK

Nickel Plated w/ 1/4 Turn Handle

SIZE	ITEM #	LEAD-FREE BRASS	
		CTN/CASE	CASE WT
FIP Flange x Hose			125 CWP
1/2"	H-30202W	12/72	43
3/4"	H-30203W	12/72	59

HOSE BIBBS

FORGED BRASS HOSE BIBB

w/ Ball Valve Action

SIZE	ITEM #	LEAD-FREE BRASS	
		CTN/CASE	CASE WT
MIP x Hose			125 CWP
1/2"	H-30314W	12/72	35
3/4"	H-30316W	12/72	39

1/2" MIP OR SWT x HOSE
Certified to NSF/ANSI 61-G



BRASS HOSE BIBB

No Kink w/ 1/4 Turn Handle

SIZE	ITEM #	LEAD-FREE BRASS	
		CTN/CASE	CASE WT
MIP x Hose			125 CWP
1/2"	H-30218W	12/72	23
3/4"	H-30219W	12/72	26

1/2" MIP OR SWT x HOSE
Certified to NSF/ANSI 61-G



UNIONS

DIELECTRIC UNION

Galvanized Steel & Brass - w/ Nylon Insulator Ring

SIZE	ITEM #	LEAD-FREE BRASS	
		CTN/CASE	CASE WT
FIP x SWT			232 F Max
1/2"	H-01102W	24/144	46
3/4"	H-01103W	24/96	39
1"	H-01104W	12/96	53
1 1/4"	H-01105W	6/48	42
1 1/2"	H-01106W	6/36	50
2"	H-01107W	6/18	45
3/4" x 1/2"	H-01132W	24/96	37



BRASS HOSE BIBB VACUUM BREAKER

Anti-Siphon Device w/ Flat Washer (CP = Chrome Plated)

SIZE	ITEM #	LEAD-FREE BRASS	
		CTN/CASE	CASE WT
Hose			150 PSI
3/4"	H-11850W	12/144	33
3/4"	H-11850W-CP	12/144	33



HYDRO-CORE™

PATENTED TECHNOLOGY

A REVOLUTIONARY APPROACH TO HYDRONIC INSTALLATIONS

The Webstone Hydro-Core Manifold is the ideal solution for most near boiler piping or secondary loops.

- Combines Webstone Isolator® and Ball Drain™ with closely spaced tees
- Eliminates costly field fabrication
- Avoids precise calculations
- Simplifies future maintenance
- Saves space
- All with EXPERT looking results
- **Press**, FIP, or SWT system connections

HYDRO-CORE™ UNION CONNECTION

Available in three distinct styles to meet your needs
SEE PAGE 15



PRO-CONNECT PRESS

Compatible with popular press tools

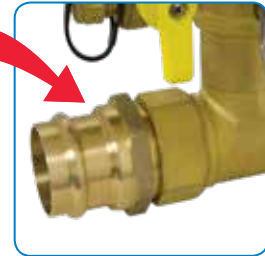

THE OLD WAY

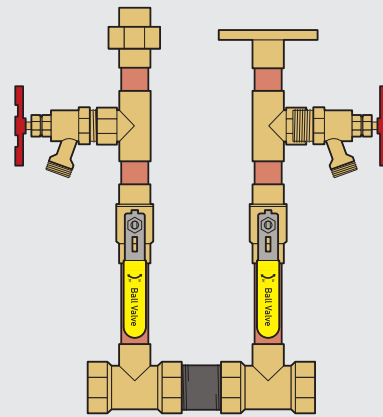

THE WEBSTONE WAY

REPLACES 17 COMPONENTS
ELIMINATES 16 LEAK PATHS
SAVES 144 MINUTES OF LABOR



T-Flow Ball
Directs flow into either the boiler or purge drain

Precision-Crafted Closely Spaced Tees
for hydraulic separation

Fully-Insulated Body **Snug-Fit Rotating Flange**



FLANGE OPTIONS



Flange Right



Flange Left



No Flange
Double Ball Drain

ADVANTAGES

PRECISE SPACING FOR HYDRAULIC SEPARATION

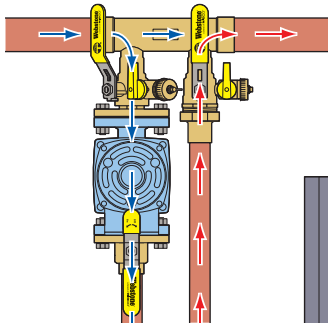

SIMPLIFIES PUMP ISOLATION

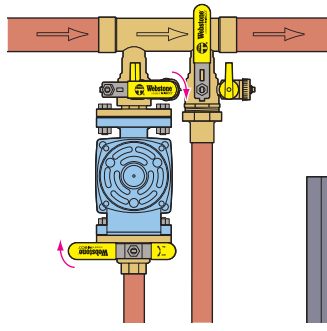

EASILY PURGE, FILL, OR DESCALE* A BOILER OR SECONDARY LOOP

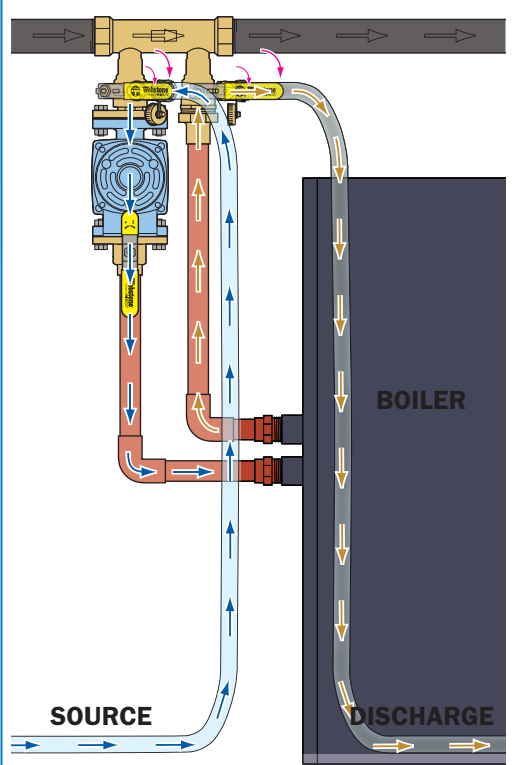

*DESCALING MAY NOT BE RECOMMENDED FOR ALL BOILERS. CONSULT BOILER MANUFACTURER FOR DETAILS.

SIMPLIFIES SYSTEM PURGING THROUGH THE BOILER OUTSIDE THE BOILER

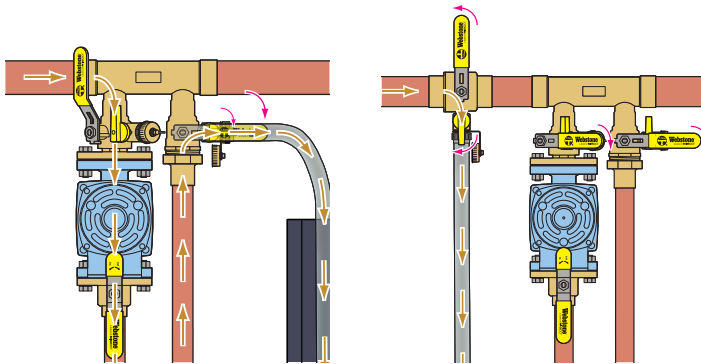

HYDRO-CORE MANIFOLD KITS

Kits include Hydro-Core Manifold and Union Connections. Ideal for field-fabricated near boiler piping or secondary loops.

Boiler Type	Pump Location	Manifold Flange Orientation	System Run	Boiler Connection	FIP	SWT	Press * FIP
FLOOR STANDING	Internal to boiler	Double Ball Drain	1 1/4"	3/4"	H-48354-43	H-58354-53	H-88354-43
			1 1/4"	1"	H-48354-44	H-58354-54	H-88354-44
FLOOR STANDING	On the system return line, to the left of system supply line	Flange Right	1 1/4"	3/4"	H-48754-43	H-58754-53	H-88754-43
			1 1/4"	1"	H-48754-44	H-58754-54	H-88754-44
			1 1/2"	1 1/4"	H-48765-45	H-58765-55	H-88765-45
			2"	2 1/2"	-	H-58776-56	-
FLOOR STANDING	On the system return line, to the right of system supply line	Flange Left	1 1/4"	3/4"	H-48854-43	H-58854-53	H-88854-43
			1 1/4"	1"	H-48854-44	H-58854-54	H-88854-44
			1 1/2"	1 1/4"	H-48865-45	H-58865-55	H-88865-45
WALL HUNG	Internal to boiler	Double Ball Drain	1 1/4"	3/4"	H-48354-43	H-58354-53	H-88354-43
			1 1/4"	1"	H-48354-44	H-58354-54	H-88354-44
WALL HUNG	On the system return line, to the left of system supply line	Flange Left	1 1/4"	3/4"	H-48854-43	H-58854-53	H-88854-43
			1 1/4"	1"	H-48854-44	H-58854-54	H-88854-44
			1 1/2"	1 1/4"	H-48865-45	H-58865-55	H-88865-45
WALL HUNG	On the system return line, to the right of system supply line	Flange Right	1 1/4"	3/4"	H-48754-43	H-58754-53	H-88754-43
			1 1/4"	1"	H-48754-44	H-58754-54	H-88754-44
			1 1/2"	1 1/4"	H-48765-45	H-58765-55	H-88765-45
			2"	2 1/2"	-	H-58776-56	-

FLOOR STANDING BOILERS

WALL HUNG BOILERS

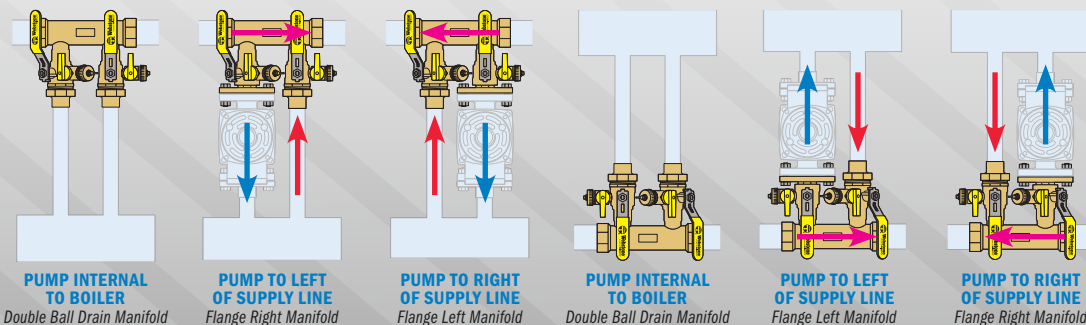

BOILER COMPATIBILITY ASSUMPTIONS:

- Hydro-Core manifolds will be selected in accordance with the manufacturers' recommended run, supply and return sizes.
- Customers will ensure that their installation can accommodate any other devices noted by the boiler manufacturer.
- Selected heat flow direction is acceptable for the installation.
- External pumps will be mounted to the manifold and connected to the boiler return.

IF AN EXTERNAL PUMP IS REQUIRED, THE MANIFOLD WILL BE INSTALLED AS FOLLOWS:

- Ports below the boiler: Manifold is installed below with the pump mounted in between.
- Ports on the top or side of the boiler: manifold is installed above the boiler with the pump mounted in between.
- Contact Webstone if your installation that varies from these conditions.

A fully-fabricated solution, kits include everything necessary for a successful installation.

WALL HUNG BOILER KITS†

- Choice of **Press**, FIP or SWT Hydro-Core Double Ball Drain Manifold
- Insulated manifold, supply & return lines
- Integrated connections for your specific boiler
- Assembled with flexible stainless steel tubing
- Tubing may be cut for installations in close quarters

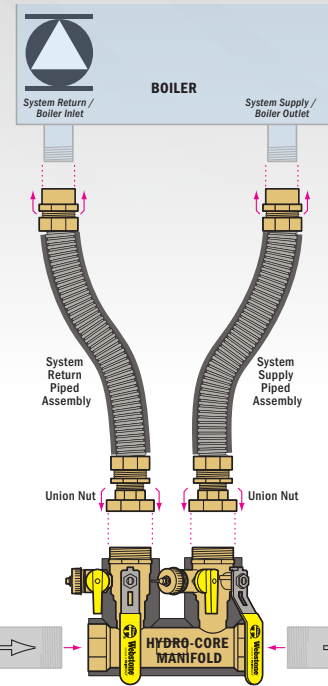

COMBI BOILER KITS†

Includes all the features of the wall hung boiler kits, plus components for DHW connections

- Plugged FIP ports for connection to other devices
- 1/4" pressure gauge port
- 30 PSI pressure gauge
- 30 PSI pressure relief valve for boiler
- 3/4" Isolator E-X-P E3 service valve kit
- 150 PSI pressure relief valve for DHW

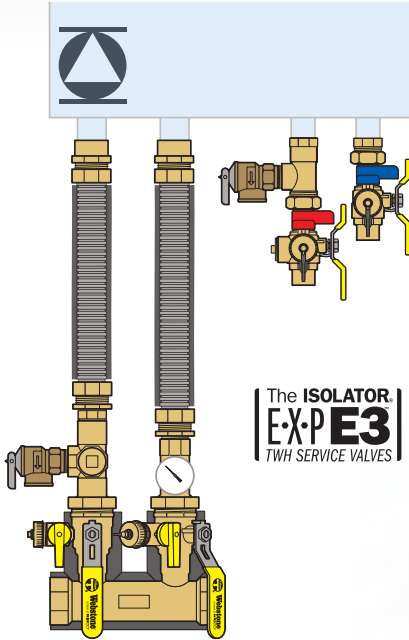

† Features vary by kit.

Boiler									
MANUFACTURER*	BOSCH	LOCHINVAR		LAARS	NAVIEN	NORITZ	RINNAI	WILLIAMSON-THERMOFLO	
MODEL	GreenStar 57 (ZBR16-3), 79 (ZBR21-3), 100 (ZBR28-3), 131 (ZBR35-3), 151 (ZBR42-3) GreenStar Combi 100 (ZWB28-3), 131 (ZWB35-3), 151 (ZWB42-3)	Noble Fire Tube Combi NKC110N, NKC150N, NKC199N		Mascot FT Combi MFTCW 140, MFTCW 199	NCB-180, NCB-210, NCB-240	CB199, CB180	E Series Combi E50 CR, E75 CR, E110 CR E Series Heat Only E60 SR, E85 S, E110 SR	Freestyle Combi FS-80, FS-120	Freestyle Combi FS-155
Compatible Complete Near Boiler Piping Kits									
SYSTEM PIPING	ITEM#	ITEM#	ITEM#	ITEM#	ITEM#	ITEM#	ITEM#	ITEM#	ITEM#
FIP	H-4FK4-WIF	H-4CC4-NBHK	H-4CC4-NBHK-E3	H-4FK5-CH	H-4FK5-CH	H-4FK5-CB	H-4FK5-RE	H-4FK4R3-WIF-E3	H-4FK4-WIF
SWT	H-5FK4-WIF	H-5CC4-NBHK	H-5CC4-NBHK-E3	H-5FK5-CH	H-5FK5-CH	H-5FK5-CB	-	H-5FK4R3-WIF-E3	H-5FK4-WIF
PRESS	H-8FK4-WIF	H-8CC4-NBHK	H-8CC4-NBHK-E3	H-8FK5-CH	H-8FK5-CH	H-8FK5-CB	-	H-8FK4R3-WIF-E3	H-8FK4-WIF
Kit Features									
SYSTEM RUN	1 1/4"	1 1/4"	1 1/4"	1 1/4"	1 1/4"	1 1/4"	1 1/4"	1 1/4"	1 1/4"
BOILER CONNECTION	1"	1"	1"	1"	1"	1"	1"	3/4"	1"
MANIFOLD TYPE	Double Ball Drain	Double Ball Drain	Double Ball Drain	Double Ball Drain	Double Ball Drain	Double Ball Drain	Double Ball Drain	Double Ball Drain	Double Ball Drain
SUPPLY & RETURN PIPING	Flexible Stainless Steel	Bent Copper	Bent Copper	Flexible Stainless Steel	Flexible Stainless Steel	Flexible Stainless Steel	Flexible Stainless Steel	Flexible Stainless Steel	Flexible Stainless Steel
FULLY INSULATED	✓	✓	✓	✓	✓	✓	✓	✓	✓
1/4" NPT GAUGE PORT	-	-	-	✓	✓	✓	✓	-	-
PRESSURE GAUGE	-	-	-	✓	✓	✓	✓	-	-
3/4" FIP DEVICE PORTS	-	-	-	✓	✓	✓	✓	✓	-
30 PSI BOILER PRV	-	-	-	✓	✓	✓	✓	-	-
COMBI BOILER DOMESTIC HOT WATER SERVICE VALVES	-	-	3/4" Isolator E-X-P E3 Service Valve Kit with Lever Handles	3/4" Isolator E-X-P E3 Service Valve Kit	3/4" Isolator E-X-P E3 Service Valve Kit	3/4" Isolator E-X-P E3 Service Valve Kit	-	3/4" Isolator E-X-P E3 Service Valve Kit	-
LEAD-FREE 150 PSI DHW PRV	-	-	✓	✓	✓	✓	-	-	-

* All manufacturer names, models and part numbers are trademarked or registered trademark property of their respective owners. Webstone products are not manufactured, sponsored, authorized, or endorsed by any party unless otherwise noted.

HYDRO-CORE ACCESSORIES

Join mixed piping types, add a gauge, connect devices, connect a pump, or add a strainer to your Hydro-Core installation.

Manifold / Union Connection Compatibility			
UNION CONNECTION SIZE	FIP MANIFOLD KIT	SWT MANIFOLD KIT	PRESS MANIFOLD KIT
1"	H-48354-43	H-58354-43	H-88354-43
1"	H-48354-44	H-58354-54	H-88354-44
1"	H-48754-43	H-58754-53	H-88754-43
1"	H-48754-44	H-58754-54	H-88754-44
1 1/4"	H-48765-45	H-58765-55	H-88765-45
1 1/2"	-	H-58776-56	-
1"	H-48854-43	H-58854-53	H-88854-43
1"	H-48854-44	H-58854-54	H-88854-44
1 1/4"	H-48865-45	H-58865-55	H-88865-45



PUMP CONNECTION

STANDARD BRASS			
SIZE	ITEM #	CTN/CASE	CASE WT
ROTATING FLANGE			
SWT × Rotating Flange			600 CWP
1"	H-RF4-54	6/24	25
1 1/4"	H-RF5-55	6/24	23
ROTATING FLANGE W/ "Y" STRAINER			
SWT × Rotating Flange			600 CWP
1"	H-FSTR4-54	6/24	39
1 1/4"	H-FSTR5-55	6/24	47

HYDRO-CORE UNION CONNECTION

STANDARD BRASS			
SIZE	ITEM #	CTN/CASE	CASE WT
1" UNION CONNECTION			
FIP			600 CWP
3/4"	H-HCE4-43	6/24	14
1"	H-HCE4-44	6/24	11
SWT			600 CWP
3/4"	H-HCE4-53	6/24	12
1"	H-HCE4-54	6/24	12
1 1/4" UNION CONNECTION			
FIP			600 CWP
1"	H-HCE5-44	6/24	20
1 1/4"	H-HCE5-45	6/24	16
SWT			600 CWP
1"	H-HCE5-54	6/24	17
1 1/4"	H-HCE5-55	6/24	18
1 1/2" UNION CONNECTION			
SWT			600 CWP
1 1/2"	H-HCE6-56	4/24	23

HYDRO-CORE UNION CONNECTION

STANDARD BRASS			
SIZE	ITEM #	CTN/CASE	CASE WT
1" UNION CONNECTION			
FIP			600 CWP
3/4"	H-HCE4-63	6/24	25
1"	H-HCE4-64	6/24	22
SWT			600 CWP
3/4"	H-HCE4-73	6/24	19
1"	H-HCE4-74	6/24	19
1 1/4" UNION CONNECTION			
FIP			600 CWP
1"	H-HCE5-64	6/24	37
1 1/4"	H-HCE5-65	6/24	38
SWT			600 CWP
1"	H-HCE5-74	6/24	27
1 1/4"	H-HCE5-75	6/24	27

HYDRO-CORE UNION CONNECTION W/ MULTIPLE DEVICE PORTS

Plugged Connections for (2) 3/4" Devices or (1) 3/4" Device & (1) 1/4" Pressure Gauge

STANDARD BRASS			
SIZE	ITEM #	CTN/CASE	CASE WT
1" UNION CONNECTION			
SWT			600 CWP
1"	H-HCE4-94	6/24	27

BRONZE WYE STRAINER

20 Mesh Screen

SIZE	ITEM #	CTN/CASE	CASE WT
FIP			300 CWP/150 WSP
3/4"	H-10563	8/48	60
1"	H-10564	8/32	59
1 1/4"	H-10565	8/32	86
1 1/2"	H-10566	2/16	57
2"	H-10567	2/8	48

STAINLESS STEEL LIQUID FILLED DUAL SCALE PRESSURE GAUGE

2" Dial w/ Center Back Connection

SIZE	ITEM #	CTN/CASE	CASE WT
NPT			30 PSI
1/4"	H-31000	1/100	38



The ISOLATOR[®] E·X·P™ TWH SERVICE VALVES

WALL HUNG & COMBI BOILER INSTALLATIONS

Save space, simplify maintenance, and eliminate leak paths utilizing an Isolator E-X-P kit for wall hung or combi boiler hydronic heat connections.

WALL HUNG & COMBI BOILER SERVICE VALVE KIT

Hot & Cold Set of Full Port Forged Brass Ball Valves w/ Hi-Flow Hose Drains, Pressure Relief Valve Outlet & Adjustable Packing Glands

STANDARD BRASS				
SIZE	ITEM #	PR3 ITEM #	CTN/CASE	CASE WT
FIP Union × FIP			500 CWP	
1"	H-44444	H-44444PR3	1/10	65
LEAD-FREE BRASS				
Certified to NSF/ANSI 61 & 372				
FIP Union × FIP			500 CWP	
1"	H-44444W	H-44444WPR3	1/10	65
FIP Union × SWT			500 CWP	
1"	H-54443W	H-54443WPR3	1/10	65
FIP Union × Press			250 CWP/250 F	
1"	H-84443W	H-84443WPR3	1/10	65

PR3 KITS
Includes 30 PSI/510,000 BTU/HR Pressure Relief Valve for Boiler/Hydronic Applications

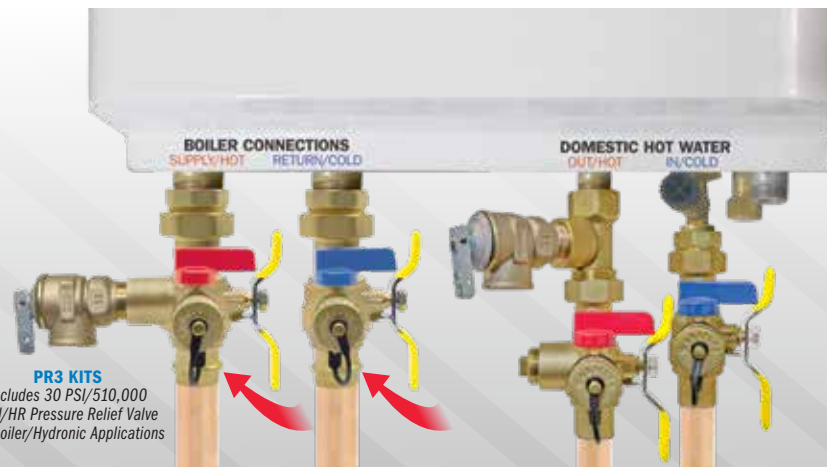

E-X-P TANKLESS WATER HEATER KITS ARE IDEAL FOR COMBI BOILER DHW CONNECTIONS - [SEE PAGE 4](#)

VERTICAL AIR SEPARATOR

KNOCKING PIPES ARE NOT NORMAL

- Reduces noise
- Improves system efficiency and operation
- Reduces wear on system components
- Vertical or horizontal mount options
- Flow may be directed into either side of the unit

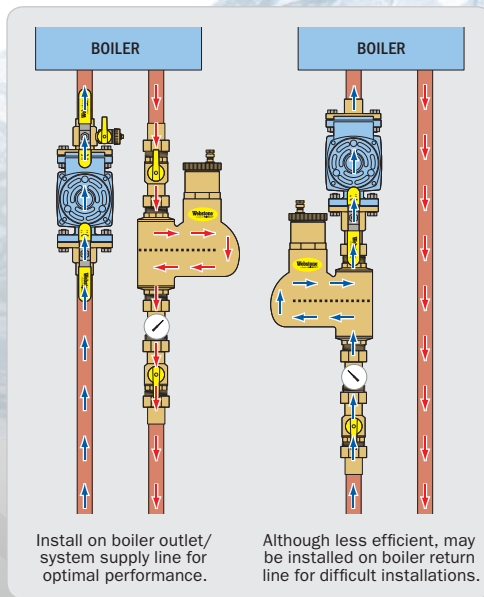
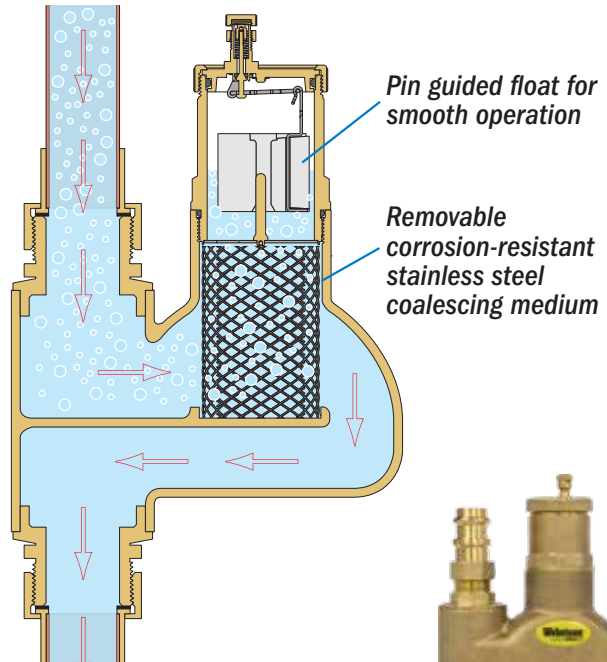

BRASS AIR SEPARATOR

w/ Removable Vent Head & Coalescing Medium - For Vertical Installations

SIZE	ITEM #	STANDARD BRASS	
		CTN/CASE	CASE WT
MIP			150 PSI
3/4"	H-72003-V	1/8	45
1"	H-72004-V	1/8	47
FIP			
3/4"	H-74003-V	1/8	47
1"	H-74004-V	1/8	48
SWT			
3/4"	H-75003-V	1/8	45
1"	H-75004-V	1/8	46
Press			
3/4"	H-78003-V	1/8	47
1"	H-78004-V	1/8	47

- Replacement vent assembly compatible with vertical and horizontal air separator



REPLACEMENT VENT ASSEMBLY

SIZE	ITEM #	CTN/CASE	CASE WT
FITS 3/4"-2" AIR SEPARATOR	H-74000	1/50	13

G1 UNION ACCESSORIES

- Vertical Air Separator compatible with optional G1 Union accessories
- Multiple options to customize your installation and simplify future service



THE ISOLATOR W/ ROTATING FLANGE

Full Port Forged Brass Uni-Flange Ball Valve w/ Detachable Rotating Flange, Adjustable Packing Gland, Nuts & Bolts

LEAD-FREE BRASS

Certified to NSF/ANSI 61 & 372

SIZE	ITEM#	HV ITEM#	CTN/CASE	CASE WT
G1 Union x Rotating Flange				600 CWP
1"	H-G1404W	H-G1404WHV	1/20	34

W/ MULTI-FUNCTION HI-FLOW HOSE DRAIN

SIZE	ITEM#	HV ITEM#	CTN/CASE	CASE WT
G1 Union x Rotating Flange				600 CWP
1"	H-G1414W	H-G1414WHV	1/20	42

HV ITEMS FIT HIGH VELOCITY & STANDARD SIZE PUMPS.



ISOLATION BALL VALVE

Full Port Forged Brass Valve - Yellow Handle

LEAD-FREE BRASS

Certified to NSF/ANSI 61 & 372

SIZE	ITEM #	CTN/CASE	CASE WT
G1 Union x G1 Thread			150 PSI
1"	H-7-G134WY	10/60	51



DUAL SCALE TEMPERATURE GAUGE

w/ Integrated Forged Brass Fitting - 1 1/2" Dial - Temperature Range 32° - 248°F

LEAD-FREE BRASS

Certified to NSF/ANSI 61 & 372

SIZE	ITEM #	CTN/CASE	CASE WT
G1 Union x G1 Thread			
1"	H-32000W	10/100	50

HORIZONTAL AIR SEPARATOR

BRASS AIR SEPARATOR

w/ Removable Vent Head & Coalescing Medium

SIZE	STANDARD BRASS		CASE WT
	ITEM #	CTN/CASE	
FIP			150 PSI
3/4"	H-74003	1/10	25
1"	H-74004	1/10	27
1 1/4"	H-74005	1/10	27
1 1/2"	H-74006	1/10	63
2"	H-74007	1/10	67
SWT			150 PSI
3/4"	H-75003	1/10	25
1"	H-75004	1/10	25
1 1/4"	H-75005	1/10	25
1 1/2"	H-75006	1/10	65
2"	H-75007	1/10	65
Press			150 PSI
3/4"	H-78003	1/10	30
1"	H-78004	1/10	32
1 1/4"	H-78005	1/10	36
1 1/2"	H-78006	1/10	76
2"	H-78007	1/10	85



- Horizontal model includes FIP expansion tank connection

IDEAL FOR USE WITH

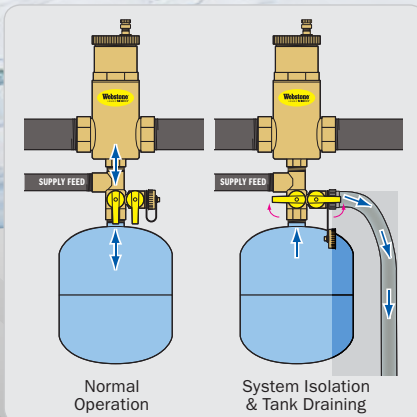

PATENTED TECHNOLOGY WITH FURTHER PATENTS PENDING

BALL DRAIN™

THE OLD WAY

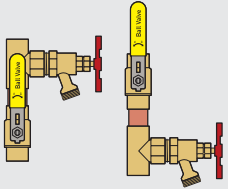

THE WEBSTONE WAY
REPLACES 4 COMPONENTS
ELIMINATES 3 LEAK PATHS
SAVES 27 MINUTES OF LABOR

- Eliminate assemblies needed to isolate & drain any portion of a piped system
- **Press** or SWT × FIP option designed specifically for use with pre-fabricated threaded headers
- Reversible handle for added versatility
- Exclusive adjustable flow path allows for draining from either side of the ball

T-Flow Ball



Adjustable stem directs flow into the **hi-flow** hose drain into either side of the ball

DRAINING FROM ABOVE BALL

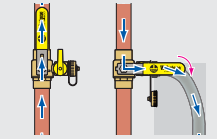

DRAINING FROM BELOW BALL

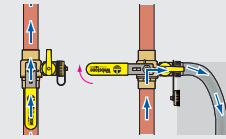

Normal Operation System Purging Normal Operation System Purging

BALL DRAIN

Full Port Forged Brass Ball Valve w/ Hi-Flow Hose Drain, Reversible Handle & Adjustable Packing Glands

STANDARD BRASS

LEAD-FREE BRASS

Certified to NSF/ANSI 61 & 372

SIZE	ITEM #	CTN/CASE	CASE WT	ITEM #	CTN/CASE	CASE WT
FIP						
1/2"	H-40612	6/36	32	H-40612W	6/36	32
3/4"	H-40613	6/36	40	H-40613W	6/36	40
1"	H-40614	4/24	39	H-40614W	4/24	38
1 1/4"	H-40615	2/12	27	H-40615W	2/12	27
1 1/2"	H-40616	2/12	37	H-40616W	2/8	26
2"	H-40617	1/6	29	H-40617W	1/6	29
SWT						
1/2"	H-50612	6/36	29	H-50612W	6/36	29
3/4"	H-50613	6/36	39	H-50613W	6/36	39
1"	H-50614	4/24	38	H-50614W	4/24	37
1 1/4"	H-50615	2/12	27	H-50615W	2/12	27
1 1/2"	H-50616	2/12	41	H-50616W	2/8	27
2"	H-50617	1/6	32	H-50617W	1/6	30
SWT × FIP						
1/2"	H-54612	6/36	30	H-54612W	6/36	30
3/4"	H-54613	6/36	40	H-54613W	6/36	39
1"	H-54614	4/24	37	H-54614W	4/24	37
Press						
1/2"	H-80612	4/40	39	H-80612W	4/40	38
3/4"	H-80613	4/32	40	H-80613W	4/32	40
1"	H-80614	2/20	35	H-80614W	2/20	35
1 1/4"	H-80615	2/16	43	H-80615W	2/16	43
1 1/2"	-	-	-	H-80616W	1/8	29
2"	-	-	-	H-80617W	1/6	34
Press × FIP						
3/4"	H-84613	4/32	37	-	-	-
1"	H-84614	2/20	33	-	-	-
Press × ASTM F1807 PEX*						
1/2"	-	-	-	H-81612W	4/40	38
3/4"	-	-	-	H-81613W	4/32	30
1"	-	-	-	H-81614W	2/20	19
Press × ASTM F1960 PEX*						
1/2"	-	-	-	H-83612W	4/40	38
3/4"	-	-	-	H-83613W	4/32	30
1"	-	-	-	H-83614W	2/20	19

*CERTIFIED TO NSF/ANSI 61 & 372, NSF/ANSI 14 & IAPMO ANSI Z1157

AVAILABLE W/

PRO-CONNECT
PP-R/PRO

EXCLUSIVELY FOR

aquatherm

SEE PAGE 28

AVAILABLE W/

PRO-CONNECT
PP-R/PRO

FOR ANY

PP-R OR PP-RCT

PIPING SYSTEM

SEE PAGE 29



THE OLD WAY

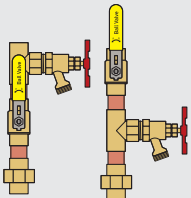

THE WEBSTONE WAY
REPLACES 6 COMPONENTS
ELIMINATES 5 LEAK PATHS
SAVES 45 MINUTES OF LABOR

UNION BALL DRAIN™

- All the features of the ball drain, with integrated union connection
- Easily disconnect and replace any portion of a piped system

UNION BALL DRAIN

Full Port Forged Brass Ball Valve w/ Single Union End, Hi-Flow Hose Drain, Reversible Handle & Adjustable Packing Glands

STANDARD BRASS

LEAD-FREE BRASS

Certified to NSF/ANSI 61 & 372

SIZE	ITEM #	CTN/CASE	CASE WT	ITEM #	CTN/CASE	CASE WT
FIP Union × FIP						
3/4"	H-40433	6/24	41	H-40433W	6/24	40
1"	H-40434	4/16	36	H-40434W	4/16	36
1 1/4"	H-40435	2/12	40	H-40435W	2/12	38
1 1/2"	H-40436	2/12	56	H-40436W	2/8	38
SWT × FIP Union						
3/4"	H-50433	6/24	40	H-50433W	6/24	39
1"	H-50434	4/16	36	H-50434W	4/16	31
1 1/4"	H-50435	2/12	38	H-50435W	2/12	38
1 1/2"	H-50436	2/12	56	H-50436W	2/8	38
Press × FIP Union						
3/4"	-	-	-	H-80433W	4/16	28
1"	-	-	-	H-80434W	2/16	36
1 1/4"	-	-	-	H-80435W	2/8	27
1 1/2"	-	-	-	H-80436W	1/5	25

- Winterize an entire building with simple quarter-turn actions

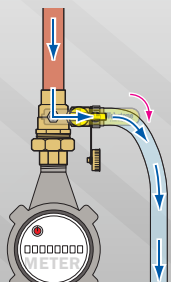

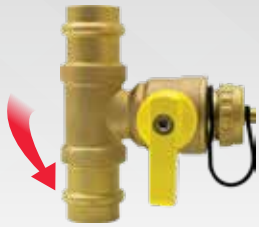

THE OLD WAY

HANDLE OPERATION

THE WEBSTONE WAY
REPLACES 2 COMPONENTS
ELIMINATES 1 LEAK PATH
SAVES 9 MINUTES OF LABOR

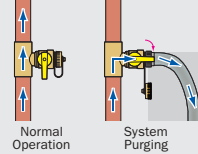

- Install anywhere a drain or purge valve is required
- Hi-flow alternative for filling, draining, or venting closed-loop hydronic systems

T-DRAIN

Full Port Forged Brass Fitting w/ Hi-Flow Hose Drain & Adjustable Packing Gland

LEAD-FREE BRASS

Certified to NSF/ANSI 61-G

SIZE	ITEM #	CTN/CASE	CASE WT
1/2"	H-50672W	8/80	42
3/4"	H-50673W	6/48	39
1"	H-50674W	4/40	36
1 1/4"	H-50675W	4/40	43
1 1/2"	H-50676W	2/24	34
2"	H-50677W	2/20	34
Press		250 CWP/250 F	
1/2"	H-80672W	4/40	25
3/4"	H-80673W	4/16	16
1"	H-80674W	4/16	18
1 1/4"	H-80675W	4/16	20

PURGE & FILL

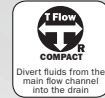

Divert fluids from the main flow channel into the drain

- Simultaneously drain, flush & refill any hydronic, solar, or closed loop system
- Reversible handle for added versatility

THE OLD WAY

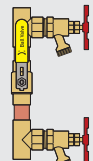

THE WEBSTONE WAY
REPLACES 7 COMPONENTS
ELIMINATES 6 LEAK PATHS
SAVES 54 MINUTES OF LABOR

HANDLE OPERATION

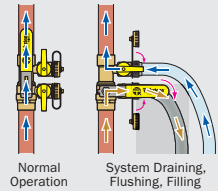

PURGE & FILL

Full Port Forged Brass Ball Valve w/ (2) Hi-Flow Hose Drains, Reversible Handle & Adjustable Packing Glands

SIZE	ITEM #	CTN/CASE	CASE WT
3/4"	H-48613	1/12	20
1"	H-48614	1/12	26
1 1/4"	H-48615	1/12	38
1 1/2"	H-48616	1/12	49
SWT		600 CWP	
3/4"	H-58613	1/12	23
1"	H-58614	1/12	26
1 1/4"	H-58615	1/12	38
1 1/2"	H-58616	1/12	51
Press		250 CWP/250 F	
3/4"	H-88613	1/12	20
1"	H-88614	1/12	27
1 1/4"	H-88615	1/12	40
1 1/2"	H-88616	1/6	27



- The only way to place a ball valve between closely spaced tees
- Precision crafting achieves hydraulic separation
- Ideal for primary/secondary piping

PURGE-TEE

Full Port Forged Brass Ball Valve w/ Reversible Handle & Adjustable Packing Gland

SIZE	ITEM #	CTN/CASE	CASE WT
SWT (1" Primary Loop)		600 CWP	
1" x 3/4"	H-58643	1/12	23
1" x 1"	H-58644	1/12	24
SWT (1 1/4" Primary Loop)		600 CWP	
1 1/4" x 3/4"	H-58653	1/12	39
1 1/4" x 1"	H-58654	1/12	38
1 1/4" x 1 1/4"	H-58655	1/12	37
Press (1" Primary Loop)		250 CWP/250 F	
1" x 3/4"	H-88643	1/12	34
1" x 1"	H-88644	1/12	34
Press (1 1/4" Primary Loop)		250 CWP/250 F	
1 1/4" x 1"	H-88654	1/12	51
1 1/4" x 1 1/4"	H-88655	1/12	52

THE OLD WAY

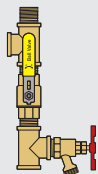

THE WEBSTONE WAY
REPLACES 7 COMPONENTS
ELIMINATES 6 LEAK PATHS
SAVES 54 MINUTES OF LABOR

HANDLE OPERATION

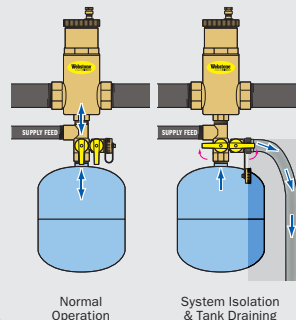

- The 3-way ball controls flow between the expansion tank and the system
- Easily install, isolate, drain & replace any expansion tank
- Quickly connect entire system to the cold water feed
- MIP model for direct connection to air separator or tee
- FIP model allows for distance between tank and system

IDEAL FOR USE WITH Webstone Air Separator

THE WEBSTONE WAY
REPLACES 5 COMPONENTS*
ELIMINATES 4 LEAK PATHS
SAVES 36 MINUTES OF LABOR



THE OLD WAY
*Correct spacing for hydraulic separation cannot be achieved using off-the-shelf components.
The Purge Tee is the **ONLY** way to place a valve between closely spaced tees.

HANDLE OPERATION

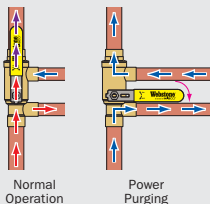

EXPANSION TANK PRO SERVICE VALVE

Full Port Forged Brass Ball Valve w/ Hi-Flow Hose Drain

SIZE	ITEM #	CTN/CASE	CASE WT
MIP/SWT x FIP x FIP x Hose		600 CWP	
1/2"	H-41672	1/30	29
FIP x Hose		600 CWP	
1/2"	H-44672	1/30	31

The ISOLATOR[®]

UNI-FLANGE BALL VALVE[®]

THE ONLY WAY TO ISOLATE CIRCULATOR PUMPS

PATENTED TECHNOLOGY WITH FURTHER PATENTS PENDING

The ISOLATOR[®]

UNI-FLANGE BALL VALVE[®]
with ROTATING FLANGE

The features and benefits you trust in our original Isolator line, with two versatile enhancements. The 360° flange rotation allows rotation to any degree necessary for your installation, and the multi-function drain that makes the Isolator the only valve that drains from both sides of the pump!

PURGES BEFORE OR AFTER PUMP

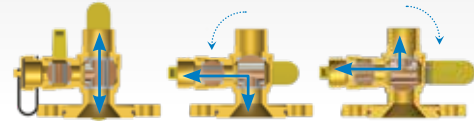

TWO FLANGE DESIGN OPTIONS

ALSO AVAILABLE W/ ROUND FLANGE FOR HIGH EFFICIENCY VARIABLE SPEED PUMPS - SEE PAGE 22

ITEM

1/2" HOLE
FITS STANDARD
SIZE PUMPS

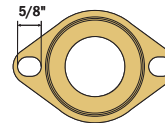
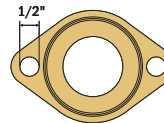

HV ITEM#

5/8" SLOTTED HOLE
FITS HIGH VELOCITY &
STANDARD SIZE PUMPS

THE OLD WAY

THE WEBSTONE WAY
REPLACES 8 COMPONENTS
ELIMINATES 7 LEAK PATHS
SAVES 63 MINUTES OF LABOR

THE ISOLATOR W/ ROTATING FLANGE

Full Port Forged Brass Uni-Flange Ball Valve w/ Detachable Rotating Flange, Adjustable Packing Gland, Nuts & Bolts

STANDARD BRASS

LEAD-FREE BRASS

Certified to NSF/ANSI 61-G

SIZE	ITEM#	HV ITEM#	CTN/CASE	CASE WT	ITEM#	HV ITEM#	CTN/CASE	CASE WT
FIP × Rotating Flange								
600 CWP								
3/4"	H-41403	H-41403HV	1/20	27	H-41403W	H-41403WHV	2/20	27
1"	H-41404	H-41404HV	1/20	34	H-41404W	H-41404WHV	2/20	35
1 1/4"	H-41405	H-41405HV	1/20	41	H-41405W	H-41405WHV	2/20	45
1 1/2"	H-41406	H-41406HV	1/20	54	H-41406W	H-41406WHV	2/10	32
2"	-	-	-	-	-	H-41407WHV	1/10	34
SWT × Rotating Flange								
600 CWP								
3/4"	H-51403	H-51403HV	1/20	25	H-51403W	H-51403WHV	2/20	27
1"	H-51404	H-51404HV	1/20	34	H-51404W	H-51404WHV	2/20	35
1 1/4"	H-51405	H-51405HV	1/20	41	H-51405W	H-51405WHV	2/20	45
1 1/2"	H-51406	H-51406HV	1/20	58	H-51406W	H-51406WHV	2/10	33
2"	-	-	-	-	-	H-51407WHV	1/10	34
Press × Rotating Flange								
250 CWP/250 F								
3/4"	H-81403	H-81403HV	1/20	28	H-81403W	H-81403WHV	1/20	28
1"	H-81404	H-81404HV	1/20	35	H-81404W	H-81404WHV	1/20	40
1 1/4"	H-81405	H-81405HV	1/20	45	H-81405W	H-81405WHV	1/20	53
1 1/2"	H-81406	H-81406HV	1/10	31	H-81406W	H-81406WHV	1/10	32
2"	-	H-81407HV	1/10	36	-	H-81407WHV	1/10	51
ASTM F1807 PEX × Rotating Flange*								
400 CWP								
3/4"	-	-	-	-	H-11403W	H-11403WHV	1/20	27
1"	-	-	-	-	H-11404W	H-11404WHV	1/20	29
ASTM F1960 PEX × Rotating Flange*								
400 CWP								
3/4"	-	-	-	-	H-31403W	H-31403WHV	1/20	27
1"	-	-	-	-	H-31404W	H-31404WHV	1/20	27
W/ MULTI-FUNCTION HI-FLOW HOSE DRAIN								
FIP × Rotating Flange								
600 CWP								
3/4"	H-41413	H-41413HV	2/20	36	H-41413W	H-41413WHV	2/20	35
1"	H-41414	H-41414HV	2/20	43	H-41414W	H-41414WHV	2/20	41
1 1/4"	H-41415	H-41415HV	2/20	54	H-41415W	H-41415WHV	2/10	27
1 1/2"	H-41416	H-41416HV	2/10	38	H-41416W	H-41416WHV	2/10	36
2"	-	-	-	-	-	H-41417WHV	1/10	38
SWT × Rotating Flange								
600 CWP								
3/4"	H-51413	H-51413HV	2/20	36	H-51413W	H-51413WHV	2/20	36
1"	H-51414	H-51414HV	2/20	43	H-51414W	H-51414WHV	2/20	41
1 1/4"	H-51415	H-51415HV	2/20	54	H-51415W	H-51415WHV	2/10	28
1 1/2"	H-51416	H-51416HV	2/10	38	H-51416W	H-51416WHV	2/10	33
2"	-	-	-	-	-	H-51417WHV	1/10	36
Press × Rotating Flange								
250 CWP/250 F								
3/4"	H-81413	H-81413HV	1/20	37	H-81413W	H-81413WHV	1/20	40
1"	H-81414	H-81414HV	1/20	43	H-81414W	H-81414WHV	1/20	48
1 1/4"	H-81415	H-81415HV	1/10	30	H-81415W	H-81415WHV	1/10	31
1 1/2"	H-81416	H-81416HV	1/10	38	H-81416W	H-81416WHV	1/10	38
2"	-	H-81417HV	1/10	40	-	H-81417WHV	1/10	53
ASTM F1807 PEX × Rotating Flange*								
400 CWP								
3/4"	-	-	-	-	H-11413W	H-11413WHV	1/20	27
1"	-	-	-	-	H-11414W	H-11414WHV	1/20	27
ASTM F1960 PEX × Rotating Flange*								
400 CWP								
3/4"	-	-	-	-	H-31413W	H-31413WHV	1/20	27
1"	-	-	-	-	H-31414W	H-31414WHV	1/20	27

*2" ISOLATORS HAVE 1 1/2" PORT.

*ALSO CERTIFIED TO NSF/ANSI 14 & IAPMO ANSI Z1157

AVAILABLE W/
PRO-CONNECT PPRPRO
EXCLUSIVELY FOR

aquatherm
SEE PAGE 28

AVAILABLE W/
PRO-CONNECT PPRPRO
FOR ANY
PP-R OR PP-RCT
PIPING SYSTEM
SEE PAGE 29



These valves have revolutionized the installation of circulator pumps. Our original Isolator Uni-Flange Ball Valve design has evolved into the largest flanged ball valve program in the industry today.

- Conical inlet to minimize turbulence
- Fits virtually any standard circulator pump
- Available slotted holes for high velocity pumps
- Prevents electrolysis
- Eliminates galvanic corrosion



THE ISOLATOR UNI-FLANGE BALL VALVE

Full Port Forged Brass Ball Valve w/ Adjustable Packing Gland, Nuts & Bolts

STANDARD BRASS				
SIZE	ITEM#	HV ITEM#	CTN/CASE	CASE WT
FIP x Flange				
1/2"	H-40402	-	1/20	24
3/4"	H-40403	-	1/20	29
1"	H-40404	H-40404HV	1/20	35
1 1/4"	H-40405	H-40405HV	1/20	41
1 1/2"	H-40406	H-40406HV	1/20	59
2"	-	H-40407HV	1/10	38
SWT x Flange				
1/2"	H-50402	-	2/20	25
3/4"	H-50403	-	1/20	28
1"	H-50404	H-50404HV	1/20	34
1 1/4"	H-50405	H-50405HV	1/20	41
1 1/2"	H-50406	H-50406HV	1/20	58
2"	-	H-50407HV	1/10	40
W/ HI-FLOW HOSE DRAIN				
FIP x Flange				
3/4"	H-40413	-	1/20	42
1"	H-40414	H-40414HV	1/20	49
1 1/4"	H-40415	H-40415HV	1/20	62
1 1/2"	H-40416	H-40416HV	1/10	41
2"	-	H-40417HV	1/10	57
SWT x Flange				
3/4"	H-50413	-	1/20	41
1"	H-50414	H-50414HV	1/20	50
1 1/4"	H-50415	H-50415HV	1/20	63
1 1/2"	H-50416	H-50416HV	1/10	43
2"	-	H-50417HV	1/10	57

HV ITEMS FIT HIGH VELOCITY & STANDARD SIZE PUMPS. 2" ISOLATORS HAVE 1 1/2" PORT.

THE ISOLATOR CIRCULATOR PUMP INSTALLATION KIT

Your choice of Isolator & Isolator w/ Drain & 2 Full-Faced Flange Gaskets, Nuts & Bolts

STANDARD BRASS					LEAD-FREE BRASS			
SIZE	ITEM#	HV ITEM#	CTN/CASE	CASE WT	ITEM#	HV ITEM#	CTN/CASE	CASE WT
THE ISOLATOR CIRCULATOR PUMP INSTALLATION KIT								
FIP x Flange								
3/4"	H-40413KIT	-	1/10	36	-	-	-	600 CWP
1"	H-40414KIT	H-40414HVKIT	1/10	43	-	-	-	-
1 1/4"	H-40415KIT	H-40415HVKIT	1/10	52	-	-	-	-
SWT x Flange								
3/4"	H-50413KIT	-	1/10	36	-	-	-	600 CWP
1"	H-50414KIT	H-50414HVKIT	1/10	43	-	-	-	-
1 1/4"	H-50415KIT	H-50415HVKIT	1/10	54	-	-	-	-
THE ISOLATOR W/ ROTATING FLANGE CIRCULATOR PUMP INSTALLATION KIT								
FIP x Rotating Flange								
3/4"	H-41413KIT	H-41413HVKIT	1/10	32	H-41413WKIT	H-41413WHVKIT	1/10	32
1"	H-41414KIT	H-41414HVKIT	1/10	38	H-41414WKIT	H-41414WHVKIT	1/10	38
1 1/4"	H-41415KIT	H-41415HVKIT	1/10	49	H-41415WKIT	H-41415WHVKIT	1/10	52
SWT x Rotating Flange								
3/4"	H-51413KIT	H-51413HVKIT	1/10	32	H-51413WKIT	H-51413WHVKIT	1/10	32
1"	H-51414KIT	H-51414HVKIT	1/10	38	H-51414WKIT	H-51414WHVKIT	1/10	38
1 1/4"	H-51415KIT	H-51415HVKIT	1/10	49	H-51415WKIT	H-51415WHVKIT	1/10	52

HV ITEMS FIT HIGH VELOCITY & STANDARD SIZE PUMPS. 2" ISOLATORS HAVE 1 1/2" PORT.



CIRCULATOR PUMP INSTALLATION KIT

INCLUDES EVERYTHING BUT THE PUMP!



DOUBLE FLANGED CHECK VALVE



SNUG-FIT ROTATING FLANGE



SECTION REMOVED TO SHOW INTERNAL CONSTRUCTION

The easiest way to add a check valve to any pump! Two sizes cover all standard Isolator installations.

- Installs between the pump & Isolator
- Limits SKUs and saves space on the truck!
- Replacement check assemblies available

THE ISOLATOR DOUBLE FLANGED CHECK

Forged Brass Check Valve w/ Rotating Flange - Includes One Set of Mounting Bolts & Full Faced Flange Gasket

STANDARD BRASS			
SIZE	HV ITEM#	CTN/CASE	CASE WT
Flange x Rotating Flange			
3/4" thru 1 1/4"	H-13703HV	1/10	16
1 1/2" thru 2"	H-13706HV	1/10	18

FITS STANDARD & HIGH VELOCITY PUMPS





The ISOLATOR[®]

UNI-FLANGE BALL VALVE[®]

with ROUND FLANGE

- Detachable rotating round flange
- Three flange styles designed specifically for each pump

High Efficiency Variable Speed Pump						
MANUFACTURER*	ARMSTRONG	BELL & GOSSETT	GRUNDFOS	TACO		WILO
MODEL	E.2 Series E16.2/E16.2B, E30.2/E30.2B	ecocirc XL 15-75, XL 20-140, XL 40-200	Magna3 50-80 F, 50-150 F	00e VR15-1	00e VR20-1	Stratos 2.0 × 3-35
Isolator w/Round Flange						
COMPATIBLE FLANGE	RF400	RF400	RF475	RF375	RF475	RF400

THE ISOLATOR W/ ROUND FLANGE

Full Port Forged Brass Uni-Flange Ball Valve w/ Detachable Rotating Flange, Adjustable Packing Gland, Nuts & Bolts

STANDARD BRASS			
SIZE	HV ITEM#	CTN/CASE	CASE WT
FIP × Rotating Flange			
1 1/2"	H-41406HV-RF375	1/6	22
2"	H-41407HV-RF400	1/6	30
2"	H-41407HV-RF475	1/6	31
SWT × Rotating Flange			
1 1/2"	H-51406HV-RF375	1/6	22
2"	H-51407HV-RF400	1/6	32
2"	H-51407HV-RF475	1/6	33
Press × Rotating Flange			
1 1/2"	H-81406HV-RF375	1/6	23
2"	H-81407HV-RF400	1/6	33
2"	H-81407HV-RF475	1/6	34
W/ MULTI-FUNCTION HI-FLOW HOSE DRAIN			
FIP × Rotating Flange			
1 1/2"	H-41416HV-RF375	1/6	26
2"	H-41417HV-RF400	1/6	37
2"	H-41417HV-RF475	1/6	38
SWT × Rotating Flange			
1 1/2"	H-51416HV-RF375	1/6	26
2"	H-51417HV-RF400	1/6	38
2"	H-51417HV-RF475	1/6	39
Press × Rotating Flange			
1 1/2"	H-81416HV-RF375	1/6	27
2"	H-81417HV-RF400	1/6	38
2"	H-81417HV-RF475	1/6	41

RF375 FLANGE

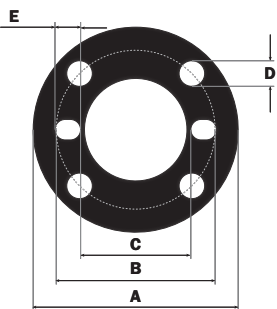

RF400 FLANGE

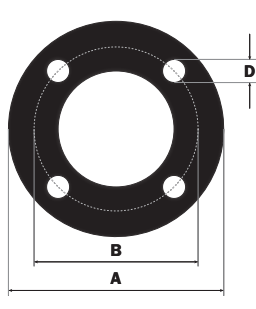

RF475 FLANGE

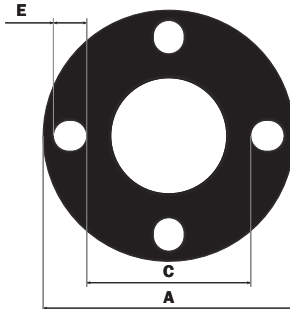

FLANGE DIMENSIONS

	A	B	C	D	E
RF375	5"	3 7/8"	2 11/16"	5/8"	5/8"
RF400	5 1/4"	4"	-	9/16"	-
RF475	6 1/8"	-	4"	-	13/16"

The ISOLATOR[®]

UNI-FLANGE BALL VALVE[®]

SELECT[™] WITH 4-WAY SELECTABLE FLOW PATH

IDEAL FOR GEOTHERMAL APPLICATIONS

- Easily fill, purge, sample or add a pressure gauge right at the pump
- 1" side ports enable quicker filling and purging – ideal for Geothermal applications
- Easily direct fluid between 4 available ports
- Easily isolate the pump for replacement

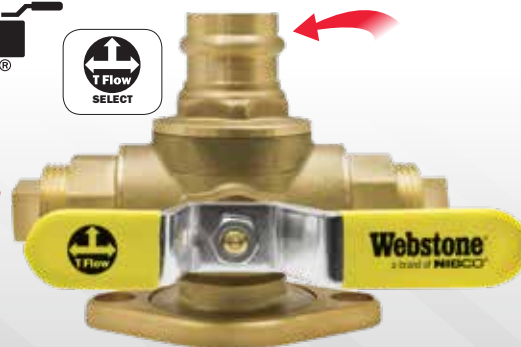

THE ISOLATOR SELECT

Full Port Forged Brass Uni-Flange Ball Valve w/ 4-Way Selectable Flow Path, Plugged FNPT Ports, Adjustable Packing Gland, Nuts, Bolts, & Flange Gasket

STANDARD BRASS			
SIZE	HV ITEM#	CTN/CASE	CASE WT
FIP × Press × Rotating Flange			
1"	H-81424HV	1/10	35

FITS STANDARD & HIGH VELOCITY PUMPS

2-PUMP GEOTHERMAL SYSTEM OVERVIEW

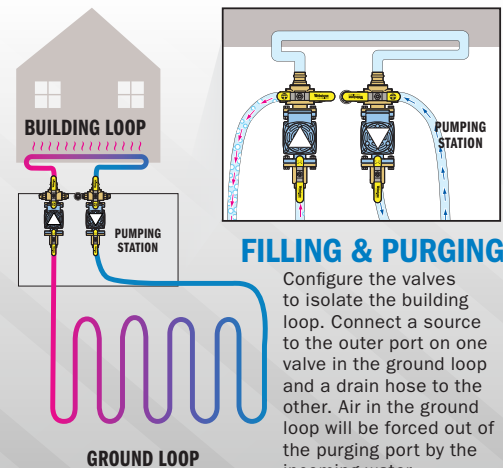

FILLING & PURGING

Configure the valves to isolate the building loop. Connect a source to the outer port on one valve in the ground loop and a drain hose to the other. Air in the ground loop will be forced out of the purging port by the incoming water.

* All manufacturer names, models and part numbers are trademarked or registered trademark property of their respective owners. Webstone products are not manufactured, sponsored, authorized, or endorsed by any party unless otherwise noted.

CONNECTIONS FOR EVERY JOB



THREADED



SWEAT



PRO-CONNECT PRESS



PRO-CONNECT PPR PRO
aquatherm



PRO-CONNECT PPR PRO



PRO-CONNECT PRO PUSH



F1960 PEX



F1807 PEX



TRANSITION



G1 UNION



HOSE



FLARE



COMPRESSION



FLANGE

**WEBSTONE EXCLUSIVE PRODUCTS
FOR COLD EXPANSION PEX CONNECTIONS**

F1960 PEX PRODUCTS

PATENTED TECHNOLOGY

The **ISOLATOR**
E·X·P·E2
TWH SERVICE VALVES



THE ISOLATOR W/ ROTATING FLANGE

Full Port Forged Dezincification Resistant Brass Uni-Flange Ball Valve w/ Detachable Rotating Flange, Adjustable Packing Gland, Nuts & Bolts

LEAD-FREE BRASS

Certified to NSF/ANSI 61 & 372, NSF/ANSI 14 & IAPMO ANSI Z1157

SIZE	ITEM #	HV ITEM #	CTN/CASE	CASE WT
ASTM F1960 PEX × Rotating Flange 400 CWP				
3/4"	H-31403W	H-31403WHV	1/20	27
1"	H-31404W	H-31404WHV	1/20	27

W/ MULTI-FUNCTION HI-FLOW HOSE DRAIN

SIZE	ITEM #	HV ITEM #	CTN/CASE	CASE WT
ASTM F1960 PEX × Rotating Flange 400 CWP				
3/4"	H-31413W	H-31413WHV	1/20	27
1"	H-31414W	H-31414WHV	1/20	27

HV ITEMS FIT HIGH VELOCITY & STANDARD SIZE PUMPS.

The **ISOLATOR**
UNI-FLANGE BALL VALVE



THE ISOLATOR E-X-P-E2 TANKLESS WATER HEATER SERVICE VALVE KIT

Hot & Cold Set of Full Port Forged Dezincification Resistant Brass Ball Valves w/ Hi-Flow Hose Drains, Pressure Relief Valve Outlet & Adjustable Packing Glands

LEAD-FREE BRASS

Certified to NSF/ANSI 61 & 372, NSF/ANSI 14 & IAPMO ANSI Z1157

SIZE	ITEM #	CTN/CASE	CASE WT
FIP Union × ASTM F1960 PEX 400 CWP			
3/4"	H-34443W	1/10	34

INCLUDES RESIDENTIAL PRESSURE RELIEF VALVE (150 PSI/500,000 BTU/HR)

SIZE	ITEM #	CTN/CASE	CASE WT
FIP Union × ASTM F1960 PEX 400 CWP			
3/4"	H-34443WPR	1/10	38

FULL FLOW FORGED BRASS BALL VALVE

w/ Stainless Steel Wing Style "T" Handle & Adjustable Packing Gland

LEAD-FREE BRASS

Certified to NSF/ANSI 61 & 372, NSF/ANSI-14 & IAPMO/ANSI Z1157

SIZE	ITEM #	CTN/CASE	CASE WT
ASTM F1960 PEX 400 CWP			
1/2"	H-31702WSSW	10/80	27
3/4"	H-31703WSSW	10/60	30
1"	H-31704WSSW	6/36	33

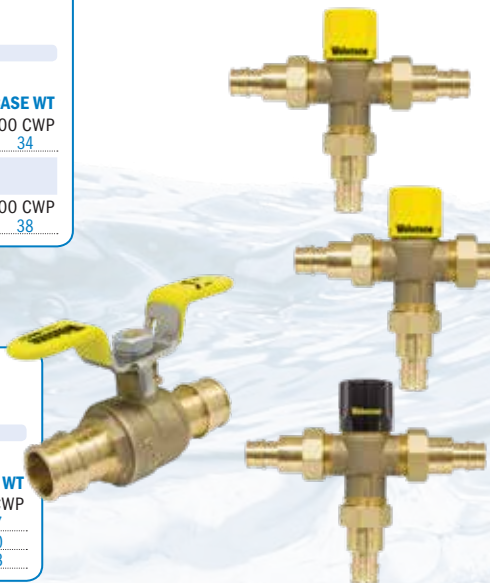

THERMOSTATIC MIXING VALVE W/ INTEGRAL CHECK VALVES

Forged Brass Valve w/ Dezincification Resistant Brass Fittings, Temperature Locking Handle & G1 Union Connections. See page 6 for application information

LEAD-FREE BRASS

Certified to NSF/ANSI 61 & 372, Body (H-7000W) Certified to ASSE 1017, CSA B125.3

SIZE	ITEM #	CTN/CASE	CASE WT
ASTM F1960 PEX 150 PSI			
OUTLET TEMPERATURE RANGE 95° - 120°F			
1/2"	H-73202W-CE-CAN	1/10	18
3/4"	H-73203W-CE-CAN	1/10	18
OUTLET TEMPERATURE RANGE 95° - 131°F			
1/2"	H-73202W-CE	1/10	18
3/4"	H-73203W-CE	1/10	18
OUTLET TEMPERATURE RANGE 104° - 176°F			
1/2"	H-73272W	1/10	18
3/4"	H-73273W	1/10	18

*CERTIFICATIONS DO NOT APPLY TO H-73272W & H-73273W
† TEMPERATURE LOCKING HANDLE NOT AVAILABLE ON -CAN ITEMS

F1960 PEX TRANSITION VALVES

• Eliminates transition fitting needed to join to other piping



PRO-PAL BALL DRAIN

Full Port Forged Dezincification Resistant Brass Ball Valve w/ Hi-Flow Hose Drain, Reversible Handle & Adjustable Packing Glands

LEAD-FREE BRASS

Certified to NSF/ANSI 61 & 372, NSF/ANSI-14 & IAPMO ANSI Z1157

SIZE	ITEM #	CTN/CASE	CASE WT
Press × ASTM F1960 PEX 250 CWP/250 F			
1/2"	H-83612W	4/40	38
3/4"	H-83613W	4/32	30
1"	H-83614W	2/20	19

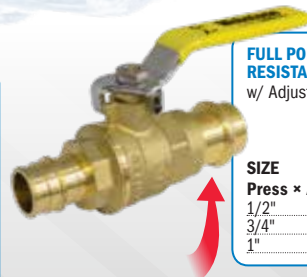

FULL PORT FORGED DEZINCIFICATION RESISTANT BRASS BALL VALVE

w/ Adjustable Packing Gland

LEAD-FREE BRASS

Certified to NSF/ANSI 61 & 372, NSF/ANSI 14 & IAPMO ANSI Z1157

SIZE	ITEM #	CTN/CASE	CASE WT
Press × ASTM F1960 PEX 250 CWP/250 F			
1/2"	H-80332W	5/50	26
3/4"	H-80333W	5/40	21
1"	H-80334W	4/20	11



FULL FLOW FORGED BRASS BALL VALVE

w/ Stainless Steel Wing Style "T" Handle & Adjustable Packing Gland

LEAD-FREE BRASS

Certified to NSF/ANSI 61 & 372, NSF/ANSI-14 & IAPMO/ANSI Z1157

SIZE	ITEM #	CTN/CASE	CASE WT
ASTM F1960 PEX × FIP 400 CWP			
1/2"	H-34702WSSW	10/80	29
3/4"	H-34703WSSW	10/60	32
1"	H-34704WSSW	6/36	32



FULL FLOW FORGED NICKEL PLATED BRASS SILLCOCK

1/4 Turn Action w/ Stainless Steel Lever Handle

LEAD-FREE BRASS

SIZE	ITEM #	CTN/CASE	CASE WT
ASTM F1960 PEX Flange × MIP Hose 125 CWP			
1/2"	H-33202WSSL	12/72	58

WEBSTONE EXCLUSIVE PRODUCTS
FOR CRIMP/CLAMP PEX & PE-RT CONNECTIONS

F1807 PEX PRODUCTS

PATENTED TECHNOLOGY

THE ISOLATOR W/ ROTATING FLANGE

Full Port Forged Dezincification Resistant Brass Uni-Flange Ball Valve w/ Detachable Rotating Flange, Adjustable Packing Gland, Nuts & Bolts

LEAD-FREE BRASS

Certified to NSF/ANSI 61 & 372, NSF/ANSI 14 & IAPMO ANSI Z1157

SIZE	ITEM#	HV ITEM#	CTN/CASE	CASE WT
ASTM F1807 PEX × Rotating Flange				
3/4"	H-11403W	H-11403WHV	1/20	27
1"	H-11404W	H-11404WHV	1/20	29

W/ MULTI-FUNCTION HI-FLOW HOSE DRAIN

SIZE	ITEM#	HV ITEM#	CTN/CASE	CASE WT
ASTM F1807 PEX × Rotating Flange				
3/4"	H-11413W	H-11413WHV	1/20	27
1"	H-11414W	H-11414WHV	1/20	27

HV ITEMS FIT HIGH VELOCITY & STANDARD SIZE PUMPS.



The ISOLATOR.
E·X·P·E·2
TWH SERVICE VALVES



THE ISOLATOR E-X-P E2 TANKLESS WATER HEATER SERVICE VALVE KIT

Hot & Cold Set of Full Port Forged Dezincification Resistant Brass Ball Valves w/ Hi-Flow Hose Drains, Pressure Relief Valve Outlet & Adjustable Packing Glands

LEAD-FREE BRASS

Certified to NSF/ANSI 61 & 372, NSF/ANSI 14 & IAPMO ANSI Z1157

SIZE	ITEM #	CTN/CASE	CASE WT
FIP Union × ASTM F1807 PEX			
3/4"	H-14443W	1/10	33

INCLUDES RESIDENTIAL PRESSURE RELIEF VALVE (150 PSI/500,000 BTU/HR)

SIZE	ITEM #	CTN/CASE	CASE WT
FIP Union × ASTM F1807 PEX			
3/4"	H-14443WPR	1/10	38

THERMOSTATIC MIXING VALVE W/ INTEGRAL CHECK VALVES

Forged Brass Valve w/ Dezincification Resistant Brass Fittings, w/ Temperature Locking Handle & G1 Union Connections - See page 6 for application information

LEAD-FREE BRASS

Certified to NSF/ANSI 61 & 372, Body (H-70000W) Certified to ASSE 1017, CSA B125.3

SIZE	ITEM #	CTN/CASE	CASE WT
ASTM F1807 PEX			
150 PSI			

OUTLET TEMPERATURE RANGE 95° - 120°F

1/2"	H-71202W-CAN	1/10	18
3/4"	H-71203W-CAN	1/10	18

OUTLET TEMPERATURE RANGE 95° - 131°F

1/2"	H-71202W	1/10	18
3/4"	H-71203W	1/10	18

OUTLET TEMPERATURE RANGE 104° - 176°F

1/2"	H-71272W	1/10	18
3/4"	H-71273W	1/10	18

*CERTIFICATIONS DO NOT APPLY TO H-71272W & H-71273W
†TEMPERATURE LOCKING HANDLE NOT AVAILABLE ON -CAN ITEMS



FULL FLOW BRONZE BALL VALVE

w/ Lever Handle - Dezincification Resistant

LEAD-FREE

Complies with NSF 61 Annex G, ASTM F877, ASTM F1807

SIZE	ITEM #	CTN/CASE	CASE WT
ASTM F1807 PEX			
1/2"	PX01526X	1/18	6
3/4"	PX01546X	1/12	6
1"	PX01566X	1/6	4

CHROME PLATED EXTRUDED BRASS MINI BALL VALVE

Hex Body

STANDARD BRASS

SIZE	ITEM #	CTN/CASE	CASE WT
ASTM F1807 PEX			
110 CWP NON-SHOCK			
1/2"	H-40782	12/144	30



FULL FLOW BRONZE MINI BALL VALVE

Dezincification Resistant

LEAD-FREE

Complies with NSF 61 Annex G, ASTM F877, ASTM F1807

SIZE	ITEM #	CTN/CASE	CASE WT
ASTM F1807 PEX			
1/2"	PX10297X	10/100	17



F1807 PEX & PE-RT TRANSITION VALVES

- Eliminates transition fitting needed to join to other piping



PRO-PAL BALL DRAIN

Full Port Forged Dezincification Resistant Brass Ball Valve w/ Hi-Flow Hose Drain, Reversible Handle & Adjustable Packing Glands

LEAD-FREE BRASS

Certified to NSF/ANSI 61 & 372, NSF/ANSI 14 & IAPMO ANSI Z1157

SIZE	ITEM #	CTN/CASE	CASE WT
Press × ASTM F1807 PEX			
250 CWP/250 F			
1/2"	H-81612W	4/40	38
3/4"	H-81613W	4/32	30
1"	H-81614W	2/20	19

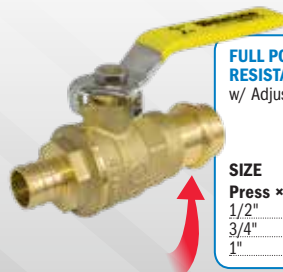

FULL PORT FORGED DEZINCIFICATION RESISTANT BRASS BALL VALVE w/ Adjustable Packing Gland

LEAD-FREE BRASS

Certified to NSF/ANSI 61 & 372, NSF/ANSI 14 & IAPMO ANSI Z1157

SIZE	ITEM #	CTN/CASE	CASE WT
Press × ASTM F1807 PEX			
250 CWP/250 F			
1/2"	H-80132W	5/50	26
3/4"	H-80133W	5/40	21
1"	H-80134W	4/20	11

FULL FLOW FORGED BRASS BALL VALVE

w/ Wing Handle

STANDARD BRASS

SIZE	ITEM #	CTN/CASE	CASE WT
ASTM F1807 PEX × SWT			
1/2"	H-50682	10/100	25



PRO-STOP® 1/4 TURN CHROME PLATED SUPPLY STOP

Blowout-Proof Stem and Nitrile O-Ring Seal

LEAD-FREE

Complies with NSF/ANSI 14, 61-9, 372

SIZE	ITEM #	CTN/CASE	CASE WT
ASTM F1807 PEX × Hose			
1/2"	PX01521E	10/150	31

PRO-CONNECT CONNECTIONS MADE SIMPLE

- Save time, save space, & save labor
- Compatible with popular press tools

EXCLUSIVE WEBSTONE PRODUCTS NOW WITH PRESS CONNECTIONS

PATENTED TECHNOLOGY WITH FURTHER PATENTS PENDING



THE ISOLATOR W/ ROTATING FLANGE

Full Port Forged Brass Uni-Flange Ball Valve w/ Detachable Rotating Flange, Adjustable Packing Gland, Nuts & Bolts

STANDARD BRASS			
SIZE	ITEM #	CTN/CASE	CASE WT
Press × Rotating Flange			250 CWP/250 F
3/4"	H-81403HV	1/20	28
1"	H-81404HV	1/20	35
1 1/4"	H-81405HV	1/20	45
1 1/2"	H-81406HV	1/10	31
2"	H-81407HV	1/10	36

W/ MULTI-FUNCTION HI-FLOW HOSE DRAIN

STANDARD BRASS			
SIZE	ITEM #	CTN/CASE	CASE WT
Press × Rotating Flange			250 CWP/250 F
3/4"	H-81413HV	1/20	37
1"	H-81414HV	1/20	43
1 1/4"	H-81415HV	1/10	30
1 1/2"	H-81416HV	1/10	38
2"	H-81417HV	1/10	40

FITS STANDARD AND HIGH VELOCITY PUMPS · 2" ISOLATORS HAVE 1 1/2" PORT

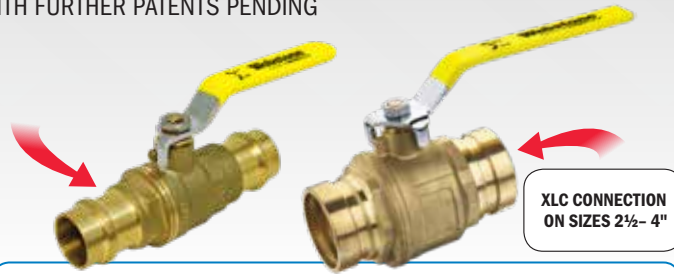

FULL PORT FORGED BRASS BALL VALVE w/ Adjustable Packing Gland

SIZE	STANDARD BRASS		LEAD-FREE BRASS	
	ITEM #	CTN/CASE	ITEM #	CASE WT
Certified to NSF/ANSI 61				
Press				250 CWP/250 F
1/2"	H-81702	5/50	H-81702W	26
3/4"	H-81703	5/40	H-81703W	32
1"	H-81704	4/20	H-81704W	24
1 1/4"	H-81705	5/20	H-81705W	38
1 1/2"	H-81706	4/16	H-81706W	43
2"	H-81707	2/8	H-81707W	33
2 1/2"	-	-	H-81708W	9
3"	-	-	H-81709W	12
4"	-	-	H-81710W	21

FULL PORT FORGED BRASS BALL VALVE w/ Cap & Strap, Reversible Handle & Adjustable Packing Gland

SIZE	LEAD-FREE BRASS	
	ITEM #	CASE WT
Certified to NSF/ANSI 61 & 372		
Press × Hose		250 CWP/250 F
1/2" × 3/4"	H-80312W	29
3/4"	H-80313W	33



THE ISOLATOR W/ ROUND FLANGE

Full Port Forged Brass Uni-Flange Ball Valve w/ Detachable Rotating Flange, Adjustable Packing Gland, Nuts & Bolts

STANDARD BRASS			
SIZE	ITEM #	CTN/CASE	CASE WT
Press × Rotating Flange			250 CWP/250 F
1 1/2"	H-81406HV-RF375	1/6	23
2"	H-81407HV-RF400	1/6	33
2"	H-81407HV-RF475	1/6	34

W/ MULTI-FUNCTION HI-FLOW HOSE DRAIN

STANDARD BRASS			
SIZE	ITEM #	CTN/CASE	CASE WT
Press × Rotating Flange			250 CWP/250 F
1 1/2"	H-81416HV-RF375	1/6	27
2"	H-81417HV-RF400	1/6	38
2"	H-81417HV-RF475	1/6	41

NOW AVAILABLE FOR HIGH EFFICIENCY VARIABLE SPEED PUMPS SEE PAGE 22 FOR PUMP COMPATIBILITY

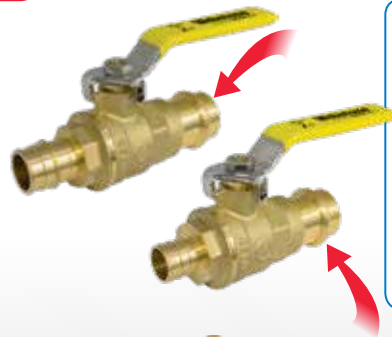

FULL PORT FORGED DEZINCIFICATION RESISTANT BRASS BALL VALVE w/ Adjustable Packing Gland

SIZE	LEAD-FREE BRASS	
	ITEM #	CASE WT
Certified to NSF/ANSI 61 & 372, NSF/ANSI 14 & IAPMO ANSI Z1157		
Press × ASTM F1960 PEX		250 CWP/250 F
1/2"	H-80332W	26
3/4"	H-80333W	21
1"	H-80334W	11
Press × ASTM F1807 PEX		250 CWP/250 F
1/2"	H-80132W	26
3/4"	H-80133W	21
1"	H-80134W	11

THE ISOLATOR SELECT

IDEAL FOR GEOTHERMAL APPLICATIONS · SEE PAGE 22

THE ISOLATOR SELECT

Full Port Forged Brass Uni-Flange Ball Valve w/ 4-Way Selectable Flow Path, Plugged FNPT Ports, Adjustable Packing Gland, Nuts, Bolts, & Flange Gasket

STANDARD BRASS			
SIZE	ITEM #	CTN/CASE	CASE WT
FIP × Press × Rotating Flange			250 CWP/250 F
1"	H-81424HV	1/10	35



FITS STANDARD & HIGH VELOCITY PUMPS

BRASS AIR SEPARATOR

w/ Removable Vent Head & Coalescing Medium · For Vertical Installations

SIZE	STANDARD BRASS	
	ITEM #	CASE WT
Press		150 PSI
3/4"	H-78003-V	47
1"	H-78004-V	47

BRASS AIR SEPARATOR

w/ Removable Vent Head & Coalescing Medium

SIZE	STANDARD BRASS	
	ITEM #	CASE WT
Press		150 PSI
3/4"	H-78003	30
1"	H-78004	32
1 1/4"	H-78005	36
1 1/2"	H-78006	76
2"	H-78007	85

The ISOLATOR.
E·X·P·E2
TWH SERVICE VALVES



THE ISOLATOR E-X-P-E2 TANKLESS WATER HEATER SERVICE VALVE KIT

Hot & Cold Set of Full Port Forged Brass Ball Valves w/ Hi-Flow Hose Drains, Pressure Relief Valve Outlet & Adjustable Packing Glands

LEAD-FREE BRASS

Certified to NSF/ANSI 61 & 372, NSF/ANSI 14 & IAPMO ANSI Z1157

SIZE	ITEM #	CTN/CASE	CASE WT
FIP Union x Press			250 CWP/250 F
3/4"	H-84443W	1/10	32
1"	H-84444W	1/10	56

INCLUDES RESIDENTIAL PRESSURE RELIEF VALVE (150 PSI/500,000 BTU/HR)

FIP Union x Press			250 CWP/250 F
3/4"	H-84443WPR	1/10	36
1"	H-84444WPR	1/10	65

INCLUDES LEAD FREE RESIDENTIAL PRESSURE RELIEF VALVE (150 PSI/500,000 BTU/HR)

FIP Union x Press			250 CWP/250 F
3/4"	H-84443WPR-LF	1/10	36
1"	H-84444WPR-LF	1/10	65

INCLUDES BOILER PRESSURE RELIEF VALVE (30 PSI/510,000 BTU/HR)

FIP Union x Press			250 CWP/250 F
1"	H-84444WPR3	1/10	65



THERMOSTATIC MIXING VALVE W/ INTEGRAL CHECK VALVES
Forged Brass Valve w/ Temperature Locking Handle & G1 Union Connections - See page 6 for application information

LEAD-FREE BRASS

Certified to NSF/ANSI 61 & 372, Body (H-70000W)
Certified to ASSE 1017, CSA B125.3

SIZE	ITEM #	CTN/CASE	CASE WT
Press			150 PSI

OUTLET TEMPERATURE RANGE 95° - 120°F

1/2"	H-78202W-CAN	1/10	19
3/4"	H-78203W-CAN	1/10	21
1"	H-78204W-CAN	1/10	22

OUTLET TEMPERATURE RANGE 95° - 131°F

1/2"	H-78202W	1/10	20
3/4"	H-78203W	1/10	21
1"	H-78204W	1/10	22

OUTLET TEMPERATURE RANGE 104° - 176°F

1/2"	H-78272W	1/10	20
3/4"	H-78273W	1/10	21
1"	H-78274W	1/10	22

*CERTIFICATIONS DO NOT APPLY TO H-7827W SERIES
† TEMPERATURE LOCKING HANDLE NOT AVAILABLE ON -CAN ITEMS



HYDRO-CORE

The ideal solution for most near boiler piping or secondary loops.

SEE PAGE 12

PRO-PAL SERIES

SAVE EVEN MORE TIME AND MONEY.
MOST PRO-PAL ITEMS AVAILABLE WITH PRESS CONNECTIONS. **SEE PAGE 18 FOR MORE DETAILS**

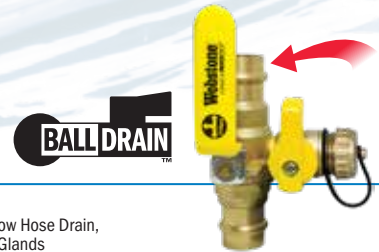

BALL DRAIN



T DRAIN

PRO-PAL T-DRAIN

Full Port Forged Brass Fitting w/ Hi-Flow Hose Drain & Adjustable Packing Gland

LEAD-FREE BRASS

Certified to NSF/ANSI 61 & 372

SIZE	ITEM #	CTN/CASE	CASE WT
Press			250 CWP/250 F
1/2"	H-80672W	4/40	25
3/4"	H-80673W	4/16	16
1"	H-80674W	4/16	18
1 1/4"	H-80675W	4/16	20

PRO-PAL BALL DRAIN

Full Port Forged Brass Ball Valve w/ Hi-Flow Hose Drain, Reversible Handle & Adjustable Packing Glands

STANDARD BRASS

SIZE	ITEM #	CTN/CASE	CASE WT	ITEM #	CTN/CASE	CASE WT
Press						250 CWP/250 F
1/2"	H-80612	4/40	39	H-80612W	4/40	38
3/4"	H-80613	4/32	40	H-80613W	4/32	40
1"	H-80614	2/20	35	H-80614W	2/20	35
1 1/4"	H-80615	2/16	43	H-80615W	2/16	43
1 1/2"	-	-	-	H-80616W	1/8	29
2"	-	-	-	H-80617W	1/6	34
Press x FIP						250 CWP/250 F
3/4"	H-84613	4/32	37	-	-	-
1"	H-84614	2/20	33	-	-	-
Press x ASTM F1807 PEX*						250 CWP/250 F
1/2"	-	-	-	H-81612W	4/40	38
3/4"	-	-	-	H-81613W	4/32	30
1"	-	-	-	H-81614W	2/20	19
Press x ASTM F1960 PEX*						250 CWP/250 F
1/2"	-	-	-	H-83612W	4/40	38
3/4"	-	-	-	H-83613W	4/32	30
1"	-	-	-	H-83614W	2/20	19

*CERTIFIED TO NSF/ANSI 61 & 372, NSF/ANSI 14 & IAPMO ANSI Z1157

PRO-PAL PURGE & FILL

Full Port Forged Brass Ball Valve w/ (2) Hi-Flow Hose Drains, Reversible Handle & Adjustable Packing Glands

STANDARD BRASS

SIZE	ITEM #	CTN/CASE	CASE WT
Press			250 CWP/250 F
3/4"	H-88613	1/12	20
1"	H-88614	1/12	27
1 1/4"	H-88615	1/12	40
1 1/2"	H-88616	1/6	27

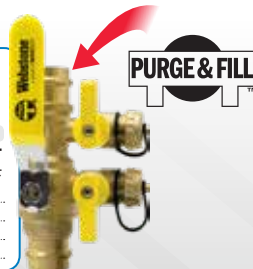

PURGE & FILL

PRO-PAL PURGE-TEE

Full Port Forged Brass Ball Valve w/ Reversible Handle & Adjustable Packing Gland

STANDARD BRASS

SIZE	ITEM #	CTN/CASE	CASE WT
Press			250 CWP/250 F
1" x 3/4"	H-88643	1/12	34
1" x 1"	H-88644	1/12	34
Press			250 CWP/250 F
1 1/4" x 1"	H-88654	1/12	51
1 1/4" x 1 1/4"	H-88655	1/12	52



PRIMARY/SECONDARY PURGE TEE

PRO-PAL UNION BALL DRAIN

Full Port Forged Brass Ball Valve w/ Single Union End, Hi-Flow Hose Drain, Reversible Handle & Adjustable Packing Glands

LEAD-FREE BRASS

Certified to NSF/ANSI 61 & 372

SIZE	ITEM #	CTN/CASE	CASE WT
Press x FIP Union			250 CWP/250 F
3/4"	H-80433W	4/16	28
1"	H-80434W	2/16	36
1 1/4"	H-80435W	2/8	27
1 1/2"	H-80436W	1/5	25

UNION BALL DRAIN



PRO-CONNECT™ PP-R PRO™

INNOVATIVE VALVES FOR AQUATHERM PP-R PIPE

PATENTED TECHNOLOGY WITH FURTHER PATENTS PENDING

- Permanent leak-free heat fused connections made in seconds
- Compatible with all Aquatherm PP-R piping systems
- Safe, clean, long-lasting, high performance materials
- Suitable for potable applications
- Available in female metric socket nominal sizes 1/2" to 2"
- Saves labor, space & leak paths
- Available exclusively at Aquatherm® dealers



BALL VALVE
Full Port Forged Brass Ball Valve w/ Adjustable Packing Gland

LEAD-FREE BRASS

Certified to NSF/ANSI 61 & 372

SIZE	SOCKET I.D.	ITEM#	CTN/CASE	CASE WT
Female PP-R Metric Socket 355 PSI*				
1/2"	20 mm	H-91702W	5/50	30
3/4"	25 mm	H-91703W	5/40	35
1"	32 mm	H-91704W	4/20	33
1 1/4"	40 mm	H-91705W	5/20	49
1 1/2"	50 mm	H-91706W	4/16	57
2"	63 mm	H-91707W	2/8	39
Female PP-R Metric Socket x FIP 355 PSI*				
1/2"	20 mm	H-94702W	5/50	28
3/4"	25 mm	H-94703W	5/40	33
1"	32 mm	H-94704W	4/20	29
1 1/4"	40 mm	H-94705W	5/20	43
1 1/2"	50 mm	H-94706W	4/16	50
2"	63 mm	H-94707W	2/8	34



THE ISOLATOR W/ ROTATING FLANGE & MULTI-FUNCTION DRAIN
Full Port Forged Brass Uni-Flange Ball Valve w/ Detachable Rotating Flange, Multi-Function Hi-Flow Hose Drain, Adjustable Packing Glands, Nuts & Bolts *Fits Standard & High Velocity Pumps

LEAD-FREE BRASS

Certified to NSF/ANSI 61 & 372

SIZE	SOCKET I.D.	HV ITEM#	CTN/CASE	CASE WT
Female PP-R Metric Socket x Rotating Flange 355 PSI*				
3/4"	25 mm	H-91413WHV	1/20	36
1"	32 mm	H-91414WHV	1/20	45
1 1/4"	40 mm	H-91415WHV	1/10	32
1 1/2"	50 mm	H-91416WHV	1/10	40
2"	63 mm	H-91417WHV	1/10	43

FITS STANDARD & HIGH VELOCITY PUMPS - 2" ISOLATORS HAVE 1 1/2" PORT

BALL DRAIN

Full Port Forged Brass Ball Valve w/ Hi-Flow Hose Drain, Reversible Handle & Adjustable Packing Glands

LEAD-FREE BRASS

Certified to NSF/ANSI 61 & 372

SIZE	SOCKET I.D.	ITEM#	CTN/CASE	CASE WT
Female PP-R Metric Socket 355 PSI*				
3/4"	25 mm	H-90613W	4/32	39
1"	32 mm	H-90614W	2/20	40
1 1/4"	40 mm	H-90615W	2/16	47
1 1/2"	50 mm	H-90616W	1/8	33
2"	63 mm	H-90617W	1/6	35



STEM EXTENSION KIT

- Replaces existing handle
- Accommodates up to 2" of insulation
- Improves handle accessibility



STEM EXTENSION KIT

For Use with Series Valves

VALVE SIZE	ITEM #	CTN/CASE	CASE WT
FITS BALL VALVE (9170 & 9470 SERIES)			
1/2" & 3/4"	H-SE-91702	12/48	23
1"	H-SE-91704	10/40	27
1 1/4"	H-SE-91705	8/32	24
1 1/2"	H-SE-91706	6/24	28
2"	H-SE-91707	6/24	28
FITS ISOLATOR W/ ROTATING FLANGE (9140 SERIES) AND BALL DRAIN (9061 SERIES)			
3/4"	H-SE-91702	12/48	23
1"	H-SE-91704	10/40	27
1 1/4"	H-SE-91705	8/32	24
1 1/2" & 2"	H-SE-91706	6/24	28
FITS ISOLATOR W/ ROTATING FLANGE & MULTI-FUNCTION DRAIN (9141 SERIES)			
3/4"	H-SE-91413	12/48	24
1"	H-SE-91414	10/40	27
1 1/4"	H-SE-91415	8/32	24
1 1/2" & 2"	H-SE-91416	8/24	29



THE ISOLATOR W/ ROTATING FLANGE
Full Port Forged Brass Uni-Flange Ball Valve w/ Detachable Rotating Flange, Adjustable Packing Glands, Nuts & Bolts

LEAD-FREE BRASS

Certified to NSF/ANSI 61 & 372

SIZE	SOCKET I.D.	HV ITEM#	CTN/CASE	CASE WT
Female PP-R Metric Socket x Rotating Flange 355 PSI*				
3/4"	25 mm	H-91403WHV	1/20	28
1"	32 mm	H-91404WHV	1/20	39
1 1/4"	40 mm	H-91405WHV	1/20	49
1 1/2"	50 mm	H-91406WHV	1/10	36
2"	63 mm	H-91407WHV	1/10	38

FITS STANDARD & HIGH VELOCITY PUMPS - 2" ISOLATORS HAVE 1 1/2" PORT

PRO-CONNECT™ PP-R PRO INNOVATIVE VALVES FOR ANY PP-R PIPE

PATENTED TECHNOLOGY WITH FURTHER PATENTS PENDING

- Permanent leak-free heat fused connections made in seconds
- PP-RCT sockets compatible with all PP-R & PP-RCT piping systems†
- Safe, clean, long-lasting, high performance materials
- Suitable for potable applications
- Available in female metric socket nominal sizes 1/2" to 2"
- Saves labor, space & leak paths

The ISOLATOR
UNI-FLANGE BALL VALVE®



THE ISOLATOR W/ ROTATING FLANGE & MULTI-FUNCTION DRAIN

Full Port Forged Brass Uni-Flange Ball Valve w/ Detachable Rotating Flange, Multi-Function Hi-Flow Hose Drain, Adjustable Packing Glands, Nuts & Bolts

LEAD-FREE BRASS

Certified to NSF/ANSI 61 & 372

SIZE	SOCKET I.D.	HV ITEM#	CTN/CASE	CASE WT
Female PP-RCT Metric Socket × Rotating Flange 600 PSI*				
3/4"	25 mm	H-101413WHV	1/20	36
1"	32 mm	H-101414WHV	1/20	45
1 1/4"	40 mm	H-101415WHV	1/10	32
1 1/2"	50 mm	H-101416WHV	1/10	38
2"	63 mm	H-101417WHV	1/10	43

FITS STANDARD & HIGH VELOCITY PUMPS - 2" ISOLATORS HAVE 1 1/2" PORT

The ISOLATOR
UNI-FLANGE BALL VALVE®



THE ISOLATOR W/ ROTATING FLANGE

Full Port Forged Brass Uni-Flange Ball Valve w/ Detachable Rotating Flange, Adjustable Packing Glands, Nuts & Bolts

LEAD-FREE BRASS

Certified to NSF/ANSI 61 & 372

SIZE	SOCKET I.D.	HV ITEM#	CTN/CASE	CASE WT
Female PP-RCT Metric Socket × Rotating Flange 600 PSI*				
3/4"	25 mm	H-101403WHV	1/20	29
1"	32 mm	H-101404WHV	1/20	39
1 1/4"	40 mm	H-101405WHV	1/20	54
1 1/2"	50 mm	H-101406WHV	1/10	36
2"	63 mm	H-101407WHV	1/10	38

FITS STANDARD & HIGH VELOCITY PUMPS - 2" ISOLATORS HAVE 1 1/2" PORT

BALL VALVE

Full Port Forged Brass Ball Valve w/ Adjustable Packing Gland

LEAD-FREE BRASS

Certified to NSF/ANSI 61 & 372

SIZE	SOCKET I.D.	ITEM#	CTN/CASE	CASE WT
Female PP-RCT Metric Socket 600 PSI*				
1/2"	20 mm	H-101702W	5/50	31
3/4"	25 mm	H-101703W	5/40	36
1"	32 mm	H-101704W	4/20	33
1 1/4"	40 mm	H-101705W	5/20	49
1 1/2"	50 mm	H-101706W	4/16	57
2"	63 mm	H-101707W	2/8	40
Female PP-RCT Metric Socket × FIP 600 PSI*				
1/2"	20 mm	H-104702W	5/50	28
3/4"	25 mm	H-104703W	5/40	33
1"	32 mm	H-104704W	4/20	29
1 1/4"	40 mm	H-104705W	5/20	42
1 1/2"	50 mm	H-104706W	4/16	50
2"	63 mm	H-104707W	2/8	35



PRO-PAL
SERIES

BALL DRAIN



BALL DRAIN

Full Port Forged Brass Ball Valve w/ Hi-Flow Hose Drain, Reversible Handle & Adjustable Packing Glands

LEAD-FREE BRASS

Certified to NSF/ANSI 61 & 372

SIZE	SOCKET I.D.	ITEM#	CTN/CASE	CASE WT
Female PP-RCT Metric Socket 600 PSI*				
3/4"	25 mm	H-100613W	4/32	39
1"	32 mm	H-100614W	2/20	40
1 1/4"	40 mm	H-100615W	2/16	47
1 1/2"	50 mm	H-100616W	1/8	33
2"	63 mm	H-100617W	1/6	35

STEM EXTENSION KIT

For Use with Series Valves

VALVE SIZE	ITEM #	CTN/CASE	CASE WT
FITS BALL VALVE (10170 & 10470 SERIES)			
1/2" & 3/4"	H-SE-91702	12/48	23
1"	H-SE-91704	10/40	27
1 1/4"	H-SE-91705	8/32	24
1 1/2"	H-SE-91706	6/24	28
2"	H-SE-91707	6/24	28

FITS ISOLATOR W/ ROTATING FLANGE (10140 SERIES) AND BALL DRAIN (10061 SERIES)

3/4"	H-SE-91702	12/48	23
1"	H-SE-91704	10/40	27
1 1/4"	H-SE-91705	8/32	24
1 1/2" & 2"	H-SE-91706	6/24	28

FITS ISOLATOR W/ ROTATING FLANGE & MULTI-FUNCTION DRAIN (10141 SERIES)

3/4"	H-SE-91413	12/48	24
1"	H-SE-91414	10/40	27
1 1/4"	H-SE-91415	8/32	24
1 1/2" & 2"	H-SE-91416	8/24	29

STEM EXTENSION KIT

- Replaces existing handle
- Accommodates up to 2" of insulation
- Improves handle accessibility



PRO-CONNECT PROPUSH™

PRO PERFORMANCE PUSH CONVENIENCE

YOUR CHOICE OF BULK OR INDIVIDUALLY PACKED PRODUCTS IN SIZES UP TO 2"



PRO-CONNECT PROPUSH BALL VALVE

Full Port Forged Dezincification Resistant Brass w/ Adjustable Packing Gland · For Connection to Copper, CPVC, or PEX · **Lead-Free**

INDIVIDUALLY PACKED

Certified to NSF/ANSI 61-G, NSF/ANSI-14, IAPMO/ANSI Z1157

SIZE	ITEM #	CTN/CASE	CASE WT
Push			
1/2"	H-62702W	10/100	44
3/4"	H-62703W	10/100	63
1"	H-62704W	5/50	56

BULK PACKED

Certified to NSF/ANSI 61-G, NSF/ANSI-14, IAPMO/ANSI Z1157

ITEM #	BOX/CASE	CASE WT
H-62702W-B	12/72	33
H-62703W-B	12/48	32
H-62704W-B	6/24	29



PRO-CONNECT PROPUSH IN-LINE SPRING CHECK VALVE

Forged Dezincification Resistant Brass Fitting · For Connection to Copper, CPVC or PEX · **Lead-Free**

INDIVIDUALLY PACKED

Certified to NSF/ANSI 61-G, ASSE 1061

SIZE	ITEM #	CTN/CASE	CASE WT
Push			
1/2"			
3/4"	H-26993W	12/120	39
1"			

BULK PACKED

Certified to NSF/ANSI 61-G, ASSE 1061

ITEM #	BOX/CASE	CASE WT
H-26992W-B	6/120	20
H-26993W-B	6/72	24
H-26994W-B	3/45	25



PRO-CONNECT PROPUSH 1/4 TURN SUPPLY STOP

Chrome Plated Dezincification Resistant Brass · For Connection to Copper, CPVC or PEX · **Lead-Free**

INDIVIDUALLY PACKED

Certified to NSF/ANSI 61 & 372, ASSE 1061, ASME A112.18.6/CSA B125.6 & IAPMO/ANSI Z1157

SIZE	ITEM #	CTN/CASE	CASE WT
ANGLED			
Push × Compression			
1/2" × 1/4"	H-26820W	20/200	53
1/2" × 3/8"	H-26821W	20/200	53

BULK PACKED

Certified to NSF/ANSI 61 & 372, ASSE 1061, ASME A112.18.6/CSA B125.6 & IAPMO/ANSI Z1157

ITEM #	BOX/CASE	CASE WT
H-26820W-B	6/120	33
H-26821W-B	12/120	33

SIZE	ITEM #	CTN/CASE	CASE WT
STRAIGHT			
Push × Compression			
1/2" × 1/4"	H-26920W	20/200	49
1/2" × 3/8"	H-26921W	20/200	49

ITEM #	BOX/CASE	CASE WT
H-26920W-B	6/120	30
H-26921W-B	12/120	31



PRO-CONNECT PROPUSH FLEXIBLE WATER HEATER CONNECTOR

Braided Stainless Steel · For Connection to Copper, CPVC or PEX · **Lead-Free**

INDIVIDUALLY PACKED

Certified to NSF/ANSI 61-G, ASSE 1061 & ASME A112.18.6/CSA B125.6

SIZE	ITEM #	CTN/CASE	CASE WT
Push × FIP · 12" Length			
1/2" × 3/4"			
3/4"	H-26033W-12	1/50	31

BULK PACKED

Certified to NSF/ANSI 61-G, ASSE 1061 & ASME A112.18.6/CSA B125.6

ITEM #	BOX/CASE	CASE WT
H-26023W-12-B	12/60	18
H-26033W-12-B	12/48	31

SIZE	ITEM #	CTN/CASE	CASE WT
Push × FIP · 15" Length			
1/2" × 3/4"			
3/4"	H-26033W-15	1/50	33

ITEM #	BOX/CASE	CASE WT
H-26023W-15-B	12/60	20
H-26033W-15-B	12/48	33

SIZE	ITEM #	CTN/CASE	CASE WT
Push × FIP · 18" Length			
1/2" × 3/4"	H-26023W-18	1/50	21
3/4"	H-26033W-18	1/50	41

ITEM #	BOX/CASE	CASE WT
H-26023W-18-B	12/60	22
H-26033W-18-B	12/36	32

SIZE	ITEM #	CTN/CASE	CASE WT
Push × FIP · 24" Length			
1/2" × 3/4"			
3/4"	H-26033W-24	1/50	44

ITEM #	BOX/CASE	CASE WT
H-26023W-24-B	12/60	25
H-26033W-24-B	12/36	36

INDIVIDUALLY PACKED

Certified to NSF/ANSI 61-G, ASSE 1061, ASME A112.18.6/CSA B125.6, IAPMO/ANSI Z1157

SIZE	ITEM #	CTN/CASE	CASE WT
W/ FULL PORT FORGED BRASS DEZINCIFICATION RESISTANT BRASS BALL VALVE			
Push × FIP · 18" Length			
1/2" × 3/4"	H-62023W-18	1/25	19
3/4"	H-62033W-18	1/25	31

BULK PACKED

Certified to NSF/ANSI 61-G, ASSE 1061, ASME A112.18.6/CSA B125.6, IAPMO/ANSI Z1157

ITEM #	BOX/CASE	CASE WT
H-62023W-18-B	12/48	40
H-62033W-18-B	12/36	34

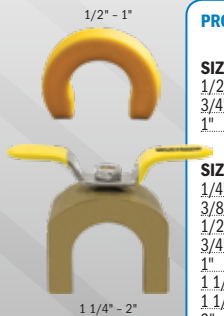

PRO-CONNECT PROPUSH REMOVAL TOOL

INDIVIDUALLY PACKED

SIZE	ITEM #	CTN/CASE	CASE WT
1/2"	H-28112	1/300	3
3/4"	H-28113	1/300	5
1"	H-28114	1/250	6

BULK PACKED

SIZE	ITEM #	BAG/CASE	CASE WT
1/4"	H-28110-B	24/1200	10
3/8"	H-28111-B	24/1200	9
1/2"	H-28112-B	24/1200	9
3/4"	H-28113-B	24/600	11
1"	H-28114-B	12/600	16
1 1/4"	H-28115-B	1/50	1
1 1/2"	H-28116-B	1/50	1
2"	H-28117-B	1/50	1



PRO-CONNECT PROPUSH DEBURR & GAUGE TOOL

SIZE	ITEM #	BAG/CASE	CASE WT
1/4" - 1"	H-28000-B	1/50	7

NOW AVAILABLE W/PUSH CONNECTIONS



The ISOLATOR
EXP E2
TWH SERVICE VALVES

THERMOSTATIC MIXING VALVE
SEE PAGE 6



PRO-CONNECT PROPUSH TAP-A-LINE KIT

Includes: Repair Tee, CTS, Straight Supply Stop & Removal Tool · **Lead-Free**

BULK PACKED

Certified to NSF/ANSI 61 & 372, ASSE 1061, ASME A112.18.6/CSA B125.6 & IAPMO/ANSI Z1157

SIZE	ITEM #	BOX/CASE	CASE WT
Push × Push			
200 PSI/200 F			
1/2" × 1/4"	H-26920WKIT-B	12/72	41
1/2" × 3/8"	H-26921WKIT-B	12/72	41
3/4" × 1/4"	H-26930WKIT-B	6/60	54



PRO-CONNECT PROPUSH WATER HEATER INSTALLATION KIT

Includes (2) Push × FIP Straight Connectors & Removal Tool · For Connection to Copper, CPVC or PEX · **Lead-Free**

INDIVIDUALLY PACKED

Certified to NSF/ANSI 61-G, ASSE 1061

SIZE	ITEM #	CTN/CASE	CASE WT
Push × FIP			
200 PSI/200 F			
1/2"	H-26223WKIT	5/50	29
3/4"	H-26203WKIT	5/50	29

BULK PACKED

Certified to NSF/ANSI 61-G, ASSE 1061

SIZE	ITEM #	BOX/CASE	CASE WT
Push × FIP			
200 PSI/200 F			
1/2" × 3/4"	H-26223WKIT-B	12/72	25
3/4"	H-26203WKIT-B	12/72	30



PRO-CONNECT PROPUSH ADAPTER SET

INDIVIDUALLY PACKED

SIZE	ITEM #	CTN/CASE	CASE WT
1/2"	H-28212	1/300	1
3/4"	H-28213	1/300	1
1"	H-28214	1/250	4

BULK PACKED

SIZE	ITEM #	BAG/CASE	CASE WT
1/2"	H-28212-B	1/100	1
3/4"	H-28213-B	1/100	1
1"	H-28214-B	1/100	2
1 1/4"	H-28215-B	1/100	5
1 1/2"	H-28216-B	1/100	8
2"	H-28217-B	1/100	13

PRO-CONNECT PROPUSH STRAIGHT COUPLING

Forged Dezincification Resistant Brass Fitting · For Connection to Copper, CPVC or PEX · **Lead-Free**

INDIVIDUALLY PACKED

Certified to NSF/ANSI 61-G, ASSE 1061

BULK PACKED

Certified to NSF/ANSI 61-G, ASSE 1061

SIZE	ITEM #	CTN/CASE	CASE WT	ITEM #	BAG/CASE	CASE WT
STRAIGHT COUPLING						
Push						
200 PSI/200 F						
1/4"	-	-	-	H-26100W-B	6/600	33
1/4" × 1/2"	-	-	-	H-26120W-B	6/150	15
3/8"	H-26101W	25/250	24	H-26101W-B	6/360	32
3/8" × 1/2"	H-26112W	25/250	29	H-26112W-B	6/150	18
1/2"	H-26102W	25/250	31	H-26102W-B	12/240	31
3/4"	H-26103W	10/100	21	H-26103W-B	12/180	35
3/4" × 1/2"	H-26132W	15/150	27	H-26132W-B	12/120	21
1"	H-26104W	9/90	29	H-26104W-B	6/90	29
1" × 3/4"	H-26143W	9/90	24	H-26143W-B	6/90	24
1 1/4"	-	-	-	H-26105W-B	1/30	26
1 1/4" × 1"	-	-	-	H-26154W-B	1/30	19
1 1/2"	-	-	-	H-26106W-B	1/27	39
1 1/2"	-	-	-	H-26165W-B	1/20	23
2"	-	-	-	H-26107W-B	1/20	38
2" × 1 1/2"	-	-	-	H-26176W-B	1/15	26

FEMALE STRAIGHT CONNECTOR

SIZE	ITEM #	CTN/CASE	CASE WT	ITEM #	BAG/CASE	CASE WT
Push × FIP						
200 PSI/200 F						
1/4" × 1/2"	-	-	-	H-26220W-B	6/180	21
3/8" × 1/2"	-	-	-	H-26212W-B	6/180	20
1/2"	H-26202W	20/200	25	H-26202W-B	12/180	22
1/2" × 3/4"	H-26223W	20/200	33	H-26223W-B	6/150	26
3/4"	H-26203W	12/120	25	H-26203W-B	6/90	19
3/4" × 1/2"	-	-	-	H-26232W-B	6/180	24
3/4" × 1"	-	-	-	H-26234W-B	6/90	23
1"	H-26204W	9/90	25	H-26204W-B	6/90	26
1 1/4"	-	-	-	H-26205W-B	1/30	22
1 1/2"	-	-	-	H-26206W-B	1/25	27
2"	-	-	-	H-26207W-B	1/20	30

MALE STRAIGHT CONNECTOR

SIZE	ITEM #	CTN/CASE	CASE WT	ITEM #	BAG/CASE	CASE WT
Push × MIP						
200 PSI/200 F						
1/4" × 1/2"	-	-	-	H-26320W-B	6/180	19
3/8" × 1/2"	-	-	-	H-26312W-B	6/180	19
1/2"	H-26302W	20/200	23	H-26302W-B	12/180	21
1/2" × 3/4"	H-26323W	20/200	35	H-26323W-B	6/120	21
3/4"	H-26303W	15/150	28	H-26303W-B	12/120	23
3/4" × 1/2"	-	-	-	H-26332W-B	6/150	21
3/4" × 1"	-	-	-	H-26334W-B	6/90	25
1"	H-26304W	9/90	24	H-26304W-B	6/90	24
1" × 3/4"	H-26343W	9/90	22	H-26343W-B	6/90	21
1 1/4"	-	-	-	H-26305W-B	1/30	23
1 1/2"	-	-	-	H-26306W-B	1/25	25
2"	-	-	-	H-26307W-B	1/20	28

POLYBUTYLENE ADAPTER

SIZE	ITEM #	CTN/CASE	CASE WT	ITEM #	BAG/CASE	CASE WT
Push × Push PB						
200 PSI/200 F						
1/2"	-	-	-	H-26192W-B	6/120	17
3/4"	-	-	-	H-26193W-B	6/90	18

PRO-CONNECT PROPUSH CONTRACTOR PUSH FITTING KIT

27-Piece Assortment of Fittings & Tools · Connection to Copper, CPVC, or PEX

LEAD-FREE BRASS

Certified to NSF/ANSI 61-G, ASSE 1061 & ASME A112.18.6/CSA B125.6

SIZE	ITEM #	CTN/CASE	CASE WT
KIT			
200 PSI/200 F			
	H-26000WKIT	1/4	30

FREE CUSTOMIZED LABELING
WHEN YOU ORDER 100 UNITS OR MORE

PRO-CONNECT PROPUSH END CAP

Forged Dezincification Resistant Brass Fitting · For Connection to Copper, CPVC or PEX · **Lead-Free**

INDIVIDUALLY PACKED

Certified to NSF/ANSI 61-G, ASSE 1061

SIZE	ITEM #	CTN/CASE	CASE WT
Push			
200 PSI/200 F			
1/2"	H-26602W	30/300	22
3/4"	H-26603W	20/200	23
1"	H-26604W	12/120	24

BULK PACKED

Certified to NSF/ANSI 61-G, ASSE 1061

SIZE	ITEM #	BAG/CASE	CASE WT
Push			
200 PSI/200 F			
3/8"	H-26601W-B	6/300	21
1/2"	H-26602W-B	12/300	21
3/4"	H-26603W-B	6/150	19
1"	H-26604W-B	6/120	24
1 1/4"	H-26605W-B	1/40	20
1 1/2"	H-26606W-B	1/35	28
2"	H-26607W-B	1/30	34

PRO-CONNECT PROPUSH SLIP COUPLING

Forged Dezincification Resistant Brass Fitting · For Connection to Copper, CPVC or PEX · **Lead-Free**

INDIVIDUALLY PACKED

Certified to NSF/ANSI 61-G, ASSE 1061

SIZE	ITEM #	CTN/CASE	CASE WT
Push			
200 PSI/200 F			
1/2"	H-26122W	15/150	34
3/4"	H-26133W	5/50	19
1"	H-26144W	5/50	27

BULK PACKED

Certified to NSF/ANSI 61-G, ASSE 1061

SIZE	ITEM #	BAG/CASE	CASE WT
Push			
200 PSI/200 F			
1/2"	H-26122W-B	3/90	22
3/4"	H-26133W-B	3/60	23
1"	H-26144W-B	1/50	25

PRO-CONNECT PROPUSH ELBOW

Forged Dezincification Resistant Brass Fitting · For Connection to Copper, CPVC or PEX · **Lead-Free**

INDIVIDUALLY PACKED

Certified to NSF/ANSI 61-G, ASSE 1061

BULK PACKED

Certified to NSF/ANSI 61-G, ASSE 1061

SIZE	ITEM #	CTN/CASE	CASE WT	ITEM #	BAG/CASE	CASE WT
90° ELBOW						
Push						
200 PSI/200 F						
1/4"	-	-	-	H-26400W-B	6/360	26
3/8"	-	-	-	H-26401W-B	6/180	23
1/2"	H-26402W	20/200	31	H-26402W-B	12/180	27
1/2" × 3/8"	-	-	-	H-26421W-B	12/180	28
3/4"	H-26403W	12/120	33	H-26403W-B	12/96	27
3/4" × 1/2"	H-26432W	12/120	25	H-26432W-B	6/120	26
1"	H-26404W	10/100	48	H-26404W-B	6/60	29
1" × 3/4"	-	-	-	H-26443W-B	3/60	24
1 1/4"	-	-	-	H-26405W-B	1/20	23
1 1/2"	-	-	-	H-26406W-B	1/15	28
2"	-	-	-	H-26407W-B	1/8	22

SIZE	ITEM #	CTN/CASE	CASE WT	ITEM #	BAG/CASE	CASE WT
Push × FIP						
200 PSI/200 F						
1/2"	H-26422W	20/200	31	H-26422W-B	6/150	27

SIZE	ITEM #	CTN/CASE	CASE WT	ITEM #	BAG/CASE	CASE WT
Push × MIP						
200 PSI/200 F						
1/2"	H-26222W	20/200	31	H-26222W-B	6/120	23
3/4"	-	-	-	H-26233W-B	6/90	27

90° DROP EAR ELBOW

SIZE	ITEM #	CTN/CASE	CASE WT	ITEM #	BAG/CASE	CASE WT
Push × FIP						
200 PSI/200 F						
1/2"	H-26412W	9/90	21	H-26412W-B	6/120	25
3/4"	-	-	-	H-26413W-B	6/90	33

SIZE	ITEM #	CTN/CASE	CASE WT	ITEM #	BAG/CASE	CASE WT
Push						
200 PSI/200 F						
1/2"	H-26462W	9/90	21	H-26462W-B	12/120	27

90° HY-EAR ELBOW

SIZE	ITEM #	CTN/CASE	CASE WT	ITEM #	BAG/CASE	CASE WT
Push × FIP						
200 PSI/200 F						
1/2"	-	-	-	H-26412WHE-B	6/120	32

PRO-CONNECT PROPUSH TEE

Forged Dezincification Resistant Brass Fitting · For Connection to Copper, CPVC or PEX · **Lead-Free**

INDIVIDUALLY PACKED

Certified to NSF/ANSI 61-G, ASSE 1061

BULK PACKED

Certified to NSF/ANSI 61-G, ASSE 1061

SIZE	ITEM #	CTN/CASE	CASE WT	ITEM #	BAG/CASE	CASE WT
TEE						
Push						
200 PSI/200 F						
1/4"	-	-	-	H-26500W-B	6/300	22
3/8"	-	-	-	H-26501W-B	6/150	26
3/8" × 3/8" × 1/2"	-	-	-	H-26512W-B	6/120	22
1/2"	H-26502W	12/120	25	H-26502W-B	12/120	22
1/2" × 1/2" × 1/4"	-	-	-	H-26520W-B	6/120	22
1/2" × 1/2" × 3/8"	-	-	-	H-26521W-B	6/120	25
3/4"	H-26503W	12/120	43	H-26503W-B	6/60	22
3/4" × 1/2" × 1/2"	H-26522W	18/180	44	H-26522W-B	6/90	24
3/4" × 3/4" × 1/2"	H-26532W	15/150	48	H-26532W-B	6/60	20
3/4" × 1/2" × 3/4"	H-26533W	12/120	39	H-26533W-B	6/60	21
1"	H-26504W	6/60	38	H-26504W-B	3/30	20
1" × 1" × 3/4"	H-26543W	6/60	30	H-26543W-B	3/30	16
1 1/4"	-	-	-	H-26505W-B	1/15	24
1 1/2"	-	-	-	H-26506W-B	1/10	25
2"	-	-	-	H-26507W-B	1/6	22

REPAIR TEE

SIZE	ITEM #	CTN/CASE	CASE WT	ITEM #	BAG/CASE	CASE WT
Push						
200 PSI/200 F						
1/2"	H-26702W	8/80	26	H-26702W-B	3/90	29
3/4"	H-26703W	6/60	32	H-26703W-B	3/60	32

SIZE	ITEM #	CTN/CASE	CASE WT	ITEM #	BAG/CASE	CASE WT
Push × Push × FIP						
200 PSI/200 F						
1/2"	H-26722W	8/80	27	H-26722W-B	3/90	29
3/4"	H-26733W	6/60	33	H-26733W-B	3/60	32

SIZE	ITEM #	CTN/CASE	CASE WT	ITEM #	BAG/CASE	CASE WT
Push × Push × CTS Slip						
200 PSI/200 F						
1/2"	-	-	-	H-26752W-B	6/60	19

BALL VALVES

PATENTS PENDING

FULL PORT FORGED BRASS BALL VALVE

w/ Adjustable Packing Gland

STANDARD BRASS

Certified to NSF/ANSI 61-8

LEAD-FREE BRASS

Certified to NSF/ANSI 61-8 & 61-2012

SIZE	ITEM #	CTN/CASE	CASE WT	ITEM #	CTN/CASE	CASE WT
FIP						
w/ Chrome Plated Lever Handle						
1/4"	H-41700	10/100	27	H-41700W	10/100	27
3/8"	H-41701	10/100	29	H-41701W	10/100	29
1/2"	H-41702	10/80	32	H-41702W	10/80	31
3/4"	H-41703	10/60	35	H-41703W	10/60	35
1"	H-41704	6/36	39	H-41704W	6/36	38
1 1/4"	H-41705	6/24	35	H-41705W	6/24	35
1 1/2"	H-41706	2/16	36	H-41706W	2/16	36
2"	H-41707	2/12	38	H-41707W	2/12	38
2 1/2"	H-41708	1/6	43	H-41708W	1/6	45
3"	H-41709	1/4	37	H-41709W	1/4	36
4"	H-41710	1/2	31	H-41710W	1/2	30

CERTIFICATIONS DO NOT APPLY TO 41708, 41709, 41710

w/ 304 Stainless Steel Handle

600 CWP/150 WSP

1/2"	H-41702SSL	10/80	31	H-41702WSSL	10/80	31
3/4"	H-41703SSL	10/60	35	H-41703WSSL	10/60	36
1"	H-41704SSL	6/36	39	H-41704WSSL	6/36	39
1 1/4"	H-41705SSL	6/24	34	H-41705WSSL	6/24	34
1 1/2"	H-41706SSL	2/16	40	H-41706WSSL	2/16	36
2"	H-41707SSL	2/12	38	H-41707WSSL	2/12	38

w/ Wing Style "T" Handle

600 CWP/150 WSP

1/2"	H-41702T	10/80	33	H-41702WT	10/80	33
3/4"	H-41703T	10/60	35	H-41703WT	10/60	38
1"	H-41704T	6/36	44	H-41704WT	6/36	40

w/ 304 Stainless Steel Wing Style "T" Handle

600 CWP/150 WSP

1/2"	H-41702SSW	10/80	39	H-41702WSSW	10/80	39
3/4"	H-41703SSW	10/60	36	H-41703WSSW	10/60	36
1"	H-41704SSW	6/48	55	H-41704WSSW	6/48	52

STANDARD BRASS

Certified to NSF/ANSI 61-8

LEAD-FREE BRASS

Certified to NSF/ANSI 61-8 & 61-2012

SIZE	ITEM #	CTN/CASE	CASE WT	ITEM #	CTN/CASE	CASE WT
SWT						
w/ Chrome Plated Lever Handle						
1/2"	H-51702	10/100	33	H-51702W	10/80	26
3/4"	H-51703	10/60	33	H-51703W	10/60	33
1"	H-51704	6/36	35	H-51704W	6/36	35
1 1/4"	H-51705	6/24	33	H-51705W	6/24	32
1 1/2"	H-51706	2/24	53	H-51706W	2/16	41
2"	H-51707	2/12	38	H-51707W	2/12	38
2 1/2"	H-51708	1/8	54	H-51708W	1/6	39
3"	H-51709	1/3	26	H-51709W	1/4	34
4"	H-51710	1/2	36	H-51710W	1/2	42

CERTIFICATIONS DO NOT APPLY TO 51708, 51709W, 51709W

w/ 304 Stainless Steel Handle

600 CWP/150 WSP

1/2"	H-51702SSL	10/80	26	H-51702WSSL	10/80	26
3/4"	H-51703SSL	10/60	33	H-51703WSSL	10/60	33
1"	H-51704SSL	6/36	34	H-51704WSSL	6/36	34
1 1/4"	H-51705SSL	6/24	31	H-51705WSSL	6/24	32
1 1/2"	H-51706SSL	2/24	53	H-51706WSSL	2/16	36
2"	H-51707SSL	2/12	38	H-51707WSSL	2/12	38

w/ Wing Style "T" Handle

600 CWP/150 WSP

1/2"	H-51702T	10/80	29	H-51702WT	10/80	27
3/4"	H-51703T	10/60	36	H-51703WT	10/60	34
1"	H-51704T	6/36	37	H-51704WT	6/36	35

w/ 304 Stainless Steel Wing Style "T" Handle

600 CWP/150 WSP

1/2"	H-51702SSW	10/80	42	H-51702WSSW	10/80	42
3/4"	H-51703SSW	10/60	43	H-51703WSSW	10/60	47
1"	H-51704SSW	6/36	42	H-51704WSSW	6/36	47



AVAILABLE W/
PRO-CONNECT PPR-PRO
EXCLUSIVELY FOR
aquatherm
SEE PAGE 28



AVAILABLE W/
PRO-CONNECT PPR-PRO
FOR ANY
PP-R OR PP-RCT
PIPING SYSTEM
SEE PAGE 29



FULL FLOW FORGED BRASS BALL VALVE

w/ Stainless Steel Wing Style "T" Handle & Adjustable Packing Gland

LEAD-FREE BRASS

Certified to NSF/ANSI 61 & 372, NSF/ANSI-14 & IAPMO/ANSI Z1157

SIZE	ITEM #	CTN/CASE	CASE WT
ASTM F1960 PEX			
1/2"	H-31702WSSW	10/80	27
3/4"	H-31703WSSW	10/60	30
1"	H-31704WSSW	6/36	33



FULL FLOW BRONZE BALL VALVE

w/ Lever Handle - Dezincification Resistant

LEAD-FREE

Complies with NSF 61 Annex G, ASTM F877, ASTM F1807

SIZE	ITEM #	CTN/CASE	CASE WT
ASTM F1807 PEX			
1/2"	PX01526X	1/18	6
3/4"	PX01546X	1/12	6
1"	PX01566X	1/6	4



PRO-CONNECT PROPUSH BALL VALVE

Full Port Forged Dezincification Resistant Brass w/ Adjustable Packing Gland - For Connection to Copper, CPVC, or PEX - Lead-Free

INDIVIDUALLY PACKED

Certified to NSF/ANSI 61-G, NSF/ANSI-14, IAPMO/ANSI Z1157

BULK PACKED

Certified to NSF/ANSI 61-G, NSF/ANSI-14, IAPMO/ANSI Z1157

SIZE	ITEM #	CTN/CASE	CASE WT	ITEM #	BOX/CASE	CASE WT
Push						
1/2"	H-62702W	10/100	44	H-62702W-B	12/72	33
3/4"	H-62703W	10/100	63	H-62703W-B	12/48	32
1"	H-62704W	5/50	56	H-62704W-B	6/24	29

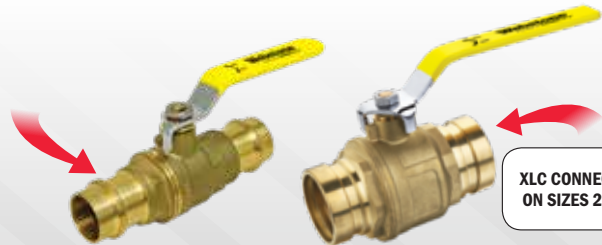

XLC CONNECTION
ON SIZES 2 1/2" - 4"

PRO-CONNECT PRESS FULL PORT FORGED BRASS BALL VALVE

w/ Adjustable Packing Gland

STANDARD BRASS

Certified to NSF/ANSI 61

LEAD-FREE BRASS

Certified to NSF/ANSI 61-G

SIZE	ITEM #	CTN/CASE	CASE WT	ITEM #	CTN/CASE	CASE WT
Press						
1/2"	H-81702	5/50	27	H-81702W	5/50	26
3/4"	H-81703	5/40	33	H-81703W	5/40	32
1"	H-81704	4/20	27	H-81704W	4/20	24
1 1/4"	H-81705	5/20	39	H-81705W	5/20	38
1 1/2"	H-81706	4/16	41	H-81706W	4/16	43
2"	H-81707	2/8	33	H-81707W	2/8	33
2 1/2"	-	-	-	H-81708W	1/1	9
3"	-	-	-	H-81709W	1/1	12
4"	-	-	-	H-81710W	1/1	21

FULL PORT NICKEL PLATED FORGED BRASS BALL VALVE
w/ 304 Stainless Steel Lever Handle & Adjustable Packing Gland

LEAD-FREE BRASS
Certified to NSF/ANSI 61-G

SIZE FIP	ITEM #	CTN/CASE	CASE WT
1/4"	H-40800W	20/120	43
3/8"	H-40801W	20/120	37
1/2"	H-40802W	20/120	54
3/4"	H-40803W	14/84	56
1"	H-40804W	8/48	53
1 1/4"	H-40805W	6/36	57
1 1/2"	H-40806W	4/24	59
2"	H-40807W	2/16	56



FULL PORT FORGED BRASS BALL VALVE
3 Way L-Port w/ Reversible Handle & Adjustable Packing Gland

STANDARD BRASS
Certified to NSF/ANSI 61-G

SIZE FIP	ITEM #	CTN/CASE	CASE WT
1/2"	H-40642	15/60	34
3/4"	H-40643	10/40	34
1"	H-40644	6/24	35

FULL PORT FORGED BRASS BALL VALVE
w/ 1/4" Threaded Gauge Hole (Plugged), Reversible Handle & Adjustable Packing Gland

STANDARD BRASS
Certified to NSF/ANSI 61-G

SIZE FIP	ITEM #	CTN/CASE	CASE WT
1/2"	H-41722	10/80	43
3/4"	H-41723	10/60	43
1"	H-41724	6/48	56
1 1/4"	H-41725	4/32	56
1 1/2"	H-41726	2/24	64
2"	H-41727	2/16	61

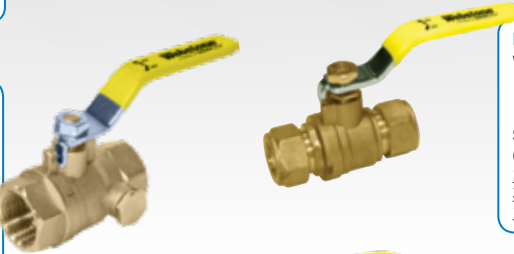

FORGED BRASS BALL VALVE
w/ Compression Ends & Adjustable Packing Gland

LEAD-FREE BRASS
Certified to NSF/ANSI 61-G

SIZE Compression	ITEM #	CTN/CASE	CASE WT
1/2"	H-40632W	25/100	56
3/4"	H-40633W	15/60	51
1"	H-40634W	10/40	52

STANDARD PORT FORGED BRASS BALL VALVE
w/ Adjustable Packing Gland

STANDARD BRASS

LEAD-FREE BRASS
Certified to NSF/ANSI 61-G

SIZE FIP	ITEM #	CTN/CASE	CASE WT	ITEM #	CTN/CASE	CASE WT
1/4"	H-41820	10/120	38	H-41820W	10/120	38
3/8"	H-41821	10/120	36	H-41821W	10/120	36
1/2"	H-41822	10/120	45	H-41822W	10/120	45
3/4"	H-41823	10/80	39	H-41823W	10/80	39
1"	H-41824	6/48	44	H-41824W	6/48	44
1 1/4"	H-41825	4/32	40	H-41825W	4/32	38
1 1/2"	H-41826	2/24	43	H-41826W	2/24	43
2"	H-41827	2/16	40	H-41827W	2/16	40
2 1/2"	H-41828	2/4	23	H-41828W	2/4	23
3"	H-41829	1/3	26	H-41829W	1/3	25
4"	H-41830	1/2	27	H-41830W	1/2	27

FORGED BRASS BALL VALVE
w/ Bleeder, Reversible Handle & Adjustable Packing Gland

LEAD-FREE BRASS
Certified to NSF/ANSI 61-G

SIZE FIP	ITEM #	CTN/CASE	CASE WT
1/2"	H-40622W	15/120	60
3/4"	H-40623W	12/48	36
1"	H-40624W	8/32	38

SIZE SWT	ITEM #	CTN/CASE	CASE WT
1/2"	H-50622W	25/100	49
3/4"	H-50623W	10/40	31
1"	H-50624W	6/24	29



TRANSITION VALVES

FULL PORT FORGED DEZINCIFICATION RESISTANT BRASS BALL VALVE
w/ Adjustable Packing Gland

LEAD-FREE BRASS
Certified to NSF/ANSI 61 & 372, NSF/ANSI 14 & IAPMO ANSI Z1157

SIZE	ITEM #	CTN/CASE	CASE WT
Press x ASTM F1960 PEX			250 CWP/250 F
1/2"	H-80332W	5/50	26
3/4"	H-80333W	5/40	21
1"	H-80334W	4/20	11



FULL PORT FORGED DEZINCIFICATION RESISTANT BRASS BALL VALVE
w/ Adjustable Packing Gland

LEAD-FREE BRASS
Certified to NSF/ANSI 61 & 372, NSF/ANSI 14 & IAPMO ANSI Z1157

SIZE	ITEM #	CTN/CASE	CASE WT
Press x ASTM F1807 PEX			250 CWP/250 F
1/2"	H-80132W	5/50	26
3/4"	H-80133W	5/40	21
1"	H-80134W	4/20	11



FULL FLOW FORGED BRASS BALL VALVE
w/ Stainless Steel Wing Style "T" Handle & Adjustable Packing Gland

LEAD-FREE BRASS
Certified to NSF/ANSI 61 & 372, NSF/ANSI-14 & IAPMO/ANSI Z1157

SIZE	ITEM #	CTN/CASE	CASE WT
ASTM F1960 PEX x FIP			400 CWP
1/2"	H-34702WSSW	10/80	29
3/4"	H-34703WSSW	10/60	32
1"	H-34704WSSW	6/36	32



FULL FLOW FORGED BRASS BALL VALVE
w/ Wing Handle

STANDARD BRASS

SIZE	ITEM #	CTN/CASE	CASE WT
ASTM F1807 PEX x SWT			160 CWP
1/2"	H-50682	10/100	25



FULL PORT FORGED BRASS BALL VALVE
w/ Reversible Handle & Adjustable Packing Gland

LEAD-FREE BRASS
Certified to NSF/ANSI 61 & 372

SIZE	ITEM #	CTN/CASE	CASE WT
MIP x FIP			600 CWP/150 WSP
1/4"	H-40530W	12/96	35
3/8"	H-40531W	12/96	33
1/2"	H-40532W	12/96	45
3/4"	H-40533W	10/60	44
1"	H-40534W	6/48	55

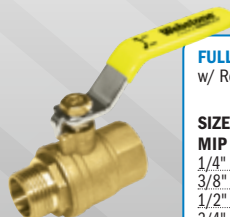

FULL PORT FORGED BRASS BALL VALVE
w/ Cap & Strap, Reversible Handle & Adjustable Packing Gland

LEAD-FREE BRASS
Certified to NSF/ANSI 61-G

SIZE	ITEM #	CTN/CASE	CASE WT
FIP x Hose			600 CWP/150 WSP
1/2" x 3/4"	H-40312W	10/60	30
3/4"	H-40313W	10/60	42
SWT x Hose			600 CWP/150 WSP
1/2" x 3/4"	H-50312W	10/100	49
3/4"	H-50313W	10/60	42



SIZE	ITEM #	CTN/CASE	CASE WT
Press x Hose			250 CWP/250 F
1/2" x 3/4"	H-80312W	5/50	29
3/4"	H-80313W	5/40	33

STAINLESS STEEL BALL VALVES

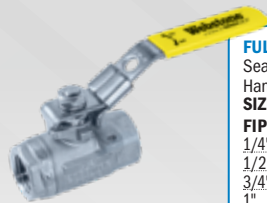

FULL PORT 316 STAINLESS STEEL BALL VALVE
Seal Welded w/ 304 Stainless Steel Locking Handle & Adjustable Packing Gland

SIZE	ITEM #	CTN/CASE	CASE WT
FIP			2000 CWP
1/4"	H-43710	12/48	29
1/2"	H-43712	10/60	38
3/4"	H-43713	2/40	47
1"	H-43714	6/18	53
2"	H-43717	2/6	53



FULL PORT 316 STAINLESS STEEL BALL VALVE
2 Piece Investment Cast w/ 304 Stainless Steel Locking Handle & Adjustable Packing Gland

SIZE	ITEM #	CTN/CASE	CASE WT
FIP			1000 CWP/150 WSP
1/4"	H-43720	2/80	43
3/8"	H-43721	2/80	39
1/2"	H-43722	2/60	45
3/4"	H-43723	2/40	45
1"	H-43724	2/40	68
1 1/4"	H-43725	2/30	80
1 1/2"	H-43726	2/16	64
2"	H-43727	2/10	52

W/ 304 STAINLESS STEEL OVAL HANDLE

1/2"	H-43722-0H	1/40	35
3/4"	H-43723-0H	1/30	37
1"	H-43724-0H	1/20	37

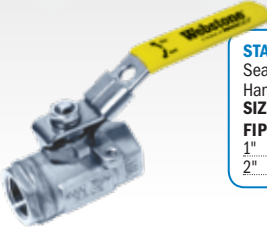

STANDARD PORT 316 STAINLESS STEEL BALL VALVE
Seal Welded w/ 304 Stainless Steel Locking Handle & Adjustable Packing Gland

SIZE	ITEM #	CTN/CASE	CASE WT
FIP			2000 CWP
1"	H-43814	9/27	50
2"	H-43817	2/8	46



STANDARD PORT 316 STAINLESS STEEL BALL VALVE
1 Piece Investment Cast w/ 304 Stainless Steel Locking Handle & Adjustable Packing Gland

SIZE	ITEM #	CTN/CASE	CASE WT
FIP			1000 CWP/150 WSP
1/4"	H-43900	4/200	31
3/8"	H-43901	4/200	45
1/2"	H-43902	2/100	38
3/4"	H-43903	2/80	47
1"	H-43904	2/50	47
1 1/4"	H-43905	2/40	50
1 1/2"	H-43906	2/30	59
2"	H-43907	2/30	87



GAS BALL VALVES



FORGED BRASS GAS BALL VALVE

STANDARD BRASS			
SIZE	ITEM #	CTN/CASE	CASE WT
FIP			UP TO 5 PSI
3/8"	H-22561	12/144	33
1/2"	H-22562	12/144	49
3/4"	H-22563	12/144	64
1"	H-22564	6/72	58
Flare x FIP			UP TO 5 PSI
1/2"	H-22522	10/120	43
5/8" x 3/4"	H-21526	6/96	59
Flare			UP TO 5 PSI
3/8"	H-21550	12/144	43
1/2"	H-21551	12/144	49
Flare x MIP			UP TO 5 PSI
3/8" x 1/2"	H-21571	12/144	51
1/2"	H-21572	12/144	43



FULL PORT 316 STAINLESS STEEL BALL VALVE
3 Piece Investment Cast w/ 304 Stainless Steel Locking Handle & Adjustable Packing Gland

SIZE	ITEM #	CTN/CASE	CASE WT
FIP			1000 CWP/150 WSP
1/2"	H-43702	2/50	65
3/4"	H-43703	2/40	76
1"	H-43704	2/30	74
1 1/4"	H-43705	2/16	60
1 1/2"	H-43706	2/10	48
2"	H-43707	2/8	61

GATE VALVES

MINI BALL VALVES



CHROME PLATED EXTRUDED BRASS MINI BALL VALVE
Hex Body

STANDARD BRASS			
SIZE	ITEM #	CTN/CASE	CASE WT
MIP x FIP			110 CWP NON SHOCK
3/8"	H-40792	50/300	46
1/2"	H-40798	30/300	73
FIP			110 CWP NON SHOCK
1/8"	H-40793	12/144	24
1/4"	H-40794	50/400	61
3/8"	H-40795	50/300	52
1/2"	H-40796	5/500	121
ASTM F1807 PEX			110 CWP NON-SHOCK
1/2"	H-40782	12/144	30

FORGED BRASS GATE VALVE
Hard Seat

STANDARD BRASS			
SIZE	ITEM #	CTN/CASE	CASE WT
FIP			200 CWP/125 WSP
2"	H-10137	2/20	58
2 1/2"	H-10138	1/10	49
3"	H-10139	1/10	74
4"	H-10140	1/4	50

CERTIFICATION APPLIES TO 2" ONLY

LEAD-FREE BRASS			
SIZE	ITEM #	CTN/CASE	CASE WT
FIP			200 CWP/125 WSP
1/2"	H-10132W	10/100	50
3/4"	H-10133W	10/100	71
1"	H-10134W	5/50	48
1 1/4"	H-10135W	5/30	52
1 1/2"	H-10136W	2/30	63
2"	H-10137W	2/20	58
2 1/2"	H-10138W	1/10	50
3"	H-10139W	1/10	73
4"	H-10140W	1/4	49

Certified to NSF/ANSI 61-G

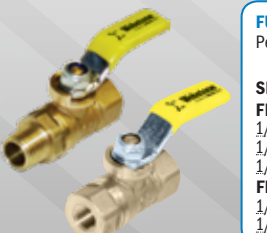

FULL PORT FORGED BRASS BALL VALVE
Pet Cock Style

STANDARD BRASS			
SIZE	ITEM #	CTN/CASE	CASE WT
FIP x MIP			600 CWP/125 WSP
1/8"	H-41685	10/100	19
1/4" x 1/8"	H-41686	10/100	10
1/4"	H-41687	10/100	18
FIP			600 CWP/125 WSP
1/8"	H-41698	10/100	18
1/4"	H-41699	10/100	17



HEAVY PATTERN BRONZE GATE VALVE
Hard Seat

SIZE	ITEM #	CTN/CASE	CASE WT
FIP			300 CWP/150 WSP
1/2"	H-10102	10/100	64
3/4"	H-10103	6/60	56
1"	H-10104	5/40	55
1 1/4"	H-10105	5/30	57
1 1/2"	H-10106	4/24	59
2"	H-10107	4/16	61
3"	H-10109	1/6	57
4"	H-10110	1/4	70

RADIATOR VALVES



BRASS RADIATOR GATE VALVE

w/ Ground Joint Union Nut & Tailpiece

SIZE	ITEM #	STANDARD BRASS CTN/CASE	CASE WT
FIP			125 PSI/15 WSP
3/4"	H-11523	6/60	73
1"	H-11524	4/36	67
1 1/4"	H-11525	2/24	59
1 1/2"	H-11526	3/18	68

BRASS STEAM RADIATOR GLOBE VALVE

Angled w/ Ground Joint Nut & Tailpiece

SIZE	ITEM #	STANDARD BRASS CTN/CASE	CASE WT
FIP			60 PSI/15 WSP
3/4"	H-11533	6/48	55
1"	H-11534	4/36	54
1 1/4"	H-11535	2/24	50
1 1/2"	H-11536	2/16	49

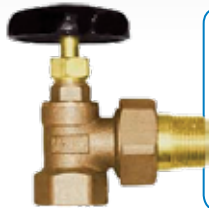

BRASS HOT WATER RADIATOR GLOBE VALVE

Angled w/ Ground Joint Union Nut & Tailpiece

SIZE	ITEM #	STANDARD BRASS CTN/CASE	CASE WT
FIP			60 PSI
3/4"	H-11553	6/60	51
1"	H-11554	4/36	49
1 1/4"	H-11555	2/24	51
1 1/2"	H-11556	2/16	40

BRASS UNION ELBOW & NUT FOR RADIATOR VALVE

Ground Joint Union Connection

SIZE	ITEM #	STANDARD BRASS CTN/CASE	CASE WT
FIP x MIP			60 PSI/15 WSP
3/4"	H-11533-E	10/100	58
1"	H-11534-E	7/70	65
1 1/4"	H-11535-E	5/50	71



BRASS UNION TAILPIECE & NUT FOR RADIATOR VALVE

Ground Joint Nut & Tailpiece

SIZE	ITEM #	STANDARD BRASS CTN/CASE	CASE WT
FIP x MIP			60 PSI/15 WSP
3/4"	H-11533-T	22/220	69
1"	H-11534-T	16/160	71
1 1/4"	H-11535-T	10/100	67



BRASS TANK VALVE (GLOBE)

Hard Seat

SIZE	ITEM #	STANDARD BRASS CTN/CASE	CASE WT
MIP			125 PSI
1/2" x 3/8"	H-11401	6/72	58
MIP x Flare			125 PSI
1/2" x 3/8"	H-11403	6/72	63



GLOBE VALVES



BRASS GLOBE VALVE

Straight - Hard Seat

SIZE	ITEM #	STANDARD BRASS CTN/CASE	CASE WT
FIP			200 CWP/125 WSP
1/4"	H-10400	10/120	59
3/8"	H-10401	10/120	61
1/2"	H-10402	10/120	65
3/4"	H-10403	10/80	59
1"	H-10404	5/40	45
1 1/4"	H-10405	5/30	49
1 1/2"	H-10406	4/24	54
2"	H-10407	2/16	57

BRASS STOP VALVE (GLOBE)

Straight - Soft Seat

SIZE	ITEM #	STANDARD BRASS CTN/CASE	CASE WT
FIP			125 CWP
1/2"	H-11802	12/72	38
3/4"	H-11803	12/72	41
1"	H-11804	5/40	43
1 1/4"	H-11805	5/30	49
1 1/2"	H-11806	4/24	60
2"	H-11807	2/16	61



BRASS BALANCING VALVE

w/ Butterfly Action & Screwdriver Slot

SIZE	ITEM #	STANDARD BRASS CTN/CASE	CASE WT
SWT			125 PSI
3/4"	H-20103	12/72	33

BRASS PURGE & BALANCING VALVE

w/ Butterfly Action & Screwdriver Slot

SIZE	ITEM #	STANDARD BRASS CTN/CASE	CASE WT
SWT x SWT x Hose			125 PSI
3/4"	H-11603	12/72	43



BRASS STEAM RADIATOR AIR VENT VALVE

Chrome Plated Float Type - Non Vacuum

SIZE	ITEM #	STANDARD BRASS CTN/CASE	CASE WT
ANGLED			
MIP			10 PSI
1/8"	H-11511	12/72	10
STRAIGHT			
MIP			10 PSI
1/8"	H-11512	12/72	10
1/4"	H-11513	12/72	13
ADJUSTABLE ANGLE			
MIP			10 PSI
1/8"	H-11515-A	12/72	10

FORGED BRASS AUTO STEAM VENT VALVE

Stainless Steel Check Ball & Spring

SIZE	ITEM #	STANDARD BRASS CTN/CASE	CASE WT
FIP			125 PSI
1/81/4"	H-11517	50/500	67



RADIATOR VALVE SPUD WRENCH

SIZE	ITEM #	CTN/CASE	CASE WT
1/2 to 2"	H-25011	10/20	49



BOILER DRAINS

BRASS BOILER DRAIN

SIZE	ITEM #	LEAD-FREE BRASS CTN/CASE	CASE WT
MIP x Hose			200 PSI
1/2"	H-11702W	12/72	28
3/4"	H-11703W	12/72	31



BRASS BOILER DRAIN

w/ Stuffing Box

SIZE	ITEM #	STANDARD BRASS CTN/CASE	CASE WT
FIP x Hose			200 PSI
3/4"	H-11712	12/72	36
LEAD-FREE BRASS			
SIZE	ITEM #	CTN/CASE	CASE WT
MIP x Hose (Hi-Flow)			200 PSI
1/2"	H-11700W	12/72	36
3/4"	H-11701W	12/72	38
MIP x Hose			200 PSI
1/2"	H-11704W	12/72	33
3/4"	H-11705W	12/72	33



BRASS WATER HEATER DRAIN VALVE

SIZE	ITEM #	LEAD-FREE BRASS CTN/CASE	CASE WT
MIP x Hose			125 PSI
3/4"	H-11710W	12/72	42



BRASS WATER HEATER DRAIN VALVE

w/ Recirculating Elbow (Tan Handle)

SIZE	ITEM #	LEAD-FREE BRASS CTN/CASE	CASE WT
FIP x FIP x Hose			125 PSI
3/4"	H-11711W	12/72	47



INDEX

PART NUMBER	PAGE	PART NUMBER	PAGE	PART NUMBER	PAGE	PART NUMBER	PAGE
H-4CC4-NBHK	14	H-10563	15	H-22563-24	5	H-26400W-B	31
H-4CC4-NBHK-E3	14	H-10564	15	H-22563-24-ADPT	5	H-26401W-B	31
H-4FK4R3-WIF-E3	14	H-10565	15	H-22564	34	H-26402W	31
H-4FK4-WIF	14	H-10566	15	H-25011	36	H-26402W-B	31
H-4FK5-CB	14	H-10567	15	H-26000WKIT	31	H-26403W	31
H-4FK5-CH	14	H-10622W	35	H-26023W-12-B	30	H-26403W-B	31
H-4FK5-RE	14	H-10623W	35	H-26023W-15-B	30	H-26404W	31
H-5CC4-NBHK	14	H-10624W	35	H-26023W-18	30	H-26404W-B	31
H-5CC4-NBHK-E3	14	H-10625W	35	H-26023W-18-B	30	H-26405W-B	31
H-5FK4R3-WIF-E3	14	H-10626W	35	H-26023W-24-B	30	H-26406W-B	31
H-5FK4-WIF	14	H-10627W	35	H-26033W-12	30	H-26407W-B	31
H-5FK5-CB	14	H-10701W	35	H-26033W-12-B	30	H-26412W	31
H-5FK5-CH	14	H-10702W	35	H-26033W-15	30	H-26412W-B	31
H-7-G134WY	9, 17	H-10703W	35	H-26033W-15-B	30	H-26412WHE-B	31
H-7-G234WB	9	H-10704W	35	H-26033W-18	30	H-26413W-B	31
H-7-G234W-KITA	9	H-10705W	35	H-26033W-18-B	30	H-26421W-B	31
H-7-G234W-KITB	9	H-10706W	35	H-26033W-24	30	H-26422W	31
H-7-G234WR	9	H-10707W	35	H-26033W-24-B	30	H-26422W-B	31
H-8CC4-NBHK	14	H-11401	36	H-26100W-B	31	H-26432W	31
H-8CC4-NBHK-E3	14	H-11403	36	H-26101W	31	H-26432W-B	31
H-8FK4R3-WIF-E3	14	H-11403W	20, 25	H-26101W-B	31	H-26443W-B	31
H-8FK4-WIF	14	H-11403WHV	20, 25	H-26102W	31	H-26462W	31
H-8FK5-CB	14	H-11404W	20, 25	H-26102W-B	31	H-26462W-B	31
H-8FK5-CH	14	H-11404WHV	20, 25	H-26103W	31	H-26500W-B	31
H-01102W	35	H-11413W	20, 25	H-26103W-B	31	H-26501W-B	31
H-01103W	35	H-11413WHV	20, 25	H-26104W	31	H-26502W	31
H-01104W	35	H-11414W	20, 25	H-26104W-B	31	H-26502W-B	31
H-01105W	35	H-11414WHV	20, 25	H-26105W-B	31	H-26503W	31
H-01106W	35	H-11511	36	H-26106W-B	31	H-26503W-B	31
H-01107W	35	H-11512	36	H-26107W-B	31	H-26504W	31
H-01132W	35	H-11513	36	H-26112W	31	H-26504W-B	31
H-10102	34	H-11515-A	36	H-26112W-B	31	H-26505W-B	31
H-10103	34	H-11517	36	H-26120W-B	31	H-26506W-B	31
H-10104	34	H-11523	36	H-26122W	31	H-26507W-B	31
H-10105	34	H-11524	36	H-26122W-B	31	H-26512W-B	31
H-10106	34	H-11525	36	H-26132W	31	H-26520W-B	31
H-10107	34	H-11526	36	H-26132W-B	31	H-26521W-B	31
H-10109	34	H-11533	36	H-26133W	31	H-26522W	31
H-10110	34	H-11533-E	36	H-26133W-B	31	H-26522W-B	31
H-10132W	34	H-11533-T	36	H-26143W	31	H-26532W	31
H-10133W	34	H-11534	36	H-26143W-B	31	H-26532W-B	31
H-10134W	34	H-11534-E	36	H-26144W	31	H-26533W	31
H-10135W	34	H-11534-T	36	H-26144W-B	31	H-26533W-B	31
H-10136W	34	H-11535	36	H-26154W-B	31	H-26543W	31
H-10137	34	H-11535-E	36	H-26165W-B	31	H-26543W-B	31
H-10137W	34	H-11535-T	36	H-26176W-B	31	H-26601W-B	31
H-10138	34	H-11536	36	H-26192W-B	31	H-26602W	31
H-10138W	34	H-11553	36	H-26193W-B	31	H-26602W-B	31
H-10139	34	H-11554	36	H-26202W	31	H-26603W	31
H-10139W	34	H-11555	36	H-26202W-B	31	H-26603W-B	31
H-10140	34	H-11556	36	H-26203W	31	H-26604W	31
H-10140W	34	H-11603	36	H-26203W-B	31	H-26604W-B	31
H-10400	36	H-11700W	36	H-26203WKIT	30	H-26605W-B	31
H-10401	36	H-11701W	36	H-26203WKIT-B	30	H-26606W-B	31
H-10402	36	H-11702W	36	H-26204W	31	H-26607W-B	31
H-10403	36	H-11703W	36	H-26204W-B	31	H-26702W	31
H-10404	36	H-11704W	36	H-26205W-B	31	H-26702W-B	31
H-10405	36	H-11705W	36	H-26206W-B	31	H-26703W	31
H-10406	36	H-11710W	36	H-26207W-B	31	H-26703W-B	31
H-10407	36	H-11711W	36	H-26212W-B	31	H-26722W	31
H-10501	35	H-11712	36	H-26220W-B	31	H-26722W-B	31
H-10502	35	H-11802	36	H-26222W	31	H-26733W	31
H-10503	35	H-11803	36	H-26222W-B	31	H-26733W-B	31
H-10504	35	H-11804	36	H-26223W	31	H-26752W-B	31
H-10505	35	H-11805	36	H-26223W-B	31	H-26820W	30
H-10506	35	H-11806	36	H-26223WKIT	30	H-26820W-B	30
H-10507	35	H-11807	36	H-26223WKIT-B	30	H-26821W	30
H-10508	35	H-11850W	35	H-26232W-B	31	H-26821W-B	30
H-10509	35	H-11850W-CP	35	H-26233W-B	31	H-26920W	30
H-10510	35	H-13703HV	21	H-26234W-B	31	H-26920W-B	30
H-10522	35	H-13706HV	21	H-26302W	31	H-26920WKIT-B	30
H-10523	35	H-14443W	4, 25	H-26302W-B	31	H-26921W	30
H-10524	35	H-14443WPR	4, 25	H-26303W	31	H-26921W-B	30
H-10525	35	H-20103	36	H-26303W-B	31	H-26921WKIT-B	30
H-10526	35	H-20713	5	H-26304W	31	H-26930WKIT-B	30
H-10527	35	H-20713W	5	H-26304W-B	31	H-26992W-B	30, 35
H-10540W	35	H-20723-CN	5	H-26305W-B	31	H-26993W	30, 35
H-10541W	35	H-20733	5	H-26306W-B	31	H-26993W-B	30, 35
H-10542W	35	H-21526	34	H-26307W-B	31	H-26994W-B	30, 35
H-10543W	35	H-21550	34	H-26312W-B	31	H-28000-B	30
H-10544W	35	H-21551	34	H-26320W-B	31	H-28023W	5
H-10545W	35	H-21571	34	H-26323W	31	H-28110-B	30
H-10546W	35	H-21572	34	H-26323W-B	31	H-28111-B	30
H-10547W	35	H-22522	34	H-26332W-B	31	H-28112	30
H-10548W	35	H-22561	34	H-26334W-B	31	H-28112-B	30
H-10549W	35	H-22562	34	H-26343W	31	H-28113	30
H-10550W	35	H-22563	34	H-26343W-B	31	H-28113-B	30

INDEX

PART NUMBER	PAGE	PART NUMBER	PAGE	PART NUMBER	PAGE	PART NUMBER	PAGE
H-28114	30	H-40615W	18	H-41700	32	H-43720	34
H-28114-B	30	H-40616	18	H-41700W	32	H-43721	34
H-28115-B	30	H-40616W	18	H-41701	32	H-43722	34
H-28116-B	30	H-40617	18	H-41701W	32	H-43722-OH	34
H-28117-B	30	H-40617W	18	H-41702	32	H-43723	34
H-28212	30	H-40622W	33	H-41702SSL	32	H-43723-OH	34
H-28212-B	30	H-40623W	33	H-41702SSW	32	H-43724	34
H-28213	30	H-40624W	33	H-41702T	32	H-43724-OH	34
H-28213-B	30	H-40632W	33	H-41702W	32	H-43725	34
H-28214	30	H-40633W	33	H-41702WSSL	32	H-43726	34
H-28214-B	30	H-40634W	33	H-41702WSSW	32	H-43727	34
H-28215-B	30	H-40642	33	H-41702WT	32	H-43814	34
H-28216-B	30	H-40643	33	H-41703	32	H-43817	34
H-28217-B	30	H-40644	33	H-41703SSL	32	H-43900	34
H-30000W-P	5	H-40782	25, 34	H-41703SSW	32	H-43901	34
H-30000W-TP	5	H-40792	34	H-41703T	32	H-43902	34
H-30202W	35	H-40793	34	H-41703T-24	5	H-43903	34
H-30203W	35	H-40794	34	H-41703T-24-ADPT	5	H-43904	34
H-30218W	35	H-40795	34	H-41703W	32	H-43905	34
H-30219W	35	H-40796	34	H-41703WSSL	32	H-43906	34
H-30314W	35	H-40798	34	H-41703WSSW	32	H-43907	34
H-30316W	35	H-40800W	33	H-41703WT	32	H-44443W	4
H-31000	15	H-40801W	33	H-41704	32	H-44443WCOM	5
H-31403W	20, 24	H-40802W	33	H-41704SSL	32	H-44443WCOM-FP	5
H-31403WHV	20, 24	H-40803W	33	H-41704SSW	32	H-44443WPR	4
H-31404W	20, 24	H-40804W	33	H-41704T	32	H-44443WPR-LF	4
H-31404WHV	20, 24	H-40805W	33	H-41704W	32	H-44444	15
H-31413W	20, 24	H-40806W	33	H-41704WSSL	32	H-44444PR3	15
H-31413WHV	20, 24	H-40807W	33	H-41704WSSW	32	H-44444W	4, 15
H-31414W	20, 24	H-41403	20	H-41704WT	32	H-44444WPR	4
H-31414WHV	20, 24	H-41403HV	20	H-41705	32	H-44444WPR3	15
H-31702WSSW	24, 32	H-41403W	20	H-41705SSL	32	H-44444WPR-LF	4
H-31703WSSW	24, 32	H-41403WHV	20	H-41705W	32	H-44672	19
H-31704WSSW	24, 32	H-41404	20	H-41705WSSL	32	H-45443WPR	4
H-32000W	9, 17	H-41404HV	20	H-41706	32	H-45443WPR-LF	4
H-33202WSSL	24, 35	H-41404W	20	H-41706SSL	32	H-45443WPR-LH	4
H-34443W	4, 24	H-41404WHV	20	H-41706W	32	H-48354-43	13
H-34443WPR	4, 24	H-41405	20	H-41706WSSL	32	H-48354-44	13
H-34702WSSW	24, 33	H-41405HV	20	H-41707	32	H-48613	19
H-34703WSSW	24, 33	H-41405W	20	H-41707SSL	32	H-48614	19
H-34704WSSW	24, 33	H-41405WHV	20	H-41707W	32	H-48615	19
H-40312W	33	H-41406	20	H-41707WSSL	32	H-48616	19
H-40313W	33	H-41406HV	20	H-41708	32	H-48754-43	13
H-40402	21	H-41406HV-RF375	22	H-41708W	32	H-48754-44	13
H-40403	21	H-41406W	20	H-41709	32	H-48765-45	13
H-40404	21	H-41406WHV	20	H-41709W	32	H-48854-43	13
H-40404HV	21	H-41407HV-RF400	22	H-41710	32	H-48854-44	13
H-40405	21	H-41407HV-RF475	22	H-41710W	32	H-48865-45	13
H-40405HV	21	H-41407WHV	20	H-41722	33	H-50312W	33
H-40406	21	H-41413	20	H-41723	33	H-50313W	33
H-40406HV	21	H-41413HV	20	H-41724	33	H-50402	21
H-40407HV	21	H-41413HVKIT	21	H-41725	33	H-50403	21
H-40413	21	H-41413KIT	21	H-41726	33	H-50404	21
H-40413KIT	21	H-41413W	20	H-41727	33	H-50404HV	21
H-40414	21	H-41413WHV	20	H-41820	33	H-50405	21
H-40414HV	21	H-41413WHVKIT	21	H-41820W	33	H-50405HV	21
H-40414HVKIT	21	H-41413WKIT	21	H-41821	33	H-50406	21
H-40414KIT	21	H-41414	20	H-41821W	33	H-50406HV	21
H-40415	21	H-41414HV	20	H-41822	33	H-50407HV	21
H-40415HV	21	H-41414HVKIT	21	H-41822W	33	H-50413	21
H-40415HVKIT	21	H-41414KIT	21	H-41823	33	H-50413KIT	21
H-40415KIT	21	H-41414W	20	H-41823W	33	H-50414	21
H-40416	21	H-41414WHV	20	H-41824	33	H-50414HV	21
H-40416HV	21	H-41414WHVKIT	21	H-41824W	33	H-50414HVKIT	21
H-40417HV	21	H-41414WKIT	21	H-41825	33	H-50414KIT	21
H-40433	18	H-41415	20	H-41825W	33	H-50415	21
H-40433W	18	H-41415HV	20	H-41826	33	H-50415HV	21
H-40434	18	H-41415HVKIT	21	H-41826W	33	H-50415HVKIT	21
H-40434W	18	H-41415KIT	21	H-41827	33	H-50415KIT	21
H-40435	18	H-41415W	20	H-41827W	33	H-50416	21
H-40435W	18	H-41415WHV	20	H-41828	33	H-50416HV	21
H-40436	18	H-41415WHVKIT	21	H-41828W	33	H-50417HV	21
H-40436W	18	H-41415WKIT	21	H-41829	33	H-50433	18
H-40443W	4	H-41416	20	H-41829W	33	H-50433W	18
H-40443WPR	4	H-41416HV	20	H-41830	33	H-50434	18
H-40530W	33	H-41416HV-RF375	22	H-41830W	33	H-50434W	18
H-40531W	33	H-41416W	20	H-43702	34	H-50435	18
H-40532W	33	H-41416WHV	20	H-43703	34	H-50435W	18
H-40533W	33	H-41417HV-RF400	22	H-43704	34	H-50436	18
H-40534W	33	H-41417HV-RF475	22	H-43705	34	H-50436W	18
H-40612	18	H-41417WHV	20	H-43706	34	H-50443W	4
H-40612W	18	H-41672	19	H-43707	34	H-50443WPR	4
H-40613	18	H-41685	34	H-43710	34	H-50612	18
H-40613W	18	H-41686	34	H-43712	34	H-50612W	18
H-40614	18	H-41687	34	H-43713	34	H-50613	18
H-40614W	18	H-41698	34	H-43714	34	H-50613W	18
H-40615	18	H-41699	34	H-43717	34	H-50614	18

INDEX

PART NUMBER	PAGE	PART NUMBER	PAGE	PART NUMBER	PAGE	PART NUMBER	PAGE
H-50614W	18	H-51704	32	H-72203W-CAN	8	H-80613	18, 27
H-50615	18	H-51704SSL	32	H-72204W	8	H-80613W	18, 27
H-50615W	18	H-51704SSW	32	H-72204W-CAN	8	H-80614	18, 27
H-50616	18	H-51704T	32	H-72272W	8	H-80614W	18, 27
H-50616W	18	H-51704W	32	H-72273W	8	H-80615	18, 27
H-50617	18	H-51704WSSL	32	H-72274W	8	H-80615W	18, 27
H-50617W	18	H-51704WSSW	32	H-73202W-CE	8, 24	H-80616W	18, 27
H-50622W	33	H-51704WT	32	H-73202W-CE-CAN	8, 24	H-80617W	18, 27
H-50623W	33	H-51705	32	H-73203W-CE	8, 24	H-80672W	19, 27
H-50624W	33	H-51705SSL	32	H-73203W-CE-CAN	8, 24	H-80673W	19, 27
H-50672W	19	H-51705W	32	H-73272W	8, 24	H-80674W	19, 27
H-50673W	19	H-51705WSSL	32	H-73273W	8, 24	H-80675W	19, 27
H-50674W	19	H-51706	32	H-74000	16	H-81403	20
H-50675W	19	H-51706SSL	32	H-74003	17	H-81403HV	20, 26
H-50676W	19	H-51706W	32	H-74003-V	16	H-81403W	20
H-50677W	19	H-51706WSSL	32	H-74004	17	H-81403WHV	20
H-50682	25, 33	H-51707	32	H-74004-V	16	H-81404	20
H-51403	20	H-51707SSL	32	H-74005	17	H-81404HV	20, 26
H-51403HV	20	H-51707W	32	H-74006	17	H-81404W	20
H-51403W	20	H-51707WSSL	32	H-74007	17	H-81404WHV	20
H-51403WHV	20	H-51708	32	H-74202W	8	H-81405	20
H-51404	20	H-51708W	32	H-74203W	8	H-81405HV	20, 26
H-51404HV	20	H-51709	32	H-74203W-CAN	8	H-81405W	20
H-51404W	20	H-51709W	32	H-74204W	8	H-81405WHV	20
H-51404WHV	20	H-51710	32	H-74204W-CAN	8	H-81406	20
H-51405	20	H-51710W	32	H-74272W	8	H-81406HV	20, 26
H-51405HV	20	H-54443W	4, 15	H-74273W	8	H-81406HV-RF375	22, 26
H-51405W	20	H-54443WCOM	5	H-74274W	8	H-81406W	20
H-51405WHV	20	H-54443WCOM-FP	5	H-74303W	10	H-81406WHV	20
H-51406	20	H-54443WPR	4	H-74303W-KITA	10	H-81407HV	20, 26
H-51406HV	20	H-54443WPR-LF	4	H-74303W-KITB	10	H-81407HV-RF400	22, 26
H-51406HV-RF375	22	H-54444W	4	H-74313W	10	H-81407HV-RF475	22, 26
H-51406W	20	H-54444WPR	4	H-74313W-KITA	10	H-81407WHV	20
H-51406WHV	20	H-54444WPR3	15	H-74313W-KITB	10	H-81413	20
H-51407HV-RF400	22	H-54444WPR-LF	4	H-74401W	8	H-81413HV	20, 26
H-51407HV-RF475	22	H-54612	18	H-75003	17	H-81413W	20
H-51407WHV	20	H-54612W	18	H-75003-V	16	H-81413WHV	20
H-51413	20	H-54613	18	H-75004	17	H-81414	20
H-51413HV	20	H-54613W	18	H-75004-V	16	H-81414HV	20, 26
H-51413HVKIT	21	H-54614	18	H-75005	17	H-81414W	20
H-51413KIT	21	H-54614W	18	H-75006	17	H-81414WHV	20
H-51413W	20	H-55443WPR	4	H-75007	17	H-81415	20
H-51413WHV	20	H-55443WPR-LF	4	H-75202W	8	H-81415HV	20, 26
H-51413WHVKIT	21	H-55443WPR-LH	4	H-75202W-CAN	8	H-81415W	20
H-51413WKIT	21	H-58354-53	13	H-75203W	8	H-81415WHV	20
H-51414	20	H-58354-54	13	H-75203W-CAN	8	H-81416	20
H-51414HV	20	H-58613	19	H-75204W	8	H-81416HV	20, 26
H-51414HVKIT	21	H-58614	19	H-75204W-CAN	8	H-81416HV-RF375	22, 26
H-51414KIT	21	H-58615	19	H-75272W	8	H-81416W	20
H-51414W	20	H-58616	19	H-75273W	8	H-81416WHV	20
H-51414WHV	20	H-58643	19	H-75274W	8	H-81417HV	20, 26
H-51414WHVKIT	21	H-58644	19	H-76202W	8	H-81417HV-RF400	22, 26
H-51414WKIT	21	H-58653	19	H-76202W-CAN	8	H-81417HV-RF475	22, 26
H-51415	20	H-58654	19	H-76203W	8	H-81417WHV	20
H-51415HV	20	H-58655	19	H-76203W-CAN	8	H-81424HV	22, 26
H-51415HVKIT	21	H-58754-53	13	H-78003	17, 26	H-81612W	18, 25, 27
H-51415KIT	21	H-58754-54	13	H-78003-V	16, 26	H-81613W	18, 25, 27
H-51415W	20	H-58765-55	13	H-78004	17, 26	H-81614W	18, 25, 27
H-51415WHV	20	H-58776-56	13	H-78004-V	16, 26	H-81702	26, 32
H-51415WHVKIT	21	H-58854-53	13	H-78005	17, 26	H-81702W	26, 32
H-51415WKIT	21	H-58854-54	13	H-78006	17, 26	H-81703	26, 32
H-51416	20	H-58865-55	13	H-78007	17, 26	H-81703W	26, 32
H-51416HV	20	H-62023W-18	30	H-78202W	8, 27	H-81704	26, 32
H-51416HV-RF375	22	H-62023W-18-B	30	H-78202W-CAN	8, 27	H-81704W	26, 32
H-51416W	20	H-62033W-18	30	H-78203W	8, 27	H-81705	26, 32
H-51416WHV	20	H-62033W-18-B	30	H-78203W-CAN	8, 27	H-81705W	26, 32
H-51417HV-RF400	22	H-62702W	30, 32	H-78204W	8, 27	H-81706	26, 32
H-51417HV-RF475	22	H-62702W-B	30, 32	H-78204W-CAN	8, 27	H-81706W	26, 32
H-51417WHV	20	H-62703W	30, 32	H-78272W	8, 27	H-81707	26, 32
H-51702	32	H-62703W-B	30, 32	H-78273W	8, 27	H-81707W	26, 32
H-51702SSL	32	H-62704W	30, 32	H-78274W	8, 27	H-81708W	26, 32
H-51702SSW	32	H-62704W-B	30, 32	H-80132W	25, 26, 33	H-81709W	26, 32
H-51702T	32	H-64443W	4	H-80133W	25, 26, 33	H-81710W	26, 32
H-51702W	32	H-64443WPR	4	H-80134W	25, 26, 33	H-83612W	18, 24, 27
H-51702WSSL	32	H-71202W	8, 25	H-80312W	26, 33	H-83613W	18, 24, 27
H-51702WSSW	32	H-71202W-CAN	8, 25	H-80313W	26, 33	H-83614W	18, 24, 27
H-51702WT	32	H-71203W	8, 25	H-80332W	24, 26, 33	H-84443W	4, 15, 27
H-51703	32	H-71203W-CAN	8, 25	H-80333W	24, 26, 33	H-84443WPR	4, 27
H-51703SSL	32	H-71272W	8, 25	H-80334W	24, 26, 33	H-84443WPR-LF	4, 27
H-51703SSW	32	H-71273W	8, 25	H-80433W	18, 27	H-84444W	4, 27
H-51703T	32	H-72003-V	16	H-80434W	18, 27	H-84444WPR	4, 27
H-51703W	32	H-72004-V	16	H-80435W	18, 27	H-84444WPR3	15, 27
H-51703WSSL	32	H-72202W	8	H-80436W	18, 27	H-84444WPR-LF	4, 27
H-51703WSSW	32	H-72202W-CAN	8	H-80612	18, 27	H-84613	18, 27
H-51703WT	32	H-72203W	8	H-80612W	18, 27	H-84614	18, 27