

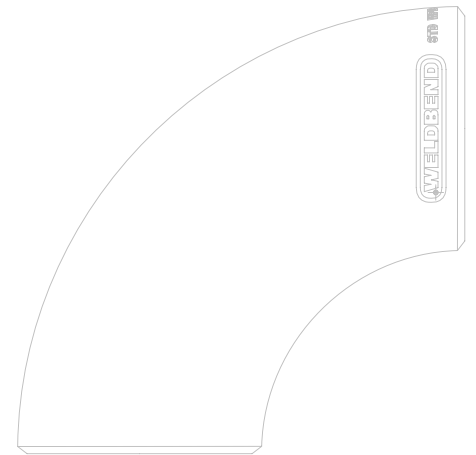

**Carbon Steel Weld Fitting & Weld Flange  
Products for Piping Construction**

**SIXTY-THIRD  
EDITION**

**Printed in U.S.A.**

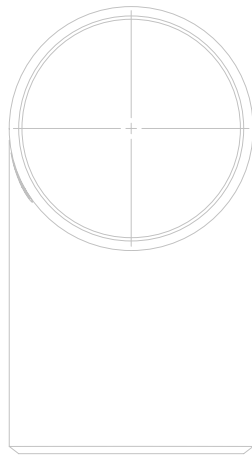
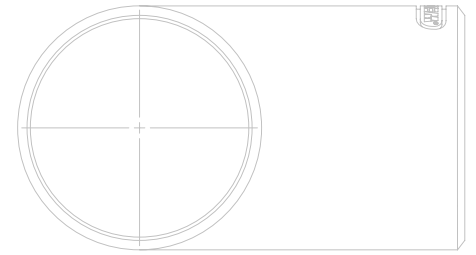
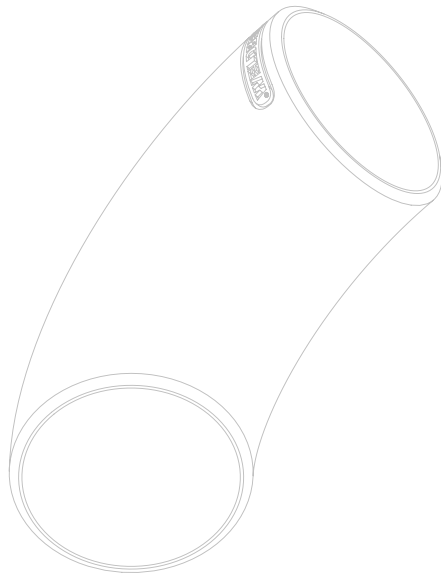

**WELDBEND CORPORATION**

6600 SOUTH HARLEM AVENUE, ARGO, IL 60501-1930

**SALES**

TEL: 708/594-1700

FAX: 708/458-0106

**GENERAL OFFICE**

TEL: 773/582-3500

FAX: 773/582-7621

**www.weldbend.com**

**info@weldbend.com**

**orders@weldbend.com**

**quotes@weldbend.com**

**customer.service@weldbend.com**



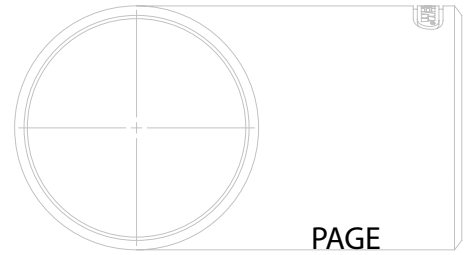

# TABLE OF CONTENTS

	PAGE
WELDBEND... TODAY.....	6
THE WELDBEND POLICY .....	21
ORDERING INFORMATION .....	22
TERMS AND CONDITIONS .....	23
FITTINGS .....	25
90° ELBOWS — <b>Long Radius</b> [Schedule: STD, XS, 40, 80, 160, XXS] .....	26
90° ELBOWS — <b>Short Radius</b> [Schedule: STD, XS, 40, 80, 160, XXS] .....	29
90° REDUCING ELBOWS — [Schedule: STD, XS, 40, 80] .....	32
90° ELBOWS — <b>3R</b> [Schedule: STD, XS, 40, 80] .....	36
45° ELBOWS — <b>Long Radius</b> [Schedule: STD, XS, 40, 80, 160, XXS] .....	38
45° ELBOWS — <b>3R</b> [Schedule: STD, XS, 40, 80] .....	41
180° RETURN BENDS — <b>Long Radius</b> [Schedule: STD, XS, 40, 80, 160, XXS] .....	43
180° RETURN BENDS — <b>Short Radius</b> [Schedule: STD, XS, 40, 80, 160, XXS] .....	46
STRAIGHT TEES — [Schedule: STD, XS, 40, 80, 160, XXS] .....	49
REDUCING TEES — [Schedule: STD, XS, 40, 80, 160, XXS] .....	52
CONCENTRIC AND ECCENTRIC REDUCERS — [Schedule: STD, XS, 40, 80, 160, XXS] .....	62
CAPS — [Schedule: STD, XS, 40, 80, 160, XXS] .....	76
LAP JOINT STUB ENDS — [Schedule: STD, XS, 40, 80, 160, XXS] .....	79
BOX QUANTITIES .....	82
FLANGES .....	84
CLASS 125 .....	85
CLASS 150 .....	86
CLASS 300 .....	88
CLASS 600 .....	90
CLASS 900 .....	92
CLASS 1500 .....	94
CLASS 2500 .....	96
REDUCING SLIP-ON AND THREADED FLANGES — ALL CLASSES .....	98
CALCULATED FLANGE WEIGHTS .....	99
FLANGE PACKAGING .....	105
TECHNICAL DATA INDEX .....	106
RING TYPE JOINT FACING DIMENSIONS .....	148

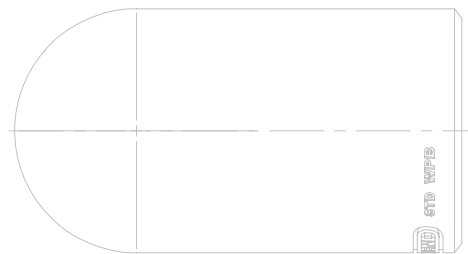
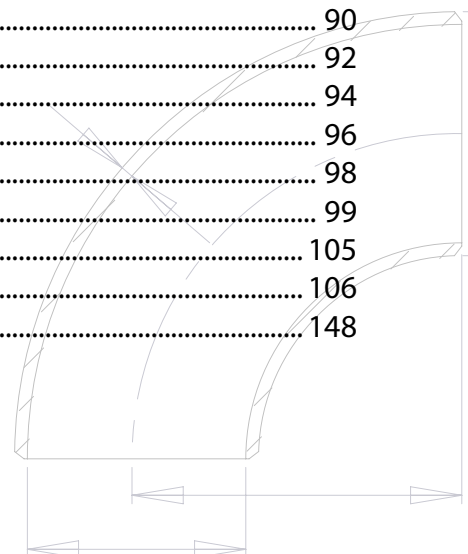
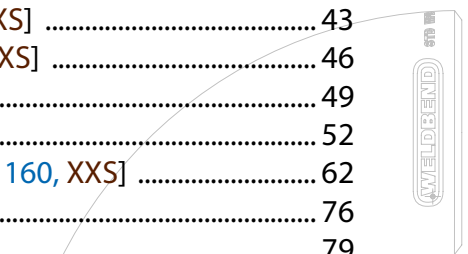

**WELDBEND**

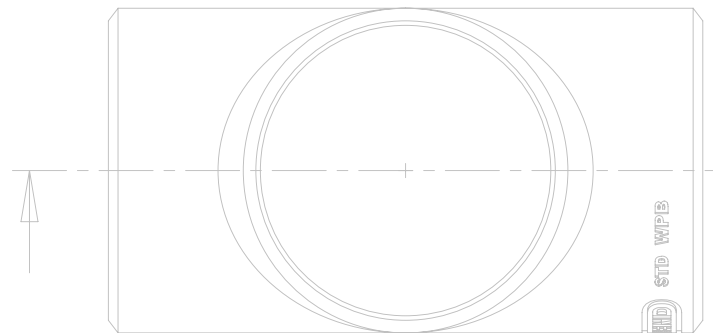
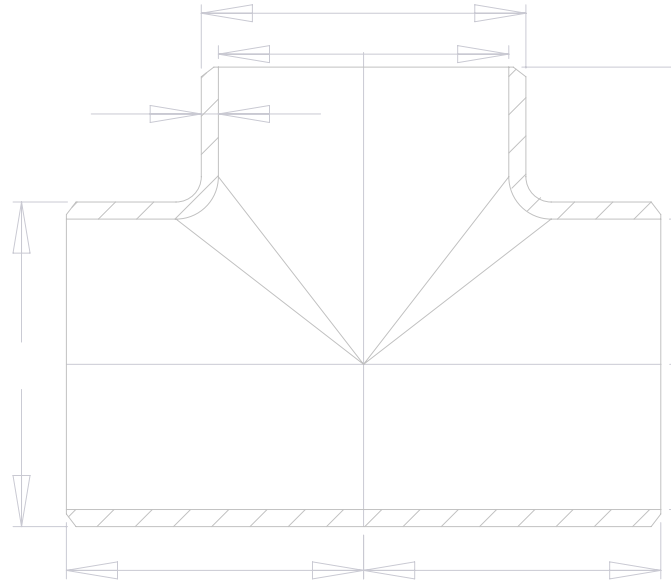
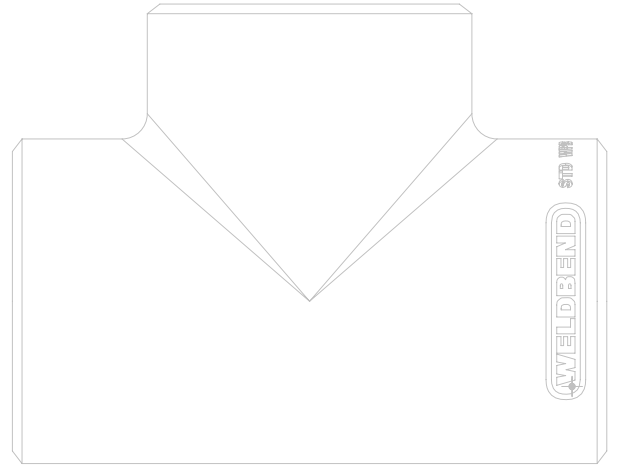
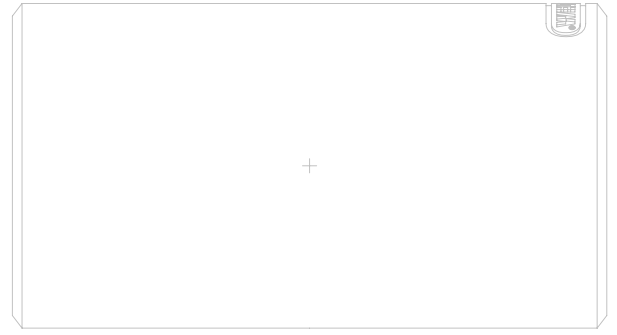
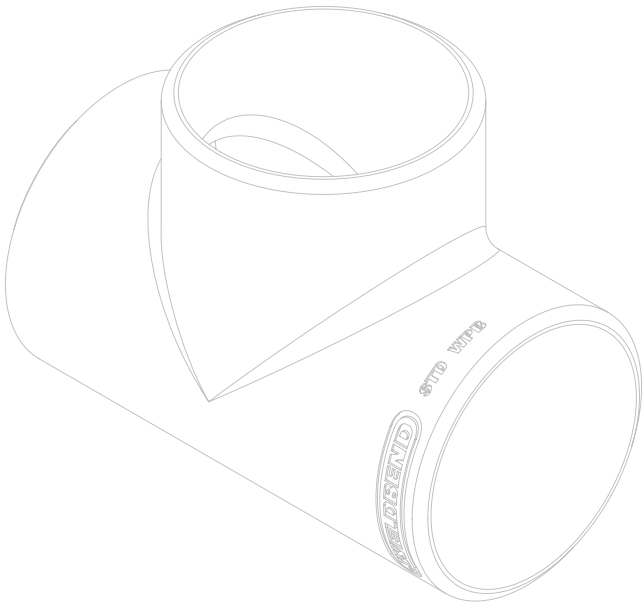
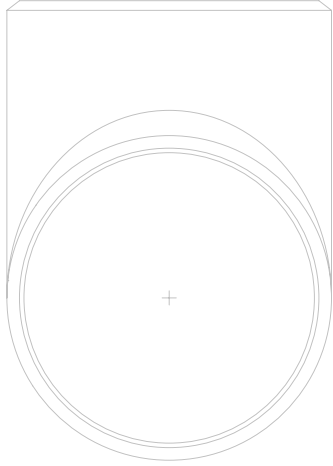
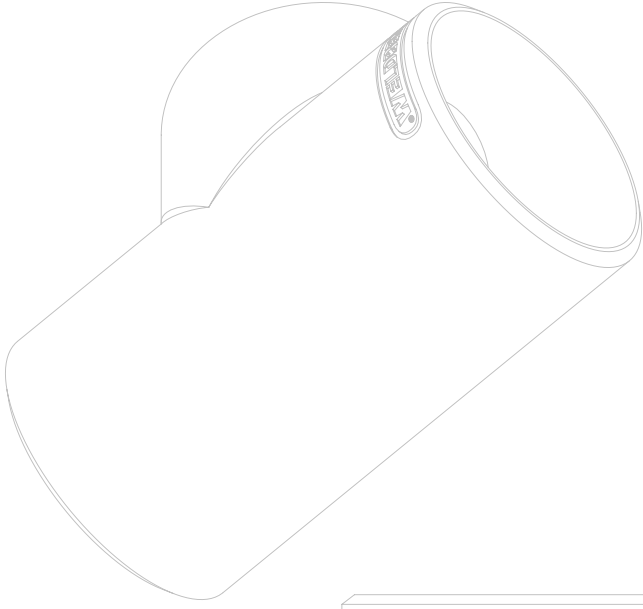

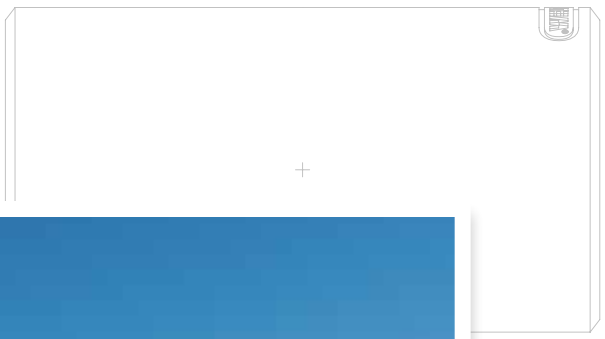

**WELDBEND CORPORATION**  
 880 SOUTH HARLEM AVENUE • ARGO, IL 60001-1950

Welcome to the World of Weldbend!

PHONE  
 773 - 882 - 2500  
 708 - 884 - 1700  
 FAX  
 773 - 882 - 3661  
 708 - 488 - 0194

For over 60 years, we've pioneered advanced techniques and designed equipment uniquely capable of producing only the finest carbon steel weld fittings and weld flange products.

As a family business, it is our pledge, and our mission, to deliver only a level of service and product that keeps you 100% satisfied.

Proud of being our industry pacesetter, we will not detour from the direction of complete customer satisfaction.

Weldbend Corporation

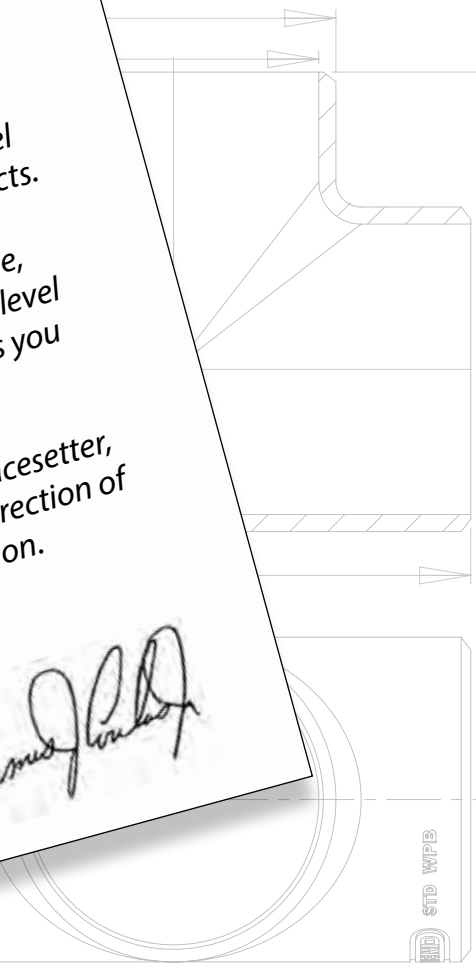
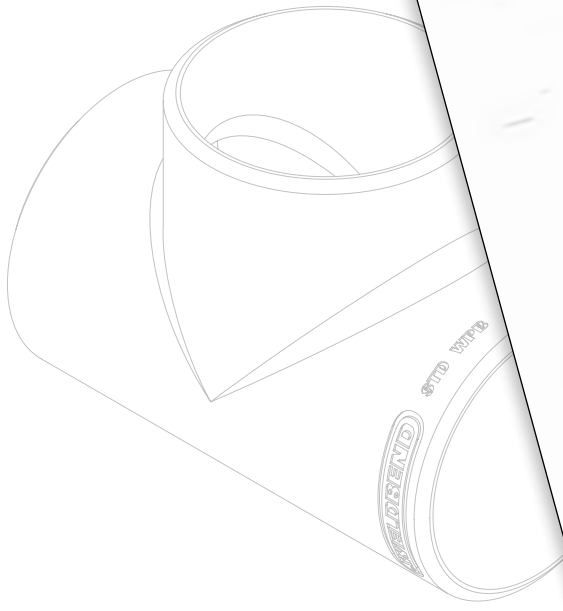



- Weldbend is the industry leader with over 60 years of performance-proven reputation.
- Over 330,000 sq. ft. of manufacturing and warehousing facilities on 36 acre site.
- A prime source producer of fittings and flanges from 1/2" through 60" sizes.
- Using "Hi-Tech" research to guarantee precision accuracy in machining and manufacturing.

- Trained personnel to guarantee prompt processing of your orders from office to the shipping dock.
- A total commitment to deliver on-spec, on-time... every time!

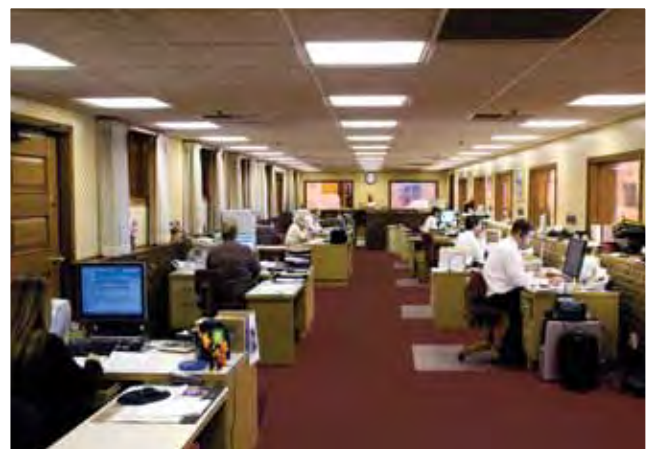

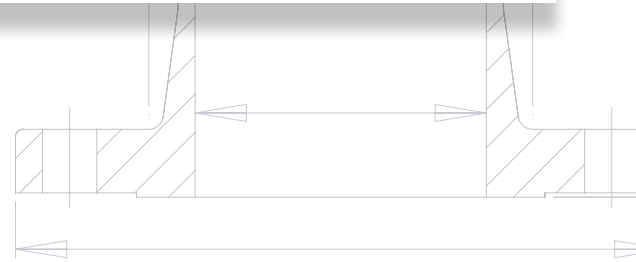
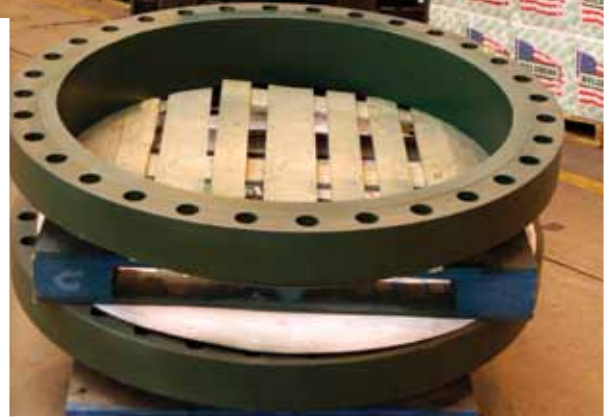

- From start to finish, Weldbend strives to be "The Standard" to which weld fittings and weld flanges are manufactured, stored, organized, and shipped. Weldbend manufactures stock for large inventories and prompt and precise shipments.



**Pictures talk.** Sounds from the scores of machines producing the highest quality weld fittings and weld flanges fills the air. The smell of the freshly painted material, the constant movement of forklifts carrying finished products, and each employee's dedication, can be clearly observed as you walk through our dynamic facilities.

Moving into our extensive warehouse, weld fittings and weld flanges are carefully arranged from floor to ceiling ready to be processed for immediate shipment to fill order requirements.

We're proud to share our company with you!



### 8" – 10" – 12" Elbow Press

To our knowledge, this is the only fully-automatic elbow machine in the world that makes either 8", 10", or 12" elbows. The blank is fed into the machine at one end and is automatically pushed to be heated to forging temperature. It is then pushed over the mandrel and, when finished, it is automatically dropped into a re-sizing die while still at forging temperature.

It is then automatically re-sized for perfect circularity. The re-sizing press opens automatically and a mechanical hand takes the red-hot forging from the die.

This huge machine requires only one operator, with additional help from a cutoff machine operator to load the blanks. This is a sight to behold!

### 14" – 24" Elbow Press

This state-of-the-art elbow press rises above the factory floor, and produces hot-formed large elbows with unsurpassed precision. Joining with the 8" – 12" press, it allows Weldbend to produce a large range of exceptional fittings to satisfy the most stringent requirements.

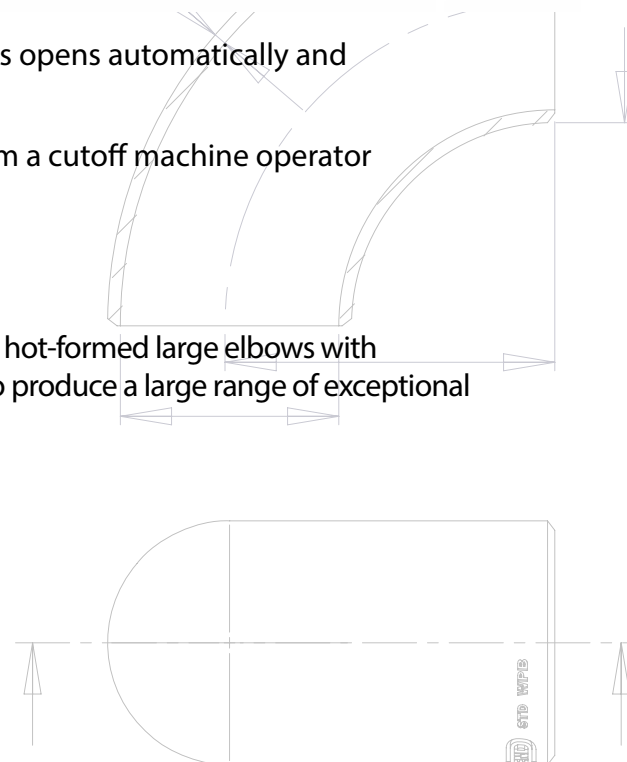



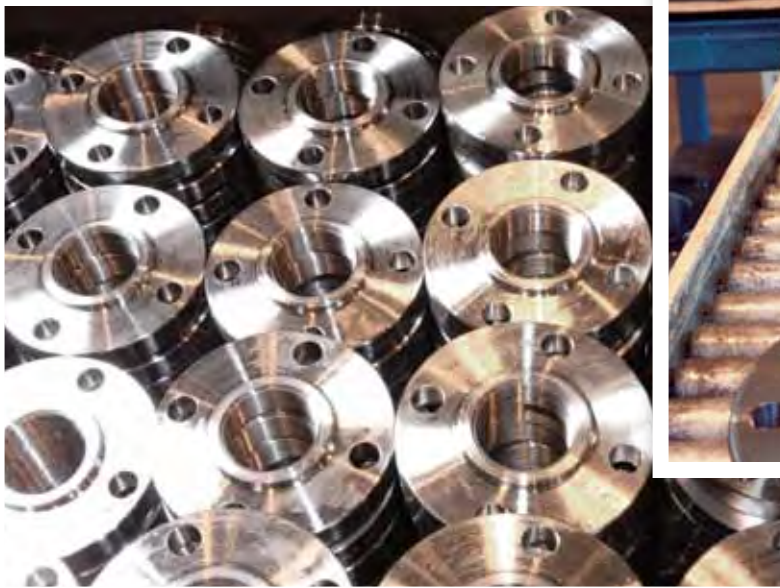
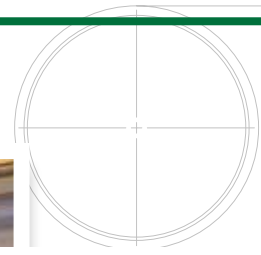

- Examples of some of the high-quality weld fittings and weld flanges Weldbend produces on its state-of-the-art equipment.

WELDBEND 878 W

WELDBEND 878 W

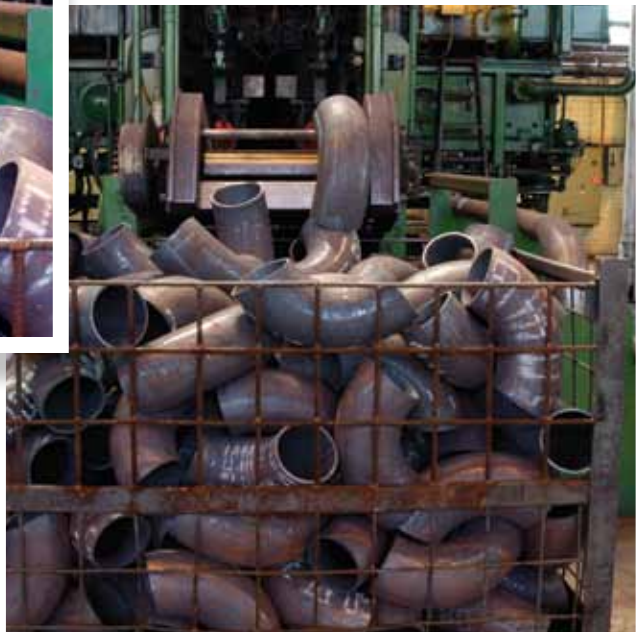

- Made only from USA pipe, the elbows hot-formed at Weldbend are done to the highest quality standards in Weldbend's unique state-of-the-art processes.

WELDBEND STD WIP

WELDBEND STD WIP



# COLD TEE PRESS



- From seamless pipe to finished seamless tees, Weldbend produces our cold-formed tees to the highest specifications.



- As with the Weldbend elbows, all seamless tees formed at Weldbend are made with only the highest quality USA pipe.





- Weldbend's production facility produces weld fittings to the highest standards possible.
- From cutting, beveling and other finishing processes, Weldbend manufactures its weld fittings in accordance to the applicable standards.





- After forming our cold tees, Weldbend subjects each tee to stringent testing, assuring the tees which leave our facility meet the quality-control standards of the world's largest companies.
- Aside from the machine finishing of our cold-formed tees after being heat treated, Weldbend subjects each seamless tee to magnetic particle testing in accordance with the applicable standard (ASTM A-234), ensuring each tee is of the highest quality possible.



- Each weld flange is machined and finished to the exacting standards of ASME B16.5 or B16.47.
- Weldbend only uses steel from the finest sources possible and is tested for compliance with the appropriate standards.

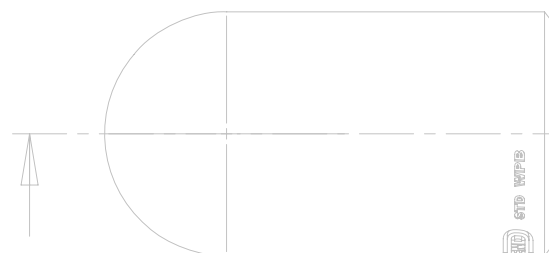
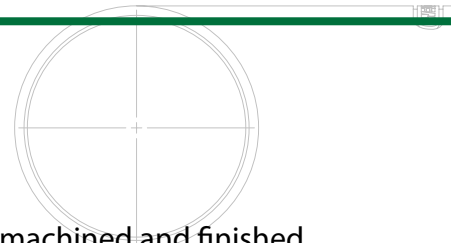

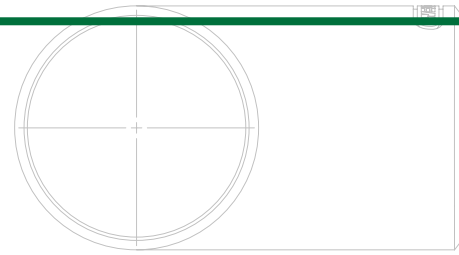

- Weldbend's "On-Hand" inventory policy is designed with the distributor in mind. Weldbend maintains a large inventory so you receive your shipments in a timely manner.
- Look to us as the single reliable source for precision-manufactured weld fittings and weld flanges, from a 1/2" elbow to a 60" flange. Be assured that it will be in stock, and it's only minutes away from our shipping dock. Weldbend stocks all materials in an organized manner, ready to ship when needed.





- Weldbend packages all fittings possible 1/2" – 12" and flanges 1/2" – 2 1/2" in reinforced cardboard cartons for ease of storage and easy identification.



- Weldbend stores inventory in this manner in order to maintain a vast inventory for fast shipments.



## "The Carton Way is the Better Way"

- Easier stacking
- Faster inventory counting
- Simplified inventory control
- Less storage space in warehouse
- Factory-fresh condition at customer's job site
- Helps control contractor's pilferage problem



- Weldbend Corporation pioneered the packing of carbon steel weld fittings in cartons, and we still deliver products (in sizes up to 12") in strong corrugated cartons at no extra cost.

**The Better Way Will Always Be The Weldbend Way!**

Management System Certificates

CERTIFICATE OF REGISTRATION

Having been audited in accordance with requirements of

**ISO 9001:2015 – ASQ/ANSI/ISO 9001:2015**

SRI Quality System Registrar, 300 Northpointe Circle, Seven Fields, Pennsylvania, 16046, USA,  
Steel Related Industries Quality System Registrar, LTD, Alexandra House, Ballsbridge, Dublin 4, Ireland, EU  
Steel Related Industries Quality Systems Registrar, Tower 42, Floor 5, 25 Old Broad Street, London, EC2N 1HN, UK  
hereby grants to:

**Weldbend Corporation**

Registration of the management system at its location:

**6600 South Harlem Avenue  
Argo, Illinois, 60501, USA**

The conditions for maintaining this certificate of registration are set forth in the SRI registration agreements R20.3 and R20.4. Further clarifications regarding the scope of this certificate and the applicability of ISO 9001:2015 requirements may be obtained by consulting the organization.

**Scope of ISO 9001:2015 registration:** "Manufacture of carbon steel butt welding fittings and forged steel flanges."

**Initial SRI Registration date:** September 7, 2004  
**Current registration period:** August 25, 2021 through August 24, 2024

Signed for SRI:   
Christopher H. Lake, President & COO

Release Date: August 25, 2021  
Certificate Number: 021806  
Registration Number: 2600-01

CERTIFICATE OF CONFORMANCE

**Steel Related Industries Quality System Registrar**  
300 Northpointe Circle, Seven Fields, Pennsylvania, 16046, USA  
Alexandra House, Ballsbridge, Dublin 4, Ireland EU  
Tower 42, Floor 5, 25 Old Broad Street, London, EC2N 1HN, UK

A legal entity within the United States, European Union (EU), and United Kingdom (UK) with competence demonstrated via ANAB and RvA accreditation as an ISO 9001 certification body with a scope of accreditation for the assessment of quality management systems of organizations which include the manufacture of materials and in the technology of the materials concerned, as specified in the scope below

-CERTIFIES-

**Weldbend Corporation**

at its location:

**6600 South Harlem Avenue  
Argo, Illinois, 60501, USA**

has implemented, operates and maintains a  
Management System in accordance with the requirements of

**Pressure Equipment Directive (PED)  
Annex I, Paragraph 4.3 of 2014/68/EU**

**Scope of PED compliance:** "Manufacture of carbon steel butt welding fittings and forged steel flanges."

Signed for SRI:   
Christopher H. Lake, President & COO

Date: August 25, 2021  
Registration Number: 2600-01

Steel Related Industries Quality System Registrar, LTD and Steel Related Industries Quality Systems Registrar is a registered, duly licensed, operating "legal entity" in the EU and UK, and as such, is fully responsible for Management System Certificates bearing its U.S., Ireland, and London addresses for the purpose of satisfying the material manufacture requirements of the EU and UK Pressure Equipment Directive. This certificate is valid and will remain in effect when accompanied by a valid ISO 9001:2015 registration certificate that bears SRI's Ireland and London addresses, as noted above.

- For full size viewing, download from [www.weldbend.com/weldbendiso.pdf](http://www.weldbend.com/weldbendiso.pdf)



Certificate No: BRS800456/1

Office: BRISTOL

Date: 17th October, 1988.

This is to certify that the undernoted Surveyor to this society did at the request of Messrs. Bacol Cylinders Ltd, attend the works of B.A.J. Ltd, Banwell on 30th September, 1988 for the purpose of witnessing Hydraulic test to destruction of the undernoted item to Bacol Cylinders Ltd, Order No. BC 8695/R202.

1 Off - Weld Bend 90 degrees long Radius Elbow,  
built into Burst Test Specimen as per  
Drg. No. M1790 Iss. 1.  
Mat. ASTM 234.  
Identification - Project 8704/R202.

The test was carried out using BAJ Ltd high pressure test rig of which calibration certificates were reviewed and found satisfactory.

The following test was observed:

The pressure was gradually increased and the test piece was determined to have yielded plastically at 5,900 p.s.i. Hydraulic pressure was continued until failure of the test piece occurred at 8,600 p.s.i.

Failure was deemed to have occurred in the parallel section of the test piece 15 mm from the weld joint extending 85 mm through the weld into the internal radius of the 90 degree elbow section of the test piece.

The defect also extended 70 mm above the welded joint culminating in 2 off 45 degrees tears approximately 40 mm in length.

  
Surveyor to Lloyd's Register  
F.D. MURRAY

NOTICE—This certificate is subject to the conditions of the Lloyd's Register Rules.  
FORM 1124 (10/87) LLOYD'S REGISTER



- Every product manufactured by Weldbend must be burst tested and certified before it goes into production for the first time.



- Weldbend uses carefully calibrated tools to continually check the tolerance of all manufactured products.



- All dimensions are checked both by the operator and our quality control department to ensure the highest quality finished goods.



- It is only after all these steps, that the Weldbend name is applied to each of our weld fitting and weld flange products. This signifies that the fitting or flange manufactured in our plant, has passed our quality control inspection, and is deemed ready for shipment.

## WELDBEND CORPORATION

6600 SOUTH HARLEM AVENUE • ARGO, IL 60501-1930

PHONES  
773 - 582 - 3500  
708 - 594 - 1700  
FAX  
773 - 582 - 7621  
708 - 458 - 0106

### THE WELDBEND POLICY

Weldbend fittings and flanges will meet all applicable ASTM and ASME specifications.

If any Weldbend product fails to meet these ASTM and ASME specifications, Weldbend, in strict accordance with the terms of its warranty, will pay all freight charges and will either replace the product or refund the purchase price.

All Weldbend fittings and flanges are covered by a blanket One Million Dollars (\$1,000,000.00) Products Liability Policy issued by a major United States insurance company.

Weldbend's Terms and Conditions of Sales, including complete warranty terms, are set forth on page 23 of this catalog. Additional copies of Weldbend's Terms and Conditions of Sales are available upon request.

Weldbend's current Terms and Conditions of Sales are available for download at [www.weldbend.com](http://www.weldbend.com).

**WE MAKE IT EASY FOR YOU TO ORDER OR INQUIRE, JUST GIVE US YOUR NEEDS:**

### REQUIRED FITTING INFORMATION

*When ordering or inquiring about Weldbend Fittings, please specify the following information:*

1. Quantity (Box quantities may apply)
2. Nominal Pipe Size
3. Pressure / Temperature Class
4. Type of Fitting
5. Piping Code Reference
6. Material
7. Box Quantities (See page 82)

### REQUIRED FLANGE INFORMATION

*When ordering or inquiring about Weldbend Flanges, please specify the following information:*

1. Quantity (Box and Bundle quantities may apply)
2. Nominal Pipe Size
3. Pressure / Temperature Class
4. Type of Flange
5. Piping Code Reference
6. Bore (When applicable)
7. Box and Bundle Quantities (See page 105)

### SPECIAL MODIFICATIONS

*If special modifications are required, the additional information must be supplied:*

1. Matching Pipe Specifications
  - a) Outside Diameter
  - b) Wall Thickness
  - c) Minimum Yield Strength of Material
2. Bore of Flange (When applicable)
3. Facing Dimensions
4. Length Through the Hub
5. Flange Thickness
6. Diameter at the Base of Hub
7. Outside Diameter of Hub
8. Bolting Dimensions
9. Flange Gasket Material

Weldbend Fittings and Flanges are products of Weldbend Corporation ("Weldbend"), a domestic manufacturer of welding fittings and welding flanges located at 6600 South Harlem Avenue, Argo, Illinois 60501-1930 U.S.A.

All Weldbend Products are sold only upon the following Terms and Conditions. The most current version of these Terms and Conditions may be found at Weldbend's on-line catalogue: <https://www.weldbend.com/catalog.pdf>.

1. ACCEPTANCE: Once Weldbend accepts Customer's purchase order, the Terms and Conditions set forth herein shall constitute the entire agreement and understanding between Weldbend and Customer relating to the Weldbend products and merge all prior discussions, understandings, agreements and documents between them. Any variation to Weldbend's Terms and Conditions and any additional or different terms or conditions on any order form or other document submitted by Customer are expressly rejected in their entirety unless and until expressly accepted in writing by a duly authorized officer of Weldbend.

2. PRICE: All orders will be invoiced at Weldbend's current price schedule prevailing at the time of shipment and are subject to change without notice. C.O.D. charges may be added to the price of the products in Weldbend's sole discretion. All sales, use, excise and other applicable taxes shall be charged to Customer and remitted by Customer to Weldbend.

3. SHIPMENTS: All materials will be delivered loaded onto the carrier Ex Works Weldbend's plant. Once loaded, all risks of loss of materials will be assumed by Customer. The shipper, method of shipment, and routing will be determined by Weldbend, absent special agreement between Weldbend and Customer. All shipping and delivery dates are approximate. Weldbend shall not be responsible for switching, spotting, handling, storage, demurrage, or any other transportation or related service, nor for any charges incurred therefor. Customer shall be responsible for filing and pursuing claims with carriers for loss or damage in transit. Railroad and other transportation permits as and when required shall be obtained by Customer. Weldbend reserves the right to deliver in more than one lot and to invoice each lot separately.

4. TERMS OF PAYMENT: Subject to the approval of Weldbend's credit department, terms of payment will be net cash thirty (30) days from the date of invoice and will be payable in Chicago, Illinois. Shipments, deliveries, and performance of work shall at times be subject to the approval of Weldbend's credit department. Failure to receive timely payment of invoices concerning work completed, and/or work in progress, shall be sufficient reason to withhold or delay subsequent shipments of materials, and/or performance of labor or to terminate all orders as set forth in Section 10. If pursuant to this provision or to Section 10 herein Weldbend were to defer any shipment or services or cancel in whole or in part any order, Customer shall be liable for and reimburse Weldbend for all damage, including any and all direct and consequential damage, incurred by Weldbend by reason of such deferment or cancellation. Unpaid invoices in excess of thirty (30) days shall be subject to an interest charge at the rate of 1% per month from the date past due (but in no event higher than the rate permitted by applicable law). In the event of Customer's default of any of the terms of the contract, including but not limited to customer's failure to pay invoices timely, customer agrees to pay Weldbend all costs and expenses incurred as a result thereof, including but not limited to reasonable attorneys' fees, court costs and all costs of collection.

5. DELAYS: Weldbend shall be not responsible for any action or inaction of any carrier, including delays in delivery, nor, under any circumstances, shall Weldbend be liable for any delay in performance, or non-performance, due to acts of God, war, riots, terrorism, civil disturbances, acts of civil or military authorities, governmental regulation, court orders, fires, strikes or other labor disputes, shortages of labor, materials, fuel or energy, or unavailability of transportation, equipment failure, failure of supplier, carrier or subcontractor to deliver on time, or due to any other cause or causes beyond the control of Weldbend.

6. LIMITED, EXCLUSIVE WARRANTY: Weldbend warrants to its ORIGINAL CUSTOMER ONLY, for a period of one year from the date of shipment, that all Weldbend fittings and flanges meet all applicable ASTM specifications and that Weldbend is the unencumbered owner of all products shipped pursuant to these terms and conditions. This warranty does not apply to products which have been damaged during shipment or by abuse, misuse, misapplication, alteration or improper installation, maintenance or repair and is conditioned upon Customer (a) advising Weldbend in writing, within 10 days of receipt of products, of its belief that said products do not conform to ASTM specifications and (b) providing Weldbend a reasonable time to inspect said products and investigate Customer's claim. If Weldbend determines, in its sole opinion, that the products fail to conform to ASTM specifications, it will, at its sole option, either refund all payments made by customer with respect to such non-conforming products or, alternatively, replace such non-conforming products and pay any additional shipping charges incurred as a result thereof. Customer agrees to dispose of or return the non-conforming products in accordance with instructions provided by Weldbend. THE FOREGOING SHALL CONSTITUTE THE EXCLUSIVE REMEDY OF THE CUSTOMER AND THE EXCLUSIVE LIABILITY OF WELDBEND. THIS WARRANTY IS EXCLUSIVE AND IN LIEU OF ALL OTHER WARRANTIES, WHETHER ORAL OR WRITTEN, EXPRESSED OR IMPLIED. NO WARRANTY OF MERCHANTABILITY, OR FITNESS FOR A PARTICULAR PURPOSE, OR NON-INFRINGEMENT SHALL APPLY. No employee, agent or representative of

Weldbend has the authority to make modifications or additions to this warranty in any respect except pursuant to a written agreement signed by a duly authorized officer of Weldbend.

7. LIMITATION OF LIABILITY: UNDER NO CIRCUMSTANCES, WHETHER ALLEGED AS A RESULT OF BREACH OF CONTRACT OR WARRANTY, NEGLIGENCE, STRICT LIABILITY OR ANY OTHER LEGAL THEORY, WILL WELDBEND BE RESPONSIBLE TO CUSTOMER, OR TO ANY THIRD PARTY, FOR ANY SPECIAL, DIRECT, INDIRECT, CONSEQUENTIAL, INCIDENTAL OR OTHER DAMAGES OF ANY KIND, INCLUDING BUT NOT LIMITED TO LOST PROFITS, LOSS OF USE OF PROPERTY, OR DAMAGES FOR PERSONAL INJURY, AND NO CLAIMS FOR ANY SUCH DAMAGES SHALL BE BROUGHT BY THE CUSTOMER. In no event shall Weldbend be liable to Customer for any amount in excess of the purchase price of the product for which a claim is made. Customer shall not back charge, counterclaim, or set-off its claims against payments due on its orders.

8. RETURN OF PRODUCTS AND/OR TERMINATION OF ORDERS: Customer shall not return any products shipped by Weldbend without receiving the prior written permission and/or consent of Weldbend. If Customer seeks to cancel any part of an order prior to shipment, such requests shall be made to Weldbend in writing at once. Except with respect to products which fail to conform to Customer's order or to Weldbend's limited warranty, all products returned shall be charged 25% of the value of the invoice and, in addition, freight charges for the return shipment (plus reimbursement to Weldbend of any freight charges incurred by Weldbend for the original shipment to Customer). Any orders shipped by Weldbend and refused by Customer will be handled as a return products shipment. Any fitting or flange once welded into a pipe line is not subject to return.

9. SPECIAL-ORDER PRODUCTS. Any order for specially manufactured products that Weldbend does not ordinarily stock, including but not limited to barred tees, may not be cancelled once accepted by Weldbend, and no such products may be returned. Barred tees are manufactured in accordance with the process described at <https://www.weldbend.com/barredteeprocedure.pdf>.

10. PATENT AND OTHER RIGHTS: The sale of the products and the publication of any information or technical data relating thereto do not imply freedom from infringement of patent, copyright, registered design, or other industrial property rights in respect of any particular combination or application of the products. Nor does the sale entail any license of Weldbend's trademark or trade name.

11. TERMINATION: If Customer defaults in payment of any sum due Weldbend or commits any breach of any of these Terms and Conditions or any other contract with Weldbend or if Customer's financial condition becomes unsatisfactory to Weldbend, then Weldbend may, without prejudice to any other rights which may have accrued or which may accrue to it, terminate all orders with that Customer by notice in writing or may defer shipment until the situation is remedied to Weldbend's satisfaction.

12. MANUFACTURE AND AVAILABILITY OF PRODUCTS: Without prior notice, Weldbend reserves the right to change manufacturing methods and availability of products and reserves the right to subcontract work out to any company of its choice. Any products resulting from such subcontract work will be deemed Weldbend products and will be die-stamped with the trademarked Weldbend name and/or Weldbend logo, and the sales of such products are subject to these Terms and Conditions.

13. ASSIGNMENT: Customer may not assign any right or duty arising under any order, in whole or in part, without Weldbend's prior written consent.

14. NO WAIVER OF RIGHTS; PARTIAL INVALIDITY: Any waiver by either party of any breach of a provision of these Terms and Conditions shall not be construed as a waiver of any other provision or of any continuing or succeeding breach of such provision. If any provision of the Terms and Conditions shall be deemed invalid, illegal, or unenforceable in any respect, the legality and enforceability of all other provisions of the Terms and Conditions shall not be in any way impaired or affected thereby.

15. INDEMNITY: Customer shall indemnify and hold harmless Weldbend from any loss, cost, damage, or expense (including but not limited to attorney fees) arising from any breach of these Terms and Conditions by Customer or from any other cause or circumstance other than that covered by Weldbend's limited, exclusive warranty.

16. COMPLIANCE WITH LAW: Customer is solely responsible for compliance with all applicable federal, state and local laws, ordinances, regulations, rules and standards relating to the installation, maintenance, and use of the products purchased from Weldbend.

17. LAW: The Terms and Conditions and any agreed amendment thereto shall be governed in all respects by the internal laws of the State of Illinois, without reference to conflicts-of-laws rules. Any disputes shall be resolved in the state or federal courts located in Cook County, Illinois.

18. NOTICES: Notices shall be deemed given if delivered by first-class, postage prepaid U.S. mail, or by courier service, to the address of the party as stated in the order or these Terms and Conditions.

Note: Weldbend's catalog is for the exclusive use of the Jobber or Distributor of Welding Fittings and Flanges. Weldbend Corporation restricts its sales to Jobbers and/or Distributors only.

**Note: This catalog is for the exclusive use of the Jobber or Distributor of Welding Fittings and Flanges. The Weldbend Corporation of Chicago restricts its sales to Jobbers and/or Distributors only.**







# FITTINGS

1/2" through 60"

- Schedule Standard (STD)
- Schedule Extra-Strong (XS)
- Schedule 40
- Schedule 80
- Schedule 160
- Schedule Double Extra-Strong (XXS)

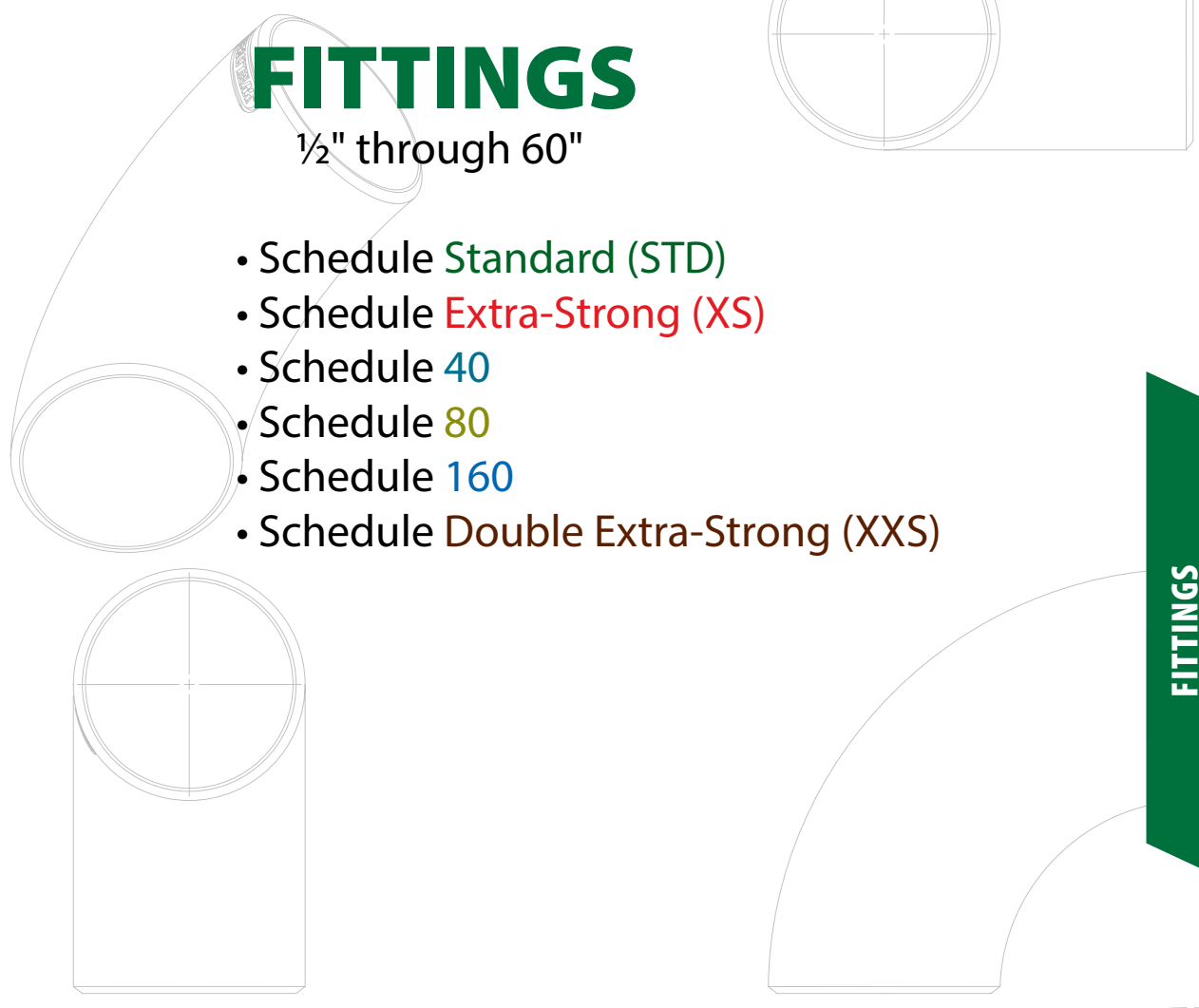

FITTINGS



All Products Backed by the Weldbend Warranty

STD WPB

**LONG RADIUS  
SCHEDULE STD**

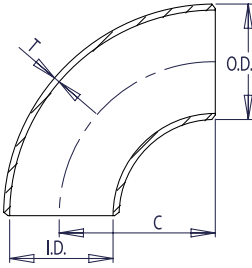

**WELDBEND NOTES**

1. Conforms to ASME B16.9 & ASTM A234 WPB.
  2. All dimensions are in inches.
  3. For bevel detail see page 107.
  4. For dimensional tolerances see page 108.
  5. For sizes larger than 48" please call.
  6. All weights are in pounds and approximated or estimated.
- \* This size and thickness does not correspond to any pipe schedule number.

Pipe Size	Outside Diameter	Inside Diameter	Wall Thickness	Center to End	Pipe Schedule Number	Approx. Weight in Pounds
	O.D.	I.D.	T	C		
½	0.84	0.622	0.109	1.50	40	0.16
¾	1.05	0.824	0.113	1.50	40	0.17
1	1.32	1.049	0.133	1.50	40	0.40
1 ¼	1.66	1.380	0.140	1.88	40	0.55
1 ½	1.90	1.610	0.145	2.25	40	0.80
2	2.38	2.067	0.154	3.00	40	1.60
2 ½	2.88	2.469	0.203	3.75	40	3.20
3	3.50	3.068	0.216	4.50	40	4.80
3 ½	4.00	3.548	0.226	5.25	40	6.60
4	4.50	4.026	0.237	6.00	40	8.90
5	5.56	5.047	0.258	7.50	40	15.10
6	6.62	6.065	0.280	9.00	40	24.00
8	8.62	7.981	0.322	12.00	40	47.80
10	10.75	10.020	0.365	15.00	40	83.40
12	12.75	12.000	0.375	18.00	*	123.00
14	14.00	13.250	0.375	21.00	30	155.00
16	16.00	15.250	0.375	24.00	30	206.00
18	18.00	17.250	0.375	27.00	*	262.00
20	20.00	19.250	0.375	30.00	20	324.00
24	24.00	23.250	0.375	36.00	20	466.00
30	30.00	29.250	0.375	45.00	*	720.00
36	36.00	35.250	0.375	54.00	*	1039.00
42	42.00	41.250	0.375	63.00	*	1420.00
48	48.00	47.250	0.375	72.00	*	2000.00

FITTINGS

**LONG RADIUS  
SCHEDULE XS**

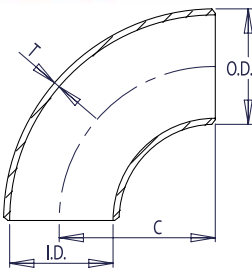

**WELDBEND NOTES**

1. Conforms to ASME B16.9 & ASTM A234 WPB.
  2. All dimensions are in inches.
  3. For bevel detail see page 107.
  4. For dimensional tolerances see page 108.
  5. For sizes larger than 48" please call.
  6. All weights are in pounds and approximated or estimated.
- \* This size and thickness does not correspond to any pipe schedule number.

Pipe Size	Outside Diameter	Inside Diameter	Wall Thickness	Center to End	Pipe Schedule Number	Approx. Weight in Pounds
	O.D.	I.D.	T	C		
½	0.84	0.546	0.147	1.50	80	0.26
¾	1.05	0.742	0.154	1.50	80	0.29
1	1.32	0.957	0.179	1.50	80	0.48
1 ¼	1.66	1.278	0.191	1.88	80	0.79
1 ½	1.90	1.500	0.200	2.25	80	1.20
2	2.38	1.939	0.218	3.00	80	2.10
2 ½	2.88	2.323	0.276	3.75	80	3.80
3	3.50	2.900	0.300	4.50	80	6.30
3 ½	4.00	3.364	0.318	5.25	80	8.60
4	4.50	3.826	0.337	6.00	80	12.50
5	5.56	4.813	0.375	7.50	80	21.20
6	6.62	5.761	0.432	9.00	80	34.40
8	8.62	7.625	0.500	12.00	80	71.30
10	10.75	9.750	0.500	15.00	60	111.00
12	12.75	11.750	0.500	18.00	*	158.00
14	14.00	13.000	0.500	21.00	*	201.00
16	16.00	15.000	0.500	24.00	40	270.00
18	18.00	17.000	0.500	27.00	*	348.00
20	20.00	19.000	0.500	30.00	30	422.00
24	24.00	23.000	0.500	36.00	*	604.00
30	30.00	29.000	0.500	45.00	20	997.00
36	36.00	35.000	0.500	54.00	20	1380.00
42	42.00	41.000	0.500	63.00	*	1880.00
48	48.00	47.000	0.500	72.00	*	2502.00

## 90° ELBOWS

### LONG RADIUS SCHEDULE 40

Pipe Size	Outside Diameter	Inside Diameter	Wall Thickness	Center to End	Pipe Schedule Number	Approx. Weight in Pounds
	O.D.	I.D.	T	C		
½	0.84	0.622	0.109	1.50	40	0.16
¾	1.05	0.824	0.113	1.50	40	0.17
1	1.32	1.054	0.133	1.50	40	0.40
1 ¼	1.66	1.380	0.140	1.88	40	0.55
1 ½	1.90	1.610	0.145	2.25	40	0.80
2	2.38	2.072	0.154	3.00	40	1.60
2 ½	2.88	2.474	0.203	3.75	40	3.20
3	3.50	3.068	0.216	4.50	40	4.80
3 ½	4.00	3.548	0.226	5.25	40	6.60
4	4.50	4.026	0.237	6.00	40	8.90
5	5.56	5.044	0.258	7.50	40	15.10
6	6.62	6.060	0.280	9.00	40	24.00
8	8.62	7.976	0.322	12.00	40	47.80
10	10.75	10.020	0.365	15.00	40	83.40
12	12.75	11.938	0.406	18.00	40	123.00
14	14.00	13.124	0.438	21.00	40	155.00
16	16.00	15.000	0.500	24.00	40	206.00
18	18.00	16.876	0.562	27.00	40	262.00
20	20.00	18.812	0.594	30.00	40	324.00
24	24.00	22.624	0.688	36.00	40	466.00

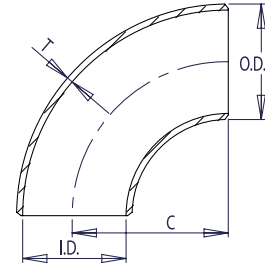

#### WELDBEND NOTES

1. Conforms to ASME B16.9 & ASTM A234 WPB.
2. All dimensions are in inches.
3. For bevel detail see page 107.
4. For dimensional tolerances see page 108.
5. For sizes larger than 24" please call.
6. All weights are in pounds and approximated or estimated.

FITTINGS

### LONG RADIUS SCHEDULE 80

Pipe Size	Outside Diameter	Inside Diameter	Wall Thickness	Center to End	Pipe Schedule Number	Approx. Weight in Pounds
	O.D.	I.D.	T	C		
½	0.84	0.546	0.147	1.50	80	0.26
¾	1.05	0.742	0.154	1.50	80	0.29
1	1.32	0.962	0.179	1.50	80	0.48
1 ¼	1.66	1.278	0.191	1.88	80	0.79
1 ½	1.90	1.500	0.200	2.25	80	1.20
2	2.38	1.944	0.218	3.00	80	2.10
2 ½	2.88	2.328	0.276	3.75	80	3.80
3	3.50	2.900	0.300	4.50	80	6.30
3 ½	4.00	3.364	0.318	5.25	80	8.60
4	4.50	3.826	0.337	6.00	80	12.50
5	5.56	4.810	0.375	7.50	80	21.20
6	6.62	5.756	0.432	9.00	80	34.40
8	8.62	7.620	0.500	12.00	80	71.30
10	10.75	9.562	0.594	15.00	80	111.00
12	12.75	11.374	0.688	18.00	80	158.00
14	14.00	12.500	0.750	21.00	80	201.00
16	16.00	14.312	0.844	24.00	80	270.00
18	18.00	16.124	0.938	27.00	80	348.00
20	20.00	17.938	1.031	30.00	80	422.00
24	24.00	21.562	1.219	36.00	80	604.00

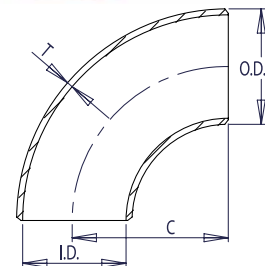

#### WELDBEND NOTES

1. Conforms to ASME B16.9 & ASTM A234 WPB.
2. All dimensions are in inches.
3. For bevel detail see page 107.
4. For dimensional tolerances see page 108.
5. All weights are in pounds and approximated or estimated.

**LONG RADIUS  
SCHEDULE 160**

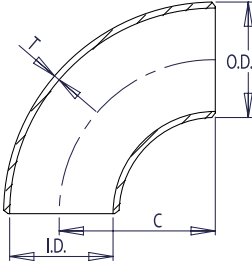

**WELDBEND NOTES**

1. Conforms to ASME B16.9 & ASTM A234 WPB.
2. All dimensions are in inches.
3. For bevel detail see page 107.
4. For dimensional tolerances see page 108.
5. All weights are in pounds and approximated or estimated.

Pipe Size	Outside Diameter	Inside Diameter	Wall Thickness	Center to End	Pipe Schedule Number	Approx. Weight in Pounds
	O.D.	I.D.	T	C		
1/2	0.84	0.464	0.188	1.50	160	0.60
3/4	1.05	0.612	0.219	1.50	160	0.60
1	1.32	0.820	0.250	1.50	160	0.60
1 1/4	1.66	1.160	0.250	1.88	160	1.00
1 1/2	1.90	1.338	0.281	2.25	160	1.80
2	2.38	1.692	0.344	3.00	160	3.20
2 1/2	2.88	2.130	0.375	3.75	160	6.00
3	3.50	2.624	0.438	4.50	160	10.00
4	4.50	3.438	0.531	6.00	160	22.00
5	5.56	4.310	0.625	7.50	160	33.00
6	6.62	5.182	0.719	9.00	160	62.00
8	8.62	6.808	0.906	12.00	160	122.00
10	10.75	8.500	1.125	15.00	160	270.00
12	12.75	10.126	1.312	18.00	160	460.00
14	14.00	11.188	1.406	21.00	160	563.00
16	16.00	12.812	1.594	24.00	160	825.00
18	18.00	14.438	1.781	27.00	160	1240.00
20	20.00	16.062	1.969	30.00	160	1510.00
24	24.00	19.312	2.344	36.00	160	1760.00

FITTINGS

**LONG RADIUS  
SCHEDULE XXS**

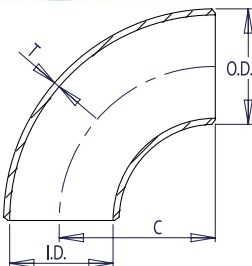

**WELDBEND NOTES**

1. Conforms to ASME B16.9 & ASTM A234 WPB.
2. All dimensions are in inches.
3. For bevel detail see page 107.
4. For dimensional tolerances see page 108.
5. All weights are in pounds and approximated or estimated.

\* This size and thickness does not correspond to any pipe schedule number.

Pipe Size	Outside Diameter	Inside Diameter	Wall Thickness	Center to End	Pipe Schedule Number	Approx. Weight in Pounds
	O.D.	I.D.	T	C		
1/2	0.84	0.252	0.294	1.50	*	0.30
3/4	1.05	0.434	0.308	1.50	*	0.30
1	1.32	0.604	0.358	1.50	*	0.80
1 1/4	1.66	0.896	0.382	1.88	*	1.40
1 1/2	1.90	1.100	0.400	2.25	*	2.00
2	2.38	1.508	0.436	3.00	*	3.90
2 1/2	2.88	1.776	0.552	3.75	*	6.80
3	3.50	2.300	0.600	4.50	*	11.30
4	4.50	3.152	0.674	6.00	*	23.00
5	5.56	4.060	0.750	7.50	*	38.00
6	6.62	4.892	0.864	9.00	*	69.00
8	8.62	6.870	0.875	12.00	*	120.00
10	10.75	8.750	1.000	15.00	140	232.00
12	12.75	10.750	1.000	18.00	120	315.00

**SHORT RADIUS  
 SCHEDULE STD**

Pipe Size	Outside Diameter	Inside Diameter	Wall Thickness	Center to End	Pipe Schedule Number	Approx. Weight in Pounds
	O.D.	I.D.	T	C		
1	1.32	1.049	0.133	1.00	40	0.30
1 ¼	1.66	1.380	0.140	1.25	40	0.40
1 ½	1.90	1.610	0.145	1.50	40	0.50
2	2.38	2.067	0.154	2.00	40	1.00
2 ½	2.88	2.469	0.203	2.50	40	2.00
3	3.50	3.068	0.216	3.00	40	3.00
3 ½	4.00	3.548	0.226	3.50	40	4.30
4	4.50	4.026	0.237	4.00	40	6.10
5	5.56	5.047	0.258	5.00	40	9.70
6	6.62	6.065	0.280	6.00	40	16.70
8	8.62	7.981	0.322	8.00	40	32.40
10	10.75	10.020	0.365	10.00	40	56.30
12	12.75	12.000	0.375	12.00	*	79.40
14	14.00	13.250	0.375	14.00	30	104.00
16	16.00	15.250	0.375	16.00	30	129.00
18	18.00	17.250	0.375	18.00	*	163.00
20	20.00	19.250	0.375	20.00	20	210.00
24	24.00	23.250	0.375	24.00	20	297.00
❖ 30	30.00	29.250	0.375	30.00	*	470.00
❖ 36	36.00	35.250	0.375	36.00	*	692.00
❖ 42	42.00	41.250	0.375	42.00	*	967.00
❖ 48	48.00	47.250	0.375	48.00	*	1340.00

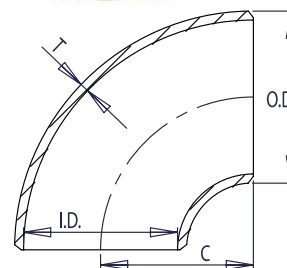

**WELDBEND NOTES**

1. Conforms to ASME B16.9 & ASTM A234 WPB.
  2. All dimensions are in inches.
  3. For bevel detail see page 107.
  4. For dimensional tolerances see page 108.
  5. For sizes larger than 48" please call.
  6. All weights are in pounds and approximated or estimated.
- \* This size and thickness does not correspond to any pipe schedule number.  
 ❖ In accordance with B16.9. Special Fittings paragraph 4.4.2.

**FITTINGS**

**SHORT RADIUS  
 SCHEDULE XS**

Pipe Size	Outside Diameter	Inside Diameter	Wall Thickness	Center to End	Pipe Schedule Number	Approx. Weight in Pounds
	O.D.	I.D.	T	C		
1	1.32	0.962	0.179	1.00	80	0.30
1 ¼	1.66	1.278	0.191	1.25	80	0.60
1 ½	1.90	1.500	0.200	1.50	80	0.80
2	2.38	1.939	0.218	2.00	80	1.50
2 ½	2.88	2.323	0.276	2.50	80	2.60
3	3.50	2.900	0.300	3.00	80	3.80
3 ½	4.00	3.364	0.318	3.50	80	5.40
4	4.50	3.826	0.337	4.00	80	7.60
5	5.56	4.813	0.375	5.00	80	13.80
6	6.62	5.761	0.432	6.00	80	22.80
8	8.62	7.625	0.500	8.00	80	47.30
10	10.75	9.750	0.500	10.00	60	71.00
12	12.75	11.750	0.500	12.00	*	104.00
14	14.00	13.000	0.500	14.00	*	137.00
16	16.00	15.000	0.500	16.00	40	171.00
18	18.00	17.000	0.500	18.00	*	214.00
20	20.00	19.000	0.500	20.00	30	277.00
24	24.00	23.000	0.500	24.00	*	390.00
❖ 30	30.00	29.000	0.500	30.00	20	632.70
❖ 36	36.00	35.000	0.500	36.00	20	913.00
❖ 42	42.00	41.000	0.500	42.00	*	1300.00
❖ 48	48.00	47.000	0.500	48.00	*	1675.00

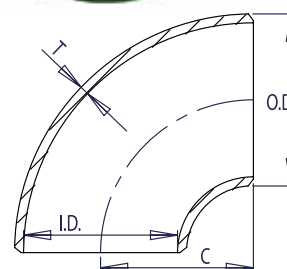

**WELDBEND NOTES**

1. Conforms to ASME B16.9 & ASTM A234 WPB.
  2. All dimensions are in inches.
  3. For bevel detail see page 107.
  4. For dimensional tolerances see page 108.
  5. For sizes larger than 48" please call.
  6. All weights are in pounds and approximated or estimated.
- \* This size and thickness does not correspond to any pipe schedule number.  
 ❖ In accordance with B16.9. Special Fittings paragraph 4.4.2.

**SHORT RADIUS  
SCHEDULE 40**

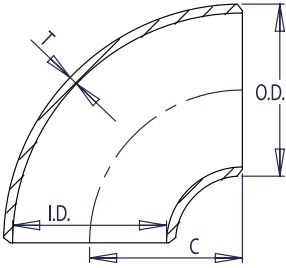

**WELDBEND NOTES**

1. Conforms to ASME B16.9 & ASTM A234 WPB.
2. All dimensions are in inches.
3. For bevel detail see page 107.
4. For dimensional tolerances see page 108.
5. For sizes larger than 24" please call.
6. All weights are in pounds and approximated or estimated.

Pipe Size	Outside Diameter	Inside Diameter	Wall Thickness	Center to End	Pipe Schedule Number	Approx. Weight in Pounds
	O.D.	I.D.	T	C		
1	1.32	1.054	0.133	1.00	40	0.30
1 ¼	1.66	1.380	0.140	1.25	40	0.40
1 ½	1.90	1.610	0.145	1.50	40	0.50
2	2.38	2.072	0.154	2.00	40	1.00
2 ½	2.88	2.474	0.203	2.50	40	2.00
3	3.50	3.068	0.216	3.00	40	3.00
3 ½	4.00	3.548	0.226	3.50	40	4.30
4	4.50	4.026	0.237	4.00	40	6.10
5	5.56	5.044	0.258	5.00	40	9.70
6	6.62	6.060	0.280	6.00	40	16.70
8	8.62	7.976	0.322	8.00	40	32.40
10	10.75	10.020	0.365	10.00	40	56.30
12	12.75	11.938	0.406	12.00	40	80.00
14	14.00	13.124	0.438	14.00	40	105.00
16	16.00	15.000	0.500	16.00	40	130.00
18	18.00	16.876	0.562	18.00	40	165.00
20	20.00	18.812	0.594	20.00	40	215.00
24	24.00	22.624	0.688	24.00	40	300.00

FITTINGS

**SHORT RADIUS  
SCHEDULE 80**

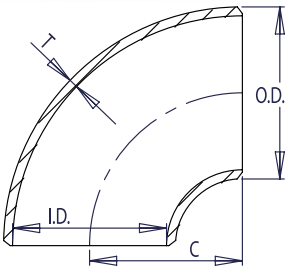

**WELDBEND NOTES**

1. Conforms to ASME B16.9 & ASTM A234 WPB.
2. All dimensions are in inches.
3. For bevel detail see page 107.
4. For dimensional tolerances see page 108.
5. All weights are in pounds and approximated or estimated.

Pipe Size	Outside Diameter	Inside Diameter	Wall Thickness	Center to End	Pipe Schedule Number	Approx. Weight in Pounds
	O.D.	I.D.	T	C		
1	1.32	0.962	0.179	1.00	80	0.30
1 ¼	1.66	1.278	0.191	1.25	80	0.60
1 ½	1.90	1.500	0.200	1.50	80	0.80
2	2.38	1.944	0.218	2.00	80	1.50
2 ½	2.88	2.328	0.276	2.50	80	2.60
3	3.50	2.900	0.300	3.00	80	3.80
3 ½	4.00	3.364	0.318	3.50	80	5.40
4	4.50	3.826	0.337	4.00	80	7.60
5	5.56	4.810	0.375	5.00	80	13.80
6	6.62	5.756	0.432	6.00	80	22.80
8	8.62	7.620	0.500	8.00	80	47.30
10	10.75	9.562	0.594	10.00	80	75.00
12	12.75	11.374	0.688	12.00	80	105.00
14	14.00	12.500	0.750	14.00	80	140.00
16	16.00	14.312	0.844	16.00	80	175.00
18	18.00	16.124	0.938	18.00	80	215.00
20	20.00	17.938	1.031	20.00	80	280.00
24	24.00	21.562	1.219	24.00	80	400.00

Pipe Size	Outside Diameter	Inside Diameter	Wall Thickness	Center to End	Pipe Schedule Number	Approx. Weight in Pounds
	O.D.	I.D.	T	C		
1	1.32	0.820	0.250	1.00	160	0.50
1 ¼	1.66	1.160	0.250	1.25	160	0.90
1 ½	1.90	1.338	0.281	1.50	160	1.50
2	2.38	1.692	0.344	2.00	160	2.90
2 ½	2.88	2.130	0.375	2.50	160	5.50
3	3.50	2.624	0.438	3.00	160	9.80
4	4.50	3.438	0.531	4.00	160	20.00
5	5.56	4.310	0.625	5.00	160	30.00
6	6.62	5.182	0.719	6.00	160	60.00
8	8.62	6.808	0.906	8.00	160	125.00
10	10.75	8.500	1.125	10.00	160	258.00
12	12.75	10.126	1.312	12.00	160	455.00
14	14.00	11.188	1.406	14.00	160	550.00
16	16.00	12.812	1.594	16.00	160	800.00
18	18.00	14.438	1.781	18.00	160	1025.00
20	20.00	16.062	1.969	20.00	160	1295.00
24	24.00	19.312	2.344	24.00	160	1450.00

**SHORT RADIUS SCHEDULE 160**

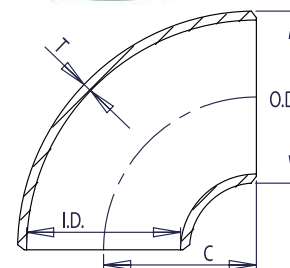

**WELDBEND NOTES**

1. Conforms to ASME B16.9 & ASTM A234 WPB.
2. All dimensions are in inches.
3. For bevel detail see page 107.
4. For dimensional tolerances see page 108.
5. All weights are in pounds and approximated or estimated.

Pipe Size	Outside Diameter	Inside Diameter	Wall Thickness	Center to End	Pipe Schedule Number	Approx. Weight in Pounds
	O.D.	I.D.	T	C		
1	1.32	0.604	0.358	1.00	*	0.65
1 ¼	1.66	0.896	0.382	1.25	*	1.30
1 ½	1.90	1.100	0.400	1.50	*	1.70
2	2.38	1.508	0.436	2.00	*	3.20
2 ½	2.88	1.776	0.552	2.50	*	6.10
3	3.50	2.300	0.600	3.00	*	11.00
4	4.50	3.152	0.674	4.00	*	22.00
5	5.56	4.060	0.750	5.00	*	35.00
6	6.62	4.892	0.864	6.00	*	60.00
8	8.62	6.870	0.875	8.00	*	123.00
10	10.75	8.750	1.000	10.00	140	225.00
12	12.75	10.750	1.000	12.00	120	365.00

**SHORT RADIUS SCHEDULE XXS**

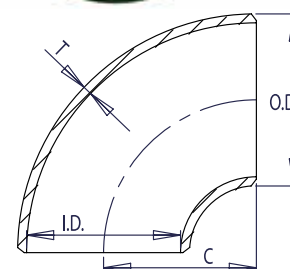

**WELDBEND NOTES**

1. Conforms to ASME B16.9 & ASTM A234 WPB.
  2. All dimensions are in inches.
  3. For bevel detail see page 107.
  4. For dimensional tolerances see page 108.
  5. All weights are in pounds and approximated or estimated.
- \* This size and thickness does not correspond to any pipe schedule number.

FITTINGS

# 90° REDUCING ELBOWS



## SCHEDULE STD For reference only

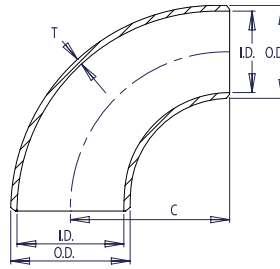

### WELDBEND NOTES

1. Conforms to ASME B16.9 & ASTM A234 WPB.
  2. All dimensions are in inches.
  3. For bevel detail see page 107.
  4. For dimensional tolerances see page 108.
  5. For sizes larger than 12" please call.
  6. All weights are in pounds and approximated or estimated.
- \* This size and thickness does not correspond to any pipe schedule number.

FITTINGS

Pipe Size	LARGE DIAMETER			SMALL DIAMETER			Center to End C	Pipe Schedule Number	Approx. Weight in Pounds
	Outside Diameter	Inside Diameter	Wall Thickness	Outside Diameter	Inside Diameter	Wall Thickness			
	O.D.	I.D.	T	O.D.	I.D.	T			
2 x 1 1/2	2.38	2.072	0.154	1.90	1.610	0.145	3.00	40	1.40
2 x 1 1/4	2.38	2.072	0.154	1.66	1.380	0.140	3.00	40	1.30
2 x 1	2.38	2.072	0.154	1.32	1.054	0.133	3.00	40	1.20
2 1/2 x 2	2.88	2.474	0.203	2.38	2.072	0.154	3.75	40	2.80
2 1/2 x 1 1/2	2.88	2.474	0.203	1.90	1.610	0.145	3.75	40	2.60
2 1/2 x 1 1/4	2.88	2.474	0.203	1.66	1.380	0.140	3.75	40	2.50
3 x 2 1/2	3.50	3.068	0.216	2.88	2.474	0.203	4.50	40	4.20
3 x 2	3.50	3.068	0.216	2.38	2.072	0.154	4.50	40	3.60
3 x 1 1/2	3.50	3.068	0.216	1.90	1.610	0.145	4.50	40	3.30
3 1/2 x 3	4.00	3.548	0.226	3.50	3.068	0.216	5.25	40	6.00
3 1/2 x 2 1/2	4.00	3.548	0.226	2.88	2.474	0.203	5.25	40	5.50
3 1/2 x 2	4.00	3.548	0.226	2.38	2.072	0.154	5.25	40	4.50
4 x 3 1/2	4.50	4.026	0.237	4.00	3.548	0.226	6.00	40	8.40
4 x 3	4.50	4.026	0.237	3.50	3.068	0.216	6.00	40	7.70
4 x 2 1/2	4.50	4.026	0.237	2.88	2.474	0.203	6.00	40	6.80
4 x 2	4.50	4.026	0.237	2.38	2.072	0.154	6.00	40	6.00
5 x 4	5.56	5.044	0.258	4.50	4.026	0.237	7.50	40	13.40
5 x 3 1/2	5.56	5.044	0.258	4.00	3.548	0.226	7.50	40	12.60
5 x 3	5.56	5.044	0.258	3.50	3.068	0.216	7.50	40	11.80
5 x 2 1/2	5.56	5.044	0.258	2.88	2.474	0.203	7.50	40	10.70
6 x 5	6.62	6.060	0.280	5.56	5.044	0.258	9.00	40	21.00
6 x 4	6.62	6.060	0.280	4.50	4.026	0.237	9.00	40	18.90
6 x 3 1/2	6.62	6.060	0.280	4.00	3.548	0.226	9.00	40	17.80
6 x 3	6.62	6.060	0.280	3.50	3.068	0.216	9.00	40	16.80
8 x 6	8.62	7.976	0.322	6.62	6.060	0.280	12.00	40	39.70
8 x 5	8.62	7.976	0.322	5.56	5.044	0.258	12.00	40	36.20
8 x 4	8.62	7.976	0.322	4.50	4.026	0.237	12.00	40	33.10
10 x 8	10.75	10.020	0.365	8.62	7.976	0.322	15.00	40	73.00
10 x 6	10.75	10.020	0.365	6.62	6.060	0.280	15.00	40	63.20
10 x 5	10.75	10.020	0.365	5.56	5.044	0.258	15.00	40	58.50
12 x 10	12.75	12.000	0.375	10.75	10.020	0.365	18.00	*	113.00
12 x 8	12.75	12.000	0.375	8.62	7.976	0.322	18.00	*	98.40
12 x 6	12.75	12.000	0.375	6.62	6.060	0.280	18.00	*	86.50



**WELDBEND NOTES**

1. Conforms to ASME B16.9 & ASTM A234 WPB.
2. All dimensions are in inches.
3. For bevel detail see page 107.
4. For dimensional tolerances see page 108.
5. For sizes larger than 12" please call.
6. All weights are in pounds and approximated or estimated.

\* This size and thickness does not correspond to any pipe schedule number.

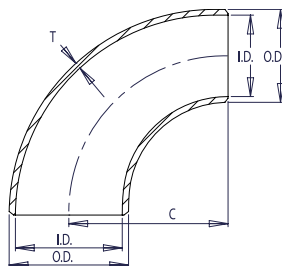

**SCHEDULE XS**  
 For reference only

Pipe Size	LARGE DIAMETER			SMALL DIAMETER			Center to End	Pipe Schedule Number	Approx. Weight in Pounds
	Outside Diameter	Inside Diameter	Wall Thickness	Outside Diameter	Inside Diameter	Wall Thickness			
	O.D.	I.D.	T	O.D.	I.D.	T	C		
2 x 1 1/2	2.38	1.944	0.218	1.90	1.500	0.200	3.00	80	1.90
2 x 1 1/4	2.38	1.944	0.218	1.66	1.278	0.191	3.00	80	1.80
2 x 1	2.38	1.944	0.218	1.32	0.962	0.179	3.00	80	1.70
2 1/2 x 2	2.88	2.328	0.276	2.38	1.944	0.218	3.75	80	3.40
2 1/2 x 1 1/2	2.88	2.328	0.276	1.90	1.500	0.200	3.75	80	3.00
2 1/2 x 1 1/4	2.88	2.328	0.276	1.66	1.278	0.191	3.75	80	2.90
3 x 2 1/2	3.50	2.900	0.300	2.88	2.328	0.276	4.50	80	5.70
3 x 2	3.50	2.900	0.300	2.38	1.944	0.218	4.50	80	4.90
3 x 1 1/2	3.50	2.900	0.300	1.90	1.500	0.200	4.50	80	4.50
3 1/2 x 3	4.00	3.364	0.318	3.50	2.900	0.300	5.25	80	8.20
3 1/2 x 2 1/2	4.00	3.364	0.318	2.88	2.328	0.276	5.25	80	7.30
3 1/2 x 2	4.00	3.364	0.318	2.38	1.944	0.218	5.25	80	6.40
4 x 3 1/2	4.50	3.826	0.337	4.00	3.364	0.318	6.00	80	11.40
4 x 3	4.50	3.826	0.337	3.50	2.900	0.300	6.00	80	10.50
4 x 2 1/2	4.50	3.826	0.337	2.88	2.328	0.276	6.00	80	9.40
4 x 2	4.50	3.826	0.337	2.38	1.944	0.218	6.00	80	8.40
5 x 4	5.56	4.810	0.375	4.50	3.826	0.337	7.50	80	18.80
5 x 3 1/2	5.56	4.810	0.375	4.00	3.364	0.318	7.50	80	17.40
5 x 3	5.56	4.810	0.375	3.50	2.900	0.300	7.50	80	16.50
5 x 2 1/2	5.56	4.810	0.375	2.88	2.328	0.276	7.50	80	15.10
6 x 5	6.62	5.756	0.432	5.56	4.810	0.375	9.00	80	31.40
6 x 4	6.62	5.756	0.432	4.50	3.826	0.337	9.00	80	27.90
6 x 3 1/2	6.62	5.756	0.432	4.00	3.364	0.318	9.00	80	26.30
6 x 3	6.62	5.756	0.432	3.50	2.900	0.300	9.00	80	24.90
8 x 6	8.62	7.620	0.500	6.62	5.756	0.432	12.00	80	60.80
8 x 5	8.62	7.620	0.500	5.56	4.810	0.375	12.00	80	54.30
8 x 4	8.62	7.620	0.500	4.50	3.826	0.337	12.00	80	49.50
10 x 8	10.75	9.750	0.500	8.62	7.620	0.500	15.00	*	102.00
10 x 6	10.75	9.750	0.500	6.62	5.756	0.432	15.00	*	86.50
10 x 5	10.75	9.750	0.500	5.56	4.810	0.375	15.00	*	78.50
12 x 10	12.75	11.750	0.500	10.75	9.750	0.500	18.00	*	148.00
12 x 8	12.75	11.750	0.500	8.62	7.620	0.500	18.00	*	132.00
12 x 6	12.75	11.750	0.500	6.62	5.756	0.432	18.00	*	114.00

FITTINGS

# 90° REDUCING ELBOWS



**SCHEDULE 40**  
For reference only

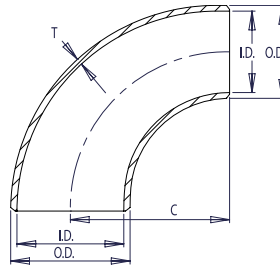

**WELDBEND NOTES**

1. Conforms to ASME B16.9 & ASTM A234 WPB.
2. All dimensions are in inches.
3. For bevel detail see page 107.
4. For dimensional tolerances see page 108.
5. For sizes larger than 12" please call.
6. All weights are in pounds and approximated or estimated.

FITTINGS

Pipe Size	LARGE DIAMETER			SMALL DIAMETER			Center to End	Pipe Schedule Number	Approx. Weight in Pounds
	Outside Diameter	Inside Diameter	Wall Thickness	Outside Diameter	Inside Diameter	Wall Thickness			
	O.D.	I.D.	T	O.D.	I.D.	T	C		
2 x 1 1/2	2.38	2.072	0.154	1.90	1.610	0.145	3.00	40	1.40
2 x 1 1/4	2.38	2.072	0.154	1.66	1.380	0.140	3.00	40	1.30
2 x 1	2.38	2.072	0.154	1.32	1.054	0.133	3.00	40	1.20
2 1/2 x 2	2.88	2.474	0.203	2.38	2.072	0.154	3.75	40	2.80
2 1/2 x 1 1/2	2.88	2.474	0.203	1.90	1.610	0.145	3.75	40	2.60
2 1/2 x 1 1/4	2.88	2.474	0.203	1.66	1.380	0.140	3.75	40	2.50
3 x 2 1/2	3.50	3.068	0.216	2.88	2.474	0.203	4.50	40	4.20
3 x 2	3.50	3.068	0.216	2.38	2.072	0.154	4.50	40	3.60
3 x 1 1/2	3.50	3.068	0.216	1.90	1.610	0.145	4.50	40	3.30
3 1/2 x 3	4.00	3.548	0.226	3.50	3.068	0.216	5.25	40	6.00
3 1/2 x 2 1/2	4.00	3.548	0.226	2.88	2.474	0.203	5.25	40	5.50
3 1/2 x 2	4.00	3.548	0.226	2.38	2.072	0.154	5.25	40	4.50
4 x 3 1/2	4.50	4.026	0.237	4.00	3.548	0.226	6.00	40	8.40
4 x 3	4.50	4.026	0.237	3.50	3.068	0.216	6.00	40	7.70
4 x 2 1/2	4.50	4.026	0.237	2.88	2.474	0.203	6.00	40	6.80
4 x 2	4.50	4.026	0.237	2.38	2.072	0.154	6.00	40	6.00
5 x 4	5.56	5.044	0.258	4.50	4.026	0.237	7.50	40	13.40
5 x 3 1/2	5.56	5.044	0.258	4.00	3.548	0.226	7.50	40	12.60
5 x 3	5.56	5.044	0.258	3.50	3.068	0.216	7.50	40	11.80
5 x 2 1/2	5.56	5.044	0.258	2.88	2.474	0.203	7.50	40	10.70
6 x 5	6.62	6.060	0.280	5.56	5.044	0.258	9.00	40	21.00
6 x 4	6.62	6.060	0.280	4.50	4.026	0.237	9.00	40	18.90
6 x 3 1/2	6.62	6.060	0.280	4.00	3.548	0.226	9.00	40	17.80
6 x 3	6.62	6.060	0.280	3.50	3.068	0.216	9.00	40	16.80
8 x 6	8.62	7.976	0.322	6.62	6.060	0.280	12.00	40	39.70
8 x 5	8.62	7.976	0.322	5.56	5.044	0.258	12.00	40	36.20
8 x 4	8.62	7.976	0.322	4.50	4.026	0.237	12.00	40	33.10
10 x 8	10.75	10.020	0.365	8.62	7.976	0.322	15.00	40	73.00
10 x 6	10.75	10.020	0.365	6.62	6.060	0.280	15.00	40	63.20
10 x 5	10.75	10.020	0.365	5.56	5.044	0.258	15.00	40	58.50
12 x 10	12.75	11.938	0.406	10.75	10.020	0.365	18.00	40	115.00
12 x 8	12.75	11.938	0.406	8.62	7.976	0.322	18.00	40	100.00
12 x 6	12.75	11.938	0.406	6.62	6.060	0.280	18.00	40	90.00

**WELDBEND NOTES**

1. Conforms to ASME B16.9 & ASTM A234 WPB.
2. All dimensions are in inches.
3. For bevel detail see page 107.
4. For dimensional tolerances see page 108.
5. For sizes larger than 12" please call.
6. All weights are in pounds and approximated or estimated.

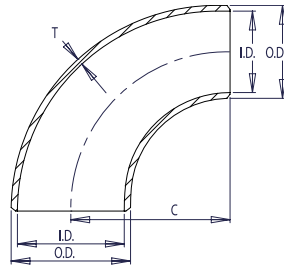

**SCHEDULE 80**  
 For reference only

Pipe Size	LARGE DIAMETER			SMALL DIAMETER			Center to End	Pipe Schedule Number	Approx. Weight in Pounds
	Outside Diameter	Inside Diameter	Wall Thickness	Outside Diameter	Inside Diameter	Wall Thickness			
	O.D.	I.D.	T	O.D.	I.D.	T	C		
2 x 1 1/2	2.38	1.944	0.218	1.90	1.500	0.200	3.00	80	1.90
2 x 1 1/4	2.38	1.944	0.218	1.66	1.278	0.191	3.00	80	1.80
2 x 1	2.38	1.944	0.218	1.32	0.962	0.179	3.00	80	1.70
2 1/2 x 2	2.88	2.328	0.276	2.38	1.944	0.218	3.75	80	3.40
2 1/2 x 1 1/2	2.88	2.328	0.276	1.90	1.500	0.200	3.75	80	3.00
2 1/2 x 1 1/4	2.88	2.328	0.276	1.66	1.278	0.191	3.75	80	2.90
3 x 2 1/2	3.50	2.900	0.300	2.88	2.328	0.276	4.50	80	5.70
3 x 2	3.50	2.900	0.300	2.38	1.944	0.218	4.50	80	4.90
3 x 1 1/2	3.50	2.900	0.300	1.90	1.500	0.200	4.50	80	4.50
3 1/2 x 3	4.00	3.364	0.318	3.50	2.900	0.300	5.25	80	8.20
3 1/2 x 2 1/2	4.00	3.364	0.318	2.88	2.328	0.276	5.25	80	7.30
3 1/2 x 2	4.00	3.364	0.318	2.38	1.944	0.218	5.25	80	6.40
4 x 3 1/2	4.50	3.826	0.337	4.00	3.364	0.318	6.00	80	11.40
4 x 3	4.50	3.826	0.337	3.50	2.900	0.300	6.00	80	10.50
4 x 2 1/2	4.50	3.826	0.337	2.88	2.328	0.276	6.00	80	9.40
4 x 2	4.50	3.826	0.337	2.38	1.944	0.218	6.00	80	8.40
5 x 4	5.56	4.810	0.375	4.50	3.826	0.337	7.50	80	18.80
5 x 3 1/2	5.56	4.810	0.375	4.00	3.364	0.318	7.50	80	17.40
5 x 3	5.56	4.810	0.375	3.50	2.900	0.300	7.50	80	16.50
5 x 2 1/2	5.56	4.810	0.375	2.88	2.328	0.276	7.50	80	15.10
6 x 5	6.62	5.756	0.432	5.56	4.810	0.375	9.00	80	31.40
6 x 4	6.62	5.756	0.432	4.50	3.826	0.337	9.00	80	27.90
6 x 3 1/2	6.62	5.756	0.432	4.00	3.364	0.318	9.00	80	26.30
6 x 3	6.62	5.756	0.432	3.50	2.900	0.300	9.00	80	24.90
8 x 6	8.62	7.620	0.500	6.62	5.756	0.432	12.00	80	60.80
8 x 5	8.62	7.620	0.500	5.56	4.810	0.375	12.00	80	54.30
8 x 4	8.62	7.620	0.500	4.50	3.826	0.337	12.00	80	49.50
10 x 8	10.75	9.562	0.594	8.62	7.620	0.500	15.00	80	105.00
10 x 6	10.75	9.562	0.594	6.62	5.756	0.432	15.00	80	90.00
10 x 5	10.75	9.562	0.594	5.56	4.810	0.375	15.00	80	80.00
12 x 10	12.75	11.374	0.688	10.75	9.562	0.594	18.00	80	155.00
12 x 8	12.75	11.374	0.688	8.62	7.620	0.500	18.00	80	135.00
12 x 6	12.75	11.374	0.688	6.62	5.756	0.432	18.00	80	120.00

FITTINGS

**3R  
SCHEDULE STD**

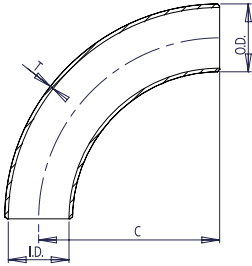

**WELDBEND NOTES**

1. Conforms to ASME B16.9 & ASTM A234 WPB.
  2. All dimensions are in inches.
  3. For bevel detail see page 107.
  4. For dimensional tolerances see page 108.
  5. For sizes larger than 24" please call.
  6. All weights are in pounds and approximated or estimated.
- \*This size and thickness does not correspond to any pipe schedule number.

Pipe Size	Outside Diameter	Inside Diameter	Wall Thickness	Center to End	Pipe Schedule Number	Approx. Weight in Pounds
	O.D.	I.D.	T	C		
¾	1.05	0.824	0.113	2.25	40	0.30
1	1.32	1.054	0.133	3.00	40	0.80
1 ¼	1.66	1.380	0.140	3.75	40	1.10
1 ½	1.90	1.610	0.145	4.50	40	1.60
2	2.38	2.072	0.154	6.00	40	3.20
2 ½	2.88	2.474	0.203	7.50	40	6.40
3	3.50	3.068	0.216	9.00	40	9.60
3 ½	4.00	3.548	0.226	10.50	40	15.00
4	4.50	4.026	0.237	12.00	40	17.80
5	5.56	5.044	0.258	15.00	40	30.00
6	6.62	6.060	0.280	18.00	40	48.00
8	8.62	7.976	0.322	24.00	40	95.00
10	10.75	10.020	0.365	30.00	40	167.00
12	12.75	12.000	0.375	36.00	*	250.00
14	14.00	13.250	0.375	42.00	30	310.00
16	16.00	15.250	0.375	48.00	30	415.00
18	18.00	17.250	0.375	54.00	*	530.00
20	20.00	19.250	0.375	60.00	20	650.00
24	24.00	23.250	0.375	72.00	20	935.00

FITTINGS

**3R  
SCHEDULE XS**

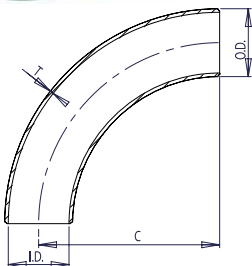

**WELDBEND NOTES**

1. Conforms to ASME B16.9 & ASTM A234 WPB.
  2. All dimensions are in inches.
  3. For bevel detail see page 107.
  4. For dimensional tolerances see page 108.
  5. For sizes larger than 24" please call.
  6. All weights are in pounds and approximated or estimated.
- \*This size and thickness does not correspond to any pipe schedule number.

Pipe Size	Outside Diameter	Inside Diameter	Wall Thickness	Center to End	Pipe Schedule Number	Approx. Weight in Pounds
	O.D.	I.D.	T	C		
¾	1.05	0.742	0.154	2.25	80	0.30
1	1.32	0.962	0.179	3.00	80	1.58
1 ¼	1.66	1.278	0.191	3.75	80	2.40
1 ½	1.90	1.500	0.200	4.50	80	4.20
2	2.38	1.944	0.218	6.00	80	7.60
2 ½	2.88	2.328	0.276	7.50	80	12.60
3	3.50	2.900	0.300	9.00	80	17.20
3 ½	4.00	3.364	0.318	10.50	80	22.00
4	4.50	3.826	0.337	12.00	80	25.00
5	5.56	4.810	0.375	15.00	80	45.00
6	6.62	5.756	0.432	18.00	80	70.00
8	8.62	7.620	0.500	24.00	80	145.00
10	10.75	9.750	0.500	30.00	60	225.00
12	12.75	11.750	0.500	36.00	*	320.00
14	14.00	13.000	0.500	42.00	*	405.00
16	16.00	15.000	0.500	48.00	40	540.00
18	18.00	17.000	0.500	54.00	*	700.00
20	20.00	19.000	0.500	60.00	30	845.00
24	24.00	23.000	0.500	72.00	*	1210.00

Pipe Size	Outside Diameter	Inside Diameter	Wall Thickness	Center to End	Pipe Schedule Number	Approx. Weight in Pounds
	O.D.	I.D.	T	C		
¾	1.05	0.824	0.113	2.25	40	0.30
1	1.32	1.054	0.133	3.00	40	0.80
1 ¼	1.66	1.380	0.140	3.75	40	1.10
1 ½	1.90	1.610	0.145	4.50	40	1.60
2	2.38	2.072	0.154	6.00	40	3.20
2 ½	2.88	2.474	0.203	7.50	40	6.40
3	3.50	3.068	0.216	9.00	40	9.60
3 ½	4.00	3.548	0.226	10.50	40	15.00
4	4.50	4.026	0.237	12.00	40	17.80
5	5.56	5.044	0.258	15.00	40	30.00
6	6.62	6.060	0.280	18.00	40	48.00
8	8.62	7.976	0.322	24.00	40	95.00
10	10.75	10.020	0.365	30.00	40	167.00
12	12.75	11.938	0.406	36.00	40	205.00
14	14.00	13.124	0.438	42.00	40	305.00
16	16.00	15.000	0.500	48.00	40	540.00
18	18.00	16.876	0.562	54.00	40	740.00
20	20.00	18.812	0.594	60.00	40	950.00
24	24.00	22.624	0.688	72.00	40	1400.00

3R  
 SCHEDULE 40

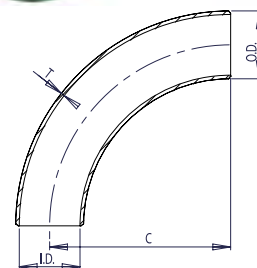

**WELDBEND** NOTES

1. Conforms to ASME B16.9 & ASTM A234 WPB.
2. All dimensions are in inches.
3. For bevel detail see page 107.
4. For dimensional tolerances see page 108.
5. For sizes larger than 24" please call.
6. All weights are in pounds and approximated or estimated.

FITTINGS

Pipe Size	Outside Diameter	Inside Diameter	Wall Thickness	Center to End	Pipe Schedule Number	Approx. Weight in Pounds
	O.D.	I.D.	T	C		
¾	1.05	0.742	0.154	2.25	80	0.30
1	1.32	0.962	0.179	3.00	80	1.58
1 ¼	1.66	1.278	0.191	3.75	80	2.40
1 ½	1.90	1.500	0.200	4.50	80	4.20
2	2.38	1.944	0.218	6.00	80	7.60
2 ½	2.88	2.328	0.276	7.50	80	12.60
3	3.50	2.900	0.300	9.00	80	17.20
3 ½	4.00	3.364	0.318	10.50	80	22.00
4	4.50	3.826	0.337	12.00	80	25.00
5	5.56	4.810	0.375	15.00	80	45.00
6	6.62	5.756	0.432	18.00	80	70.00
8	8.62	7.620	0.500	24.00	80	145.00
10	10.75	9.562	0.594	30.00	80	200.00
12	12.75	11.374	0.688	36.00	80	320.00
14	14.00	12.500	0.750	42.00	80	600.00
16	16.00	14.312	0.844	48.00	80	810.00
18	18.00	16.124	0.938	54.00	80	1020.00
20	20.00	17.938	1.031	60.00	80	1400.00
24	24.00	21.562	1.219	72.00	80	1800.00

3R  
 SCHEDULE 80

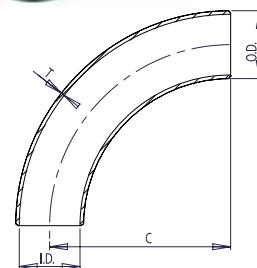

**WELDBEND** NOTES

1. Conforms to ASME B16.9 & ASTM A234 WPB.
2. All dimensions are in inches.
3. For bevel detail see page 107.
4. For dimensional tolerances see page 108.
5. All weights are in pounds and approximated or estimated.

## LONG RADIUS SCHEDULE STD

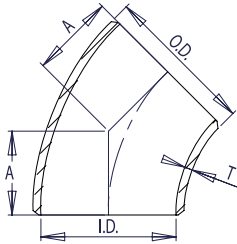

### WELDBEND NOTES

1. Conforms to ASME B16.9 & ASTM A234 WPB.
  2. All dimensions are in inches.
  3. For bevel detail see page 107.
  4. For dimensional tolerances see page 108.
  5. For sizes larger than 48" please call.
  6. All weights are in pounds and approximated or estimated.
- \* This size and thickness does not correspond to any pipe schedule number.

Pipe Size	Outside Diameter	Inside Diameter	Wall Thickness	Center to End	Pipe Schedule Number	Approx. Weight in Pounds
	O.D.	I.D.	T	A		
1/2	0.84	0.622	0.109	0.62	40	0.09
3/4	1.05	0.824	0.113	0.75	40	0.10
1	1.32	1.049	0.133	0.88	40	0.22
1 1/4	1.66	1.380	0.140	1.00	40	0.33
1 1/2	1.90	1.610	0.145	1.12	40	0.43
2	2.38	2.067	0.154	1.38	40	0.85
2 1/2	2.88	2.469	0.203	1.75	40	1.70
3	3.50	3.068	0.216	2.00	40	2.50
3 1/2	4.00	3.548	0.226	2.25	40	3.40
4	4.50	4.026	0.237	2.50	40	4.50
5	5.56	5.047	0.258	3.12	40	7.50
6	6.62	6.065	0.280	3.75	40	11.70
8	8.62	7.981	0.322	5.00	40	23.30
10	10.75	10.020	0.365	6.25	40	40.90
12	12.75	12.000	0.375	7.50	*	61.40
14	14.00	13.250	0.375	8.75	30	78.10
16	16.00	15.250	0.375	10.00	30	101.00
18	18.00	17.250	0.375	11.25	*	128.00
20	20.00	19.250	0.375	12.50	20	159.00
24	24.00	23.250	0.375	15.00	20	231.00
30	30.00	29.250	0.375	18.50	*	358.00
36	36.00	35.250	0.375	22.25	*	518.00
42	42.00	41.250	0.375	26.00	*	707.00
48	48.00	47.250	0.375	29.88	*	1000.00

FITTINGS

## LONG RADIUS SCHEDULE XS

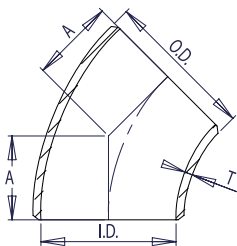

### WELDBEND NOTES

1. Conforms to ASME B16.9 & ASTM A234 WPB.
  2. All dimensions are in inches.
  3. For bevel detail see page 107.
  4. For dimensional tolerances see page 108.
  5. For sizes larger than 48" please call.
  6. All weights are in pounds and approximated or estimated.
- \* This size and thickness does not correspond to any pipe schedule number.

Pipe Size	Outside Diameter	Inside Diameter	Wall Thickness	Center to End	Pipe Schedule Number	Approx. Weight in Pounds
	O.D.	I.D.	T	A		
1/2	0.84	0.546	0.147	0.62	80	0.15
3/4	1.05	0.742	0.154	0.75	80	0.16
1	1.32	0.957	0.179	0.88	80	0.28
1 1/4	1.66	1.278	0.191	1.00	80	0.45
1 1/2	1.90	1.500	0.200	1.12	80	0.61
2	2.38	1.939	0.218	1.38	80	1.20
2 1/2	2.88	2.323	0.276	1.75	80	2.00
3	3.50	2.900	0.300	2.00	80	3.30
3 1/2	4.00	3.364	0.318	2.25	80	4.50
4	4.50	3.826	0.337	2.50	80	6.20
5	5.56	4.813	0.375	3.12	80	10.50
6	6.62	5.761	0.432	3.75	80	17.00
8	8.62	7.625	0.500	5.00	80	34.30
10	10.75	9.750	0.500	6.25	60	53.50
12	12.75	11.750	0.500	7.50	*	77.60
14	14.00	13.000	0.500	8.75	*	100.00
16	16.00	15.000	0.500	10.00	40	134.00
18	18.00	17.000	0.500	11.25	*	170.00
20	20.00	19.000	0.500	12.50	30	209.00
24	24.00	23.000	0.500	15.00	*	302.00
30	30.00	29.000	0.500	18.50	20	475.10
36	36.00	35.000	0.500	22.25	20	686.10
42	42.00	41.000	0.500	26.00	*	936.10
48	48.00	47.000	0.500	29.88	*	1250.00

## 45° ELBOWS

### LONG RADIUS SCHEDULE 40

Pipe Size	Outside Diameter	Inside Diameter	Wall Thickness	Center to End	Pipe Schedule Number	Approx. Weight in Pounds
	O.D.	I.D.	T	A		
1/2	0.84	0.622	0.109	0.62	40	0.09
3/4	1.05	0.824	0.113	0.75	40	0.10
1	1.32	1.054	0.133	0.88	40	0.22
1 1/4	1.66	1.380	0.140	1.00	40	0.33
1 1/2	1.90	1.610	0.145	1.12	40	0.43
2	2.38	2.072	0.154	1.38	40	0.85
2 1/2	2.88	2.474	0.203	1.75	40	1.70
3	3.50	3.068	0.216	2.00	40	2.50
3 1/2	4.00	3.548	0.226	2.25	40	3.40
4	4.50	4.026	0.237	2.50	40	4.50
5	5.56	5.044	0.258	3.12	40	7.50
6	6.62	6.060	0.280	3.75	40	11.70
8	8.62	7.976	0.322	5.00	40	23.30
10	10.75	10.020	0.365	6.25	40	40.90
12	12.75	11.938	0.406	7.50	40	65.00
14	14.00	13.124	0.438	8.75	40	80.00
16	16.00	15.000	0.500	10.00	40	105.00
18	18.00	16.876	0.562	11.25	40	130.00
20	20.00	18.812	0.594	12.50	40	165.00
24	24.00	22.624	0.688	15.00	40	235.00

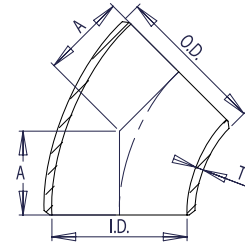

#### WELDBEND NOTES

1. Conforms to ASME B16.9 & ASTM A234 WPB.
2. All dimensions are in inches.
3. For bevel detail see page 107.
4. For dimensional tolerances see page 108.
5. For sizes larger than 24" please call.
6. All weights are in pounds and approximated or estimated.

FITTINGS

### LONG RADIUS SCHEDULE 80

Pipe Size	Outside Diameter	Inside Diameter	Wall Thickness	Center to End	Pipe Schedule Number	Approx. Weight in Pounds
	O.D.	I.D.	T	A		
1/2	0.84	0.546	0.147	0.62	80	0.15
3/4	1.05	0.742	0.154	0.75	80	0.16
1	1.32	0.962	0.179	0.88	80	0.28
1 1/4	1.66	1.278	0.191	1.00	80	0.45
1 1/2	1.90	1.500	0.200	1.12	80	0.61
2	2.38	1.944	0.218	1.38	80	1.20
2 1/2	2.88	2.328	0.276	1.75	80	2.00
3	3.50	2.900	0.300	2.00	80	3.30
3 1/2	4.00	3.364	0.318	2.25	80	4.50
4	4.50	3.826	0.337	2.50	80	6.20
5	5.56	4.810	0.375	3.12	80	10.50
6	6.62	5.756	0.432	3.75	80	17.00
8	8.62	7.620	0.500	5.00	80	34.30
10	10.75	9.562	0.594	6.25	80	55.00
12	12.75	11.374	0.688	7.50	80	80.00
14	14.00	12.500	0.750	8.75	80	100.00
16	16.00	14.312	0.844	10.00	80	135.00
18	18.00	16.124	0.938	11.25	80	175.00
20	20.00	17.938	1.031	12.50	80	210.00
24	24.00	21.562	1.219	15.00	80	305.00

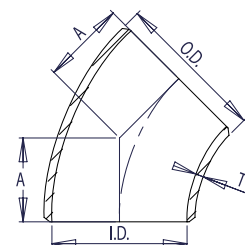

#### WELDBEND NOTES

1. Conforms to ASME B16.9 & ASTM A234 WPB.
2. All dimensions are in inches.
3. For bevel detail see page 107.
4. For dimensional tolerances see page 108.
5. All weights are in pounds and approximated or estimated.

## LONG RADIUS SCHEDULE 160

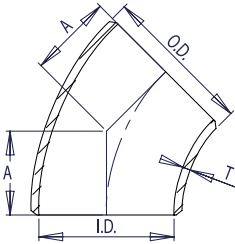

### WELDBEND NOTES

1. Conforms to ASME B16.9 & ASTM A234 WPB.
2. All dimensions are in inches.
3. For bevel detail see page 107.
4. For dimensional tolerances see page 108.
5. All weights are in pounds and approximated or estimated.

Pipe Size	Outside Diameter	Inside Diameter	Wall Thickness	Center to End	Pipe Schedule Number	Approx. Weight in Pounds
	O.D.	I.D.	T	A		
1/2	0.84	0.464	0.188	0.62	160	1.80
3/4	1.05	0.612	0.219	0.75	160	2.00
1	1.32	0.820	0.250	0.88	160	3.00
1 1/4	1.66	1.160	0.250	1.00	160	3.50
1 1/2	1.90	1.338	0.281	1.12	160	3.70
2	2.38	1.692	0.344	1.38	160	5.00
2 1/2	2.88	2.130	0.375	1.75	160	3.70
3	3.50	2.624	0.438	2.00	160	5.60
4	4.50	3.438	0.531	2.50	160	5.60
5	5.56	4.310	0.625	3.12	160	15.00
6	6.62	5.182	0.719	3.75	160	28.00
8	8.62	6.808	0.906	5.00	160	48.00
10	10.75	8.500	1.125	6.25	160	72.00
12	12.75	10.126	1.312	7.50	160	98.00
14	14.00	11.188	1.406	8.75	160	130.00
16	16.00	12.812	1.594	10.00	160	180.00
18	18.00	14.438	1.781	11.25	160	260.00
20	20.00	16.062	1.969	12.50	160	390.00
24	24.00	19.312	2.344	15.00	160	560.00

FITTINGS

## LONG RADIUS SCHEDULE XXS

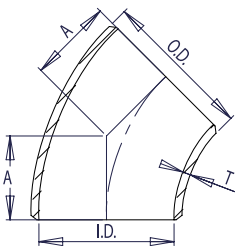

### WELDBEND NOTES

1. Conforms to ASME B16.9 & ASTM A234 WPB.
2. All dimensions are in inches.
3. For bevel detail see page 107.
4. For dimensional tolerances see page 108.
5. All weights are in pounds and approximated or estimated.

\* This size and thickness does not correspond to any pipe schedule number.

Pipe Size	Outside Diameter	Inside Diameter	Wall Thickness	Center to End	Pipe Schedule Number	Approx. Weight in Pounds
	O.D.	I.D.	T	A		
1/2	0.84	0.252	0.294	0.62	*	1.80
3/4	1.05	0.434	0.308	0.75	*	2.00
1	1.32	0.604	0.358	0.88	*	3.00
1 1/4	1.66	0.896	0.382	1.00	*	3.50
1 1/2	1.90	1.100	0.400	1.12	*	3.70
2	2.38	1.508	0.436	1.38	*	5.00
2 1/2	2.88	1.776	0.552	1.75	*	3.70
3	3.50	2.300	0.600	2.00	*	6.00
4	4.50	3.152	0.674	2.50	*	10.40
5	5.56	4.060	0.750	3.12	*	19.20
6	6.62	4.892	0.864	3.75	*	30.00
8	8.62	6.870	0.875	5.00	*	50.00
10	10.75	8.750	1.000	6.25	140	75.00
12	12.75	10.750	1.000	7.50	120	95.00



Pipe Size	Outside Diameter	Inside Diameter	Wall Thickness	Center to End	Pipe Schedule Number	Approx. Weight in Pounds
	O.D.	I.D.	T	A		
¾	1.05	0.824	0.113	0.94	40	0.50
1	1.32	1.054	0.133	1.25	40	0.70
1 ¼	1.66	1.380	0.140	1.56	40	1.00
1 ½	1.90	1.610	0.145	1.88	40	1.30
2	2.38	2.072	0.154	2.50	40	1.50
2 ½	2.88	2.474	0.203	3.12	40	1.75
3	3.50	3.068	0.216	3.75	40	3.00
3 ½	4.00	3.548	0.226	4.38	40	5.00
4	4.50	4.026	0.237	5.00	40	9.00
5	5.56	5.044	0.258	6.19	40	16.00
6	6.62	6.060	0.280	7.44	40	22.50
8	8.62	7.976	0.322	9.94	40	45.00
10	10.75	10.020	0.365	12.44	40	80.00
12	12.75	12.000	0.375	14.88	*	120.00
14	14.00	13.250	0.375	17.38	30	150.00
16	16.00	15.250	0.375	19.88	30	193.00
18	18.00	17.250	0.375	22.38	*	248.00
20	20.00	19.250	0.375	24.88	20	308.00
24	24.00	23.250	0.375	29.81	20	440.00

3R  
 SCHEDULE STD

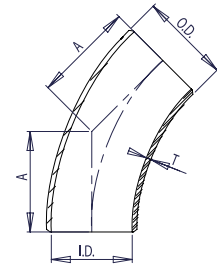

**WELDBEND** NOTES

1. Conforms to ASME B16.9 & ASTM A234 WPB.
  2. All dimensions are in inches.
  3. For bevel detail see page 107.
  4. For dimensional tolerances see page 108.
  5. For sizes larger than 24" please call.
  6. All weights are in pounds and approximated or estimated.
- \* This size and thickness does not correspond to any pipe schedule number.

Pipe Size	Outside Diameter	Inside Diameter	Wall Thickness	Center to End	Pipe Schedule Number	Approx. Weight in Pounds
	O.D.	I.D.	T	A		
¾	1.05	0.742	0.154	0.94	80	0.16
1	1.32	0.962	0.179	1.25	80	0.28
1 ¼	1.66	1.278	0.191	1.56	80	0.45
1 ½	1.90	1.500	0.200	1.88	80	0.61
2	2.38	1.944	0.218	2.50	80	1.20
2 ½	2.88	2.328	0.276	3.12	80	2.00
3	3.50	2.900	0.300	3.75	80	3.30
3 ½	4.00	3.364	0.318	4.38	80	4.50
4	4.50	3.826	0.337	5.00	80	6.20
5	5.56	4.810	0.375	6.19	80	10.50
6	6.62	5.756	0.432	7.44	80	17.00
8	8.62	7.620	0.500	9.94	80	34.30
10	10.75	9.750	0.500	12.44	60	53.50
12	12.75	11.750	0.500	14.88	*	77.60
14	14.00	13.000	0.500	17.38	*	100.00
16	16.00	15.000	0.500	19.88	40	134.00
18	18.00	17.000	0.500	22.38	*	170.00
20	20.00	19.000	0.500	24.88	30	209.00
24	24.00	23.000	0.500	29.81	*	302.00

3R  
 SCHEDULE XS

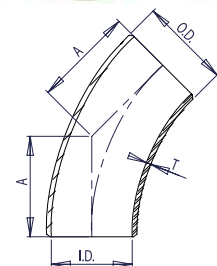

**WELDBEND** NOTES

1. Conforms to ASME B16.9 & ASTM A234 WPB.
  2. All dimensions are in inches.
  3. For bevel detail see page 107.
  4. For dimensional tolerances see page 108.
  5. For sizes larger than 24" please call.
  6. All weights are in pounds and approximated or estimated.
- \* This size and thickness does not correspond to any pipe schedule number.

FITTINGS

**3R  
SCHEDULE 40**

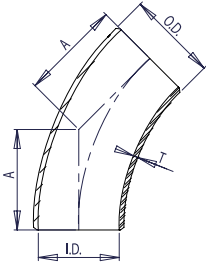

**WELDBEND NOTES**

1. Conforms to ASME B16.9 & ASTM A234 WPB.
2. All dimensions are in inches.
3. For bevel detail see page 107.
4. For dimensional tolerances see page 108.
5. For sizes larger than 24" please call.
6. All weights are in pounds and approximated or estimated.

Pipe Size	Outside Diameter	Inside Diameter	Wall Thickness	Center to End	Pipe Schedule Number	Approx. Weight in Pounds
	O.D.	I.D.	T	A		
3/4	1.05	0.824	0.113	0.94	40	0.50
1	1.32	1.054	0.133	1.25	40	0.70
1 1/4	1.66	1.380	0.140	1.56	40	1.00
1 1/2	1.90	1.610	0.145	1.88	40	1.30
2	2.38	2.072	0.154	2.50	40	1.50
2 1/2	2.88	2.474	0.203	3.12	40	1.75
3	3.50	3.068	0.216	3.75	40	3.00
3 1/2	4.00	3.548	0.226	4.38	40	5.00
4	4.50	4.026	0.237	5.00	40	9.00
5	5.56	5.044	0.258	6.19	40	16.00
6	6.62	6.060	0.280	7.44	40	22.50
8	8.62	7.976	0.322	9.94	40	45.00
10	10.75	10.020	0.365	12.44	40	80.00
12	12.75	11.938	0.406	14.88	40	160.00
14	14.00	13.124	0.438	17.38	40	270.00
16	16.00	15.000	0.500	19.88	40	360.00
18	18.00	16.876	0.562	22.38	40	490.00
20	20.00	18.812	0.594	24.88	40	615.00
24	24.00	22.624	0.688	29.81	40	775.00

FITTINGS

**3R  
SCHEDULE 80**

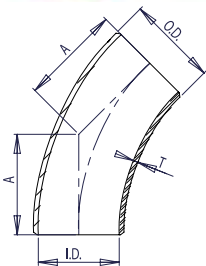

**WELDBEND NOTES**

1. Conforms to ASME B16.9 & ASTM A234 WPB.
2. All dimensions are in inches.
3. For bevel detail see page 107.
4. For dimensional tolerances see page 108.
5. All weights are in pounds and approximated or estimated.

Pipe Size	Outside Diameter	Inside Diameter	Wall Thickness	Center to End	Pipe Schedule Number	Approx. Weight in Pounds
	O.D.	I.D.	T	A		
3/4	1.05	0.742	0.154	0.94	80	0.16
1	1.32	0.962	0.179	1.25	80	0.28
1 1/4	1.66	1.278	0.191	1.56	80	0.45
1 1/2	1.90	1.500	0.200	1.88	80	0.61
2	2.38	1.944	0.218	2.50	80	1.20
2 1/2	2.88	2.328	0.276	3.12	80	2.00
3	3.50	2.900	0.300	3.75	80	3.30
3 1/2	4.00	3.364	0.318	4.38	80	4.50
4	4.50	3.826	0.337	5.00	80	6.20
5	5.56	4.810	0.375	6.19	80	10.50
6	6.62	5.756	0.432	7.44	80	17.00
8	8.62	7.620	0.500	9.94	80	34.30
10	10.75	9.562	0.594	12.44	80	150.00
12	12.75	11.374	0.688	14.88	80	200.00
14	14.00	12.500	0.750	17.38	80	337.50
16	16.00	14.312	0.844	19.88	80	450.00
18	18.00	16.124	0.938	22.38	80	612.50
20	20.00	17.938	1.031	24.88	80	768.75
24	24.00	21.562	1.219	29.81	80	968.75

## 180° RETURN BENDS

Pipe Size	Outside Diameter	Inside Diameter	Wall Thickness	Center to Center	Back to Face	Pipe Schedule Number	Approx. Weight in Pounds
	O.D.	I.D.	T	V	W		
1/2	0.84	0.622	0.109	3.00	1.88	40	0.32
3/4	1.05	0.824	0.113	3.00	2.00	40	0.34
1	1.32	1.049	0.133	3.00	2.19	40	0.74
1 1/4	1.66	1.380	0.140	3.75	2.75	40	1.10
1 1/2	1.90	1.610	0.145	4.50	3.25	40	1.60
2	2.38	2.067	0.154	6.00	4.19	40	3.20
2 1/2	2.88	2.469	0.203	7.50	5.19	40	6.10
3	3.50	3.068	0.216	9.00	6.25	40	9.40
3 1/2	4.00	3.548	0.226	10.50	7.25	40	12.80
4	4.50	4.026	0.237	12.00	8.25	40	17.50
5	5.56	5.047	0.258	15.00	10.31	40	29.30
6	6.62	6.065	0.280	18.00	12.31	40	47.00
8	8.62	7.981	0.322	24.00	16.31	40	87.00
10	10.75	10.020	0.365	30.00	20.38	40	164.00
12	12.75	12.000	0.375	36.00	24.38	*	237.00
14	14.00	13.250	0.375	42.00	28.00	30	311.00
16	16.00	15.250	0.375	48.00	32.00	30	408.00
18	18.00	17.250	0.375	54.00	36.00	*	514.00
20	20.00	19.250	0.375	60.00	40.00	20	636.00
24	24.00	23.250	0.375	72.00	48.00	20	908.00

### LONG RADIUS SCHEDULE STD

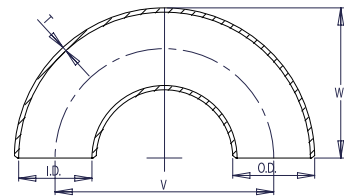

#### WELDBEND NOTES

1. Conforms to ASME B16.9 & ASTM A234 WPB.
  2. All dimensions are in inches.
  3. For bevel detail see page 107.
  4. For dimensional tolerances see page 108.
  5. For sizes larger than 24" please call.
  6. All weights are in pounds and approximated or estimated.
- \* This size and thickness does not correspond to any pipe schedule number.

Pipe Size	Outside Diameter	Inside Diameter	Wall Thickness	Center to Center	Back to Face	Pipe Schedule Number	Approx. Weight in Pounds
	O.D.	I.D.	T	V	W		
1/2	0.84	0.546	0.147	3.00	1.88	80	0.45
3/4	1.05	0.742	0.154	3.00	2.00	80	0.52
1	1.32	0.957	0.179	3.00	2.19	80	0.97
1 1/4	1.66	1.278	0.191	3.75	2.75	80	1.60
1 1/2	1.90	1.500	0.200	4.50	3.25	80	2.20
2	2.38	1.939	0.218	6.00	4.19	80	4.10
2 1/2	2.88	2.323	0.276	7.50	5.19	80	7.70
3	3.50	2.900	0.300	9.00	6.25	80	12.40
3 1/2	4.00	3.364	0.318	10.50	7.25	80	17.10
4	4.50	3.826	0.337	12.00	8.25	80	24.10
5	5.56	4.813	0.375	15.00	10.31	80	41.70
6	6.62	5.761	0.432	18.00	12.31	80	68.20
8	8.62	7.625	0.500	24.00	16.31	80	140.00
10	10.75	9.750	0.500	30.00	20.38	60	217.00
12	12.75	11.750	0.500	36.00	24.38	*	311.00
14	14.00	13.000	0.500	42.00	28.00	*	400.00
16	16.00	15.000	0.500	48.00	32.00	40	540.00
18	18.00	17.000	0.500	54.00	36.00	*	686.00
20	20.00	19.000	0.500	60.00	40.00	30	840.00
24	24.00	23.000	0.500	72.00	48.00	*	1210.00

### LONG RADIUS SCHEDULE XS

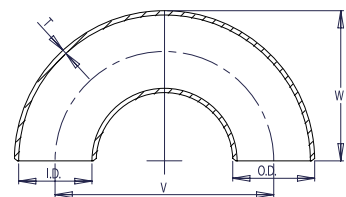

#### WELDBEND NOTES

1. Conforms to ASME B16.9 & ASTM A234 WPB.
  2. All dimensions are in inches.
  3. For bevel detail see page 107.
  4. For dimensional tolerances see page 108.
  5. For sizes larger than 24" please call.
  6. All weights are in pounds and approximated or estimated.
- \* This size and thickness does not correspond to any pipe schedule number.

## LONG RADIUS SCHEDULE 40

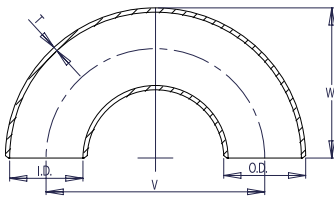

### WELDBEND NOTES

1. Conforms to ASME B16.9 & ASTM A234 WPB.
2. All dimensions are in inches.
3. For bevel detail see page 107.
4. For dimensional tolerances see page 108.
5. For sizes larger than 24" please call.
6. All weights are in pounds and approximated or estimated.

Pipe Size	Outside Diameter	Inside Diameter	Wall Thickness	Center to Center	Back to Face	Pipe Schedule Number	Approx. Weight in Pounds
	O.D.	I.D.	T	V	W		
1/2	0.84	0.622	0.109	3.00	1.88	40	0.32
3/4	1.05	0.824	0.113	3.00	2.00	40	0.34
1	1.32	1.054	0.133	3.00	2.19	40	0.74
1 1/4	1.66	1.380	0.140	3.75	2.75	40	1.10
1 1/2	1.90	1.610	0.145	4.50	3.25	40	1.60
2	2.38	2.072	0.154	6.00	4.19	40	3.20
2 1/2	2.88	2.474	0.203	7.50	5.19	40	6.10
3	3.50	3.068	0.216	9.00	6.25	40	9.40
3 1/2	4.00	3.548	0.226	10.50	7.25	40	12.80
4	4.50	4.026	0.237	12.00	8.25	40	17.50
5	5.56	5.044	0.258	15.00	10.31	40	29.30
6	6.62	6.060	0.280	18.00	12.31	40	47.00
8	8.62	7.976	0.322	24.00	16.31	40	87.00
10	10.75	10.020	0.365	30.00	20.38	40	164.00
12	12.75	11.938	0.406	36.00	24.38	40	240.00
14	14.00	13.124	0.438	42.00	28.00	40	315.00
16	16.00	15.000	0.500	48.00	32.00	40	410.00
18	18.00	16.876	0.562	54.00	36.00	40	520.00
20	20.00	18.812	0.594	60.00	40.00	40	640.00
24	24.00	22.624	0.688	72.00	48.00	40	915.00

FITTINGS

## LONG RADIUS SCHEDULE 80

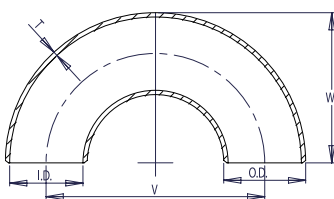

### WELDBEND NOTES

1. Conforms to ASME B16.9 & ASTM A234 WPB.
2. All dimensions are in inches.
3. For bevel detail see page 107.
4. For dimensional tolerances see page 108.
5. All weights are in pounds and approximated or estimated.

Pipe Size	Outside Diameter	Inside Diameter	Wall Thickness	Center to Center	Back to Face	Pipe Schedule Number	Approx. Weight in Pounds
	O.D.	I.D.	T	V	W		
1/2	0.84	0.546	0.147	3.00	1.88	80	0.45
3/4	1.05	0.742	0.154	3.00	2.00	80	0.52
1	1.32	0.962	0.179	3.00	2.19	80	0.97
1 1/4	1.66	1.278	0.191	3.75	2.75	80	1.60
1 1/2	1.90	1.500	0.200	4.50	3.25	80	2.20
2	2.38	1.944	0.218	6.00	4.19	80	4.10
2 1/2	2.88	2.328	0.276	7.50	5.19	80	7.70
3	3.50	2.900	0.300	9.00	6.25	80	12.40
3 1/2	4.00	3.364	0.318	10.50	7.25	80	17.10
4	4.50	3.826	0.337	12.00	8.25	80	24.10
5	5.56	4.810	0.375	15.00	10.31	80	41.70
6	6.62	5.756	0.432	18.00	12.31	80	68.20
8	8.62	7.620	0.500	24.00	16.31	80	140.00
10	10.75	9.562	0.594	30.00	20.38	80	220.00
12	12.75	11.374	0.688	36.00	24.38	80	315.00
14	14.00	12.500	0.750	42.00	28.00	80	410.00
16	16.00	14.312	0.844	48.00	32.00	80	550.00
18	18.00	16.124	0.938	54.00	36.00	80	695.00
20	20.00	17.938	1.031	60.00	40.00	80	850.00
24	24.00	21.562	1.219	72.00	48.00	80	1225.00

## 180° RETURN BENDS

Pipe Size	Outside Diameter	Inside Diameter	Wall Thickness	Center to Center	Back to Face	Pipe Schedule Number	Approx. Weight in Pounds
	O.D.	I.D.	T	V	W		
1/2	0.84	0.464	0.188	3.00	1.88	160	0.40
3/4	1.05	0.612	0.219	3.00	2.00	160	0.43
1	1.32	0.820	0.250	3.00	2.19	160	0.93
1 1/4	1.66	1.160	0.250	3.75	2.75	160	1.38
1 1/2	1.90	1.338	0.281	4.50	3.25	160	2.00
2	2.38	1.692	0.344	6.00	4.19	160	4.00
2 1/2	2.88	2.130	0.375	7.50	5.19	160	7.63
3	3.50	2.624	0.438	9.00	6.25	160	11.75
4	4.50	3.438	0.531	12.00	8.25	160	21.88
5	5.56	4.310	0.625	15.00	10.31	160	36.63
6	6.62	5.182	0.719	18.00	12.31	160	58.75
8	8.62	6.808	0.906	24.00	16.31	160	108.75
10	10.75	8.500	1.125	30.00	20.38	160	205.00
12	12.75	10.126	1.312	36.00	24.38	160	296.25
14	14.00	11.188	1.406	42.00	28.00	160	388.75
16	16.00	12.812	1.594	48.00	32.00	160	510.00
18	18.00	14.438	1.781	54.00	36.00	160	642.50
20	20.00	16.062	1.969	60.00	40.00	160	795.00
24	24.00	19.312	2.344	72.00	48.00	160	1135.00

### LONG RADIUS SCHEDULE 160

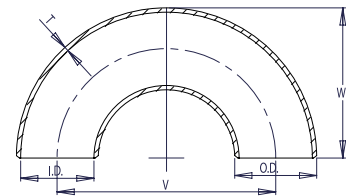

#### WELDBEND NOTES

1. Conforms to ASME B16.9 & ASTM A234 WPB.
2. All dimensions are in inches.
3. For bevel detail see page 107.
4. For dimensional tolerances see page 108.
5. All weights are in pounds and approximated or estimated.

Pipe Size	Outside Diameter	Inside Diameter	Wall Thickness	Center to Center	Back to Face	Pipe Schedule Number	Approx. Weight in Pounds
	O.D.	I.D.	T	V	W		
1/2	0.84	0.252	0.294	3.00	1.88	*	0.44
3/4	1.05	0.434	0.308	3.00	2.00	*	0.47
1	1.32	0.604	0.358	3.00	2.19	*	1.02
1 1/4	1.66	0.896	0.382	3.75	2.75	*	1.51
1 1/2	1.90	1.100	0.400	4.50	3.25	*	2.20
2	2.38	1.508	0.436	6.00	4.19	*	4.40
2 1/2	2.88	1.776	0.552	7.50	5.19	*	8.39
3	3.50	2.300	0.600	9.00	6.25	*	12.93
4	4.50	3.152	0.674	12.00	8.25	*	24.06
5	5.56	4.060	0.750	15.00	10.31	*	40.29
6	6.62	4.892	0.864	18.00	12.31	*	64.63
8	8.62	6.870	0.875	24.00	16.31	*	119.63
10	10.75	8.750	1.000	30.00	20.38	140	225.50
12	12.75	10.750	1.000	36.00	24.38	120	325.88

### LONG RADIUS SCHEDULE XXS

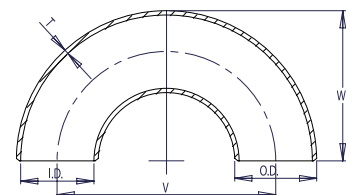

#### WELDBEND NOTES

1. Conforms to ASME B16.9 & ASTM A234 WPB.
  2. All dimensions are in inches.
  3. For bevel detail see page 107.
  4. For dimensional tolerances see page 108.
  5. All weights are in pounds and approximated or estimated.
- \* This size and thickness does not correspond to any pipe schedule number.

## SHORT RADIUS SCHEDULE STD

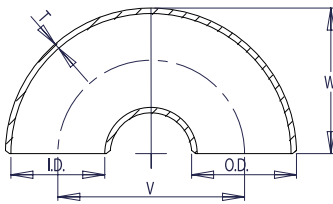

### WELDBEND NOTES

1. Conforms to ASME B16.9 & ASTM A234 WPB.
  2. All dimensions are in inches.
  3. For bevel detail see page 107.
  4. For dimensional tolerances see page 108.
  5. For sizes larger than 24" please call.
  6. All weights are in pounds and approximated or estimated.
- \*This size and thickness does not correspond to any pipe schedule number.

Pipe Size	Outside Diameter	Inside Diameter	Wall Thickness	Center to Center	Back to Face	Pipe Schedule Number	Approx. Weight in Pounds
	O.D.	I.D.	T	V	W		
1	1.32	1.049	0.133	2.00	1.62	40	0.50
1 ¼	1.66	1.380	0.140	2.50	2.06	40	0.80
1 ½	1.90	1.610	0.145	3.00	2.44	40	1.10
2	2.38	2.067	0.154	4.00	3.19	40	1.90
2 ½	2.88	2.469	0.203	5.00	3.94	40	4.00
3	3.50	3.068	0.216	6.00	4.75	40	6.00
3 ½	4.00	3.548	0.226	7.00	5.50	40	8.70
4	4.50	4.026	0.237	8.00	6.25	40	12.20
5	5.56	5.047	0.258	10.00	7.75	40	19.20
6	6.62	6.065	0.280	12.00	9.31	40	32.90
8	8.62	7.981	0.322	16.00	12.31	40	64.90
10	10.75	10.020	0.365	20.00	15.38	40	112.00
12	12.75	12.000	0.375	24.00	18.38	*	157.00
14	14.00	13.250	0.375	28.00	21.00	30	208.00
16	16.00	15.250	0.375	32.00	24.00	30	257.00
18	18.00	17.250	0.375	36.00	27.00	*	325.00
20	20.00	19.250	0.375	40.00	30.00	20	416.00
24	24.00	23.250	0.375	48.00	36.00	20	592.00

FITTINGS

## SHORT RADIUS SCHEDULE XS

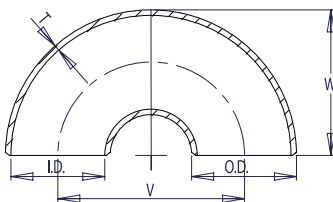

### WELDBEND NOTES

1. Conforms to ASME B16.9 & ASTM A234 WPB.
  2. All dimensions are in inches.
  3. For bevel detail see page 107.
  4. For dimensional tolerances see page 108.
  5. For sizes larger than 24" please call.
  6. All weights are in pounds and approximated or estimated.
- \*This size and thickness does not correspond to any pipe schedule number.

Pipe Size	Outside Diameter	Inside Diameter	Wall Thickness	Center to Center	Back to Face	Pipe Schedule Number	Approx. Weight in Pounds
	O.D.	I.D.	T	V	W		
1	1.32	0.962	0.179	2.00	1.62	80	0.70
1 ¼	1.66	1.278	0.191	2.50	2.06	80	1.00
1 ½	1.90	1.500	0.200	3.00	2.44	80	1.50
2	2.38	1.939	0.218	4.00	3.19	80	2.90
2 ½	2.88	2.323	0.276	5.00	3.94	80	5.20
3	3.50	2.900	0.300	6.00	4.75	80	8.20
3 ½	4.00	3.364	0.318	7.00	5.50	80	11.70
4	4.50	3.826	0.337	8.00	6.25	80	16.40
5	5.56	4.813	0.375	10.00	7.75	80	27.70
6	6.62	5.761	0.432	12.00	9.31	80	45.70
8	8.62	7.625	0.500	16.00	12.31	80	96.30
10	10.75	9.750	0.500	20.00	15.38	60	143.00
12	12.75	11.750	0.500	24.00	18.38	*	212.00
14	14.00	13.000	0.500	28.00	21.00	*	271.00
16	16.00	15.000	0.500	32.00	24.00	40	339.00
18	18.00	17.000	0.500	36.00	27.00	*	425.00
20	20.00	19.000	0.500	40.00	30.00	30	555.00
24	24.00	23.000	0.500	48.00	36.00	*	778.00

**SHORT RADIUS  
 SCHEDULE 40**

Pipe Size	Outside Diameter	Inside Diameter	Wall Thickness	Center to Center	Back to Face	Pipe Schedule Number	Approx. Weight in Pounds
	O.D.	I.D.	T	V	W		
1	1.32	1.054	0.133	2.00	1.62	40	0.50
1 ¼	1.66	1.380	0.140	2.50	2.06	40	0.80
1 ½	1.90	1.610	0.145	3.00	2.44	40	1.10
2	2.38	2.072	0.154	4.00	3.19	40	1.90
2 ½	2.88	2.474	0.203	5.00	3.94	40	4.00
3	3.50	3.068	0.216	6.00	4.75	40	6.00
3 ½	4.00	3.548	0.226	7.00	5.50	40	8.70
4	4.50	4.026	0.237	8.00	6.25	40	12.20
5	5.56	5.044	0.258	10.00	7.75	40	19.20
6	6.62	6.060	0.280	12.00	9.31	40	32.90
8	8.62	7.976	0.322	16.00	12.31	40	64.90
10	10.75	10.020	0.365	20.00	15.38	40	112.00
12	12.75	11.938	0.406	24.00	18.38	40	165.00
14	14.00	13.124	0.438	28.00	21.00	40	215.00
16	16.00	15.000	0.500	32.00	24.00	40	265.00
18	18.00	16.876	0.562	36.00	27.00	40	335.00
20	20.00	18.812	0.594	40.00	30.00	40	425.00
24	24.00	22.624	0.688	48.00	36.00	40	605.00

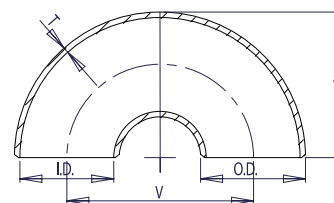

**WELDBEND NOTES**

1. Conforms to ASME B16.9 & ASTM A234 WPB.
2. All dimensions are in inches.
3. For bevel detail see page 107.
4. For dimensional tolerances see page 108.
5. For sizes larger than 24" please call.
6. All weights are in pounds and approximated or estimated.

FITTINGS

**SHORT RADIUS  
 SCHEDULE 80**

Pipe Size	Outside Diameter	Inside Diameter	Wall Thickness	Center to Center	Back to Face	Pipe Schedule Number	Approx. Weight in Pounds
	O.D.	I.D.	T	V	W		
1	1.32	0.962	0.179	2.00	1.62	80	0.70
1 ¼	1.66	1.278	0.191	2.50	2.06	80	1.00
1 ½	1.90	1.500	0.200	3.00	2.44	80	1.50
2	2.38	1.944	0.218	4.00	3.19	80	2.90
2 ½	2.88	2.328	0.276	5.00	3.94	80	5.20
3	3.50	2.900	0.300	6.00	4.75	80	8.20
3 ½	4.00	3.364	0.318	7.00	5.50	80	11.70
4	4.50	3.826	0.337	8.00	6.25	80	16.40
5	5.56	4.810	0.375	10.00	7.75	80	27.70
6	6.62	5.756	0.432	12.00	9.31	80	45.70
8	8.62	7.620	0.500	16.00	12.31	80	96.30
10	10.75	9.562	0.594	20.00	15.38	80	160.00
12	12.75	11.374	0.688	24.00	18.38	80	225.00
14	14.00	12.500	0.750	28.00	21.00	80	280.00
16	16.00	14.312	0.844	32.00	24.00	80	350.00
18	18.00	16.124	0.938	36.00	27.00	80	435.00
20	20.00	17.938	1.031	40.00	30.00	80	570.00
24	24.00	21.562	1.219	48.00	36.00	80	790.00

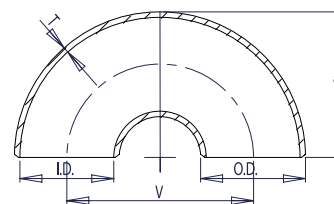

**WELDBEND NOTES**

1. Conforms to ASME B16.9 & ASTM A234 WPB.
2. All dimensions are in inches.
3. For bevel detail see page 107.
4. For dimensional tolerances see page 108.
5. All weights are in pounds and approximated or estimated.

## SHORT RADIUS SCHEDULE 160

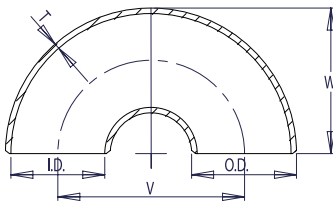

### WELDBEND NOTES

1. Conforms to ASME B16.9 & ASTM A234 WPB.
2. All dimensions are in inches.
3. For bevel detail see page 107.
4. For dimensional tolerances see page 108.
5. All weights are in pounds and approximated or estimated.

Pipe Size	Outside Diameter	Inside Diameter	Wall Thickness	Center to Center	Back to Face	Pipe Schedule Number	Approx. Weight in Pounds
	O.D.	I.D.	T	V	W		
1	1.32	0.820	0.250	2.00	1.62	160	0.85
1 ¼	1.66	1.160	0.250	2.50	2.06	160	1.21
1 ½	1.90	1.338	0.281	3.00	2.44	160	1.82
2	2.38	1.692	0.344	4.00	3.19	160	3.51
2 ½	2.88	2.130	0.375	5.00	3.94	160	6.29
3	3.50	2.624	0.438	6.00	4.75	160	9.92
4	4.50	3.438	0.531	8.00	6.25	160	19.84
5	5.56	4.310	0.625	10.00	7.75	160	33.52
6	6.62	5.182	0.719	12.00	9.31	160	55.30
8	8.62	6.808	0.906	16.00	12.31	160	116.52
10	10.75	8.500	1.125	20.00	15.38	160	173.03
12	12.75	10.126	1.312	24.00	18.38	160	256.52
14	14.00	11.188	1.406	28.00	21.00	160	327.91
16	16.00	12.812	1.594	32.00	24.00	160	410.19
18	18.00	14.438	1.781	36.00	27.00	160	514.25
20	20.00	16.062	1.969	40.00	30.00	160	671.55
24	24.00	19.312	2.344	48.00	36.00	160	941.38

FITTINGS

## SHORT RADIUS SCHEDULE XXS

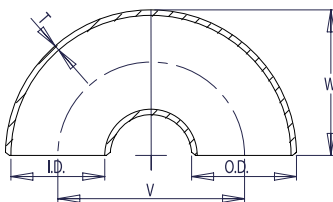

### WELDBEND NOTES

1. Conforms to ASME B16.9 & ASTM A234 WPB.
2. All dimensions are in inches.
3. For bevel detail see page 107.
4. For dimensional tolerances see page 108.
5. All weights are in pounds and approximated or estimated.

\* This size and thickness does not correspond to any pipe schedule number.

Pipe Size	Outside Diameter	Inside Diameter	Wall Thickness	Center to Center	Back to Face	Pipe Schedule Number	Approx. Weight in Pounds
	O.D.	I.D.	T	V	W		
1	1.32	0.604	0.358	2.00	1.62	*	0.93
1 ¼	1.66	0.896	0.382	2.50	2.06	*	1.33
1 ½	1.90	1.100	0.400	3.00	2.44	*	2.00
2	2.38	1.508	0.436	4.00	3.19	*	3.90
2 ½	2.88	1.776	0.552	5.00	3.94	*	6.92
3	3.50	2.300	0.600	6.00	4.75	*	10.91
4	4.50	3.152	0.674	8.00	6.25	*	21.83
5	5.56	4.060	0.750	10.00	7.75	*	36.87
6	6.62	4.892	0.864	12.00	9.31	*	60.83
8	8.62	6.870	0.875	16.00	12.31	*	128.18
10	10.75	8.750	1.000	20.00	15.38	140	190.33
12	12.75	10.750	1.000	24.00	18.38	120	282.17



# STRAIGHT TEES

## SCHEDULE STD

Pipe Size	Outside Diameter	Inside Diameter	Wall Thickness	Center to Center	Center to End	Pipe Schedule Number	Approx. Weight in Pounds
	O.D.	I.D.	T	R	B		
1/2	0.84	0.622	0.109	1.00	1.00	40	0.35
3/4	1.05	0.824	0.113	1.12	1.12	40	0.50
1	1.32	1.049	0.133	1.50	1.50	40	0.75
1 1/4	1.66	1.380	0.140	1.88	1.88	40	1.30
1 1/2	1.90	1.610	0.145	2.25	2.25	40	1.90
2	2.38	2.067	0.154	2.50	2.50	40	3.20
2 1/2	2.88	2.469	0.203	3.00	3.00	40	5.80
3	3.50	3.068	0.216	3.38	3.38	40	7.20
3 1/2	4.00	3.548	0.226	3.75	3.75	40	9.50
4	4.50	4.026	0.237	4.12	4.12	40	12.70
5	5.56	5.047	0.258	4.88	4.88	40	20.80
6	6.62	6.065	0.280	5.62	5.62	40	33.10
8	8.62	7.981	0.322	7.00	7.00	40	56.50
10	10.75	10.020	0.365	8.50	8.50	40	90.90
12	12.75	12.000	0.375	10.00	10.00	*	136.00
14	14.00	13.250	0.375	11.00	11.00	30	162.00
16	16.00	15.250	0.375	12.00	12.00	30	206.00
18	18.00	17.250	0.375	13.50	13.50	*	272.00
20	20.00	19.250	0.375	15.00	15.00	20	350.00
24	24.00	23.250	0.375	17.00	17.00	20	508.00
30	30.00	29.250	0.375	22.00	22.00	*	835.00
36	36.00	35.250	0.375	26.50	26.50	*	1294.00
42	42.00	41.250	0.375	30.00	28.00	*	1495.00
48	48.00	47.250	0.375	35.00	33.00	*	2300.00

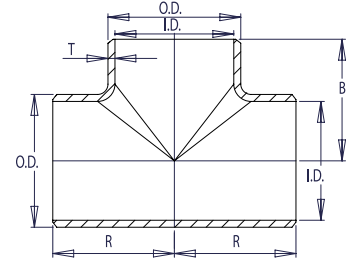

### WELDBEND NOTES

1. Conforms to ASME B16.9 & ASTM A234 WPB.
  2. All dimensions are in inches.
  3. For bevel detail see page 107.
  4. For dimensional tolerances see page 108.
  5. For sizes larger than 48" please call.
  6. All weights are in pounds and approximated or estimated.
- \* This size and thickness does not correspond to any pipe schedule number.

FITTINGS

## SCHEDULE XS

Pipe Size	Outside Diameter	Inside Diameter	Wall Thickness	Center to Center	Center to End	Pipe Schedule Number	Approx. Weight in Pounds
	O.D.	I.D.	T	R	B		
1/2	0.84	0.546	0.147	1.00	1.00	80	0.37
3/4	1.05	0.742	0.154	1.12	1.12	80	0.58
1	1.32	0.957	0.179	1.50	1.50	80	0.87
1 1/4	1.66	1.278	0.191	1.88	1.88	80	1.60
1 1/2	1.90	1.500	0.200	2.25	2.25	80	2.30
2	2.38	1.939	0.218	2.50	2.50	80	3.90
2 1/2	2.88	2.323	0.276	3.00	3.00	80	6.50
3	3.50	2.900	0.300	3.38	3.38	80	9.00
3 1/2	4.00	3.364	0.318	3.75	3.75	80	12.20
4	4.50	3.826	0.337	4.12	4.12	80	16.20
5	5.56	4.813	0.375	4.88	4.88	80	26.60
6	6.62	5.761	0.432	5.62	5.62	80	41.80
8	8.62	7.625	0.500	7.00	7.00	80	76.20
10	10.75	9.750	0.500	8.50	8.50	60	115.00
12	12.75	11.750	0.500	10.00	10.00	*	169.00
14	14.00	13.000	0.500	11.00	11.00	*	237.00
16	16.00	15.000	0.500	12.00	12.00	40	284.00
18	18.00	17.000	0.500	13.50	13.50	*	353.00
20	20.00	19.000	0.500	15.00	15.00	30	442.00
24	24.00	23.000	0.500	17.00	17.00	*	625.00
30	30.00	29.000	0.500	22.00	22.00	20	1065.00
36	36.00	35.000	0.500	26.50	26.50	20	1610.00
42	42.00	41.000	0.500	30.00	28.00	*	1788.00
48	48.00	47.000	0.500	35.00	33.00	*	2300.00

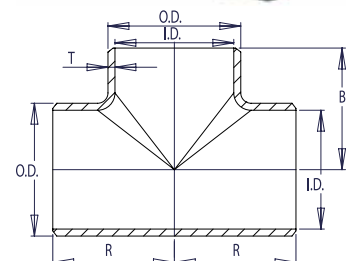

### WELDBEND NOTES

1. Conforms to ASME B16.9 & ASTM A234 WPB.
  2. All dimensions are in inches.
  3. For bevel detail see page 107.
  4. For dimensional tolerances see page 108.
  5. For sizes larger than 48" please call.
  6. All weights are in pounds and approximated or estimated.
- \* This size and thickness does not correspond to any pipe schedule number.

# STRAIGHT TEES



## SCHEDULE 40

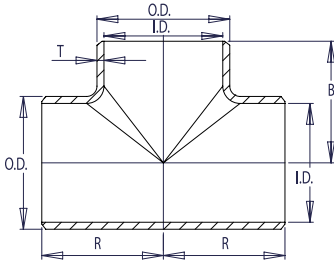

### WELDBEND NOTES

1. Conforms to ASME B16.9 & ASTM A234 WPB.
2. All dimensions are in inches.
3. For bevel detail see page 107.
4. For dimensional tolerances see page 108.
5. For sizes larger than 24" please call.
6. All weights are in pounds and approximated or estimated.

Pipe Size	Outside Diameter	Inside Diameter	Wall Thickness	Center to Center	Center to End	Pipe Schedule Number	Approx. Weight in Pounds
	O.D.	I.D.	T	R	B		
1/2	0.84	0.622	0.109	1.00	1.00	40	0.35
3/4	1.05	0.824	0.113	1.12	1.12	40	0.50
1	1.32	1.054	0.133	1.50	1.50	40	0.75
1 1/4	1.66	1.380	0.140	1.88	1.88	40	1.30
1 1/2	1.90	1.610	0.145	2.25	2.25	40	1.90
2	2.38	2.072	0.154	2.50	2.50	40	3.20
2 1/2	2.88	2.474	0.203	3.00	3.00	40	5.80
3	3.50	3.068	0.216	3.38	3.38	40	7.20
3 1/2	4.00	3.548	0.226	3.75	3.75	40	8.50
4	4.50	4.026	0.237	4.12	4.12	40	9.50
5	5.56	5.044	0.258	4.88	4.88	40	12.70
6	6.62	6.060	0.280	5.62	5.62	40	20.80
8	8.62	7.976	0.322	7.00	7.00	40	33.10
10	10.75	10.020	0.365	8.50	8.50	40	56.50
12	12.75	11.938	0.406	10.00	10.00	40	90.90
14	14.00	13.124	0.438	11.00	11.00	40	165.00
16	16.00	15.000	0.500	12.00	12.00	40	210.00
18	18.00	16.876	0.562	13.50	13.50	40	275.00
20	20.00	18.812	0.594	15.00	15.00	40	355.00
24	24.00	22.624	0.688	17.00	17.00	40	510.00

FITTINGS

## SCHEDULE 80

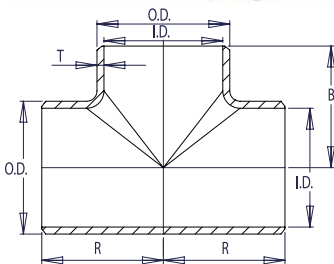

### WELDBEND NOTES

1. Conforms to ASME B16.9 & ASTM A234 WPB.
2. All dimensions are in inches.
3. For bevel detail see page 107.
4. For dimensional tolerances see page 108.
5. All weights are in pounds and approximated or estimated.

Pipe Size	Outside Diameter	Inside Diameter	Wall Thickness	Center to Center	Center to End	Pipe Schedule Number	Approx. Weight in Pounds
	O.D.	I.D.	T	R	B		
1/2	0.84	0.546	0.147	1.00	1.00	80	0.37
3/4	1.05	0.742	0.154	1.12	1.12	80	0.58
1	1.32	0.962	0.179	1.50	1.50	80	0.87
1 1/4	1.66	1.278	0.191	1.88	1.88	80	1.60
1 1/2	1.90	1.500	0.200	2.25	2.25	80	2.30
2	2.38	1.944	0.218	2.50	2.50	80	3.90
2 1/2	2.88	2.328	0.276	3.00	3.00	80	6.50
3	3.50	2.900	0.300	3.38	3.38	80	9.00
3 1/2	4.00	3.364	0.318	3.75	3.75	80	12.20
4	4.50	3.826	0.337	4.12	4.12	80	16.20
5	5.56	4.810	0.375	4.88	4.88	80	26.60
6	6.62	5.756	0.432	5.62	5.62	80	41.80
8	8.62	7.620	0.500	7.00	7.00	80	76.20
10	10.75	9.562	0.594	8.50	8.50	80	120.00
12	12.75	11.374	0.688	10.00	10.00	80	175.00
14	14.00	12.500	0.750	11.00	11.00	80	240.00
16	16.00	14.312	0.844	12.00	12.00	80	290.00
18	18.00	16.124	0.938	13.50	13.50	80	360.00
20	20.00	17.938	1.031	15.00	15.00	80	450.00
24	24.00	21.562	1.219	17.00	17.00	80	630.00

# STRAIGHT TEES

## SCHEDULE 160

Pipe Size	Outside Diameter	Inside Diameter	Wall Thickness	Center to Center	Center to End	Pipe Schedule Number	Approx. Weight in Pounds
	O.D.	I.D.	T	R	B		
1/2	0.84	0.464	0.188	1.00	1.00	160	0.46
3/4	1.05	0.612	0.219	1.12	1.12	160	0.73
1	1.32	0.820	0.250	1.50	1.50	160	1.09
1 1/4	1.66	1.160	0.250	1.88	1.88	160	2.00
1 1/2	1.90	1.338	0.281	2.25	2.25	160	2.88
2	2.38	1.692	0.344	2.50	2.50	160	4.88
2 1/2	2.88	2.130	0.375	3.00	3.00	160	8.13
3	3.50	2.624	0.438	3.38	3.38	160	11.25
4	4.50	3.438	0.531	4.12	4.12	160	20.25
5	5.56	4.310	0.625	4.88	4.88	160	33.25
6	6.62	5.182	0.719	5.62	5.62	160	52.25
8	8.62	6.808	0.906	7.00	7.00	160	95.25
10	10.75	8.500	1.125	8.50	8.50	160	143.75
12	12.75	10.126	1.312	10.00	10.00	160	211.25
14	14.00	11.188	1.406	11.00	11.00	160	296.25
16	16.00	12.812	1.594	12.00	12.00	160	355.00
18	18.00	14.438	1.781	13.50	13.50	160	441.25
20	20.00	16.062	1.969	15.00	15.00	160	552.50
24	24.00	19.312	2.344	17.00	17.00	160	781.25

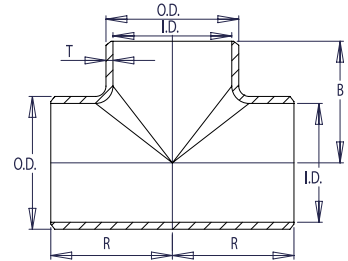

### WELDBEND NOTES

1. Conforms to ASME B16.9 & ASTM A234 WPB.
2. All dimensions are in inches.
3. For bevel detail see page 107.
4. For dimensional tolerances see page 108.
5. All weights are in pounds and approximated or estimated.

FITTINGS

Pipe Size	Outside Diameter	Inside Diameter	Wall Thickness	Center to Center	Center to End	Pipe Schedule Number	Approx. Weight in Pounds
	O.D.	I.D.	T	R	B		
1/2	0.84	0.252	0.294	1.00	1.00	*	0.51
3/4	1.05	0.434	0.308	1.12	1.12	*	0.80
1	1.32	0.604	0.358	1.50	1.50	*	1.20
1 1/4	1.66	0.896	0.382	1.88	1.88	*	2.20
1 1/2	1.90	1.100	0.400	2.25	2.25	*	3.16
2	2.38	1.508	0.436	2.50	2.50	*	5.36
2 1/2	2.88	1.776	0.552	3.00	3.00	*	8.94
3	3.50	2.300	0.600	3.38	3.38	*	12.38
4	4.50	3.152	0.674	4.12	4.12	*	22.28
5	5.56	4.060	0.750	4.88	4.88	*	36.58
6	6.62	4.892	0.864	5.62	5.62	*	57.48
8	8.62	6.870	0.875	7.00	7.00	*	104.78
10	10.75	8.750	1.000	8.50	8.50	140	158.13
12	12.75	10.750	1.000	10.00	10.00	120	232.38

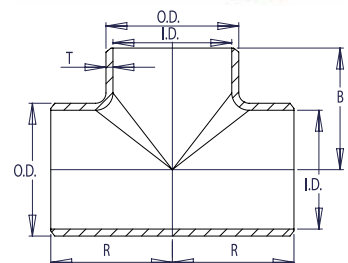

### WELDBEND NOTES

1. Conforms to ASME B16.9 & ASTM A234 WPB.
  2. All dimensions are in inches.
  3. For bevel detail see page 107.
  4. For dimensional tolerances see page 108.
  5. All weights are in pounds and approximated or estimated.
- \* This size and thickness does not correspond to any pipe schedule number.

# REDUCING TEES



## SCHEDULE STD

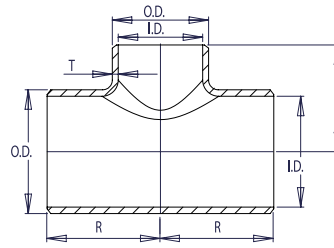

### WELDBEND NOTES

1. Conforms to ASME B16.9 & ASTM A234 WPB.
  2. All dimensions are in inches.
  3. For bevel detail see page 107.
  4. For dimensional tolerances see page 108.
  5. For sizes larger than 48" please call.
  6. All weights are in pounds and approximated or estimated.
- \* This size and thickness does not correspond to any pipe schedule number.  
 ♦ In accordance with B16.9. Special Fittings paragraph 4.4.2.

FITTINGS

Pipe Size	DIMENSIONS OF RUN				DIMENSIONS OF BRANCH				Pipe Schedule Number	Approx. Weight in Pounds
	Outside Diameter	Inside Diameter	Wall Thickness	Center to End	Outside Diameter	Inside Diameter	Wall Thickness	Center to End		
	O.D.	I.D.	T	R	O.D.	I.D.	T	B		
3/4 x 1/2	1.05	0.824	0.113	1.12	0.84	0.622	0.109	1.12	40	0.41
1 x 3/4	1.32	1.049	0.133	1.50	1.05	0.824	0.113	1.50	40	0.81
1 x 1/2	1.32	1.049	0.133	1.50	0.84	0.622	0.109	1.50	40	0.78
1 1/4 x 1	1.66	1.380	0.140	1.88	1.32	1.049	0.133	1.88	40	1.30
1 1/4 x 3/4	1.66	1.380	0.140	1.88	1.05	0.824	0.113	1.88	40	1.30
1 1/4 x 1/2	1.66	1.380	0.140	1.88	0.84	0.622	0.109	1.88	40	1.30
1 1/2 x 1 1/4	1.90	1.610	0.145	2.25	1.66	1.380	0.140	2.25	40	2.00
1 1/2 x 1	1.90	1.610	0.145	2.25	1.32	1.049	0.133	2.25	40	1.90
1 1/2 x 3/4	1.90	1.610	0.145	2.25	1.05	0.824	0.113	2.25	40	1.80
1 1/2 x 1/2	1.90	1.610	0.145	2.25	0.84	0.622	0.109	2.25	40	1.80
2 x 1 1/2	2.38	2.067	0.154	2.50	1.90	1.610	0.145	2.38	40	3.10
2 x 1 1/4	2.38	2.067	0.154	2.50	1.66	1.380	0.140	2.25	40	3.00
2 x 1	2.38	2.067	0.154	2.50	1.32	1.049	0.133	2.00	40	2.80
2 x 3/4	2.38	2.067	0.154	2.50	1.05	0.824	0.113	1.75	40	2.50
2 1/2 x 2	2.88	2.469	0.203	3.00	2.38	2.067	0.154	2.75	40	5.40
2 1/2 x 1 1/2	2.88	2.469	0.203	3.00	1.90	1.610	0.145	2.62	40	5.10
2 1/2 x 1 1/4	2.88	2.469	0.203	3.00	1.66	1.380	0.140	2.50	40	4.80
2 1/2 x 1	2.88	2.469	0.203	3.00	1.32	1.049	0.133	2.25	40	4.60
3 x 2 1/2	3.50	3.068	0.216	3.38	2.88	2.469	0.203	3.25	40	7.20
3 x 2	3.50	3.068	0.216	3.38	2.38	2.067	0.154	3.00	40	7.00
3 x 1 1/2	3.50	3.068	0.216	3.38	1.90	1.610	0.145	2.88	40	6.80
3 x 1 1/4	3.50	3.068	0.216	3.38	1.66	1.380	0.140	2.75	40	6.60
❖ 3 x 1	3.50	3.068	0.216	3.38	1.32	1.049	0.133	2.62	40	6.50
3 1/2 x 3	4.00	3.548	0.226	3.75	3.50	3.068	0.216	3.62	40	9.80
3 1/2 x 2 1/2	4.00	3.548	0.226	3.75	2.88	2.474	0.203	3.50	40	9.40
3 1/2 x 2	4.00	3.548	0.226	3.75	2.38	2.072	0.154	3.25	40	9.20
3 1/2 x 1 1/2	4.00	3.548	0.226	3.75	1.90	1.610	0.145	3.12	40	8.90
4 x 3 1/2	4.50	4.026	0.237	4.12	4.00	3.548	0.226	4.00	40	11.90
4 x 3	4.50	4.026	0.237	4.12	3.50	3.068	0.216	3.88	40	11.60
4 x 2 1/2	4.50	4.026	0.237	4.12	2.88	2.469	0.203	3.75	40	11.40
4 x 2	4.50	4.026	0.237	4.12	2.38	2.067	0.154	3.50	40	11.20
4 x 1 1/2	4.50	4.026	0.237	4.12	1.90	1.610	0.145	3.38	40	11.20
5 x 4	5.56	5.047	0.258	4.88	4.50	4.026	0.237	4.62	40	20.50
5 x 3 1/2	5.56	5.047	0.258	4.88	4.00	3.548	0.226	4.50	40	20.00
5 x 3	5.56	5.047	0.258	4.88	3.50	3.068	0.216	4.38	40	19.40
5 x 2 1/2	5.56	5.047	0.258	4.88	2.88	2.469	0.203	4.25	40	19.00
5 x 2	5.56	5.047	0.258	4.88	2.38	2.067	0.154	4.12	40	18.80
6 x 5	6.62	6.065	0.280	5.62	5.56	5.047	0.258	5.38	40	32.00
6 x 4	6.62	6.065	0.280	5.62	4.50	4.026	0.237	5.12	40	30.50
6 x 3 1/2	6.62	6.065	0.280	5.62	4.00	3.548	0.226	5.00	40	30.00
6 x 3	6.62	6.065	0.280	5.62	3.50	3.068	0.216	4.88	40	30.00
6 x 2 1/2	6.62	6.065	0.280	5.62	2.88	2.469	0.203	4.75	40	29.70
❖ 6 x 2	6.62	6.065	0.280	5.62	2.38	2.067	0.154	4.75	40	29.00
8 x 6	8.62	7.981	0.322	7.00	6.62	6.065	0.280	6.62	40	56.50
8 x 5	8.62	7.981	0.322	7.00	5.56	5.047	0.258	6.38	40	54.00
8 x 4	8.62	7.981	0.322	7.00	4.50	4.026	0.237	6.12	40	53.20

Pipe Size	DIMENSIONS OF RUN				DIMENSIONS OF BRANCH				Pipe Schedule Number	Approx. Weight in Pounds
	Outside Diameter	Inside Diameter	Wall Thickness	Center to End	Outside Diameter	Inside Diameter	Wall Thickness	Center to End		
	O.D.	I.D.	T	R	O.D.	I.D.	T	B		
8 x 3 1/2	8.62	7.981	0.322	7.00	4.00	3.548	0.226	6.00	40	53.00
❖ 8 x 3	8.62	7.981	0.322	7.00	3.50	3.068	0.216	6.00	40	52.00
10 x 8	10.75	10.020	0.365	8.50	8.62	7.981	0.322	8.00	40	86.50
10 x 6	10.75	10.020	0.365	8.50	6.62	6.060	0.280	7.62	40	85.90
10 x 5	10.75	10.020	0.365	8.50	5.56	5.047	0.258	7.50	40	82.50
10 x 4	10.75	10.020	0.365	8.50	4.50	4.026	0.237	7.25	40	82.00
❖ 10 x 3	10.75	10.020	0.365	8.50	3.50	3.068	0.216	7.25	40	79.00
12 x 10	12.75	12.000	0.375	10.00	10.75	10.020	0.365	9.50	*	123.00
12 x 8	12.75	12.000	0.375	10.00	8.62	7.981	0.322	9.00	*	120.00
12 x 6	12.75	12.000	0.375	10.00	6.62	6.060	0.280	8.62	*	118.00
12 x 5	12.75	12.000	0.375	10.00	5.56	5.047	0.258	8.50	*	117.00
❖ 12 x 4	12.75	12.000	0.375	10.00	4.50	4.026	0.237	8.50	*	112.00
14 x 12	14.00	13.250	0.375	11.00	12.75	12.000	0.375	10.62	*	151.00
14 x 10	14.00	13.250	0.375	11.00	10.75	10.020	0.365	10.12	*	148.00
14 x 8	14.00	13.250	0.375	11.00	8.62	7.981	0.322	9.75	*	146.00
14 x 6	14.00	13.250	0.375	11.00	6.62	6.065	0.280	9.38	*	145.00
16 x 14	16.00	15.250	0.375	12.00	14.00	13.250	0.375	12.00	*	221.00
16 x 12	16.00	15.250	0.375	12.00	12.75	12.000	0.375	11.62	*	213.00
16 x 10	16.00	15.250	0.375	12.00	10.75	10.020	0.365	11.12	*	197.00
16 x 8	16.00	15.250	0.375	12.00	8.62	7.981	0.322	10.75	*	190.00
16 x 6	16.00	15.250	0.375	12.00	6.62	6.060	0.280	10.38	*	180.00
18 x 16	18.00	17.250	0.375	13.50	16.00	15.250	0.375	13.00	*	262.00
18 x 14	18.00	17.250	0.375	13.50	14.00	13.250	0.375	13.00	*	248.00
18 x 12	18.00	17.250	0.375	13.50	12.75	12.000	0.375	12.62	*	241.00
18 x 10	18.00	17.250	0.375	13.50	10.75	10.020	0.365	12.12	*	229.00
18 x 8	18.00	17.250	0.375	13.50	8.62	7.981	0.322	11.75	*	216.00
20 x 18	20.00	19.250	0.375	15.00	18.00	17.250	0.375	14.50	*	352.00
20 x 16	20.00	19.250	0.375	15.00	16.00	15.250	0.375	14.00	*	339.00
20 x 14	20.00	19.250	0.375	15.00	14.00	13.250	0.375	14.00	*	327.00
20 x 12	20.00	19.250	0.375	15.00	12.75	12.000	0.375	13.62	*	315.00
20 x 10	20.00	19.250	0.375	15.00	10.75	10.020	0.365	13.12	*	305.00
20 x 8	20.00	19.250	0.375	15.00	8.62	7.976	0.322	12.75	*	293.00
24 x 20	24.00	23.250	0.375	17.00	20.00	19.250	0.375	17.00	*	500.00
24 x 18	24.00	23.250	0.375	17.00	18.00	17.250	0.375	16.50	*	487.00
24 x 16	24.00	23.250	0.375	17.00	16.00	15.250	0.375	16.00	*	475.00
24 x 14	24.00	23.250	0.375	17.00	14.00	13.250	0.375	16.00	*	465.00
24 x 12	24.00	23.250	0.375	17.00	12.75	12.000	0.375	15.62	*	450.00
24 x 10	24.00	23.250	0.375	17.00	10.75	10.020	0.365	15.12	*	447.00
30 x 24	30.00	29.250	0.375	22.00	24.00	23.250	0.375	21.00	*	795.00
30 x 20	30.00	29.250	0.375	22.00	20.00	19.250	0.375	20.00	*	749.00
30 x 18	30.00	29.250	0.375	22.00	18.00	17.250	0.375	19.50	*	727.00
30 x 16	30.00	29.250	0.375	22.00	16.00	15.250	0.375	19.00	*	715.00
36 x 30	36.00	35.250	0.375	26.50	30.00	29.250	0.375	25.00	*	1207.00
36 x 24	36.00	35.250	0.375	26.50	24.00	23.250	0.375	24.00	*	1129.00
36 x 20	36.00	35.250	0.375	26.50	20.00	19.250	0.375	23.00	*	1072.00
36 x 18	36.00	35.250	0.375	26.50	18.00	17.250	0.375	22.50	*	1136.00
42 x 36	42.00	41.250	0.375	30.00	36.00	35.250	0.375	28.00	*	1415.00
42 x 30	42.00	41.250	0.375	30.00	30.00	29.250	0.375	28.00	*	1327.00
42 x 24	42.00	41.250	0.375	30.00	24.00	23.250	0.375	26.00	*	1248.00
42 x 20	42.00	41.250	0.375	30.00	20.00	19.250	0.375	26.00	*	1200.00
48 x 42	48.00	47.250	0.375	35.00	42.00	41.250	0.375	32.00	*	2207.00
48 x 36	48.00	47.250	0.375	35.00	36.00	35.250	0.375	31.00	*	2127.00
48 x 30	48.00	47.250	0.375	35.00	30.00	29.250	0.375	30.00	*	2048.00
48 x 24	48.00	47.250	0.375	35.00	24.00	23.250	0.375	29.00	*	1900.00

**FITTINGS**

# REDUCING TEES



## SCHEDULE XS

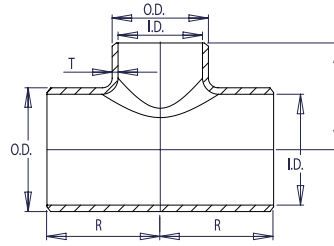

### WELDBEND NOTES

1. Conforms to ASME B16.9 & ASTM A234 WPB.
  2. All dimensions are in inches.
  3. For bevel detail see page 107.
  4. For dimensional tolerances see page 108.
  5. For sizes larger than 48" please call.
  6. All weights are in pounds and approximated or estimated.
- \* This size and thickness does not correspond to any pipe schedule number.  
 ♦ In accordance with B16.9. Special Fittings paragraph 4.4.2.

FITTINGS

Pipe Size	DIMENSIONS OF RUN				DIMENSIONS OF BRANCH				Pipe Schedule Number	Approx. Weight in Pounds
	Outside Diameter	Inside Diameter	Wall Thickness	Center to End	Outside Diameter	Inside Diameter	Wall Thickness	Center to End		
	O.D.	I.D.	T	R	O.D.	I.D.	T	B		
3/4 x 1/2	1.05	0.742	0.154	1.12	0.84	0.546	0.147	1.12	80	0.47
1 x 3/4	1.32	0.957	0.179	1.50	1.05	0.742	0.154	1.50	80	0.98
1 x 1/2	1.32	0.957	0.179	1.50	0.84	0.546	0.147	1.50	80	0.92
1 1/4 x 1	1.66	1.278	0.191	1.88	1.32	0.957	0.179	1.88	80	1.60
1 1/4 x 3/4	1.66	1.278	0.191	1.88	1.05	0.742	0.154	1.88	80	1.60
1 1/4 x 1/2	1.66	1.278	0.191	1.88	0.84	0.546	0.147	1.88	80	1.60
1 1/2 x 1 1/4	1.90	1.500	0.200	2.25	1.66	1.278	0.191	2.25	80	2.40
1 1/2 x 1	1.90	1.500	0.200	2.25	1.32	0.957	0.179	2.25	80	2.30
1 1/2 x 3/4	1.90	1.500	0.200	2.25	1.05	0.742	0.154	2.25	80	2.20
1 1/2 x 1/2	1.90	1.500	0.200	2.25	0.84	0.546	0.147	2.25	80	2.20
2 x 1 1/2	2.38	1.944	0.218	2.50	1.90	1.500	0.200	2.38	80	3.80
2 x 1 1/4	2.38	1.944	0.218	2.50	1.66	1.278	0.191	2.25	80	3.70
2 x 1	2.38	1.944	0.218	2.50	1.32	0.957	0.179	2.00	80	3.50
2 x 3/4	2.38	1.944	0.218	2.50	1.05	0.742	0.154	1.75	80	3.50
2 1/2 x 2	2.88	2.323	0.276	3.00	2.38	1.944	0.218	2.75	80	6.30
2 1/2 x 1 1/2	2.88	2.323	0.276	3.00	1.90	1.500	0.200	2.62	80	6.20
2 1/2 x 1 1/4	2.88	2.323	0.276	3.00	1.66	1.278	0.191	2.50	80	6.00
2 1/2 x 1	2.88	2.323	0.276	3.00	1.32	0.957	0.179	2.25	80	5.80
3 x 2 1/2	3.50	2.900	0.300	3.38	2.88	2.323	0.276	3.25	80	8.80
3 x 2	3.50	2.900	0.300	3.38	2.38	1.939	0.218	3.00	80	8.60
3 x 1 1/2	3.50	2.900	0.300	3.38	1.90	1.500	0.200	2.88	80	8.10
3 x 1 1/4	3.50	2.900	0.300	3.38	1.66	1.278	0.191	2.75	80	8.00
❖ 3 x 1	3.50	2.900	0.300	3.38	1.32	0.957	0.179	2.62	80	7.80
3 1/2 x 3	4.00	3.364	0.318	3.75	3.50	2.900	0.300	3.62	80	12.60
3 1/2 x 2 1/2	4.00	3.364	0.318	3.75	2.88	2.323	0.276	3.50	80	12.10
3 1/2 x 2	4.00	3.364	0.318	3.75	2.38	1.939	0.218	3.25	80	11.70
3 1/2 x 1 1/2	4.00	3.364	0.318	3.75	1.90	1.500	0.200	3.12	80	11.60
4 x 3 1/2	4.50	3.826	0.337	4.12	4.00	3.364	0.318	4.00	80	15.70
4 x 3	4.50	3.826	0.337	4.12	3.50	2.900	0.300	3.88	80	15.40
4 x 2 1/2	4.50	3.826	0.337	4.12	2.88	2.323	0.276	3.75	80	15.10
4 x 2	4.50	3.826	0.337	4.12	2.38	1.939	0.218	3.50	80	15.10
4 x 1 1/2	4.50	3.826	0.337	4.12	1.90	1.500	0.200	3.38	80	15.00
5 x 4	5.56	4.813	0.375	4.88	4.50	3.826	0.337	4.62	80	25.40
5 x 3 1/2	5.56	4.813	0.375	4.88	4.00	3.364	0.318	4.50	80	24.80
5 x 3	5.56	4.813	0.375	4.88	3.50	2.900	0.300	4.38	80	24.20
5 x 2 1/2	5.56	4.813	0.375	4.88	2.88	2.323	0.276	4.25	80	23.90
5 x 2	5.56	4.813	0.375	4.88	2.38	1.939	0.218	4.12	80	23.60
6 x 5	6.62	5.761	0.432	5.62	5.56	4.813	0.375	5.38	80	39.50
6 x 4	6.62	5.761	0.432	5.62	4.50	3.826	0.337	5.12	80	39.30
6 x 3 1/2	6.62	5.761	0.432	5.62	4.00	3.364	0.318	5.00	80	38.80
6 x 3	6.62	5.761	0.432	5.62	3.50	2.900	0.300	4.88	80	38.60
6 x 2 1/2	6.62	5.761	0.432	5.62	2.88	2.323	0.276	4.75	80	38.20
❖ 6 x 2	6.62	5.761	0.432	5.62	2.38	1.939	0.218	4.75	80	37.40
8 x 6	8.62	7.625	0.500	7.00	6.62	5.761	0.432	6.62	80	70.20
8 x 5	8.62	7.625	0.500	7.00	5.56	4.813	0.375	6.38	80	69.40
8 x 4	8.62	7.625	0.500	7.00	4.50	3.826	0.337	6.12	80	69.20

Pipe Size	DIMENSIONS OF RUN				DIMENSIONS OF BRANCH				Pipe Schedule Number	Approx. Weight in Pounds
	Outside Diameter	Inside Diameter	Wall Thickness	Center to End	Outside Diameter	Inside Diameter	Wall Thickness	Center to End		
	O.D.	I.D.	T	R	O.D.	I.D.	T	B		
8 x 3 1/2	8.62	7.625	0.500	7.00	4.00	3.364	0.318	6.00	80	68.60
❖ 8 x 3	8.62	7.625	0.500	7.00	3.50	2.900	0.300	6.00	80	68.30
10 x 8	10.75	9.750	0.500	8.50	8.62	7.620	0.500	8.00	*	107.00
10 x 6	10.75	9.750	0.500	8.50	6.62	5.761	0.432	7.62	*	104.00
10 x 5	10.75	9.750	0.500	8.50	5.56	4.813	0.375	7.50	*	103.00
10 x 4	10.75	9.750	0.500	8.50	4.50	3.826	0.337	7.25	*	101.00
❖ 10 x 3	10.75	9.750	0.500	8.50	3.50	2.900	0.300	7.25	*	99.00
12 x 10	12.75	11.750	0.500	10.00	10.75	9.750	0.500	9.50	*	165.00
12 x 8	12.75	11.750	0.500	10.00	8.62	7.625	0.500	9.00	*	156.00
12 x 6	12.75	11.750	0.500	10.00	6.62	5.761	0.432	8.62	*	151.00
12 x 5	12.75	11.750	0.500	10.00	5.56	4.813	0.375	8.50	*	149.00
❖ 12 x 4	12.75	11.750	0.500	10.00	4.50	3.826	0.337	8.50	*	148.00
14 x 12	14.00	13.000	0.500	11.00	12.75	11.750	0.500	10.62	*	210.00
14 x 10	14.00	13.000	0.500	11.00	10.75	9.750	0.500	10.12	*	203.00
14 x 8	14.00	13.000	0.500	11.00	8.62	7.625	0.500	9.75	*	200.00
14 x 6	14.00	13.000	0.500	11.00	6.62	5.761	0.432	9.38	*	196.00
16 x 14	16.00	15.000	0.500	12.00	14.00	13.000	0.500	12.00	*	268.00
16 x 12	16.00	15.000	0.500	12.00	12.75	11.750	0.500	11.62	*	261.00
16 x 10	16.00	15.000	0.500	12.00	10.75	9.750	0.500	11.12	*	250.00
16 x 8	16.00	15.000	0.500	12.00	8.62	7.625	0.500	10.75	*	240.00
16 x 6	16.00	15.000	0.500	12.00	6.62	5.761	0.432	10.38	*	235.00
18 x 16	18.00	17.000	0.500	13.50	16.00	15.000	0.500	13.00	*	348.00
18 x 14	18.00	17.000	0.500	13.50	14.00	13.000	0.500	13.00	*	335.00
18 x 12	18.00	17.000	0.500	13.50	12.75	11.750	0.500	12.62	*	328.00
18 x 10	18.00	17.000	0.500	13.50	10.75	9.750	0.500	12.12	*	308.00
18 x 8	18.00	17.000	0.500	13.50	8.62	7.625	0.500	11.75	*	300.00
20 x 18	20.00	19.000	0.500	15.00	18.00	17.000	0.500	14.50	*	445.00
20 x 16	20.00	19.000	0.500	15.00	16.00	15.000	0.500	14.00	*	427.00
20 x 14	20.00	19.000	0.500	15.00	14.00	13.000	0.500	14.00	*	412.00
20 x 12	20.00	19.000	0.500	15.00	12.75	11.750	0.500	13.62	*	397.00
20 x 10	20.00	19.000	0.500	15.00	10.75	9.750	0.500	13.12	*	384.00
20 x 8	20.00	19.000	0.500	15.00	8.62	7.625	0.500	12.75	*	375.00
24 x 20	24.00	23.000	0.500	17.00	20.00	19.000	0.500	17.00	*	610.00
24 x 18	24.00	23.000	0.500	17.00	18.00	17.000	0.500	16.50	*	588.00
24 x 16	24.00	23.000	0.500	17.00	16.00	15.000	0.500	16.00	*	578.00
24 x 14	24.00	23.000	0.500	17.00	14.00	13.000	0.500	16.00	*	565.00
24 x 12	24.00	23.000	0.500	17.00	12.75	11.750	0.500	15.62	*	558.00
24 x 10	24.00	23.000	0.500	17.00	10.75	9.750	0.500	15.12	*	550.00
30 x 24	30.00	29.000	0.500	22.00	24.00	23.000	0.500	21.00	*	994.00
30 x 20	30.00	29.000	0.500	22.00	20.00	19.000	0.500	20.00	*	945.00
30 x 18	30.00	29.000	0.500	22.00	18.00	17.000	0.500	19.50	*	920.00
30 x 16	30.00	29.000	0.500	22.00	16.00	15.000	0.500	19.00	*	900.00
36 x 30	36.00	35.000	0.500	26.50	30.00	29.000	0.500	25.00	*	1510.00
36 x 24	36.00	35.000	0.500	26.50	24.00	23.000	0.500	24.00	*	1415.00
36 x 20	36.00	35.000	0.500	26.50	20.00	19.000	0.500	23.00	*	1345.00
36 x 18	36.00	35.000	0.500	26.50	18.00	17.000	0.500	22.50	*	1321.00
42 x 36	42.00	41.000	0.500	30.00	36.00	35.000	0.500	28.00	*	1709.00
42 x 30	42.00	41.000	0.500	30.00	30.00	29.000	0.500	28.00	*	1629.00
42 x 24	42.00	41.000	0.500	30.00	24.00	23.000	0.500	26.00	*	1550.00
42 x 20	42.00	41.000	0.500	30.00	20.00	19.000	0.500	26.00	*	1500.00
48 x 42	48.00	47.000	0.500	35.00	42.00	41.000	0.500	32.00	*	2207.00
48 x 36	48.00	47.000	0.500	35.00	36.00	35.000	0.500	31.00	*	2127.00
48 x 30	48.00	47.000	0.500	35.00	30.00	29.000	0.500	30.00	*	2048.00
48 x 24	48.00	47.000	0.500	35.00	24.00	23.000	0.500	29.00	*	1980.00

**FITTINGS**

## SCHEDULE 40

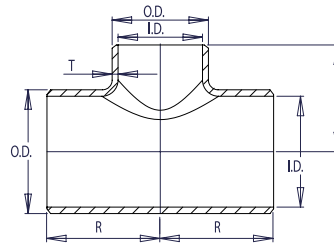

### WELDBEND NOTES

1. Conforms to ASME B16.9 & ASTM A234 WPB.
  2. All dimensions are in inches.
  3. For bevel detail see page 107.
  4. For dimensional tolerances see page 108.
  5. For sizes larger than 24" please call.
  6. All weights are in pounds and approximated or estimated.
- ❖ In accordance with B16.9. Special Fittings paragraph 4.4.2.

**FITTINGS**

Pipe Size	DIMENSIONS OF RUN				DIMENSIONS OF BRANCH				Pipe Schedule Number	Approx. Weight in Pounds
	Outside Diameter	Inside Diameter	Wall Thickness	Center to End	Outside Diameter	Inside Diameter	Wall Thickness	Center to End		
	O.D.	I.D.	T	R	O.D.	I.D.	T	B		
<b>FOR DIMENSION SPECIFICATIONS 1/2" THROUGH 10" REFER TO SCHEDULE STD</b>										
12 x 10	12.75	11.938	0.406	10.00	10.75	10.020	0.365	9.50	40	153.75
12 x 8	12.75	11.938	0.406	10.00	8.62	7.976	0.322	9.00	40	150.00
12 x 6	12.75	11.938	0.406	10.00	6.62	6.060	0.280	8.62	40	147.50
12 x 5	12.75	11.938	0.406	10.00	5.56	5.044	0.258	8.50	40	146.25
❖ 12 x 4	12.75	11.938	0.406	10.00	4.50	4.026	0.237	8.50	40	140.00
14 x 12	14.00	13.124	0.438	11.00	12.75	11.938	0.406	10.62	40	188.75
14 x 10	14.00	13.124	0.438	11.00	10.75	10.020	0.365	10.12	40	185.00
14 x 8	14.00	13.124	0.438	11.00	8.62	7.976	0.322	9.75	40	182.50
14 x 6	14.00	13.124	0.438	11.00	6.62	6.060	0.280	9.38	40	181.25
16 x 14	16.00	15.000	0.500	12.00	14.00	13.124	0.438	12.00	40	276.25
16 x 12	16.00	15.000	0.500	12.00	12.75	11.938	0.406	11.62	40	266.25
16 x 10	16.00	15.000	0.500	12.00	10.75	10.020	0.365	11.12	40	246.25
16 x 8	16.00	15.000	0.500	12.00	8.62	7.976	0.322	10.75	40	237.50
16 x 6	16.00	15.000	0.500	12.00	6.62	6.060	0.280	10.38	40	225.00
18 x 16	18.00	16.876	0.562	13.50	16.00	15.000	0.500	13.00	40	327.50
18 x 14	18.00	16.876	0.562	13.50	14.00	13.124	0.438	13.00	40	310.00
18 x 12	18.00	16.876	0.562	13.50	12.75	11.938	0.406	12.62	40	301.25
18 x 10	18.00	16.876	0.562	13.50	10.75	10.020	0.365	12.12	40	286.25
18 x 8	18.00	16.876	0.562	13.50	8.62	7.976	0.322	11.75	40	270.00
20 x 18	20.00	18.812	0.594	15.00	18.00	16.876	0.562	14.50	40	440.00
20 x 16	20.00	18.812	0.594	15.00	16.00	15.000	0.500	14.00	40	423.75
20 x 14	20.00	18.812	0.594	15.00	14.00	13.124	0.438	14.00	40	408.75
20 x 12	20.00	18.812	0.594	15.00	12.75	11.938	0.406	13.62	40	393.75
20 x 10	20.00	18.812	0.594	15.00	10.75	10.020	0.365	13.12	40	381.25
20 x 8	20.00	18.812	0.594	15.00	8.62	7.976	0.322	12.75	40	366.25
24 x 20	24.00	22.624	0.688	17.00	20.00	18.812	0.594	17.00	40	625.00
24 x 18	24.00	22.624	0.688	17.00	18.00	16.876	0.562	16.50	40	608.75
24 x 16	24.00	22.624	0.688	17.00	16.00	15.000	0.500	16.00	40	593.75
24 x 14	24.00	22.624	0.688	17.00	14.00	13.124	0.438	16.00	40	581.25
24 x 12	24.00	22.624	0.688	17.00	12.75	11.938	0.406	15.62	40	562.50
24 x 10	24.00	22.624	0.688	17.00	10.75	10.020	0.365	15.12	40	558.75



SCHEDULE 80

**WELDBEND** NOTES

1. Conforms to ASME B16.9 & ASTM A234 WPB.
  2. All dimensions are in inches.
  3. For bevel detail see page 107.
  4. For dimensional tolerances see page 108.
  5. All weights are in pounds and approximated or estimated.
- ❖ In accordance with B16.9-2007. Special Fittings paragraph 4.4.2.

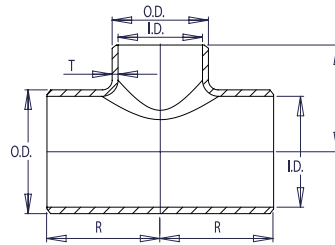

Pipe Size	DIMENSIONS OF RUN				DIMENSIONS OF BRANCH				Pipe Schedule Number	Approx. Weight in Pounds
	Outside Diameter	Inside Diameter	Wall Thickness	Center to End	Outside Diameter	Inside Diameter	Wall Thickness	Center to End		
	O.D.	I.D.	T	R	O.D.	I.D.	T	B		
<b>FOR DIMENSION SPECIFICATIONS                      ½" THROUGH 8" REFER TO SCHEDULE XS</b>										
10 x 8	10.75	9.562	0.594	8.50	8.62	7.620	0.500	8.00	80	151.38
10 x 6	10.75	9.562	0.594	8.50	6.62	5.756	0.432	7.62	80	150.33
10 x 5	10.75	9.562	0.594	8.50	5.56	4.810	0.375	7.50	80	144.38
10 x 4	10.75	9.562	0.594	8.50	4.50	3.826	0.337	7.25	80	143.50
❖ 10 x 3	10.75	9.562	0.594	8.50	3.50	2.900	0.300	7.25	80	142.00
12 x 10	12.75	11.374	0.688	10.00	10.75	9.562	0.594	9.50	80	215.25
12 x 8	12.75	11.374	0.688	10.00	8.62	7.620	0.500	9.00	80	210.00
12 x 6	12.75	11.374	0.688	10.00	6.62	5.756	0.432	8.62	80	206.50
12 x 5	12.75	11.374	0.688	10.00	5.56	4.810	0.375	8.50	80	204.75
❖ 12 x 4	12.75	11.374	0.688	10.00	4.50	3.826	0.337	8.50	80	196.00
14 x 12	14.00	12.500	0.750	11.00	12.75	11.374	0.688	10.62	80	264.25
14 x 10	14.00	12.500	0.750	11.00	10.75	9.562	0.594	10.12	80	259.00
14 x 8	14.00	12.500	0.750	11.00	8.62	7.620	0.500	9.75	80	255.50
14 x 6	14.00	12.500	0.750	11.00	6.62	5.756	0.432	9.38	80	253.75
16 x 14	16.00	14.312	0.844	12.00	14.00	12.500	0.750	12.00	80	386.75
16 x 12	16.00	14.312	0.844	12.00	12.75	11.374	0.688	11.62	80	372.75
16 x 10	16.00	14.312	0.844	12.00	10.75	9.562	0.594	11.12	80	344.75
16 x 8	16.00	14.312	0.844	12.00	8.62	7.620	0.500	10.75	80	332.50
16 x 6	16.00	14.312	0.844	12.00	6.62	5.756	0.432	10.38	80	315.00
18 x 16	18.00	16.124	0.938	13.50	16.00	14.312	0.844	13.00	80	458.50
18 x 14	18.00	16.124	0.938	13.50	14.00	12.500	0.750	13.00	80	434.00
18 x 12	18.00	16.124	0.938	13.50	12.75	11.374	0.688	12.62	80	421.75
18 x 10	18.00	16.124	0.938	13.50	10.75	9.562	0.594	12.12	80	400.75
18 x 8	18.00	16.124	0.938	13.50	8.62	7.620	0.500	11.75	80	378.00
20 x 18	20.00	17.938	1.031	15.00	18.00	16.124	0.938	14.50	80	616.00
20 x 16	20.00	17.938	1.031	15.00	16.00	14.312	0.844	14.00	80	593.25
20 x 14	20.00	17.938	1.031	15.00	14.00	12.500	0.750	14.00	80	572.25
20 x 12	20.00	17.938	1.031	15.00	12.75	11.374	0.688	13.62	80	551.25
20 x 10	20.00	17.938	1.031	15.00	10.75	9.562	0.594	13.12	80	533.75
20 x 8	20.00	17.938	1.031	15.00	8.62	7.620	0.500	12.75	80	512.75
24 x 20	24.00	21.562	1.219	17.00	20.00	17.938	1.031	17.00	80	875.00
24 x 18	24.00	21.562	1.219	17.00	18.00	16.124	0.938	16.50	80	852.25
24 x 16	24.00	21.562	1.219	17.00	16.00	14.312	0.844	16.00	80	831.25
24 x 14	24.00	21.562	1.219	17.00	14.00	12.500	0.750	16.00	80	813.75
24 x 12	24.00	21.562	1.219	17.00	12.75	11.374	0.688	15.62	80	787.50
24 x 10	24.00	21.562	1.219	17.00	10.75	9.562	0.594	15.12	80	782.25

FITTINGS

## SCHEDULE 160

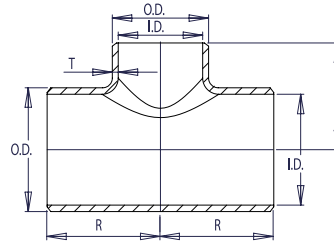

### WELDBEND NOTES

1. Conforms to ASME B16.9 & ASTM A234 WPB.
  2. All dimensions are in inches.
  3. For bevel detail see page 107.
  4. For dimensional tolerances see page 108.
  5. All weights are in pounds and approximated or estimated.
- ❖ In accordance with B16.9. Special Fittings paragraph 4.4.2.

**FITTINGS**

Pipe Size	DIMENSIONS OF RUN				DIMENSIONS OF BRANCH				Pipe Schedule Number	Approx. Weight in Pounds
	Outside Diameter	Inside Diameter	Wall Thickness	Center to End	Outside Diameter	Inside Diameter	Wall Thickness	Center to End		
	O.D.	I.D.	T	R	O.D.	I.D.	T	B		
3/4 x 1/2	1.05	0.612	0.219	1.12	0.84	0.464	0.188	1.12	160	0.66
1 x 3/4	1.32	0.820	0.250	1.50	1.05	0.612	0.219	1.50	160	1.37
1 x 1/2	1.32	0.820	0.250	1.50	0.84	0.464	0.188	1.50	160	1.29
1 1/4 x 1	1.66	1.160	0.250	1.88	1.32	0.820	0.250	1.88	160	2.24
1 1/4 x 3/4	1.66	1.160	0.250	1.88	1.05	0.612	0.219	1.88	160	2.24
1 1/4 x 1/2	1.66	1.160	0.250	1.88	0.84	0.464	0.188	1.88	160	2.24
1 1/2 x 1 1/4	1.90	1.338	0.281	2.25	1.66	1.160	0.250	2.25	160	3.36
1 1/2 x 1	1.90	1.338	0.281	2.25	1.32	0.820	0.250	2.25	160	3.22
1 1/2 x 3/4	1.90	1.338	0.281	2.25	1.05	0.612	0.219	2.25	160	3.08
1 1/2 x 1/2	1.90	1.338	0.281	2.25	0.84	0.464	0.188	2.25	160	3.08
2 x 1 1/2	2.38	1.692	0.344	2.50	1.90	1.338	0.281	2.38	160	5.32
2 x 1 1/4	2.38	1.692	0.344	2.50	1.66	1.160	0.250	2.25	160	5.18
2 x 1	2.38	1.692	0.344	2.50	1.32	0.820	0.250	2.00	160	4.90
2 x 3/4	2.38	1.692	0.344	2.50	1.05	0.612	0.219	1.75	160	4.90
2 1/2 x 2	2.88	2.130	0.375	3.00	2.38	1.692	0.344	2.75	160	8.82
2 1/2 x 1 1/2	2.88	2.130	0.375	3.00	1.90	1.338	0.281	2.62	160	8.68
2 1/2 x 1 1/4	2.88	2.130	0.375	3.00	1.66	1.160	0.250	2.50	160	8.40
2 1/2 x 1	2.88	2.130	0.375	3.00	1.32	0.820	0.250	2.25	160	8.12
3 x 2 1/2	3.50	2.624	0.438	3.38	2.88	2.130	0.375	3.25	160	12.32
3 x 2	3.50	2.624	0.438	3.38	2.38	1.692	0.344	3.00	160	12.04
3 x 1 1/2	3.50	2.624	0.438	3.38	1.90	1.338	0.281	2.88	160	11.34
3 x 1 1/4	3.50	2.624	0.438	3.38	1.66	1.160	0.250	2.75	160	11.20
❖ 3 x 1	3.50	2.624	0.438	3.38	1.32	0.820	0.250	2.62	160	11.20
4 x 3	4.50	3.438	0.531	4.12	3.50	2.624	0.438	3.88	160	21.56
4 x 2 1/2	4.50	3.438	0.531	4.12	2.88	2.130	0.375	3.75	160	21.14
4 x 2	4.50	3.438	0.531	4.12	2.38	1.692	0.344	3.50	160	21.14
4 x 1 1/2	4.50	3.438	0.531	4.12	1.90	1.338	0.281	3.38	160	21.00
5 x 4	5.56	4.310	0.625	4.88	4.50	3.438	0.531	4.62	160	35.56
5 x 3	5.56	4.310	0.625	4.88	3.50	2.624	0.438	4.38	160	33.88
5 x 2 1/2	5.56	4.310	0.625	4.88	2.88	2.130	0.375	4.25	160	33.46
5 x 2	5.56	4.310	0.625	4.88	2.38	1.692	0.344	4.12	160	33.04
6 x 5	6.62	5.182	0.719	5.62	5.56	4.310	0.625	5.38	160	55.30
6 x 4	6.62	5.182	0.719	5.62	4.50	3.438	0.531	5.12	160	55.02
6 x 3	6.62	5.182	0.719	5.62	3.50	2.624	0.438	4.88	160	54.04
6 x 2 1/2	6.62	5.182	0.719	5.62	2.88	2.130	0.375	4.75	160	53.48
❖ 6 x 2	6.62	5.182	0.719	5.62	2.38	1.692	0.344	4.75	160	52.36

Pipe Size	DIMENSIONS OF RUN				DIMENSIONS OF BRANCH				Pipe Schedule Number	Approx. Weight in Pounds
	Outside Diameter	Inside Diameter	Wall Thickness	Center to End	Outside Diameter	Inside Diameter	Wall Thickness	Center to End		
	O.D.	I.D.	T	R	O.D.	I.D.	T	B		
8 x 6	8.62	6.808	0.906	7.00	6.62	5.182	0.719	6.62	160	98.28
8 x 5	8.62	6.808	0.906	7.00	5.56	4.310	0.625	6.38	160	97.16
8 x 4	8.62	6.808	0.906	7.00	4.50	3.438	0.531	6.12	160	96.88
❖ 8 x 3	8.62	6.808	0.906	7.00	3.50	2.624	0.438	6.00	160	95.62
10 x 8	10.75	8.500	1.125	8.50	8.62	6.808	0.906	8.00	160	149.80
10 x 6	10.75	8.500	1.125	8.50	6.62	5.182	0.719	7.62	160	145.60
10 x 5	10.75	8.500	1.125	8.50	5.56	4.310	0.625	7.50	160	144.20
10 x 4	10.75	8.500	1.125	8.50	4.50	3.438	0.531	7.25	160	141.40
❖ 10 x 3	10.75	8.500	1.125	8.50	3.50	2.624	0.438	7.25	160	140.00
12 x 10	12.75	10.126	1.312	10.00	10.75	8.500	1.125	9.50	160	231.00
12 x 8	12.75	10.126	1.312	10.00	8.62	6.808	0.906	9.00	160	218.40
12 x 6	12.75	10.126	1.312	10.00	6.62	5.182	0.719	8.62	160	211.40
12 x 5	12.75	10.126	1.312	10.00	5.56	4.310	0.625	8.50	160	208.60
❖ 12 x 4	12.75	10.126	1.312	10.00	4.50	3.438	0.531	8.50	160	207.20
14 x 12	14.00	11.188	1.406	11.00	12.75	10.126	1.312	10.62	160	294.00
14 x 10	14.00	11.188	1.406	11.00	10.75	8.500	1.125	10.12	160	284.20
14 x 8	14.00	11.188	1.406	11.00	8.62	6.808	0.906	9.75	160	280.00
14 x 6	14.00	11.188	1.406	11.00	6.62	5.182	0.719	9.38	160	274.40
16 x 14	16.00	12.812	1.594	12.00	14.00	11.188	1.406	12.00	160	375.20
16 x 12	16.00	12.812	1.594	12.00	12.75	10.126	1.312	11.62	160	365.40
16 x 10	16.00	12.812	1.594	12.00	10.75	8.500	1.125	11.12	160	350.00
16 x 8	16.00	12.812	1.594	12.00	8.62	6.808	0.906	10.75	160	336.00
16 x 6	16.00	12.812	1.594	12.00	6.62	5.182	0.719	10.38	160	329.00
18 x 16	18.00	14.438	1.781	13.50	16.00	12.812	1.594	13.00	160	487.20
18 x 14	18.00	14.438	1.781	13.50	14.00	11.188	1.406	13.00	160	469.00
18 x 12	18.00	14.438	1.781	13.50	12.75	10.126	1.312	12.62	160	459.20
18 x 10	18.00	14.438	1.781	13.50	10.75	8.500	1.125	12.12	160	431.20
18 x 8	18.00	14.438	1.781	13.50	8.62	6.808	0.906	11.75	160	420.00
20 x 18	20.00	16.062	1.969	15.00	18.00	14.438	1.781	14.50	160	623.00
20 x 16	20.00	16.062	1.969	15.00	16.00	12.812	1.594	14.00	160	597.80
20 x 14	20.00	16.062	1.969	15.00	14.00	11.188	1.406	14.00	160	576.80
20 x 12	20.00	16.062	1.969	15.00	12.75	10.126	1.312	13.62	160	555.80
20 x 10	20.00	16.062	1.969	15.00	10.75	8.500	1.125	13.12	160	537.60
20 x 8	20.00	16.062	1.969	15.00	8.62	6.808	0.906	12.75	160	525.00
24 x 20	24.00	19.312	2.344	17.00	20.00	16.062	1.969	17.00	160	854.00
24 x 18	24.00	19.312	2.344	17.00	18.00	14.438	1.781	16.50	160	823.20
24 x 16	24.00	19.312	2.344	17.00	16.00	12.812	1.594	16.00	160	809.20
24 x 14	24.00	19.312	2.344	17.00	14.00	11.188	1.406	16.00	160	791.00
24 x 12	24.00	19.312	2.344	17.00	12.75	10.126	1.312	15.62	160	781.20
24 x 10	24.00	19.312	2.344	17.00	10.75	8.500	1.125	15.12	160	770.00



## SCHEDULE XXS

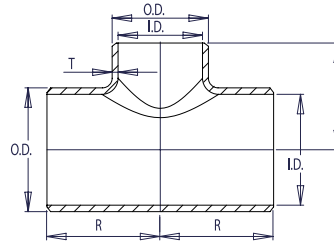

### WELDBEND NOTES

1. Conforms to ASME B16.9 & ASTM A234 WPB.
  2. All dimensions are in inches.
  3. For bevel detail see page 107.
  4. For dimensional tolerances see page 108.
  5. All weights are in pounds and approximated or estimated.
- \* This size and thickness does not correspond to any pipe schedule number.
- ❖ In accordance with B16.9. Special Fittings paragraph 4.4.2.

**FITTINGS**

Pipe Size	DIMENSIONS OF RUN				DIMENSIONS OF BRANCH				Pipe Schedule Number	Approx. Weight in Pounds
	Outside Diameter	Inside Diameter	Wall Thickness	Center to End	Outside Diameter	Inside Diameter	Wall Thickness	Center to End		
	O.D.	I.D.	T	R	O.D.	I.D.	T	B		
3/4 x 1/2	1.05	0.434	0.308	1.12	0.84	0.252	0.294	1.12	*	0.74
1 x 3/4	1.32	0.604	0.358	1.50	1.05	0.434	0.308	1.50	*	1.54
1 x 1/2	1.32	0.604	0.358	1.50	0.84	0.252	0.294	1.50	*	1.45
1 1/4 x 1	1.66	0.896	0.382	1.88	1.32	0.604	0.358	1.88	*	2.52
1 1/4 x 3/4	1.66	0.896	0.382	1.88	1.05	0.434	0.308	1.88	*	2.52
1 1/4 x 1/2	1.66	0.896	0.382	1.88	0.84	0.252	0.294	1.88	*	2.52
1 1/2 x 1 1/4	1.90	1.100	0.400	2.25	1.66	0.896	0.382	2.25	*	3.78
1 1/2 x 1	1.90	1.100	0.400	2.25	1.32	0.604	0.358	2.25	*	3.62
1 1/2 x 3/4	1.90	1.100	0.400	2.25	1.05	0.434	0.308	2.25	*	3.47
1 1/2 x 1/2	1.90	1.100	0.400	2.25	0.84	0.252	0.294	2.25	*	3.47
2 x 1 1/2	2.38	1.508	0.436	2.50	1.90	1.100	0.400	2.38	*	5.99
2 x 1 1/4	2.38	1.508	0.436	2.50	1.66	0.896	0.382	2.25	*	5.83
2 x 1	2.38	1.508	0.436	2.50	1.32	0.604	0.358	2.00	*	5.51
2 x 3/4	2.38	1.508	0.436	2.50	1.05	0.434	0.308	1.75	*	5.51
2 1/2 x 2	2.88	1.776	0.552	3.00	2.38	1.508	0.436	2.75	*	9.92
2 1/2 x 1 1/2	2.88	1.776	0.552	3.00	1.90	1.100	0.400	2.62	*	9.77
2 1/2 x 1 1/4	2.88	1.776	0.552	3.00	1.66	0.896	0.382	2.50	*	9.45
2 1/2 x 1	2.88	1.776	0.552	3.00	1.32	0.604	0.358	2.25	*	9.14
3 x 2 1/2	3.50	2.300	0.600	3.38	2.88	1.776	0.552	3.25	*	13.86
3 x 2	3.50	2.300	0.600	3.38	2.38	1.508	0.436	3.00	*	13.55
3 x 1 1/2	3.50	2.300	0.600	3.38	1.90	1.100	0.400	2.88	*	12.76
3 x 1 1/4	3.50	2.300	0.600	3.38	1.66	0.896	0.382	2.75	*	12.60
❖ 3 x 1	3.50	2.300	0.600	3.38	1.32	0.604	0.358	2.62	*	12.60
4 x 3	4.50	3.152	0.674	4.12	3.50	2.300	0.600	3.88	*	24.26
4 x 2 1/2	4.50	3.152	0.674	4.12	2.88	1.776	0.552	3.75	*	23.78
4 x 2	4.50	3.152	0.674	4.12	2.38	1.508	0.436	3.50	*	23.78
4 x 1 1/2	4.50	3.152	0.674	4.12	1.90	1.100	0.400	3.38	*	23.63
5 x 4	5.56	4.060	0.750	4.88	4.50	3.152	0.674	4.62	*	40.01
5 x 3	5.56	4.060	0.750	4.88	3.50	2.300	0.600	4.38	*	38.12
5 x 2 1/2	5.56	4.060	0.750	4.88	2.88	1.776	0.552	4.25	*	37.64
5 x 2	5.56	4.060	0.750	4.88	2.38	1.508	0.436	4.12	*	37.17

Pipe Size	DIMENSIONS OF RUN				DIMENSIONS OF BRANCH				Pipe Schedule Number	Approx. Weight in Pounds
	Outside Diameter	Inside Diameter	Wall Thickness	Center to End	Outside Diameter	Inside Diameter	Wall Thickness	Center to End		
	O.D.	I.D.	T	R	O.D.	I.D.	T	B		
6 x 5	6.62	4.892	0.864	5.62	5.56	4.060	0.750	5.38	*	62.21
6 x 4	6.62	4.892	0.864	5.62	4.50	3.152	0.674	5.12	*	61.90
6 x 3	6.62	4.892	0.864	5.62	3.50	2.300	0.600	4.88	*	60.80
6 x 2 ½	6.62	4.892	0.864	5.62	2.88	1.776	0.552	4.75	*	60.17
❖ 6 x 2	6.62	4.892	0.864	5.62	2.38	1.508	0.436	4.75	*	58.91
8 x 6	8.62	6.870	0.875	7.00	6.62	4.892	0.864	6.62	*	110.57
8 x 5	8.62	6.870	0.875	7.00	5.56	4.060	0.750	6.38	*	109.31
8 x 4	8.62	6.870	0.875	7.00	4.50	3.152	0.674	6.12	*	108.99
❖ 8 x 3	8.62	6.870	0.875	7.00	3.50	2.300	0.600	6.00	*	107.57
10 x 8	10.75	8.750	1.000	8.50	8.62	6.870	0.875	8.00	*	168.53
10 x 6	10.75	8.750	1.000	8.50	6.62	4.892	0.864	7.62	*	163.80
10 x 5	10.75	8.750	1.000	8.50	5.56	4.060	0.750	7.50	*	162.23
10 x 4	10.75	8.750	1.000	8.50	4.50	3.152	0.674	7.25	*	159.08
❖ 10 x 3	10.75	8.750	1.000	8.50	3.50	2.300	0.600	7.25	*	158.00
12 x 10	12.75	10.750	1.000	10.00	10.75	8.750	1.000	9.50	*	259.88
12 x 8	12.75	10.750	1.000	10.00	8.62	6.870	0.875	9.00	*	245.70
12 x 6	12.75	10.750	1.000	10.00	6.62	4.892	0.864	8.62	*	237.83
12 x 5	12.75	10.750	1.000	10.00	5.56	4.060	0.750	8.50	*	234.68
❖ 12 x 4	12.75	10.750	1.000	10.00	4.50	3.152	0.674	8.50	*	233.10



# CONCENTRIC AND ECCENTRIC REDUCERS



## SCHEDULE STD

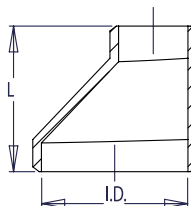
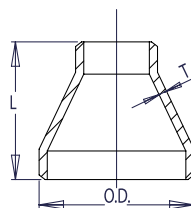

### WELDBEND NOTES

1. Conforms to ASME B16.9 & ASTM A234 WPB.
  2. All dimensions are in inches.
  3. For bevel detail see page 107.
  4. For dimensional tolerances see page 108.
  5. For sizes larger than 48" please call.
  6. All weights are in pounds and approximated or estimated.
- \* This size and thickness does not correspond to any pipe schedule number.  
 ❖ In accordance with B16.9. Special Fittings paragraph 4.4.2.

FITTINGS

Pipe Size	LARGE DIAMETER			SMALL DIAMETER			Length L	Pipe Schedule Number	Approx. Weight in Pounds
	Outside Diameter	Inside Diameter	Wall Thickness	Outside Diameter	Inside Diameter	Wall Thickness			
	O.D.	I.D.	T	O.D.	I.D.	T			
¾ x ½	1.05	0.824	0.113	0.84	0.622	0.109	1.50	40	0.21
1 x ¾	1.32	1.054	0.133	1.05	0.824	0.113	2.00	40	0.36
1 x ½	1.32	1.054	0.133	0.84	0.622	0.109	2.00	40	0.36
1 ¼ x 1	1.66	1.380	0.140	1.32	1.054	0.133	2.00	40	0.48
1 ¼ x ¾	1.66	1.380	0.140	1.05	0.824	0.113	2.00	40	0.42
1 ¼ x ½	1.66	1.380	0.140	0.84	0.622	0.109	2.00	40	0.42
1 ½ x 1 ¼	1.90	1.610	0.145	1.66	1.380	0.140	2.50	40	0.65
1 ½ x 1	1.90	1.610	0.145	1.32	1.054	0.133	2.50	40	0.57
1 ½ x ¾	1.90	1.610	0.145	1.05	0.824	0.113	2.50	40	0.56
1 ½ x ½	1.90	1.610	0.145	0.84	0.622	0.109	2.50	40	0.56
2 x 1 ½	2.38	2.072	0.154	1.90	1.610	0.145	3.00	40	0.94
2 x 1 ¼	2.38	2.072	0.154	1.66	1.380	0.140	3.00	40	0.88
2 x 1	2.38	2.072	0.154	1.32	1.054	0.133	3.00	40	0.81
2 x ¾	2.38	2.072	0.154	1.05	0.824	0.113	3.00	40	0.74
2 ½ x 2	2.88	2.474	0.203	2.38	2.072	0.154	3.50	40	1.60
2 ½ x 1 ½	2.88	2.474	0.203	1.90	1.610	0.145	3.50	40	1.50
2 ½ x 1 ¼	2.88	2.474	0.203	1.66	1.380	0.140	3.50	40	1.40
2 ½ x 1	2.88	2.474	0.203	1.32	1.054	0.133	3.50	40	1.30
3 x 2 ½	3.50	3.068	0.216	2.88	2.474	0.203	3.50	40	2.20
3 x 2	3.50	3.068	0.216	2.38	2.072	0.154	3.50	40	2.00
3 x 1 ½	3.50	3.068	0.216	1.90	1.610	0.145	3.50	40	1.90
3 x 1 ¼	3.50	3.068	0.216	1.66	1.380	0.140	3.50	40	1.80
❖ 3 x 1	3.50	3.068	0.216	1.32	1.054	0.133	3.50	40	1.70
3 ½ x 3	4.00	3.548	0.226	3.50	3.068	0.216	4.00	40	2.80
3 ½ x 2 ½	4.00	3.548	0.226	2.88	2.474	0.203	4.00	40	2.70
3 ½ x 2	4.00	3.548	0.226	2.38	2.072	0.154	4.00	40	2.60
3 ½ x 1 ½	4.00	3.548	0.226	1.90	1.610	0.145	4.00	40	2.60
3 ½ x 1 ¼	4.00	3.548	0.226	1.66	1.380	0.140	4.00	40	2.50
4 x 3 ½	4.50	4.026	0.237	4.00	3.548	0.226	4.00	40	3.50
4 x 3	4.50	4.026	0.237	3.50	3.068	0.216	4.00	40	3.30
4 x 2 ½	4.50	4.026	0.237	2.88	2.474	0.203	4.00	40	3.20
4 x 2	4.50	4.026	0.237	2.38	2.072	0.154	4.00	40	3.10
4 x 1 ½	4.50	4.026	0.237	1.90	1.610	0.145	4.00	40	3.00

## CONCENTRIC AND ECCENTRIC REDUCERS

Pipe Size	LARGE DIAMETER			SMALL DIAMETER			Length	Pipe Schedule Number	Approx. Weight in Pounds
	Outside Diameter	Inside Diameter	Wall Thickness	Outside Diameter	Inside Diameter	Wall Thickness			
	O.D.	I.D.	T	O.D.	I.D.	T	L		
❖ 4 x 1 1/4	4.50	4.026	0.237	1.66	1.380	0.140	4.00	40	3.00
❖ 4 x 1	4.50	4.026	0.237	1.32	1.054	0.133	4.00	40	2.80
5 x 4	5.56	5.044	0.258	4.50	4.026	0.237	5.00	40	5.50
5 x 3 1/2	5.56	5.044	0.258	4.00	3.548	0.226	5.00	40	5.30
5 x 3	5.56	5.044	0.258	3.50	3.068	0.216	5.00	40	5.10
5 x 2 1/2	5.56	5.044	0.258	2.88	2.474	0.203	5.00	40	4.80
5 x 2	5.56	5.044	0.258	2.38	2.072	0.154	5.00	40	4.70
6 x 5	6.62	6.060	0.280	5.56	5.044	0.258	5.50	40	7.60
6 x 4	6.62	6.060	0.280	4.50	4.026	0.237	5.50	40	7.40
6 x 3 1/2	6.62	6.060	0.280	4.00	3.548	0.226	5.50	40	7.10
6 x 3	6.62	6.060	0.280	3.50	3.068	0.216	5.50	40	6.90
6 x 2 1/2	6.62	6.060	0.280	2.88	2.474	0.203	5.50	40	6.60
❖ 6 x 2	6.62	6.060	0.280	2.38	2.072	0.154	5.50	40	6.50
8 x 6	8.62	7.976	0.322	6.62	6.060	0.280	6.00	40	12.30
8 x 5	8.62	7.976	0.322	5.56	5.044	0.258	6.00	40	11.50
8 x 4	8.62	7.976	0.322	4.50	4.026	0.237	6.00	40	10.80
8 x 3 1/2	8.62	7.976	0.322	4.00	3.548	0.226	6.00	40	10.60
❖ 8 x 3	8.62	7.976	0.322	3.50	3.068	0.216	6.00	40	9.80
10 x 8	10.75	10.020	0.365	8.62	7.976	0.322	7.00	40	22.10
10 x 6	10.75	10.020	0.365	6.62	6.060	0.280	7.00	40	20.70
10 x 5	10.75	10.020	0.365	5.56	5.044	0.258	7.00	40	19.50
10 x 4	10.75	10.020	0.365	4.50	4.026	0.237	7.00	40	18.40
12 x 10	12.75	12.000	0.375	10.75	10.020	0.365	8.00	*	32.40
12 x 8	12.75	12.000	0.375	8.62	7.976	0.322	8.00	*	30.50
12 x 6	12.75	12.000	0.375	6.62	6.060	0.280	8.00	*	29.50
12 x 5	12.75	12.000	0.375	5.56	5.044	0.258	8.00	*	27.80
❖ 12 x 4	12.75	12.000	0.375	4.50	4.026	0.237	8.00	*	26.20
14 x 12	14.00	13.250	0.375	12.75	12.000	0.375	13.00	*	63.10
14 x 10	14.00	13.250	0.375	10.75	10.020	0.365	13.00	*	61.40
14 x 8	14.00	13.250	0.375	8.62	7.976	0.322	13.00	*	60.00
14 x 6	14.00	13.250	0.375	6.62	6.060	0.280	13.00	*	59.20
16 x 14	16.00	15.250	0.375	14.00	13.250	0.375	14.00	*	75.40
16 x 12	16.00	15.250	0.375	12.75	12.000	0.375	14.00	*	72.70
16 x 10	16.00	15.250	0.375	10.75	10.020	0.365	14.00	*	71.10
16 x 8	16.00	15.250	0.375	8.62	7.976	0.322	14.00	*	69.40
❖ 16 x 6	16.00	15.250	0.375	6.62	6.060	0.280	14.00	*	67.40
18 x 16	18.00	17.250	0.375	16.00	15.250	0.375	15.00	*	87.30
18 x 14	18.00	17.250	0.375	14.00	13.250	0.375	15.00	*	86.00
18 x 12	18.00	17.250	0.375	12.75	12.000	0.375	15.00	*	84.80
18 x 10	18.00	17.250	0.375	10.75	10.020	0.365	15.00	*	83.70
❖ 18 x 8	18.00	17.250	0.375	8.62	7.976	0.322	15.00	*	81.75
20 x 18	20.00	19.250	0.375	18.00	17.250	0.375	20.00	*	123.00
20 x 16	20.00	19.250	0.375	16.00	15.250	0.375	20.00	*	121.00
20 x 14	20.00	19.250	0.375	14.00	13.250	0.375	20.00	*	119.00

# CONCENTRIC AND ECCENTRIC REDUCERS



## SCHEDULE STD

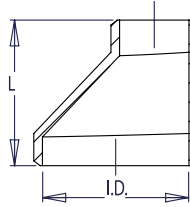
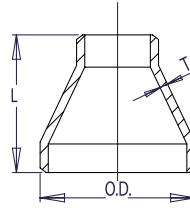

### WELDBEND NOTES

1. Conforms to ASME B16.9 & ASTM A234 WPB.
  2. All dimensions are in inches.
  3. For bevel detail see page 107.
  4. For dimensional tolerances see page 108.
  5. For sizes larger than 48" please call.
  6. All weights are in pounds and approximated or estimated.
- \* This size and thickness does not correspond to any pipe schedule number.  
 ❖ In accordance with B16.9. Special Fittings paragraph 4.4.2.

FITTINGS

Pipe Size	LARGE DIAMETER			SMALL DIAMETER			Length L	Pipe Schedule Number	Approx. Weight in Pounds
	Outside Diameter	Inside Diameter	Wall Thickness	Outside Diameter	Inside Diameter	Wall Thickness			
	O.D.	I.D.	T	O.D.	I.D.	T			
20 x 12	20.00	19.250	0.375	12.75	12.000	0.375	20.00	*	118.00
❖ 20 x 10	20.00	19.250	0.375	10.75	10.020	0.365	20.00	*	117.00
24 x 20	24.00	23.250	0.375	20.00	19.250	0.375	20.00	*	156.00
24 x 18	24.00	23.250	0.375	18.00	17.250	0.375	20.00	*	153.00
24 x 16	24.00	23.250	0.375	16.00	15.250	0.375	20.00	*	150.00
❖ 24 x 14	24.00	23.250	0.375	14.00	13.250	0.375	20.00	*	147.00
❖ 24 x 12	24.00	23.250	0.375	12.75	12.000	0.375	20.00	*	144.00
❖ 24 x 10	24.00	23.250	0.375	10.75	10.020	0.365	20.00	*	141.00
30 x 24	30.00	29.250	0.375	24.00	23.250	0.375	24.00	*	315.00
30 x 20	30.00	29.250	0.375	20.00	19.250	0.375	24.00	*	315.00
❖ 30 x 18	30.00	29.250	0.375	18.00	17.250	0.375	24.00	*	315.00
36 x 30	36.00	35.250	0.375	30.00	29.250	0.375	24.00	*	379.00
36 x 24	36.00	35.250	0.375	24.00	23.250	0.375	24.00	*	379.00
❖ 36 x 20	36.00	35.250	0.375	20.00	19.250	0.375	24.00	*	379.00
42 x 36	42.00	41.250	0.375	36.00	35.250	0.375	24.00	*	443.00
42 x 30	42.00	41.250	0.375	30.00	29.250	0.375	24.00	*	443.00
❖ 42 x 24	42.00	41.250	0.375	24.00	23.250	0.375	24.00	*	443.00
48 x 42	48.00	47.250	0.375	42.00	41.250	0.375	28.00	*	525.00
❖ 48 x 36	48.00	47.250	0.375	36.00	35.250	0.375	28.00	*	525.00
❖ 48 x 30	48.00	47.250	0.375	30.00	29.250	0.375	28.00	*	525.00
❖ 48 x 24	48.00	47.250	0.375	24.00	23.250	0.375	28.00	*	525.00



# CONCENTRIC AND ECCENTRIC REDUCERS

## SCHEDULE XS

### WELDBEND NOTES

1. Conforms to ASME B16.9 & ASTM A234 WPB.
2. All dimensions are in inches.
3. For bevel detail see page 107.
4. For dimensional tolerances see page 108.
5. For sizes larger than 48" please call.
6. All weights are in pounds and approximated or estimated.

\* This size and thickness does not correspond to any pipe schedule number.

❖ In accordance with B16.9. Special Fittings paragraph 4.4.2.

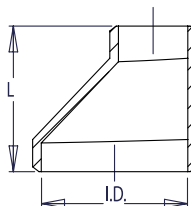
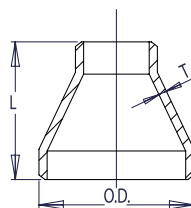

Pipe Size	LARGE DIAMETER			SMALL DIAMETER			Length	Pipe Schedule Number	Approx. Weight in Pounds
	Outside Diameter	Inside Diameter	Wall Thickness	Outside Diameter	Inside Diameter	Wall Thickness			
	O.D.	I.D.	T	O.D.	I.D.	T			
¾ x ½	1.05	0.742	0.154	0.84	0.546	0.147	1.50	80	0.25
1 x ¾	1.32	0.962	0.179	1.05	0.742	0.154	2.00	80	0.43
1 x ½	1.32	0.962	0.179	0.84	0.546	0.147	2.00	80	0.42
1 ¼ x 1	1.66	1.278	0.191	1.32	0.962	0.179	2.00	80	0.57
1 ¼ x ¾	1.66	1.278	0.191	1.05	0.742	0.154	2.00	80	0.53
1 ¼ x ½	1.66	1.278	0.191	0.84	0.546	0.147	2.00	80	0.50
1 ½ x 1 ¼	1.90	1.500	0.200	1.66	1.278	0.191	2.50	80	0.78
1 ½ x 1	1.90	1.500	0.200	1.32	0.962	0.179	2.50	80	0.72
1 ½ x ¾	1.90	1.500	0.200	1.05	0.742	0.154	2.50	80	0.65
1 ½ x ½	1.90	1.500	0.200	0.84	0.546	0.147	2.50	80	0.65
2 x 1 ½	2.38	1.944	0.218	1.90	1.500	0.200	3.00	80	1.20
2 x 1 ¼	2.38	1.944	0.218	1.66	1.278	0.191	3.00	80	1.10
2 x 1	2.38	1.944	0.218	1.32	0.962	0.179	3.00	80	1.00
2 x ¾	2.38	1.944	0.218	1.05	0.742	0.154	3.00	80	0.94
2 ½ x 2	2.88	2.328	0.276	2.38	1.944	0.218	3.50	80	2.10
2 ½ x 1 ½	2.88	2.328	0.276	1.90	1.500	0.200	3.50	80	1.90
2 ½ x 1 ¼	2.88	2.328	0.276	1.66	1.278	0.191	3.50	80	1.70
2 ½ x 1	2.88	2.328	0.276	1.32	0.962	0.179	3.50	80	1.50
3 x 2 ½	3.50	2.900	0.300	2.88	2.328	0.276	3.50	80	2.80
3 x 2	3.50	2.900	0.300	2.38	1.944	0.218	3.50	80	2.60
3 x 1 ½	3.50	2.900	0.300	1.90	1.500	0.200	3.50	80	2.40
3 x 1 ¼	3.50	2.900	0.300	1.66	1.278	0.191	3.50	80	2.30
❖ 3 x 1	3.50	2.900	0.300	1.32	0.962	0.179	3.50	80	2.20
3 ½ x 3	4.00	3.364	0.318	3.50	2.900	0.300	4.00	80	3.70
3 ½ x 2 ½	4.00	3.364	0.318	2.88	2.328	0.276	4.00	80	3.50
3 ½ x 2	4.00	3.364	0.318	2.38	1.944	0.218	4.00	80	3.30
3 ½ x 1 ½	4.00	3.364	0.318	1.90	1.500	0.200	4.00	80	3.20
3 ½ x 1 ¼	4.00	3.364	0.318	1.66	1.278	0.191	4.00	80	3.20
4 x 3 ½	4.50	3.826	0.337	4.00	3.364	0.318	4.00	80	4.90
4 x 3	4.50	3.826	0.337	3.50	2.900	0.300	4.00	80	4.70
4 x 2 ½	4.50	3.826	0.337	2.88	2.328	0.276	4.00	80	4.60
4 x 2	4.50	3.826	0.337	2.38	1.944	0.218	4.00	80	4.30
4 x 1 ½	4.50	3.826	0.337	1.90	1.500	0.200	4.00	80	4.20

# CONCENTRIC AND ECCENTRIC REDUCERS



## SCHEDULE XS

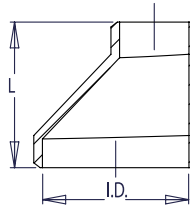
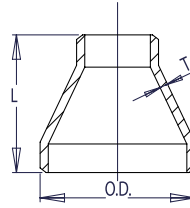

### WELDBEND NOTES

1. Conforms to ASME B16.9 & ASTM A234 WPB.
  2. All dimensions are in inches.
  3. For bevel detail see page 107.
  4. For dimensional tolerances see page 108.
  5. For sizes larger than 48" please call.
  6. All weights are in pounds and approximated or estimated.
- \* This size and thickness does not correspond to any pipe schedule number.  
 ❖ In accordance with B16.9. Special Fittings paragraph 4.4.2.

FITTINGS

Pipe Size	LARGE DIAMETER			SMALL DIAMETER			Length L	Pipe Schedule Number	Approx. Weight in Pounds
	Outside Diameter	Inside Diameter	Wall Thickness	Outside Diameter	Inside Diameter	Wall Thickness			
	O.D.	I.D.	T	O.D.	I.D.	T			
❖ 4 x 1 ¼	4.50	3.826	0.337	1.66	1.278	0.191	4.00	80	4.10
❖ 4 x 1	4.50	3.826	0.337	1.32	0.962	0.179	4.00	80	4.00
5 x 4	5.56	4.810	0.375	4.50	3.826	0.337	5.00	80	7.50
5 x 3 ½	5.56	4.810	0.375	4.00	3.364	0.318	5.00	80	6.90
5 x 3	5.56	4.810	0.375	3.50	2.900	0.300	5.00	80	6.30
5 x 2 ½	5.56	4.810	0.375	2.88	2.328	0.276	5.00	80	6.10
5 x 2	5.56	4.810	0.375	2.38	1.944	0.218	5.00	80	6.00
6 x 5	6.62	5.756	0.432	5.56	4.810	0.375	5.50	80	11.50
6 x 4	6.62	5.756	0.432	4.50	3.826	0.337	5.50	80	10.70
6 x 3 ½	6.62	5.756	0.432	4.00	3.364	0.318	5.50	80	10.00
6 x 3	6.62	5.756	0.432	3.50	2.900	0.300	5.50	80	9.70
6 x 2 ½	6.62	5.756	0.432	2.88	2.328	0.276	5.50	80	9.10
❖ 6 x 2	6.62	5.756	0.432	2.38	1.944	0.218	5.50	80	8.60
8 x 6	8.62	7.620	0.500	6.62	5.756	0.432	6.00	80	18.80
8 x 5	8.62	7.620	0.500	5.56	4.810	0.375	6.00	80	17.60
8 x 4	8.62	7.620	0.500	4.50	3.826	0.337	6.00	80	17.00
8 x 3 ½	8.62	7.620	0.500	4.00	3.364	0.318	6.00	80	15.90
❖ 8 x 3	8.62	7.620	0.500	3.50	2.900	0.300	6.00	80	15.00
10 x 8	10.75	9.750	0.500	8.62	7.620	0.500	7.00	*	29.40
10 x 6	10.75	9.750	0.500	6.62	5.756	0.432	7.00	*	28.30
10 x 5	10.75	9.750	0.500	5.56	4.810	0.375	7.00	*	26.90
10 x 4	10.75	9.750	0.500	4.50	3.826	0.337	7.00	*	24.20
12 x 10	12.75	11.750	0.500	10.75	9.750	0.500	8.00	*	41.50
12 x 8	12.75	11.750	0.500	8.62	7.620	0.500	8.00	*	38.60
12 x 6	12.75	11.750	0.500	6.62	5.756	0.432	8.00	*	37.40
12 x 5	12.75	11.750	0.500	5.56	4.810	0.375	8.00	*	36.30
❖ 12 x 4	12.75	11.750	0.500	4.50	3.826	0.337	8.00	*	34.70
14 x 12	14.00	13.000	0.500	12.75	11.750	0.500	13.00	*	81.00
14 x 10	14.00	13.000	0.500	10.75	9.750	0.500	13.00	*	76.70
14 x 8	14.00	13.000	0.500	8.62	7.620	0.500	13.00	*	74.60
14 x 6	14.00	13.000	0.500	6.62	5.756	0.432	13.00	*	72.30
16 x 14	16.00	15.000	0.500	14.00	13.000	0.500	14.00	*	98.00

## CONCENTRIC AND ECCENTRIC REDUCERS

Pipe Size	LARGE DIAMETER			SMALL DIAMETER			Length	Pipe Schedule Number	Approx. Weight in Pounds
	Outside Diameter	Inside Diameter	Wall Thickness	Outside Diameter	Inside Diameter	Wall Thickness			
	O.D.	I.D.	T	O.D.	I.D.	T	L		
16 x 12	16.00	15.000	0.500	12.75	11.750	0.500	14.00	*	95.80
16 x 10	16.00	15.000	0.500	10.75	9.750	0.500	14.00	*	93.30
16 x 8	16.00	15.000	0.500	8.62	7.620	0.500	14.00	*	91.10
❖ 16 x 6	16.00	15.000	0.500	6.62	5.756	0.432	14.00	*	89.80
18 x 16	18.00	17.000	0.500	16.00	15.000	0.500	15.00	*	118.00
18 x 14	18.00	17.000	0.500	14.00	13.000	0.500	15.00	*	117.00
18 x 12	18.00	17.000	0.500	12.75	11.750	0.500	15.00	*	115.00
18 x 10	18.00	17.000	0.500	10.75	9.750	0.500	15.00	*	113.00
❖ 18 x 8	18.00	17.000	0.500	8.62	7.620	0.500	15.00	*	100.00
20 x 18	20.00	19.000	0.500	18.00	17.000	0.500	20.00	*	162.00
20 x 16	20.00	19.000	0.500	16.00	15.000	0.500	20.00	*	159.00
20 x 14	20.00	19.000	0.500	14.00	13.000	0.500	20.00	*	157.00
20 x 12	20.00	19.000	0.500	12.75	11.750	0.500	20.00	*	155.00
❖ 20 x 10	20.00	19.000	0.500	10.75	9.750	0.500	20.00	*	152.00
24 x 20	24.00	23.000	0.500	20.00	19.000	0.500	20.00	*	201.00
24 x 18	24.00	23.000	0.500	18.00	17.000	0.500	20.00	*	197.00
24 x 16	24.00	23.000	0.500	16.00	15.000	0.500	20.00	*	194.00
❖ 24 x 14	24.00	23.000	0.500	14.00	13.000	0.500	20.00	*	190.00
❖ 24 x 12	24.00	23.000	0.500	12.75	11.750	0.500	20.00	*	188.00
❖ 24 x 10	24.00	23.000	0.500	10.75	9.750	0.500	20.00	*	186.00
30 x 24	30.00	29.000	0.500	24.00	23.000	0.500	24.00	*	315.00
30 x 20	30.00	29.000	0.500	20.00	19.000	0.500	24.00	*	315.00
❖ 30 x 18	30.00	29.000	0.500	18.00	17.000	0.500	24.00	*	315.00
36 x 30	36.00	35.000	0.500	30.00	29.000	0.500	24.00	*	379.00
36 x 24	36.00	35.000	0.500	24.00	23.000	0.500	24.00	*	379.00
❖ 36 x 20	36.00	35.000	0.500	20.00	19.000	0.500	24.00	*	379.00
42 x 36	42.00	41.000	0.500	36.00	35.000	0.500	24.00	*	443.00
42 x 30	42.00	41.000	0.500	30.00	29.000	0.500	24.00	*	443.00
❖ 42 x 24	42.00	41.000	0.500	24.00	23.000	0.500	24.00	*	443.00
48 x 42	48.00	47.000	0.500	42.00	41.000	0.500	28.00	*	525.00
❖ 48 x 36	48.00	47.000	0.500	36.00	35.000	0.500	28.00	*	525.00
❖ 48 x 30	48.00	47.000	0.500	30.00	29.000	0.500	28.00	*	525.00
❖ 48 x 24	48.00	47.000	0.500	24.00	23.000	0.500	28.00	*	525.00

FITTINGS

# CONCENTRIC AND ECCENTRIC REDUCERS



## SCHEDULE 40

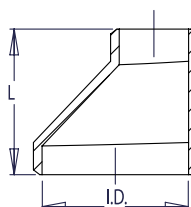
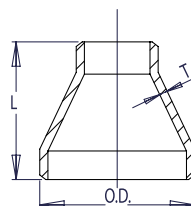

### WELDBEND NOTES

1. Conforms to ASME B16.9 & ASTM A234 WPB.
  2. All dimensions are in inches.
  3. For bevel detail see page 107.
  4. For dimensional tolerances see page 108.
  5. For sizes larger than 24" please call.
  6. All weights are in pounds and approximated or estimated.
- ❖ In accordance with B16.9. Special Fittings paragraph 4.4.2.

FITTINGS

Pipe Size	LARGE DIAMETER			SMALL DIAMETER			Length L	Pipe Schedule Number	Approx. Weight in Pounds
	Outside Diameter	Inside Diameter	Wall Thickness	Outside Diameter	Inside Diameter	Wall Thickness			
	O.D.	I.D.	T	O.D.	I.D.	T			
<b>FOR DIMENSION SPECIFICATIONS 1/2" THROUGH 10" REFER TO SCHEDULE STD</b>									
12 x 10	12.75	11.938	0.406	10.75	10.020	0.365	8.00	40	35.80
12 x 8	12.75	11.938	0.406	8.62	7.976	0.322	8.00	40	35.80
12 x 6	12.75	11.938	0.406	6.62	6.060	0.280	8.00	40	35.80
12 x 5	12.75	11.938	0.406	5.56	5.044	0.258	8.00	40	35.80
❖ 12 x 4	12.75	11.938	0.406	4.50	4.026	0.237	8.00	40	35.80
14 x 12	14.00	13.124	0.438	12.75	11.938	0.406	13.00	40	68.60
14 x 10	14.00	13.124	0.438	10.75	10.020	0.365	13.00	40	68.60
14 x 8	14.00	13.124	0.438	8.62	7.976	0.322	13.00	40	68.60
14 x 6	14.00	13.124	0.438	6.62	6.060	0.280	13.00	40	68.60
16 x 14	16.00	15.000	0.500	14.00	13.124	0.438	14.00	40	96.50
16 x 12	16.00	15.000	0.500	12.75	11.938	0.406	14.00	40	96.50
16 x 10	16.00	15.000	0.500	10.75	10.020	0.365	14.00	40	96.50
16 x 8	16.00	15.000	0.500	8.62	7.976	0.322	14.00	40	96.50
❖ 16 x 6	16.00	15.000	0.500	6.62	6.060	0.280	14.00	40	96.50
18 x 16	18.00	16.876	0.562	16.00	15.000	0.500	15.00	40	131.00
18 x 14	18.00	16.876	0.562	14.00	13.124	0.438	15.00	40	131.00
18 x 12	18.00	16.876	0.562	12.75	11.938	0.406	15.00	40	131.00
18 x 10	18.00	16.876	0.562	10.75	10.020	0.365	15.00	40	131.00
❖ 18 x 8	18.00	16.876	0.562	8.62	7.976	0.322	15.00	40	131.00
20 x 18	20.00	18.812	0.594	18.00	16.876	0.562	20.00	40	205.00
20 x 16	20.00	18.812	0.594	16.00	15.000	0.500	20.00	40	205.00
20 x 14	20.00	18.812	0.594	14.00	13.124	0.438	20.00	40	205.00
20 x 12	20.00	18.812	0.594	12.75	11.938	0.406	20.00	40	205.00
❖ 20 x 10	20.00	18.812	0.594	10.75	10.020	0.365	20.00	40	205.00
❖ 20 x 8	20.00	18.812	0.594	8.62	7.976	0.322	20.00	40	205.00
24 x 20	24.00	22.624	0.688	20.00	18.812	0.594	20.00	40	285.00
24 x 18	24.00	22.624	0.688	18.00	16.876	0.562	20.00	40	285.00
24 x 16	24.00	22.624	0.688	16.00	15.000	0.500	20.00	40	285.00
❖ 24 x 14	24.00	22.624	0.688	14.00	13.124	0.438	20.00	40	285.00
❖ 24 x 12	24.00	22.624	0.688	12.75	11.938	0.406	20.00	40	285.00
❖ 24 x 10	24.00	22.624	0.688	10.75	10.020	0.365	20.00	40	285.00

# CONCENTRIC AND ECCENTRIC REDUCERS

## SCHEDULE 80

### WELDBEND NOTES

1. Conforms to ASME B16.9 & ASTM A234 WPB.
  2. All dimensions are in inches.
  3. For bevel detail see page 107.
  4. For dimensional tolerances see page 108.
  5. All weights are in pounds and approximated or estimated.
- ❖ In accordance with B16.9. Special Fittings paragraph 4.4.2.

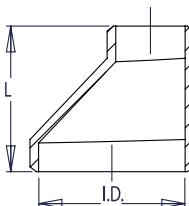
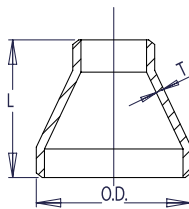

Pipe Size	LARGE DIAMETER			SMALL DIAMETER			Length L	Pipe Schedule Number	Approx. Weight in Pounds
	Outside Diameter	Inside Diameter	Wall Thickness	Outside Diameter	Inside Diameter	Wall Thickness			
	O.D.	I.D.	T	O.D.	I.D.	T			
<b>FOR DIMENSION SPECIFICATIONS 1/2" THROUGH 8" REFER TO SCHEDULE XS</b>									
10 x 8	10.75	9.562	0.594	8.62	7.620	0.500	7.00	80	37.50
10 x 6	10.75	9.562	0.594	6.62	5.756	0.432	7.00	80	37.50
10 x 5	10.75	9.562	0.594	5.56	4.810	0.375	7.00	80	37.50
10 x 4	10.75	9.562	0.594	4.50	3.826	0.337	7.00	80	37.50
12 x 10	12.75	11.374	0.688	10.75	9.562	0.594	8.00	80	59.00
12 x 8	12.75	11.374	0.688	8.62	7.620	0.500	8.00	80	59.00
12 x 6	12.75	11.374	0.688	6.62	5.756	0.432	8.00	80	59.00
12 x 5	12.75	11.374	0.688	5.56	4.810	0.375	8.00	80	59.00
❖ 12 x 4	12.75	11.374	0.688	4.50	3.826	0.337	8.00	80	59.00
14 x 12	14.00	12.500	0.750	12.75	11.374	0.688	13.00	80	115.00
14 x 10	14.00	12.500	0.750	10.75	9.562	0.594	13.00	80	115.00
14 x 8	14.00	12.500	0.750	8.62	7.620	0.500	13.00	80	115.00
14 x 6	14.00	12.500	0.750	6.62	5.756	0.432	13.00	80	115.00
16 x 14	16.00	14.312	0.844	14.00	12.500	0.750	14.00	80	159.00
16 x 12	16.00	14.312	0.844	12.75	11.374	0.688	14.00	80	159.00
16 x 10	16.00	14.312	0.844	10.75	9.562	0.594	14.00	80	159.00
16 x 8	16.00	14.312	0.844	8.62	7.620	0.500	14.00	80	159.00
❖ 16 x 6	16.00	14.312	0.844	6.62	5.756	0.432	14.00	80	159.00
18 x 16	18.00	16.124	0.938	16.00	14.312	0.844	15.00	80	213.00
18 x 14	18.00	16.124	0.938	14.00	12.500	0.750	15.00	80	213.00
18 x 12	18.00	16.124	0.938	12.75	11.374	0.688	15.00	80	213.00
18 x 10	18.00	16.124	0.938	10.75	9.562	0.594	15.00	80	213.00
❖ 18 x 8	18.00	16.124	0.938	8.62	7.620	0.500	15.00	80	213.00

# CONCENTRIC AND ECCENTRIC REDUCERS



## SCHEDULE 80

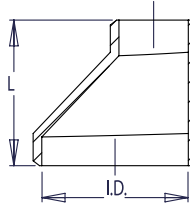
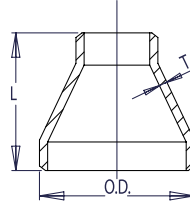

### WELDBEND NOTES

1. Conforms to ASME B16.9 & ASTM A234 WPB.
  2. All dimensions are in inches.
  3. For bevel detail see page 107.
  4. For dimensional tolerances see page 108.
  5. All weights are in pounds and approximated or estimated.
- ❖ In accordance with B16.9. Special Fittings paragraph 4.4.2.

FITTINGS

Pipe Size	LARGE DIAMETER			SMALL DIAMETER			Length L	Pipe Schedule Number	Approx. Weight in Pounds
	Outside Diameter	Inside Diameter	Wall Thickness	Outside Diameter	Inside Diameter	Wall Thickness			
	O.D.	I.D.	T	O.D.	I.D.	T			
20 x 18	20.00	17.938	1.031	18.00	16.124	0.938	20.00	80	348.00
20 x 16	20.00	17.938	1.031	16.00	14.312	0.844	20.00	80	348.00
20 x 14	20.00	17.938	1.031	14.00	12.500	0.750	20.00	80	348.00
20 x 12	20.00	17.938	1.031	12.75	11.374	0.688	20.00	80	348.00
❖ 20 x 10	20.00	17.938	1.031	10.75	9.562	0.594	20.00	80	348.00
❖ 20 x 8	20.00	17.938	1.031	8.62	7.620	0.500	20.00	80	348.00
24 x 20	24.00	21.562	1.219	20.00	17.938	1.031	20.00	80	494.00
24 x 18	24.00	21.562	1.219	18.00	16.124	0.938	20.00	80	494.00
24 x 16	24.00	21.562	1.219	16.00	14.312	0.844	20.00	80	494.00
❖ 24 x 14	24.00	21.562	1.219	14.00	12.500	0.750	20.00	80	494.00
❖ 24 x 12	24.00	21.562	1.219	12.75	11.374	0.688	20.00	80	494.00
❖ 24 x 10	24.00	21.562	1.219	10.75	9.562	0.594	20.00	80	494.00

## SCHEDULE 160

### WELDBEND NOTES

1. Conforms to ASME B16.9 & ASTM A234 WPB.
  2. All dimensions are in inches.
  3. For bevel detail see page 107.
  4. For dimensional tolerances see page 108.
  5. All weights are in pounds and approximated or estimated.
- ❖ In accordance with B16.9. Special Fittings paragraph 4.4.2.

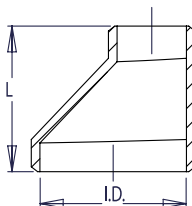
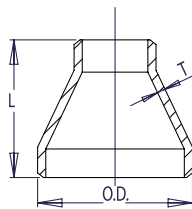

Pipe Size	LARGE DIAMETER			SMALL DIAMETER			Length L	Pipe Schedule Number	Approx. Weight in Pounds
	Outside Diameter	Inside Diameter	Wall Thickness	Outside Diameter	Inside Diameter	Wall Thickness			
	O.D.	I.D.	T	O.D.	I.D.	T			
3/4 x 1/2	1.05	0.612	0.219	0.84	0.464	0.188	1.50	160	0.37
1 x 3/4	1.32	0.820	0.250	1.05	0.612	0.219	2.00	160	0.45
1 x 1/2	1.32	0.820	0.250	0.84	0.464	0.188	2.00	160	0.45
1 1/4 x 1	1.66	1.160	0.250	1.32	0.820	0.250	2.00	160	0.70
1 1/4 x 3/4	1.66	1.160	0.250	1.05	0.612	0.219	2.00	160	0.70
1 1/4 x 1/2	1.66	1.160	0.250	0.84	0.464	0.188	2.00	160	0.70
1 1/2 x 1 1/4	1.90	1.338	0.281	1.66	1.160	0.250	2.50	160	0.90
1 1/2 x 1	1.90	1.338	0.281	1.32	0.820	0.250	2.50	160	0.90
1 1/2 x 3/4	1.90	1.338	0.281	1.05	0.612	0.219	2.50	160	0.90
1 1/2 x 1/2	1.90	1.338	0.281	0.84	0.464	0.188	2.50	160	0.90
2 x 1 1/2	2.38	1.692	0.344	1.90	1.338	0.281	3.00	160	1.85
2 x 1 1/4	2.38	1.692	0.344	1.66	1.160	0.250	3.00	160	1.85
2 x 1	2.38	1.692	0.344	1.32	0.820	0.250	3.00	160	1.85
2 x 3/4	2.38	1.692	0.344	1.05	0.612	0.219	3.00	160	1.50
2 1/2 x 2	2.88	2.130	0.375	2.38	1.692	0.344	3.50	160	3.00
2 1/2 x 1 1/2	2.88	2.130	0.375	1.90	1.338	0.281	3.50	160	3.00
2 1/2 x 1 1/4	2.88	2.130	0.375	1.66	1.160	0.250	3.50	160	2.80
2 1/2 x 1	2.88	2.130	0.375	1.32	0.820	0.250	3.50	160	2.80
3 x 2 1/2	3.50	2.624	0.438	2.88	2.130	0.375	3.50	160	4.00
3 x 2	3.50	2.624	0.438	2.38	1.692	0.344	3.50	160	4.00
3 x 1 1/2	3.50	2.624	0.438	1.90	1.338	0.281	3.50	160	4.00
3 x 1 1/4	3.50	2.624	0.438	1.66	1.160	0.250	3.50	160	3.50
❖ 3 x 1	3.50	2.624	0.438	1.32	0.820	0.250	3.50	160	3.50
4 x 3	4.50	3.438	0.531	3.50	2.624	0.438	4.00	160	6.00
4 x 2 1/2	4.50	3.438	0.531	2.88	2.130	0.375	4.00	160	6.00
4 x 2	4.50	3.438	0.531	2.38	1.692	0.344	4.00	160	5.00
4 x 1 1/2	4.50	3.438	0.531	1.90	1.338	0.281	4.00	160	5.00
❖ 4 x 1 1/4	4.50	3.438	0.531	1.66	1.160	0.250	4.00	160	5.00
❖ 4 x 1	4.50	3.438	0.531	1.32	0.820	0.250	4.00	160	5.00



# CONCENTRIC AND ECCENTRIC REDUCERS



## SCHEDULE 160

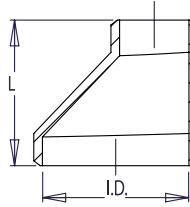
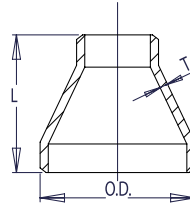

### WELDBEND NOTES

1. Conforms to ASME B16.9 & ASTM A234 WPB.
  2. All dimensions are in inches.
  3. For bevel detail see page 107.
  4. For dimensional tolerances see page 108.
  5. All weights are in pounds and approximated or estimated.
- ❖ In accordance with B16.9. Special Fittings paragraph 4.4.2.

FITTINGS

Pipe Size	LARGE DIAMETER			SMALL DIAMETER			Length L	Pipe Schedule Number	Approx. Weight in Pounds
	Outside Diameter	Inside Diameter	Wall Thickness	Outside Diameter	Inside Diameter	Wall Thickness			
	O.D.	I.D.	T	O.D.	I.D.	T			
5 x 4	5.56	4.310	0.625	4.50	3.438	0.531	5.00	160	14.00
5 x 3	5.56	4.310	0.625	3.50	2.624	0.438	5.00	160	14.00
5 x 2 1/2	5.56	4.310	0.625	2.88	2.130	0.375	5.00	160	14.00
5 x 2	5.56	4.310	0.625	2.38	1.692	0.344	5.00	160	14.00
6 x 5	6.62	5.182	0.719	5.56	4.310	0.625	5.50	160	18.00
6 x 4	6.62	5.182	0.719	4.50	3.438	0.531	5.50	160	18.00
6 x 3	6.62	5.182	0.719	3.50	2.624	0.438	5.50	160	15.50
6 x 2 1/2	6.62	5.182	0.719	2.88	2.130	0.375	5.50	160	15.50
❖ 6 x 2	6.62	5.182	0.719	2.38	1.692	0.344	5.50	160	15.00
8 x 6	8.62	6.808	0.906	6.62	5.182	0.719	6.00	160	31.50
8 x 5	8.62	6.808	0.906	5.56	4.310	0.625	6.00	160	28.00
8 x 4	8.62	6.808	0.906	4.50	3.438	0.531	6.00	160	28.00
❖ 8 x 3	8.62	6.808	0.906	3.50	2.624	0.438	6.00	160	30.00
10 x 8	10.75	8.500	1.125	8.62	6.808	0.906	7.00	160	58.00
10 x 6	10.75	8.500	1.125	6.62	5.182	0.719	7.00	160	58.00
10 x 5	10.75	8.500	1.125	5.56	4.310	0.625	7.00	160	54.00
10 x 4	10.75	8.500	1.125	4.50	3.438	0.531	7.00	160	52.00
12 x 10	12.75	10.126	1.312	10.75	8.500	1.125	8.00	160	95.00
12 x 8	12.75	10.126	1.312	8.62	6.808	0.906	8.00	160	85.00
12 x 6	12.75	10.126	1.312	6.62	5.182	0.719	8.00	160	80.00
12 x 5	12.75	10.126	1.312	5.56	4.310	0.625	8.00	160	80.00
❖ 12 x 4	12.75	10.126	1.312	4.50	3.438	0.531	8.00	160	80.00
14 x 12	14.00	11.188	1.406	12.75	10.126	1.312	13.00	160	115.00
14 x 10	14.00	11.188	1.406	10.75	8.500	1.125	13.00	160	115.00
14 x 8	14.00	11.188	1.406	8.62	6.808	0.906	13.00	160	159.00
14 x 6	14.00	11.188	1.406	6.62	5.182	0.719	13.00	160	159.00
16 x 14	16.00	12.812	1.594	14.00	11.188	1.406	14.00	160	159.00
16 x 12	16.00	12.812	1.594	12.75	10.126	1.312	14.00	160	159.00
16 x 10	16.00	12.812	1.594	10.75	8.500	1.125	14.00	160	159.00
16 x 8	16.00	12.812	1.594	8.62	6.808	0.906	14.00	160	213.00
❖ 16 x 6	16.00	12.812	1.594	6.62	5.182	0.719	14.00	160	213.00



## CONCENTRIC AND ECCENTRIC REDUCERS

Pipe Size	LARGE DIAMETER			SMALL DIAMETER			Length	Pipe Schedule Number	Approx. Weight in Pounds
	Outside Diameter	Inside Diameter	Wall Thickness	Outside Diameter	Inside Diameter	Wall Thickness			
	O.D.	I.D.	T	O.D.	I.D.	T	L		
18 x 16	18.00	14.438	1.781	16.00	12.812	1.594	15.00	160	213.00
18 x 14	18.00	14.438	1.781	14.00	11.188	1.406	15.00	160	213.00
18 x 12	18.00	14.438	1.781	12.75	10.126	1.312	15.00	160	213.00
18 x 10	18.00	14.438	1.781	10.75	8.500	1.125	15.00	160	348.00
❖ 18 x 8	18.00	14.438	1.781	8.62	6.808	0.906	15.00	160	327.00
20 x 18	20.00	16.062	1.969	18.00	14.438	1.781	20.00	160	348.00
20 x 16	20.00	16.062	1.969	16.00	12.812	1.594	20.00	160	348.00
20 x 14	20.00	16.062	1.969	14.00	11.188	1.406	20.00	160	494.00
20 x 12	20.00	16.062	1.969	12.75	10.126	1.312	20.00	160	494.00
❖ 20 x 10	20.00	16.062	1.969	10.75	8.500	1.125	20.00	160	494.00
24 x 20	24.00	19.312	2.344	20.00	16.062	1.969	20.00	160	494.00
24 x 18	24.00	19.312	2.344	18.00	14.438	1.781	20.00	160	535.00
24 x 16	24.00	19.312	2.344	16.00	12.812	1.594	20.00	160	535.00
❖ 24 x 14	24.00	19.312	2.344	14.00	11.188	1.406	20.00	160	535.00
❖ 24 x 12	24.00	19.312	2.344	12.75	10.126	1.312	20.00	160	535.00
❖ 24 x 10	24.00	19.312	2.344	10.75	8.500	1.125	20.00	160	535.00

FITTINGS

# CONCENTRIC AND ECCENTRIC REDUCERS



## SCHEDULE XXS

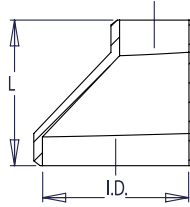
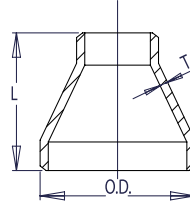

### WELDBEND NOTES

1. Conforms to ASME B16.9 & ASTM A234 WPB.
2. All dimensions are in inches.
3. For bevel detail see page 107.
4. For dimensional tolerances see page 108.
5. All weights are in pounds and approximated or estimated.

\* This size and thickness does not correspond to any pipe schedule number.  
 ❖ In accordance with B16.9. Special Fittings paragraph 4.4.2.

FITTINGS

Pipe Size	LARGE DIAMETER			SMALL DIAMETER			Length L	Pipe Schedule Number	Approx. Weight in Pounds
	Outside Diameter	Inside Diameter	Wall Thickness	Outside Diameter	Inside Diameter	Wall Thickness			
	O.D.	I.D.	T	O.D.	I.D.	T			
3/4 x 1/2	1.05	0.434	0.308	0.84	0.252	0.294	1.50	*	0.39
1 x 3/4	1.32	0.604	0.358	1.05	0.434	0.308	2.00	*	0.50
1 x 1/2	1.32	0.604	0.358	0.84	0.252	0.294	2.00	*	0.50
1 1/4 x 1	1.66	0.896	0.382	1.32	0.604	0.358	2.00	*	0.75
1 1/4 x 3/4	1.66	0.896	0.382	1.05	0.434	0.308	2.00	*	0.75
1 1/4 x 1/2	1.66	0.896	0.382	0.84	0.252	0.294	2.00	*	0.75
1 1/2 x 1 1/4	1.90	1.100	0.400	1.66	0.896	0.382	2.50	*	1.00
1 1/2 x 1	1.90	1.100	0.400	1.32	0.604	0.358	2.50	*	1.00
1 1/2 x 3/4	1.90	1.100	0.400	1.05	0.434	0.308	2.50	*	1.00
1 1/2 x 1/2	1.90	1.100	0.400	0.84	0.252	0.294	2.50	*	1.00
2 x 1 1/2	2.38	1.508	0.436	1.90	1.100	0.400	3.00	*	2.00
2 x 1 1/4	2.38	1.508	0.436	1.66	0.896	0.382	3.00	*	2.00
2 x 1	2.38	1.508	0.436	1.32	0.604	0.358	3.00	*	2.00
2 x 3/4	2.38	1.508	0.436	1.05	0.434	0.308	3.00	*	1.75
2 1/2 x 2	2.88	1.776	0.552	2.38	1.508	0.436	3.50	*	4.00
2 1/2 x 1 1/2	2.88	1.776	0.552	1.90	1.100	0.400	3.50	*	4.00
2 1/2 x 1 1/4	2.88	1.776	0.552	1.66	0.896	0.382	3.50	*	3.50
2 1/2 x 1	2.88	1.776	0.552	1.32	0.604	0.358	3.50	*	3.50
3 x 2 1/2	3.50	2.300	0.600	2.88	1.776	0.552	3.50	*	5.00
3 x 2	3.50	2.300	0.600	2.38	1.508	0.436	3.50	*	5.00
3 x 1 1/2	3.50	2.300	0.600	1.90	1.100	0.400	3.50	*	5.00
3 x 1 1/4	3.50	2.300	0.600	1.66	0.896	0.382	3.50	*	4.50
❖ 3 x 1	3.50	2.300	0.600	1.32	0.604	0.358	3.50	*	4.50
4 x 3	4.50	3.152	0.674	3.50	2.300	0.600	4.00	*	8.00
4 x 2 1/2	4.50	3.152	0.674	2.88	1.776	0.552	4.00	*	8.00
4 x 2	4.50	3.152	0.674	2.38	1.508	0.436	4.00	*	7.50
4 x 1 1/2	4.50	3.152	0.674	1.90	1.100	0.400	4.00	*	7.50
❖ 4 x 1 1/4	4.50	3.152	0.674	1.66	0.896	0.382	4.00	*	7.50
❖ 4 x 1	4.50	3.152	0.674	1.32	0.604	0.358	4.00	*	7.00

## CONCENTRIC AND ECCENTRIC REDUCERS

Pipe Size	LARGE DIAMETER			SMALL DIAMETER			Length	Pipe Schedule Number	Approx. Weight in Pounds
	Outside Diameter	Inside Diameter	Wall Thickness	Outside Diameter	Inside Diameter	Wall Thickness			
	O.D.	I.D.	T	O.D.	I.D.	T	L		
5 x 4	5.56	4.060	0.750	4.50	3.152	0.674	5.00	*	16.00
5 x 3	5.56	4.060	0.750	3.50	2.300	0.600	5.00	*	16.00
5 x 2 ½	5.56	4.060	0.750	2.88	1.776	0.552	5.00	*	16.00
5 x 2	5.56	4.060	0.750	2.38	1.508	0.436	5.00	*	16.00
6 x 5	6.62	4.892	0.864	5.56	4.060	0.750	5.50	*	23.00
6 x 4	6.62	4.892	0.864	4.50	3.152	0.674	5.50	*	23.00
6 x 3	6.62	4.892	0.864	3.50	2.300	0.600	5.50	*	20.00
6 x 2 ½	6.62	4.892	0.864	2.88	1.776	0.552	5.50	*	20.00
❖ 6 x 2	6.62	4.892	0.864	2.38	1.508	0.436	5.50	*	19.00
8 x 6	8.62	6.870	0.875	6.62	4.892	0.864	6.00	*	36.00
8 x 5	8.62	6.870	0.875	5.56	4.060	0.750	6.00	*	33.00
8 x 4	8.62	6.870	0.875	4.50	3.152	0.674	6.00	*	33.00
❖ 8 x 3	8.62	6.870	0.875	3.50	2.300	0.600	6.00	*	33.00
10 x 8	10.75	8.750	1.000	8.62	6.870	0.875	7.00	*	48.00
10 x 6	10.75	8.750	1.000	6.62	4.892	0.864	7.00	*	58.00
10 x 5	10.75	8.750	1.000	5.56	4.060	0.750	7.00	*	54.00
10 x 4	10.75	8.750	1.000	4.50	3.152	0.674	7.00	*	52.00
12 x 10	12.75	10.750	1.000	10.75	8.750	1.000	8.00	*	95.00
12 x 8	12.75	10.750	1.000	8.62	6.870	0.875	8.00	*	85.00
12 x 6	12.75	10.750	1.000	6.62	4.892	0.864	8.00	*	80.00
12 x 5	12.75	10.750	1.000	5.56	4.060	0.750	8.00	*	80.00
❖ 12 x 4	12.75	10.750	1.000	4.50	3.152	0.674	8.00	*	80.00

**SCHEDULE STD**

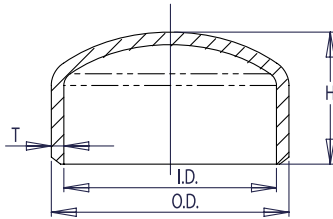

**WELDBEND NOTES**

1. Conforms to ASME B16.9 & ASTM A234 WPB.
  2. All dimensions are in inches.
  3. For bevel detail see page 107.
  4. For dimensional tolerances see page 108.
  5. For sizes larger than 48" please call.
  6. All weights are in pounds and approximated or estimated.
  7. The shape of the cap is 2:1 ellipsoidal and conforms to the shape requirements given in the ASME Boiler and Pressure Vessel Code.
- \* This size and thickness does not correspond to any pipe schedule number.

Pipe Size	Outside Diameter	Inside Diameter	Wall Thickness	Height	Pipe Schedule Number	Approx. Weight in Pounds
	O.D.	I.D.	T	H		
½	0.84	0.622	0.109	1.00	40	0.08
¾	1.05	0.824	0.113	1.00	40	0.14
1	1.32	1.049	0.133	1.50	40	0.21
1 ¼	1.66	1.380	0.140	1.50	40	0.33
1 ½	1.90	1.610	0.145	1.50	40	0.54
2	2.38	2.067	0.154	1.50	40	0.80
2 ½	2.88	2.469	0.203	1.50	40	1.00
3	3.50	3.068	0.216	2.00	40	1.70
3 ½	4.00	3.548	0.226	2.50	40	2.30
4	4.50	4.026	0.237	2.50	40	2.80
5	5.56	5.047	0.258	3.00	40	4.60
6	6.62	6.065	0.280	3.50	40	6.90
8	8.62	7.981	0.322	4.00	40	11.80
10	10.75	10.020	0.365	5.00	40	20.80
12	12.75	12.000	0.375	6.00	*	30.30
14	14.00	13.250	0.375	6.50	30	36.50
16	16.00	15.250	0.375	7.00	30	43.50
18	18.00	17.250	0.375	8.00	*	57.00
20	20.00	19.250	0.375	9.00	20	75.70
24	24.00	23.250	0.375	10.50	20	101.00
30	30.00	29.250	0.375	10.50	*	137.00
36	36.00	35.250	0.375	10.50	*	175.00
42	42.00	41.250	0.375	12.00	*	229.00
48	48.00	47.250	0.375	13.50	*	350.00

FITTINGS

**SCHEDULE XS**

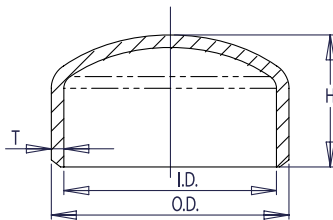

**WELDBEND NOTES**

1. Conforms to ASME B16.9 & ASTM A234 WPB.
  2. All dimensions are in inches.
  3. For bevel detail see page 107.
  4. For dimensional tolerances see page 108.
  5. For sizes larger than 48" please call.
  6. All weights are in pounds and approximated or estimated.
  7. The shape of the cap is 2:1 ellipsoidal and conforms to the shape requirements given in the ASME Boiler and Pressure Vessel Code.
- \* This size and thickness does not correspond to any pipe schedule number.

Pipe Size	Outside Diameter	Inside Diameter	Wall Thickness	Height	Pipe Schedule Number	Approx. Weight in Pounds
	O.D.	I.D.	T	H		
½	0.84	0.546	0.147	1.00	80	0.10
¾	1.05	0.742	0.154	1.00	80	0.16
1	1.32	0.957	0.179	1.50	80	0.28
1 ¼	1.66	1.278	0.191	1.50	80	0.48
1 ½	1.90	1.500	0.200	1.50	80	0.67
2	2.38	1.939	0.218	1.50	80	0.92
2 ½	2.88	2.323	0.276	1.50	80	1.30
3	3.50	2.900	0.300	2.00	80	2.10
3 ½	4.00	3.364	0.318	2.50	80	3.00
4	4.50	3.826	0.337	2.50	80	3.50
5	5.56	4.813	0.375	3.00	80	5.80
6	6.62	5.761	0.432	3.50	80	9.30
8	8.62	7.625	0.500	4.00	80	16.00
10	10.75	9.750	0.500	5.00	60	26.00
12	12.75	11.750	0.500	6.00	*	38.00
14	14.00	13.000	0.500	6.50	*	47.00
16	16.00	15.000	0.500	7.00	40	57.00
18	18.00	17.000	0.500	8.00	*	78.00
20	20.00	19.000	0.500	9.00	30	100.00
24	24.00	23.000	0.500	10.50	*	145.00
30	30.00	29.000	0.500	10.50	20	634.00
36	36.00	35.000	0.500	10.50	20	913.00
42	42.00	41.000	0.500	12.00	*	1300.00
48	48.00	47.000	0.500	13.50	*	1675.00

**SCHEDULE 40**

Pipe Size	Outside Diameter	Inside Diameter	Wall Thickness	Height	Pipe Schedule Number	Approx. Weight in Pounds
	O.D.	I.D.	T	H		
½	0.84	0.622	0.109	1.00	40	0.08
¾	1.05	0.824	0.113	1.00	40	0.14
1	1.32	1.054	0.133	1.50	40	0.21
1 ¼	1.66	1.380	0.140	1.50	40	0.33
1 ½	1.90	1.610	0.145	1.50	40	0.54
2	2.38	2.072	0.154	1.50	40	0.80
2 ½	2.88	2.474	0.203	1.50	40	1.00
3	3.50	3.068	0.216	2.00	40	1.70
3 ½	4.00	3.548	0.226	2.50	40	2.30
4	4.50	4.026	0.237	2.50	40	2.80
5	5.56	5.044	0.258	3.00	40	4.60
6	6.62	6.060	0.280	3.50	40	6.90
8	8.62	7.976	0.322	4.00	40	11.80
10	10.75	10.020	0.365	5.00	40	20.80
12	12.75	11.938	0.406	6.00	40	30.30
14	14.00	13.124	0.438	6.50	40	36.50
16	16.00	15.000	0.500	7.00	40	43.50
18	18.00	16.876	0.562	9.00	40	57.00
20	20.00	18.812	0.594	10.00	40	75.70
24	24.00	22.624	0.688	12.00	40	101.00

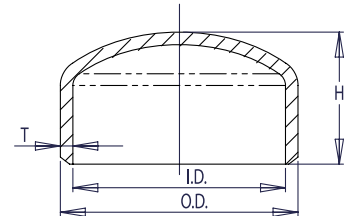

**WELDBEND NOTES**

1. Conforms to ASME B16.9 & ASTM A234 WPB.
2. All dimensions are in inches.
3. For bevel detail see page 107.
4. For dimensional tolerances see page 108.
5. For sizes larger than 24" please call.
6. All weights are in pounds and approximated or estimated.
7. The shape of the cap is 2:1 ellipsoidal and conforms to the shape requirements given in the ASME Boiler and Pressure Vessel Code.

**FITTINGS**

**SCHEDULE 80**

Pipe Size	Outside Diameter	Inside Diameter	Wall Thickness	Height	Pipe Schedule Number	Approx. Weight in Pounds
	O.D.	I.D.	T	H		
½	0.84	0.546	0.147	1.00	80	0.10
¾	1.05	0.742	0.154	1.00	80	0.16
1	1.32	0.962	0.179	1.50	80	0.28
1 ¼	1.66	1.278	0.191	1.50	80	0.48
1 ½	1.90	1.500	0.200	1.50	80	0.67
2	2.38	1.944	0.218	1.50	80	0.92
2 ½	2.88	2.328	0.276	1.50	80	1.30
3	3.50	2.900	0.300	2.00	80	2.10
3 ½	4.00	3.364	0.318	2.50	80	3.00
4	4.50	3.826	0.337	2.50	80	3.50
5	5.56	4.810	0.375	3.00	80	5.80
6	6.62	5.756	0.432	3.50	80	9.30
8	8.62	7.620	0.500	4.00	80	16.00
10	10.75	9.562	0.594	6.00	80	26.00
12	12.75	11.374	0.688	7.00	80	38.00
14	14.00	12.500	0.750	7.50	80	47.00
16	16.00	14.312	0.844	8.00	80	57.00
18	18.00	16.124	0.938	9.00	80	78.00
20	20.00	17.938	1.031	10.00	80	100.00
24	24.00	21.562	1.219	12.00	80	145.00

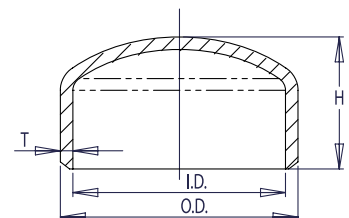

**WELDBEND NOTES**

1. Conforms to ASME B16.9 & ASTM A234 WPB.
  2. All dimensions are in inches.
  3. For bevel detail see page 107.
  4. For dimensional tolerances see page 108.
  5. All weights are in pounds and approximated or estimated.
  6. The shape of the cap is 2:1 ellipsoidal and conforms to the shape requirements given in the ASME Boiler and Pressure Vessel Code.
- \* This size and thickness does not correspond to any pipe schedule number.

**SCHEDULE 160**

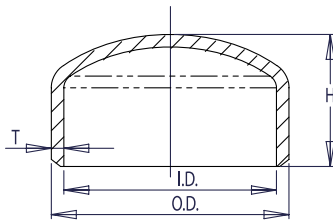

**WELDBEND NOTES**

1. Conforms to ASME B16.9 & ASTM A234 WPB.
2. All dimensions are in inches.
3. For bevel detail see page 107.
4. For dimensional tolerances see page 108.
5. All weights are in pounds and approximated or estimated.
6. The shape of the cap is 2:1 ellipsoidal and conforms to the shape requirements given in the ASME Boiler and Pressure Vessel Code.

Pipe Size	Outside Diameter	Inside Diameter	Wall Thickness	Height	Pipe Schedule Number	Approx. Weight in Pounds
	O.D.	I.D.	T	H		
1/2	0.84	0.464	0.188	1.00	160	0.30
3/4	1.05	0.612	0.219	1.00	160	0.30
1	1.32	0.820	0.250	1.50	160	0.40
1 1/4	1.66	1.160	0.250	1.50	160	0.50
1 1/2	1.90	1.338	0.281	1.50	160	0.60
2	2.38	1.692	0.344	1.75	160	1.30
2 1/2	2.88	2.130	0.375	2.00	160	1.80
3	3.50	2.624	0.438	2.50	160	2.90
4	4.50	3.438	0.531	3.00	160	5.90
5	5.56	4.310	0.625	3.50	160	10.00
6	6.62	5.182	0.719	4.00	160	15.00
8	8.62	6.808	0.906	5.00	160	31.00
10	10.75	8.500	1.125	6.00	160	57.00
12	12.75	10.126	1.312	7.00	160	95.00
14	14.00	11.188	1.406	7.50	160	200.00
16	16.00	12.812	1.594	8.00	160	297.00
18	18.00	14.438	1.781	9.00	160	360.00
20	20.00	16.062	1.969	10.00	160	420.00
24	24.00	19.312	2.344	12.00	160	535.00

FITTINGS

**SCHEDULE XXS**

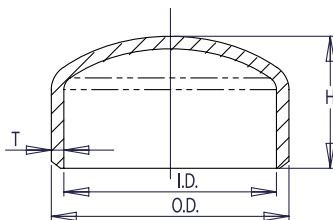

**WELDBEND NOTES**

1. Conforms to ASME B16.9 & ASTM A234 WPB.
  2. All dimensions are in inches.
  3. For bevel detail see page 107.
  4. For dimensional tolerances see page 108.
  5. All weights are in pounds and approximated or estimated.
  6. The shape of the cap is 2:1 ellipsoidal and conforms to the shape requirements given in the ASME Boiler and Pressure Vessel Code.
- \*This size and thickness does not correspond to any pipe schedule number.

Pipe Size	Outside Diameter	Inside Diameter	Wall Thickness	Height	Pipe Schedule Number	Approx. Weight in Pounds
	O.D.	I.D.	T	H		
1/2	0.84	0.252	0.294	1.00	*	0.50
3/4	1.05	0.434	0.308	1.00	*	0.75
1	1.32	0.604	0.358	1.50	*	1.00
1 1/4	1.66	0.896	0.382	1.50	*	1.50
1 1/2	1.90	1.100	0.400	1.50	*	2.50
2	2.38	1.508	0.436	1.75	*	3.00
2 1/2	2.88	1.776	0.552	2.00	*	4.00
3	3.50	2.300	0.600	2.50	*	6.00
4	4.50	3.152	0.674	3.00	*	9.00
5	5.56	4.060	0.750	3.50	*	13.50
6	6.62	4.892	0.864	4.00	*	18.00
8	8.62	6.870	0.875	5.00	*	26.00
10	10.75	8.750	1.000	6.00	140	46.00
12	12.75	10.750	1.000	7.00	120	68.00

## LAP JOINT STUB ENDS

### SCHEDULE STD

Pipe Size	Outside Diameter (Max.)	Outside Diameter (Min.)	Wall and Lap Thickness		Fillet Radius		Overall Length	Pipe Schedule Number	Approx. Weight in Pounds
			T	K	N	J			
1/2	0.896	0.809	0.109	1.38	0.12	3.00	40	0.30	
3/4	1.106	1.019	0.113	1.69	0.12	3.00	40	0.40	
1	1.376	1.284	0.133	2.00	0.12	4.00	40	0.75	
1 1/4	1.716	1.629	0.140	2.50	0.19	4.00	40	1.10	
1 1/2	1.965	1.869	0.145	2.88	0.25	4.00	40	1.25	
2	2.456	2.344	0.154	3.62	0.31	6.00	40	2.25	
2 1/2	2.966	2.844	0.203	4.12	0.31	6.00	40	3.50	
3	3.596	3.469	0.216	5.00	0.38	6.00	40	4.75	
3 1/2	4.096	3.969	0.226	5.50	0.38	6.00	40	6.00	
4	4.593	4.469	0.237	6.19	0.44	6.00	40	7.25	
5	5.683	5.532	0.258	7.31	0.44	8.00	40	12.00	
6	6.743	6.594	0.280	8.50	0.50	8.00	40	16.00	
8	8.743	8.594	0.322	10.62	0.50	8.00	40	23.00	
10	10.913	10.719	0.365	12.75	0.50	10.00	40	36.00	
12	12.913	12.719	0.375	15.00	0.50	10.00	*	47.00	
14	14.170	13.969	0.375	16.25	0.50	12.00	30	35.40	
16	16.180	15.969	0.375	18.50	0.50	12.00	30	44.80	
18	18.190	17.969	0.375	21.00	0.50	12.00	*	57.20	
20	20.240	19.969	0.375	23.00	0.50	12.00	20	71.00	
24	24.240	23.969	0.375	27.25	0.50	12.00	20	102.00	

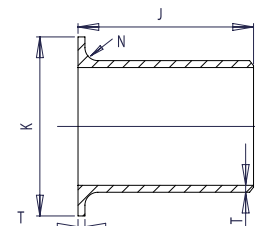

#### WELDBEND NOTES

1. Conforms to ASME B16.9 & ASTM A234 WPB.
  2. All dimensions are in inches.
  3. For bevel detail see page 107.
  4. For dimensional tolerances see page 108.
  5. All weights are in pounds and approximated or estimated.
- \* This size and thickness does not correspond to any pipe schedule number.

FITTINGS

### SCHEDULE XS

Pipe Size	Outside Diameter (Max.)	Outside Diameter (Min.)	Wall and Lap Thickness		Fillet Radius		Overall Length	Pipe Schedule Number	Approx. Weight in Pounds
			T	K	N	J			
1/2	0.896	0.809	0.147	1.38	0.12	3.00	80	0.38	
3/4	1.106	1.019	0.154	1.69	0.12	3.00	80	0.51	
1	1.376	1.284	0.179	2.00	0.12	4.00	80	1.00	
1 1/4	1.716	1.629	0.191	2.50	0.19	4.00	80	1.25	
1 1/2	1.965	1.869	0.200	2.88	0.25	4.00	80	1.75	
2	2.456	2.344	0.218	3.62	0.31	6.00	80	3.00	
2 1/2	2.966	2.844	0.276	4.12	0.31	6.00	80	4.50	
3	3.596	3.469	0.300	5.00	0.38	6.00	80	6.50	
3 1/2	4.096	3.969	0.318	5.50	0.38	6.00	80	7.75	
4	4.593	4.469	0.337	6.19	0.44	6.00	80	9.50	
5	5.683	5.532	0.375	7.31	0.44	8.00	80	17.00	
6	6.743	6.594	0.432	8.50	0.50	8.00	80	23.00	
8	8.743	8.594	0.500	10.62	0.50	8.00	80	32.00	
10	10.913	10.719	0.500	12.75	0.50	10.00	60	53.00	
12	12.913	12.719	0.500	15.00	0.50	10.00	*	62.00	
14	14.170	13.969	0.500	16.25	0.50	12.00	*	89.00	
16	16.180	15.969	0.500	18.50	0.50	12.00	40	96.00	
18	18.190	17.969	0.500	21.00	0.50	12.00	*	112.00	
20	20.240	19.969	0.500	23.00	0.50	12.00	30	125.00	
24	24.240	23.969	0.500	27.25	0.50	12.00	*	151.00	

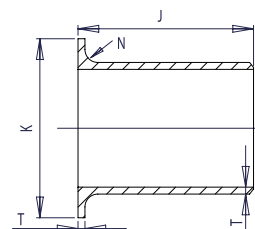

#### WELDBEND NOTES

1. Conforms to ASME B16.9 & ASTM A234 WPB.
  2. All dimensions are in inches.
  3. For bevel detail see page 107.
  4. For dimensional tolerances see page 108.
  5. All weights are in pounds and approximated or estimated.
- \* This size and thickness does not correspond to any pipe schedule number.

## SCHEDULE 40

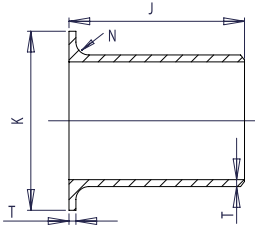

### WELDBEND NOTES

1. Conforms to ASME B16.9 & ASTM A234 WPB.
2. All dimensions are in inches.
3. For bevel detail see page 107.
4. For dimensional tolerances see page 108.
5. All weights are in pounds and approximated or estimated.

Pipe Size	Outside Diameter (Max.)	Outside Diameter (Min.)	Wall and Lap Thickness		Fillet Radius		Overall Length	Pipe Schedule Number	Approx. Weight in Pounds
			T	K	N	J			
1/2	0.896	0.809	0.109	1.38	0.12	3.00	40	0.30	
3/4	1.106	1.019	0.113	1.69	0.12	3.00	40	0.40	
1	1.376	1.284	0.133	2.00	0.12	4.00	40	0.75	
1 1/4	1.716	1.629	0.140	2.50	0.19	4.00	40	1.10	
1 1/2	1.965	1.869	0.145	2.88	0.25	4.00	40	1.25	
2	2.456	2.344	0.154	3.62	0.31	6.00	40	2.25	
2 1/2	2.966	2.844	0.203	4.12	0.31	6.00	40	3.50	
3	3.596	3.469	0.216	5.00	0.38	6.00	40	4.75	
3 1/2	4.096	3.969	0.226	5.50	0.38	6.00	40	6.00	
4	4.593	4.469	0.237	6.19	0.44	6.00	40	7.25	
5	5.683	5.532	0.258	7.31	0.44	8.00	40	12.00	
6	6.743	6.594	0.280	8.50	0.50	8.00	40	16.00	
8	8.743	8.594	0.322	10.62	0.50	8.00	40	23.00	
10	10.913	10.719	0.365	12.75	0.50	10.00	40	36.00	
12	12.913	12.719	0.406	15.00	0.50	10.00	40	52.00	
14	14.170	13.969	0.438	16.25	0.50	12.00	40	73.00	
16	16.180	15.969	0.500	18.50	0.50	12.00	40	97.00	
18	18.190	17.969	0.562	21.00	0.50	12.00	40	126.00	
20	20.240	19.969	0.594	23.00	0.50	12.00	40	147.00	
24	24.240	23.969	0.688	27.25	0.50	12.00	40	205.00	

FITTINGS

## SCHEDULE 80

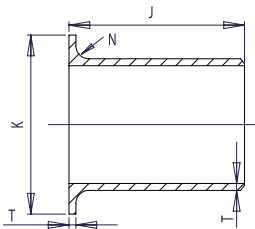

### WELDBEND NOTES

1. Conforms to ASME B16.9 & ASTM A234 WPB.
2. All dimensions are in inches.
3. For bevel detail see page 107.
4. For dimensional tolerances see page 108.
5. All weights are in pounds and approximated or estimated.

Pipe Size	Outside Diameter (Max.)	Outside Diameter (Min.)	Wall and Lap Thickness		Fillet Radius		Overall Length	Pipe Schedule Number	Approx. Weight in Pounds
			T	K	N	J			
1/2	0.896	0.809	0.147	1.38	0.12	3.00	80	0.38	
3/4	1.106	1.019	0.154	1.69	0.12	3.00	80	0.51	
1	1.376	1.284	0.179	2.00	0.12	4.00	80	1.00	
1 1/4	1.716	1.629	0.191	2.50	0.19	4.00	80	1.25	
1 1/2	1.965	1.869	0.200	2.88	0.25	4.00	80	1.75	
2	2.456	2.344	0.218	3.62	0.31	6.00	80	3.00	
2 1/2	2.966	2.844	0.276	4.12	0.31	6.00	80	4.50	
3	3.596	3.469	0.300	5.00	0.38	6.00	80	6.50	
3 1/2	4.096	3.969	0.318	5.50	0.38	6.00	80	7.75	
4	4.593	4.469	0.337	6.19	0.44	6.00	80	9.50	
5	5.683	5.532	0.375	7.31	0.44	8.00	80	17.00	
6	6.743	6.594	0.432	8.50	0.50	8.00	80	23.00	
8	8.743	8.594	0.500	10.62	0.50	8.00	80	32.00	
10	10.913	10.719	0.594	12.75	0.50	10.00	80	63.00	
12	12.913	12.719	0.688	15.00	0.50	10.00	80	87.00	
14	14.170	13.969	0.750	16.25	0.50	12.00	80	123.00	
16	16.180	15.969	0.844	18.50	0.50	12.00	80	161.00	
18	18.190	17.969	0.938	21.00	0.50	12.00	80	205.00	
20	20.240	19.969	1.031	23.00	0.50	12.00	80	251.00	
24	24.240	23.969	1.219	27.25	0.50	12.00	80	359.00	



## LAP JOINT STUB ENDS

### SCHEDULE 160

Pipe Size	Outside Diameter (Max.)	Outside Diameter (Min.)	Wall and Lap Thickness	Lap Diameter	Fillet Radius	Overall Length	Pipe Schedule Number	Approx. Weight in Pounds
			T	K	N	J		
1/2	0.896	0.809	0.188	1.38	0.12	3.00	160	0.75
3/4	1.106	1.019	0.219	1.69	0.12	3.00	160	0.95
1	1.376	1.284	0.250	2.00	0.12	4.00	160	1.13
1 1/4	1.716	1.629	0.250	2.50	0.19	4.00	160	1.51
1 1/2	1.965	1.869	0.281	2.88	0.25	4.00	160	2.02
2	2.456	2.344	0.344	3.62	0.31	6.00	160	4.51
2 1/2	2.966	2.844	0.375	4.12	0.31	6.00	160	6.02
3	3.596	3.469	0.438	5.00	0.38	6.00	160	8.80
4	4.593	4.469	0.531	6.19	0.44	6.00	160	14.10
5	5.683	5.532	0.625	7.31	0.44	8.00	160	26.40
6	6.743	6.594	0.719	8.50	0.50	8.00	160	36.40
8	8.743	8.594	0.906	10.62	0.50	8.00	160	60.00
10	10.913	10.719	1.125	12.75	0.50	10.00	160	113.00
12	12.913	12.719	1.312	15.00	0.50	10.00	160	160.00
14	14.170	13.969	1.406	16.25	0.50	12.00	160	190.00
16	16.180	15.969	1.594	18.50	0.50	12.00	160	245.00
18	18.190	17.969	1.781	21.00	0.50	12.00	160	309.00
20	20.240	19.969	1.969	23.00	0.50	12.00	160	379.00
24	24.240	23.969	2.344	27.25	0.50	12.00	160	542.00

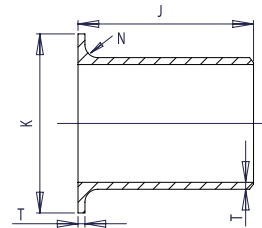

#### WELDBEND NOTES

1. Conforms to ASME B16.9 & ASTM A234 WPB.
2. All dimensions are in inches.
3. For bevel detail see page 107.
4. For dimensional tolerances see page 108.
5. All weights are in pounds and approximated or estimated.

FITTINGS

### SCHEDULE XXS

Pipe Size	Outside Diameter (Max.)	Outside Diameter (Min.)	Wall and Lap Thickness	Lap Diameter	Fillet Radius	Overall Length	Pipe Schedule Number	Approx. Weight in Pounds
			T	K	N	J		
1/2	0.896	0.809	0.294	1.38	0.12	3.00	*	1.75
3/4	1.106	1.019	0.308	1.69	0.12	3.00	*	2.50
1	1.376	1.284	0.358	2.00	0.12	4.00	*	4.00
1 1/4	1.716	1.629	0.382	2.50	0.19	4.00	*	6.25
1 1/2	1.965	1.869	0.400	2.88	0.25	4.00	*	6.50
2	2.456	2.344	0.436	3.62	0.31	6.00	*	9.00
2 1/2	2.966	2.844	0.552	4.12	0.31	6.00	*	14.00
3	3.596	3.469	0.600	5.00	0.38	6.00	*	18.50
4	4.593	4.469	0.674	6.19	0.44	6.00	*	27.50
5	5.683	5.532	0.750	7.31	0.44	8.00	*	39.00
6	6.743	6.594	0.864	8.50	0.50	8.00	*	54.00
8	8.743	8.594	0.875	10.62	0.50	8.00	*	73.00
10	10.913	10.719	1.000	12.75	0.50	10.00	140	116.00
12	12.913	12.719	1.000	15.00	0.50	10.00	120	167.00

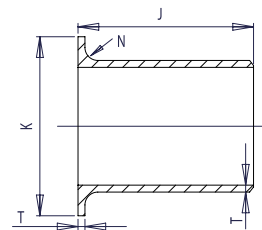

#### WELDBEND NOTES

1. Conforms to ASME B16.9 & ASTM A234 WPB.
  2. All dimensions are in inches.
  3. For bevel detail see page 107.
  4. For dimensional tolerances see page 108.
  5. All weights are in pounds and approximated or estimated.
- \* This size and thickness does not correspond to any pipe schedule number.

# BOX QUANTITIES



FITTINGS

Box Quantities Size / Wall	Short Radius 90° Elbows		Long Radius 90° Elbows		Straight Tees		Caps	
	STD	XS	STD	XS	STD	XS	STD	XS
½"	—	—	6-bag	6-bag	6-bag	6-bag	—	—
¾"	—	—	4-bag	4-bag	6-bag	6-bag	6-bag	6-bag
1"	—	—	4-bag	4-bag	6-bag	6-bag	6-bag	6-bag
1 ¼"	—	—	12	4-bag	6-bag	6-bag	6-bag	6-bag
1 ½"	—	—	12	4-bag	6-bag	6-bag	6-bag	6-bag
2"	—	—	12	12	—	—	12	12
2 ½"	—	—	12	12	12	—	12	12
3"	—	—	12	12	6	—	12	12
3 ½"	—	—	8	8	—	—	—	—
4"	—	—	12	12	6	—	12	12
5"	—	—	6	6	—	—	6	6
6"	—	—	4	4	4	—	6	6
8"	—	—	1	1	—	—	4	4
10"	—	—	1	1	—	—	2	2
12"	—	—	1	1	—	—	2	2

Box Quantities Size / Wall	Reducing Tees		Concentric Reducers		Eccentric Reducers	
	STD	XS	STD	XS	STD	XS
¾ x ½"	6-bag	6-bag	—	—	—	—
1 x ½"	6-bag	6-bag	—	—	—	—
1 x ¾"	6-bag	6-bag	—	—	—	—
1 ¼ x ½"	6-bag	6-bag	—	—	—	—
1 ¼ x 1"	6-bag	6-bag	—	—	—	—
1 ½ x ½"	6-bag	6-bag	—	—	—	—
1 ½ x ¾"	6-bag	6-bag	—	—	—	—
1 ½ x 1"	6-bag	6-bag	—	—	—	—
1 ½ x 1 ¼"	6-bag	6-bag	—	—	—	—
2 x 1"	—	—	12	12	12	—
2 x 1 ¼"	—	—	12	12	12	—
2 x 1 ½"	—	—	12	12	12	—
2 ½ x 1 ¼"	—	—	12	12	12	—
2 ½ x 1 ½"	—	—	12	12	12	—
2 ½ x 2"	—	—	12	12	12	—
3 x 1 ½"	—	—	12	12	12	—
3 x 2"	—	—	12	12	12	—
3 x 2 ½"	—	—	12	12	12	—
4 x 2"	6	—	12	12	12	—
4 x 2 ½"	6	—	12	12	12	—
4 x 3"	6	—	12	12	12	—
5 x 2 ½"	—	—	6	6	6	—
5 x 3"	—	—	6	6	6	—
5 x 4"	—	—	6	6	6	—
6 x 3"	—	—	6	6	6	—
6 x 4"	—	—	6	6	6	—
6 x 5"	—	—	6	6	6	—

**WELDBEND**

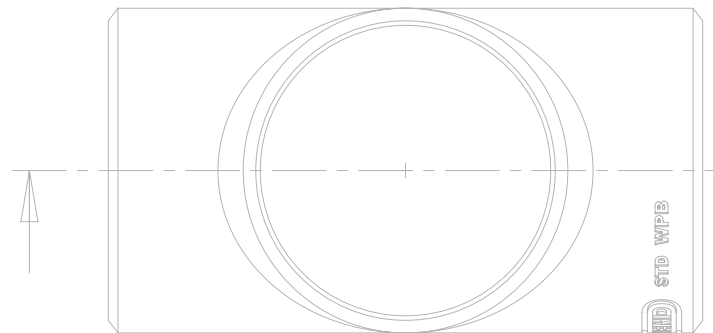
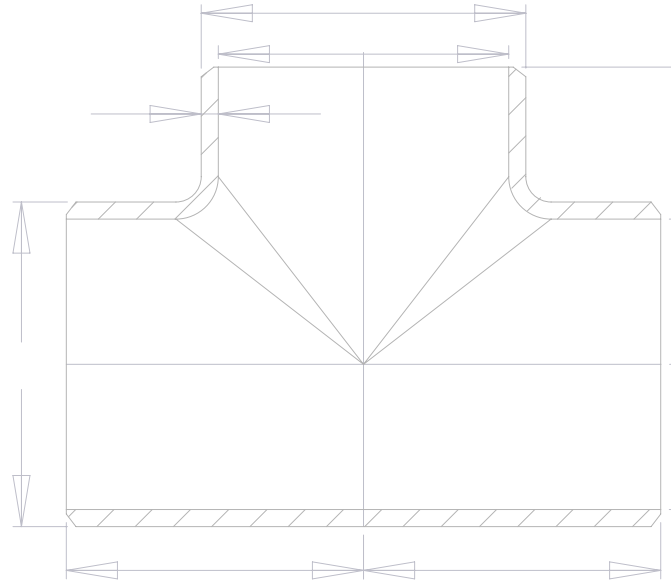
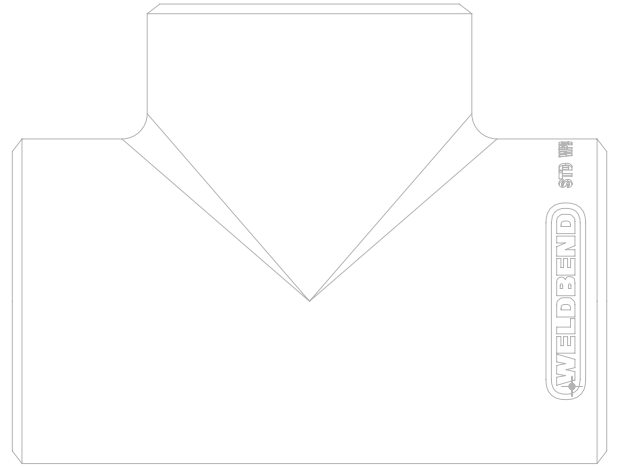
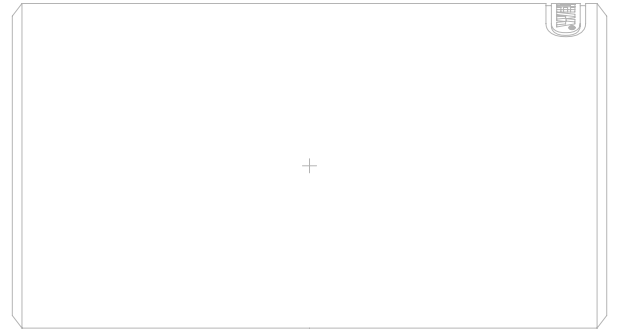
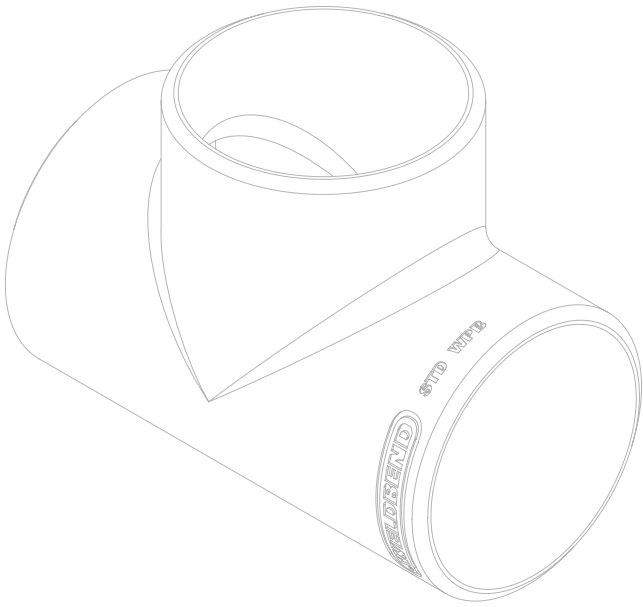
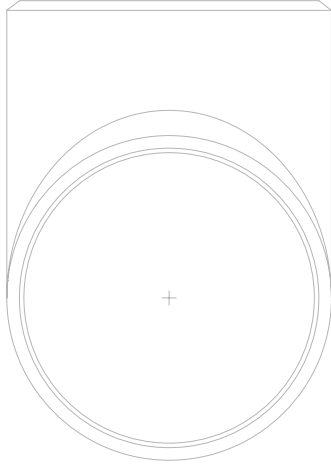
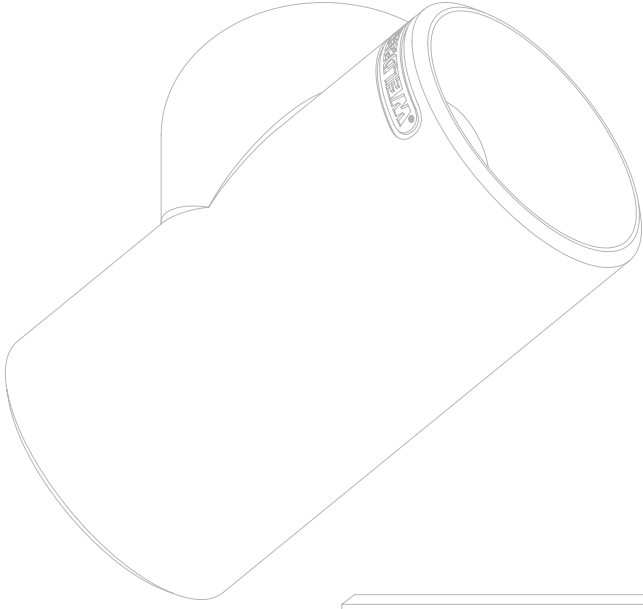

# FLANGES

1/2" through 60"

- Class 125
- Class 150
- Class 300
- Class 600
- Class 900
- Class 1500
- Class 2500

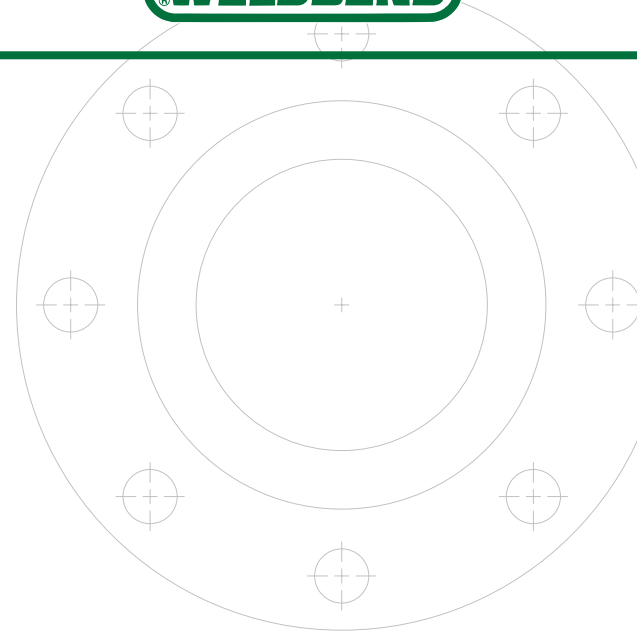
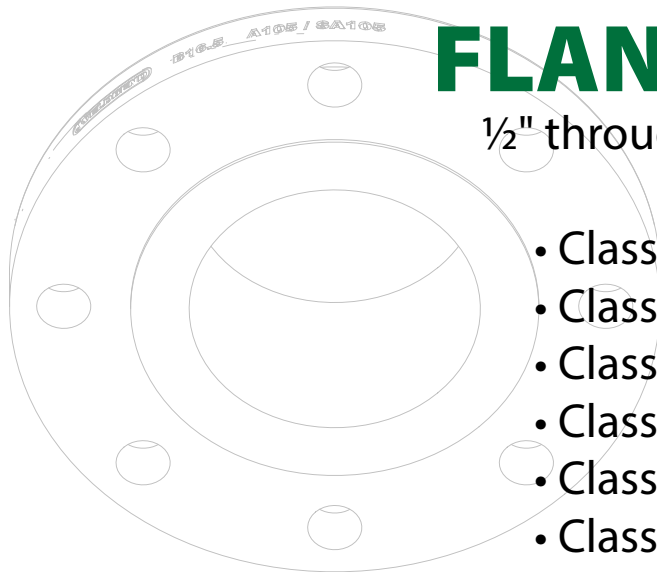

For Ring Type Joint Facing Dimension information see page 148-153.



FLANGES



**All Products Backed by the Weldbend Warranty**

Formula for determining bolt lengths (P) see page 159.

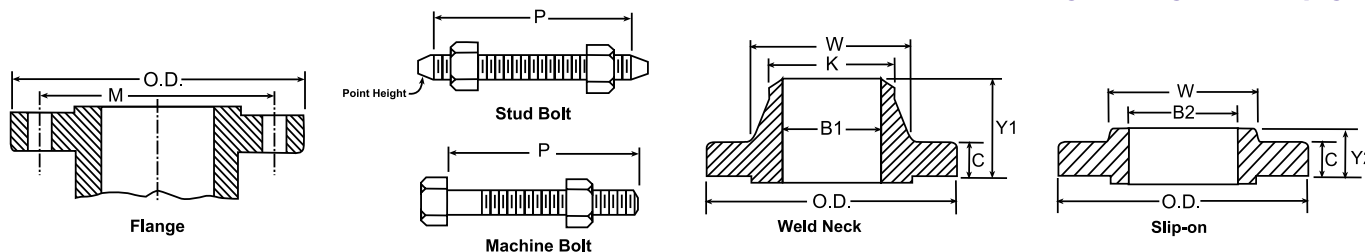

Pipe Size	Common Dimensions			Length Through Hub		Bore		Diameter of Hub at Bevel	Approx. Weight Pounds		Drilling Template			
	Outside Diameter	Thickness	Diameter at Base of Hub	Weld Neck	Slip-On	Weld Neck	Slip-On		Weld Neck	Slip-On	Diameter of Bolt Circle	Number of Bolt Holes	Diameter of Bolt Holes	Diameter of Bolts
	O.D.	C	W	Y1	Y2	B1	B2		K	M				

30	38.75	2.13	32.75	5.13	3.50	To be specified by purchaser.	30.19	30.00	340.00	305.00	36.00	28	1 3/8	1 1/4
36	46.00	2.38	39.25	5.38	3.75		36.19	36.00	495.00	450.00	42.75	32	1 5/8	1 1/2
42	53.00	2.63	46.00	5.63	4.00		42.19	42.00	710.00	650.00	49.50	36	1 5/8	1 1/2
48	59.50	2.75	52.25	5.75	4.13		48.19	48.00	870.00	800.00	56.00	44	1 5/8	1 1/2
54	66.25	3.00	58.75	6.00	4.34		54.19	54.00	1100.00	1025.00	62.75	44	2	1 3/4
60	73.00	3.13	65.25	6.13	4.50		60.19	60.00	1350.00	1250.00	69.25	52	2	1 3/4

**WELDBEND NOTES**

- Standard flange facings on page 146.
  - All dimensions are in inches.
  - For dimensional tolerances see page 144.
  - All flanges conform to ASTM A105/ASME SA105.
  - All weights are in pounds and approximated or estimated.
    - ▼ There is no standard for Class 125 as it is applicable to Cast Iron Standard ASME B16.1. These flanges correspond to ASME B16.1 in diameter, thickness, and drilling.
- Class 125 flanges are wide in face and used for connections to cast steel valves or equipment containing flanged ends made to Cast Iron Standard dimensions. Carbon steel bolting is intended and alloy studs should be avoided. Class 125 flanges are identical with Class E AWWA.

**FLANGES**

For Ring Type Joint Facing Dimension information see page 148.

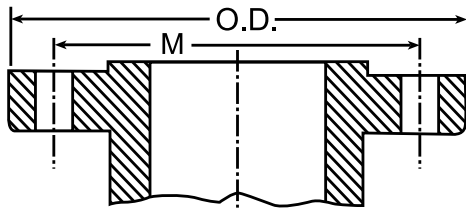

Flange

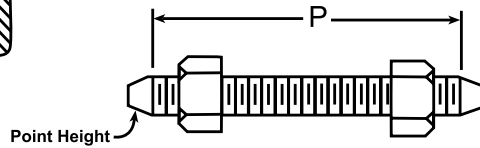

Stud Bolt

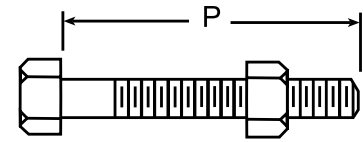

Machine Bolt

Bolting Pattern and Bolt Lengths								
Pipe Size	Outside Diameter	Drilling				Length of Bolts		
		Diameter of Bolt Circle	Diameter of Bolt Holes	Number of Bolt Holes	Diameter of Bolts	Stud Bolts Raised Face 0.06 in.	Stud Bolts Ring Joint	Machine Bolts Raised Face 0.06 in.
	O.D.	M				P	P	P

**ASME B16.5**

1/2	3.50	2.38	5/8	4	1/2	2.25	*	2.00
3/4	3.88	2.75	5/8	4	1/2	2.50	*	2.00
1	4.25	3.12	5/8	4	1/2	2.50	3.00	2.25
1 1/4	4.62	3.50	5/8	4	1/2	2.75	3.25	2.25
1 1/2	5.00	3.88	5/8	4	1/2	2.75	3.25	2.50
2	6.00	4.75	3/4	4	5/8	3.25	3.75	2.75
2 1/2	7.00	5.50	3/4	4	5/8	3.50	4.00	3.00
3	7.50	6.00	3/4	4	5/8	3.50	4.00	3.00
3 1/2	8.50	7.00	3/4	8	5/8	3.50	4.00	3.00
4	9.00	7.50	3/4	8	5/8	3.50	4.00	3.00
5	10.00	8.50	7/8	8	3/4	3.75	4.25	3.25
6	11.00	9.50	7/8	8	3/4	4.00	4.50	3.25
8	13.50	11.75	7/8	8	3/4	4.25	4.75	3.50
10	16.00	14.25	1	12	7/8	4.50	5.00	4.00
12	19.00	17.00	1	12	7/8	4.75	5.25	4.00
14	21.00	18.75	1 1/8	12	1	5.25	5.75	4.50
16	23.50	21.25	1 1/8	16	1	5.25	5.75	4.50
18	25.00	22.75	1 1/4	16	1 1/8	5.75	6.25	5.00
20	27.50	25.00	1 1/4	20	1 1/8	6.25	6.75	5.50
24	32.00	29.50	1 3/8	20	1 1/4	6.75	7.25	6.00

**ASME B16.47 Series A**

30	38.75	36.00	1 3/8	28	1 1/4	Formula for determining bolt lengths (P) see page 159.
36	46.00	42.75	1 5/8	32	1 1/2	
42	53.00	49.50	1 5/8	36	1 1/2	
48	59.50	56.00	1 5/8	44	1 1/2	

**ASME B16.47 Series B**

30	34.94	33.31	7/8	44	3/4	Formula for determining bolt lengths (P) see page 159.
36	41.62	39.75	1	44	7/8	
42	48.25	46.12	1 1/8	48	1	
48	54.81	52.56	1 1/4	44	1 1/8	

**WELDBEND NOTES**

- Standard flange facings on page 146.
- All dimensions are in inches.
- Calculated flange weights on page 99.
- For dimensional tolerances see page 144.

- All flanges conform to ASTM A105/ASME SA105.
- All flanges 1/2"-24" conform to ASME B16.5.  
All flanges 30" and larger conform to ASME B16.47.

\*This size and thickness does not correspond to any pipe schedule number.

For Ring Type Joint Facing Dimension information see page 148.

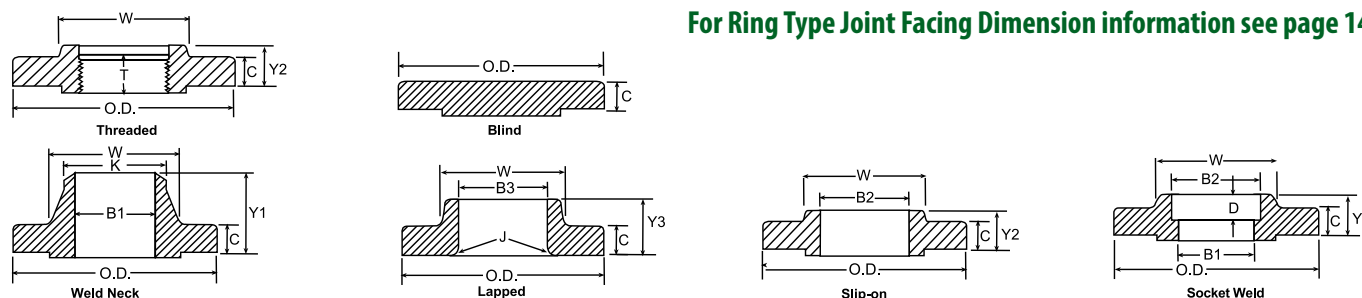

Pipe Size	Outside Diameter of Flange	Thickness of Flange (Min.)	Thickness of Lap Joint (Min.)	Diameter of Hub*	Diameter of Weld Neck	Length Through Hub			Thread Length (Min.)	Bore			Lap Joint Radius	Depth of Socket
						Threaded, Slip-on & Socket Weld	Lap Joint	Weld Neck		Slip-on & Socket Weld (Min.)	Lap Joint (Min.)	Weld Neck & Socket Weld		
	O.D.	C	C	W	K	Y2	Y3	Y1	T	B2	B3	B1 ▲	J	D

### ASME B16.5

1/2	3.50	0.38	0.44	1.19	0.84	0.56	0.62	1.81	0.62	0.88	0.90	0.62	0.12	0.38
3/4	3.88	0.44	0.50	1.50	1.05	0.56	0.62	2.00	0.62	1.09	1.11	0.82	0.12	0.44
1	4.25	0.50	0.56	1.94	1.32	0.62	0.69	2.12	0.69	1.36	1.38	1.05	0.12	0.50
1 1/4	4.62	0.56	0.62	2.31	1.66	0.75	0.81	2.19	0.81	1.70	1.72	1.38	0.19	0.56
1 1/2	5.00	0.62	0.69	2.56	1.90	0.81	0.88	2.38	0.88	1.95	1.97	1.61	0.25	0.62
2	6.00	0.69	0.75	3.06	2.38	0.94	1.00	2.44	1.00	2.44	2.46	2.07	0.31	0.69
2 1/2	7.00	0.81	0.88	3.56	2.88	1.06	1.12	2.69	1.12	2.94	2.97	2.47	0.31	0.75
3	7.50	0.88	0.94	4.25	3.50	1.12	1.19	2.69	1.19	3.57	3.60	3.07	0.38	0.81
3 1/2	8.50	0.88	0.94	4.81	4.00	1.19	1.25	2.75	1.25	4.07	4.10	3.55	0.38	
4	9.00	0.88	0.94	5.31	4.50	1.25	1.31	2.94	1.31	4.57	4.60	4.03	0.44	
5	10.00	0.88	0.94	6.44	5.56	1.38	1.44	3.44	1.44	5.66	5.69	5.05	0.44	
6	11.00	0.94	1.00	7.56	6.63	1.50	1.56	3.44	1.56	6.72	6.75	6.07	0.50	
8	13.50	1.06	1.12	9.69	8.63	1.69	1.75	3.94	1.75	8.72	8.75	7.98	0.50	
10	16.00	1.12	1.19	12.00	10.75	1.88	1.94	3.94	1.94	10.88	10.92	10.02	0.50	
12	19.00	1.19	1.25	14.38	12.75	2.12	2.19	4.44	2.19	12.88	12.92	12.00	0.50	
14	21.00	1.31	1.38	15.75	14.00	2.19	3.12	4.94	2.25	14.14	14.18	13.25	0.50	
16	23.50	1.38	1.44	18.00	16.00	2.44	3.44	4.94	2.50	16.16	16.19	15.25	0.50	
18	25.00	1.50	1.56	19.88	18.00	2.62	3.81	5.44	2.69	18.18	18.20	17.25	0.50	
20	27.50	1.62	1.69	22.00	20.00	2.81	4.06	5.62	2.88	20.20	20.25	19.25	0.50	
24	32.00	1.81	1.88	26.12	24.00	3.19	4.38	5.94	3.25	24.25	24.25	23.25	0.50	

### ASME B16.47 Series A

	WN	BLD				
30	38.75	2.88	2.88	30.75	30.00	5.32
36	46.00	3.50	3.50	36.75	36.00	6.13
42	53.00	3.75	3.75	43.00	42.00	6.69
48	59.50	4.19	4.19	49.12	48.00	7.50

### ASME B16.47 Series B

	WN	BLD				
30	34.94	1.69	1.94	31.00	30.06	3.88
36	41.62	2.00	2.25	37.19	36.06	4.57
42	48.25	2.25	2.65	43.38	42.12	5.19
48	54.81	2.50	3.00	49.50	48.12	5.82

### WELDBEND NOTES

- Standard flange facings on page 146.
- All dimensions are in inches.
- Calculated flange weights on page 99.
- For dimensional tolerances see page 144.
- Weld end preparations on page 154.

- Thread standards on page 156.
- Blind flanges may be produced with or without hubs.
- All flanges conform to ASTM A105/ASME SA105.
- All flanges 1/2"-24" conform to ASME B16.5.
- All flanges 30" and larger conform to ASME B16.47.

- \* A taper shall not exceed 7 degrees on threaded, slip-on and lapped flanges.  
 ▲ Dimensions listed for socket weld and weld neck flanges are for Standard bore unless specified by purchaser.

For Ring Type Joint Facing Dimension information see page 149.

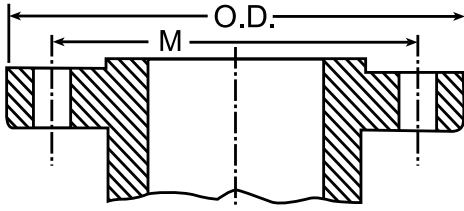

Flange

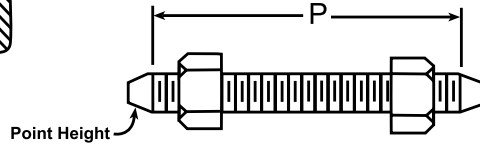

Stud Bolt

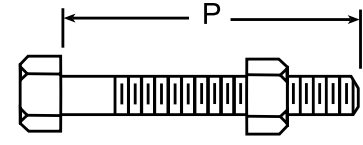

Machine Bolt

Bolting Pattern and Bolt Lengths								
Pipe Size	Outside Diameter	Drilling				Length of Bolts		
		Diameter of Bolt Circle	Diameter of Bolt Holes	Number of Bolt Holes	Diameter of Bolts	Stud Bolts Raised Face 0.06 in.	Stud Bolts Ring Joint	Machine Bolts Raised Face 0.06 in.
	O.D.	M				P	P	P

**ASME B16.5**

1/2	3.75	2.62	5/8	4	1/2	2.50	3.00	2.25
3/4	4.62	3.25	3/4	4	5/8	3.00	3.50	2.50
1	4.88	3.50	3/4	4	5/8	3.00	3.50	2.50
1 1/4	5.25	3.88	3/4	4	5/8	3.25	3.75	2.75
1 1/2	6.12	4.50	7/8	4	3/4	3.50	4.00	3.00
2	6.50	5.00	3/4	8	5/8	3.50	4.00	3.00
2 1/2	7.50	5.88	7/8	8	3/4	4.00	4.50	3.25
3	8.25	6.62	7/8	8	3/4	4.25	4.75	3.50
3 1/2	9.00	7.25	7/8	8	3/4	4.25	5.00	3.75
4	10.00	7.88	7/8	8	3/4	4.50	5.00	3.75
5	11.00	9.25	7/8	8	3/4	4.75	5.25	4.25
6	12.50	10.62	7/8	12	3/4	4.75	5.50	4.25
8	15.00	13.00	1	12	7/8	5.50	6.00	4.75
10	17.50	15.25	1 1/8	16	1	6.25	6.75	5.50
12	20.50	17.75	1 1/4	16	1 1/8	6.75	7.25	5.75
14	23.00	20.25	1 1/4	20	1 1/8	7.00	7.50	6.25
16	25.50	22.50	1 3/8	20	1 1/4	7.50	8.00	6.50
18	28.00	24.75	1 3/8	24	1 1/4	7.75	8.25	6.75
20	30.50	27.00	1 3/8	24	1 1/4	8.00	8.75	7.25
24	36.00	32.00	1 5/8	24	1 1/2	9.00	10.00	8.00

**ASME B16.47 Series A**

30	43.00	39.25	1 7/8	28	1 3/4	Formula for determining bolt lengths (P) see page 159.
36	50.00	46.00	2 1/8	32	2	
42	50.75	47.50	1 3/4	32	1 5/8	
48	57.75	54.00	2	32	1 7/8	

**ASME B16.47 Series B**

30	39.00	36.25	1 1/2	36	1 3/8	Formula for determining bolt lengths (P) see page 159.
36	46.12	42.88	1 3/4	32	1 5/8	
42	52.50	49.00	1 7/8	36	1 3/4	
48	59.50	55.75	2	40	1 7/8	

**WELDBEND NOTES**

- Standard flange facings on page 146.
- All dimensions are in inches.
- Calculated flange weights on page 100.
- For dimensional tolerances see page 144.
- All flanges conform to ASTM A105/ASME SA105.
- All flanges 1/2"-24" conform to ASME B16.5.  
All flanges 30" and larger conform to ASME B16.47.



For Ring Type Joint Facing Dimension information see page 149.

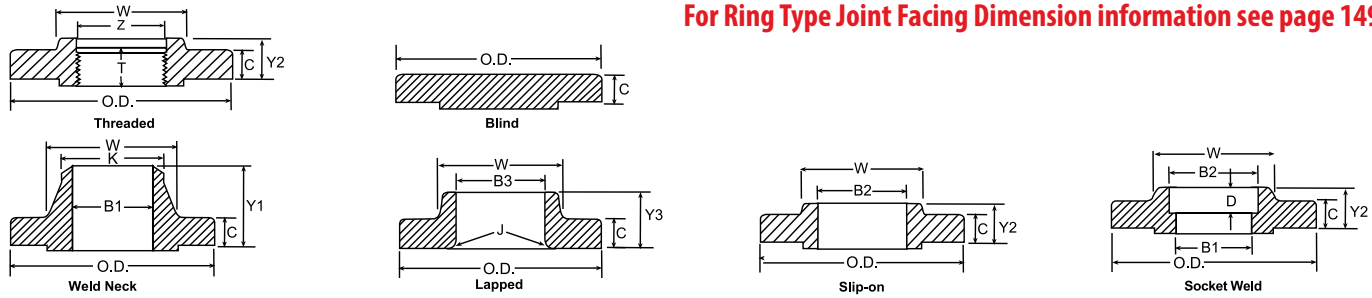

Pipe Size	Outside Diameter of Flange	Thickness of Flange (Min.)	Thickness of Lap Joint (Min.)	Diameter of Hub*	Diameter of Weld Neck	Length Through Hub			Thread Length (Min.)	Bore			Lap Joint Radius	Min. Counter Bore Threaded Flange	Depth of Socket
						Threaded, Slip-on & Socket Weld	Lap Joint	Weld Neck		Slip-on & Socket Weld (Min.)	Lap Joint (Min.)	Weld Neck & Socket Weld			
	O.D.	C	C	W	K	Y2	Y3	Y1	T	B2	B3	B1▲	J	Z	D

**ASME B16.5**

1/2	3.75	0.50	0.56	1.50	0.84	0.81	0.88	2.00	0.62	0.88	0.90	0.62	0.12	0.93	0.38
3/4	4.62	0.56	0.62	1.88	1.05	0.94	1.00	2.19	0.62	1.09	1.11	0.82	0.12	1.14	0.44
1	4.88	0.62	0.69	2.12	1.32	1.00	1.06	2.38	0.69	1.36	1.38	1.05	0.12	1.41	0.50
1 1/4	5.25	0.69	0.75	2.50	1.66	1.00	1.06	2.50	0.81	1.70	1.72	1.38	0.19	1.75	0.56
1 1/2	6.12	0.75	0.81	2.75	1.90	1.13	1.19	2.63	0.88	1.95	1.97	1.61	0.25	1.98	0.62
2	6.50	0.81	0.88	3.31	2.38	1.25	1.31	2.69	1.12	2.44	2.46	2.07	0.31	2.50	0.69
2 1/2	7.50	0.94	1.00	3.94	2.88	1.44	1.50	2.94	1.25	2.94	2.97	2.47	0.31	3.00	0.75
3	8.25	1.06	1.12	4.62	3.50	1.63	1.69	3.06	1.25	3.57	3.60	3.07	0.38	3.63	0.81
3 1/2	9.00	1.12	1.19	5.25	4.00	1.69	1.75	3.13	1.44	4.07	4.10	3.55	0.38	4.13	
4	10.00	1.19	1.25	5.75	4.50	1.82	1.88	3.32	1.44	4.57	4.60	4.03	0.44	4.63	
5	11.00	1.31	1.38	7.00	5.56	1.94	2.00	3.82	1.69	5.66	5.69	5.05	0.44	5.69	
6	12.50	1.38	1.44	8.12	6.63	2.00	2.06	3.82	1.81	6.72	6.75	6.07	0.50	6.75	
8	15.00	1.56	1.62	10.25	8.63	2.38	2.44	4.32	2.00	8.72	8.75	7.98	0.50	8.75	
10	17.50	1.81	1.88	12.62	10.75	2.56	3.75	4.56	2.19	10.88	10.92	10.02	0.50	10.88	
12	20.50	1.94	2.00	14.75	12.75	2.82	4.00	5.06	2.38	12.88	12.92	12.00	0.50	12.94	
14	23.00	2.06	2.12	16.75	14.00	2.94	4.38	5.56	2.50	14.14	14.18	13.25	0.50	14.19	
16	25.50	2.19	2.25	19.00	16.00	3.19	4.75	5.69	2.69	16.16	16.19	15.25	0.50	16.19	
18	28.00	2.31	2.38	21.00	18.00	3.44	5.12	6.19	2.75	18.18	18.20	17.25	0.50	18.19	
20	30.50	2.44	2.50	23.12	20.00	3.69	5.50	6.32	2.88	20.20	20.25	19.25	0.50	20.19	
24	36.00	2.69	2.75	27.62	24.00	4.13	6.00	6.56	3.25	24.25	24.25	23.25	0.50	24.19	

**WN BLD**

**ASME B16.47 Series A**

30	43.00	3.57	3.69	32.56	30.00	8.19
36	50.00	4.07	4.32	39.00	36.00	9.44
42	50.75	4.63	4.63	43.25	42.00	7.82
48	57.75	5.19	5.19	49.38	48.00	8.75

**WN BLD**

**ASME B16.47 Series B**

30	39.00	3.63	3.63	32.00	30.25	6.16
36	46.12	4.00	4.00	38.00	36.25	7.06
42	52.50	4.63	4.63	44.00	42.31	8.00
48	59.50	5.00	5.25	50.31	48.31	8.75

**WELDBEND NOTES**

- Standard flange facings on page 146.
- All dimensions are in inches.
- Calculated flange weights on page 100.
- For dimensional tolerances see page 144.
- Weld end preparations on page 154.

- Thread standards on page 156.
- Blind flanges may be produced with or without hubs.
- All flanges conform to ASTM A105/ASME SA105.
- All flanges 1/2"-24" conform to ASME B16.5.  
All flanges 30" and larger conform to ASME B16.47.

- \* A taper shall not exceed 7 degrees on threaded, slip-on and lapped flanges.  
 ▲ Dimensions listed for socket weld and weld neck flanges are for Standard bore unless specified by purchaser.

# CLASS 600 STEEL PIPE FLANGES



For Ring Type Joint Facing Dimension information see page 150.

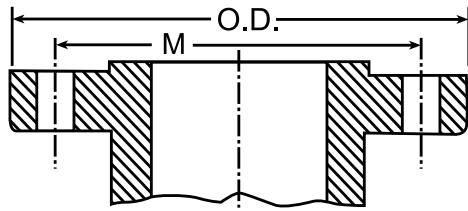

Flange

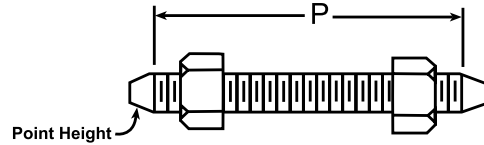

Stud Bolt

Bolting Pattern and Bolt Lengths								
Pipe Size	Outside Diameter	Drilling				Length of Bolts		
		Diameter of Bolt Circle	Diameter of Bolt Holes	Number of Bolt Holes	Diameter of Bolts	Raised Face 0.25 in.	Male & Female / Tongue & Groove	Ring Joint
	O.D.	M				P	P	P

### ASME B16.5

1/2	3.75	2.62	5/8	4	1/2	3.00	2.75	3.00
3/4	4.62	3.25	3/4	4	5/8	3.50	3.25	3.50
1	4.88	3.50	3/4	4	5/8	3.50	3.25	3.50
1 1/4	5.25	3.88	3/4	4	5/8	3.75	3.50	3.75
1 1/2	6.12	4.50	7/8	4	3/4	4.25	4.00	4.25
2	6.50	5.00	3/4	8	5/8	4.25	4.00	4.25
2 1/2	7.50	5.88	7/8	8	3/4	4.75	4.50	4.75
3	8.25	6.62	7/8	8	3/4	5.00	4.75	5.00
3 1/2	9.00	7.25	1	8	7/8	5.50	5.25	5.50
4	10.75	8.50	1	8	7/8	5.75	5.50	5.75
5	13.00	10.50	1 1/8	8	1	6.50	6.25	6.50
6	14.00	11.50	1 1/8	12	1	6.75	6.50	6.75
8	16.50	13.75	1 1/4	12	1 1/8	7.50	7.25	7.75
10	20.00	17.00	1 3/8	16	1 1/4	8.50	8.25	8.50
12	22.00	19.25	1 3/8	20	1 1/4	8.75	8.50	8.75
14	23.75	20.75	1 1/2	20	1 3/8	9.25	9.00	9.25
16	27.00	23.75	1 5/8	20	1 1/2	10.00	9.75	10.00
18	29.25	25.75	1 3/4	20	1 5/8	10.75	10.50	10.75
20	32.00	28.50	1 3/4	24	1 5/8	11.25	11.00	11.50
24	37.00	33.00	2	24	1 7/8	13.00	12.75	13.25

### ASME B16.47 Series A

30	44.50	40.25	2 1/8	28	2	Formula for determining bolt lengths (P) see page 159.
36	51.75	47.00	2 5/8	28	2 1/2	
42	55.25	50.50	2 5/8	28	2 1/2	
48	62.75	57.50	2 7/8	32	2 3/4	

### ASME B16.47 Series B

30	40.25	36.50	2	28	1 7/8	Formula for determining bolt lengths (P) see page 159.
36	47.75	43.50	2 3/8	28	2 1/4	
42						
48						

### WELDBEND NOTES

- Standard flange facings on page 146.
- All dimensions are in inches.
- Calculated flange weights on page 101.
- For dimensional tolerances see page 144.
- All flanges conform to ASTM A105/ASME SA105.
- All flanges 1/2"-24" conform to ASME B16.5.  
All flanges 30" and larger conform to ASME B16.47.

# CLASS 600 STEEL PIPE FLANGES

For Ring Type Joint Facing Dimension information see page 150.

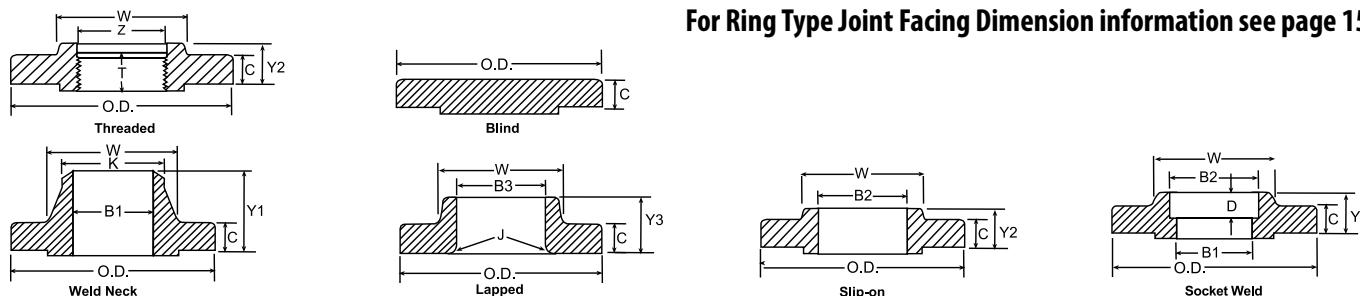

Pipe Size	Outside Diameter of Flange	Thickness of Flange (Min.)	Diameter of Hub*	Diameter of Weld Neck	Length Through Hub			Thread Length (Min.)	Bore			Lapped Flange Radius	Min. Counter Bore Threaded Flange	Depth of Socket
					Threaded, Slip-on & Socket Weld	Lap Joint	Weld Neck		Slip-on & Socket Weld (Min.)	Lap Joint (Min.)	Weld Neck & Socket Weld			
	O.D.	C	W	K	Y2	Y3	Y1	T	B2	B3	B1 ▲	J	Z	D

### ASME B16.5

½	3.75	0.56	1.50	0.84	0.88	0.88	2.06	0.62	0.88	0.90	.55	0.12	0.93	0.38
¾	4.62	0.62	1.88	1.05	1.00	1.00	2.25	0.62	1.09	1.11	.74	0.12	1.14	0.44
1	4.88	0.69	2.12	1.32	1.06	1.06	2.44	0.69	1.36	1.38	.96	0.12	1.41	0.50
1 ¼	5.25	0.81	2.50	1.66	1.12	1.12	2.62	0.81	1.70	1.72	1.28	0.19	1.75	0.56
1 ½	6.12	0.88	2.75	1.90	1.25	1.25	2.75	0.88	1.95	1.97	1.50	0.25	1.99	0.62
2	6.50	1.00	3.31	2.38	1.44	1.44	2.88	1.12	2.44	2.46	1.94	0.31	2.50	0.69
2 ½	7.50	1.12	3.94	2.88	1.62	1.62	3.12	1.25	2.94	2.97	2.32	0.31	3.00	0.75
3	8.25	1.25	4.62	3.50	1.81	1.81	3.25	1.38	3.57	3.60	2.90	0.38	3.63	0.81
3 ½	9.00	1.38	5.25	4.00	1.94	1.94	3.38	1.56	4.07	4.10	3.36	0.38	4.13	
4	10.75	1.50	6.00	4.50	2.12	2.12	4.00	1.62	4.57	4.60	3.83	0.44	4.63	
5	13.00	1.75	7.44	5.56	2.38	2.38	4.50	1.88	5.66	5.69	4.81	0.44	5.69	
6	14.00	1.88	8.75	6.63	2.62	2.62	4.62	2.00	6.72	6.75	5.76	0.50	6.75	
8	16.50	2.19	10.75	8.63	3.00	3.00	5.25	2.25	8.72	8.75	7.63	0.50	8.75	
10	20.00	2.50	13.50	10.75	3.38	4.38	6.00	2.56	10.88	10.92	9.75	0.50	10.88	
12	22.00	2.62	15.75	12.75	3.62	4.62	6.12	2.75	12.88	12.92	11.75	0.50	12.94	
14	23.75	2.75	17.00	14.00	3.69	5.00	6.50	2.88	14.14	14.18	13.00	0.50	14.19	
16	27.00	3.00	19.50	16.00	4.19	5.50	7.00	3.06	16.16	16.19	15.00	0.50	16.19	
18	29.25	3.25	21.50	18.00	4.62	6.00	7.25	3.12	18.18	18.20	17.00	0.50	18.19	
20	32.00	3.50	24.00	20.00	5.00	6.50	7.50	3.25	20.20	20.25	19.00	0.50	20.19	
24	37.00	4.00	28.25	24.00	5.50	7.25	8.00	3.62	24.25	24.25	23.00	0.50	24.19	

WN BLD

### ASME B16.47 Series A

30	44.50	4.50	5.50	33.94	30.00		9.75	
36	51.75	4.88	6.38	40.62	36.00		11.12	
42	55.25	6.62	6.75	44.38	42.00		11.00	
48	62.75	7.44	7.69	50.75	48.00		12.44	

WN BLD

### ASME B16.47 Series B

30	40.25	4.94	5.00	31.75	30.00		8.06	
36	47.75	5.75	5.94	38.12	36.00		9.56	
42								
48								

### WELDBEND NOTES

- Standard flange facings on page 146.
- All dimensions are in inches.
- Calculated flange weights on page 101.
- For dimensional tolerances see page 144.
- Weld end preparations on page 154.

- Thread standards on page 156.
- Blind flanges may be produced with or without hubs.
- All flanges conform to ASTM A105/ASME SA105.
- All flanges ½"-24" conform to ASME B16.5.  
All flanges 30" and larger conform to ASME B16.47.

- \* A taper shall not exceed 7 degrees on threaded, slip-on and lapped flanges.  
 ▲ Dimensions listed for socket weld and weld neck flanges are for Extra-Strong bore unless specified by purchaser.

FLANGES

For Ring Type Joint Facing Dimension information see page 151.

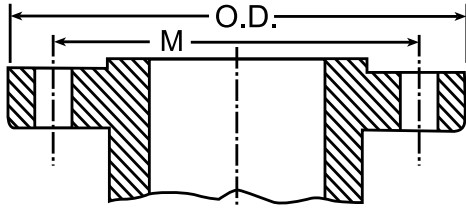

Flange

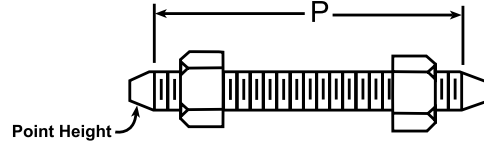

Stud Bolt

Bolting Pattern and Bolt Lengths								
Pipe Size	Outside Diameter	Drilling				Length of Bolts		
		Diameter of Bolt Circle	Diameter of Bolt Holes	Number of Bolt Holes	Diameter of Bolts	Raised Face 0.25 in.	Male & Female/Tongue & Groove	Ring Joint
	O.D.	M				P	P	P

**ASME B16.5**

1/2	4.75	3.25	7/8	4	3/4	4.25	4.00	4.25
3/4	5.12	3.50	7/8	4	3/4	4.50	4.25	4.50
1	5.88	4.00	1	4	7/8	5.00	4.75	5.00
1 1/4	6.25	4.38	1	4	7/8	5.00	4.75	5.00
1 1/2	7.00	4.88	1 1/8	4	1	5.50	5.25	5.50
2	8.50	6.50	1	8	7/8	5.75	5.50	5.75
2 1/2	9.62	7.50	1 1/8	8	1	6.25	6.00	6.25
3	9.50	7.50	1	8	7/8	5.75	5.50	5.75
4	11.50	9.25	1 1/4	8	1 1/8	6.75	6.50	6.75
5	13.75	11.00	1 3/8	8	1 1/4	7.50	7.25	7.50
6	15.00	12.50	1 1/4	12	1 1/8	7.50	7.25	7.75
8	18.50	15.50	1 1/2	12	1 3/8	8.75	8.50	8.75
10	21.50	18.50	1 1/2	16	1 3/8	9.25	9.00	9.25
12	24.00	21.00	1 1/2	20	1 3/8	10.00	9.75	10.00
14	25.25	22.00	1 5/8	20	1 1/2	10.75	10.50	11.00
16	27.75	24.25	1 3/4	20	1 5/8	11.25	11.00	11.50
18	31.00	27.00	2	20	1 7/8	12.75	12.50	13.25
20	33.75	29.50	2 1/8	20	2	13.75	13.50	14.25
24	41.00	35.50	2 3/8	20	2 1/2	17.25	17.00	18.00

**ASME B16.47 Series A**

30	48.50	42.75	3 1/8	20	3	Formula for determining bolt lengths (P) see page 159.
36	57.50	50.75	3 5/8	20	3 1/2	
42	61.50	54.75	3 5/8	24	3 1/2	
48	70.25	62.50	4 1/8	24	4	

**ASME B16.47 Series B**

30	46.50	40.75	3 1/8	20	3	Formula for determining bolt lengths (P) see page 159.
36	53.00	47.25	3 1/8	24	3	
42						
48						

**WELDBEND NOTES**

- Standard flange facings on page 146.
- All dimensions are in inches.
- Calculated flange weights on page 102.
- For dimensional tolerances see page 144.
- All flanges conform to ASTM A105/ASME SA105.
- All flanges 1/2"-24" conform to ASME B16.5.  
All flanges 30" and larger conform to ASME B16.47.

For Ring Type Joint Facing Dimension information see page 151.

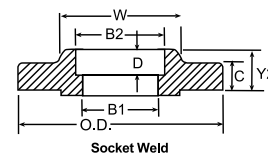
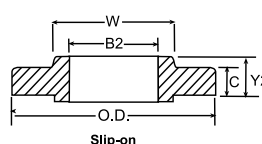
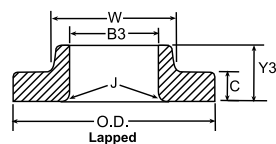
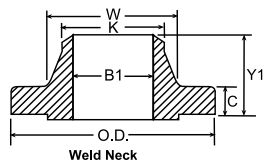
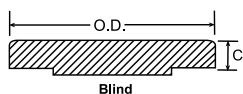
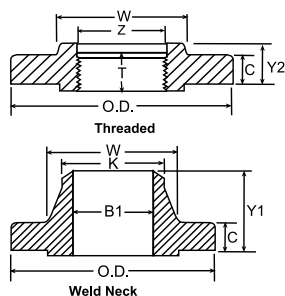

Pipe Size	Outside Diameter of Flange	Thickness of Flange (Min.)	Diameter of Hub*	Diameter of Weld Neck	Length Through Hub			Thread Length (Min.)	Bore			Lap Joint Radius	Min. Counter Bore Threaded Flange	Depth of Socket
					Threaded, Slip-on & Socket Weld	Lap Joint	Weld Neck		Slip-on & Socket Weld (Min.)	Lap Joint (Min.)	Weld Neck & Socket Weld			
	O.D.	C	W	K	Y2	Y3	Y1	T	B2	B3	B1	J	Z	D

### ASME B16.5

1/2	4.75	0.88	1.50	0.84	1.25	1.25	2.38	0.88	0.88	0.90	To be specified by the purchaser.	0.12	0.93	0.38
3/4	5.12	1.00	1.75	1.05	1.38	1.38	2.75	1.00	1.09	1.11		0.12	1.14	0.44
1	5.88	1.12	2.06	1.32	1.62	1.62	2.88	1.12	1.36	1.38		0.12	1.41	0.50
1 1/4	6.25	1.12	2.50	1.66	1.62	1.62	2.88	1.19	1.70	1.72		0.19	1.75	0.56
1 1/2	7.00	1.25	2.75	1.90	1.75	1.75	3.25	1.25	1.95	1.97		0.25	1.99	0.62
2	8.50	1.50	4.12	2.38	2.25	2.25	4.00	1.50	2.44	2.46		0.31	2.50	0.69
2 1/2	9.62	1.62	4.88	2.88	2.50	2.50	4.12	1.88	2.94	2.97		0.31	3.00	0.75
3	9.50	1.50	5.00	3.50	2.12	2.12	4.00	1.62	3.57	3.60		0.38	3.63	To be specified by the purchaser.
4	11.50	1.75	6.25	4.50	2.75	2.75	4.50	1.88	4.57	4.60		0.44	4.63	
5	13.75	2.00	7.50	5.56	3.12	3.12	5.00	2.12	5.66	5.69		0.44	5.69	
6	15.00	2.19	9.25	6.63	3.38	3.38	5.50	2.25	6.72	6.75		0.50	6.75	
8	18.50	2.50	11.75	8.63	4.00	4.50	6.38	2.50	8.72	8.75		0.50	8.75	
10	21.50	2.75	14.50	10.75	4.25	5.00	7.25	2.81	10.88	10.92		0.50	10.88	
12	24.00	3.12	16.50	12.75	4.62	5.62	7.88	3.00	12.88	12.92		0.50	12.94	
14	25.25	3.38	17.75	14.00	5.12	6.12	8.38	3.25	14.14	14.18		0.50	14.19	
16	27.75	3.50	20.00	16.00	5.25	6.50	8.50	3.38	16.16	16.19		0.50	16.19	
18	31.00	4.00	22.25	18.00	6.00	7.50	9.00	3.50	18.18	18.20	0.50	18.19		
20	33.75	4.25	24.50	20.00	6.25	8.25	9.75	3.62	20.20	20.25	0.50	20.19		
24	41.00	5.50	29.50	24.00	8.00	10.50	11.50	4.00	24.25	24.25	0.50	24.19		

WN BLD

### ASME B16.47 Series A

30	48.50	5.88	7.18	35.00	30.00		12.25	
36	57.50	6.75	8.44	41.88	36.00		14.25	
42	61.50	8.12	9.12	46.31	42.00		14.62	
48	70.25	9.19	10.38	52.88	48.00		16.50	

WN BLD

### ASME B16.47 Series B

30	46.50	6.12	6.93	33.50	30.00		11.38	
36	53.00	6.81	7.94	40.00	36.00		12.81	
42								
48								

### WELDBEND NOTES

- Standard flange facings on page 146.
- All dimensions are in inches.
- Calculated flange weights on page 102.
- For dimensional tolerances see page 144.
- Weld end preparations on page 154.
- Thread standards on page 156.

- Blind flanges may be produced with or without hubs.
- All flanges conform to ASTM A105/ASME SA105.
- All flanges 1/2"-24" conform to ASME B16.5.  
All flanges 30" and larger conform to ASME B16.47.
- \* A taper shall not exceed 7 degrees on threaded, slip-on, and lapped flanges.

FLANGES

For Ring Type Joint Facing Dimension information see page 152.

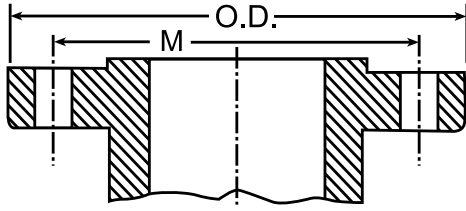

Flange

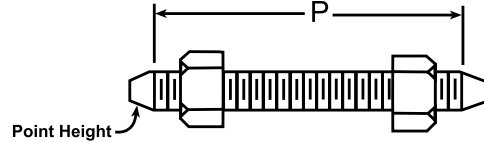

Stud Bolt

Bolting Pattern and Bolt Lengths								
Pipe Size	Outside Diameter	Drilling				Length of Bolts		
		Diameter of Bolt Circle	Diameter of Bolt Holes	Number of Bolt Holes	Diameter of Bolts	Raised Face 0.25 in.	Male & Female / Tongue & Groove	Ring Joint
	O.D.	M				P	P	P

**ASME B16.5**

1/2	4.75	3.25	7/8	4	3/4	4.25	4.00	4.25
3/4	5.12	3.50	7/8	4	3/4	4.50	4.25	4.50
1	5.88	4.00	1	4	7/8	5.00	4.75	5.00
1 1/4	6.25	4.38	1	4	7/8	5.00	4.75	5.00
1 1/2	7.00	4.88	1 1/8	4	1	5.50	5.25	5.50
2	8.50	6.50	1	8	7/8	5.75	5.50	5.75
2 1/2	9.62	7.50	1 1/8	8	1	6.25	6.00	6.25
3	10.50	8.00	1 1/4	8	1 1/8	7.00	6.75	7.00
4	12.25	9.50	1 3/8	8	1 1/4	7.75	7.50	7.75
5	14.75	11.50	1 5/8	8	1 1/2	9.75	9.50	9.75
6	15.50	12.50	1 1/2	12	1 3/8	10.25	10.00	10.50
8	19.00	15.50	1 3/4	12	1 5/8	11.50	11.25	11.75
10	23.00	19.00	2	12	1 7/8	13.25	13.00	13.50
12	26.50	22.50	2 1/8	16	2	14.75	14.50	15.25
14	29.50	25.00	2 3/8	16	2 1/4	16.00	15.75	16.75
16	32.50	27.75	2 5/8	16	2 1/2	17.50	17.25	18.50
18	36.00	30.50	2 7/8	16	2 3/4	19.50	19.25	20.75
20	38.75	32.75	3 1/8	16	3	21.25	21.00	22.25
24	46.00	39.00	3 5/8	16	3 1/2	24.25	24.00	25.50

**WELDBEND NOTES**

1. Standard flange facings on page 146.
2. All dimensions are in inches.
3. Calculated flange weights on page 103.
4. For dimensional tolerances see page 144.
5. All flanges conform to ASTM A105/ASME SA105.
6. All flanges 1/2"-24" conform to ASME B16.5.

For Ring Type Joint Facing Dimension information see page 152.

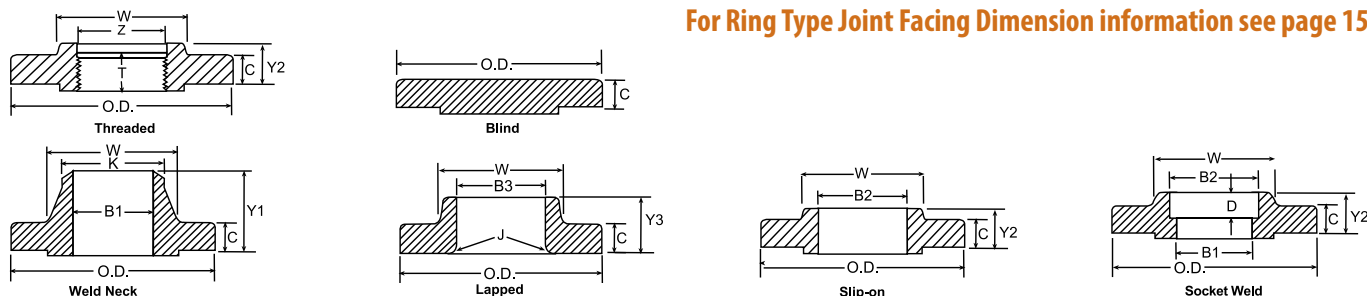

Pipe Size	Outside Diameter of Flange	Thickness of Flange (Min.)	Diameter of Hub*	Diameter of Weld Neck	Length Through Hub			Thread Length (Min.)	Bore			Lap Joint Radius	Min. Counter Bore Threaded Flange	Depth of Socket
					Threaded, Slip-on & Socket Weld	Lap Joint	Weld Neck		Slip-on & Socket Weld (Min.)	Lap Joint (Min.)	Weld Neck & Socket Weld			
	O.D.	C	W	K	Y2	Y3	Y1	T	B2	B3	B1	J	Z	D

**ASME B16.5**

1/2	4.75	0.88	1.50	0.84	1.25	1.25	2.38	0.88	0.88	0.90	To be specified by the purchaser.	0.12	0.93	0.38
3/4	5.12	1.00	1.75	1.05	1.38	1.38	2.75	1.00	1.09	1.11		0.12	1.14	0.44
1	5.88	1.12	2.06	1.32	1.62	1.62	2.88	1.12	1.36	1.38		0.12	1.41	0.50
1 1/4	6.25	1.12	2.50	1.66	1.62	1.62	2.88	1.19	1.70	1.72		0.19	1.75	0.56
1 1/2	7.00	1.25	2.75	1.90	1.75	1.75	3.25	1.25	1.95	1.97		0.25	1.99	0.62
2	8.50	1.50	4.12	2.38	2.25	2.25	4.00	1.50	2.44	2.46		0.31	2.50	0.69
2 1/2	9.62	1.62	4.88	2.88	2.50	2.50	4.12	1.88	2.94	2.97		0.31	3.00	0.75
3	10.50	1.88	5.25	3.50			2.88	4.62		3.60		0.38		
4	12.25	2.12	6.38	4.50			3.56	4.88		4.60		0.44		
5	14.75	2.88	7.75	5.56			4.12	6.12		5.69		0.44		
6	15.50	3.25	9.00	6.63			4.69	6.75		6.75		0.50		
8	19.00	3.62	11.50	8.63			5.62	8.38		8.75		0.50		
10	23.00	4.25	14.50	10.75			7.00	10.00		10.92		0.50		
12	26.50	4.88	17.75	12.75			8.62	11.12		12.92		0.50		
14	29.50	5.25	19.50	14.00			9.50	11.75		14.18		0.50		
16	32.50	5.75	21.75	16.00			10.25	12.25		16.19		0.50		
18	36.00	6.38	23.50	18.00			10.88	12.88		18.20	0.50			
20	38.75	7.00	25.25	20.00			11.50	14.00		20.25	0.50			
24	46.00	8.00	30.00	24.00			13.00	16.00		24.25	0.50			

**WELDBEND NOTES**

- Standard flange facings on page 146.
  - All dimensions are in inches.
  - Calculated flange weights on page 103.
  - For dimensional tolerances see page 144.
  - Weld end preparations on page 154.
  - Thread standards on page 156.
  - Blind flanges may be produced with or without hubs.
  - All flanges conform to ASTM A105/ASME SA105.
  - All flanges 1/2"-24" conform to ASME B16.5.
- \* A taper shall not exceed 7 degrees on threaded, slip-on and lapped flanges.

For Ring Type Joint Facing Dimension information see page 153.

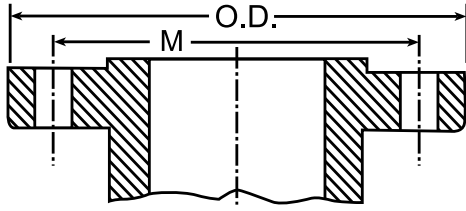

Flange

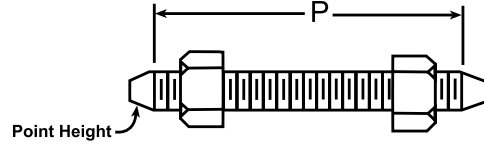

Stud Bolt

Bolting Pattern and Bolt Lengths								
Pipe Size	Outside Diameter	Drilling				Length of Bolts		
		Diameter of Bolt Circle	Diameter of Bolt Holes	Number of Bolt Holes	Diameter of Bolts	Raised Face 0.25 in.	Male & Female / Tongue & Groove	Ring Joint
	O.D.	M				P	P	P

**ASME B16.5**

1/2	5.25	3.50	7/8	4	3/4	4.75	4.50	4.75
3/4	5.50	3.75	7/8	4	3/4	5.00	4.75	5.00
1	6.25	4.25	1	4	7/8	5.50	5.25	5.50
1 1/4	7.25	5.12	1 1/8	4	1	6.00	5.75	6.00
1 1/2	8.00	5.75	1 1/4	4	1 1/8	6.75	6.50	6.75
2	9.25	6.75	1 1/8	8	1	7.00	6.75	7.00
2 1/2	10.50	7.75	1 1/4	8	1 1/8	7.75	7.50	8.00
3	12.00	9.00	1 3/8	8	1 1/4	8.75	8.50	9.00
4	14.00	10.75	1 5/8	8	1 1/2	10.00	9.75	10.25
5	16.50	12.75	1 7/8	8	1 3/4	11.75	11.50	12.25
6	19.00	14.50	2 1/8	8	2	13.50	13.25	14.00
8	21.75	17.25	2 1/8	12	2	15.00	14.75	15.50
10	26.50	21.25	2 5/8	12	2 1/2	19.25	19.00	20.00
12	30.00	24.38	2 7/8	12	2 3/4	21.25	21.00	22.00

**WELDBEND NOTES**

1. Standard flange facings on page 146.
2. All dimensions are in inches.
3. Calculated flange weights on page 104.
4. For dimensional tolerances see page 144.
5. All flanges conform to ASTM A105/ASME SA105.
6. All flanges 1/2"-12" conform to ASME B16.5.



For Ring Type Joint Facing Dimension information see page 153.

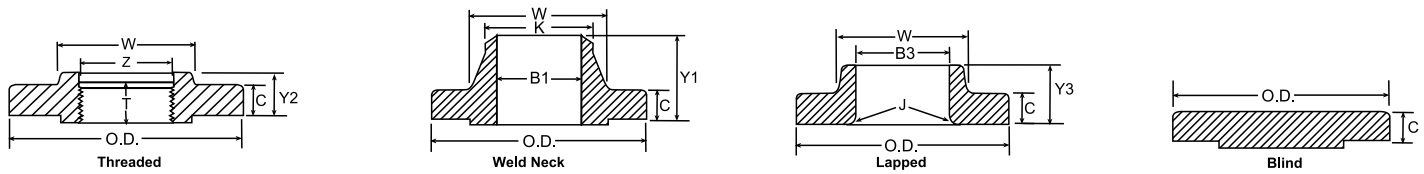

Pipe Size	Outside Diameter of Flange	Thickness of Flange (Min.)	Diameter of Hub*	Diameter of Weld Neck	Length Through Hub			Thread Length (Min.)	Bore		Lap Joint Radius	Min. Counter Bore Threaded Flange		
					Threaded	Lap Joint	Weld Neck		Lap Joint (Min.)	Weld Neck				
	O.D.	C	W	K	Y2	Y3	Y1	T	B3	B1	J	Z		
<b>ASME B16.5</b>														
½	5.25	1.19	1.69	0.84	1.56	1.56	2.88	1.12	0.90	To be specified by the purchaser.	0.12	0.93		
¾	5.50	1.25	2.00	1.05	1.69	1.69	3.12	1.25	1.11		0.12	1.14		
1	6.25	1.38	2.25	1.32	1.88	1.88	3.50	1.38	1.38		0.12	1.41		
1 ¼	7.25	1.50	2.88	1.66	2.06	2.06	3.75	1.50	1.72		0.19	1.75		
1 ½	8.00	1.75	3.12	1.90	2.38	2.38	4.38	1.75	1.97		0.25	1.99		
2	9.25	2.00	3.75	2.38	2.75	2.75	5.00	2.00	2.46		0.31	2.50		
2 ½	10.50	2.25	4.50	2.88	3.12	3.12	5.62	2.25	2.97		0.31	3.00		
3	12.00	2.62	5.25	3.50					3.60		0.38			
4	14.00	3.00	6.50	4.50					4.25		7.50		4.60	0.44
5	16.50	3.62	8.00	5.56					5.12		9.00		5.69	0.44
6	19.00	4.25	9.25	6.63					6.00		10.75		6.75	0.50
8	21.75	5.00	12.00	8.63					7.00		12.50		8.75	0.50
10	26.50	6.50	14.75	10.75					9.00	16.50	10.92		0.50	
12	30.00	7.25	17.38	12.75					10.00	18.25	12.92		0.50	

**WELDBEND NOTES**

- Standard flange facings on page 146.
  - All dimensions are in inches.
  - Calculated flange weights on page 104.
  - For dimensional tolerances see page 144.
  - Weld end preparations on page 154.
  - Thread standards on page 156.
  - Blind flanges may be produced with or without hubs.
  - All flanges conform to ASTM A105/ASME SA105.
  - All flanges ½"-12" conform to ASME B16.5.
- \* A taper shall not exceed 7 degrees on threaded, slip-on and lapped flanges.

**FLANGES**

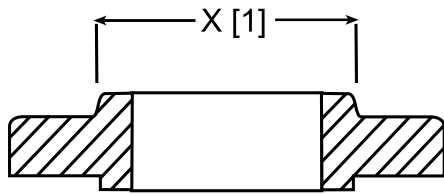

Slip-on

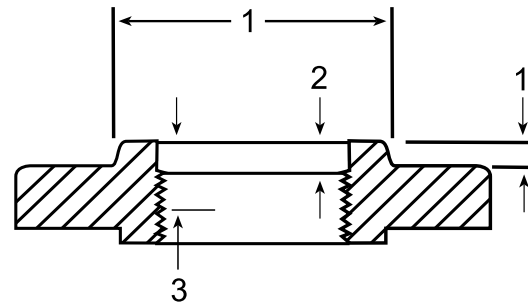

Threaded

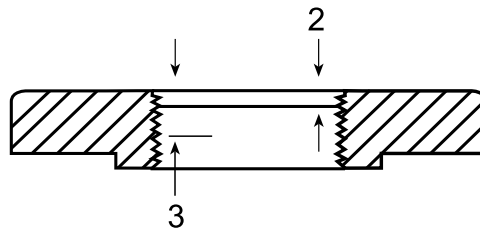

Blind

Pipe Size	Smallest Size of Reducing Outlet Requiring Hub Flanges	
1	Group I	1/2
1 1/4		1/2
1 1/2		1/2
2		1
2 1/2		1 1/4
3	Group II	1 1/4
3 1/2		1 1/2
4		1 1/2
5		1 1/2
6		2 1/2
8	Group III	3
10		3 1/2
12		3 1/2
14		3 1/2
16		4
18	4	
20	4	
24	4	

Note:

1. The hub dimensions shall be at least as large as those of the standard flanges of the size to which the reduction is being made, except flanges reducing to a size smaller than those Groups I, II and III may be made from blind flanges.
2. Class 150 flanges do not have a counter bore. Class 300 and higher pressure flanges will have depth of counter bore (q) of 0.25 in. for NPS 2 and smaller tapping and 0.38 in. for NPS 2 1/2" and larger. The diameter (Q) of counter bore is the same as that given in the tables of threaded flanges for the corresponding tapping.
3. Minimum length of effective threads shall be at least equal to dimension (T) of the corresponding pressure class threaded flange as shown in tables, but do not necessarily extend to the face of the flange. For thread of threaded flanges, see page 158.

<b>CLASS 150</b>					
Pipe Size	Outside Diameter	Threaded & Slip-on	Weld Neck	Blind	Lap Joint
	O.D.				

**ASME B16.5**

Pipe Size	Outside Diameter	Threaded & Slip-on	Weld Neck	Blind	Lap Joint
½	3.50	2.00	2.00	2.00	1.00
¾	3.88	2.00	2.00	2.00	2.00
1	4.25	2.00	3.00	2.00	2.00
1 ¼	4.62	3.00	3.00	3.00	3.00
1 ½	5.00	3.00	4.00	4.00	3.00
2	6.00	5.00	6.00	5.00	5.00
2 ½	7.00	8.00	10.00	7.00	8.00
3	7.50	9.00	11.50	9.00	9.00
3 ½	8.50	12.00	12.00	13.00	11.00
4	9.00	13.00	16.50	17.00	13.00
5	10.00	15.00	21.00	20.00	15.00
6	11.00	19.00	26.00	27.00	19.00
8	13.50	30.00	42.00	47.00	30.00
10	16.00	43.00	54.00	70.00	43.00
12	19.00	64.00	88.00	123.00	64.00
14	21.00	90.00	114.00	140.00	105.00
16	23.50	106.00	140.00	180.00	140.00
18	25.00	130.00	165.00	220.00	160.00
20	27.50	165.00	197.00	285.00	195.00
24	32.00	220.00	268.00	430.00	275.00

**ASME B16.47 Series A**

30	38.75	—	400.00	982.00	—
36	46.00	—	640.00	1676.00	—
42	53.00	—	890.00	2381.00	—
48	59.50	—	1185.00	3348.00	—

**ASME B16.47 Series B**

30	34.94	—	150.00	543.00	—
36	41.62	—	240.00	890.00	—
42	48.25	—	345.00	1393.00	—
48	54.81	—	480.00	2045.00	—

**WELDBEND NOTES**

1. All dimensions are in inches.
2. All weights are in pounds and approximated or estimated.

**FLANGES**

CLASS 300					
Pipe Size	Outside Diameter	Threaded & Slip-on	Weld Neck	Blind	Lap Joint
	O.D.				

### ASME B16.5

1/2	3.75	3.00	2.00	2.00	2.00
3/4	4.62	3.00	3.00	3.00	3.00
1	4.88	3.00	4.00	4.00	3.00
1 1/4	5.25	4.50	5.00	6.00	4.50
1 1/2	6.12	6.50	7.00	7.00	6.50
2	6.50	7.00	9.00	8.00	7.00
2 1/2	7.50	10.00	12.00	12.00	10.00
3	8.25	14.00	18.00	16.00	14.00
3 1/2	9.00	17.00	20.00	21.00	17.00
4	10.00	24.00	26.50	28.00	24.00
5	11.00	31.00	36.00	37.00	28.00
6	12.50	39.00	45.00	50.00	39.00
8	15.00	58.00	69.00	81.00	58.00
10	17.50	81.00	100.00	124.00	91.00
12	20.50	115.00	142.00	185.00	140.00
14	23.00	165.00	206.00	250.00	190.00
16	25.50	220.00	250.00	315.00	234.00
18	28.00	280.00	320.00	415.00	305.00
20	30.50	325.00	400.00	515.00	375.00
24	36.00	490.00	580.00	800.00	550.00

### ASME B16.47 Series A

30	43.00	—	870.00	1543.00	—
36	50.00	—	1275.00	2436.00	—
42	50.75	—	950.00	2688.00	—
48	57.75	—	1380.00	3896.00	—

### ASME B16.47 Series B

30	39.00	—	550.00	1249.00	—
36	46.12	—	840.00	1921.00	—
42	52.50	—	1135.00	2876.00	—
48	59.50	—	1575.00	4183.00	—

### WELDBEND NOTES

1. All dimensions are in inches.
2. All weights are in pounds and approximated or estimated.

<b>CLASS 600</b>					
Pipe Size	Outside Diameter	Threaded & Slip-on	Weld Neck	Blind	Lap Joint
	O.D.				

**ASME B16.5**

1/2	3.75	2.00	3.00	3.00	2.00
3/4	4.62	3.00	4.00	4.00	3.00
1	4.88	4.00	4.00	4.00	4.00
1 1/4	5.25	5.00	6.00	6.00	5.00
1 1/2	6.12	7.00	8.00	8.00	7.00
2	6.50	9.00	12.00	10.00	9.00
2 1/2	7.50	13.00	18.00	15.00	12.00
3	8.25	16.00	23.00	20.00	15.00
3 1/2	9.00	21.00	26.00	29.00	20.00
4	10.75	37.00	42.00	41.00	36.00
5	13.00	63.00	68.00	68.00	63.00
6	14.00	80.00	81.00	86.00	78.00
8	16.50	115.00	120.00	140.00	112.00
10	20.00	177.00	190.00	231.00	195.00
12	22.00	215.00	226.00	295.00	240.00
14	23.75	259.00	347.00	378.00	290.00
16	27.00	366.00	481.00	527.00	400.00
18	29.25	476.00	555.00	665.00	469.00
20	32.00	612.00	690.00	855.00	604.00
24	37.00	876.00	977.00	1250.00	866.00

**ASME B16.47 Series A**

30	44.50	—	1210.00	2423.00	—
36	51.75	—	1705.00	3802.00	—
42	55.25	—	2030.00	4585.00	—
48	62.75	—	2855.00	6737.00	—

**ASME B16.47 Series B**

30	40.25	—	810.00	1802.00	—
36	47.75	—	1340.00	3013.00	—

**WELDBEND NOTES**

1. All dimensions are in inches.
2. All weights are in pounds and approximated or estimated.

CLASS 900					
Pipe Size	Outside Diameter	Threaded & Slip-on	Weld Neck	Blind	Lap Joint
	O.D.				

### ASME B16.5

1/2	4.75	6.00	7.00	4.00	6.00
3/4	5.12	6.00	7.00	6.00	6.00
1	5.88	7.50	8.50	9.00	7.50
1 1/4	6.25	10.00	10.00	10.00	10.00
1 1/2	7.00	14.00	14.00	14.00	14.00
2	8.50	22.00	24.00	25.00	21.00
2 1/2	9.62	31.00	31.00	32.00	25.00
3	9.50	36.00	36.00	35.00	29.00
4	11.50	53.00	53.00	54.00	51.00
5	13.75	83.00	86.00	87.00	81.00
6	15.00	110.00	110.00	115.00	105.00
8	18.50	172.00	187.00	200.00	190.00
10	21.50	245.00	268.00	290.00	277.00
12	24.00	326.00	372.00	415.00	371.00
14	25.25	400.00	562.00	520.00	415.00
16	27.75	459.00	685.00	619.00	488.00
18	31.00	647.00	924.00	880.00	670.00
20	33.75	792.00	1164.00	1107.00	868.00
24	41.00	1480.00	2107.00	2099.00	1659.00

### ASME B16.47 Series A

30	48.50	—	2120.00	3758.00	—
36	57.50	—	3395.00	6209.00	—
42	61.50	—	3960.00	7675.00	—
48	70.25	—	4980.00	11398.00	—

### ASME B16.47 Series B

30	46.50	—	1820.00	3334.00	—
36	53.00	—	2520.00	4963.00	—

### WELDBEND NOTES

1. All dimensions are in inches.
2. All weights are in pounds and approximated or estimated.

<b>CLASS 1500</b>					
Pipe Size	Outside Diameter	Threaded & Slip-on	Weld Neck	Blind	Lap Joint
	O.D.				

**ASME B16.5**

1/2	4.75	6.00	7.00	4.00	6.00
3/4	5.12	6.00	7.00	6.00	6.00
1	5.88	8.00	9.00	9.00	8.00
1 1/4	6.25	10.00	10.00	10.00	10.00
1 1/2	7.00	14.00	14.00	14.00	14.00
2	8.50	25.00	25.00	25.00	25.00
2 1/2	9.62	36.00	36.00	35.00	35.00
3	10.50	48.00	48.00	48.00	47.00
4	12.25	73.00	73.00	73.00	75.00
5	14.75	132.00	132.00	140.00	140.00
6	15.50	165.00	165.00	160.00	170.00
8	19.00	260.00	275.00	302.00	286.00
10	23.00	436.00	455.00	510.00	485.00
12	26.50	667.00	690.00	775.00	749.00
14	29.50	940.00	940.00	975.00	890.00
16	32.50	1250.00	1250.00	1300.00	1250.00
18	36.00	1625.00	1625.00	1750.00	1475.00
20	38.75	2050.00	2050.00	2225.00	1775.00
24	46.00	2825.00	3325.00	3625.00	2825.00

**WELDBEND NOTES**

1. All dimensions are in inches.
2. All weights are in pounds and approximated or estimated.

CLASS 2500					
Pipe Size	Outside Diameter	Threaded & Slip-on	Weld Neck	Blind	Lap Joint
	O.D.				

**ASME B16.5**

1/2	5.25	7.00	8.00	7.00	7.00
3/4	5.50	9.00	9.00	10.00	8.00
1	6.25	12.00	13.00	12.00	12.00
1 1/4	7.25	18.00	20.00	18.00	17.00
1 1/2	8.00	25.00	28.00	25.00	24.00
2	9.25	38.00	42.00	39.00	37.00
2 1/2	10.50	55.00	52.00	56.00	53.00
3	12.00	83.00	94.00	86.00	80.00
4	14.00	127.00	146.00	133.00	122.00
5	16.50	210.00	244.00	223.00	204.00
6	19.00	323.00	378.00	345.00	314.00
8	21.75	485.00	576.00	533.00	471.00
10	26.50	925.00	1068.00	1025.00	897.00
12	30.00	1300.00	1608.00	1464.00	1262.00

**WELDBEND NOTES**

1. All dimensions are in inches.
2. All weights are in pounds and approximated or estimated.



<b>BOX QUANTITIES</b>						
<b>SLIP-ON, THREADED, LAP JOINT, SOCKET WELD (STD &amp; XS), BLINDS</b>						
<b>Box Quantities</b>	<b>Class 150</b>	<b>Class 300</b>	<b>Class 600</b>	<b>Class 900</b>	<b>Class 1500</b>	<b>Class 2500</b>
<b>Nominal Pipe Size</b>	<b>(Raised &amp; Flat Face)</b>	<b>(Raised &amp; Flat Face)</b>	<b>(Raised &amp; Flat Face)</b>	<b>(Raised &amp; Flat Face)</b>	<b>(Raised &amp; Flat Face)</b>	<b>(Raised &amp; Flat Face)</b>
1/2"	12	6	6	—	—	—
3/4"	12	6	6	—	—	—
1"	12	6	6	—	—	—
1 1/4"	12	6	6	—	—	—
1 1/2"	12	6	6	—	—	—

<b>BOX QUANTITIES</b>						
<b>WELD-NECK (STD &amp; XS)</b>						
<b>Box Quantities</b>	<b>Class 150</b>	<b>Class 300</b>	<b>Class 600</b>	<b>Class 900</b>	<b>Class 1500</b>	<b>Class 2500</b>
<b>Nominal Pipe Size</b>	<b>(Raised &amp; Flat Face)</b>	<b>(Raised &amp; Flat Face)</b>	<b>(Raised &amp; Flat Face)</b>	<b>(Raised &amp; Flat Face)</b>	<b>(Raised &amp; Flat Face)</b>	<b>(Raised &amp; Flat Face)</b>
1/2"	12	6	6	—	—	—
3/4"	12	6	6	—	—	—
1"	12	6	6	—	—	—
1 1/4"	12	6	6	—	—	—
1 1/2"	12	6	6	—	—	—

<b>BUNDLE QUANTITIES</b>						
<b>SLIP-ON, THREADED, LAP JOINT, SOCKET WELD (STD &amp; XS)</b>						
<b>Bundle Quantities</b>	<b>Class 150</b>	<b>Class 300</b>	<b>Class 600</b>	<b>Class 900</b>	<b>Class 1500</b>	<b>Class 2500</b>
<b>Nominal Pipe Size</b>	<b>(Raised &amp; Flat Face)</b>	<b>(Raised &amp; Flat Face)</b>	<b>(Raised &amp; Flat Face)</b>	<b>(Raised &amp; Flat Face)</b>	<b>(Raised &amp; Flat Face)</b>	<b>(Raised &amp; Flat Face)</b>
2"	20	16	—	—	—	—
2 1/2"	18	14	—	—	—	—
3"	17	12	—	—	—	—
3 1/2"	15	—	—	—	—	—
4"	15	11	—	—	—	—
5"	14	11	—	—	—	—
6"	13	10	—	—	—	—
8"	12	8	—	—	—	—
10"	11	—	—	—	—	—
12"	9	—	—	—	—	—

<b>BUNDLE QUANTITIES</b>						
<b>WELD-NECK (STD &amp; XS)</b>						
<b>Bundle Quantities</b>	<b>Class 150</b>	<b>Class 300</b>	<b>Class 600</b>	<b>Class 900</b>	<b>Class 1500</b>	<b>Class 2500</b>
<b>Nominal Pipe Size</b>	<b>(Raised &amp; Flat Face)</b>	<b>(Raised &amp; Flat Face)</b>	<b>(Raised &amp; Flat Face)</b>	<b>(Raised &amp; Flat Face)</b>	<b>(Raised &amp; Flat Face)</b>	<b>(Raised &amp; Flat Face)</b>
2"	9	8	—	—	—	—
2 1/2"	8	8	—	—	—	—
3"	8	8	—	—	—	—
3 1/2"	8	8	—	—	—	—
4"	8	7	—	—	—	—
5"	7	6	—	—	—	—
6"	7	6	—	—	—	—
8"	6	5	—	—	—	—
10"	6	—	—	—	—	—
12"	—	—	—	—	—	—



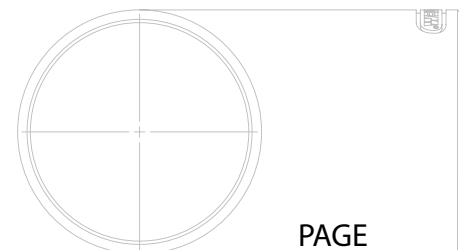

# TECHNICAL DATA INDEX

BEVEL DETAIL-WELDING FITTINGS .....	107
BUTTWELD FITTINGS TOLERANCES .....	108
BUTTWELD FITTINGS PRESSURE-TEMPERATURE RATINGS B31.1 [SCHEDULE: STD, XS, 40, 80, 160, XXS] ....	109
BUTTWELD FITTINGS PRESSURE RATINGS <b>WPB</b> B31.8 [SCHEDULE: STD, XS, 40, 80, 160, XXS] .....	114
BUTTWELD FITTINGS PRESSURE RATINGS <b>WPHY-52</b> B31.8 [SCHEDULE: STD, XS, 40, 80, 160, XXS] .....	119
BUTTWELD FITTINGS PRESSURE RATINGS <b>WPHY-65</b> B31.8 [SCHEDULE: STD, XS, 40, 80, 160, XXS] .....	124
FLOW RESISTANCE FOR FITTINGS .....	129
FLEXIBILITY AND STRESS INTENSIFICATION FACTORS .....	131
THERMAL EXPANSION FOR CARBON STEEL PIPE .....	132
DIMENSIONS OF WELDING ENDS [SCHEDULE: STD, XS, 40, 80, 160, XXS] .....	133
DIMENSIONS OF STEEL PIPE .....	138
DIMENSIONAL TOLERANCES FOR FLANGES .....	144
GASKET SURFACE FINISHES .....	145
STANDARD FLANGE FACINGS .....	146
RING TYPE JOINT FACING DIMENSIONS [CLASS: 150, 300, 600, 900, 1500, 2500] .....	148
WELD END PREPARATIONS .....	154
THREAD STANDARD PRACTICES .....	156
THREAD STANDARDS .....	158
METHOD FOR CALCULATING BOLT LENGTHS .....	159
PRESSURE-TEMPERATURE RATINGS FOR FLANGES .....	161
USEFUL FORMULAS .....	162
CONVERSION CHART .....	165
METRIC SYSTEM CONVERSIONS .....	166
MATERIAL TEST REPORT IDENTIFICATION .....	168
TORQUE REQUIRED TO PRODUCE INDICATED BOLT STRESS .....	170
BOLT TORQUE PROCEDURE .....	172
MATERIAL SAFETY DATA .....	175

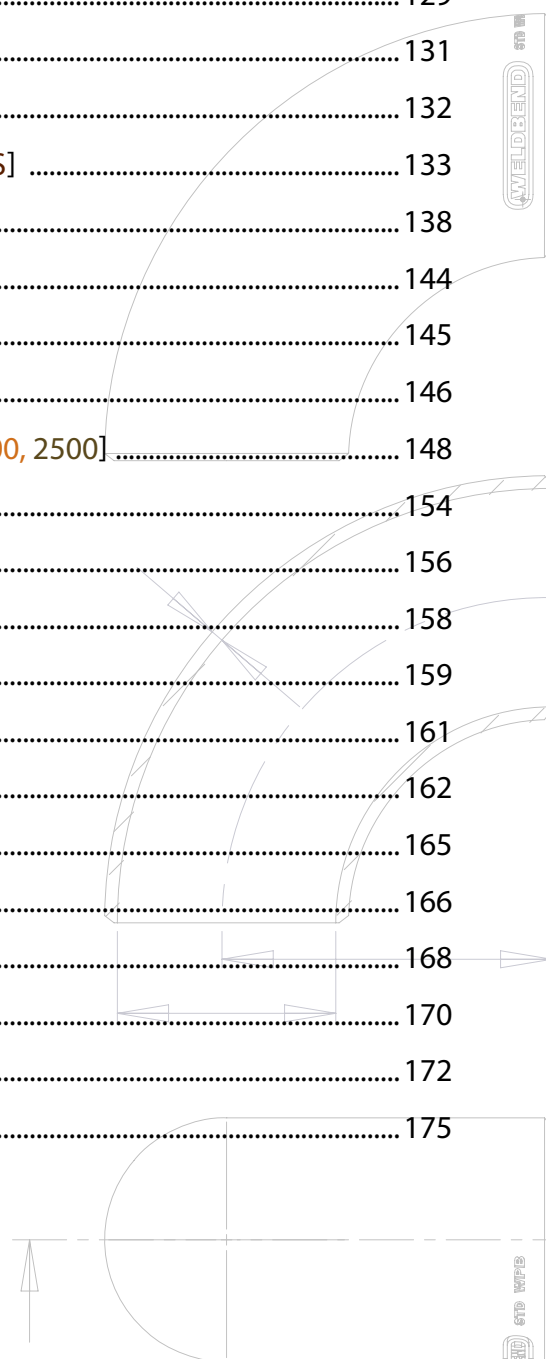



**PLAIN BEVEL**  
 Figure 1

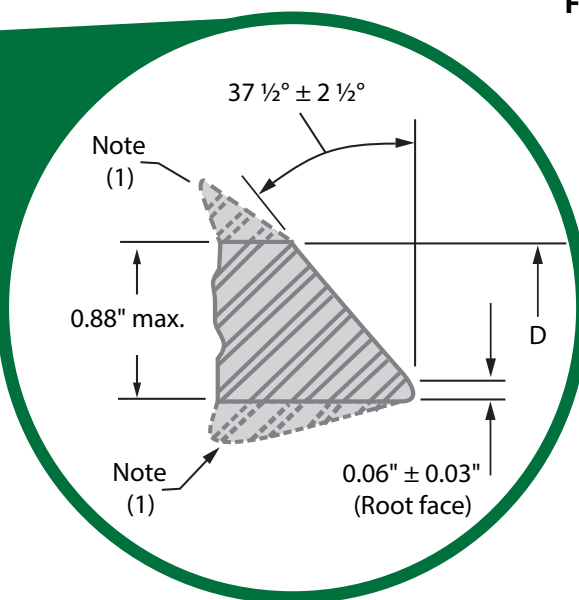

**COMPOUND BEVEL**  
 Figure 2

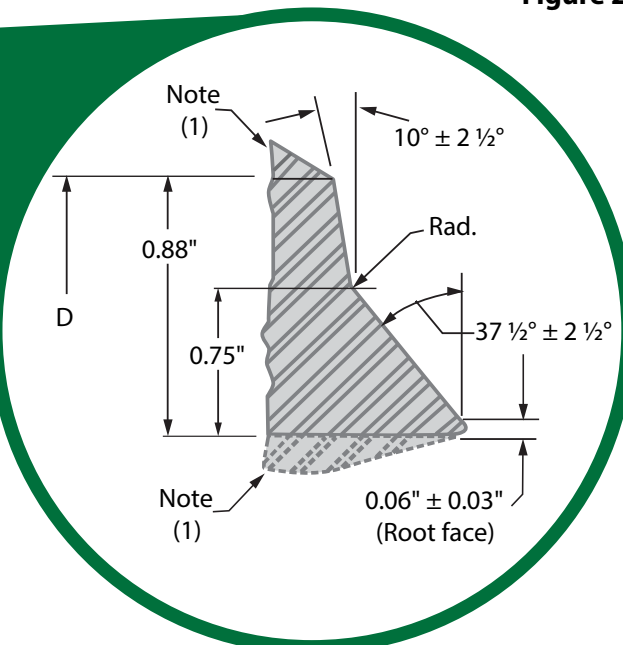

Wall Thickness (T)	End Preparation
Less than x [2]	Cut square or slightly chamfer, at manufacturer's option (not illustrated).
x to 0.88, inclusive	Plain bevel as in Figure 1 above.
More than 0.88	Compound bevel as in Figure 2 above.

Note:

1. See ASME B16.9 for transition contours.
2. x = 0.19" for carbon steel or ferritic alloy steel and 0.12" for austenitic alloy steel.

# BUTTWELD FITTINGS TOLERANCES



Weldbend Fittings			3R 90° and 3R 45° Elbows	90° and 45° Elbows and Tees	Reducers and Lap Joint Stub Ends	Caps	180° Return Bends			Stub Ends		
Pipe Size	Outside Diameter	Inside Diameter	Center to End	Center to End	Overall Length	Overall Length	Center to Center	Back to Face	Alignment of Ends	Outside Diameter of Lap	Thickness of Lap	Radius of Lap
	O.D.	I.D.	C, A	C, A, B, R	L, J	H	V	W		K	T	N
½ to 2 ½	+0.06, -0.03	0.03	0.09	0.06	0.06	0.12	0.25	0.25	0.03	+0, -0.03	+0, -0.03	+0.06, -0
3 to 3 ½	0.06	0.06	0.09	0.06	0.06	0.12	0.25	0.25	0.03	+0, -0.03	+0, -0.06	+0.06, -0
4	0.06	0.06	0.09	0.06	0.06	0.12	0.25	0.25	0.03	+0, -0.03	+0, -0.06	+0.06, -0
5 to 8	+0.09, -0.06	0.06	0.09	0.06	0.06	0.25	0.25	0.25	0.03	+0, -0.03	+0, -0.06	+0.06, -0
10 to 18	+0.16, -0.12	0.12	0.12	0.09	0.09	0.25	0.38	0.25	0.06	+0, -0.06	+0, -0.06	+0.12, -0
20 to 24	+0.25, -0.19	0.19	0.12	0.09	0.09	0.25	0.38	0.25	0.06	+0, -0.06	+0, -0.06	+0.12, -0
26 to 30	+0.25, -0.19	0.19	0.25	0.12	0.19	0.38						
30 to 48	+0.25, -0.19	0.19	0.38	0.19	0.19	0.38						

## WELDBEND NOTES

- All dimensions are in inches.
- Tolerances are equal plus and minus unless indicated.
- The inside diameter and nominal wall thickness at ends are to be specified by purchaser.
- Please refer to ASME B16.9 for further information regarding tolerances.
- Minimum wall thickness of 87.5% applies.
- The out-of-round is the sum of the absolute values of the plus and minus tolerances.

Pipe Size	Off Angle	Off Plane
½ - 4	0.03	0.06
5 - 8	0.06	0.12
10 - 12	0.09	0.19
14 - 16	0.09	0.25
18 - 24	0.12	0.38
26 - 30	0.19	0.38
32 - 42	0.19	0.50
44 - 48	0.19	0.75

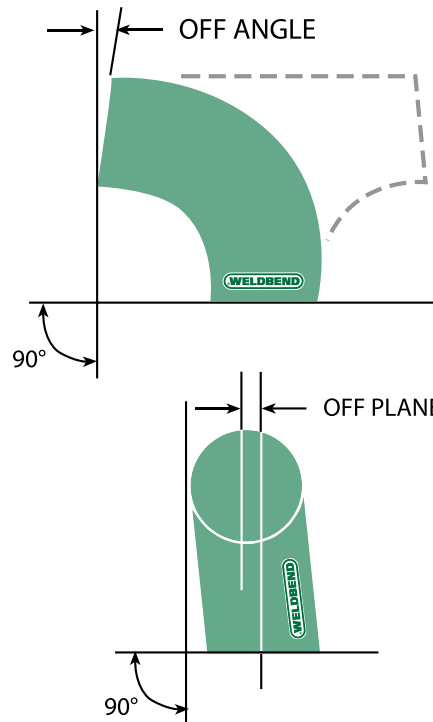

## BUTTWELD FITTINGS PRESSURE-TEMPERATURE RATINGS

BASED ON CODE FOR PRESSURE PIPING B31.1  
**SCHEDULE STD**  
 For reference only

Pipe Size	Wall Thickness Inches*	Working Pressure – Lbs per Square Inch at the Fahrenheit Temperature Indicated**			
	T	-20° to 650°	700°	750°	800°***
½	0.109	4989	4551	3793	3151
¾	0.113	4065	3709	3091	2568
1	0.133	3800	3467	2889	2400
1 ¼	0.140	3124	2850	2375	1973
1 ½	0.145	2806	2560	2134	1773
2	0.154	2360	2153	1794	1491
2 ½	0.203	2583	2357	1964	1632
3	0.216	2240	2043	1703	1415
3 ½	0.226	2041	1862	1551	1289
4	0.237	1895	1729	1441	1197
5	0.258	1659	1514	1261	1048
6	0.280	1506	1374	1145	951
8	0.322	1324	1208	1007	836
10	0.365	1201	1095	913	758
12	0.375	1035	945	787	654
14	0.375	941	858	715	594
16	0.375	820	748	624	518
18	0.375	727	664	553	459
20	0.375	653	596	497	413
24	0.375	543	495	413	343
30	0.375	433	395	329	273
36	0.375	360	328	274	227
42	0.375	308	281	234	195
48	0.375	269	246	205	170

Please review B31.1 for formula information.

### WELDBEND NOTES

- All dimensions are in inches.
  - All values listed in table above to be considered as a guide only. Please refer to B31.1 for formula and other factors that could effect the determination of pressure ratings.
- \* Nominal wall thickness; they correspond respectively to the thickness of SCHEDULE **STANDARD** WALL GRADE B steel pipe.
- \*\* Ratings apply in accordance with Sections 1 and 5 of the Code for Pressure Pipe. The values shown are based upon a corrosion allowance of 0 inches.
- \*\*\* Upon prolonged exposure to temperatures about 775° the carbide phase of carbon steel may be converted to graphite. For other applications refer to appropriate section of B31 Code for Pressure Piping.

# BUTTWELD FITTINGS PRESSURE-TEMPERATURE RATINGS



BASED ON CODE FOR PRESSURE PIPING B31.1

**SCHEDULE XS**

For reference only

Pipe Size	Wall Thickness Inches*	Working Pressure – Lbs per Square Inch at the Fahrenheit Temperature Indicated**			
	T	-20° to 650°	700°	750°	800°***
½	0.147	6942	6333	5278	4385
¾	0.154	5709	5209	4341	3606
1	0.179	5258	4797	3998	3321
1 ¼	0.191	4373	3989	3324	2762
1 ½	0.200	3969	3620	3017	2506
2	0.218	3422	3121	2601	2161
2 ½	0.276	3591	3276	2730	2268
3	0.300	3178	2900	2416	2007
3 ½	0.318	2932	2675	2229	1852
4	0.337	2751	2509	2091	1737
5	0.375	2459	2243	1870	1553
6	0.432	2374	2166	1805	1499
8	0.500	2097	1913	1594	1324
10	0.500	1664	1518	1265	1051
12	0.500	1394	1271	1059	880
14	0.500	1265	1154	962	799
16	0.500	1102	1005	838	696
18	0.500	976	891	742	617
20	0.500	876	799	666	553
24	0.500	727	664	553	459
30	0.500	579	529	441	366
36	0.500	482	439	366	304
42	0.500	412	376	313	260
48	0.500	360	328	274	227

Please review B31.1 for formula information.

**WELDBEND NOTES**

1. All dimensions are in inches.
2. All values listed in table above to be considered as a guide only. Please refer to B31.1 for formula and other factors that could effect the determination of pressure ratings.
- \* Nominal wall thickness; they correspond respectively to the thickness of SCHEDULE **EXTRA-STRONG** WALL GRADE B steel pipe.
- \*\* Ratings apply in accordance with Sections 1 and 5 of the Code for Pressure Pipe. The values shown are based upon a corrosion allowance of 0 inches.
- \*\*\* Upon prolonged exposure to temperatures about 775° the carbide phase of carbon steel may be converted to graphite. For other applications refer to appropriate section of B31 Code for Pressure Piping.

## BUTTWELD FITTINGS PRESSURE-TEMPERATURE RATINGS

BASED ON CODE FOR PRESSURE PIPING B31.1  
**SCHEDULE 40**  
 For reference only

Pipe Size	Wall Thickness Inches*	Working Pressure – Lbs per Square Inch at the Fahrenheit Temperature Indicated**			
	T	-20° to 650°	700°	750°	800°***
FOR DIMENSION SPECIFICATIONS ½" THROUGH 10" REFER TO SCHEDULE STD					
12	0.406	1124	1025	854	710
14	0.438	1103	1007	839	697
16	0.500	1102	1005	838	696
18	0.562	1101	1004	837	695
20	0.594	1046	954	795	661
24	0.688	1008	920	767	637

BASED ON CODE FOR PRESSURE PIPING B31.1  
**SCHEDULE 80**  
 For reference only

Pipe Size	Wall Thickness Inches*	Working Pressure – Lbs per Square Inch at the Fahrenheit Temperature Indicated**			
	T	-20° to 650°	700°	750°	800°***
FOR DIMENSION SPECIFICATIONS ½" THROUGH 8" REFER TO SCHEDULE XS					
10	0.594	1993	1819	1515	1259
12	0.688	1944	1774	1478	1228
14	0.750	1930	1760	1467	1219
16	0.844	1899	1732	1443	1199
18	0.938	1875	1710	1425	1184
20	1.031	1853	1691	1409	1171
24	1.219	1825	1665	1387	1153

Please review B31.1 for formula information.

### WELDBEND NOTES

- All dimensions are in inches.
  - All values listed in table above to be considered as a guide only. Please refer to B31.1 for formula and other factors that could effect the determination of pressure ratings.
- \* Nominal wall thickness; they correspond respectively to the thickness of SCHEDULE 40 and SCHEDULE 80 WALL GRADE B steel pipe.
- \*\* Ratings apply in accordance with Sections 1 and 5 of the Code for Pressure Pipe. The values shown are based upon a corrosion allowance of 0 inches.
- \*\*\* Upon prolonged exposure to temperatures about 775° the carbide phase of carbon steel may be converted to graphite. For other applications refer to appropriate section of B31 Code for Pressure Piping.

# BUTTWELD FITTINGS PRESSURE-TEMPERATURE RATINGS



## BASED ON CODE FOR PRESSURE PIPING B31.1 SCHEDULE 160

For reference only

Pipe Size	Wall Thickness Inches*	Working Pressure – Lbs per Square Inch at the Fahrenheit Temperature Indicated**			
	T	-20° to 650°	700°	750°	800°***
½	0.188	9104	8306	6921	5750
¾	0.219	8428	7688	6407	5323
1	0.250	7609	6941	5785	4806
1 ¼	0.250	5879	5363	4469	3713
1 ½	0.281	5762	5257	4381	3639
2	0.344	5631	5137	4281	3556
2 ½	0.375	5017	4577	3814	3169
3	0.438	4794	4373	3645	3028
4	0.531	4495	4101	3417	2839
5	0.625	4260	3887	3239	2691
6	0.719	4103	3743	3119	2591
8	0.906	3960	3612	3010	2501
10	1.125	3944	3598	2998	2491
12	1.312	3872	3532	2944	2445
14	1.406	3771	3440	2867	2382
16	1.594	3738	3410	2842	2361
18	1.781	3711	3385	2821	2344
20	1.969	3691	3367	2806	2331
24	2.344	3659	3338	2782	2311

Please review B31.1 for formula information.

### WELDBEND NOTES

- All dimensions are in inches.
  - All values listed in table above to be considered as a guide only. Please refer to B31.1 for formula and other factors that could effect the determination of pressure ratings.
- \* Nominal wall thickness; they correspond respectively to the thickness of SCHEDULE 160 WALL GRADE B steel pipe.
- \*\* Ratings apply in accordance with Sections 1 and 5 of the Code for Pressure Pipe. The values shown are based upon a corrosion allowance of 0 inches.
- \*\*\* Upon prolonged exposure to temperatures about 775° the carbide phase of carbon steel may be converted to graphite. For other applications refer to appropriate section of B31 Code for Pressure Piping.



## BUTTWELD FITTINGS PRESSURE-TEMPERATURE RATINGS

BASED ON CODE FOR PRESSURE PIPING B31.1

**SCHEDULE XXS**

For reference only

Pipe Size	Wall Thickness Inches*	Working Pressure – Lbs per Square Inch at the Fahrenheit Temperature Indicated**			
	T	-20° to 650°	700°	750°	800°***
½	0.294	14276	13024	10853	9017
¾	0.308	12110	11047	9206	7648
1	0.358	11223	10239	8532	7088
1 ¼	0.382	9384	8561	7134	5927
1 ½	0.400	8515	7768	6473	5378
2	0.436	7320	6678	5565	4623
2 ½	0.552	7692	7018	5848	4858
3	0.600	6785	6190	5158	4286
4	0.674	5843	5331	4442	3691
5	0.750	5203	4747	3955	3286
6	0.864	5016	4576	3814	3168
8	0.875	3813	3478	2899	2408
10	1.000	3471	3167	2639	2192
12	1.000	2890	2636	2197	1825

Please review B31.1 for formula information.

### WELDBEND NOTES

- All dimensions are in inches.
  - All values listed in table above to be considered as a guide only. Please refer to B31.1 for formula and other factors that could effect the determination of pressure ratings.
- \* Nominal wall thickness; they correspond respectively to the thickness of SCHEDULE **DOUBLE EXTRA-STRONG** WALL GRADE B steel pipe.
- \*\* Ratings apply in accordance with Sections 1 and 5 of the Code for Pressure Pipe. The values shown are based upon a corrosion allowance of 0 inches.
- \*\*\* Upon prolonged exposure to temperatures about 775° the carbide phase of carbon steel may be converted to graphite. For other applications refer to appropriate section of B31 Code for Pressure Piping.

# BUTTWELD FITTINGS PRESSURE RATINGS



## BASED ON THE CODE FOR PRESSURE PIPING B31.8 SCHEDULE STD

For reference only

Nominal		Wall Thickness Inches	35,000 psi Yield Strength			
Pipe Size	Outside Diameter		Basic Design Factor			
		O.D.	T	0.40	0.50	0.60
1/2	0.840	0.109	3633	4542	5450	6540
3/4	1.050	0.113	3013	3767	4520	5424
1	1.315	0.133	2832	3540	4248	5097
1 1/4	1.660	0.140	2361	2952	3542	4251
1 1/2	1.900	0.145	2137	2671	3205	3846
2	2.375	0.154	1816	2269	2723	3268
2 1/2	2.875	0.203	1977	2471	2966	3559
3	3.500	0.216	1728	2160	2592	3110
3 1/2	4.000	0.226	1582	1978	2373	2848
4	4.500	0.237	1475	1843	2212	2654
5	5.563	0.258	1299	1623	1948	2337
6	6.625	0.280	1183	1479	1775	2130
8	8.625	0.322	1045	1307	1568	1882
10	10.750	0.365	951	1188	1426	1711
12	12.750	0.375	824	1029	1235	1482
14	14.000	0.375	750	938	1125	1350
16	16.000	0.375	656	820	984	1181
18	18.000	0.375	583	729	875	1050
20	20.000	0.375	525	656	788	945
24	24.000	0.375	438	547	656	788
30	30.000	0.375	350	438	525	630
36	36.000	0.375	292	365	438	525
42	42.000	0.375	250	313	375	450
48	48.000	0.375	219	273	328	394

Please review B31.8 for formula information.

### WELDBEND NOTES

- All dimensions are in inches.
- All values listed in table above to be considered as a guide only.  
Please refer to B31.8 for formula and other factors that could effect the determination of pressure ratings.
- A joint sufficiency factor of 1.00 is assumed.
- Ratings are for a temperature of 250°F or less.

TECHNICAL DATA



## BUTTWELD FITTINGS PRESSURE RATINGS

BASED ON THE CODE FOR PRESSURE PIPING B31.8

**SCHEDULE XS**

For reference only

Nominal		Wall Thickness Inches	35,000 psi Yield Strength			
Pipe Size	Outside Diameter		Basic Design Factor			
	O.D.		T	0.40	0.50	0.60
½	0.840	0.147	4900	6125	7350	8820
¾	1.050	0.154	4107	5133	6160	7392
1	1.315	0.179	3811	4764	5717	6861
1 ¼	1.660	0.191	3222	4027	4833	5799
1 ½	1.900	0.200	2947	3684	4421	5305
2	2.375	0.218	2570	3213	3855	4626
2 ½	2.875	0.276	2688	3360	4032	4838
3	3.500	0.300	2400	3000	3600	4320
3 ½	4.000	0.318	2226	2783	3339	4007
4	4.500	0.337	2097	2621	3145	3774
5	5.563	0.375	1887	2359	2831	3397
6	6.625	0.432	1826	2282	2739	3286
8	8.625	0.500	1623	2029	2435	2922
10	10.750	0.500	1302	1628	1953	2344
12	12.750	0.500	1098	1373	1647	1976
14	14.000	0.500	1000	1250	1500	1800
16	16.000	0.500	875	1094	1313	1575
18	18.000	0.500	778	972	1167	1400
20	20.000	0.500	700	875	1050	1260
24	24.000	0.500	583	729	875	1050
30	30.000	0.500	467	583	700	840
36	36.000	0.500	389	486	583	700
42	42.000	0.500	333	417	500	600
48	48.000	0.500	292	365	438	525

Please review B31.8 for formula information.

**WELDBEND NOTES**

- All dimensions are in inches.
- All values listed in table above to be considered as a guide only. Please refer to B31.8 for formula and other factors that could effect the determination of pressure ratings.
- A joint sufficiency factor of 1.00 is assumed.
- Ratings are for a temperature of 250°F or less.



## BASED ON THE CODE FOR PRESSURE PIPING B31.8 SCHEDULE 40

For reference only

Nominal		Wall Thickness Inches	35,000 psi Yield Strength			
Pipe Size	Outside Diameter		Basic Design Factor			
	O.D.	T	0.40	0.50	0.60	0.72
FOR DIMENSION SPECIFICATIONS ½" THROUGH 10" REFER TO SCHEDULE STD						
12	12.750	0.406	892	1115	1337	1605
14	14.000	0.438	876	1095	1314	1577
16	16.000	0.500	875	1094	1313	1575
18	18.000	0.562	874	1093	1311	1574
20	20.000	0.594	832	1040	1247	1497
24	24.000	0.688	803	1003	1204	1445
36	36.000	0.750	583	729	875	1050

## BASED ON THE CODE FOR PRESSURE PIPING B31.8 SCHEDULE 80

For reference only

Nominal		Wall Thickness Inches	35,000 psi Yield Strength			
Pipe Size	Outside Diameter		Basic Design Factor			
	O.D.	T	0.40	0.50	0.60	0.72
FOR DIMENSION SPECIFICATIONS ½" THROUGH 8" REFER TO SCHEDULE XS						
10	10.750	0.594	1547	1934	2321	2785
12	12.750	0.688	1511	1889	2266	2720
14	14.000	0.750	1500	1875	2250	2700
16	16.000	0.844	1477	1846	2216	2659
18	18.000	0.938	1459	1824	2189	2626
20	20.000	1.031	1443	1804	2165	2598
24	24.000	1.219	1422	1778	2133	2560

Please review B31.8 for formula information.

### WELDBEND NOTES

- All dimensions are in inches.
- All values listed in table above to be considered as a guide only.  
Please refer to B31.8 for formula and other factors that could effect the determination of pressure ratings.
- A joint sufficiency factor of 1.00 is assumed.
- Ratings are for a temperature of 250°F or less.



## BUTTWELD FITTINGS PRESSURE RATINGS

BASED ON CODE FOR PRESSURE PIPING B31.8  
**SCHEDULE 160**  
 For reference only

Nominal		Wall Thickness Inches	35,000 psi Yield Strength			
Pipe Size	Outside Diameter		Basic Design Factor			
		O.D.	T	0.40	0.50	0.60
½	0.840	0.188	6267	7833	9400	11280
¾	1.050	0.219	5840	7300	8760	10512
1	1.315	0.250	5323	6654	7985	9582
1 ¼	1.660	0.250	4217	5271	6325	7590
1 ½	1.900	0.281	4141	5176	6212	7454
2	2.375	0.344	4056	5069	6083	7300
2 ½	2.875	0.375	3652	4565	5478	6574
3	3.500	0.438	3504	4380	5256	6307
4	4.500	0.531	3304	4130	4956	5947
5	5.563	0.625	3146	3932	4719	5662
6	6.625	0.719	3039	3798	4558	5470
8	8.625	0.906	2941	3677	4412	5294
10	10.750	1.125	2930	3663	4395	5274
12	12.750	1.312	2881	3602	4322	5186
14	14.000	1.406	2812	3515	4218	5062
16	16.000	1.594	2790	3487	4184	5021
18	18.000	1.781	2770	3463	4156	4987
20	20.000	1.969	2757	3446	4135	4962
24	24.000	2.344	2735	3418	4102	4922

Please review B31.8 for formula information.

**WELDBEND** NOTES

1. All dimensions are in inches.
2. All values listed in table above to be considered as a guide only.  
Please refer to B31.8 for formula and other factors that could effect the determination of pressure ratings.
3. A joint sufficiency factor of 1.00 is assumed.
4. Ratings are for a temperature of 250°F or less.



# BUTTWELD FITTINGS PRESSURE RATINGS



## BASED ON CODE FOR PRESSURE PIPING B31.8 SCHEDULE XXS

For reference only

Nominal		Wall Thickness Inches	35,000 psi Yield Strength			
Pipe Size	Outside Diameter		Basic Design Factor			
		O.D.	T	0.40	0.50	0.60
1/2	0.840	0.294	9800	12250	14700	17640
3/4	1.050	0.308	8213	10267	12320	14784
1	1.315	0.358	7623	9529	11434	13721
1 1/4	1.660	0.382	6443	8054	9665	11598
1 1/2	1.900	0.400	5895	7368	8842	10611
2	2.375	0.436	5140	6425	7710	9252
2 1/2	2.875	0.552	5376	6720	8064	9677
3	3.500	0.600	4800	6000	7200	8640
4	4.500	0.674	4194	5242	6291	7549
5	5.563	0.750	3775	4719	5662	6795
6	6.625	0.864	3652	4565	5477	6573
8	8.625	0.875	2841	3551	4261	5113
10	10.750	1.000	2605	3256	3907	4688
12	12.750	1.000	2196	2745	3294	3953

Please review B31.8 for formula information.

### WELDBEND NOTES

1. All dimensions are in inches.
2. All values listed in table above to be considered as a guide only.  
Please refer to B31.8 for formula and other factors that could effect the determination of pressure ratings.
3. A joint sufficiency factor of 1.00 is assumed.
4. Ratings are for a temperature of 250°F or less.

## BUTTWELD FITTINGS PRESSURE RATINGS

BASED ON CODE FOR PRESSURE PIPING B31.8  
 SCHEDULE STD **WPHY-52**  
 For reference only

Nominal		Wall Thickness Inches	52,000 psi Yield Strength			
Pipe Size	Outside Diameter		Basic Design Factor			
		O.D.	T	0.40	0.50	0.60
1/2	0.840	0.109	5398	6748	8097	9717
3/4	1.050	0.113	4477	5596	6715	8059
1	1.315	0.133	4207	5259	6311	7573
1 1/4	1.660	0.140	3508	4386	5263	6315
1 1/2	1.900	0.145	3175	3968	4762	5715
2	2.375	0.154	2697	3372	4046	4855
2 1/2	2.875	0.203	2937	3672	4406	5287
3	3.500	0.216	2567	3209	3851	4621
3 1/2	4.000	0.226	2350	2938	3526	4231
4	4.500	0.237	2191	2739	3286	3944
5	5.563	0.258	1929	2412	2894	3473
6	6.625	0.280	1758	2198	2637	3165
8	8.625	0.322	1553	1941	2330	2796
10	10.750	0.365	1412	1766	2119	2542
12	12.750	0.375	1224	1529	1835	2202
14	14.000	0.375	1114	1393	1671	2006
16	16.000	0.375	975	1219	1463	1755
18	18.000	0.375	867	1083	1300	1560
20	20.000	0.375	780	975	1170	1404
24	24.000	0.375	650	813	975	1170
30	30.000	0.375	520	650	780	936
36	36.000	0.375	433	542	650	780
42	42.000	0.375	371	464	557	669
48	48.000	0.375	325	406	488	585

Please review B31.8 for formula information.

**WELDBEND** NOTES

- All dimensions are in inches.
- All values listed in table above to be considered as a guide only.  
Please refer to B31.8 for formula and other factors that could effect the determination of pressure ratings.
- A joint sufficiency factor of 1.00 is assumed.
- Ratings are for a temperature of 250°F or less.

# WPHY-52

# BUTTWELD FITTINGS PRESSURE RATINGS



BASED ON CODE FOR PRESSURE PIPING B31.8

**SCHEDULE XS WPHY-52**

For reference only

Nominal		Wall Thickness Inches	52,000 psi Yield Strength			
Pipe Size	Outside Diameter		Basic Design Factor			
	O.D.		T	0.40	0.50	0.60
1/2	0.840	0.147	7280	9100	10920	13104
3/4	1.050	0.154	6101	7627	9152	10982
1	1.315	0.179	5663	7078	8494	10193
1 1/4	1.660	0.191	4787	5983	7180	8616
1 1/2	1.900	0.200	4379	5474	6568	7882
2	2.375	0.218	3818	4773	5728	6873
2 1/2	2.875	0.276	3994	4992	5990	7188
3	3.500	0.300	3566	4457	5349	6418
3 1/2	4.000	0.318	3307	4134	4961	5953
4	4.500	0.337	3115	3894	4673	5608
5	5.563	0.375	2804	3505	4206	5048
6	6.625	0.432	2713	3391	4069	4883
8	8.625	0.500	2412	3014	3617	4341
10	10.750	0.500	1935	2419	2902	3483
12	12.750	0.500	1631	2039	2447	2936
14	14.000	0.500	1486	1857	2229	2674
16	16.000	0.500	1300	1625	1950	2340
18	18.000	0.500	1156	1444	1733	2080
20	20.000	0.500	1040	1300	1560	1872
24	24.000	0.500	867	1083	1300	1560
30	30.000	0.500	693	867	1040	1248
36	36.000	0.500	578	722	867	1040
42	42.000	0.500	495	619	743	891
48	48.000	0.500	433	542	650	780

Please review B31.8 for formula information.

**WELDBEND NOTES**

1. All dimensions are in inches.
2. All values listed in table above to be considered as a guide only. Please refer to B31.8 for formula and other factors that could effect the determination of pressure ratings.
3. A joint sufficiency factor of 1.00 is assumed.
4. Ratings are for a temperature of 250°F or less.

TECHNICAL DATA

# WPHY-52



## BUTTWELD FITTINGS PRESSURE RATINGS

BASED ON CODE FOR PRESSURE PIPING B31.8  
**SCHEDULE 40 WPHY-52**  
 For reference only

Nominal		Wall Thickness Inches	52,000 psi Yield Strength			
Pipe Size	Outside Diameter		Basic Design Factor			
	O.D.	T	0.40	0.50	0.60	0.72
FOR DIMENSION SPECIFICATIONS $\frac{1}{2}$ " THROUGH 10" REFER TO SCHEDULE STD						
12	12.750	0.406	1325	1656	1987	2384
14	14.000	0.438	1301	1627	1952	2343
16	16.000	0.500	1300	1625	1950	2340
18	18.000	0.562	1299	1624	1948	2338
20	20.000	0.594	1236	1544	1853	2224
24	24.000	0.688	1193	1491	1789	2147
36	36.000	0.750	867	1083	1300	1560

BASED ON CODE FOR PRESSURE PIPING B31.8  
**SCHEDULE 80 WPHY-52**  
 For reference only

Nominal		Wall Thickness Inches	52,000 psi Yield Strength			
Pipe Size	Outside Diameter		Basic Design Factor			
	O.D.	T	0.40	0.50	0.60	0.72
FOR DIMENSION SPECIFICATIONS $\frac{1}{2}$ " THROUGH 8" REFER TO SCHEDULE XS						
10	10.750	0.594	2299	2873	3448	4138
12	12.750	0.688	2245	2806	3367	4041
14	14.000	0.750	2229	2786	3343	4011
16	16.000	0.844	2194	2743	3292	3950
18	18.000	0.938	2168	2710	3252	3902
20	20.000	1.031	2144	2681	3217	3860
24	24.000	1.219	2113	2641	3169	3803

Please review B31.8 for formula information.

**WELDBEND NOTES**

- All dimensions are in inches.
- All values listed in table above to be considered as a guide only.  
 Please refer to B31.8 for formula and other factors that could effect the determination of pressure ratings.
- A joint sufficiency factor of 1.00 is assumed.
- Ratings are for a temperature of 250°F or less.

# WPHY-52

# BUTTWELD FITTINGS PRESSURE RATINGS



BASED ON CODE FOR PRESSURE PIPING B31.8

SCHEDULE 160 **WPHY-52**

For reference only

Nominal		Wall Thickness Inches	52,000 psi Yield Strength			
Pipe Size	Outside Diameter		Basic Design Factor			
		O.D.	T	0.40	0.50	0.60
1/2	0.840	0.188	9310	11638	13966	16759
3/4	1.050	0.219	8677	10846	13015	15618
1	1.315	0.250	7909	9886	11863	14236
1 1/4	1.660	0.250	6265	7831	9398	11277
1 1/2	1.900	0.281	6152	7691	9229	11074
2	2.375	0.344	6025	7532	9038	10846
2 1/2	2.875	0.375	5426	6783	8139	9767
3	3.500	0.438	5206	6507	7809	9371
4	4.500	0.531	4909	6136	7363	8836
5	5.563	0.625	4674	5842	7011	8413
6	6.625	0.719	4515	5643	6772	8127
8	8.625	0.906	4370	5462	6555	7866
10	10.750	1.125	4353	5442	6530	7836
12	12.750	1.312	4281	5351	6421	7705
14	14.000	1.406	4178	5222	6267	7520
16	16.000	1.594	4144	5181	6217	7460
18	18.000	1.781	4116	5145	6174	7409
20	20.000	1.969	4096	5119	6143	7372
24	24.000	2.344	4063	5079	6094	7313

Please review B31.8 for formula information.

**WELDBEND NOTES**

1. All dimensions are in inches.
2. All values listed in table above to be considered as a guide only.  
Please refer to B31.8 for formula and other factors that could effect the determination of pressure ratings.
3. A joint sufficiency factor of 1.00 is assumed.
4. Ratings are for a temperature of 250°F or less.

TECHNICAL DATA

# WPHY-52

## BUTTWELD FITTINGS PRESSURE RATINGS

BASED ON CODE FOR PRESSURE PIPING B31.8

SCHEDULE XXS **WPHY-52**

For reference only

Nominal		Wall Thickness Inches	52,000 psi Yield Strength			
Pipe Size	Outside Diameter		Basic Design Factor			
		O.D.	T	0.40	0.50	0.60
½	0.840	0.294	14560	18200	21840	26208
¾	1.050	0.308	12203	15253	18304	21965
1	1.315	0.358	11325	14157	16988	20386
1 ¼	1.660	0.382	9573	11966	14360	17231
1 ½	1.900	0.400	8758	10947	13137	15764
2	2.375	0.436	7637	9546	11455	13746
2 ½	2.875	0.552	7987	9984	11981	14377
3	3.500	0.600	7131	8914	10697	12837
4	4.500	0.674	6231	7788	9346	11215
5	5.563	0.750	5608	7011	8413	10095
6	6.625	0.864	5425	6782	8138	9765
8	8.625	0.875	4220	5275	6330	7597
10	10.750	1.000	3870	4837	5805	6966
12	12.750	1.000	3263	4078	4894	5873

Please review B31.8 for formula information.

### WELDBEND NOTES

1. All dimensions are in inches.
2. All values listed in table above to be considered as a guide only.  
Please refer to B31.8 for formula and other factors that could effect the determination of pressure ratings.
3. A joint sufficiency factor of 1.00 is assumed.
4. Ratings are for a temperature of 250°F or less.

# WPHY-52

# BUTTWELD FITTINGS PRESSURE RATINGS



## BASED ON CODE FOR PRESSURE PIPING B31.8 SCHEDULE STD WPHY-65

For reference only

Nominal		Wall Thickness Inches	65,000 psi Yield Strength			
Pipe Size	Outside Diameter		Basic Design Factor			
		O.D.	T	0.40	0.50	0.60
1/2	0.840	0.109	6748	8435	10121	12146
3/4	1.050	0.113	5596	6995	8394	10073
1	1.315	0.133	5259	6574	7889	9467
1 1/4	1.660	0.140	4386	5482	6578	7894
1 1/2	1.900	0.145	3968	4961	5953	7143
2	2.375	0.154	3372	4215	5058	6069
2 1/2	2.875	0.203	3672	4590	5507	6609
3	3.500	0.216	3209	4011	4814	5776
3 1/2	4.000	0.226	2938	3673	4407	5288
4	4.500	0.237	2739	3423	4108	4930
5	5.563	0.258	2412	3015	3617	4341
6	6.625	0.280	2198	2747	3297	3956
8	8.625	0.322	1941	2427	2912	3494
10	10.750	0.365	1766	2207	2648	3178
12	12.750	0.375	1529	1912	2294	2753
14	14.000	0.375	1393	1741	2089	2507
16	16.000	0.375	1219	1523	1828	2194
18	18.000	0.375	1083	1354	1625	1950
20	20.000	0.375	975	1219	1463	1755
24	24.000	0.375	813	1016	1219	1463
30	30.000	0.375	650	813	975	1170
36	36.000	0.375	542	677	813	975
42	42.000	0.375	464	580	696	836
48	48.000	0.375	406	508	609	731

Please review B31.8 for formula information.

### WELDBEND NOTES

- All dimensions are in inches.
- All values listed in table above to be considered as a guide only.  
Please refer to B31.8 for formula and other factors that could effect the determination of pressure ratings.
- A joint sufficiency factor of 1.00 is assumed.
- Ratings are for a temperature of 250°F or less.

TECHNICAL DATA

# WPHY-65

## BUTTWELD FITTINGS PRESSURE RATINGS

BASED ON CODE FOR PRESSURE PIPING B31.8  
**SCHEDULE XS WPHY-65**  
 For reference only

Nominal		Wall Thickness Inches	65,000 psi Yield Strength			
Pipe Size	Outside Diameter		Basic Design Factor			
	O.D.		T	0.40	0.50	0.60
1/2	0.840	0.147	9100	11375	13650	16380
3/4	1.050	0.154	7627	9533	11440	13728
1	1.315	0.179	7078	8848	10617	12741
1 1/4	1.660	0.191	5983	7479	8975	10770
1 1/2	1.900	0.200	5474	6842	8211	9853
2	2.375	0.218	4773	5966	7160	8591
2 1/2	2.875	0.276	4992	6240	7488	8986
3	3.500	0.300	4457	5571	6686	8023
3 1/2	4.000	0.318	4134	5168	6201	7441
4	4.500	0.337	3894	4868	5841	7010
5	5.563	0.375	3505	4382	5258	6310
6	6.625	0.432	3391	4238	5086	6103
8	8.625	0.500	3014	3768	4522	5426
10	10.750	0.500	2419	3023	3628	4353
12	12.750	0.500	2039	2549	3059	3671
14	14.000	0.500	1857	2321	2786	3343
16	16.000	0.500	1625	2031	2438	2925
18	18.000	0.500	1444	1806	2167	2600
20	20.000	0.500	1300	1625	1950	2340
24	24.000	0.500	1083	1354	1625	1950
30	30.000	0.500	867	1083	1300	1560
36	36.000	0.500	722	903	1083	1300
42	42.000	0.500	619	774	929	1114
48	48.000	0.500	542	677	813	975

Please review B31.8 for formula information.

**WELDBEND NOTES**

- All dimensions are in inches.
- All values listed in table above to be considered as a guide only. Please refer to B31.8 for formula and other factors that could effect the determination of pressure ratings.
- A joint sufficiency factor of 1.00 is assumed.
- Ratings are for a temperature of 250°F or less.

# WPHY-65

TECHNICAL DATA

# BUTTWELD FITTINGS PRESSURE RATINGS

BASED ON CODE FOR PRESSURE PIPING B31.8

**SCHEDULE 40 WPHY-65**

For reference only

Nominal		Wall Thickness Inches	65,000 psi Yield Strength			
Pipe Size	Outside Diameter		Basic Design Factor			
	O.D.	T	0.40	0.50	0.60	0.72
FOR DIMENSION SPECIFICATIONS ½" THROUGH 10" REFER TO SCHEDULE STD						
12	12.750	0.406	1656	2070	2484	2981
14	14.000	0.438	1627	2034	2440	2928
16	16.000	0.500	1625	2031	2438	2925
18	18.000	0.562	1624	2029	2435	2922
20	20.000	0.594	1544	1931	2317	2780
24	24.000	0.688	1491	1863	2236	2683
36	36.000	0.750	1083	1354	1625	1950

BASED ON CODE FOR PRESSURE PIPING B31.8

**SCHEDULE 80 WPHY-65**

For reference only

Nominal		Wall Thickness Inches	65,000 psi Yield Strength			
Pipe Size	Outside Diameter		Basic Design Factor			
	O.D.	T	0.40	0.50	0.60	0.72
FOR DIMENSION SPECIFICATIONS ½" THROUGH 8" REFER TO SCHEDULE XS						
10	10.750	0.594	2873	3592	4310	5172
12	12.750	0.688	2806	3507	4209	5051
14	14.000	0.750	2786	3482	4179	5014
16	16.000	0.844	2743	3429	4115	4937
18	18.000	0.938	2710	3387	4065	4878
20	20.000	1.031	2681	3351	4021	4825
24	24.000	1.219	2641	3301	3962	4754

Please review B31.8 for formula information.

**WELDBEND NOTES**

1. All dimensions are in inches.
2. All values listed in table above to be considered as a guide only.  
Please refer to B31.8 for formula and other factors that could effect the determination of pressure ratings.
3. A joint sufficiency factor of 1.00 is assumed.
4. Ratings are for a temperature of 250°F or less.

# WPHY-65

## BUTTWELD FITTINGS PRESSURE RATINGS

BASED ON CODE FOR PRESSURE PIPING B31.8  
 SCHEDULE 160 WPHY-65  
 For reference only

Nominal		Wall Thickness Inches	65,000 psi Yield Strength			
Pipe Size	Outside Diameter		Basic Design Factor			
		O.D.	T	0.40	0.50	0.60
1/2	0.840	0.188	11638	14548	17457	20949
3/4	1.050	0.219	10846	13557	16269	19522
1	1.315	0.250	9886	12357	14829	17795
1 1/4	1.660	0.250	7831	9789	11747	14096
1 1/2	1.900	0.281	7691	9613	11536	13843
2	2.375	0.344	7532	9415	11298	13557
2 1/2	2.875	0.375	6783	8478	10174	12209
3	3.500	0.438	6507	8134	9761	11713
4	4.500	0.531	6136	7670	9204	11045
5	5.563	0.625	5842	7303	8763	10516
6	6.625	0.719	5643	7054	8465	10158
8	8.625	0.906	5462	6828	8193	9832
10	10.750	1.125	5442	6802	8163	9795
12	12.750	1.312	5351	6689	8026	9632
14	14.000	1.406	5222	6528	7833	9400
16	16.000	1.594	5181	6476	7771	9325
18	18.000	1.781	5145	6431	7718	9261
20	20.000	1.969	5119	6399	7679	9215
24	24.000	2.344	5079	6348	7618	9142

Please review B31.8 for formula information.

**WELDBEND** NOTES

1. All dimensions are in inches.
2. All values listed in table above to be considered as a guide only.  
Please refer to B31.8 for formula and other factors that could effect the determination of pressure ratings.
3. A joint sufficiency factor of 1.00 is assumed.
4. Ratings are for a temperature of 250°F or less.

# WPHY-65

# BUTTWELD FITTINGS PRESSURE RATINGS



## BASED ON CODE FOR PRESSURE PIPING B31.8 SCHEDULE XXS WPHY-65

For reference only

Nominal		Wall Thickness Inches	65,000 psi Yield Strength			
Pipe Size	Outside Diameter		Basic Design Factor			
		O.D.	T	0.40	0.50	0.60
½	0.840	0.294	18200	22750	27300	32760
¾	1.050	0.308	15253	19067	22880	27456
1	1.315	0.358	14157	17696	21235	25482
1 ¼	1.660	0.382	11966	14958	17949	21539
1 ½	1.900	0.400	10947	13684	16421	19705
2	2.375	0.436	9546	11933	14319	17183
2 ½	2.875	0.552	9984	12480	14976	17971
3	3.500	0.600	8914	11143	13371	16046
4	4.500	0.674	7788	9736	11683	14019
5	5.563	0.750	7011	8763	10516	12619
6	6.625	0.864	6782	8477	10172	12207
8	8.625	0.875	5275	6594	7913	9496
10	10.750	1.000	4837	6047	7256	8707
12	12.750	1.000	4078	5098	6118	7341

Please review B31.8 for formula information.

### WELDBEND NOTES

1. All dimensions are in inches.
2. All values listed in table above to be considered as a guide only.  
Please refer to B31.8 for formula and other factors that could effect the determination of pressure ratings.
3. A joint sufficiency factor of 1.00 is assumed.
4. Ratings are for a temperature of 250°F or less.

# WPHY-65



## EQUIVALENT LENGTH OF WELDBEND ELBOWS AND TEES

Nominal Pipe Size	Long Radius	Short Radius	Welding Tee
1	1.1	1.4	3.9
1 ¼	1.4	1.8	5.2
1 ½	1.6	2.1	6.0
2	2.1	2.8	7.8
2 ½	2.6	3.3	9.3
3	3.1	4.1	11.0
4	4.0	5.4	15.0
5	5.1	6.7	19.0
6	6.1	8.1	23.0
8	8.0	11.0	30.0
10	10.0	12.0	38.0
12	12.0	16.0	45.0
14	13.0	18.0	49.0
16	15.0	20.0	56.0
18	17.0	23.0	63.0
20	19.0	25.0	71.0
24	23.0	30.0	85.0
30	30.0	36.0	140.0
36	38.0	42.0	170.0
42	45.0	50.0	200.0
48	52.0	58.0	240.0

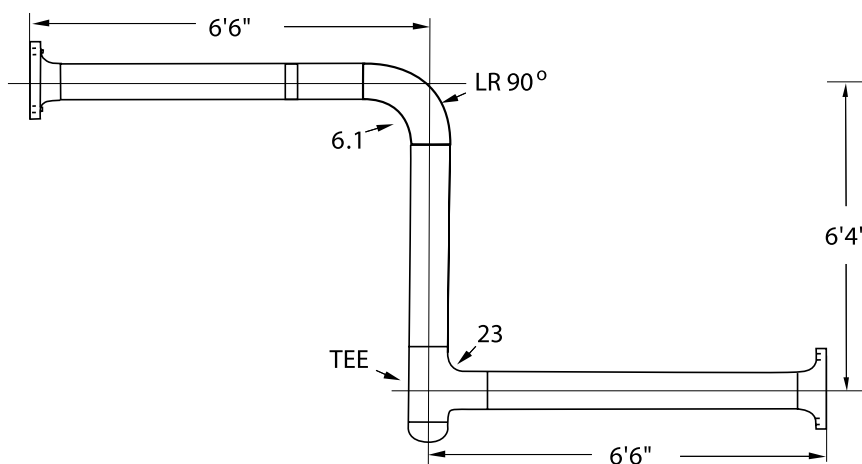

The information given in the chart above illustrates the resistance of fittings to the flow of liquids. This resistance is given in the equivalent of the straight pipe, and should be assumed as approximate information. Allowances have been made up for the curvature of elbows, so that the resistance values should be added to the total center-to-end dimensions of the piping configuration.

As an example: Using 6" pipe:

Resistance of Pipe:	(6.6 + 6.4 + 6.6) = 19.6
+ Resistance of Elbow:	= 6.1
Resistance of Tee:	= 23.0
	<hr/>
	= 48.7

Therefore, the total resistance of the entire assembly to the flow of liquid would be equal to the resistance of 48.7 Linear feet of 6" straight pipe.

# FLOW RESISTANCE FOR FITTINGS

There are a number of general formulas for determination of steady flow pressure drop available. One preferred by many is expressed as follows:

$$\Delta p = \frac{.00219 f \rho v^2 L}{d}$$

- Where:  $\Delta p$  = Pressure drop (psi)  
 $f$  = Friction factor (dimensionless)  
 $\rho$  = Density (lb/ft<sup>3</sup>)  
 $v$  = Velocity of flow (ft/sec)  
 $L$  = Equivalent length of straight pipe (ft)  
 $d$  = Inside diameter of pipe (in)

In order to determine the friction factor,  $f$ , for use with this formula, it is necessary to first calculate the appropriate Reynolds number,  $R$ , and then to select it from the graph below.

The formula for calculating  $R$  is:

$$R = \frac{124 d v \rho}{\mu}$$

- Where:  $R$  = Reynolds number (dimensionless)  
 $\mu$  = Absolute viscosity (centipoise)

Values for  $\rho$  and  $\mu$  for different liquids and gases are available in various engineering handbooks.

As an example, if water at 70°F is flowing through the 6" assembly of the previous page at an average velocity of 20 ft/sec. the pressure drop due to flow friction (only) may be calculated as follows:

For water  $\mu = 470 (T + 30)^{-1.35} = 0.94$  and  $\rho = 62.37 \text{ lb/ft}^3$

$$R = \frac{124(6.06)(20)(62.37)}{0.94} = 997000 \approx 10^6$$

then  $f = .015$  (From graph below)

and  $\Delta p = \frac{.00129(.015)(62.37)(20)^2(48.43)}{6.06} = 3.86 \approx 4$

Therefore, the approximate pressure drop from flange to flange, due only to flow friction, is 4 psi. Calculation of total pressure drop would have to also take into account any change in elevation.

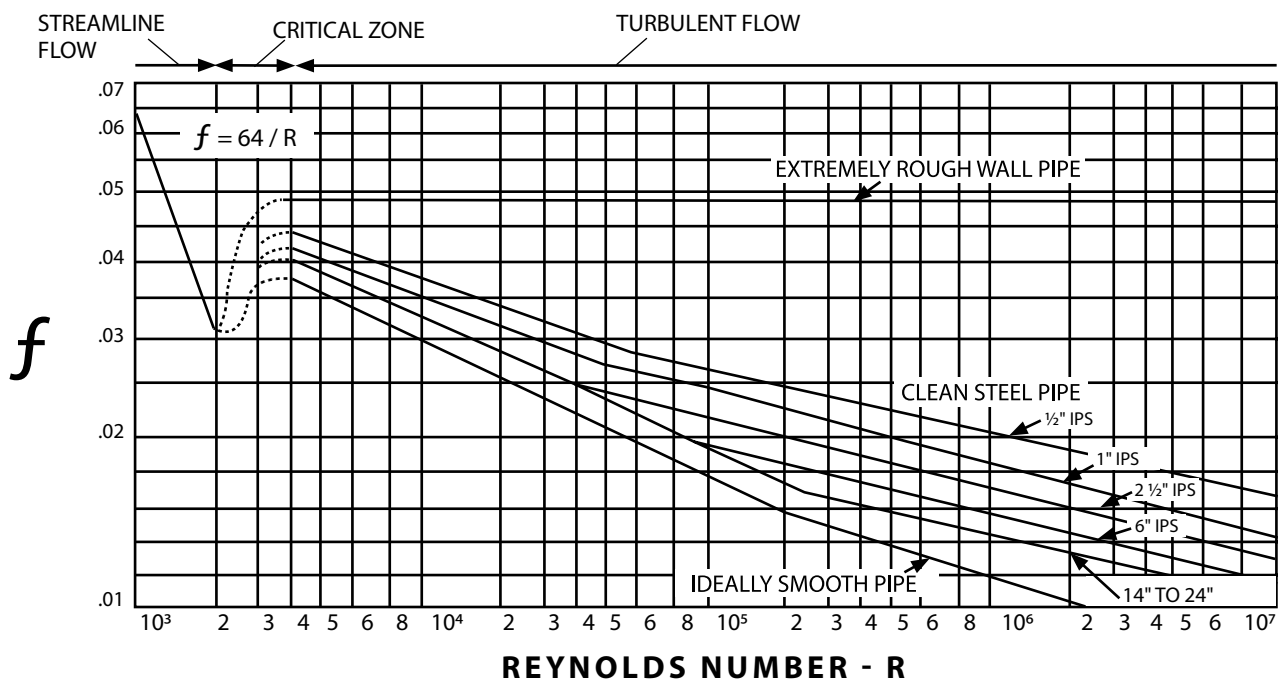

## FLEXIBILITY AND STRESS INTENSIFICATION FACTORS

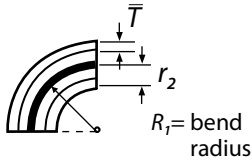
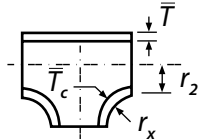
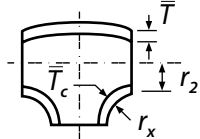
Stress Intensification Factor [Notes 2, 3]					
Description	Flexibility Factor $k$	Out-plane $i_o$	In-plane $i_i$	Flexibility Characteristic $h$	Sketch
Welding elbow or pipe bend [Notes 1, 2]	$\frac{1.65}{h}$	$\frac{0.75}{h^{2/3}}$	$\frac{0.9}{h^{2/3}}$	$\frac{\bar{T}R_1}{r_2^2}$	
Welding tee with $r_x \geq 0.05 D_b$ $\bar{T}_c < 1.5 \bar{T}$ [Notes 1, 2, 3]	1	$\frac{0.9}{h^{2/3}}$	$3/4 i_o + 1/4$	$\left(1 + \frac{r_x}{r_2}\right) \frac{\bar{T}}{r_2}$	
Welding tee with $r_x \geq 1/8 D_b$ $\bar{T}_c \geq 1.5 \bar{T}$ [Notes 1, 2, 3]	1	$\frac{0.9}{h^{2/3}}$	$3/4 i_o + 1/4$	$4.4 \frac{\bar{T}}{r_2}$	

Description	Flexibility Factor $k$	Stress Intensification Factor $i$
Butt welded joint, reducer, or weld neck flange	1	1.0
Double-welded slip-on flange	1	1.2
Lap joint flange (with ASME B16.9 lap joint stub)	1	1.6
Threaded pipe joint, or threaded flange	1	2.3

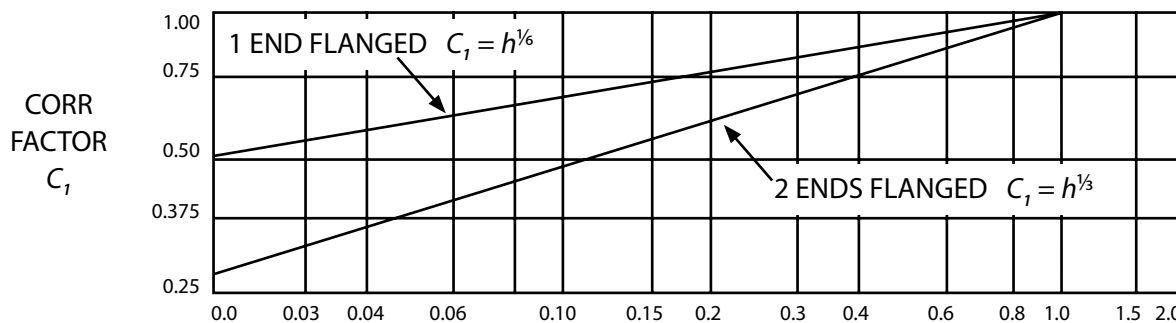

### WELDBEND NOTES

1. The flexibility factor,  $k$ , applies to bending in any plane. The flexibility factor  $k$ , and stress intensification factor,  $i$ , shall not be less than unity.
2.  $\bar{T}$  = Nominal wall thickness of elbows.  
 $\bar{T}$  = Nominal wall thickness of matching pipe or tees.  
 $\bar{T}_c$  = Crotch thickness of tees.  
 $r_2$  = Mean radius of matching pipe.
3. When radius and thickness limits are not met for this component, use  $h = \bar{T}/r_2$ .
4. Where flanges are attached to one or both ends, the values of  $k$  and  $i$  shall be corrected by the factors  $C_1$  from graph above.

## TOTAL LINEAR THERMAL EXPANSION FROM 70° F TO THE TEMPERATURE

Temperature °F	Expansion Inches / 100 ft.
-325	-2.37
-300	-2.24
-275	-2.11
-250	-1.98
-225	-1.85
-200	-1.71
-175	-1.30
-150	-1.45
-125	-1.30
-100	-1.15
-75	-1.00
-50	-0.84
-25	-0.68
0	-0.49
25	-0.32
50	-0.14
70	0.00
100	0.23
125	0.42
150	0.61
200	0.99
225	1.21
250	1.40
275	1.61
300	1.82
325	2.04
350	2.26
375	2.48
400	2.70
425	2.93
450	3.16
475	3.39
500	3.62
525	3.86
550	4.11

Temperature °F	Expansion Inches / 100 ft.
575	4.35
600	4.60
625	4.86
650	5.11
675	5.37
700	5.63
725	5.90
750	6.16
775	6.43
800	6.70
825	6.97
850	7.25
875	7.53
900	7.81
925	8.08
950	8.35
975	8.62
1000	8.89
1075	9.75
1050	9.46
1075	9.75
1100	10.04
1125	10.31
1150	10.57
1175	10.83
1200	11.10
1225	11.38
1250	11.66
1275	11.94
1300	12.22
1325	12.50
1350	12.78
1375	13.06
1400	13.34

**SCHEDULE STD**  
 For reference only

Pipe Size	Wall Thickness Designation	Outside Diameter	Inside Diameter	Wall Thickness
		O.D.	I.D.	T
½	STD	0.840	0.622	0.109
¾	STD	1.050	0.824	0.113
1	STD	1.315	1.049	0.133
1 ¼	STD	1.660	1.380	0.140
1 ½	STD	1.900	1.610	0.145
2	STD	2.375	2.067	0.154
2 ½	STD	2.875	2.469	0.203
3	STD	3.500	3.068	0.216
3 ½	STD	4.000	3.548	0.226
4	STD	4.500	4.026	0.237
5	STD	5.563	5.047	0.258
6	STD	6.625	6.065	0.280
8	STD	8.625	7.981	0.322
10	STD	10.750	10.020	0.365
12	STD	12.750	12.000	0.375
14	STD	14.000	13.250	0.375
16	STD	16.000	15.250	0.375
18	STD	18.000	17.250	0.375
20	STD	20.000	19.250	0.375
24	STD	24.000	23.250	0.375
30	STD	30.000	29.250	0.375
36	STD	36.000	35.250	0.375
42	STD	42.000	41.250	0.375
48	STD	48.000	47.250	0.375

**WELDBEND NOTES**

1. All dimensions are in inches.
2. Designations per ASME B36.10.  
 STD = SCHEDULE STANDARD WALL THICKNESS
3. Conforms to ASME B36.10.

## SCHEDULE XS

For reference only

Pipe Size	Wall Thickness Designation	Outside Diameter	Inside Diameter	Wall Thickness
		O.D.	I.D.	T
½	XS	0.840	0.546	0.147
¾	XS	1.050	0.742	0.154
1	XS	1.315	0.957	0.179
1 ¼	XS	1.660	1.278	0.191
1 ½	XS	1.900	1.500	0.200
2	XS	2.375	1.939	0.218
2 ½	XS	2.875	2.323	0.276
3	XS	3.500	2.900	0.300
3 ½	XS	4.000	3.364	0.318
4	XS	4.500	3.826	0.337
5	XS	5.563	4.813	0.375
6	XS	6.625	5.761	0.432
8	XS	8.625	7.625	0.500
10	XS	10.750	9.750	0.500
12	XS	12.750	11.750	0.500
14	XS	14.000	13.000	0.500
16	XS	16.000	15.000	0.500
18	XS	18.000	17.000	0.500
20	XS	20.000	19.000	0.500
24	XS	24.000	23.000	0.500
30	XS	30.000	29.000	0.500
36	XS	36.000	35.000	0.500
42	XS	42.000	41.000	0.500
48	XS	48.000	47.000	0.500

### WELDBEND NOTES

1. All dimensions are in inches.
2. Designations per ASME B36.10.  
XS = SCHEDULE **EXTRA-STRONG** WALL THICKNESS
3. Conforms to ASME B36.10.

**SCHEDULE 40**  
 For reference only

Pipe Size	Wall Thickness Designation	Outside Diameter	Inside Diameter	Wall Thickness
		O.D.	I.D.	T
<b>FOR DIMENSION SPECIFICATIONS            ½" THROUGH 10" REFER TO SCHEDULE STD</b>				
12	40	12.750	11.938	0.406
14	40	14.000	13.124	0.438
16	40	16.000	15.000	0.500
18	40	18.000	16.876	0.562
20	40	20.000	18.812	0.594
24	40	24.000	22.624	0.688
36	40	36.000	34.500	0.750

**SCHEDULE 80**  
 For reference only

Pipe Size	Wall Thickness Designation	Outside Diameter	Inside Diameter	Wall Thickness
		O.D.	I.D.	T
<b>FOR DIMENSION SPECIFICATIONS            ½" THROUGH 8" REFER TO SCHEDULE XS</b>				
14	80	14.000	12.500	0.750
16	80	16.000	14.312	0.844
18	80	18.000	16.124	0.938
20	80	20.000	17.938	1.031
24	80	24.000	21.562	1.219

**WELDBEND NOTES**

- All dimensions are in inches.
- Designations per ASME B36.10.  
 40 = SCHEDULE 40 WALL THICKNESS  
 80 = SCHEDULE 80 WALL THICKNESS
- Conforms to ASME B36.10.

## SCHEDULE 160

For reference only

Pipe Size	Wall Thickness Designation	Outside Diameter	Inside Diameter	Wall Thickness
		O.D.	I.D.	T
½	160	0.840	0.464	0.188
¾	160	1.050	0.612	0.219
1	160	1.315	0.815	0.250
1 ¼	160	1.660	1.160	0.250
1 ½	160	1.900	1.338	0.281
2	160	2.375	1.687	0.344
2 ½	160	2.875	2.125	0.375
3	160	3.500	2.624	0.438
4	160	4.500	3.438	0.531
5	160	5.563	4.313	0.625
6	160	6.625	5.187	0.719
8	160	8.625	6.813	0.906
10	160	10.750	8.500	1.125
12	160	12.750	10.126	1.312
14	160	14.000	11.188	1.406
16	160	16.000	12.812	1.594
18	160	18.000	14.438	1.781
20	160	20.000	16.062	1.969
24	160	24.00	19.314	2.343

### WELDBEND NOTES

- All dimensions are in inches.
- Designations per ASME B36.10.  
160 = SCHEDULE 160 WALL THICKNESS
- Conforms to ASME B36.10.



**SCHEDULE XXS**  
 For reference only

Pipe Size	Wall Thickness Designation	Outside Diameter	Inside Diameter	Wall Thickness
		O.D.	I.D.	T
½	XXS	0.840	0.252	0.294
¾	XXS	1.050	0.434	0.308
1	XXS	1.315	0.599	0.358
1 ¼	XXS	1.660	0.896	0.382
1 ½	XXS	1.900	1.100	0.400
2	XXS	2.375	1.503	0.436
2 ½	XXS	2.875	1.771	0.552
3	XXS	3.500	2.300	0.600
4	XXS	4.500	3.152	0.674
5	XXS	5.563	4.063	0.750
6	XXS	6.625	4.897	0.864
8	XXS	8.625	6.875	0.875
10	XXS	10.750	8.750	1.000
12	XXS	12.750	10.750	1.000

**WELDBEND NOTES**

1. All dimensions are in inches.
2. Designations per ASME B36.10.  
 XXS = SCHEDULE **DOUBLE EXTRA-STRONG** WALL THICKNESS
3. Conforms to ASME B36.10.

# DIMENSIONS OF STEEL PIPE



Pipe Size	Outside Diameter	Designation	Wall Thickness	Inside Diameter	Weight Per Foot	Weight of Water per Foot of Pipe	Sq. Ft. Outside Surface per Ft.	Sq. Ft. Inside Surface per Ft.
	O.D.	SCH	T	I.D.				
1/2	0.840	5	0.065	0.710	0.54	0.172	0.220	0.186
		10	0.083	0.674	0.67	0.155	0.220	0.176
		30	0.095	0.650	0.76	0.144	0.220	0.170
		STD (40)	0.109	0.622	0.85	0.132	0.220	0.163
		XS (80)	0.147	0.546	1.09	0.101	0.220	0.143
		160	0.188	0.464	1.31	0.073	0.220	0.121
		XXS	0.294	0.252	1.72	0.022	0.220	0.066
3/4	1.050	5	0.065	0.920	0.69	0.288	0.275	0.241
		10	0.083	0.884	0.86	0.266	0.275	0.231
		30	0.095	0.860	0.97	0.252	0.275	0.225
		STD (40)	0.113	0.824	1.13	0.231	0.275	0.216
		XS (80)	0.154	0.742	1.48	0.187	0.275	0.194
		160	0.219	0.612	1.95	0.127	0.275	0.160
		XXS	0.308	0.434	2.44	0.064	0.275	0.114
1	1.315	5	0.065	1.185	0.87	0.478	0.344	0.310
		10	0.109	1.097	1.41	0.409	0.344	0.287
		30	0.114	1.087	1.46	0.402	0.344	0.285
		STD (40)	0.133	1.049	1.68	0.374	0.344	0.275
		XS (80)	0.179	0.957	2.17	0.312	0.344	0.251
		160	0.250	0.815	2.85	0.226	0.344	0.213
		XXS	0.358	0.599	3.66	0.122	0.344	0.157
1 1/4	1.660	5	0.065	1.530	1.11	0.796	0.435	0.401
		10	0.109	1.442	1.81	0.707	0.435	0.378
		30	0.117	1.426	1.93	0.692	0.435	0.373
		STD (40)	0.140	1.380	2.27	0.648	0.435	0.361
		XS (80)	0.191	1.278	3.00	0.556	0.435	0.335
		160	0.250	1.160	3.77	0.458	0.435	0.304
		XXS	0.382	0.896	5.22	0.273	0.435	0.235
1 1/2	1.900	5	0.065	1.770	1.28	1.066	0.497	0.463
		10	0.109	1.682	2.09	0.963	0.497	0.440
		30	0.125	1.650	2.37	0.926	0.497	0.432
		STD (40)	0.145	1.610	2.72	0.882	0.497	0.421
		XS (80)	0.200	1.500	3.63	0.766	0.497	0.393
		160	0.281	1.338	4.86	0.609	0.497	0.350
		XXS	0.400	1.100	6.41	0.412	0.497	0.288

TECHNICAL DATA

## DIMENSIONS OF STEEL PIPE

Pipe Size	Outside Diameter	Designation	Wall Thickness	Inside Diameter	Weight Per Foot	Weight of Water per Foot of Pipe	Sq. Ft. Outside Surface per Ft.	Sq. Ft. Inside Surface per Ft.
	O.D.	SCH	T	I.D.				
2	2.375	5	0.065	2.245	1.61	1.715	0.622	0.588
		10	0.109	2.157	2.64	1.583	0.622	0.565
		30	0.125	2.125	3.01	1.536	0.622	0.556
		STD (40)	0.154	2.067	3.66	1.454	0.622	0.541
		XS (80)	0.218	1.939	5.03	1.279	0.622	0.508
		160	0.344	1.687	7.47	0.968	0.622	0.442
		XXS	0.436	1.503	9.04	0.769	0.622	0.393
2 ½	2.875	5	0.083	2.709	2.48	2.497	0.753	0.709
		10	0.120	2.635	3.53	2.362	0.753	0.690
		30	0.188	2.499	5.40	2.125	0.753	0.654
		STD (40)	0.203	2.469	5.80	2.074	0.753	0.646
		XS (80)	0.276	2.323	7.67	1.836	0.753	0.608
		160	0.375	2.125	10.02	1.536	0.753	0.556
		XXS	0.552	1.771	13.71	1.067	0.753	0.464
3	3.500	5	0.083	3.334	3.03	3.782	0.916	0.873
		10	0.120	3.260	4.34	3.616	0.916	0.853
		30	0.188	3.124	6.66	3.320	0.916	0.818
		STD (40)	0.216	3.068	7.58	3.202	0.916	0.803
		XS (80)	0.300	2.900	10.26	2.861	0.916	0.759
		160	0.438	2.624	14.34	2.343	0.916	0.687
		XXS	0.600	2.300	18.60	1.800	0.916	0.602
3 ½	4.000	5	0.083	3.834	3.48	5.001	1.047	1.004
		10	0.120	3.760	4.98	4.810	1.047	0.984
		30	0.188	3.624	7.66	4.468	1.047	0.949
		STD (40)	0.226	3.548	9.12	4.283	1.047	0.929
		XS (80)	0.318	3.364	12.52	3.850	1.047	0.881
4	4.500	5	0.083	4.334	3.92	6.391	1.178	1.135
		10	0.120	4.260	5.62	6.174	1.178	1.115
		30	0.188	4.124	8.67	5.786	1.178	1.080
		STD (40)	0.237	4.026	10.80	5.515	1.178	1.054
		XS (80)	0.337	3.826	15.00	4.980	1.178	1.002
		120	0.438	3.624	19.02	4.468	1.178	0.949
		160	0.531	3.438	22.53	4.022	1.178	0.900
		XXS	0.674	3.152	27.57	3.380	1.178	0.825

# DIMENSIONS OF STEEL PIPE



Pipe Size	Outside Diameter	Designation	Wall Thickness	Inside Diameter	Weight Per Foot	Weight of Water per Foot of Pipe	Sq. Ft. Outside Surface per Ft.	Sq. Ft. Inside Surface per Ft.
	O.D.	SCH	T	I.D.				
5	5.563	5	0.109	5.345	6.36	9.720	1.456	1.399
		10	0.134	5.295	7.78	9.539	1.456	1.386
		STD (40)	0.258	5.047	14.63	8.667	1.456	1.321
		XS (80)	0.375	4.813	20.80	7.882	1.456	1.260
		120	0.500	4.563	27.06	7.084	1.456	1.195
		160	0.625	4.313	32.99	6.329	1.456	1.129
		XXS	0.750	4.063	38.59	5.617	1.456	1.064
6	6.625	5	0.109	6.407	7.59	13.967	1.734	1.677
		10	0.134	6.357	9.30	13.749	1.734	1.664
		STD (40)	0.280	6.065	18.99	12.515	1.734	1.588
		XS (80)	0.432	5.761	28.60	11.292	1.734	1.508
		120	0.562	5.501	36.43	10.296	1.734	1.440
		160	0.719	5.187	45.39	9.154	1.734	1.358
		XXS	0.864	4.897	53.21	8.159	1.734	1.282
8	8.625	5	0.109	8.407	9.92	24.047	2.258	2.201
		10	0.148	8.329	13.41	23.603	2.258	2.181
		20	0.250	8.125	22.38	22.461	2.258	2.127
		30	0.277	8.071	24.72	22.163	2.258	2.113
		STD (40)	0.322	7.981	28.58	21.672	2.258	2.089
		60	0.406	7.813	35.67	20.769	2.258	2.045
		XS (80)	0.500	7.625	43.43	19.781	2.258	1.996
		100	0.594	7.437	51.00	18.818	2.258	1.947
		120	0.719	7.187	60.77	17.574	2.258	1.882
		140	0.812	7.001	67.82	16.676	2.258	1.833
		XXS	0.875	6.875	72.49	16.081	2.258	1.800
		160	0.906	6.813	74.76	15.793	2.258	1.784
10	10.750	5	0.134	10.482	15.21	37.382	2.814	2.744
		10	0.165	10.420	18.67	36.941	2.814	2.728
		20	0.250	10.250	28.06	35.746	2.814	2.683
		30	0.307	10.136	34.27	34.955	2.814	2.654
		STD (40)	0.365	10.020	40.52	34.160	2.814	2.623
		XS (60)	0.500	9.750	54.79	32.344	2.814	2.553
		80	0.594	9.562	64.49	31.108	2.814	2.503
		100	0.719	9.312	77.10	29.503	2.814	2.438
		120	0.844	9.062	89.38	27.940	2.814	2.372
		XXS (140)	1.000	8.750	104.23	26.049	2.814	2.291
		160	1.125	8.500	115.75	24.582	2.814	2.225

TECHNICAL DATA

## DIMENSIONS OF STEEL PIPE

Pipe Size	Outside Diameter	Designation	Wall Thickness	Inside Diameter	Weight Per Foot	Weight of Water per Foot of Pipe	Sq. Ft. Outside Surface per Ft.	Sq. Ft. Inside Surface per Ft.
	O.D.	SCH	T	I.D.				
12	12.750	5	0.156	12.438	21.00	52.636	3.338	3.256
		10	0.180	12.390	24.19	52.230	3.338	3.244
		20	0.250	12.250	33.41	51.056	3.338	3.207
		30	0.330	12.090	43.81	49.731	3.338	3.165
		STD	0.375	12.000	49.61	48.994	3.338	3.142
		40	0.406	11.938	53.47	48.489	3.338	3.125
		XS	0.500	11.750	65.48	46.974	3.338	3.076
		60	0.562	11.626	73.22	45.987	3.338	3.044
		80	0.688	11.374	88.71	44.015	3.338	2.978
		100	0.844	11.062	107.42	41.634	3.338	2.896
		XXS (120)	1.000	10.750	125.61	39.318	3.338	2.814
		140	1.125	10.500	139.81	37.511	3.338	2.749
160	1.312	10.126	160.42	34.886	3.338	2.651		
14	14.000	5	0.156	13.688	23.09	63.747	3.665	3.584
		10	0.250	13.500	36.75	62.008	3.665	3.534
		20	0.312	13.376	45.65	60.874	3.665	3.502
		STD (30)	0.375	13.250	54.62	59.732	3.665	3.469
		40	0.438	13.124	63.50	58.602	3.665	3.436
		XS	0.500	13.000	72.16	57.500	3.665	3.403
		60	0.594	12.812	85.13	55.849	3.665	3.354
		80	0.750	12.500	106.23	53.162	3.665	3.272
		100	0.938	12.124	130.98	50.012	3.665	3.174
		120	1.094	11.812	150.93	47.471	3.665	3.092
		140	1.250	11.500	170.37	44.996	3.665	3.011
		160	1.406	11.188	189.29	42.588	3.665	2.929
16	16.000	5	0.165	15.670	27.93	83.544	4.189	4.102
		10	0.250	15.500	42.09	81.741	4.189	4.058
		20	0.312	15.376	52.32	80.439	4.189	4.025
		STD (30)	0.375	15.250	62.64	79.126	4.189	3.992
		XS (40)	0.500	15.000	82.85	76.553	4.189	3.927
		60	0.656	14.688	107.60	73.401	4.189	3.845
		80	0.844	14.312	136.74	69.691	4.189	3.747
		100	1.031	13.938	164.98	66.097	4.189	3.649
		120	1.219	13.562	192.61	62.579	4.189	3.551
		140	1.438	13.124	223.85	58.602	4.189	3.436
		160	1.594	12.812	245.48	55.849	4.189	3.354

# DIMENSIONS OF STEEL PIPE



Pipe Size	Outside Diameter	Designation	Wall Thickness	Inside Diameter	Weight Per Foot	Weight of Water per Foot of Pipe	Sq. Ft. Outside Surface per Ft.	Sq. Ft. Inside Surface per Ft.
	O.D.	SCH	T	I.D.				
18	18.000	5	0.165	17.670	31.46	106.231	4.712	4.626
		10	0.250	17.500	47.44	104.197	4.712	4.581
		20	0.312	17.376	58.99	102.725	4.712	4.549
		STD	0.375	17.250	70.65	101.241	4.712	4.516
		30	0.438	17.124	82.23	99.767	4.712	4.483
		XS	0.500	17.000	93.54	98.328	4.712	4.451
		40	0.562	16.876	104.76	96.899	4.712	4.418
		60	0.750	16.500	138.30	92.629	4.712	4.320
		80	0.938	16.124	171.08	88.455	4.712	4.221
		100	1.156	15.688	208.15	83.736	4.712	4.107
		120	1.375	15.250	244.37	79.126	4.712	3.992
		140	1.562	14.876	274.48	75.292	4.712	3.895
160	1.781	14.438	308.79	70.924	4.712	3.780		
20	20.000	5	0.188	19.624	39.82	131.025	5.236	5.138
		10	0.250	19.500	52.78	129.374	5.236	5.105
		STD (20)	0.375	19.250	78.67	126.078	5.236	5.040
		XS (30)	0.500	19.000	104.23	122.825	5.236	4.974
		40	0.594	18.812	123.23	120.406	5.236	4.925
		60	0.812	18.376	166.56	114.889	5.236	4.811
		80	1.031	17.938	209.06	109.478	5.236	4.696
		100	1.281	17.438	256.34	103.460	5.236	4.565
		120	1.500	17.000	296.65	98.328	5.236	4.451
		140	1.750	16.500	341.41	92.629	5.236	4.320
		160	1.969	16.062	379.53	87.776	5.236	4.205
24	24.000	5	0.218	23.564	55.42	188.919	6.283	6.169
		10	0.250	23.500	63.47	187.894	6.283	6.152
		STD (20)	0.375	23.250	94.71	183.918	6.283	6.087
		XS	0.500	23.000	125.61	179.984	6.283	6.021
		30	0.562	22.876	140.81	178.049	6.283	5.989
		40	0.688	22.624	171.45	174.147	6.283	5.923
		60	0.969	22.062	238.57	165.603	6.283	5.776
		80	1.219	21.562	296.86	158.182	6.283	5.645
		100	1.531	20.938	367.74	149.159	6.283	5.482
		120	1.812	20.376	429.79	141.259	6.283	5.334
		140	2.062	19.876	483.57	134.411	6.283	5.204
		160	2.344	19.312	542.67	126.892	6.283	5.056

TECHNICAL DATA

## DIMENSIONS OF STEEL PIPE

Pipe Size	Outside Diameter	Designation	Wall Thickness	Inside Diameter	Weight Per Foot	Weight of Water per Foot of Pipe	Sq. Ft. Outside Surface per Ft.	Sq. Ft. Inside Surface per Ft.
	O.D.	SCH	T	I.D.				
30	30.000	5	0.250	29.500	79.51	296.089	7.854	7.723
		10	0.312	29.376	99.02	293.605	7.854	7.691
		STD	0.375	29.250	118.76	291.092	7.854	7.658
		XS (20)	0.500	29.000	157.68	286.137	7.854	7.592
		30	0.625	28.750	196.26	281.225	7.854	7.527
36	36.000	10	0.312	35.376	119.03	425.790	9.425	9.261
		STD	0.375	35.250	142.81	422.763	9.425	9.228
		XS (20)	0.500	35.000	189.75	416.787	9.425	9.163
		30	0.625	34.750	236.35	410.854	9.425	9.098
		40	0.750	34.500	282.62	404.964	9.425	9.032
42	42.000	STD	0.375	41.250	166.86	578.930	10.996	10.799
		XS	0.500	41.000	221.82	571.934	10.996	10.734
48	48.000	STD	0.375	47.250	190.92	759.595	12.566	12.370
		XS	0.500	47.000	253.89	751.578	12.566	12.305

## FOR WELDBEND FORGED STEEL PIPE FLANGES

Listed below are the dimensional tolerances to which Weldbend flanges are manufactured. These tolerances are a part of ASME B16.5 except where noted otherwise. The limits given are maximum.

Slip-on, Threaded, Blind and Lap Joint		
Outside Diameter	When O.D. is 24" or Less	± .06" *
	When O.D. is Over 24"	± .12" *
Inside Diameter	Threaded	To Standard Gauge Limits*
	Slip-on and Lap Joint	10" and Smaller + .03" , - 0" * 12" and Larger + .06" , - 0" *
Outside Diameter of Hub	NPS ≤ 5"	+ .09" , - .03" *
	NPS ≥ 6"	+ .16" , - .03" *
Diameter of Contact Face	NPS ≤ 10"	± .03"
	NPS ≥ 12"	± .06"
Diameter of Counterbore (Threaded)	NPS ≤ 10"	+ .03" , - 0"
	NPS ≥ 12"	+ .06" , - 0"
Drilling	Bolt Circle Diameter	± .06"
	Hole Spacing	± .03"
	Bolt Circle Concentricity	2 1/2" and Smaller ± .03"
3" and Larger ± .06"		
Thickness	NPS ≤ 18"	+ .12" , - 0"
	NPS ≥ 20"	+ .19" , - 0"
Length Thru Hub	NPS ≤ 10"	10" and Smaller ± .06" * , - 0" *
	NPS ≥ 12"	12" through 48" ± .12" *

Welding Neck **		
Outside Diameter	When O.D. is 24" or Less	± .06"
	When O.D. is Over 24"	± .12"
Inside Diameter		10" and Smaller ± .03"
		12" through 18" ± .06"
		20" through 48" + .12" , - .06"
Diameter of Contact Face	NPS ≤ 10"	± .03"
	NPS ≥ 12"	± .06"
Drilling	Bolt Circle Diameter	± .06"
	Hole Spacing	± .03"
	Bolt Circle Concentricity	2 1/2" and Smaller ± .03"
3" and Larger ± .06"		
Thickness	NPS ≤ 18"	+ .12" , - 0"
	NPS ≥ 20"	+ .19" , - 0"
Length Thru Hub	NPS ≤ 4"	± .06"
	5" ≤ NPS ≤ 10"	+ .06" , - .12"
	12" ≤ NPS ≤ 24"	+ .12" , - .18"
	NPS ≥ 26"	+ .12" , - .18"

### WELDBEND NOTES

1. All dimensions are in inches.

\* This Tolerance not covered in ASME B16.5.

\*\* For bevel detail see page 107.

\*\*\* This Tolerance applies to flat face flanges, sizes 1/2" through 24", and sizes 3" and larger flanges with raised face and other machined facings.

Refer to Section 7 of ASME B16.5 for complimentary information.



Flanges, welding necks, and other products designed for bolted connection, when furnished with raised face (or flat faced) may have any type of gasket surface finished that is required. The common finishes are described in the following paragraphs and it should be noted particularly that, unless otherwise specified by the purchaser, the STOCK FINISH will be furnished.

### STOCK FINISH (WELDBEND STANDARD FINISH)

From 125 micro inches to 250 micro inches average roughness shall be furnished. The cutting tool employed should have an approximate 0.06 inches or larger radius.

### SMOOTH FINISH

This finish, which can be produced by several shapes of tools, shows no definite tool markings apparent to the naked eye. In the past this finish was sometimes known as "Smooth Plane". This term, however, should be avoided because of a tendency to confuse it with "flat faced" which, of course, applies to the flange facing and not to the gasket surface finish.

### COLD WATER FINISH

Producing by using a wide tool at high speeds, this finish is equivalent to that of a ground surface. It is mirror-like in appearance and surfaces finished in this manner are usually expected to be used without gaskets.

### SPIRAL SERRATED

This too, is a continuous spiral groove, but it differs from the stock finish in that the groove is generated with a 90° included angle "V" tool. This groove is 1/64" deep and the feed is 1/32" for all sizes.

### CONCENTRIC SERRATED

As the name suggests this surface finish is made up of concentric grooves. A 90° included angle "V" tool is used and the grooves are 1/64" deep and 1/32" apart.

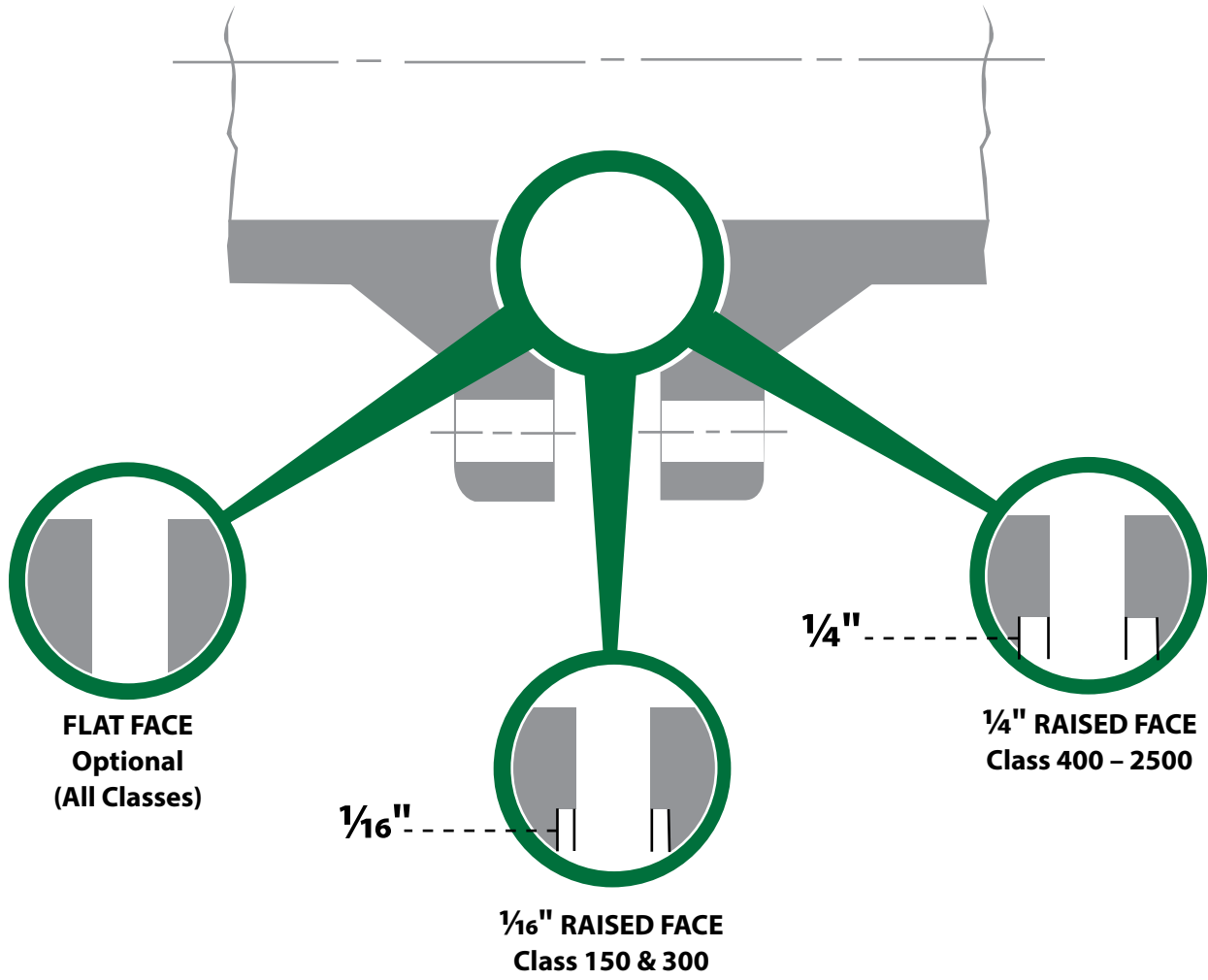

**FACING DIMENSIONS (OTHER THAN RING JOINTS)**

Below are B16.5 facing dimensions for Classes 150, 300, 600, 900, 1500 and 2500\* through 24 inches. Above 24" is in accord with ASME B16.47.

Pipe Size	Outside Diameter	Height	
	Raised Face,	Raised Face Class 150 & 300	Raised Face Class 400 - 2500
1/2	1.38	0.06	0.25
3/4	1.69	0.06	0.25
1	2.00	0.06	0.25
1 1/4	2.50	0.06	0.25
1 1/2	2.88	0.06	0.25
2	3.62	0.06	0.25
2 1/2	4.12	0.06	0.25
3	5.00	0.06	0.25
3 1/2	5.50	0.06	0.25
4	6.19	0.06	0.25
5	7.31	0.06	0.25
6	8.50	0.06	0.25
8	10.62	0.06	0.25
10	12.75	0.06	0.25
12	15.00	0.06	0.25
14	16.25	0.06	0.25
16	18.50	0.06	0.25
18	21.00	0.06	0.25
20	23.00	0.06	0.25
24	27.25	0.06	0.25

Pipe Size	Maximum Radial Projection of Imperfections Which Are No Deeper Than the Bottom of the Serrations, in.	Maximum Depth and Projection of Imperfections Which Are Deeper Than the Bottom of the Serrations, in.
1/2	0.12	0.06
3/4	0.12	0.06
1	0.12	0.06
1 1/4	0.12	0.06
1 1/2	0.12	0.06
2	0.12	0.06
2 1/2	0.12	0.06
3	0.18	0.06
3 1/2	0.25	0.12
4	0.25	0.12
5	0.25	0.12
6	0.25	0.12
8	0.31	0.18
10	0.31	0.18
12	0.31	0.18
14	0.31	0.18
16	0.38	0.18
18	0.50	0.25
20	0.50	0.25
24	0.50	0.25

**WELDBEND NOTES**

1. All dimensions are in inches.
  2. Finishes for raised face portion of the flange can be found on page 145.
  3. Flange finishing is also in accordance with MSS-SP6.
  4. For facing tolerances, see page 144.
- \* ASME B16.5 only covers 2500 flanges up thru 12".

**TECHNICAL DATA**

# RING TYPE JOINT FACING DIMENSIONS

## CLASS 150

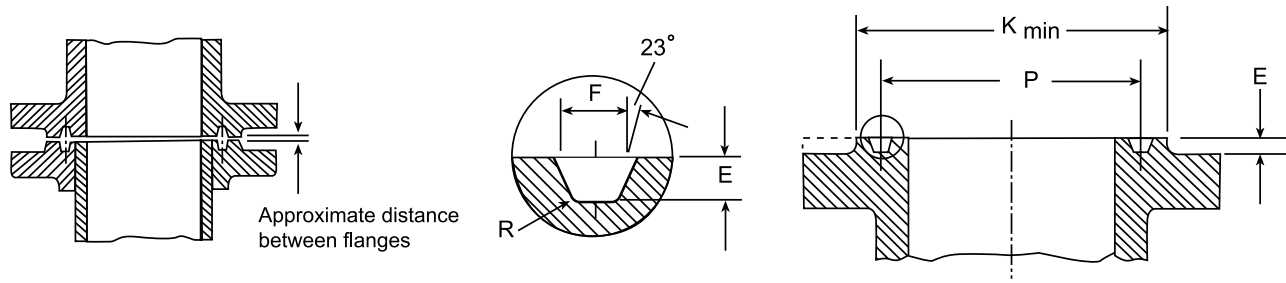

Nominal		Groove Number	Groove Dimensions				
Pipe Size	Outside Diameter		Pitch Diameter	Depth	Width	Radius at Bottom	Diameter of Gasket
	O.D.		P	E	F	R	K
1	4.25	R15	1.875	0.250	0.344	0.03	2.50
1 ¼	4.62	R17	2.250	0.250	0.344	0.03	2.88
1 ½	5.00	R19	2.562	0.250	0.344	0.03	3.25
2	6.00	R22	3.250	0.250	0.344	0.03	4.00
2 ½	7.00	R25	4.000	0.250	0.344	0.03	4.75
3	7.50	R29	4.500	0.250	0.344	0.03	5.25
3 ½	8.50	R33	5.188	0.250	0.344	0.03	6.06
4	9.00	R36	5.875	0.250	0.344	0.03	6.75
5	10.00	R40	6.750	0.250	0.344	0.03	7.62
6	11.00	R43	7.625	0.250	0.344	0.03	8.62
8	13.50	R48	9.750	0.250	0.344	0.03	10.75
10	16.00	R52	12.000	0.250	0.344	0.03	13.00
12	19.00	R56	15.000	0.250	0.344	0.03	16.00
14	21.00	R59	15.625	0.250	0.344	0.03	16.75
16	23.50	R64	17.875	0.250	0.344	0.03	19.00
18	25.00	R68	20.375	0.250	0.344	0.03	21.50
20	27.50	R72	22.000	0.250	0.344	0.03	23.50
24	32.00	R76	26.500	0.250	0.344	0.03	28.00

### WELDBEND NOTES

- All dimensions are in inches.
- Height of raised portion is equal to the depth of groove dimension E, but is not subjected to the tolerances for E. Former full-face contour may be used.
- Tolerances:
  - E (depth) + 0.016, - 0.0
  - F (width) ± 0.008
  - P (pitch diameter) ± 0.005
  - R (radius at bottom)
  - R ≤ 0.06 + 0.03, - 0.0;
  - R > 0.06 ± 0.03
  - 23° (angle) = ½°

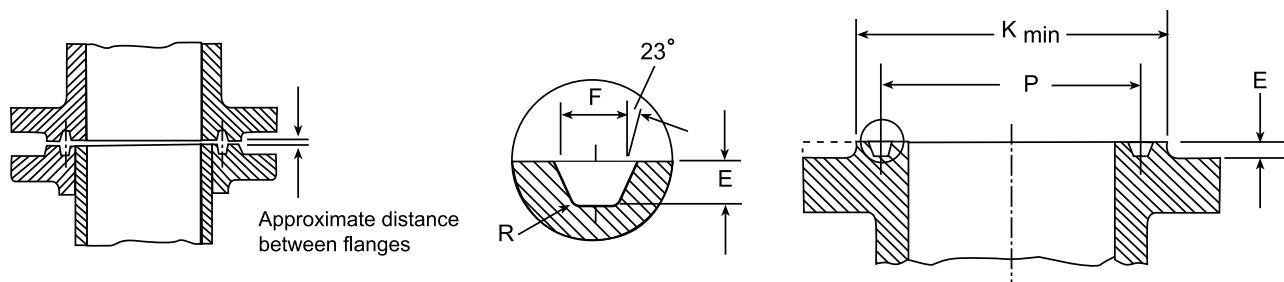

Nominal		Groove Number	Groove Dimensions				
Pipe Size	Outside Diameter		Pitch Diameter	Depth	Width	Radius at Bottom	Diameter of Gasket
	O.D.		P	E	F	R	K
1/2	3.75	R11	1.344	0.219	0.281	0.03	2.00
3/4	4.62	R13	1.688	0.250	0.344	0.03	2.50
1	4.88	R16	2.000	0.250	0.344	0.03	2.75
1 1/4	5.25	R18	2.375	0.250	0.344	0.03	3.12
1 1/2	6.12	R20	2.688	0.250	0.344	0.03	3.56
2	6.50	R23	3.250	0.312	0.469	0.03	4.25
2 1/2	7.50	R26	4.000	0.312	0.469	0.03	5.00
3	8.25	R31	4.875	0.312	0.469	0.03	5.75
3 1/2	9.00	R34	5.188	0.312	0.469	0.03	6.25
4	10.00	R37	5.875	0.312	0.469	0.03	6.88
5	11.00	R41	7.125	0.312	0.469	0.03	8.25
6	12.50	R45	8.312	0.312	0.469	0.03	9.50
8	15.00	R49	10.625	0.312	0.469	0.03	11.88
10	17.50	R53	12.750	0.312	0.469	0.03	14.00
12	20.50	R57	15.000	0.312	0.469	0.03	16.25
14	23.00	R61	16.500	0.312	0.469	0.03	18.00
16	25.50	R65	18.500	0.312	0.469	0.03	20.00
18	28.00	R69	21.000	0.312	0.469	0.03	22.62
20	30.50	R73	23.000	0.375	0.531	0.06	25.00
24	36.00	R77	27.250	0.438	0.656	0.06	29.50

### WELDBEND NOTES

- All dimensions are in inches.
- Height of raised portion is equal to the depth of groove dimension E, but is not subjected to the tolerances for E. Former full-face contour may be used.
- Tolerances:  
 E (depth) + 0.016, - 0.0  
 F (width) ± 0.008  
 P (pitch diameter) ± 0.005  
 R (radius at bottom)  
 R ≤ 0.06 + 0.03, - 0.0;  
 R > 0.06 ± 0.03  
 23° (angle) = 1/2°
- For ring joints with lapped flanges in Class 300 and 600, ring and groove number R30 are used instead of R31.

# RING TYPE JOINT FACING DIMENSIONS

## CLASS 600

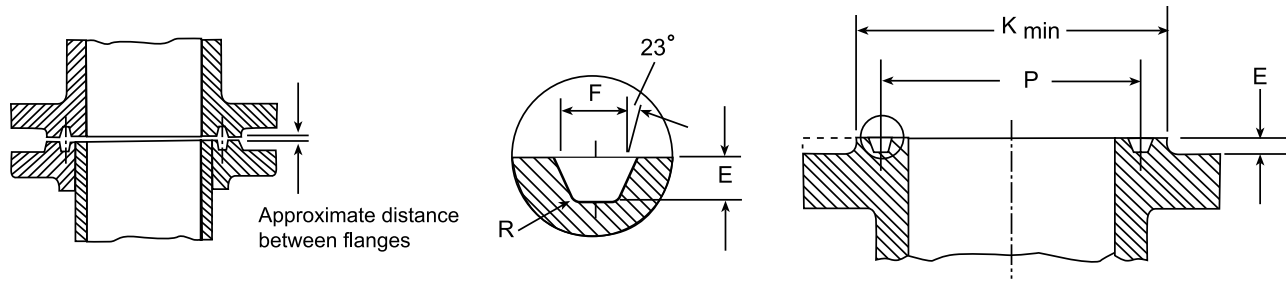

Nominal		Groove Number	Groove Dimensions				
Pipe Size	Outside Diameter		Pitch Diameter	Depth	Width	Radius at Bottom	Diameter of Gasket
	O.D.						
1/2	3.75	R11	1.344	0.219	0.281	0.03	2.00
3/4	4.62	R13	1.688	0.250	0.344	0.03	2.50
1	4.88	R16	2.000	0.250	0.344	0.03	2.75
1 1/4	5.25	R18	2.375	0.250	0.344	0.03	3.12
1 1/2	6.12	R20	2.688	0.250	0.344	0.03	3.56
2	6.50	R23	3.250	0.312	0.469	0.03	4.25
2 1/2	7.50	R26	4.000	0.312	0.469	0.03	5.00
3	8.25	R31	4.875	0.312	0.469	0.03	5.75
3 1/2	9.00	R34	5.188	0.312	0.469	0.03	6.25
4	10.75	R37	5.875	0.312	0.469	0.03	6.88
5	13.00	R41	7.125	0.312	0.469	0.03	8.25
6	14.00	R45	8.312	0.312	0.469	0.03	9.50
8	16.50	R49	10.625	0.312	0.469	0.03	11.88
10	20.00	R53	12.750	0.312	0.469	0.03	14.00
12	22.00	R57	15.000	0.312	0.469	0.03	16.25
14	23.75	R61	16.500	0.312	0.469	0.03	18.00
16	27.00	R65	18.500	0.312	0.469	0.03	20.00
18	29.25	R69	21.000	0.312	0.469	0.03	22.62
20	32.00	R73	23.000	0.375	0.531	0.06	25.00
24	37.00	R77	27.250	0.438	0.656	0.06	29.50

### WELDBEND NOTES

- All dimensions are in inches.
- Height of raised portion is equal to the depth of groove dimension E, but is not subjected to the tolerances for E. Former full-face contour may be used.
- Tolerances:  
 E (depth) + 0.016, - 0.0  
 F (width) ± 0.008  
 P (pitch diameter) ± 0.005  
 R (radius at bottom)  
 R ≤ 0.06 + 0.03, - 0.0;  
 R > 0.06 ± 0.03  
 23° (angle) = 1/2°
- For ring joints with lapped flanges in Class 300 and 600, ring and groove number R30 are used instead of R31.

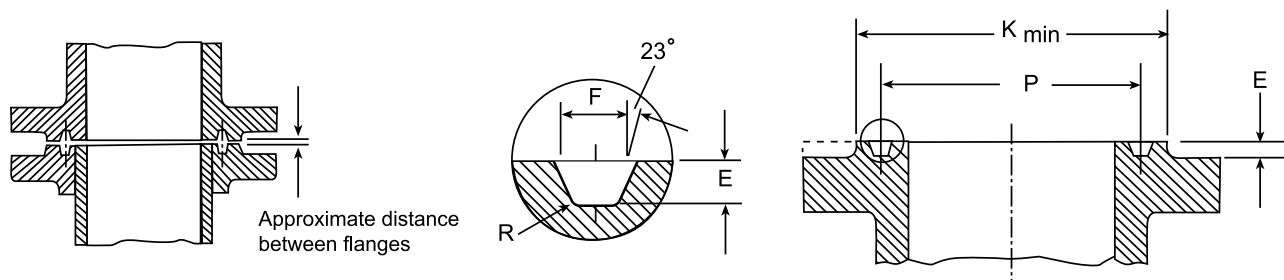

Nominal		Groove Number	Groove Dimensions				
Pipe Size	Outside Diameter		Pitch Diameter	Depth	Width	Radius at Bottom	Diameter of Gasket
	O.D.						
½	4.75	R12	1.562	0.250	0.344	0.03	2.38
¾	5.12	R14	1.750	0.250	0.344	0.03	2.62
1	5.88	R16	2.000	0.250	0.344	0.03	2.81
1 ¼	6.25	R18	2.375	0.250	0.344	0.03	3.19
1 ½	7.00	R20	2.688	0.250	0.344	0.03	3.62
2	8.50	R24	3.750	0.312	0.469	0.03	4.88
2 ½	9.62	R27	4.250	0.312	0.469	0.03	5.38
3	9.50	R31	4.875	0.312	0.469	0.03	6.12
4	11.50	R37	5.875	0.312	0.469	0.03	7.12
5	13.75	R41	7.125	0.312	0.469	0.03	8.50
6	15.00	R45	8.312	0.312	0.469	0.03	9.50
8	18.50	R49	10.625	0.312	0.469	0.03	12.12
10	21.50	R53	12.750	0.312	0.469	0.03	14.25
12	24.00	R57	15.000	0.312	0.469	0.03	16.50
14	25.25	R62	16.500	0.438	0.656	0.06	18.38
16	27.75	R66	18.500	0.438	0.656	0.06	20.62
18	31.00	R70	21.000	0.500	0.781	0.06	23.38
20	33.75	R74	23.000	0.500	0.781	0.06	25.50
24	41.00	R78	27.250	0.625	1.062	0.09	30.38

### WELDBEND NOTES

- All dimensions are in inches.
- Height of raised portion is equal to the depth of groove dimension E, but is not subjected to the tolerances for E. Former full-face contour may be used.
- Tolerances:  
 E (depth) + 0.016, - 0.0  
 F (width) ± 0.008  
 P (pitch diameter) ± 0.005  
 R (radius at bottom)  
 R ≤ 0.06 + 0.03, - 0.0;  
 R > 0.06 ± 0.03  
 23° (angle) = ½°
- Use Class 1500 in sizes NPS ½ to NPS 2 ½ for Class 900.

# RING TYPE JOINT FACING DIMENSIONS



## CLASS 1500

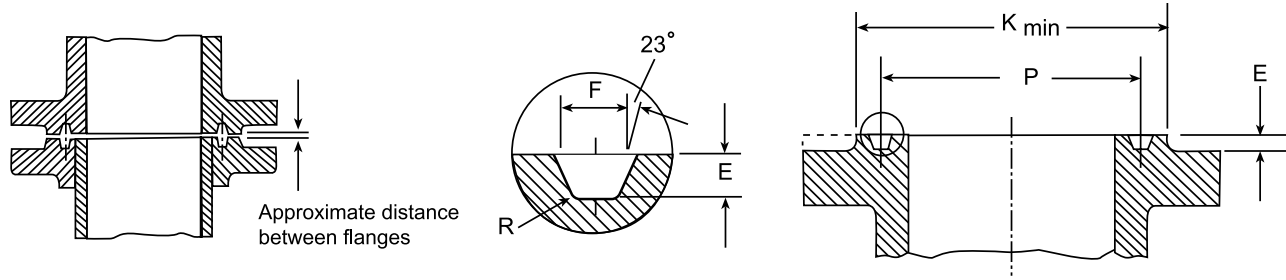

Nominal		Groove Number	Groove Dimensions				
Pipe Size	Outside Diameter		Pitch Diameter	Depth	Width	Radius at Bottom	Diameter of Gasket
	O.D.		P	E	F	R	K
1/2	4.75	R12	1.562	0.250	0.344	0.03	2.38
3/4	5.12	R14	1.750	0.250	0.344	0.03	2.62
1	5.88	R16	2.000	0.250	0.344	0.03	2.81
1 1/4	6.25	R18	2.375	0.250	0.344	0.03	3.19
1 1/2	7.00	R20	2.688	0.250	0.344	0.03	3.62
2	8.50	R24	3.750	0.312	0.469	0.03	4.88
2 1/2	9.62	R27	4.250	0.312	0.469	0.03	5.38
3	10.50	R35	5.375	0.312	0.469	0.03	6.62
4	12.25	R39	6.375	0.312	0.469	0.03	7.62
5	14.75	R44	7.625	0.312	0.469	0.03	9.00
6	15.50	R46	8.312	0.375	0.531	0.06	9.75
8	19.00	R50	10.625	0.438	0.656	0.06	12.50
10	23.00	R54	12.750	0.438	0.656	0.06	14.62
12	26.50	R58	15.000	0.562	0.906	0.06	17.25
14	29.50	R63	16.500	0.625	1.062	0.09	19.25
16	32.50	R67	18.500	0.688	1.188	0.09	21.50
18	36.00	R71	21.000	0.688	1.188	0.09	24.12
20	38.75	R75	23.000	0.688	1.312	0.09	26.50
24	46.00	R79	27.250	0.812	1.438	0.09	31.25

### WELDBEND NOTES

- All dimensions are in inches.
- Height of raised portion is equal to the depth of groove dimension E, but is not subjected to the tolerances for E. Former full-face contour may be used.
- Tolerances:  
 E (depth) + 0.016, - 0.0  
 F (width) ± 0.008  
 P (pitch diameter) ± 0.005  
 R (radius at bottom)  
 R ≤ 0.06 + 0.03, - 0.0;  
 R > 0.06 ± 0.03  
 23° (angle) = 1/2°



# RING TYPE JOINT FACING DIMENSIONS

## CLASS 2500

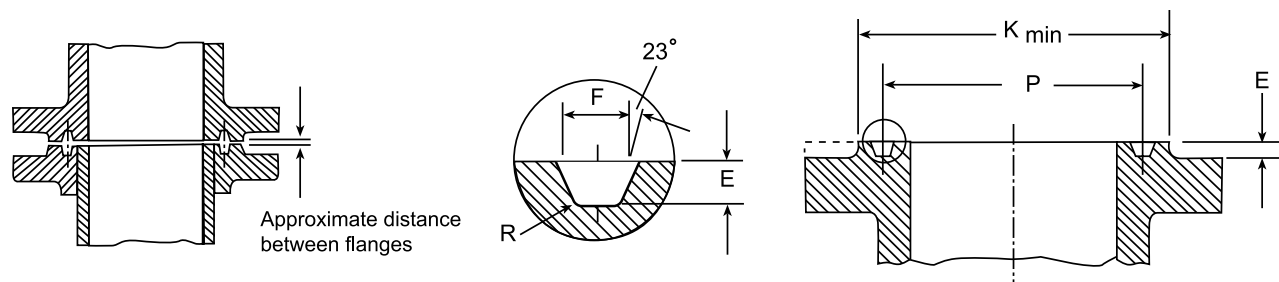

Nominal		Groove Number	Groove Dimensions				
Pipe Size	Outside Diameter		Pitch Diameter	Depth	Width	Radius at Bottom	Diameter of Gasket
	O.D.		P	E	F	R	K
1/2	5.25	R13	1.688	0.250	0.344	0.03	2.56
3/4	5.50	R16	2.000	0.250	0.344	0.03	2.88
1	6.25	R18	2.375	0.250	0.344	0.03	3.25
1 1/4	7.25	R21	2.844	0.312	0.469	0.03	4.00
1 1/2	8.00	R23	3.250	0.312	0.469	0.03	4.50
2	9.25	R26	4.000	0.312	0.469	0.03	5.25
2 1/2	10.50	R28	4.375	0.375	0.531	0.06	5.88
3	12.00	R32	5.000	0.375	0.531	0.06	6.62
4	14.00	R38	6.188	0.438	0.656	0.06	8.00
5	16.50	R42	7.500	0.500	0.781	0.06	9.50
6	19.00	R47	9.000	0.500	0.781	0.06	11.00
8	21.75	R51	11.000	0.562	0.906	0.06	13.38
10	26.50	R55	13.500	0.688	1.188	0.09	16.75
12	30.00	R60	16.000	0.688	1.312	0.09	19.50

### WELDBEND NOTES

- All dimensions are in inches.
- Height of raised portion is equal to the depth of groove dimension E, but is not subjected to the tolerances for E. Former full-face contour may be used.
- Tolerances:  
 E (depth) + 0.016, - 0.0  
 F (width) ± 0.008  
 P (pitch diameter) ± 0.005  
 R (radius at bottom)  
 $R \leq 0.06 + 0.03, - 0.0;$   
 $R > 0.06 \pm 0.03$   
 23° (angle) = 1/2°

## BEVEL FOR WELDNECK FLANGES

**Bevel for Wall Thicknesses (T)  
from 0.19 in. to 0.88 in. Inclusive**

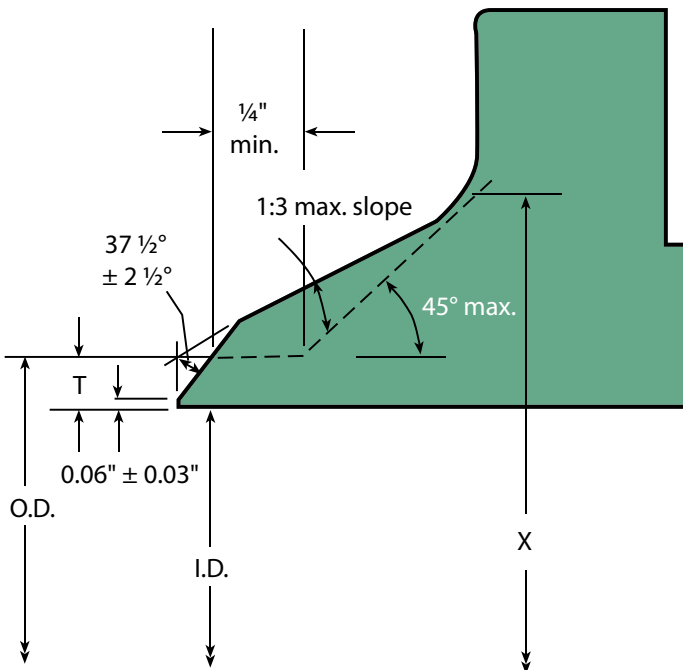

**Bevel for Wall Thicknesses (T)  
Greater Than 0.88 in.**

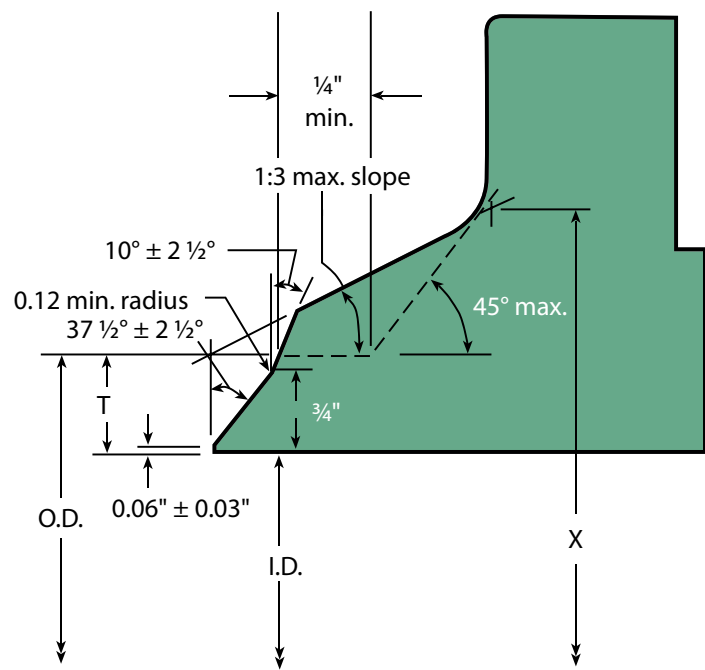

**O.D. = Outside Diameter of pipe**  
**I.D. = Inside Diameter of pipe**  
**T = Wall thickness of pipe**  
**X = diameter of hub**

### WELDBEND NOTES

1. All dimensions are in inches.
2. When the thickness of the hub at the bevel is greater than that of the pipe to which the flange is joined and the additional thickness is provided on the outside diameter, a taper weld having a slope not exceeding 1 to 3 may be employed or, alternatively, the greater outside diameter may be tapered at the same maximum slope or less, from a point on the welding bevel equal to the outside diameter of the mating pipe. Similarly, when the greater thickness is provided on the inside of the flange, it shall be taper-bored from the welding end at the slope not exceeding 1 to 3. When flanges covered by this Standard are intended for services with light wall, higher strength pipe, the thickness of the hub at the bevel may be greater than that of the pipe to which the flange is joined. Under these conditions, a single taper hub may be provided, and the outside diameter of the hub at the base (dimension X) may also be modified. The additional thickness may be provided on either inside or outside or partially on each side, but the total additional thickness shall not exceed one-half times the nominal wall thickness of intended mating pipe. See page 155.
3. The hub transition from the outside diameter to the X diameter shall fall within the maximum and minimum envelope outlined by the 1:3 max. slope and the dashed line.
4. For welding end dimensions, refer to ASME B16.25.

JOINING BUTTWELDING FITTINGS TO PIPE  
 OF EQUAL OR LESSER WALL THICKNESS

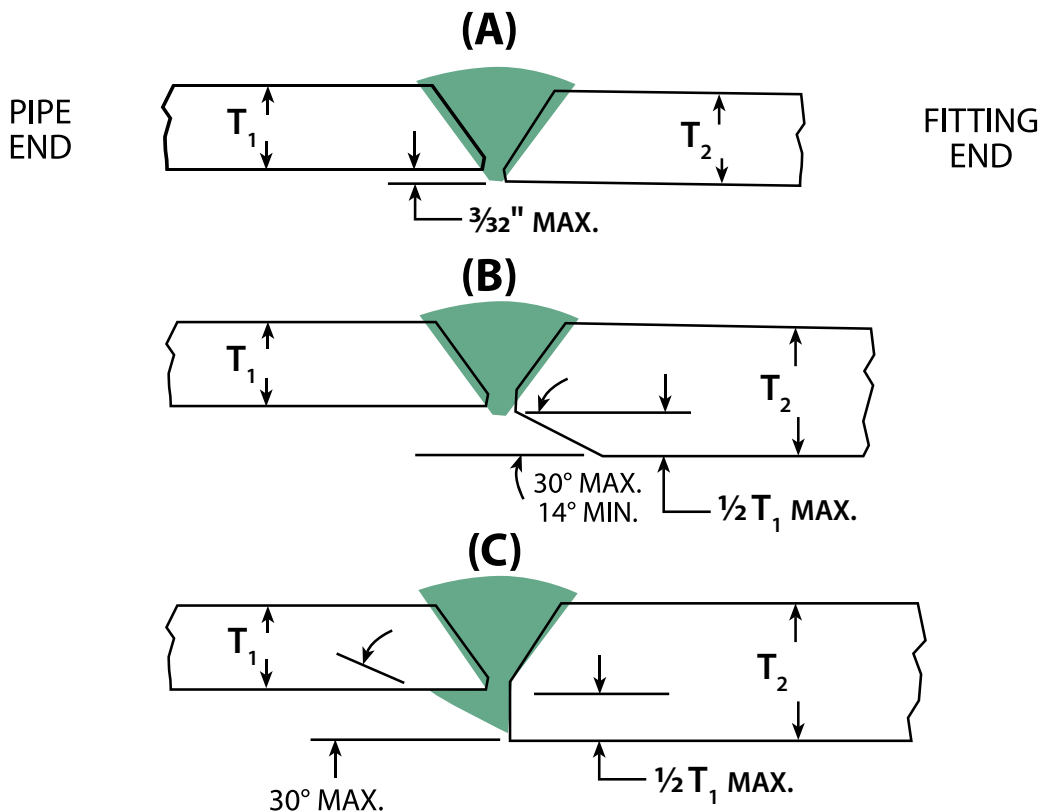

**WELDBEND** NOTES

1. Buttwelding fittings can be joined to pipe of lesser wall thickness with proper end preparation and joint design.
2. Above diagrams and recommendations that follow apply to components with ends originally prepared as standard 37 1/2° or 30° degree bevels and where the wall thickness of the thicker end to be joined does not exceed 1 1/2 times the thinner (pipe) end.
3. The nominal thickness  $T_1$  (pipe) and  $T_2$  (fitting) shall comply with the design requirements of the applicable section of the ASME B31 Code For Pressure Piping.
4. Where the total nominal offset ( $T_2 - T_1$ ) does not exceed  $3/32$ " and full penetration and bonding is obtained during welding, no special treatment is required [see (A)].
5. When the internal offset exceeds  $3/32$ ", taper cut in accordance with (B) ...or taper weld in accordance with (C).
6. When joining ends with materials of unequal minimum specified yield strengths (or unequal allowable stress), the deposited weld metal shall have mechanical properties at least equal to those of the higher strength (pipe) end.
7. For treatments of ends with unequal external diameters and/or where  $T_2$  is thicker than 1 1/2 times  $T_1$ , refer to the applicable section of the ASME Code, e., B31.4 or B31.8 or B16.9.

## AMERICAN STANDARD TAPER PIPE THREADS NPT BASIC DIMENSIONS

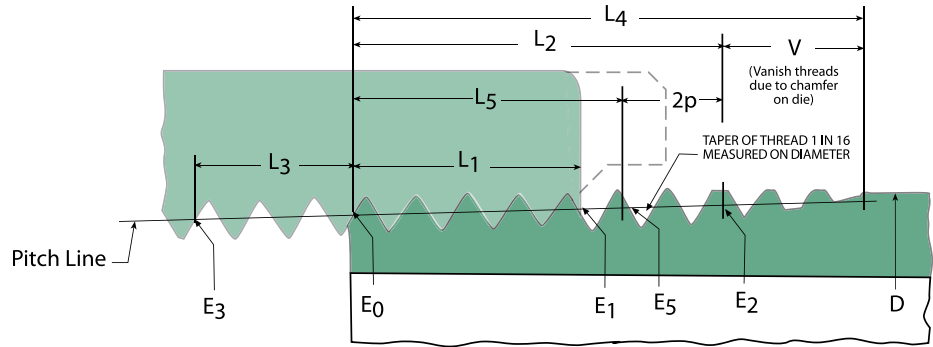

Pipe Size	Outside Diameter of Pipe	Threads Per Inch	Pitch of Thread	Pitch Diameter at Beginning of External Thread	Hand-Tight Engagement			Effective Thread-External			Length L <sub>1</sub> Plane to L <sub>2</sub> Plane External Thread (L <sub>1</sub> -L <sub>2</sub> )	
					Length <sup>2</sup>		Diameter <sup>3</sup>	Length <sup>4</sup>		Diameter <sup>3</sup>	Inch	Thread
					Inch	Threads		Inch	Threads			
					O.D.	n	P	E <sub>0</sub>	L <sub>1</sub>	L <sub>1</sub>	E <sub>1</sub>	L <sub>2</sub>
1/16	0.313	27.0	0.03704	0.27118	0.160	4.32	0.28118	0.2611	7.05	0.28750	0.1011	2.73
1/8	0.405	27.0	0.03704	0.36351	0.162	4.36	0.37360	0.2639	7.12	0.38000	0.1024	2.76
1/4	0.540	18.0	0.05556	0.47739	0.228	4.10	0.49163	0.4018	7.23	0.50250	0.1740	3.13
3/8	0.675	18.0	0.05556	0.61201	0.240	4.32	0.62701	0.4078	7.34	0.63750	0.1678	3.02
1/2	0.840	14.0	0.07143	0.75843	0.320	4.48	0.77843	0.5337	7.47	0.79179	0.2137	2.99
3/4	1.050	14.0	0.07143	0.96768	0.339	4.75	0.98887	0.5457	7.64	1.00179	0.2067	2.89
1	1.315	11.5	0.08696	1.21363	0.400	4.60	1.23863	0.6828	7.85	1.25630	0.2828	3.25
1 1/4	1.660	11.5	0.08686	1.55713	0.420	4.83	1.58338	0.7068	8.13	1.60130	0.2868	3.30
1 1/2	1.900	11.5	0.08686	1.79609	0.420	4.83	1.82234	0.7235	8.32	1.84130	0.3035	3.49
2	2.375	11.5	0.08686	2.26902	0.436	5.01	2.29627	0.7565	8.70	2.31630	0.3205	3.69
2 1/2	2.875	8.0	0.12500	2.71953	0.682	5.46	2.76216	1.1375	9.10	2.79062	0.4555	3.64
3	3.500	8.0	0.12500	3.34062	0.766	6.13	3.38850	1.2000	9.60	3.41562	0.4340	3.47
3 1/2	4.000	8.0	0.12500	3.83750	0.821	6.57	3.88881	1.2500	10.00	3.91562	0.4290	3.43
4	4.500	8.0	0.12500	4.33438	0.844	6.75	4.38712	1.3000	10.40	4.41562	0.4560	3.65
5	5.563	8.0	0.12500	5.39073	0.937	7.50	5.44929	1.4063	11.25	5.47862	0.4693	3.75
6	6.625	8.0	0.12500	6.44609	0.958	7.66	6.50597	1.5125	12.10	6.54062	0.5545	4.44
8	8.625	8.0	0.12500	8.43359	1.063	8.50	8.50003	1.7125	13.70	8.54062	0.6495	5.20
10	10.750	8.0	0.12500	10.54531	1.210	9.68	10.62094	1.9250	15.40	10.66562	0.7150	5.72
12	12.750	8.0	0.12500	12.53281	1.360	10.88	12.61781	2.1250	17.00	12.66562	0.7650	6.12
14	14.000	8.0	0.12500	13.77500	1.562	12.50	13.87262	2.2500	18.00	13.91562	0.6880	5.50
16	16.000	8.0	0.12500	15.76250	1.812	14.50	15.87575	2.4500	19.60	15.91562	0.6380	5.10
18	18.000	8.0	0.12500	17.75000	2.000	16.00	17.87500	2.6500	21.20	17.91562	0.6500	5.20
20	20.000	8.0	0.12500	19.73750	2.125	17.00	19.87031	2.8500	22.80	19.91562	0.7250	5.80
24	24.000	8.0	0.12500	23.71250	2.375	19.00	23.86094	3.2500	26.00	23.91562	0.8750	7.00

# THREAD STANDARD PRACTICES

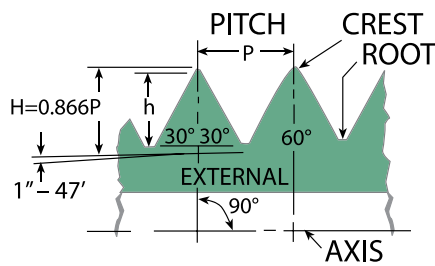

INSERT PLUG GAUGE UNTIL NOTCH IS FLUSH WITH FIRST THREAD, STANDARD TOLERANCE IS ± ONE THREAD

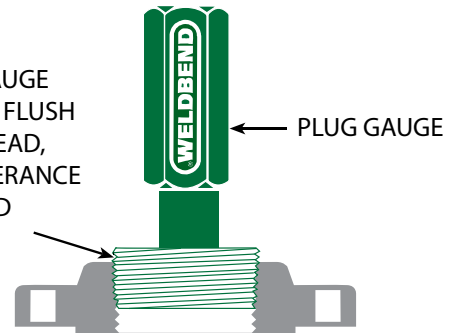

Wrench Makeup Length for Internal Thread <sup>7</sup>			Vanish Thread		Overall <sup>8</sup> Length External Thread	Nominal Complete External Threads		Height of Thread	Increase in Diameter Thread (0.0625/n)	Basic Minor Diameter at Small End of Pipe	Pipe Size		
Length (L <sup>3</sup> )		Diameter	Inch	Thread		Length	Diameter						
Inch	Thread				Inch			Thread	L <sub>3</sub>	L <sub>3</sub>	E <sub>3</sub>	V	V
0.1111	3	0.26424	0.1285	3.47	0.3896	0.1870	0.28287	0.02963	0.00231	0.2416	1/16		
0.1111	3	0.35656	0.1285	3.47	0.3924	0.1898	0.37537	0.02963	0.00231	0.3339	1/8		
0.1667	3	0.46697	0.1928	3.47	0.5946	0.2907	0.49556	0.04444	0.00347	0.4329	1/4		
0.1667	3	0.60160	0.1928	3.47	0.6006	0.2967	0.63056	0.04444	0.00347	0.5676	3/8		
0.2143	3	0.74504	0.2478	3.47	0.7815	0.3909	0.78286	0.05714	0.00446	0.7013	1/2		
0.2143	3	0.95429	0.2478	3.47	0.7935	0.4029	0.99286	0.05714	0.00446	0.9105	3/4		
0.2609	3	1.19733	0.3017	3.47	0.9845	0.5089	1.24543	0.06957	0.00543	1.1441	1		
0.2609	3	1.54083	0.3017	3.47	1.0085	0.5329	1.59043	0.06957	0.00543	1.4876	1 1/4		
0.2609	3	1.77978	0.3017	3.47	1.0252	0.5496	1.83043	0.06957	0.00543	1.7265	1 1/2		
0.2609	3	2.25272	0.3017	3.47	1.0582	0.5826	2.30543	0.06957	0.00543	2.1995	2		
0.2500	2	2.70391	0.4337	3.47	1.5712	0.8875	2.77500	0.10000	0.00781	2.6195	2 1/2		
0.2500	2	3.32500	0.4337	3.47	1.6337	0.9500	3.40000	0.10000	0.00781	3.2406	3		
0.2500	2	3.82188	0.4337	3.47	1.6837	1.0000	3.90000	0.10000	0.00781	3.7375	3 1/2		
0.2500	2	4.31875	0.4337	3.47	1.7337	1.0500	4.40000	0.10000	0.00781	4.2344	4		
0.2500	2	5.37511	0.4337	3.47	1.8400	1.1563	5.46300	0.10000	0.00781	5.2907	5		
0.2500	2	6.43047	0.4337	3.47	1.9462	1.2625	6.52500	0.10000	0.00781	6.3461	6		
0.2500	2	8.41797	0.4337	3.47	2.1462	1.4625	8.52500	0.10000	0.00781	8.3336	8		
0.2500	2	10.52969	0.4337	3.47	2.3587	1.6750	10.65000	0.10000	0.00781	10.4453	10		
0.2500	2	12.51719	0.4337	3.47	2.5587	1.8750	12.65000	0.10000	0.00781	12.4328	12		
0.2500	2	13.75938	0.4337	3.47	2.6837	2.0000	13.90000	0.10000	0.00781	13.6750	14		
0.2500	2	15.74688	0.4337	3.47	2.8837	2.2000	15.90000	0.10000	0.00781	15.6625	16		
0.2500	2	17.73438	0.4337	3.47	3.0837	2.4000	17.90000	0.10000	0.00781	17.6500	18		
0.2500	2	19.72188	0.4337	3.47	3.2837	2.6000	19.90000	0.10000	0.00781	19.6375	20		
0.2500	2	23.69688	0.4337	3.47	3.6837	3.0000	23.90000	0.10000	0.00781	23.6125	24		

# THREAD STANDARDS

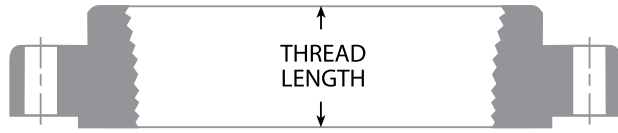

CLASS 150 STANDARD WITH 1/16" RAISED FACE

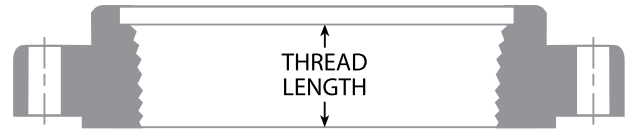

CLASS 300 – 2500 STANDARD WITH 1/16" RAISED FACE

Pipe Size	Thread Length (Inches)					
	150	300	600	900	1500	2500
1/2	0.62	0.62	0.62	0.88	0.88	1.12
3/4	0.62	0.62	0.62	1.00	1.00	1.25
1	0.69	0.69	0.69	1.12	1.12	1.38
1 1/4	0.81	0.81	0.81	1.19	1.19	1.50
1 1/2	0.88	0.88	0.88	1.25	1.25	1.75
2	1.00	1.12	1.12	1.50	1.50	2.00
2 1/2	1.12	1.25	1.25	1.88	1.88	2.25
3	1.19	1.25	1.38	1.62	1.88	2.25
3 1/2	1.25	1.44	1.56			
4	1.31	1.44	1.62	1.88		
5	1.44	1.69	1.88	2.12		
6	1.56	1.81	2.00	2.25		
8	1.75	2.00	2.25	2.50		
10	1.94	2.19	2.56	2.81		
12	2.19	2.38	2.75	3.00		
14	2.25	2.50	2.88	3.25		
16	2.50	2.69	3.06	3.38		
18	2.69	2.75	3.12	3.50		
20	2.88	2.88	3.25	3.62		
24	3.25	3.25	3.62	4.00		
30						
36						
42						
48						

**WELDBEND NOTES**

1. All dimensions are in inches.
2. Weldbend flanges are tapped with American National Standard taper pipe threads. These threads have longer thread lengths in proportion to the flange thickness of elevated temperatures.
3. The gauging notch of the plug gauge should come flush with a manufacturing tolerance + one turn.

The following formulas were used in establishing length for flanges on pages 85 - 97. They are given for convenience in determining lengths not given in the tables.

$$L_{CSB} \text{ (See Note 1)} = A + n$$

$$L_{CMB} \text{ (See Note 1)} = B + n$$

Where:

$A = 2(C + t + d) + G + F - a$ , (i.e. stud-bolt length exclusive of negative tolerance  $n$ ).

$B = 2(C + t) + d + G + F + p - a$ , (i.e. machine bolt length exclusive of negative length tolerance  $n$ ).

$C$  = Minimum flange thickness.

$F$  = Total height of facings or depth of ring-joint groove for both flanges, see "F" Values on page 160.

$G$  = 0.12 in. (3.2 mm) gasket thickness for raised face, M & F and T & G flanges; also approximate distance between ring-joint flanges.

$L_{CMB}$  = Calculated machine bolt length as measured from underside of head to end of point.

$L_{SMB}$  = Specified machine bolt length (from under head to end, including end point) which is  $L_{CMB}$  rounded off to the next larger 0.25 in. increment; see Figure 2.

$L_{SSB}$  = Specified stud-bolt length (effective thread length, excluding end points) which is  $L_{CSB}$  rounded off to the next larger 0.25 in. increment; see Figure 1.

$a$  = Zero, except where the small female face is on the end of pipe,  $a = 0.19$  in.

$d$  = Heavy nut thickness (equals nominal bolt diameter, see ASME B18.2.2).

$n$  = Negative tolerance on bolt length.

$p$  = Allowance for height of point of machine bolt (= 1.5 times thread pitch).

$t$  = Plus tolerance for flange thickness.



FIGURE 1

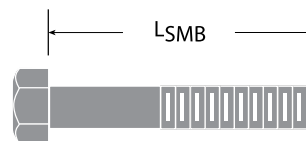

FIGURE 2

### WELDBEND NOTES

1. For lapped joints calculate stud-bolt and machine bolt lengths as follows:

For ring-joint groove facing	$L_{CSB} = (A + \text{pipe thickness for each lap}) + n$ $L_{CMB} = (B + \text{pipe thickness for each lap}) + n$
For other than ring-joint groove facing	$L_{CSB} = A - F + (\text{Table C-1 thickness}) + n$ $L_{CMB} = B - F + (\text{Table C-1 thickness}) + n$

2. The equations used on this page are for calculated bolt lengths established to assure full thread engagement of heavy hexagon nuts when worst case tolerances occur on all relevant dimensions of the flanged joint.

## "F" VALUES

Flanged Joint Class	Total Height of Facings or Depth of Ring-Joint Groove for Both Flanges "F"			
	Type of Flange Facing			
	0.06 in.	0.25 in.	M & F T & G	Ring Joint
150 & 300	0.12 in. 0.12 in.	0.50 in. 0.50 in.	0.25 in. 0.25 in.	2 x groove depth 2 x groove depth
400 to 1500	0.12 in. 0.12 in.	0.50 in. 0.50 in.	0.25 in. 0.25 in.	2 x groove depth 2 x groove depth

## "n" VALUES

Length	Negative Tolerance on Bolt Lengths "n"
<b>Stud Bolt</b> A or [A+(pipe thickness for each lap)] or [A-F+(Table C-1 thickness)]	0.06 in., for lengths up to 12 in. incl. 0.12 in., for lengths over 12 in. to 18 in. incl. 0.25 in., for lengths over 18 in. incl.
<b>Machine Bolt</b> B or [B+(pipe thickness for each lap)] or [B-F+(Table C-1 thickness)]	For "n" values use negative length tolerances per ASME B18.2.1

**TABLE C-1: THICKNESS FOR LAPPED JOINTS**

Lap Combination	Class 150 Thru 2500 Flanges
For Lapped to 0.06 in. Raised Face, male face on flange	One Lap and 0.06 in.
For Lapped to Lapped	Both Laps
For Lapped to 0.25 in. Male Face on Flange	One Lap and 0.25 in.
For Lapped to Female Face on Flange	One Lap not less than 0.25 in.
For Male in Lap to Female in Lap	2 x pipe wall with Lap for Male not less than 0.25 in.



## PRESSURE-TEMPERATURE RATINGS FOR FLANGES

Weldbend manufactures flanges for Class 125, 150, 300, 600, 900, 1500 and 2500. Note that the table specifically rates carbon steel products within the temperatures listed.

### Pressure – Temperature Ratings for Group 1.1 Materials

Nominal Designation	Forgings	Castings	Plates
C–Si	A 105 (1)	A 216 Gr. WCB (1)	A 515 Gr. 70 (1)
C–Mn–Si	A 350 Gr. LF2 (1)		A 516 Gr. 70 (1), (2)
C–Mn–Si–V	A 350 Gr. LF6 Cl. 1 (4)		A 537 Cl. 1 (3)
3 ½ Ni	A 350 Gr. LF 3		

### Rating (Carbon Steel)

Temperature in °F	Working Pressure in psig by Classes						
	125	150	300	600	900	1500	2500
-20 to 100	*	285	740	1480	2220	3705	6170
200	*	260	680	1360	2035	3395	5655
300	*	230	655	1310	1965	3270	5450
400	*	200	635	1265	1900	3170	5280
500	*	170	605	1205	1810	3015	5025
600	*	140	570	1135	1705	2840	4730
650	*	125	550	1100	1650	2745	4575
700	*	110	530	1060	1590	2655	4425
750	*	95	505	1015	1520	2535	4230
800	*	80	410	825	1235	2055	3430
850	*	65	320	640	955	1595	2655
900	*	50	230	460	690	1150	1915
950	*	35	135	275	410	685	1145
1000	*	20	85	170	255	430	715

\*There is no standard for Class 125 as it is applicable to Cast Iron Standard ASME B16.1. Class 125 flanges are wide in face and used for connections to cast steel valves or equipment containing flanged ends made to Cast Iron Standard dimensions. Carbon steel bolting is intended and alloy studs should be avoided. Class 125 flanges are identical with Class E AWWA.

#### WELDBEND NOTES

1. Upon prolonged exposure to temperatures above 800°F, the carbide phase of steel may be converted to graphite. Permissible, but not recommended for prolonged use above 800°F.
2. Not to be used over 850°F
3. Not to be used over 700°F
4. Not to be used over 500°F

# USEFUL FORMULAS



TECHNICAL DATA

MULTIPLY	BY	TO OBTAIN
<b>Atmospheres (Std.)</b>		
760 mm. of Mercury @ 32° F	14.696	lbs. / sq. in.
Atmospheres	76.0	cm. of Mercury
Atmospheres	29.13	in. of Mercury
Atmospheres	33.905	ft. of water
Atmospheres	1.0325	kgs. / sq. cm.
Atmospheres	14.70	lbs. / sq. in.
<b>British Thermal Units (BTU)</b>		
British Thermal Units	0.2520	kgs. - cal.
British Thermal Units	778.3	ft. - lbs.
British Thermal Units	0.0003931	hph.
<b>BTU / minute</b>		
BTU / minute	12.969	ft. - lbs. / sec.
BTU / minute	0.02358	HP
BTU / minute	0.01758	kW
BTU / minute	17.5784	W
<b>Calorie (cal.)</b>		
Calorie (cal.)	0.003966	BTU
<b>Centimeter (cm.)</b>		
Centimeter	0.3937	in.
Centimeter	0.03280	ft.
Centimeter	0.01	m.
Centimeter	10	mm.
<b>Centimeters of Mercury</b>		
Centimeters of Mercury	0.01315	Atmospheres
Centimeters of Mercury	0.4461	ft. of water
Centimeters of Mercury	136.0	kgs. / sq. m.
Centimeters of Mercury	27.85	lbs. / sq. ft.
Centimeters of Mercury	0.1934	lbs. / sq. in.
<b>Cubic feet (cu. ft.)</b>		
Cubic feet	2.832 x 104	cu. cm.
Cubic feet	1728	cu. in.
Cubic feet	0.02832	cu. m.
Cubic feet	0.03737	cu. yd.
Cubic feet	7.48052	gal.
<b>Cubic feet / minute</b>		
Cubic feet / minute	472.0	cu. cm. / sec.
Cubic feet / minute	0.1247	gal. / sec.
<b>Cubic foot of water</b>		
Cubic foot of water	62.4	lbs. @ 60° F
<b>Feet (ft.)</b>		
Feet	30.48	cm.
Feet	12	in.
Feet	0.3048	m.
Feet	0.33	yd.
<b>Feet of water</b>		
Feet of water	0.02950	Atmospheres
Feet of water	0.8226	in. of Mercury
Feet of water	0.03048	kgs. / sq. cm.
Feet of water	62.43	lbs. / sq. ft.
Feet of water	0.4355	lbs. / sq. in.

MULTIPLY	BY	TO OBTAIN
<b>Feet / minute</b>		
Feet / minute	0.5080	cm. / sec.
Feet / minute	0.01667	ft. / sec.
Feet / minute	0.01829	km. / hr.
Feet / minute	0.3048	m. / min.
Feet / minute	0.01136	mi. / hr.
<b>Fluid Ounces (fl. oz.)</b>		
Fluid Ounces	1.805	cu. in.
Fluid Ounces	0.02957	L
<b>Fluid Ounces / square inch</b>		
Fluid Ounces / square inch	0.0625	lbs. / sq. in.
Fluid Ounces / square inch	1.73	in. of water
<b>Foot / pounds</b>		
Foot / pounds	0.001286	BTU
<b>Gallons (gal.)</b>		
Gallons	3785	cu. cm.
Gallons	0.1337	cu. ft.
Gallons	231	cu. in.
Gallons	128	fl. oz.
Gallons	3.785	L
<b>Gallons of water</b>		
Gallons of water	8.35	lbs./water@60°F
<b>Horsepower (HP)</b>		
Horsepower	42.41	BTU / min.
Horsepower	33,000	ft. - lbs. / min.
Horsepower	550	ft. - lbs. / sec.
Horsepower	0.7457	kW 1060 W
Horsepower	745.7	W
<b>Boiler Horsepower (BHP)</b>		
Boiler Horsepower	33,520	BTU / hr.
Boiler Horsepower	9,803	kW - hr.
<b>Horsepower - hours (hph)</b>		
Horsepower - hours	2544	BTU
Horsepower - hours	0.7457	kW - hr.
<b>Inches (in.)</b>		
Inches	2,540	cm.
Inches	25.4	mm.
Inches	0.0254	m.
Inches	0.0833	ft.
<b>Inches of Mercury</b>		
Inches of Mercury	0.03342	Atmospheres
Inches of Mercury	1.133	ft. of water
Inches of Mercury	13.57	in. of water
Inches of Mercury	70.73	lbs. / sq. ft.
Inches of Mercury	0.4912	lbs. / sq. in.
<b>Inches of water</b>		
Inches of water	0.002458	Atmospheres
Inches of water	0.07355	in. of Mercury
Inches of water	0.5781	oz. / sq. in.
Inches of water	5.202	lbs. / sq. ft.
Inches of water	0.03613	lbs. / sq. in.

MULTIPLY	BY	TO OBTAIN
<b>Kilowatts (kW)</b>	56.87	BTU / min.
Kilowatts	1.341	HP
Kilowatts	1000	W
<b>Kilowatt - hours</b>	3.415	BTU
<b>Liters (L)</b>	0.2642	gal.
Liters	2.113	pt. (liq.)
Liters	1.057	qt. (liq.)
<b>Meters (m.)</b>	1.805	cu. in.
Meters	3.281	ft.
Meters	39.37	in.
Meters	1000	mm.
Meters	1.094	yd.
<b>Pints (pt.)</b>	0.4732	L
<b>Pounds (avoird)</b>	16	oz.
<b>Pounds of water</b>	0.01602	cu. ft.
Pounds of water	27.68	cu. in.
Pounds of water	0.1198	gal.
<b>Pounds / square foot</b>	0.01602	ft. of water
Pounds / square foot	0.006945	lbs. / sq. in.
<b>Pounds / square inch</b>	0.06804	Atmospheres
Pounds / square inch	2.307	ft. of water
Pounds / square inch	2.036	in. of Mercury
Pounds / square inch	27.68	in. of water
<b>Temp. (°C) + 273</b>	1	abs. temp. (°C)
Temp. (°C) + 273	1.8	temp. (°F)
Temp. (°C) + 273	1	abs. temp. (°F)
Temp. (°C) + 273	5/9	temp. (°C)

MULTIPLY	BY	TO OBTAIN
<b>Therm</b>	100,000	BTU
<b>Ton of Refrigeration</b>	12,000	BTU / hr.
<b>Tons (long)</b>	2240	lbs.
<b>Tons (short)</b>	2000	lbs.
<b>Watts (W)</b>	3.412	BTU
Watts	0.05692	BTU / min.
Watts	44.26	ft. - lbs. / min.
Watts	0.7376	ft. - lbs. / sec.
Watts	0.001341	HP
Watts	0.001	kW
<b>Watts - hours</b>	3.415	BTU / hr.
Watts - hours	2655	ft. - lbs.
Watts - hours	0.001341	hph.
Watts - hours	0.001	kW - hr.

746 W = 1HP

**Additional Unit Abbreviations:**

- kilograms = kgs.
- quarts = qt.
- miles = mi.
- millimeters = mm.
- yards = yd.
- minute = min.
- cubic = cu.
- kilometers = km.
- absolute = abs.
- hours = hr.

**Calculation of Transition Slope**

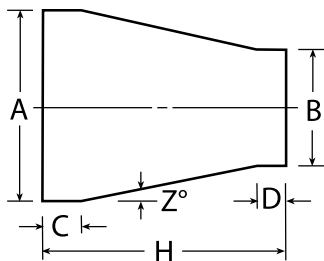

$$\tan Z = \frac{A - B}{H - (C + D)}$$

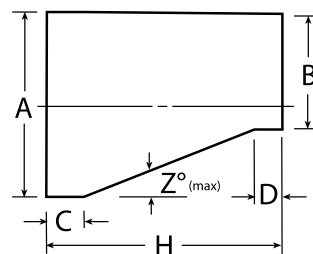

$$\tan Z (\text{Max}) = \frac{A - B}{H - (C + D)}$$

**Where:**

A = Area; A<sub>1</sub> = Surface area of solids;  
V = Volume; C = Circumference

**Rectangle**

$A = W \times L$



**Parallelogram**

$A = H \times L$

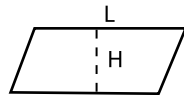

**Trapezoid**

$A = H \times \frac{L_1 + L_2}{2}$

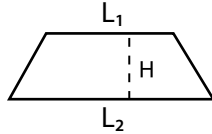

**Triangle**

$A = \frac{W \times H}{2}$

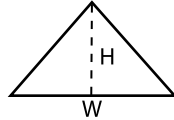

**Circle**

$A = 3.142 \times R \times R$

$C = 3.142 \times D$

$R = \frac{D}{2}$

$D = 2 \times R$

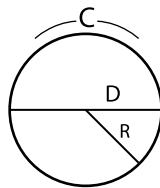

**Sector of Circle**

$A = \frac{3.142 \times R \times R \times a}{360}$

$L = .01745 \times R \times R \times a$

$a = \frac{L}{.01745 \times R}$

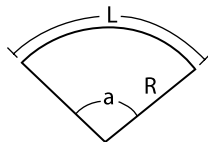

**Ellipse**

$A = 3.142 \times A \times B$

$C = 6.283 \times \frac{\sqrt{A^2 + B^2}}{2}$

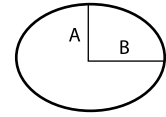

**Rectangular Solid**

$A_1 = 2[W \times L + L \times H + H \times W]$

$V = W \times L \times H$

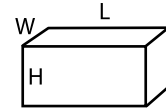

**Cone**

$A_1 = 3.142 \times R \times S + 3.142 \times R \times R$

$V = 1.047 \times R \times R \times H$

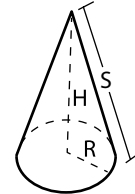

**Cylinder**

$A_1 = 6.283 \times R \times H + 6.283 \times R \times R$

$V = 3.142 \times R \times R \times H$

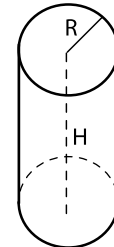

**Elliptical Tanks**

$A_1 = 6.283 \times \frac{\sqrt{A^2 + B^2}}{2} \times H + 6.283 \times A \times B$

$V = 3.142 \times A \times B \times H$

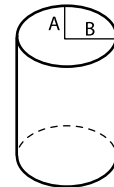

**Sphere**

$A_1 = 12.56 \times R \times R$

$V = 4.188 \times R \times R \times R$

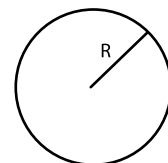

**For above containers:**

Capacity in gallons = V / 231 when V is cubic inches

Capacity in gallons = 7.48 x V when V is cubic feet.

Equivalent Inches		Pressure Per Square Inch		Equivalent Inches		Pressure Per Square Inch	
Water	Mercury	Pounds	Ounces	Water	Mercury	Pounds	Ounces
0.10	0.007	0.0036	0.058	8.00	0.588	0.2890	4.620
0.20	0.015	0.0072	0.115	9.00	0.662	0.3250	5.200
0.30	0.022	0.0108	4.173	10.00	0.735	0.3610	5.770
0.40	0.029	0.0145	0.231	11.00	0.809	0.3970	6.340
0.50	0.037	0.0181	0.289	12.00	0.883	0.4330	6.920
0.60	0.044	0.0217	0.346	13.00	0.956	0.4690	7.500
0.70	0.051	0.0253	0.404	13.60	1.000	0.4910	7.860
0.80	0.059	0.0289	0.462	13.90	1.022	0.5000	8.000
0.90	0.066	0.3250	0.520	14.00	1.030	0.5050	8.080
1.00	0.074	0.0360	0.577	15.00	1.103	0.5420	8.700
1.36	0.100	0.0490	0.785	16.00	1.177	0.5780	9.200
1.74	0.128	0.0670	1.000	17.00	1.250	0.6140	9.800
2.00	0.147	0.0720	1.150	18.00	1.324	0.6500	10.400
2.77	0.203	0.1000	1.600	19.00	1.397	0.6860	10.900
3.00	0.221	0.1090	1.730	20.00	1.471	0.7220	11.500
4.00	0.294	0.1440	2.310	25.00	1.839	0.9030	14.400
5.00	0.368	0.1810	2.890	27.20	2.000	0.9750	15.700
6.00	0.441	0.2170	3.460	27.70	2.037	1.0000	16.000
7.00	0.515	0.2530	4.040				

**Compression Ratio  
or  
Pressure Ratio**

$$\frac{\text{ABSOLUTE DISCHARGE PRESSURE}}{\text{ABSOLUTE SUCTION PRESSURE}} = \text{PRESSURE RATIO}$$

$$\text{GAUGE PRESSURE} + 14.75 \text{ LBS} = \text{ABSOLUTE PRESSURE}$$

TECHNICAL DATA

## MEASUREMENT EQUIVALENTS — LENGTH

### Inches to Millimeters

1 in. = 25.4 mm.

Inches	Millimeters
0.50	12.700
1.00	25.400
1.50	38.100
2.00	50.800
2.50	63.500
3.00	76.200
3.50	88.900
4.00	101.600
4.50	114.300
5.00	127.000
5.50	139.700
6.00	152.400
6.50	165.100
7.00	177.800
7.50	190.500
8.00	203.200
8.50	215.900
9.00	228.600
9.50	241.300
10.00	254.000
10.50	266.700
11.00	279.400
11.50	292.100
12.00	304.800

### Millimeters to Inches

1 mm. = 0.0393700787 in.

Millimeters	Inches
0.50	0.0200
1.00	0.0393
1.50	0.0591
2.00	0.0787
2.50	0.0984
3.00	0.1181
3.50	0.1378
4.00	0.1575
4.50	0.1772
5.00	0.1970
5.50	0.2165
6.00	0.2362
6.50	0.2559
7.00	0.2760
7.50	0.2953
8.00	0.3150
8.50	0.3347
9.00	0.3543
9.50	0.3740
10.00	0.3937
20.00	0.7874
30.00	1.1811
40.00	1.5748
50.00	1.9685

### Feet to Meters

1 ft. = 0.3048 m.

Feet	Meters
1	0.3048
2	0.6096
3	0.9144
4	1.2192
5	1.5240
6	1.8288
7	2.1336
8	2.4384
9	2.7432
10	3.0480
11	3.3528
12	3.6576
13	3.9624
14	4.2672
15	4.5720
20	6.0960
30	9.1440
40	12.1920
50	15.2400
60	18.2880
70	21.3360
80	24.3840
90	27.4320
100	30.4800

### Meters to Feet

1 m. = 3.2808398895 ft.

Meters	Feet
1	3.2808
2	6.5617
3	9.8425
4	13.1234
5	16.4042
6	19.6850
7	22.9659
8	26.2467
9	29.5276
10	32.8084
11	36.0892
12	39.3701
13	42.6509
14	45.9318
15	49.2126
20	65.6168
30	98.4252
40	131.2336
50	164.0420
60	196.8504
70	229.6588
80	262.4672
90	295.2756
100	328.0840

KELVIN SCALE TEMPERATURE

Another temperature scale used with the metric system is called the Kelvin scale. It was named after Lord Kelvin, a great British physicist.

As shown below, the starting or zero point on the Kelvin scale is *absolute zero*. Absolute zero is the lowest theoretical temperature that a gas can reach.

Notice that the difference between the freezing and the boiling temperatures of water is 100 Celsius units and also 100 Kelvin units. The only difference between the two scales is that the Kelvin scale has a "head start" of 273.15 units.

You can change a Celsius reading (*c*) to a Kelvin reading (*k*) as follows:

$$k = c + 273.15$$

$$72^{\circ}\text{C} = \text{? } ^{\circ}\text{K}$$

$$k = 72 + 273.15$$

$$k = 345.15$$

$$72^{\circ}\text{C} = 345.15^{\circ}\text{K}$$

You can change a Kelvin reading to a Celsius reading as follows:

$$c = k - 273.15$$

$$250^{\circ}\text{K} = \text{? } ^{\circ}\text{C}$$

$$c = 250 - 273.15$$

$$c = -23.15$$

$$250^{\circ}\text{K} = -23.15^{\circ}\text{C}$$

By laying the edge of a ruler or paper perpendicular to the scales shown here, you can estimate equivalent temperatures on all three scales.

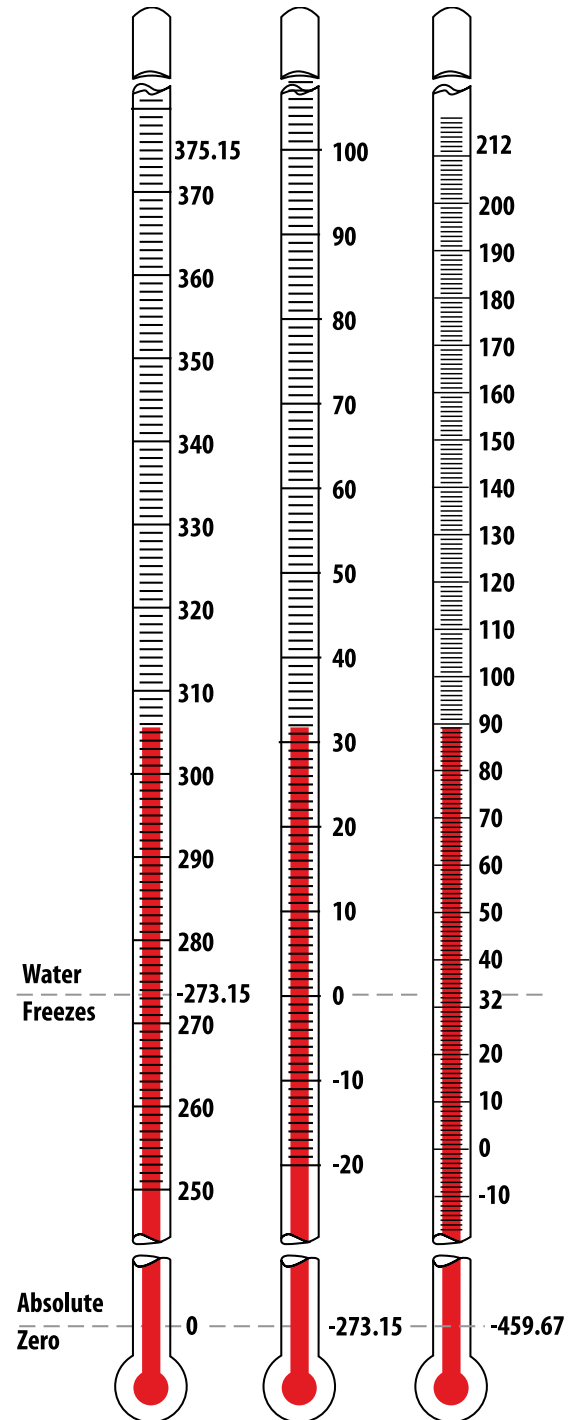

FITTINGS

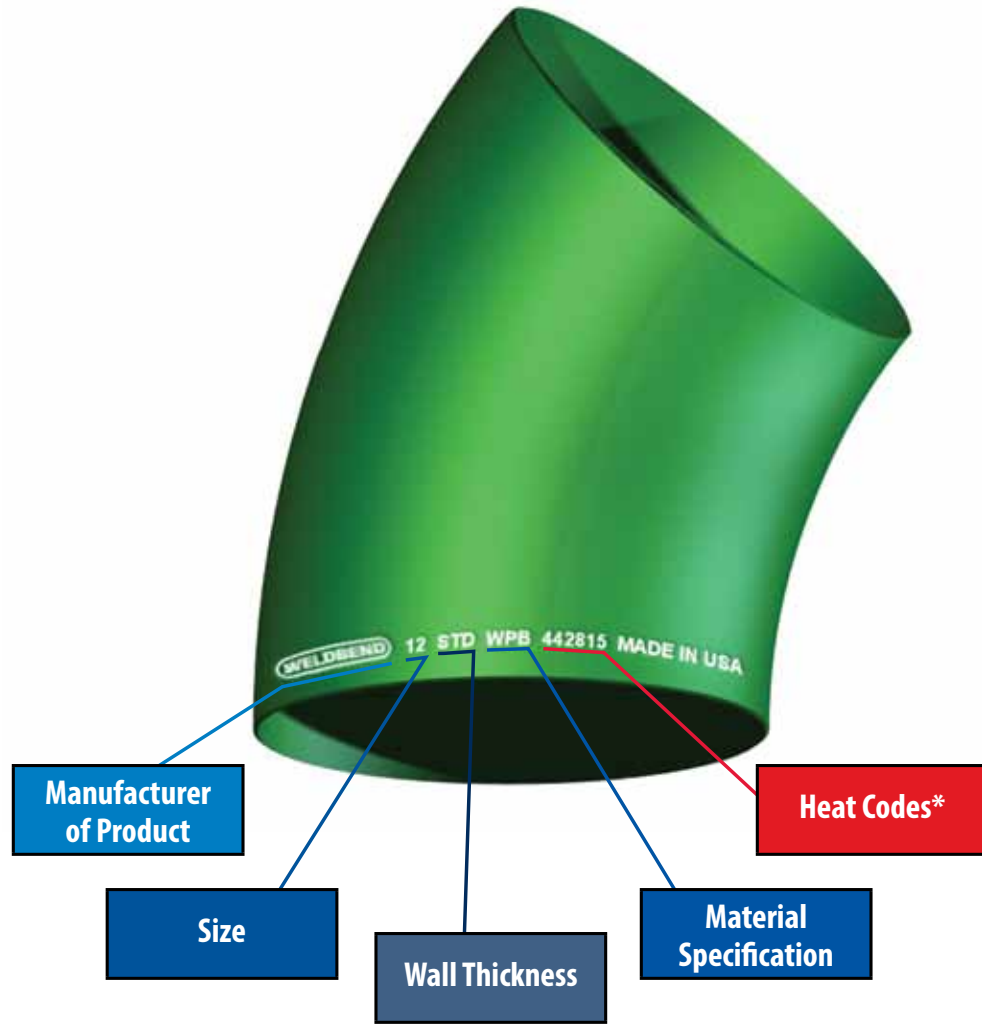

Description of designations:

WPB - ASTM A234 WPB

STD - Standard Weight

USA - NOTE: If Weldbend marks their fittings "Made in USA", it is your assurance that both the starting material and the complete production is of USA origin.

**\*All heat codes follow the material specification marking.**

Weldbend weld fittings are permanently identified by die marking to designate:

**As seen in illustrated example:**

- |                                  |   |
|----------------------------------|---|
| 1. <b>Manufacturer</b>           | [  ] |
| 2. <b>Size</b>                   | [12]  |
| 3. <b>Wall Thickness</b>         | [STD]   |
| 4. <b>Material Specification</b> | [WPB]   |
| 5. <b>Heat Codes</b>             | [442815]  |

The identification on each Weldbend weld fitting is your assurance that the fitting has successfully passed inspection and quality control, and that the accurate record of chemical and physical properties of the steel from which the fitting was made is fully traceable.



FLANGES

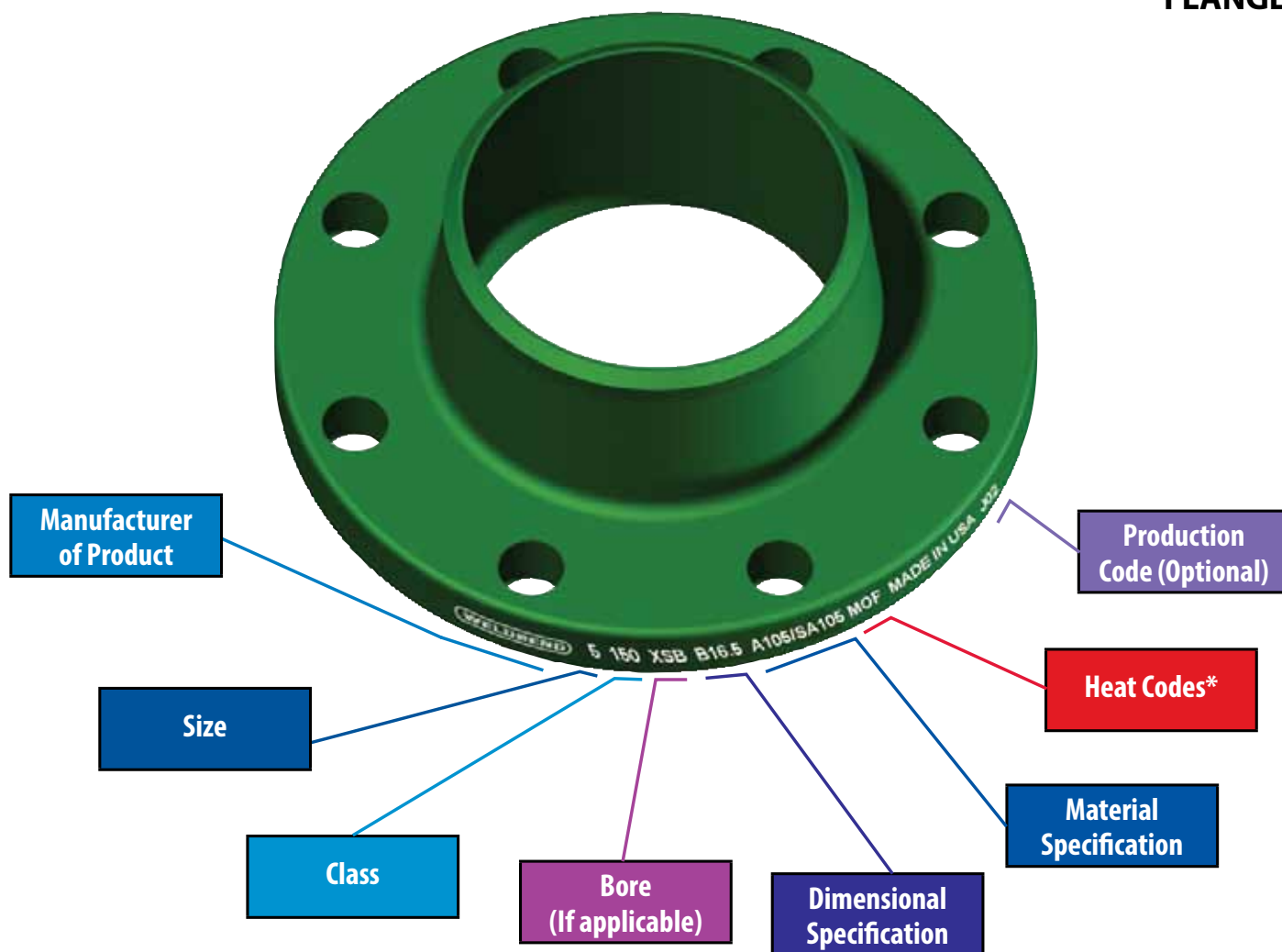

Description of designations:

150 - Class 150 (Weld Neck and Socket Weld Only)

USA - NOTE: If Weldbend marks their fittings "Made in USA", it is your assurance that both the starting material and the complete production is of USA origin.

**\*All heat codes follow the material specification marking.**

Weldbend flanges are permanently identified by die marking to designate:

**As seen in illustrated example:**

- |                                      |                       |
|--------------------------------------|-----------------------|
| 1. <b>Manufacturer</b>               | [ <b>WELDBEND</b> ]   |
| 2. <b>Size</b>                       | [ <b>5</b> ]          |
| 3. <b>Class</b>                      | [ <b>150</b> ]        |
| 4. <b>Bore (If applicable)</b>       | [ <b>XSB</b> ]        |
| 5. <b>Dimensional Specification</b>  | [ <b>B16.5</b> ]      |
| 6. <b>Material Specification</b>     | [ <b>A105/SA105</b> ] |
| 7. <b>Heat Codes</b>                 | [ <b>MOF</b> ]        |
| 8. <b>Production Code (Optional)</b> | [ <b>J02</b> ]        |

The identification on each Weldbend weld flange is your assurance that the flange has successfully passed inspection and quality control, and that the accurate record of chemical and physical properties of the steel from which the flange was made is fully traceable.

# TORQUE REQUIRED TO PRODUCE INDICATED BOLT STRESS



## TORQUE REQUIRED TO PRODUCE INDICATED BOLT STRESS

BOLT STRESS (PSI)	MEASURED IN	Bolt Diameters									
		¼	⅝	⅜	⅞	½	⅝	⅜	¾	⅞	1
1,000	Ft. - Lbs.	0.1	0.3	0.4	0.7	1	1.5	2	3	5	8
	In. - Lbs.	2	3	5	8	12	18	24	40	64	98
2,000	Ft. - Lbs.	0.3	0.5	0.8	1.3	2	3	4	7	11	16
	In. - Lbs.	3	6	10	16	24	36	48	80	128	196
3,000	Ft. - Lbs.	0.4	0.8	1	2	3	4.5	6	10	16	25
	In. - Lbs.	5	10	14	24	36	54	72	120	192	294
4,000	Ft. - Lbs.	0.5	1	2	3	4	6	8	13	21	32
	In. - Lbs.	6	13	19	32	48	72	96	160	256	392
5,000	Ft. - Lbs.	0.7	1	2	3	5	8	10	17	27	41
	In. - Lbs.	8	16	24	40	60	90	120	200	320	490
6,000	Ft. - Lbs.	0.8	2	2	4	6	9	12	20	32	49
	In. - Lbs.	5	10	14	24	36	54	144	240	384	588
7,000	Ft. - Lbs.	1	2	3	5	7	11	14	23	37	57
	In. - Lbs.	11	22	34	56	84	126	168	280	448	686
8,000	Ft. - Lbs.	1	2	3	5	8	12	16	27	65	65
	In. - Lbs.	13	26	38	64	96	144	192	320	784	784
9,000	Ft. - Lbs.	1	2	4	6	9	14	18	30	48	74
	In. - Lbs.	14	29	43	72	108	162	216	360	576	—
10,000	Ft. - Lbs.	1	3	4	7	10	15	20	33	53	82
	In. - Lbs.	16	32	48	80	120	180	240	400	640	—
20,000	Ft. - Lbs.	3	5	8	13	20	30	40	67	107	163
	In. - Lbs.	32	64	96	160	240	360	480	800	—	—
30,000	Ft. - Lbs.	4	8	12	20	30	45	60	100	160	245
	In. - Lbs.	48	98	144	240	360	540	720	—	—	—
40,000	Ft. - Lbs.	5	11	16	27	40	60	80	133	213	327
	In. - Lbs.	64	128	192	320	480	720	—	—	—	—
50,000	Ft. - Lbs.	7	13	20	33	50	75	100	167	267	408
	In. - Lbs.	80	160	240	400	600	—	—	—	—	—
60,000	Ft. - Lbs.	8	16	24	40	60	90	120	200	320	490
	In. - Lbs.	96	192	288	480	720	—	—	—	—	—

## TORQUE REQUIRED TO PRODUCE INDICATED BOLT STRESS

Bolt Diameters											
1 1/8	1 1/4	1 3/8	1 1/2	1 5/8	1 3/4	1 7/8	2	2 1/4	2 1/2	2 3/4	3
12	17	23	27	37	50	57	73	107	147	197	257
142	200	272	320	800	600	800	—	—	—	—	—
24	33	45	53	133	100	133	146	213	293	394	515
285	400	544	640	—	—	—	—	—	—	—	—
35	50	68	80	110	150	200	220	320	440	592	772
426	600	—	—	—	—	—	—	—	—	—	—
47	57	91	107	147	200	257	293	427	587	789	1029
568	800	—	—	—	—	—	—	—	—	—	—
59	83	113	133	183	250	333	366	533	733	987	1287
710	—	—	—	—	—	—	—	—	—	—	—
71	100	136	160	220	300	400	440	640	880	1184	1544
—	—	—	—	—	—	—	—	—	—	—	—
83	117	159	187	257	350	467	513	747	1027	1381	1801
—	—	—	—	—	—	—	—	—	—	—	—
95	133	181	213	293	400	533	587	853	1173	1579	2059
—	—	—	—	—	—	—	—	—	—	—	—
107	150	204	330	330	450	600	660	690	1320	1776	2316
—	—	—	—	—	—	—	—	—	—	—	—
118	167	227	267	367	500	667	733	1067	1467	1973	2513
—	—	—	—	—	—	—	—	—	—	—	—
237	333	453	533	733	1000	1333	1467	2133	2933	3947	5147
—	—	—	—	—	—	—	—	—	—	—	—
355	500	680	800	1100	1500	2000	2200	3200	4400	5920	7720
—	—	—	—	—	—	—	—	—	—	—	—
473	667	907	1067	1467	2000	2667	2933	4267	5867	7893	10293
—	—	—	—	—	—	—	—	—	—	—	—
592	833	1133	1333	1833	2500	3333	3667	5333	7333	9867	12867
—	—	—	—	—	—	—	—	—	—	—	—
710	1000	1360	1600	2200	3000	4000	4400	6400	8800	11840	15430
—	—	—	—	—	—	—	—	—	—	—	—

TECHNICAL DATA

## PROCEDURE FOR APPLICATION OF BOLT TORQUE ON FLANGED JOINTS

**STEP 1.** Align component parts and clamp together with hold down.

**STEP 2.** Lubricate stud (or bolt) threads in area of nut or forged ring engagement, also lubricate face of nuts (or bolt head) using a suitable lubricant.

**STEP 3.** Install all bolts and nuts finger tight.

**STEP 4.** Number bolts so that torquing requirements can be followed.

**STEP 5.** Apply torque in 20% (1/5) steps of required final torque, loading all bolts at each step before proceeding to next step.

**STEP 6.** Tighten bolts in sequential order 0°-180°, 90°-270°, 45°-225° and 135°-315° at each step until final torque is reached (see attached sketches).

**STEP 7.** Continue to tighten bolts now using rotational order until all bolts are stable at final torque level. Two complete times around is usually required (see attached sketches).

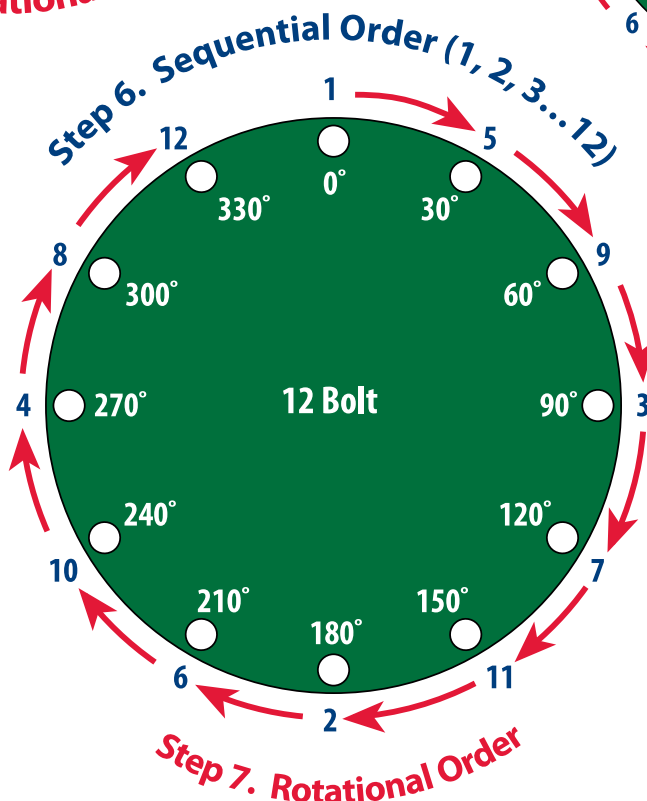
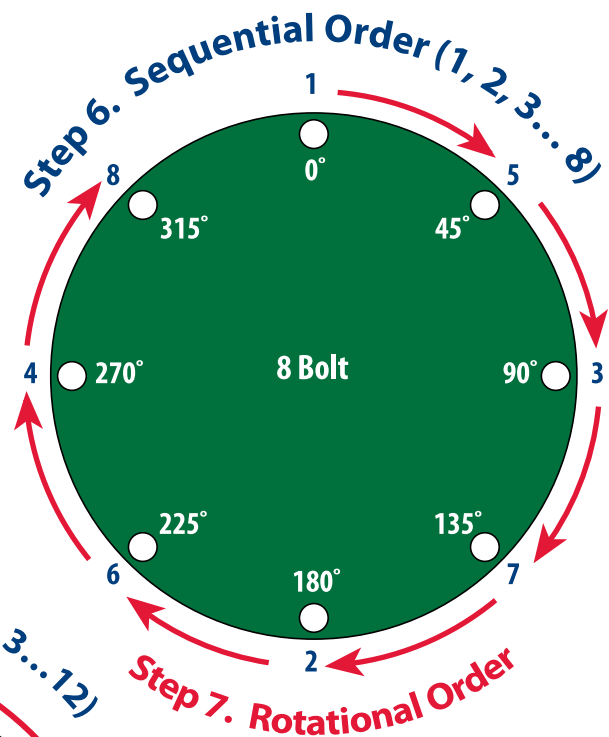
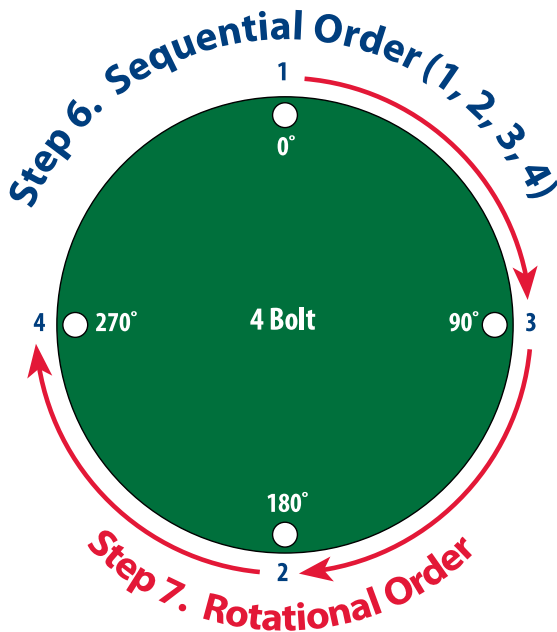

Refer to Bolt Torque Procedure on page 172 before proceeding.

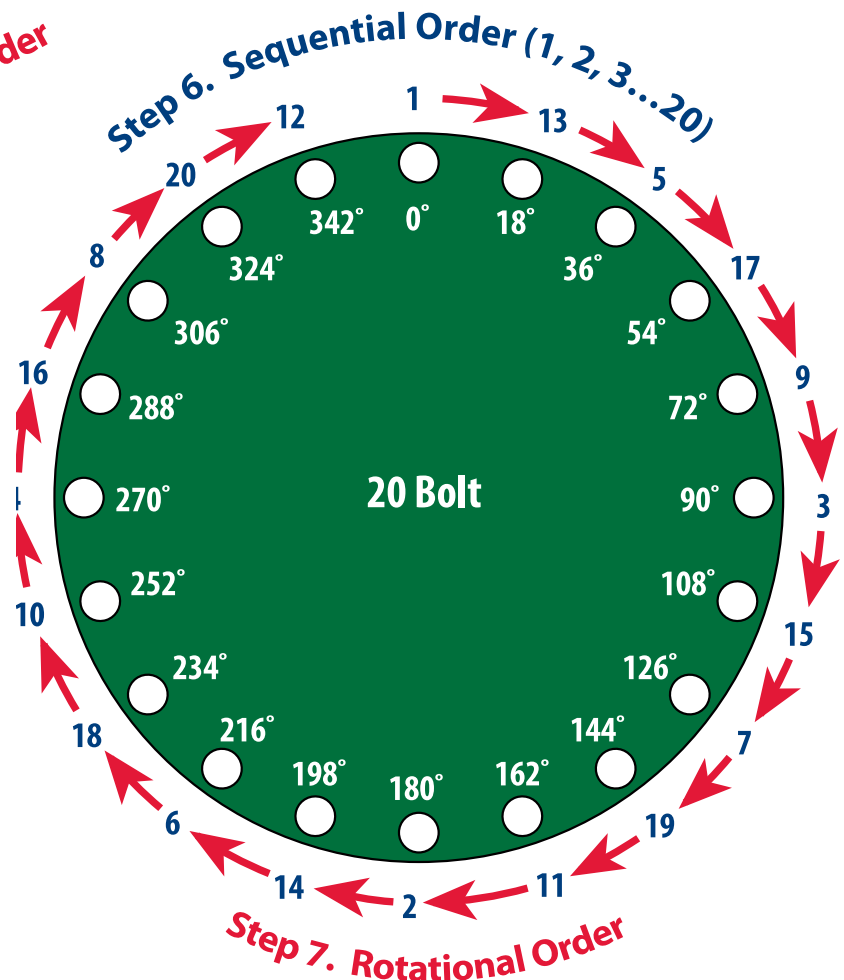
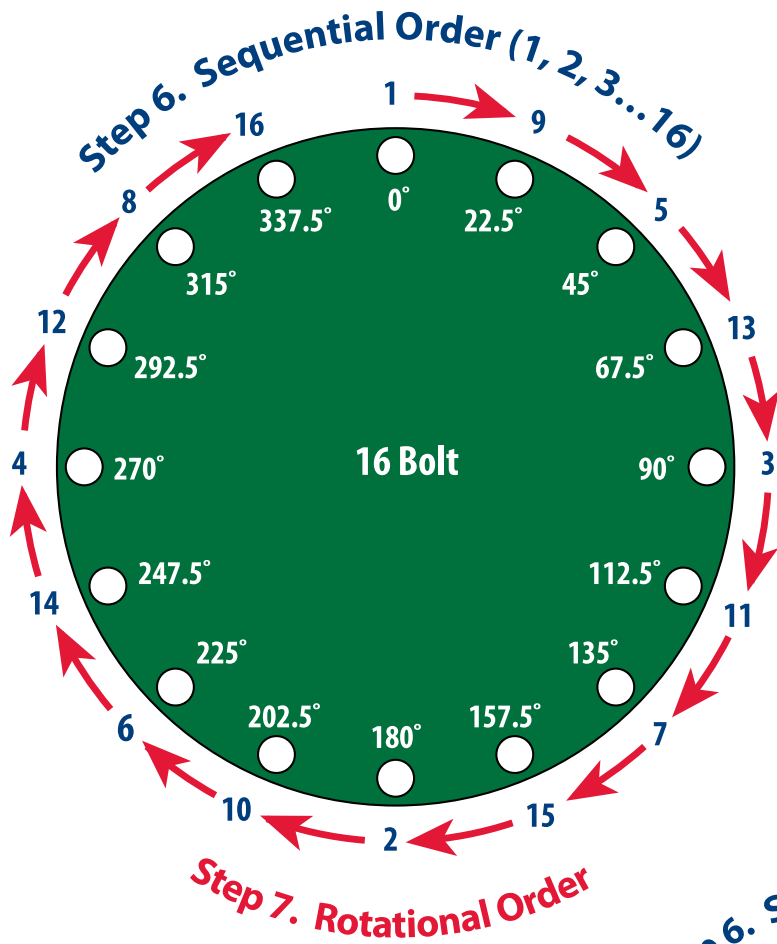

Refer to Bolt Torque Procedure on page 172 before proceeding.

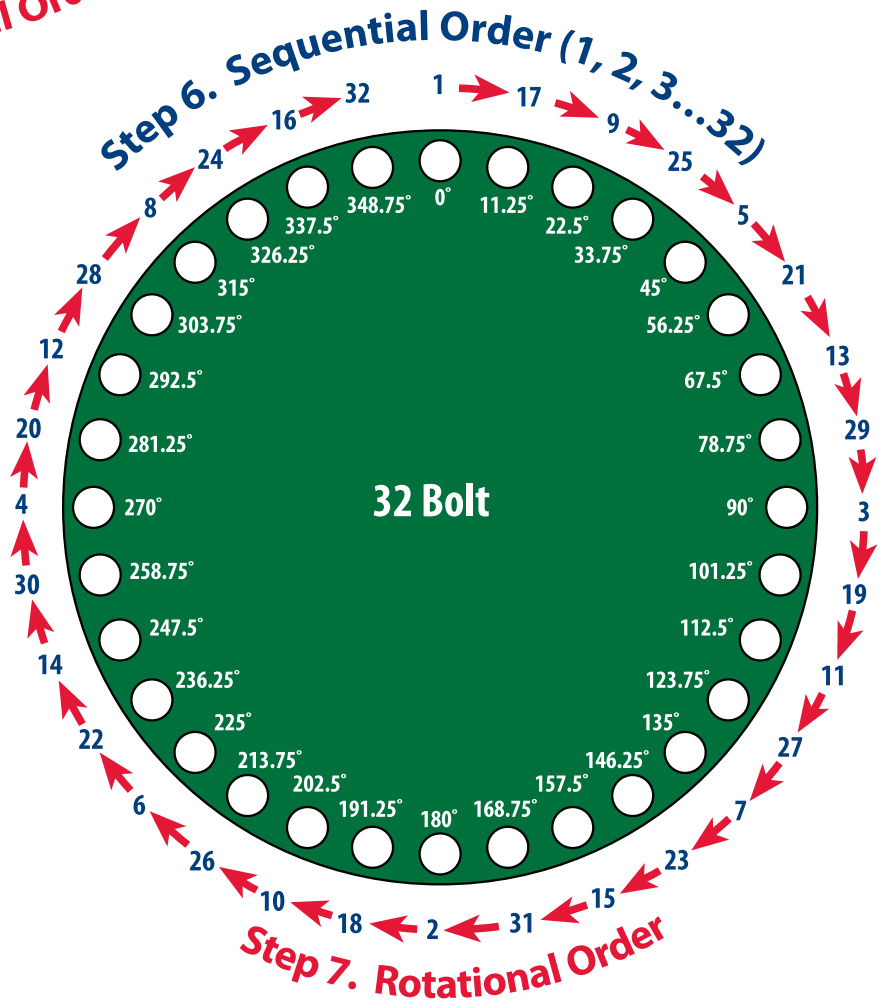
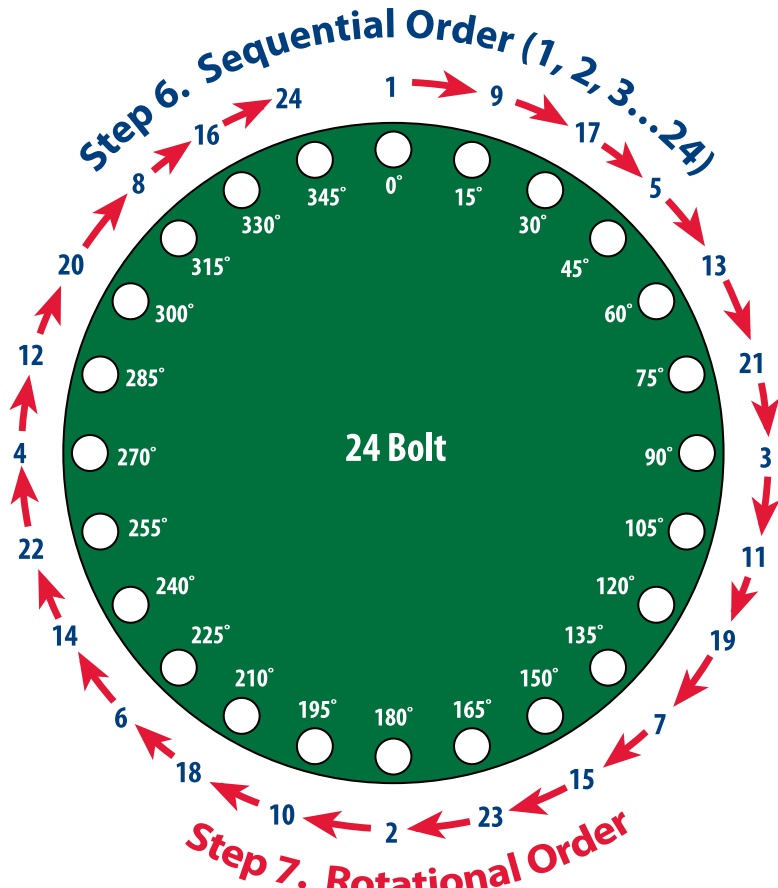

## 1. PRODUCT IDENTIFICATION:

Manufacturer's Name: Weldbend Corporation  
Address: 6600 South Harlem Avenue  
Argo, Illinois 60501-1930  
Telephone Number: (708) 594-1700  
Emergency Number: (800) 424-9300 CHEMTREC  
Chemical Name & Synonyms: Weld Fittings & Flanges  
Chemical Family: Carbon Steel Grade WPB  
Formula: Not Applicable

## 2. PRODUCT DESCRIPTION & HAZARDOUS INGREDIENTS / IDENTITY INFORMATION:

ALLOYING ELEMENTS	CAS NO.
Iron (Fe)	7439-89-6
Manganese (Ma)*	7439-96-5
Carbon (C)*	7440-44-0
Aluminum (Al)	7429-90-5
Chromium (Cr)	7440-47-3
Copper (Cu)	7440-50-8
Molybdenum (Mo)	7439-98-7
Nickel (Ni)	7440-02-0
Phosphorus (P)*	7723-14-0
Silicon (Si)*	7440-21-3
Sulfur (S)*	7704-34-9
Boron (B)	7440-42-8
Bismuth (Bi)	7440-69-9
Tellurium (Te)	13494-80-9
Lead (Pb)	7439-92-1
Vanadium (V)	7440-62-2
Titanium (Ti)	7440-32-6
Zinc Coating (Zn)	1314-13-2
Zinc (Zn)	7440-66-6
Cobalt (Co)	7440-48-4
Tungsten (W)	7440-33-7
Tin (Sn)	7440-31-5

\*Basic Chemistry carbon steel ASTM requirement

## 3. PHYSICAL DATA:

- Melting Point °F (°C): Greater than 2800 (1540)
- Vapor Pressure: Not Applicable
- Vapor Density (Air = 1): Not Applicable
- Solubility in Water: Negligible
- Specific Gravity (H<sub>2</sub>O = 1): Greater than 7
- % Volatile by Volume (%): Not Applicable
- Evaporation Rate: Not Applicable

**4. FIRE AND EXPLOSION HAZARD DATA:**

- Flash Point F (C): Not applicable.
- Extinguishing Media: Use methods applicable to surrounding area.
- Flammable Limits: Not applicable.
- Unusual Fire and Explosion Hazards: None.
- Special Fire Fighting Procedures: Use self-contained breathing apparatus for protection against degradation products and fire fighting technique or agent(s) applicable to surrounding materials.

**5. HEALTH HAZARD DATA:**

Applicable Statutory or Recommended Occupational Exposure Limits: No Threshold Limit Value (TLV) or Permissible Exposure Limit (PEL) exists for steel. See chart for listing of individual constituents.

**EXPOSURE LIMITS**

<b>MATERIAL OR COMPONENT:</b>	<b>OSHA PEL (mg/m3)</b>	<b>ACGIH TLV (mg/m3)</b>
Base Metal		
Iron (Fe)	10 (Fe2O3 Fume)	5.0 (Fe2O3 Fume)
Alloying Elements		
Aluminum (Al)	None Listed	5.0 as welding fume
Carbon (C)*	None Listed	None Listed
Chromium (Cr)	1.0 as chrome	0.5 as chrome
Cobalt (Co)	0.1 as cobalt and fume	0.05 as fume
Columbium (Niobium)	5.0 as dust	10.0 as dust
Copper (Cu)	0.2 as copper; 1.0 as dust	0.2 as fume; 1.0 as dust
Lead (Pb)	0.05 as fume and dust	0.15 as dust and fume
Manganese (Mn)*	5 as manganese	5 as dust; 1 as fume
Molybdenum (Mo)	15 as insoluble compounds	10 as insoluble compounds
Nickel (Ni)	1.0 as Nickel	1.0 as Nickel
Phosphorous (P)*	0.1 as Phosphorus	0.1 as Phosphorus
Silicon (Si)*	None Listed	10 total dust
Sulfur (S)*	13 sulfur dioxide	5 sulfur dioxide
Tungsten (W)	None Listed	5 insoluble compounds
Vanadium (V)	0.5 dust; 0.1 fume	0.05 dust and fume
Zinc (Zn)	coating 5.0 as fume	5.0 as fume
Boron (B)	15.0 as Oxide	10.0 as Oxide
Bismuth (Bi)	None Listed	None Listed
Tellurium (Te)	0.10 as Compound	0.10 as Compound
Titanium (Ti)	15.0 Dioxide	10.0 Dioxide
Zinc (Zn)	10.0 as Dust	5.0 Oxide; 5 fume
Tin (Sn)	None Listed	10.0 as Tin Oxide

\*Basic Chemistry carbon steel ASTM requirement

**NOTE:** The above listing is a summary of elements used in alloying steel. Various grades of steel will contain different combinations of these elements. Trace elements may also be present in minute amounts.

**\*Carbon Steel:** The light coating applied to our products does not contain toxic materials such as mercury, arsenic or lead.



## 6. EFFECTS OF OVEREXPOSURE:

**ACUTE:** Dust or fume may cause irritation to the eyes, nose, or throat; may leave metallic taste in mouth; result in metal fume fever; or produce flu-like symptoms.

### CHRONIC:

Aluminum:	May initiate fibrotic changes to lung tissue.
Bismuth:	No chronic debilitating symptoms indicated from metal.
Boron:	No chronic debilitating symptoms indicated.
Chromium:	Skin ulceration, irritative dermatitis, allergic reaction, ulceration of the mucous membranes, perforation of the nasal septum, bronchial carcinoma, adenocarcinoma, mutagen (?) listed in the National Toxicology Program (NTP). Annual Report on Carcinogens and found to be a potential carcinogen in the International Agency for Research on Cancer (IARC) Monographs.
Copper:	No chronic debilitating symptoms indicated.
Iron:	Siderosis.
Lead:	Anemia, urinary dysfunction, metallic taste in mouth, weakness, constipation, nausea, nervous disorder.
*Manganese:	Bronchitis, pneumonitis, lack of coordination.
Molybdenum:	Morphological changes in the liver, kidneys, and spleen, anemia, diarrhea, bone deformity and growth retardation.
Nickel:	Inflammation of respiratory tract, pneumoconiosis. Skin sensitizer. Certain nickel compounds can cause cancer. Listed in NTP Annual Report on Carcinogens and found to be a potential carcinogen in IARC Monographs.
*Phosphorous:	Necrosis of the mandible.
*Sulfur (as sulfur dioxide):	Edema of the lungs.
Tellurium:	Garlic odor of breath and perspiration, metallic taste in mouth, dryness of the mouth, inhibition of sweat function, anorexia, nausea.
Titanium:	No chronic debilitating symptoms indicated.
Vanadium:	Emphysema, pneumonia.
Zinc:	Chromosomal anomalies in leukocytes reported. Arthritis, lameness and inflammation of the gastrointestinal tract reported from animal studies.
Tin:	Inorganic tin dust/fumes can cause benign pneumoconiosis of the lungs.
*Carbon Steel	

## 7. EMERGENCY AND FIRST AID PROCEDURES:

In the event of acute exposure, remove to fresh air, administer oxygen, and seek a physician's assistance.

## 8. REACTIVITY DATA:

Stability: Considered stable.

Incompatibility: Not incompatible with materials.

Hazardous Polymerization: Not applicable.

Hazardous Decomposition Products: Not applicable.

Conditions to avoid: May liberate metal fumes, metal oxides, or other oxides if exposed to elevated temperatures.

## 9. SPILL OR LEAK PROCEDURES:

Steps To Be Take In Case Material is Released or Spilled: Not applicable.

Waste Disposal Method: This material may be reclaimed for reuse.

## 10. SPECIAL PROTECTION INFORMATION:

If operations are such that atmospheric levels of contaminants exceed prescribed limits, provide local exhaust ventilation and/or adequate respiratory protection. Consult your regional codes or code of Federal Regulations, Title 29, Part 1910.252, Welding, Cutting and Brazing, 1910.134, Respiratory Protection, and 1910 - Subpart Z. Toxic and Hazardous Substances. Personal protective equipment, such as gloves for handling, goggles and dust filter masks for grinding, proper respirators for welding, etc. should be provided and worn.

Please note that all carbon steel forgings that we manufacture present no health hazard in their natural state during use, transportation or storage. However, operations such as burning, welding or grinding may generate concentrations of dust particles or fumes of the alloying elements that may present hazards. For the information to be effective, it must be passed along to all safety and health personnel in your firm, as well as to all personnel who handle or use the products and/or are involved with the implementation or control of operations involving the products.

## DISCLAIMER

Weldbend Corporation believes that the product described in the MSDS would be considered an "article" within the meaning of Section 1910.1200. This MSDS is intended to be used solely for the purpose of satisfying informational requests. It is not intended to preempt, replace or expand the terms contained in Weldbend Corporation Conditions of Sale. Compliance with all the applicable federal, state and local laws and regulations remains the responsibility of the user, and the user has the responsibility to provide a safe working place, to examine all aspects of its operation, and to determine if or where precautions, in addition to those described herein, are required.



***“The Industry Standard for  
Welding Fittings & Flanges”***

Weldbend restricts its sales to Jobbers and/or Distributors only. Before an order from a new customer is accepted, proof of that customer's status as a Jobber and/or Distributor is required.

ALL WELDBEND SALES ARE MADE SOLELY IN ACCORDANCE WITH WELDBEND'S STANDARD TERMS AND CONDITIONS OF SALES WHICH ARE SET FORTH HEREIN. Weldbend provides this catalog for the convenience of its customers in ordering Weldbend products. Weldbend is not responsible for any printing errors in the data contained herein, and verification of all specifications are the sole responsibility of the customers.

We acknowledge the Technical Abilities and Assistance of Mr. Leslie F. Wasdell, C. Eng., M. I. Mech. E.

We acknowledge the Technical Abilities and Assistance of Mr. A.J. DelBuono, P.E.

We acknowledge and appreciate the cooperation of the American Society of Mechanical Engineers, The American Society of Testing Materials, and the American National Society Institute for providing a portion of the technical data displayed in this catalog. For further technical information, the promulgating standard society may be contacted.

## **WELDBEND CORPORATION**

6600 SOUTH HARLEM AVENUE, ARGO, IL 60501-1930

### **SALES**

TEL: 708/594-1700

FAX: 708/458-0106

### **GENERAL OFFICE**

TEL: 773/582-3500

FAX: 773/582-7621

**[www.weldbend.com](http://www.weldbend.com)**

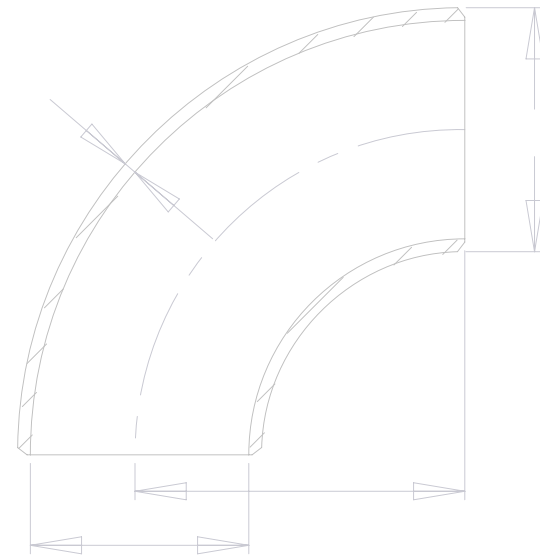
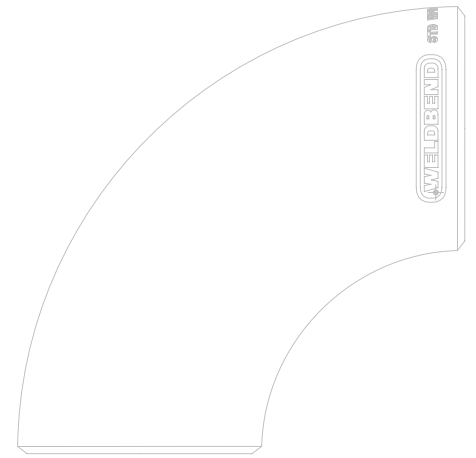
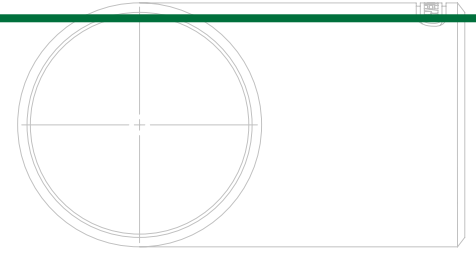
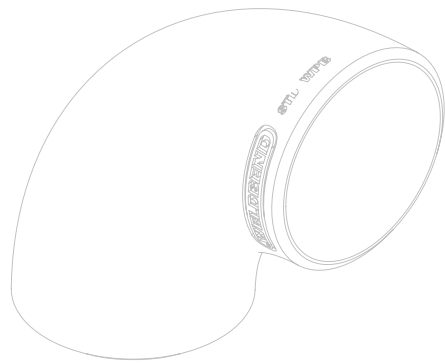
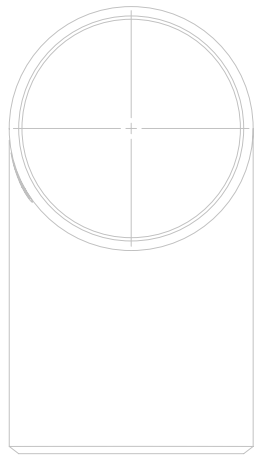



# NOTES

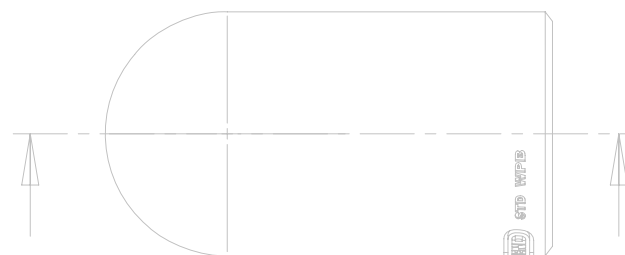
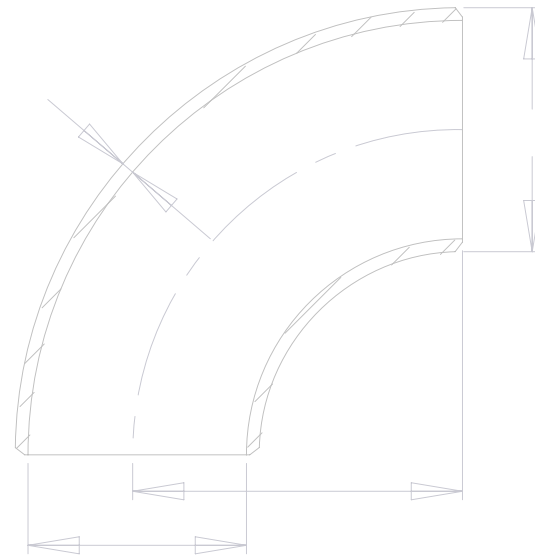
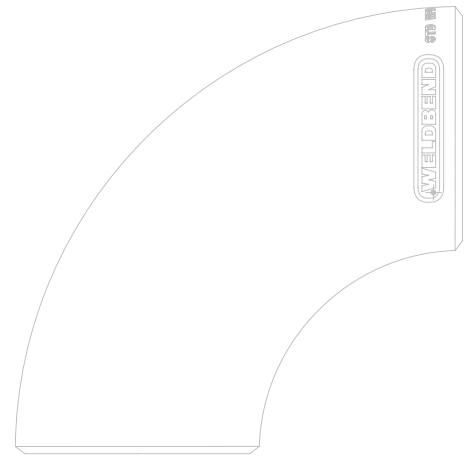
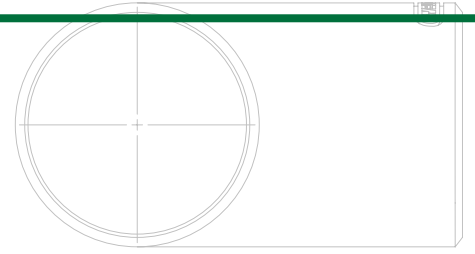
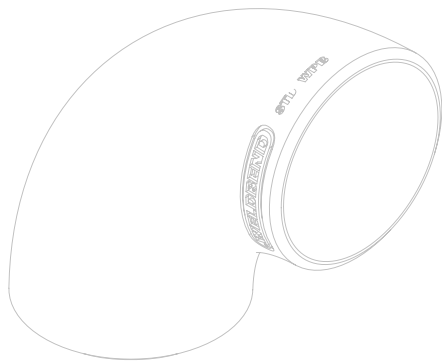
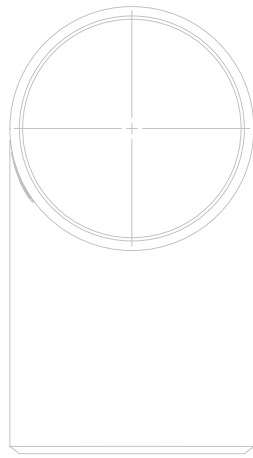
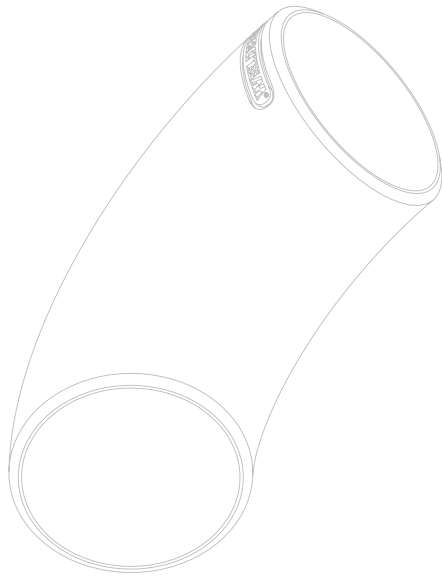

NOTES

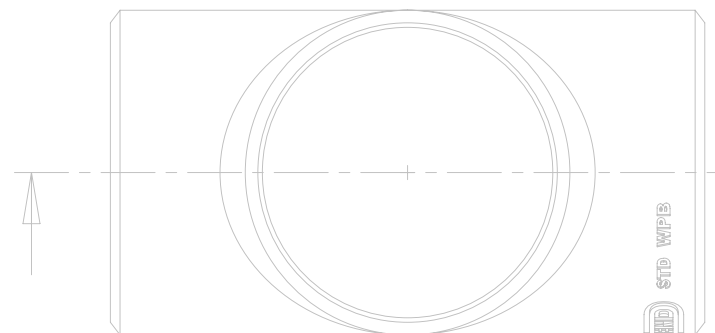
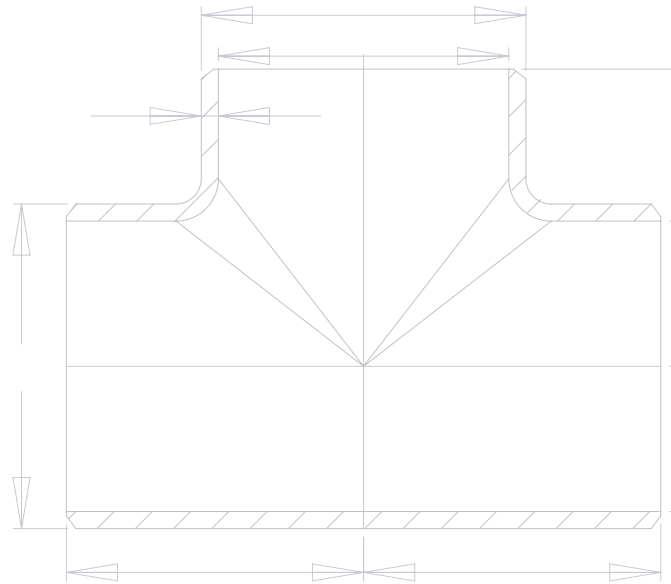
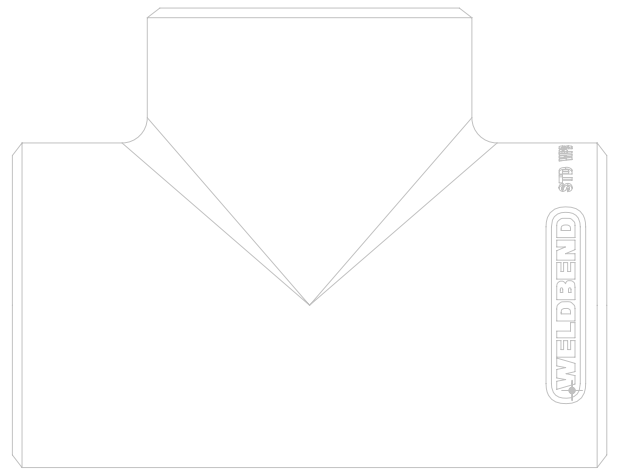
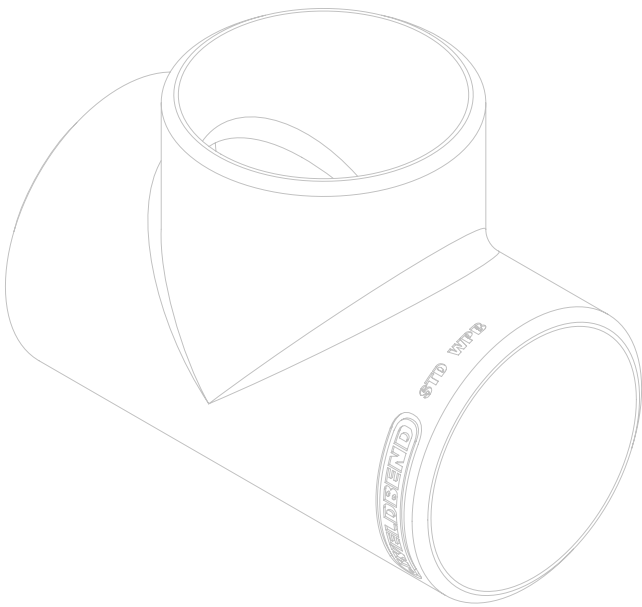
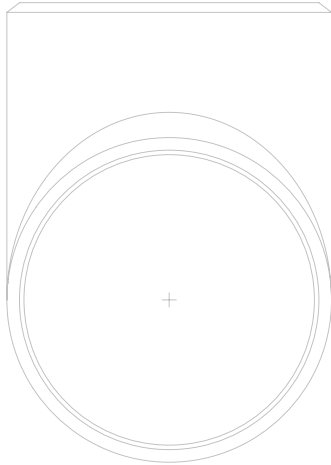
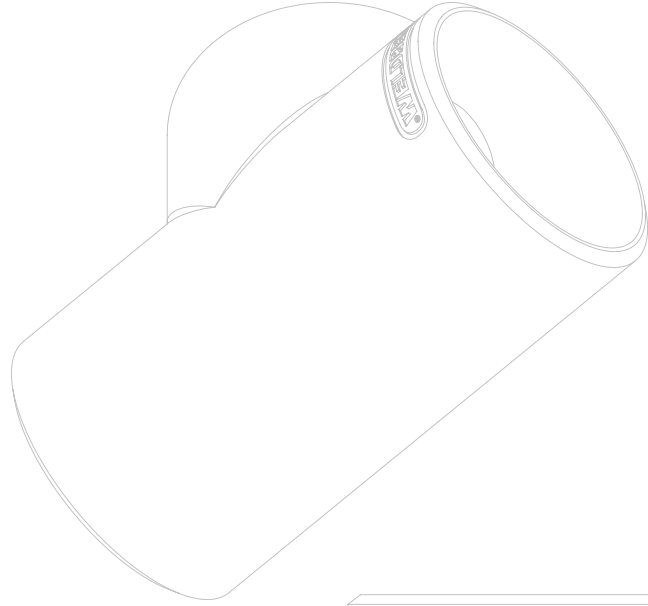



NOTES

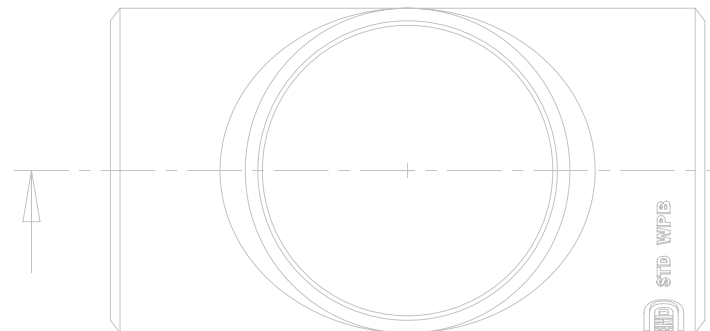
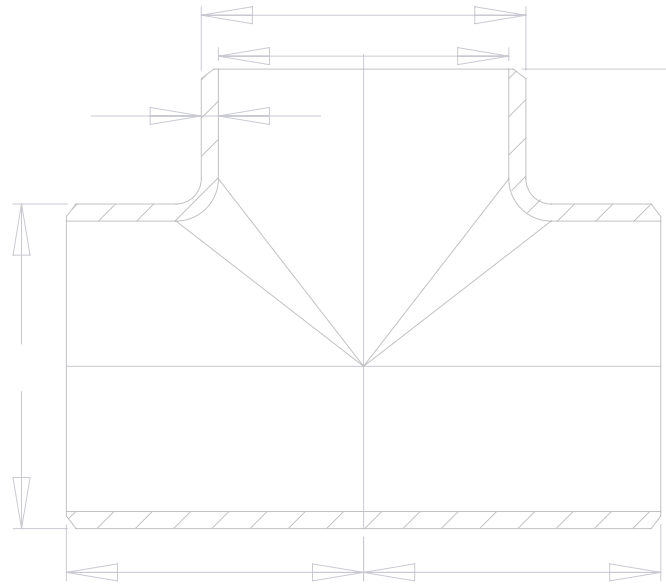
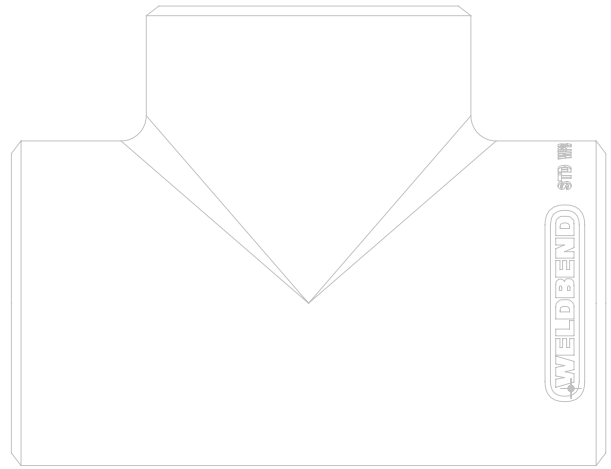
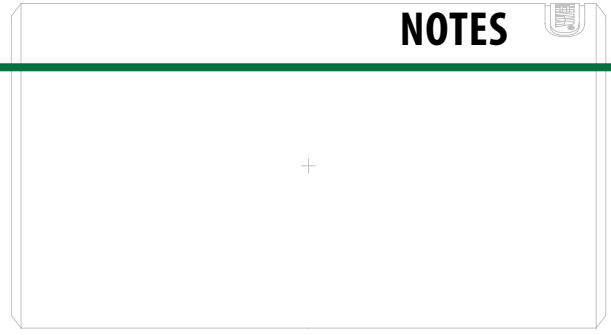
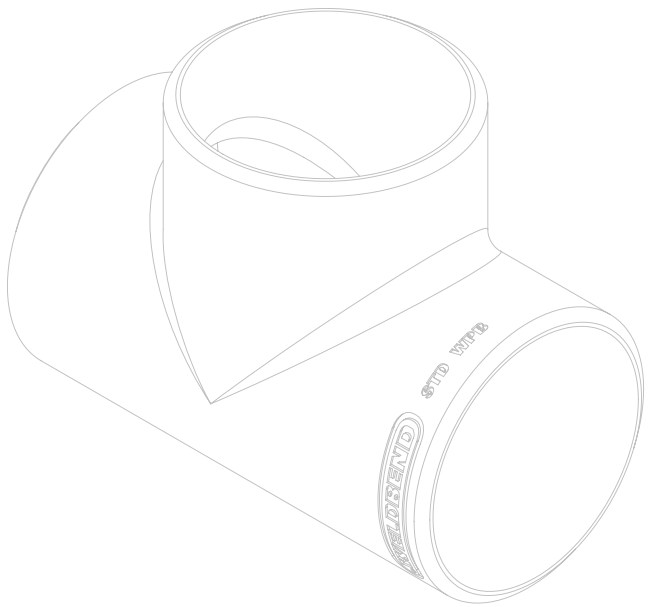
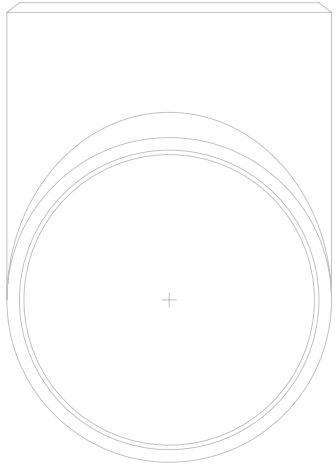
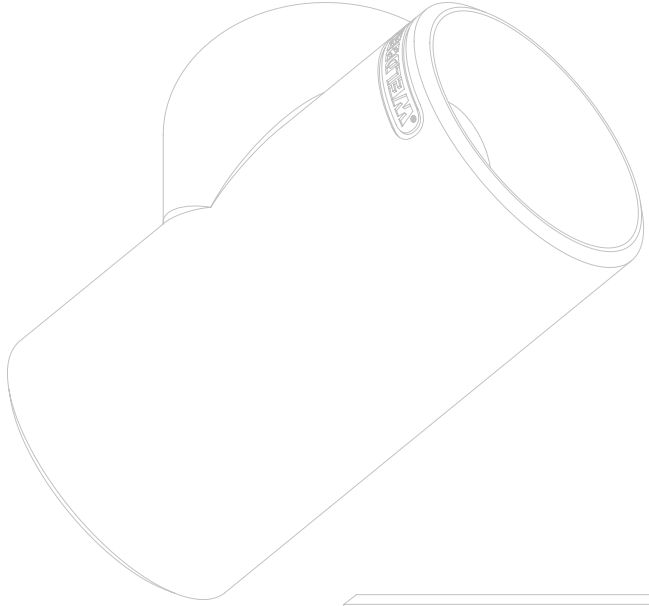

NOTES

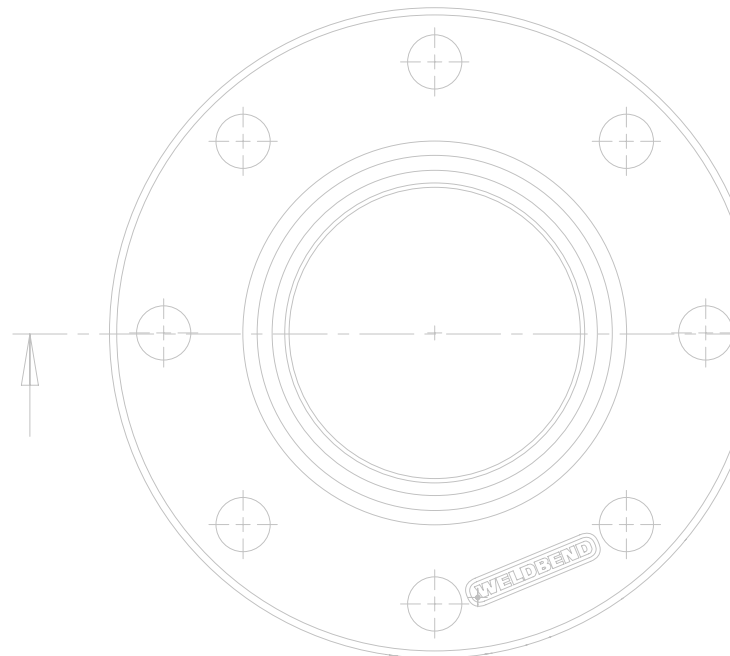
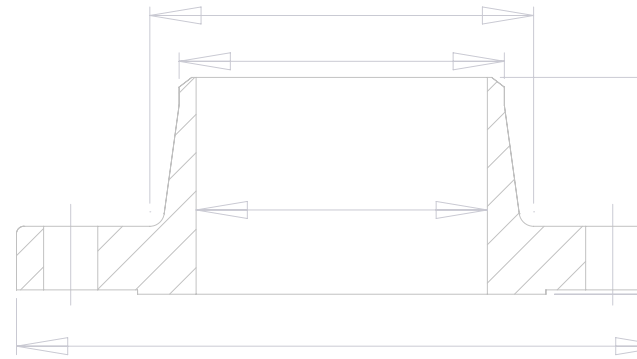
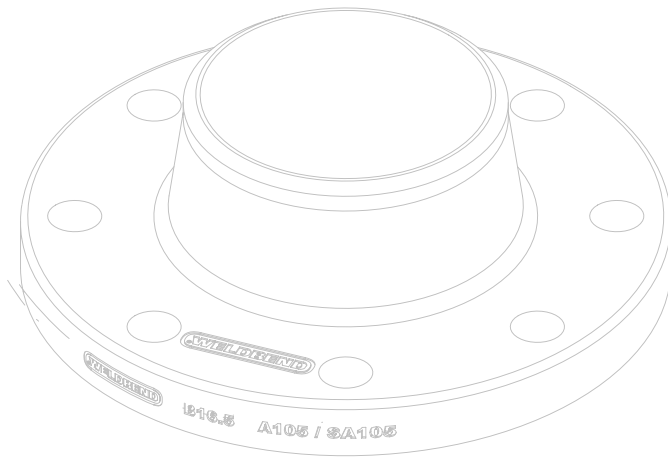
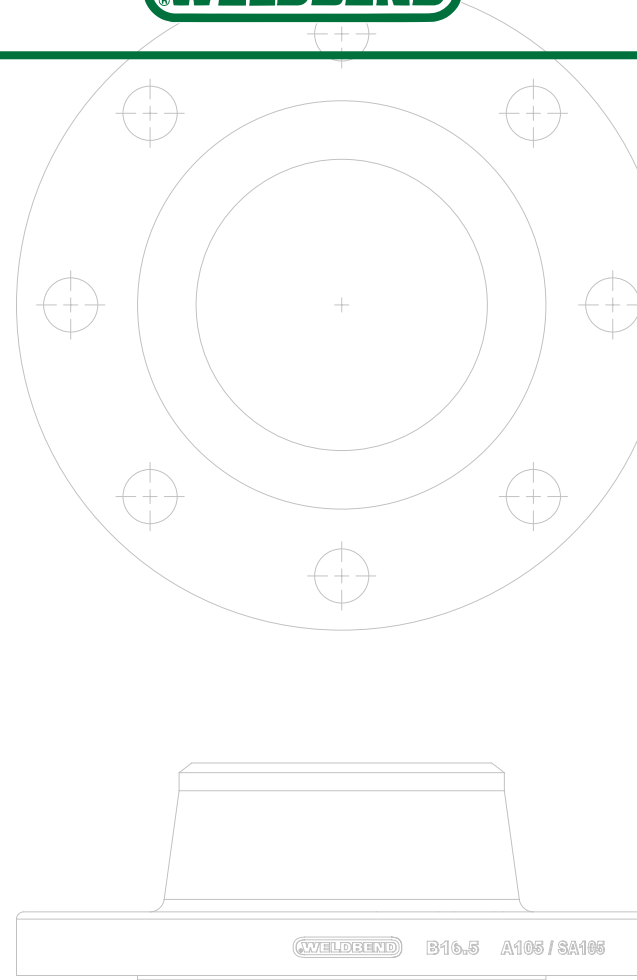
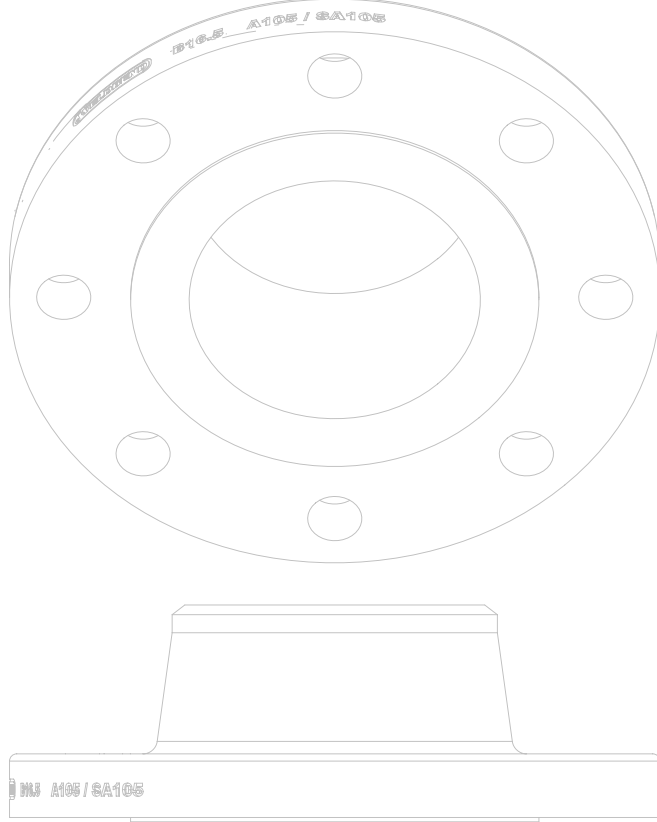





NOTES

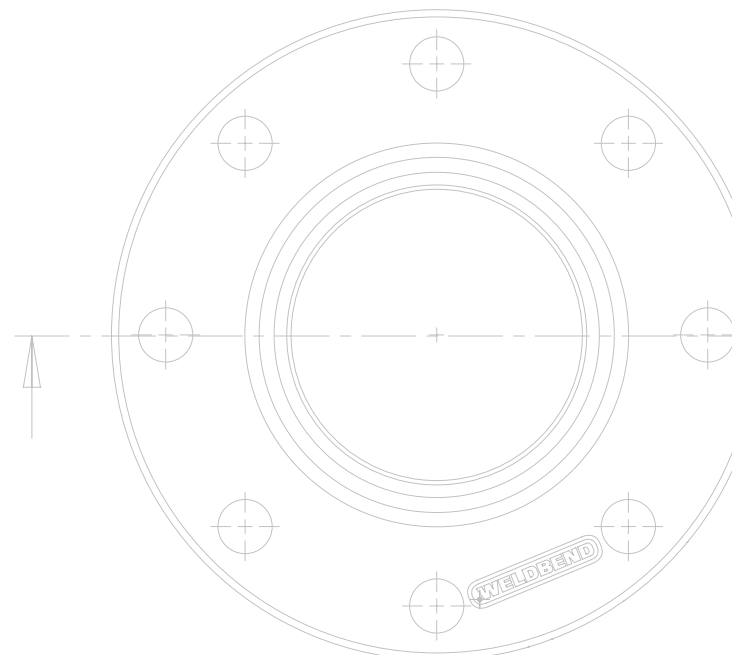
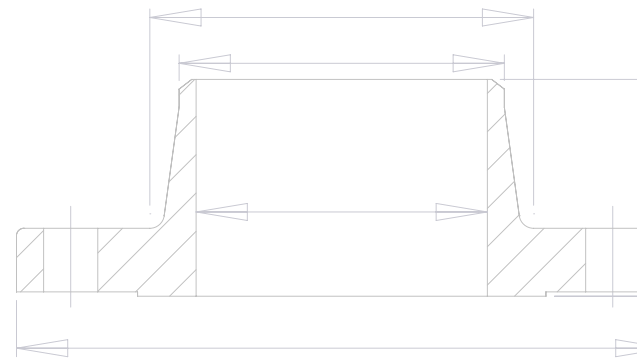
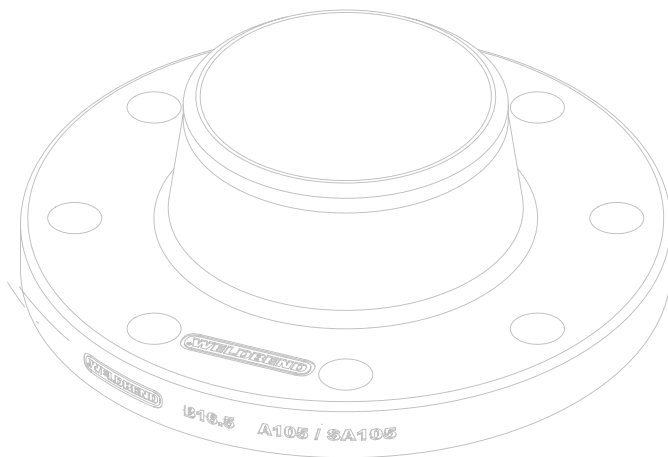
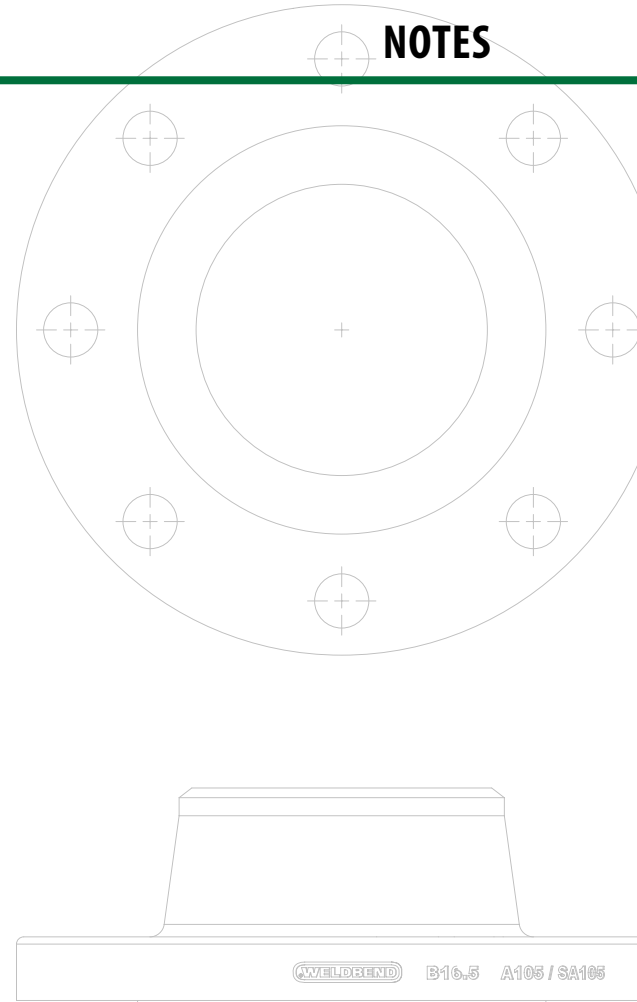
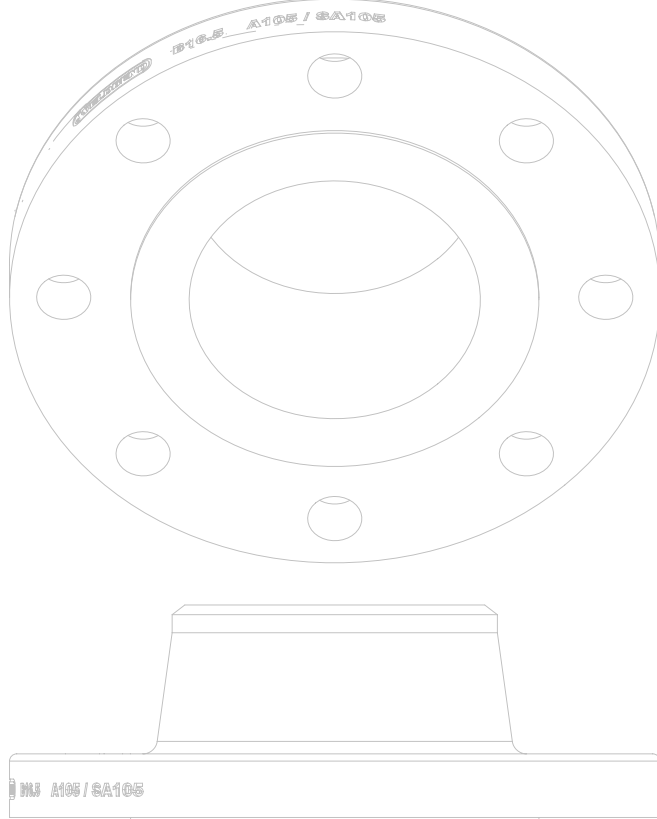



**WELDBEND CORPORATION**

6600 SOUTH HARLEM AVENUE, ARGO, IL 60501-1930

**SALES**

TEL: 708/594-1700

FAX: 708/458-0106

**GENERAL OFFICE**

TEL: 773/582-3500

FAX: 773/582-7621

**[www.weldbend.com](http://www.weldbend.com)**