

Victaulic® Check Valves

Series 716 Check Valve

Series 716H High Pressure Check Valve



Series 716H
(2 – 3"/DN50 – DN80)



Series 716
(2 ½ – 3"/73.0mm – DN80)



Series 716
(4 – 12"/DN100 – DN300)

1.0 PRODUCT DESCRIPTION

Available Sizes

- Series 716H: 2 – 3"/DN50 – DN80
- Series 716: 2 ½ – 12"/73.0mm – DN300

Maximum Working Pressure

- Accommodates pressures ranging from full vacuum (29.9 in Hg/760 mm Hg) up to 365 psi/2500 kPa/25 bar – see section 5.0 Performance for more information
- Working pressure dependent on size of pipe, valve size, and approval requirements

Operating Temperature

- Dependent on seat selection from section 3.0

Application

- Prevents back flow
- Single-disc mechanism incorporates a spring-assisted feature for non-slamming operation
- Can be installed either vertically (flow upwards only) or horizontally
- Valve body cast with arrow indicator to assist with proper valve orientation
- Optional upstream and downstream pressure taps included on select sizes – see section 3.0

End Preparation

- Victaulic Original Groove System (OGS) standard groove

2.0 CERTIFICATION/LISTINGS



BS EN 10311 EN 10311
CPR (UK) CPR (EU)
2019 No. 465 No. 305/2011

Product designed and manufactured under Victaulic's Quality Management System, as certified by LPCB in accordance with ISO 9001.

ALWAYS REFER TO ANY NOTIFICATIONS AT THE END OF THIS DOCUMENT REGARDING PRODUCT INSTALLATION, MAINTENANCE OR SUPPORT.

3.0 SPECIFICATIONS – MATERIAL

Body: (specify choice)

Ductile iron conforming to ASTM A536, Grade 65-45-12.

Ductile iron conforming to ASTM A395, Grade 65-45-15, is available upon special request.

Body Coating: (specify choice)

Series 716H body: Black paint

Series 716H endface: Electroless nickel conforming to ASTM B733

Series 716 (2 ½ – 3"/73.0mm – DN80): PPS coating

Series 716 (4 – 12"/DN100 – DN300): Black paint

Body Seat: (specify choice)

Series 716H: O-ring installed into an electroless nickel plating conforming to ASTM B733

Series 716 (2 ½ – 3"/73.0mm – DN80): PPS coated ductile iron

Series 716 (4 – 12"/DN100 – DN300): Ductile iron with electroless nickel plating conforming to ASTM B733

Seat: (specify choice)

Victaulic EPDM

(Green color code). Temperature range –30°F to +230°F/–34°C to +110°C. NOT COMPATIBLE FOR USE WITH PETROLEUM SERVICES OR STEAM SERVICES.

Victaulic Nitrile

(Orange color code). Temperature range –20°F to +180°F/–29°C to +82°C. Not compatible with hot water services over +150°F/+66°C or for hot dry air over +140°F/+60°C. NOT COMPATIBLE FOR USE WITH STEAM SERVICES.

Victaulic Fluoroelastomer

(Blue color code). Temperature range +20°F to +300°F/–7°C to +149°C. May be specified for many oxidizing acids, petroleum oils, halogenated hydrocarbons, lubricants, hydraulic fluids, organic liquids and air with hydrocarbons. NOT COMPATIBLE FOR USE WITH HOT WATER SERVICES OR STEAM SERVICES.

Disc: (specify choice)

Series 716H: CF8M cast stainless steel

Series 716 (2 ½ – 3"/73.0mm – DN80): Aluminum bronze with elastomer seal

Series 716 (4 – 12"/DN100 – DN300): Ductile iron disc conforming to ASTM A536, Grade 65-45-12 encapsulated in rubber

Shaft: (specify choice)

Series 716H: Brass

Series 716 (2 ½ – 3"/73.0mm – DN80): Type 416 stainless steel

Series 716 (4 – 12"/DN100 – DN300): Type 316 stainless steel

Spring: Type 302/304 stainless steel

Shaft Plug: Type 416 stainless steel

Pipe Plug: Carbon steel zinc plated

Optional Pressure Taps: (specify choice)

Series 716H: Available on all sizes

Series 716: Available on sizes 4 – 12"/DN100 – DN300

4.0 DIMENSIONS

Series 716H High Pressure Check Valve

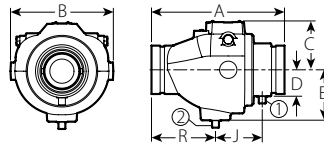

- ① ½" NPT Upstream Drain
- ② ½" NPT Downstream Drain

2 – 3"/DN50 – DN80

Size		Dimensions							Weight
Nominal	Actual Outside Diameter	E to E A	B	C	D	E	J	R	Approximate (Each)
inches DN	inches mm	inches mm	inches mm	inches mm	inches mm	inches mm	inches mm	inches mm	lb kg
2	2.375	8.75	6.50	3.25	1.50	3.13	2.88	4.25	10.7
DN50	60.3	220	165	83	38	77	71	108	4.9
2½	2.875	9.38	7.00	3.38	1.75	3.50	3.38	4.38	13.8
	73.0	238	177	85	43	87	86	112	6.3
DN65	3.000	9.38	7.00	3.38	1.75	3.50	3.38	4.38	13.8
	76.1	238	177	85	43	87	86	112	6.3
3	3.500	9.63	7.50	3.63	2.00	3.75	3.38	4.63	20.0
DN80	88.9	245	189	90	49	93	86	118	9.1

4.1 DIMENSIONS

Series 716 Check Valve

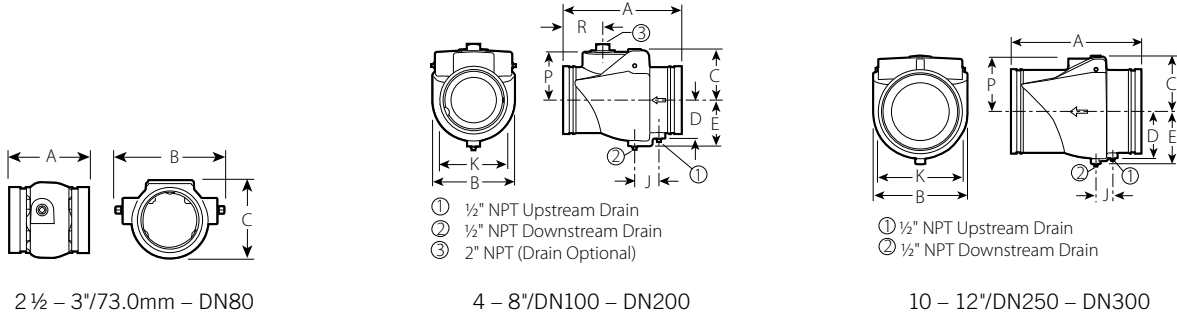

Size		Dimensions										Weight
Nominal inches DN	Actual Outside Diameter inches mm	E to E A inches mm	B inches mm	C inches mm	D inches mm	E inches mm	J inches mm	K inches mm	P inches mm	R inches mm	Approximate (Each) lb kg	
2 ½	2.875 73.0	3.88 99	4.25 108	3.63 91	-	-	-	-	-	-	3.6 1.6	
DN65	3.000 76.1	3.88 99	4.25 108	3.63 91	-	-	-	-	-	-	3.6 1.6	
3 DN80	3.500 88.9	4.25 108	5.13 129	4.25 106	-	-	-	-	-	-	4.5 2.0	
4 DN100	4.500 114.3	9.63 245	6.00 152	3.88 99	2.75 70	3.50 89	2.00 51	4.50 114	3.50 89	3.38 85	20.0 9.1	
	5.500 139.7	10.50 267	6.88 173	4.50 114	-	4.25 106	2.25 55	5.88 149	4.13 104	4.00 101	27.0 12.3	
5 DN125	5.563 141.3	10.50 267	6.88 173	4.50 114	-	4.25 106	2.25 55	5.88 149	4.13 104	4.00 101	27.0 12.3	
	6.500 165.1	11.50 292	8.00 203	5.00 127	-	4.50 114	2.38 61	6.75 169	4.75 120	3.88 99	38.0 17.2	
6 DN150	6.625 168.3	11.50 292	8.00 203	5.00 127	-	4.50 114	2.38 61	6.75 169	4.75 120	3.88 99	38.0 17.2	
8 DN200	8.625 219.1	14.00 356	9.88 251	6.13 154	5.13 128	5.75 144	2.25 55	8.88 225	5.75 144	5.75 146	64.0 29.0	
10 DN250	10.750 273.0	17.00 432	12.00 305	7.13 180	6.00 151	6.75 170	2.25 55	11.00 277	6.75 171	-	100.0 45.4	
12 DN300	12.750 323.9	19.50 495	14.00 356	8.13 205	7.00 176	7.75 194	2.50 64	12.88 925	7.75 196	-	140.0 63.5	

5.0 PERFORMANCE

Series 716H High Pressure Check Valve

Size		Maximum Working Pressure
Nominal	Actual Outside Diameter	
inches DN	inches mm	psi kPa
2 DN50	2.375 60.3	365 2500
2½	2.875 73.0	365 2500
DN65	3.000 76.1	365 2500
3 DN80	3.500 88.9	365 2500

NOTE

- WARNING: FOR ONE-TIME FIELD TEST ONLY, the Maximum Working Pressure may be increased to 1½ times the figures shown.

Series 716 Check Valve

Size		Maximum Working Pressure
Nominal	Actual Outside Diameter	
inches DN	inches mm	psi kPa
2½	2.875 73.0	300 2100
DN65	3.000 76.1	300 2100
3 DN80	3.500 88.9	300 2100
4 DN100	4.500 114.3	365 2500
	5.500 139.7	365 2500
5 DN125	5.563 141.3	365 2500
	6.500 165.1	365 2500
6 DN150	6.625 168.3	365 2500
8 DN200	8.625 219.1	365 2500
10 DN250	10.750 273.0	300 2100
12 DN300	12.750 323.9	300 2100

NOTE

- WARNING: FOR ONE-TIME FIELD TEST ONLY, the Maximum Working Pressure may be increased to 1½ times the figures shown.

5.1 PERFORMANCE

The Series 716/716H check valve seat provides leak-free sealing under conditions as low as five feet of head. Cv/Kv values for flow of water at +60°F/+16°C with a fully open valve are shown in the table below.

Formulas for Cv/Kv values:

$$\Delta P = \frac{Q^2}{C_v^2}$$

$$Q = C_v \times \sqrt{\Delta P}$$

Where:

Q = Flow (GPM)

ΔP = Pressure Drop (psi)

C_v = Flow Coefficient

$$\Delta P = \frac{Q^2}{K_v^2}$$

$$Q = K_v \times \sqrt{\Delta P}$$

Where:

Q = Flow (m³/hr)

ΔP = Pressure Drop (Bar)

K_v = Flow Coefficient

Series 716H High Pressure Check Valve

Size		C _v K _v (Full Open)
Nominal inches DN	Actual Outside Diameter inches mm	
2 DN50	2.375 60.3	160 138
2½	2.875 73.0	215 186
DN65	3.000 76.1	215 186
3 DN80	3.500 88.9	315 273

Series 716 Check Valve

Size		C _v K _v (Full Open)
Nominal inches DN	Actual Outside Diameter inches mm	
2½	2.875 73.0	140 121
DN65	3.000 76.1	140 121
3 DN80	3.500 88.9	250 216
4 DN100	4.500 114.3	390 337
	5.500 139.7	700 606
5 DN125	5.563 141.3	700 606
	6.500 165.1	1000 865
6 DN150	6.625 168.3	1000 865
8 DN200	8.625 219.1	1800 1557
10 DN250	10.750 273.0	3000 2595
12 DN300	12.750 323.9	4200 3633

5.2 PERFORMANCE

Flow Characteristics

The charts below express the flow of water at 60°F/16°C through valve.

Series 716H High Pressure Check Valve

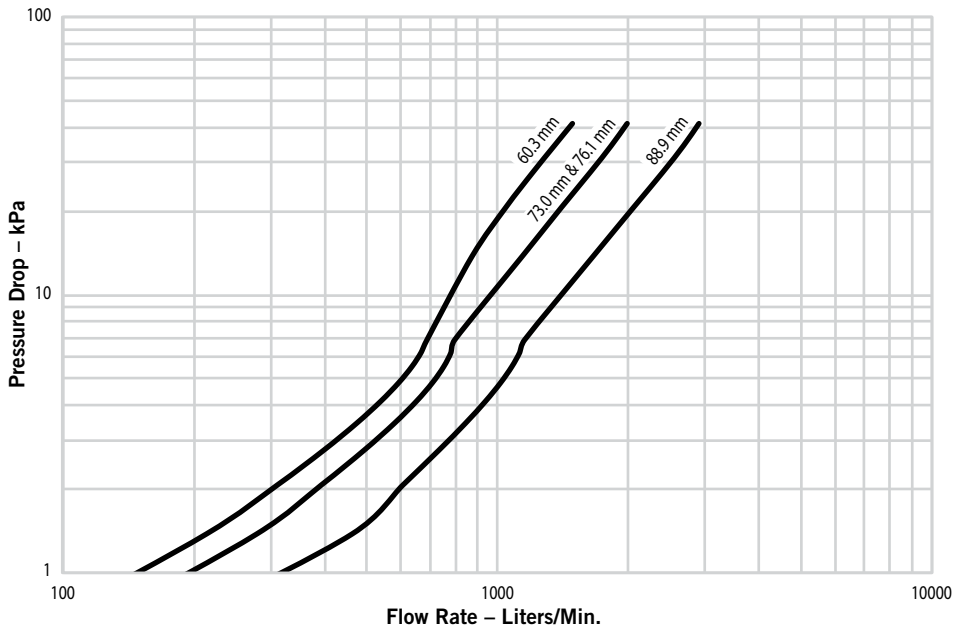
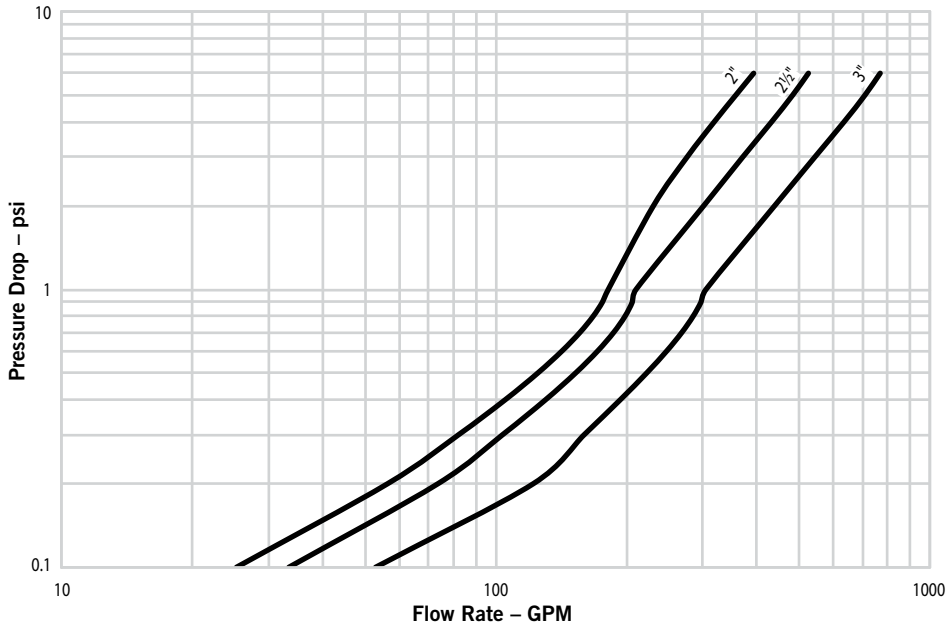

5.2 PERFORMANCE (CONTINUED)

Flow Characteristics

The charts below express the flow of water at 60°F/16°C through valve.

Series 716H High Pressure Check Valve

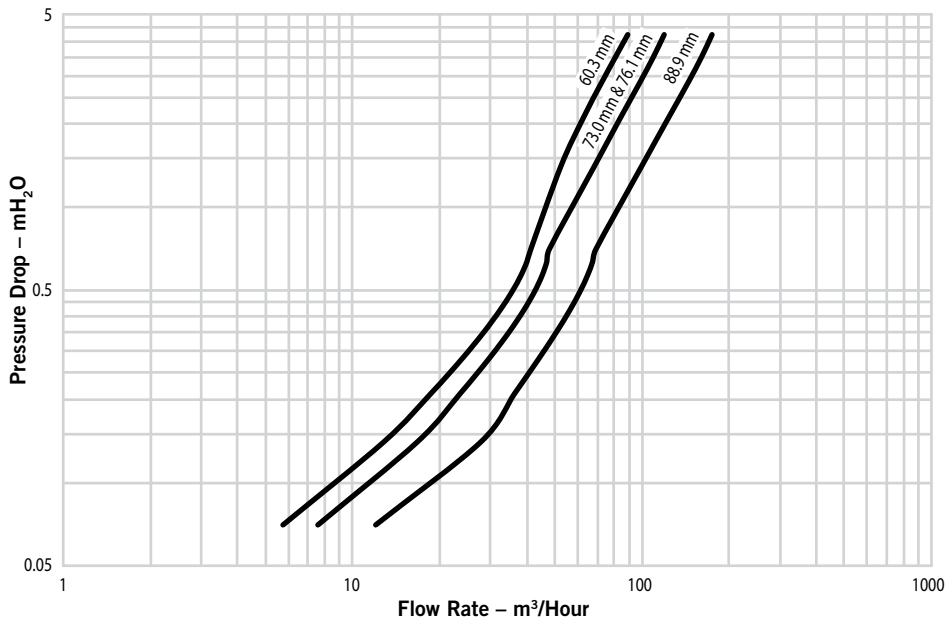

5.2 PERFORMANCE (CONTINUED)

Flow Characteristics

The charts below express the flow of water at 60°F/16°C through valve.

Series 716 Check Valve

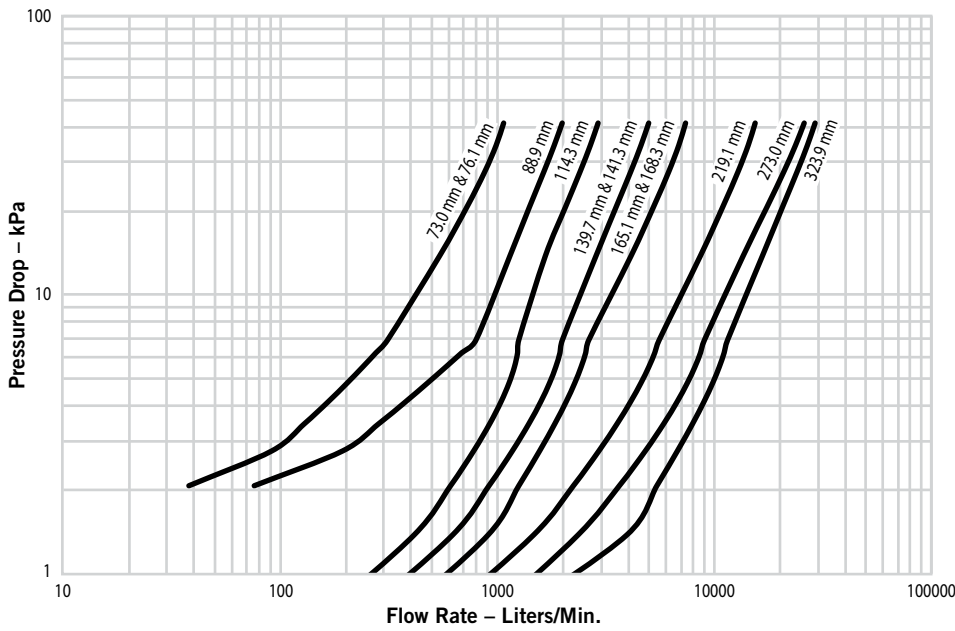
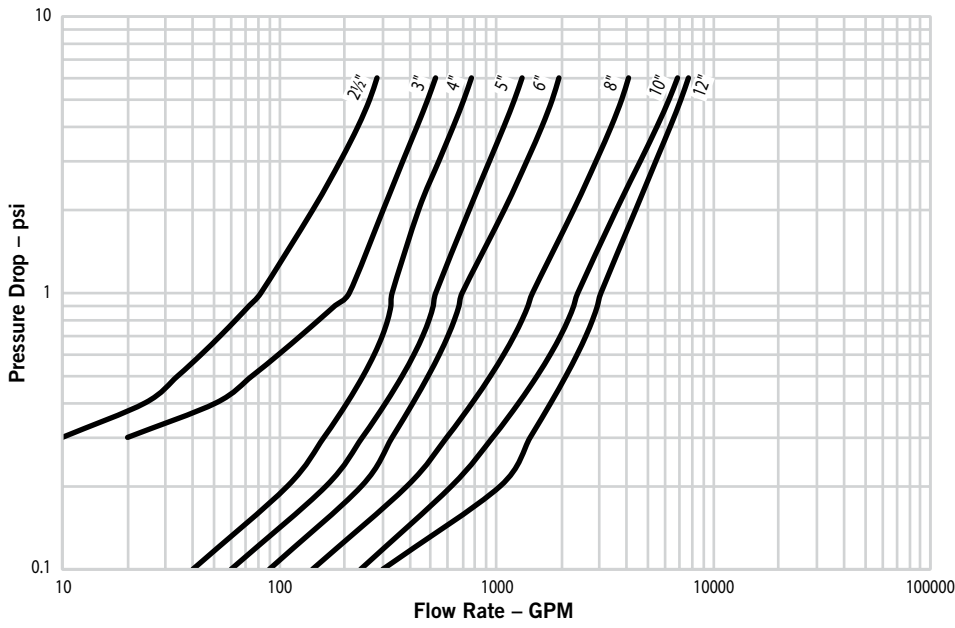

5.2 PERFORMANCE (CONTINUED)

Flow Characteristics

The charts below express the flow of water at 60°F/16°C through valve.

Series 716 Check Valve

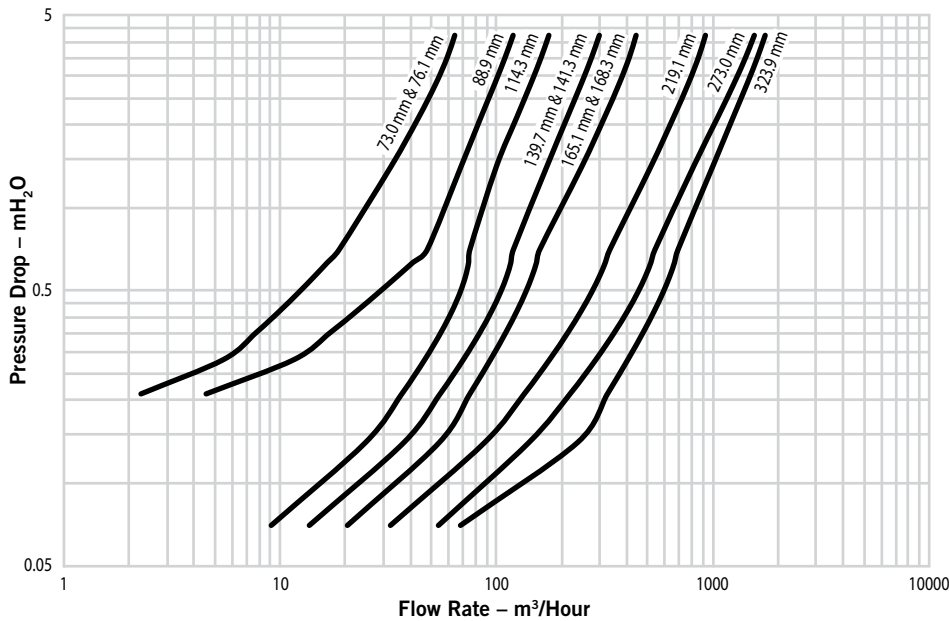

6.0 NOTIFICATIONS

WARNING



- Read and understand all instructions before attempting to install, remove, adjust, or maintain any Victaulic piping products.
- Depressurize and drain the piping system before attempting to install, remove, adjust, or maintain any Victaulic piping products.
- Wear safety glasses, hardhat, and foot protection.

Failure to follow these instructions could result in death or serious personal injury and property damage.

7.0 REFERENCE MATERIALS

[05.01: Victaulic Seal Selection Guide](#)

[29.01: Victaulic Terms and Conditions/Warranty](#)

[I-100: Victaulic Field Installation Handbook](#)

User Responsibility for Product Selection and Suitability

Each user bears final responsibility for making a determination as to the suitability of Victaulic products for a particular end-use application, in accordance with industry standards and project specifications, as well as Victaulic performance, maintenance, safety, and warning instructions. Nothing in this or any other document, nor any verbal recommendation, advice, or opinion from any Victaulic employee, shall be deemed to alter, vary, supersede, or waive any provision of Victaulic Company's standard conditions of sale, installation guide, or this disclaimer.

Intellectual Property Rights

No statement contained herein concerning a possible or suggested use of any material, product, service, or design is intended, or should be construed, to grant any license under any patent or other intellectual property right of Victaulic or any of its subsidiaries or affiliates covering such use or design, or as a recommendation for the use of such material, product, service, or design in the infringement of any patent or other intellectual property right. The terms "Patented" or "Patent Pending" refer to design or utility patents or patent applications for articles and/or methods of use in the United States and/or other countries.

Note

This product shall be manufactured by Victaulic or to Victaulic specifications. All products to be installed in accordance with current Victaulic installation/assembly instructions. Victaulic reserves the right to change product specifications, designs and standard equipment without notice and without incurring obligations.

Installation

Reference should always be made to the Victaulic installation handbook or installation instructions of the product you are installing. Handbooks are included with each shipment of Victaulic products, providing complete installation and assembly data, and are available in PDF format on our website at www.victaulic.com.

Warranty

Refer to the Warranty section of the current Price List or contact Victaulic for details.

Trademarks

Victaulic and all other Victaulic marks are the trademarks or registered trademarks of Victaulic Company, and/or its affiliated entities, in the U.S. and/or other countries.