

# Victaulic® Stainless Steel Check Valve for Potable Water Applications

## Series 816



17.46



2 – 3"/DN50 – DN80



4 – 12"/DN100 – DN300

### 1.0 PRODUCT DESCRIPTION

#### Available Sizes

- 2 – 12"/DN50 – DN300

#### Maximum Working Pressure

- Accommodates pressures ranging from full vacuum (29.9 in Hg/760 mm Hg) up to 300 psi/2100 kPa/21 bar

#### Operating Temperature

- +20°F to +180°F/-7°C to +82°C

#### Function

- Intended for use in potable water systems
- Resilient-seat spring return swing check valve for horizontal or vertical (upward flow) applications
- For sizes 2 – 3"/DN50 – DN80, one (1) ½" NPT drain hole on the downstream side of the seat is available as an option.
- For sizes 4 – 12"/DN100 – DN 300, two (2) ½" NPT drain holes or one hole on each side of the seat are available as options.

#### NOTE

- For use in non-potable water systems, refer to [publication 17.41](#): Victaulic Stainless Steel Check Valve Series 416.

#### Minimum Backpressure to Seal

- 5 feet/1.5 meters of water (2.2 psi/14.9 kPa)

### 2.0 CERTIFICATION/LISTINGS



When utilizing a Victaulic Fluoroelastomer seat, the Series 816 is UL Classified in accordance with ANSI/NSF 61 for cold +73°F/+23°C and hot +180°F/+82°C potable water service and ANSI/NSF 372.

#### NOTE

- See [publication 02.06](#): Victaulic Approvals for Potable Water Products - ANSI/NSF 61 and ANSI/NSF 372 for more details.

ALWAYS REFER TO ANY NOTIFICATIONS AT THE END OF THIS DOCUMENT REGARDING PRODUCT INSTALLATION, MAINTENANCE OR SUPPORT.

System No.		Location	
Submitted By		Date	

Spec Section		Paragraph	
Approved		Date	



### 3.0 SPECIFICATIONS – MATERIAL

#### Series 816 Stainless Steel Check Valve for Potable Water Applications

**Body:** Stainless steel conforming to ASTM A351 Grade CF8M.

**Seat: Victaulic Fluoroelastomer**

Fluoroelastomer (Blue color code). Temperature range +20°F to +180°F/-7°C to +82°C. Specifically formulated for compatibility with potable water systems. Optimized for improved resistance to chlorine, chloramine and other typical potable water disinfectants. UL Classified in accordance with ANSI/NSF 61 for cold +73°F/+23°C and hot +180°F/+82°C potable water service and ANSI/NSF 372.

**Disc:** Stainless steel conforming to ASTM A351 Grade CF8M.

**Shaft:** 17-4PH stainless steel conforming to ASTM A564.

**Spring:** 17-7PH stainless steel conforming to ASTM A564 or 316 stainless steel.

**Shaft Plug and Optional Drain Plug:** 316 stainless steel.

**Seat Plate:** 316 stainless steel.

**Ball:** Ball material will match the seat material chosen above.

**Spacer Bushing:** Polytetrafluoroethylene (PTFE).

**Washer:** Polytetrafluoroethylene (PTFE).

**Split Lock Washer:** 316/18-8 stainless steel.

**Hex Head Cap Screw:** 316 stainless steel.

**Shaft Bushing:** 316 stainless steel.

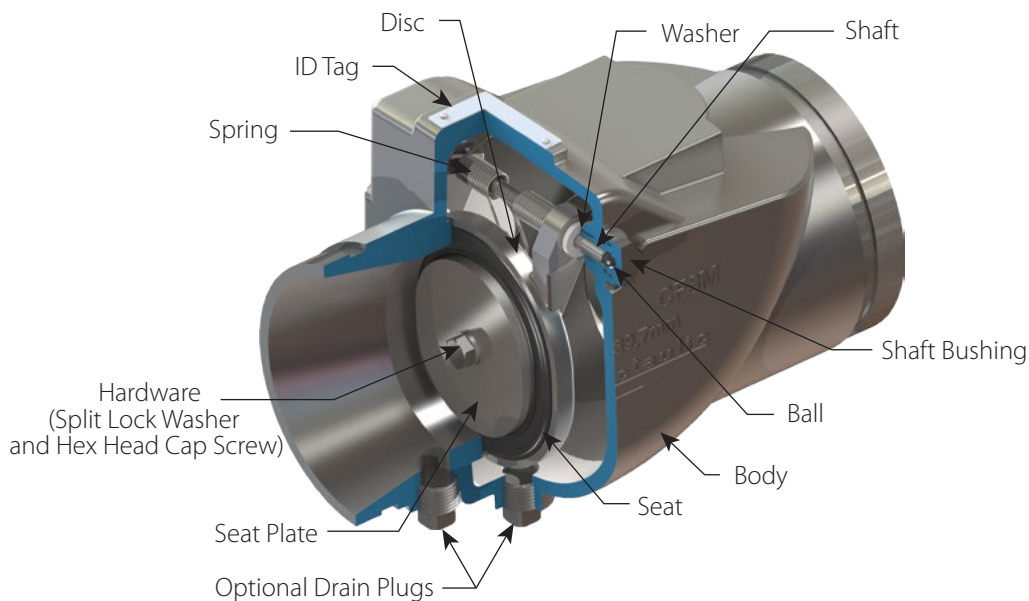

## 4.0 DIMENSIONS

### Series 816 Stainless Steel Check Valve for Potable Water Applications

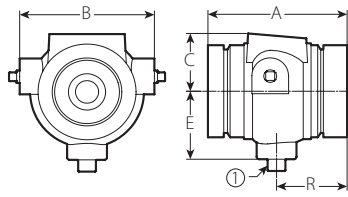

2 – 3"/DN50 – DN80  
 ① NPT or BSPT Downstream Drain (Optional)

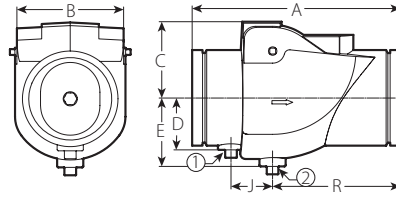

4 – 12"/DN100 – DN300  
 ① NPT or BSPT Upstream Drain (Optional)  
 ② NPT or BSPT Downstream Drain (Optional)

Size		Dimensions							Weight
Nominal inches DN	Actual Outside Diameter inches mm	End to End A inches mm	B inches mm	C inches mm	D inches mm	E inches mm	J inches mm	R inches mm	Approximate (Each) lb kg
2	2.375	4.50	4.00	1.75	–	2.25	–	2.25	3.8
DN50	60.3	114	102	44	–	57	–	57	1.7
2½	2.875	4.50	4.38	1.88	–	2.25	–	2.25	4.6
	73.0	114	111	48	–	57	–	57	2.1
3	3.500	4.75	5.13	3.75	–	2.50	–	2.50	6.2
DN80	88.9	121	130	95	–	64	–	64	2.8
4	4.500	10.13	5.38	4.50	2.50	3.38	2.00	6.25	20.1
DN100	114.3	257	137	114	64	86	51	159	9.1
6	6.625	12.00	7.25	6.13	4.25	4.25	2.00	8.13	42.0
DN150	168.3	305	184	156	108	108	51	206	19.0
8	8.625	14.63	9.75	7.25	4.63	5.00	2.38	10.00	85.0
DN200	219.1	371	248	184	117	127	60	254	38.6
10	10.750	16.75	11.63	8.50	5.75	6.25	2.25	12.13	130.0
DN250	273.0	425	295	216	146	159	57	308	59.0
12	12.750	19.50	13.38	8.50	6.63	7.13	2.63	14.00	206.0
DN300	323.9	495	340	216	168	181	67	356	93.4

## 5.0 PERFORMANCE

### Series 816 Stainless Steel Check Valve for Potable Water Applications

#### Flow Data

C<sub>v</sub>/K<sub>v</sub> values for flow of water at +60°F/+16°C with a fully open valve are shown in the table below.

Formulas for C<sub>v</sub>/K<sub>v</sub> Values:

$$\Delta P = \frac{Q^2}{C_v^2}$$

$$Q = C_v \times \sqrt{\Delta P}$$

**Where:**

Q = Flow (GPM)

ΔP = Pressure Drop (psi)

C<sub>v</sub> = Flow Coefficient

$$\Delta P = \frac{Q^2}{K_v^2}$$

$$Q = K_v \times \sqrt{\Delta P}$$

**Where:**

Q = Flow (m<sup>3</sup>/hr)

ΔP = Pressure Drop (Bar)

K<sub>v</sub> = Flow Coefficient

Size		(Full Open) C <sub>v</sub> K <sub>v</sub>
Nominal inches DN	Actual Outside Diameter inches mm	
2 DN50	2.375 60.3	34 29
2½	2.875 73.0	140 121
3 DN80	3.500 88.9	250 216
4 DN100	4.500 114.3	500 433
6 DN150	6.625 168.3	1300 1125
8 DN200	8.625 219.1	1800 1557
10 DN250	10.750 273.0	3000 2575
12 DN300	12.750 323.9	4200 3653

## 5.1 PERFORMANCE

### Series 816 Stainless Steel Check Valve for Potable Water Applications

#### Flow Characteristics





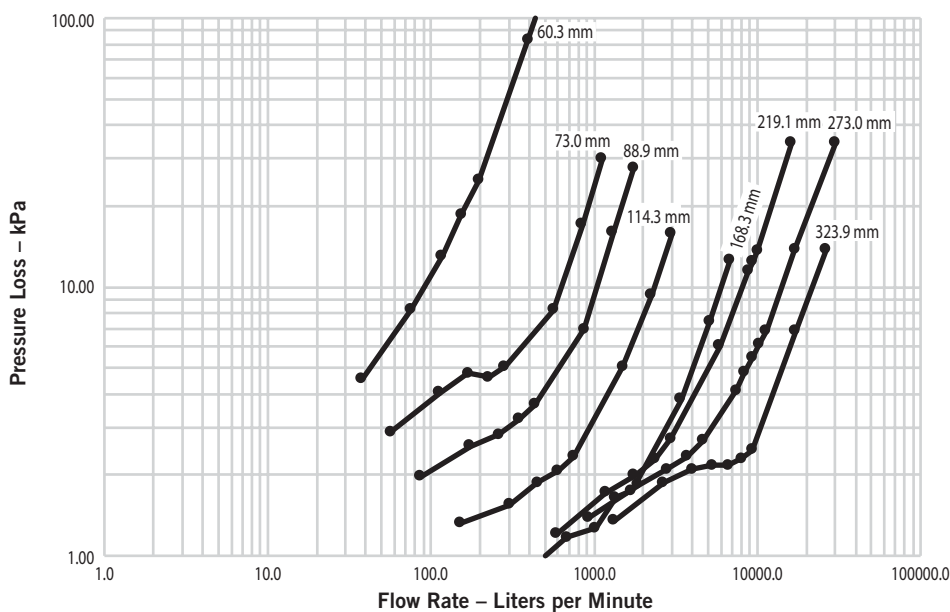
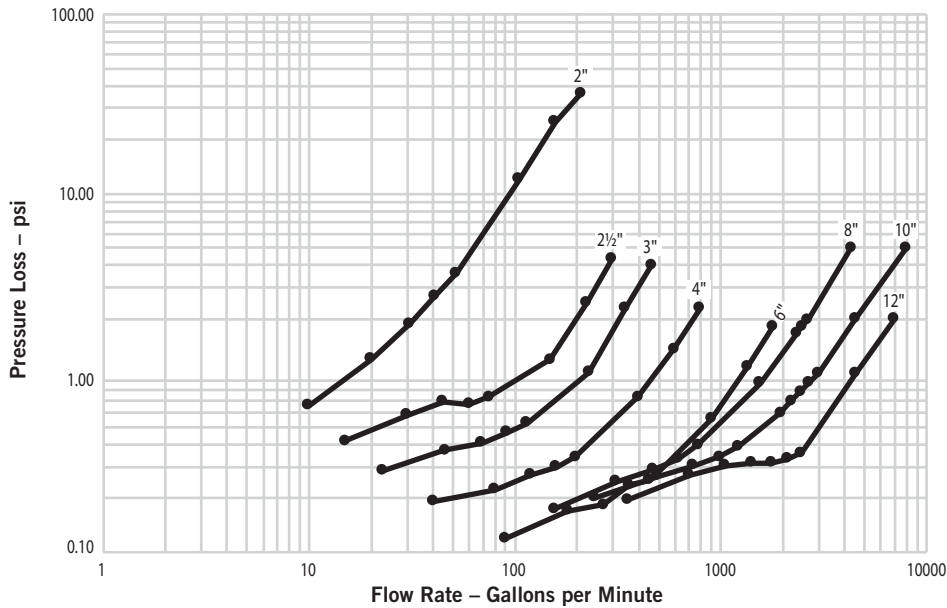

Placement of check valves too close to sources of unstable flow will shorten the life of the valve and potentially may damage the system. To extend valve life, valves should be installed a reasonable distance downstream from pumps, elbows, expanders, reducers or other similar devices. Sound piping practices dictate a minimum of five (5) times the pipe diameter for general use. Distances between three (3) and five (5) diameters are allowable provided the flow velocity is less than eight (8) feet per second (2.4 meters per second). Distances less than three (3) diameters are not recommended and will violate the Victaulic product warranty.

The charts below express the flow of water at 60°F/16°C through the valve.



## 6.0 NOTIFICATIONS

**⚠ WARNING**



- **Read and understand all instructions before attempting to install, remove, adjust, or maintain any Victaulic piping products.**
- **Depressurize and drain the piping system before attempting to install, remove, adjust, or maintain any Victaulic piping products.**
- **Wear safety glasses, hardhat, and foot protection.**

**Failure to follow these instructions could result in death or serious personal injury and property damage.**

## 7.0 REFERENCE MATERIALS

- [02.06: Victaulic Approvals for Potable Water Products – ANSI/NSF 61 and ANSI/NSF 372](#)
- [17.01: Victaulic Stainless Steel Pipe End Preparation](#)
- [24.01: Victaulic Pipe Preparation Tool Specifications](#)
- [25.01: Victaulic Original Groove System \(OGS\) Groove Specifications](#)
- [I-100: Victaulic Field Installation Handbook](#)
- [I-ENDCAP: Victaulic End Cap Installation Safety Instructions](#)

### User Responsibility for Product Selection and Suitability

Each user bears final responsibility for making a determination as to the suitability of Victaulic products for a particular end-use application, in accordance with industry standards and project specifications, and the applicable building codes and related regulations as well as Victaulic performance, maintenance, safety, and warning instructions. Nothing in this or any other document, nor any verbal recommendation, advice, or opinion from any Victaulic employee, shall be deemed to alter, vary, supersede, or waive any provision of Victaulic Company's standard conditions of sale, installation guide, or this disclaimer.

### Intellectual Property Rights

No statement contained herein concerning a possible or suggested use of any material, product, service, or design is intended, or should be construed, to grant any license under any patent or other intellectual property right of Victaulic or any of its subsidiaries or affiliates covering such use or design, or as a recommendation for the use of such material, product, service, or design in the infringement of any patent or other intellectual property right. The terms "Patented" or "Patent Pending" refer to design or utility patents or patent applications for articles and/or methods of use in the United States and/or other countries.

### Note

This product shall be manufactured by Victaulic or to Victaulic specifications. All products to be installed in accordance with current Victaulic installation/assembly instructions. Victaulic reserves the right to change product specifications, designs and standard equipment without notice and without incurring obligations.

### Installation

Reference should always be made to the Victaulic installation handbook or installation instructions of the product you are installing. Handbooks are included with each shipment of Victaulic products, providing complete installation and assembly data, and are available in PDF format on our website at [www.victaulic.com](http://www.victaulic.com).

### Warranty

Refer to the Warranty section of the current Price List or contact Victaulic for details.

### Trademarks

*Victaulic* and all other Victaulic marks are the trademarks or registered trademarks of Victaulic Company, and/or its affiliated entities, in the U.S. and/or other countries.