



# Style 004N FireLock™ Installation-Ready™ Flexible Coupling

## ⚠ WARNING



- Read and understand all instructions before attempting to install any Victaulic products.
  - Always verify that the piping system has been completely depressurized and drained immediately prior to installation, removal, adjustment, or maintenance of any Victaulic products.
  - Confirm that any equipment, branch lines, or sections of piping that may have been isolated for/ during testing or due to valve closures/positioning are identified, depressurized, and drained immediately prior to installation, removal, adjustment, or maintenance of any Victaulic products.
  - Wear safety glasses, hardhat, and foot protection.
- Failure to follow these instructions could result in death or serious personal injury and property damage.

- The Style 004N Victaulic® FireLock™ Installation-Ready™ Flexible Coupling shall be used only in fire protection systems that are designed and installed in accordance with current, applicable National Fire Protection Association (NFPA 13, 13D, 13R, etc.) standards, or equivalent standards, and in accordance with applicable building and fire codes. These standards and codes contain important information regarding protection of systems from freezing temperatures, corrosion, mechanical damage, etc.
  - These installation instructions are intended for an experienced, trained installer. The installer shall understand the use of this product and why it was specified for the particular application.
  - The installer shall understand common industry safety standards and potential consequences of improper product installation.
- Failure to follow installation requirements and local and national codes and standards could compromise system integrity or cause system failure, resulting in death or serious personal injury and property damage.

## INSTRUCTIONS FOR THE INITIAL INSTALLATION OF STYLE 004N COUPLINGS



**1. DO NOT DISASSEMBLE THE COUPLING:** Style 004N FireLock™ Installation-Ready™ Flexible Couplings are designed so that the installer does not need to remove the nuts and bolts for initial installation. This facilitates installation by allowing the installer to directly insert the grooved end of mating components into the coupling.

**2. CHECK MATING COMPONENT ENDS:** The outside surface of the mating components, between the groove and the mating component ends, shall be generally free from indentations, projections, weld seam anomalies, and roll marks to ensure a leak-tight seal. All oil, grease, loose paint, dirt, and cutting particles shall be removed.

The mating components' outside diameter ("OD"), groove dimensions, and maximum allowable flare diameter shall be within the tolerances published in current Victaulic Original Groove System (OGS) specifications, publication 25.01, which can be downloaded at [victaulic.com](http://victaulic.com).

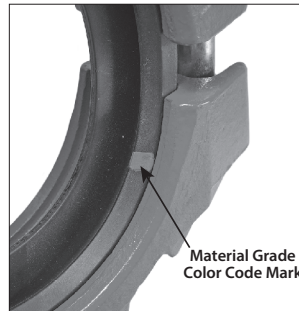

**3. CHECK GASKET:** Check the gasket to verify that it is suitable for the intended service. The color code identifies the material grade. For the color code chart and complete compatibility information, reference Victaulic publications 05.01 and GSG-100, which can be downloaded at [victaulic.com](http://victaulic.com), and the "NOTICE" on the following page for important gasket information.

## ⚠ CAUTION

- If any conditions listed in the "NOTICE" on the following page are met, a thin coat of a compatible lubricant shall be applied only to the gasket sealing lips to help prevent the gasket from pinching, rolling, or tearing during installation.
  - DO NOT use excessive lubricant on the gasket sealing lips.
- Failure to use a compatible lubricant may cause gasket damage, resulting in joint leakage and property damage.



**3a.** If any conditions listed in the "NOTICE" on the following page are met, apply a thin coat of a compatible lubricant only to the gasket sealing lips. Refer to the "Lubricant Compatibility for Gaskets" table below. **NOTE: It is not necessary to remove the gasket from the housings to apply lubricant to the exterior surface.**

## NOTICE

- Victaulic does not recommend the use of any furnace butt-welded pipe in sizes NPS 2" | DN150 and smaller with Victaulic gasketed joint products. This includes, but is not limited to, ASTM A53 Type F pipe.



Scan QR Code for Application Note AN-001

## Lubricant Compatibility for Gaskets

The following recommendations are for the gasket materials listed. Commercial lubricants may contain multiple ingredients. Always refer to the lubricant manufacturer's recommendations for material compatibility.

	Victaulic Lubricant*	Soap-Based Solutions	Glycerin	Silicone Grease	Silicone Spray	Corn Oil	Soybean Oil	Hydrocarbon-Based Oils	Petroleum-Based Greases
Compatible with EPDM Gaskets?	Yes*	Yes	Yes	Yes	Not Recommended	Not Recommended	Not Recommended	Not Recommended	Not Recommended

\*Victaulic Lubricant shall not be mixed with Poly Olester (POE) Oil during installation.



## NOTICE

- Gaskets for Style 004N Couplings are pre-lubricated. Additional lubrication is not required for the initial installation of wet pipe systems that are installed at or continuously operating above 0°F/-18°C.

Supplemental lubrication is required only if any of the following conditions exist. Apply a thin coat of a compatible lubricant to the gasket sealing lips, as noted in step 3a on the previous page. It is not necessary to remove the gasket from the housings to apply additional lubricant to the gasket sealing lips.

- If the installation or continuous operating temperature is below 0°F/-18°C
- If the gasket has been exposed to fluids prior to installation
- If the gasket is being installed into a dry pipe system
- If the system will be subjected to air tests prior to being filled with water
- If the gasket was involved in a previous installation

Lubricated gaskets will not enhance sealing capabilities on adverse mating component conditions. Mating component condition and preparation shall conform to the requirements listed in these product installation instructions (refer to step 2 on the previous page).

## ⚠ WARNING



- Never leave a Style 004N Coupling partially assembled on mating component ends. **ALWAYS TIGHTEN THE HARDWARE IMMEDIATELY, IN ACCORDANCE WITH THESE INSTRUCTIONS.** A partially assembled coupling poses a drop or fall hazard during installation and a burst hazard during testing.
- Keep hands away from the mating component ends and the openings of the coupling when attempting to insert grooved mating component ends into the coupling.
- Keep hands away from coupling openings during tightening.

Failure to follow these instructions could result in death or serious personal injury and property damage.

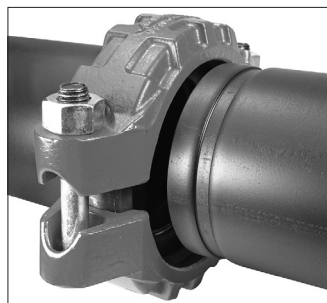

**4. ASSEMBLE JOINT:** Assemble the joint by inserting the grooved end of a mating component into each opening of the coupling. The grooved mating component ends shall be inserted into the coupling until contact with the center leg of the gasket occurs.

A visual check is required to verify that the coupling keys align with the groove of each mating component and that the gasket is seated properly. **NOTE:** Prior to tightening, the coupling may be rotated to verify that the gasket is seated properly on the mating component ends and within the coupling housings.

### Important Information for Use of Style 004N Couplings with End Caps and Fittings

## ⚠ WARNING

- Always read and follow the I-ENDCAP instructions, which can be downloaded at [victaulic.com](http://victaulic.com).

Failure to follow the I-ENDCAP instructions could result in death or serious personal injury and property damage.

- When assembling Style 004N Couplings onto end caps, take additional time to inspect and verify that the end cap is seated fully against the center leg of the gasket.
- Use only Victaulic FireLock™ No. 006 End Caps containing the “EZ” marking on the inside face or Victaulic End Caps containing the “QV” or “EZ QV” marking on the inside face.
- Always confirm that any equipment, branch lines, or sections of piping that may have been isolated for/during testing or due to valve closures/positioning are identified, depressurized, and drained immediately prior to working with an end cap.
- Victaulic recommends the use of Victaulic FireLock™ fittings with Style 004N Couplings.

**⚠ WARNING**

- Nuts shall be tightened evenly by alternating sides, maintaining nearly uniform bolt pad gaps, until metal-to-metal contact occurs at the bolt pads, as indicated in steps 5 and 6.

Failure to tighten nuts as instructed will cause increased loading of the hardware, resulting in the following conditions:

- Excessive bolt torque required to assemble the joint (incomplete assembly)
- Damage to the assembled joint (damaged or broken bolt pads or fractures to housings)
- Bolt damage or fracture
- Joint leakage and property damage
- A negative impact on system integrity
- Personal injury or death

DO NOT continue to tighten the nuts after the visual, metal-to-metal bolt pad inspection requirement is achieved.

- Failure to follow this instruction could result in the conditions listed above.

**NOTICE**

- It is important to tighten the nuts evenly by alternating sides to prevent gasket pinching.
- An impact tool or standard socket wrench with a deep-well socket can be used to bring the bolt pads into metal-to-metal contact.
- Refer to the “Helpful Information” table below, along with the “Impact Tool Usage Guidelines” and “Impact Tool Selection” sections.



**5. TIGHTEN NUTS:** Using an impact tool or a standard socket wrench with a deep-well socket, tighten the nuts evenly by alternating sides, maintaining nearly uniform bolt pad gaps, until metal-to-metal contact occurs at the bolt pads. Verify that the oval neck of each bolt seats properly in the bolt holes. DO NOT continue to tighten the nuts after the visual, metal-to-metal bolt pad inspection requirement is achieved. **If you suspect that any hardware has been over-tightened (as indicated by a bend in the bolt, bulging of the nut at the bolt pad interface, or damage to the bolt pad, etc.), the entire coupling assembly shall be replaced immediately.**

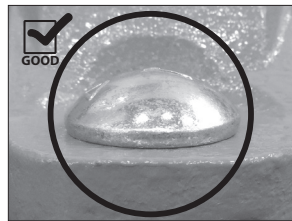

OVAL NECK OF BOLT SEATED PROPERLY



OVAL NECK OF BOLT NOT SEATED PROPERLY

**⚠ WARNING**

- Visual inspection of each joint is required.
- Improperly assembled joints shall be corrected before the system is filled, tested, or placed into service.
- Any components that exhibit physical damage due to improper assembly shall be replaced before the system is filled, tested, or placed into service.

Failure to follow these instructions could cause joint failure, resulting in death or serious personal injury and property damage.

**HELPFUL INFORMATION**

Nominal Pipe Size inches/DN	Actual Pipe Outside Diameter inches/mm	Nut Size inches/Metric	Deep-Well Socket Size inches/mm	Maximum Allowable Bolt Torque*
2 – 3 DN50 – DN80	2.375 – 3.500 60.3 – 88.9	½ M12	⅞ 22	135 ft-lbs 183 N•m
4 DN100	4.500 114.3	⅝ M16	1 ⅛ 27	235 ft-lbs 319 N•m
5	5.563 141.3	¾ M20	1 ¼ 32	425 ft-lbs 576 N•m
6 DN150	6.625 168.3	¾ M20	1 ¼ 32	425 ft-lbs 576 N•m
8 DN200	8.625 219.1	⅞ M22	1 ⅞ 36	675 ft-lbs 915 N•m

\*Maximum allowable bolt torque values have been derived from actual test data

Instructions continue on the following page

6. Visually inspect each bolt pad location at every joint to verify that metal-to-metal contact is achieved across the entire bolt pad section.

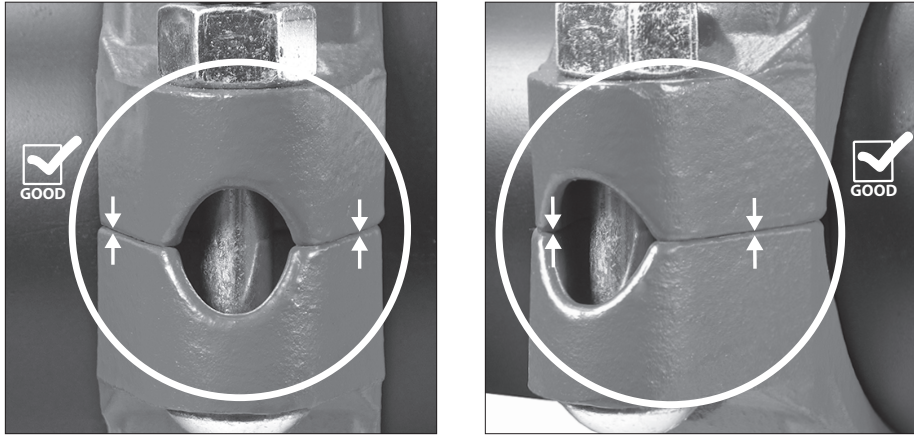

PROPERLY ASSEMBLED JOINT  
METAL-TO-METAL CONTACT AS INDICATED

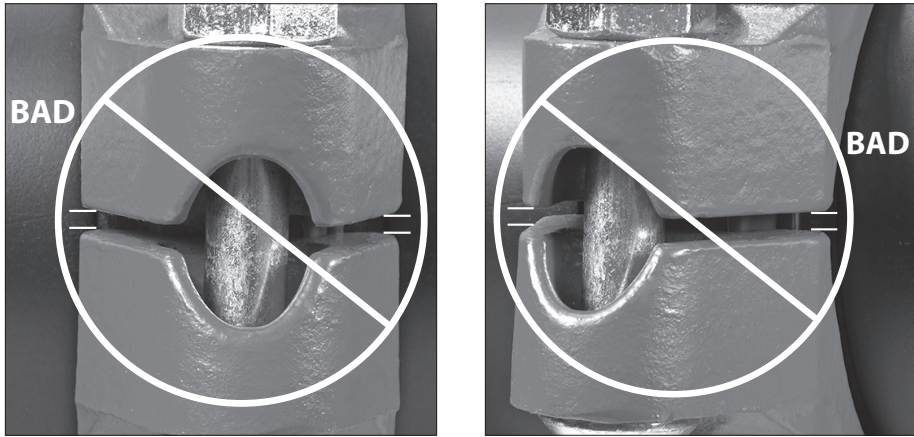

IMPROPERLY ASSEMBLED JOINT – BOLT PAD GAP/UNDER-TIGHTENED

Bolt pad gaps occur when the nuts are not tightened sufficiently. Refer to the “Impact Tool Usage Guidelines” section. These photos represent improper assemblies, which could result in joint failure, property damage, serious personal injury, or death.

## INSTRUCTIONS FOR REASSEMBLY OF STYLE 004N COUPLINGS

### ⚠ WARNING



- Always verify that the piping system has been completely depressurized and drained immediately prior to installation, removal, adjustment, or maintenance of any Victaulic products.
- Confirm that any equipment, branch lines, or sections of piping that may have been isolated for/during testing or due to valve closures/positioning are identified, depressurized, and drained immediately prior to installation, removal, adjustment, or maintenance of any Victaulic products.

Failure to follow these instructions could result in death or serious personal injury and property damage.

### NOTICE



Two methods can be followed for reassembly of Style 004N Couplings.

- **METHOD 1 FOR REASSEMBLY:** The coupling can be reassembled into its “installation-ready” condition by installing the gasket into the housings, then inserting the bolts and threading a nut onto each bolt until 2 – 3 threads are exposed, as shown to the left. If this method is chosen, steps 1 – 5 on this page, along with steps 4 – 6 on pages 2 – 3, shall be followed.
- OR**
- **METHOD 2 FOR REASSEMBLY:** The gasket and housings can be assembled onto the mating component ends by following steps 1 – 5 on this page, along with all steps in the “Method 2 for Reassembly” section on the following page.

Follow these five steps for Method 1 or Method 2:

1. Verify that the system is depressurized and drained completely before attempting to disassemble any couplings.
2. Loosen the nuts of the coupling assembly to permit removal of the coupling from the mating component ends.
3. Remove the nuts, bolts, and gasket from the housings. Inspect all components for any damage or wear. If any damage or wear is present, use a new Victaulic-supplied coupling assembly.
4. Check mating component ends, as described in step 2 on page 1.

### ⚠ CAUTION

- A thin coat of a compatible lubricant shall be used to help prevent the gasket from pinching, rolling, or tearing during reassembly.
- **DO NOT** use excessive lubricant on the gasket sealing lips and exterior.

Failure to use a compatible lubricant may cause gasket damage, resulting in joint leakage and property damage.

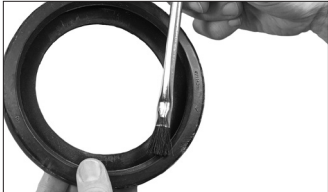

5. **FOR REASSEMBLY OF STYLE 004N COUPLINGS, LUBRICATE GASKET:** Apply a thin coat of a compatible lubricant to the gasket sealing lips and exterior. Refer to the “Lubricant Compatibility for Gaskets” table on page 1.



## METHOD 2 FOR REASSEMBLY

1. Verify that steps 1 – 5 on the previous page have been followed.

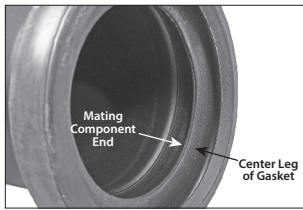

**2. INSTALL GASKET:** Insert the grooved end of a mating component into the gasket until it contacts the center leg of the gasket.



**3. JOIN MATING COMPONENTS:** Align the centerlines of the two grooved mating component ends. Insert the other mating component end into the gasket until it contacts the center leg of the gasket. **NOTE:** Verify that no portion of the gasket extends into the groove of either mating component.

### CAUTION

- Verify that the gasket does not become rolled or pinched while installing the housings.  
Failure to follow this instruction could cause gasket damage, resulting in joint leakage.



**4. INSTALL HOUSINGS:** Install the housings over the gasket. Verify that the housings' keys engage the grooves completely on both mating components.

**5. INSTALL BOLTS/NUTS:** Install the bolts, and thread a nut finger-tight onto each bolt. **NOTE:** Verify that the oval neck of each bolt seats properly in the bolt hole.

6. **TIGHTEN NUTS:** Follow steps 5 – 6 on pages 3 – 4 to complete the assembly.

**IMPACT TOOL USAGE GUIDELINES**

**NOTICE**

- These guidelines are for couplings that require metal-to-metal bolt pad contact without a specified assembly torque.
- These guidelines are for non-lubricated, zinc-electroplated carbon steel hardware only.
- These guidelines are for products used on metallic piping only.

Impact tools do not provide the installer with direct “wrench feel” to judge nut torque. Since some impact tools are capable of high output speed and torque, it is important to develop a familiarity with the impact tool to avoid over-shifting and/or over-torquing, which may damage or fracture the bolts or the coupling’s bolt pads during installation.

**⚠ WARNING**

- **DO NOT** exceed the “Maximum Allowable Bolt Torque” values specified in the table on this page for the applicable bolt/nut size. Failure to follow these instructions could cause joint failure, resulting in property damage, serious personal injury, or death.

Assemble couplings per the applicable Victaulic installation instructions. Scan the QR code provided for a listing of product installation instructions that can be downloaded on victaulic.com.



Continue to tighten the nut(s) until the visual inspection requirements are achieved. Visual inspection of each joint is required for verification of proper assembly. **For angled-bolt-pad couplings:** Equal and positive or neutral offsets shall be present at the angled bolt pads.

During the installation process, the installation torque shall not exceed the “Maximum Allowable Bolt Torque” values specified in the table on this page for the applicable bolt/nut size. Conditions that may result in over-shifting and/or excessive bolt torque include, but are not limited to, the following:

- **Improperly-Sized Impact Tool** – Refer to the “Impact Tool Selection” section on the following page.
- **Uneven tightening of hardware** – For couplings containing two or more bolts, the nuts shall be tightened evenly by alternating sides until the visual inspection requirements for the particular coupling are achieved.
- **Over-shifting of the angled bolt pad** – Over-shifting of an angled bolt pad results in an offset that prevents metal-to-metal contact and equal and positive or neutral offset at the opposite angled bolt pad. This occurs when the hardware is not tightened evenly by alternating sides. Attempting to tighten the hardware on one side while the other side is over-shifted is improper installation and will result in bolt torque that exceeds the “Maximum Allowable Bolt Torque” values specified in the table on this page. Continuing to tighten the hardware in an attempt to achieve metal-to-metal bolt pad contact at the other bolt pad will cause joint failure, resulting in property damage, serious personal injury, or death. For over-shifted couplings, the hardware for the angled bolt pads shall be loosened and then re-tightened to achieve equal and positive or neutral offsets at both angled bolt pads.
- **Out-of-specification grooved pipe end dimensions (particularly large and out-of-specification “C” diameters)** – If proper visual assembly is not achieved, remove the coupling and confirm that all grooved pipe end dimensions are within Victaulic specifications. If grooved pipe end dimensions are not within Victaulic specifications, rework the pipe ends by following all instructions in the applicable pipe preparation tool’s operating and maintenance manual.
- **Continued tightening of nut(s) after the visual inspection requirements are achieved** – DO NOT continue to tighten the nut(s) after the visual inspection requirements are achieved. Continuing to tighten the hardware after proper visual inspection requirements are achieved will cause joint failure, resulting in property damage, serious personal injury, or death. In addition, continued tightening may cause excessive stresses that compromise the long-term integrity of the bolts and may cause joint failure, resulting in property damage, serious personal injury, or death. Additional bolt torque will not provide a better installation; bolt torque that exceeds the “Maximum Allowable Bolt Torque” values specified in the table on this page could damage or fracture the bolts and/or the coupling’s bolt pads during installation.
- **Pinched gasket** – A pinched gasket could result in the inability to achieve proper visual inspection requirements. The coupling shall be disassembled and inspected to verify that the gasket is not pinched. If the gasket is pinched, a new coupling assembly shall be used.
- **Coupling was not assembled per the applicable Victaulic installation instructions** – Adherence to installation instructions will help to avoid the conditions covered in this document.

If you suspect that any hardware has been over-torqued, the entire coupling assembly shall be replaced immediately (as indicated by a bend in the bolt, bulging of the nut at the bolt pad interface, or damage to the bolt pad, etc.).

**Maximum Allowable Bolt Torque**

Bolt/Nut Size		Maximum Allowable Bolt Torque*
inches	Metric	
5/16	–	15 ft-lbs 20 N•m
3/8	M10	55 ft-lbs 75 N•m
7/16	M11	100 ft-lbs 136 N•m
1/2	M12	135 ft-lbs 183 N•m

Bolt/Nut Size		Maximum Allowable Bolt Torque*
inches	Metric	
5/8	M16	235 ft-lbs 319 N•m
3/4	M20	425 ft-lbs 576 N•m
7/8	M22	675 ft-lbs 915 N•m
1	M24	875 ft-lbs 1186 N•m

\*Maximum allowable bolt torque values have been derived from actual test data

Continued on the following page

## Style 004N FireLock™ Installation-Ready™ Flexible Coupling

### IMPACT TOOL SELECTION

Appropriate selection of an impact tool is required to ensure proper installation in accordance with the applicable coupling installation instructions. Improper impact tool selection could cause coupling mis-assembly and damage, resulting in property damage, serious personal injury, or death.

To determine the suitability of an impact tool, perform trial installation assemblies with a standard socket wrench or a torque wrench. These trial coupling assemblies shall meet the visual installation requirements for the particular coupling. After visual installation requirements are achieved, measure the torque applied to each nut with a torque wrench. Using the torque value measured, select an impact tool with a torque output or torque output setting that conforms to the measured value but does not exceed the “Maximum Allowable Bolt Torque” values specified in the table on the previous page.

#### **Selection of an Impact Tool:**

**Impact Tools with Single Output Torque** – Selection of an impact tool with an output torque considerably higher than the required installation torque could result in hardware and/or coupling damage due to the possibility of hardware over-torque. Under no circumstances shall an impact tool be selected for use that has a torque output setting that exceeds the “Maximum Allowable Bolt Torque” values specified in the table on the previous page.

**Impact Tools with Multiple Output Torque Settings** – If an impact tool with multiple output torque settings is selected, the impact tool shall have at least one torque setting that satisfies the above requirements for an “Impact Tool with Single Output Torque.”

Use of impact tools with excessive output torques creates installation difficulties for the installer due to the tool’s unmanageable rotational speed and power. Using the same method above, periodically check nut torque on coupling assemblies throughout the system installation process.

For safe and proper use of impact tools, always refer to the impact tool manufacturer’s operating instructions. In addition, verify that proper impact grade sockets are being used for coupling installation.

### **WARNING**

Failure to follow instructions for tightening hardware could result in:

- Bolt damage or fracture
- Damaged or broken bolt pads or fractures to housings
- Joint leakage and property damage
- A negative impact on system integrity
- Personal injury or death