

Victaulic KOIL-KIT™ Coil Pack

Series 799/79V/79B/79A

Series 78Y/78T/78U and Coil Hoses



Series 78Y



Series 78T



Series 78U



Coil Hose

1.0 PRODUCT DESCRIPTION

Available Sizes

- ½ – 2"/DN15 – DN50

Function

- Provides simplified coil circuit installation that meets optimal hydronic system design requirements

Maximum Working Pressure

- 400 psi/2758 kPa/28 bar

NOTES

- The coil pack's maximum working pressure is equivalent to the pressure rating of the hose used on it.
- If QuickVic™ SD ends are used, the coil pack's maximum working pressure is 300 psi/2068 kPa/21 bar.

Operating Temperature Range

- –4°F to +230°F/–20°C to +110°C

Application

- Hot and cold water, including treated and untreated water systems
- Victaulic offers (4) KOIL-KIT™ Coil Packs: Series 799, Series 79V, Series 79B and Series 79A
 - Each KOIL-KIT™ Coil Pack may include:
 - (1) Series 78Y Y-Strainer/Ball Valve Combination or (1) Series 78T Ball Valve Union Combination
 - (2) Coil Hoses
 - (1) Series 78U Union Port Fitting
 - Various balancing valves – Manual, automatic or balancing and control

2.0 CERTIFICATIONS/LISTINGS



ALWAYS REFER TO ANY NOTIFICATIONS AT THE END OF THIS DOCUMENT REGARDING PRODUCT INSTALLATION, MAINTENANCE OR SUPPORT.

3.0 SPECIFICATIONS - MATERIAL

Series 78Y Y-Strainer/Ball Valve Combination

Body: Dezincification resistant (DZR) brass alloy

Union: DZR brass with EPDM O-ring

Tailpiece: DZR brass

Stem: Brass

Stem O-Ring Seals: EPDM

Ball: Plated brass

Handle: Steel with vinyl grip

Strainer: Stainless steel, 20 mesh

Strainer Seal: EPDM O-ring

NOTE

- Stem and Ball may be provided with optional 316 stainless steel material.

Series 78T Ball Valve Union Combination

Body: DZR brass

Union: DZR brass with EPDM O-ring

Tailpiece: DZR brass

Stem: Brass

Stem O-Ring Seals: EPDM

Handle: Steel with vinyl grip

NOTE

- Stem and Ball may be provided with optional 316 stainless steel material.

Series 78U Union Port Fitting

Body: DZR brass alloy

Union: DZR brass with EPDM O-ring

Seals: EPDM O-ring

Tailpiece: DZR brass alloy

Coil Hose

Hose: Braided stainless steel

Core: EPDM polymer with stainless ferrules

End Material: CW617 brass

Bypass Tee

Body: DZR brass alloy

Union: DZR brass with EPDM O-ring

Seals: EPDM O-ring

Flush Tee

Body: DZR brass alloy

Union: DZR brass with EPDM O-ring

Seals: EPDM O-ring

4.0 DIMENSIONS

Series 78Y Y-Strainer/Ball Valve Combination

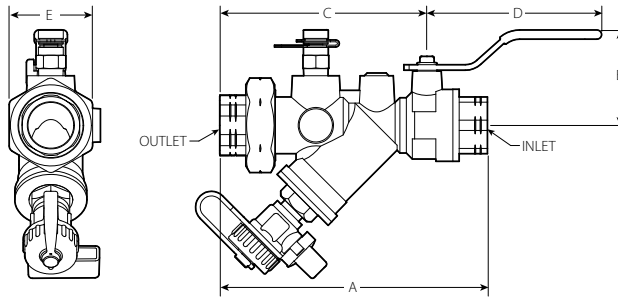

Size			Dimensions							Weight
Nominal Inlet x Outlet inches DN	Actual Outside Diameter Inlet x Outlet inches mm	A Sweat or Female Threaded End inches mm	A QuickVic™ SD x Female Threaded End inches mm	A Copper Press x Female Threaded End inches mm	B inches mm	C inches mm	D inches mm	E inches mm	Approx. (Each) lb kg	
1/2 DN15 x 1/2 DN15	0.840 x 0.840 21.3 x 21.3	5.1 130	8.35 212	6.28 160	1.9 49	3.8 97	4.0 100	1.5 38	1.7 0.8	
3/4 DN20 x 1/2 DN15	1.050 x 0.840 26.9 x 21.3	5.9 150	9.14 232	7.28 184	2.0 51	4.5 114	4.0 100	1.8 46	2.4 1.1	
		3/4 DN20 1.050 26.9	6.1 155	9.14 232	7.48 190	2.0 51	4.6 117	4.0 100	1.8 46	2.4 1.1
1 DN25 x 1/2 DN15	1.315 x 0.840 33.7 x 21.3	6.1 155	9.40 239	7.59 192	2.0 51	4.5 114	4.0 100	1.8 46	2.4 1.1	
		3/4 DN20 1.050 26.9	6.2 157	9.40 239	7.69 196	2.0 51	4.6 117	4.0 100	1.8 46	2.4 1.1
		1 DN25 1.315 33.7	6.4 163	9.40 239	7.89 200	2.0 51	4.9 124	4.0 100	1.8 46	2.4 1.1
1 1/4 DN32 x 3/4 DN20	1.660 x 1.050 42.4 x 26.9	7.8 198	11.10 282	9.45 240	2.4 61	5.9 150	5.3 135	2.6 66	5.4 2.4	
		1 DN25 1.315 33.7	8.0 203	11.10 282	9.65 246	2.4 61	6.1 155	5.3 135	2.6 66	5.4 2.4
		1 1/4 DN32 1.660 42.4	8.0 203	11.10 282	9.65 246	2.4 61	6.1 155	5.3 135	2.6 66	5.4 2.4
1 1/2 DN40 x 1 DN25	1.900 x 1.315 48.3 x 33.7	8.1 206	11.77 299	10.08 256	2.4 61	6.1 155	5.3 135	2.6 66	5.4 2.4	
		1 1/4 DN32 1.660 42.4	8.1 206	11.77 299	10.08 256	2.4 61	6.1 155	5.3 135	2.6 66	5.4 2.4
		1 1/2 DN40 1.900 48.3	8.3 211	11.77 299	10.08 256	2.4 61	6.3 160	5.3 135	2.6 66	5.4 2.4
2 DN50 x 1 1/4 DN32	2.375 x 1.660 60.3 x 42.4	11.2 284	14.87 378	13.51 344	3.1 79	8.5 216	5.9 151	3.3 84	11.3 5.1	
		1 1/2 DN40 1.900 48.3	11.2 284	14.87 378	13.51 344	3.1 79	8.5 216	5.9 151	3.3 84	11.5 5.2
		2 DN50 2.375 60.3	11.2 284	14.87 378	13.51 344	3.1 79	8.5 216	5.9 151	3.3 84	11.5 5.2

NOTES

- The Series 78Y is available with the following end configurations:
sweat x sweat union
sweat x female union
sweat x male union
female x sweat union
female x female union
female x male union
QuickVic SD x female union
- The QuickVic SD x female union uses a Style P07 coupling and a No. P40 threaded adapter.
- Optional tailpieces must be ordered for double reductions and for changing end configurations from sweat to threaded or threaded to sweat. If needed, specify tailpiece when ordering.

4.1 DIMENSIONS

Series 78T Ball Valve Union Combination

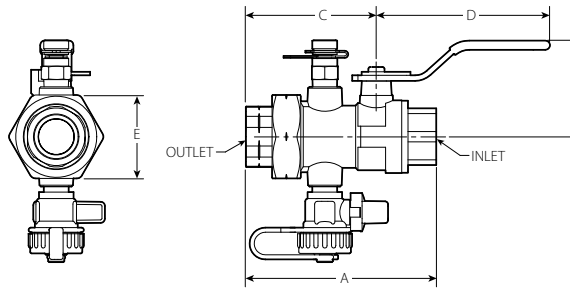

Size		Dimensions								Weight
Nominal Inlet x Outlet inches DN	Actual Outside Diameter Inlet x Outlet inches mm	A Sweat or Female Threaded End inches mm	A QuickVic™ SD x Female Threaded End inches mm	A Copper Press x Male Threaded End inches mm	B inches mm	C inches mm	D inches mm	E inches mm	Approx. (Each) lb kg	
1/2 x 1/2 DN15 x DN15	0.840 x 0.840 21.3 x 21.3	4.1 105	7.35 187	5.29 134	1.9 49	2.8 71	4.0 100	1.5 37	1.4 0.6	
3/4 x 1/2 DN20 x DN15	1.050 x 0.840 26.9 x 21.3	4.3 109	7.54 192	5.69 145	2.0 51	2.9 73	4.0 100	1.8 46	1.7 0.8	
		4.4 112	7.54 192	5.69 145	2.0 51	2.9 73	4.0 100	1.8 46	1.7 0.8	
1 x 1/2 DN25 x DN15	1.315 x 0.840 33.7 x 21.3	4.6 117	7.90 201	6.09 155	2.2 55	3.0 75	5.3 135	1.8 46	2.0 0.9	
		4.8 121	7.90 201	6.09 155	2.2 55	3.0 75	5.3 135	1.8 46	2.0 0.9	
		5.0 126	7.90 201	6.09 155	2.2 55	3.3 84	5.3 135	1.8 46	2.1 1.0	
1 1/4 x 3/4 DN32 x DN20	1.660 x 1.050 42.4 x 26.9	5.2 131	8.50 216	6.86 174	2.4 60	3.2 80	5.3 135	2.6 67	3.6 1.6	
		5.4 136	8.50 216	6.86 174	2.4 60	3.5 89	5.3 135	2.6 67	3.6 1.6	
		5.4 136	8.50 216	6.86 174	2.4 60	3.5 89	5.3 135	2.6 67	3.5 1.6	
1 1/2 x 1 DN40 x DN25	1.900 x 1.315 48.3 x 33.7	5.9 150	9.57 243	7.87 200	2.8 71	3.7 94	5.9 151	2.6 67	4.9 2.2	
		5.9 150	9.57 243	7.87 200	2.8 71	3.7 94	5.9 151	2.6 67	4.9 2.2	
		6.1 155	9.57 243	7.87 200	2.8 71	3.9 99	5.9 151	2.6 67	4.9 2.2	
2 x 1 1/4 DN50 x DN32	2.375 x 1.660 60.3 x 42.4	6.9 174.5	10.57 268	9.21 234	3.0 77	3.8 97	5.9 151	3.3 83	7.1 3.2	
		16.9 48.3	10.57 268	9.21 234	3.0 77	4.0 102	5.9 151	3.3 83	7.2 3.3	
		6.9 174	10.57 268	9.21 234	3.0 77	4.1 104	5.9 151	3.3 83	7.3 3.3	

NOTES

- The Series 78T is available with the following end configurations:
sweat x sweat union
sweat x female union
sweat x male union
female x sweat union
female x female union
female x male union
QuickVic SD x female union
- The QuickVic SD x female union uses a Style P07 coupling and a No. P40 threaded adapter.
- Optional tailpieces must be ordered for double reductions and for changing end configurations from sweat to threaded or threaded to sweat. If needed, specify tailpiece when ordering.
- The Series 78T may be used on the supply and/or return side of the coil. Best practices recommend having the ball valve on the system side and the union on the coil/equipment side.

4.2 DIMENSIONS

Series 78U Union Port Fitting

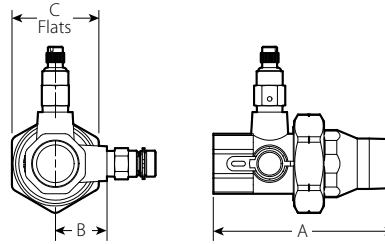

Size		Dimensions					Weight	
Nominal Inlet x Outlet inches DN	Actual Outside Diameter Inlet x Outlet inches mm	A Sweat or Female Threaded x Male Threaded End inches mm	A QuickVic™ SD x Male Threaded End inches mm	A Copper Press x Male Threaded End inches mm	B inches mm	C inches mm	Approximate (Each) lb kg	
1/2 x 1/2 DN15 x DN15	0.840 x 0.840 21.3 x 21.3	3.48 89	6.73 171	4.67 119	0.84 21	1.46 37	0.7 0.3	
	3/4 x 1/2 DN20 x DN15	1.050 x 0.840 26.9 x 21.3	3.87 98	7.11 181	5.26 134	1.08 27	1.81 46	1.0 0.5
3/4 x 3/4 DN20 x DN20		1.050 x 1.050 26.9 x 26.9	3.87 98	7.11 181	5.26 134	1.08 27	1.81 46	0.9 0.4
	1 x 1/2 DN25 x DN15	1.315 x 0.840 33.7 x 21.3	4.03 102	7.33 186	5.52 140	1.08 27	1.81 46	1.0 0.5
3/4 x 3/4 DN20 x DN20		1.050 x 1.050 26.9 x 26.9	4.03 102	7.33 186	5.52 140	1.08 27	1.81 46	1.1 0.5
		1 x 1 DN25 x DN25	1.315 x 1.315 33.7 x 33.7	4.14 105	7.33 186	5.52 140	1.08 27	1.81 46
1 1/4 x 1/2 DN32 x DN15	1.660 x 0.840 42.4 x 21.3	4.36 111	7.66 195	6.02 153	1.46 37	2.63 67	1.9 0.9	
	3/4 x 3/4 DN20 x DN20	1.050 x 1.050 26.9 x 26.9	4.36 111	7.66 195	6.02 153	1.46 37	2.63 67	1.9 0.9
		1 x 1 DN25 x DN25	1.315 x 1.315 33.7 x 33.7	4.36 111	7.66 195	6.02 153	1.46 37	2.63 67
	1 1/4 x 1 1/4 DN32 x DN32	1.660 x 1.660 42.4 x 42.4	4.19 106	7.66 195	6.02 153	1.46 37	2.63 67	2.1 1.0
		1 1/2 x 1 1/2 DN40 x DN40	1.900 x 1.900 48.3 x 48.3	4.19 106	7.86 200	6.16 156	1.46 37	2.63 67
1 1/2 x 3/4 DN40 x DN20	1.050 x 1.050 26.9 x 26.9	4.19 106	7.86 200	6.16 156	1.46 36	2.63 67	2.2 1.0	
	1 x 1 DN25 x DN25	1.315 x 1.315 33.7 x 33.7	4.19 106	7.86 200	6.16 156	1.46 36	2.63 67	2.2 1.0
	1 1/4 x 1 1/4 DN32 x DN32	1.660 x 1.660 42.4 x 42.4	4.19 106	7.86 200	6.16 156	1.46 37	2.63 67	2.3 1.0
	1 1/2 x 1 1/2 DN40 x DN40	1.900 x 1.900 48.3 x 48.3	4.40 112	7.86 200	6.16 156	1.46 37	2.63 67	2.3 1.0
2 x 1 DN50 x DN25	1.315 x 1.315 33.7 x 33.7	4.47 114	8.14 207	6.78 172	1.76 45	3.26 83	3.1 1.4	
	1 1/4 x 1 1/4 DN32 x DN32	1.660 x 1.660 42.4 x 42.4	4.47 114	8.14 207	6.78 172	1.76 45	3.26 83	3.1 1.4
		1 1/2 x 1 1/2 DN40 x DN40	1.900 x 1.900 48.3 x 48.3	4.47 114	8.14 207	6.78 172	1.76 45	3.26 83
	2 x 2 DN50 x DN50	2.375 x 2.375 60.3 x 60.3	4.47 114	8.14 207	6.78 172	1.76 45	3.26 83	3.2 1.5
		2 x 2 DN50 x DN50	2.375 x 2.375 60.3 x 60.3	4.47 114	8.14 207	6.78 172	1.76 45	3.26 83

NOTES

- The Series 78U is available with the following end configurations:
 - sweat x sweat union
 - sweat x female union
 - sweat x male union
 - female x sweat union
 - female x female union
 - female x male union
 - QuickVic SD x female union
- The QuickVic SD x female union uses a Style P07 coupling and a No. P40 threaded adapter.
- Optional tailpieces must be ordered for double reductions and for changing end configurations from sweat to threaded or threaded to sweat. If needed, specify tailpiece when ordering.

4.3 OPTIONAL PARTS

Coil Hose (Optional)



Hose Assembly

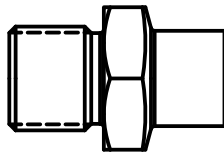

Male x Sweat

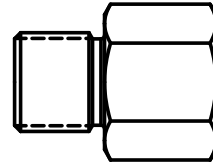

Male x Female

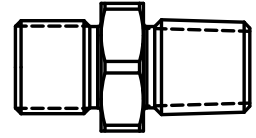

Male x Male

Size inches mm	End Connections		Rated Pressure psi kPa	Minimum Bend Radius inches mm	Nominal Length inches mm	Weight
	A Fixed Male NPT End	B Adapter End Sweat, Female NPT or Male NPT Outlet				Approximate (Each) lbs. kg
1/2 15	1/2 NPT	1/2	375 2585	2.6 66.7	12	0.3
					300	0.1
					18	0.5
					450	0.2
					24	0.5
3/4 20	3/4 NPT	3/4	300 2068	4.5 114.3	610	0.2
					36	0.7
					914	0.3
					12	0.6
					300	0.3
1 25	1 NPT	1	300 2068	5.5 139.7	18	0.9
					450	0.4
					24	1.0
					610	0.5
					36	1.5
1 1/4 32	1 1/4 NPT	1 1/4	225 1550	6.8 171.5	914	0.7
					12	1.0
					300	0.5
					18	1.4
					450	0.6
1 1/2 40	1 1/2 NPT	1 1/2	150 1034	8.4 212.7	24	1.5
					610	0.7
					36	2.3
					914	1.0
					12	1.2
2 50	2 NPT	2	150 1034	11.3 285.8	300	0.5
					18	1.7
					450	0.8
					24	2.0
					610	0.9
					914	1.4
					12	2.2
					300	1.0
					18	3.0
					450	1.4
					24	4.4
					610	2.0
					36	6.6
					914	3.0
					12	2.5
					300	1.1
					18	3.5
					450	1.6
					24	4.8
					610	2.2
					914	7.2
					36	7.2
					914	3.3

4.4 OPTIONAL PARTS

Series 78Y/78T/78U Union Tailpieces (Optional)



Female Tailpiece



Sweat Tailpiece

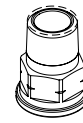

Male Tailpiece

Size		Victaulic Part Code		
Nominal inches		Female Tailpiece	Sweat Tailpiece	Male Tailpiece
1/2	x 1/2	P00478Y304	P00478Y504	P00478U404
3/4	x 1/2	P00678Y304	P00678Y504	P00678U404
		P00678Y306	P00678Y506	P00678U406
1	x 1/2	P00678Y304*	P00678Y504*	P00678U404*
		P00678Y306*	P00678Y506*	P00678U406*
		P00678Y310	P00678Y510*	P00678U410*
1 1/4	x 1/2	-	-	P01278U404
		P01278Y306	P01278Y506	P01278U406
		P01278Y310	P01278Y510	P01278U410
		P01278Y312	P01278Y512	P01278U412
1 1/2	x 1/2	-	-	P01278U404*
		P01278Y306*	P01278Y506*	P01278U406*
		P01278Y310*	P01278Y510*	P01278U410*
		P91278Y312*	P01278Y512*	P01278U412*
		P01278Y314	P01278Y514*	P01278U414*
2	x 1	-	-	P02078U410*
		P02078Y312*	P01278Y512*	P02078U412*
		P02078Y314*	P01278Y514*	P02078U414*
		P02078Y320	P02078Y520*	P02078U420*

NOTES

- The union tailpieces listed above can also be used on Series 78KH, 76K and 76V valves.
- *When swapping a tailpiece from the line size female tailpiece provided, a union collar is also needed. The 1", 1 1/2" and 2" female tailpieces have an integrated collar that cannot be reused with these tailpieces. See "Union Collar" chart in section 4.5 for more information.

4.5 OPTIONAL PARTS

Union Collar



Valve Size	Victaulic Part Code
Nominal inches	
1/2	P00478Y204
3/4 - 1	P00678Y206
1 1/4 - 1 1/2	P01278Y212
2	P02078Y220

4.6 OPTIONAL PARTS

Hose End Drain Valve (Optional)

For Series 78Y, 78T & 78U

A hose end drain valve with a 3/4 garden hose thread is factory-installed on the Series 78Y and the Series 78T. The 1/4" NPT size drain valve can also be mounted on the Series 78U or provided loose for other piping needs.

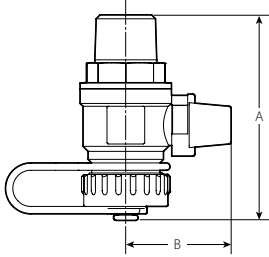

Size NPT inches mm	Dimensions		Part Code
	A inches mm	B inches mm	
1/4	2.04	1.37	P00278YDRN
6	52	35	
1/2	2.74	1.53	P00478YDRN
13	70	39	

4.7 OPTIONAL PARTS

Probe Port (Optional)

For Series 78Y, 78T & 78U

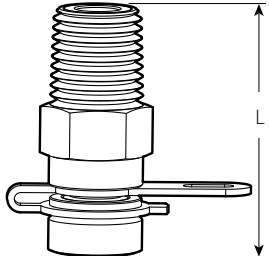

Connection Size	Dimensions	Part Code
	L inches mm	
1/4 NPT	1.55 39	P00278YPTP

4.8 OPTIONAL PARTS

Port Extender (Optional)

For Series 78Y, 78T & 78U

The port extender is used to extend accessories to clear 2"/50 mm or 4"/100 mm insulation (M x F ¼").

Extends probe port and air vent.



Length inches mm	Part Code
2 50	P01278Y2XT
4 100	P04378Y0XT

4.9 OPTIONAL PARTS

Handle Extension (Optional)

For Series 78Y & 78T

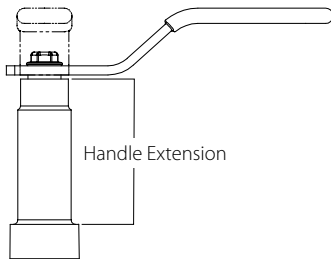

Valve	Valve Inlet Size	Victaulic Part Code	
		2" Handle Extension	4" Handle Extension
78Y	½ – 1"	P00478Y2HL	P00478Y4HL
78Y	1 ¼ – 1 ½"	P01278Y2HL	P01278Y4HL
78Y	2"	P02078Y2HL	P02078Y4HL
78T	½ – ¾"	P00478Y2HL	P00478Y4HL
78T	1 – 1 ¼"	P01278Y2HL	P01278Y4HL
78T	1 ½ – 2"	P02078Y2HL	P02078Y4HL

4.10 OPTIONAL PARTS

Bypass Tee (Optional)

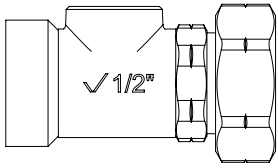

Valve Size Nominal inches	Victaulic Part Code
1/2	P004799500
3/4	P006799500
1	P010799500
1 1/4	P012799500
1 1/2	P014799500
2	P020799500

4.11 OPTIONAL PARTS

Flush Kits (Optional)

Threaded Flush Kits

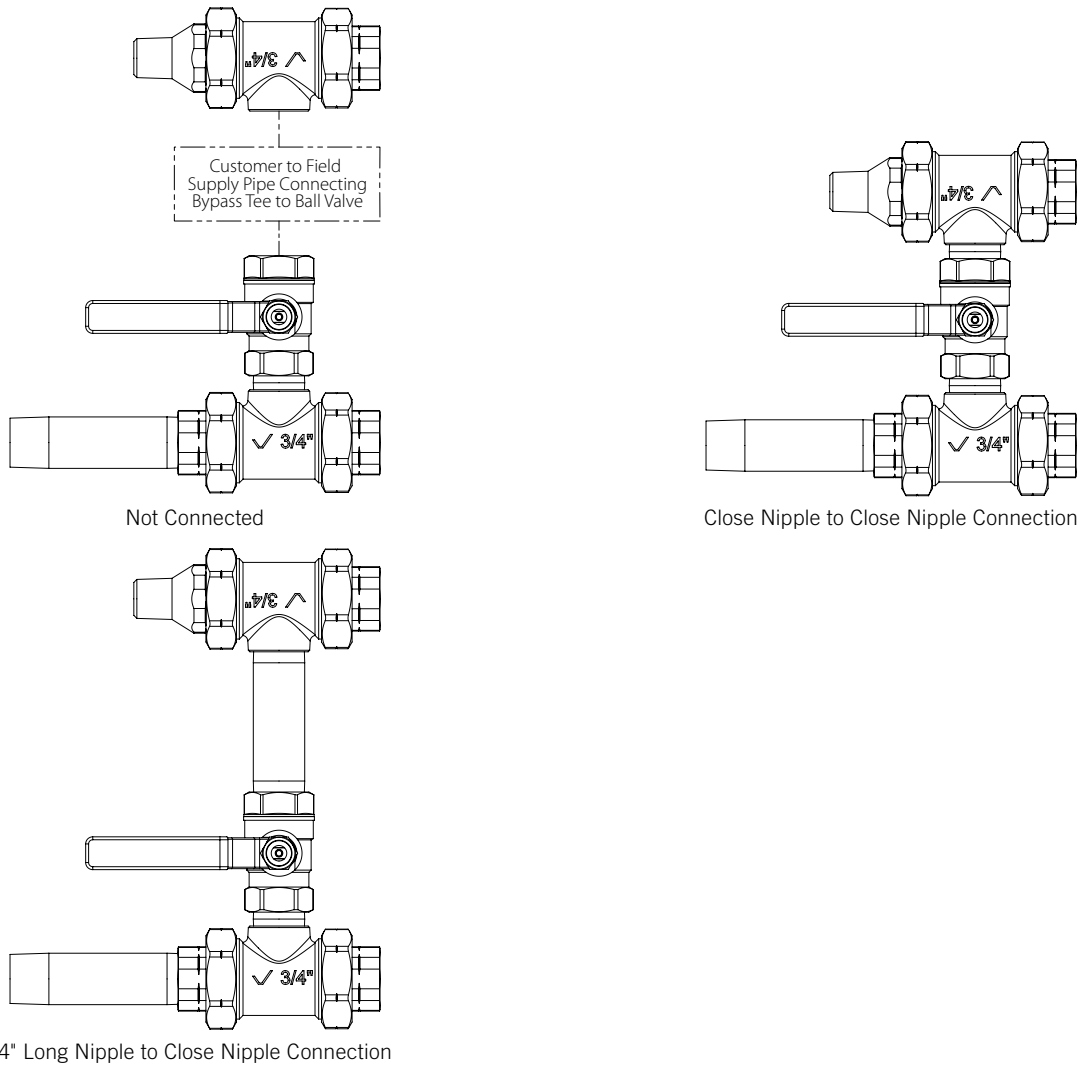

Size	Total Supply Side Length	Total Return Side Length	Center-Line to Center-Line Takeouts		
			Not Connected to Upper Tee; Field Provides Nipple From Valve to Return Side Tee; Minimum C/L to C/L Takeout When Field Provides Close Nipple	Connected At Factory – Close Nipple and Close Nipple	Connected At Factory – 4" Long Nipple and Close Nipple
Nominal inches DN	inches mm	inches mm	inches mm	inches mm	inches mm
1/2 DN15	6.85 174	4.06 103	3.85 98	3.85 98	6.72 171
3/4 DN20	7.01 178	4.48 114	5.17 131	5.17 131	7.79 198
1 DN25	8.15 207	5.41 137	5.92 150	5.92 150	8.42 214
1 1/4 DN32	9.03 229	6.53 166	7.73 196	7.73 196	10.11 257
1 1/2 DN40	10.09 256	7.28 185	8.27 210	8.27 210	10.52 267
2 DN50	10.58 269	7.77 197	10.14 258	10.14 258	12.14 308

4.11 OPTIONAL PARTS (CONTINUED)

Flush Kits (Optional)

QuickVic™ SD Flush Kits

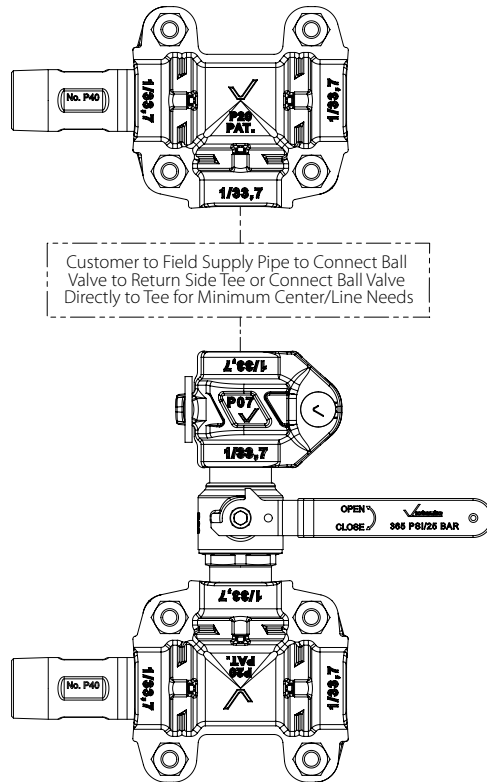

Size	Length Addition From End of Kit When Threaded In	Minimum C/L to C/L – No Make-Up Nipple		Minimum C/L to C/L Using Minimum-Length Field Nipple	
		inches	mm	inches	mm
Nominal	inches				
DN	mm				
1/2	6.35	6.01	153	8.64	219
DN15	161				
3/4	6.58	6.38	162	9.01	229
DN20	167				
1	6.69	6.75	171	9.38	238
DN25	170				
1 1/4	7.17	7.5	191	10.13	257
DN32	182				
1 1/2	8.16	9.13	232	12.76	324
DN40	207				
2	8.62	9.88	251	13.89	353
DN50	219				

4.12 OPTIONAL PARTS

Air Vent

For Series 78Y & 78U

A manual air vent is factory-installed on the Series 78U. This product can also be mounted on the Series 78Y or provided loose for other piping needs.



Connection size	Part Code
¼ NPT	P-002-78U-MAV

4.13 OPTIONAL PARTS

Automatic Air Vent

Victaulic Part Code
P-002-78U-AAV

4.14 OPTIONAL PARTS

Replacement O-Rings

Valve Size inches	Series 78Y, 78T & 78U End Face O-Rings*	Series 78Y Strainer O-Rings*
½	P004799ORG	G00478YGSK
¾ – 1	P006799ORG	G00678YGSK
1 ¼ – 1 ½	P012799ORG	G01278YGSK
2"	P020799ORG	G02078YGSK

NOTE

* The part codes listed in this column represent one (1) O-ring. However, O-rings are only sold in multiples of ten (10) and must be ordered in multiples of ten (10).

4.15 OPTIONAL PARTS

Replacement Series 78Y Strainer Basket

Valve Size inches	Part Code
1/2	P00478YSTN
3/4 – 1	P00678YSTN
1 1/4 – 1 1/2	P01278YSTN
2	P02078YSTN

4.16 OPTIONAL PARTS

Hose Adapter Replacement Parts

Size inches	Part Code			
	Male Adapter	Female Adapter	Sweat Adapter	O-Rings*
1/2	P004799MOR	P004799FOR	P004799SOR	K004799HOR
3/4	P006799MOR	P006799FOR	P006799SOR	K006799HOR
1	P010799MOR	P010799FOR	P010799SOR	K010799HOR
1 1/4	P012799MOR	P012799FOR	P012799SOR	K012799HOR
1 1/2	P014799MOR	P014799FOR	P014799SOR	K014799HOR
2	P020799MOR	P020799FOR	P020799SOR	K020799HOR

NOTE

* The part codes listed in this column represent one (1) O-ring. However, O-rings are only sold in multiples of ten (10) and must be ordered in multiples of ten (10).

5.0 PERFORMANCE

Cv/Kv values for flow of water at +60°F/+16°C are shown in the table.

Formulas for Cv and Kv values:

$$\Delta P = Q^2/Cv^2 \quad \Delta P = Q^2/Kv^2$$

$$Q = Cv \times \sqrt{\Delta P} \quad Q = Kv \times \sqrt{\Delta P}$$

Series 78Y Y-Strainer/Ball Valve Combination

Size		Flow Coefficient (Fully Open)
Nominal inches DN	Actual Outside Diameter inches mm	Threaded Cv Kv
½ DN15	0.840 21.3	5.1 4.4
¾ DN20	1.050 26.9	7.8 6.7
1 DN25	1.315 33.7	7.4 6.4
1 ¼ DN32	1.660 42.4	28.8 25.0
1 ½ DN40	1.900 48.3	28.8 24.9
2 DN50	2.375 60.3	56.6 49.0

Series 78T Ball Valve Union Combination

Size		Flow Coefficient (Fully Open)
Nominal inches DN	Actual Outside Diameter inches mm	Threaded Cv Kv
½ DN15	0.840 21.3	10.4 9.0
¾ DN20	1.050 26.9	20.4 17.7
1 DN25	1.315 33.7	39.4 34.1
1 ¼ DN32	1.660 42.4	63.2 54.6
1 ½ DN40	1.900 48.3	98.4 85.1
2 DN50	2.375 60.3	169.3 146.4

Series 78U Union Port Fitting

Size		Flow Coefficient (Fully Open)
Nominal inches DN	Actual Outside Diameter inches mm	Threaded Cv Kv
½ DN15	0.840 21.3	9.8 6.1
¾ DN20	1.050 26.9	21.2 17.2
1 DN25	1.315 33.7	41.4 35.2
1 ¼ DN32	1.660 42.4	76.0 6.2
1 ½ DN40	1.900 48.3	103.0 6.8
2 DN50	2.375 60.3	159.5 137.9

5.0 PERFORMANCE (CONTINUED)

Coil Hose

Size		Nominal Length inches mm	Flow Coefficient (Fully Open)	
Nominal inches DN	Actual Outside Diameter inches mm		Straight Form Cv Kv	90° Cv Kv
1/2 DN15	0.840 21.3	12	3.9	3.8
		300	3.4	3.3
		18	3.7	3.6
		450	3.2	3.1
		24	3.5	3.4
		600	3.0	3.0
3/4 DN20	1.050 26.9	36	3.2	3.3
		915	3.0	3.0
		12	10.5	10.1
		300	9.1	8.7
		18	10.3	9.9
		450	8.9	8.6
1 DN25	1.315 33.7	24	10.0	9.6
		600	8.7	8.3
		36	8.4	8.3
		915	7.3	7.2
		12	20.0	Not Recommended
		300	17.2	Not Recommended
1 1/4 DN32	1.660 42.4	18	19.5	Not Recommended
		450	16.8	Not Recommended
		24	18.9	18.3
		600	16.3	15.8
		36	18.2	18.2
		915	15.7	15.7
1 1/2 DN40	1.900 48.3	12	33.5	Not Recommended
		300	28.9	Not Recommended
		18	33.3	Not Recommended
		450	28.8	Not Recommended
		24	33.0	32.6
		600	28.4	28.1
2 DN50	2.375 60.3	36	30.5	30.2
		915	26.3	26.0
		12	63.7	Not Recommended
		300	54.9	Not Recommended
		18	63.4	Not Recommended
		450	54.8	Not Recommended
2 DN50	2.375 60.3	24	63.1	60.2
		600	54.4	51.9
		36	53.1	51.4
		915	45.8	44.3
		12	128.6	Not Recommended
		300	110.9	Not Recommended
2 DN50	2.375 60.3	18	121.6	Not Recommended
		450	105.1	Not Recommended
		24	114.6	Not Recommended
		600	98.8	Not Recommended
		36	106.1	102.0
		915	91.5	87.9

6.0 NOTIFICATIONS

WARNING



- Read and understand all instructions before attempting to install, remove, adjust, or maintain any Victaulic piping products.
- Always verify that the piping system has been completely depressurized and drained immediately prior to installation, removal, adjustment, or maintenance of any Victaulic products.
- Wear safety glasses, hardhat, and foot protection.

Failure to follow these instructions could result in death or serious personal injury and property damage.

7.0 REFERENCE MATERIALS

[08.16: Victaulic Balancing Valves TA Series 786/787H/788/789 and Series 78KH](#)

[08.34: Victaulic Automatic Balancing Valves - Series 76T, 76B, 76K, 76V & 76G](#)

[08.37: Victaulic Compact Pressure Independent Balancing and Control Valve \(Compact P\) - TA Series 7CP](#)

[08.38: Victaulic TBV Terminal Balancing and Control Valves TA Series TC/TCM](#)

[08.46: Victaulic Differential Pressure Controller - TA Series 7PR](#)

[08.50: Victaulic Balancing Valve TA Series 78BL](#)

[08.53: Victaulic Combined Balancing and Control Valves TA Series 7FP](#)

[08.55: Victaulic Pressure Independent Balancing and Modulating Control Valve TA Series 7MP](#)

[I-KOIL-KIT: Victaulic Installation and Maintenance Instructions - KOIL-KIT™ Coil Pack](#)

User Responsibility for Product Selection and Suitability

Each user bears final responsibility for determining the suitability of Victaulic products for their end-use application, in accordance with industry standards, project specifications, and Victaulic's published performance, maintenance, and safety data, as well as all warnings and installation instructions. Nothing in this or any other document, nor any verbal recommendation, advice, or opinion from any Victaulic employee, shall be deemed to alter, vary, supersede, or waive any provision of Victaulic Company's standard conditions of sale, warranty, installation instructions, or this disclaimer.

Installation

Always refer to and follow the [Victaulic Installation Handbook](#) or installation instructions for the product you are installing. Handbooks are included with each shipment of Victaulic products, providing complete installation and assembly data, and are available in PDF format on our website at [victaulic.com](#).

Warranty

Refer to the Warranty section of the current Price List or contact Victaulic for details.

Intellectual Property Rights

No statement concerning the use of any material, product, service, or design is intended, or should be construed, to grant any license under any patent or other intellectual property right of Victaulic or any of its affiliates, or as a recommendation for the use of such material, product, service, or design in the infringement of any patent or other intellectual property right. The terms "Patented" or "Patent Pending" refer to design or utility patents or patent applications for articles and/or methods of use in the United States and/or other countries. Victaulic and all other Victaulic marks are the trademarks or registered trademarks of Victaulic Company, and/or its affiliated entities, in the U.S. and/or other countries.

Note

All products bearing a Victaulic trademark are manufactured by Victaulic or to Victaulic specifications. All products are to be installed only in accordance with the applicable Victaulic installation instructions. Victaulic reserves the right to change product specifications, designs and standard equipment without notice and without incurring obligations.