

⚠ WARNING:

RECOGNIZE THIS SYMBOL AS AN INDICATION OF IMPORTANT SAFETY INFORMATION

⚠ WARNING

THESE INSTRUCTIONS ARE INTENDED AS AN AID TO QUALIFIED, LICENSED SERVICE PERSONNEL FOR PROPER INSTALLATION, ADJUSTMENT, AND OPERATION OF THIS UNIT. READ THESE INSTRUCTIONS THOROUGHLY BEFORE ATTEMPTING INSTALLATION OR OPERATION. FAILURE TO FOLLOW THESE INSTRUCTIONS MAY RESULT IN IMPROPER INSTALLATION, ADJUSTMENT, SERVICE, OR MAINTENANCE POSSIBLY RESULTING IN FIRE, ELECTRICAL SHOCK, PROPERTY DAMAGE, PERSONAL INJURY, OR DEATH.

Do not destroy this manual. Please read carefully and keep in a safe place for future reference by a serviceman.

R-410A HEAT PUMP OUTDOOR UNITS

INSTALLATION INSTRUCTIONS

RP13 (13 SEER)

RP14 (14 SEER) AND RP15 (15 SEER)

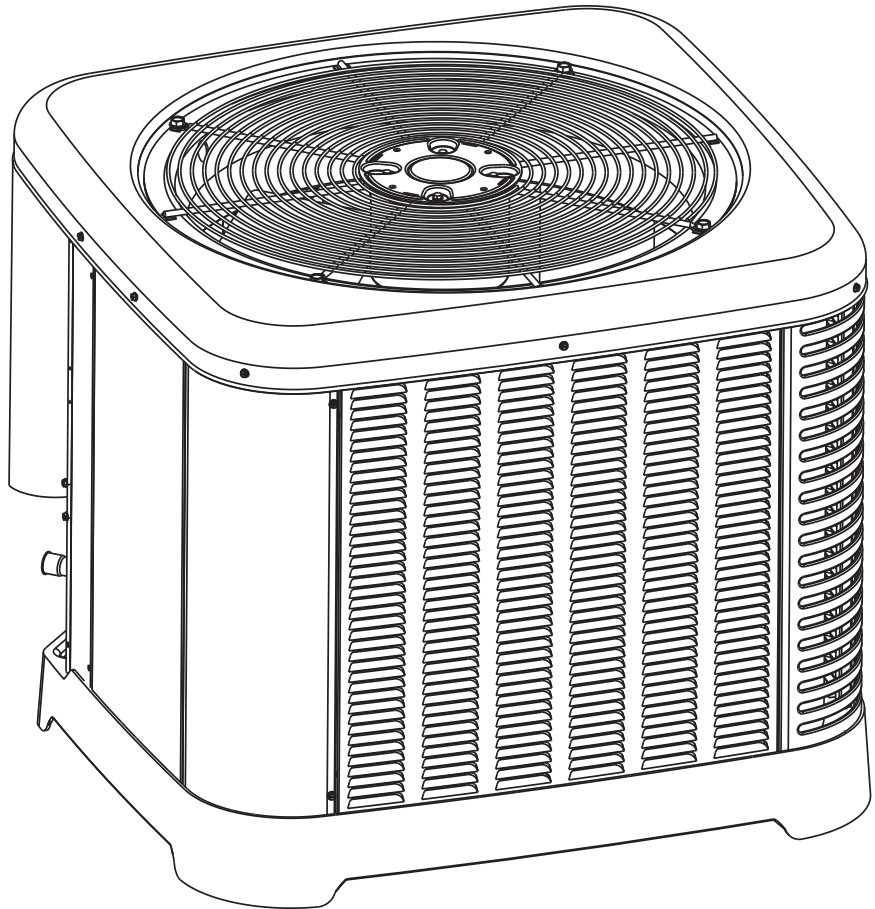

[] indicates metric conversions.

92-105074-04-03 (8/15) Printed in USA



CONTENTS

Important Safety Information	3	Start-Up	29-33
General Information.....	4-7	Start-Up.....	29
Checking Product Received	4	Checking Airflow	29
Application	4	Evacuation Procedure	30
Electrical and Physical Data.....	5-6	Final Leak Testing.....	30
Specifications.....	7	Checking	
Proper Installation	7	Refrigerant Charge	31-33
Installation.....	8-19	Charging Units	
Choosing a Location.....	8-10	With R-410A Refrigerant	31
Operational Issues.....	8	Confirm ID Airflow	
Corrosive Environment.....	8	and Coils Are Clean	31
For Units With		Measurement Device Setup.....	31
Space Limitations.....	9	Charging by Weight.....	31
Customer Satisfaction Issues	9	Gross Charging by Pressures	32
Unit Mounting.....	9	Final Charge by Subcooling.....	32
Factory-Preferred		Finishing Up Installation.....	33
Tie-Down Method.....	9	Components and Controls	34
Snow Depth Table	10	Compressor	
Tools and Refrigerant	11	Crankcase Heat (CCH).....	34
Tools Required for Installing and		Hard-Start Components.....	34
Service R-410A Models	11	High- and Low-Pressure	
Specifications of R-410A	11	Controls (HPC and LPC).....	34
Quick-Reference		Demand Defrost	35-36
Guide for R-410A	11	Accessories	37
Replacement Units	12	Remote Outdoor	
Indoor Coil	12	Temperature Model	37
Location.....	12	Low Ambient Control (LAC)	37
Interconnecting Tubing.....	12-26	Diagnostics.....	38-40
Refrigerant Level Adjustment.....	12	Cooling Mechanical	
Maximum Length of Lines.....	12	Checks Flowchart	38
Outdoor Unit Installed		Heating Mechanical	
Above or Below Indoor Coil.....	13-26	Checks Flowchart	39
Tubing Installation	24	Defrost Mechanical	
Tubing Connections	25	Checks Flowchart	40
Leak Testing	26	General Troubleshooting Chart	41
Wiring	27-28	Service Analyzer Charts.....	42-46
Control Wiring	27	Cooling/Heating Tips	47
Conventional 24 VAC		Wiring Diagrams	48-50
Thermostat Control Wiring	27		
Typical Thermostat Wiring Diagrams	27		
Power Wiring	28		
Grounding.....	28		

IMPORTANT SAFETY INFORMATION

⚠️ WARNINGS:

- These instructions are intended as an aid to qualified, licensed service personnel for proper installation, adjustment, and operation of this unit. Read these instructions thoroughly before attempting installation or operation. **Failure to follow these instructions may result in improper installation, adjustment, service, or maintenance possibly resulting in fire, electrical shock, property damage, personal injury, or death.**
- **The unit must be permanently grounded. Failure to do so can cause electrical shock resulting in severe personal injury or death.**
- **Turn off electric power at the fuse box or service panel before making any electrical connections.**
- **Complete the ground connection before making line voltage connections. Failure to do so can result in electrical shock, severe personal injury, or death.**
- **Disconnect all power to unit before starting maintenance. Failure to do so can cause electrical shock resulting in severe personal injury or death.**
- **Never assume the unit is properly wired and/or grounded. Always test the unit cabinet with a noncontact voltage detector available at most electrical supply houses or home centers before removing access panels or coming into contact with the unit cabinet.**
- **Do not use oxygen to purge lines or pressurize system for leak test. Oxygen reacts violently with oil, which can cause an explosion resulting in severe personal injury or death.**
- The top of the scroll compressor shell is hot. Touching the compressor top may result in serious personal injury.
- The manufacturer's warranty does not cover any damage or defect to the unit caused by the attachment or use of any components, accessories, or devices (other than those authorized by the manufacturer) into, onto, or in conjunction with the heat pump. **You should be aware that the use of unauthorized components, accessories, or devices may adversely affect the operation of the heat pump and may also endanger life and property.** The manufacturer disclaims any responsibility for such loss or injury resulting from the use of such unauthorized components, accessories, or devices.

⚠️ CAUTIONS:

- R-410A systems operate at approximately 60% higher pressures (1.6 times) than R-22 systems. Do not use R-22 service equipment or components on R-410A equipment. Use appropriate care when using this refrigerant. Failure to exercise care may result in equipment damage or personal injury.
- Only match this outdoor unit with a matched indoor coil or air handler approved for use with this outdoor unit per the unit manufacturer's specification sheet. The use of unmatched coils or air handler will likely result in a charge imbalance between the cooling and heating modes which can cause unsatisfactory operation including a high-pressure switch lockout condition.
- Only use indoor coils approved for use on R-410A systems. An R-22 coil will have a TXV or fixed restrictor device that is not designed to operate properly in an R-410A system and will result in serious operational issues. The R-22 coil could also contain mineral oil which is incompatible with the POE oil used in R-410A systems and could result in reliability issues with the compressor and TXVs.
- When coil is installed over a finished ceiling and/or living area, it is required that a secondary sheet metal condensate pan be constructed and installed under the entire unit. Failure to do so can result in property damage.
- The compressor has an internal overload protector. Under some conditions, it can take up to 2 hours for this overload to reset. Make sure overload has had time to reset before condemning the compressor.
- **UNIT MAY START SUDDENLY AND WITHOUT WARNING.** A flashing red light on the heat pump/defrost control indicates a call for unit operation is present at the heat pump/defrost control. The heat pump/defrost control will attempt to start unit after the anti-short cycle time expires, when a high or low pressure control automatically resets, or when the heat pump/defrost control exits the lockout mode as the temperature rises above 5°F.

GENERAL INFORMATION

⚠ WARNING:

Improper installation, or installation not made in accordance with these instructions, can result in unsatisfactory operation and/or dangerous conditions and can cause the related warranty not to apply.

The RP series of heat pumps are designed to operate with standard 24 VAC thermostats and air handlers or gas furnaces.

This installation instruction manual contains complete instructions for installation and setup using conventional 24 VAC controls. Please refer to the manufacturer's specification sheets for complete performance data, thermostat, and accessory listings.

The information contained in this manual has been prepared to assist in the proper installation, operation, and maintenance of the air conditioning system.

Read this manual and any instructions packaged with separate equipment required to make up the system prior to installation. Homeowner should retain this manual for future reference.

To achieve optimum efficiency and capacity, the matching indoor cooling coils listed in the manufacturer's specification sheet must be used for this model heat pump.

Checking Product Received

Upon receiving unit, inspect it for any shipping damage. Claims for damage, either apparent or concealed, should be filed immediately with the shipping company. Check model number, electrical characteristics, and accessories to determine if they are correct. Check system components (indoor coil, outdoor unit, air handler/furnace, etc.) to make sure they are properly matched.

Application

Before specifying any heat pump equipment, a survey of the structure and a heat loss and heat gain calculation must be made. A heat loss calculation involves identifying all surfaces and openings that lose heat to the surrounding air and quantifying that heat loss. A cooling heat gain calculation makes similar measurements and determines the amount of heat needed to be removed. A heat gain calculation also calculates the extra heat load caused by sunlight and by humidity removal. These factors must be considered before selecting a heat pump system to provide year-round comfort. The Air Conditioning Contractors of America (ACCA) J Manual method of load calculation is one recognized procedure for determining the heating and cooling load.

After the proper equipment combination has been selected, satisfying both sensible and latent requirements, the system must be properly installed. Only then can the unit provide the comfort it was designed to provide.

There are several factors that installers must consider.

- Outdoor unit location
- Indoor unit blower speed and airflow
- Proper equipment evacuation
- Supply and return air duct design and sizing
- Refrigerant charge
- System air balancing
- Diffuser and return air grille location and sizing



Electrical and Physical Data

RP13

Model Number	ELECTRICAL								PHYSICAL						
	Voltage	Phase	Freq	Compressor		Fan Motor Full Load Amperes (FLA)	Minimum Circuit Ampacity Amperes	Fuse or HACR Circuit Breaker		Outdoor Coil			Refrig. Per Circuit (oz.) [g]	Weight	
				Rated Load Amperes (RLA)	Locked Rotor Amperes (LRA)			Minimum Amperes	Maximum Amperes	Face Area Sq. Ft. [m ²]	No. Rows	CFM [L/s]		Net Lbs. [kg]	Shipping Lbs. [kg]
RP1336AC1NA	208-230	3	60	10.4	73.0	0.60	14	20/20	20/20	14.82 [1.38]	1	3333 [1573]	111 [3146]	171 [77.6]	184 [83.5]
RP1342AC1NA	208-230	3	60	13.5	88.0	1.00	18	25/25	30/30	14.82 [1.38]	1	2933 [1384]	155 [4394]	201 [91.2]	208 [94.3]
RP1348AC1NA	208-230	3	60	13.7	83.1	1.20	19	25/25	30/30	19.76 [1.84]	1	4055 [1913]	143 [4054]	227 [103.0]	234 [106.1]
RP1360AC1NA	208-230	3	60	15.9	110.0	1.00	21	25/25	35/35	24.23 [2.25]	1	4780 [2255]	232 [6577]	262 [118.8]	269 [122.0]
RP1336AD1NA	460	3	60	5.8	38.0	0.50	8	15/15	15/15	14.82 [1.38]	1	3333 [1573]	111 [3146]	171 [77.6]	178 [80.7]
RP1342AD1NA	460	3	60	6.0	44.0	0.50	8	15/15	15/15	14.82 [1.38]	1	2933 [1384]	155 [4394]	201 [91.2]	208 [94.3]
RP1348AD1NA	460	3	60	6.2	41.0	0.60	9	15/15	15/15	19.76 [1.84]	1	4055 [1913]	143 [4054]	227 [103.0]	234 [106.1]
RP1360AD1NA	460	3	60	7.1	52.0	0.50	10	15/15	15/15	24.23 [2.25]	1	4780 [2255]	232 [6577]	262 [118.8]	269 [122.0]

GENERAL INFORMATION



Electrical and Physical Data

RP14

Model Number	ELECTRICAL									PHYSICAL					
	Voltage	Phase	Freq	Compressor		Fan Motor Full Load Amperes (FLA)	Minimum Circuit Ampacity Amperes	Fuse or HACR Circuit Breaker		Outdoor Coil			Refrig. Per Circuit (oz.) [g]	Weight	
				Rated Load Amperes (RLA)	Locked Rotor Amperes (LRA)			Minimum Amperes	Maximum Amperes	Face Area Sq. Ft. [m ²]	No. Rows	CFM [L/s]		Net Lbs. [kg]	Shipping Lbs. [kg]
RP1418AJ1NA	208-230	1	60	9/9	48.0	0.70	12	15/15	20/20	9.06 [0.84]	1	2411 [1137]	97 [2750]	151 [68.5]	158 [71.7]
RP1418FJ1NA	208-230	1	60	9/9	47.5	0.70	12	15/15	20/20	9.06 [0.84]	1	2411 [1137]	99 [2806]	149 [67.6]	156 [70.8]
RP1424AJ1NA	208-230	1	60	10.3/10.3	61.6	0.70	14	20/20	20/20	9.06 [0.84]	1	2411 [1137]	89 [2523]	146 [66.2]	153 [69.4]
RP1424FJ1NA	208-230	1	60	10.9/10.9	62.9	0.70	15	20/20	25/25	11.14 [1.03]	1	2478 [1169]	105 [2977]	152 [68.9]	159 [72.1]
RP1430AJ1NA	208-230	1	60	14.1/14.1	73.0	0.70	19	25/25	30/30	11.14 [1.03]	1	2535 [1196]	106 [3005]	155 [70.3]	162 [73.5]
RP1430FJ1NA	208-230	1	60	12.8/12.8	67.8	1.00	18	25/25	25/25	17.29 [1.61]	1	3852 [1817]	116 [3288]	191 [86.6]	198 [89.8]
RP1436AJ1NA	208-230	1	60	16.7/16.7	79.0	0.60	22	30/30	35/35	14.82 [1.38]	1	3333 [1573]	111 [3146]	177 [80.3]	184 [83.5]
RP1436FJ1NA	208-230	1	60	15.4/15.4	83.9	2.80	22	30/30	35/35	19.76 [1.84]	1	3121 [1472]	118 [3345]	199 [90.3]	206 [93.4]
RP1442AJ1NA	208-230	1	60	17.9/17.9	112.0	0.90	24	30/30	40/40	14.82 [1.38]	1	2933 [1384]	155 [4394]	201 [91.2]	208 [94.3]
RP1442FJ1NA	208-230	1	60	17.9/17.9	112.0	1.00	24	30/30	40/40	19.76 [1.84]	1	3815 [1800]	139 [3941]	221 [100.2]	228 [103.4]
RP1448AJ1NA	208-230	1	60	21.8/21.8	117.0	1.20	29	35/35	50/50	19.76 [1.82]	1	4055 [1913]	143 [4054]	227 [103.0]	234 [106.1]
RP1448FJ1NA	208-230	1	60	18.5/18.5	124.0	2.80	26	35/35	40/40	24.23 [2.25]	1	4379 [2066]	188 [5330]	257 [116.6]	264 [119.7]
RP1460AJ1NA	208-230	1	60	23.7/23.7	152.5	1.00	31	40/40	50/50	24.23 [2.25]	1	4780 [2255]	232 [6577]	262 [118.8]	269 [122.0]
RP1460FJ1NA	208-230	1	60	23.7/23.7	152.5	1.00	31	40/40	50/50	28.26 [2.62]	1	3654 [1724]	212 [6010]	278 [126.1]	285 [129.3]
RP1436AC1NA	208-230	3	60	10.4	73.0	0.60	14	20/20	20/20	14.82 [1.38]	1	3333 [1573]	111 [3146]	177 [80.3]	184 [83.5]
RP1436FC1NA	208-230	3	60	10.4	73.0	2.80	16	20/20	25/25	19.76 [1.84]	1	3121 [1472]	124 [3515]	199 [90.3]	206 [93.4]
RP1442AC1NA	208-230	3	60	13.5	88.0	1.00	18	25/25	30/30	14.82 [1.38]	1	2933 [1384]	155 [4394]	201 [91.2]	208 [94.3]
RP1442FC1NA	208-230	3	60	13.5	88.0	1.00	18	25/25	30/30	19.76 [1.84]	1	3815 [1800]	145 [4110]	221 [100.2]	228 [103.4]
RP1448AC1NA	208-230	3	60	13.7	83.1	1.20	19	25/25	30/30	19.76 [1.84]	1	4055 [1913]	143 [4054]	227 [103.0]	234 [106.1]
RP1448FC1NA	208-230	3	60	13.8	83.1	2.80	21	25/25	30/30	24.23 [2.25]	1	4379 [2066]	194 [5500]	257 [116.6]	264 [119.7]
RP1460AC1NA	208-230	3	60	15.9	110.0	1.00	21	25/25	35/35	24.23 [2.25]	1	4780 [2255]	232 [6577]	262 [118.8]	269 [122.0]
RP1460FC1NA	208-230	3	60	15.9	110.0	1.00	21	25/25	35/35	28.26 [2.62]	1	3654 [1724]	223 [6321]	278 [126.1]	285 [129.3]
RP1436AD1NA	460	3	60	5.8	38.0	0.50	8	15/15	15/15	14.82 [1.38]	1	3333 [1573]	111 [3146]	177 [80.3]	184 [83.5]
RP1442AD1NA	460	3	60	6.0	44.0	0.50	8	15/15	15/15	14.82 [1.38]	1	2933 [1384]	155 [4394]	201 [91.2]	208 [94.3]
RP1448AD1NA	460	3	60	6.2	41.0	0.60	9	15/15	15/15	19.76 [1.84]	1	4055 [1913]	143 [4054]	227 [103.0]	234 [106.1]
RP1460AD1NA	460	3	60	7.1	52.0	0.50	10	15/15	15/15	24.23 [2.25]	1	4780 [2255]	232 [6577]	262 [118.8]	269 [122.0]

General Information

RP15

Model Number	ELECTRICAL									PHYSICAL					
	Voltage	Phase	Freq	Compressor		Fan Motor Full Load Amperes (FLA)	Minimum Circuit Ampacity Amperes	Fuse or HACR Circuit Breaker		Outdoor Coil			Refrig. Per Circuit (oz.) [g]	Weight	
				Rated Load Amperes (RLA)	Locked Rotor Amperes (LRA)			Minimum Amperes	Maximum Amperes	Face Area Sq. Ft. [m ²]	No. Rows	CFM [L/s]		Net Lbs. [kg]	Shipping Lbs. [kg]
RP1518AJ1NA	208-230	1	60	9/9	48.0	0.70	12	15/15	20/20	9.06 [0.84]	1	2411 [1137]	97 [2750]	149 [67.6]	156 [70.8]
RP1518BJ1NA	208-230	1	60	9/9	47.5	0.70	12	15/15	20/20	9.06 [0.84]	1	2411 [1137]	99 [2806]	149 [67.6]	156 [70.8]
RP1524AJ1NA	208-230	1	60	10.3/10.3	61.6	0.70	14	20/20	20/20	11.14 [1.03]	1	2478 [1169]	88 [2495]	152 [68.9]	159 [72.1]
RP1524BJ1NA	208-230	1	60	10.9/10.9	62.9	0.70	15	20/20	25/25	11.14 [1.03]	1	2478 [1169]	105 [2977]	152 [68.9]	159 [72.1]
RP1530AJ1NA	208-230	1	60	14.1/14.1	73.0	1.00	19	25/25	30/30	17.29 [1.61]	1	3852 [1817]	122 [3459]	191 [86.6]	198 [89.8]
RP1530BJ1NA	208-230	1	60	12.8/12.8	67.8	1.00	18	25/25	25/25	17.29 [1.61]	1	3852 [1817]	116 [3288]	191 [86.6]	198 [89.8]
RP1536AJ1NA	208-230	1	60	15.4/15.4	83.9	2.80	22	30/30	35/35	19.76 [1.84]	1	3121 [1472]	118 [3345]	199 [90.3]	206 [93.4]
RP1542AJ1NA	208-230	1	60	17.9/17.9	112.0	1.00	24	30/30	40/40	19.76 [1.84]	1	3815 [1800]	139 [3941]	221 [100.2]	228 [103.4]
RP1548AJ1NA	208-230	1	60	18.5/18.5	124.0	2.80	26	35/35	40/40	24.23 [2.25]	1	4379 [2066]	188 [5330]	257 [116.6]	264 [119.7]
RP1560AJ1NA	208-230	1	60	23.7/23.7	152.5	1.00	31	40/40	50/50	28.26 [2.62]	1	3654 [1724]	212 [6010]	278 [126.1]	285 [129.3]
RP1536AC1NA	208-230	3	60	10.4	73.0	2.80	16	20/20	25/25	19.76 [1.84]	1	3121 [1472]	124 [3515]	199 [90.3]	206 [93.4]
RP1542AC1NA	208-230	3	60	13.5	88.0	1.00	18	25/25	30/30	19.76 [1.84]	1	3815 [1800]	145 [4110]	221 [100.2]	228 [103.4]
RP1548AC1NA	208-230	3	60	13.8	83.1	2.80	21	25/25	30/30	24.23 [2.25]	1	4379 [2066]	194 [5500]	257 [116.6]	264 [119.7]
RP1560AC1NA	208-230	3	60	15.9	110.0	1.00	21	25/25	35/35	28.26 [2.62]	1	3654 [1724]	223 [6321]	278 [126.1]	285 [129.3]

GENERAL INFORMATION

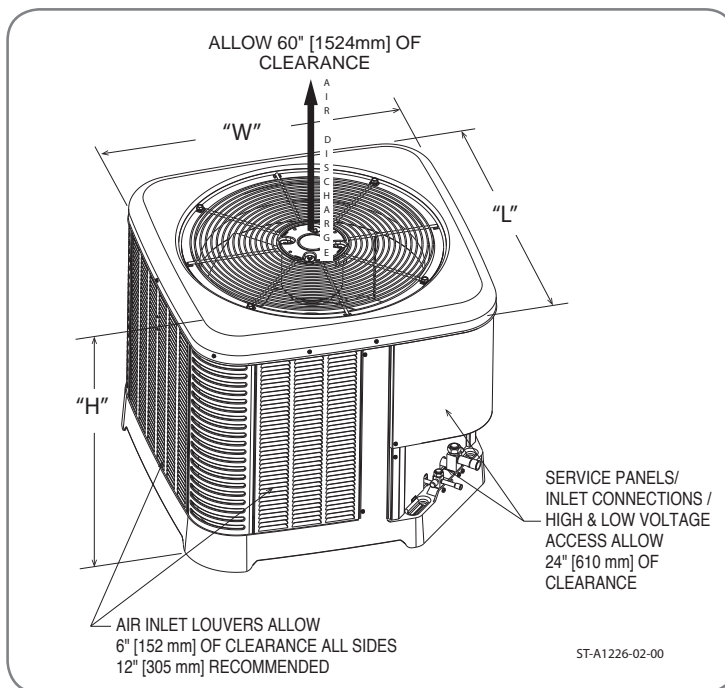
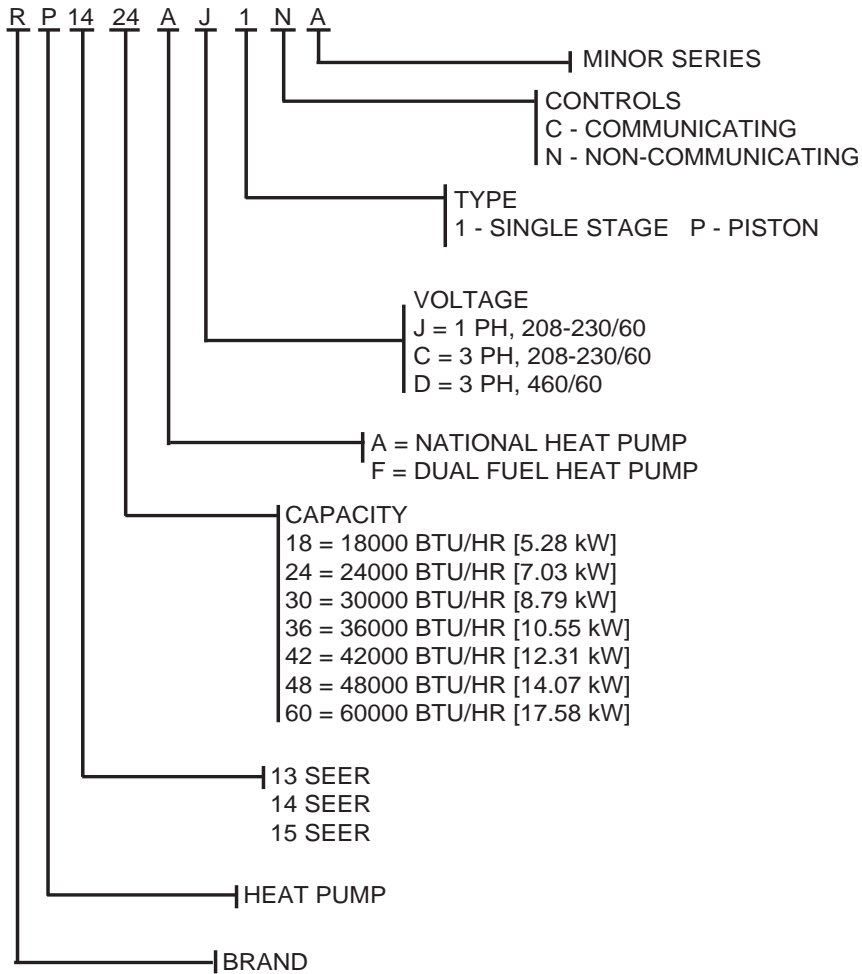

GENERAL INFORMATION



Specifications

DIMENSIONAL DATA

RP13	36, 42	48	60
Height "H" inches (mm)	27 (686)	35 (889)	39 (991)
Length "L" inches (mm)	33.75 (857)	33.75 (857)	35.75 (908)
Width "W" inches (mm)	33.75 (857)	33.75 (857)	35.75 (908)

RP14	18A, 24A, 30A 18F, 24F	30F	36A, 42A	36F, 42F 48A	48F, 60A	60F
Height "H" inches (mm)	25 (635)	31 (787)	27 (686)	35 (889)	39 (991)	45 (1143)
Length "L" inches (mm)	29.75 (756)	33.75 (857)	33.75 (857)	33.75 (857)	35.75 (908)	35.75 (908)
Width "W" inches (mm)	29.75 (756)	33.75 (857)	33.75 (857)	33.75 (857)	35.75 (908)	35.75 (908)

RP15	18, 24	30	36, 42	48	60
Height "H" inches (mm)	25 (635)	31 (787)	35 (889)	39 (991)	45 (1143)
Length "L" inches (mm)	29.75 (756)	33.75 (857)	33.75 (857)	35.75 (908)	35.75 (908)
Width "W" inches (mm)	29.75 (756)	33.75 (857)	33.75 (857)	35.75 (908)	35.75 (908)

Proper Installation

Proper sizing and installation of this equipment is critical to achieve optimal performance. Use the information in this Installation Instruction Manual and reference the applicable manufacturer's specification sheet when installing this product.

IMPORTANT: This product has been designed and manufactured to meet ENERGY STAR criteria for energy efficiency when matched with appropriate indoor components. However, proper refrigerant charge and proper airflow are critical to achieve rated capacity and efficiency. Installation of this product should follow the manufacturer's refrigerant charging and airflow instructions. **Failure to confirm proper charge and airflow may reduce energy efficiency and shorten equipment life.**

MATCH ALL COMPONENTS:

- OUTDOOR UNIT
- INDOOR COIL
- INDOOR AIR HANDLER/FURNACE
- REFRIGERANT LINES
- INDOOR THERMOSTAT

INSTALLATION



Choosing a Location

IMPORTANT: Consult local and national building codes and ordinances for special installation requirements. Following location information will provide longer life and simplified servicing of the outdoor heat pump.

NOTICE: These units must be installed outdoors. No ductwork can be attached, or other modifications made, to the discharge grille. Modifications will affect performance or operation.

Operational Issues

IMPORTANT: Locate the unit in a manner that will not prevent, impair, or compromise the performance of other equipment installed in proximity to the unit. Maintain all required minimum distances to gas and electric meters, dryer vents, and exhaust and inlet openings. In the absence of national codes or manufacturers' recommendations, local code recommendations and requirements will take precedence.

- Refrigerant piping and wiring should be properly sized and kept as short as possible to avoid capacity losses and increased operating costs.
- Locate the unit where water runoff will not create a problem with the equipment. Position the unit away from the drip edge of the roof whenever possible. Units are weatherized, but can be affected by the following:
 - Water pouring into the unit from the junction of rooflines, without protective guttering. Large volumes of water entering the heat pump while in operation can impact fan blade or motor life, and coil damage may occur to a heat pump if moisture cannot drain from the unit under freezing conditions.
 - Freezing moisture or sleeting conditions can cause the cabinet to ice-over prematurely and prevent heat pump operation, requiring backup heat, which generally results in less economical operation.
- Closely follow the clearance recommendations on page 8.
 - 24" [61.0 cm] to the service panel access
 - 60" [152.4 cm] above heat pump fan discharge (unit top) to prevent recirculation
 - 6" [15.2 cm] to heat pump coil grille air inlets with 12" [30.5 cm] minimum recommended

Corrosive Environment

The metal parts of this unit may be subject to rust or deterioration if exposed to a corrosive environment. This oxidation could shorten the equipment's useful life.

Corrosive elements include, but are not limited to, salt spray, fog or mist in seacoast areas, sulphur or chlorine from lawn watering systems, and various chemical contaminants from industries such as paper mills and petroleum refineries.

If the unit is to be installed in an area where contaminants are likely to be a problem, special attention should be given to the equipment location and exposure.

- Avoid having lawn sprinkler heads spray directly on the unit cabinet.
- In coastal areas, locate the unit on the side of the building away from the waterfront.
- Shielding provided by a fence or shrubs may give some protection, but cannot violate minimum airflow and service access clearances.
- Elevating the unit off its slab or base enough to allow air circulation will help avoid holding water against the base pan.

⚠ WARNING: Disconnect all power to unit before starting maintenance. Failure to do so can cause electrical shock resulting in severe personal injury or death.

Regular maintenance will reduce the buildup of contaminants and help to protect the unit's finish.

- Frequent washing of the cabinet, fan blade, and coil with fresh water will remove most of the salt or other contaminants that build up on the unit.
- Regular cleaning and waxing of the cabinet with a good automobile polish will provide some protection.
- A good liquid cleaner may be used several times a year to remove matter that will not wash off with water.



Choosing a Location (cont.)

For Units With Space Limitations

In the event that a space limitation exists, we will permit the following clearances:

Single-Unit Applications: Clearances below 6" [15.2 cm] will reduce unit capacity and efficiency. Do not reduce the 60" [152.4 cm] discharge or the 24" [61.0 cm] service clearances.

Multiple-Unit Applications: When multiple condenser grille sides are aligned, a 6" [15.2 cm] clearance is recommended for 1.5 and 2 ton models and 9" [22.9 cm] for 2.5 ton to 5 ton models. Two combined clearances below the minimum will reduce capacity and efficiency. Do not reduce the 60" [152.4 cm] discharge or 24" [61.0 cm] service clearances.

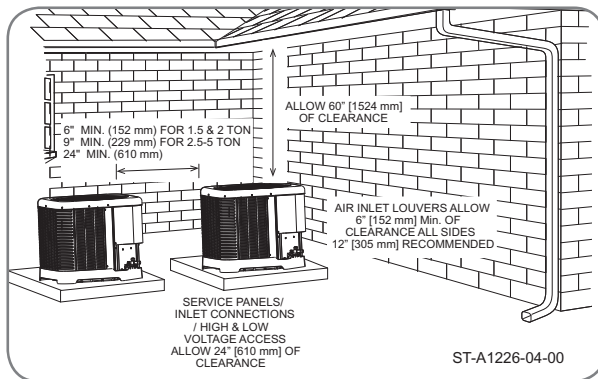

Customer Satisfaction Issues

- The heat pump should be located away from the living, sleeping, and recreational spaces of the owner and those spaces on adjoining property.
- To prevent noise transmission, the mounting pad for the outdoor unit should not be connected to the structure and should be located a sufficient distance above grade to prevent ground water from entering the unit.

Unit Mounting

⚠ WARNING: Secure an elevated unit and its elevating stand in order to prevent tipping. Failure to do so may result in severe personal injury or death.

Elevation of Unit

If elevating the heat pump, either on a flat roof or on a slab, observe the following guidelines.

- If elevating a unit on a flat roof, use 4" x 4" [10.2 cm x 10.2 cm] or equivalent stringers positioned to distribute unit weight evenly and prevent noise and vibration.
- Where snowfall is anticipated, raise the unit above the base pad to prevent ice buildup and coil damage. Mount the unit high enough to be above the average accumulated area snowfall. See "Ground Snow Depth" chart on page 10 for representative snow depths.

NOTICE: Do not block drain openings on bottom of unit.

- If unit must be elevated because of anticipated snowfall, secure unit and elevating stand such that unit and/or stand will not tip over or fall off. Keep in mind that someone may try to climb on unit.

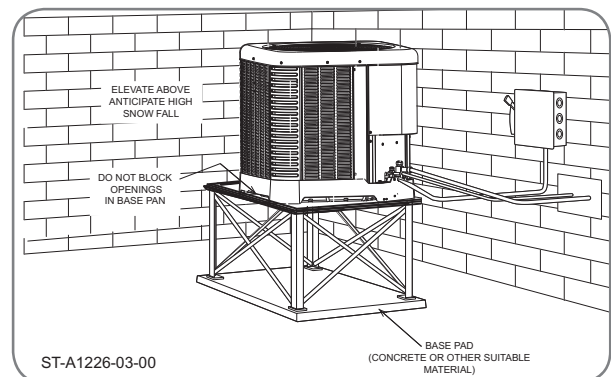

Factory-Preferred Tie-Down Method for High Wind or Seismic Loads

IMPORTANT: The manufacturer-approved/recommended method is a guide to securing equipment for wind and seismic loads. Other methods might provide the same result, but the manufacturer method is the only one endorsed by the manufacturer for securing equipment where wind or earthquake damage can occur. Additional information is available in the PTS (Product Technical Support) section of the manufacturer's Web sites Rheemote.net, MyRheem.com, or MyRuud.com and can be found as a listing under each outdoor model. If you do not have access to this site, your distributor can offer assistance.

INSTALLATION



Choosing a Location (cont.)

Location

GROUND SNOW DEPTH – INCHES

ALABAMA	INDIANA	MINNESOTA	NEW MEXICO	PENNSYLVANIA	VIRGINIA
Huntsville 7	Evansville 12	Duluth 64	Albuquerque 4	Allentown 23	Dulles Airport 19
ARIZONA	Fort Wayne 17	International Falls 43	Clayton 10	Erie 19	Lynchburg 16
Flagstaff 48	Indianapolis 21	Minneapolis/St. Paul 50	Roswell 8	Harrisburg 23	National Airport 18
Prescott 3	South Bend 44	Rochester 50	NEW YORK	Philadelphia 16	Norfolk 9
Winslow 7	IOWA	St. Cloud 53	Albany 25	Pittsburgh 22	Richmond 12
ARKANSAS	Burlington 17	MISSISSIPPI	Binghamton 35	Scranton 16	Roanoke 17
Ft. Smith 5	Des Moines 22	Jackson 3	Buffalo 42	Williamsport 20	WASHINGTON
Little Rock 6	Dubuque 38	MISSOURI	NYC – Kennedy Airport 18	RHODE ISLAND	Olympia 24
CALIFORNIA	Sioux City 33	Columbia 21	NYC – LaGuardia Airport 18	Providence 21	Quillayute 24
Blue Canyon 25	Waterloo 36	Kansas City 18	Rochester 38	SOUTH CAROLINA	Seattle-Tacoma 14
Mt. Shasta 69	KANSAS	St. Louis 16	Syracuse 35	Columbia 12	Spokane 41
COLORADO	Concordia 23	Springfield 14	NORTH CAROLINA	Greenville 4	Stampede Pass 51
Alamosa 15	Dodge City 12	MONTANA	Asheville 12	SOUTH DAKOTA	Yakima 25
Colorado Springs 14	Goodland 14	Billings 17	Cape Hattaras 5	Aberdeen 42	WEST VIRGINIA
Denver 15	Topeka 19	Glasgow 17	Charlotte 10	Huron 43	Beckley 51
Grand Junction 16	Wichita 11	Great Falls 16	Greensboro 11	Rapid City 14	Charleston 20
Pueblo 7	KENTUCKY	Havre 24	Raleigh-Durham 10	Sioux Falls 38	Elkins 21
CONNECTICUT	Covington 12	Helena 18	Wilmington 9	TENNESSEE	Huntington 15
Bridgeport 23	Lexington 12	Kalispell 53	Winston-Salem 17	Bristol 8	WISCONSIN
Hartford 29	Louisville 11	Missoula 23	NORTH DAKOTA	Chattanooga 6	Green Bay 36
New Haven 15	MAINE	NEBRASKA	Bismarck 25	Knoxville 8	La Crosse 32
DELAWARE	Caribou 100	Grand Island 30	Fargo 34	Memphis 5	Madison 32
Wilmington 13	Portland 62	Lincoln 20	Williston 25	Nashville 8	Milwaukee 32
GEORGIA	MARYLAND	Norfolk 29	OHIO	TEXAS	WYOMING
Athens 5	Baltimore 17	North Platte 15	Akron-Canton 15	Abilene 6	Casper 10
Macon 8	MASSACHUSETTS	Omaha 20	Cleveland 16	Amarillo 10	Cheyenne 15
IDAHO	Boston 30	Scottsbluff 11	Columbus 10	Dallas 3	Lander 20
Boise 6	Nantucket 18	Valentine 22	Dayton 11	El Paso 5	Sheridan 25
Lewiston 9	Worcester 35	NEVADA	Mansfield 17	Fort Worth 6	
0 Pocatello 7	MICHIGAN	Elko 20	Toledo Express 8	Lubbock 10	
ILLINOIS	Alpena 53	Ely 9	Youngstown 12	Midland 2	
Chicago O'Hare 18	Detroit City 9	Reno 11	OKLAHOMA	San Antonio 3	
Chicago 22	Detroit Airport 17	Winnemucca 6	Oklahoma City 5	Wichita Falls 5	
Moline 17	Detroit – Willow Run 21	NEW HAMPSHIRE	Tulsa 8	UTAH	
Peoria 16	Flint 28	Concord 66	OREGON	Milford 16	
Rockford 25	Grand Rapids 37	NEW JERSEY	Burns City 24	Salt Lake City 8	
Springfield 23	Houghton Lake 56	Atlantic City 11	Eugene 17	Wendover 3	
	Lansing 42	Newark 15	Medford 8	VERMONT	
	Marquette 53		Pendleton 11	Burlington 37	
	Muskegon 43		Portland 10		
	Sault Ste. Marie 80		Salem 7		

NOTICE: Local records and experience must be considered when establishing the unit installation height. There is a 2% probability that the ground snow depth shown in this table will be exceeded annually. Drifts have not been considered. This data represents 184 National Weather Service locations at which measurements are made and assumes a nationwide snow density of 12 lb./ft.³



Tools and Refrigerant

Tools Required for Installing and Servicing R-410A Models

Manifold Sets:

- Up to 800 PSIG High-Side
- Up to 250 PSIG Low-Side
- 550 PSIG Low-Side Retard

Manifold Hoses:

- Service Pressure Rating of 800 PSIG

Recovery Cylinders:

- 400 PSIG Pressure Rating
- Dept. of Transportation 4BA400 or BW400

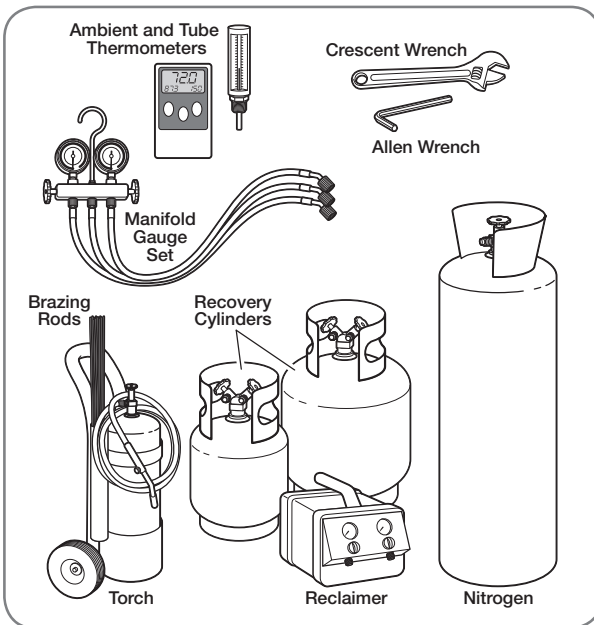

CAUTION: R-410A systems operate at higher pressures than R-22 systems. Do not use R-22 service equipment or components on R-410A equipment.

Specifications of R-410A

Application: R-410A is not a drop-in replacement for R-22. Equipment designs must accommodate its higher pressures. It cannot be retrofitted into R-22 heat pumps.

Physical Properties: R-410A has an atmospheric boiling point of -62.9°F [-52.7°C] and its saturation pressure at 77°F [25°C] is 224.5 psig.

Composition: R-410A is a near-azeotropic mixture of 50% by weight difluoromethane (HFC-32) and 50% by weight pentafluoroethane (HFC-125).

Pressure: The pressure of R-410A is approximately 60% (1.6 times) greater than R-22. Recovery and recycle equipment, pumps, hoses, and the like must have design pressure ratings appropriate for R-410A. *Manifold sets need to range up to 800 psig high-side and 250 psig low-side with a 550 psig low-side retard. Hoses need to have a service pressure rating of 800 psig. Recovery cylinders need to have a 400 psig service pressure rating, DOT 4BA400 or DOT BW400.*

Combustibility: At pressures above 1 atmosphere, a mixture of R-410A and air can become combustible. **R-410A and air should never be mixed in tanks or supply lines or be allowed to accumulate in storage tanks. Leak checking should never be done with a mixture of R-410A and air.** Leak-checking can be performed safely with nitrogen or a mixture of R-410A and nitrogen.

Quick-Reference Guide For R-410A

- R-410A refrigerant operates at approximately 60% higher pressure (1.6 times) than R-22. Ensure that servicing equipment is designed to operate with R-410A.
- R-410A refrigerant cylinders are light rose in color.
- R-410A, as with other HFCs, is only compatible with POE oils.
- Vacuum pumps will not remove moisture from POE oil used in R-410A systems.
- R-410A systems are to be charged with liquid refrigerants. Prior to March 1999, R-410A refrigerant cylinders had a dip tube. These cylinders should be kept upright for equipment charging. Post-March 1999 cylinders do not have a dip tube and should be inverted to ensure liquid charging of the equipment.
- Do not install a suction line filter drier in the liquid line.
- A factory-approved biflow liquid line filter drier is shipped with every unit and must be installed in the liquid line at the time of installation. Only manufacturer-approved liquid line filter driers can be used. These are Sporlan (CW083S) and Alco (80K083S) driers. These filter driers are rated for minimum working pressure of 600 psig. The filter drier will only have adequate moisture-holding capacity if the system is properly evacuated.
- Desiccant (drying agent) must be compatible for POE oils and R-410A refrigerant.

INSTALLATION



Replacement Units

To prevent failure of a new unit, the existing line set must be correctly sized and cleaned or replaced. Care must be exercised that the expansion device is not plugged. For new and replacement units, a liquid line filter drier must be installed and refrigerant tubing must be properly sized. Test the oil for acid. If positive, a suction line filter drier is mandatory.

IMPORTANT: When replacing an R-22 unit with an R-410A unit, either replace the line set or ensure that residual mineral oil is drained from existing lines including oil trapped in low spots.



Indoor Coil

CAUTION: Only use evaporators approved for use on R-410A systems that are specifically matched with the outdoor unit per the manufacturer's specification sheets. Use of existing R-22 evaporators can introduce mineral oil to the R-410A refrigerant, forming two different liquids and decreasing oil return to the compressor. This can result in compressor failure.

REFER TO INDOOR COIL MANUFACTURER'S INSTALLATION INSTRUCTIONS.

IMPORTANT: The manufacturer is not responsible for the performance and operation of a mismatched system or for a match listed with another manufacturer's coil.

NOTICE: All outdoor units must be installed with a matched TXV indoor coil. Refer to manufacturer's outdoor unit specification sheet for approved indoor coils.

The thermostatic expansion valve in the matching coil is specifically designed to operate with R-410A. **DO NOT use an R-22 TXV or evaporator. The existing evaporator must be replaced with the factory-specified TXV evaporator specifically designed for R-410A.**

Location

Do not install the indoor coil in the return duct system of a gas or oil furnace. Provide a service inlet to the coil for inspection and cleaning. Keep the coil pitched toward the drain connection.

CAUTION: When coil is installed over a finished ceiling and/or living area, it is required that a secondary condensate pan be installed under entire unit. Failure to do so can result in property damage.

Tubing



Interconnecting Tubing

The purpose of this section is to specify the best construction/sizing practices for installing interconnection tubing between the indoor and outdoor unit.

Refrigerant Level Adjustment

All units are factory-charged with R-410A refrigerant to cover 15 feet of standard size interconnecting liquid and vapor lines with a required field installed filter drier. Adjustment of charge may be necessary even if the application has exactly 15 feet of line set due to other installation variables such as pressure drop, vertical lift, and indoor coil size. For different lengths, adjust the charge as indicated below.

- 1/4" ± .3 oz./foot [6.4 mm ± 8.5 g/.30 m]
- 5/16" ± .4 oz./foot [7.9 mm ± 11.3 g/.30 m]
- 3/8" ± .6 oz./foot [9.5 mm ± 17.0 g/.30 m]
- 1/2" ± 1.2 oz./foot [12.7 mm ± 34.0 g/.30 m]
- 6 oz. required factory supplied field-installed filter drier.

Charge Adjustment = (Line Set (oz./ft.) x Total Length) – Factory Charge for Line Set

Example: A three ton heat pump unit with factory installed 3/8" liquid service valve requires 75 ft. of line set with a liquid line diameter of 1/2".

Factory Charge for Line Set = 15 ft. x .6 oz. = 9 oz.
Charge Adjustment = (1.2 oz. x 75 ft.) – 9 oz. = + 81 oz.



Interconnecting Tubing (cont.)

Interconnecting Tubing and Fitting Losses

Refrigerant tubing is measured in terms of actual length and equivalent length. Actual length is used for refrigerant charge applications. Equivalent length takes into account pressure losses from

tubing length, fittings, vertical separation, accessories, and filter dryers. The table below references different commonly used equivalent lengths.

Table 1

Equivalent Length for Fittings (ft)							
Line Size (in)	90° Short Radius Elbow	90° Long Radius Elbow	45° Elbow	Solenoid Valve	Check Valve	Site Glass	Filter Dryer
3/8	1.3	0.8	0.3	6	4	0.4	6
1/2	1.4	0.9	0.4	9	5	0.6	6
5/8	1.5	1	0.5	12	6	0.8	6
3/4	1.9	1.3	0.6	14	7	0.9	6
7/8	2.3	1.5	0.7	15	8	1	6
1-1/8	2.7	1.8	0.9	22	12	1.5	6

Liquid Line Selection

The purpose of the liquid line is to transport warm sub-cooled liquid refrigerant from the outdoor unit to the indoor unit. It is important not to allow the refrigerant to flash any superheated vapor prior to the expansion device of the indoor coil. The flashing of refrigerant can occur for the following reasons:

- Low refrigerant charge
- Improperly selected liquid line size
- Absorption of heat prior to expansion device
- Excessive vertical rise between the condenser and evaporator

Table 2 lists the equivalent length per 25' of liquid line at various diameters up to 300'. The total pres-

sure drop allowed for the liquid line is 50 PSI. The procedure for selecting the proper liquid line is as follows:

- Measure the total amount of vertical rise
- Measure the total amount of liquid line needed
- Add all of the equivalent lengths associated with any fittings or accessories using the table above.
- Add the total length and fitting pressure drop. This will equal your total equivalent length.
- Round-down the total equivalent length to the closest value in Table 2.
- Reference Table 2 to verify the rounded-down value of the calculated equivalent length is compatible with the required vertical rise and diameter of liquid line.

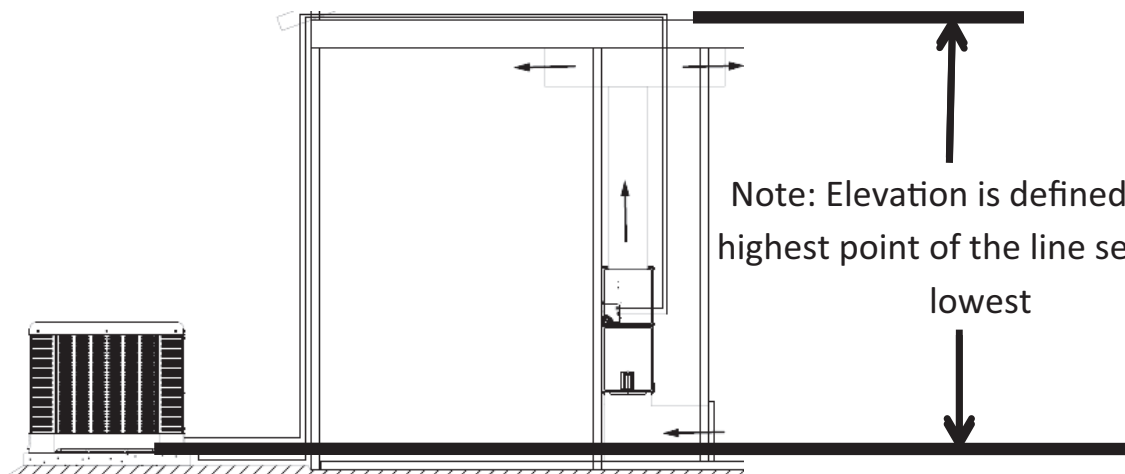

INSTALLATION



Interconnecting Tubing (cont.)

Example: A 3-Ton heat pump unit is installed 50' below the ID unit, requires a 75' of 1/2" diameter liquid line, and 4 90° LR elbows.

- Fitting Equivalent Length (ft.) = 4 x .9 = 3.6'
- Total Equivalent Length (ft.) = 75' + 3.6' = 78.6'
- Rounded-down value (ft.) = 75'

This application is acceptable because the 50' vertical rise is less than the maximum rise of 75' for this application. The application is also considered to have a long line set. Reference the long line set section of the I&O for detail.

R-410A System Capacity Model	Liquid Line Size Connection Size (Inch I.D.) [mm]	Liquid Line Size (Inch O.D.) [mm]	Liquid Line Size											
			Elevation (Above or Below) Indoor Coil											
			Total Equivalent Length - Feet [m]											
			25 [7.62]	50 [15.24]	75 [22.86]	100 [30.48]	125 [45.72]	150 [45.72]	175 [53.34]	200 [60.96]	225 [68.58]	250 [76.20]	275 [83.82]	300 [91.44]
			Maximum Vertical Separation - Feet [m]											
37	3/8" [9.53]	1/4 [6.35]	25 [7.62]	N/R	N/R	N/R	N/R	N/R	N/R	N/R	N/R	N/R	N/R	N/R
		5/16 [7.94]	25 [7.62]	50 [15.24]	60 [18.29]	45 [13.72]	35 [10.67]	20 [6.1]	5 [1.52]	N/R	N/R	N/R	N/R	N/R
		3/8 [9.53]	25 [7.62]	50 [15.24]	75 [22.86]	80 [24.38]	80 [24.38]	75 [22.86]	70 [21.34]	65 [19.81]	60 [18.29]	55 [16.76]	50 [15.24]	45 [13.72]
		7/16 [11.12]	25 [7.62]	50 [15.24]	75 [22.86]	95 [28.96]	90 [27.43]	90 [27.43]	85 [25.91]	85 [25.91]	85 [25.91]	80 [24.38]	80 [24.38]	80 [24.38]
		1/2 [12.71]	25 [7.62]	50 [15.24]	75 [22.86]	95 [28.96]	95 [28.96]	95 [28.96]	95 [28.96]	95 [28.96]	95 [28.96]	90 [27.43]	90 [27.43]	90 [27.43]

(Excerpt from Table 2, page 17)

Long Line Set Applications

Long line set applications are defined as applications that require accessories or alternate construction methods. The following are special considerations that need to be addressed when installing a long line set application:

- Additional refrigerant charge
- Fitting losses and maximum equivalent length considerations
- Refrigerant migration during the off cycle
- Oil return to the compressor
- Capacity losses
- System oil level adjustment

Table 2 is used to determine if the application is considered to have a long line set. **The region of the chart that is shaded grey is considered to be a long line set application.**

Oil Level Adjustments for Long Line Set Applications

Additional oil will need to be added for long line set applications. (Ref. Table 2). Below is the equation for the oil level adjustment and the compressor name plate oil charge for the different od units.

Oil to be Added = [(Charge Adjustment + OD Unit Name Plate Charge (oz.)) x (0.022) - ((0.10) x (Compressor Name Plate Oil Charge (oz.)))]

Example: An application requires 125ft of line set with a liquid line diameter of 3/8", Charge Adjustment = 52.4 oz., Name Plate Charge = 107 oz., Name Plate Oil Charge = 25 oz., Oil to be Added = ((52.4 oz. + 107 oz.) x .022) - (.10 x 25 oz.) = 1.0 oz.

OD Model	Compressor	Name Plate Oil Charge (oz)	Factory Installed CCH
RP1336AC	ZP31K5E-TF5-13R	42	N
RP1342AC	ZP36K5E-TF5-13R	42	Y
RP1348AC	ZP42K5E-TF5-13R	42	N
RP1360AC	ZP49K6E-TF5-130	42	Y
RP1336AD	ZP31K5E-TFD-13R	42	N
RP1342AD	ZP36K5E-TFD-13R	42	Y
RP1348AD	ZP42K5E-TFD-13R	42	Y
RP1360AD	ZP49K6E-TFD-130	42	Y

OD Model	Compressor	Name Plate Oil Charge (oz)	Factory Installed CCH
RP1436AC	ZP31K5E-T5F-13R	42	N
RP1442AC	ZP36K5E-TF5-13R	42	Y
RP1448AC	ZP42K5E-TF5-13R	42	N
RP1460AC	ZP49K6E-TF5-130	42	Y
RP1436AD	ZP31K5E-TFD-13R	42	N
RP1442AD	ZP36K5E-TFD-13R	42	Y
RP1448AD	ZP42K5E-TFD-13R	42	Y
RP1460AD	ZP49K6E-TFD-130	42	Y
RP1418AJ	ZP16K5E-PFV-13R	21	N
RP1430AJ	ZP25K5E-PFV-13R	25	N
RP1436AJ	ZP31K5E-PFV-13R	21	N
RP1442AJ	ZP21K6E-PFV-130	21	N
RP1442AJ	ZP36K5E-PFV-13R	42	N
RP1448AJ	ZP42K5E-PFV-13R	42	Y
RP1460AJ	ZP49K6E-PFV-130	42	N
RP1436FC	ZP31K6E-TF5-130	21	N
RP1442FC	ZP36K5E-TF5-13R	42	N
RP1448FC	ZP40K6E-TF5-130	42	Y
RP1460FC	ZP49K6E-TF5-130	42	Y
RP1418FJ	ZP14K6E-PFV-130	21	N
RP1424FJ	ZP20K6E-PFV-130	21	N
RP1430FJ	ZP24K6E-PFV-130	25	N
RP1436FJ	ZP31K6E-PFV-130	21	N
RP1442FJ	ZP36K5E-PFV-13R	42	N
RP1448FJ	ZP40K6E-PFV-130	42	N
RP1460FJ	ZP49K6E-PFV-130	42	Y



Interconnecting Tubing (cont.)

OD Model	Compressor	Name Plate Oil Charge (oz)	Factory Installed CCH
RP1518AJ	ZP16K5E-PFV-13R	21	N
RP1518BJ	ZP14K6E-PFV-130	21	N
RP1524AJ	ZP21K5E-PFV-13R	21	N
RP1524BJ	ZP20K6E-PFV-130	21	N
RP1530AJ	ZP25K5E-PFV-13R	25	N
RP1530BJ	ZP24K6E-PFV-130	25	N
RP1536AJ	ZP31K6E-PFV-130	21	N
RP1542AJ	ZP36K5E-PFV-13R	42	N
RP1548AJ	ZP40K6E-PFV-130	42	N
RP1560AJ	ZP49K6E-PFV-130	42	Y
RP1536AC	ZP31K6E-TF5-130	21	N
RP1542AC	ZP36K5E-TF5-13R	42	N
RP1548AC	ZP40K6E-TF5-130	42	Y
RP1560AC	ZP49K6E-TF5-130	42	Y

Suction Line Selection

Purpose of the suction line is to return superheated vapor to the condensing unit from the evaporator. Proper suction line sizing is important because it plays an important role in returning oil to the compressor to prevent potential damage to the bearings, valves, and scroll sets. Also, an improperly sized suction line can dramatically reduce capacity

and performance of the system. The procedure for selecting the proper suction line is as follows:

- The total amount of suction line needed
- Add all of the equivalent lengths associated with any fittings or accessories using the table on previous page.
- Add the total length and fitting pressure drop. This will equal your total equivalent length.
- Reference Table 2 to verify that the calculated equivalent length falls within the compatibility region of the chart.
- Verify Table 3 to verify the capacity difference is compatible with the application.

Refrigerant Migration During Off Cycle

Long line set applications can require a considerable amount of additional refrigerant. This additional refrigerant needs to be managed throughout the entire ambient operating envelope that the system will go through during its life cycle. Off-Cycle migration is where excess refrigerant condenses and migrates to the lowest part of the system. Excessive build-up of refrigerant at the compressor will result in poor reliability and noisy operation during startup. This section demonstrates the required accessories and unit configuration for different applications.

OUTDOOR UNIT LEVEL OR NEAR LEVEL TO INDOOR SECTION LINE SET

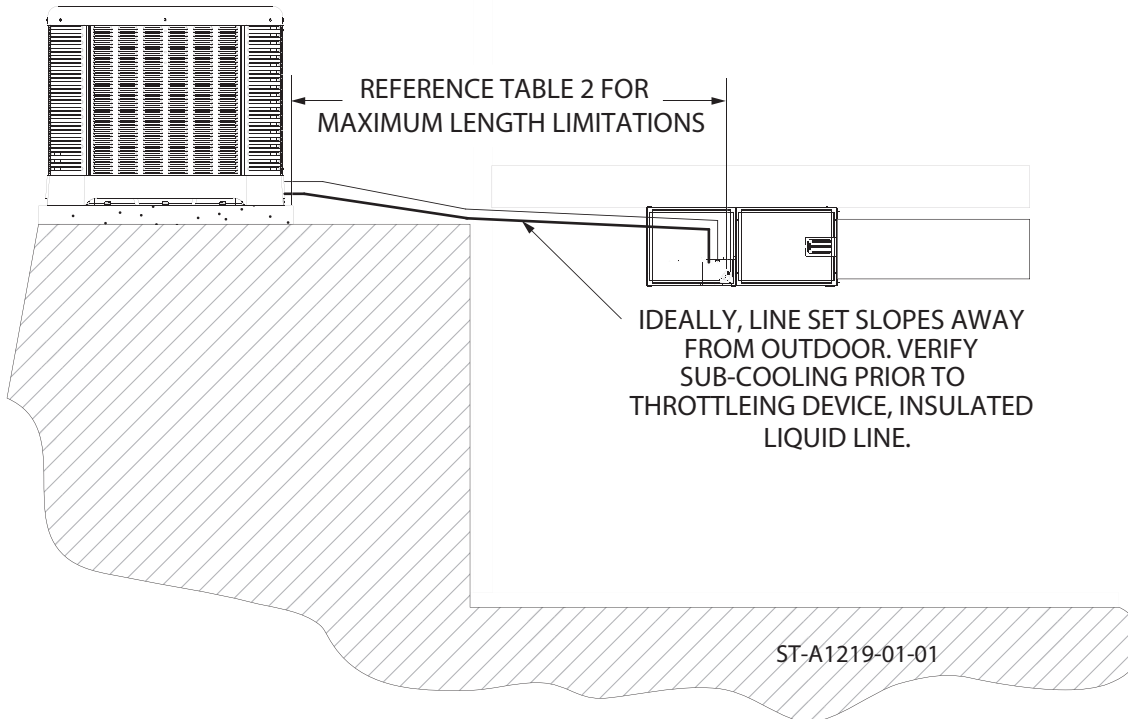

INSTALLATION



Interconnecting Tubing (cont.)

For applications that are considered to have a long line set with the outdoor unit and indoor unit on the same level the following is required:

- TXV or EEV on the indoor unit
- Start components may be required depending upon quality of voltage (consistently <200vac at outdoor unit)
- Crankcase heater (Some models have factory installed CCH's. Refer to tables on pages 14 and 15.)

- Insulated liquid and suction line
- Vapor line should slope toward the indoor unit
- Follow the proper line sizing, equivalent length, charging requirements, and oil level adjustments spelled out in this document and the outdoor units I&O
- Verify at least 5°F sub-cooling at the ID unit prior to throttling device

OUTDOOR UNIT BELOW INDOOR SECTION LINE SET

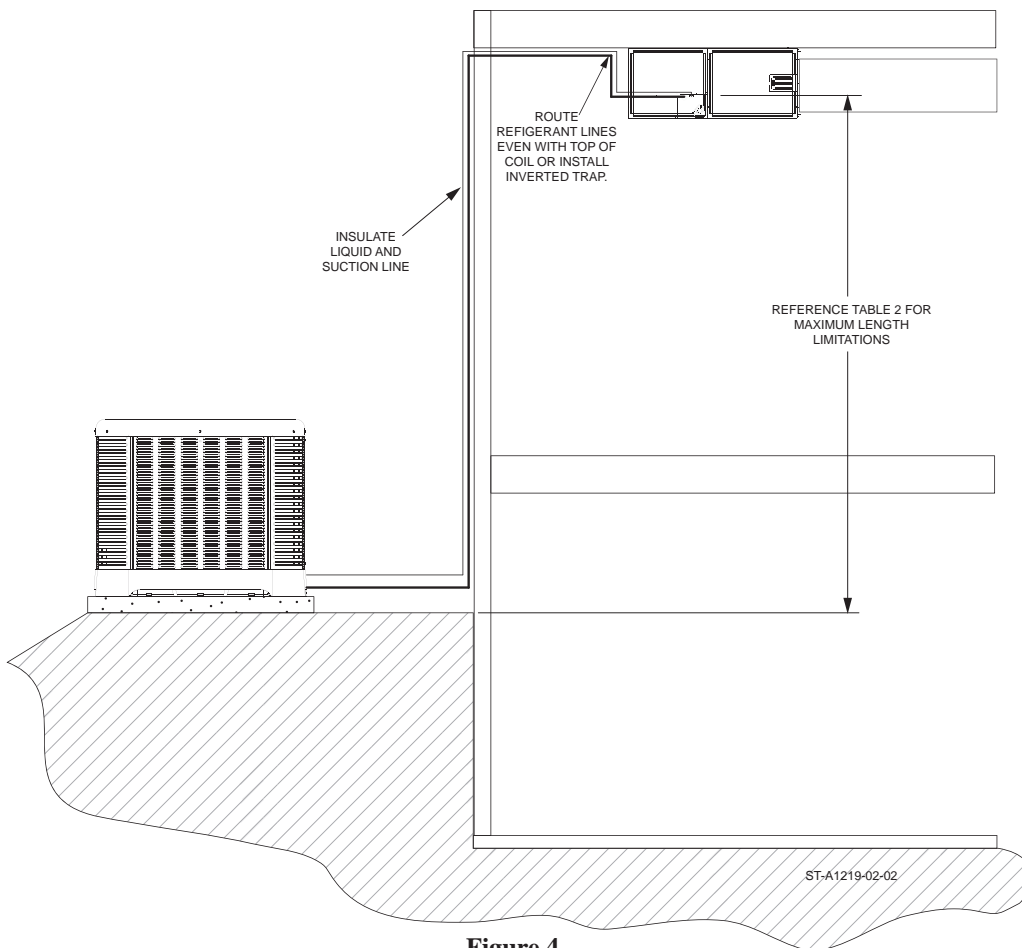

Figure 4

For applications that are considered to have a long line set with the outdoor unit below the indoor unit the following is required:

- TXV or EEV at the IDunit
- Crankcase heater (Some models have factory installed CCH's. Refer to tables on pages 14 and 15.)
- Start components may be required depending upon quality of voltage (consistently <200vac at OD unit)
- Refrigerant lines should be routed even with the top of the ID coil or an inverted trap is to be ap-

- plied (refer to figure 4).
- Insulated liquid and suction line
- Follow the proper line sizing, equivalent length, charging requirements, and oil level adjustments spelled out in this document and the outdoor units I&O
- Measure pressure at the liquid line service valve and prior to expansion device. Verify that it is not greater than 50 PSI
- For elevations greater that 25' can expect a lower sub-cooling

INSTALLATION



Interconnecting Tubing (cont.)

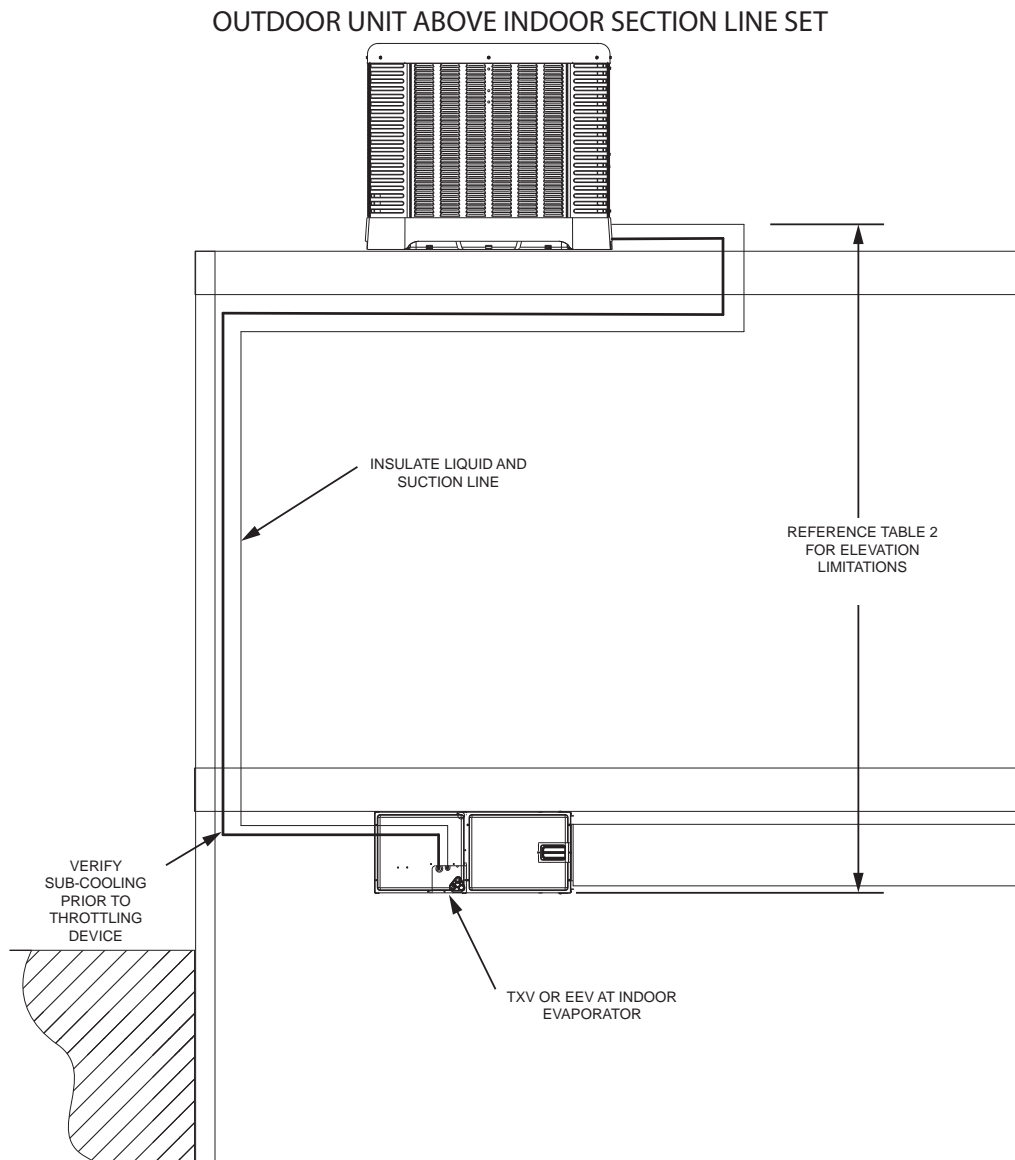

For applications that are considered to have a long line set with the outdoor unit above the indoor unit the following is required:

- TXV at the indoor unit
- Crankcase heater (Some models have factory installed CCH's. Refer to tables on pages 14 and 15.)
- Start components maybe required depending upon quality of voltage (consistently <200 vac at outdoor unit)
- Insulated liquid and suction line
- Follow the proper line sizing, equivalent length, charging requirements, and oil level adjustments spelled out in this document and the outdoor units I&O
- Verify at least 5°F sub-cooling at the ID unit prior to throttling device

INSTALLATION

❄️ Interconnecting Tubing (cont.)

Table 3

R-410A System Capacity Model	Vapor Line Connection Size (Inch I.D.) [mm]	Vapor Line Size (Inch O.D.) [mm]	Suction Line Selection Chart Capacity Multiplier Table															
			Total Equivalent Length - Feet [m]															
			25 [7.62]	50 [15.24]	75 [22.86]	100 [30.48]	125 [45.72]	150 [45.72]	175 [53.34]	200 [60.96]	225 [68.58]	250 [76.20]	275 [83.82]	300 [91.44]				
RP1324	3/4" [19.06]	5/8 [15.88] 3/4 [19.05] 7/8 [22.23] 1 [25.4]	0.99	0.99	0.98	0.98	0.97	0.97	0.96	0.96	0.96	0.96	0.95	0.95	0.95	0.94		
			1.00	1.00	1.00	1.00	1.00	1.00	1.00	1.00	1.01	1.01	1.01	1.01	1.01	1.01		
			N/R	N/R	N/R	N/R	N/R	N/R	N/R	N/R	N/R	N/R	N/R	N/R	N/R	N/R	N/R	
			1 [25.4]	N/R	N/R	N/R	N/R	N/R	N/R	N/R	N/R	N/R	N/R	N/R	N/R	N/R	N/R	
			5/8 [15.88]	0.99	0.97	0.95	0.93	0.92	0.91	0.9	0.9	0.9	0.9	0.9	0.87	0.87	0.87	0.86
			3/4 [19.05]	1.00	0.99	0.98	0.98	0.97	0.97	0.97	0.97	0.96	0.96	0.96	0.95	0.95	0.94	0.94
RP1336	3/4" [19.06]	7/8 [22.23] 1 [25.4] 1-1/8 [28.58]	1.00	1.00	1.00	1.00	1.00	0.99	0.99	0.99	0.99	0.99	0.98	0.98	0.98	0.98		
			1.00	1.00	1.00	1.00	1.00	1.00	1.00	1.00	1.00	1.00	1.00	1.00	1.00	1.00		
			N/R	N/R	N/R	N/R	N/R	N/R	N/R	N/R	N/R	N/R	N/R	N/R	N/R	N/R	N/R	
			1 [25.4]	N/R	N/R	N/R	N/R	N/R	N/R	N/R	N/R	N/R	N/R	N/R	N/R	N/R	N/R	
			5/8 [15.88]	0.99	0.97	0.94	0.92	0.89	0.88	0.88	0.86	0.86	0.86	0.84	0.84	0.83	0.83	0.83
			3/4 [19.05]	1.00	0.99	0.98	0.97	0.96	0.96	0.95	0.95	0.94	0.94	0.93	0.93	0.92	0.92	0.92
RP1348	7/8 [22.22]	1 [25.4] 1-1/8 [28.58]	1.00	1.00	1.00	0.99	0.98	0.98	0.98	0.98	0.98	0.97	0.97	0.97	0.97	0.97		
			1.00	1.00	1.00	1.00	1.00	1.00	1.00	1.00	1.00	1.00	1.00	1.00	1.00	1.00		
			N/R	N/R	N/R	N/R	N/R	N/R	N/R	N/R	N/R	N/R	N/R	N/R	N/R	N/R	N/R	
			1 [25.4]	N/R	N/R	N/R	N/R	N/R	N/R	N/R	N/R	N/R	N/R	N/R	N/R	N/R	N/R	
			5/8 [15.88]	0.98	0.94	0.92	0.9	0.88	0.85	0.85	0.84	0.84	0.84	0.83	0.83	0.82	0.82	0.82
			3/4 [19.05]	1.00	0.99	0.98	0.96	0.95	0.94	0.94	0.93	0.93	0.93	0.92	0.92	0.92	0.92	0.92
RP1360	7/8 [22.22]	7/8 [22.23] 1 [25.4] 1-1/8 [28.58]	1.00	1.00	1.00	0.99	0.99	0.98	0.98	0.98	0.98	0.98	0.98	0.98	0.98	0.98		
			1.00	1.00	1.00	1.00	1.00	1.00	1.00	1.00	1.00	1.00	1.00	1.00	1.00	1.00		
			N/R	N/R	N/R	N/R	N/R	N/R	N/R	N/R	N/R	N/R	N/R	N/R	N/R	N/R	N/R	
			1 [25.4]	N/R	N/R	N/R	N/R	N/R	N/R	N/R	N/R	N/R	N/R	N/R	N/R	N/R	N/R	
			5/8 [15.88]	0.98	0.94	0.92	0.9	0.88	0.85	0.85	0.84	0.84	0.84	0.83	0.83	0.82	0.82	0.82
			3/4 [19.05]	1.00	0.99	0.98	0.96	0.95	0.94	0.94	0.93	0.93	0.93	0.92	0.92	0.92	0.92	0.92

NOTES:
N/R = Application not recommended.

INSTALLATION

Interconnecting Tubing (cont.)

R-410A System Capacity/Model	Vapor Line Connection Size (Inch I.D.) (mm)	Vapor Line Size (Inch O.D.) (mm)	Suction Line Selection Chart														
			Capacity Multiplier Table														
			Total Equivalent Length - Feet (m)														
			25 [7.62]	50 [15.24]	75 [22.86]	100 [30.48]	125 [45.72]	150 [45.72]	175 [53.34]	200 [60.96]	225 [68.58]	250 [76.20]	275 [83.82]	300 [91.44]			
RP1418A	3/4" [19.06]	5/8 [15.88]	1.00	0.99	0.99	0.99	0.99	0.99	0.98	0.98	0.98	0.98	0.97	0.97	0.97	0.97	
		3/4 [19.05]	1.00	1.00	1.00	1.00	1.00	1.00	1.00	1.00	1.00	1.00	1.00	1.00	1.00	1.00	
		7/8 [22.23]	N/R	N/R	N/R	N/R	N/R	N/R	N/R	N/R	N/R	N/R	N/R	N/R	N/R	N/R	N/R
RP1424A	3/4" [19.06]	1 [25.4]	N/R	N/R	N/R	N/R	N/R	N/R	N/R	N/R	N/R	N/R	N/R	N/R	N/R	N/R	
		1-1/8 [28.58]	N/R	N/R	N/R	N/R	N/R	N/R	N/R	N/R	N/R	N/R	N/R	N/R	N/R	N/R	
		5/8 [15.88]	0.99	0.99	0.98	0.98	0.97	0.97	0.96	0.96	0.96	0.96	0.95	0.95	0.94	0.94	
RP1430A	3/4" [19.06]	3/4 [19.05]	1.00	1.00	1.00	1.00	1.00	0.98	0.98	0.98	0.98	0.98	0.98	0.97	0.96	0.96	
		7/8 [22.23]	1.00	1.01	1.01	1.01	1.01	1.01	1.01	1.01	1.01	1.01	1.01	1.01	1.01	1.00	
		1 [25.4]	N/R	N/R	N/R	N/R	N/R	N/R	N/R	N/R	N/R	N/R	N/R	N/R	N/R	N/R	N/R
RP1436A	3/4" [19.06]	1-1/8 [28.58]	N/R	N/R	N/R	N/R	N/R	N/R	N/R	N/R	N/R	N/R	N/R	N/R	N/R	N/R	
		5/8 [15.88]	0.99	0.97	0.95	0.93	0.92	0.91	0.9	0.9	0.9	0.87	0.87	0.86	0.86	0.86	
		3/4 [19.05]	1.00	0.99	0.98	0.98	0.97	0.97	0.97	0.97	0.96	0.96	0.95	0.94	0.94	0.94	
RP1442A	7/8" [22.22]	7/8 [22.23]	1.00	1.00	1.00	1.00	1.00	0.99	0.99	0.99	0.99	0.99	0.98	0.98	0.98	0.98	
		1 [25.4]	1.01	1.00	1.00	1.00	1.00	1.00	1.00	1.00	1.00	1.00	1.00	1.00	1.00	1.00	
		1-1/8 [28.58]	1.01	1.01	1.00	1.00	0.99	0.97	0.97	0.96	0.96	0.95	0.95	0.94	0.94	0.94	
RP1448A	7/8" [22.22]	5/8 [15.88]	0.97	0.95	0.94	0.94	0.92	0.89	0.86	0.86	0.86	0.84	0.84	0.84	0.84	0.84	
		3/4 [19.05]	0.99	0.99	0.98	0.97	0.96	0.96	0.95	0.94	0.94	0.93	0.93	0.93	0.93	0.93	
		7/8 [22.23]	1.00	0.99	0.99	0.99	0.98	0.98	0.98	0.98	0.98	0.97	0.97	0.97	0.97	0.97	
RP1460A	7/8" [22.22]	1 [25.4]	1.00	1.00	1.00	0.99	0.99	1.00	0.99	1.00	0.99	0.99	0.99	0.99	0.99	0.99	
		1-1/8 [28.58]	N/R	N/R	N/R	N/R	N/R	N/R	N/R	N/R	N/R	N/R	N/R	N/R	N/R	N/R	
		5/8 [15.88]	0.98	0.94	0.92	0.9	0.88	0.88	0.85	0.84	0.84	0.84	0.84	0.84	0.84	0.84	
RP1460A	7/8" [22.22]	3/4 [19.05]	1.00	0.99	0.98	0.96	0.94	0.94	0.94	0.94	0.94	0.94	0.94	0.94	0.94	0.94	
		7/8 [22.23]	1.00	1.00	1.00	0.99	0.99	0.98	0.98	0.98	0.98	0.98	0.98	0.98	0.98	0.98	
		1 [25.4]	1.01	1.00	1.01	1.01	1.01	1.01	1.01	1.01	1.01	1.01	1.01	1.01	1.01	1.01	
RP1460A	7/8" [22.22]	1-1/8 [28.58]	N/R	N/R	N/R	N/R	N/R	N/R	N/R	N/R	N/R	N/R	N/R	N/R	N/R	N/R	

NOTES:
N/R = Application not recommended.

Table 3 cont.

INSTALLATION

Interconnecting Tubing (cont.)

R-410A System Capacity Model	Vapor Line Connection Size (Inch I.D.) [mm]	Vapor Line Size (Inch O.D.) [mm]	Vapor Line Selection Chart Capacity Multiplier Table																
			Total Equivalent Length - Feet [m]																
			25 [7.62]	50 [15.24]	75 [22.86]	100 [30.48]	125 [45.72]	150 [45.72]	175 [53.34]	200 [60.96]	225 [68.58]	250 [76.20]	275 [83.82]	300 [91.44]					
RP-418F	3/8" [9.53]	5/8 [15.88]	1.00	0.99	0.99	0.98	0.98	0.98	0.98	0.98	0.96	0.97	0.97	0.97	0.97	0.97	0.97	0.96	
		3/4 [19.05]	1.00	1.00	1.00	1.00	1.00	1.00	1.00	1.00	1.00	1.00	1.00	0.98	0.99	1.00	1.00	0.99	
		7/8 [22.23]	N/R	N/R	N/R	N/R	N/R	N/R	N/R	N/R	N/R	N/R	N/R	N/R	N/R	N/R	N/R	N/R	N/R
		1 [25.4]	N/R	N/R	N/R	N/R	N/R	N/R	N/R	N/R	N/R	N/R	N/R	N/R	N/R	N/R	N/R	N/R	N/R
RP-424F	3/8" [9.53]	5/8 [15.88]	0.99	0.99	0.98	0.98	0.97	0.97	0.96	0.96	0.96	0.97	0.97	0.95	0.96	0.95	0.94	0.94	
		3/4 [19.05]	1.00	1.00	1.00	1.00	1.00	1.00	1.00	1.00	1.00	0.99	0.99	0.99	0.99	1.00	1.00	0.99	
		7/8 [22.23]	1.00	1.00	1.00	1.00	1.00	1.00	1.00	1.00	1.00	1.00	1.00	1.00	1.00	1.00	1.00	1.00	0.98
		1 [25.4]	N/R	N/R	N/R	N/R	N/R	N/R	N/R	N/R	N/R	N/R	N/R	N/R	N/R	N/R	N/R	N/R	N/R
RP-430F	3/8" [9.53]	5/8 [15.88]	0.99	0.98	0.97	0.96	0.96	0.95	0.94	0.94	0.92	0.92	0.92	0.92	0.91	0.91	0.88	0.86	
		3/4 [19.05]	1.00	0.99	0.99	0.99	0.99	0.99	0.99	0.99	0.99	0.98	0.97	0.97	0.97	0.97	0.96	0.95	
		7/8 [22.23]	1.00	0.99	1.00	1.00	1.00	1.00	1.00	1.00	1.00	1.00	1.00	1.00	1.00	1.00	1.00	0.99	0.98
		1 [25.4]	N/R	N/R	N/R	N/R	N/R	N/R	N/R	N/R	N/R	N/R	N/R	N/R	N/R	N/R	N/R	N/R	N/R
RP-436F	3/8" [9.53]	5/8 [15.88]	1.00	0.97	0.97	0.96	0.94	0.94	0.93	0.91	0.92	0.92	0.91	0.88	0.87	0.86	0.86	0.85	
		3/4 [19.05]	1.00	1.00	0.99	0.98	0.99	0.98	0.98	0.98	0.98	0.97	0.97	0.97	0.96	0.96	0.95	0.94	
		7/8 [22.23]	1.01	1.01	1.01	1.00	1.00	1.00	1.00	1.00	1.00	1.00	1.00	1.00	1.00	1.00	1.00	0.98	0.98
		1 [25.4]	1.01	1.01	1.01	1.01	1.01	1.01	1.01	1.01	1.01	1.00	1.00	1.00	1.00	1.00	1.00	1.01	1.01
RP-442F	3/8" [9.53]	5/8 [15.88]	1.00	0.98	0.96	0.95	0.94	0.92	0.91	0.89	0.88	0.88	0.87	0.87	0.86	0.86	0.85	0.85	
		3/4 [19.05]	1.01	1.01	1.00	0.99	0.99	0.98	0.97	0.97	0.96	0.95	0.95	0.95	0.94	0.94	0.94	0.94	
		7/8 [22.23]	1.00	1.01	1.01	1.01	1.01	1.01	1.01	1.01	1.00	1.00	0.99	1.00	1.00	1.00	1.00	0.99	0.99
		1 [25.4]	1.03	1.02	1.02	1.02	1.02	1.01	1.01	1.01	1.01	1.01	1.01	1.01	1.01	1.01	1.01	1.01	1.01
RP-448F	3/8" [9.53]	5/8 [15.88]	0.99	0.96	0.94	0.92	0.91	0.89	0.87	0.86	0.86	0.84	0.83	0.83	0.82	0.82	0.82	0.81	
		3/4 [19.05]	1.01	1.00	0.99	0.97	0.97	0.96	0.94	0.94	0.94	0.94	0.93	0.93	0.92	0.92	0.92	0.92	
		7/8 [22.23]	1.00	1.01	1.01	1.00	1.00	0.99	0.99	0.99	0.98	0.98	0.98	0.98	0.97	0.97	0.97	0.97	0.97
		1 [25.4]	N/R	N/R	N/R	N/R	N/R	N/R	N/R	N/R	N/R	N/R	N/R	N/R	N/R	N/R	N/R	N/R	N/R
RP-460F	3/8" [9.53]	5/8 [15.88]	0.79	0.99	0.95	0.93	0.91	0.89	0.89	0.89	0.89	0.89	0.89	0.89	0.89	0.89	0.89	0.89	
		3/4 [19.05]	0.9	1.01	1.00	0.99	0.97	0.96	0.96	0.96	0.96	0.96	0.96	0.96	0.96	0.96	0.96	0.96	
		7/8 [22.23]	1.00	1.01	1.01	1.01	1.01	1.01	1.01	1.01	1.01	1.01	1.01	1.01	1.01	1.01	1.01	1.01	1.01
		1 [25.4]	1.00	1.02	1.01	1.01	1.01	1.01	1.01	1.01	1.01	1.01	1.01	1.01	1.01	1.01	1.01	1.01	1.01

NOTES:
 N/R = Application not recommended.
 All calculations assume a 3/8" liquid line.

INSTALLATION



Interconnecting Tubing (cont.)

R-410A System Capacity Model	Vapor Line Connection Size (Inch I.D.) [mm]	Vapor Line Size (Inch O.D.) [mm]	Vapor Line Selection Chart Capacity Multiplier Table																	
			Total Equivalent Length - Feet [m]																	
			26 [7.62]	50 [15.24]	75 [22.86]	100 [30.48]	125 [45.72]	150 [45.72]	175 [53.34]	200 [60.96]	225 [68.58]	250 [76.20]	275 [83.82]	300 [91.44]						
RP1518A	3/4" [19.06]	5/8 [15.88]	1.00	1.00	1.00	1.00	0.99	0.99	0.98	0.98	0.98	0.98	0.98	0.97	0.97	0.97	0.97	0.97	0.97	
		3/4 [19.06]	1.00	1.00	1.00	1.00	1.00	1.00	1.00	1.00	1.00	1.00	1.00	1.00	1.00	1.00	1.00	1.00	1.00	
		7/8 [22.23]	N/R	N/R	N/R	N/R	N/R	N/R	N/R	N/R	N/R	N/R	N/R	N/R	N/R	N/R	N/R	N/R	N/R	N/R
		1 [25.4]	N/R	N/R	N/R	N/R	N/R	N/R	N/R	N/R	N/R	N/R	N/R	N/R	N/R	N/R	N/R	N/R	N/R	N/R
RP1518B	3/4" [19.06]	5/8 [15.88]	1.00	0.99	0.99	0.98	0.98	0.98	0.97	0.97	0.97	0.96	0.96	0.96	0.95	0.95	0.94	0.94	0.93	
		3/4 [19.06]	1.00	1.00	1.00	1.00	0.99	0.99	0.99	0.99	0.99	0.99	0.99	0.99	0.99	0.99	0.99	0.99	0.99	
		7/8 [22.23]	N/R	N/R	N/R	N/R	N/R	N/R	N/R	N/R	N/R	N/R	N/R	N/R	N/R	N/R	N/R	N/R	N/R	N/R
		1 [25.4]	N/R	N/R	N/R	N/R	N/R	N/R	N/R	N/R	N/R	N/R	N/R	N/R	N/R	N/R	N/R	N/R	N/R	N/R
RP1524A	3/4" [19.06]	5/8 [15.88]	1.00	0.99	0.98	0.98	0.98	0.97	0.97	0.97	0.96	0.96	0.96	0.95	0.95	0.94	0.94	0.94	0.93	
		3/4 [19.06]	1.00	1.00	1.00	1.00	1.00	1.00	1.00	1.00	1.00	1.00	1.00	1.00	1.00	1.01	1.01	1.01	1.01	
		7/8 [22.23]	N/R	N/R	N/R	N/R	N/R	N/R	N/R	N/R	N/R	N/R	N/R	N/R	N/R	N/R	N/R	N/R	N/R	N/R
		1 [25.4]	N/R	N/R	N/R	N/R	N/R	N/R	N/R	N/R	N/R	N/R	N/R	N/R	N/R	N/R	N/R	N/R	N/R	N/R
RP1524B	3/4" [19.06]	5/8 [15.88]	1.00	0.99	0.98	0.98	0.98	0.97	0.97	0.97	0.96	0.96	0.96	0.95	0.95	0.94	0.94	0.94	0.93	
		3/4 [19.06]	1.00	1.00	1.00	1.00	1.00	1.00	1.00	1.00	1.00	1.00	1.00	1.00	1.00	1.01	1.01	1.01	1.01	
		7/8 [22.23]	N/R	N/R	N/R	N/R	N/R	N/R	N/R	N/R	N/R	N/R	N/R	N/R	N/R	N/R	N/R	N/R	N/R	N/R
		1 [25.4]	N/R	N/R	N/R	N/R	N/R	N/R	N/R	N/R	N/R	N/R	N/R	N/R	N/R	N/R	N/R	N/R	N/R	N/R
RP1530A	3/4" [19.06]	5/8 [15.88]	1.00	0.98	0.97	0.97	0.95	0.94	0.94	0.93	0.93	0.92	0.92	0.91	0.91	0.91	0.9	0.88	0.88	
		3/4 [19.06]	1.00	1.00	1.00	1.00	0.98	0.98	0.98	0.98	0.98	0.98	0.98	0.98	0.98	0.98	0.98	0.98	0.98	
		7/8 [22.23]	N/R	N/R	N/R	N/R	N/R	N/R	N/R	N/R	N/R	N/R	N/R	N/R	N/R	N/R	N/R	N/R	N/R	N/R
		1 [25.4]	N/R	N/R	N/R	N/R	N/R	N/R	N/R	N/R	N/R	N/R	N/R	N/R	N/R	N/R	N/R	N/R	N/R	N/R
RP1530B	3/4" [19.06]	5/8 [15.88]	1.00	0.99	0.99	0.99	0.99	0.99	0.99	0.99	0.99	0.99	0.99	0.99	0.99	0.99	0.99	0.99	0.99	
		3/4 [19.06]	1.00	1.00	1.00	1.00	1.00	1.00	1.00	1.00	1.00	1.00	1.00	1.00	1.00	1.00	1.00	1.00	1.00	
		7/8 [22.23]	N/R	N/R	N/R	N/R	N/R	N/R	N/R	N/R	N/R	N/R	N/R	N/R	N/R	N/R	N/R	N/R	N/R	N/R
		1 [25.4]	N/R	N/R	N/R	N/R	N/R	N/R	N/R	N/R	N/R	N/R	N/R	N/R	N/R	N/R	N/R	N/R	N/R	N/R
RP1536A	3/4" [19.06]	5/8 [15.88]	1.00	0.98	0.96	0.96	0.95	0.94	0.92	0.91	0.91	0.91	0.91	0.91	0.91	0.91	0.91	0.91	0.91	
		3/4 [19.06]	1.00	1.00	1.00	1.00	0.99	0.99	0.99	0.99	0.99	0.99	0.99	0.99	0.99	0.99	0.99	0.99	0.99	
		7/8 [22.23]	N/R	N/R	N/R	N/R	N/R	N/R	N/R	N/R	N/R	N/R	N/R	N/R	N/R	N/R	N/R	N/R	N/R	N/R
		1 [25.4]	N/R	N/R	N/R	N/R	N/R	N/R	N/R	N/R	N/R	N/R	N/R	N/R	N/R	N/R	N/R	N/R	N/R	N/R
RP1542A	3/4" [19.06]	5/8 [15.88]	1.00	0.98	0.96	0.96	0.95	0.94	0.92	0.91	0.91	0.91	0.91	0.91	0.91	0.91	0.91	0.91	0.91	
		3/4 [19.06]	1.00	1.00	1.00	1.00	0.99	0.99	0.99	0.99	0.99	0.99	0.99	0.99	0.99	0.99	0.99	0.99	0.99	
		7/8 [22.23]	N/R	N/R	N/R	N/R	N/R	N/R	N/R	N/R	N/R	N/R	N/R	N/R	N/R	N/R	N/R	N/R	N/R	N/R
		1 [25.4]	N/R	N/R	N/R	N/R	N/R	N/R	N/R	N/R	N/R	N/R	N/R	N/R	N/R	N/R	N/R	N/R	N/R	N/R
RP1548A	3/4" [19.06]	5/8 [15.88]	1.00	0.99	0.96	0.94	0.92	0.91	0.89	0.87	0.86	0.86	0.84	0.84	0.83	0.82	0.82	0.82	0.8	
		3/4 [19.06]	1.00	1.00	1.00	1.00	0.97	0.97	0.97	0.97	0.97	0.97	0.97	0.97	0.97	0.97	0.97	0.97	0.97	
		7/8 [22.23]	N/R	N/R	N/R	N/R	N/R	N/R	N/R	N/R	N/R	N/R	N/R	N/R	N/R	N/R	N/R	N/R	N/R	N/R
		1 [25.4]	N/R	N/R	N/R	N/R	N/R	N/R	N/R	N/R	N/R	N/R	N/R	N/R	N/R	N/R	N/R	N/R	N/R	N/R
RP1560A	3/4" [19.06]	5/8 [15.88]	0.79	0.99	0.95	0.95	0.93	0.91	0.89	0.89	0.89	0.89	0.89	0.89	0.89	0.89	0.89	0.89	0.89	
		3/4 [19.06]	0.9	1.01	1.00	1.00	0.99	0.97	0.97	0.96	0.96	0.96	0.96	0.96	0.96	0.96	0.96	0.96	0.96	
		7/8 [22.23]	1.00	1.01	1.01	1.01	1.00	1.00	1.00	1.00	1.00	1.00	1.00	1.00	1.00	1.00	1.00	1.00	1.00	1.00
		1 [25.4]	1.00	1.02	1.01	1.01	1.01	1.01	1.01	1.01	1.01	1.01	1.01	1.01	1.01	1.01	1.01	1.01	1.01	1.01

NOTES:
 N/R = Application not recommended.
 All calculations assume a 3/8" liquid line

INSTALLATION



Interconnecting Tubing (cont.)

Tubing Installation

Observe the following when installing correctly sized type “L” refrigerant tubing between the condensing unit and evaporator coil:

- Check the tables on page 12 for the correct suction line size and liquid line size.
- If a portion of the liquid line passes through a very hot area where liquid refrigerant can be heated to form vapor, insulating the liquid line is required.
- Use clean, dehydrated, sealed refrigeration-grade tubing.
- Always keep tubing sealed until tubing is in place and connections are to be made.
- A high-quality biflow filter drier is included with all R-410A heat pump units and must be installed in the liquid line upon unit installation.
- When replacing an R-22 system with an R-410A system and the line set is not replaced, use a flush kit available through aftermarket stores such as Prostock.

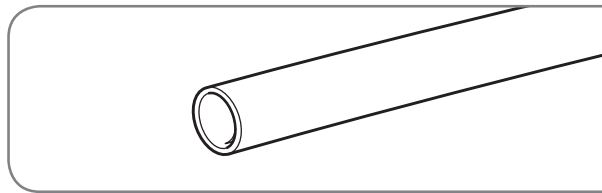

- If tubing has been cut, make sure ends are deburred while holding in a position to prevent chips from falling into tubing. Burrs such as those caused by tubing cutters can affect performance dramatically, particularly on small liquid line sizes.
- For best operation, keep tubing run as short as possible with a minimum number of elbows or bends.
- Locations where the tubing will be exposed to mechanical damage should be avoided. If it is necessary to use such locations, the copper tubing should be housed to prevent damage.



Interconnecting Tubing (cont.)

- If tubing is to be run underground, it must be run in a sealed watertight chase.
- Use care in routing tubing and do not kink or twist. Use a good tubing bender on the vapor line to prevent kinking.

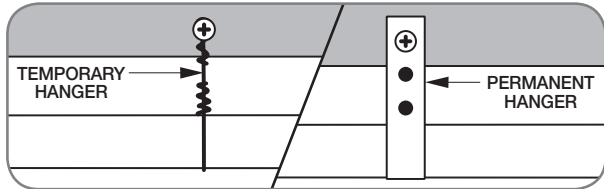

- Route the tubing using temporary hangers; then straighten the tubing and install permanent hangers. Line must be adequately supported.
- If the vapor line comes in contact with inside walls, ceiling, or flooring, the vibration of the vapor line in the heating mode will result in noise inside the structure.

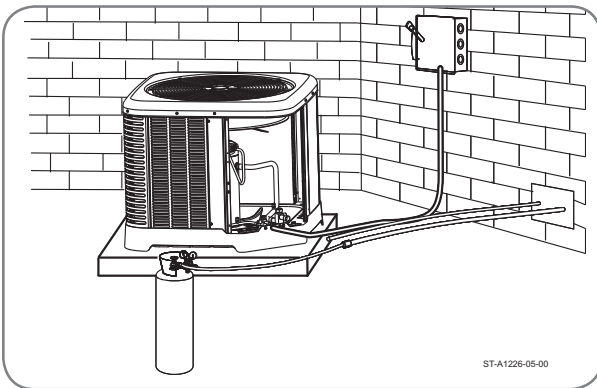

- Blow out the liquid and vapor lines with dry nitrogen before connecting to the outdoor unit and indoor coil. Any debris in the line set will end up plugging the expansion device.

Tubing Connections

Indoor coils have only a holding charge of dry nitrogen. Keep all tube ends sealed until connections are to be made.

- Use type “L” copper refrigeration tubing. Braze the connections with the following alloys:
 - copper to copper, 5% silver minimum
 - copper to steel or brass, 15% silver minimum

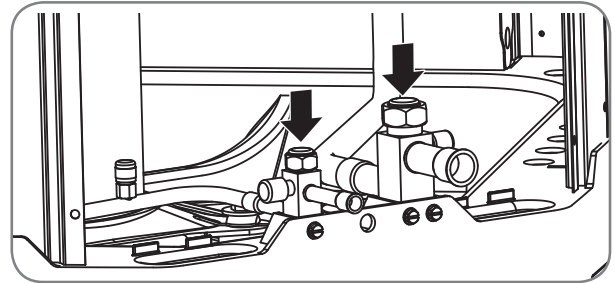

- Be certain both refrigerant shutoff valves at the outdoor unit are closed.

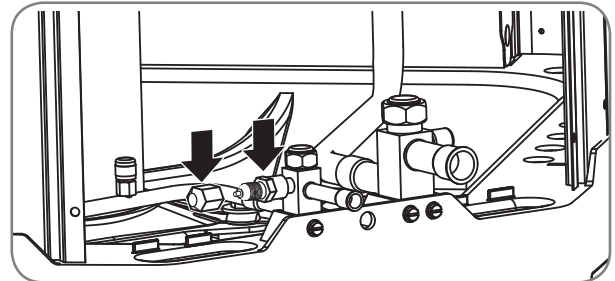

- Remove the caps and Schrader cores from the pressure ports to protect seals from heat damage. Both the Schrader valves and the service valves have seals that may be damaged by excessive heat.

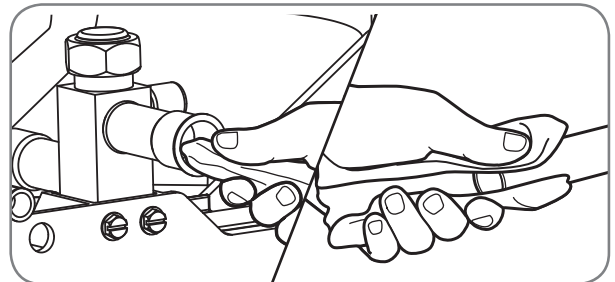

- Clean the inside of the fittings and outside of the tubing with a clean, dry cloth before soldering. Clean out debris, chips, dirt, etc., that enters tubing or service valve connections.

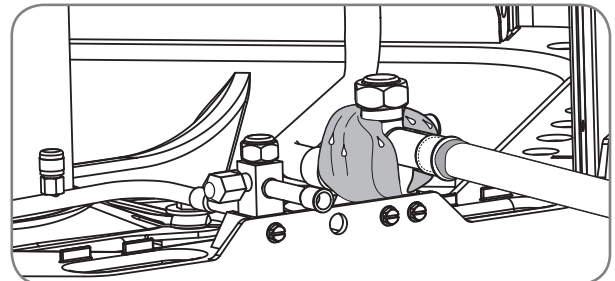

- Wrap valves with a wet rag or thermal barrier compound before applying heat.

INSTALLATION



Interconnecting Tubing (cont.)

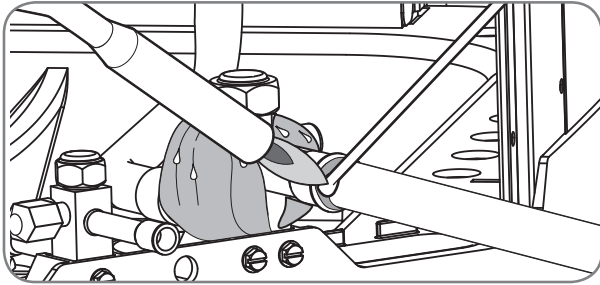

- Braze the tubing between the outdoor unit and indoor coil. Flow dry nitrogen into a pressure port and through the tubing while brazing, but do not allow pressure inside tubing which can result in leaks. Once the system is full of nitrogen, the nitrogen regulator should be turned off to avoid pressuring the system.

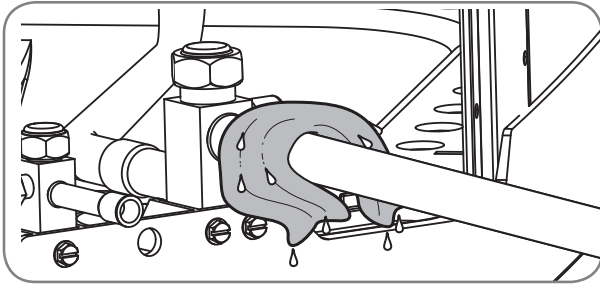

- After brazing, use an appropriate heatsink material to cool the joint.
- Reinstall the Schrader cores into both pressure ports.

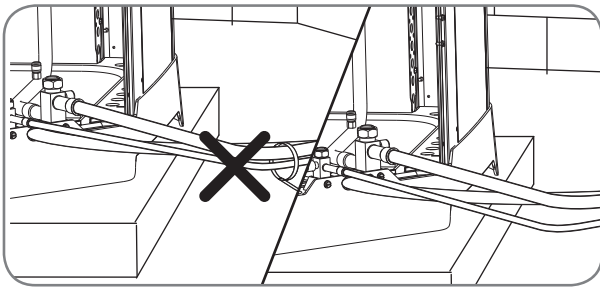

- Do not allow the vapor line and liquid line to be in contact with each other. This causes an undesirable heat transfer resulting in capacity loss and increased power consumption.

Leak Testing

Indoor coils have only a holding charge of dry nitrogen. Keep all tube ends sealed until connections are to be made.

⚠WARNING: Do not use oxygen to purge lines or pressurize system for leak test. Oxygen reacts violently with oil, which can cause an explosion resulting in severe personal injury or death.

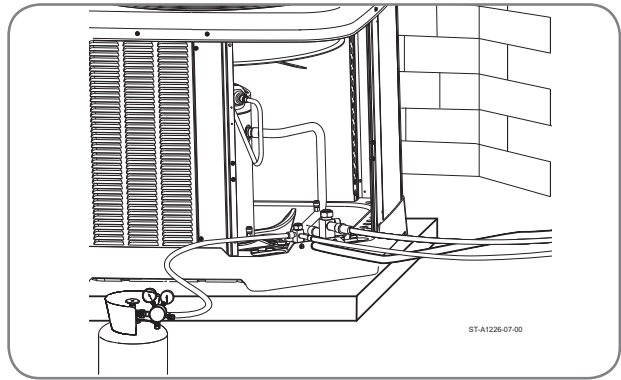

- Pressurize line set and coil through service fittings with dry nitrogen to 150 PSIG maximum. Close nitrogen tank valve, let system sit for at least 15 minutes, and check to see if the pressure has dropped. If the pressure has dropped, check for leaks at the line set braze joints with soap bubbles and repair leak as necessary. Repeat pressure test. If line set and coil hold pressure, proceed with line set and coil evacuation (see page 21).

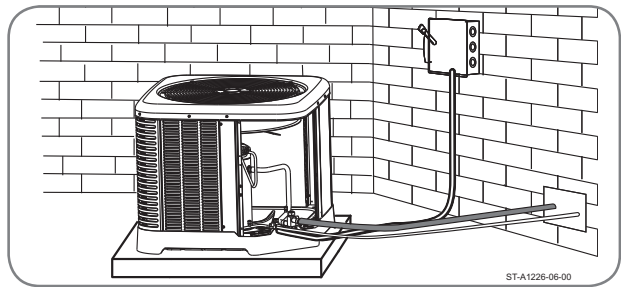

- The vapor line must be insulated for its entire length to prevent dripping (sweating) and prevent performance losses. Closed-cell foam insulation such as Armaflex and Rubatex® are satisfactory insulations for this purpose. Use 1/2" [12.7 mm] minimum insulation thickness. Additional insulation may be required for long runs.



Control Wiring

⚠WARNING: Turn off electric power at the fuse box or service panel before making any electrical connections. Also, the ground connection must be completed before making line voltage connections. Failure to do so can result in electrical shock, severe personal injury, or death.

Control Wiring

Running low-voltage wires in conduit with line voltage power wires is not recommended. Low-voltage wiring may be run through the insulated plastic bushing provided in the 7/8" [19 mm] hole in the base panel, up to and attached to the pigtails from the bottom of the control box. Conduit can be run to the base panel if desired by removing the insulated bushing.

A thermostat and a 24-volt, 40 VA minimum transformer are required for the control circuit of the system. The furnace or the air handler transformer may be used if sufficient. See the wiring diagram for reference. Use "Wire Size" table on this page to size the 24-volt control wiring.

Do not use phone cord to connect indoor and outdoor units and thermostat. This could damage the controls and may not be adequately sized for the control's electrical load.

FIELD WIRE SIZE FOR 24-VOLT THERMOSTAT CIRCUITS

Thermostat load (amps)	SOLID COPPER WIRE – AWG.						
3.0	18	16	14	12	10	10	10
2.5	18	16	14	12	10	10	10
2.0	18	16	14	12	10	10	10
	20	50	100	150	200	250	300
	[6]	[15]	[30]	[46]	[51]	[76]	[91]
	Length of Run – Feet [m] (1)						

(1) Wire length equals twice the run distance.

NOTICE: Do not use control wiring smaller than No. 18 AWG between thermostat and outdoor unit.

Typical Noncommunicating Thermostat Wiring Diagrams

The following figures show the typical wiring diagrams for RH1T; RHIV air handlers and 1-stage heat pump and dual fuel applications with a gas furnace and 1-stage heat pump. Cooling and heat pump airflows may need to be adjusted for homeowner comfort once the system is operational.

WIRE COLOR CODE		
BK – BLACK	GY – GRAY	W – WHITE
BR – BROWN	O – ORANGE	Y – YELLOW
BL – BLUE	PR – PURPLE	
G – GREEN	R – RED	

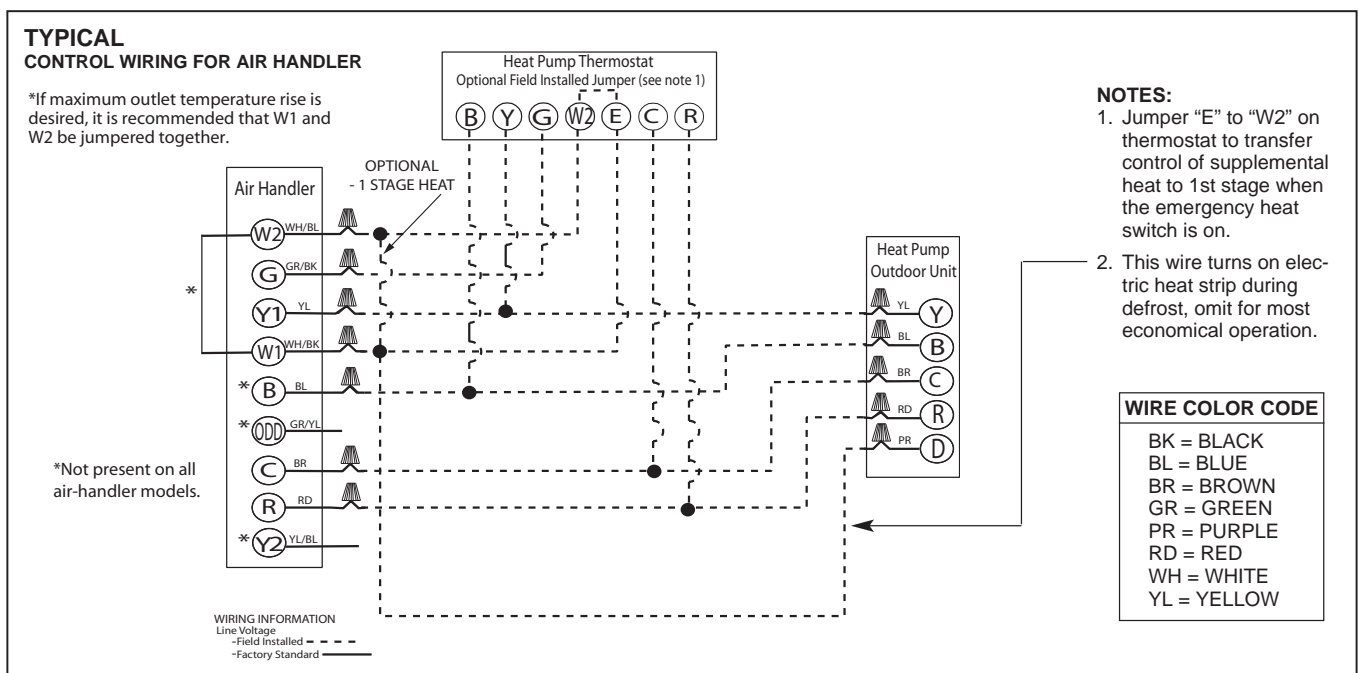

WIRING



Control Wiring (cont.)

TYPICAL 1-STAGE DUAL FUEL THERMOSTAT AND DUAL-FUEL APPLICATION

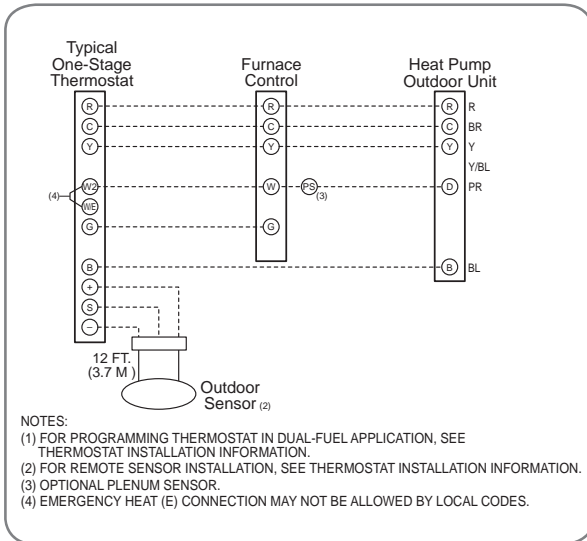

Field wiring must comply with the National Electric Code (C.E.C. in Canada) and any applicable local code.

Power Wiring

It is important that proper electrical power from a commercial utility is available at the heat pump contactor. Voltage ranges for operation are shown below.

VOLTAGE RANGES (60 HZ)

Nameplate Voltage	Operating Voltage Range at Maximum Load Design Conditions for Compressors Copeland
208/230 (1 Phase)	187 - 253
208/230 (3 Phase)	187 - 253
460	414 - 506
575	517 - 633

Install a branch circuit disconnect within sight of the unit and of adequate size to handle the starting current (see "Electrical Data" on page 5.)

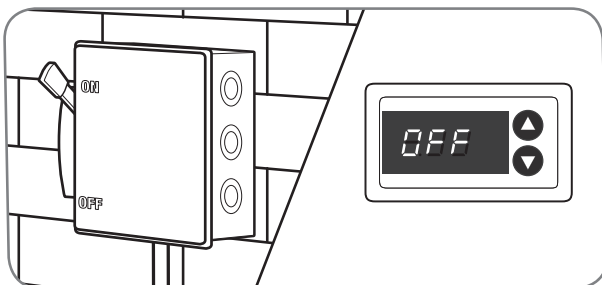

Power wiring must be run in a rain-tight conduit. Conduit must be run through the connector panel below the access cover (see page 6) and attached to the bottom of the control box.

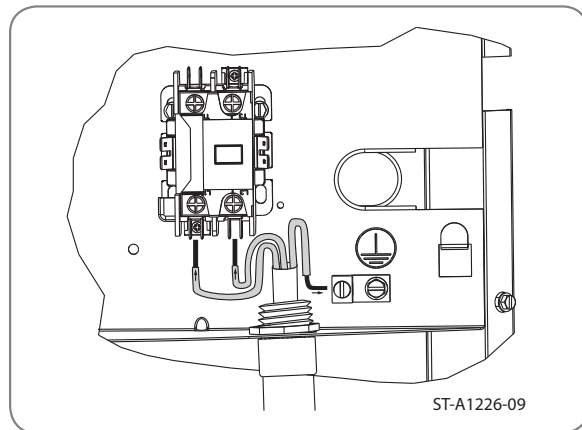

Connect power wiring to line-voltage lugs located in the outdoor heat pump unit electrical box. (See wiring diagram attached to unit access panel.)

Check all electrical connections, including factory wiring within the unit and make sure all connections are tight.

DO NOT connect aluminum field wire to the *Comfort Control*² terminals.

Grounding

⚠WARNING: The unit must be permanently grounded. Failure to do so can cause electrical shock resulting in severe personal injury or death.

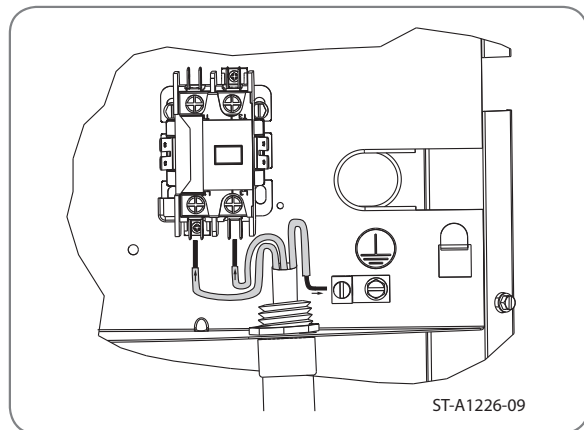

A grounding lug is provided near the line-voltage power entrance for a ground wire.



Start-Up

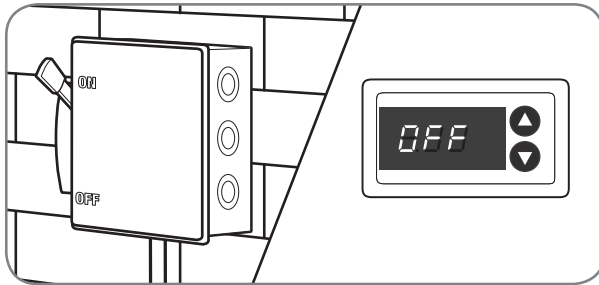

At initial start-up or after extended shutdown periods, make sure the crankcase heater is energized for at least 12 hours before the compressor is started. (Disconnect switch is on and wall thermostat is off.)

Even though the unit is factory-charged with Refrigerant-410A, the charge must be checked to the charge table attached to the service panel and adjusted, if required. Allow a minimum of 15 minutes of run time before analyzing charge.

CAUTION: Single-pole contactors are used on all standard single-phase units through 5 tons. Caution must be exercised when servicing as only one leg of the power supply is broken by the contactor.



Checking Airflow

The air distribution system has the greatest effect on airflow. The duct system is totally controlled by the contractor. For this reason, the contractor should use only industry-recognized procedures.

The correct air quantity is critical to air conditioning systems. Proper operation, efficiency, compressor life, and humidity control depend on the correct balance between indoor load and outdoor unit capacity. Excessive indoor airflow increases the possibility of high humidity problems. Low indoor airflow reduces total capacity and can cause coil icing. Serious harm can be done to the compressor by low airflow, such as that caused by refrigerant flooding.

Heat pump systems require a specified airflow. Each ton of cooling requires between 320 and 450 cubic feet of air per minute (CFM). See the manufacturer's spec sheet for rated airflow for the system being installed.

Duct design and construction should be carefully done. System performance can be lowered dramatically through bad planning or workmanship.

Air supply diffusers must be selected and located carefully. They must be sized and positioned to deliver treated air along the perimeter of the space. If they are too small for their intended airflow, they become noisy. If they are not located properly, they cause drafts. Return air grilles must be properly sized to carry air back to the blower. If they are too small, they also cause noise.

The installers should balance the air distribution system to ensure proper quiet airflow to all rooms in the home. This ensures a comfortable living space.

These simple mathematical formulas can be used to determine the CFM in a residential or light commercial system.

Electric resistance heaters can use:

$$\text{CFM} = \frac{\text{volts} \times \text{amps} \times 3.413}{\text{SHC} \times \text{temp rise}}$$

Gas furnaces can use:

$$\text{CFM} = \frac{\text{Output Capacity in BTUH}^*}{\text{SHC} \times \text{temp rise}}$$

*Refer to furnace data plate for furnace output capacity. SHC = Sensible Heat Constant (see table below)

An air velocity meter or airflow hood can give a more accurate reading of the system CFM.

The measurement for temperature rise should be performed at the indoor coil inlet and near the outlet, but out of direct line of sight of the heater element or heat exchanger. For best results, measure air temperature at multiple points and average the measurements to obtain coil inlet and outlet temperatures.

ALTITUDE (FEET)	SENSIBLE HEAT CONSTANT (SHC)	ALTITUDE (FEET)	SENSIBLE HEAT CONSTANT (SHC)
Sea Level	1.08	6000	0.87
500	1.07	7000	0.84
1000	1.05	8000	0.81
2000	1.01	9000	0.78
3000	0.97	10000	0.75
4000	0.94	15000	0.61
5000	0.90	20000	0.50

START-UP



Evacuation and Leak Testing

Evacuation Procedure

Evacuation is the most important part of the entire service procedure. The life and efficiency of the equipment is dependent upon the thoroughness exercised by the serviceman when evacuating air and moisture from the system.

Air or nitrogen in the system causes high condensing temperatures and pressure, resulting in increased power input and nonverifiable performance.

Moisture chemically reacts with the refrigerant and oil to form corrosive hydrofluoric acid. This attacks motor windings and parts, causing breakdown.

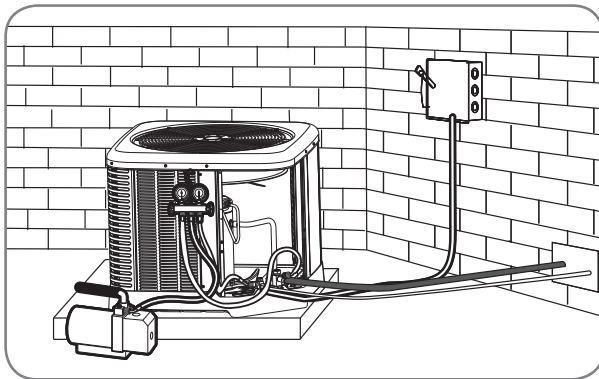

- After the system has been leak-checked and proven sealed, connect the vacuum pump and evacuate system to 500 microns and hold 500 microns or less for at least 15 minutes. The vacuum pump must be connected to both the high and low sides of the system by connecting to the two pressure ports. Use the largest size connections available since restrictive service connections may lead to false readings because of pressure drop through the fittings.

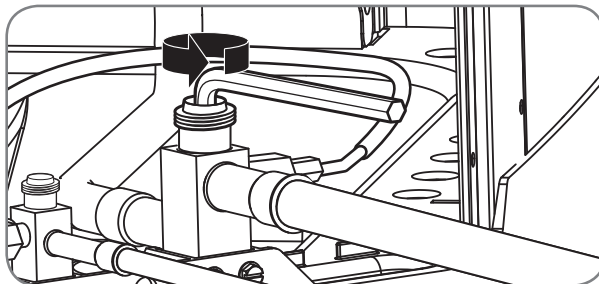

- After adequate evacuation, open both service valves by removing both brass service valve caps with an adjustable wrench. Insert a 3/16" [5 mm] or 5/16" [8 mm] hex wrench into the stem and turn counterclockwise until the wrench stops.

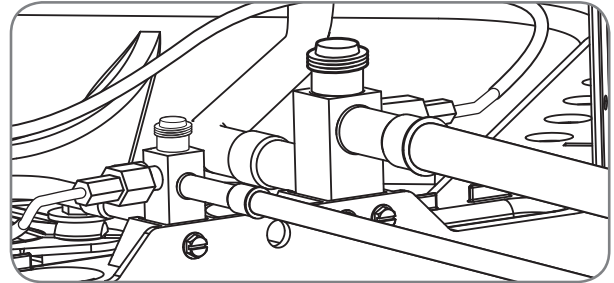

- Gauges must be connected at this point to check and adjust charge. Do not replace caps yet.

IMPORTANT: Compressors (especially scroll type) should never be used to evacuate the air conditioning system because internal electrical arcing may result in a damaged or failed compressor. Never run a scroll compressor while the system is in a vacuum or compressor failure will occur.

Final Leak Testing

After the unit has been properly evacuated and service valves opened, a halogen leak detector should be used to detect leaks in the system. All piping within the heat pump, evaporator, and interconnecting tubing should be checked for leaks. If a leak is detected, the refrigerant should be recovered before repairing the leak. The Clean Air Act prohibits releasing refrigerant into the atmosphere.



Checking Refrigerant Charge

Charge for all systems should be checked against the Charging Chart inside the access panel cover.

⚠ WARNING: The top of the scroll compressor shell is hot. Touching the compressor top may result in serious personal injury.

IMPORTANT: Use factory-approved charging method as outlined on the next page to ensure proper system charge.

NOTICE: The optimum refrigerant charge for any outdoor unit matched with an indoor coil/air handler is affected by the application. Therefore, charging data has been developed to assist the field technician in optimizing the charge for all mounting configurations (UF – Upflow, DF – Downflow, LH – Left-Hand Discharge, and RH – Right-Hand Discharge). Refer to the charging chart inside the access panel cover on the unit and choose the appropriate column for the specific application being installed or serviced. New installations utilizing either an RCF indoor coil installed on a gas furnace or an RH series air handler in the downflow or horizontal right-hand discharge may require removal of refrigerant since the factory charge could result in an overcharge condition.

Charging Units With R-410A Refrigerant

⚠ CAUTION: R-410A pressures are approximately 60% higher (1.6 times) than R-22 pressures. Use appropriate care when using this refrigerant. Failure to exercise care may result in equipment damage or personal injury.

Charge for all systems should be checked against the Charging Chart inside the access panel cover.

IMPORTANT: Do not operate the compressor without charge in the system.

Addition of R-410A will raise high-side pressures (liquid and discharge).

NOTICE: System maintenance is to be performed by a qualified and certified technician.

The following method is used for charging systems in the cooling and heating mode. All steps listed should be performed to ensure proper charge has been set. For measuring pressures, the service valve port on the liquid valve (small valve) and the service port on the suction line between the reversing valve and compressor are to be used.

Confirm ID Airflow and Coils Are Clean

Confirm adequate indoor supply airflow prior to starting the system. See the Technical Specification Sheet for rated airflow for each ID/OD unit match. Air filter(s) and coils (indoor and outdoor) are to be clean and free of frost prior to starting the system. Supply airflow must be between 320 and 450 cfm per rated cooling ton prior to adjusting system charge. If a humidification system is installed, disengage it from operation prior to charge adjustment. *Verify that the outdoor unit is operating in second stage and the indoor air mover is delivering the second-stage airflow for this system size.* Refer to the “Checking Airflow” section of this manual for further instruction.

NOTICE: Verify system components are matched according to the outdoor unit Specification Sheet.

Measurement Device Setup

1. With an R-410A gauge set, attach the high-pressure hose to the access fitting on the liquid line (small) service valve at the OD unit.
2. Attach the low-pressure hose to the common suction port connected to the common suction line between the reversing valve and compressor.
3. Attach a temperature probe within 6" [15.2 cm] outside of the unit on the copper liquid line (small line). For more accurate measurements, clean the copper line prior to measurement and use a calibrated clamp-on temperature probe or an insulated surface thermocouple.

Charging by Weight

NOTICE: Adjust the system charge by weight for the straight length of the refrigerant line set.

For a new installation, evacuation of inter-connecting tubing and indoor coil is adequate; otherwise, evacuate the entire system. Use the factory charge shown in “Electrical and Physical Data” on page 5 of these instructions or on the unit data plate. Note that the charge value includes charge required for 15 ft. [4.6 m] of standard-size interconnecting liquid line without a filter drier.

Calculate actual charge required with installed liquid line size and length using:

1/4" [6.4 mm] O.D. = .3 oz./ft. [8.5 g/.30 m]

5/16" [7.9 mm] O.D. = .4 oz./ft. [11.3 g/.30 m]

3/8" [9.5 mm] O.D. = .6 oz./ft. [17.0 g/.30 m]

1/2" [12.7 mm] O.D. = 1.2 oz./ft. [34.0 g/.30 m]

Add 6 oz. for field-installed filter drier.

START-UP



Checking Refrigerant Charge (cont.)

With an accurate scale (+/- 1 oz. [28.3 g]) or volumetric charging device, adjust charge difference between that shown on the unit data plate and that calculated for the new system installation. If the entire system has been evacuated, add the total calculated charge.

IMPORTANT: Charging by weight is not always accurate since the application can affect the optimum refrigerant charge. Charging by weight is considered a starting point ONLY. Always check the charge by using the Charging Chart and adjust as necessary. CHARGING BY LIQUID SUBCOOLING MUST BE USED FOR FINAL CHARGE ADJUSTMENT.

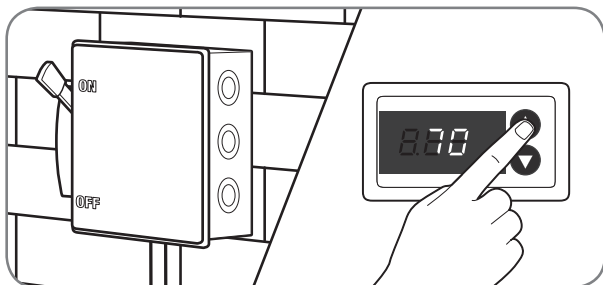

With thermostat in the “Off” position, turn on the power to the furnace or air handler and the heat pump. Start the heat pump and the furnace or air handler with the thermostat. Verify that the outdoor unit is operating in second stage and the indoor air mover is delivering the correct airflow for the system size.

Gross Charging by Pressures

1. Following airflow verification and charge weighing, run the unit for a minimum of 15 minutes prior to noting pressures and temperature.

IMPORTANT: Indoor conditions as measured at the indoor coil must be within 2°F [1.1°C] of the following during gross charge (pressure) evaluation:

Cooling Mode: 80°F [26.7°C] Dry Bulb

Heating Mode: 70°F [21.1°C] Dry Bulb

NOTICE: If the Indoor temperature is above or below this range, run the system to bring the temperature down or run the electric heat/furnace to bring the temperature within this range. System pressure values provided in the Charging Chart for outdoor dry bulbs corresponding to conditions outside of these ranges are provided as reference ONLY.

2. Note the Outdoor Dry Bulb Temperature, ODDB° = ____°F [____°C]. Unit charging is recommended under the following outdoor conditions ONLY:

Cooling Mode ONLY: 55°F [12.8°C] outdoor dry bulb and above

Heating Mode ONLY: Between 40°F [4.4°C] and 60°F [15.6°C] outdoor dry bulb

3. Locate and note the design pressures. The correct liquid and vapor pressures are found at the intersection of the installed system and the outdoor ambient temperature on the Charging Chart located inside the access panel cover.

Liquid Pressure: = ____psig; Vapor Pressure = ____psig

NOTICE: The refrigerant pressures provided are for gross charge check ONLY. These pressure values are typical, but may vary due to application. Evaporator load (indoor coil in cooling mode/outdoor coil in heating mode) will cause pressures to deviate. Note that all systems have unique pressure curves. The variation in the slope and value is determined by the component selection for that indoor/outdoor matched system. The variation from system to system seen in the table is normal. The values listed are for the applicable indoor coil match ONLY!

4. If the measured liquid pressure is below the listed requirement for the given outdoor and indoor conditions, add charge. If the measured liquid pressure is above the listed requirement for the given outdoor and indoor conditions, remove charge.

Final Charge by Subcooling

1. After gross charging, note the designed subcooling value. The correct subcooling value is found at the intersection of the installed system and the outdoor ambient temperature on the Charging Chart located inside the access panel cover.

SC° from Charging Chart = ____°F [____°C].

IMPORTANT: Indoor conditions as measured at the indoor coil are required to be between 70°F [21.1°C] and 80°F [26.7°C] dry bulb for fine-tuned unit charge adjustment. Unit charging is recommended under the following outdoor conditions ONLY:

Cooling Mode ONLY: 55°F [12.8°C] outdoor dry bulb and above

Heating Mode ONLY: Between 40°F [4.4°C] and 60°F [15.6°C] outdoor dry bulb



Checking Refrigerant Charge (cont.)

NOTICE: If the indoor temperature is above or below the recommended range, run the system to bring the temperature down or run the electric heat/furnace to bring the temperature up. System subcooling values provided in the Charging Chart for outdoor dry bulbs corresponding to conditions outside of the above range are provided as reference ONLY.

2. Note the measured Liquid Pressure, $P_{liq} =$ _____ psig, as measured from the liquid (small) service valve. Use the Temperature Pressure Chart below to note the corresponding saturation temperature for R-410A at the measured liquid pressure.

Liquid Saturation Temperature, $SAT^\circ =$ _____ °F [_____ °C].

3. Note the liquid line temperature, $Liq^\circ =$ _____ °F [_____ °C], as measured from a temperature probe located within 6" [15.2 cm] outside of the unit on the copper liquid line (small line). It is recommended to use a calibrated clamp-on temperature probe or an insulated surface thermocouple.

4. Subtract the liquid line temperature from the saturation temperature to calculate subcooling.
 SAT° _____ °F [_____ °C] - Liq° _____ °F [_____ °C] =
 SC° _____ °F [_____ °C]

5. Adjust charge to obtain the specified subcooling value. If the measured subcool is below the listed

requirement for the given outdoor and indoor conditions, add charge. If the measured subcool is above the listed requirement for the given outdoor and indoor conditions, remove charge.

Finishing Up Installation

- Disconnect pressure gauges from pressure ports; then replace the pressure port caps and tighten adequately to seal caps. **Do not overtighten.**
- Replace the service valve caps finger-tight and then tighten with an open-end wrench adequately to seal caps. **Do not overtighten.**
- Replace control box cover and service panel and install screws to secure service panel.
- Restore power to unit at disconnect if required.
- Configure indoor thermostat per the thermostat installation instructions and set thermostat to desired mode and temperature.

NOTICE: Systems should not be fine-tune charged below 40°F [4.4°C] outdoor dry bulb.

IMPORTANT: Excessive use of elbows in the refrigerant line set can produce excessive pressure drop. Follow industry best practices for installation. Installation and commissioning of this equipment is to be performed by trained and qualified HVAC professionals. For technical assistance, contact your Distributor Service Coordinator.

TEMPERATURE PRESSURE CHART

SATURATION TEMP (Deg. F) [Deg. C]	R-410A PSIG	SATURATION TEMP (Deg. F) [Deg. C]	R-410A PSIG	SATURATION TEMP (Deg. F) [Deg. C]	R-410A PSIG	SATURATION TEMP (Deg. F) [Deg. C]	R-410A PSIG
-150 [-101]	-	-30 [-34]	17.9	35 [2]	107.5	100 [38]	317.4
-140 [-96]	-	-25 [-32]	22.0	40 [4]	118.5	105 [41]	340.6
-130 [-90]	-	-20 [-29]	26.4	45 [7]	130.2	110 [43]	365.1
-120 [-84]	-	-15 [-26]	31.3	50 [10]	142.7	115 [46]	390.9
-110 [-79]	-	-10 [-23]	36.5	55 [13]	156.0	120 [49]	418.0
-100 [-73]	-	-5 [-21]	42.2	60 [16]	170.1	125 [52]	446.5
-90 [-68]	-	0 [-18]	48.4	65 [18]	185.1	130 [54]	476.5
-80 [-62]	-	5 [-15]	55.1	70 [21]	201.0	135 [57]	508.0
-70 [-57]	-	10 [-12]	62.4	75 [24]	217.8	140 [60]	541.2
-60 [-51]	0.4	15 [-9]	70.2	80 [27]	235.6	145 [63]	576.0
-50 [-46]	5.1	20 [-7]	78.5	85 [29]	254.5	150 [66]	612.8
-40 [-40]	10.9	25 [-4]	87.5	90 [32]	274.3		
-35 [-37]	14.2	30 [-1]	97.2	95 [35]	295.3		

COMPONENTS AND CONTROLS



Compressor Crankcase Heat (CCH)

Components

While scroll compressors usually do not require crankcase heaters, there are instances when a heater should be added. Refrigerant migration during the off cycle can result in a noisy start up. Add a crankcase heater to minimize refrigeration migration, and to help eliminate any start up noise or bearing “wash out.”

NOTE: The installation of a crankcase heater is recommended if the system charge exceeds the values in the table below. The 5 ton model comes with a crankcase heater factory installed.

Its purpose is to drive refrigerant from the compressor shell during long cycles, thus preventing damage to the compressor during start-up.

At initial start-up or after extended shutdown periods, make sure the heater is energized for at least 12 hours before the compressor is started. (Disconnect switch on and wall thermostat off.)

MAXIMUM SYSTEM CHARGE VALUES		
Model Size*	Compressor Model Number	Charge Limit Without Crankcase Heater*
RP1336AC	ZP31K5E-TF5-13R	9.6 lbs.
RP1342AC	ZP36K5E-TF5-13R	9.6 lbs.
RP1348AC	ZP42K5E-TF5-13R	12 lbs.
RP1360AC	ZP49K6E-TF5-130	12 lbs.
RP1336AD	ZP31K5E-TFD-13R	9.6 lbs.
RP1342AD	ZP36K5E-TFD-13R	9.6 lbs.
RP1348AD	ZP42K5E-TFD-13R	12 lbs.
RP1360AD	ZP49K6E-TFD-130	12 lbs.

MAXIMUM SYSTEM CHARGE VALUES		
Model Size*	Compressor Model Number	Charge Limit Without Crankcase Heater*
RP1518AJ	ZP16K5E-PFV-13R	9.6 lbs.
RP1518BJ	ZP14K6E-PFV-130	9.6 lbs.
RP1524AJ	ZP21K5E-PFV-13R	9.6 lbs.
RP1524BJ	ZP20K6E-PFV-130	9.6 lbs.
RP1530AJ	ZP25K5E-PFV-13R	9.6 lbs.
RP1530BJ	ZP24K6E-PFV-130	9.6 lbs.
RP1536AJ	ZP31K6E-PFV-130	9.6 lbs.
RP1542AJ	ZP36K5E-PFV-13R	9.6 lbs.
RP1548AJ	ZP40K6E-PFV-130	12 lbs.
RP1560AJ	ZP49K6E-PFV-130	12 lbs.
RP1536AC	ZP31K6E-TF5-130	9.6 lbs.
RP1542AC	ZP36K5E-TF5-13R	9.6 lbs.
RP1548AC	ZP40K6E-TF5-130	12 lbs.
RP1560AC	ZP49K63-TF5-130	12 lbs.

MAXIMUM SYSTEM CHARGE VALUES		
Model Size*	Compressor Model Number	Charge Limit Without Crankcase Heater*
RP1418AJ	ZP16K5E-PFV-13R	9.6 lbs.
RP1424AJ	ZP21K6E-PFV-130	9.6 lbs.
RP1430AJ	ZP25K5E-PFV-13R	9.6 lbs.
RP1436AJ	ZP31K5E-PFV-13R	9.6 lbs.
RP1442AJ	ZP36K5E-PFV-13R	9.6 lbs.
RP1448AJ	ZP42K5E-PFV-13R	12 lbs.
RP1460AJ	ZP49K6E-PFV-130	12 lbs.
RP1436AC	ZP31K5E-TF5-13R	9.6 lbs.
RP1442AC	ZP36K5E-TF5-13R	9.6 lbs.
RP1448AC	ZP42K5E-TF5-13R	12 lbs.
RP1460AC	ZP49K6E-TF5-130	12 lbs.
RP1436AD	ZP31K53-TFD-13R	9.6 lbs.
RP1442AD	ZP36K53-TFD-13R	9.6 lbs.
RP1448AD	ZP42K5E-TFD-13R	12 lbs.
RP1460AD	ZP49K6E-TFD-130	12 lbs.
RP1418FJ	ZP14K6E-PFV-130	9.6 lbs.
RP1424FJ	ZP20K6E-PFV-130	9.6 lbs.
RP1430FJ	ZP24K6E-PFV-130	9.6 lbs.
RP1436FJ	ZP31K6E-PFV-130	9.6 lbs.
RP1442FJ	ZP36K5E-PFV-13R	9.6 lbs.
RP1448FJ	ZP40K6E-PFV-130	12 lbs.
RP1460FJ	ZP49K6E-PFV-130	12 lbs.
RP1436FC	ZP31K6E-TF5-130	9.6 lbs.
RP1442FC	ZP36K5E-TF5-13R	9.6 lbs.
RP1448FC	ZP40K6E-TF5-130	12 lbs.
RP1460FC	ZP49K63-TFS-130	12 lbs.



Hard-Start Components

Start components are not usually required with the scroll compressors used in heat pumps, but are available for special cases and where

start components are desirable to reduce light dimming. Hard start components are available through Prostock.

COMPONENTS AND CONTROLS



High- and Low-Pressure Controls (HPC and LPC)

Standard on RP14: These controls keep the compressor from operating in pressure ranges which can cause damage to the compressor. Both controls are in the low-voltage control circuit.

The high-pressure control (HPC) is an automatic-reset which opens near 610 PSIG and closes near 420 PSIG.

The low-pressure control (LPC) is an automatic-reset which opens near 15 PSIG and closes near 40 PSIG.

⚠ CAUTION: The compressor has an internal overload protector. Under some conditions, it can take up to 2 hours for this overload to reset. Make sure overload has had time to reset before condemning the compressor.



Demand Defrost Control (cont.)

The demand defrost control monitors the outdoor ambient temperature, outdoor coil temperature and the compressor run time to determine when a defrost cycle is required.

Enhanced Feature Demand Defrost Control

This defrost control has high and low pressure control inputs with unique pressure switch logic built into the microprocessor to provide compressor and system protection without nuisance lockouts. The control cycles the compressor off for 30 seconds at the beginning and the end of the defrost cycle to eliminate the increased compressor noise caused by rapidly changing system pressures when the reversing valve switches. See next page for diagnostic flash codes and sensor resistance values at various temperatures.

Defrost Initiation

A defrost will be initiated when the three conditions below are satisfied:

1. The outdoor coil temperature is below 35°F as measured by a good coil sensor,
2. The compressor has operated for at least 34 minutes with the outdoor coil temperature below 35°F and
3. The measured difference between the ambient temperature and the outdoor coil temperature is greater than the calculated difference determined by the microprocessor.

Defrost Termination

Once a defrost is initiated, the defrost will continue until fourteen minutes has elapsed or the coil temperature has reached the selected termination temperature. The factory setting is 70°F but can be changed to 50°F, 60°F or 80°F by relocating the jumper on the control board.

Temperature Sensors

The coil sensor is located on the outdoor coil at the point fed by the distribution tubes from the expansion device (short 3/8" dia. Tube). The ambient air sensor is located outside the control box so it can sense outdoor temperatures.

If the ambient sensor fails, the defrost control will initiate a defrost every 34 minutes of compressor run time with the coil temperature below 35°F.

If the coil sensor fails, the defrost control will not initiate a defrost.

Test Mode

The test mode is initiated by shorting the TEST pins. The unit must have an active heat pump heating call to enter the test mode. In this mode of operation, the enable temperature is ignored and all timers are sped up. To initiate a manual defrost, short and hold the TEST pins. Remove the short when the system switches to defrost mode after the compressor noise abatement delay. The defrost will terminate on time (14 minutes) or when the termination temperature has been reached.

Test Sequence of Operation:

- 1) Provide a heating call to the heat pump.
- 2) Short test pins to bypass anti-short cycle timer. (If unit is running, this step is not necessary.)
- 3) Short test pins and hold them shorted to enter defrost mode.
- 4) Release test pins once control exits noise abatement delay.
- 5) Monitor coil temperature when control exits defrost.
- 6) Unit should return to heating mode.

Trouble Shooting Demand Defrost

During the test mode the coil temperature should be monitored. If the system exits defrost at approximately the termination temperature, the control is operating normally.

If not, one item to check is the coil and ambient temperature sensor resistance, using the temperature/resistance chart.

Immerse the sensor in water and measure the resistance of the sensor. At 35°F the resistance of the sensor should be approximately 30,000 ohms.

Ensure that the coil sensor is properly installed that it is not loose or touching the cabinet.

COMPONENTS AND CONTROLS



Demand Defrost Control (cont.)

High/Low Pressure Control Monitoring – Enhanced Defrost Control Only

Status of high and low pressure controls is monitored by the enhanced feature demand defrost control and the following actions are taken.

High Pressure Control – Provides active protection in both cooling and heating modes at all outdoor ambient temperatures. The high pressure control is an automatic reset type and opens at approximately 610 psig and closes at approximately 420 psig. The compressor and fan motor will stop when the high pressure control opens and will start again if the high side pressure drops to approximately 420 psig where the automatic reset high pressure control resets. If the high pressure control opens 3 times within a particular call for heating or cooling operation, the defrost control will lock out compressor and outdoor fan operation.

Low Pressure Control – Provides active protection in both heating and cooling modes at all outdoor ambient temperatures. The low pressure control is an automatic reset type and opens at approximately 15 psig and closes at approximately 40 psig. Operation is slightly different between cooling and heating modes.

Cooling Mode: The compressor and fan motor will stop when the low pressure control opens and will start again when the low side pressure rises

to approximately 40 psig when the low pressure control automatically resets. If the low pressure switch opens 3 times within a particular call for cooling operation, the defrost control will lock out compressor and fan operation.

Heating Mode: The compressor and fan motor will stop when the low pressure control opens and will start again when the low side pressure rises to approximately 40 psig when the low pressure automatically resets. If the low pressure switch trips 3 times within 120 minutes of operation during a particular call for heating operation, the defrost control will lock out compressor and outdoor fan operation. If the lock out due to low pressure occurs at an outdoor ambient temperature below 5°F, the defrost control will automatically exit the lockout mode when the outdoor ambient temperature rises 5°F. This feature is necessary since the low pressure control could possibly have opened due to the outdoor ambient being very low rather than an actual system fault.

Exiting Lock-Out Mode: To exit the lock-out mode, remove 24 volts to the defrost control by removing power to the indoor air handler/furnace or by shooting the two defrost control test pins together.

ENHANCED FEATURE DEFROST CONTROL DIAGNOSTIC CODES

LED 1	LED 2	Control Board Status
OFF	OFF	No Power
ON	ON	Coil Sensor Failure
OFF	ON	Ambient Sensor Failure
FLASH	FLASH	Normal
OFF	FLASH	Low Pressure Lockout (short test pins to reset)
FLASH	OFF	High Pressure Lockout (short test pins to reset)
ON	FLASH	Low Pressure Control Open
FLASH	ON	High Pressure Control Open
Alternate Flashing		5 Minute Time Delay

Sensor Temperature vs. Resistance Table:

Degrees C	Degrees F	Ohms
-20	-4	96,974
-10	14	55,298
0	32	32,650
10	50	19,903
20	68	12,493
25	77	10,000
30	86	8,056
40	104	5,324

⚠WARNING: Turn off electric power at the fuse box or service panel before making any electrical connections. Also, the ground connection must be completed before making line voltage connections. Failure to do so can result in electrical shock, severe personal injury, or death.

Time Delay Control (TDC)

The time delay (TDC) is in the low voltage control circuit. When the compressor shuts off due to a power failure or thermostat operation, this control keeps it off at least 5 minutes which allows the system pressure to equalize, thus not damaging the compressor or blowing fuses on start-up.

Remote Outdoor Temperature Model (Part No. 47-102709-03)

This is a kit that has a longer remote sensor that can be installed away from the outdoor unit for better thermostat temperature display.

Heat Pump Thermostat Warning Light Kit RXPX-D01

This component senses a compressor lock out and tells the thermostat service light to come on. This will let the homeowner know that service is needed on the system.

NOTE: Warning light on thermostat will come on during a 5 minute compressor time delay and for 5 seconds during defrost while the compressor is off. Homeowner should only be concerned if light stays on for more than 5 minutes.

Low Ambient Control (LAC) (Part No. RXAD-A08)

This component senses compressor head pressure and shuts the heat pump fan off when the head pressure drops to approximately 250 PSIG. This allows the unit to build a sufficient head pressure at lower outdoor ambient (down to 0°F [-18°C]) in order to maintain system balance and obtain improved capacity. Low ambient control should be used on all equipment operated below 70°F [21°C] ambient.

DIAGNOSTICS

Cooling Mechanical Checks Flowchart

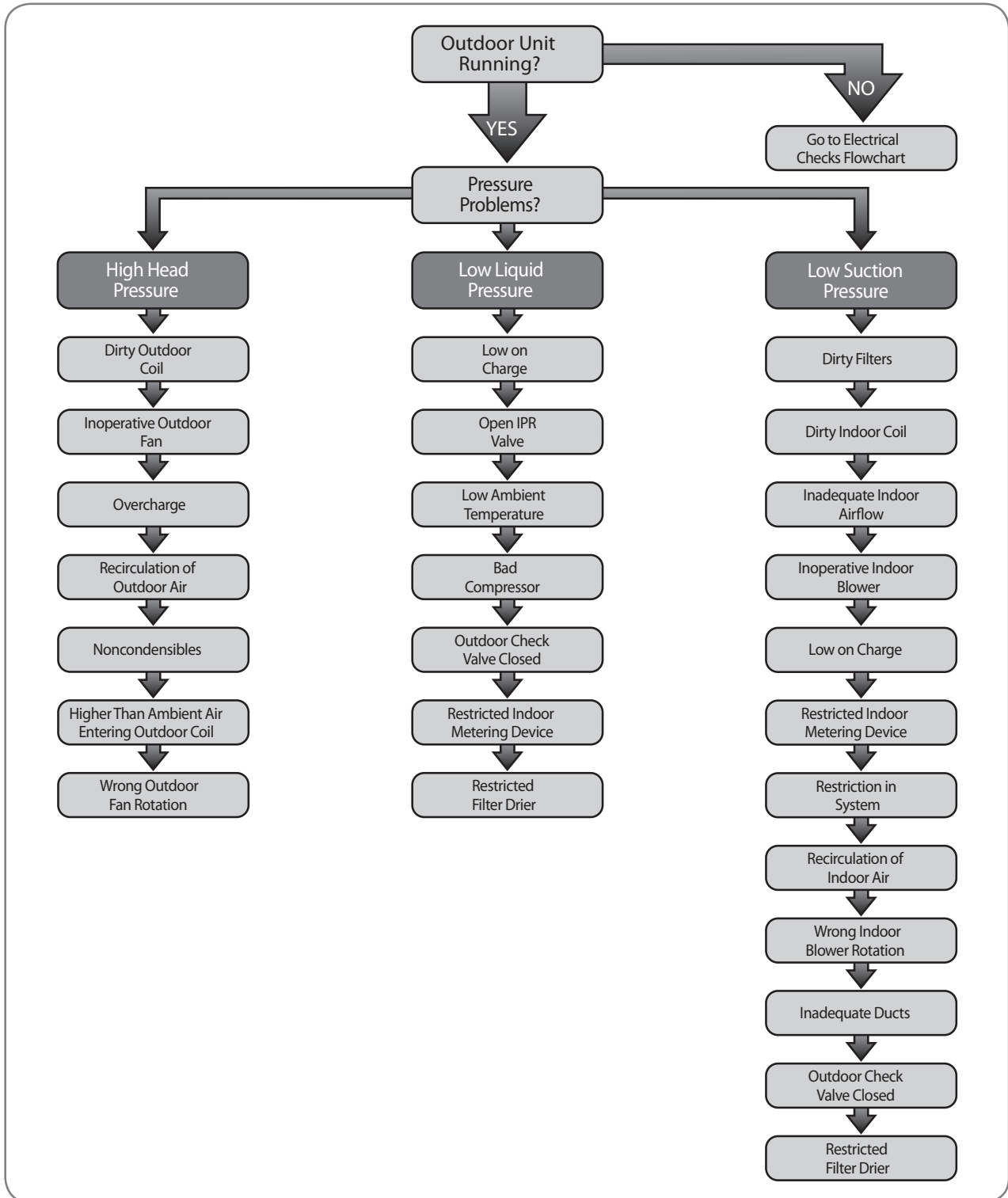

Heating Mechanical Checks Flowchart

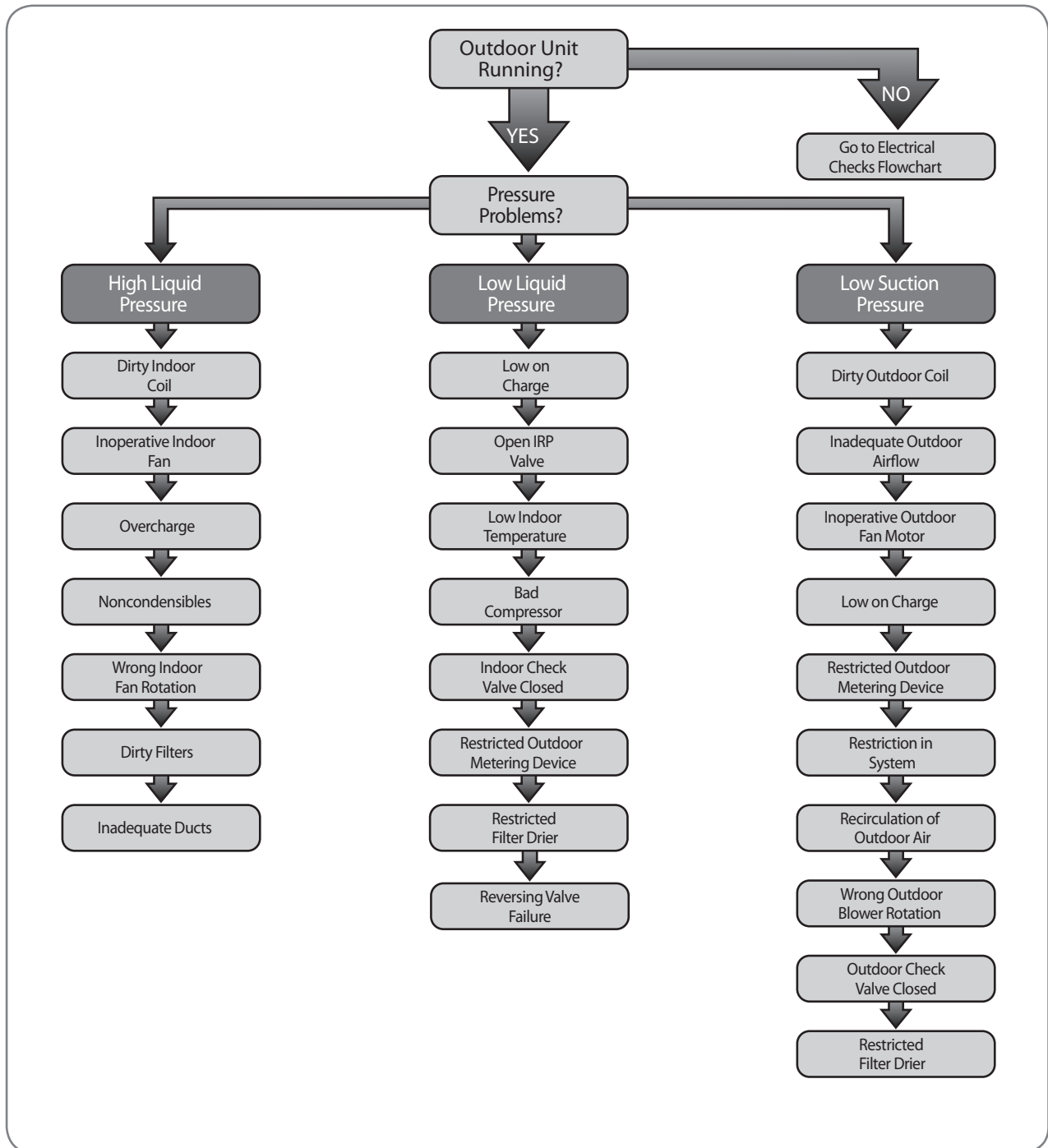

DIAGNOSTICS

Defrost Mechanical Checks Flowchart

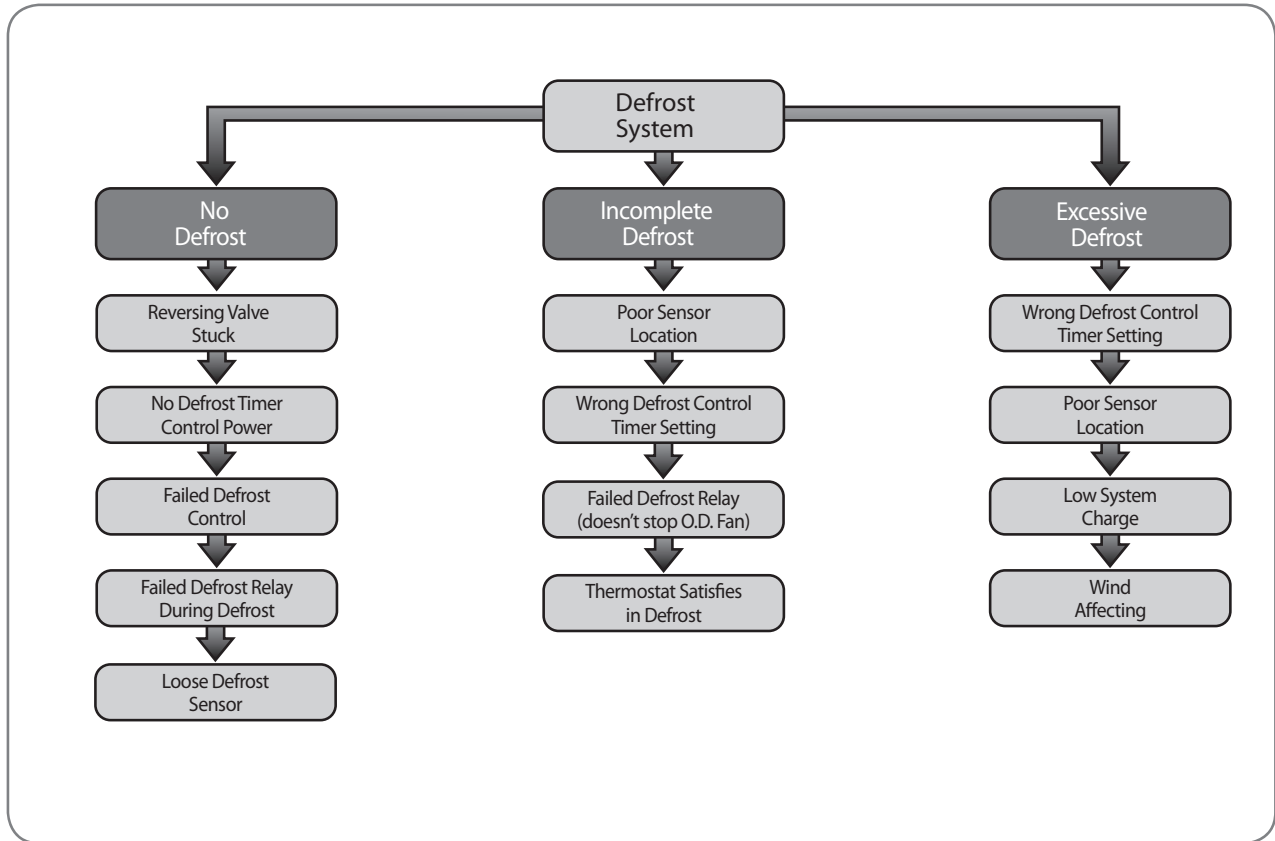

General Troubleshooting Chart

⚠️WARNING: Disconnect all power to unit before servicing. Contactor may break only one side. Failure to shut off power can cause electrical shock resulting in personal injury or death.

SYMPTOM	POSSIBLE CAUSE	REMEDY
Unit will not run	<ul style="list-style-type: none"> • Power off or loose electrical connection • Thermostat out of calibration – set too high • Defective control board • Blown fuses/tripped breaker • Transformer defective • High-pressure control open • Miswiring of communications (communication light on continuously) 	<ul style="list-style-type: none"> • Check for correct voltage at line voltage connections in condensing unit. • Reset. • Check control board diagnostic codes. • Replace fuses/reset breaker. • Check wiring. Replace transformer. • Reset. Also see high head pressure remedy. The high-pressure control opens at 610 PSIG. • Check communication wiring.
Outdoor fan runs, compressor doesn't	<ul style="list-style-type: none"> • Run or start capacitor defective • Start relay defective • Loose connection • Compressor stuck, grounded or open motor winding, open internal overload. • Low-voltage condition 	<ul style="list-style-type: none"> • Replace. • Replace. • Check for correct voltage at compressor. Check and tighten all connections. • Wait at least 3 hours for overload to reset. If still open, replace the compressor. • Add start kit components.
Insufficient cooling	<ul style="list-style-type: none"> • Improperly sized unit • Improper indoor airflow • Incorrect refrigerant charge • Air, noncondensibles, or moisture in system 	<ul style="list-style-type: none"> • Recalculate load. • Check. Should be approximately 400 CFM per ton. • Charge per procedure attached to unit service panel. • Recover refrigerant. Evacuate and recharge. Add filter drier.
Compressor short cycles	<ul style="list-style-type: none"> • Incorrect voltage • Defective overload protector • Refrigerant undercharge 	<ul style="list-style-type: none"> • At compressor terminals, voltage must be $\pm 10\%$ of nameplate marking when unit is operating. • Replace. Check for correct voltage. • Add refrigerant.
Registers sweat	<ul style="list-style-type: none"> • Low indoor airflow 	<ul style="list-style-type: none"> • Increase speed of blower or reduce restriction. Replace air filter.
High head, low vapor pressures	<ul style="list-style-type: none"> • Restriction in liquid line, expansion device, or filter drier • Bad TXV 	<ul style="list-style-type: none"> • Remove or replace defective component. • Replace TXV.
High head, high or normal vapor pressure – Cooling mode	<ul style="list-style-type: none"> • Dirty outdoor coil • Refrigerant overcharge • Outdoor fan not running • Air or noncondensibles in system 	<ul style="list-style-type: none"> • Clean coil. • Correct system charge. • Repair or replace. • Recover refrigerant. Evacuate and recharge.
Low head, high vapor pressures	<ul style="list-style-type: none"> • Bad TXV • Bad compressor 	<ul style="list-style-type: none"> • Replace TXV. • Replace compressor.
Low vapor, cool compressor, iced indoor coil	<ul style="list-style-type: none"> • Low indoor airflow • Operating below 65°F outdoors • Moisture in system 	<ul style="list-style-type: none"> • Increase speed of blower or reduce restriction. Replace air filter. • Add Low Ambient Kit. • Recover refrigerant. Evacuate and recharge. Add filter drier.
High vapor pressure	<ul style="list-style-type: none"> • Excessive load • Defective compressor 	<ul style="list-style-type: none"> • Recheck load calculation. • Replace.
Fluctuating head and vapor pressures	<ul style="list-style-type: none"> • TXV hunting • Air or noncondensibles in system 	<ul style="list-style-type: none"> • Check TXV bulb clamp. Check air distribution on coil. Replace TXV. • Recover refrigerant. Evacuate and recharge.
Gurgle or pulsing noise at expansion device or liquid line	<ul style="list-style-type: none"> • Air or noncondensibles in system 	<ul style="list-style-type: none"> • Recover refrigerant. Evacuate and recharge.

DIAGNOSTICS

Service Analyzer Charts

COMPRESSOR OVERHEATING		
SYMPTOM	POSSIBLE CAUSE	CHECK/REMEDY
High superheat (greater than 15°F [-9°C] at coil)	Low charge	Check system charge.
	Faulty metering device	Restricted cap tube, TEV (TXV)
		Power element superheat out of adjustment internally
		Foreign matter stopping flow
	High internal load	Hot air (attic) entering return
		Heat source on; miswired or faulty control
	Restriction in liquid line	Drier plugged.
		Line kinked.
	Low head pressure	Low charge
		Operating in low ambient temperatures
Suction or liquid line subjected to high heat source	Hot attic	
	Hot water line	
Low line voltage	Loose wire connections	Check wiring.
	Power company problem, transformer	Have problem corrected before diagnosis continues.
	Undersized wire feeding unit	Correct and complete diagnosis.
High line voltage	Power company problem	Have problem corrected.
High head pressure	Overcharge	Check system charge.
	Dirty heat pump coil	Clean coil.
	Faulty or wrong size heat pump fan motor	Replace fan motor.
	Faulty fan blade or wrong rotation	Replace fan blade.
		Replace with correct rotation motor.
	Recirculation of air	Correct installation.
	Additional heat source	Check for dryer vent near unit.
		Check for recirculation from other equipment.
	Noncondensibles	Recover refrigerant. Evacuate and recharge system.
Equipment not matched	Correct mismatch.	
Short cycling of compressor	Faulty pressure control	Replace pressure control.
	Loose wiring	Check unit wiring.
	Thermostat	Located in supply air stream
		Differential setting too close
		Customer misuse
	TEV	Internal foreign matter
		Power element failure
		Valve too small
		Distributor tube/tubes restricted
	Distributor tube	Restricted with foreign matter
		Kinked
I.D. reduced from previous compressor failure		

Service Analyzer Charts

COMPRESSOR OVERHEATING (cont.)		
SYMPTOM	POSSIBLE CAUSE	CHECK OR REMEDIES
Short cycling of compressor (cont.)	Low charge	Check system charge.
	Low evaporator airflow	Dirty coil
		Dirty filter
		Duct too small or restricted
	Faulty run capacitor	Replace.
Faulty internal overload	Replace compressor.	
Faulty Compressor Valves	Fast equalization/Low pressure difference	Replace compressor and examine system to locate reason.
ELECTRICAL		
SYMPTOM	POSSIBLE CAUSE	CHECK OR REMEDIES
Voltage present on load side of compressor contactor and compressor won't run	Compressor start components	Check start capacitor.
		Check potential relay.
	Run capacitor	Check with ohmmeter
	Internal overload	Allow time to reset.
Voltage present on line side of compressor contactor only	Compressor windings	Check for correct ohms.
	Thermostat	Check for control voltage to contactor coil.
	Compressor control circuit	High-pressure switch
		Low-pressure switch
		Ambient thermostat
Solid-state protection control or internal thermal sensors		
Compressor timed off/on control or interlock		
No voltage on line side of compressor contactor	Blown fuses or tripped circuit breaker	Check for short in wiring or unit.
	Improper wiring	Recheck wiring diagram.
Improper voltage	High voltage	Wrong unit
		Power supply problem
	Low voltage	Wrong unit
		Power supply problem
		Wiring undersized
		Loose connections
Single Phasing (3 phase)	Check incoming power and fusing.	
FLOODED STARTS		
SYMPTOM	POSSIBLE CAUSE	CHECK OR REMEDIES
Liquid in the compressor shell	Faulty or missing crankcase heater	Replace crankcase heater.
Too much liquid in system	Incorrect piping	Check piping guidelines.
	Overcharge	Check and adjust charge.

DIAGNOSTICS

Service Analyzer Charts

CONTAMINATION		
SYMPTOM	POSSIBLE CAUSE	REMEDY
Moisture	Poor evacuation on installation or during service	In each case, the cure is the same. Recover refrigerant. Add filter drier, evacuate, and recharge.
High head pressure	Noncondensibles air	
Unusual head and suction readings	Wrong refrigerant or mixed refrigerants	
Foreign matter – copper filings	Copper tubing cuttings	
Copper oxide	Dirty copper piping or nitrogen not used when brazing	
Welding scale	Nitrogen not used during brazing	
Soldering flux	Adding flux before seating copper partway	
Excess soft solder	Wrong solder material	
LOSS OF LUBRICATION		
SYMPTOM	POSSIBLE CAUSE	REMEDY
Compressor failures	Line tubing too large	Reduce pipe size to improve oil return.
Low suction pressure	Low charge	Check system charge.
	Refrigerant leaks	Repair and recharge.
Cold, noisy compressor – Slugging	Dilution of oil with refrigerant	Observe piping guidelines.
Noisy compressor	Migration	Check crankcase heater.
Cold, sweating compressor	Flooding	Check system charge.
Low load	Reduced airflow	Dirty filter
		Dirty coil
		Wrong duct size
		Restricted duct
	Thermostat setting	Advise customer.
Short cycling of compressor	Faulty high- or low-pressure control	Replace control.
	Loose wiring	Check all control wires.
	Thermostat	In supply air stream, out of calibration
		Customer misuse
SLUGGING		
SYMPTOM	POSSIBLE CAUSE	REMEDY
On start-up	Incorrect piping	Review pipe size guidelines.
TEV hunting when running	Faulty TEV	Replace TEV.

Service Analyzer Charts

FLOODING		
SYMPTOM	POSSIBLE CAUSE	REMEDY
Poor system control using a TEV	Loose sensing bulb	Secure the bulb and insulate.
	Bulb in wrong location	Relocate bulb.
	Wrong size TEV	Use correct replacement.
	Improper superheat setting (less than 5°F [-15°C])	Replace TEV.
THERMOSTATIC EXPANSION VALVES		
SYMPTOM	POSSIBLE CAUSE	REMEDY
High Superheat, Low Suction Pressure (superheat over 15°F [-9°C])	Moisture freezing and blocking valve	Recover charge, install filter-drier, evacuate system, recharge.
	Dirt or foreign material blocking valve	Recover charge, install filter-drier, evacuate system, recharge.
	Low refrigerant charge	Correct the charge.
	Vapor bubbles in liquid line	Remove restriction in liquid line. Correct the refrigerant charge.
		Remove noncondensable gases.
		Size liquid line correctly.
	Misapplication of internally equalized valve	Use correct TEV.
	Plugged external equalizer line	Remove external equalizer line restriction.
	Undersized TEV	Replace with correct valve.
	Loss of charge from power head sensing bulb	Replace power head or complete TEV.
Charge migration from sensing bulb to power head (Warm power head with warm, wet cloth. Does valve operate correctly now?)	Ensure TEV is warmer than sensing bulb.	
Valve feeds too much refrigerant, with low superheat and higher than normal suction pressure	Moisture causing valve to stick open.	Recover refrigerant, replace filter-drier, evacuate system, and recharge.
	Dirt or foreign material causing valve to stick open	Recover refrigerant, replace filter drier, evacuate system, and recharge.
	TEV seat leak (a gurgling or hissing sound is heard AT THE TEV during the off cycle, if this is the cause). NOT APPLICABLE TO BLEED PORT VALVES.	Replace the TEV.
	Oversized TEV	Install correct TEV.
	Incorrect sensing bulb location	Install bulb with two mounting straps, in 2:00 or 4:00 position on suction line, with insulation.
	Low superheat adjustment	Replace TEV.
	Incorrectly installed, or restricted external equalizer line	Remove restriction, or relocate external equalizer.

DIAGNOSTICS

Service Analyzer Charts

THERMOSTATIC EXPANSION VALVES (cont.)		
SYMPTOM	POSSIBLE CAUSE	REMEDY
Compressor flood back upon start-up	Refrigerant drainage from flooded evaporator	Install trap riser to the top of the evaporator coil.
	Inoperable crankcase heater or crankcase heater needed	Replace or add crankcase heater.
	Any of the causes listed under symptoms of Electrical problems on page 45	Any of the solutions listed under solutions of Electrical problems on page 45
Superheat is low to normal with low suction pressure	Unequal evaporator circuit loading	Ensure airflow is equally distributed through evaporator. Check for blocked distributor tubes.
	Low load or airflow entering evaporator coil	Ensure blower is moving proper air CFM.
		Remove/Correct any airflow restriction.
Superheat and suction pressure fluctuate (valve is hunting)	Expansion valve is oversized	Install correct TEV.
	Sensing bulb is affected by liquid refrigerant or refrigerant oil flowing through suction line	Relocate sensing bulb in another position around the circumference of the suction line.
	Unequal refrigerant flow through evaporator circuits	Ensure sensing bulb is located properly.
		Check for blocked distributor tubes.
	Moisture freezing and partially blocking TEV	Recover refrigerant, change filter-drier, evacuate system, and recharge.
Valve does not regulate at all	External equalizer line not connected or line plugged	Connect equalizer line in proper location, or remove any blockage.
	Sensing bulb lost its operating charge	Replace TEV.
	Valve body damaged during soldering or by improper installation	Replace TEV.

DIAGNOSTICS

COOLING MODE TROUBLESHOOTING TIPS					
SYSTEM PROBLEM	INDICATORS				
	DISCHARGE PRESSURE	SUCTION PRESSURE	SUPERHEAT Normal: 5°–15°F [-15° – -9°C]	SUBCOOLING Normal: See Charging Chart	COMPRESSOR AMPS
Overcharge	High	High	Low	High	High
Undercharge	Low	Low	High	Low	Low
Liquid Restriction (Drier)	Low	Low	High	High	Low
Low Indoor Airflow	Low	Low	Low	Low	Low
Dirty Outdoor Coil	High	High	Low	Low	High
Low Outdoor Ambient Temperature	Low	Low	High	High	Low
Inefficient Compressor	Low	High	High	High	Low
Indoor TXV Feeler Bulb Charge Lost	Low	Low	High	High	Low
Poorly Insulated Indoor Sensing Bulb	High	High	Low	Low	High

HEATING MODE TROUBLESHOOTING TIPS					
SYSTEM PROBLEM	INDICATORS				
	DISCHARGE PRESSURE	SUCTION PRESSURE	SUPERHEAT Normal: 5°–15°F [-15° – -9°C]	SUBCOOLING Normal: See Charging Chart	COMPRESSOR AMPS
Overcharge	High	High	OK	High	High
Undercharge	Low	Low	OK or High	Low	Low
Liquid Restriction (Drier)	Low	Low	High	High	Low
Low Outdoor Airflow	Low	Low	Low	Low	Low
Dirty Indoor Coil	High	High	Low	Low	High
Low Indoor Ambient Temperature	Low	Low	OK	High	Low
Inefficient Compressor	Low	High	High	High	Low
Outdoor TXV Feeler Bulb Charge Lost	Low	Low	High	High	Low
Poorly Insulated Outdoor Sensing Bulb	High	High	Low	Low	High

WIRING DIAGRAMS

FOR SINGLE PHASE WITH PSC FAN MOTORS

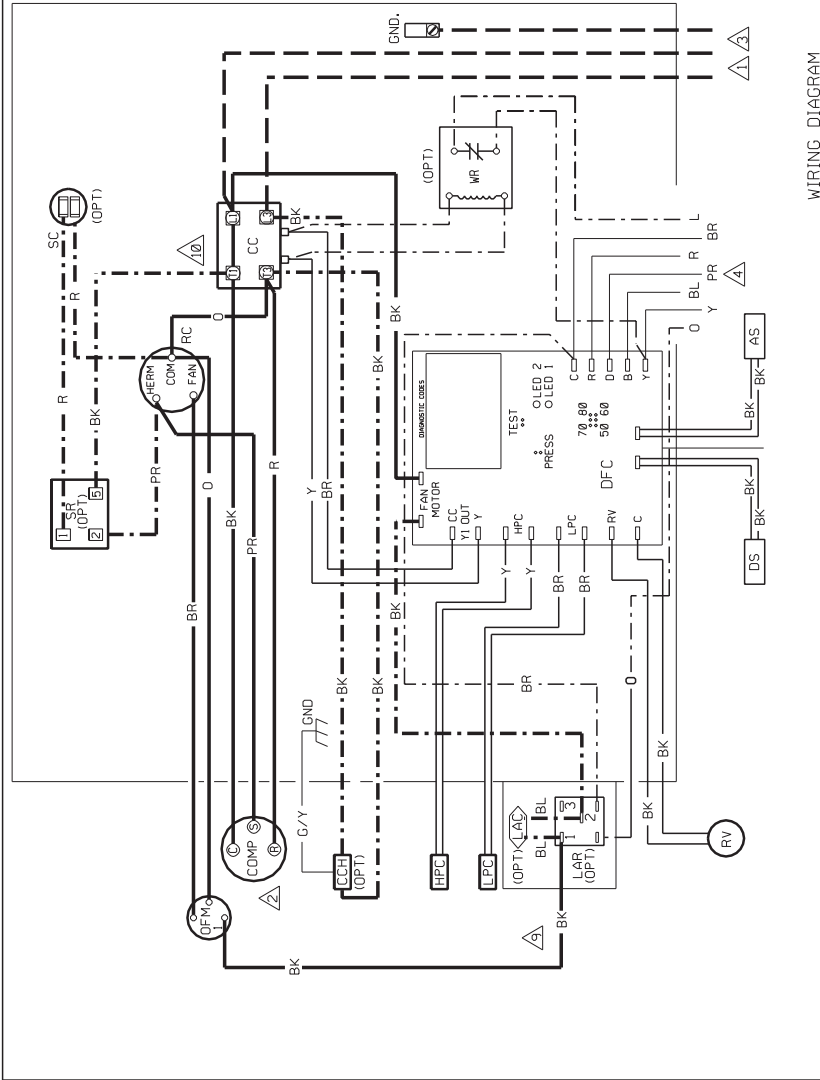
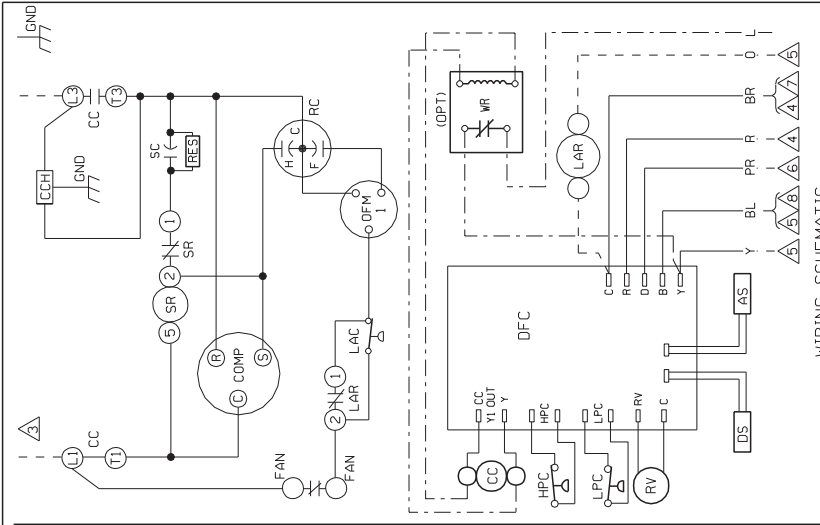

WIRE COLOR CODE	
BK	BLACK
GY	GRAY
R	RED
BR	BROWN
OR	ORANGE
W	WHITE
BL	BLUE
PK	PINK
Y	YELLOW
G	GREEN
PR	PURPLE

ELECTRICAL WIRING DIAGRAM
 REMOTE HEAT PUMP
 SINGLE PHASE
 DEMAND DEFROST CONTROL

WIRING INFORMATION	
---	LINE VOLTAGE
---	-FACTORY STANDARD
---	-FACTORY OPTION
---	-FIELD INSTALLED
---	LOW VOLTAGE
---	-FACTORY STANDARD
---	-FACTORY OPTION
---	-FIELD INSTALLED
---	REPLACEMENT WIRE
---	-MUST BE THE SAME SIZE AND TYPE OF INSULATION AS ORIGINAL (105 C MIN.)
---	WARNING
---	-CABINET MUST BE PERMANENTLY GROUNDED AND CONFORM TO I.E.C., N.E.C., C.E.C. AND LOCAL CODES AS APPLICABLE.

- NOTES:**
- CONNECTORS SUITABLE FOR USE WITH COPPER CONDUCTORS ONLY.
 - COMPRESSOR MOTOR THERMALLY PROTECTED AND ALL 3 PHASE ARE PROTECTED UNDER PRIMARY SINGLE PHASE CONDITIONS.
 - CONNECT FIELD WIRING IN GROUNDED RAIN-TIGHT CONDUIT TO 60 HERTZ FUSE DISCONNECT, VOLTAGE AND PHASE PER RATING PLATE.
 - LOW VOLTAGE CIRCUIT TO BE N.E.C. CLASS 2 WITH A CLASS 2 TRANSFORMER 24 VOLTS, 60 HERTZ.
 - TO THERMOSTAT SUB-BASE REFER TO SYSTEM SCHEMATICS OR SCHEMATICS ON INDOOR SECTION FOR LOW VOLTAGE CONTROL WIRING.
 - THIS WIRE IS USED TO TURN ON STRIP HEAT DURING DEFROST. OMIT CONNECTION FOR MOST ECONOMICAL OPERATION.
 - TO HEAT PUMP MONITOR 2.5 VA MAX. WHEN USED.
 - THIS COMPONENT IS ENERGIZED IN HEATING MODE.
 - IF LAC/LAR IS NOT USED, CONNECT BLACK WIRE FROM OFM TO DFC FAN MOTOR.
 - BLACK WIRE FROM SR (5) TO CC (T1) DELETED WHEN PTCR IS USED.

COMPONENT CODE	
AS	AMBIENT SENSOR
CC	COMPRESSOR CONTACTOR
COMP	COMPRESSOR HEATER
DFC	DEFROST CONTROL
DS	DEFROST CONTROL SENSOR
HPC	HIGH PRESS. CUT-OUT CONTROL
LAC	LOW AMBIENT COOLING CONTROL
LPC	LOW PRESSURE CUT-OUT CONTROL
OFM	OUTDOOR FAN MOTOR
RC	RUN CAPACITOR
RV	START RELAY
SC	START RELAY
SR	WARNING RELAY
WR	

WIRING DIAGRAMS

FOR 3 PHASE, 460/575V

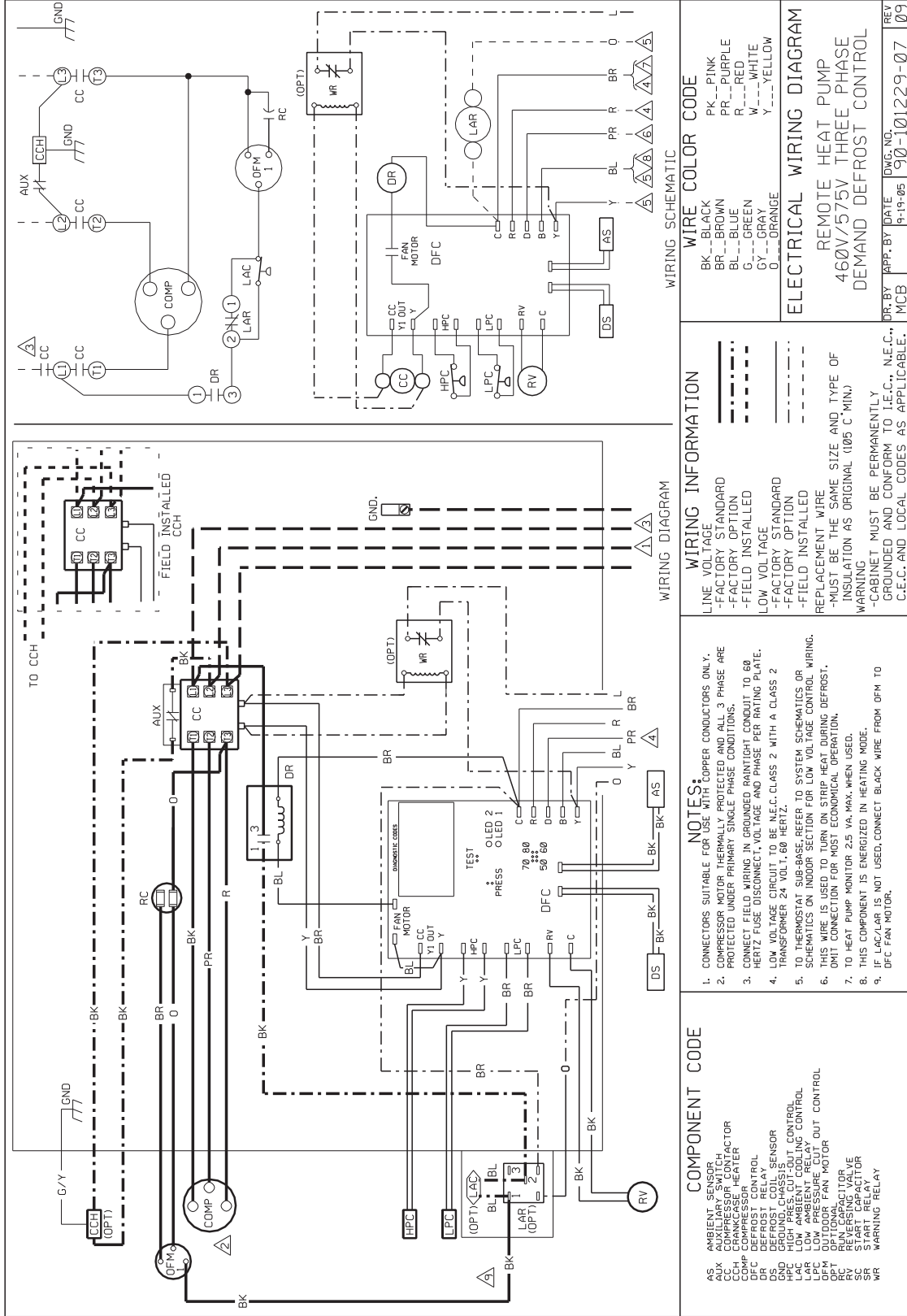

COMPONENT CODE	WIRING INFORMATION	WIRE COLOR CODE	ELECTRICAL WIRING DIAGRAM
AS	AMBIENT SENSOR	BK...BLACK	REMOTE HEAT PUMP
BK	CONNECTOR	BR...BROWN	460V/575V THREE PHASE
CC	COMPRESSOR CONTACTOR	BL...BLUE	DEMAND DEFROST CONTROL
CCH	CRANKCASE HEATER	R...RED	
DFC	DEFROST HEATER	G...GREEN	
DR	DEFROST CONTROL	W...WHITE	
DS	DEFROST RELAY	GY...GRAY	
HPC	DEFROST COIL SENSOR	O...ORANGE	
LAC	HIGH PRESS. CUT-OUT CONTROL		
LPC	LOW AMBIENT COOLING CONTROL		
LPC	LOW PRESSURE CUT-OUT CONTROL		
LPC	OUTDOOR FAN MOTOR		
OFM	OUTDOOR FAN MOTOR		
RC	RELAY		
RV	RELAY		
SR	START RELAY		
MR	WARNING RELAY		

NOTES:
 1. CONNECTORS SUITABLE FOR USE WITH COPPER CONDUCTORS ONLY.
 2. COMPRESSOR MOTOR THERMALLY PROTECTED AND ALL 3 PHASE ARE PROTECTED UNDER PRIMARY SINGLE PHASE CONDITIONS.
 3. CONNECT FIELD WIRINGS IN GROUNDED RAINTIGHT CONDUIT TO 60 HERTZ FUSE DISCONNECT, VOLTAGE AND PHASE PER RATING PLATE.
 4. LOW VOLTAGE CIRCUIT TO BE N.E.C. CLASS 2 WITH A CLASS 2 TRANSFORMER 24 VOLT, 60 HERTZ.
 5. TO THERMOSTAT SUB-BASE REFER TO SYSTEM SCHEMATICS OR SCHEMATICS ON INDOOR SECTION FOR LOW VOLTAGE CONTROL WIRING.
 6. THIS WIRE IS USED TO TURN ON STRIP HEAT DURING DEFROST. UNIT CONNECTION FOR MOST ECONOMICAL OPERATION.
 7. TO HEAT PUMP MONITOR 2.5 VA. MAX. WHEN USED.
 8. THIS COMPONENT IS ENERGIZED IN HEATING MODE.
 9. IF LAC/LAR IS NOT USED, CONNECT BLACK WIRE FROM OFM TO DFC FAN MOTOR.

REVISIONS:
 DATE: 9-19-05
 APP. BY: MCB
 Dwg. No.: 910-101229-07
 REV: 09

WIRING DIAGRAMS

<p>WIRING SCHEMATIC ESQUEMA DE CABLEADO</p>	<p>COMPONENT CODE CÓDIGO DE LOS COMPONENTES</p> <p>CCH Compressor contactor/Contactador del compresor CCH Can/kase heater/Calentador del cather COMP Compressor/Compresor GND Ground chassis/Tierra del chasis HPS Hot gas sensor/Sensor de gas caliente HPC High Pressure cut out control/Control de interrupción por alta presión LAC Low ambient cooling control/Control de límite de refrigeración inferior LFC Low pressure cut-out control/Control de interrupción por baja presión OFM Outdoor fan motor/Motor del ventilador exterior OPT Optional/Opcional RC Run capacitor/Capacitor de marcha RES Resistor/Resistorio SC Start capacitor/Capacitor de arranque SB Start relay/Relé de arranque TB Terminal block/Bloque de terminales TDC Time delay control/Control de tiempo de retardo</p>	<p>NOTES OBSERVACIONES</p> <ol style="list-style-type: none"> 1. Connectors suitable for use with copper conductors only. / Los conectores se pueden usar únicamente con conductores de cobre. 2. Compressor Motor: thermally protected and all 3 phase are protected under primary single phase conditions. / El motor del compresor posee protección térmica y las tres fases están protegidas en condiciones de funcionamiento monofásico. 3. Connect field wiring in grounded rain/tight conduit to fused disconnect disconnect, voltage and phase per rating plate. / Ejecute la instalación con tubería estanca para uso eléctrico y conectada a tierra. La alimentación se debe conectar a un secundario con fusibles y a tensión, frecuencia y cantidad de fases del suministro deben cumplir lo indicado en la placa de características del equipo. 4. Low voltage circuit to be N.E.C. Class 2, with a Class 2 transformer 24 vts./50 or 60 hertz. El circuito de baja tensión cumple lo especificado en el NEC (Código nacional eléctrico) e interconectado para cable y es provisto de un transformador clase 2 de 24 V, 50 o 60 Hz. 5. To thermostat sub-base refer to system schematic or schematics on motor section for low voltage control wiring. / Si necesita información sobre la base de conexión del termostato, consulte los esquemas del sistema o los esquemas del cableado de control de baja tensión de la sección interior. 	<p>WIRE COLOR CODE CÓDIGO DE COLORES DEL CABLEADO</p> <p>BK...BLACK/NEGRO O...ORANGE/NARANJA PR...PURPLE/VIOLETA R...RED/ROJO BL...BLUE/AZUL W...WHITE/BLANCO G...GREEN/VERDE Y...YELLOW/AMARILLO</p> <p>WIRING DIAGRAM DIAGRAMA ELÉCTRICO DE CABLEADO</p> <p>REMO-TE HEAT PUMP 3 PHASE BOMBA DE CALOR REMOTA, TRIPLE FASE ECM MOTOR</p>
<p>WIRING SCHEMATIC ESQUEMA DE CABLEADO</p>	<p>WIRING INFORMATION INFORMACIÓN SOBRE EL CABLEADO</p> <p>Line Voltage / Tensión de alimentación - Factory standard / Estándar de fábrica - Factory option / Opcional de fábrica - Field installed / Instalación en el lugar Low Voltage / Baja Tensión - Factory standard / Estándar de fábrica - Factory option / Opcional de fábrica - Field installed / Instalación en el lugar Replacement Wire / Reemplazo de conductores - Must be the same size and type of insulation as original (US C,mm) - Los conductores deben ser de la misma medida y tipo de aislamiento que los originales (US C,mm) Warning / Advertencia - Cabinet must be permanently grounded and conform to I.E.C., N.E.C., C.E.C. and local codes as applicable. - El gabinete debe estar conectado a tierra de forma permanente y de acuerdo a las normas I.E.C., (NEMA), N.E.C. (IEEE), C.E.C. (Canada) y los códigos locales que sean de aplicación.</p>	<p>WIRING DIAGRAM DIAGRAMA DE CABLEADO</p>	<p>WIRING DIAGRAM DIAGRAMA DE CABLEADO</p>
<p>DR. BY: JHB</p>	<p>APP. BY: DATE: 10-17-14</p>	<p>ENG. NO.: 90-101229-32</p>	<p>REV.: 01</p>





