



Electronic Faucets

5EF-2D-DS-VF05

TAG:

Electronic Sensor Faucet

Architect/Engineering Specifications:

4" deck mount electronic sensor faucet with polished chrome plated brass body with integral spout, 0.5 GPM vandal resistant non-aerated spray device, AC/DC control module, temperature control mixing valve with check valves and 18" flexible stainless steel supply hoses with 3/8" compression connections. Certified to ASME A112.18.1/CSA B125.1, NSF 61-Section 9, NSF 372 and UL 1951. Meets ADA ANSI/ICC A117.1 requirements

Job Name _____
 Model Specified _____ Quantity _____
 Variations Specified _____
 Date _____

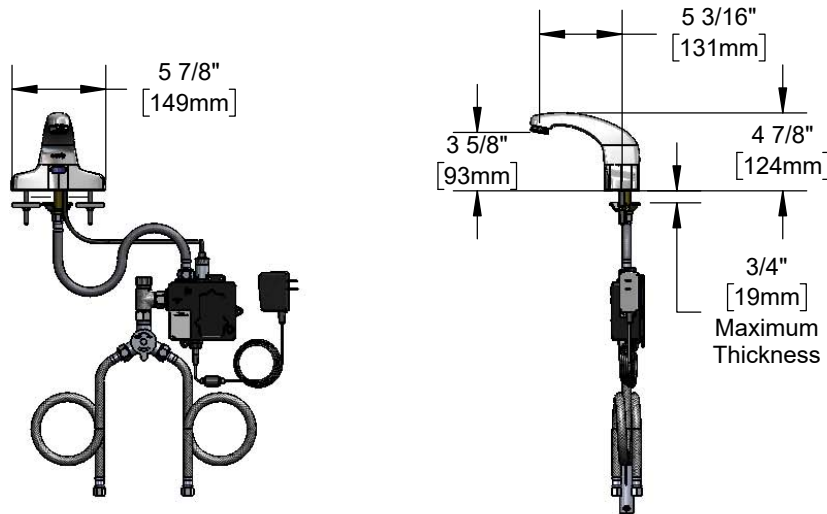

Features & Benefits:

- 4" deck mount faucet w/ polished chrome plated brass body with integral spout
- 0.5 GPM vandal resistant non-aerated spray device, Series 9 (B-0199-09-N05)
- Water resistant control module
- Plug in AC transformer or (4) AA battery (DC) power options
- Temperature control mixing valve w/ check valves
- 18" flexible stainless steel supply hoses w/ 3/8" compression connections
- Low battery LED indicator light
- Material: Polished chrome plated brass body

Product Compliance:

- ASME A112.18.1 / CSA B125.1
- NSF 61 - Section 9
- NSF 372 (Low Lead Content)
- ANSI A117.1 (ADA)
- UL 1951



Warranty: One Year (Limited)



ADA Compliant

Performance Data:

- Pressure: 20 - 125 psi
- Temperature: 40 °F - 140 °F
- Flow Rate: 0.5 GPM @ 60 psi
- Water Consumption: @ 10 sec = .08 gal
@ 15 sec = .13 gal



Optional Outlets (Series 4 / VR Series 9)

GPM	Aerated	Non-Aerated (Laminar)	VR Aerated	VR Non-Aerated (VR Laminar)
0.35	N/A	<input type="checkbox"/> B-0199-04-N035	N/A	<input type="checkbox"/> B-0199-09-N035
0.5	N/A	<input type="checkbox"/> B-0199-04-N05	N/A	Standard
1.0	N/A	N/A	N/A	<input type="checkbox"/> B-0199-09-LF10
1.5	<input type="checkbox"/> B-0199-04-WS	N/A	<input type="checkbox"/> B-0199-09-WS	<input type="checkbox"/> B-0199-09-LF15
2.2	<input type="checkbox"/> B-0199-04	<input type="checkbox"/> B-0199-25	<input type="checkbox"/> B-0199-09	<input type="checkbox"/> B-0199-27



equip Foodservice Accessories



• 2 Saddleback Cove • Travelers Rest, SC 29690
Ph 800-891-4808 • Fax 800-868-0084
www.tsbrass.com

Date: 09/10/18