



TRU-AIRE's **SmoothGlide™**

REGISTER

COMPLETELY
RE-ENGINEERED

HIGH QUALITY
STEEL COMPONENTS

RIVETS INSTALLED
AFTER ASSEMBLY
FOR SMOOTHEST OPERATION

BLADE & LINKAGE COMPONENTS INDIVIDUALLY
POWDER COATED **BEFORE** ASSEMBLY

Tired of Register Problems?

Dampers that stick?

Products that rust or won't open?

Paint that flakes?

Dampers too loose?

Tru-Aire's new SmoothGlide™ multi-shutter registers are made from the highest quality steel and are now completely re-engineered. Our secret is that every register is powder coated **BEFORE** it is assembled. This ensures optimal performance you can count on. The results are the smoothest working registers, every time. Tru-Aire continues to provide the highest quality registers on the market...and we keep getting better! Don't settle for anything less.

Shhhhh!

TOP SECRET

(562) 466-1000 • www.truaire.com



What's New...

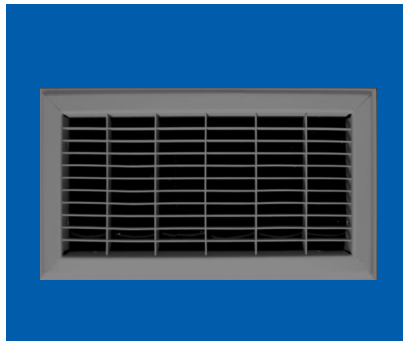

Model 154R
Floor Return Grille
Page 02

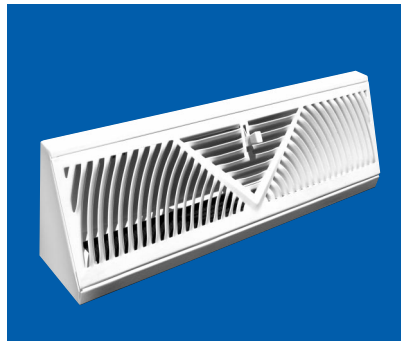

Model 115/118
Baseboard Supply & Return
Page 03

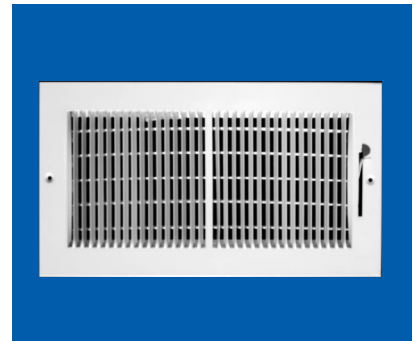

Model 124
Baseboard 1/3" Supply
Page 03

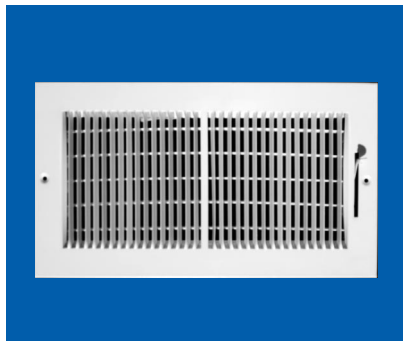

Model 132
Stamped 1/3" Spacing
Sidewall Supply
Page 06



Model 800
Round Ceiling Diffuser
Page 16

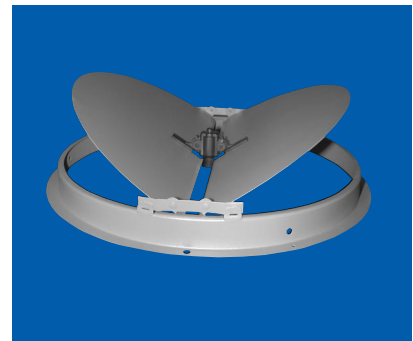

Model 801
Round Ceiling Diffuser
Page 16

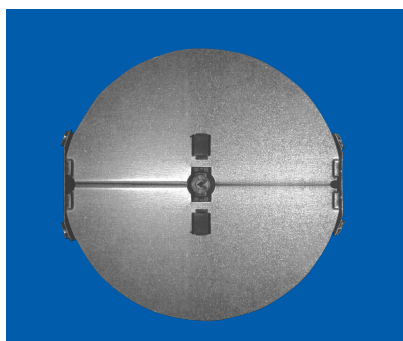

Model 802
Round Ceiling Diffuser
Page 16

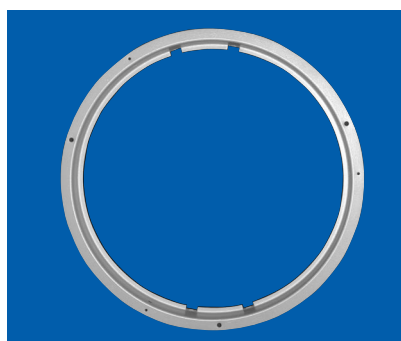

Model 803
Duct Ring
Page 16



Model ACD2440
Ceiling Access Panels
Page 24



PAGE

Floor Registers & Grilles

- 1 150MB Floor Diffuser-Stamped Face-Brown
- 1 150MW Floor Diffuser-Stamped Face-White
- 1 150TSB Toe Space Grille-Brown
- 1 150TSW Toe Space Grille-White



- 2 154R Floor Return Grille-Heavy Gage



Baseboard Registers & Grilles

- 3 115SB Baseboard Diffuser-Brown-15"
- 3 115SW Baseboard Diffuser-White-15"
- 3 115RB Baseboard Diffuser-Brown-15"
- 3 115RW Baseboard Diffuser-White-15"
- 3 118SB Baseboard Diffuser-Brown-18"
- 3 118SW Baseboard Diffuser-White-18"
- 3 118RB Baseboard Return-Brown-18"
- 3 118RW Baseboard Return-White-18"
- 3 124M Baseboard Supply Register-1/3" spacing w/ 3/4" Turnback-No Bottom
- 4 122R Baseboard Return-Stamped 1/2" Fin Spacing 3/4" Turnback
- 4 123R Baseboard Return-Stamped 1/3" Fin Spacing 3/4" Turnback

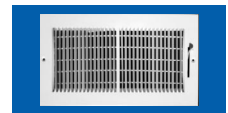

Sidewall Registers & Ceiling Diffusers - Stamped

- 5 101MD Stamped Register - Down Side Air Pattern
- 5 101MR Stamped Register - Right Side Air Pattern
- 5 101ML Stamped Register - Left Side Air Pattern
- 5 102M Stamped Register - 2 Way Air Pattern
- 5 103M Stamped Register - 3 Way Air Pattern
- 6 104M Stamped Register - 4 Way Air Pattern
- 6 132M Stamped Register 1/3" Fin- 2 Way Air Pattern



Sidewall Registers & Ceiling Diffusers - Bar Type

- 7 210VM Bar Type Supply Register-Adjustable-Multi Shutter Damper
- 7 220H Bar Type Supply Register-Face Bar Horiz./2nd Bar Vert.
- 7 220V Bar Type Supply Register-Face Bar Vert./2nd Bar Horiz.
- 7 220HM Bar Type Supply Register-Face Bar Horiz./2nd Bar Vert. w/Multi Shutter Damper
- 7 220VM Bar Type Supply Register-Face Bar Vert./2nd Bar Horiz. w/Multi Shutter Damper
- 7 230M Bar Type Supply Register-Adjustable-Multi Shutter Damper
- 8 210VO Bar Type Supply Register-OBDD
- 8 220HO Bar Type Supply Register-Face Bar Horiz./2nd Bar Vert. w/OBD
- 8 220VO Bar Type Supply Register-Face Bar Vert./2nd Bar Horiz. w/OBD

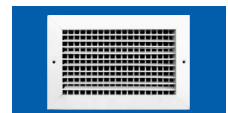



Adjustable Curved Blade

PAGE

301M	Curved Blade-Adjustable-Multi Shutter Damper-1 Way	9
302HM	Curved Blade-Adjustable-Multi Shutter Damper-Horiz. Blade-2 Way	9
302VM	Curved Blade-Adjustable-Multi Shutter Damper-Vert. Blade-2 Way	9
303M	Curved Blade-Adjustable-Multi Shutter Damper-3 Way	9
304M	Curved Blade-Adjustable-Multi Shutter Damper-4 Way	9



301O	Curved Blade-Adjustable-OBD-1 Way	10
302HO	Curved Blade-Adjustable-OBD-Horiz. Blade-2 Way	10
302VO	Curved Blade-Adjustable-OBD-Vert. Blade-2 Way	10
303O	Curved Blade-Adjustable-OBD-3 Way	10
304O	Curved Blade-Adjustable-OBD-4 Way	10

Stamped Curved Blade



401M	Curved Blade-Stamped-Multi Shutter Damper-1 Way	11
402HM	Curved Blade-Stamped-Multi Shutter Damper-Horiz. Blade-2 Way	11
402VM	Curved Blade-Stamped-Multi Shutter Damper-Vert. Blade-2 Way	11



403M	Curved Blade-Stamped-Multi Shutter Damper-3 Way	12
404M	Curved Blade-Stamped-Multi Shutter Damper-4 Way	12



560M	Step-down Square Ceiling Diffuser-Multi Shutter Damper	13
------	--	----



600	Evaporative Cooler Diffuser	14
-----	-----------------------------	----

700	High Velocity Cooler Diffuser-Multi Shutter Damper	15
-----	--	----

800	Round Diffuser	16
-----	----------------	----

801	Round Duct Ring w/Butterfly Damper	16
-----	------------------------------------	----

802	Round Butterfly Damper	16
-----	------------------------	----

803	Round Duct Ring	16
-----	-----------------	----

Return Air Grille - Stamped



170	Stamped Face Return Air Grille 1/2" Fin Spaced	17
-----	--	----

173	Stamped Face Return Air Grille 1/3" Fin Spaced	18
-----	--	----

Return Air Grille - Fixed Bar

270	Fixed Bar Return Air Grille 1/2" Fin Spaced	19
-----	---	----

Return Air Filter Grille - Stamped



190	Stamped Face Return Air Grille 1/2" Fin Spaced	20
-----	--	----

190F	190 Filter Grille - Removable Face	21
------	------------------------------------	----

Return Air Filter Grille - Fixed Bar



290	Fixed Bar Return Air Grille 1/2" Fin Spaced	22
-----	---	----

Access Door

ACD690	Single Access Door	23
--------	--------------------	----

Ceiling Access Panels







ACD2440L	3 Sectional Door w/Filter Grille(20"x20") Opening 24"x40"	24
----------	---	----

ACD2440S	3 Sectional Solid Door Opening 24"x40"	24
----------	--	----

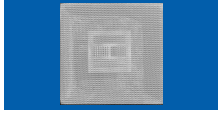
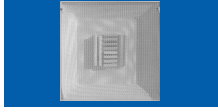
PAGE

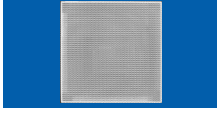
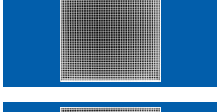
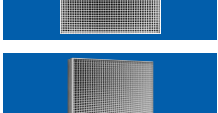
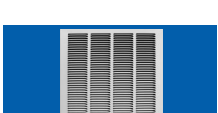
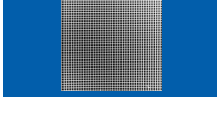
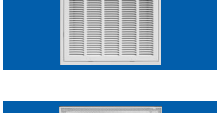
Supply & Return

25	1010MAS	2'X2'	Supply	4 Way Deflector	Perforated	Fiberglass Molded	
25	1010MAS	2'X2'	Return		Perforated	Fiberglass Molded	
25	1020MAS	2'X2'	Supply	4 Way Deflector	Perforated	Steel	
25	1020MAS	2'X2'	Return		Perforated	Steel	
25	1020MAS -INS	2'X2'	Supply	4 Way Deflector	Perforated	Steel w/R6-Insulated	
25	1020MAS -INS	2'X2'	Return		Perforated	Steel w/Insulated	
26	1400CB	2'X2'	Supply	Curved Blade	Step Down	Steel	
26	1444RB	2'X2'	Return		Step Down	Steel	
27	2002CD	2'X2'	Supply		Step Down	Steel	
27	2003CD	2'X2'	Supply	2 Cone	Step Down	Steel	
27	2004CD	2'X2'	Supply	3 Cone	Step Down	Steel	
28	2002CDIN	2'X2'	Supply		Step Down	Steel w/Insulated	
28	2003CDIN	2'X2'	Supply	2 Cone	Step Down	Steel w/Insulated	
28	2004CDIN	2'X2'	Supply	3 Cone	Step Down	Steel w/Insuated	
29	1120S	2'X2'	Supply	4 way deflector	Perforated	Metal Frame-No Back	
29	1120R	2'X2'	Return		Perforated	Metal Frame-No Back	
29	1120DBS	2'X2'	Supply	4 way deflector	Perforated	1" Fiberglass Ductboard	
29	1120DBR	2'X2'	Return		Perforated	1" Fiberglass Ductboard	
29	1130R-1	1'X2'	Return	Acrylic	Egg Crate	Metal Frame-No Back	
29	1130R-2	2'X2'	Return	Acrylic	Egg Crate	Metal Frame-No Back	
29	1130R-4	4'X2'	Return	Acrylic	Egg Crate	Metal Frame-No Back	
29	1130DBR-1	1'X2'	Return	Acrylic	Egg Crate	1" Fiberglass Ductboard	
29	1130DBR-2	2'X2'	Return	Acrylic	Egg Crate	1" Fiberglass Ductboard	
29	1130DBR-4	4'X2'	Return	Acrylic	Egg Crate	1" Fiberglass Ductboard	
29	1140R-1	1'X2'	Return	Aluminum	Egg Crate	Metal Frame-No Back	
29	140R-2	2'X2'	Return	Aluminum	Egg Crate	Metal Frame-No Back	
29	1140R-4	4'X2'	Return	Aluminum	Egg Crate	Metal Frame-No Back	
29	1140DBR-1	1'X2'	Return	Aluminum	Egg Crate	1" Fiberglass Ductboard	
29	1140DBR-2	2'X2'	Return	Aluminum	Egg Crate	1" Fiberglass Ductboard	
29	1140DBR-4	4'X2'	Return	Aluminum	Egg Crate	1" Fiberglass Ductboard	
Face Panel-Return							
30	1110RG	2'X2'	Return	Steel	Stamped	Face Panel Only	
30	1210RG	2'X2'	Return	Steel	Fixed Bar	Face Panel Only	
30	1920RG	2'X2'	Return	Steel	Perforated	Face Panel Only	
31	1930RG	2'X2'	Return	Acrylic	Egg Crate	Face Panel Only	
31	1934RG	2'X2'	Return	Acrylic	Egg Crate	Face Panel w/Frame	
31	1940RG	2'X2'	Return	Aluminum	Egg Crate	Face Panel Only	
31	1944RG	2'X2'	Return	Aluminum	Egg Crate	Face Panel w/Frame	
Filter Grille							
32	4010FG	2'X2'	Filter-Return	Steel	Stamped 1/2"	Metal Frame-No Back	
32	4010FG-DB	2'X2'	Filter-Return	Steel	Stamped 1/2"	1" Fiberglass Ductboard	
32	4020FG	2'X2'	Filter-Return	Steel	Fixed Bar	Metal Frame-No Back	
32	4020FG-DB	2'X2'	Filter-Return	Steel	Fixed Bar	1" Fiberglass Ductboard	
32	4030FG	2'X2'	Filter-Return	Steel	Perforated	Metal Frame-No Back	
32	4030FG-DB	2'X2'	Filter-Return	Steel	Perforated	1" Fiberglass Ductboard	

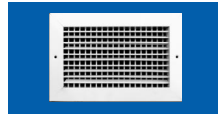

Sidewall Registers & Ceiling Diffusers - Bar Type

A210H	Bar Type Supply Register - Face Bar-Horizontal	33
A210V	Bar Type Supply Register - Face Bar-Vertical	33
A210VM	Bar Type Supply Register - Adjustable-Multi Shutter Damper	33
A230M	Bar Type Supply Register - Adjustable-Multi Shutter Damper	33
A220H	Bar Type Supply Register - Face Bar Horizontal - 2nd Bar Vertical	34
A220V	Bar Type Supply Register - Face Bar Vertical - 2nd Bar Horizontal	34
A220HO	Bar Type Supply Register - Face Bar Horizontal - 2nd Bar Vertical w/OBD	34
A220VO	Bar Type Supply Register-Face Bar Vert./2nd Bar Horiz. w/OBD	34
A230M	Bar Type Supply Register-Adjustable-Multi Shutter Damper	34

Adjustable Curved Blade

A301M	Curved Blade-Adjustable-Multi Shutter Damper-1 Way	35
A301O	Curved Blade-Adjustable-OBD-1 Way	35
A302HM	Curved Blade-Adjustable-Multi Shutter Damper-Horiz. Blade-2 Way	35
A302HO	Curved Blade-Adjustable-OBD-Horiz. Blade-2 Way	35
A302VM	Curved Blade-Adjustable-Multi Shutter Damper-Vert. Blade-2 Way	35
A302VO	Curved Blade-Adjustable-OBD-Vert. Blade-2 Way	35
A303M	Curved Blade-Adjustable-Multi Shutter Damper-3 Way	36
A303O	Curved Blade-Adjustable-OBD-3 Way	36
A304M	Curved Blade-Adjustable-Multi Shutter Damper-4 Way	36
A304O	Curved Blade-Adjustable-OBD-4 Way	36

Square

A501M	Square Ceiling Diffuser-1 Way	37
A502M	Square Ceiling Diffuser-2 Way	37
A503M	Square Ceiling Diffuser-3 Way	37
A504M	Square Ceiling Diffuser-4 Way	37
A505M	Square Ceiling Diffuser-Corner-2 Way	37

Return Air Grille

A270	Fixed Bar Return Air Grille 3/4" Fin Spaced	38
------	---	----

Return Air Filter Grille

A290	Fixed Bar Return Air Filter Grille 3/4" Fin Spaced	39
------	--	----

PAGE





STAMPED FACE: Floor Grille

Model 150MB/MW

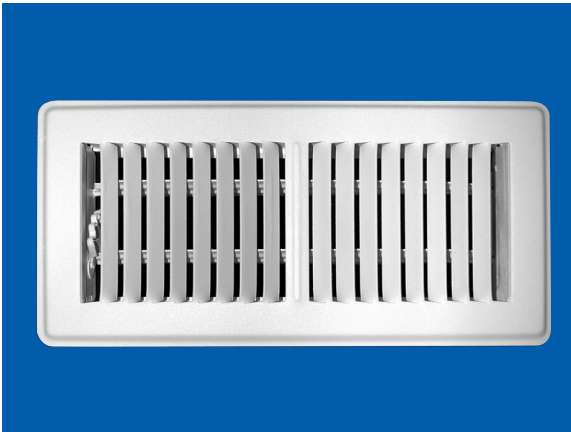

- ❖ Sturdy, all-steel construction
- ❖ Multi-shutter damper
- ❖ Widespread air diffusion
- ❖ Durable white gloss powder coated finish
- ❖ "No-Scuff" finish - Brown or White

Face Frame: Listed Size (+1.50")

Except: 02 x 10 (3.750" x 11.50")
 02 x 12 (3.750" x 13.50")
 02 x 14 (3.750" x 15.50")

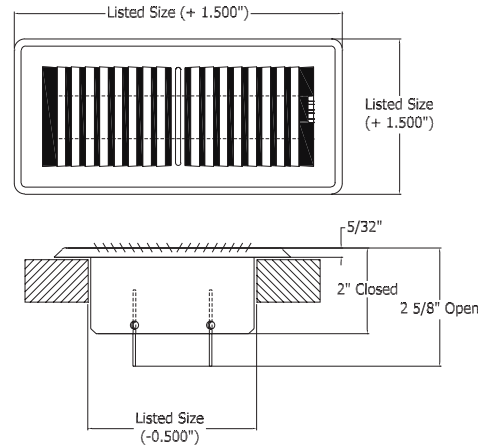

150MB/MW - Available Sizes (in inches)								
HEIGHT	WIDTH							
	2	4	6	8	10	12	14	18
6								
8	❖	❖	❖					
10	❖	❖	❖					
12	❖	❖	❖					
14	❖	❖	❖					

* PLEASE CONTACT US FOR ALL SIZES NOT LISTED

Damper: Listed Size (- 0.50")

Except: 02 x 10 (2.00" x 9.50")
 02 x 12 (2.00" x 11.50")
 02 x 14 (2.00" x 13.50")

Model 150TSB/TSW

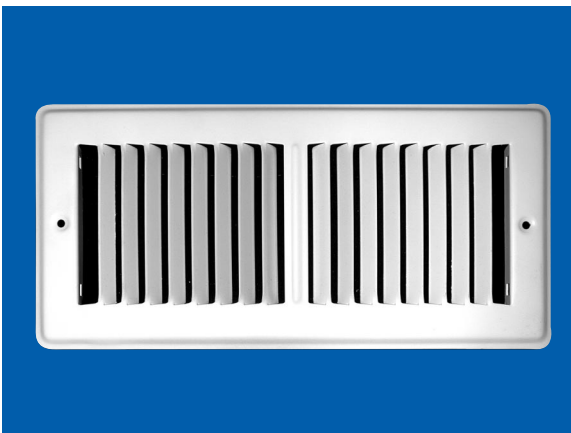

- ❖ Sturdy, all-steel construction
- ❖ Widespread air diffusion
- ❖ Durable white gloss powder coated finish
- ❖ Available in "No-Scuff" finish - Brown or White

Face Frame: Listed Size (+1.50")

Except: 02 x 10 (3.750" x 11.50")
 02 x 12 (3.750" x 13.50")
 02 x 14 (3.750" x 15.50")

STAMPED FACE: Toe Space Grille

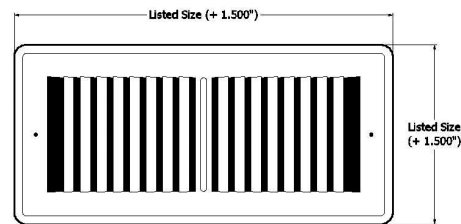

150TSB/TSW - Available Sizes (in inches)								
HEIGHT	WIDTH							
	2	4	6	8	10	12	14	18
6								
8		❖						
10	❖	❖	❖					
12	❖	❖	❖					
14	❖	❖	❖					

* PLEASE CONTACT US FOR ALL SIZES NOT LISTED

Model 154R

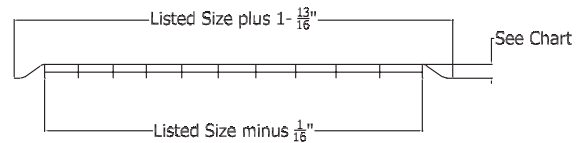
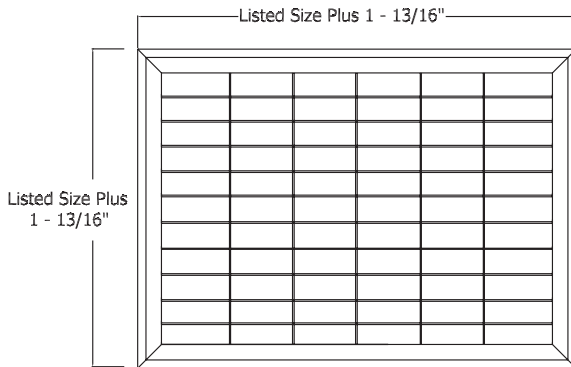
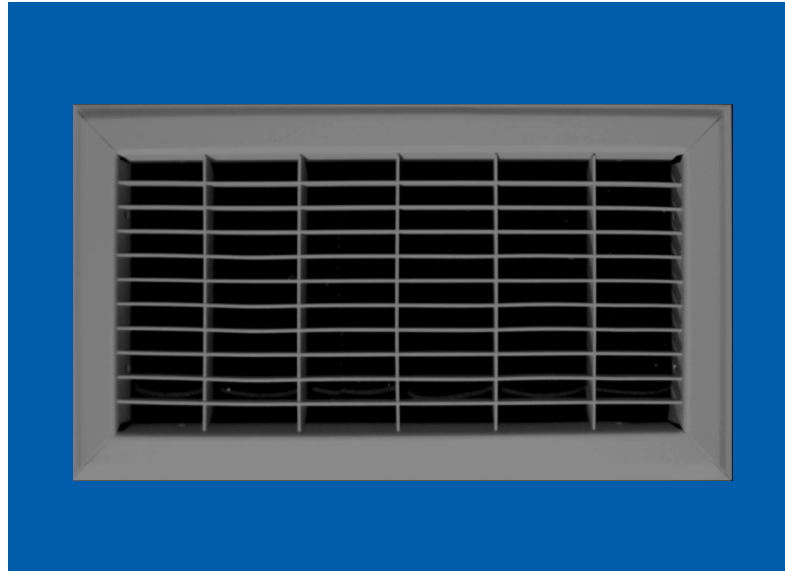

Model 154R

- ❖ Heavy gauge steel construction
- ❖ 75% average Free Area
- ❖ Brown powder coat finish

WIDTH	LENGTH	MAX DEPTH
4 thru 12	6 thru 30	21/32
14 thru 16	32 thru 36	25/32
16 thru 18	16 thru 36	25/32
20 thru 30	20 thru 36	

154R - Available Sizes (in inches)												
HEIGHT	WIDTH											
	4	6	8	10	12	14	16	18	20	24	30	36
4			❖	❖	❖	❖	❖	❖	❖	❖	❖	❖
6			❖	❖	❖	❖	❖	❖	❖	❖	❖	❖
8		❖	❖	❖	❖	❖	❖	❖	❖	❖	❖	❖
10				❖	❖	❖	❖	❖	❖	❖	❖	❖
12					❖	❖	❖	❖	❖	❖	❖	❖
14						❖	❖	❖	❖	❖	❖	❖
16							❖	❖	❖	❖	❖	❖
18								❖	❖	❖	❖	❖
20									❖	❖	❖	❖
24										❖	❖	❖
30											❖	❖

* PLEASE CONTACT US FOR ALL SIZES NOT LISTED



BASEBOARD SUPPLY/RETURN AIR GRILLES

Model 115S/118S Supply

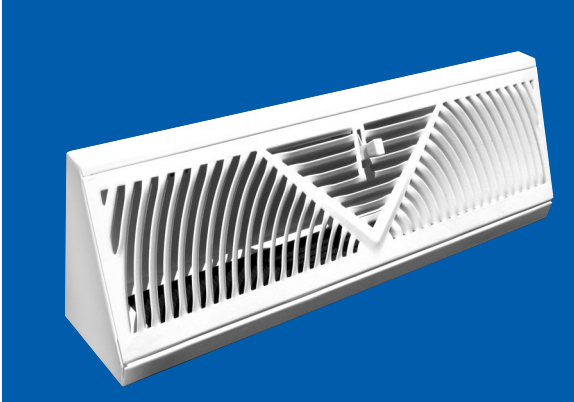

Model 115R/118R Return

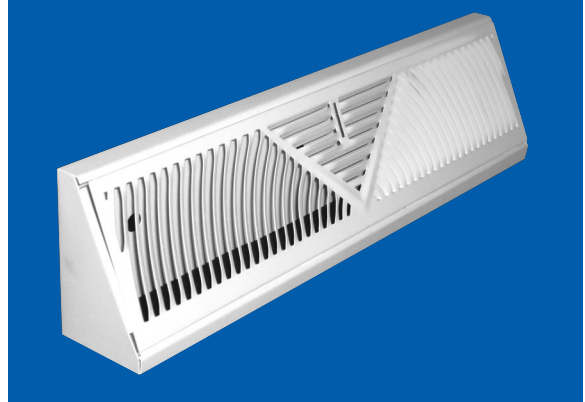

Model 115/118

- ❖ 15" and 18" Supply and Return Baseboard Diffuser
- ❖ All steel construction
- ❖ Durable white gloss powder coated finish
- ❖ "No-Scuff" finish - Brown or White
- ❖ Each grille is individually shrink wrapped

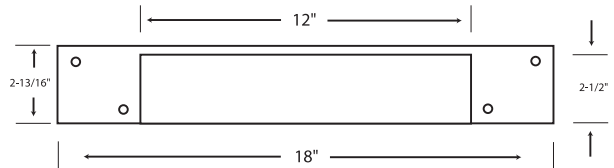

Bottom View of Model 118

	LENGTH	HEIGHT	FREE AREA
115	15"	4-1/2"	32sq.in.
118	18"	4-1/2"	32sq.in.

Model 124M

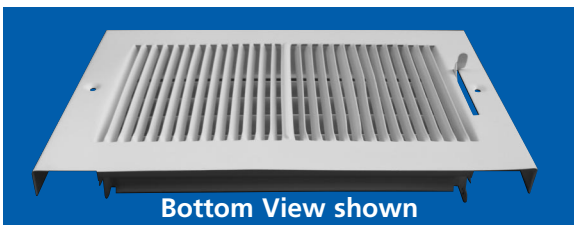
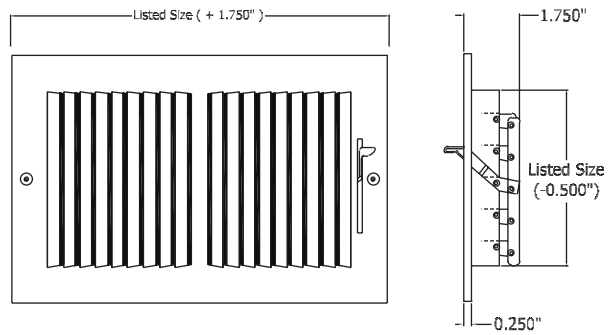
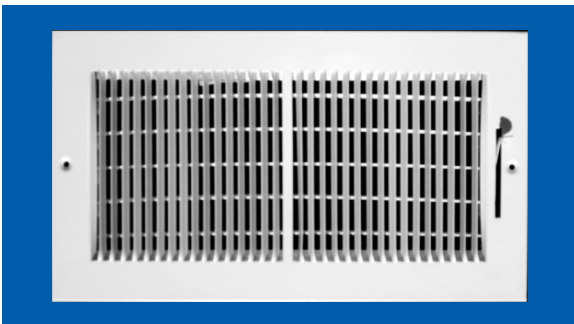

124M - Available Sizes (in inches)									
HEIGHT	WIDTH								
	6	8	10	12	14	16	18	20	24
4		❖	❖	❖	❖				
6		❖	❖	❖	❖		❖		❖
8		❖		❖					
10				❖	❖	❖			

* PLEASE CONTACT US FOR ALL SIZES NOT LISTED

- ❖ Stamped louver in 2-way air pattern
- ❖ 1/3" spacing available only with this two-way model
- ❖ Single lever operated multi-louver shutter
- ❖ Counter-sunk screw holes with 2" screws (provided)

- ❖ Finished with white powder coating
- ❖ Each grille is individually shrink wrapped
- ❖ 3/4" margin turnback

Model 122R

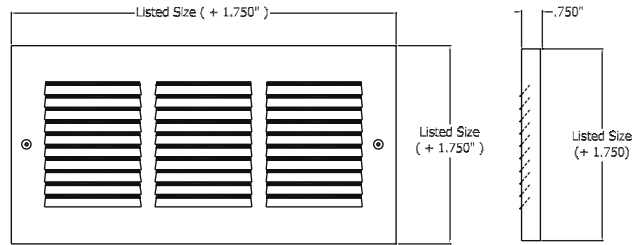
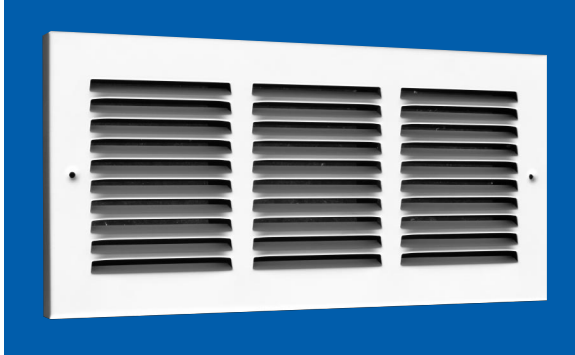

Model 123R

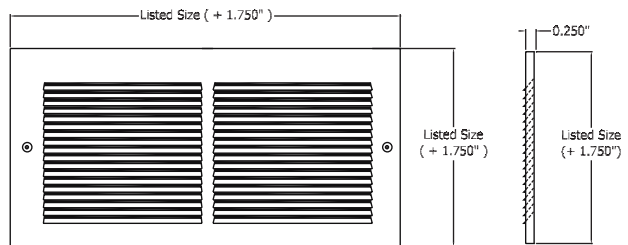
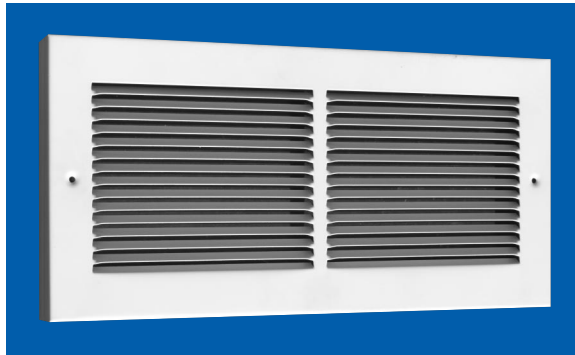

Models 122R & 123R

- ❖ Model 122R features 1/2" spaced with 45° blade angle
- ❖ Model 123R features 1/3" spaced with 45° blade angle
- ❖ Counter-sunk screw holes with 2" screws (provided)
- ❖ Finished with white powder coating
- ❖ Each grille is individually shrink wrapped
- ❖ 3/4" margin turnback

Model 122/123 - Available Sizes (in inches)							
HEIGHT	WIDTH						
	8	10	12	14	20	24	30
4	❖						
6	❖	❖	❖	❖	❖	❖	❖
8		❖	❖	❖	❖	❖	❖
10				❖	❖	❖	❖
12				❖		❖	❖

* PLEASE CONTACT US FOR ALL SIZES NOT LISTED



STAMPED FACE: Side Wall/Ceiling Registers

Model 101MD Down-Side

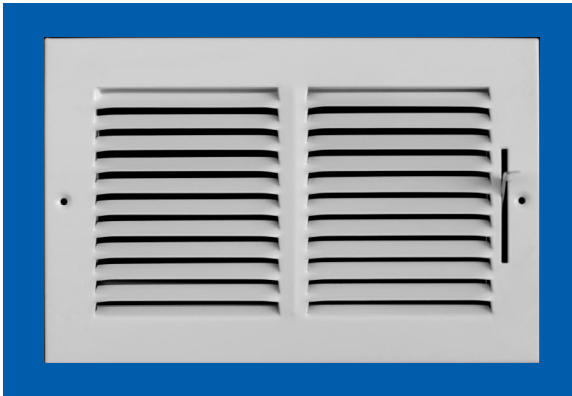

101M - Available Sizes (in inches)									
HEIGHT	WIDTH								
	4	6	8	10	12	14	16	18	20
2									
4			❖	❖					
6			❖	❖	❖	❖	❖		
8				❖	❖	❖			
10									
12									
14									
16									

* PLEASE CONTACT US FOR ALL SIZES NOT LISTED

Model 101MR One Way to Right

Model 101ML One Way to Left

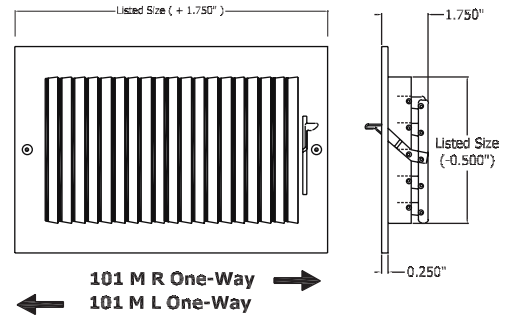
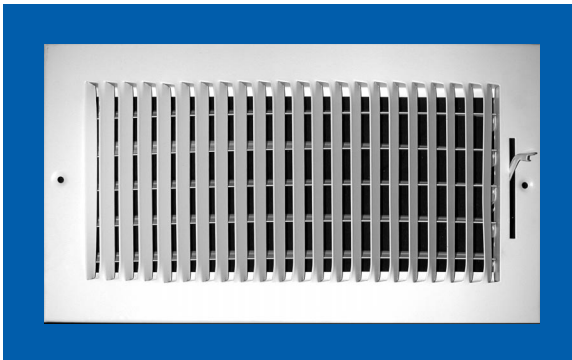

Model 102M Two Way

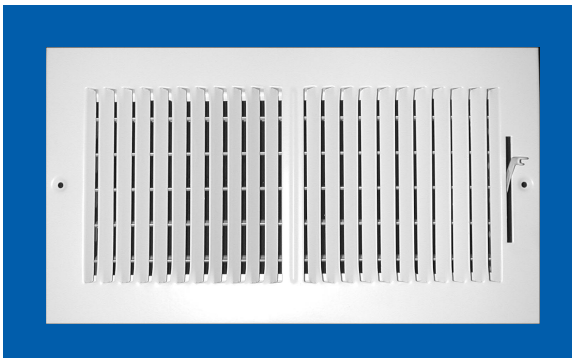

102M - Available Sizes (in inches)									
HEIGHT	WIDTH								
	6	8	10	12	14	16	18	20	24
4	❖	❖	❖	❖	❖	❖	❖	❖	❖
6	❖	❖	❖	❖	❖	❖	❖	❖	❖
8		❖	❖	❖	❖	❖	❖	❖	❖
10			❖	❖	❖	❖	❖	❖	❖
12				❖	❖		❖	❖	❖
14					❖				❖
16									
18							❖	❖	

100 Series Registers

- ❖ Stamped louver in 1-way (right, left or down-side airflow) 2-way patterns
- ❖ 1/2" spaced with 45° blade angle
- ❖ Single lever operated multi-louver shutter

- ❖ Counter-sunk screw holes with 2" screws (*provided*)
- ❖ Finished with white powder coating
- ❖ Each grille is individually shrink wrapped

STAMPED FACE: Side Wall/Ceiling Registers



Model 103M Three Way

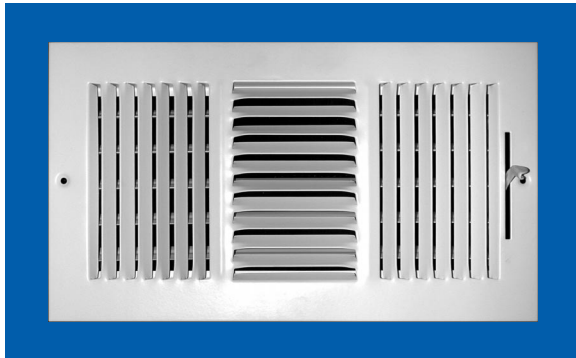

103M - Available Sizes (in inches)									
HEIGHT	WIDTH								
	6	8	10	12	14	16	18	20	24
4	❖	❖	❖	❖	❖			❖	
6	❖	❖	❖	❖	❖	❖	❖	❖	❖
8		❖	❖	❖	❖	❖	❖	❖	❖
10			❖	❖	❖	❖	❖		
12				❖	❖		❖		
14					❖				
16									
18									

Model 104M Four Way

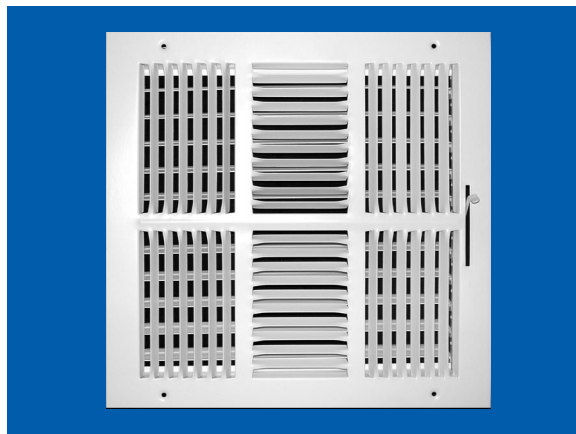

104M - Available Sizes (in inches)									
HEIGHT	WIDTH								
	6	8	10	12	14	16	18	20	24
6	❖		❖						
8		❖	❖						
10			❖						
12				❖					
14					❖				
16						❖			
18							❖		
20								❖	

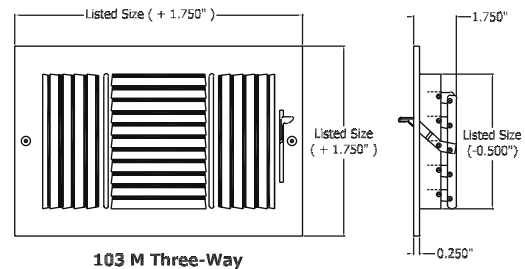

Model 132M Two Way

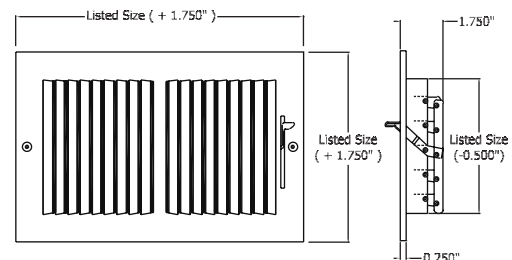
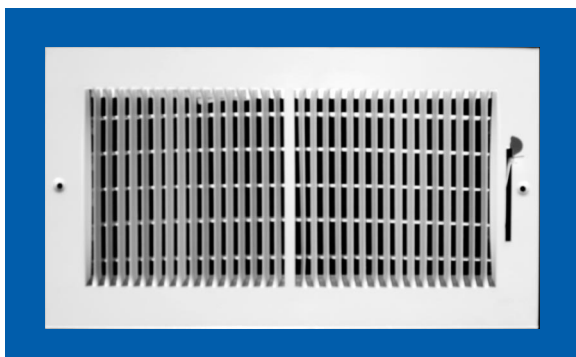

132M - Available Sizes (in inches)									
HEIGHT	WIDTH								
	6	8	10	12	14	16	18	20	24
4		❖	❖	❖	❖				
6		❖	❖	❖	❖	❖			❖
8		❖	❖	❖	❖				
10									

- ❖ Stamped louver in 2-way air pattern
- ❖ 1/3" spacing available only with this two-way model
- ❖ Single lever operated multi-louver shutter
- ❖ Counter-sunk screw holes with 2" screws (provided)

* PLEASE CONTACT US FOR ALL SIZES NOT LISTED



BAR TYPE SUPPLY: Side Wall/Ceiling Registers

Bar Type Supply Register

Model 210VM Single Deflection



Model 230M Three-Way Deflection

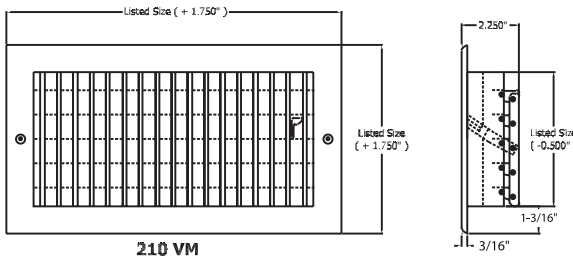

210 VM

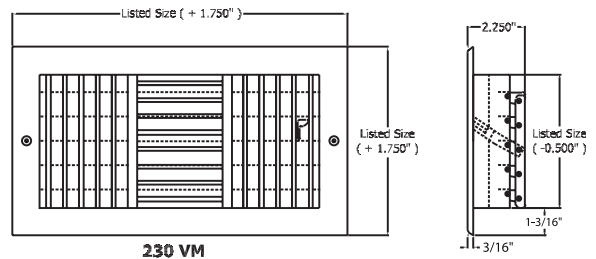

230 VM

210VM, 220VM, 230M

- ❖ Single lever operated multi-louver rear damper
- ❖ One piece frame (up to 14" x 10")
- ❖ Counter-sunk screw holes with 1/4" hexagon-head screws (provided)
- ❖ Finished with white powder coating
- ❖ Each grille is individually shrink wrapped
- ❖ Adjustable fins provide individual deflection control

Also Available *Not Shown

- 220H - Face Bar - Horizontal • 2nd Bar Vertical
- 220V - Face Bar - Vertical • 2nd Bar Horizontal
- 220HM - Multi Louver Damper
- 220VM - Multi Louver Damper

210 and 220 Series - Available Sizes (in inches)											
HEIGHT	WIDTH										
	6	8	10	12	14	16	18	20	24	26	30
4	❖	❖	❖	❖	❖	❖	❖	❖	❖		❖
6	❖	❖	❖	❖	❖	❖	❖	❖	❖		❖
8		❖	❖	❖	❖	❖	❖	❖	❖		❖
10			❖	❖	❖	❖	❖	❖	❖		❖
12				❖	❖	❖	❖	❖	❖		❖
14					❖	❖	❖	❖	❖		❖
16						❖	❖	❖	❖		❖
18							❖	❖	❖	❖	❖
20								❖	❖		❖
24									❖		❖

230M - Available Sizes (in inches)						
HEIGHT	WIDTH					
	8	10	12	14	16	
4	❖	❖				
6	❖	❖	❖	❖		
8		❖	❖	❖		
10			❖	❖		
12				❖		
14					❖	

* PLEASE CONTACT US FOR ALL SIZES NOT LISTED

Model 210VO Vertical with Single Deflection

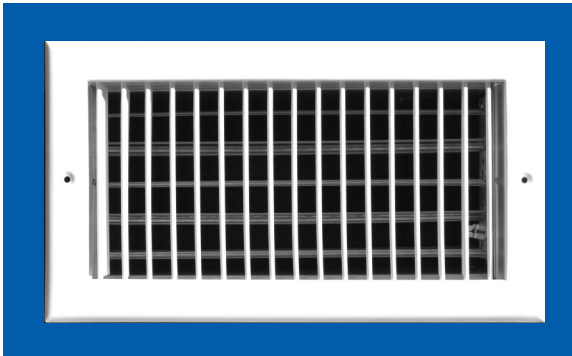

Model 220VO Vertical with Double Deflection



Model 220VO Reverse Side Shown

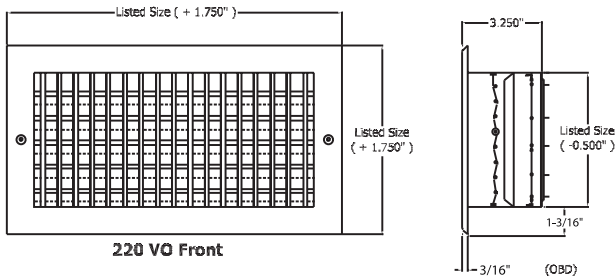

210VO & 220VO

- ❖ Opposite blade damper
- ❖ One piece frame (up to 14" x 10")
- ❖ Counter-sunk screw holes with 1/4" hexagon-head screws (*provided*)
- ❖ Finished with white powder coating
- ❖ Each diffuser is individually shrink wrapped
- ❖ Adjustable fins provide individual deflection control

Also Available *Not Shown

- 210HO - Face Bar - Horizontal
- 220HO - Face Bar - Horizontal • 2nd Bar Vertical

210 and 220 Series - Available Sizes (in inches)											
HEIGHT	WIDTH										
	6	8	10	12	14	16	18	20	24	26	30
4	❖	❖	❖	❖	❖	❖	❖	❖	❖		❖
6	❖	❖	❖	❖	❖	❖	❖	❖	❖		❖
8		❖	❖	❖	❖	❖	❖	❖	❖		❖
10			❖	❖	❖	❖	❖	❖	❖		❖
12				❖	❖	❖	❖	❖	❖		❖
14					❖	❖	❖	❖	❖		❖
16						❖	❖	❖	❖		❖
18							❖	❖	❖	❖	❖
20								❖	❖		❖
24									❖		❖

* PLEASE CONTACT US FOR ALL SIZES NOT LISTED



ADJUSTABLE CURVED BLADE SUPPLY: Side Wall/Ceiling

Adjustable Curved Blade Supply

Model 301M / 301O One Way

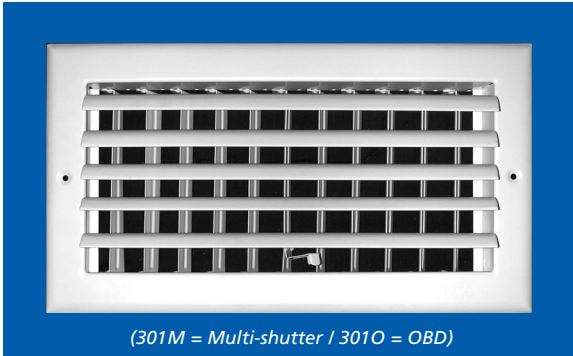

301M - Available Sizes (in inches)									
HEIGHT	WIDTH								
	6	8	10	12	14	16	18	20	24
4		❖	❖	❖	❖				
6	❖	❖	❖	❖	❖	❖	❖		
8		❖		❖	❖				
10			❖	❖	❖				
12				❖					
14					❖				
16						❖			
18							❖		

Model 302M / 302O Two Way Horizontal



302M - Available Sizes (in inches)									
HEIGHT	WIDTH								
	6	8	10	12	14	16	18	20	24
4		❖	❖	❖	❖				
6	❖	❖	❖	❖	❖				
8		❖		❖	❖				
10			❖	❖	❖				
12				❖					
14					❖				
16						❖			
18							❖		

Model 302VM / 302VO Two Way Vertical



302VM - Available Sizes (in inches)									
HEIGHT	WIDTH								
	6	8	10	12	14	16	18	20	24
4		❖	❖	❖	❖				
6	❖	❖	❖	❖	❖				
8		❖		❖	❖				
10			❖	❖	❖				
12				❖					
14					❖				
16						❖			
18							❖		

300 Series Registers

- ❖ 1, 2, 3, and 4-way air patterns
- ❖ Available with or without OBD
- ❖ Corner block directional air way control fin is encased in roll formed 22 guage steel
- ❖ Single lever operated multi-louver shutter
- ❖ Counter-sunk screw holes with 1/4" hexagonal screws (provided)
- ❖ Finished with white powder coating

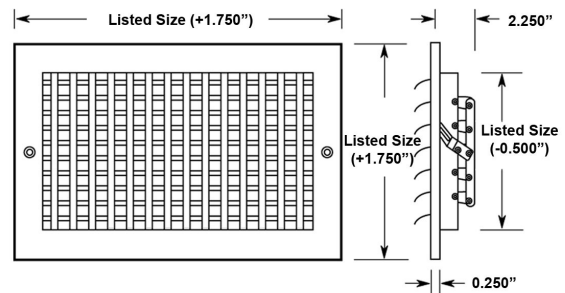

Model 303M / 303O Three Way

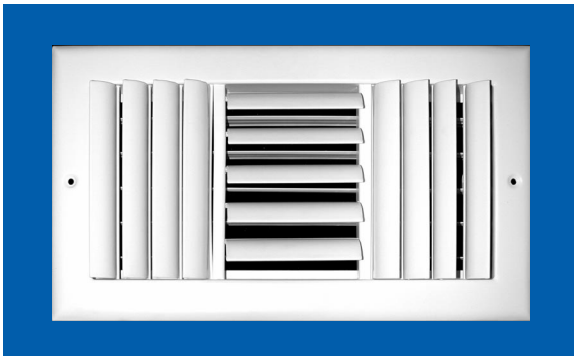

303M - Available Sizes (in inches)									
HEIGHT	WIDTH								
	6	8	10	12	14	16	18	20	24
4		❖	❖	❖	❖				
6	❖	❖	❖	❖	❖			❖	
8		❖	❖	❖	❖	❖		❖	
10			❖	❖	❖	❖			
12				❖					
14					❖				
16						❖			
18							❖		

Model 304M / 304O Four Way



304M - Available Sizes (in inches)										
HEIGHT	WIDTH									
	6	8	10	12	14	16	18	20	24	30
4		❖			❖					
6	❖	❖	❖	❖	❖					❖
8		❖			❖					
10			❖		❖					
12				❖						
14					❖					
16						❖				
18							❖			
20								❖		
24									❖	

* PLEASE CONTACT US FOR ALL SIZES NOT LISTED

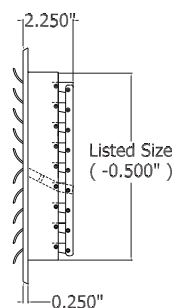
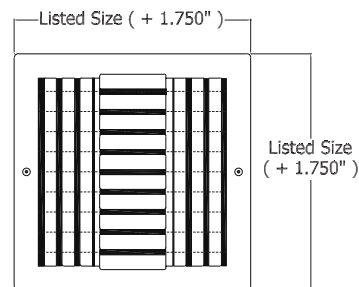
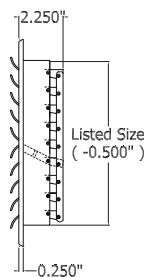
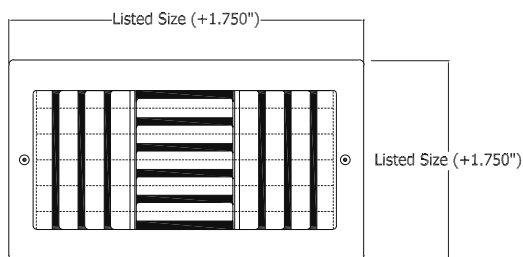



STAMPED CURVED BLADE SUPPLY: Side Wall/Ceiling

Stamped Curved Blade Supply

Model 401M One Way



401M - Available Sizes (in inches)									
HEIGHT	WIDTH								
	6	8	10	12	14	16	18	20	24
4		❖	❖	❖	❖				
6	❖	❖	❖	❖	❖	❖			
8		❖	❖	❖	❖				
10			❖	❖	❖				
12				❖	❖				
14					❖				
16									
18									

Model 402HM Two Way Horizontal

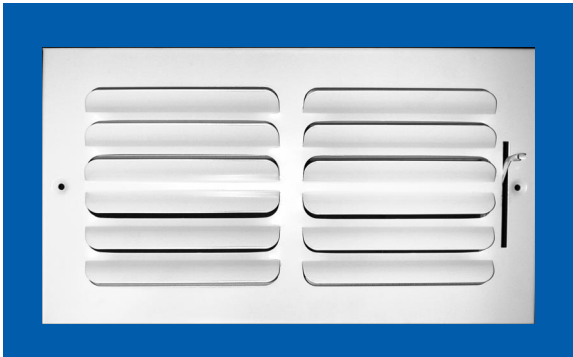

402M - Available Sizes (in inches)									
HEIGHT	WIDTH								
	4	6	8	10	12	14	16	18	20
2									
4			❖	❖	❖	❖			
6			❖	❖	❖	❖			❖
8			❖	❖	❖	❖			
10				❖	❖	❖			
12					❖	❖			
14						❖			
16									

Model 402VM Two Way Vertical

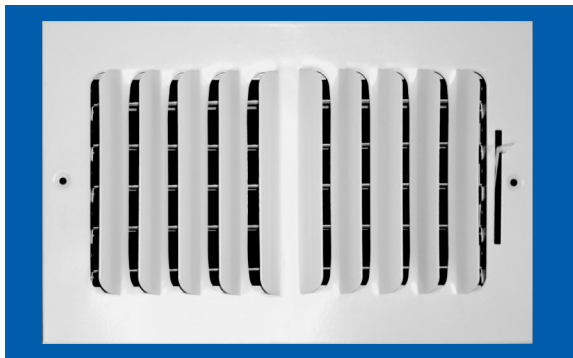

402VM - Available Sizes (in inches)									
HEIGHT	WIDTH								
	4	6	8	10	12	14	16	18	20
2									
4			❖	❖		❖			
6				❖	❖	❖			❖
8					❖	❖			
10									
12									
14									
16									

400 Series Registers

- ❖ 1, 2, 3, and 4-way air patterns on face with multi-louver shutter damper in rear
- ❖ Single lever operated multi-louver shutter
- ❖ Counter-sunk screw holes with 1/4" hexagonal screws (provided)
- ❖ Finished with white powder coating
- ❖ Each grille is individually shrink wrapped

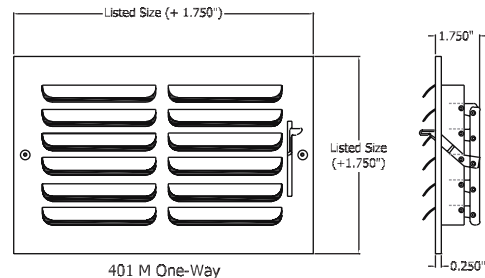

Model 403M Three Way



403M - Available Sizes (in inches)

HEIGHT	WIDTH									
	4	6	8	10	12	14	16	18	20	
2										
4			✦	✦	✦	✦				
6		✦	✦	✦	✦	✦	✦			
8			✦	✦	✦	✦				
10				✦	✦	✦				
12					✦	✦				
14						✦				
16							✦			

Model 404M Four Way



404M - Available Sizes (in inches)

HEIGHT	WIDTH									
	4	6	8	10	12	14	16	18	20	
2										
4										
6		✦								
8			✦							
10				✦						
12					✦					
14						✦				
16							✦			

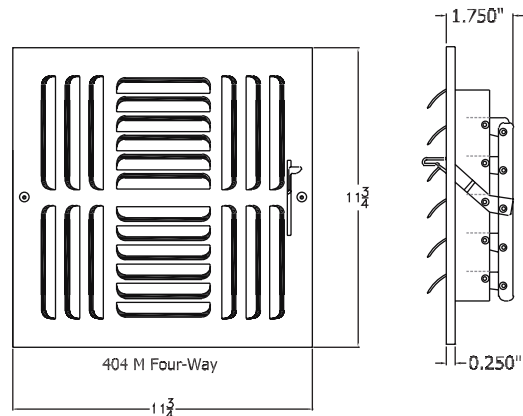
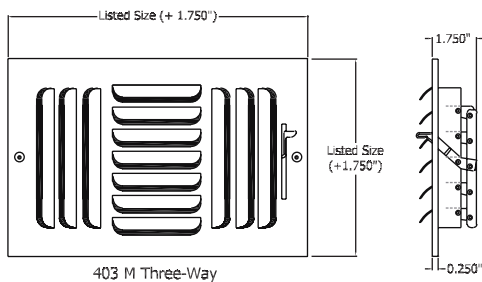



SQUARE CEILING DIRECTIONAL DIFFUSERS

Square Ceiling Diffuser

Model 560M Square Ceiling Diffuser

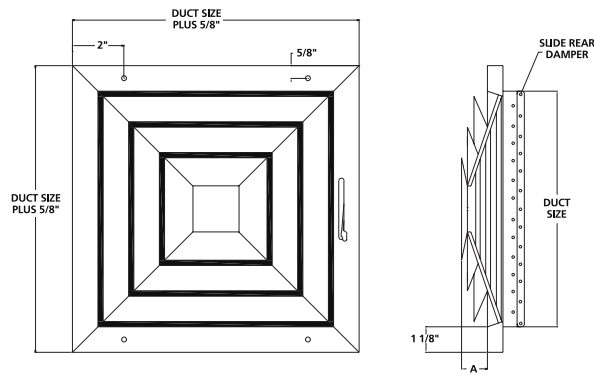
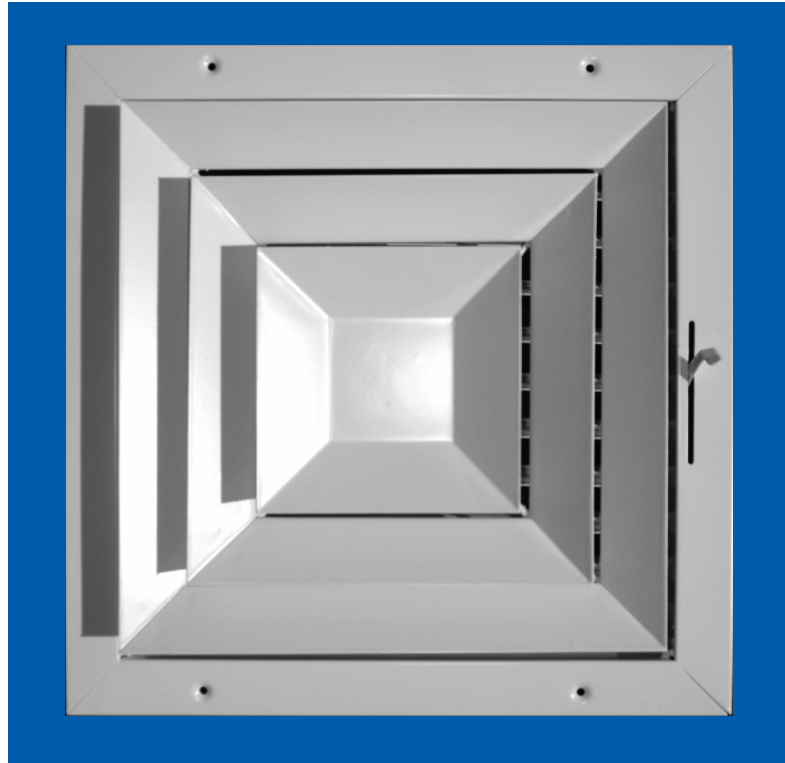

Model 560M

- ❖ Square ceiling directional diffuser
- ❖ 4-way air diffusion
- ❖ Single lever operated multi-louver shutter
- ❖ Finished with white powder coating
- ❖ Each grille is individually shrink wrapped

560M - Available Sizes (in inches)									
HEIGHT	WIDTH								
	6	8	10	12	14	16	18	20	22
6	❖								
8		❖							
10			❖						
12				❖					
14					❖				
16						❖			
18							❖		
20								❖	



Model 600M 4 Way Cooler Diffuser



SIZE	A	B
10 X 10	13"	10.25"
10 X 10	13"	10.25"
12 X 12	15"	12.25"
14 X 14	17"	14.25"
16 X 16	19"	16.25"
18 X 18	21"	18.25"
20 X 20	23"	20.25"
22 X 22	25"	22.25"
24 X 24	27"	24.25"
26 X 26	29"	26.25"
30 X 30	33"	30.25"
32 X 32	35"	32.25"

* PLEASE CONTACT US FOR ALL SIZES NOT LISTED

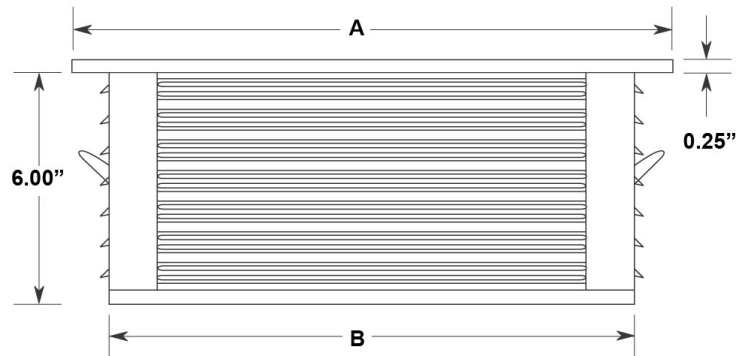

Model 600M

- ❖ Suitable for large air volume delivery from control blower system for evaporative cooling, heating and ventilation systems
- ❖ Adjustable louver shutter dampers on all four sides
- ❖ 22 gauge steel is used for longer lasting product life
- ❖ Finished with white powder coating

600M - Available Sizes (in inches)												
HEIGHT	WIDTH											
	10	12	14	16	18	20	22	24	26	28	30	32
10	❖											
12		❖										
14			❖									
16				❖								
18					❖							
20						❖						
22							❖					
24								❖				
26									❖			
28										❖		
30											❖	
32												❖

* PLEASE CONTACT US FOR ALL SIZES NOT LISTED



FLUSH DIFFUSER: High Velocity Multi-Louver

High Velocity Flush Diffuser

Model 700M Flush Diffuser

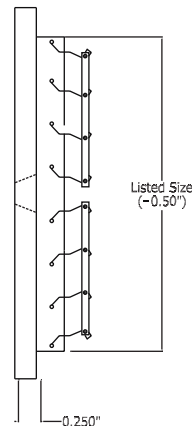
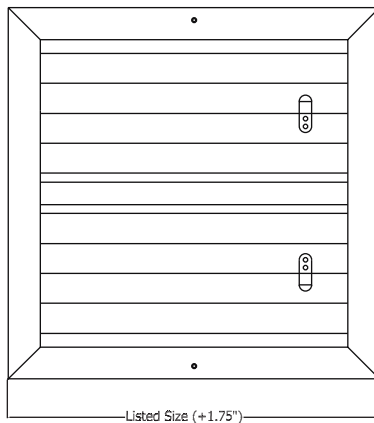

Model 700M

- ❖ Designed for evaporative air supply or high velocity air exhaust applications
- ❖ Center divided multi-louver with slit-in-handle on the frame
- ❖ Counter sunk screw holes with 2" screws (*provided*)
- ❖ Finished with white powder coating
- ❖ Each grille is individually shrink wrapped

700M - Available Sizes (in inches)										
HEIGHT	WIDTH									
	6	8	10	12	14	16	18	20	22	24
6	❖									
8		❖								
10			❖							
12				❖						
14					❖					
16						❖				
18							❖			
20								❖		
22									❖	
24										❖

* PLEASE CONTACT US FOR ALL SIZES NOT LISTED

Model 800



- ❖ Round ceiling diffuser
- ❖ Step-down diffuser rings deflect air stream 360°
- ❖ All steel construction
- ❖ Finished with white powder coating

MODEL	SIZES AVAILABLE
800	6" • 8" • 10" • 12" • 14" • 18"

Model 801

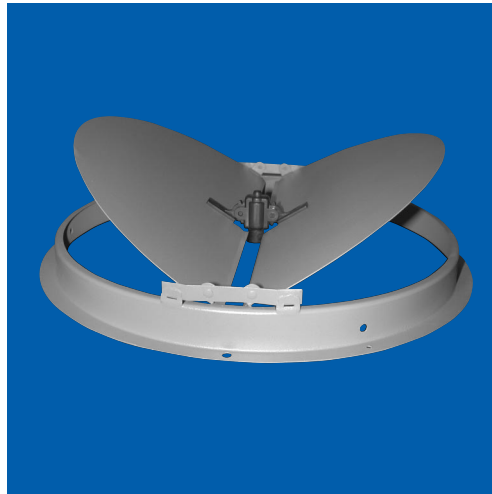

- ❖ Round duct ring with butterfly damper (assembled)
- ❖ Removable knob control
- ❖ Brown powder coat finish

MODEL	SIZES AVAILABLE
801	6" • 8" • 10" • 12" • 14" • 18"

Model 802

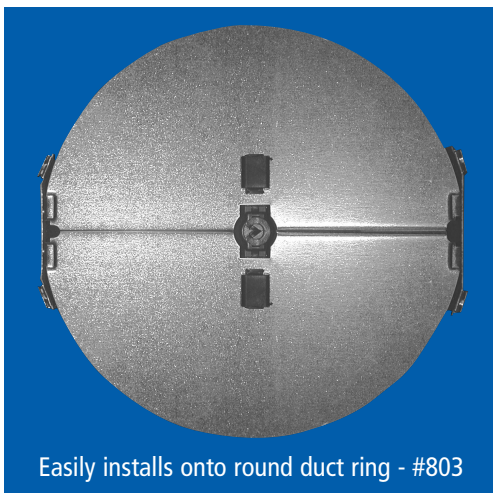

- ❖ Round butterfly damper
- ❖ Removable knob control
- ❖ All steel construction
- ❖ Brown powder coat finish

MODEL	SIZES AVAILABLE
802	6" • 8" • 10" • 12" • 14" • 18"

Model 803

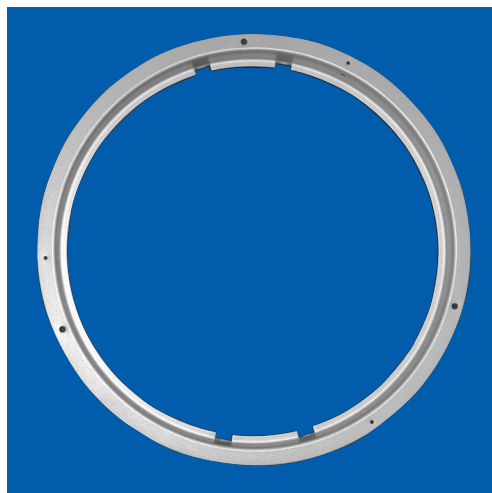

- ❖ Duct ring - to install onto a round diffuser when not using a damper
- ❖ All steel construction
- ❖ Brown powder coat finish

MODEL	SIZES AVAILABLE
803	6" • 8" • 10" • 12" • 14" • 18"



STAMPED FACE: Return Air Grille - 1/2" Spaced Fin

Return Air Grille - 1/2" Spaced Fin

Model 170

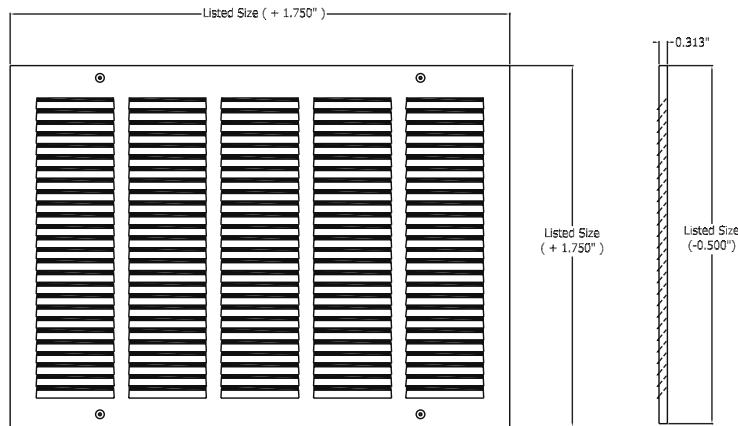
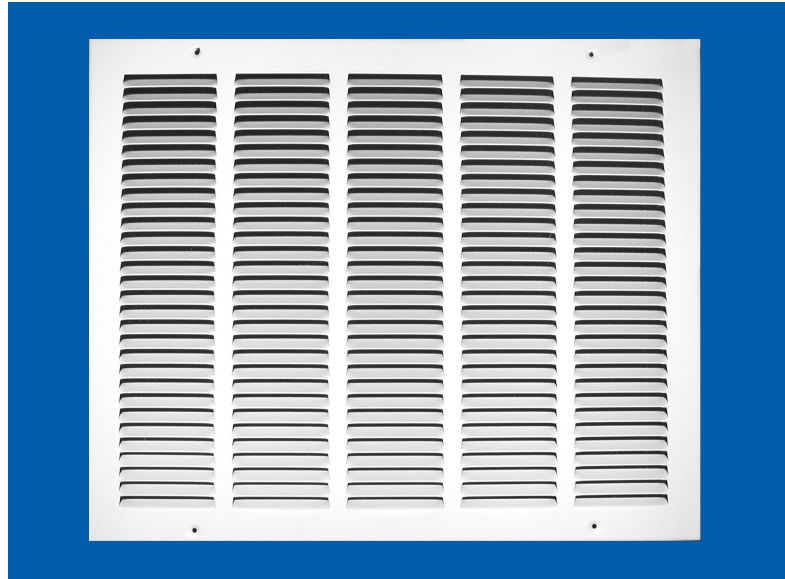

Model 170

- ❖ 1/2" louver spaced in dual angular formation for greater strength and maximum area
- ❖ Counter-sunk screw holes with 2" screws (provided)
- ❖ Finished with white powder coating
- ❖ Each grille is individually shrink wrapped

170 - Available Sizes (in inches)														
HEIGHT	WIDTH													
	6	8	10	12	14	16	18	20	24	25	26	30	36	40
2									❖			❖		
4	❖	❖	❖	❖	❖	❖	❖	❖	❖			❖		
6	❖	❖	❖	❖	❖	❖	❖	❖	❖			❖	❖	❖
8		❖	❖	❖	❖	❖	❖	❖	❖			❖	❖	❖
10			❖	❖	❖	❖	❖	❖	❖			❖	❖	❖
12				❖	❖	❖	❖	❖	❖		❖	❖	❖	❖
14		❖	❖		❖	❖	❖	❖	❖	❖	❖	❖	❖	❖
16				❖	❖	❖	❖	❖	❖	❖		❖	❖	❖
18					❖	❖	❖	❖	❖			❖	❖	❖
20				❖	❖	❖	❖	❖	❖	❖		❖	❖	❖
24				❖	❖	❖	❖	❖	❖			❖	❖	❖
25					❖	❖	❖	❖	❖			❖	❖	❖
30			❖	❖	❖		❖	❖	❖			❖	❖	❖
32								❖	❖					❖
36					❖		❖	❖						❖



Model 173

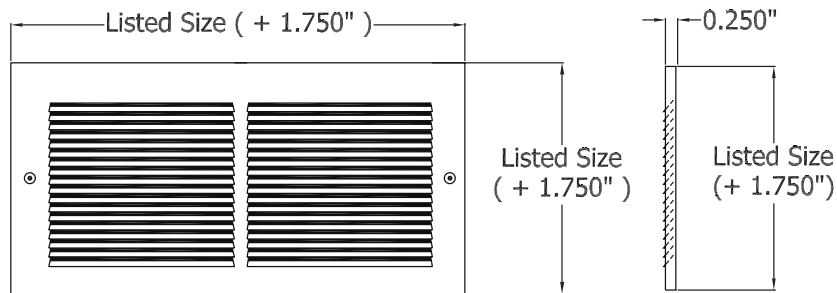
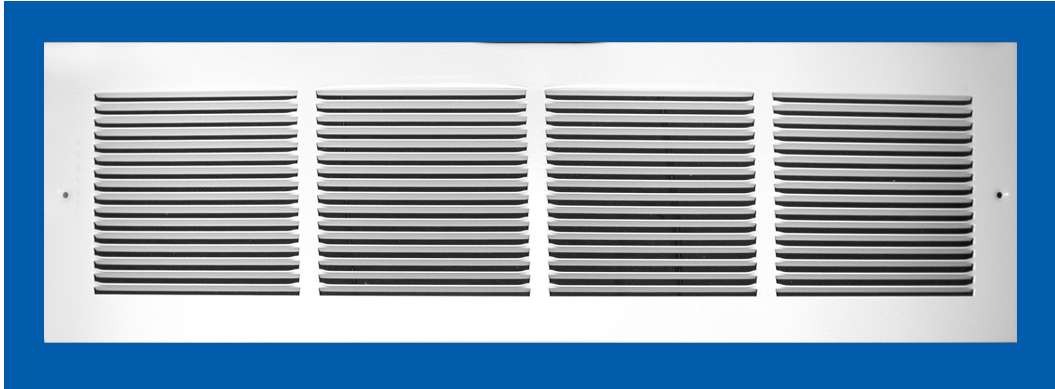

Model 173

- ❖ 1/3" louver spaced in dual angular formation for greater strength and maximum area
- ❖ Counter-sunk screw holes with 2" screws (provided)
- ❖ Finished with white powder coating
- ❖ Each grille is individually shrink wrapped

HEIGHT	WIDTH						
	8	10	12	14	20	24	30
4	❖						
6	❖	❖	❖	❖	❖	❖	
8		❖	❖	❖	❖	❖	
10				❖	❖	❖	❖
12				❖		❖	❖

* PLEASE CONTACT US FOR ALL SIZES NOT LISTED

Model 270 Shown Closed

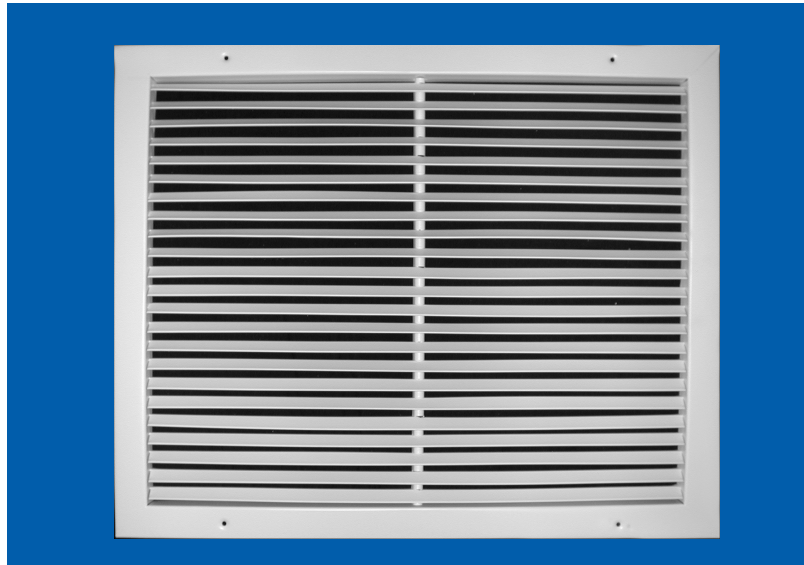

270 Series Registers

- ❖ Fixed horizontal blade return air grille
- ❖ Front fin angle is fixed at 45° in 1/2" spacing
- ❖ Counter-sunk screw holes with 1/4" hexagon-head screws (provided)
- ❖ Finished with white powder coating
- ❖ Each grille is individually shrink wrapped

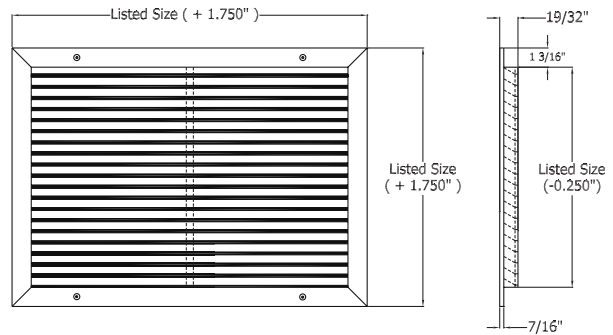

270 - Available Sizes (in inches)																
HEIGHT	WIDTH															
	6	8	10	12	14	16	18	20	24	25	26	28	30	36	38	40
4		❖	❖	❖	❖				❖				❖			
6	❖	❖	❖	❖	❖	❖	❖	❖	❖				❖	❖		
8		❖	❖	❖	❖	❖	❖	❖	❖				❖	❖		
10			❖	❖	❖	❖	❖	❖	❖				❖	❖		
12				❖	❖	❖	❖	❖	❖		❖		❖	❖		
14					❖	❖	❖	❖	❖	❖		❖	❖	❖	❖	
16						❖		❖	❖	❖	❖		❖	❖	❖	❖
18			❖				❖	❖	❖			❖	❖	❖		
20			❖		❖			❖	❖	❖			❖	❖		❖
24				❖	❖	❖		❖	❖				❖	❖		
26													❖			
30					❖			❖	❖				❖			
36				❖			❖									
40													❖			

* PLEASE CONTACT US FOR ALL SIZES NOT LISTED

STAMPED FACE: Return Air Filter Grilles



Model 190 Shown Closed

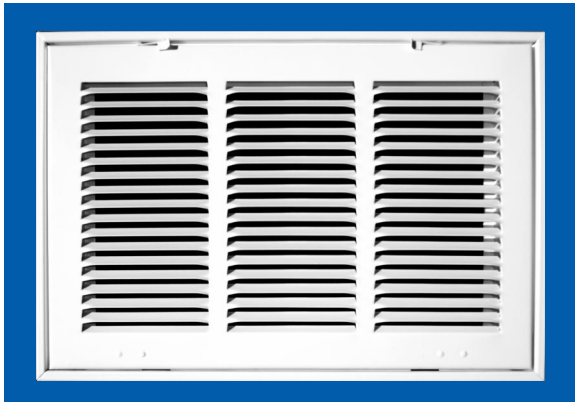

Model 190 Shown Open - Hinged



- ❖ 1/2" louver spaced in dual angular formation for greater strength and maximum area
- ❖ Sturdy steel case is en-framed for a 1" air filter (not included)
- ❖ Counter-sunk screw holes with 1/4" hexagon-head screws (provided)
- ❖ Top latch and bottom hinge
- ❖ Finished with white powder coating
- ❖ Each grille is individually shrink wrapped

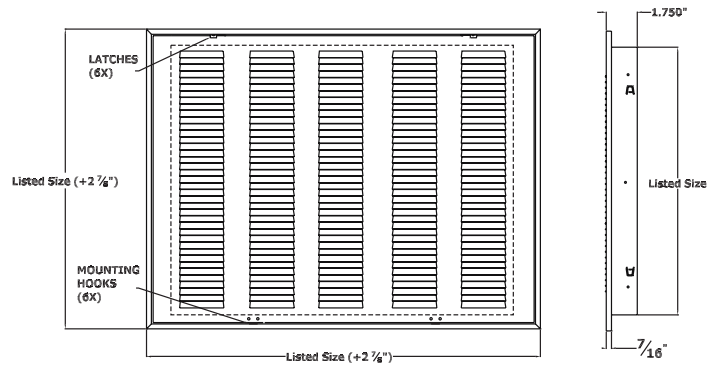

190 - Available Sizes (in inches)

HEIGHT	WIDTH																
	8	10	12	14	16	18	20	22	24	25	26	29	30	32	36	40	50
6							❖		❖				❖				
8	❖			❖			❖		❖				❖				
10		❖		❖	❖	❖	❖	❖	❖				❖	❖	❖	❖	
12			❖			❖	❖	❖	❖	❖			❖		❖		
14				❖	❖	❖	❖	❖	❖	❖	❖		❖		❖		
16					❖		❖	❖	❖	❖	❖	❖		❖		❖	
18			❖			❖	❖	❖	❖	❖			❖		❖		
20		❖	❖	❖	❖	❖	❖	❖	❖	❖			❖		❖	❖	❖
22								❖				❖	❖				
24		❖	❖	❖	❖	❖	❖		❖				❖		❖		
25				❖	❖		❖			❖							
26				❖													
29								❖				❖	❖				
30			❖	❖	❖	❖	❖		❖				❖		❖		
32										❖							
36			❖	❖	❖	❖	❖		❖						❖		
40							❖										
50							❖										

* PLEASE CONTACT US FOR ALL SIZES NOT LISTED



STAMPED FACE: Return Air Filter Grilles

Model 190RF Shown Closed

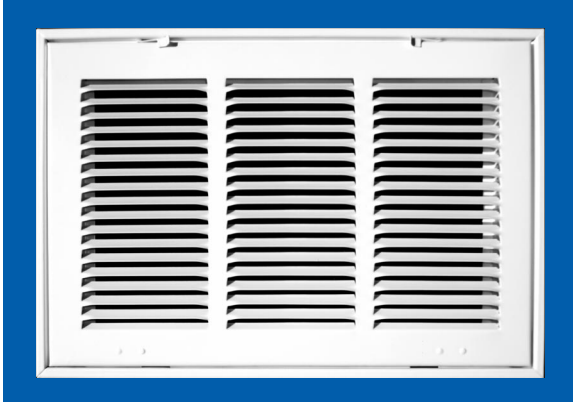

Model 190RF Shown Open - Removable Face

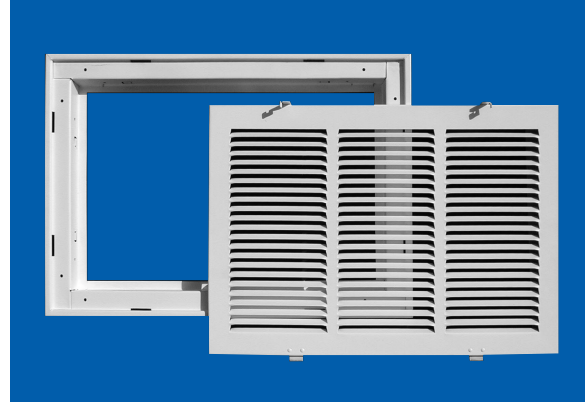

- ❖ 1/2" louver spaced in dual angular formation for greater strength and maximum area
- ❖ Sturdy steel case is en-framed for a 1" air filter (*not included*)
- ❖ Counter-sunk screw holes with 1/4" hexagon-head screws (*provided*)
- ❖ Top latch and bottom hinge
- ❖ Finished with white powder coating
- ❖ Each grille is individually shrink wrapped

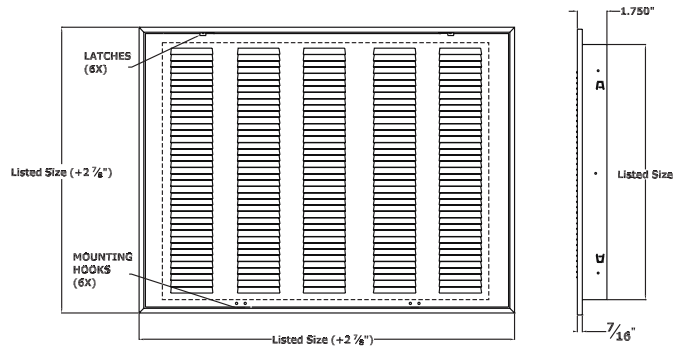

NOTE: Model 190RF features a completely removable front panel for easy-to-use access.

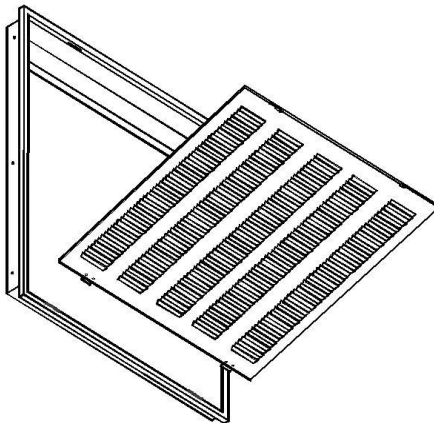

190RF - Available Sizes (in inches)										
HEIGHT	WIDTH									
	10	12	14	16	18	20	24	25	30	36
6							❖			
8									❖	
10	❖		❖	❖		❖			❖	❖
12		❖			❖	❖	❖		❖	
14			❖			❖	❖	❖	❖	
16				❖		❖		❖	❖	
18		❖			❖		❖		❖	
20	❖	❖	❖	❖			❖	❖	❖	
24		❖	❖	❖			❖	❖	❖	
25			❖	❖			❖			
30		❖	❖	❖			❖			

* PLEASE CONTACT US FOR ALL SIZES NOT LISTED



Model 290 Shown Closed



Model 290 Shown Open

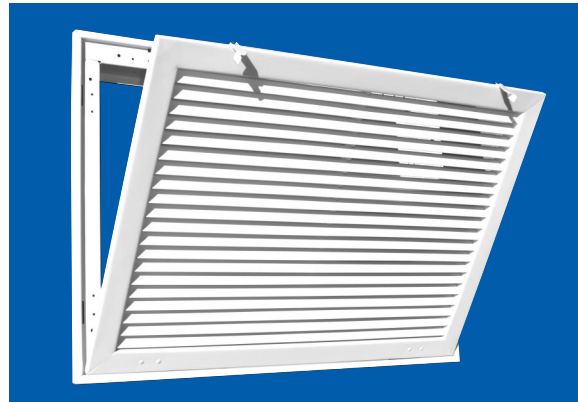

290 Series Registers

- ❖ Fixed horizontal blade return air filter grille
- ❖ Sturdy steel case is enframed for 1" air filter (*not included*)
- ❖ Front fin angle is fixed at 45° in 1/2" spacing
- ❖ Counter-sunk screw holes with 1/4" hexagon-head screws (*provided*)
- ❖ Finished with white powder coating
- ❖ Each grille is individually shrink wrapped

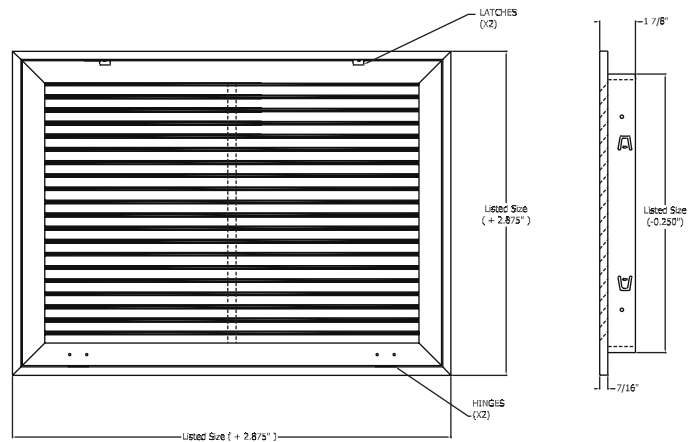

290 - Available Sizes (in inches)												
HEIGHT	WIDTH											
	10	12	14	16	18	20	24	25	30	36	40	50
6						❖						
8			❖						❖			
10	❖	❖		❖		❖	❖		❖			
12		❖			❖	❖	❖	❖	❖	❖		
14			❖			❖	❖	❖	❖	❖		
16				❖		❖	❖	❖	❖	❖		
18					❖	❖	❖		❖			
20		❖	❖			❖	❖	❖	❖	❖	❖	❖
24		❖	❖			❖	❖		❖	❖		
25						❖		❖				
30			❖	❖	❖	❖						
40						❖						
50						❖						

* PLEASE CONTACT US FOR ALL SIZES NOT LISTED



ACCESS DOOR: Single Panel

Model ACD690 Access Door - Shown Closed

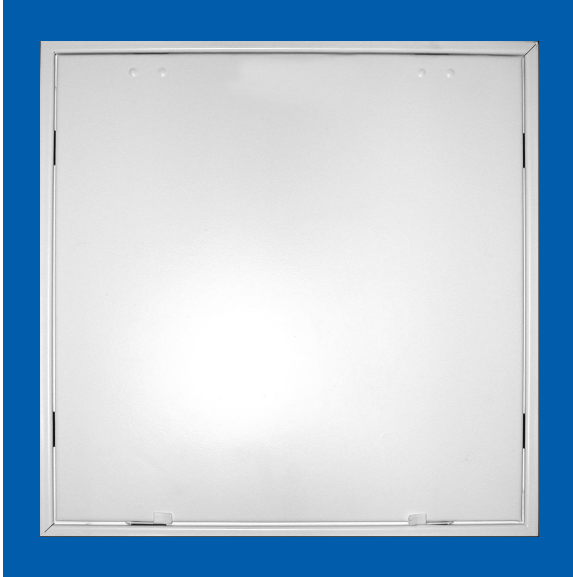

Model ACD690 Access Door - Shown Open



Access Door

Model ACD690	
SIZES AVAILABLE	PACKAGE
10 x 10	10
12 x 12	10
14 x 14	10
16 x 16	5
18 x 18	5
20 x 20	1

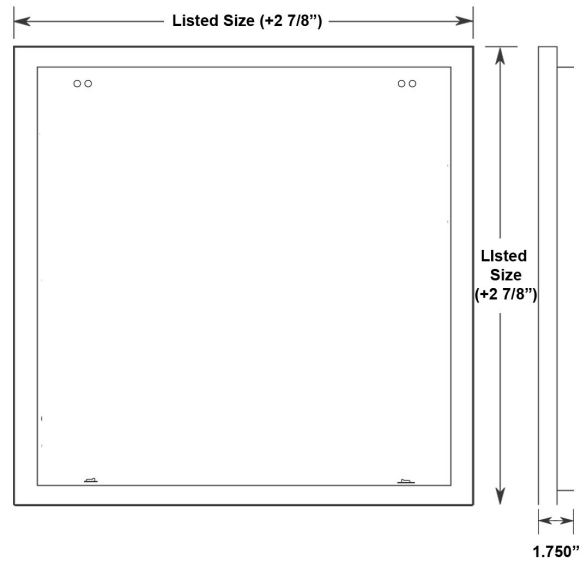

Model ACD690

- ❖ 22 gauge steel frame
- ❖ 22/24 gauge steel door panel
- ❖ Finished with white powder coating
- ❖ Hinged at top and bottom latched
- ❖ Each door panel individually shrink wrapped

Model ACD2440 Shown Closed

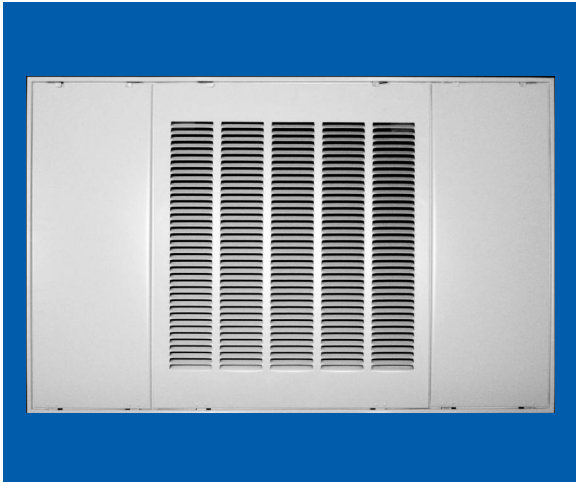

Model ACD2440 Shown Open

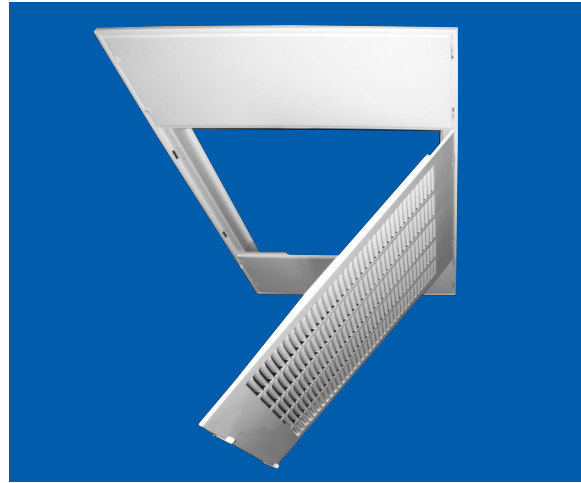

MODEL	DESCRIPTION	PACKAGE
ACD2440L	24 x 40	1
ACD2446L	24 x 46	1
ACD2452L	24 x 52	1
ACD2460L	24 x 60	1

MODEL	DESCRIPTION	PACKAGE
ACD2440S	24 x 40	1
ACD2446S	24 x 46	1
ACD2452S	24 x 52	1
ACD2460S	24 x 60	1

ACD2440 Series

- ❖ Designed for ceiling or sidewall access panel application
- ❖ Access only (solid) - Service/Return air (louvered)
- ❖ Heavy gauge steel and sturdy steel case is enframed to accept standard 20" x 20" x 1" filter (not included)
- ❖ Top mounted with hooks and bottom latched face
- ❖ 1/2" louvered spaced in dual angular formation for higher strength and maximum free area
- ❖ Easy install and maintenance
- ❖ White powder coat finish

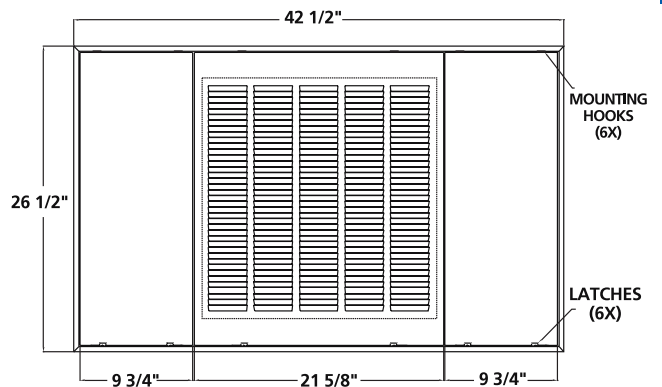

MODEL ACD2440L Shown

	A	B	C	D	
MODEL	DESCRIPTION	Drywall Opening	Frame Dimensions	Access Clearance	Outside Frame Dimensions
ACD2440L	Louvered	24" x 40"	23 5/8" x 39 5/8"	22 5/8" x 38 5/8"	26 1/2" x 42 1/2"
ACD2440S	Solid	24" x 40"	23 5/8" x 39 5/8"	22 5/8" x 38 5/8"	26 1/2" x 42 1/2"
ACD2446L	Louvered	24" x 46"	23 5/8" x 45 5/8"	22 5/8" x 44 5/8"	26 1/2" x 48 1/2"
ACD2446S	Solid	24" x 46"	23 5/8" x 45 5/8"	22 5/8" x 44 5/8"	26 1/2" x 48 1/2"
ACD2452L	Louvered	24" x 52"	23 5/8" x 51 5/8"	22 5/8" x 50 5/8"	26 1/2" x 54 1/2"
ACD2452S	Solid	24" x 52"	23 5/8" x 51 5/8"	22 5/8" x 50 5/8"	26 1/2" x 54 1/2"
ACD2460L	Louvered	24" x 60"	23 5/8" x 59 5/8"	22 5/8" x 58 5/8"	26 1/2" x 62 1/2"
ACD2460S	Solid	24" x 60"	23 5/8" x 59 5/8"	22 5/8" x 58 5/8"	26 1/2" x 62 1/2"

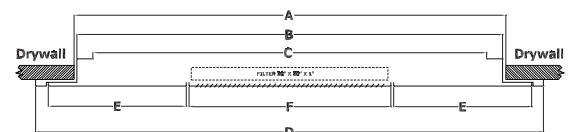



T-BAR LAY-IN: Perforated-Fiberglass Return/Supply

Model 1010MAS / MAR Front

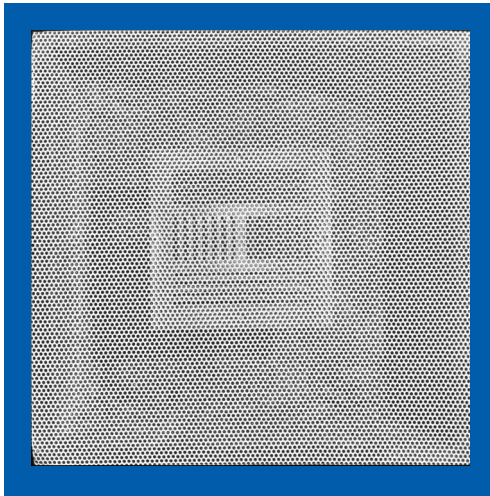

Model 1010MAS / MAR Back

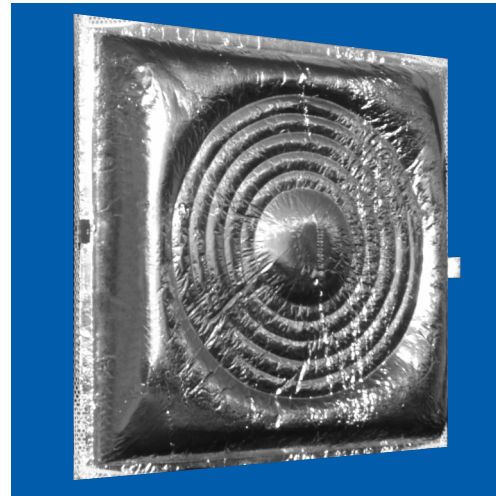

1010MAS / MAR

- ❖ Face: Perforated steel with a white powder finish
- ❖ Back: Fiberglass molded plenum / Seismic support tab
- ❖ MAS Model: 4 way directional air control blade

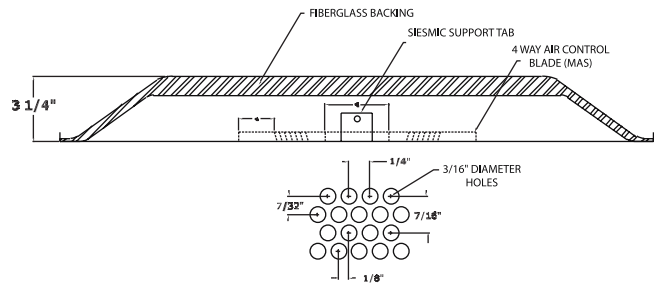

MODEL	DESCRIPTION	PACKAGE
1010MAR	Fiberglass Back/Return	4
1010MAS	Fiberglass Back/Supply	4

Model 1020MAS / MAR Front

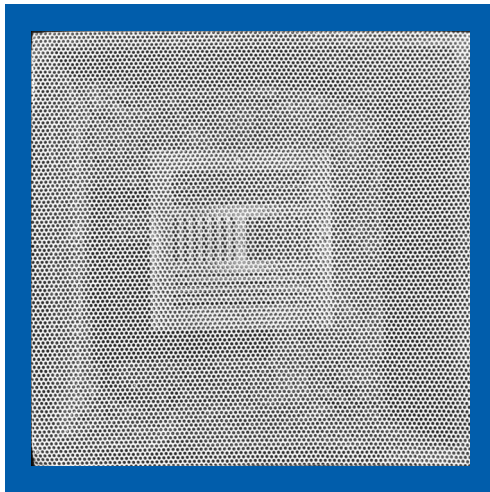

Model 1020MAS / MAR Back

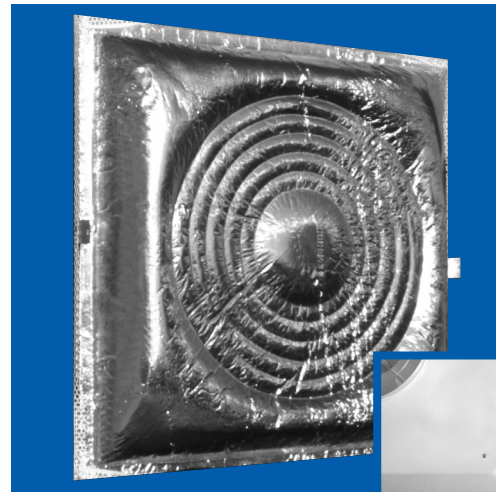

Detail

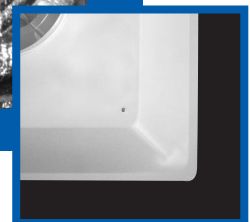

1020MAS / MAR

- ❖ Face: Perforated steel with a white powder finish
- ❖ Back: Steel / Seismic support tab
- ❖ MAS Model: 4 way directional air control blade
- ❖ Insulation Available

MODEL	DESCRIPTION	PACKAGE
1020MAS	Steel Back/Return	4
1020MAR	Steel Back/Supply	4

T-Bar Lay-In - Perforated Return/Supply

T-BAR LAY-IN: Perforated T-Bar Supply/Return



T-Bar Lay-In - Perforated Return/Supply

Model 1400CB

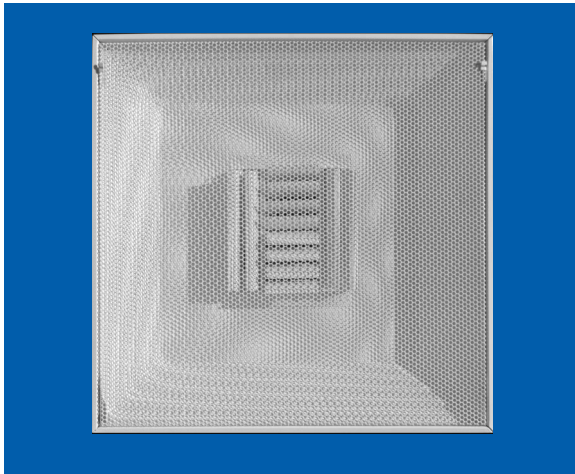

Model 1444RG

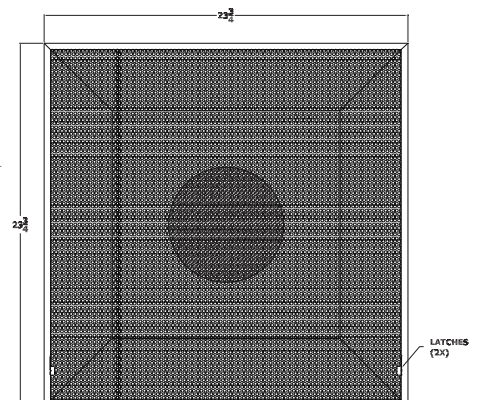
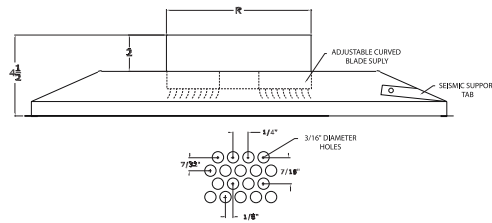
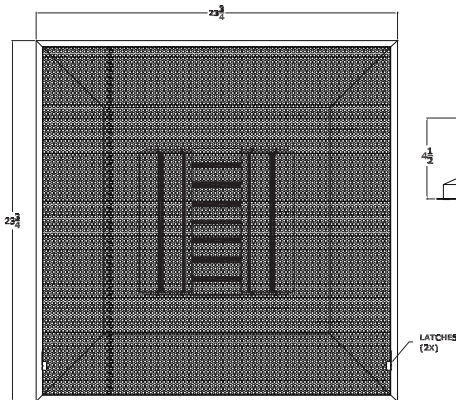
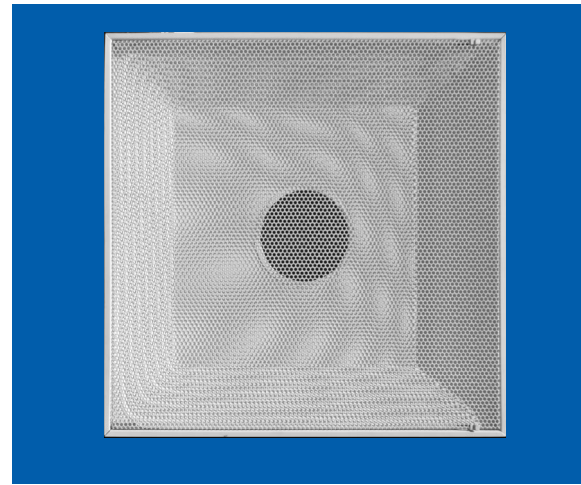

1400CB

- ❖ Perforated T-bar supply
- ❖ Adjustable curved blade supply
- ❖ Removable perforated panel
- ❖ Seismic support tab

1444RG

- ❖ Perforated T-bar return
- ❖ Removable perforated panel
- ❖ Seismic support tab

MODEL	DESCRIPTION	PACKAGE
1400CB-6	6" Round Neck	2
1400CB-8	8" Round Neck	2
1400CB-10	10" Round Neck	2
1400CB-12	12" Round Neck	2
1400CB-14	14" Round Neck	2
1400CB-16	16" Round Neck	2
1400CB-18	18" Round Neck	2
1400CB-20	20" Round Neck	2
1410CB-14	14" Square Neck	2

MODEL	DESCRIPTION	PACKAGE
1444RG-6	6" Round Neck	2
1444RG-8	8" Round Neck	2
1444RG-10	10" Round Neck	2
1444RG-12	12" Round Neck	2
1444RG-14	14" Round Neck	2
1444RG-16	16" Round Neck	2
1444RG-18	18" Round Neck	2
1444RG-20	20" Round Neck	2
1455RG-14	14" Square Neck	2

Model 2002CD

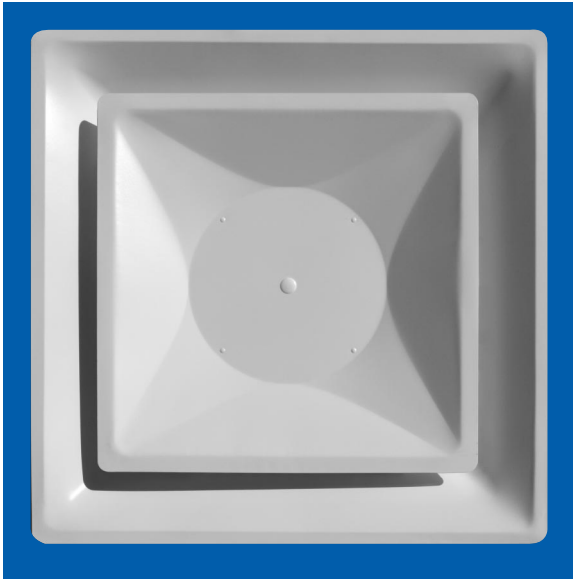

Model 2003CD

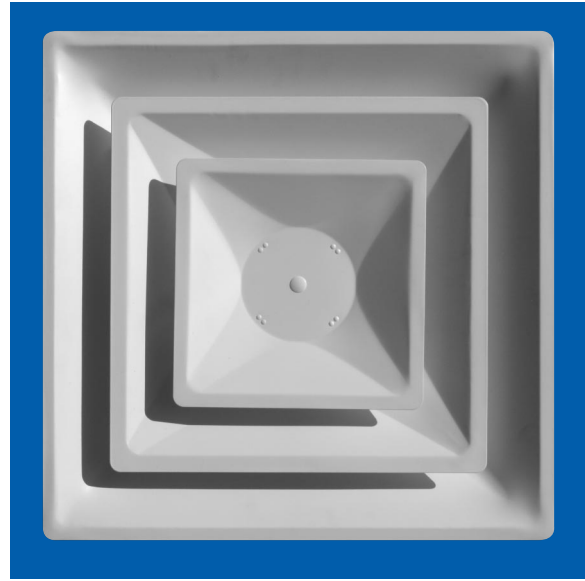

Model 2004CD

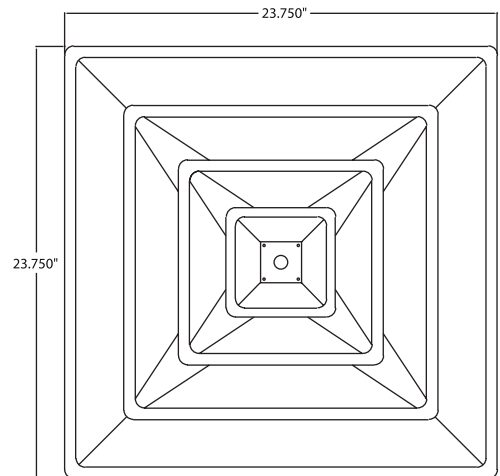
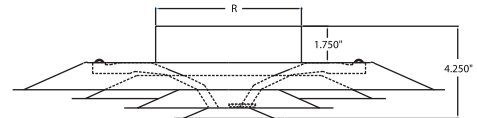

- ❖ 2 and 3 cone step-down diffusers
- ❖ Heavy Electro-Galvanized steel construction
- ❖ Finished with white powder coating
- ❖ Seismic support tab
- ❖ Also available with insulation & butterfly dampers

Model 2002CD

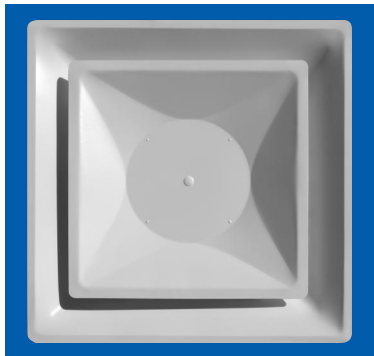

Steel Construction

Standard		
MODEL	DESCRIPTION	PACKAGE
2002CD-6	6" Round Neck	2
2002CD-8	8" Round Neck	2
2002CD-10	10" Round Neck	2
2002CD-12	12" Round Neck	2
2002CD-14	14" Round Neck	2
2010CD-14	14" Square Neck	2

Steel Construction

with R-6 Insulation		
MODEL	DESCRIPTION	PACKAGE
2002CD-6IN	6" Round Neck	2
2002CD-8IN	8" Round Neck	2
2002CD-10IN	10" Round Neck	2
2002CD-12IN	12" Round Neck	2
2002CD-14IN	14" Round Neck	2
2010CD-14IN	14" Square Neck	2

Steel Construction

with R-6 Insulation & Butterfly Damper		
MODEL	DESCRIPTION	PACKAGE
2002CD-6INBD	6" Round Neck	2
2002CD-8INBD	8" Round Neck	2
2002CD-10INBD	10" Round Neck	2
2002CD-12INBD	12" Round Neck	2
2002CD-14INBD	14" Round Neck	2
2010CD-14INBD	14" Square Neck	2

Model 2003CD Two Cone

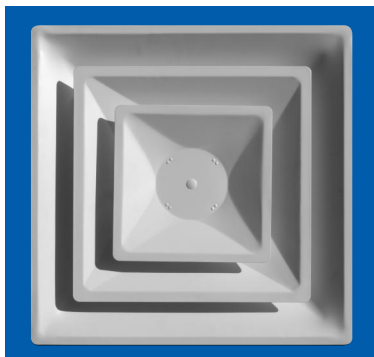

Steel Construction

Standard		
MODEL	DESCRIPTION	PACKAGE
2003CD-6	6" Round Neck	2
2003CD-8	8" Round Neck	2
2003CD-10	10" Round Neck	2
2003CD-12	12" Round Neck	2
2003CD-14	14" Round Neck	2
2013CD-14	14" Square Neck	2

Steel Construction

with R-6 Insulation		
MODEL	DESCRIPTION	PACKAGE
2003CD-6IN	6" Round Neck	2
2003CD-8IN	8" Round Neck	2
2003CD-10IN	10" Round Neck	2
2003CD-12IN	12" Round Neck	2
2003CD-14IN	14" Round Neck	2
2013CD-14IN	14" Square Neck	2

Steel Construction

with R-6 Insulation & Butterfly Damper		
MODEL	DESCRIPTION	PACKAGE
2003CD-6INBD	6" Round Neck	2
2003CD-8INBD	8" Round Neck	2
2003CD-10INBD	10" Round Neck	2
2003CD-12INBD	12" Round Neck	2
2003CD-14INBD	14" Round Neck	2
2013CD-14INBD	14" Square Neck	2

Model 2004CD Three Cone



Steel Construction

Standard		
MODEL	DESCRIPTION	PACKAGE
2004CD-6	6" Round Neck	2
2004CD-8	8" Round Neck	2
2004CD-10	10" Round Neck	2
2004CD-12	12" Round Neck	2
2004CD-14	14" Round Neck	2
2014CD-14	14" Square Neck	2

Steel Construction

with R-6 Insulation		
MODEL	DESCRIPTION	PACKAGE
2004CD-6IN	6" Round Neck	2
2004CD-8IN	8" Round Neck	2
2004CD-10IN	10" Round Neck	2
2004CD-12IN	12" Round Neck	2
2004CD-14IN	14" Round Neck	2
2014CD-14IN	14" Square Neck	2

Steel Construction

with R-6 Insulation & Butterfly Damper		
MODEL	DESCRIPTION	PACKAGE
2004CD-6INBD	6" Round Neck	2
2004CD-8INBD	8" Round Neck	2
2004CD-10INBD	10" Round Neck	2
2004CD-12INBD	12" Round Neck	2
2004CD-14INBD	14" Round Neck	2
2014CD-14INBD	14" Square Neck	2

T-BAR LAY-IN: Perforated-Fiberglass Return/Supply

Model 1120 Front

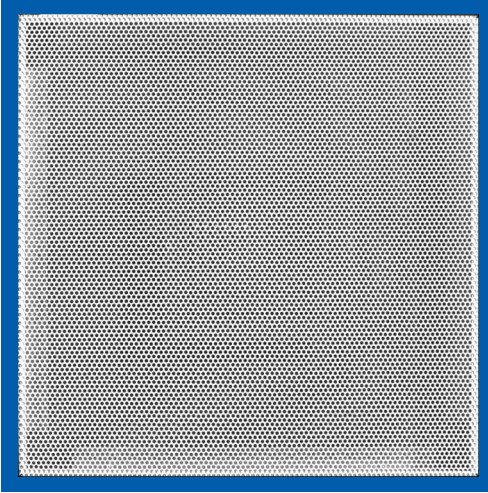

Model 1120 Back

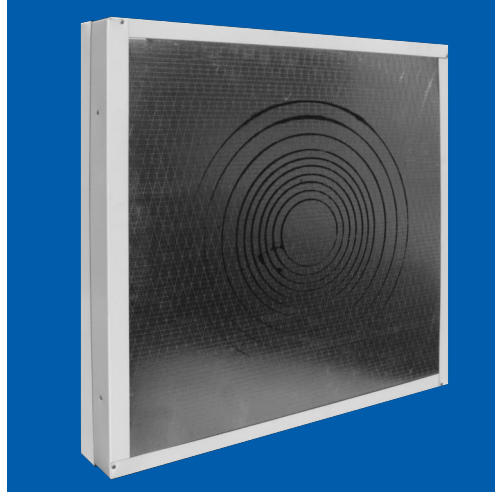

1120

- ❖ Face: Perforated steel with a white powder finish
- ❖ Supply: 4 way directional air control blade
- ❖ Available with or without 1" thick fiberglass ductboard with premarked radius and support tab

MODEL	DESCRIPTION	PACKAGE
1120R	Return NO ductboard	4
1120S	Supply NO ductboard	4
1120DBR	Return with ductboard	4
1120DBS	Supply with ductboard	4

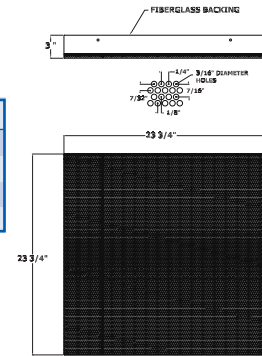

Model 1130/1140 Front

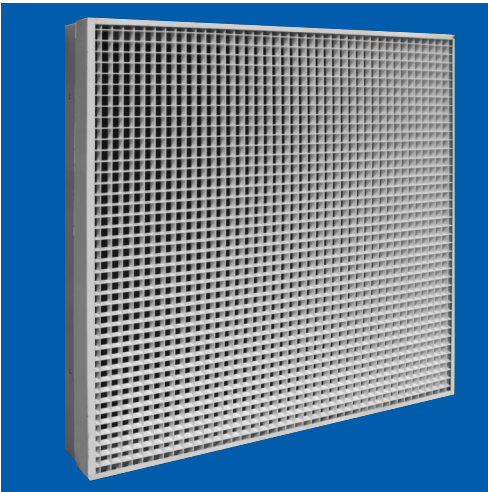

Model 1130/1140 Back

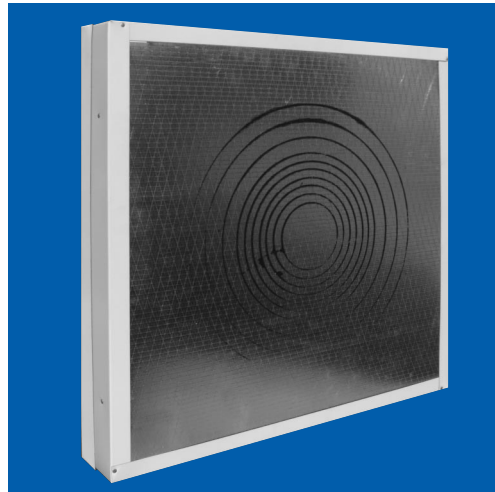

1130/1140

- ❖ Egg crate T-Bar return air grille
- ❖ 1130 - Acrylic • 1140 - Aluminum
- ❖ Available with or without 1" thick fiberglass ductboard with premarked radius and support tab

MODEL	DESCRIPTION	SIZE	PACKAGE
1130R-1	Acrylic/No Ductboard	1' x 2'	2
1130R-2	Acrylic/No Ductboard	2' x 2'	2
1130R-4	Acrylic/No Ductboard	4' x 2'	2
1130DBR-1	Acrylic with Ductboard	1' x 2'	2
1130DBR-2	Acrylic with Ductboard	2' x 2'	2
1130DBR-4	Acrylic with Ductboard	4' x 2'	2

MODEL	DESCRIPTION	SIZE	PACKAGE
1140R-1	Aluminum/No Ductboard	1' x 2'	2
1140R-2	Aluminum/No Ductboard	2' x 2'	2
1140R-4	Aluminum/No Ductboard	4' x 2'	2
1140DBR-1	Aluminum with Ductboard	1' x 2'	2
1140DBR-2	Aluminum with Ductboard	2' x 2'	2
1140DBR-4	Aluminum with Ductboard	4' x 2'	2

Model 1110RG Stamped Face

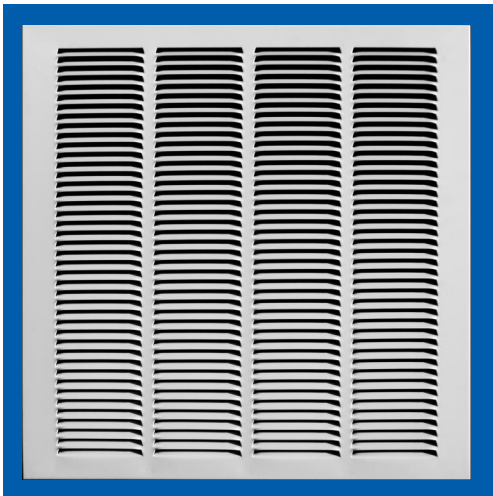

MODEL	DESCRIPTION	PACKAGE
1110RG	Stamped Face	5

- ❖ Stamped 1/2" Spaced
- ❖ Steel construction
- ❖ Mount flush with T-Bar ceiling
- ❖ White powder coated

Model 1210RG Fixed Bar Type



MODEL	DESCRIPTION	PACKAGE
1120RG	Fixed Bar Type	5

- ❖ Fixed Bar 1/2" Spaced
- ❖ Steel construction
- ❖ Mount flush with T-Bar ceiling
- ❖ White powder coated

1920RG

- ❖ Steel construction
- ❖ Mount flush with T-Bar ceiling
- ❖ White powder coated
- ❖ Perforated Face

Model 1920RG Peforated Screen

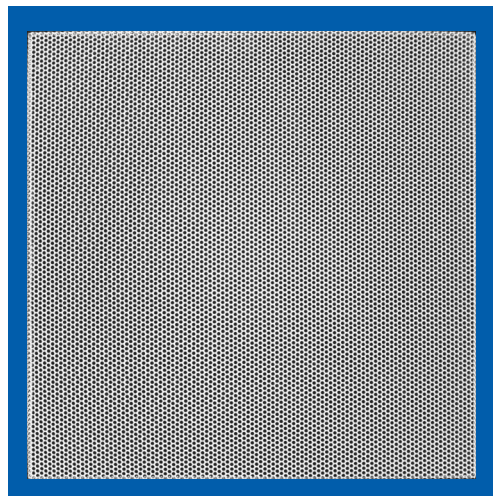

MODEL	SIZE	PACKAGE
1920G/1	1' x 2'	20
1920G/2	2' x 2'	20
1920G/4	2' x 4'	5



T-BAR LAY-IN: Egg Crate Return Grille

T-Bar Egg Crate Return Grille

Model 1930RG Acrylic

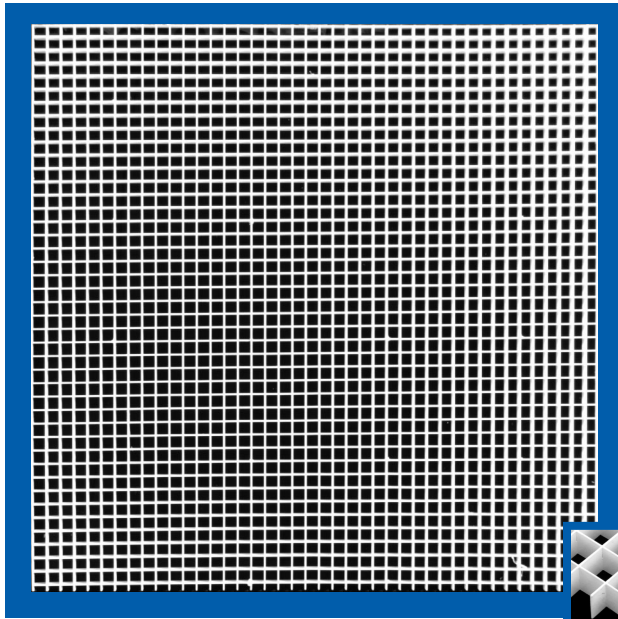

MODEL	DESC.	SIZE	PACKAGE
1930G/1	Acrylic	1' x 2'	20
1930G/2	Acrylic	2' x 2'	10
1930G/4	Acrylic	2' x 4'	10

Acrylic

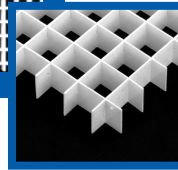

1/2" x 1/2" Acrylic Cell

Model 1940RG Aluminum

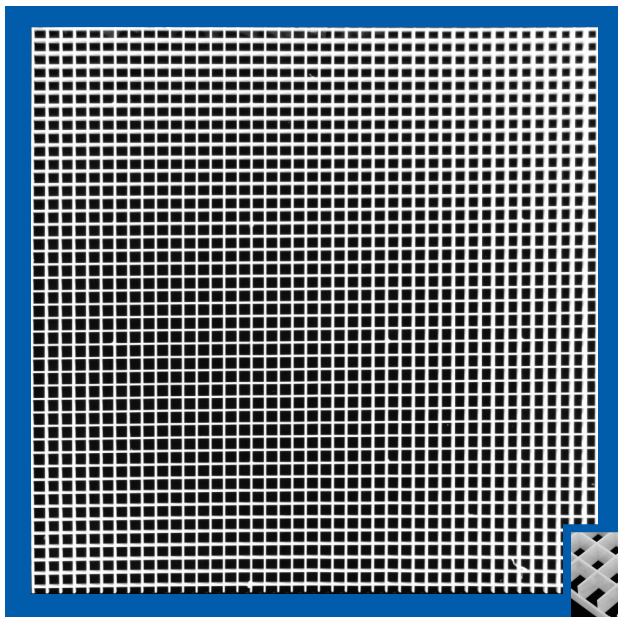

MODEL	DESC.	SIZE	PACKAGE
1940G/1	Aluminum	1' x 2'	20
1940G/2	Aluminum	2' x 2'	10
1940G/4	Aluminum	2' x 4'	10

Aluminum

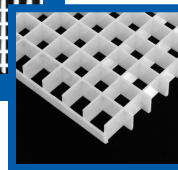

1/2" x 1/2" Aluminum Cell

Model 4010 Stamped Face

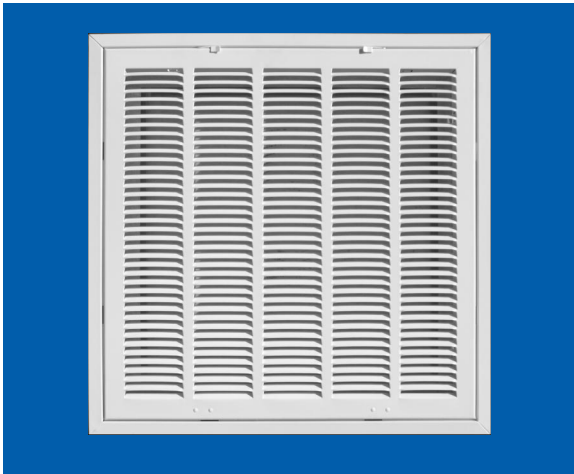

Model 4020 Fixed Blade



Model 4030 Perforated Face

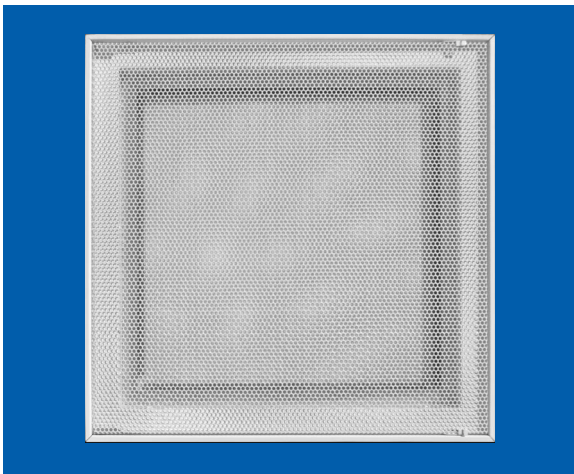

Fiberglass Backing

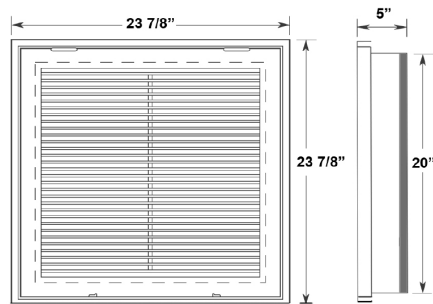
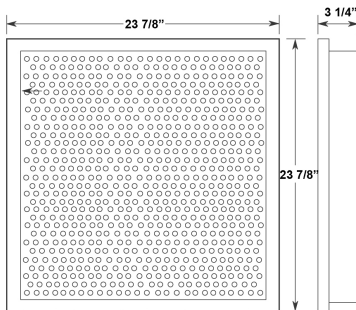
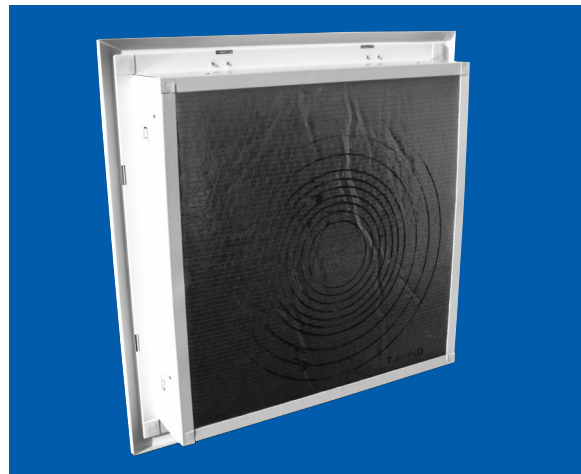

4010, 4020, 4030

- ❖ All models accept a standard 20" x 20" x 1" filter (Not included)
- ❖ Top latched and bottom hinged face for quick filter changes
- ❖ Finished with softder coating
- ❖ Available with or without fiberglass ductboard with pre-marked radius

MODEL	DESCRIPTION	SIZE	PACKAGE
4010FG	Stamped Face - NO Ductboard	2' x 2'	2
4010FG-DB	Stamped Face - WITH Ductboard	2' x 2'	2
4020FG	Fixed Bar - NO Ductboard	2' x 2'	2
4020FG-DB	Fixed Bar - WITH Ductboard	2' x 2'	2
4030FG	Perforated Face - NO Ductboard	2' x 2'	2
4030FG-DB	Perforated Face - WITH Ductboard	4' x 2'	2



ALUMINUM BAR TYPE SUPPLY: Side Wall/Ceiling

Model A210VM Single Deflection

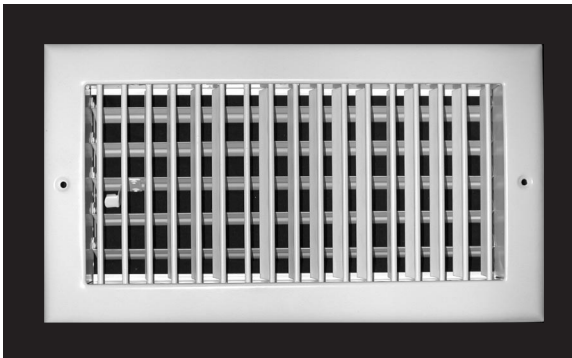

Model A230M Three-Way Deflection

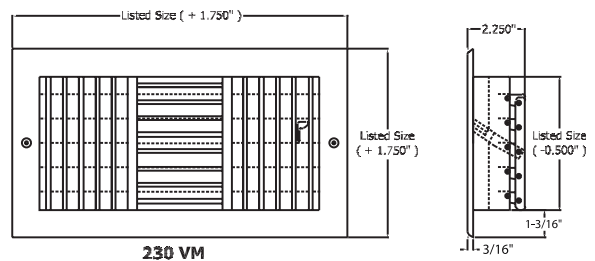
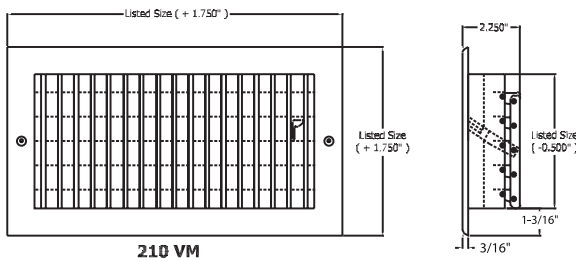
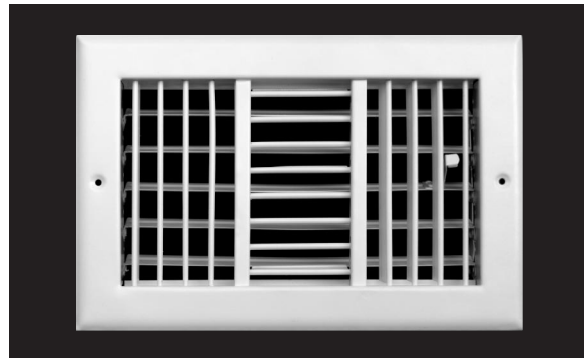

A200 Series Registers

- ❖ Aluminum single lever operated multi-louver rear damper (in steel)
- ❖ Aluminum face / Steel louver & damper
- ❖ Aluminum adjustable fins provide individual deflection control
- ❖ Counter-sunk screw holes with 1/4" hexagon-head screws (provided)
- ❖ Finished with white powder coating

Also Available *Not Shown

- A220H - Face Bar - Horizontal • 2nd Bar Vertical**
- A220V - Face Bar - Vertical • 2nd Bar Horizontal**

HEIGHT	WIDTH										
	6	8	10	12	14	16	18	20	24	26	30
4	❖	❖	❖	❖	❖	❖	❖	❖	❖		❖
6	❖	❖	❖	❖	❖	❖	❖	❖	❖		❖
8		❖	❖	❖	❖	❖	❖	❖	❖		❖
10			❖	❖	❖	❖	❖	❖	❖		❖
12				❖	❖	❖	❖	❖	❖		❖
14					❖	❖	❖	❖	❖		❖
16						❖	❖	❖	❖		❖
18							❖	❖	❖	❖	❖
20								❖	❖		❖
24									❖		❖

HEIGHT	WIDTH				
	8	10	12	14	16
4	❖	❖			
6	❖	❖	❖	❖	
8		❖	❖	❖	
10			❖	❖	
12				❖	
14					❖

* PLEASE CONTACT US FOR ALL SIZES NOT LISTED

ALUMINUM BAR TYPE SUPPLY: Side Wall/Ceiling



Aluminum Bar Type Register

Model A210VO Vertical with Single Deflection

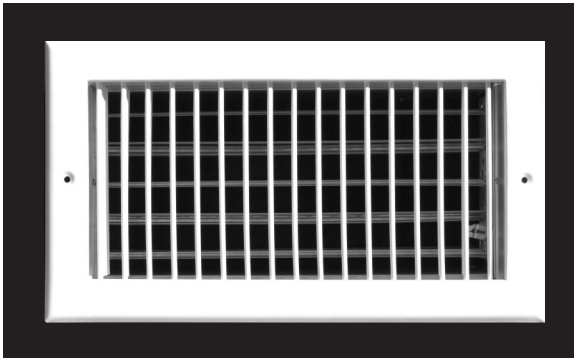

Model A220VO Vertical with Double Deflection

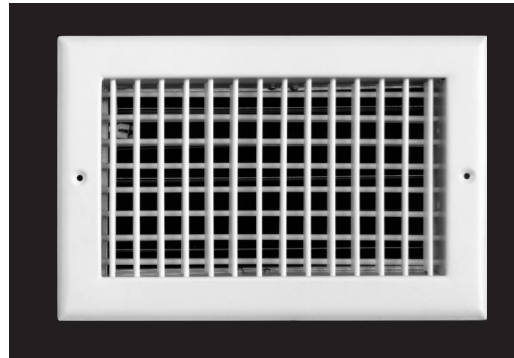

Model A220VO Reverse Side Shown

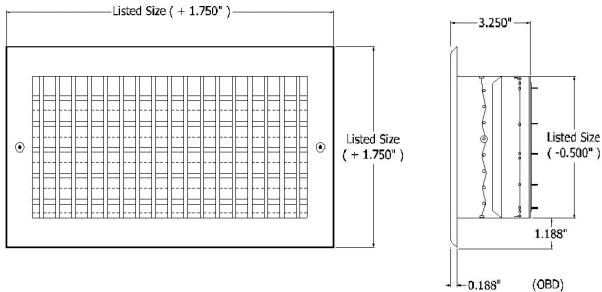
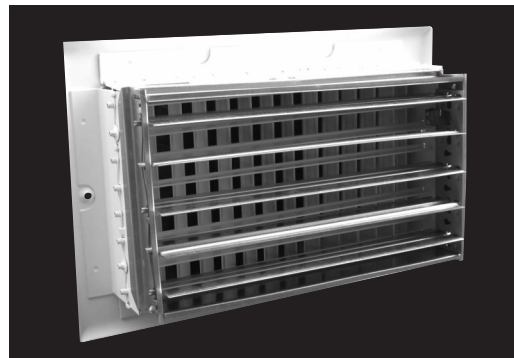

- ❖ Aluminum OBD rear damper (in steel)
- ❖ Aluminum face / Steel damper
- ❖ Aluminum adjustable fins provide individual deflection control
- ❖ Counter-sunk screw holes with 1/4" hexagon-head screws (*provided*)
- ❖ Finished with white powder coating
- ❖ Each diffuser is individually shrink wrapped

Also Available *Not Shown

A210HO - Horizontal

A220HO - Horizontal

A210 and A220 Series - Available Sizes (in inches)											
HEIGHT	WIDTH										
	6	8	10	12	14	16	18	20	24	26	30
4	❖	❖	❖	❖	❖	❖	❖	❖	❖		❖
6	❖	❖	❖	❖	❖	❖	❖	❖	❖		❖
8		❖	❖	❖	❖	❖	❖	❖	❖		❖
10			❖	❖	❖	❖	❖	❖	❖		❖
12				❖	❖	❖	❖	❖	❖		❖
14					❖	❖	❖	❖	❖		❖
16						❖	❖	❖	❖		❖
18							❖	❖	❖	❖	❖
20								❖	❖		❖
24									❖		❖

* PLEASE CONTACT US FOR ALL SIZES NOT LISTED



ALUMINUM ADJUSTABLE CURVED BLADE SUPPLY

Aluminum Adjustable Curved Blade Supply

Model A301M / A301O One Way

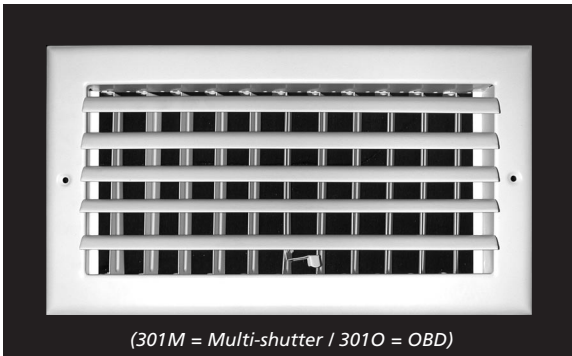

A301 - Available Sizes (in inches)									
HEIGHT	WIDTH								
	6	8	10	12	14	16	18	20	24
4		❖	❖	❖	❖	❖			
6	❖	❖	❖	❖	❖	❖	❖		
8		❖	❖	❖	❖	❖		❖	
10			❖	❖	❖			❖	
12				❖	❖				
14					❖				
16						❖			
18							❖		

Model A302HM / A302HO Two Way Horizontal

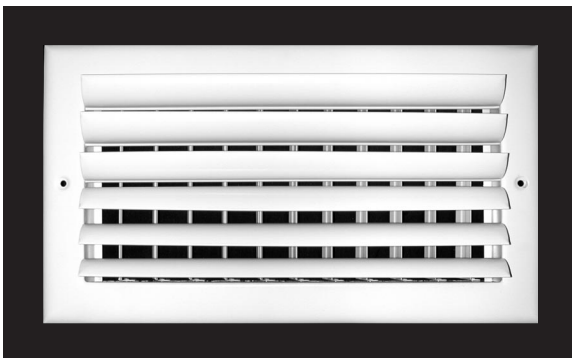

A302M - Available Sizes (in inches)									
HEIGHT	WIDTH								
	6	8	10	12	14	16	18	20	24
4		❖	❖	❖	❖				
6	❖	❖	❖	❖	❖				
8		❖	❖	❖	❖				
10			❖	❖	❖				
12				❖					
14					❖				
16						❖			
18							❖		

Model A302VM / A302VO Two Way Vertical

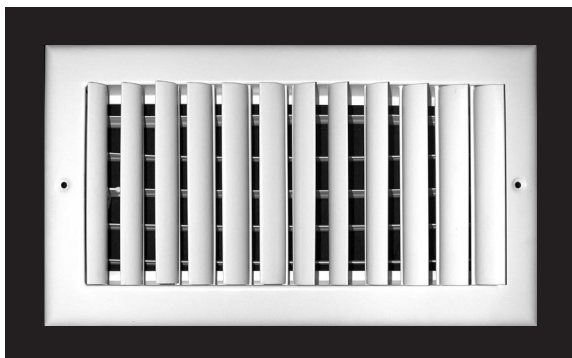

A302VM - Available Sizes (in inches)									
HEIGHT	WIDTH								
	6	8	10	12	14	16	18	20	24
4		❖	❖	❖	❖				
6	❖	❖	❖	❖	❖				
8		❖		❖	❖				
10			❖		❖				
12				❖					
14					❖				
16						❖			
18							❖		

A300 Series Registers

- ❖ Aluminum 1,2, 3, and 4-way air patterns
- ❖ Available with or without steel OBD
- ❖ Corner block directional air way control fin is encased in roll formed aluminum
- ❖ Aluminum face and steel louver
- ❖ Counter-sunk screw holes

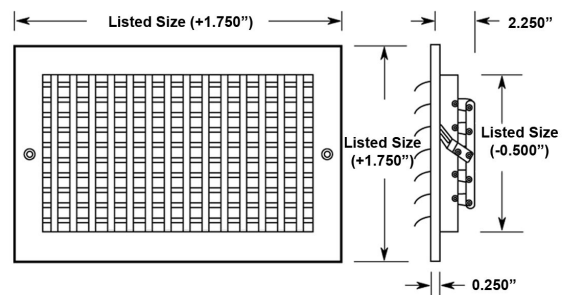

ALUMINUM ADJUSTABLE CURVED BLADE SUPPLY



Aluminum Adjustable Curved Blade Supply

Model A303M / A303O Three Way

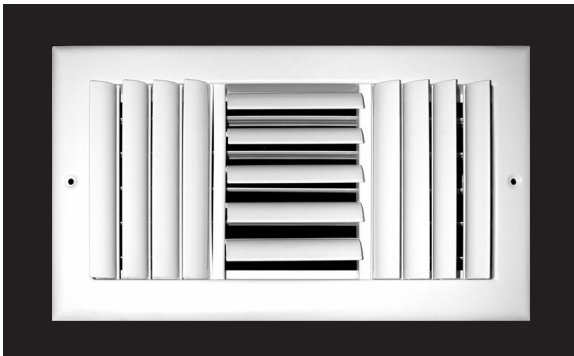

303M - Available Sizes (in inches)									
HEIGHT	WIDTH								
	6	8	10	12	14	16	18	20	24
4		❖	❖	❖	❖				
6	❖	❖	❖	❖	❖			❖	
8		❖		❖	❖	❖		❖	
10			❖	❖	❖	❖			
12				❖					
14					❖				
16						❖			
18									

Model A304M / A304O Four Way



304M - Available Sizes (in inches)										
HEIGHT	WIDTH									
	6	8	10	12	14	16	18	20	24	30
4		❖			❖					
6	❖	❖	❖	❖	❖					❖
8		❖			❖					
10			❖		❖					
12				❖						
14					❖					
16						❖				
18							❖			
20								❖		
24									❖	

* PLEASE CONTACT US FOR ALL SIZES NOT LISTED

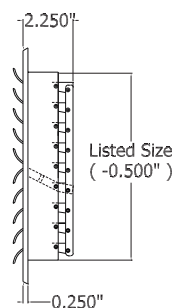
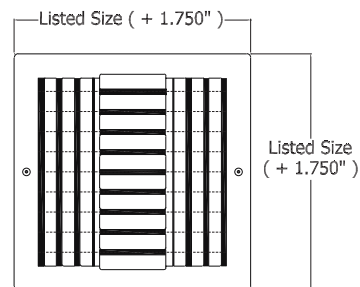
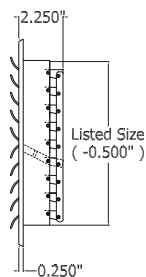
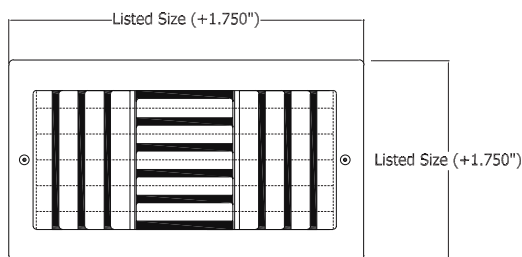



■ ■ ■ ALUMINUM SQUARE CEILING DIFFUSERS

Aluminum Square Ceiling Diffusers

A501M / A501O One-Way

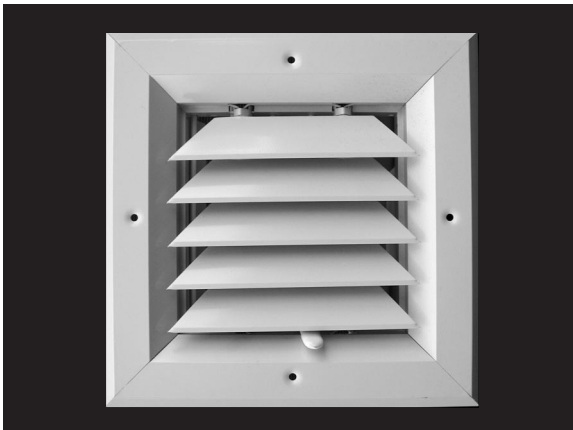

A502M / A502O Two-Way

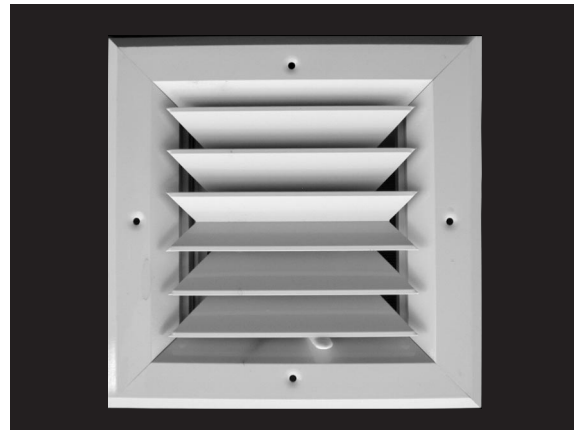

A503M / A503O Three-Way

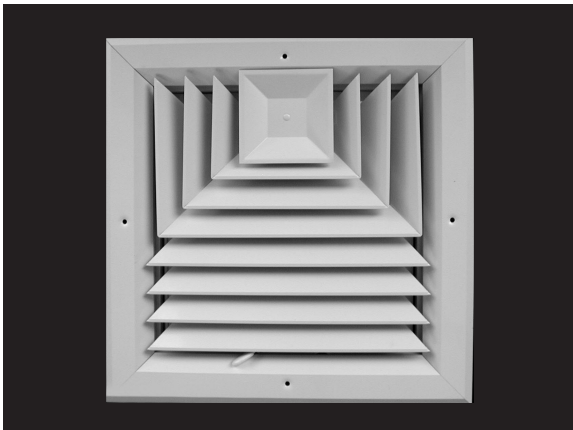

A504M / A504O Four-Way

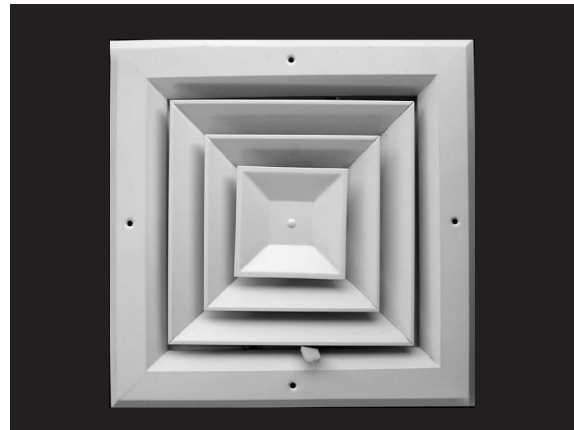

A505M / A505O

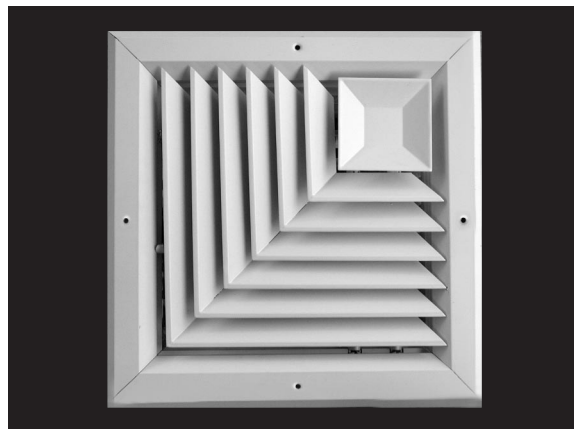

A500 Series Diffusers

- ❖ Square ceiling diffusers with multi-damper or OBD damper
- ❖ Extruded aluminum frame construction
- ❖ Counter-sunk screw holes with 2" screws (*provided*)
- ❖ Finished with white powder coating or aluminum finish
- ❖ Each grille is individually shrink wrapped

A500 Series - Available Sizes (in inches)									
HEIGHT	WIDTH								
	6	8	10	12	14	16	18	20	24
6	❖								
8		❖							
10			❖						
12				❖					
14					❖				

* PLEASE CONTACT US FOR ALL SIZES NOT LISTED

Model A270 Shown Closed



A270 Series Registers

- ❖ Aluminum fixed horizontal blade return air grille
- ❖ Extruded aluminum frame for extra strength
- ❖ Large free area designed for maximum air flow
- ❖ Front fin angle is fixed at 45° in 1/2" spacing
- ❖ Counter-sunk screw holes

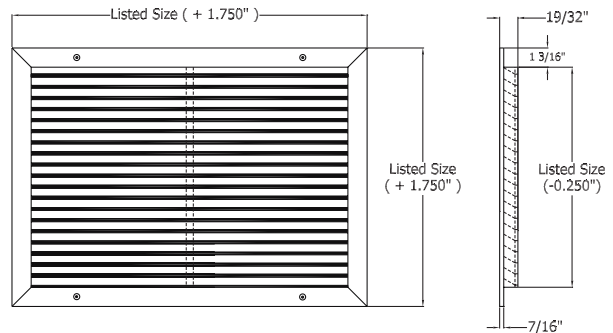

A270 - Available Sizes (in inches)																
HEIGHT	WIDTH															
	6	8	10	12	14	16	18	20	24	25	26	28	30	36	38	40
4		❖	❖	❖	❖				❖							
6	❖	❖	❖	❖	❖	❖	❖	❖	❖					❖	❖	
8		❖	❖	❖	❖	❖	❖	❖	❖					❖	❖	
10			❖	❖	❖	❖	❖	❖	❖					❖	❖	
12				❖	❖	❖	❖	❖	❖		❖			❖	❖	
14					❖	❖	❖	❖	❖	❖				❖	❖	❖
16						❖		❖	❖	❖			❖	❖	❖	❖
18			❖				❖	❖	❖				❖	❖	❖	❖
20			❖		❖			❖	❖	❖				❖	❖	❖
24				❖	❖	❖			❖	❖				❖	❖	
26														❖		
30					❖			❖	❖					❖		
36				❖			❖									
40								❖						❖		

* PLEASE CONTACT US FOR ALL SIZES NOT LISTED



ALUMINUM BAR TYPE: Return Air Filter Grilles

Model A290 Shown Closed



Model A290 Shown Open

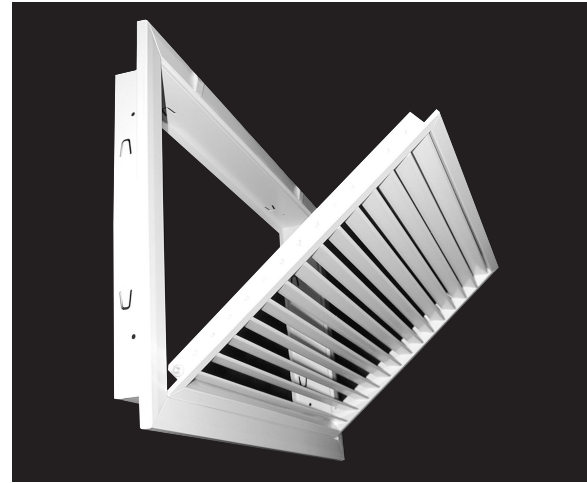

A290 Series Registers

- ❖ Fixed horizontal blade return air filter grille
- ❖ Extruded aluminum frame for extra strength
- ❖ Case is enframed for 1" air filter (*not included*)
- ❖ Large free area designed for maximum air flow
- ❖ Front fin angle is fixed at 45° in 1/2" spacing
- ❖ Counter-sunk screw holes with 1/4" hexagon-head

screws (*provided*)

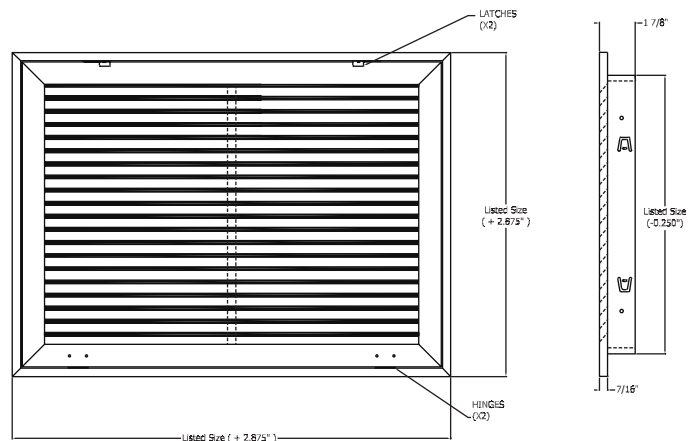

A290 - Available Sizes (in inches)												
HEIGHT	WIDTH											
	10	12	14	16	18	20	24	25	30	36	40	50
6						❖						
8			❖						❖			
10	❖	❖		❖		❖	❖		❖			
12		❖			❖	❖	❖		❖	❖		
14			❖			❖	❖	❖	❖	❖		
16				❖		❖	❖	❖	❖	❖		
18					❖	❖	❖		❖	❖		
20			❖		❖	❖	❖	❖	❖	❖	❖	
24		❖	❖			❖	❖		❖	❖		
25						❖		❖				
30			❖	❖	❖	❖						
40						❖						
50						❖						

* PLEASE CONTACT US FOR ALL SIZES NOT LISTED



Guarantee

All registers, grilles, and diffusers in this catalog are guaranteed to be free from defects in workmanship and material. Any products found defective may be returned with prior authorization at no charge for full credit.

Prices and Discounts

All prices in this catalog are list prices. Refer to current discount sheet for applicable discounts.

Credit

Shipments will be made on open account to those firms with an established current account.

Damage

Tru Aire cannot assume responsibility for loss or damage to products during transit or for delays with carrier. All damages must be reported immediately to Tru Aire.

Returned Goods

Tru Aire will only accept returned goods with prior written authorization. We cannot accept returns of non-stock or made-to-order items. All authorized returns must be in new and sellable condition and are subject to inspection and count. There will be a restocking charge on all returns. The customer is responsible for freight on all authorized returns.

Broken Cartons

A \$5.00 broken carton charge will be added to the invoice when the will call order is less than our standard carton quantity or under \$500.00.

Will Calls

All will call orders must be placed 24 hours prior to pickup.

Freight Orders

A \$10.00 service charge will be added to all UPS and Freight orders.

Disclaimer

We reserve the right to make changes to products, packaging, and prices without notice.