

★ Western  
Distribution Center

11335 Greenstone Avenue  
Santa Fe Springs, California  
90670 • USA

tel: (562) 466-1000  
fax: (562) 466-1010

★ Central  
Distribution Center

13800 John F Kennedy Blvd  
Suite #100  
Houston, Texas  
77039 • USA

tel: (713) 460-3200  
fax: (713) 460-3203

★ Southern  
Distribution Center

3509 Port Jacksonville Pkwy  
Building #1  
Jacksonville, Florida  
32226 • USA

tel: (912) 330-8270  
fax: (912) 330-8271

★ Eastern  
Distribution Center

1501 Perryman Road  
Building #100  
Aberdeen, Maryland  
21001 • USA

tel: (410) 272-3850  
fax: (410) 272-3852



Truair's factory located in Vietnam

RESIDENTIAL | COMMERCIAL

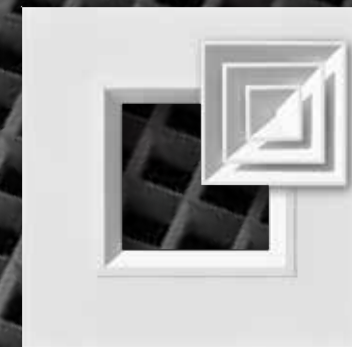
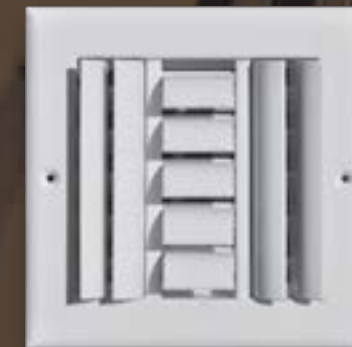

Baltimore, MD

Los Angeles, CA

Jacksonville, FL

Houston, TX



toll free: (888) 878-2473 (TRUAIRE) • www.truair.com

REGISTERS • GRILLES • DIFFUSERS

EDITION 3

PRODUCT CATALOG

**Regional Distribution Centers**

**Santa Fe Springs, California**  
Western Distribution Center & Corporate Offices

11335 Greenstone Avenue  
Santa Fe Springs, CA 90670

PH 562-466-1000 Fax 562-466-1010

**Jacksonville, Florida**  
Southern Distribution Center

3509 Port Jacksonville Pkwy., Building #1  
Jacksonville, FL 32226

PH 912-330-8270 Fax 912-330-8271

**Houston, Texas**  
Central Distribution Center

13800 John F Kennedy Blvd. Suite #100  
Houston, TX 77039

PH 713-460-3200 Fax 713-460-3203

**Baltimore, Maryland**  
Eastern Distribution Center

1501 Peryman Rd., Building #100  
Aberdeen, MD 21001

PH 410-272-3850 Fax 410-272-3852

*We're Here  
to Serve You...*

**Los Angeles, CA**

**Houston, TX**

**Jacksonville, FL**

**Baltimore, MD**

**Strategic Distribution**

In order to be recognized for providing the best service in our industry, we must be able to maintain geographically strategic distribution locations. We have 4 distribution centers across the country, Los Angeles, CA, Houston, TX, Jacksonville, FL and Baltimore, MD these 4 distribution center represent over 500,000 sq. ft. of finished goods inventory.

Maintaining huge inventories means filling orders complete and quicker than any of our competitors. Our 4 distribution centers are situated so that 90% of our customers receive there shipments within 72 hours after they place there orders.

When you consider that we at TRUaire are providing the best quality, service to the market at competitive prices, the rest is a winning combination for our customers.

**Unmatched Quality**

Often times as consumers we're faced with the stark reality that we are living in an era where quality is often compromised; an era in which economy trumps real value, and quality takes a backseat to a quick discount. This is not the case at TRUaire. We believe quality still means value, and we are strongly committed to keeping this value.

*"The bitterness of poor quality remains long after the sweetness of low price is forgotten".*

— Benjamin Franklin



*For more information about your Region please give us a call...  
or feel free to visit us online.*

## Welcome

Welcome to the completely redesigned TRUaire catalog! In these pages we hope you will find the most user-friendly product catalog in the industry.

Feel free to open the catalog to any page. Notice that no matter what page you've chosen that both pages contain information for the same product making it even easier to order and compare models. Everything you want to know for that particular model is right there in front of you with some of the features listed on the left, and some information for that series listed on the right. No need to flip back and forth from page to page for that model to find exactly what you need.



## Our Mission

As a nationally recognized leading manufacturer of registers and grilles for the Heating and Air Conditioning Industry, TRUaire is focused on providing the highest quality standards in the industry through innovation, customer care, and expertise. TRUaire takes pride in its dynamic workplace, offering each employee the necessary support to realize their full potential.

Every member of this impassioned team helps to carve each step of the TRUaire success story with hard work, superior products, exceptional customer service, and the largest inventory of finished goods in the industry. TRUaire always puts its customers first, striving to be courteous, respectful, and honest in every circumstance: as the greatest successes are achieved through genuine partnership.

## The Right Choice.

TRUaire has been producing a wide variety of outstanding products for the heating & air conditioning industries for over 30 years. When you select TRUaire, you're choosing a company that prides itself on decades of experience, superior customer service and high quality products that are sure to exceed your expectations.

Our business is to sell the highest quality grilles, registers and diffusers we can build at the most competitive prices possible.

## Our Vision

Today's business leaders agree that the only way to survive in our competitive world is by obtaining full customer satisfaction through the consistent delivery of high quality products and services. This is only part of the necessary formula for success. Our vision is to continually strive for improvement by focusing on operational excellence, creating valued business development and in the continuous improvement and development of our employees.



## We have you covered...

For quick reference, inside the front cover you'll find all of our locations and contact information, and in the back, a current up to date reference by Model Comparison and Manufacturer.

You can always visit us 24 x 7 online or stay connected with your mobile device or smartphone at [www.truair.com](http://www.truair.com). Our mobile app features are always changing to keep up with your needs in the field.

*Quick and easy access at your fingertips. Call by phone, visit online or on any mobile device or smartphone.*



You'll also notice that each 2-page set is designed for consistency and formatted in exactly same way. Flip through a few pages and you will quickly get the hang of the layout. Each left-hand page includes general information; description, pictures, features, and cross-reference information. Each right-hand page gives more specific information; options, dampers, drawings, available sizes, carton quantity, and information to help you when ordering.

**Sidewall/Ceiling Supply Registers**  
**STEEL PRODUCTS**

	PAGE
 <b>100 Series</b> Stamped Standard Fin Ceiling & Sidewall Registers	1
 <b>210/230 Series</b> Single Deflection Adjustable Bar Type	3
 <b>220 Series</b> Double Deflection Adjustable Bar Type	5
 <b>300 Series</b> Adjustable Curved Blade Registers	7
 <b>400 Series</b> Stamped Curved Blade Registers	9
 <b>Model 560</b> High Velocity Square Ceiling Directional Diffusers	11
 <b>600 Series</b> Evaporative Cooler Make-up Air Diffuser	11
 <b>700 Series</b> Flush Mount Diffuser High Velocity	11
 <b>800 Series</b> Round Ceiling Diffusers & Dampers	13

**Sidewall/Ceiling Supply Registers**  
**ALUMINUM PRODUCTS**

	PAGE
 <b>A210 Series</b> Single Deflection Adjustable Bar Type	15
 <b>A220 Series</b> Double Deflection Adjustable Bar Type	17
 <b>A300 Series</b> Aluminum Adjustable Curved Blade Registers	19
 <b>A500 Series</b> Square Aluminum Ceiling Diffusers	21

**Sidewall/Ceiling Return Grilles**  
**STEEL PRODUCTS**

	PAGE
 <b>170 Series</b> Stamped Steel Return Grilles	23
 <b>190 Series</b> Stamped Sidewall Return Air Filter Grilles - Fixed Face	25
 <b>190RF Series</b> Stamped Sidewall Return Air Filter Grilles - Removable Face	25
 <b>270 Series</b> Fixed Bar Return Air Grilles	27
 <b>290 Series</b> Fixed Bar Return Air Filter Grilles Accepts 1" Filters	27

**Sidewall/Ceiling Return Grilles**  
**ALUMINUM PRODUCTS**

	PAGE
 <b>A270 Series</b> Fixed Bar Return Air Grille and Filter Grilles	29
 <b>A290 Series</b> Fixed Bar Return Air Grille and Filter Grilles	29





**Floor and Baseboard  
Registers and Grilles**

	PAGE
 <b>150M Series</b> Floor Registers	31
 <b>115/118/121 Series</b> Baseboard Registers	33
 <b>122 Series</b> Baseboard Return Registers 3/4" Turnback	33
 <b>123 Series</b> Baseboard Supply Registers 3/4" Turnback	33
 <b>124 Series</b> Baseboard Supply Registers	33
 <b>125 Series</b> Baseboard Supply/Return Registers	33

**Floor and Baseboard  
Registers and Grilles**

	PAGE
 <b>Designer Baseboards</b> ABS Composite, Plated Finish and Solid Oak Baseboards	35
 <b>150TS Series</b> Heavy Duty Toe Space Grilles 150TSB (Brown) 150TSW (White)	37
 <b>154 Series</b> Heavy Duty Floor Grilles	37
 <b>173 Series</b> Heavy Duty Floor Grilles 173TSB (Brown) 173TSW (White)	37
 <b>160 Designer's Series</b> Decorative - Composite & Stamped Steel Floor Registers	39
 <b>168 Solid Oak Series</b> Oak Floor, Sidewall & Flush Mount Registers	41
<b>Access Doors</b>	
 <b>ACD690 Series</b> Access Doors	43
<b>Accessories</b>	
 <b>Dampers, Round Collars, Air Vents &amp; Push Pins</b>	45
 <b>Opposed Blade Dampers, T-Bar Panels, Frames and Insulation</b>	47

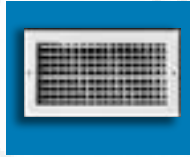
**Bar Type Supply Registers**

	<b>210 Series - STEEL</b> Single Deflection Adjustable Bar Type	<b>PAGE</b> 49
	<b>A210 Series - ALUMINUM</b> Single Deflection Adjustable Bar Type	51
	<b>220 Series - STEEL</b> Double Deflection Adjustable Bar Type	53
	<b>A220 Series - ALUMINUM</b> Double Deflection Adjustable Bar Type	55

**Fixed Bar Type Return Air Grilles**

	<b>270 Series - STEEL</b> Fixed Bar Return Air Grilles	<b>PAGE</b> 57
	<b>A270 Series - ALUMINUM</b> Fixed Return Air Grilles	57

**Wall Mount A/C Registers and Grilles**

	<b>220V / A220V Series</b> Supply - Steel & Aluminum	<b>PAGE</b> 59
	<b>270 / A270 Series</b> Return - Steel & Aluminum	59
	<b>290 / A290 Series</b> Return FG - Steel & Aluminum	59

**Surface Mount Diffusers**

	<b>A520 Series - ALUMINUM</b> A520F - Modular Core - Flat Frame A520B - Modular Core - Beveled Frame	<b>PAGE</b> 61
	<b>A540 Series - ALUMINUM</b> A540F - Directional - Flat Frame A540B - Directional - Beveled Frame	63

**Evaporative Cooler/Make-up Air Diffuser**

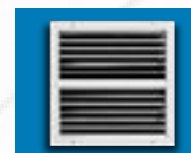
	<b>600 Series</b> Ceiling Mount Diffuser	<b>PAGE</b> 65
	<b>700 Series</b> Flush Mount Diffuser	65

**Perforated Face T-Bar Lay-In Diffusers**

	<b>1000 Series</b> 1010MAS / MAR - Universal 1020MAS / MAR - Fixed Collar	<b>PAGE</b> 67
---	---	-------------------

**T-Bar Grille with Plenum Frame**

	<b>1100 Series</b> 1120 Perforated Face	<b>PAGE</b> 69
	<b>1100 Series</b> 1130 Acrylic Egg-Crate Face 1140 Aluminum Egg-Crate Face	69

**T-Bar Perforated Curved Blade**

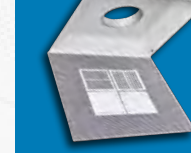
	<b>1400 Series</b> 1400CB Perforated Face Curved Blade	<b>PAGE</b> 71
	<b>1400 Series</b> 1420AB Perforated Face Adjustable Blade	71

**T-Bar Perforated Curved Blade (cont'd)**

	<b>1400 Series</b> 1444RG Perforated Face Return Grille	<b>PAGE</b> 71
	<b>1400 Series</b> 1480RD Perforated Face Supply Diffuser	71



**T-Bar Step Down Diffusers**

	<b>2000 Series</b> 2000PD Plaque Diffuser 2003CD Step Down Diffuser - 2 cone 2004CD Step Down Diffuser - 3 cone	<b>PAGE</b> 73
---	--	-------------------

**T-Bar Stamped Curved Blade Diffusers**

	<b>2600 Series</b> 2604SC Stamped Curved Blade Diffuser	<b>PAGE</b> 75
--	---	-------------------

**T-Bar Return Air Filter Grilles**

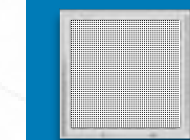
	<b>4000 Series</b> 4010FG Filter Grille - Stamped Face 4020FG Filter Grille - Bar Type	<b>PAGE</b> 77
	<b>4000 Series</b> 4030FG Filter Grille Stamped Face	77
	<b>4000 Series</b> 4040FG Filter Grille - Acrylic Eggcrate 4050FG Filter Grille - Aluminum Eggcrate	77

**T-Bar Modular Core Diffusers**

	<b>5200 Series</b> 5200CB Modular Core Diffuser A5200CB Modular Core Diffuser	<b>PAGE</b> 79
---	---	-------------------

**T-Bar Modular Directional Diffusers**

	<b>5400 Series</b> 5400SD Directional Diffuser Steel & Aluminum	<b>PAGE</b> 81
---	---	-------------------

**T-Bar Return Air Panels**

	1110RG Return Grille - Stamped	<b>PAGE</b> 83
	1210RG Return Grille - Bar Type	
	A1210RG Return Grille - Aluminum	
	1920RG Perforated Steel Panel	83
	A960/A970 Surface Mount Return Air Grill	
	1930RG Return Eggcrate Panel - Acrylic	83
	1940RG Return Eggcrate Panel - Aluminum	

**Air Handler Access Panels**

	<b>Access Panels</b> ACD2440S Solid Face Access Panel ACD2440L Louvered Face Access Panel	<b>PAGE</b> 85
--	---	-------------------

**Round Commercial Diffusers**

	<b>880 Series</b> Round Commercial Diffuser, Round OBD & Surface Mount Ring	<b>PAGE</b> 87
---	---	-------------------

**Spiral Duct Diffusers**

	<b>Spiral Series</b> SU Universal Mount Single & Double Deflection	<b>PAGE</b> 89
	<b>Spiral Series</b> SD Saddle Mount Double Deflection	89

**Linear Slot Diffusers**

	<b>Linear Series</b> LD Two-Slot Linear Diffusers 72", 48", 36", 24" & Custom	<b>PAGE</b> 91
---	---	-------------------

# SmoothGlide™

## REGISTERS & GRILLES



High quality steel or aluminum components.

Rivets installed AFTER assembly for the smoothest operation.

Blade & linkage components individually powder-coated BEFORE assembly.

The decades old practice of painting a register and damper after it has been assembled leads to chipping paint, unpainted exposed surfaces, frozen linkage parts, rattling damper blades, and ultimately... rust. The process saves time and money. It's the best way to build a cheap register cheaply. We can't and won't ever build our registers that way again.



High quality steel or aluminum components.

Easy to use filter grille latch is powder-coated BEFORE installation and requires no screwdriver to open.

**TRUaire**  
REGISTERS & GRILLES™



**100 SERIES**

While the 100 Series style of registers has been the mainstay of the residential new construction market for more than 50 years, each model we manufacture reflects our continued commitment to product quality. This quality can be seen in our pristine white powder-coat finish on our products, the countersunk screw holes, and our exclusive SmoothGlide Damper Technology, which is second to nothing else in the industry today.



**Model 101MD**

One Way Down Facing

**Model 101ML**

One Way Left Facing

**Model 101MR**

One Way Right Facing



**Model 102M**

Two Way 1/2" Fin Spacing

**Model 103M**

Three Way 1/2" Fin Spacing



**Model 122M**

Two Way 1/2" Fin Spacing - 3/4 Turnback

**Model 123M**

Two Way 1/3" Fin Spacing - 3/4 Turnback

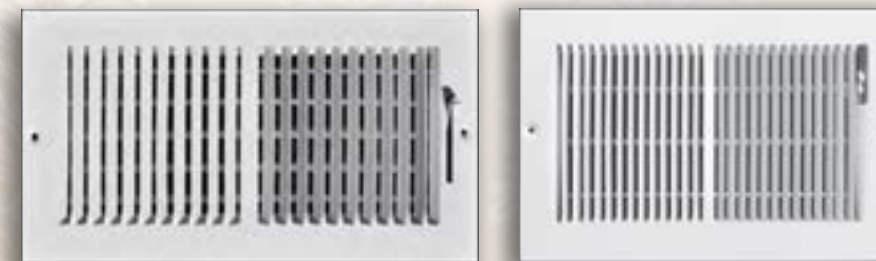

**Model 132M**

Two Way 1/3" Fin Spacing

**Model 133M**

Three Way 1/3" Fin Spacing

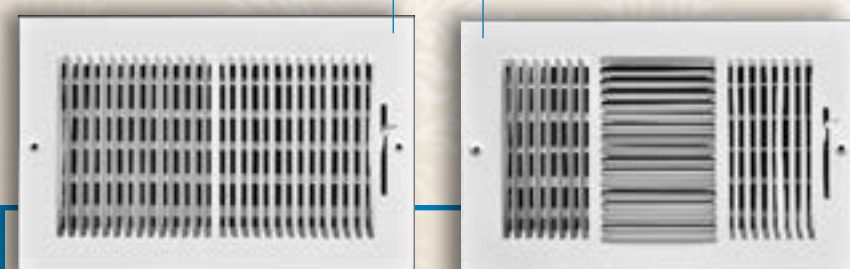

Compare to:

	101M	102M	103M	104M	122M	123M	132M
Hart & Cooley	681	682	683	684	-	657	661
Shoemaker	-	850	845	150	-	133	833
USAire	101M	102M	103M	104M	-	-	132M
Continental	21	22	23	24	-	BG31	32
Lima	SW1W	SW2W	SW3W	SW4W	-	671	632
Aimate	-	160	140	190	-	-	163

**Model 104M**

Four Way 1/2" Fin Spacing



**Features**

- Heavy steel construction
- Countersunk screw holes
- Pristine white powder-coat finish
- Revolutionary SmoothGlide Technology
- OBD Option Available

**Product Detail**



SmoothGlide Technology dampers



Recessed Screw Holes



**Model 103-O**

Opposed Blade Damper

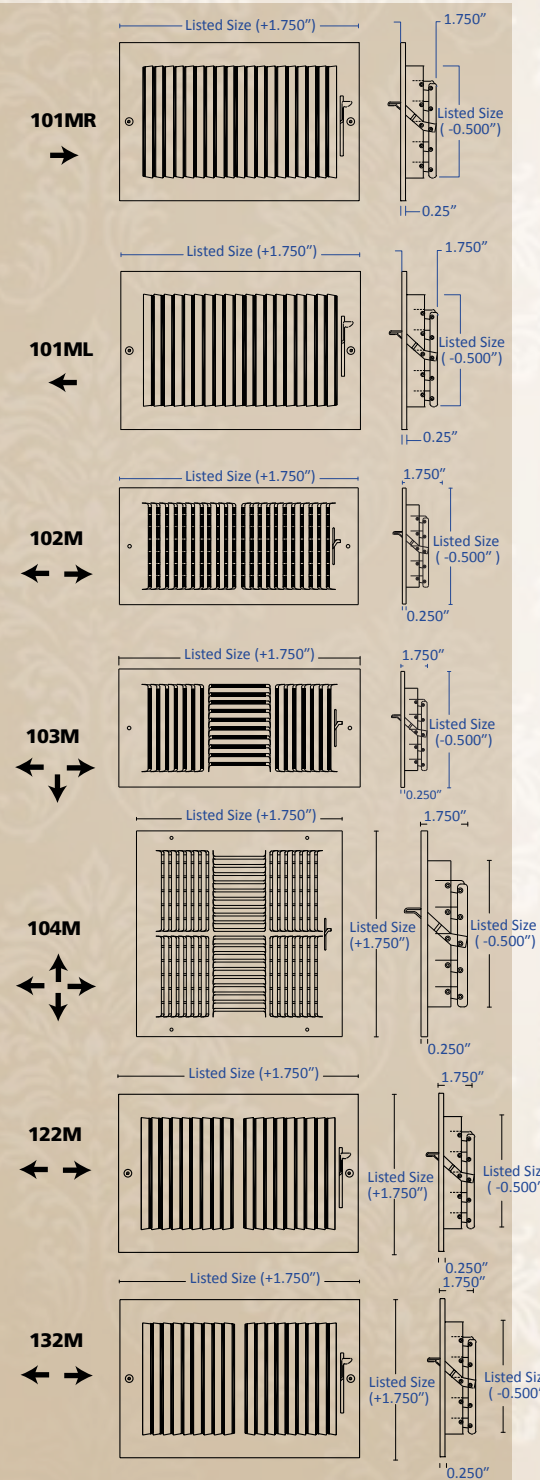
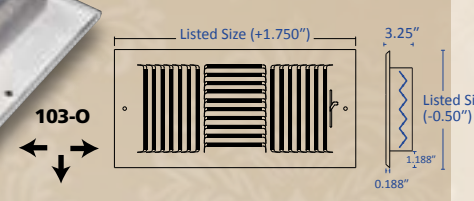

**SIZES & CARTON QUANTITY CHART**

	101M	102M	103M	104M	122M	123M	132M	133M
6x4		20	20				20	
6x6		20	20	20			20	
8x4	20	20	20				20	
8x6	20	20	20				20	
8x8		20	20	20			20	
10x4	20	20	20				20	
10x6	20	20	20	20	20	20	20	20
10x8	20	20	20	20			20	
10x10		20	20	20			20	
12x4		20	20				20	
12x6	20	20	20		20	20	20	20
12x8	20	20	20				20	
12x10		10	10				10	
12x12		10	10	20			10	
14x4		20	20				20	
14x6	20	20	20		20	20	20	
14x8	10	10	10				10	
14x10		10	10	10				
14x12		10	10					
14x14		10	10	10				
16x4		20					20	
16x6	20	20	20				20	
16x8		10	10				10	
16x10		10	10					
16x12		10						
16x16				5				
18x4		20						
18x6		20	20				20	
18x8		10	10					
18x10		10	10					
18x12		10	10					
18x18		5		5				
20x4		20	20					
20x6		10	10				10	
20x8		10	10					
20x10		10						
20x12		10						
20x18		5						
20x20					5			
24x4		20						
24x6		10	10				10	
24x8		10	10					
24x10		5						
24x12		5						
24x14		5						
30x6		5						

**210 SERIES / 230 SERIES**

Arguably the most versatile of all supply registers, the 210 Series Single Deflection register is available in a wide variety of configurations for almost any application. The highly effective open blade design and TRUaire's exclusive one piece frame allows for greater airflow. Our 210 Series is available with our unique SmoothGlide multi-shutter damper mechanism, a high quality opposed blade damper mechanism or without a damper.

Whether ceiling or sidewall, commercial or residential, these registers deliver high capacity airflow, style & solid construction.



**Model 210H**  
Adjustable Horizontal Blades  
No Damper

*\*NOTE: Not available in all sizes*

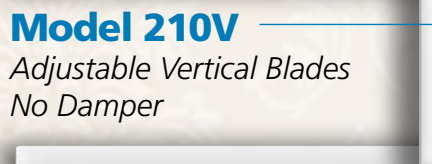

**Model 210V**  
Adjustable Vertical Blades  
No Damper

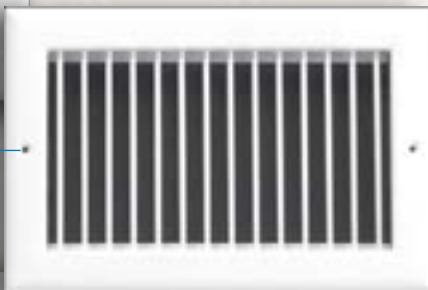

**Model 210VM**  
Adjustable Vertical Blades  
SmoothGlide Multi-Shutter Damper



**Model 210HO**  
Adjustable Horizontal Blades  
Opposed Blade Damper

*\*NOTE: Not available in all sizes*



**Model 210VO**  
Adjustable Vertical Blades  
Opposed Blade Damper

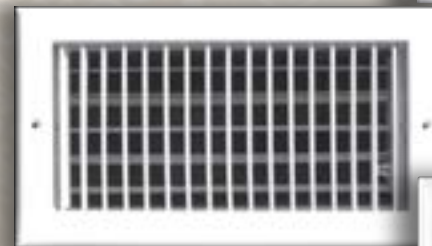

**Model 230M**  
Adjustable 3-Way Blades  
Multi-Shutter Damper



**Compare to:** 210VM 210VO 220VO 230M

Hart & Cooley	821	--	92VHO	--
Shoemaker	951	951-O	904-O	945
USAire	100SVM	--	--	--
Continental	RGV	RGV-O	--	--
Lima	900V	90VOBD	990VOBD	--
Airmate	220V	200VO	240V	--

**Features**

- Adjustable horizontal or vertical Airfoil blades
- Steel construction
- White powder-coat finish
- Unique beveled edges
- Recessed screw holes
- Variety of damper configurations Including: SmoothGlide multi-shutter
- Remarkable One-piece frame (Up to 14x10)

**Product Detail**



Beveled Edges



One Piece Frame Construction

**SmoothGlide Damper**

There is nothing like it on the market. Our SmoothGlide Damper prevents rust, rattling, and sticking. These dampers use high quality all-steel components. The idea behind this technology is that we powder coat the blade and the linkage component individually BEFORE we assemble our products and then we install the rivets to our blades.

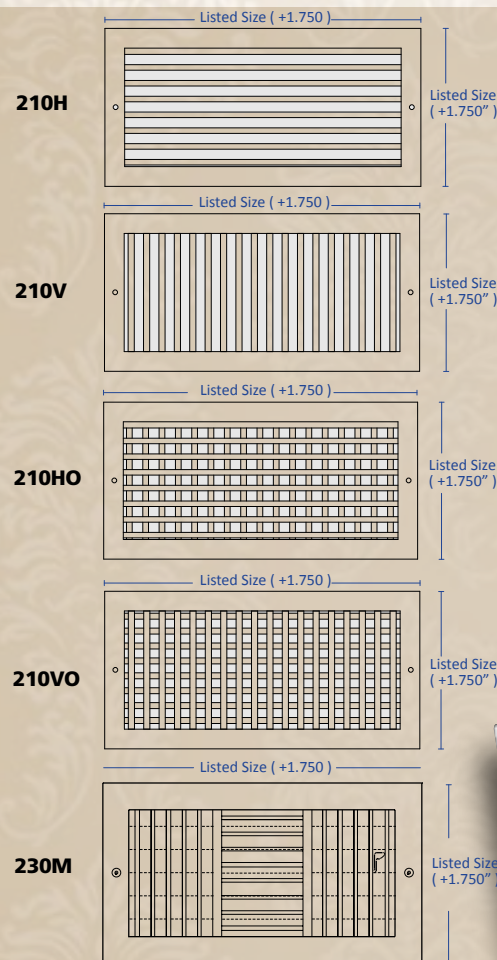

The Model 210 Series is available in over 60 sizes and configurations. For available sizes and current pricing please refer to our **Pricing Guide Supplement**.

**210 / 230 SERIES Options**

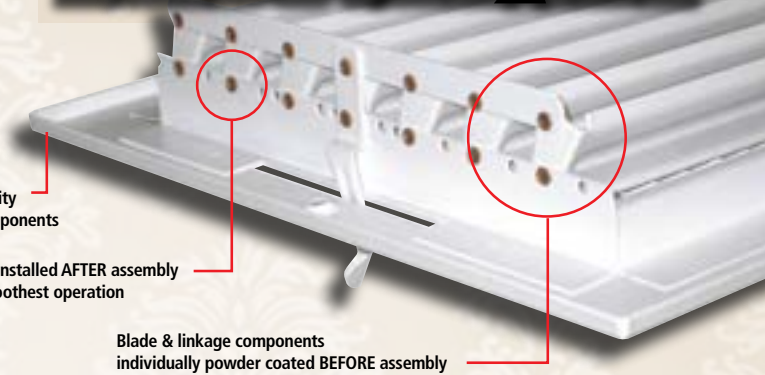

High Quality Steel Components

Rivets installed AFTER assembly for smoothest operation

Blade & linkage components individually powder coated BEFORE assembly

**Opposed Blade Damper (OBD)**

Top notch craftsmanship includes nylon bushings to ensure the blades stay in place according to the airflow you wish.



Durable nylon bushings

High Quality Steel Components

**Model 230M**  
Three Way Fixed Bar with adjustable damper

Reverse side shown with adjustable damper

**ORDERING HINTS**

1. Start with the base model
2. Select the blade positioning
3. Select the damper configuration

Note: The 210VM is the most common and popular configuration.

DESCRIPTION	Example Model
Model 210 Model 230	<b>210</b> <b>230</b>
V = Vertical blades H = Horizontal blades	<b>210V</b> <b>210H</b>
M = Multi-shutter Damper (SmoothGlide) O = Opposed Blade Damper Blank = Without Damper	<b>210VM</b> <b>210VO</b> <b>210V</b>

**220 SERIES**

TRUaire's 220 Series Double-Deflection registers represent the top-of-the line adjustable bar-type product. These registers feature two perpendicular rows of individually adjustable Airfoil bars for maximum airflow control. They can be ordered with the horizontal row in front, (220H), or with the vertical row in front, (220V).

Whether commercial or residential, using an OBD damper or no damper at all, the 220 Series register delivers high capacity airflow with a sleek aesthetic style and rock solid construction.

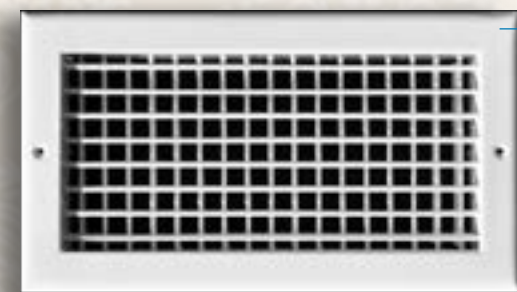

**Model 220H**

Adjustable  
Horizontal Blades  
No Damper

*\*NOTE: Not available in all sizes*

**Model 220V**

Adjustable Vertical Blades  
No Damper

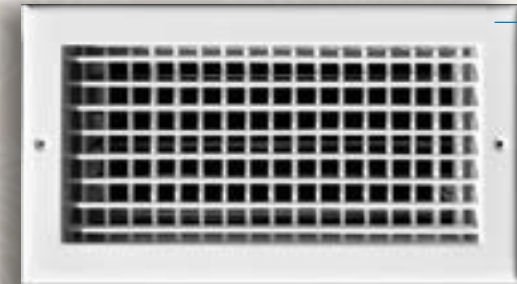

**Model 220HO**

Adjustable  
Horizontal Blades in front  
Opposed Blade Damper

*\*NOTE: Not available in all sizes*

**Model 220VO**

Adjustable  
Vertical Blades in front  
Opposed Blade Damper

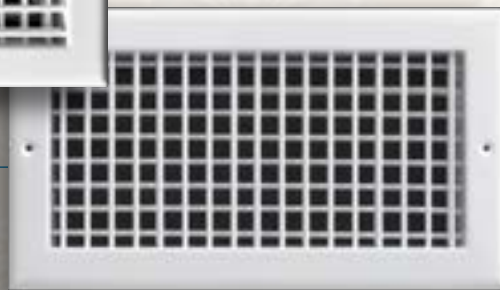

*NOTE: Also available in aluminum. See the A220 Series*

Compare to:	220 Series
Hart & Cooley	92VHO
Titus	300RS
Shoemaker	934
Metal Aire	
Price	520S
Krueger	880V

**Features**

- Adjustable horizontal and vertical Airfoil blades
- Solid Steel construction
- White powder-coat finish
- Recessed screw holes
- Opposed Blade Damper (OBD), or no damper at all
- Remarkable one-piece beveled frame (up to 14x10)

**Product Detail**



Non-Beveled Corners



Opposed Blade Damper with Nylon Bushings

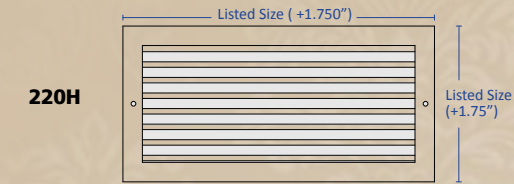

220H



220V



220HO

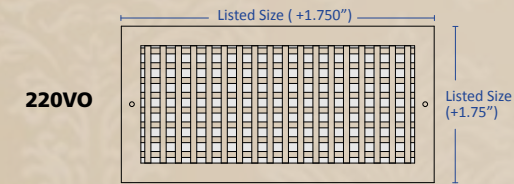

220VO

**NOTE:**

The Model 220 Series is available in over 60 sizes and configurations. "H" model configurations are not stocked in many sizes. For available sizes and current pricing please refer to our **Pricing Guide Supplement**.

**220 Series Options**

**Opposed Blade Damper (OBD)**

Top notch craftsmanship includes nylon bushings to ensure the blades stay in place according to the airflow you wish.

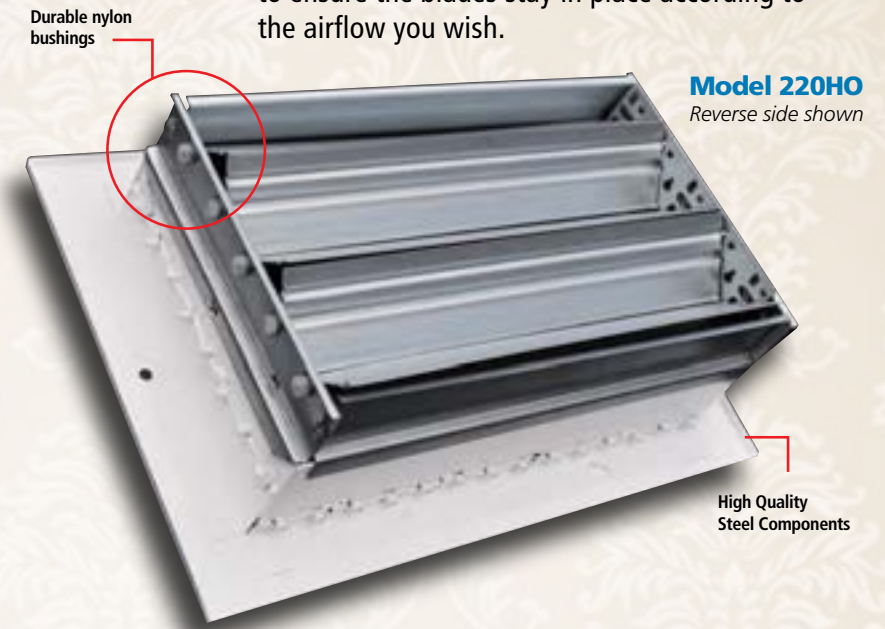

**Model 220HO**  
Reverse side shown

**Standard Configuration**

Two perpendicular rows of individually adjustable Airfoil bars

**Model 220H**  
Reverse side shown

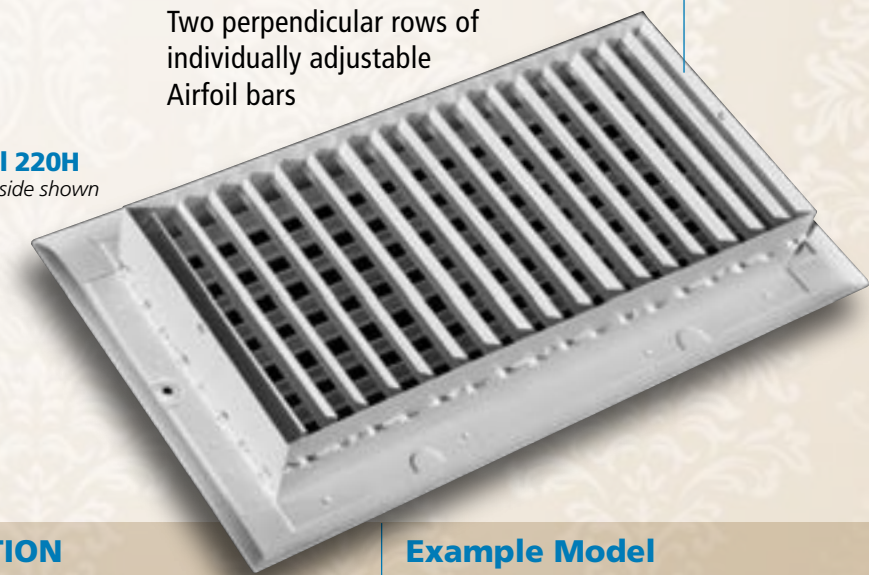

**ORDERING HINTS**

1. Start with the base model
2. Select the blade positioning
3. Select the damper configuration

**DESCRIPTION**

Model 220  
V = Vertical blades  
H = Horizontal blades  
VO = Vertical Opposed Blade Damper  
HO = Horizontal Opposed Blade Damper  
Blank = Without Damper

**Example Model**

220  
220V  
220H  
220VO  
220HO  
220V

**300 SERIES**

Also available in Aluminum - see A300 Series

The 300 series register is the height of both form and function. Each individual curved blade is fully adjustable for total control. The outside frame is slightly beveled, and manufactured without mitered corners. The various configurations of this diffuser include damper choices and blade direction, each available in your choice of either steel or aluminum.



**Model 301HM**

Curved Blade - 1 Way

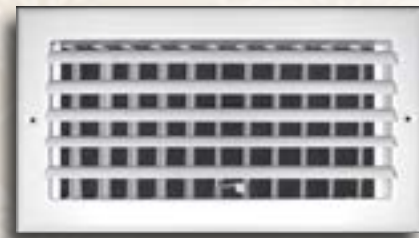

**Model 302HM**

Curved Blade - 2 Way Horizontal

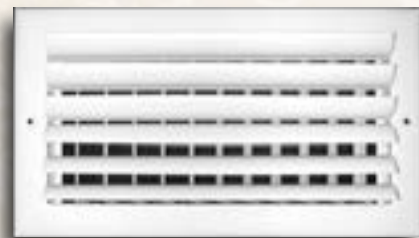

**Model 303M**

Curved Blade - 3 Way



**Model 302VM**

Curved Blade - 2 Way Vertical

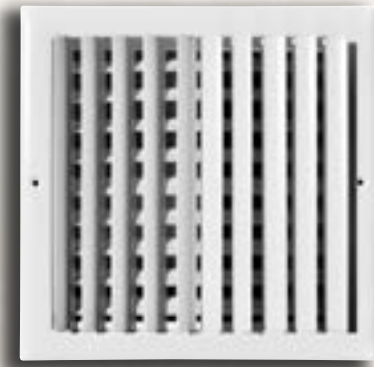

**Model 304M**

Curved Blade - 4 Way



**Compare to:**

	301M	302M	303M	304M
Hart & Cooley	CHM1	CHM2	CM3	CM4
Shoemaker	CB10M	CB20M	CB30M	CB40M
USAire	--	--	--	--
Continental	SACB1	SACB2	SACB3	SACB4
Lima	291ML	292ML	293ML	294ML
Airmate	401HM	402M	403HM	404M

**Features**

- Individually adjusting curved blades
- Aesthetically designed on-piece frame
- Optional OBD
- Pristine powder-coat finish.
- Recessed screw holes

**Product Detail**

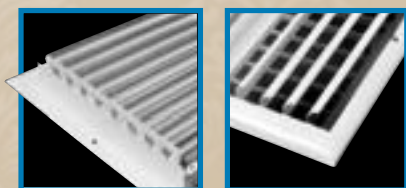

SmoothGlide Technology dampers    One Piece Frame without mitered pieces

**300 Series Options**

The decades old practice of painting a register and damper after it has been assembled leads to chipped paint, unpainted exposed surfaces, frozen linkage parts, rattling damper blades, and ultimately...rust. The process saves time and money. It's the best way to build a cheap register cheaply.

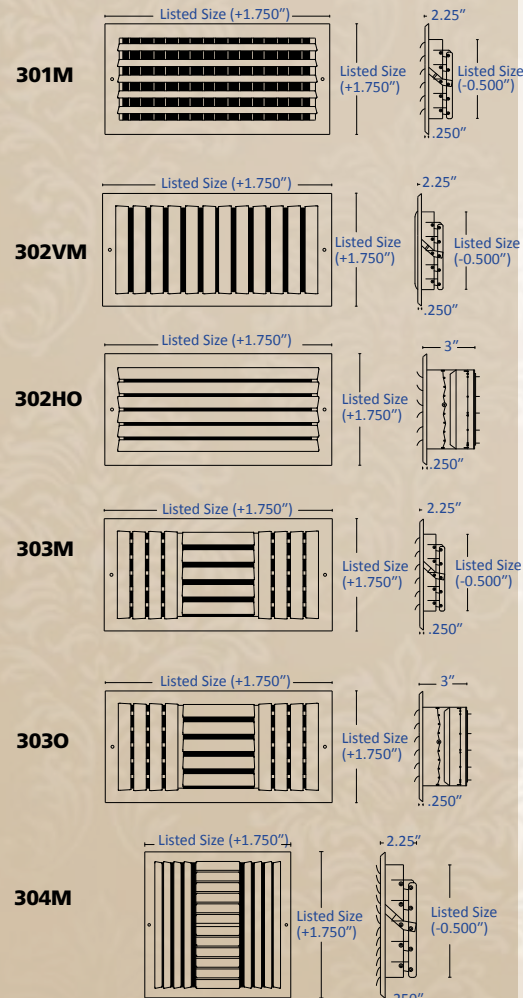
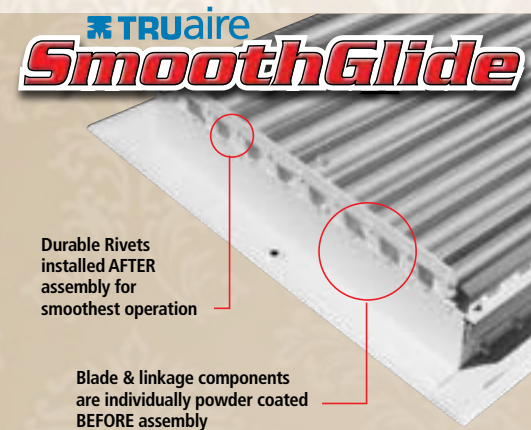

**Sizes & Carton Quantity Chart**

SIZE	301	302	303	304
6 X 6	20	20	20	20
8 X 4	20	20	20	20
8 X 6	20	20	20	20
8 X 8	10	10	10	10
10 X 4	20	20	20	
10 X 6	10	10	10	10
10 X 8	10	10	10	
10 X 10	10	10	10	10
12 X 4	20	20		
12 X 6	10	10	10	10
12 X 8	10	10	10	
12 X 10	10	10	10	10
12 X 12	10	10	10	10
14 X 4	10	10	10	10
14 X 6	10	10	10	10
14 X 8	10	10	10	10
14 X 10	10	10	10	10
14 X 12			5	
14 X 14	5		5	5
16 X 6	10			
16 X 8			10	
16 X 10			5	
16 X 16	5	5	5	5
18 X 6	10			
18 X 8			2	2
20 X 6	10		10	
20 X 8			10	
20 X 18	5			
20 X 20				2
24 X 24				2

PLEASE CONTACT US FOR ANY SIZES NOT LISTED

NOTE: For Opposed Blade Damper option please specify "O" for OBD feature

**SmoothGlide Damper**

SmoothGlide Technology is the very simple, albeit very expensive, process of carefully powder-coating each and every individual steel component of a register, *prior to assembly*. The finished product is a stamped steel register with 100% powder coat coverage and a smooth quiet damper assembly that glides open or closed with the touch of a finger.

**Model 303-O**

Three Way - OBD Option

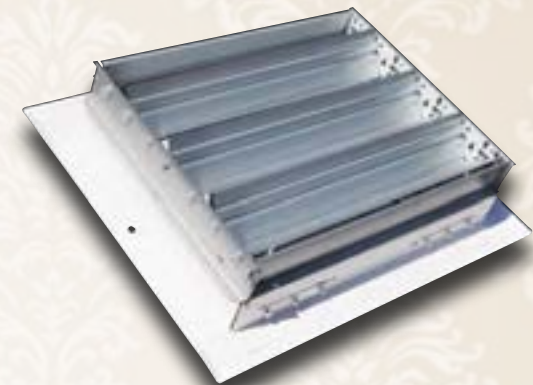

All 300 Series registers through 14x10 are manufactured with our exclusive "one-piece" beveled frame design. No mitered corners... just one solid frame.



Individually adjustable curved blades with pristine powder-coat finish and recessed screw holes.

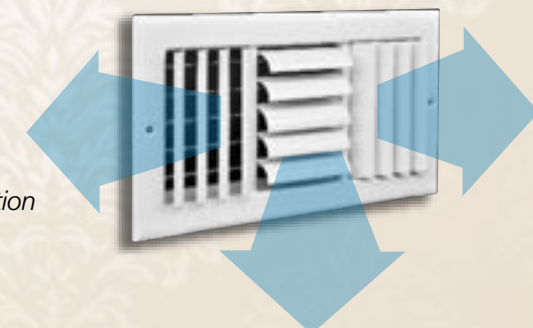

**400 SERIES**

TRUaire's 400 series is a stamped steel register at heart, but with a big difference. Unlike the 100 series stamped steel register, the blades on the face of the 400 series are stamped in a curve. This configuration provides a classy look, and a more even air pattern, all with the cost benefit of stamped steel.



**Model 401M**

*Stamped Curved Blade  
1 Way Horizontal*



**Model 402HM**

*Stamped Curved Blade  
2 Way Horizontal*



**Model 403M**

*Stamped Curved Blade - 3 Way*



**Model 402VM**

*Stamped Curved Blade  
2 Way Vertical*



**Model 404M**

*Curved Blade - 4 Way*



**Compare to:**

	401M	402M	403M	404M
Hart & Cooley	301	302	303	304
Shoemaker	201H	202H	203	204
USAire	1201M	1202M	1203M	1204M
Continental	C1H	C2H	C3H	C4H
Lima	501CB1W	502CB2W	503CB3W	504CB4W
Airmate	601M	602M	603M	604M

**Features**

- SmoothGlide Damper Technology
- Curved blade face
- Counter-sunk screw holes
- Pristine Powder-coat finish

**Product Detail**

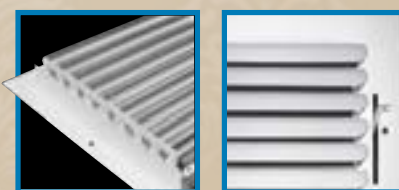

SmoothGlide Technology dampers      Stamped Curved Blade Detail

**400 Series Options**

The decades old practice of painting a register and damper after it has been assembled leads to chipped paint, unpainted exposed surfaces, frozen linkage parts, rattling damper blades, and ultimately...rust. The process saves time and money. It's the best way to build a cheap register cheaply.



Durable Rivets installed AFTER assembly for smoothest operation

Blade & linkage components are individually powder coated BEFORE assembly

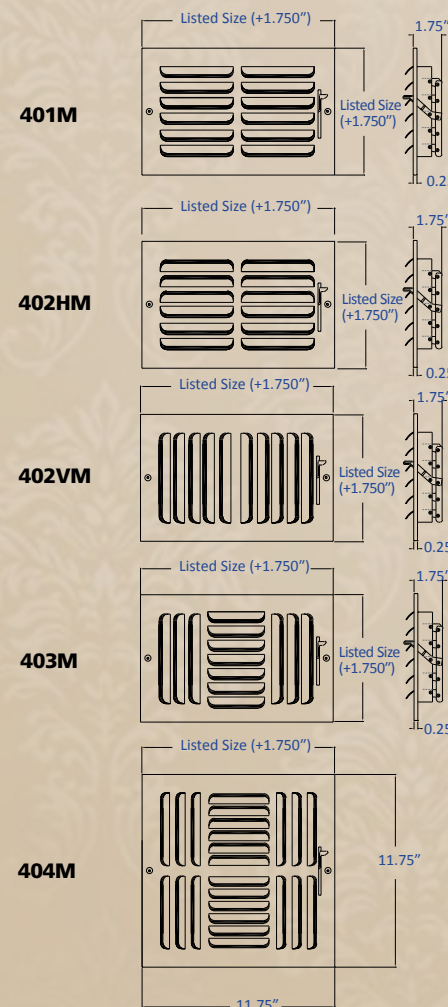

**Sizes & Carton Quantity Chart**

	401M	402HM	402VM	403M	404M
<b>SIZE</b>					
6 X 6	20			20	20
8 X 4	20	20	20	20	
8 X 6	20	20		20	
8 X 8	20	20		20	20
10 X 4	20	20	20	20	
10 X 6	20	20	20	20	
10 X 8	20	20		20	
10 X 10	20	20	20	20	20
12 X 4	20	20		20	
12 X 6	20	20	20	20	
12 X 8	20	20	20	20	
12 X 10	10	10		10	
12 X 12	10	10	10	10	10
14 X 4	20	20	20	20	
14 X 6	20	20	20	20	
14 X 8	10	10	10	10	
14 X 10	10	10	10	10	
14 X 12	10	10		10	
14 X 14	10			10	10
16 X 6	20			20	
16 X 16				10	5
18 X 6	10	10			
20 X 6		10	10		

PLEASE CONTACT US FOR ANY SIZES NOT LISTED



**Model 402VM**

*Stamped Curved Blade  
2 Way - Vertical*



**Model 403M**

*Stamped Curved Blade  
3 Way*

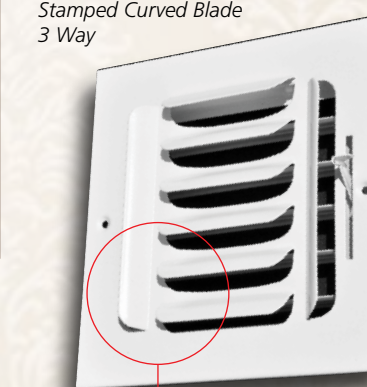

Engineered stamped curved blades with pristine powder-coat finish and recessed screw holes.

**560, 600, and 700 Series**  
Includes Evaporative Cooler Diffusers

These high capacity diffusers cover a variety of design requirements. Each of these models is available in square sizes only. The blade design is unusually wide specifically for allowing large volumes of air to move through them. The 600 and 700 Series are primarily used for evaporative cooler, or make-up air applications.



**Model 560M**

Square Ceiling Directional Diffuser



**Model 560 - No Damper**  
Square Ceiling Directional Diffuser



Compare to:	560	600	700
Hart & Cooley	ESSD/D	ECBX	ECHVD
Shoemaker	--	--	450
US Aire	--	--	--
Continental	--	--	--
Lima	1103/2	1150	1170
Airmate	1020/30	100	1200

Profile view shown without damper

**Model 600**

Evaporative Cooler Make-up Air Diffuser



Blade design allows for maximum air flow

\*Available in white or stainless steel finish

**Model 700**

Flush Mount Diffuser - High Velocity



Blades shown in OPEN position

**Features**

- Wide blade design
- Multi-shutter damper
- Powder-coat finish

**Product Detail**



High capacity blade design (Model 600 shown)

Multi-Tier Diffusion (Model 560M shown)

**Model 560M With Damper**  
**Model 560 No Damper**  
Square Ceiling Directional Diffuser

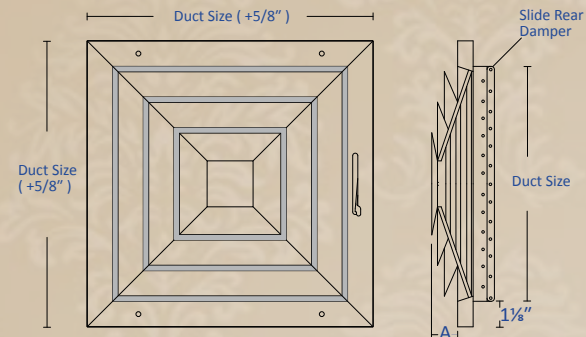

Model 560	
CEILING MOUNT	
6 x 6	20
8 x 8	20
10 x 10	10
12 x 12	10
14 x 14	10
16 x 16	5
18 x 18	2
20 x 20	2



Model 560M Reverse side shown with damper

Model 560 Reverse side shown without damper

**Model 600**  
Evaporative Cooler Make-up Air Diffuser

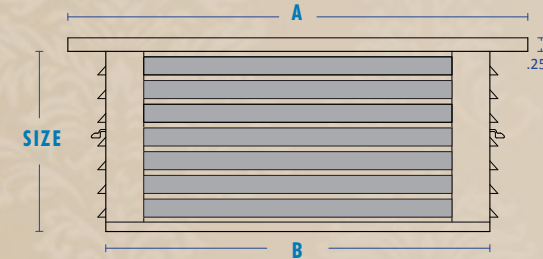

See chart at right for available configurations

Model 600M	
CEILING MOUNT	
10 x 10	1
12 x 12	1
14 x 14	1
16 x 16	1
18 x 18	1
20 x 20	1
22 x 22	1
22 x 22T	1
24 x 24	1
26 x 26	1
28 x 28	1
30 x 30	1
32 x 32	1

\*Available in white or stainless steel finish

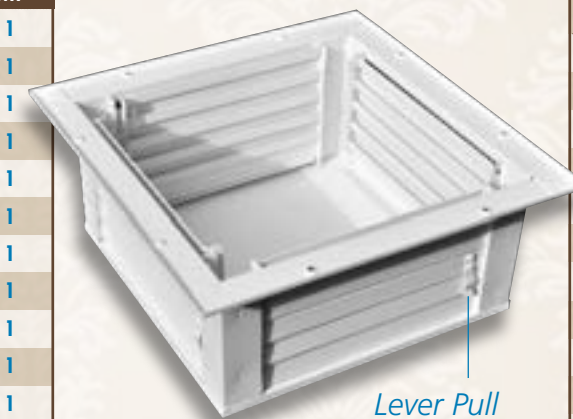

Lever Pull

SIZE	A	B
10 X 10	13"	10.25"
12 X 12	15"	12.25"
14 X 14	17"	14.25"
16 X 16	19"	16.25"
18 X 18	21"	18.25"
20 X 20	23"	20.25"
22 X 22	25"	22.25"
22 X 22T	23.75"	21.00"
24 X 24	27"	24.25"
26 X 26	29"	26.25"
30 X 30	33"	30.25"
32 X 32	35"	32.25"

**Model 700**  
Flush Mount Diffuser - High Velocity

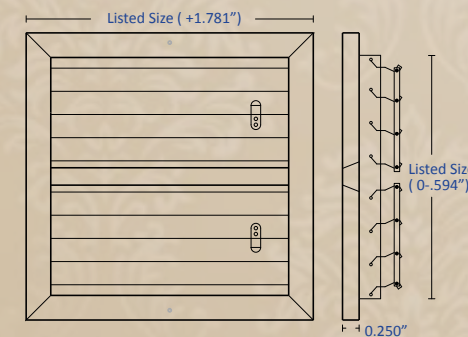

Model 700M	
FLUSH MOUNT	
6 x 6	10
8 x 8	10
10 x 10	10
12 x 12	10
14 x 14	10
16 x 16	5
18 x 18	5
20 x 20	5
22 x 22	5
24 x 24	5

Large, adjustable fins

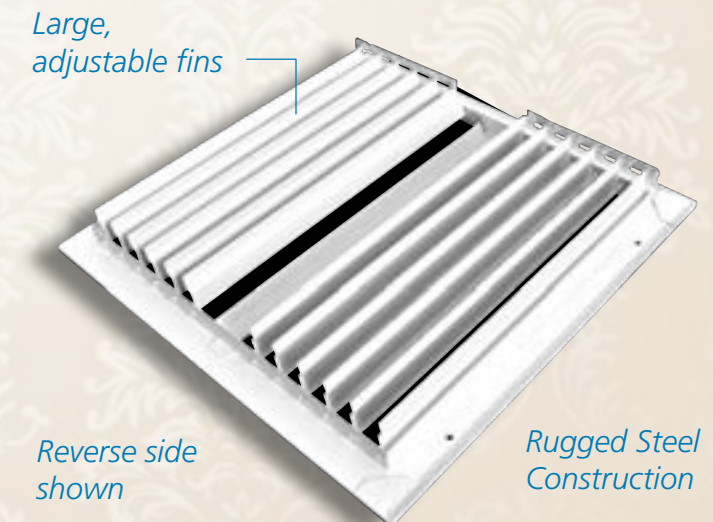

Reverse side shown

Rugged Steel Construction

**800 SERIES**

Simple, versatile, easy to operate, and easy to install. The 800 Series register face is the same pristine white powder-coat we use on everything we make. There are two different damper configurations, and both of them work with our ceiling mounted T-bar Step Down Diffusers, the 2000 Series.



**Model 800**

Register Face



**Model 801**

Butterfly damper & installation ring



**Model 802**

Butterfly damper only

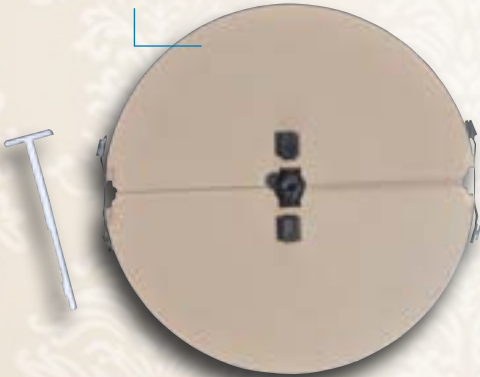

For use only with 2000 Series T-bar diffusers

**Model 803**

Installation ring only



**Model 804**

Radial damper only

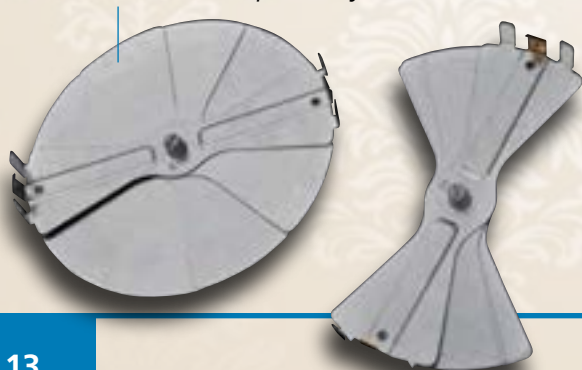

Butterfly damper shown in both OPEN and CLOSED positions. For use only with 2000 Series T-bar diffusers

**Compare to:**

800
Hart & Cooley 16
Shoemaker 90
USAire 900
Continental 16
Lima 150
Airmate 800

**Features**

- Pristine White Powder-Coat Finish
- Butterfly or Radial Dampers
- Individually Packaged

**Product Detail**

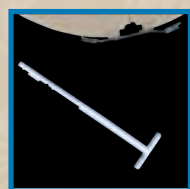

Operating Handle

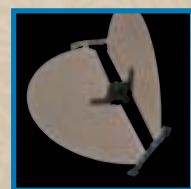

Butterfly Damper



**800 Series Options**

Register manufacturers have never done a good job of explaining how different round ceiling diffusers and dampers work together. The illustration at right will demonstrate a couple of the more commonly used installation configurations for you to choose from.

**Typical Installations**

A typical installation of round registers requires the register face, and a mounting ring. The ring will be attached to the drywall or sheet rock, and then the register can be installed on the ring.

**800**

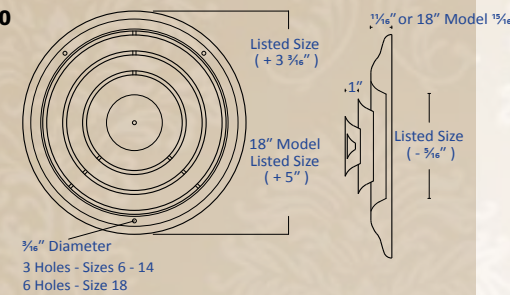

**801**

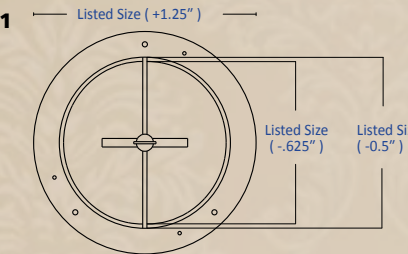

**802**

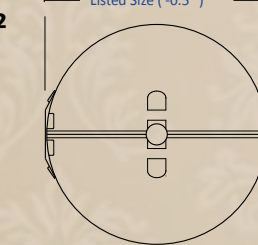

**Model 801**



**Model 800**

There are two different installation rings to choose from. The Model 801 installation ring includes a round butterfly damper. The damper can be opened and closed using the plastic "T" handle that is provided.



**Model 803**

**Model 800**

The other installation ring, Model 803, is used for installations where no damper is going to be required.



**Model 802**  
Butterfly Damper

The other two damper Models, 802, and 804, are used only with the 2000 Series Step-down T-bar diffusers. There are two options for this installation type. Model 802 is a Butterfly Damper configuration, while model 804 is called a Radial Damper.

**Model 804**  
Radial Damper

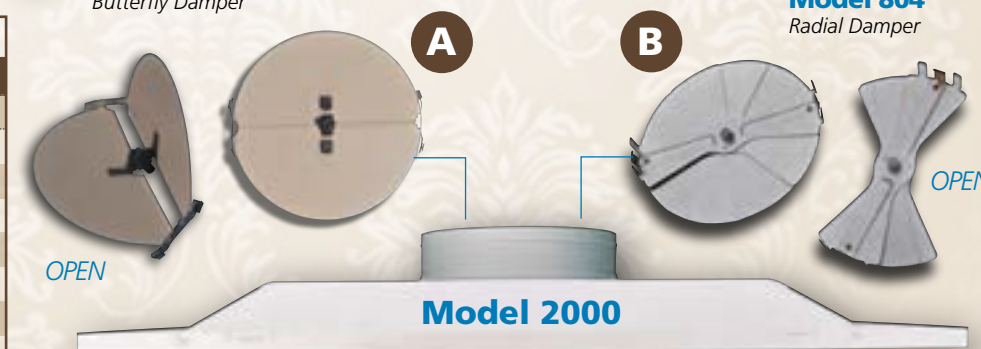

**Sizes & Carton Quantity Chart**

	800	801	802	803	804
<b>SIZE</b>					
6	20	20	20	20	10
8	20	20	10	20	10
10	10	20	10	20	10
12	10	20	10	20	10
14	10	10	10	10	10
16	2	10	10	10	
18	1	10	10	10	

NOTE: Model 2000 Shown above is not included with dampers.

## A210 SERIES - Aluminum

Among the most versatile of all supply registers, the A210 Series Single Deflection register is available in a wide variety of configurations for almost any application. These registers feature an attractive and highly effective open blade design which allows increased airflow when compared to any stamped fin design. The single row of adjustable airfoil designed blades can be arranged horizontally or vertically.

Whether ceiling or sidewall, commercial or residential, these register delivers high capacity airflow, style & solid construction.

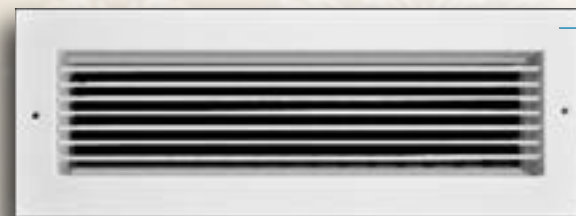

**Model A210H**  
Adjustable Horizontal Blades  
No Damper

*\*NOTE: Not available in all sizes*



**Model A210V**  
Adjustable Vertical Blades  
No Damper



**Model A210VM**  
Adjustable Vertical Blades  
SmoothGlide Multi-Shutter Damper

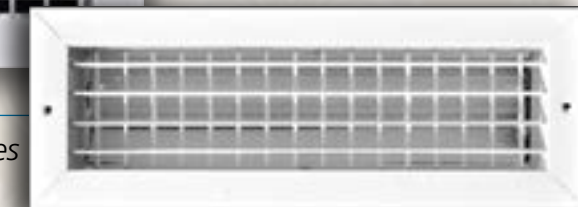

**Model A210HO**  
Adjustable Horizontal Blades  
Opposed Blade Damper  
*\*NOTE: Not available in all sizes*



**Model A210VO**  
Adjustable Vertical Blades  
Opposed Blade Damper

Compare to:	A210VM	A210VO
Hart & Cooley	A618MS	A618OB
Shoemaker	950	950-O
USAire	VM	VD
Continental	AVM	X
Lima	AL900V	AL990VOBD
Airmate	A420-VM	AT420-VO

### Features

- Adjustable horizontal or vertical Airfoil blades
- Aluminum construction
- White powder-coat finish
- Recessed screw holes
- Variety of damper configurations Including: SmoothGlide multi-shutter

### Product Detail



Durable Nylon Bushings

## A210 Series Options

### Opposed Blade Damper (OBD)

Top notch craftsmanship includes nylon bushings to ensure the aluminum blades stay in place according to the airflow that is desired.

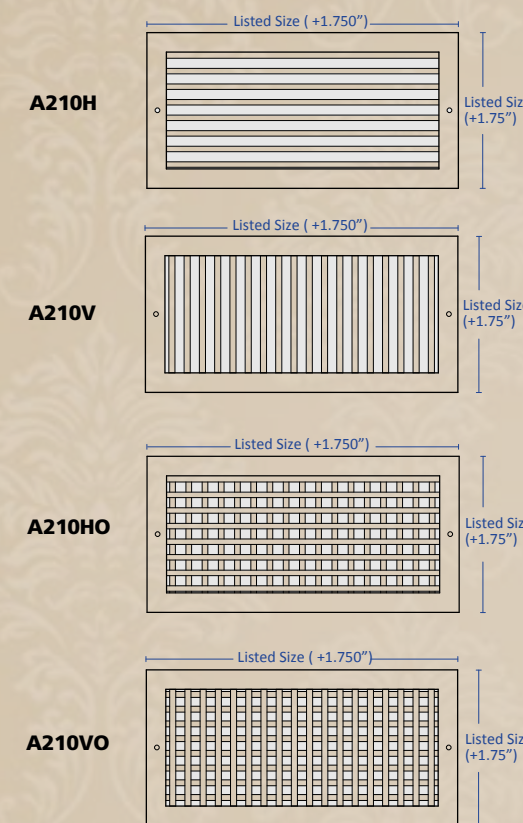

### NOTE:

The Model A210 Series is available in over 60 sizes and configurations. For available sizes and current pricing please refer to our **Pricing Guide Supplement**.

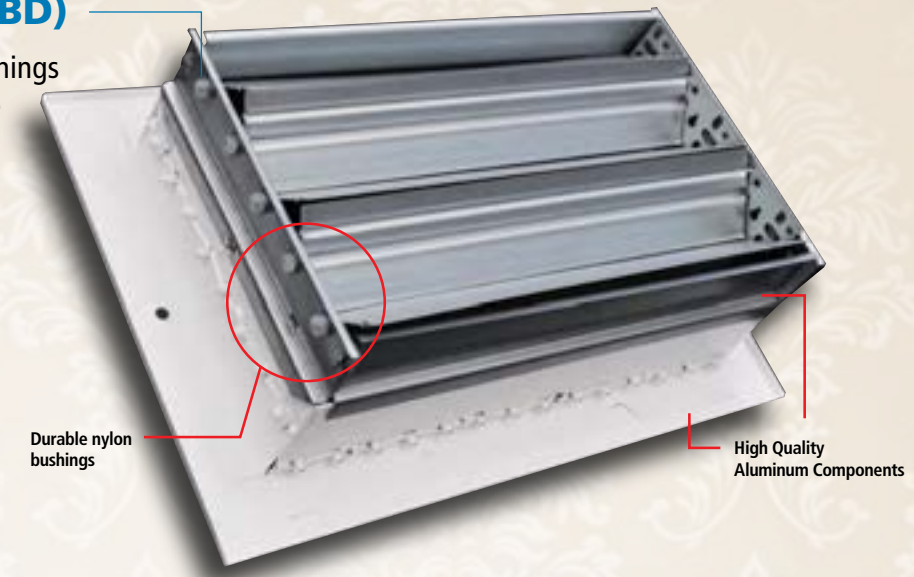

Durable nylon bushings

High Quality Aluminum Components

### SmoothGlide Damper

There is nothing like it on the market. Our SmoothGlide Damper prevents rust, rattling, and sticking. These dampers use high quality components. The idea behind this technology is that we powder coat the blade and the linkage component individually BEFORE we assemble our products and then we install the rivets to our blades.

Blade & linkage components individually powder coated BEFORE assembly



Rivets installed AFTER assembly for smoothest operation

High Quality Steel & Aluminum Components

ORDERING HINTS	DESCRIPTION	Example Model
<b>1. Start with the base model</b>	Model A210	<b>A210</b>
<b>2. Select the blade positioning</b>	V = Vertical blades H = Horizontal blades	A210V A210H
<b>3. Select the damper configuration</b>	M = Multi-shutter Damper (SmoothGlide) O = Opposed Blade Damper Blank = Without Damper	A210VM A210VO A210V

*Note: The A210VM is the most common and popular configuration.*

### A220 SERIES - Aluminum

TRUaire's A220 Series Double-Deflection registers represent the top-of-the line adjustable bar-type product. These registers feature two perpendicular rows of individually adjustable Airfoil blades for maximum airflow control. They can be ordered with the horizontal row in front, (A220H), or with the vertical row in front, (A220V).

Whether commercial or residential, using an OBD damper or no damper at all, the A220 Series register delivers high capacity airflow with a sleek aesthetic style and rock solid construction.



**Model A220H**

Adjustable  
Horizontal Blades  
No Damper

\*NOTE: Not available in all sizes

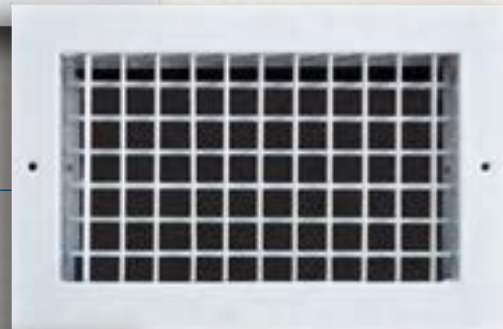

**Model A220V**

Adjustable Vertical Blades  
No Damper



**Model A220HO**

Adjustable  
Horizontal Blades in front  
Opposed Blade Damper

\*NOTE: Not available in all sizes

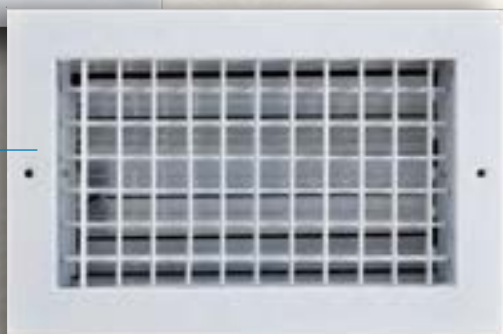

**Model A220VO**

Adjustable  
Vertical Blades in front  
Opposed Blade Damper

**NOTE:** Also available in steel.  
See the 220 Series

Compare to:	A220V	A220VO
Hart & Cooley	--	--
Shoemaker	904	904-O
USAire	VH	VHD
Continental	--	--
Lima	AL990V	AL990VOBD
Airmate	E240V	E240VO

**Features**

- Adjustable horizontal and vertical Airfoil blades
- Aluminum construction
- White powder-coat finish
- Recessed screw holes
- Opposed Blade Damper (OBD), or no damper at all

**Product Detail**



Non-Beveled Corners



Nylon Bushings add tension to damper blades

### A220 Series Options

#### Opposed Blade Damper (OBD)

Top notch craftsmanship includes nylon bushings to ensure the aluminum blades stay in place according to the airflow you wish.

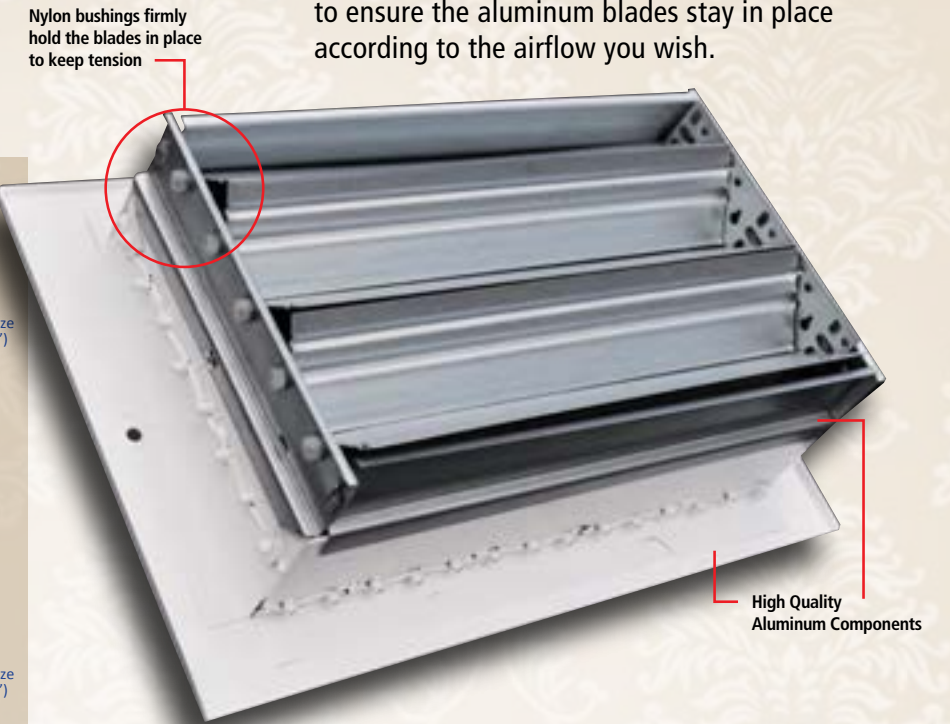

Nylon bushings firmly hold the blades in place to keep tension

High Quality Aluminum Components

**A220 Horizontal**

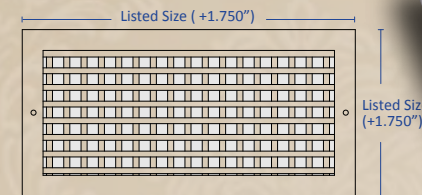

**A220 Vertical**

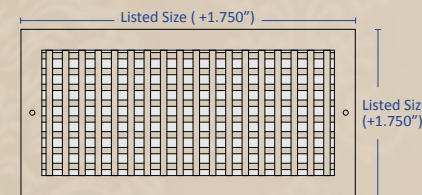

**NOTE:**

The Model A220 Series is available in over 60 sizes and configurations. "H" model configurations are not stocked in many sizes. For available sizes and current pricing please refer to our **Pricing Guide Supplement**.

Easily adjust aluminum blades to preferred air deflection.

Also available in steel. See the 220 Series

ORDERING HINTS	DESCRIPTION	Example Model
1. Start with the base model	Model A220	<b>A220</b>
2. Select the blade positioning	V = Vertical blades H = Horizontal blades	A220V A220H
3. Select the damper configuration	VO = Vertical Opposed Blade Damper HO = Horizontal Opposed Blade Damper Blank = Without Damper	A220VO A220HO A220V

**A300 SERIES - Aluminum**

Also available in Steel - see 300 Series

Truair's A300 series diffusers are the best of the best. Individually adjustable curved blades combined with 5 different face patterns provide the ultimate in air control. These sleek diffusers are made of aluminum so they are light-weight and will not rust. You can even add the extra control of our high-quality Opposed Blade Damper (OBD).



**Model A301HM**

Curved Blade - 1 Way

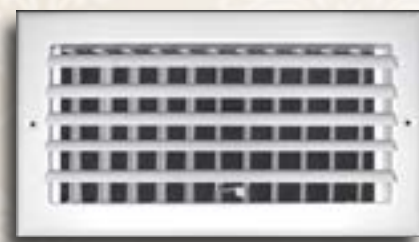

**Model A302HM**

Curved Blade - 2 Way Horizontal

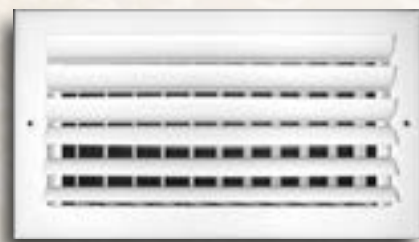

**Model A303M**

Curved Blade - 3 Way



**Model A302VM**

Curved Blade - 2 Way Vertical

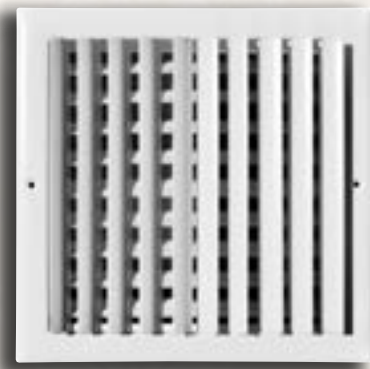

**Model A304M**

Curved Blade - 4 Way



**Compare to:** A301M A301O A302M A302O

Hart & Cooley	A611MS	A611OB	A612MS	A612OB
Shoemaker	CB10HM	--	CB20HM	--
USAire	LM/LMH	LD	LTM	LTD
Continental	AACB1	--	AACB2	--
Lima	A271ML	--	AL272ML	--
Airmate	A451HM	AT451HO	A452HM	AT452HO

**Compare to:** A303M A303O A304M A304O

Hart & Cooley	A613MS	A613OB	A614MS	A614OB
Shoemaker	CB30HM	--	CB40HM	--
USAire	LSM3	LSD3	LS4M	LS4D
Continental	AACB3	--	AACB4	--
Lima	AL273ML	--	AL274ML	--
Airmate	A453HM	AT453HO	A454HM	AT454HO

**Features**

- Individually adjusting curved blades
- Aesthetically designed on-piece frame
- Optional OBD
- Pristine powder-coat finish.
- Recessed screw holes

**Product Detail**

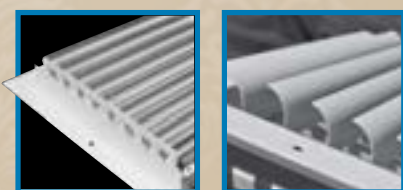

SmoothGlide Technology dampers Large, adjustable blades

**SmoothGlide Damper**

SmoothGlide Technology is the very simple, albeit very expensive, process of carefully powder-coating each and every individual component of a register, *prior to assembly*. The finished product is a stamped register with 100% powder coat coverage and a smooth quiet damper assembly that glides open or closed with the touch of a finger.



**Model A303-O**  
Three Way - OBD Option



Durable Rivets installed AFTER assembly for smoothest operation

Blade & linkage components are individually powder coated BEFORE assembly

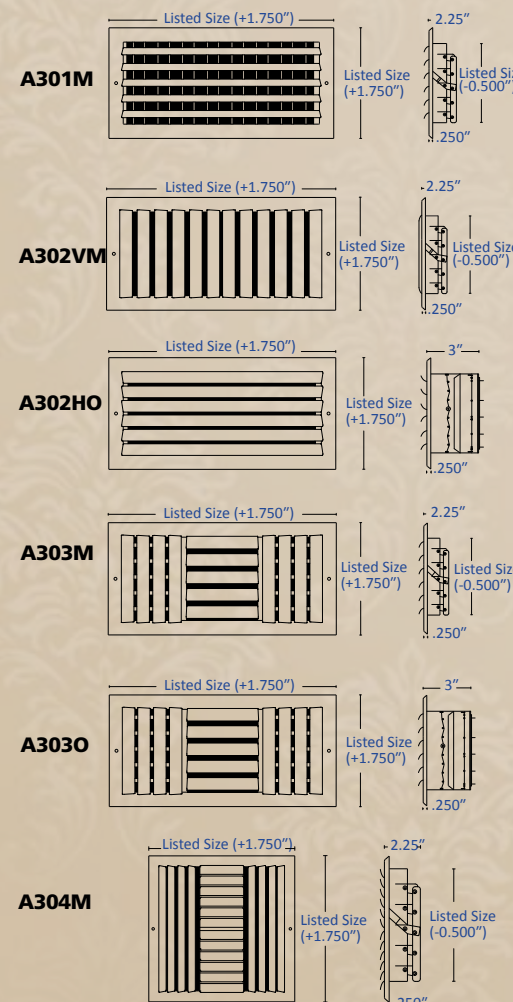

**Sizes & Carton Quantity Chart**

SIZE	A301M	A302M	A302VM	A303M	A304M
4 X 4	20				
6 X 4	20	20			
6 X 6	20	20		20	20
8 X 4	20	20	20	20	
8 X 6	20	20		20	
8 X 8	20	10	10	10	10
10 X 4	20	20		20	
10 X 6	10	10	10	10	
10 X 8	10	10	10	10	
10 X 10	10	10	10	10	10
12 X 4	20	20			
12 X 6	10	10	10	10	
12 X 8	10	10	10	10	
12 X 10	10	10			
12 X 12	10	10	10	10	10
14 X 4	10	10			
14 X 6	10	10		10	
14 X 8	10	10	10	10	
14 X 10	10	10			
14 X 14	5	10			10
16 X 4	10				
16 X 16	5			5	5
18 X 18	2				2
20 X 8	10			10	
20 X 10	10				
20 X 20					

**OBD Sizes & Qty. Chart**

SIZE	A301-O	A303-O	A304-O
4 X 4			
6 X 4			
6 X 6	10	10	10
8 X 4	10		
8 X 6			
8 X 8	5	5	5
10 X 4			
10 X 6	5		
10 X 8	5		
10 X 10	5	5	5
12 X 4			
12 X 6	5		
12 X 8	5		
12 X 10			
12 X 12	2	2	2
14 X 4			
14 X 6	10		
14 X 8	5		
14 X 10			
14 X 14		2	2
16 X 4			
16 X 16	5		1
18 X 18			1
20 X 8			
20 X 10			
20 X 20			1

PLEASE CONTACT US FOR ANY SIZES NOT LISTED

NOTE: FOR OPPOSED BLADE DAMPER OPTION PLEASE SPECIFY "O" FOR OBD FEATURE

**A300MG with Gasket**

For markets that require a gasket on the back of the register face, we offer the A300MG. These models are otherwise identical to the rest of the A300 Series, and are available in 1, 2, and 4 way air throw configurations, and in all popular or common sizes.



Foam gasket

**A500 SERIES - Aluminum**

The A500 Series represents a great blend of form and function. The extruded aluminum blade and frame design is sleek, and finished with our pristine white powder-coat process. The mitered corners are clean to the point of barely a notice.

At the same time, the durability of extruded aluminum won't rust, and the sturdy frame and blade design come together for a lifetime of use. The A500 Series is available in a variety of airflow configurations, and two different damper designs. Altogether then, this diffuser is as flexible as it is attractive.



**Model A501M**  
Ceiling Diffuser - 1 Way



**Model A502M**  
Ceiling Diffuser - 2 Way



**Model A503M**  
Ceiling Diffuser - 3 Way



**Model A504M**  
Ceiling Diffuser - 4 Way



**Model A505M**  
Ceiling Diffuser - 2 Way Corner



**Compare to:**

	A500M	A500-O
Hart & Cooley	A500MS	A500-OB
Shoemaker	SDD	SDD-O
USAire	5200	5200-DA
Continental	AE-MS	AE-OB
Lima	AL160ML	AL160OBD
Airmate	E105M	E105-O

**Features**

- Extruded Aluminum Construction
- Multi-shutter or Opposed Blade Damper
- Beautifully Mitered Corners
- Damper choices
- Air Pattern Choices

**Product Detail**

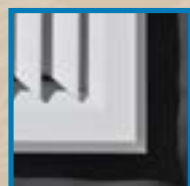

Perfectly Mitered Frame Corner



Optional Multi-shutter or OBD Damper

Square Aluminum Ceiling Diffusers

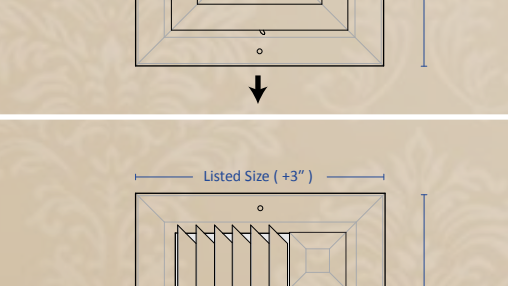
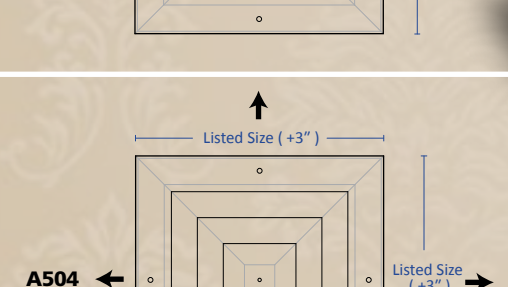
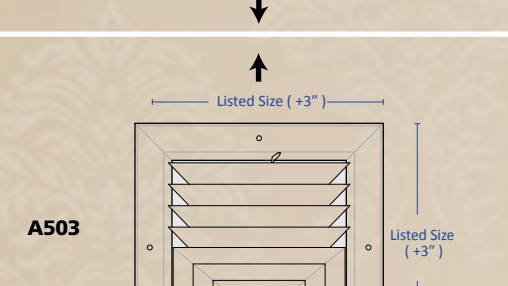
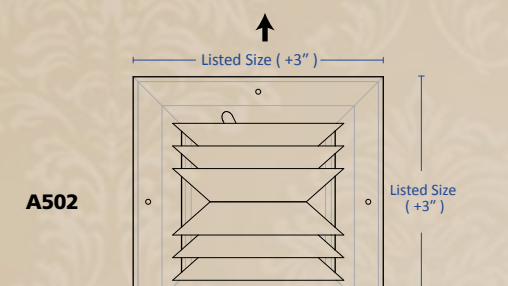
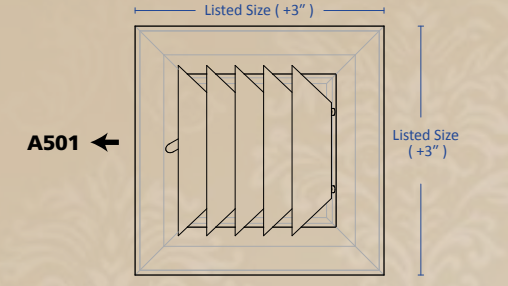

**SmoothGlide Damper**

SmoothGlide Technology is the very simple, albeit very expensive, process of carefully powder-coating each and every individual component of a register, *prior to assembly*. The finished product is a register with 100% powder coat coverage and a smooth quiet damper assembly that glides open or closed with the touch of a finger.

**Sizes & Carton Quantities**

MODEL	A501-M	A501-O
	A502-M	A502-O
	A503-M	A503-O
	A504-M	A504-O
	A505-M	A505-O
SIZE		
6 X 6	20	10
8 X 8	10	5
10 X 10	10	5
12 X 12	10	5
14 X 14	10	5

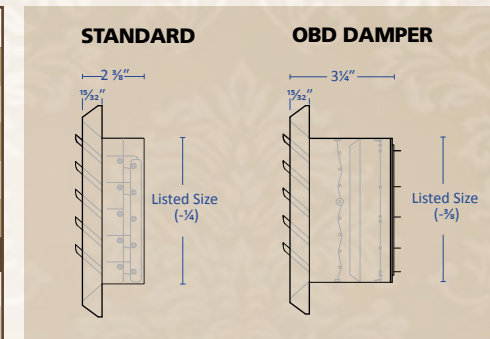

PLEASE CONTACT US FOR ANY SIZES NOT LISTED



**Standard Damper (M)**  
Standard SmoothGlide Multi-Shutter Damper System

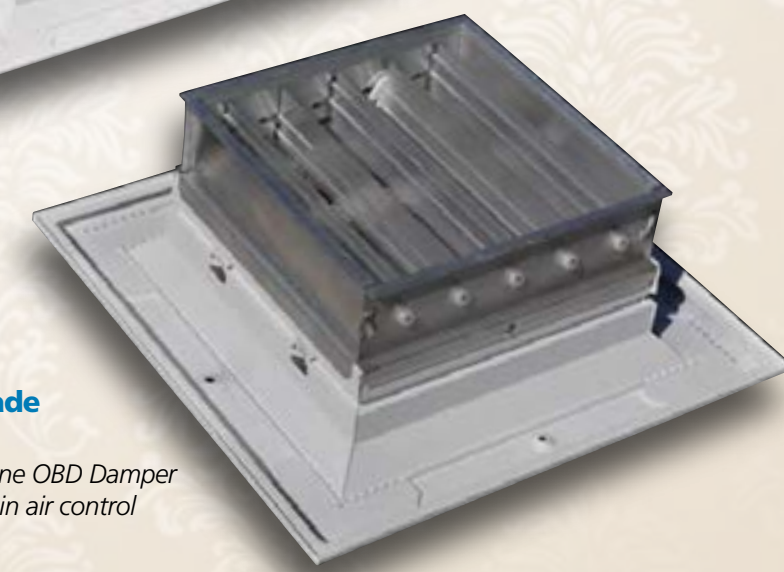

**Opposed Blade Damper (O)**  
Our top of the line OBD Damper for the ultimate in air control

**170 Series**

Stamped steel return grilles represent the most economical way to provide return air. These high quality stamped steel models are not only available in a wide variety of sizes, but fin design, and fin spacing as well. Although most commonly found in a pristine white powder-coat finish, the model 170 is also available in a brown finish.



**Model 170**  
Stamped Return Grille  
1/2" Fin Spacing

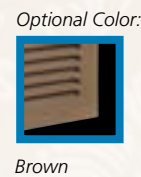

**Model 173**  
Stamped Return Grille  
1/3" Fin Spacing



**Model 174**  
Stamped Return Grille  
Fixed Curved Blade

*NOTE: Available in steel only*

**Compare to:**

	170	173
Hart & Cooley	672	650
Shoemaker	1050	1033
USAire	1400	--
Continental	G25	G35
Lima	60GH	63GH
Airmate	170	173

**Features**

- High quality stamped steel
- Variety of fin styles
- Finished in white or brown
- Counter-sunk screw holes
- Individually shrink-wrapped

**Product Detail**

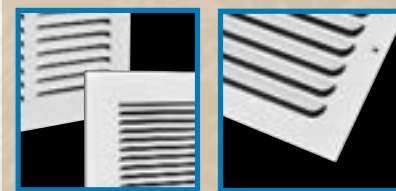

Available in either 1/2" or 1/3" Fin Spacing

Unique curved blade design on Model 174

**170 Series Configurations**

Whether large or small, we have the right grille for the job. Screw-hole placement varies according to typical industry standards, although on the Model 170 12x12 and 14x14 sizes, we exclusively offer both a 2-hole and 4-hole configuration.

**Model 170**  
• 1/2" Fin Spacing

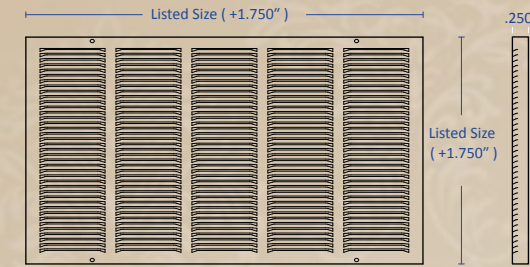

**Model 173**  
• 1/3" Fin Spacing

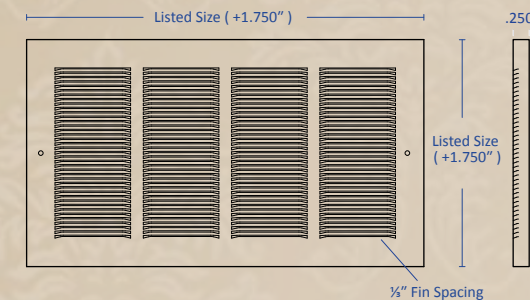

**Model 174**  
• Fixed Curved Blade

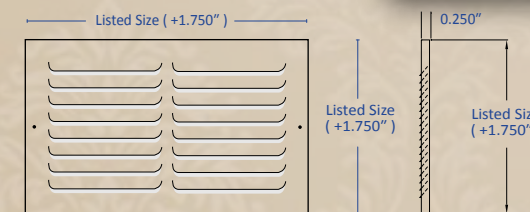

Unique curved blade design on Model 174



Model 170 20 "x16"

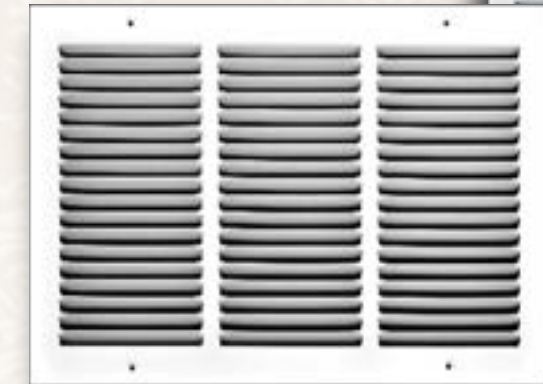

Model 170 16 "x20"

MODEL NUMBER	SIZES AVAILABILTY	LARGEST SIZE
<b>Model 170</b>	Available in 125 popular sizes	Up to 40x20
<b>Model 170B (BROWN)</b>	Available in 40 popular sizes	Up to 36x36
<b>Model 173</b>	Available in 50 popular sizes	Up to 36x36
<b>Model 174</b>	Available in 20 popular sizes	Up to 36x16

*NOTE: Please use the TRUaire Price List Catalog for specific Carton Quantity Data*

### 190/190RF Series

Different home heating and air-conditioning designs utilize a variety of filter placement strategies. Most new homes in the "sunbelt states" choose to use a filter grille design.

As with everything that TRUaire makes, we offer a wide variety of designs to fit virtually every residential application; different fin spacing, different filter thicknesses, and different door designs. One look at the Comparison Chart, and it becomes clear that no one offers the variety that we do.



**Model 190**  
Fixed face  
1/2" fin design

**Model 190RF**  
Sidewall Filter Grille  
Removable face  
1/2" fin design

**Model 193RF**  
Sidewall Filter Grille  
Removable face  
1/3" fin design  
for 1" filters

**Model 192RF**  
Sidewall Filter Grille  
Removable face  
1/2" fin design  
for 2" filters

**Model 194**  
Fixed face  
1/2" fin design  
for 4" filters

**Compare to: 190 190RF 192RF 193RF 194**

Hart & Cooley	--	673	--	659	--
Shoemaker	--	FG	FG-2	--	FG-4
USAire	--	1410F	--	--	--
Continental	--	FG-2	--	--	--
Lima	--	60GHFF	--	--	--
Airmate	--	170FF	--	--	--

**Features**

- Removable face or fixed hinge design
- Available in 1", 2", and 4" filters
- 1/2" or 1/3" fin spacing
- Pristine white powder-coat finish
- All popular sizes are individually boxed

**Product Detail**

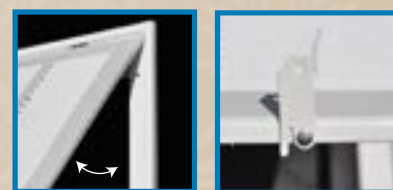

Removable face design suggested for sidewall applications  
SmoothGlide latch for increased durability and ease of use

### 190 Series Options

No other register and grille manufacturer offers both a **removable face**, and **fixed hinge** version of their filter grilles. We do, and the reason is simple; safety. We highly recommend using only the fixed hinge Model 190 filter grille for all ceiling applications to reduce the possibility of injury.

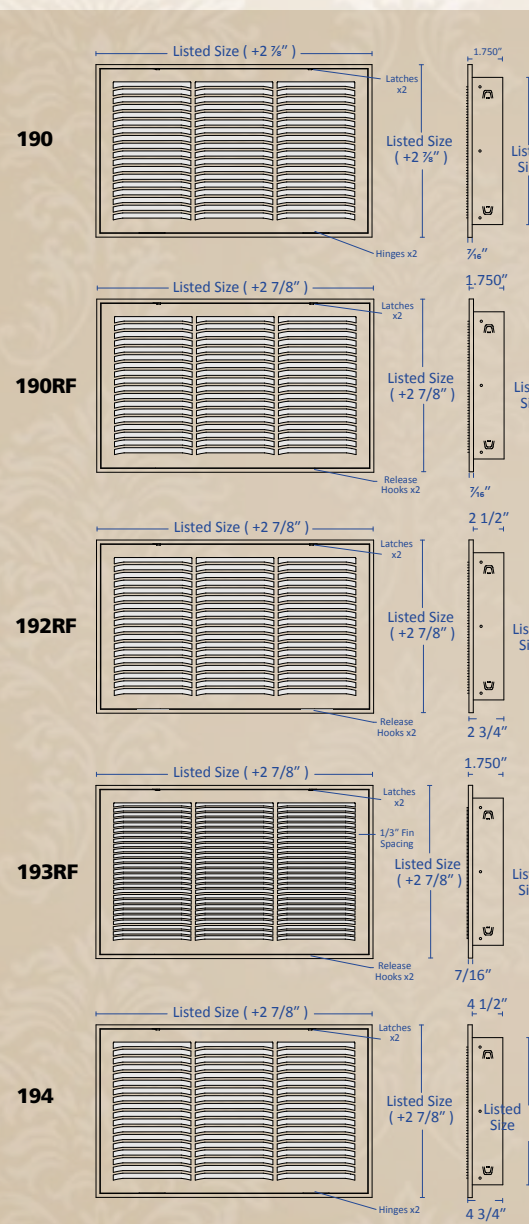

**Model 190 Sizes & Carton Quantity Chart**

HEIGHT	WIDTH																		
	8	10	12	14	16	18	20	22	24	25	26	28	30	32	36	38	40	50	
6		1					1	1					1						
8	1			1			1	1					1						
10		1		1	1	1	1	1					1	1	1		1		
12			1			1	1	1	1				1		1				
14				1	1	1	1	1	1	1			1		1				
16		1			1		1	1	1	1	1		1		1				
18			1			1	1	1	1	1			1		1				
20		1	1	1	1	1	1	1	1	1			1	1		1	1	1	
22								1						1					
24		1	1	1	1	1	1	1	1				1		1				
25				1	1	1	1			1					1				
26				1															
28																			
30			1	1	1	1	1	1	1				1		1				
32																			
36			1	1	1	1	1	1	1	1							1		
40								1											
50								1											

PLEASE CONTACT US FOR ANY SIZES NOT LISTED

**Model 190RF Sizes & Carton Quantity Chart**

HEIGHT	WIDTH																		
	8	10	12	14	16	18	20	22	24	25	26	29	30	32	38	40	50		
6		1					1	1					1						
8	1			1			1	1					1						
10		1		1	1	1	1	1					1	1	1	1			
12			1			1	1	1	1				1		1				
14				1	1	1	1	1	1	1			1		1				
16		1			1		1	1	1	1	1		1		1				
18			1			1	1	1	1	1			1		1				
20		1	1	1	1	1	1	1	1	1			1	1	1	1	1		
22								1					1	1					
24		1	1	1	1	1	1	1	1				1		1				
25			1	1		1				1					1				
26				1															
29									1										
30			1	1	1	1	1	1	1				1		1				
32																			
36			1	1	1	1	1	1	1	1						1			
40								1											
50								1											

PLEASE CONTACT US FOR ANY SIZES NOT LISTED

MODEL NUMBER	SIZES AVAILABILITY	LARGEST SIZE
<b>Model 190 &amp; Model 190RF</b>	Available in 75 popular sizes (see list above)	Up to 50x20
<b>Model 192RF</b>	Available in 20 popular sizes	Up to 30x20
<b>Model 193RF</b>	Available in 20 popular sizes	Up to 30x20
<b>Model 194</b>	Available in 20x25	20x25 Only

NOTE: Please use the TruAire Price List Catalog for specific Carton Quantity Data

### Model 270 and Model 290

When choosing return air grilles, whether filter grille or straight return air, the most economical choice is stamped steel every time. But for a few dollars more more, the Fixed Bar models provide the luxury of ruggedness and appearance.

Each heavy gauge bar is individually set at 45 degrees, and spaced 3/4" apart. There's nothing "flimsy" about this grille. It is rock-solid, individually welded, and looks fantastic!

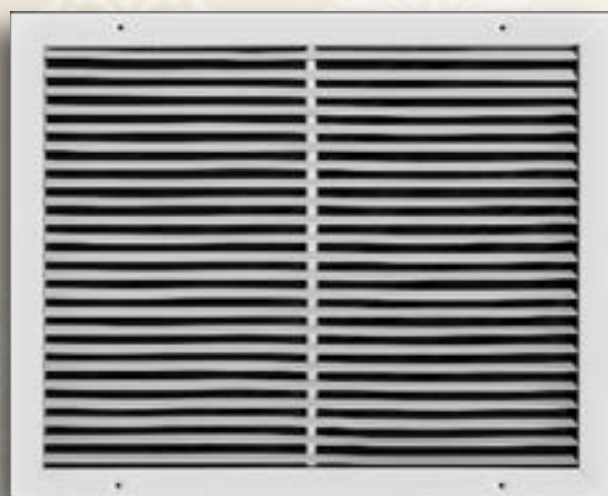

**Model 270**  
Fixed Bar Return Air Grille  
3/4" blade separation  
60° blade angle from face



**Model 290**  
Fixed Bar Return Air Filter Grille  
3/4" blade separation  
60° blade angle from face

Model 290 accepts 1" filters

Compare to:	270	290
Hart & Cooley	94A	96AFB
Shoemaker	--	920FG-2
USAire	SRH	SRHF
Continental	FBG40	FBFG
Lima	S90H	S90HFF
Airmate	280	280FF

#### Features

- Pristine white Powder-coat finish
- Individually shrink-wrapped
- Counter-sunk screw holes (Model 270)
- Fixed hinge door (Model 290)

#### Product Detail



Blades at 45 degrees    Detail view of latch

### Model 270

#### • Steel Construction Return Air Grille

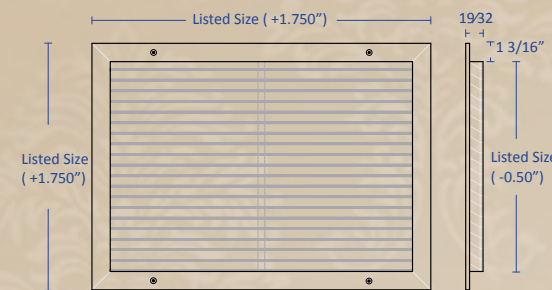

### Model 290

#### • Steel Construction Return Air Filter Grille

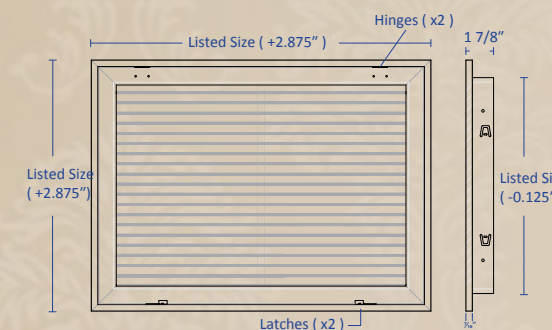

NOTE: Model 290 Return Filter Grille is a fixed hinge design, and not available in a removable face design.

Model 290 accepts 1" filters



3/4 inch blade spacing

#### Model 270 Sizes & Carton Quantity Chart

HEIGHT	WIDTH																				
	4	6	8	10	12	14	16	17	18	20	24	25	26	28	30	32	36	38	40	44	48
4				20	20	20	20						10								
6		20	20	20	20	20	20			10	10	10		5	5	10					
8			20	20	20	20	20			10	10	10		5	5	10					
10				20	20	20	20			10	10	10		5	5	10					
12					10	10	10			10	10	10		5							
14						20	10	10		5	10	5	5		5	5	5	5			
16							10	10			5	5	5		5	5				5	1
18					10		10			5	5	5			5	5					
20						10	10				5	5	5			5				5	
22																				5	
24	10					10	5	5			5	5				5			5		1
25											5		5								
26																					
30								5			5	5				5					
32																					
34																					
36						5				5											
40											5					1					

#### Model 290 Sizes & Carton Quantity Chart

HEIGHT	WIDTH																			
	4	6	8	10	12	14	16	18	20	24	25	26	28	30	36	38	40	48		
4				1	1	1	1				1				1					
6		1	1	1	1	1	1	1	1	1					1	1				
8			1	1	1	1	1	1	1	1					1					
10				1	1	1	1	1	1	1					1	1				
12					1	1	1	1	1	1		1			1	1				
14						1	1	1	1	1	1	1		1	1	1	1			
16							1			1	1	1		1	1	1			1	
18					1			1	1	1	1	1		1	1	1				
20	1					1			1	1	1				1	1			1	
24							1	1			1	1				1	1			1
25											1									
26																				
28																				
30									1			1								
36							1			1	1									
38																				
40																				
48											1									

#### ORDERING HINTS

Select a Base Model:

#### DESCRIPTION

Model 270 - Return Air Grille  
Model 290 - Return Air Filter Grille

#### Example Model

270  
290

Select register size:

20 x 16 (Return Air Grille)  
20 x 16 (Return Air Filter Grille)

270 20 x 16  
290 20 x 16

Special Note:

There is a significant difference between a 20 x 16 Return Grille and a 16 x 20 Return Grille. The first dimension is the approximate length of the blades. In most cases, this would be called the **horizontal** dimension or the **width** of the Return Grille.

## Model A270 and Model A290 Aluminum Fixed Bar Return Grilles

The top-of-the-line Return Air Grille is bar-type. And the best bar-type Return Air Grille is made of aluminum. Lightweight, rust resistant, and durable; Truair's A270 Return Air Grille and A290 Return Air Filter Grille is the best of the best for residential return air applications.

Each aluminum fixed blade is set at 45 degrees and 3/4" apart. Finished in our pristine white powder-coat, this is a tough act to follow!

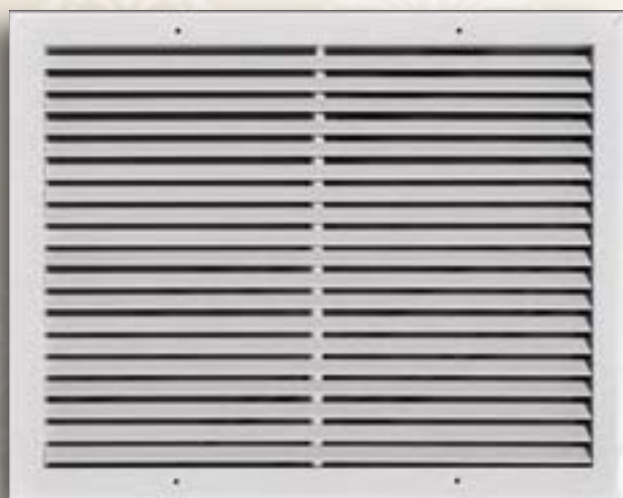

**Model A270**  
Aluminum Fixed Bar Return Air Grille  
3/4" blade separation  
60° blade angle from face



**Model A290**  
Aluminum Fixed Bar Return Air Filter Grille  
3/4" blade separation  
60° blade angle from face

Easy-to-open finger latch

Model A290 accepts 1" filters

Compare to:	A270	A290
Hart & Cooley	RH45	RHF45
Shoemaker	905	--
USAire	RH	RHF
Continental	AFBG40	--
Lima	ALS90	ALS90HFF
Airmate	E280	E289FF

### Features

- White powder-coat finish
- Individually shrink-wrapped
- Counter-sunk screw holes (Model A270)
- Fixed hinge filter door (Model A290)

### Product Detail



Blades at 45 degrees    Detail view of latch

### Model A270

- Aluminum Construction Return Air Grille



### Model A290

- Aluminum Construction Return Air Filter Grille

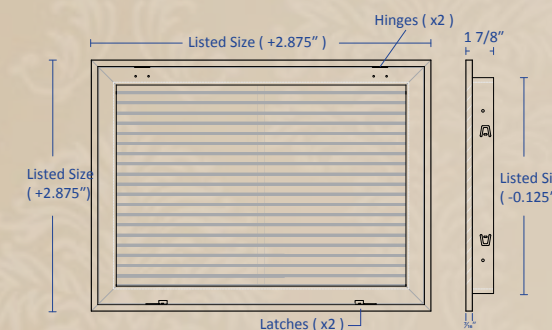

NOTE: Model A290 Return Filter Grille is a fixed hinge design, and not available in a removable face design.

Model A290 accepts 1" filters

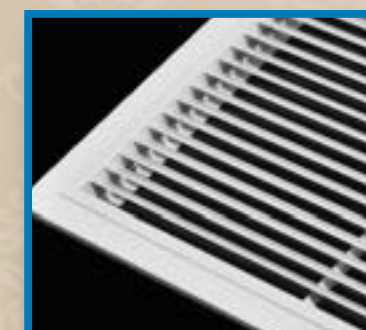

3/4 inch blade spacing

### Model A270 Sizes & Carton Quantity Chart

HEIGHT	WIDTH																
	6	8	10	12	14	16	18	20	22	24	25	28	30	36	40	46	48
4	20	20				20				10							
6	20	20	20	20	20	20	10	10					10	10	1		
8		20	20	20	20	20		10		10			10				
10			20		20	20	10	10		10			10	10			
12				10			10	10		10			5	5			
14					10		5	10		5	5	5	5				
16						10		5		5	5	5	5	5			1
18							5	5		5			5	5			
20				10	10	5		5		5	5	5	5				
22									5								
24			10	10	5	5	5	5		5							
25					5	5		5									
30					5	5				5							1

### Model A290 Sizes & Carton Quantity Chart

HEIGHT	WIDTH																
	4	6	8	10	12	14	16	18	20	22	24	25	28	30	36	40	48
4																	
6				10	10	10				5							
8			10		10	10											
10				10	10	10	10		5	5				5			
12					10		10	5	5	5				1	1		
14						10			5	5	5	1	1				
16							5	5		5	1		1	1			
18				5				5	5		1			1	1		
20				5	5	10	5	5	1		1	1		1	1	1	1
22										1							
24					5	5	5	1	1		1			1	1	1	1
25						5	1		1			1					
30					1		1	1	1		1						
36											1						
40									1								
48												1					

### ORDERING HINTS

Select a Base Model:

### DESCRIPTION

Model A270 - Aluminum Return Air Grille  
Model A290 - Aluminum Return Air Filter Grille

### Example Model

A270  
A290

Select Register Size:

20 x 16 (Return Air Grille)  
20 x 16 (Return Air Filter Grille)

A270 20 x 16  
A290 20 x 16

Special Note:

There is a significant difference between a 20 x 16 Return Grille and a 16 x 20 Return Grille. The first dimension is the approximate length of the blades. In most cases, this would be called the **horizontal** dimension or the **width** of the Return Grille.

**150 SERIES**

The 150M floor register series represents a wide range of variety, creative design and bold innovation. Even the most basic model brings with it unparalleled standards of excellence that is the hallmark of the TRUaire brand. This wide variety of designs includes the basic register model, the deluxe register model, the over-sized mobile home model and models that require screw holes. Each is available in our high quality brown or white powder-coat finish.



**Model 150MB**  
Two Way - Brown Finish

**Model 150MW**  
Two Way - White Finish

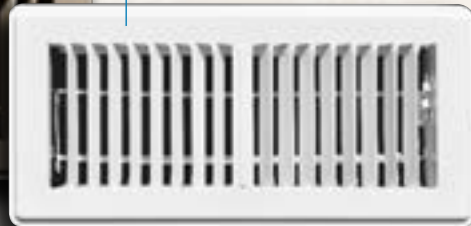

**Model 153MB**  
Three Way - Brown Finish

**Model 153MW**  
Three Way - White Finish



**Model 155MB** Mobile Home

**Model 155MW** Mobile Home



**Model 157MB**  
Deluxe - Brown Finish

**Model 157MW**  
Deluxe - White Finish

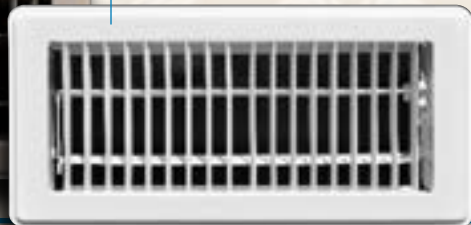
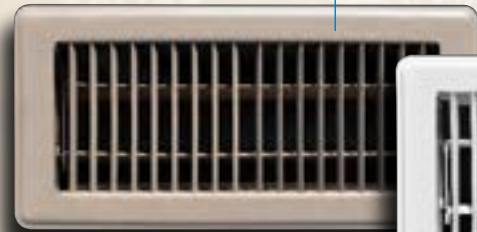

**Compare to:**

	150	153	150T	150R
Hart & Cooley	421	--	420	265
Shoemaker	350	--	TS	1600
USAire	1510D	--	1320	1530
Continental	28	--	TG32	F25
Lima	800	--	875	825
Airmate	302	--	301	325

**Features**

- Heavy steel construction
- Revolutionary SmoothGlide Technology
- No-Scuff powder-coat finish
- 21st Century color pallet
- Innovative Three-way air pattern
- Model 150 and 153 available with OBD



**Product Detail**



SmoothGlide Damper Linkage and Rivets    Revolutionary, New Three-Way Floor Register

**150 Series Options**

The decades old practice of painting a register and damper after it has been assembled leads to chipped paint, unpainted exposed surfaces, frozen linkage parts, rattling damper blades, and ultimately...rust. The process saves time and money. It's the best way to build a cheap register cheaply.

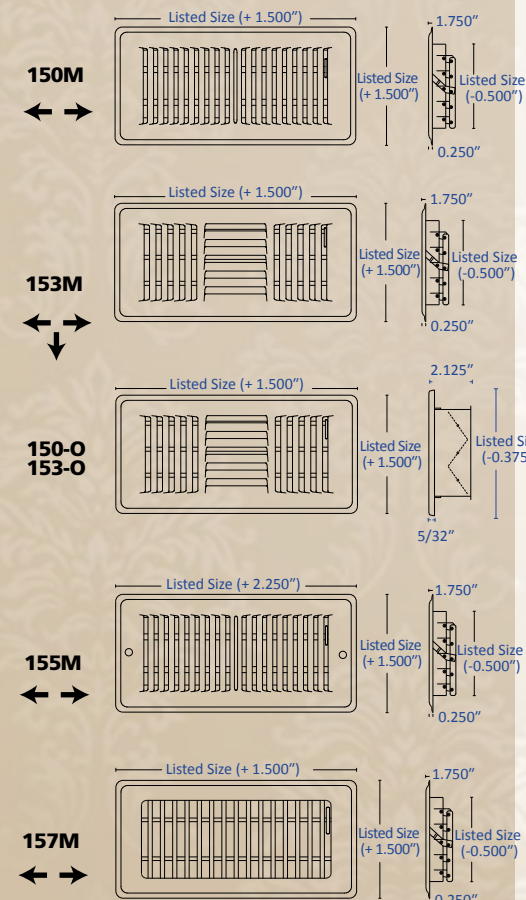
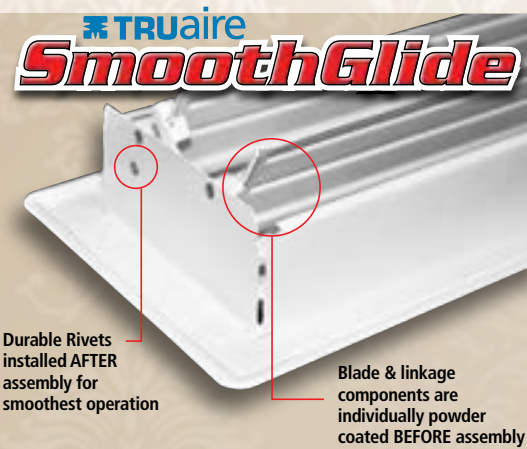

**SmoothGlide Damper**

SmoothGlide Technology is the very simple, albeit very expensive, process of carefully powder-coating each and every individual steel component of a register, *prior to assembly*. The finished product is a stamped steel register with 100% powder coat coverage and a smooth quiet damper assembly that glides open or closed with the touch of a finger.

**SIZES & CARTON QUANTITY CHART**

	150MB/MW	153MB/MW	155MM/MW	157MB/MW
2x8	20			
2x10	20		20	20
2x12	20		20	20
2x14	20		20	20
4x8	20		20	20
4x10	20	20	20	20
4x12	10	10		10
4x14	10			10
6x8	20			20
6x10	10		10	10
6x12	10			10
6x14	10			10

**Model 150MB** Two Way - Brown Finish

Face Frame: Listed Size (+1.50")  
 Except: 02x10 (3.750" x 11.50")  
 02x12 (3.750" x 13.50")  
 02x14 (3.750" x 15.50")

Standard 2-way model...although there's nothing "standard" about it!

**Model 153MB** Three Way - Brown Finish

Revolutionary New 3-way floor register. Innovation for a new generation.

**Model 155MB** Mobile Home

Featuring a wider frame and recessed screw holes, which is ideal for the Mobile Home industry.

**Model 157MB** Deluxe - Brown Finish

The Deluxe Model is manufactured with individually welded blades, each set at gradually greater angles, for better air dispersion.

**BASEBOARD SERIES**

Models: 115, 118, 120, 121, 122, 123, 124, 125

TRUaire proudly offers a complete line of baseboard products, manufactured with the same high-quality features including SmoothGlide dampers and pristine powder-coating. Most of these models are available in a variety of fin designs, fin spacing, and in either white or brown finishes.



**SUPPLY**

**Model 115SW**

15" Shown

15" = 115SW  
18" = 118SW  
24" = 120SW

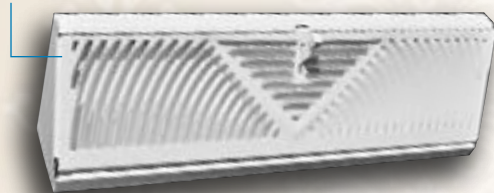

**Model 121SW**

121SW-24 = 24" Deluxe Baseboard Diffuser  
121SW-48 = 48" Deluxe Baseboard Diffuser



**Model 123M**

Two Way 1/3" Spaced Fins - 3/4" Turnback



**Model 124M**

Sidewall Supply - Bottom Open - 3/4" Turnback



**Model 125TS**

Single Damper - Supply  
1/3" Fin Spacing



**RETURN**

**Model 115RW**

15" Shown

15" = 115RW  
18" = 118RW  
24" = 120RW

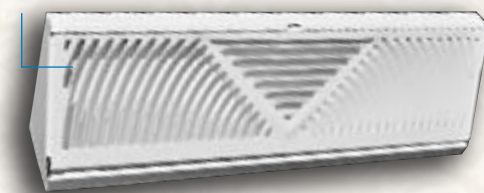

**Model 122RW**

One Way - 1/2" Spaced Fins - 3/4" Turnback



**Model 123RW**

One Way - 1/3" Spaced Fins - 3/4" Turnback



**Model 125TR**

No Damper - Return  
1/3" Fin Spacing



**Compare to:** 115SW 115RW 118SW 118RW 121

Hart & Cooley	470	471	470	471	462
Shoemaker	406	407	406	407	--
USAire	1330	1341	1340	1340	--
Continental	150	1505	180	1805	240
Lima	--	--	--	--	72
Airmate	350	351	350	351	350

**Compare to:** 122 123M 123R 124M 125TR 125TS

Hart & Cooley	674	664	657	--	658	655
Shoemaker	1150	855	133	855	1165	--
USAire	--	1300	--	--	--	--
Continental	BG21	BG32	BG31	B32	BEG21	55
Lima	60GH7	--	671	667	652	649
Airmate	171	--	174	164	--	--

**Features**

- Smoothglide damper technology
- Powder-coat
- Sunburst fin design
- Easy-Open Slotted Face

**Product Detail**

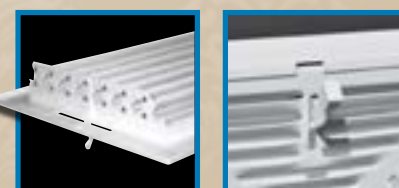

SmoothGlide Damper Linkage and Rivets    Easy-Open Slotted Face

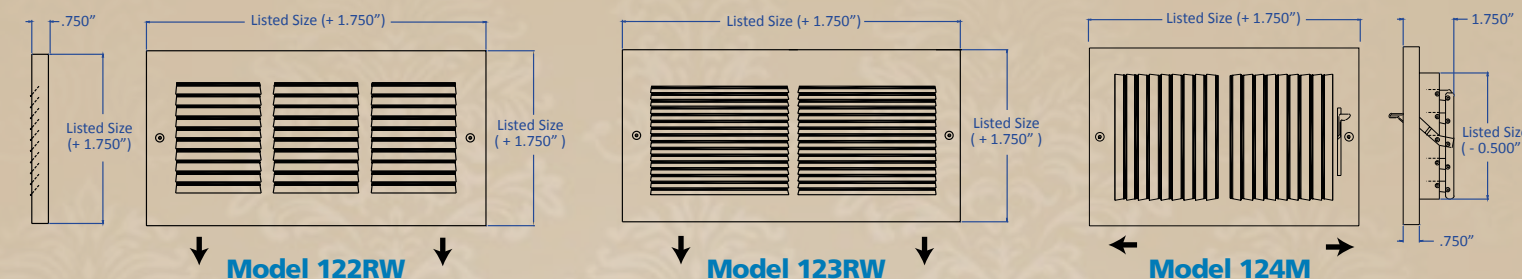

Three-sided for specific floor installations - Without a fourth turnback side on bottom

**Model 115SW Supply**  
15" Shown - Also available in 18" & 24"

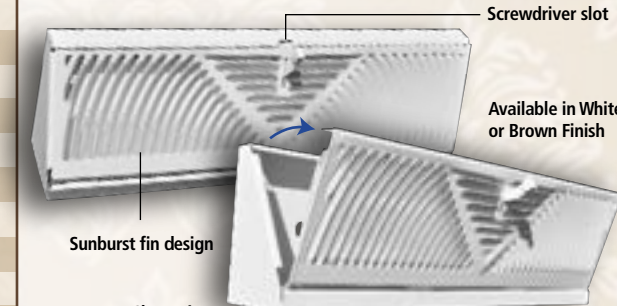

Shown in OPEN position  
**Model 115RW Return**  
15" Shown - Also available in 18" & 24"

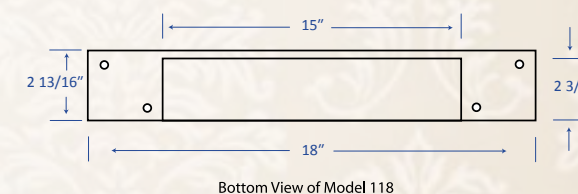

**NOTE:** The 120SW is only available as a SUPPLY configuration, and only in a white finish.

**TRUaire SmoothGlide**

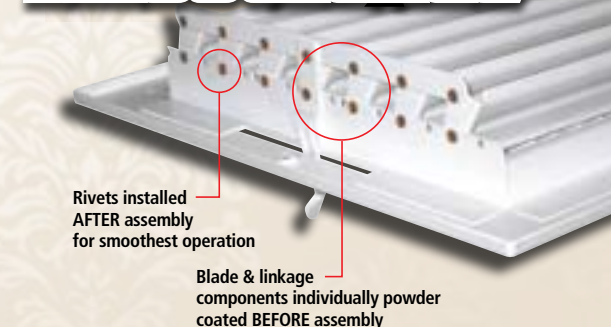

**Sizes & Carton Quantity Chart**

SIZE	115	118	120	121	122	123	123	124	125	125
	S/R	S/R	S	S	R	M	R	M	TR	TS
8 X 4							20			
8 X 6							20			10
10 X 6						20	20	20	10	10
10 X 8					20		20	20		
12 X 6					20	20	20	20	10	10
12 X 8					20		20	20		
14 X 4							20			
14 X 6					20	20	20	20	10	10
14 X 8					20		20	10	10	
14 X 10					20		20			
14 X 12					20		20			
15	20									
16 X 6							20			
16 X 8					20		20			
18		20								
20 X 6					20		10			
20 X 8					10		10			
20 X 10							10			
24			10	10						
24 X 6					20		20			
24 X 8					10		10			
24 X 10					10		10			
24 X 12					10		10			
30 X 6					20		20			
30 X 8					10		10			
30 X 10					10		10			
30 X 12					10		10			
36 X 6					10		10			
36 X 8							10			
36 X 10					10					
36 X 12					5					
48				1						

PLEASE CONTACT US FOR ANY SIZES NOT LISTED

**DESIGNER'S SERIES BASEBOARDS**  
**ABS Composite, Plated Finishes and Solid Oak**

Each of our decorative baseboard diffusers allow the ability to update your home's look while also improving the heating or cooling. Choose from plated steel, ABS Composite or solid oak designs. These grilles are easy to install along the baseboard due to the removable faceplate and cleaning them is a snap.



**SUPPLY**

**Model 115SRB**  
*Oil Rubbed Bronze Finish*

15" = 115SRB  
 18" = 118SRB  
 24" = 120SRB



**Model 115SSN**  
*Satin Nickel Finish*

15" = 115SSN  
 18" = 118SSN  
 24" = 120SSN



**Model 115SWP**  
*ABS Composite Baseboard White Finish*

15" = 115SWP  
 18" = 118SWP  
 24" = 120SWP



**RETURN**

**Model 115RRB**  
*Oil Rubbed Bronze Finish*

15" = 115RRB  
 18" = 118RRB  
 24" = 120RRB



**Model 115RSN**  
*Satin Nickel Finish*

15" = 115RSN  
 18" = 118RSN  
 24" = 120RSN

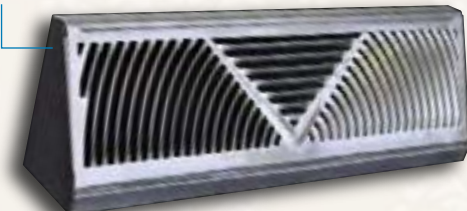

**Model 115SBP**  
*ABS Composite Baseboard Brown Finish*

15" = 115SBP  
 18" = 118SBP  
 24" = 120SBP



**Model 168BB**  
*Solid Oak Baseboard in three distinct finishes*

15"  
 18"  
 24"



Solid Oak Finishes Available:



*Shown in Light Finish*

**Compare to:** 115SW 115RW 118SW 118RW 121

Hart & Cooley	470	471	470	407	462
Shoemaker	875	875	875	875	--
USAire	1330	1341	1340	1340	--
Continental	150	1505	180	1805	240
Lima	470	471	470	471	72 24
Airmate	350	351	350	351	350

**Features**

- Smoothglide damper technology
- Powder-coat
- Sunburst fin design
- Easy-Open Slotted Face

**Product Detail**

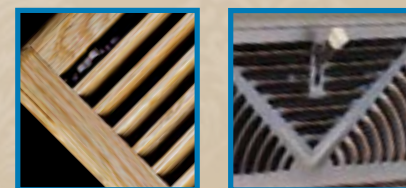

Hand Assembled Oak Components    Easy-Open Slotted Face

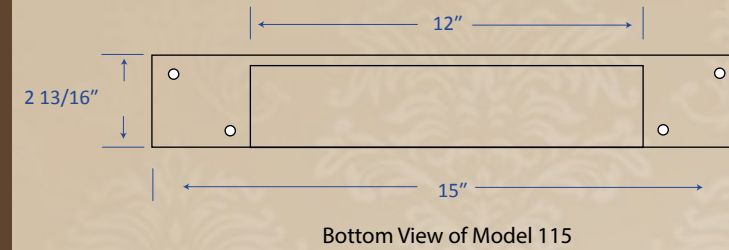

**Model 115**

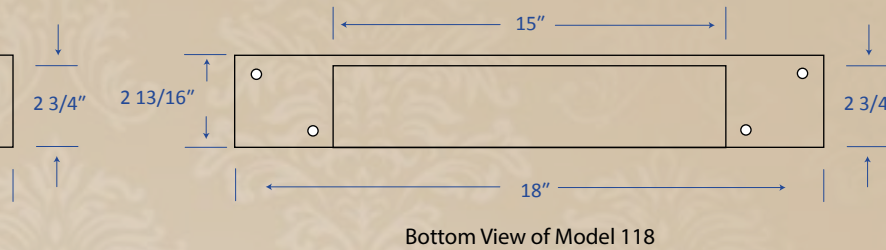

**Model 118**

**Baseboard Supply** *Stamped Face*

15" Shown - Available in the following finishes:

SIZE	OIL RUBBED BRONZE	SATIN NICKEL
15"	115SRB	115RSN
18"	118SRB	118RSN
24"	120SRB	120RSN

**Baseboard Return** *Stamped Face*

15" Shown - Available in the following finishes:

SIZE	OIL RUBBED BRONZE	SATIN NICKEL
15"	115RRB	115RSN
18"	118RRB	118RSN
24"	120RRB	120RSN

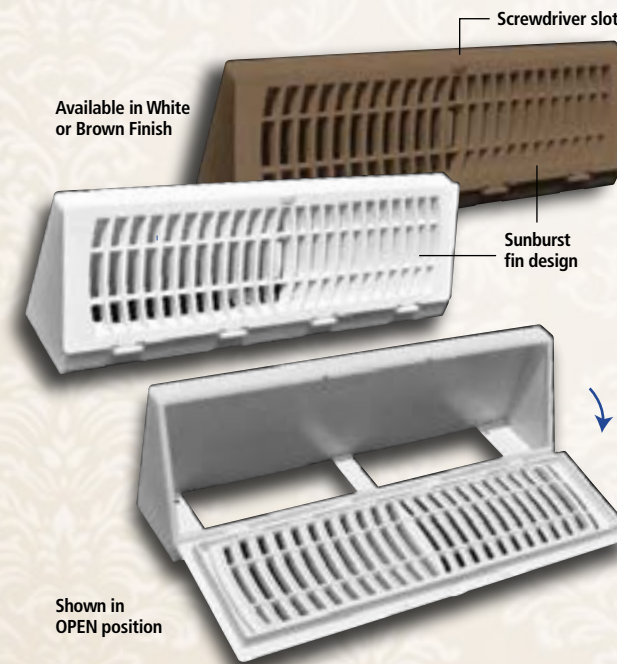

**Baseboard Supply** *ABS Composite*

15" Shown - Available in the following sizes and in white or brown

SIZE	WHITE FINISH	BROWN FINISH
15"	115SWP	115SBP
18"	118SWP	118SBP
24"	120SWP	120SBP

**Baseboard Return** *ABS Composite*

15" Shown - Available in the following sizes and in white or brown

SIZE	WHITE FINISH	BROWN FINISH
15"	115RWP	115RBP
18"	118RWP	118RBP
24"	120RWP	120RBP

**Model 168-BB** *Baseboard*

SIZE	UNFINISHED	LIGHT FINISH	DARK FINISH
15"	168-BBU 15	168-BBL 15	168-BBD 15
18"	168-BBU 18	168-BBL 18	168-BBD 18
24"	168-BBU 24	168-BBL 24	168-BBD 24



\*PLEASE CONTACT US FOR ANY SIZES NOT LISTED

### 154 Series Heavy Duty Floor Grilles

These two different floor application products round out the TRUaire floor grille offering, in two very different ways. The 154 Series is perfect when the application calls for extra strength and rigidity in the floor grille. Generally used as a return air product, several sizes are available with a damper mechanism as well.



**Model 154-O**  
Supply diffuser  
and OBD damper



**Model 154R**  
Straight return grille



**Model 150TSW**  
Grille only, no damper  
White Finish



**Model 150TSB**  
Grille only, no damper  
Brown Finish



**Model 173TSW**  
Grille only, no damper  
White Finish



**Model 173TSB**  
Grille only, no damper  
Brown Finish

**Compare to:** 154R 154-O 150TS 173TS

Hart & Cooley	265	210	420
Shoemaker	1600	1550	TS
Continental	F25	F20	TG32
USAire	1530	1530M	1320

**Features**

- 154 Series is extremely heavy duty
- Rugged brown powder coat finish
- 150TS available in white or brown

### 150 & 173 Series Toe Space Grilles

Each model in the toe space grille lineup offers an understated yet dependable and simple vent underneath your cabinet. Available in brown or white, this is a grille only, no damper product.

**Product Detail**



Heavy duty blades



Detail view of durable bushings on OBD damper

**Model 154R**

• Steel Construction Floor Grille

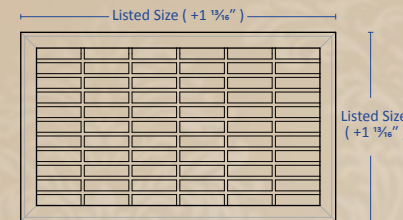

**Model 154-O**

• Steel Construction Floor Grille with damper

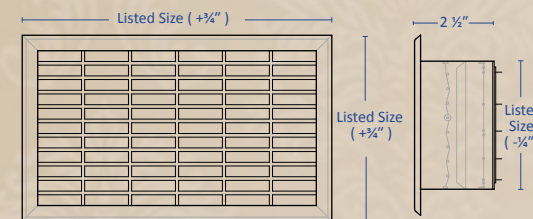

**Model 150TS**

• Steel Construction Toe Space Grille

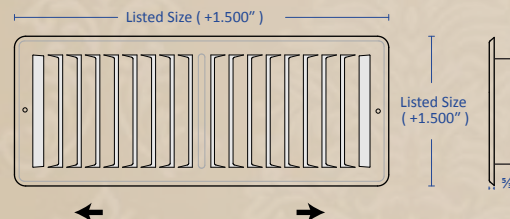

NOTE: Model 150TS is not available with a damper mechanism.

### Available Sizes & Options

**Model 154R Sizes & Carton Quantity Chart**

HEIGHT	WIDTH															
	4	6	8	10	12	14	16	18	20	24	25	26	28	30	36	
4				10	10	10	10	10	10	5				5		
6				10	10	10	10	5	5	5	5			5	2	
8	10	10	10	10	10	10	5	5	5	5				5		
10				10	10	5	5	5	5	5				5		
12				10	5	5	5	5	5	5				2		
14							5	5		5	2			2		
16								2	2	2	2			2		
18									2		2			2	2	
20					5	5				2	2	2		2		
24											2			2	1	
28																
30									2							

**Model 154-O**

SIZE	QUANTITY
4 x 10	5
6 x 10	5
8 x 12	5

**Model 150TS SIZES**

SIZE	150TSB	150TSW
02 x 08	20	
02 x 10	20	20
02 x 12	20	20
02 x 14	20	20
04 x 08	20	20
04 x 10	20	20
04 x 12	20	20
04 x 14	20	20
06 x 08	20	20
06 x 10	20	20
06 x 12	20	20
06 x 14	20	

**Model 154-O**  
Heavy Duty with OBD Option  
(Reverse side shown)



**Model 154R**  
Heavy Duty without damper  
(Reverse side shown)

**Model 173TS**

SIZE	QUANTITY	SIZE	QUANTITY
2 x 10	5	4 x 10	5
2 x 12	5	4 x 12	5

**ORDERING HINTS**

Select a Floor Grille:

**DESCRIPTION**

Model 154R - Heavy Duty Return Grille  
Model 154-O - Heavy Duty Supply Grille with OBD

**Example Model**

154R  
154-O

Select a Toe Space Grille:

Model 150TSB - Toe Space Grille in **Brown** Finish  
Model 150TSW - Toe Space Grille in **White** Finish

150TSB  
150TSW

Model 173TSB - Toe Space Grille in **Brown** Finish  
Model 173TSW - Toe Space Grille in **White** Finish

173TSB  
173TSW

**Special Note:**

Please refer to corresponding "Sizes and Carton Quantity Chart" listed for reference above. Feel free to contact us with any sizes not listed.

**160 DESIGNER'S SERIES**

Inspired by fine interiors the world over, TRUaire's Designer Series™ collection of air vent covers, registers and grilles is designed to fit over any existing or new floor opening. Each register is handcrafted using quality materials and remarkable craftsmanship suited for an array of fine architectural styles while complimenting any home's interior.



**Model 163**

*Retro Couture Design*

**Model 164**

*Ornamental Scroll Design*

**Model 165**

*Cosmopolitan Design*

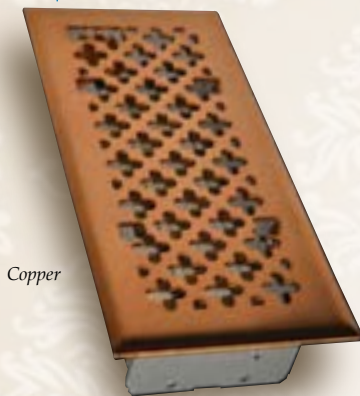

Copper



Polished Brass



Oil Rubbed Bronze

*Designer's Series™*

**Model 166**

*Vintage Victorian Design*



Antique Brass

**Model 167**

*Modern Contempo Design*



Matte Black

**Model 160**

*ABS Composite Collection*



Shown in White Finish

**Model 160** *ABS Composite Collection*

	BROWN	WHITE
SIZE	MODEL	MODEL
02x12	160MBP 02X12	160MWP 02X12
04x08	160MBP 04X08	160MWP 04X08
04x10	160MBP 04X10	160MWP 04X10
04x12	160MBP 04X12	160MWP 04X12

**Features**

- Heavy steel construction
- Choose from five decorative designs
- Choose from five designer finishes
- Revolutionary SmoothGlide Technology dampers



**Product Detail**



Durable, Laser-Cut Designer Styles  
Composite also available in Brown Finish

**Designer's Series Collection**

Our Designer's Series features a combination of exquisite design, clean lines & functionality that works well with a diversity of architectural palettes. Each is fashioned with an eye towards accurately reproducing the styles of the decorative past while using materials of the present.



**Model 163** *Retro Couture*

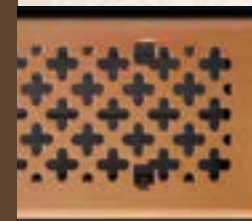

Copper

	OIL RUBBED BRONZE	ANTIQUe BRASS	COPPER	POLISHED BRASS	SATIN NICKEL	MATTE BLACK
SIZE	MODEL	MODEL	MODEL	MODEL	MODEL	MODEL
02x10	163R-OB 02X10	163R-AB 02X10	163R-CP 02X10	163R-PB 02X10	163R-SN 02X10	163R-MB 02X10
02x12	163R-OB 02X12	163R-AB 02X12	163R-CP 02X12	163R-PB 02X12	163R-SN 02X12	163R-MB 02X12
04x10	163R-OB 04X10	163R-AB 04X10	163R-CP 04X10	163R-PB 04X10	163R-SN 04X10	163R-MB 04X10
04x12	163R-OB 04X12	163R-AB 04X12	163R-CP 04X12	163R-PB 04X12	163R-SN 04X12	163R-MB 04X12

**Model 164** *Ornamental Scroll*



Satin Nickel

	OIL RUBBED BRONZE	ANTIQUe BRASS	COPPER	POLISHED BRASS	SATIN NICKEL	MATTE BLACK
SIZE	MODEL	MODEL	MODEL	MODEL	MODEL	MODEL
02x10	164O-OB 02X10	164O-AB 02X10	164O-CP 02X10	164O-PB 02X10	164O-SN 02X10	164O-MB 02X10
02x12	164O-OB 02X12	164O-AB 02X12	164O-CP 02X12	164O-PB 02X12	164O-SN 02X12	164O-MB 02X12
04x10	164O-OB 04X10	164O-AB 04X10	164O-CP 04X10	164O-PB 04X10	164O-SN 04X10	164O-MB 04X10
04x12	164O-OB 04X12	164O-AB 04X12	164O-CP 04X12	164O-PB 04X12	164O-SN 04X12	164O-MB 04X12

**Model 165** *Cosmopolitan*



Oil Rubbed Bronze

	OIL RUBBED BRONZE	ANTIQUe BRASS	COPPER	POLISHED BRASS	SATIN NICKEL	MATTE BLACK
SIZE	MODEL	MODEL	MODEL	MODEL	MODEL	MODEL
02x10	165C-OB 02X10	165C-AB 02X10	165C-CP 02X10	165C-PB 02X10	165C-SN 02X10	165C-MB 02X10
02x12	165C-OB 02X12	165C-AB 02X12	165C-CP 02X12	165C-PB 02X12	165C-SN 02X12	165C-MB 02X12
04x10	165C-OB 04X10	165C-AB 04X10	165C-CP 04X10	165C-PB 04X10	165C-SN 04X10	165C-MB 04X10
04x12	165C-OB 04X12	165C-AB 04X12	165C-CP 04X12	165C-PB 04X12	165C-SN 04X12	165C-MB 04X12
02x10	165C-OB 02X10	165C-AB 02X10	165C-CP 02X10	165C-PB 02X10	165C-SN 02X10	165C-MB 02X10
02x12	165C-OB 02X12	165C-AB 02X12	165C-CP 02X12	165C-PB 02X12	165C-SN 02X12	165C-MB 02X12
04x10	165C-OB 04X10	165C-AB 04X10	165C-CP 04X10	165C-PB 04X10	165C-SN 04X10	165C-MB 04X10
04x12	165C-OB 04X12	165C-AB 04X12	165C-CP 04X12	165C-PB 04X12	165C-SN 04X12	165C-MB 04X12

**Model 166** *Vintage Victorian*



Antique Brass

	OIL RUBBED BRONZE	ANTIQUe BRASS	COPPER	POLISHED BRASS	SATIN NICKEL	MATTE BLACK
SIZE	MODEL	MODEL	MODEL	MODEL	MODEL	MODEL
02x10	166V-OB 02X10	166V-AB 02X10	166V-CP 02X10	166V-PB 02X10	166V-SN 02X10	166V-MB 02X10
02x12	166V-OB 02X12	166V-AB 02X12	166V-CP 02X12	166V-PB 02X12	166V-SN 02X12	166V-MB 02X12
04x10	166V-OB 04X10	166V-AB 04X10	166V-CP 04X10	166V-PB 04X10	166V-SN 04X10	166V-MB 04X10
04x12	166V-OB 04X12	166V-AB 04X12	166V-CP 04X12	166V-PB 04X12	166V-SN 04X12	166V-MB 04X12

**Model 167** *Modern Contempo*

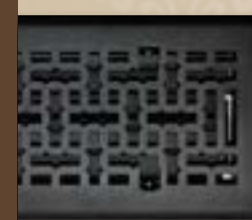

Matte Black

	OIL RUBBED BRONZE	ANTIQUe BRASS	COPPER	POLISHED BRASS	SATIN NICKEL	MATTE BLACK
SIZE	MODEL	MODEL	MODEL	MODEL	MODEL	MODEL
02x10	167M-OB 02X10	167M-AB 02X10	167M-CP 02X10	167M-PB 02X10	167M-SN 02X10	167M-MB 02X10
02x12	167M-OB 02X12	167M-AB 02X12	167M-CP 02X12	167M-PB 02X12	167M-SN 02X12	167M-MB 02X12
04x10	167M-OB 04X10	167M-AB 04X10	167M-CP 04X10	167M-PB 04X10	167M-SN 04X10	167M-MB 04X10
04x12	167M-OB 04X12	167M-AB 04X12	167M-CP 04X12	167M-PB 04X12	167M-SN 04X12	167M-MB 04X12

**168 Solid Oak Registers**

Inspired by fine interiors the world over, TRUaire's Designer Series™ collection of air vent covers, registers and grilles is designed to fit over any existing or new floor opening. Each register is handcrafted using quality materials and remarkable craftsmanship suited for an array of fine architectural styles while complimenting any home's interior.



**Model 168-FL**  
Solid Oak Floor

**Model 168-SQ**  
Solid Oak Square Floor



Shown Unfinished



Shown in Dark Finish

**Model 168-FM**  
Solid Oak Flush Mount



Shown in Light Finish

**Model 168-SW**  
Solid Oak Sidewall



Shown in Light Finish

*Designer's Series™*

**Features**

- Solid Oak construction
- Choose from three designer finishes
- Revolutionary SmoothGlide Technology dampers

Solid Oak Finishes Available:

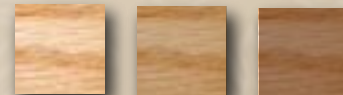

Unfinished Light Finish Dark Finish

**Product Detail**



Hand Assembled Oak Components Made from real wood and hand-stained

**Designer's Series Collection**

Our Designer's Series features a combination of exquisite design, clean lines & functionality that works well with a diversity of architectural palettes. Each is fashioned with an eye towards accurately reproducing the styles of the decorative past while using materials of the present.



**Model 168-FL** Solid Oak Floor

	UNFINISHED	LIGHT FINISH	DARK FINISH
SIZE	MODEL	MODEL	MODEL
02x10	168-FLU 02x10	168-FLL 02x10	168-FLD 02x10
02x12	168-FLU 02x12	168-FLL 02x12	168-FLD 02x12
04x10	168-FLU 04x10	168-FLL 04x10	168-FLD 04x10
04x12	168-FLU 04x12	168-FLL 04x12	168-FLD 04x12
06x10	168-FLU 06x10	168-FLL 06x10	168-FLD 06x10
06x12	168-FLU 06x12	168-FLL 06x12	168-FLD 06x12

**Model 168-SQ** Solid Oak Square Floor

	UNFINISHED	LIGHT FINISH	DARK FINISH
SIZE	MODEL	MODEL	MODEL
02x10	168-SQU 02x10	168-SQL 02x10	168-SQD 02x10
02x12	168-SQU 02x12	168-SQL 02x12	168-SQD 02x12
04x10	168-SQU 04x10	168-SQL 04x10	168-SQD 04x10
04x12	168-SQU 04x12	168-SQL 04x12	168-SQD 04x12
06x10	168-SQU 06x10	168-SQL 06x10	168-SQD 06x10
06x12	168-SQU 06x12	168-SQL 06x12	168-SQD 06x12

**Model 168-SW** Solid Oak Sidewall

	UNFINISHED	LIGHT FINISH	DARK FINISH
SIZE	MODEL	MODEL	MODEL
02x10	168-SWU 02x10	168-SWL 02x10	168-SWD 02x10
02x12	168-SWU 02x12	168-SWL 02x12	168-SWD 02x12
04x10	168-SWU 04x10	168-SWL 04x10	168-SWD 04x10
04x12	168-SWU 04x12	168-SWL 04x12	168-SWD 04x12
06x10	168-SWU 06x10	168-SWL 06x10	168-SWD 06x10
06x12	168-SWU 06x12	168-SWL 06x12	168-SWD 06x12

**Model 168-FM** Solid Oak Flush Mount

	UNFINISHED	LIGHT FINISH	DARK FINISH
SIZE	MODEL	MODEL	MODEL
02x10	168-FMU 02x10	168-FML 02x10	168-FMD 02x10
02x12	168-FMU 02x12	168-FML 02x12	168-FMD 02x12
04x10	168-FMU 04x10	168-FML 04x10	168-FMD 04x10
04x12	168-FMU 04x12	168-FML 04x12	168-FMD 04x12
06x10	168-FMU 06x10	168-FML 06x10	168-FMD 06x10
06x12	168-FMU 06x12	168-FML 06x12	168-FMD 06x12

Example of available oak floor and sidewall sizes.

2"x 10"

Shown in Dark Finish

4"x 12"

Shown in Dark Finish

6"x 10"

### ACD690 Access Door

Simple and straightforward, TRUaire's ACD Series Access Doors are rock-solid 22 and 24 gauge fully hinged and framed doors. Available in half-a-dozen square sizes and finished in our pristine white powder-coating, the ACD690 Series doors are an affordable solution.



#### Model ACD690 Solid Face Access Panel



Access Door Panel shown in open position

Compare to:	ACD690
Hart & Cooley	HCAD
Shoemaker	AD
USAire	LAD
Continental	AD
Lima	--
Airmate	--

#### Features

- Easy filter access
- Fixed hinge panel
- Easy TRUaire latch system
- White powder-coat finish

#### Product Detail

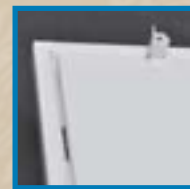

Access Panel Latch



Access Panel Fixed Hinge

#### Model ACD690 • Steel Access Panel Door

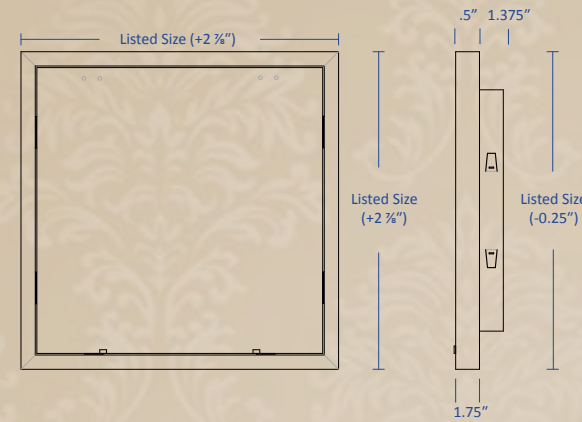

Detail View

#### Model ACD690

SIZE & CARTON QTY.	
10 x 10	10
12 x 12	10
14 x 14	10
16 x 16	5
18 x 18	5
20 x 20	1
30 x 10	1

### ACD690 Access Door Features



Latch System

Durable Fixed Hinges

Shown in open position

Rugged Steel Construction

Model ACD690  
Heavy Duty Access Panel Door  
(Reverse side shown)

Seismic installation tabs

#### ORDERING HINTS

Select a Door Panel Size:

#### DESCRIPTION

Select a size from the size chart listed above

#### Example Model

16 x 16

Include Model Number:

Model ACD690 - Access Door Panel

ACD690 16 x 16

Special Note:

Please refer to corresponding "Sizes and Carton Quantity Chart" listed for reference above. Feel free to contact us with any sizes not listed.

## Dampers and Accessories

Most of these accessory items in this catalog can be found within the corresponding pages that relate to their specific application. To make each accessory that we offer even easier to find, we have organized each of them together here in one place.

From Dampers and Mounting Gear to the new snap-in collar system, or whether you're looking for optional Opposed Blade Dampers or product specific T-Bar mounting extras, you are sure to find whatever you need.



**Model 801** Butterfly Damper & Installation Ring  
This assembly is used only in conjunction with our Model 800 Round Register. Up to 18"

**Model 802** Butterfly Damper with Mounting Clips  
This is the damper to use in conjunction with our 2000 Series T-Bar Diffusers. Up to 18"

**Model 803** Installation Ring only  
This mounting ring is used when installing the 800 Series Round Register without a damper. Up to 18"

**Model 804** Radial Damper  
Also referred to as a bow-tie damper, this damper is used in conjunction with the 2000 Series T-Bar Diffusers, particularly when the blades of the butterfly damper extend too far into the duct. Up to 14".

Depending on the application, these damper assemblies are designed to work with our round Model 800 registers, or, with the 2000 Series T-Bar Diffusers.

Sizes & Carton Quantity Chart				
	801	802	803	804
SIZE				
6	20	20	20	10
8	20	10	20	10
10	20	10	20	10
12	20	10	20	10
14	10	10	10	10
16	10	10	10	
18	10	10	10	

## Round Collars and Push Pins



The Model 820 Collar and Model 821 Push-pin fasteners are the perfect solution for getting a start collar into the compressed fiberglass of our molded R6 backs. These can be used with any application where a molded R6 back is present. Used on Models:

- 1010MAS/MAR
- 2000 Series w/R6 molded backs
- 2600 Series
- 5400 Series
- T-Bar Return Air Panels

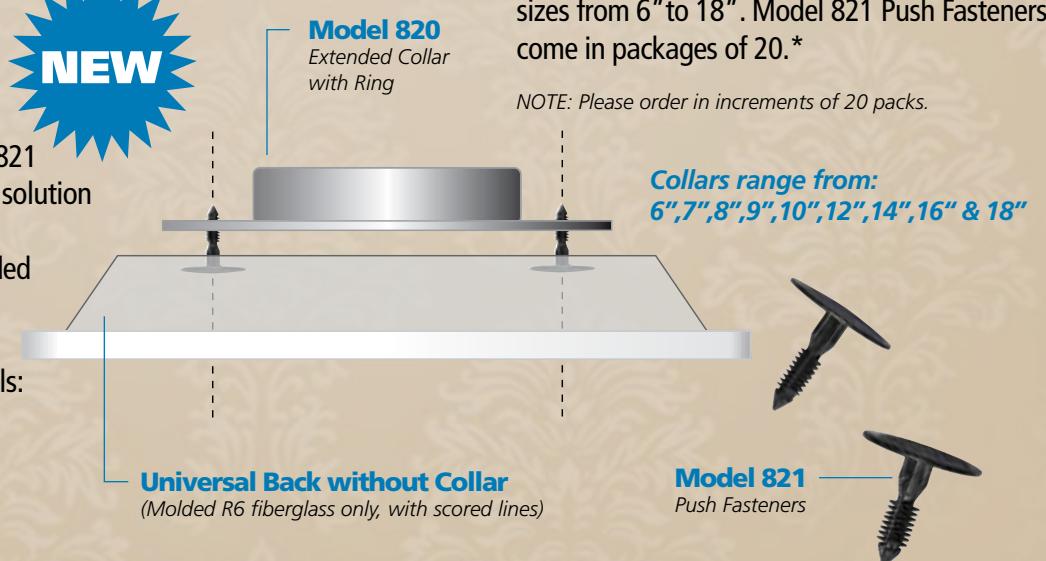

Model 820 Collars are available in round sizes from 6" to 18". Model 821 Push Fasteners come in packages of 20.\*

NOTE: Please order in increments of 20 packs.

Collars range from: 6", 7", 8", 9", 10", 12", 14", 16" & 18"

**Model 820**

**Ring Collar**

- 820 Ring Collar available in round neck size 6" - 18"



**Model 640 - Outside Air Vent**

- Shown with and without wire mesh backing. Please specify your preference when ordering.

**Model 821**

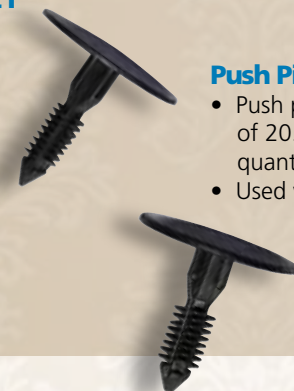

**Push Pin Fasteners**

- Push pins come in packages of 20. (Please order in quantities divisible by 20)
- Used with Model 820 pictured above

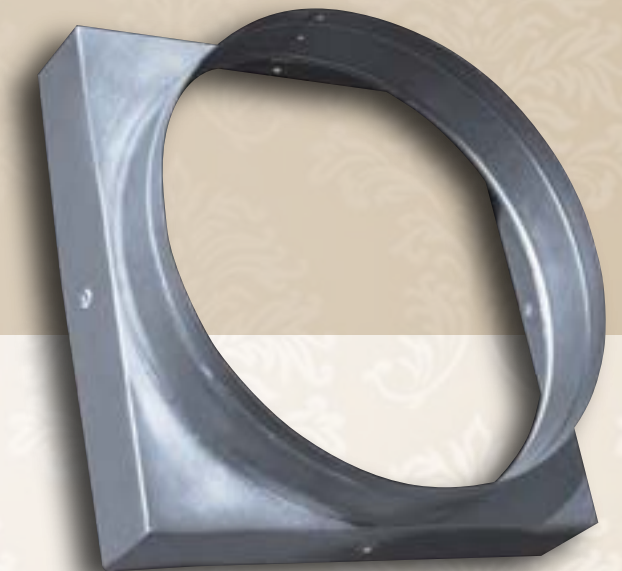

**Model OBD**



**Model SQRD - Square to Round Transition**

- Galvanized steel construction
- Allows flexible duct installation with square neck diffusers
- 2" High collar
- 802 & 804 damper can be used

**Opposed Blade Damper**

- Extruded Aluminum Construction
- Controls air flow from full flow to shut off
- Durable nylon bushings (easy to open and close)

## Opposed Blade Dampers

You'll not find a higher quality Opposed Blade Damper system anywhere. Our Model OBD-1 works with almost anything we make that would typically require an OBD. Durable nylon bushings make for clean, smooth operation without rattling or spontaneous closing of the blades in the airstream.

**Model OBD-1**  
Heavy Duty Opposed Blade Damper Option

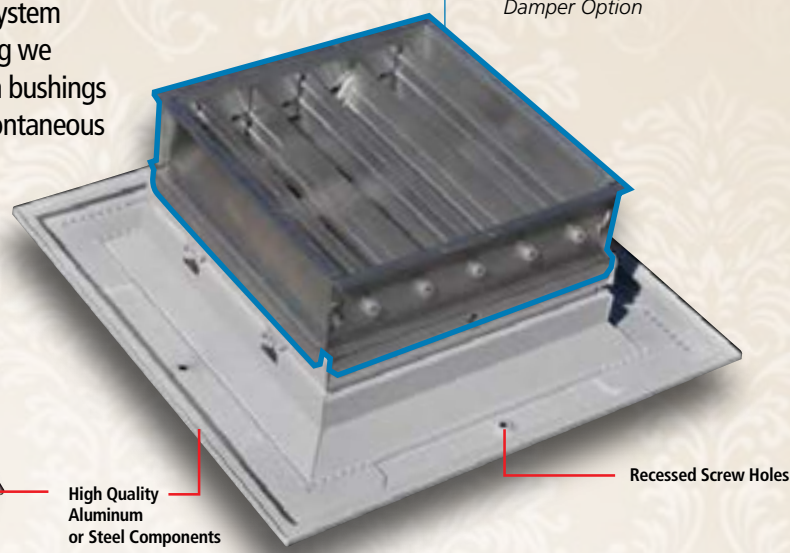

High Quality Aluminum or Steel Components

Recessed Screw Holes

**Example:**  
**Model 154-O**  
Heavy Duty Floor Grille with OBD Option

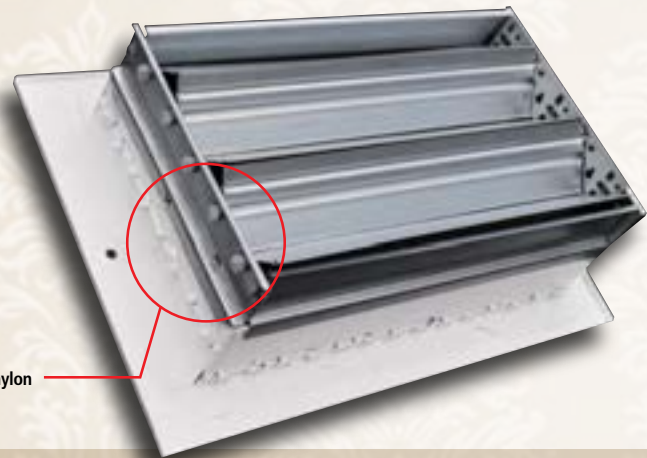

Durable nylon bushings

Our top of the line OBD Dampers offer the ultimate in air control. Top notch craftsmanship includes hand assembled nylon bushings on each blade linkage to ensure that the aluminum blades stay in place according to the airflow that is desired.

Most square sizes are a standard stocking product. Please call for availability of other sizes.

## T-Bar Panels, Frames and Insulation



**5000 XF** Aluminum Surface Mount Frame  
This all aluminum frame is used for drywall or sheetrock applications where no traditional T-bar drop ceiling hardware exists. Any of our T-bar diffusers will "lay-in" comfortably once the Ex Frame is installed.

Available in: 12x12 24x12 24x24 24x48

**Model 5000P**  
This T-Bar Panel is ready to accept a A500 Series ceiling diffuser. The sturdy panel is pre-punched with a variety of square center openings. (Available in 24x24, with center openings from 6"x6" up to 20"x20")

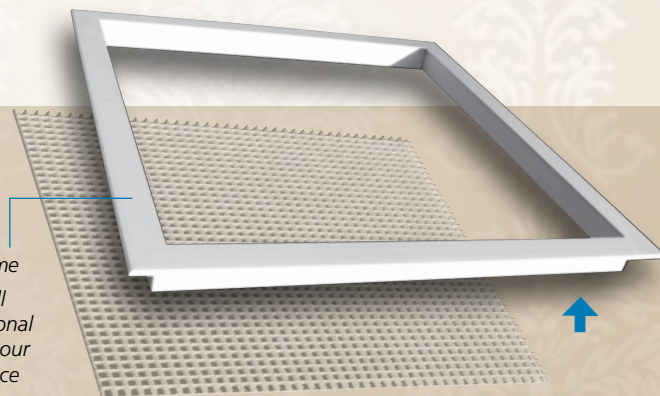

Outside

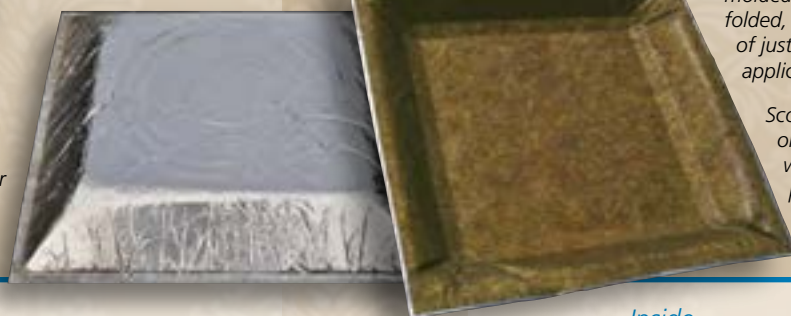

Inside

**Model 1056FB**  
Molded R6 Insulated Back

Incredibly convenient, this 24x24 R6 molded fiberglass plenum can be cut, folded, bent, and glued onto the back of just about any T-Bar product for applications calling for insulation.

Scored and marked concentric lines on the facing make it easy to work with, and with our new collar and pin accessories on the opposite page, labor can be cut to a minimum.



**210 SERIES**

Arguably the most versatile of all supply registers, the 210 Series Single Deflection register is available in a wide variety of configurations for almost any application. The highly effective open blade design and TRUAIRE's exclusive one piece frame allows for greater airflow. Our 210 Series is available with our unique SmoothGlide multi-shutter damper mechanism, a high quality opposed blade damper mechanism or without a damper.

Whether ceiling or sidewall, commercial or residential, these registers deliver high capacity airflow, style & solid construction.

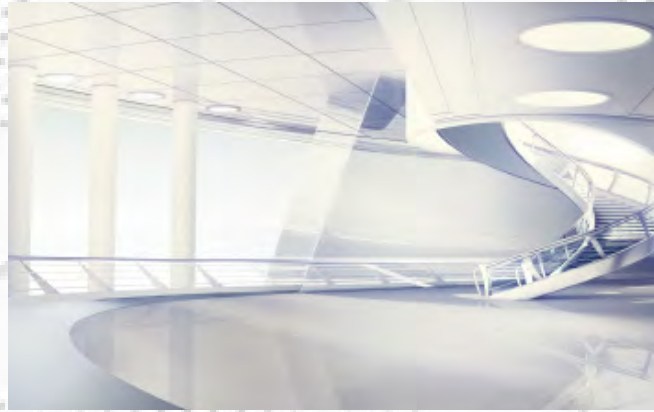

**Model 210H**  
Adjustable Horizontal Blades  
No Damper

*\*NOTE: Not available in all sizes*



**Model 210V**  
Adjustable Vertical Blades  
No Damper

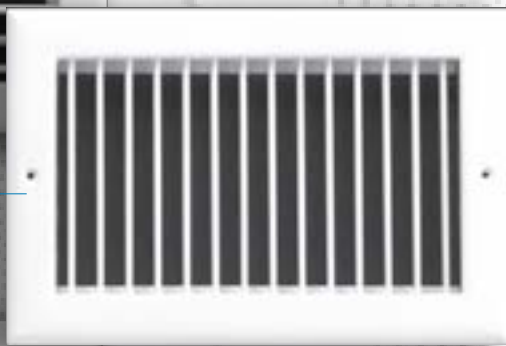

**Model 210VM**  
Adjustable Vertical Blades  
SmoothGlide Multi-Shutter Damper



**Model 210HO**  
Adjustable Horizontal Blades  
Opposed Blade Damper

*\*NOTE: Not available in all sizes*



**Model 210VO**  
Adjustable Vertical Blades  
Opposed Blade Damper

Compare to:	210VM	210VO
Hart & Cooley	821	--
Shoemaker	951	951-O
USAire	100SVM	--
Continental	RGV	RGV-O
Lima	900V	90VOBD
Airmate	220V	200VO

**Features**

- Adjustable horizontal or vertical Airfoil blades
- Steel construction
- White powder-coat finish
- Unique beveled edges
- Recessed screw holes
- Variety of damper configurations Including: SmoothGlide multi-shutter
- Remarkable One-piece frame (Up to 14x10)

**Product Detail**



Beveled Edges

One Piece Frame Construction

**SmoothGlide Damper**

There is nothing like it on the market. Our SmoothGlide Damper prevents rust, rattling, and sticking. These dampers use high quality all-steel components. The idea behind this technology is that we powder coat the blade and the linkage component individually BEFORE we assemble our products and then we install the rivets to our blades.

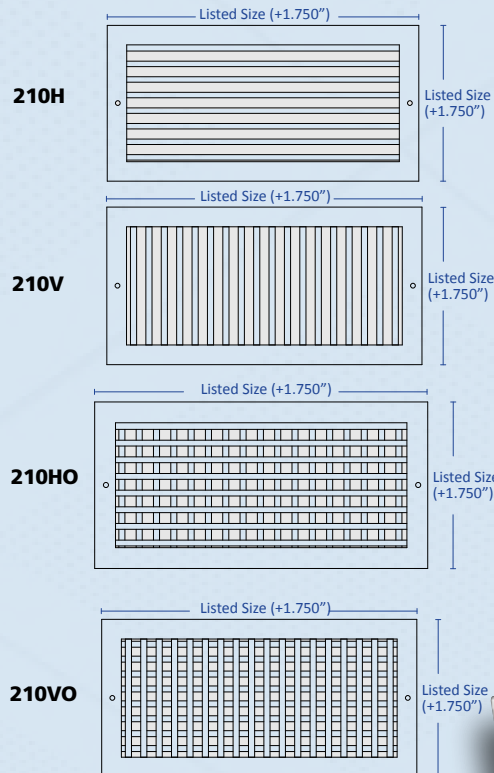

**NOTE:**

The Model 210 Series is available in over 60 sizes and configurations. For available sizes and current pricing please refer to our **Pricing Guide Supplement**.

**210 Series Options**

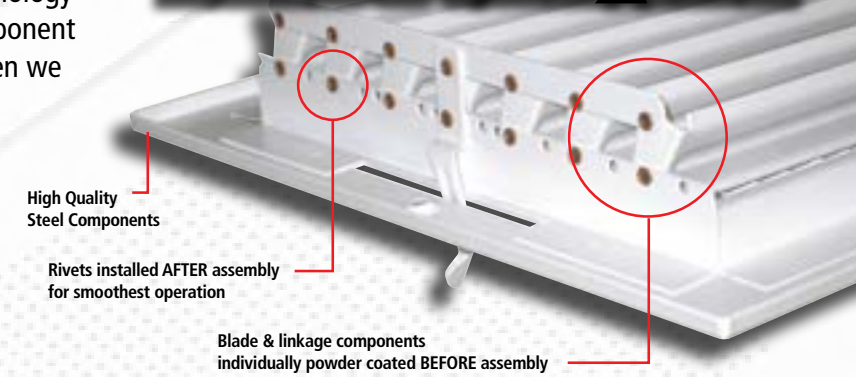

High Quality Steel Components

Rivets installed AFTER assembly for smoothest operation

Blade & linkage components individually powder coated BEFORE assembly

**Opposed Blade Damper (OBD)**

Top notch craftsmanship includes nylon bushings to ensure the blades stay in place according to the airflow you wish.

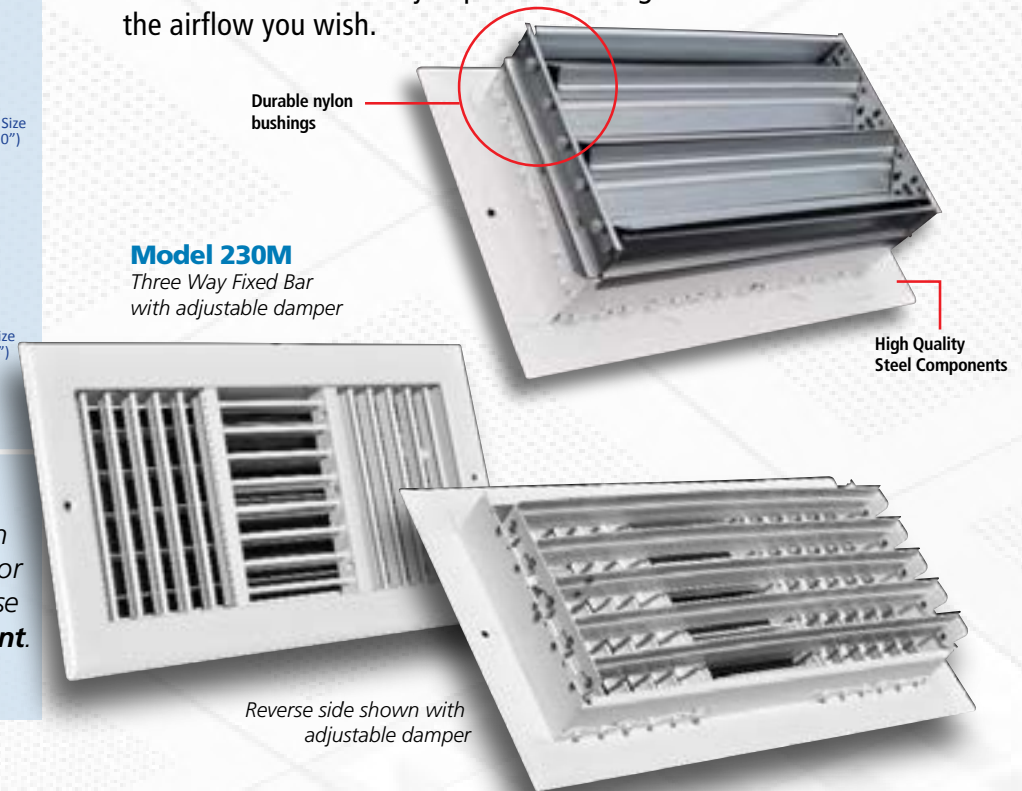

Durable nylon bushings

**Model 230M**  
Three Way Fixed Bar with adjustable damper

High Quality Steel Components

Reverse side shown with adjustable damper

**ORDERING HINTS**

1. Start with the base model
2. Select the blade positioning
3. Select the damper configuration

Note: The 210VM is the most common and popular configuration.

**DESCRIPTION**

Model 210  
 V = Vertical blades  
 H = Horizontal blades  
 M = Multi-shutter Damper (SmoothGlide)  
 O = Opposed Blade Damper  
 Blank = Without Damper

**Example Model**

210  
 210V  
 210H  
 210VM  
 210VO  
 210V

**A210 SERIES - Aluminum**

Among the most versatile of all supply registers, the A210 Series Single Deflection register is available in a wide variety of configurations for almost any application. These registers feature an attractive and highly effective open blade design which allows increased airflow when compared to any stamped fin design. The single row of adjustable airfoil designed blades can be arranged horizontally or vertically.

Whether ceiling or sidewall, commercial or residential, these register delivers high capacity airflow, style & solid construction.



**Model A210H**  
Adjustable Horizontal Blades  
No Damper

*\*NOTE: Not available in all sizes*



**Model A210V**  
Adjustable Vertical Blades  
No Damper



**Model A210VM**  
Adjustable Vertical Blades  
SmoothGlide Multi-Shutter Damper

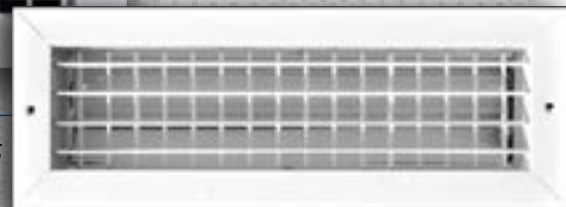

**Model A210HO**  
Adjustable Horizontal Blades  
Opposed Blade Damper  
*\*NOTE: Not available in all sizes*



**Model A210VO**  
Adjustable Vertical Blades  
Opposed Blade Damper

**Compare to:**

	A210VM	A210VO
Hart & Cooley	A618MS	A618OB
Shoemaker	950	950-O
USAire	VM	VD
Continental	AVM	X
Lima	AL900V	AL990VOBD
Airmate	A420-VM	AT420-VO

**Features**

- Adjustable horizontal or vertical Airfoil blades
- Aluminum construction
- White powder-coat finish
- Recessed screw holes
- Variety of damper configurations Including: SmoothGlide multi-shutter

**Product Detail**



Durable Nylon Bushings

**A210 Series Options**

**Opposed Blade Damper (OBD)**

Top notch craftsmanship includes nylon bushings to ensure the aluminum blades stay in place according to the airflow that is desired.

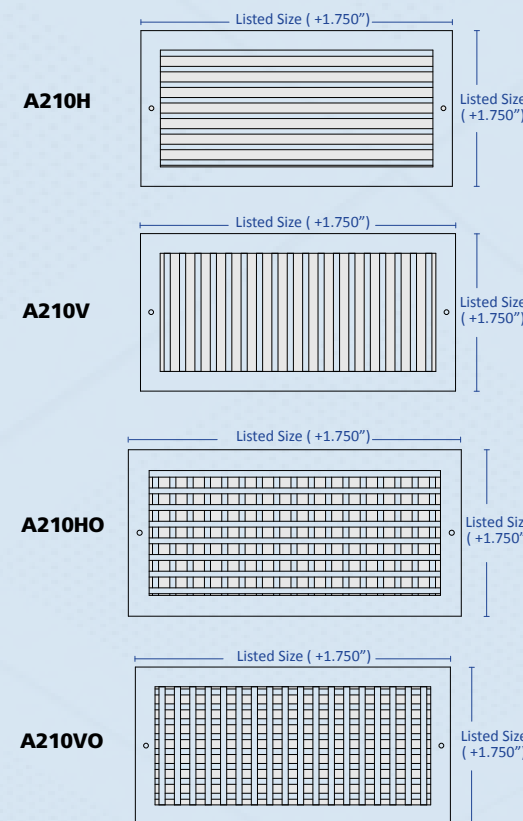

**NOTE:**

The Model A210 Series is available in over 60 sizes and configurations. For available sizes and current pricing please refer to our **Pricing Guide Supplement**.

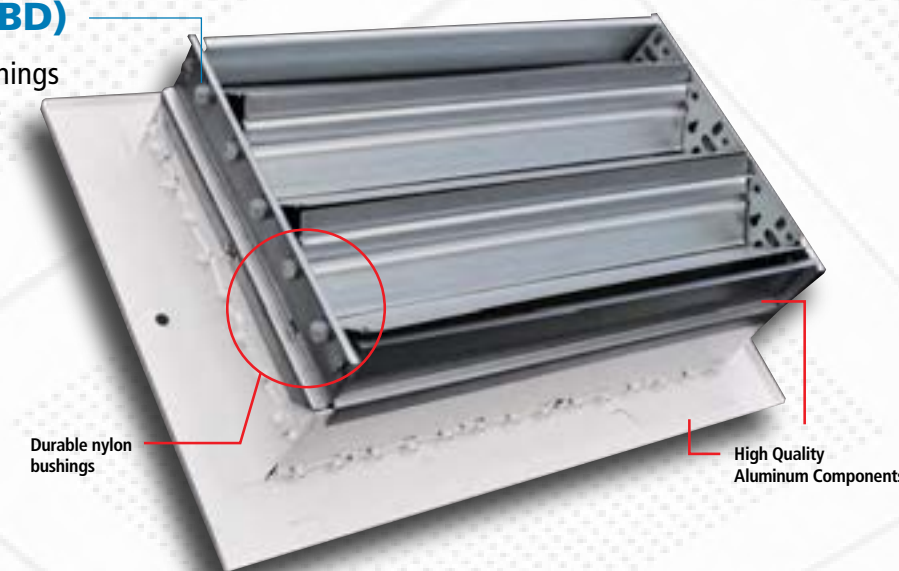

Durable nylon bushings

High Quality Aluminum Components

**SmoothGlide Damper**

There is nothing like it on the market. Our SmoothGlide Damper prevents rust, rattling, and sticking. These dampers use high quality components. The idea behind this technology is that we powder coat the blade and the linkage component individually BEFORE we assemble our products and then we install the rivets to our blades.

Blade & linkage components individually powder coated BEFORE assembly



Rivets installed AFTER assembly for smoothest operation

High Quality Steel & Aluminum Components

ORDERING HINTS	DESCRIPTION	Example Model
<b>1. Start with the base model</b>	Model A210	<b>A210</b>
<b>2. Select the blade positioning</b>	V = Vertical blades H = Horizontal blades	A210V A210H
<b>3. Select the damper configuration</b>	M = Multi-shutter Damper (SmoothGlide) O = Opposed Blade Damper Blank = Without Damper	A210VM A210VO A210V

*Note: The A210VM is the most common and popular configuration.*

**220 SERIES**

TruAire's 220 Series Double-Deflection registers represent the top-of-the line adjustable bar-type product. These registers feature two perpendicular rows of individually adjustable Airfoil bars for maximum airflow control. They can be ordered with the horizontal row in front, (220H), or with the vertical row in front, (220V).

Whether commercial or residential, using an OBD damper or no damper at all, the 220 Series register delivers high capacity airflow with a sleek aesthetic style and rock solid construction.

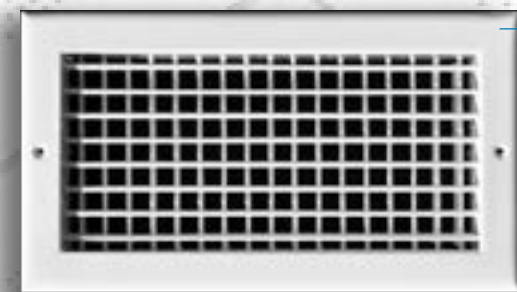

**Model 220H**

Adjustable  
Horizontal Blades  
No Damper

*\*NOTE: Not available in all sizes*

**Model 220V**

Adjustable Vertical Blades  
No Damper

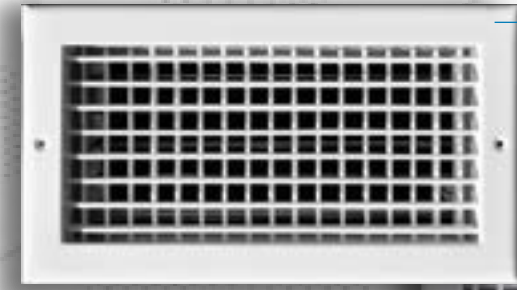
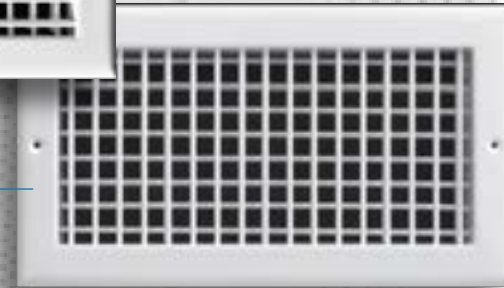

**Model 220HO**

Adjustable  
Horizontal Blades in front  
Opposed Blade Damper

*\*NOTE: Not available in all sizes*

**Model 220VO**

Adjustable  
Vertical Blades in front  
Opposed Blade Damper

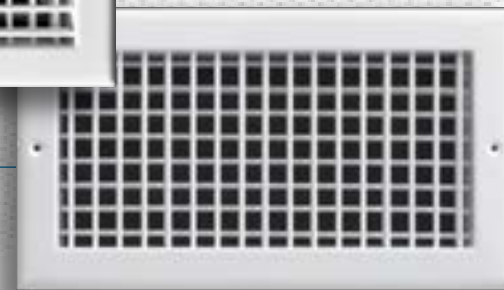

*NOTE: Also available in aluminum. See the A220 Series*

Compare to:	220 Series
Hart & Cooley	92VHO
Titus	300RS
Shoemaker	934
Metal Aire	
Price	520S
Krueger	880V

**Features**

- Adjustable horizontal and vertical Airfoil blades
- Solid Steel construction
- White powder-coat finish
- Recessed screw holes
- Opposed Blade Damper (OBD), or no damper at all
- Remarkable one-piece beveled frame (up to 14x10)

**Product Detail**



Non-Beveled Corners



Opposed Blade Damper with Nylon Bushings

220H

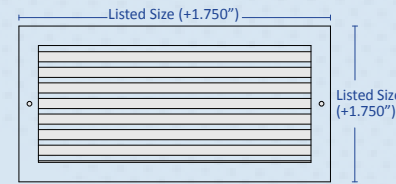

220V

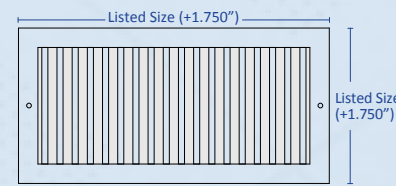

220HO

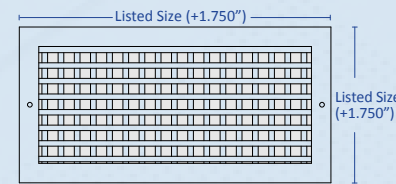

220VO

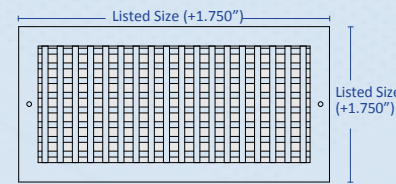

**NOTE:**

The Model 220 Series is available in over 60 sizes and configurations. For available sizes and current pricing please refer to our **Pricing Guide Supplement**.

**220 Series Options**

**Opposed Blade Damper (OBD)**

Top notch craftsmanship includes nylon bushings to ensure the blades stay in place according to the airflow you wish.

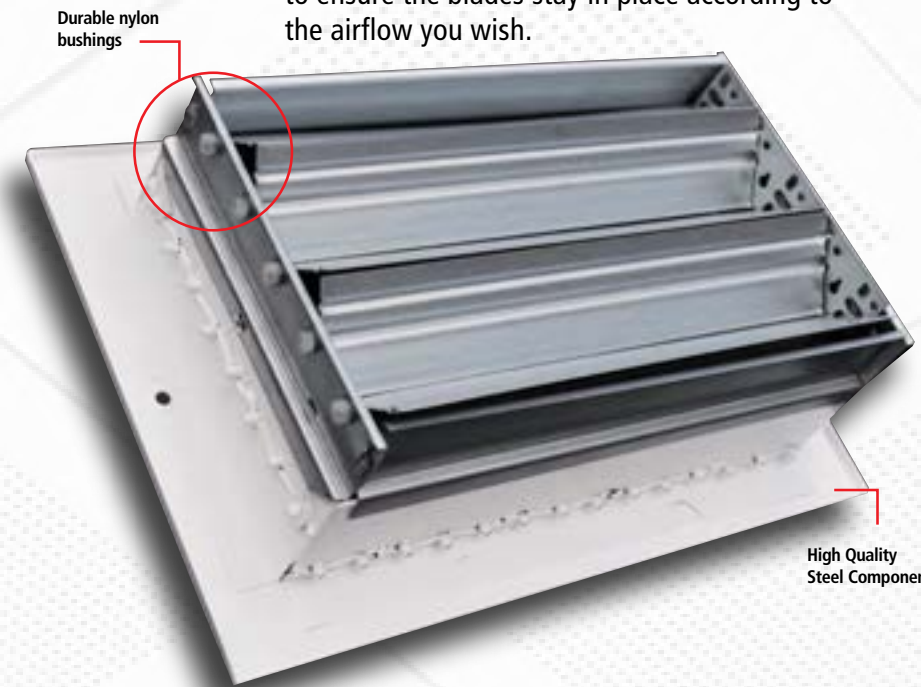

Durable nylon bushings

High Quality Steel Components

**ORDERING HINTS**

1. Start with the base model
2. Select the blade positioning
3. Select the damper configuration

DESCRIPTION	Example Model
Model 220	<b>220</b>
V = Vertical blades H = Horizontal blades	220V 220H
VO = Vertical Opposed Blade Damper HO = Horizontal Opposed Blade Damper Blank = Without Damper	220VO 220HO 220V

**A220 SERIES - Aluminum**

TruAire's A220 Series Double-Deflection registers represent the top-of-the line adjustable bar-type product. These registers feature two perpendicular rows of individually adjustable Airfoil blades for maximum airflow control. They can be ordered with the horizontal row in front, (A220H), or with the vertical row in front, (A220V).

Whether commercial or residential, using an OBD damper or no damper at all, the A220 Series register delivers high capacity airflow with a sleek aesthetic style and rock solid construction.



**Model A220H**

Adjustable  
Horizontal Blades  
No Damper

*\*NOTE: Not available in all sizes*

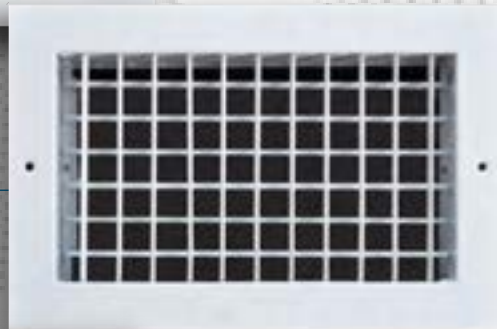

**Model A220V**

Adjustable Vertical Blades  
No Damper



**Model A220HO**

Adjustable  
Horizontal Blades in front  
Opposed Blade Damper

*\*NOTE: Not available in all sizes*

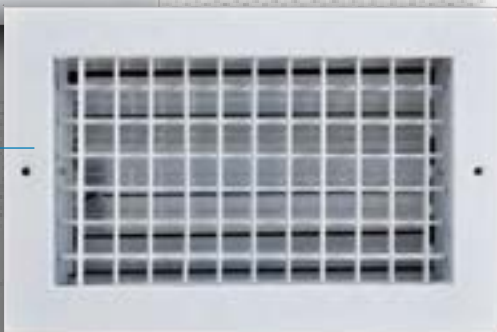

**Model A220VO**

Adjustable  
Vertical Blades in front  
Opposed Blade Damper

*NOTE: Also available in steel.  
See the 220 Series*

Compare to:	A220V	A220VO
Hart & Cooley	--	--
Shoemaker	904	904-O
USAire	VH	VHD
Continental	--	--
Lima	AL990V	AL990VOBD
Airmate	E240V	E240VO

**Features**

- Adjustable horizontal and vertical Airfoil blades
- Aluminum construction
- White powder-coat finish
- Recessed screw holes
- Opposed Blade Damper (OBD), or no damper at all

**Product Detail**



Non-Beveled Corners



Nylon Bushings add tension to damper blades

**A220 Series Options**

**Opposed Blade Damper (OBD)**

Top notch craftsmanship includes nylon bushings to ensure the aluminum blades stay in place according to the airflow you wish.

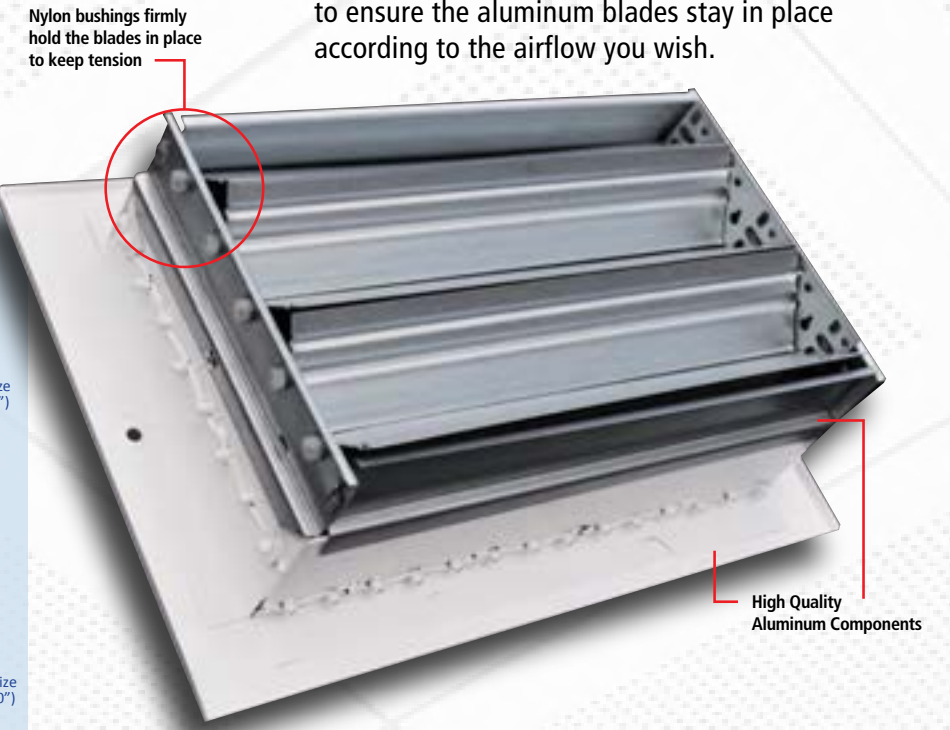

Nylon bushings firmly hold the blades in place to keep tension

High Quality Aluminum Components

**A220 Horizontal**

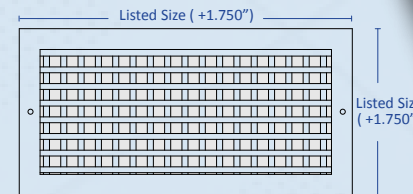

**A220 Vertical**

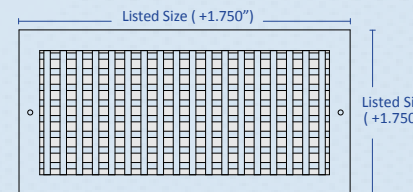

**NOTE:**

The Model A220 Series is available in over 60 sizes and configurations. For available sizes and current pricing please refer to our **Pricing Guide Supplement**.

Easily adjust aluminum blades to preferred air deflection.

Also available in steel. See the 220 Series

ORDERING HINTS	DESCRIPTION	Example Model
1. Start with the base model	Model A220	<b>A220</b>
2. Select the blade positioning	V = Vertical blades H = Horizontal blades	A220V A220H
3. Select the damper configuration	VO = Vertical Opposed Blade Damper HO = Horizontal Opposed Blade Damper Blank = Without Damper	A220VO A220HO A220V

**Model 270 and A270**

Bar type return air grilles look better, perform better, and bring a touch of class to any installation; commercial or residential. This bar type return air grille's fixed bars are solidly placed at 45 degrees to ensure maximum airflow and reduced visibility into the ductwork itself.

These high quality return air grille products are manufactured in durable steel or aluminum materials and finished with our pristine white powder-coat finish. Available in virtually any size up to 40 x 20.



**Model 270**  
Shown in horizontal size format  
60° Blade angle from face



**Model A270**  
Shown in vertical size format  
60° Blade angle from face

**NOTE:** Available in both steel and aluminum.

Compare to:	270	A270
Hart & Cooley	94A	RH45
Titus	350RL	350FL
Shoemaker	935	905
Metal Aire	SRH	RHE
Price	530L	60
Krueger		

**Features**

- Aluminum or steel construction
- Low visibility 45 degree fixed blades
- 3/4 inch blade spacing
- White powder-coat finish

**Product Detail**



Individually fixed bars placed at 45 degrees

**Model 270 and A270**

**Model 270**

- Steel construction

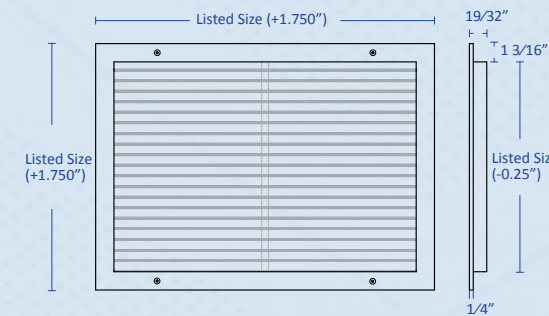

**Model A270**

- Aluminum Construction

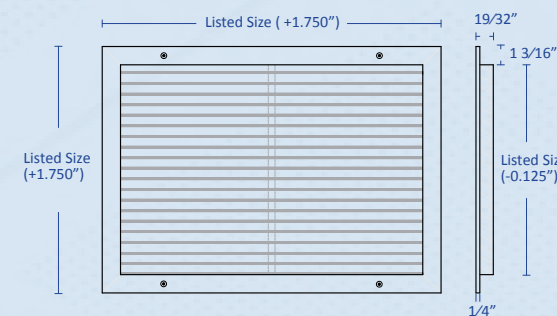

3/4 inch blade spacing

**Model 270 Sizes & Carton Quantity Chart**

HEIGHT	WIDTH																				
	4	6	8	10	12	14	16	17	18	20	24	25	26	28	30	32	36	38	40	44	48
4			20	20	20	20					10				10						
6		20	20	20	20	20	20		10	10	10		5	5	10		10				
8			20	20	20	20	20		10	10	10		5	5	10		10				
10				20	20	20	20		10	10	10	10	5	5	10		10				
12					10	10	10		10	10	10		5	5			5				
14					20	10	10		5	10	5	5		5	5	5	5	5			
16						10	10			5	5	5		5	5	5	5	5	5	1	
18					10	10			5	5	5			5	5	5	5				
20					10	10				5	5	5			5	5	5	5	5		
22																	5				
24	10				10	5	5			5	5				5	5					1
25										5		5									
26																	5				
30						5				5	5				5						
32																					
34																					
36						5				5											
40											5					1					

**Model A270 Sizes & Carton Quantity Chart**

HEIGHT	WIDTH																
	6	8	10	12	14	16	18	20	22	24	25	28	30	36	40	46	48
4	20	20				20				10							
6	20	20	20	20	20	20	10	10		10			10	10	1		
8		20	20	20	20	20		10		10			10				
10			20		20	20	10	10		10			10	10			
12				10			10	10		10			5	5			
14					10		5	10		5	5	5	5				
16						10		5		5	5		5	5		1	
18							5	5		5	5		5	5			
20					10	10	5		5	5	5		5				
22									5								
24			10	10	5	5	5	5		5							
25					5	5		5									
30					5	5				5						1	

**ORDERING HINTS**

**Select Steel or Aluminum:**

**DESCRIPTION**

Model 270 - **Steel Construction**  
Model A270 - **Aluminum Construction**

**Example Model**

270  
A270

**Select register size:**

20 x 16 (Steel)  
20 x 16 (Aluminum)

270 **20 x 16**  
A270 **20 x 16**

**Special Note:**

There is a significant difference between a 20 x 16 Return Grille and a 16 x 20 Return Grille. The first dimension is the length of the blades. In most cases, this would be called the **horizontal** dimension or the **width** of the Return Grille.

**Model 200 and A200 Series**

Manufactured specifically for Packaged Wall Mount A/C applications, this line-up of registers and grilles is perfect for through-the-wall sleeve installations. Each is sized to work with all wall-mount manufacturers' products each with a wide variety of options for material and finish requirements.

**Model A220V-AL**

Aluminum Construction- Aluminum Finish  
Adjustable Vertical & Horizontal Blades

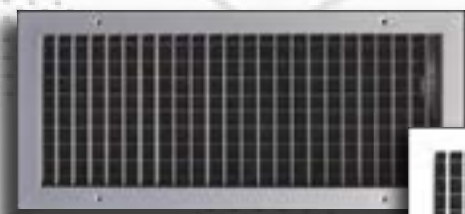

**Model 220V**

Steel Construction - White Finish  
Adjustable Vertical & Horizontal Blades

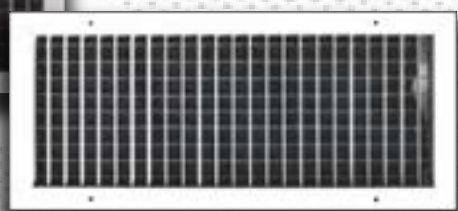

**Model A270-AL**

Aluminum - Aluminum Finish



**Model 270**

Steel - White Finish



**Model A290-AL**

Aluminum Filter Grille - Aluminum Finish



**Model 290**

Steel Filter Grille - White Finish



**Features**

- Double Deflection Supply Diffuser
- Bar type grille and filter grille
- Steel or aluminum material
- White or Aluminum Finish

**Product Detail**



Aluminum or White Powder-Coat Finish

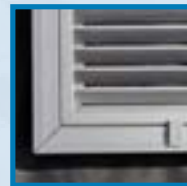

Easy-to-open thumb guides on aluminum model only

**Wall Mount Register Options**

**Model 220 / A220**

Featuring two perpendicular rows of individually adjustable airfoil bars for maximum airflow control, the 220 Series register delivers high capacity airflow with a sleek aesthetic style.



Shown with Steel Construction in Aluminum Finish

**Model 220**

- Steel construction

**Model A220**

- Aluminum construction

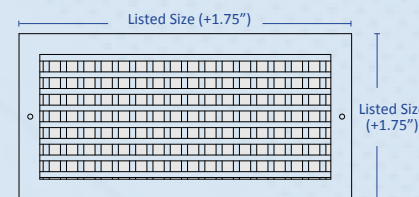

**Model 270**

- Steel Construction

**Model A270**

- Aluminum Construction

Shown in White Finish

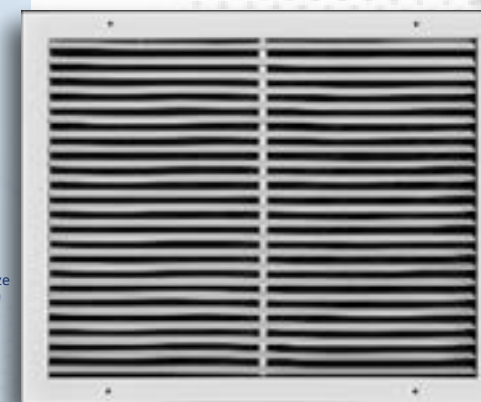
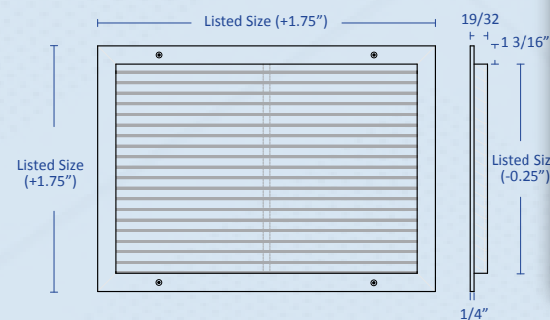

**Model 270 / A270**

Featuring individually fixed bars which are solidly placed at 45°, maximizing return airflow while reducing visibility into the ductwork itself.

**Model 290**

- Steel Construction

**Model A290**

- Aluminum Construction

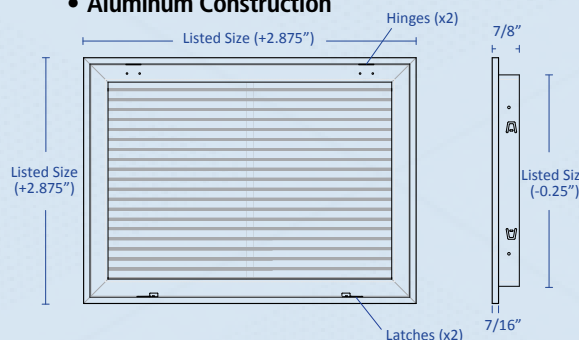

Shown in Aluminum Finish

**Model 290 / A290**

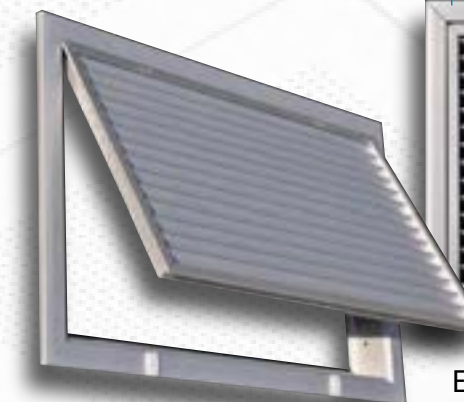

Model 290 Shown Open



Easy-to-access wall mount grille is also available as a filter grille model.

	STEEL Supply Diffuser	STEEL Bar-Type Return Grille	STEEL Bar-Type Filter Grille	ALUMINUM Supply Diffuser	ALUMINUM Bar-Type Return Grille	ALUMINUM Bar-Type Filter Grille
White Finish	<b>220V</b>	<b>270</b>	<b>290</b>	<b>A220V</b>	<b>A270</b>	<b>A290</b>
Aluminum Finish	<b>220V-AL</b>	<b>270-AL</b>	<b>290-AL</b>	<b>A220V-AL</b>	<b>A270-AL</b>	<b>A290-AL</b>
Available Sizes:	17x5 20x8 28x8 30x10	17x10 20x12 28x14 30x16	17x10 20x12 28x14 30x16	17x5 20x8 28x8 30x10	17x10 20x12 28x14 30x16	17x10 20x12 28x14 30x16

**Model A520F & Model A520B**

These modular core products are manufactured in a surface mount design, bringing total versatility to any drywall or sheetrock ceiling installation. Made with top-quality extruded aluminum, the removable "cores" can be arranged in one, two, three, four, and two-way corner throw configurations.

TruAire proudly offers two architecturally different frame styles; featuring either flat-frame or bevel-frame designs and an optional high-quality aluminum Opposed Blade Damper (OBD) system.



commercial

**Model A520F**

Flat-frame design



Detachable core panels can be arranged in a variety of airflow patterns

**Model A520B**

Beveled-frame design



Compare to:	A520
Hart & Cooley	MCD-1
Titus	MCD-1
Shoemaker	MA
Metal Aire	9000
Price	AMCD
Krueger	1200

**Features**

- Beautifully crafted removable aluminum cores
- One, two, three, four-way and corner throw patterns
- White powder-coat finish
- Attractive Beveled-frame or Flat-frame designs
- Square neck sizes from 6x6 to 20x20

**Product Detail**



Beveled Frame Design Flat Frame Design

**Model A520F - Flat Frame**

• Modular Core Surface Mount Diffuser

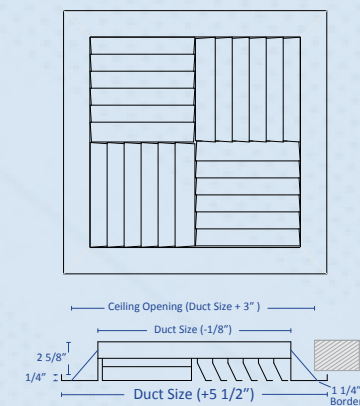

**Model A520B - Beveled Frame**

• Modular Core Surface Mount Diffuser

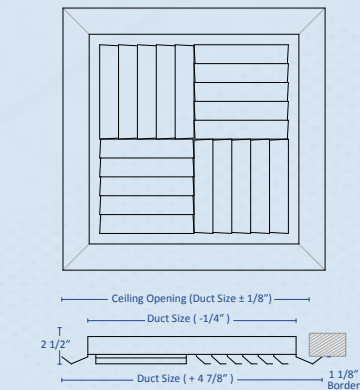

**Pattern Throw Configurations**

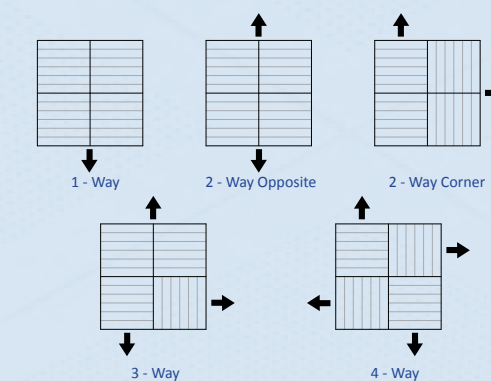

**Models A520F & A520B**

**Model A520F - Flat Frame Design**  
(Shown with detached core)

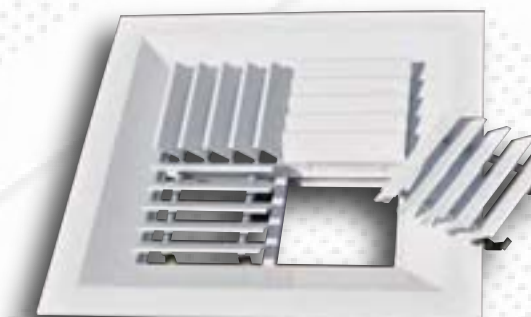

Remove cores to access screw holes along interior frame

**Reverse Side**



**Optional Opposed Blade Damper**

With quiet, high-quality nylon bushings



**Model A520B Beveled Frame Design**  
(Shown with detached core)

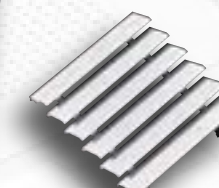

ORDERING HINTS	DESCRIPTION	EXAMPLE
1. Select frame design style:	Flat Frame Design Beveled Frame Design	A520F A520B
2. Select size(s) needed:	From 6"x6" to 24"x24"	A520F - 10x10
3. Select Optional OBD:	O = Opposed Blade Damper	A520FO 10x10

**A540 Series**

The Directional Diffusers made for surface mount installations represent an attractive alternative to other ceiling diffuser options. These diffusers are manufactured exclusively in top-quality aluminum material, with removable cores and feature a sleek low profile blade design that comes in a Flat-frame or Beveled-frame style.

This is a versatile, attractive series for office installations with drywall/sheetrock ceilings instead of a T-Bar design. Each is available with optional aluminum Opposed Blade Dampers and feature several airflow patterns.



commercial

**Model A544F**  
Flat-frame design

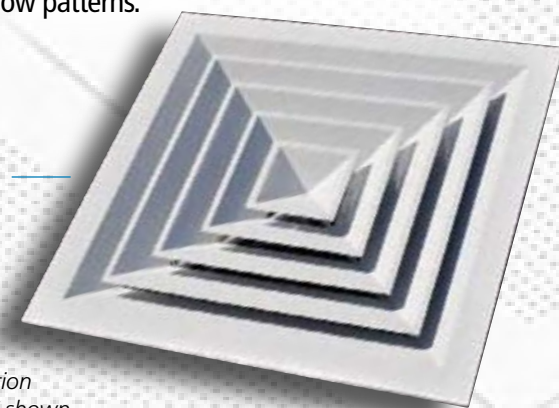

4-way Deflection  
Model A544F shown

**Model A544B**  
Beveled-frame design

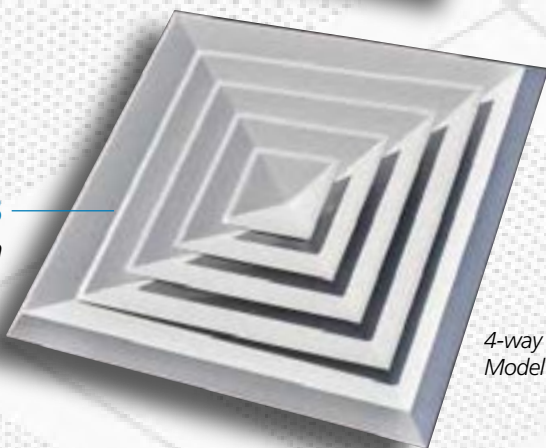

4-way Deflection  
Model A544B shown

**Model A541**  
1-Way Deflection

**Model A542**  
2-Way Deflection

**Model A543**  
3-Way Deflection

**Model A545**  
2-Way Corner

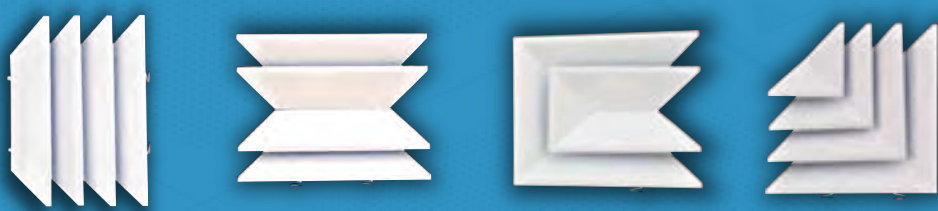

Choose your air-throw pattern

Compare to:	A540
Hart & Cooley	SRE/SRS
Titus	TDC
Shoemaker	DVD
Metal Aire	5500
Price	SMD
Krueger	SH

**Features**

- All aluminum construction
- Sleek low-profile blade design
- Flat or Beveled-frame design
- Removable core
- Square neck sizes form 6 x 6 to 20 x 20
- White powder-coat finish

**Product Detail**



Beveled Frame Design Flat Frame Design

**Model A540F - Flat Frame**

- Modular Core Surface Mount Diffuser

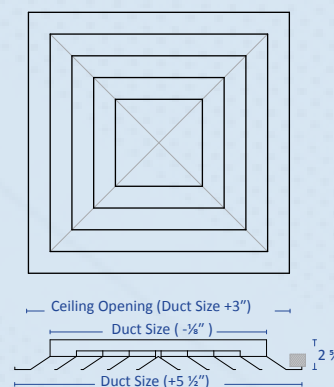

**Model A540B - Beveled Frame**

- Modular Core Surface Mount Diffuser

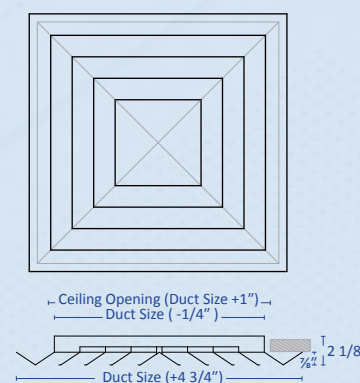

**Pattern Throw Configurations**

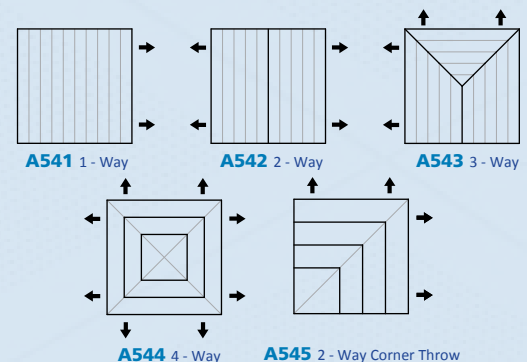

**A540 Series**

**Model A544F - Flat Frame**  
(Shown with core attached)



Model A544F shown

**Reverse Side**

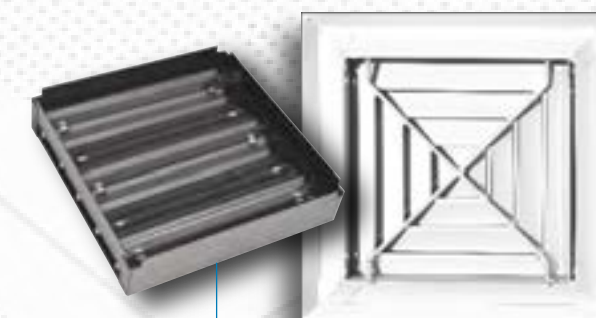

**Optional Opposed Blade Damper**

With quiet, high-quality nylon bushings

**Model A544B Beveled Frame**  
(Shown with core removed)



Remove cores to access screw holes along interior frame

Model A544B shown

ORDERING HINTS	DESCRIPTION	EXAMPLE
Select the Base Model:	Model A540	<b>A540</b>
Select Frame Style:	<b>B</b> = Beveled Frame Design <b>F</b> = Flat Frame Design	A540B A540F
Determine Air-flow Direction:	1-Way, 2-Way, 3-Way, 4-Way or 5 for Corner	A544B
Determine Square Neck Size:	6", 9", 12", 15", 18", 21" or 24" square	A544B <b>9 x 9</b>
Select Optional OBD:	<b>O</b> = Opposed Blade Damper	A544BO 9 x 9

**Model 600 and Model 700**

There are two types of installations that require large volumes of air to be introduced to an enclosed space. The first is unique to hot dry climates, and is typically called the evaporative or swamp cooler. The second type is seen when air needs to be introduced into environments where high-capacity exhaust fans are removing large volumes of air.



**Model 600M**  
Ceiling Mount Diffuser



\*Available in either white or stainless steel finish

Truair's 600 Series Diffuser mounts in the ceiling, and extends down into the conditioned space about 6 inches. From there the air can be diffused on all four sides. The 700 Series is a flush mount design, and utilizes a wide blade configuration to diffuse high air volumes.



Shown Open



Shown Closed

**Model 700M**  
Flush Mount Diffuser

commercial

**Features**

- High velocity designs
- Pristine white Powder-coat finish
- Rugged steel construction
- Adjustable blades

**Product Detail**



Model 600 Open

Model 600 Closed

Large adjustable fins

SmoothGlide Technology

**Model 600M**

- Ceiling Mount

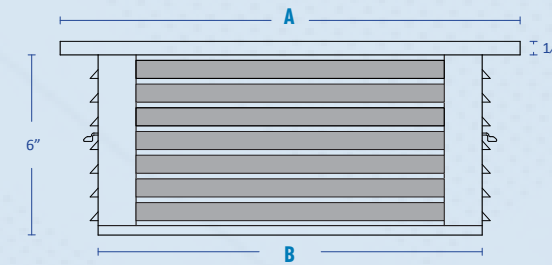

SIZE	A	B
10 X 10	13"	10.25"
12 X 12	15"	12.25"
14 X 14	17"	14.25"
16 X 16	19"	16.25"
18 X 18	21"	18.25"
20 X 20	23"	20.25"
22 X 22	25"	22.25"
22 X 22T	23.75"	21.00"
24 X 24	27"	24.25"
26 X 26	29"	26.25"
30 X 30	33"	30.25"
32 X 32	35"	32.25"

\* PLEASE CONTACT US FOR ALL SIZES NOT LISTED

**Model 700M**

- Flush Mount

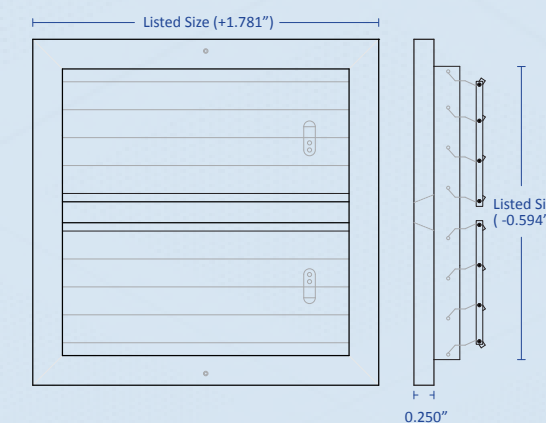

**Model 600M**

Ceiling Mount Diffuser

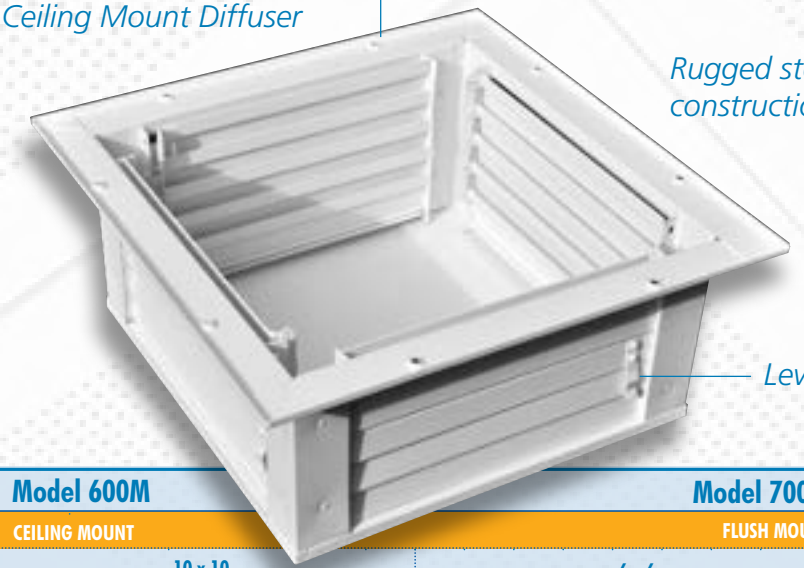

Rugged steel construction

Lever Pull

Model 600M	Model 700M
CEILING MOUNT	FLUSH MOUNT
10 x 10	6 x 6
12 x 12	8 x 8
14 x 14	10 x 10
16 x 16	12 x 12
18 x 18	14 x 14
20 x 20	16 x 16
22 x 22	18 x 18
22 x 22T	20 x 20
24 x 24	22 x 22
26 x 26	24 x 24
28 x 28	
30 x 30	
32 x 32	

**Model 700M**

Flush Mount Diffuser

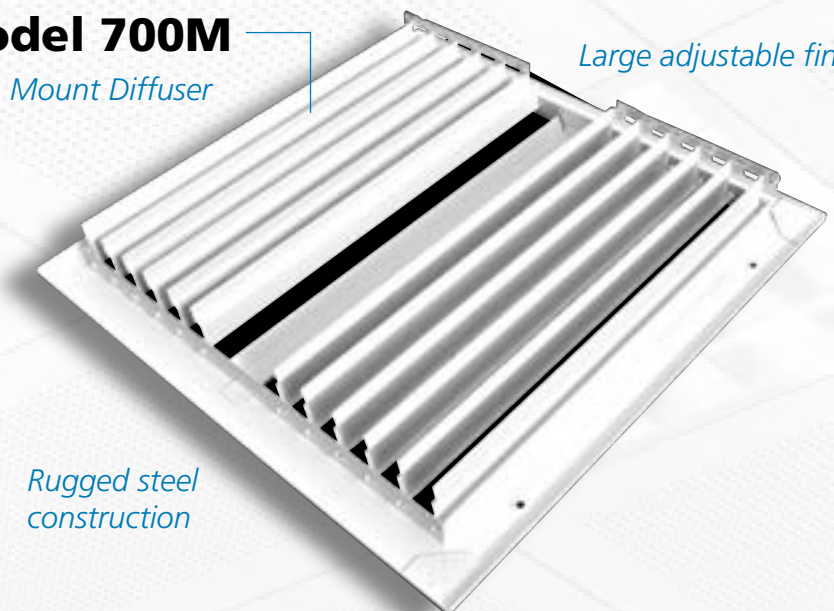

Large adjustable fins

Rugged steel construction

**1000 SERIES**

The 1000 Series T-Bar models are designed with budget in mind. These diffusers come with an attractive perforated steel face finished in white powder-coat. The supply model (MAS) includes an air deflector for enhanced air distribution.

These diffusers can be ordered with the universal R6 molded fiberglass back, with a heavy duty steel back and fixed collar or a combination of both the formed steel back, collar, and R6 insulation.

**Model 1010MAS / MAR**

*With universal R6 fiberglass back*

Reverse side shown



**Model 1020MAS / MAR**

*With steel back and fixed collar*

Reverse side shown



commercial

Compare to:	1010
Hart & Cooley	REN/RENPS
Titus	
Shoemaker	110/111
Metal Aire	7300
Price	
Krueger	

**Features**

- Steel perforated face
- White powder coat finish
- Seismic support tabs
- Air deflector on supply models
- Optional configurations include:
  - Insulated
  - Uninsulated
- Universal cut-in collar or fixed steel collar
- New accessory collar and fastener configuration

**Product Detail**

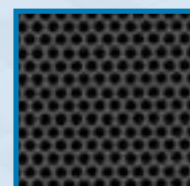

Steel Perforated Face



Seismic Support Tabs

**1010 MAS - Supply**  
**1010 MAR - Return**

- Universal molded R6 fiberglass back

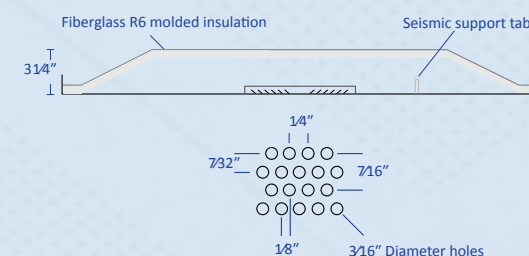

**1020 MAS - Supply**  
**1020 MAR - Return**

- Uninsulated: Steel backing with fixed collar

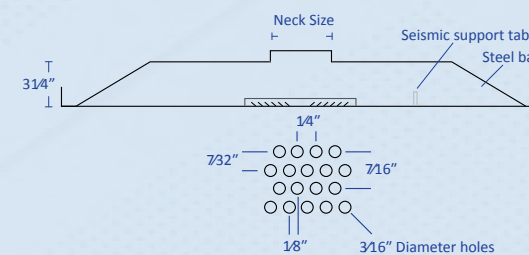

**1020 MAS-INS - Supply (Insulated)**  
**1020 MAR-INS - Return (Insulated)**

- Insulated: R6 backing with fixed collar

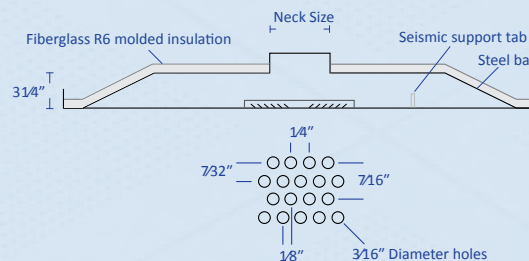

NOTE: Both Butterfly and Radial dampers shown (Models 801 and 804) can be used with the Perforated Face T-bar Lay-in Diffusers.

**1010 MAS/MAR Options**

**Model 820**  
Extended Collar with Ring

Collars range from: 6", 7", 8", 9", 10", 12", 14", 16" & 18" (Sold separately as accessories)

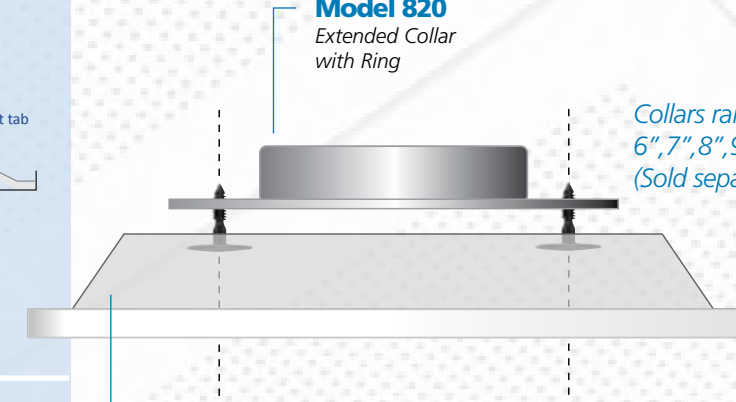

**Universal Back without Collar**  
(Molded R6 fiberglass only, with scored lines)

**Model 821**  
Push Fasteners



**1020 MAS/MAR Options**

**Steel Back - with Collar**  
(Uninsulated with fixed collar)

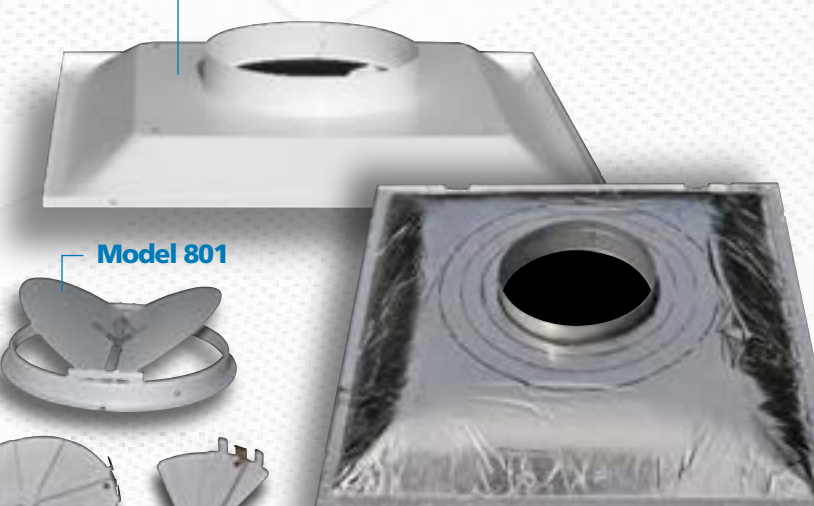

**Insulated Back - with Collar**  
(Insulated with scored lines and fixed collar)

**Model 804**

**ORDERING HINTS**

	DESCRIPTION	Supply	Return
<b>OPTION 1:</b>	Universal Back - No Collar	1010MAS	1010MAR
<b>OPTION 2:</b>	Steel back with fixed collar + Collar Size (Uninsulated)	1020MAS-8	1020MAR-8
<b>OPTION 3:</b> (See images shown above)	Steel back with fixed collar + Collar Size (Insulated)	1020MAS-8 INS	1020MAR-8 INS

**1100 Series**

Drawing from our close relationship with contractors who know the industry, these T-Bar Grilles cut installation time by utilizing a unique plenum frame design. The three face designs available are perforated steel, acrylic eggcrate and aluminum eggcrate. These easy to use and ready to go T-Bar Grilles come with or without the 1 1/2" ductboard.

The 1120 perforated model is available as a Supply Diffuser employing the stamped deflector and each model is also available in full-size T-Bar configurations including half T-Bar and double T-Bar dimensions.



commercial

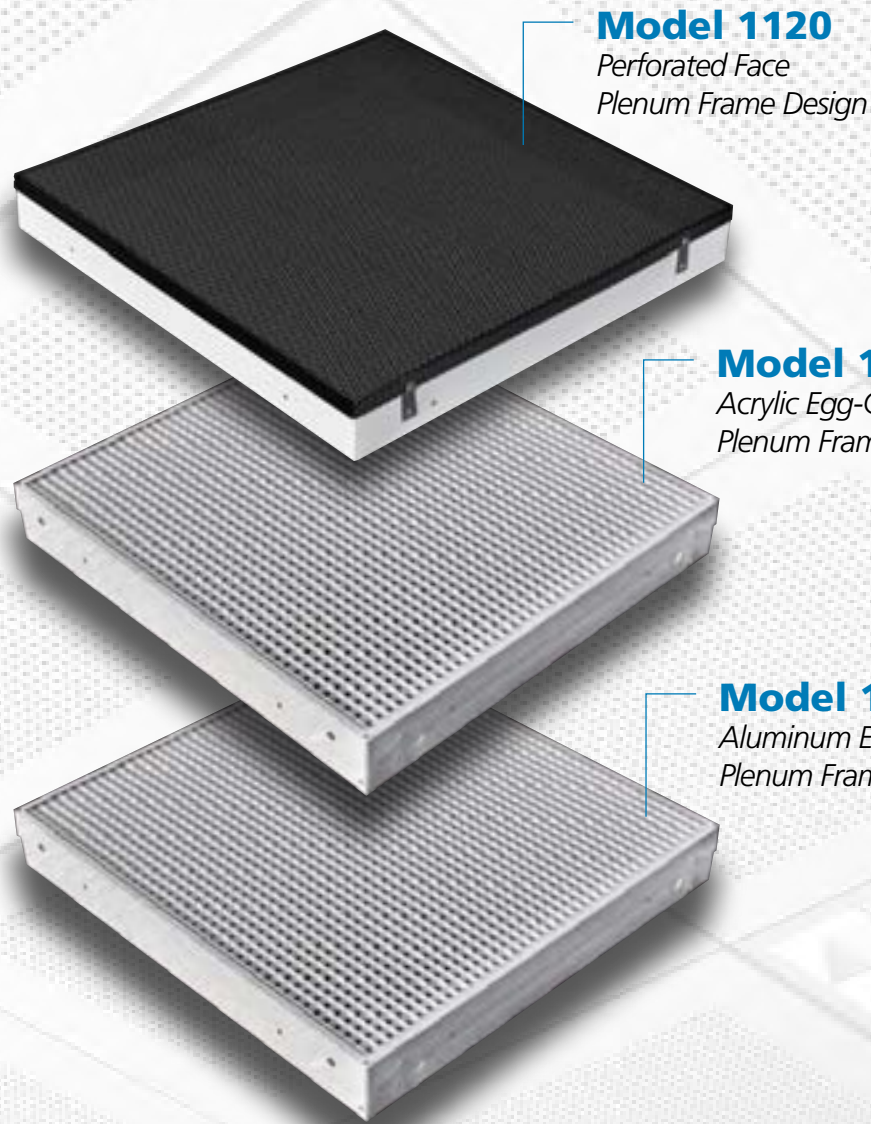

**Features**

- Unique plenum frame design
- Perforated or eggcrate face
- 12" x 24" Dimension
- 24" x 24" Dimension
- 24" x 48" Dimension
- Optional 1 1/2" ductboard

**Product Detail**



Plenum box on reverse side



Seismic support tabs

**Model 1120**

- Perforated Face Plenum Frame

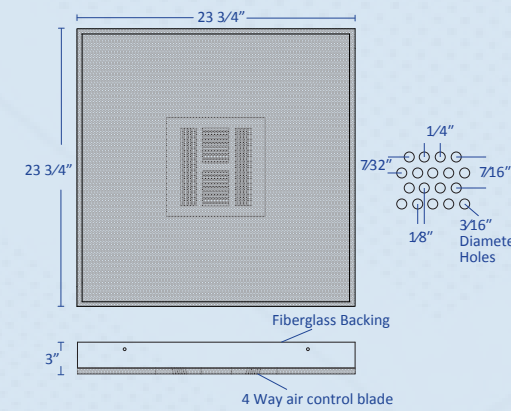

**Model 1130**

- Acrylic Eggcrate Face Plenum Frame

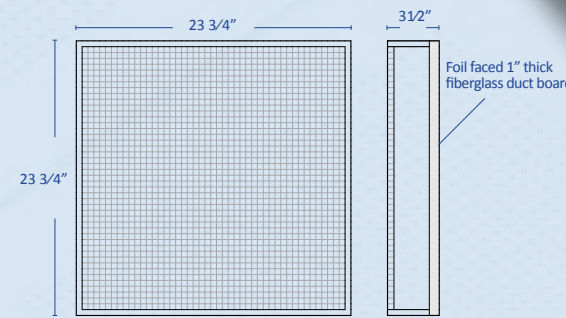

**Model 1140**

- Aluminum Eggcrate Face Plenum Frame

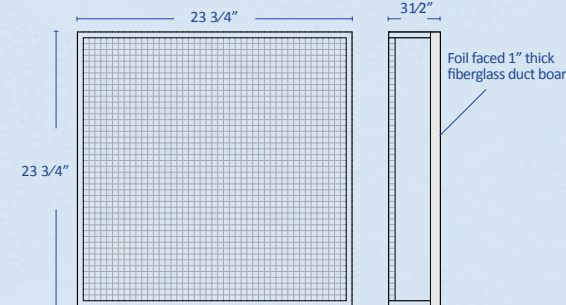

**1100 Series Options**

**Open Back - Without Plenum**

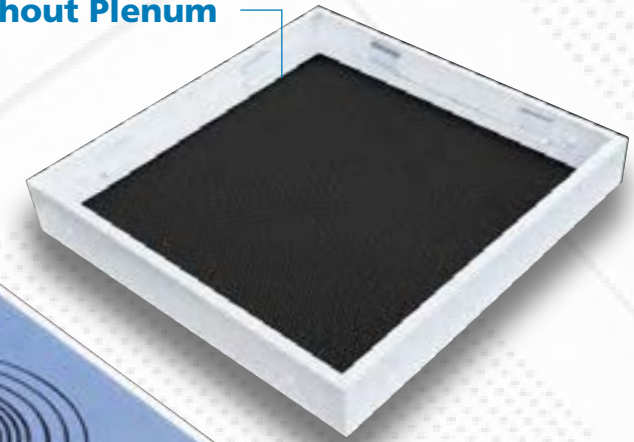

**1 1/2" Ductboard Back**

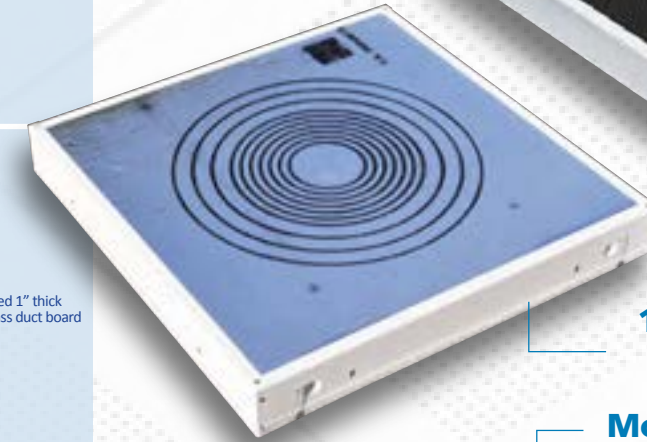

**Model 1120S**  
Shown with Supply Deflectors

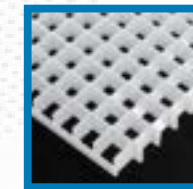

Acrylic

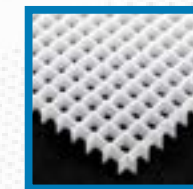

Aluminum



ORDERING HINTS	DESCRIPTION	EXAMPLE
<b>Select Base Model:</b>	Model 1120* - Model 1130 - Model 1140	<b>1120</b>
<b>Select Face Design:</b>	<b>S</b> = Supply, perforated face, open back <b>DBS</b> = Supply, perforated, 1 1/2" ductboard <b>R</b> = Return, open back <b>DBR</b> = Return, 1 1/2" ductboard	1120S 1120DBS 1120R 1120DBR
<b>Select Appropriate Size:</b>	<b>1</b> = 12" x 24" <b>2</b> = 24" x 24" <b>4</b> = 24" x 48"	1120DBR-1 1120DBR-2 1120DBR-4

\*Special Note:

Model 1120 is the only model available with the Supply deflector.

**1400 SERIES**

The 1400 Series is a set of hinged perforated face T-Bar products. Choose from models providing the luxury of high-quality adjustable blades, smooth and even 360° airflow, or the economy of adjustable deflectors. The 1444RG is the perfect match for either Supply Diffuser. Every 1400 Series Diffuser comes standard with the TRUaire Super-Collar and is also available with optional insulation.

**Model 1400CB**

T-Bar Perforated Curved Blade - Supply Diffuser

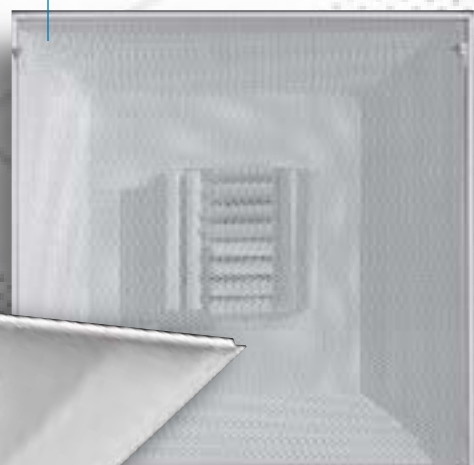

**Model 1420AB**

T-Bar Perforated Supply Diffuser with Rotating Deflectors

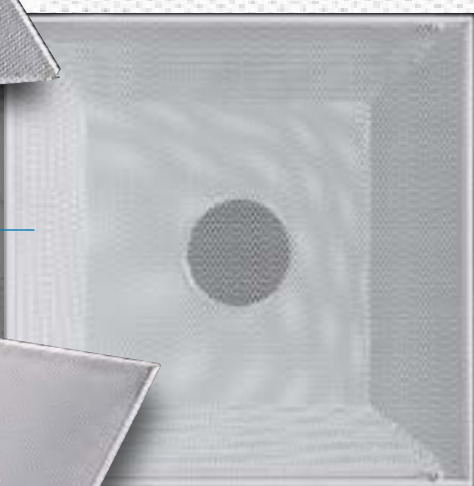

**Model 1444RG**

T-Bar Perforated Return Grille

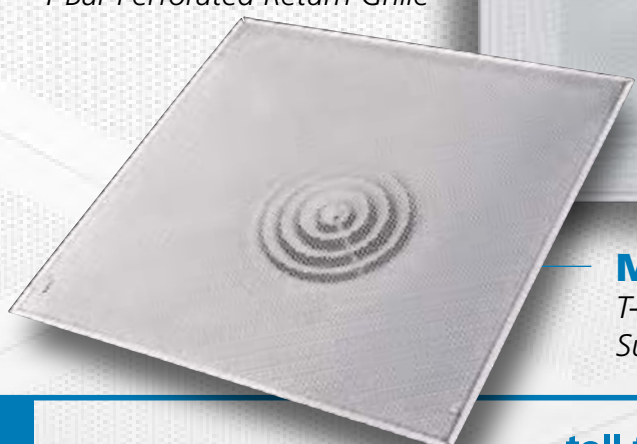

**Model 1480RD**

T-Bar Perforated Supply Diffuser

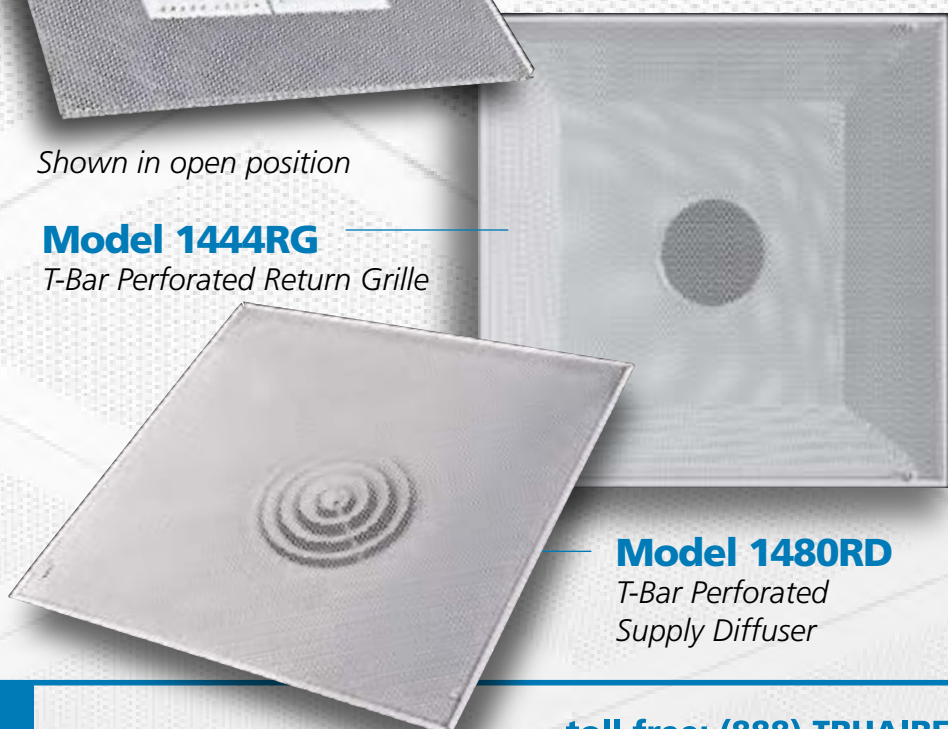

commercial

Compare to:	1400	1444	1480
Hart & Cooley	CBPS	CBPR	--
Titus	PCS	PDR	--
Shoemaker	825	830	--
Metal Aire	7600	--	--
Price	--	--	--
Krueger	--	--	--

**Features**

- Hinged perforated face
- Four-way adjustable curved blade diffuser on supply Model 1400CB
- Four-way adjustable stamped deflectors on the supply Model 1420AB
- Round Model 800 diffuser on the supply Model 1480RD
- White powder coat finish
- Seismic support tabs
- Insulation available
- Steel construction
- Exclusive TRUaire Super Collar

**Product Detail**

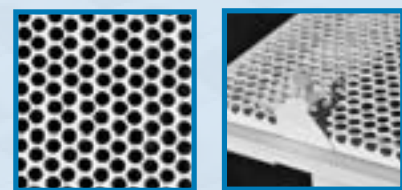

Steel Perforated Face SmoothGlide™ Latch Technology

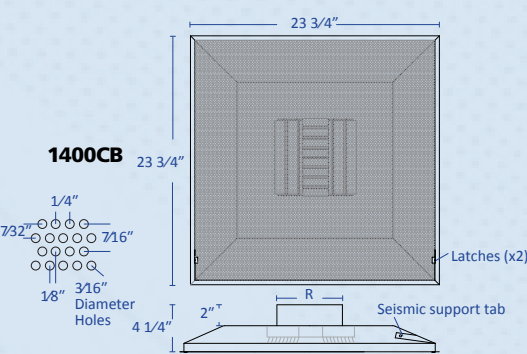

**1400FL** Fine Line / Narrow-T  
**1444RG-FL**

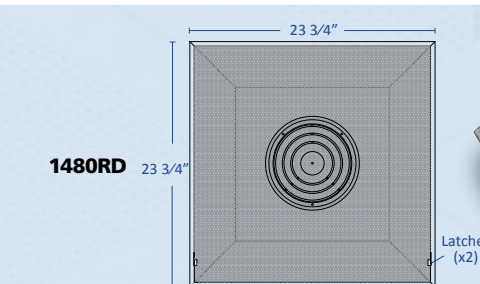
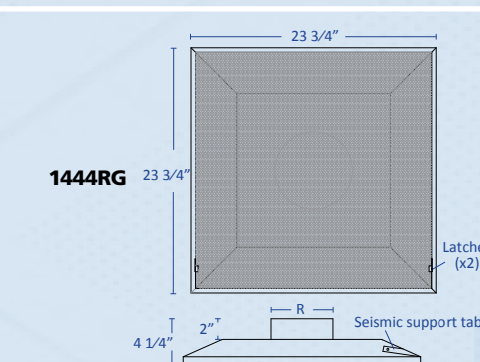
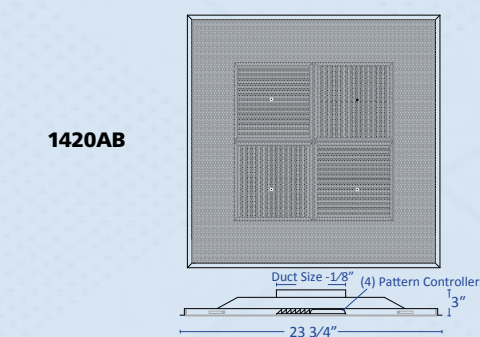
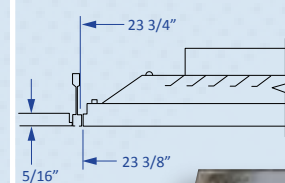

**Super Collar** 2"



**1400 Series Options**

**Accessory Insulation - Model 1056FB**  
(NOTE: Must be ordered as a separate item)

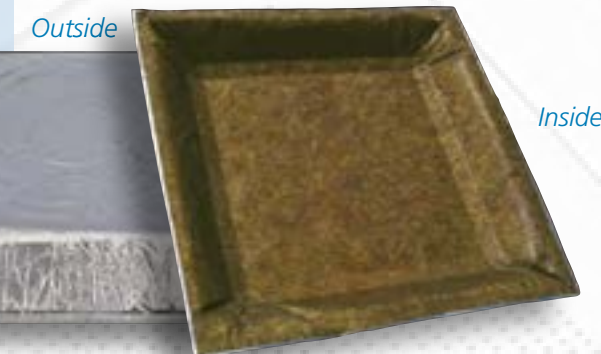

> **SQUARE:** neck size: 14" x14"

> **ROUND:** 6", 8", 10", 12", 14", 16", 18", & 20"

**Available Neck Sizes**

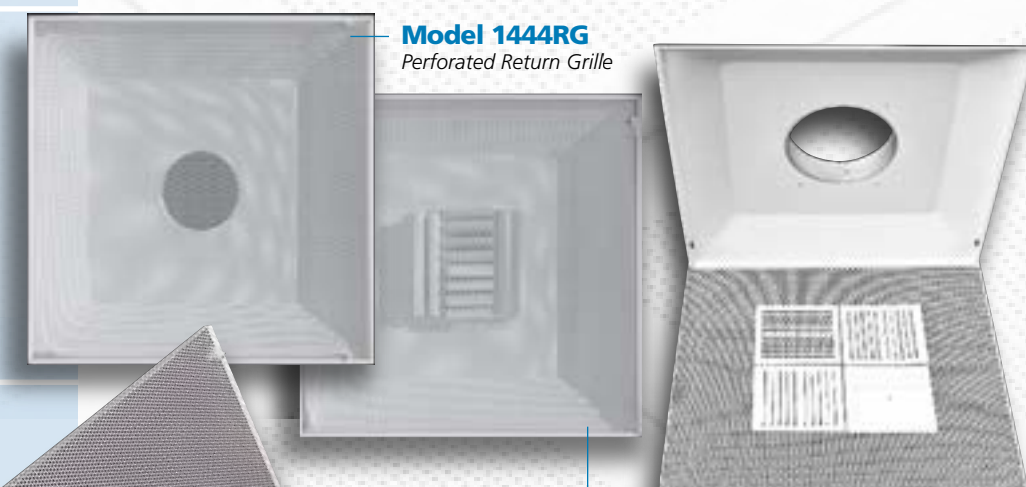

**Model 1400CB**  
Curved Blade Supply Diffuser

**Model 1420AB**  
Shown Open with Rotating Deflector Fins

**Model 1480RD**  
T-Bar Perforated Supply Diffuser

ORDERING HINTS	DESCRIPTION	Supply	Supply	Return	Supply
<b>Step 1:</b>	Select <b>Supply</b> or <b>Return</b> Models	1400CB	1420AB	1444RG	1480RD
<b>Step 2: Round Neck</b>	Select <b>Round</b> neck size: (6, 8, 10, 12, 14, 16, 18, or 20)	1400CB-8	1420AB-8	1444RG-8	1480RD-8
<b>Step 2: Square Neck</b>	...Or Select <b>Square</b> 14" neck	1410CB-14	1425AB-14	1455RG-14	
<b>OPTION: Accessory Insulation</b>	Add Molded R6 Insulated Backing	+ Model 1056FB			

**2000 SERIES**

Step Down Diffusers go by many names; Lay-ins, Cone Diffusers, or even T-Bar Diffusers. The term "T-Bar" comes from the shape of the railing that holds the ceiling tiles in a drop ceiling. The railing forms a grid of squares and T-Bar Diffusers are designed to fit, or "lay-in", those grid squares.

The "cone" shape of the diffuser allows for a maximum volume of airflow into the air-conditioned space.



commercial

**Model 2000PD**  
Single Plaque Diffuser



**Model 2003CD**  
2 Cone Diffuser



**Model 2004CD**  
3 Cone Diffuser



Compare to:	2000PD	2003CD	2004CD
Hart & Cooley	DPD	FPD/FPD3	FPD/FPD3
Titus	OMNI	TMS	TMS
Shoemaker	HL	HVL/HVD	HVL/HVD
Metal Aire	5750	5800	5800
Price		SCD	SCD
Krueger	PLQ	1400	1400

**Features**

- Single plaque, 2 or 3 cone diffusers available
- Extra heavy gauge steel
- Seismic support tabs
- Pristine white powder coat finish
- New Exclusive Truair Super-collar
- Options for insulation and dampers

**Product Detail**



- 1) Thumb-tab can be bent over easily to hold insulation in place
- 2) Recessed hole for hanging wire used in the installation process

**2000 Series Options**

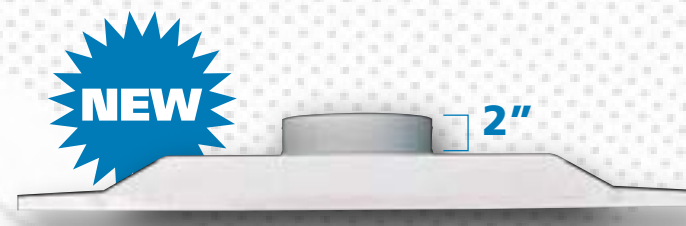

**Super Collar**

This exclusive Truair Super-collar is the Installer's dream come true. Made from extra-heavy gauge Electro-galvanized steel, this collar will not flex or buckle under the pressure of a zip-screw gun. It stands a full 2" tall, and comes with a solid steel "bead" around the entire collar to help prevent any flex duct slippage.

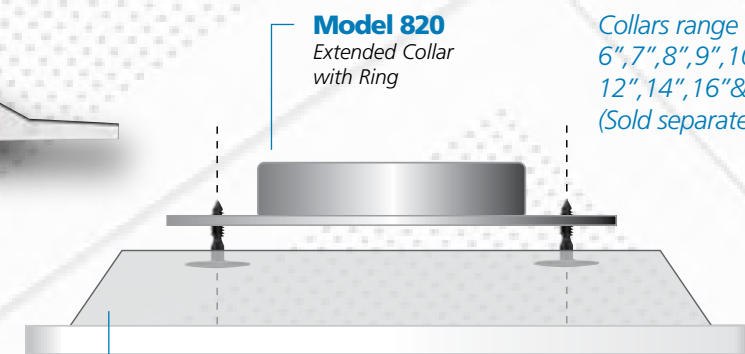

**Model 820**  
Extended Collar with Ring

Collars range from: 6", 7", 8", 9", 10", 12", 14", 16" & 18" (Sold separately)

**Universal Back without Collar**  
(Molded R6 fiberglass only, with scored lines)

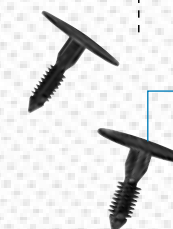

**Model 821**  
Push Fasteners

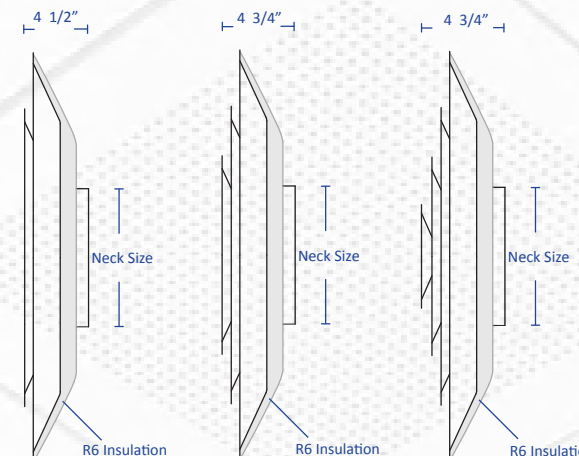

**2000PD**

**2003CD**

**2004CD**

**Steel Back with Collar**  
(uninsulated, fixed Super-Collar)



**Insulated Steel Back - with Collar**  
(Steel back, R6 insulation, fixed Super-Collar)

**Optional Dampers**



*Radial Damper*

*Butterfly Damper*

ORDERING HINTS	DESCRIPTION	EXAMPLE ORDER
<b>1. Select a face pattern:</b>	Model 2000PD OR Model 2003CD OR Model 2004CD	2004CD
<b>2. Select the collar size:</b>	6", 8", 10", 12", or 14" diameter	2004CD-8 (for 8")
<b>3. Select insulation options:</b>	<b>IN</b> = R6 insulated steel back with collar <b>R6</b> = Universal back only - No collar - No damper	2004CD-8 <b>IN</b> 2004CD-8 <b>R6</b>
<b>4. Select damper options:</b> (See images shown above)	<b>BD</b> = Butterfly Damper <b>RD</b> = Radial Damper <i>Note: To select models with insulation &amp; damper; Designate BOTH</i>	2004CD-8 <b>BD</b> 2004CD-8 <b>RD</b> 2004CD-8 <b>INBD</b>

**2600 SERIES**

The 2600 Series diffusers are the perfect blend of style, function, and economy. As with everything TruAire makes, economy doesn't mean sacrificing quality. Manufactured with the highest standards, using heavy gauge steel and finished with our pristine white powder-coat, these stamped four-way diffusers utilize a large curved blade design providing a wide area of effective air diffusion. The outwardly curved blade pattern is an architecturally attractive design proving that form can also follow function.



commercial

**Model 2604SC**

*Curved Blade Diffuser - Steel Construction*



**Compare to:** 2604SC

Hart & Cooley	--
Shoemaker	104
USAire	--
Continental	--
Lima	--
Airmate	--

**Features**

- Economical
- Highly effective air distribution
- Attractive face pattern
- Optional damper and insulation
- White powder-coat finish
- Durable steel stamped curved blade construction

**Product Detail**



Optional Opposed Blade Damper



Detail view of stamped curved blades

**Model 2604SC**

- Stamped Curved Blade Diffuser
- Steel Construction

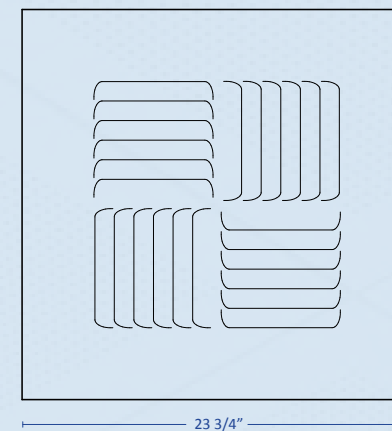
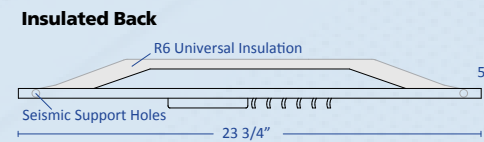
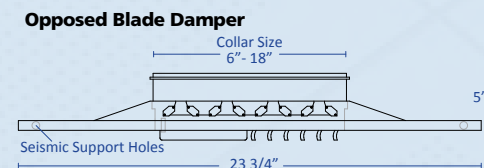
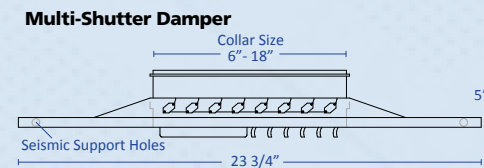
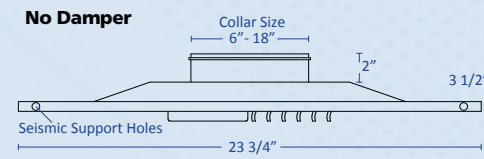

**2600 Series Options**

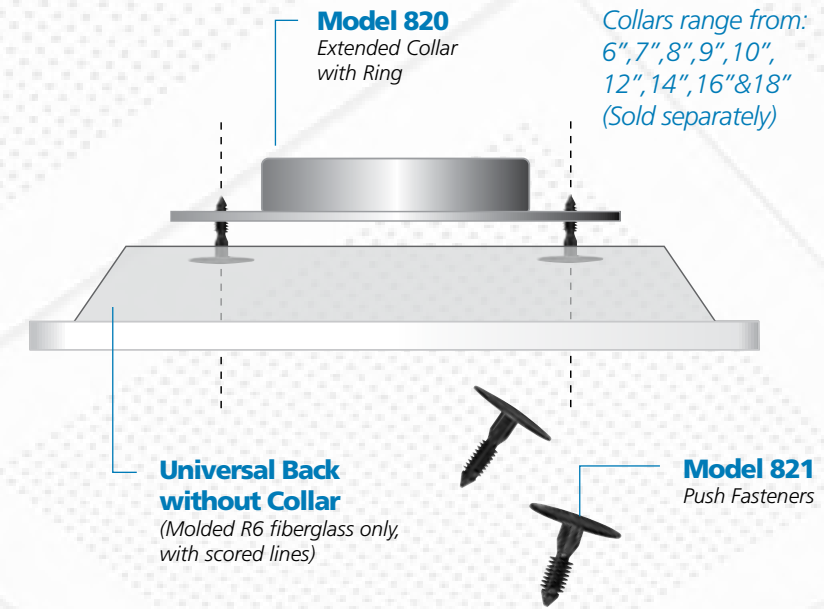

**Available Sizes:**

- 6 x 6
- 8 x 8
- 10 x 10
- 12 x 12
- 14 x 14
- 16 x 16
- 18 x 18

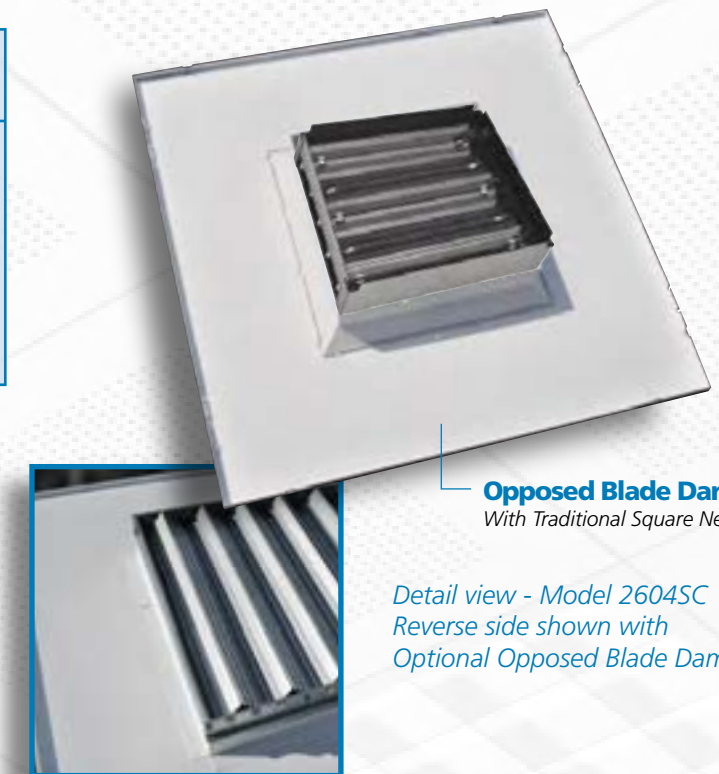

ORDERING HINTS	DESCRIPTION	Model Example
<b>Step 1:</b> Select the Base Model	Model 2604SC	2604SC
<b>Step 2:</b> Select the Size	Choose from 6"x 6" through 18"x 18"	2604SC-10
<b>Step 3:</b> Select any Options	<b>O = Opposed Blade Damper</b>	2604SC <b>O</b> -10
	<b>MLD = Molded R6 insulation</b>	2604SC-10- <b>MLD</b>

**4000 SERIES**

The 4000 Series T-Bar Filter Grille line-up is a comprehensive combination of design, function, and budget. From the economy of stamped steel to the shine of aluminum egg-crate, and every design in between, we pour the same commitment to quality into every product.

Whether you're building your own plenum box or utilizing our pre-made plenum backs, we've got the right design and the right installation options to fit every project.

**Model 4010FG**

Stamped Face Return - 1/2" Fins

**Model 4013FG**

Stamped Face Return - 1/3" Fins



**Model 4020FG**

Fixed Bar Return Air Filter Grille

**Model 4030FG**

Perforated Face Return Air Filter Grille

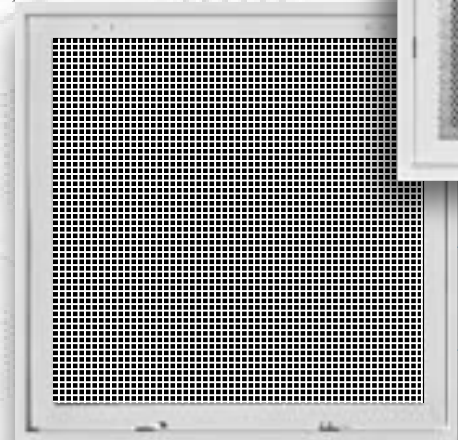

**Model 4040FG (Acrylic)**  
Egg-Crate Return Air Filter Grille

**Model 4050FG (Aluminum)**  
Egg-Crate Return Air Filter Grille



commercial

Compare to:	4020	4030	4050
Hart & Cooley	96AFBT	PFT/PFTI	REF5T
Titus			50FF-3
Shoemaker		105/106	600TFG
Metal Aire			CC5FB-TB
Price			80FF-TB
Krueger			EGC5

**Features**

- Solid craftsmanship; steel or aluminum
- White powder-coat finish
- SmoothGlide Latch Technology
- Full set of plenum-back options
- Full set of face design and material options
- For use with 1" or 2" filters

**NOTE:**

- The Universal Molded R6 back is available only on the low profile 4010FG1 frame, and will accept only a 1" filter

**Product Detail**

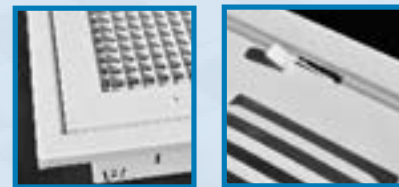

Premium Egg Crate    SmoothGlide Latch

**Model 4010FG**

- Stamped Face Return - 1/2" Spacing

**Model 4013FG**

- Stamped Face Return - 1/3" Spacing

**Model 4020FG**

- Fixed Bar Return Air Filter Grille

**Model 4030FG**

- Perforated Face Return Air Filter Grille

**Model 4040FG**

- Acrylic Egg-Crate Return Air Filter Grille

**Model 4050FG**

- Aluminum Egg-Crate Return Air Filter Grille

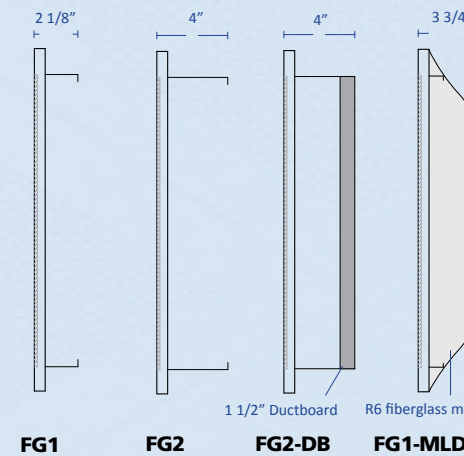
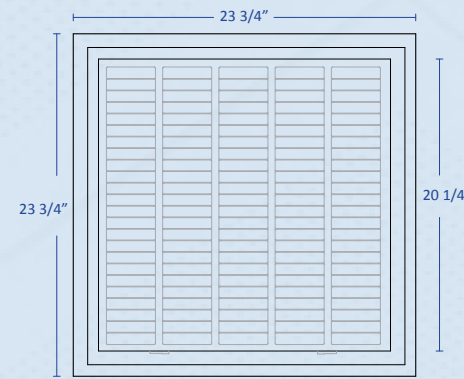

**4000 Series Options**

**Open Back - Without Plenum**



**Universal R6 Molded Fiberglass Back**

(\*NOTE: The molded R6 back is only available on Model 4010FG-1)

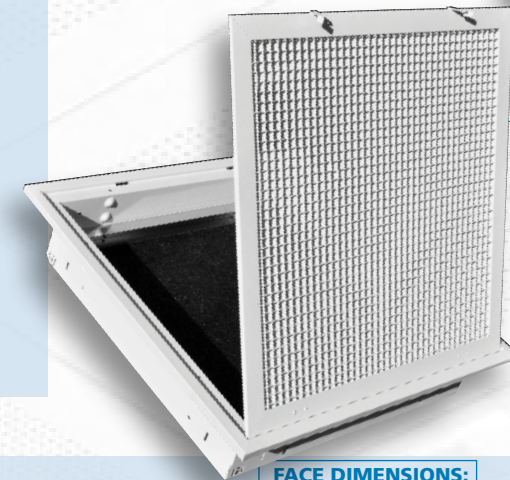

**Hinged Face**

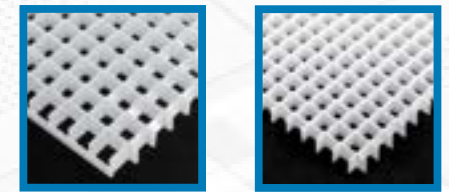

Acrylic    Aluminum

**ORDERING HINTS**

**MODEL DESCRIPTION:**

1	1/2" Fin Spacing Stamped Face
2	Fixed Bar Face
3	Perforated Face
4	Acrylic Egg Crate Face
5	Aluminum Egg Crate Face
6	1/3" Fin Spacing Stamped Face

**FACE DIMENSIONS:**

1	23 3/4" x 11 3/4"
2	23 3/4" x 23 3/4"
4	23 3/4" x 47 3/4"

**4 0 1 0 FG 2 DB**

**FILTER REQUIREMENTS:**

0	1" to 4" Filter
1	1" Filter Only

**REVERSE SIDE BACKING:**

LEAVE BLANK	Open Back (1" - 4" Filters)
DB	Duct Board (1" - 2" Filter)
R6	Molded Insulation only (available on 4010FG-1)

**5200 SERIES**

The 5200 Series Diffuser stands alone as the most versatile of all T-Bar Supply Diffusers. Four individually mounted aluminum snap-in **cores** can be arranged in one, two, three, or four-way throw configurations. The Model 5200 can also be arranged in a two-way corner throw for added versatility.

These four core sections are positioned together forming a square in the interior of either a top quality aluminum T-Bar panel, or less expensive steel T-Bar panel; both are 100% powder-coated to prevent rust and corrosion. Available with either steel or aluminum panels and in square or round duct connections or with the optional Opposed Blade Damper.

**Model 5200CB**

*Aluminum Core - Steel Panel*



**Model A5200CB**

*Aluminum Core - Aluminum Panel*



*Shown with core component removed*



commercial

Compare to:	5200	A5200
Hart & Cooley	MCDST	MCDST
Titus	MCD-3	MCD-3
Shoemaker	700MA	700MA
Metal Aire	9000	9000
Price	AMCD	AMCD
Krueger	1200	1200

**Features**

- Beautifully crafted removable aluminum cores
- One, two, three, four-way and corner throw patterns
- Steel or aluminum T-Bar panel
- White powder-coat finish
- Traditional square neck
- Convenient round collar
- Perfect for VAV applications

**Product Detail**

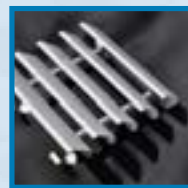

Detachable Cores



Insulation thumb-tab and recessed hanger wire hole

**Model 5200CB**

- Aluminum Core - Steel Panel

**Model A5200CB**

- Aluminum Core - Aluminum Panel

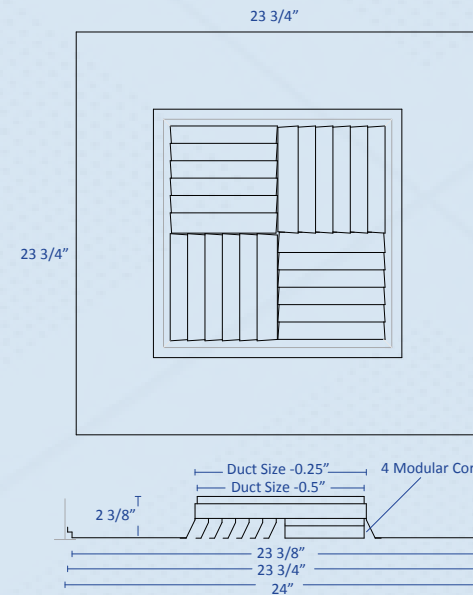

**5200 Series Options**



Round Collar (RD)

Traditional Square Neck (SQ)

Opposed Blade Damper with Round Collar

Opposed Blade Damper with Traditional Square Neck

ORDERING HINTS	DESCRIPTION	Example Model
Select base model and panel:	5200CB - Steel Panel A5200CB - Aluminum Panel	5200CB A5200CB
Select round or square neck:	RD = Round Collar SQ = Square Neck	5200CB-RD 5200CB-SQ
Select Neck Size:	6", 8", 10", 12", 14", 16", 18" or 20"	5200CB-RD-8 5200CB-SQ-8
Optional Damper:	O = Opposed Blade Damper	5200CBO-RD-8
Optional R6 fiberglass back:	IN = Include molded Fiberglass Backing	5200CB-RD-8-IN

## 5400 SERIES

This attractive T-Bar design comes in a sleek low-profile blade arrangement, engineered to be "flush" with the ceiling. This diffuser might be considered the architects first choice for small to medium-sized commercial projects.

The all aluminum blade construction, in one, two, three, four-way, and even two-way corner throw configurations, can be ordered in a matching aluminum T-Bar panel, or a rugged steel T-Bar panel. The back of this diffuser comes in 6, 9, 12, 15, and 18-inch square neck configurations or with a Universal Fiberglass Back. Optional high-quality Opposed Blade Dampers and optional insulation rounds out the offering.

**Model 5404SD** *Steel*  
**Model A5404SD** *Aluminum*  
 4-Way Deflection (Shown with blades removed)

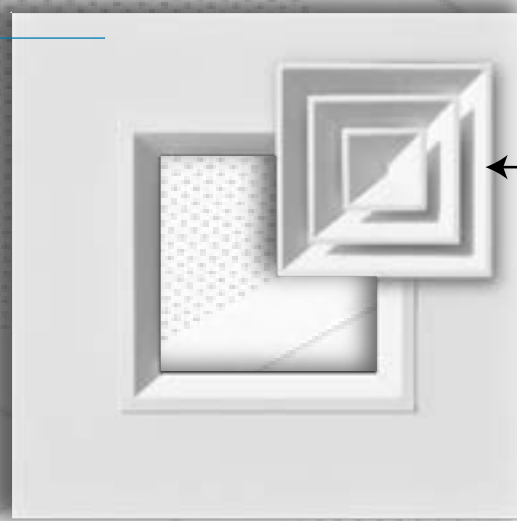

Easy-to-change modular blades are interchangeable. Choose from air-throw patterns below.  
**NOTE:** Model 5404SD is most common.

commercial

Compare to:	5400	A5400
Hart & Cooley	SRT/ART	SRT/ART
Titus	TDC	TDC
Shoemaker	700	700
Metal Aire	5500	5500
Price	SMD	SMD
Krueger	SH23	SH23

### Features

- Sleek blade design
- One, two, three, four-way and corner air throw.
- Aluminum construction
- Steel or aluminum T-Bar panel

### Product Detail



Insulation thumb-tab and recessed hanger wire hole  
 Low-Profile Blade Design

- Model 5401SD** 1-Way Deflection
- Model 5402SD** 2-Way Deflection
- Model 5403SD** 3-Way Deflection
- Model 5405SD** 2-Way Corner

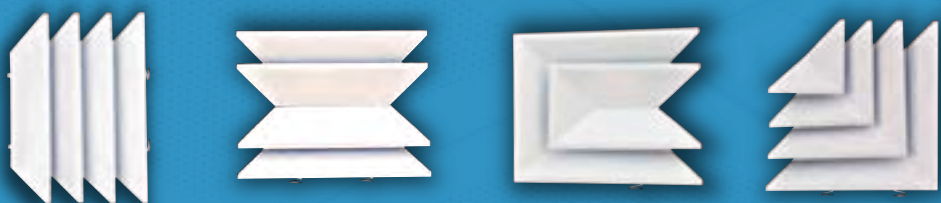

Choose your air-throw pattern



- Model 5401SD** • Steel 1-Way Air Deflection
- Model 5402SD** • Steel 2-Way Air Deflection
- Model 5403SD** • Steel 3-Way Air Deflection
- Model 5404SD** • Steel 4-Way Air Deflection
- Model 5405SD** • Steel 2-Way Corner Air Deflection



- Model A5401SD** • Aluminum 1-Way Air Deflection
- Model A5402SD** • Aluminum 2-Way Air Deflection
- Model A5403SD** • Aluminum 3-Way Air Deflection
- Model A5404SD** • Aluminum 4-Way Air Deflection
- Model A5405SD** • Aluminum 2-Way Corner Air Deflection

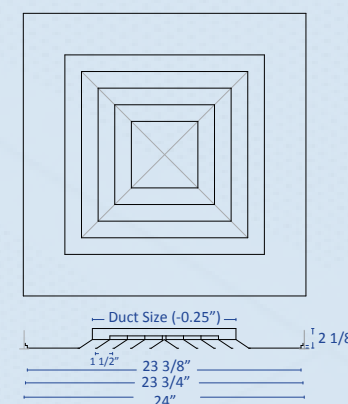

## 5400 Series Options

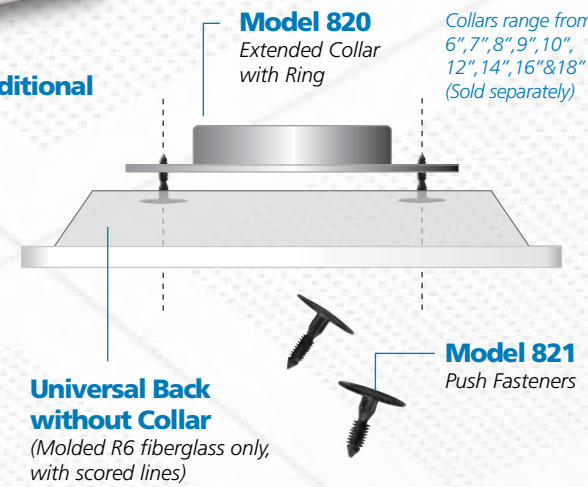
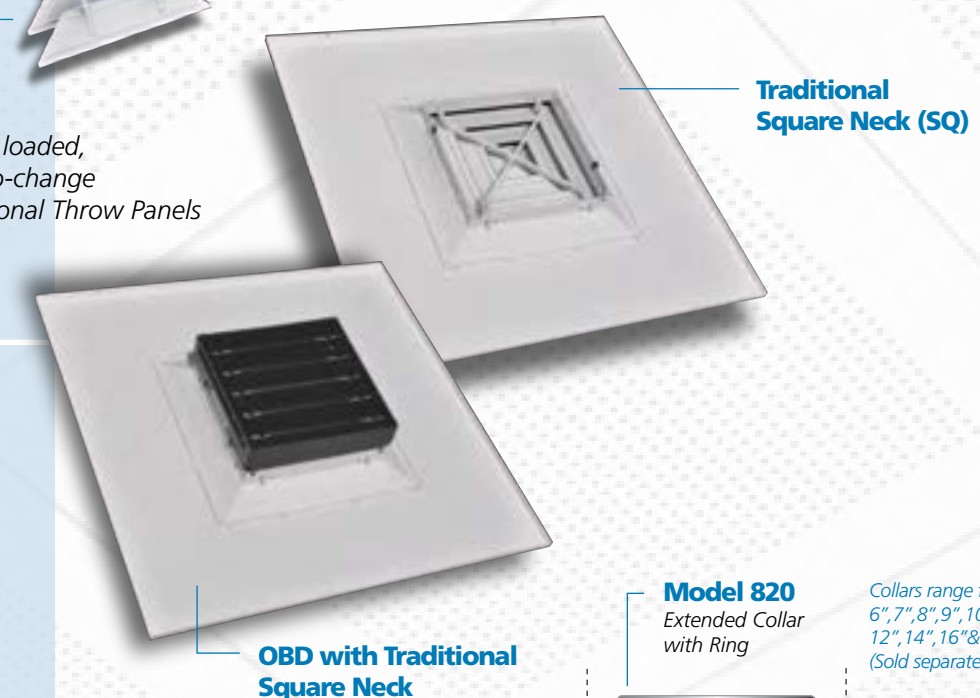

**Model 820** Extended Collar with Ring  
**Model 821** Push Fasteners

**Universal Back without Collar** (Molded R6 fiberglass only, with scored lines)  
**Accessory Part - 5400SD-06PAN** (Available accessory frame panel ONLY)

ORDERING HINTS	DESCRIPTION	Example Model
<b>Start with the base model:</b>	Model 5400SD - <b>Steel</b> T-Bar Panel Model A5400SD - <b>Aluminum</b> T-Bar Panel	<b>5400SD</b> <b>A5400SD</b>
<b>Determine air-flow direction:</b>	1-Way, 2-Way, 3-Way, 4-Way or 5 for Corner	5404SD
<b>Select Round or Square Neck:</b>	RD = Round Sizes 6", 9", 12", 15", or 18" SQ = Square Sizes 6", 9", 12", 15", or 18"	5404SD-RD-12x12 5404SD-SQ-12x12
<b>For optional insulation:</b>	IN = Include molded <b>Fiberglass Backing</b>	5404SD-12x12-IN
<b>For optional OBD:</b>	O = Opposed Blade Damper	5404SDO-12x12-IN
<b>For the Universal R6:</b> <small>(NOTE: OBD not available on Universal model)</small>	R6 = Universal Molded Back	5404SD-R6
<b>Accessory Part:</b>	PAN = Directional Diffuser Panel Only	5400SD-06PAN A5400SD-06PAN (Aluminum)

**T-Bar Return Air Panels**

There are four basic face designs available in our T-Bar Return Panel product line with a couple of options for each model to address every installation concern.

Each model is designed to be simple and flexible; ranging from the economy of stamped steel to the more luxurious and stylish look of aluminum egg crate. Several models offer a fully framed option, or select the Surface Mount Frame which works in a variety of installation configurations.

**Model 1110RG**

Stamped Steel Panel

**Model 1210RG**

Fixed Bar Panel

60° Blade Angle from Face



**Model 1920RG**

Perforated Steel Panel

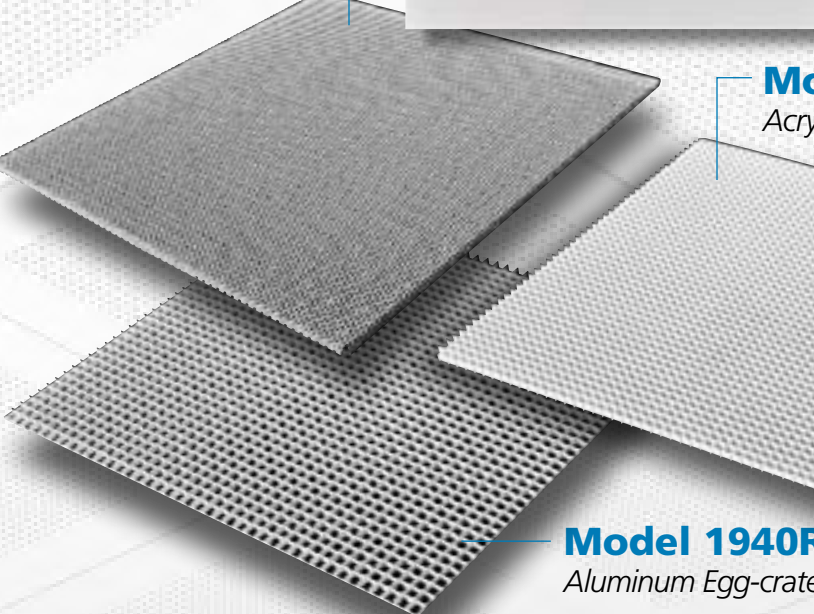

**Model 1930RG**

Acrylic Egg-crate Panel

**Model 1940RG**

Aluminum Egg-crate Panel

**Model A960 / A970**

Surface Mount Return Air Grill

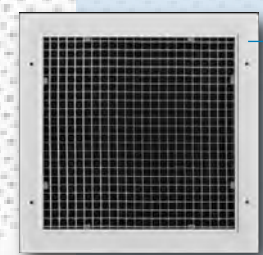

12"x 12"  
Model Shown

**Features**

- Versatile face designs
- T-Bar or Surface mount
- Rugged steel or aluminum models
- Durable white powder-coat (except aluminum egg-crate)

**Product Detail**

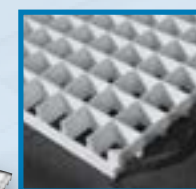

Acrylic Egg Crate



Perforated Panel Detail



Aluminum Egg Crate



**T-Bar Return Air Panel Options**

**Model 1110RG**

• Stamped Steel Panel

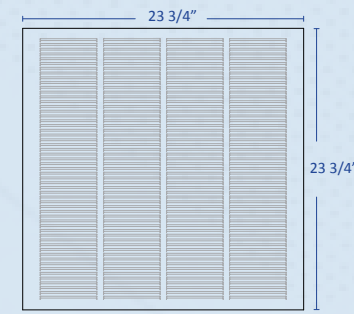

**Model 1210RG**

• Fixed Bar Panel

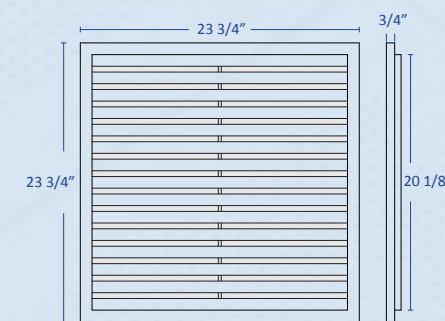

**Model 1920RG**

• Perforated Steel Panel

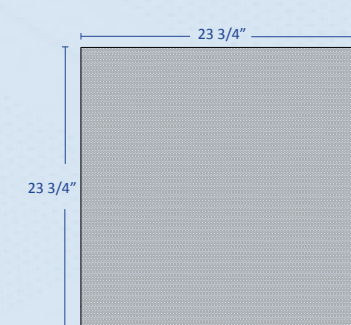

**Model 1930RG / Model 1940RG**

• Acrylic or Aluminum Egg-crate Panels

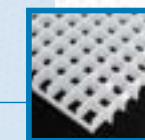
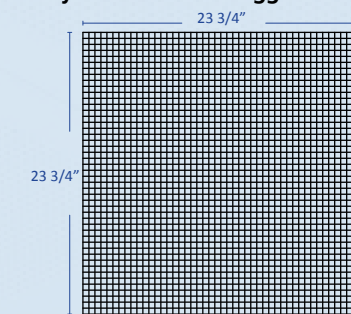

Acrylic

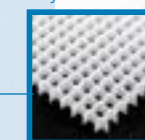

Aluminum

**Model 820**  
Extended Collar  
with Ring

Collars range from:  
6", 7", 8", 9", 10",  
12", 14", 16" & 18"  
(Sold separately)

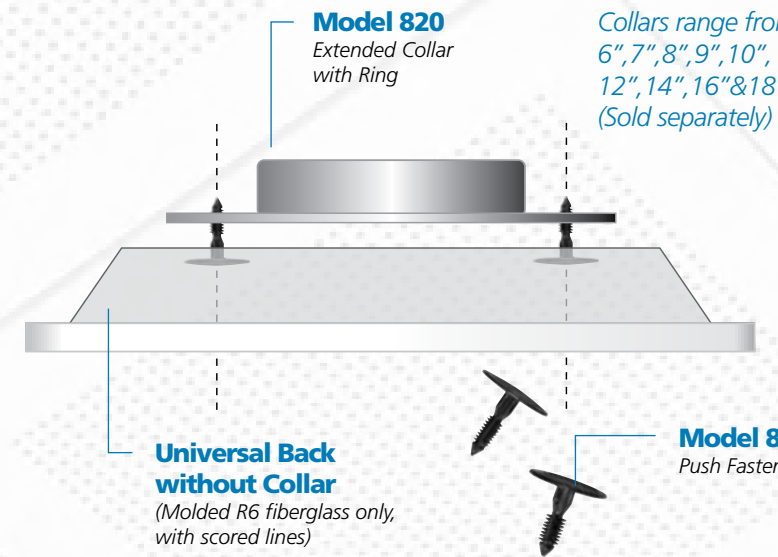

**Universal Back  
without Collar**  
(Molded R6 fiberglass only,  
with scored lines)

**Model 821**  
Push Fasteners

**ORDERING HINTS**

FACE DESIGN	MATERIAL	SIZE	MODEL
Stamped	Steel	24 x 24	1110RG
Fixed Bar	Steel	24 x 12	1210RG
Fixed Bar	Steel	24 x 24	1210RG
Fixed Bar	Aluminum	24 x 12	A1210RG
Fixed Bar	Aluminum	24 x 24	A1210RG
Fixed Bar	Aluminum w/R6 molded back	24 x 24	A1210RG-MLD
Perforated	Steel	12 x 24	1920RG-1
Perforated	Steel	24 x 24	1920RG-2
Perforated	Steel	24 x 48	1920RG-4
Egg Crate	Acrylic	12 x 24	1930RG-1
Egg Crate	Acrylic	24 x 24	1930RG-2
Egg Crate	Acrylic	24 x 48	1930RG-4
Egg Crate	Aluminum	12 x 24	1940RG-1
Egg Crate	Aluminum	24 x 24	1940RG-2
Egg Crate	Aluminum	24 x 48	1940RG-4
EX Frame	Aluminum	24 x 24	5000XF
EX Frame	Aluminum	24 x 48	5000XF

**EX-Frame  
Aluminum Surface Mount Frame**

For use with any one of the T-Bar products where the ceiling is not a T-Bar ceiling. The adaptor frame allows you to insert whatever panel is desired.

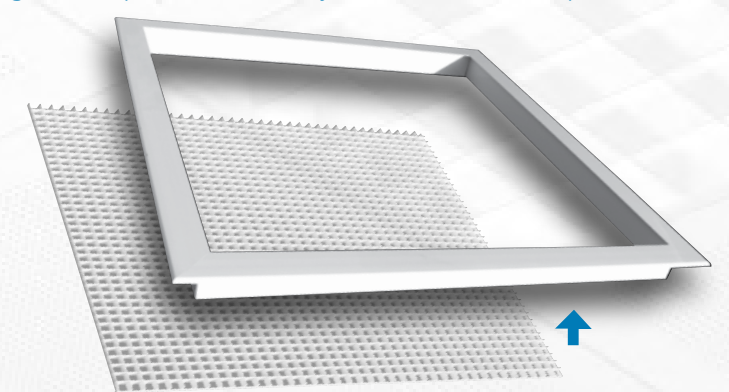

**ACD24 Series**

The Truair ACD Series Access Panel is the solution to an entire range of complications from installation to everyday use. The access doors for each panel have been segmented into three sections; each individually hinged. The center panel is only 20" wide, and swings down gently and easily for monthly filter change operations. All three panels are easily removable for easy and unrestricted access to the unit for servicing.

Both models feature our signature latch system which means they are really easy to use compared to traditional access doors which typically require the loosening of 6-8 thumbscrews to service or change the air filter.



**Features**

- Unique Segmented Face design
- Easy filter access
- Completely removable panels
- Center panel is louvered or solid face
- Easy Truair Latch System

**Product Detail**

1. All Panels Closed

2. Center Panel Open

3. Center & Left Panel Open

SmoothGlide™ Latch Technology



**Model ACD2440L**

- Steel Louvered Face

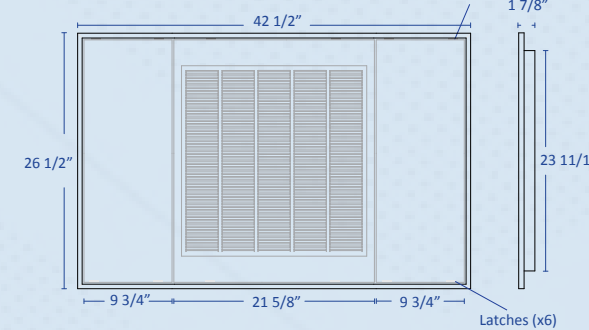

**Model ACD2440S**

- Steel Solid Face

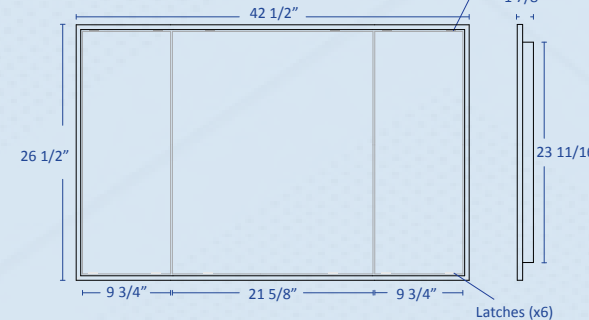

**Hinged Face Panel**

- With SmoothGlide Technology Latch System

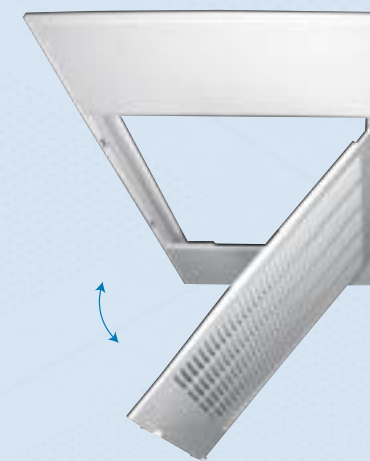

**ACD24 Series Options**

**Model ACD2440L (Louvered)**

Louvered center panel is used for applications designed for direct return air.

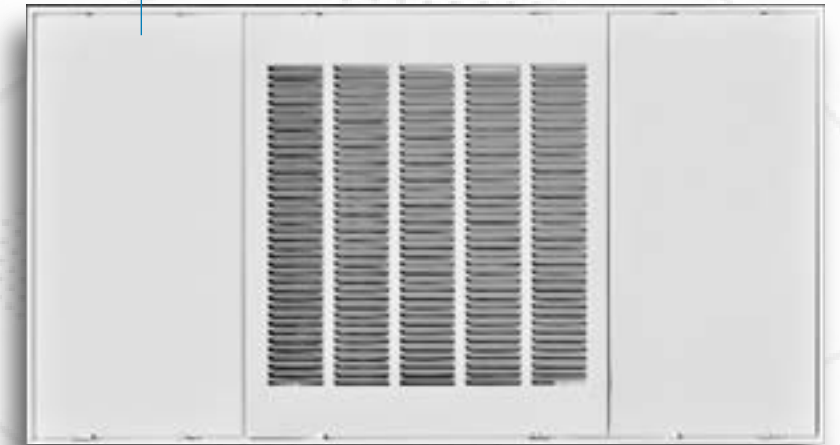

Shown in closed position

**Model ACD2440S (Solid)**

The solid center panel is used for ducted return air applications.

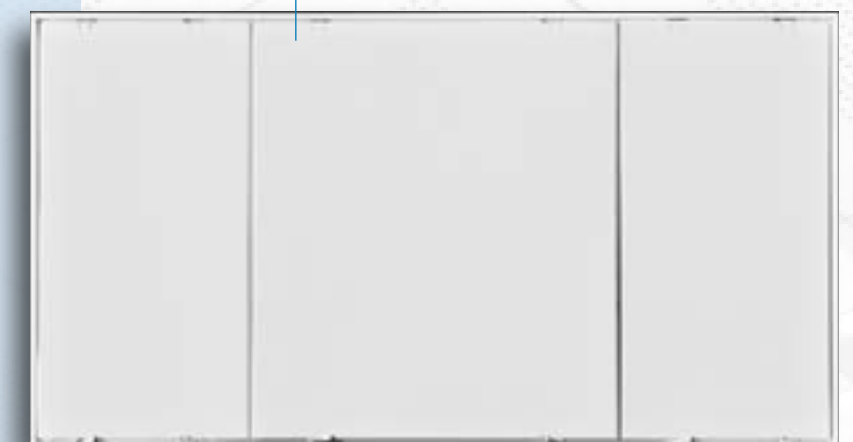

**Available Sizes:**

- 24 x 40
- 24 x 46
- 24 x 52
- 24 x 60

ORDERING HINTS	DESCRIPTION	Model Example
<b>Step 1:</b> Select the Base Model	Model ACD24	ACD24
<b>Step 2:</b> Select the Length Size	Choose from 40", 46", 52", or 60"	ACD2440
<b>Step 3:</b> Select the Face Design	L = Louvered Face	ACD2440L
	S = Solid Face	ACD2440S

**880 Series**

The 880 Series Round Commercial Diffusers are step-down ringed diffusers which are used to cover duct openings. Our product is constructed to ensure maximum airflow and the simple design will ensure that this duct diffuser streams air directly into your room. Made of high quality steel with a white powder coat finish each of our step down diffuser rings deflect the air stream 360 degrees.



**Model 880**  
Round Commercial Diffuser - Steel



FRONT SIDE

**Model 881**  
Round Opposed Blade Damper



commercial

**Features**

- Steel construction
- Round Step-Down Face
- 360-degree pattern
- Removable center core
- Diffuser outer shell fastens directly to duct
- Bright White finish
- Available with OBD

**Product Detail**



3 Tier Step-Down



Durable Louvered Design

**Model 883**  
Round Surface Mount Ring



**Model 880**

- Round Commercial Diffuser

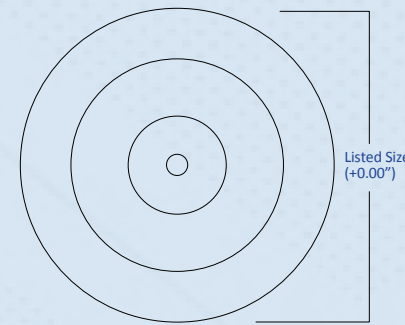

**Model 881**

- Round Opposed Blade Damper

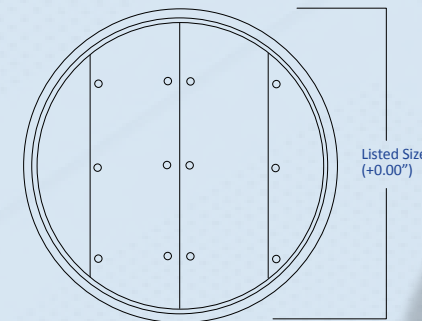

**Model 883**

- Round Surface Mount Ring

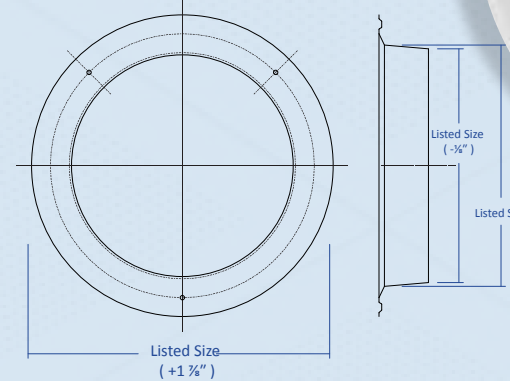

**Product Detail**



360-degree pattern, horizontal to vertical pattern change

**Available Duct Sizes**

6"	14"
8"	16"
10"	18"
12"	

**880 Series Options**

Duct sizes range from:  
6", 8", 10", 12",  
14", 16" & 18"

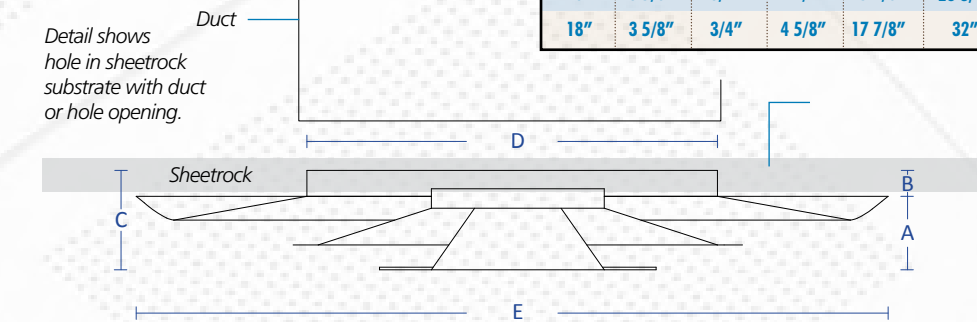

REVERSE SIDE

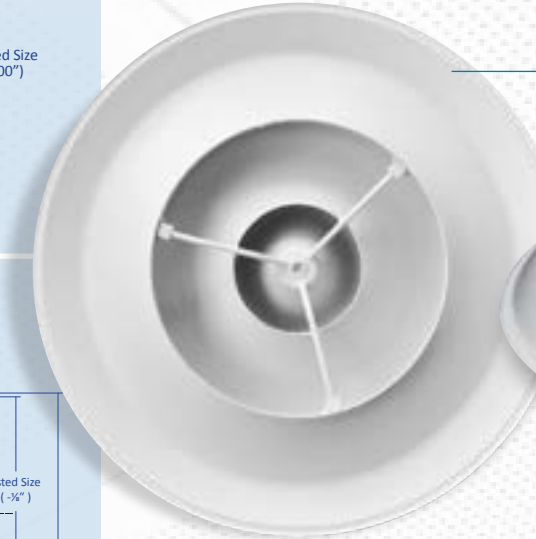

**Model 880**  
Round Commercial Diffuser - Steel



PROFILE VIEW

REVERSE SIDE

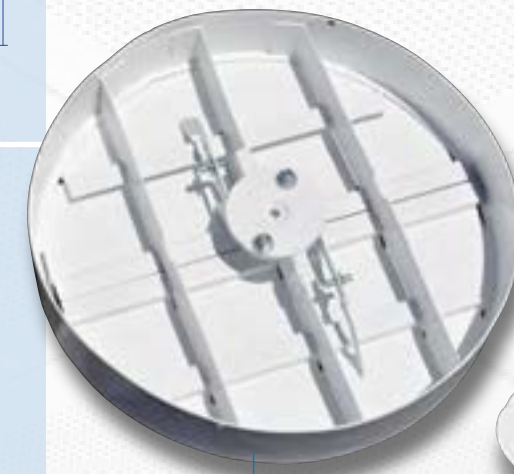

**Model 881**  
Round Opposed Blade Damper



**Model 883**  
Round Surface Mount Ring



**Sizes & Carton Quantity Chart**

SIZE	A	B	C	D	E
6"	1 1/2"	3/4"	2 1/4"	5 7/8"	11"
8"	1 1/2"	3/4"	2 1/4"	7 7/8"	14 3/4"
10"	2"	3/4"	2 3/4"	9 7/8"	18 1/8"
12"	2 1/8"	3/4"	2 7/8"	11 7/8"	21 3/4"
14"	2 7/8"	3/4"	3 5/8"	13 7/8"	25"
16"	3 5/8"	3/4"	4 1/2"	15 7/8"	28 3/4"
18"	3 5/8"	3/4"	4 5/8"	17 7/8"	32"

**Spiral Duct Series**

Spiral Duct Diffusers were born of the rustic exposed ceiling era in architectural design. Wherever air needs to leave ductwork and enter the conditioned space a hole is cut in the duct. A register is then attached for directional air control and aesthetics.

There are two ways to attach a virtually flat register to a round piece of pipe and Truair proudly features both styles. The Universal models utilize thick foam material to form to the round duct; while the saddle models more closely form to the pipe's round shape.



**Model SU1A**  
Single Deflection  
Aluminum Finish

Profile View shown with foam perimeter



**Model SU2W**  
Double Deflection  
White Finish

Compare to:	SU
Hart & Cooley	USV
Titus	US
Shoemaker	
Metal Aire	
Price	SDG
Krueger	DMG

**Features**

- Solid steel construction
- Adjustable vertical & horizontal blades
- Pristine white or aluminum finish
- Adjustable Scoop options
- Damper options
- Finish options

Profile View showing rounded saddle style

**Model SD2A**  
Saddle Type  
Double Deflection  
Aluminum Finish

**Model SD2W**  
Saddle Type  
Double Deflection  
White Finish

**Product Detail**



Reverse side of Universal Model showing thick foam

**Model SU1**

- Single Deflection
- Model SU2**
- Double Deflection

Front Side

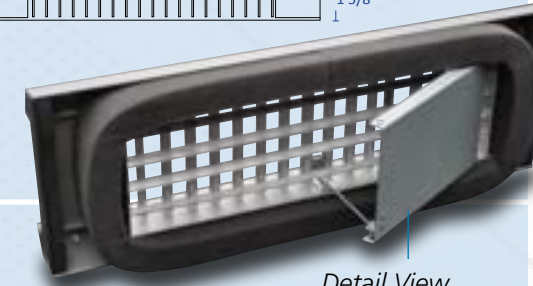
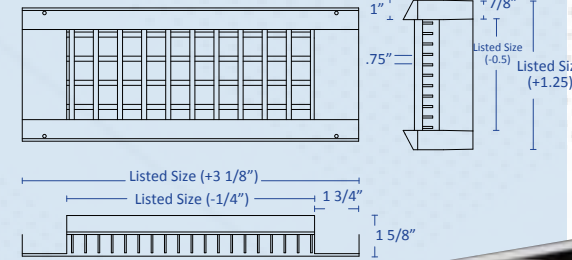

Detail View of Scoop Option

**Model SD1**

- Single Deflection
- Model SD2**
- Double Deflection

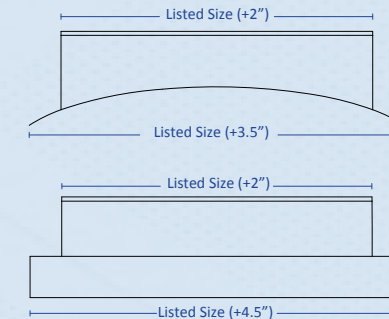

Aluminum Finish



Detail of Opposed Blade Damper

**Model SU1 & Model SU2 Options**

**STEEL Construction**

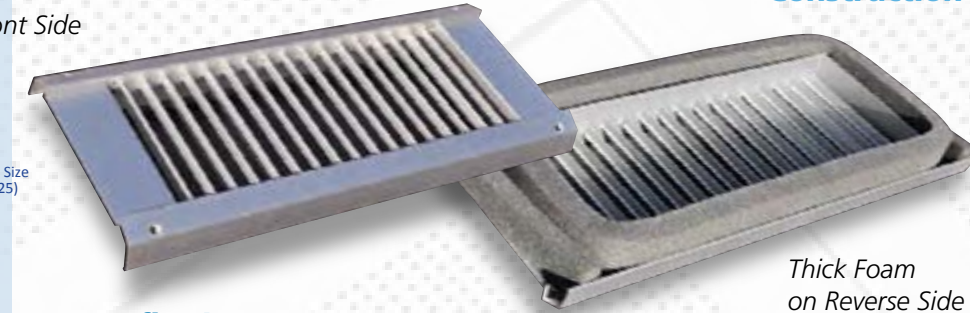

Thick Foam on Reverse Side

- 1. Deflection:** The universal Model SU1 = Single Deflection or SU2 = Double Deflection blade configurations.
- 2. Scoop:** An optional air scoop is available to divert a portion of the airstream out through the register.
- 3. Finish:** The SU model now comes in both white and an unfinished aluminum appearance to match the Spiral Ductwork.  
A = Aluminum  
W = White

**Model SD1 & Model SD2 Options**

**ALUMINUM Construction**



Powder-Coated White Finish

- 1. Deflection:** The Saddle Type Diffuser SD1 = Single Deflection or SD2 = Double Deflection blade configurations.
- 2. Scoop:** An optional air scoop is available to divert a portion of the airstream out through the register.
- 3. Finish:** The SD models come standard in our white powder-coat finish. It is also available in an aluminum powder-coat finish to match the spiral ductwork.  
A = Aluminum  
W = White

**NOTE: Spiral duct MUST be at least 4 inches larger than height of grille.**

ORDERING HINTS	DESCRIPTION	Example Model
<b>Universal Mount Diffuser</b>		
<b>Start with Base Model:</b>	<b>SU1</b> = Single Deflection <b>SU2</b> = Double Deflection	<b>SU1</b> or <b>SU2</b>
<b>Select Finish:</b>	<b>A</b> = Aluminum or <b>W</b> = White Finish	<b>SU1-W</b>
<b>ADD optional Scoop:</b>	<b>S</b> = Scoop	<b>SU1-S-W</b>
<b>Saddle Mounted Diffuser</b>		
<b>Start with Base Model:</b>	<b>SD1</b> = Single Deflection <b>SD2</b> = Double Deflection	<b>SD2</b>
<b>Select Finish:</b>	<b>A</b> = Aluminum or <b>W</b> = White Finish	<b>SD2-W</b>
<b>ADD Options:</b>	<b>O</b> = Opposed Blade Damper	<b>SD2-O-W</b>
	<b>S</b> = Scoop <b>M</b> = Multi-shutter Damper	<b>SD2-S-W</b>

**LD Series Linear Slot Diffusers**

Sleek and unobtrusive; linear diffusers are the architects dream come true. Long narrow slots take the place of traditional "fins". The installation is flush with the wall or ceiling, and the diffuser all but disappears within the natural lines of the structure.

Linear Slot Diffusers come in an almost endless variety of sizes, styles, lengths, widths and configurations. However, by far the most common, most used model is the simplest; standard 3/4" 2-slot diffuser in 2', 4', and 6' lengths. In stock, and on the shelf.



**Model LD72**  
72" Linear Diffuser

**Model LD48**  
48" Linear Diffuser

**Model LD36**  
36" Linear Diffuser

**Model LD24**  
24" Linear Diffuser



**Custom Sizing Now Available**  
Need a customized size? No problem...just add our linear extension coupler.

Compare to:	LD Series
Hart & Cooley	S75-1-2
Titus	ML
Price	SDS
Shoemaker	LSD
Metalaire	6600

- Features**
- Capped on both ends
  - 1/2", 3/4", or 1" two-slot models
  - Durable white powder-coat finish
  - Installation brackets with screws
  - Standard 2', 3', 4', 6' lengths
  - Custom cut lengths available
  - Extension coupler available

Select from one of three slot sizes:  
**A - 1/2"      B - 3/4"      C - 1"**

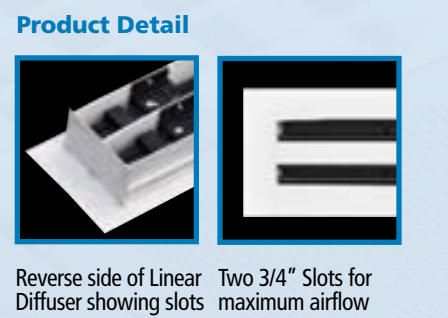
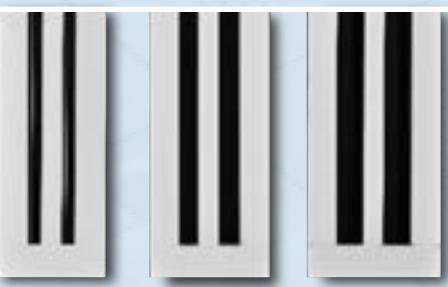

**LD Series Linear Slot Diffusers**

Featuring TRUaire's simple yet effective 2-slot linear diffuser series, engineered in three standard lengths based on the most popular configurations. Our ever expanding product line now includes additional lengths and the even greater capability to accept customized sizing for linear products.

High Quality Aluminum Components



**Model LD24**  
Two-Slot Linear Diffuser  
Reverse Side Shown with Adjustable Damper

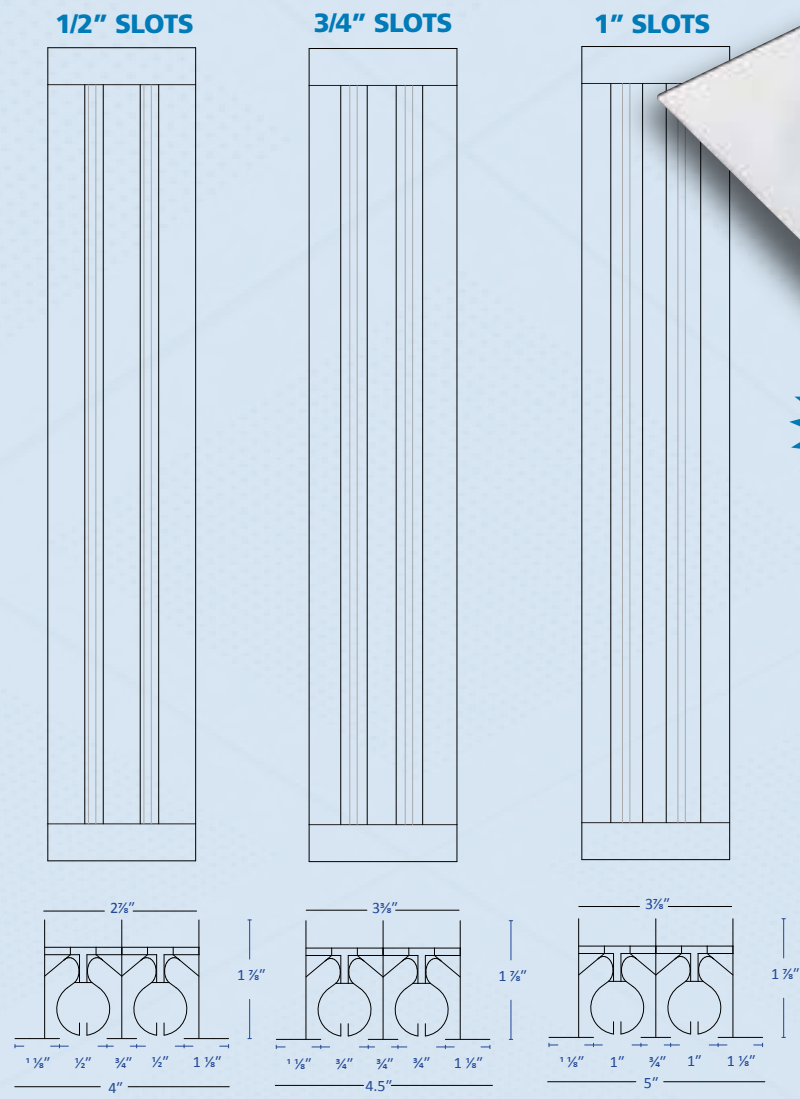

**Greater Design Flexibility**

TRUaire's linear slot diffusers offer high performance with a 180° range of air pattern adjustment and complete flow rate control. Each model features a solid extruded aluminum border and frame construction which is sure to compliment any modern architectural design giving you true flexibility in application.



ORDERING HINTS	DESCRIPTION	Example Model
<b>1. Start with the base model</b>	LD	<b>LD</b>
<b>2. Select overall length</b>	24" • 36" • 48" • 72"	<b>LD48</b>
<b>3. Select Number of slots</b>	2 slots	<b>LD48-2</b>

*Note: Now available in 1/2", 3/4" and 1"*

STEEL								
TRUAIRE	PAGE #	HART &	SHOEMAKER	LIMA	CONTINENTAL	AIRMATE	US AIRE	AIRGUIDE
101MD	1	681	X	601	21	180	1101M	X
101M-R	1	681	X	601	21	180-R	1101MR	X
101M-L	1	681	X	601	21	180-L	1101ML	X
120M	1	682	850	602/SW2W	22	160	102M	X
103M	1	683	845	603/SW3W	23	140	103M	X
104M	1	684	150	604/SW4W	24	190	104M	X
1155W	33	470	875	470	150	350	1330	X
115RW	33	471	875	471	1505	351	1341	X
1185W	33	470	875	470	180	350	1340	X
118RW	33	407	875	471	1805	351	1340	X
121SW	33	462	X	72 24	240	350	X	X
122RW	33	674	X	60GH7	BG21	171	1300	X
123M	33	657	133	671	BG31	X	X	X
124M	33	664	855	667	B32	164	X	X
132M	1	661	833	632	32	163	1132M	X
133M	1	631	X	633	33	143	1133M	X
134M	1	621	X	X	34	193	X	X
150M	31	421	350	800	28	302	1510D	X
153M	31	x420	X	X	X	X	X	X
150TS	37	265	TS	875	TG32	301	1320	X
154R	37	672	1600	825	F25	325	1530	X
170	23	650	1050	60GH7	G25	170	1400	X
173	23	673	1033	63GH	G35	173	X	X
190	25	673	FG	60GHFF	FG2	170FF	1410F	X
190RF	25	659	FG	60GHFF	FG2	170FF	1410F	X
193	25	821	X	X	FG3	173FF	X	X
210VM	3	X	950VM	900V	X	220V	1005VM	VMLME-WH
210VO	3	X	X	X	X	X	X	VOBME-WH
210HO	3	X	X	X	X	X	X	HOBME-WH
210VM-50	3	X	X	900-50	X	X	X	X
230VM	3	X	X	X	X	X	X	X
220VO	5	92VHO	RSDBV	990V	RGV-O	240-V	X	VHOBME-WH
270	27	94A	X	S90H	FBG40	280	SRH	RAME-WH
290	27	96AFB	920FG	S90HFF	FBFG	280FF	SRHF	X
301M	7	CHM1	CB10M	291ML	SACB1	401HM	X	CBML1ME-WH
302VM	7	X	X	X	X	X	X	X
302M	7	CHM2	CB20M	292ML	SHCB2	402M	X	CBML2ME-WH
303M	7	CM3	CB30M	293ML	SACB3	403HM	X	CBML3ME-WH
304M	7	CM4	CB40M	294ML	SACB4	404M	X	CBML4ME-WH
401M	9	301	201H	501/CB1W	C1H	601M	1201M	X
402M	9	302	202H	502/CB2W	C2H	602M	1202M	X

STEEL								
TRUAIRE	PAGE #	HART &	SHOEMAKER	LIMA	CONTINENTAL	AIRMATE	US AIRE	AIRGUIDE
402HM	9	302	202H	502	C2H	602-HM	1202M	X
402VM	9	X	X	X	X	X	X	X
403M	9	303	203	503/CB3W	C3	603M	1203M	X
404M	9	304	204	504/CB4W	C4	604M	1204M	X
540M	11	X	X	X	X	X	X	X
560M	11	ECS/D	X	1103/2	X	1020/30	X	X
600	11	ECBX	400	1150	X	1100	X	X
690	43	X	X	X	X	X	X	X
700	11	ECHVD	450	1170	X	1200	X	X
800	13	16	90	150	16	800	900	X
801	13	12	91	155	12B	800-D	900-D	X
802	13	3800	X	X	X	X	X	X
803	13	11	92	156	11	800-R	X	X
804	13	RD	X	X	X	X	X	X
820	46	5400	X	X	X	X	X	X
821	46	5400PP	X	X	X	X	X	X

ALUMINUM								
TRUAIRE	PAGE #	HART &	SHOEMAKER	LIMA	CONTINENTAL	AIRMATE	US AIRE	AIRGUIDE
A210VM	15	A618MS	X	AL278ML	X	A420-VM	VM	V,VML
A210VO	15	A618OB	X	X	X	AT420-VO	VD	V-OB
A270	29	RH45	X	X	X	E280	RH	RA, RAME
A290	29	RH45	X	X	X	E289FF	RHF	RAFB
A301M	19	A611MS	CB10-HM	A271ML	AACB1	A451-HM	LM/LMH	CB1, CBML
A301O	19	A611OB	X	X	X	AT451-HO	LD	CB0B1ME-AL
A302-M	19	A612MS	CB20-HM	AL272ML	AACB2	A452-HM	LTM/LTMH	CB2, CBML2
A302-O	19	A612OB	X	X	X	AT452-HO	LTD	CB0B2ME-AL
A303-M	19	A613MS	CB30M	AL273ML	AACB3	A453-HM	LS3M	CB3, CBML3
A303-O	19	A613OB	X	X	X	AT453-HO	LS3D	CB0B3ME-AL
A304-M	19	A614MS	CB40M	AL274ML	AACB4	A454-HM	LS4M	CBM4, CBML4
A304-O	19	A614OB	X	X	X	AT454-HO	LS4D	CB0B4ME-AL
A501-M	21	A501MS	SDD-15-D	AL161ML	AE1	E1051-M	5400	X
A501-O	21	A501OB	SDD-15-O	AL161OBD	AE1	X	X	JSOB-WH-1W
A502-M	21	A502MS	SDD-25-D	AL162ML	AE2	E1052-M	5400	X
A502-O	21	A502OB	SDD-25-O	AL162OBD	AE2	X	X	JSOB-WH-2W
A503-M	21	A503MS	SDD-35-D	AL163ML	AE3	E1053-M	5400	X
A503-O	21	A503OB	SDD-35-O	AL163OBD	AE3	X	X	JSOB-WH-3W
A504-M	21	A504MS	SDD-45-D	AL164ML	AE4	E1054-M	5400	X
A504-O	21	A504OB	SDD-45-O	AL164OBD	AE4	X	X	JSOB-WH-4W
A505-M	21	A505MS	SDD-50-D	AL165ML	AE5	E1050-M	5400	X
A505-O	21	A505OB	SDD-50-O	AL165OBD	AE5	X	X	JSOB-WH-5W

COMPARISON CHART							
TRUAIRE MODEL	PAGE #	HART & COOLEY	TITUS	SHOEMAKER	METAL AIRE	PRICE	KRUEGER
210VM	49	821	301RS	951	V4002SM	X	800V
A210VM	51	X	301FS	950	V4002SM	X	5800
220V	53	92VHO	300RS	934	V4004S	520S	880V
220VO	53	92VHV	300RS-AG15	934-0	V4004SD	520DS	880VOBD
A220VO	55	VD	300FL	903	V4004	X	5880VOBD
270	57	94A	350RL	935	EPHR	530L	S80H
A270	57	RH45	350RL	905	RHE	60	S58H
290	59	RHF45T	355RLF1	920FG-1	X	700FF	X
A290	59	RH45	350FLF	900FG	RHEF	60FH	S580H-5FF
A520F	61	MCD	MCD-AA-1	MA	9000-1	AMCD-1	51240
A520B	61	MCDST	MCD-AA-6	MA	9000-2	AMCD-6	
A540F	63	SRE	TDC-1	DVD	5500-M-1	SMD-1	SH
A540B	63	SRS	TDC-6	X	5500	SMD-6	X
1010MAS	67	REMP	PSS	110	7500	X	X
1010MAR	67	RENP	PXP	111	7500R	X	1196A
1020MAR	67	PDS	PAR	781	X	X	X
1400CB	71	CBPS	PCS	825	7600	PDC	650
1444RG	71	CBPR	PDR	830	SPRB	PDDR	6590
2000PD	73	DPD	OMNI	HL	5750	SPD	PLQ
2003CD	73	FPD	TMS	HVL	5700	SCD-3C	X
2004CD	73	FPD3	TMS	HVD/FTD	5800	SCD-4C	1400
2600SC	75	X	X	104	X	X	X
4010FG2	77	673T	X	105FG	1400F-TB	X	X
4010FG2-DB	77	673TPI	X	X	X	X	X
4010FG2-MLD	77	659TI	X	X	X	X	X
4020FG2	77	96ABFBT	350RLF-3	900FG	X	530FFTB	X
4020FG-MLD	77	96ABFBTI	X	X	X	X	X
4030FG2	77	PFT	X	105PFG	RP-FB-TB	10FFTB	X
4030FG2-MLD	77	PFTI	X	106PFG	X	X	X
4040FG2	77	REFST	REFST	X	X	X	X
4050FG2	77	REFST	50FF-3	600TFG	CCSFB-TB	80FF-TB	EGC5
4050FG2-DB	77	REFSTI	X	X	X	X	X
5200CB	79	MCDST	MDC-3	700-MA	9000-6	AMCD	1240-23
A5200CB	79	MCDST	MCD-AA	700-MA	X	X	51240-23
5400SD	81	SRT	TDC	700	5000	SMD	SH23
A5400SD	81	ART	TDC-AA	X	5500	X	55H
5000XF	84	SMF	PF	X	TBPF	X	X
SU1	89	USV	US301FS	USR52	X	X	DMGSU
SU2	89	USVH	US300FS	USR53	X	SDG-AL	DMGDU
SD1	89	X	X	SD52	X	X	X
SD2	89	X	X	SD34	X	X	X

COMPARISON CHART							
TRUAIRE MODEL	PAGE #	HART & COOLEY	TITUS	SHOEMAKER	METAL AIRE	PRICE	KRUEGER
LD24	91	S SERIES	ML	LDS-LP	6600	SDS	DFM
LD36	91	S SERIES	ML	LDS-LP	6600	SDS	DFM
LD48	91	S SERIES	ML	LDS-LP	6600	SDS	DFM
LD72	91	S SERIES	ML	LDS-LP	6600	SDS	DFM
880	87	20	TMR	RD	3100	RCD	RM1
A960	83						
A970	83	RE5		600			
1960RG	83						
1970RG	83	RE5T		700/600			

