

PLUMBING & MECHANICAL PRODUCT CATALOGUE



www.ipexna.com

ISSUE DATE: AUGUST 2021

- Potable Water Systems
- DWV Systems
- Gas Venting
- Fire Protection
- Xirtec® PVC and CPVC
- Cements and Primers

IPEX
by aliaxis

We build tough products for tough environments.®



Committed to EXCELLENCE

As one of the world's leading manufacturer's of thermoplastic pipe, valves, fittings and related products for plumbing and mechanical applications, IPEX Inc. offers a comprehensive range of integrated solutions to meet the needs of engineers and contractors in commercial, institutional, industrial and residential construction.

18





Contents

04 EASY SPECIFICATIONS

07 POTABLE WATER SYSTEMS

- AquaRise Hot & Cold Water Distribution Systems
- Pipe-with-the-Stripe Piping Systems
- Gold901 Water Service Tubing
- Blue904 PEX Water Service Tubing
- Q-Line Water Service Tubing
- Philmac 3G Compression Fittings for Water Supply

25 DWV SYSTEMS

- DRAIN-WAY ABS DWV Systems
- Solvent Weld Sewer & Drain Piping Systems
- DWV for Noncombustible Buildings
- Backwater Valves

73 GAS VENTING

- System 636 Flue Gas Venting
- RadonX Soil Gas Venting

87 FIRE PROTECTION

- BlazeMaster Fire Sprinkler Systems

95 XIRTEC PVC & CPVC

- Vinyl Process Piping Systems

119 CEMENTS & PRIMERS

MECHANICAL EASY SPEC

ABOVEGROUND UNDERGROUND
COLD HOT UNDER OUTSIDE
BLDG BLDG

POTABLE WATER PIPING SYSTEMS							
AquaRise® Pipe	1/2" - 4"	CSA B137.6, NSF 61	Hot and cold domestic water	P 1,2,3	P 1,2,3	P	P
Pipe-with-the-Stripe® PE Tubing	1/2" - 3"	CSA B137.1 (Red stripe & Green stripe only)	Water supply piping for residential wells, irrigation and agriculture	N	N	P	P
Gold901™ HDPE Water Service Tubing	3/4" - 2"	AWWA C901, CSA B137.1, NSF-61,	Municipal water service	N	N	P	P
Blue904® PEX Water Service Tubing	3/4" - 2"	ASTM F876, ASTM F877, AWWA C904, CSA B137.5, NSF 61 & 14	Municipal water service	P 1,2,3	P 1,2,3	P	P
Q-Line® Water Service Tubing	3/4" - 1"	ASTM F1282, CSA B137.9, NSF 61 & 14	Municipal water service	N	N	P	P
Xirtec® PVC Pressure Pipe	1/2" - 24"	ASTM D1785, CSA B137.3, NSF 14 & 61	Potable cold water pressure pipe	P 1,2,3	N	P	P

PROCESS PIPING SYSTEMS							
Xirtec® PVC Pressure Pipe	1/2" - 24"	ASTM D1785, CSA B137.3, NSF 14 & 61	Pressure or drainage piping for water supply, chilled water, irrigation, chemical process lines, brine lines, pressure sewers and swimming pool or fountain piping	P 1,2,3	N	P	P
Xirtec® CPVC Schedule 40 & 80	1/4" - 16"	ASTM F441, NSF 14 & 61		P 1,2,3	P 1,2,3	P	P

PRODUCT	SIZE RANGE	STANDARDS	APPLICATIONS	ABOVE GROUND INSIDE BUILDING	UNDERGROUND UNDER BUILDING	BUILDING SEWER
DWW SYSTEMS						
ABS DWW (Solid Wall)	1-1/4" - 6"	CSA B181.1	Sanitary or storm gravity flow drain, waste and vent (DWW)	P 1,2,3	P	P
ABS DWW (Cell Core)	1-1/2" - 4"	ASTM F628	Sanitary or storm gravity flow drain, waste and vent (DWW)	P 1,2,3	P	P
PVC Building Sewer & Drain Pipe	3" - 6"	CSA B182.1	Building sewer pipe, Septic fields, Perimeter drainage, Landscape drainage	N	P	P
System 15® DWW Pipe	1-1/2" - 24"	CSA B181.2	Sanitary or storm gravity flow drain, waste and vent (DWW)	P 1,2,3	P	P
System XFR® DWW Pipe	1-1/2" - 18"	CSA B181.2	Sanitary or storm gravity flow drain, waste and vent (DWW)	P 1,2,3	P	P
Drain-Guard™ Dual Containment	Drain-Guard is a dual containment piping system using System 15 and or System XFR as its primary components.					

PRODUCT	SIZE RANGE	STANDARDS	APPLICATIONS	ABOVEGROUND	INSIDE BUILDING UNDERGROUND
GAS VENTING					
System 636® Flue Gas Venting	PVC: 1-1/2" - 6" CPVC: 2" - 8"	ULC S636	Flue gas venting for gas-fired appliances, residential or commercial	P 1,2,3	P
RadonX™ Soil Gas Venting	PVC: 4"	CSA B181.2, ULC S636* *only includes: 3.4.2, 3.4.3, 3.13, 3.14	Soil gas venting for low-rise construction	P 1,2,3	P

FIRE PROTECTION					
BlazeMaster® CPVC	3/4" - 3"	ASTM F437, F438, F439 & F442, FM, NSF 61, ULC	Approved for use in NFPA 13 Light Hazard applications in both new and retrofit construction: High buildings (including apartments and hotels), Schools and institutions and Single-family residences	P 1,2,3	P

APPLICATIONS AS PER 2015 NBC SUITABILITY FOR USE ^{1,2,3}

PRODUCT PIPE	NONCOMBUSTIBLE BUILDING			
	GENERAL USAGE	AIR PLENUM	VERTICAL SERVICE SPACE	HIGH BUILDING
AquaRise® CPVC	P	P	N	P
Xirtec® PVC	P*	N	N	N
Xirtec® CPVC	P*	P*	N	P*
ABS DWV	N	N	N	N
System 15® DWV	P†	N	N	N
System XFR® DWV	P	P	N	P
Drain-Guard™ Dual Containment	Drain-Guard is a dual containment piping system using System 15 and or System XFR as its primary components.			
System 636® PVC	P	N	N	N
System 636® CPVC	P	P	N	P
RadonX™ PVC	P	N	N	N
BlazeMaster® CPVC	P	P	N	P

† 24" is not permitted

* Some limitations apply. Contact IPEX for details.

FOOTNOTES:

P = Permitted, N = Not Permitted

1. Combustible piping in noncombustible construction is subject to the requirements of 3.1.5.16.(1) of the NBC 2015.
2. Combustible piping that penetrates a fire separation is subject to the requirements in articles 3.1.9.1, 3.10.9.6 and 9.10.9.7 of the NBC 2015.
3. Products may not be approved for use in a Vertical Service Space, (check the table above or contact IPEX).
4. Use of pipe and fittings per the National Plumbing Code of Canada 2015 (Tables A-2.25, 2.26 and 2.27).



PROFIT FROM A NEW CONNECTION

AquaRise®
Potable
Water Piping
Systems

The cost-effective, time-saving alternative to metal systems.

AquaRise®, a nonmetallic potable water distribution system for commercial and high building construction. Based on over 15 years' experience designing and manufacturing industry-leading CPVC systems, AquaRise offers numerous benefits over metal with a system that's fully-approved for noncombustible applications.

- A SOLID ALTERNATIVE TO METAL
- BETTER LONG-TERM PERFORMANCE
- FULLY-CERTIFIED COMPLIANCE
- FULL FLAME & SMOKE LISTINGS
- PERMANENT JOINING SYSTEM
- PROJECT SAVINGS

Add AquaRise® to your toolbox and stay current with these proven advantages on your next project.

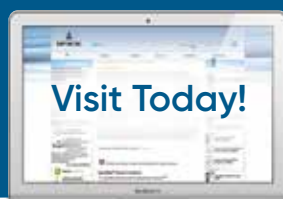

Learn more about **thermoplastic potable water piping systems**, review **system design, installation and solvent welding steps**, watch the **product videos** or schedule your lunch and learn.

All you need to get started!

ipexaquaarise.com

Specifiers, builders and contractors in the construction industry across Canada have made IPEX Inc. thermoplastic plumbing systems the preferred choice for their ability to outperform and outlast traditional metal systems.

Like all IPEX integrated solutions, IPEX pipe, valves and fittings are designed to function as a system, yet flexible enough to work universally with other products. Since it's built and backed by IPEX, our products come with technical support, onsite trouble-shooting if you need it and one of the best total system warranties in the business—all from one reliable supplier who stands behind you and your complete piping system.

Potable Water Systems



AquaRise Hot & Cold Water Distribution Systems

8

Polyethylene Pipe-with-the-Stripe Piping systems

14

Gold901 Water Service Tubing

15

Blue904 Pex Water Service Tubing

16

Q-Line Water Service Tubing

18

Philmac 3G Compression Fittings For Water Supply

20

CPVC HOT & COLD WATER DISTRIBUTION SYSTEMS

1/2" - 4" (12mm - 100mm)

AquaRISE®

While contractors and engineers have traditionally had few viable alternatives to increasingly-expensive metal for their water distribution systems, IPEX Inc. now offers a solution that ensures time and cost-savings without sacrificing the strength or performance. With AquaRise, IPEX introduces a CPVC hot and cold water distribution system that comes with reduced material costs, offers superior features and exceeds all industry testing standards.

A SOLID ALTERNATIVE TO METAL

Compare AquaRise to traditional metal systems, and AquaRise proves itself a strong, highly-engineered and affordable improvement over copper. Manufactured tough and robust, AquaRise performs as well as—and in many cases, better than—metal, offering a rugged system that exceeds all required standards. At the same time, AquaRise costs less than copper, yielding significant project savings. Thanks to its superior durability, these cost savings will pay off even more in years to come. AquaRise's corrosion resistance ensures a longer, maintenance-free life and better performance over the long-term.

PROJECT SAVINGS

IPEX created AquaRise to be a system that saves valuable time and money on the jobsite. Even greater savings can be achieved by using SDR 21 AquaRise, which is designed specifically for cold water applications. Its simple solvent cement system makes AquaRise fast and easy to assemble. No product specific training is needed, and no flames or torches are required during installation, reducing jobsite safety risks. In addition, AquaRise sweats less than metal pipe due to its excellent insulating properties. As a result, it can reduce the need for insulation, lowering overall job costs. AquaRise also represents a lower risk of jobsite theft.

Proven strength, competitive price, easy installation – what all this adds up to is significant time and cost-savings for contractors and building owners over the long term.

APPLICATIONS

- Potable Water Distribution
- Hot Water Recirculating Systems

STANDARDS



Certified to ASTM F442 and CSA B137.6



Certified to CAN/ULC-S102.2



DID YOU KNOW?

AquaRise interior and exterior walls remain smooth in virtually any service condition, unlike metal which, over time, will rust, pit, scale and corrode.



ADVANTAGES

- 1 Proven to Exceed Toughest Standards**
Thanks to its advanced materials and rugged design, AquaRise SDR 11 for hot water provides long term pressure ratings of 400 psi at 73°F (23°C) and 150 psi at 160°F (71°C). AquaRise SDR 21 for cold water use provides a long-term pressure rating of 200 psi at 73°F (23°C), meeting the requirements of CSA B137.6. AquaRise passes the punishing burst pressure tests conforming to ASTM F442.

- 2 Better Long-Term Performance**
Unlike metal piping which may pit, scale and degrade over time, AquaRise's rugged thicker walls and excellent corrosion resistance ensure years of consistent flow and maintenance-free performance, even in demanding hot water recirculation applications.

- 3 Fully-Certified**
Designed to be safely used in hot and cold water distribution systems, AquaRise is certified to the following:

- CSA B137.6 (CPVC Pipe, Tubing and Fittings for Hot and Cold Water Distribution Systems)
- NSF 61 (Potable Water Classification)
- CAN/ULC S102.2

- 4 Full Flame & Smoke Approvals**
Listed to the CAN/ULC S102.2 standard, AquaRise achieved a Flame Spread rating of not more than 25 and a Smoke Development classification of not more than 50. Unlike competitive products, AquaRise does not need insulation to achieve certification. Ideal for noncombustible applications, AquaRise is code compliant to the following sections of the National Building Code of Canada:

- High buildings as defined by NBC article 3.2.6
- Air plenums as defined by NBC article 3.6.4.3
- Noncombustible buildings as defined by NBC article 3.1.5.16

- 5 Permanent Joining System**
IPEX supplies high quality CPVC cement, primer and applicators for enabling tough, permanent welded pipe-fitting connections.

SPECIFICATIONS

AQUARISE PIPE & FITTINGS

AquaRise pipe and fittings are certified to CSA B137.6. When used in noncombustible construction, high buildings and air plenums, AquaRise pipe shall be tested and listed in accordance with CAN/ULC S102.2 and clearly marked with the certification logo indicating a Flame Spread Rating not more than 25 and a Smoke Developed Classification not exceeding 50. Pipe shall be SDR 11 or SDR 21 thickness and IPS outside diameter.

FIRESTOPPING DEVICES

Firestopping systems shall be listed under CAN/ULC S115 and tested with a pressure differential of 50 Pa. Certified firestopping devices are required whenever the system penetrates a vertical or horizontal fire separation.

ONE-STEP & TWO STEP SOLVENT CEMENTS

IPEX has made a significant change to the current solvent cement products to be used with AquaRise Domestic Water Piping. The product offering has been modified to now offer two customized solvent cements for small and large size ranges. Both products are certified to CSA B137.6, listed to NSF 61 and sold as a kit coming complete with necessary applicators and installation instructions.

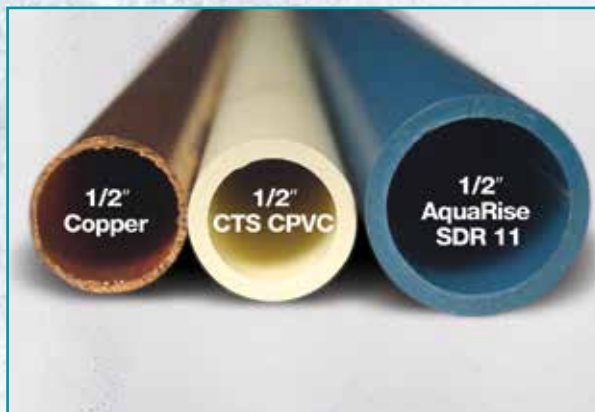

PIPE DIMENSIONS AND WEIGHTS SDR 11

AquaRise pipe is produced (1/2" through 4") in SDR 11 dimensions with IPS (Iron Pipe Size) outside diameters. The SDR (Standard Dimension Ratio) value means that all sizes of pipe maintain a constant ratio between the pipe outside diameter and minimum wall thickness. This results in all diameters carrying the same pressure ratings of 400 psi at 73°F and 150 psi at 160°F.

AquaRise Pipe Dimensions & Weights IPS / SDR 11 (Imperial)

Nominal Size (Inches)	Average OD (Inches)	Average ID (Inches)	Average Wall Thickness (inches)	Weight - Empty lb/ft
1/2	0.840	0.687	0.076	0.130
3/4	1.050	0.859	0.095	0.202
1	1.315	1.076	0.120	0.319
1-1/4	1.660	1.358	0.151	0.507
1-1/2	1.900	1.555	0.173	0.663
2	2.375	1.943	0.216	1.037
2-1/2	2.875	2.352	0.261	1.519
3	3.500	2.864	0.318	2.250
4	4.500	3.633	0.434	3.722

AquaRise Pipe Dimensions & Weights IPS / SDR 11 (Metric)

Nominal Size (mm)	Average OD (mm)	Average ID (mm)	Average Wall Thickness (mm)	Weight - Empty Kg/m
12	21.3	17.5	1.9	0.19
19	26.7	21.8	2.4	0.30
25	33.4	27.3	3.0	0.47
32	42.2	34.5	3.8	0.76
40	48.3	39.5	4.4	0.99
50	60.3	49.4	5.5	1.55
65	73.0	59.7	6.6	2.26
75	88.9	72.7	8.1	3.35
100	114.3	92.3	11.0	5.55

PIPE DIMENSIONS AND WEIGHTS SDR 21

AquaRise SDR 21 pipe is produced (1-1/2" through 4") in SDR 21 dimensions with IPS (Iron Pipe Size) outside diameters. The SDR (Standard Dimension Ratio) value means that all sizes of pipe maintain a constant ratio between the pipe outside diameter and minimum wall thickness. This results in all diameters carrying the same pressure ratings of 200 psi at 73°F.

AquaRise Pipe Dimensions & Weights IPS / SDR 21 (Imperial)

Nominal Size (Inches)	Average OD (Inches)	Average ID (Inches)	Average Wall Thickness (inches)	Weight - Empty lb/ft
1-1/2	1.900	1.802	0.100	0.33
2	2.375	2.251	0.123	0.52
2-1/2	2.875	2.727	0.147	0.76
3	3.500	3.323	0.177	1.13
4	4.500	4.273	0.227	1.94

AquaRise Pipe Dimensions & Weights IPS / SDR 21 (Metric)

Nominal Size (Inches)	Average OD (Inches)	Average ID (Inches)	Average Wall Thickness (inches)	Weight - Empty lb/ft
40	48.3	45.76	2.54	0.50
50	60.3	57.18	3.12	0.78
65	73.0	69.27	3.73	1.14
75	88.9	84.41	4.50	1.68
100	114.3	108.53	5.77	2.89

PRODUCT SELECTION CHART

Dimension		Product Code
inches	mm	

AquaRise CPVC SDR 11 Pipe 10 Ft. Lengths, PE x PE

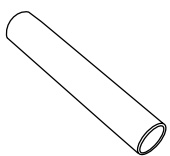

1/2	12	119100
3/4	20	119101
1	25	119102
1-1/4	32	119103
1-1/2	40	119104
2	50	119105
2-1/2	65	119106
3	75	119107
4	100	119108

Dimension		Product Code
inches	mm	

AquaRise CPVC SDR 21 (Cold Water) Pipe 10 Ft. Lengths, PE x PE

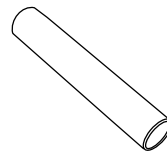

1-1/2	40	119120
2	50	119121
2-1/2	65	119122
3	75	119123
4	100	119124

PRODUCT SELECTION CHART

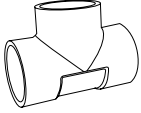
	Dimension		Product Code
	inches	mm	
	Tee Soc x Soc x Soc		
	1/2	12	359481
	3/4	20	359482
	1	25	359483
	1-1/4	32	359484
	1-1/2	40	359485
	2	50	359486
	2-1/2	65	359487
	3	75	359488
	4	100	359489

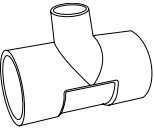
	Dimension		Product Code
	inches	mm	
	Reducing Tee Soc x Soc x Soc		
	3/4 x 1/2 x 1/2	20 x 12 x 12	359514
	3/4 x 1/2 x 3/4	20 x 12 x 20	359513
	3/4 x 3/4 x 1/2	20 x 20 x 12	359492
	1 x 1 x 1/2	25 x 25 x 12	359493
	1 x 1 x 3/4	25 x 25 x 20	359494
	1-1/4 x 1-1/4 x 1	32 x 32 x 25	359495
	1-1/2 x 1-1/2 x 1/2	40 x 40 x 12	359515
	1-1/2 x 1-1/2 x 3/4	40 x 40 x 20	359496
	1-1/2 x 1-1/2 x 1	40 x 40 x 25	359497
	2 x 2 x 1/2	50 x 50 x 12	359498
	2 x 2 x 3/4	50 x 50 x 20	359499
	2 x 2 x 1	50 x 50 x 25	359500
	2 x 2 x 1-1/2	50 x 50 x 40	359501
	2-1/2 x 2-1/2 x 1/2	65 x 65 x 12	359503
	2-1/2 x 2-1/2 x 3/4	65 x 65 x 20	359504
	2-1/2 x 2-1/2 x 1	65 x 65 x 25	359505
	2-1/2 x 2-1/2 x 1-1/4	65 x 65 x 32	359506
	2-1/2 x 2-1/2 x 2	65 x 65 x 50	359507
	3 x 3 x 2	75 x 75 x 50	359502
4 x 4 x 2	100 x 100 x 50	359508	
4 x 4 x 3	100 x 100 x 75	359509	

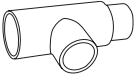
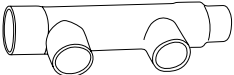
	Dimension		Product Code
	inches	mm	
	U Do-It Manifold Soc x Sp x Soc		
	3/4 x 3/4 x 1/2 x 1/2		359060
	3/4 x 3/4 x 1/2		359061

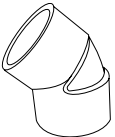
	Dimension		Product Code
	inches	mm	
	45° Elbow Soc x Soc		
	1/2	12	359164
	3/4	20	359165
	1	25	359166
	1-1/4	32	359167
	1-1/2	40	359168
	2	50	359169
	2-1/2	65	359170
	3	75	359171
	4	100	359172

	Dimension		Product Code
	inches	mm	
	90° Elbow Soc x Soc		
	1/2	12	359194
	3/4	20	359195
	1	25	359196
	1-1/4	32	359197
	1-1/2	40	359198
	2	50	359199
	2-1/2	65	359200
	3	75	359201
	4	100	359202

	Dimension		Product Code
	inches	mm	
	90° Street Elbow Soc x Sp		
	1/2	12	359175
	3/4	20	359476
	1	25	359177

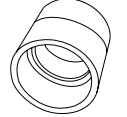
	Dimension		Product Code
	inches	mm	
	Coupling Soc x Soc		
	1/2	12	359132
	3/4	20	359133
	1	25	359134
	1-1/4	32	359135
	1-1/2	40	359136
	2	50	359137
	2-1/2	65	359138
	3	75	359139
	4	100	359140

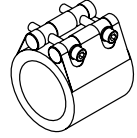
	Dimension		Product Code
	inches	mm	
	Maintenance Coupling*		
	1	25	359204
	1-1/4	32	359205
	1-1/2	40	359206
	2	50	359207
	2-1/2	65	359208
	3	75	359209
	4	100	359210

*Torque wrench kits are available through IPEX

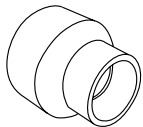
	Dimension		Product Code
	inches	mm	
	Reducer Coupling Soc x Soc		
	3/4 x 1/2	20 x 12	359460
	1 x 1/2	25 x 12	359461
	1 x 3/4	25 x 20	359462
	1-1/4 x 1	32 x 25	359463
	1-1/2 x 1	40 x 25	359465
	1-1/2 x 1-1/4	40 x 32	359466
	2 x 1	50 x 25	359467
	2 x 1-1/2	50 x 40	359458
	3 x 2	75 x 50	359470
4 x 2	100 x 50	359459	
4 x 3	100 x 75	359472	

PRODUCT SELECTION CHART

Dimension		Product Code
inches	mm	

Reducer Bushing Sp x Soc

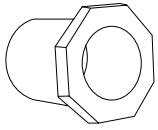

Dimension (inches)	Dimension (mm)	Product Code
3/4 x 1/2	20 x 12	359375
1 x 1/2	25 x 12	359376
1 x 3/4	25 x 20	359377
1-1/4 x 1/2	32 x 12	359378
1-1/4 x 3/4	32 x 20	359379
1-1/4 x 1	32 x 25	359380
1-1/2 x 1/2	40 x 12	359381
1-1/2 x 3/4	40 x 20	359382
1-1/2 x 1	40 x 25	359383
1-1/2 x 1-1/4	40 x 32	359384
2 x 1/2	50 x 12	359385
2 x 3/4	50 x 20	359386
2 x 1	50 x 25	359387
2 x 1-1/4	50 x 32	359388
2 x 1-1/2	50 x 40	359389
2-1/2 x 3/4	65 x 20	359390
2-1/2 x 1	65 x 25	359391
2-1/2 x 2	65 x 50	359392
3 x 1-1/2	75 x 40	359393
3 x 2	75 x 50	359394
3 x 2-1/2	75 x 65	359395
4 x 1-1/4	100 x 32	359428
4 x 1-1/2	100 x 40	359429
4 x 2	100 x 50	359396
4 x 2-1/2	100 x 65	359430
4 x 3	100 x 75	359397

Cap Soc

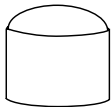

Dimension (inches)	Dimension (mm)	Product Code
1/2	12	359109
3/4	20	359110
1	25	359111
1-1/4	32	359112
1-1/2	40	359113
2	50	359114
2-1/2	65	359115
3	75	359116
4	100	359107

Union Soc x Soc

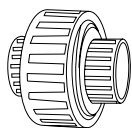

Dimension (inches)	Dimension (mm)	Product Code
1/2	12	359520
3/4	20	359521
1	25	359522
1-1/4	32	359523
1-1/2	40	359524
2	50	359525
3	75	359051
4	100	359550

Dimension		Product Code
inches	mm	

Flange Soc Solid Style

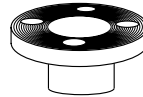

Dimension (inches)	Dimension (mm)	Product Code
1/2	12	359228
3/4	20	359229
1	25	359230
1-1/4	32	359231
1-1/2	40	359232
2	50	359233
2-1/2	65	359234
3	75	359235
4	100	359236

Vanstone Flange Soc

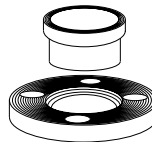

4	100	359270
---	-----	--------

Repair Flange Solid Style Flange x Pipe Stub

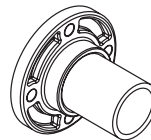

2-1/2	65	359057
3	75	359058
4	100	359059

Full Pressure Flange Kit

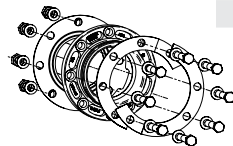

2-1/2	65	359040
3	75	359041

CPVC Copper Tube Size Adapter (CTS)

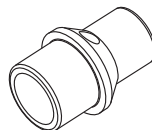

AquaRise Spigot x CTS Spigot		
1/2		359100
3/4		359101
AquaRise Socket x CTS Spigot		
1/2		359097
3/4		359098

Female Threaded Adapter Soc x Bronze FNPT

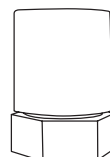

1/2	359800
3/4	359801
1	359802
1-1/4	359803
1-1/2	359804
2	359805

PRODUCT SELECTION CHART

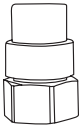
	Nominal Pipe Size (inches)	Product Code
	1/2	359820
	3/4	359821
	1	359822

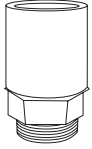
	Nominal Pipe Size (inches)	Product Code
	1/2	359811
	3/4	359812
	1	359813
	1-1/4	359814
	1-1/2	359815
	2	359816

	Nominal Pipe Size (inches)	Product Code
	1/2	359823
	3/4	359824
	1	359825

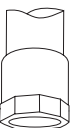
	Nominal Pipe Size (inches)	Product Code
	1	359063
	1-1/4	359064
	1-1/2	359077
	2	359065

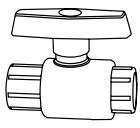
	Nominal Pipe Size (inches)	Product Code
	1/2	359070
	3/4	359071
	1	359072

Rated to 400 psi @ 73°F (23°C)
Rated to 150 psi @ 160°F (71°C)

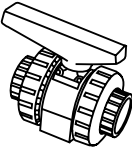
	Nominal Pipe Size (inches)	Quantity	Product Code
	1/2	12	359000
	3/4	20	359001
	1	25	359002
	1-1/4	32	359003
	1-1/2	40	359004
	2	50	359005
	2-1/2	65	359102
	3	80	359103
4	100	359104	

Rated to 232 psi @ 73°F (23°C)
72 psi @ 160°F (71°C)

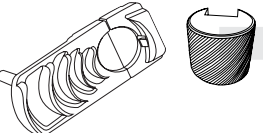
	Nominal Pipe Size (inches)	Product Code
	1/2, 3/4, 1	359044
	1-1/4 to 4	359062

	Description imperial	metric	Product Code
	Pint	473 ml	359086
	Quart	946 ml	359092
	Gallon	3785 ml	359091

**FOR USE ON 1/2" TO 2"

	Description imperial	metric	Product Code
	Quart	946 ml	359087
	Gallon	3785 ml	359093

***FOR USE ON 2-1/2", 3" & 4"

Cement products come complete with Primer as required plus extra daubers

	Nominal Pipe Size (inches)	Product Code
	CM-75 (pipe sizes 1/2" - 1-1/4")	074436
	CM-150 (pipe sizes 1-1/2" - 3")	074437

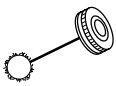
	Nominal Pipe Size (inches)	Product Code
	DP 50 (pipe sizes 1/2" - 1")	074455
	DP 150 (pipe sizes 1-1/4" - 3")	074421
	DQ 50 (pipe sizes 1/2" - 1")	074193
	DQ 150 (pipe sizes 1-1/4" - 3")	074422

Note: DP fits Pint cans and DQ fits Quart cans

	Length (inches)	Length (mm)	Product Code
	4"	100 mm	074456

	Description	Product Code
	Swab is disposable and replaceable	359826

PIPE-WITH-THE-STRIPE PIPING SYSTEMS

1/2" – 2" (12mm – 50mm)

Polyethylene
Pipe with the Stripe®

Pipe with the Stripe is available in standard and CSA-certified polyethylene. It combines the features of flexibility, durability, light weight and ease of installation. Factors such as life expectancy and economics should be considered when selecting the appropriate product from the wide range of products offered.

ADVANTAGES

- ① Several pressure rating options
- ② Choice of Standard or CSA certified pipe
- ③ Convenient sequential footage marking
- ④ Our patented stripe identification system
- ⑤ Available in convenient coils or reels
The smooth interior of Pipe with the Stripe virtually eliminates interior scaling or deposits from aggressive water. So the water supply line stays cleaner longer – providing optimum water quality. Pipe-with-the-Stripe is also very flexible, ideal to withstand underground soil loads from frost or settlement.

APPLICATIONS

- Waterwell Tubing • Ice Skating Rinks
- Irrigation Systems
- Maple Sap Collection

STANDARDS

 CSA B137.1

DID YOU KNOW?

Asking for and installing the right pipe has never been easier. Simply mention the colour of the stripe you want. Stripes on the pipe clearly identify one from another.

Pipe Pressure Ratings		
Color	psi	kPa
Utility Black	50	345
White Stripe	75	517
* Red Stripe	75	517
Blue Stripe	100	689
* Green Stripe	100	689
Black Stripe	100	689
(Poly blue)	160	1103
'Super D'	200	1379

* Pipe certified to CSA B137.1 for potable water

Dimensions			
Nominal Size		Average Inside Diameter	
inches	mm	inches	mm
1/2	12	0.62	15.8
3/4	20	0.82	20.9
1	25	1.05	26.6
1-1/4	32	1.38	35.0
1-1/2	40	1.61	40.8
2	50	2.06	52.4

Note: For wall thickness dimensions, contact IPEX



GOLD901 WATER SERVICE TUBING

3/4" - 2" (20mm - 50mm)

GOLD901™

Gold901™ is a lightweight, easy to install, 250 psi rated water service tubing that can be used on both the municipal and private-side of a project.

Gold901 is manufactured to Copper Tube Size (CTS) from High-Density Polyethylene (HDPE) and is third-party certified and listed to AWWA C901, CSA B137.1, and NSF 61.

Gold901 is conveniently available in both coils and reels and is available in 3/4" to 2".

DIMENSIONS - GOLD901 TUBING

Nominal Size		Coil Length	Product	O.D.	I.D.	Min. Bend
in	mm	feet	Code	Avg (in)	Avg. (in)	Radius (in)
3/4	20	100	121402	0.875	0.671	19
		200	121403			
		400	121404			
		500	121405			
		3000	121406			
1	25	100	121407	1.125	0.863	23
		150	121408			
		200	121409			
		300	121410			
		500	121411			
		1000	121412			
		1500	121413			
1-1/4	32	100	121414	1.375	1.055	30
		300	121415			
		1000	121416			
1-1/2	40	100	121417	1.625	1.245	34
		250	121418			
		400	121419			
		1000	121420			
2	50	100	121421	2.125	1.629	44
		200	121422			
		500	121423			

Note: Custom coil and reel sizes may be available upon request.

APPLICATIONS

- Water Service Tubing

STANDARDS



ADVANTAGES

- 1 Non-corroding
Resistant to corrosive soils, aggressive water, stray electrical currents and moist environments
- 2 Lightweight
A 200 foot coil of 3/4" Gold901 weighs 20 lbs
- 3 Sequential Markings
Every 2 or 5 feet
- 4 Superior Flow
Hazen Williams C-Factor = 150
- 5 High Pressure
Rated at 250 psi at 73°F (1725 kPa at 23°C)



BLUE904 PEX WATER SERVICE TUBING

3/4" - 2" (20mm - 50mm)

BLUE904[®]

As copper prices continue to rise, cities across North America are turning to cost effective alternatives for their water service lines that connect municipal watermains to buildings.

Blue904™ is fully certified, lightweight and flexible PEX water service tubing. Installation friendly, Blue904 will resist corrosion, maximizing water flow over the lifetime of the system. Made with a copper tube size (CTS) OD (SDR 9), Blue904 works with standard compression fittings and is available in 3/4", 1", 1-1/4", 1-1/2" and 2" (20, 25, 32, 40 and 50mm) sizes.

APPLICATIONS

- Water Service Tubing

STANDARDS



PRESSURE RATING

Sizes (in.)	Pressure Rating
All Sizes	160 psi @ 23°C (73.4°F) 100 psi @ 82°C (180°F)

DIMENSIONS - BLUE904 PEX TUBING

Nominal Size		Product Code	Coil Length feet	I.D.		Min. Bend Radius	
in.	mm			in.	mm	in.	mm
3/4	20	117001	300	0.681	17.3	4.5	114
		117002	100				
1	25	117003	300	0.875	22.2	6.0	152
		117004	100				
1-1/2	40	117006	100	1.241	31.5	9.0	229
2	50	117007	100	1.625	41.3	12.0	305

DID YOU KNOW?

Blue904 has a significantly lower coefficient of thermal conductivity and much higher allowable strain than copper, thus making it less susceptible to freeze damage. Blue904 will remain flexible and easy to bend at temperatures below 30°C (86°F).

ADVANTAGES

- 1 Easy Installation**
No special tools required.
- 2 Corrosion Resistant for Long Life**
Blue904 will resist the effects of chlorine and scaling and will not corrode in soil.
- 3 Lightweight and Flexible for Easy Handling**
- 4 Jobsite Safe**
Unlike copper tubing, PEX tubing has no scrap value, eliminating the threat of jobsite theft common with copper. As a result, no special storage precautions are necessary.
- 5 Packaging and Markings**
Blue904 is available in 100 ft and 300 ft coils and is packaged in boxes for UV protection and portability. Each coil has footage markings to assist during installation and is identified with product name, size, certifications and manufacturing date.



IPEX TECHNICAL MANUALS

available at www.ipexna.com



Obtaining the most up-to-date technical information has never been easier with our innovative **ON-LINE MANUALS**

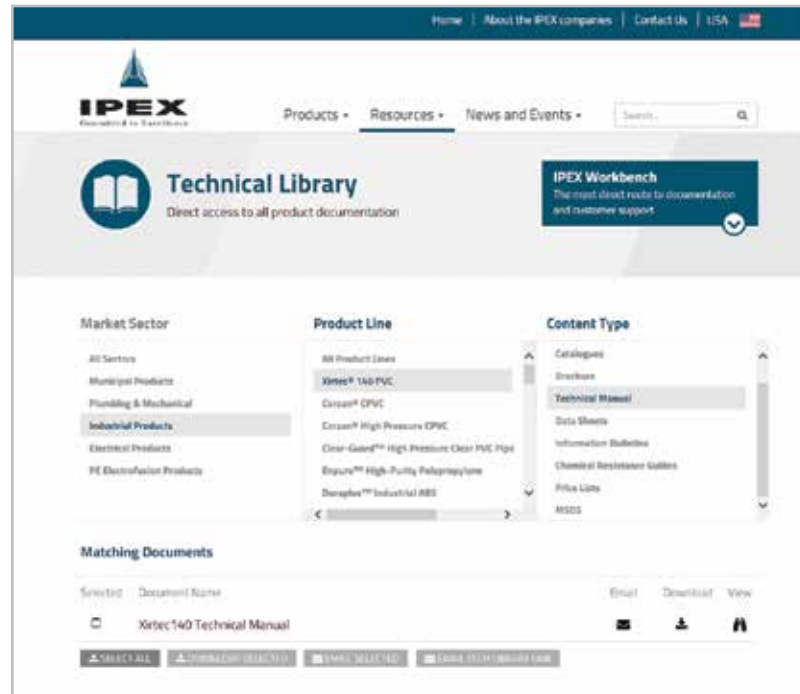

WHAT YOU CAN DO



Zoom to specific paragraph or chart for easy reading



Download as PDFs



Search document for key words



Environmentally Friendly!



Save and email clippings for ultimate convenience



Visit ipexna.com & check it out!

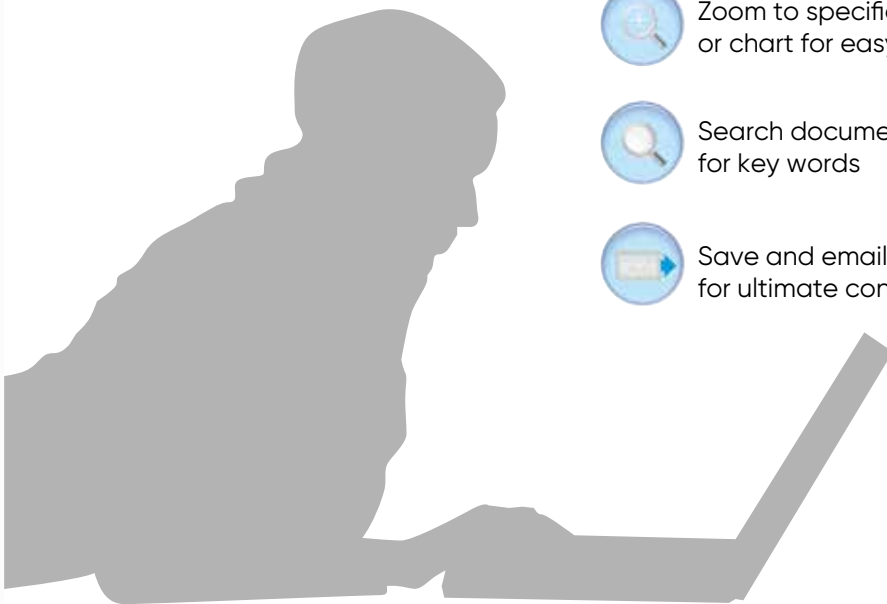

Q-LINE WATER SERVICE TUBING

3/4" & 1" (20mm - 25mm)

Q-Line®

Q-Line is a composite water service tubing that delivers the strength of metal, a flexibility similar to that of soft copper, and the durability of thermoplastic. The pipe is manufactured to AWWA C903 and CSA B137.9 to ensure a high quality product that can eliminate the shortcomings of traditional piping materials.

ADVANTAGES

- 1 Engineered Composite Construction**
A composite pipe constructed of flexible aluminum tubing permanently bonded between inner and outer layers of raised temperature polyethylene (PE-RT), Q-Line's unique structure offers optimum strength and toughness in a lightweight, easily handled and installed water service tubing.
- 2 Superior to Traditional Pipe**
Unlike copper, Q-Line's non-corroding thermoplastic layers resist the most aggressive water conditions and hot-soil environments.
Q-Line won't leach copper or other metallic ions, so the quality of drinking water is assured and service life is longer.
- 3 Potable Water Certified**
Q-Line carries third-party ASTM F1282 and CSA B137.9 certification, as well as NSF-PW potable water certification, and meets all North American plumbing codes for water supply up to and inside the building.
- 4 High Flow Rates**
With larger inside diameters than CTS polyethylene piping and a super-smooth interior wall that does not permit build-up of calcium or other minerals, Q-Line offers the best flow rates in the industry.
- 5 Handles Like Copper**
Simply roll Q-Line tubing down the trench and it stays where it's laid (unlike plain polyethylene). You can make goosenecks and bends easily just as you would with copper, and Q-Line keeps its shape.

APPLICATIONS

- Water Service Tubing
- Reclaimed Water Applications

STANDARDS



Q-Line water service tubing is manufactured to AWWA C903, ASTM F1282 and CSA B137.9, and meets NSF-PW potable water requirements as well as requirements of the following national codes.

- National Plumbing code of Canada
- Uniform Plumbing Code
- International Plumbing Code
- International Residential Code
- National Standard Plumbing Code
- SBCCI Standard Plumbing Code

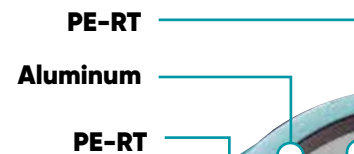

ADVANTAGES

- 6** **Excellent Corrosion Resistance, Long Service Life**
 Q-Line's tough inner and outer polyethylene layers resist most acids, salt solutions and alkalis found in aggressive water and soil environments. Q-Line also carries tough NSF CL-TD chlorine resistance certification. Bury Q-Line directly in the ground or encase it in concrete – without the need for protective sleeving. And because Q-Line is not susceptible to corrosion and pitting, it provides longer service life than metallic water service tubing.
- 7** **Built-in Permeation Barrier**
 Permeation is a real issue with small diameter water service tubing. Unlike poly water service tubing which is susceptible to permeation by a variety of chemicals, Q-Line's built-in aluminum core creates a permeation barrier against ground source contaminants. In fact, Q-Line composite water service tubing has been successfully tested against the most aggressive contaminants, like termiticides.
- 8** **Increased Electrical Safety, Reduced Galvanic Corrosion**
 Unlike metallic pipe, Q-Line will not conduct stray electrical current. So the chance of electrical shock is greatly reduced. A separate grounding plate or rod must be installed according to AWWA recommendations. And because Q-Line won't conduct stray current, it reduces corrosion of metallic components within the distribution system.
- 9** **Zero Scrap Value**
 Because Q-Line's metallic core is permanently locked between layers of polyethylene, it has zero scrap metal value. So unlike copper and other valuable metals which are continually disappearing due to theft, Q-Line is more likely to stay on the job site where it's needed.

DID YOU KNOW?

Like other nonmetallic pipes, Q-Line can be located using a standard tracer wire installed at the same time as the water service line.

SHORT FORM SPECIFICATIONS

TUBING

Water service tubing shall be composite PE-AL-PE tubing manufactured in accordance with the requirements of AWWA C903 and certified to CSA B137.9 and ASTM F1282. It shall have a long term pressure rating of 1380kPa at 23°C (200 psi at 73°F) and 690kPa at 82°C (100 psi at 180°F). The pipe shall be third-party tested and certified to comply with NSF-PW potable water and NSF CL-TD chlorine resistance requirements. The service tubing shall be color coded light blue as manufactured by IPEX under the trade name "Q-Line" or approved equal.



FITTINGS

Fittings for composite PE-AL-PE tubing shall be brass water service fittings conforming to AWWA C800.



PRODUCT SELECTION & DIMENSIONS

Q-Line has unique inside and outside diameters that are different both from copper and conventional PE service tubing. Easily installed adapters that allow Q-line to be used with standard brass fittings are widely available.

Nominal Size	Product Code	Coil Length	Avg. ID		Min. Wall Thickness		Avg. OD		Weight	Volume	Min. Bending Radius				
			in	mm	in	mm	in	mm			lbs/100ft	kg/100m	U.S. gal/ft	l/m	in
3/4	115001	150													
	115002	300	.79	20	.10	2.5	.98	25	12.4	18.4	.025	.314	5.0	125	
	115003	1000													
1	115004	150	.98	25	.14	3.5	1.26	32	21.0	31.2	.040	.500	6.3	160	

PHILMAC 3G COMPRESSION FITTINGS FOR WATER SUPPLY

1/2" - 2" (12mm - 50mm)



Turn on to the next generation of water line compression fittings: Philmac 3G. Based on 25 years of fitting experience, 3G is our most innovative and revolutionary fitting yet. It represents the culmination of years of development and engineering, cutting-edge manufacturing technology and punishing performance testing.

To create a truly advanced next generation fitting, Philmac questioned every detail—from fitting design to material. The end result is a plastic fitting that's strong, easy to install and long-lasting, all at a cost lower than that of brass fittings with a quality far superior to metal insert fittings.

Something definitely worth turning on to.

IPEX offers Philmac 3G in two preassembled fittings (CTSOD and ID Series) for all sizes, as well as easy-to-use adaptor kits that can convert these fittings for IPSOD, COPPER and Q-Line pipe applications.

ADVANTAGES

- 1 Turn-to-Tighten Design**
Philmac's unique design allows you to achieve a perfect seal with the turn of a hand or wrench. Visual stops and gradually increasing mechanical resistance as the nut is tightened reduces the risk of over-tightening.
- 2 Compact Ergonomic Grip**
Small and lightweight, Philmac 3G fittings are specially shaped to your hand for easy turning. Their compact size is perfect for working in confined areas.
- 3 Advanced Material**
Philmac 3G fittings are made from an advanced high-performance polypropylene so they're UV-, impact- and corrosion-resistant—tough enough for 50+ years of reliable service.
- 4 Dynamic Compression Sealing**
Philmac 3G fittings are highly engineered to provide a robust leak-proof seal with superior pull-out resistance. In addition, the strength of the nut ensures minimal distortion when tightened with a wrench.
- 5 Component Interchangeability**
Because both the CTSOD and ID Series fittings are based on the same core fitting design, components can be easily interchanged in order to transition from one type to another on the same fitting. And with adaptor kits available for other material types, you'll always have the right fitting for the job.

APPLICATIONS

- Residential Water Service
- Residential Irrigation Systems
- Cottage Country Water Service
- Rural Irrigation • Geothermal

STANDARDS



i DID YOU KNOW?

Philmac 3G used in conjunction with CSA certified Pipe with the Stripe Poly can give users the only CSA and potable water certified pipe and fitting system for well water supply.



PHILMAC 3G CTSOD

VISUAL STOPS & GRADUAL MECHANICAL RESISTANCE PREVENT OVER-TIGHTENING

A clear visual stop and mechanical resistance indicates when fully tightened.

FEWER TURNS TO TIGHTEN

Only 1-1/2 turns are needed to tighten up the nut.

NO FORCE TO SLIDE IN

No force is required to slide the pipe into the fitting.

NO PIPE TWISTING DURING INSTALLATION

Fitting designed to avoid pipe twist, reducing risk of untightening joints.

EASY CONNECT / DISCONNECT

The split collet enables easy connection and disconnection, ideal for seasonal water lines.

MINIMAL DISTORTION WHEN TIGHTENED WITH WRENCH

The strength of the acetal nut ensures minimal distortion when tightening with a wrench.

ADAPTER KITS

If IPSOD, Q-LINE or COPPER is being used, the joint can be easily converted using adaptor kits.

PHILMAC 3G ID

MINIMAL DISTORTION WHEN TIGHTENED WITH WRENCH

The strength of the acetal nut ensures minimal distortion when tightening with a wrench.

EASY CONNECT/DISCONNECT FOR SEASONAL WATER LINES

Disconnection and reconnection to pumps or seasonal water lines is made quick and easy.

LESS FORCE TO PUSH INSERTS IN

Simply push or hammer in inserts—no heating as with barb assemblies on metal insert fittings.

VISUAL STOPS & GRADUAL MECHANICAL RESISTANCE PREVENT OVER-TIGHTENING

A clear visual stop and mechanical resistance indicates when fully tightened.

ONE FITTING CONNECTS TO ANY 75 TO 200 SERIES PIPE

Compatible with all types of ID Series pipe, the 3G fittings eliminate the need for dedicated fittings and reduces inventory.

PRODUCT SELECTION CHART - CTSOD FITTINGS

	Dimension		Product Code
	inches	mm	
Coupling Compression x Compression	3/4	20	258000
	1	25	258001
	1-1/4	32	258002
	1-1/2	40	258003
	2	50	258004

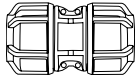

	Dimension		Product Code
	inches	mm	
Elbow Compression x Compression	3/4	20	258029
	1	25	258030
	1-1/4	32	258031
	1-1/2	40	258032
	2	50	258033

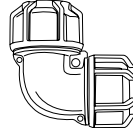

	Dimension		Product Code
	inches	mm	
Reducing Coupling Compression x Compression	1 x 3/4	25 x 20	258005
	1-1/4 x 1	32 x 25	258131

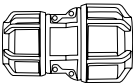

	Dimension		Product Code
	inches	mm	
Elbow Compression x FIPT	3/4	20	258034
	1 x 3/4	25 x 20	258035
	1	25	258036
	1-1/4 x 1	32 x 25	258037
	1-1/4	32	258038
	1-1/2 x 1-1/4	40 x 32	258039
	1-1/2	40	258040

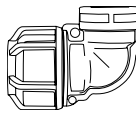

	Dimension		Product Code
	inches	mm	
Male Adapter Compression x MIPT	3/4 x 1/2	20 x 12	258006
	3/4	20	258007
	1 x 1/2	25 x 12	258008
	1 x 3/4	25 x 20	258009
	1	25	258010
	1-1/4 x 3/4	32 x 20	258011
	1-1/4 x 1	32 x 25	258012
	1-1/4	32	258013
	1-1/2 x 1	40 x 25	258014
	1-1/2 x 1-1/4	40 x 32	258015
	1-1/2	40	258016
	2 x 1-1/2	50 x 40	258017
	2	50	258018

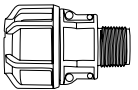

	Dimension		Product Code
	inches	mm	
End Cap Compression	3/4	20	258151
	1	25	258152
	1-1/4	32	258153
	1-1/2	40	258154



	Dimension		Product Code
	inches	mm	
Female Adapter Compression x FIPT	3/4 x 1/2	20 x 12	258019
	3/4	20	258020
	1 x 3/4	25 x 20	258021
	1	25	258022
	1-1/4 x 1	32 x 25	258023
	1-1/4	32	258024
	1-1/2 x 1-1/4	40 x 32	258025
	1-1/2	40	258026
	2 x 1-1/2	50 x 40	258027
	2	50	258028

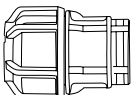

	Dimension		Product Code
	inches	mm	
Tee Compression	3/4	20	258042
	1	25	258043
	1-1/4	32	258044
	1-1/2	40	258045

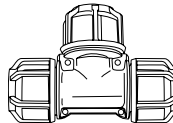

	Dimension		Product Code
	inches	mm	
Tee Compression x Compression x FIPT	3/4	20	258047
	1 x 3/4	25 x 20	258048
	1	25	258049
	1-1/4 x 3/4	32 x 20	258050
	1-1/4 x 1	32 x 25	258051
	1-1/4	32	258052
	1-1/2 x 3/4	40 x 19	258053
	1-1/2 x 1-1/4	40 x 32	258054
	1-1/2	40	258055

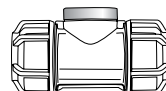

Note: Philmac 3G CTSOD fittings can be used with IPEX GOLD STRIPE pipe Blue904 pipe or any other CTSOD PE Pipe.

PRODUCT SELECTION CHART - ID SERIES FITTINGS

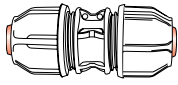
	Dimension		Product Code
	inches	mm	
	Compression x Compression		
	1/2	12	258059
	3/4 x 1/2	20 x 12	258065
	3/4	20	258060
	1	25	258061
	1-1/4	32	258062
	1-1/2	40	258063
	2	50	258064

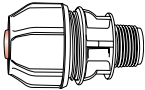
	Dimension		Product Code
	inches	mm	
	Compression x MIPT		
	1/2	12	258066
	1/2 x 3/4	12 x 20	258067
	3/4 x 1/2	20 x 12	258068
	3/4	20	258069
	3/4 x 1	20 x 25	258070
	1 x 3/4	25 x 20	258071
	1	25	258072
	1 x 1-1/4	25 x 32	258073
	1-1/4 x 1	32 x 25	258074
	1-1/4	32	258075
	1-1/4 x 1-1/2	32 x 40	258076
	1-1/2	40	258077
1-1/2 x 2	40 x 50	258078	
	2	50	258079

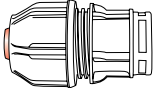
	Dimension		Product Code
	inches	mm	
	Compression x FIPT		
	1/2	12	258080
	1/2 x 3/4	12 x 20	258081
	3/4	20	258082
	3/4 x 1	20 x 25	258083
	1	25	258084
	1 x 1-1/4	25 x 32	258085
	1-1/4	32	258086
	1-1/4 x 1-1/2	32 x 40	258087
	1-1/2	40	258088
	1-1/2 x 2	40 x 50	258089
	2	50	258090

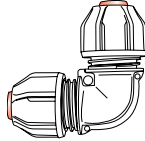
	Dimension		Product Code
	inches	mm	
	Compression x Compression		
	1/2	12	258091
	3/4	20	258092
	1	25	258093
	1-1/4	32	258094
	1-1/2	40	258095
	2	50	258096

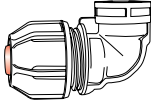
	Dimension		Product Code
	inches	mm	
	Compression x FIPT		
	1/2 x 3/4	12 x 20	258097
	3/4	20	258098
	3/4 x 1	20 x 25	258099
	1	25	258100
	1 x 1-1/4	25 x 32	258101
	1-1/4	32	258130

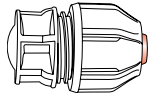
	Dimension		Product Code
	inches	mm	
	Compression		
	1/2	12	258114
	3/4	20	258115
	1	25	258116
	1-1/4	32	258117
	1-1/2	40	258118
	2	50	258183

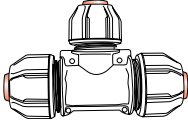
	Dimension		Product Code
	inches	mm	
	Compression		
	1/2	12	258102
	3/4	20	258103
	1	25	258104
	1-1/4	32	258105
	1-1/2	40	258106

	Dimension		Product Code
	inches	mm	
	Compression x Compression x FIPT		
	3/4	20	258107
	1 x 1/2	25 x 12	258108
	1	25	258109
	1-1/4 x 1/2	32 x 12	258110
	1-1/4 x 3/4	32 x 20	258111
	1-1/4 x 1-1/2	32 x 40	258112
	1-1/2 x 2	40 x 50	258113

Note: ID Series fittings can be used with all IPEX Pipe with a Stripe (except Gold Stripe) and other ID series PE Pipe

PRODUCT SELECTION CHART - ADAPTER KITS

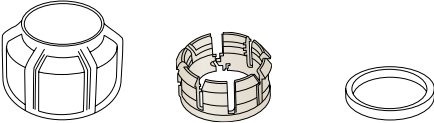
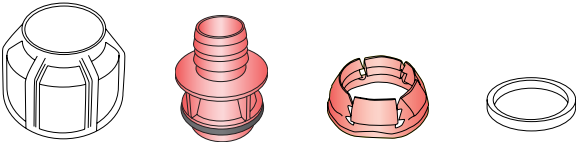
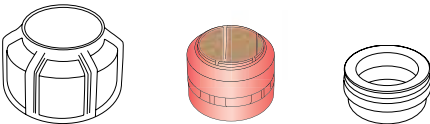
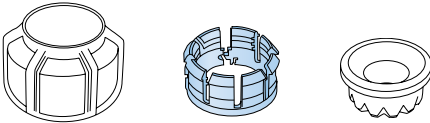
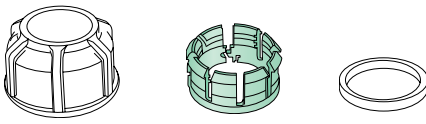
			Dimension		Product Code
			inches	mm	
CTS Adapter Kit (Includes CTS Nut, Gold Collet, CTS Seal)					
	3/4	20	258132		
	1	25	258133		
	1-1/4	32	258134		
	1-1/2	40	258135		
ID Series Adapter Kit (Includes ID Series Nut, Red Insert, Red Collet, ID Series Seal)					
	1/2	12	258137		
	3/4	20	258138		
	1	25	258139		
	1-1/4	32	258140		
	1-1/2	40	258141		
	2	50	258142		
Copper Adapter Kit (Includes Copper Nut, Brown Carborundum Gripper, Copper Seal)					
	1/2	12	258119		
	3/4	20	258120		
	1	25	258121		
Q-Line Adapter Kit (Includes Q-Line Nut, Blue Collet, Q-Line Seal)					
	1/2	12	258122		
	3/4	20	258123		
	1	25	258124		
IPS OD Adapter Kit (Includes IPS Nut, Green Collet, IPS Seal)					
	3/4	20	258125		
	1	25	258126		
	1-1/4	32	258127		
	1-1/2	40	258128		
	2	50	258129		

Note: These conversion kits are used to convert CTSOD fittings into Copper, Q-Line or IPSOD fittings. Simply remove the existing nut, collet and seal from the CTSOD fitting and assemble according to the instructions contained on page 8 of this ordering guide - "Converting Philmac 3G Fittings"

Philmac 3G collets and inserts are colour coded according to pipe type, the following chart lists the 5 pipe types and their corresponding Philmac 3G colour :

Pipe Type	Philmac 3G Collet Colour
CTS	Gold
ID Series	Red
IPS	Green
Q-Line	Blue
Copper	Brown

IPEX drain, waste and vent (DWV) systems have been proving themselves across North America – both below and above grade – for more than three decades. Lightweight and easy to install, even in confined spaces, IPEX DWV systems for combustible and noncombustible applications have become the material of choice in residential, industrial and commercial construction.

DWV Systems



DRAIN-WAY ABS DWV Systems 26

Solvent Weld Sewer & Drain Piping Systems 34

Noncombustible Drainage Systems 40

- System 15 Pipe & Fittings
- System XFR Pipe & Fittings
- Drain-Guard Double Containment
- MJ Grey Mechanical Couplings
- Cements & Fire Stopping Products

Backwater Valves 70

DRAIN-WAY® ABS DWV SYSTEMS

1-1/4" - 6" (30mm - 150mm)

ABS-DWV

Throughout Canada, ABS-DWV (drain, waste and vent) piping has been successfully used in single family homes and general wood-frame construction. Builders and contractors have enjoyed the durability, ease of installation and overall value of ABS in providing a plumbing drain system.

The pipe may be used both above ground and underground and is made in Schedule 40 pipe dimensions in either solid wall or cell core composition. Sizes range from 1-1/4" - 6" (32mm to 150mm) and a broad range of ABS DWV fittings are also provided by IPEX for complete system installations.

ADVANTAGES

- 1 Years of Maintenance-Free Service**
ABS will not rust, pit or degrade when exposed to moisture and is extremely resilient and durable. This lightweight ABS-DWV offers easy and quick installation without specialized equipment, even in confined spaces.
- 2 Code Compliant**
IPEX ABS (Solid Wall) and fittings have been third-party certified to CSA B181.1 while ABS (Cell Core) pipe is certified to ASTM F628, both ensuring a consistent quality product with reliable long-term performance. In addition, IPEX can be of assistance in suggesting where ABS piping is permitted by Building codes and or where other products may be a more suitable alternative.
- 3 Complete Line of Fittings**
IPEX manufacturers not only ABS-DWV pipe, but a complete line of ABS fittings, ensuring integrity throughout the plumbing system. In addition, our products are promptly available throughout any IPEX distributor.

APPLICATIONS

Drain Waste and Vent Piping for:

- Single Family Homes
- Multi-Plex Residential
- General Wood Frame Buildings

STANDARDS



Solid Wall CSA B181.1



Cell Core ASTM F628



DID YOU KNOW?

ABS is commonly used by the automotive industry for car bumpers due to its affordable cost, high impact strength and general toughness.



PRODUCT SELECTION CHART

Dimension	Dimension		Product Code	Lengths / Bundle
	inches	mm		

ABS Solid Wall Pipe



1-1/4	32	009112	165
1-1/2	40	009117	221
2	50	009121	176
3	75	009133	78
4	100	009143	60
6	150	009161	26

Lengths: 12 feet

ABS Cell Core Pipe



1-1/2	40	079117	221
2	50	079121	176
3	75	079133	78
4	100	079143	60
6	150	079161	26

Lengths: 12 feet

Dimension	Dimension		Product Code
	inches	mm	

Straight Tee H x H x H

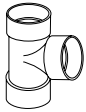

1-1/2	40	027021
-------	----	--------

Sanitary Tee H x H x H

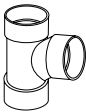

1-1/4	32	027079
1-1/2	40	027081
1-1/2x1-1/4x1-1/2	40 x 32 x 40	027055
1-1/2x1-1/2x1-1/4	40 x 40 x 32	027062
2	50	027082
2x1-1/2x1-1/2	50 x 40 x 40	027058
2 x 1-1/2 x 2	50 x 40 x 50	027057
2 x 2 x 1-1/4	50 x 50 x 32	027063
2 x 2 x 1-1/2	50 x 50 x 40	027056
3	75	027083
3 x 3 x 1-1/4	75 x 75 x 32	027065
3 x 3 x 1-1/2	75 x 75 x 40	027061
3 x 3 x 2	75 x 75 x 50	027060
4	100	027084
4 x 4 x 2	100 x 100 x 50	027064
4 x 4 x 3	100 x 100 x 75	027066
6 x 6 x 6	150 x 150 x 150	027085



Dimension	Dimension		Product Code
	inches	mm	

Sanitary Tee Sp x H x H

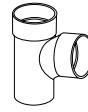

3	75	027059
3 x 3 x 1-1/2	75 x 75 x 40	027671
3 x 3 x 2	75 x 75 x 50	027672

Double Sanitary Tee H x H x H x H

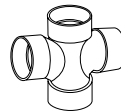

1-1/2	40	027097
2	50	027096
2x2x1-1/2x1-1/2	50x50x40x40	027098
3	75	027094
3x3x1-1/2x1-1/2	75x75x40x40	027099
3 x 3 x 2 x 2	75x75x50x50	027100
4	100	027095

Sanitary Tee LSI H x H x H x Hsi

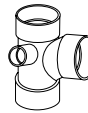

3x3x3x1-1/2	75x75x75x40	027071
3 x 3 x 3 x 2	75x75x75x50	027073

Sanitary Tee RSI H x H x H x Hsi

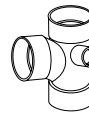

3x3x3x1-1/2	75x75x75x40	027072
3 x 3 x 3 x 2	75x75x75x50	027074

Double Sanitary Tee - Single Side Inlet H x H x H x H x Hsi

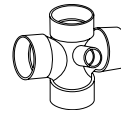

3x3x3x3x1-1/2	75x75x75x75x40	027001
---------------	----------------	--------

Cleanout Tee (with plug) H x H x FPT

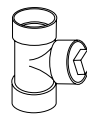

1-1/2	40	027144
2	50	027145
3	75	027146
4	100	027147
4 x 3 x 4	100 x 75 x 100	027148

Double Wye H x H x H x H



1-1/2	40	027206
2	50	027207
2x2x1-1/2x1-1/2	50x50x40x40	027212
3	75	027208
3x3x1-1/2x1-1/2	75x75x40x40	027213
3 x 3 x 2 x 2	75x75x50x50	027214
4	100	027209
4 x 4 x 2 x 2	100x100x50x50	027216
4 x 4 x 3 x 3	100x100x75x75	027215

PRODUCT SELECTION CHART

Dimension		Product Code
inches	mm	

45° Wye H x H x H

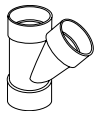

1-1/4	32	027170
1-1/2	40	027171
1-1/2 x 1-1/2 x 1-1/4	40 x 40 x 32	027193
2	50	027172
2 x 1-1/2 x 1-1/2	50 x 40 x 40	027194
2 x 2 x 1-1/2	50 x 50 x 40	027195
3	75	027173
3 x 3 x 1-1/2	75 x 75 x 40	027201
3 x 3 x 2	75 x 75 x 50	027196
4	100	027174
4 x 4 x 2	100 x 100 x 50	027198
4 x 4 x 3	100 x 100 x 75	027197
6	150	027176
6 x 6 x 4	150 x 150 x 100	027202

45° Wye Sp x H x H



3	75	027693
3 x 3 x 1-1/2	75 x 75 x 40	027199

90° Reducing Elbow H x H



4 x 3	100 x 75	027127
-------	----------	--------

90° Elbow H x H



1-1/4	32	027120
1-1/2 - Short	40 - Short	027121
1-1/2 - Long	40 - Long	027131
2 - Short	50 - Short	027122
2 - Long	50 - Long	027132
3 - Short	75 - Short	027125
3 - Long	75 - Long	027123
4 - Short	100 - Short	027134
4 - Long	100 - Long	027124
6	150	027126

90° Elbow H x Sp



1-1/4	32	027230
1-1/2	40	027231
2	50	027232
3 - Short	75 - Short	027235
3 - Long	75 - Long	027233
4	100	027234

90° Elbow Extra Long Turn H x H

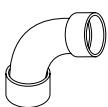

1-1/2	40	027156
2	50	027157
3	75	027158

Dimension		Product Code
inches	mm	

90° Elbow Extra Long Turn S x H

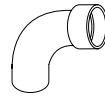

1-1/2	40	027037
-------	----	--------

90° Vent Elbow H x H



1-1/2	40	027111
3	75	027113

90° Elbow Slip Joint Nut x H



1-1/2	40	027161
1-1/2 x 1-1/4	40 x 32	027166

90° 3-Way Elbow H x H x H

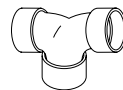

1-1/2	40	027022
-------	----	--------

60° Elbow H x H



1-1/4	32	027260
1-1/2	40	027261
2	50	027262
3	75	027263
4	100	027264

45° Elbow H x H



1-1/4	32	027240
1-1/2 - Short	40 - Short	027241
1-1/2 - Long	40 - Long	027033
2	50	027242
3	75	027243
4 - Short	100 - Short	027247
4 - Long	100 - Long	027244
6	150	027246

45° Elbow H x Sp





1-1/4	32	027220
1-1/2 - Short	40 - Short	027221
1-1/2 - Long	40 - Long	027024
2	50	027222
3	75	027223
4 - Short	100 - Short	027227
4 - Long	100 - Long	027224
6	150	027226

PRODUCT SELECTION CHART

	Dimension		Product Code
	inches	mm	
	H x H		
	1-1/4	32	027250
	1-1/2	40	027251
	2	50	027252
	3	75	027253
	4	100	027254
6	150	027256	

	Dimension		Product Code
	inches	mm	
	H x MPT		
	1-1/4	32	027330
	1-1/2	40	027331
	1-1/2 x 1-1/4	40 x 32	027336
	2	50	027332
	3	75	027333
4	100	027334	

	Dimension		Product Code
	inches	mm	
	H x FPT		
	1-1/4	32	027340
	1-1/2	40	027341
	2	50	027342
	3	75	027343
	4	100	027344
6	150	027599	

	Dimension		Product Code
	inches	mm	
	Sp x FPT		
	1-1/4	32	027705
	1-1/2	40	027706
	2	50	027707
	3	75	027708
	4	100	027709
6	150	027610	

	Dimension		Product Code
	inches	mm	
	Sp x FPT		
	1-1/4	32	027600
	1-1/2	40	027601
	2	50	027602
	3	75	027603
4	100	027604	

	Dimension		Product Code
	inches	mm	
	MPT		
	1-1/4	32	027500
	1-1/2	40	027501
	2	50	027502
	3	75	027503
	4	100	027504
6	150	027406	

	Dimension		Product Code
	inches	mm	
	Sp		
	2	50	027412

	Dimension		Product Code
	inches	mm	
	Sp x H		
	1-1/2 x 1-1/4	40 x 32	027280
	2 x 1-1/4	50 x 32	027290
	2 x 1-1/2	50 x 40	027282
	3 x 1-1/2	75 x 40	027292
	3 x 2	75 x 50	027284
	4 x 1-1/2	100 x 40	027276
	4 x 2	100 x 50	027288
6 x 4	150 x 100	027297	

	Dimension		Product Code
	inches	mm	
	Sp x FPT		
	1-1/2 x 3/4	40 x 20	027279
	1-1/2 x 1-1/4	40 x 32	027281
2 x 1-1/2	50 x 40	027285	

	Dimension		Product Code
	inches	mm	
	Sp x H		
	4 x 3	100 x 75	027034

	Dimension		Product Code
	inches	mm	
	Sp x FPT		
	1-1/2 x 1/2	40 x 12	027277

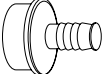
	Dimension		Product Code
	inches	mm	
	Sp x Barb		
	1-1/2 x 1/2	40 x 12	027278

	Dimension		Product Code
	inches	mm	
	H x H		
	1-1/2 x 1-1/2 x 1/2	40 x 40 x 12	027192
1-1/2 x 1-1/2 x 3/4	40 x 40 x 20	027203	

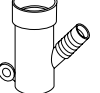
	Dimension		Product Code
	inches	mm	
	Sp x H		
	1-1/2 x 1-1/2 x 1/2	40 x 40 x 12	027191

	Dimension		Product Code
	inches	mm	
	FPT x MPT		
	1-1/4	32	027987
	1-1/2 x 1-1/4	40 x 32	027988
	1-1/2 x 1-1/2	40 x 40	027984
	2	50	027989

*CSA Certified for use in P-Trap area only.

PRODUCT SELECTION CHART

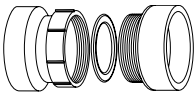
	Dimension		Product Code
	inches	mm	
Union (Special washer included)			
	1-1/2 x 1-1/2	40 x 40	027985
	2	50	027357

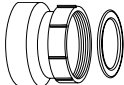
Swivel Nut - ABS Pipe to Tray Plug (Washer included)			
	inches	mm	Product Code
	1-1/2	40	027983

Strainer Adapter H x FPT			
	inches	mm	Product Code
	1-1/2	40	027036

Permanent Cap H			
	inches	mm	Product Code
	1-1/4	32	027410
	1-1/2	40	027411
	2	50	027415
	3	75	027413
	4	100	027414

Threaded Cap (Washer included)			
	inches	mm	Product Code
	1-1/2	40	027891

Coupling H x H			
	inches	mm	Product Code
	1-1/4	32	027350
	1-1/2	40	027351
	2	50	027352
	3	75	027353
	4	100	027354
	6	150	027356

Increaser H x H			
	inches	mm	Product Code
	1-1/2 x 1-1/4	40 x 32	027360
	2 x 1-1/2	50 x 40	027362
	3 x 1-1/2	75 x 40	027363
	3 x 2	75 x 50	027364
	4 x 1-1/2	100 x 40	027369
	4 x 2	100 x 50	027365
	4 x 3	100 x 75	027366

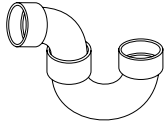
	Dimension		Product Code
	inches	mm	
"P" Trap H x H			
	1-1/4	32	027430
	1-1/2	40	027431
	2	50	027432
	3	75	027433
	4	100	027434
	4 x 3	100 x 75	027949

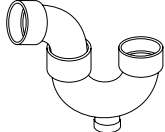
"P" Trap with Cleanout H x H			
	inches	mm	Product Code
	1-1/4	32	027440
	1-1/2	40	027441
	2	50	027442

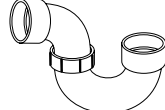
"P" Trap Union H x H			
	inches	mm	Product Code
	1-1/4	32	027470
	1-1/2	40	027471
	2	50	027472

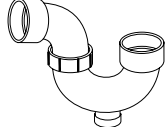
"P" Trap Union with Cleanout H x H			
	inches	mm	Product Code
	1-1/4	32	027467
	1-1/2	40	027468
	2	50	027443

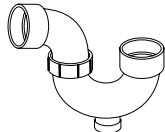
"P" Trap Union (Pivoting) with Cleanout H x H			
	inches	mm	Product Code
	1-1/2	40	027012

"S" Trap H x H			
	inches	mm	Product Code
	1-1/2	40	027289

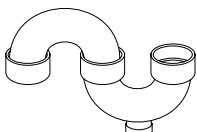
"S" Trap with Cleanout H x H			
	inches	mm	Product Code
	1-1/4	32	027450
	1-1/2	40	027451

Threaded Cap for "P" Trap			
	inches	mm	Product Code
	1-1/4	32	090890

PRODUCT SELECTION CHART

	Dimension		Product Code
	inches	mm	
Male Trap Adapter Sp x Plastic Nut	1-1/4	32	027476
	1-1/2	40	027477
	1-1/2 x 1-1/4	40 x 32	027478
	1-1/2 x 7 Long	40 x 175 Long	027651
	2	50	027302



	Dimension		Product Code
	inches	mm	
Female Trap Adapter Plastic Nut x H	1-1/4	32	027320
	1-1/2	40	027321
	1-1/2 x 1-1/4	40 x 32	027329



	Dimension		Product Code
	inches	mm	
Closet Flange H	4 x 3	100 x 75	027584
	4 x 4	100 x 100	027573



	Dimension		Product Code
	inches	mm	
Adjustable Closet Flange Flush Fit H	4 x 3	100 x 75	027582
	4 x 4	100 x 100	027573



	Dimension		Product Code
	inches	mm	
Closet Flange with Test Plug H	4 x 3	100 x 75	027591
	4 x 4	100 x 100	027573



	Dimension		Product Code
	inches	mm	
Adjustable Closet Flange with Test Plug (Flush fit) H	4 x 3	100 x 75	027583
	4 x 4	100 x 100	027573



	Dimension		Product Code
	inches	mm	
Closet Flange Sp	4 x 3	100 x 75	027585
	4 x 4	100 x 100	027573



	Dimension		Product Code
	inches	mm	
Adjustable Closet Flange Kit for Concrete	4 x 3	100 x 75	027592
	4 x 4	100 x 100	027573

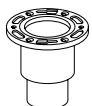

	Dimension		Product Code
	inches	mm	
Adjustable Closet Flange Kit for Concrete	for use in Slab on Grade W.C. Installations		
	4 x 3	100 x 75	027593

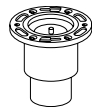

	Dimension		Product Code
	inches	mm	

	Dimension		Product Code
	inches	mm	
Adjustable Offset Closet Flange H	4 x 3	100 x 75	027574
	4 x 4	100 x 100	027573



	Dimension		Product Code
	inches	mm	
45° Discharge Closet Flange adjustable w plastic ring H	4 x 3	100 x 75	027950
	4 x 4	100 x 100	027573



	Dimension		Product Code
	inches	mm	
Adjustable Closet Flange H	4 x 3	100 x 75	027586
	4 x 4	100 x 100	027573



	Dimension		Product Code
	inches	mm	
Adjustable Closet Flange with Test Plug	4 x 3	100 x 75	027588
	4 x 4	100 x 100	027573



	Dimension		Product Code
	inches	mm	
Adjustable Closet Flange I.D. Sized 3" (Non-CSA)	4 x 3	100 x 75	027950
	4 x 4	100 x 100	027573



	Dimension		Product Code
	inches	mm	
Adjustable Closet Flange Sp	4 x 3	100 x 75	027587
	4 x 4	100 x 100	027573



	Dimension		Product Code
	inches	mm	
Closet Flange Spacer Ring	4 x 3	100 x 75	027002
	4 x 4	100 x 100	027573



	Dimension		Product Code
	inches	mm	
Reducing Adapter (Sewer to DWV) Sp x H	4 x 3	100 x 75	027294
	4 x 4	100 x 100	027050



	Dimension		Product Code
	inches	mm	
Reducing Adapter (DWV to DWV) Sp x H	4 x 3	100 x 75	027286
	4 x 4	100 x 100	027050



	Dimension		Product Code
	inches	mm	
Hub Adapter (Sewer to DWV) H x H	4 x 3	100 x 75	027376
	4 x 4	100 x 100	027050



PRODUCT SELECTION CHART

	Dimension		Product Code
	inches	mm	

Adapter Bushing (Sewer to DWV) H x Sp



2	50	027310
3	75	027311
4	100	027312

Drain Grate Sp



3	75	027619
4	100	027741

Continuous Waste End Outlet 16" Long

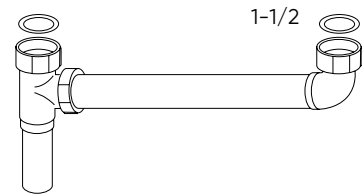

1-1/2	40	027730
-------	----	--------

Continuous Waste Centre Outlet 16" Long

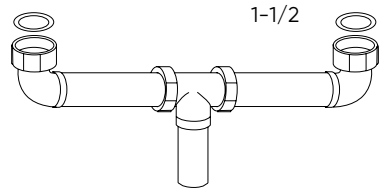

1-1/2	40	027740
-------	----	--------

M.J. Cast Iron Adapter Sp x H

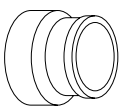

2	50	027522
3	75	027523
4	100	027524
4 x 3	100 x 75	027528

Cast Iron Adapter C.I. Hub x DWV Sp

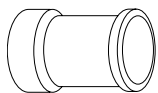

2	50	027532
3	75	027533
4	100	027534
4 x 3	100 x 75	027535

Galvanized Pipe Adapter H x Slip Joint

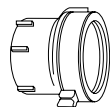

1-1/2	40	027900
-------	----	--------

2-in-1 Combination Trap Adapter

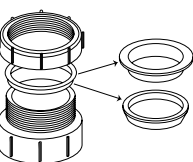

1-1/2x1-1/2x1-1/4	40 x 40 x 32	027039
-------------------	--------------	--------

	Dimension		Product Code
	inches	mm	

Expansion Joint H x H (3" Travel)

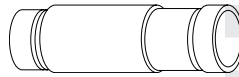

1-1/2	40	027611
2	50	027612
3	75	027613
4	100	027614

* Note: 027614 has 8" (200mm) of travel

Expansion Joint H x Sp

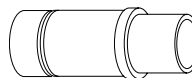

3	75	027615
---	----	--------

Slip Joint Nut (Washerless) FPT



1-1/4	32	090630
1-1/2	40	090631

Slip Joint Nut FPT



1-1/2	40	027633
2	50	027632

Slip Joint Washer



1-1/4	32	027856
1-1/2	40	027857
2	50	027855

Polyethylene Orange Flexible Test Cap



1-1/4	32	027874
1-1/2	40	027875
2	50	027876
3	75	027878
4	100	027880

Roof Flashing (Neoprene)

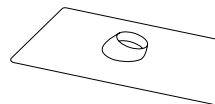

3	75	027623
4	100	027624

Test Plate



3	75	027658
---	----	--------

Drum Trap (with plug) H x H

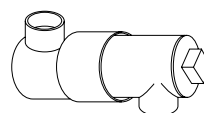

1-1/2	40	027010
-------	----	--------

Why not take
the leap?

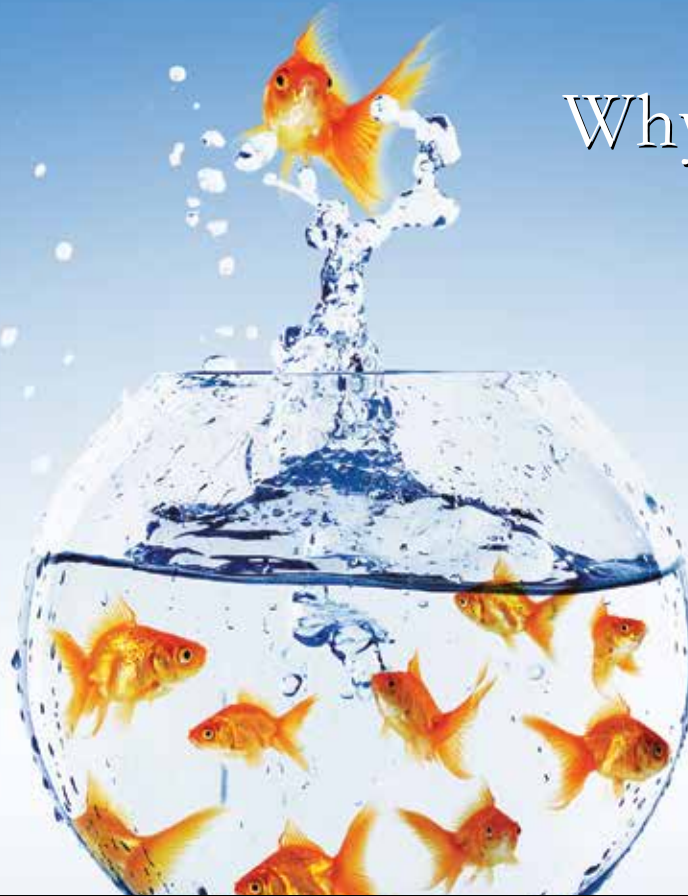

IPEX Mechanical Systems...times have changed!

System 636®

FLUE GAS VENTING



- ✓ A fully certified system of pipe, fittings and cements
 - ✓ Two system options cover a broad range of operating temperatures
 - ✓ PVC sizes 1-1/2" to 4"
CPVC sizes 1-1/2" to 8"
- Use standard CIOD or IPS fittings

SYSTEM 15® DWV SYSTEM XFR® DWV

DWV SYSTEMS



- ✓ Meets code requirements for noncombustible buildings
- ✓ Significantly lighter than cast iron
- ✓ High impact resistance
- ✓ Improved Flow

MJ GREY™ DWV

DWV COUPLINGS



- ✓ Used with System 15 / System XFR
- ✓ Sizes 8" to 12"
- ✓ Designed specifically for PVC Diameters

SOLVENT WELD SEWER & DRAIN PIPING SYSTEMS

3" - 6" (75mm - 150mm)

PVC Solvent Weld

IPEX offers an engineered integral PVC sewer and drainage system. PVC solid sewer pipe is used for the collection of domestic waste and storm water. PVC perforated sewer pipe is used for septic fields and foundation drainage. The solvent weld assembly method offers tight joints, eliminating infiltration, exfiltration and root infestation. A complete line of solvent weld sewer fittings is available for use with our pipe. IPEX PVC solvent weld pipe and fittings are available in nominal sizes from 3" to 6" (75mm to 150mm).

ADVANTAGES

- 1** **Costs Less to Operate**
A plastic sewer system costs less to operate and maintain because it has greater flow capacity per given size and fewer joints. The pipe is flexible enough to conform to shifts and setting caused by unstable soil conditions or traffic without cracking, breaking or opening of the joints.
- 2** **Greater Hydraulic Efficiency**
PVC has the smoothest flow surface of any piping material today resulting in a Manning flow coefficient, N of .009. As a result, the pipe will not be susceptible to blockages and will maintain a high flow capacity over the life of the pipeline. The BDS piping will outperform corrugated interior tubing products in flow capacity and structural performance, especially in perimeter drain applications.
- 3** **Life Cycle**
The economic life cycle of a PVC sewer system is projected at more than 50 years.

APPLICATIONS

- Building sanitary or storm drain lines
- Foundation perimeter drains
- Septic field distribution piping

STANDARDS



BDS sewer pipe is available in Standard Spec or third-party certified to CSA B182.1 or BNQ 3624-050 and conforms to ASTM.

BDS fittings, made to SDR35 wall, are third party certified to CSA B182.2 and BNQ 3624-130 and conform to ASTM D2729.

i DID YOU KNOW?

No other pipe approaches BDS plastic pipe in terms of low weight per foot ratio to strength. The light-weight section reduces manpower needs, reduces equipment handling cost, and freight cost.



DIMENSIONS

IPEX BDS Solid Wall Sewer Pipe – Dimensions									
Nominal Pipe Size		Average Outside Diameter		Standards	Minimum Wall Thickness		Minimum Stiffness		
inches	mm	inches	mm		inches	mm	psi	kpa	
3	75	3.2	82.5	CSA B182.1 - SDR35	.093	2.36	46	320	
4	100	4.2	107.0	CSA B182.1 - SDR35	.120	3.06	46	320	
6	150	6.3	159.4	CSA B182.1 - SDR35	.179	4.55	46	320	
3	75	3.2	82.5	CSA B182.1 - Western Canada	.093	2.36	46	320	
4	100	4.2	107.0	CSA B182.1 - Western Canada	.115	2.92	46	320	
6	150	6.3	159.4	CSA B182.1 - Western Canada	.171	4.35	46	320	
3	75	3.2	82.5	CSA B182.1-SDR38 (Nova Scotia Spec)	.093	2.36	40	275	
4	100	4.2	107.0	CSA B182.1-SDR38 (Nova Scotia Spec)	.114	2.90	40	275	
6	150	6.3	159.4	CSA B182.1-SDR38 (Nova Scotia Spec)	.165	4.19	40	275	
3	75	3.2	82.5	ASTM D2729	.070	1.78	19	131	
4	100	4.2	107.0	ASTM D2729	.075	1.90	11	76	
6	150	6.3	159.4	ASTM D2729	.100	2.54	8	55	
3	75	3.2	82.5	IPEX Standard	.070	1.78	19	131	
4	100	4.2	107.0	IPEX Standard	.075	1.91	11	76	
6	150	6.3	159.4	IPEX Standard	.123	3.12	14	96	

IPEX Perforated Sewer Pipe – Dimensions									
Nominal Pipe Size		Average Outside Diameter		Standards	Minimum Wall Thickness		Perforation* Configuration	Minimum Stiffness	
inches	mm	inches	mm		inches	mm		psi	kpa
3	75	3.3	82.5	CSA B182.1 Eastern Canada	.085	2.16	A	29	200
4	100	4.2	107.0	CSA B182.1 Eastern Canada	.093	2.36	A	29	200
6	150	6.3	159.4	CSA B182.1 Eastern Canada	.130	3.30	A	29	200
3	75	3.3	82.5	CSA B182.1 Western Canada	.079	2.02	B	29	200
4	100	4.2	107.0	CSA B182.1 Western Canada	.088	2.24	B	29	200
6	150	6.3	159.4	CSA B182.1 Western Canada	.114	2.90	B	29	200
4	100	4.2	107.0	CSA B182.1 Nova Scotia Spec	.104	2.63	C	29	200
3	75	3.3	82.5	BNQ 3624-050	.085	2.15	D	29	200
4	100	4.2	107.0	BNQ 3624-050	.143	3.63	D	29	200
6	150	6.3	159.4	BNQ 3624-050	.139	3.52	D	29	200
3	75	3.3	82.5	ASTM D2729	.070	1.78	E	19	131
4	100	4.2	107.0	ASTM D2729	.075	1.90	E	11	76
6	150	6.3	159.4	ASTM D2729	.100	2.54	E	8	55
3	75	3.3	82.5	IPEX Standard	.070	1.78	F	19	131
4	100	4.2	107.0	IPEX Standard	.075	1.91	F	11	76
6	150	6.3	159.4	IPEX Standard	.123	3.12	F	14	96

*See table on following page

PERFORATED PIPE HOLE DIMENSIONS

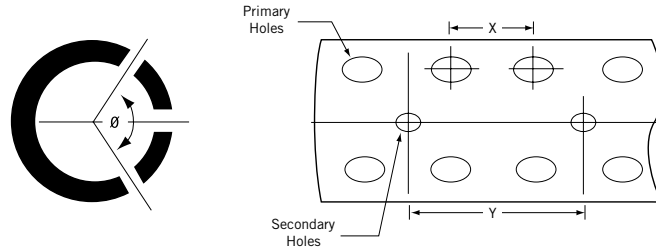

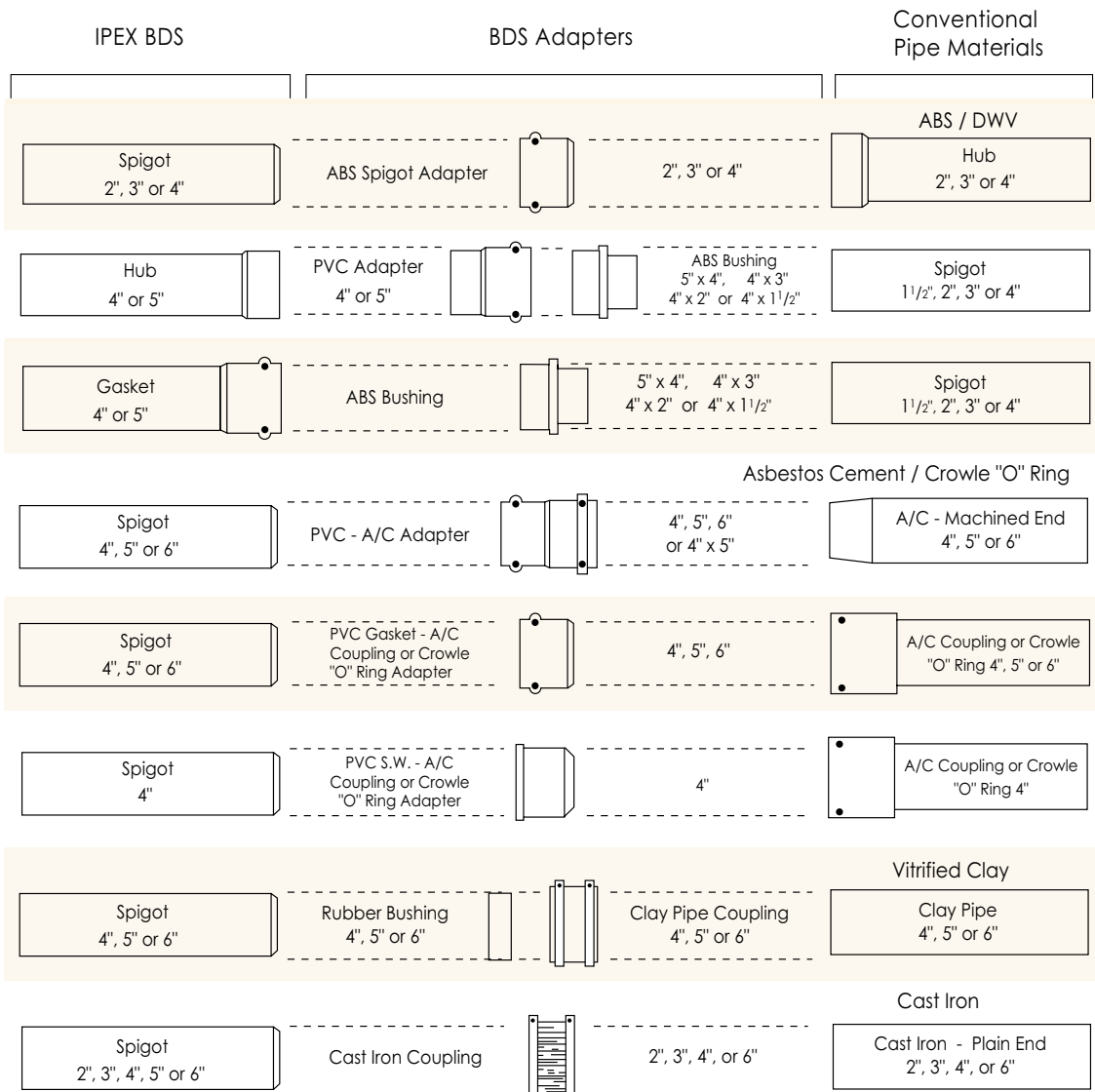

Configuration Type	Primary Hole Size		Secondary Hole Size		Dimension X		Dimension Y		Angle f degree
	inches	mm	inches	mm	inches	mm	inches	mm	
A	.63	16	.51	13	5.00	127	28.8	732	120
B	.63	16	none	none	5.00	127	n/a	n/a	120
C	.63	16	.51	13	5.00	127	138.8	3525	120
D	.51	13	.35	9	5.00	127	60.0	1524	120
E	.51	13	.39	10	5.00	127	30.0	762	120
F	.63	16	.51	13	4.65	118	30.0	763	120

ADAPTER CHART TO CONVENTIONAL MATERIALS



PRODUCT SELECTION CHART

	Dimension		Product Code
	inches	mm	
 CSA - Eastern Canada	2	50	003520
	3	75	003530
	4	White 100	003644
	4	Green 100	003645
	6	White 150	003560
	6	Green 150	003561

	Dimension		Product Code
	inches	mm	
	3	75	004530
	4	100	004140
	6	150	004565

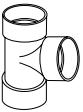
Straight Tee	H x H x H		Product Code
	inches	mm	
	3 x 3 x 3	75 x 75 x 75	040102
	4 x 4 x 3	100 x 100 x 75	040109
	4 x 4 x 4	100 x 100 x 100	040104
	6 x 6 x 4	150 x 150 x 100	040105
	6 x 6 x 6	150 x 150 x 150	040106
	8 x 8 x 4	200 x 200 x 100	040117
	8 x 8 x 6	200 x 200 x 150	040118
	8 x 8 x 8	200 x 200 x 200	040108

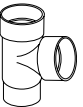
Straight Tee	Sp x H x H		Product Code
	inches	mm	
	4 x 4 x 4	100 x 100 x 100	040114

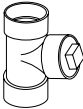
Cleanout Tee	H x H x FPT		Product Code
	inches	mm	
	4	100	040922

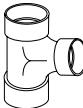
2 Way Cleanout	H x H x H		Product Code
	inches	mm	
	4 x 4 x 4	100 x 100 x 100	040350

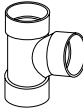
Sanitary Tee	H x H x H		Product Code
	inches	mm	
	3 x 3 x 3	75 x 75 x 75	040155
	4 x 4 x 4	100 x 100 x 100	040156
	6 x 6 x 4	150 x 150 x 100	040158
	6 x 6 x 6	150 x 150 x 150	040159

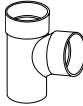
Sanitary Tee	Dimension		Product Code
	inches	mm	
	4 x 4 x 4	100 x 100 x 100	040157

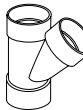
45° Wye	H x H x H		Product Code
	inches	mm	
	3 x 3 x 2	75 x 75 x 50	040303
	3 x 3 x 3	75 x 75 x 75	040302
	4 x 4 x 2	100 x 100 x 50	040308
	4 x 4 x 3	100 x 100 x 75	040309
	4 x 4 x 4	100 x 100 x 100	040304
	6 x 6 x 4	150 x 150 x 100	040307
	6 x 6 x 6	150 x 150 x 150	040306
	8 x 8 x 4	200 x 200 x 100	040310
	8 x 8 x 6	200 x 200 x 150	040312
	8 x 8 x 8	200 x 200 x 200	040311
	10 x 10 x 10	250 x 250 x 250	040313
	12 x 12 x 12	300 x 300 x 300	040314

45° Wye	Sp x H x H		Product Code
	inches	mm	
	3 x 3 x 3	75 x 75 x 75	040332
	4 x 4 x 4	100 x 100 x 100	040334
	6 x 6 x 6	150 x 150 x 150	040338

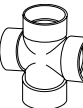
Cross	H x H x H x H		Product Code
	inches	mm	
	3	75	040975
	4	100	040976

90° Elbow (1/4 Bend)	H x H		Product Code	
	inches	mm		
	2	50	040254	
	3	75	040255	
	4	100	040214	
	4 x 3	100 x 75	040259	
	6	150	040206	
	8	200	040208	
	*	4	100	040256
	*Short Radius (BNQ ONLY)			

90° Elbow (1/4 Bend)	Sp x H		Product Code	
	inches	mm		
	2	50	040270	
	3	75	040272	
	4	100	040234	
	6	150	040236	
	*	4	100	040274
	*Short Radius (BNQ ONLY)			

PRODUCT SELECTION CHART

	Dimension		Product Code
	inches	mm	

45° Elbow (1/8 Bend) H x H

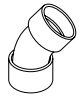

2	50	040500
3	75	040502
4	100	040504
6	150	040506
8	200	040508
10	250	040407

45° Elbow (1/8 Bend) Sp x H



2	50	040400
3	75	040402
4	100	040404
6	150	040406
8	200	040408

22-1/2° Elbow (1/16 Bend) H x H



3	75	040963
4	100	040964
6	150	040969

22-1/2° Elbow (1/16 Bend) Sp x H



4	100	040864
6	150	040866

P Trap H x H

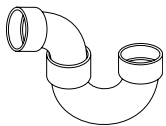

2	50	040978
3	75	040979
4	100	040980

Coupling with Pipe Stop H x H



2	50	040600
3	75	040602
4	100	040604
6	150	040606
8	200	040631

Repair Coupling without Pipe Stop H x H



4	100	040624
6	150	040626

	Dimension		Product Code
	inches	mm	

Reducer Coupling with Pipe Stop H x H

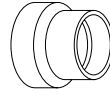

4 x 2	100 x 50	040656
4 x 3	100 x 75	040654
6 x 4	150 x 100	040661

Cap H



3	75	040986
4	100	040959
6	150	040988
8	200	040990

Cleanout Plug MPT



3	75	040923
4	100	040924
6	150	040926
8	200	040927
12	300	040929

Closet Flange H



4	100	040965
---	-----	--------

Reducer Bushing Sp x H



3 x 2	75 x 50	040930
4 x 3	100 x 75	040933
6 x 4	150 x 100	040896

Extended Bushing Sp x H

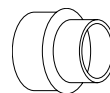

5 x 4	125 x 100	040994
6 x 4	150 x 100	040939
8 x 4	200 x 100	040897
8 x 6	200 x 150	040940

Reducer Bushing S/D to ABS/DWV Sp x H



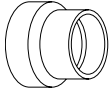

3 x 1-1/2	75 x 38	040932
3 x 2	75 x 50	040341
4 x 1-1/2	100 x 38	040415
4 x 2	100 x 50	040935

PRODUCT SELECTION CHART

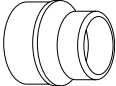
	Dimension		Product Code
	inches	mm	
Reducer Coupling S/D to ABS/DWV H x H 	4 x 3	100 x 75	040655
	4 x 4	100 x 100	040725
	6 x 4	150 x 100	040727
	6 x 6	150 x 150	040756

	Dimension		Product Code
	inches	mm	
Adapter Bushing S/D to ABS/DWV Sp x H 	4 x 3	100 x 75	040934
	5 x 4	125 x 100	040895
	6 x 4	150 x 100	040941

	Dimension		Product Code
	inches	mm	
Adapter Bushing S/D to Female IPS Sp x FIP Thread 	4 x 1-1/2	100 x 40	040416

	Dimension		Product Code
	inches	mm	
Flush Plug MPT 	4	100	040992

	Dimension		Product Code
	inches	mm	
Plugs / Covers 	6	150	040024
	8	200	040025
	10	250	040026

	Dimension		Product Code
	inches	mm	
Floor Drain Grate Sp 	3	75	040811
	4	100	040911
	6	150	040912

	Dimension		Product Code
	inches	mm	
Floor Grate (pp) Sp 	3	75	040032
	4	100	040033
	3	75	040034
	4	100	040035

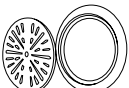
	Dimension		Product Code
	inches	mm	
Grates 	6	150	040027
	8	200	040028
	10	250	040029

	Dimension		Product Code
	inches	mm	
Sleeve Adapter ABS/DWV Hub to S/D H x Sp 	4	100	040342

	Dimension		Product Code
	inches	mm	
Male Adapter H x MPT 	3	75	040720
	4	100	040723

	Dimension		Product Code
	inches	mm	
Female Adapter S/D to Female IPS H x FIP Threads 	3	75	040948
	4	100	040949
	6	150	040952
	8	200	040945

	Dimension		Product Code
	inches	mm	
Adapter S/D to AC Coupling. Or Crowle G x Sp 	4	100	040724

	Dimension		Product Code
	inches	mm	
Adapter to Cast Iron S/D to CI Spigot H x H 	4	100	040704
	Caulk with Oakum & Mortar		

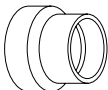
	Dimension		Product Code
	inches	mm	
DWV Hub x Sewer Spigot 10" Long 	4	100	040808

	Dimension		Product Code
	inches	mm	
Cleanout Adapter Sp x FIP Thread 	3	75	040953
	4	100	040954
	6	150	040956

	Dimension		Product Code
	inches	mm	
Spigot Adapter ABS/DWV to S.W. Sp x G 	4 (ABS)	100	043150

	Dimension		Product Code
	inches	mm	
Rectangular Down Spout Adapter to BDS 	4	100	040960
	Down spout to corrugated		

DRAINAGE SYSTEMS FOR NONCOMBUSTIBLE BUILDINGS

SYSTEM 15® DWV DRAIN-GUARD™ DWV

SYSTEM XFR® DWV MJ GREY™ DWV

From underground parking garages to hospitals to high buildings, more and more mechanical contractors and engineers are switching to a long-lasting DWV solution.

Why are PVC systems from IPEX becoming the new standard? As an integrated solution, System 15® and System XFR® meet all code requirements for noncombustible buildings. More importantly, they provide the required rugged reliability with all the added benefits of PVC. They're lighter than their metal counterparts, making them easier to handle and install. Very durable, they resist corrosion and require virtually no maintenance. And they yield substantial cost savings both now and down the road.

Clearly System 15 and System XFR have raised the bar—and pipe—for DWV systems in noncombustible buildings.

Drain-Guard™ double containment piping systems provide safe transport of sanitary or storm drainage in critical areas. Should a leak occur, people, equipment and valuable property will be protected from possible harm.

Depending on your application, Drain-Guard is a double containment piping system using System 15 and/or System XFR as its primary components. The many performance benefits of System 15 and System XFR are enhanced by this dual pipe concept.

MJ Grey™ mechanical couplings are a great alternative to solvent welding when working in cold weather conditions or from heights in a scissor lift or bucket.

APPLICATIONS

Drain Waste and Vent Piping in:

- Commercial
- Residential
- Above ground or underground
- Industrial

STANDARDS



CSA B181.2
CAN/ULC S102.2

ADVANTAGES

- 1** **Lightweight, Easier to Install**
A PVC system is as much as 75% lighter than equivalent lengths of cast iron, making it easier to handle, store and install. It's so light no special equipment is needed to hoist it up during installation, making what used to be awkward, back-breaking work now an easy one man job. In this way, a PVC system can lower labour requirements and reduce installation costs.
- 2** **Corrosion-Resistant, Less Maintenance**
Unlike cast iron pipe, a PVC system doesn't rust, pit, scale or corrode. In fact, its interior and exterior walls remain smooth in virtually any service condition, requiring virtually no maintenance and ensuring years of reliable service.
- 3** **Cost-Savings Now and Over Long-term**
No matter how you look at it, a PVC system is more cost-effective than a traditional metal system. It's less costly to transport and store. It's easier to install, bringing down installation costs. It lasts longer. What this all adds up to is substantial savings now and in the future.
- 4** **A More Aesthetic Alternative**
Sleek and streamlined, PVC presents a more pleasing, aesthetic alternative to traditional metal systems. And as they won't rust and degrade, your PVC system will look as good in ten years as it does the day you install it.

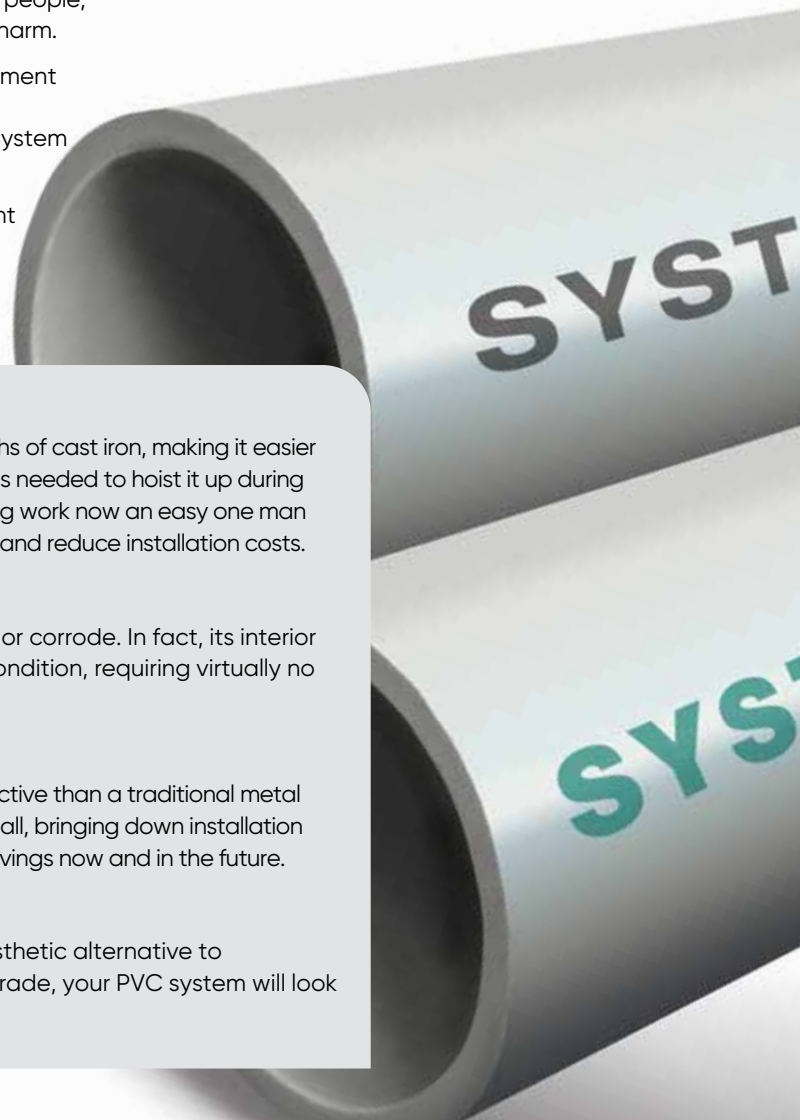

CODE COMPATIBILITY

System 15 pipe and fittings, when used in combination with System XFR, not only satisfies National and Provincial Building Codes but also provides a cost effective trouble-free long-term installation.

- To use thermoplastic piping in a building classified as noncombustible, the material must meet a Flame Spread Rating of 25 or less. Approval to use thermoplastic piping in noncombustible buildings is detailed in clause 3.1.5.16 of the building code.
- Products for use within air plenums must meet a Flame Spread of 25 or less and a Smoke Developed Classification of 50 or less. (Building Code article 3.6.4.3. (1).)
- Products to be used within a building deemed to be high-rise must also meet the Smoke Developed Classification of 50 or less. (Building Code article 3.2.6).
- The fire resistance rating of a material is attained by having the product tested according to a prescribed test method. National and Provincial Codes specify the test requirements in 3.1.12.1.(2). In the case of thermoplastic piping the prescribed test method is CAN/ULC S102.2.

By using System 15 and System XFR in combination, designers and contractors can maximize the potential installation and cost benefits offered by these two products.

System 15®

System 15 meets the general requirements of noncombustible construction. However, System 15 is not approved for use in air plenums (transitions to System XFR are acceptable here) or buildings classified as high-rise. System 15 also is a viable option for a more rugged underground storm or sanitary drain on the private side of commercial buildings.

System XFR®

System XFR meets the requirements for noncombustible buildings, and the further restrictions of smoke development for air plenums and high rise buildings.

In high-rise buildings, System XFR must be used throughout the building to satisfy the requirement for a 50 Smoke Developed Criterion.

Drain-Guard™

Drain-Guard is our latest innovation to the System 15 and System XFR family of products. The many performance benefits of System 15 and System XFR are enhanced by this dual pipe concept.

Contact IPEX for product availability and pricing for a customized solution on your next project.

MJ Grey™

Meets all the same requirements of System 15 and System XFR and can be used in the same applications.

Note: Combustible DWV piping products are not allowed in a vertical service space.



SYSTEM 15 DRAINAGE SYSTEMS

1-1/2" - 24" (40mm - 600mm)

SYSTEM 15® DWV

As an investment, System 15® is a winner. It's a cost-effective "workhorse" designed for the majority of low-rise and light commercial applications where DWV systems don't run through air plenums.

In addition to costing less than cast iron, System 15 pipe and fittings are engineered to withstand years of uninterrupted service. Made of tough, impact resistant PVC, System 15 won't rust, pit, scale or degrade, even under continued exposure to moisture, salts, aggressive soils and most acids. Interior and exterior walls remain smooth, ensuring years of reliable, maintenance-free flow.

As well, System 15 is lightweight and easy to handle, making installation – even in confined or awkward wall spaces – fast and easy. There's no need to pay for special hoisting equipment or extra manpower. This all converts to significant cost savings over copper and cast iron piping.

Do the math: System 15 is an unbeatable, cost-effective investment – now and for years to come.

ADVANTAGES

- 1** **Flame Spread**
When tested to the CAN/ULC S102.2 Standard, System 15 achieved a Flame Spread Rating of not greater than 25.
- 2** **Cost Effective**
Lightweight. Easy to handle. Fast installation with no special equipment required. Substantial project cost savings over traditional piping materials.
- 3** **Broad Range of Sizes**
CSA certified in sizes from 1-1/2" to 24" in diameter. The most extensive DWV package available in North America.
- 4** **Long-term Reliability**
System 15 performs well under constant use in harsh environments corrosive to other materials.
- 5** **Impact Resistance**
The high impact strength of System 15 reduces jobsite damage and wastage.
- 6** **Simple Joining**
Solvent welding eliminates the need for cumbersome tools and the hazards of torches on site.
- 7** **Direct Burial**
Suitable for both above- and below-grade applications, eliminating the transition to other pipe materials at grade level.

APPLICATIONS

Drain Waste and Vent Piping in:

- Commercial
- Industrial
- Residential
- Above ground or underground

STANDARDS



CSA B181.2
CAN/ULC S102.2





DID YOU KNOW?

SYSTEM 15 is lightweight and easy to handle, making installation—even in confined or awkward wall spaces—fast and easy.

There's no need to pay for special hoisting equipment or extra manpower. This all converts to significant cost savings over copper and cast iron piping

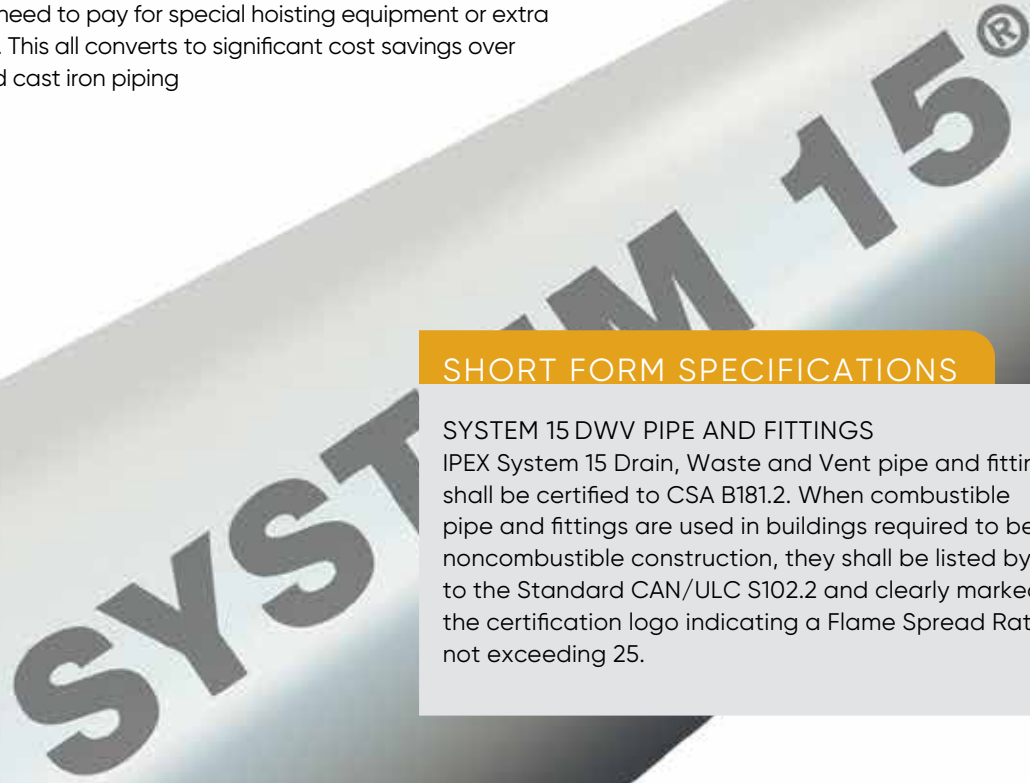

SHORT FORM SPECIFICATIONS

SYSTEM 15 DWV PIPE AND FITTINGS

IPEX System 15 Drain, Waste and Vent pipe and fittings shall be certified to CSA B181.2. When combustible pipe and fittings are used in buildings required to be of noncombustible construction, they shall be listed by ULC to the Standard CAN/ULC S102.2 and clearly marked with the certification logo indicating a Flame Spread Rating not exceeding 25.

IPEX System 15[®] pipe and fittings have been tested and certified by CSA to the CSA B181.2 standard.

Test Results

ITS (Warnock Hersey) conducted the testing in accordance with CAN/ULC S102.2 test standard. The following table summarizes the results of these tests.

Component	Flame Spread Rating	Smoke-Developed Classification
System 15 [®]		
Pipe	10	> 50
Fittings	15	> 50

PRODUCT SELECTION CHART - SYSTEM 15

	Dimension		Product Code	
	inches	mm		
System 15 DWV Pipe				
	1-1/2	40	010001	
	2	50	010002	
	3	75	010003	
	4	100	010004	
	6	150	010006	
	8	200	010087	
	10	250	010088	
	12	300	010089	
	Plain End			
	12 foot lengths			

Bell End	4	100	010005
	6	150	010046
	8	200	010008
	10	250	010010
20 foot lengths	12	300	010012
	14	350	010031
	16	400	010032
	18	450	010034
	20	500	010035
	24	600	010036

Note: Sizes 4" and 6", 20 foot lengths are sold in Western Canada only.

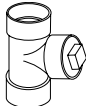
Line Cleanout	H x H x Gasket Plug		
	1-1/2	40	026040
	2	50	026041
	3	75	026103
	4	100	026104
	4 x 3 x 4	100 x 75 x 100	026105
	6	150	026161

Line Cleanout	Sp x Sp x Threaded Plug	FOR USE WITH MJ GREY™	
	8	200	226953

Plug Cleanout	MPT with Gasket		
	1-1/2	40	026401
	2	50	026402
	3	75	026403
	4	100	026404
	6	150	026405

Fitting Cleanout	Sp x FPT		
	1-1/2	40	026042
	2	50	026046
	3	75	026047
	4	100	026048
	6	150	026050

Fitting Cleanout	Sp x Gasket Threaded Plug		Product Code
	inches	mm	
	1-1/2	40	026345
	2	50	026346
	3	75	026347
	4	100	026348
	6	150	026349
	8	200	026301

Tube End Cleanout	H x Gasket Plug		
	1-1/2	40	026291
	2	50	026298
	3	75	026299
	4	100	026300

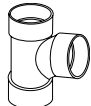
Sanitary Tee	H x H x H		
	1-1/2	40	026081
	2	50	026082
	2 x 1-1/2 x 1-1/2	50 x 40 x 40	026058
	2 x 1-1/2 x 2	50 x 40 x 50	026057
	2 x 2 x 1-1/2	50 x 50 x 40	026056
	3	75	026083
	3 x 3 x 1-1/2	75 x 75 x 40	026061
	3 x 3 x 2	75 x 75 x 50	026060
	4	100	026084
	4 x 4 x 2	100 x 100 x 50	026064
	4 x 4 x 3	100 x 100 x 75	026066
	6	150	026377
	6 x 6 x 4	150 x 150 x 100	026385
	8	200	026810
	8 x 4	200 x 100	026808
	8 x 6	200 x 150	026809
	10	250	026814
	10 x 4	250 x 100	026811
	10 x 6	250 x 150	026812
	10 x 8	250 x 200	026813
12 x 4	300 x 100	026815	
12 x 6	300 x 150	026816	
12 x 8	300 x 200	026817	
12 x 10	300 x 250	026818	
14 x 4	350 x 100	026820	
14 x 6	350 x 150	026821	
16 x 4	400 x 100	026826	
16 x 6	400 x 150	026827	
18 x 4	450 x 100	026833	
18 x 6	450 x 150	026834	

PRODUCT SELECTION CHART - SYSTEM 15

	Dimension		Product Code
	inches	mm	

Sanitary Tee Sp x H x H

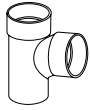

1-1/2	40	026550
3 x 3 x 1-1/2	75 x 75 x 40	026552
4 x 4 x 2	100 x 100 x 50	026554
4	100	026557

Sanitary Tee Sp x Sp x H

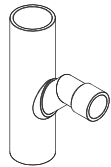

FOR USE WITH MJ GREY™		
8 x 4	200 x 100	226955
8 x 6	200 x 150	226940
10 x 4	250 x 100	226939
10 x 6	250 x 150	226942
12 x 4	300 x 100	226945
12 x 6	300 x 150	226946

Sanitary Tee Sp x Sp x Sp

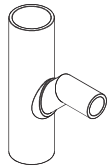

FOR USE WITH MJ GREY™		
8	200	226941
10 x 8	250 x 200	226943
10	250	226944
12 x 8	300 x 200	226947
12 x 10	300 x 250	226948
12	300	226949

Double Sanitary Tee H x H x H x H

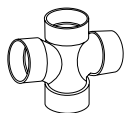

1-1/2	40	026542
2	50	026543
2 x 2 x 1-1/2 x 1-1/2	50 x 50 x 40 x 40	026547
3	75	026544
3 x 3 x 1-1/2 x 1-1/2	75 x 75 x 40 x 40	026538
3 x 3 x 2 x 2	75 x 75 x 50 x 50	026539
4	100	026545

Sanitary Tee Side Inlet (left hand) H x H x H x H SI

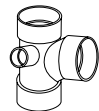

3 x 3 x 3 x 1-1/2	75 x 75 x 75 x 40	026395
3 x 3 x 3 x 2	75 x 75 x 75 x 50	026396

Sanitary Tee Side Inlet (right hand) H x H x H x H SI

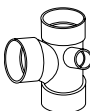

3 x 3 x 3 x 1-1/2	75 x 75 x 75 x 40	026397
3 x 3 x 3 x 2	75 x 75 x 75 x 50	026398

	Dimension		Product Code
	inches	mm	

90° Elbow H x H



1 1/2	40	026121
1-1/2 L	40 L	026024
2	50	026035
2 L	50 L	026122
3	75	026025
3 L	75 L	026123
4	100	026124
4 L	100 L	026115
6	150	026125
8	200	026126
10	250	026127
12	300	026128
14	350	026129
16	400	026130
18	450	026131

90° Elbow Sp x H



1-1/2	40	026231
2	50	026232
3	75	026233
3 L	75 L	026230
4	100	026234
4 L	100 L	026070
6	150	026235
8	200	026236
10	250	026237
12	300	026238
14	350	026135
16	400	026136
18	450	026137

90° Elbow Sp x Sp



FOR USE WITH MJ GREY™		
8	200	226934
10	250	226908
12	300	226909
14	350	226871
16	400	226872
18	450	226873

90° Reducing Elbow Closet Bend Reducing Sp x H



4 x 3	100 x 75	026026
-------	----------	--------

90° Reducing Elbow H x H



4 x 3	100 x 75	026155
-------	----------	--------

PRODUCT SELECTION CHART - SYSTEM 15

	Dimension		Product Code
	inches	mm	

60° Elbow H x H

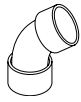

1-1/2	40	026261
2	50	026262
3	75	026263
4	100	026264

45° Elbow - Short Turn H x H



1-1/2	40	026241
2	50	026242
3	75	026243
4	100	026244
6	150	026245
8	200	026246
10	250	026247
12	300	026248
14	350	026249
16	400	026250
18	450	026425

45° Elbow - Short Turn Sp x H



1-1/2	40	026221
2	50	026071
3	75	026223
4	100	026072
6	150	026073
8	200	026226
10	250	026270
12	300	026271
14	350	026272
16	400	026273
18	450	026274

45° Elbow - Short Turn Sp x Sp

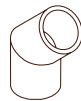

			FOR USE WITH MJ GREY™
8	200	226910	
10	250	226911	
12	300	226912	
14	350	226773	
16	400	226774	
18	450	226775	

	Dimension		Product Code
	inches	mm	

22-1/2° Elbow H x H



1-1/2	40	026251
2	50	026252
3	75	026253
4	100	026254
6	150	026255
8	200	026256
10	250	026257
12	300	026258
14	350	026259
16	400	026260

22-1/2° Elbow Sp x H



6	150	026651
8	200	026652
10	250	026653
12	300	026654
14	350	026655
16	400	026656

22-1/2° Elbow - Short Turn Sp x Sp



			FOR USE WITH MJ GREY™
8	200	226913	
10	250	226914	
12	300	226915	

11-1/4° Elbow H x H



6	150	026671
8	200	026672
10	250	026673
12	300	026674
14	350	026675
16	400	026676

11-1/4° Elbow Sp x H



6	150	026681
8	200	026682
10	250	026683
12	300	026684
14	350	026685
16	400	026686

PRODUCT SELECTION CHART - SYSTEM 15

Dimension		Product Code
inches	mm	

45° Wye H x H x H

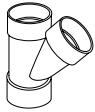

1 1/2	40	026171
2	50	026172
2 x 1-1/2 x 1-1/2	50 x 40 x 40	026194
2 x 1-1/2	50 x 50 x 40	026195
3	75	026173
3 x 1-1/2	75 x 75 x 40	026201
3 x 2	75 x 75 x 50	026196
4	100	026174
4 x 2	100 x 100 x 50	026198
4 x 3	100 x 100 x 75	026197
6	150	026175
6 x 4	150 x 150 x 100	026199
8	200	026560
8 x 4	200 x 100	026606
8 x 6	200 x 150	026607
10	250	026706
10 x 4	250 x 100	026703
10 x 6	250 x 150	026704
10 x 8	250 x 200	026705
12 x 4	300 x 100	026707
12 x 6	300 x 150	026708
12 x 8	300 x 200	026709
12 x 10	300 x 250	026710
12	300	026711
14 x 4	350 x 100	026712
14 x 6	350 x 150	026713
16 x 4	400 x 100	026718
16 x 6	400 x 150	026719
18 x 4	450 x 100	026725
18 x 6	450 x 150	026726

45° Wye Sp x H x H



3	75	026635
---	----	--------

45° Wye Sp x Sp x H

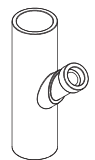

Dimension		FOR USE WITH MJ GREY™	
inches	mm	inches	mm
8 x 4	200 x 100	226926	
8 x 6	200 x 150	226927	
10 x 4	250 x 100	226930	
10 x 6	250 x 150	226929	
12 x 4	300 x 100	226933	
12 x 6	300 x 150	226935	

Dimension		Product Code
inches	mm	

45° Wye Sp x Sp x Sp

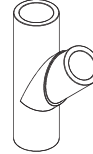

Dimension		FOR USE WITH MJ GREY™	
inches	mm	inches	mm
8	200	226928	
10 x 8	250 x 200	226931	
10	250	226932	
12 x 8	300 x 200	226936	
12 x 10	300 x 250	226937	
12	300	226938	
14	350	226145	
14 x 4	350 x 100	226140	
14 x 6	350 x 150	226141	
14 x 8	350 x 200	226142	
14 x 10	350 x 250	226143	
14 x 12	350 x 300	226144	
16	400	226152	
16 x 4	400 x 100	226146	
16 x 6	400 x 150	226147	
16 x 8	400 x 200	226148	
16 x 10	400 x 250	226149	
16 x 12	400 x 300	226150	
16 x 14	400 x 350	226151	
18	450	226160	
18 x 4	450 x 100	226153	
18 x 6	450 x 150	226154	
18 x 8	450 x 200	226155	
18 x 10	450 x 250	226156	
18 x 12	450 x 300	226157	
18 x 14	450 x 350	226158	
18 x 16	450 x 400	226159	

45° Double Wye Sp x Sp x H x H

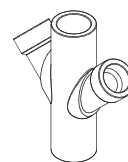

8 x 4	200 x 100	226954
8 x 6	200 x 150	226916
10 x 4	250 x 100	226917
10 x 6	250 x 150	226919
12 x 4	300 x 100	226922
12 x 6	300 x 150	226923

45° Double Wye Sp x Sp x Sp x Sp

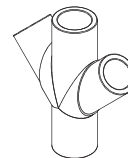

8	200	226918
10	250	226921
10 x 8	250 x 200	226920
12 x 8	300 x 200	226924
12 x 10	300 x 250	226925

PRODUCT SELECTION CHART - SYSTEM 15

Dimension		Product Code
inches	mm	

Double 45° Wye H x H x H x H



1- 1/2	40	026637
2	50	026456
2x2x1-1/2x1-1/2	50x50x40x40	026642
3	75	026639
3x3x1-1/2x1-1/2	75x75x40x40	026643
3 x 3 x 2 x 2	75x75x50x50	026644
4 x 4 x 3 x 3	100x100x75x75	026457
6 x 4	150 x 100	026646
8	200	026755
8 x 4	200 x 100	026753
8 x 6	200 x 150	026754
10 x 4	250 x 100	026756
10 x 6	250 x 150	026757
10 x 8	250 x 200	026758
12 x 4	300 x 100	026760
12 x 6	300 x 150	026761
12 x 8	300 x 200	026762
12 x 10	300 x 250	026763
14 x 4	350 x 100	026765
14 x 6	350 x 150	026766
16 x 4	400 x 100	026771
16 x 6	400 x 150	026772
18 x 4	450 x 100	026778
18 x 6	450 x 150	026779

Reducer Coupling H x H

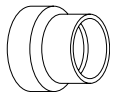

2 x 1-1/2	50 x 40	026362
3 x 1-1/2	75 x 40	026363
3 x 2	75 x 50	026364
4 x 1-1/2	100 x 40	026369
4 x 2	100 x 50	026365
4 x 3	100 x 75	026366
6 x 4	150 x 100	026860
8 x 4	200 x 100	026861
8 x 6	200 x 150	026867
10 x 4	250 x 100	026862
10 x 6	250 x 150	026868
10 x 8	250 x 200	026900
12 x 10	300 x 250	026907
14 x 12	350 x 300	026913

Reducer Bushing Sp x H



2 x 1-1/2	50 x 40	026282
3 x 1-1/2	75 x 40	026292
3 x 2	75 x 50	026284
4 x 2	100 x 50	026288
4 x 3	100 x 75	026286
6 x 4	150 x 100	026054
8 x 4	200 x 100	026446
8 x 6	200 x 150	026447

Dimension		Product Code
inches	mm	

Reducer Bushing (Extended) Sp x H

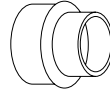

10 x 4	250 x 100	026296
10 x 6	250 x 150	026297
10 x 8	250 x 200	026962
12 x 4	300 x 100	026963
12 x 6	300 x 150	026964
12 x 8	300 x 200	026965
12 x 10	300 x 250	026966
14 x 12	350 x 300	026971

Reducer Bushing (Extended) Sp x Sp

FOR USE WITH
MJ GREY™

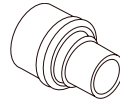

10 x 8	250 x 200	226950
12 x 8	300 x 200	226951
12 x 10	300 x 250	226952
14 x 10	350 x 250	226134
14 x 12	350 x 300	226135
16 x 12	400 x 300	226136
16 x 14	400 x 350	226137
18 x 14	450 x 350	226138
18 x 16	450 x 400	226139

Reducer Bushing (Dishwasher Bushing) Sp x FPT



1-1/2 x 1/2	40 x 12	026277
1-1/2 x 3/4	40 x 20	026278

Reducer Bushing Sp x H



4 x 3	100 x 75	026294
-------	----------	--------

Adapts Plastic Sewer Ftg. to Plastic DWV Pipe

Adapter Sleeve Sp x H



2	50	026310
3	75	026311
4	100	026312
6	150	026313

Adapts Plastic DWV Ftg. to Plastic Sewer Pipe

Male Adapter H x MPT





1-1/2	40	026331
2	50	026332
3	75	026333
4	100	026334

PRODUCT SELECTION CHART - SYSTEM 15

	Dimension		Product Code
	inches	mm	
Female Adapter H x FPT			
	1-1/2	40	026341
	2	50	026342
	3	75	026343
	4	100	026344

	Dimension		Product Code
	inches	mm	
Coupling H x H			
	1-1/2	40	026351
	2	50	026352
	3	75	026353
	4	100	026354
	6	150	026356
	8	200	026358
	10	250	026359
	12	300	026360
	14	350	026361
	16	400	026367
	18	450	026368

	Dimension		Product Code
	inches	mm	
Plastic Sewer Hub H x H			
	4 x 3	100 x 75	026376
Adapts Plastic Sewer Pipe to Plastic DWV Pipe			

	Dimension		Product Code
	inches	mm	
Plastic M-J Spigot MJ Sp x H			
	2	50	026522
	3	75	026523
	4	100	026524
	4 x 3	100 x 75	026535
Adapts M-J Cast Iron Pipe to Plastic DWV Pipe			

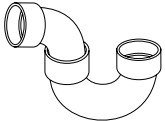
	Dimension		Product Code
	inches	mm	
P Trap Solvent Weld H x H			
	1-1/2	40	026431
	2	50	026432
	3	75	026433
	4	100	026434
	4 x 3	100 x 75	026669

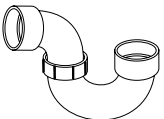
	Dimension		Product Code
	inches	mm	
P Trap Union Connection H x H			
	1-1/2	40	026443
	2	50	026444

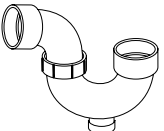
	Dimension		Product Code
	inches	mm	
P Trap Union Connection with Cleanout H x H			
	1-1/2	40	026505

	Dimension		Product Code
	inches	mm	
U Bend H x H			
	2	50	026502
	3	75	026498
	4	100	026499
	6	150	026503

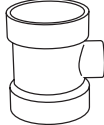
	Dimension		Product Code
	inches	mm	
P Trap Primer Connection Tee H x H x 1/2 FPT			
	3	75	326531
	4	100	326532

	Dimension		Product Code
	inches	mm	
Fitting Trap Adapter Plastic Nut & Washer Sp x Slip Joint			
	1-1/2	40	026304
	2	50	026305

	Dimension		Product Code
	inches	mm	
Pipe Trap Adapter Plastic Nut & Washer H x Slip Joint			
	1-1/2	40	026321
	1-1/2 x 1-1/4	40 x 32	026329
	2	50	026328

	Dimension		Product Code
	inches	mm	
90° Pipe Trap Adapter H x Slip Joint			
	1-1/2 x 1-1/4	40 x 32	026335
	1-1/2 x 1-1/2	40 x 40	026330

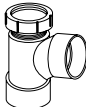
	Dimension		Product Code
	inches	mm	
Sanitary Tee Trap Adapter H x H x Slip Joint			
	1-1/2	40	026179

	Dimension		Product Code
	inches	mm	
Copper to DWV Pipe Adapter H x Slip Joint			
	1-1/2	40	026320
	1-1/2 x 1-1/4	40 x 32	026430
	2	50	026510

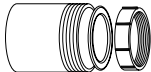
	Dimension		Product Code
	inches	mm	
Tail Piece Adapter (Plastic Nut & Washer) Sp x Slip Joint			
	1-1/2	40	026555
	1-1/2 x 1-1/4	40 x 32	026556

	Dimension		Product Code
	inches	mm	
Swivel Strainer Adapter H x Swivel Nut			
	1-1/2	40	026577

PRODUCT SELECTION CHART - SYSTEM 15

	Dimension		Product Code
	inches	mm	
Closet Flange One Piece Plastic Slip 	4	100	026573
	4 x 3	100 x 75	026584

	Dimension		Product Code
	inches	mm	
Adjustable Closet Flange with Plastic Ring Slip 	4 x 3 Close	100 x 75 Close	026587

Closet Flange One Piece Plastic Slip with Spigot End 	4 x 3	100 x 75	026592
--	-------	----------	--------

45° Discharge Closet Flange Adjustable with Plastic Ring Slip 	4 x 3	100 x 75	026589
---	-------	----------	--------

Closet Flange One Piece Plastic Slip with Molded Test Plate 	4 x 3	100 x 75	026591
---	-------	----------	--------

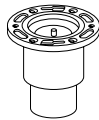
Closet Flange Kit for Concrete 	4 x 3	100 x 75	026593
for use in Slab on Grade W.C. installations			

Closet Flange One Piece Plastic Slip Flush Fit 	4 x 3	100 x 75	026594
--	-------	----------	--------

Closet Flange Spacer Ring 	4	100	026176
---	---	-----	--------

Closet Flange One Piece Plastic Slip Flush Fit w Molded Test Plate 	4 x 3	100 x 75	026595
--	-------	----------	--------

Urinal Flange Hub 	2	50	026459
---	---	----	--------

Adjustable Closet Flange with Plastic Ring Slip 	4 x 3	100 x 75	026586
---	-------	----------	--------

Adjustable Closet Flange w Plastic Ring Slip w Molded Ring Slip 	4 x 3	100 x 75	026588
---	-------	----------	--------

PRODUCT SELECTION CHART - SYSTEM 15

	Dimension		Product Code
	inches	mm	

Expansion Joint - Type 1 (Vertical Use Only) H x H

	1-1/2	40	026485
	2	50	026486
	3	75	026487

Expansion Joint - Type 1 (Vertical Use Only) H x Sp End Piston

	1-1/2	40	026491
	2	50	026492

Expansion Joint - Type 2 (Vertical Use Only) H x H

	4	100	026489
---	---	-----	--------

Dishwasher Wye H x H x Hose Barb

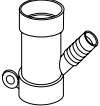
	1-1/2x1-1/2x1/2	40 x 40 x 12	026495
---	-----------------	--------------	--------

Drain Grate Sp

	4	100	026482
---	---	-----	--------

	Dimension		Product Code
	inches	mm	

Slip Cap H

	1-1/2	40	026411
	2	50	026412
	3	75	026413
	4	100	026414
	6	150	026415
	8	200	026416

Polyethylene Cap Slip-on Style

	1-1/2	40	026875
	2	50	026876
	3	75	026878
	4	100	026880

SYSTEM XFR DRAINAGE SYSTEMS

1-1/2" – 18" (40mm – 300mm)

SYSTEM XFR® DWV

Contractors installing DWV pipe in high buildings and plenums had few alternatives to heavy cast iron and copper. IPEX has changed that. System XFR® is the world's first PVC DWV system rated for high buildings and air plenums where the National Building Code mandates more stringent Flame Spread and Smoke Development requirements which previously limited the use of thermoplastic.

Suitable for use in noncombustible environments, System XFR's advanced material has a Flame Spread Rating of 25 and Smoke Developed Classification of 50 which permits it to be installed in High Buildings and Air Return Plenums in accordance with local Codes.

And in addition to its flame and smoke attributes, System XFR delivers all the performance advantages you'd expect from thermoplastic piping.

APPLICATIONS

Drain Waste and Vent Piping in:

- Commercial
- Residential
- Above ground or underground
- Industrial

STANDARDS



CSA B181.2
CAN/ULC S102.2

ADVANTAGES

Flame & Smoke

System XFR possesses superior fire- and smoke- retardant capabilities. When tested to the CAN/ULC S102.2 Standard, System XFR achieved a Flame Spread Rating of not greater than 25 and a Smoke Developed Classification of not greater than 50.

Code Compliance

Ideal for noncombustible applications, System XFR meets these national and provincial building codes:

- High buildings as defined by NBC article 3.2.6
- Air plenums as defined by NBC article 3.6.4.3
- Noncombustible construction as defined by NBC article 3.1.5
- Penetrating a rated fire separation as defined by NBC article 3.1.9.4.(4)

High Impact Resistance

Thanks to its advanced materials, System XFR demonstrates a high impact strength in cold temperatures. Impact-tested at 0°C and 23°C, XFR is tough enough to exceed the CSA requirements.

Improved Flow

System XFR has a substantially lower roughness factor compared to metal systems, allowing for overall improved flow. It's also made with a larger inside diameter which provides a greater cross-sectional area for flow and raises both carrying capacity and flow rates. This feature gives engineers the versatility to design smaller, compact systems that can still handle the necessary flow rates.

Lower Thermal Conductivity

System XFR sweats less than metal pipe due to its excellent insulating properties. As a result, XFR can reduce – and in many cases, eliminate – the need for insulation.

Comparable Noise Attenuation

In real world sound tests performed on constructed buildings, IPEX DWV systems have proven to provide comparable noise attenuation when compared to cast iron from drainage flow. Numerous installations from schools to hospitals and nursing homes have been plumbed with these IPEX drainage systems, all proving that in these critical installations the IPEX systems measure up in terms of sound transfer.





DID YOU KNOW?

SYSTEM XFR – the world’s first uncoated PVC rated for high buildings and plenums where tighter fire and smoke regulations have previously limited the use of thermoplastic.

Suitable for use in noncombustible environments, System XFR’s advanced material meets all fire-resistance and smoke development codes. Its revolutionary fire-retardant properties virtually eliminate flame spread and reduce the volume of smoke generated.

SHORT FORM SPECIFICATIONS

SYSTEM XFR DWV PIPE AND FITTINGS

IPEX System XFR Drain, Waste and Vent pipe and fittings shall be certified to CSA B181.2 and when used in noncombustible construction, high buildings and air plenums, they shall be tested and listed in accordance with CAN/ULC S102.2 and clearly marked with the certification logo indicating a Flame Spread Rating not more than 25 and a Smoke Developed Classification not exceeding 50.

System XFR® pipe and fittings have been tested and certified by CSA to the CSA B181.2 standard. System XFR pipe and fittings are listed with ITS (Warnock Hersey) to exhibit Flame and Smoke values as per CAN/ULC S102.2-10.

Test Results

ITS (Warnock Hersey) conducted the testing in accordance with CAN/ULC S102.2 test standard. The following table summarizes the results of these tests.

Component	Flame Spread Rating	Smoke-Developed Classification
System XFR®		
Pipe	≤ 25	≤ 50
Fittings	≤ 25	≤ 50
Fabricated PVC fittings with XFR Coating	≤ 25	≤ 50

PRODUCT SELECTION CHART - SYSTEM XFR

Dimension		Product Code
inches	mm	

System XFR DWV Pipe



Dimension (inches)	Dimension (mm)	Product Code
1-1/2	40	110067
2	50	110068
3	75	110069
4	100	110070
6	150	110071
8	200	110072
10	250	110073
12	300	110074
14	350	110076
16	400	110077
18	450	110078

Line Cleanout H x H x Gasket Plug

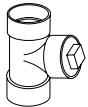

Dimension (inches)	Dimension (mm)	Product Code
1-1/2	40	526040
2	50	526041
3	75	526103
4	100	526104
4 x 3 x 4	100 x 75 x 100	526105
6	150	526161
8	200	526162
10	250	526163
12	300	526164

Line Cleanout Sp x Sp x Threaded Plug

FOR USE WITH **MJ GREY™**



8	200	526766
---	-----	--------

Plug Cleanout MPT with gasket



Dimension (inches)	Dimension (mm)	Product Code
1-1/2	40	526401
2	50	526402
3	75	526403
4	100	526404
6	150	526405

Fitting Cleanout Sp x FPT



Dimension (inches)	Dimension (mm)	Product Code
1-1/2	40	526042
2	50	526046
3	75	526047
4	100	526048

Fitting Cleanout Sp x Gasket Plug



Dimension (inches)	Dimension (mm)	Product Code
1-1/2	40	526345
2	50	526346
3	75	526347
4	100	526348
6	150	526349

Dimension		Product Code
inches	mm	

Tube End Cleanout H x Gasket Plug



Dimension (inches)	Dimension (mm)	Product Code
1-1/2	40	526291
2	50	526298
3	75	526299
4	100	526300

Tube End Cleanout H x Bolted Cover



Dimension (inches)	Dimension (mm)	Product Code
8	200	526000
10	250	526001
12	300	526002

Fitting Cleanout Sp x Bolted Cover



Dimension (inches)	Dimension (mm)	Product Code
8	200	526140
10	250	526141
12	300	526142

Sanitary Tee H x H x H

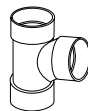

Dimension (inches)	Dimension (mm)	Product Code
1-1/2	40	526081
2	50	526082
2 x 1-1/2 x 1-1/2	50 x 40 x 40	526058
2 x 1-1/2 x 2	50 x 40 x 50	526057
2 x 1-1/2	50 x 40	526056
3	75	526083
3 x 1 1/2	75 x 40	526061
3 x 2	75 x 50	526060
4	100	526084
4 x 2	100 x 50	526064
4 x 3	100 x 75	526066
6	150	526377
6 x 4	150 x 100	526385
8	200	526810
8 x 4	200 x 100	526808
8 x 6	200 x 150	526809
10	250	526814
10 x 4	250 x 100	526811
10 x 6	250 x 150	526812
10 x 8	250 x 200	526813
12	300	526819
12 x 4	300 x 100	526815
12 x 6	300 x 150	526816
12 x 8	300 x 200	526817
12 x 10	300 x 250	526818
14 x 4	350 x 100	526820
14 x 6	350 x 150	526821
16 x 4	400 x 100	526826
16 x 6	400 x 150	526827
18 x 4	450 x 100	526833
18 x 6	450 x 150	526834

PRODUCT SELECTION CHART - SYSTEM XFR

Dimension		Product Code
inches	mm	

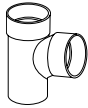
Sanitary Tee	Sp x H x H			
	1-1/2	40		526550
	3 x 1-1/2	75 x 40		526552
	4	100		426557

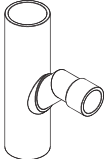
Sanitary Tee	Sp x Sp x H			
	8 x 4	200 x 100		526926
	8 x 6	200 x 150		526998
	10 x 4	250 x 100		526997
	10 x 6	250 x 150		526758
	12 x 4	300 x 100		526761
	12 x 6	300 x 150		526762

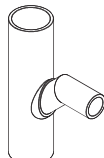
Sanitary Tee	Sp x Sp x Sp			
	8	200		526999
	10 x 8	250 x 200		526759
	10	250		526760
	12 x 8	300 x 200		526763
	12 x 10	300 x 250		526764
	12	300		526765

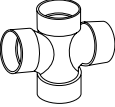
Double Sanitary Tee	H x H x H x H			
	1-1/2	40		526542
	2	50		526543
	2 x 1-1/2	50 x 40		526547
	3	75		526544
	3 x 1-1/2	75 x 40		526538
	3 x 2	75 x 50		526539

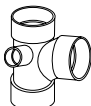
Sanitary Tee Side Inlet (left hand)	H x H x H x H SI			
	3 x 3 x 3 x 1-1/2	75 x 75 x 75 x 40		526395
	3 x 3 x 3 x 2	75 x 75 x 75 x 50		526396

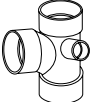
Sanitary Tee Side Inlet (right hand)	H x H x H SI x H			
	3 x 3 x 3 x 1-1/2	75 x 75 x 75 x 40		526397
	3 x 3 x 3 x 2	75 x 75 x 75 x 50		526398

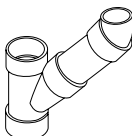
Upright Extended Wye	H x x H x Sp			
	3	75		526006

Dimension		Product Code
inches	mm	

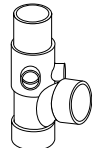
Single Apartment Fitting	H x Sp x H			
	3	75		526007

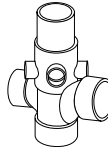
Double Apartment Fitting	H x Sp x H x H			
	3	75		526008

90° Elbow	H x H			
	1-1/2	40		526121
	1-1/2 L	40 L		426024
	2	50		526035
	2 L	50 L		526122
	3	75		526025
	3 L	75 L		526123
	4	100		526124
	6	150		526125
	8	200		526126
	10	250		526127
	12	300		526128
	14	350		526129
	16	400		526130
	18	450		526131

90° Elbow	Sp x H			
	1-1/2	40		526231
	2	50		526232
	3	75		526233
	4	100		526234
	6	150		526235
	8	200		526236
	10	250		526237
	12	300		526238
	14	350		526135
	16	400		526136
18	450		526137	

90° Elbow	Sp x Sp			
	8	200		526967
	10	250		526968
	12	300		526970
	14	350		526871
	16	400		526872
	18	450		526873

PRODUCT SELECTION CHART - SYSTEM XFR

	Dimension		Product Code
	inches	mm	

90° Reducing Elbow Closet Bend Reducing Sp x H



4 x 3	100 x 75	426026
-------	----------	--------

90° Reducing Elbow H x H



4 x 3	100 x 75	526155
-------	----------	--------

90° Elbow Extra Long Sweep H x H

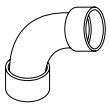

2	50	426157
---	----	--------

60° Elbow H x H

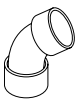

1-1/2	40	526261
2	50	526262
3	75	526253
4	100	526264

45° Elbow Short Turn H x H



1-1/2	40	526241
2	50	526242
3	75	526243
4	100	526244
6	150	526245
8	200	526246
10	250	526247
12	300	526248
14	350	526249
16	400	526250
18	450	526425

45° Elbow Short Turn Sp x H



1-1/2	40	526221
2	50	526071
3	75	526223
4	100	526072
6	150	526073
8	200	526226
10	250	526270
12	300	526271
14	350	526272
16	400	526273
18	450	526274

45° Elbow Short Turn Sp x Sp

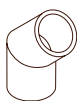

FOR USE WITH MJ GREY™		
8	200	526971
10	250	526770
12	300	526771
14	350	526773
16	400	526774
18	450	526775

	Dimension		Product Code
	inches	mm	

45° Elbow Long Turn H x H



6	150	426038
---	-----	--------

45° Elbow Long Turn Sp x H



6	150	426225
---	-----	--------

22-1/2° Elbow H x H



1-1/2	40	526251
2	50	526252
3	75	526253
4	100	526254
6	150	526255
8	200	526256
10	250	526257
12	300	526258
14	350	526259
16	400	526260

22-1/2° Elbow Sp x H



6	150	526651
8	200	526652
10	250	526653
12	300	526654
14	350	526655
16	400	526656

22-1/2° Elbow Sp x Sp



FOR USE WITH MJ GREY™		
8	200	526972
10	250	526973
12	300	526908

11-1/4° Elbow H x H



6	150	526671
8	200	526672
10	250	526673
12	300	526674
14	350	526675
16	400	526676

11-1/4° Elbow Sp x H



6	150	526681
8	200	526682
10	250	526683
12	300	526684
14	350	526685
16	400	526686

PRODUCT SELECTION CHART - SYSTEM XFR

Dimension	Product Code	
	inches	mm

45° Wye H x H x H

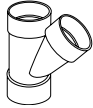

Dimension	mm	Product Code
1-1/2	40	526171
2	50	526172
2 x 1-1/2 x 1-1/2	50 x 40 x 40	526194
2 x 1-1/2	50 x 40	526195
3	75	526173
3 x 1-1/2	75 x 40	526201
3 x 2	75 x 50	526196
4	100	526174
4 x 2	100 x 50	526198
4 x 3	100 x 75	526197
6	150	526175
6 x 4	150 x 100	526199
8	200	526560
8 x 4	200 x 100	526606
8 x 6	200 x 150	526607
10	250	526706
10 x 4	250 x 100	526703
10 x 6	250 x 150	526704
10 x 8	250 x 200	526705
12	300	526711
12 x 4	300 x 100	526707
12 x 6	300 x 150	526708
12 x 8	300 x 200	526709
12 x 10	300 x 250	526710
14 x 4	350 x 100	526712
14 x 6	350 x 150	526713
16 x 4	400 x 100	526718
16 x 6	100 x 150	526719
18 x 4	450 x 100	526725
18 x 6	450 x 150	526726

45° Wye Sp x H x H



3	75	426635
3 x 1-1/2	75 x 40	426638

45° Wye Sp x Sp x Sp

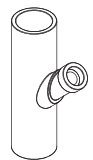

FOR USE WITH		
MJ GREY™		
8 x 4	200 x 100	526985
8 x 6	200 x 150	526986
10 x 4	250 x 100	526988
10 x 6	250 x 150	526989
12 x 4	300 x 100	526992
12 x 6	300 x 150	526993

Dimension	Product Code	
	inches	mm

45° Wye Sp x Sp x Sp

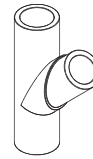

FOR USE WITH		
MJ GREY™		
8	200	526987
10 x 8	250 x 200	526990
10	250	526991
12 x 8	300 x 200	526994
12 x 10	300 x 250	526995
12	300	526996
14	350	526945
14 x 4	350 x 100	526940
14 x 6	350 x 150	526941
14 x 8	350 x 200	526942
14 x 10	350 x 250	526943
14 x 12	350 x 300	526944
16	400	526952
16 x 4	400 x 100	526946
16 x 6	400 x 150	526947
16 x 8	400 x 200	526948
16 x 10	400 x 250	526949
16 x 12	400 x 300	526950
16 x 14	400 x 350	526951
18	450	526960
18 x 4	450 x 100	526953
18 x 6	450 x 150	526954
18 x 8	450 x 200	526955
18 x 10	450 x 250	526956
18 x 12	450 x 300	529957
18 x 14	450 x 350	526958
18 x 16	450 x 400	526959

45° Double Wye Sp x Sp x H x H

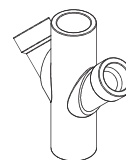

8 x 4	200 x 100	526769
8 x 6	200 x 150	526974
10 x 4	250 x 100	526976
10 x 6	250 x 150	526977
12 x 4	300 x 100	526980
12 x 6	300 x 150	526982

45° Double Wye Sp x Sp x Sp x Sp

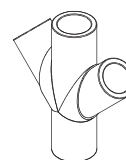

FOR USE WITH		
MJ GREY™		
8	200	526975
10	250	526979
10 x 8	250 x 200	526978
12 x 8	300 x 200	526983
12 x 10	300 x 250	526984

PRODUCT SELECTION CHART - SYSTEM XFR

Dimension	Product Code	
	inches	mm

Double 45° Wye H x H x H x H



Dimension	inches	mm	Product Code
1-1/2	40		526637
2	50		526456
2 x 1-1/2	50 x 40		526642
3	75		526639
3 x 1-1/2	75 x 40		526643
3 x 2	75 x 50		526644
4 x 3	100 x 75		526457
6	150		426752
8	200		426755
8 x 4	200 x 100		426753
8 x 6	200 x 150		526754
10	250		426759
10 x 4	250 x 100		426756
10 x 6	250 x 150		
10 x 8	250 x 200		426758
12	300		426764
12 x 4	300 x 100		426760
12 x 6	300 x 150		426761
12 x 8	300 x 200		426762
12 x 10	300 x 250		426763
14 x 4	350 x 100		526009
14 x 6	350 x 150		526005
16 x 4	400 x 100		526010
16 x 6	400 x 150		526772
18 x 4	450 x 100		526778
18 x 6	450 x 150		526779

Increaser Coupling H x H



Dimension	inches	mm	Product Code
2 x 1-1/2	50 x 40		526362
3 x 1-1/2	75 x 40		526363
3 x 2	75 x 50		526364
4 x 1-1/2	100 x 40		526369
4 x 2	100 x 50		526365
4 x 3	100 x 75		526366
5 x 3	125 x 75		526944
6 x 4	150 x 100		526860
8 x 4	200 x 100		526861
8 x 6	200 x 150		526867
10 x 4	250 x 100		526862
10 x 6	250 x 150		526868
10 x 8	250 x 200		526900
12 x 6	300 x 150		526869
12 x 8	300 x 200		526901
12 x 10	300 x 250		526907

Dimension	Product Code	
	inches	mm

Reducer Bushing Sp x H



Dimension	inches	mm	Product Code
2 x 1-1/2	50 x 40		526282
3 x 1-1/2	75 x 40		526292
3 x 2	75 x 50		526284
4 x 2	100 x 50		526288
4 x 3	100 x 75		526286
6 x 4	150 x 100		526054
8 x 4	200 x 100		526446
8 x 6	200 x 150		526447

Reducer Bushing (Extended) Sp x H

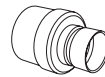

Dimension	inches	mm	Product Code
10 x 4	250 x 100		526296
10 x 6	250 x 150		526297
10 x 8	250 x 200		526962
12 x 4	300 x 100		526963
12 x 6	300 x 150		526964
12 x 8	300 x 200		526965
12 x 10	300 x 250		526966
14 x 10	350 x 250		526960
14 x 12	350 x 300		526913
16 x 12	400 x 300		526004
16 x 14	400 x 350		526927
18 x 14	450 x 350		526932
18 x 16	450 x 400		526933

Reducer Bushing (Extended) Sp x Sp

FOR USE WITH
MJ GREY™



Dimension	inches	mm	Product Code
10 x 8	250 x 200		526981
12 x 8	300 x 200		526767
12 x 10	300 x 250		526768
14 x 10	350 x 250		526934
14 x 12	350 x 300		526935
16 x 12	400 x 300		526936
16 x 14	400 x 350		526937
18 x 14	450 x 350		526938
18 x 16	450 x 400		526939

Male Adapter H x MPT



Dimension	inches	mm	Product Code
1-1/2	40		526331
2	50		526332
3	75		526333
4	100		526334

Female Adapter H x FPT



Dimension	inches	mm	Product Code
1-1/2	40		526341
2	50		526342
3	75		526343
4	100		526344

PRODUCT SELECTION CHART - SYSTEM XFR

	Dimension		Product Code
	inches	mm	

Coupling H x H

	1-1/2	40	526351
	2	50	526352
	3	75	526353
	4	100	526354
	6	150	526356
	8	200	526358
	10	250	526359
	12	300	526360
	14	350	526361
	16	400	526367
	18	450	526368

Plastic MJ Spigot MJ Sp x H

	2	50	526522
	3	75	526523
	4	100	526524

Adapts M-J Cast Iron Pipe to Plastic DWV Pipe

P Trap Solvent Weld H x H

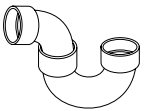
	1-1/2	40	526431
	2	50	526432
	3	75	526433
	4	100	526434

P Trap Solvent Weld with Cleanout H x H

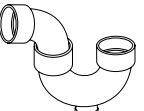
	1-1/2	40	526441
	2	50	526442

P Trap Union Connection H x H

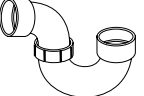
	1-1/2	40	526443
	2	50	526444

P Trap Union Connection with Cleanout H x H

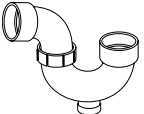
	1-1/2	40	526505
---	-------	----	--------

U Bend H x H

	4	100	526499
	6	150	426503

	Dimension		Product Code
	inches	mm	

Fitting Trap Adapter Sp x Slip Joint

	1-1/2	40	426304
	2	50	426305

Plastic Nut & Washer

Pipe Trap Adapter H x Slip Joint

	1-1/2	40	526321
	1-1/2 x 1-1/4	40 x 32	526329

Plastic Nut & Washer

90° Pipe Trap Adapter H x Slip Joint

	1-1/2 x 1-1/2	40 x 40	526330
---	---------------	---------	--------

Sanitary Tee Trap Adapter H x Slip Joint x H

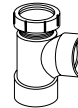
	1-1/2	40	426179
--	-------	----	--------

Copper to DWV Pipe Adapter H x Slip Joint

	1-1/2	40	426320
	1-1/2 x 1-1/4	40 x 32	426430
	2	50	426510

Tail Piece Adapter Sp x Slip Joint

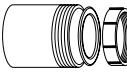
	1-1/2	40	526555
	1-1/2 x 1-1/4	40 x 32	526556

Plastic Nut & Washer

Swivel Strainer Adapter H x Swivel Nut

	1-1/2	40	426894
---	-------	----	--------

Water Line Guide

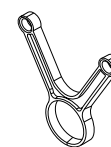
	1-1/2 x 1/2	40 x 12	526014
---	-------------	---------	--------

PRODUCT SELECTION CHART - SYSTEM XFR

Dimension	Dimension		Product Code
	inches	mm	

Clotet Flange	One Piece Plastic Slip		
	4	100	526573
	4 x 3	100 x 75	526584

Dimension	Dimension		Product Code
	inches	mm	

Adjustable Clotet Flange	w Plastic Ring Slip w Molded Test Plate		
	4 x 3	100 x 75	526588

Clotet Flange	One Piece Plastic Slip w Spigot End		
	4 x 3	100 x 75	526592

45° Discharge Clotet Flange	Adjustable w Plastic Ring		
	4 x 3	100 x 75	426589

Clotet Flange	One Piece Plastic Slip w Molded Test Plate		
	4 x 3	100 x 75	526591

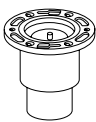
Clotet Flange Kit	for Concrete		
	4 x 3	100 x 75	426593
for use in Slab on Grade W.C. installations			

Clotet Flange	One Piece Plastic Slip Flush Kit		
	4 x 3	100 x 75	426594

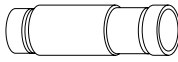
Expansion Joint - Type 1	(Vertical & Horizontal Use) H x H		
	1-1/2	40	526485
	2	50	526486
	3	75	526487
	4	100	526489
	6	150	426209
	8	200	426210
	10	250	426211
	12	300	426212

Clotet Flange	One Piece Plastic Slip Flush Kit w Molded Test Plate		
	4 x 3	100 x 75	526595

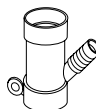
Dishwasher Wye	H x H x Hose Barb		
	1-1/2 x 1-1/2 x 1/2	40 x 40 x 12	526495
	1-1/2 x 1-1/2 x 3/4	40 x 40 x 20	526496

Adjustable Clotet Flange	with Plastic Ring Slip		
	4 x 3	100 x 75	526586

Slip Cap	H		
	1-1/2	40	526411
	2	50	526412
	3	75	526413
	4	100	526414
	6	150	526415
	8	200	526416
	10	250	526417
	12	300	526418

The Modern Age of DWV is here

Mechanical engineers and contractors are converting from metal piping to System XFR[®] and System I5[®]

SYSTEM XFR[®] DWV SYSTEM I5[®] DWV

PROVEN BENEFITS

IMPROVED FLOW – Larger inside diameter and smoother interior walls for more efficient waste removal

THERMAL PROPERTIES – Storm drains can often be used without insulation

LONGEVITY – Extremely durable, will not rust or corrode

JOINING METHODS – Solvent welding or MJ Grey™ mechanical joint coupling options

PLENUM/HIGH-RISE – System XFR[®] carries 25/50 Flame/Smoke requirements

LABOUR SAVINGS – Easy to handle, cut and assemble

ENVIRONMENTAL EFFECTS – Local manufacturing minimizes transport and reduces carbon footprint

SYSTEM XFR[®] DWV



Proven in noncombustible environments, the advanced material meets all Flame and Smoke code requirements.

SYSTEM I5[®] DWV



A cost-effective "workhorse" designed for low-rise, light commercial and underground applications.

DRAIN-GUARD DOUBLE CONTAINMENT

DRAIN-GUARD™ DWV

Drain-Guard™ double containment piping systems provide safe transport of sanitary or storm drainage in critical areas. Should a leak occur, people, equipment and valuable property will be protected from possible harm.

Drain-Guard provides the secure environment necessary for piping in vital areas of a wide variety of buildings, including hospitals, museums, historical sites, libraries, art galleries, theatres, data centres, restaurants, and arenas.

Drain-Guard is a double containment piping system using System 15 and or System XFR as its primary components. The many performance benefits of System 15 and System XFR are enhanced by this dual pipe concept.

THE PROBLEM

What would happen if there was a leak over a computer server room or a backup system causing significant loss of data? What if there was a drop of water on a rare renaissance oil painting? What if there was a plumbing leak above a new grand piano in a resident's condominium? Insurance may cover the costs associated with ceiling and property repairs, but it cannot recover valuable user data and priceless artifacts.

THE SOLUTION

A double containment piping system is an engineered solution to the above concerns.

ADVANTAGES

- 1 CERTIFICATION**
Drain-Guard pipe and fitting components are third party certified to CSA B181.2
- 2 RELIABLE JOINTS**
Double wall solvent weld joints set a new standard for joint-tightness in a DWV application.
- 3 LOWER CONDENSATION POTENTIAL**
The excellent insulative properties of System 15 and System XFR are enhanced with the secondary pipe and air barrier. Thus, condensation potential is greatly reduced.

APPLICATIONS

- Healthcare/Hospital Use
- Historical Sites • Museums & Libraries
- High-Tech & Data Storage Environments (Network & Server Rooms etc.)
- Theatres, Restaurants (Public Areas)
- Residential Buildings
- Laboratory Applications

STANDARDS

Meets the same requirements of System 15 and System XFR.

Primary Pipe





DID YOU KNOW?

Depending on your application, **DRAIN-GUARD** is a double containment piping system using System 15 and or System XFR as its primary components. Both of which have been used successfully in noncombustible buildings for many years. The performance benefits of System 15 and System XFR are enhanced by this dual pipe concept, including excellent thermal properties, improved flow, longevity and durability, and the security of meeting all code requirements for noncombustible buildings.

CODES & STANDARDS



FLAME & SMOKE

Drain-Guard is listed to the CAN/ULC S102.2 Standard with a Flame Spread Rating of not greater than 25 and a Smoke Developed Classification of not greater than 50.



CODE COMPLIANCE

Drain-Guard conforms to the following National Building Code of Canada requirements.

- High buildings as defined by NBC article 3.2.6
- Air plenums as defined by NBC article 3.6.4.3
- noncombustible construction as defined by NBC article 3.1.5



- Combustible construction as defined by Part 9

CERTIFICATION

Drain-Guard pipe and fitting components are third party certified to CSA B181.2



Secondary Pipe

Carrier (inches)	Containment (inches)
1-1/2	4
2	4
3	6
4	8
6	10
8	12

MJ GREY COUPLINGS

1-1/2" - 18" (38mm - 450mm)

MJ GREY™ DWV

IPEX is proud to announce the extension of our MJ Grey family of System 15 and System XFR DWV products to include mechanical couplings in sizes 1-1/2" through 18". The new couplings will have the familiar grey rubber lining to indicate their use for IPEX System 15 or System XFR only.

MJ Grey offers installers an alternative joining method for System 15 and System XFR in all sizes. In particular, MJ Grey may be advantageous for colder weather, minor offsets, difficult installation areas, repairs or tie-ins.

APPLICATIONS

Drain Waste and Vent Piping in:

- Commercial
- Industrial
- Residential
- Above ground or underground

STANDARDS



CSA B602
CAN/ULC S102.2

FEATURES

MJ Grey Size Range
1-1/2" - 6" 8" - 12" 14" - 18"

	1-1/2" - 6"	8" - 12"	14" - 18"
CSA B602	✓	✓	✓
Flame / Smoke of 25/50 as per ULC S012.2	✓	✓	✓
Pipe to Pipe Connections (DWV to DWV)*	✓	✓	✓
Spigot Fittings	4" & 6"	✓	✓
Cast Iron Adapters (Cast to DWV)	✓	-	-

* MJ Grey couplings are suitable only for use with System 15 and System XFR pipe and fittings



Test Results

Normal testing procedures for System 15 or System XFR may be employed if using MJ Grey couplings. Maximum water or air test pressure shall be 10 feet of head or 4.3 psi for all sizes.

Proper safety precautions and protective equipment should be employed during all testing procedures.

Component	Flame Spread Rating	Smoke-Developed Classification
MJ Grey™		
Couplings	≤ 25	≤ 50

i DID YOU KNOW?

MJ GREY – The MJ Grey coupling may be used to accommodate small changes in alignment up to 1.5° in any direction.

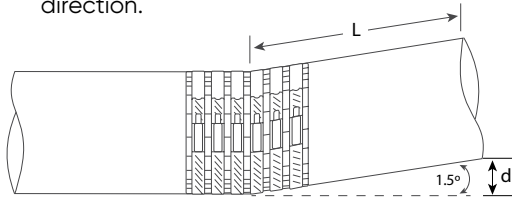

PRODUCT SELECTION CHART - MJ GREY

Dimension		# of Clamps	Product Code DWV to DWV	Product Code CI to DWV
inches	mm			

MJ Coupling H x H

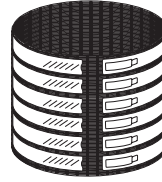

1-1/2	38	4	094056	094061
2	50	4	094057	094062
3	75	4	094058	094063
4	100	4	094059	094064
6	150	6	094060	094065
8	200	6	094053	-
10	250	6	094054	-
12	300	6	094055	-
14	350	8	094086	-
16	400	8	094087	-
18	450	8	094088	-

Description	Product Code
-------------	--------------

T-Handle Torque Wrench 80 in-lb

5/16" socket

094139

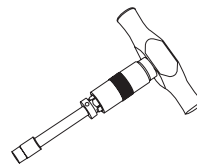

SHORT FORM SPECIFICATIONS

MJ GREY™ COUPLINGS

MJ Grey couplings are a mechanical joint assembly suitable only for use on IPEX System 15 or System XFR DWV piping. These couplings come in a range of sizes from 1-1/2" to 18" in diameter. They are designed specifically for PVC pipe and are Certified to CSA B602, as well as Listed to ULC 102.2, while exhibiting a Flame Smoke Rating of 25/50.

DRAINAGE SYSTEMS – CEMENTS & FIRE STOPPING PRODUCTS

LEED COMPLIANT, SYSTEM 15 & XFR SOLVENT CEMENT IPEX offers a variety of cements to ensure easy installation and a good joint every time. System 15 and XFR cements are formulated to the highest standards and manufactured with the strictest quality control. We also offer low VOC solvent cements that comply with LEED building standards.



SHORT FORM SPECIFICATIONS

SOLVENT CEMENTS

System 15 and System XFR cements shall be CSA-certified and meet the requirements of ASTM D2564. System 15 and System XFR One-Step cement may be used for sizes 1-1/2" to 6" (40mm to 150mm) only. For sizes 8" through 12", System 15 or System XFR Two-Step cement should be used along with System 15 / XFR Primer. For System 15 pipe 14" to 24" (350mm to 600mm), refer to Xirtec 19 cement. Proper solvent welding procedures must be followed at all times.

IPEX FIRE STOPPING PRODUCTS

Whatever the installation—concrete floor, concrete wall, Q-Deck, wood frame, drywall or core slab construction—IPEX offers a wide range of firestop products certified for use with System 15 and System XFR. These products include straps, collars and cast-in-place devices as well as caulks and sealants.



SHORT FORM SPECIFICATIONS

IPEX FIRESTOPPING DEVICES

System 15 or System XFR shall be firestopped at all penetrations of fire-rating floors and walls using devices or systems that are listed to ULC/CAN4 S115. Listings shall include the application of DWV, material specified as PVC, all required components and exact method of installation. All listings shall include testing done with a 50 Pa pressure differential.

PRODUCT SELECTION CHART - CEMENTS AND PRIMERS

	Volume		Product Code
	imperial	liters	

One-Step Heavy Bodied Cement medium setting

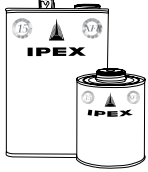

1 quart	.946	074232
1 gallon	3.785	074231

Low VOC

Estimated number of solvent-weld joints per quart of cement consumption using proper procedures.

Pipe Size		Number of Joints
inches	mm	
1-1/2	40	90
2	50	60
3	75	40
4	100	30
6	150	10
8	200	5
10	250	2 - 3
12	300	1 - 2
14	350	1 qt per joint
16	400	1-1/2 qt per joint
18	450	2 qt per joint

One-Step Medium Bodied Cement fast setting

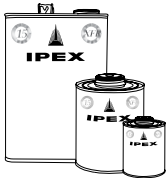

1 pint	.473	074098
1 quart	.946	074097
1 gallon	3.785	074096

Low VOC

DWV Two-Step Heavy Bodied Cement medium setting



1 quart	.946	074226
1 gallon	3.785	074225

Low VOC

DWV Primer

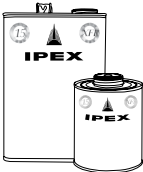

1 quart	.946	074354
1 gallon	3.785	074355

Low VOC

Note: One-Step cement suitable for maximum pipe diameter of 6" (150mm).
Two-Step step cement may be used on diameters, 8" - 12" (200mm - 300mm).

Reduced VOC emissions, meets required SCAQMD rule 1168/316A.

PRODUCT SELECTION CHART - FIRESTOP MATERIALS

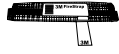
	Dimension		Product Code
	inches	mm	
Firestrap (2 hour rating)			
	1-1/2	40	075347
	2	50	075348
	3	75	075349

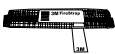
Fire Plug			
	1-1/2, 2	40, 50	075003
	3	75	075004

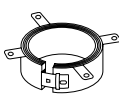
Ultra Plastic Pipe Devices (PPD)			
	1-1/2	40	075330
	2	50	075331
	3	75	075332
	4	100	075333
	6	150	075345

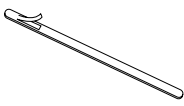
Ultra Fast Anchor Straps			
	16	400	075151
	Note: For use with above Ultra Plastic Pipe Devices		

Large Diameter Firestop			
	8	200	075039

Cast-in-Place Devices			
	1-1/2, 2	40, 50	075005
	3	75	075006
	4	100	075007

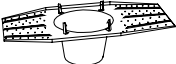
Metal Deck Adapter			
	1-1/2, 2	40, 50	075019
	3	75	075032
	4	100	075033

Height Adapter			
	1-1/2, 2	40, 50	075034
	3	75	075035
	4	100	075036

Description	Product Code
Wrap Strips and Collar	
	
FS195 2 feet x 2 inches	075339
Ultra GS Intumescent Wrap Strip 40 feet x 2 inches	075346
RC 1 Collar 25 feet x 4-3/4 inches	075340
Note: Stainless Steel hose clamps and fasteners are required but not supplied.	

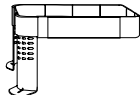
Tub Box Adapter		
	Fits All Sizes	075037

Firestop Caulking		
	IC 15WB+ (10 oz)	075220
	IC 15WB+ (20 oz)	075045

Sealant		
	FireDam 150+ (10 oz)	075153
	FireDam 150+ (20 oz)	075046

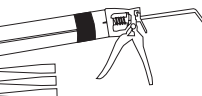
Applicators		
	Caulking Gun for 20 oz Tubes	075050
	Spare Nozzles	075051

Visit our website:

www.ipexna.com

for
ON-SITE TRAINING



Learn more about IPEX products through in-person and online training programs.



ON-SITE SYSTEM 636 FLUE GAS VENTING TRAINING

Do you or your organization require System 636 product installation and solvent welding training? Contact IPEX to discuss organizing a group training session or find out when courses are being held in your local area.

BACKWATER VALVES

1-1/2" - 4" (40mm - 100mm)

BACKWATER VALVES

TODAY'S BEST PROTECTION AGAINST SEWER BACKUPS

Any building connected to a sewer is subject to a possible sewer backup. An IPEX Backwater Valve can offer protection against this potential disaster. Available in both PVC and ABS lightweight, corrosion-resistant plastic, and are certified with CSA and IAPMO to B181.2 for PVC and to B181.1 for ABS.

HOW IT WORKS

The IPEX Backwater Valve will allow flow in only one direction. Effluent flowing out of the house pushes the flapper open and drains to the sewer. During backup conditions however, the flapper is pushed closed which creates a positive seal against backflow from progressing further up the pipeline.

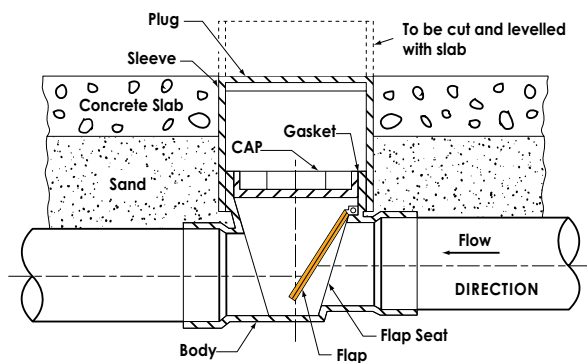

ADVANTAGES

- 1 Available in both PVC and ABS
- 2 Lightweight
- 3 Corrosion resistant
- 4 Smooth walls provide high flow capacity
- 5 Easy to install – hubs are sized to fit DWV or sewer pipe
- 6 Arrows clearly indicate the flow direction
- 7 Access chimneys and plugs are available to facilitate installation under concrete floor slabs
- 8 Approved by CSA and IAPMO

APPLICATIONS

- Back Flow Prevention (gravity flow only)

STANDARDS



i DID YOU KNOW?

IPEX recommends annual inspection of backwater valves to ensure no obstructions interfere with the sealing of the flapper.



PRODUCT SELECTION CHART

	Dimension		Product Code
	inches	mm	
Backwater Valve with Threaded Cap ABS DWV Hub			
without chimney	1-1/2	40	017009
Hub x Hub x Male Pipe Thread	2	50	017010

	Dimension		Product Code
	inches	mm	
Backwater Valve with Threaded Plug ABS DWV Hub			
without chimney	3	75	017011
Hub x Hub x Female Pipe Thread	4	100	017012

	Dimension		Product Code
	inches	mm	
Backwater Valve with Threaded Plug PVC DWV Hub			
without chimney	1-1/2	40	026045
Hub x Hub x Male Pipe Thread	2	50	026044
	3	75	017503
	4	100	017504

	Dimension		Product Code
	inches	mm	
Backwater Valve with Threaded Plug PVC Sewer Hub			
without chimney	4	100	040523
Hub x Hub x Male Pipe Thread			

	Dimension		Product Code
	inches	mm	
Backwater Valve with Threaded Plug ABS DWV Hub			
with chimney and spigot plug	3	75	017014
Hub x Hub x Female Pipe Thread	4	100	017013

	Dimension		Product Code
	inches	mm	
Backwater Valve with Threaded Plug PVC DWV Hub			
with chimney and spigot plug	3	75	017523
Hub x Hub x Male Pipe Thread	4	100	017524

	Dimension		Product Code
	inches	mm	
Backwater Valve with Threaded Plug PVC Sewer Hub			
with chimney and spigot plug	4	100	040524
Hub x Hub x Male Pipe Thread			

NOTE – Replacement caps, plugs, flappers and chimneys are available upon request.



Don't take chances with your Flue Gas Venting system installations



System 636® is available in PVC and CPVC.

System 636 product installation and solvent welding training is recommended every three (3) years

System 636® Flue Gas Venting provides a complete product offering to get the job done on-time and to the finished quality customers need.

Avoid uncertainty and go with the proven system solution – System 636 by IPEX.

- Unmatched quality
- Permanent solvent weld connections
- Rugged Schedule 40 thickness
- Installer training
- Leading distributors
- Technical support

Everything an installer needs for quality, safe vent installations.

System 636® – Ask for it by name

For Flue Gas Venting Applications



System 636®
FLUE GAS VENTING

IPEX offers complete certified systems of pipes, fittings and cements for gas venting. All with the quality, performance and support you've come to expect from IPEX.

Gas Venting



System 636 Flue Gas Venting

74

RadonX Soil Gas Venting

82



SYSTEM 636 FLUE GAS VENTING

PVC 1-1/2" - 6" (40mm - 150mm)
CPVC 1-1/2" - 8" (40mm - 200mm)

System 636®

The use of plastic venting systems on gas fired water heaters, furnaces and boilers has undergone a significant change. CSA B149.1 Natural Gas and Propane Installation Code now requires all special venting material to be certified to ULC S636 across Canada. IPEX addressed this market need with System 636, a fully certified flue gas vent system.

Since the inception of System 636, IPEX has made numerous product line additions and extensions to now offer the most complete product offering in the market. Also, System 636 is very professionally represented by IPEX with sales, technical, code issues and training support.

Front and centre to aid installers and inspectors is the System 636 Installation Guide. The contents of this guide are part of the certification process and contain many important aspects of installation to ensure successful, code-compliant installations. Issues addressed in the Guide include support spacing, expansion and contraction, solvent welding procedures and special installation and terminations.

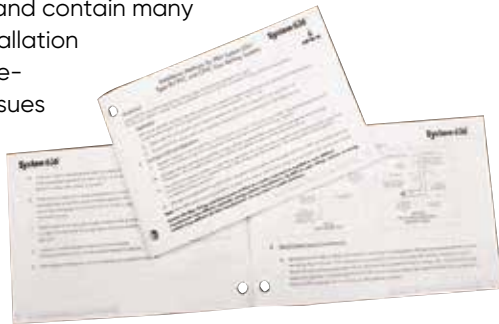

ADVANTAGES

- 1 Fully certified as a complete pipe, fittings and cement system.
- 2 2 system options cover a broad range of operating temperatures.
- 3 Manufactured and supported by the Canadian PVC & CPVC piping system experts.
- 4 No mixing clause of ULC S636 ensures full compatibility of all pipe, fittings and cement.

APPLICATIONS

- Flue Gas Venting
- Residential or Commercial

STANDARDS



CSA B149.1



ULC S636



Intertek
ULC S636



DID YOU KNOW?

To help fully understand the procedures for cementing PVC and CPVC System 636 versus traditional ABS material, IPEX offers an on-line System 636 solvent welding refresher course.



TWO CERTIFIED SOLUTIONS

SYSTEM 636 PVC

System 636 PVC is classified as Type BH Class II A vent, suitable for use on appliances with flue gas temperatures up to and including 65°C (149°F). Sizes include 40, 50, 65, 75 and 100mm (1-1/2", 2", 2- 1/2", 3", 4" and 6"). Coloured white with unique blue certification markings, System 636 PVC pipe is made to sturdy Sch. 40 dimensions to provide a strong, rigid pipe for the application. A full range of certified vent fittings and accessories offered.



SYSTEM 636 CPVC

System 636 CPVC is classified as Type BH Class II B vent, suitable for use on appliances with flue gas temperatures up to and including 90°C (194°F). CPVC sizes include 40, 50, 65, 75, 100, 150 and 200mm (1-1/2", 2", 2- 1/2", 3", 4", 6" and 8"). Coloured grey, System 636 CPVC pipe is also made to sturdy Sch. 40 dimensions to be tough enough for the application's demands.



SYSTEM 636 CEMENTS & PRIMERS



System 636 PVC & CPVC solvent cements are specifically formulated and certified for flue gas venting applications. Primer is always required for 6" and 8" (150 mm and 200 mm) piping systems and for all installations performed at temperatures of 0°C (32°F) or less.

System 636[®]
FLUE GAS VENTING

THREE CERTIFIED WAYS TO TERMINATE YOUR SYSTEM 636® FLUE GAS VENTING SYSTEM



UNIVERSAL CONCENTRIC VENT KITS (UCVK™)

The System 636 UCVK™ offers horizontal coaxial termination specifically for venting tank-less water heaters installed on an exterior wall. An engineered air intake hub, pivots to accommodate the spacing requirements between the fresh air, and exhaust collars for the majority of tankless water heaters offered on the market today. Designed utilizing the fundamentals of the Concentric Vent kits, the 2" and 3" UCVK is made to optimize productivity through ease of installation.

CONCENTRIC KITS (PVC & CPVC)

System 636 Concentric Kits, are available in a variety of lengths and come in 2", 3" and 4" diameters. These "pipe-in-pipe" kits allow for both exhaust and intake pipes to penetrate the roof or side wall through only one hole. The concentric vent kits are now certified with mechanically fastened rain caps. When installed with the included stainless steel screw/nut the rain cap can be easily removed for cleaning or replacement.



SIDE WALL KITS (PVC)

For a traditional vent style, IPEX's PVC Side Wall Vent Kits are available in convenient 2", 2-1/2" and 3" sizes. These PVC kits require only two small wall penetrations for intake and exhaust. Kits include a white finishing plate with a self sealing foam back that can be screwed to the exterior wall.

LOW PROFILE TERMINATION KITS (PVC)

The kits offer a lower profile alternative to the typical two pipe side wall termination kit. They include integrally molded vent screens, and the design neatly disguises both the intake and exhaust. Each kit is molded with a ULC S636 certified beige PVC compound.



VENT SCREENS

IPEX also offers 2", 3", 4", 6" and 8" vent screens to prevent debris and rodents from entering and plugging the venting system. These non-certified vent screens can be friction fit in any IPEX termination kit.

ROUND FACE PLATES

These round face plates are the perfect accessory for single wall penetrations like the Concentric Vent Kits, or in instances where two pipes are too far apart to use a two hole termination kit. The face plates help cover unsightly bore holes created during the pipe installation. They are available in both white and grey to match the certified vent pipe, and each plate includes a self sealing foam back.

PRODUCT SELECTION CHART - SYSTEM 636

Material	Dimension		Product Code
	inches	mm	
Gas Vent Pipe Plain End (10ft lengths)			
 PVC	1-1/2	40	194003
	2	50	194000
	2-1/2	65	194004
	3	75	194001
	4	100	194002
 CPVC	6	150	194011
	1-1/2	40	198003
	2	50	198001
	2-1/2	65	198004
	3	75	198000
CPVC LG DIA.	4	100	198002
	6	150	198005
	8	200	198006

Material	Dimension	Product Code
	H x H	
 PVC	2	196252

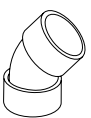
Material	Dimension	Product Code
	H x H	
 PVC	1-1/2	196241
	2	196242
	2-1/2	196487
	3	196243
	4	196244
CPVC	2	197169
	3	197171
	4	197172
CPVC LG DIA.	6	197173
	8	197174

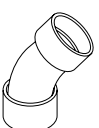
Material	Dimension	Product Code
	H x H	
 PVC	2	196010
	3	196011

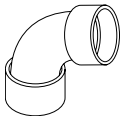
Material	Dimension	Product Code	
	H x Sp		
 PVC	2	196071	
	3	196223	
 PVC	2	196035	
	2-1/2	196525	
	3	196025	
	6	196140	
	CPVC	2	197199
		3	197201
		4	197202
	CPVC LG DIA.	6	197203
		8	197204

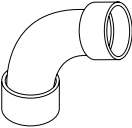
Material	Dimension	Product Code
	H x H	
 PVC	1-1/2	196121
	2	196122
	2-1/2	196120
	3	196123
CPVC	4	196124
	2	197122
	3	197123
	4	197124
CPVC LG DIA.	6	197125
	8	197126

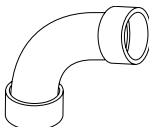
Material	Dimension	Product Code
	H x H	
 PVC	2	196022
	3	196023

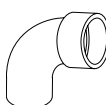
Material	Dimension	Product Code
	Sp x H	
 PVC	2	196232
	3	196233

PVC Note: For use with gas fired appliances producing flue gases 65°C (149°F) or less.
 CPVC Note: For use with gas fired appliances producing flue gases 90°C (194°F) or less.

PRODUCT SELECTION CHART - SYSTEM 636

Material	Dimension		Product Code
	inches	mm	

FGV Tee H x H x H

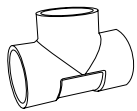

CPVC	2	50	197486
	3	75	197488
	4	100	197489
CPVC LG DIA.	6	150	197490
	8	200	197491

FGV Sanitary Tee H x H x H

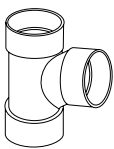

PVC	1-1/2	40	196081
	2	50	196082
	2-1/2	65	196781
	3	75	196083
	4	100	196084
	6	150	196785

FGV Reducer Tee H x H x H

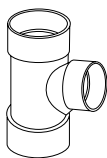

PVC	2 x 1-1/2	50 x 40	196056
	3 x 1-1/2	75 x 40	196061
	3 x 2	75 x 50	196822
	4 x 2	100 x 50	196828
CPVC	3 x 2	75 x 50	197502
	4 x 2	100 x 50	197504
CPVC LG DIA.	6 x 6 x 4	150 x 150 x 100	197506
	8 x 8 x 6	200 x 200 x 150	197567

FGV Access Tee H x H x FTP

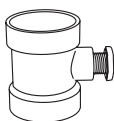

PVC	1-1/2	40	196510
	2	50	196511
	3	75	196512
	4	100	196513
CPVC	1-1/2	40	197510
	2	50	197511
	3	75	197512
	4	100	197513

Material	Dimension		Product Code
	inches	mm	

FGV Coupling H x H

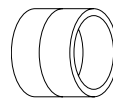

PVC	1-1/2	40	196452
	2	50	196352
	2-1/2	65	196454
	3	75	196353
	4	100	196354
	6	150	196142
CPVC	2	50	197026
	3	75	197027
	4	100	197023
CPVC LG DIA.	6	150	197141
	8	200	197142

FGV Deep Socket Coupling H x H

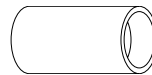

PVC	2	50	196453
	3	75	196455
CPVC	1-1/2	40	197136
	2	50	197137
	2-1/2	65	197138
	3	75	197139
	4	100	197140

FGV Increaser Coupling H x H

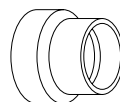

PVC	2 x 1-1/2	50 x 40	196362
	3 x 2	75 x 50	196364
	4 x 2	100 x 50	196365
	4 x 3	100 x 75	196366
CPVC	6 x 4	150 x 100	196367
	3 x 2	75 x 50	197470
	4 x 3	100 x 50	197472

FGV Appliance Adapter H x SP

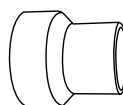

PVC	2-1/2 x 2	65 x 50	196302
-----	-----------	---------	--------

PRODUCT SELECTION CHART - SYSTEM 636

Material	Dimension		Product Code
	inches	mm	

FGV Reducer Bushing SP x H



PVC	1-1/2 x 1/2	40 x 15	196653
	2 x 1-1/2	50 x 40	196282
	2-1/2 x 1-1/2	65 x 40	196666
	2-1/2 x 2	65 x 50	196667
	3 x 2	75 x 50	196284
	3 x 2-1/2	75 x 65	196673

FGV Reducer Bushing Sp x Hose Barb

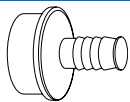

Material	Dimension inches	Dimension mm	Product Code
			PVC
CPVC	1-1/2 x 1/2	40 x 15	197278

FGV HEX Head Reducer Bushing Sp x H

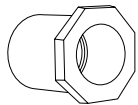

Material	Dimension inches	Dimension mm	Product Code
			PVC
CPVC	2 x 1/2	50 x 15	197385
	2 x 3/4	50 x 20	197386
	2 x 1-1/2	50 x 40	197389
	3 x 2	75 x 50	197394
	3 x 2-1/2	75 x 65	197395
	4 x 2	100 x 50	197396
CPVC LG DIA.	6 x 4	150 x 100	197400
	8 x 6	200 x 150	197401

FGV Female Thread Adapter H x FPT

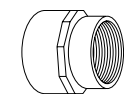

Material	Dimension inches	Dimension mm	Product Code
			PVC
CPVC	2	50	197224

FGV Condensate Drain Assembly Sp x FPT

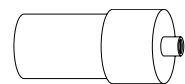

Material	Dimension inches	Dimension mm	Product Code
			CPVC
LG DIA.	6 x 1/2	150 x 15	197003

Material	Dimension		Product Code
	inches	mm	

FGV Universal Concentric Vent Kit (UCVK™)

Material	Dimension inches	Dimension mm	Product Code
			PVC
CPVC	3 x 24	75 x 600	197256

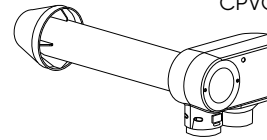

FGV Concentric Vent Kit



Material	Dimension inches	Dimension mm	Product Code
			PVC
	2 x 28	50 x 700	196105
	2 x 40	50 x 1000	196125
	3 x 20	75 x 500	196006
	3 x 32	75 x 800	196106
	3 x 44	75 x 1100	196116
	4 x 36	100 x 900	196021
CPVC	2 x 16	50 x 400	197040
	2 x 28	50 x 700	197033
	3 x 20	75 x 500	197009
	3 x 32	75 x 800	197107
	3 x 44	75 x 1100	197117
	4 x 36	100 x 900	197021

Vent Screen not included

FGV Wall Termination Kit

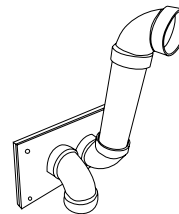

Material	Dimension inches	Dimension mm	Product Code			
			PVC	2	50	081216
				2-1/2	65	081218
	3	75	081219			

Vent Screen not included
Vent Screen not included

FGV Low Profile Termination Kit (Beige)

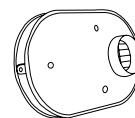

Material	Dimension inches	Dimension mm	Product Code			
			PVC	2	50	196984
				3	75	196985
	4	100	196986			

PRODUCT SELECTION CHART - SYSTEM 636

	Dimension		Product Code
	inches	mm	

Faceplate – Round (w/ self sealing foam back)

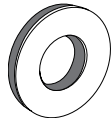

PVC	2	50	196063
		3	75
	4	100	196055
	2 grey	50	197053
	3 grey	75	197054
	4 grey	100	197055

grey matches CPVC

Faceplate – Rectangular (white w/ self sealing foam back)

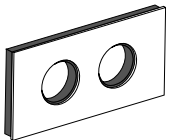

	2	50	196216
	2-1/2	65	196218
	3	75	196219

Termination Vent Screens

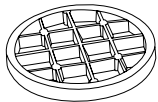

* 2	50	196050
* 3	75	196051
* 4	100	196052
† 6	150	196090
† 8	200	196091

Vent screens are not ULC S636 Certified.

Friction fit vent screens inside termination fitting bells to prevent debris & rodents from entering vent.

* Polyethylene † Stainless Steel

Deburring Tool (deb 4)

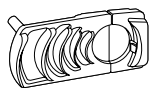

1-1/2 to 4 pipe	40 to 100 pipe	196246
-----------------	----------------	--------

To ensure quality solvent cement connections, deburr all pipe ends prior to cementing. For guidance on deburring 6" & 8" (150mm & 200mm) pipe, contact IPEX.

Cutter

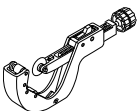

1-1/2 to 3	40 to 75	196247
------------	----------	--------

	Volume		Product Code
	imperial	litres	

PVC cement (LOW VOC)



1/4 pint	118	296366
1 pint	473	196040
1 quart	946	196041

CPVC cement (LOW VOC)



1 pint	473	196046
1 quart	946	196047

also certified for transitions to PVC

PVC / CPVC Primer (LOW VOC)

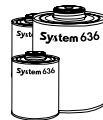

1/4 pint (purple)	118 (purple)	296367
1 pint (purple)	473 (purple)	196042
1 pint (clear)	473 (clear)	196017
1 quart (purple)	946 (purple)	196043

- Primer shall be used when installing System 636® PVC or CPVC products at temperatures below 0°C (32°F).
- Primer is always required on 6" & 8".
- Primer is required in some jurisdictions regardless of temperature, verify with your local Authority Having Jurisdiction.

Note: Use only System 636 cements and primers. Substituting other cements and primers will void certification and warranty.

All pint and quart cans supplied with dauber (applicator) for use up to 4".

Swab



gallon	3785	074456
--------	------	--------

For pipe diameters 6" and larger fits 074425 can.

PVC Note: For use with gas fired appliances producing flue gases 65°C (149°F) or less.

CPVC Note: For use with gas fired appliances producing flue gases 90°C (194°F) or less.



Protect yourself and your family with RadonX™ Soil Gas Venting

Radon gas is a colourless, odourless gas that occurs naturally from decaying uranium in the soil. Over time, it can seep into a home through cracks and openings in the foundation. If not adequately vented, it can build to concentrations that pose a serious health hazard.

RadonX™ Soil Gas Venting systems from IPEX is Canada's first PVC radon gas piping system. The product line consists of perforated gas collector and venting pipes, fittings, accessories and solvent cement.

Working together as an engineered system, RadonX™ safely collects and vents soil gas before it enters your home.

While it is easier and less expensive to install when a home is being built, it can also be installed retroactively in existing homes.

For more information please contact 1-866-473-9462 or visit ipexna.com

 According to Health Canada, Radon is the second leading cause of lung cancer after smoking. More than 3,000 people die from radon-induced lung cancer every year in Canada.*



*canada.ca/en/health-canada/services/health-risks-safety/radiation/radon/take-action-on-radon.html
RadonX™ and Peace of Mind from the Ground Up™ are trademarks used under license.

Peace of Mind from the Ground-Up™

RADONX SOIL GAS VENTING

PVC 4" (100mm)



Radon is a colourless, odourless gas that occurs naturally from the decay of uranium, a natural radioactive material found in all soil and rock. Radon gas can accumulate to dangerous levels inside a home and become a risk to human health causing lung cancer.



DID YOU KNOW?

Radon is the second leading cause of lung cancer after smoking. More than 3,000 people die from radon-induced lung cancer every year in Canada*.

Radon gas can enter the building through openings in contact with soil such as cracks in foundation walls, floor slabs and gaps around service pipes and floor sumps etc. The most common and effective radon gas reduction method is called sub-slab depressurization. This involves installing a perforated pipe through the foundation floor slab that draws the radon gas from below the home and a vent stack that releases it into the outdoors where it is quickly diluted.

RadonX™ is the first PVC piping solution that is specifically designed, tested and labeled to address the need for collecting and venting soil gas from the sub-slab area to help reduce indoor radon levels. Focusing on low-rise construction, RadonX is designed to maximize system integrity including compatible perforated and non-perforated pipes, fittings, cements and accessories.

Description	RadonX pipe & fittings
Nominal Size	4" / 100mm
Wall thickness	Schedule 40
Colour	Grey

RadonX Soil Gas Venting can help reduce humidity and Volatile Organic Compound (VOCs) levels in basements. Research** shows that soil gas depressurization systems can lower humidity levels and VOCs that originate from contaminated soils and groundwater and enter basements through cracks and openings similar to radon gas.

APPLICATIONS

- Soil Gas Venting
- Residential

STANDARDS

RadonX is tested to and complies with the following recognized standards:

Description	Standards	RadonX
Tolerances and dimensions	CSA B181.2; ASTM D2665	✓
All material and testing requirements	CSA B181.2; ASTM D2665	✓
Gas venting system performance tests		
-Gas leakage	ULC S636	✓
-Pull-out		
-Torque		
-Combustibility		
Solvent cement	ASTM D2564	✓
Product markings	CGSB/CAN 149.11; CGSB/CAN 149.12	✓



* Canada.ca/en/health-canada/services/health-risks-safety/radiation/radon/take-action-on-radon.html

** Exploratory Study of Basement Moisture During Operation of ASD Radon Control Systems, 2007 Assessment of Mitigation Systems on Vapor Intrusion: Temporal Trends, Attenuation Factors, and Contaminant Migration Routes under Mitigated And Non-mitigated Conditions, 2015

TESTED AND PROVEN

RadonX Soil Gas Venting has gone through various material and performance tests to ensure product quality and safety. Radon diffusion and radon gas venting performance tests have been conducted by third party testing facilities. Based on the test results, the RadonX PVC pipe material is suitable for venting soil gas containing radon with negligible risk of radon diffusing through the wall of the piping system. In addition, regardless of depressurization system type being active or passive, RadonX gas collection pipe buried within the gravel layer resulted in the highest airflow in the vent stack and the largest depressurization in the sub-slab area. This implies that more soil gas can be removed from below ground with the RadonX piping system.

ADVANTAGES

- 1 Low maintenance solution for soil gas, humidity and VOC reduction in low-rise construction.
- 2 Complete PVC piping system meeting standards and relevant building codes.
- 3 Products specifically designed and tested for soil gas venting application.
- 4 Improved airflow in the sub-slab area with RadonX gas collection pipe featuring smooth interior surface and unique perforation pattern.
- 5 Ease of identification with unique product features, markings and warning labels.
- 6 Roof and side wall termination options.
- 7 Ultra low VOC PVC solvent cement.



NOT LIKE ANY OTHER PIPING SYSTEMS FOUND IN LOW-RISE CONSTRUCTION



A.



B.



C.

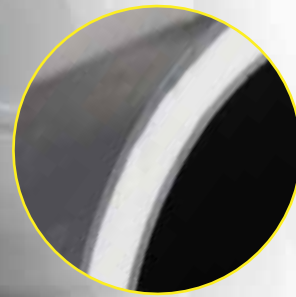

D.



E.



F.

A. Fitting warning labels are not only for ease of identification but encourage installers to use proper joining methods.

B. Pipe warning labels meet CAN/CGSB 149.11 and CAN/CGSB 149.12 guidelines.

C. Yellow print-lines are printed on both sides of the pipe (180 degree apart) that includes the material type, its intended application (below or above ground use) and conforming standards.

D. RadonX soil gas venting and collection pipes are grey in colour featuring interior and exterior layers and white in the centre layer.

E. New ultra low VOC PVC solvent cement is yellow in colour and includes an optical brightener as an additive that is visible under UV light for identification of the proper cement for the application.

F. Unique perforation features 6-row hole-drilling pattern.

TERMINATION OPTIONS

All RadonX soil gas vent stacks must terminate outdoors. Full passive stacks are routed vertically through the roof. In fan operated active type installations, the RadonX vent pipe can also be routed through a side wall as an alternative option.

1. ROOF TERMINATION:

The patent-pending rain cap developed by IPEX is a perfect solution to protect the vent stack from unwanted debris, rodents and rain while maintaining excellent airflow. The rain cap is attached to the vertical RadonX vent stack that penetrates the roof, whether it is a passive or an active system. 4" molded PVC rain cap with socket features three vent screens, which improve air movement and help reduce ice and snow build-up during winter months. The cap is mechanically fastened, allowing for quick removal and easy cleaning if required.

2. SIDE-WALL TERMINATION:

Sidewall terminations are only allowed in active soil depressurization systems and can be achieved by installing a 45° elbow and a 4" friction fit vent screen. Round faceplates are the perfect accessory for single wall penetrations. The faceplates include a self-sealing foam back to help cover unsightly bore holes created during the pipe installation. All RadonX™ pipe and fittings are supplied grey in colour; but can easily be painted to blend in with the exterior of the house.

Description	Termination Options Allowed
Full Passive Vertical Stack (without a fan)	Roof
Active Soil Gas Depressurization System (with a fan)	Sidewall or Roof



PRODUCT SELECTION CHART - RADONX

	Dimension		Product Code
	inches	mm	

Soil Gas Vent Pipe (Plain End x 10 ft)

	4	100	181004
---	---	-----	--------

Soil Gas Collection Pipe – Perforated (Plain End x 10 ft)

	4	100	181008
---	---	-----	--------

SGV Tee-Wye H x H x H

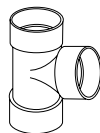
	4	100	286084
--	---	-----	--------

SGV 90° Elbow H x H

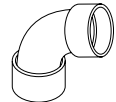
	4	100	286124
---	---	-----	--------

SGV 45° Elbow H x H

	4	100	286244
---	---	-----	--------

SGV 22-1/2° Elbow H x H

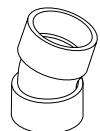
	4	100	286254
---	---	-----	--------

SGV Coupling H x H

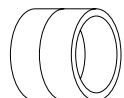
	4	100	286354
---	---	-----	--------

	Dimension		Product Code
	inches	mm	

SGV Cap H

	4	100	286414
---	---	-----	--------

SGV Rain Cap

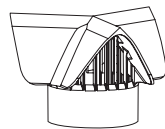
	4	100	286715
--	---	-----	--------

PE Termination Vent Screen

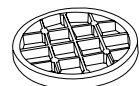
	4	100	196052
Friction fit inside fitting hub at termination to prevent debris & rodents from entering vent.			

Faceplate – Round (w/ self sealing foam back)

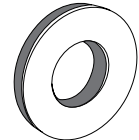
	4	100	197055
--	---	-----	--------

Deburring Tool (DEB 4)

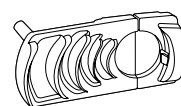
	1-1/2 - 4	40 - 100	196246
To ensure quality solvent weld connections, deburr all pipe ends prior to cementing.			

	Volume		Product Code
	imperial	metric	

SGV PVC Cement (Eco - Ultra Low Voc) Yellow

	quart	946ml	286041
--	-------	-------	--------

Approved for more applications than any other nonmetallic system on the market, IPEX BlazeMaster is the new industry standard in fire sprinkler systems.

Fire Protection



BlazeMaster Fire Sprinkler Systems

88

BLAZEMASTER FIRE SPRINKLER SYSTEMS

3/4" - 3" (20mm - 75mm)

BlazeMaster®

Specially formulated for fire sprinkler systems, IPEX BlazeMaster pipe and fittings are made from post-chlorinated polyvinyl chloride (CPVC) and is fully approved for use in NFPA 13 Light Hazard applications in both new and retrofit construction including:

- High buildings, including apartments and hotels
- Schools and institutions
- Single-family residences

Manufactured by IPEX, a world leader in thermoplastic piping systems, CPVC has a 40-year history of continuous and proven service.

With a high flash ignition temperature, low flame spread and smoke development ratings, and a fuel contribution of 0, IPEX BlazeMaster pipe and fittings are an ideal choice for fire sprinkler systems.

IPEX BlazeMaster pipe and fittings meet the most stringent requirements governing the use of combustible pipe in most building types. IPEX BlazeMaster pipe and fittings have been successfully exposed to flame temperatures of 1400°F. After undergoing continuous elevated pressure testing at 400 psi (more than twice the rated pressure) for more than one year, IPEX BlazeMaster CPVC systems showed no sign of weakness or failure.

IPEX BlazeMaster pipe and fittings are manufactured under a strict Quality Assurance Program that guarantees consistency and reliability.



APPLICATIONS

IPEX BlazeMaster Fire Sprinkler Systems offer a level of superior performance that exceeds your requirements:

- Fully approved for use in all NFPA 13 Light Hazard applications
- Field fabrication reduces design engineering
- Smooth inner surface allows pipe downsizing with superior hydraulics – Hazen-Williams “C” factor of 150
- Great in corrosive environments – immune to Microbiology Influenced Corrosion (MIC)
- Less impact on occupants during retrofits
- Design savings
- UL and ULC Listed for use in NFPA 13, 13R, and 13D Light Hazard applications including high buildings
- FM Approved, NSF certified, and permitted for use in air plenums per NFPA 90A

STANDARDS



LISTINGS AND APPROVALS

UL 1821 Listed

- Exposed system risers NFPA 13D, 13R
- Exposed basement NFPA 13D (solid wood joist)
- Extended coverage (exposed) – 20' spacing on pendent in lieu of 15'
- Exposed extended coverage sidewall sprinkler Listings for exposed pipe & fittings
 - 24' extended coverage sidewall sprinkler, 12" drop, 155°F sprinkler head
 - 18' extended coverage sidewall sprinkler, 12" drop, 165°F sprinkler head
 - 16' extended coverage sidewall sprinkler, 12" drop, 175°F sprinkler head
 - 14' standard coverage sidewall sprinkler, 12" drop, 200°F sprinkler head
- Permitted for use with return air plenums with no set-back at ceiling openings per NFPA 90A

ULC Listed

Factory Mutual Approved

- Factory Mutual Approval exposed
- Factory Mutual Approval above drop-in ceilings
- Factory Mutual Approval exposed w/ Soffi-Steel® soffit covering system

Listed to NSF Standard 61



DID YOU KNOW?

Properly selected and correctly installed, BlazeMaster pipe and fittings provide years of maintenance-free service.

ADVANTAGES

IPEX BlazeMaster® pipe and fittings are designed specifically for fire sprinkler systems. They are made from a specialty thermoplastic known chemically as post-chlorinated polyvinyl chloride (CPVC). IPEX BlazeMaster pipe and fittings provide unique advantages in sprinkler installations including superior hydraulics, ease of joining, increased hanger spacing in comparison to other thermoplastics and ease of assembly. They also are based on a technology with a continuous and proven service history of more than 40 years.

- 1 Lower Installation Costs**

In addition to a lower material cost, IPEX BlazeMaster pipe and fittings can significantly reduce labor and transportation costs on a typical installation. The reason? Plastics are easily handled, stored, cut and joined. And, heavy equipment used to install metallic and other piping systems is not required, thereby reducing project costs.
- 2 Extended Life**

The IPEX BlazeMaster System is fundamentally ageless and impervious to normal weather conditions. IPEX BlazeMaster Systems in uninterrupted service have operated successfully for over 20 years. During maintenance or revisions, examinations of the original plastic materials showed excellent physical and hydraulic characteristics. Once properly selected for the application and correctly installed, IPEX BlazeMaster provides years of maintenance-free service. Our materials will not rust, pit, scale or corrode on either interior or exterior surfaces.
- 3 Improved Flow**

IPEX piping has a substantially lower Roughness Factor than metal and other materials, and since IPEX BlazeMaster CPVC does not rust, pit, scale or corrode, the interior walls remain smooth in virtually any service. This high carrying capacity may result in the use of smaller diameter pipe.
- 4 Fire Performance**

IPEX BlazeMaster will not independently support combustion, and as such will not burn once the flame source is removed. CPVC's ignition resistance is demonstrated by its flash ignition temperature of 900°F. CPVC has a low Flame Spread Rating and provides excellent Smoke-Developed characteristics. In testing conducted to CAN/ULC S102.2, CPVC showed a flame spread of less than 15, and a smoke-developed classification of 15. And, like PVC, CPVC has a fuel contribution of 0. Extensive tests on PVC and CPVC compounds prove their outstanding fire performance. These materials meet the most stringent requirements governing the use of combustible pipe in most building types.

IPEX SST™ FITTING REVOLUTIONIZES SPRINKLER INSTALLATION

The new patent pending SST sprinkler head adapter (SHA) fittings improve how quickly, easily and reliably fire sprinkler heads are installed. Here's how...

A CROSS-THREADING REDUCED

Its one-of-a-kind stainless steel leading thread helps align sprinkler heads during installation, greatly reducing the chances of cross-threading.

B FRICTION AND INSTALLATION EFFORT IS REDUCED

Installers will benefit from the reduced level of installation friction between sprinkler heads and the new SST fitting when compared to typical brass SHA fittings. Less friction means less effort and reduced installation time.



IPEX SST™
SPRINKLER HEAD ADAPTER



PHYSICAL AND THERMAL PROPERTIES OF IPEX BLAZEMASTER CPVC

Property	CPVC	ASTM
Specific Gravity	1.53	D792
IZOD Impact Strength (ft. lbs./inch, notched)	3.0	D256A
Modulus of Elasticity @ 73°F, psi	4.23 x 10 ⁵	D638
Ultimate Tensile Strength, psi	8,000	D638
Compressive Strength, psi	9,600	D695
Poisson's Ratio	.35 - .38	-
Working Stress @ 73°F, psi	2,000	D1598
Hazen-Williams C Factor	150	-
Coefficient of Linear Expansion in./in.°F	3.4 x 10 ⁻⁵	D696
Thermal Conductivity BTU/hr./ft.2/°F/in	0.95	C177
Limiting Oxygen Index	60%	D2863
Electrical Conductivity	Non Conductor	

PRESSURE RATING

BlazeMaster pipe and fittings 3/4" – 3" are rated for continuous service of 175psi at 150°F.

PIPE DIMENSIONS & WEIGHTS

IPEX BlazeMaster pipe is produced in SDR 13.5 dimensions. SDR, or standard dimensional ratio, means the pipe wall thickness is directly proportional to the outside diameter. This results in all diameters carrying the same pressure capability. IPEX BlazeMaster pipe is produced to the specifications of ASTM F 442. IPEX BlazeMaster fittings are produced to ASTM F 437, F 438, or F 439 specifications depending on the size and configuration.

IPEX BLAZEMASTER PIPE DIMENSIONS & WEIGHTS SDR 13.5 (ASTM F 442)

Nominal Size		Average OD		Average ID		lb/ft	kg/m	lb/ft	kg/m
In	mm	In	mm	In	mm	Empty	Empty	H ₂ O Filled	H ₂ O Filled
3/4	19.05	1.050	26.67	.874	22.2	0.168	0.250	0.428	0.637
1	25.40	1.315	33.40	1.101	28.0	0.262	0.390	.0675	0.100
1-1/4	31.75	1.660	42.16	1.394	35.4	0.418	0.622	1.079	1.606
1-1/2	38.10	1.900	48.26	1.598	40.6	0.548	0.816	1.417	2.109
2	50.80	2.375	60.33	2.003	50.9	0.859	1.278	2.224	3.310
2-1/2	63.50	2.875	73.03	2.423	61.5	1.257	1.871	3.255	4.844
3	76.20	3.500	88.90	2.950	75.0	1.867	2.778	4.829	7.186

PRODUCT SELECTION CHART

Dimension	Dimension		Product Code
	inches	mm	

IPEX BlazeMaster CPVC Pipe



3/4	20	013401
1	25	013404
1-1/4	32	013406
1-1/2	40	013415
2	50	013411
2-1/2	65	013416
3	75	013417

Tee Soc x Soc x Soc

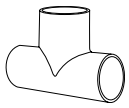

3/4	20	048486
1	25	048487
1-1/4	32	048488
1-1/2	40	048489
2	50	048490
2-1/2	65	048491
3	75	048492

90° Elbow Soc x Soc

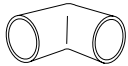

3/4	20	048431
1	25	048432
1-1/4	32	048433
1-1/2	40	048434
2	50	048435
2-1/2	65	048436
3	75	048437

45° Elbow Soc x Soc

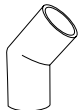

3/4	20	048420
1	25	048421
1-1/4	32	048422
1-1/2	40	048423
2	50	048424
2-1/2	65	048425
3	75	048426

Coupling Soc x Soc



3/4	20	048407
1	25	048408
1-1/4	32	048409
1-1/2	40	048410
2	50	048411
2-1/2	65	048412
3	75	048413

Dimension	Dimension		Product Code
	inches	mm	

Reducer Tee Soc x Soc x Soc

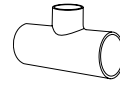

1 x 3/4 x 3/4	25 x 20 x 20	048497
1 x 3/4 x 1	25 x 20 x 25	048498
1 x 1 x 3/4	25 x 25 x 20	048495
1-1/4 x 1 x 3/4	32 x 25 x 20	048499
1-1/4 x 1 x 1	32 x 25 x 25	048506
1-1/4 x 1 x 1-1/4	32 x 25 x 32	048501
1-1/4 x 1-1/4 x 3/4	32 x 32 x 20	048502
1-1/4 x 1-1/4 x 1	32 x 32 x 25	048504
1-1/4 x 1-1/4 x 1-1/2	32 x 32 x 40	048505
1-1/2 x 1-1/4 x 3/4	40 x 32 x 20	048507
1-1/2 x 1-1/4 x 1	40 x 32 x 25	048508
1-1/2 x 1-1/2 x 3/4	40 x 40 x 20	048509
1-1/2 x 1-1/2 x 1	40 x 40 x 25	048510
1-1/2 x 1-1/2 x 1-1/4	40 x 40 x 32	048511
1-1/2 x 1-1/2 x 2	40 x 40 x 50	048512
2 x 2 x 3/4	50 x 50 x 20	048513
2 x 2 x 1	50 x 50 x 25	048514
2 x 2 x 1-1/2	50 x 50 x 40	048515
2-1/2 x 2-1/2 x 1	65 x 65 x 25	048530
2-1/2 x 2-1/2 x 1-1/4	65 x 65 x 32	048516
2-1/2 x 2-1/2 x 1-1/2	65 x 65 x 40	048531
3 x 3 x 2	75 x 75 x 50	048517
3 x 3 x 2-1/2	75 x 75 x 65	048518

Cap Soc



3/4	20	048400
1	25	048401
1-1/4	32	048402
1-1/2	40	048403
2	50	048404
2-1/2	65	048405
3	75	048406

Reducer Bushing Sp x Soc



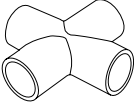

1 x 3/4	25 x 20	048459
1-1/4 x 3/4	32 x 20	048460
1-1/4 x 1	32 x 25	048461
1-1/2 x 3/4	40 x 20	048462
1-1/2 x 1	40 x 25	048463
1-1/2 x 1-1/4	40 x 32	048464
2 x 3/4	50 x 20	048465
2 x 1	50 x 25	048466
2 x 1-1/4	50 x 32	048467
2 x 1-1/2	50 x 40	048468
2-1/2 x 2	65 x 50	048469
3 x 2	75 x 50	048470
3 x 2-1/2	75 x 65	048471

PRODUCT SELECTION CHART

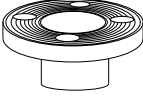
Cross	Dimension		Product Code
	inches	mm	
	Soc x Soc x Soc x Soc		
	3/4	20	048414
	1	25	048415
	1-1/4	32	048416
	1-1/2	40	048417
	2	50	048418
	2-1/2	65	048419

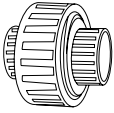
Flange	Soc	Dimension		Product Code
		inches	mm	
	3/4	20	048443	
	1	25	048444	
	1-1/4	32	048445	
	1-1/2	40	048446	
	2	50	048447	
	2-1/2	65	048448	
	3	75	048449	

Union	Soc x Soc	Dimension		Product Code
		inches	mm	
	3/4	20	048519	
	1	25	048520	
	1-1/4	32	048521	
	1-1/2	40	048522	
	2	50	048523	

Adapter Coupling	Soc x Groove	Dimension		Product Code
		inches	mm	
	1-1/4	32	048524	
	1-1/2	40	048540	
	2	50	048541	
	2-1/2	65	048542	
	3	75	048543	

Female Adapter	Soc x FPT	Dimension		Product Code
		inches	mm	
	3/4	20	048023	
	1	25	048024	
	1-1/4	32	048025	
	1-1/2	40	048036	
	2	50	048035	

Sprinkler Head Adapter Tee	Soc x Soc x FPT	Dimension		Product Code
		inches	mm	
	3/4 x 3/4 x 1/2	20 x 20 x 12	048010	
	1 x 1 x 1/2	25 x 25 x 12	048012	
	1 x 3/4 x 1/2	25 x 20 x 12	048011	
	1 x 1 x 1	25 x 25 x 25	048008	
	1-1/4 x 1 x 1/2	32 x 25 x 12	048013	
	1-1/4 x 1-1/4 x 1/2	32 x 32 x 12	048014	
	1-1/2 x 1-1/4 x 1/2	40 x 32 x 12	048015	
	1-1/2 x 1-1/2 x 1/2	40 x 40 x 12	048016	
	2 x 1-1/2 x 1/2	50 x 40 x 12	048017	
	2 x 2 x 1/2	50 x 50 x 12	048018	

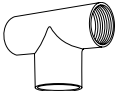
Sprinkler Head Adapter Tee	FPT x FPT x Soc	Dimension		Product Code
		inches	mm	
	1/2 x 1/2 x 1	12 x 12 x 25	048062	

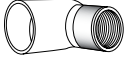
Sprinkler Head Adapter 90° Elbow	Soc x FPT	Dimension		Product Code
		inches	mm	
	3/4 x 1/2	20 x 12	048019	
	1 x 1/2	25 x 12	048020	
	1 x 3/4	25 x 20	048021	
	1-1/4 x 1/2	32 x 12	048022	

Sprinkler Head Adapter	Soc x FPT	Dimension		Product Code
		inches	mm	
	3/4 x 1/2	20 x 12	048026	
	1 x 1/2	25 x 12	048527	
	1 x 3/4	25 x 20	048028	

Sprinkler Head Adapter	Sp x FPT	Dimension		Product Code
		inches	mm	
	3/4 x 1/2	20 x 12	048029	
	1 x 1/2	25 x 12	048030	

PRODUCT SELECTION CHART

Volume		Product Code
imperial	ml	

One-Step Cement 3/4" - 3" (20mm - 75mm)



1 pint	473	074328
1 quart	946	074329

Note: BlazeMaster cement is LOW VOC

Cement Consumption Chart

Pipe and Fittings		Number of Joints per 946 ml (quart)
inches	mm	
3/4	20	200
1	25	125
1-1/4	32	100
1-1/2	40	90
2	50	60
2-1/2	65	50
3	75	40

Size		Product Code
------	--	--------------

Cement Brush

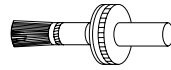

1" - 2"	for 3/4" - 3" pipe	074428
---------	--------------------	--------

Cement Daubers

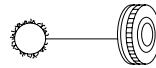

3/4" - 1-1/4"	for 3/4" - 1-1/4" pipe	074420
1-1/2" - 3"	for 1-1/2" - 3" pipe	074421

Visit our website: www.ipexna.com

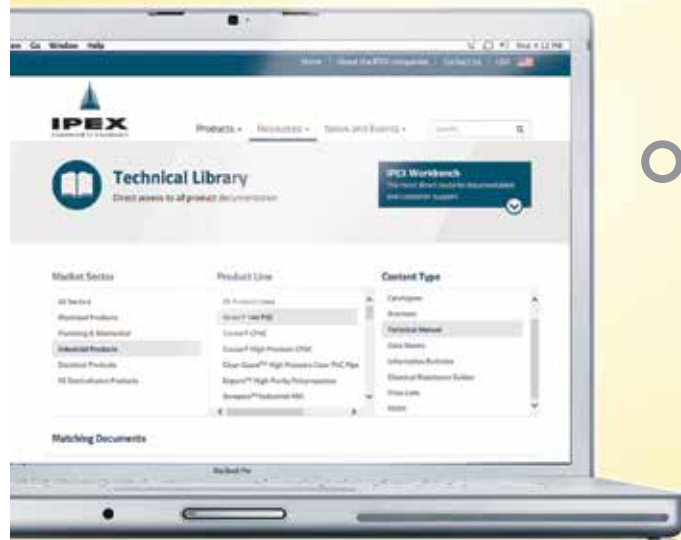

PRODUCT INFO

TECHNICAL DOCUMENTS

ON-SITE TRAINING

& MUCH MORE ...

DOWNLOAD

OUR MECHANICAL SYSTEMS TECHNICAL MANUALS

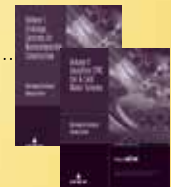

IPEX Industrial CADonDemand Center



REGISTER TO GAIN
ACCESS TO:

- Complete dimensions of Schedule 40 and Schedule 80, Xirtec PVC and CPVC fittings
- 2D & 3D CAD drawing formats available

Register at www.ipexna.com

Xirtec® PVC and CPVC pipe, valves and fittings are quality manufactured for easy integration into high-performance systems that deliver exceptional chemical resistance, high carrying capacity, low thermal conductivity and extended life – both above and below ground.

Xirtec PVC & CPVC



Vinyl Process Piping Systems

96

XIRTEC PVC & CPVC

PVC Sch 40 - 1/2" - 24" (12mm - 600mm)
PVC Sch 80 - 1/2" - 24" (12mm - 600mm)
CPVC Sch 40 & 80 - 1/2" - 16" (12mm - 400mm)

Xirtec® PVC Xirtec® CPVC

THE IPEX SYSTEM ADVANTAGE

Introducing IPEX vinyl process piping systems – A complete line of pipe, fittings, flanges, strainers and valves to meet all your process system requirements.

IPEX manufactures the Xirtec® PVC and Xirtec® CPVC systems to meet industry demands for a complete Pipe, Valves and Fittings (PVF) package that is designed, produced and backed by a single manufacturer. These systems are engineered and manufactured to IPEX's strict quality, performance and dimensional standards, and therefore eliminate compatibility concerns associated with mixed brands of pipe and fittings.

IPEX high-performance vinyl systems are designed to meet the temperature, pressure and flow requirements of piping systems used in chemical processes and other industrial applications. They feature outstanding resistance to corrosion, and are exceptionally suited for use with a wide range of acids, alcohols, salts and halogens. The perfect extended service, low maintenance alternative to common and exotic metal systems.

Xirtec PVC pipe and fittings and Xirtec CPVC pipe are available in Schedule 40 and 80 thicknesses. Xirtec CPVC fittings are also available in Schedule 80 thicknesses.

DESIGNED, MANUFACTURED AND BACKED BY IPEX

Our total systems approach means you can be confident that all the material you need is designed, manufactured and backed by the same company. One source to stand behind you and your complete system.

APPLICATIONS

- Plant chemical distribution lines
- Water and wastewater treatment
- Acid systems for refineries, pickling lines and plating shops
- Chlorine injection, chlorine dioxide and chloralkali plant piping
- Steel wire plants
- Battery manufacturing
- Bleach lines in textile and paper mills
- Alum and caustic handling systems
- Circuit board manufacturing
- Semiconductor
- Pharmaceutical
- Cooling water and cooling tower systems
- Tailing and slurry lines
- Washwater recovery systems
- Plant water supply
- Brine and seawater systems
- Fish farming
- Waterworks
- Aquariums and swimming pools
- Irrigation systems in golf courses, greenhouses, etc.

STANDARDS

XIRTEC PVC



ASTM D1785



CSA B137.3



NSF 14

XIRTEC CPVC



ASTM F441

ADVANTAGES

- 1 Lower Installation Costs, Easy Handling**

In addition to a lower material cost, Xirtec pipe can significantly reduce labor and transportation costs on a typical installation. The reason? They are lightweight, easily handled, stored, cut and joined.
- 2 Extended Life**

Xirtec PVC and CPVC are fundamentally ageless and impervious to normal weather conditions. These piping components in uninterrupted service and in a variety of demanding industrial applications have operated successfully for over 40 years.
- 3 Superior Underground Performance**

Xirtec PVC and CPVC are immune to deterioration from naturally corrosive soil conditions as well as electrochemical and galvanic corrosion. This is particularly advantageous in underground installations where galvanic reaction often causes damage to metal piping products.
- 4 Exceptional Chemical Resistance**

The IPEX vinyl systems, including pipe, valves and fittings, provide outstanding resistance to a wide range of chemicals such as most acids, alcohols, alkalis, salt solutions, halogens and more.
- 5 Improved Flow**

Xirtec has a substantially lower Roughness Factor than metal and other materials, and since it does not rust, pit, scale or corrode, the interior walls remain smooth in virtually any service.
- 6 Potable Water Approved**

Xirtec PVC (polyvinyl chloride) and Xirtec CPVC (chlorinated polyvinyl chloride) are suitable for use with potable water as listed with NSF International and CSA.
- 7 Broad Temperature Range**

IPEX vinyl systems are designed to meet a broad range of service temperatures. Xirtec PVC has a recommended maximum service temperature of 140°F (60°C) in pressure, with intermittent flow capability of 180°F (82°C) for drainage. Xirtec CPVC has a maximum service temperature of 200°F (93°C).
- 8 Lower Thermal Conductivity**

With a low thermal conductivity factor, IPEX vinyl systems have less heat loss or gain, thus sustaining service temperature more efficiently than metal piping. As a result, pipe insulation is often not required.
- 9 Environmentally Responsible**

With energy conservation a prime concern, you can rely on the fact that IPEX's manufacturing process for Xirtec piping materials require less than half the energy needed to produce the equivalent size of carbon steel or steel alloy materials.



DID YOU KNOW?

One of the outstanding characteristics of PVC is its resistance to ignition. This is demonstrated by its flash point of 730°F (388°C), compared to 400°F (204°C) for woodchips.

CPVC offers an even greater fire safety profile than PVC. CPVC's ignition resistance is demonstrated by its flash point of 900°F (482°C), with a low flame spread as well.

XIRTEC PIPE PRESSURE RATINGS

Sizes		IPEX Schedule 40 PVC / CPVC			IPEX Schedule 80 PVC / CPVC		
Diameter (in.)	O.D. (in.)	Wall Thickness (in.)	I.D. (in.)	*Max. Pressure 73°F (psi)	Wall Thickness (in.)	I.D. (in.)	*Max. Pressure 73°F (psi)
1/4	.540	–	–	–	.119	.302	1,130
3/8	.675	–	–	–	.126	.423	920
1/2	.840	.109	.602	600	.147	.526	850
3/4	1.050	.113	.804	480	.154	.722	690
1	1.315	.133	1.029	450	.179	.936	630
1-1/4	1.660	.141	1.360	370	.191	1.255	520
1-1/2	1.900	.145	1.590	330	.200	1.476	470
2	2.375	.154	2.047	280	.218	1.913	400
2-1/2	2.875	.203	2.445	300	.276	2.290	420
3	3.500	.216	3.042	260	.300	2.864	370
4	4.500	.237	3.998	220	.337	3.786	320
6	6.625	.280	6.031	180	.432	5.709	280
8	8.625	.322	7.941	160	.500	7.565	250
10	10.750	.365	9.976	140	.593	9.493	230
12	12.750	.406	11.888	130	.687	11.294	230
14	14.000	.438	13.072	130	.750	12.412	220
16	16.000	.500	14.936	130	.843	14.224	220
18	18.000	.562	16.809	130	.937	16.014	220
20	20.000	.593	18.743	120	1.031	17.814	220
24	24.000	.687	22.544	120	1.218	21.418	210

PRODUCT SELECTION CHART

XIRTEC PRESSURE PIPE

Dimension		PVC Sch 40 White Plain End	PVC Sch 40 Grey Solvent Bell End	PVC Sch 80 Grey Plain End	PVC Sch 80 Grey Solvent Bell End	CPVC Sch 40 Plain End	CPVC Sch 80 Plain End
inches	mm	Product Code	Product Code	Product Code	Product Code	Product Code	Product Code
1/2 x 10'	12 x 3m	022600	022004	-	-	-	-
3/4 x 10'	20 x 3m	022633	022011	-	-	-	-
1 x 10'	25 x 3m	022612	022016	-	-	-	-
1-1/4 x 10'	32 x 3m	022608	022027	-	-	-	-
1-1/2 x 10'	40 x 3m	022614	022032	-	-	-	-
2 x 10'	50 x 3m	022618	022037	-	-	-	-
2-1/2 x 10'	65 x 3m	022621	022042	-	-	-	-
3 x 10'	75 x 3m	022637	022046	-	-	-	-
1/4 x 20'	6 x 6m	-	-	085103	-	-	019100
3/8 x 20'	10 x 6m	-	-	085104	-	019300	019203
1/2 x 20'	12 x 6m	-	-	085101	-	-	-
3/4 x 20'	20 x 6m	-	-	085107	-	019301	019205
1 x 20'	25 x 6m	-	-	085110	-	019302	019207
1-1/4 x 20'	32 x 6m	-	-	085117	-	019303	019209
1-1/2 x 20'	40 x 6m	-	-	085115	085127	019304	019211
2 x 20'	50 x 6m	-	-	085120	085132	019305	019213
2-1/2 x 20'	65 x 6m	-	-	085125	085134	019306	019216
3" x 20'	75 x 6m	-	-	085130	085137	019307	019217
4 x 20'	100 x 6m	-	022040	085140	085139	019308	019219
6 x 20'	150 x 6m	-	022060	085160	085162	019309	019220
8 x 20'	200 x 6m	-	022058	085180	085147	019310	019221
10 x 20'	250 x 6m	-	022061	085190	085192	019013	019222
12 x 20'	300 x 6m	-	022064	085195	085151	019016	019223
14 x 20'	350 x 6m	-	022066	085158	085152	019227	019228
16 x 20'	400 x 6m	-	022068	085153	085155	019226	019229
18 x 20'	450 x 6m	-	022069	085159	085156	-	-
20 x 20'	500 x 6m	-	022072	085170	085170	-	-
24 x 20'	600 x 6m	-	022073	085171	085171	-	-

LEGEND

FOR XIRTEC PVC SCHEDULE 40 WHITE

† Fabricated fittings

■ Molded fittings: 150 psi max. working pressure, non-shock @ 73°F (23°C)

FOR XIRTEC PVC SCHEDULE 40 GREY

† Indicates fabricated and fiberglass reinforced pipe fittings

■ Indicates Series 160 Fabricated and Fiberglass reinforced pipe fittings. The maximum continuous working pressure of fittings is 160 psi @ 73°F (23°C) under ideal conditions. no provisions have been made for pressure surges, water hammer, or other conditions which should be considered.

PRODUCT SELECTION CHART - XIRTEC PVC SCH. 40 WHITE & SCH. 40 GREY FITTINGS

Dimension		Sch 40 White	Sch 40 Grey
inches	mm	Product Code	Product Code

Dimension		Sch 40 White	Sch 40 Grey
inches	mm	Product Code	Product Code

Tee Soc x Soc x Soc

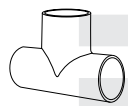

1/2	12	035775	035290
3/4	20	035776	035291
1	25	035777	035292
1-1/4	32	035778	035293
1-1/2	40	035779	035294
2	50	035780	035295
2-1/2	65	035781	035296
3	75	035782	035297
4	100	035783	035298
5	125	035784	035299
6	150	035785	035300
8	200	035786	035301
10	250	035930 ■	-
12	300	035931 ■	-
10	250	- †	035302 †
12	300	035787 †	035303 †
14	350	035788 †	035304 †
16	400	- †	- †
18	450	- †	- ▶
20	500	- †	- ▶
24	600	- †	- ▶

Reducing Tee Soc x Soc x Soc

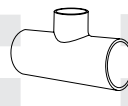

1/2 x 1/2 x 3/4	12 x 12 x 20	035789	-
1/2 x 1/2 x 1	12 x 12 x 25	035354	-
3/4 x 1/2 x 1/2	20 x 12 x 12	035790	-
3/4 x 1/2 x 3/4	20 x 12 x 20	235007	-
3/4 x 3/4 x 1/2	20 x 20 x 12	035792	035305
3/4 x 3/4 x 1	20 x 20 x 25	035791	-
1 x 1/2 x 1	25 x 12 x 25	235008	-
1 x 3/4 x 1/2	25 x 20 x 12	235009	-
1 x 3/4 x 3/4	25 x 20 x 20	035994	-
1 x 3/4 x 1	25 x 20 x 25	035962	-
1 x 1 x 1/2	25 x 25 x 12	035794	035307
1 x 1 x 3/4	25 x 25 x 20	035795	035308
1 x 1 x 1-1/4	25 x 25 x 32	035989	-
1 x 1 x 1-1/2	25 x 25 x 40	035793	-
1-1/4 x 1 x 1/2	32 x 25 x 12	235010	-
1-1/4 x 1 x 3/4	32 x 25 x 20	035796	-
1-1/4 x 1 x 1	32 x 25 x 25	235011	-
1-1/4 x 1-1/4 x 1/2	32 x 32 x 12	035797	035311
1-1/4 x 1-1/4 x 3/4	32 x 32 x 20	035798	035312
1-1/4 x 1-1/4 x 1	32 x 32 x 25	035799	035313
1-1/4 x 1-1/4 x 1-1/2	32 x 32 x 40	235012	-
1-1/2 x 1-1/4 x 1/2	40 x 32 x 12	235014	-
1-1/2 x 1-1/4 x 3/4	40 x 32 x 20	235015	-
1-1/2 x 1-1/4 x 1	40 x 32 x 25	035959	-
1-1/2 x 1-1/2 x 1/2	40 x 40 x 12	035800	035315
1-1/2 x 1-1/2 x 3/4	40 x 40 x 20	035801	035316
1-1/2 x 1-1/2 x 1	40 x 40 x 25	035802	035317
1-1/2 x 1-1/2 x 1-1/4	40 x 40 x 32	035803	035318
1-1/2 x 1-1/2 x 2	40 x 40 x 50	035082	-
1-1/2 x 1-1/2 x 2-1/2	40 x 40 x 65	235016	-
2 x 1-1/2 x 3/4	50 x 40 x 20	235017	-
2 x 1-1/2 x 1	50 x 40 x 25	035804	-
2 x 1-1/2 x 1-1/2	50 x 40 x 40	035805	-
2 x 2 x 1/2	50 x 50 x 12	035806	035319
2 x 2 x 3/4	50 x 50 x 20	035807	035320
2 x 2 x 1	50 x 50 x 25	035808	035321
2 x 2 x 1-1/4	50 x 50 x 32	035809	-
2 x 2 x 1-1/2	50 x 50 x 40	035810	035322
2-1/2 x 2-1/2 x 1/2	65 x 65 x 12	035811	-
2-1/2 x 2-1/2 x 3/4	65 x 65 x 20	035812	-
2-1/2 x 2-1/2 x 1	65 x 65 x 25	035813	-
2-1/2 x 2-1/2 x 1-1/4	65 x 65 x 32	035814	-
2-1/2 x 2-1/2 x 1-1/2	65 x 65 x 40	035815	-
2-1/2 x 2-1/2 x 2	65 x 65 x 50	035816	-
3 x 3 x 1/2	75 x 75 x 12	035817	-
3 x 3 x 3/4	75 x 75 x 20	035818	-
3 x 3 x 1	75 x 75 x 25	035819	035326
3 x 3 x 1-1/4	75 x 75 x 32	035820	-
3 x 3 x 1-1/2	75 x 75 x 40	035821	035327
3 x 3 x 2	75 x 75 x 50	035822	035328
3 x 3 x 2-1/2	75 x 75 x 65	035823	035329
3 x 3 x 4	75 x 75 x 100	235018	-

Tee Soc x Soc x FPT

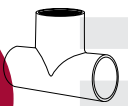

1/2	12	035851	-
3/4	20	035852	-
1	25	035853	-
1-1/4	32	035854	-
1-1/2	40	035855	-
2	50	035856	-
2-1/2	65	035857	-
3	75	035858	-
4	100	035859	-
3/4 x 3/4 x 1/2	20 x 20 x 12	-	035348
1 x 1 x 1/2	25 x 25 x 12	-	-
1 x 1 x 3/4	25 x 25 x 20	-	035349
1-1/4 x 1-1/4 x 1/2	32 x 32 x 12	-	035350
1-1/4 x 1-1/4 x 3/4	32 x 32 x 20	-	035977
1-1/4 x 1-1/4 x 1	32 x 32 x 25	-	-
1-1/2 x 1-1/2 x 1/2	40 x 40 x 12	-	035351
1-1/2 x 1-1/2 x 3/4	40 x 40 x 20	-	035352
1-1/2 x 1-1/2 x 1	40 x 40 x 25	-	035353
2 x 2 x 3/4	50 x 50 x 20	-	035355
2 x 2 x 1	50 x 50 x 25	-	035356
2 x 2 x 1-1/2	50 x 50 x 40	-	-

Tee FPT x FPT x FPT

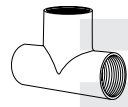

1/2	12	035844	-
3/4	20	035845	-
1	25	035846	-
1-1/4	32	035847	-
1-1/2	40	035848	-
2	50	035849	-

■, †, ▶ See page 75 for descriptions

PRODUCT SELECTION CHART - XIRTEC PVC SCH. 40 WHITE & SCH. 40 GREY FITTINGS

Dimension		Sch 40 White	Sch 40 Grey
inches	mm	Product Code	Product Code

Dimension		Sch 40 White	Sch 40 Grey
inches	mm	Product Code	Product Code

Reducing Tee Soc x Soc x Soc (cont'd)

Reducing Tee Soc x Soc x FPT

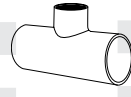
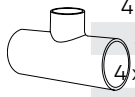

4 x 4 x 3/4	100 x 100 x 20	035824	-
4 x 4 x 1	100 x 100 x 25	035825	-
4 x 4 x 1-1/4	100 x 100 x 32	035826	-
4 x 4 x 1-1/2	100 x 100 x 40	035827	-
4 x 4 x 2	100 x 100 x 50	035828	035331
4 x 4 x 3	100 x 100 x 75	035829	035332
5 x 5 x 2	125 x 125 x 50	035956	-
5 x 5 x 3	125 x 125 x 75	035830	-
5 x 5 x 4	125 x 125 x 100	035831	-
6 x 6 x 2	150 x 150 x 50	035832	-
6 x 6 x 3	150 x 150 x 75	035833	035334
6 x 6 x 4	150 x 150 x 100	035834	035335
8 x 8 x 3	200 x 200 x 75	035835	- †
8 x 8 x 4	200 x 200 x 100	035836	035336 †
8 x 8 x 6	200 x 200 x 150	035837	035337 †
10 x 10 x 4	250 x 250 x 100	035971 †	035339
10 x 10 x 6	250 x 250 x 150	035838 †	035340
10 x 10 x 8	250 x 250 x 200	035839 †	035341
12 x 12 x 4	300 x 300 x 100	- †	035342
12 x 12 x 6	300 x 300 x 150	035840 †	035343
12 x 12 x 8	300 x 300 x 200	035949 †	035344
12 x 12 x 10	300 x 300 x 250	- †	035345
14 x 14 x 6	350 x 350 x 150	035841 †	-
14 x 14 x 8	350 x 350 x 200	035961 †	-
14 x 14 x 10	350 x 350 x 250	035842 †	-
14 x 14 x 12	350 x 350 x 300	- †	- †
16 x 16 x 8	400 x 400 x 200	- †	- †
16 x 16 x 10	400 x 400 x 250	035843 †	- †
16 x 16 x 12	400 x 400 x 300	- †	- †
16 x 16 x 14	400 x 400 x 350	- †	- †
18 x 18 x 8	450 x 450 x 200	- †	- ▶
18 x 18 x 10	450 x 450 x 250	- †	- ▶
18 x 18 x 12	450 x 450 x 300	- †	- ▶
18 x 18 x 14	450 x 450 x 350	- †	- ▶
18 x 18 x 16	450 x 450 x 400	- †	- ▶
20 x 20 x 12	500 x 500 x 300	- †	- ▶
20 x 20 x 14	500 x 500 x 350	- †	- ▶
20 x 20 x 16	500 x 500 x 400	- †	- ▶
20 x 20 x 18	500 x 500 x 450	- †	- ▶
24 x 24 x 14	600 x 600 x 350	- †	- ▶
24 x 24 x 16	600 x 600 x 400	- †	- ▶
24 x 24 x 18	600 x 600 x 450	- †	- ▶
24 x 24 x 20	600 x 600 x 500	- †	- ▶

1/2 x 1/2 x 3/4	12 x 12 x 20	035860	-
3/4 x 1/2 x 1/2	20 x 12 x 12	035862	-
3/4 x 1/2 x 3/4	20 x 12 x 20	235019	-
3/4 x 3/4 x 1/2	20 x 20 x 12	035863	-
1 x 3/4 x 1/2	25 x 20 x 12	035867	-
1 x 1 x 1/2	25 x 25 x 12	035865	-
1 x 1 x 3/4	25 x 25 x 20	035866	-
1-1/4 x 1 x 1/2	32 x 25 x 12	035868	-
1-1/4 x 1 x 1	32 x 25 x 25	235020	-
1-1/4 x 1-1/4 x 1/2	32 x 32 x 12	035869	-
1-1/4 x 1-1/4 x 3/4	32 x 32 x 20	035870	-
1-1/4 x 1-1/4 x 1	32 x 32 x 25	035871	-
1-1/2 x 1-1/4 x 1/2	40 x 32 x 12	235021	-
1-1/2 x 1-1/4 x 3/4	40 x 32 x 20	035872	-
1-1/2 x 1-1/4 x 1	40 x 32 x 25	235022	-
1-1/2 x 1-1/2 x 1/2	40 x 40 x 12	035873	-
1-1/2 x 1-1/2 x 3/4	40 x 40 x 20	035874	-
1-1/2 x 1-1/2 x 1	40 x 40 x 25	035875	-
1-1/2 x 1-1/2 x 1-1/4	40 x 40 x 32	035876	-
2 x 1-1/2 x 3/4	50 x 40 x 20	235023	-
2 x 1-1/2 x 1	50 x 40 x 25	235024	-
2 x 2 x 1/2	50 x 50 x 12	035877	-
2 x 2 x 3/4	50 x 50 x 20	035878	-
2 x 2 x 1	50 x 50 x 25	035879	-
2 x 2 x 1-1/4	50 x 50 x 32	035880	-
2 x 2 x 1-1/2	50 x 50 x 40	035881	-
2-1/2 x 2-1/2 x 1/2	65 x 65 x 12	235025	-
2-1/2 x 2-1/2 x 3/4	65 x 65 x 20	035592	-
2-1/2 x 2-1/2 x 1	65 x 65 x 25	035882	-
2-1/2 x 2-1/2 x 1-1/4	65 x 65 x 32	035883	-
2-1/2 x 2-1/2 x 1-1/2	65 x 65 x 40	035884	-
3 x 3 x 1/2	75 x 75 x 12	035885	-
3 x 3 x 3/4	75 x 75 x 20	035886	-
3 x 3 x 1	75 x 75 x 25	035887	-
3 x 3 x 1-1/4	75 x 75 x 32	035888	-
3 x 3 x 1-1/2	75 x 75 x 40	035889	-
3 x 3 x 2	75 x 75 x 50	035890	-
4 x 4 x 1	100 x 100 x 25	035891	-
4 x 4 x 1-1/2	100 x 100 x 40	035893	-
4 x 4 x 2	100 x 100 x 50	035894	-
4 x 4 x 3	100 x 100 x 75	035895	-
5 x 5 x 4	125 x 125 x 100	235026	-
6 x 6 x 2	150 x 150 x 50	035896	-
6 x 6 x 3	150 x 150 x 75	235027	-
6 x 6 x 4	150 x 150 x 100	035897	-
8 x 8 x 3	200 x 200 x 75	235028	-
8 x 8 x 4	200 x 200 x 100	035898	-

†, ▶ See page 75 for descriptions

PRODUCT SELECTION CHART - XIRTEC PVC SCH. 40 WHITE & SCH. 40 GREY FITTINGS

Dimension		Sch 40 White	Sch 40 Grey
inches	mm	Product Code	Product Code

90° Elbow Soc x Soc



Dimension (inches)	Dimension (mm)	Sch 40 White Product Code	Sch 40 Grey Product Code
3/8	9	-	035108
1/2	12	035519	035109
3/4	20	035520	035110
1	25	035521	035111
1-1/4	32	035522	035112
1-1/2	40	035523	035113
2	50	035524	035114
2-1/2	65	035525	035115
3	75	035526	035116
4	100	035527	035117
5	125	035528	035118
6	150	035529	035119
8	200	035530	035120
10	250	035928 ■	-
12	300	035929 ■	-
10	250	035531 †	035121 †
12	300	035532 †	035122 †
14	350	035533 †	035123 †
16	400	035534 †	035124 †
18	450	- †	- ▶
20	500	- †	- ▶
24	600	- †	- ▶

90° Elbow Soc x FPT



Dimension (inches)	Dimension (mm)	Sch 40 White Product Code	Sch 40 Grey Product Code
1/2	12	035506	035101
3/4	20	035507	035102
1	25	035508	035103
1-1/4	32	035509	035104
1-1/2	40	035510	035105
2	50	035511	035106
2-1/2	65	035512	-
3	75	035589	-
4	100	035513	-

90° Elbow FPT x FPT

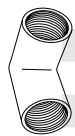

Dimension (inches)	Dimension (mm)	Sch 40 White Product Code	Sch 40 Grey Product Code
1/2	12	035538	035125
3/4	20	035539	035126
1	25	035540	035127
1-1/4	32	035541	-
1-1/2	40	035542	-
2	50	035543	-

90° Street Elbow MPT x Soc

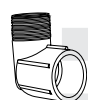

Dimension (inches)	Dimension (mm)	Sch 40 White Product Code	Sch 40 Grey Product Code
1/2	12	035500	-
3/4	20	035501	-
1	25	035502	-
1-1/4	32	035503	-
1-1/2	40	035504	-
2	50	035505	-

Dimension		Sch 40 White	Sch 40 Grey
inches	mm	Product Code	Product Code

90° Street Elbow Spig x Soc



Dimension (inches)	Dimension (mm)	Sch 40 White Product Code	Sch 40 Grey Product Code
1/2	12	035544	-
3/4	20	035545	-
1	25	035546	035128
1-1/4	32	035547	-
1-1/2	40	035548	035129
2	50	035549	-

90° Street Elbow MPT x FPT



Dimension (inches)	Dimension (mm)	Sch 40 White Product Code	Sch 40 Grey Product Code
1/2	12	035552	035132
3/4	20	035553	035133
1	25	035554	035134
1-1/4	32	035555	-
1-1/2	40	035556	035135
2	50	035557	-

90° Reducing Elbow Soc x Soc



Dimension (inches)	Dimension (mm)	Sch 40 White Product Code	Sch 40 Grey Product Code
3/4 x 1/2	20 x 12	035535	-
1 x 1/2	25 x 12	035536	-
1 x 3/4	25 x 20	035978	-
1-1/4 x 1/2	32 x 12	235029	-
1-1/4 x 3/4	32 x 20	235030	-
1-1/4 x 1	32 x 25	035991	-
1-1/2 x 1/2	40 x 12	235031	-
1-1/2 x 1	40 x 25	235032	-
2 x 1-1/2	50 x 40	035537	-

90° Reducing Elbow Soc x FPT



Dimension (inches)	Dimension (mm)	Sch 40 White Product Code	Sch 40 Grey Product Code
1/2 x 3/4	12 x 20	035514	-
3/4 x 1/2	20 x 12	035515	-
1 x 1/2	25 x 12	035516	-
1 x 3/4	25 x 20	035517	-
1-1/4 x 1	32 x 25	051007	-
1-1/2 x 1	40 x 25	035594	-
2 x 1-1/2	50 x 40	035518	-

Side Outlet Elbow Soc x Soc x Soc

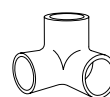

Dimension (inches)	Dimension (mm)	Sch 40 White Product Code	Sch 40 Grey Product Code
1/2	12	035498	-

Side Outlet Elbow Soc x Soc x FPT



Dimension (inches)	Dimension (mm)	Sch 40 White Product Code	Sch 40 Grey Product Code
1/2	12	235033	-
3/4	20	235034	-
3/4 x 3/4 x 1/2	20 x 20 x 12	235035	-
1 x 1 x 1/2	25 x 25 x 12	235036	-

■, †, ▶ See page 75 for descriptions

PRODUCT SELECTION CHART - XIRTEC PVC SCH. 40 WHITE & SCH. 40 GREY FITTINGS

Dimension		Sch 40 White	Sch 40 Grey
inches	mm	Product Code	Product Code

45° Elbow Soc x Soc



Dimension (inches)	Dimension (mm)	Sch 40 White Product Code	Sch 40 Grey Product Code
1/2	12	035481	035083
3/4	20	035482	035084
1	25	035483	035085
1-1/4	32	035484	035086
1-1/2	40	035485	035087
2	50	035486	035088
2-1/2	65	035487	035089
3	75	035488	035090
4	100	035489	035091
5	125	035490	035092
6	150	035491	035093
8	200	035492	035094
10	250	035926 ■	-
12	300	035927 ■	-
10	250	035493 †	035095 †
12	300	035494 †	035096 †
14	350	- †	035097 †
16	400	035495 †	035098 †
18	450	- †	- ▶
20	500	035496 †	- ▶
24	600	035497 †	- ▶

90° Radius Bends - 6D Sp x Sp



Dimension (inches)	Dimension (mm)	Sch 40 White Product Code	Sch 40 Grey Product Code
1/2	12	- †	035932 †
3/4	20	035396 †	035009 †
1	25	035397 †	035010 †
1-1/4	32	035398 †	035011 †
1-1/2	40	035399 †	035012 †
2	50	035400 †	035013 †
2-1/2	65	035401 †	035957 †
3	75	035402 †	035014 †
4	100	035403 †	035015 †
6	150	035404 †	035016 †
8	200	- †	n/a †
10	250	- †	n/a †
12	300	- †	- †

45° Radius Bends - 6D Sp x Sp



Dimension (inches)	Dimension (mm)	Sch 40 White Product Code	Sch 40 Grey Product Code
1/2	12	- †	- †
3/4	20	035391 †	- †
1	25	- †	- †
1-1/4	32	- †	- †
1-1/2	40	035392 †	035004 †
2	50	035939 †	035005 †
2-1/2	65	- †	- †
3	75	035393 †	035006 †
4	100	035394 †	035007 †
6	150	035395 †	035008 †
8	200	- †	- †
10	250	- †	- †
12	300	- †	- †

Dimension		Sch 40 White	Sch 40 Grey
inches	mm	Product Code	Product Code

22-1/2° Radius Bends - 6D Sp x Sp



Dimension (inches)	Dimension (mm)	Sch 40 White Product Code	Sch 40 Grey Product Code
1/2	12	n/a †	- †
3/4	20	n/a †	035000 †
1	25	035383 †	- †
1-1/4	32	035384 †	- †
1-1/2	40	035385 †	035970 †
2	50	035386 †	035001 †
2-1/2	65	035387 †	- †
3	75	035388 †	035002 †
4	100	035389 †	035003 †
6	150	035390 †	- †
8	200	- †	- †
10	250	- †	057502 †
12	300	- †	- †

Hose Adapter Insert x IPS Soc

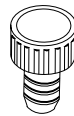

Dimension (inches)	Dimension (mm)	Sch 40 White Product Code	Sch 40 Grey Product Code
1/2	12	035596	-
3/4	20	035597	-
1	25	035598	-
1-1/4	32	035599	-
1-1/2	40	035600	-
2	50	035601	-
3	75	235037	-
4	100	235038	-

Hose Adapter Insert x MPT

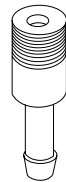

Dimension (inches)	Dimension (mm)	Sch 40 White Product Code	Sch 40 Grey Product Code
1/2	12	-	035157
3/4	20	-	035158
1	25	-	035159
1-1/4	32	-	035160
1-1/2	40	-	035161
2	50	-	035162
2-1/2	65	-	035163
3	75	-	035164
4	100	-	035165

ASTM D2609 - Plastic Insert fitting for polyethylene

■, †, ▶ See page 75 for descriptions

PRODUCT SELECTION CHART - XIRTEC PVC SCH. 40 WHITE & SCH. 40 GREY FITTINGS

Dimension		Sch 40 White	Sch 40 Grey
inches	mm	Product Code	Product Code

Dimension		Sch 40 White	Sch 40 Grey
inches	mm	Product Code	Product Code

Cross Soc x Soc x Soc x Soc

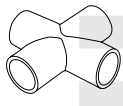

Dimension (inches)	Dimension (mm)	Sch 40 White Product Code	Sch 40 Grey Product Code
1/2	12	035469	035068
3/4	20	035470	035069
1	25	035471	035070
1-1/4	32	035472	035071
1-1/2	40	035473	035072
2	50	035474	035073
2-1/2	65	035475	035074
3	75	035476	035075
4	100	035477	035076
6	150	035478 †	035077 †
8	200	- †	- †
10	250	- †	- †
12	300	- †	- †
14	350	- †	- †
16	400	- †	- †
18	450	- †	- †
20	500	- †	- †
24	600	- †	- †

Coupling Soc x Soc



Dimension (inches)	Dimension (mm)	Sch 40 White Product Code	Sch 40 Grey Product Code
3/8	9	035447	-
1/2	12	035448	035052
3/4	20	035449	035053
1	25	035450	035054
1-1/4	32	035451	035055
1-1/2	40	035452	035056
2	50	035453	035057
2-1/2	65	035454	035058
3	75	035455	035059
4	100	035456	035060
5	125	035457	035061
6	150	035458	035062
8	200	035459	035063
10	250	035460 †	035064 †
12	300	035461 †	035065 †
14	350	035462 †	035066 †
16	400	035463 †	035067 †
18	450	- †	035933 †
20	500	035464 †	- †
24	600	035465 †	- †

Reducing Cross Soc x Soc x Soc x Soc

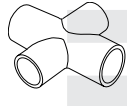

Dimension (inches)	Dimension (mm)	Sch 40 White Product Code	Sch 40 Grey Product Code
8 x 4	200 x 100	- †	-
8 x 6	200 x 150	- †	-
10 x 6	250 x 150	- †	-
10 x 8	250 x 200	- †	-
12 x 8	300 x 200	- †	-
12 x 10	300 x 250	- †	-
14 x 10	350 x 250	- †	-
14 x 12	350 x 300	- †	-
16 x 12	400 x 300	- †	-
16 x 14	400 x 350	- †	-
18 x 14	450 x 350	- †	-
18 x 16	450 x 400	- †	-
20 x 16	500 x 400	- †	-
20 x 18	500 x 450	- †	-
24 x 18	600 x 450	- †	-
24 x 20	600 x 500	- †	-

Female Adapter Soc x FPT



Dimension (inches)	Dimension (mm)	Sch 40 White Product Code	Sch 40 Grey Product Code
1/2	12	035559	035136
3/4	20	035560	035137
1	25	035561	035138
1-1/4	32	035562	035139
1-1/2	40	035563	035140
2	50	035564	035141
2-1/2	65	035565	035142
3	75	035566	035143
4	100	035567	035144
5	125	035568	035145
6	150	035569	035146
8	200	035570	-

Female Adapter Spig x FPT

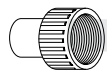

Dimension (inches)	Dimension (mm)	Sch 40 White Product Code	Sch 40 Grey Product Code
1/2	12	-	035148
3/4	20	-	035149
1	25	-	035150
1-1/4	32	-	035151
1-1/2	40	-	035152
2	50	-	035153
3	75	-	035155
4	100	-	035156

Coupling FPT x FPT



Dimension (inches)	Dimension (mm)	Sch 40 White Product Code	Sch 40 Grey Product Code
1/2	12	035466	-
3/4	20	035467	-
1	25	035468	-

Reducing Coupling Soc x Soc



Dimension (inches)	Dimension (mm)	Sch 40 White Product Code	Sch 40 Grey Product Code
3/4 x 1/2	20 x 12	035759	-
1 x 3/4	25 x 20	035760	-
1-1/4 x 1	32 x 25	035761	-
1-1/2 x 1-1/4	40 x 32	035762	-
2 x 1-1/2	50 x 40	035764	-
4 x 3	100 x 75	035765	-

Reducing Female Adapter Soc x FPT

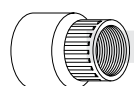

Dimension (inches)	Dimension (mm)	Sch 40 White Product Code	Sch 40 Grey Product Code
1/2 x 1/4	12 x 6	035571	-
1/2 x 3/8	12 x 9	035951	-
1/2 x 3/4	12 x 20	035572	-
3/4 x 1/2	20 x 12	035992	-
3/4 x 1	20 x 25	035990	-
1 x 3/4	25 x 20	035958	-

†, † See page 75 for descriptions

PRODUCT SELECTION CHART - XIRTEC PVC SCH. 40 WHITE & SCH. 40 GREY FITTINGS

Dimension		Sch 40 White	Sch 40 Grey
inches	mm	Product Code	Product Code

Concentric Coupling Soc x Soc

	8 x 3	200 x 75	035437	†	-	†
	8 x 4	200 x 100	035438	†	035042	†
	8 x 6	200 x 150	035439	†	035043	†
	10 x 4	250 x 100	035440	†	035044	†
	10 x 6	250 x 150	035441	†	035045	†
	10 x 8	250 x 200	035442	†	035046	†
	12 x 4	300 x 100	-	†	-	†
	12 x 6	300 x 150	035443	†	035047	†
	12 x 8	300 x 200	035444	†	035048	†
	12 x 10	300 x 250	-	†	035049	†
	14 x 6	350 x 150	-	†	-	†
	14 x 8	350 x 200	035445	†	-	†
	14 x 10	350 x 250	-	†	-	†
	14 x 12	350 x 300	-	†	-	†
	16 x 8	400 x 200	035446	†	-	†
	16 x 10	400 x 250	-	†	-	†
	16 x 12	400 x 300	-	†	035051	†
	16 x 14	400 x 350	-	†	-	†
	18 x 8	450 x 200	-	†	-	▶
	18 x 10	450 x 250	-	†	-	▶
	18 x 12	450 x 300	-	†	-	▶
	18 x 14	450 x 350	-	†	-	▶
	18 x 16	450 x 400	-	†	-	▶
	20 x 12	500 x 300	-	†	-	▶
	20 x 14	500 x 350	-	†	-	▶
	20 x 16	500 x 400	-	†	-	▶
	20 x 18	500 x 450	-	†	-	▶
	24 x 14	600 x 350	-	†	-	▶
	24 x 16	600 x 400	035436	†	-	▶
	24 x 18	600 x 450	-	†	-	▶
	24 x 20	600 x 500	-	†	-	▶

Male Adapter Soc x MPT

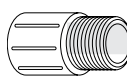
	3/8	9	035934	-
	1/2	12	035602	-
	3/4	20	035603	-
	1	25	035604	-
	1-1/4	32	035605	-
	1-1/2	40	035606	-
	2	50	035607	-
	2-1/2	65	035608	-
	3	75	035609	-
	4	100	035610	-
	5	125	035611	-
	6	150	035612	-
	8	200	035613	-

IPS to PIP Adapter Spig x Soc

	6	150	235045	-
	8	200	235046	-

Dimension		Sch 40 White	Sch 40 Grey
inches	mm	Product Code	Product Code

Eccentric Coupling Soc x Soc

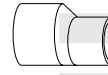
	8 x 4	200 x 100	-	†	035078	†
	8 x 6	200x150	-	†	035079	†
	10 x 4	250 x 100	035479	†	-	†
	10 x 6	250 x 150	-	†	035080	†
	10 x 8	250 x 200	-	†	035081	†
	12 x 4	300 x 100	-	†	-	†
	12 x 6	300 x 150	035480	†	-	†
	12 x 8	300 x 200	-	†	-	†
	12 x 10	300 x 250	-	†	-	†
	14 x 6	350 x 150	-	†	-	†
	14 x 8	350 x 200	-	†	-	†
	14 x 10	350 x 250	-	†	-	†
	14 x 12	350 x 300	-	†	-	†
	16 x 8	400 x 200	-	†	-	†
	16 x 10	400 x 250	-	†	-	†
	16 x 12	400 x 300	-	†	-	†
	16 x 14	400 x 350	-	†	-	†
	18 x 8	450 x 200	-	†	-	▶
	18 x 10	450 x 250	-	†	-	▶
	18 x 12	450 x 300	-	†	-	▶
	18 x 14	450 x 350	-	†	-	▶
	18 x 16	450 x 400	-	†	-	▶
	20 x 12	500 x 300	-	†	-	▶
	20 x 14	500 x 350	-	†	-	▶
	20 x 16	500 x 400	-	†	-	▶
	20 x 18	500 x 450	-	†	-	▶
	24 x 14	600 x 350	-	†	-	▶
	24 x 16	600 x 400	-	†	-	▶
	24 x 18	600 x 450	-	†	-	▶
	24 x 20	600 x 500	-	†	-	▶

Reducing Male Adapter MPT x Soc

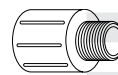
	1/2	12	-	035167
	1/2 x 3/4	12 x 20	035614	-
	3/4	20	-	035168
	3/4 x 1/2	20 x 12	035615	-
	3/4 x 1	20 x 25	035616	-
	1	25	-	035169
	1 x 3/4	25 x 20	035617	-
	1 x 1-1/4	25 x 32	035618	-
	1 1/4	32	-	035170
	1-1/4 x 1	32 x 25	035380	-
	1-1/4 x 1-1/2	32 x 40	035593	-
	1-1/2	40	-	035171
	1-1/2 x 1-1/4	40 x 32	035619	-
	1-1/2 x 2	40 x 50	035620	-
	2	50	-	035172
	2 x 1-1/2	50 x 40	035973	-
	2 x 2-1/2	50 x 65	235041	-
	2-1/2	65	-	035173
	2-1/2 x 3	65 x 75	235042	-
	2-1/2 x 4	65 x 100	235043	-
	3	75	-	035174
	3 x 4	75 x 100	235044	-
	4	100	-	035175
	5	125	-	035176
	6	150	-	035177

†, ▶ See page 75 for descriptions

PRODUCT SELECTION CHART - XIRTEC PVC SCH. 40 WHITE & SCH. 40 GREY FITTINGS

Dimension		Sch 40 White	Sch 40 Grey
inches	mm	Product Code	Product Code

Dimension		Sch 40 White	Sch 40 Grey
inches	mm	Product Code	Product Code

Riser Extension FPT x MPT

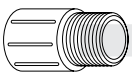
	1/2	12	035591	-
	3/4	20	035944	-
	1	25	035947	-

Spigot x Female Adapter Spig x FPT

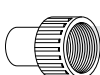
	1/2	12	035578	-
	3/4	20	035579	-
	1	25	035580	-
	1-1/4	32	035581	-
	1-1/2	40	035582	-
	2	50	035583	-
	2-1/2	65	035584	-
	3	75	035585	-
	4	100	035586	-

Reducer Bushing Spig x Soc

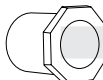
	1/2 x 1/4	12 x 6	035643	-
	1/2 x 3/8	20 x 9	035644	-
	3/4 x 1/2	20 x 12	035646	035209
	1 x 1/2	25 x 12	035648	035211
	1 x 3/4	25 x 20	035649	035212
	1-1/4 x 1/2	32 x 12	035650	035213
	1-1/4 x 3/4	32 x 20	035651	035214
	1-1/4 x 1	32 x 25	035652	035215
	1-1/2 x 1/2	40 x 12	035653	035216
	1-1/2 x 3/4	40 x 20	035654	035217
	1-1/2 x 1	40 x 25	035655	035218
	1-1/2 x 1-1/4	40 x 32	035656	035219
	2 x 1/2	50 x 12	035657	035220
	2 x 3/4	50 x 20	035658	035221
	2 x 1	50 x 25	035659	035222
	2 x 1-1/4	50 x 32	035660	035223
	2 x 1-1/2	50 x 40	035661	035224
	2-1/2 x 1/2	65 x 12	035662	-
	2-1/2 x 3/4	65 x 20	035663	-
	2-1/2 x 1	65 x 25	035664	-
	2-1/2 x 1-1/4	65 x 32	035665	035227
	2-1/2 x 1-1/2	65 x 40	035666	035228
	2-1/2 x 2	65 x 50	035667	035229
	3 x 3/4	75 x 20	035668	-
	3 x 1	75 x 25	035669	035231
	3 x 1-1/4	75 x 32	035670	035232
	3 x 1-1/2	75 x 40	035671	035233
	3 x 2	75 x 50	035672	035234
	3 x 2-1/2	75 x 65	035673	035235
	4 x 2	100 x 50	035677	035238
	4 x 2-1/2	100 x 65	035678	035239
	4 x 3	100 x 75	035679	035240
	5 x 2	125 x 50	035680	-
	5 x 3	125 x 75	035681	-
	5 x 4	125 x 100	035682	035241

Reducer Bushing Spig x Soc (con't)

	6 x 2	150 x 50	035683	-
	6 x 3	150 x 75	035684	-
	6 x 4	150 x 100	035685	035244
	6 x 5	150 x 125	035686	-
	8 x 4	200 x 100	035687	035245 †
	8 x 6	200 x 150	035688	035246
	10 x 4	250 x 100	035689 †	035247 †
	10 x 6	250 x 150	035690 †	035248 †
	10 x 8	250 x 200	035691 †	035249 †
	12 x 4	300 x 100	035041 †	035250 †
	12 x 6	300 x 150	035692 †	035251 †
	12 x 8	300 x 200	035693 †	035252 †
	12 x 10	300 x 250	035694 †	035253 †
	14 x 6	350 x 150	- †	- †
	14 x 8	350 x 200	- †	- †
	14 x 10	350 x 250	- †	035254 †
	14 x 12	350 x 300	035695 †	035255 †
	16 x 8	400 x 200	- †	- †
	16 x 10	400 x 250	- †	035256 †
	16 x 12	400 x 300	- †	035207 †
	16 x 14	400 x 350	- †	035257 †
	18 x 10	450 x 250	- †	- †
	18 x 12	450 x 300	- †	- †
	18 x 14	450 x 350	- †	- †
	18 x 16	450 x 400	- †	- †
	20 x 12	500 x 300	- †	- †
	20 x 14	500 x 350	- †	- †
	20 x 16	500 x 400	- †	- †
	20 x 18	500 x 450	- †	- †
	24 x 14	600 x 350	- †	- †
	24 x 16	600 x 400	- †	- †
	24 x 18	600 x 450	- †	- †
	24 x 20	600 x 500	- †	- †

T.T. Bushing MPT x FPT

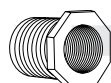
	3/8 x 1/4	9 x 6	035696	-
	1/2 x 1/4	12 x 6	035697	-
	1/2 x 3/8	12 x 9	035698	-
	3/4 x 1/4	20 x 6	035699	-
	3/4 x 3/8	20 x 9	035968	-
	3/4 x 1/2	20 x 12	035700	-
	1 x 1/2	25 x 12	035701	-
	1 x 3/4	25 x 20	035702	-
	1-1/4 x 1/2	32 x 12	035703	-
	1-1/4 x 3/4	32 x 20	035704	-
	1-1/4 x 1	32 x 25	035705	-
	1-1/2 x 1/2	40 x 12	035706	-
	1-1/2 x 3/4	40 x 20	035707	-
	1-1/2 x 1	40 x 25	035708	-
	1-1/2 x 1-1/4	40 x 32	035709	-
	2 x 1	50 x 25	035711	-
	2 x 1-1/4	50 x 32	035712	-
	2 x 1-1/2	50 x 40	035713	-
	2-1/2 x 2	65 x 50	035714	-
	3 x 2	75 x 50	035715	-
	3 x 2-1/2	75 x 65	035716	-

†, † See page 75 for descriptions

PRODUCT SELECTION CHART - XIRTEC PVC SCH. 40 WHITE & SCH. 40 GREY FITTINGS

Dimension		Sch 40 White	Sch 40 Grey
inches	mm	Product Code	Product Code

Dimension		Sch 40 White	Sch 40 Grey
inches	mm	Product Code	Product Code

Reducer Bushing Spig x FPT

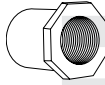

1/2 x 1/8	12 x 3	035717	-
1/2 x 1/4	12 x 6	035718	035258
1/2 x 3/8	12 x 9	035719	035259
3/4 x 1/4	20 x 6	035720	-
3/4 x 1/2	20 x 12	035722	035260
1 x 3/8	25 x 9	035723	-
1 x 1/2	25 x 12	035724	035262
1 x 3/4	25 x 20	035725	035263
1-1/4 x 1/2	32 x 12	035726	035264
1-1/4 x 3/4	32 x 20	035727	035265
1-1/4 x 1	32 x 25	035728	035266
1-1/2 x 1/2	40 x 12	035729	035267
1-1/2 x 3/4	40 x 20	035730	035268
1-1/2 x 1	40 x 25	035731	035269
1-1/2 x 1-1/4	40 x 32	035732	035270
2 x 1/2	50 x 12	035733	035271
2 x 3/4	50 x 20	035734	035272
2 x 1	50 x 25	035735	035273
2 x 1-1/4	50 x 32	035736	035274
2 x 1-1/2	50 x 40	035737	035275
2-1/2 x 1/2	65 x 12	035738	-
2-1/2 x 3/4	65 x 20	035739	-
2-1/2 x 1	65 x 25	035740	-
2-1/2 x 1-1/4	65 x 32	035741	-
2-1/2 x 1-1/2	65 x 40	035742	035277
2-1/2 x 2	65 x 50	035743	035278
3 x 3/4	75 x 20	035744	-
3 x 1	75 x 25	035745	-
3 x 1-1/4	75 x 32	035746	-
3 x 1-1/2	75 x 40	035747	035282 †
3 x 2	75 x 50	035748	035283
3 x 2-1/2	75 x 65	035749	-
4 x 2	100 x 50	035750	035285
4 x 2-1/2	100 x 65	035751	-
4 x 3	100 x 75	035752	035286
5 x 3	125 x 75	035753	-
5 x 4	125 x 100	035754	235062
6 x 2	150 x 50	035755	-
6 x 3	150 x 75	035756	-
6 x 4	150 x 100	035757	035287
6 x 5	150 x 125	035758	-

45° Wye Soc x Soc x Soc (50 psi / 345 kPa max)

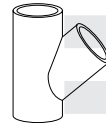

1/2	12	-	035357 †
3/4	20	-	035358 †
1-1/2	40	-	035359 †
2	50	-	035360 †
2-1/2	65	-	035361 †
3	75	-	- †
4	100	-	035363 †
6	150	-	035364 †
8	200	-	035365 †
10	250	-	035366 †
12	300	-	035367 †
14	350	-	- †
16	400	-	- †
18	450	-	- †
20	500	-	- †
24	600	-	- †

45° Reducing Wye Soc x Soc x Soc (50 psi / 345 kPa max)

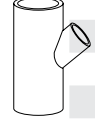

8 x 8 x 4	200 x 200 x 100	-	035372 †
8 x 8 x 6	200 x 200 x 150	-	035373 †
10 x 10 x 4	250 x 250 x 100	-	- †
10 x 10 x 6	250 x 250 x 150	-	035374 †
10 x 10 x 8	250 x 250 x 200	-	- †
12 x 12 x 4	300 x 300 x 100	-	- †
12 x 12 x 6	300 x 300 x 150	-	035935 †
12 x 12 x 8	300 x 300 x 200	-	- †
12 x 12 x 10	300 x 300 x 250	-	- †
14 x 14 x 6	350 x 350 x 150	-	- †
14 x 14 x 8	350 x 350 x 200	-	- †
14 x 14 x 10	350 x 350 x 250	-	- †
14 x 14 x 12	350 x 350 x 300	-	- †
16 x 16 x 8	400 x 400 x 200	-	035375 †
16 x 16 x 10	400 x 400 x 250	-	- †
16 x 16 x 12	400 x 400 x 300	-	- †
16 x 16 x 14	400 x 400 x 350	-	- †
18 x 18 x 8	450 x 450 x 200	-	- †
18 x 18 x 10	450 x 450 x 250	-	- †
18 x 18 x 12	450 x 450 x 300	-	- †
18 x 18 x 14	450 x 450 x 350	-	- †
18 x 18 x 16	450 x 450 x 400	-	- †
20 x 20 x 12	500 x 500 x 300	-	- †
20 x 20 x 14	500 x 500 x 350	-	- †
20 x 20 x 16	500 x 500 x 400	-	- †
20 x 20 x 18	500 x 500 x 450	-	- †
24 x 24 x 14	600 x 600 x 350	-	- †
24 x 24 x 16	600 x 600 x 400	-	- †
24 x 24 x 18	600 x 600 x 450	-	- †
24 x 24 x 20	600 x 600 x 500	-	- †

45° Wye Soc x Soc x Soc

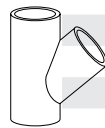

1-1/2	40	035912 ■	-
2	50	035913 ■	-
3	75	035915 ■	-
4	100	035916 ■	-
6	150	035917 ■	-
6 x 6 x 4	150 x 150 x 100	035922 ■	-

1/2" - 2" - 235 psi maximum internal pressure rating @ 73°F
 (12 - 50mm - 1620 kPa maximum internal pressure rating @ 23°C)
 3" - 6" - 150 psi maximum internal pressure rating @ 73°F
 (75 - 150mm - 1034 kPa maximum internal pressure rating @ 23°C)

■, † See page 75 for descriptions

PRODUCT SELECTION CHART - XIRTEC PVC SCH. 40 WHITE & SCH. 40 GREY FITTINGS

Dimension		Sch 40 White	Sch 40 Grey
inches	mm	Product Code	Product Code

Cap Soc



Dimension (inches)	Dimension (mm)	Sch 40 White Product Code	Sch 40 Grey Product Code
3/8	9	035406	035590
1/2	12	035407	035017
3/4	20	035408	035018
1	25	035409	035019
1-1/4	32	035410	035020
1-1/2	40	035411	035021
2	50	035412	035022
2-1/2	65	035413	035023
3	75	035414	035024
4	100	035415	035025
5	125	035416	035026
6	150	035417	035027
8	200	035418	035028
10	250	035419 †	035029 †
12	300	035420 †	035030 †
14	350	035421 †	035031 †
16	400	- †	- †
18	450	035422 †	- ▶
20	500	035940 †	- ▶
24	600	- †	- ▶

Dimension		Sch 40 White	Sch 40 Grey
inches	mm	Product Code	Product Code

Plug MPT

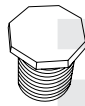

Dimension (inches)	Dimension (mm)	Sch 40 White Product Code	Sch 40 Grey Product Code
3/8	9	035621	-
1/2	12	035622	035188
3/4	20	035623	035189
1	25	035624	035190
1-1/4	32	035625	035191
1-1/2	40	035626	035192
2	50	035627	035193
2-1/2	65	035628	035194
3	75	035629	035195
4	100	035630	035196
6	150	235047	-

Plug Spig



Dimension (inches)	Dimension (mm)	Sch 40 White Product Code	Sch 40 Grey Product Code
3/8	9	035946	-
1/2	12	035631	035197
3/4	20	035632	035198
1	25	035633	035199
1-1/4	32	035634	035200
1-1/2	40	035635	035201
2	50	035636	035202
2-1/2	65	035637	035203 †
3	75	035638	035204
4	100	035639	-

Cap FPT



Dimension (inches)	Dimension (mm)	Sch 40 White Product Code	Sch 40 Grey Product Code
3/8	9	035948	-
1/2	12	035423	035032
3/4	20	035424	035033
1	25	035425	035034
1-1/4	32	035426	035035
1-1/2	40	035427	035036
2	50	035428	035037
2-1/2	65	035429	035038
3	75	035430	035039
4	100	035431	-
5	125	035432	-
6	150	035433	-

Saddles Pipe OD x Soc (Rated for 80 psi / 552 kPa Open-Ended)

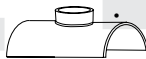

• These sizes are bushed.

Dimension (inches)	Dimension (mm)	Sch 40 White Product Code	Sch 40 Grey Product Code
2-1/2 x 3/4	65 x 20	235048	-
3 x 1-1/4	75 x 32	035996	-
3 x 1-1/2	75 x 40	235049	-
3 x 2	75 x 50	035995	-
4 x 1-1/4	100 x 32	035767	-
4 x 1-1/2	100 x 40	035768	-
4 x 2	100 x 50	035769	-
5 x 1-1/2	125 x 40	235050	-
5 x 2	125 x 50	035955	-
6 x 1-1/4	150 x 32	235051	-
6 x 1-1/2	150 x 40	035588	-
6 x 2	150 x 50	035942	-
6 x 4	150 x 100	035770	-
8 x 1-1/4	200 x 32	235052	-
8 x 1-1/2	200 x 40	235053	-
8 x 2	200 x 50	235054	-
8 x 4	200 x 100	035976	-
10 x 4	250 x 100	035771	-

Union Soc x Soc Buna O-ring Seal



Dimension (inches)	Dimension (mm)	Sch 40 White Product Code	Sch 40 Grey Product Code
1/2	12	035900	-
3/4	20	035901	-
1	25	035902	-
1-1/4	32	035903	-
1-1/2	40	035904	-
2	50	035905	-

Union FPT x FPT Buna O-ring Seal

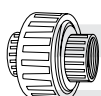

Dimension (inches)	Dimension (mm)	Sch 40 White Product Code	Sch 40 Grey Product Code
1/2	12	035906	-
3/4	20	035907	-
1	25	035908	-
1-1/4	32	035909	-
1-1/2	40	035910	-
2	50	035911	-

Saddles Pipe OD x FPT (Rated for 80 psi / 552 kPa Open-Ended)



Dimension (inches)	Dimension (mm)	Sch 40 White Product Code	Sch 40 Grey Product Code
2-1/2 x 3/4	65 x 20	235055	-
3 x 1-1/2	75 x 40	035993	-
4 x 1-1/2	100 x 40	035772	-
5 x 2	125 x 50	035943	-
6 x 1-1/2	150 x 40	035587	-
6 x 4	150 x 100	235056	-
8 x 1-1/2	200 x 40	235057	-
8 x 4	200 x 100	035774	-
10 x 4	250 x 100	235058	-

▶, † See page 75 for descriptions

PRODUCT SELECTION CHART - XIRTEC PVC SCH. 80 & CPVC SCH. 80 FITTINGS

Dimension		PVC Sch 80	CPVC Sch 80
inches	mm	Product Code	Product Code

Dimension		PVC Sch 80	CPVC Sch 80
inches	mm	Product Code	Product Code

Tee Soc x Soc x Soc

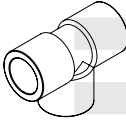

1/4	6	036768	059479
3/8	9	036769	059480
1/2	12	036770	059481
3/4	20	036771	059482
1	25	036772	059483
1-1/4	32	036773	059484
1-1/2	40	036774	059485
2	50	036775	059486
2-1/2	65	036776	059487
3	75	036777	059488
4	100	036778	059489
6	150	036780	059490
8	200	036781	059491
10	250	036866 ■	059062 ■
12	300	036876 ■	059084 ■
10	250	036782 †	-
12	300	036783 †	-
14	350	036784 †	-
16	400	036785 †	-
18	450	036126 †	-

Reducing Tee Soc x Soc x Soc

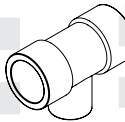

3/4 x 3/4 x 1/2	20 x 20 x 12	036786	059492
1 x 3/4 x 3/4	25 x 20 x 20	036790	-
1 x 3/4 x 1	25 x 20 x 25	036791	059493
1 x 1 x 1/2	25 x 25 x 12	036788	059494
1 x 1 x 3/4	25 x 25 x 20	036789	-
1-1/4 x 1 x 3/4	32 x 25 x 20	036792	-
1-1/4 x 1 x 1-1/4	32 x 32 x 25	-	059495
1-1/4 x 1-1/4 x 3/4	32 x 32 x 20	036793	-
1-1/4 x 1-1/4 x 1	32 x 32 x 25	036794	-
1-1/2 x 1-1/2 x 3/4	40 x 40 x 20	036795	059496
1-1/2 x 1-1/2 x 1	40 x 40 x 25	036796	059497
2 x 2 x 1/2	50 x 50 x 12	036797	059498
2 x 2 x 3/4	50 x 50 x 20	036798	059499
2 x 2 x 1	50 x 50 x 25	036799	059500
2 x 2 x 1-1/2	50 x 50 x 40	036800	059501
3 x 3 x 2	75 x 75 x 50	036802	059502
3 x 3 x 2-1/2	75 x 75 x 65	036803	059504
4 x 4 x 2	100 x 100 x 50	036804	059505
4 x 4 x 3	150 x 100 x 75	036805	-
6 x 6 x 3	150 x 150 x 75	036807	-
6 x 6 x 4	150 x 150 x 100	036808 †	059506
8 x 8 x 4	200 x 200 x 100	036809	-
8 x 8 x 6	200 x 200 x 150	036810 †	059567
10 x 10 x 4	250 x 250 x 100	036919 †	-
10 x 10 x 6	250 x 250 x 150	036812 †	-
10 x 10 x 8	250 x 250 x 200	036813 †	-
12 x 12 x 8	300 x 300 x 200	036814 †	-
12 x 12 x 10	300 x 300 x 250	036815 †	-
14 x 14 x 10	350 x 350 x 250	036816 †	-
14 x 14 x 12	350 x 350 x 300	- †	-
16 x 16 x 12	400 x 400 x 300	- †	-
16 x 16 x 14	400 x 400 x 350	-	-

Tee Soc x Soc x FPT



1/2	12	036828	059942
3/4	20	036829	059943
1	25	036830	059518
2	50	036832	-

Tee FPT x FPT x FPT

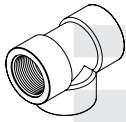

1/4	6	036817	059507
3/8	9	036818	059508
1/2	12	036819	059509
3/4	20	036820	059510
1	25	036821	059511
1-1/4	32	036822	059512
1-1/2	40	036823	059513
2	50	036824	059514
2-1/2	65	036825	059515
3	75	036826	059516
4	100	036827	059517

90° Elbow FPT x FPT

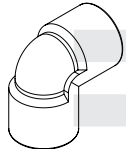

1/4	6	036197	059206
3/8	9	036198	059207
1/2	12	036199	059208
3/4	20	036200	059209
1	25	036201	059210
1-1/4	32	036202	059211
1-1/2	40	036203	059212
2	50	036204	059213
2-1/2	65	036205	059214
3	75	036206	059215
4	100	036207	059216

90° Elbow Soc x Soc

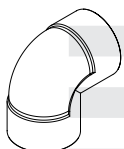

1/4	6	036179	059192
3/8	9	036180	059193
1/2	12	036181	059194
3/4	20	036182	059195
1	25	036183	059196
1-1/4	32	036184	059197
1-1/2	40	036185	059198
2	50	036186	059199
2-1/2	65	036187	059200
3	75	036188	059201
4	100	036189	059202
6	150	036191	059203
8	200	036192	059204
10	250	036864 ■	059085 ■
12	300	036865 ■	059086 ■
10	250	036193 †	-
12	300	036194 †	-
14	350	036195 †	-
16	400	036196 †	-
18	450	036132 †	-

■,† See page 75 for descriptions

PRODUCT SELECTION CHART - XIRTEC PVC SCH. 80 & CPVC SCH. 80 FITTINGS

Dimension		PVC Sch 80	CPVC Sch 80
inches	mm	Product Code	Product Code

Dimension		PVC Sch 80	CPVC Sch 80
inches	mm	Product Code	Product Code

90° Elbow Soc x FPT

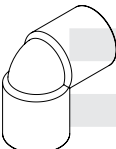

Dimension (inches)	Dimension (mm)	PVC Sch 80 Product Code	CPVC Sch 80 Product Code
1/2	12	036172	059187
3/4	20	036173	059941
1	25	036174	059188
1-1/4	32	036175	059189
1-1/2	40	036176	059190
2	50	036177	059191

22-1/2° Elbow Soc x Soc



Dimension (inches)	Dimension (mm)	PVC Sch 80 Product Code	CPVC Sch 80 Product Code
2	50	036134	059614
3	75	036135	059615
4	100	036136	059616
6	150	036137 †	-
8	200	036138 †	-
10	250	036139 †	-
12	300	036140 †	-

45° Elbow Soc x Soc



Dimension (inches)	Dimension (mm)	PVC Sch 80 Product Code	CPVC Sch 80 Product Code
1/4	6	036142	059162
3/8	9	036143	059163
1/2	12	036144	059164
3/4	20	036145	059165
1	25	036146	059166
1-1/4	32	036147	059167
1-1/2	40	036148	059168
2	50	036149	059169
2-1/2	65	036150	059170
3	75	036151	059171
4	100	036152	059172
6	150	036154	059173
8	200	036155	059174
10	250	036862 ■	059087 ■
12	300	036863 ■	059088 ■
10	250	036156 †	-
12	300	036157 †	-
14	350	036158 †	-
16	400	036159 †	-

11-1/4° Elbow Soc x Soc



Dimension (inches)	Dimension (mm)	PVC Sch 80 Product Code	CPVC Sch 80 Product Code
2	50	-	059617
3	75	-	059618
4	100	-	059619

Cross Soc x Soc x Soc x Soc

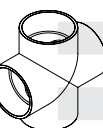

Dimension (inches)	Dimension (mm)	PVC Sch 80 Product Code	CPVC Sch 80 Product Code
1/4	6	-	059620
1/2	12	036116	059154
3/4	20	036117	059155
1	25	036118	059156
1-1/4	32	036119	059157
1-1/2	40	036120	059158
2	50	036121	059159
2-1/2	65	036122	059018
3	75	036123	059160
4	100	036124	059161
6	150	036125 †	-

45° Elbow FPT x FPT

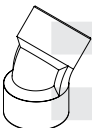

Dimension (inches)	Dimension (mm)	PVC Sch 80 Product Code	CPVC Sch 80 Product Code
1/4	6	036160	059176
3/8	9	036161	059177
1/2	12	036162	059178
3/4	20	036163	059179
1	25	036164	059180
1-1/4	32	036165	059181
1-1/2	40	036166	059182
2	50	036167	059183
2-1/2	65	036168	059184
3	75	036169	059185
4	100	036170	059186

Coupling Soc x Soc



Dimension (inches)	Dimension (mm)	PVC Sch 80 Product Code	CPVC Sch 80 Product Code
1/4	6	036088	059130
3/8	9	036089	059131
1/2	12	036090	059132
3/4	20	036091	059133
1	25	036092	059134
1-1/4	32	036093	059135
1-1/2	40	036094	059136
2	50	036095	059137
2-1/2	65	036096	059138
3	75	036097	059139
4	100	036098	059140
6	150	036099	059141
8	200	036100	059142
10	250	036101 †	059033 †
12	300	036102 †	059043 †
14	350	036103 †	-
16	400	036889 †	-

30° Elbow Soc x Soc



Dimension (inches)	Dimension (mm)	PVC Sch 80 Product Code	CPVC Sch 80 Product Code
6	150	236003	059022

■, † See page 75 for descriptions

PRODUCT SELECTION CHART - XIRTEC PVC SCH. 80 & CPVC SCH. 80 FITTINGS

Dimension		PVC Sch 80	CPVC Sch 80
inches	mm	Product Code	Product Code

Coupling FPT x FPT

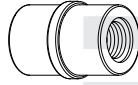
	1/4	6	036104	059143
	3/8	9	036105	059144
	1/2	12	036106	059145
	3/4	20	036107	059146
	1	25	036108	059147
	1-1/4	32	036109	059148
	1-1/2	40	036110	059149
	2	50	036111	059150
	2-1/2	65	036112	059151
	3	75	036113	059152
	4	100	036114	059153

Dimension		PVC Sch 80	CPVC Sch 80
inches	mm	Product Code	Product Code

45° Wye Soc x Soc x Soc

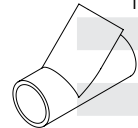
	1-1/2	40	036854	059553
	2	50	036855	059536
	3	75	036856	059537
	4	100	036857	059538
	6	150	036858	059539
	6 x 4	150 x 100	036861	059541
	8	200	036859	-
	8 x 6	200 x 150	036884	-

1/2" - 2" - 235 psi maximum internal pressure rating @ 73°F
 (12 - 50mm - 1620 kPa maximum internal pressure rating @ 23°C)
 3" - 6" - 150 psi maximum internal pressure rating @ 73°F
 (75 - 150mm - 1034 kPa maximum internal pressure rating @ 23°C)

Reducer Coupling Soc x Soc

	3/4 x 1/2	20 x 12	036719	059460
	1 x 1/2	25 x 12	036720	059461
	1 x 3/4	25 x 20	036721	059462
	1-1/4 x 3/4	32 x 20	036723	-
	1-1/4 x 1	32 x 25	036724	059463
	1-1/2 x 1/2	40 x 12	036725	-
	1-1/2 x 3/4	40 x 20	036726	059464
	1-1/2 x 1	40 x 25	036727	059465
	1-1/2 x 1-1/4	40 x 32	036728	059466
	2 x 1/2	50 x 12	036897	-
	2 x 1	50 x 25	036729	059467
	2 x 1-1/2	50 x 40	036731	059458
	3 x 2	75 x 50	036735	059470
	4 x 2	100 x 50	036736	059459
	4 x 3	100 x 75	036738	059472
	6 x 4	150 x 100	036740	059471
	8 x 6	200 x 150	036743	059473

Reducer Bushing Spig x Soc (flushstyle)

	3/8 x 1/4	9 x 6	036599	-
	1/2 x 1/4	12 x 6	036600	059373
	1/2 x 3/8	12 x 9	036601	059374
	3/4 x 1/2	20 x 12	036604	059375
	1 x 1/2	25 x 12	036605	059376
	1 x 3/4	25 x 20	036606	059377
	1-1/4 x 1/2	32 x 12	036607	059378
	1-1/4 x 3/4	32 x 20	036608	059379
	1-1/4 x 1	32 x 25	036609	059380
	1-1/2 x 1/2	40 x 12	036610	059381
	1-1/2 x 3/4	40 x 20	036611	059382
	1-1/2 x 1	40 x 25	036612	059383
	1-1/2 x 1-1/4	40 x 32	036613	059384
	2 x 1/2	50 x 12	036614	059385
	2 x 3/4	50 x 20	036615	059386
	2 x 1	50 x 25	036616	059387
	2 x 1-1/4	50 x 32	036617	059388
	2 x 1-1/2	50 x 40	036618	059389
	2 -1/2 x 1-1/4	65 x 32	036620	-
	2-1/2 x 1-1/2	65 x 40	036621	-
	2-1/2 x 2	65 x 50	036622	059392
	3 x 1	75 x 25	036623	-
	3 x 1-1/2	75 x 40	036624	059393
	3 x 2	75 x 50	036625	059394
	3 x 2-1/2	75 x 65	036626	059395
	4 x 2	100 x 50	036628	059396
	4 x 3	100 x 75	036630	059397
	6 x 2	150 x 50	036632	059398
	6 x 3	150 x 75	036633	059399
	6 x 4	150 x 100	036634	059400
	8 x 6	200 x 150	036638	059401
	10 x 6	250 x 150	036922	+
	10 x 8	250 x 200	036270	+
	12 x 10	300 x 250	036208	+
	12 x 6	300 x 150	036908	-
	12 x 8	300 x 200	036645	-

Reducer Coupling FPT x FPT

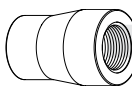
	1/2 x 1/4	12 x 6	036746	-
	3/4 x 1/2	20 x 12	036748	-
	1 x 1/2	25 x 12	036749	-
	1 x 3/4	25 x 20	036750	-
	1-1/4 x 3/4	32 x 20	036751	-
	1-1/2 x 1	40 x 25	036754	-
	2 x 1-1/2	50 x 40	036758	-

PRODUCT SELECTION CHART - XIRTEC PVC SCH. 80 & CPVC SCH. 80 FITTINGS

Dimension		PVC Sch 80	CPVC Sch 80
inches	mm	Product Code	Product Code

Dimension		PVC Sch 80	CPVC Sch 80
inches	mm	Product Code	Product Code

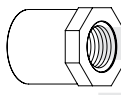
Reducer Bushing	Spig x FPT (flushstyle)			
	3/8 x 1/4	9 x 6	036679	-
	1/2 x 1/4	12 x 6	036681	059428
	1/2 x 3/8	12 x 9	036682	059429
	3/4 x 1/4	20 x 6	036683	059430
	3/4 x 1/2	20 x 12	036684	059431
	1 x 3/8	25 x 9	036685	-
	1 x 1/2	25 x 12	036686	059432
	1 x 3/4	25 x 20	036687	059433
	1-1/4 x 1/2	32 x 12	036688	059434
	1-1/4 x 3/4	32 x 20	036689	059435
	1-1/4 x 1	32 x 25	036690	059436
	1-1/2 x 1/2	40 x 12	036691	059437
	1-1/2 x 3/4	40 x 20	036692	059438
	1-1/2 x 1	40 x 25	036693	059439
	1-1/2 x 1-1/4	40 x 32	036694	059440
	2 x 1/2	50 x 12	036695	059441
	2 x 3/4	50 x 20	036696	059442
	2 x 1	50 x 25	036697	059443
	2 x 1-1/4	50 x 32	036698	059444
	2 x 1-1/2	50 x 40	036699	059445
	2-1/2 x 3/4	65 x 20	036700	059446
	2-1/2 x 1	65 x 25	036701	059447
	2-1/2 x 1-1/4	65 x 32	036702	059448
	2-1/2 x 1-1/2	65 x 40	036703	059449
	2-1/2 x 2	65 x 50	036704	059450
	3 x 3/4	75 x 20	036705	-
	3 x 1	75 x 25	036706	059547
	3 x 1-1/4	75 x 32	036707	-
	3 x 1-1/2	75 x 40	036708	059451
	3 x 2	75 x 50	036709	059452
	3 x 2-1/2	75 x 65	036710	059453
	4 x 2	100 x 50	036711	059454
	4 x 2-1/2	100 x 65	036712	059640
	4 x 3	100 x 75	036713	059455
	6 x 2	150 x 50	036714	-
	6 x 3	150 x 75	036715	059641
	6 x 4	150 x 100	036716	059456

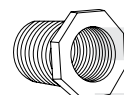
T T Bushing	MPT x FPT (flushstyle)			
	3/8 x 1/4	9 x 6	036647	059402
	1/2 x 1/4	12 x 6	036648	059403
	1/2 x 3/8	12 x 9	036649	059404
	3/4 x 1/4	20 x 6	036651	059405
	3/4 x 3/8	20 x 9	036652	059406
	3/4 x 1/2	20 x 12	036653	059407
	1 x 1/4	25 x 6	036654	059643
	1 x 3/8	25 x 9	036655	-
	1 x 1/2	25 x 12	036656	059408
	1 x 3/4	25 x 20	036657	059409
	1-1/4 x 1/2	32 x 12	036658	059410
	1-1/4 x 3/4	32 x 20	036659	059411
	1-1/4 x 1	32 x 25	036660	059412
	1-1/2 x 1/2	40 x 12	036661	059413
	1-1/2 x 3/4	40 x 20	036662	059414
	1-1/2 x 1	40 x 25	036663	059415
	1-1/2 x 1-1/4	40 x 32	036664	059416
	2 x 1/2	50 x 12	036665	059417
	2 x 3/4	50 x 20	036666	059418
	2 x 1	50 x 25	036667	059419
	2 x 1-1/4	50 x 32	036668	059420
	2 x 1-1/2	50 x 40	036669	059421
	2-1/2 x 2	65 x 50	036672	059422
	3 x 1-1/2	75 x 40	036673	059423
	3 x 2	75 x 50	036674	059424
	3 x 2-1/2	75 x 65	036675	059425
	4 x 2	100 x 50	036676	059426
	4 x 3	100 x 75	036677	059427

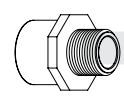
Male Adapter	Soc x MPT			
	1/2	12	036420	059286
	3/4	20	036421	059287
	1	25	036422	059288
	1-1/4	32	036423	059289
	1-1/2	40	036424	059290
	2	50	036425	059291
	2-1/2	65	036426	059292
	3	75	036427	059293
	4	100	036428	059294
	6	150	036887	+

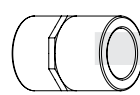
Female Adapter	Soc x FPT			
	1/4	6	036209	059217
	3/8	9	036210	059218
	1/2	12	036211	059219
	3/4	20	036212	059220
	1	25	036213	059221
	1-1/4	32	036214	059222
	1-1/2	40	036215	059223
	2	50	036216	059224
	2-1/2	65	036217	059225
	3	75	036218	059226
	4	100	036219	059227
	6	150	036221	† -

†, ‡ See page 75 for descriptions

PRODUCT SELECTION CHART - XIRTEC PVC SCH. 80 & CPVC SCH. 80 FITTINGS

Dimension		PVC Sch 80	CPVC Sch 80
inches	mm	Product Code	Product Code

Female Adapter Soc x FPT (SS reinforced)

	1/2	12	036971	059951
	3/4	20	036972	059952
	1	25	036973	059953
	1-1/4	32	036974	059954
	1-1/2	40	036975	059955
	2	50	036976	059956
	2-1/2	65	036977	-
	3	75	036978	059957
	4	100	036979	059958

Female Adapter Spig x FPT (SS reinforced)

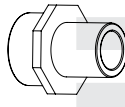
	1/2	12	036965	059945
	3/4	20	036966	059946
	1	25	036967	059947
	1-1/4	32	036968	059948
	1-1/2	40	036969	059949
	2	50	036970	059950
	3	75	236000	059647
	4	100	236001	059648

Hose Adapter Hose x MPT

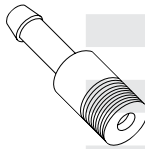
	1/4	6	036394	†	-
	3/8	9	036395	†	-
	1/2	12	036396	†	-
	3/4	20	036397	†	-
	1	25	036398	†	-
	1 1/4	32	036399	†	-
	1 1/2	40	036400	†	-
	2	50	036401	†	-
	2 1/2	65	036402	†	-
	3	75	036403	†	-
	4	100	036404	†	-

Cap Soc

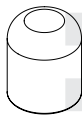
	1/4	6	036056	059107	
	3/8	9	036057	059108	
	1/2	12	036058	059109	
	3/4	20	036059	059110	
	1	25	036060	059111	
	1-1/4	32	036061	059112	
	1-1/2	40	036062	059113	
	2	50	036063	059114	
	2-1/2	65	036064	059115	
	3	75	036065	059116	
	4	100	036066	059117	
	6	150	036067	059118	
	8	200	036068	059029	
	10	250	036069	†	-
	12	300	036070	†	-
	14	350	-	†	-
	16	400	036071	†	-

Dimension		PVC Sch 80	CPVC Sch 80
inches	mm	Product Code	Product Code

Cap FPT

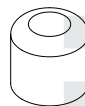
	1/4	6	036072	059119
	3/8	9	036073	059120
	1/2	12	036074	059121
	3/4	20	036075	059122
	1	25	036076	059123
	1-1/4	32	036077	059124
	1-1/2	40	036078	059125
	2	50	036079	059126
	2-1/2	65	036080	059127
	3	75	036081	059128
	4	100	036082	059129

Plug MPT

	1/4	6	036568	059361
	3/8	9	036569	059362
	1/2	12	036570	059363
	3/4	20	036571	059364
	1	25	036572	059365
	1-1/4	32	036573	059366
	1-1/2	40	036574	059367
	2	50	036575	059368
	2-1/2	65	036576	059369
	3	75	036577	059370
	4	100	036578	059371
	6	150	036579	-

Plug Spig

	2	50	036585	-
---	---	----	--------	---

90° Radius Bends - 6D Spig x Spig

	1/2	12	-	†	-
	3/4	20	036027	†	-
	1	25	036028	†	-
	1-1/4	32	036029	†	-
	1-1/2	40	036030	†	-
	2	50	036031	†	-
	2-1/2	65	036032	†	-
	3	75	036033	†	-
	4	100	036034	†	-
	6	150	036035	†	-
	8	200	036036	†	-
	10	250	036868	†	-
	12	300	-	†	-

†, † See page 75 for descriptions

PRODUCT SELECTION CHART - XIRTEC PVC SCH. 80 & CPVC SCH. 80 FITTINGS

Dimension		PVC Sch 80	CPVC Sch 80
inches	mm	Product Code	Product Code

Dimension		PVC Sch 80	CPVC Sch 80
inches	mm	Product Code	Product Code

45° Radius Bends - 6D Spig x Spig



1/2	12	-	†	-
3/4	20	036020	†	-
1	25	036021	†	-
1-1/4	32	-	†	-
1-1/2	40	036022	†	-
2	50	036023	†	-
2-1/2	65	036867	†	-
3	75	036024	†	-
4	100	036025	†	-
6	150	036026	†	-
8	200	-	†	-
10	250	-	†	-
12	300	-	†	-

Union Soc x FPT (Viton® O-ring Seal)

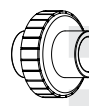

1/2	12	036410	-
3/4	20	036411	-
1	25	036412	-
1-1/4	32	036413	-
1-1/2	40	036414	-
2	50	036415	-
3	75	236010	-
4	100	236011	-

22-1/2° Radius Bends - 6D Spig x Spig



1/2	12	036012	†	-
3/4	20	-	†	-
1	25	036013	†	-
1-1/4	32	-	†	-
1-1/2	40	-	†	-
2	50	036014	†	-
2-1/2	65	036015	†	-
3	75	036016	†	-
4	100	036017	†	-
6	150	036018	†	-
8	200	036019	†	-
10	250	-	†	-
12	300	-	†	-

Tank Adapter Soc x FPT

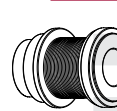

1/2	12	036038	059100	
3/4	20	036039	059101	
1	25	036040	059102	
1-1/4	32	036041	-	
1-1/2	40	036042	059103	
2	50	036043	059104	
3	75	036045	059105	
4	100	036046	059106	
6	150	-	†	-

Tank Adapter FPT x FPT



1/2	12	036047	-	
3/4	20	036048	-	
1	25	036049	-	
1-1/4	32	036050	-	
1-1/2	40	036051	-	
2	50	036052	-	
3	75	036054	-	
4	100	036055	-	
6	150	-	†	-

Union Soc x Soc (Viton® O-ring Seal)

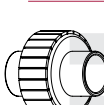

1/4	6	036833	059519
3/8	9	036834	-
1/2	12	036835	059520
3/4	20	036836	059521
1	25	036837	059522
1-1/4	32	036838	059523
1-1/2	40	036839	059524
2	50	036840	059525
3	75	036842	059526
4	100	036843	059550

Flange Soc (solid style)

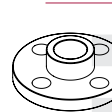

1/2	12	036223	059228	
3/4	20	036224	059229	
1	25	036225	059230	
1-1/4	32	036226	059231	
1-1/2	40	036227	059232	
2	50	036228	059233	
2-1/2	65	036229	059234	
3	75	036230	059235	
4	100	036231	059236	
5	125	036232	-	
6	150	036233	059238	
8	200	036234	059239	
10	250	036235	†	-
12	300	036236	†	-
14	350	036237	†	-
16	400	036238	†	-
18	450	036870	†	-
20	500	-	†	-
24	600	036239	†	-

Union FPT x FPT (Viton® O-ring Seal)

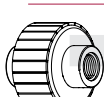

1/4	6	036844	059527
3/8	9	036845	-
1/2	12	036846	059529
3/4	20	036847	059530
1	25	036848	059531
1-1/4	32	036849	059532
1-1/2	40	036850	059533
2	50	036851	059534
3	75	036852	059535
4	100	036853	059651

†, ‡ See page 75 for descriptions

PRODUCT SELECTION CHART - XIRTEC PVC SCH. 80 & CPVC SCH. 80 FITTINGS

Dimension	PVC Sch 80	CPVC Sch 80

Dimension	PVC Sch 80	CPVC Sch 80

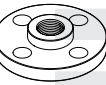
Flange	FPT (solid style)			
	1/2	12	036240	059240
	3/4	20	036241	059241
	1	25	036242	059242
	1-1/4	32	036243	059243
	1-1/2	40	036244	059244
	2	50	036245	059245
	2-1/2	65	036246	059246
	3	75	036247	059247
	4	100	036248	059248
	6	150	036249	059249

Heavy Duty Vanstone Flange	Soc w Fibre-Loc Ring			
	1/2	12	-	059262
	3/4	20	-	059263
	1	25	-	059264
	1-1/4	32	-	059265
	1-1/2	40	036323	059266
	2	50	036324	059267
	2-1/2	65	-	059268
	3	75	036326	059269
	4	100	036416	059270
	6	150	036417	059271
	8	200	036418	059272
	10	250	036419 †	059273
	12	300	036429 †	059569
	▼ 14	350	036358 †	-
	▼ 16	400	036359 †	-

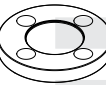
Flange	Blind			
	1/2	12	036250	059250
	3/4	20	036251	059251
	1	25	036252	059252
	1-1/4	32	036253	059253
	1-1/2	40	036254	059254
	2	50	036255	059255
	2-1/2	65	036256	059256
	3	75	036257	059257
	4	100	036258	059258
	6	150	036259	059259
	8	200	036260	059260
	10	250	036261 †	-
	12	300	036262 †	-
	◆ 14	350	036263 †	-
◆ 16	400	036264 †	-	
◆ 18	450	036265 †	-	
◆ 20	500	- †	-	
◆ 24	600	036266 †	-	

Vanstone Flange	Soc w PVC Ring			
	1/2	12	036344	-
	3/4	20	036345	-
	1	25	036346	-
	1-1/4	32	036347	-
	1-1/2	40	036348	-
	2	50	036349	-
	2-1/2	65	036350	-
	3	75	036351	-
	4	100	036352	-
	5	125	036353	-
	6	150	036354	-
	8	200	036355	-
	▼ 10	250	036356	-
	▼ 12	300	036357	-

No-Leak Flange	Spig x Spig			
	1/2	12	036331 †	-
	3/4	20	036332 †	-
	1	25	036923 †	-
	1-1/4	32	036333 †	-
	1-1/2	40	036334 †	-
	2	50	036335 †	-
	2-1/2	65	036336 †	-
	3	75	036337 †	-
	4	100	036338 †	-
	6	150	036339 †	-
	8	200	036340 †	-
	10	250	036341 †	-
	12	300	036342 †	-
	14	350	036915 †	-
16	400	036343 †	-	
18	450	036871 †	-	
20	500	- †	-	
24	600	036924 †	-	

Vanstone Flange	Soc w Steel Ring			
	18	450	036947 †	-
	20	500	036913 †	-
	24	600	036914 †	-

Note: these flanges are rated at 50 psi (345 kPa) maximum operating

†, † See page 75 for descriptions

PRODUCT SELECTION CHART - XIRTEC PVC SCH. 80 & CPVC SCH. 80 FITTINGS

Dimension		PVC Sch 80	CPVC Sch 80
inches	mm	Product Code	Product Code

Dimension		PVC Sch 80	CPVC Sch 80
inches	mm	Product Code	Product Code

Vanstone Flange Spig

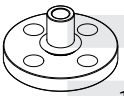

1/2	12	036374	059274
3/4	20	036375	059275
1	25	036376	059276
1-1/4	32	036377	059277
1-1/2	40	036378	059278
2	50	036379	059279
2-1/2	65	036380	059280
3	75	036381	059281
4	100	036382	059282
6	150	036383	059283
8	200	036384	059570
10	250	036321 †	-
12	300	036406 †	-

Nipples

1/4" (6mm) diameter



7/8 close	22	036434	059296
1-1/2	40	036445	059306
2	50	036456	059316
2-1/2	65	036457	-
3	75	036458	059317
3 1/2	90	036459	-
4	100	036460	059318
4-1/2	115	036461	-
5	125	036462	059319
6	150	036463	059320
8	200	036464	-
10	250	236012	-
12	300	236013	-

Vanstone Flange FPT

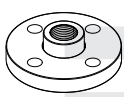

1/2	12	036385	059656
3/4	20	036386	059657
1	25	036387	059658
1-1/4	32	036388	059284
1-1/2	40	036389	059659
2	50	036390	059660
2-1/2	65	036391	059661
3	75	036392	059285
4	100	036393	059662

3/8" (9mm) diameter

1 close	25	036435	059551
1-1/2	40	036446	059307
2	50	036466	059552
2-1/2	65	036467	-
3	75	036468	059939
3-1/2	90	036469	-
4	100	036470	059554
4-1/2	115	036471	-
5	125	036472	-
6	150	036473	-
8	200	036474	-

1/8" Flange Gasket Neoprene

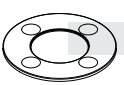

1/2	12	036296	-
3/4	20	036297	-
1	25	036298	-
1-1/4	32	036299	-
1-1/2	40	036300	-
2	50	036301	-
2-1/2	65	036302	-
3	75	036303	-
4	100	036304	-
5	125	036305	-
6	150	036306	-
8	200	036307	-
10	250	036308	-
12	300	036309	-
14	350	036310	-
16	400	036311	-
18	450	036312	-
20	500	036313	-
24	600	036314	-

1/2" (12mm) diameter

1-1/8 close	28	036436	059297
1-1/2	40	036447	059308
2	50	036475	059322
2-1/2	65	036476	-
3	75	036477	059321
3-1/2	90	036478	-
4	100	036479	059324
4-1/2	115	036480	-
5	125	036481	059325
5-1/2	140	036482	-
6	150	036483	059326
8	200	036484	-
10	250	036485	-
12	300	036486	-

† See page 75 for descriptions

PRODUCT SELECTION CHART - XIRTEC PVC SCH. 80 & CPVC SCH. 80 FITTINGS

Dimension		PVC Sch 80	CPVC Sch 80
inches	mm	Product Code	Product Code

Dimension		PVC Sch 80	CPVC Sch 80
inches	mm	Product Code	Product Code

Nipples

3/4" (20mm) diameter



1-3/8 close	35	036437	059298
1-1/2	40	036448	059309
2	50	036490	059327
2-1/2	65	036491	-
3	75	036492	059328
3-1/2	90	036493	-
4	100	036494	059329
4-1/2	115	036495	-
5	125	036496	059331
5-1/2	140	036497	-
6	150	036498	059332
8	200	036500	-
10	250	036501	-
12	300	036502	-

1" (25mm) diameter

1-1/2 close	40	036438	059299
2	50	036449	059310
2-1/2	65	036504	-
3	75	036505	059333
3-1/2	90	036506	-
4	100	036507	059334
4-1/2	115	036508	-
5	125	036509	059335
5-1/2	140	036510	-
6	150	036511	059336
8	200	036512	-
10	250	036514	-
12	300	036515	-

1-1/4" (32mm) diameter

1-5/8 close	41	036439	059300
2	50	036450	059311
2-1/2	65	036516	-
3	75	036517	059338
3-1/2	90	036518	-
4	100	036519	059339
4-1/2	115	036520	-
5	125	036521	059340
6	150	036522	059341
8	200	036523	-
10	250	036524	-
12	300	036525	-

Nipples

1-1/2" (40mm) diameter



1-3/4 close	45	036440	059301
2	50	036451	059312
2-1/2	65	036526	-
3	75	036527	059342
3-1/2	90	036528	-
4	100	036529	059343
4-1/2	115	036530	-
5	125	036531	059344
5-1/2	140	036532	-
6	150	036533	059345
8	200	036534	-
10	250	036535	-
12	300	036536	-

2" (50mm) diameter

2 close	50	036441	059302
2-1/2	65	036452	-
3	75	036539	059346
3-1/2	90	036540	-
4	100	036541	059347
4-1/2	115	036542	-
5	125	036543	059348
5-1/2	140	036544	-
6	150	036545	059349
8	200	036546	-
10	250	036547	-
12	300	036548	-

2-1/2" (65mm) diameter

2-1/2 close	65	036442	059303
3	75	036549	-
4	100	036550	059351
6	150	036551	059352
8	200	036552	-
12	300	036553	-

3" (75mm) diameter

2-5/8 close	67	036443	059304
3	75	036554	059353
4	100	036555	059354
5	125	036556	059355
6	150	036557	059356
8	200	036558	-
10	250	036559	-
12	300	036560	-

4" (100mm) diameter

2-7/8 close	72	036444	059305
4	100	036562	-
5	125	036563	-
6	150	036564	059357
8	200	036565	-
10	250	036566	-
12	300	036567	-

PRODUCT SELECTION CHART - XIRTEC PVC SCH. 80 & CPVC SCH. 80 FITTINGS

Dimension		PVC Sch 80	CPVC Sch 80
inches	mm	Product Code	Product Code

Dimension		PVC Sch 80	CPVC Sch 80
inches	mm	Product Code	Product Code

Expansion Joint 6" (150mm) Travel EPDM

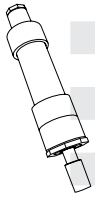

1/2	12	136115	059973
3/4	20	136117	059975
1	25	136119	059977
1-1/2	40	136121	059979
2	50	136123	059981
3	75	136125	059983
4	100	136127	059985

Polypropylene Pipe Clamps

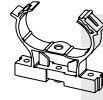

1/2	12	035180	-
3/4	20	035181	-
1	25	035182	-
1-1/4	32	035183	-
1-1/2	40	035184	-
2	50	035185	-

Expansion Joint 12" (1300mm) Travel EPDM

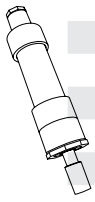

1/2	12	136116	059959
3/4	20	136118	059961
1	25	136120	059963
1-1/2	40	136122	059965
2	50	136124	059967
3	75	136126	059969
4	100	136128	059971

Strut Base

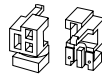

-	-	035186	
---	---	--------	--

Note: Strut Bases are sold individually, two Strut Bases are required to create one Strut Base Unit.
Example: If you require 10 complete Strut Base Units you must order 20 strut bases.

Expansion Joint 6" (150mm) Travel Viton®

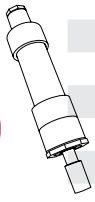

1/2	12	136101	059974
3/4	20	136103	059976
1	25	136105	059978
1-1/2	40	136107	059980
2	50	136109	059982
3	75	136111	059984
4	100	136113	059986

Pipe Straps 2 holes



1/2	12	036000
3/4	20	036001
1	25	036002
1-1/4	32	036003
1-1/2	40	036004
2	50	036005

Expansion Joint 12" (1300mm) Travel Viton®

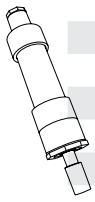

1/2	12	136102	059960
3/4	20	136104	059962
1	25	136106	059964
1-1/2	40	136108	059966
2	50	136110	059968
3	75	136112	059970
4	100	136114	059972

Pipe Straps PVC Coated Steel 2 holes



2-1/2	65	036006
3	75	036007
3-1/2	90	036008
4	100	036009
5	125	036010
6	150	036011

"U" Bend 4" (100mm) O.C. for Ice Rink Piping



1	25	059019 Barbed end
1	25	- Plain End (Spigot)

Fits 1" (25mm) ID Poly Pipe

Choosing the correct solvent cement is vital to the performance of your IPEX integrated piping system. We offer a complete range of IPEX brand cements, primers and applicators, designed to ensure the integrity of your application.

Cements & Primers



Solvent Cements

120



IPEX Solvent Cements

Choosing the correct cement is a vital link in a thermoplastic piping system. Although cement is one of the most critical components of a piping system, it is most often overlooked.

Cements are formulated to best meet specific needs – for example, general-purpose cement is thinner and less aggressive in bonding than heavy-duty industrial cement.

IPEX offers a wide range of high strength solvent cements for thermoplastic piping systems. Regular, medium, heavy or extra heavy cements are specially formulated for PVC pipe and fittings up to 900 mm (36") diameter for both pressure and non-pressure applications, CPVC through 300 mm (12") diameter and ABS through 200 mm (8") diameter.

IPEX offers a complete range of cements, primers and applicators so installers can choose the RIGHT ONE for their project and, following the basic steps, be assured of a good joint every time.

Call your nearest IPEX representative for assistance with this critical part of your plastic piping system. On-the-job training, videos and instruction booklets are all available to help ensure you achieve perfect results.

APPLICATIONS

- Industrial Piping Systems
- Plumbing Piping Systems
- Pressure & Non-pressure applications

STANDARDS



ASTM D2564	PVC Solvent Cements
ASTM D2846	CPVC Solvent Cements
ASTM D3138	Transition Cements
ASTM F493	CPVC Solvent Cements
ASTM F656	Primers

i DID YOU KNOW?

You can take IPEX's 'Solvent Cements Online Training' course, developed by leading experts in thermoplastic systems and offered through the IPEX Training Room. To register for this course go to www.ipexna.com.



SELECTION GUIDES

General Purpose Solvent Cement Products		
Product	IPEX Products / Material	Size Range
Xirtec 05	Xirtec PVC Sch 40/80 Pressure	up to 6" (Sch 40) up to 4" (Sch 80)
Xirtec 11	Xirtec PVC Sch 40/80 Pressure	up to 12"
Xirtec 17	Xirtec PVC Sch 40/80 Pressure	up to 12"
Xirtec 19	Xirtec PVC Sch 40/80 Pressure	14" to 30"
Xirtec 24	Xirtec CPVC Sch 40/80 Pressure	up to 12"
IPS 729	Xirtec CPVC Sch 40/80 Pressure	14" and larger
Xirtec 7	Primer for Xirtec PVC and CPVC	all sizes
IPEX 04	PVC Building Drain Sewer, Septic	3" to 6"
IPEX 25	PVC Wet/Dry Rigid PVC or Flexible	up to 6" (Sch 40) up to 4" (Sch 80)
IPEX 47	PVC Pool/Spa Rigid PVC or Flexible	up to 6" (Sch 40) up to 4" (Sch 80)
IPEX 95	PVC Flexible	up to 6" (Sch 40) up to 3" (Sch 80)
IPEX 71	ABS Drain, Waste and Vent	up to 6"
IPEX 90	PVC-ABS Transition Low Pressure	up to 6" (Sch 40) up to 4" (Sch 80)
IPEX 96	PVC-ABS Transition Non-Pressure	up to 6" (Sch 40)

Product Specific Cements		
Product	Application	Size Range
System 15 / XFR Cement	Drain, Waste & Vent	1-1/2" to 6" (One-Step) 8" and larger (Two-Step)
System 15 / XFR Primer	Drain, Waste & Vent	1-1/2" to 6" (optional) 8" and larger (mandatory)
System 636 PVC	Flue Gas Vent	up to 6"
System 636 CPVC	Flue Gas Vent	up to 8"
System 636 Primer	Flue Gas Vent	up to 4" (at 0°C or lower) 6" & 8" (mandatory)
AquaRise One-Step Cement	AquaRise Pressure	1/2 to 2" (do not use primer)
AquaRise Two-Step Cement & Primer	AquaRise Pressure	2-1/2", 3", 4"
IPEX 100	Scepter PVC Conduit/Duct	up to 6"
IPEX 100T Primer	Scepter PVC Conduit/Duct	all sizes (cold weather)
BlazeMaster One-Step	BlazeMaster CPVC	3/4" to 3"
Duraplus	Duraplus ABS Pressure	up to 12"



XIRTEC® INDUSTRIAL CEMENTS & PRIMER

	Volume		Product Code
	imperial	metric	

XIRTEC 05 PVC CEMENT

GREY ■

LOW VOC, 3 Year Shelf Life

NSF and IAPMO listed to ASTM D2564 standard. NSF listed for potable water and sewer pipe. CSA listed for pressure and non-pressure applications.

Medium-bodied, fast setting PVC cement for all classes and schedules through 150 mm (6") diameter with interference fit Sch. 80 through 100 mm (4") only.



pint	473 ml	074346
quart	946 ml	074347

	Volume		Product Code
	imperial	metric	

XIRTEC 11 PVC CEMENT

GREY ■

LOW VOC, 3 Year Shelf Life

NSF listed to ASTM D2564 for potable water and sewer pipe. IAPMO listed to ASTM D2564 standard. CSA certified for PVC pressure and non-pressure applications.

Heavy-bodied, medium setting, PVC cement for all classes and schedules through 300 mm (12") diameter, including Schedule 80. Its strong, aggressive penetration properties provide a strong bond. Its medium set allows more working time in warm weather.



1/2 pint	236 ml	074362
pint	473 ml	074363
quart	946 ml	074364
gallon	3785 ml	074365

XIRTEC 7 PRIMER

PURPLE/CLEAR ■ □

LOW VOC, 3 Year Shelf Life

NSF listed to ASTM F656 standard for potable water and sewer pipe.

Xirtec 7 is the most aggressive PVC and CPVC primer commercially available. Excellent product for cold weather applications. If used properly, Xirtec 7 will soften pipe and fitting surfaces which is necessary for the proper solvent welding of the materials.



PURPLE PRIMER

1/2 pint	236 ml	074335
pint	473 ml	074336
quart	946 ml	074337
gallon	3785 ml	074338

CLEAR PRIMER

1/4 pint	118 ml	074339
1/2 pint	236 ml	074340
pint	473 ml	074341
quart	946 ml	074342
gallon	3785 ml	074343

XIRTEC 17 PVC CEMENT

GREY ■

LOW VOC, 3 Year Shelf Life

NSF listed to ASTM D2564 for potable water and sewer pipe. IAPMO listed to ASTM D2564 standard. CSA certified for PVC pressure and non-pressure applications.

Heavy-bodied, medium setting, PVC cement for all classes and schedules through 300 mm (12") diameter, including Schedule 80. It has good gap filling properties and its medium set allows more working time in warm weather.



quart	946 ml	074379
-------	--------	--------

DURAPLUS® CEMENTS & CLEANER

	Volume		Product Code
	imperial	metric	

XIRTEC 19 PVC CEMENT

GREY ■

LOW VOC, 3 Year Shelf Life

NSF listed to ASTM D2564 for potable water and sewer pipe. IAPMO listed to ASTM D2564 standard. CSA certified for PVC pressure and non-pressure applications.

Extra heavy-bodied, slow setting, PVC cement for all classes and schedules through 750 mm (30") diameter, including Sch. 80 and System 15 in sizes 350 mm - 600 mm (14" - 24"). It is a good fabrication cement, as it has excellent gap filling properties, and because of its slow set, it is ideal for hot weather cement on large diameter pipe.



gallon	3785 ml	074387
--------	---------	--------

XIRTEC 24 CPVC CEMENT

ORANGE ■

LOW VOC, 2 Year Shelf Life

NSF listed to ASTM F493 standard for potable water and sewer pipe.

Heavy-bodied, medium setting, CPVC cement for all classes and schedules through 300 mm (12") diameter. Formulated for improved chemical resistance to caustics including hypochlorite solutions. May be used on PVC industrial piping systems for chemical applications. Approved for Xirtec CPVC Industrial Systems.



pint	473 ml	074008
quart	946 ml	074009

	Volume		Product Code
	imperial	metric	

DURAPLUS ABS INDUSTRIAL CEMENT

GREY ■

LOW VOC, 1 Year Shelf Life

Medium-bodied, fast setting ABS cement for all sizes and products in the Duraplus Industrial line. The Grey Duraplus ABS solvent cement is manufactured from ABS particles identical to the material used for the manufacturing of Duraplus Industrial components. The cement is designed to withstand continuous applied pressures up to 230 psi @ 23°C (73°F). Duraplus MEK primer must be used prior to cementing.



pint	473 ml	337085
quart	946 ml	337084

DURAPLUS AIR-LINE CEMENT

LIGHT BLUE ■

LOW VOC, 1 Year Shelf Life

Medium-bodied, fast setting ABS cement for all sizes and products in the Duraplus Air-Line. Duraplus ABS solvent cement, is manufactured from ABS particles identical to the material used for the manufacturing of Duraplus Air-Line components. The cement is designed to withstand continuous applied pressures up to 185 psi @ 23°C (73°F). Duraplus MEK primer must be used prior to cementing.



pint	473 ml	437037
quart	946 ml	437038

DURAPLUS MEK CLEANER

CLEAR □

Duraplus MEK Cleaner/Primer must be used prior to solvent welding of any Duraplus and IPEX industrial ABS piping systems.



pint	473 ml	337468
quart	946 ml	337469

GENERAL PLUMBING CEMENTS & PRIMER

Volume		Product Code
imperial	metric	

IPEX 04 GENERAL PURPOSE PVC CEMENT

CLEAR/GREY

LOW VOC, 3 Year Shelf Life

Meets ASTM D2564. NSF and IAPMO listed for potable water and sewer pipe.

Medium-bodied, fast setting, PVC cement For rigid pipe sizes with interference fit through 160 mm (6") diameter. Sch 80 through 110 mm (4") diameter. For irrigation or drain. No primer needed for drainage applications unless required by local code.



CLEAR

1/4 pint	118 ml	074314
1/2 pint	236 ml	074313
pint	473 ml	074312
quart	946 ml	074311
gallon	3785 ml	074310

GREY

1 gal	3785 ml	074800
-------	---------	--------

Volume		Product Code
imperial	metric	

IPEX 25 WET/DRY PVC CEMENT

AQUA BLUE

LOW VOC, 3 Year Shelf Life

Meets the requirements of ASTM D2564 for use with PVC pipe and fittings. NSF and IAPMO listed for potable water and sewer pipe.

Medium-bodied, extremely fast setting PVC cement for pipe sizes through 150 mm (6") interference fit, Sch. 80 through 100 mm (4"). Specially formulated for rigid and flexible applications where conditions are very wet and/or when quick pressurization is desired.



1/2 pint	236 ml	074392
pint	473 ml	074393
quart	946 ml	074394

IPEX 47 POOL/SPA PVC CEMENT

BLUE - Blue fades to clear

LOW VOC, 3 Year Shelf Life

Meets ASTM D2564. CSA certified for joining flexible PVC pipe to rigid PVC fittings used in hydromassage bathtubs. NSF and IAPMO listed for potable water and sewer pipe.

Medium-bodied, extremely fast setting, for PVC pipe sizes through 150 mm (6") interference fit, Sch. 80 through 100 mm (4"). Developed for rigid & flexible applications, wet conditions and/or when quick pressurization is desired.



quart	946 ml	074139
-------	--------	--------

IPEX 5 WET/DRY PRIMER

AQUA BLUE

3 Year Shelf Life

Meets the requirements of ASTM F656 for use with PVC pipe and fittings. NSF listed for potable water and sewer pipe.

Very fast acting primer especially formulated for use with IPEX 25 Wet/Dry cement. Excellent primer for wet applications or when quick penetration of pipe and fitting surfaces is desired. Can also be used with any other PVC or CPVC cement.



pint	473 ml	074397
quart	946 ml	074398

Volume		Product Code
imperial	metric	

IPEX 71 ABS CEMENT

YELLOW ■

LOW VOC, 3 Year Shelf Life

Meets ASTM D2235 for use with ABS pipe. NSF listed to CSA B181.1 for ABS DWV pipe and fittings.

Medium-bodied, fast setting ABS cement for all classes and schedules through 150 mm (6") interference fit.



quart	946 ml	074180
-------	--------	--------

Volume		Product Code
imperial	metric	

IPEX 95 FLEX PVC CEMENT

CLEAR

Low VOC, 3 Year Shelf Life

Meets ASTM D2564. NSF and IAPMO listed for potable water and sewer pipe.

Medium-bodied, fast setting, for bonding flex/flex and flex/rigid PVC pipe and fittings through 150 mm (6") diameter interference fit, Sch. 80 through 75 mm (3") only. Excellent product for flex/rigid applications. It has an elastomer in the formulation which allows a more flexible joint.



1/4 pint	118 ml	074440
1/2 pint	236 ml	074163
quart	946 ml	074412

IPEX 96 ABS/PVC CEMENT

WHITE

3 Year Shelf Life

CSA certified for nonpressure ABS/PVC systems only. Meets ASTM D3138.

Regular-bodied, fast setting, FOR TRANSITION JOINTS ONLY IN NON-PRESSURE SYSTEMS. Pipe sizes through 150 mm (6") interference fit. Not for Sch. 80. Suitability of IPEX 96 should be verified for specific ABS/PVC materials.



pint	473 ml	074461
------	--------	--------

AQUARISE® CEMENTS & PRIMER

	Volume		Product Code
	imperial	metric	

AQUARISE CPVC ONE-STEP CEMENT

YELLOW ■

LOW VOC, 2 Year Shelf Life

Meets ASTM F493. ANSI/NSF Standard 14 & 61 listed for potable water. Certified to CSA B137.6.

Medium-bodied, for use on 12 mm to 50 mm (1/2" to 2") diameters only. DO NOT USE PRIMER.



473	pint	359086
946	quart	359092
3785	gallon	359091

AQUARISE CPVC TWO-STEP CEMENT W/PRIMER

YELLOW ■

LOW VOC, 2 Year Shelf Life

AQUARISE TWO-STEP CEMENT meets ASTM F493. ANSI/NSF Standard 14 & 61 listed for potable water. Certified to CSA B137.6.

Heavy-bodied, for use on 63 mm, 75 mm & 100 mm (2-1/2", 3" & 4") diameters only.

MUST BE USED IN CONJUNCTION WITH AQUARISE CPVC PRIMER.



CLEAR □

LOW VOC, 2 Year Shelf Life

AQUARISE CPVC PRIMER meets ASTM F656. ANSI/NSF Standard 14 & 61 listed for potable water, drain waste & vent & sewer.

AquaRise CPVC Primer will soften pipe and fitting surfaces which is necessary for the proper solvent welding of the materials. Approved for use with AquaRise in potable water applications. For use on 63 mm, 75 mm & 100 mm (2-1/2", 3" and 4") diameters only.



473	pint	primer	359087
946	quart	cement	-
473	pint	primer	359093
3785	gallon	cement	-

SYSTEM 15 DWV, SYSTEM XFR CEMENTS & PRIMER

	Volume		Product Code
	imperial	metric	

SYSTEM 15/SYSTEM XFR ONE-STEP PVC CEMENT

GREY ■

LOW VOC, 3 Year Shelf Life

Meets the requirements of ASTM D2564. cNSF Listed to CSA B181.2 for DWV applications.

Heavy-bodied, medium setting, grey, suitable for 40 mm to 150 mm (1-1/2 – 6"), without primer. Not recommended for use below 0°C (32°F).



quart	946 ml	074232
gallon	3785 ml	074231

Medium-bodied, fast setting, grey, suitable for 40 mm to 150 mm (1-1/2 – 6"), without primer. Not recommended for use below 0°C (32°F).



pint	473 ml	074098
quart	946 ml	074097
gallon	3785 ml	074096

	Volume		Product Code
	imperial	metric	

SYSTEM 15/SYSTEM XFR TWO-STEP PVC CEMENT

GREY ■

LOW VOC, 3 Year Shelf Life

Meets the requirements of ASTM D2564. cNSF Listed to CSA B181.2 for DWV applications.

Heavy-bodied, medium setting, suitable for System 15 and System XFR pipe sizes 200 mm to 300 mm (8" to 12") where gap filling is required. Use with System 15 / System XFR DWV primer. For System 15 pipe 14" to 24" (350mm to 600mm), refer to Xirtec 19 PVC cement.



quart	946 ml	074226
gallon	3785 ml	074225

SYSTEM 15/SYSTEM XFR DWV PRIMER

PURPLE ■

LOW VOC, 3 Year Shelf Life

Meets the requirements of ASTM F656.

For quick softening and preparation of System 15 and System XFR pipe and fitting sizes 40 mm to 600 mm (1-1/2" to 24"). A primer suitable for use with System 15 / System XFR DWV Two-Step Cement.



quart	946 ml	074354
gallon	3785 ml	074355

SYSTEM 636® CEMENTS & PRIMERS

	Volume		Product Code
	imperial	metric	

SYSTEM 636 PVC CEMENT

GREY ■

LOW VOC, 3 Year Shelf Life

Suitable for use with System 636 Flue Gas Venting, Type BH, Class IIA 65°C (149°F) pipe and fittings.

Meets ASTM D2564 "Standard Specification for Solvent Cements for Polyvinyl Chloride (PVC) Plastic Piping Systems".

Medium-bodied, fast setting, PVC cement certified as a system component for use with all diameters of System 636 PVC pipe and fittings. Primer is always required for 6" and 8" (150 mm and 200 mm) piping systems and for all installations performed at temperatures of 0°C (32°F) or less.



pint	473 ml	196040
quart	946 ml	196041

	Volume		Product Code
	imperial	metric	

SYSTEM 636 CPVC CEMENT

ORANGE ■

LOW VOC, 2 Year Shelf Life

Suitable for use with System 636 Flue Gas Venting, Type BH, Class IIB 90°C (194°F) pipe and fittings.

Meets ASTM F493 "Standard Specification for Chlorinated Polyvinyl Chloride (CPVC) Plastic Pipe and Fittings".

Heavy-bodied, medium setting, CPVC cement certified as a system component for use with all diameters of System 636 PVC or CPVC pipe and fittings. Primer is always required for 6" and 8" (150 mm and 200 mm) piping systems and for all installations performed at temperatures of 0°C (32°F) or less.



pint	473 ml	196046
quart	946 ml	196047

SYSTEM 636 PVC/CPVC PRIMER

CLEAR/PURPLE □ ■

LOW VOC, 3 Year Shelf Life

Suitable for use with System 636 Flue Gas Venting pipe and fittings that meet ULC S636 standards.

Meets ASTM F656 "Standard Specification for Primers for use in Solvent Cement Joints of Polyvinyl Chloride (PVC) Plastic Pipe and Fittings"

System 636 PVC/CPVC Primer is certified as a system component for use with all diameters of System 636 PVC/CPVC pipe and fittings. Primer is always required for 6" and 8" (150 mm and 200 mm) piping systems and for all installations performed at temperatures of 0°C (32°F) or less. DO NOT USE PRIMER ON ABS SURFACES.



CLEAR

pint	473 ml	196017
------	--------	--------



PURPLE

pint	473 ml	196042
quart	946 ml	196043

BLAZEMASTER® CEMENT

	Volume		Product Code
	imperial	metric	

BLAZEMASTER BM5 ONE-STEP CEMENT

RED ■

LOW VOC, 2 Year Shelf Life

Meets the requirements of ASTM F493 for use with CPVC pipe. NSF listed for potable water.

Heavy-bodied, for use with BlazeMaster® CPVC pipe & fittings 20 mm – 80 mm (3/4" – 3"). Component for sprinkler pipe and fittings. For use with ULC 15S7 labeled IPEX BlazeMaster sprinkler pipe and fittings.



pint	473 ml	074328
quart	946 ml	074329

ADHESIVE

	Volume		Product Code
	inches	mm	

IPEX / IPS 810 REACTIVE ADHESIVE

WHITE □

Low VOC, 1 Year Shelf Life

Two-component, high-strength reactive adhesive for joining, fabricating and repairing PVC and CPVC pipe and fittings.



1/4 pint	118 ml	074176
----------	--------	--------

AVERAGE NUMBER OF JOINTS PER 946 ML (1 QUART) OF IPEX CEMENT AND PRIMER

Pipe Diameter mm	Pipe Diameter inches	Average Primer Joints per quart	Average Cement Joints per quart
12	1/2	600	300
20	3/4	400	200
25	1	250	125
40	1-1/2	180	90
50	2	120	60
75	3	80	40
100	4	60	30
150	5	20	10
200	6	10	5
250	10	4 – 6	2 – 3
300	12	2 – 4	1 – 2
400	16	1-1/2	3/4
450	18	1	1/2

These figures are estimates based on laboratory tests. Due to the many variables in the field, these figures should be used as a general guide only.

APPLICATORS & ACCESSORIES

	Size		Product Code
	imperial	metric	

BRISTLE BRUSH / CAP

PB-1: Plastic Handle Brush; fits standard pint and quart cans.

CM BCP Can-Mate: Adjustable Plastic Handle Natural Bristle Brush; fits standard pint and quart cans.



1"	25 mm	074454
----	-------	--------

CAN-MATE DAUBER

Adjustable plastic applicator with telescoping stem to fit all cans (except 1/4 pint). Available in 3/4" and 1-1/2" dauber sizes.



3/4"	20 mm	074436
1-1/2 - 3"	40-75 mm	074437

CAP DAUBER

DP daubers fit 1/2 pint & pint cans; DQ daubers fit quart cans. Available in 1/2", 3/4", and 1-1/2" dauber sizes.



1/2"	12 mm	074455
3/4"	20 mm	074420
1-1/2"	40 mm	074421
1-1/2"	40 mm	074422

SWAB

4020 swab for pipe diameters of 150 mm (6") or larger; fits MT-648 can. 5020 Swab available for quart can.



4"	100 mm	074456
		074317

	Size		Product Code
	imperial	metric	

AQUARISE SUPERSWAB REPLACEMENT

Swab holder and handle are reusable and can be used to cap the cement can. The swab is disposable and replaceable.



			359826
--	--	--	--------

ROLL-A-WELD ROLLER

3020 roller for pipe diameters from 75 mm through 150 mm (3" through 6"); fits MT-653 empty quart can.

7020 roller for pipe diameters of 150 mm (6") or larger; fits MT-648 can.



3"	75 mm	074426
7"	180 mm	074427

Description	Volume		Product Code
	U.S.	metric	

CAN WITH NECK

Can with neck is available in gallon (with 2-7/8" neck), quarts (with 2-7/8" neck or paint style neck) and pint (1-3/4" neck).



MT-654: 1-3/4" neck	pint	473 ml	074423
MT-653: paint style neck	quart	946 ml	074419
MT-651: 1-3/4" neck	quart	946 ml	074424
MT-648: 2-7/8" neck	gallon	3785 ml	074425

	Size		Product Code
	imperial	metric	

EMPTY APPLICAN WITH BRUSH



pint	500 ml	074728
------	--------	--------

Visit our website:

www.ipexna.com

for
ON-SITE TRAINING



Learn more about IPEX products through in-person and online training programs.



ON-SITE SYSTEM 636 FLUE GAS VENTING TRAINING

Do you or your organization require System 636 product installation and solvent welding training? Contact IPEX to discuss organizing a group training session or find out when courses are being held in your local area.

Bookmark Our Website

www.ipexna.com



PRODUCT INFO,
TECHNICAL
DOCUMENTS,
ON-SIGHT TRAINING
& MUCH MORE ...



OUR TECHNICAL MANUALS INCLUDE:

- Standards
- Specifications
- Dimensions
- Pressure Ratings
- Design Calculations
- and much more ...

available at ipexna.com

SALES AND CUSTOMER SERVICE

IPEX Inc.

Toll free: (866) 473-9462

ipexna.com

About the IPEX Group of Companies

As leading suppliers of thermoplastic piping systems, the IPEX Group of Companies provides our customers with some of the world's largest and most comprehensive product lines. All IPEX products are backed by more than 50 years of experience. With state-of-the-art manufacturing facilities and distribution centers across North America, we have earned a reputation for product innovation, quality, end-user focus and performance.

Markets served by IPEX group products are:

- Electrical systems
- Telecommunications and utility piping systems
- Industrial process piping systems
- Municipal pressure and gravity piping systems
- Plumbing and mechanical piping systems
- Electrofusion systems for gas and water
- Industrial, plumbing and electrical cements
- Irrigation systems
- PVC, CPVC, PP, PVDF, PE, ABS, and PEX pipe and fittings

Products are manufactured by IPEX Inc.

Blue904[®], Drain-Guard[™], DRAIN-WAY[®], Gold901[™], MJ Grey[™], Peace of Mind from the Ground Up[™], Pipe-with-the-Stripe[®], Q-Line[®], RadonX[™], System 15[®], System XFR[®], System 636[®], UCVK[™], and Xirtec[®] are trademarks used under license.

AquaRise[®] and the colour of the AquaRise[®] pipes and fittings are registered trademarks. Distributed in Canada by IPEX Inc., Mississauga, Ontario.

RadonX[™] Soil Gas Venting pipe, fittings and venting accessories are manufactured by IPEX Inc. and/or IPEX USA LLC and RadonX piping system is distributed in Canada by IPEX Inc., Mississauga, Ontario.

Xirtec[®] CPVC piping systems are made with Corzan[®] CPVC compounds. Corzan[®] and BlazeMaster[®] are registered trademarks of The Lubrizol Corporation.

This literature is published in good faith and is believed to be reliable. However, it does not represent and/or warrant in any manner the information and suggestions contained in this brochure. Data presented is the result of laboratory tests and field experience.

A policy of ongoing product improvement is maintained. This may result in modifications of features and/or specifications without notice.



IPEX
by **alixis**

CTMENAIP200805CR7
© 2021 IPEX MS001C