

# FLOOR OR SHOWER DRAINS WITH ADJUSTABLE STRAINER HEADS

Load Rating: Light Duty having a Safe Live (Static) Load less than 2,000 lbs. (900 kg) per ASME A112.6.3 Floor Drain Standard. For the specific Safe Live Load rating of any grate, contact the Smith representative or factory direct.

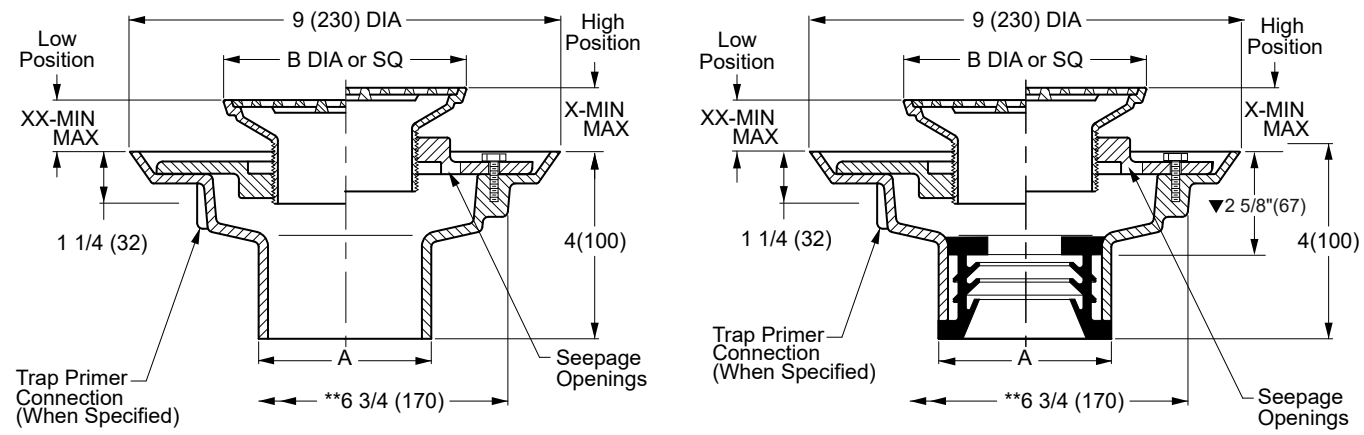

A (Pipe Size) = 02(50), 03(75), 04(100), 05(125) or 06(150)

### NO-HUB OUTLET

- Fig. 2005Y.....(A) ROUND TOP
- Fig. 2005Y.....(B) SQUARE TOP

Outlet Size	Nickel Bronze Strainer Head
▲ 02(50)	05(125) DIA or SQ
▲ 03(75)	06(150) DIA or SQ
▲ 04(100)	08(205) DIA or SQ

### SPEEDI-SET® OUTLET

- Fig. 2005L.....(A) ROUND TOP
- Fig. 2005L.....(B) SQUARE TOP

Strainer Size B DIA or SQ	*Collar In High Position X		*Collar In Low Position XX		Free Area SQ IN (SQ CM)	
	MIN	MAX	MIN	MAX	ROUND	SQUARE
05 (125)	1 1/4(32)	2 1/4(57)	3/4(19)	1 5/8(41)	7(45)	6.5(42)
06 (150)	1 1/4(32)	2 1/4(57)	3/4(19)	1 5/8(41)	9(58)	12.5(81)
07 (180)	1 1/4(32)	2 1/4(57)	7/8(22)	1 7/8(48)	14(90)	11(71)
08 (205)	1 1/2(38)	2 1/2(64)	1(25)	1 7/8(48)	17(110)	14(90)
*09 (230)	1 1/2(38)	2 3/8(60)	1(25)	1 7/8(48)	18(116)	16(103)
*10 (255)	1 1/2(38)	2 3/8(60)	1(25)	1 7/8(48)	23(48)	16(103)

- ▼ This dimension to internal stop of speedi-set® gasket.
- Add 3/8"(10) to all min/max dimensions for round strainers.
- \* Collar is reversible to obtain extreme high and low strainer positions.
- \*\* Not available for 5"(125) size strainer.
- \*\* MIN 6 3/4"(170) hole required for core drilled application.

**REGULARLY FURNISHED:**  
 Duco Cast Iron Body with Flashing Collar and Adjustable Strainer Head as Indicated by Suffix Letter Selected.

- VARIATIONS:**
- Flapper Type Backwater Valve -V (NOTE 2)
  - Hinged Grate -H (NOTE 1)
  - L Speedi-Set® Service Weight 2(50), 3(75) & 4"(100) only
  - LXH Speedi-Set® Extra Heavy 2(50), 3(75) & 4"(100) only
  - Sediment Bucket -B
  - Trap Primer Connection -P050 1/2" (13) & -P075 3/4" (19)
  - Vandal Proof Screws -U
  - Wide Flanged Strainer (Specify Fig. DX2005)
  - T Threaded Outlet (Specify 2010T)
  - Heelproof Grate -HP -AHP (Round) or -BHP (Square)
  - Quad Close Trap Seal (Specify Fig. 2692)

- OPTIONAL MATERIALS:**
- Bronze Body -BB
  - Chrome Plated Strainer -CP
  - Galvanized Cast Iron Body -G
  - Nickel Bronze Strainer -NB
  - Polished Bronze Strainer -PB
  - All Stainless Steel (Specify Fig. 9700)
  - Stainless Steel Strainers -SS [Available in 05(125) & 06(150) sizes only]

**NOTE:** Dimensions shown in parentheses are in millimeters.  
 ▲ Meets ASME Standard A112.6.3-2001 02(50), 03(75) or 04"(100) sizes only.

**NOTE 1:** Sediment Bucket -B not provided for a Hinged Grate (-H)  
**NOTE 2:** Sediment Bucket -B not provided for a Ball Float (-BFV) or a Flapper Type (-V)

**SEE PM 0457 FOR OPTIONAL STRAINER HEADS.**

DRAWING NUMBER: S2005  
 SIZE: A  
 SCALE: NONE  
 DATE: 5-17-85  
 APPROVED BY: TD  
 CHECKED BY: TD  
 DRAWN BY: PJ  
 FIGURE NUMBER: 2005  
 DIMENSIONS ARE SUBJECT TO MANUFACTURERS TOLERANCE AND CHANGE WITHOUT NOTICE

REV.	DATE	DESCRIPTION	BY	CKD. BY	WEIGHT POUNDS	VOLUME CUBIC FEET	FIGURE NUMBER
Y	8-9-23	Removed Function	HS	CL			<b>2005</b>
X	3-10-23	Added @ to "Speedi-Set"	KK	CL			
W	10-8-21	Added NOTE 1 & 2	KK	JM			
V	8-27-21	Edited Variations	KK	JM			

**NOTE 1:** Sediment Bucket -B not provided for a Hinged Grate (-H)

**NOTE 2:** Sediment Bucket -B not provided for a Ball Float (-BFV) or a Flapper Type (-V)

# OPTIONAL STRAINER HEADS

## ROUND STRAINER

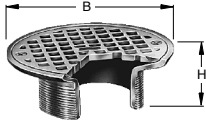

**MATERIALS:**  
 Chrome Plated -CP  
 Polished Bronze -PB  
 Nickel Bronze -NB  
 Stainless Steel  
 Strainers -SS [Available in 05(125) & 06(150) sizes only]

**VARIATIONS:**  
 \*Hinged Grate (Specify Suffix -AH) (NOTE 1)  
 Sediment Bucket -B  
 Vandal Proof Screws -U

B DIA	05 (125)	06 (150)	07 (180)	08 (205)	09 (230)	10 (255)
H	2 (51)	2 (51)	2 1/4 (57)	2 1/2 (64)	2 1/2 (64)	2 3/4 (70)
X MIN	1 1/4 (32)	1 1/4 (32)	1 1/4 (32)	1 1/2 (38)	1 1/2 (38)	1 1/2 (38)
X MAX	2 1/4 (57)	2 1/4 (57)	2 1/4 (57)	2 1/2 (64)	2 1/2 (64)	2 3/4 (70)

LIGHT DUTY

**SUFFIX -A**

Specify Type, Size & Finish eg: A05NB  
 \*Not available for 05" (125) size

## FLAPPER TYPE BACKWATER VALVE

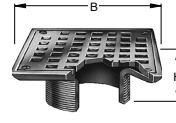

**FUNCTION:** Provides backwater protection at point where protection is needed.

**MATERIALS:**  
 Chrome Plated -CP  
 Polished Bronze -PB  
 Nickel Bronze -NB

**VARIATIONS:**  
 \*Hinged Grate (Specify Suffix -AH)  
 Vandal Proof Screws -U

B SQ	05 (125)	06 (150)	07 (180)	08 (205)
H	2 (51)	2 (51)	2 1/4 (57)	2 1/2 (64)
X MIN	1 1/4 (32)	1 1/4 (32)	1 1/4 (32)	1 1/2 (38)
X MAX	2 1/4 (57)	2 1/4 (57)	2 1/4 (57)	2 1/2 (64)

LIGHT DUTY

**SUFFIX -AV**

Specify Type, Size & Finish eg: AV05NB  
 \*Not available for 05" (125) size

## SQUARE STRAINER

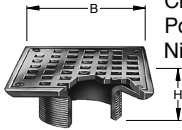

**MATERIALS:**  
 Chrome Plated -CP  
 Polished Bronze -PB  
 Nickel Bronze -NB

**VARIATIONS:**  
 Flapper Type Backwater Valve (Specify Suffix -BV) 05 (125), 06 (150), 07 (180) or 08" (205) sizes only (NOTE 2)  
 \*Hinged Grate (Specify Suffix -BH) (NOTE 1)  
 Sediment Bucket -B  
 Vandal Proof Screws -U

B SQ	05 (125)	06 (150)	07 (180)	08 (205)	09 (230)	10 (255)
H	2 (51)	2 (51)	2 1/4 (57)	2 1/2 (64)	2 1/4 (57)	2 1/4 (57)
X MIN	1 1/4 (32)	1 1/4 (32)	1 1/4 (32)	1 1/2 (38)	1 1/2 (38)	1 1/2 (38)
X MAX	2 1/4 (57)	2 1/4 (57)	2 1/4 (57)	2 1/2 (64)	2 1/4 (57)	2 3/8 (60)

LIGHT DUTY

**SUFFIX -B**

Specify Type, Size & Finish eg: B05NB  
 \*Not available for 05" (125) size

## STRAINER HEAD w/SQUARE HINGED COVER

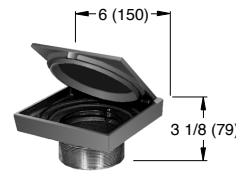

**MATERIALS:**  
 Chrome Plated -CP  
 Polished Bronze -PB  
 Nickel Bronze -NB

**VARIATIONS:**  
 Gasketed Water Tight Cover -GC  
 Secured Cover -SC  
 Secondary Strainer Grate-SG

LIGHT DUTY

**SUFFIX -BS**

Specify Type, Size & Finish eg: BSNB

## REINFORCED ROUND STRAINER

**FUNCTION:** Used in finished floors where light wheeled loads are anticipated.

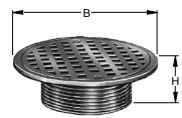

**MATERIALS:**  
 Chrome Plated -CP  
 Polished Bronze -PB  
 Nickel Bronze -NB

**VARIATIONS:**  
 Flapper Type Backwater Valve (Specify Suffix -CV) (NOTE 2)  
 Sediment Bucket -B  
 Vandal Proof Screws -U

B DIA	05 (125)	06 (150)	08 (205)	10 (255)
H	2 (51)	2 (51)	2 1/2 (64)	2 3/4 (70)
MIN	1 1/4 (32)	1 1/4 (32)	1 1/2 (38)	1 7/8 (48)
MAX	2 1/4 (57)	2 1/4 (57)	2 1/2 (64)	2 3/4 (70)

LIGHT DUTY

**SUFFIX -C**

Specify Type, Size & Finish eg: C06NB

## REINFORCED TRACTOR STRAINER

**FUNCTION:** Used in finished floors where light weight wheeled loads are anticipated and loose set non-tilt tractor grate is desired.



**MATERIALS:**  
 Cast Iron -CI  
 Chrome Plated -CP  
 Polished Bronze -PB  
 Nickel Bronze -NB

**VARIATIONS:**  
 Flapper Type Backwater Valve (Specify Suffix -DV or -EV) (NOTE 2)  
 Sediment Bucket -B  
 Vandal Proof Screws -U

SUFFIX	B DIA	H	X	
			MIN	MAX
-D	07 (180)	3 1/4 (83)	2 5/8 (67)	3 1/2 (89)
-E	09 (230)	3 1/2 (89)	2 3/4 (70)	3 1/2 (89)

LIGHT DUTY

**SUFFIX -D-E**

Specify Type, Size & Finish eg: D07PB  
 E09PB

## TILE FLANGE

**FUNCTION:** Provides integral flange set 5/32"(4) below rim to receive floor covering. Flange may have option of tapped holes for securing pan and gasket.

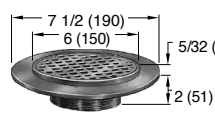

**MATERIALS:**  
 Chrome Plated -CP  
 Polished Bronze -PB  
 Nickel Bronze -NB

**VARIATIONS:**  
 Flapper Type Backwater Valve (Specify Suffix -FV) (NOTE 2)  
 Holes in Flange -SH  
 Sediment Bucket -B  
 Vandal Proof Screws -U

X	
MIN	MAX
1 1/4 (32)	2 1/8 (54)

LIGHT DUTY

**SUFFIX -F**

Specify Type, Size & Finish eg: F06NB

## ADJUSTABLE STRAINER HEAD

**FUNCTION:** Used in a non-traffic area when a funnel type strainer head is required and space does not allow use of the 3500 series funnel. The extended rim allows use as an anti-flood and anti-splash drip pan.

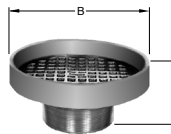

**VARIATIONS:**  
 Flapper Type Backwater Valve (Specify Suffix -F37V or F38V)

**MATERIALS:**  
 Cast Iron -CI  
 Chrome Plated -CP  
 Galvanized Cast Iron -G  
 Polished Bronze -PB  
 Nickel Bronze -NB

SUFFIX	-F37	-F38
	B DIA	07 (180)
H	3 1/4 (83)	3 1/2 (89)
X MIN	2 5/8 (67)	2 3/4 (70)
X MAX	3 1/2 (89)	3 1/2 (89)

NON-TRAFFIC

**SUFFIX -F37-F38**

Specify Type, Size & Finish eg: F37NB F38CP

DRAWING NUMBER  
PM0457 SH 1 of 2

SCALE  
NONE

DATE:  
5-17-85

APPROVED BY:  
TD

CHECKED BY:  
TD

DRAWN BY:  
PJ

2010 SERIES OPTIONAL STRAINER HEADS

FIGURE NUMBER

DIMENSIONS ARE SUBJECT TO MANUFACTURERS TOLERANCE AND CHANGE WITHOUT NOTICE

REV.	DATE	DESCRIPTION	BY	CKD. BY	FIGURE NUMBER
M	10-8-21	Added NOTE 1 & 2	KK	JM	2010 SERIES OPTIONAL STRAINER HEADS 1 of 2
L	10-26-20	Rev. Finish (Tractor Stainer)	MW	CL	
K	7-29-19	Added Load Rating(s)	MW	JM	

NOTE: Dimensions shown in parentheses are in millimeters.



**WARNING:** Cancer and Reproductive Harm - www.P65Warnings.ca.gov

# OPTIONAL STRAINER HEADS

DRAWING NUMBER: PM0457 SH 2 of 2  
 SIZE: A  
 SCALE: NONE  
 DATE: 5-17-85  
 APPROVED BY: TD  
 CHECKED BY: TD  
 DRAWN BY: PJ  
 2010 SERIES OPTIONAL STRAINER HEADS

ASSUME NO RESPONSIBILITY OR USE OF SUPERSEDED OR VOID DATA  
 DIMENSIONS ARE SUBJECT TO MANUFACTURERS TOLERANCE AND CHANGE WITHOUT NOTICE

### LOW DOME STRAINER

**FUNCTION:** Used in gutters and recessed areas where excessive debris build-up is expected. Dome insures drainage even when partly covered.

**MATERIALS:**  
 Chrome Plated -CP  
 Polished Bronze -PB  
 Nickel Bronze -NB

**VARIATIONS:**  
 Flapper Type Backwater Valve (Specify Suffix -GV)  
 Sediment Bucket -B  
 Vandal Proof Screws -U



B DIA	05 (125)	06 (150)	08 (205)
H	2 (51)	2 (51)	2 1/2 (64)
MIN	1 1/4 (32)	1 1/4 (32)	1 1/2 (38)
MAX	2 1/4 (57)	2 1/4 (57)	2 1/2 (64)

**SUFFIX -G** Specify Type, Size & Finish eg: G08PB

### SOLID HINGED COVER

**FUNCTION:** Used in areas where intermittent drain use is required. Solid cover prevents intrusion of chips, saw-dust, etc., which are swept up before cover is opened for washdown. The secondary strainer prevents debris from entering the waste line.

**MATERIALS:**  
 Chrome Plated -CP  
 Polished Bronze -PB  
 Nickel Bronze -NB

**VARIATIONS:**  
 Flapper Type Backwater Valve (Specify Suffix -GV)  
 Vandal Proof Screws -U



B DIA	05 (125)	06 (150)	07 (180)	08 (205)
H	2 (51)	2 (51)	2 1/4 (57)	2 1/2 (64)
X MIN	1 1/4 (32)	1 1/4 (32)	1 1/4 (32)	1 1/2 (38)
MAX	2 1/4 (57)	2 1/4 (57)	2 1/4 (57)	2 1/2 (64)

**SUFFIX -H** Specify Type, Size & Finish eg: H05CP

### SPANNER WRENCH COVER

**FUNCTION:** Solid gas tight, vandal proof, threaded cover for areas where intermittent drain use is required.

**MATERIALS:**  
 Chrome Plated -CP  
 Polished Bronze -PB  
 Nickel Bronze -NB

**VARIATIONS:**  
 Flapper Type Backwater Valve (Specify Suffix -JV)  
 Sediment Bucket -B

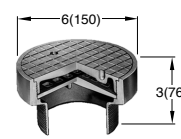

MEDIUM DUTY	
X	
MIN	2 (51)
MAX	3 (76)

**SUFFIX -J** Specify Type, Size & Finish eg: J06NB

### REINFORCED SQUARE STRAINER

**FUNCTION:** Used in finished floors where some light wheeled traffic is anticipated.

**MATERIALS:**  
 Chrome Plated -CP  
 Polished Bronze -PB  
 Nickel Bronze -NB

**VARIATIONS:**  
 Flapper Type Backwater Valve (Specify Suffix -KV)  
 Sediment Bucket -B  
 Vandal Proof Screws -U

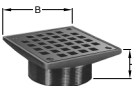

B SQ	05 (125)	06 (150)	07 (180)	08 (205)
H	2 (51)	2 (51)	2 1/4 (57)	2 1/2 (64)
X MIN	1 1/4 (32)	1 1/4 (32)	1 1/4 (32)	1 1/2 (38)
MAX	2 1/4 (57)	2 1/4 (57)	2 1/4 (57)	2 1/2 (64)

**SUFFIX -K** Specify Type, Size & Finish eg: K07CP

### RECTANGULAR STRAINER

**FUNCTION:** Used in finished floors where light wheeled loads and or heavy foot traffic are anticipated.

**MATERIALS:**  
 Chrome Plated -CP  
 Polished Bronze -PB  
 Nickel Bronze -NB

**VARIATIONS:**  
 Sediment Bucket -B  
 Vandal Proof Screws -U

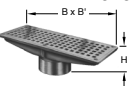

SUFFIX	L	M	N	P	R	T
B x B'	4 1/2(115)x8(205)	4(100)x12(305)	5(125)x9(230)	5(125)x13(330)	6(150)x10(255)	5(125)x17(430)
H	2 1/4 (57)	2 1/2 (64)	2 1/4 (57)	3 (76)	2 1/4 (57)	3 (76)
X MIN	1 3/8 (35)	1 7/8 (48)	1 3/8 (35)	2 1/8 (54)	1 3/8 (35)	2 1/4 (57)
MAX	2 3/8 (60)	2 3/4 (70)	2 3/8 (60)	3 (76)	2 3/8 (60)	3 1/8 (79)

**SUFFIX -L-M-N-P-R-T** Specify Type, Size & Finish eg: LNB

### ANGLE STRAINER

**FUNCTION:** Shower room drain set at wall and floor junction. Vertical grate openings prevent drain stoppage should flat surface become covered.

**MATERIALS:**  
 Chrome Plated -CP  
 Polished Bronze -PB  
 Nickel Bronze -NB

**VARIATIONS:**  
 Vandal Proof Screws -U

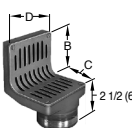

SUFFIX	B	C	D	X	
				MIN	MAX
-V	3 1/2 (89)	3 1/2 (89)	4 1/2 (115)	1 5/8 (41)	2 5/8 (67)
-W	6 3/4 (170)	6 3/4 (170)	6 1/2 (165)	1 5/8 (41)	2 5/8 (67)

**SUFFIX -V -W** Specify Type, Size & Finish eg: VPB, WNB

### EXTENSION ADAPTOR

**FUNCTION:** Used when a strainer head must be raised to accommodate deeper floor fill.

**REGULARLY FURNISHED:**  
 Duco Cast Iron -CI

**MATERIALS:**  
 Cast Bronze -CB  
 Galvanized Cast Iron -G

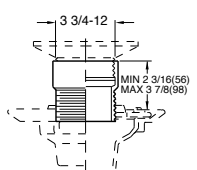

**NOTE:** Extension can be stacked for increased maximum adjustment.

**SUFFIX -X**

### OVERFLOW WITH STANDPIPE

**FUNCTION:** Used as overflow drain in decorative pools, fish ponds or similar areas. Dome prevents floating objects from entering drain line.

**MATERIALS:**  
 Chrome Plated -CP  
 Nickel Bronze -NB  
 Polished Bronze -PB

**VARIATIONS:**  
 Less Dome -LD  
 Standpipe Height other than 6" (150) (Specify Height)

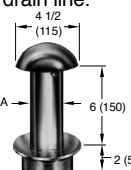

SUFFIX	A	X	
	SIZE	MIN	MAX
-Y	2 (51)	3/4 (19)	2 1/8 (54)
-Z	3 (76)	3/4 (19)	2 1/8 (54)

**SUFFIX -Y-Z** Specify Type, Size & Finish eg: YCP, ZCP

### HEAVY DUTY ADJUSTABLE

**FUNCTION:** Used in finished floors where light wheeled loads and or heavy foot traffic are anticipated.

**MATERIALS:**  
 Polished Bronze -PB  
 Rough Bronze -RB  
 Nickel Bronze -NB

**VARIATIONS:**  
 Flapper Type Backwater Valve (Specify Suffix -69V)  
 Sediment Bucket -B  
 Vandal Proof Screws -U

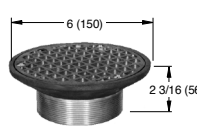

**SUFFIX -69** eg: A06NB-69

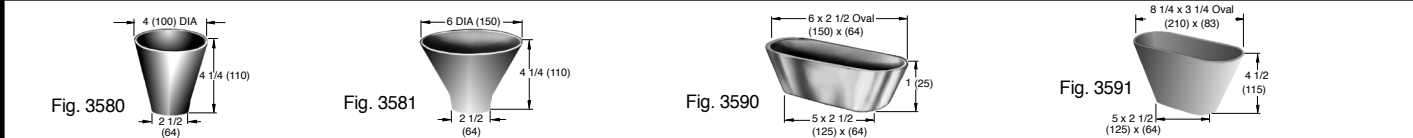

L	7-29-19	Added Load Rating(s) Rev. Materials Suffix -H, -V-W Rev. Variations of Suffix -J Revised Revised Tables	MW	JM	FIGURE NUMBER 2010 SERIES OPTIONAL STRAINER HEADS 2 of 2
K	10-20-17		TBW	CL	
J	1-17-12		TBW	AM	
H	8-24-99		TBW	BS	
G	6-11-99		CMD		
REV.	DATE	DESCRIPTION	BY	CKD. BY	

NOTE: Dimensions shown in parentheses are in millimeters.



**WARNING:** Cancer and Reproductive Harm - www.P65Warnings.ca.gov