



Utility Jack

Model Number:

74407 74407HD 74410 74410HD 74413 74413HD
74412 74415 70429

- Rolled Acme Thread and Anti-Friction thrust Bearings
- High Strength Tubing



 **This Instruction Sheet contains IMPORTANT safety information. Please read and keep for future reference.**

For assistance with this product or to order replacement parts, please contact:



Cequent Consumer Products, Inc.
29000-2 Aurora Road
Solon, OH 44139
Technical Service: (800) 234-6992
CequentConsumerProducts.com

Date of Purchase: _____

WARNING

READ and FOLLOW all instructions and safety messages before using the Utility Jack.

- Purchaser/owner must ensure that product is installed according to these instructions. Purchaser/owner must not alter or modify product.
- Operator and bystanders should never position any part of body under any portion of this product or the load being supported.
- Fully retract and rotate jack before towing.
- When using the drop foot or drop leg, make certain the supplied pin is fully inserted through both sides of the inner tube and the drop tube before using the jack.
- If using optional drop foot or caster, always remove drop foot or caster before towing to maximize ground clearance.
- This product is not intended to be used as a transport device for the implement it is attached to. Minimize movement of implement while jack is under load.
- Do not allow children to play on or around this product or the load being supported.
- Secure the load, vehicle and trailer from rolling (by blocking wheels) when operating jack or coupling trailer.
- Jack capacity is limited to the lesser of the jack, foot plate, or caster wheel capacity.
- Never exceed maximum rated capacity. Refer to stamped markings or decals on product to obtain rated capacity. If uncertain, contact Cequent Consumer Products at 800-234-6992 or CequentConsumerProducts.com.
- These jacks are designed for vertical loading. Excessive side forces may cause jack failure and must be avoided.
- Before manually moving trailer, crank to lowest position.
- If this product has a pivot tube mount, make certain the pivot pin is fully inserted through both sides on the pivot tube and the pivot mount.
- If this product is a swivel jack, lock the plunger pin into a hole in the mounting bracket before raising or lowering the tongue.
- Before installing the snap ring, inspect the snap ring groove and remove any debris. Seat the snap ring fully into the groove.
- Do not attempt to weld Bolt-On brackets or straps to the tongue. Special brackets are available for Weld-On applications.
- If this product has a drop foot or drop leg, never attempt to adjust the drop foot or drop leg when there is any load on the jack.
- If this product is a rack jack, do not raise the gear housing above inner tube.
- These jacks are not designed for mounting to round tongues.
- All welding must be performed by an AWS certified welder.
- Always replace bent, broken, or worn parts before using this product.

THIS WARNING IS GIVEN IN COMPLIANCE WITH CALIFORNIA PROPOSITION 65

WARNING: This product contains chemicals known to the state of California to cause cancer, birth defects or other reproductive harm.

Installation Instructions

Before mounting the jack confirm that there will be no interference from the tow vehicle, tongue, ground, and any other mounted accessories while stationary or in motion. Before installing, check for interference in all positions including handle swing and swivel positions if applicable. Check for interference again after installation is complete.

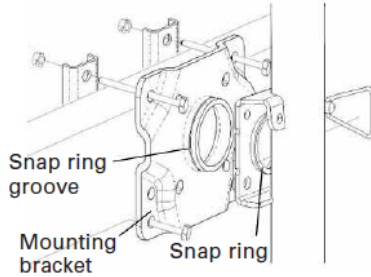

Bolt-On Mounting Bracket Instructions:

If using a bolt-on jack, assure the correct mounting hole pattern for your tongue size. The gap between the mounting bolts and the tongue is not to exceed 1/16"

- 1) Place the jack against the tongue and position the mounting straps on the opposite side of the tongue. Align the holes in the mounting bracket with the holes in the mounting straps.
- 2) Insert the 4 bolts through the mounting bracket and mounting straps. The upper bolts should rest on the top of the tongue. The lower bolts should be less than 1/16" from the bottom of the tongue.
- 3) Secure with locknuts, torque to 25 ft. lbs.
- 4) Check for clearance of handle, trailer light cables and coupler.

To Attach a Top-wind Handle Assembly:

- 1) Place the washer over the screw stem and then place the handle over the screw stem.
- 2) Secure the handle to the screw stem with the bolt and nut provided.

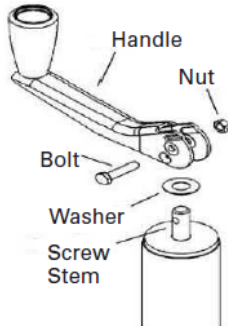
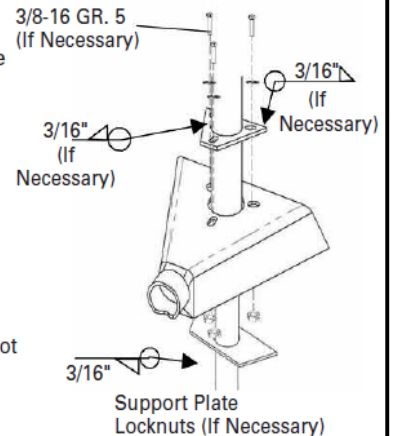

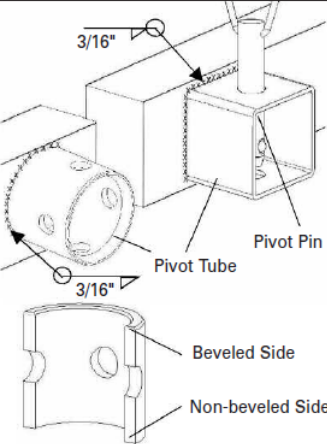

Plate Mounting Instructions (Bolt-On or Weld-On):

A-plate jacks are designed for mounting to trailers with A-plate couplers. It is recommended to attach a bottom support plate to the bottom of the tongue.

- 1) All welding must be performed by an AWS certified welder.
- 2) If the plate is separate from the jack, align the jack (and foot, if equipped) with the jack and coupler as desired before welding. Use a 3/16" fillet weld.
- 3) Bolt the jack plate to the coupler. Use three 3/8-16 grade 5 bolts with washers, torque to 15-20 ft. lbs.
- 4) Weld the recommended support plate to the bottom of the trailer frame. Use a 3/16" fillet weld.
- 5) If your jack is a plain mount type, it may be mounted directly to a coupler with a 3/16" fillet weld. Align the foot (with the jack and coupler) as desired before welding.
- 6) Rack jacks with a similar plate incorporated into their design may be attached according to these instructions.

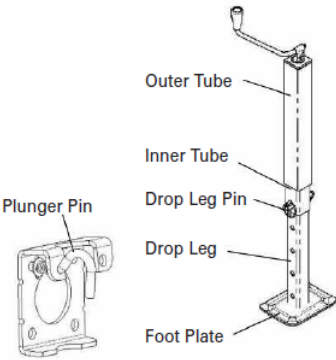
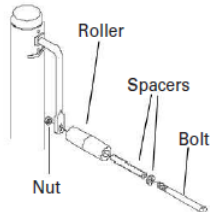
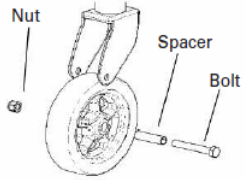

Installation Instructions Cont.'d

 <p style="margin-left: 20px;">Weld-on Pivot Tube Mounting Instructions (Round and Square Pivot Tubes):</p> <ol style="list-style-type: none"> 1) All welding must be performed by an AWS certified welder. 2) The non-beveled side of the pivot tube is welded to the tongue unless otherwise specified on hardware. 3) Place the weld-on pivot tube against the tongue and weld all around with a 3/16" fillet weld. Align one set of pivot mount holes vertically. 4) Mate the jack to the pivot tube and secure with the supplied pin. 	 <p style="text-align: center;">Drop Foot</p> <p style="text-align: center;">Removable Caster</p>	 <p style="text-align: right;">Outer Tube</p> <p style="text-align: right;">Inner Tube</p> <p style="text-align: right;">Drop Leg Pin</p> <p style="text-align: right;">Drop Leg</p> <p style="text-align: right;">Foot Plate</p> <p style="text-align: center;">Plunger Pin</p>
<p>To attach a handle assembly:</p> <ol style="list-style-type: none"> 1) Insert the long spacer into the roller followed by the thin spacer and the bolt. 2) Secure to the crank stem with the nut provided. 	<p>To attach a wheel assembly:</p> <ol style="list-style-type: none"> 1) If included, insert the long spacer into the wheel. (not all jacks require spacer) 2) Set the wheel into the caster body and place the bolt through the caster body and wheel. 3) Secure with the nut provided. 	

Maintenance Instructions

The following procedures should be performed at least annually:

For side-wind models, the internal gearing and bushings of the jack must be kept lubricated. Apply a small amount of automotive grease to the internal gearing by removing the jack cover, or if equipped, use a needle nose applicator or standard grease gun on the lubrication point found on the side of the jack near the crank. Rotate the jack handle to distribute the grease evenly. A lightweight oil must be applied to the handle unit at both sides of the tube for side-wind models. If equipped, the axle bolt and nut assembly of the caster wheel must also be lubricated with the same light weight oil. For top-wind models, apply a lightweight oil to the screw stem. If this product is used in a marine environment, flush the jack assembly and bushings with fresh water, and apply fresh lubricant.

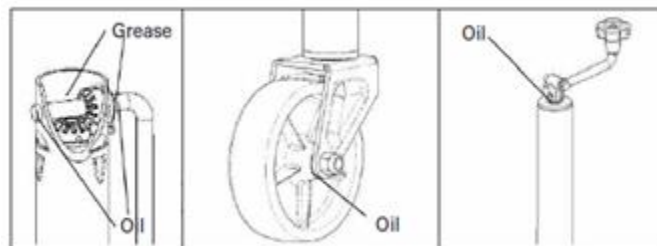

REESE One (1) Year Limited Warranty

- Warranty.** Cequent Consumer Products, Inc. warrants to the original consumer purchaser ("You") that the Product will be free from defects in material or workmanship for one year from the date of your retail purchase. Cequent Consumer Products, Inc. makes no other warranties. If the Product does not comply with the Warranty, Cequent Consumer Products, Inc. will replace the Product without charge and within a reasonable time or, at Cequent Consumer Products, Inc. option, otherwise refund the purchase price.
- Limitations on the Warranty.** The Warranty does not cover the following: (a) normal wear and tear; (b) service or labor charges incurred in removing or replacing any Product; (c) the finish on the Product; (d) a Product that has been damaged through abuse, neglect, misuse or as a result of any accident or in any other manner; (e) a Product which is misapplied, overloaded, or improperly installed; and (f) a Product altered in any manner by anyone other than Cequent Consumer Products, Inc.
- Obligations of Purchaser.** To obtain the benefits of the Warranty, You must promptly present the defective Product and proof of purchase to Cequent Consumer Products Inc., 29000-2 Aurora Road, Solon, Ohio 44139 or any of its branches, factories, or authorized dealers listed in local directories. Any returned Product that is replaced or refunded becomes the property of Cequent Consumer Products, Inc.
- Legal Rights.** This Warranty gives You specific legal rights, and You also may have other rights which vary from state to state. ANY IMPLIED WARRANTY OF MERCHANTABILITY OR FITNESS FOR A PARTICULAR PURPOSE ON ANY PRODUCT SHALL BE LIMITED TO ONE YEAR FROM THE DATE OF RETAIL PURCHASE BY YOU. Some states do not allow limitations on how long an implied warranty lasts, so the above limitation may not apply to You.
- Remedy Limits.** Replacement of the Product or refund in the manner provided above is Your exclusive remedy and shall constitute fulfillment of all liabilities of Cequent Consumer Products, Inc. to You whether based on contract or otherwise. Cequent Consumer Products, Inc. shall not be liable or assume responsibility for the loss of the use of any vehicle, loss of time, rental of vehicles, loss or damage to personal property, expenses such as gasoline, telephone, lodging, or towing, or any other incidental or consequential damages incurred as a result of the use or ownership of any Product. Some states do not allow the exclusion or limitation of incidental or consequential damages, so the above limitation or exclusion may not apply to You. Any of the above remedy limitations shall be inoperative to the extent they are not permitted by applicable state law.

The proper attachment of this product in accordance with the enclosed instructions is critical to its proper performance. Cequent Consumer Products, Inc. has no control over, or responsibility for, the attachment or the installation. Cequent Consumer Products, Inc. is NOT responsible nor will be held liable for any damage resulting from its attachment or improper use. Cequent Consumer Products, Inc. shall not be liable for any claims of any kind greater than the purchase price of the product. Warranty information available at www.trimascorp.com/terms.



Cequent Consumer Products, Inc.
29000-2 Aurora Road
Solon, OH 44139
Technical Service: (800) 234-6992
CequentConsumerProducts.com