

2023



**PROFESSIONAL TOOLS
FOR PROFESSIONAL RESULTS**
CERAMIC AND STONE INSTALLATION TOOLS
SINCE 1979



Our 2023 QEP catalog cover features Natalia Mestre, QEP Product Manager, demonstrating the installation of tile using the Original QEP® LASH® Tile Leveling Clips and Wedges.



About QEP Co., Inc.

Q.E.P. Co., Inc. is the parent company of iconic brands and trusted products with a broad range of best-in-class flooring and installation solutions for commercial and home improvement projects worldwide.

Founded in 1979 with a vision that impacted the DIY era, today QEP manufactures, distributes and designs innovative, quality, and value-driven flooring solutions featuring a comprehensive line of flooring, flooring installation tools and adhesives, as well as cutting-edge tools for all industrial trades.

Constantly growing and innovating, QEP continues to introduce trailblazing products for the people who design and build new spaces, contractors who transform and improve spaces, people aiming to add allure to their space, and everyone intending to enhance their quality of life by improving their space.

One Company. One Source. One Solution.



ROBERTS



HARRIS

KRAUS

NATURALLY AGED
FLOORING

The QEP® Brand

QEP is the #1 Tile Tool brand worldwide. We are the innovation leader with best-in-class product design, packaging and merchandising. QEP is the trusted brand for the world's largest retailers and professional distributors.

Now you can find QEP tile tools in over 100 countries around the world wherever professional tools are sold. QEP offers 24/7 customer service and technical support for DIYers and professional installers.



Original Grout Kits

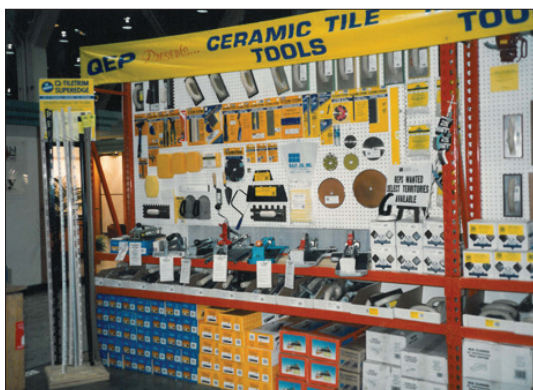

Chicago 1992



Las Vegas 2022

For those professionals seeking superior performance and rugged durability, QEP Xtreme™ is a series of QEP products with unique design elements, additional features and new innovation that are preferred by professional installers. This series of upgraded products are developed with and engineered for the professional.



CONTENTS

TILE SAWS & DIAMOND BLADES

05

TILE CUTTERS

CUTTERS & SCORING WHEELS

16

INSTALLATION & BACKERBOARD TOOLS

MIXERS, NIPPERS, HOLE SAWS, SUCTION CUPS, FILES, MALLETS, GROUT SAWS, SPONGES, KNIVES, SEAM TAPE

22

TILE SPACERS

TILE LEVELING SYSTEMS, HORSESHOE SHIMS, TRADITIONAL & LEAVE-IN SPACERS

41

KNEE PADS

47

TROWELS & FLOATS

49

UNDERLAYMENTS & BARRIERS

CORK, AQUABAR®

54

TEAR-OUT TOOLS

SCRAPERS

57

DISPLAYS & MERCHANDISING

GONDOLAS, COUNTER DISPLAYS, GRAVITY DISPLAYS, FLOOR DISPLAYS

60

INDEX

64



Rodrigo Vera, QEP President of Specialty Markets, cuts tile with the QEP 22700Q 700XT ¾ HP wet tile saw.

TILE SAWS & DIAMOND BLADES

QEP's line of award-winning Tile Saws for cutting large format ceramic, porcelain, granite, stone and marble tile are engineered by the pros for the pros. Designed with features such as splash guard water containment systems, extension tables and safety locks, QEP Tile Saws make work easier. Our Diamond Blade line assures smooth and precise cuts every time.

10" 900XT Pro Wet Tile Saw

Portable electric wet tile saw with fold-out stand for cutting large format tile including ceramic, porcelain, granite, and marble.

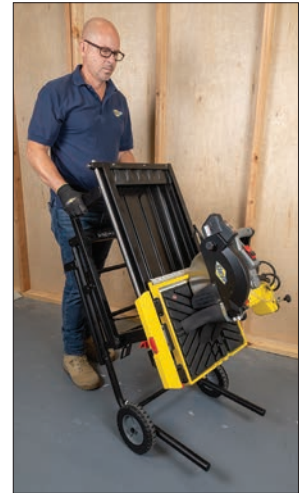
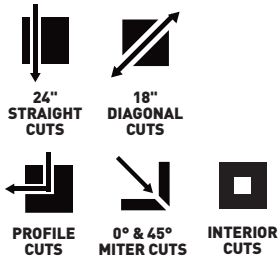

- Adjustable plunging and pivoting motor head for interior cutting, miter cuts and rip/angle cuts
- Full coverage splash guard water containment system
- Side extension table
- Laser cutting guide & LED work area light

* Complies with Canadian and U.S. requirements

ACCESSORIES INCLUDED

- Premium porcelain rated 10" blade
- Rip/Angle cutting guide
- 2 wrenches

Item No.	Description	Case Qty	Packaging
61900Q	10" 900XT Pro Wet Tile Saw	1	Color Carton
Replacement Part			
61900Q-31	High Volume Water Pump	1	Carton



SPECIFICATIONS

Item No	61900Q
Motor	2.25 HP / 120V-60Hz / 15 Amps
Watts	1750
RPM	3600
Blade Capacity	10"
Arbor	5/8"
Size	51" L x 33" W x 45" H (w/stand)
Weight	96 lbs (w/stand)

* For porcelain and hard tiles, we recommend QEP's Black Widow® (6-1008BW)



For more information, scan here

7" Power Pro 1HP Wet Tile Saw

Portable electric cutter for cutting porcelain tile, ceramic tile, marble, slate and stone.



- Interior water baffle minimize water-spray and reduces refills
- Locking on/off switch with security key
- Oversized die cast aluminum table
- Non-slip feet and fold-out bench stop keep saw in place during use
- Tested and Compliant - Exceeds OSHA Silica Rule 29 CFR 1926.1153

* Complies with Canadian and U.S. requirements

ACCESSORIES INCLUDED

- 7" continuous rim wet diamond blade
- Locking rip guide
- Angle cutting guide
- Bench stop



SPECIFICATIONS

Item No	22900Q
Motor	1 HP / 120 V ~ 60 Hz. / 6.5 Amps
Watts	750
RPM	3600
Blade Capacity	7"
Arbor	5/8"
Size	22.5" L x 18" W x 8" H
Weight	29 lbs

Item No.	Description	Case Qty	Packaging
22900Q	7" Power Pro 1HP Wet Tile Saw	1	Color Carton

* For porcelain and hard tiles, we recommend QEP's Black Widow® (#6-7008BW)



For more information, scan here

7" 750XT Wet Tile Saw

Portable electric cutter for cutting porcelain tile, ceramic tile, marble, slate and stone.

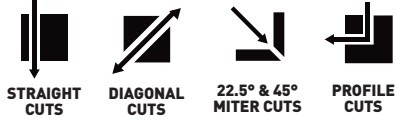

- Powerful 3/4 Peak HP motor
- Locking adjustable angle and rip guides for accurate cuts
- Interior water baffle minimize water-spray and reduces refills
- Unique back extension table to support large format tile during cut
- Tested and Compliant - Exceeds OSHA Silica Rule 29 CFR 1926.1153

* Complies with Canadian and U.S. requirements

ACCESSORIES INCLUDED

- 7" continuous rim wet diamond blade
- 45° angle guide
- Blade guard



SPECIFICATIONS

Item No	22750Q
Motor	3/4-Peak HP/120 V~ 60 Hz. / 4.8 Amps
Watts	550
RPM	3600
Blade Capacity	7"
Arbor	5/8"
Size	21" L x 22.2" W x 9.5" H
Weight	21.4 lbs

Item No.	Description	Case Qty	Packaging
22750Q	7" 750XT Wet Tile Saw	1	Color Carton

* For porcelain and hard tiles, we recommend QEP's Black Widow® (6-7008BW)



For more information, scan here

7" 700XT Wet Tile Saw

Portable electric wet saw for cutting ceramic, slate, marble, granite and porcelain.



- Powerful 3/4 Peak HP motor
- Lock-down rip guide for fast, multiple cuts
- Extension side table
- Deep water tray means no refilling
- Water recirculation channel

* Complies with Canadian and U.S. requirements

ACCESSORIES INCLUDED

- 7" continuous rim wet diamond blade
- Blade wrench



SPECIFICATIONS

Item No	22700Q
Motor	3/4-Peak HP/120V ~ 60 Hz. / 4.8 Amps
Watts	550
RPM	3600
Blade Capacity	7"
Arbor	5/8"
Size	20.08" L x 15.74" W x 9.88" H
Weight	23 lbs

Item No.	Description	Case Qty	Packaging
22700Q	7" 700XT Tile Wet Saw	1	Color Carton

* For porcelain and hard tiles, we recommend QEP's Black Widow® (6-7008BW)



For more information, scan here

4" Torque Master XT Portable Wet Tile Saw

Portable electric cutter for cutting porcelain tile, ceramic tile, marble, slate and stone.



- 3/5 HP, hi-torque geared motor for maximum cutting performance
- Fully adjustable miter guide with unique ratchet mechanism
- Water recirculation system saves time when replenishing water supply and keep work area drier
- Dual extension tables add extra 5" of cutting surface

* Complies with Canadian and U.S. requirements

ACCESSORIES INCLUDED

- 4" continuous rim diamond blade (#6-4003Q)
- 45° angle guide
- Blade guard



SPECIFICATIONS

Item No	22400Q
Motor	3/5-Peak HP / 120 V ~ 60 Hz. / 4 Amps
Watts	450
RPM	4600
Blade Capacity	4"
Arbor	5/8"
Size	14.3" L x 15.8" W x 4.6" H
Weight	8 lbs

Item No.	Description	Case Qty	Packaging
22400Q	4" Torque Master XT Portable Wet Tile Saw	1	Color Carton

* For porcelain and hard tiles, we recommend QEP's Black Widow® (6-4008BW)



For more information, scan here

Wet Tile Saws at a glance

Standing Saw

ITEM NO.	DESCRIPTION	SIZE (L x W x H)	WEIGHT (lbs)	BLADE	ARBOR	HP
61900Q	10" 900XT Pro Wet Tile Saw	45" x 51" x 33" (w/ stand)	96	10"	5/8"	2.25

ITEM NO.	AMPS	WATTS	RPM	RIP CUT (Tile Size)	DIAGONAL (Tile Size)	CUTTING DEPTH	WATER PUMP	ACCESSORIES INCLUDED
61900Q	15	1750	3600	24"	18"	3-3/4"	#61900Q-31	A, B, D, F, G, I, J, K, L, M

Table Saws

ITEM NO.	DESCRIPTION	SIZE (L x W x H)	WEIGHT (lbs)	BLADE	ARBOR	HP
22900Q	7" Power Pro Wet Tile Saw	22.5" x 18" x 8"	29	7"	5/8"	1
22750Q	7" 750XT Wet Tile Saw	21" x 22.2" x 9.5"	21.4	7"	5/8"	3/4
22700Q	7" 700XT Wet Tile Saw	20" x 15.7" x 9.8"	23	7"	5/8"	3/4
22400Q	4" Torque Master XT Portable Tile Saw	14.3" x 15.8" x 4.6"	8	4"	5/8"	3/5

ITEM NO.	AMPS	WATTS	RPM	RIP CUT (Tile Size)	DIAGONAL (Tile Size)	CUTTING DEPTH	WATER PUMP	ACCESSORIES INCLUDED
22900Q	6.5	750	3600	Unlimited	Unlimited	1-1/8"	N/A	B, G, H, I, K, N
22750Q	4.8	550	3600	Unlimited	Unlimited	1-1/4"	N/A	B, F, G, H, I, K, N
22700Q	4.8	550	3600	Unlimited	Unlimited	1-1/4"	N/A	B, F, G, H, I, K, N
22400Q	4	450	4600	Unlimited	Unlimited	1/4"	N/A	B, F, G, H, I, N

ACCESSORY GUIDE:

- A. Water Pump
- B. Continuous rim wet diamond blade
- C. Heavy duty legs / fold-out stand
- D. Folding stand w/ locking wheels
- E. Rear wheel attachments
- F. Side/rear extension table(s)
- G. Angle/rip cutting guide
- H. 45° miter cutting guide / block
- I. Handle(s)
- J. Laser cutting guide
- K. Wrench, wrenches and/or hex keys
- L. Tilting head
- M. Plunge cut capable
- N. Self contained water reservoir

Diamond Blades

The QEP diamond blade line offers a blade for every application and budget. Whether your tile project requires the cutting of ceramic, porcelain, marble, granite, glass, slate, concrete pavers or stone, QEP has a blade that will cut it quickly and efficiently. The high quality of QEP's diamond blades is due to our stringent testing and exact specifications assuring the user a wobble-free blade that produces smooth and precise cuts. QEP blades are designed to use with any tile saws.



Black Series General purpose blade for wet cutting of ceramic tile.

Item No.	Description	Rim Height	Width	Arbor Size	Max RPM	No. in Case	Package
6-4001Q	4" Continuous Rim	7 mm	.060	5/8" - 20 mm - 7/8"	15000	4	Hang Card
6-7001Q	7" Continuous Rim	7 mm	.060	7/8" - 5/8" - DM	8730	4	Hang Card
6-8001Q	8" Continuous Rim	7 mm	.060	7/8" - 5/8" - DM	7640	4	Hang Card
6-1001Q	10" Continuous Rim	7 mm	.060	7/8" - 5/8" - DM	6115	4	Hang Card



Gold Series Premium blade for wet or dry* cutting of ceramic, porcelain and marble tile.

Item No.	Description	Rim Height	Width	Arbor Size	Max RPM	No. in Case	Package
6-4003Q	4" Continuous Rim	7 mm	.060	5/8" - 20 mm - 7/8"	15000	4	Hang Card
6-7003Q	7" Continuous Rim	7 mm	.060	5/8"	8730	4	Hang Card
6-8003Q	8" Continuous Rim	7 mm	.060	5/8"	7640	4	Hang Card
6-1003Q	10" Continuous Rim	7 mm	.060	5/8"	6115	4	Hang Card

*4" can be used for wet/dry cutting, other sizes are for wet cutting only.



Glass Series Premium blade for wet cutting of glass tile.

Item No.	Description	Rim Height	Width	Arbor Size	Max RPM	No. in Case	Package
6-4006GLQ	4" Continuous Rim	7 mm	.060	5/8" - 20 mm - 7/8"	15000	3	Hang Card
6-7007GL	7" Continuous Rim	7 mm	.060	5/8"	8730	3	Hang Card

⚠WARNING: Cancer and Reproductive Harm- www.P65Warnings.ca.gov. See P. 67, *Prop 65 - 1.

Black Widow® Blades

The QEP Black Widow® Premium-Grade, thin-rim Diamond Blades quickly cut through the toughest ceramic, porcelain, marble and granite. Independent lab test results have proven Black Widow® Blades continuously out perform the competition in durability. QEP blades are designed to use with any tile saws.

- Premium-grade, thin-rim diamond blade for fast wet cutting of porcelain, ceramic, granite and marble tile
- Ideal for high speed cutting of hard masonry tile
- Unique diamond-shaped laser cutouts prevent blade wobble and keep blade cooler for a longer life
- 7 mm rim height for a longer life and for increased cutting contact with the blade

⚠ WARNING: Cancer and Reproductive Harm- www.P65Warnings.ca.gov. See P. 63, *Prop 65 - 1.



Item No.	Description	Application	Rim Height	Width	Arbor Size	Max RPM	No. in Case	Package
6-4008BW	4" Black Widow®	Ceramic, Porcelain, Marble, Granite - Wet/Dry	7 mm	.060	5/8" - 20 mm - 7/8"	15000	5	Hang Card
6-7008BW	7" Black Widow®	Ceramic, Porcelain, Marble, Granite - Wet	7 mm	.060	5/8"	8730	5	Hang Card
6-8008BW	8" Black Widow®	Ceramic, Porcelain, Marble, Granite - Wet	7 mm	.060	5/8"	7640	5	Hang Card
6-1008BW	10" Black Widow®	Ceramic, Porcelain, Marble, Granite - Wet	7 mm	.060	5/8"	6115	5	Hang Card

CHECK OUT THESE ROBERTS® JAMB SAWS

10-56 LONGNECK PLUS 6" JAMB SAW with dust containment system



POWERFUL

1100-watt industrial-grade power motor

ACCURATE

Adjustable cutting depth guide prevents cutting into plaster or wall board when trimming baseboards

VARIABLE

Cuts under toe kicks and full inside corners in molding up to 1/2" thick

PRECISION

Blade height adjusts from "flush" to 1-1/16"

COMFORT

Extended "tail" for maximum comfort & leverage against torque

CONVENIENT

1-1/2" vacuum port for optimal dust containment

2 BLADES INCLUDED

36-Tooth Carbide Tip blade (10-47-2)

Masonry Blade (10-55-24)

Also available: 20-Tooth (10-47-6)

SAFETY

Extended blade guard lever for added safety

DURABLE

Includes custom molded carrying case to protect unit when not in use

FOR MORE INFORMATION

Scan this code



Quality & Excellence Since 1938.

INVENTED BY QEP, THESE ARE GREAT ADDITIONS TO YOUR TILE TOOL ASSORTMENT!

10-46 SUPER SIX 6" JAMB SAW with molded carrying case



POWERFUL

900-watt industrial-grade motor

ACCURATE

Adjustable cutting depth guide prevents cutting into plaster or wallboards when trimming baseboards

PRECISION

Blade height adjusts from flush to the floor to 1-1/16" to allow proper heights for all flooring materials

EASY OPERATION

Spiral ground gears for smooth, quiet operation

1 BLADE INCLUDED

36-Tooth Carbide Tip blade (10-47-2)

Also available: 20-Tooth (10-47-6)

DURABLE

Includes custom molded carrying case to protect unit when not in use

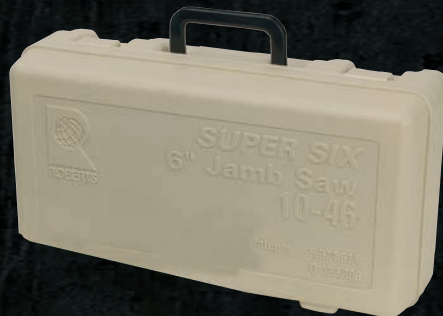

FOR MORE INFORMATION
Scan this code



A woman with blonde hair, wearing a dark blue polo shirt, light blue jeans, and black gloves, is kneeling on a grey floor. She is operating a large, blue, manual tile cutter. The cutter is positioned over a large, light-colored rectangular tile. She is holding the handle of the cutter, which is in the process of scoring the tile. In the background, there are stacks of similar tiles, a white bucket, and a yellow sponge. The setting appears to be a workshop or a construction site.

Ashlee Dudding, QEP
Digital Content Specialist,
demonstrating the QEP 10800
28" Big Clinker tile cutter.

TILE CUTTERS & SCORING WHEELS

QEP offers several professional cutters for cutting tile, porcelain, mosaics and other materials. The QEP lightweight Slimline cutters, multipurpose Big Clinkers and traditional cutters are engineered for the Pros by the Pros. Designed to make cutting easy with features like side arm extensions, ball bearing slides and locking features, QEP puts quality and safety first. Replacement scoring wheels are available for all cutter styles.

24", 30" and 36" Slimline Cutters

ENGINEERED FOR THE PROS BY THE PROS

BLUE DESIGN
AVAILABLE
SPRING 2023



SLIMLINE

- Lightweight and easy to carry from site to site
- Equipped with replaceable tungsten-carbide 7/8" scoring wheel
- Reinforced thick steel base with tile support arms
- Die cast aluminum rail supports
- Metal rip guide



Item No.	Description	Case Qty	Packaging
10624Q	24" Slimline Manual Tile Cutter, with 2 legs	1	Color Carton
10632Q	30" Slimline Manual Tile Cutter, with 2 legs	1	Color Carton
10636Q	36" Slimline Manual Tile Cutter, with 4 legs	1	Color Carton



RIP CUT
10624Q: Up to 24" Tile
10632Q: Up to 30" Tile
10636Q: Up to 36" Tile



DIAGONAL
10624Q: Up to 18" Tile
10632Q: Up to 21" Tile
10636Q: Up to 25" Tile

TILE DEPTH
1/2" Max.



For more information, scan here

28", 25" & 22-1/2" Big Clinker Tile Cutter

Multipurpose cutter for most tile including ceramic and porcelain

BLUE DESIGN
AVAILABLE
SPRING 2023



- Height adjustable 4-position wheel for easy snapping in any position on tile
- Equipped with replaceable 7/8" titanium-coated tungsten carbide ball bearing scoring wheel
- Side arm extensions to support large format tiles
- Durable chrome plated steel rails
- Rip/Angle guide for fast multiple cuts
- Heavy duty cast aluminum base



Item No.	Description	Case Qty	Packaging
10800	28" Big Clinker Tile Cutter	1	Color Carton
10600	25" Big Clinker Tile Cutter	1	Color Carton
10500	22-1/2" Big Clinker Tile Cutter	1	Color Carton

REPLACEMENT SCORING WHEEL:
211230 7/8" PREMIUM Titanium-Coated Tungsten Carbide Ball Bearing Scoring Wheel (6/cs)



RIP CUT

10800: Up to 28" Tile
10600: Up to 25" Tile
10500: Up to 22.5" Tile



DIAGONAL

10800: Up to 20" Tile
10600: Up to 18" Tile
10500: Up to 16" Tile



TILE DEPTH

10800: 1/2" Max.
10600: 5/8" Max.
10500: 1/2" Max.

10800



10600



10500



For more information, scan here

48" LFT Manual Tile Cutter

Cuts porcelain, floor tile, mosaics, and other materials

Large breaker bar and spring loaded pads for easy snapping of tile



- Allows thick materials to be easily cut
- Ball bearings in the cutting head allow for accurate and easy scoring
- Breaking System Lever produces max amount of pressure
- Locking slide to prevent damage in transport
- Locking swivel angle and measurement bar
- Dual breaker bar for narrow and wide tile
- Equipped with replaceable tungsten-carbide 7/8" scoring wheel
- Breaking pads are mounted on springs for better shock absorption
- Cut-out under breaking pads allows for tile cuttings to fall through for easy cleaning



Item No.	Description	Case Qty	Packaging
10480Q	48" LFT Manual Cutter	1	Color Carton



RIP CUT
10480Q: Up to 48" Tile

DIAGONAL
10480Q: Up to 34" Tile

TILE DEPTH
5/8" Max.



For more information, scan here

35" & 24" Pro Tile Cutters

Multipurpose cutter for most tile including ceramic and porcelain

- Ball bearing slide for smooth scoring
- Side arm extensions to support large format tiles
- Equipped with replaceable 7/8" titanium-coated tungsten carbide ball bearing scoring wheel
- Durable chrome plated steel rails
- Rip/Angle guide for fast multiple cuts



Item No.	Description	Case Qty	Packaging
10900	35" Pro Tile Cutter	2	Color Carton
10630	24" Pro Tile Cutter	1	Color Carton



RIP CUT
10900: Up to 35" Tile
10630: Up to 24" Tile

DIAGONAL
10900: Up to 24" Tile
10630: Up to 17.5" Tile

TILE DEPTH
1/2" Max.



For more information, scan here

21" Pro Tile Cutter

Cuts ceramic, porcelain and mosaics



- Straight edge adjustable measurement guide
- Dual chrome-plated solid steel rails for smooth scoring
- Includes replaceable titanium tungsten carbide 7/8" scoring wheel
- Powder coated steel base with extra reinforcement

Item No.	Description	Case Qty	Packaging
10521Q	21" Pro Tile Cutter	2	Color Carton



21" Pro Tile Cutter

Cuts ceramic and porcelain tile



- High leverage, padded handle makes cutting easier and reduces fatigue
- Durable chrome-plated solid steel rails for smooth scoring
- Includes replaceable tungsten carbide 10 mm post scoring wheel
- Powder coated steel base with extra reinforcement

Item No.	Description	Case Qty	Packaging
10221Q	21" Pro Tile Cutter	2	Color Carton



20" & 14" Pro Tile Cutter

Cuts ceramic and porcelain tile



- Equipped with replaceable 1/2" titanium-coated tungsten carbide scoring wheel
- Reinforced steel base

Item No.	Description	Case Qty	Packaging
10220Q	20" Pro Tile Cutter	4	Color Carton
10214Q	14" Pro Tile Cutter	6	Color Carton



Replacement Wheels for Tile Cutters

ITEM NO.	DESCRIPTION	21127Q 10 mm Wheel	10010HD 1/2" Wheel	21123Q 7/8" Wheel	21125 7/8" Wheel	21178 7/8" Wheel
10480Q	48" LFT Manual Tile Cutter					•
10636Q	36" Slimline Tile Cutter					•
10632Q	30" Slimline Tile Cutter					•
10624Q	24" Slimline Cutter					•
10900Q	35" Tile Cutter				•	
10800	28" Big Clinker Tile Cutter			•		
10630	24" Tile Cutter				•	
10600	24" Big Clinker Tile Cutter			•		
10521Q	21" Pro Tile Cutter					•
10221Q	21" Pro Tile Cutter	•				
10500	22-1/2" Big Clinker Tile Cutter			•		
10220Q	20" QEP Tile Cutter		•			
10214Q	14" QEP Tile Cutter		•			

10 mm Post Scoring Wheel

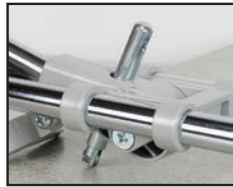

- For cutting ceramic, porcelain and glass tiles
- Tungsten carbide scoring edge for long cutting life
- For use with 10221Q 21" Professional Tile Cutter

Item No.	Description	Case Qty	Packaging
21127Q	10 mm Post Scoring Wheel	6	Hang Card

1/2" Tungsten Carbide Scoring Wheel

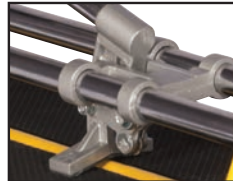

- For cutting ceramic, porcelain and glass tiles
- For use with 10220Q 20" QEP Tile Cutter and 10214Q 14" QEP Tile Cutter

Item No.	Description	Case Qty	Packaging
10010HD	1/2" Tungsten Carbide Scoring Wheel	12	Hang Card

7/8" Replacement Scoring Wheels with Ball Bearings

• For use with:

- 10800 2" Big Clinker Tile Cutter
- 10600 24" Big Clinker Tile Cutter
- 10500 22-1/2" Big Clinker Tile Cutter

• For use with:

- 10900 35" Tile Cutter
- 10603 24" Tile Cutter

- For cutting ceramic, porcelain and glass tiles
- Ball bearing wheel for smooth scoring
- Designed to use with any tile cutters

• For use with:

- 10480Q LFT Manual Tile Cutter
- 10636Q 36" Slimline Tile Cutter
- 10632Q 30" Slimline Tile Cutter
- 10624Q 24" Slimline Tile Cutter
- 10521Q 21" Pro Tile Cutter



Item No.	Description	Case Qty	Packaging
21123Q	7/8" Premium Tile Cutter Replacement Scoring Wheel with Ball Bearings	6	Hang Card

Item No.	Description	Case Qty	Packaging
21125	7/8" Tile Cutter Replacement Scoring Wheel with Ball Bearings	6	Hang Card

Item No.	Description	Case Qty	Packaging
21178	7/8" Titanium Coated Replacement Scoring Wheel for Multiple Tile Types	3	Hang Card



INSTALLATION & BACKERBOARD TOOLS

QEP Mixers, Nippers, Sanding Blocks, Mallets, Grout Removers, Sponges, Hole Saws, Suction Cups, Gloves, Tape, Knives, Specialty Tools and more is what you will find in our Installation and Backerboard Tool assortment!

Power Mixer Pro

Designed to mix thinset, grout, mortar, and other viscous materials with minimal effort



- Strong enough to mix cement
- High quality, powerful 1400 Watt motor
- 0-800 RPM variable speed dial to select appropriate speed
- Locked on function keeps mixer at desired RPM

Item No.	Description	Case Qty	Packaging
21700	Power Mixer Pro w/ Paddle	1	Color Carton
21661	24" Pro Mixing Paddle	1	Shelf Case

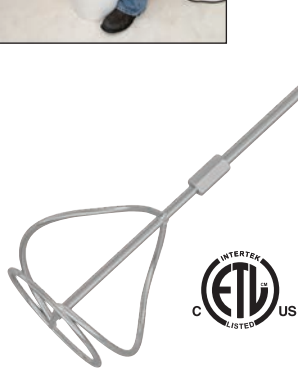

Includes Chuck Kit



SPECIFICATIONS

Item No	21700
Motor	120 V ~ 1300 Watts 1st gear: 0-480 RPM 2nd gear: 0-800RPM
Amps	12.5
Weight	10.5 lbs



For more information, scan here

Pro Mixing Paddles

QEP offers a variety of mixing paddles for fast and effective mixing of grouts, thinsets and other setting materials.

61230 – 30"

21161 – 24"

61205 – 23 1/2"

61210 – 16"

Designed to reduce air in mixture

M-14 thread



Fits in 1 Gallon Bucket

Includes Chuck Kit



Item No.	Description	Blade Width	Case Qty	Packaging
21661	24" Pro Mixing Paddle	5-1/2"	1	Shelf Case
61230	30" XL Spiral Pro Mixer	5-1/2"	6	Shelf Case
61205	23-1/2" Pro Mixing Paddle	4-7/8"	8	Shelf Case
61205D	23-1/2" Pro Mixing Paddle Display	4-7/8"	30	Floor Display
61210	16" Universal Mixing Paddle	3-1/4"	12	Shelf Case

X-TREME PRO-SERIES Pro Control Glass Tile Nipper

Designed for cutting irregular shapes in glass tiles and mosaics up to 5/16" thick

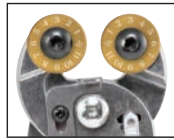

SharpTrack Cutting Wheels identify used cutting edges



- 7/8" titanium coated tungsten carbide cutting wheels for long lasting toughness and durability
- 3-position Tile Thickness Lock minimizes hand fatigue during repeat cutting of the same tile thicknesses

⚠WARNING: Cancer and Reproductive Harm-
www.P65Warnings.ca.gov. See P. 67, *Prop 65 - 1.

Item No.	Description	Case Qty	Packaging
32014	Xtreme Pro Control Glass Tile Nipper	6	Hang Card



For more information, scan here

Glass Tile Nipper



- Cuts irregular shapes in glass tile and mosaics from 1/32" to 1/4" thick
- Ideal for quickly cutting small mosaic pieces of glass and removing tiny points from glass tile
- Single piece, drop-forged steel construction for maximum strength with comfortable, contoured handles

Item No.	Description	Case Qty	Packaging
32010	Glass Tile Nipper	6	Hang Card

X-TREME PRO-SERIES Offset Tile Nipper

Designed for cutting irregular shapes in tile, helps fit tile around oddly-shaped objects, like pipes or sinks



- For cutting irregular shapes in ceramic and porcelain tile up to 5/16" thick
- Steel construction with protective coating and tough, tungsten carbide tips for long lasting use
- Contoured, rubberized handle is more comfortable in the hand
- Offset tungsten carbide tips for more control when making irregular and curved cuts

⚠WARNING: Cancer and Reproductive Harm-
www.P65Warnings.ca.gov. See P. 67, *Prop 65 - 1.

Item No.	Description	Case Qty	Packaging
10103	Xtreme Offset Tile Nipper	6	Hang Card



For more information, scan here

Compound Tile Nipper



- Compound mechanism delivers 3 times more force with less effort
- Use to cut irregular shapes in all tile from 1/8" to 1/4" thick
- Durable tungsten carbide tip provides a long cutting life
- Co-molded plastic handle with non-slip, rubber grip for comfortable repeat use

Item No.	Description	Case Qty	Packaging
32036	Compound Tile Nipper	6	Hang Card

Tile Nipper



- 8" carbide tipped nippers with offset jaws
- For cutting irregular shapes in tile from 1/8" to 1/4" thick
- Single piece, drop-forged steel construction for maximum strength

Item No.	Description	Case Qty	Packaging
10003	Tile Nipper	12	Hang Card

Tile Cutter



- Recommended for manually scoring and cutting ceramic wall tiles up to 6" x 6" and 1/4" thick
- Uses a durable tungsten carbide wheel for scoring and a breaker bar to "snap" ceramic tile

Item No.	Description	Case Qty	Packaging
32024	Tile Cutter	6	Hang Card

6" Locking Contour Gauge



Irregular shapes are locked into place



- Easily forms around any shape for a precise template, reducing waste created when guessing the dimension of irregular shapes
- Locking feature holds patterns in place while tracing on any surface
- Great for marking precise cutouts in vinyl, wood, porcelain and ceramic tiles

Item No.	Description	Case Qty	Packaging
10038	6" Locking Contour Gauge	6	Hang Card

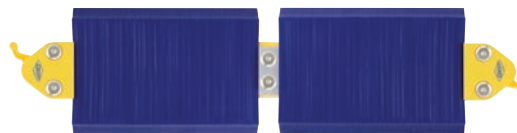

Combine 2 Gauges for longer profiles

3" Diamond Jigsaw Blade



- For cutting hard materials, including porcelain and ceramic tile
- Cuts faster and cleaner than standard carbide blades
- Heat treated alloy steel backer for superior strength

Item No.	Description	Case Qty	Packaging
10585	3" Diamond Jigsaw Blade	6	Hang Card

X-TREME PRO-SERIES Diamond Hole Saws

QEP's Diamond Hole Saws deliver fast and accurate wet or dry cutting of porcelain, stone, marble, ceramic, and glass tiles.

Tough and strong, these Diamond Hole Saws attach to drills, cutting with precision and good resistance to wear, making them ideal to use when installing fixtures, or working around pipes.

up to
12X
LONGER LIFE
than standard hole saws

X-TREME PRO-SERIES Diamond Hole Saws for Drills

For cutting holes in glass, ceramic, porcelain, marble and granite



- Advanced metallurgical technology bonds diamond grit to chrome alloy steel base to produce a long lasting cutting edge
- Extremely durable and built to last longer than conventional diamond drill bits and standard hole saws
- Simply dip in water, no need for a constant water delivery system, for quick and easy use
- Fits standard 1/2" or 3/8" drill chucks

Item No.	Description	Case Qty	Packaging
10075	Xtreme 1/4" Diamond Hole Saw	6	Hang Card
10080	Xtreme 5/16" Diamond Hole Saw	6	Hang Card
10087	Xtreme 1-3/8" Diamond Hole Saw	6	Hang Card



For more information, scan here

wax/DRY **X-TREME** PRO-SERIES Diamond Hole Saws Kit

For drilling all types of ceramic tile, porcelain, stone, marble and granite

NEW



- Convenient kit contains 4 size: 1/4", 5/16", 3/8" & 1/2" (6 mm, 8 mm, 10 mm, 12 mm)
- No constant water needed
- Ideal for placing bathroom accessories or any type of decoration accessory on ceramic surfaces

Item No.	Description	Case Qty	Packaging
10485	wax/DRY Xtreme Diamond Hole Saw Kit	6	Hang Card



For more information, scan here

X-TREME PRO-SERIES Diamond Hole Saws for Angle Grinders

NEW INNOVATION

For fast, clean hole cutting in porcelain tile, ceramic tile, granite, marble and slate



up to
50% FASTER
THAN A DRILL

- Last at least 2x longer than drill attachment
- Superior brazing technology ensures diamonds stay bonded
- No water cooling required on any sizes
- Wax lubricant for cooling the diamond edge (1/4", 5/16" sizes)

Item No.	Description	Case Qty	Packaging
10469	Xtreme 1/4" Hole Saw for grinder	6	Hang Card
10470	Xtreme 5/16" Hole Saw for grinder	6	Hang Card
10471	Xtreme 1" Hole Saw for grinder	6	Hang Card
10472	Xtreme 1 3/8" Hole Saw for grinder	6	Hang Card
10473	Xtreme 2" Hole Saw for grinder	6	Hang Card
10474	Xtreme 2 1/2" Hole Saw for grinder	6	Hang Card
10475	Xtreme 4" Hole Saw for grinder	6	Hang Card

NEW 4" SIZE



For more information, scan here

X-TREME PRO-SERIES Diamond Milling Bits & Cone

NEW

Designed to enlarge, shape and round bevel existing holes in porcelain, hard ceramic, granite and marble



- Works on all standard grinders, no adaptor necessary



Item No.	Description	Case Qty	Packaging
10051	Xtreme 3/8" Diamond Milling Bit	6	Hang Card
10052	Xtreme 3/4" Diamond Milling Bit	6	Hang Card
10066	Xtreme 1 1/2" Diamond Milling Cone	6	Hang Card



For more information, scan here

Suction Cups

USE 2 SUCTION CUPS TO LIFT HEAVIER TILE

QEP offers a wide array of suction cups for lifting large format tile. Heavy-duty options include single suction cup design, double suction cups and our newest addition, pump suction cups for even more holding power. Let us do the heavy lifting!

XXTREME[™] PRO-SERIES 8" Electric Suction Cup

NEW INNOVATION

Hand held, portable tool for lifting large tiles, stone, glass, and more



- Provides steady suction with 48 hour non-stop running time
- Multi-layered sealed safety rim
- Rechargeable lithium-ion battery (6-8 hours charging time)
- USB-C charging cable included

220 POUNDS

Item No.	Description	Case Qty	Packaging
75023	Xtreme Pro Series 8" Electric Suction Cup	10	Color Carton



For more information, scan here

8" Pump Suction Cup with Gauge

NEW INNOVATION



- Hand held, portable tool for lifting large tiles, stone, glass, and more
- Red line indicator shows when to engage suction
- Safety gauge to monitor suction
- Sealed safely rim line

285 POUNDS

Item No.	Description	Case Qty	Packaging
75022	8" Pump Suction Cup with Gauge	10	Color Carton



For more information, scan here

8" Vacuum Pump Suction Cup

NEW INNOVATION



- Hand held, portable tool for lifting large tiles, stone, glass, and more
- Red line indicator shows when to engage suction
- Sealed safely rim line

285 POUNDS

Item No.	Description	Case Qty	Packaging
75021	8" Vacuum Pump Suction Cup	10	Color Carton



For more information, scan here

XTREME^{PRO-SERIES} Double Suction Cup

Designed for maneuvering non-porous, smooth tiles, stone, marble, cultured marble, granite and glass during horizontal and vertical applications



- 200 lb. holding capacity is ideal for large format tile
- Rigid, aluminum alloy body with textured, non-slip grip
- Two, 4.75" durable rubber pads will not mar tile
- Hold-and-release levers for easy, secure use



⚠WARNING: Cancer and Reproductive Harm-
www.P65Warnings.ca.gov. See P. 67, *Prop 65 - 1.

Item No.	Description	Case Qty	Packaging
75012	Xtreme Double Suction Cup	3	Color Carton



For more information, scan here

ProMAXGrip Double Suction Cup

NEW INNOVATION



- For use on clean, non-porous large format tile, stone and marble
- Dual action suction and release system
- Simple single hand operation
- Strong, textured, non-slip grip



Item No.	Description	Case Qty	Packaging
75013	ProMAX [®] Grip Double Suction Cup	3	Color Carton

Double Suction Cup



- Maximum vacuum hold to move smooth, non-porous tile, stone and cultured marble
- Heavy duty, aluminum frame



Item No.	Description	Case Qty	Packaging
75003	Double Suction Cup	3	Shelf Case

Suction Cup



- For easy handling of non-porous tile, marble and glass during installation
- Suction cup pad is 4-1/2" in diameter
- 3-1/2" wide handle opening easily accommodates large hands



Item No.	Description	Case Qty	Packaging
75000	Suction Cup	6	Shelf Case

Mechanical China Markers



- For marking on hard, glossy, non-porous surfaces such as porcelain, glass, ceramics or polished stone
- Plastic outer material is more durable than standard china markers
- Resistant to moisture and easily wipes off when the job is complete

Item No.	Description	Case Qty	Packaging
38778	Mechanical China Markers	12	Hang Card

Diamond Drill Bit with Water Delivery System



- Ideal for cutting holes when installing towel bars, soap dishes, shelves, cabinets and shower door frames
- Diamond Grit edge drills through ceramic, glass, marble, porcelain and granite
- Convenient, single piece water delivery system keeps hole saw cool for a longer life
- Fits standard 1/2" or 3/8" drill chucks
- Kit includes 6 adhesive pads, water cooling system, drill guide and drill bit
- Only for wet use with cordless drills

⚠WARNING: Cancer and Reproductive Harm-
www.P65Warnings.ca.gov. See P. 67, *Prop 65 - 1.

Item No.	Description	Case Qty	Packaging
10571	5/16" Porcelain Diamond Drill Bit w/Drill Guide and Water Cooling System	6	Hang Card
10572	1/4" Porcelain Diamond Drill Bit w/Drill Guide and Water Cooling System	6	Hang Card

Diamond Hole Saw with Water Delivery System



- For cutting 1-3/8" diameter holes in glass, ceramic, porcelain, marble and granite
- Special diamond grit edge for faster smoother cuts
- Included drill guide and water cooling cup easily supplies water to drill bit (use wet-only)
- Fits standard 1/2" or 3/8" drill chucks
- Includes 6 adhesive strips, water cooling cup and 1-3/8" diameter x 3" tall drill bit
- Only for wet use with cordless drills

Item No.	Description	Case Qty	Packaging
10569	1-3/8" Porcelain Diamond Hole Saw w/Drill Guide and Water Cooling System	6	Hang Card
10570	1-3/8" Hole Saw Mounting Tape	6/cs (12 pc/bag)	Hang Card

Multi-Use Trim Shears



- Easily cuts quarter round, tile trim, PVC piping, tackstrip and other light materials
- Makes fast angle cuts in wood quarter round, tile trim, PVC piping, tackstrip and other materials
- Eliminates the need for a chop or miter saw
- Miter guide is clearly marked at 45, 90 and 120 degrees

Item No.	Description	Case Qty	Packaging
10711	Multi-Use Trim Shears	6	Hang Card

Tile Mallet



- Measures 70-75 on the Shore A hardness scale, for a firm hardness with minimum bounce when striking
- Designed for installing both unfinished and prefinished flooring
- Large chamfered mallet head spreads force across the flooring to move it into place during installation
- 16 oz. white rubber head will not mar tile or other surfaces
- Co-molded plastic 11.5" handle with non-slip, rubber grip for comfortable extended use

Item No.	Description	Case Qty	Packaging
61625	Tile Mallet	3	Hang Handle

White Rubber Mallet



- 16 oz. non-marring rubber head securely mounted on hardwood handle
- 12-1/2" in length, 2" diameter rubber head

Item No.	Description	Case Qty	Packaging
61613	White Rubber Mallet	12	Shelf Case

Rubbing Stone



- Dual grit surfaces smooth rough edges on freshly cut ceramic & porcelain tile, stone, marble and brick
- Medium 60-grit on one side and fine 80-grit on the other
- Ideal for dressing diamond blades by exposing fresh diamonds in the blade rim

Item No.	Description	Case Qty	Packaging
10022	Rubbing Stone (6" x 2" x 1")	6	Hang Card

Diamond Sanding Blocks

NEW

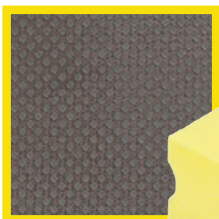
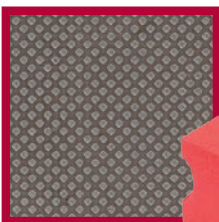
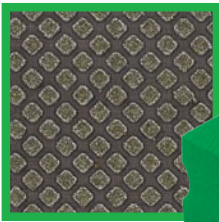

- Smooth tile, stone, granite, glass, ceramic, and marble
- Manufactured with superior brazed diamond bonding and a lightweight foam base
- Flexible and easy to use in hard to reach places, corners, and edges
- Can be used wet or dry
- Rinse to use again

Item No.	Description	Case Qty	Packaging
10046	60 Grit Sanding Block	6	Hang Card
10047	120 Grit Sanding Block	6	Hang Card
10048	200 Grit Sanding Block	6	Hang Card
10049	400 Grit Sanding Block	6	Hang Card



10046 60 COARSE GRIT 10047 120 MEDIUM GRIT 10048 200 FINE GRIT 10049 400 POLISHING GRIT

Grit	Purpose
60	Aggressive coarse grit for high rough spots
120	Medium grit for smoothing
200	Fine grit for smoothing
400	Smooth for polishing

Diamond Grit File



- The high quality diamond bond strength maintains a tough grit surface for working with the hardest materials, including ceramic, porcelain, glass and stone
- Can also be used to smooth other materials, including fiberglass, laminate flooring, cement board and carbon fiber
- Flat/round profiles allow for smoothing both straight and curved edges
- Co-molded plastic handle with non-slip, rubber grip for comfortable repeat use

Item No.	Description	Case Qty	Packaging
10586	Diamond Grit File	6	Hang Card

Pro Grout Saw



2 BLADES INCLUDED

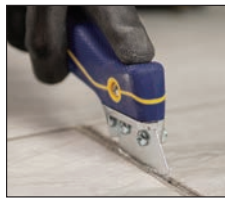

- Curved heavy duty carbide blades easily remove stubborn grout
- Blade storage in handle can hold up to 2 blades
- Use 1 blade for thinner grout lines and 2 blades for wider grout lines

Item No.	Description	Case Qty	Packaging
10093	Pro Grout Saw	6	Hang Card
75011	Replacement Grout Saw Blades 2 pack	6	Hang Card

Grout Saw



- Strips, cleans and removes old grout and may be used on all grout types
- Includes 1 steel tooth blade for initially removing tough grout and 1 carbide grit blade for finishing and fine removal
- Use both blades for wide grout lines

Item No.	Description	Case Qty	Packaging
10057	Grout Saw	12	Hang Card
75011	Replacement Grout Saw Blades 2 pack	6	Hang Card

Grout Saw Blades



- Replacement blades for QEP's and Pro Grout Saw 10093 and 10057

Item No.	Description	Case Qty	Packaging
75011	Replacement Grout Saw Blades 2 pack	6	Hang Card

Grout Remover



- For removing unwanted grout, mortar, thinset, calcium, caulking and surface rust
- Double-sided head with 3 durable carbide tips
- Includes 1/16", 1/8" and 3/16" tips

Item No.	Description	Case Qty	Packaging
10020	Grout Remover	12	Hang Card

Thinset Removal Tool



- For removing excess thinset between tiles, during installation
- Durable, easy to clean plastic material will not scratch tile
- Clearly marked tips for most popular grout joints 1/16", 1/8", 3/16" and 1/4"
- Patent pending 4-in-1 flat, compact tool for easy storage and portability

Item No.	Description	Case Qty	Packaging
62963	Thinset Removal Tool	10	Hang Card

Grout Bag



- Reinforced tip for smooth application and long life
- Protects hands from grout and other harsh substances
- Made of puncture and tear resistant coated vinyl

Item No.	Description	Case Qty	Packaging
76000	Grout Bag	12	Shelf Case

Grout Sealer Applicator



Roller



Brush

- Includes (2) roller wheels for multiple grout widths:
Use 1/8" wheel for grout joints 1/8" and smaller
Use 1/4" wheel for grout joints 1/4" and larger
- Works with all grout sealers
- Patented roller wheel system provides complete coverage
- Holds 12 oz. (355 ml)

Item No.	Description	Case Qty	Packaging
10279	Grout Sealer Applicator	12	Hang Tab

- Great for small projects with narrow grout joints
- Works with all grout sealers
- Plastic bottle holds up to 4 oz. of grout sealer

Item No.	Description	Case Qty	Packaging
19999	Grout Sealer Brush Applicator	12	Hang Tab

Folding Backerboard Knife

NEW



- Long lasting carbide tip
- Serrated blade base for cutting mesh
- Folding design for storage and safe transport
- Designed to score all types of backerboards
- Strong, lightweight aluminum handle with liner lock

Item No.	Description	Case Qty	Packaging
10072	Folding Backerboard Knife	6	Hang Card

Backerboard Scoring Knife



- Long lasting carbide tips for scoring backerboard
- 2 tips deliver accurate, straight cuts
- Non-slip, rubber grip handle for comfortable repeat use

Item No.	Description	Case Qty	Packaging
10058	Backerboard Scoring Knife	12	Hang Card

Board Seam Tape



- For use in seaming all types of cement backerboard and tile underlayment
- Alkali resistant fiberglass mesh, self-adhesive tape – reduces taping time
- Resists tears and will not shrink

Item No.	Description	Case Qty	Packaging
99600	Board Seam Tape – 2" x 50' roll	24	Shelf Case
99605	Cement Board Seam Tape – 2" x 150' roll	18	Shelf Case

Cleaning Tools

QEP offers all the tools you need for cleanup, including cleaning cloths, sponges and more!
No one sells more tile sponges worldwide!

Heavy Duty All-Purpose Sponge



- Professional, heavy duty sponge for grout clean-up
- Foam density is engineered for quicker grout pick-up and faster rinse
- Rounded corner design prevents digging out or marring grout
- Perfect for residential, commercial, drywall, auto and marine cleaning



Rounded Corner – 7.5" x 5.5" x 1.875			
Item No.	Description	Case Qty	Packaging
70005-24	Heavy Duty All-Purpose Sponge, Individually bagged	24	Shelf Case
70005Q-144	Heavy Duty All-Purpose Sponge, Individually bagged	144	Floor Display
70005Q-6D	Heavy Duty All-Purpose Sponge, Value 6 Pack	144	Shelf Case
70005-750	Heavy Duty All-Purpose Sponge, Bulk Bale	750	Bale
70005D	Heavy Duty All-Purpose Single Pack Sponge Display	252	Floor Display
70005-3VPD	Heavy Duty All-Purpose 3 Pack Sponge	84	Floor Display

QEP Canada (English/French Packaging)			
Item No.	Description	Case Qty	Packaging
70005	XL All-Purpose Sponge, Bulk Bale	600	Bale
70005C-24	XL All-Purpose Sponge, Individually bagged	36	Shelf Case
70005QC-144	XL All-Purpose Sponge, Display	144	Floor Display
70005QC-6D	XL All-Purpose Sponge, Value 6 Pack	24	Floor Display

Square Corner – 6.5" x 4.5" x 1.875			
Item No.	Description	Case Qty	Packaging
70006	Square Heavy Duty All-Purpose Sponge, Individually bagged	18	Shelf Case

**AVAILABLE
SPRING 2023**

Scrubbing Sponge



- Designed for removing wet and drying grout during floor and wall tile installation
- Premium density, heavy duty sponge on one side and scrubbing pad on the other for all in one cleaning
- Hydrophilic design for high water holding capacity and scrub pad removes tough stains
- Rounded corner design prevents digging out or marring grout
- Perfect for residential, commercial, office, car, boat and RV cleaning
- 7-1/2" x 5-1/4" x 1.875"

Item No.	Description	Case Qty	Packaging
70007-24	Scrubbing Sponge, Individually bagged	24	Shelf Case
70007C-24	Scrubbing Sponge, Individually bagged - Only available in Canada	24	Shelf Case

Microfiber Polishing Sponge



- Microfiber side ideal for cleaning grout, applying sealer and polishing tile
- Rounded corners prevent digging out or marring of grout joints
- For use on sanded and non-sanded grouts
- 7-1/2" x 5-1/2" x 2"
- Great for washing and polishing cars, boats, countertops and furniture

Item No.	Description	Case Qty	Packaging
70010	Microfiber Polishing Sponge	24	Shelf Case
70010C-24	Microfiber Polishing Sponge - Only available in Canada	24	Shelf Case

Microfiber Grout Cleaning Cloth



- Oversized, microfiber cloth for removing grout haze, as well as general dusting, washing and cleaning
- Soft, yet durable and heavy duty material is great for wet or dry use
- 100% microfiber cloth, including double sided edge stitching
- Machine washable, and great for general purpose cleaning on most home surfaces, including cars and boats

Item No.	Description	Case Qty	Packaging
70018	Microfiber Grout Cleaning Cloth 18" x 18"	12	Hang Card

Microfiber Surface Cleaning



2-Pack



- High absorbency cloth absorbs up to 5x its weight in water
- Soft microfiber on one side, non-abrasive scrubbing micro-bristles on the other
- Rows of micro-bristles safely scrub away dried grout and tough to remove dirt and grime
- Machine washable

Item No.	Description	Case Qty	Packaging
70019	Microfiber Grout Cleaning Cloth 14" x 14" 2-Pack	12	Hang Card

Polishing Cheesecloth



- For removing grout haze after installation
- 5 square yards (36" x 180")
- Great for polishing most tile surfaces to a bright shiny finish
- 100% cotton, professional grade fine mesh

Item No.	Description	Case Qty	Packaging
76030	Polishing Cheesecloth	12	Hang Card

Plastic Mixing Buckets



AVAILABLE
SPRING 2023

- Durable white opaque plastic buckets with handles

Item No.	Description	Case Qty	Packaging
78105	5 Gallon Plastic Mixing Bucket - White with QEP logo	6	Open Stock
78200	5 Gallon Plastic Mixing Bucket - White	6	Open Stock
78208	3-1/2 Gallon Plastic Mixing Bucket - White	1	Open Stock

Large Handle Scrub Brush

NEW



Handle Sold Separately



- Features corner brush head design
- Stiff nylon V cut bristles for cleaning deep into grout
- Built in scraper for tough dirt and grime
- Swivel head pole attachment allows for use standing up and provides additional leverage

Item No.	Description	Case Qty	Packaging
20839	Large Handle Scrub Brush	8	Hang Card

Grout Brush



- Multi-purpose cleaning brush with outstanding performance on tile and grout
- Ergonomic handle includes thumb rest for leverage and comfort
- Durable, angled nylon bristles remove grime in creases

Item No.	Description	Case Qty	Packaging
20842	Grout Brush	12	Hang Card

Heavy Duty Multipurpose Gloves



- Protects hands from the corrosive action of grout, chemicals and other harsh substances
- 100% heavy duty latex is puncture and tear resistant
- One size fits most
- Non-slip ribbing on thumb and finger surfaces

Item No.	Description	Case Qty	Packaging
21591	Heavy Duty Multipurpose Gloves	24	Shelf Case

SureGrip Tiler's Gloves



2 Pairs/
Pack

- Provides excellent grip and dexterity when handling tile and stone
- Patented SureGrip® technology provides an over 400% better grip in wet conditions and 60% better grip in dry conditions compared to standard latex and nitrile material
- Durable, lightweight mesh fabric with elastic wrist band to keep gloves in place
- Touchscreen compatible for easy smartphone and tablet use without removing gloves
- 2 pair of gloves per set
- One size fits most

⚠WARNING: Cancer and Reproductive Harm-
www.P65Warnings.ca.gov. See P. 67, *Prop 65 - 2.

Item No.	Description	Case Qty	Packaging
21595	SureGrip® Tiler's Gloves (2 pairs of gloves)	10	Shelf Case

Floor & Wall Tile Installation Kit



- Complete kit containing all the tools necessary to install ceramic tile on floors
- Kit contains:
 - Trowel handle with 2 attachments:
 - 1/4" x 1/4" x 1/4" square notch
 - 1/4" x 3/8" x 1/4" square notch
 - rubber grout float
 - handheld tile cutter
 - sponge
 - multipurpose gloves
 - washable kneepads
 - reusable 2.5 gallon plastic bucket
 - with complete installation instructions

Item No.	Description	Case Qty	Packaging
78250Q	Floor & Wall Tile Installation Kit	1	Shelf Case

Tile Installation Kit



- Complete kit containing all the tools necessary to install ceramic tile on floors
- Kit contains: Molded rubber float, 1/4" x 3/8" x 1/4" square notch floor trowel, 8" tile nippers, sponge, disposable gloves and reusable 2.5 gallon plastic bucket with complete installation instructions

Item No.	Description	Case Qty	Packaging
78220Q	Tile Installation Kit	1	Shelf Case
QEP Canada (English/French Packaging)			
78220QC	Tile Installation Kit	1	Shelf Case

Toilet Installation Kit & Accessories

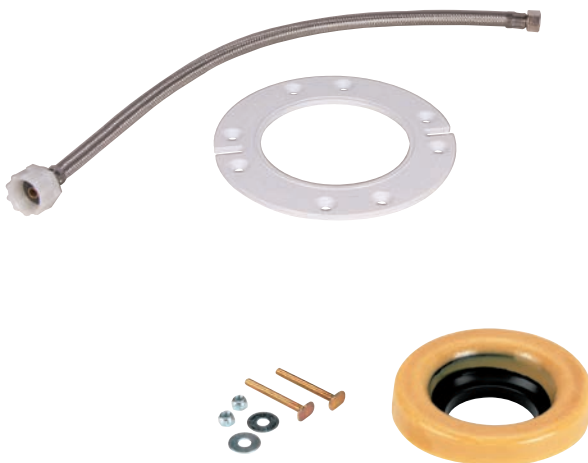

- Includes: Wm Harvey No-Seep® No. 50 Extra Thick Wax Gasket with Polyethylene Flange, Fluidmaster® 12" SS Braided Toilet Connector, Bolt Kit - 1/4" x 2-1/4" brass-plated closet bolts with nuts and washers

Item No.	Description	Case Qty	Packaging
38229	Toilet Installation Kit with 12" Connector	1	Shelf Case
38233	No-Seep Wax Ring, No. 50	1	Shelf Case



TILE SPACERS

QEP offers a variety of systems and spacer styles to eliminate tile lippage. The original LASH® Tile Leveling System and Xtreme™ Pro Series Tile Leveling System are two-part clip & wedge systems to eliminate uneven tiles. Our horseshoe shims, flexible tile spacers, hard tile spacers, and “T” tile spacers are all solid options for aligning floor and wall tile based on your installation preferences.

XTREME^{PRO-SERIES} Tile Leveling System

NEW

**Wide
Format
Design**

Extra wide, flat base design is ideal for large format tile installations

- Two part system eliminates uneven tiles
- Available in 4 sizes
- For tiles up to 1/2" thick
- Easy to use, even with heavy tile

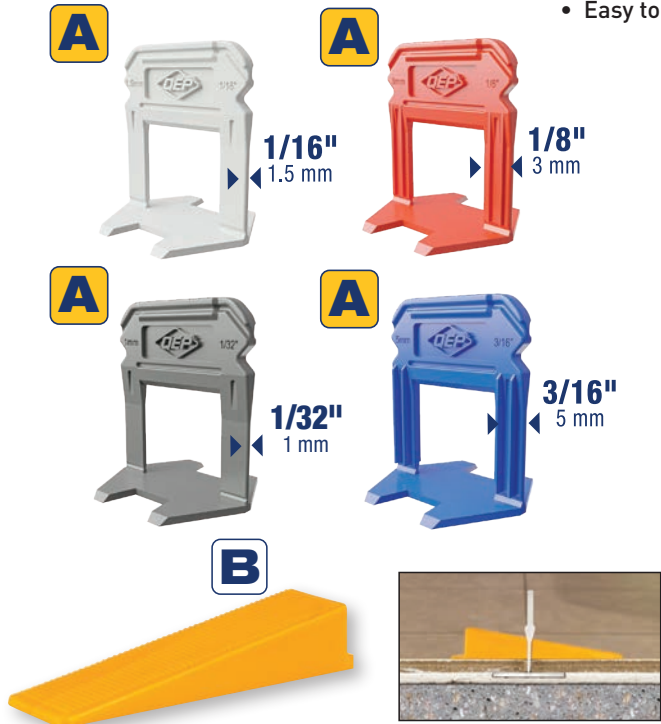

Item No.	Description	Qty	Case Qty	Packaging
99771	Xtreme 1/32" Leveling Clips, Box	500	8	Shelf Case
99776	Xtreme 1/32" Leveling Clips, Box	2000	1	Shelf Case
99761	Xtreme 1/16" Leveling Clips, Bag	100	8	Shelf Case
99772	Xtreme 1/16" Leveling Clips, Bag	500	8	Shelf Case
99777	Xtreme 1/16" Leveling Clips, Box	2000	1	Shelf Case
99769	Xtreme 1/8" Leveling Clips, Bag	100	8	Shelf Case
99773	Xtreme 1/8" Leveling Clips, Box	500	8	Shelf Case
99778	Xtreme 1/8" Leveling Clips, Box	2000	1	Shelf Case
99774	Xtreme 3/16" Leveling Clips, Box	500	8	Shelf Case
99779	Xtreme 3/16" Leveling Clips, Box	2000	1	Shelf Case
99762	Xtreme Leveling Wedges, Bag	100	8	Shelf Case
99775	Xtreme Leveling Wedges, Box	500	8	Shelf Case
99780	Xtreme Leveling Wedges, Box	2000	1	Shelf Case

For faster installation use QEP Pro Installation Pliers. See page 44 for details.



500 2000 PACKS

Now Introducing the **NEW** Xtreme Tile Leveling System with larger format clips and wedges. Available in sizes 1/32", 1/16", 1/8", 3/16" and contractor quantities of 500 or 2000.

**Ceramic and Stone Tools.
Worldwide Leader.
For a Reason.**



**TILE LEVELING SYSTEM IN EXTRA LARGE PRO PACKS
FROM THE INVENTOR OF THE ORIGINAL LASH**



www.qep.com
866.435.8665



X-TREME PRO-SERIES **Tile Leveling Clips and Wedges Pallets**

**SAVE
10%
ON PALLET
QUANTITIES**

Tile Leveling System for 500 Count Boxes

Order Xtreme Tile Leveling Clips and Wedges in Pallet quantities

Order the following to fill pallets:

500 count clips: 16 boxes – 500 count wedges: 4 boxes

See page 42 for details on each sku

X-TREME PRO-SERIES **Tile Leveling Clips and Wedges – 500 Count**



X-TREME PRO-SERIES **Tile Leveling Clips and Wedges – 2000 Count**

Tile Leveling System for 2000 Count Boxes

Order Xtreme Tile Leveling Clips and Wedges in Pallet quantities

Order the following to fill pallets:

2000 count clips: 32 boxes – 2000 count wedges: 12 boxes

See page 42 for details on each sku



LASH® Tile Leveling System

made in
USA



The ORIGINAL
LASH®
LEVEL ALIGN SPACE HOLD

For perfect tile-to-tile leveling

The patented LASH® Tile Leveling System is designed for quick installation and reduces costly call backs by ensuring that the finished floor surface is lippage-free. This time-saving system helps adjust the height of the tiles and evenly holds their edges throughout the curing process of the setting material.

- For use with all floor and wall tiles between 1/4" and 7/16" thick
- Durable nylon construction for a secure installation
- Specially designed break-off point on clips for swift removal
- Produces 1/16" or 1/8" joint spacing
- May be combined with regular tile spacers for wider joints - up to 1/4"
- Wedges are reusable

A



A

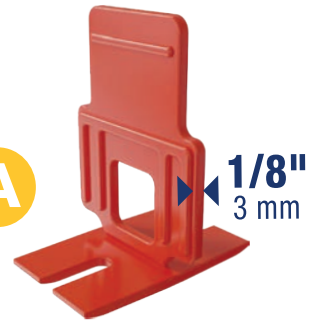

B

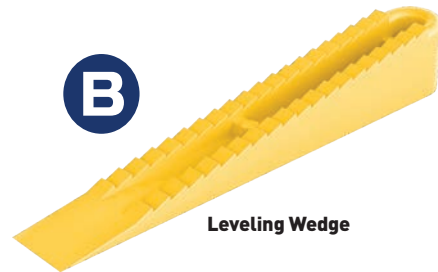

Leveling Wedge

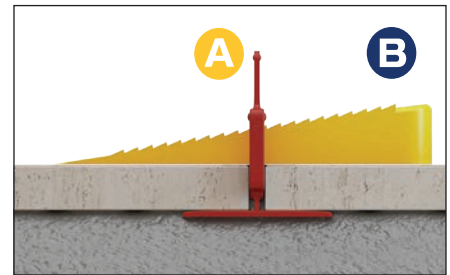

LASH® Flat Clip for Floor and Wall Tiles

Item No.	Description	Qty	Case Qty	Packaging
99730	1/16" LASH® Flat Clips, Bag	100	8	Shelf Case
99731	1/16" LASH® Flat Clips, Box	300	4	Shelf Case
99740	1/16" LASH® Flat Clips, Box	1000	1	Shelf Case
99707Q	1/16" LASH® Flat Clips, Box	4800	1	Contractor Pack
99781	1/8" LASH® Flat Clips, Bag	100	8	Shelf Case
99782	1/8" LASH® Flat Clip, Box	300	4	Shelf Case
99783	1/8" LASH® Flat Clips, Box	1000	1	Shelf Case
99726	LASH® Wedges, Bag	100	8	Shelf Case
99727	LASH® Wedges, Bag	300	4	Shelf Case
99703	LASH® Wedges, Box	3600	1	Contractor Pack

Pro Installation Pliers



- Speeds installation time
- Easily adjusts for different tile thickness
- Fully adjustable pliers ensure wedges are set properly in the leveling clips, ever allow pliers to accommodate both the Original LASH® and Xtreme™ Pro Series tile leveling systems

Item No.	Description	Case Qty	Packaging
99757	Pro Installation Pliers	6	Hang Card

Wedge Tile Spacers

made in
USA

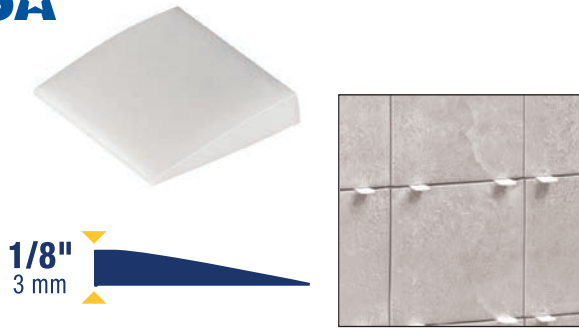

- Crucial for achieving a level first row of wall tile
- Ideal for maintaining level horizontal grout lines during installation
- Avoids tile slippage on vertical surfaces - will not compress
- Can be used for up to 1/8" (3 mm)

Item No.	Description	Case Qty	Packaging
10285	Wedge Tile Spacers, Bag - 500 Qty	16	Hang Card Shelf Case

Horseshoe Shims



- Ideal for marble, granite, stone, large format tiles and vertical installations.
- Allows user to lift both corners and align the joints from tile to tile
- Non-compressive

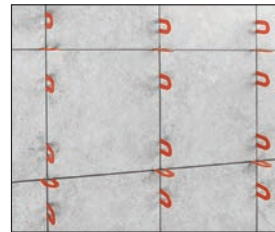

Packaged
in reusable
storage
container

Item No.	Description	Case Qty	Packaging
10320	1/16" Horseshoe Shims - 200 Qty	6	Tub
10321	1/8" Horseshoe Shims - 150 Qty	6	Tub
10322	3/16" Horseshoe Shims - 100 Qty	6	Tub
10323	1/4" Horseshoe Shims - 75 Qty	6	Tub

Traditional, Flexible Tile Spacers

made in
USA

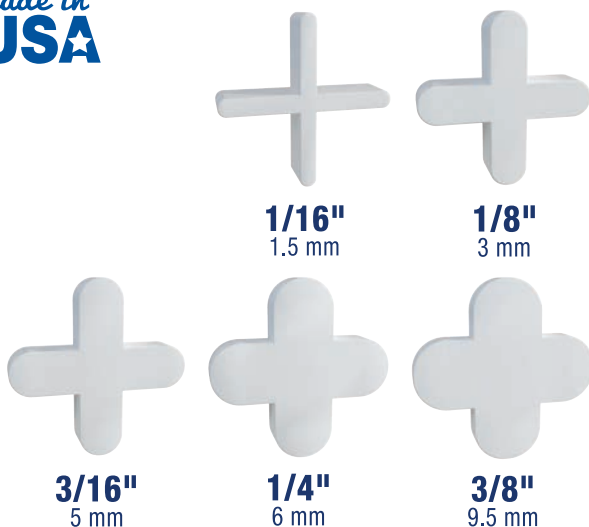

- Works with all sizes of ceramic tile, porcelain, stone and marble
- Flexible, soft plastic design for easy maneuvering in tile joints
- Evenly space tiles for uniform grout lines
- For easy removal, use spacers vertically in traditional tombstone-style

Item No.	Description	Case Qty	Packaging
10334	1/16" Tile Spacers, Bag - 300 Qty	24	Shelf Case
10335	1/8" Tile Spacers, Bag - 500 Qty	14	Shelf Case
10336	3/16" Tile Spacers, Bag - 300 Qty	14	Shelf Case
10005	1/4" Tile Spacers, Bag - 200 Qty	15	Shelf Case
10027	3/8" Tile Spacers, Bag - 100 Qty	20	Shelf Case

Hard, Leave-in Tile Spacers

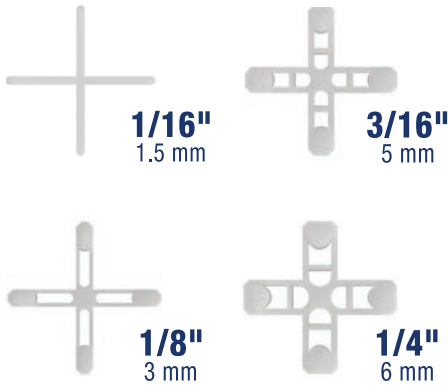

- Will not compress when setting marble, granite, stone and large format tile
- Use as traditional vertical tombstone-style or inset leave-in installation method
- Leave-In design reduces installation time
- Easy to handle, extra long prongs assure perfect 90° grout corners

NOW AVAILABLE IN JAR QUANTITIES

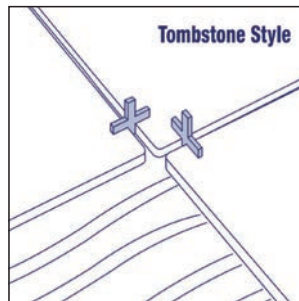
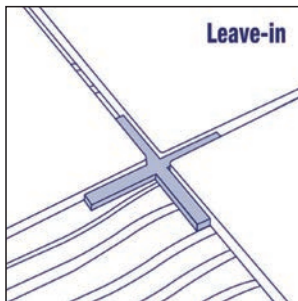

Item No.	Description	Case Qty	Packaging
10330-20	1/16" Leave-In Spacers, Bag - 300 Qty	20	Shelf Case
10331-18	1/8" Leave-In Spacers, Bag - 300 Qty	18	Shelf Case
10332	3/16" Leave-In Spacers, Bag - 200 Qty	12	Shelf Case
10333	1/4" Leave-In Spacers, Bag - 200 Qty	10	Shelf Case
10324	1/16" Leave-In Spacers, Jar - 1500 Qty	6	Shelf Case
10325	1/8" Leave-In Spacers, Jar - 1000 Qty	6	Shelf Case
10326	3/16" Tile Spacers, Jar - 500 Qty	6	Shelf Case

"T" Tile Spacers



- For aligning all floor and wall tiles
- Designed for Subway, brick layout or any offset tiling patterns and perimeters
- Will not compress when setting marble, granite, stone and large format tile
- Use in traditional "tombstone" style or leave between tiles and grout over
- Support bar and extended solid tip for improved tile support, keeping the spacer from compressing
- Longer leg length for easier installation

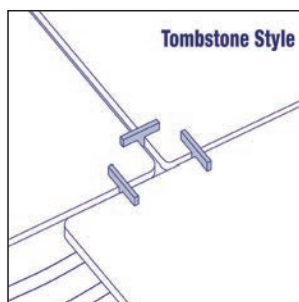
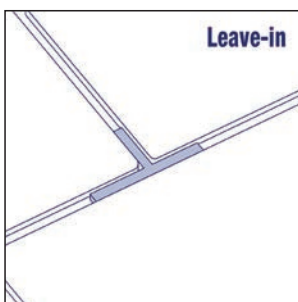

Item No.	Description	Case Qty	Packaging
10202	1/16" "T" Tile Spacers, Bag - 300 Qty	24	Hang Card Shelf Case
10203	1/8" "T" Tile Spacers, Bag - 300 Qty	20	Hang Card Shelf Case
10204	3/16" "T" Tile Spacers, Bag - 200 Qty	14	Hang Card Shelf Case



KNEE PADS

Offering installers several designs for knee protection, QEP prioritizes your time and safety. From EVA foam and memory foam to encapsulated gel layers, we've got you covered. Most QEP kneepads also offer convenient side loops for pen storage to quickly make marks.

ProMAXGel Knee Pads

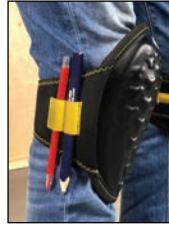

- Gel layer is fully encapsulated in EVA foam to prevent delamination and minimize wear
- Textured cap surface for a non-slip grip and moisture-wicking neoprene liner for comfort
- Micro hook and loop fastening technology down the length of the strap for a perfect fit
- Convenient side pen loops for pen storage

Item No.	Description	Case Qty	Packaging
79645	ProMAX® Gel Knee Pads	6	Hang Card Shelf Case
79645D	ProMAX® Gel Knee Pad Display	20 pair per display	Floor Display see page 63

F3 STABILIZER Professional Knee Pads

FORMS FITS FLEXES

Comfort Wrap Technology *with Memory Foam*



- Memory foam conforms to your knee shape for a custom fit
- XL Patella Gel Zone and 5 Layer Comfort System provides extended total knee comfort
- Soft Cap Stabilizer for hard or soft surfaces
- Micro hook and loop fastening technology on the entire strap length for a perfect fit
- Convenient side pen loops for pen storage

Item No.	Description	Case Qty	Packaging
79642	F3 Stabilizer Professional Knee Pads	6	Hang Card Shelf Case

Comfort Grip Knee Pads



- Comfortable EVA form-fitting foam padding for cushioning
- Soft neoprene inner lining will not adsorb sweat so the knee pads won't develop an odor
- Stretching, neoprene strap with adjustable hook and loop fasteners hold the knee pads in place
- New - Convenient side pen loops for pen storage

Item No.	Description	Case Qty	Packaging
79634	Comfort Grip Knee Pads	8	Hang Card Shelf Case

Washable Knee Pads



- Compression molded EVA foam for easy washing with a neoprene liner for comfort
- Economical and lightweight for comfort and easy mobility
- Adjustable hook and loop fastening straps hold the knee pads in place

Item No.	Description	Case Qty	Packaging
79640	Washable Knee Pads	14	Hang Card



TROWELS & FLOATS

QEP boasts an extensive offering of Trowels and Floats. With a variety of grips, sizes and designs, QEP makes it easy to find the right products for your tile installation project. Favorites of professional installers include the QEP Xtreme Pro Series Cork Handle Notched Trowels, QEP Margin Trowels and Floats, which feature bucket hooks for easy storage, and the QEP Extreme Pro Series Stone Grout Float, shaped to contour and flex giving you the leverage you need.

Notched Trowels

LONGEST LASTING BLADES IN THE INDUSTRY

XTREME PRO-SERIES Cork Handle Notched Trowels

- 25% longer shank with reinforced exposed rivets for added strength
- Extra handle-to-shank distance allows maximum hand clearance
- Rustproof 12" x 4-1/2" stainless steel blade designed for long lasting durability
- Cork comfort grip for better cushion and anti-slippage in the hand



Item No.	Description	Case Qty	Packaging
49950	Xtreme Cork Handle Trowel Square Notch 1/4" x 1/4" x 1/4"	12	Shelf Case
49951	Xtreme Cork Handle Trowel Square Notch 1/4" x 3/8" x 1/4"	12	Shelf Case
49952	Xtreme Cork Handle Trowel Square Notch 1/2" x 1/2" x 1/2"	12	Shelf Case
49953 Canada Only	Xtreme Cork Handle Trowel with ruler Square Notch 1/4" x 1/4" x 1/4"	12	Shelf Case
49954 Canada Only	Xtreme Cork Handle Trowel with ruler Square Notch 1/4" x 3/8" x 1/4"	12	Shelf Case
49955 Canada Only	Xtreme Cork Handle Trowel with ruler Square Notch 1/2" x 1/2" x 1/2"	12	Shelf Case

Comfort Grip Stainless Steel Notched Trowels

- High quality 11" x 4-1/2" trowel designed for the professional
- Durable 230 mm aluminum die-cast shank
- Rustproof stainless steel blade
- Longer shank with 9 rivets
- Extra handle-to-shank clearance to allow for complete hand rotation
- Large, contoured and cushioned grip handles for comfort
- First and last rivet reinforced and welded



Item No.	Description	Case Qty	Packaging
49915	Comfort Grip Stainless Steel Trowel Square Notch 1/4" x 1/4" x 1/4"	12	Shelf Case
49916	Comfort Grip Stainless Steel Trowel Square Notch 1/4" x 3/8" x 1/4"	12	Shelf Case
49917	Comfort Grip Stainless Steel Trowel V Notch 3/16" x 5/32"	12	Shelf Case
49919	Comfort Grip Stainless Steel Trowel Square Notch 1/2" x 1/2" x 1/2"	12	Shelf Case

Wood Handle Notched Trowels

- Quality 11" x 4-1/2" trowel designed for the professional installer
- Large wooden handle for an easy grip
- Aluminum die-cast shank
- Hardened and tempered steel blade, ground and polished for long lasting durability
- Some notches available in 16" lengths



Item No.	Description	Case Qty	Packaging
49713	Wood Handle Trowel Square Notch 1/4" x 1/4" x 1/4"	12	Shelf Case
49714	Wood Handle Trowel Square Notch 1/4" x 3/8" x 1/4"	12	Shelf Case
49716	Wood Handle Trowel V Notch 1/4" x 3/16"	12	Shelf Case
49720	Wood Handle Trowel Square Notch 1/2" x 1/2" x 1/2"	12	Shelf Case

Standard Notched Trowels

- Quality trowel measuring 9" x 4"
- Hard, cold-rolled steel blade for longer wear
- High-impact black plastic handle







Item No.	Description	Case Qty	Packaging
10113	Standard Trowel Square Notch 1/4" x 1/4" x 1/4"	30	Shelf Case
10114	Standard Trowel Square Notch 1/4" x 3/8" x 1/4"	30	Shelf Case
10115	Standard Trowel V Notch 3/16" x 5/32"	30	Shelf Case
10116 Canada Only	Standard Trowel V Notch 1/4" x 3/16"	30	Shelf Case
10120	Standard Trowel Square Notch 1/2" x 1/2" x 1/2"	30	Shelf Case

Benefits of Cork Trowels

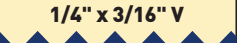

A favorite of installers, trowels with cork handles harness the natural moisture repellent properties of cork to provide a secure grip even with wet hands. Sustainable and naturally ergonomic, cork handles contribute to minimize fatigue and are easy to cleanup.

Notched Trowels at a glance

Notch Size	Application	X-TREME PRO-SERIES Cork Handle (12" Blade)	Comfort Grip (11" Blade)	Wood Handle (11" Blade)	Standard (9" Blade)
3/16" x 5/32" V 	For plastic, wall, ceramic & metal tile 6" x 6" or smaller and mosaics on drywall. Also for wall base.		49917		10115
1/4" x 3/16" V 	For ceramic, metal & aluminum wall tile 6" x 6" up to 12" x 12"			49716	10116 Canada Only
1/4" x 1/4" x 1/4" SQ 	For thinset application of ceramic tile 8" x 8" or smaller, laminated wood plank flooring, flat milled solid & shorts or plywood	49950 49953 Canada Only	49915	49713	10113
1/4" x 3/8" x 1/4" SQ 	Thinset application of ceramic tile 8" x 8" up to 16" x 16"	49951 49954 Canada Only	49916	49714	10114
1/2" x 1/2" x 1/2" SQ 	Thinset or medium bed mortar application of natural stone, quarry tile, pavers, saltillo and ceramic tiles 12" x 12" and larger	49952 49955 Canada Only	49919	49720	10120

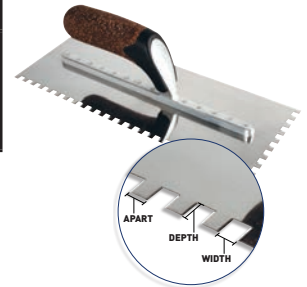

Always check adhesive/mortar manufacturer's trowel recommendations before selecting a trowel notch.

All Trowels Measure: Width x Depth x Space Apart

Recommended notch sizes by NTCA (National Tile Contractors Association)

Margin Trowel



Patent Pending Bucket Hook For Easy Storage



- Enlarged 6" x 2" blade is made from ground, tempered and hardened steel for flexibility and durability
- Patent pending bucket hook for easy storage on the side of your bucket
- Co-molded plastic handle with non-slip, rubber grip for comfortable repeat use

Item No.	Description	Case Qty	Packaging
42112	6" x 2" Comfort Grip Margin Trowel No Notch	12	Shelf Case
42114	6" x 2" Comfort Grip Margin Trowel Square Notch 1/4" x 1/4" x 1/4"	12	Shelf Case

Patch & Finishing Trowel



- For leveling, patching and finishing
- Hardened, tempered, ground and polished steel blade
- Die-cast aluminum shank with wood handle

Item No.	Description	Case Qty	Packaging
49708	Patch & Finishing Trowel 11" x 4-1/2" No Notch	12	Shelf Case

Bucket Scoop



- Quickly scoop setting materials, stucco and more
- Large comfort grip, contoured cushion handle
- 33% longer blade to hold more material
- Curved blade fits 5 gallon buckets
- Stainless steel blade

Item No.	Description	Case Qty	Packaging
42113	Bucket Scoop	6	Hang Card

XTREME^{PRO-SERIES} Stone Grout Float

For all grout types, including epoxy

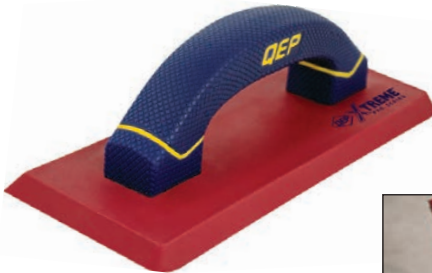

- Soft body design provides maximum flex and leverage for working grout into tile joints, with sanded and non-sanded grouts, for textured tile and natural stone
- Inner aluminum backing plate offers strength and stability
- Beveled sides hold edge longer
- Squared corners ensure complete coverage in corners

Item No.	Description	Case Qty	Packaging
10069	Xtreme Stone Grout Float, 10" x 3-1/2"	12	Shelf Case



For more information, scan here

Gum Rubber Grout Float



- Non-stick gum rubber ensures smooth application
- 2-rounded corners prevent gouging of grout joints
- 2-square corners ensure complete grout coverage in corners
- Extra thick aluminum backing plate for maximum leverage and applying grout into joints
- Premium gum rubber laminated to lightweight, closed cell core is built to last

Item No.	Description	Case Qty	Packaging
10070	Gum Rubber Grout Float, Wood Handle, 10-1/2" x 4"	12	Shelf Case

Universal Grout Float



- Non-stick gum rubber ensures smooth application for all grout types including epoxy
- 2-rounded corners prevent gouging of grout joints
- 2-square corners ensure complete grout coverage in corners
- Extra thick aluminum backing plate for maximum leverage and applying grout into joints.
- Comfortable, contoured and cushioned grip handle

Item No.	Description	Case Qty	Packaging
10074	Universal Grout Float 9-1/2" x 4"	8	Shelf Case

Molded Rubber Grout Float



- Non-stick 5/8 in. molded gum rubber pad prevents absorption of materials
- Aluminum back plate for durability and beveled sides for a smooth application

Item No.	Description	Case Qty	Packaging
10060	Molded Rubber Grout Float 9-1/2" x 4"	12	Shelf Case

Grout Float



- High-impact plastic handle with closed cell foam rubber pad for a smooth application

Item No.	Description	Case Qty	Packaging
10062	Grout Float 9" x 4"	24	Shelf Case

Margin Float



**Patent Pending
Bucket Hook
For Easy
Storage**

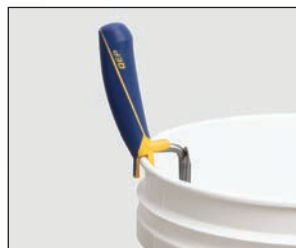

- Ideal for hard-to-reach areas such as kitchen backsplashes or under bath and kitchen counters
- Enlarged 6" x 2" gum rubber pad with tempered and hardened steel backing plate
- Patent pending bucket hook for easy storage on the side of your bucket
- Co-molded plastic handle with non-slip, rubber grip

Item No.	Description	Case Qty	Packaging
42117	6" Comfort Grip Margin Float	12	Shelf Case

Kevin Keefe, QEP Regional Sales Manager and 2022 Regional Finalist for Installer of the Year at the International Surface Event's National Competition, installs Naturally Aged Flooring's North Shore Laminate in Palmer Oak over QEP Cork Plus Underlayment.



UNDERLAYMENTS & BARRIERS

QEP offers both Aquabar® "B" Moisture Vapor Barrier and cork underlayments to enhance crack suppression. Natural Cork and Cork Plus Underlayments help control sound under ceramic tile and stone and reduce thermal transmissions. Cork Plus is made of natural cork plus recycled EVA foam, making it more flexible.

Benefits of Cork Underlayment



A staple in green building, cork offers superior durability, is impermeable, resistant to mold, mildew, and termites. A natural insulator, cork is fire resistant, and provides unrivalled noise reduction properties.

Exceptional as a flooring underlayment, cork is a sustainable material that assists with stress crack prevention, supports home insulation, and absorbs vibrations and footfalls, trapping the sound and reducing the volume.

Cork Plus Sheets and Rolls



- Constructed of natural cork and recycled EVA foam, making it more flexible and less prone to breakage than standard cork underlayment
- Acoustical sound control under ceramic tile and stone
- Enhances stress crack suppression
- Reduces thermal transmission, increasing effectiveness of floor heating systems
- Can also be used under laminate and floating floors
- Easy to install on and above grade in both glue-down and floating floor installations

Item No.	Description	Case Qty	Packaging
72019	1/4" (6 mm) Sheets - 30 sq. ft./pack	8	Sheets
72019-25	1/4" (6 mm) Sheets - 150 sq. ft./pack	25	Sheets
72002	1/4" (6 mm) Roll - 200 sq. ft. roll, 48" x 50'	1	Roll

	Test Results	IIC Rating	STC Rating	Δ Rating*	R-Value
72019	Engineered wood on a 6" cement slab	52	51	22	0.187
	Ceramic tile on a 6" concrete slab with a suspended ceiling	63	61		
72019-25	Engineered wood on a 6" cement slab	52	51	22	0.187
	Ceramic tile on a 6" concrete slab with a suspended ceiling	63	61		
72002	Engineered wood on a 6" cement slab	52	51	22	0.187
	Ceramic tile on a 6" concrete slab with a suspended ceiling	63	61		

* IIC measures sound such as moving furniture and walking, STC measures sound such as voices and television. Minimum sound rating required by most building codes and architects is 50. Δ Delta Rating is the only true measurement of sound reduction from a product (not a floor assembly) in the industry.

Natural Cork Sheets



- Reduces sound transmission from both the surface of a floor as well as through the floor to living spaces below
- Use under ceramic tile, stone, marble, engineered hardwood and laminate floors
- Acts as a crack isolation membrane that resists transfer of stress cracks from subfloor through to flooring surfaces
- Reduces thermal transmission, increasing the effectiveness of floor heating systems
- Each sheet: 2' x 3'

	Test Results	IIC Rating	STC Rating	Δ Rating*
72025	With 6" cement slab and suspended ceiling	60	59	22
72005Q / 72005-25	With 6" cement slab	51	52	22
72005Q	With 6" cement slab and suspended ceiling	61	60	22

Item No.	Description	Case Qty	Packaging
72025	2.5 mm Sheets – 696 sq. ft./case, Only available in Canada	116	Shelf Case
72004	3/16" (4 mm) Sheets – 456 sq. ft./case, Only available in Canada	76	Shelf Case
72005Q	1/4" (6 mm) Sheets - 30 sq. ft./pack, (5 sh/pk)	8	Shelf Case
72005-25	1/4" (6 mm) Sheets - 150 sq. ft./pack, (25 sh/pk)	1	Shelf Case
72001Q	1/2" (12 mm) Sheets - 150 sq. ft./case, (25 sh/pk)	1	Shelf Case

Natural Cork Roll



- Reduces sound transmission from both the surface of a floor as well as through the floor to living spaces below
- Use under ceramic tile, stone, marble, engineered hardwood and laminate floors
- Acts as a crack isolation membrane that resists transfer of stress cracks from subfloor through to flooring surfaces
- Reduces thermal transmission, increasing the effectiveness of floor heating systems

	Test Results	IIC Rating	STC Rating	Δ Rating*
72000Q	With 6" cement slab	51	52	22
72000Q	With 6" cement slab & suspended ceiling	61	60	22
72003Q	With 6" cement slab	51	52	22
72003Q	With 6" cement slab & suspended ceiling	61	60	22

Item No.	Description	Case Qty	Packaging
72000Q	1/4" (6 mm) Natural Cork 200 sq. ft. roll, 48" x 50'	1	Roll
72003Q	1/4" (6 mm) Natural Cork 100 sq. ft. roll, 48" x 25'	1	Roll

Aquabar® "B" Moisture Vapor Barrier



- Sub-floor barrier helps prevent buckling, cupping and cracking
- Ideal for interior installations of: ceramic, porcelain or stone over cement board, plywood or concrete; and, finished or unfinished wood floors over plywood or concrete

Item No.	Description	Case Qty	Packaging
70-195	Aquabar "B" Moisture Vapor Barrier - 500 sq.ft, 36" x 167"	1	Roll

* IIC measures sound such as moving furniture and walking, STC measures sound such as voices and television. Minimum sound rating required by most building codes and architects is 50. Δ Delta Rating is the only true measurement of sound reduction from a product (not a floor assembly) in the industry.



TEAR-OUT TOOLS

When starting a new project, QEP knows scrapers and chisels need to be strong and durable to get the job done. We offer smaller handheld options, chisels and scrapers that can accommodate handles for extended reach and traditional demolition, surface and floor scrapers. All of these tools are designed for better leverage, comfort and control while working.

14" Surface Scraper

made in
USA



- Flexible 14" blade helps remove old floors and cleans up excess debris
- Great for removing vinyl, carpet glue, plaster and popcorn ceilings
- 5' long handle and flex blade made of premium quality carbon steel offer long-lasting durability

Item No.	Description	Case Qty	Packaging
20900Q	14" Surface Scraper with Blade	6	Hang Card
21000Q	14" Replacement Blade	3	Hang Card
QEP Canada (English/French Packaging)			
20902C	14" Surface Scraper with Blade (Made in China)	6	Hang Card

7" Heavy Duty Floor Scraper

made in
USA

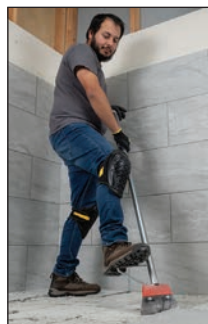

- Thick, professional high-carbon steel 7" blade scrapes up concrete, marble, ceramic tile and wood floors
- All welded construction made of pipe steel with a replaceable rigid blade
- Rips up roofing and vinyl flooring; Chips away cement and plaster
- 4' long handle includes foot peg for better leverage on difficult projects
- Great for ice removal

Item No.	Description	Case Qty	Packaging
75006Q	7" Heavy-Duty Floor Scraper with Blade	6	Hang Card
75007Q	7" Replacement Blade	3	Hang Card
QEP Canada (English/French Packaging)			
75017C	7" Heavy-Duty Floor Scraper with Blade (Made in China)	6	Hang Card

Demolition Scraper

made in
USA



- Unique reversible hardened steel blade can easily be converted from 5" to 3" wide (ideal for scraping in tight areas)
- Double angled design offers increased leverage during scraping and prying
- Great for removing tile, wood, laminate, stone, carpet, ice and roofing
- Resharpener hard steel (use file or grinder)
- Galvanized steel ergonomic handle reduces fatigue

Item No.	Description	Case Qty	Packaging
62965Q	Demolition Scraper	3	Hang Card

8" Adjustable Razor Floor Scraper



Includes canvas cover

- Twist lock adjustable telescoping handle adjusts from 3' to 6' in length
- Removes old adhesive, vinyl, carpet and other floor covering materials
- Deluxe cushioned grip handle provides added comfort
- 15° angled 8" blade head for ease of comfort when scraping

Item No.	Description	Case Qty	Packaging
62909Q	8" Adjustable Razor Floor Stripper	6	Hang Card
Replacement Blades			
62904Q	8" Stripper Blades (3 on a skincard)	10	Hang Card
62907Q	8" Stripper Blades (10 on a skincard)	1	Hang Card
QEP Canada (English/French Packaging)			
62909QC	8" Adjustable Razor Floor Stripper	6	Hang Card

Floor and Wall Scraper



- Handle features internal blade storage and built-in screwdriver for easy accessibility
- Attach handle to a threaded pole for an extended reach
- Metal hammer end for use on stubborn material
- Includes five 4" stainless steel blades
- Co-molded plastic handle core with non-slip, rubber grip

Item No.	Description	Case Qty	Packaging
62920	Floor and Wall Scraper	6	Hang Card
Replacement Blades			
62901	4" Razor Scraper Blades (5 on a skincard)	6	Hang Card

XTREME PRO-SERIES Heavy Duty Chisel

For splitting and breaking concrete, brick and more



- Features over strike impact guard
- Industrial grade with rust preventative coating
- Precision ground cutting edge
- Shock-absorb handle features non-slip grip for added control

Item No.	Description	Case Qty	Packaging
62971	Xtreme Heavy Duty Chisel	4	Hang Card

NEW



For more information, scan here

Chisel Scraper



- Heavy duty 3 in. stainless steel blade
- Attach handle to a threaded pole for an extended reach
- End of handle features a rubber mallet plate for stubborn material
- Co-molded plastic handle core with non-slip, rubber grip

Item No.	Description	Case Qty	Packaging
62972	Chisel Scraper	6	Hang Card



DISPLAYS & MERCHANDISING

We are pleased to offer both promotional floor stands and permanent fixtures for some of our best-selling installation tools. The floor displays are made of cardboard which can be recycled and the countertop displays can be used for any QEP product you would like to feature. Our 4' and 8' QEP branded gondola fixtures are designed to hold pegged product, shelf cartons and boxes. The gondola presentation allows for the full range of QEP tile tools to be merchandised together with overhead signage.



Corrugated Floor Displays

Perfect for promotions or secondary placement.

Single Pack Sponge



252
Sponges
per display



70005D
Heavy Duty All Purpose
Single Pack Sponge Floor Display

3-Pack Sponge

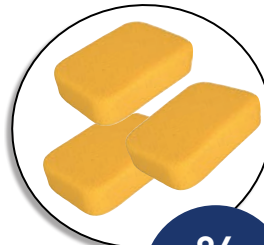

84
3-packs
per display



70005-3VPD
Heavy Duty All-Purpose
3-Pack Sponge Floor Display

Gel Knee Pads

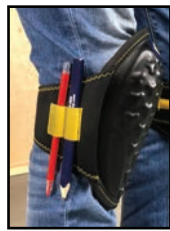

20
Pairs
per display

79645D
ProMAX® Gel Knee Pad
Floor Display



Mixers

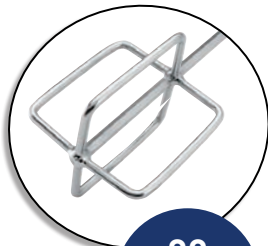

30
Mixers
per display



61205D
Pro Mixing Paddle
Floor Display

LASH® Project Pack



48
Project Packs
per display

99741D
LASH® Project Pack
Floor Display



Project Pack includes:

- 100 1/16" Flat Tile Leveling Clips
- 100 Leveling Wedges

QEP Tile Tool Merchandising Displays

NEW

QEP is pleased to offer free displays that can be customized based on the product assortment of top-selling tools you carry! These portable gondolas are designed and merchandised to deliver incremental sales at high margins. Includes free branded header insert.

QEP 4' Tile Tool Merchandising Display

\$500 Value



- Header is adjustable and measures 48" wide x 10" tall
- Display measures 48" wide x 26" deep x 72" high

See Your Sales Rep for more details

Example of 4' Planogram

QEP 8' Tile Tool Merchandising Display

\$1000 Value



- Header is adjustable and measures 96" wide x 10" tall
- Display measures 96" wide x 26" deep x 72" high

See Your Sales Rep for more details

Example of 8' Planogram

QEP Tile Tool Merchandising Displays

NEW

QEP is pleased to offer counter top displays that can be customized based on the product assortment and skus you carry! These displays should be merchandised near check out for incremental sales. All displays includes free branded header insert.

QEP Counter Display

\$48
Value



- Vertical display measures 18.85" wide x 15.68" deep x 33.75" high
- QEP Xtreme Hole Saws are an example of product assortment that can be displayed on this fixture.

**See Your
Sales Rep
for more
details**

QEP Gravity Display

\$52
Value



- Silicone injected hook design allows product to slide to front
- Vertical display measures 27.28" wide x 11.92" deep x 18.70" high
- QEP Xtreme Hole Saws are an example of product assortment that can be displayed on this fixture.

**See Your
Sales Rep
for more
details**

INDEX *By Item Number*

Item #	Description	Page
6-1001Q	10" Continuous Rim Diamond Blade- Black Series	12
6-1003Q	10" Continuous Rim Diamond Blade- Gold Series	12
6-1008BW	10" Black Widow® Blade	13
6-4001Q	4" Continuous Rim Diamond Blade- Black Series	12
6-4003Q	4" Continuous Rim Diamond Blade- Gold Series	12
6-4006GLQ	4" Continuous Rim Diamond Blade- Glass Series	12
6-4008BW	4" Black Widow® Blade	13
6-7001Q	7" Continuous Rim Diamond Blade- Black Series	12
6-7003Q	7" Continuous Rim Diamond Blade- Gold Series	12
6-7007GL	7" Continuous Rim Diamond Blade- Glass Series	12
6-7008BW	7" Black Widow® Blade	13
6-8001Q	8" Continuous Rim Diamond Blade- Black Series	12
6-8003Q	8" Continuous Rim Diamond Blade- Gold Series	12
6-8008BW	8" Black Widow® Blade	13
70-195	Aquabar® "B" Moisture Vapor Barrier	56
10003	Tile Nipper	25
10005	1/4" Tile Spacers	45
10010HD	Tungsten Carbide Cutting Wheel	21
10020	Grout Remover	34
10022	Rubbing Stone	32
10027	3/8" Tile Spacers	45
10038	6" Locking Contour Gauge	25
10046	Diamond Sanding Block, 60 grit	32
10047	Diamond Sanding Block, 120 grit	32
10048	Diamond Sanding Block, 200 grit	32
10049	Diamond Sanding Block, 400 grit	32
10051	Xtreme 3/8" Diamond Milling Bit	27
10052	Xtreme 3/4" Diamond Milling Bit	27
10057	Grout Saw	33
10058	Backerboard Scoring Knife	35
10060	Molded Rubber Grout Float 9-1/2" x 4"	53
10062	Grout Float 9-1/2" x 4"	53
10066	Xtreme 3/4" Diamond Milling Cone	27
10069	Xtreme Stone Grout Float	52
10070	Gum Rubber Grout Float, Wood Handle	52
10072	Folding Backerboard Knife	35
10074	Universal Grout Float 9-1/2" x 4"	53
10075	Xtreme 1/4" Diamond Hole Saw	26
10080	Xtreme 5/16" Diamond Hole Saw	26
10087	Xtreme 1-3/8" Diamond Hole Saw	26
10093	Pro Grout Saw	33
10103	Xtreme Pro Series Offset Tile Nipper	24
10113	Standard Trowel 1/4" x 1/4" x 1/4"	50-51

Item #	Description	Page
10114	Standard Trowel 1/4" x 3/8" x 1/4"	50
10115	Standard Trowel 3/16" x 5/32" V	50
10116 (Canada Only)	Standard Trowel 1/4" x 3/16" V	50
10120	Standard Trowel 1/2" x 1/2" x 1/2"	50
10202	1/16" "T" Tile Spacers	46
10203	1/8" "T" Tile Spacers	46
10204	3/16" "T" Tile Spacers	46
10214Q	14" Pro Tile Cutter	21
10220Q	20" Pro Tile Cutter	21
10221Q	21" Pro Tile Cutter	21
10279	Grout Sealer Applicator	34
10285	Wedge Tile Spacers	45
10320	1/16" Horseshoe Shims	45
10321	1/8" Horseshoe Shims	45
10322	3/16" Horseshoe Shims	45
10323	1/4" Horseshoe Shims	45
10324	1/16" Leave-In Spacers Jar	46
10325	1/8" Leave-In Spacers Jar	46
10326	3/16" Leave-In Spacers Jar	46
10330-20	1/16" Leave-In Spacers	46
10331-18	1/8" Leave-In Spacers	46
10332	3/16" Leave-In Spacers	46
10333	1/4" Leave-In Spacers	46
10334	1/16" Tile Spacers	45
10335	1/8" Tile Spacers	45
10336	3/16" Tile Spacers	45
10469	1/4" Xtreme Hole Saw for grinder	27
10470	5/16" Xtreme Hole Saw for grinder	27
10471	1" Xtreme Hole Saw for grinder	27
10472	1-3/8" Xtreme Hole Saw for grinder	27
10473	2" Xtreme Hole Saw for grinder	27
10474	2-1/2" Xtreme Hole Saw for grinder	27
10475	4" Xtreme Hole Saw for grinder	27
10480Q	48" LFT Manual Cutter	19
10485	Xtreme Diamond Hole Saw Kit	26
10500	22-1/2" Big Clinker Tile Cutter	18
10521Q	21" Pro Tile Cutter	20
10569	1-3/8" Porcelain Diamond Hole Saw w/Drill Guide and Water Cooling System	30
10570	1-3/8" Hole Saw Mounting Tape	30
10571	5/16" Porcelain Diamond Drill Bit w/Drill Guide and Water Cooling System	30
10572	1/4" Porcelain Diamond Drill Bit w/Drill Guide and Water Cooling System	30
10585	3" Diamond Jigsaw Blade	25
10586	Diamond Grit File	33

INDEX *By Item Number Continued*

Item #	Description	Page	Item #	Description	Page
10600	25" Big Clinker Tile Cutter	18	49915	Comfort Grip Stainless Steel Trowel Square Notch 1/4" x 1/4" x 1/4"	50
10624Q	24" Slimline Manual Tile Cutter	17	49916	Comfort Grip Stainless Steel Trowel Square Notch 1/4" x 3/8" x 1/4"	50
10630	24" Pro Tile Cutter	19	49917	Comfort Grip Stainless Steel Trowel Square Notch 3/16" x 5/32" V	50
10632Q	30" Slimline Manual Tile Cutter	17	49919	Comfort Grip Stainless Steel Trowel Square Notch 1/2" x 1/2" x 1/2"	50
10636Q	36" Slimline Manual Tile Cutter	17	49950	Xtreme Cork Handle Trowel Square Notch 1/4" x 1/4" x 1/4"	50
10711	Multi-Use Trim Shears	31	49951	Xtreme Cork Handle Trowel Square Notch 1/4" x 3/8" x 1/4"	50
10800	28" Big Clinker Tile Cutter	18	49952	Xtreme Cork Handle Trowel Square Notch 1/2" x 1/2" x 1/2"	50
10900	35" Pro Tile Cutter	19	49953 (Canada Only)	Xtreme Cork Handle Trowel Square Notch with ruler 1/4" x 1/4" x 1/4"	50
19999	Grout Sealer Brush Applicator	34	49954 (Canada Only)	Xtreme Cork Handle Trowel Square Notch with ruler 1/4" x 3/8" x 1/4"	50
20839	Large Handle Scrub Brush	39	49955 (Canada Only)	Xtreme Cork Handle Trowel Square Notch with ruler 1/2" x 1/2" x 1/2"	50
20842	Grout Brush	39	61205	23-1/2" Pro Mixing Paddle	23
20900Q	14" Surface Scraper with Blade	58	61205D	23-1/2" 16" Pro Mixing Paddle Floor Display	61
20902C (Canada Only)	14" Surface Scraper with Blade	58	61210	Universal Mixing Paddle	23
21000Q	14" Replacement Blade	58	61230	30" XL Spiral Pro Mixer	23
21123Q	7/8" Titanium-Coated Tungsten Carbide Cutting Wheel	21	61613	White Rubber Mallet	31
21125	7/8" Titanium-Coated Tungsten Carbide Cutting Wheel	21	61625	Tile Mallet	31
21127Q	10 mm Post Scoring Wheel	20	61900Q	10" 900XT Pro Wet Tile Saw	6
21178	7/8" Titanium-Coated Tungsten Carbide Cutting Wheel	21	62901	4" Razor Scraper Replacement Blades	59
21591	Heavy Duty Multipurpose Gloves	39	62904Q	8" Stripper Blade (5 pack)	59
21595	SureGrip® Tiler's Gloves (2 pairs of gloves)	39	62907Q	8" Stripper Blade (3 pack)	59
21661	24" Pro Mixing Paddle	23	62909/62909QC	8" Adjustable Razor Floor Stripper (10 pack)	59
21700	Power Mixer Pro w/Paddle	23	62920	Floor and Wall Scraper	59
22400Q	4" Torque Master XT Portable Wet Tile Saw	10	62963	Thinset Removal Tool	34
22700Q	7" 700XT Wet Tile Saw	9	62965Q	Demolition Scraper	58
22750Q	7" 750XT Wet Tile Saw	8	62971	Xtreme Heavy Duty Chisel	59
22900Q	7" Power Pro 1HP Wet Tile Saw	7	62972	Chisel Scraper	59
32010	Glass Tile Nipper	24	70005 (Canada Only)	XL All-Purpose Sponge, Bale	36
32014	Xtreme Glass Tile Nipper	24	70005D	Heavy Duty All-Purpose Single Pack Sponge Floor Display	36
32024	Tile Cutter	25	70005Q-6D	Heavy Duty All-Purpose Sponge, Value 6 Pack	36
32036	Compound Tile Nipper	24	70005Q-24	Heavy Duty All-Purpose Sponge, 24 ct Case	36
38229	Toilet Installation Kit with 12" Connector	40	70005C-24 (Canada Only)	Heavy Duty All-Purpose Sponge, 36 ct Case	36
38233	No-Seep Wax Ring, No. 50	40	70005Q-144/ 70005QC-144	Heavy Duty All-Purpose Sponge, 144/display	36
38778	Mechanical China Markers	30	70005QC-6D (Canada Only)	XL All-Purpose Sponge, Value 6 Pack	36
42112	6" x 2" Comfort Grip Margin Trowel	51	70005-750	Heavy Duty All-Purpose Sponge Bale	36
42113	Bucket Scoop	53	70005-3VPD	Heavy Duty All-Purpose 3- Pack Sponge Floor Display	61
42114	6" x 2" Comfort Grip Margin Trowel Square Notch 1/4" x 1/4" x 1/4"	51	70006	Square Heavy Duty All-Purpose Sponge	36
42117	6" Comfort Grip Margin Float	53	70007-24/ 70007C-24	Scrubbing Sponge	37
49708	Patch & Finishing Trowel 11" x 4-1/2"	52	70010/ 70010C-24	Microfiber Polishing Sponge	37
49713	Wood Handle Trowel Square Notch 1/4" x 1/4" x 1/4"	50	70018	Microfiber Grout Cleaning Cloth 18" x 18"	38
49714	Wood Handle Trowel Square Notch 1/4" x 3/8" x 1/4"	50	70019	Microfiber Surface Cleaning Cloth 14" x 14" 2-pack	38
49716	Wood Handle Trowel V Notch 1/4" x 3/16"	50			
49720	Wood Handle Trowel Square Notch 1/2" x 1/2" x 1/2"	50			

INDEX *By Item Number Continued*

Item #	Description	Page
72000Q	1/4" Natural Cork 6 mm Roll 200 sq ft	56
72001Q	1/2" Natural Cork 12 mm Sheets 150 sq ft	56
72002	1/4" Cork Plus 6 mm Roll 200 sq ft	55
72003Q	1/4" Natural Cork 6 mm Roll 100 sq ft	56
72004 (Canada Only)	3/16" Natural Cork 4 mm Sheets 456 sq ft	56
72005Q	1/4" Natural Cork 6 mm Sheets 30 sq ft	56
72005-25	1/4" Natural Cork 6 mm Sheets 150 sq ft	56
72019	1/4" Cork Plus 6 mm Sheets 30 sq ft	55
72019-25	1/4" Cork Plus 6 mm Sheets 150 sq ft	55
72025 (Canada Only)	Natural 2.5 mm Cork Sheets 696 sq ft	56
75000	Suction Cup	29
75003	Double Suction Cup	29
75006Q	7" Heavy-Duty Floor Scraper with Blade	58
75007Q	7" Replacement Blade	58
75011	Replacement Grout Saw Blades 2 pack	33
75012	Xtreme Pro Series Double Suction Cup	29
75013	ProMAX® GRIP Double Suction Cup	29
75017C (Canada Only)	7" Heavy-Duty Floor Scraper with Blade	58
75021	8" Vacuum Pump Suction Cup	28
75022	8" Pump Suction Cup with Gauge	28
75023	Xtreme 8" 8" Electric Suction Cup	28
76000	Grout Bag	34
76030	Polishing Cheesecloth	38
78200	5 Gallon Plastic Mixing Bucket-white	38
78205	5 Gallon Plastic Mixing Bucket-white with QEP logo	38
78208	3-1/2 Gallon Plastic Mixing Bucket-white	38
78220Q 78220QC	Tile Installation Kit	40
78250Q	Floor & Wall Tile Installation Kit	40
79634	Comfort Grip Knee Pads	48
79640	Washable Knee Pads	48
79642	F3 Stabilizer Professional Knee Pads	48
79645	ProMAX® Gel Knee Pads	48
79645D	ProMAX® Gel Knee Pad Floor Display	61
99600	Board Seam Tape	35
99605	Cement Board Seam Tape	35
99703	LASH® Wedges 3600 Qty Contractor Pack	44
99707Q	LASH® 1/16" Flat Clips 4800 Qty Contractor Pack	44
99726	LASH® Wedges, bag 100 Qty	44
99727	LASH® Wedges, box 300 Qty	44
99730	LASH® 1/16" Flat Clips, bag 100 Qty	44
99731	LASH® 1/16" Flat Clips, box 300 Qty	44
99740	LASH® 1/16" Flat Clips, box 1000 Qty	44

Item #	Description	Page
99741D	LASH® Project Pack Floor Display	61
99757	Pro Installation Pliers	44
99761	Xtreme 1/16" Leveling Clips, Bag 100 Qty	42
99762	Xtreme Leveling Wedges, Bag 100 Qty	42
99769	Xtreme 3/16" Leveling Clips, Bag 100 Qty	42
99771	Xtreme 1/32" Leveling Clips, Box 500 Qty	42-43
99772	Xtreme 1/16" Leveling Clips, Box 500 Qty	42-43
99773	Xtreme 1/8" Leveling Clips, Box 500 Qty	42-43
99774	Xtreme 3/16" Leveling Clips, Box 500 Qty	42-43
99775	Xtreme Leveling Wedges, Box 500 Qty	42-43
99776	Xtreme 1/32" Leveling Clips, Box 2000 Qty	42-43
99777	Xtreme 1/16" Leveling Clips, Box 2000 Qty	42-437
99778	Xtreme 1/8" Leveling Clips, Box 2000 Qty	42-43
99779	Xtreme 3/16" Leveling Clips, Box 2000 Qty	42-43
99780	Xtreme Leveling Wedges, Box 2000 Qty	42-43
99781	LASH® 1/8" Flat Clips, bag 100 Qty	42
99782	LASH® 1/8" Flat Clips, box 300 Qty	42
99783	LASH® 1/8" Flat Clips, box 1000 Qty	42

INDUSTRY PARTNERSHIPS



QEP Warranty

All Q.E.P. products include a Manufacturer's Limited Warranty ensuring the product is free from defects in materials and workmanship for a period of one-year from the date of purchase. This warranty does not cover accidental damages, unreasonable or improper use, normal wear and tear, loss of use, or consequential damages. Some items, such as electric tile saws, mixers and cutters, carry a QEP 1-Year Limited Warranty. Product registration, included with the product packaging, must be completed within 30 days of purchase for eligibility. This warranty covers refund or replacement due to a defect in materials or workmanship for a term of one year.

About California Proposition 65

Proposition 65 is a California regulatory law that requires businesses to notify California consumers about specific chemicals in the products they purchase so they can make informed decisions about protecting themselves from exposure to these chemicals. This law requires companies to properly label products that contain chemical(s) above certain threshold levels.

As part of Q.E.P. Co. Inc.'s continued best business practice and compliance program, we comply with Proposition 65 warning requirements and provide product-associated warnings. We are dedicated to meeting consumer product safety requirements applicable to our products and strive to provide high quality and safe products.

For more information on California Proposition 65, go to www.P65Warnings.ca.gov.

*Prop 65 - 1. WARNING: This product can expose you to chemicals including DEHP which is known to the State of California to cause cancer, birth defects or other reproductive harm.

*Prop 65 - 2. WARNING: This product can expose you to chemicals including N, N-Dimethylformamide, which is known to the State of California to cause cancer, birth defects and other reproductive harm.

QEP®, LASH® and Black Widow® are registered trademarks of Q.E.P. Co., Inc.

Aquabar® "B" is a registered trademark of Fortifiber LLC.

Fluidmaster® is a registered trademark of Fluidmaster, Inc.

No-Seep® is a registered trademark of William H. Harvey Co.

The products, specifications, and Prop 65 Warnings listed in this catalog are current as of the printed date of this catalog and are subject to change.

Access product data sheets, technical bulletins, warranties and SDS documents 24 hours a day, 7 days a week through our continuously updated website.

Providing Professional Quality Tile Tools
for over 40 Years



**1001 Broken Sound Parkway, NW
Boca Raton, Florida 33487**

**www.qep.com
www.qepcorporate.com**

**For more information call
866-435-8665
Se habla español**

