

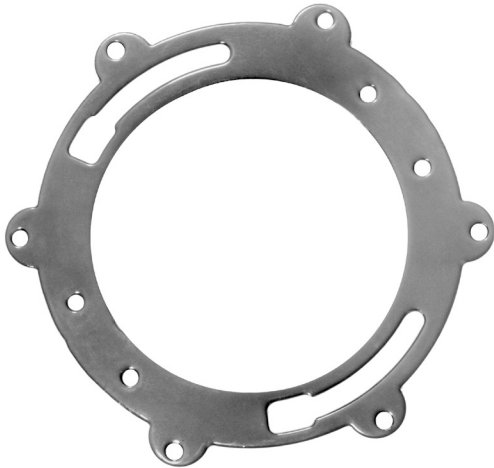

QUICK RING

Replaces ANY Closet Ring!



Unique screw tabs attach to wood or concrete.
Plastisol coat provides corrosion protection.
Slotted for 1/4" or 5/16" closet bolt.
Old closet ring does not need to be present.
Replaces any and all closet rings.



INSTALLATION INSTRUCTIONS

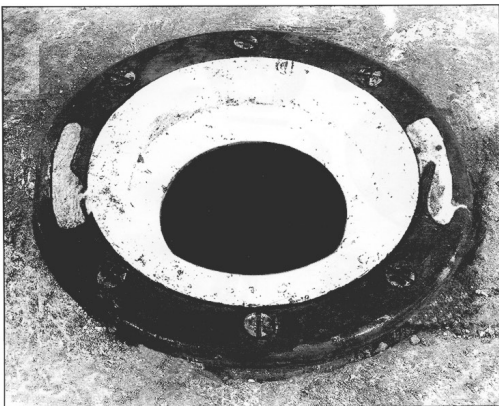

FOR SOLVENT WELDED STEEL/PLASTIC COMBO AND PLASTIC CLOSET RINGS

Remove portion of broken ring, if remaining portion cannot be removed, Quick Ring will mount on top.

Apply a bead of butyl rubber caulk to the underside of the Quick Ring that will mount on top of the old ring.

Set Quick Ring on top of remaining portion of old ring. Note location of old toilet bolt slots. The length of the bolt slots in the Quick Ring allows for some centering of toilet. Secure the Quick Ring to wood or concrete sub floor with screws or anchors.

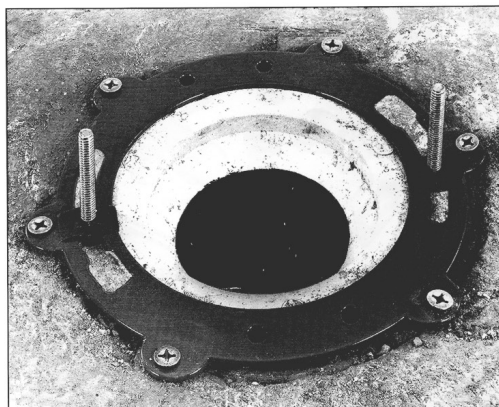

FOR CAST IRON RINGS

The Quick Ring can be mounted directly on top of an old cast iron closet ring. Drill holes in any remaining portion of cast iron ring that corresponds with holes in Quick Ring. Before securing the Quick Ring with screws, apply a bead of butyl rubber caulk to its underside. Large gaps or spaces around or underneath the closet ring, can be filled with any quicksetting type grouts, cements, etc.

PLEASE NOTE:

When setting the toilet use the proper wax bowl ring with plastic flange.

PART NUMBER
21013

Hose Bibb Anchor

A quick, easy, long lasting solution to stop loose exterior hose bibbs.

- Works with any wall material (brick, concrete, vinyl, or stucco)
- Repair or new home applications
- 5 minute installation that lasts
- Fits 1/2" - 3/4" - 1" water supply lines

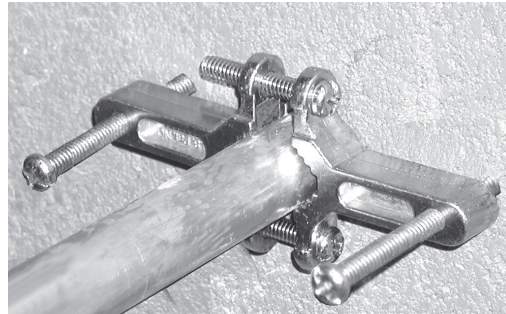
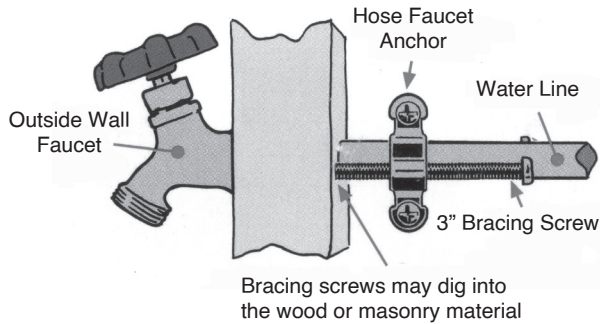

PART NUMBER
5023

Quick Hose Bibb Lock

Prevents unwanted use of most hose bibbs and commercial faucets with hose threads

- Simple, secure, economical
- High quality diecast
- Key alike padlock
- Fits hose bibb vacuum breakers

Sold with Padlock



Hose bibb shown with vacuum breaker



PART NUMBER
21540

Hose Bibb Vacuum Breaker

- Vandal - proof breakoff screw
- ASSE 1011 compliant.
- UPC compliant
- Rough brass or chrome plated



PART NUMBER	DESCRIPTION
2139	Rough Brass
2139-C	CP Brass

Compliant: Lead Leaching AB 100 Low Lead AB 1953



Dishwasher and Condensate Drain Hose

PASCO Invented Dishwasher Drain Hose!

Our hose is made of braided rubber with a rayon tire grade cord. It is an extremely durable hose and resists kinking.

- Meets AHAM Standard DW-1
- Listed in Table A of the UPC
- 7/8" hose approved for air conditioner condensate drain
- Exposed locations only

SINCE 1966



Order by the roll

PART NUMBER	SIZE	LENGTH
50650	5/8"	50'
50750	7/8"	50'

Dishwasher Air Gap

- White polypropylene body with chrome plated ABS top
- UPC listed



PART NUMBER	DESCRIPTION
50710	Chrome Plated Air Gap
50712	Chrome Plated Air Gap w/Hose

Dishwasher Air Gap Kit

- Contains air gap, 7/8" x 24" dishwasher drain hose and 3 clamps



PART NUMBER	DESCRIPTION
50710-BN	Brass Nickel Air Gap
50712-BN	Brushed Nickel Air Gap w/Hose

Dishwasher Connector Kit



PART NUMBER
496

Dishwasher Inlet Elbow

3/8" OD x 3/4" FHT
3/8" OD Ferrule
Brass



Compliant AB 1953

PART NUMBER
506

Rubber Washing Machine Inlet Hose

- 3/4" female x 3/4" female hose thread
- Braided and reinforced

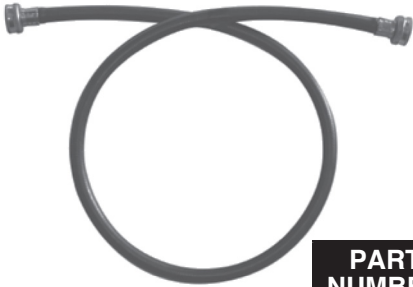

PART NUMBER	LENGTH
464	4'
465	5'
466	6'
468	8'



Rubber Washing Machine Inlet Hose w/ 90 Degree Elbow

- 3/4" female x 3/4" female hose thread
- Braided and reinforced

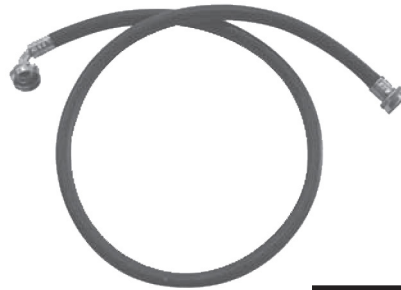

PART NUMBER	LENGTH
474	4'
475	5'
476	6'



Rubber Hook Drain Hose

- Flanged end for multiple sizes
- Fits 3/4" – 7/8" – 1" outlets



PART NUMBER	LENGTH
485	5'
486	6'



Rubber Utility Hose

- "Y" MIXER HOSE
- 3/4" female hose thread



PART NUMBER
481



Reinforced Rubber Mop Sink Hoses

- 3/4" female hose thread
- 36" braided hose
- 2 Lengths



PART NUMBER	LENGTH
489	3'
491	6'



Mop Sink Hose with Mop Hanging Bracket

- 3/4" female hose thread
- Cam action wall bracket to hold hose



PART NUMBER	LENGTH
490	3'
492	6'

Mop Sink Hose Bracket

- Cam action wall bracket to hold hose
- With mounting screws

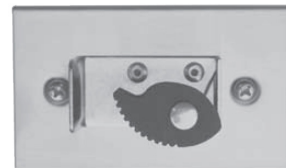

PART NUMBER
488



Packaged BRASS Bolt Sets with Nuts & Washers

Brass bolts made in the U.S.A.

- 2 – Stainless steel hex nuts
- 2 – Stainless steel washers
- 2 – Brass bolts

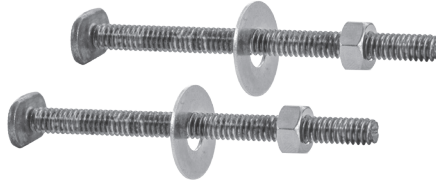

PART NUMBER	SIZE
100	1/4" x 2-1/4"
94	1/4" x 3-1/2"
82	5/16" x 2-1/4"
82-BB	5/16" x 2-1/4"
BREAKOFF BOLT	

- With steel speed nuts
- 2 – Stainless steel hex nuts
- 2 – Tinnerman nuts
- 2 – Stainless steel washers
- 2 – Brass bolts

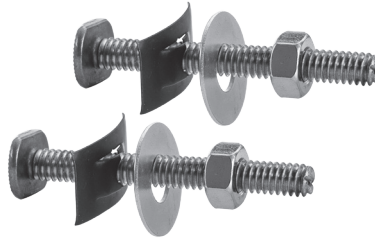

PART NUMBER	SIZE
102	1/4" x 2-1/4"
107	1/4" x 3-1/2"
59	5/16" x 2-1/4"

- With "Push On" speed washers
- 2 – Stainless steel hex nuts
- 2 – Plastic push on speed washers
- 2 – Stainless steel washers
- 2 – Brass bolts

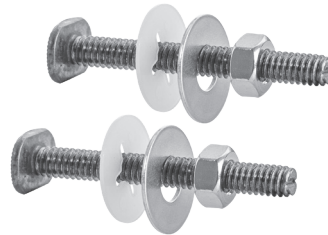

PART NUMBER	SIZE
102-SN	1/4" x 2-1/4"
107-SN	1/4" x 3-1/2"

DOUBLE NUT - DOUBLE WASHER

- 4 – Stainless steel hex nuts
- 4 – Stainless steel washers
- 2 – Brass bolts

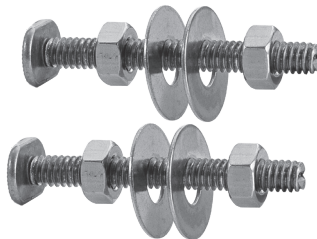

PART NUMBER	SIZE
28	1/4" x 2-1/4"
30	1/4" x 3-1/2"

All Stainless Steel "DOUBLE NUT" - DOUBLE WASHER

- 4 – Stainless steel hex nuts
- 4 – Stainless steel washers
- 2 – Stainless steel bolts

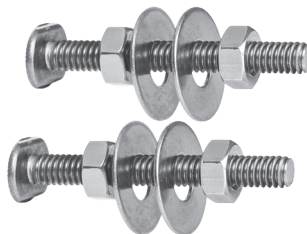

PART NUMBER	SIZE
28-SS	1/4" x 2-1/4"
30-SS	1/4" x 3-1/2"

Bulk Pack Brass Closet Bolts, Nuts and Washers

100 Bolts, Nuts, Washers Per Box

Closet Studs

• Brass



PART NUMBER	SIZE
108	1/4" x 2-1/4"

Closet Screws

• Brass



PART NUMBER	SIZE
120	1/4" x 2-1/2"
121	1/4" x 3-1/2"

Closet Bolt Washers



Round Washer

Oval Washer

PART NUMBER	MATERIAL	HOLE SIZE	PART NUMBER
138	Plated Steel - Round	5/16"	—
140	Heavy Stainless Steel	5/16"	147
142	Heavy NP Brass	5/16"	—

Closet Bolts

• Brass



PART NUMBER	SIZE
110	1/4" x 2-1/4"
111	1/4" x 3-1/2"
112	5/16" x 2-1/4"
113	5/16" x 3-1/2"



Combo Brass Closet Bolts, Nuts & Washers - Bulk

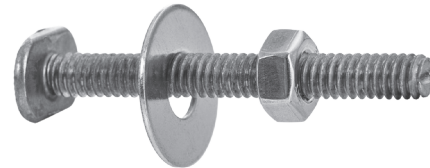

100 - Bolts - Nuts - Washers per box

PART NUMBER	SIZE	ROUND WASHER
180	1/4" x 2-1/4"	Plated Steel

Plastic Round Bolt Caps



* With snap on washer

PART NUMBER	SIZE	SHAPE
913	1/4"	Round
917-PR*	1/4" or 5/16"	Round

Speed Tinnerman Nuts

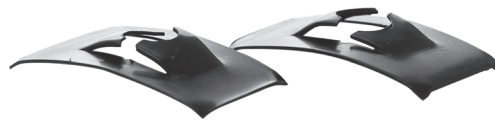

PART NUMBER	SIZE	MATERIAL
136	1/4"	Steel
143	5/16"	Steel

Open Head Closet Bolt Nuts



PART NUMBER	SIZE	MATERIAL
132	1/4"	Plated Brass
133	5/16"	Plated Brass
1647	1/4"	Hex Stainless Steel

Closed Head Closet Screw Nuts

• Plated Brass



PART NUMBER	SIZE
134	1/4"



Plastic Toilet Shims

- "Takes the Wobble Out"
- Hard or Soft

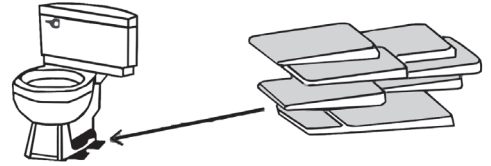

PART NUMBER	TYPE	QUANTITY
233	Soft	10
234	Hard	10
2346	Hard	300
2347	Soft	300



Closet Flange Extension

- 1/4" thick
- Durable ABS

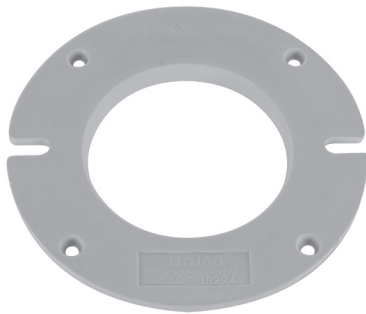

PART NUMBER
1018

Closet Flange Extension Kit

Kit Contains:

- 3 Self-sealing extenders
- With 1/4" x 3-1/2" closet bolts, nuts & washers

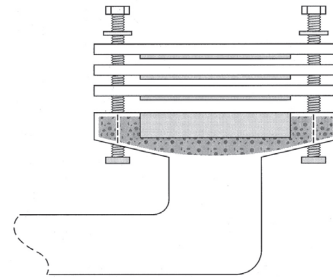

PART NUMBER	BOLT SET
1018-K	Stainless Steel
1018-BR	Brass

Sponge Rubber Straight Through Closet Bowl Gasket

- Resists mold, mildew and fungus



PART NUMBER	THICKNESS & DIAMETER
2230	3/4" x 5-1/4"

Sponge Rubber Flanged Closet Bowl Gasket

Covers Entire Width of Closet Ring

- Resists mold, mildew and fungus
- Has holes for closet bolts



PART NUMBER	THICKNESS & DIAMETER
2227	3/8" x 6-3/4"
2231	3/4" x 6-3/4"

Brass Tank to Bowl Bolt Sets

Each Set Contains:

- Brass Bolts
- Brass Hex Nuts
- Cloth Inserted Rubber Washers
- Plated Brass Washers

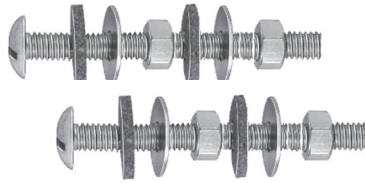

PART NUMBER	SIZE	WASHERS	
		RUBBER	PLATED BRASS
235	5/16" x 3"	2	2
237	5/16" x 3"	4	4

Stainless Steel Tank to Bowl Bolt Sets

Each Set Contains:

- 2 Stainless Steel Bolts
- 4 Stainless Steel Hex Nuts
- 4 Cloth Inserted Rubber Washers
- 4 Stainless Steel Washers

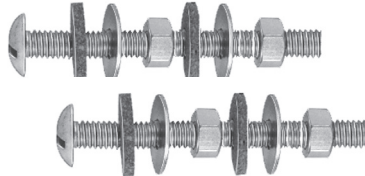

Won't Corrode

PART NUMBER	SIZE
237-SS	5/16" x 3"

Tank to Bowl Connector Kit with Rubber Components

With Rubber Gasket

Each Set Contains:

- 1 Rubber Gasket
- 2 Bolts:
Brass or Stainless Steel
- 4 Heavy Washers:
Stainless Steel
- 4 Rubber Washers
- 4 Hex Nuts: Brass or Stainless Steel

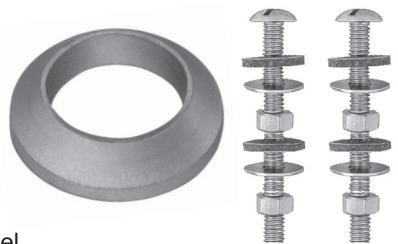

PART NUMBER	GASKET TYPE	BOLT MATERIAL
437	Regular	Brass
437-SS	Regular	Stainless Steel
439	AmStan	Brass
439-SS	AmStan	Stainless Steel

Tank to Bowl Connector Kit with Sponge Components

With Sponge Gasket

Each Set Contains:

- 1 Rubber Gasket
- 3 Bolts:
Brass
- 4 Heavy Washers:
Stainless Steel
- 4 Rubber Washers
- 4 Hex Nuts: Brass



PART NUMBER	GASKET TYPE	MATERIAL
439-3	AmStan	Brass

Cloth Inserted Rubber Washers

- For Tank to Bowl Bolt

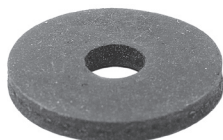

PART NUMBER
242

Hex Nut - Brass or Stainless Steel

- For Tank to Bowl Bolt



PART NUMBER	SIZE	MATERIAL
243-B	5/16"	Brass

Tank to Bowl Bolts - Brass

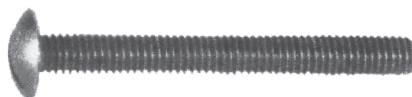

PART NUMBER	SIZE	MATERIAL
232	5/16" x 3"	Brass



Toilet Tank Trip Levers

Standard

- 8" Round brass arm
- CP Die cast handle
- Die cast spud
- **NEW** finger tight locknut



**PART
NUMBER**
1040

Economy

- 8" Round brass arm
- CP Die cast handle
- Plastic spud
- **NEW** finger tight locknut



**PART
NUMBER**
1041

Index Style

- 8" Round brass arm
- CP Die cast handle
- Plastic spud
- Plastic locknut



**PART
NUMBER**
1057

Premium Quality

- 8" Flat brass arm
- CP Die cast handle
- Die Cast locknut

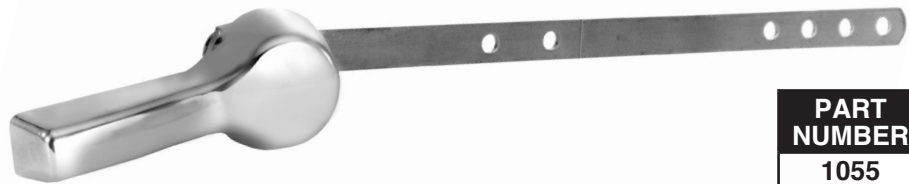

**PART
NUMBER**
1055

Offset - Premium Quality

- 9-1/2" Offset flat brass arm
- CP Die cast handle
- Modern styling
- High Quality
- Die cast locknut



**PART
NUMBER**
1056

Toilet Tank Trip Levers

Replaces Western Pottery

- 10" Round brass arm
- CP Die cast handle
- Plastic spud
- Plastic locknut
- Side mount



**PART
NUMBER**
1058

Replaces ToTo

- 10" Round brass arm
- CP Die cast handle
- Plastic spud
- Plastic locknut
- Side mount



**PART
NUMBER**
1059

Replaces Mansfield

- 9" White plastic arm
- CP Die cast handle
- Plastic spud
- Plastic locknut



**PART
NUMBER**
1045

Replaces Kohler Wellworth II

- 8" Plastic arm
- CP Die cast handle
- Plastic spud
- Plastic locknut



**PART
NUMBER**
1053

Replaces Eljer

- 10" Brass arm
- CP Die cast handle
- Plastic spud
- Plastic locknut
- Side mount



**PART
NUMBER**
1054



2" Universal Trade Black Flapper

- Resists chlorine
- SS Chain assembly
- Made in USA



PART NUMBER
22054

2" Universal Trade Red Flapper

- Heavy duty Chloroblock*TP Rubber
- Resists chlorine
- SS Chain assembly
- Made in USA



PART NUMBER
22001

2" Adjustable Blue Flapper Replacement for Kohler®

- With Styrofoam float for adjustable flush timing
- Heavy Duty
- Resists chlorine
- SS Chain assembly
- Also used in some American Std, UR & TOTO* toilets
- Made in USA



PART NUMBER
22004

3" Red Flapper Replacement for TOTO® G-MAX™

- Heavy duty Chloroblock*TP rubber
- Resists chlorine
- SS Chain assembly
- Made in USA



PART NUMBER
22021

3" Blue Flapper Replacement for TOTO® POWER GRAVITY™

- Heavy duty Chloroblock*TP rubber
- Resists chlorine
- SS Chain assembly
- Made in USA



PART NUMBER
22022

2" Universal Blue Flapper Replacement for Coast

- Preferred by plumbers and the trades for decades
- Heavy duty
- Resists chlorine
- SS Chain assembly
- Made in USA



PART NUMBER
2503



3" Universal Black Flapper Replacement for TOTO®

- Replaces most all TOTO*3" flappers
- Adjustable flush timing
- Resists chlorine
- SS Chain Assembly
- Made in USA



PART NUMBER
2505



3" Universal Adjustable Red Flapper

- Fully adjustable, fits most all 3" toilets
- Heavy duty
- Resists chlorine
- SS Chain assembly
- Made in USA



PART NUMBER
2588



3" Big Arm Black Flapper Replacement for MANSFIELD

- For models requiring oversized arm on one side
- With chain float for adjustable flush timing
- Resists chlorine
- SS chain assembly
- Also found on many American Std, UR and their popular brands
- Made in USA



PART NUMBER
2500





Brass Urinal Outlet Spud

IPS or Sweat Connection

- With studs, washers and nuts and #2096 sponge type gasket



PART NUMBER	DRAIN CONNECTION	URINAL TYPE	BOLT HOLE CENTERS
94700	2" IPS	Crane	5-1/2"
94702	2" IPS	Crane Hex Bolts	5-1/2"
94703	2" IPS	UR	4-1/2"
94704	2" IPS	Elijer	4-1/4"
94706	2" IPS	AmStand	4"

Closet & Urinal Spuds



PART NUMBER	TYPE	SIZE	LOCKNUT
956	Closet	2"	Brass
957	Closet	2" x 1-1/2"	Brass
958	Closet	2" x 1-1/4"	Brass
959	Closet	1-1/2"	Brass
960	Closet	1-1/4"	Brass
961	Urinal	1" x 3/4"	Brass
962	Urinal	1-1/4" x 3/4"	Brass
963	Closet	1-1/2" x 1-1/4"	Brass

Broken Urinal Flange Repair Kit

New!

Hardware included:

- Gasket
- 4 Screws
- 4 Anchors
- 8 Spacers

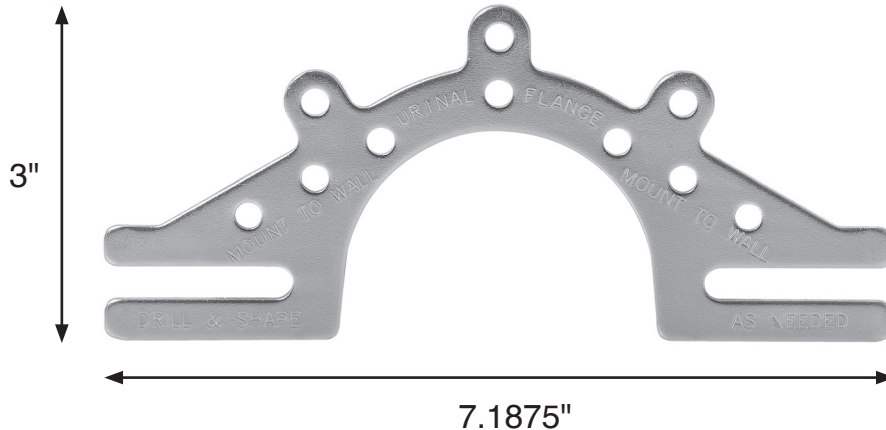

PART NUMBER
21014

Douglas Flush Valve

- White plastic flush valve
- With Flapper
- Rubber washer
- Solid ring guide
- Locknut
- Overflow tube



PART NUMBER
1029

Lock Nuts

- For lav faucets



PART NUMBER	SIZE	MATERIAL
1294	1/2"	Die Cast

Lavatory Coupling Nuts

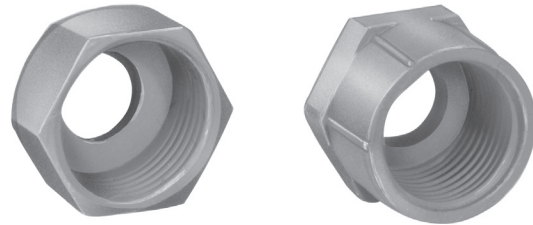

PART NUMBER	SIZE	MATERIAL
1322	1/2" x 7/16"	Brass
1326-C	1/2" x 3/8"	CP Die Cast
1328-C	1/2" x 1/2"	CP Die Cast
1335	1/2" x 1/2"	Brass

Ballcock Coupling Nut

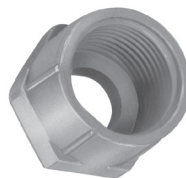

PART NUMBER	MATERIAL	SIZE
1320	Plastic	1/2"
1321	Brass	1/2"



Die Cast Slip Joint Nuts



PART NUMBER	SIZE	FINISH
1330-C	1-1/4"	Chrome
1331-C	1-1/2" x 1-1/4"	Chrome
1333-C	1-1/2"	Chrome

Brass Slip Joint Nuts

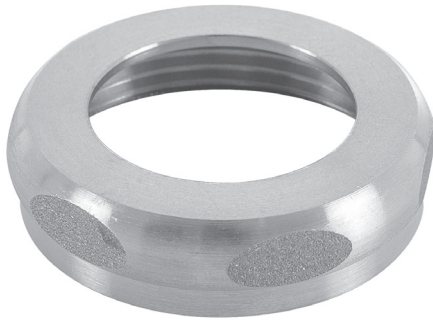

PART NUMBER	SIZE	FINISH
1336-C	1-1/4"	Chrome
1337	1-1/2" x 1-1/4"	Rough
1337-C	1-1/2" x 1-1/4"	Chrome
1338	1-1/2"	Rough
1338-C	1-1/2"	Chrome
1339-C	2"	Chrome

Chrome Slip Joint Nut Sets with Washer, Friction Ring

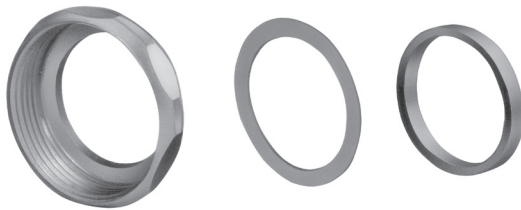

PART NUMBER	SIZE	MATERIAL
1346-C	1-1/4"	Brass
1347-C	1-1/2" x 1-1/4"	Brass
1348-C	1-1/2"	Brass
1349-C	1-1/4"	Die Cast
1350-C	1-1/2" x 1-1/4"	Die Cast
1351-C	1-1/2"	Die Cast

Brass Friction Rings



PART NUMBER	SIZE
1391	1-1/4"
1392	1-1/2" x 1-1/4"
1394	1-1/2"

Tank-to-Bowl Gaskets

- Sponge Rubber



PART NUMBER	DESCRIPTION
2096	Regular
2097	Recessed for AmStand

Slip Joint Washers

- Square Cut Washers

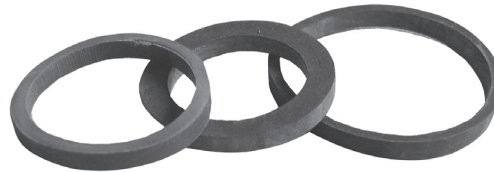

PART NUMBER	SIZE
2204	1-1/2"
2208	1-1/2" x 1-1/4"
2209	1-1/4"

Poly Washers for Tailpieces

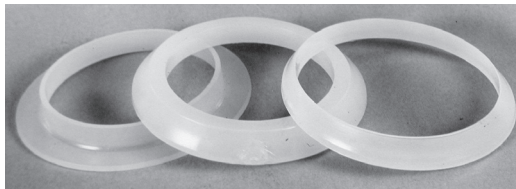

PART NUMBER	SIZE	DESCRIPTION
2214	1-1/2"	Beveled
2218	1-1/2" x 1-1/4"	Beveled
2219	1-1/4"	Beveled
2222	1-1/2"	Flanged

Garden Hose Washer

- Fits 3/4" FHT

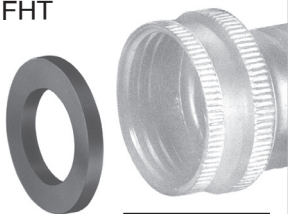

PART NUMBER
2224

Cone Filter Washer

- Fits 3/4" FHT



PART NUMBER
2244

Tailpiece Washer

- 1-1/2" x 1-1/4"
- Cloth Inserted Rubber
- Top quality, excellent seal

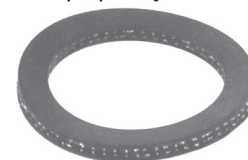

PART NUMBER
2211

Graphite Packing for Stems or Slip Joints

- 3/32" x 24" Length



PART NUMBER
2290



Plumbers Pack O-Ring Kit

Popular O-ring sizes in a reusable box



PART NUMBER
2250

Faucet Stem Washer Assortment - Flat

- 00-1/2" Trade Size
- 350 Pieces
- 8 common sizes fit most stems manufactured



PART NUMBER
2870



Spud Friction Ring

Galvanized



PART NUMBER	SIZE
2078	1-1/2"

O-Ring Pick

- Quickly & easily removes worn out o-rings
- Steel



PART NUMBER
5200

Spud Washers

- Rubber



PART NUMBER	SIZE
2088	1-1/2"
2089	1-1/4"
2090	1" x 3/4"

Wall Hung Urinal Spud Washer

- Large style for additional sealing surface
- 4-1/2" OD x 2-7/8" ID
- 1/2" Thick
- Sponge Rubber



PART NUMBER
2083

Waste & Overflow Washers

- Sponge Rubber

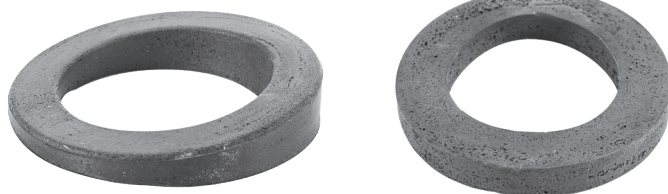

PART NUMBER	DESCRIPTION
2091	2-1/8" x 3-3/16" x Beveled
2092	1-7/8" x 2-7/8" x 3/8"

Brass Waste Connectors (Desanko Fittings)

To order waste connectors with chrome plated brass nuts, add **CP** to waste connector part number.

Tubular X Male Pipe Thread (Outlet) Female Copper Sweat Under MPT



*Complies with UPC

PART NUMBER	TUBULAR X MPT	SLIP NUT	COMPRESSION RING
1893	1-1/4" x 1-1/2"	Chrome Die Cast	Brass
1894	1-1/2"		
1942	1-1/4"	Rough Brass	
1943	1-1/4" x 1-1/2"		
1944	1-1/2"		
1906	1-1/2"	Chrome Die Cast	
1944-S w/stops*	1-1/2"	Rough Brass	Brass

Tubular X Female Pipe Thread (Outlet)



*Complies with UPC

PART NUMBER	TUBULAR X MPT	SLIP NUT	COMPRESSION RING
1895	1-1/4"	Chrome Die Cast	Brass
1896	1-1/4" x 1-1/2"		
1897	1-1/2"		
1946	1-1/4" x 1-1/2"	Rough Brass	
1947	1-1/2"		
1909	1-1/2"	Chrome Die Cast	
1947-S w/stops*	1-1/2"	Rough Brass	Brass

Female Copper Sweat (Outlet)



PART NUMBER	TUBULAR X COPPER	SLIP NUT	COMPRESSION RING
1900	1-1/2"	Chrome Die Cast	Brass
1950		Rough Brass	
1912		Chrome Die Cast	Poly

Continued on following page



Brass Waste Connectors (Desanko Fittings)

The charts below let you choose the type of slip joint nut, either chrome plated die cast or plain brass and the type of compression ring, either brass or poly.

To order waste connectors with chrome plated brass nuts, add CP to waste connector part number.

Male Copper Sweat (Outlet)



PART NUMBER	TUBULAR X COPPER	SLIP NUT	COMPRESSION RING
1903	1-1/2"	Chrome Die Cast	Brass

Brass Tubular Compression Rings



PART NUMBER	SIZE
1992	1-1/2"

Chrome Plated Brass Cover Tube for Copper or CPVC

- Slips over either copper or CPVC supply lines between the wall and angle stop.
- Fits over 5/8" OD Tube
- 3-1/2" Length



PART NUMBER
8489

Kitchen Sink Hose & Spray Head

- Replaces existing units



PART NUMBER	DUAL THREADS
1366	Complete Unit
1368	Head ONLY

Junior Basket Strainer

For 2" - 2-1/2" Outlet

- Stainless steel body
- Stainless steel basket
- Complete with washers & brass nuts



PART NUMBER	LOCKNUT	SLIP JOINT NUT
1361*	Brass	Brass
1361-B	Basket Only	

*1361 replaces 1361-BN

Junior Duo Strainer

For 2" - 2-1/2" Outlet

- Stainless steel body
- Stainless steel basket
- Complete with washers & brass nuts



PART NUMBER	LOCKNUT	SLIP JOINT NUT
1365*	Brass	Brass
1365-B	Basket Only	

*1365 replaces 1365-BN

Tray Plug

For 2" - 2-1/2" Outlet

- Stainless steel body
- Rubber Plug
- Complete with washers & brass nuts



PART NUMBER	LOCKNUT	SLIP JOINT NUT
1370*	Brass	Brass

*1370 replaces 1370-BN

Flat Duplex Strainer

For 2" - 2-1/2" Outlet

- Stainless steel body
- Stainless steel strainer
- Complete with washers & brass nuts



PART NUMBER	LOCKNUT	SLIP JOINT NUT
1371*	Brass	Brass

*1371 replaces 1371-BN



EZ ON Basket Strainer

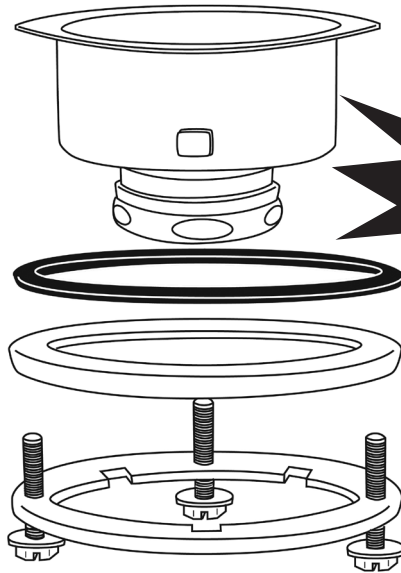

Installs in less than 30 seconds!

EZ ON Satin Stainless Steel Finish

- 304 stainless steel body
- Polished drain flange
- Stainless steel basket
- Fits sink openings of 3 1/2" to 4"
- Available in display box of 16 pcs



PART NUMBER
21901

EZ ON Bright Polished Stainless Steel Finish

- 304 stainless steel body
- All surfaces polished
- Stainless steel basket
- Fits sink openings of 3 1/2" to 4"
- Available in display box of 16 pcs



PART NUMBER
21907

EZ ON Brushed Nickel Finish

- All surfaces are PVD finish
- Finish will not chip or corrode
- Basket finished to match
- Fits sink openings of 3 1/2" to 4"



PART NUMBER
21905

Specification Grade Stainless Steel Basket Strainer

- Heavy duty - cup style
- 3-1/2" to 4" Sink drain opening
- 304 Stainless steel bodies
- Stainless steel basket
- Brass locknut and slip joint nut
- Poly tailpiece washer



Equal to:
Watts 644003
Dearborn 14
Watts 652003

PART NUMBER	DESCRIPTION
21914	Complete Unit

Spin Lock Chrome Plated Brass Basket Strainer

- 3-1/2" to 4" sink drain openings
- 304 Stainless steel body
- Stainless steel basket
- Brass locknut and slip joint nut
- Poly tailpiece washer



Equal to:
Dearborn 17
Watts 653003

PART NUMBER	DESCRIPTION
21917	Complete Unit
21923	Basket Only

Plumber Quality Chrome Plated Brass Basket Strainer

- 3-1/2" to 4" sink drain openings
- Stainless steel stick post basket
- Die cast slip joint nut and locknut
- Poly tailpiece washer



Equal to:
Dearborn 16
Watts 2-8-3
Sanitary Dash SS250
Garvin 2250

PART NUMBER	DESCRIPTION
21906	Complete Unit



Lavatory Legs

Adjustable To Fit a Variety of China and Enamel Lavatories

- Chrome plated
- 2" Adjustment
- 30" overall length
- Boxed by the pair
- Installation instructions with each pair

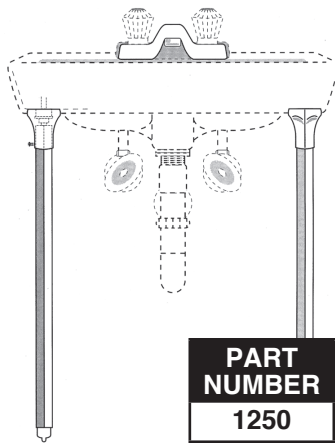

PART NUMBER
1250

Brass Pop-Up Assemblies

Highest Quality

- Chrome plated brass
- Brass locknut
- Plastic
- Generic



PART NUMBER	FITS
11701	Moen
11702	Price Pfister
11703	Gerber

Crumb Cup Strainer

- Chrome plated brass
- #1344 - 1-1/4" x 1-1/16"



PART NUMBER	FITS
1344	Lavatory less post

Faucet Hole Covers

- Stainless steel top cover



PART NUMBER	SIZE
1274	2"
1275	1-3/4"

Deep Basin Rosette

- Stamped steel



PART NUMBER
1266

Flat Basin Rosette

- Stamped steel



PART NUMBER
1268

Replacement Strainers

Snap-in stainless steel



PART NUMBER	STRAINER SIZE	FITS
1205	3"	2" DWV
1206	4"	3" DWV
1207	5"	4" DWV

Lavatory Hanger

For China Lavatories

- Stamped steel
- Supplied in pairs

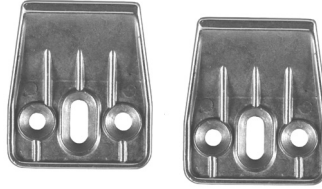

**PART
NUMBER**
1220

“Z” Hanger

Adjustable For Enameled Iron or China Lavatories

- For iron, side lugs fit the pockets
- For china, knock off the side lugs
- 5” to 16” adjustment
- Cast iron



**PART
NUMBER**
1221

Lavatory Hanger

For China Lavatories

- Stamped steel
- Plated for corrosion resistance
- 8” wide

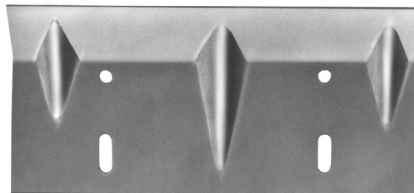

**PART
NUMBER**
1222

Amstan Style Lavatory Hanger

**Designed to fit
Amstan Style Lavatories**

- Stamped steel
- Plated for corrosion resistance
- 10-1/2” wide

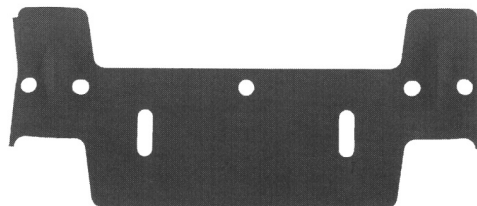

**PART
NUMBER**
1223



Aerators

Quality recognized for years throughout the industry!
 Components in contact with water are lead free.

The only component made of brass is the housing and it does not come in contact with water.

Premium Quality Aerators

- Chrome plated brass
- Special stainless steel screen
- Stylized appearance
- NSF listed Santoprene® washer
- All aerators are individually bagged
- Meets ANSI A-112.18.1M
- 2.2 GPM at 60 PSI - 2105
- 1.5 GPM at 60 PSI - 2104



SLOTTED

PART NUMBER	THREADS	GPM
2105*	Dual 15/16 - 55/64" - 27	2.2

SLOTTED WATER SAVER

2104	Dual 15/16 - 55/64" - 27	1.5
------	--------------------------	-----

*Exceeds California Standard. Not for sale in CA.

Economy Quality Aerators

- Chrome plated brass
- Stylized appearance
- NSF listed Santoprene® washer
- All aerators are individually bagged
- Meets ANSI A-112.18.1M
- 2.2 GPM at 60 PSI - 2130
- 2.5 GPM at 80 PSI - 2124



SLOTTED

PART NUMBER	THREADS	GPM
2124*	Dual 15/16 - 55/64" - 27	2.5
2130*	Male 13/16" - 27	2.2

*Exceeds California Standard. Not for sale in CA.

Aerator Counter Displays

These displays are guaranteed to trigger an impulse purchase by the plumber!

Small display generates BIG profits!

24 tubes - 6 aerators per tube



SLOTTED PREMIUM QUALITY

PART NUMBER	THREADS	GPM
2106*	Contains 144-2105	2.2
2107	Contains 144-2104 Water Saver	1.5

NON-SLOTTED ECONOMY QUALITY

2125	Contains 144-2124	2.5
------	-------------------	-----

*Exceeds California Standard. Not for sale in CA.

Tub Spouts

- Chrome plated brass or die cast
- 5-5/8" Length



PART NUMBER	MATERIAL	FINISH	MOUNT	FPT
1115	Brass	Chrome	Front	1/2"
1126	Brass	Chrome	Back	1/2" - 3/4"
1134	Die Cast	Chrome	Front	1/2"

Diverter Spouts, Front Lift

- Chrome plated brass or die cast
- 5-5/8" Length
- Front mount



PART NUMBER	MATERIAL	FINISH	FPT
1117	Brass	Chrome	1/2"
1128	Die Cast	Chrome	1/2"

Diverter Spouts Lift Replacement

Fits Spouts:
1128, 1134, 1136, 11287,
11427, 1142, 1143 & 1144

- Brass lift
- Rubber washer
- Plastic slide
- Installs in seconds



PART NUMBER
1109

Adjustable Tub and Diverter Spouts

- Copper or IPS**
- Chrome plated die cast
 - 5-5/8" Length



PART NUMBER	FINISH	ADJUST.	DIVERTER	PIPE SIZE
1136	Chrome	2-1/4"	No	1/2" CWT
1142	Chrome	2-1/4"	Yes	1/2" CWT
1143	Chrome	1"	No	1/2" - 3/4" IPS
1144	Chrome	1"	Yes	1/2" - 3/4" IPS



Diverter Spouts, Decorative

- Chrome plated die cast
- 1/2" FPT front mount
- 5-5/8" Length



PART NUMBER	MOUNT
1120	1/2" FPT Front

Diverter Spouts, Back Lift

- Chrome plated brass or die cast
- 5-5/8" Length
- Back mount

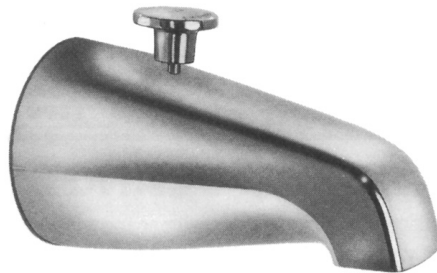

PART NUMBER	MATERIAL	FPT
1127	Brass	1/2"
1129	Brass	3/4"
1140	Die Cast	1/2" - 3/4"

7" Long Diverter & Tub Spouts

- Available in four styles
- Chrome plated die cast
- Individually boxed
- Diverter are front lift
- IPS are front mount
- CWT are slip fit



PART NUMBER	DIVERTER	PIPE SIZE
11287	Yes	1/2" IPS
11347	No	
11367	No	1/2" CWT
11427	Yes	

Fiberglass Shower Arm Ell

This brass Ell securely mounts a shower arm to a fiberglass shower stall. Also can be used to secure a tub spout nipple. Can be used with copper, iron pipe or compression fittings. Prevents movement of shower arm and tub spout.

- Locknuts secure Ell to fiberglass wall
- Requires 1-1/32" hole through fiberglass
- Outlet end 1/2" FIP
- Inlet end 1/2" CWT or 1/2" MPT

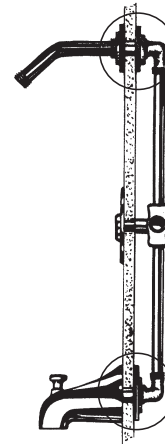
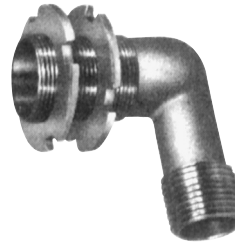

PART NUMBER
1195

Bathcock Coupling

- 1/2" MPT x 3/4" MPT
- Satin finish brass
- Sold by the pair



PART NUMBER
1793

Solid Brass Twin Ell

For use with Diverter Spouts



PART NUMBER	SIZE NPT		
	SPOUT	IN	SHOWER
1145	3/4"	1/2"	1/2"

Diverter Spout

For Hand Held Shower

- Chrome plated die cast
- 1/2" male hose adapter included for hand shower hose
- 1/2"-3/4" IPS Back mount



PART NUMBER	FIP	PROTUSION FROM WALL
1133	1/2" or 3/4"	5-1/8"

Bath Supplies for Leg Style or Old Style Bath Tubs

2 Styles With Nuts and Washers

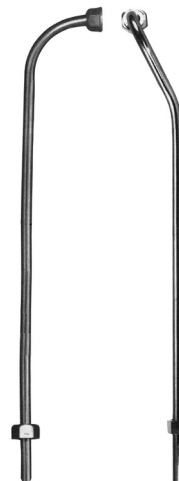

1/2" Chrome plated copper

PART NUMBER	DESCRIPTION
17925	Offset Bend for 3-3/8" to 4" Centers
1794	KIT ONLY 2 each of nuts, cone washers & friction rings



Shower Valve Rebuild Kits

For the most popular brands. These conveniently packed kits contain all parts needed to rebuild shower valves.

Price Pfister Verve®

- 3 Handle Valve w/ Diverter
- Sold complete as shown
- Seats included
- Parts not sold separately

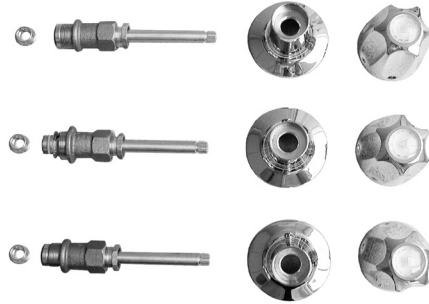

PART NUMBER	DESCRIPTION
28314	Two Handle
28315	Three Handle

Sayco®

- 3 Handle Valve w/ Diverter
- Sold complete as shown
- Seats included
- Parts not sold separately

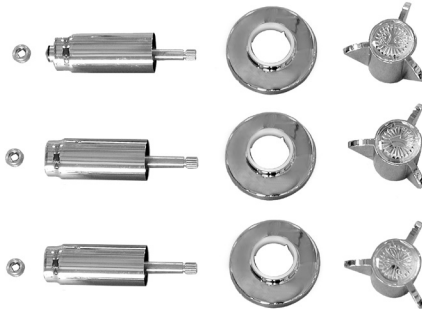

PART NUMBER
28317

American Standard - Colony®

- 3 Handle Valve w/ Diverter
- Sold complete as shown
- Seats included
- Parts not sold separately



PART NUMBER	STEM LENGTH
28310	Short
28311	Long

American Standard - Aquaseal®

- 3 Handle Valve w/ Diverter
- Sold complete as shown
- Seats included
- Parts not sold separately



PART NUMBER
28312

Shower Valve Rebuild Kits

For the most popular brands. These conveniently packed kits contain all parts needed to rebuild shower valves.

Gerber®

- 3 Handle Valve w/ Diverter
- Sold complete as shown
- Seats included
- Parts not sold separately

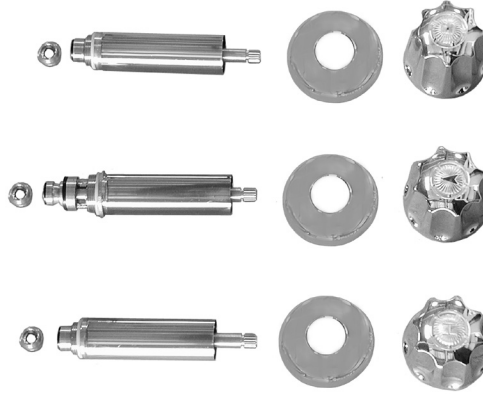

PART NUMBER	DESCRIPTION
28319	Canopy

Sterling®

- 3 Handle Valve w/ Diverter
- Sold complete as shown
- Seats included
- Parts not sold separately



PART NUMBER
28318

Kohler®

- 2 Handle Valve
- Sold complete as shown
- Seats included
- Parts not sold separately



PART NUMBER
28321

NOTE: Please do not confuse PASCO Specialty & Mfg., Inc. with these companies. PASCO is an independent manufacturing distributor of quality plumbing specialty products, which, although may not be manufactured by the original product manufacturer, are precision made.



Simply The Best Shower Head

- 1/2" FPT
- Easily adjusts from fine to medium spray
- Chrome plated brass ball joint
- Vandal resistant
- #1167 - 2.5 GPM @ 80 PSI
- #1167RF - 1.5 GPM @ 80 PSI
- Removable filter screen prevents clogging of spray

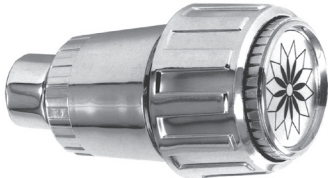

PART NUMBER
1167*
1167RF

*Exceeds California standard. Not for sale in CA.

Economy Shower Head

- 1/2" FPT
- 1.8 GPM @ 80 PSI
- Chrome plated plastic
- Adjustable



PART NUMBER
1189-RF

Shower Arm Shut Off

- 1/2" MPT x 1/2" FPT
- Chrome plated brass



**Shower head will still dribble after shut off to prevent back flow.*

PART NUMBER
1168

EZ ROUGH-IN TEST PLUG

- Reusable
- Money Saver
- Hand tighten
- Blue plastic poly
- 1/2" MPT
- O-ring sealed gasket
- No thread sealant or tape needed

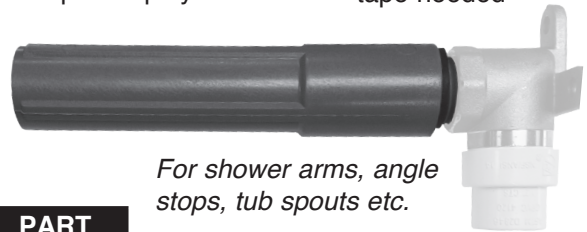

For shower arms, angle stops, tub spouts etc.

PART NUMBER
4760

Shower Arm Flanges

- For 1/2" O.D. shower arms



PART NUMBER	FLANGE STYLE	FINISH
1187	Set Screw	CP Die Cast

Face Bushings - IPS and CWT

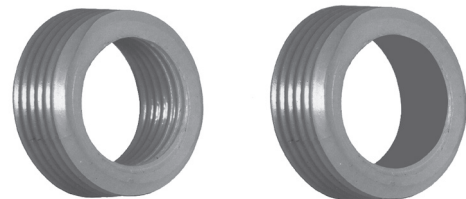

PART NUMBER	MATERIAL	SIZE
1141	Brass	3/4" x 1/2" IPS
1146	Brass	1/2" x 3/8" IPS
1317	Brass	1/2" IPS x 1/2" CWT
1318	Brass	3/4" IPS x 3/4" CWT

Shower Arms

- Chrome plated brass
- 1/2" IPS - Heavy wall thickness



PART NUMBER	LENGTH
1185	6"
1186	8"
1193	10"

Carded with flange

PART NUMBER	LENGTH
11857	6"
11867	8"

High Rise Shower Arm

- Increases height of any shower head
- Chrome plated brass
- 1/2" IPS
- With CP flange



PART NUMBER	HEIGHT
1190	10"
1191	8"

Adjustable Shower Arm

- 1/2" MPT x 1/2" FPT
- 10" Length
- Chrome plated brass

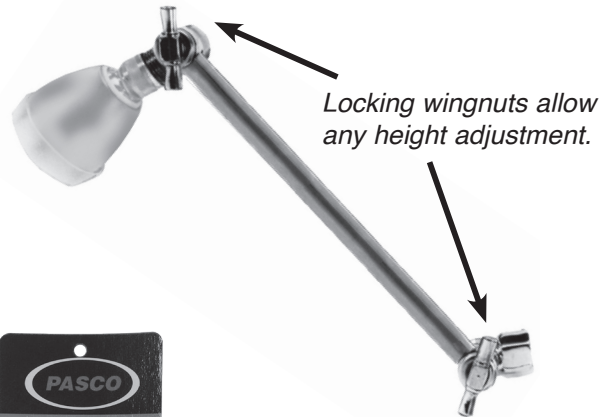

PART NUMBER	DESCRIPTION
1192	Shower arm LESS shower head
1192-RK	Washers and Gaskets



Add-A-Shower: Non-Siphon with Rectangular Shower Rod

- 60" CP Brass Riser
- Water saving showerhead
- Wall mount bracket

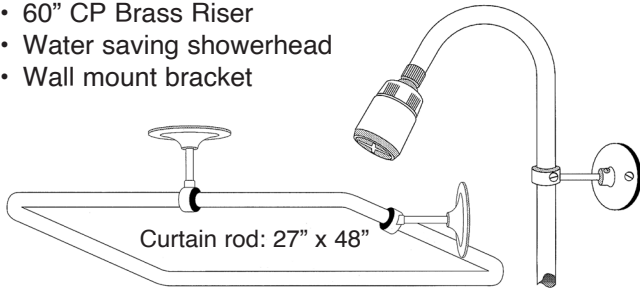

- 1" Diameter Polished Aluminum
- 1-36" Ceiling support
- 1-10" Wall support
- Round flanges
- Individually boxed
- Complies with UPC
- Spout rises above rim of tub

PART NUMBER	DESCRIPTION
2827-K	Non-Siphon bathcock 3-3/8" centers supplied complete as shown

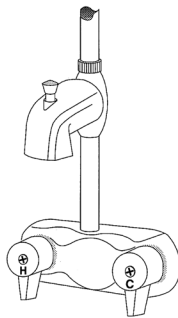

Add-A-Shower: Non-Siphon

- Complies with UPC
- Spout rises above rim of tub

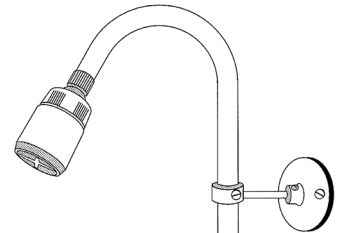

*Complies with UPC

PART NUMBER	DESCRIPTION
2827*	Non-Siphon bathcock 3-3/8" centers supplied complete as shown

Replacement Parts

2833	Bathcock ONLY
1247	Wall Bracket w/Rod
2836-3	3/8" x 60" CP Brass Riser
1189-RF	Shower Head
1258	Rod-to-Riser Adapter
2837-C	Cold Stem
2837-H	Hot Stem

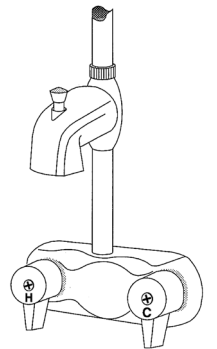

Add-A-Shower: Regular Style

- Chrome plated brass bathcock
- Specifically for 4 leg bathtubs

PART NUMBER	DESCRIPTION
2826	Regular style bathcock 3-3/8" centers supplied complete as shown
28260	Regular style w/1167-RF & 1247

Replacement Parts

2832	Bathcock ONLY
1247	Wall Bracket w/Rod
2836-3	3/8" x 60" CP Brass Riser
1167-RF	1.5 GPM Shower Head
1189-RF	1.5 GPM Shower Head
1258	Rod-to-Riser Adapter
2837-C	Cold Stem
2837-H	Hot Stem

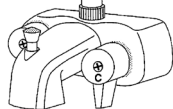
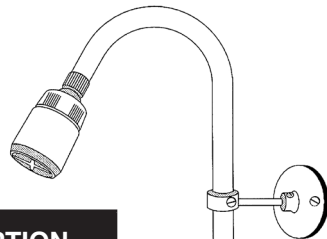

Add-A-Shower: Over the Rim

- Chrome plated die cast spout
- 1/2" IPS

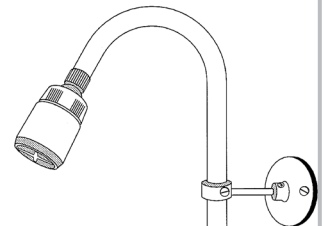

PART NUMBER	DESCRIPTION
2825	Over the rim supplied complete as shown

Replacement Parts

2831	Spout ONLY
2836-3	3/8" x 60" CP Brass Riser
1189-RF	Shower Head

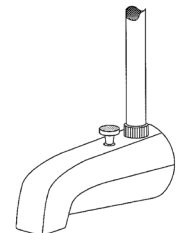



Overflow Plate - Chrome

With Trip Lever

- Square handle
- Covers 3-1/4" hole
- 2" bolt hole centers



PART NUMBER	W/1148 BOLTS
1157	2

Overflow Plate - Chrome

- Covers 3-1/4" hole
- 2" bolt hole centers



PART NUMBER	W/1148 BOLTS
1154	None
1160	2

Overflow Plate - Chrome

- Covers 3-1/4" hole



PART NUMBER	W/1148 BOLTS
1159	1

Overflow Plate Bolt - Chrome

For trip lever and overflow face plates

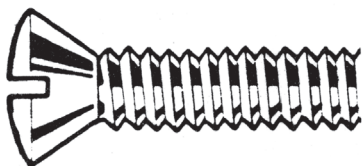

PART NUMBER	SIZE/LENGTH
1147	1/4" x 20 x 2-1/2"
1148	1/4" x 20 x 1-1/2"
1149	1148 - 2 per bag

Straight Shower Rods

- 1" Diameter
- Polished aluminum LESS flange

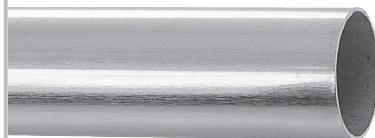

PART NUMBER	ROD LENGTH
1260	60"

Shower Rod Flanged Holder

For 1" Shower Rods

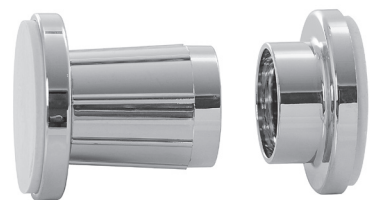

PART NUMBER	DESCRIPTION
1253	Adjustable CP plastic



Quick Valve Plate

Stainless Steel Shower Valve Cover Plate

Old ceramic tile is impossible to match.

The Quick Valve Plate covers the unsightly hole left in the tile after the shower valve is replaced.

- Screws & brackets provided
- Polished stainless steel not affected by household cleaners
- 13" long X 7-1/4" wide



Stainless Steel

PART NUMBER	HOLES	HOLE SIZE OR CENTERS
815	1	5"
816	2	8" Centers
817	3	
818	1	3-1/2"
819	1	4-1/2"
820	0	no holes

Bath Tub Waste Shoe & Strainer

- Brass
- 20 Gauge tube
- Price Pfister style

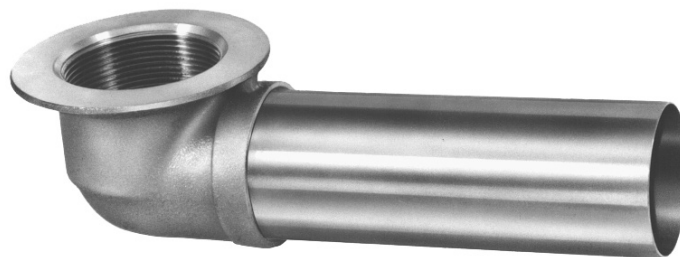

PART NUMBER	DESCRIPTION
1372	1-1/2" Brass Waste Shoe
1373	1-3/8" Brass Waste Shoe
1374	16 Thread Tub Drain Body w/Cross
1374-W	Tub Drain Washer
1376	Stainless Steel Strainer w/Bolt
1380	1-1/2" Brass Waste Shoe - Complete
1381	1-3/8" Brass Waste Shoe - Complete

P Traps

All 17 gauge P Traps have **CP brass nuts**.
 All 17 gauge P Traps have **box flange & sure grip flange**.
 All 20 gauge P Traps have **CP die cast nuts**.

Less Cleanout - 8" Wall Bend - Chrome

- Beaded with slip joint washers or ground joint
- **DB-** with die castnut & sure grip flange only

Add 15 to part number for 15" wall bend
 Both sure grip shallow flange and box flange included

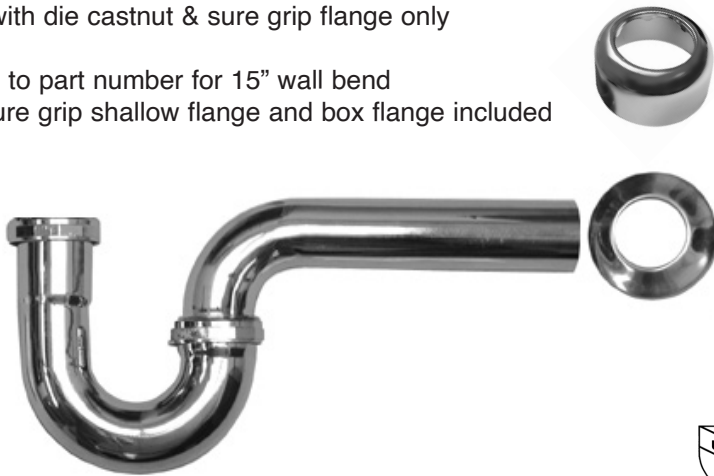

30 pieces per case
 *Choked inlet



*

PART NUMBER	SIZE	GAUGE
34100	1-1/4"	20
34104	1-1/2"	
34108	1-1/2" x 1-1/4"	17
34110	1-1/2"	
34110-15	1-1/2" x 15"	

Rough Brass

34107	1-1/2"	17
-------	--------	----

Ground Joint - Chrome

34111	1-1/2"	17
-------	--------	----

With Cleanout - 8" Wall Bend - Chrome

- Beaded with slip joint washers or ground joint

Add 15 to part number for 15" wall bend
 Both sure grip shallow flange and box flange included

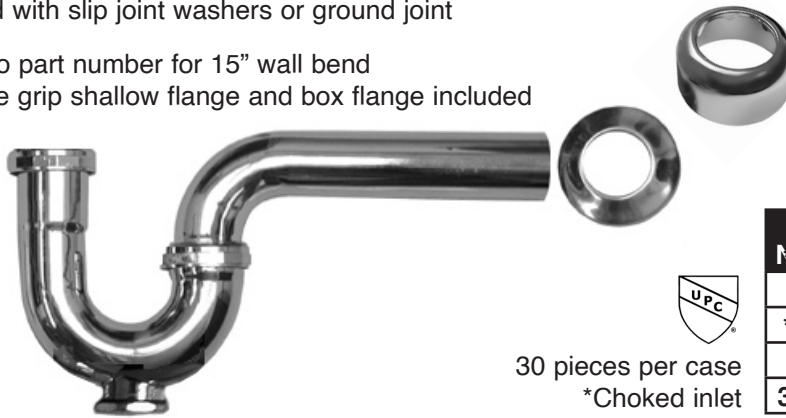

30 pieces per case
 *Choked inlet



PART NUMBER	SIZE	GAUGE
34122	1-1/4"	17
*34124	1-1/2" x 1-1/4"	
34126	1-1/2"	
34126-15	1-1/2" x 15"	

Wall Bend for P Trap - Chrome



PART NUMBER	SIZE	GAUGE
34130	1-1/2" x 9"	20
34132	1-1/2" x 15"	
34138	1-1/2" x 15"	17
34134	1-1/4" x 8"	



Sink Traps

All 17 gauge Sink Traps have CP Brass nuts. All 20 gauge Sink Traps have CP Die Cast nuts.

Sink Traps with Cast Brass Outlet Elbow - Chrome



PART NUMBER	SIZE	GAUGE	CASE QTY
34174	1-1/2"	20	40
34178	1-1/2"	17	30



IPS cast elbow ONLY

34141	1-1/2" CP outlet elbow ONLY
-------	-----------------------------

J Bends for Sink Traps with Captured Nut - Chrome



50 pieces per case



PART NUMBER	SIZE	GAUGE
34180	1-1/4"	20
34182	1-1/2"	
34184	1-1/4"	17
34186	1-1/2"	

J Bends for P Traps - Chrome



Without Cleanout *Reducing Washer

PART NUMBER	SIZE	GAUGE
*34190	1-1/2"	20
34192	1-1/4"	17
34194	1-1/2"	

Low Inlet

34197	1-1/2"	17
-------	--------	----

Choked Inlet

34201	1-1/2" x 1-1/4"	20
-------	-----------------	----

High Inlet †

34211	1-1/2"	17
-------	--------	----



50 pieces per case
† 30 pieces per case

**Los Angeles Code Sink Trap
Cast Brass Elbow - Ground Joint**

- Brass nuts and 1-1/2" x 1-1/4" reducing washer



50 pieces per case



Complete

PART NUMBER	SIZE	FINISH	GAUGE
34140	1-1/2"	Chrome	17
34142	1-1/2"	Rough	

"J" bend ONLY for LA trap

PART NUMBER	SIZE	FINISH	GAUGE
34137	1-1/2"	Chrome	17
34139	1-1/2"	Rough	
34143	1-1/2"	Rough	20

IPS cast elbow ONLY

34141	1-1/2" CP outlet elbow ONLY
-------	-----------------------------

S Traps with Flanges - Less Cleanout - Chrome

To receive with deep box flange, add "BF" to part number.

- All 17 gauge traps have CP brass nuts.
- All 20 gauge traps have CP die cast nuts.



Complete

PART NUMBER	SIZE	TRAP GAUGE
34146	1-1/2" x 20"	20
34150	1-1/2" x 20"	17

Cast Tees with Tailpieces - Nuts & Washers - 1-1/2" Chrome



34314
34315*

34320

34318

34312



50 pieces per case
*Rough Brass

PART NUMBER	SIZE
34312	Direct connect tee w/ highway insert
34314	End outlet tee w/ baffle
34315*	End outlet tee w/ tail piece
34318	Center outlet tee w/ baffle
34320	3 Way slip tee no baffle



Continuous Wastes

All 17 gauge Slip Joint Cast Tee's have CP Brass nuts.
All 20 gauge Slip Joint Cast Tee's have CP Die Cast nuts.

Continuous Wastes - End Outlet, Slip Joint Cast Tee

- With Baffle - Chrome



30 pieces per case

PART NUMBER	SIZE	FINISH	GAUGE
34160	1-1/2" x 16"	Chrome	20
34168	1-1/2" x 16"	Chrome	17

Continuous Wastes - End Outlet, Direct Connect Cast Tee

- With Baffle - Chrome



30 pieces per case

PART NUMBER	SIZE	GAUGE
34286	1-1/2" x 16"	20
34290	1-1/2" x 16"	17

Continuous Wastes - Center Outlet, Slip Joint Cast Tee

- With Baffle - Chrome



PART NUMBER	SIZE	GAUGE
34294	1-1/2" x 16"	20
34298	1-1/2" x 16"	17
34300	1-1/2" x 21"	

Waste Arms

All 17 gauge Waste Arms have CP Brass nuts.
 All 20 gauge Waste Arms have CP Die Cast nuts.

1-1/2" Waste Arms - Slip Joint

- Rough and Chrome



7" 60 pieces per case
 11-1/2" 50 pieces per case
 15" 40 pieces per case
 20" 30 pieces per case
 24" 24 pieces per case

PART NUMBER	SIZE	FINISH	GAUGE
34204	7"	Chrome	20
34206	11-1/2"		
34208	15"		
34210	20"		
34212	24"		
34228	11-1/2"	Chrome	17
34230	15"		
34234	24"		
34244	24"	Rough	17

1-1/2" Waste Arms - Direct Connect

- Rough and Chrome



7" 60 pieces per case
 11-1/2" 30 pieces per case
 15" 40 pieces per case
 20" 30 pieces per case
 24" 24 pieces per case

PART NUMBER	SIZE	FINISH	GAUGE
34246	7"	Chrome	20
34250	15"		
34252	20"		
34270	15"		
34278	11-1/2"	Rough	17



Sink Tailpieces - Flanged One End

- Rough and Chrome



4" 80 pieces per case
 6" 60 pieces per case
 8" 60 pieces per case
 12" 50 pieces per case

PART NUMBER	LENGTH	DIAMETER	FINISH	GAUGE
34328	8"	1-1/4"	Chrome	20
34330	12"			
34334	6"	1-1/2"	Chrome	20
34336	8"			
34338	12"			
34346	12"	1-1/2"	Rough	20
34348	4"	1-1/2"	Chrome	17
34350	6"			
34352	8"			
34354	12"			
34356	4"	1-1/2"	Rough	17
34358	6"			
34360	8"			
34362	12"			

Sink Tailpieces - Double End Flanged

- 1-1/2" - Chrome



12" 50 pieces per case
 16" 40 pieces per case
 * Rough Brass

PART NUMBER	LENGTH	GAUGE
34366	16"	20
* 34367	16"	
34388	16"	17

Sink Tailpieces - Reducing

- 1-1/2" x 1-1/4" - Chrome



60 pieces per case

PART NUMBER	LENGTH	GAUGE
34390	8"	20
34392		17

Extension Tube - Slip Joint

- Double End - Chrome
- With CP die cast nuts
- 40 Pieces per case

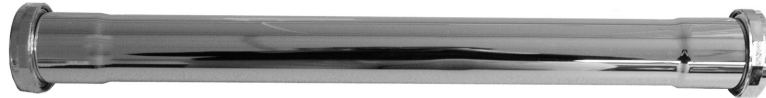

40 pieces per case

PART NUMBER	SIZE	GAUGE
34394	1-1/4" x 16"	20
34396	1-1/2" x 16"	

Extensions Tubes - Slip Joint, With Nuts & Washers

- All 17 gauge Slip Joint Extension Tubes have CP brass nuts
- All 20 gauge Slip Joint Extension Tubes have CP die cast nuts



6" 80 pieces per case
 8" 60 pieces per case
 12" 50 pieces per case

PART NUMBER	LENGTH	SIZE	GAUGE	FINISH
34398	6"	1-1/4"	20	Chrome
34400	8"			
34401	10"			
34402	12"			
34404	6"	1-1/4"	17	Chrome
34406	8"			
34408	12"			
34410	6"	1-1/2"	20	Chrome
34412	8"			
34413	10"			
34414	12"			
34418	8"	1-1/2"	17	Chrome
34420	12"			
34422	12"	1-1/2"	17	Rough



Extension Tubes - Threaded Both Ends

- Rough and Chrome

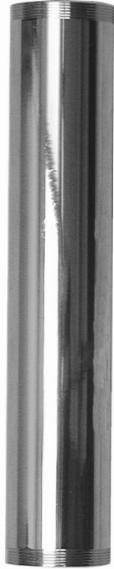

PART NUMBER	LENGTH	DIAMETER	FINISH	GAUGE
34450	8"	1-1/4"	Chrome	20
34452	12"			
34460	6"	1-1/4"	Chrome	17
34462	8"			
34464	12"	1-1/2"	Chrome	20
34468	6"			
34472	12"	1-1/2"	Rough	20
34476	8"			
34478	12"	1-1/2"	Chrome	17
34480	12"		Rough	
34482	12"			



6" 80 pieces per case
 8" 60 pieces per case
 12" 50 pieces per case

Repair Couplings & Ells

- Chrome - With CP die cast nuts



25 pieces per case

PART NUMBER	GAUGE	DESCRIPTION	SIZE
34518	20	Straight	1-1/4
34520	17	90°	
34522	20	45°	1-1/2
34524	20	Straight	
34526	20	90°	
34528	20	45°	

Double Offset 12"

- With die cast nuts

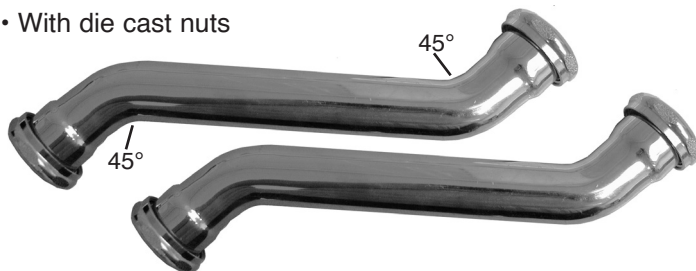

24 pieces per case



PART NUMBER	LENGTH	GAUGE	FINISH
34530	1-1/4"	20	Chrome
34532	1-1/2"		Chrome

Slip Joint Elbows

- With CP die cast nuts



PART NUMBER	LENGTH	DIAMETER	GAUGE	FINISH
34496	8"	1-1/4"	20	Chrome

Closet Ells

- With CP die cast nuts

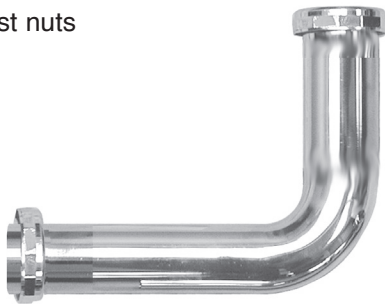

PART NUMBER	SIZE	GAUGE	FINISH
34512	2" x 4" x 6"	20	Chrome
34514	2" x 5" x 7"		
34516	2" x 6" x 8"		
34517 *	2" x 6" x 8"		

* Two-Piece Repair Ell

Branch Tailpieces

- Branch for 5/8" and 7/8" dishwasher drain hose



PART NUMBER	BRANCH OUTLET	SIZE	GAUGE	STYLE	TAILPIECE FINISH
34540	7/8"	1-1/2" X 8"	17	Chrome Plated Brass Nut Captive	Chrome Plated
34541	5/8"				
34542	7/8"		20	Chrome Plated Diecast Nut Slip Joint Down	Rough Brass
34544	7/8"				Chrome Plated

Brass Tubular Solder Collars

- Threads fit slip joint nuts



PART NUMBER	SLIP JOINT	FOR USE WITH
1315	1-1/2"	CWT



Commercial Grid Style Lavatory Drain

Highest Quality

- Stainless steel body change
- 1-1/4" Stainless steel tailpiece
- Brass locknut
- Rubber gasket with overflow
- Small drain snake will fit through center hole of strainer



Individually Boxed

PART NUMBER	TAILPIECE LENGTH
1176	6"

Rubber Stopper Lav Drain

- 20 GA CP brass
- 1-1/4" x 6" tailpiece
- Rubber stopper with chain



Individually Boxed

PART NUMBER
1178

Handicap Commercial Grid Style Lavatory Drain

Highest Quality

- Stainless steel strainer
- Stainless steel body
- 1-1/4" x 9" Stainless steel tailpiece
- Stainless steel locknut
- Rubber gasket with overflow



Individually Boxed

PART NUMBER	DESCRIPTION
1177-TP	With Tailpiece



1 1/2" "Freedom Arm" Offset Chrome Plated Brass Tubular Wall Bend

The **PASCO** "Freedom Arm" offers the plumber a simple solution to an age-old plumbing remodeling puzzle.

As a plumber replaces an old sink with a new sink, the new configuration of the sink drain opening, trap and wall bend may not align with the existing waste tee in the wall. The common and past practices of breaking into the wall to move the waste tee, or even soldering unsightly pieces of copper together to achieve the proper degree of offset for the wall bend, are now just that... PAST.

The 8 different offset designs of the "Freedom Arm" will, for the most part, eliminate the frustrating and time consuming practices mentioned above. The "Freedom Arm" was designed by a plumber for the plumber.

The eight models of the "Freedom Arm" cover left or right offsets (as the plumber faces the wall), 22 or 45 degrees of offset and either a short or long version of the straight run of the wall bend, which allows for the difference in the distance between sink trap and the wall.

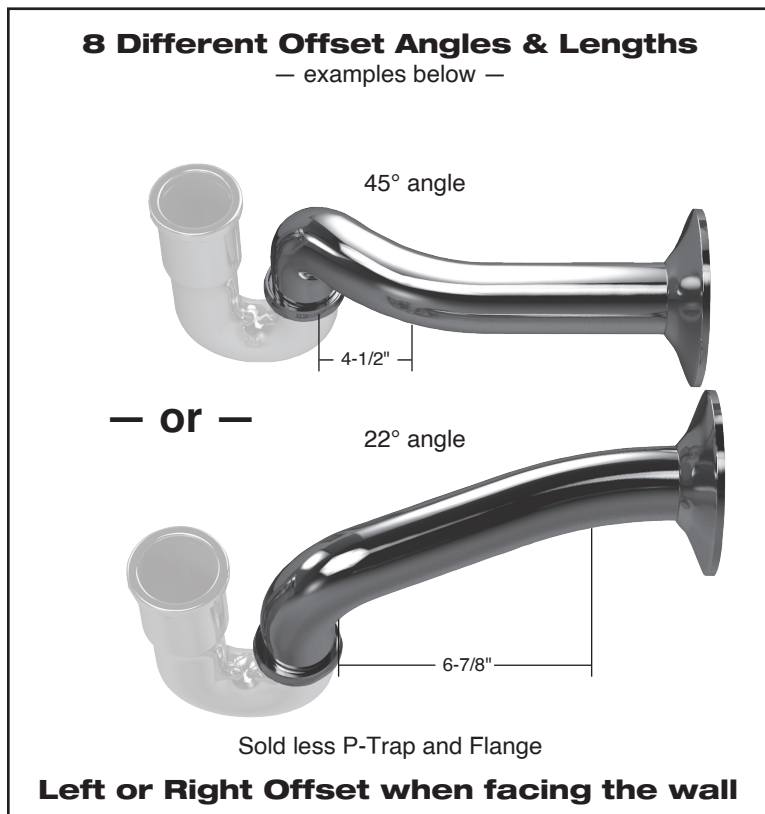

Features:

- 17 Gauge CP Bass
- Supplied with CP Brass SJ Nut and Square Cut Rubber Washer
- Sold without P-Trap and Flange
- Individually Bagged with ID Card Indicating Offset and Degree of Offset
- Professionally Designed for a Professionally Finished Installation

8 Sizes & Offsets
— listed on the following page —



1 1/2" 17 Gauge Left or Right Offset CP Brass Wall Bends

Measurements are from p-trap outlet to wall, when facing the wall.

Left-Short 22° Bend

- 2-1/2" offset
- 4-1/2" front length
- 4" back length

Sold less
P-Trap and
Flange



top view side view

**PART
NUMBER**
35101

Left-Short 45° Bend

- 3-3/8" offset
- 4-1/2" front length
- 4" back length

Sold less
P-Trap and
Flange



top view side view

**PART
NUMBER**
35102

Left-Long 22° Bend

- 2-3/4" offset
- 6-3/4" front length
- 2-3/4" back length

Sold less
P-Trap and
Flange



top view side view

**PART
NUMBER**
35103

Left-Long 45° Bend

- 4-3/4" offset
- 6-7/8" front length
- 2-3/4" back length

Sold less
P-Trap and
Flange



top view side view

**PART
NUMBER**
35104

Right-Short 22° Bend

- 2-1/2" offset
- 4-1/2" front length
- 4" back length

Sold less
P-Trap and
Flange

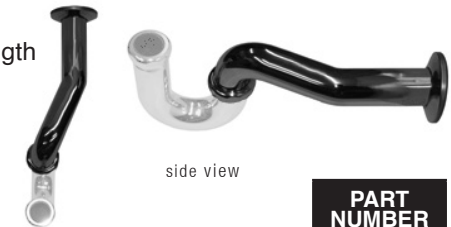

top view

side view

**PART
NUMBER**
35105

Right-Short 45° Bend

- 3-3/8" offset
- 4-1/2" front length
- 4" back length

Sold less
P-Trap and
Flange



top view

side view

**PART
NUMBER**
35106

Right-Long 22° Bend

- 2-3/4" offset
- 6-3/4" front length
- 2-3/4" back length

Sold less
P-Trap and
Flange



top view

side view

**PART
NUMBER**
35107

Right-Long 45° Bend

- 4-3/4" offset
- 6-7/8" front length
- 2-3/4" back length

Sold less
P-Trap and
Flange

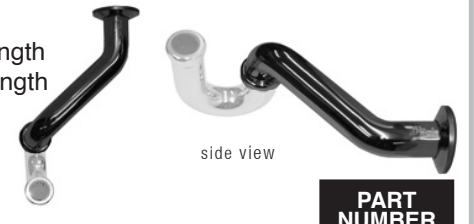

top view

side view

**PART
NUMBER**
35108

Sure Grip Flanges (or Shallow Flanges)

• Box Quantities Only - 50 per box



		Chrome Plated Steel	White Plastic		
PART NUMBER	PART NUMBER	IPS	CWT	OUTSIDE DIAMETER	
1224	1217	1-1/2" Tubular		3"	
1225	1211	3/8"	—	2-1/2"	
1226	1212	1/2"	—	2-1/2"	
1227	1213	3/4"	—	2-1/2"	
1228	1214	1-1/2"	—	3"	
1229	1215	2"	—	3-1/4"	
1230	1209	—	1/2"	2-1/2"	
1231	1210	—	3/4"	2-1/2"	
1232	—	1-1/4"	1-1/2"	3"	
1233	—	1"	—	2-3/4"	
1240	—	—	2"	3-1/2"	
1241	—	—	1"	2-3/4"	

Extra Wide Sure Grip Flanges (or Shallow Flanges)

Chrome Plated Steel

• Box Quantities Only - 50 per box



PART NUMBER	IPS	TUBULAR	OUTSIDE DIAMETER
1238	1-1/2"	—	3-1/2"
1239	2"	—	3-1/2"
1240	—	2"	3-1/2"



Sure Grip Bell Flanges (or Deep Flanges)

Chrome Plated Steel

- Box Quantities Only - 25 per box



PART NUMBER	IPS	CWT	TUBULAR	OUTSIDE DIAMETER
2841	3/8"	—	—	2-1/2"
2842	1/2"	—	—	2-1/2"
2844	1-1/4"	—	—	3"
2845	—	1/2"	—	2-1/2"
2846	1-1/2"	—	—	3"
2854	—	—	1-1/2"	3"

Sure Grip Floor and Ceiling Plate

Chrome Plated Steel

- Light pattern - no springs
- Box Quantities Only - 12 per box



PART NUMBER	IPS	CWT	OUTSIDE DIAMETER
2810	3/8"	—	3"
2811	1/2"	—	2-3/4"
2812	3/4"	—	2-3/4"
2813	1"	—	3-1/2"
2814	1-1/4"	1-1/2"	3-1/2"
2815	1-1/2"	—	3-1/2"
2816	2"	—	4-1/2"
2821	—	1/2"	3"
2822	—	3/4"	2-3/4"
2823	—	1"	2-3/4"
2824	—	1-1/4"	3-1/2"

Sure Grip Box Flanges

Chrome Plated

- Box Quantities Only - 50 per box



Chrome Plated Steel

PART NUMBER	IPS	TUBULAR	OUTSIDE DIAMETER
1235	1-1/2"	—	3"
1236	—	1-1/4"	3"
1237	—	1-1/2"	3"

Plastic Floor and Ceiling Plate - Chrome Plated or White

- Simply bend and place around pipe.
 - Chrome or white finish 100% rustproof
 - Non-corrosive
 - Non-breakable
 - Box Quantities Only - 12 per box
- SPECIFY SUFFIX "W" FOR WHITE**



PART NUMBER	IPS	CWT	OUTSIDE DIAMETER
2856	1/2"	—	2-3/4"
2857	3/4"	—	3"
2858	1"	—	3-1/4"
2859	1-1/4"	—	3-1/2"
2860	1-1/2"	—	4-1/4"
2861	2"	—	5-1/4"
2862	2-1/2"	—	5-1/2"
2863	3"	—	5-3/4"
2864	4"	—	6-3/4"
2873	—	1/2"	2-1/2"
2874	—	3/4"	2-3/4"
2875	—	1"	3"
2876	—	1-1/4"	3-1/4"
2877	—	1-1/2"	3-1/2"
2878	—	2"	4-1/2"

Floor and Ceiling Plate

Heavy Pattern With Springs - Hinged

- Chrome plated steel
- Box Quantities Only - 12 per box



PART NUMBER	IPS	CWT	OUTSIDE DIAMETER
2880	3/8"	—	2-1/4"
2881	1/2"	—	2-1/2"
2882	3/4"	—	2-3/4"
2883	1"	—	3-1/4"
2884	1-1/4"	—	3-1/2"
2885	1-1/2"	—	3-7/8"
2886	2"	—	4-1/2"
2888	—	1/2"	2-1/4"
2889	2-1/2"	—	5-3/8"
2890	3"	—	5-7/8"
2891	—	3/4"	2-1/2"
2892	4"	—	7-1/8"
2893	—	1"	2-7/8"
2894	—	1-1/4"	3-1/4"
2895	—	2"	4"
2896	—	1-1/2"	3.5"
9860	5"	—	9"
9861	6"	—	9-3/4"
9862	8"	—	13"



**Plastic
Dryer Vent Hood**

With 4" Aluminum Duct Pipe and Wall Flange

- Weather resistant
- Paintable
- Wide outlet

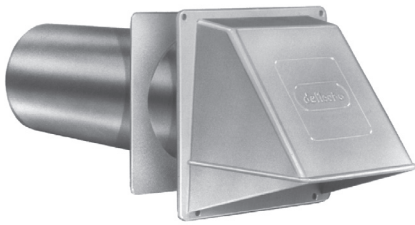

**PART
NUMBER**
1718-W

**Plastic
Louvered Dryer Vent Hood**

With 4" Aluminum Duct Pipe and Wall Flange

- Weather resistant
- Paintable
- Narrow profile
- Prevents drafts

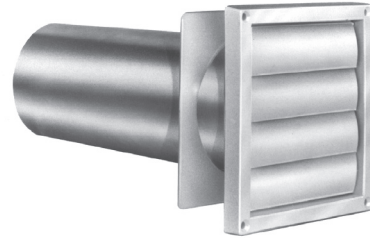

**PART
NUMBER**
1721-W

Vent Hood Kit

With Above Hood #1718-W

- 1- 4" x 5 ft. Vinyl or Aluminum Dryer Duct
- 2- #1724 Clamps
- 1- #1718-W Vent Hood

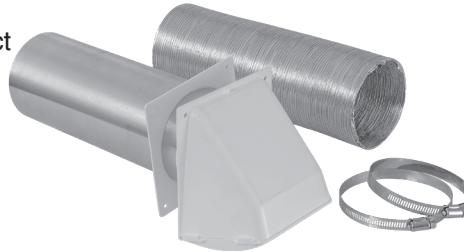

PART NUMBER	DESCRIPTION
1697	Aluminum
1718-HK	Vinyl

Vinyl or Aluminum Dryer Duct

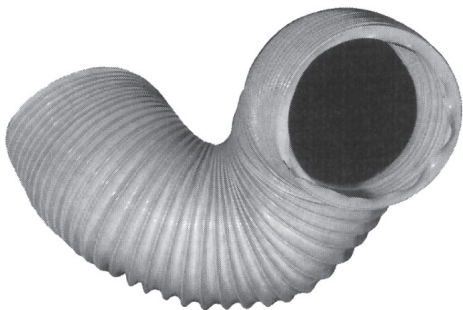

PART NUMBER	MATERIAL	SIZE
1687	Aluminum	4" x 5 ft.
1688		4" x 8 ft.
1689		4" x 25 ft.
1720	Vinyl	4" x 20 ft.

Dryer Duct Clamp

Stainless Steel



PART NUMBER	SIZE
1723	4"

Anchor Sets

Phillips hex head screws allow a nutdriver, nut setter or screwdriver to be used.

EACH SET CONTAINS:

- 100 Anchors
- 100 Phillips hex head screws
- Carbide tipped masonry drill (optional)
- Transparent, reusable box
- Flat head wood screws



PART NUMBER	DRILL INCLUDED	SCREW SIZE	ANCHOR SIZES	STYLE
1600	1/4"	1" x #10	8 - 10	Collar

Brass Flat Head Woodscrews

- Phillips
- 100 per plastic jar



PART NUMBER	SIZE	LENGTH	MATERIAL
1503	12	1-1/2"	Brass
1505		2"	Brass
1531	#14	1-1/2"	Brass

Toggle Bolts

- 50 per box



PART NUMBER	SIZE
1484	1/4" x 3"
1485	1/4" x 4"

Drop In Concrete Anchors

- 100 per box
- Complies ICBO # 3631 RR# 24682



PART NUMBER	SIZE
1558	3/8"

Sheet Metal Screws

- 1/4" Hex slotted head
- 100 per box
- Self piercing



PART NUMBER	SIZE	LENGTH
1831	#7	1/2"

Setting Tool

- Plated steel



PART NUMBER	SIZE
1552	3/8" or 1/2"

Stove Bolts

- Round head with hex nuts
- 100 bolts and nuts per box



PART NUMBER	SIZE
1640	1/4" x 3/4"
1641	1/4" x 1"

Self-Drilling Screws

- 100 per box
- Self-drilling point
- 1/4" hex head



PART NUMBER	SIZE
1830	1/2" x #8



Steel DWV Hangers

- Galvanized steel hanger
- Felt lined pipe holder
- Body bends for easy installation
- Locking screws keeps pipe secure
- Keyhole design provides faster installations
- Use in horizontally suspended piping applications.
- Hangers can be used for noise suppression applications
- Faster and easier installation



PART NUMBER	DESCRIPTION
37001	1-1/2"
37002	2"
37003	3"
37004	4"

Pipe Straps

- Allows pipes to be flush mounted



See price page for quantity pack

*with nails

Galvanized

PART NUMBER	IPS SIZE	PACK QTY
1614	1/2"	100
1615	3/4"	100
1616	1"	100
1617	1-1/4"	50
1618	1-1/2"	50
1619	2"	50
1620	2-1/2"	25
1621	3"	20
1622	4"	10

Copper

PART NUMBER	IPS SIZE	PACK QTY
1623*	1/2"	100
1624*	3/4"	100

Ice Maker Hook-Up Kits

For use on refrigerators with automatic icemakers. Also used on humidifiers.



Polypropylene Tubing

KIT CONTAINS

- 1. 1/4" x 25' Poly tubing
- 1. Self-piercing needle valve
- 1. 1/4" Compression union
- 2. 1/4" Brass insert sleeves
- 2. 1/4" Delrin Sleeves

Polypropylene Tubing

PART NUMBER	SIZE
2045	Hook-Up Kit
2056-25	25' Poly Tubing ONLY



Copper Tubing

KIT CONTAINS

- 1. 1/4" x 25' Copper Tubing
- 1. Self piercing needle valve
- 1. 1/4" Compression union
- 1. 1/4" Compression male
- 1. 1/4" 90° Compression elbow

Copper Tubing

PART NUMBER	SIZE
2049	Copper Hook-Up Kit ONLY
2059-25	25' Copper Tubing ONLY

Granulated Carbon Filter

Filters contain granulated carbon for taste and odor removal from municipal drinking water.

SPECIFICATIONS:

- Container - Polypropylene
- Media- Activated Carbon
- Filter/Screen - Polyester Felt
- Micron Size - 20
- Flow Rate - 1 GPM @ 60 PSI
- Life Span - 3-6 months
- Effective Filterings - 2000 gal.
- Temp Rating - 120° F
- Pressure Rating - 125 PSI

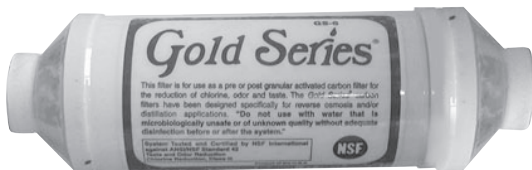

PART NUMBER	SIZE
2060	Use 1/4" Compression Fittings
2060-38	Use 3/8" Compression Fittings

Self-Piercing Needle Valve

For 1/4" To 1" Copper Tube



KIT CONTAINS:

- 1. Needle valve
- 1. Saddle clamp
- 2. Nuts
- 2. Bolts

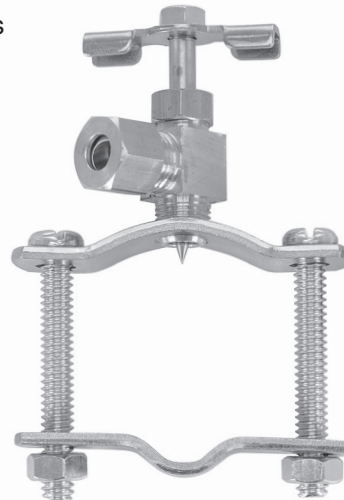

PART NUMBER
2162

Compliant: Lead Leaching AB 100

Low Lead AB 1953