

# Instruction Manual

## 1-PC Screwed End Ball Valve

156RT

HIM-017 Version: C

Office : 4061 CLOUGH WOODS DR. BATAVIA, OHIO 45103

Fax: 513 752 8267 Tel: 513 752 5600

 Document No. HIM-017		1-PC Screwed End Ball Valve 156RT	<b>Version</b>	<b>C</b>
			Date	Sep.18,2009

# CONTENTS

1. Introduction and Safety Information .....	1
1.1 Introduction .....	1
1.2 Safety Information.....	1
2. General Precautions.....	2
2.1 Material Selection .....	2
2.2 Pressure-Temperature Rating .....	2
2.3 Fluid Thermal Expansion.....	2
2.4 Hydrostatic Test .....	2
2.5 Liquids with High Fluid Velocity .....	2
2.6 Throttling Service .....	3
2.7 Static Electric Effect (Option) .....	3
3. Storage and Preparation .....	4
3.1 Storage .....	4
3.2 Preparation .....	4
4. Installation and Operation .....	5
4.1 Installation .....	5
4.2 Operation.....	5
4.3 Manual Operation .....	5

		<b>1-PC Screwed End Ball Valve 156RT</b>	<b>Version</b>	<b>C</b>
			Date	Sep.18,2009
Document No.	HIM-017			

5. Maintenance and Repair .....	6
5.1 Inspection and Maintenance .....	6
5.2 Trouble-Shooting.....	7
5.3 Stem Packing Replacement .....	8
5.4 Assembly .....	9
6. Quality Assurance and Service .....	10
6.1 Quality Assurance.....	10
6.2 Service.....	10
7. Technical Parameters and Valve Structure .....	11
7.1 Specification List.....	11
7.2 Stem Nut & Retainer Torque .....	11
7.3 Pressure-Temperature Ratings .....	12
7.4 Repair Parts List.....	12
7.5 Valve Structure.....	12

		<b>1-PC Screwed End Ball Valve 156RT</b>	<b>Version</b>	<b>C</b>
			Date	Sep.18,2009
Document No.	HIM-017		Page	1

## 1. INTRODUCTION AND SAFETY INFORMATION

### 1.1 INTRODUCTION

This manual has been prepared to serve as a guide to insure continuous satisfactory service and assist in restoring a valve to proper working condition.

It covers 1 pieces 1000 WOG, screw ends, and carbon steel, stainless steel ball valves.

The installation, storage, operation, inspection and repair, service problems, maintenance and preventive maintenance, quality assurance and service, technical parameters covering these valves are also included in this manual.

All these valves are widely used in water system, petroleum, chemical, power plant and allied industries.

### 1.2 SAFETY INFORMATION

The following general safety notices supplement the specific warnings and cautions appearing elsewhere in this manual. They are recommended precautions that must be understood and applied during operation and maintenance of the equipment covered herein.

- a. Always wear eye shields, gloves and overalls. Wear protective footwear and headgear.
- b. To avoid injury, never attempt disassembly while there are pressures either upstream, or downstream. Even when replacing packing rings, caution is necessary to avoid possible injury.
- c. Do not attempt to disassemble a valve while there is pressure in the line. Make sure both upstream and downstream pressures are removed. Disassemble with caution in the event all pressures have not been relieved.
- d. Prior to replacing packing rings remove all pressure from the valve.
- e. To prevent valve distortion, inefficient operation, or early maintenance problems, support piping on each side of the valve.
- f. Do not touch surface of valve on high temperature.
- g. Valves are not to be used with unstable fluids.
- h. If provided, the Locking device on the handle is to avoid improper use of the valve by unauthorized people. This can be locked with a patch lock.

		<b>1-PC Screwed End Ball Valve 156RT</b>	<b>Version</b>	<b>C</b>
			Date	Sep.18,2009
Document No.	HIM-017		Page	2

## 2. GENERAL PRECAUTIONS

### 2.1 MATERIAL SELECTION

The possibility of material deterioration in service and the need for periodic inspections is depended on the contained fluid. Carbide phase conversion to graphite, oxidation of ferrite materials, and decrease in ductility of carbon steels at low temperature (even in applications above 29°F) and susceptibility to inter-granular corrosion of austenitic materials or grain boundary attack of nickel-base alloys are among those items. Information about corrosion data is provided in this I.O.M, the user is requested to take attention or consideration to determine if the used materials are suitable for the application.

### 2.2 PRESSURE-TEMPERATURE RATING

The Pressure-Temperature rating, published by manufacturer is usually considered an appropriate guide to the maximum temperature and pressure those ball valves may withstand. The principle of pressure-temperature rating is depending on static pressure. For reference client can ask the valve distributor or manufacturer for assurance of suitability when ball valves are subjected to the following conditions:

- Valves are left closed for long periods of service under high-temperature or high-pressure service conditions
- Valves are operated frequently for long periods with high-temperature or high-pressure service conditions.

### 2.3 FLUID THERMAL EXPANSION

It is possible, with the ball in closed condition; the sealed cavity inside the valve body is filled with liquid. If this liquid is not released, by partially opening the valve, and the valve is subject to a temperature increase, excessive pressure can occur inside the body. These OVC ball valves have self-relieving pressure seats to prevent pressure built up. Our client is recommended to prevent a pressure build-up inside the valve exceeding the design pressure, by means of piping design, installation, or operation procedure.

### 2.4 HYDROSTATIC TEST

Before delivery, all valve body's are tested 1.5 times the working pressure in open position. After installation, the pipeline system may be subject to a system test not to exceed the above mention pressure.

**(For example: PN 16 is hydrostatic tested 1.5 X 16 = 24 bar testing pressure)**

### 2.5 LIQUIDS WITH HIGH FLUID VELOCITY

When ball valves must be operated frequently on liquids with very high velocity, a check shall be made with the valve distributor or manufacturer for appropriate advice to minimize the possibility of seat deformation, especially when working pressure and temperature is reaching maximum ranges.

		<b>1-PC Screwed End Ball Valve 156RT</b>	<b>Version</b>	<b>C</b>
			Date	Sep.18,2009
Document No.	HIM-017		Page	3

## 2.6 THROTTLING SERVICE

Standard ball valves are generally not recommended for throttling service. The fluid flow can damage the leading edge of the ball and/or damage or deform the resilient ball seats causing leakage. High fluid velocity and/or the presence of solid particles in the media will reduce the lifetime of seat and ball during throttling applications.

## 2.7 STATIC ELECTRIC EFFECT (OPTION)

The ball valves are provided with anti-static devices for ball-stem-body. When service conditions require electrical continuity to prevent static discharge, the user is responsible for specifying static grounding.

		<b>1-PC Screwed End Ball Valve 156RT</b>		<b>Version</b>	<b>C</b>
				Date	Sep.18,2009
Document No.	HIM-017			Page	4

### 3. STORAGE AND PREPARATION

#### 3.1 STORAGE

##### 3.1.1 Temporary Storage

If valves are to be stored before installation, the following should be observed.

- a. Keep the valves wrapped and protected as shipped from the manufacturer.
- b. Do not remove the plastic bag or protective end covering until the valve is ready for installation. This will reduce the possibility of foreign material damaging internal valve components.
- c. Valves stored outdoors should be positioned such that water does not accumulate in the valve body.

##### 3.1.2 Long Term Storage

If the valves are to be stored more than one year, they should be prepared in the following manner.

- a. Remove the packing and apply a preservative to the packing chamber.
- b. Do not remove the protective end covering.
- c. Valve which will remain in storage for an excessive period of time should have a preservative applied to the external surface.
- d. Do not store the valves outdoors.

#### 3.2 PREPARATION

- a. Remove the plastic bag or valve end protection (if any).
- b. Prior to shipment from the manufacturer, a preservative may have been applied to the inner body of the valve. This preservative may be removed with a solvent.
- c. The inside of the valve should be inspected and blown out with compressed air. Adjacent piping must be clean and free from debris to prevent damage to the valve.
- d. To prevent valve distortion, inefficient operation or early maintenance problems, support piping on each side of the valve.
- e. Make sure the valve is positioned such that there is sufficient space so that the handle is easily and safely reached.
- f. The 1 piece ball valves can be installed in any position without regard for the direction of the flow, unless marked in the flow direction.
- g. The 1 piece ball valves are not designed for throttling and should be kept in the fully open or closed position. Should the valve be used in a partially open or closed position, the ball and seats may become eroded in a very short time. This may also cause a chatter noise in the line.

		<b>1-PC Screwed End Ball Valve 156RT</b>	<b>Version</b>	<b>C</b>
			Date	Sep.18,2009
Document No.	HIM-017		Page	5

## 4. INSTALLATION AND OPERATION

### 4.1 INSTALLATION

#### Screwed Ends

Do not dismantle these valves before fitting, treat as a unit. Taper thread fittings should not be over-tightened. In some applications screwed valves are back welded on site and these valves must be dismantling as per instruction for weld end valves.

### 4.2 OPERATION

OVC valves provide tight shut off when used under normal conditions and in accordance with pressure/temperature chart. If these valves are used in partially open (throttled) position seat life may be reduced. Any media which might solidify, crystallize or polymerize should not be allowed to stand in the ball valve cavities unless regular maintenance is provided.

### 4.3 MANUAL OPERATION

The basic type of handle which is fitted to all sizes of valve is sheet steel with integral stop. The 1 pieces ball valves have 1/4 turn operation closing in a counter-clockwise direction. It is possible to see when the valve is open or closed by the position of the handle. When the handle is across the pipeline, the valve is closed.



		<b>1-PC Screwed End Ball Valve 156RT</b>	<b>Version</b>	<b>C</b>
			Date	Sep.18,2009
Document No.	HIM-017		Page	6

## 5. MAINTENANCE AND REPAIR

### 5.1 INSPECTION AND MAINTENANCE

A periodic inspection and maintenance schedule should be established for each valve. The time frames given for the implementation of these schedules are to be used as a guide only in establishing routine inspection and maintenance schedules. Exact time periods for performing these procedures cannot be provided due to the unknown nature of the service conditions each valve is in.

#### 5.1.1 Periodic Inspection

A periodic inspection should be performed on each unit. The time frame should be adjusted depending on usage and service conditions. An infrequently used unit may have more time between inspections than a valve in constant service.

A periodic inspection should include the following:

- a. Open and close the valve. The actions should be smooth without any binding of the stem and ball through full travel.
- b. If valve is in service and under pressure:
  - (1) Check the stem packing for any leakage during the opening and closing action. If a leak is found tighten the stem nut alternately with no more than a quarter turn on it until the leak stop. If the leakage persists, see section 5.2
  - (2) Inspect the exterior of the valves for cleanliness. Remove any dirt, grime or oil from the valve body and caps.

#### 5.1.2 Post Inspection

After completion of a periodic inspection, valves that are providing satisfactory service require no further disassembly or inspection. Should a valve be found which is not performing satisfactorily, see section 5.2 "Trouble-Shooting".

#### 5.1.3 Maintenance

Other than periodic inspection, no routine maintenance is required. Routine replacement of parts, such as gasket and packing is not usually performed until required. Once in service, it may become apparent that these and other parts require repair or replacement due to usage and service conditions. A maintenance schedule should be developed taking these conditions into consideration. Parts can be replaced during a routine overhaul.

		<b>1-PC Screwed End Ball Valve 156RT</b>	<b>Version</b>	<b>C</b>
			Date	Sep.18,2009
Document No.	HIM-017		Page	7

## 5.2 TROUBLE-SHOOTING

The following chart will cover the various problems which are common to most valves.

The information provided will aid in isolating and correcting these problems.

PROBLEM	PROBABLE CAUSE	SOLUTION
Leakage through the Stem and packing	a. Stem nut loose b. Packing aged or failure c. Inadequate amount of packing rings d. Packing is hard and dry e. Spring washer is damaged f. Stem is damaged	a. Tighten stem nut b. Replace packing c. Install additional packing rings See section 5.3 d. Replace with new packing See section 5.3 e. Replace with new spring washer f. Repair or replace as required
Problems in operating valve	g. Stem nut over wear h. Packing is exerting excessive force on the stem i. Stem is damaged j. Internal components may be damaged	g. Replace stem nut h. Check torque on stem nuts. Proper loose stem nut. i. Repair or replace as required j. Disassemble the valve. Inspect ball, seat, stem and repair as needed
Seat Leakage	k. Valve not properly seated l. Internal components (ball, seat, stem) are damaged or worn m. Leakage by foreign material	k. Check to see if valve is fully closed l. Inspect internal components (ball, seat, and stem) and repair or replace as required m. Disassemble and clean the ball and seats and repair or replace as required

Table 1 - Valve Trouble-Shooting

		<b>1-PC Screwed End Ball Valve 156RT</b>	<b>Version</b>	<b>C</b>
			Date	Sep.18,2009
Document No.	HIM-017		Page	8

### 5.3 STEM PACKING REPLACEMENT

**WARNING**

To prevent injury ensure that all pressure is removed from the valve both upstream and downstream before disassembly.

- a. Check original tightness of valve operation. Remove stem nut, washer, handle, and gland nut. Clear the packing chamber.
- b. Remove the existing or defective packing rings with a sharp tool or packing remover.
- c. Examine the machined surfaces of the stem and packing chamber. Remove any scoriae or burrs with emery cloth or hand filing. Clean the stem with a solvent soaked rag.
- d. Install new packing. Install rings individually using a split ring spacer, compressing each ring by hand tightening the stem nut.
- e. When packing chamber becomes filled with packing, reassemble stem nut. Tightening the stem nut until stem nut begin to get tight. If gland travels more than the height of one packing ring into the packing chamber, insert one more ring and repeat step F until chamber is filled.
- f. Compare valve operation to original tightness. If valve operation is considerably tighter than original operating tightness, back off 1/4 turn on the stem nut and recheck tightness.
- g. Several hours after a repacked valve has been returned to service, inspect the packing area to ensure full compression, tight bolting and no leakage. Should leakage occur, tighten the stem nut at 1/4 turn increments until leakage stops.



# 1-PC Screwed End Ball Valve 156RT

**Version**

**C**

Date

Sep.18,2009

Document No.

HIM-017

Page

9

## 5.4 ASSEMBLY

To assemble the valve, it takes the opposite way of the dismantling process. The valve must be in close position during assembling of the body and returner, the stopper must be located at the right place; otherwise, the open and close operation will be opposite.

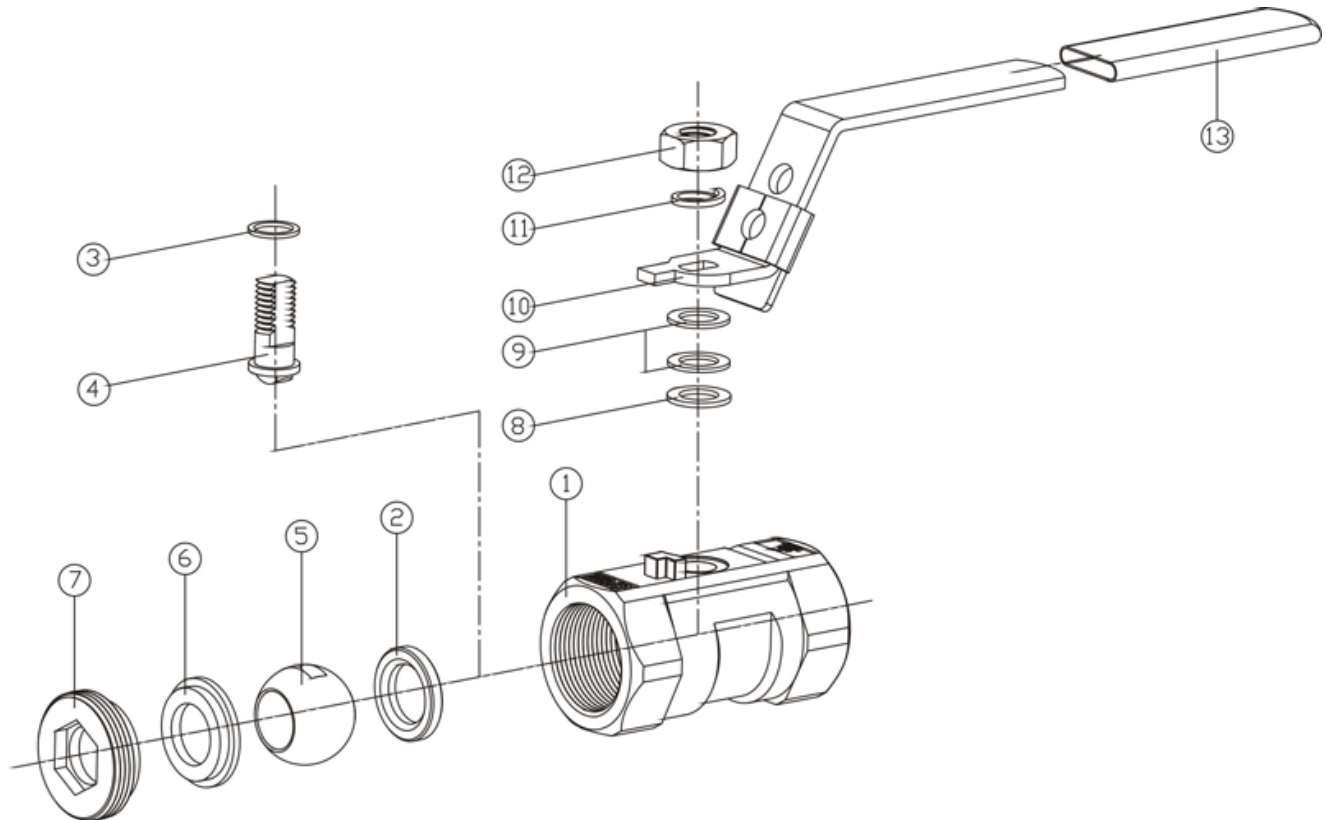

		<b>1-PC Screwed End Ball Valve 156RT</b>	<b>Version</b>	<b>C</b>
			Date	Sep.18,2009
Document No.	HIM-017		Page	10

## 6. QUALITY ASSURANCE AND SERVICE

### 6.1 QUALITY ASSURANCE

OVC's warrants its products to be free from defects in material and workmanship for a period of eighteen (18) months from the date of shipment or twelve (12) months from the date of installation whichever comes first. This warranty is limited to the repair or replacement of the defective item providing that it was handled, installed, used and maintained in accordance with the manufacturer's recommendations and applicable standard industry practices. OVC will not be liable for any additional direct or indirect costs beyond the repair or replacement of the defective item.

This warranty is in lieu of any other warranty expressed or implied.

### 6.2 SERVICE

Manufacturer may provide field installation and debugging where contractually specified.

Manufacturer will follow up the quality of the valve provided and offer service in accordance with customer requirements.

		<b>1-PC Screwed End Ball Valve 156RT</b>	<b>Version</b>	<b>C</b>
			Date	Sep.18,2009
Document No.	HIM-017		Page	11

## 7. TECHNICAL PARAMETERS AND VALVE STRUCTURE

### 7.1 SPECIFICATION LIST

Type	156RT
Technical Parameters	
Nominal pipe size	DN8 ~ DN50, (1/4" ~ 2")
Nominal pressure	1000 WOG
Working temperature	-20°C ~ 200°C, (-4°F ~ 392°F)
Medium	Water, Steam, Oxygen, Vacuum, Chemical, Oil, Food Processing
Pressure test	API 598

Table 2 - Specification List

### 7.2 STEM NUT & RETAINER TORQUE

NPS	DN	Stem nut		Retainer	
		N-m	in-lb	N-m	in-lb
1/4"	8	1.7	15	5	44
3/8"	10	2.5	22	9	80
1/2"	15	3.5	31	10	89
3/4"	20	6.5	58	25	221
1"	25	8.5	75	35	310
1-1/4"	32	8.5	75	68	602
1-1/2"	40	10	88.5	73	646
2"	50	10	88.5	100	885

Table 3 - Stem Nut & Retainer Torque

		<b>1-PC Screwed End Ball Valve 156RT</b>		<b>Version</b>	<b>C</b>
				Date	Sep.18,2009
Document No.	HIM-017			Page	12

### 7.3 PRESSURE-TEMPERATURE RATINGS

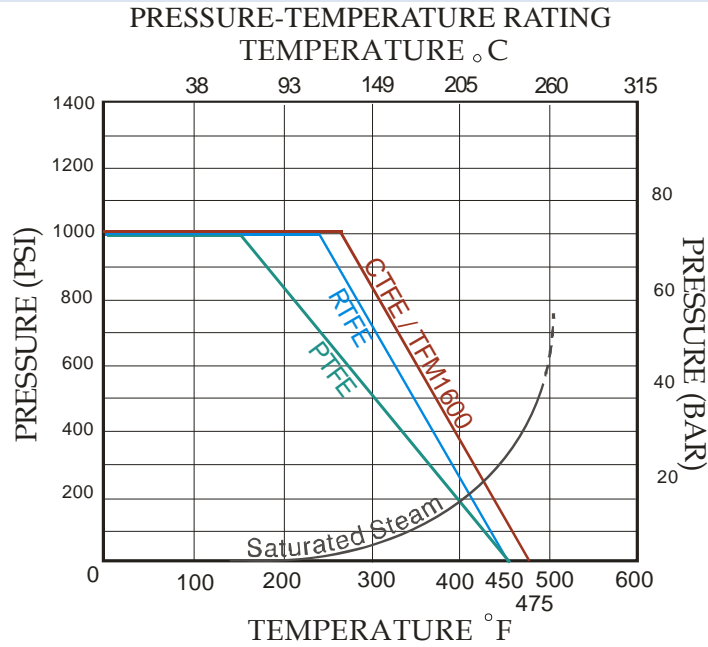

Table 3 - Pressure-Temperature Ratings

### 7.4 REPAIR PARTS LIST

Parts	Quantity
Ball	1 piece
Seat	2 piece
Seal ( Gasket )	1 piece
Thrust Washer	1 piece
Packing	1 Set

Table 4 - Repair Parts List

### 7.5 VALVE STRUCTURE

Please refer to drawings for each type of valve structure, main parts, materials and dimensions.