

Table of Contents

ITEM	PAGE	ITEM	PAGE	ITEM	PAGE
A		G		Slip Joint Extensions	16
Aerators.....	34	Gauge.....	41	Soap Dispenser.....	42
Adapter.....	11	Grid Drain Assemblies.....	8	Socket Wrench Set.....	41
B		H		Spouts.....	29
Basin Faucet.....	35	Hand Held Shower		Spuds.....	32
Bathcock.....	35	Diverter.....	28	Standing Waste.....	6
Bath & Shower Drains		Shower With Bracket.....	28	Parts For Standing Bath Waste.....	7
Brass.....	6	Volume Control.....	28	Stems.....	37
Shower Drains.....	7	Handles.....	37	Supply Valves	
White Polypropylene.....	6	I		Multi-Turn.....	18, 19
Boiler Tube Plug.....	38	Ice Maker Connectors.....	24	Quarter Turn.....	20-22
C		Integral Stop.....	42	T	
Ceiling Plates.....	30	M		Tailpiece.....	12,15,16
Cleanouts.....	11, 38, 39	Milwaukee Trap.....	14	Tape.....	40
Cleanout Tee.....	11	Mobile Home Products		Thread Sealing.....	40
Closet Flanges.....	31	Faucets.....	44	Threaded Tube.....	16
Closet Spuds.....	32	Sink Drains.....	45	Toilet Tank Accessories.....	29
Copper Stub Out Elbow.....	17	Strainers.....	44	Traps	
Curtain Rod Holder.....	42	Tub Drains.....	45	Cast Brass.....	9, 10
D		P		DWW P.....	11
Deck Plate Cleanout.....	39	P Trap.....	9, 11, 12	Milwaukee.....	14
Dishwasher Accessories.....	33	Pipe Cutters.....	41	P Trap.....	9, 11, 12
Dishwashing Connectors.....	24	Pipe Wrap.....	40	S Trap.....	12
Dishwasher Fitting.....	24	Plain Bend.....	12	Trip Lever Face Plate.....	6
Dishwasher Tailpiece.....	12	Plugs		Tub	
Dispenser.....	42	Boiler Tube.....	38	Mobile Home.....	45
Diverter.....	28	Lead "Fit All".....	38	Spouts.....	29
Double Offset.....	15	Test Plug.....	38	Test Plug.....	38
Double Waste Bend.....	14	Pop Up & P.O. Plug.....	8	Tubular Products.....	12-16
Drains		Pressure Gauge.....	41	U	
Bath.....	6	Pressure Relief Valve.....	43	Urinal Spuds.....	32
Grid Assemblies.....	8	PVC		V	
Lift & Turn.....	6	Electrical Tape.....	40	Valves	
Mobile Home.....	44, 45	Pipe Cutters.....	41	Integral Stop.....	42
Pop Up & P.O. Plug.....	8	Pipe Wrap.....	40	Pressure Relief.....	43
Shower.....	7	R		Saddle.....	32
Toe Tap.....	6	Replacement Baskets.....	5	Self Closing.....	36
DWW		S		Washing Machine.....	33
Dandy Cleanout.....	11	Saddle Tee.....	39	Volume Control.....	28
P Trap.....	11	Saddle Valves.....	32	W	
Trap Adapter.....	11	Self Closing Valves.....	36	Washing Machine Tee.....	33
Wye.....	11	Shower		Washing Machine Valves.....	33
E		Drains.....	7	Waste Bend.....	13-15
Electrical Tape.....	40	Hose.....	28	Water Supply Connectors	
Escutcheons		S Trap.....	12	Dishwasher Connectors.....	24
Chrome Plated Steel.....	30	Showerheads, Arms, Flanges & Accessories		Faucet Supply Connectors.....	23
Low Pattern.....	30	Accessories.....	27-28	Ice Maker Connectors.....	24
Floor & Ceiling Plates.....	30	Adjustable Metal.....	26	Supply Connectors.....	23-25
Gerber Style.....	37	Arm With Flange.....	27	Tank Supply Connectors.....	25
Extension Shanks.....	43	Arms.....	27	Vinyl Supply Connectors.....	23-25
F		Hand Shower.....	28	Washing Machine Connectors.....	25
Faucet		Massaging.....	27	Water Heater Connectors.....	25
Basin.....	35	Standard Plastic.....	26	Wrench Set.....	41
Handles.....	37	Water Miser.....	26		
Hole Cover.....	43	Sink Drains.....	45		
Mobile Home.....	44	Sink Strainers			
Stems, Diverter & Seats.....	37	Chrome Plated Brass.....	4		
Flanges		Mobile Home.....	45		
Closet.....	31	Replacement Baskets.....	5		
Shower.....	27	Stainless Steel.....	4, 5		
Floor Plates.....	30	Slip Nuts.....	17		
Flush Cleanout.....	11	Slip Joint Elbow.....	14		

Copyright ©2025 by MATCO-NORCA Incorporated. Reproduction or duplication of the contents herein prohibited without permission.



















MATCO-NORCA reserves the right to change products depicted herein at any time, and accepts no liability for errors or omissions.

For Terms & Conditions of Sale please visit our website.



Certifications and Approvals

Matco-Norca is committed to maintaining a high standard of quality for all the products we offer. Most products in this catalog are labeled with a designated approval or certification code. Below is a brief description of these approvals.

- 
ADA **Americans with Disabilities Act** — Protecting the rights of people with physical or mental disabilities.
- 
ANSI **American National Standards Institute** — Organization that coordinates work among U.S. Standards writing groups; Works in conjunction with other groups such as ISO, ASME, ASTM, etc.
- 
ASME **American Society of Mechanical Engineers** — Develops standards and testing criteria for finished products.
- 
ASSE **American Society of Sanitary Engineering** — Develops standards and qualifies products for plumbing and sanitary installations.
- 
ASTM **American Society for Testing Materials** — Develops standards for materials, products, systems and services.
- 
AWWA **American Water Works Association** — Promotes public health through improvement of water quality. Develops standards for valves, fittings and equipment.
- 
CSA **The CSA Group (formerly the Canadian Standards Association; CSA)** — is a global organization dedicated to safety, social good and sustainability. They are a leader in Standards Development and in Testing, Inspection and Certification around the world including Canada, the U.S., Europe and Asia. Their mandate is to hold the future to a higher standard.
- 
CEC **California Energy Commission** — As the state's primary energy policy and planning agency, the California Energy Commission is committed to reducing energy costs and environmental impacts of energy use - such as greenhouse gas emissions - while ensuring a safe, resilient, and reliable supply of energy.
- 
EPA **EPA WaterSense®** — A U.S. Environmental Protection Agency (EPA) program designed to encourage water efficiency in the United States through the use of a special label on consumer products.
- 
FM **Factory Mutual** — Develops standards and qualifies products for use by the general public.
- 
ISO **International Organization for Standardization** — Develops voluntary, consensus-based, market relevant International Standards that support innovation and provide solutions to global challenges. More specifically, ISO 9001 sets out the criteria for a quality management system and is the only standard within the family that can be certified to.
- 
MSS **Mechanics Standardization Society of the Valves & Fittings Industry, Inc.** — A committee of manufacturers that develops technical codes and standards for the valve & fitting industry.
- 
NACE **National Association of Corrosion Engineers** — Equips society to protect people, assets and the environment from the adverse effects of corrosion.
- 
NSF **NSF International** — An organization committed to public health that writes standards and certifies products for food, water and consumer products.
- 
SDWA **The Safe Drinking Water Act** — Is the main federal law that ensures the quality of Americans' drinking water. Under SDWA, EPA sets standards for drinking water quality and oversees the states, localities, and water suppliers who implement those standards. Weighted average lead content of water contact components must be 0.25% or less.
- 
UL **Underwriter's Laboratory** — Tests and qualifies valve and fittings products under UL standards for safety.
- 
UPC **Uniform Plumbing Code** — Developed by the International Association of Plumbing and Mechanical Officials to govern the installation and inspection of plumbing systems as a means of promoting the public's health, safety and welfare.
- 
USC **University of Southern California** — Foundation for Cross-Connection Control and Hydraulic Research that lists approved backflow prevention assemblies.



Sink Strainers

Sink Strainers

MODEL NUMBER	DESCRIPTION	CARTON QUANTITIES	
		INNER	MASTER

SS Stainless Steel Sink Strainers



SS-100	<i>Fits 3-1/2" to 4" Openings</i> Neoprene Stopper, Fixed Stick Post	1	50
SS-102S	Neoprene Stopper, Fixed Stick Post, Satin Nickel Finish	1	50
SS-105	Wing Nuts with Screwdriver Slot for Easy Installation, Brass Slipnut	1	50
SS-111	Double Cup Economy - 1 Piece Construction, Fixed Stick Post	1	50
SS-112	Deep Double Cup - Long Shank, Neoprene Stopper, Fixed Stick Post	1	50
SS-145	Deep Double Cup - Long Shank 3-3/8" Extra Heavy Rubber Washer, Spring Clip Basket with Ribbed Rubber Stopper for Positive Water Seal	1	50
SS-185B	Deep Double Cup - Long Shank, Snap Lock Basket with Ribbed Rubber Washer for Positive Water Seal, Brass Slipnut	1	50
SS-195	Twist & Seal - Metal to Metal Seal, Heavy Die Cast Locknut	1	50
SS-195B	Twist & Seal - Metal to Metal Seal, Heavy Die Cast Locknut, with Brass Slipnut	1	50
SS-400	4-1/2" Flat Top Sink Strainer - Galvanized Locking Shell	1	50



MODEL NUMBER	DESCRIPTION	CARTON QUANTITIES	
		INNER	MASTER

SS Chrome Plated Brass Sink Strainers



SS-125	Stamped Brass - Heavy Die Cast Locknut, Thick 3-3/8" Rubber Washer, Neoprene Stopper, Fixed Stick Post	1	50
SS-175	Cast Brass - Brass Locknut, Chrome Brass Slipnut, Neoprene Stopper	1	25



SS	Stainless Steel Sink Strainers	MODEL NUMBER	DESCRIPTION	CARTON QUANTITIES	
				INNER	MASTER



SS-200



SS-300



SS-605

SS-200	<i>Fits 1-7/8" to 2-1/2" Openings</i> Duplex Strainer with Flat Grid, Zinc Plated Nut	1	100
SS-300	Wash Tray Design with Rubber Stopper	1	100
SS-600	Junior Dual Basket Strainer, Printed Box	1	100
SS-605	Chrome Junior Dual Basket Strainer, Deep Pattern	1	100

SS	Replacement Baskets for Strainers				
----	-----------------------------------	--	--	--	--



SS-500M

SS-500M	Fits All Sink Strainers - Rubber Seals	1	100
SS-510	Fits SS-100, SS-105 & SS-111	10	200
SS-512	Fits SS-112	1	100
SS-525	Fits SS-125	1	100
SS-575	Fits SS-175	1	100
SS-585	Fits SS-185B	1	100
SS-595	Fits SS-195 & SS-195B	1	100
SS-610	Fits SS-600 & SS-6000	1	100
SS-615	Fits SS-605	1	100

Bath & Shower Drains

	MODEL NUMBER	DESCRIPTION	CARTON QUANTITIES	
			INNER	MASTER

TWB Bath Drains - Brass - Gerber Style



<i>Extra Heavy Castings, Brass Nuts, 20 Gauge Tubes</i>				
TWB-100	1-1/2" Trip Lever with Grid Drain	1	12	
TWB-605	1-1/2" Pop-up Drain	1	12	

TWB Bath Drains - White Polypropylene



TWB-150	Trip Lever	1	20	
TWB-250	Lift & Turn	1	20	
TWB-350	Toe Touch	1	20	

TWB Trip Lever Face Plate - Chrome Plated



TWB-FP	Replacement Face Plate for TWB Trip Lever Waste	20	160	
--------	---	----	-----	--

TTD Toe Tap Drain - Chrome Plated



TTD-150	1-1/2" Brass Toe Tap Bath Drain	1	100	
---------	---------------------------------	---	-----	--

LNT Lift & Turn Drain



LNT-151	1-1/2" Drain - Chrome Plated Die Cast	1	100	
---------	---------------------------------------	---	-----	--

413 Standing Waste - Brass



41375	1-1/2" Male	1	10	
41380	1-1/2" Female	1	10	
41390	1-1/2" Male / Female Combination	1	10	



Bath Wastes & Shower Drains

SBW	Parts for Standing Bath Waste	MODEL NUMBER	DESCRIPTION	CARTON QUANTITIES	
				INNER	MASTER

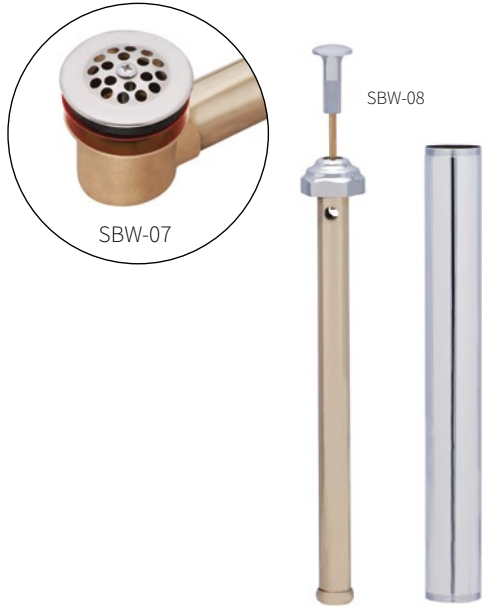

SBW-07	1-1/2" x 18" Standing Waste Shoe	1	24
SBW-08	Plunger Assembly	1	50
SBW-09	Chrome Plated Barrel Only	1	150

SDB/SDP	Shower Drains	MODEL NUMBER	DESCRIPTION	INNER	MASTER
---------	---------------	--------------	-------------	-------	--------



SDB2NC	2" Brass Body No Caulk, Stainless Steel Snap In Grid, Wrench Included	1	20
SDBC-200	2" Die Cast, Brass Plated Body with Stainless Steel Grid, Quick Connect, Rubber Gasket	1	40
SDP2WSS	2" White Plastic Body with Stainless Steel Grid, Quick Caulk, Wrench Included	1	40
SDP2WSW	2" White Plastic Solvent Weld with Stainless Steel Grid	1	40
SDPVC2	PVC With Adjustable Strainer With Stainless Steel Grid	1	1



Pop Up & Grid Drain Assemblies

Pop Up & Grid Drain Assemblies

SS Pop Ups & P.O. Plugs



MODEL NUMBER	DESCRIPTION	CARTON QUANTITIES	
		INNER	MASTER
FY-925	<i>Cast Brass - Chrome Plated</i> Two Piece P.O. Plug with Chain & Stopper Cast Top with 4" Tail Piece, Chrome Brass Nut	1	50
FY-950	<i>Chrome</i> With Lift Rod	1	24
FY-950BN	<i>Brushed Nickel</i> With Lift Rod	1	24

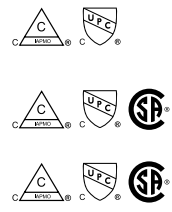

FY Cast Brass Grid Drain Assemblies - Chrome Plated



MODEL NUMBER	DESCRIPTION	CARTON QUANTITIES	
		INNER	MASTER
FY-155	Cast Brass Grid Drain with 4" 17 Gauge Tail Piece, Brass Nut 6" Tail Piece Available (FY-155TP)	1	50
FY-156	Cast Brass Grid Drain with 6" 17 Gauge Tail Piece, Brass Nut	1	100
FY-159WC	Offset Wheelchair Drain, 17 Gauge Tubing	1	20



TRAP	Semi Cast Brass P Traps - Chrome	MODEL NUMBER	DESCRIPTION	CARTON QUANTITIES	
				INNER	MASTER



TRAP-0606SC	<i>J-Bend, 17 Gauge Wall Bend, with Brass Coupling Nut & Flange</i> 1-1/4" x 1-1/4"	1	24
TRAP-0706SC	1-1/2" x 1-1/4"	1	24
TRAP-0707SC	1-1/2" x 1-1/2"	1	24

TRAP	Cast Brass Traps	MODEL NUMBER	DESCRIPTION	CARTON QUANTITIES	
				INNER	MASTER



TRAP-A	<i>Chrome LA Trap, IPS</i> With Cleanout, 1-1/2" x 1-1/4"	1	20
TRAP-B	Less Cleanout, 1-1/2" x 1-1/4"	1	20
TRAP-C	<i>Rough Brass LA Trap, Sweat</i> Less Cleanout, 1-1/2" x 1-1/2"	1	20
TRAP-D	<i>Rough Brass LA Trap, IPS</i> With Cleanout, 1-1/2" x 1-1/4"	1	20
TRAP-E	Less Cleanout, 1-1/2" x 1-1/2"	1	20
TRAP-F	<i>Rough Brass NY Trap, IPS</i> With Cleanout, 1-1/2" x 1-1/4"	1	20
TRAP-G	<i>Chrome NY Trap, IPS</i> With Cleanout, 1-1/2" x 1-1/4"	1	20
TRAP-H	<i>Rough Brass NY Trap, IPS</i> With Cleanout, 2" x 1-1/2"	1	20

Traps

Traps

TRAP	Cast Brass Traps	MODEL NUMBER	DESCRIPTION	CARTON QUANTITIES	
				INNER	MASTER



TRAP-J



TRAP-L



TRAP-M



TRAP-N





TRAP-Q

TRAP-J	<i>Rough Brass Swing Tee Trap With Cleanout, 2" x 1-1/2"</i>	1	25
TRAP-L	<i>Rough Brass Low Seal Trap, IPS With Cleanout, 1-1/2" x 1-1/2"</i>	1	25
TRAP-M	<i>Chrome NY Trap, IPS With Cleanout, 2" x 1-1/2"</i>	1	25
TRAP-N	<i>Rough Brass LA Trap, IPS With Cleanout, 2" x 1-1/2"</i>	1	20
TRAP-Q	<i>Rough Brass LA Trap, Sweet With Cleanout, 2" x 1-1/2"</i>	1	15





DWV Traps, Cleanouts & Wyes

PTRAP	DWV P Traps - CxC	MODEL NUMBER	DESCRIPTION	CARTON QUANTITIES	
				INNER	MASTER
 <p>PTRAP07L PTRAP08W</p>	PTRAP07L	1-1/2" Less Cleanout	1	25	
	PTRAP07W	1-1/2" With Cleanout	1	20	
	PTRAP08L	2" Less Cleanout	1	20	
	PTRAP08W	2" With Cleanout	1	20	

COT	DWV Dandy Cleanout Tees with Plug	MODEL NUMBER	DESCRIPTION	INNER	MASTER
 <p>COT08</p>	COT07	1-1/2"	5	50	
	COT08	2"	5	50	

CO	Flush Cleanouts	MODEL NUMBER	DESCRIPTION	INNER	MASTER
 <p>CO-200</p>	CO-150	1-1/2"	1	180	
	CO-200	2"	1	150	

DWVY	Cast Brass DWV Wyes - CxC	MODEL NUMBER	DESCRIPTION	INNER	MASTER
 <p>DWVY-08</p>	DWVY-07	1-1/2"	5	60	
	DWVY-08	2"	1	40	

DWV	Cast Brass DWV Trap Adapters	MODEL NUMBER	DESCRIPTION	INNER	MASTER
 <p>DWV-07TA</p>	DWV-07TA	1-1/2" SWT x Slip	12	120	
	DWV-07A	1-1/2" SWT x Male Bushing	25	100	
	DWV-08A	2" SWT x Male Bushing	25	100	



Plain Bend, Dishwasher Tailpiece, Tubular P-Trap & S-Trap

MODEL NUMBER	DESCRIPTION	CARTON QUANTITIES	
		INNER	MASTER

PB Plain Bend



PB071212RB17	1-1/2" x 12" x 12" Rough Brass, 17 Gauge	1	25
PB071818RB17	1-1/2" x 12 x 12" Rough Brass, 17 Gauge	1	25

DWT Dishwasher Tailpiece



<i>Solid Brass Slip Nut & Copper Branch</i>			
DWT071203RB22	1-1/2" x 12 x 1/2" Rough Brass, 22 Gauge	1	25
DWT071204RB22	1-1/2" x 12 x 3/4" Rough Brass, 22 Gauge	1	25
DWT071203RB17	1-1/2" x 12 x 1/2" Rough Brass, 17 Gauge	1	25

PTRAP Tubular P-Traps



PTRAP0706CP20CO	1-1/2" x 1-1/4" Chrome Plated, 20 Gauge, With Cleanout	1	25
PTRAP0706CP22	1-1/2" x 1-1/4" Chrome Plated, 22 Gauge, Less Cleanout	1	25
PTRAP0706CP17	1-1/2" x 1-1/4" Chrome Plated, 17 Gauge, Less Cleanout	1	25
PTRAP0706CP17CO	1-1/2" x 1-1/4" Chrome Plated, 17 Gauge, With Cleanout	1	25

STRAP Tubular S-Trap



STRAP0706CP22	1-1/2" x 1-1/4" Chrome Plated, 22 Gauge, Less Cleanout	1	25
---------------	--	---	----



WB Waste Bends

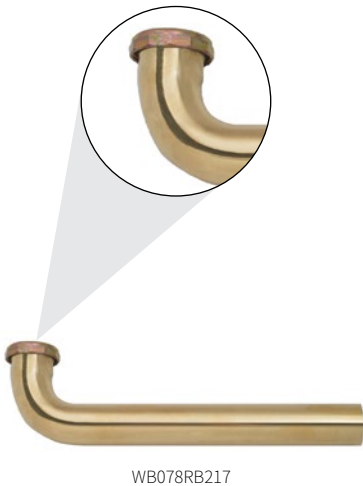
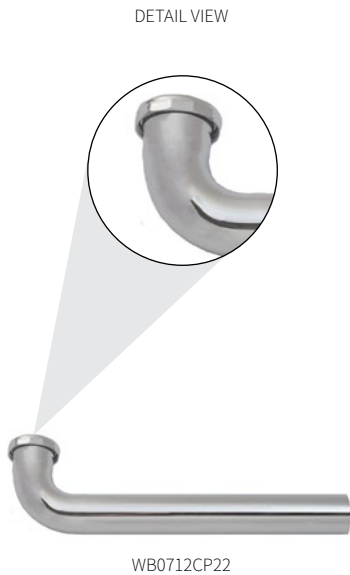

MODEL NUMBER	DESCRIPTION	CARTON QUANTITIES	
		INNER	MASTER
<i>One Zinc Die Cast Slip Nut Attached</i>			
WB076RB22	1-1/2" x 6" Rough Brass, 22 Gauge	1	25
WB078RB22	1-1/2" x 8" Rough Brass, 22 Gauge	1	25
WB0712RB22	1-1/2" x 12" Rough Brass, 22 Gauge	1	25
WB0715RB22	1-1/2" x 12 x 1/2" Rough Brass, 17 Gauge	1	25
WB0718RB22	1-1/2" x 15" Rough Brass, 22 Gauge	1	25
WB0724RB22	1-1/2" x 24" Rough Brass, 22 Gauge	1	25
WB0730RB22	1-1/2" x 30" Rough Brass, 22 Gauge	1	25
WB0736RB22	1-1/2" x 36" Rough Brass, 22 Gauge	1	25
WB0712CP22	1-1/2" x 12" Chrome Plated, 22 Gauge	1	25
WB0718CP22	1-1/2" x 18" Chrome Plated, 22 Gauge	1	25
WB0724CP22	1-1/2" x 24" Chrome Plated, 22 Gauge	1	25
<i>One Brass Slip Nut Attached</i>			
WB078RB17	1-1/2" x 8" Rough Brass, 17 Gauge	1	25
WB0712RB17	1-1/2" x 12" Rough Brass, 17 Gauge	1	25
WB0715RB17	1-1/2" x 15" Rough Brass, 17 Gauge	1	25
WB0718RB17	1-1/2" x 18" Rough Brass, 17 Gauge	1	25
WB0724RB17	1-1/2" x 24" Rough Brass, 17 Gauge	1	25
WB0712CP17	1-1/2" x 12" Chrome Plated, 17 Gauge	1	25



Milwaukee Trap, Double Waste Bend & Slip Joint Elbow

Tubular Products

MTRAP	Milwaukee Traps	MODEL NUMBER	DESCRIPTION	CARTON QUANTITIES	
				INNER	MASTER



MTRAP0706CP17CO



MTRAP0706CP20

MTRAP0706CP17CO	1-1/2" x 1-1/4" Chrome Plated, 17 Gauge, With Cleanout	1	25
MTRAP0706CP20	1-1/2" x 1-1/4" Chrome Plated, 20 Gauge, Less Cleanout	1	25

DWB	Double Waste Bends		
-----	--------------------	--	--

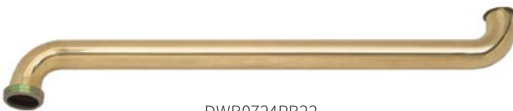

DWB0724RB22

<i>One Zinc Die Cast Slip Nut Attached</i>			
DWB0724RB22	1-1/2" x 24" Rough Brass, 22 Gauge	1	25
<i>One Brass Slip Nut Attached</i>			
DWB0724RB17	1-1/2" x 24" Rough Brass, 17 Gauge	1	25

SJL	Slip Joint Elbows		
-----	-------------------	--	--



SJL066CP22

<i>Two Zinc Die Cast Slip Nuts Attached</i>			
SJL066CP22	1-1/4" x 6" Chrome Plated, 22 Gauge	1	25
SJL068CP22	1-1/4" x 8" Chrome Plated, 22 Gauge	1	25
SJL0612CP22	1-1/4" x 12" Chrome Plated, 22 Gauge	1	25
<i>Two Brass Slip Nuts Attached</i>			
SJL066CP17	1-1/4" x 6" Chrome Plated, 17 Gauge	1	25
SJL068CP17	1-1/4" x 8" Chrome Plated, 17 Gauge	1	25
SJL0612CP17	1-1/4" x 12" Chrome Plated, 17 Gauge	1	25



Direct Connect Waste Bend & Double Offset

Tubular Products

DCWB	Direct Connect Waste Bends	MODEL NUMBER	DESCRIPTION	CARTON QUANTITIES	
				INNER	MASTER
 <p>DCWB0712RB22</p> <p>DCWB0712CP22</p>	DCWB0712RB22	1-1/2" x 12" Rough Brass, 22 Gauge	1	25	
	DCWB0715RB22	1-1/2" x 15" Rough Brass, 22 Gauge	1	25	
	DCWB0718RB22	1-1/2" x 18" Rough Brass, 22 Gauge	1	25	
	DCWB0724RB22	1-1/2" x 24" Rough Brass, 22 Gauge	1	25	
	DCWB0712CP22	1-1/2" x 12" Chrome Plated, 22 Gauge	1	25	
	DCWB0712RB17	1-1/2" x 12" Rough Brass, 17 Gauge	1	25	
	DCWB0715RB17	1-1/2" x 15" Rough Brass, 17 Gauge	1	25	
	DCWB0718RB17	1-1/2" x 18" Rough Brass, 17 Gauge	1	25	
	DCWB0712CP17	1-1/2" x 12" Chrome Plated, 17 Gauge	1	25	

FT	Flanged Tailpiece	MODEL NUMBER	DESCRIPTION	INNER	MASTER
 <p>FT078RB22</p>	FT078RB22	1-1/2" x 12" Rough Brass, 22 Gauge	1	25	
	FT0712RB22	1-1/2" x 15" Rough Brass, 22 Gauge	1	25	
	FT0718RB22	1-1/2" x 18" Rough Brass, 22 Gauge	1	25	
	FT0724RB22	1-1/2" x 24" Rough Brass, 22 Gauge	1	25	
	FT0712CP22	1-1/2" x 12" Chrome Plated, 22 Gauge	1	25	
	FT0708RB17	1-1/2" x 8" Rough Brass, 17 Gauge	1	25	
	FT0712RB17	1-1/2" x 12" Rough Brass, 17 Gauge	1	25	
	FT0712CP17	1-1/2" x 12" Chrome Plated, 17 Gauge	1	25	
	FT0718RB17	1-1/2" x 18" Rough Brass, 17 Gauge	1	25	

DO	Double Offset	MODEL NUMBER	DESCRIPTION	INNER	MASTER
 <p>DO0712RB22</p> <p>DO0612CP17</p>	<i>Two Zinc Die Cast Slip Nuts Attached</i>				
	DO0612CP22	1-1/4" x 12" Chrome Plated, 22 Gauge	1	25	
	DO0712RB22	1-1/2" x 12" Rough Brass, 22 Gauge	1	25	
	DO0712CP22	1-1/2" x 12" Chrome Plated, 22 Gauge	1	25	
	<i>Two Brass Slip Nuts Attached</i>				
	DO0612CP17	1-1/4" x 12" Chrome Plated, 17 Gauge	1	25	
	DO0712RB17	1-1/2" x 12" Rough Brass, 17 Gauge	1	25	
	DO0712CP17	1-1/2" x 12" Chrome Plated, 17 Gauge	1	25	





Threaded Tube & Slip Joint Ext.

TT	Threaded Tube	MODEL NUMBER	DESCRIPTION	CARTON QUANTITIES	
				INNER	MASTER
 <p>TT078RB22</p> <p>TT068CP17</p>	TT068CP22	1-1/4" x 8" Chrome Plated, 22 Gauge	1	25	
	TT0612CP22	1-1/4" x 12" Chrome Plated, 22 Gauge	1	25	
	TT0618CP22	1-1/4" x 18" Chrome Plated, 22 Gauge	1	25	
	TT0712CP22	1-1/2" x 12" Chrome Plated, 22 Gauge	1	25	
	TT078RB22	1-1/2" x 8" Rough Brass, 22 Gauge	1	25	
	TT0712RB22	1-1/2" x 12" Rough Brass, 22 Gauge	1	25	
	TT0718RB22	1-1/2" x 18" Rough Brass, 22 Gauge	1	25	
	TT068CP17	1-1/4" x 8" Chrome Plated, 17 Gauge	1	25	
	TT0612CP17	1-1/4" x 12" Chrome Plated, 17 Gauge	1	25	
	TT0618CP17	1-1/4" x 18" Chrome Plated, 17 Gauge	1	25	
	TT0712CP17	1-1/2" x 12" Chrome Plated, 17 Gauge	1	25	
	TT078RB17	1-1/2" x 8" Rough Brass, 17 Gauge	1	25	
	TT0712RB17	1-1/2" x 12" Rough Brass, 17 Gauge	1	25	
	TT0718RB17	1-1/2" x 18" Rough Brass, 17 Gauge	1	25	

SJX	Slip Joint Extensions	MODEL NUMBER	DESCRIPTION	CARTON QUANTITIES	
				INNER	MASTER
 <p>SJX068CP22</p> <p>SJX078RB22</p>	<i>One Zinc Die Cast Slip Nut Attached</i>				
	SJX068CP22	1-1/4" x 8" Chrome Plated, 22 Gauge	1	25	
	SJX0612CP22	1-1/4" x 12" Chrome Plated, 22 Gauge	1	25	
	SJX0618CP22	1-1/4" x 18" Chrome Plated, 22 Gauge	1	25	
	SJX0712CP22	1-1/2" x 12" Chrome Plated, 22 Gauge	1	25	
	SJX078RB22	1-1/2" x 8" Rough Brass, 22 Gauge	1	25	
	SJX0712RB22	1-1/2" x 12" Rough Brass, 22 Gauge	1	25	
	SJX0718RB22	1-1/2" x 18" Rough Brass, 22 Gauge	1	25	
	<i>One Brass Slip Nut Attached</i>				
	SJX0612CP17	1-1/4" x 12" Chrome Plated, 17 Gauge	1	25	
	SJX0712RB17	1-1/2" x 12" Rough Brass, 17 Gauge	1	25	



Slip Nuts & Copper Stub Out Elbows

NT	Slip Nuts	MODEL NUMBER	DESCRIPTION	CARTON QUANTITIES	
				INNER	MASTER
<i>Solid Brass Chrome</i>					
		NT-125C	1-1/4" x 1-1/4"	250	500
		NT-152C	1-1/2" x 1-1/4"	250	500
		NT-155C	1-1/2" x 1-1/2"	250	500
<i>Solid Brass Chrome</i>					
		NT-125R	1-1/4" x 1-1/4"	250	500
		NT-152R	1-1/2" x 1-1/4"	250	500
		NT-155R	1-1/2" x 1-1/2"	250	500
<i>Solid Brass Chrome</i>					
		NT-125DCC	1-1/4" x 1-1/4"	250	500
		NT-152DCC	1-1/2" x 1-1/4"	200	400
		NT-155DCC	1-1/2" x 1-1/2"	200	400
<i>Solid Brass Chrome</i>					
		NT-125DCR	1-1/4" x 1-1/4"	250	500
		NT-152DCR	1-1/2" x 1-1/4"	200	400
		NT-155DCR	1-1/2" x 1-1/2"	250	500

CSOL	Copper Stub Out Elbows	MODEL NUMBER	DESCRIPTION	INNER	MASTER
		CSOL-036PXWP	1/2" x 3-1/2" x 6" F1807 PEX With Wall Plate	1	80
		CSOL-038PX	1/2" x 3-1/2" x 8" F1807 PEX	1	120
		CSOL-038PXWP	1/2" x 3-1/2" x 8" F1807 PEX With Wall Plate	1	60
		CSOL-038PXCE	1/2" x 3-1/2" x 8" F1960 CE PEX	25	50
		CSOL-038PXCEWP	1/2" x 3-1/2" x 8" F1960 CE PEX With Wall Plate	25	25



Multi-Turn Supply Valves

MODEL NUMBER	DESCRIPTION	CARTON QUANTITIES	
		INNER	MASTER

29LF Lead Free Supply Valves - Oval Handle With Compression Outlet - Angle



29-1001LF



29-1003PXLF



29-1009LF



29-1015LF



29-1019LF



29-1019CPVCLF

125 PSI - NSF/ANSI/CAN 61-2023

29-1001LF	CP 3/8" FIP x 3/8" OD Compression	10	200
29-1003LF	CP 1/2" FIP x 3/8" OD Compression	10	200
29-1003PXLF	CP 1/2" PEX x 3/8" OD Compression	10	200
29-1003BLF	Unplated 1/2" FIP x 3/8" OD Compression	10	200
29-1009LF	CP 1/2" SWT x 3/8" OD Compression	10	200
29-1009LF	Unplated 1/2" SWT x 3/8" OD Compression	10	200
29-1009BLF	CP 1/2"C x 1/4" OD Compression	10	200
29-1015LF	Unplated 1/2" C x 1/4" OD Compression	10	200
29-1015BLF	CP 5/8" OD Compression x 3/8" OD Compression	10	200
29-1019LF	Unplated 5/8" OD Compression x 3/8" OD Compression	10	200
29-1019BLF	Unplated 5/8" OD Compression x 3/8" OD Compression	10	200
29-1019CPVCLF	CP 5/8" OD CPVC x 3/8" OD	10	200
29-1019BLF	Unplated 5/8" OD Compression x 3/8" OD Compression	10	200



29LF Lead Free Supply Valves - Oval Handle With Compression Outlet - Angle



29-1004LF



29-1004PXLF



29-1010 LF



29-1010BLF



29-1014LF



29-1014CPVCLF

125 PSI - NSF/ANSI/CAN 61-2023

29-1002LF	CP 3/8" FIP x 3/8" OD Compression	10	200
29-1004LF	CP 1/2" FIP x 3/8" OD Compression	10	200
29-1004PXLF	CP 1/2" PEX x 3/8" OD Compression	10	200
29-1010LF	CP 1/2" SWT x 3/8" OD Compression	10	200
29-1010BLF	Unplated 1/2" SWT x 3/8" OD Compression	10	200
29-1014LF	CP 5/8" OD Compression x 3/8" OD Compression	10	200
29-1014CPVCLF	CP 5/8"C x 3/8" OD Straight Stop	10	200
29-1575LF	CP 5/8" OD Compression x 5/8" OD Compression	10	200



Multi-Turn Supply Valves

29LF Lead Free Supply Valves - With Compression Outlet - Angle



29-1040LF



29-1041LF

MODEL NUMBER	DESCRIPTION	CARTON QUANTITIES	
		INNER	MASTER
<i>125 PSI - With 5" Extension and Bell Escutcheon - NSF/ANSI/CAN 61-2023</i>			
29-1040LF	CP 1/2" SWT x 3/8" OD Compression - Angle	10	100
29-1004LF	CP 1/2" SWT x 3/8" OD Compression - Straight	10	100



29LF Lead Free Supply Valves - Loose Key With Compression Outlet - Angle



29-1001LKLF



29-1003LKLF



29-1009LKLF

<i>125 PSI - NSF/ANSI/CAN 61-2023</i>			
29-1001LKLF	CP 3/8" FIP x 3/8" OD Compression	10	200
29-1003LKLF	CP 1/2" FIP x 3/8" OD Compression	10	200
29-1009LKLF	CP 1/2" C x 3/8" OD Compression	10	200



29LF Lead Free Supply Valves - With Dual Compression Outlet - Angle



29-2001PXLF



29-2003LF



29-2003BLF

<i>125 PSI - NSF/ANSI/CAN 61-2023</i>			
29-2001LF	CP 5/8" OD x 3/8" OD x 3/8" OD	10	200
29-2001BLF	Unplated 5/8" OD x 3/8" OD x 3/8" OD	10	200
29-2001PXLF	CP 1/2" PEX x 3/8" OD Compression x 3/8" OD Compression	10	200
29-2003LF	CP 1/2" FIP x 3/8" OD x 3/8" OD Compression	10	200
29-2003BLF	Unplated 1/2" FIP x 3/8" OD x 3/8" OD Compression	10	200



Supply Valves



Quarter Turn Supply Valves

MODEL NUMBER	DESCRIPTION	CARTON QUANTITIES	
		INNER	MASTER

26LF Lead Free Supply Valves - With Compression Outlet - Angle



125 PSI - NSF/ANSI/CAN 61-2023			
26-1001LF	CP 3/8" FIP x 3/8" OD Compression	10	200
26-1003LF	CP 1/2" FIP x 3/8" OD Compression	10	200
26-1003PXLF	CP 1/2" PEX x 3/8" OD Compression	10	200
26-1009LF	CP 1/2" Sweat x 3/8" OD Compression	10	200
26-1009BLF	Unplated 1/2" Sweat x 3/8" OD Compression	10	200
26-1015PXLF	CP 1/2" PEX x 1/4" OD Compression	10	200
26-1017LF	CP 5/8" OD x 1/4" OD Compression	10	200
26-1019LF	CP 5/8" OD Compression x 3/8" OD Compression	10	200
26-1019BLF	Unplated 5/8" OD Compression x 3/8" OD Compression	10	200
26-1019CPVCLF	CP 5/8" OD CPVC Compression x 3/8" OD Compression	10	200
26-1023LF	CP 5/8" OD x 1/2" OD Compression	10	200



26LF Lead Free Supply Valves - With Compression Outlet - Straight



125 PSI - NSF/ANSI/CAN 61-2023			
26-1002LF	CP 3/8" FIP x 3/8" OD Compression	10	200
26-1004LF	CP 1/2" FIP x 3/8" OD Compression	10	200
26-1004PXLF	CP 1/2" PEX x 3/8" OD Compression	10	200
26-1010LF	CP 1/2" Sweat x 3/8" OD Compression	10	200
26-1010BLF	Unplated 1/2" Sweat x 3/8" OD Compression	10	200
26-1012PXLF	CP 1/2" PEX x 1/2" PEX	10	200
26-1014LF	CP 5/8" OD Compression x 3/8" OD Compression	10	200
26-1014CPVCLF	CP 5/8" OD CPVC Compression x 3/8" OD Compression	10	200
26-1016LF	CP 1/2" PEX x 1/4" OD Compression	10	200



Quarter Turn Supply Valves

MODEL NUMBER	DESCRIPTION	CARTON QUANTITIES	
		INNER	MASTER

26LF Lead Free Supply Valves - With Compression Outlet - F1960



26-1003PXCELF



26-1015PXCELF



26-1004PXCELF



26-1016PXCELF

125 PSI - NSF/ANSI/CAN 61-2023

26-1003PXCELF	CP 1/2" CE PEX x 3/8" OD Compression - Angle	10	100
26-1015PXCELF	CP 1/2" CE PEX x 1/4" OD Compression - Angle	10	100
26-104PXCELF	CP 1/2" CE PEX x 3/8" OD Compression - Straight	10	100
26-1016PXCELF	CP 1/2" CE PEX x 1/4" OD Compression - Straight	10	100



26LF Lead Free Supply Valves - With Compression Outlet



26-1041LF



26-1040LF

125 PSI - With 5" Extension and Bell Escutcheon - NSF/ANSI/CAN 61-2023

26-1041LF	CP 1/2" Sweat x 3/8" OD Compression - Angle	10	100
26-1040LF	CP 1/2" Sweat x 3/8" OD Compression - Straight	10	100



26LF Lead Free Supply Valves - With Compression Outlet - Angle



26-2001LF



26-2021BLF

125 PSI - NSF/ANSI/CAN 61-2023

26-2001LF	CP 5/8" OD Compression x 3/8" OD Compression	10	200
26-2001BLF	Unplated 5/8" OD Compression x 3/8" OD Compression	10	200
26-2009BLF	Unplated 1/2" C x 3/8" OD x 3/8" OD Compression	10	200
26-2021BLF	Unplated 5/8" OD x 3/8" OD x 1/4" OD Compression	10	200



Quarter Turn Supply Valves

MODEL NUMBER	DESCRIPTION	CARTON QUANTITIES	
		INNER	MASTER

26LF Lead Free Supply Valves - With Compression Outlet - Press



125 PSI - NSF/ANSI/CAN 61-2023			
26-1003PLF	CP 1/2" Press x 3/8" OD Compression - Angle	24	96
26-1004PLF	CP 1/2" Press x 3/8" OD Compression - Straight	24	96
26-2009PLF	CP 1/2" Press x 3/8" OD Compression x 3/8" OD Compression	10	100
26-1015PLF	CP 1/2" Press x 1/4" OD Compression - Angle	24	96
26-1016PLF	CP 1/2" Press x 1/4" OD Compression - Straight	24	96
26-2021PLF	CP 1/2" Press x 3/8" OD Compression x 1/4" OD Compression	10	200



26LF Lead Free Supply Valves - With Compression Outlet - Push



125 PSI - Compatible with Copper Tube, PEX, & CPVC - NSF/ANSI/CAN 61-2023			
26-1003PCLF	CP 1/2" Push x 3/8" OD Compression - Angle	24	96
26-1015PCLF	CP 1/2" Push x 1/4" OD Compression - Angle	24	96
26-2003PCLF	CP 1/2" Push x 3/8" OD Compression x 3/8" OD Compression	24	96
26-1004PCLF	CP 1/2" Push x 3/8" OD Compression - Straight	24	96
26-1016PCLF	CP 1/2" Push x 1/4" OD Compression - Straight	24	96
26-PCRT	Push Connect Removal Tool Available		



26LF Lead Free Supply Valves - With Dual Outlet & Dual Handle - Angle



125 PSI - NSF/ANSI/CAN 61-2023			
26-2022LF	1/2" Nom Compression Inlet x 3/8" OD Compression x 3/8" OD Compression	10	100



25LF Lead Free Supply Valve - With Compression Outlet - Straight - Retro-Fit



125 PSI - NSF/ANSI/CAN 61-2023			
25-2000LF	CP 3/8" OD Captured Nut x 3/8" OD Compression	10	200



Water Supply Connectors

MODEL NUMBER	DESCRIPTION	CARTON QUANTITIES	
		INNER	MASTER

DDFLF Lead Free Braided Stainless Steel Supply Connectors - Delta Style



DDFLF

3/8" Compression x 3/8" Compression, With Nut & Ferrule - NSF/ANSI/CAN 61-2022

DDF-12LF	12" Long	1	100
DDF-20LF	20" Long	1	100

SSFLF Lead Free Braided Stainless Steel Supply Connectors - Delta Style



SSFLF

3/8" Compression x 3/8" Compression, With Nut & Ferrule - NSF/ANSI/CAN 61-2022

SSF-12LF	12" Long	1	100
SSF-16LF	16" Long	1	100
SSF-20LF	20" Long	1	100
SSF-30LF	30" Long	1	100
SSF-36LF	36" Long	1	100
<i>1/2" Compression x 1/2" FIP, With Chrome Brass Nut - NSF/ANSI/CAN 61-2022</i>			
SSF-0315LF	15" Long	25	100
SSF-0336LF	36" Long	10	40
SSF-0348LF	48" Long	10	40

SSMLF Lead Free Braided Stainless Steel Supply Connectors



SSMLF

3/8" Compression x 3/8" Compression - NSF/ANSI/CAN 61-2022

SSM-12LF	12" Long	25	100
SSM-16LF	16" Long	25	100
SSM-20LF	20" Long	25	100

VFLF Lead Free Vinyl Reinforced Supply Connectors



VFC-0360LF

1/2" IPS x 1/2" IPS, With Brass Nut - NSF/ANSI/CAN 61-2022

VFB-0320LF	Faucet Tube, 20" Long	25	100
VFB-0348LF	Faucet Tube, 48" Long	10	40

3/8" Compression x 1/2" IPS, With Brass Nut - NSF/ANSI/CAN 61-2022

VFB-12LF	Faucet Tube, 12" Long	25	100
----------	-----------------------	----	-----

3/8" IPS x 1/2" IPS, With Celcon Nut - NSF/ANSI/CAN 61-2022

VFC-0212LF	12" Long	25	100
VFC-0220LF	20" Long	25	100
VFC-0230LF	30" Long	25	100
VFC-0236LF	36" Long	25	100

3/8" Compression x 1/2" IPS, With Brass Nut - NSF/ANSI/CAN 61-2022

VFC-0312LF	12" Long	25	100
VFC-0316LF	16" Long	25	100
VFC-0320LF	20" Long	25	100
VFC-0324LF	24" Long	25	100
VFC-0336LF	36" Long	25	40
VFC-0348LF	48" Long	25	40
VFC-0360LF	60" Long	25	40

APPROVALS FOR PRODUCTS
ON PAGE 23



Water Supply Connectors

MODEL NUMBER	DESCRIPTION	CARTON QUANTITIES	
		INNER	MASTER

SSDWLF Lead Free Braided Stainless Steel Dishwasher Connectors



SSDWLF

3/8" OD Compression, With 90° Brass Elbow - NSF/ANSI/CAN 61-2022

SSDW-36LF	36" Long	1	40
SSDW-48LF	48" Long	1	40
SSDW-60LF	60" Long	1	40
SSDW-72LF	72" Long	1	40

For Dishwasher Connector With Garden Hose Elbow Use Part Number SSDWL



DWLLF Lead Free Dishwasher Fitting



DWLLF

DWLLF	3/8" OD Compression x 3/4" Garden Hose Swivel - Bulk	10	200
-------	--	----	-----

VDWBLF Lead Free Vinyl Dishwasher Connectors



VDWB-60LF

3/8" Compression x 1/2" FIP, With Chrome Brass Nuts - NSF/ANSI/CAN 61-2022

VDWB-60LF	60" Long, With 3/8" Elbow	10	40
VDWB-60LELF	60" Long, Less Elbow	10	40



SSIMLF Lead Free Braided Stainless Steel Ice Maker Connectors



SSIM-60LF

1/4" Compression x 1/4" OD Compression - NSF/ANSI/CAN 61-2022

SSIM-60LF	60" Long	10	40
SSIM-72LF	72" Long	10	40
SSIM-96LF	96" Long	10	40



VIMKLF Lead Free Vinyl Reinforced Ice Maker Connectors



VIMK-60LF

1/4" OD - NSF/ANSI/CAN 61-2022

VIMK-60LF	60" Long	10	40
VIMK-72LF	72" Long	10	40



SST Braided Stainless Steel Closet Connectors



SST-M

SST-P

3/8" Compression x 7/8" Ballock, With Chrome Brass Nuts - NSF/ANSI 14-2010a

SST-09M	9" Long	1	100
SST-12M	12" Long	1	100
SST-16M	16" Long	1	100
SST-20M	20" Long	1	100

1/2" Compression x 7/8" Ballock, With Chrome Brass Nuts - NSF/ANSI 14-2010a

SST-09M	9" Long	25	10
---------	---------	----	----

3/8" Compression x 7/8" Ballock, With Plastic Nuts - NSF/ANSI 14-2010a

SST-09P	9" Long	1	100
SST-12P	12" Long	1	100
SST-16P	16" Long	1	100





Water Supply Connectors

	MODEL NUMBER	DESCRIPTION	CARTON QUANTITIES		
			INNER	MASTER	
VTC	Vinyl Reinforced Tank Connectors				
 VTC-0312	<i>1/2" IPS x 7/8" OD, With Celcon Nut - NSF/ANSI 14-2010a</i>				
	VTC-0312	Tank Tube, 12" Long	25	100	
	<i>3/8" IPS x 7/8" OD, With Celcon Nut - NSF/ANSI 14-2010a</i>				
	VTC-0212	Tank Tube, 12" Long	25	100	
	VTC-0220	Tank Tube, 20" Long	25	100	

VTB	Vinyl Reinforced Tank Connectors				
 VTB-039	<i>1/2" FIP x 7/8", With Chrome Brass Nut - NSF/ANSI 14-2010a</i>				
	VTB-039	Tank Tube, 9" Long	25	100	

SSWM	Braided Stainless Steel Washing Machine Connectors				
 SSWM-48	<i>3/4" FHT x 3/4" FHT - NSF/ANSI 14-2010a</i>				
	SSWM-48	48" Long	10	40	
	SSWM-60	60" Long	10	40	
	SSWM-72	72" Long	10	40	

SSWHLF	Lead Free Braided Stainless Steel Flexible Water Heater Connectors				
 SSWH-18LF	<i>3/4" FIP - NSF/ANSI 14-2010a</i>				
	SSWH-12LF	12" Long	10	40	
	SSWH-18LF	18" Long	10	40	
	SSWH-24LF	24" Long	10	40	

SSCWHLF	Lead Free Braided Stainless Steel Flexible Water Heater Connectors - Corrugated				
 SSCWH-18LF	<i>3/4" FIP - NSF/ANSI 14-2010a</i>				
	SSCWH-12LF	12" Long	10	40	
	SSCWH-18LF	18" Long	10	40	
	SSCWH-24LF	24" Long	10	40	

SSCWHPXLF	Lead Free PEX Braided Stainless Steel Flexible Water Heater Connectors - Corrugated				
 SSCWH-18PXLF	<i>3/4" FIP x 3/4" PEX - NSF/ANSI 14-2010a</i>				
	SSCWH-18PXLF	18" Long	10	40	
	SSCWH-24PXLF	24" Long	10	40	

SSCWHPXCELf	Lead Free Cold Expansion PEX Braided Stainless Steel Flexible Water Heater Connectors - Corrugated				
 SSCWH-18PXCELf	<i>3/4" FIP x 3/4" Cold Expansion PEX - NSF/ANSI 14-2010a</i>				
	SSCWH-18PXCELf	18" Long	10	40	
	SSCWH-24PXCELf	24" Long	10	40	



Showerheads

Showerheads

S	Water Miser Showerheads	MODEL NUMBER	DESCRIPTION	CARTON QUANTITIES	
				INNER	MASTER
		<i>Chrome, 2.0 GPM</i>			
		S-050	1"	1	200



S	Standard Showerheads - Single Function	MODEL NUMBER	DESCRIPTION	CARTON QUANTITIES	
				INNER	MASTER
		S-100	2" Chrome	1	200
		S-105	2" Chrome	1	200
		S-1025	2" Chrome	1	200
		S-125S	2" Brushed Nickel	1	200
		<i>Watersaver With Pressure Compensating Flow Restrictor, 1.5 GPM @ 80 PSI</i>			
		S-125F	2" Chrome	1	200



S	Adjustable Metal Showerheads	MODEL NUMBER	DESCRIPTION	CARTON QUANTITIES	
				INNER	MASTER
		<i>2.0 GPM</i>			
		S-200	2" - 4 Outlets - Chrome	1	100
		S-300	3" - 6 Outlets - Chrome	1	50
		S-400	2" - Chrome	1	100
		S500	3" - Chrome	1	50
		S-500BN	3" - Brushed Nickel	1	50
		S-500L	3" - With Lever - Chrome	10	50



Showerheads, Arms & Flanges

M Massaging Showerhead - 5 Function



M350S

MODEL NUMBER	DESCRIPTION	CARTON QUANTITIES	
		INNER	MASTER
<i>2.5 GPM</i>			
M350	3" - Chrome	1	50
M350S	3" - Brushed Nickel	1	50
<i>Reduced Flow, 1.5 GPM</i>			
M350RF	3" - Chrome	1	50
M350SRF	3" - Brushed Nickel	1	50

S-AB Shower Arms & Flanges - Brass



S-AB6



S-AB6F

S-AB6	6" - Chrome	1	200
S-AB8	8" - Chrome	10	100
S-AB6F	6" - With Flange Chrome	10	200
S-AB8F	8" - With Flange Chrome	10	200



Hand Held Showers & Accessories

MODEL NUMBER	DESCRIPTION	CARTON QUANTITIES	
		INNER	MASTER

AS Hand Shower With Bracket

AS	59" Hose	1	24
----	----------	---	----



CP / VHW Shower Hose



<i>Stainless Steel Hose, Chrome Plated Nuts, With Washer</i>			
CP59	1/2" FIP x 1/2" FIP - 59"	1	100
CP72	1/2" FIP x 1/2" FIP - 72"	1	100
<i>White Reinforced Vinyl Hose, White Plastic End Connector</i>			
VHW72	1/2" FIP x 1/2" FIP - 72"	1	100

DV Diverter For Hand Held Showers - Brass



DV841	Lever Handle - Chrome	10	100
DV841S	Lever Handle - Brushed Nickel	10	100

VC Volume Control For Hand Held Showers



VC841	Chrome Plated Brass	10	200
VC842	Polished Brass	1	200



Tub Spouts & Toilet Tank Accessories

FY Tub Spouts



FY-801B



FY-801DC



FY-802



FY-803DC



FY-804DCS



FY-806DCL

MODEL NUMBER	DESCRIPTION	CARTON QUANTITIES	
		INNER	MASTER
<i>Brass Diverter Spout</i>			
FY-801	3/4" FIP Inlet In Tail - Chrome	1	48
FY-801B	3/4" FIP Inlet In Tail, With Bushing - Chrome	1	48
<i>Die Cast Diverter Spout</i>			
FY-801DC	1/2" FIP Inlet In Nose - Chrome	1	50
<i>Die Cast Diverter Spout</i>			
FY-802	1/2" FIP Inlet In Tail - Chrome	1	48
<i>Die Cast Spout</i>			
FY-803DC	1/2" FIP Inlet In Nose - Chrome	1	50
FY-803DCS	1/2" FIP Inlet In Nose - Brushed Nickel	1	50
<i>Die Cast Slip On Diverter Tub Spout</i>			
FY-804DC	For 1/2" Copper Tubing - Chrome	1	50
FY-804DCS	For 1/2" Copper Tubing - Brushed Nickel	1	50
<i>Die Cast Slip On Diverter Tub Spout</i>			
FY-805DC	For 1/2" Copper Tubing - With Decorative Ring - Chrome	1	50
FY-805DCS	For 1/2" Copper Tubing - With Decorative Ring - Brushed Nickel	1	50
<i>Die Cast Slip On Diverter Garden Tub Spout</i>			
FY-806DCL	For 1/2" Copper Tubing - 5-3/4" Long - Chrome	1	50

T Toilet Tank Accessories



T-250



T-300M

T-250	Brass Douglas Flush Valve With Guide Arm	2	50
<i>Single Action Tank Lever</i>			
T-300M	With Chrome Plated Handle	50	200



Escutcheons

MODEL NUMBER	DESCRIPTION	CARTON QUANTITIES	
		INNER	MASTER

BPF Chrome Plated Steel Escutcheons



BPF

BPF125OD	1-1/4" O.D. Fits Tubular	50	200
BPF150OD	1-1/2" O.D. Fits Tubular	50	200
<i>Box Pattern</i>			
BPFT07	1-1/2" IPS	50	200

ESC Low Pattern Escutcheons - Chrome Plated Steel



ESC

<i>Fits Copper Tube</i>			
ESCC03	1/2"	500	1000
ESCC04	3/4"	500	1000
<i>Fits Iron Pipe</i>			
ESCT02	3/8"	500	1000
ESCT03	1/2"	500	1000
ESCT04	3/4"	500	1000
ESCT05	1"	100	500
ESCT06	1-1/4"	100	500
ESCT07	1-1/2"	100	1000
ESCT08	2"	100	1000

FCP Floor & Ceiling Plates - Chrome Plated Steel



FCP

<i>Fits Copper Tube</i>			
FCPC03	1/2"	12	288
FCPC04	3/4"	12	288
FCPC05	1"	12	288
FCPC06	1-1/4"	12	288
FCPC07	1-1/2"	12	288
<i>Fits Iron Pipe</i>			
FCPT02	3/8"	12	288
FCPT03	1/2"	12	288
FCPT04	3/4"	12	288
FCPT05	1"	12	288
FCPT06	1-1/4"	12	288
FCPT07	1-1/2"	12	288
FCPT08	2"	12	144



CF	Cast Brass Close Flanges	MODEL NUMBER	DESCRIPTION	CARTON QUANTITIES	
				INNER	MASTER



CF-100



CF-200



CF-250



CF-300



CF-400



CF-500

CF-100	4" For Lead	1	50
CF-200	4"x 3" DWV For Sweat	1	50
CF-250	3" DWV Shallow	1	50
CF-300	4" Deep Seal	1	50
CF-400	4"x 3" For Sweat	1	50
CF-500	4" Offset	10	50
62FCLV	Cleveland Code Close Flange	1	50

Close Flanges



Spuds & Saddle Valves

MODEL NUMBER	DESCRIPTION	CARTON QUANTITIES	
		INNER	MASTER

SP Urinal & Closet Spuds - Sact Brass



<i>Urinal Spud With Heavy Mack Washer & Friction Ring</i>			
SP-125	1-1/4" x 1-1/4"	15	150
SP-1275	1-1/4" x 3/4"	25	150
SP-175	1" x 3/4"	10	200
<i>Closet Spud With Heavy Mack Washer & Friction Ring</i>			
SP-152	1-1/2" x 1-1/4"	25	125
SP-155	1-1/2" x 1-1/2"	25	125
SP-225	2" x 1-1/4"	10	100
SP-250	2" x 1-1/2"	10	100
SP-200	2" x 2"	10	100

Spuds & Saddle Valves

BSV Saddle Valves - Brass

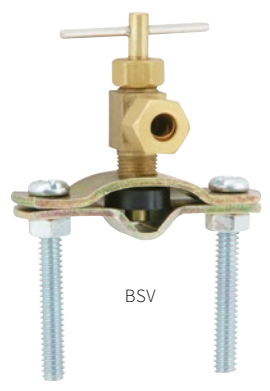

BSV-100	Standard - 1/4" OD Outlet, Fits 3/8" - 1-1/4" Tubing	12	144
BSV-200	Self Piercing - 1/4" OD Outlet, Fits 3/8" - 1-1/4" Tubing	12	144



Washing Machine & Dishwasher Specialties

MODEL NUMBER	DESCRIPTION	CARTON QUANTITIES	
		INNER	MASTER
WMV Washing Machine Valves - 1/4 Turn Shut Off Valve			
<i>Top Handle - Pack of Two (One Hot & One Cold)</i>			
WMV-2PK	3/4" Threaded	1	40
WMVPX-2PK	3/4" PEX	1	40
WMVPXCE-2PK	3/4" Cold Expansion PEX	1	40
WMVP-2PK	3/4" Press	1	40



WMV-2PK



WMVPXCE-2PK



MODEL NUMBER	DESCRIPTION	CARTON QUANTITIES	
		INNER	MASTER
WTI / WTS Washing Machine Tee - Cast Brass			
<i>1-1/2" FIP x 1-1/2" MIP</i>			
WTI-75	3/4" MIP x 1/2" FIP	10	100
WTI-77	3/4" Hose x 1/2" FIP	10	100
WTI-78	3/4" Hose x 1/2" SWT	10	100
<i>1-1/2" MIP x 1-1/2" Slip Joint</i>			
WTS-80	3/4" MIP x 1/2" FIP	10	100
WTS-82	3/4" Hose x 1/2" FIP	10	100



WTI-75



WTS-80

MODEL NUMBER	DESCRIPTION	INNER	MASTER
WSI Washing Machine Valve - Ball Type - Dual Close - Bronze			
WSI-050	Dual 1/2" IPS & Sweat Inlet x Dual Hose Outlet	1	40
WSI-051	Oval 1/2" SWT Inlet x Dual Hose Outlet	1	40



WSI

MODEL NUMBER	DESCRIPTION	CARTON QUANTITIES	
		INNER	MASTER
AG / DDC Dishwasher Accessories			
AG-007	Dishwasher Airgap - Chrome Top	1	50
DDC-100	4 Clamp Dishwasher Disposal Connector	1	200



AG-007



DDC-100



Washing Machine & Dishwasher Specialties



Aerators

AER	Aerators	MODEL NUMBER	DESCRIPTION	CARTON QUANTITIES	
				INNER	MASTER
		AER-05PC	Fits PD-500C, Low Flow, 0.5 GPM - Chrome	1	50
		AER-05PBN	Fits PD-500BN, Low Flow, 0.5 GPM - Brushed Nickel	1	50
		AER-100C	Fits VE & CL Lavatory Faucets, 1.5 GPM - Chrome	1	1
		AER-100BN	Fits CL Lavatory Faucets, 1.5 GPM - Brushed Nickel	1	1
		AER-101C	Fits VE & CL 100 & 200 Series, BL-200 & BL-240 Models, BL 300 Series, PO-320 & PA-320 Models, 2.2 GPM - Chrome	1	1
		AER-101BN	Fits CL 100 & 200 Series, BL-200 & BL-240 Models, BL 300 Series, PO-320 & PA-320 Models, 2.2 GP - Brushed Nickel / Stainless Steel	1	1
		AER-102C	Fits BL-400 & PO-400 Model Faucets, 1.5 GPM - Chrome	1	1
		AER-102BN	Fits BL-400 & PO-400 Model Faucets, 1.5 GPM - Brushed Nickel	1	1
		AER-102ORB	Fits BL-400 & PO-400 Model Faucets, 1.5 GPM - Oil Rubbed Bronze	1	1
		AER-103C	Fits BL-260 & BL-250 Models, PO & PA 200 Series, CR 300 Series, 2.2 GPM - Chrome	1	1
		AER-103BN	Fits BL-260 & BL-250 Models, PO & PA 200 Series, CR 300 Series, 2.2 GPM - Brushed Nickel / Stainless Steel	1	1
		AER-103ORB	Fits BL-260 & BL-250 Models, PO & PA 200 Series, CR 300 Series, 2.2 GPM - Oil Rubbed Bronze	1	1
		AER-104C	Fits BL-480 & PA-480 Models, PD-510 Models, 1.5 GPM - Chrome	1	1
		AER-104BN	Fits BL-480 & PA-480 Models, PD-510 Models, 1.5 GPM - Brushed Nickel	1	1
		AER-104ORB	Fits BL-480 & PA-480 Models, PD-510 Models, 1.5 GPM - Oil Rubbed Bronze	1	1
		AER-105C	Fits PA-300 Models, PD-300 & PD-400 Models, 1.5 GPM - Chrome	1	1
		AER-105BN	Fits PA-300 Models, PD-300 & PD-400 Models, 1.5 GPM - Brushed Nickel/Stainless Steel	1	1
		AER-105ORB	Fits PA-300 Models, PD-300 & PD-400 Models, 1.5 GPM - Oil Rubbed Bronze	1	1
		AER-106C	Fits CR 400 Series, PD-500 Models, 1.5 GPM - Chrome	1	1
		AER-106BN	Fits CR 400 Series, PD-500 Models, 1.5 GPM - Brushed Nickel	1	1
		AER-106ORB	Fits CR 400 Series, PD-500 Models, 1.5 GPM - Oil Rubbed Bronze	1	1
		AERD05	Fits VE & CL Families, Dual Thread Low Flow Aerator, 0.5 GPM - Chrome	1	50
		AERM05S	Regular Male Thread, 15/16, 0.5 GPM - Brushed Nickel	1	50
		AERM10	Regular Male Thread, 15/16, 1.0 GPM - Chrome	1	50
		AERM15	Fits VE & CL Families, Regular Male Thread, 15/16, 1.5 GPM - Chrome	1	50
		AER15	Fits All VE & CL Series Families, Low Flow, 1.5 GPM @ 60 PSI - Chrome	1	1



Bathcocks, Basin Faucets & Drinking Water Faucets

FY / BCL	Bathcock - For Claw Foot Tub	MODEL NUMBER	DESCRIPTION	CARTON QUANTITIES	
				INNER	MASTER
		FY-750	3-3/8" - Chrome	1	24
		FY-775	3-3/8", Brass #3 Bathcock - Chrome	1	24
	<i>Bathcock Elbow</i>				
		BCL-050	1/2" Union x 1/2", Sold as a Pair, 2 Per Box	6	72



FY	Basin Faucet	MODEL NUMBER	DESCRIPTION	CARTON QUANTITIES
		FY-700	With Hot & Cold Index Butons, Removable Seat - Chrome	6 24
		FY-700X	Extra Heavy Pattern, With Hot & Cold Index Butons, With Aerato - Chrome	1 30



Self Closing Valves

MODEL NUMBER	DESCRIPTION	CARTON QUANTITIES	
		INNER	MASTER

SCB / SCV Self Closing Valves - Chrome Plated

SCB-050	1/2" Basin Faucet With Hot, Cold & Plain Buttons	1	36
SCV-050	1/2" Valve With Cross Handle	1	50
SCV-053	1/2" Valve With Lever Handle, Chain & Ring	1	50
SCV-054H	1/2" Heavy Pattern Bubbler Faucet	1	40
SCV-055	1/2" Wall Mounted With Cross Handle, Plain End	1	50



Self Closing Valves



Faucet Handles & Stems

RH / 437	Faucet Handles - Sold in Pairs	MODEL NUMBER	DESCRIPTION	CARTON QUANTITIES	
				INNER	MASTER
		RH-7280	"Jaws" Fit All Replacement Cross Handles - Chrome	25	100
		RH-7290	"Jaws" Fit All Replacement Lever Handles - Chrome	25	100
		RH-8000	"Jaws" Fit All Replacement Acrylic Handles	1	100
		RH-830WB	Blade Handles For the Value Engineered & Classic Family of Faucets - Chrome	1	50
		437100	Cross Handles, Set Screw "Fit All" Version With Wrench - Chrome	1	100

GH	Gerber Style Faucet & Shower Handles - Sold in Pairs	Chrome			
		MODEL NUMBER	DESCRIPTION	INNER	MASTER
		GH-150	Faucet Replacement Handles	2	200
		GH-300	Tub & Shower Replacement Handles	1	50
		GH-050WB-1	Wrist Blade Handles	1	50

GES	Gerber Style Escutcheon	MODEL NUMBER	DESCRIPTION	INNER	MASTER
		GES-200	1-1/8" I.D. - Chrome Plated Steel	1	500

STM / GS	Stems, Diverters & Seats	MODEL NUMBER	DESCRIPTION	INNER	MASTER
		STMG-23	Gerber Style Faucet Stem - Hot & Cold	1	100
		STMG-0458	Gerber Style Shower Diverter Stem	1	100
		STMP-78	Price Pfister Style, 2 & 3 Handle Tub & Shower Stem - Hot & Cold	1	100
		STMP-79D	Price Pfister Style Shower Diverter Stem	1	25
		<i>Gerber Style Faucet Set</i>		GS-100	For Lavatory, Tub & Shower



Plugs

	MODEL NUMBER	DESCRIPTION	CARTON QUANTITIES	
			INNER	MASTER

BTP Cast Iron Boiler Plugs



BTP-300

BTP-150	1-1/2"	1	60
BTP-200	2"	1	50
BTP-250	2-1/2"	1	30
BTP-300	3"	1	24

LFP Lead "Fit-All" Plugs



LFP-400

LFP200	2"	1	1
LFP250	2-1/2"	1	48
LFP300	3"	1	24
LFP350	3-1/2"	1	24
LFP400	4"	1	24
LFP450	4-1/2"	1	12
LFP500	5"	1	12
LFP550	5-1/2"	1	1
LFP600	6"	1	12

TP Test Plugs - Metal - With Rubber Gasket & Wing Nut



TP-10

TP-07	1-1/2"	6	36
TP-08	2"	6	36
TP-10	3"	166	36
TP-11	4"	1	36
TP-13	6"	1	20

IBC Iron Body Cleanouts - With Plug



IBC-43

<i>Raised Head Square Plug</i>			
IBC-43	4" Pipe Size x 3"	1	300
IBC-435	4" Pipe Size x 3-1/2"	1	600
IBC-65	6" Pipe Size x 5"	1	170
<i>Square Countersunk Plug</i>			
IBC-435CS	4" Pipe Size x 3-1/2"	1	300



Saddle Tee & Deck Plate Cleanout

451 Saddle Tee-Brass



451803

MODEL NUMBER	DESCRIPTION	CARTON QUANTITIES	
		INNER	MASTER
<i>For Polyethylene Tubing Only Lead Free Version Available</i>			
451403	3/4" x 1/2"	40	160
451404	3/4" x 3/4"	40	160
451503	1" x 1/2"	40	160
451504	1" x 3/4"	36	144
451603	1-1/4" x 1/2"	12	60
451604	1-1/4" x 3/4"	12	60
451605	1-1/4" x 1"	10	60
451703	1-1/2" x 1/2"	10	60
451704	1-1/2" x 3/4"	12	60
451705	1-1/2" x 1"	15	60
451803	2" x 1/2"	10	40
451804	2" x 3/4"	10	40
451805	2" x 1"	10	40
4511004	3" x 3/4"	5	20

DKP Deck Plate Cleanouts - Cast Brass



DKP

DKP-201	2"	1	40
DKP-301	3"	1	20
DKP-401	4"	1	20
DKP-501	5"	1	8
DKP-601	6"	1	8



Thread Sealing Tape, PVC Tape & PVC Wrap

	MODEL NUMBER	DESCRIPTION	CARTON QUANTITIES	
			INNER	MASTER

TF Thread Sealing Tape



THREAD SEALING TAPE

<i>Mil Spec T-27730A</i>				
TF03260	1/2" x 260"		100	500
TF03520	1/2" x 520"		100	500
TF031296	1/2" x 1296"		50	250
TF04260	3/4" x 260"		70	350
TF04520	3/4" x 520"		70	350
TF041296	3/4" x 1296"		50	250
TF05260	1" x 260"		50	250
TF05520	1" x 520"		50	250
TF051296	1" x 1296"		1	150

TE PVC Electrical Tape - 60' Rolls

TE0460	34" x 7" mil.		1	200
--------	---------------	--	---	-----



TE0460



TW PVC Pipe Wrap - 100' Rolls

TW0810	2" x 10 mil.		1	36
TW0820	2" x 20 mil.		1	24
TW1110	4" x 10 mil.		1	12





TW0810





Tape and Wrap



Miscellaneous Plumbing Specialties

PC	PVC Pipe Cutters & Replacement Blades	MODEL NUMBER	DESCRIPTION	CARTON QUANTITIES	
				INNER	MASTER
 <p>PC-05</p>  <p>PC-08</p>  <p>PC-08B</p>	PC-05	1/2" to 1-1/4" Cutter	1	60	
	PC-05B	1/2" to 1-1/4" Blade Only	1	200	
	PC-08	1-1/4" to 2" Cutter	1	20	
	PC-08B	1-1/4" to 2" Blade Only	1	1	
	<i>Economy</i>				
	PC-05N	1/2" to 1-1/4" Economy Cutter	1	60	
PC-05NB	1/2" to 1-1/4" Economy Blade Only	1	200		

SW	Plumbers Socket Wrench Set	MODEL NUMBER	DESCRIPTION	INNER	MASTER
 <p>SW-100</p>	SW-100	5 Piece Set	1	25	

PGLF	Lead Free Pressure Gauge	MODEL NUMBER	DESCRIPTION	INNER	MASTER
 <p>PG-100LF</p>	PG-100LF	1/4" MIP x 2" Diameter, 100 PSI	1	24	
					



Miscellaneous Plumbing Specialties

IS	Integral Stop For Shower Valves	MODEL NUMBER	DESCRIPTION	CARTON QUANTITIES	
				INNER	MASTER



<i>Slotted Stem</i>					
IS-23	1/2" MIP x 1/2" FIP - Chrome	10	200		
IS-24	1/2" MIP x 1/2" SWT - Chrome	10	200		



LSD	Liquid Soap Dispensers	MODEL NUMBER	DESCRIPTION	CARTON QUANTITIES	
				INNER	MASTER



LSD-100	Chrome	1	12		
LSD-100S	Brushed Nickel	1	12		
LSD-100ORB	Oil Rubbed Bronze	1	12		

JCR	Curtain Rod Holder	MODEL NUMBER	DESCRIPTION	CARTON QUANTITIES	
				INNER	MASTER



<i>Chrome ABS</i>					
JCR-650	Jiffy Flange Curatin Rod Holder	1	200		



Miscellaneous Plumbing Specialties

	MODEL NUMBER	DESCRIPTION	CARTON QUANTITIES	
			INNER	MASTER

CH Faucet Hole Cover - Chrome

CH-175	1-7/8" Faucet Hole Cover	1	500
--------	--------------------------	---	-----



CH-175

SE Extension Shanks

SE-200	Polymer, For 2 Handle 4" Centerset & 8" Kitchen Faucet	1	100
SE-280	Brass, For 8" Widespread Lavatory Faucets	1	50



SE-200



SE-280

PRVLF Lead Free Pressure Relief Valve - Cast Brass

<i>Set to 75 PSI</i>			
PRV0303LF	1/2" x 1/2"	10	120
PRV0403LF	3/4" x 1/2"	10	120



PRV0404LF



Mobile Home Products

MODEL NUMBER	DESCRIPTION	CARTON QUANTITIES	
		INNER	MASTER

NM Non Metallic Faucets - Acrylic Handles



NM-300	Two Handle Kitchen Faucet, Less Spray - Chrome	1	12	
NM-300SPOUT	Spout for NM-300 - Chrome	1	60	
NM-310	Two Handle Kitchen Faucet, With Spray - Chrome	1	24	
NM-600	Two Handle Tub & Shower With Diverter Spout, Less Head, Arm & Flange - Chrome	1	24	
NM-600SC	Two Handle Shower Valve Only, Less Head, Arm & Flange - Chrome	1	24	
NM-985	Two Handle 4" Laundry Faucet - Chrome	1	24	
NM-990	Two Handle 4" Bar Faucet - Chrome	1	24	

SS Strainer & Drains - Less Coupling Nut & Washer



<i>Polybagged - Bulk Packed</i>				
SS-150MH	Plastic Dual Strainer Stainless Steel Clad	1	50	
SS-150MHW	Plastic Dual Strainer White	1	50	
SS-300MH	2-1/2" Stainless Steel Wash Tray Plug	1	50	
SS-600MHPL	Plastic Basket Only - White For SS - 150MHW	1	50	
SS-610MHPC	Chrome Plated Plastic Insert Only For Junior Dual Strainer	1	50	
SS-625MHPC	2-1/2" Plastic Junior Dual Strainer With Screw In Basket	1	50	



FY	Sink Drains	MODEL NUMBER	DESCRIPTION	CARTON QUANTITIES	
				INNER	MASTER



FY-926CMH

FY-926CMH	Cleanout Plug Chrome Plated Plastic	1	200
FY-926STOPCP	Chrome Plated Stopper - Only For FY-926 Plug	1	100
FY-926WMH	Cleanout Plug White Plastic	1	200

TTD	Tub Drain - Less Coupling Nut & Washer	MODEL NUMBER	DESCRIPTION	INNER	MASTER
-----	--	--------------	-------------	-------	--------



TTD-150MH

TTD-150MH	1-1/2" Touch Toe Drain, Chrome Plated Die Cast Zinc	1	100
-----------	---	---	-----



ITEM	PAGE
20	
25LF.....	22
26LF.....	20-22
29LF.....	18, 19
60	
62.....	31
400	
413.....	6
437.....	37
451.....	39
A	
AER.....	34
AG.....	33
AS.....	28
B	
BCL.....	35
BPF.....	30
BSV.....	32
BTP.....	38
C	
CF.....	31
CH.....	42
CO.....	11
COT.....	11
CP.....	28
CSOL.....	17
D	
DCWB.....	15
DDC.....	33
DDFLF.....	23
DKP.....	39
DO.....	15
DV.....	28
DWB.....	14
DWLLF.....	24
DWT.....	12
DWV.....	11
DWVY.....	11
E	
ESC.....	30

ITEM	PAGE
F	
FCP.....	30
FT.....	15
FY.....	8, 29, 45
G	
GES.....	37
GH.....	37
GS.....	37
I	
IBC.....	38
IS.....	42
J	
JCR.....	42
L	
LFP.....	38
LNT.....	6
LSD.....	42
M	
M.....	27
MTRAP.....	14
N	
NM.....	43
NT.....	17
P	
PB.....	12
PC.....	41
PGLF.....	41
PRVLF.....	42
PTRAP.....	11,12
R	
RH.....	37
S	
S.....	26
S-AB.....	27
SBW.....	7
SCB.....	36
SCV.....	36
SDB.....	7

ITEM	PAGE
SDP.....	7
SE.....	42
SJL.....	14
SJX.....	16
SP.....	32
STRAP.....	12
SS.....	4, 5, 43
SSCWH.....	25
SSDWLF.....	24
SSFLF.....	23
SSIMLF.....	24
SSM.....	23
SST.....	24
SSWH.....	25
SSWM.....	25
STM.....	37
SW.....	41
T	
T.....	29
TE.....	40
TF.....	40
TP.....	38
TT.....	16
TRAP.....	9, 10
TTD.....	6, 45
TW.....	40
TWB.....	6
V	
VC.....	28
VDWBLF.....	24
VFBLF.....	23
VFCLF.....	23
VHW.....	28
VIMKLF.....	24
VTC.....	25
W	
WB.....	13
WMV.....	33
WSI.....	33
WTI.....	33
WTS.....	33



mail@matco-norca.com
www.MATCO-NORCA.com



Global sourcing. National compliance. Local service.

CALIFORNIA

5595 Fresca Dr.,
La Palma, CA 90623
Toll Free: 866-532-8306
Fax: 866-532-8307

TEXAS

1150 Silber Rd.,
Houston TX 77055
Toll Free: 800-935-5456
Fax: 713-680-2999

ILLINOIS

278 Windy Point Dr.,
Glendale Heights, IL 60139
Toll Free: 844-412-5068
Fax: 800-640-2252

GEORGIA

113 Industrial Blvd.,
Americus, GA 31709
Toll Free: 800-433-7526
Fax: 800-533-5134

NEW YORK

PO Box 27, R.22,
Brewster NY 10509
Toll Free: 800-431-2082
Fax: 845-278-9056