

### INSTALLATION INSTRUCTIONS FOR MIFAB's MC-10, 12, 13 SERIES WATER CLOSET CARRIERS

#### Fitting Installation:

1. Install the carrier fitting in the waste line rough-in. Support at the correct pitch and height. Typical pitch for drainage lines is 1/4" per foot.
2. Place the faceplate gasket (MC-10-PFPG) onto the face of the carrier fitting so that the four slots in the gasket are aligned with the four tappings in the face of the fitting. Note how the back of the faceplate gasket has a ridge that will lock into the oval opening of the fitting.
3. Place the faceplate/leg assembly (MC-10-PFPOZ) against the installed faceplate gasket positioned so that the four slots in the faceplate are aligned with the four tappings in the face of the fitting. Secure the carrier fitting and faceplate together with the four H-1143 bolts and H-1149 washers provided in the MC-10-PHP2 hardware pack. Torque the screws to 25-30 ft. lbs. to ensure a seal between the faceplate and the fitting. Ensure that the o-ring gasket (MC-FP o-ring) is placed evenly in the groove within the 4" NPS threads of the faceplate.
4. Adjust the two screws with washers on the legs of the faceplate so that the legs are resting evenly on the ground.

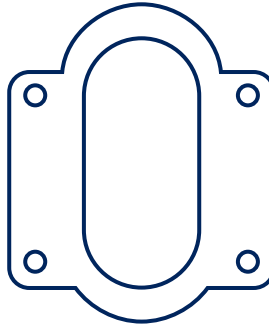

PART # MC-10-PFPG  
(Fitting Gasket)

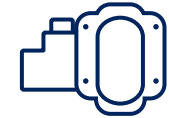

HORIZONTAL  
CARRIER FITTING

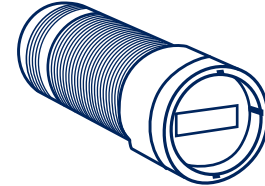
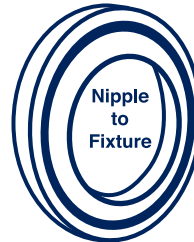

DIAGRAM 2A  
(Tapered Thread Nipple)

#### Nipple Installation:

- **(Standard) tapered thread.** Apply thread sealant (MC-10-PNS) to the tapered threads of the nipple and thread into the 4" NPS threads of the carrier faceplate. Water test the system for leaks; then carefully knock out the integral test cap within the nipple and cut the nipple to the desired finished length. Be careful to make this cut at 90 degrees to ensure an even seal against the gasket placed in the horn of the water closet.
- **Tapered thread two piece nipple with adjustable horn (Suffix - AH)**  
Remove the small adjustable horn threaded onto the end of the nipple. Apply thread sealant (MC-10-PNS) to the tapered end threads of the nipple and thread into the 4" NPS threads of the carrier faceplate. Water test the system for leaks; then carefully knock out the integral test cap within the nipple and cut the nipple to the desired finished length. Thread the adjustable horn onto the end of the nipple with the supplied sealant (MC-10-PNS) and adjust to finished length relative to finished wall. Flanged end of nipple will seal against the gasket placed in the horn of the water closet. See Diagram 2A.
- **Rolled straight thread and o-ring (Suffix - AH).**  
Determine the length of the nipple required relative to the finished wall. Cut the nipple to this length. Remove any burrs after cutting. Apply thread lubricant to the threads of the nipple and to the o-ring in the carrier face-plate. Thread the nipple into the 4" NPS threads of the carrier faceplate. Water test the system for leaks; then carefully knock out the integral test cap within the nipple. Flanged end of nipple will seal against the gasket placed in the horn of the water closet.



PART # MC-10-PBG  
(Bowl Gasket)

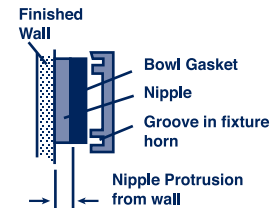

DIAGRAM 2B

#### NIPPLE SHOULD PROTRUDE FROM THE FINISHED WALL AS FOLLOWS:

Protrusion = depth of groove in fixture horn - 1/2". This will allow for sufficient compression of bowl gasket to ensure a good seal at fixture. See Diagram 2B.

5. Install the fixture mounting threaded rods (H-1167) into the faceplate and adjust to extend beyond the finished wall the thickness of the fixture flange +5/8". Lock the rods in place with two H-1164 5/8" hex nuts against the faceplate (see Detail 3). Install the factory supplied threaded rod protectors (MC-10-PRP) over the threaded rods.
6. Secure the faceplate legs to the floor with at least 1/2" anchor bolts (by others). Install the rear anchor foot support (supplied inside the carrier fitting box). The carrier is now ready for the completion of the construction.

#### FIXTURE MOUNTING

7. Thread the four bowl saver threaded washers (H-1176) from the MC-10-PHP1 hardware pack onto each of the 5/8" x 10" long threaded rods (H-1167). Set the bowl saver washers to be flush with the finished wall (Detail 4). Level each; then slide the four plastic washers provided over the threaded rods to rest against the bowl saver washers. Install the bowl gasket (MC-10-PBG) into the groove of the fixture outlet horn. Slide and hang the fixture onto the threaded rods. Assemble the finishing hardware (MC-10-PFH) (plastic washers and chrome plated cap nuts) onto the four threaded rods. Check for any irregularities in closet flange or finished wall. If flange is flat to wall, tighten.

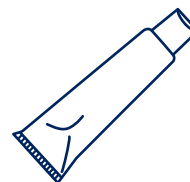

PART # MC-10-PNS  
(Thread Sealant)

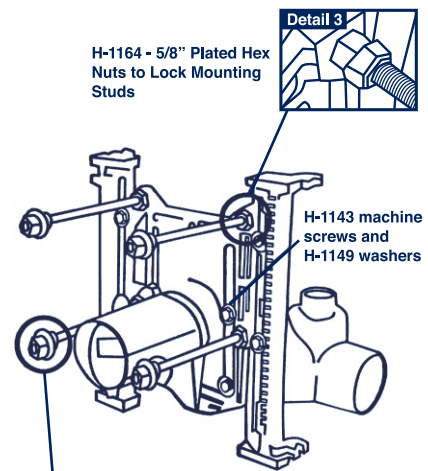

PART # MC-FP O-RING  
Faceplate O-ring Gasket

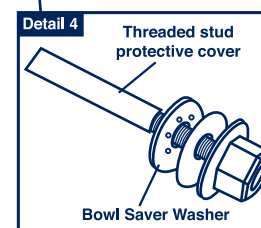

MC-10-PFH  
Finishing  
Hardware  
(Cap Nuts &  
HDPE Washers  
including Bowl  
Saver Washer)