

Rubix 6032 Acrylic Alcove Bathtub

Model number:

105705-000-001-002

Dimensions: 59.75" x 32" x 18.375"

Installation: Alcove

Material: Acrylic

Standard Features:

- Alcove installation
- Acrylic surface resistant to stains
- Available in white, bone or biscuit color to complement any bathroom decor
- Available in left-hand and right-hand drain configurations to fit your specific bathroom layout
- Integrated flat skirt and tiling flange
- Available in an Above-the-Floor Rough (AFR) configuration for easier drain, waste and overflow installation

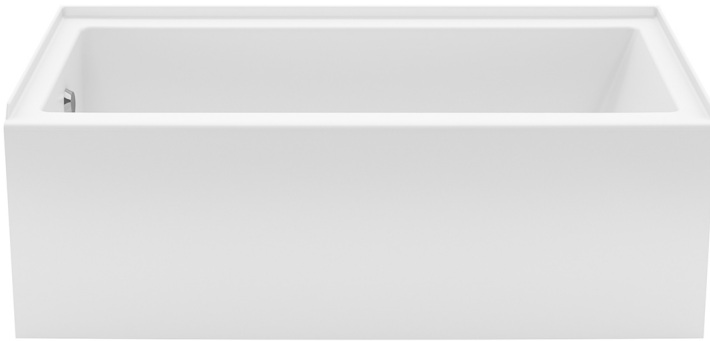

Standard Colors:



White



Bone



Biscuit

Certifications

MAAX products adhere to one or more of the following certifications:



MAAX

Rubix 6032 Acrylic Alcove Bathtub

Model number:

105705-000-001-002

Dimensions: 59.75" x 32" x 18.375"

Installation: Alcove

Material: Acrylic

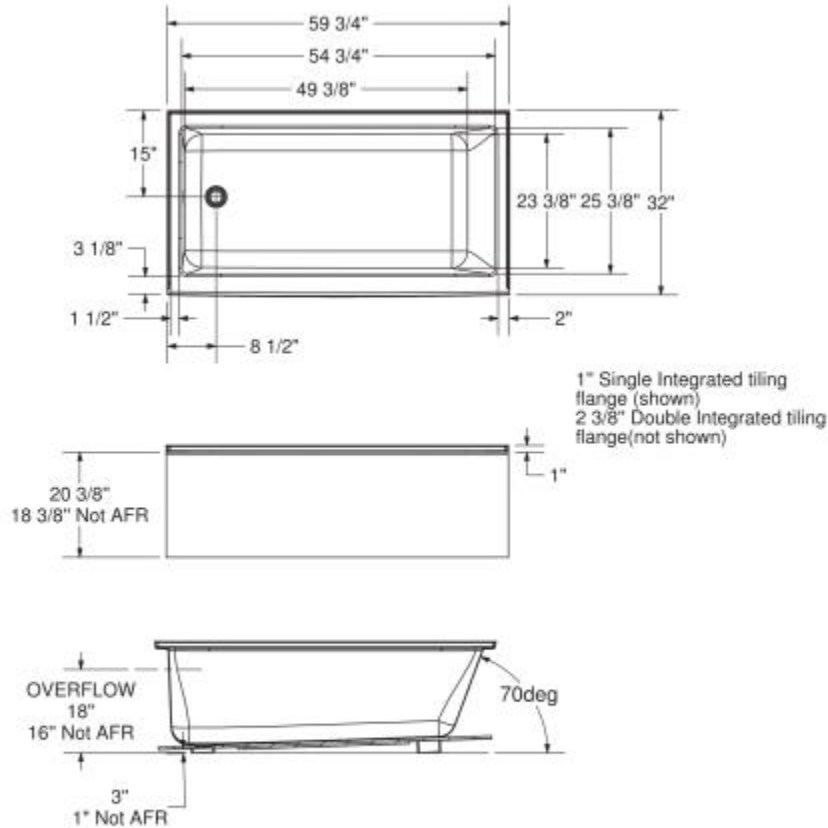

Wood support design may vary.
Single integrated tiling flange: 1" height x 1/4" thickness (shown)
All dimensions are approximate. Structure measurements must be verified against the unit to ensure proper fit.

Dimensions

59 3/4 x 32 x 18 1/2 In.
(1518 x 813 x 467 mm)

Water Capacity

59 gallons - 223 liters

Weight

80 lbs - 36 kg

Bathing Well

54 3/4 In. x 25 1/2 In.
(1391 mm x 645 mm)

Deep Sump Height

16.75 In. - 425 mm

Deck Width

3.125 In. - 79 mm

Drain location:

Left

Right

Project:

Contractor:

Representative:

Date:

Tel:

Notes:

MAAX