



MANUFACTURING CO., INC.

5330 East 25th Street  
Indianapolis, Indiana 46218  
Phone (317) 261-1212  
Fax (317) 261-1208

www.temperedwater.com

Installation &  
Maintenance Manual  
M 802 E

# Model 802 SEA Deluxe



## NOTICE!

ASSE 1017 Approved

Certified to  
CSA B125.3

Thermostatic Water Controllers will not work satisfactorily if improperly installed. Read these instructions carefully before installing and follow directions as outlined.

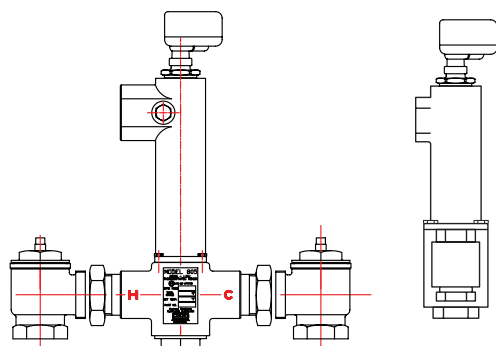

### CAPACITIES - MODEL 802

Pressure Drop PSI	5	10	20	30	45	60	80
Valve Number	Capacity						
802-GPM	28	39	54	66	80	91	103
802-LPM	106	148	208	247	303	341	388

## General Description

The Model 802 water temperature controller is carefully assembled and tested at the factory to mix hot and cold water to any desired temperature within range. The temperature of the hot water should be at least 20°F higher than the maximum valve setting. The major safety features are:

1. Failure of cold water supply causes the hot water ports to reduce hot water flow.
2. Failure of hot water supply causes the cold water ports to reduce cold water flow.
3. Failure of the thermostat allows both ports to reduce flow of hot and cold water.

At each inlet of the controller is a union end stop and check valve with removable strainer. Stop and check valves are to prevent water from bypassing between hot and cold water supply lines. These valves should be fully open when in operation.

### Maximum Inlet Conditions

Pressure: 125 psi  
Temperature: 200°F

## Maintenance

The controller should be checked periodically and, if needed, cleaned as outlined in "INSPECTING and CLEANING VALVE." To test for proper setting and operation - proceed as follows:

1. Turn on full hot and cold water supply to the valve. The mixing valve should deliver water

at the outlet temperature stamped on the label. Standard setting is 110°F. If the outlet temperature is different than that shown on the label, readjust valve according to "TEMPERATURE ADJUSTMENT" procedure on page 2.

2. If after adjusting the outlet temperature the water stays below the set temperature, see "CHECKING COLD WATER SHUT-OFF." If the temperature stays above the set temperature, see "CHECKING HOT WATER SHUT-OFF."

**Caution:** When maintaining and adjusting the mixing valve, all fixtures should be isolated from use. Lawler Manufacturing Co., Inc. recommends that you work safely at all times and in a manner consistent with the OSHA Lock/Tagout standard, 29 CFR 1910.147 and other applicable standards. **WARNING:** Opening of the actuator may result in electrical shock.

## Checking Cold Water Shut-Off

Turn on full hot and cold water supply to the valve and let it run for one minute. Then shut off the hot water stop and check valve only. Cold water should flow through the controller momentarily then be reduced to a negligible amount.

Failure to do so indicates that:

- a. Plunger is sticking and requires cleaning or replacement.

## Checking Cold Water Shut-Off (Cont.)

- b. Spring #13 has lost its strength and should be replaced.

**Note:** Lack of water flow can be normal on the first test if the temperature of the cold water is below 75°F. A quick test is to momentarily turn on the hot water to warm the thermostat. If flow then starts, the thermostat is good; failure to obtain flow when first starting, or when valve is cold, is a normal reaction.

## Checking Hot Water Shut-Off

Allow full hot and cold water to flow through the valve for one minute. Shut off the cold water stop and check valve only. The hot water should be reduced to a negligible amount.

Failure to do so will indicate:

- a. The hot water supply is not 20°F above the required maximum temperature setting.
- b. The plunger is sticking and requires cleaning or replacement.

## Inspection and Cleaning Valve

Shut off the hot and cold water supply to the controller. Remove bonnet #19. To replace pusher O-ring #18, remove pusher #21 from bonnet #19 and replace O-ring. Reassemble in reverse order.

With the bonnet assembly off the valve, remove thermostat #22 and check and clean (see fig. A). Unscrew bottom plug #14 and remove valve spring #13 and plunger #12 (see fig. C). If the assembly does not slide out, remove the plunger with liner #11 and gently tap plunger until it becomes free. Clean and polish the liner and plunger with very fine emery cloth until the plunger moves freely in the liner.

With the liner out of the valve, replace liner O-ring #10.

**Note:** If the piston or liner is nicked or shows signs of excessive wear, it should be replaced.

**Caution:** The liner and plunger cannot be dropped please handle carefully. The liner must be inserted correctly. Carefully examining the outside of the liner will reveal a very small difference in diameter between the upper half and the lower half. On reassembly, the smaller diameter must be inserted first through bottom plug opening.

**Warning:** This product contains chemicals known to the State of California to cause cancer and birth defects or other reproductive harm.

*(Installer: California law requires that this warning be given to the consumer.)*

For more information: [www.oehha.org/prop65](http://www.oehha.org/prop65)

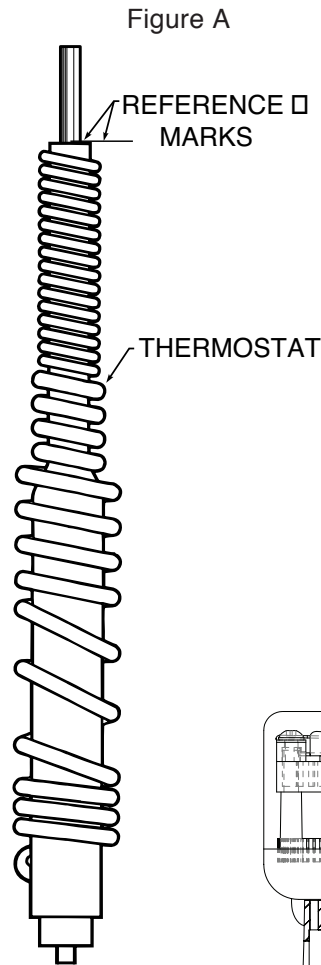

1. Place a 3/8" wooden dowel rod into center of thermostat then place in 85° F water. Make a reference mark on the rod as shown in fig. A.

2. Now insert thermostat into hot water that is at least 20°F higher than the set temperature stamped on label.

3. The rod should move out of the thermostat approximately 1/8". If the rod shows no movement or can be pushed inward, a new thermostat is required.

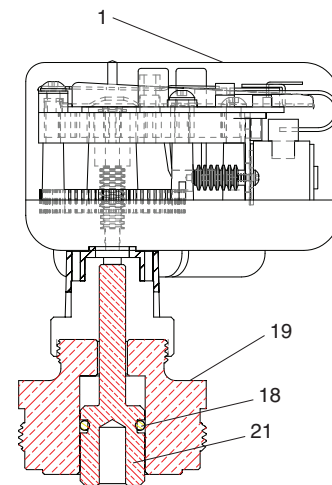

Figure B

## Temperature Adjustment

Valves are normally factory set for a maximum 110°F outlet temperature, or that stamped on the label. If it is desired to change this setting, proceed as follows:

1. Turn off the recirculation pump.
2. Create sufficient demand on the system.
3. Turn the key to set mode. The set light and flow light will illuminate green. If flow light does not illuminate, increase the demand until it does.
4. Press the scroll button once to indicate you want to make a change. Press the scroll button a second time to indicate you want to change the set temperature. Press the up and down arrows to adjust the set temperature. Press the scroll button once to confirm your change. Press the page button to indicate all necessary changes have been made. (Note: The set point must have a 20° temperature differential between hot and cold inlet temperatures and is limited to a range of 90-120° F).
5. Once the set point is reached and stabilized, turn the key to operate mode and remove key.

**Note:** If outlet temperature desired is 15°F or more higher than that stamped on the label, contact the factory or a representative for a special thermostat.

# Model 802 Repair Parts

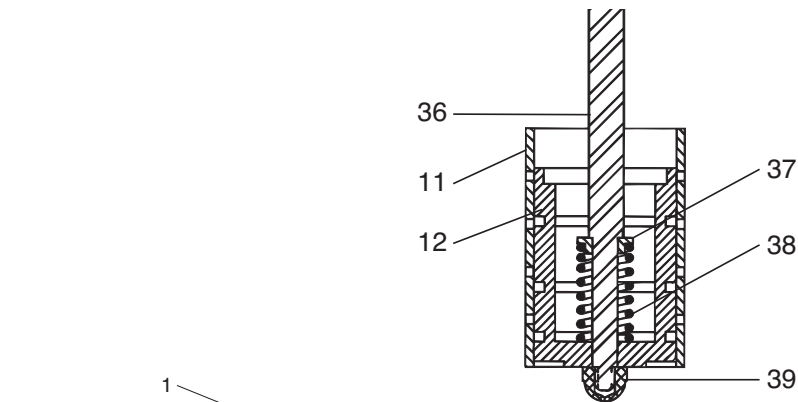
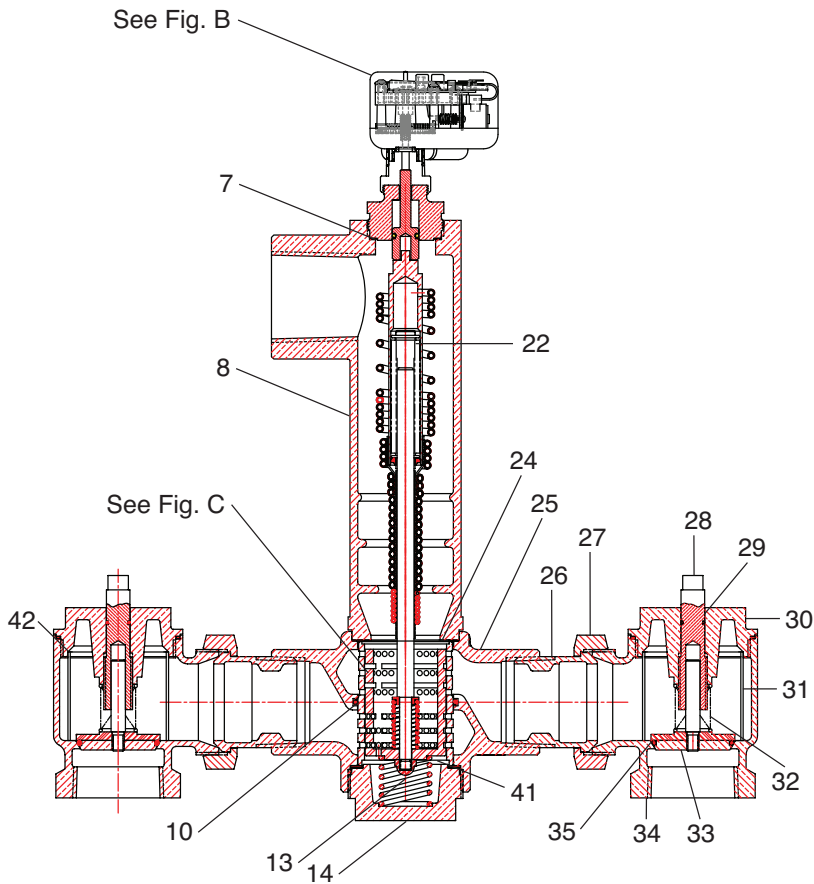

Figure C

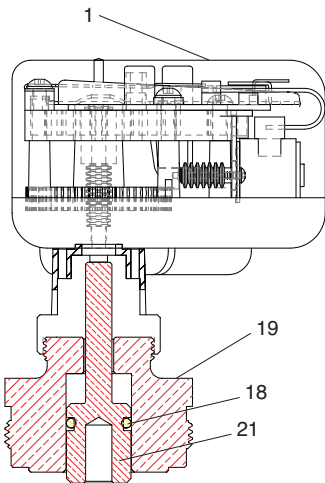

Figure B

Item	Description	Part No.
1	Actuator	—
7	Bonnet Gasket	—
8	Dome	—
10	Liner O-Ring	—
11	Liner	—
12	Plunger	—
12a	Piston Liner Assembly	Figure C
13	Valve Spring	—
14	Bottom Plug	—
18	Pusher O-Ring	—
19	Bonnet	—
21	Pusher	—
22	Thermostat	—
23	Body Screw (NS)	—
24	Liner Gasket, Upper	—
25	Valve Body	—
26	Tailpiece	—
27	Union Nut	—
28	Stop & Check Stem	—
29	S & C Stem O-Ring	—
30	S & C Bonnet	—
31	Strainer	—
32	S & C Spring	—
33	Shutoff Disc Assembly	—
34	S & C Body	—
35	Seat O-Ring	—
36	Pushrod	—
37	Spring Retainer	—
38	Relief Spring	—
39	Acorn Nut	—
40	Nameplate (NS)	—
41	Liner Gasket, Lower	—
42	S & C Gasket	—

(NS) - Not Shown

12a Only available in Assembly

## Repair Kits and Assemblies

Kit H

Item	Description	Contains	Part No.
1	Complete Repair Kit	7,10,12a,13,18,22,24,31,32,35	79978-01
2	Piston and Liner Assy.	10,11,12a,24,41	71945-16
3	Stop and Check Repair Kit	28,29,31,32,33,35	79908-02
4	Thermostat Repair Kit	7,22	72911-11
5	Bonnet Assy.	1,2,18,19,21	-
6	O-Ring and Gasket Kit	7,10,18,24,29,35,41,42	79830-02

## Typical Installation

Install the mixing valve below the hot water tank or heater. If this is not possible, pipe in a heat trap as shown in Figure 1 with an approximate 2' drop.

Connect a tempered water return line as shown in Figure 1. This allows flow through both ports of the mixing valve during periods of no draw.

If a dual temperature system is used, a separate recirculating loop and pump are required to return high temperature hot water to the water heater. See Figure 2. Install an aquastat at the tempered water return pump. Install the water heater per manufacturer's instructions.

## Setting The Mixing Valve To The System

1. After installations be sure to flush the system thoroughly.
2. Make sure the hot water supply is heated to normal design temperature.
3. Close and tag all fixtures to ensure they are not used during this procedure.
4. Turn off the recirculating pump.
5. Create a draw on the system greater than the minimum flow rating of the mixing valve. All open fixtures must be tagged to ensure they are not tampered with or used during this procedure.
6. Allow water to flow through the mixing valve until the water temperature is stable. If necessary, readjust the mixing valve in accordance with the TEMPERATURE ADJUSTMENT section of the installation manual.
7. Once the temperature is set, start the recirculating pump and allow the system to reach set temperature.
8. Measure the water temperature at the return pump and adjust the aquastat to shut off the pump should the return water exceed the set point by 2 degrees F. Set the low limit switch to restart the return pump when return water drops 5 degrees F below the set temperature.
9. If adjustment of the diverting valve is necessary, rotate the adjustment stem 1/16" of a turn.
10. Shut off all fixtures and ensure there is no draw on the system. The cold inlet to the mixing valve should be warm.
11. Allow the system to run in this condition for at least 30 minutes.
12. In some cases, an increase in water temperature may occur during a no draw period. If this occurs, slowly close the balancing valve until the water temperature is back to the original set temperature.

Figure 1

## Typical Installation

### When used in a single temperature recirculating system

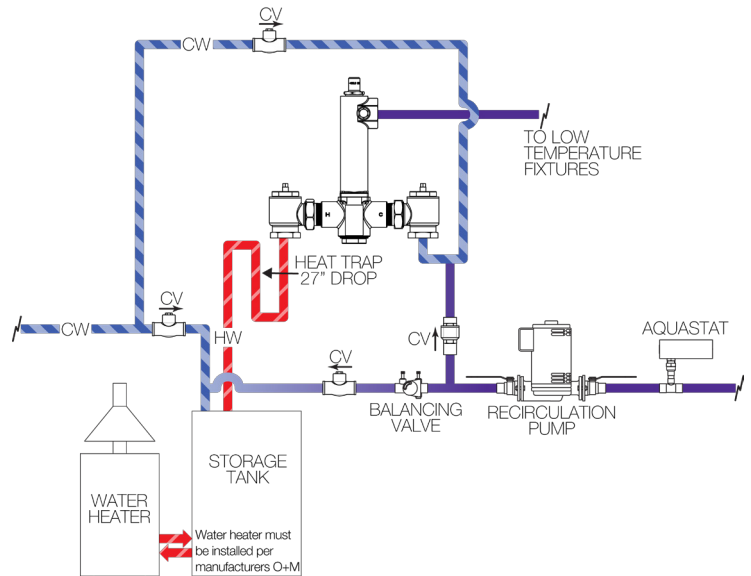
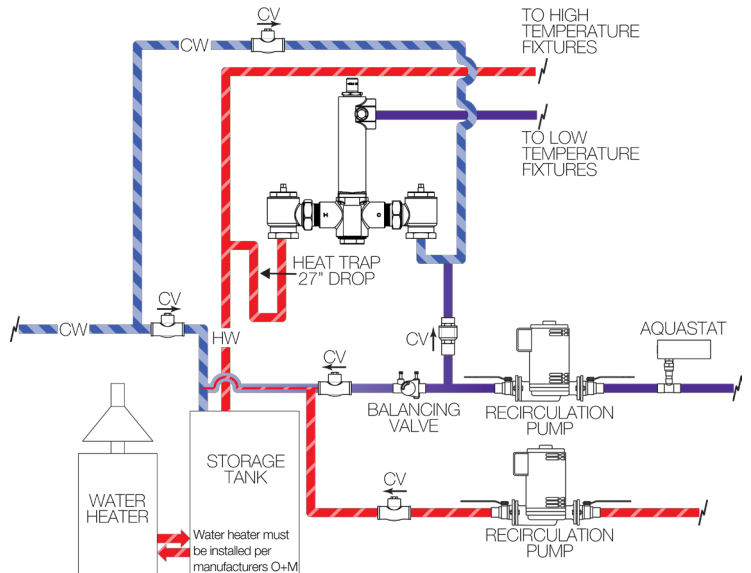

Figure 2

## Typical Installation

### When used in a dual temperature recirculating system



## GUARANTEE

We guarantee the Lawler Mixing Valve to be free from defects in workmanship and material, and for a period of one year from date of purchase, will replace any parts found by us to be defective. We will not be

held responsible, however, for any labor incidental to, or for any damages caused by defective material. Each mixing valve is thoroughly inspected and tested under actual conditions at our factory.