



Iron Works®

1-1/2" Exposed Bath Drain

K-7104

Features

- 17-gauge brass construction
- Brass tailpiece
- Adjustable trip lever
- For above-the-floor installations
- For use with Iron Works Historic™ freestanding baths

Recommended Products/Accessories

K-23726 Drain treatment



Codes/Standards







ASME A112.18.2/CSA B125.2

KOHLER® One-Year Limited Warranty

See website for detailed warranty information.

Available Colors/Finishes

Color tiles intended for reference only.

Color	Code	Description
	CP	Polished Chrome
	SN	Vibrant® Polished Nickel
	AF	Vibrant® French Gold
	BN	Vibrant® Brushed Nickel
	BV	Vibrant® Brushed Bronze
	2MB	Vibrant® Brushed Moderne Brass

1-800-4KOHLER (1-800-456-4537)

Kohler Co. reserves the right to make revisions without notice to product specifications.

For the most current Specification Sheet, go to www.kohler.com USA or www.kohler.ca Canada

6-2-2025 19:38 - US/CA

THE BOLD LOOK
OF **KOHLER**®

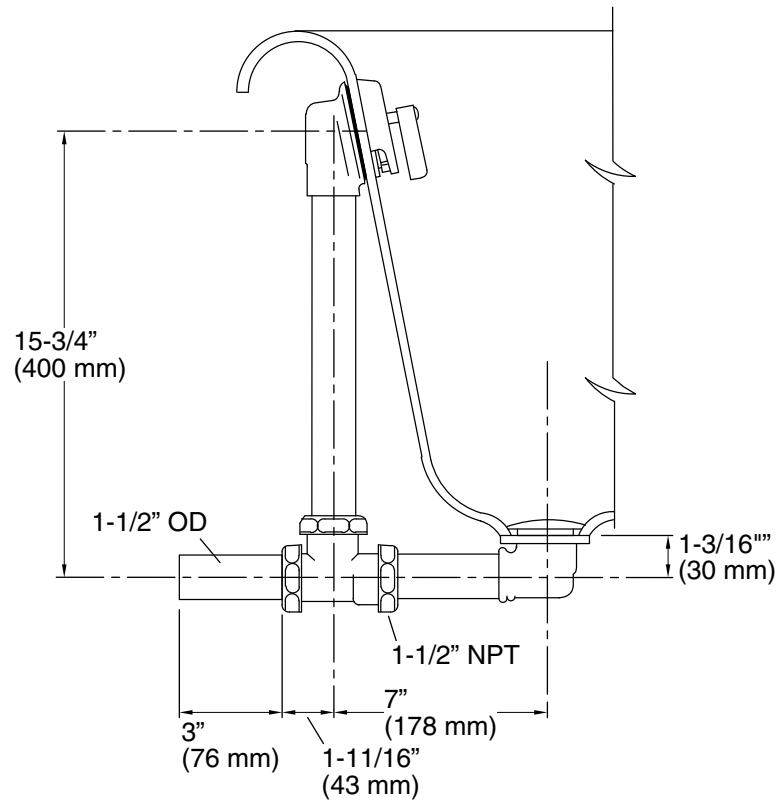

Technical Information

All product dimensions are nominal.

Material: Brass

Notes

Install this product according to the installation instructions.