

Features

- 36" minimum base cabinet width.
- Large/medium bowls.
- 9" (229 mm) depth provides generous workspace.
- Shortened apron allows sink to be used in most standard cabinetry or retrofitted to existing standard cabinetry.
- Self-Trimming® apron overlaps cabinet face for easy installation and beautiful results.
- Smart Divide® feature offers a lower bowl divider that increases workspace versatility.
- Basin slopes toward drain to minimize water pooling.
- Offset drain increases workspace in the sink and storage space underneath.

Material

- KOHLER® enameled cast iron.

Installation

- Undermount.

Recommended Products/Accessories

- K-5828 Sink Rack
- K-5874 Sink Rack
- K-8801 Sink drain and strainer with tailpiece
- K-8799 Sink drain and strainer basket
- K-23726 Drain treatment
- K-23725 Cast iron cleaner

Optional Products/Accessories

- K-11352 Disposal Flange with Stopper
- K-9000 P-Trap

Included Components

Additional Components:

- Cabinet face cut-out template
- Countertop cut-out template



Codes/Standards















ASME A112.19.1/CSA B45.2

KOHLER® Enameled Cast Iron Kitchen Sink Lifetime Limited Warranty

See website for detailed warranty information.

Available Colors/Finishes

Color tiles intended for reference only.

Color	Code	Description
	0	White
	FF	Sea Salt™
	96	Biscuit
	NY	Dune
	95	Ice™ Grey
	G9	Sandbar
	K4	Cashmere
	FT	Basalt
	58	Thunder™ Grey
	FP	Caviar
	7	Black Black™
	GRL	Grey Lavender
	DGB	Indigo Blue
	PLM	Black Plum

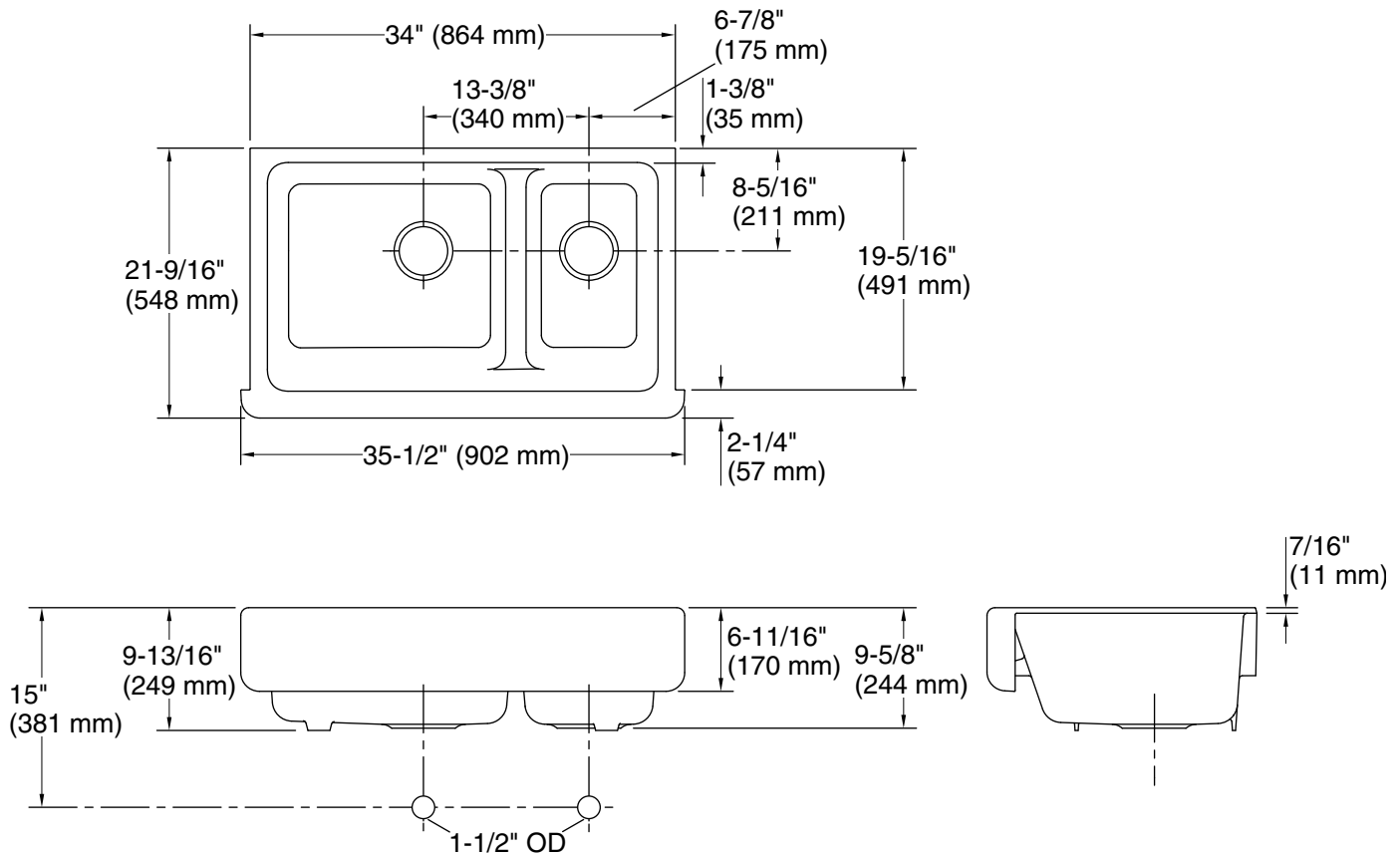

Technical Information

All product dimensions are nominal.

Bowl configuration:	Off-set Large/small
Installation:	Under-mount
Min. base cabinet width:	36" (914 mm)
Bowl area:	Length: 18-13/16" (478 mm) Width: 18-1/16" (459 mm) Bowl depth: 9" (229 mm) Water depth: 9" (229 mm)
Bowl area:	Length: 10-5/16" (262 mm) Width: 18-1/16" (459 mm) Bowl depth: 9" (229 mm) Water depth: 9" (229 mm)
Drain hole:	3-5/8" (92 mm)

Notes

Install this product according to the installation instructions.

NOTICE: The countertop manufacturer or cutter must use the cut-out template provided with the product, or a current one provided by Kohler Co. (call 1-800-4KOHLER). Kohler Co. is not responsible for cut-out errors when the incorrect cut-out template is used.

IMPORTANT! The distance from the top edge of the cabinet to the top of the cabinet door must be at least 6-7/8" (175 mm) to install this sink.