

## Material

- Premium metal construction for durability and reliability
- KOHLER finishes resist corrosion and tarnishing

## Installation

- Installation template and tools included



ADA

### Codes/Standards









ADA  
ICC/ANSI A117.1

### KOHLER® Faucet Lifetime Limited Warranty

See website for detailed warranty information.

### Available Colors/Finishes

*Color tiles intended for reference only.*

Color	Code	Description
	S	Polished Stainless
	SN	Vibrant® Polished Nickel
	BN	Vibrant® Brushed Nickel
	BS	Brushed Stainless
	BV	Vibrant® Brushed Bronze
	BL	Matte Black
	2MB	Vibrant® Brushed Moderne Brass
	TT	Vibrant Titanium
	BGP	Brushed Graphite

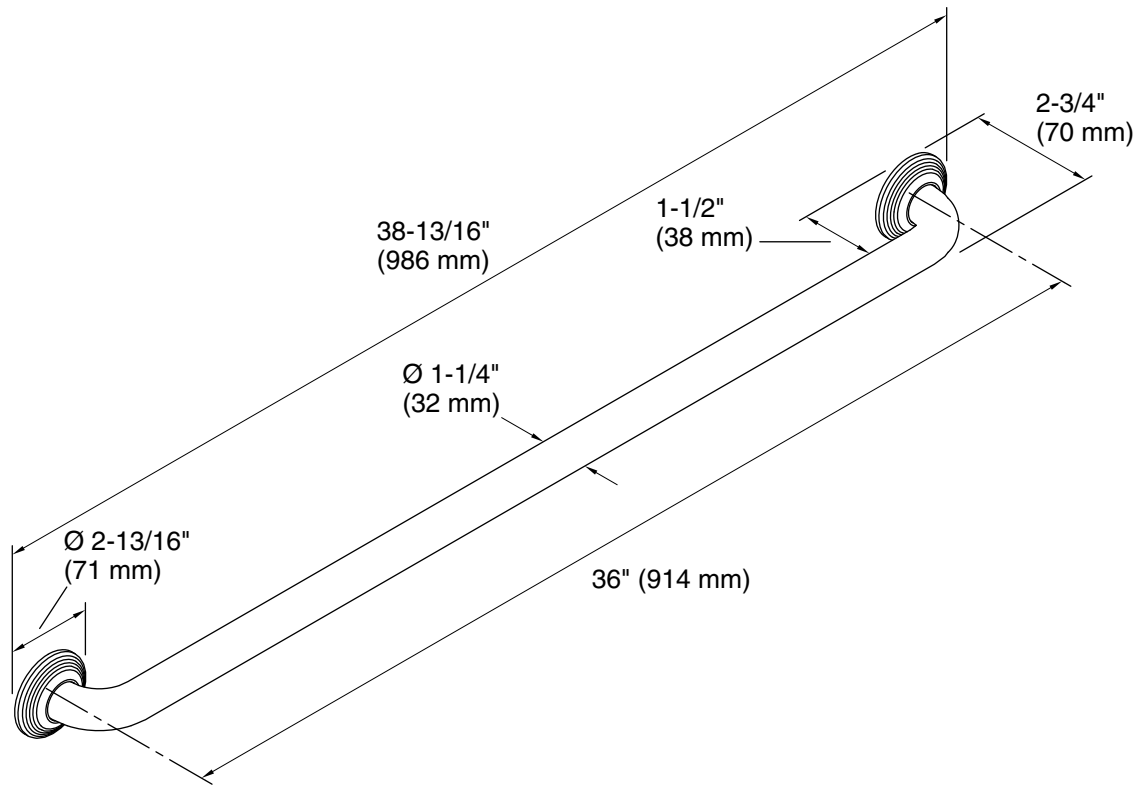

## Technical Information

All product dimensions are nominal.

Material: Metal

## Notes

Measure your actual product for roughing-in details.

**WARNING:** Risk of personal injury. The wall plates on the grab bar must be mounted to a brace between the wall studs. This will ensure that the weight of the user is adequately supported.

ADA compliant when installed to the specific requirements of these regulations.