

### Features

- Fits minimum 33" (838 mm) base cabinet width.
- Single bowl.
- 9" (229 mm) depth provides generous workspace.
- Shortened apron allows sink to be used in most standard cabinetry or retrofitted to existing standard cabinetry.
- Self-Trimming® apron overlaps cabinet face for easy installation and beautiful results.
- Basin slopes toward drain to minimize water pooling.
- Offset drain increases workspace in the sink and storage space underneath.
- Includes cutout templates.

### Material

- KOHLER® enameled cast iron.

### Installation

- Undermount.

### Recommended Products/Accessories

- K-8801 Sink drain and strainer with tailpiece
- K-8799 Sink drain and strainer basket
- K-23726 Drain treatment
- K-23725 Cast iron cleaner

### Optional Products/Accessories

- K-6449 Steel rack for Whitehaven® K-5826/5827 sinks
- K-11352 Disposal Flange with Stopper
- K-9000 P-Trap

### Included Components

Additional Components:

- Cabinet face cutout template
- Countertop cutout template



### Codes/Standards















ASME A112.19.1/CSA B45.2

### KOHLER® Enameled Cast Iron Kitchen Sink Lifetime Limited Warranty

See website for detailed warranty information.

### Available Colors/Finishes

*Color tiles intended for reference only.*

Color	Code	Description
	0	White
	FF	Sea Salt™
	96	Biscuit
	47	Almond
	NY	Dune
	95	Ice™ Grey
	G9	Sandbar
	K4	Cashmere
	FT	Basalt
	58	Thunder™ Grey
	FP	Caviar
	7	Black Black™
	GRL	Grey Lavender
	DGB	Indigo Blue
	PLM	Black Plum

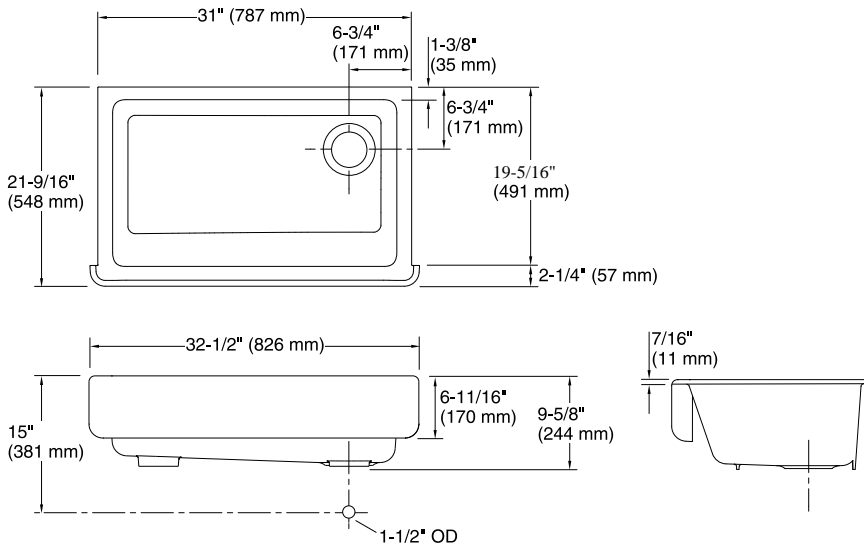

### Technical Information

All product dimensions are nominal.

Bowl configuration: Single

Installation: Under-mount

Min. base cabinet width: 33" (838 mm)

Bowl area: Length: 27-3/4" (705 mm)  
Width: 18-1/16" (459 mm)  
Bowl depth: 9-5/8" (244 mm)  
Water depth: 9" (229 mm)

Drain hole: 3-5/8" (92 mm)

Template: 1214395-7, required, included  
1214396-7, required, included

### Notes

Install this product according to the installation instructions.

**NOTICE:** Countertop manufacturer or cutter must use the current product template available at [www.kohler.com](http://www.kohler.com), or by calling 1-800-4KOHLER. Kohler Co. is not responsible for cutout errors when the incorrect cutout template is used.

**IMPORTANT!** The distance from the top edge of the cabinet to the top of the cabinet door must be at least 6-7/8" (175 mm) to install this sink.