

PlumBest®



Welcome to our newest catalog. Back by popular demand, no three ring binder, no brochures falling out, and hopefully, no shoving the book away on a shelf to be seen no more. All of us at Jones Stephens have been hearing from all of you telling us you want the “old” catalog back. So here it is, the new “old” catalog. 22,000 SKU’s under one catalog cover. We truly believe we offer our customers the broadest, deepest and most value-laden inventory of plumbing specialties in the world. Part of the proof of that is in the breadth of inventory in our new catalog.

Our Alabama and Pennsylvania distribution centers stand ready to serve you. Nationwide. People tell us Jones Stephens has a market reputation of being fast, accurate, and always of high-quality. We want to keep getting better at all that for you. We want you to win by using our people, our inventory and our reputation to help you and your customers succeed. If you’re one of our regular customers, thank you for your years of loyalty to Jones Stephens. If this catalog is a new experience for you, or you’re just coming back to Jones Stephens – we are really glad to work with you.

Enjoy our broad, deep, valuable new catalog. And best wishes from all of us at Jones Stephens for a successful and prosperous new year.

Sincerely,

Dennis Allen
Chief Executive Officer

Mark Williams
VP of Supply Chain

Larry Waldron
VP of Sales

Gary Hurst
Director of Operations

Lance Hunter
National Sales Manager

Jones Stephens Corp. South
3249 Moody Parkway
Moody, AL 35004
Phone 800-355-6637
Fax 800-462-6991

Jones Stephens Corp. North
50 Keystone Blvd. East
Pottsville, PA 17901
Phone 800-325-8999
Fax 866-922-0076

Quality
Products *for*
the Plumbing
Professional

SECTION A - DECORATIVE -Page 1

In the decorative section, you will find our FINAL TOUCH line of products. We offer a variety of decorative bath and kitchen items available in eighteen special finishes.

A**SECTION B - SPECIALTIES AND REPAIR - Page 29**

The Specialties and Repair section contains all of the items that you will need for your basic plumbing and repair needs.

B**SECTION C - MISC. PLUMBING SPECIALTIES - Page 89**

Our misc. plumbing specialties section covers a wide range of items from basic plumbing items such as water heater stands, access panels and compression couplings to water meter boxes and pipe insulation.

C**SECTION D - FITTINGS AND VALVES - Page 129**

In the fittings and valves section you will find our large variety of brass fittings, nylon fittings, push on fittings, PEX fittings, ball valves and much, much more.

D**SECTION E - COMMERCIAL / RESIDENTIAL PLASTICS - Page 179**

This section is full of assembled coverall drains and cleanouts that have both plastic and metal spuds with a variety of different strainer and cover diameters and finishes. You will also find residential plastics such as shower drains, roof drains and floor sinks.

E**SECTION F - CAST IRON - Page 249**

This section contains all of our cast iron products such as closet flanges, drains, "Code Blue" drains, and cleanouts.

F**SECTION G - TOOLS - Page 283**

Our tool section has hand tools, plumbing tools, cutting tools, shovels, measuring tools, caulk, chemicals and safety equipment.

G**GASKETS AND COUPLINGS - Page 311**

Here you will find our compression gaskets and no hub couplings.

GASKETS & COUPLINGS**SECTION T: TUBULAR - Page 315**

This section contains all of our chrome plated, rough brass, PVC and ABS plastic tubular products as well as lav drains and pop-up assemblies.

T**PVC/DWV FITTINGS - Page 337**

We offer a wide variety of PVC/DWV fittings including couplings, adapters, elbows, p-traps and bushings.

PVC/DWV FITTINGS**BLACK AND GALVANIZED MALLEABLES/PIPE NIPPLES - Page 347**

In this section you will find our black and galvanized malleable fittings, pipe nipples, readycut pipe and merchant couplings.

BLACK & GALVANIZED MALLEABLES/PIPE NIPPLES**COPPER - Page 361**

Our copper section contains a large variety of fittings including wrot/ACR fittings, forged brass/cast brass pressure fittings, wrot DWV solder fittings, cast DWV solder fittings and cast brass flanges.

COPPER**SECTION M: MERCHANDISING - Page 381**

We have a wide range of merchandising displays to fit your needs. We have peg board, tilt bin, gondola and free standing options available.

M

SECTION A - DECORATIVE

Decorative Kitchen 3-5
Decorative Bathroom 6-28

Disposal Assembly

Fits In-Sink-Erator



- Also acts as a basket strainer
- All stainless steel construction
- Positive stopper
- PVD on Polished Nickel
- Clamshell or box package

CLAM SHELL	BOX	FINISH	CTN QTY
B03004	B03004B	Almond	1
B03003	B03003B	Biscuit	1
B03005	B03005B	Black	1
B03408	—	Brushed Nickel	1
B03401	—	Brushed Stainless	1
B03406	—	Oil Rubbed Bronze	1
B03407	—	Old World Bronze	1
B03001	B03001B	Polar White	1
B03405	—	Polished Nickel (PVD)	1
B03400	—	Polished Stainless	1

Basket Strainers



- Simple to install, operate and maintain
- Positive Seal
- Stainless steel flange and basket
- Positive seal
- PVD on Polished Nickel
- Clamshell or box packaging

PART NO.	FINISH	CTN QTY
B02004	Almond	1
B02404	Antique Nickel	1
B02003	Biscuit	1
B02005	Black	1
B02408	Brushed Nickel	1
B02401	Brushed Stainless	1
B02406	Oil Rubbed Bronze	1
B02407	Old World Bronze	1
B02001	Polar White	1
B02405	Polished Nickel (PVD)	1
B02400	Polished Stainless	1

Replacement Basket Strainers



PART NO.	FINISH	FITS PART NO.	CTN QTY
B02304	Almond	B02004	1
B02303	Biscuit	B02003	1
B02305	Black	B02005	1
B0240BN	Brushed Nickel	B02408	1
B0240BS	Brushed Stainless	B02401	1
B0240RB	Oil Rubbed Bronze	B02406	1
B0240WB	Old World Bronze	B02407	1
B02301	Polar White	B02001	1
B0240PN	Polished Nickel	B02405	1
B0240PS	Polished Stainless	B02400	1

Polished Brass Basket Strainers



- All metal construction with polished brass finish

PART NO.	FINISH	CTN QTY
B02008	Polished Brass	1

Duo Strainer



- PVD finish on Brushed Nickel
- Cast brass

PART NO.	FINISH	CTN QTY
S14007	Chrome Plated	1
S1407BN	Brushed Nickel	1
S1407RB	Oil Rubbed Bronze	1
S1407WB	Old World Bronze	1
S1407NP	Pearl Nickel	1

Junior Duo Basket Strainer



- Complete with nuts and washers

PART NO.	FINISH	CTN QTY
B02050	Chrome Plated	1
B0250BN	Brushed Nickel	1
B0250RB	Oil Rubbed Bronze	1
B0250WB	Old World Bronze	1
B0250NP	Pearl Nickel	1
B02100	Polished Brass	1

Deep Junior Duo Basket Strainer



- Polished brass body
- Complete with nuts and washers
- For 2" and 2 1/2" outlets

PART NO.	FINISH	CTN QTY
B02102	Chrome Plated	1
B02101	Polished Brass	1

A

Dispenser Faucet



- 9-1/2" high
- Poly bagged
- Ceramic cartridge
- Quarter-turn handle
- Sleek European design
- For use with cold water only
- Manufactured of Celcon- will not crack, chip or peel
- Blister card packaging with 1/4" and 3/8" adapters

PART NO.	FINISH	CTN QTY
B70013	Almond	1
B70012	Biscuit	1
B70014	Black	1
B70020	Black body gold spout	1
B70017	White body chrome spout	1

Lotion And Soap Dispenser with Brass Pump



- 2" spout
- All brass pump
- Seven ounce poly bottle
- Blister card packaging

PART NO.	FINISH	CTN QTY
S08020	Chrome	1
S10022	Biscuit	1
S10023	Black	1
S10025	Brushed Nickel (PVD)	1
S10024	Oil Rubbed Bronze	1
S10021	Polar White	1
S10020	Polished Brass	1

Bar Tap Faucet



- Lead Free
- All brass construction
- 1/2" connection
- Epoxy coated
- 1/4" inlet
- 6-1/2" high
- Blister card packaging

PART NO.	FINISH	CTN QTY
B70009	Biscuit	1
B70003	Black	1
B70008	Brushed Nickel	1
B70007	Oil Rubbed Bronze	1
B70004	Old World Bronze	1
B70001	Polar White	1
B70006	Polished Brass	1

Cock Hole Cover



- 1-3/4" diameter top

PART NO.	FINISH	MATERIAL	CTN QTY
B1020AL	Almond	Stainless Steel	1
B1020AB	Antique Brass	Brass	1
B1020AN	Antique Nickel	Brass	1
B1020BI	Biscuit	Stainless Steel	1
B1020BL	Black	Stainless Steel	1
B1020BN	Brushed Nickel (PVD)	Brass	1
B1020RB	Oil Rubbed Bronze	Brass	1
B1020WB	Old World Bronze	Brass	1
B1020NP	Pearl Nickel (PVD)	Brass	1
B1020PW	Polar White	Stainless Steel	1
B1020PN	Polished Nickel	Brass	1
B1020PS	Polished Stainless (PVD)	Brass	1

Decorative Hose And Spray



- Blister card packaging with 1/4" universal coupling adapter

PART NO.	FINISH	CTN QTY
K52011	Biscuit	10
K52013	Black	10
K52014	Brushed Nickel	10
K52016	Oil Rubbed Bronze	10
K52017	Old World Bronze	10
K52010	Polar White	10

Celcon Faucet Hole Cover



- Molded Celcon- will not chip or peel
- Blister card packaging
- 1-3/4" diameter top

PART NO.	FINISH	CTN QTY
C06011	Chrome	1
C06007	Almond	1
C06006	Biscuit	1
C06008	Black	1
C06014	Brushed Nickel	1
C06005	Euro White	1
C06016	Oil Rubbed Bronze	1
C06013	Old World Bronze	1
C06017	Pearl Nickel (PVD)	1
C06004	Polar White	1
C06018	Polished Nickel (PVD)	1

Faucet Hole Cover



- Screw down type
- Fit all
- 1-3/4" diameter top
- Made of ABS

PART NO.	FINISH	CTN QTY
C06002	Almond	1
C06001	Polar White	1

Faucet Hole Cover



- Heavy duty brass construction
- 1-3/4" diameter top

PART NO.	FINISH	CTN QTY
C06021	Brushed Stainless	1
C06024	Polished Nickel	1
C06020	Polished Stainless	1

Decorative Air Gap



- Protects dishwasher from sewage backflow
- Boxed
- UPC listed

PART NO.	FINISH	CTN QTY
A10001	Chrome Plated	
A10011	Polar White	50
A10010	Polished Brass	50

Decorative Air Gap Cover



- Replaces chrome cover on most air gaps
- Blister card packaging

PART NO.	FINISH	CTN QTY
A10015	Chrome	1
A10005	Almond	1
A10004	Biscuit	1
A10006	Black	1
A10018	Brushed Nickel	1
A10003	Euro White	1
A10017	Oil Rubbed Bronze	1
A10019	Old World Bronze	1
A10002	Polar White	1

A

Pop-up Vessel Drain



- With overflow holes
- 18 gauge
- 4" Drain Body
- 8" Brass Tailpiece
- Decorative finish covers all metal parts including tailpiece and lock nut.
- Tailpiece opening – 1-1/4" OD
- Fits sinks with 1-1/2" drain hole

PART NO.	FINISH	CTN QTY
P35033	Chrome Plated	1
P3503BN	Brushed Nickel	1
P3503RB	Oil Rubbed Bronze	1
P3503WB	Old World Bronze	1

Grid Vessel Drain



- Without overflow holes
- 18 gauge
- 4" Drain Body
- 8" Brass Tailpiece
- Decorative finish covers all metal parts including tailpiece and lock nut.
- Tailpiece opening – 1-1/4" OD
- Fits sinks with 1-1/2" drain hole

PART NO.	FINISH	CTN QTY
D70205	Chrome Plated	1
D7020BN	Brushed Nickel	1
D7020RB	Oil Rubbed Bronze	1
D7020WB	Old World Bronze	1

Polished Brass Pop-Up Assembly



- PVD durable finish
- All metal construction
- Tool free locknut and ballrod nut
- 1-1/4" tubular
- 17 gauge
- Boxed

PART NO.	FINISH	CTN QTY
P35001	Chrome Plated	25
P35002	Polished Brass	10

Replacement Parts

PART NO.	DESCRIPTION	CTN QTY
P35920	Plunger	25
P35921	Flange	25
P35922	Lift Rod	25

Lav Lift & Turn Drain Without Overflow Holes



- For vessel sinks
- Tailpiece opening- 1-1/4" OD
- 3" Drain Body
- 4-3/4" Brass Tailpiece
- Blister card packaging

PART NO.	FINISH	CTN QTY
P35003	Chrome Plated	1
P3500BN	Brushed Nickel (PVD)	1
P3500RB	Oil Rubbed Bronze	1
P3500WB	Old World Bronze	1
P3500NP	Pearl Nickel (PVD)	1
P3500PB	Polished Brass	1

Lav Drain Without Overflow



- For vessel sinks
- Tailpiece opening- 1-1/4" OD
- 2-1/4" Drain Body
- 6" (5-7/8") Brass Tailpiece
- Blister card packaging

PART NO.	FINISH	CTN QTY
D70105	Chrome Plated	1
D7010BN	Brushed Nickel	5
D7010RB	Oil Rubbed Bronze	5
D7010WB	Old World Bronze	5
D7010NP	Pearl Nickel	5
D7010PB	Polished Brass	5

Brass Tubular P-Trap



- 17 gauge
- Brass slip joint nut and rubber washers

PART NO.	OD	FINISH	CTN QTY
P3892BN	1-1/4"	Brushed Nickel	1
P3892RB	1-1/4"	Oil Rubbed Bronze	1
P3892WB	1-1/4"	Old World Bronze	1
P3892NP	1-1/4"	Pearl Nickel	1
P36125	1-1/4"	Polished Brass	12
P36150	1-1/2"	Polished Brass	12
P3892PB	1-1/4"	Polished Brass (PVD)	1

Brass Tubular P-Trap w/Box Escutcheon



- 17 gauge
- Brass slip joint nut and rubber washers

PART NO.	OD	FINISH	CTN QTY
P3450CP	1-1/4"	Chrome Plated	1
P3450BN	1-1/4"	Brushed Nickel	1
P3450RB	1-1/4"	Oil Rubbed Bronze	1

Polished Brass Finished P-Trap



- Complete with nuts, washers and escutcheons
- Plastic

PART NO.	SIZE	CTN QTY
P36100	1-1/4"	1
P36101	1-1/2"	1

Slip Joint Extension Tube



- 17 gauge
- Brass slip joint nut and rubber washers

PART NO.	SIZE	FINISH	CTN QTY
P3819BN	1-1/4" x 8"	Brushed Nickel	1
P3819RB	1-1/4" x 8"	Oil Rubbed Bronze	1

Offset Bath Supplies



- Chrome plated
- 1/2" supply tubes
- All hardware needed for connection included

PART NO.	DESCRIPTION	CTN QTY
B49020	Single offset (pair)	6
B49021	Double offset (pair)	6
B49022	Replacement nuts, washers and escutcheons	6

Polished Brass Shower Rod Flange With Set Screws



- Includes: two flanges, two set screws and four wood screws

PART NO.	FINISH	CTN QTY
S03152	Shower Rod Flange	1

Polished Brass Jiffy Rod Flanges



- Die Cast

PART NO.	FINISH	CTN QTY
S03151	Metal Jiffy Rod Holder	1

Shower Diverter Valve



- Installs between arm and shower head
- Allows usage of hand-held shower or shower head
- Not a positive shut off

PART NO.	FINISH	CTN QTY
S01070	Chrome Plated	1
S01071	Brushed Nickel	1
S01072	Oil Rubbed Bronze	1
S01073	Old World Bronze	1

3" Adjustable Shower Head



- 2.5 GPM
- Solid Brass

PART NO.	FINISH	CTN QTY
S01010	Chrome Plated	1
S0101BN	Brushed Nickel	1
S0101RB	Oil Rubbed Bronze	1
S0101WB	Old World Bronze	1

Polished Brass Shower Head & Kit



- Shower head is solid brass with PVD finish
- Adjustable
- 2.5 GPM at 80 psi

PART NO.	DESCRIPTION	CTN QTY
S03009	2-1/4" face adjustable	1
S03051	Kit includes arm & flange w/set screws	1

Classic Shower Head



- 1/2" swivel connection
- 2.5 GPM at 80 PSI

PART NO.	FINISH	SIZE	CTN QTY
S01087	Chrome Plated	5"	1
S0187BN	Brushed Nickel	5"	1
S0187RB	Oil Rubbed Bronze	5"	1
S0187WB	Old World Bronze	5"	1
S01187	Polished Brass	5"	1

Round Shower Head With Tips



- 1/2" swivel connection
- 2.5 GPM at 80 PSI

PART NO.	FINISH	SIZE	CTN QTY
S01084	Chrome Plated	6"	1
S0184BN	Brushed Nickel	6"	1
S0184RB	Oil Rubbed Bronze	6"	1
S0184WB	Old World Bronze	6"	1
S01184	Polished Brass	6"	1

PART NO.	FINISH	SIZE	CTN QTY
S01085	Chrome Plated	8"	1
S0185BN	Brushed Nickel	8"	1
S0185RB	Oil Rubbed Bronze	8"	1
S0185WB	Old World Bronze	8"	1
S01185	Polished Brass	8"	1

PART NO.	FINISH	SIZE	CTN QTY
S01086	Chrome Plated	10"	1
S0186BN	Brushed Nickel	10"	1
S0186RB	Oil Rubbed Bronze	10"	1
S0186WB	Old World Bronze	10"	1
S01186	Polished Brass (PVD)	10"	1

A

Round Rain Style Shower Head with Dimples



- 1/2" swivel connection
- 2.5 GPM at 80 PSI

PART NO.	FINISH	SIZE	CTN QTY
S01088	Chrome Plated	5"	1
S0188BN	Brushed Nickel	5"	1
S0188RB	Oil Rubbed Bronze	5"	1
S0188WB	Old World Bronze	5"	1

PART NO.	FINISH	SIZE	CTN QTY
S01089	Chrome Plated	8"	1
S0189BN	Brushed Nickel	8"	1
S0189RB	Oil Rubbed Bronze	8"	1
S0189WB	Old World Bronze	8"	1

Round Shower Head With Gold Tips



- Chrome plated body with gold tips (removable)
- 2.5 GPM at 80 PSI

PART NO.	SIZE	CTN QTY
S01090	5"	20
S01091	9"	12

Shower Head with Rubber Tips



- 2.5 GPM at 80psi
- Chrome & Brushed Nickel finishes have grey tips
- Oil Rubbed Bronze & Old World Bronze finishes have black tips

PART NO.	FINISH	SIZE	CTN QTY
S01096	Chrome Plated	10"	1
S0196BN	Brushed Nickel	10"	1
S0196RB	Oil Rubbed Bronze	10"	1
S0196WB	Old World Bronze	10"	1



- 2.5 GPM at 80psi
- Chrome & Brushed Nickel finishes have grey tips
- Oil Rubbed Bronze & Old World Bronze finishes have black tips

PART NO.	FINISH	SIZE	CTN QTY
S01092	Chrome Plated	8"	1
S0192BN	Brushed Nickel	8"	1
S0192RB	Oil Rubbed Bronze	8"	1
S0192WB	Old World Bronze	8"	1
S01093	Chrome Plated	10"	1
S0193BN	Brushed Nickel	10"	1
S0193RB	Oil Rubbed Bronze	10"	1
S0193WB	Old World Bronze	10"	1



- 2.5 GPM at 80psi
- Chrome & Brushed Nickel finishes have grey tips
- Oil Rubbed Bronze & Old World Bronze finishes have black tips

PART NO.	FINISH	SIZE	CTN QTY
S01094	Chrome Plated	8"	1
S0194BN	Brushed Nickel	8"	1
S0194RB	Oil Rubbed Bronze	8"	1
S0194WB	Old World Bronze	8"	1
S01095	Chrome Plated	10"	1
S0195BN	Brushed Nickel	10"	1
S0195RB	Oil Rubbed Bronze	10"	1
S0195WB	Old World Bronze	10"	1

S-Shaped Shower Arm



- 18" length
- Adds 12" to height
- 1/2" female threads
- Fixed escutcheon

PART NO.	FINISH	CTN QTY
S01055	Chrome Plated	1
S0155BN	Brushed Nickel	1
S0155RB	Oil Rubbed Bronze	1
S0155WB	Old World Bronze	1
S01155	Polished Brass (PVD)	1

S-Shaped Shower Arm



- Chrome plated brass
- 8" or 10" length

PART NO.	DESCRIPTION	CTN QTY
S01035	8" arm	1
S01038	10" arm	1

Ceiling Mount Shower Arm



- 1/2" female threads
- Fixed escutcheon

1/2" x 6"		
PART NO.	FINISH	CTN QTY
S01051	Chrome Plated	10
S0151BN	Brushed Nickel	10
S0151RB	Oil Rubbed Bronze	10
S0151WB	Old World Bronze	10
S01151	Polished Brass (PVD)	10

1/2" x 12"		
PART NO.	FINISH	CTN QTY
S01052	Chrome Plated	10
S0152BN	Brushed Nickel	10
S0152RB	Oil Rubbed Bronze	10
S0152WB	Old World Bronze	10
S01152	Polished Brass (PVD)	10

1/2" x 18"		
PART NO.	FINISH	CTN QTY
S01053	Chrome Plated	10
S0153BN	Brushed Nickel	10
S0153RB	Oil Rubbed Bronze	10
S0153WB	Old World Bronze	10
S01153	Polished Brass (PVD)	10

90° Shower Arm With Flange



- 18" length
- 1/2" female threads
- Fixed escutcheon

PART NO.	FINISH	CTN QTY
S01056	Chrome Plated	1
S0156BN	Brushed Nickel	1
S0156RB	Oil Rubbed Bronze	1
S0156WB	Old World Bronze	1
S01156	Polished Brass	1

Raised Bend Shower Arm



- 18" length
- 1/2" female threads
- Fixed escutcheon

PART NO.	FINISH	CTN QTY
S01057	Chrome Plated	1
S0157BN	Brushed Nickel	1
S0157RB	Oil Rubbed Bronze	1
S0157WB	Old World Bronze	1
S01157	Polished Brass (PVD)	1

Double Offset Shower Arm



- 18" length
- 1/2" female threads
- Adds 12" to height
- Fixed escutcheon

PART NO.	FINISH	CTN QTY
S01058	Chrome Plated	1
S0158BN	Brushed Nickel	1
S0158RB	Oil Rubbed Bronze	1
S0158WB	Old World Bronze	1
S01158	Polished Brass (PVD)	1

Shower Arm



- Solid Brass
- Fits E02 series escutcheons

68" Arm		
PART NO.	FINISH	CTN QTY
S01030	Chrome Plated	1
S0130BN	Brushed Nickel	1
S0130RB	Oil Rubbed Bronze	1
S0130WB	Old World Bronze	1

8" Arm		
PART NO.	FINISH	CTN QTY
S01032	Chrome Plated	1
S0132BN	Brushed Nickel	1
S0132RB	Oil Rubbed Bronze	1
S0132WB	Old World Bronze	1

Polished Brass Shower Arm



- Solid Brass
- Fits E81050 escutcheon

PART NO.	DESCRIPTION	CTN QTY
S03030	1/2" x 6"	1
S03032	1/2" x 8"	1
S01036	1/2" x 8" s-style	1
S01037	1/2" x 10" s-style	1

A

Contoured Shower Curtain Rods

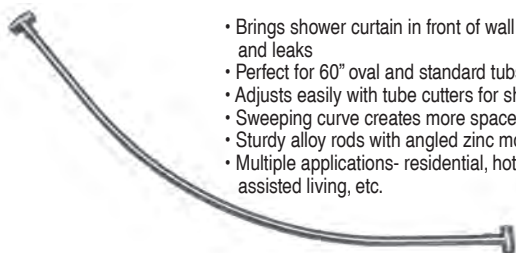

- Brings shower curtain in front of wall to prevent gaps and leaks
- Perfect for 60" oval and standard tubs
- Adjusts easily with tube cutters for shower walls
- Sweeping curve creates more space in center of tub
- Sturdy alloy rods with angled zinc mounting brackets
- Multiple applications- residential, hotel, motel, assisted living, etc.

PART NO.	FINISH	CTN QTY
S02190	Chrome Plated	1
S02191	Polar White	1
S02193	Satin Nickel	1

PART NO.	FINISH	CTN QTY
S02290	Chrome Flanges (Fits S02190)	1
S02293	Satin Nickel Flanges (Fits S02193)	1
S02291	White Flanges (Fits S02191)	1

Cover Plates

- Mirrored acrylic
- Conceals damaged/cracked tiles
- Fits all standard bath/shower fittings
- No tools required-use silicone caulk
- DO NOT use abrasive cleaners



PART NO.	DESCRIPTION	SIZE	CTN QTY
T73001	Tub spout model	3-1/2" diameter	1
T73002	One handle model	8" x 14"	1
T73003	Two handle model	6" x 14"	1
T73004	Three handle model	6" x 14"	1

Polished Stainless Steel Repair Cover Plates

- 1, 2 or 3 hole design to fit multitude of valves
- Polished stainless steel finish
- Easily attaches with silicone caulk; one hole has brackets and screw
- 7-1/4" x 13" long



PART NO.	# OF HOLES	DIAMETER	CTN QTY
T73815	1	5-1/8"	1
T73816	2	1-3/8"	1
T73817	3	1-3/8"	1
T73818	1	3-3/4"	1

Polished Brass Shower Arm Flange



- The S03-040 is die cast with a set screw
- Poly bagged

PART NO.	DESCRIPTION	CTN QTY
S03040	1/2" with set screw	5

Polished Brass TubSpouts



- PVD durable finish
- All brass
- Boxed

PART NO.	DESCRIPTION	MATERIAL	CONNECTION	CTN QTY
D03016	3/4" x 1/2"x 8-1/2"	Brass	Base	1



- Brass plated zamak
- Boxed

PART NO.	DESCRIPTION	MATERIAL	CONNECTION	CTN QTY
D03020	1/2" FIP	Zamak	Nose	1

Polished Brass Diverter Spouts



- PVD durable finish
- Brass plated zamak
- Boxed

PART NO.	DESCRIPTION	MATERIAL	CONNECTION	CTN QTY
D03001	1/2" FIP	Zamak	Nose	1



- PVD durable finish
- Brass plated zamak
- Boxed

PART NO.	DESCRIPTION	MATERIAL	CONNECTION	CTN QTY
D03002	3/4" x 1/2" FIP	Zamak	Base	1
D03004	1/2" CTS (5/8" OD) Slip-on with hex key	Zamak	Base	1



- Brass plated zamak
- Boxed

PART NO.	DESCRIPTION	MATERIAL	CONNECTION	CTN QTY
D03010	3/4" x 1/2" FIP with 1/2" top connection for hand-held shower	Zamak	Base	1



- Brass plated zamak
- Boxed

PART NO.	DESCRIPTION	MATERIAL	CONNECTION	CTN QTY
D03011	3/4" x 1/2" FIP with 1/2" bottom connection for hand-held shower	Zamak	Base	1



- PVD durable finish
- All brass
- Boxed

PART NO.	DESCRIPTION	MATERIAL	CONNECTION	CTN QTY
D03015	3/4" x 1/2" x 8-1/2" long	Brass	Base	1

Chrome Plated Diverter Spouts and Extensions

8-1/2" One Piece Diverter Spout



- All brass
- Boxed

PART NO.	DESCRIPTION	MATERIAL	CONNECTION	CTN QTY
D01015	3/4" x 1/2" FIP	Brass	Base	1

Extension Only



- All brass

PART NO.	DESCRIPTION	MATERIAL	CTN QTY
D01030	3" extension only	CP Brass	1
D01031	4-3/4" extension only	CP Brass	1

Diverter Spout for Hand Held Shower



- Chrome plated zamak

PART NO.	DESCRIPTION	MATERIAL	CONNECTION	CTN QTY
D01010	3/4" x 1/2" FIP top hookup	Zamak	Base	10
D01011	3/4" x 1/2" MIP lower hookup	Zamak	Base	10

7" Chrome Plated Diverter Spout



- Longer length for today's larger tubs
- CTS unit comes with hex key
- Chrome plated zamak

PART NO.	CONNECTION	CTN QTY
D01024	1/2" FIP Nose	25
D01025	1/2" CTS Nose	25

Chrome Plated Diverter Spout with Polished Brass Knob



- Brass plated zamak or all brass
- Boxed

PART NO.	DESCRIPTION	MATERIAL	CONNECTION	CTN QTY
D01032	CP slip on diverter with PB knob	Zamak	Base	1

Chrome Plated Tub Spouts

Chrome Plated Zamak



- Key included in slide connection

PART NO.	DESCRIPTION	MATERIAL	CONNECTION	CTN QTY
D01020	1/2" FIP	CP Zamak	Nose	10
D01021	1/2" CTS Slide	CP Zamak	Base	10

8-1/2" One Piece Chrome Plated Brass



PART NO.	DESCRIPTION	MATERIAL	CONNECTION	CTN QTY
D01016	3/4" x 1/2" FIP	CP Brass	Base	1

9" Chrome Plated Tub & Diverter Spout



- One piece design
- 1/2" nose connection
- Solid brass construction

PART NO.	DESCRIPTION	CTN QTY
D01017	9" CP brass diverter spout	1
D01018	9" CP brass tub spout	1

7" Chrome Plated Tub Spout



- CTS unit comes with hex key
- Longer length for today's larger tubs
- Chrome plated zamak

PART NO.	SIZE	CONNECTION	CTN QTY
D01026	7"	1/2" FIP Nose	25
D01027	7"	1/2" CTS Slide	25

Decorative Ring for Tub Spouts & Diverter



- Adds decorative touch to any tub spout or diverter
- Fits between the wall and the tub spout or diverter
- 3-5/16" OD 2-3/8" ID

PART NO.	FINISH	CTN QTY
D01050	Chrome Plated	1
D01050BN	Brushed Nickel	1
D01050RB	Oil Rubbed Bronze	1
D01050WB	Old World Bronze	1

A

Tub Trip Lever with Spring



• Includes screws

PART NO.	FINISH	# OF HOLES	CTN QTY
T05003	Chrome Plated	2	25
T08003	Polished Brass	2	1
T08004	PVD Polished Brass	2	1

Overflow Plates



• Includes screws

PART NO.	FINISH	# OF HOLES	CTN QTY
T08012	Polished Brass	1	1
T08013	Polished Brass	2	1
P35616	Satin Nickel	2	1
T05015	White	2	1

PVD Polished Brass Overflow Plates



• Includes screws

PART NO.	FINISH	# OF HOLES	CTN QTY
T08112	PVD Durable Finish	1	1
T08113	PVD Durable Finish	2	1

Waste And Overflow Faceplate with Screw



• Includes screws

PART NO.	FINISH	# OF HOLES	CTN QTY
T05012	Chrome Plated	1	25
T0812BN	Brushed Nickel	1	1
T0812RB	Oil Rubbed Bronze	1	1
T0812WB	Old World Bronze	1	1
T0812NP	Pearl Nickel	1	1

Polished Brass Bath Waste Conversion Kits



- Converts regular bath waste to polished brass
- Fits 1-3/8" or 1-1/2" waste elbows
- Includes drain, bushing, face plate, and 2 screws
- Blister card packaging

For Trip Lever Wastes

PART NO.	SIZE	# OF HOLES	CTN QTY
B51001	1-1/2" and 1-3/8"	2	12

For Toe Touch Wastes

PART NO.	SIZE	# OF HOLES	CTN QTY
B51002	1/2" and 1-3/8"	2	12

For Lift and Turn Wastes

PART NO.	SIZE	# OF HOLES	CTN QTY
B51003	1/2" and 1-3/8"	2	12
B51020	1/2" and 1-3/8"	1	12

Decorative Lift And Turn Conversion Kit



- 1- Hole faceplate
- Clamshell packaging
- Aluminum adapter bar
- 1-3/8" drain with bushing
- Includes drain, bushing, face plate and screw
- Blister card packaging

PART NO.	FINISH	# OF HOLES	CTN QTY
B51019	Chrome Plated	1	1
B5160AP	Antique Pewter	1	1
B5160BB	Brushed Bronze	1	1
B5160BN	Brushed Nickel	1	1
B5160BS	Brushed Stainless	1	1
B5160RB	Oil Rubbed Bronze	1	1
B5160WB	Old World Bronze	1	1
B5160NP	Pearl Nickel	1	1
B5160PN	Polished Nickel	1	1
B5160PS	Polished Stainless	1	1

Toe Touch Conversion Kit



- With aluminum adapter bar
- 1-3/8" drain with bushing, screw and faceplate
- Clamshell packaging

PART NO.	FINISH	# OF HOLES	CTN QTY
B51010	Chrome Plated	1	1
B5161AP	Antique Pewter	1	1
B5161BB	Brushed Bronze	1	1
B5161BN	Brushed Nickel	1	1
B5161RB	Oil Rubbed Bronze	1	1
B5161WB	Old World Bronze	1	1
B5161NP	Pearl Nickel	1	1
B5161PS	Polished Stainless	1	1

Lift And Turn Conversion Kit



- 1-3/8" drain with bushing, screw and faceplate
- Clamshell packaging
- 2-hole faceplate

PART NO.	FINISH	# OF HOLES	CTN QTY
B51005	Chrome Plated	2	1
B5155AL	Almond	2	1
B5155AB	Antique Brass	2	1
B5155AN	Antique Nickel	2	1
B5155AP	Antique Pewter	2	1
B5155BI	Biscuit	2	1
B5155BL	Black	2	1
B5155BB	Brushed Bronze	2	1
B5155BN	Brushed Nickel	2	1
B5155BS	Brushed Stainless	2	1
B5155RB	Oil Rubbed Bronze	2	1
B5155WB	Old World Bronze	2	1
B5155NP	Pearl Nickel	2	1
B5155PW	Polar White	2	1
B5155PS	Polished Stainless	2	1
B51004	Satin Nickel	2	1

Toe Touch Conversion Kit



- Fits 1-3/8" or 1-1/2" waste elbows
- Includes drain, bushing, face plate and 2 screws
- Clamshell packaging
- 2-hole faceplate

PART NO.	FINISH	# OF HOLES	CTN QTY
B51007	Chrome Plated	2	1
B5156AP	Antique Pewter	2	1
B5156BB	Brushed Bronze	2	1
B5156BN	Brushed Nickel	2	1
B5156RB	Oil Rubbed Bronze	2	1
B5156WB	Old World Bronze	2	1
B5156NP	Pearl Nickel	2	1
B5156PS	Polished Stainless	2	1

Trip Lever Conversion Kit



- Fits 1-3/8" or 1-1/2" waste elbows
- Includes drain, bushing, face plate and 2 screws
- Clamshell packaging

PART NO.	FINISH	# OF HOLES	CTN QTY
B51015	Chrome Plated	2	1
B5112AP	Antique Pewter	2	1
B5112BI	Biscuit	2	1
B5112BB	Brushed Bronze	2	1
B5112BN	Brushed Nickel	2	1
B5112BS	Brushed Stainless	2	1
B5112RB	Oil Rubbed Bronze	2	1
B5112WB	Old World Bronze	2	1
B5112NP	Pearl Nickel	2	1
B5112PW	Polar White	2	1

Trip Lever Trim Only



- Clamshell packaging
- Includes faceplate, screws and strainer

PART NO.	FINISH	# OF HOLES	CTN QTY
B51014	Chrome Plated	2	1
B5114AP	Antique Pewter	2	1
B5114BB	Brushed Bronze	2	1
B5114BN	Brushed Nickel	2	1
B5114RB	Oil Rubbed Bronze	2	1
B5114WB	Old World Bronze	2	1
B5114NP	Pearl Nickel	2	1
B5114PB	Polished Brass	2	1
B5114PN	Polished Nickel	2	1
B5114PS	Polished Stainless	2	1

A Trip Lever Faceplate And Handle



• Less screws

PART NO.	FINISH	# OF HOLES	CTN QTY
T05002	Chrome Plated	2	1
P3566AL	Almond	2	1
P3566AB	Antique Brass	2	1
P3566AN	Antique Nickel	2	1
P3566BI	Biscuit	2	1
P3566BL	Black	2	1
P3566BN	Brushed Nickel	2	1
P3566BS	Brushed Stainless	2	1
P3566RB	Oil Rubbed Bronze	2	1
P3566WB	Old World Bronze	2	1
P3566NP	Pearl Nickel	2	1
P3566PW	Polar White	2	1
P3566PN	Polished Nickel	2	1
P3566PS	Polished Stainless	2	1

Two-Hole Overflow Faceplate & Screws



PART NO.	FINISH	# OF HOLES	CTN QTY
T05013	Chrome Plated	2	1
T0813BN	Brushed Nickel	2	1
T0813RB	Oil Rubbed Bronze	2	1
T0813WB	Old World Bronze	2	1
T0813NP	Pearl Nickel	2	1
T0813PW	Polar White	2	1

Waste And Overflow Faceplate Only



• Less screws

PART NO.	FINISH	# OF HOLES	CTN QTY
T05011	Chrome Plated	2	1
P3565AL	Almond	2	1
P3565AB	Antique Brass	2	1
P3565AN	Antique Nickel	2	1
P3565BI	Biscuit	2	1
P3565BL	Black	2	1
P3565BN	Brushed Nickel	2	1
P3565BS	Brushed Stainless	2	1
P3565RB	Oil Rubbed Bronze	2	1
P3565WB	Old World Bronze	2	1
P3565NP	Pearl Nickel	2	1
P3565PW	Polar White	2	1
P3565PN	Polished Nickel	2	1
P3565PS	Polished Stainless	2	1

PB Satin Nickel / Faceplate Screws



PART NO.	FINISH	SIZE	CTN QTY
T08021	Polished Brass	1/4" x 2"	25
P35615	Satin Nickel	1/4" x 2"	25

Waste And Overflow Faceplate Screws



PART NO.	FINISH	CTN QTY
T05021	Chrome Plated	1
T0521AL	Almond	1
T0521AB	Antique Brass	1
T0521AN	Antique Nickel	1
T0521BI	Biscuit	1
T0521BL	Black	1
T0521BN	Brushed Nickel	1
T0521BS	Brushed Stainless	1
T0521RB	Oil Rubbed Bronze	1
T0521WB	Old World Bronze	1
T0521NP	Pearl Nickel	1
T0521PW	Polar White	1
T0521PN	Polished Nickel	1
T0521PS	Polished Stainless	1

Flip-It Conversion Kit



- No tools needed for installation
- Open or close with a flip of the toe
- Fits most popular tub drains (assorted o-ring included)
- One piece construction Delrin and ABS

PART NO.	FINISH	CTN QTY
P35170	Chrome Plated	1
P35172	Brushed Nickel	1
P35171	Polished Brass	1

Flip-It Tub Stopper



- No tools needed for installation
- Open or close with a flip of the toe
- Fits most popular tub drains (assorted o-ring included)
- One piece construction Delrin and ABS

PART NO.	FINISH	CTN QTY
P35070	Chrome Plated	12
P35071	Polished Brass	12



Bath Drains



PART NO.	DESCRIPTION	CTN QTY
P35061	1-3/8" CP Lift and Turn Drain	
P35051	1-3/8" PB Lift and Turn Drain	1
P35060	1-1/2" CP Lift and Turn Drain	
P35050	1-1/2" PB Lift and Turn Drain	1
P35065	1-1/2" White Lift and Turn Drain	1



PART NO.	DESCRIPTION	CTN QTY
P35063	1-3/8" CP Pop-Up Drain	0
P35053	1-3/8" PB Pop-Up Drain	1
P35062	1-1/2" CP Pop-Up Drain	0
P35052	1-1/2" PB Pop-Up Drain	1



PART NO.	DESCRIPTION	CTN QTY
P35056	5/16" CP Pop-Up Cartridge	0
P35055	5/16" PB Pop-Up Cartridge	1



- 1-3/8" are fine threads
- 1-1/2" are course threads

PART NO.	DESCRIPTION	CTN QTY
T05024	1-3/8" female- 1-1/2" male bushing	1

Polished Brass/Satin Nickel Bath Drains



- PVD durable finish

PART NO.	DESCRIPTION	FINISH	CTN QTY
P35072	1-1/2" Lift and Turn Drain	Polished Brass	1
P35073	1-1/2" Pop-Up	Polished Brass	1
P35068	1-1/2" Friction Lift	Polished Brass	1
P35058	3/8" Pop-Up Replacement	Polished Brass	1
P35610	1-1/2" Lift and Turn Drain	Satin Nickel	1
P35611	1-1/2" Friction Lift	Satin Nickel	1
P35612	1-1/2" Toe Touch	Satin Nickel	1
P35613	1-1/2" Trip Lever Drain	Satin Nickel	1
P35614	1-1/2" Cable Drive Drain	Satin Nickel	1

Toe Touch Tub Drain



- 1-1/2" drain
- Course thread

PART NO.	FINISH	CTN QTY
P35062	Chrome Plated	1
P3562AL	Almond	1
P3562AB	Antique Brass	1
P3562AN	Antique Nickel	1
P3562BI	Biscuit	1
P3562BL	Black	1
P3562BN	Brushed Nickel	1
P3562BS	Brushed Stainless	1
P3562RB	Oil Rubbed Bronze	1
P3562WB	Old World Bronze	1
P3562NP	Pearl Nickel	1
P3562PW	Polar White	1
P3562PN	Polished Nickel	1
P3562PS	Polished Stainless	1

Trip Lever Body, Grid And Screw



- 1-1/2" drain
- Course thread

PART NO.	FINISH	CTN QTY
P35064	Chrome Plated	1
P3563AL	Almond	1
P3563AB	Antique Brass	1
P3563AN	Antique Nickel	1
P3563BI	Biscuit	1
P3563BL	Black	1
P3563BN	Brushed Nickel	1
P3563BS	Brushed Stainless	1
P3563RB	Oil Rubbed Bronze	1
P3563WB	Old World Bronze	1
P3563NP	Pearl Nickel	1
P3563PW	Polar White	1
P3563PN	Polished Nickel	1
P3563PS	Polished Stainless	1

A

Lift And Turn Tub Drain



- Solid Brass
- Body and stopper
- 1-1/2" drain
- Course thread

PART NO.	FINISH	CTN QTY
P35066	Chrome Plated	1
P3560AL	Almond	1
P3560AB	Antique Brass	1
P3560AN	Antique Nickel	1
P3560BI	Biscuit	1
P3560BL	Black	1
P3560BN	Brushed Nickel	1
P3560BS	Brushed Stainless	1
P3560RB	Oil Rubbed Bronze	1
P3560WB	Old World Bronze	1
P3560NP	Pearl Nickel	1
P3560PW	Polar White	1
P35050	Polished Brass	1
P3560PN	Polished Nickel	1
P3560PS	Polished Stainless	1
P35610	Satin Nickel	1

Friction Lift Tub Drain



- Solid Brass
- 1-1/2" drain
- Course thread

PART NO.	FINISH	CTN QTY
P35067	Chrome Plated	1
P3561AL	Almond	1
P3561AB	Antique Brass	1
P3561AN	Antique Nickel	1
P3561BI	Biscuit	1
P3561BL	Black	1
P3561BN	Brushed Nickel	1
P3561BS	Brushed Stainless	1
P3561RB	Oil Rubbed Bronze	1
P3561WB	Old World Bronze	1
P3561NP	Pearl Nickel	1
P3561PW	Polar White	1
P35068	Polished Brass	1
P3561PN	Polished Nickel	1
P3561PS	Polished Stainless	1
P35611	Satin Nickel	1

Standard One-Hole Schedule 40 Lift & Turn Half Kit



PVC#	ABS#	FINISH	CTN QTY
B07010	B07011	Chrome Plated	1
B0750BN	B0850BN	Brushed Nickel	1
B0750RB	B0850RB	Oil Rubbed Bronze	1
B0750WB	B0850WB	Old World Bronze	1
B0750NP	B0850NP	Pearl Nickel	1
B07014	B07015	Polished Brass	1

Standard One-Hole Schedule 40 Lift & Turn Full Kit



PVC#	ABS#	FINISH	CTN QTY
B07030	B07031	Chrome Plated	1
B0751BN	B0851BN	Brushed Nickel	1
B0751RB	B0851RB	Oil Rubbed Bronze	1
B0751WB	B0851WB	Old World Bronze	1
B0751NP	B0851NP	Pearl Nickel	1
B07034	B07035	Polished Brass	1

Standard One-Hole Schedule 40 Friction Lift Half Kit



PVC#	ABS#	FINISH	CTN QTY
B07052	B07053	Chrome Plated	1
B0752BN	B0852BN	Brushed Nickel	1
B0752RB	B0852RB	Oil Rubbed Bronze	1
B0752WB	B0852WB	Old World Bronze	1
B0752NP	B0852NP	Pearl Nickel	1
B07054	B07055	Polished Brass	1

Standard One-Hole Schedule 40 Friction Lift Full Kit



PVC#	ABS#	FINISH	CTN QTY
B07058	B07059	Chrome Plated	1
B0753BN	B0853BN	Brushed Nickel	1
B0753RB	B0853RB	Oil Rubbed Bronze	1
B0753WB	B0853WB	Old World Bronze	1
B0753NP	B0853NP	Pearl Nickel	1
B07060	B08060	Polished Brass	1

Standard One-Hole Schedule 40 Toe Touch Half Kit



PVC#	ABS#	FINISH	CTN QTY
B07012	B07013	Chrome Plated	24
B0754BN	B0854BN	Brushed Nickel	1
B0754RB	B0854RB	Oil Rubbed Bronze	1
B0754WB	B0854WB	Old World Bronze	1
B0754NP	B0854NP	Pearl Nickel	1
B07016	B07017	Polished Brass	1

Standard One-Hole Schedule 40 Toe Touch Full Kit



PVC#	ABS#	FINISH	CTN QTY
B07032	B07033	Chrome Plated	1
B0755BN	B0855BN	Brushed Nickel	1
B0755RB	B0855RB	Oil Rubbed Bronze	1
B0755WB	B0855WB	Old World Bronze	1
B0755NP	B0855NP	Pearl Nickel	1
B07036	B07037	Polished Brass	1

Standard Two-Hole Schedule 40 Lift & Turn Half Kit



PVC#	ABS#	FINISH	CTN QTY
B07110	B07111	Chrome Plated	1
B0711AL	B0811AL	Almond	1
B0711AB	B0811AB	Antique Brass	1
B0711AN	B0811AN	Antique Nickel	1
B0711BI	B0811BI	Biscuit	1
B0711BL	B0811BL	Black	1
B0711BN	B0811BN	Brushed Nickel	1
B0711BS	B0811BS	Brushed Stainless	1
B0711RB	B0811RB	Oil Rubbed Bronze	1
B0711WB	B0811WB	Old World Bronze	1
B0711NP	B0811NP	Pearl Nickel	1
B0711PW	B0811PW	Polar White	1
B07114	B07115	Polished Brass	1
B0711PN	B0811PN	Polished Nickel	1
B0711PS	B0811PS	Polished Stainless	1

Standard Two-Hole Schedule 40 Lift And Turn Full Kit



PVC#	ABS#	FINISH	CTN QTY
B07130	B07131	Chrome Plated	1
B0713AL	B0813AL	Almond	1
B0713AB	B0813AB	Antique Brass	1
B0713AN	B0813AN	Antique Nickel	1
B0713BI	B0813BI	Biscuit	1
B0713BL	B0813BL	Black	1
B0713BN	B0813BN	Brushed Nickel	1
B0713RB	B0813RB	Oil Rubbed Bronze	1
B0713WB	B0813WB	Old World Bronze	1
B0713NP	B0813NP	Pearl Nickel	1
B0713PW	B0813PW	Polar White	1
B07134	B07135	Polished Brass	1
B0713PN	B0813PN	Polished Nickel	1
B0713PS	B0813PS	Polished Stainless	1

Standard Two-Hole Schedule 40 Toe Touch Half Kit



PVC#	ABS#	FINISH	CTN QTY
B07112	B07113	Chrome Plated	1
B0717AL	B0817AL	Almond	1
B0717AB	B0817AB	Antique Brass	1
B0717AN	B0817AN	Antique Nickel	1
B0717BI	B0817BI	Biscuit	1
B0717BL	B0817BL	Black	1
B0717BN	B0817BN	Brushed Nickel	1
B0717BS	B0817BS	Brushed Stainless	1
B0717RB	B0817RB	Oil Rubbed Bronze	1
B0717WB	B0817WB	Old World Bronze	1
B0717NP	B0817NP	Pearl Nickel	1
B0717PW	B0817PW	Polar White	1
B07116	B07117	Polished Brass	1
B0717PN	B0817PN	Polished Nickel	1
B0717PS	B0817PS	Polished Stainless	1

A

Standard Two-Hole Schedule 40 Friction Lift Full Kit



PVC#	ABS#	FINISH	CTN QTY
B07158	B07159	Chrome Plated	1
B0716AL	B0816AL	Almond	1
B0716AB	B0816AB	Antique Brass	1
B0716AN	B0816AN	Antique Nickel	1
B0716BI	B0816BI	Biscuit	1
B0716BL	B0816BL	Black	1
B0716BN	B0816BN	Brushed Nickel	1
B0716BS	B0816BS	Brushed Stainless	1
B0716RB	B0816RB	Oil Rubbed Bronze	1
B0716WB	B0816WB	Old World Bronze	1
B0716NP	B0816NP	Pearl Nickel	1
B0716PW	B0816PW	Polar White	1
B07160	B07161	Polished Brass	1
B0716PN	B0816PN	Polished Nickel	1
B0716PS	B0816PS	Polished Stainless	1

Standard Two-Hole Schedule 40 Toe Touch Full Kit



PVC#	ABS#	FINISH	CTN QTY
B07132	B07133	Chrome Plated	1
B0718AL	B0818AL	Almond	1
B0718AB	B0818AB	Antique Brass	1
B0718AN	B0818AN	Antique Nickel	1
B0718BI	B0818BI	Biscuit	1
B0718BL	B0818BL	Black	1
B0718BN	B0818BN	Brushed Nickel	1
B0718RB	B0818RB	Oil Rubbed Bronze	1
B0718WB	B0818WB	Old World Bronze	1
B0718NP	B0818NP	Pearl Nickel	1
B0718PW	B0818PW	Polar White	1
B07136	B07137	Polished Brass	1
B0718PN	B0818PN	Polished Nickel	1
B0718PS	B0818PS	Polished Stainless	1

Standard Two-Hole Schedule 40 Friction Lift Half Kit



PVC#	ABS#	FINISH	CTN QTY
B07152	B07153	Chrome Plated	1
B0715AL	B0815AL	Almond	1
B0715AB	B0815AB	Antique Brass	1
B0715AN	B0815AN	Antique Nickel	1
B0715BI	B0815BI	Biscuit	1
B0715BL	B0815BL	Black	1
B0715BN	B0815BN	Brushed Nickel	1
B0715RB	B0815RB	Oil Rubbed Bronze	1
B0715WB	B0815WB	Old World Bronze	1
B0715NP	B0815NP	Pearl Nickel	1
B0715PW	B0815PW	Polar White	1
B07154	B07155	Polished Brass	1
B0715PN	B0815PN	Polished Nickel	1
B0715PS	B0815PS	Polished Stainless	1

Tubular Lift and Turn Full Kit



PVC#	ABS#	FINISH	CTN QTY
P37500	P39500	Chrome Plated	1
P3750AL	P3950AL	Almond	1
P3750AB	P3950AB	Antique Brass	1
P3750AN	P3950AN	Antique Nickel	1
P3750BI	P3950BI	Biscuit	1
P3750BL	P3950BL	Black	1
P3750BN	P3950BN	Brushed Nickel	1
P3750BS	P3950BS	Brushed Stainless	1
P3750RB	P3950RB	Oil Rubbed Bronze	1
P3750WB	P3950WB	Old World Bronze	1
P3750NP	P3950NP	Pearl Nickel	1
P3750PW	P3950PW	Polar White	1
P3750PN	P3950PN	Polished Nickel	1
P3750PS	P3950PS	Polished Stainless	1
P37502	P39502	Satin Nickel	1

Tubular Friction Lift Full Kit



PVC#	ABS#	FINISH	CTN QTY
P37503	P39503	Chrome Plated	1
P3751AL	P3951AL	Almond	1
P3751AB	P3951AB	Antique Brass	1
P3751AN	P3951AN	Antique Nickel	1
P3751BI	P3951BI	Biscuit	1
P3751BL	P3951BL	Black	1
P3751BN	P3951BN	Brushed Nickel	1
P3751BS	P3951BS	Brushed Stainless	1
P3751RB	P3951RB	Oil Rubbed Bronze	1
P3751WB	P3951WB	Old World Bronze	1
P3751NP	P3951NP	Pearl Nickel	1
P3751PW	P3951PW	Polar White	1
P3751PN	P3951PN	Polished Nickel	1
P3751PS	P3951PS	Polished Stainless	1
P37505	P39505	Satin Nickel	1

Tubular Toe Touch Kit



PVC#	ABS#	FINISH	CTN QTY
P37506	P39506	Chrome Plated	1
P3752AL	P3952AL	Almond	1
P3752AB	P3952AB	Antique Brass	1
P3752AN	P3952AN	Antique Nickel	1
P3752BI	P3952BI	Biscuit	1
P3752BL	P3952BL	Black	1
P3752BN	P3952BN	Brushed Nickel	1
P3752RB	P3952RB	Oil Rubbed Bronze	1
P3752WB	P3952WB	Old World Bronze	1
P3752NP	P3952NP	Pearl Nickel	1
P3752PW	P3952PW	Polar White	1
P3752PN	P3952PN	Polished Nickel	1
P3752PS	P3952PS	Polished Stainless	1
P37508	P39508	Satin Nickel	1

27" Cable Drive Full Kit

1-1/2" Schedule 40 Cable Drive



PVC#	FINISH	CTN QTY
P37550	Chrome Plated	1
P3755BN	Brushed Nickel	1
P3755RB	Oil Rubbed Bronze	1
P3755WB	Old World Bronze	1
P3755NP	Pearl Nickel	1
P3755PB	Polished Brass	1
P3755WH	White	1

Tubular Trip Lever Kit



PVC#	ABS#	FINISH	CTN QTY
P37509	P39509	Chrome Plated	1
P3761AL	P3961AL	Almond	1
P3761AB	P3961AB	Antique Brass	1
P3761AN	P3961AN	Antique Nickel	1
P3761BI	P3961BI	Biscuit	1
P3761BL	P3961BL	Black	1
P3761BN	P3961BN	Brushed Nickel	1
P3761BS	P3961BS	Brushed Stainless	1
P3761RB	P3961RB	Oil Rubbed Bronze	1
P3761WB	P3961WB	Old World Bronze	1
P3761NP	P3961NP	Pearl Nickel	1
P3761PW	P3961PW	Polar White	1
P3761PN	P3961PN	Polished Nickel	1
P3761PS	P3961PS	Polished Stainless	1
P37511	P39511	Satin Nickel	1

A

**2" Metal Spud
w/ 4-1/4" Round Strainer**



- All brass spud & strainer
- Works with shower drain base D50001

PART NO.	FINISH	CTN QTY
D60981	Chrome Plated	1
D6098BN	Brushed Nickel	1
D6098RB	Oil Rubbed Bronze	1
D6098WB	Old World Bronze	1
D6098NP	Pearl Nickel	1
D60982	Polished Brass	1
D60980	Stainless Steel	1

**3-1/2" Metal Spud
w/5" Square Strainer**



- All brass spud & strainer
- Works with shower drain base D49804/D49801

PART NO.	FINISH	CTN QTY
D60954	Chrome Plated	1
D6096BN	Brushed Nickel	1
D60962	Nickel Bronze	3
D6096RB	Oil Rubbed Bronze	1
D6096WB	Old World Bronze	1
D6096NP	Pearl Nickel	1
D60960	Polished Brass	2

**2" Brass Spud
w/4" Square Strainer**



- All brass spud & strainer
- Grout ring
- Works with shower drain base D50001

PART NO.	FINISH	CTN QTY
D60942	Chrome Plated	1
D6094BN	Brushed Nickel	1
D6094RB	Oil Rubbed Bronze	1
D6094WB	Old World Bronze	1
D6094NP	Pearl Nickel	1
D6094PB	Polished Brass	1

**2" x 3" Shower Drain w/2" Brass
Spud & 4-1/4" Square Strainer**



- All brass spud and strainer
- Grout ring

PART NO.	FINISH	CTN QTY
D50942	Chrome Plated	1
D5094BN	Brushed Nickel	1
D5094RB	Oil Rubbed Bronze	1
D5094WB	Old World Bronze	1

**2" x 3" Shower Drain w/2" Spud &
Snap-in 4-1/4" Square Strainer**



- No screws
- Four prong installation

PART NO.	FINISH	CTN QTY
D5088BN	Brushed Nickel	1
D5088RB	Oil Rubbed Bronze	1
D5088WB	Old World Bronze	1
D50888	Stainless Steel	1

**2" x 3" Shower Drain w/2" Spud &
4-1/4" Strainer**



- Flow rate - 3.102 GPM

PART NO.	FINISH	CTN QTY
D50111	Chrome Plated (cast brass)	1
D5001BN	Brushed Nickel (cast brass)	1
D5001RB	Oil Rubbed Bronze (cast brass)	1
D5001WB	Old World Bronze (cast brass)	1
D5001NP	Pearl Nickel (cast brass)	1

**2" PVC Spud with 4-1/4" Stamped
Square Strainer**



PART NO.	FINISH	CTN QTY
D5087BN	Brushed Nickel	1
D5087RB	Oil Rubbed Bronze	1
D5087WB	Old World Bronze	1
D50887	Stainless Steel	1

2" x 3" Heavy Duty Shower Drain w/3-1/2" Spud & 5" Round Cast Brass Strainer



- PVC spud
- Round strainer
- For multi-head showers
- Flow rate - 15.260 GPM
- Primer tapped

PART NO.	FINISH	CTN QTY
D49059	Chrome Plated	1
D4912BN	Brushed Nickel	1
D49057	Nickel Bronze	1
D4912RB	Oil Rubbed Bronze	1
D4912WB	Old World Bronze	1
D4912NP	Pearl Nickel	1
D49055	Polished Brass	1

3" x 4" Heavy Duty Shower Drain w/3-1/2" Spud & 5" Strainer



- Metal spud
- Round strainer
- For multi-head showers
- Flow rate - 15.260 GPM
- Primer tapped

PART NO.	FINISH	CTN QTY
D49159	Chrome Plated	1
D4991BN	Brushed Nickel	1
D49157	Nickel Bronze	1
D4991RB	Oil Rubbed Bronze	1
D4991WB	Old World Bronze	1
D4991NP	Pearl Nickel	1
D49155	Polished Brass	1

3" x 4" Heavy Duty PVC Shower Drain w/3-1/2" Spud & 5" Square Strainer



- Metal spud
- Square strainer
- For multi-head showers
- Flow rate - 15.260 GPM
- Primer tapped

PART NO.	FINISH	CTN QTY
D4996BN	Brushed Nickel	1
D4996RB	Oil Rubbed Bronze	1
D4996WB	Old World Bronze	1
D4996NP	Pearl Nickel	1

3" x 4" Heavy Duty PVC Shower Drain w/3-1/2" Plastic Spud & 5" Round Cast Brass Strainer



- PVC spud
- Round strainer
- For multi-head showers
- Flow rate - 15.260 GPM
- Primer tapped

PART NO.	FINISH	CTN QTY
D4984BN	Brushed Nickel	1
D4984RB	Oil Rubbed Bronze	1
D4984WB	Old World Bronze	1
D4984NP	Pearl Nickel	1

4-1/4" Stamped Strainers



- For D50001 tile shower drain
- Blister packaging
- Center to Center Screwholes- 3.374"

PART NO.	FINISH	CTN QTY
C60806	Chrome Plated	1
C6089AL	Almond	1
C6089AB	Antique Brass	1
C6089AN	Antique Nickel	1
C6089BI	Biscuit	1
C6089BL	Black	1
C6089BN	Brushed Nickel	1
C6089RB	Oil Rubbed Bronze	1
C6089WB	Old World Bronze	1
C6089NP	Pearl Nickel	1
C6089PW	Polar White	1
C60810	Polished Brass-PVD	10
C6089PN	Polished Nickel	1
C6089PS	Polished Stainless	1
C60814	Satin Nickel	1

4-1/4" Snap-in Strainers



- For no caulk fiberglass shower stalls
- Fits D40101, D40140 and D50001
- Blister packaging
- Snap-in prong to Snap-in prong - 3"

PART NO.	FINISH	CTN QTY
D4005BN	Brushed Nickel	1
D4005RB	Oil Rubbed Bronze	1
D4005WB	Old World Bronze	1
D4005NP	Pearl Nickel	1
D40003	Polished Brass-PVD	5
D40010	Satin Nickel	1
D40005	Stainless Steel	1
D40004	White	1

A 4-1/4" Round Cast Brass Heavy Duty Strainers



• Center to center screwholes- 3.375"

PART NO.	FINISH	CTN QTY
C6087BN	Brushed Nickel	1
C6087RB	Oil Rubbed Bronze	1
C6087WB	Old World Bronze	1
C6087NP	Pearl Nickel	1
C60807	Polished Brass-PVD	10

4-1/4" Square Cast Brass Heavy Duty Strainers



• Center to center screwholes- 3.375"

PART NO.	FINISH	CTN QTY
C6083BN	Brushed Nickel	1
C6083RB	Oil Rubbed Bronze	1
C6083WB	Old World Bronze	1
C6083NP	Pearl Nickel	1
C60813	Polished Brass-PVD	10

5.196" Round Cast Brass Heavy Duty Strainers



• Center to center screwholes- 4.375"

PART NO.	FINISH	CTN QTY
C60803	Chrome Plated	1
C6084BN	Brushed Nickel	1
C6084RB	Oil Rubbed Bronze	1
C6084WB	Old World Bronze	1
C6084NP	Pearl Nickel	1
C60804	Polished Brass	1

"Code Blue" Replacement Strainers



• Regular Strainers
• Fits non-adjustable "Code Blue" drains

PART NO.	DESCRIPTION	CTN/MSTR
D64000	2" SS	1
D64401	SS Crown	1
D64001	2" PB/PVD	1/100
D6400BN	Brushed Nickel	1/250
D6400RB	Oil Rubbed Bronze	1/250
D6400WB	Old World Bronze	1/250

4" Shower Drain Strainers



• Center to center screwholes- 3.362"

PART NO.	DESCRIPTION	STRAINER	CTN QTY
D54010	4" PB Stamped to fit inside plastic ring	PVD	10

4-1/4" Strainer w/Screws for Fiberglass Shower Stalls



• Fits D41001 and D41600
• Tapping screws included
• Blister card packaging
• Center to center screwholes- 2-11/16"

PART NO.	FINISH	CTN QTY
D4110BN	Brushed Nickel	1
D4110RB	Oil Rubbed Bronze	1
D4110WB	Old World Bronze	1
D4110NP	Pearl Nickel	1
D41102	Polished Brass-PVD	1
D41107	Satin Nickel	1
D41101	Stainless Steel	1

3-1/2" PVC Spud w/5" Round Strainer



PART NO.	FINISH	CTN QTY
D56216	Chrome Plated	1
D6084BN	Brushed Nickel	1
D56214	Nickel Bronze	1
D6084RB	Oil Rubbed Bronze	1
D6084WB	Old World Bronze	1
D6084NP	Pearl Nickel	1
D56212	Polished Brass	1
D56211	Stainless Steel	1

3-1/2" Metal Spud w/5" Round Strainer



• All brass

PART NO.	FINISH	CTN QTY
D60990	Chrome Plated	1
D6091BN	Brushed Nickel	1
D60996	Nickel Bronze	1
D6091RB	Oil Rubbed Bronze	1
D6091WB	Old World Bronze	1
D6091NP	Pearl Nickel	1
D60991	Polished Brass	1

Escutcheons



1/2" CTS - 5/8" OD Low Pattern - 2-1/2" OD

PART NO.	FINISH	CTN QTY
E0105BN	Brushed Nickel	1
E0105RB	Oil Rubbed Bronze	1
E0105WB	Old World Bronze	1

1/2" IPS LOW PATTERN- 2- 1/2" OD

PART NO.	FINISH	CTN QTY
E0205BN	Brushed Nickel	1
E0205RB	Oil Rubbed Bronze	1
E0205WB	Old World Bronze	1

1-1/4" TUBULAR BOX PATTERN - 3" OD

PART NO.	FINISH	CTN QTY
E0412BN	Brushed Nickel	1
E0412RB	Oil Rubbed Bronze	1
E0412WB	Old World Bronze	1

1-1/2" TUBULAR BOX PATTERN- 3" OD

PART NO.	FINISH	CTN QTY
E0415BN	Brushed Nickel	1
E0415RB	Oil Rubbed Bronze	1
E0415WB	Old World Bronze	1

1/2" CTS - 5/8" OD BELL PATTERN 2- 3/8" OD

PART NO.	FINISH	CTN QTY
E0705BN	Brushed Nickel	1
E0705RB	Oil Rubbed Bronze	1
E0705WB	Old World Bronze	1
E0705PB	Polished Brass	1

1/2" IPS BELL PATTERN 2-3/8" OD

PART NO.	FINISH	CTN QTY
E0605BN	Brushed Nickel	1
E0605RB	Oil Rubbed Bronze	1
E0605WB	Old World Bronze	1
E0605PB	Polished Brass	1

1-1/4" TUBULAR BELL PATTERN- 3" OD

PART NO.	FINISH	CTN QTY
E0812BN	Brushed Nickel	1
E0812RB	Oil Rubbed Bronze	1
E0812WB	Old World Bronze	1
E0812PB	Polished Brass	1

1-1/2" TUBULAR BELL PATTERN- 3" OD

PART NO.	FINISH	CTN QTY
E0815BN	Brushed Nickel	1
E0815RB	Oil Rubbed Bronze	1
E0815WB	Old World Bronze	1
E0815PB	Polished Brass	1

Polished Brass Escutcheons



PART NO.	DESCRIPTION	CTN QTY
E80050	1/2" CTS (5/8" OD)	25
E81375	3/8" IPS	25
E81050	1/2" IPS	25



Box Pattern

PART NO.	DESCRIPTION	CTN QTY
E82125	1-1/4" OD tubular	12
E82150	1-1/2" OD tubular	12

Polished Brass Finish Flexible Floor And Ceiling Plates



• Plastic

PART NO.	DESCRIPTION	CTN QTY
F08375	3/8" IPS or 1/2" CTS	12
F08050	1/2" IPS or 3/4" CTS	12
F08124	1-1/4" CTS	12
F08150	1-1/2" IPS	12

Non-Slotted Full Flow Aerator



• Dual threads (15/16 -27 male x 55/64 -27 female)

PART NO.	FINISH	CTN QTY
A01019	Polished Brass	1

A

Brass Nipples



• Lead Free

3/8" x 4"

PART NO.	FINISH	CTN QTY
N2206BN	Brushed Nickel (PVD)	1
N2206RB	Oil Rubbed Bronze	1
N2206WB	Old World Bronze	1
N17375	Polished Brass	12

3/8" x 6"

PART NO.	FINISH	CTN QTY
N2210BN	Brushed Nickel (PVD)	1
N2210RB	Oil Rubbed Bronze	1
N2210WB	Old World Bronze	1
N2210PB	Polished Brass	1

1/2" x 4"

PART NO.	FINISH	CTN QTY
N2306BN	Brushed Nickel (PVD)	12
N2306RB	Oil Rubbed Bronze	1
N2306WB	Old World Bronze	1
N17050	Polished Brass	1

1/2" x 6"

PART NO.	FINISH	CTN QTY
N2310BN	Brushed Nickel (PVD)	1
N2310RB	Oil Rubbed Bronze	1
N2310WB	Old World Bronze	1
N2310PB	Polished Brass	1

1/2" x 3-1/2" Sleeves



PART NO.	FINISH	CTN QTY
T73300	Chrome	1
T7330BN	Brushed Nickel (PVD)	1
T7330RB	Oil Rubbed Bronze	1
T7330WB	Old World Bronze	1
T7330PB	Polished Brass (PVD)	1

Quarter Turn Angle Stop with 5" Sweat Extension And Escutcheon



PART NO.	FINISH	CTN QTY
S42220	Chrome Plated	1
S4222BN	Brushed Nickel	1
S4222RB	Oil Rubbed Bronze	1
S4222WB	Old World Bronze	1
S4222PB	Polished Brass	1

Quarter Turn Angle Stop



• Cross handle
• Includes hot, cold and blank buttons

1/2" FIP x 3/8" OD

PART NO.	FINISH	CTN QTY
S43021	Chrome Plated	1
S4302BN	Brushed Nickel	1
S4302RB	Oil Rubbed Bronze	1
S4302WB	Old World Bronze	1
S4302PB	Polished Brass (PVD)	1

5/8" FIP x 3/8" OD

PART NO.	FINISH	CTN QTY
S42031	Chrome Plated	1
S4203BN	Brushed Nickel	1
S4203RB	Oil Rubbed Bronze	1
S4203WB	Old World Bronze	1
S4203PB	Polished Brass	1

Quarter Turn Straight Stop



• Includes hot, cold and blank buttons

1/2" FIP x 3/8" OD

PART NO.	FINISH	CTN QTY
S43021	Chrome Plated	1
S4302BN	Brushed Nickel	1
S4302RB	Oil Rubbed Bronze	1
S4302WB	Old World Bronze	1
S4302PB	Polished Brass (PVD)	1

5/8" FIP x 3/8" OD

PART NO.	FINISH	CTN QTY
S43031	Chrome Plated	1
S4303BN	Brushed Nickel	1
S4303RB	Oil Rubbed Bronze	1
S4303WB	Old World Bronze	1
S4303PB	Polished Brass (PVD)	1

Compression Angle Stop

5/8" COMP. x 3/8" COMP.



PART NO.	FINISH	CTN QTY
S10210	Chrome Plated	1
S4211BN	Brushed Nickel	20
S4211RB	Oil Rubbed Bronze	20
S4211WB	Old World Bronze	20
S4211PN	Polished Nickel	20

Compression Angle Stop

1/2" FIP x 3/8" COMP.



PART NO.	FINISH	CTN QTY
S10203	Chrome Plated	1
S4213BN	Brushed Nickel	20
S4213RB	Oil Rubbed Bronze	20
S4213WB	Old World Bronze	20
S4213PN	Polished Nickel	20

Compression Straight Stop

5/8" COMP. x 3/8" COMP.



PART NO.	FINISH	CTN QTY
S10214	Chrome Plated	1
S4312BN	Brushed Nickel	20
S4312RB	Oil Rubbed Bronze	20
S4312WB	Old World Bronze	20
S4312PN	Polished Nickel	20

Compression Straight Stop

1/2" FIP x 3/8" COMP.



PART NO.	FINISH	CTN QTY
S10206	Chrome Plated	1
S4314BN	Brushed Nickel	20
S4314RB	Oil Rubbed Bronze	20
S4314WB	Old World Bronze	20
S4314PN	Polished Nickel	20

Closet Supply And Stop Kit



- Supply
- Stop
- 1/2" CTS Escutcheon

3/8" x 20" Closet Supply and 3/8" x 5/8" Angle Stop Kit

PART NO.	FINISH	CTN QTY
S1037CP	Chrome	1
S1037AP	Antique Pewter	1
S1037BB	Brushed Bronze	1
S1037BN	Brushed Nickel	1
S1037RB	Oil Rubbed Bronze	1
S1037WB	Old World Bronze	1
S10371	Polished Brass	1
S1037PS	Polished Stainless	1

3/8" x 20" Closet Supply and 3/8" x 5/8" Straight Stop Kit

PART NO.	FINISH	CTN QTY
S1038CP	Chrome Plated	1
S1038AP	Antique Pewter	1
S1038BB	Brushed Bronze	1
S1038BN	Brushed Nickel	1
S1038RB	Oil Rubbed Bronze	1
S1038WB	Old World Bronze	1
S10381	Polished Brass	1
S1038PS	Polished Stainless	1

3/8" x 20" Closet Supply and 1/2" x 3/8" Angle Stop Kit

PART NO.	FINISH	CTN QTY
S1039CP	Chrome Plated	1
S1039BN	Brushed Nickel	1
S1039RB	Oil Rubbed Bronze	1

3/8" x 20" Closet Supply and 5/8" x 3/8" Angle Stop Kit

PART NO.	FINISH	CTN QTY
S1137BN	Brushed Nickel	1
S1137RB	Oil Rubbed Bronze	1

3/8" x 20" Closet Supply and 5/8" x 3/8" Straight Stop Kit

PART NO.	FINISH	CTN QTY
S1138BN	Brushed Nickel	1
S1138RB	Oil Rubbed Bronze	1

Polished Brass Water Supply Tubes



- Bullnose rigid supply tube

PART NO.	DESCRIPTION	CTN QTY
S44002	3/8" x 20" Basin Tube	12
S44003	3/8" x 12" Tank Tube	12
S44005	3/8" x 20" Tank Tube	12

A

Lavatory Supply And Stop Kit



- Supply (2 pieces)
- Stop (2 pieces)
- 1/2" CTS Escutcheon (2 pieces)

3/8" x 20" Lavatory Supply and 3/8" x 5/8" Angle Stop Kit

PART NO.	FINISH	CTN QTY
S1036CP	Chrome Plated	1
S1036AP	Antique Pewter	1
S1036BB	Brushed Bronze	1
S1036BN	Brushed Nickel	1
S1036RB	Oil Rubbed Bronze	1
S1036WB	Old World Bronze	1
S10361	Polished Brass	1
S1036PS	Polished Stainless	1

3/8" x 20" Lavatory Supply and 3/8" x 5/8" Straight Stop Kit

PART NO.	FINISH	CTN QTY
S1035CP	Chrome Plated	1
S1035AP	Antique Pewter	1
S1035BB	Brushed Bronze	1
S1035BN	Brushed Nickel	1
S1035RB	Oil Rubbed Bronze	1
S1035WB	Old World Bronze	1
S10351	Polished Brass	1
S1035PS	Polished Stainless	1

3/8" x 20" Lavatory Supply and 1/2" x 3/8" Angle Stop Kit

PART NO.	FINISH	CTN QTY
S1034CP	Chrome Plated	1
S1034BN	Brushed Nickel	1
S1034RB	Oil Rubbed Bronze	1

3/8" x 20" Lavatory Supply and 5/8" x 3/8" Angle Stop Kit

PART NO.	FINISH	CTN QTY
S1136BN	Brushed Nickel	1
S1136RB	Oil Rubbed Bronze	1

3/8" x 20" Lavatory Supply and 5/8" x 3/8" Straight Stop Kit

PART NO.	FINISH	CTN QTY
S1135BN	Brushed Nickel	1
S1135RB	Oil Rubbed Bronze	1

Lav Supply Tubes



- Basin supply
- Bullnose rigid supply tube

3/8" x 12"

PART NO.	FINISH	CTN QTY
S04020	Chrome Plated	100
S4401BN	Brushed Nickel	1
S4401RB	Oil Rubbed Bronze	1
S4401WB	Old World Bronze	1

3/8" x 20"

PART NO.	FINISH	CTN QTY
S04022	Chrome Plated	100
S4402BN	Brushed Nickel	1
S4402RB	Oil Rubbed Bronze	1
S4402WB	Old World Bronze	1

Closest Supply Tubes



- Tank supply
- Flat head rigid supply tube

3/8" x 12"

PART NO.	FINISH	CTN QTY
S04027	Chrome Plated	100
S4403BN	Brushed Nickel	1
S4403RB	Oil Rubbed Bronze	1
S4403WB	Old World Bronze	1

3/8 x 20"

PART NO.	FINISH	CTN QTY
S04029	Chrome Plated	100
S4405BN	Brushed Nickel	1
S4405RB	Oil Rubbed Bronze	1
S4405WB	Old World Bronze	1

Ultrafit Tank Lever - Replaces 96% of All Tank Levers



- PATENTED
- New shapable arm bends to fit the needed arm angle
- Arm can be cut to fit 4", 6" or 8" lengths for customized fit
- Heavy duty plastic handle comes in a variety of finishes
- Sturdy plastic arm, spud and nut
- Blister card packaging

PART NO.	FINISH	CTN QTY
T01100	Chrome Plated	25
T01101	Polished Brass	25
T01102	White	1
T01103	Bone	1
T04001	Display for UltraFit Tank levers 12 each of above	1

Decorative Tank Trip Levers



• 8" arm

PART NO.	DESCRIPTION	FINISH	CTN QTY
T01003	Brass arm with metal spud and nut	PB Metal	25
T01004	Brass plated arm with metal spud and nut	AB Metal	25
T01007	Brass arm with metal spud and nut	Satin Nickel	1

Decorative Tank Trip Levers



• 8" arm

PART NO.	DESCRIPTION	FINISH	CTN QTY
T01061	Brass plated arm with plastic spud & nut / universal fit	PB Metal	25

Decorative Tank Trip Levers



• 8" arm

PART NO.	DESCRIPTION	FINISH	CTN QTY
T01006	Brass arm with metal spud and nut / universal fit	PB Metal	25
T01008	Brass arm with die cast nut	Satin Nickel	1

Decorative Tank Trip Levers



• 8" arm

PART NO.	DESCRIPTION	FINISH	CTN QTY
T01071	Side mount push button brass arm with plastic spud and nut	PB ABS	6
T01075	Front mount push button brass arm with plastic spud and nut	PV ABS	6

Decorative Tank Trip Levers for American Standard



• 9-1/2" arm

PART NO.	DESCRIPTION	FINISH	CTN QTY
T01065	Brass arm with metal spud and nut. Offset for thick walls	PB Metal	25

Decorative Tank Trip Levers for American Standard



• 8" arm

PART NO.	DESCRIPTION	FINISH	CTN QTY
T01049	Neo 28° combo with plastic arm, spud and nut	PB ABS	1

Decorative Tank Trip Levers for American Standard



• 6" arm

PART NO.	DESCRIPTION	FINISH	CTN QTY
T01043	45° arm for Cadet 2* plastic arm, spud and nut	PB ABS	25
T01044	45° arm with Cadet 2* plastic arm, spud and nut	White ABS	25
T01045	45° arm with Cadet 2* plastic arm, spud and nut	Bone ABS	25

Decorative Tank Trip Levers for American Standard



• 4" arm

PART NO.	DESCRIPTION	FINISH	CTN QTY
T01031	Plastic arm, spud and nut for beaded chain	PB ABS	25
T01032	Plastic arm, spud and nut for beaded chain	White ABS	25
T01033	Plastic arm, spud and nut for beaded chain	Bone ABS	25

A

Decorative Tank Trip Levers for American Standard



PART NO.	DESCRIPTION	FINISH	CTN QTY
T01051	Plastic arm, spud and nut for Plebe* and Cadet*	PB ABS	25
T01052	Plastic arm, spud and nut for Plabe* and Cadet*	White ABS	25
T01053	Plastic arm, spud and nut for Pleve* and Cadet*	Bone ABS	25

Decorative Tank Trip Levers for Crane



PART NO.	DESCRIPTION	FINISH	CTN QTY
T01035	Plastic arm, spud and nut	PB ABS	25
T01036	Plastic arm, spud and nut	White ABS	25
T01037	Plastic arm, spud and nut	Bone ABS	25

Decorative Tank Trip Levers for Eljer



PART NO.	DESCRIPTION	FINISH	CTN QTY
T01021	Side mount / Brass arm with non-crack nylon spud and nut	PB Metal	25

Decorative Tank Trip Levers for Kohler



PART NO.	DESCRIPTION	FINISH	CTN QTY
T01017	Wellworth/Barrington Lite new style / side mount 1.6 gal. unit replacement	PB Metal	6
T01015	Cast brass arm with metal spud and nut	PB Metal	6

Decorative Tank Trip Levers for Mansfield



PART NO.	DESCRIPTION	FINISH	CTN QTY
T01073	#41* plastic arm, spud and nut	PB ABS	25

Decorative Tank Trip Levers for Universal Rundle/Sears



PART NO.	DESCRIPTION	FINISH	CTN QTY
T01067	Brass arm with plastic spud and nut fits Universal Rundle/Sears*	PB Metal	25

Universal Decorative Closet Flush Lever



PART NO.	FINISH	CTN QTY
T01000	Chrome Plated	1
T0100BN	Brushed Nickel	1
T0100RB	Oil Rubbed Bronze	1
T0100WB	Old World Bronze	1
T0100NP	Pearl Nickel	1
T0100PB	Polished Brass	1

Eljer Side Mount Tank Lever



PART NO.	FINISH	CTN QTY
T0102BN	Brushed Nickel	1
T0102RB	Oil Rubbed Bronze	1
T0102WB	Old World Bronze	1
T0102NP	Pearl Nickel	1

Universal Front or Side Mount Tank Lever

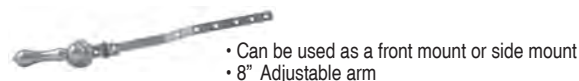

PART NO.	FINISH	CTN QTY
T01330	Chrome	1
T0133BN	Brushed Nickel	1
T0133RB	Oil Rubbed Bronze	1
T0133WB	Old World Bronze	1
T0133NP	Pearl Nickel	1

Kohler Side Mount Tank Lever



PART NO.	FINISH	CTN QTY
T0108BN	Brushed Nickel	1
T0108NP	Pearl Nickel	1
T0108RB	Oil Rubbed Bronze	1
T0108WB	Old World Bronze	1
T01181	Polished Brass	1

SECTION B - SPECIALTIES & REPAIR

Toilet Repairs 31-43

Kitchen & Bath 44-72

Plumbing Connectors/Supply Stops 73-76

Drinking Fountain Bubbler/Sink Faucets & Accessories 77-78

Gas Connectors 79-88

B

TANK LEVER TO TANK REFERENCE CHART

MFR.	PART NO.	FINISH	SECTION PAGE NO.	TANK STYLE
American Standard*	T01030	CP ABS	B2	Glenwall with vent #4049.177 Compack with vent #4052.346 Norwall with vent #4041.091
	T01031	PB ABS	DECORATIVE (SECT. A)	
	T01032 T01033	White ABS Bone ABS		
	T01042	CPS ABS	B2	Cadet II #4072 Cadet #4029 Cadet II #4014 Ellisse #4075 High Hamilton - 1 pc. #2096 Hamilton - 1 pc. #2092
	T01043	PB ABS	DECORATIVE (SECT. A)	Carlyle #2010.031 New Cadet line
	T01044	White ABS		
	T01045	Bone ABS		
	T01048	CPS ABS	B2	Glenwall #2093 Cadet #2108 Cadet #2109 Cadet #2120 Cadet #2124 Plebe #2131 Plebe #2138 Plebe #2139 Plebe Aquameter
	T01049	PB ABS	DECORATIVE (SECT. A)	
	T01050	CPS ABS	B2	
	T01051	PB ABS	DECORATIVE (SECT. A)	
	T01052	White ABS		
T01053	Bone ABS			
T01064	CP Metal	B2		
T01065	PB Metal	DECORATIVE (SECT. A)		
Crane*	T01034	CPS ABS	B2	Galaxy New Galaxy Sante Fe Avon Antigua
Eljer*	T01020	CP Metal	B3	New Emblem
	T01021	PB Metal	DECORATIVE (SECT. A)	
Kohler*	T01010	CP Metal	B3	Wellworth*/Barrington* - Old Style
	T01012	CP Metal	B3	
	T01015	PB Metal	DECORATIVE (SECT. A)	Kohler 9400
	T01016	CP Metal	B3	Wellworth*/Barrington Lite* - Old Style
	T01017	PB Metal	DECORATIVE (SECT. A)	
Mansfield*	T01040	CPS ABS	B3	Mansfield #35 Mansfield #51 Mansfield #8 Mansfield #16 Mansfield #35LT
	T01073	PB ABS	DECORATIVE (SECT. A)	
	T01072	CP Metal	B3	Mansfield old style #42
	T01041	PB Metal	DECORATIVE (SECT. A)	
Universal Rundle*/Sears*	T01066	CP Metal	B3	Saturn 4012 Low Boy 4445
	T01067	PB Metal	DECORATIVE (SECT. A)	

*The manufacturers' names are used only to describe whose products the tank levers will fit. The tank levers are not manufactured by those companies.

B

Fit-All Tank Trip Lever



B

PART NO.	FINISH	DESCRIPTION	CTN/MSTR
T01001	CP Metal	Brass arm with Metal spud and nut	25/200
T01002	CP Metal	Brass plated arm with Metal spud and nut	25/200
T01200	CP Metal	Aluminum arm with Zinc spud and nut	25/200
T01201	CP Metal	Aluminum arm with Plastic spud and nut	25/200
T01099	Brass	Replacement spud nut	1/25

Fit-All Economy Tank Trip Lever

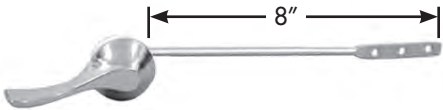

PART NO.	FINISH	DESCRIPTION	CTN/MSTR
T01060	CP Metal	Brass plated arm with Plastic spud & nut/ Universal fit	25/200

Fit-All Tank Trip Lever



PART NO.	FINISH	DESCRIPTION	CTN/MSTR
T01062	CP ABS	Plastic arm, spud & nut Universal fit	25/125

Fit-All Heavy Duty Tank Trip Lever

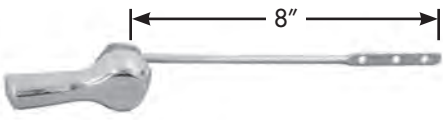

PART NO.	FINISH	DESCRIPTION	CTN/MSTR
T01005	CP Metal	Brass arm with Metal spud and nut/ Universal fit	25/150

Fit-All Premium Tank Trip Lever

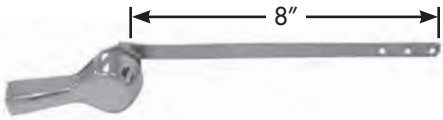

PART NO.	FINISH	DESCRIPTION	CTN/MSTR
T01068	CP Metal	Flat brass arm with Metal spud and nut	25/200

Fit-All Side Mount Tank Trip Lever



PART NO.	FINISH	DESCRIPTION	CTN/MSTR
T01070	CP ABS	Side Mount push button Brass arm with Plastic spud and nut	1/50

Fit-All Front Mount Tank Trip Lever

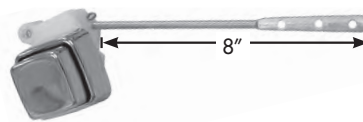

PART NO.	FINISH	DESCRIPTION	CTN/MSTR
T01074	CP ABS	Front Mount push button Brass arm with Plastic spud and nut	1/50

American Standard* Tank Trip Lever



PART NO.	FINISH	DESCRIPTION	CTN/MSTR
T01064	CP Metal	Brass arm with Metal spud and nut Offset for thick tank walls	25/150

* The manufacturers' names are used only to describe whose products the tank levers will fit. The tank levers are not manufactured by those companies.

American Standard* Tank Trip Lever

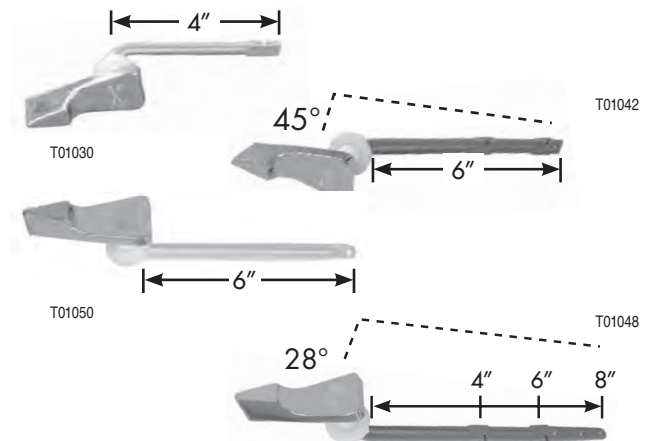

PART NO.	FINISH	DESCRIPTION	CTN/MSTR
T01030	CP ABS	Plastic arm, spud and nut for beaded chain	25/250
T01042	CP ABS	45° arm for Cadet 2* Plastic arm, spud and nut	1/25
T01050	CP ABS	Plastic arm, spud and nut for Plebe* and Cadet*	1/25
T01048	CP ABS	Neo 28° combo with Plastic arm, spud and nut	1/25

* The manufacturers' names are used only to describe whose products the tank levers will fit. The tank levers are not manufactured by those companies.

Crane* Tank Trip Lever

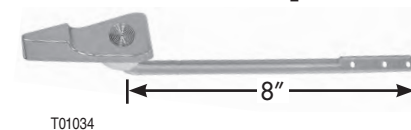

PART NO.	FINISH	DESCRIPTION	CTN/ QTY
T01034	CP ABS	Plastic arm with Plastic spud and nut	25/250

* The manufacturers' names are used only to describe whose products the tank levers will fit. The tank levers are not manufactured by those companies.

Eljer* Tank Trip Lever

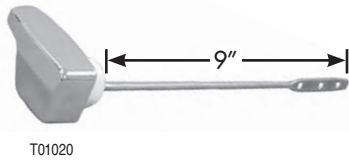

PART NO.	FINISH	DESCRIPTION	CTN/MSTR
T01020	CP Metal	Side Mount/Brass arm with Non-crack nylon spud and nut	25/200

* The manufacturers' names are used only to describe whose products the tank levers will fit. The tank levers are not manufactured by those companies.

Kohler* Tank Trip Lever

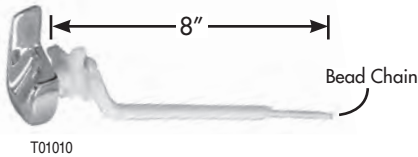

PART NO.	FINISH	DESCRIPTION	CTN/MSTR
T01010	CP Metal	Wellworth*/Barrington* Old style/Side mount Plastic arm (less bead hook), spud and nut	25/150
T01016	CP Metal	Wellworth*/Barrington Lite* New style/Side Mount 1.6 gal. unit replacement Plastic arm, spud and nut	25/125

* The manufacturers' names are used only to describe whose products the tank levers will fit. The tank levers are not manufactured by those companies.

Kohler* Tank Trip Lever

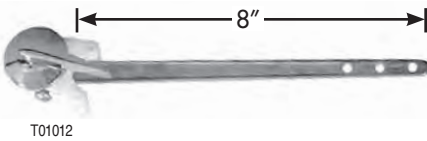

PART NO.	FINISH	DESCRIPTION	CTN/MSTR
T01012	CP Metal	Cast brass arm with Metal spud and nut	25/125

* The manufacturers' names are used only to describe whose products the tank levers will fit. The tank levers are not manufactured by those companies.

Mansfield* Tank Trip Lever

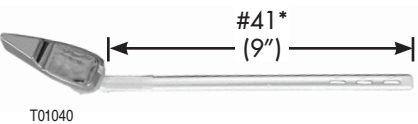

PART NO.	FINISH	DESCRIPTION	CTN/MSTR
T01040	CP ABS	#41* Plastic arm, spud and nut	1/25

* The manufacturers' names are used only to describe whose products the tank levers will fit. The tank levers are not manufactured by those companies.

Mansfield* Tank Trip Lever

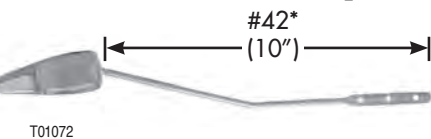

PART NO.	FINISH	DESCRIPTION	CTN/MSTR
T01072	CP Metal	#42* Brass arm with plastic spud and nut	25/100

* The manufacturers' names are used only to describe whose products the tank levers will fit. The tank levers are not manufactured by those companies.

Universal Rundle*/Sears* Tank Trip Lever

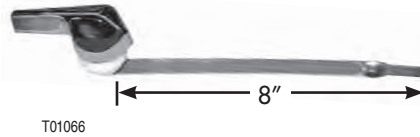

PART NO.	FINISH	DESCRIPTION	CTN/MSTR
T01066	CP Metal	Brass arm with Plastic spud and nut Fits Universal Rundle*/Sears*	25/100

* The manufacturers' names are used only to describe whose products the tank levers will fit. The tank levers are not manufactured by those companies.

Ultrafit Tank Lever



- Bagged
- Patented!
- Heavy Duty plastic arm, spud and nut
- Display Available- Part No. T04-001
- Shapeable arm bends to fit the needed arm angle
- Arm can be cut to 4", 6" or 8" lengths for customized fit
- Fits American Standard, Eljer, Kohler, Mansfield and ToTo

PART NO.	DESCRIPTION	CTN/MSTR
T01100	CP ABS Ultrafit tank lever	25/200

Western Pottery Tank Trip Lever



- Side Mount
- 10 inch brass arm
- Plastic spud and nut

PART NO.	DESCRIPTION	CTN/MSTR
T01080	Western Pottery tank trip lever	25/200

ToTo Chrome Plated Tank Lever



- Side Mount
- 10 inch brass arm
- Plastic spud and nut

PART NO.	DESCRIPTION	CTN/MSTR
T01081	ToTo chrome plated tank trip lever	25/200

Eljer* Touch Flush* Assembly



- CARTON QUANTITIES ONLY
- Complete with tank, lever, chain, ball and arm

PART NO.	DESCRIPTION	CTN/MSTR
C04019	Touch Flush assembly	1/5

* The manufacturers' names are used only to describe whose products the products will fit.

Tank Ball and Seat Discs



- CARTON QUANTITIES ONLY
- New boxing to protect shape of units

PART NO.	DESCRIPTION	CTN QTY
C04020	Eljer* tank ball for touch flush	1/10
C04021	Fit-All tank ball less guide	1/10
C04030	2 1/4" - 2 5/8" Tri-seal tank ball boxed	1/100
C04031	3" Tri-seal tank ball boxed	1/100

American Standard* Seat Disc Tank Ball

(for small tilt flush valves)

B



C04024



T02025

- CARTON QUANTITIES ONLY
- Units are in a plastic housing to protect the shape of the seats

PART NO.	DESCRIPTION	CTN/MSTR
C04024	Screw-on unit	1/25
C04025	Snap-on unit	1/25
T02025	Combo seat disc, snap-on and screw-on	1/25

* The manufacturers' names are used only to describe whose products the tank levers will fit. The tank levers are not manufactured by those companies.

Float Ball



- CARTON QUANTITIES ONLY ON THE C05041

PART NO.	DESCRIPTION	CTN/MSTR
C05040	Plastic 4" x 5"	1/24
C05041	Copper 4" x 5"	12/72

Flappers



C04005



C04006 comes with strap and chain



C04007 comes with strap and chain



C04008



C04010



C04011

- High grade vinyl construction
- CARTON QUANTITIES ONLY
- New boxing to protect shape of units

PART NO.	DESCRIPTION	CTN/MSTR
C04005	3 way with strap (fits plastic, brass and old Crane* 57 flush valves)	25/100
C04006	3 way with stainless chain (fits plastic, brass and old Crane* 57 flush valves)	25/100
C04007	Standard unit (9" chain)	1/10
C04008	Kohler* unit (8" chain)	50/200
C04010	Crane* unit (9" chain)	50/200
C04011	Eljer* original unit with rigid arms and foam cone with beaded chain	1/10

* The manufacturers' names are used only to describe whose products the products will fit.

Kohler Rialto™ Flapper



C04028



C04029

MADE IN THE USA



- 5 year warranty
- Blister carded for easy display
- Made from high grade chlorazone
- Resists chemicals and toilet tank cleaners

PART NO.	DESCRIPTION	FITS KOHLER MODELS	CTN/MSTR
C04028	Kohler Flapper 2010 BP	Rialto, San Raphael, Santa Martine and Rosario	12/72
C04029	Sharkfin Flapper 2012 BP	Rialto, San Raphael, Santa Rosa, Revival and Gabrielle	12/72

2 Way Flapper With Separate Trunion



- Siliconized chemical resistant material
- Stainless steel chain

PART NO.	DESCRIPTION	CTN/MSTR
C04002	2 way flapper	1/10

Carded Blue Vinyl Flapper



- Chemical resistant
- Individually carded
- Soft body replacement flapper
- 9" stainless steel chain and hook
- Five year warranty on flapper life

PART NO.	DESCRIPTION	CTN/MSTR
C04004	Carded blue fit-all vinyl flapper	25/100

Jumbo ToTo Style Flapper



PART NO.	DESCRIPTION	CTN/MSTR
C04000	Blue Flapper (Power Gravity)	1/10
C04001	Red Flapper (G-Max)	1/10

Blue Vinyl Flapper



- Chemical Resistant
- Five Year Warranty
- Fits most plastic flush valves
- CARTON QUANTITIES ONLY
- Easily installed- no collar to cut
- 9" stainless steel chain and hook

MADE IN THE USA



PART NO.	DESCRIPTION	CTN/MSTR
C04014	Blue vinyl flapper	1/80

Korky® Flappers



C04032

- C04032 Fits Kohler® Class Five™ Flapper
- Larger 3 1/4" replacement flapper
 - Replaces Kohler No. 1016546 & 1042313
 - Engineered materials resist chlorine



C04033

- C04033 Fits Eljer®Titan™ Flapper
- Replaces Eljer No. 495-6077-00
 - Engineered materials chlorine



C04034

- C04034 Fits American Standard® Cadet 3® Flapper
- Replaces American Stand No. 738920-0070P
 - Engineered materials resist chlorine

PART NO.	DESCRIPTION	CTN/MSTR
C04032	Fits Kohler® Class Five™ Flapper	1/5
C04033	Fits Eljer®Titan™ Flapper	1/5
C04034	Fits American Standard® Cadet 3® Flapper	1/5

Korky® Flappers

The Original Korky® Flapper



- No tank centering
- Assures a positive seal
- Easy fingertip operation
- Individually carded in cartons
- Eliminates lift wire misalignment
- Chemical resistant- Effective--/--/07 in areas with poor water quality



PART NO.	DESCRIPTION	CTN/MSTR
C04015	(54 BP)	12/72
C04017	Fits Kohler (58 BP)	10/100

Red Korky® Plus Flapper



- Guaranteed chemical resistant for 5 years
- Individually carded in cartons of 12



PART NO.	DESCRIPTION	CTN/MSTR
C04016	Red Korky® Plus (2001BP)	12/72

Korky® 1.6 Adjustable Flapper



- Chemical resistant
- Easy to install and adjust
- Individually carded in cartons of 12
- Flush volume changes with just a twist
- Can be used as a water saving device
- Adjustable sealing ball for precise water control
- Universal design fits most popular brands of 1.6 toilets



PART NO.	DESCRIPTION	CTN/MSTR
C04027	Korky® 1.6 adjustable flapper (16BP)	12/72

Korky® Plus Adjustable Flapper



- Adjust flush volume with movable float on chain
- Slide the float up for water savings or down for increased flush volume
- Premium red Chlorazone rubber resists chlorine



PART NO.	DESCRIPTION	CTN/MSTR
C04013	Korky® Plus adjustable flapper	1/12

Closest Spuds



- Cast brass
- Includes spud washer and metal friction ring

PART NO.	DESCRIPTION	CTN/MSTR
C27125	1 1/4"	25/100
C27150	1 1/2"	25/100
C27200	2"	25/75
C27201	2" x 1 1/4"	25/100
C27202	2" x 1 1/2"	25/75
C27127	1 1/2" x 1 1/4"	25/100
C27150A	1 1/2" (For American Standard)	25/100

Urinal Spuds



- Cast brass
- Includes spud washer and metal friction ring

PART NO.	DESCRIPTION	CTN/MSTR
C27134	1" x 3/4"	25/200
C27126	1 1/4" x 3/4"	25/125
C27310	1 1/2" x 3/4"	25/500

Closest Spud Washers



- CARTON QUANTITIES ONLY

PART NO.	DESCRIPTION	CTN/MSTR
C27301	1 1/4"	25/500
C27302	1 1/2"	25/500
C27303	2"	25/500
C27304	2" x 1 1/4"	25/500
C27305	2" x 1 1/2"	25/500
C27308	1" x 3/4"	25/500
C27309	1 1/4" x 3/4"	25/500

Closest Spud Friction Rings



- Zinc plated
- CARTON QUANTITIES ONLY

PART NO.	SIZE	CTN/MSTR
C27321	1 1/4"	25/1000
C27322	1 1/2"	25/1000
C27323	2"	25/1000
C27324	2" x 1 1/4"	25/1000
C27325	2" x 1 1/2"	25/1000
C27328	1" x 3/4"	25/1000

Flush Valve Shank Washer

• 3 1/16" OD x 2 1/4" ID



PART NO.	DESCRIPTION	CTN/MSTR
T02028	3/8" Height flush valve shank washer	1/100

Aqua Seal Washer



• Rubber
• American Standard Top Hat Washer

PART NO.	DESCRIPTION	CTN/MSTR
T85057	Aqua Seal Washer	1/100

Beveled Ballcock Shank Washer



• Rubber
• 1 3/4" OD x 15/16" ID

PART NO.	DESCRIPTION	CTN/MSTR
T85056	1/2" Beveled Ballcock shank Washer	1/100

Flat Bibb Washer



• Priced per carton
• 100 pieces per carton

PART NO.	SIZE	TRADE SIZE	OD	CTN/MSTR
O25202	1/4"	00	1/2"	1
O25203	1/4"	0	17/32"	1
O25204	1/4"	1/4	9/16"	1
O25205	1/4"	1/4L	19/32"	1
O25206	3/8"	3/8	5/8"	1
O25207	3/8"	3/8M	21/32"	1
O25208	3/8"	3/8L	11/16"	1
O25209	1/2"	1/2	3/4"	1
O25210	1/2"	1/2L	25/32"	1

Beveled Bibb Washer



• Priced per carton
• 100 pieces per carton

PART NO.	SIZE	TRADE SIZE	OD	CTN/MSTR
O25302	1/4"	00	1/2"	1
O25303	1/4"	0	17/32"	1
O25304	1/4"	1/4	9/16"	1
O25305	1/4"	1/4L	19/32"	1
O25306	3/8"	3/8	5/8"	1
O25307	3/8"	3/8M	21/32"	1
O25308	3/8"	3/8L	11/16"	1
O25309	1/2"	1/2	3/4"	1
O25310	1/2"	1/2L	25/32"	1

Sponge Closet Gaskets

• All have 2 bolt holes



G13500

G13534

G13634

PART NO.	OD x ID x THICKNESS	CTN/MSTR
G13534	5 3/8" x 3 1/2" x 3/4"	10/200
G13516	5 3/8" x 3 1/2" x 9/16"	10/232
G13634	6 3/4" x 3 1/2" x 3/4" w/ 2 bolt holes	10/120
G13601	6 3/4" x 3 1/2" x 1" w/ 2 bolt holes	10/84
G13616	6 3/4" x 3 1/2" x 9/16" w/ 2 bolt holes	10/134
G13638	6 3/4" x 3 1/2" x 3/8" w/ 2 bolt holes	10/200
G13500	4 3/8" x 2 7/8" x 1/2" wall hung urinal	10/225

Brass Lift Wire Guide



C05056

C05057

• Fit-All
• CARTON QUANTITIES ONLY

PART NO.	DESCRIPTION	CTN/MSTR
C05056	Adjustable heavy pattern	25/500
C05057	Standard split ring	25/500

Brass Lift Wire



• CARTON QUANTITIES ONLY

PART NO.	DESCRIPTION	CTN/MSTR
C05045	4 1/2" lower	25/2000
C05046	5" lower	25/2000
C05047	5 1/2" lower	25/2000
C05048	8" upper	25/1000
C05049	9" upper	25/1000

Copper Refill Tube



• CARTON QUANTITIES ONLY

PART NO.	SIZE	CTN/MSTR
C05051	9"	25/1000

Brass Float Rod



• CARTON QUANTITIES ONLY

PART NO.	SIZE	CTN/MSTR
C05052	1/4" x 8"	25/1000
C05053	1/4" x 10"	25/1000
C05054	1/4" x 12"	25/1000

Brass Overflow Tube



• 22 gauge

PART NO.	SIZE	CTN/MSTR
C05042	1" x 1 1/8" x 10"	1/200

Douglas Flush Valve



C05070



C05071

- Brass unit includes split guide
- Includes locknut, beveled washer
- Plastic unit includes flapper tank ball

PART NO.	DESCRIPTION	CTN/MSTR
C05070	Plastic with stainless steel chain	1/50
C05071	Brass	1/40

Mansfield* Style Ballcock



- All brass
- Compound lever

PART NO.	DESCRIPTION	CTN/MSTR
T02075	Brass Ballcock	1/50

* The manufacturer's name is used only to describe whose product the ballcock will fit. The part listed is not necessarily manufactured by that company.

Mansfield Style Ballcock With Float Rod



T03008

- Genuine Mansfield Ballcock

PART NO.	DESCRIPTION	CTN/MSTR
T03008	Ballcock with float rod #08	1/20

Mansfield Flush Valve #210



- Water saver
- 3.5 gal. toilets
- Instant shut-off
- Won't rust or corrode

PART NO.	DESCRIPTION	CTN/MSTR
T02066	Flush Valve	1/50

Korky® QuietFill Valve



- Resists chlorine
- 5 year guarantee



PART NO.	DESCRIPTION	CTN/MSTR
C05200	Korky® QuietFill Valve	1/24

American Standard* Toilet Repair Parts



T02020



T02021



T02022



T02023



T02024



T02026

PART NO.	DESCRIPTION	CTN/MSTR
T02020	#5 (33642-07) old style low profile actuator unit, black, with disc, chain, clip and grommet	1/5
T02021	#6 (72880-07) old style high profile actuator unit, complete, black with disc, chain, clip and grommet	1/5
T02022	#4 (8162-07) old style high profile actuator unit with legs for one piece low boy* with brass flush valves, complete, black with disc, chain, clip, grommet and legs	1/5
T02023	#4 (70711-07) old style Cadet* water saver actuator unit, white with blue cap complete with disc, chain, clip and grommet	1/5
T02024	Chain kit complete for all actuator units (American Standard* 8321-07)	1/5
T02026	#4 (47107-07) new style complete flush valve unit, white, short actuator	1/5
T02027	#5 (47089-07) complete flush valve tall black for standard two-piece closets	1/5

Ballcock Repair Parts For American Standard*



T02035



T02036

PART NO.	DESCRIPTION	CTN/MSTR
T02035	7307 cap and plunger with seat, new style	1/10
T02036	N3010 ballcock plunger with thumb hole	1/10

Ballcock Repair Parts For Coast*



T02037



T02038



T02039

PART NO.	DESCRIPTION	CTN/MSTR
T02037	Coast 1B1*, 1B1P*, standard large head kit with 3 screws	1/10
T02038	Coast 1B1A*, smaller head kit with 3 screws	1/10
T02039	Coast 1B1X*, Kohler*, UR*, Eljer*, Briggs*, American Standard*, kits with 3 screws, high and low boy	1/10

Ballcock Repair Parts For Hoover* / Amerline*



PART NO.	DESCRIPTION	CTN/MSTR
T02050	Standard kit with 4 screws	1/25

Ballcock Repair Parts For Kohler*



PART NO.	DESCRIPTION	CTN/MSTR
T02051	Black plunger with cap and seal	1/10

Ballcock Repair Parts For Fluidmaster*



PART NO.	DESCRIPTION	CTN/MSTR
T02052	Diaphragm N/S heavy duty white for hard water and chloramines (Ref. 242F)	1/10
T02053	Standard black diaphragm (Ref. 242)	1/10

Mansfield Ballcock and Flush Valve Repair Parts

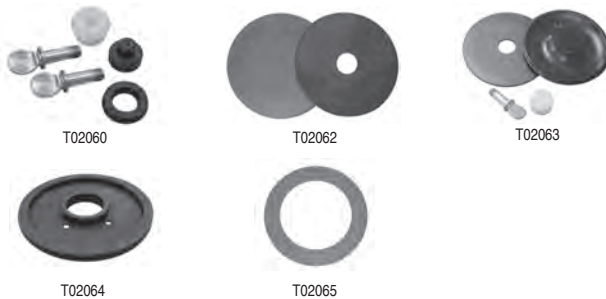

• Original Mansfield parts

PART NO.	DESCRIPTION	CTN/MSTR
T02060	03, 09, XQ-16 ballcock repair kit	1/10
T02062	08 ballcock repair kit	1/10
T02064	208/209 flush valve diaphragm	10/50
T02065	210/211 flush valve seal	10/700

Dual Flush Toilet Kit



- Simple to install
- Save water with every flush!
- Push one way to rinse liquid
- Push the other way to flush solids

PART NO.	DESCRIPTION	CTN/MSTR
T02067	Dual Flush Toilet Kit	1/40

Toilet Tank Cover



- Fit-All
- White plastic
- Fits most tanks with outside dimensions of 21 1/8" x 7 3/8" or less

PART NO.	DESCRIPTION	CTN/MSTR
T02005	White	1/1

Enduro Closet Bolts



- Never Rusts
- Space age composite
- Fits all closet flange styles
- CARTON QUANTITIES ONLY
- Withstands over 1,000 PSI

PART NO.	DESCRIPTION	CTN/MSTR
C02050	5/16" x 2 1/2" closet bolt	50 pairs/500 pairs

Enduro Closet Bolt Jar Display



- Never rusts
- Space age material
- Fits all closet flange styles

PART NO.	DESCRIPTION	CTN/MSTR
CJ1003	5/16" x 2 1/2" closet bolt (50 pairs per display)	1/1

Flexible and Rigid Super Shims

MADE IN THE USA



- Stackable
- Rigid, can be driven
- Flexible, can be trimmed
- Priced per bag
- 10 per bag

PART NO.	DESCRIPTION	CTN/MSTR
S55950	1-1/8" x 1-15/16" x 1/4" flexible	1 bag of 10/400
S55951	1-1/8" x 1-15/16" x 1/4" rigid	1 bag of 10/400

Closet Wedge Shims

MADE IN THE USA



- Stackable
- 3/8" width x 1-3/8" length x 5/16" height
- Easily trimmed to desired height
- Priced per bag or display

PART NO.	DESCRIPTION	CTN/MSTR
S55902	100 shims poly bagged	1/1
S55903	1000 shims counter display	1/1

Flexible Super Shims

MADE IN THE
USA



- 200 Flexible super shims packaged in a convenient refillable "candy bowl" counter display
- Priced per display

PART NO.	DESCRIPTION	CTN/MSTR
S55952	200 Flexible super shims	1/1

Rigid Super Shims

MADE IN THE
USA



- 200 Rigid super shims packaged in a convenient refillable "candy bowl" counter display
- Priced per display

PART NO.	DESCRIPTION	CTN/MSTR
S55953	200 Rigid super shims	1/1

"Bucket Of Bolts"



- Attractive counter/shelf display
- Closet bolts are custom packed (2 bolts, nuts, and washers per bag)

Brass Plated

PART NO.	SIZE	WASHER	CTN/MSTR
CB2001	1/4" x 2 1/4"	Oval	50 pairs/1
CB2011	1/4" x 2 1/4"	Round	50 pairs/1
CB2002	1/4" x 3 1/2"	Oval	50 pairs/1
CB2012	1/4" x 3 1/2"	Round	50 pairs/1
CB2003	5/16" x 1 3/4"	Oval	50 pairs/1
CB2013	5/16" x 1 3/4"	Round	50 pairs/1
CB2004	5/16" x 2 1/4"	Oval	50 pairs/1
CB2014	5/16" x 2 1/4"	Round	50 pairs/1
CB2005	5/16" x 3 1/2"	Oval	50 pairs/1
CB2015	5/16" x 3 1/2"	Round	50 pairs/1

Brass

PART NO.	SIZE	WASHER	CTN/MSTR
CB2021	1/4" x 2 1/4"	Oval	50 pairs/1
CB2030	1/4" x 2 1/4"	Round	50 pairs/1
CB2022	1/4" x 3 1/2"	Oval	50 pairs/1
CB2031	1/4" x 3 1/2"	Round	50 pairs/1
CB2023	5/16" x 1 3/4"	Oval	50 pairs/1
CB2032	5/16" x 1 3/4"	Round	50 pairs/1
CB2024	5/16" x 2 1/4"	Oval	50 pairs/1
CB2033	5/16" x 2 1/4"	Round	50 pairs/1
CB2025	5/16" x 3 1/2"	Oval	50 pairs/1
CB2034	5/16" x 3 1/2"	Round	50 pairs/1

Closet Bolts With Tinnerman Nuts



- CARTON QUANTITIES ONLY
- Two each bolts, nuts, round washers and tinnerman nuts per bag

Brass Plated

PART NO.	SIZE	CTN/MSTR
C02401	1/4" x 2 1/4"	50 pairs/400
C02402	1/4" x 3 1/2"	50 pairs/200
C02403	5/16" x 1 3/4"	50 pairs/200
C02404	5/16" x 2 1/4"	50 pairs/200
C02405	5/16" x 3 1/2"	50 pairs/200

Brass

PART NO.	SIZE	CTN/MSTR
C02421	1/4" x 2 1/4"	50 pairs/400
C02990	1/4" x 3 1/2"	50 pairs/200
C02422	5/16" x 1 3/4"	50 pairs/400
C02423	5/16" x 2 1/4"	50 pairs/400
C02424	5/16" x 3 1/2"	50 pairs/200

Closet Bolts



- Packed with acorn nuts and washers
- CARTON QUANTITIES ONLY
- Custom Packed

Brass Plated Bolts, Zinc Plated Washers and Acorn Nuts

Custom Packed - Two each bolts, nuts, washers and acorn nuts per bag

PART NO.	SIZE	WASHER	CTN/MSTR
C02000	1/4" x 1 3/4"	Oval	50 pairs/400
C02001	1/4" x 2 1/4"	Oval	50 pairs/400
C02002	1/4" x 3 1/2"	Oval	50 pairs/400
C02003	5/16" x 1 3/4"	Oval	50 pairs/400
C02004	5/16" x 2 1/4"	Oval	50 pairs/200
C02005	5/16" x 3 1/2"	Oval	50 pairs/200
C02010	1/4" x 1 3/4"	Round	50 pairs/400
C02011	1/4" x 2 1/4"	Round	50 pairs/400
C02012	1/4" x 3 1/2"	Round	50 pairs/200
C02013	5/16" x 1 3/4"	Round	50 pairs/400
C02014	5/16" x 2 1/4"	Round	50 pairs/200
C02015	5/16" x 3 1/2"	Round	50 pairs/200

Brass Bolts, Stainless Washers, Nickel Plated Acorn Nuts

Custom Packed - Two each bolts, nuts, washers and acorn nuts per bag

PART NO.	SIZE	WASHER	CTN/MSTR
C02020	1/4" x 1 3/4"	Oval	50 pairs/400
C02021	1/4" x 2 1/4"	Oval	50 pairs/400
C02022	1/4" x 3 1/2"	Oval	50 pairs/200
C02023	5/16" x 1 3/4"	Oval	50 pairs/200
C02024	5/16" x 2 1/4"	Oval	50 pairs/200
C02025	5/16" x 3 1/2"	Oval	50 pairs/200
C02029	1/4" x 1 3/4"	Round	50 pairs/200
C02030	1/4" x 2 1/4"	Round	50 pairs/400
C02031	1/4" x 3 1/2"	Round	50 pairs/200
C02032	5/16" x 1 3/4"	Round	50 pairs/200
C02033	5/16" x 2 1/4"	Round	50 pairs/200
C02034	5/16" x 3 1/2"	Round	50 pairs/200

Closest Bolts



- Packed with acorn nuts and washers
- CARTON QUANTITIES ONLY
- Bulk Packed

B

Brass Plated Bolts, Zinc Plated Washers and Acorn Nuts

Bulk Packed - One each bolt, nut, washer and acorn nut per bag

PART NO.	SIZE	WASHER	CTN/MSTR
C02000B	1/4" x 1 3/4"	Oval	100 each/400
C02001B	1/4" x 2 1/4"	Oval	100 each/400
C02002B	1/4" x 3 1/2"	Oval	100 each/400
C02003B	5/16" x 1 3/4"	Oval	100 each/400
C02004B	5/16" x 2 1/4"	Oval	100 each/400
C02005B	5/16" x 3 1/2"	Oval	100 each/400
C02010B	1/4" x 1 3/4"	Round	100 each/400
C02011B	1/4" x 2 1/4"	Round	100 each/400
C02012B	1/4" x 3 1/2"	Round	100 each/400
C02013B	5/16" x 1 3/4"	Round	100 each/400
C02014B	5/16" x 2 1/4"	Round	100 each/400
C02015B	5/16" x 3 1/2"	Round	100 each/400

Brass Bolts, Stainless Washers, Nickel Plated Acorn Nuts

Bulk Packed - One each bolt, nut, washer and acorn nut per bag

PART NO.	SIZE	WASHER	CTN/MSTR
C02020B	1/4" x 1 3/4"	Oval	100 each/400
C02021B	1/4" x 2 1/4"	Oval	100 each/400
C02022B	1/4" x 3 1/2"	Oval	100 each/400
C02023B	5/16" x 1 3/4"	Oval	100 each/400
C02024B	5/16" x 2 1/4"	Oval	100 each/400
C02025B	5/16" x 3 1/2"	Oval	100 each/400
C02029B	1/4" x 1 3/4"	Round	100 each/400
C02030B	1/4" x 2 1/4"	Round	100 each/400
C02031B	1/4" x 3 1/2"	Round	100 each/400
C02032B	5/16" x 1 3/4"	Round	100 each/400
C02033B	5/16" x 2 1/4"	Round	100 each/400
C02034B	5/16" x 3 1/2"	Round	100 each/400

Closest Bolt Component Parts



Closest Bolt



Closest Screw



Tinnerman Nut

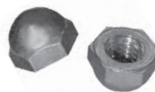

Close Acorn Nut



Open Acorn Nut



Oval Washer



Round Washer

PART NO.	DESCRIPTION	CTN/MSTR
C02800	1/4" x 1 3/4" brass plated closet bolt	100/1200
C02801	1/4" x 2 1/4" brass plated bolt	100/1200
C02802	1/4" x 3 1/2" brass plated bolt	100/700
C02803	5/16" x 1 3/4" brass plated bolt	100/700
C02804	5/16" x 2 1/4" brass plated bolt	100/800
C02805	5/16" x 3 1/2" brass plated bolt	100/500
C02820	1/4" x 1 3/4" brass bolt	100/1500
C02821	1/4" x 2 1/4" brass bolt	100/1200
C02822	1/4" x 3 1/2" brass bolt	100/700
C02823	5/16" x 1 3/4" brass bolt	100/1000
C02824	5/16" x 2 1/4" brass bolt	100/800
C02825	5/16" x 3 1/2" brass bolt	100/500
C02830	1/4" x 2 1/4" brass snap-off bolt	100/1000
C02832	5/16" x 2 1/4" brass snap-off bolt	100/800
C02808	1/4" x 2 1/2" brass plated screw	100/1000
C02815	1/4" x 3 1/2" brass plated screw	100/1000
C02811	5/16" x 2 1/2" brass plated screw	100/700
C02812	1/4" x 2 1/2" brass screw	100/800
C02813	1/4" x 3 1/2" brass screw	100/1000
C02814	5/16" x 2 1/2" brass screw	100/1000
C02807	5/16" tinnerman nut	100/3500
C02860	1/4" x 7/16" nickel plated open acorn nut	100/5000
C02861	1/4" x 7/16" zinc plated open acorn nut	100/5000
C02862	5/16" x 9/16" nickel plated open acorn nut	100/3000
C02863	5/16" x 9/16" zinc plated open acorn nut	100/3000
C02809	1/4" x 7/16" zinc plated closed acorn nut	100/2500
C02810	5/16" x 9/16" zinc plated closed acorn nut	100/4000
C02900	1/4" nickel plated closed acorn nut	100/2500
C02901	5/16" nickel plated closed acorn nut	100/4000
C02864	1/4" brass open acorn nut	100/2500
C02865	5/16" brass open acorn nut	100/4000
C02850	Oval stainless steel washer	100/5000
C02851	Oval zinc plated washer	100/4000
C02852	Round stainless steel washer	100/5000
C02853	Round zinc plated washer	100/5000

Snap-Off Closet Bolts



Counter Display

- Custom packed
- 2 each: Brass bolts, captive washers, nickel nuts, and stainless washers
- Available boxed or in counter display ("Bucket of Bolts")

Boxed

PART NO.	SIZE	WASHER	CTN/MSTR
C02040	1/4" x 2 1/4"	Oval	50 pairs/400
C02045	1/4" x 2 1/4"	Round	50 pairs/400
C02041	5/16" x 2 1/4"	Oval	50 pairs/200
C02046	5/16" x 2 1/4"	Round	50 pairs/200

Counter Display

PART NO.	SIZE	WASHER	CTN QTY
CB2040	1/4" x 3 1/2"	Oval	50 pairs
CB2045	1/4" x 3 1/2"	Round	50 pairs
CB2041	5/16" x 1 3/4"	Oval	50 pairs
CB2046	5/16" x 1 3/4"	Round	50 pairs

Closet Bolt - Elite Packs



- CARTON QUANTITIES ONLY

Packed with 4 acorn nuts and 4 washers

PART NO.	DESCRIPTION	CTN/MSTR
C02989	5/16" x 1 3/4" brass plated bolts	50 pairs/400
C02999	1/4" x 2 1/4" brass plated bolts	50 pairs/400
C02998	1/4" x 2 1/4" solid brass bolts	50 pairs/400
C02997	1/4" x 3 1/2" brass plated bolts	50 pairs/200
C02996	1/4" x 3 1/2" solid brass bolts	50 pairs/200
C02992	1/4" x 2 1/4" solid brass bolts	50 pairs/400
C02993	5/16" x 2 1/4" brass plated bolts	50 pairs/200

Packed with 2 acorn nuts, 2 hex nuts, and 4 washers

PART NO.	DESCRIPTION	CTN/MSTR
C02995	1/4" x 2 1/4" brass plated bolts	50 pairs/400
C02994	1/4" x 2 1/4" solid brass bolts	50 pairs/400

Packed with 2 acorn nuts, 2 hex nuts, 4 washers, and 2 tinnerman nuts

PART NO.	DESCRIPTION	CTN/MSTR
C02987	1/4" x 2 1/4" solid brass bolts	50 pairs/400

Closet Bolt Cap



Oval Cap

Round Cap

- CARTON QUANTITIES ONLY

Bulk Packed - Priced Per Cap And Washer

PART NO.	DESCRIPTION	CTN/MSTR
C02100	Oval white (less washer)	100/900
C02105	Round white (with washer)	100/2000
C02106	Round bone (with washer)	100/4000

Custom Packed - Priced Per Bag Of Two Each

PART NO.	DESCRIPTION	CTN/MSTR
C02103	Round white (with washer)	50 pairs/50
C02104	Round bone (with washer)	50 pairs/50

Closet Screws



With Round Washer

With Oval Washer

- CARTON QUANTITIES ONLY
- Two each screws, nuts, and washers per bag

Brass Plated

PART NO.	SIZE	WASHER	CTN/MSTR
C02210	1/4" x 2 1/2"	Round	50 pairs/400
C02202	1/4" x 3 1/2"	Round	50 pairs/200
C02211	5/16" x 2 1/2"	Round	50 pairs/200
C02200	1/4" x 2 1/2"	Oval	50 pairs/200
C02203	1/4" x 3 1/2"	Oval	50 pairs/200
C02201	5/16" x 2 1/2"	Oval	50 pairs/200

Brass

PART NO.	SIZE	WASHER	CTN/MSTR
C02310	1/4" x 2 1/2"	Round	50 pairs/400
C02302	1/4" x 3 1/2"	Round	50 pairs/400
C02311	5/16" x 2 1/2"	Round	50 pairs/200
C02300	1/4" x 2 1/2"	Oval	50 pairs/400
C02303	1/4" x 3 1/2"	Oval	50 pairs/200
C02301	5/16" x 2 1/2"	Oval	50 pairs/200

Tank to Bowl Set



- CARTON QUANTITIES ONLY
- Universal fit sponge rubber gasket
- Domed poly wingnut fits into china, eliminating bottom washer

PART NO.	DESCRIPTION	BOLT	CTN QTY
C03250	5/16" x 3"	Brass plated	25 pairs
C03251	5/16" x 3" with gasket	Brass plated	25 pairs
C03252	5/16" x 3"	Brass	25 pairs
C03253	5/16" x 3" with gasket	Brass	25 pairs

Tank To Bowl Bolt Set



- CARTON QUANTITIES ONLY
- Universal fit sponge rubber gasket

With Wing Nut

PART NO.	DESCRIPTION	BOLT	CTN/MSTR
C03200	5/16" x 3"	Brass plated	50 pairs/200
C03201	5/16" x 3" with gasket	Brass plated	25 pairs/200
C03202	5/16" x 3"	Brass	50 pairs/200
C03203	5/16" x 3" with gasket	Brass	25 pairs/200

With Hex Nut

PART NO.	DESCRIPTION	BOLT	CTN/MSTR
C03210	5/16" x 3"	Brass plated	50 pairs/200
C03211	5/16" x 3" with gasket	Brass plated	25 pairs/200
C03212	5/16" x 3"	Brass	50 pairs/200
C03213	5/16" x 3" with gasket	Brass	5 pairs/100

With Hex Nut and Wing Nut

PART NO.	DESCRIPTION	BOLT	CTN/MSTR
C03240	5/16" x 3"	Brass	50 pairs/100

Tank to Bowl Bolt Kit For Mansfield*



- Includes brass plated bolts, hex nuts, round washers, sponge rubber gasket and ballcock coupling nut

PART NO.	DESCRIPTION	CTN/MSTR
C03260	Mansfield* kit	1/25

Tank to Bowl Bolt Kit For Gerber*



- Includes brass bolts, hex nuts, round washers, sponge rubber gasket and ballcock coupling nut

PART NO.	DESCRIPTION	CTN/MSTR
C03265	Gerber* kit	1/25

Tank to Bowl Bolt Kit for American Standard*



- Includes bolts, nuts, round washers and sponge rubber gasket

PART NO.	DESCRIPTION	CTN/MSTR
C03270	American Standard* kit (brass plated bolts)	1/25
C03271	American Standard* (brass bolts)	1/25

Tri-Tank To Bowl Bolt Kit For American Standard*



- Brass plated

PART NO.	DESCRIPTION	CTN/MSTR
C03272	American Standard* Tank to Bowl Bolt Kit	1/25

Tri-Bolt Tank To Bowl Bolt Set



- For units requiring 3-bolt attachment
- Custom packed with 3 brass bolts, washers and hex nuts

PART NO.	DESCRIPTION	CTN/MSTR
C03280	5/16" x 3"	1/50

Offset Tank To Bowl Bolts



- All Brass
- Rubber washers
- 2" maximum adjustment

PART NO.	DESCRIPTION	CTN/MSTR
C02075	Offset tank to bowl bolts	50/200

Tank To Bowl Components



C03800



C03803



C03804



C03805



C03807



C03810



C02852

PART NO.	DESCRIPTION	CTN/MSTR
C03800	5/16"-18 x 3" brass plated tank bolt	100/500
C03801	5/16"-18 x 3" brass tank bolt	100/500
C03803	5/16"-18 brass plated forged wing nut	100/500
C03804	5/16"-18 brass plated heavy hex jam nut	100/5500
C03805	5/16"-18 brass heavy hex jam nut	100/5000
C03807	5/16" acetal tank bowl wing nut	100/3500
C03810	Cloth inserted washer	100
C02852	Stainless steel washer	100

Tank to Bowl Gasket



C03300



C03301



C03302



C03303



C03304



C03305

- Close coupled tank to bowl gaskets
- Beveled sponge rubber material
- CARTON QUANTITIES ONLY

Universal Fit-All

PART NO.	DESCRIPTION	CTN/MSTR
C03300	2 1/4" ID x 3 3/8" OD x 11/16" thick	25/1000

Kohler* (fits Alamo and other Kohler* integral units with two piece closets)

PART NO.	DESCRIPTION	CTN/MSTR
C03301	2 1/2" ID x 3 3/4" OD x 3/4" thick	25/1000

Eljer* (rubber)

PART NO.	DESCRIPTION	CTN/MSTR
C03302	2 5/16" ID x 3 1/8" OD x 3/8" thick	25/1000

American Standard Cadet*, Kohler*, Crane*, Borg Warner*

PART NO.	DESCRIPTION	CTN/MSTR
C03303	2 1/8" ID x 3 1/2" OD x 1 1/4" thick	25/300

Crane*

PART NO.	DESCRIPTION	CTN/MSTR
C03304	2 1/8" ID x 3 1/4" OD x 1 1/16" thick	25/300

Gerber* (free standing late models)

PART NO.	DESCRIPTION	CTN/MSTR
C03305	2 1/8" ID x 3 1/4" OD x 1 3/16" thick	25/300

Mansfield*

PART NO.	DESCRIPTION	CTN/MSTR
C03306	2 1/2" ID x 3 5/8" OD x 3/4" thick	25/200

Wax Gaskets



Standard Wax Gasket

With Plastic Flange

- Boxed
- CARTON QUANTITIES ONLY

PART NO.	DESCRIPTION	CTN/MSTR
G13001	Full size standard wax gasket	1/48
G13002	Gasket with plastic flange	1/24
G13003	Urinal gasket- fits 2" outlet	1/12
G13004	Jumbo wax gasket	1/12

Radiant Seal Sponge Rubber Closet Gasket



- Easy installation
- Unaffected by radiant heat
- Seals effectively with uneven floors
- 3 3/4" ID x 5 1/8" OD x 1/2" Thick

PART NO.	DESCRIPTION	CTN/MSTR
G13005	3 3/4" ID x 5 1/8" OD x 1/2" thick	1/12

Closet Bend Spacer



- One size fits all
- Eliminates the need to chip out concrete
- 6" OD x 4" high (fits 3" and 4" waste lines)
- Keeps poured concrete away from waste lines and closet bends
- Replaces styrofoam, styrene coverings, coffee cans and duct tape
- CARTON QUANTITIES ONLY

PART NO.	DESCRIPTION	CTN QTY
S12005	Closet bend spacer	18

Styrofoam Closet Flange Spacer



- Eliminates needless chipping of concrete
- Styrofoam breaks away or melts with flame
- Bulk pack- CARTON QUANTITIES ONLY

PART NO.	DESCRIPTION	CTN QTY
S13130	3" Flange spacer	120
S13140	4" Flange spacer	120

Foam Spacer



- Foam closet bend protector
- CARTON QUANTITIES ONLY

PART NO.	DESCRIPTION	CTN QTY
S13240	4"x 4" foam spacer	60

Shower Rod Flanges



• Flanges fit 15/16" and 1" OD rod

PART NO.	DESCRIPTION	CTN/MSTR
S02150	Jiffy flange chrome-plated plastic	1/200
S02151	Jiffy flange chrome die cast zinc	1/100
S02152	Chrome flanges with screws (bagged)	50/500

Jumbo Shower Bar Flange



PART NO.	DESCRIPTION	CTN/MSTR
S02300	Jumbo shower bar flange	1/50

Contoured Shower Rod



- Brings shower curtain in front of wall to prevent gaps and leaks
- Perfect for 60° oval or standard tubs
- Adjusts easily with tube cutter for shorter walls
- Sweeping curve increases space in center of oval tubs
- Sturdy alloy rods with zinc angled mounting brackets
- Multiple applications - residential, hotel, motel, assisted living, etc.

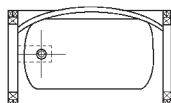

PART NO.	DESCRIPTION	CTN/MSTR
S02190	Chrome plated	1/12
S02193	Satin Nickel	1

Aluminum Shower Rod



- 1" OD - .025 wall (22 gauge)
- Individually wrapped
- CARTON QUANTITIES ONLY

PART NO.	DESCRIPTION	CTN QTY
S02055	5' rod	50
S02015	5' rod	10
S02056	6' rod	50
S02016	6' rod	10

Aluminum Shower Rod With Holders



- 1" OD - .025 wall (22 gauge)
- Fifty each Individually wrapped rods and holders boxed together
- 10 packs (S02071/-072/-073/-074)
- CARTON QUANTITIES ONLY

PART NO.	DESCRIPTION	CTN QTY
S02057	5' rod with plastic Jiffy flange	50
S02058	5' rod with die cast Jiffy flange	50
S02059	5' rod with chrome flange and screws	50
S02071	5' rod with chrome flange and screws	10
S02072	6' rod with chrome flange and screws	10
S02073	5' rod with plastic Jiffy flange	10
S02074	6' rod with plastic Jiffy flange	10

Adjustable Aluminum Shower Curtain Rod



- Sturdy, self-supporting
- 1" OD/.025 wall (22 gauge)
- Expandable from 58" to 61" or 69" to 73"
- Individually wrapped
- CARTON QUANTITIES ONLY

PART NO.	DESCRIPTION	CTN QTY
S02070	Adjustable shower rod 58" - 61" (bulk)	50
S02066	Adjustable shower rod 69" - 73" (bulk)	50
S02069	Adjustable shower rod 58" - 61" (10 pack)	10

Deluxe Shower Head



- 2.5 gpm flow rate
- Chrome plated die cast zinc

PART NO.	DESCRIPTION	CTN/MSTR
S01004	Deluxe shower head	1/100

Shower Heads



Plastic



Die cast



Brass

• 2.5 gpm flow rate

Plastic		
PART NO.	DESCRIPTION	CTN/MSTR
S01001	2" Chrome with plastic ball	1/100
S01002	2" White with plastic ball	1/200
S01003	2" Chrome with brass ball	1/100

Die Cast		
PART NO.	DESCRIPTION	CTN/MSTR
S01005	2" Chrome- adjustable	1/100

Brass		
PART NO.	DESCRIPTION	CTN/MSTR
S01008	1 3/4" Chrome- adjustable	1/50
S01009	2 1/8" Chrome- adjustable	1/50
S01010	3" Chrome- adjustable	1/20

Brass Aerating Water Saver Shower Head

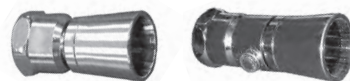

Chrome

Chrome with Shutoff

- Permanent built-in water restrictor
- Mixes air and water for invigorating spray
- Restricts water to 2-2.5 gpm, depending on water pressure

PART NO.	DESCRIPTION	CTN/MSTR
S01013	1" Chrome	50/200
S01014	1" Chrome with shutoff	50/200

Vandal Proof Shower Head



- 2.5 gpm flow rate
- Brass ball
- Spray adjusts from coarse to fine
- Secures with set screw, hex key included

PART NO.	DESCRIPTION	CTN/MSTR
S01015	Chrome plated plastic shower head	1/100

Adjustable Plastic Shower Head



- 1.5 gpm flow rate
- Chrome plated plastic
- Brass ball

PART NO.	DESCRIPTION	CTN/MSTR
S01016	Chrome plated adjustable plastic shower head	1/100

Adjustable Massage Shower Head



- 2.5 gpm flow rate
- Brass ball

PART NO.	DESCRIPTION	CTN/MSTR
S01020	Chrome plated plastic shower head	1/100

Octagonal Shower Head



- 2.5 gpm flow rate
- Brass ball

PART NO.	DESCRIPTION	CTN/MSTR
S01025	Chrome plated octagonal shower head	25/100

Shower Arms and Kits



Shower Arm

Shower Arm with Flange

"S" Style Shower Arm

- Chrome plated brass arms

PART NO.	DESCRIPTION	CTN/MSTR
S01030	6" Arm only	1/200
S01032	8" Arm only	1/100
S01044	6" Arm and stainless steel flange	1/25
S01045	8" Arm and stainless steel flange	1/25
S01035	8" "S" style arm	10/80
S01038	10" "S" style arm	25/50

Heavy Adjustable Shower Arm



- 10" length
- Chrome plated brass
- Locking wing nut adjustment

PART NO.	DESCRIPTION	CTN/MSTR
S01039	1/2" x 10" adjustable	10/50

Shower Arm and Flange w/Set Screw



- 1/2" x 6" shower arm

PART NO.	DESCRIPTION	CTN/MSTR
S01042	6" Shower arm and flange w/set screw	1/25

Plastic Shower Arm



- 1/2" x 6" chrome-plated plastic with flange

PART NO.	DESCRIPTION	CTN/MSTR
S01049	Plastic shower arm and flange	1/200

Shower Arm Flange



S01041

S01040

PART NO.	DESCRIPTION	CTN/MSTR
S01040	Chrome flange with set screw (2 1/2" OD)	40/400
S01041	Stainless steel flange (2 1/2" OD)	50/2000

Shower Curtain Pin



- CARTON QUANTITY ONLY

PART NO.	DESCRIPTION	CTN/MSTR
S02100	Shower curtain pin	10/500

Shower Pan Liner

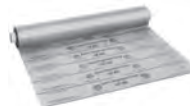

- 40 mil thickness
- Meets ASTM D4551
- FREIGHT LINE ONLY
- PVC shower pan liner is listed by UPC
- Marked in 6 inch increments for easy measurements
- Treated to prevent the growth of fungus, molds and mildew

PART NO.	DESCRIPTION	CTN QTY
S994050	4' x 50'	1
S995040	5' x 40'	1
S996050	6' x 50'	1
S996080	5' x 80'	1

PVC Shower Pan Liner Cement



- 3 year shelf life
- Not for PE liner use
- Instant contact strength
- CARTON QUANTITY ONLY

PART NO.	DESCRIPTION	CTN QTY
S99100	Shower pan liner cement (pint)	12

Water Volume Control



- 1/2" female x 1/2" male IPS
- Allows reduced water flow (does not shut water completely off)

PART NO.	DESCRIPTION	CTN/MSTR
S01060	Chrome-brass	50/200
S01061	Chrome-plastic	1/25

Plastic Flow Restrictor



- 2.5 GPM

PART NO.	DESCRIPTION	CTN/MSTR
S01080	Shower head flow restrictor	1/25

54" D-Style Add-A-Shower



- Heavy duty jumbo flanges
- 61" riser with shower head
- Standard bathcock (3 3/8" centers)
- 54" x 27" chrome plated brass shower rod (1" diameter)

PART NO.	DESCRIPTION	CTN/MSTR
S10083	54" x 27" D-Style Add-A-Shower	1/5

Add-A-Shower Complete Unit

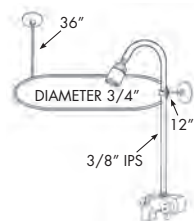

- Bathcock with diverter spout
- Chrome plated plastic shower head
- 61" rise with 12" rod and riser support
- 24" x 42" rectangular aluminum shower rod with 36" ceiling rod and support

PART NO.	DESCRIPTION	CTN/MSTR
S10070	Complete unit with S10080 diverter	1/5
S10069	Complete unit with S10074 diverter	1/5

Complete Add-A-Shower

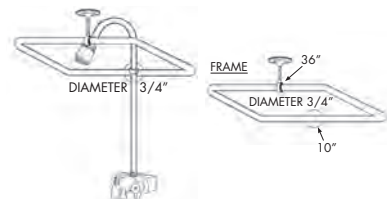

- Rectangular frame
- Aluminum shower rod
- Bathcock with diverter spout
- 3/8" mounting brackets included
- 61" riser with 10" rod and riser support

PART NO.	DESCRIPTION	CTN/MSTR
S10067	Shower with 24" x 42" frame	1/5
S10068	24" x 42" Frame only	1

Add-A-Shower Less Oval Shower Rod

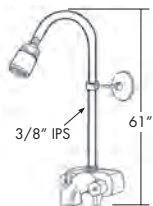

- 61" riser and wall support
- Bathcock with diverter spout
- Chrome plated plastic shower head

PART NO.	DESCRIPTION	CTN/MSTR
S10072	Complete unit	1/10

Add-A-Shower Diverter Spout & Riser

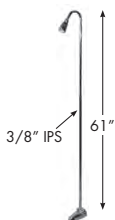

- Diverter valve
- 61" riser with wall support
- Chrome plated plastic shower head

PART NO.	DESCRIPTION	CTN/MSTR
S10071	Spout and riser	1/10

Add-A-Shower Code Pattern

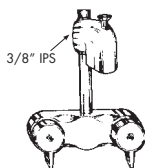

PART NO.	DESCRIPTION	CTN QTY
S10074	Code pattern anti-syphon diverter bathcock	1

Add-A-Shower Accessories

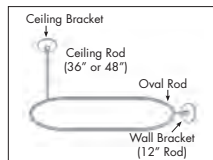

PART NO.	DESCRIPTION	CTN/MSTR
S10075	24" x 42" oval shower rod	1/10
B60001	Wall bracket and rod holder with 12" rod (can be cut to fit)	1/100
B60002	Ceiling bracket and rod holder with standard size 36" rod	1/100
S10073	48" ceiling rod only	1
S10080	Replacement Bathcock Assembly	1/12
S10081	Diverter spout only for S10071	1/50
S10077	Wall bracket for S10071	1/200
S10078	Diverter spout with 65" riser	1/10
S10082	61" CP brass riser only	1/20
S10076	61" CP brass riser with shower head	1/10

Shower Diverter Valve



- Installs between arm and shower head
- Allows usage of hand-held personal shower or shower head

PART NO.	DESCRIPTION	CTN/MSTR
S01070	Chrome push button- brass	1/5

Offset Bath Supplies



- Chrome plated
- 1/2" supply tubes
- All hardware needed for connection included

PART NO.	DESCRIPTION	CTN/MSTR
B49020	Single offset (pair)	1/25
B49021	Double offset (pair)	1/25
B49022	Replacement nuts, washers and escutcheons	1/25

Utility Shower

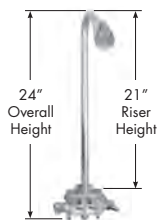

- 21" galvanized riser
- Top or bottom connection
- Chrome plated brass body with shower head and soap dish
- Combination 1/2" threaded or sweat connection union inlets on 3" centers

PART NO.	DESCRIPTION	CTN/MSTR
S10079	Utility shower	1/6

Bathcocks



B49001



B49002



B49010

- Chrome plated brass body
- Replaceable stem and seat
- 3 3/8" centers and 3/4" threaded inlets

PART NO.	DESCRIPTION	CTN/MSTR
B49001	"O" pattern with slip-on spout	1/48
B49002	Code pattern with goose neck spout	1/48
B49010	Coupling elbows (pair) chrome plated 3/4" bath-cock threads x 1/2" male IPS	6/60
B49011	Code spout only	1/10
B49012	Hot repair kit (handle, stem and seat)	1/100
B49013	Cold repair kit (handle, stem and seat)	1/100

Brass Trap Bushing



- Heavy pattern/cast
- 1 1/2" sweat x 1 1/2" IPS
- Knurled end for ease of tightening

PART NO.	DESCRIPTION	CTN/MSTR
B55150	1 1/2" SWT x 1 1/2" MIP	1/250

Twin Elbow And Face Bushings



FIP x FIP



MIP x FIP

• Brass

PART NO.	DESCRIPTION	CTN/MSTR
D01040	3/4" FIP x 1/2" FIP twin elbow	1/144
D01041	3/4" MIP x 1/2" FIP face bushing	1/1000
D01042	1/2" MIP x 3/8" FIP face bushing	1/40

Brass Shower Elbow For Fiberglass Shower Stall



- Outlet 1/2" FIP
- Secures tub spout nipple
- Secures shower arm to stall
- Lock nuts secure ell to fiberglass wall
- Requires 1 1/8" hole through fiberglass wall
- Combination inlet 1/2" female sweat or 1/2" threaded

PART NO.	DESCRIPTION	CTN/MSTR
S01050	Brass elbow	6/144

Diverter Spouts and Extensions



D01001
D01004
D01101
D01104



D01002
D01003
D01103

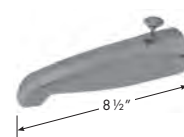

D01015



D01008
D01009



D01030
D01031



D01010



D01011

- D01002 and D01004 Meets IAPMO and California Energy Commission approval

Chrome Plated Diverter Spouts

PART NO.	DESCRIPTION	CONNECTION	MATERIAL	CTN/MSTR
D01001	1/2" FIP	Nose	Zamak	1/50
D01002	3/4" x 1/2" FIP	Base	Zamak	1/50
D01003	3/4" x 1/2" FIP	Base	Brass	1/50
D01004	1/2" CTS slide connection (unit includes hex key)	Base	Zamak	1/50

8 1/2" One Piece Diverter Spouts

PART NO.	DESCRIPTION	CONNECTION	MATERIAL	CTN/MSTR
D01015	3/4" x 1/2" FIP	Base	Brass	1/20

Two Piece Diverter Spouts

PART NO.	DESCRIPTION	CONNECTION	MATERIAL	CTN QTY
D01008	8 1/4" two piece	Nose	Zamak	1
D01009	10 1/8" two piece	Nose	Zamak	1

Extension Only

PART NO.	DESCRIPTION	CONNECTION	MATERIAL	CTN/MSTR
D01030	3" extension only	-	CP Brass	1/100
D01031	4 3/4" extension only	-	CP Brass	1/80

Diverter Spout For Hand Held Shower- 1/2" MIP Hookup

PART NO.	DESCRIPTION	CONNECTION	MATERIAL	CTN/MSTR
D01010	3/4" x 1/2" FIP top hookup	Base	Zamak	1/50
D01011	3/4" x 1/2" MIP lower hookup	Base	Zamak	1/50

Chrome Plated Diverter Spout



- Longer length for today's larger tubs
- CTS unit comes with hex key

PART NO.	SIZE	CONNECTION	CTN/MSTR
D01024	7"	1/2" FIP Nose	1/50
D01025	7"	1/2" CTS Slide	1/25

Chrome Plated Slip-On Diverter Spout With Polished Brass Knob

B



- Hex key included
- Polished brass knob
- Standard 5 1/2" diverter spout
- 1/2" CTS slip-on connection with set screw

PART NO.	DESCRIPTION	CTN/MSTR
D01032	Slip-On Diverter Spout With PB Knob	1/50

Tub Spouts

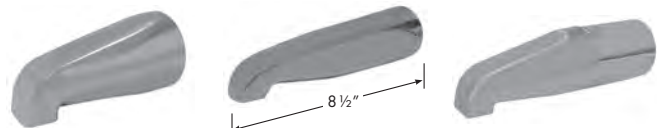

Chrome Plated Zamak Slide Connection With Hex Key

PART NO.	DESCRIPTION	CONNECTION	MATERIAL	CTN/MSTR
D01020	1/2" FIP	Nose	CP Zamak	1/50
D01021	1/2" CTS slide connection	Base	CP Zamak	1/50

8 1/2" One Piece Chrome Plated Brass

PART NO.	DESCRIPTION	CONNECTION	MATERIAL	CTN/MSTR
D01016	3/4" x 1/2" FIP	Base	CP brass	1/20

Two Piece Chrome Plated

PART NO.	DESCRIPTION	CONNECTION	MATERIAL	CTN QTY
D01028	8" two piece	Nose	Zamak	1
D01029	10" two piece	Nose	Zamak	1

Telescoping Tub and Diverter Spouts



- 5 1/2" overall length
- Adjustment up to 1" to accommodate various rough-ins

PART NO.	DESCRIPTION	CTN/MSTR
D01022	1/2" x 3/4" tub spout	1/50
D01023	1/2" x 3/4" diverter spout	1/50

9" Chrome Plated Tub Spouts



- One piece design
- 1/2" nose connection
- Solid brass construction

PART NO.	DESCRIPTION	CTN/MSTR
D01017	9" CP brass diverter spout	1/12
D01018	9" CP brass tub spout	1/12

7" Chrome Plated Tub Spout



- CTS unit comes with hex key
- Longer length for today's larger tubs

PART NO.	SIZE	CONNECTION	CTN/MSTR
D01026	7"	1/2" FIP Nose	1/50
D01027	7"	1/2" CTS Slide	1/25

Tub Spout



Solid Brass

Zinc

Solid brass

PART NO.	SIZE	CONNECTION	CTN/MSTR
D01005	3/4" x 1/2"	Base	1/40

Zinc

PART NO.	SIZE	CONNECTION	CTN/MSTR
D01035	1/2" x 3/4"	Base	1/25

Overflow Plates



One-Hole

Two-Hole

Chrome Plated Screws

- Chrome plated
- 2" screws
- UPC listed

PART NO.	DESCRIPTION	CTN/MSTR
T05012	One-hole with screw	20/200
T05013	Two-hole with screws	20/200
T05010	One-hole less screw	20/200
T05011	Two-hole less screw	20/200
T05021	1/4" x 2" chrome plated screw	500/2000

Tub Trip Levers With Spring



Round

Chrome Plated Screws

- Chrome plated
- Coil-type spring
- 2" screws

PART NO.	DESCRIPTION	CTN/MSTR
T05002	Round trip lever less screws	25/200
T05003	Round trip lever with 2" screws	25/200
T05021	1/4" x 2" chrome plated screw	500/2000

Face Plate Gasket And Shoe Gasket



T05025

T05026

PART NO.	DESCRIPTION	CTN/MSTR
T05025	Beveled face plate gasket 2 1/8" ID x 3 3/16" OD - 9/16"-3/16" thick	25/300
T05026	Shoe gasket 1 3/4" ID x 2 5/8" OD - 3/32" thick	25/50

Wraparound Sponge Rubber Face Plate Gasket



- Grips top elbow for easy installation

PART NO.	DESCRIPTION	CTN/MSTR
T05029	Wraparound sponge rubber face gasket	25/500

#15 Plumb Kit



- Stainless steel flange (S01041)
- 1/2" x 6" chrome plated brass shower arm (S01030)
- Chrome plated plastic shower head with brass ball (S01003)

PART NO.	DESCRIPTION	CTN/MSTR
S03220	#15 Plumb kit	1/25

#51 Plumb Kit



- Chrome plated flange with set screw (S01040)
- 1/2" x 6" chrome plated brass shower arm (S01030)
- Chrome plated die cast adjustable shower head (S01005)

PART NO.	DESCRIPTION	CTN/MSTR
S03222	#51 Plumb kit	1/25

Bathtub Protectors



- High impact plastic
- Fluted side walls and foam bottom
- CARTON QUANTITIES ONLY
- MOTOR FREIGHT (LTL) ONLY

For Steel Tubs

PART NO.	DESCRIPTION	CTN QTY
T10014	14" deep x 60" long x 30" wide	35

For Oval Tubs

PART NO.	DESCRIPTION	CTN QTY
T10016	16" deep x 60" long x 42" wide	25

For Cast Iron Tubs

PART NO.	DESCRIPTION	CTN QTY
T10216	16" deep x 60" long x 30" wide	35

Adapter Bushing For Bath Drain



- Brass bushing

PART NO.	DESCRIPTION	CTN/MSTR
T05023	Kohler Bushing	50/300
T05024	1 1/2" MIP x 1 3/8" FIP	50/300

Standard Waste And 1-Hole Overflow

Half Kit With Chrome Plated Lift And Turn



- 2-hole test kit converts to one hole face plate

PART NO.	DESCRIPTION	CTN/MSTR
B07220T	Waste and overflow kit- PVC	1/24
B07221T	Waste and overflow kit- ABS	1/24

Standard Waste And 2-Hole Overflow

Half Kit With Satin Nickel Lift And Turn



- 2-hole face plate

PART NO.	DESCRIPTION	CTN/MSTR
B07111S	Waste and Overflow kit- ABS	1/24
B07114S	Waste and Overflow kit- PVC	1/24

Standard Waste And Overflow

Full Kit With Chrome Plated Friction Lift



- Includes bar
- 1-hole face plate

PART NO.	DESCRIPTION	CTN/MSTR
B07219	Waste and overflow Kit- PVC	1/10

Lift And Turn Bath Drain



- Chrome plated
- 2 11/16" OD flange

PART NO.	DESCRIPTION	CTN/MSTR
P35061	1 3/8" bath drain (1 5/8" thread OD) zinc body	1/100
P35060	1 1/2" bath drain (1 7/8" thread OD) zinc body	1/100
P35066	1 1/2" bath drain (1 7/8" thread OD) brass	1/100

Friction Lift Tub Drain



- Chrome plated zinc

PART NO.	DESCRIPTION	CTN/MSTR
P35067	1 1/2" bath drain	1/100
P35077	1 3/8" CP Friction Lift Tub Drain	1/100

Chrome Plated Grid Drain Body With Screw



- Chrome plated zinc

PART NO.	DESCRIPTION	CTN/MSTR
P35064	1 1/2" CP grid drain	1/100

Toe Touch Bath Drain



Bath Drain



CP Replacement Drain

- Chrome plated zinc

PART NO.	DESCRIPTION	CTN/MSTR
P35063	1 3/8" bath drain (1 5/8" thread OD)	1/100
P35062	1 1/2" bath drain (1 7/8" thread OD)	1/100
P35056	5/16" CP replacement cartridge	1/300
P35057	3/8" CP replacement cartridge	1/250

Roman Tub Drains



- Solid brass construction
- Screws are included
- U-shaped handle design
- Designed to fit D64 series "Code Blue" drains

PART NO.	DESCRIPTION	CTN/MSTR
D40000	CP Roman Tub Drain	1/50
D40001	PB/PVD Roman Tub Drain	1/50
D40002	Satin Nickel PVD Roman Tub Drain	1/50

Basin And Tub Stopper



- White hollow rubber with rustproof ring

PART NO.	TRADE SIZE	TOP	BOTTOM	CTN/MSTR
P35125	1 1/4"	1 3/8"	1 3/16"	100/500
P35150	1 1/2"	1 5/8"	1 3/8"	100/500
P35158	1 5/8"	1 25/32"	1 19/32"	100/500
P35175	1 3/4"	1 55/64"	1 11/16"	100/500

Fit-All Stopper



Part No.	Top	Bottom
P35-160	1 1/2"	7/8"
P35-161	3"	1 1/2"

- White rubber construction

PART NO.	DESCRIPTION	CTN/MSTR
P35160	1" - 1 3/8" basin stopper	100/500
P35161	1 1/2" - 2" bathtub or laundry tub stopper	100/500

Pop-Up Basin Stopper



P36002



P36003



P36004

PART NO.	DESCRIPTION	CTN/MSTR
P36002	Delta pop-up basin stopper	1/50
P36003	Price-Pfister pop-up stopper	1/200
P36004	Moen pop-up basin stopper	1/200

Flip-It Tub Stopper



- No tools needed for installation
- Open or close with a flip of the toe
- One piece construction of Derlin and ABS
- Fits most popular tub drains (assorted o-rings included)

PART NO.	DESCRIPTION	CTN/MSTR
P35070	Chrome plated Flip-it	1/100

Flip-It Conversion Kit



- No bending or stooping necessary to operate
- Open or close with a flip of the toe
- Fits most popular tub drains

PART NO.	DESCRIPTION	CTN QTY
P35170	Chrome plated Flip-It Conversion kit	1

Schedule 40 Bath Waste Kits - Expanded Views

*See pages B22 - B23 for a complete list of available Schedule 40 Bath Waste Kits

Standard **One-Hole** Schedule 40 Bath Waste Kits

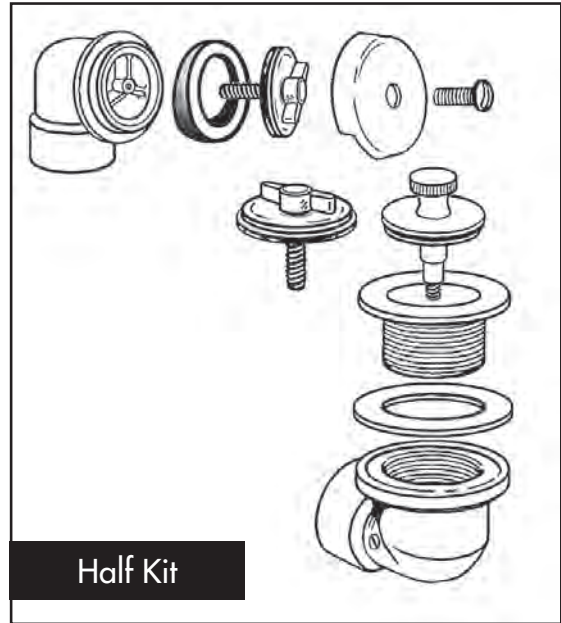
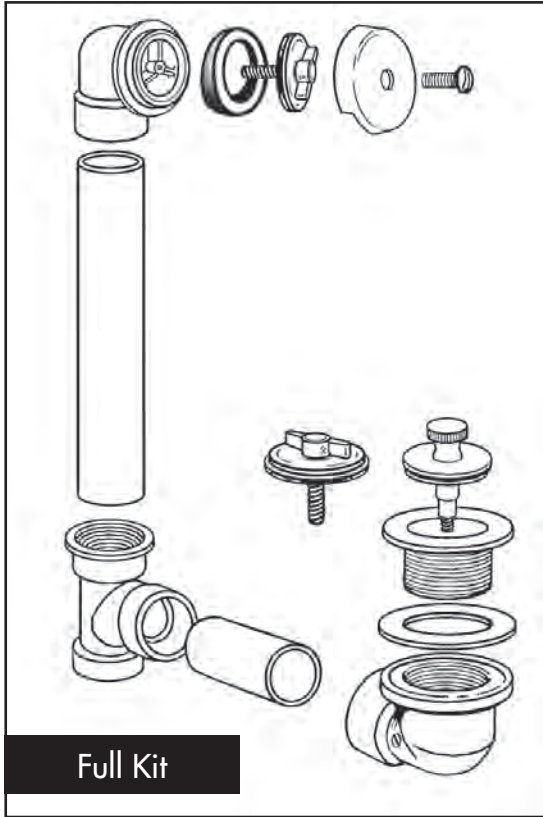

Standard **Two-Hole** Schedule 40 Bath Waste Kits

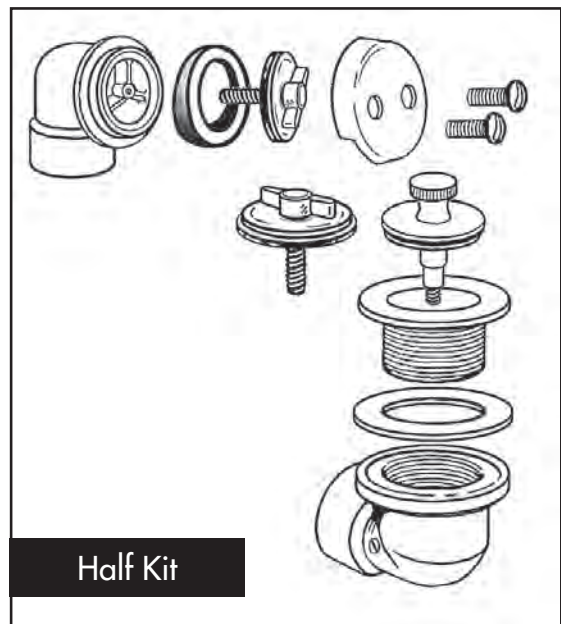
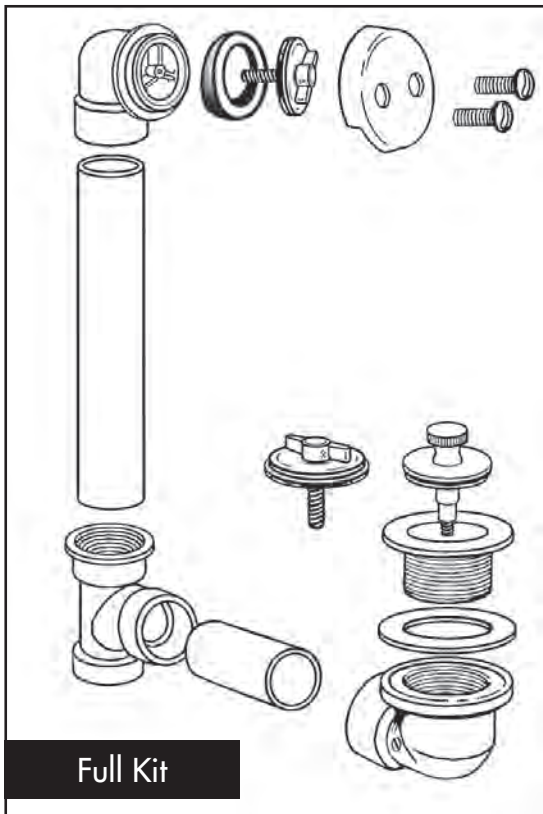

B

Schedule 40 Direct Waste Bath Kits

With One-Hole Face Plates

For use in apartments, motels, hotels - anywhere with back to back baths



T-Waste Kit Benefits:

- Direct access to trap from tub
- Direct waste much less likely to clog
- Solvent weld = homogeneous
- Code required for back to back installation
- Never needs access through walls or ceilings

- NO ACCESS PANEL NEEDED!
- UPC listed
- One-hole face plates
- Bolt holes on top elbows are pre-threaded
- All drains 3/8" thread size for testing

Note: Please use suffix "T" when ordering any waste and overflow kit to have test kit included. Add \$4.99 to list price. When a complete kit with a two-hole test kit is ordered, a one-hole face plate with aluminum conversion bar will be supplied.



Half Kit - Lift & Turn Drain



Half Kit - Toe Pop-Up Drain

T-Waste Half Kit- No Pipe Or Elbow

PART NO.	MATERIAL	DESCRIPTION	CTN/MSTR
B07038	PVC	CP brass lift and turn drain	1/24
B07001	PVC	CP lift and turn drain	1/24
B07005	PVC	PB lift and turn drain	1/24
B07003	PVC	CP toe pop-up drain	1/24
B07007	PVC	PB toe pop-up drain	1/24
B07040	PVC	CP friction lift drain	1/24
B07042	PVC	PB friction lift drain	1/24
B07006	ABS	PB lift and turn drain	1/24
B07039	ABS	CP brass lift and turn drain	1/24
B07002	ABS	CP lift and turn drain	1/24
B07004	ABS	CP toe pop-up drain	1/24
B07008	ABS	PB toe pop-up drain	1/24
B07041	ABS	CP friction lift drain	1/24
B07043	ABS	PB friction lift drain	1/24



Full Kit - Lift & Turn Drain



Full Kit - Toe Pop-Up Drain

T-Waste Full Kit- Includes Pipe And 90° Elbow

PART NO.	MATERIAL	DESCRIPTION	CTN/MSTR
B07044	PVC	CP brass lift and turn drain	1/10
B07020	PVC	CP lift and turn drain	1/10
B07024	PVS	PB lift and turn drain	1/10
B07022	PVC	CP toe pop-up drain	1/10
B07046	PVC	CP friction lift drain	1/10
B07048	PVC	PB friction lift drain	1/10
B07045	ABS	CP brass lift and turn drain	1/10
B07021	ABS	CP lift and turn drain	1/10
B07025	ABS	PB lift and turn drain	1/10
B07023	ABS	CP toe pop-up drain	1/10
B07027	ABS	PB toe pop-up drain	1/10
B07047	ABS	CP friction lift drain	1/10
B07049	ABS	PB friction lift drain	1/10

Schedule 40 Direct Waste Bath Kits

With Two-Hole Face Plates

For use in apartments, motels, hotels - anywhere with back to back baths



T-Waste Kit Benefits:

- Direct access to trap from tub
- Direct waste much less likely to clog
- Solvent weld = homogeneous
- Code required for back to back installation
- Never needs access through walls or ceilings

- NO ACCESS PANEL NEEDED!
- UPC listed
- Two-hole face plates
- Bolt holes on top elbow are pre-threaded
- All drains 3/8" thread size for testing

Note: Please use suffix "T" when ordering any waste and overflow kit to have test kit included. Add \$4.99 to list price. When a complete kit with a two-hole test kit is ordered, a one-hole face plate with aluminum conversion bar will be supplied.



Half Kit - Lift & Turn Drain



Half Kit - Toe Pop-Up Drain

T-Waste Half Kit- No Pipe Or Elbow

PART NO.	MATERIAL	DESCRIPTION	CTN/MSTR
B07138	PVC	CP brass lift and turn drain	1/24
B07101	PVC	CP lift and turn drain	1/24
B07105	PVC	PB lift and turn drain	1/24
B07103	PVC	CP toe pop-up drain	1/24
B07107	PVC	PB toe pop-up drain	1/24
B07140	PVC	CP friction lift drain	1/24
B07142	PVC	PB friction lift drain	1/24
B07139	ABS	CP brass lift and turn drain	1/24
B07102	ABS	CP lift and turn drain	1/24
B07106	ABS	PB lift and turn drain	1/24
B07104	ABS	CP toe pop-up drain	1/24
B07108	ABS	PB toe pop-up drain	1/24
B07141	ABS	CP friction lift drain	1/24
B07143	ABS	PB friction lift drain	1/24



Full Kit - Lift & Turn Drain



Full Kit - Toe Pop-Up Drain

T-Waste Full Kit- Includes Pipe And 90° Elbow

PART NO.	MATERIAL	DESCRIPTION	CTN/MSTR
B07144	PVC	CP brass lift and turn drain	1/10
B07120	PVC	CP lift and turn drain	1/10
B07124	PVC	PB lift and turn drain	1/10
B07122	PVC	CP toe pop-up drain	1/10
B07126	PVC	PB toe pop-up drain	1/10
B07146	PVC	CP friction lift drain	1/10
B07148	PVC	PB friction lift drain	1/10
B07121	ABS	CP lift and turn drain	1/10
B07125	ABS	PB lift and turn drain	1/10
B07123	ABS	CP toe pop-up drain	1/10
B07127	ABS	PB toe pop-up drain	1/10
B07147	ABS	CP friction lift drain	1/10
B07149	ABS	PB friction lift drain	1/10

Schedule 40 Bath Waste Kits

With One-Hole Face Plates

- UPC listed
- One-hole face plates
- Bolt holes on top elbows are pre-threaded
- All drains 3/8" thread size for testing

Note: Please use suffix "T" when ordering any waste and overflow kit to have test kit included. Add \$4.99 to list price. When a complete kit with a two-hole test kit is ordered, a one-hole face plate with aluminum conversion bar will be supplied.



Half Kit - Lift & Turn Drain

Half Kit - Toe Pop-Up Drain

Standard Half Kit- No Pipe Or Elbow

PART NO.	MATERIAL	DESCRIPTION	CTN/MSTR
B07050	PVC	CP brass lift and turn drain	1/24
B07010	PVC	CP lift and turn drain	1/24
B07014	PVC	PB lift and turn drain	1/24
B07012	PVC	CP toe pop-up drain	1/24
B07016	PVC	PB toe pop-up drain	1/24
B07052	PVC	CP friction lift drain	1/24
B07054	PVC	PB friction lift drain	1/24
B07051	ABS	CP brass lift and turn drain	1/24
B07011	ABS	CP lift and turn drain	1/24
B07015	ABS	PB lift and turn drain	1/24
B07013	ABS	CP toe pop-up drain	1/24
B07017	ABS	PB toe pop-up drain	1/24
B07053	ABS	CP friction lift drain	1/24
B07055	ABS	PB friction lift drain	1/24



Full Kit - Lift & Turn Drain



Full Kit - Toe Pop-Up Drain

Standard Full Kit- Includes Pipe And Tee PVC

PART NO.	MATERIAL	DESCRIPTION	CTN/MSTR
B07056	PVS	CP brass lift and turn drain	1/10
B07030	PVC	CP lift and turn drain	1/10
B07034	PVC	PB lift and turn drain	1/10
B07032	PVC	CP toe pop-up drain	1/10
B07036	PVC	PB toe pop-up drain	1/10
B07058	PVC	CP friction lift drain	1/10
B07060	PVC	PB friction lift drain	1/10
B07057	ABS	CP brass lift and turn drain	1/10
B07031	ABS	CP lift and turn drain	1/10
B07035	ABS	PB lift and turn drain	1/10
B07033	ABS	CP toe pop-up drain	1/10
B07037	ABS	PB toe pop-up drain	1/10
B07059	ABS	CP friction lift drain	1/10
B07061	ABS	PB friction lift drain	1/10

Schedule 40 Bath Waste Kits

With Two-Hole Face Plates

- UPC listed
- Two-hole face plates
- Bolt holes on top elbow are pre-threaded
- All drains 3/8" thread size for testing

Note: Please use suffix "T" when ordering any waste and overflow kit to have test kit included. Add \$4.99 to list price. When a complete kit with a two-hole test kit is ordered, a one-hole face plate with aluminum conversion bar will be supplied.



Half Kit - Lift & Turn Drain

Half Kit - Toe Pop-Up Drain

Standard Half Kit- No Pipe Or Tee

PART NO.	MATERIAL	DESCRIPTION	CTN/MSTR
B07150	PVC	CP brass lift and turn drain	1/24
B07110	PVC	CP lift and turn drain	1/24
B07114	PVC	PB lift and turn drain	1/24
B07112	PVC	CP toe pop-up drain	1/24
B07116	PVC	PB toe pop-up drain	1/24
B07152	PVC	CP friction lift drain	1/24
B07154	PVC	PB friction lift drain	1/24
B07151	ABS	CP brass lift and turn drain	1/24
B07111	ABS	CP lift and turn drain	1/24
B07115	ABS	PB lift and turn drain	1/24
B07113	ABS	CP toe pop-up drain	1/24
B07117	ABS	PB toe pop-up drain	1/24
B07153	ABS	CP friction lift drain	1/24
B07155	ABS	PB friction lift drain	1/24



Full Kit - Lift & Turn Drain



Full Kit - Toe Pop-Up Drain

Standard Full Kit- Includes Pipe Or Tee

PART NO.	MATERIAL	DESCRIPTION	CTN/MSTR
B07156	PVC	CP brass lift and turn drain	1/10
B07130	PVS	CP lift and turn drain	1/10
B07134	PVC	PB lift and turn drain	1/10
B07132	PVC	CP toe pop-up drain	1/10
B07136	PVC	PB toe pop-up drain	1/10
B07158	PVC	CP friction lift drain	1/10
B07160	PVC	PB friction lift drain	1/10
B07157	ABS	CP brass lift and turn drain	1/10
B07131	ABS	CP lift and turn drain	1/10
B07135	ABS	PB lift and turn drain	1/10
B07133	ABS	CP toe pop-up drain	1/10
B07137	ABS	PB toe pop-up drain	1/10
B07159	ABS	CP friction lift drain	1/10
B07161	ABS	PB friction lift drain	1/10

Waste And Overflow Test Kits



• Drain thread size is 3/8"

PART NO.	DESCRIPTION	CTN/MSTR
B07201	One-hole waste and overflow test kit	1/200
B07202	Two-hole waste and overflow test kit	1/200

Aluminum Bar For Waste And Overflow

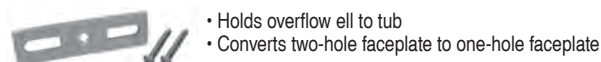

- Holds overflow ell to tub
- Converts two-hole faceplate to one-hole faceplate

PART NO.	DESCRIPTION	CTN/MSTR
B07200	Aluminum bar with 2 screws	1/500
B07203	One-hole overflow face plate with aluminum bar	1

Bath Waste Trim Kits



One-Hole		
PART NO.	DESCRIPTION	CTN QTY
B07071	Overflow plate trim kit with CP lift and turn stopper	1
B07073	Overflow plate trim kit with CP friction lift stopper	1
Two-Hole		
PART NO.	DESCRIPTION	CTN QTY
B07171	Overflow plate trim kit with CP lift and turn stopper	1
B07173	Overflow plate trim kit with CP friction lift stopper	1

One Hole Polished Brass Face Plate Trim Kit



- Overflow plate, screws and lift and turn stopper
- PVD finish

PART NO.	DESCRIPTION	CTN QTY
B08071	1 Hole PB face plate trim kit	1

Conversion Kits With Cross Bar



- Includes cross bar
- 1- Hole face plate
- 1 3/8" chrome plated zinc drain
- Includes bushing for 1 1/2" installation

PART NO.	DESCRIPTION	CTN QTY
B51019	CP lift and turn conversion kit	1
B51020	PB lift and turn conversion kit	1
B07210	CP friction lift conversion kit	1

Trip Lever Trim



- Trip lever overflow plate, screws and strainer

PART NO.	DESCRIPTION	CTN/MSTR
B51014	Chrome trip lever trim only	5/25

Trip Lever Conversion Kit



- Trip lever overflow plate, screws, strainer assembly and brass adapter

PART NO.	DESCRIPTION	CTN/MSTR
B51015	Chrome trip lever conversion kit	5/25

Bath Waste Conversion Kits



- Carded for display
- B51006, B51008, B51011 are 1 1/2" kits
- All others are 1 1/2"x 1 3/8" and include bushings

2-Hole Kits		
PART NO.	DESCRIPTION	CTN QTY
B51005	CP lift and turn kit	1
B51006	White lift and turn kit	1
B51007	CP pop-up kit	1
B51008	CP friction lift kit	1
1-Hole Kits		
PART NO.	DESCRIPTION	CTN QTY
B51009	CP lift and turn kit	1
B51010	CP pop-up kit	1
B51011	CP friction lift kit	1

Schedule 40 Bath Waste Rough-In Kits



One-Hole Rough In Kits B07070
*(Shown with Test Kit)

One-Hole				
PART NO.	MATERIAL	DESCRIPTION	CTN	QTY
B07074	PVC	Std. rough-in kit w/ CP lift & turn drain body	1	
B07374	ABS	Std. rough-in kit w/ CP lift & turn drain body	1	
B07075	PVC	Std. rough-in kit w/ CP friction lift drain body	1	
B07375	ABS	Std. rough-in kit w/ CP friction lift drain body	1	
Two-Hole				
PART NO.	MATERIAL	DESCRIPTION	CTN	QTY
B07076	PVC	Std. rough-in kit w/ CP lift & turn drain body	1	
B07376	ABS	Std. rough-in kit w/ CP list & turn drain body	1	
B07077	PVC	Std. rough-in kit w/ CP friction lift drain body	1	
B07377	ABS	Std. rough-in kit w/ CP friction lift drain body	1	

Schedule 40 Bath Waste Rough-In Kits With Test Kits



Two-Hole Rough In Kits B07170
*(Shown with Test Kit)

*One-Hole			
PART NO.	MATERIAL	DESCRIPTION	CTN QTY
B07070	PVC	Std. rough-in kit w/ CP lift & turn drain body & test kit	1
B07470	ABS	Std. rough-in kit w/ CP lift & turn drain body & test kit	1
B07072	PVC	Std. rough-in kit w/ CP friction lift drain body & test kit	1
B07472	ABS	Std. rough-in kit w/ CP friction lift drain body & test kit	1
*Two-Hole			
PART NO.	MATERIAL	DESCRIPTION	CTN QTY
B07170	PVC	Std. rough-in kit w/ CP lift & turn drain body & test kit	1
B07476	ABS	Std. rough-in kit w/ CP lift & turn drain body & test kit	1
B07172	PVC	Std. rough-in kit w/ CP friction lift drain body & test kit	1
B07477	ABS	Std. rough-in kit w/ CP friction lift drain body & test kit	1

Grab Bar With Exposed Flange



Satin Finish



Peened Finish

- 18 gauge stainless steel
- Meets 900 lb. downward pull when installed properly
- Meets federal specification WW-P-541/8B, Amendment 1, 16 April 1990
- Meets ANSI 1171 and all ADA Code requirements
- Meets federal specifications for FHA, VA hospital, private construction
- Individually bagged with stainless steel mounting screws

Satin Finish		
PART NO.	DESCRIPTION	CTN/MSTR
G12012	1 1/4" x 12"	1/5
G12016	1 1/4" x 16"	1/5
G12018	1 1/4" x 18"	1/5
G12024	1 1/4" x 24"	1/5
G12030	1 1/4" x 30"	1/5
G12032	1 1/4" x 32"	1/5
G12036	1 1/4" x 36"	1/5
G12042	1 1/4" x 42"	1/5
G12048	1 1/4" x 48"	1/5
G13012	1 1/2" x 12"	1/5
G13016	1 1/2" x 16"	1/5
G13018	1 1/2" x 18"	1/5
G13024	1 1/2" x 24"	1/5
G13030	1 1/2" x 30"	1/5
G13032	1 1/2" x 32"	1/5
G13036	1 1/2" x 36"	1/5
G13042	1 1/2" x 42"	1/5
G13048	1 1/2" x 48"	1/5

Grab Bar With Exposed Flange (cont.)



Satin Finish



Peened Finish

- 18 gauge stainless steel
- Meets 900 lb. downward pull when installed properly
- Meets federal specification WW-P-541/8B, Amendment 1, 16 April 1990
- Meets ANSI 117.1 and all ADA Code requirements
- Meets federal specifications for FHA, VA hospital, private construction
- Individually bagged with stainless steel mounting screws

Peened Finish		
PART NO.	DESCRIPTION	CTN/MSTR
G12212	1 1/4" x 12"	1/5
G12216	1 1/4" x 16"	1/5
G12218	1 1/4" x 18"	1/5
G12224	1 1/4" x 24"	1/5
G12230	1 1/4" x 30"	1/5
G12232	1 1/4" x 32"	1/5
G12236	1 1/4" x 36"	1/5
G12242	1 1/4" x 42"	1/5
G12248	1 1/4" x 48"	1/5
G13212	1 1/2" x 12"	1/5
G13216	1 1/2" x 16"	1/5
G13218	1 1/2" x 18"	1/5
G13224	1 1/2" x 24"	1/5
G13230	1 1/2" x 30"	1/5
G13232	1 1/2" x 32"	1/5
G13236	1 1/2" x 36"	1/5
G13242	1 1/2" x 42"	1/5
G13248	1 1/2" x 48"	1/5

Grab Bar With Concealed Snap-On Flange



Satin Finish



Peened Finish

- 18 gauge stainless steel
- Meets 900 lb. downward pull when installed properly
- Meets federal specification WW-P-541/8B, Amendment 1, 16 April 1990
- Meets ANSI 117.1 and all ADA Code requirements
- Meets federal specifications for FHA, VA hospital, private construction
- Individually bagged with stainless steel mounting screws

Satin Finish		
PART NO.	DESCRIPTION	CTN/MSTR
G12112	1 1/4" x 12"	1/5
G12116	1 1/4" x 16"	1/5
G12118	1 1/4" x 18"	1/5
G12124	1 1/4" x 24"	1/5
G12130	1 1/4" x 30"	1/5
G12132	1 1/4" x 32"	1/5
G12136	1 1/4" x 36"	1/5
G12142	1 1/4" x 42"	1/5
G12148	1 1/4" x 48"	1/5
G13112	1 1/2" x 12"	1/5
G13116	1 1/2" x 16"	1/5
G13118	1 1/2" x 18"	1/5
G13124	1 1/2" x 24"	1/5
G13130	1 1/2" x 30"	1/5
G13132	1 1/2" x 32"	1/5
G13136	1 1/2" x 36"	1/5
G13142	1 1/2" x 42"	1/5
G13148	1 1/2" x 48"	1/5

Grab Bar With Concealed Snap-On Flange (cont.)

B



Satin Finish



Peened Finish

- 18 gauge stainless steel
- Meets 900 lb. downward pull when installed properly
- Meets federal specification WW-P-541/8B, Amendment 1, 16 April 1990
- Meets ANSI 117.1 and all ADA Code requirements
- Meets federal specifications for FHA, VA hospital, private construction
- Individually bagged with stainless steel mounting screws

Peened Finish

PART NO.	DESCRIPTION	CTN/MSTR
G12312	1 1/4" x 12"	1/5
G12316	1 1/4" x 16"	1/5
G12318	1 1/4" x 18"	1/5
G12324	1 1/4" x 24"	1/5
G12330	1 1/4" x 30"	1/5
G12332	1 1/4" x 32"	1/5
G12336	1 1/4" x 36"	1/5
G12342	1 1/4" x 42"	1/5
G12348	1 1/4" x 48"	1/5
G13312	1 1/2" x 12"	1/5
G13316	1 1/2" x 16"	1/5
G13318	1 1/2" x 18"	1/5
G13324	1 1/2" x 24"	1/5
G13330	1 1/2" x 30"	1/5
G13332	1 1/2" x 32"	1/5
G13336	1 1/2" x 36"	1/5
G13342	1 1/2" x 42"	1/5
G13348	1 1/2" x 48"	1/5

Grab Bar Fastening Systems



G12998



G12999



S02999

- G12998
- Made of stainless steel screws and fire retardant plastic
 - Installs in minutes in any wall
 - Will hold up to 600 lbs. per grab bar

- G12999
- Made of stainless steel
 - Will hold up to 1000 lbs. per grab bar
 - Blocking/studs are not required

- S02999
- Will not be visible when installed
 - Prevents shower rod sag
 - Will not loosen over time

PART NO.	DESCRIPTION	CTN/MSTR
G12998	Residential Grab Bar Wing It	1/50
G12999	Commercial Grab Bar Wing It	1/60
S02999	Crescent Rod Wing It	1/50

Brass Pop-up Assembly/Replacement Parts

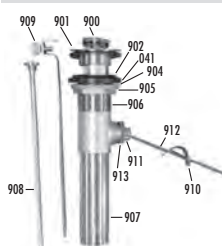

- All metal construction
- Tool free locknut and ballrod nut
- 17 gauge

PART NO.	DESCRIPTION	CTN/MSTR
P35001	Chrome-brass	1/50

Replacement Parts

PART NO.	DESCRIPTION	CTN/MSTR
P35041	1 1/4" Mack Gasket	1/500
P35900	Universal plastic plunger with CP brass cap	1/25
P35901	CP brass flange	16/800
P35902	Flat rubber washer	1/25
P35904	Polyethylene washer	1/1000
P35905	Brass locknut	1/25
P35906	CP brass drain body	1/250
P35907	CP brass tailpiece	1/250
P35908	Brass lift rod	1/500
P35909	Steel clevis with thumb screw	1/25
P35910	Stainless steel spring clip	1/2000
P35911	CP brass ball nut	1/600
P35912	CP steel ball rod with plastic all (6 3/8" long)	1/150
P35913	Friction washer- under nut (not visible)	1/600

Lift & Lock Pop-Up



- Chrome plated

With overflow holes

PART NO.	DESCRIPTION	CTN/MSTR
P35000	CP Lift & Lock pop-up w/ overflow holes	1/50

Without overflow holes

PART NO.	DESCRIPTION	CTN/MSTR
P35003	CP Lift & Lock pop-up w/o overflow holes	1/50

ABS Pop-Up Assembly



- Carded

PART NO.	DESCRIPTION	CTN/MSTR
P35004	Grey plastic	6/30

Chrome Plated ABS Pop-Up Assembly



- Carded

PART NO.	DESCRIPTION	CTN/MSTR
P35005	Chrome plated plastic	6/30

Brass P.O. Plug Drain



- With chain and stopper

PART NO.	DESCRIPTION	CTN/MSTR
D70103	1 1/4" P.O. plug drain	1/50

Trap Primer Tailpiece



T74010



T74011

- 17 gauge tubular chrome plated steel
- Sturdy one-piece construction eliminates leaks and crossthreading

PART NO.	DESCRIPTION	CTN/MSTR
T74010	1 1/4" x 8" - threaded top	1/50
T74011	1 1/2" x 8" - slip joint top direct connection	1/50

Commercial P-Trap with Cleanout



- Carded
- Brass nuts
- Chrome plated
- 17 gauge semi-cast P-trap
- 17 gauge tubular wall bend

PART NO.	DESCRIPTION	CTN/MSTR
J37124	1 1/4" OD with cleanout	1/12
J37150	1 1/2" OD with cleanout	1/12

Chrome Plated PVC P-Trap



- Complete with nuts, washers and escutcheon

PART NO.	DESCRIPTION	CTN/MSTR
P36102	1 1/4"	1/50
P36103	1 1/2"	1/50

Handicap Style Lav Drain



- Twin 90° construction
- Polished chrome plated brass
- Mack washer and brass locknut
- 17 gauge 1 1/4" tailpiece; cast brass elbows

PART NO.	DESCRIPTION	CTN/MSTR
D70101	Handicap drain	1/25
D70104	One piece tubular elbow	1/25

Commercial Handicap Drain With Elbow



- 1 1/4" female thread
- Complete with gaskets and brass locknut
- Polished chrome plated brass; cast brass elbow

PART NO.	DESCRIPTION	CTN/MSTR
D70102	Handicap drain with elbow	1/25

Commercial Grid Drain Without Overflow Holes



- 17 gauge
- For vessel sinks

PART NO.	DESCRIPTION	CTN/MSTR
D70105	CP grid drain	1/25

Commercial Lav Drain



- Polished chrome plated brass
- Mack washer and brass locknut
- 17 gauge 1 1/4" tailpiece; 6" long

PART NO.	DESCRIPTION	CTN/MSTR
D70100	Commercial lav drain	1/50

Flush Valve Pipe Support



- 1 1/2" OD size
- 5" center of pipe to wall
- Chrome plated split ring type
- Mounting hardware included

PART NO.	DESCRIPTION	CTN/MSTR
F39800	1 1/2" x 5" pipe support	10/100
F39700	1 1/2" x 3 1/2" pipe support	10/100

Tissue Rollers

- CARTON QUANTITIES ONLY



PART NO.	DESCRIPTION	CTN/MSTR
B10195	Fit-All white plastic	25/200

Provent



- Manufactured housing and RV's only
- Automatic anti-siphon trap vent used as secondary venting
- Must be located at least 60" above trap arm
- Two individually protected fixtures may be connected to same 1 1/2" drain
- Three or more fixtures must be drained by 2" line
- Simply hand tighten, no thread seal needed
- Water closet must have main stack to outside
- Must be installed in accessible location with free flow air
- Do not install in sealed wall cavity
- 1 1/2" MPT threads

PART NO.	DESCRIPTION	CTN/MSTR
P21150	1 1/2" Provent	1/50

Air Gap



- Prevents sewage backflow by breaking siphoning action in drain line
- White polypro body with chrome plated ABS top
- UPC approved

PART NO.	DESCRIPTION	CTN QTY
A10001	Air Gap	36/72

Air Gap Spacer



PART NO.	DESCRIPTION	CTN/MSTR
A10901	Air gap spacer	1/25

Air Gap Dishwasher Kit



- Contains air gap, 24" dishwasher hose (7/8"), and two gear clamps
- Poly bagged and labeled

PART NO.	DESCRIPTION	CTN/MSTR
A10100	Air gap installation pack	1/10
A10200	Air gap installation pack-white	1/10
A10150	Air gap deluxe pack (includes dishwasher elbow and vacuum breaker)	1/10

Plumb Aire Air Vent



- Up to 160 fixture units
- May be exposed to temperatures ranging from -40 ° + 150°F
- No protective cover required when installed per code specifications
- Back pressure rated to 20 PSI

PVC

PART NO.	DESCRIPTION	CTN/MSTR
P21100	Plumb Aire vent- 1 1/2"x 2"	1/20
P21101	Plumb Aire vent with adapter	1/20

ABS

PART NO.	DESCRIPTION	CTN/MSTR
P21102	Plumb Aire vent - 1 1/2"x 2"	1/20
P21103	Plumb Aire vent with adapter	1/20

PVC Adapter For Air Inlet Valve

PART NO.	DESCRIPTION	CTN/MSTR
P21104	PVC adapter for air inlet valve	1/20
P21107	ABS adapter for air inlet valve	1/20

Rosettes



• CARTON QUANTITIES ONLY

PART NO.	DESCRIPTION	CTN/MSTR
B10110	Shallow pattern (zinc plated)	25/5000
B10111	Deep pattern (zinc plated)	25/1000

Basin Cock Locknut



• CARTON QUANTITIES ONLY

PART NO.	DESCRIPTION	CTN/MSTR
B10080	1/2" - 14 hex locknut	25/1000
B10081	1/2" - 14 flanged hex locknut	25/750

Basket Strainer Locknuts & Washers



Locknut

Rubber Washer

Friction Washer

- Die cast zinc
- CARTON QUANTITIES ONLY

PART NO.	DESCRIPTION	CTN/MSTR
B10090	1 1/2" locknut	25/350
B10091	2" locknut	25/350
B10092	3 3/8" locknut for 4" duo strainer	25/350
B10093	3 3/8" heavy pattern locknut for 4" duo strainer	25/100
B10094	Basket strainer rubber washer (4 7/16" OD)	25/300

Fiber Friction Washer

PART NO.	DESCRIPTION	CTN/MSTR
D02002	Basket strainer friction washer (4 3/16" OD) [Fiber Friction Washer]	1/100

Ballcock Coupling Nut And Locknut



• CARTON QUANTITIES ONLY

PART NO.	DESCRIPTION	CTN/MSTR
C05080	5/8" x 1 1/2" 7 threads zinc die cast	25/500
C05081	5/8" x 7/8" brass	25/500
C05082	15/16" - 14 locknut	25/500

Plastic Slip Joint Nut



- White
- CARTON QUANTITIES ONLY (T85125 and T85150)

WINGS MAKE INSTALLATION EASIER!

PART NO.	DESCRIPTION	CTN/MSTR
T83150	1 1/2" with wings	100/1200
T85125	1 1/4" x 1 1/4"	100/1200
T85150	1 1/2" x 1 1/2"	100/1200

Basin Nut



• CARTON QUANTITIES ONLY

PART NO.	DESCRIPTION	CTN/MSTR
B10100	1/2" - 14 x 3/8" regular Zamak	25/500
B10102	1/2" - 14 x 1/2" regular Zamak	25/500
B10103	1/2" - 14 x 9/16" regular Zamak	25/500
B10104	1/2" - 14 x 9/16" regular brass	25/1000

Plastic Lavatory Supply Nut



• Wing nut design
• CARTON QUANTITIES ONLY

PART NO.	DESCRIPTION	CTN/MSTR
B10105	1/2" - 14 x 1/2" white faucet nut	25/1100

Sink Connection Washer



PART NO.	DESCRIPTION	CTN/MSTR
T79000	1 3/4" x 1 3/8" x 1/8"	100/1000

Split Nut



• Replace fractured or stripped slip nuts without tubular disassembly
• Supplied with washer

PART NO.	DESCRIPTION	CTN/MSTR
T82125	1 1/4" split nut	100/400
T82150	1 1/2" split nut	100/400

Slip Joint Nut



• CARTON QUANTITIES ONLY

Die Cast Zinc		
PART NO.	IPS x SLIP TUBE	CTN/MSTR
T77125	1 1/4" x 1 1/4"	25/500
T77138	1 1/2" x 1 3/8"	25/300
T77150	1 1/2" x 1 1/2"	25/300
T77151	1 1/2" x 1 1/4"	25/300
T77152	2" x 1 1/2"	25/300
T77200	2" x 2"	25/200
Chrome Plated Brass		
PART NO.	IPS x SLIP TUBE	CTN/MSTR
T78125	1 1/4" x 1 1/4"	25/400
T78150	1 1/2" x 1 1/2"	25/400
T78151	1 1/2" x 1 1/4"	25/400
T78152	2" x 1 1/2"	25/400
T78200	2" x 2"	25/400

Rough Brass Slip Joint Nut



• Heavy cast brass
• CARTON QUANTITIES ONLY

PART NO.	IPS x SLIP TUBE	CTN/MSTR
T84125	1 1/4" x 1 1/4"	25/300
T84150	1 1/2" x 1 1/2"	25/300
T84151	1 1/2" x 1 1/4"	25/300
T84200	2" x 2"	25/300

Slip Joint Washer



Square Cut Rubber



Poly Beveled

• CARTON QUANTITIES ONLY

Square Cut Rubber		
PART NO.	NUT x TUBE	CTN/MSTR
T79125	1 1/4" x 1 1/4"	100/5600
T79150	1 1/2" x 1 1/2"	100/5600
T79151	1 1/2" x 1 1/4"	100/5600
T79200	2" x 2"	100/2400
T79201	2" x 1 1/2"	100/2400
Poly Beveled		
PART NO.	NUT x TUBE	CTN/MSTR
T80125	1 1/4" x 1 1/4"	100/5000
T80150	1 1/2" x 1 1/2"	100/5000
T80151	1 1/2" x 1 1/4"	100/5000
T80200	2" x 2"	100/5000

Slip Joint Nut And Washer



Die Cast Nut



Brass Nut

• Chrome plated nut packed with square cut rubber washer
• CARTON QUANTITIES ONLY

Die Cast Nut		
PART NO.	DESCRIPTION	CTN/MSTR
T77014	1 1/4" x 1 1/4"	25/500
T77012	1 1/2" x 1 1/2"	25/500
T77013	1 1/2" x 1 1/4"	25/500
T77020	2" x 2"	25/500
Brass Nut		
PART NO.	DESCRIPTION	CTN/MSTR
T78014	1 1/4" x 1 1/4"	25/400
T78012	1 1/2" x 1 1/2"	25/400
T78013	1 1/2" x 1 1/4"	25/400
T78020	2" x 2"	25/400

Cone Slip Joint Washer

- Black
- CARTON QUANTITIES ONLY

B

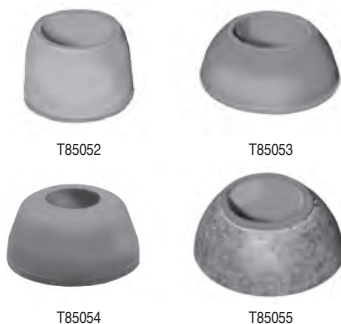

PART NO.	NUT	TUBE	OD x ID	CTN/MSTR
T85050	1/2"	3/8"	23/32" x 3/8"	100/1600
T85051	1/2"	3/8" threaded	23/32" x 3/8"	100/1600
T85052	1/2"	7/16" or 1/2"	5/8" x 7/16"	100/1600
T85053	Ballcock supply -	-	3/4" x 7/16"	100/1600
T85054	Ballcock supply -	-	13/16" x 11/32"	100/1600
T85055	Upper bath supply -	-	27/32" x 7/16"	100/1600

Brass Friction Rings

- CARTON QUANTITIES ONLY (T85-125 and T85-150)



PART NO.	NUT	TUBE	OD x ID	CTN QTY
T86050	1/2"	3/8"	21/32" x 25/64"	100
T86052	1/2"	7/16"	21/32" x 29/64"	100
T86053	Ballcock	1/2"	13/16" x 17/32"	100
T86054	Ballcock	3/8"	13/16" x 25/64"	100
T86055	Ballcock	7/16"	13/16" x 15/32"	100

Flanged Poly Tailpiece Washer

- CARTON QUANTITIES ONLY



PART NO.	NUT x TUBE	CTN QTY
T81150	1 1/2" x 1 1/2"	100
T79152	1 1/2" x 1 1/4" cloth inserted	100

Waste Connector



- Brass body ferrule and nut
- MIP units are combination female sweat

FIP x SLIP

PART NO.	DESCRIPTION	CTN/MSTR
T75125	1 1/4" FIP x 1 1/4" OD	12/72
T75150	1 1/2" FIP x 1 1/2" OD	12/72
T75151	1 1/2" FIP x 1 1/4" OD	12/72
T75250	1 1/2" FIP x 1 1/2" OD with poly washer	12/72

MIP x SLIP

PART NO.	DESCRIPTION	CTN/MSTR
T76125	1 1/4" MIP x 1 1/4" OD	12/72
T76150	1 1/2" MIP x 1 1/2" OD	12/72
T76151	1 1/2" MIP x 1 1/4" OD	12/72
T76250	1 1/2" MIP x 1 1/2" OD with poly washer	12/72

Brass Compression Ring

PART NO.	DESCRIPTION	CTN/MSTR
T75000	1 1/4" OD	1/1000
T75001	1 1/2" OD	1/1000

Double Slip Fittings



- Chrome plated brass
- 22 gauge

PART NO.	DESCRIPTION	CTN/MSTR
T74001	1 1/4" Coupling	10/100
T74002	1 1/2" Coupling	10/100
T74003	1 1/4" 90° Ell	10/100
T74004	1 1/2" 90° Ell	10/100
T74005	1 1/4" 45° Ell	10/100
T74006	1 1/2" 45° Ell	10/100

Slip Joint Tee

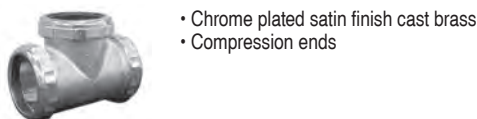

- Chrome plated satin finish cast brass
- Compression ends

PART NO.	DESCRIPTION	CTN/MSTR
C74105	1 1/2" x 1 1/2" x 1 1/2" tee	10/60

90° Drop Ear Elbow



• Cast brass

PART NO.	DESCRIPTION	CTN/MSTR
B55000	1/2" FIP x 1/2" FSWT	60/240
B55100	1/2" FIP x 1/2" FIP	45/180
B55103	1/2" FSWT x 1/2" FSWT	1/100

LEAD FREE

PART NO.	DESCRIPTION	CTN/MSTR
B55050	1/2" FIP x 1/2" FSWT	60/240

90° Drop Ear Elbow



• Cast brass

PART NO.	DESCRIPTION	CTN/MSTR
B55104	3/4" FIP x 3/4" FSWT	1/100

90° Drop Ear Transition Elbow



• Cast brass
• Fits CPVC connection
• Permanent joint

PART NO.	DESCRIPTION	CTN/MSTR
B55101	1/2" FIP x 1/2" CPVC socket	1/25

Sweat Male Adapter/Marvel Rings



Sweat Male Adapter



Marvel Adapter

• Use on tub spout ell or closet/urinal stub out adapter

Sweat Male Adapter

PART NO.	FSWT x MIP	CTN/MSTR
B55001	1/2" x 1/2"	1/1000
B55002	3/4" x 3/4"	1/1000
B55003	1" SJ x 1" SWT	1/1000

Marvel Adapter

PART NO.	FSWT x MIP	CTN/MSTR
B55004	1 1/4" SJ x 1 1/4" SWT	1/1000
B55005	1 1/2" SJ x 1 1/2" SWT	1/500
B55006	2" SJ x 2" SWT	1/500
B55007	1 1/2" SJ x 1 1/4" SWT	1/500
B55008	1 1/2" SJ x 1 1/2" Tubular	1/500
B55009	1 1/4" SJ x 1 1/4" Tubular	1/500

Assorted Washer Kit



• 210 pieces packaged in reusable plastic case
• Available with flat or beveled washers
• Contains: 40-00, 40-0, 40-1/4, 30-1/4 large, 20-3/8, 20-3/8 medium, 10-3/8 large, 10-1/2 large

PART NO.	DESCRIPTION	CTN/MSTR
J40150	Beveled washer kit	12/24
J40151	Flat washer kit	12/24

O-Ring Kit And Pick

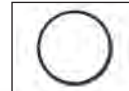

O25199

O25200

• Packed in resealable plastic case with fitting chart on lid
• Manufactured from nitrile compound
• Made in the USA

PART NO.	DESCRIPTION	CTN/MSTR
O25200	200 pc plumber's pack	12/24
O25199	O-ring pick	1/25

Solid Brass Bibb Screw Assortment Kit



• 208 pieces packaged in reusable plastic case
• Contains: 3/8" x 6-32, 1/2" x 6-32, 3/8" x 8-32, 1/2" x 8-32, 3/8" x 10-24, 1/2" x 6-24, 3/8" x 10-32, 1/2" x 10-32

PART NO.	DESCRIPTION	CTN/MSTR
J40153	Bibb screw assortment	10/40

Faucet Seat Kit



• Made in USA
• Reusable compartment box with seat guide on inside cover
• Kit B40000 contains all 36 seats
• Kit B40101 contains: B40002, B40005, B40006, B40015, B40020, B40028

MADE IN THE
USA

PART NO.	DESCRIPTION	CTN/MSTR
B40000	144-piece faucet seat kit (36 different parts)	1/4

Faucet Seats

- All brass
- Made in the USA

MADE IN THE
USA

B



PART NO.	FITS BRAND/SIZE	CTN/MSTR
B40001	Speakman 9/16" x 28 x 3/8"	1/100
B40003	Speakman 7/16" x 27 x 11/32"	1/100
B40002	American Standard 7/16" x 24 x 13/32"	1/100
B40004	American Standard 9/16" x 24" x 3/8"	1/100
B40012	American Standard 1/2" x 20 x 3/8"	1/100
B40013	American Standard 1/2" x 20 x 7/16"	1/100
B40021	American Standard 9/16" x 18 x 3/8"	1/100
B40031	American Standard 1/2" x 20 x 5/8"	1/100
B40005	Price Pfister 1/2" x 20" x 3/8"	1/100
B40006	Price Pfister .65" x 18 x 3/8"	1/100
B40007	Briggs, RPCL 1/2" x 24 x 7/16"	1/100
B40008	Briggs, RPCL 9/16" x 20 x 3/8"	1/100
B40023	Briggs 5/8" x 20 x 13/16"	1/100
B40035	Briggs, Republic 5/8" x 24 x 7/16"	1/100
B40009	Repal 9/16" x 28 x 11/32"	1/100
B40010	Eljer 1/2" x 27 x 1/2"	1/100
B40026	Eljer 1/2" x 20 x 3/8"	1/100
B40011	Kohler 1/2" x 27 x 3/8"	1/100
B40028	Kohler 1/2" x 27 x .318"	1/100
B40027	Kohler Push-In x .348"	1/100
B40014	Central Brass 9/16" x 27 x 13/32"	1/100
B40018	Central Brass 1/2" x 24 x .418"	1/100
B40019	Central Brass 5/8" x 24 x 23/32"	1/100
B40015	Sterling 1/2" x 24 x 3/8"	1/100
B40017	Universal 17/32" x 24 x 3/8"	1/100
B40020	Gerber 5/8" x 20 x 27/64"	1/100
B40024	Dick Brothers 1/2" x 27 x 13/32"	1/100
B40025	Indiana Brass 1/2" x 27 x 13/32"	1/100
B40034	Indiana Brass 9/16" x 27 x 5/8"	1/100
B40030	Union Brass 5/8" x 18 x 5/16"	1/100
B40033	Union Brass 5/8" x 18 x 29/32"	1/100
B40032	Sayco 1/2" x 20 x 5/16"	1/100
B40036	Steamway 1/2" x 24 x 11/32"	1/100

Cock Hole Cover



- Stainless steel
- CARTON QUANTITIES ONLY

PART NO.	DESCRIPTION	CTN/MSTR
B10201	1 3/4" OD with washer	25/500
B10202	2" OD with washer	25/500
B10200	1 1/2" snap in	25/1200

Plastic Faucet Hole Cover



- 1 3/4" OD
- Push-in style/ white plastic
- CARTON QUANTITIES ONLY

PART NO.	DESCRIPTION	CTN/MSTR
B10203	1 3/4" OD	100/1200

Long Reach Bar Tap Faucet



- 1/4" connection
- 10" meets NSF 61.9
- Lead Free

PART NO.	DESCRIPTION	CTN/MSTR
B45014	Long reach bar tap faucet	5/50

Bar Tap Faucet



- Meets NSF standard 61.9
- 1/4" compression inlet connection
- Chrome plated brass faucets individually bagged
- Kit includes: stem, spring, 2 "o" rings and black handle
- Lead Free

PART NO.	DESCRIPTION	CTN/MSTR
B45010	1/4" connection	1/36

Kitchen Hose And Spray (Fit All)



K52001



K52002

- Reinforced hose with universal coupling adapter
- Individually boxed for display
- Automatic off
- Replacement for thumb controlled sink spray



K52004



K52010

PART NO.	DESCRIPTION	CTN/MSTR
K52001	Head only	1/200
K52002	Head, hose and adapter	1/50
K52003	4' hose and adapter	1/100
K52004	Hose guide	1/500
K52010	White hose and spray	1/100
K52005	White head only	50/200

Rinse-Quik Hose And Spray



Complete Spray Head Assembly



Spray Head



Pet Sprayer

- Made in the USA
- Individually boxed

PART NO.	DESCRIPTION	RQ #	CTN/MSTR
K53001	Black spray assembly complete	(MR4224)	1/50
K53005	White spray assembly complete	(MR-4224WH)	1/50
K53006	Black spray assembly with 1/4" female swivel nut to fit Delta faucet	(MR422-4C)	1/50
K53002	Black spray head only w/ chrome ring	(MR4-22)	1/100
K53003	4' hose only	(MR-4)	1/50
K53004	Hose guide	(MR-200)	1/10
K53007	Replacement hose for Delta	(MR4C)	1/100
K53008	White spray head only w/ chrome ring	(MR422WH)	1/100
K53056	Black spray head with black ring	(MR427)	1/100
K53057	White spray head assembly	(MR4274WH)	1/100
K53058	White spray head with white ring	(MR427WH)	1/100
K53055	Black spray head assembly	(MR42474)	1
K53077	Black spray head assembly with 6' hose	-	1
K53060	Pet Sprayer	(MR421)	1

Delta Style Spray Assembly



K55006



K55007

- 4' hose and 1/4" female swivel nut
- Replaces Delta style thumb-controlled sink sprays and hoses

PART NO.	DESCRIPTION	CTN/MSTR
K55006	Spray assembly	1/50
K55007	Replacement hose only	1/50

Chrome Plated Soap And Lotion Dispenser



- All brass pump
- Large 7 oz. capacity bottle

PART NO.	DESCRIPTION	CTN/MSTR
S08020	Chrome plated dispenser	1/100

Sink Lugs



S58050



S58052



S58051



S58053

- Four lugs bagged with screws
- PRICED PER BAG

PART NO.	DESCRIPTION	CTN/MSTR
S58050	Combo clip for counters 5/8"- 1 1/8" thick	1/100
S58052	E-lug for counters 3/8"- 1/2" thick	1/100
S58051	Adjustable clips for counters 3/4"-2 3/4" thick	1/100
S58053	KT lug with bolt	1/100

Undermount Sink Installation Kit



- Includes 4 each brackets, brass inserts, washers, bolts and wing nuts
- PRICED PER BAG

PART NO.	DESCRIPTION	CTN/MSTR
S58101	Undermount Kit	1/250

Lavatory Legs



- Fits vitreous china, steel or cast iron lavatories
- Sold in pairs

Total length ranges from 31 1/2" - 32 3/4" extended

PART NO.	DESCRIPTION	CTN/MSTR
L65001	27" legs	1/20

Lavatory And Sink Hangers

B



L56020



L56026



L56021



L56023



L56024



L56025

• Wall mount

PART NO.	DESCRIPTION	CTN/MSTR
L56020	Cast iron (for cast iron or vitreous china)	1/24
L56026	Pair cast iron hangers (for cast iron or vitreous china)	1/12
L56021	3-way steel (allows mounting in 3 directions)	1/24
L56023	Steel 10" centers (one piece)	1/100
L56024	7" stamped steel lavatory hanger	1/25
L56025	3-way steel lavatory bracket pair	1 pair/25

Adjustable Lavatory Hanger



- Durable cast iron
- Adjusts from 10 1/2" to 16"
- For iron, lugs fit into pockets
- For china, remove side lugs

PART NO.	DESCRIPTION	CTN/MSTR
L56027	Lav Hanger	1/25

Economy Replacement Basket Strainer



- ABS post
- Stainless steel basket

PART NO.	DESCRIPTION	CTN/MSTR
B03015	Replacement basket	1/200

Fit-All Basket Strainer



- Stainless steel

PART NO.	DESCRIPTION	CTN/MSTR
B03010	Fit-All strainer	1/200

Duo Basket Strainer



- 4 1/2" diameter to fit 3 1/2" drilling
- All stainless steel with zinc locknut
- Basket with rolled edge

PART NO.	DESCRIPTION	CTN/MSTR
S14001	SS duo strainer	1/50

Flat Top Grid Strainer



- 4 1/2" diameter to fit 3 1/2" drilling
- All stainless steel with zinc locknut (less tailpiece)

PART NO.	DESCRIPTION	CTN/MSTR
S14002	Flat grid strainer	1/24

Snap Lock Basket Strainer



- 4 1/2" diameter to fit 3 1/2" drilling
- All stainless steel
- Ball bearing basket with rolled edge (less tailpiece)

PART NO.	DESCRIPTION	CTN/MSTR
S14005	Snap lock basket strainer with zinc locknut	1/50
S14010	Snap lock basket strainer with brass locknut	1/50

Shallow Cup Duo Basket Strainer



- 4 1/2" diameter to fit 3 1/2" drilling
- All stainless steel with zinc locknut
- Basket with rolled edge (less tailpiece)

PART NO.	DESCRIPTION	CTN/MSTR
S14006	Shallow cup duo strainer	1/50

CP Brass Duo Strainer



PART NO.	DESCRIPTION	CTN/MSTR
S14007	CP brass duo strainer	1/25
S14011	Replacement strainer	1/25

Twist And Lock Basket Strainer



- 4 1/2" diameter to fit 3 1/2" drilling
- All stainless steel with zinc locknut
- Screw-in basket (less tailpiece)

PART NO.	DESCRIPTION	CTN/MSTR
S14003	Twist and lock basket strainer	1/50
S14103	Twist and lock replacement basket	1/50

Deep Cup Basket Strainer



- 4 1/2" diameter to fit 3 1/2" drilling
- All stainless steel with zinc locknut
- Basket with rolled edge (less tailpiece)

PART NO.	DESCRIPTION	CTN/MSTR
S14004	Deep cup basket strainer	1/50

Quick Fit Stainless Steel Basket Strainer



- Minimizes installation time
- Triangle frame mounts to underside
- Fits virtually all sinks
- Durable stainless construction with brass nut
- For replacement basket use B03015

PART NO.	DESCRIPTION	CTN/MSTR
S14008	Basket Strainer	1/50

Chrome Plated Brass Duo Basket Strainer



- Chrome plated brass body with stainless steel basket
- Heavy Duty construction
- Neoprene stopper

PART NO.	DESCRIPTION	CTN/MSTR
S14250	CP brass duo basket strainer	1/50

Stainless Steel Duo Basket Strainer



- SS body and basket
- Polished inner cup
- Chrome plated zinc post and slip nut
- Heavy duty rubber gasket and zinc locknut

PART NO.	DESCRIPTION	CTN/MSTR
S14251	SS duo post style basket strainer	1/50

Stainless Steel Deep Cup Basket Strainer



- Stainless steel body and locknut
- Neoprene stopper
- Spring style snap-in basket

PART NO.	DESCRIPTION	CTN/MSTR
S14014	SS cup basket strainer	1/50

Stainless Steel Duo Basket Strainer



- Stainless steel body and locknut
- Neoprene stopper
- Spring style snap-in basket

PART NO.	DESCRIPTION	CTN/MSTR
S14606	SS duo basket strainer	1/50

ABS Body And Post Basket Strainer



- Plastic nut

PART NO.	DESCRIPTION	CTN/MSTR
S14030	ABS body and post basket strainer	1/50

Deep Junior Duo Basket Strainer



B02102



B02103

- For 2" and 2 1/2" deep outlets and bar sinks

PART NO.	DESCRIPTION	CTN/MSTR
B02102	2" deep basket strainer	1/100
B02103	Replacement strainer	1/250

Junior Duo Basket Strainer



B02050



B02049

- Stainless steel body and basket with die cast locknut; 1 1/2" threads
- Complete with washers
- Fits 1 3/4" bar sink

PART NO.	DESCRIPTION	CTN/MSTR
B02050	Junior duo strainer	1/100
B02049	Replacement basket	1/500

Flat Duplex Strainer



- Stainless steel body and strainer with die cast locknut
- Complete with washers
- Fits 1 1/2" bar sink

PART NO.	DESCRIPTION	CTN/MSTR
B02052	Flat duplex strainer	1/100

Cast Brass Beehive Urinal Strainer



- Chrome plated brass strainer and body
- Brass locknut
- 2" caulk connection

PART NO.	DESCRIPTION	CTN/MSTR
D45000	Cast brass beehive urinal strainer	1/30
D45001	Replacement top with screws for D45000	1/100

Flexible Hair Strainer



- Soft rubber flexible strainer fits neatly over drain

PART NO.	DESCRIPTION	CTN/MSTR
P35180	Flexible hair strainer	1/1000

B

1" Brass Bar Plug



- Cast brass
- Includes ground seat plug

PART NO.	DESCRIPTION	CTN/MSTR
B02060	1" x 3"	1/50

Tray Plug



- Stainless steel body with die cast locknut
- Fits 1 1/2" bar sink
- Complete with washers and stoppers

PART NO.	DESCRIPTION	CTN/MSTR
B02051	Tray plug	1/100

In-Sink-Erator Rubber Hush Cushion



- Black

PART NO.	DESCRIPTION	CTN/MSTR
P35159	In-Sink-Erator	1/500

Kitchen Sink And Garbage Disposal Stopper



- Vinyl construction
- Flanged to fit all sizes

PART NO.	DESCRIPTION	CTN/MSTR
P35162	Sink stopper	1/50

Garbage Disposal Splash Guard



- Snap-fit reinforced ring
- Fits all disposal brands

PART NO.	DESCRIPTION	CTN/MSTR
P35163	Rubber fit-all	1/200

Three Prong Drain Protector



- Aluminum

PART NO.	DESCRIPTION	CTN QTY
D18062	1 5/8" drain protector	1/2500
D18063	1 7/8" drain protector	1/500

Sink And Basin Crumb Cups



- Nickel plated brass

PART NO.	DESCRIPTION	CTN/MSTR
P35165	1 1/2" crumb cup with post	1/500
P35166	1" crumb cup	1/1000
P35167	1 3/8" crumb cup	1/160

Slotted Full Flow Aerators



Male Thread



Female Thread



Dual Thread

- Chrome-plated brass
- Non-corrosive mixing chamber
- Individually bagged
- 4.5 gpm
- LEAD FREE

PART NO.	DESCRIPTION	CTN/MSTR
A01001	15/16"-27 male thread	25/600
A01002	55/64"-27 female thread	25/600
A01003	Dual threads (15/16"-27 male x 55/64"-27 female)	25/2000

Slotted 2.2 GPM Flow Aerators



- NSF listed santoprene washer
- Meets ANSI A-112.18M
- Easily cleaned
- Individually bagged
- LEAD FREE

PART NO.	DESCRIPTION	CTN/MSTR
A01004	Dual threads (15/16"-27 male x 55/64"-27 female)	25/600

Non-Slotted Full Flow Aerators



Male Thread



Female Thread



Dual Thread

- Individually bagged
- 4.5 GPM
- LEAD FREE

PART NO.	DESCRIPTION	CTN/MSTR
A01005	15/16"-27 male thread	25/600
A01006	55/64"-27 female thread	25/600
A01007	13/16"-27 male thread	25/600
A01008	3/4"-27 female thread	25/600
A01010	Dual threads (15/16"-27 male x 55/64"-27 female)	25/600

Non-Slotted .5 GPM Aerators



- Individually bagged
- LEAD FREE

PART NO.	DESCRIPTION	CTN/MSTR
A01037	Dual thread (15/16"-27 male x 55/64"-27 female	25/600

Non-Slotted Reduced Flow Aerators



Male Thread



Female Thread



Dual Thread

- Meets ANSI A-112.18M
- Individually bagged
- LEAD FREE

PART NO.	DESCRIPTION	CTN/MSTR
A01011	15/16"-27 male thread 2.2 gpm	25/600
A01012	55/64"-27 female thread 2.2 gpm	25/600
A01013	Dual threads 2.2 gpm (15/16"-27 male x 55/64"-27 female)	25/600
A01050	Dual threads 2.0 gpm (15/16"-27 male x 55/64"-27 female)	25/600
A01051	Dual threads 1.5 gpm (15/16"-27 male x 55/64"-27 female)	25/600

Chicago Style Faucet Aerator



- Individually bagged
- LEAD FREE

PART NO.	DESCRIPTION	CTN/MSTR
A01062	Non-slotted full flow (55/64"-27 female thread)	1/600

Aerator Counter Display



Display

- Dual threads are 15/16"-27 male x 55/64"-27 female
- 24 tubes per display box, six aerators per tube
- 144 pieces per display; priced per display
- LEAD FREE

PART NO.	DESCRIPTION	CTN/MSTR
A01015	Slotted full flow (A01003)	1/5
A01016	Slotted 2.2 gpm (A01004)	1/5
A01017	Non-slotted full flow (A01010)	1/5
A01018	Non-slotted 2.2 gpm (A01013)	1/5
A01060	Non-slotted 2.0 gpm (A01050)	1/5

Spring-Flo Faucet Aerator



- Dual thread
- Fully compliant with California AB1953 and Vermont S152
- LEAD FREE

PART NO.	DESCRIPTION	CTN QTY
A01900	Slotted 2.2 Spring-Flo	1
A01901	Slotted 2.2 Spring-Flo	Tube of 6/24

Aerator Six Pack Tubes For Counter Display



Six Aerators per Tube

- Dual threads are 15/16"-27 male x 55/64"-27 female
- Six aerators per tube; priced per display
- LEAD FREE

PART NO.	DESCRIPTION	CTN/MSTR
A01020	Slotted full flow (A01003)	Tube of 6/200
A01021	Slotted 2.2 gpm (A01004)	Tube of 6/200
A01022	Non-slotted full flow (A01010)	Tube of 6/200
A01023	Non-slotted 2.2 gpm (A01013)	Tube of 6/200
A01061	Non-slotted 2.0 gpm (A01050)	Tube of 6/200

Snap Fitting



A01029



A01036

- Aerated

PART NO.	DESCRIPTION	CTN/MSTR
A01029	Dual thread (15/16"-27 male x 55/64"-27 female x aerated snap fitting)	1/300
A01036	Nonplated brass snap coupler x 3/4" GHT for use with A01029 as a Quick-Disconnect unit	1/300

Swivel Spray Aerator



- Individually bagged
- Brass coupling nut
- Unit reverts to non-splash mode when water is turned off

PART NO.	DESCRIPTION	CTN/MSTR
A01014	Dual thread (15/16"-27 male x 55/64"-27 female))	12/72

Vandal-Proof Aerators



Male



Female

- Special key wrench included
- Prevents unauthorized removal

PART NO.	DESCRIPTION	CTN QTY
A01024	15/16"-27 male full flow	1/600
A01026	15/16"-27 male 2.0 gpm	1/600
A01027	55/64"-27 female 2.0 gpm	1/25

Faucet Adapters

B



• These parts are not OEM

To Fit Delta*, American Standard* Style

PART NO.	DESCRIPTION	CTN/MSTR
A01030	CP brass 15/16"-27 male x 55/64"-27 male threads	1/25
A01031	Plastic 15/16"-27 male x 55/64"-27 male threads	1/300

To Fit Price Pfister, Kohler* Style

PART NO.	DESCRIPTION	CTN/MSTR
A01032	CP brass female 3/4"-27 x 55/64"-27 male threads	1/300

To Fit Kohler*, Union*, Savoy* Style

PART NO.	DESCRIPTION	CTN/MSTR
A01033	CP brass male 13/16"-27 x 55/64"-27 male threads	1/300
A01034	Plastic male 13/16"-27 x 55/64"-27 male threads	1/500

To Fit Chicago* Style

PART NO.	DESCRIPTION	CTN/MSTR
A01035	CP brass female 13/16"-24 x 55/64"-27 male threads	1/500

Faucet To Garden Hose Adapters



• Chrome plated brass
• Lead Free

PART NO.	DESCRIPTION	CTN/MSTR
A01040	Dual threads 15/16"-27 male x 55/64"-27 female x 3/4" MGH	1/600
A01041	Dual threads 15/16"-27 male x 55/64"-27 female x 3/4" MGH and 55/64"-27 male	1/600

* The manufacturers' names are used only to describe whose products the replacement handles will fit. The products are not manufactured by those companies.

Fit All Replacement Handles



Cross Pattern

Lever Pattern

Acrylic

• Vise grip design allows units to fit all types of stems, including rounded
• Each pair individually bagged

PART NO.	DESCRIPTION	CTN/MSTR
H54001	Cross pattern	5/100
H54002	Lever pattern	5/100
H54003	Acrylic	5/100

Delta*/Peerless* Replacement Handles



• New design
• Includes button and screw

PART NO.	DESCRIPTION	CTN/MSTR
H54010	Single layer crystal handle for all lav faucets using 212* ball	1/5
H54011	Single layer crystal handle offset broach for tub and shower valves using 212* ball	1/5
H54012	Single layer crystal tub handle for Scald Guard*	1/5

Delex*/Peerless* Replacement Handles



• Includes button and screws

PART NO.	DESCRIPTION	CTN/MSTR
H54013	Two chrome plated canopy handles for center set	1/5
H54014	Two crystal handles for center set new style	1/5
H54015	Two crystal handles for wide spread lav and tub and shower valves	1/5

Mixet* Replacement Handles



• Includes screw

PART NO.	DESCRIPTION	CTN/MSTR
H54017	Clear outer handle (MRH-CLR*)	1/5
H54018	Clear inner handle (MTH-CLR*)	1/5

* The manufacturers' names are used only to describe whose products the replacement handles will fit. The products are not manufactured by those companies.

Valley*/Aqualine*/Eljer*/Sears* Replacement Handles



• New style crystal handle
• Complete with button and screw

PART NO.	DESCRIPTION	CTN/MSTR
H54030	Crystal single handle	1/5

Moen®/Stanadyne® Replacement Handles



H54025



H54026



H54027



H54028



H54029

- Complete with button and screw
- Teardrop® replaces both round and Teardrop® handles

PART NO.	DESCRIPTION	CTN/MSTR
H54025	Crystal Teardrop® single lav handle shallow broach	1/5
H54026	Crystal Teardrop® single tub handle deep broach	1/5
H54027	Round crystal single lav handle shallow broach	1/5
H54028	Round crystal single tub handle deep broach	1/5
H54029	Chrome plated cap and cover for single handle kitchen faucet	1/5

Delta®/Peerless® Faucet Index Buttons



H54040



H54041

- Single handle models

PART NO.	DESCRIPTION	CTN/MSTR
H54040	Old style crystal button for lav and tub and shower valve 1" OD	5/35
H54041	New large style crystal button for lav and tub and shower valve 1 1/2" OD	5/35

Moen®/Stanadyne® Single Handle Replacement Buttons



H54060



H54061

PART NO.	DESCRIPTION	CTN/MSTR
H54060	Button for new style Teardrop® crystal handle	1/5
H54061	Button for round crystal handle lav and tub and shower valve	1/5

* The manufacturers' names are used only to describe whose products the replacement handles will fit. The products are not manufactured by those companies.

Sure Grip Escutcheons



Low Pattern



Box Pattern



Bell Pattern

- Chrome plated steel
- CARTON QUANTITIES ONLY

Low-Pattern- Copper Tube Size			
PART NO.	SIZE	FLANGE OD	CTN QTY
E01375	3/8" (1/2" OD)	2 1/2"	25/2000
E01050	1/2" (5/8" OD)	2 1/2"	25/2000
E01075	3/4" (7/8" OD)	2 1/2"	252000
E01100	1" (1 1/8" OD)	2 7/8"	25/2000
E01125	1 1/4" (1 3/8" OD)	2 7/8"	25/1200
E01150	1 1/2" (1 5/8" OD)	2 7/8"	25/1200

Low-Pattern- Iron Pipe Size			
PART NO.	SIZE	FLANGE OD	CTN QTY
E02375	3/8"	2 1/2"	25/2000
E02050	1/2"	2 1/2"	25/2000
E02075	3/4"	2 1/2"	25/2000
E02100	1"	2 7/8"	25/1000
E02125	1 1/4"	2 7/8"	25/1200
E02150	1 1/2"	3"	25/1200
E02152	1 1/2"	3 1/2"	25/1200
E02200	2"	3 1/2"	25/1200

Low Pattern- Tubular			
PART NO.	SIZE	FLANGE OD	CTN QTY
E03125	1 1/4"	2 7/8"	25/1200
E03150	1 1/2"	2 7/8"	25/1200
E03200	2"	3 1/2"	25/1200

Box Pattern- Tubular			
PART NO.	SIZE	FLANGE OD	CTN QTY
E04125	1 1/4"	3"	5/300
E04150	1 1/2"	3"	5/300
E04200	2"	3"	5/300

Box Pattern- Iron Pipe Size			
PART NO.	SIZE	FLANGE OD	CTN QTY
E05125	1 1/4"	3"	5/300
E05150	1 1/2"	3"	5/300

Bell Pattern- Iron Pipe Size			
PART NO.	SIZE	FLANGE OD	CTN QTY
E06375	3/8"	2 3/8"	25/1000
E06050	1/2"	2 3/8"	25/1000
E06075	3/4"	2 3/8"	25/1000
E06100	1"	3"	25/1000
E06125	1 1/4"	3"	25/1000
E06150	1 1/2"	3"	25/1000

Bell Pattern- Copper Tube Size			
PART NO.	SIZE	FLANGE OD	CTN QTY
E07025	1/4" (3/8" OD)	2 3/8"	25/1000
E07375	3/8" (1/2" OD)	2 3/8"	25/1000
E07050	1/2" (5/8" OD)	2 3/8"	25/1000

Bell Pattern- Tubular			
PART NO.	SIZE	FLANGE OD	CTN QTY
E08125	1 1/4" OD	3"	25/1000
E08138	1 3/8" OD	3"	25/1000
E08150	1 1/2" OD	3"	25/1000

Plastic Shallow Flange Escutcheons



- Tight fit
- Low cost
- Corrosion-proof, indestructible, high-density polyethylene
- CARTON QUANTITIES ONLY

B

Copper Tube Size

PART NO.	SIZE	COLOR	CTN QTY
E15375	1/2" OD (3/8" CTS)	White	50 per bag
E15050	5/8" OD (1/2" CTS)	White	50 per bag
E15052	5/8" OD (1/2" CTS)	Almond	50 per bag
E15075	7/8" OD (3/4" CTS)	White	50 per bag

Iron Pipe Size

PART NO.	SIZE	COLOR	CTN QTY
E16375	3/8" IPS	White	50 per bag
E16050	1/2" IPS	White	50 per bag
E16075	3/4" IPS	White	50 per bag
E16150	1 1/2" IPS	White	50 per bag
E16151	1 1/2" IPS	Almond	50 per bag
E16200	2" IPS	White	50 per bag

Tubular

PART NO.	SIZE	COLOR	CTN QTY
E03225	1 1/4" Tubular	White	50 per bag
E03250	1 1/2" Tubular	White	50 per bag

Poly Bagged Escutcheons



- 50 per bag
- Chrome plated steel
- CARTON QUANTITIES ONLY

PART NO.	DESCRIPTION	CTN/MSTR
E01049	1/2" CTS (5/8" O.D.)	50/2000
E01074	3/4" CTS (7/8" O.D.)	50/2000

Floor & Ceiling Plates



- Chrome plated
- CARTON QUANTITIES ONLY

Light Gauge- Copper Tube Size

PART NO.	SIZE	FLANGE OD	CTN QTY
F01375	3/8" (1/2" OD)	2 1/2"	12/576
F01050	1/2" (5/8" OD)	2 5/8"	12/576
F01075	3/4" (7/8" OD)	2 27/32"	12/576
F01100	1" (1 1/8" OD)	3 9/32"	12/576
F01125	1 1/4" (1 3/8" OD)	3 5/8"	12/576
F01150	1 1/2" (1 5/8" OD)	3 15/16"	12/576

Light Gauge- Iron Pipe Size

PART NO.	SIZE	FLANGE OD	CTN QTY
F02375	3/8"	2 1/2"	12/576
F02050	1/2"	2 5/8"	12/576
F02075	3/4"	2 27/32"	12/576
F02100	1"	3 9/32"	12/576
F02125	1 1/4"	3 5/8"	12/576
F02150	1 1/2"	3 15/16"	12/576
F02200	2"	4 3/8"	12/576

Heavy Gauge With Springs- Copper Tube Size

PART NO.	SIZE	FLANGE OD	CTN QTY
F03375	3/8" (1/2" OD)	2 1/8"	12/480
F03050	1/2" (5/8" OD)	2 7/16"	12/480
F03075	3/4" (7/8" OD)	2 21/32"	12/480
F03100	1" (1 1/8" OD)	2 27/32"	12/480
F03125	1 1/4" (1 3/8" OD)	3 9/32"	12/240
F03150	1 1/2" (1 5/8" OD)	3 5/8"	12/240
F03200	2" (2 1/8" OD)	4 3/16"	12/240
F03250	2 1/2" (2 5/8" OD)	4 15/16"	6/240
F03300	3" (3 1/8" OD)	5 3/16"	6/240

Heavy Gauge With Springs- Iron Pipe Size

PART NO.	SIZE	FLANGE OD	CTN QTY
F04375	3/8"	2 1/2"	12/480
F04050	1/2"	2 5/8"	12/480
F04075	3/4"	2 27/32"	12/480
F04100	1"	3 9/32"	12/480
F04125	1 1/4"	3 5/8"	12/240
F04150	1 1/2"	3 15/16"	12/240
F04200	2"	4 3/8"	12/240
F04250	2 1/2"	5 7/32"	6/120
F04300	3"	5 29/32"	6/120
F04350	3 1/2"	6 9/16"	6/120
F04400	4"	7 3/16"	6/120
F04500	5"	8 7/8"	1/60
F04600	6"	10"	1/60
F04800	8"	13"	1/48
F04999	10"	15"	1/48

Flexible Floor & Ceiling Plates



- Chrome plated
- CARTON QUANTITIES ONLY

Chrome Plated Plastic

PART NO.	IPS	CTS	FLANGE OD	CTN/MSTR
F06375	3/8"	1/2"	2.572	12/1080
F06050	1/2"	3/4"	2.787	12/1080
F06075	3/4"	-	2.997	12/1440
F06099	-	1"	3.077	12/1440
F06100	1"	-	3.210	12/1440
F06124	-	1 1/4"	3.308	12/1440
F06125	1 1/4"	1 1/2"	3.580	12/1200
F06150	1 1/2"	-	3.900	12/1200
F06200	2"	-	4.450	12/720
F06201	-	2"	4.205	12/720
F06250	2 1/2"	-	5.313	12/600
F06251	-	2 1/2"	4.688	12/600
F06300	3"	-	5.875	12/480
F06301	-	3"	5.375	12/240
F06351	-	3 1/2"	5.875	12/240
F06400	4"	-	6.781	12/240
F06401	-	4"	6.344	12/240
F06500	5"	-	8.531	6/240
F06600	6"	-	9.688	6/120
F06800	8"	-	13.000	6/96

White Plastic

PART NO.	IPS	CTS	FLANGE OD	CTN/MSTR
F07375	3/8"	1/2"	2.572	12/1080
F07050	1/2"	3/4"	2.787	12/1080
F07075	3/4"	-	2.997	12/1440
F07099	-	1"	3.077	12/1080
F07100	1"	-	3.210	12/1440
F07124	-	1 1/4"	3.308	12/1440
F07125	1 1/4"	1 1/2"	3.580	12/1200
F07150	1 1/2"	-	3.900	12/1200
F07200	2"	-	4.450	12/720
F07201	-	2"	4.205	12/720
F07300	3"	-	5.825	12/480

Sewer Popper™ Cleanout And Relief Valve

- Automatic pop-up releases sewage overflow outside the house
- Prevents thousands of dollars in property damages
- Eliminates health hazards associated with sewage overflow
- Vandal- and tamper-resistant center
- Threaded for 3" or 4" pipe or tapped together
- Constructed of white PVC
- Threaded unit can be used with PVC or ABS tapped together
- For cast iron pipe, use standard no hub clamp
- Meets Southern Building Code Section 301.10, Principle No.10
- Patent No. 5,209,257



B

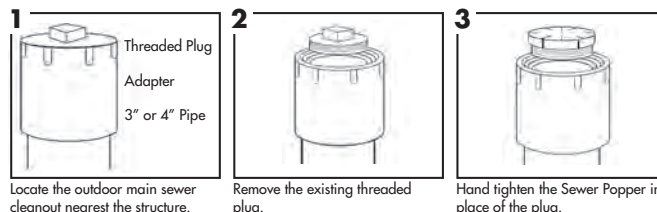

PART NO.	DESCRIPTION	CTN/MSTR
S62304	3"x 4" Sewer Popper™	1/6

Sewer Relief Valve And Cleanout

- Releases waste to outside of buildings in the event of sewer line blockage, preventing costly damage due to sewage backflow or overflow.
- Applicable in residential, commercial, or industrial settings- any structure connected to sewer lines or septic tanks
- Patent #4,475,571
- Meets ASTM specifications
- Automatic unlock and re-lock
- Vandal-resistant
- Safe in yard or high traffic areas
- Solvent welds over 4" Schedule 40 DWV pipe
- Removable lid provides full access to cleanout
- May be used to replace existing exterior cleanouts
- Easily adaptable to new or existing sewer lines
- Water and waste swirl in bowl until blockage is cleared

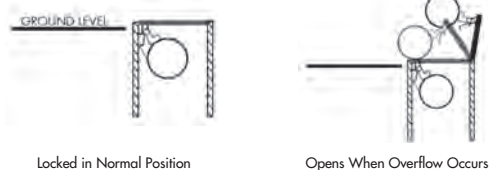

PART NO.	DESCRIPTION	CTN QTY
S62100	PVC sewer relief valve	1
S62101	ABS sewer relief valve	1

Sewer Stopper/ Backflow Preventer



- Use inside drain line to help guard against backups
- Creates seal in pipe to reduce sewer gases
- Secures into place with set screws
- Compression fit

PART NO.	DESCRIPTION	CTN/MSTR
S63200	2" sewer stopper (ZP steel)	1/100
S63300	3" sewer stopper (brass)	1/80
S63400	4" sewer stopper (brass)	1/60

Cover Plates

- Mirrored acrylic
- Conceals damaged/cracked tiles
- Fits all standard bath/shower fittings
- No tools required- use silicone caulk
- DO NOT use abrasive cleaners



B

T73001

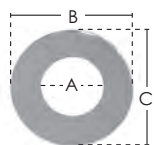

A	B	C	THICKNESS
1 11/16"	3 1/2"	3 1/2"	1/8"

T73002

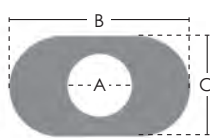

A	B	C	THICKNESS
5"	14"	8"	1/8"

T73003

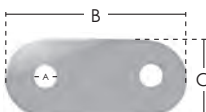

A	B	C	THICKNESS
1 3/4"	14"	6"	1/8"

T73004



A	B	C	THICKNESS
1 3/4"	14"	6"	1/8"

PART NO.	DESCRIPTION	SIZE	CTN/MSTR
T73001	Tub spout model	3 1/2" diameter	1/300
T73002	One handle model	8" x 14"	1/100
T73003	Two handle model	6" x 14"	1/40
T73004	Three handle model	6" x 14"	1/36

Stainless Steel Repair Cover Plates



- 1, 2 or 3 hole design to fit multitude of valves
- Polished stainless steel finish
- Easily attaches with silicone caulk; one hole has brackets and screw
- 7 1/4" x 13" long

PART NO.	# OF HOLES	DIAMETER	CTN/MSTR
T73815	1	5 1/8"	1/40
T73816	2	1 3/8"	1/40
T73817	3	1 3/8"	1/40
T73818	1	3 3/4"	1/40

Flexible Stainless-Steel Plumbing Connectors



- Reliable, trouble-free service- Inner core of non-toxic polymer withstands temperatures of 33°F (1°C) to 174°F (99°C)
- Leak proof seal- High quality outer braid of stainless steel and exclusive crimp-on fittings for maximum performance
- Quick and easy installation- No special tools; no soldering
- No pipe bending- Flexible connectors simplify installation- even in cramped spaces
- Chrome plated nut
- These products are NSF approved
- LEAD FREE

Faucet

PART NO.	OD x FIP	LENGTH	CTN/MSTR
S04200	3/8" x 1/2"	9	25/100
S04201	3/8" x 1/2"	12	25/100
S04202	3/8" x 1/2"	16	25/100
S04203	3/8" x 1/2"	20	25/100
S04204	3/8" x 1/2"	30	25/50
S04205	3/8" x 1/2"	36	25/100
S04206	1/2" x 1/2"	12	25/100
S04207	1/2" x 1/2"	16	25/100
S04208	1/2" x 1/2"	20	25/100
S04209	1/2" x 1/2"	30	25/50
S04210	1/2" x 1/2"	36	25/100

Faucet

PART NO.	FIP x FIP	LENGTH	CTN/MSTR
S04211	1/2" x 1/2"	12	25/100
S04212	1/2" x 1/2"	16	25/175
S04213	1/2" x 1/2"	20	25/100
S04214	1/2" x 1/2"	30	25/50
S04215	1/2" x 1/2"	36	25/50

Flexible Stainless-Steel Plumbing Connectors



- Reliable, trouble-free service- Inner core of non-toxic polymer withstands temperatures of 33°F (1°C) to 174°F (99°C)
- Leak proof seal- High quality outer braid of stainless steel and exclusive crimp-on fittings for maximum performance
- Quick and easy installation- No special tools; no soldering
- No pipe bending- Flexible connectors simplify installation- even in cramped spaces
- LEAD FREE

Ballcock

PART NO.	OD x BC	LENGTH	CTN QTY
S04216	3/8" x 7/8"	9	25/100
S04217	3/8" x 7/8"	12	25/100
S04218	3/8" x 7/8"	16	25/100
S04219	3/8" x 7/8"	20	25/100
S04220	1/2" x 7/8"	9	25/100
S04221	1/2" x 7/8"	12	25/100
S04222	1/2" x 7/8"	16	25/100
S04223	1/2" x 7/8"	20	25/100
S04255	3/8" x 7/8" w/ brass nut	12	25/100

Ballcock

PART NO.	FIP x BC	LENGTH	CTN QTY
S04224	1/2" x 7/8"	9	25/100
S04225	1/2" x 7/8"	12	25/100
S04226	1/2" x 7/8"	20	25/100

Ballcock

PART NO.	FLARE x BC	LENGTH	CTN QTY
S04280	1/2" x 7/8"	20	25/100
S04285	3/8" x 7/8"	20	25/50

Washing Machine

PART NO.	FEM HOSE x FEM HOSE	LENGTH	CTN QTY
S04227	3/4" x 3/4"	48	5/50
S04228	3/4" x 3/4"	60	5/175
S04229	3/4" x 3/4"	72	5/50

Icemaker

PART NO.	OD x OD	LENGTH	CTN QTY
S04230	1/4" x 1/4"	12	5/50
S04231	1/4" x 1/4"	60	5/50
S04232	1/4" x 1/4"	84	5/50

B

Flexible Stainless-Steel Plumbing Connectors

B



- Reliable, trouble-free service- Inner core of non-toxic polymer withstands temperatures of 33°F (1°C) to 174°F (81°C); burst pressure 1,000 PSI
- Leak proof seal- High quality outer braid of stainless steel and exclusive crimp-on fittings for maximum performance
- Quick and easy installation- No special tools; no soldering
- No pipe bending- Flexible connectors simplify installation- even in cramped spaces
- Chrome plated nut
- These products are NSF approved
- LEAD FREE

Dishwasher Connectors

90° Elbow

PART NO.	OD x MIP	LENGTH	CTN/MSTR
S04233	3/8" x 3/8"	48	25/50
S04234	3/8" x 3/8"	60	25/50
S04235	3/8" x 3/8"	72	25/50
S04236	1/2" x 3/8"	48	25/50
S04237	1/2" x 3/8"	60	25/50
S04238*	1/2" x 3/8"	72	25/50

*elbow not included

Dishwasher Connectors

PART NO.	OD x OD	LENGTH	CTN/MSTR
S04260	3/8" x 3/8"	48	25/50
S04268	3/8" x 3/8"	12	25/100
S04269	3/8" x 3/8"	16	25/100
S04270	3/8" x 3/8"	20	25/100

SS "Delta" Style Faucet Connectors

*Complies with NSF 61

PART NO.	OD x COMP FITTING	LENGTH	CTN/MSTR
S04239	3/8" x 3/8"	9	25/100
S04240	3/8" x 3/8"	12	25/100
S04241	3/8" x 3/8"	16	25/100
S04242	3/8" x 3/8"	20	25/100
S04243	3/8" x 3/8"	30	25/50
S04244	3/8" x 3/8"	36	25/100

Texas Style Faucet Connectors

*Complies with NSF 61

PART NO.	FL x OD	LENGTH	CTN/MSTR
S04245	3/8" x 3/8"	9	25/100
S04246	3/8" x 3/8"	12	25/100
S04247	3/8" x 3/8"	16	25/100
S04248	3/8" x 3/8"	20	25/100
S04249	3/8" x 3/8"	30	25/50
S04250	3/8" x 3/8"	36	25/100

Stainless Steel Dishwasher Connection w/Garden Hose Fitting & 90



- Use to connect Whirlpool, Maytag, Amana, Kitchen Aid and Jenn-Air dishwashers manufactured after September 2009

PART NO.	DESCRIPTION	CTN QTY
S04275	3/8" OD x 3/8" MIP x 60"	1
S04276	3/8" OD x 3/8" MIP x 72"	1
G20086	Garden Hose Ftg & 90 only - 3/4" FGHT x 3/8" OD Comp	1

Braided Nylon Plumbing Connectors



- Reliable, economy style connectors
- Temperature rated 173° (82°C)
- Burst pressure is 450 PSI
- Chrome plated nut
- These products are UPC approved
- LEAD FREE

Nylon Faucet Connectors

PART NO.	OD x FIP	LENGTH	CTN/MSTR
S04400	3/8" x 1/2"	9	25/100
S04401	3/8" x 1/2"	12	25/100
S04402	3/8" x 1/2"	16	25/100
S04403	3/8" x 1/2"	20	25/100
S04404	3/8" x 1/2"	30	25/50
S04405	1/2" x 1/2"	12	25/100
S04406	1/2" x 1/2"	16	25/100
S04407	1/2" x 1/2"	20	25/150
S04408	1/2" x 1/2"	30	25/100

Nylon Faucet Connectors

PART NO.	FIP x FIP	LENGTH	CTN/MSTR
S04409	1/2" x 1/2"	12	25/100
S04410	1/2" x 1/2"	16	25/100
S04411	1/2" x 1/2"	20	25/100
S04440	1/2" x 1/2"	36	25/100

Nylon Faucet Connectors

PART NO.	COMP x FIP	LENGTH	CTN/MSTR
S04450	3/8" x 1/2"	24	25/100
S04455	3/8" x 1/2"	36	25/50

Nylon Delta Connectors

PART NO.	OD x COMP FITTING	LENGTH	CTN/MSTR
S04412	3/8" x 3/8"	12	25/100
S04413	3/8" x 3/8"	20	25/100

Nylon Toilet Connectors

PART NO.	OD x BC	LENGTH	CTN/MSTR
S04414	3/8" x 7/8"	9	25/100
S04415	3/8" x 7/8"	12	25/100
S04416	3/8" x 7/8"	16	25/100
S04417	3/8" x 7/8"	20	25/100
S04418	1/2" x 7/8"	9	25/100
S04419	1/2" x 7/8"	12	25/200
S04420	1/2" x 7/8"	16	25/100
S04421	1/2" x 7/8"	20	25/100

Nylon Toilet Connectors

PART NO.	FIP x BC	LENGTH	CTN/MSTR
S04422	1/2" x 7/8"	9	25/100
S04423	1/2" x 7/8"	12	25/100
S04424	1/2" x 7/8"	20	25/100

Nylon Dishwasher Connectors

90° Elbow

PART NO.	OD x MIP	LENGTH	CTN/MSTR
S04430	3/8" x 3/8"	72	25/50

"PEX" Supply Tubes (3/8" OD)



- NSF listed material
- Rated 100 psi at 180°F
- Resistant to corrosion and damage due to freezing
- Use with standard compression stops or valves

Basin Supply Tubes

PART NO.	DESCRIPTION	CTN/MSTR
S04101	3/8" x 12"	10/325
S04102	3/8" x 15"	10/250
S04103	3/8" x 20"	10/150
S04104	3/8" x 30"	10/200
S04108	3/8" x 36"	10/200

Tank Supply Tubes

PART NO.	DESCRIPTION	CTN/MSTR
S04105	3/8" x 12"	10/300
S04106	3/8" x 15"	10/250
S04107	3/8" x 20"	10/175

PEX Supply Tube With Ferrule



- NSF listed material
- Supplied with ferrule
- Rated 100 PSI at 180°

PART NO.	DESCRIPTION	CTN/MSTR
S04121	3/8" x 12 Basin	10/100
S04123	3/8" x 20 Basin	10/100
S04124	3/8" x 30 Basin	10/100
S04128	3/8" x 36 Basin	10/100
S04125	3/8" x 12 Tank	10/100
S04127	3/8" x 20 Tank	10/100

Chrome Plated Flexible Basin Supply Tube



- Lead Free

PART NO.	DESCRIPTION	CTN/MSTR
S04020	3/8" x 12"	1/500
S04021	3/8" x 16"	1/400
S04022	3/8" x 20"	1/300
S04023	3/8" x 30"	1/200
S04024	3/8" x 36"	1/200
S04025	1/2" x 12"	1/200
S04026	1/2" x 20"	1/200

Chrome Plated Flexible Tank Supply Tube



- Lead Free

PART NO.	DESCRIPTION	CTN/MSTR
S04027	3/8" x 12"	1/500
S04028	3/8" x 16"	1/300
S04029	3/8" x 20"	1/300
S04030	1/2" x 12"	1/50

Flexible Basin Supply Tube



- Lead Free
- Chrome plated
- With rubber nose cone

PART NO.	DESCRIPTION	CTN/MSTR
S04031	3/8" x 12"	1/100
S04032	3/8" x 20"	1/100

B

Supply Stop-180° Turn

B



• UPC listed

PART NO.	DESCRIPTION	CTN QTY
S10200	3/8 FIP x OD Angle	1/200
S10201	3/8 FIP x 3/8 OD Straight	1/200
S10202	1/2 FIP x 1/4 OD Angle	1/200
S10203	1/2 FIP x 3/8 OD Angle	1/200
S10204	1/2 FIP x 7/16 OD Angle	1/200
S10205	1/2 FIP x 1/2 OD Angle	1/200
S10206	1/2 FIP x 3/8 OD Straight	1/200
S10207	1/2 FIP x 1/2 OD Straight	1/200
S10208	3/8 OD x 3/8 OD Straight	1/200
S10209	5/8 OD x 1/4 OD Angle	1/200
S10210	5/8 OD x 3/8 OD Angle	1/200
S10211	5/8 OD x 3/8 OD Crse Thread Angle	1/200
S10212	5/8 OD x 7/16 OD Angle	1/200
S10213	5/8 OD x 1/2 OD Angle	1/200
S10214	5/8 OD x 3/8 OD Straight	1/200
S10215	5/8 OD x 1/2 OD Straight	1/200
S10216	1/2 Sweat x 3/8 OD Angle	1/200
S10217	1/2 Sweat x 1/2 OD Angle	1/200
S10218	1/2 Sweat x 3/8 OD Straight	1/200
S10219	1/2 Sweat x 1/2 OD Straight	1/200
S10220	1/2 FIP x 3/8 OD Dual	1/200
S10221	1/2 FIP x 7/16 OD x 7/16 OD Dual	1/200
S10222	1/2 FIP x 7/16 OD x 1/2 OD Dual	1/200
S10223	1/2 FIP x 1/2 OD x 3/8 OD Dual	1/200
S10224	1/2 FIP x 1/2 OD x 1/2 OD Dual	1/200
S10260	1/2 PEX x 1/4 OD Angle	1/200
S10261	1/2 PEX x 3/8 OD Angle	1/200
S10262	3/8 PEX x 3/8 OD Angle	1/200
S10267	1/2 PEX x 3/8 OD Straight	1/200
S10275	1/2 CPVC x 3/8 OD Straight	1/200
S10280	1/2 CPVC x 3/8 OD Angle	1/200

LEAD FREE

PART NO.	DESCRIPTION	CTN QTY
S10300	1/2 FIP x 3/8 OD Angle	1/200
S10301	5/8 OD x 3/8 OD Angle	1/200
S10302	1/2 FIP x 3/8 OD Straight	1/200
S10303	5/8 OD x 5/8 OD Straight	1/200
S10316	5/8 OD x 1/2 OD Straight	1/200
S10318	1/2 PEX x 3/8 OD Angle	1/200
S10319	1/2 CPVC x 3/8 COMP Straight	1/200
S10320	1/2 CPVC x 3/8 COMP Angle	1/200

Supply Stop-1/4 Turn



• UPC listed

PART NO.	DESCRIPTION	CTN QTY
S10225	3/8 FIP x 3/8 OD Angle	1/200
S10226	3/8 FIP x 3/8 OD Straight	1/200
S10227	1/2 FIP x 1/4 OD Angle	1/200
S10228	1/2 FIP x 3/8 OD Angle	1/200
S10229	1/2 FIP x 7/16 OD Angle	1/200
S10230	1/2 FIP x 1/2 OD Angle	1/200
S10231	1/2 FIP x 3/8 OD Straight	1/200
S10232	1/2 FIP x 1/2 OD Straight	1/200
S10233	3/8 OD x 3/8 OD Straight	1/200
S10234	5/8 OD x 1/4 OD Angle	1/200
S10235	5/8 OD x 3/8 OD Angle	1/200
S10236	5/8 OD x Crse Thrd x 3/8 OD Angle	1/200
S10237	5/8 OD x 7/16 OD Angle	1/200
S10238	5/8 OD x 1/2 OD Angle	1/200
S10239	5/8 OD x 3/8 OD Straight	1/200
S10240	5/8 OD x 1/2 OD Straight	1/200
S10241	1/2 Sweat x 3/8 OD Angle	1/200
S10242	1/2 Sweat x 1/2 OD Angle	1/200
S10243	1/2 Sweat x 3/8 OD Straight	1/200
S10244	1/2 Sweat x 1/2 OD Straight	1/200
S10247	1/2 FIP x 3/8 OD x 3/8 OD Dual	1/200
S10248	1/2 FIP x 7/16 OD x 7/16 OD Dual	1/200
S10249	1/2 FIP x 7/16 OD x 1/2 Dual	1/200
S10250	1/2 FIP x 1/2 OD x 3/8 OD Dual	1/200
S10251	1/2 FIP x 1/2 OD x 1/2 OD Dual	1/200
S10252	5/8 OD x 3/8 OD x 3/8 OD Dual	1/200
S10253	5/8 OD x 3/8 OD x 1/4 OD Dual	1/200
S10263	1/2 PEX x 1/4 OD Angle	1/150
S10264	1/2 PEX x 3/8 OD Angle	1/144
S10265	3/8 PEX x 3/8 OD Angle	1/150
S10266	1/2 PEX x 3/8 OD Straight	1/144

LEAD FREE

PART NO.	DESCRIPTION	CTN QTY
S10310	1/2 FIP x 3/8 OD Angle	1/200
S10311	5/8 OD x 3/8 OD Angle	1/200
S10312	1/2 FIP x 3/8 OD Straight	1/200
S10313	5/8 OD x 3/8 OD Straight	1/200
S10314	1/2 PEX x 3/8 OD Angle	1/200
S10315	1/2 PEX x 3/8 OD Straight	1/200
S10317	5/8 OD x 1/4 OD Angle	1/200

Drinking Fountain Bubbler and Cartridge



- 3/8" FIP connection
- Stainless steel cartridge
- Chrome plated brass body
- LEAD FREE- meets NSF standard 61.9

PART NO.	DESCRIPTION	CTN/MSTR
B45215	CP Brass bubbler with stainless steel cartridge	1/40
B45216	Replacement cartridge	100/500

Drinking Fountain Bubbler With Face Guard



Flexible Water Shield

- LEAD FREE- Meets NSF 61.9
- Chrome plated brass body
- Equipped with unique neo-poly water shield to prevent injuries to teeth, gums and face
- Tamper proof design requires 5/16" hex key to remove/ replace water shield for cleaning
- B45218 Kit includes new water shield, washer, and retainer nut

PART NO.	DESCRIPTION	CTN/MSTR
B45216	Replacement cartridge	100/500
B45217	Bubbler	1/40
B45218	Polymer Water Shield Kit	1/120

Self-Closing Drinking Fountain



- Mildew resistant
- Perfect for schools
- Chrome plated brass
- Stainless steel cartridge
- 1/2" Female pipe threads
- LEAD FREE

PART NO.	DESCRIPTION	CTN/MSTR
B45200	Drinking Fountain	1/25

Retrofit Bubbler Kit



- Replaces fountain on china fixtures
- Contains bubbler 1/2" x 3/8" x 3 1/2" nipple, rosette flange, locknut, coupling nut and 1 3/4" faucet cover

PART NO.	DESCRIPTION	CTN/MSTR
B45220	Drinking Fountain	1/20

Cross Handle Self Closing Valve



- Heavy brass construction
- Chrome plated

PART NO.	DESCRIPTION	CTN/MSTR
S05105	1/2" FIP	25/50

Single Kitchen Sink Faucet



- Chrome plated bodies and tee handles
- Replaceable washers

PART NO.	INLET	FLANGE	CTN/MSTR
S08003	1/2" FIP	Fixed (3/4" hose outlet)	12/72

Wall Mount Sink Faucet



- 8" center to center
- Adjustable 1/2" female threaded eccentric couplings
- Replaceable seats and stems
- Chrome plated with soap dish mounted on body
- Meets NSF standard 61.9
- Lead Free

PART NO.	DESCRIPTION	CTN/MSTR
S08008	8" tubular spout	1/20
S08012	12" tubular spout	1/20
S08030	Hot repair kit (handle, stem and seat)	1/100
S08031	Cold repair kit (handle, stem and seat)	1/100
S08032	Union repair kit (union assembly)	1/50

LEAD FREE

PART NO.	DESCRIPTION	CTN/MSTR
S08018	8" tubular spout	1/20

Laundry Tray Faucets



A01006

- Supplied with garden hose adapter and A01006 aerator
- Can be used either way with either adapter or aerator
- Meets Detroit Code

PART NO.	DESCRIPTION	CTN/MSTR
L47001	Chrome	1/24
L47004	With Gooseneck spout	1/24

Basin Faucet



Heavy Pattern



Standard Pattern

- Chrome plated
- Replaceable seats and stems
- Furnished with hot and cold buttons
- Meets NSF standard 61.9
- Lead Free

PART NO.	DESCRIPTION	CTN/MSTR
F39001	Heavy pattern with aerator - LEAD FREE	1/30
F39002	Standard pattern - LEAD FREE	1/50
F39004	Repair kit for 002 series (Handle, seat, stem and buttons)	1/100
F39005	Repair kit for 001 series (Handles, seat, stem and buttons)	1/24

Self-Closing Basin Faucet and Shower Valve

B



Self-Closing Basin Faucet



Shower Valve with Pull Chain

- Chrome plated heavy duty pattern
- Deluxe aerator
- 1/2" FIP connection
- Replaceable stem, cam and spring mechanism
- Shower valves ideal for urinals when used with standpipe assembly

PART NO.	DESCRIPTION	CTN/MSTR
F39010	Basin Faucet	1/36
S05100	Shower valve with pull chain (7" chain)	1/50
S05102	Standpipe assembly for urinal	25/100
S05101	Repair kit (stem and cam mechanism)	1/10

Service Sink Faucets



Lever Handles



Cross Handles



S55352

- Integral stops; 1/4 turn for S55349
- Complete with all mounting hardware
- Integrated vacuum breaker (ASSE 1001)
- Front hook to hang bucket

PART NO.	DESCRIPTION	CTN/MSTR
S55349	Service sink faucet with lever handles	1/8
S55350	Service sink faucet with cross handles	1/6
S55351	Cross handle stem repair kit for S55350	1/100
S55352	Lever handle and stem repair kit S55349	1/50
S55353	Integral stop repair kit for S55350	1/100
S55354	Vacuum breaker repair kit for S55350	1/100

Hose & Hose Bracket for Service Sink



- Heavy duty 300 PSI cloth-reinforced hose
- 3/4" brass hose coupling at one end
- 5" x 3" stainless steel bracket with rubber grips

PART NO.	DESCRIPTION	CTN/MSTR
M05001	30" hose with bracket	1
M05005	Bracket only	1/100

Mop Hanger for Service Sink

- 24" x 3" stainless steel hanger with three rubber tool grips
- Anchors included



PART NO.	DESCRIPTION	CTN/MSTR
M05003	Mop hanger	1/25

3/8" OD Uncoated w/Fittings



- Corrugation extends all the way to the fitting for increased tubing flexibility
- CSA Design certified domestically and internationally for indoor and outdoor use
- 100% leak tested to ensure Safety and Quality and a product you can trust
- Quality flared end fittings to create a metal to metal seal in critical applications
- Durable stainless steel 304. Corrosion resistant.

PART NO.	DESCRIPTION	CTN QTY
G70000	1/2" MIP x 1/2" MIP x 12"	1/25
G70001	1/2" FIP x 1/2" FIP x 12"	1/25
G70002	3/8" FIP x 3/8" FIP x 12"	1/25
G70003	1/2" FIP x 1/2" MIP x 12"	1/25
G70004	1/2" FIP x 3/8" MIP x 12"	1/25
G70005	3/8" FIP x 1/2" MIP x 12"	1/25
G70006	3/8" FIP x 3/8" MIP x 12"	1/25
G70007	1/2" MIP x 1/2" MIP x 18"	1/25
G70008	1/2" FIP x 1/2" FIP x 18"	1/25
G70009	3/8" FIP x 3/8" FIP x 18"	1/25
G70010	1/2" FIP x 1/2" MIP x 18"	1/25
G70011	1/2" FIP x 3/8" MIP x 18"	1/25
G70012	3/8" FIP x 1/2" MIP x 18"	1/25
G70013	3/8" FIP x 3/8" MIP x 18"	1/25
G70014	1/2" MIP x 1/2" MIP x 24"	1/25
G70015	1/2" FIP x 1/2" FIP x 24"	1/25
G70016	3/8" FIP x 3/8" FIP x 24"	1/25
G70017	1/2" FIP x 1/2" MIP x 24"	1/25
G70018	1/2" FIP x 3/8" MIP x 24"	1/25
G70019	3/8" FIP x 1/2" MIP x 24"	1/25
G70020	3/8" FIP x 3/8" MIP x 24"	1/25
G70021	1/2" MIP x 1/2" MIP x 30"	1/25
G70022	1/2" FIP x 1/2" FIP x 30"	1/25
G70023	3/8" FIP x 3/8" FIP x 30"	1/25
G70024	1/2" FIP x 1/2" MIP x 30"	1/25
G70025	1/2" FIP x 3/8" MIP x 30"	1/25
G70026	3/8" FIP x 1/2" MIP x 30"	1/25
G70027	3/8" FIP x 3/8" MIP x 30"	1/25
G70028	1/2" MIP x 1/2" MIP x 36"	1/25
G70029	1/2" FIP x 1/2" FIP x 36"	1/25
G70030	3/8" FIP x 3/8" FIP x 36"	1/25
G70031	1/2" FIP x 1/2" MIP x 36"	1/25
G70032	1/2" FIP x 3/8" MIP x 36"	1/25
G70033	3/8" FIP x 1/2" MIP x 36"	1/25
G70034	3/8" FIP x 3/8" MIP x 36"	1/25
G70035	1/2" MIP x 1/2" MIP x 48"	1/25
G70036	1/2" FIP x 1/2" FIP x 48"	1/25
G70037	3/8" FIP x 3/8" FIP x 48"	1/25
G70038	1/2" FIP x 1/2" MIP x 48"	1/25
G70039	1/2" FIP x 3/8" MIP x 48"	1/25
G70040	3/8" FIP x 1/2" MIP x 48"	1/25
G70041	3/8" FIP x 3/8" MIP x 48"	1/25
G70042	1/2" MIP x 1/2" MIP x 60"	1/25
G70043	1/2" FIP x 1/2" FIP x 60"	1/25
G70044	3/8" FIP x 3/8" FIP x 60"	1/25
G70045	1/2" FIP x 1/2" MIP x 60"	1/25

3/8" OD Uncoated w/Fittings (cont.)



- Corrugation extends all the way to the fitting for increased tubing flexibility
- CSA Design certified domestically and internationally for indoor and outdoor use
- 100% leak tested to ensure Safety and Quality and a product you can trust
- Quality flared end fittings to create a metal to metal seal in critical applications
- Durable stainless steel 304. Corrosion resistant.

PART NO.	DESCRIPTION	CTN QTY
G70046	1/2" FIP x 3/8" MIP x 60"	1/25
G70047	3/8" FIP x 1/2" MIP x 60"	1/25
G70048	3/8" FIP x 3/8" MIP x 60"	1/25
G70049	1/2" MIP x 1/2" MIP x 72"	1/25
G70050	1/2" FIP x 1/2" FIP x 72"	1/25
G70051	3/8" FIP x 3/8" FIP x 72"	1/25
G70052	1/2" FIP x 1/2" MIP x 72"	1/25
G70053	1/2" FIP x 3/8" MIP x 72"	1/25
G70054	3/8" FIP x 1/2" MIP x 72"	1/25
G70055	3/8" FIP x 3/8" MIP x 72"	1/25

3/8" OD Coated w/Fittings



- Corrugation extends all the way to the fitting for increased tubing flexibility
- CSA Design certified domestically and internationally for indoor and outdoor use
- 100% leak tested to ensure Safety and Quality and a product you can trust
- Quality flared end fittings to create a metal to metal seal in critical applications
- Durable stainless steel 304. Corrosion resistant.
- Coated connectors add additional safety in highly corrosive environments or in areas where caustic chemicals are located

PART NO.	DESCRIPTION	CTN QTY
G70100	1/2" MIP x 1/2" MIP x 12"	1/25
G70101	1/2" FIP x 1/2" FIP x 12"	1/25
G70102	3/8" FIP x 3/8" FIP x 12"	1/25
G70103	1/2" FIP x 1/2" MIP x 12"	1/25
G70104	1/2" FIP x 3/8" MIP x 12"	1/25
G70105	3/8" FIP x 1/2" MIP x 12"	1/25
G70106	3/8" FIP x 3/8" MIP x 12"	1/25
G70107	1/2" MIP x 1/2" MIP x 18"	1/25
G70108	1/2" FIP x 1/2" FIP x 18"	1/25
G70109	3/8" FIP x 3/8" FIP x 18"	1/25
G70110	1/2" FIP x 1/2" MIP x 18"	1/25
G70111	1/2" FIP x 3/8" MIP x 18"	1/25
G70112	3/8" FIP x 1/2" MIP x 18"	1/25
G70113	3/8" FIP x 3/8" MIP x 18"	1/25
G70114	1/2" MIP x 1/2" MIP x 24"	1/25
G70115	1/2" FIP x 1/2" FIP x 24"	1/25
G70116	3/8" FIP x 3/8" FIP x 24"	1/25
G70117	1/2" FIP x 1/2" MIP x 24"	1/25
G70118	1/2" FIP x 3/8" MIP x 24"	1/25
G70119	3/8" FIP x 1/2" MIP x 24"	1/25
G70120	3/8" FIP x 3/8" MIP x 24"	1/25
G70121	1/2" MIP x 1/2" MIP x 30"	1/25
G70122	1/2" FIP x 1/2" FIP x 30"	1/25

3/8" OD Coated w/Fittings (cont.)



B

- Corrugation extends all the way to the fitting for increased tubing flexibility
- CSA Design certified domestically and internationally for indoor and outdoor use
- 100% leak tested to ensure Safety and Quality and a product you can trust
- Quality flared end fittings to create a metal to metal seal in critical applications
- Durable stainless steel 304. Corrosion resistant.
- Coated connectors add additional safety in highly corrosive environments or in areas where caustic chemicals are located

PART NO.	DESCRIPTION	CTN QTY
G70123	3/8" FIP x 3/8" FIP x 30"	1/25
G70124	1/2" FIP x 1/2" MIP x 30"	1/25
G70125	1/2" FIP x 3/8" MIP x 30"	1/25
G70126	3/8" FIP x 1/2" MIP x 30"	1/25
G70127	3/8" FIP x 3/8" MIP x 30"	1/25
G70128	1/2" MIP x 1/2" MIP x 36"	1/25
G70129	1/2" FIP x 1/2" FIP x 36"	1/25
G70130	3/8" FIP x 3/8" FIP x 36"	1/25
G70131	1/2" FIP x 1/2" MIP x 36"	1/25
G70132	1/2" FIP x 3/8" MIP x 36"	1/25
G70133	3/8" FIP x 1/2" MIP x 36"	1/25
G70134	3/8" FIP x 3/8" MIP x 36"	1/25
G70135	1/2" MIP x 1/2" MIP x 48"	1/25
G70136	1/2" FIP x 1/2" FIP x 48"	1/25
G70137	3/8" FIP x 3/8" FIP x 48"	1/25
G70138	1/2" FIP x 1/2" MIP x 48"	1/25
G70139	1/2" FIP x 3/8" MIP x 48"	1/25
G70140	3/8" FIP x 1/2" MIP x 48"	1/25
G70141	3/8" FIP x 3/8" MIP x 48"	1/25
G70142	1/2" MIP x 1/2" MIP x 60"	1/25
G70143	1/2" FIP x 1/2" FIP x 60"	1/25
G70144	3/8" FIP x 3/8" FIP x 60"	1/25
G70145	1/2" FIP x 1/2" MIP x 60"	1/25
G70146	1/2" FIP x 3/8" MIP x 60"	1/25
G70147	3/8" FIP x 1/2" MIP x 60"	1/25
G70148	3/8" FIP x 3/8" MIP x 60"	1/25
G70149	1/2" MIP x 1/2" MIP x 72"	1/25
G70150	1/2" FIP x 1/2" FIP x 72"	1/25
G70151	3/8" FIP x 3/8" FIP x 72"	1/25
G70152	1/2" FIP x 1/2" MIP x 72"	1/25
G70153	1/2" FIP x 3/8" MIP x 72"	1/25
G70154	3/8" FIP x 1/2" MIP x 72"	1/25
G70155	3/8" FIP x 3/8" MIP x 72"	1/25

3/8" OD Uncoated with Ball Valves



- Corrugation extends all the way to the fitting for increased tubing flexibility
- CSA Design certified domestically and internationally for indoor and outdoor use
- 100% leak tested to ensure Safety and Quality and a product you can trust
- Quality flared end fittings to create a metal to metal seal in critical applications
- Durable stainless steel 304. Corrosion resistant.

PART NO.	DESCRIPTION	CTN QTY
G70200	3/8" MIP x 1/2" FIP Ball x 12"	1/25
G70201	1/2" MIP x 1/2" FIP Ball x 12"	1/25
G70202	1/2" FIP x 1/2" FIP Ball x 12"	1/25
G70203	3/8" FIP x 1/2" FIP Ball x 12"	1/25
G70204	3/8" MIP x 1/2" FIP Ball x 18"	1/25
G70205	1/2" MIP x 1/2" FIP Ball x 18"	1/25
G70206	1/2" FIP x 1/2" FIP Ball x 18"	1/25
G70207	3/8" FIP x 1/2" FIP Ball x 18"	1/25
G70208	3/8" MIP x 1/2" FIP Ball x 24"	1/25
G70209	1/2" MIP x 1/2" FIP Ball x 24"	1/25
G70210	1/2" FIP x 1/2" FIP Ball x 24"	1/25
G70211	3/8" FIP x 1/2" FIP Ball x 24"	1/25
G70212	3/8" MIP x 1/2" FIP Ball x 30"	1/25
G70213	1/2" MIP x 1/2" FIP Ball x 30"	1/25
G70214	1/2" FIP x 1/2" FIP Ball x 30"	1/25
G70215	3/8" FIP x 1/2" FIP Ball x 30"	1/25
G70216	3/8" MIP x 1/2" FIP Ball x 36"	1/25
G70217	1/2" MIP x 1/2" FIP Ball x 36"	1/25
G70218	1/2" FIP x 1/2" FIP Ball x 36"	1/25
G70219	3/8" FIP x 1/2" FIP Ball x 36"	1/25
G70220	3/8" MIP x 1/2" FIP Ball x 48"	1/25
G70221	1/2" MIP x 1/2" FIP Ball x 48"	1/25
G70222	1/2" FIP x 1/2" FIP Ball x 48"	1/25
G70223	3/8" FIP x 1/2" FIP Ball x 48"	1/25
G70224	3/8" MIP x 1/2" FIP Ball x 60"	1/25
G70225	1/2" MIP x 1/2" FIP Ball x 60"	1/25
G70226	1/2" FIP x 1/2" FIP Ball x 60"	1/25
G70227	3/8" FIP x 1/2" FIP Ball x 60"	1/25
G70228	3/8" MIP x 1/2" FIP Ball x 72"	1/25
G70229	1/2" MIP x 1/2" FIP Ball x 72"	1/25
G70230	1/2" FIP x 1/2" FIP Ball x 72"	1/25
G70231	3/8" FIP x 1/2" FIP Ball x 72"	1/25
G70232	1/2" MIP x 1/2" FIP Angle Ball x 48"	1/25
G70233	3/8" FIP x 1/2" FIP Angle Ball x 48"	1/25
G70234	1/2" MIP x 1/2" FIP Angle Ball x 60"	1/25
G70235	3/8" FIP x 1/2" FIP Angle Ball x 60"	1/25
G70236	1/2" MIP x 1/2" FIP Angle Ball x 72"	1/25
G70237	3/8" FIP x 1/2" FIP Angle Ball x 72"	1/25

3/8" OD Coated with Ball Valves



- Corrugation extends all the way to the fitting for increased tubing flexibility
- CSA Design certified domestically and internationally for indoor and outdoor use
- 100% leak tested to ensure Safety and Quality and a product you can trust
- Quality flared end fittings to create a metal to metal seal in critical applications
- Durable stainless steel 304. Corrosion resistant.
- Coated connectors add additional safety in highly corrosive environments or in areas where caustic chemicals are located

PART NO.	DESCRIPTION	CTN QTY
G70300	3/8" MIP x 1/2" FIP Ball x 12"	1/25
G70301	1/2" MIP x 1/2" FIP Ball x 12"	1/25
G70302	1/2" FIP x 1/2" FIP Ball x 12"	1/25
G70303	3/8" FIP x 1/2" FIP Ball x 12"	1/25
G70304	3/8" MIP x 1/2" FIP Ball x 18"	1/25
G70305	1/2" MIP x 1/2" FIP Ball x 18"	1/25
G70306	1/2" FIP x 1/2" FIP Ball x 18"	1/25
G70307	3/8" FIP x 1/2" FIP Ball x 18"	1/25
G70308	3/8" MIP x 1/2" FIP Ball x 24"	1/25
G70309	1/2" MIP x 1/2" FIP Ball x 24"	1/25
G70310	1/2" FIP x 1/2" FIP Ball x 24"	1/25
G70311	3/8" FIP x 1/2" FIP Ball x 24"	1/25
G70312	3/8" MIP x 1/2" FIP Ball x 30"	1/25
G70313	1/2" MIP x 1/2" FIP Ball x 30"	1/25
G70314	1/2" FIP x 1/2" FIP Ball x 30"	1/25
G70315	3/8" FIP x 1/2" FIP Ball x 30"	1/25
G70316	3/8" MIP x 1/2" FIP Ball x 36"	1/25
G70317	1/2" MIP x 1/2" FIP Ball x 36"	1/25
G70318	1/2" FIP x 1/2" FIP Ball x 36"	1/25
G70319	3/8" FIP x 1/2" FIP Ball x 36"	1/25
G70320	3/8" MIP x 1/2" FIP Ball x 48"	1/25
G70321	1/2" MIP x 1/2" FIP Ball x 48"	1/25
G70322	1/2" FIP x 1/2" FIP Ball x 48"	1/25
G70323	3/8" FIP x 1/2" FIP Ball x 48"	1/25
G70324	3/8" MIP x 1/2" FIP Ball x 60"	1/25
G70325	1/2" MIP x 1/2" FIP Ball x 60"	1/25
G70326	1/2" FIP x 1/2" FIP Ball x 60"	1/25
G70327	3/8" FIP x 1/2" FIP Ball x 60"	1/25
G70328	3/8" MIP x 1/2" FIP Ball x 72"	1/25
G70329	1/2" MIP x 1/2" FIP Ball x 72"	1/25
G70330	1/2" FIP x 1/2" FIP Ball x 72"	1/25
G70331	3/8" FIP x 1/2" FIP Ball x 72"	1/25
G70332	1/2" MIP x 1/2" FIP Angle Ball x 48"	1/25
G70333	3/8" FIP x 1/2" FIP Angle Ball x 48"	1/25
G70334	1/2" MIP x 1/2" FIP Angle Ball x 60"	1/25
G70335	3/8" FIP x 1/2" FIP Angle Ball x 60"	1/25
G70336	1/2" MIP x 1/2" FIP Angle Ball x 72"	1/25
G70337	3/8" FIP x 1/2" FIP Angle Ball x 72"	1/25

5/8" OD Uncoated w/Fittings



- Corrugation extends all the way to the fitting for increased tubing flexibility
- CSA Design certified domestically and internationally for indoor and outdoor use
- 100% leak tested to ensure Safety and Quality and a product you can trust
- Quality flared end fittings to create a metal to metal seal in critical applications
- Durable stainless steel 304. Corrosion resistant.

PART NO.	DESCRIPTION	CTN QTY
G71000	3/4" MIP x 3/4" MIP x 12"	1/25
G71001	3/4" MIP x 1/2" MIP x 12"	1/25
G71002	1/2" MIP x 1/2" MIP x 12"	1/25
G71003	3/4" FIP x 3/4" FIP x 12"	1/25
G71004	3/4" FIP x 1/2" FIP x 12"	1/25
G71005	1/2" FIP x 1/2" FIP x 12"	1/25
G71006	1/2" FIP x 3/4" MIP x 12"	1/25
G71007	3/4" FIP x 3/4" MIP x 12"	1/25
G71008	3/4" FIP x 1/2" MIP x 12"	1/25
G71009	1/2" FIP x 1/2" MIP x 12"	1/25
G71010	3/4" MIP x 3/4" MIP x 18"	1/25
G71011	3/4" MIP x 1/2" MIP x 18"	1/25
G71012	1/2" MIP x 1/2" MIP x 18"	1/25
G71013	3/4" FIP x 3/4" FIP x 18"	1/25
G71014	3/4" FIP x 1/2" FIP x 18"	1/25
G71015	1/2" FIP x 1/2" FIP x 18"	1/25
G71016	1/2" FIP x 3/4" MIP x 18"	1/25
G71017	3/4" FIP x 3/4" MIP x 18"	1/25
G71018	3/4" FIP x 1/2" MIP x 18"	1/25
G71019	1/2" FIP x 1/2" MIP x 18"	1/25
G71020	3/4" MIP x 3/4" MIP x 24"	1/25
G71021	3/4" MIP x 1/2" MIP x 24"	1/25
G71022	1/2" MIP x 1/2" MIP x 24"	1/25
G71023	3/4" FIP x 3/4" FIP x 24"	1/25
G71024	3/4" FIP x 1/2" FIP x 24"	1/25
G71025	1/2" FIP x 1/2" FIP x 24"	1/25
G71026	1/2" FIP x 3/4" MIP x 24"	1/25
G71027	3/4" FIP x 3/4" MIP x 24"	1/25
G71028	3/4" FIP x 1/2" MIP x 24"	1/25
G71029	1/2" FIP x 1/2" MIP x 24"	1/25
G71030	3/4" MIP x 3/4" MIP x 30"	1/25
G71031	3/4" MIP x 1/2" MIP x 30"	1/25
G71032	1/2" MIP x 1/2" MIP x 30"	1/25
G71033	3/4" FIP x 3/4" FIP x 30"	1/25
G71034	3/4" FIP x 1/2" FIP x 30"	1/25
G71035	1/2" FIP x 1/2" FIP x 30"	1/25
G71036	1/2" FIP x 3/4" MIP x 30"	1/25
G71037	3/4" FIP x 3/4" MIP x 30"	1/25
G71038	3/4" FIP x 1/2" MIP x 30"	1/25
G71039	1/2" FIP x 1/2" MIP x 30"	1/25
G71040	3/4" MIP x 3/4" MIP x 36"	1/25
G71041	3/4" MIP x 1/2" MIP x 36"	1/25
G71042	1/2" MIP x 1/2" MIP x 36"	1/25
G71043	3/4" FIP x 3/4" FIP x 36"	1/25
G71044	3/4" FIP x 1/2" FIP x 36"	1/25
G71045	1/2" FIP x 1/2" FIP x 36"	1/25

B

5/8" OD Uncoated w/Fittings (cont.)



- Corrugation extends all the way to the fitting for increased tubing flexibility
- CSA Design certified domestically and internationally for indoor and outdoor use
- 100% leak tested to ensure Safety and Quality and a product you can trust
- Quality flared end fittings to create a metal to metal seal in critical applications
- Durable stainless steel 304. Corrosion resistant.

B

PART NO.	DESCRIPTION	CTN QTY
G71046	1/2" FIP x 3/4" MIP x 36"	1/25
G71047	3/4" FIP x 3/4" MIP x 36"	1/25
G71048	3/4" FIP x 1/2" MIP x 36"	1/25
G71049	1/2" FIP x 1/2" MIP x 36"	1/25
G71050	3/4" MIP x 3/4" MIP x 48"	1/25
G71051	3/4" MIP x 1/2" MIP x 48"	1/25
G71052	1/2" MIP x 1/2" MIP x 48"	1/25
G71053	3/4" FIP x 3/4" FIP x 48"	1/25
G71054	3/4" FIP x 1/2" FIP x 48"	1/25
G71055	1/2" FIP x 1/2" FIP x 48"	1/25
G71056	1/2" FIP x 3/4" MIP x 48"	1/25
G71057	3/4" FIP x 3/4" MIP x 48"	1/25
G71058	3/4" FIP x 1/2" MIP x 48"	1/25
G71059	1/2" FIP x 1/2" MIP x 48"	1/25
G71060	3/4" MIP x 3/4" MIP x 60"	1/25
G71061	3/4" MIP x 1/2" MIP x 60"	1/25
G71062	1/2" MIP x 1/2" MIP x 60"	1/25
G71063	3/4" FIP x 3/4" FIP x 60"	1/25
G71064	3/4" FIP x 1/2" FIP x 60"	1/25
G71065	1/2" FIP x 1/2" FIP x 60"	1/25
G71066	1/2" FIP x 3/4" MIP x 60"	1/25
G71067	3/4" FIP x 3/4" MIP x 60"	1/25
G71068	3/4" FIP x 1/2" MIP x 60"	1/25
G71069	1/2" FIP x 1/2" MIP x 60"	1/25
G71070	3/4" MIP x 3/4" MIP x 72"	1/25
G71071	3/4" MIP x 1/2" MIP x 72"	1/25
G71072	1/2" MIP x 1/2" MIP x 72"	1/25
G71073	3/4" FIP x 3/4" FIP x 72"	1/25
G71074	3/4" FIP x 1/2" FIP x 72"	1/25
G71075	1/2" FIP x 1/2" FIP x 72"	1/25
G71076	1/2" FIP x 3/4" MIP x 72"	1/25
G71077	3/4" FIP x 3/4" MIP x 72"	1/25
G71078	3/4" FIP x 1/2" MIP x 72"	1/25
G71079	1/2" FIP x 1/2" MIP x 72"	1/25

5/8" OD Coated w/Fittings



- Corrugation extends all the way to the fitting for increased tubing flexibility
- CSA Design certified domestically and internationally for indoor and outdoor use
- 100% leak tested to ensure Safety and Quality and a product you can trust
- Quality flared end fittings to create a metal to metal seal in critical applications
- Durable stainless steel 304. Corrosion resistant.
- Coated connectors add additional safety in highly corrosive environments or in areas where caustic chemicals are located

PART NO.	DESCRIPTION	CTN QTY
G71100	3/4" MIP x 3/4" MIP x 12"	1/25
G71101	3/4" MIP x 1/2" MIP x 12"	1/25
G71102	1/2" MIP x 1/2" MIP x 12"	1/25
G71103	3/4" FIP x 3/4" FIP x 12"	1/25
G71104	3/4" FIP x 1/2" FIP x 12"	1/25
G71105	1/2" FIP x 1/2" FIP x 12"	1/25
G71106	1/2" FIP x 3/4" MIP x 12"	1/25
G71107	3/4" FIP x 3/4" MIP x 12"	1/25
G71108	3/4" FIP x 1/2" MIP x 12"	1/25
G71109	1/2" FIP x 1/2" MIP x 12"	1/25
G71110	3/4" MIP x 3/4" MIP x 18"	1/25
G71111	3/4" MIP x 1/2" MIP x 18"	1/25
G71112	1/2" MIP x 1/2" MIP x 18"	1/25
G71113	3/4" FIP x 3/4" FIP x 18"	1/25
G71114	3/4" FIP x 1/2" FIP x 18"	1/25
G71115	1/2" FIP x 1/2" FIP x 18"	1/25
G71116	1/2" FIP x 3/4" MIP x 18"	1/25
G71117	3/4" FIP x 3/4" MIP x 18"	1/25
G71118	3/4" FIP x 1/2" MIP x 18"	1/25
G71119	1/2" FIP x 1/2" MIP x 18"	1/25
G71120	3/4" MIP x 3/4" MIP x 24"	1/25
G71121	3/4" MIP x 1/2" MIP x 24"	1/25
G71122	1/2" MIP x 1/2" MIP x 24"	1/25
G71123	3/4" FIP x 3/4" FIP x 24"	1/25
G71124	3/4" FIP x 1/2" FIP x 24"	1/25
G71125	1/2" FIP x 1/2" FIP x 24"	1/25
G71126	1/2" FIP x 3/4" MIP x 24"	1/25
G71127	3/4" FIP x 3/4" MIP x 24"	1/25
G71128	3/4" FIP x 1/2" MIP x 24"	1/25
G71129	1/2" FIP x 1/2" MIP x 24"	1/25
G71130	3/4" MIP x 3/4" MIP x 30"	1/25
G71131	3/4" MIP x 1/2" MIP x 30"	1/25
G71132	1/2" MIP x 1/2" MIP x 30"	1/25
G71133	3/4" FIP x 3/4" FIP x 30"	1/25
G71134	3/4" FIP x 1/2" FIP x 30"	1/25
G71135	1/2" FIP x 1/2" FIP x 30"	1/25
G71136	1/2" FIP x 3/4" MIP x 30"	1/25
G71137	3/4" FIP x 3/4" MIP x 30"	1/25
G71138	3/4" FIP x 1/2" MIP x 30"	1/25
G71139	1/2" FIP x 1/2" MIP x 30"	1/25
G71140	3/4" MIP x 3/4" MIP x 36"	1/25
G71141	3/4" MIP x 1/2" MIP x 36"	1/25
G71142	1/2" MIP x 1/2" MIP x 36"	1/25

5/8" OD Coated w/Fittings (cont.)



- Corrugation extends all the way to the fitting for increased tubing flexibility
- CSA Design certified domestically and internationally for indoor and outdoor use
- 100% leak tested to ensure Safety and Quality and a product you can trust
- Quality flared end fittings to create a metal to metal seal in critical applications
- Durable stainless steel 304. Corrosion resistant.
- Coated connectors add additional safety in highly corrosive environments or in areas where caustic chemicals are located

PART NO.	DESCRIPTION	CTN QTY
G71143	3/4" FIP x 3/4" FIP x 36"	1/25
G71144	3/4" FIP x 1/2" FIP x 36"	1/25
G71145	1/2" FIP x 1/2" FIP x 36"	1/25
G71146	1/2" FIP x 3/4" MIP x 36"	1/25
G71147	3/4" FIP x 3/4" MIP x 36"	1/25
G71148	3/4" FIP x 1/2" MIP x 36"	1/25
G71149	1/2" FIP x 1/2" MIP x 36"	1/25
G71150	3/4" MIP x 3/4" MIP x 48"	1/25
G71151	3/4" MIP x 1/2" MIP x 48"	1/25
G71152	1/2" MIP x 1/2" MIP x 48"	1/25
G71153	3/4" FIP x 3/4" FIP x 48"	1/25
G71154	3/4" FIP x 1/2" FIP x 48"	1/25
G71155	1/2" FIP x 1/2" FIP x 48"	1/25
G71156	1/2" FIP x 3/4" MIP x 48"	1/25
G71157	3/4" FIP x 3/4" MIP x 48"	1/25
G71158	3/4" FIP x 1/2" MIP x 48"	1/25
G71159	1/2" FIP x 1/2" MIP x 48"	1/25
G71160	3/4" MIP x 3/4" MIP x 60"	1/25
G71161	3/4" MIP x 1/2" MIP x 60"	1/25
G71162	1/2" MIP x 1/2" MIP x 60"	1/25
G71163	3/4" FIP x 3/4" FIP x 60"	1/25
G71164	3/4" FIP x 1/2" FIP x 60"	1/25
G71165	1/2" FIP x 1/2" FIP x 60"	1/25
G71166	1/2" FIP x 3/4" MIP x 60"	1/25
G71167	3/4" FIP x 3/4" MIP x 60"	1/25
G71168	3/4" FIP x 1/2" MIP x 60"	1/25
G71169	1/2" FIP x 1/2" MIP x 60"	1/25
G71170	3/4" MIP x 3/4" MIP x 72"	1/25
G71171	3/4" MIP x 1/2" MIP x 72"	1/25
G71172	1/2" MIP x 1/2" MIP x 72"	1/25
G71173	3/4" FIP x 3/4" FIP x 72"	1/25
G71174	3/4" FIP x 1/2" FIP x 72"	1/25
G71175	1/2" FIP x 1/2" FIP x 72"	1/25
G71176	1/2" FIP x 3/4" MIP x 72"	1/25
G71177	3/4" FIP x 3/4" MIP x 72"	1/25
G71178	3/4" FIP x 1/2" MIP x 72"	1/25
G71179	1/2" FIP x 1/2" MIP x 72"	1/25

5/8" OD Uncoated w/ Ball Valves



- Corrugation extends all the way to the fitting for increased tubing flexibility
- CSA Design certified domestically and internationally for indoor and outdoor use
- 100% leak tested to ensure Safety and Quality and a product you can trust
- Quality flared end fittings to create a metal to metal seal in critical applications
- Durable stainless steel 304. Corrosion resistant.

PART NO.	DESCRIPTION	CTN QTY
G71200	3/4" FIP x 3/4" FIP Ball x 12"	1/25
G71201	1/2" FIP x 3/4" FIP Ball x 12"	1/25
G71202	3/4" FIP x 1/2" FIP Ball x 12"	1/25
G71203	1/2" FIP x 1/2" FIP Ball x 12"	1/25
G71204	3/4" MIP x 3/4" FIP Ball x 12"	1/25
G71205	1/2" MIP x 3/4" FIP Ball x 12"	1/25
G71206	3/4" MIP x 1/2" FIP Ball x 12"	1/25
G71207	1/2" MIP x 1/2" FIP Ball x 12"	1/25
G71208	3/4" FIP x 3/4" FIP Ball x 18"	1/25
G71209	1/2" FIP x 3/4" FIP Ball x 18"	1/25
G71210	3/4" FIP x 1/2" FIP Ball x 18"	1/25
G71211	1/2" FIP x 1/2" FIP Ball x 18"	1/25
G71212	3/4" MIP x 3/4" FIP Ball x 18"	1/25
G71213	1/2" MIP x 3/4" FIP Ball x 18"	1/25
G71214	3/4" MIP x 1/2" FIP Ball x 18"	1/25
G71215	1/2" MIP x 1/2" FIP Ball x 18"	1/25
G71216	3/4" FIP x 3/4" FIP Ball x 24"	1/25
G71217	1/2" FIP x 3/4" FIP Ball x 24"	1/25
G71218	3/4" FIP x 1/2" FIP Ball x 24"	1/25
G71219	1/2" FIP x 1/2" FIP Ball x 24"	1/25
G71220	3/4" MIP x 3/4" FIP Ball x 24"	1/25
G71221	1/2" MIP x 3/4" FIP Ball x 24"	1/25
G71222	3/4" MIP x 1/2" FIP Ball x 24"	1/25
G71223	1/2" MIP x 1/2" FIP Ball x 24"	1/25
G71224	3/4" FIP x 3/4" FIP Ball x 30"	1/25
G71225	1/2" FIP x 3/4" FIP Ball x 30"	1/25
G71226	3/4" FIP x 1/2" FIP Ball x 30"	1/25
G71227	1/2" FIP x 1/2" FIP Ball x 30"	1/25
G71228	3/4" MIP x 3/4" FIP Ball x 30"	1/25
G71229	1/2" MIP x 3/4" FIP Ball x 30"	1/25
G71230	3/4" MIP x 1/2" FIP Ball x 30"	1/25
G71231	1/2" MIP x 1/2" FIP Ball x 30"	1/25
G71232	3/4" FIP x 3/4" FIP Ball x 36"	1/25
G71233	1/2" FIP x 3/4" FIP Ball x 36"	1/25
G71234	3/4" FIP x 1/2" FIP Ball x 36"	1/25
G71235	1/2" FIP x 1/2" FIP Ball x 36"	1/25
G71236	3/4" MIP x 3/4" FIP Ball x 36"	1/25
G71237	1/2" MIP x 3/4" FIP Ball x 36"	1/25
G71238	3/4" MIP x 1/2" FIP Ball x 36"	1/25
G71239	1/2" MIP x 1/2" FIP Ball x 36"	1/25
G71240	3/4" FIP x 3/4" FIP Ball x 48"	1/25
G71241	1/2" FIP x 3/4" FIP Ball x 48"	1/25
G71242	3/4" FIP x 1/2" FIP Ball x 48"	1/25
G71243	1/2" FIP x 1/2" FIP Ball x 48"	1/25

B

5/8" OD Uncoated w/ Ball Valves (cont.)

B



- Corrugation extends all the way to the fitting for increased tubing flexibility
- CSA Design certified domestically and internationally for indoor and outdoor use
- 100% leak tested to ensure Safety and Quality and a product you can trust
- Quality flared end fittings to create a metal to metal seal in critical applications
- Durable stainless steel 304. Corrosion resistant.

PART NO.	DESCRIPTION	CTN QTY
G71244	3/4" MIP x 3/4" FIP Ball x 48"	1/25
G71245	1/2" MIP x 3/4" FIP Ball x 48"	1/25
G71246	3/4" MIP x 1/2" FIP Ball x 48"	1/25
G71247	1/2" MIP x 1/2" FIP Ball x 48"	1/25
G71248	3/4" FIP x 3/4" FIP Ball x 60"	1/25
G71249	1/2" FIP x 3/4" FIP Ball x 60"	1/25
G71250	3/4" FIP x 1/2" FIP Ball x 60"	1/25
G71251	1/2" FIP x 1/2" FIP Ball x 60"	1/25
G71252	3/4" MIP x 3/4" FIP Ball x 60"	1/25
G71253	1/2" MIP x 3/4" FIP Ball x 60"	1/25
G71254	3/4" MIP x 1/2" FIP Ball x 60"	1/25
G71255	1/2" MIP x 1/2" FIP Ball x 60"	1/25
G71256	3/4" FIP x 3/4" FIP Ball x 72"	1/25
G71257	1/2" FIP x 3/4" FIP Ball x 72"	1/25
G71258	3/4" FIP x 1/2" FIP Ball x 72"	1/25
G71259	1/2" FIP x 1/2" FIP Ball x 72"	1/25
G71260	3/4" MIP x 3/4" FIP Ball x 72"	1/25
G71261	1/2" MIP x 3/4" FIP Ball x 72"	1/25
G71262	3/4" MIP x 1/2" FIP Ball x 72"	1/25
G71263	1/2" MIP x 1/2" FIP Ball x 72"	1/25
G71264	1/2" MIP x 3/4" FIP Angle Ball x 36"	1/25
G71265	1/2" MIP x 3/4" FIP Angle Ball x 48"	1/25
G71266	1/2" MIP x 3/4" FIP Angle Ball x 60"	1/25
G71267	1/2" MIP x 3/4" FIP Angle Ball x 72"	1/25

5/8" OD Coated w/ Ball Valves



- Corrugation extends all the way to the fitting for increased tubing flexibility
- CSA Design certified domestically and internationally for indoor and outdoor use
- 100% leak tested to ensure Safety and Quality and a product you can trust
- Quality flared end fittings to create a metal to metal seal in critical applications
- Durable stainless steel 304. Corrosion resistant.
- Coated connectors add additional safety in highly corrosive environments or in areas where caustic chemicals are located

PART NO.	DESCRIPTION	CTN QTY
G71300	3/4" FIP x 3/4" FIP Ball x 12"	1/25
G71304	3/4" MIP x 3/4" FIP Ball x 12"	1/25
G71305	1/2" MIP x 3/4" FIP Ball x 12"	1/25
G71307	1/2" MIP x 1/2" FIP Ball x 12"	1/25
G71308	3/4" FIP x 3/4" FIP Ball x 18"	1/25
G71312	3/4" MIP x 3/4" FIP Ball x 18"	1/25
G71313	1/2" MIP x 3/4" FIP Ball x 18"	1/25
G71315	1/2" MIP x 1/2" FIP Ball x 18"	1/25
G71316	3/4" FIP x 3/4" FIP Ball x 24"	1/25
G71320	3/4" MIP x 3/4" FIP Ball x 24"	1/25
G71321	1/2" MIP x 3/4" FIP Ball x 24"	1/25
G71323	1/2" MIP x 1/2" FIP Ball x 24"	1/25
G71324	3/4" FIP x 3/4" FIP Ball x 30"	1/25
G71328	3/4" MIP x 3/4" FIP Ball x 30"	1/25
G71329	1/2" MIP x 3/4" FIP Ball x 30"	1/25
G71331	1/2" MIP x 1/2" FIP Ball x 30"	1/25
G71332	3/4" FIP x 3/4" FIP Ball x 36"	1/25
G71336	3/4" MIP x 3/4" FIP Ball x 36"	1/25
G71337	1/2" MIP x 3/4" FIP Ball x 36"	1/25
G71339	1/2" MIP x 1/2" FIP Ball x 36"	1/25
G71340	3/4" FIP x 3/4" FIP Ball x 48"	1/25
G71344	3/4" MIP x 3/4" FIP Ball x 48"	1/25
G71345	1/2" MIP x 3/4" FIP Ball x 48"	1/25
G71347	1/2" MIP x 1/2" FIP Ball x 48"	1/25
G71348	3/4" FIP x 3/4" FIP Ball x 60"	1/25
G71352	3/4" MIP x 3/4" FIP Ball x 60"	1/25
G71353	1/2" MIP x 3/4" FIP Ball x 60"	1/25
G71356	3/4" FIP x 3/4" FIP Ball x 72"	1/25
G71360	3/4" MIP x 3/4" FIP Ball x 72"	1/25
G71361	1/2" MIP x 3/4" FIP Ball x 72"	1/25

1/2" OD Uncoated w/Fittings



- Corrugation extends all the way to the fitting for increased tubing flexibility
- CSA Design certified domestically and internationally for indoor and outdoor use
- 100% leak tested to ensure Safety and Quality and a product you can trust
- Quality flared end fittings to create a metal to metal seal in critical applications
- Durable stainless steel 304. Corrosion resistant.

1/2" OD Uncoated w/Fittings (cont.)



- Corrugation extends all the way to the fitting for increased tubing flexibility
- CSA Design certified domestically and internationally for indoor and outdoor use
- 100% leak tested to ensure Safety and Quality and a product you can trust
- Quality flared end fittings to create a metal to metal seal in critical applications
- Durable stainless steel 304. Corrosion resistant.



PART NO.	DESCRIPTION	CTN QTY
G72000	1/2" MIP x 1/2" MIP x 12"	1/25
G72001	1/2" MIP x 3/8" MIP x 12"	1/25
G72002	3/8" MIP x 3/8" MIP x 12"	1/25
G72003	1/2" FIP x 1/2" FIP x 12"	1/25
G72004	1/2" FIP x 3/8" FIP x 12"	1/25
G72005	1/2" FIP x 1/2" MIP x 12"	1/25
G72006	1/2" FIP x 3/8" MIP x 12"	1/25
G72007	3/8" FIP x 1/2" MIP x 12"	1/25
G72008	1/2" MIP x 1/2" MIP x 18"	1/25
G72009	1/2" MIP x 3/8" MIP x 18"	1/25
G72010	3/8" MIP x 3/8" MIP x 18"	1/25
G72011	1/2" FIP x 1/2" FIP x 18"	1/25
G72012	1/2" FIP x 3/8" FIP x 18"	1/25
G72013	1/2" FIP x 1/2" MIP x 18"	1/25
G72014	1/2" FIP x 3/8" MIP x 18"	1/25
G72015	3/8" FIP x 1/2" MIP x 18"	1/25
G72016	1/2" MIP x 1/2" MIP x 24"	1/25
G72017	1/2" MIP x 3/8" MIP x 24"	1/25
G72018	3/8" MIP x 3/8" MIP x 24"	1/25
G72019	1/2" FIP x 1/2" FIP x 24"	1/25
G72020	1/2" FIP x 3/8" FIP x 24"	1/25
G72021	1/2" FIP x 1/2" MIP x 24"	1/25
G72022	1/2" FIP x 3/8" MIP x 24"	1/25
G72023	3/8" FIP x 1/2" MIP x 24"	1/25
G72024	1/2" MIP x 1/2" MIP x 30"	1/25
G72025	1/2" MIP x 3/8" MIP x 30"	1/25
G72026	3/8" MIP x 3/8" MIP x 30"	1/25
G72027	1/2" FIP x 1/2" FIP x 30"	1/25
G72028	1/2" FIP x 3/8" FIP x 30"	1/25
G72029	1/2" FIP x 1/2" MIP x 30"	1/25
G72030	1/2" FIP x 3/8" MIP x 30"	1/25
G72031	3/8" FIP x 1/2" MIP x 30"	1/25
G72032	1/2" MIP x 1/2" MIP x 36"	1/25
G72033	1/2" MIP x 3/8" MIP x 36"	1/25
G72034	3/8" MIP x 3/8" MIP x 36"	1/25
G72035	1/2" FIP x 1/2" FIP x 36"	1/25
G72036	1/2" FIP x 3/8" FIP x 36"	1/25
G72037	1/2" FIP x 1/2" MIP x 36"	1/25
G72038	1/2" FIP x 3/8" MIP x 36"	1/25
G72039	3/8" FIP x 1/2" MIP x 36"	1/25
G72040	1/2" MIP x 1/2" MIP x 48"	1/25
G72041	1/2" MIP x 3/8" MIP x 48"	1/25
G72042	3/8" MIP x 3/8" MIP x 48"	1/25
G72043	1/2" FIP x 1/2" FIP x 48"	1/25
G72044	1/2" FIP x 3/8" FIP x 48"	1/25
G72045	1/2" FIP x 1/2" MIP x 48"	1/25

PART NO.	DESCRIPTION	CTN QTY
G72046	1/2" FIP x 3/8" MIP x 48"	1/25
G72047	3/8" FIP x 1/2" MIP x 48"	1/25
G72048	1/2" MIP x 1/2" MIP x 60"	1/25
G72049	1/2" MIP x 3/8" MIP x 60"	1/25
G72050	3/8" MIP x 3/8" MIP x 60"	1/25
G72051	1/2" FIP x 1/2" FIP x 60"	1/25
G72052	1/2" FIP x 3/8" FIP x 60"	1/25
G72053	1/2" FIP x 1/2" MIP x 60"	1/25
G72054	1/2" FIP x 3/8" MIP x 60"	1/25
G72055	3/8" FIP x 1/2" MIP x 60"	1/25
G72056	1/2" MIP x 1/2" MIP x 72"	1/25
G72057	1/2" MIP x 3/8" MIP x 72"	1/25
G72058	3/8" MIP x 3/8" MIP x 72"	1/25
G72059	1/2" FIP x 1/2" FIP x 72"	1/25
G72060	1/2" FIP x 3/8" FIP x 72"	1/25
G72061	1/2" FIP x 1/2" MIP x 72"	1/25
G72062	1/2" FIP x 3/8" MIP x 72"	1/25
G72063	3/8" FIP x 1/2" MIP x 72"	1/25
G72064	1/2" MIP x 3/8" FIP Angle x 36"	1/25
G72065	1/2" MIP x 3/8" FIP Angle x 48"	1/25
G72066	1/2" MIP x 3/8" FIP Angle x 72"	1/25

1/2" OD Coated w/Fittings



B

- Corrugation extends all the way to the fitting for increased tubing flexibility
- CSA Design certified domestically and internationally for indoor and outdoor use
- 100% leak tested to ensure Safety and Quality and a product you can trust
- Quality flared end fittings to create a metal to metal seal in critical applications
- Durable stainless steel 304. Corrosion resistant.
- Coated connectors add additional safety in highly corrosive environments or in areas where caustic chemicals are located

PART NO.	DESCRIPTION	CTN QTY
G72100	1/2" MIP x 1/2" MIP x 12"	1/25
G72101	1/2" MIP x 3/8" MIP x 12"	1/25
G72102	3/8" MIP x 3/8" MIP x 12"	1/25
G72103	1/2" FIP x 1/2" FIP x 12"	1/25
G72104	1/2" FIP x 3/8" FIP x 12"	1/25
G72105	1/2" FIP x 1/2" MIP x 12"	1/25
G72106	1/2" FIP x 3/8" MIP x 12"	1/25
G72107	3/8" FIP x 1/2" MIP x 12"	1/25
G72108	1/2" MIP x 1/2" MIP x 18"	1/25
G72109	1/2" MIP x 3/8" MIP x 18"	1/25
G72110	3/8" MIP x 3/8" MIP x 18"	1/25
G72111	1/2" FIP x 1/2" FIP x 18"	1/25
G72112	1/2" FIP x 3/8" FIP x 18"	1/25
G72113	1/2" FIP x 1/2" MIP x 18"	1/25
G72114	1/2" FIP x 3/8" MIP x 18"	1/25
G72115	3/8" FIP x 1/2" MIP x 18"	1/25
G72116	1/2" MIP x 1/2" MIP x 24"	1/25
G72117	1/2" MIP x 3/8" MIP x 24"	1/25
G72118	3/8" MIP x 3/8" MIP x 24"	1/25
G72119	1/2" FIP x 1/2" FIP x 24"	1/25
G72120	1/2" FIP x 3/8" FIP x 24"	1/25
G72121	1/2" FIP x 1/2" MIP x 24"	1/25
G72122	1/2" FIP x 3/8" MIP x 24"	1/25
G72123	3/8" FIP x 1/2" MIP x 24"	1/25
G72124	1/2" MIP x 1/2" MIP x 30"	1/25
G72125	1/2" MIP x 3/8" MIP x 30"	1/25
G72126	3/8" MIP x 3/8" MIP x 30"	1/25
G72127	1/2" FIP x 1/2" FIP x 30"	1/25
G72128	1/2" FIP x 3/8" FIP x 30"	1/25
G72129	1/2" FIP x 1/2" MIP x 30"	1/25
G72130	1/2" FIP x 3/8" MIP x 30"	1/25
G72131	3/8" FIP x 1/2" MIP x 30"	1/25
G72132	1/2" MIP x 1/2" MIP x 36"	1/25
G72133	1/2" MIP x 3/8" MIP x 36"	1/25
G72134	3/8" MIP x 3/8" MIP x 36"	1/25
G72135	1/2" FIP x 1/2" FIP x 36"	1/25
G72136	1/2" FIP x 3/8" FIP x 36"	1/25
G72137	1/2" FIP x 1/2" MIP x 36"	1/25
G72138	1/2" FIP x 3/8" MIP x 36"	1/25
G72139	3/8" FIP x 1/2" MIP x 36"	1/25
G72140	1/2" MIP x 1/2" MIP x 48"	1/25
G72141	1/2" MIP x 3/8" MIP x 48"	1/25
G72142	3/8" MIP x 3/8" MIP x 48"	1/25
G72143	1/2" FIP x 1/2" FIP x 48"	1/25
G72144	1/2" FIP x 3/8" FIP x 48"	1/25
G72145	1/2" FIP x 1/2" MIP x 48"	1/25

1/2" OD Coated w/Fittings (cont.)



- Corrugation extends all the way to the fitting for increased tubing flexibility
- CSA Design certified domestically and internationally for indoor and outdoor use
- 100% leak tested to ensure Safety and Quality and a product you can trust
- Quality flared end fittings to create a metal to metal seal in critical applications
- Durable stainless steel 304. Corrosion resistant.
- Coated connectors add additional safety in highly corrosive environments or in areas where caustic chemicals are located

PART NO.	DESCRIPTION	CTN QTY
G72146	1/2" FIP x 3/8" MIP x 48"	1/25
G72147	3/8" FIP x 1/2" MIP x 48"	1/25
G72148	1/2" MIP x 1/2" MIP x 60"	1/25
G72149	1/2" MIP x 3/8" MIP x 60"	1/25
G72150	3/8" MIP x 3/8" MIP x 60"	1/25
G72151	1/2" FIP x 1/2" FIP x 60"	1/25
G72152	1/2" FIP x 3/8" FIP x 60"	1/25
G72153	1/2" FIP x 1/2" MIP x 60"	1/25
G72154	1/2" FIP x 3/8" MIP x 60"	1/25
G72155	3/8" FIP x 1/2" MIP x 60"	1/25

1/2" OD Uncoated with Ball Valves



- Corrugation extends all the way to the fitting for increased tubing flexibility
- CSA Design certified domestically and internationally for indoor and outdoor use
- 100% leak tested to ensure Safety and Quality and a product you can trust
- Quality flared end fittings to create a metal to metal seal in critical applications
- Durable stainless steel 304. Corrosion resistant.

PART NO.	DESCRIPTION	CTN QTY
G72200	1/2" MIP x 1/2" FIP Ball x 12"	1/25
G72201	3/8" MIP x 1/2" FIP Ball x 12"	1/25
G72202	1/2" FIP x 1/2" FIP Ball x 12"	1/25
G72203	3/8" FIP x 1/2" FIP Ball x 12"	1/25
G72204	1/2" MIP x 1/2" FIP Ball x 18"	1/25
G72205	3/8" MIP x 1/2" FIP Ball x 18"	1/25
G72206	1/2" FIP x 1/2" FIP Ball x 18"	1/25
G72207	3/8" FIP x 1/2" FIP Ball x 18"	1/25
G72208	1/2" MIP x 1/2" FIP Ball x 24"	1/25
G72209	3/8" MIP x 1/2" FIP Ball x 24"	1/25
G72210	1/2" FIP x 1/2" FIP Ball x 24"	1/25
G72211	3/8" FIP x 1/2" FIP Ball x 24"	1/25
G72212	1/2" MIP x 1/2" FIP Ball x 30"	1/25
G72213	3/8" MIP x 1/2" FIP Ball x 30"	1/25
G72214	1/2" FIP x 1/2" FIP Ball x 30"	1/25
G72215	3/8" FIP x 1/2" FIP Ball x 30"	1/25
G72216	1/2" MIP x 1/2" FIP Ball x 36"	1/25
G72217	3/8" MIP x 1/2" FIP Ball x 36"	1/25
G72218	1/2" FIP x 1/2" FIP Ball x 36"	1/25
G72219	3/8" FIP x 1/2" FIP Ball x 36"	1/25
G72220	1/2" MIP x 1/2" FIP Ball x 48"	1/25
G72221	3/8" MIP x 1/2" FIP Ball x 48"	1/25
G72222	1/2" FIP x 1/2" FIP Ball x 48"	1/25
G72223	3/8" FIP x 1/2" FIP Ball x 48"	1/25
G72224	1/2" MIP x 1/2" FIP Ball x 60"	1/25
G72225	3/8" MIP x 1/2" FIP Ball x 60"	1/25
G72226	1/2" FIP x 1/2" FIP Ball x 60"	1/25
G72227	3/8" FIP x 1/2" FIP Ball x 60"	1/25
G72228	1/2" MIP x 1/2" FIP Ball x 72"	1/25
G72229	3/8" MIP x 1/2" FIP Ball x 72"	1/25
G72230	1/2" FIP x 1/2" FIP Ball x 72"	1/25
G72231	3/8" FIP x 1/2" FIP Ball x 72"	1/25

1/2" OD Coated w/Ball Valves



- Corrugation extends all the way to the fitting for increased tubing flexibility
- CSA Design certified domestically and internationally for indoor and outdoor use
- 100% leak tested to ensure Safety and Quality and a product you can trust
- Quality flared end fittings to create a metal to metal seal in critical applications
- Durable stainless steel 304. Corrosion resistant.
- Coated connectors add additional safety in highly corrosive environments or in areas where caustic chemicals are located

PART NO.	DESCRIPTION	CTN QTY
G72300	1/2" MIP x 1/2" FIP Ball x 12"	1/25
G72302	1/2" FIP x 1/2" FIP Ball x 12"	1/25
G72304	1/2" MIP x 1/2" FIP Ball x 18"	1/25
G72306	1/2" FIP x 1/2" FIP Ball x 18"	1/25
G72308	1/2" MIP x 1/2" FIP Ball x 24"	1/25
G72310	1/2" FIP x 1/2" FIP Ball x 24"	1/25
G72312	1/2" MIP x 1/2" FIP Ball x 30"	1/25
G72314	1/2" FIP x 1/2" FIP Ball x 30"	1/25
G72316	1/2" MIP x 1/2" FIP Ball x 36"	1/25
G72318	1/2" FIP x 1/2" FIP Ball x 36"	1/25
G72320	1/2" MIP x 1/2" FIP Ball x 48"	1/25
G72322	1/2" FIP x 1/2" FIP Ball x 48"	1/25
G72324	1/2" MIP x 1/2" FIP Ball x 60"	1/25
G72326	1/2" FIP x 1/2" FIP Ball x 60"	1/25
G72328	1/2" MIP x 1/2" FIP Ball x 72"	1/25
G72330	1/2" FIP x 1/2" FIP Ball x 72"	1/25
G72332	1/2" MIP x 1/2" FIP Angle Ball x 24"	1/25
G72333	1/2" MIP x 1/2" FIP Angle Ball x 36"	1/25
G72334	1/2" MIP x 1/2" FIP Angle Ball x 48"	1/25
G72335	1/2" MIP x 1/2" FIP Angle Ball x 72"	1/25

1" OD Coated w/Fittings



- Corrugation extends all the way to the fitting for increased tubing flexibility
- CSA Design certified domestically and internationally for indoor and outdoor use
- 100% leak tested to ensure Safety and Quality and a product you can trust
- Quality flared end fittings to create a metal to metal seal in critical applications
- Durable stainless steel 304. Corrosion resistant.
- Coated connectors add additional safety in highly corrosive environments or in areas where caustic chemicals are located

PART NO.	DESCRIPTION	CTN QTY
G71401	3/4" MIP x 3/4" FIP x 18"	1/25
G71402	3/4" MIP x 3/4" FIP x 24"	1/25
G71403	3/4" MIP x 3/4" MIP x 18"	1/25
G71404	3/4" MIP x 3/4" MIP x 24"	1/25

1/2" OD Black Coated

B



- For use with gas logs
- Corrugation extends all the way to the fitting for increased tubing flexibility
- CSA Design certified domestically and internationally for indoor and outdoor use
- 100% leak tested to ensure Safety and Quality and a product you can trust
- Quality flared end fittings to create a metal to metal seal in critical applications
- Durable stainless steel 304. Corrosion resistant.
- Coated connectors add additional safety in highly corrosive environments or in areas where caustic chemicals are located.

PART NO.	DESCRIPTION	CTN QTY
G74103	1/2" FIP x 1/2" FIP x 12"	1/25
G74105	1/2" FIP x 1/2" MIP x 12"	1/25
G74111	1/2" FIP x 1/2" FIP x 18"	1/25
G74113	1/2" FIP x 1/2" MIP x 18"	1/25
G74119	1/2" FIP x 1/2" FIP x 24"	1/25
G74121	1/2" FIP x 1/2" MIP x 24"	1/25
G74127	1/2" FIP x 1/2" FIP x 30"	1/25
G74129	1/2" FIP x 1/2" MIP x 30"	1/25
G74135	1/2" FIP x 1/2" FIP x 36"	1/25
G74137	1/2" FIP x 1/2" MIP x 36"	1/25

3/8" OD Black Coated



- For use with gas logs
- Corrugation extends all the way to the fitting for increased tubing flexibility
- CSA Design certified domestically and internationally for indoor and outdoor use
- 100% leak tested to ensure Safety and Quality and a product you can trust
- Quality flared end fittings to create a metal to metal seal in critical applications
- Durable stainless steel 304. Corrosion resistant.
- Coated connectors add additional safety in highly corrosive environments or in areas where caustic chemicals are located.

PART NO.	DESCRIPTION	CTN QTY
G73101	1/2" FIP x 1/2" FIP x 12"	1/25
G73108	1/2" FIP x 1/2" FIP x 18"	1/25
G73115	1/2" FIP x 1/2" FIP x 24"	1/25
G73122	1/2" FIP x 1/2" FIP x 30"	1/25
G73129	1/2" FIP x 1/2" FIP x 36"	1/25

Nominal Connector Series (I.D. Inches)	Straight Length Capacity - Ptu Per Hr (W) 0.64 Sp Gr.1000 Btu Per Cu Ft (37.2 MJ Per Cu Meter) Gas at @ 0.5 inch Water Column (124 Pa) Pressure Drop		
	12"	24"	36"
1/4	48000	40000	33400
3/8	102000	85000	71000
1/2	180000	150000	125000

NOTE: When using 0.2 inch water column pressure drop, capacity can be determined by multiplying the figures above by 0.632.

SECTION C - MISC. PLUMBING SPECIALTIES

Repair 91-92

Test Caps & Plugs 93-94

Flexible Transition Couplings 95

Dishwasher/Washing Machine Parts 96

Dryer Vents..... 97-98

Tape..... 99

Pipe Sleeving/Sand Cloth 100

Rubber Insulation 101-104

Poly Insulation..... 105-107

Insulation Tools/Dielectric Union..... 108

Water Heater Connectors..... 109

Water Heater Supplies..... 110

Pressure Gauges 111-112

Tubing 113

Stud Guards 114-116

Hooks & Nails..... 117

Pipe Strap/Clamps..... 118

Hanger Tape/Packing..... 119

Lead Supplies/Roofing Repair 120

Service Sink Repair 121

Bolts & Screws 122

Washers/Clamps 123

Conduit Hanger 124

Water Meter Supplies 125

Meter Boxes..... 126-127

Boxes 128



Snap-Ease Access Panel



- Can be painted or wallpapered
- Constructed of high-impact white ABS
- Easily installed to eliminate unsightly drywall repairs
- Provides for future access to plumbing or wiring behind wall
- 5/8" depth

PART NO.	SIZE	CTN/MSTR
A04006	6" x 9"	10/80
A05008	8" x 8"	1/10
A05014	14" x 14"	10/30
A05027	14" x 27"	1/6

Plastic Access Panel



- Beveled edges
- Indented screw holes in corners

PART NO.	SIZE	CTN/MSTR
A04012	12" x 12"	1/20

Stainless Steel Repair Clamp



Two Bolt



One Bolt

- Plated lug, carriage bolt and nuts for corrosion protection
- 301 stainless steel clamp with neoprene gaskets for up to 180°F
- Long neck carriage bolts for easy installation

3" One Bolt			
PART NO.	IPS/SCH 40	CTS NOM	CTN/MSTR
R30375	3/8"	1/2"	6/72
R30050	1/2"	3/4"	6/72
R30075	3/4"	1"	6/72
R30100	1"	1 1/4"	6/72
R30125	1 1/4"	1 1/2"	6/72
R30150	1 1/2"	-	6/72
R30200	2"	-	6/72
R30250	2 1/2"	-	6/48
R30300	3"	-	6/36
R30400	4"	-	6/24
R30600	6"	-	1/36

6" Two Bolt			
PART NO.	IPS/SCH 40	CTS NOM	CTN/MSTR
R60375	3/8"	1/2"	6/36
R60050	1/2"	3/4"	6/36
R60075	3/4"	1"	6/36
R60100	1"	1 1/4"	6/36
R60125	1 1/4"	1 1/2"	6/36
R60150	1 1/2"	-	6/36
R60200	2"	-	6/36
R60250	2 1/2"	-	6/24
R60300	3"	-	6/24
R60400	4"	-	6/24
R60600	6"	-	1/20

Malleable Iron Compression Coupling



- EPDM gaskets
- Metal friction ring
- Maximum 125 PSI at 120°F
- Pipe ends must be restrained
- Fits both IPS and Schedule 40 pipe
- Galvanized for corrosion protection

Long Pattern			
PART NO.	IPS	BODY LENGTH	CTN/MSTR
C11050	1/2"	3 3/8"	1/42
C11075	3/4"	3 5/8"	1/32
C11100	1"	3 7/8"	1/24
C11125	1 1/4"	4 1/8"	1/18
C11150	1 1/2"	4 5/16"	1/15
C11200	2"	4 1/2"	1/12
C11250	2 1/2"	6 3/4"	1/4
C11300	3"	7"	1/4
C11400	4"	8 1/8"	1/2

Bronze Compression Coupling



- EPDM gaskets
- Bronze coated brass bodies and nuts
- Maximum 125 PSI at temperatures up to 180°F
- Pipe ends must be restrained on both ends
- For use on galvanized pipe and copper tubing (check sizes)

3" Length			
PART NO.	CTS	IPS	CTN/MSTR
C14050	1/2"	3/8"	1/120
C14075	3/4"	1/2"	12/120
C14100	1"	3/4"	12/72

LEAD FREE			
PART NO.	CTS	IPS	CTN/MSTR
C14205	1/2"	3/8"	1/120
C14206	3/4"	1/2"	12/72
C14207	1"	3/4"	12/72

5" Length			
PART NO.	CTS	IPS	CTN/MSTR
C15050	1/2"	3/8"	1/96
C15075	3/4"	1/2"	12/72
C15100	1"	3/4"	12/48
C15125	1 1/4"	1"	12/48
C15150	1 1/2"	1 1/4"	12/36
C15151	-	1 1/2"	1/36
C15200	2"	-	1/30
C15201	-	2"	12/24

LEAD FREE			
PART NO.	CTS	IPS	CTN/MSTR
C15300	1/2"	3/8"	1/96
C15301	3/4"	1/2"	12/72
C15302	1"	3/4"	12/48
C15303	1 1/4"	1"	12/48
C15304	1 1/2"	1 1/4"	12/36
C15305	-	1 1/2"	12/36
C15306	2"	-	1/30
C15307	-	2"	12/24

PVC Compression Coupling



- For use on cold water lines only
- Ribbed body and nuts for gripping
- Fits IPS and Schedule 40 pipe
- EPDM gaskets
- 150 PSI at 73°F
- Pipe ends must be restrained

PART NO.	IPS	BODY LENGTH	CTN/MSTR
C12050	1/2"	3 3/4"	30/120
C12075	3/4"	3 15/16"	30/120
C12100	1"	4 3/4"	25/100
C12125	1 1/4"	5 3/16"	25/100
C12150	1 1/2"	5 3/8"	15/60
C12200	2"	6"	6/24
C12250	2 1/2"	7 7/8"	1/15
C12300	3"	8"	1/18
C12400	4"	12"	1/4
C12600	6"	11 1/8"	1/2

PVC Expansion Coupling



- Rated 200 PSI

PART NO.	IPS	BODY LENGTH	CTN/MSTR
E09050	1/2"	5 3/4"	1/160
E09075	3/4"	6 3/4"	1/120
E09100	1"	7 3/4"	1/54
E09125	1 1/4"	9"	1/40
E09150	1 1/2"	10"	1/35
E09200	2"	10 1/2"	1/24
E09250	2 1/2"	13"	1/3
E09300	3"	14 1/2"	1/3
E09400	4"	14 1/2"	1/3

CPVC Compression Coupling



- For use on hot water lines
- 100 PSI at temperatures up to 180°F
- Tubing sizes copper and plastic tubing
- EPDM gaskets
- Ribbed body and nuts for gripping
- Pipe ends must be restrained

PART NO.	TUBING SIZE	CTN/MSTR
C13050	1/2" (5/8" OD)	20/360
C13075	3/4" (7/8" OD)	20/240

Compression Tee

Malleable Iron



- Galvanized for corrosion protection
- Metal friction ring
- Compression tees must be restrained on both ends
- Fits both IPS and Schedule 40 pipe
- EPDM gaskets
- FIP branch
- 125 PSI at 120°F

PART NO.	SIZE	CTN/MSTR
C16050	1/2"	1/12
C16075	3/4"	1/12

Compression Tee

Bronze



- FIP branch
- EPDM gaskets
- Pipe ends must be restrained
- Bronze coated brass bodies and nuts
- Maximum 125 PSI at temperatures up to 180°F
- For use on galvanized pipe and copper tubing (check sizes)

PART NO.	CTS	IPS	BRANCH	CTN/MSTR
C19050	1/2"	3/8"	1/2" FIP	1/12
C19051	3/4"	1/2"	1/2" FIP	1/96
C19075	3/4"	1/2"	3/4" FIP	1/12

Compression Tee

PVC



- For use on cold water lines only
- Ribbed body and nuts for gripping
- Fits both IPS and Schedule 40 pipe
- EPDM gaskets
- 150 PSI at 73°F
- Threaded branch

PART NO.	SIZE	CTN/MSTR
C17050	1/2"	1/25
C17075	3/4"	24/120
C17100	1"	15/60
C17125	1 1/4"	1/40
C17150	1 1/2"	1/20
C17200	2"	1/20

Economy Test Plug



- Molded rubber gasket
- Galvanized steel flanges
- Fits cast iron and plastic pipe

PART NO.	PIPE SIZE	CTN/MSTR
T31001	1 1/2"	24/192
T31002	2"	24/96
T31003	3"	24/48
T31004	4"	24/48
T31006	6"	4/16
T31000	Replacement wing nut	1/10

Combination Test Plug



Raised Head



Countersunk

- Test up to three floors at once
- Combination test plug and cleanout
- Fits Schedule 40 DWV pipe
- Positive sealing
- No metal parts to rust

Raised Head		
PART NO.	PIPE SIZE	CTN/MSTR
T34001	1 1/2"	1/392
T34002	2"	1/288
T34003	3"	1/200
T34004	4"	1/128
T34006	6"	1/54
T34008	8"	1/24
Countersunk		
PART NO.	PIPE SIZE	CTN/MSTR
T34012	2"	1/288
T34013	3"	1/200
T34014	4"	1/128

T-Cone Cleanout Repair Plugs



- Easily repairs damaged or corroded metal or plastic cleanout threads

PART NO.	PIPE SIZE	THREAD ID	CTN/MSTR
T34150	1 1/2"	1.780	1/50
T34200	2"	2.255	1/50
T34300	3"	3.375	1/50
T34350	3 1/2"	3.900	1/50
T34400	4"	4.336	1/50

"Plum-Tite" Mechanical Test Plugs



- Neoprene gasket
- Extra large wingnut
- Rust and corrosion proof
- High density plastic construction

PART NO.	SIZE	CTN/MSTR
T37001	1 1/2"	10/200
T37002	2"	10/150
T37003	3"	10/40
T37004	4"	10/40
T37006	6"	5/20
T37008	8"	5/10

Cast Iron Test Plug



- Maximum 10 PSI
- To test cast iron soil pipe drainage systems
- Cold water ONLY

PART NO.	PIPE SIZE	CTN QTY
T39002	2"	1
T39003	3"	1
T39004	4"	1
T39006	6"	1
T39008	8"	1
T39010	10"	1
T39012	12"	1

Flexible PVC Test Cap



- Reinforced top
- 5/16" hex screw with screwdriver slot
- Fits both cast iron and plastic pipe

PART NO.	PIPE SIZE	CTN/MSTR
T32001	1 1/2"	24/288
T32002	2"	24/288
T32003	3"	24/144
T32004	4"	1/50
T32006	6"	1/24
T32008	8"	1/16
T32011	1 1/2"	1/200
T32022	2"	1/100
T32033	3"	1/50
T32044	4"	1/50

PVC Dual Fit Test Cap



- Each cap fits two sizes of Schedule 40 pipe
- CARTON QUANTITIES ONLY

PART NO.	PIPE SIZE	CTN QTY
T33152	1 1/2" and 2"	100
T33304	3" and 4"	50

Slip-On Plastic Cap



- DWV protection cap in various colors
- Protects from debris during construction

PART NO.	SIZE	CTN/MSTR
T36150	1 1/2"	300
T36200	2"	200
T36300	3"	75
T36400	4"	1/45
T36600	6"	1/25

Techno Test Plug Cap



- Heavy duty PVC, high pressure tested over six stories
- Easily solvent cemented over end of DWV pipe
- Will not clog or go down pipe
- CARTON QUANTITIES ONLY

PART NO.	DESCRIPTION	CTN QTY
T35001	1 1/2" DWV	100
T35002	2" DWV	100
T35003	3" DWV	50
T35004	4" DWV	25

PVC Test Cap



- Easily solvent cemented over end of DWV pipe
- CARTON QUANTITIES ONLY

PART NO.	DESCRIPTION	CTN/MSTR
T35201	1 1/2" PVC Test Cap	100/1000
T35202	2" PVC Test Cap	100/1000
T35203	3" PVC Test Cap	50/250
T35204	4" PVC Test Cap	25/250
T35206	6" PVC Test Cap	1/100

Knockout Test Cap



- For use in plastic waste and drain pipe
- Disposable
- CARTON QUANTITIES ONLY

PART NO.	PIPE SIZE	CTN/MSTR
T33001	1 1/2"	100/5000
T33002	2"	100/1900
T33003	3"	50
T33004	4"	50/3600

Pneumatic Test Plug



- Manufactured in the USA
- All units smaller than 8" are supplied with chain and ring
- All units 8" or larger are supplied with a removable eye bolt
- For use with cast iron, PVC, ABS, copper, clay and concrete pipe

MADE IN THE
USA

Regular					
PART NO.	NOM. PIPE SIZE	MAX AIR PRESSURE	MAX TEST PRESSURE	MAX HEAD	CTN/MSTR
T45150	1 1/4"-1 1/2"	40 PSI	5 PSI	30'	1/6
T45200	2"	40 PSI	5 PSI	30'	1/6
T45300	3"	35 PSI	5 PSI	30'	1/6
T45400	4"	30 PSI	5 PSI	30'	1/4
T45600	6"	25 PSI	5 PSI	30'	1
T45800	8"	25 PSI	15 PSI	40'	1
T45010	10"	25 PSI	15 PSI	40'	1
T45012	12"	25 PSI	15 PSI	40'	1

Long					
PART NO.	NOM. PIPE SIZE	MAX AIR PRESSURE	MAX TEST PRESSURE	MAX HEAD	CTN QTY
T46200	2"	45 PSI	5 PSI	30'	1
T46300	3"	35 PSI	5 PSI	30'	1
T46400	4"	30 PSI	5 PSI	30'	1

Pneumatic-Hydraulic Test Plug



- Uses either water or air
- Temperature range 30° - 200°F
- User safe; cannot be overinflated
- Individually tested for 24 hours to insure proper operation
- Using water, stack can be filled and plugged from same position

MADE IN THE
USA

PART NO.	PIPE SIZE	MFG PART NO.	CTN/MSTR
T30002	1 1/4"-2"	WATP 2	1/6
T30034	3"-4"	WATP 3-4	1/10
T30046	4"-6"	WATP 4-6	1
T30068	5"-8"	WATP 6-8	1
T30102	10"-12"	WATP 10-12	1

Two Stage Long Test Plug



- Two stage deflation allows access pipe to remain sealed while water clears drain line

PART NO.	PIPE SIZE	MFG PART NO.	CTN QTY
T30203	2"-3"	DDO203	1
T30304	3"-4"	DDO304	1

Inflatable Tee Plug



- Threads directly into test tee
- Threads into both CI and plastic pipe
- Body is high quality natural rubber
- Top is made from high impact ABS plastic

PART NO.	DESCRIPTION	CTN/MSTR
T33200	2" Inflatable Tee Plug	6/36
T33300	3" Inflatable Tee Plug	1/6
T33400	4" Inflatable Tee Plug	1/6

Drain King®



- Insert in drain line opening
- Turn water on
- Automatically seals drain and powerful water pulses loosen and clear drain

PART NO.	PIPE SIZE	DK NO.	CTN/MSTR
D18501	1"-2"	D501	1/12
D18186	1 1/2"-3"	D186	12/144
D18034	3"-4"	H34	1/6
D18750	3"-6"	D750	1/6
D18850	6"-10"	D850	1
D18560	1"-2" with drain adapter	H560	1/5
D18340	1 1/2"-3" with 10" hose and faucet adapter	PE60	1/12
D18060	Drain Adapter	PE60	1/12

Plumbjet



- Attaches to garden hose
- All natural
- Environmentally safe

PART NO.	PIPE SIZE	DK NO.	CTN/MSTR
D18400	1"-2"	D501	10/60
D18401	1 1/2"-3"	D186	10/60
D18402	4"-6"	H34	10/40

Extension Hose



- For pneumatic test plug
- Can be used in tandem

PART NO.	SIZE	CTN QTY
T45002	2'	1
T45003	3'	1

Force Cup Plunger



- Supplied with handle
- Highest quality rubber plungers

PART NO.	DESCRIPTION	CTN QTY
D18001	5 1/2" diameter (red rubber)	12
D18002	6" professional style (black rubber)	12

Professional Force Cup Display



Cloghopper Display

- Supplied with handle
- Highest quality rubber plungers
- Attractive point of purchase display
- Display box contains 30 rubber plungers
- CARTON QUANTITIES ONLY

PART NO.	DESCRIPTION	CTN QTY
D18000	Rubber plungers and display box	30

Flexible PVC Saddle Fitting



Tee Pattern



Wye Pattern

- Provided with stainless steel clamp on inlet
- Includes stainless steel clamps on saddle to fit up to 12" clay pipe
- Extension clamps may be used for larger pipe sizes

Tee Pattern		
PART NO.	DESCRIPTION	CTN/MSTR
S26001	4" plastic-12" clay saddle x 4" Sch.40 Cl or SDR35 inlet	1
S26002	4" plastic - 6" clay saddle x 4" Sch.40 Cl or SDR35 inlet	1
S26003	4" saddle blanket	1/6

Wye Pattern		
PART NO.	DESCRIPTION	CTN QTY
S27001	4" plastic - 12" clay saddle x 4" Sch. 40 cast iron or SDR35 inlet	1
S27002	4" plastic - 6" clay saddle x 4" Sch. 40 cast iron or SDR35 inlet	1

Replacement Clamp		
PART NO.	DESCRIPTION	CTN/MSTR
S26100	4"-12" gear clamp	1/100

Flexible Trap Drain Connector



PART NO.	DESCRIPTION	CTN/MSTR
T06001	Connects 1 1/4"-1 1/2" tubular to 1 1/4"-1 1/2" tubular	1/180
T06002	Connects 1" DWV or 1 1/2" CTS to 1 1/4"-1 1/2" tubular	1/100
T06003	Connects 1 1/2" DWV or CTS to 1 1/4"-1 1/2" tubular	1/100
T06004	Connects 2" DWV to 1 1/4"-1 1/2" tubular	1/100

Flexible Transition Coupling



T06320



T06400

- EPDM rubber
- UPC listed
- For use on PVC, DWV and CI pipe
- Stainless steel clamps and housing

PART NO.	DESCRIPTION	CTN/MSTR
T06025	1 1/4" PL + CI to PL + CI	1/300
T06050	1 1/2" PL + CI to PL + CI	1/150
T06200	2" PL + CI to PL + CI	1/105
T06250	2" x 1 1/2" PL + CI to PL + CI	1/105
T06300	3" PL + CI to PL + CI	1/60
T06320	3" x 2" PL + CI to PL + CI	1/80
T06400	4" PL + CI to PL + CI	1/36
T06430	4" x 3" PL + CI to PL + CI	1/44
T06600	6" PL + CI to PL + CI	1/12
T06640	6" x 4" PL + CI to PL + CI	1/15
T06800	8" PL + CI to PL + CI	1/6

Bore O-Ring



PART NO.	DESCRIPTION	CTN/MSTR
B12640	6" bore x 4" plastic or cast iron	1/60

Qwik Tee



PART NO.	DESCRIPTION	CTN/MSTR
T07150	1 1/2" x 1 1/2" x 1 1/2" tee	1/50
T07200	2" x 2" x 2" tee	1/20
T07300	3" x 3" x 3" tee	1/20
T07400	4" x 4" x 4" tee	1/6

Qwik Elbow



PART NO.	DESCRIPTION	CTN/MSTR
E10150	1 1/2" x 1 1/2" elbow	1/50
E10200	2" x 2" elbow	1/20
E10300	3" x 3" elbow	1/20
E10400	4" x 4" elbow	1/6

Bushing for Qwik Tees and Qwik Elbows



PART NO.	DESCRIPTION	CTN/MSTR
B12210	2" x 1 1/2" bushing	1/24
B12320	3" x 2" bushing	1/24
B12430	4" x 3" bushing	1/24

Hose Grip Clothes Washer Connector



- Fits 1 1/2" or 2" standpipe
- Fits 1" - 1 7/16" drain hose
- Securely holds drain hose in standpipe

PART NO.	DESCRIPTION	CTN/MSTR
D08001	Drain hose connector	1/100

Flexible Drain Trap



PART NO.	DESCRIPTION	CTN QTY
J01001	1 1/4" or 1 1/2" tubular trap j-bend	1/20

Washing Machine Boxes with Valves



- Long shank MIP valve
- White box with valve installed
- Combo 1 1/2" or 2" drain
- CARTON QUANTITIES ONLY

B05900

B05901

PART NO.	DESCRIPTION	CTN/MSTR
B05900	Offset drain	1/10
B05901	Center drain	1/10

Washing Machine Boxes with Hammer Arrester



B05920

B05921

B05922



B05923

B05924

- 1/4 Turn valves or lever handle mixer valve

Dual Drain

PART NO.	DESCRIPTION	CTN/MSTR
B05920	1/4 Turn valve with Solder connection	1/10
B05921	1/4 Turn valve with CPVC connection	1/10
B05922	Single lever handle with Solder connection	1/10

Center Drain

PART NO.	DESCRIPTION	CTN/MSTR
B05923	1/4 Turn valve with Solder connection	1/10
B05924	1/4 Turn valve with CPVC connection	1/10

Replacement Frame

PART NO.	DESCRIPTION	CTN/MSTR
B05927	Replacement Frame for Washer Box	1/10
B05928	Replacement Frame for Icemaker Box	1/10

Icemaker Boxes with Hammer Arrester



B05925



B05926

- 1/4 Turn valve

PART NO.	DESCRIPTION	CTN/MSTR
B05925	Icemaker box with Solder connection	1/10
B05926	Icemaker box with CPVC connection	1/10

Icemaker Boxes with Valves



- White box with valve installed
- CARTON QUANTITIES ONLY

PART NO.	DESCRIPTION	CTN/MSTR
B05910	Icemaker box with brass valve	1/10
B05911	Icemaker box with Flowguard all CPVC icemaker valve	1/10

Dishwasher Hose

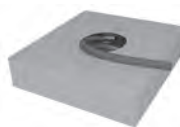

- IAPMO/UPC listed; meets ANSI, AHAM-DWI specifications
- 5/8" connects dishwasher pump to airgap inlet or dishwasher tailpiece
- 7/8" connects airgap outlet to branch tailpiece or disposal
- EPDM material with single spiral reinforcement
- Resists kinking
- Marked per foot
- -40°F to +180°F

PART NO.	SIZE	WP	BURST PRESSURE	CTN QTY
D10625	5/8" ID x 50'	90	200	1
D10875	7/8" ID x 50'	70	100	1

Dishwasher Drain Connector



- Includes two worm gear clamps

PART NO.	DESCRIPTION	CTN/MSTR
D10001	Universal connector	50/200

Washing Machine Hose



Straight Female



With 90° Elbow

- For hot or cold use
- Bagged with washers
- Standard female hose threads
- Bursting pressure 800 lbs. per sq. inch
- 3/8" ID

With 90° Elbow

PART NO.	LENGTH	CTN/MSTR
J04104	4'	1/12
J04105	5'	1/12
J04106	6'	1/12

Straight Female

PART NO.	LENGTH	CTN/MSTR
J04004	4'	1/12
J04005	5'	1/12
J04006	6'	1/12

Washing Machine Hose



- Industrial quality
- 1/2" ID EPDM rubber for hot and cold use
- Polyester yarn reinforcement
- 3/4" female hose ends
- Temp. rating -40°F to +190°F
- Stamped brass ends and crimps
- 200 PSI working pressure
- Bagged with washers

PART NO.	LENGTH	CTN/MSTR
J04204	4'	1/12
J04205	5'	1/12
J04206	6'	1/12

Mixer Hose



- High pressure hose; 12" arms
- Individually bagged

PART NO.	DESCRIPTION	CTN/MSTR
J04012	Mixer	1/12

Fit-All Drain Hose for Washing Machine



- Individually bagged
- 3 size step down 3/4", 7/8" and 1" for drain lines

PART NO.	SIZE	CTN/MSTR
J04016	5'	1/12

Washing Machine Drain Hose



PART NO.	SIZE	CTN QTY
D10900	1" x 50' roll	1

Washing Machine Pan



- 2 1/2" deep heavy gauge plastic pan
- CARTON QUANTITIES ONLY

PART NO.	DESCRIPTION	CTN/MSTR
J04250	29" x 31" with side mount drain	1/5

Dryer Vent Hood



- PVC hood
- Weather proof 12" aluminum extension
- Pre-punched mounting holes
- CARTON QUANTITIES ONLY

PART NO.	SIZE	CTN/MSTR
D04012	4"	1/12

Aluminum Vent Hood



- For clothes dryers or exhaust fans
- Complete with damper and flange plate

PART NO.	SIZE	CTN/MSTR
D04023	3"	1/12
D04024	4"	1/12

Louvered Dryer Vent Hood



- Includes hood, aluminum pipe and collar

PART NO.	DESCRIPTION	CTN/MSTR
D04025	4" white hood assembly	1/12
D04026	4" brown hood assembly	1/12

White Back Collar for Dryer Vent Kits



PART NO.	DESCRIPTION	CTN/MSTR
D04064	White back collar	1/6

Complete Dryer Vent Kit



- Kit includes hose (5' or 8'), vent and 2 plastic clamps
- Hood is waterproof plastic
- 5 3/4" square back plate
- 12" aluminum extension, pre-punched mounting holes

PART NO.	DESCRIPTION	CTN/MSTR
D04005	4" x 5'	1/10
D04008	4" x 8'	1/10
D04009	4" x 8' flex aluminum duct with louvered hood and two metal clamps	1/6

Clamp for Dryer Vent Kit



PART NO.	DESCRIPTION	CTN/MSTR
D04010	4" clamp only	1/10

Metal Clamp for Dryer Vent



- Heavy duty all metal design
- Excellent for use with metal ducting

PART NO.	SIZE	CTN/MSTR
D04015	3"	1/12
D04016	4"	1/12
D04017	5"	1/12
D04018	6"	1/12

Aluminum Elbow and Pipe



- All aluminum

PART NO.	DESCRIPTION	CTN/MSTR
D04013	3" x 90° swivel elbow	1/12
D04014	3" x 24" aluminum pipe	1/25
D04027	4" x 90° swivel elbow	1/12
D04028	4" x 24" aluminum pipe	1/25

Flexible Duct Connector Kit



- Connects flexible ducting
- Extends exhaust collar of clothes dryer

PART NO.	SIZE	CTN/MSTR
D04019	4"	1/6

Increaser/Decreaser



- Connects 3" to 4" ducting or 4" ducting to 3" exhaust collar

PART NO.	DESCRIPTION	CTN/MSTR
D04021	3"-4" plastic increaser/decreaser	1/6
D04022	4"-3" aluminum reducer	1/6
D04055	3"-4" aluminum increaser	1/6

Flexible Aluminum Ducting



- Ideal for exhausting clothes dryers
- Bendable to any configuration
- No fire or UL ratings

PART NO.	SIZE	CTN/MSTR
D04031	3" x 8'	1/14
D04032	4" x 8'	1/9
D04033	5" x 8'	1/6
D04034	6" x 8'	1/3
D04053	3" x 25'	1/10
D04054	4" x 25'	1/6

Proflex Aluminum Foil Ducting



- Flexible, fire resistant
- Will not support combustion
- Wire reinforced
- UL listed

PART NO.	SIZE	CTN/MSTR
D04058	4" x 5'	1/12
D04059	4" x 8'	1/12
D04060	4" x 50'	1

Flexible Aluminum Foil Ducting



- Ideal for exhausting clothes dryers and bathroom fans
- Will not support combustion
- No fire or UL ratings

PART NO.	SIZE	CTN/MSTR
D04056	4" x 25'	1
D04057	4" x 8'	1/12

Dryer Vent Hose



- Wire-reinforced vinyl

PART NO.	DESCRIPTION	CTN/MSTR
D04020	4" x 20' (boxed)	1/5
D04051	4" x 5' (bagged)	1/12

Dryer Vent Kit w/Louvered Hood



- Includes vinyl hose, aluminum pipe, collar, clamps and louvered hood

PART NO.	DESCRIPTION	CTN/MSTR
D04001	4" x 5' with white hood	1/10
D04002	4" x 5' with brown hood	1/10
D04003	4" x 8' with white hood	1/10
D04004	4" x 8' with brown hood	1/10

Bathroom Fan Vent Kit



- Contains the following part for 3" and 4" wall type exhaust fans: 4" x 5' flexible vinyl ducting, clamps, 4" louvered vent, 3"-4" foam increaser

PART NO.	DESCRIPTION	CTN/MSTR
D04035	Bathroom fan vent kit	1/10
D04050	4" x 50' (boxed)-vinyl hose only	1
D04062	3" x 50' (boxed)-vinyl hose only	1

Indoor Dryer Vent Kit



- Use on electric clothes dryers when outside venting is not possible
- Recirculates warm, moist air
- Specially designed lint reservoir

PART NO.	DESCRIPTION	CTN/MSTR
D04036	Indoor dryer vent kit	1/6

Domestic Pipe Wrap Tape



• CARTON QUANTITIES ONLY

Yellow			
PART NO.	SIZE	THICKNESS	CTN QTY
T16002	2" x 100'	12 mil.	24
T16004	4" x 100'	12 mil.	12
Black			
PART NO.	SIZE	THICKNESS	CTN QTY
T17002	2" x 100'	12 mil.	24
T17004	4" x 100'	12 mil.	12

Imported Pipe Wrap Tape



• UPC listed black tape with PVC backing
• CARTON QUANTITIES ONLY

PART NO.	SIZE	THICKNESS	CTN QTY
T17101	1" x 100'	10 mil.	48
T17102	2" x 100'	10 mil.	24
T17104	4" x 100'	10 mil.	12
T18201	1" x 100'	20 mil.	48
T18202	2" x 100'	20 mil.	24

Primer for Pipe Wrap Tape



• Maximizes tape performance
• Final step in preparing steel surfaces for taping
• Can more than double adhesion of corrosion tapes to cleaned steel
• CARTON QUANTITIES ONLY
• MOTOR FREIGHT ONLY / FLAMMABLE

PART NO.	SIZE	CTN QTY
T16100	Quart	12

Electrical Tape



• UL listed
• Individually wrapped
• Black vinyl
• CARTON QUANTITIES ONLY

PART NO.	SIZE	CTN/MSTR
T20030	3/4" x 60'	10/250

Slic-tite® High Density Thread Sealants



• Thickness 4 mils
• Provides a highly resistant seal on pipe threads for all types of service
• Non-toxic
• Permits easy disassembly, even after years of service
• Meets Mil. Spec T-27730A
• Sealing temperature: -450°F to 550°F (-268°C to 288°C)
• Pressures: to 2,000 PSI (136 BAR)



PART NO.	SIZE	CTN/MSTR
T19118	1/2" x 600"	12/36
T19119	3/4" x 600"	12/72

PTFE Thread Seal Tape



• Temperature range is 500°F to +650°F
• Withstands pressure up to 5000 PSI
• Meets U.S. government military specification MIL-T27730A
• Thickness 3 mil. plus

PART NO.	SIZE	CTN/MSTR
T19122	1/2" x 260"	100/500
T19125	1/2" x 520"	50/350
T19342	3/4" x 260"	50/350
T19345	3/4" x 520"	50/350

Thread Seal Tape Jar Display



• Meets U.S. MILSPEC T27730A
• Withstands pressure up to 5000 PSI
• Temperatures to +650°F
• Thickness 3 mil. plus

PART NO.	DESCRIPTION	CTN QTY
CJ1002	1/2" x 260" Teflon Tape	1

PTFE Yellow Gas Line Thread Seal Tape



• Temperature range is -450°F to +500°F
• Withstands pressure up to 5000 PSI
• Meets U.S. government military specification MIL-T27730A
• 0035 mil
• UL listed

PART NO.	SIZE	CTN/MSTR
T19222	1/2" x 260"	100/500

Duct Tape



• Premium grade, waterproof non-elastic reinforced cloth
• Pressure sensitive; vapor and flame resistant
• CARTON QUANTITIES ONLY

PART NO.	SIZE	THICKNESS	CTN QTY
T20020	2" x 60 yds (gray)	8.5 mil.	24
T20023	2" x 60 yds (black)	10 mil.	24

Box Sealing Tape



PART NO.	DESCRIPTION	CTN/MSTR
T20040	2" x 55 yds	36
T20041	2" x 110 yds	36
T20050	Dispenser	1/24

Self-Fusing Tape



TOMMY TAPE®



• Silicone all purpose repair tape
• Water-tight seal for automotive, electrical, marine, plumbing and general-purpose applications
• Carded

PART NO.	DESCRIPTION	CTN/MSTR
T20200	20 mil x 1 x 16 self-fusing tape	1/100

Stretch Wrap

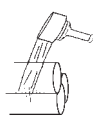

- Use instead of tape to bind packages or parts
- Protects products from dirt and moisture
- Can be used on palletted shipments or small orders
- Great for wrapping lengths of pipe
- **CARTON QUANTITIES ONLY**



PART NO.	SIZE	GAUGE	ROLLS/CTN
S51120	3" x 700'	120	18
S51080	3" x 1000'	80	18

Stretch Wrap Film and Dispenser



- Secures packages to pallets
- Reduces lost packages
- Retards moisture
- Lowers handling costs
- Wrapping is priced per carton - no broken cartons

PART NO.	DESCRIPTION	CTN QTY
S51001	80 gauge wrap 18" x 1500'	1
S51002	Hand dispenser	1

Pipe Sleeving



- Underground sleeving protects against lime reaction in concrete
- Allows expansion and contraction of pipe, minimizing stress
- Individually boxed; color-coded (red for hot, blue for cold)
- UPC approved and IAPMO listed

PART NO.	PIPE SIZE	THICKNESS	COLOR	LENGTH	CTN/MSTR
S22001	1/2"-1"	6 mil	Red	200'	1/20
S22002	1/2"-1"	6 mil	Blue	200'	1/20
S22003	1/2"-1"	10 mil	Red	100'	1/20
S22004	1/2"-1"	10 mil	Blue	100'	1/20
S22005	1/2"-1"	25 mil	Red	100'	1/20
S22006	1/2"-1"	25 mil	Blue	100'	1/20

Water Resistant Sand Cloth



- Dispenser box
- Water resistant aluminum oxide
- 120 grit abrasive cloth for cleaning pipe and fittings

PART NO.	SIZE	CTN/MSTR
C25000	1 1/2" x 2 yds	1/50
C25001	1 1/2" x 5 yds	1/50
C25002	1 1/2" x 10 yds	1/50
C25003	1 1/2" x 25 yds	1/25

Open Mesh



- Dispenser box
- 100% waterproof
- Polyester on both sides
- 180 grit with large holes for aggressive sanding
- Can be exposed to water and solvents indefinitely without breakdown

PART NO.	SIZE	CTN/MSTR
C25010	1 1/2" x 5 yds	1/50
C25011	1 1/2" x 10 yds	1/50

Flexible Open Mesh



- Dispenser box
- 100% waterproof
- Polyester on both sides
- 180 grit
- Smaller holes for finer sanding

PART NO.	SIZE	CTN/MSTR
C25012	1 1/2" x 5 yds	1/50
C25013	1 1/2" x 10 yds	1/50

Waterproof Aluminum Oxide



- Dispenser box
- 100% waterproof
- Wet cut
- 120 grit

PART NO.	SIZE	CTN/MSTR
C25020	1 1/2" x 5 yds	1/50
C25021	1 1/2" x 10 yds	1/50
C25022	1 1/2" x 25 yds	1/25

SEAMLESS RUBBER

Pipe Insulation

Flexible Closed Cell Insulation

C



DESCRIPTION

Seamless Rubber Pipe Insulation is an environmentally friendly, CFC-free, flexible elastomeric thermal insulation.

APPLICATIONS

Seamless Rubber Pipe Insulation is used to retard heat gain and prevent condensation or frost formation on refrigerant lines, cold water plumbing, and chilled water systems. It also retards heat flow for hot water plumbing, liquid heating, dual temperature piping, and many solar systems.

Seamless Rubber is recommended for applications ranging from -70°F to 220° F (-57° C to 104° C). The expanded closed cell structure makes Seamless Rubber an efficient insulator and an effective moisture vapor retarder.

Due to its unique microwave curing process, Seamless Rubber has a very tough skin which withstands tearing, rough handling, and severe environmental conditions, and yet is quite flexible for easy installation.

Seamless Rubber has superior cold weather flexibility.

INSTALLATION

With a factory-applied coating of talc on the smooth inner surface, Seamless Rubber slides easily over pipe or tubing for quick installation. When applied to existing lines, tubing is slit lengthwise and snapped into place. (Slitting can be done on the job with a sharp knife. All seams and butt joints should be sealed with Seamless Rubber Contact Adhesive, making sure both surfaces to be joined are coated with adhesive.

OUTDOOR APPLICATIONS

Outdoor applications require UV Protective Coating. For best appearance, two coats are recommended.

UNDERGROUND

For buried lines above the water table, use a clean fill such as sand (3"-5" layer) to protect Seamless Rubber before backfilling. It is recommended that materials to be buried are properly sealed at all seams and butt joints with Contact Adhesive. For optimum performance, the lines should be encased in a conduit to protect them from problems associated with ground water.

RESISTANCE TO MOISTURE VAPOR FLOW

The closed-cell structure of Seamless Rubber effectively retards the flow of moisture vapor, and is considered a low transmittance vapor retarder. For most applications, Seamless Rubber needs no additional protection. Additional vapor barrier protection may be necessary for Seamless Rubber when

installed on low temperature surfaces or where it is exposed to continuous high humidity.

FLAME AND SMOKE RATING

Seamless Rubber Pipe Insulation in wall thicknesses of 1" (25 mm) and below has a flame spread rating of 25 or less and a smoke development rating of 50 or less as tested by ASTM E 84 Method of Testing entitled: "Surface Burning Characteristics of Building Materials."

Numerical flammability ratings alone may not define the performance of products under actual fire conditions. They are provided only for us in the selection of products to meet limits specified, when compared to a known standard.

SPECIFICATION COMPLIANCE

ASTM C 534 Type 1 (Tubing)
ASTM D 1056-91-2C1
MEA 186-86-M Vol. IV (New York City)
USDA Requirements

UL 94-5V Flammability Classification (Recognition No. E55475)
Complies with requirements of CAN/ULC S102-M88
ASTM E 84 1" 25/50-tested according to UL 723 and NFPA 255

Meets requirements of NFPA 90A Sect. 2.3.3 for Supplementary Materials for Air Distribution Systems

NFPA No. 101 Class A Rating
Meets requirements of UL 181 sections 11.0 and 16.0

MIL-P-15280, For T (Tubing)

PHYSICAL PROPERTIES		SEAMLESS RUBBER INSULATION	TEST METHODS
Thermal Conductivity (K)	90° F (32° C) Mean Temp	.282 (.041)	ASTM C 177
BTU -in/hr-Ft2 - °F (W/mK)	75° F (24° C) Mean Temp	.277 (.040)	ASTM C 177
	50° F (10° C) Mean Temp	.270 (.039)	ASTM C 177
Operating Temperature Range	Upper	200° F (104° C)	
Flexible to -100° F (-73° C)	Lower	-70° F (-57° C)	
Water Vapor Permeability Dry Cup. Perm-In		.10	ASTM E 96
Water Absorption % weight gain		5%	ASTM D 1056
Ozone Resistant		Pass	ASTM D 1171
Chemical/Solvent Resistance		Good	
Mildew Resistance/Air Erosion		Pass	UL 181

THICKNESS RECOMMENDATIONS* - TO CONTROL CONDENSATION								
PIPE SIZE	LINE TEMP		LINE TEMP		LINE TEMP		LINE TEMP	
	50° F	10° C	35° F	2° C	0° F	-18° C	-20° F	-29° C
Normal Conditions (Max 85°F, 29°C - 70% R.H.)								
3/8" ID thru 1 3/8" ID	3/8"	10 mm	1/2"	13 mm	3/4"	19 mm	1"	25 mm
Over 1 3/8" thru 3" IPS	3/8"	10 mm	1/2"	13 mm	1"	25 mm	1"	25 mm
Over 3" IPS thru 4" IPS**	1/2"	13 mm	1/2"	13 mm	1"	25 mm	1 1/4"	32 mm
Over 4" IPS	1/2"	13 mm	3/4"	19 mm	1"	25 mm	1 1/4"	32 mm
Mild Conditions (Max 80°F, 26°C - 50% R.H.)								
3/8" ID thru 2 1/8" ID	3/8"	10 mm	3/8"	10 mm	1/2"	13 mm	1/2"	13 mm
Over 2 1/8" thru 3" IPS	3/8"	10 mm	3/8"	10 mm	1/2"	13 mm	3/4"	19 mm
Over 3" IPS thru 4" IPS**	1/2"	13 mm	1/2"	13 mm	3/4"	19 mm	3/4"	19 mm
Over 4" IPS	1/2"	13 mm	1/2"	13 mm	3/4"	19 mm	3/4"	19 mm
Severe Conditions (Max 90°F, 32°C - 80% R.H.)								
3/8" ID thru 1 1/8" ID	3/4"	19 mm	3/4"	19 mm	1 1/4"	32 mm	1 1/4"	32 mm
Over 1 1/8" ID thru 4" IPS	3/4"	19 mm	1"	25 mm	1 1/2"	38 mm	1 1/2"	38 mm
Over 4" IPS	3/4"	19 mm	1 1/4"	32 mm	1 3/4"	44 mm	2"	50 mm

Seamless Rubber in thickness notes within the specified temperature ranges will prevent condensation on indoor piping under design conditions defined below. Thickness recommendations above 1" can be sleeved to achieve thickness desired.

Normal: Maximum severity of indoor conditions seldom exceed 85° F (29° C) and 70% R.H. in United States.

Mild: Typical conditions are most air-conditioned spaces and arid climates.

Severe: Generally found in areas which excessive moisture is introduced or in poorly ventilated areas where the temperature may be depressed below the ambient.

Under conditions of high humidity, additional thickness of insulation may be required.

**Available: Nom. 1/2" or Nom. 3/4" thickness only

SEAMLESS RUBBER "R" VALUES PER SQUARE FOOT					
Pipe OD or Nominal Insulation ID		R Value 3/8" (10 mm) Wall	R Value 1/2" (13 mm) Wall	R Value 3/4" (19 mm) Wall	R Value 1" (25 mm) Wall
3/8"	10 mm	2.3	3.1	4.7	-
1/2"	13 mm	2.2	2.9	4.7	7.6
5/8"	16 mm	2.1	2.7	4.6	7.1
3/4"	19 mm	2.0	2.6	4.6	6.7
7/8"	22 mm	1.9	2.7	4.6	6.5
1 1/8"	29 mm	1.8	2.6	4.6	5.1
1 3/8"	35 mm	1.8	2.7	4.4	5.8
1 1/2" IPS	-	2.0	2.6	4.3	5.5
1 5/8"	41 mm	2.1	2.7	4.3	5.5
2 1/8"	54 mm	1.9	2.6	4.0	5.2
2" IPS	-	2.0	2.7	4.1	5.2
2 1/2" IPS	64 mm	1.9	2.6	3.9	5.0
2 5/8"	67 mm	2.0	2.7	4.0	5.1
3 1/8"	79 mm	1.9	2.5	3.8	4.9
3" IPS	-	2.0	2.8	3.9	5.0
3 5/8"	92 mm	-	2.6	3.7	-
4 1/8"	105 mm	-	2.6	3.7	-
4" IPS	-	-	2.8	3.9	-
5" IPS	-	1.9	2.6	3.9	-
6" IPS	-	-	2.4	3.6	-
8" IPS	-	-	2.4	3.6	-

Note: "R" factors were calculated from using the K factor of .277 (75°F, 24°C mean temp) and nominal wall thickness is each case. Lower operating temperatures will result in improved R values.

Seamless Rubber Pipe Insulation



- Environmentally friendly
- 4 Wall thicknesses: 3/8", 1/2", 3/4" and 1"
- Sizes range from 3/8" ID to 4" IPS
- Sizes not listed are special order. Allow two weeks for delivery.
- CFC-free
- Color - Black with blue ink
- Easy installation, flexible
- CARTON QUANTITIES ONLY

3/8" Wall Thickness

PART NO.	COPPER OD	IPS/PVC	FT/BOX
I60025	1/4"	-	630'
I60038	3/8"	-	612'
I60050	1/2"	1/4"	432'
I60058	5/8"	3/8"	378'
I60075	3/4"	-	342'
I60078	7/8"	1/2"	288'
I60118	1 1/8"	-	216'
I60138	1 3/8"	-	168'
I60158	1 5/8"	1 1/4"	150'
I60200	-	1 1/2"	120'
I60218	2 1/8"	-	96'
I60250	-	2"	84'
I60258	2 5/8"	-	72'
I60300	-	2 1/2"	60'
I60318	3 1/8"	-	60'
I60350	-	3"	48'

1/2" Wall Thickness

PART NO.	COPPER OD	IPS/PVC	FT/BOX
I61038	3/8"	-	456'
I61050	1/2"	1/4"	360'
I61058	5/8"	3/8"	324'
I61075	3/4"	-	270'
I61078	7/8"	1/2"	228'
I61118	1 1/8"	-	156'
I61138	1 3/8"	-	120'
I61158	1 5/8"	1 1/4"	114'
I61200	-	1 1/2"	114'
I61218	2 1/8"	-	102'
I61250	-	2"	66'
I61258	2 5/8"	-	60'
I61300	-	2 1/2"	48'
I61318	3 1/8"	-	48'
I61350	-	3"	36'
I61358	3 5/8"	-	36'
I61418	4 1/8"	-	24'
I61450	-	4"	24'

Seamless Rubber Pipe Insulation



- Environmentally friendly
- 4 Wall thicknesses: 3/8", 1/2", 3/4" and 1"
- Sizes range from 3/8" ID to 4" IPS
- Sizes not listed are special order. Allow two weeks for delivery.
- CFC-free
- Color - Black with blue ink
- Easy installation, flexible
- CARTON QUANTITIES ONLY

3/4" Wall Thickness

PART NO.	COPPER OD	IPS/PVC	FT/BOX
I62038	3/8"	-	294'
I62050	1/2"	1/4"	228'
I62058	5/8"	3/8"	180'
I62075	3/4"	-	144'
I62078	7/8"	1/2"	126'
I62118	1 1/8"	-	90'
I62138	1 3/8"	-	78'
I62158	1 5/8"	1 1/4"	72'
I62200	-	1 1/2"	66'
I62218	2 1/8"	-	60'
I62250	-	2"	48'
I62258	2 5/8"	-	42'
I62300	-	2 1/2"	36'
I62318	3 1/8"	-	36'
I62350	-	3"	30'
I62358	3 5/8"	-	30'
I62418	4 1/8"	-	24'
I62450	-	4"	24'

1" Wall Thickness

PART NO.	COPPER OD	IPS/PVC	FT/BOX
I63058	5/8"	3/8"	108'
I63075	3/4"	-	108'
I63078	7/8"	1/2"	90'
I63118	1 1/8"	-	66'
I63138	1 3/8"	-	60'
I63158	1 5/8"	1 1/2"	54'
I63200	-	1 1/2"	42'
I63218	2 1/8"	-	42'
I63250	-	2"	36'
I63258	2 5/8"	-	36'
I63300	-	2 1/2"	36'
I63318	3 1/8"	-	30'
I63350	-	3"	30'
I63358	3 5/8"	-	30'

Double Stick Rubber Pipe Insulation



- Environmentally friendly
- 4 Wall thicknesses: 3/8", 1/2", 3/4" and 1"
- Sizes range from 3/8" ID to 4" IPS
- Split with adhesive on both sides
- CFC-free
- Color - Black with blue ink
- Easy installation, flexible
- CARTON QUANTITIES ONLY

3/8" Wall Thickness

PART NO.	COPPER OD/IPS	FT/BOX
I80038	3/8"	570'
I80050	1/2"	402'
I80058	5/8"	348'
I80034	3/4"	318'
I80078	7/8"	288'
I80118	1 1/8"	216'
I80138	1 3/8"	150'
I80150	1 1/2" IPS	120'
I80158	1 5/8"	132'
I80200	2" IPS	78'
I80218	2 1/8"	78'
I80250	2 1/2" IPS	60'
I80258	2 5/8"	72'
I80318	3 1/8"	60'

1/2" Wall Thickness

PART NO.	COPPER OD/IPS	FT/BOX
I81038	3/8"	420'
I81050	1/2"	312'
I81058	5/8"	312'
I81034	3/4"	270'
I81078	7/8"	216'
I81118	1 1/8"	150'
I81138	1 3/8"	120'
I81150	1 1/2" IPS	108'
I81158	1 5/8"	108'
I81200	2" IPS	60'
I81218	2 1/8"	60'
I81250	2 1/2" IPS	48'
I81258	2 5/8"	60'
I81300	3" IPS	36'
I81318	3 1/8"	48'
I81358	3 5/8"	36'
I81400	4" IPS	24'
I81418	4 1/8"	24'

Double Stick Rubber Pipe Insulation



- Environmentally friendly
- 4 Wall thicknesses: 3/8", 1/2", 3/4" and 1"
- Sizes range from 3/8" ID to 4" IPS
- Split with adhesive on both sides
- CFC-free
- Color - Black with blue ink
- Easy installation, flexible
- CARTON QUANTITIES ONLY

3/4" Wall Thickness

PART NO.	COPPER OD/IPS	FT/BOX
I82038	3/8"	258'
I82050	1/2"	192'
I82058	5/8"	180'
I82034	3/4"	120'
I82078	7/8"	126'
I82118	1 1/8"	90'
I82138	1 3/8"	78'
I82150	1 1/2" IPS	66'
I82158	1 5/8"	72'
I82200	2" IPS	48'
I82218	2 1/8"	60'
I82250	2 1/2" IPS	36'
I82258	2 5/8"	42'
I82300	3" IPS	30'
I82318	3 1/8"	36'
I82358	3 5/8"	30'
I82400	4" IPS	24'
I82418	4 1/8"	24'

1" Wall Thickness

PART NO.	COPPER OD/IPS	FT/BOX
I83058	5/8"	108'
I83034	3/4"	78'
I83078	7/8"	78'
I83118	1 1/8"	66'
I83138	1 3/8"	60'
I83150	1 1/2" IPS	42'
I83158	1 5/8"	42'
I83200	2" IPS	36'
I83218	2 1/8"	42'
I83250	2 1/2" IPS	36'
I83258	2 5/8"	36'
I83300	3" IPS	30'
I83318	3 1/8"	30'
I83358	3 5/8"	30'
I83418	4 1/8"	18'

CLOSED CELL Pipe Insulation

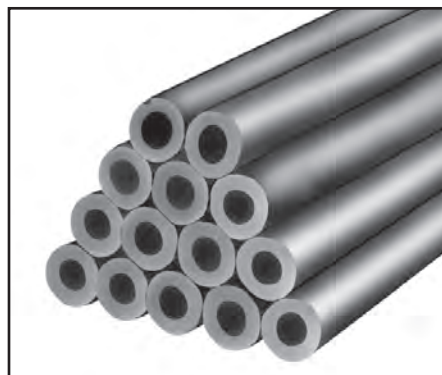

DESCRIPTION

Closed Cell Pipe Insulation is a flexible and easy-to-apply tubing product available in Semi-Slit and Self-Sealing styles. These chemically inert pipe insulations are specially formulated to retard heat gain and their closed-cell structures allow them to function as efficient insulators. The Self-Sealing version has yellow self-seal release liner that is both easy to see and peel.

APPLICATIONS

To reduce unwanted heat loss or heat gain, control condensation, decrease plumbing noise and maximize energy savings. They can be used on hot and cold water lines, refrigeration lines, air conditioning lines; line set tubing, condenser coils, and connection and distribution lines.

Closed Cell Pipe Insulation has low thermal conductivity and a very low water vapor transmission rate. This low density product demonstrates excellent thermal, physical and chemical resistant properties, and has a broad service temperature range between -90° F and 180° F (-68° C and 82° C). It can be installed in commercial, industrial, and residential insulation projects.

INSTALLATION

Closed Cell Pipe Insulation is installed by sliding the stick over pipe or tubing. For existing lines, the insulation should be slit lengthwise and fitted over the pipe. When in place, make sure all seams are adhered with contact adhesive and pressed together to form a seal. The Self-Sealing version does not require adhesive. Fittings can be fabricated from miter-cut tubular sections. Closed Cell Pipe Insulation is easily cut with a sharp knife.

OUTDOOR APPLICATIONS

Outdoor applications require a protective coating (high quality exterior acrylic latex paint) for optimum performance. For best appearance, two coats are recommended.

UNDERGROUND

For buried lines above the water table, use a clean fill such as sand (3"-5" layer) to protect Closed Cell Pipe Insulation before backfilling. It is recommended that all materials to be buried are properly sealed at all seams and butt joints with Contact Adhesive. For optimum performance, the lines should be encased in conduit to protect them from problems associated with ground water.

RESISTANCE TO MOISTURE VAPOR FLOW

The closed-cell structure effectively retards the flow of moisture vapor, and is considered a low transmittance vapor retarder. For most applications, Closed Cell Pipe Insulation needs no additional protection.

Additional vapor barrier protection may be necessary for Closed Cell Pipe Insulation when installed on low temperature surfaces or where it is exposed to continuous high humidity.

FLAME AND SMOKE RATING

Closed Cell Pipe Insulation in wall thicknesses of 1" (25mm) and below has a flame spread rating of 25 or less and a smoke development rating of 50 or less as tested by ASTM E 84; CAN/ULC-S102.2-M88 Method of Testing entitled: "Surface Burning Characteristics of Building Materials."

Numerical flammability ratings alone may not define the performance of products under actual fire conditions. They are provided only for use in the selection of products to meet limits specified, when compared to a known standard.

SPECIFICATION COMPLIANCE

Complies with requirements of:

ASTM E 84; CAN/ULC S102.2

ASTM D 1622

ASTM D 1171

ASTM C 177 or C518

ASTM E 96

PHYSICAL DATA	PROPERTIES	TEST METHODS
Material	Closed Cell Polyolefin	-
Color	Charcoal	-
Upper Use Limit	180°F (82°C) constant	-
Lower Use Limit	-90°F (-68°C)	-
Density	1.5 lbs/ft ³	ASTM D 1622
Ozone Resistant	Good	ASTM D 1171
Thermal Conductivity (K)	at 75° F (24°C) Mean Temp	ASTM C 177 or C 518
BTU-in/hr-ft ² - F° (W/m-K)	0.230 (0.033)	-
Water Absorption	0.02% by Volume	ASTM E 96
Flame Speed	Less than 25	ASTM E 84; CAN/ULC-S102.2-M88
Smoke Classification	Less than 50	ASTM E 84; CAN/ULC-S102.2-M88

THICKNESS RECOMMENDATIONS* - TO CONTROL CONDENSATION								
PIPE SIZE	LINE TEMP		LINE TEMP		LINE TEMP		LINE TEMP	
	50° F	10° C	35° F	2° C	0° F	-18° C	-20° F	-29° C
Normal Conditions (Max 85°F, 29°C - 70% R.H.)								
3/8" ID thru 1 3/8" ID	3/8"	10 mm	1/2"	13 mm	3/4"	19 mm	1"	25 mm
Over 1 3/8" thru 3" IPS	3/8"	10 mm	1/2"	13 mm	1"	25 mm	1"	25 mm
Over 3" IPS thru 4" IPS**	3/8"	10 mm	1/2"	13 mm	1"	25 mm	1"	25 mm
Over 4" IPS	1/2"	13 mm	3/4"	19 mm	1"	25 mm	1 1/4"	32 mm
Mild Conditions (Max 80°F, 26°C - 50% R.H.)								
3/8" ID thru 2 1/8" ID	3/8"	10 mm	3/8"	10 mm	3/8"	10 mm	1/2"	13 mm
Over 2 1/8" thru 3" IPS	3/8"	10 mm	3/8"	10 mm	3/8"	10 mm	1/2"	13 mm
Over 3" IPS thru 4" IPS**	3/8"	10 mm	3/8"	10 mm	1/2"	13 mm	3/4"	19 mm
Over 4" IPS	3/8"	10 mm	1/2"	13 mm	1/2"	13 mm	3/4"	19 mm
Severe Conditions (Max 90°F, 32°C - 80% R.H.)								
3/8" ID thru 1 1/8" ID	3/4"	19 mm	3/4"	19 mm	1 1/4"	32 mm	1 1/4"	32 mm
Over 1 1/8" ID thru 4" IPS	3/4"	19 mm	1"	25 mm	1 1/2"	38 mm	1 1/2"	38 mm
Over 4" IPS	3/4"	19 mm	1"	25 mm	1 1/2"	38 mm	2"	50 mm

Closed Cell Pipe Insulation in thickness notes within the specified temperature ranges will prevent condensation on indoor piping under design conditions defined below. Thickness recommendations above 1" can be sleeved to achieve thickness desired.

Normal: Maximum severity of indoor conditions seldom exceed 85° F (29° C) and 70% R.H. in United States.

Mild: Typical conditions are most air-conditioned spaces and arid climates.

Severe: Generally found in areas which excessive moisture is introduced or in poorly ventilated areas where the temperature may be depressed below the ambient. Under conditions of high humidity, additional thickness of insulation may be required.

**Available: Nom. 1/2" or Nom. 3/4" thickness only

CLOSED CELL "R" VALUES PER SQUARE FOOT					
Pipe OD or Nominal Insulation ID		R Value 3/8" (10 mm) Wall	R Value 1/2" (13 mm) Wall	R Value 3/4" (19 mm) Wall	R Value 1" (25 mm) Wall
3/8"	10 mm	2.687	3.844	-	-
1/2"	13 mm	2.490	3.582	6.027	-
5/8"	16 mm	2.357	3.375	5.653	8.189
3/4"	19 mm	2.680	3.223	5.374	7.767
7/8"	22 mm	2.187	3.107	5.155	7.435
1 1/8"	29 mm	2.082	4.835	4.835	6.941
1 3/8"	35 mm	2.011	2.822	4.610	6.588
1 5/8"	41 mm	1.959	2.737	4.420	6.323
1 7/8"	-	1.920	2.672	4.313	6.115
2 1/8"	54 mm	1.889	2.620	4.209	5.948
2 3/8"	-	1.864	2.578	4.124	5.810
2 5/8"	67 mm	1.844	2.544	4.053	5.695
2 7/8"	-	1.827	2.514	3.993	5.596
3 1/8"	79 mm	1.812	2.490	3.942	5.512
3 1/2"	-	-	2.459	3.877	5.404
3 5/8"	92 mm	-	2.449	-	5.373
4"	105 mm	-	2.425	-	-
4 1/8"	-	-	2.418	-	5.264
4 1/2"	-	-	2.399	-	5.196

Note: "R" factors were calculated from using the K factor of .230 (75°F, 24°C mean temp) and nominal wall thickness in each case. Lower operating temperatures will result in improved R values.

Semi-Slit Pipe Insulation



- 100% closed cell polyethylene
- UPS shippable cartons - CARTON QUANTITIES ONLY
- For outdoor use, paint with a high quality exterior acrylic latex paint

SPECIFICATIONS:

Density: 1.5 lbs./cubic foot; Mold growth: None;
 Temperature Range: -90° to 180°F; Flame/Smoke:
 25/50; Water vapor permeability: less than .02
 inches; Ozone resistance: Good

3/8" Wall Thickness

PART NO.	NOMINAL ID	R VALUES	CTS	IPS	FT/BOX
I50058	5/8"	2.357	1/2"	3/8"	408'
I50075	3/4"	2.680	5/8"	-	360'
I50078	7/8"	2.187	3/4"	1/2"	300'
I50118	1 1/8"	2.082	1"	3/4"	240'
I50138	1 3/8"	2.011	1 1/4"	1"	192'
I50158	1 5/8"	1.959	1 1/2"	1 1/4"	132'
I50178	2"	1.920	-	1 1/2"	108'
I50218	2 1/8"	1.889	2"	-	90'
I50238	2 3/8"	1.864	-	2"	90'
I50258	2 5/8"	1.844	2 1/2"	-	72'

1/2" Wall Thickness

PART NO.	NOMINAL ID	R VALUES	CTS	IPS	FT/BOX
I51058	5/8"	3.375	1/2"	3/8"	306'
I51078	7/8"	3.107	3/4"	1/2"	240'
I51118	1 1/8"	4.835	1"	3/4"	180'
I51138	1 3/8"	2.822	1 1/4"	1"	150'
I51158	1 5/8"	2.737	1 1/2"	1 1/4"	120'
I51178	2"	2.672	-	1 1/2"	90'
I51218	2 1/8"	2.620	2"	-	84'
I51238	2 3/8"	2.578	-	2"	66'
I51258	2 5/8"	2.544	2 1/2"	-	60'

3/4" Wall Thickness

PART NO.	NOMINAL ID	R VALUES	CTS	IPS	FT/BOX
I54050	1/2"	6.027	3/8"	1/4"	204'
I54058	5/8"	5.653	1/2"	3/8"	180'
I54075	3/4"	5.374	5/8"	1/2"	168'
I54078	7/8"	5.155	3/4"	-	156'
I54118	1 1/8"	4.835	1"	-	102'
I54138	1 3/8"	4.610	1 1/4"	1"	90'
I54158	1 5/8"	4.420	1 1/2"	1 1/4"	84'
I54178	2"	4.313	-	1 1/2"	66'
I54218	2 1/8"	4.209	2"	-	54'
I54258	2 5/8"	4.053	2 1/2"	-	48'

1" Wall Thickness

PART NO.	NOMINAL ID	R VALUES	CTS	IPS	FT/BOX
I55058	5/8"	8.189	1/2"	3/8"	108'
I55075	3/4"	7.767	5/8"	1/2"	102'
I55078	7/8"	7.435	3/4"	-	90'
I55118	1 1/8"	6.941	1"	-	90'
I55138	1 3/8"	6.588	1 1/4"	1"	72'
I55158	1 5/8"	6.323	1 1/2"	1 1/4"	60'
I55178	2"	6.115	-	1 1/2"	54'
I55218	2 1/8"	5.948	2"	-	48'
I55258	2 5/8"	5.695	2 1/2"	-	42'

Self-Sealing Pipe Insulation



- 100% closed cell polyethylene
- UPS shippable cartons - CARTON QUANTITIES ONLY
- Complete seal on hot or cold pipe
- Two strips of self-adhesive seal easily at any length

SPECIFICATIONS:

Density: 1.5 lbs./cubic foot; Mold growth: None;
 Temperature Range: -90° to 180°F; Flame/Smoke:
 25/50; Water vapor permeability: less than .02
 inches; Ozone resistance: Good

3/8" Wall Thickness

PART NO.	NOMINAL ID	R VALUES	CTS	IPS	FT/BOX
I52058	5/8"	2.357	1/2"	3/8"	408'
I52034	3/4"	2.680	5/8"	-	360'
I52078	7/8"	2.187	3/4"	1/2"	300'
I52118	1 1/8"	2.082	1"	3/4"	240'
I52138	1 3/8"	2.011	1 1/4"	1"	192'
I52158	1 5/8"	1.959	1 1/2"	1 1/4"	132'
I52178	2"	1.920	-	1 1/2"	108'
I52218	2 1/8"	1.889	2"	-	90'
I52238	2 3/8"	1.864	-	2"	90'
I52258	2 5/8"	1.844	2 1/2"	-	72'
I52318	3 1/8"	1.812	3"	-	54'
I52358	3 5/8"	-	-	-	42'

1/2" Wall Thickness

PART NO.	NOMINAL ID	R VALUES	CTS	IPS	FT/BOX
I53038	3/8"	3.844	-	-	-
I53050	1/2"	3.582	-	-	-
I53058	5/8"	3.375	1/2"	3/8"	306'
I53075	3/4"	3.223	3/4"	1/2"	270'
I53078	7/8"	3.107	3/4"	1/2"	240'
I53118	1 1/8"	4.835	1"	3/4"	180'
I53138	1 3/8"	2.822	1 1/4"	1"	150'
I53158	1 5/8"	2.737	1 1/2"	1 1/4"	120'
I53178	2"	2.672	-	1 1/2"	90'
I53218	2 1/8"	2.620	2"	-	84'
I53238	2 3/8"	2.578	-	2"	66'
I53258	2 5/8"	2.544	2 1/2"	-	60'
I53318	3 1/8"	2.490	3"	-	48'
I53312	3 1/2"	2.459	-	3"	42'
I53358	3 5/8"	2.449	3 1/2"	-	42'
I53418	4 1/8"	2.418	4"	-	30'
I53412	4 1/2"	2.399	-	4"	30'

3/4" Wall Thickness

PART NO.	NOMINAL ID	R VALUES	CTS	IPS	FT/BOX
I56058	5/8"	5.653	1/2"	3/8"	180'
I56075	3/4"	5.374	5/8"	1/2"	168'
I56078	7/8"	5.155	3/4"	1/2"	156'
I56118	1 1/8"	4.835	1"	3/4"	102'
I56138	1 3/8"	4.610	1 1/4"	1"	90'
I56158	1 5/8"	4.420	1 1/2"	1 1/4"	84'
I56218	2 1/8"	4.209	2"	-	54'

1" Wall Thickness

PART NO.	NOMINAL ID	R VALUES	CTS	IPS	FT/BOX
I57058	5/8"	8.189	1/2"	3/8"	108'
I57078	7/8"	7.435	3/4"	1/2"	90'
I57115	3/4"	7.767	5/8"	-	102'
I57118	1 1/8"	6.941	1"	-	90'
I57138	1 3/8"	6.588	1 1/4"	1"	72'
I57158	1 5/8"	6.323	1 1/2"	1 1/4"	60'
I57178	2"	6.115	-	1 1/2"	54'
I57218	2 1/8"	5.948	2"	-	56'
I57238	2 3/8"	5.810	-	2"	42'
I57258	2 5/8"	5.695	2 1/2"	-	36'

Poly Pipe Insulation Tees & Elbows



- 100% closed cell polyethylene
- UPS shippable cartons - CARTON QUANTITIES ONLY
- Complete seal on hot or cold pipe
- Two strips of self-adhesive to seal easily



SPECIFICATIONS:

Density: 1.5 lbs./cubic foot; Mold growth: None;
 Temperature Range: -90° to 180°F; Flame/Smoke:
 25/50; Water vapor permeability: less than .02
 inches; Ozone resistance: Good

PART NO.	DESCRIPTION	WALL THICKNESS	CTN/MSTR
I59050	1/2" Tee	3/8"	1/16
I59075	3/4" Tee	3/8"	1/12
I59100	1" Tee	3/8"	1/12
I59125	1-1/4" Tee	3/8"	1/8
I59150	1/2" Elbow	3/8"	1/32
I59175	3/4" Elbow	3/8"	1/20
I59200	1" Elbow	3/8"	1/16
I59225	1-1/4" Elbow	3/8"	1/12

Insulation Contact Adhesive



- Brush top cans
- For use with rubber insulation only
- CARTON QUANTITIES ONLY
- MOTOR FREIGHT ONLY/FLAMMABLE

PART NO.	DESCRIPTION	CTN QTY
IA1050	Fast Tack 1/2 pint	48
IA1100	Fast Tack 1 pint	24
IA2050	Slow Tack 1/2 pint	48
IA2100	Slow Tack 1 pint	24

Insulation Protective Coating



PART NO.	SIZE	CTN QTY
IPC004	1 gallon	4

Insulation Tape



PART NO.	DESCRIPTION	CTN QTY
INT001	1/8" x 2" x 30' cork tape	12
INT002	1/8" x 2" x 30' tape	12

Flanged Dielectric Union



- Temperature range: 180°F at 200 PSI
- Maximum temperature 200°F

PART NO.	FIP x COPPER SWEAT	CTN/MSTR
D06250	2-1/2" x 2-1/2"	1/5
D06300	3" x 3"	1/5
D06400	4" x 4"	1/5

Thermal Expansion Tanks



- Designed for the protection of potable hot water systems
- Install between the backflow preventer and the water heater
- Specifications:
 Factory pre-charge: 40psi
 System Connection: 304 Stainless Steel
 Diaphragm: Butyl Rubber
 Liner Material: Food Grade Polypropylene
 Max. Operating Temp.: 200°F
 Max. Operating Pressure: 150psi

PART NO.	DESCRIPTION	CTN. QTY.	PALLET QTY.
R15202	2 gallon tank	1	150
R15204	4-1/2 gallon tank	1	80

Dual Port Self Cleaning Thermal Expansion Tank



- Designed for the protection of potable hot water systems
- Install between the backflow preventer and the water heater
- Specifications:
 Factory pre-charge: 15psi
 System Connection: 304 Stainless Steel
 Diaphragm: Butyl Rubber
 Liner Material: Food Grade Polypropylene
 Max. Operating Temp.: 200°F
 Max. Operating Pressure: 150psi

PART NO.	DESCRIPTION	CTN. QTY.	PALLET QTY.
R15206	2 gallon tank	1	150

Dielectric Union - Lead Free



Female x Sweat



Male x Sweat

- Prevents electrolysis or galvanic action when connecting dissimilar metals
- Residential or commercial use
- Zinc plated forged steel
- Solder ends conform to ANSI B16.19
- EPDM washer, ABS fiber sleeve
- Threads conform to ANSI B2.1
- Pressure rated at 250 PSI at 180°F

Female x Sweat			
PART NO.	FIP x COPPER SWEAT	OD	CTN/MSTR
D06050	1/2" x 1/2"	5/8"	24/144
D06075	3/4" x 3/4"	7/8"	12/144
D06100	1" x 1"	1-1/8"	12/120
D06125	1-1/4" x 1-1/4"	1-3/8"	6/48
D06150	1-1/2" x 1-1/2"	1-5/8"	6/48
D06200	2" x 2"	2-1/8"	6/24

Reducing			
PART NO.	FIP x COPPER SWEAT	OD	CTN/MSTR
D06350	3/4" x 1/2"	5/8"	24/144

Male x Sweat			
PART NO.	MIP x COPPER SWEAT	OD	CTN/MSTR
D06005	1/2" x 1/2"	7/8"	12/144
D06750	3/4" x 3/4"	7/8"	24/96

Reducing			
PART NO.	MIP x COPPER SWEAT	OD	CTN/MSTR
D06755	3/4" x 1/2"	5/8"	24/144

Universal Copper Thermocouple



- All copper with brass fittings
- Adaptable to 5 different pilot valves
- Kit includes 2 clips and nuts
- Individually carded

PART NO.	LENGTH	CTN/MSTR
J36118	18"	10/100
J36124	24"	10/100
J36130	30"	1/10
J36136	36"	1/10
J36148	48"	1/10

Gasket and Insert for Dielectric Union



Insert



Gasket

- For water
- 200°F temperature rating

Insert		
PART NO.	DESCRIPTION	CTN QTY
D06800	1/2" insert	25
D06801	3/4" insert	25
D06802	1" insert	25
D06803	1-1/4" insert	25
D06804	1-1/2" insert	25
D06805	2" insert	25
Gasket		
PART NO.	DESCRIPTION	CTN QTY
D06850	1/2" gasket	25
D06875	3/4" gasket (EPDM rubber)	25
D06900	1" gasket	25
D06901	1 1/4" gasket	25
D06902	1 1/2" gasket	25
D06903	2" gasket	25

Dielectric Nipple



- 180° maximum temperature
- Prevents corrosion, lime and scale buildup
- Adds years of life to any water system
- For use on water heaters, dishwashers, water filtration systems
- Electroplated steel casing with non-corrosion thermoplastic lining

PART NO.	SIZE	CTN/MSTR
D06753	3/4" MIP x 3" length	1/200
D06450	1/2" MIP x 3" length	1/350
D06500	1" MIP x 3" length	1/100
D06510	1" MIP x 4" length	1/100
D06525	1 -1/4" MIP x 4" length	1/30
D06550	1-1/2" MIP x 4" length	1/30
D06600	2" MIP x 4" length	1/30
D06650	2-1/2" MIP x 6" length	1/20
D06700	3" MIP x 6" length	1/12

PlumBite Push On Water Heater Connector



- Leak-Free, Tool-Free & Solvent Free
- Approved for behind-the-wall installation
- Fittings may be reused if necessary
- Internal PEX Tube insert provided for Perfect PEX connections
- For use with hot and cold potable water
- Operating temperature 0°F to 200°F, 200 PSI

PART NO.	SIZE	CTN/MSTR
C76605	1/2" Push Fitting x 3/4" FIP x 12"	1/80
C76606	1/2" Push Fitting x 3/4" FIP x 15"	1/80
C76607	1/2" Push Fitting x 3/4" FIP x 18"	1/80
C76608	1/2" Push Fitting x 3/4" FIP x 24"	1/80
C76612	3/4" Push Fitting x 3/4" FIP x 12"	1/80
C76613	3/4" Push Fitting x 3/4" FIP x 15"	1/80
C76614	3/4" Push Fitting x 3/4" FIP x 18"	1/80
C76615	3/4" Push Fitting x 3/4" FIP x 24"	1/80
C76616	1/2" Push Valve x 3/4" FIP x 18"	1/80
C76617	3/4" Push Valve x 3/4" FIP x 18"	1/80

Corrugated Water Heater Connector

- Corrugated for easy flex on water heaters and softeners
- Includes rubber washers

Copper



PART NO.	FPT x LENGTH	CTN/MSTR
J34712	3/4" x 12"	1/50
J34715	3/4" x 15"	1/50
J34718	3/4" x 18"	1/50
J34724	3/4" x 24"	1/50



PART NO.	FIP x SWT x LENGTH	CTN/MSTR
J35712	3/4" x 3/4" x 12"	25/50
J35715	3/4" x 3/4" x 15"	25/50
J35718	3/4" x 3/4" x 18"	25/50
J35724	3/4" x 3/4" x 24"	25/50



PART NO.	FIP x MIP x LENGTH	CTN/MSTR
J36712	3/4" x 3/4" x 12"	1/25
J36715	3/4" x 3/4" x 15"	1/25
J36718	3/4" x 3/4" x 18"	1/25
J36724	3/4" x 3/4" x 24"	1/25

Stainless Steel



PART NO.	MIP x FIP x LENGTH	CTN/MSTR
J38712	3/4" x 3/4" x 12"	25/50
J38715	3/4" x 3/4" x 15"	25/50
J38718	3/4" x 3/4" x 18"	25/50
J38724	3/4" x 3/4" x 24"	25/50



PART NO.	FIP x FIP x LENGTH	CTN/MSTR
J39712	3/4" x 3/4" x 12"	25/50
J39715	3/4" x 3/4" x 15"	25/50
J39718	3/4" x 3/4" x 18"	25/50
J39724	3/4" x 3/4" x 24"	25/50

Braided Stainless Steel Water Heater Connector

- UPC listed
- LEAD FREE



PART NO.	FIP x LENGTH	CTN/MSTR
S04350	3/4" x 12"	10/40
S04351	3/4" x 18"	10/40
S04352	3/4" x 24"	10/40



PART NO.	FIP x COMP x LENGTH	CTN/MSTR
S04353	3/4" x 3/4" x 12"	10/40
S04354	3/4" x 3/4" x 18"	10/40
S04355	3/4" x 3/4" x 24"	10/40



PART NO.	FIP x MIP x LENGTH	CTN/MSTR
S04356	3/4" x 3/4" x 12"	10/40
S04357	3/4" x 3/4" x 18"	10/40
S04358	3/4" x 3/4" x 24"	10/40



PART NO.	MIP x COMP x LENGTH	CTN/MSTR
S04359	3/4" x 3/4" x 12"	10/40
S04360	3/4" x 3/4" x 18"	10/50
S04361	3/4" x 3/4" x 24"	10/50

Water Heater Stand



- Galvanized
- Snap-in legs
- Easy to assemble
- Rating approval at 2,000 lbs. static weight

PART NO.	DESCRIPTION	CTN/MSTR
J36200	18" square x 17" high water heater stand	1/4

Water Heater Stand



- No assembly required
- 3/4 tubular steel construction
- Non-rust paint
- 800 lbs. static weight

PART NO.	DESCRIPTION	CTN QTY
J36300	25 1/2" x 17" high water heater stand	1
J36250	28" x 17" high water heater stand	1

Stand-rite Water Heater Stand



- Lab tested
- Meets UPC requirements
- Heavy duty
- Corrosion resistant
- 14 gauge galvanized steel
- Top 21.5" x 21.5"
- Rated up to 650 pounds
- For water heaters up to 65 gallons
- Includes mounting clips for securing to wall/floor
- Quick assembly

PART NO.	DESCRIPTION	CTN QTY
J36400	Water heater stand	1

Water Heater Safety Pan



- Supplied with 1" hookup adapter for any drain type (J34-800)
- 2 1/2" depth
- High impact plastic
- Southern Building Code and natural gas approved
- CARTON QUANTITIES ONLY

PART NO.	BOTTOM ID	TOP ID	CTN/MSTR
J36018	19"	20 1/2"	1/20
J36022	22"	22 1/2"	1/20
J36024	24"	25 1/2"	1/20
J36026	26"	27 1/2"	1/10
J36030	30"	31 1/2"	1/5

Galvanized Hot Water Heater Pans



- 24 gauge
- Flared sides
- 1" fitting (J34-800)

PART NO.	DESCRIPTION	CTN QTY
J37022	22" x 22" x 4"	1
J37024	24" x 24" x 4"	1
J37026	26" x 26" x 4"	1
J37028	28" x 28" x 4"	1
J37030	30" x 30" x 4"	1

Water Heater Pan



Seamless Galvanized Corner



- Seamless galvanized water heater pans are holded not welded
- 1" drain connector included (J34-800)
- One piece stamped aluminum .032 mil (20 gauge)
- Aluminum pans comply with SBCCI, sec. 1213.7

Round Aluminum

PART NO.	DESCRIPTION	CTN/MSTR
J38020	20" round water heater pan	1/10
J38022	22" round water heater pan	1/10
J38024	24" round water heater pan	1/10
J38026	26" round water heater pan	1/10
J38030	30" round water heater pan	1/5

Seamless Galvanized

PART NO.	DESCRIPTION	CTN QTY
J39019	19" seamless water heater pan	1
J39023	23" seamless water heater pan	1
J39027	27" seamless water heater pan	1
J39030	30" seamless water heater pan	1

Water Heater Pan Adapter



- 1" PVC
- Washer and locknut
- Fits all Jones Stephens pans

PART NO.	DESCRIPTION	CTN/MSTR
J34800	1" Adapter	1/25

Run-Off Tube



- UL listed
- For water heaters
- Electroplated fittings
- 230°F temperature rating
- Hand tighten to T and P valve

PART NO.	DESCRIPTION	CTN/MSTR
J34975	3/4" NPT x 60" side mount	1/100
J34980	3/4" NPT top mount	1/25
J34970	3/4" NPT x 60" side mount	1/15

Gas Testing Equipment



- Large 4" face
- Class 1A gauge
- 5 lb. gas test gauge/15 lb. gas test gauge
- 1/10 # increments
- Inches of mercury scale
- External set hand
- Bellows design
- 1/4 NPT connection
- Gauge meets all requirements of the City of Houston code Word 94-108, Section 1204.3.2, revised January 18, 2001
- ALL SALES FINAL; NO WARRANTY; NO RETURN

PART NO.	DESCRIPTION	CTN/MSTR
G60055	15 lb. gas test gauge only	1/20
G65055	15 lb. gauge, body and valve-complete	1/20
G60005	5 lb. gas test gauge only	1/20
G64055	5 lb. gauge, body and valve-complete	1/20

2 1/2" Face Liquid Filled Pressure Gauge



- +/- 1.5% accuracy
- Glycerin filled for use where vibration or pressure pulsation occur
- -50 to 150°F operating temperature
- 1/4" NPT bottom connection
- Polished 304 stainless steel case with vent plug

PART NO.	DESCRIPTION	CTN/MSTR
J40553	0-30 PSI	1/50
J40554	0-60 PSI	1/50
J40555	0-100 PSI	1/50
J40556	0-200 PSI	1/50
J40557	0-300 PSI	1/50

Pressure Gauge



- 1/4" MIP brass lower connection
- Applicable with air, water, oil and gas - anything which does not attack brass
- Not for use on oxygen service
- Individually boxed
- Steel case
- Shatterproof face
- Class 2.5-2% accuracy

2" Face

PART NO.	PRESSURE RATING	CTN/MSTR
G60015	15 PSI	1/100
G60030	30 PSI	1/100
G60060	60 PSI	1/100
G60100	100 PSI	1/100
G60160	160 PSI	1/100
G60200	200 PSI	1/100
G60300	300 PSI	1/100

2 1/2" Face

PART NO.	PRESSURE RATING	CTN/MSTR
G61015	15 PSI	1/100
G61030	30 PSI	1/60
G61060	60 PSI	1/100
G61100	100 PSI	1/100
G61160	160 PSI	1/100
G61200	200 PSI	1/100
G61300	300 PSI	1/100

3 1/2" Face

PART NO.	PRESSURE RATING	CTN/MSTR
G62030	30 PSI	1/50
G62060	60 PSI	1/50
G62100	100 PSI	1/50
G62200	200 PSI	1/50
G62300	300 PSI	1/50

Pigtail Syphon



G60000



G60001

- For use with gauges on steam line
- 1/4" MPT x 1/4" MPT
- Steel construction

PART NO.	DESCRIPTION	CTN/MSTR
G60000	Straight	20/200
G60001	90° Angle	10/200

Water Test Gauge



- Individually boxed
- 3/4" brass hose connection
- Steel case with 2 1/2" shatterproof face

PART NO.	DESCRIPTION	CTN/MSTR
J66300	300 PSI	1/50
J66301	300 PSI with indicator	1/50

Silkcock/Water or Gas Test Gauge Assembly



- Brass air valve
- Individually boxed
- Adapts to 3/4" male garden hose or 3/4" MIP
- Comes with garden hose adapter
- Steel case with 2" shatterproof face

PART NO.	DESCRIPTION	CTN/MSTR
G64101	200 PSI	1/50

5 Pound Gas Test Gauge



- 1/4" NPT
- 2 1/2" diaphragm
- 1/10 # increments
- For building code inspection

PART NO.	DESCRIPTION	CTN/MSTR
G61005	5 lb. gas test gauge	1/100

Gas Test Gauge



- 2" steel case gauge on 15 lb.
- 5 lb. is marked in 1/10 lb. increments
- 15 lbs. is marked in 1/10 lb. increments
- Plated body with 3/4" FIP inlet
- 2 1/2" diaphragm on 5 lb.
- Adapts to 3/4" MPT
- Brass air valve
- Individually boxed

PART NO.	DESCRIPTION	CTN/MSTR
G64015	15 lb. gas test gauge assembly	1/50
G64005	5 lb. gas test gauge assembly	1/50

Test Gauge Assembly

Bell Type



PART NO.	DESCRIPTION	CTN/MSTR
G66015	13# x 3/4" FIP	1/50
G66030	30# x 3/4" FIP	1/50
G66060	60# x 3/4" FIP	1/50
G66100	100# x 3/4" FIP	1/24
G67015	15# x 1" FIP	1/50
G67030	30# x 1" FIP	1/50
G67060	60# x 1" FIP	1/50
G67100	100# x 1" FIP	1/100
G66000	3/4" Bell body (less air valve)	1/100
G66002	3/4" Bell body (with air valve)	1/100
G67000	1" Bell body (less air valve)	1/59
G67002	1" Bell body (with air valve)	1/80

Gas Test Assembly



- 4" face and pressure snubber
- Regulates air to an even flow
- Over pressurization will void the warranty
- Protects the diaphragm from compressed air damage
- Class 1A gauge

PART NO.	DESCRIPTION	CTN QTY
G64155	5 lb. Test Assembly	1
G65155	15 lb. Test Assembly	1

Gas Test Gauge Assembly



- Adapts to 3/4" MPT
- Steel case with 2" shatterproof face
- Plated body with 3/4" FIP inlet
- Brass air valve
- Individually boxed

PART NO.	DESCRIPTION	CTN/MSTR
G64030	30 PSI	1/50
G64060	60 PSI	1/50
G64100	100 PSI	1/50
G64160	160 PSI	1/50
G64200	200 PSI	1/50
G64333	300 PSI	1/50
G64000	1/4" air valve and cap	50/300
G64001	Gas test body only	1/100
G64002	1/8" air valve and cap	500/1000
G64020	Gas test body and air valve assembly	1/100

Tridicator



- 0-55 PSI
- 70°F to 250°F temperature range

PART NO.	DESCRIPTION	CTN/MSTR
J40550	2 1/2" face angle 2 1/4" stem (1/4" NPT)	1/50
J40551	2 1/2" face angle 2 1/2" stem (1/4" NPT)	1/50
J40558	2 1/2" face angle 1" stem (1/4" NPT)	1/50
J40560	3 1/2" face angle 2 3/4" stem (1/2" NPT)	1/50

Vacuum Gauge



- 1/4" brass lower connection
- -30 to 0 inch Hg
- Black steel case with bronze internals

PART NO.	DESCRIPTION	CTN/MSTR
G63001	Vacuum gauge (2" face)	1/100

Pressure Snubber



- Use on lines with noticeable pressure changes/oscillations
- Bronze body and core
- 1000 PSI maximum

PART NO.	DESCRIPTION	CTN/MSTR
G64300	1/4" NPT for air or gas	1/700
G64301	1/4" NPT for oil, steam or water	1/200

Needle Valve for Pressure Gauge



- 1/4" NPT
- Brass body, seat, stem and handle
- 300°F maximum temperature
- Female x female
- Teflon packing
- 2000 PSI

PART NO.	DESCRIPTION	CTN/MSTR
G64004	1/4" needle valve	1/125

Hot Water/Refrigerant Line Thermometer



- Straight or angle pattern
- Steel or brass well
- 40°-280°F x 5°F (5-120°C x 2°C)
- 1/2" NPT; 1" stem

PART NO.	DESCRIPTION	DIM (A)	DIM (B)	CTN/MSTR
J40500	Straight pattern steel well	1"	1/2" NPT	1/50
J40501	Straight pattern brass well	1"	1/2" NPT	1/50
J40502	Angle pattern steel well	1"	1/2" NPT	1/50
J40503	Angle pattern brass well	1"	1/2" NPT	1/50

Dial Thermometer



- 2 1/2" face
- 5° increments
- Dual scale: 40°-240°/0°-120°C
- Brass wells/removable thermometers
- Thermometers are supplied with wells

PART NO.	DESCRIPTION	CTN/MSTR
J40702	3/4" SWT connection	1/50
J40703	1/2" MIP connection	1/100
J40704	3/4" SWT well	1/100
J40705	1/2" MIP well	1/100

Weksler Industrial Multi-Angle Thermometer

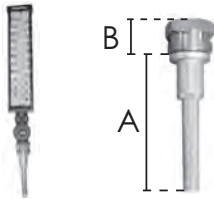

- No well provided; order wells separately
- 9° scale, red-reading mercury tubes
- Molded cyclac case with glass window
- Adjustable to any angle
- Accurate to +/- one scale division
- Must have well

PART NO.	DESCRIPTION	DIM (A)	DIM (B)	CTN/MSTR
J40505	Hot water 30°-240°F	3 1/2" stem	1" NPSM	1/50
J40506	Cold water 0°-120°F	3 1/2" stem	1" NPSM	1/25
J40510	Standard brass well	2 1/2" stem	3/4" NPT	1/100
J40511	Extended well	1 3/4" stem	3/4" NPT	1/100

Bi-Metal Dial Thermometer



- For commercial or home heating systems
- 1/2" NPT
- 20°-240°F temperature range
- 3" dial in steel case
- Angle has back connection; straight has bottom connection

PART NO.	DESCRIPTION	DIM (A)	DIM (B)	CTN/MSTR
J40561	Angle outlet with brass well	1 1/8" stem	1/2" NPT	1/50
J40562	Straight outlet with brass well	2 3/8" stem	1/2" NPT	1/50

Brass Wells



- Solid brass construction
- 1 1/2" stem
- 1/2" MPT x 1/4" FPT threads

PART NO.	DESCRIPTION	CTN/MSTR
J40563	Brass wells for J40-562	1/200

Pocket Test Thermometer



- 2% accuracy for hot and cold
- Pocket clip on sheath; 5" stem

PART NO.	DESCRIPTION	CTN/MSTR
J40700	Cold thermometer (-40° to 160°F)	1/80
J40701	Hot thermometer (0° to 220°F)	1/80

Natural Polyethylene Tubing



- Non-toxic, 100% virgin material
- 100' coils in dispenser box
- FDA
- -40°F to +135°F

PART NO.	OD	ID	PSI	WALL	CTN QTY
T25250	1/4"	.170"	120	.040	100'
T25312	5/16"	.187"	150	.040	100'
T25375	3/8"	.250"	125	.062	100'
T25500	1/2"	.375"	95	.062	100'
T25625	5/8"	.500"	75	.500	100'

Clear Vinyl Tubing



- 75 duro clear
- -5°F to +125°F
- Self-dispensing cartons
- FDA

PART NO.	OD	ID	WALL	WPPSI	CTN QTY
T26124	3/16"	1/8"	1/32"	50	100'
T26125	1/4"	1/8"	1/16"	80	100'
T26186	1/4"	3/16"	1/32"	40	100'
T26187	5/16"	3/16"	1/16"	60	100'
T26250	3/8"	1/4"	1/16"	55	100'
T26252	1/2"	1/4"	1/8"	90	100'
T26312	7/16"	5/16"	1/16"	50	100'
T26313	1/2"	5/16"	3/32"	60	100'
T26375	1/2"	3/8"	1/16"	45	100'
T26376	9/16"	3/8"	3/32"	55	100'
T26377	5/8"	3/8"	1/8"	65	100'
T26498	5/8"	1/2"	1/16"	30	100'
T26500	3/4"	1/2"	1/8"	45	100'
T26626	3/4"	5/8"	1/16"	30	100'
T26625	7/8"	5/8"	1/8"	40	100'
T26750	1"	3/4"	1/8"	35	100'
T26875	1 1/8"	7/8"	1/8"	30	50'
T26000	1 1/4"	1"	1/8"	28	50'

Soft Aluminum Tubing



- 50' coils
- Alloy 3003-O, ASTM B-483

PART NO.	OD	WALL	CTN/MSTR
T27125	1/8"	.025	1/10
T27188	3/16"	.028	1/10
T27250	1/4"	.032	1/10
T27313	5/16"	.035	1/10
T27375	3/8"	.035	1/10
T27438	7/16"	.035	1/10
T27500	1/2"	.035	1/10
T27625	5/8"	.035	1/10

Stud Protectors and Plate



- Protects piping and wiring from nails
- CARTON QUANTITIES ONLY

PART NO.	SIZE	GAUGE	CTN QTY
S33001	1 1/2" x 6"	18	100
S33002	1 1/2" x 3"	18	100
S33003	5" x 8" (not self nailed)	16	50
S33005	1 1/2" x 6"	16	100
S33006	1 1/2" x 5"	18	100
S33010	1 1/2" x 6"	22	100
S33011	1 1/2" x 3"	22	100
S33012	3 1/2" x 6" (not self nailed)	16	25
S33014	3 1/2" x 6" (self nailed)	16	25

Interlocking Stud Guard



- CARTON QUANTITIES ONLY

PART NO.	SIZE	GAUGE	CTN QTY
S33004	1 1/2" x 6"	20	100
S33007	1 1/2" x 6"	16	100
S33016	3 1/2" x 6"	16	25

Stud Shoe



- 18 gauge galvanized
- Four nail holes on each side
- Pipe opening accommodates 2" IPS or smaller pipe
- Stud/joist reinforcement when drilling or notching for pipe runs
- CARTON QUANTITIES ONLY

PART NO.	DESCRIPTION	CTN QTY
S33021	Single stud shoe	50
S33022	Double stud shoe	25
S33023	Triple stud shoe	10

Stud Guard



- 6 Holes
- 2 Nailers
- Protects pipes
- CARTON QUANTITIES ONLY

PART NO.	SIZE	GAUGE	CTN QTY
S33013	5" x 8"	16	25

Stud Guard



- CARTON QUANTITIES ONLY

PART NO.	SIZE	GAUGE	CTN QTY
S33318	3 1/2" x 18"	16	25

Stud Guard



- 20 Holes
- CARTON QUANTITIES ONLY

PART NO.	SIZE	GAUGE	CTN QTY
S33518	5" x 18"	16	25

Stud Guard



S180032



S16006



S163566

- CARTON QUANTITIES ONLY

Self Nailing Stud Guard with 2 Holes Centered

PART NO.	SIZE	GAUGE	CTN QTY
S180032	1 1/2" x 3"	18	200

2 Hole Stud Guard

PART NO.	SIZE	GAUGE	CTN QTY
S16006	1 1/2" x 6"	16	100

6 Hole Stud Guard

PART NO.	SIZE	GAUGE	CTN QTY
S163566	3 1/2" x 6"	16	25

Self Nailed Stud Guard

PART NO.	SIZE	GAUGE	CTN QTY
S16009	1 1/2" x 9"	16	100
S16012	1 1/2" x 12"	16	100
S16018	1 1/2" x 18"	16	50
S16024	1 1/2" x 24"	16	25
S20012	1 1/2" x 12"	20	100
S20009	1 1/2" x 9"	20	100
S16005	1 1/2" x 5"	16	100
S16003	1 1/2" x 3"	16	100

F.H.A. Strap - Galvanized Steel



- Tie plates
- CARTON QUANTITIES ONLY

PART NO.	SIZE	GAUGE	CTN QTY
F12009	1 1/2" x 9"	12	50
F18009	1 1/2" x 9"	18	100
F12012	1 1/2" x 12"	12	50
F18012	1 1/2" x 12"	18	100
F12018	1 1/2" x 18"	12	50
F18018	1 1/2" x 18"	18	100
F12024	1 1/2" x 24"	12	50
F18024	1 1/2" x 24"	18	100

F.H.A. Strap

• CARTON QUANTITIES ONLY

PART NO.	SIZE	GAUGE	CTN QTY
F18309	3" x 9"	18	50
F18312	3" x 12"	18	50
F18318	3" x 18"	18	50
F18324	3" x 24"	18	50

F.H.A. Strap

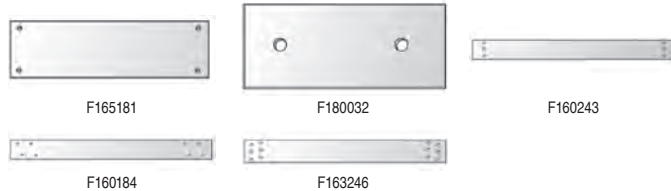

• CARTON QUANTITIES ONLY

One Hole in Each Corner

PART NO.	SIZE	GAUGE	CTN QTY
F165181	5" x 18"	16	15

2 Holes

PART NO.	SIZE	GAUGE	CTN QTY
F180032	1 1/2" x 3"	18	200

3 Holes Vertically Aligned

PART NO.	SIZE	GAUGE	CTN QTY
F160123	1 1/2" x 12"	16	50
F160183	1 1/2" x 18"	16	50
F160243	1 1/2" x 24"	16	50
F160363	3" x 6"	16	50
F160393	3" x 9"	16	50
F160063	1 1/2" x 6"	16	50
F160093	1 1/2" x 9"	16	50

Standard F.H.A. with 4 Offset Holes

PART NO.	SIZE	GAUGE	CTN QTY
F14012	1 1/2" x 12"	14	50
F16012	1 1/2" x 12"	16	50
F160184	1 1/2" x 18"	16	50
F160094	1 1/2" x 9"	16	50

Standard F.H.A. with 6 Offset Holes

PART NO.	SIZE	GAUGE	CTN QTY
F160126	1 1/2" x 12"	16	50
F16016	1 1/2" x 16"	16	50
F160186	1 1/2" x 18"	16	50
F160246	1 1/2" x 24"	16	50
F163186	3" x 18"	16	50
F163246	3" x 24"	16	50
F165186	5" x 18"	16	15

Galvanized Bracket



- For use on sinks, lavatories and toilets on 16" center studs
- For use with 1/2" and 3/4" CPVC; 1/2", 3/4" and 1" copper or PEX
- 1 3/8" keyed holes, 20" long
- Use with B00016, B00017, B00018 and B00013
- CARTON QUANTITIES ONLY

PART NO.	HR #	DESCRIPTION	CTN QTY
B00001	103-18	1/2" - 1" x 20"	50

Flat Copper Plated Bracket



- For use on sinks, lavatories or other fixtures
- Use for 1/2" copper pipe
- CARTON QUANTITIES ONLY

PART NO.	HR #	DESCRIPTION	CTN QTY
B00003	101-18	1/2" x 20"	50
B00021	101-26	1/2" x 26"	50

Flat Copper Plated Bracket



- For use on water heater connections
- Use for 3/4" and 1" copper pipe
- CARTON QUANTITIES ONLY

PART NO.	HR #	DESCRIPTION	CTN QTY
B00004	102-18	3/4" - 1" x 20"	50

Flat Copper Plated Bracket



- For use on 1/2", 3/4" or 1" copper pipe
- CARTON QUANTITIES ONLY

PART NO.	HR #	DESCRIPTION	CTN QTY
B00005	107-18	1/2" - 1" x 20"	50

Flat Copper Plated Bracket



- Copper-Bonded™ steel
- For support of 1/2" and 3/4" pipes on 4" or 8" centers
- Positions copper water supplies for sinks, water closets, and other fixtures
- 25 lb. load rating
- CARTON QUANTITIES ONLY

PART NO.	HR #	DESCRIPTION	CTN QTY
B00025	150-20	1/2" - 3/4" x 20"	50

Carrier Bracket



- Copper plated
- Secures 1" stub out at 11 1/2" above the rim
- CARTON QUANTITIES ONLY

PART NO.	HR #	DESCRIPTION	CTN QTY
B00022	114-C	Carrier Bracket	6
B00023	114-R	Carrier Bracket	6

Holdrite Bracket



- 150 lb. load capacity
- Can attach to stud or directly to wall

PART NO.	HR #	DESCRIPTION	CTN QTY
B00024	V2	Pipe Bracket	25

Extruded Hole Copper Plated Bracket



- For use on 1/2", 3/4" or 1" copper pipe
- Extruded holes
- CARTON QUANTITIES ONLY

PART NO.	HR #	DESCRIPTION	CTN QTY
B00006	108-20	1/2" - 1" x 20"	50
B00019	108-26	1/2" - 1" x 26"	50

Extruded Notches Copper Plated Bracket



- For use on 1/2", 3/4" or 1" copper pipe
- Extruded holes
- CARTON QUANTITIES ONLY

PART NO.	HR #	DESCRIPTION	CTN QTY
B00007	140	1/2" - 3/4" x 20"	50

Galvanized Lockright Pipe Bracket-CPVC



- For use on sinks or lavatories using CPVC
- 20 gauge galvanized steel with 1" holes on 2" centers
- Use with B00-014 and B00-015
- CARTON QUANTITIES ONLY

PART NO.	HR #	DESCRIPTION	CTN QTY
B00008	601-20	1/2" - 3/4" x 20"	50

Galvanized Lockright Bracket



- CARTON QUANTITIES ONLY

PART NO.	HR #	DESCRIPTION	CTN QTY
B00020	601-26	1/2" - 3/4" x 26"	50

Bracket for Water Closet-Copper Clad



- For use on 1/2" copper pipe
- For use with water closets or hose bibbs
- CARTON QUANTITIES ONLY

PART NO.	HR #	DESCRIPTION	CTN QTY
B00002	109-N-6	1/2"	50

Galvanized L Bracket



- For use with PEX on overhead and side runs
- Use with B00-013, B00-016, B00-017 and B00-018 inserts
- CARTON QUANTITIES ONLY

PART NO.	HR #	DESCRIPTION	CTN QTY
B00009	709L	Bracket with 1 3/8" keyed holes-PEX	50

Galvanized Bracket



- For use on lavatories and toilets
- Use with B00-013, B00-016, B00-017 and B00-018 inserts
- CARTON QUANTITIES ONLY

PART NO.	HR #	DESCRIPTION	CTN QTY
B00010	709	Bracket with 1 3/8" keyed holes-PEX	50

18 Gauge Galvanized Bracket-CPVC



- For use on residential toilets or hose bibbs
- Use with B00-014 or B00-015 inserts
- CARTON QUANTITIES ONLY

PART NO.	HR #	DESCRIPTION	CTN QTY
B00011	609-N-6	Bracket with 1" hole	50

Turnout Bend Support for PEX



- PEX turnout bend support for potable water installations
- CARTON QUANTITIES ONLY

PART NO.	HR #	DESCRIPTION	CTN QTY
B00013	704	3/8" - 1/2"	50

Insert for CPVC



- Fire retardant plastic
- CARTON QUANTITIES ONLY

PART NO.	HR #	DESCRIPTION	CTN QTY
B00014	604	1/2" insert	100
B00015	605	3/4" insert	100

Metal Stud Insulator



- Fire retardant plastic
- Use for copper pipe
- CARTON QUANTITIES ONLY

PART NO.	HR #	DESCRIPTION	CTN QTY
B00016	404-R	1/2" insulator	100
B00017	405-R	3/4" insulator	100
B00018	406-R	1" insulator	100

Schedule 40 Pipe Hanger



- Alternating screw and nail holes
- Load rating 250# max

Galvanized

PART NO.	SIZE	CTN QTY
H30001	1 1/2"	50
H30002	2"	50
H30003	3"	50
H30004	4"	50

Vinyl

PART NO.	SIZE	CTN QTY
H30011	1 1/2"	100
H30022	2"	50
H30033	3"	50
H30044	4"	50

Plastic Coated Pipe Hook



- Steel pipe hook with plastic insulation

PART NO.	SIZE	CTN QTY
H12054	1/2" x 4"	50/1000
H12056	1/2" x 6"	50/1000
H12074	3/4" x 4"	50/1000
H12076	3/4" x 6"	50/1000
H12106	1" x 6"	50/1000

"Copper Boy" Pipe Hook



- CARTON QUANTITIES ONLY

PART NO.	DESCRIPTION	CTN/MSTR
H10052	1/2" x 2 1/2" copper clad pipe hook	50/2200
H10072	3/4" x 2 1/2" copper clad pipe hook	50/500

Drive J-Hook



- Copper clad
- CARTON QUANTITIES ONLY

PART NO.	CTS	CTN QTY
H23050	1/2" x 3/4"	100

Pipe Hook



Plain Steel



Copper Clad

- 10 gauge
- CARTON QUANTITIES ONLY

Plain Steel

PART NO.	SIZE	CTN QTY
H10054	1/2" x 4"	50/500
H10056	1/2" x 6"	50/500
H10058	1/2" x 8"	50/500
H10074	3/4" x 4"	50/500
H10076	3/4" x 6"	50/500
H10078	3/4" x 8"	50/500
H10080	3/4" x 10"	50/500
H10106	1" x 6"	50/500
H10108	1" x 8"	50/500
H10110	1" x 10"	50/500
H10126	1 1/4" x 6"	50/500
H10128	1 1/4" x 8"	50/500
H10156	1 1/2" x 6"	50/500
H10158	1 1/2" x 8"	50/500
H10208	2" x 8"	50/500

Copper Clad

PART NO.	SIZE	CTN QTY
H11054	1/2" x 4"	50/500
H11056	1 1/2" x 6"	50/500
H11058	1/2" x 8"	50/500
H11074	3/4" x 4"	50/500
H11076	3/4" x 6"	50/500
H11078	3/4" x 8"	50/500
H11080	3/4" x 10"	50/500
H11106	1" x 6"	50/500
H11108	1" x 8"	50/500
H11126	1 1/4" x 6"	50/500
H11156	1 1/2" x 6"	50/500
H11208	2" x 8"	50/500
H11210	2" x 10"	50/500

J-Hook for CTS Water System



- Nail holes on all four sides - nails are included!
- No heat distortion even at 250°
- Eliminates corrosion and electrolysis on copper pipe
- Fabricated of durable ABS plastic
- FULL BAG QUANTITIES ONLY

Baby J-Hooks

PART NO.	DESCRIPTION	BAG/CTN QTY
J01050	1/2" CTS x 4" length	25/300
J01075	3/4" CTS x 4" length	25/300
J01100	1" CTS x 4" length	25/200

Long Baby J-Hooks

PART NO.	DESCRIPTION	BAG/CTN QTY
J01057	1/2" CTS x 7 1/2" length	25/200
J01077	3/4" CTS x 7 1/2" length	25/200

Double J-Hooks

PART NO.	DESCRIPTION	BAG/CTN QTY
J01051	1/2" CTS x 1/2" CTS x 4" length	25/200
J01052	1/2" CTS x 3/4" CTS x 4" length	25/200
J01053	3/4" CTS x 3/4" CTS x 4" length	25/200

J-Hook for Drain Pipe System



- Nails included
- Reduces installation time
- Glueable with universal cement
- Designed for PVC and ABS pipe
- Fabricated of durable ASB plastic
- Calibrated for 1/8" fall per foot - no more measuring & adjusting for fall
- FULL BAG QUANTITIES ONLY



PART NO.	DESCRIPTION	BAG/CTN QTY
J01150	1 1/2" DWV x 7" length	25/300
J01200	2" DWV x 7" length	25/300
J01300	3" DWV x 7" length	25/300
J01400	4" DWV x 7" length	25/300

Pipe Strap



- Priced each
- CARTON QUANTITIES ONLY

Two-Hole Galvanized - IPS

PART NO.	SIZE	CTN QTY
H13038	3/8"	200
H13050	1/2"	150
H13075	3/4"	50
H13100	1"	50
H13125	1 1/4"	50
H13150	1 1/2"	25
H13200	2"	25
H13250	2 1/2"	25
H13300	3"	10
H13400	4"	10

Two-Hole Copper Clad - CTS

PART NO.	SIZE	CTN QTY
H15050	1/2"	100
H15075	3/4"	100
H15100	1"	100
H15125	1 1/4"	100
H15150	1 1/2"	100
H15200	2"	100

Two-Hole Solid Copper - CTS

PART NO.	SIZE	CTN QTY
H16038	3/8"	100
H16050	1/2"	100
H16075	3/4"	100
H16100	1"	100

One-Hole Galvanized - IPS

PART NO.	SIZE	CTN QTY
H18050	1/2"	100
H18075	3/4"	100

Copper Clad Nail



- CARTON QUANTITIES ONLY

PART NO.	SIZE	CTN/MSTR
H15001	1 1/4"	200/2000

Copper Coated J-Nails



- CARTON QUANTITIES ONLY

PART NO.	SIZE	CTN/MSTR
H22050	1/2"	100/1300
H22075	3/4"	100/1300

Full Clamp



- Plastic clamp with preloaded nail for copper, CPVC, polybutylene tubing
- CARTON QUANTITIES ONLY

PART NO.	TUBING SIZE	CTN/MSTR
H25050	1/2"	100/4000
H25075	3/4"	50/2000
H25100	1"	25/1025

Half Clamp



- Plastic clamp with preloaded nail for copper, CPVC, polybutylene tubing
- CARTON QUANTITIES ONLY

PART NO.	TUBING SIZE	CTN/MSTR
H24038	3/8"	100/7500
H24050	1/2"	50/1000
H24075	3/4"	50/3000
H24100	1"	50/2000

Insulating/Suspension Clamp



- Plastic insulating and suspension clamp in one
- Eliminates noise from tubing expansion and contraction
- For copper, CPVC and polybutylene tubing
- CARTON QUANTITIES ONLY

PART NO.	TUBING SIZE	CTN/MSTR
H26050	1/2"	50/1000
H26075	3/4"	50/1000
H26100	1"	50/600
H26125	1 1/4"	50/500
H26150	1 1/2"	25/500
H26200	2"	25/350

Pipe Insulator



- Plastic insulator eliminates noise from expansion and contraction
- For copper, CPVC and polybutylene tubing
- UPC listed
- Drill hole size 1 3/8"
- CARTON QUANTITIES ONLY

PART NO.	TUBING SIZE	CTN/MSTR
H27050	1/2"	25/1000
H27075	3/4"	25/1000
H27100	1"	25/1000

Two-Hole Pipe Clamp



- Plastic clamp eliminates noise from tubing expansion and contraction
- Supports copper, CPVC and polybutylene tubing
- CARTON QUANTITIES ONLY

PART NO.	TUBING SIZE	CTN/MSTR
H28050	1/2"	100/1000
H28075	3/4"	100/1000
H28100	1"	50/500
H28125	1 1/4"	50/750
H28150	1 1/2"	25/500
H28200	2"	25/250

F.H.A. Tub Hanger



- 12 gauge galvanized steel
- Adjustable on stud
- CARTON QUANTITIES ONLY

PART NO.	DESCRIPTION	CTN QTY
T12001	Tub Hanger	100

Metal Stud Pipe Insulator



PART NO.	SIZE	CTN/MSTR
H29000	3/8", 1/2", 3/4"	50/500
H29010	1"	50/500

Earthquake Strap



- Holes are spread 1" apart on center

PART NO.	SIZE	GAUGE	CTN QTY
H20500	2" x 10'	22	10

Perforated Hanger Iron



- Alternating holes (bolt and nail)
- CARTON QUANTITIES ONLY

Galvanized			
PART NO.	SIZE	GAUGE	CTN QTY
H20001	3/4" x 10'	20 (heavy)	50 rolls
H20002	3/4" x 10'	24 (medium)	50 rolls
H20003	3/4" x 10'	28 (light)	50 rolls
H20005	3/4" x 50'	20 (heavy)	10 rolls
H20006	3/4" x 50'	24 (medium)	10 rolls
H20007	3/4" x 50'	28 (light)	10 rolls
H20010	3/4" x 100'	20 (heavy)	5 rolls
H20011	3/4" x 100'	24 (medium)	10 rolls
H20012	3/4" x 100'	28 (light)	10 rolls

Copper Clad			
PART NO.	SIZE	GAUGE	CTN QTY
H20100	3/4" x 10'	22 (heavy)	50 rolls
H20150	3/4" x 50'	22	10 rolls

Plastic Hanger Tape



- Flexible, non-conductive polypropylene
- 3/4" wide, .050 thick
- 1/8" diameter holes every 3/4"
- 125 lb. ultimate load ASTM A-370-77
- Can be cut with scissors or utility knife
- Uses: pipe hanger, duct hanger and tubing utility strapping

PART NO.	DESCRIPTION	CTN/MSTR
H21010	10' roll poly bagged	1/200
H21025	25' roll poly bagged	1/50
H21050	50' roll poly bagged	1/20
H21100	100' roll poly bagged	1/30
H21101	100' roll dispenser box	1/25

Plastic Hanger Tape



- 125# max load
- 1/8" diameter holes every 3/4"
- 2" wide; .05 thickness; cuts with scissors

PART NO.	SIZE	CTN/MSTR
H21200	2" x 100'	1/5

Mason's Nylon Twine



- Approximately 165 lb. break strength
- Twisted yellow twine

PART NO.	DESCRIPTION	CTN/MSTR
T60001	#18 x 225'	24/192
T60000	#18 x 1100'	12/72

Binder Sisal Twine



• Used to tie down material for hauling

PART NO.	DESCRIPTION	CTN/MSTR
T60002	5 lb. bale (approx. 2500')	1/8

Candle Wick Packing



• Medium packing in 2 ounce balls

PART NO.	DESCRIPTION	CTN/MSTR
T60003	Candle wick packing	12/396

Graphite Packing



• Non-asbestos material in resealable spoos

PART NO.	DESCRIPTION	CTN/MSTR
T60005	1/8" diameter x 12' spool	12/120
T60006	1/4" diameter x 8' spool	12/120

Oakum



• The original Oakum with benonite-expands over 10 times when wet
 • Baled in coils or cut length for easy use
 • No tar in brown oakum
 • CARTON QUANTITIES ONLY (except 1 lb. bags)

PART NO.	DESCRIPTION	INNER PACK	CTN/MSTR
O15001	Brown random cut	10 - 5 lb. bags	1
O15002	White 3/8" cord	6 - 10 lb. coils	1
O15003	White 3/8" cord (27" cut length)	10 - 5 lb. bags	1
O15006	Brown random cut	1 lb. bags	1/20
O15007	White 3/8" cord (27" cut length)	1 lb. bags	1/20

Lead Wool



• Five pound box

PART NO.	SIZE	CTN/MSTR
L40001	5 pounds	1/10

Lead Ingot



L42002



L42052

PART NO.	SIZE	CTN QTY
L40002	25 pounds (Handle w/ four 5 lb. plugs)	1
L42052	5 pounds	1

Lead Melting Pot



• Wire handle

PART NO.	SIZE	CTN QTY
L42006	6" pot	1
L42008	8" pot	1

Lead Pouring Ladle



• Wrought steel

PART NO.	SIZE	CTN/MSTR
L42102	3" ladle	1/100
L42103	3 1/2" ladle	1/50
L42104	4" ladle	1/50

Drum Trap Cover



• Flanged, plated die cast
 • Cover supplied with gasket
 • D02-002 CARTON QUANTITIES ONLY

PART NO.	DESCRIPTION	CTN/MSTR
D02001	Cover and gasket	1/100
D02002	Gasket only	25/100
P55300	Rough brass cover	1/60

Trap Covers



C98001



C98002

• Stainless steel

PART NO.	DESCRIPTION	CTN/MSTR
C98001	5 3/4" flat SS trap cover	150/300
C98002	5 3/4" raised SS trap cover	50/200

Wet-R-Dri Roofing Cement



• All-weather plastic
 • Chemically fortified to bond to water-covered, damp or dry surfaces
 • Great for emergency repairs under wet conditions

PART NO.	DESCRIPTION	CTN/MSTR
C09000	5 gallon can	1/1
C09001	One gallon can	1/6
C09002	10.5 ounce cartridge	1/12

Foundation and Roof Coating



- Non-fibred liquid damp-proof seal
- All weather plastic
- Chemically fortified to bond to water covered, damp or dry surfaces
- Great for emergency repairs under wet conditions

PART NO.	DESCRIPTION	CTN/MSTR
C09003	1 Gal. Foundation and Roof Coating	1/6

Sewage Ejector/Sump Pump Check Valve



- Couplings are sized for IPS ID hose
- Combination unit for 1 1/2" and 1 1/4" IPS, 1 1/2" copper

PART NO.	DESCRIPTION	CTN/MSTR
C29150	1 1/2" slip x 1 1/2" slip	1/50
C29200	2" slip x 2" slip	1/50
C29126	1 1/4" slip x 1 1/2" slip	1/50

Flexible Discharge Hose



- Ideal for sump pumps, centrifugal pumps, and submersible pumps
- Complete kit includes 24' hose, 1 1/4" adapter and steel clamp

PART NO.	DESCRIPTION	CTN/MSTR
C29123	1 1/2" Flex Discharge Hose Kit	1/5
C29124	1 1/4" Complete Kit	1/5

Roofrite® Hi-Heat Silicone Flashing



- Silicone range is designed for high temperature applications up to 390°F
- Ideal for corrugated metal roofs
- Can be used on flat roofs
- Pipe diameter markings
- For plumbing, heating, air conditioning, electrical or exhaust vents
- Pleated cone adjusts to any pitch up to 45° F
- Ozone and UV resistant

PART NO.	SIZE	CTN/MSTR
R16100	0"-2 3/4"	1/25
R16101	2"-6 1/8"	1/20
R16107	6"-10 1/32"	1/10
R16108	9 1/2"-14 3/4"	1/10

Roofrite® Roof Flashing



- Ideal for corrugated metal roofs
- Can be used on flat roofs
- Pipe diameter markings
- For plumbing, heating, air conditioning, electrical or exhaust vents
- Made of EPDM with flexible aluminum base
- Pleated cone adjusts to any pitch
- -30°F to +250°F
- Ozone and UV resistant

PART NO.	SIZE	CTN/MSTR
R15109	0"-1 1/4"	1/20
R15100	0"-2 3/4" pipe	1/20
R15101	2"-6 1/8" pipe	1/20
R15107	6"-10 1/32" pipe	1/10
R15108	9 1/2"-14 3/4" pipe	1/10

Galvanized Roof Flashing



- Double seal neoprene collar
- UPC, BOCA ad SBCCI approved

PART NO.	SIZE	FLANGE	CTN/MSTR
R40150	1 1/4" and 1 1/2"	8 3/4" x 12 1/2"	1/12
R40200	2"	8 3/4" x 12 1/2"	1/12
R40300	3"	10 3/4" x 14 1/2"	1/12
R40400	4"	12" x 16"	1/12

Aluminum Roof Flashing



- Double seal neoprene collar

PART NO.	SIZE	FLANGE	CTN/MSTR
R45150	1 1/4" and 1 1/2"	8 3/4" x 12 1/2"	1/12
R45200	2"	8 3/4" x 12 1/2"	1/12
R45300	3"	10 3/4" x 14 1/2"	1/12
R45400	4"	12" x 16"	1/12

All Neoprene Roof Flashing



- Double seal neoprene collar

PART NO.	SIZE	FLANGE	CTN/MSTR
R50150	1 1/4" and 1 1/2"	9" x 11 3/8"	1/20
R50200	2"	9" x 11 3/8"	1/20
R50300	3"	10" x 13 1/4"	1/20
R50400	4"	12" x 14 3/4"	1/20

Neo-poly Roof Flashing



- Poly vinyl base
- Neoprene collar

PART NO.	SIZE	FLANGE	CTN/MSTR
R57150	1 1/4" and 1 1/2"	9 1/4" x 13"	1/12
R57200	2"	9 1/4" x 13"	1/12
R57300	3"	11 1/8" x 15"	1/12
R57400	4"	12" x 15 1/2"	1/12

Lead Roof Flashing



- Southeastern Code
- 2 1/2 pounds
- Multi-pitch from flat to 7/12"
- CARTON QUANTITIES ONLY

PART NO.	SIZE	FLANGE	CTN QTY
R70150	1 1/2"	8 1/2" x 10 1/2"	12
R70200	2"	8 1/2" x 10 1/2"	12
R70300	3"	10 1/2" x 11 1/2"	6
R70400	4"	10 1/2" x 11 1/4"	6

Instant Sealant



- Flame resistant
- Fills holes and cracks
- Deadens sound
- Insulates against air conditioning and heat loss
- Prevents passage of dirt, water and insects
- Both 12 and 24 oz. cans spray in any position
- UPS GROUND AND MOTOR FREIGHT ONLY
- CARTON QUANTITIES ONLY

PART NO.	DESCRIPTION	CTN QTY
S30012	12 oz. cans	12
S30024	24 oz. cans	12

Hose and Hose Bracket for Service Sink



- Heavy duty 300 cloth-reinforced 5/8" rubber hose (2 1/2" long)
- 3/4" brass hose coupling at one end
- 5" x 3" stainless steel bracket with rubber grip

PART NO.	DESCRIPTION	CTN/MSTR
M05001	Hose with bracket	1
M05005	Bracket only	1/25

Mop Hanger for Service Sink



- 24" x 3" stainless steel hanger with three rubber tool grips
- Anchors included

PART NO.	DESCRIPTION	CTN/MSTR
M05003	Mop hanger	1/5

Anchor Bolt Kit



- Includes anchors, hex head screws and drill bit

PART NO.	SIZE	PIECES	DRILL BIT	CTN/MSTR
A33001	#8 x 1"	100	3/16"	1/50
A33002	#10 x 1 1/4"	100	1/4"	1/36
A33005	#14 x 1 1/2"	50	5/16"	1/36

Stove Bolt with Nut



- Zinc plated
- CARTON QUANTITIES ONLY

PART NO.	SIZE	CTN QTY
F33009	3/16" x 3/4"	100
F33010	1/4" x 3/4"	100
F33011	1/4" x 1"	100
F33012	1/4" x 1 1/4"	100
F33013	1/4" x 1 1/2"	100
F33014	1/4" x 2"	100

Flat Phillips Head Brass Wood Screw



- Flat Phillips head
- Solid brass construction
- CARTON QUANTITIES ONLY

PART NO.	SIZE	CTN QTY
F33300	#12 x 1 1/4"	100
F33301	#12 x 1 1/2"	100
F33302	#12 x 2"	100
F33303	#14 x 1 1/4"	100

Phillips Head Wood Screw



- Zinc plated
- CARTON QUANTITIES ONLY

PART NO.	SIZE	CTN QTY
F33030	#10 x 1 1/2"	100
F33031	#12 x 1"	100
F33032	#12 x 1 1/4"	100
F33033	#12 x 1 1/2"	100
F33034	#12 x 2"	100
F33035	#12 x 2 1/2"	100
F33036	#12 x 3"	100
F33037	#14 x 1 1/4"	100
F33038	#14 x 1 1/2"	100
F33039	#14 x 2"	100
F33040	#14 x 2 1/2"	100
F33041	#14 x 3"	100

Hex Head Lag Screw



- CARTON QUANTITIES ONLY

PART NO.	SIZE	CTN QTY
F33140	3/8" x 1"	100
F33141	3/8" x 1 1/2"	100
F33142	3/8" x 2"	100
F33143	3/8" x 2 1/2"	50
F33144	3/8" x 3"	50

E-Z Anchor/Self-Drilling Wall Board



- Die cast zinc
- Installs with #2 Phillips screwdriver
- CARTON QUANTITIES ONLY

PART NO.	DESCRIPTION	CTN QTY
A33010	E-Z Anchor with 1 1/4" screws	10

Toggle Bolt



Toggle Bolt



Toggle Wing

- Zinc plated
- Spring loaded wing
- CARTON QUANTITIES ONLY

PART NO.	SIZE	CTN QTY
F33060	3/16" x 3/4"	50
F33061	1/4" x 3"	50
F33062	1/4" x 4"	50
F33063	1/4" x 6"	50
F33064	3/8" x 4"	50
F33065	3/8" x 6"	50
Toggle Wing Only		
PART NO.	SIZE	CTN QTY
F33066	3/16"	100
F33067	1/4"	100
F33068	3/8"	100
F33069	1/2"	100

Hex Head Tapping Screw



- Zinc plated
- CARTON QUANTITIES ONLY

PART NO.	SIZE	CTN QTY
F33101	#7 x 1/2"	100
F33102	#7 x 1/2"	1000
F33103	#8 x 1/2"	100
F33104	#8 x 1/2"	1000
F33105	#8 x 3/4"	100
F33106	#8 x 3/4"	1000
F33107	#8 x 1"	100
F33108	#8 x 1"	500
F33109	#8 x 1 1/2"	50
F33110	#8 x 1 1/2"	500
F33111	#8 x 2"	50
F33112	#8 x 2"	250
F33113	#10 x 3/4"	100
F33114	#10 x 3/4"	1000
F33115	#10 x 1"	100
F33116	#10 x 1"	500

Drill Point Tech Screw



- CARTON QUANTITIES ONLY

PART NO.	SIZE	CTN QTY
F33120	#8 x 1/2"	100
F33121	#8 x 1/2"	500
F33122	#8 x 3/4"	100
F33123	#8 x 3/4"	500
F33124	#10 x 3/4"	100
F33125	#10 x 3/4"	500
F33126	#10 x 1"	100
F33127	#10 x 1"	500
F33128	#10 x 1 1/2"	100
F33129	#12 x 3/4"	100
F33130	#12 x 1"	100
F33131	#12 x 1 1/2"	100
F33132	#12 x 2"	100

Hex Nut



- Zinc plated
- CARTON QUANTITIES ONLY

PART NO.	SIZE	CTN QTY
F33080	1/4" - 20	100
F33081	5/16" - 18	100
F33082	3/8" - 16	100
F33083	1/2" - 13	50

Zinc Plated Fender Washer



- CARTON QUANTITIES ONLY

PART NO.	SIZE	OD	CTN QTY
F33098	1/4"	1 1/2"	100
F33096	3/8"	1 1/2"	100
F33097	1/2"	2"	100

Flat Washer



- Zinc plated
- CARTON QUANTITIES ONLY

PART NO.	SIZE	OD	CTN QTY
F33094	3/8"	1"	100
F33095	1/2"	1 3/8"	100

Carrier Nuts and Washer Set



- 4 nuts and washers
- 5/8 - 11 threads
- Much lower cost than specification companies

PART NO.	DESCRIPTION	CTN/MSTR
C56100	Carrier nuts and washer set (4-pack)	1/100

Universal Beam Clamp



- 3/8" UNC bolt thread
- Steel set screw

PART NO.	SIZE	ROD SIZE	CTN QTY
H60375	3/8"	3/8"	25
H60050	1/2"	1/2"	25
H60625	5/8"	5/8"	25
H60075	3/4"	3/4"	25

Copper Pipe Hangers - Bell & Milford Types



Bell Type



Milford Type

- Copper clad

Bell Type		
PART NO.	SIZE	CTN/MSTR
H83050	1/2"	25/500
H83075	3/4"	25/500
H83100	1"	25/500

Milford Type		
PART NO.	SIZE	CTN QTY
H84050	1/2" x 6"	25
H84075	3/4" x 6"	25
H84100	1" x 6"	25
H85050	1/2" x 12"	25
H85075	3/4" x 12"	25
H85100	1" x 12"	25

Conduit Hangers



- Packed with bolts and nuts
- CARTON QUANTITIES ONLY

Zinc Plated				
PART NO.	CODE NO.	RIGID	THIN WALL	CTN QTY
H14050	0	1/2"-3/8"	1/2"	100
H14075	1	3/4"	3/4"	50
H14100	2	1"	1"	50
H14125	3	1 1/4"	-	50
H14150	4	1 1/2"	1 1/2"	25
H14200	5	2"	2"	25
H14250	6	2 1/2"	-	10
H14300	7	3"	-	10
H14350	8	3 1/2"	-	10
H14400	9	4"	-	10

Copper Plated				
PART NO.	CODE NO.	RIGID	THIN WALL	CTN QTY
H17050	0	1/2"-3/8"	1/2"	100
H17075	1	3/4"	3/4"	100
H17100	2	1"	1"	50
H17125	3	1 1/4"	-	50
H17150	4	1 1/2"	1 1/2"	25
H17200	5	2"	2"	25
H17250	6	2 1/2"	-	25
H17300	7	3"	-	25
H17350	8	3 1/2"	-	25
H17400	9	4"	-	25

Swivel Ring



- Supplied with nuts

Zinc Plated			
PART NO.	SIZE	ROD SIZE	CTN QTY
H65050	1/2"	3/8"	25
H65075	3/4"	3/8"	25
H65100	1"	3/8"	25
H65125	1 1/4"	3/8"	25
H65150	1 1/2"	3/8"	25
H65200	2"	1/2"	20
H65250	2 1/2"	1/2"	20
H65300	3"	1/2"	10
H65400	4"	1/2"	10
H65500	5"	1/2"	5
H65600	6"	1/2"	5

Copper Plated			
PART NO.	SIZE	ROD SIZE	CTN QTY
H66050	1/2"	3/8"	25
H66075	3/4"	3/8"	25
H66100	1"	3/8"	25
H66125	1 1/4"	3/8"	25
H66150	1 1/2"	3/8"	25
H66200	2"	1/2"	20
H66250	2 1/2"	1/2"	20
H66300	3"	1/2"	10
H66400	4"	1/2"	10

Zinc Plated Clevis Hanger



Standard - 401# Steel

PART NO.	SIZE	ROD SIZE	CTN QTY
H68050	1/2"	3/8"	25
H68075	3/4"	3/8"	25
H68100	1"	3/8"	25
H68125	1 1/4"	3/8"	25
H68150	1 1/2"	3/8"	25
H68200	2"	3/8"	20
H68250	2 1/2"	1/2"	20
H68300	3"	1/2"	10
H68350	3 1/2"	1/2"	10
H68400	4"	5/8"	10
H68500	5"	5/8"	5
H68600	6"	3/4"	5
H68800	8"	7/8"	5

Light Duty - 400# Steel

PART NO.	SIZE	ROD SIZE	CTN QTY
H69050	1/2"	3/8"	25
H69075	3/4"	3/8"	25
H69100	1"	3/8"	25
H69150	1 1/2"	3/8"	25
H69200	2"	3/8"	20
H69250	2 1/2"	1/2"	20
H69300	3"	1/2"	10
H69400	4"	5/8"	10

Riser Clamp



• For Schedule 40 iron pipe only - Not for soil pipe

PART NO.	SIZE	OVERALL WIDTH	CTN QTY
H70050	1/2"	9 3/8"	25
H70075	3/4"	9 3/8"	25
H70100	1"	9 3/8"	25
H70125	1 1/4"	10"	25
H70150	1 1/2"	10 3/8"	25
H70200	2"	10 7/8"	25
H70250	2 1/2"	11 1/4"	25
H70300	3"	11 3/4"	10
H70350	3 1/2"	13 1/4"	10
H70400	4"	13 1/2"	10

Hinged Split Ring



Zinc Plated for Iron Pipe

PART NO.	SIZE	ROD SIZE	CTN QTY
H72375	3/8"	3/8"	25
H72050	1/2"	3/8"	25
H72075	3/4"	3/8"	25
H72100	1"	3/8"	25
H72125	1 1/4"	3/8"	25
H72150	1 1/2"	3/8"	25
H72200	2"	3/8"	20
H72250	2 1/2"	1/2"	20
H72300	3"	1/2"	10
H72400	4"	1/2"	10

Copper Plated for Copper Tube

PART NO.	SIZE	ROD SIZE	CTN QTY
H73375	3/8"	3/8"	25
H73050	1/2"	3/8"	25
H73075	3/4"	3/8"	25
H73100	1"	3/8"	25
H73125	1 1/4"	3/8"	25
H73150	1 1/2"	3/8"	25
H73200	2"	3/8"	10

Ceiling Flange

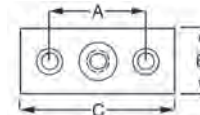

DIMENSIONS		
A	B	C
2"	1 3/8"	2 3/4"

PART NO.	SIZE	CTN QTY
H80375	3/8" plain finish	25
H80050	1/2" plain finish	25
H81375	3/8" zinc finish	25
H81050	1/2" zinc finish	25
H82375	3/8" copper finish	25
H82050	1/2" copper finish	25

Threaded Steel Rod



• Priced per rod
• CARTON QUANTITIES ONLY

PART NO.	DESCRIPTION	CTN QTY
T38006	3/8" x 6' plain finish	25
T38010	3/8" x 10' plain finish	25
T12006	1/2" x 6' plain finish	12
T12010	1/2" x 10' plain finish	12
T38106	3/8" x 6' zinc finish	25
T38110	3/8" x 10' zinc finish	25
T12106	1/2" x 6' zinc finish	12
T12110	1/2" x 10' zinc finish	12

Drop-In Concrete Anchor



- Priced per rod
- CARTON QUANTITIES ONLY

PART NO.	DESCRIPTION	CTN/MSTR
T38038	3/8" Drop-In Anchor	50/900
T12050	1/2" Drop-In Anchor	50/500

Rod Coupling Nut



- Hex, zinc plated, carbon steel

PART NO.	DESCRIPTION	CTN/MSTR
R60001	1/4" x 7/8"	50/1000
R60002	3/8" x 1 3/4"	50/1000
R60003	1/2" x 1 3/4"	50/1000
R60004	5/8" x 2 1/8"	50/200

Water Meter Box Keys and Covers



M07001



M07002



M25900

- All brass



M25900 bottom view

PART NO.	DESCRIPTION	CTN/MSTR
M07001	Meter box key	1/100
M07002	Combination key and wrench	1/50
M25900	Penta head meter box and roadway box wrench	1/15

Water Meter Coupling Complete



- Heavy cast brass
- Complete with gasket
- LEAD FREE

PART NO.	SIZE	NPSM	LENGTH	NPT	CTN/MSTR
M20058	1/2"	3/4"	2 3/8"	1/2"	25/100
M20075	3/4"	1"	2 1/2"	3/4"	1/100
M20100	1"	1 1/4"	2 5/8"	1"	1/100

Gasket Only for Water Meter Couplings

- CARTON QUANTITIES ONLY



PART NO.	DESCRIPTION	CTN QTY
M20581	5/8" gasket for coupling	25
M20751	3/4" gasket for coupling	25
M20101	1" gasket for coupling	25

10" Economy Meter Box

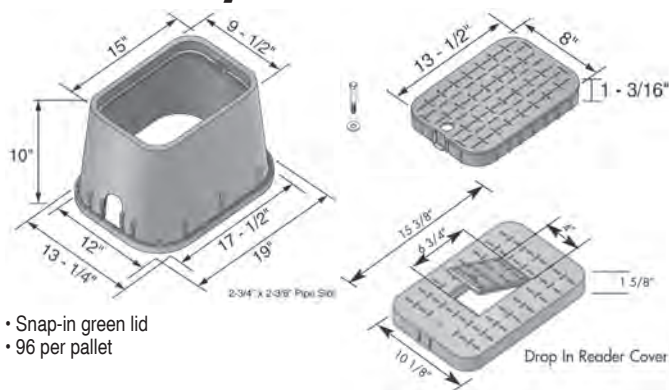

- Snap-in green lid
- 96 per pallet

PART NO.	DESCRIPTION	CTN/MSTR
M06001	10" rectangular box and lid	1/96
M06002	10" green snap-in lid only	1

Note: All items shown are for non-vehicular applications. Concrete and asphalt installations are not recommended for plastic parts.

12" Water Meter Box

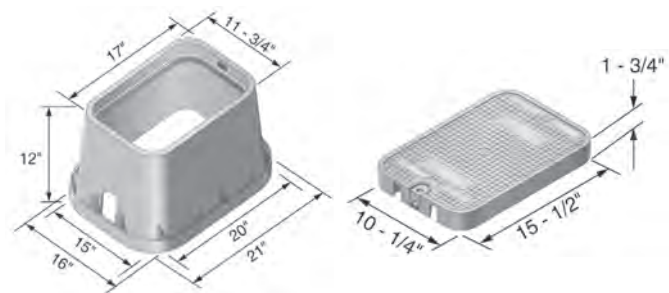

PART NO.	DESCRIPTION	CTN/MSTR
M12001	12" box and solid green lid	1/72
M12002	12" box and black reader lid	1/72
M12022	12" box and lid marked "sewer"	1/72
M12003	6" extension	1/42
M12005	12" solid green lid only	1
M12006	12" black reader lid only	1
M12009	12" box and solid black lid	1/72

Note: All items shown are for non-vehicular applications. Concrete and asphalt installations are not recommended for plastic parts.

12" Water Meter Box with Solid Cast Iron Lid

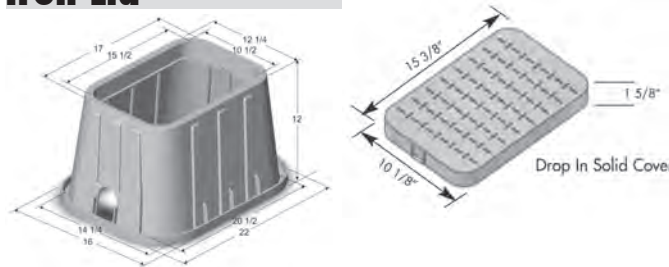

PART NO.	DESCRIPTION	CTN QTY
M12100	12" box with cast iron lid	1
M12085	Cast iron cover only	1

Note: All items shown are for non-vehicular applications. Concrete and asphalt installations are not recommended for plastic parts.

12" Standard Meter Box with Plastic Lid and Cast Iron Reader

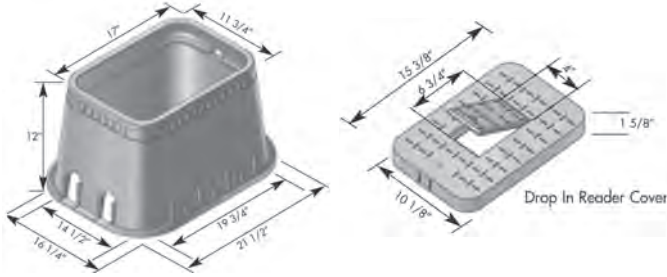

• 72 per pallet

PART NO.	DESCRIPTION	CTN QTY
M12004	12" box with plastic lid & cast iron reader	1

Note: All items shown are for non-vehicular applications. Concrete and asphalt installations are not recommended for plastic parts.

12" Irrigation Box (6" Deep)

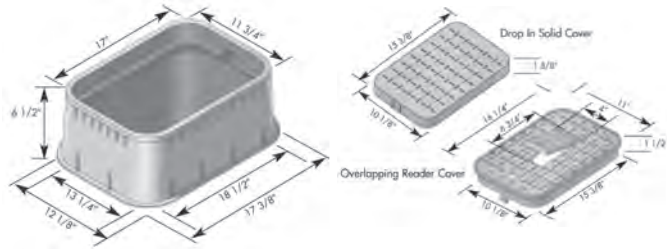

PART NO.	DESCRIPTION	CTN QTY
M12007	6" depth with green lid	1
M12005	12" solid green lid only	1
M12006	12" black reader lid only	1
M12008	12" valve box 6" deep with reader lid	1

Note: All items shown are for non-vehicular applications. Concrete and asphalt installations are not recommended for plastic parts.

15" Jumbo Water Meter Boxes

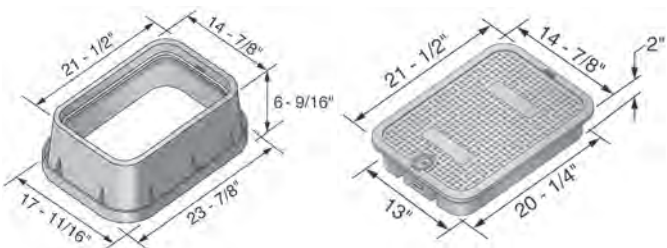

PART NO.	DESCRIPTION	CTN/MSTR
M15001	15" box and green solid lid	1/48
M15009	6" extension for M15001	1/36
M15002	15" box and black reader lid	1/48
M15004	15" solid green lid only	1
M15005	15" black reader lid only	1
M15006	6" extension with solid green lid	1

Note: All items shown are for non-vehicular applications. Concrete and asphalt installations are not recommended for plastic parts.

6" Residential Valve Boxes

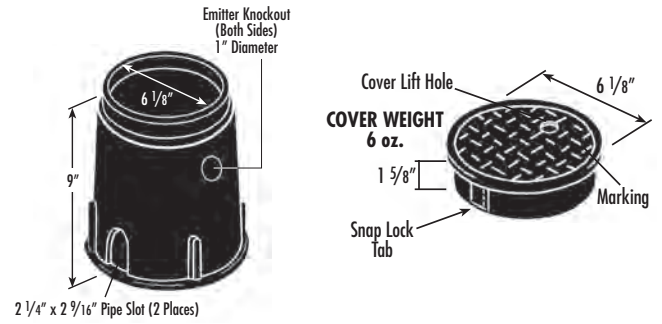

- Snap-in green lid
- Overlapping cover keeps dirt or grass from between body and lid
- Valve box can be extended with any 6" plastic or iron pipe
- 36 per carton

PART NO.	DESCRIPTION	CTN/MSTR
M06006	6" valve box 9" tall	1/36
M06007	6" green snap-in lid only	1

Note: All items shown are for non-vehicular applications. Concrete and asphalt installations are not recommended for plastic parts.

10" Round Valve Boxes

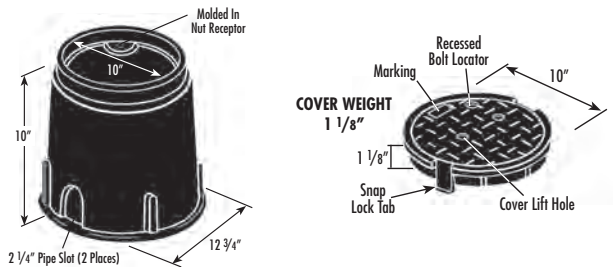

- Snap-in green lid
- Overlapping cover keeps dirt or grass from between body and lid
- 99 per pallet

PART NO.	DESCRIPTION	CTN QTY
M06010	10" round body and green lid	1/180

Note: All items shown are for non-vehicular applications. Concrete and asphalt installations are not recommended for plastic parts.

Shipping Boxes



- 32 ECT board test
- Kraft (brown)
- 200 pound burst strength
- BUNDLE QUANTITIES ONLY

PART NO.	SIZE	CTN/MSTR
BOX012	12 3/4"L x 12 3/4"W x 13 1/2"D	1/20
BOX011	11 1/8"L x 11 1/8"W x 9 1/8"D	1/20
BOX008	8"L x 8"W x 8"D	1/20
BOX006	6"L x 6"W x 8"D	1/20

Bin Boxes



PART NO.	SIZE	CTN/MSTR
BIN004	4"L x 12"W x 6 5/8"D	1/20
BIN005	5 1/4"L x 11 3/4"W x 6"D	1/20
BIN008	8"L x 12 1/4"W x 7 1/2"D	1/20
BIN012	12"L x 12 3/8"W x 7 1/2"D	1/20

Plastic Tub Box



PART NO.	SIZE	CTN QTY
T40001	13"L x 13"W x 7"D	1
T40002	12"L x 8 1/8"W x 6 1/2"D	1

Cardboard Tub Box



PART NO.	SIZE	CTN/MSTR
T40003	12"L x 8"W x 8 1/2"D wax coated	1/10
T40004	14 1/2"L x 11 5/16"W x 6"D wax coated	1/10
T40005	15"L x 12"W x 9"D	1/10
T40007	12"L x 12"W x 9"D	1/10
T40008	12"L x 12"W x 12"D non-coated	1/10

SECTION D - FITTINGS & VALVES

Brass Compression Fittings 131-132

Chrome Plated Compression Fittings 133

45° Flare Tube Fittings 134-135

Space Heater & Gas Range Fittings 136

Yellow Brass Pipe Fittings 137-138

PEX Fittings 139-140

Push On Fittings 141-146

Red Brass Pipe Fittings 147-148

Bronze Pipe Fittings 149-153

Chrome Plated Pipe Nipples & Fittings 154-155

Brass Garden Hose Fittings 156-157

Brass Hose Barbs 158

Nylon Fittings..... 159-160

Poly Insert Fittings..... 161

Red Brass Insert Fittings..... 162

Galvanized Insert Fittings..... 163

Brass Needle Valves 164

Shut-Off Valves 165

Drain Cocks/Air Cocks..... 166

Ball Valves 167-169

Valves 170

Hose Bibbs 171

Gear Clamps 172-173

Flange Connection Gaskets & Kits 174-175

Rubber Sheet/Gasket Material 176

Water Hammer Arresters 177-178

Compression Cap

Style 61C



PART NO.	TUBE SIZE	CTN/MSTR
C74001	1/4"	500/1000
C74002	3/8"	500/1000
C74147	1/2"	1
C74155	5/8"	1

Compression Sleeve

Style 60



PART NO.	TUBE SIZE	CTN/MSTR
C74003	1/8"	1
C74004	3/16"	1
C74005	1/4"	1
C74006	5/16"	1
C74007	3/8"	10000
C74151	7/16"	1
C74008	1/2"	1
C74009	5/8"	2000/4000
C74010	3/4"	100/1000
C74011	7/8"	1

Compression Nuts

Style 61



• CARTON QUANTITIES ONLY

PART NO.	TUBE SIZE	CTN/MSTR
C74012	1/8"	200
C74013	3/16"	100
C74014	1/4"	500/2000
C74015	5/16"	25
C74016	3/8"	1/2000
C74152	7/16"	10
C74017	1/2"	1
C74018	5/8"	100/400
C74019	3/4"	1
C74020	7/8"	1

Delrin Compression Sleeve

Style 60P



• CARTON QUANTITIES ONLY

PART NO.	TUBE SIZE	CTN/MSTR
C74096	1/4"	100
C74097	3/8"	100
C74098	1/2"	100
C74099	5/8"	50

Brass Compression Insert

Style 63P



PART NO.	TUBE SIZE	CTN/MSTR
C74100	1/4"	100/5000
C74100T	1/4"	10
C74101	3/8"	1000/9000
C74101T	3/8"	10
C74102	1/2"	50
C74103	5/8"	100/3000

Compression Union

Style 62



PART NO.	TUBE SIZE	CTN/MSTR
C74021	1/8"	100/1000
C74022	3/16"	1
C74023	1/4"	100/500
C74024	5/16"	50/500
C74025	3/8"	250/500
C74154	7/16"	1
C74026	1/2"	20/260
C74027	5/8"	20/200
C74028	3/4"	50/150
C74029	7/8"	50/100
C74030	3/8" x 1/4"	1/500
C74031	1/2" x 3/8"	50/300
C74032	5/8" x 3/8"	100/400
C74033	5/8" x 1/2"	25/200

Compression Union - LEAD FREE

Style 62



PART NO.	TUBE SIZE	CTN/MSTR
C74023LF	1/4"	100/600
C74025LF	3/8"	50/400
C74026LF	1/2"	20/260
C74027LF	5/8"	250
C74029LF	7/8"	1/100
C74030LF	3/8" x 1/4"	1/500
C74031LF	1/2" x 3/8"	1
C74032LF	5/8" x 3/8"	1

Compression Tee

Style 64



PART NO.	TUBE SIZE	CTN/MSTR
C74034	1/4"	1/500
C74035	5/16"	1
C74036	3/8"	125/250
C74037	3/8" x 3/8" x 1/4"	1/300
C74038	1/2"	1/150
C74104	1/2" x 1/2" x 3/8"	1
C74039	5/8"	50/100
C74145	5/8" x 5/8" x 3/8"	1
C74106	5/8" x 5/8" x 1/2"	1
C74107	3/4"	1
C74108	7/8"	10/30

Compression Tee - LEAD FREE

Style 64



PART NO.	TUBE SIZE	CTN/MSTR
C74034LF	1/4"	1
C74036LF	3/8"	300
C74038LF	1/2"	1
C74039LF	5/8"	1

Compression x FIP Branch Tee

Style 78



PART NO.	TUBE x FIP	CTN/MSTR
C74091	3/8" x 1/8"	1
C74092	3/8" x 1/4"	1

Compression x MIP Branch Tee

Style 72



PART NO.	TUBE x MIP	CTN/MSTR
C74056	3/8" x 1/4"	1
C74057	3/8" x 3/8"	1

Compression x Sweat Adapter

Style 666



PART NO.	TUBE x OD (1/2" swt)	CTN/MSTR
C74093	3/8" x 5/8"	100/250

Compression x FIP Connector

Style 66



PART NO.	TUBE x FIP	CTN/MSTR
C74045	1/4" x 1/8"	250/1000
C74046	1/4" x 1/4"	50/500
C74113	1/4" x 3/8"	250/500
C74114	1/4" x 1/2"	100/400
C74115	5/16" x 1/8"	1
C74047	5/16" x 1/4"	1
C74048	3/8" x 1/8"	1
C74049	3/8" x 1/4"	50/500
C74050	3/8" x 3/8"	100/400
C74051	3/8" x 1/2"	100/400
C74156	3/8" x 3/4"	50/400
C74116	1/2" x 1/4"	50/500
C74052	1/2" x 3/8"	1
C74053	1/2" x 1/2"	1
C74117	1/2" x 3/4"	75/300
C74054	5/8" x 1/2"	1
C74118	5/8" x 3/4"	1/100
C74119	3/4" x 1/2"	1
C74120	3/4" x 3/4"	10
C74150	7/8" x 1/2"	1
C74055	7/8" x 3/4"	10/150

Compression x FIP Connector - LEAD FREE

Style 66



PART NO.	TUBE x FIP	CTN/MSTR
C74050LF	3/8" x 3/8"	1
C74051LF	3/8" x 1/2"	1
C74052LF	1/2" x 3/8"	1
C74053LF	1/2" x 1/2"	1
C74054LF	5/8" x 1/2"	1
C74055LF	7/8" x 3/4"	1

Compression x MIP Connector

Style 68



PART NO.	TUBE x MIP	CTN/MSTR
C74121	1/8" x 1/8"	1
C74122	3/16" x 1/8"	1
C74058	1/4" x 1/8"	100/1000
C74059	1/4" x 1/4"	50/600
C74060	1/4" x 3/8"	50/500
C74123	1/4" x 1/2"	125/500
C74061	5/16" x 1/8"	250/500
C74062	5/16" x 1/4"	50/500
C74063	3/8" x 1/8"	1
C74064	3/8" x 1/4"	200/800
C74065	3/8" x 3/8"	100/400
C74066	3/8" x 1/2"	100/400
C74067	3/8" x 3/4"	20/200
C74068	1/2" x 1/4"	50/500
C74069	1/2" x 3/8"	10/250
C74070	1/2" x 1/2"	100/400
C74124	1/2" x 3/4"	125/250
C74146	5/8" x 3/8"	50/200
C74071	5/8" x 1/2"	50/200
C74072	5/8" x 3/4"	20/200
C74125	3/4" x 1/2"	100/200
C74126	3/4" x 3/4"	50/100
C74149	7/8" x 1/2"	20/200
C74073	7/8" x 3/4"	1
C74157	7/8" x 1"	50/100

Compression x MIP Connector - LEAD FREE

Style 68



PART NO.	TUBE x MIP	CTN/MSTR
C74058LF	1/4" x 1/8"	1
C74059LF	1/4" x 1/4"	1
C74060LF	1/4" x 3/8"	1
C74064LF	3/8" x 1/4"	1
C74065LF	3/8" x 3/8"	1
C74066LF	3/8" x 1/2"	1
C74069LF	1/2" x 3/8"	1
C74070LF	1/2" x 1/2"	1
C74071LF	5/8" x 1/2"	1
C74072LF	5/8" x 3/4"	1
C74073LF	7/8" x 3/4"	1

Compression Elbow

Style 65



PART NO.	TUBE SIZE	CTN/MSTR
C74040	1/4"	1
C74041	3/8"	50/300
C74042	1/2"	50/200
C74109	1/2" x 3/8"	1
C74043	5/8"	50/100
C74044	5/8" x 3/8"	100/400
C74110	5/8" x 1/2"	1
C74111	3/4"	1/30
C74112	7/8"	1

Compression Elbow - LEAD FREE

Style 65



PART NO.	TUBE SIZE	CTN/MSTR
C74041LF	3/8"	1
C74042LF	1/2"	1
C74043LF	5/8"	1
C74044LF	5/8" x 3/8"	1

Compression x FIP Elbow

Style 70



PART NO.	TUBE x MIP	CTN/MSTR
C74074	1/4" x 1/8"	1
C74075	1/4" x 1/4"	1
C74127	1/4" x 3/8"	1
C74128	1/4" x 1/2"	1
C74129	3/8" x 1/8"	1
C74076	3/8" x 1/4"	1
C74077	3/8" x 3/8"	1
C74078	3/8" x 1/2"	20/250
C74130	1/2" x 1/4"	1
C74131	1/2" x 3/8"	1
C74079	1/2" x 1/2"	1
C74080	5/8" x 1/2"	1
C74132	5/8" x 3/4"	1

Compression x MIP Elbow

Style 69



PART NO.	TUBE x MIP	CTN/MSTR
C74133	1/8" x 1/8"	1
C74134	3/16" x 1/8"	1
C74081	1/4" x 1/8"	1
C74082	1/4" x 1/4"	50/700
C74135	1/4" x 3/8"	1
C74136	1/4" x 1/2"	1
C74083	5/16" x 1/8"	1
C74084	5/16" x 1/4"	1
C74137	3/8" x 1/8"	50/400
C74085	3/8" x 1/4"	50/500
C74086	3/8" x 3/8"	20/300
C74087	3/8" x 1/2"	100/400
C74138	3/8" x 3/4"	1
C74139	1/2" x 1/4"	1
C74088	1/2" x 3/8"	1
C74089	1/2" x 1/2"	50/300
C74140	1/2" x 3/4"	1
C74141	5/8" x 3/8"	75/300
C74090	5/8" x 1/2"	10/250
C74142	5/8" x 3/4"	1
C74143	3/4" x 1/2"	1
C74144	3/4" x 3/4"	10/100
C74148	7/8" x 3/4"	1

Compression x MIP Elbow - LEAD FREE

Style 69



PART NO.	TUBE x MIP	CTN/MSTR
C74081LF	1/4" x 1/8"	1
C74082LF	1/4" x 1/4"	1
C74085LF	3/8" x 1/4"	1
C74086LF	3/8" x 3/8"	1
C74087LF	3/8" x 1/2"	1
C74088LF	1/2" x 3/8"	1
C74089LF	1/2" x 1/2"	1

Pilot Line Breakaway Nut



PART NO.	DESCRIPTION	CTN/MSTR
C74158	1/4" OD	1

Chrome Plated Compression Nut



PART NO.	TUBE SIZE	CTN/MSTR
C74094	3/8"	500/2000
C74095	1/2"	1
N61010	5/8"	1

Chrome Plated Union



PART NO.	TUBE SIZE	CTN/MSTR
N62006	3/8"	50
N62008	1/2"	1
N62010	5/8"	125/300
N62086	1/2" x 3/8"	1
N62106	5/8" x 3/8"	1
N62108	5/8" x 1/2"	1

Chrome Plated Elbow



PART NO.	TUBE SIZE	CTN/MSTR
N65106	5/8" x 3/8"	1

CP Compression x FIP Connector



PART NO.	TUBE x FIP	CTN/MSTR
N66066	3/8" x 3/8"	1
N66068	3/8" x 1/2"	125/250
N66086	1/2" x 3/8"	25/250
N66088	1/2" x 1/2"	125/250

CP Compression x MIP Connector



PART NO.	TUBE x MIP	CTN/MSTR
N68066	3/8" x 3/8"	100/500
N68068	3/8" x 1/2"	100/400
N68086	1/2" x 3/8"	150/300
N68088	1/2" x 1/2"	150/300

CP Compression x Sweat Adapter



PART NO.	TUBE x OD	CTN/MSTR
N66610	3/8" x 5/8" (1/2" swt)	100/200

CP Compression x FIP Elbow



PART NO.	TUBE x FIP	CTN/MSTR
N70066	3/8" x 3/8"	100/400
N70068	3/8" x 1/2"	1/150
N70086	1/2" x 3/8"	1
N70088	1/2" x 1/2"	1

CP Compression x MIP Elbow



PART NO.	TUBE x MIP	CTN/MSTR
N69066	3/8" x 3/8"	1
N69068	3/8" x 1/2"	1
N69086	1/2" x 3/8"	1
N69088	1/2" x 1/2"	1

3' Chrome Plated Brass Cover Tubes



- Plain ends (no threads)
- 20 gauge

PART NO.	DESCRIPTION	CTN/MSTR
T73125	1-1/4" OD x 3' tube	1/25
T73138	1-3/8" OD x 3' tube	1/25
T73150	1-1/2" OD x 3' tube	1/25
T73175	1-3/4" OD x 3' tube	1/25
T73200	2" OD x 3' tube	1/20

Short Flare Nut

Style 41S



PART NO.	TUBE SIZE	CTN/MSTR
F40001	3/16"	1
F40002	1/4"	100/1200
F40003	5/16"	1
F40004	3/8"	100/2000
F40005	1/2"	10/200
F40006	5/8"	5/200
F40007	3/4"	1
F40126	7/8"	1

D

Long Flare Nut

Style 641FS Style 41L



PART NO.	TUBE SIZE	CTN/MSTR
F40008	3/8"	1
F40131	1/4"	1
F40132	1/2"	1
F40133	5/8"	1

Short Forged Flare Nut

Style 641 FS



PART NO.	TUBE SIZE	CTN/MSTR
F40009	1/4"	1
F40010	3/8"	1
F40011	1/2"	5/200
F40012	5/8"	5/200
F40013	3/8"x 1/4"	1
F40014	1/2"x 3/8"	1
F40119	5/8"x 1/2"	1

Plug

Style 39



PART NO.	TUBE SIZE	CTN/MSTR
F40015	1/4"	1
F40016	3/8"	90/960
F40017	1/2"	50/500
F40018	5/8"	1

Cap

Style 40



PART NO.	TUBE SIZE	CTN/MSTR
F40019	1/4"	1
F40098	5/16"	1
F40020	3/8"	100
F40021	1/2"	100/500
F40022	5/8"	40/480

Flare Tees

Style 44



PART NO.	TUBE SIZE	CTN/MSTR
F40033	1/4"	1
F40034	5/16"	1
F40035	3/8"	10/200
F40036	1/2"	10/200
F40037	5/8"	5/200
F40124	3/4"	1
F40038	3/8"x 3/8"x 1/4"	1
F40039	1/2"x 1/2"x 3/8"	1
F40120	5/8"x 5/8"x 1/2"	1

Flare x MIP Branch Tee

Style 45



PART NO.	TUBE x MIP	CTN/MSTR
F40040	3/8"x 1/4"	1
F40041	3/8"x 3/8"	1

Female Flare Swivel

Style 70



PART NO.	TUBE SIZE	CTN/MSTR
F40125	1/4"	1
F40095	3/8"	100/400
F40096	1/2"	20/250
F40097	5/8"	10/150

Flare Union

Style 42



PART NO.	TUBE SIZE	CTN/MSTR
F40123	3/16"	1
F40023	1/4"	1
F40024	5/16"	1
F40025	3/8"	50/400
F40026	1/2"	10/200
F40027	5/8"	10/200
F40100	3/4"	10/150
F40127	7/8"	1
F40028	3/8"x 1/4"	1
F40029	1/2"x 1/4"	1
F40030	1/2"x 3/8"	10/200
F40031	5/8"x 3/8"	1
F40032	5/8"x 1/2"	1

Flare x MIP Half Union

Style 48



PART NO.	TUBE x MIP	CTN/MSTR
F40062	3/16" x 1/8"	1
F40063	1/4" x 1/8"	1
F40064	1/4" x 1/4"	10/200
F40107	1/4" x 3/8"	1
F40108	1/4" x 1/2"	1
F40065	5/16" x 1/8"	1
F40066	5/16" x 1/4"	1
F40067	3/8" x 1/8"	1
F40068	3/8" x 1/4"	50/500
F40069	3/8" x 3/8"	10/200
F40070	3/8" x 1/2"	10/200
F40071	3/8" x 3/4"	20/240
F40072	1/2" x 1/4"	1
F40073	1/2" x 3/8"	10/200
F40074	1/2" x 1/2"	10/200
F40075	1/2" x 3/4"	10/200
F40109	5/8" x 3/8"	1
F40076	5/8" x 1/2"	20/300
F40077	5/8" x 3/4"	20/200
F40110	3/4" x 1/2"	1
F40112	3/4" x 3/4"	1
F40122	7/8" x 3/4"	1

Flare Elbow

Style 55



PART NO.	TUBE SIZE	CTN/MSTR
F40078	1/4"	1
F40079	3/8"	1
F40080	1/2"	10/250
F40081	5/8"	1

Flare x FIP Elbow

Style 50



PART NO.	TUBE x FIP	CTN/MSTR
F40104	1/4" x 1/4"	1
F40105	1/4" x 3/8"	1
F40056	3/8" x 1/4"	1
F40057	3/8" x 3/8"	1
F40058	3/8" x 1/2"	1
F40059	1/2" x 3/8"	1
F40060	1/2" x 1/2"	1
F40061	5/8" x 1/2"	1
F40106	5/8" x 3/4"	1
F40135	1/2" x 3/4"	1/200

Flare x FIP Coupling

Style 46



PART NO.	TUBE x FIP	CTN/MSTR
F40042	1/4" x 1/8"	1
F40043	1/4" x 1/4"	1
F40117	1/4" x 3/8"	1
F40118	1/4" x 1/2"	1
F40044	5/16" x 1/8"	1
F40045	5/16" x 1/4"	1
F40046	3/8" x 1/8"	1
F40047	3/8" x 1/4"	1
F40048	3/8" x 3/8"	30/300
F40049	3/8" x 1/2"	10/200
F40050	3/8" x 3/4"	1
F40051	1/2" x 1/4"	1
F40052	1/2" x 3/8"	30/300
F40053	1/2" x 1/2"	10/200
F40054	1/2" x 3/4"	20/240
F40055	5/8" x 1/2"	10/200
F40101	5/8" x 3/4"	1
F40102	3/4" x 1/2"	1
F40103	3/4" x 3/4"	1
F40121	7/8" x 3/4"	1

Flare x MIP Elbow

Style 49



PART NO.	TUBE x MIP	CTN/MSTR
F40082	1/4" x 1/8"	1
F40083	1/4" x 1/4"	1
F40113	1/4" x 3/8"	1
F40084	5/16" x 1/8"	1
F40085	5/16" x 1/4"	1
F40086	3/8" x 1/8"	1
F40087	3/8" x 1/4"	1
F40088	3/8" x 3/8"	32/384
F40089	3/8" x 1/2"	20/300
F40090	3/8" x 3/4"	1
F40091	1/2" x 3/8"	10/200
F40114	1/2" x 1/4"	1
F40092	1/2" x 1/2"	10/200
F40093	1/2" x 3/4"	1
F40128	5/8" x 3/8"	1
F40094	5/8" x 1/2"	1
F40115	5/8" x 3/4"	1
F40111	3/4" x 1/2"	1
F40116	3/4" x 3/4"	1

Space Heater Fittings

Nut



• 9/16"-24 Fine threaded flare

PART NO.	OD	CTN/MSTR
F41001	3/8"	1
F41002	3/8"x 1/4"	1

Cap



• 9/16"-24 Fine threaded flare

PART NO.	OD	CTN/MSTR
F41003	3/8"	1

Union



• 9/16"-24 Fine threaded flare

PART NO.	OD	CTN/MSTR
F41008	3/8"	1

Female Coupling



• 9/16"-24 Fine threaded flare

PART NO.	OD x FIP	CTN/MSTR
F41004	3/8"x 3/8"	1
F41005	3/8"x 1/2"	1

Male Half Union



• 9/16"-24 Fine threaded flare

PART NO.	OD x MIP	CTN/MSTR
F41006	3/8"x 3/8"	1
F41007	3/8"x 1/2"	1

Tee



• 9/16"-24 Fine threaded flare

PART NO.	OD	CTN/MSTR
F41009	3/8"	1/100

Female Elbow



• 9/16"-24 Fine threaded flare

PART NO.	OD x FIP	CTN/MSTR
F41011	3/8" x 1/2"	1

Male Elbow



• 9/16"-24 Fine threaded flare

PART NO.	OD x MIP	CTN/MSTR
F41012	3/8" x 3/8"	1
F41013	3/8" x 1/2"	1

Gas Range Fittings

Flare x Male



• CARTON QUANTITY: 5

PART NO.	OD x MIP	CTN/MSTR
F48108	5/8" (15/16-16)x 1/2"	1
F481012	5/8" (15/16-16)x 3/4"	1

Flare x Female



• CARTON QUANTITY: 5

PART NO.	OD x FIP	CTN/MSTR
F46108	5/8"(15/16-16) x 1/2"	1
F461012	5/8" (15/16-16) x 3/4"	1

Flare Cap & Nut



• CARTON QUANTITY: 5

PART NO.	SIZE	CTN/MSTR
F401516 (cap)	15/16"	1
F411516 (nut)	15/16"	1

D

90° Elbow



PART NO.	IPT	CTN/MSTR
P20002	1/8"	1
P20004	1/4"	1
P20006	3/8"	1
P20008	1/2"	1

90° Male Elbow



PART NO.	IPT	CTN/MSTR
P13986	1/2"	1

90° Street Elbow



PART NO.	IPT	CTN/MSTR
P16002	1/8"	1
P16004	1/4"	200/600
P16006	3/8"	1
P16008	1/2"	1

45° Elbow



PART NO.	IPT	CTN/MSTR
P10452	1/8"	1
P10454	1/4"	1

45° Street Elbow



PART NO.	IPT	CTN/MSTR
P12402	1/8"	1
P12404	1/4"	1
P12406	3/8"	1
P12408	1/2"	1

Tee



PART NO.	IPT	CTN/MSTR
P10012	1/8"	1
P10014	1/4"	1
P10016	3/8"	1
P10018	1/2"	1

Bell Reducer



PART NO.	IPT	CTN/MSTR
P19042	1/4" x 1/8"	1
P19062	3/8" x 1/8"	1
P19064	3/8" x 1/4"	1
P19082	1/2" x 1/8"	1
P19084	1/2" x 1/4"	1
P19086	1/2" x 3/8"	1
P19128	3/4" x 1/2"	1

Coupling



PART NO.	IPT	CTN/MSTR
P10032	1/8"	1
P10034	1/4"	1
P10036	3/8"	1
P10038	1/2"	1
P10312	3/4"	1

Cap



PART NO.	IPT	CTN/MSTR
P10082	1/8"	1
P10084	1/4"	1
P10086	3/8"	1
P10088	1/2"	1
P10812	3/4"	1

Square Head Plug



PART NO.	IPT	CTN/MSTR
P10092	1/8"	1
P10094	1/4"	84/1008
P10096	3/8"	1
P10098	1/2"	1
P10912	3/4"	1

HEX Head Plug



PART NO.	IPT	CTN/MSTR
P12102	1/8"	1
P12104	1/4"	1
P12106	3/8"	1
P12108	1/2"	1
P12112	3/4"	1

Countersunk Plug



PART NO.	IPT	CTN/MSTR
P20092	1/8"	1
P20094	1/4"	1
P20096	3/8"	1
P20098	1/2"	1

Long Nipple



PART NO.	IPT	CTN/MSTR
P13224	1/8" x 1-1/2"	1
P13232	1/8" x 2"	1
P13424	1/4" x 1-1/2"	1
P13432	1/4" x 2"	1
P13624	3/8" x 1-1/2"	1
P13632	3/8" x 2"	1

Lock Nut

D



PART NO.	IPT	CTN/MSTR
P11102	1/8"	1
P11104	1/4"	1
P11106	3/8"	1
P11108	1/2"	1

HEX Nipple



PART NO.	IPT	CTN/MSTR
P12202	1/8"	1
P12204	1/4"	1
P12206	3/8"	50/450
P12208	1/2"	1
P12212	3/4"	1
P12342	1/4" x 1/8"	1
P12362	3/8" x 1/8"	1
P12364	3/8" x 1/4"	1
P12384	1/2" x 1/4"	1
P12386	1/2" x 3/8"	1
P12328	3/4" x 1/2"	1/200

HEX Bushing



PART NO.	IPT	CTN/MSTR
P11042	1/4" x 1/8"	1
P11062	3/8" x 1/8"	1
P11064	3/8" x 1/4"	90/1080
P11082	1/2" x 1/8"	40/320
P11084	1/2" x 1/4"	40/400
P11086	1/2" x 3/8"	40/480
P11122	3/4" x 1/8"	1
P11124	3/4" x 1/4"	1
P11126	3/4" x 3/8"	40/240
P11128	3/4" x 1/2"	1/400

Face Bushing



PART NO.	IPT	CTN/MSTR
P11964	3/8" x 1/4"	1
P11986	1/2" x 3/8"	1
P11928	3/4" x 1/2"	1

Close Nipple



PART NO.	IPT	CTN/MSTR
P11202	1/8"	1
P11204	1/4"	1
P11206	3/8"	1
P11208	1/2"	1
P11212	3/4"	1

Brass PEX Couplings



PART NO.	SIZE	CTN/MSTR
C76001	1/2"	100/1000
C76002	3/4"	50/500
C76003	1"	50/300
C76004	3/4" x 1/2"	50/500
C76005	1" x 3/4"	25/250

Brass PEX 90° Ell



PART NO.	SIZE	CTN/MSTR
C76008	1/2"	100/500
C76009	3/4"	50/250
C76010	1"	25/100

Brass PEX x MIP 90° Ell



PART NO.	SIZE	CTN/MSTR
C76013	1/2" x 1/2"	25/100

Brass PEX Equal Tee



PART NO.	SIZE	CTN/MSTR
C76014	1/2"	50/500
C76015	3/4"	50/250
C76016	1"	25/100

Brass PEX Tee



PART NO.	SIZE	CTN/MSTR
C76017	1/2" x 1/2" x 3/4"	50/250
C76018	3/4" x 1/2" x 1/2"	50/250
C76019	3/4" x 1/2" x 3/4"	25/250
C76020	3/4" x 3/4" x 1/2"	25/250
C76021	1" x 3/4" x 3/4"	25/100
C76022	1" x 1" x 1/2"	25/100
C76023	1" x 1" x 3/4"	25/100
C76024	3/4" x 3/4" x 1"	25/100
C76025	1" x 3/4" x 1/2"	5/100

Brass PEX x Female Sweat Adapter



PART NO.	PEX x FSW	CTN/MSTR
C76027	1/2" x 1/2"	100/500
C76028	3/4" x 3/4"	50/250
C76029	1/2" x 3/4"	25/250
C76030	1" x 1"	25/200

Brass PEX x Male Adapter



PART NO.	PEX x MIP	CTN/MSTR
C76034	1/2" x 1/2"	25/400
C76035	1/2" x 3/4"	25/200
C76036	3/4" x 3/4"	50/250
C76037	1" x 1"	50/250
C76038	1" x 3/4"	25/100

Brass PEX x FIP Female Adapter



PART NO.	PEX x FIP	CTN/MSTR
C76041	1/2" x 1/2"	50/250
C76042	1/2" x 3/4"	50/200
C76043	3/4" x 3/4"	25/200
C76044	1" x 1"	25/250

Brass PEX x Male Sweat Adapter



PART NO.	PEX x MALE	CTN/MSTR
C76047	3/8" x 1/2"	50/500
C76048	1/2" x 1/2"	50/500
C76049	1/2" x 3/4"	25/100
C76050	3/4" x 3/4"	50/250
C76051	1" x 1"	25/100

Brass PEX x FIP Swivel Plastic Nut



PART NO.	PEX x FIP	CTN/MSTR
C76055	3/8" x 1/2"	25/250
C76056	1/2" x 1/2"	25/100
C76057	1/2" x 7/8"	25/100

Brass PEX x FIP 90° Ell Swivel Plastic Nut



PART NO.	PEX x FIP	CTN/MSTR
C76060	1/2" x 1/2"	50/200
C76061	1/2" x 7/8"	50/200

Brass PEX Ball Valve



PART NO.	PEX x PEX	CTN/MSTR
B63050	1/2"	10/100
B63075	3/4"	10/100
B63100	1"	6/48

Brass PEX Plug



PART NO.	PEX x FIP	CTN/MSTR
C76065	1/2"	100/1000
C76066	3/4"	100/500
C76067	1"	25/250

Brass PEX Crimp Ring



PART NO.	PEX x FIP	CTN/MSTR
C76070	3/8"	100/2000
C76071	1/2"	100/2000
C76072	3/4"	100/1000
C76073	1"	100/1000

Brass PEX x FIP Drop Ear 90° Ell



PART NO.	PEX x FIP	CTN/MSTR
C76080	1/2" x 1/2"	25/200
C76081	3/4" x 1/2"	25/200
C76079	1/2" x 1/2"	25/200

Plastic Pex Elbow

Lead Free



- Listed by Warnock Hersey
- Meets ASTM F2159, F877 and CSA B1375
- Will not rust or corrode
- Unaffected by household cleaners and chemicals
- Smooth interior for better water flow
- Resists scale build-up

PART NO.	SIZE	CTN/MSTR
C76702	1/2"	50/500
C76703	3/4"	25/350
C76720	1"	10/150

D

Plastic Pex Coupling

Lead Free



- Listed by Warnock Hersey
- Meets ASTM F2159, F877 and CSA B1375
- Will not rust or corrode
- Unaffected by household cleaners and chemicals
- Smooth interior for better water flow
- Resists scale build-up

PART NO.	SIZE	CTN/MSTR
C76704	1/2"	50/1000
C76705	3/4"	50/600
C76706	3/4" x 1/2"	50/600
C76722	1"	25/200
C76723	1" x 3/4"	25/300

Oetiker PEX Stainless Steel Clamp



- The original patented pex assembly clamp designated by ASTM F 2098
- Ingenious stepless design provides uniform compression for a 360° watertight seal
- Available for 3/8", 1/2", 3/4" and 1" ASTM F 876/877 pex tubing sizes
- Specified for use with ASTM F 1807 and F 2159 insert fittings

PART NO.	SIZE	CTN/MSTR
C76074	3/8"	100/2000
C76075	1/2"	100/2000
C76076	3/4"	50/2000
C76077	1"	50/1300

TECHNICAL DATA

APPLICATION: HOT AND COLD WATER PLUMBING & HYDRONIC HEATING

MAXIMUM OPERATING TEMPERATURE: 180°F

MAXIMUM OPERATING PRESSURE (PSI): 100

MATERIAL: STAINLESS STEEL UNS S304000

Plastic Pex Adapter

Lead Free



- Listed by Warnock Hersey
- Meets ASTM F2159, F877 and CSA B1375
- Will not rust or corrode
- Unaffected by household cleaners and chemicals
- Smooth interior for better water flow
- Resists scale build-up

PART NO.	PEX x MPT	CTN/MSTR
C76707	1/2" x 1/2"	50/500
C76708	3/4" x 3/4"	25/300
C76727	1" x 1"	10/150

Plastic Pex Tee

Lead Free



- Listed by Warnock Hersey
- Meets ASTM F2159, F877 and CSA B1375
- Will not rust or corrode
- Unaffected by household cleaners and chemicals
- Smooth interior for better water flow
- Resists scale build-up

PART NO.	SIZE	CTN/MSTR
C76709	1/2" x 1/2" x 3/4"	25/300
C76710	3/4" x 1/2" x 1/2"	25/300
C76711	3/4" x 1/2" x 3/4"	25/250
C76712	3/4" x 3/4" x 1/2"	25/300

Plastic Pex Tee

Lead Free



- Listed by Warnock Hersey
- Meets ASTM F2159, F877 and CSA B1375
- Will not rust or corrode
- Unaffected by household cleaners and chemicals
- Smooth interior for better water flow
- Resists scale build-up

PART NO.	SIZE	CTN/MSTR
C76700	1/2"	50/400
C76701	3/4"	25/200

Plastic Pex Plug

Lead Free



- Listed by Warnock Hersey
- Meets ASTM F2159, F877 and CSA B1375
- Will not rust or corrode
- Unaffected by household cleaners and chemicals
- Smooth interior for better water flow
- Resists scale build-up

PART NO.	SIZE	CTN/MSTR
C76740	1/2"	100/2000
C76741	3/4"	100/1000

PlumBite Push On Fittings

- Heat free method for joining Copper, CPVC and PEX tube and are designed to save time and money on installations
- To make an effective joint with PEX tube, the included liner must be used. (DO NOT SUBSTITUTE with other manufacturer's liner.)
- Push fit
- Reduced installation time
- Ideal for service and repair
- "O-ring" design for leak free seals
- EPDM O-ring seal
- 316 Stainless steel retaining ring
- Designed for use with ASTM B88 hard drawn and annealed copper tube, type K, L, or M, in the 1/2" through 3/4" size range; CPVC water tube per ASTM D2846/2846M and PEX tube that meets the requirements of ASTM F876 & F877
- Operate at temperatures from 0° to 250°F at a maximum working pressure of 200 PSI
- Sold in bag quantity only

Type of Service	System Operating Conditions
FLUIDS	
Hot and Cold Potable Water	32°F to 200°F, max. 200 PSI
Potable Water System Flushing	Compliant with major plumbing codes
Chilled Water w/Corrosion Inhibitors	0°F to 250°F, max 200 PSI Ethylene Glycol - 50% max. concentration Propylene Glycol - 50% max. concentration
Hydronic Heating	0°F to 250°F, max 200 PSI Ethylene Glycol - 50% max. concentration Propylene Glycol - 50% max. concentration
Rainwater/Greywater	32° F to 250°F, max. 200 PSI

Coupling



PART NO.	SIZE	CTN/MSTR
C76500	1/2"	5/100
C76501	3/4"	5/100
C76550	1"	5/100

Reducer Coupling



PART NO.	SIZE	CTN/MSTR
C76502	3/4" x 1/2"	15/60
C76551	1" x 3/4"	5/100

Adapter C x F



PART NO.	SIZE	CTN/MSTR
C76503	1/2"	10/100
C76504	3/4"	20/60
C76553	1"	5/100

Adapter C x M



PART NO.	SIZE	CTN/MSTR
C76505	1/2"	10/200
C76506	3/4"	5/100
C76554	1"	5/100

90° Ell



PART NO.	SIZE	CTN/MSTR
C76507	1/2"	10/150
C76508	3/4"	5/80
C76558	1"	5/50

Drop Ear 90° Ell C x F



PART NO.	SIZE	CTN/MSTR
C76509	1/2"	10/100

Tee



PART NO.	SIZE	CTN/MSTR
C76510	1/2"	10/100
C76511	3/4"	10/100
C76512	3/4" x 3/4" x 1/2"	5/50
C76513	3/4" x 1/2" x 3/4"	5/50
C76514	3/4" x 1/2" x 1/2"	5/50
C76555	1"	5/50
C76556	1" x 1" x 3/4"	5/50

Cap



PART NO.	SIZE	CTN/MSTR
C76515	1/2"	10/200
C76516	3/4"	5/150
C76557	1"	5/200

Ball Valve



PART NO.	SIZE	CTN/MSTR
C76561	1/2"	10/60
C76562	3/4"	10/40
C76563	1"	6/24

Repair Coupling



PART NO.	SIZE	CTN/MSTR
C76530	1/2"	5/70
C76531	3/4"	5/70
C76532	1"	5/40

Supply Stop



PART NO.	SIZE	CTN QTY
C76570	Straight 1/2" x 3/8"OD	1/120
C76571	Angle 1/2" x 3/8"OD	1/120

Removal Tool



PART NO.	SIZE	CTN QTY
C76520	1/2"	1/500
C76521	3/4"	5/250
C76522	1"	5/200

PlumBite Push On Fittings - LEAD FREE

- Heat free method for joining Copper, CPVC and PEX tube and are designed to save time and money on installations
- To make an effective joint with PEX tube, the included liner must be used. (DO NOT SUBSTITUTE with other manufacturer's liner.)
- Push fit
- Reduced installation time
- Ideal for service and repair
- "O-ring" design for leak free seals
- EPDM O-ring seal
- 316 Stainless steel retaining ring
- Designed for use with ASTM B88 hard drawn and annealed copper tube, type K, L, or M, in the 1/2" through 3/4" size range; CPVC water tube per ASTM D2846/2846M and PEX tube that meets the requirements of ASTM F876 & F877
- Operate at temperatures from 0° to 250°F at a maximum working pressure of 200 PSI
- Sold in bag quantity only

D

Type of Service	System Operating Conditions
FLUIDS	
Hot and Cold Potable Water	32°F to 200°F, max. 200 PSI
Potable Water System Flushing	Compliant with major plumbing codes
Chilled Water w/Corrosion Inhibitors	0°F to 250°F, max 200 PSI
	Ethylene Glycol - 50% max. concentration Propylene Glycol - 50% max. concentration
Hydronic Heating	0°F to 250°F, max 200 concentration
	Ethylene Glycol - 50% max. concentration Propylene Glycol - 50% max. concentration
Rainwater/Greywater	32° F to 250°F, max. 200 PSI

Coupling



PART NO.	SIZE	CTN/MSTR
C76500LF	1/2"	1
C76501LF	3/4"	1

Reducer Coupling



PART NO.	SIZE	CTN/MSTR
C76502LF	3/4" x 1/2"	1

Adapter C x F



PART NO.	SIZE	CTN/MSTR
C76503LF	1/2"	1
C76504LF	3/4"	1

Adapter C x M



PART NO.	SIZE	CTN/MSTR
C76505LF	1/2"	1
C76506LF	3/4"	1

90° Ell



PART NO.	SIZE	CTN/MSTR
C76507LF	1/2"	1
C76508LF	3/4"	1

Drop Ear 90° Ell C x F



PART NO.	SIZE	CTN/MSTR
C76509LF	1/2"	1

Tee



PART NO.	SIZE	CTN/MSTR
C76510LF	1/2"	1
C76511LF	3/4"	1
C76512LF	3/4" x 3/4" x 1/2"	1
C76513LF	3/4" x 1/2" x 3/4"	1
C76514LF	3/4" x 1/2" x 1/2"	1

Cap



PART NO.	SIZE	CTN/MSTR
C76515LF	1/2"	1
C76516LF	3/4"	1

Removal Tool



PART NO.	SIZE	CTN/MSTR
C76520	1/2"	1
C76521	3/4"	1
C76522	1"	1

Twist To Lock Plastic Fittings

- IAPMO Listed NSF-61, ASSE 1061
- Reduced installation time
- Ideal for service and repair
- “O-ring” design for leak-free seals
- Working temps and pressure:
180PSI@68°F, 100PSI@150°F, 45PSI@180°F

INSTRUCTIONS FOR USE

To Connect: Squarely cut tubing or pipe to desired length, removing all burrs. Push fitting onto the end of tube or pipe. Fitting will grip before it seals. Ensure that tubing or pipe is pushed into the fitting until the end is fully seated into the internal tube stop.



To Lock Fitting: Twist the screw cap until colored line is no longer visible.

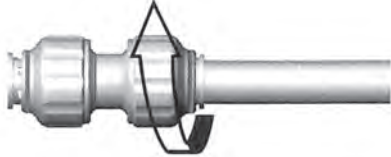

Plastic inserts are required for plastic pipe connections in heating installations. It is recommended to use pipe inserts for plastic pipe connections in standard residential plumbing (hot and cold water) installations.

Drop Ear Elbow CTS



PART NO.	SIZE	CTN/MSTR
C76800	1/2"	3/144

Enlarger Connector CTS STACK x CTS



PART NO.	SIZE	CTN/MSTR
C76801	3/4" x 1"	3/120

Female Adapter CTS x FIP



PART NO.	SIZE	CTN/MSTR
C76802	1/2" x 1/2"	3/321
C76803	1/2" x 3/4"	3/480
C76804	3/4" x 3/4"	3/216
C76805	1" x 1"	3/36

Female Garden Hose Adapter CTS x FGH



PART NO.	SIZE	CTN/MSTR
C76806	1/2" x 3/4"	3/168

Male Adapter CTS x MIP



PART NO.	SIZE	CTN/MSTR
C76807	1/2" x 1/2"	3/330
C76808	1/2" x 3/4"	3/282
C76809	3/4" x 3/4"	3/192

Male Elbow CTS x MIP



PART NO.	SIZE	CTN/MSTR
C76810	1/2" x 1/2"	3/168

Reducing Connector CTS x CTS Stem



PART NO.	SIZE	CTN/MSTR
C76811	1/2" x 3/4"	3/300

Swivel Elbow Union CTS x FIP



PART NO.	SIZE	CTN/MSTR
C76812	1/2" x 1/2"	3/160

Swivel Union Connector CTS x BC



PART NO.	SIZE	CTN/MSTR
C76813	1/2" x BC	3/300

Tube End Stop CTS



PART NO.	SIZE	CTN/MSTR
C76814	1/2"	3/336
C76815	3/4"	3/640
C76816	1"	3/135

Union Connector CTS x CTS



PART NO.	SIZE	CTN/MSTR
C76825	3/8"	3/351
C76826	1/2" x 3/8"	3/528
C76827	1/2"	3/480
C76828	3/4" x 1/2"	3/330
C76829	3/4"	3/288
C76830	1" x 3/4"	3/180
C76831	1"	3/165

Tube Elbow Union CTS x CTS Stem

D



PART NO.	SIZE	CTN/MSTR
C76817	1/2" x 1/2"	3/345
C76818	3/4" x 3/4"	3/180

Tee Union CTS x CTS x CTS



PART NO.	SIZE	CTN/MSTR
C76832	1/2"	3/150
C76833	3/4" x 3/4" x 1/2"	3/180
C76834	3/4"	3/90
C76835	1"	3/78
C76836	1" x 3/4" x 3/4"	3/81
C76837	3/4" x 1/2" x 1/2"	3/180

Elbow Union CTS x CTS



PART NO.	SIZE	CTN/MSTR
C76819	1/2"	3/480
C76820	3/4"	3/60
C76821	1"	3/138

Hand Valve Union Connector CTS x CTS



PART NO.	SIZE	CTN/MSTR
C76838	1/2"	3/210
C76839	3/4"	3/120

Tube Tee Union Connector CTS x CTS x CTS Stem

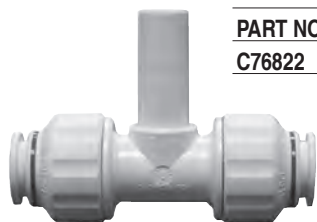

PART NO.	SIZE	CTN/MSTR
C76822	1/2" x 1/2" x 1/2"	3/180

Stack Tube Tee Union CTS

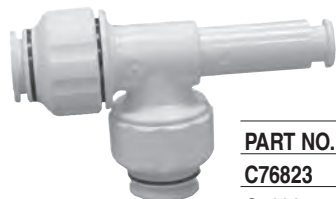

PART NO.	SIZE	CTN/MSTR
C76823	1/2"	3/195
C76824	3/4"	3/102

Plastic Push On Fittings

- Quick and easy installation
- Very durable and fatigue resistant
- Manufactured from safe, non-toxic materials meeting the requirements of the US FDA, WRAS, ANSI/NSF-51, 61 and SK Zert
- All connections can be assembled and disassembled repeatedly



1. Cut the part of the tube to be inserted into the fitting to plane the end.
2. Make sure to use a clean tube without any foreign material or cracks.



3. When inserting the tube, remove any obstructions before fully inserting the tube. Make sure the tube is fully inserted.

4. Inserting the tube into the fitting only takes moderate force. The tube or fitting should not be scratched or damaged in the process, as this is the main cause for water leaks later on.



5. To make sure that the fitting is properly connected to the tube, pull it once. After pulling, insert a spanner under the collet and push the tube into the fitting once more for a complete insertion.



6. When no play is desired for the fitting and tube, use our company's LC to eliminate the play of the fitting.



7. Make sure to completely eliminate pressure before disassembling the fitting.

8. When disassembling the tube, push the clip in direction to the main assembly and then pull the tube out for easy disassembling.

9. Fittings and tubes can be reused.

Straight Needle Valve CTS x MIP



PART NO.	SIZE	CTN/MSTR
C76840	1/4" x 1/4"	400/1600
C76841	3/8" x 3/8"	100/400

Straight Needle Valve CTS



PART NO.	SIZE	CTN/MSTR
C76842	1/4"	100/400
C76843	3/8"	150/600

Angle Valve CTS x FIP



PART NO.	SIZE	CTN/MSTR
C76844	1/4" x 1/4"	300/1200
C76845	3/8" x 3/8"	100/400

Straight Valve CTS x MIP



PART NO.	SIZE	CTN/MSTR
C76846	1/4" x 1/4"	50/600
C76847	3/8" x 3/8"	100/400

Straight Valve CTS x CTS



PART NO.	SIZE	CTN/MSTR
C76848	1/4"	150/600
C76849	3/8"	100/400

End Cap CTS



PART NO.	SIZE	CTN/MSTR
C76850	1/4"	500/3600
C76851	3/8"	600/2400
C76852	1/2"	400/1600

Plug CTS



PART NO.	SIZE	CTN/MSTR
C76853	1/4"	600/2400
C76854	3/8"	1000/4000
C76855	1/2"	500/2000

Union & Reducing Union CTS x CTS



PART NO.	SIZE	CTN/MSTR
C76856	1/4"	700/2800
C76857	3/8" x 1/4"	250/1000
C76858	3/8" x 3/8"	250/1000
C76859	1/2" x 3/8"	200/800

Bulkhead Union CTS x CTS



PART NO.	SIZE	CTN/MSTR
C76860	1/4" x 1/4"	200/800
C76861	3/8" x 3/8"	200/800
C76862	1/2" x 3/8"	100/400

Tee & Reducing Tee CTS x CTS x CTS



PART NO.	SIZE	CTN/MSTR
C76863	1/4"	400/1600
C76864	3/8" x 3/8" x 1/4"	200/800
C76865	3/8"	150/600
C76866	1/2" x 1/2" x 3/8"	100/400
C76867	1/2"	100/400

Elbow CTS x MIP



PART NO.	SIZE	CTN/MSTR
C76884	1/4" x 1/8"	800/3200
C76885	1/4" x 1/4"	600/2400
C76886	1/4" x 3/8"	500/2000
C76887	3/8" x 1/4"	800/3200
C76888	3/8" x 3/8"	300/1200

D

Elbow & Reducing Elbow CTS x CTS



PART NO.	SIZE	CTN/MSTR
C76868	1/4"	700/2800
C76869	3/8"	300/1200
C76870	1/2"	150/600

Elbow Adapter CTS x CTS Stem



PART NO.	SIZE	CTN/MSTR
C76889	1/4" x 1/4"	500/2000
C76890	3/8" x 3/8"	200/800

Coupling CTS x FIP



PART NO.	SIZE	CTN/MSTR
C76871	1/4" x 1/8"	400/1600
C76872	1/4" x 1/4"	600/2400
C76873	3/8" x 1/4"	300/1200

Connector CTS Stem x Tube ID



PART NO.	SIZE	CTN/MSTR
C76891	3/8" x 3/8"	800/3200
C76892	3/8" x 1/2"	200/800
C76893	1/2" x 1/2"	400/1600

Kitchen Faucet Adapter Tee FIP x MIP x CTS



PART NO.	SIZE	CTN/MSTR
C76874	1/2" x 1/2" x 1/4"	100/400
C76875	1/2" x 1/2" x 3/8"	100/400

Connector CTS x MIP



PART NO.	SIZE	CTN/MSTR
C76876	1/4" x 1/8"	800/3200
C76877	1/4" x 1/4"	800/3200
C76878	1/4" x 3/8"	600/2400
C76879	3/8" x 1/4"	400/1600
C76880	3/8" x 3/8"	400/1600
C76881	3/8" x 1/2"	200/800
C76882	1/2" x 3/8"	300/1200
C76883	1/2" x 1/2"	200/800

Red Brass Pipe Nipples - LEAD FREE

Meets ASTM B687



PART NO.	IPT	CTN/MSTR
N20000	1/8"x close	5/200
N20001	1/8"x 1 1/2"	5/200
N20002	1/8"x 2"	5/200
N20003	1/8"x 2 1/2"	5/25
N20004	1/8"x 3"	5/100
N20005	1/8"x 3 1/2"	5/100
N20006	1/8"x 4"	5/100
N20007	1/8"x 4 1/2"	5/100
N20008	1/8"x 5"	5/100
N20009	1/8"x 5 1/2"	1
N20010	1/8"x 6"	5/125
N20012	1/8"x 7"	1
N20014	1/8"x 8"	1
N20016	1/8"x 9"	5/300
N20018	1/8"x 10"	1
N20020	1/8"x 11"	1
N20022	1/8"x 12"	1/200
N21000	1/4"x close	5/200
N21001	1/4"x 1 1/2"	5/100
N21002	1/4"x 2"	5/100
N21003	1/4"x 2 1/2"	5/100
N21004	1/4"x 3"	5/100
N21005	1/4"x 3 1/2"	5/100
N21006	1/4"x 4"	5/50
N21007	1/4"x 4 1/2"	5/50
N21008	1/4"x 5"	5/40
N21009	1/4"x 5 1/2"	5/25
N21010	1/4"x 6"	5/40
N21012	1/4"x 7"	1
N21014	1/4"x 8"	5/150
N21016	1/4"x 9"	1
N21018	1/4"x 10"	1/100
N21020	1/4"x 11"	1/100
N21022	1/4"x 12"	5/100
N22000	3/8"x close	5/100
N22001	3/8"x 1 1/2"	5/100
N22002	3/8"x 2"	5/30
N22003	3/8"x 2 1/2"	5/80
N22004	3/8"x 3"	5/50
N22005	3/8"x 3 1/2"	5/25
N22006	3/8"x 4"	5/40
N22007	3/8"x 4 1/2"	5/35
N22008	3/8"x 5"	5/30
N22009	3/8"x 5 1/2"	25/100
N22010	3/8"x 6"	5/30
N22012	3/8"x 7"	5/160
N22014	3/8"x 8"	1/160
N22016	3/8"x 9"	1
N22018	3/8"x 10"	1

Red Brass Pipe Nipples cont...

PART NO.	IPT	CTN/MSTR
N22020	3/8"x 11"	1
N22022	3/8"x 12"	1
N23000	1/2"x close	5/75
N23001	1/2"x 1 1/2"	5/60
N23002	1/2"x 2"	5/50
N23003	1/2"x 2 1/2"	5/35
N23004	1/2"x 3"	5/35
N23005	1/2"x 3 1/2"	5/25
N23006	1/2"x 4"	5/25
N23007	1/2"x 4 1/2"	25/100
N23008	1/2"x 5"	5/25
N23009	1/2"x 5 1/2"	5/25
N23010	1/2"x 6"	5/25
N23012	1/2"x 7"	1/100
N23014	1/2"x 8"	1/100
N23016	1/2"x 9"	1/80
N23018	1/2"x 10"	1/80
N23020	1/2"x 11"	1
N23022	1/2"x 12"	1/50
N24000	3/4"x close	5/40
N24001	3/4"x 1 1/2"	5/30
N24002	3/4"x 2"	5/30
N24003	3/4"x 2 1/2"	5/25
N24004	3/4"x 3"	5/25
N24005	3/4"x 3 1/2"	5/35
N24006	3/4"x 4"	5/25
N24007	3/4"x 4 1/2"	5/30
N24008	3/4"x 5"	5/30
N24009	3/4"x 5 1/2"	5/25
N24010	3/4"x 6"	5/25
N24012	3/4"x 7"	1/65
N24014	3/4"x 8"	1/25
N24016	3/4"x 9"	1/25
N24018	3/4"x 10"	1/45
N24020	3/4"x 11"	1/45
N24022	3/4"x 12"	1/45
N25000	1"x close	5/25
N25002	1"x 2"	5/25
N25003	1"x 2 1/2"	5/40
N25004	1"x 3"	5/40
N25005	1"x 3 1/2"	5/25
N25006	1"x 4"	5/25
N25007	1"x 4 1/2"	5/25
N25008	1"x 5"	20/80
N25009	1"x 5 1/2"	1
N25010	1"x 6"	5/10
N25012	1"x 7"	1/400
N25014	1"x 8"	1/40
N25016	1"x 9"	1
N25018	1"x 10"	1/30
N25020	1"x 11"	1/30



Red Brass Pipe Nipples cont...

PART NO.	IPT	CTN/MSTR
N25022	1"x 12"	1/30
N27000	1 1/4"x close	5/25
N27002	1 1/4"x 2"	5/25
N27003	1 1/4"x 2 1/2"	5/10
N27004	1 1/4"x 3"	5/10
N27005	1 1/4"x 3 1/2"	5/10
N27006	1 1/4"x 4"	5/10
N27007	1 1/4"x 4 1/2"	5/10
N27008	1 1/4"x 5"	5/10
N27009	1 1/4"x 5 1/2"	5/10
N27010	1 1/4"x 6"	5/10
N27012	1 1/4"x 7"	1/20
N27014	1 1/4"x 8"	1/10
N27016	1 1/4"x 9"	1/10
N27018	1 1/4"x 10"	1/10
N27020	1 1/4"x 11"	1/10
N27022	1 1/4"x 12"	1/20
N28000	1 1/2"x close	5/25
N28002	1 1/2"x 2"	5/25
N28003	1 1/2"x 2 1/2"	1/60
N28004	1 1/2"x 3"	5/15
N28005	1 1/2"x 3 1/2"	5/10
N28006	1 1/2"x 4"	5/15
N28007	1 1/2"x 4 1/2"	5/10
N28008	1 1/2"x 5"	5/20
N28009	1 1/2"x 5 1/2"	5/10
N28010	1 1/2"x 6"	5/10
N28012	1 1/2"x 7"	1/30
N28014	1 1/2"x 8"	5/20
N28016	1 1/2"x 9"	1/20
N28018	1 1/2"x 10"	1/10
N28020	1 1/2"x 11"	1/15
N28022	1 1/2"x 12"	1/15
N29000	2"x close	5/10
N29003	2"x 2 1/2"	5/10
N29004	2"x 3"	5/10
N29005	2"x 3 1/2"	5/15
N29006	2"x 4"	5/15
N29007	2"x 4 1/2"	5/10
N29008	2"x 5"	1/25
N29009	2"x 5 1/2"	1/25
N29010	2"x 6"	1/25
N29012	2"x 7"	1/10
N29014	2"x 8"	1/10

Red Brass Pipe Nipples cont...

PART NO.	IPT	CTN/MSTR
N29016	2"x 9"	1/10
N29018	2"x 10"	1/10
N29020	2"x 11"	1/10
N29022	2"x 12"	1/10
N30000	2 1/2" x close	1/40
N30004	2 1/2"x 3"	1/40
N30005	2 1/2"x 3 1/2"	5/10
N30006	2 1/2"x 4"	1/20
N30007	2 1/2"x 4 1/2"	1/20
N30008	2 1/2"x 5"	1/20
N30009	2 1/2"x 5 1/2"	1/15
N30010	2 1/2"x 6"	1/20
N31000	3"x close	1/20
N31004	3"x 3"	1/20
N31005	3"x 3 1/2"	1/10
N31006	3"x 4"	1/10
N31007	3"x 4 1/2"	1/10
N31008	3"x 5"	1/10
N31009	3"x 5 1/2"	1/10
N31010	3"x 6"	1/10

D

90° Elbow



PART NO.	SIZE	CTN/MSTR
B74001	1/8"	150/600
B74002	1/4"	100/400
B74003	3/8"	75/300
B74004	1/2"	50/200
B74005	3/4"	25/100
B74006	1"	1/80
B74007	1-1/4"	1/50
B74008	1-1/2"	1/35
B74009	2"	1/20
B74010	2-1/2"	1/10
B74011	3"	1/6
B74012	4"	1
B74340	3/8" x 1/4"	1
B74341	1/2" x 1/4"	1
B74342	1/2" x 3/8"	1
B74343	3/4" x 1/2"	30/120
B74344	1" x 1/2"	1
B74345	1" x 3/4"	25/100
B74346	1-1/4" x 1"	1/60
B74347	1-1/2" x 1-1/4"	1/40
B74348	2" x 1-1/2"	1/20
B74386	3/4" x 1/4"	40/160
B74387	3/4" x 3/8"	1
B74388	1-1/4" x 1/2"	1
B74389	1-1/4" x 3/4"	1
B74390	1-1/2" x 3/4"	1/20
B74391	1-1/2" x 1"	1/15

90° Street Elbow



PART NO.	SIZE	CTN/MSTR
B74021	1/8"	200/800
B74022	1/4"	100/400
B74023	3/8"	60/240
B74024	1/2"	50/200
B74025	3/4"	25/100
B74026	1"	1/50
B74027	1-1/4"	1/40
B74028	1-1/2"	1/35
B74029	2"	1/20
B74030	2-1/2"	1/9
B74031	3"	1/6
B74032	4"	1/2

D

90° Street Elbow - LEAD FREE



PART NO.	SIZE	CTN/MSTR
B74024LF	1/2"	5/60
B74025LF	3/4"	5/35
B74026LF	1"	5/45

90° Elbow - LEAD FREE



PART NO.	SIZE	CTN/MSTR
B74002LF	1/4"	1
B74003LF	3/8"	1
B74004LF	1/2"	1
B74341LF	1/2" x 1/4"	1
B74005LF	3/4"	1
B74006LF	1"	1
B74344LF	1" x 1/2"	1
B74345LF	1" x 3/4"	1
B74008LF	1-1/2"	1
B74347LF	1-1/2" x 1-1/4"	1
B74009LF	2"	1

45° Elbow



PART NO.	SIZE	CTN/MSTR
B74041	1/8"	200/800
B74042	1/4"	1
B74043	3/8"	75/300
B74044	1/2"	50/200
B74045	3/4"	25/100
B74046	1"	1/90
B74047	1-1/4"	1
B74048	1-1/2"	1/40
B74049	2"	25
B74050	2-1/2"	1/12
B74051	3"	1/8
B74052	4"	1/4

SPECIFICATIONS:

ANSI B16.15
 ANSI B2.1 (PIPE THREADS)
 FED WW-P-460
 FED WW-U-516
 150 PSI @400°F WSP
 225 PSI WOG@ -20°F / 150°F

45° Elbow - LEAD FREE



PART NO.	SIZE	CTN/MSTR
B74044LF	1/2"	1
B74045LF	3/4"	1
B74046LF	1"	1

45° Street Elbow



PART NO.	SIZE	CTN/MSTR
B74061	1/8"	200/800
B74062	1/4"	60/240
B74063	3/8"	25/150
B74064	1/2"	50/200
B74065	3/4"	25/100
B74066	1"	1/80
B74067	1-1/4"	1/50
B74068	1-1/2"	1/35
B74069	2"	1/20

D

45° Street Elbow - LEAD FREE



PART NO.	SIZE	CTN/MSTR
B74067LF	1-1/4"	1

Union



PART NO.	SIZE	CTN/MSTR
B74261	1/8"	1
B74262	1/4"	60/240
B74263	3/8"	30/120
B74264	1/2"	25/100
B74265	3/4"	20/80
B74266	1"	1/50
B74267	1-1/4"	1/35
B74268	1-1/2"	1/25
B74269	2"	1/18
B74270	2-1/2"	1/10
B74271	3"	1/8
B74272	4"	1/3

Union - LEAD FREE



PART NO.	SIZE	CTN/MSTR
B74264LF	1/2"	1
B74265LF	3/4"	1
B74266LF	1"	1
B74267LF	1-1/4"	1
B74269LF	2"	1

Tee



PART NO.	SIZE	CTN/MSTR
B74081	1/8"	120/480
B74082	1/4"	75/300
B74083	3/8"	50/200
B74084	1/2"	25/100
B74085	3/4"	1/85
B74086	1"	1/35
B74087	1-1/4"	1/35
B74088	1-1/2"	1/24
B74089	2"	1/15
B74090	2-1/2"	8
B74091	3"	1/4
B74092	4"	1/2
B74354	1/2" x 3/8"	35
B74355	3/4" x 1/4"	25/100
B74356	3/4" x 3/8"	25/100
B74357	3/4" x 1/2" x 1/2"	100
B74358	3/4" x 1/2" x 3/4"	1/100
B74359	3/4" x 1/2"	25/100
B74360	1" x 1/2" x 1/2"	1/70
B74361	1" x 1/2" x 1"	1
B74362	1" x 1/2"	1/75
B74363	1" x 3/4" x 3/4"	5/120
B74364	1" x 3/4" x 1"	1/65
B74365	1" x 3/4"	1/70
B74369	1-1/4" x 3/4"	1/35
B74366	1-1/4" x 1"	1/35
B74367	1-1/2" x 1-1/4"	1
B74368	2" x 1-1/2"	1/15
B74392	3/8" x 1/4"	60/240
B74393	1/2" x 3/8" x 1/2"	1
B74394	1/2" x 1/2" x 3/4"	1
B74397	1-1/2" x 1"	1/20

Tee - LEAD FREE



PART NO.	SIZE	CTN/MSTR
B74082LF	1/4"	1
B74083LF	3/8"	1
B74084LF	1/2"	1
B74085LF	3/4"	1
B74086LF	1"	1
B74087LF	1-1/4"	1
B74088LF	1-1/2"	1
B74090LF	2-1/2"	1
B74354LF	1/2" x 3/8"	1
B74395LF	3/4" x 1/4"	1
B74358LF	3/4" x 1/2" x 3/4"	1
B74359LF	3/4" x 1/2"	1
B74395LF	3/4" x 3/8"	1
B74365LF	1" x 3/4"	1
B74367LF	1-1/2" x 1-1/4"	1
B74369LF	1-1/4" x 3/4"	1
B74368LF	2" x 1-1/2"	1

Cap



PART NO.	SIZE	CTN/MSTR
B74181	1/8"	1
B74182	1/4"	200/800
B74183	3/8"	150/600
B74184	1/2"	100/400
B74185	3/4"	50/200
B74186	1"	40/160
B74187	1-1/4"	1/100
B74188	1-1/2"	1/100
B74189	2"	1/70
B74190	2-1/2"	1
B74191	3"	1/25
B74192	4"	1/10

Cap - LEAD FREE



PART NO.	SIZE	CTN/MSTR
B74183LF	3/8"	1
B74184LF	1/2"	1
B74185LF	3/4"	1
B74186LF	1"	1

Bronze Locknuts



PART NO.	SIZE	CTN/MSTR
B74380	1/2"	150/600
B74381	3/4"	90/360
B74382	1"	60/240
B74383	1-1/4"	1
B74384	1-1/2"	1
B74385	2"	1

Coupling/ Reducer



PART NO.	SIZE	CTN/MSTR
B74121	1/8"	200/800
B74122	1/4"	150/600
B74123	3/8"	100/400
B74124	1/2"	50/200
B74125	3/4"	5/100
B74126	1"	1/100
B74127	1-1/4"	1/175
B74128	1-1/2"	1/50
B74129	2"	1/30
B74130	2-1/2"	1/18
B74131	3"	1/12
B74132	4"	1/6
B74140	1/4" x 1/8"	150/600
B74141	3/8" x 1/8"	1
B74142	3/8" x 1/4"	90/360
B74143	1/2" x 1/8"	75/300
B74144	1/2" x 1/4"	75/300
B74145	1/2" x 3/8"	70/280
B74146	3/4" x 1/4"	50/200
B74147	3/4" x 3/8"	45/180
B74148	3/4" x 1/2"	45/180
B74149	1" x 1/2"	30/120
B74150	1" x 3/4"	25/100
B74151	1-1/4" x 1/2"	1
B74152	1-1/4" x 3/4"	1/90
B74153	1-1/4" x 1"	1/80
B74154	1-1/2" x 1/2"	1
B74155	1-1/2" x 3/4"	1/80
B74156	1-1/2" x 1"	1/65
B74157	1-1/2" x 1-1/4"	60
B74158	2" x 3/4"	1/40
B74159	2" x 1"	1/40
B74160	2" x 1-1/4"	1/40
B74161	2" x 1-1/2"	1/35
B74162	2-1/2" x 2"	1/20
B74163	3" x 2"	1/16
B74164	4" x 3"	1/6

D

Coupling/ Reducer - LEAD FREE



PART NO.	SIZE	CTN/MSTR
B74123LF	3/8"	1
B74124LF	1/2"	1
B74125LF	3/4"	1
B74126LF	1"	1
B74127LF	1-1/4"	1
B74128LF	1-1/2"	1
B74129LF	2"	1
B74132LF	4"	1
B74144LF	1/2" x 1/4"	1
B74145LF	1/2" x 3/8"	1
B74148LF	3/4" x 1/2"	1
B74150LF	1" x 3/4"	1
B74152LF	1-1/4" x 3/4"	1
B74153LF	1-1/4" x 1"	1
B74154LF	1-1/2" x 1/2"	1
B74161LF	2" x 1-1/2"	1

Extension Piece



PART NO.	SIZE	CTN/MSTR
B74370	3/4"	40/160
B74400	1/2"	1

Countersunk Plug



PART NO.	SIZE	CTN/MSTR
B74321	1/8"	1
B74322	1/4"	1
B74323	3/8"	1
B74324	1/2"	150/600
B74325	3/4"	100/400
B74326	1"	50/200
B74327	1-1/4"	30/140
B74328	1-1/2"	1/120
B74329	2"	1/75
B74330	2-1/2"	1/72
B74331	3"	1/32
B74332	4"	1/20

Corded Square Head Plug

D



PART NO.	SIZE	CTN/MSTR
B74284	1/2"	150/600
B74285	3/4"	100/400
B74286	1"	50/200
B74287	1-1/4"	140
B74288	1-1/2"	120
B74289	2"	1/75
B74290	2-1/2"	1/40
B74291	3"	1/32
B74292	4"	1/20

Countersunk Plug - LEAD FREE



PART NO.	SIZE	CTN/MSTR
B74331LF	3"	1

Cored Square Head Plug - LEAD FREE



PART NO.	SIZE	CTN/MSTR
B74284LF	1/2"	1
B74285LF	3/4"	1
B74286LF	1"	1

Cross



PART NO.	SIZE	CTN/MSTR
B74101	1/8"	1
B74102	1/4"	60/240
B74103	3/8"	35/140
B74104	1/2"	25/100
B74105	3/4"	1/60
B74106	1"	1/40
B74107	1-1/4"	1/24
B74108	1-1/2"	1/22
B74109	2"	1/12

Solid Square Head Plug



PART NO.	SIZE	CTN/MSTR
B74301	1/8"	1
B74302	1/4"	1/690
B74303	3/8"	1/310
B74304	1/2"	100/400
B74305	3/4"	50/200
B74306	1"	35/140
B74307	1-1/4"	1/100
B74308	1-1/2"	1/65
B74309	2"	1/35
B74310	2-1/2"	1/20
B74311	3"	1/12
B74312	4"	1/8

Cross - LEAD FREE



PART NO.	SIZE	CTN/MSTR
B74107LF	1-1/4"	1
B74108LF	1-1/2"	1

Solid Square Head Plug - LEAD FREE



PART NO.	SIZE	CTN/MSTR
B74304LF	1/2"	1
B74305LF	3/4"	1
B74306LF	1"	1

HEX Brushing

PART NO.	SIZE	CTN/MSTR
B74200	1/4" x 1/8"	1
B74201	3/8" x 1/8"	250/1000
B74202	3/8" x 1/4"	250/1000
B74203	1/2" x 1/8"	150/600
B74204	1/2" x 1/4"	150/600
B74205	1/2" x 3/8"	1/1000
B74206	3/4" x 1/8"	75/300
B74207	3/4" x 1/4"	80/320
B74208	3/4" x 3/8"	85/340
B74209	3/4" x 1/2"	90/360
B74210	1" x 1/4"	50/200
B74211	1" x 3/8"	50/200
B74212	1" x 1/2"	50/200
B74213	1" x 3/4"	50/200
B74214	1-1/4" x 1/4"	1/160
B74215	1-1/4" x 3/8"	1
B74216	1-1/4" x 1/2"	1/120
B74217	1-1/4" x 3/4"	1/120
B74218	1-1/4" x 1"	1/120
B74219	1-1/2" x 1/4"	1
B74220	1-1/2" x 3/8"	1
B74221	1-1/2" x 1/2"	1/120
B74222	1-1/2" x 3/4"	1/85
B74223	1-1/2" x 1"	1/115
B74224	1-1/2" x 1-1/4"	1/120
B74225	2" x 1/4"	1
B74226	2" x 3/8"	1/70
B74227	2" x 1/2"	1/20
B74228	2" x 3/4"	1/60
B74229	2" x 1"	1/60
B74230	2" x 1-1/4"	1/65
B74231	2" x 1-1/2"	1/65
B74232	2-1/2" x 2"	1/40
B74233	3" x 2"	1/20
B74234	3" x 2-1/2"	1/24
B74235	4" x 3"	1/12

HEX Bushing - LEAD FREE

PART NO.	SIZE	CTN/MSTR
B74203LF	1/2" x 1/8"	1
B74204LF	1/2" x 1/4"	1
B74205LF	1/2" x 3/8"	1
B74207LF	3/4" x 1/4"	1
B74209LF	3/4" x 1/2"	1
B74212LF	1" x 1/2"	1
B74213LF	1" x 3/4"	1
B74217LF	1-1/4" x 3/4"	1
B74218LF	1-1/4" x 1"	1
B74220LF	1-1/2" x 3/8"	1
B74222LF	1-1/2" x 3/4"	1
B74223LF	1-1/2" x 1"	1
B74224LF	1-1/2" x 1-1/4"	1
B74228LF	2" x 3/4"	1
B74229LF	2" x 1"	1
B74231LF	2" x 1-1/2"	1
B74232LF	2-1/2" x 2"	1
B74235LF	4" x 3"	1

D

Chrome Plated Nipples & Pipe Lengths



PART NO.	SIZE	CTN/MSTR
N15100	3/8" x close	50/400
N15150	3/8" x 1-1/2"	25/400
N15200	3/8" x 2"	50/400
N15250	3/8" x 2-1/2"	50/300
N15300	3/8" x 3"	50/300
N15350	3/8" x 3-1/2"	50/200
N15400	3/8" x 4"	25/100
N15450	3/8" x 4-1/2"	50/200
N15500	3/8" x 5"	50/200
N15550	3/8" x 5-1/2"	25/100
N15600	3/8" x 6"	25/100
N15900	3/8" x 12"	25/50
N15918	3/8" x 18"	1/50
N15924	3/8" x 24"	1/10
N15936	3/8" x 36"	1/10
N15948	3/8" x 48"	1/10
N15960	3/8" x 60"	1/8
N15972	3/8" x 72"	1/10
N16100	1/2" x close	50/400
N16150	1/2" x 1-1/2"	50/400
N16200	1/2" x 2"	50/400
N16250	1/2" x 2-1/2"	75/300
N16300	1/2" x 3"	75/300
N16350	1/2" x 3-1/2"	50/200
N16400	1/2" x 4"	25/100
N16450	1/2" x 4-1/2"	25/100
N16500	1/2" x 5"	1
N16550	1/2" x 5-1/2"	25/100
N16600	1/2" x 6"	25/100
N16900	1/2" x 12"	10/50
N16918	1/2" x 18"	1/10
N16924	1/2" x 24"	1/10
N16936	1/2" x 36"	1/10
N16948	1/2" x 48"	1/10
N16960	1/2" x 60"	1/10
N16972	1/2" x 72"	10
N17100	3/4" x close	50/100
N17150	3/4" x 1-1/2"	50/200
N17200	3/4" x 2"	100/200
N17250	3/4" x 2-1/2"	25/200
N17300	3/4" x 3"	1/30
N17350	3/4" x 3-1/2"	1
N17400	3/4" x 4"	25/100
N17450	3/4" x 4-1/2"	25/100
N17500	3/4" x 5"	25/100
N17550	3/4" x 5-1/2"	25/100
N17600	3/4" x 6"	25/100
N18100	1" x close	20/200
N18200	1" x 2"	20/200
N18250	1" x 2-1/2"	20/100
N18300	1" x 3"	25/100
N18400	1" x 4"	25/100
N18500	1" x 5"	10/50
N18600	1" x 6"	10/50

D

90° Elbow



PART NO.	SIZE	CTN/MSTR
B50001	3/8"	25/100
B50002	1/2"	50/200
B50003	3/4"	25/100
B50004	1"	1/80

90° Elbow - LEAD FREE



PART NO.	SIZE	CTN/MSTR
B50002LF	1/2"	1
B50003LF	3/4"	1

90° Street Elbow



PART NO.	SIZE	CTN/MSTR
B50093	3/8"	60/240
B50094	1/2"	25/100
B50098	3/4"	25/100
B50103	1"	1/50

90° Street Elbow - LEAD FREE



PART NO.	SIZE	CTN/MSTR
B50094LF	1/2"	1
B50098LF	3/4"	1

45° Elbow



PART NO.	SIZE	CTN/MSTR
B50011	3/8"	25/100
B50012	1/2"	50/200
B50013	3/4"	25/100
B50014	1"	1/90

45° Elbow - LEAD FREE



PART NO.	SIZE	CTN/MSTR
B50011LF	3/8"	1
B50012LF	1/2"	1
B50013LF	3/4"	1

Tee



PART NO.	SIZE	CTN/MSTR
B50031	3/8"	50/200
B50032	1/2"	50/100
B50033	3/4"	1/85
B50034	1"	1

Tee - LEAD FREE



PART NO.	SIZE	CTN/MSTR
B50032LF	1/2"	1
B50033LF	3/4"	1

Coupling



PART NO.	SIZE	CTN/MSTR
B50041	3/8"	25/400
B50042	1/2"	50/200
B50043	3/4"	25/100
B50044	1"	25/100

Coupling - LEAD FREE



PART NO.	SIZE	CTN/MSTR
B50042LF	1/2"	1
B50043LF	3/4"	1
B50044LF	1"	1

Reducer



PART NO.	SIZE	CTN/MSTR
B50051	1/2"x 3/8"	70/280
B50052	3/4"x 1/2"	45/180

Reducer - LEAD FREE



PART NO.	SIZE	CTN/MSTR
B50052LF	3/4"x 1/2"	1

Bushing



PART NO.	SIZE	CTN/MSTR
B50072	1/2"x 3/8"	50/200
B50073	3/4"x 1/2"	90/360
B50074	1"x 1/2"	1
B50075	1"x 3/4"	50/200

Bushing - LEAD FREE



PART NO.	SIZE	CTN/MSTR
B50073LF	3/4"x 1/2"	1

Union



PART NO.	SIZE	CTN/MSTR
B50091	3/8"	30/120
B50092	1/2"	25/100
B50097	3/4"	20/80
B50100	1"	50

Union - LEAD FREE



PART NO.	SIZE	CTN/MSTR
B50092LF	1/2"	1
B50097LF	3/4"	1

Plug



PART NO.	SIZE	CTN/MSTR
B50095	3/8"	75/300
B50096	1/2"	100/400
B50099	3/4"	1
B50101	1"	35/140

Plug - LEAD FREE



PART NO.	SIZE	CTN/MSTR
B50096LF	1/2"	1
B50099LF	3/4"	1

Cap



PART NO.	SIZE	CTN/MSTR
B50081	3/8"	150/600
B50082	1/2"	100/400
B50083	3/4"	50/200
B50084	1"	40/160

Cap - LEAD FREE



PART NO.	SIZE	CTN/MSTR
B50082LF	1/2"	1
B50083LF	3/4"	1

D

Male Hose To Male Pipe



PART NO.	MHT x MPT	CTN/MSTR
G20002	3/4" x 1/2"	20/200
G20003	3/4" x 3/4" (1/2" FIP tap)	20/200
G20004	3/4" x 1/2" (1/2" swt)	50/200

Male Hose To Male Pipe - LEAD FREE



PART NO.	MHT x MPT	CTN/MSTR
G20102	3/4" x 1/2"	1/40
G20103	3/4" x 3/4" (1/2" FIP tap)	50/200

Male Hose To Male Hose



PART NO.	MHT x MHT	CTN/MSTR
G20008	3/4" x 3/4" (1/2" FIP tap)	20/200

Male Hose To Male Hose - LEAD FREE



PART NO.	MHT x MHT	CTN. QTY.
G20108	3/4" x 3/4" (1/2" FIP tap)	1/40

Male Hose To Female Pipe



PART NO.	MHT x FPT	CTN/MSTR
G20010	3/4" x 1/2"	100/500
G20011	3/4" x 3/4"	20/200

Male Hose To Female Pipe - LEAD FREE



PART NO.	MHT x FPT	CTN/MSTR
G20110	3/4" x 1/2"	1/40
G20111	3/4" x 3/4"	1/40

Female Hose To Male Pipe



PART NO.	FHT x MPT	CTN/MSTR
G20005	3/4" x 1/2" (1/2" SWT)	
G20015	3/4" x 1/2"	50/250
G20016	3/4" x 3/4"	50/250
G20017	3/4" x 3/4" (1/2" FIP tap)	50/200

Female Hose To Male Pipe - LEAD FREE



PART NO.	FHT x MPT	CTN/MSTR
G20115	3/4" x 1/2"	50/200
G20116	3/4" x 3/4"	1/40

Female Hose To Female Pipe



PART NO.	FHT x FPT	CTN/MSTR
G20020	3/4" x 1/2"	50/200
G20021	3/4" x 3/4"	50/200

Female Hose To Female Pipe - LEAD FREE



PART NO.	FHT x FPT	CTN/MSTR
G20120	3/4" x 1/2"	1/40
G20121	3/4" x 3/4"	1/40

Female Hose To Female Hose Swivel



PART NO.	FHT x FHT	CTN/MSTR
G20030	3/4" x 3/4"	20/200

Female Hose To Female Hose Swivel - LEAD FREE



PART NO.	FHT x FHT	CTN/MSTR
G20130	3/4" x 3/4"	1/40

Female Hose To Female Pipe Swivel



PART NO.	FHT x FPT	CTN/MSTR
G20031	3/4" x 1/2"	20/200
G20032	3/4" x 3/4"	125/250

Female Hose To Female Pipe Swivel - LEAD FREE



PART NO.	FHT x FPT	CTN/MSTR
G20131	3/4" x 1/2"	1/40
G20132	3/4" x 3/4"	1/40

Hose Barb To Female Hose Swivel



PART NO.	HB x FHT	CTN/MSTR
G20035	3/8" x 3/4"	140
G20036	1/2" x 3/4"	20/245
G20037	5/8" x 3/4"	1
G20038	3/4" x 3/4"	1

Hose Barb To Female Hose Swivel - LEAD FREE



PART NO.	HB x FHT	CTN/MSTR
G20136	1/2" x 3/4"	50/200
G20137	5/8" x 3/4"	50/200
G20138	3/4" x 3/4"	50/200

Hose Barb To Male Hose



PART NO.	HB x MHT	CTN/MSTR
G20040	3/8" x 3/4"	1
G20041	1/2" x 3/4"	50/200
G20042	5/8" x 3/4"	1/200
G20043	3/4" x 3/4"	50/200

Hose Barb To Male Hose - LEAD FREE



PART NO.	HB x MHT	CTN/MSTR
G20141	1/2" x 3/4"	50/200
G20142	5/8" x 3/4"	50/200
G20143	3/4" x 3/4"	50/200

Male Pipe To Female Hose Swivel



PART NO.	MPT x FHT	CTN/MSTR
G20045	1/4" x 3/4"	1
G20047	1/2" x 3/4"	50/200

Hose WYE



PART NO.	DESCRIPTION	CTN/MSTR
G20050	3/4" x 3/4"	20/200

Hose WYE - LEAD FREE



PART NO.	DESCRIPTION	CTN/MSTR
G20150	3/4" x 3/4"	1/100

Garden Hose Shut Off



• Buna-N seals

PART NO.	DESCRIPTION	CTN/MSTR
G20051	Dual shut off/green ABS	100
G20052	Single shut off/green ABS	1/200
G20053	Brass hose with shut off "y"	15/60
G20054	CP die cast with shut off "y"	20/100

Garden Hose Cap



PART NO.	FHT	CTN/MSTR
G20055	3/4"	100/600
G20056	3/4" with chain	1/500

Garden Hose Cap - LEAD FREE



PART NO.	FHT	CTN/MSTR
G20155	3/4" with washer	1/500

Garden Hose Washer



PART NO.	SIZE	CTN/MSTR
G20057	3/4" vinyl	100/5000
G20057R	3/4" red rubber	100/2500

Garden Hose Filter Washer



PART NO.	SIZE	CTN/MSTR
G20060	3/4"	2000

Evaporation Cooler Drain



PART NO.	MHT x FPT	CTN/MSTR
G20006	3/4" x 1/2"	25/200

Hose Barb To Male Pipe

• Barb refers to hose I.D.



PART NO.	BARB x MPT	CTN/MSTR
G25022	1/8" x 1/8"	1
G25032	3/16" x 1/8"	1
G25034	3/16" x 1/4"	1
G25042	1/4" x 1/8"	1
G25044	1/4" x 1/4"	1
G25046	1/4" x 3/8"	1
G25048	1/4" x 1/2"	1
G25052	5/16" x 1/8"	500/1000
G25054	5/16" x 1/4"	1
G25056	5/16" x 3/8"	1
G25062	3/8" x 1/8"	1
G25064	3/8" x 1/4"	1
G25066	3/8" x 3/8"	1
G25068	3/8" x 1/2"	50/500
G25612	3/8" x 3/4"	1
G25084	1/2" x 1/4"	1
G25086	1/2" x 3/8"	1
G25088	1/2" x 1/2"	350
G25812	1/2" x 3/4"	1
G25106	5/8" x 3/8"	250/500
G25108	5/8" x 1/2"	1
G25101	5/8" x 3/4"	1
G25128	3/4" x 1/2"	1
G25121	3/4" x 3/4"	200
G25161	1" x 3/4"	1
G25169	1" x 1"	1

Hose Barb To Female Pipe

• Barb refers to hose I.D.



PART NO.	BARB x FPT	CTN/MSTR
G26022	1/8" x 1/8"	1
G26032	3/16" x 1/8"	1
G26034	3/16" x 1/4"	1
G26042	1/4" x 1/8"	1
G26044	1/4" x 1/4"	1
G26046	1/4" x 3/8"	1
G26052	5/16" x 1/8"	1
G26054	5/16" x 1/4"	1
G26056	5/16" x 3/8"	1
G26062	3/8" x 1/8"	1
G26064	3/8" x 1/4"	1
G26066	3/8" x 3/8"	1
G26068	3/8" x 1/2"	100/200
G26084	1/2" x 1/4"	1
G26086	1/2" x 3/8"	1
G26088	1/2" x 1/2"	1
G26121	3/4" x 3/4"	1
G26161	1" x 3/4"	1

D

Hose Barb To Male Pipe Elbow



PART NO.	BARB x MPT	CTN/MSTR
G27042	1/4" x 1/8"	1
G27044	1/4" x 1/4"	1
G27054	5/16" x 1/4"	1
G27062	3/8" x 1/8"	1
G27064	3/8" x 1/4"	1
G27066	3/8" x 3/8"	1
G27068	3/8" x 1/2"	1
G27084	1/2" x 1/4"	1
G27086	1/2" x 3/8"	1
G27088	1/2" x 1/2"	1
G27106	5/8" x 3/8"	1
G27108	5/8" x 1/2"	1

Barb To Barb Hose Splicers



PART NO.	BARB	CTN/MSTR
G29003	3/16"	1
G29004	1/4"	1
G29005	5/16"	250/1000
G29006	3/8"	100/800
G29008	1/2"	1
G29010	5/8"	1

Hose Barb To Female Ball End Swivel



PART NO.	BARB x NPSM	CTN/MSTR
G28044	1/4" x 1/4"	1
G28066	3/8" x 3/8"	1
G28088	1/2" x 1/2"	1

Hose Barb Tee



PART NO.	BARB x MPT	CTN/MSTR
G24004	1/4"	1
G24006	3/8"	1

Nylon Hose Barb Splicer



PART NO.	BARB x BARB	CTN/MSTR
N10001	1/8" x 1/8"	10/100
N10002	1/4" x 1/4"	10/100
N10003	5/16" x 5/16"	10/100
N10004	3/8" x 3/8"	10/100
N10005	1/2" x 1/2"	10/100
N10006	5/8" x 5/8"	10/100
N10007	3/4" x 3/4"	10/100
N10008	1" x 1"	5/50

Nylon Hose Barb Tees



PART NO.	BARB x BARB	CTN/MSTR
N11001	1/8" x 1/8" x 1/8"	10/100
N11002	1/4" x 1/4" x 1/4"	10/100
N11003	3/8" x 3/8" x 3/8"	10/100
N11004	1/2" x 1/2" x 3/8"	10/100
N11005	1/2" x 1/2" x 1/2"	10/100
N11006	5/8" x 5/8" x 5/8"	10/100
N11007	3/4" x 3/4" x 3/4"	10/100
N11008	1" x 1" x 1"	5/50

Nylon Hose Barb Elbows



PART NO.	BARB x BARB	CTN/MSTR
N12001	1/4" x 1/4"	10/100
N12002	3/8" x 3/8"	10/100
N12003	1/2" x 1/2"	10/100
N12004	5/8" x 5/8"	10/100
N12005	3/4" x 3/4"	10/100
N12006	1" x 1"	5/50

Nylon Garden Hose Cap



PART NO.	FHT	CTN/MSTR
N06001	3/4"	10/100

Nylon Female Hose Barb Adapter



PART NO.	BARB x FPT	CTN/MSTR
N15001	1/2" x 1/2"	10/100

Nylon Hose Barb Adapter



PART NO.	MPT x BARB	CTN/MSTR
N14001	1/4" x 1/4"	10/100
N14002	1/4" x 3/8"	10/100
N14003	3/8" x 1/4"	10/100
N14004	3/8" x 3/8"	10/100
N14005	3/8" x 1/2"	10/100
N14006	1/2" x 1/4"	10/100
N14007	1/2" x 3/8"	10/100
N14008	1/2" x 1/2"	10/100
N14009	1/2" x 5/8"	10/100
N14010	1/2" x 3/4"	10/100
N14011	3/4" x 3/8"	10/100
N14012	3/4" x 1/2"	10/100
N14013	3/4" x 5/8"	10/100
N14014	3/4" x 3/4"	10/100
N14015	3/4" x 1"	5/50
N14016	1" x 1/2"	5/50
N14017	1" x 5/8"	5/50
N14018	1" x 3/4"	5/50
N14019	1" x 1"	5/50

D

Nylon Male Garden Hose To Female Pipe



PART NO.	MHT x FPT	CTN/MSTR
N18001	3/4" x 1/2"	10/100
N18002	3/4" x 3/4"	10/100

Nylon Male Garden Hose To Male Pipe



PART NO.	MHT x MPT	CTN/MSTR
N09001	3/4" x 1/2"	10/100
N09002	3/4" x 3/4"	10/100

Nylon Female Garden Hose To Female Pipe



PART NO.	FHT x FPT	CTN/MSTR
N07001	3/4" x 1/2"	10/100

Male Insert Adapter



- NSF certified
- For flexible polyethylene plastic pipe

PART NO.	SIZE	CTN/MSTR
I11001	1/2"	10/100
I11002	3/4"	10/100
I11003	1"	10/100
I11004	1 1/4"	10/100
I11005	1 1/2"	10/100
I11006	2"	10/100

Insert Combination Elbow



- NSF certified
- For flexible polyethylene plastic pipe

PART NO.	SIZE	CTN. QTY.
I11025	1/2"	10/100
I11026	3/4"	10/100
I11027	1"	10/100
I11028	1 1/4"	10/100

D

Insert Coupling



- NSF certified
- For flexible polyethylene plastic pipe

PART NO.	SIZE	CTN/MSTR
I11007	1/2"	10/100
I11008	3/4"	10/100
I11009	1"	10/100
I11010	1 1/4"	10/100
I11011	1 1/2"	10/100
I11012	2"	10/100

Insert Elbow



- NSF certified
- For flexible polyethylene plastic pipe

PART NO.	SIZE	CTN/MSTR
I11013	1/2"	10/100
I11014	3/4"	10/100
I11015	1"	10/100
I11016	1 1/4"	10/100
I11017	1 1/2"	10/100
I11018	2"	5/50

Insert Tee



- NSF certified
- For flexible polyethylene plastic pipe

PART NO.	SIZE	CTN/MSTR
I11019	1/2"	10/100
I11020	3/4"	10/100
I11021	1"	10/100
I11022	1 1/4"	10/100
I11023	1 1/2"	10/100
I11024	2"	5/50

Male Insert Adapter



- NSF approved
- For flexible polyethylene plastic pipe

PART NO.	SIZE	CTN/MSTR
I10001	1/2"	10/100
I10002	3/4"	10/250
I10003	1"	10/160
I10004	1-1/4"	10/80
I10005	1-1/2"	5/60
I10006	2"	5/40

Insert Elbow



- NSF approved
- For flexible polyethylene plastic pipe

PART NO.	SIZE	CTN/MSTR
I10023	1/2"	10/300
I10024	3/4"	10/180
I10025	1"	10/100
I10026	1-1/4"	5/60
I10027	1-1/2"	5/40
I10028	2"	5/25

Female Insert Adapter



- NSF approved
- For flexible polyethylene plastic pipe

PART NO.	SIZE	CTN/MSTR
I10007	1/2"	10/400
I10008	3/4"	10/250
I10009	1"	10/160
I10010	1-1/4"	10/80

Insert Tee



- NSF approved
- For flexible polyethylene plastic pipe

PART NO.	SIZE	CTN/MSTR
I10029	1/2"	10/180
I10030	3/4"	10/100
I10031	1"	10/60
I10032	1-1/4"	5/40
I10033	1-1/2"	5/30
I10034	2"	5/15

Insert Coupling



- NSF approved
- For flexible polyethylene plastic pipe

PART NO.	SIZE	CTN/MSTR
I10011	1/2"	10/400
I10012	3/4"	10/250
I10013	1"	10/160
I10014	1-1/4"	10/80
I10015	1-1/2"	5/60
I10016	2"	5/40

Insert x MIP Combination Elbow



- NSF approved
- For flexible polyethylene plastic pipe

PART NO.	SIZE	CTN/MSTR
I10035	1/2"	10/300
I10036	3/4"	10/200
I10037	1"	10/100
I10038	1-1/4"	5/50
I10039	1-1/2"	5/50

Reducing Insert Coupling



- NSF approved
- For flexible polyethylene plastic pipe

PART NO.	SIZE	CTN/MSTR
I10017	3/4" x 1/2"	10/300
I10018	1" x 1/2"	10/220
I10019	1" x 3/4"	10/220
I10020	1-1/4" x 1"	10/100
I10021	1-1/2" x 1-1/4"	5/15
I10022	2" x 1-1/2"	5/15

Insert Reducing Tee



- NSF approved
- For flexible polyethylene plastic pipe

PART NO.	SIZE	CTN/MSTR
I10043	3/4" x 3/4" x 1/2"	1
I10044	3/4" x 1/2" x 1/2"	1
I10045	1" x 1" x 1/2"	1
I10046	1" x 1" x 3/4"	1
I10047	1" x 3/4" x 3/4"	1
I10048	1-1/2" x 1-1/2" x 1"	1
I10049	2" x 2" x 1"	1

Male Insert Reducer



- NSF approved
- For flexible polyethylene plastic pipe

PART NO.	SIZE	CTN/MSTR
I10040	3/4" x 1/2"	10/300
I10041	1" x 3/4"	10/220
I10042	1-1/4" x 1"	10/100

Steel Male Insert Adapter



• For flexible polyethylene plastic pipe

PART NO.	SIZE	CTN/MSTR
I12001	1/2"	25/100
I12002	3/4"	25/100
I12003	1"	20/120
I12004	1-1/4"	20/80
I12005	1-1/2"	10/100
I12006	2"	10/40

D

INSERT FITTINGS VS HOSE BARBS?

Insert Fittings only fit polyethylene plastic pipe (water service pipe).

Hose Barbs are designed to fit the inside diameter of various rubber hose sizes.

Both types of fittings are normally secured with hose gear clamps.

Steel Female Insert Adapter



• For flexible polyethylene plastic pipe

PART NO.	SIZE	CTN/MSTR
I12007	1/2"	1
I12008	3/4"	1
I12009	1"	10/30
I12010	1-1/4"	1
I12011	1-1/2"	10
I12012	2"	1

Steel Insert Coupling



• For flexible polyethylene plastic pipe

PART NO.	SIZE	CTN/MSTR
I12013	1/2"	1
I12014	3/4"	1/25
I12015	1"	1/20
I12016	1-1/4"	1/20
I12017	1-1/2"	10/60
I12018	2"	10

Male Insert Adapter



• For flexible polyethylene plastic pipe

PART NO.	SIZE	CTN/MSTR
I13001	1/2"	10/200
I13002	3/4"	10/200
I13003	1"	10/100
I13004	1 1/4"	10/100
I13005	1 1/2"	10/60
I13006	2"	5/40

Male Insert Reducer



• For flexible polyethylene plastic pipe

PART NO.	INSERT x MPT	CTN/MSTR
I13007	1" x 3/4"	1/100
I13008	1-1/4" x 1"	1/100
I13030	1" x 1 1/4"	10/100

Female Insert Adapter



• For flexible polyethylene plastic pipe

PART NO.	SIZE	CTN/MSTR
I13009	1/2"	10/100
I13010	3/4"	10/100
I13011	1"	1/200
I13012	1 1/4"	1/100
I13013	1 1/2"	1
I13014	2"	5/50

Insert x MIP 90° Elbow



• For flexible polyethylene plastic pipe

PART NO.	INSERT	MIP	CTN/MSTR
I13031	3/4"	3/4"	1/100
I13032	1"	3/4"	1/100
I13033	1"	1"	10/100
I13034	1 1/4"	1 1/4"	1/50

Insert x Sweat Adapters



• For flexible polyethylene plastic pipe

PART NO.	INSERT	SWEAT	CTN/MSTR
I13035	1/2"	1/2"	1
I13036	3/4"	3/4"	10/100
I13037	1"	1"	10/200
I13038	1 1/4"	1-1/4"	1

Insert x FIP Tee



• For flexible polyethylene plastic pipe

PART NO.	INSERT x FIP TEE	CTN/MSTR
I13039	1/2" x 1/2"	1
I13040	3/4" x 3/4"	1
I13041	1" x 1"	1
I13042	1 1/4" x 1 1/4"	1/10

Insert Coupling



• For flexible polyethylene plastic pipe

PART NO.	SIZE	CTN/MSTR
I13015	1/2"	1
I13016	3/4"	1/100
I13017	1"	1/100
I13018	1 1/4"	1/100
I13019	1 1/2"	1/100
I13020	2"	10/100

Insert Tee



• For flexible polyethylene plastic pipe

PART NO.	SIZE	CTN/MSTR
I13021	3/4"	1/100
I13022	1"	1/100
I13023	1 1/4"	10/50

Insert Elbow



• For flexible polyethylene plastic pipe

PART NO.	SIZE	CTN/MSTR
I13024	3/4"	1/100
I13025	1"	1/100
I13026	1 1/4"	1/50

Insert Male Rope Adapter



• For flexible polyethylene plastic pipe

PART NO.	SIZE	CTN/MSTR
I13027	1"	1/100
I13028	1 1/4"	1
I13029	1" x 1 1/4"	1/100

Straight Needle Valve



PART NO.	FLARE x FLARE	CTN/MSTR
N10244	1/4" x 1/4"	1
N10266	3/8" x 3/8"	1

Brass Saddle Clamp With Valve



- Fits up to 3/4" iron pipe
- Fits up to 1" hard copper
- Unassembled

PART NO.	OD	CTN/MSTR
N01039	1/4"	1

Angle Compression Needle Valve



PART NO.	COMP x MIP	CTN/MSTR
N10442	1/4" x 1/8"	50/500
N10444	1/4" x 1/4"	1
N10464	3/8" x 1/4"	1

Self Piercing Valve



- 1/4" OD compression outlet
- Fits 3/8" to 1.315" OD tube
- Lead Free

PART NO.	TUBE SIZE	CTN/MSTR
S92001	1/4"	50/100

Straight Compression Needle Valve



PART NO.	COMP x COMP	CTN/MSTR
N10544	1/4" x 1/4"	150/300
N10566	3/8" x 3/8"	25/250

Ice Maker Or Humidifier Kit



- 1/4" tubing
- Self piercing valve
- Brass fittings
- Lead Free

PART NO.	TUBE SIZE	CTN/MSTR
S92025	1/4" x 25' poly tubing	1/10
S92030	1/4" x 25' copper tubing	1/10
S92031	1/4" x 15' copper tubing	1/10

Straight Compression Needle Valve

• N10642 is Lead Free



PART NO.	COMP x MIP	CTN/MSTR
N10642	1/4" x 1/8"	50/500
N10644	1/4" x 1/4"	25
N10664	3/8" x 1/4"	1

Pipe Needle Valves



PART NO.	FIP x FIP	CTN/MSTR
N10944	1/4" x 1/4"	1

Needle Valve Tee Kit



PART NO.	COMP x COMP	CTN/MSTR
N78064	3/8" x 1/4"	1

Brass Saddle Clamp



- Fits up to 3/4" iron pipe
- Fits up to 1" hard copper
- Unassembled

PART NO.	FPT	CTN/MSTR
N01038	1/8"	1

Gas Shut-Off Valve

- Rated at 2 PSIG
- Cast bronze plug style

MADE IN THE
USA



Lever Handle

Part No.	Size	CTN/MSTR
G17025	1/4"	25
G17037	3/8"	1
G17050	1/2"	1
G17075	3/4"	1
G17100	1"	1
G17125	1-1/4"	1
G17150	1-1/2"	10
G17200	2"	5



Square Head

G18025	1/4"	1
G18037	3/8"	1
G18050	1/2" AGA	50
G18075	3/4" AGA	50
G18100	1"	25
G18125	1-1/4"	1
G18150	1-1/2"	10
G18200	2"	5



Flat/Tee Head

G19025	1/4"	1
G19037	3/8"	1
G19050	1/2" AGA	50
G19075	3/4" AGA	1
G19100	1"	25
G19125	1-1/4"	15
G19150	1-1/2"	10
G19200	2"	5

Flare x Flare



• 30 PSI

PART NO.	SIZE	CTN/MSTR
N01014	3/8"	1

Female Pipe x Female Pipe



• 30 PSI

PART NO.	SIZE	CTN/MSTR
N01010	1/8"	1
N01011	1/4"	1

Female Pipe x Male Pipe



• 30 PSI

PART NO.	SIZE	CTN/MSTR
N01027	1/8"	1
N01028	1/4"	1
N01029	3/8"	1

Drain Cock Tee Handle w/Bibb



• Hose x Male IPT

PART NO.	SIZE	CTN/MSTR
N01032	1/4"	100/500

Drain Cock External Seat



PART NO.	SIZE	CTN/MSTR
N01033	1/8"	1
N01034	1/4"	200/1000
N01035	3/8"	5/200

Drain Cock



PART NO.	SIZE	CTN/MSTR
N01001	1/8"	1
N01002	1/4"	1

Satin Brass Air Cock Female x Male Lever Handle Hex Shoulder



• Spring Bottoms

PART NO.	SIZE	CTN/MSTR
A11011	1/8" x 1/8"	1/100
A11001	1/4" x 1/4"	100/200

Satin Brass Air Cock Male x Spigot Tee Handle Hex Shoulder



• Spring Bottoms

PART NO.	SIZE	CTN/MSTR
A11002	1/4" x spigot	100/200

Satin Brass Air Cock Female x Male Tee Handle Hex Shoulder



• Spring Bottoms

PART NO.	SIZE	CTN/MSTR
A11003	1/4" x 1/4"	1/200

Satin Brass Air Cock Female x Female Lever Handle Round Shoulder



• Spring Bottoms

PART NO.	SIZE	CTN/MSTR
A11004	1/4" x 1/4"	1/100

Satin Brass Air Cock Female x Female Tee Handle Hex Shoulder



• Spring Bottoms

PART NO.	SIZE	CTN/MSTR
A11005	1/4" x 1/4"	1/200

Satin Brass Air Cock Female x Female Tee Handle Round Shoulder



• Spring Bottoms

PART NO.	SIZE	CTN/MSTR
A11016	1/8" x 1/8"	1/50
A11006	1/4" x 1/4"	100/200

Satin Brass Air Cock Female x Female Lever Handle Hex Shoulder



• Spring Bottoms

PART NO.	SIZE	CTN/MSTR
A11017	1/8" x 1/8"	1/100
A11007	1/4" x 1/4"	1/100

Satin Brass Air Cock Female x Male Tee Handle Round Shoulder



• Spring Bottoms

PART NO.	SIZE	CTN/MSTR
A11008	1/4" x 1/4"	100/200

Gas Ball Valves

- CSA- certified for use with natural, manufactured, mixed, liquefied petroleum and LP gas/air mixtures up to 2 psig
- UL listed 757x (1/2" and 3/4")
- Forged brass body
- Chrome plated brass ball
- Temperatures up to 175°F
- Threaded ends comply with ANSI B2.1
- 3/8"x 3/4" one piece body
- 1"-2" two-piece body with plated steel handle
- Made in Italy



Lever Handle, Female x Female



PART NO.	SIZE	CTN/MSTR
B64375	3/8" FIP	10/100
B64050	1/2" FIP	10/100
B64075	3/4" FIP	10/100
B64100	1" FIP	6/36
B64125	1 1/4" FIP	4/24
B64150	1 1/2" FIP	4/16
B64200	2" FIP	2/10

Tee Handle, Female x Female



PART NO.	SIZE	CTN/MSTR
B65375	3/8" FIP	10/100
B65050	3/8" FIP	10/100
B65075	3/4" FIP	10/100
B65100	1" FIP	6/36

Square Head, Female x Female



PART NO.	SIZE	CTN/MSTR
B66375	3/8" FIP	10/100
B66050	1/2" FIP	10/100
B66075	3/4" FIP	10/100
B66100	1" FIP	6/36

Two-Piece Gas Ball Valves

- CSA- certified for use with natural, manufactured, mixed liquefied petroleum and L.P. gas/air mixtures up to 2 psig
- Forged brass body
- Chrome plated brass ball
- Temperatures up to 125°F
- Two-piece body
- Made in Italy



PART NO.	SIZE	CTN/MSTR
B64450	1/2"	10/50
B64475	3/4"	10/50

Texas Pattern Gas Ball Valve

- CSA certified
- Female IPS x hose end x 1/8" MIP
- Lever handle
- One piece forged body
- Made in Italy



PART NO.	SIZE	CTN/MSTR
B69121	1/2" FIP x 1/8" MIP	10/100

Lever Handle Gas Ball Valves

- Forged brass body
- 3/4" Chrome plated forged brass ball
- Temperatures up to 175°F
- Threaded ends comply with ANSI B2.1
- CSA- certified for use with natural, manufactured, mixed, liquefied petroleum and LP gas/air mixtures up to 2 psig
- One piece body construction
- Made in Italy



Flare x Female



PART NO.	SIZE	CTN/MSTR
B67375	3/8" flare x 1/2" FIP	10/100
B67050	1/2" flare x 1/2" FIP	10/100
B67937	15/16" flare x 1/2" FIP	10/100
B67975	15/16" flare x 3/4" FIP	10/100

Flare x Male



PART NO.	SIZE	CTN/MSTR
B68001	1/2" flare x 1/2" MIP	10/100

Flare x Flare



PART NO.	SIZE	CTN/MSTR
B68375	3/8" flare x 3/8" flare	10/100
B68050	1/2" flare x 1/2" flare	10/100
B68058	5/8" flare x 5/8" flare	10/100

Gas Heater Valves

- 9/16" - 24 Fine Thread Flare (for 3/8" tube)
- Forged brass body
- Chrome plated forged brass ball
- CSA certified for use with natural, manufactured, mixed, liquefied petroleum and LP gas/air mixtures up to 2 psig
- One piece body construction
- Temperatures up to 175°F
- Made in Italy



PART NO.	SIZE	CTN/MSTR
B69050	9/16"-24 x 1/2" FIP	10/100

Brass Gas Ball Valves

- Two-piece forged brass body with chrome plated brass ball
- Double O-ring packing
- PTFE Seats
- 1/4 turn aluminum handle
- 1/2 PSI for indoor appliance connections per ANSI Z21.15/CGA 9.1
- Blowout-proof stem
- 5 PSI for indoor shutoff per CGA 91-002 & ASME B16.44
- CUS certified



Female x Female		
PART NO.	SIZE	CTN/MSTR
B67100	1/2" FIP x 1/2" FIP	1/160
B67101	3/4" FIP x 3/4" FIP	1/100

- Two-piece forged brass body with chrome plated brass ball
- Double O-ring packing
- PTFE Seats
- 1/4 turn aluminum handle
- 1/2 PSI for indoor appliance connections per ANSI Z21.15/CGA 9.1
- 5 PSI for indoor shutoff per CGA 91-002 & ASME B16.44
- CUS certified



Flare x Female		
PART NO.	SIZE	CTN/MSTR
B67102	3/8" FL x 1/2" FIP	1/160
B67103	1/2" FL x 1/2" FIP	1/160

Flare x Male		
PART NO.	SIZE	CTN/MSTR
B67104	1/2" FL x 1/2" MIP	1/160

Flare		
PART NO.	SIZE	CTN/MSTR
B67105	3/8" FL x 3/8" FL	1/160
B67106	1/2" FL x 1/2" FL	1/160

- Full-port design
- Forged brass body up to 4"
- Chrome plated brass ball
- Adjustable packing nut
- Non-sticking teflon seats
- 1/4 turn zinc plated steel handle
- 600psi, WOG (water, oil, gas)
- Working steam pressure: 150psi
- Blowout-proof stem
- Teflon packing for safety against leakage
- CUS / FM / NSF61 / UL certified



Threaded		
PART NO.	SIZE	CTN/MSTR
B67200	3/8"	20/100
B67201	1/2"	50/100
B67202	3/4"	30/60
B67203	1"	20/40
B67204	1-1/4"	12/24
B67205	1-1/2"	9/18
B67206	2"	6/12

- Full-port design
- Forged brass body up to 4"
- Chrome plated brass ball
- Adjustable packing nut
- Non-sticking teflon seats
- 1/4 turn zinc plated steel handle
- 600psi, WOG (water, oil, gas)
- Working steam pressure: 150psi
- Blowout-proof stem
- Teflon packing for safety against leakage
- FM / NSF61 / UL certified



Sweat		
PART NO.	SIZE	CTN/MSTR
B67207	3/8"	20/100
B67208	1/2"	50/100
B67209	3/4"	30/60
B67210	1"	20/40
B67211	1-1/4"	12/24
B67212	1-1/2"	9/18
B67213	2"	6/12

- Full-port with waste design
- Forged brass body
- Chrome plated brass ball
- Adjustable packing nut
- Non-sticking teflon seats
- 1/4 turn zinc plated steel handle
- 600psi, WOG (water, oil, gas)
- Working steam pressure: 150psi
- Blowout-proof stem
- Teflon packing for safety against leakage
- NSF61 certified



Brass Ball & Waste Valve Sweat		
PART NO.	SIZE	CTN/MSTR
B67214	1/2"	10/60
B67215	3/4"	10/60
B67216	1"	5/40



Brass Ball & Waste Valve Threaded		
PART NO.	SIZE	CTN/MSTR
B67217	1/2"	10/60
B67218	3/4"	10/60
B67219	1"	5/40

- Cast brass body
- Cast iron handle
- 125 PSI WOG to 100° F
- Maximum Temperature 180°F



Brass Stop Valve Threaded		
PART NO.	SIZE	CTN/MSTR
B67312	1/2"	6/48
B67313	3/4"	6/48



Brass Stop & Waste Valve Threaded		
PART NO.	SIZE	CTN/MSTR
B67315	3/4"	6/48



Brass Stop Valve Sweat		
PART NO.	SIZE	CTN/MSTR
B67316	1/2"	6/48
B67317	3/4"	6/48

- Forged brass body
- Copper or threads to hose
- Cast iron handle
- Non-sticking teflon seats
- 125 PSI WOG to 100°F
- Maximum Temperature 180°F
- Size range- 1/2" MIP (1/2" SWEAT) 3/4"MHT 3/4"MIP (1/2" SWEAT) 3/4"MHT



Brass Broiler Drain Valve - Male		
PART NO.	SIZE	CTN/MSTR
B67320	1/2" MIP x 3/4" MHT	6/48
B67321	3/4" MIP x 3/4" MHT	6/48

- Forged brass body
- Threads to hose
- Cast iron handle
- 125 PSI WOG to 100°F
- Maximum Temperature 180°F
- Size range- 1/2" FIP * 3/4"MHT



Brass Broiler Drain Valve - Female		
PART NO.	SIZE	CTN/MSTR
B67322	1/2" FIP x 3/4" MHT	6/48
B67323	3/4" FIP x 3/4" MHT	6/48

Full Port Ball Valves

600# WOG/ 125# WSP

- Forged brass
- Chrome plated ball
- Teflon seats
- Blowout-proof stem
- Vinyl grip and vibration-proof locknut
- Temperature range: -20°F to 350°F (call for pressure rating when temperature is above 210°F)
- CSA- certified (1/2"-2") for use with natural, manufactured, mixed, liquefied petroleum and LP gas/air mixtures up to 2 psi
- Complies with Federal Specification WW-V-35B, Type II, Style 3
- Threaded ends comply with ANSI B2.1
- Solder ends comply with ANSI B16.18
- Made in Italy



Threaded Ends



PART NO.	SIZE	PORT	CTN/MSTR
B60025	1/4"	0.315	20/200
B60375	3/8"	0.394	10/100
B60050	1/2"	0.590	10/100
B60075	3/4"	0.787	10/100
B60100	1"	0.984	10/50
B60125	1 1/4"	1.260	10/20
B60150	1 1/2"	1.575	4/20
B60200	2"	1.968	4/20
B60250	2 1/2"	2.283	2/6
B60300	3"	2.677	2/2
B60400	4"	3.543	1/2

Solder Ends



PART NO.	SIZE	PORT	CTN/MSTR
B61050	1/2"	0.590	10/100
B61075	3/4"	0.787	5/60
B61100	1"	0.984	6/36
B61125	1 1/4"	1.260	4/24
B61150	1 1/2"	1.575	4/16
B61200	2"	1.968	2/10

Threaded Ends With 1/8" Waste



PART NO.	SIZE	PORT	CTN/MSTR
B60650	1/2"	0.590	10/100
B60675	3/4"	0.787	10/100
B60610	1"	0.984	10/100

Solder Ends With 1/8" Waste



PART NO.	SIZE	PORT	CTN/MSTR
B60750	1/2"	0.590	10/100
B60775	3/4"	0.787	10/100
B60710	1"	0.984	10/100

PVC Ball Valves Solvent End

- One piece body construction
- Standard port
- EPDM seats and o-rings
- Working pressure 150 psi at 73°F
- Quarter turn operation
- Not for compressed air
- Ideal for swimming pools, irrigation and water supply uses
- Solvent ends comply with ASTM D 2466
- Threaded ends comply with ANSI B2.1
- For cold water lines
- Large flow opening



PART NO.	SIZE	CTN/MSTR
B90050	1/2"	1/162
B90075	3/4"	1/80
B90100	1"	1/84
B90125	1 1/4"	1/50
B90150	1 1/2"	1/50
B90200	2"	1/24
B90250	2 1/2"	1/15
B90300	3"	1/2
B90400	4"	1/1

PVC Ball Valves Threaded Ends

- One piece body construction
- Standard port
- EPDM seats and o-rings
- Working pressure 150 psi at 73°F
- Quarter turn operation
- Not for compressed air
- Ideal for swimming pools, irrigation and water supply uses
- Solvent ends comply with ASTM D 2466
- Threaded ends comply with ANSI B2.1
- For cold water lines
- Large flow opening



PART NO.	SIZE	CTN/MSTR
B91050	1/2"	1/162
B91075	3/4"	25/100
B91100	1"	1/84
B91125	1 1/4"	1/60
B91150	1 1/2"	1/40
B91200	2"	6/24
B91250	2 1/2"	1/16
B91300	3"	1/10
B91400	4"	1/1

CPVC Ball Valves

- NSF approved!
- Standard port
- For use on CPVC tubing size (OD)
- Teflon seats
- EPDM o-rings
- One piece body construction
- Large flow opening
- For hot or cold water lines up to 100 psi at temperature up to 180°F
- Solvent ends comply with ASTM D2846
- Quarter turn operation



PART NO.	SIZE	CTN/MSTR
B92050	1/2" (5/8" OD)	10/100
B92075	3/4" (7/8" OD)	10/100

Radiator Coin Key Air Valve And Key

• CARTON QUANTITY ONLY



PART NO.	DESCRIPTION	CTN/MSTR
R20001	Vent valve with key	1/100
R20002	Key only	100/5000
R20003	Valve only	100/1000

Single Union PVC Swimming Pool Valves



- Teflon seats
- 150 psi working pressure
- EPDM o-rings seal on union end
- Suitable for swimming pools, spas and plumbing
- Full port
- Solvent ends

PART NO.	SIZE	CTN/MSTR
B95150	1-1/2"	8/32
B95200	2"	5/20

Inline PVC Check Valves



- Stainless steel spring
- EPDM seats
- Maintenance-free operation
- .5 psi required to open unit
- 200 psi static pressure rating at 77°F
- Use anywhere to stop backflow and siphoning
 - Swimming Pools - Hot Tubs - Spas
 - Solar Installations

Solvent Ends

PART NO.	SIZE	CTN/MSTR
C30050	1/2"	30/120
C30075	3/4"	30/120
C30100	1"	16/64
C30125	1-1/4"	12/48
C30150	1-1/2"	1/32
C30200	2"	4/16

Threaded Ends

PART NO.	SIZE	CTN/MSTR
C31050	1/2"	30/120
C31075	3/4"	30/120
C31100	1"	16/64
C31125	1-1/4"	12/48
C31150	1-1/2"	6/32
C31200	2"	4/16



Dual Check Backflow Preventer



- Female by female
- Forged brass body
- 150 psi
- Acetyl-resin check modules
- Stainless steel spring
- 180° F maximum temperature

PART NO.	SIZE	CTN/MSTR
B59001	3/4"	1/100
B59002	1"	1/25

D

Forged Brass Hose Bibb



- Hard chrome ball
- Quarter-turn operation
- Teflon seats
- T-handle

PART NO.	SIZE	CTN/MSTR
B60950	1/2"	10/100
B60975	3/4"	10/100

Cast Brass Hose Bibb



PART NO.	MIP x MALE HOSE	CTN/MSTR
B59050	1/2" x 3/4"	10/100
B59075	3/4" x 3/4"	10/100
B59100	1" x 1"	6/72

Hose Bibb Reducer



- Reduces 1" hose bibb to standard 3/4" garden hose

PART NO.	FHT x MHT	CTN/MSTR
G20058	1" x 3/4"	1

Hose Bibb Vacuum Breaker



- 3/4" hose thread
- Vandal-proof breakoff screw
- Brass
- ASSE 1011

PART NO.	DESCRIPTION	CTN/MSTR
G04003	Vacuum breaker	20/200

Economy Hose Bibb Vacuum Breaker



- Brass
- 3/4" hose thread

PART NO.	DESCRIPTION	CTN/MSTR
G04004	Economy Vacuum Breaker	20/200

Hose Faucet Anchor



- Long lasting solution to loosen exterior faucets
- Works with any wall material (brick, concrete, vinyl siding or stucco)
- For repair or new home applications
- Fits all exterior or faucet water lines
- Corrosion free



PART NO.	DESCRIPTION	CTN/MSTR
B59000	Hose faucet anchor	1/100

D

Micro Size

• CARTON QUANTITY ONLY
• 5/16" band

MADE IN THE
USA

Part Stainless



PART NO.	TRADE SIZE	SIZE	CTN/MSTR
G08004	4	1/4" - 5/8"	10/1000
G08006	6	5/16" - 7/8"	10/1000
G08008	8	3/8" - 1"	10/500
G08012	12	1/2" - 1 1/4"	10/500
G08016	16	1/2" - 1 1/2"	10/500
G08020	20	3/4" - 1 3/4"	10/500
G08024	24	1" - 2"	10/500

All Stainless



PART NO.	TRADE SIZE	SIZE	CTN/MSTR
G09004	4	1/4" - 5/8"	10/1000
G09006	6	5/16" - 7/8"	10/1000
G09008	8	1/2" - 1"	10/500
G09012	12	1/2" - 1 1/4"	10/500
G09016	16	1/2" - 1 1/2"	10/500
G09020	20	3/4" - 1 3/4"	10/500
G09024	24	1" - 2"	10/500

Full Size

• CARTON QUANTITY ONLY
• 1/2" band

MADE IN THE
USA

Part Stainless



PART NO.	TRADE SIZE	SIZE	CTN/MSTR
G10006	6	3/8" - 7/8"	10/200
G10008	8	7/16" - 1"	10/200
G10010	10	1/2" - 1 1/16"	10/500
G10012	12	1/2" - 1 1/4"	10/500
G10016	16	3/4" - 1 1/2"	10/500
G10020	20	3/4" - 1 3/4"	10/500
G10024	24	1" - 2"	10/500
G10032	32	1 1/2" - 2 1/2"	10/500
G10036	36	7/8" - 2 3/4"	10/500
G10040	40	1 1/8" - 3"	10/200
G10052	52	1 7/8" - 3 3/4"	10/100
G10072	72	3 1/8" - 5"	10/100
G10080	80	3 5/8" - 5 1/2"	10/100
G10104	104	5" - 7"	10/100

All Stainless



PART NO.	TRADE SIZE	SIZE	CTN/MSTR
G11006	6	3/8" - 7/8"	10/200
G11008	8	7/16" - 1"	10/200
G11010	10	1/2" - 1 1/16"	10/500
G11012	12	1/2" - 1 1/4"	10/500
G11016	16	11/16" - 1 1/2"	10/500
G11020	20	3/4" - 1 3/4"	10/500
G11024	24	1" - 2"	10/500
G11028	28	1 5/16" - 2 1/4"	10/500
G11032	32	1 9/16" - 2 1/2"	10/500
G11036	36	7/8" - 2 3/4"	10/500
G11040	40	1 1/8" - 3"	10/200
G11044	44	2 1/4" - 3 1/4"	10/200
G11048	48	1 5/8" - 3 1/2"	10/200
G11052	52	1 7/8" - 3 3/4"	10/200
G11056	56	2 1/8" - 4"	10/100
G11064	64	2 1/2" - 4 1/2"	10/100
G11072	72	3" - 5"	10/100
G11080	80	3 1/2" - 5 1/2"	10/100
G11088	88	4" - 6"	10/100
G11096	96	4 3/4" - 6 1/2"	10/100
G11104	104	5" - 7"	10/100

"68" Series Stainless Gear Clamps

- 9/16" band
- All stainless, 300 grade construction
- Ideal for well drilling and applications requiring marine grade stainless clamps
- CARTON QUANTITY ONLY

MADE IN THE
USA



PART NO.	TRADE SIZE	SIZE	CTN/MSTR
G14006	6	3/8" - 7/8"	10/200
G14008	8	7/16" - 1"	10/200
G14010	10	1/2" - 1 1/16"	10/500
G14012	12	1/2" - 1 1/4"	10/500
G14016	16	11/16" - 1 1/2"	10/500
G14020	20	3/4" - 1 3/4"	10/500
G14024	24	1" - 2"	10/500
G14028	28	1 1/4" - 2 1/4"	10/500
G14032	32	1 1/2" - 2 1/2"	10/500
G14036	36	1 3/4" - 2 3/4"	10/200
G14040	40	1 1/8" - 3"	10/200
G14044	44	2 1/4" - 3 1/4"	10/200
G14048	48	1 5/8" - 3 1/2"	10/200
G14052	52	1 7/8" - 3 3/4"	10/100
G14056	56	2 1/8" - 4"	10/100
G14064	64	2 1/2" - 4 1/2"	10/100
G14072	72	3" - 5"	10/100
G14080	80	3 1/2" - 5 1/2"	10/100
G14088	88	4" - 6"	10/100
G14096	96	4 1/2" - 6 1/2"	10/100
G14104	104	5" - 7"	10/100

Stainless Steel Gear Clamps

- All stainless
- Hanging bag
- CARTON QUANTITY ONLY



PART NO.	TRADE SIZE	SIZE	CTN/MSTR
G16008	8	7/16" - 1"	100/1000
G16010	10	1/2" - 1 1/16"	100/1000
G16012	12	1/2" - 1 1/4"	100/1000
G16016	16	11/16" - 1 1/2"	100/1000
G16020	20	3/4" - 1 3/4"	100/1000
G16024	24	1" - 2"	1
G16028	28	1 1/4" - 2 1/4"	100/1000
G16032	32	1 1/2" - 2 1/2"	100/1000
G16036	36	1 3/4" - 2 3/4"	100/1000
G16040	40	1 1/8" - 3"	100/500
G16044	44	2 1/4" - 3 1/4"	100/500
G16048	48	1 5/8" - 3 1/2"	100/500
G16052	52	1 7/8" - 3 3/4"	100/500
G16056	56	2 1/8" - 4"	100/500
G16064	64	2 1/2" - 4 1/2"	100/500
G16072	72	3" - 5"	1
G16080	80	3 1/2" - 5 1/2"	50/200
G16088	88	4" - 6"	50/250
G16096	96	4 1/2" - 6 1/2"	50
G16104	104	5" - 7"	50/250

D

Replacement Clamp For Flexible Couplings



- CARTON QUANTITY ONLY

MADE IN THE
USA

PART NO.	DESCRIPTION	CTN/MSTR
G15002	2" Replacement clamp	10
G15003	3" Replacement clamp	10
G15004	4" Replacement clamp	10/100
G15006	6" Replacement clamp	1
G15008	8" Replacement clamp	1

Asbestos- Free Full Face Gasket



- Meets ASTM F152, F36A and F146
- Manufactured of Garlock 4401
- 1/16" thick
- Temperature rating of 750°F

PART NO.	SIZE	LBS.
G54075	3/4"	150
G54001	1"	150
G54013	1 1/4"	150
G54015	1 1/2"	150
G54002	2"	150
G54025	2 1/2"	150
G54003	3"	150
G54035	3 1/2"	150
G54004	4"	150
G54005	5"	150
G54006	6"	150
G54008	8"	150
G54010	10"	150
G54012	12"	150

Red Rubber Full Face Gasket



- Meets ASTM D1330
- 1/16" thick
- Temperature rating of 350° F

PART NO.	SIZE	LBS.
G51050	1/2"	150
G51075	3/4"	150
G51001	1"	150
G51013	1 1/4"	150
G51015	1 1/2"	150
G51002	2"	150
G51025	2 1/2"	150
G51003	3"	150
G51035	3 1/2"	150
G51004	4"	150
G51005	5"	150
G51006	6"	150
G51008	8"	150
G51010	10"	150
G51012	12"	150

D

Asbestos- Free Ring Gasket



- Meets ASTM F152, F36A and F146
- Manufactured of Garlock 4401
- 1/16" thick
- Temperature rating of 750°F

PART NO.	SIZE	LBS.
G53050	1/2"	150
G53075	3/4"	150
G53001	1"	150
G53013	1 1/4"	150
G53015	1 1/2"	150
G53002	2"	150
G53025	2 1/2"	150
G53003	3"	150
G53035	3 1/2"	150
G53004	4"	150
G53005	5"	150
G53006	6"	150
G53008	8"	150
G53010	10"	150
G53012	12"	150

Red Rubber Ring Gasket



- Meets ASTM D1330
- 1/16" thick
- Temperature rating of 350° F

PART NO.	SIZE	LBS.
G52075	3/4"	150
G52001	1"	150
G52013	1 1/4"	150
G52015	1 1/2"	150
G52002	2"	150
G52025	2 1/2"	150
G52003	3"	150
G52035	3 1/2"	150
G52004	4"	150
G52005	5"	150
G52006	6"	150
G52008	8"	150
G52010	10"	150
G52012	12"	150

Asbestos- Free Full Face Gasket



- Meets ASTM F152, F36A and F146
- Gaskets are 1/16" thick
- ASTM A307 hex bolts and heavy hex nuts
- Constructed of Garlock 4401

PART NO.	PIPE SIZE	BOLT SIZE	BOLTS/ KIT
G54115	1-1/2"	1/2" x 2-1/4"	4
G54102	2"	5/8" x 2-3/4"	4
G54125	2-1/2"	5/8" x 3"	4
G54103	3"	5/8" x 3"	4
G54104	4"	5/8" x 3"	8
G54105	5"	3/4" x 3-1/4"	8
G54106	6"	3/4" x 3-1/4"	8
G54108	8"	3/4" x 3-1/2"	8
G54110	10"	7/8" x 3-3/4"	12
G54112	12"	7/8" x 4"	12

Red Rubber Ring Gasket Kits



- Meets ASTM D1330
- Gaskets are 1/16" thick
- ASTM A307 hex bolts and heavy hex nuts

PART NO.	PIPE SIZE	BOLT SIZE	BOLTS/ KIT
G52115	1-1/2"	1/2" x 2-1/4"	4
G52102	2"	5/8" x 2-3/4"	4
G52125	2-1/2"	5/8" x 3"	4
G52103	3"	5/8" x 3"	4
G52104	4"	5/8" x 3"	8
G52105	5"	3/4" x 3-1/4"	8
G52106	6"	3/4" x 3-1/4"	8
G52108	8"	3/4" x 3-1/2"	8
G52110	10"	7/8" x 3-3/4"	12

Asbestos- Free Ring Gasket Kits



- Meets ASTM F152, F36A and F146
- Gaskets are 1/16" thick
- ASTM A307 hex bolts and heavy hex nuts
- Constructed of Garlock 4401

PART NO.	PIPE SIZE	BOLT SIZE	BOLTS/ KIT
G53101	1"	1/2" x 2"	4
G53113	1-1/4"	1/2" x 2-1/4"	4
G53115	1-1/2"	1/2" x 2-1/4"	4
G53102	2"	5/8" x 2-3/4"	4
G53125	2-1/2"	5/8" x 3"	4
G53103	3"	5/8" x 3"	4
G53104	4"	5/8" x 3"	8
G53105	5"	3/4" x 3-1/4"	8
G53106	6"	3/4" x 3-1/4"	8
G53108	8"	3/4" x 3-1/2"	8
G53110	10"	7/8" x 3-3/4"	12

Insulation Kits With Poly Sleeves



- Use with flange connection kits
- To form dielectric connection; fiber washers

PART NO.	DESCRIPTION	CTN. QTY.
G55150	1-1/2" Insulation kit	1
G55200	2" Insulation kit	1
G55250	2-1/2" Insulation kit	1
G55300	3" Insulation kit	1
G55350	4" Insulation kit	1
G55400	5" Insulation kit	1
G55450	6" Insulation kit	1
G55500	8" Insulation kit	1
G55550	10" Insulation kit	1
G55600	12" Insulation kit	1

Red Rubber Full Face Gasket Kits



- Meets ASTM D1330
- Gaskets are 1/16" thick
- ASTM A307 hex bolts and heavy hex nuts

PART NO.	PIPE SIZE	BOLT SIZE	BOLTS/ KIT
G51102	2"	5/8" x 2-3/4"	4
G51125	2-1/2"	5/8" x 3"	4
G51103	3"	5/8" x 3"	4
G51135	3-1/2"	5/8" x 3"	8
G51104	4"	5/8" x 3"	8
G51105	5"	3/4" x 3-1/4"	8
G51106	6"	3/4" x 3-1/4"	8
G51108	8"	3/4" x 3-1/2"	8
G51110	10"	7/8" x 3-3/4"	12
G51112	12"	7/8" x 4"	12

Asbestos-Free Ring Gasket Kits Supplied w/Insulation Kits



PART NO.	PIPE SIZE	BOLT SIZE	BOLTS/ KIT
G53203	3"	5/8" x 3"	4
G53204	4"	5/8" x 3"	8
G53206	6"	3/4" x 3 1/4"	8
G53215	1 1/2"	1/2" x 2 1/4"	4
G53225	2 1/2"	5/8" x 3"	4

Asbestos-Free Full Face Gasket Kits Supplied w/Insulation Kits



PART NO.	PIPE SIZE	BOLT SIZE	BOLTS/ KIT
G54215	1-1/2"	1/2" x 2-1/4"	4
G54202	2"	5/8" x 2-3/4"	4
G54225	2-1/2"	5/8" x 3"	4
G54203	3"	5/8" x 3"	4
G54204	4"	5/8" x 3"	8
G54205	5"	3/4" x 3-1/4"	8
G54206	6"	3/4" x 3-1/4"	8
G54208	8"	3/4" x 3-1/2"	8
G54210	10"	7/8" x 3-3/4"	12
G54212	12"	7/8" x 4"	12

Red Rubber Sheet Packing/Gasket Material

- Priced per roll (approximately 100 pounds)
- FULL ROLLS ONLY



PART NO.	DESCRIPTION	CTN QTY
G55016	1/16"x 36"x 60'	1 roll
G55018	1/8"x 36"x 30'	1 roll
G55014	1/4"x 36"x 15'	1 roll

D

Red Rubber Sheet Packing/Gasket Material



- Single 3'x 5' sheet

PART NO.	MATERIAL	THICKNESS	CTN QTY
G55116	Red Rubber (1 sheet)	1/16"	1 roll/
G55118	Red Rubber (1 sheet)	1/8"	1 roll

Gasket And Washer Materials



- Make your own gaskets and washers
- 6"x 6" square in hanging display bag

PART NO.	MATERIAL	THICKNESS	CTN QTY
G55001	Red Rubber (1 sheet)	1/16"	1
G55002	Black Fiber (1 sheet)	1/32"	1
G55003	Cork/Rubber (1 sheet)	1/16"	1
G55004	Combo (1 sheet of each)	—	1

Circulator Flange Gasket Pair

- SOLD IN PAIRS ONLY



PART NO.	DESCRIPTION	CTN QTY
G55005	Circulator Flange Gasket	1

Water Hammer Arresters

- Maximum working temp: 250°F
- Maximum working pressure: 300psi
- Burst pressure: 2900psi
- Polly Bagged



FIXTURE	TYPE OF SUPPLY CONTROL	PUBLIC			PRIVATE		
		TOTAL	C.W.	H.W.	TOTAL	C.W.	H.W.
Water Closet	Flush Valve	10	10	--	6	6	--
Water Closet	Flush Tank	5	5	--	3	3	--
Pedestal Urinal	Flush Valve	10	10	--	--	--	--
Stall or Wall Unit	Flush Valve	5	5	--	--	--	--
Stall or Wall Unit	Flush Tank	3	3	--	--	--	1
Lavatory	Faucet	2	1-1/2	1-1/2	1	1	1-1/2
Bathtub	Faucet	4	2	3	2	1-1/2	1-1/2
Shower Head	Mixing Valve	4	2	3	2	1	2
Bathroom Group	Flush Valve Closet	--	--	--	8	8	3
Bathroom Group	Flush Tank Closet	--	--	--	6	6	3
Separate Shower	Mixing Valve	--	--	--	2	1	2
Service Sink	Faucet	3	3	3	--	--	--
Laundry Tubs (3)	Faucet	--	--	--	3	3	3
Combination Fixture	Faucet	--	--	--	3	3	3

Now apply the total fixture units to Table B to obtain your PDI size value.

PDI SIZE ARRESTER:	AA	A	B	C	D	E	F
FIXTURE UNITS:	1-5	1-11	12-32	33-60	61-113	114-154	155-330
THREAD SIZE:	1/2	1/2	3/4	3/4	1	1	1
CATALOG NUMBER:	ALL A95 SERIES						

MIP AA



PART NO.	SIZE	CTN/MSTR
A95001	1/2"	25/150

MSWT AA



PART NO.	SIZE	CTN/MSTR
A95002	1/2"	25/150

MSWT AA



PART NO.	SIZE	CTN/MSTR
A95003	3/4"	25/150

CPVC AA



PART NO.	SIZE	CTN/MSTR
A95004	1/2"	25/150

OD COMP AA



PART NO.	SIZE	CTN/MSTR
A95005	5/8"	25/150

PEX TEE AA



PART NO.	SIZE	CTN/MSTR
A95006	3/8"	25/150
A95007	1/2"	25/150

OD TEE AA



PART NO.	SIZE	CTN/MSTR
A95008	1/4"	25/75
A95009	3/8"	25/75
A95010	5/8"	25/75

Female Comp. x OD Comp.



PART NO.	SIZE	CTN/MSTR
A95014	3/8" x 3/8"	25/75

MHT x FHS AA



PART NO.	SIZE	CTN/MSTR
A95011	3/4"	25/75

Water Hammer Arresters - LEAD FREE

- Maximum working temp: 250°F
- Maximum working pressure: 300psi
- Burst pressure: 2900psi
- Polly Bagged



D

FIXTURE	TYPE OF SUPPLY CONTROL	PUBLIC			PRIVATE		
		TOTAL	C.W.	H.W	TOTAL	C.W.	H.W
Water Closet	Flush Valve	10	10	--	6	6	--
Water Closet	Flush Tank	5	5	--	3	3	--
Pedestal Urinal	Flush Valve	10	10	--	--	--	--
Stall or Wall Unit	Flush Valve	5	5	--	--	--	--
Stall or Wall Unit	Flush Tank	3	3	--	--	--	1
Lavatory	Faucet	2	1-1/2	1-1/2	1	1	1-1/2
Bathtub	Faucet	4	2	3	2	1-1/2	1-1/2
Shower Head	Mixing Valve	4	2	3	2	1	2
Bathroom Group	Flush Valve Closet	--	--	--	8	8	3
Bathroom Group	Flush Tank Closet	--	--	--	6	6	3
Separate Shower	Mixing Valve	--	--	--	2	1	2
Service Sink	Faucet	3	3	3	--	--	--
Laundry Tubs (3)	Faucet	--	--	--	3	3	3
Combination Fixture	Faucet	--	--	--	3	3	3

Now apply the total fixture units to Table B to obtain your PDI size value.

PDI SIZE ARRESTER:	AA	A	B	C	D	E	F
FIXTURE UNITS:	1-5	1-11	12-32	33-60	61-113	114-154	155-330
THREAD SIZE:	1/2	1/2	3/4	3/4	1	1	1
CATALOG NUMBER:	ALL A95 SERIES						

MIP AA



PART NO.	SIZE	CTN/MSTR
A97001	1/2"	1

MSWT AA



PART NO.	SIZE	CTN/MSTR
A97002	1/2"	1

CPVC AA



PART NO.	SIZE	CTN/MSTR
A97004	1/2"	1

PEX TEE AA



PART NO.	SIZE	CTN/MSTR
A97007	1/2"	1

OD TEE AA













PART NO.	SIZE	CTN/MSTR
A97009	3/8"	1

MHT x FHS AA



PART NO.	SIZE	CTN/MSTR
A97011	3/4"	1

SECTION E - COMMERCIAL & RESIDENTIAL PLASTICS

Closet Flanges & Accessories	180-184	
Residential Drains	185-194	
LevelBest Drain & Cleanout System	195-198	
Commercial Drain Bases	199-200	
Commercial Spuds & Strainers	201-204	
Commercial Drains.....	205-233	
Residential & Light Commercial Cleanouts	234-236	
Cleanout Spuds.....	237-238	
Commerical Cleanouts.....	239-244	
Floor Sinks & Accessories	245-246	
Roof Drains.....	247	



Plumbfit Closet Flange

3" x 4" Fits Flush with Floor
3" Fits Inside 3" Schedule 40 DWV Pipe



- Long shank
- Six screw holes
- Extra-thick flange with short slots for extra strength
- For 3" units cut pipe 1/8" below floor and remove concrete so unit will fit flush
- 3" has 4 closet bolt slots



PVC		
PART NO.	DESCRIPTION	CTN QTY
C51300	3" less knockout	20
C50300	3" with Knockout	20
C51340	3" x 4" less knockout	20
C50340	3" x 4" with knockout	20

ABS		
PART NO.	DESCRIPTION	CTN QTY
C51301	3" less knockout	20
C50301	3" with Knockout	20
C51341	3" x 4" less knockout	20
C50341	3" x 4" with knockout	20

Plumbfit Closet Flange

Fits Over 4" Schedule 40 DWV Pipe



- Extra thick flange with short slots for extra strength
- Six screw holes
- Long shank



PVC		
PART NO.	DESCRIPTION	CTN QTY
C51400	4" less knockout	20
C50400	4" with knockout	20

ABS		
PART NO.	DESCRIPTION	CTN QTY
C51401	4" less knockout	20

Plumbfit Closet Flange w/Metal Rings

Fits Over 3" or Inside 4" Schedule 40 DWV Pipe
Fits Over 4" Schedule 40 DWV Pipe



- Adjustable metal ring
- Two radial slots for closet bolts



PVC		
PART NO.	DESCRIPTION	CTN QTY
C53340	3" x 4" less knockout	20
C52340	3" x 4" with knockout	20
C53400	4" less knockout	20
C52400	4" with knockout	20

ABS		
PART NO.	DESCRIPTION	CTN QTY
C53341	3" x 4" less knockout	20
C52341	3" x 4" with knockout	20
C53401	4" less knockout	20
C52401	4" with knockout	20

Plumbfit Closet Flange with SS Ring



- Exclusive 400 grade stainless with plumb fit bodies
- Radial slots for closet bolts; 6 screw holes
- For Schedule 40 DWV pipe



PVC		
PART NO.	DESCRIPTION	CTN QTY
C57234	Inside 3" pipe; 4" long shank less knockout	20
C57236	Inside 3" pipe; 6" long shank less knockout	20
C57134	Over 3" inside 4" less knockout	20
C57034	Over 3" inside 4" with knockout	20
C57334	Over 3" Inside 4"; 6" long shank less knockout	20
C57040	Over 4" pipe with knockout	20
C57140	Over 4" pipe less knockout	20

ABS		
PART NO.	DESCRIPTION	CTN QTY
C58234	Inside 3" pipe; 4" long shank less knockout	20
C58236	Inside 3" pipe; 6" long shank less knockout	20
C58134	Over 3" inside 4" less knockout	20
C58034	Over 3" Inside 4" with knockout	20
C58334	Over 3" Inside 4"; 6" long shank less knockout	20
C58040	Over 4" pipe with knockout	20
C58140	Over 4" pipe less knockout	20

Offset Plumbfit Closet Flange w/SS Ring



- Exclusive 400 grade stainless with plumb fit bodies
- Radial slots for closet bolts; 6 screw holes
- For Schedule 40 DWV pipe



PVC		
PART NO.	DESCRIPTION	CTN QTY
C57434	Over 3" Inside 4"; offset less knockout	20

ABS		
PART NO.	DESCRIPTION	CTN QTY
C58434	Over 3" Inside 4"; offset less knockout	20

Spigot Fit Closet Flange



- Extra-thick flange with short slots for extra strength
- Six screw holes



PVC		
PART NO.	DESCRIPTION	CTN QTY
C51350	3" less knockout	20
C51450	4" less knockout	20

ABS		
PART NO.	DESCRIPTION	CTN QTY
C51351	3" less knockout	20
C51451	4" less knockout	20

Plumbfit Closet Flanges w/Adj. Rings

Fits Over 3" and Inside 4" Schedule 40 DWV Pipe



- 6" long shank
- Can be cut to desired length
- Swivel rings

MADE IN THE
USA

PVC		
PART NO.	DESCRIPTION	CTN QTY
C53600	Metal Ring	10
C53700	Plastic ring	10
ABS		
PART NO.	DESCRIPTION	CTN QTY
C53601	Metal Ring	10
C53701	Plastic ring	10

3" Closet Flange with Long Barrel

Fits Inside 3" Schedule 40 DWV



- 4" long shank
- Adjustable swivel rings

MADE IN THE
USA

PVC		
PART NO.	DESCRIPTION	CTN QTY
C50302	3" Metal ring	10
C50306	3" Plastic ring	10
C50304	3" Metal ring	10
C50308	3" Plastic ring	10
ABS		
PART NO.	DESCRIPTION	CTN QTY
C50303	3" Metal ring	10
C50307	3" Plastic ring	10
C50305	3" Metal ring	10
C50309	3" Plastic ring	10

Plastic Two Finger Flange



- Fits flush
- Patent #: 5,937,450
- Will fit oblong horns
- Pushes easily into 3" or 4" cast iron or Schedule 40 DWV pipe
- ASTM C-564 rubber gasket

MADE IN THE
USA



White Plastic		
PART NO.	DESCRIPTION	CTN QTY
C4733P	3" x 3"	6
C4743P	4" x 3"	6
Black Plastic		
PART NO.	DESCRIPTION	CTN QTY
C4733A	3" x 3"	6
C4743A	4" x 3"	6

Closest Flange w/3-1/2" Extended Threads



MADE IN THE
USA

PVC		
PART NO.	DESCRIPTION	CTN/MSTR
C54150	with 3-1/2" extended threads	20

Plumbfit Closet Flanges with Plastic Swivel Ring

3" x 4" Fits Over 3" or Inside 4" Schedule 40 DWV Pipe



- Plastic ring will not deteriorate
- 360° rotation
- 2 radial slots and 2 grooved slots for closet bolts
- 6 screw holes for securing to floor

MADE IN THE
USA



PVC		
PART NO.	DESCRIPTION	CTN QTY
C53342	3" x 4" less knockout	20
C54402	3" x 4" offset - less knockout	20
C52342	3" x 4" with knockout	6
ABS		
PART NO.	DESCRIPTION	CTN QTY
C53343	3" x 4" less knockout	20
C54403	3" x 4" offset - less knockout	20
C52343	3" x 4" with knockout	20

Plumbfit Closet Flanges with Plastic Swivel Ring

4" Fits Over Schedule 40 DWV Pipe



- Plastic ring will not deteriorate
- 360° rotation
- 2 radial slots and 2 grooved slots for closet bolts
- 6 screw holes for securing to floor

MADE IN THE
USA



PVC		
PART NO.	DESCRIPTION	CTN QTY
C52402	4" with knockout	10
C53402	4" less knockout	10
ABS		
PART NO.	DESCRIPTION	CTN QTY
C52403	4" with knockout	10
C53403	4" less knockout	10

45° Closet Flange

Fits Over 3" DWV with a 4" Sweep



- CSA certified
- With plastic swivel ring
- More versatile than an offset closet flange
- Provides unlimited offset when used in conjunction with a socket x socket 45° elbow



PVC

PART NO.	DESCRIPTION	CTN QTY
C55043	3" with Plastic ring	20

ABS

PART NO.	DESCRIPTION	CTN QTY
C55143	3" with Plastic ring	20

3" Over Schedule 30 Pipe Closet Flange

MADE IN THE USA



PVC

PART NO.	DESCRIPTION	CTN QTY
C51150	3" less knockout	20
C52150	3" with knockout	20

Offset Closet Flange

Fits Over 3" or Inside 4" Schedule 40 DWV Pipe



- 2" Offset
- Four closet bolt slots and two mounting screw holes

MADE IN THE USA



PVC

PART NO.	DESCRIPTION	CTN QTY
C54340	3" x 4"	20

ABS

PART NO.	DESCRIPTION	CTN QTY
C54341	3" x 4"	20

Adjustable Urinal Flange Kits

Socket Fits Over 2" Schedule 40 DWV Pipe

Spigot Fits Inside Hub of Fitting



- 3-1/4" - 7" flange mounting centers
- Kits include bolts, nuts, washers and gasket

	A	B	C	D
Spigot	2-3/8"	1-13/16"	7"	1-11/16"
Socket/Hub	2-11/16"	1-1/2"	7"	1-11/16"

PVC

PART NO.	DESCRIPTION	CTN QTY
F10001	Spigot outlet	20
F10002	Socket/hub outlet	20

ABS

PART NO.	DESCRIPTION	CTN QTY
F11001	Spigot Outlet	20
F11002	Socket/hub outlet	20

Offset Closet Flange with Metal Ring

Fits Over 3" or Inside 4" Schedule 40 DWV Pipe



- Adjustable metal ring
- Two radial slots for closet bolts

MADE IN THE USA



PVC

PART NO.	DESCRIPTION	CTN QTY
C54400	3" x 4" less knockout	20

ABS

PART NO.	DESCRIPTION	CTN QTY
C54401	3" x 4" less knockout	20

Radial Fit Urinal Flange Kits



- Permits parallel alignment using radial slots
- Adjusts to 4" to 6" centers
- Socket and spigot connections
- Kit includes bolts, nuts, washers and gasket

PVC

PART NO.	DESCRIPTION	CTN QTY
F10003	2" with socket connection	1
F10004	2" with spigot connection	1

ABS

PART NO.	DESCRIPTION	CTN QTY
F11003	2" with socket connection	1
F11004	2" with spigot connection	1

4-Way Offset Closet Flange

Fits Over 3" or Inside 4" Schedule 40 DWV Pipe



- 2" Offset
- 1-13/16" barrel depth

MADE IN THE USA



PVC

PART NO.	DESCRIPTION	CTN QTY
C54342	3" x 4"	20

ABS

PART NO.	DESCRIPTION	CTN QTY
C54343	3" x 4"	20

Closest Flange Extenders



- Stackable to desired height
- For raising floor height when adding ceramic tile or hardwood

MADE IN THE **USA**

PVC		
PART NO.	DESCRIPTION	CTN QTY
C88001	1/2" Thick	20
C88501	1/4" Thick	20

Waxless Gasket



- Reusable
- Seals closest flange without using wax

MADE IN THE **USA**

PART NO.	DESCRIPTION	CTN QTY
C88002	Waxless gasket	1

Closest Flange Rings



- Fits over 3" or 4" PVC
- Converts 3 and 4" PVC pipe into a toilet ready application

MADE IN THE **USA**

PVC		
PART NO.	DESCRIPTION	CTN QTY
C51302	3" Ring	10
C51402	4" Ring	10

ABS		
PART NO.	DESCRIPTION	CTN QTY
C51303	3" Ring	10
C51403	4" Ring	10

Closest Flange Repair Ring



- Securely attaches to concrete or wood sub-floor
- Replaces most closest rings
- Corrosion resistant
- Mounting ears offset by 1/8" to allow closet bolts to be installed

PART NO.	DESCRIPTION	CTN /MSTR
C85000	Closest flange repair ring	20/80

Set-Rite® Toilet Flange Spacer Kits



- Code Approved: Water and Gas tight seal!
- Raises existing toilet flange from 1/4" up to 1-5/8"
- Kit includes yellow extender, 4 spacers, gasket & 6 stainless steel screws

PART NO.	DESCRIPTION	CTN QTY
C89500	Etender Kit	5

Complete Closest Flange Extension Kit with Gaskets



- Useful when overlaying, replacing or tiling bathroom floors
- Two 3-1/2" closet bolts with washers and nuts
- Anchors toilet bolts when closet ring is broken
- No caulking required
- Has built-in gaskets
- One 1/4" flange & one 1/2" flange

MADE IN THE **USA**

PART NO.	DESCRIPTION	CTN QTY
C88500	Complete Kit	10
C88502	Kit less bolts	10

Complete Closest Flange Extension Kit



- Three 1/4" extenders for easy adjustment
- Two 3-1/2" closet bolts with washers and nuts
- Adhesive caulk and all hardware included

MADE IN THE **USA**

PART NO.	DESCRIPTION	CTN QTY
C88500C	Complete Kit	10

Closest Flange Extension Kit



- No mastic necessary between pieces as with stackable units
- Heavy solid plastic construction
- Two 3-1/2" closet bolts with washers and nuts
- Packaged in display header bag
- One 1/2" flange

MADE IN THE **USA**

PART NO.	DESCRIPTION	CTN QTY
C88050	1/2"	10

Set-Rite® Toilet Flange Spacer Kit



- Set your flange height right the first time!
- Install under the flange during rough-in
- Kit includes 4 spacers: 3/4", 1/2", 1/4" & 1/8"

PART NO.	DESCRIPTION	CTN QTY
C89600	Spacer Kit	12

Closest Flange Spacer Kit



- Reusable toilet seal gasket
- For repair or correction of problems resulting from installation errors or remodeling projects
- Complete kit includes: 2 gaskets, 1/2" spacer, 1/4" x 3-1/2" closet bolt kit, 2 plastic shims

MADE IN THE **USA**

PART NO.	DESCRIPTION	CTN/MSTR
C88600	1" repair ring	1/10

Gapper Flange



- Used to repair broken closest flanges
- Individually carded for easy display or bulk

PART NO.	DESCRIPTION	CTN/MSTR
C87100	Repair flange carded	24/240

Flexible and Rigid Super Shims



- Stackable
- Rigid, can be driven
- Flexible, can be trimmed
- **Priced per bag**
- 10 per bag

MADE IN THE
USA

PART NO.	DESCRIPTION	CTN QTY
S55950	1-1/8" x 1-15/16" x 1/4" flexible	1
S55951	1-1/8" x 1-15/16" x 1/4" rigid	1

Flexible Super Shims



- 200 Flexible super shims packaged in a convenient refillable "candy bowl" counter display
- **Priced per display**

MADE IN THE
USA

PART NO.	DESCRIPTION	CTN QTY
S55952	200 Flexible super shims	1

Rigid Super Shims



- 200 Rigid super shims packaged in a convenient refillable "candy bowl" counter display
- **Priced per display**

MADE IN THE
USA

PART NO.	DESCRIPTION	CTN QTY
S55953	200 Rigid super shims	1

Close Wedge Shims



- Stackable
- 3/8" width x 1-3/8" length x 5/16" height
- Easily trimmed to desired height
- **Priced per bag or display**

MADE IN THE
USA

PART NO.	DESCRIPTION	CTN/MSTR
S55902	100 shims poly bagged	1 bag of 100
S55903	1000 shims counter display	1 bowl of 1000

Shower/Floor Drains

Fits Over 2" or Inside 3" Schedule 40 DWV Pipe

MADE IN THE
USA



- Low profile for first and second floor installations
- Beveled edge allows for recessed installation
- Reversible clamping ring for additional 1/2" height adjustment
- Brass inserts ensure secure clamping of membrane
- Dual weeps holes
- Recessed sump area for added drainage
- D50001 UPC Listed

PVC			
PART NO.	STRAINER	REPL. STRAINER	CTN QTY
D50001	4"SS	C60809	20
D50002	4"PB	C60810	20
D50132	4" PB cast	C60807	20
D50133	4" PB cast w/ring	C60807/C60824	20
D50130	4" NB cast	C60808	20
D50131	4" NB cast w/ring	C60808/C60825	20
D50011	4" CP cast	C60806	20
D50010	4" CP cast w/ring	C60806/C60818	20
D50134	4" CP cast square	C60812	20
D50135	4" PB cast square	C60813	20
D50120	2" x 3" SS w/PT	C60809	1
D50121	2" x 3" PB w/PT	C60810	1
D50122	2" x 3" PB cast w/PT	C60807	1
D50123	2" x 3" CP cast w/PT	C60806	1
D50124	2" x 3" NB cast w/PT	C60808	1

ABS			
PART NO.	STRAINER	REPL. STRAINER	CTN QTY
D50301	4" SS	C60809	20
D50302	4" PB	C60810	20
D50332	4" PB cast	C60807	20
D50333	4" PB cast w/ring	C60807/C60824	20
D50330	4" NB cast	C60808	20
D50331	4" NB cast w/ring	C60808/C60825	20
D50311	4" CP cast	C60806	20
D50310	4" CP cast w/ring	C60806/C60818	20
D50334	4" CP cast square	C60812	20
D50335	4" PB cast square	C60813	20

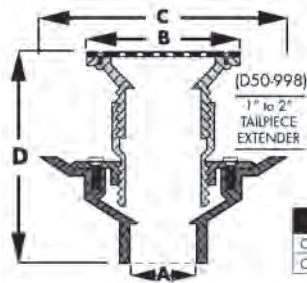

• Use **D50998** Tailpiece Extension (listed below) when additional height is needed.

A	B	C	D
Over 2" pipe	4-1/4"	6-1/2"	3-1/4" - 4-3/8"
Over 3" pipe	4-1/4"	6-1/2"	3-1/4" - 4-3/8"

Tailpiece Extension

MADE IN THE
USA



- Use when additional height is needed
- Compensates for thick shower bases

PART NO.	DESCRIPTION	CTN QTY
D50998	1" - 2" tailpiece extension	1

Shower/Floor Drains w/Brass Tailpiece

Fits Over 2" or Inside 3" Schedule 40 DWV Pipe

MADE IN THE
USA



BRASS TAILPIECE

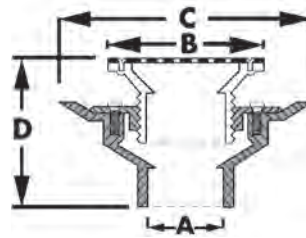

- Low profile for first and second floor installations
- Beveled edge allows for recessed installation
- Reversible clamping ring for additional 1/2" height adjustment
- Brass inserts ensure secure clamping of membrane
- Dual weeps holes
- Redressed sump area for added drainage

A	B	C	D
Over 2" pipe	4-1/4"	6-1/2"	3-1/4" - 4-3/8"
Over 3" pipe	4-1/4"	6-1/2"	3-1/4" - 4-3/8"

PVC			
PART NO.	STRAINER	REPL. STRAINER	CTN QTY
D50101	4" SS	D60780	20
D50111	4"CP	D60781	20
D50102	4" PB	D60782	20
D50800	6" CP	-	20
D50802	6" PB	-	20
D50161	4" CP square	C60812	20
D50152	4" PB square	C60813	20

ABS			
PART NO.	STRAINER	REPL. STRAINER	CTN QTY
D50401	4" SS	D60780	20
D50411	4" CP	D60781	20
D50402	4" PB	D60782	20
D50830	6" CP	-	20
D50832	6" PB	-	20
D50162	4" CP square	C60812	20
D50153	4" PB square	C60813	20

Brass Drain Extension



- 2" MIP x 2" FIP for 2" drain spuds
- Use when additional height is required to overcome inconsistent concrete pours
- Height extension from 1-1/2" to 3-1/2"
- Solid brass construction

PART NO.	DESCRIPTION	CTN QTY
D60978	Brass drain extension	1

"Perfect Low Profile" Drain

Fits Over 2" or Inside 3" PVC Schedule 40 DWV Pipe

MADE IN THE
USA

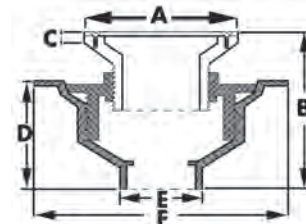

- 3" total height; perfect for multiple stories
- Reversible clamping ring, stainless steel strainer

A	B	C	D	E	F
4-1/4"	MIN: 3" - MAX: 4-1/4"	3/8"	2"	ID: 2-3/8" OD: 3-1/16"	6-5/8"

PVC		
PART NO.	DESCRIPTION	CTN QTY
D50PLP	"Perfect low profile" drain	20

PVC Low Profile Drain

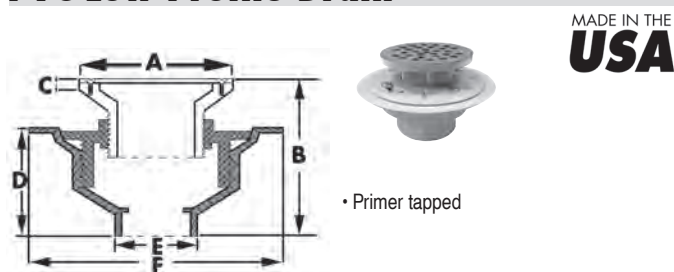

MADE IN THE
USA

• Primer tapped

A	B	C	D	E	F
4-1/4"	MIN: 3" - MAX: 4-1/4"	3/8"	2"	ID: 2-3/8" OD: 3-1/16"	6-5/8"

PVC

PART NO.	DESCRIPTION	CTN QTY
D50125	2" x 3" with SS strainer	1
D50126	2" x 3" with NB cast strainer	1

Shower/Floor Drains with Plastic Tailpiece

Fits Over 2" Schedule 40 DWV Pipe

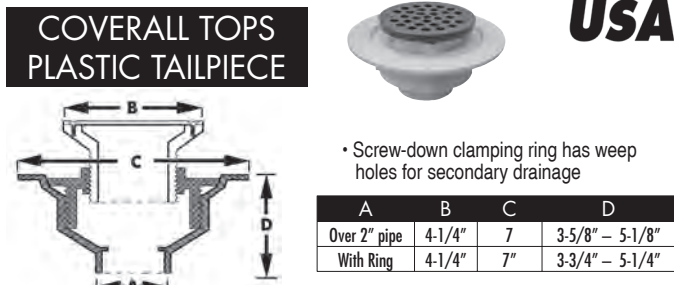

MADE IN THE
USA

• Screw-down clamping ring has weep holes for secondary drainage

A	B	C	D
Over 2" pipe	4-1/4"	7"	3-5/8" - 5-1/8"
With Ring	4-1/4"	7"	3-3/4" - 5-1/4"

PVC

PART NO.	DESCRIPTION	CTN QTY
D50700	4" SS strainer	10
D50702	4" PB strainer	10
D50708	4" PB strainer cast	10
D50709	4" PB strainer with ring	10
D50701	4" CP strainer	10
D50706	4" NB strainer	10
D50707	4" NB strainer with ring	10

ABS

PART NO.	DESCRIPTION	CTN QTY
D50703	4" SS strainer	10
D50705	4" PB strainer	10
D50726	4" PB strainer cast	10
D50727	4" PB strainer with ring	10
D50704	4" CP strainer	10
D50724	4" NB strainer	10
D50725	4" NB strainer with ring	10

Shower/Floor Drains with Brass Tailpiece

Fits Over 2" Schedule 40 DWV Pipe

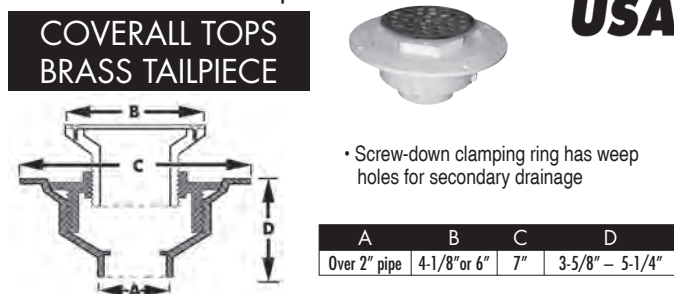

MADE IN THE
USA

• Screw-down clamping ring has weep holes for secondary drainage

A	B	C	D
Over 2" pipe	4-1/8" or 6"	7"	3-5/8" - 5-1/4"

PVC

PART NO.	DESCRIPTION	CTN QTY
D50710	4" SS strainer	10
D50712	4" PB strainer	10
D50711	4" CP strainer	10
D50721	6" PB strainer	10
D50720	6" CP strainer	10

ABS

PART NO.	DESCRIPTION	CTN QTY
D50713	4" SS strainer	10
D50715	4" PB strainer	10
D50714	4" CP strainer	10
D50723	6" PB strainer	10
D50722	6" CP strainer	10

No Caulk Shower Drains

Pushes Over 2" DWV Pipe



MADE IN THE
USA

• Tongue-and-grooved beveled clamping ring
• Brass inserts
• Supplied with gasket

A	B	C	D
2" no caulk	4-1/4"	6-1/2"	3-1/2" - 4-3/4"

PVC - PLASTIC TAILPIECE

PART NO.	DESCRIPTION	CTN QTY
D50500	SS Strainer	10
D50510	CP Strainer	10

PVC - BRASS TAILPIECE

PART NO.	DESCRIPTION	CTN QTY
D50501	SS Strainer	10
D50502	PB Strainer	10
D50511	CP Strainer	10

No Caulk Shower Stall Drains

Fits Over 2" Schedule 40 DWV Pipe

**COVERALL TOPS
NO CAULK**

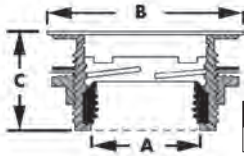

- Snap-in strainer
- Wrench included
- For 2" CTS order gasket separately
- D40140 UPC Listed

A	B	C
2"	4-1/4"	2"

Plastic Body

PART NO.	DESCRIPTION	CTN QTY
D40101	SS Strainer (101PNC) with plastic body	20
D40151	White plastic strainer with plastic body	20
D40201	PB strainer with plastic body	10
D40401	White epoxy coated SS str. with plastic body	10

Brass Body

PART NO.	DESCRIPTION	CTN QTY
D40140	SS Strainer (140NC) with brass body	20
D40240	PB strainer with brass body	10
D40440	White epoxy coated SS str. with brass body	10

Snap-in Replacement Strainers

PART NO.	DESCRIPTION	CTN QTY
D40005	SS replacement strainer for solvent outlet drains	1
D40003	PB replacement strainer	1
D40004	White epoxy coated SS replacement strainer	1
D40006	Replacement Wrench key	1
D40007	2" Schedule 40 DWV gasket	1
D40008	2" CTS replacement gasket	1
D40009	White plastic replacement strainer	1
D40010	SN replacement strainer	1

Drop-in Shower Stall Drains

Fits Over 2" Schedule 40 DWV Pipe

DROP-IN

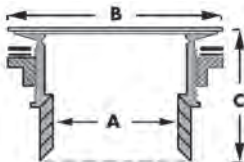

- Drain body drops through shower base
- Locknut tightens from underside
- Snap-in strainer

A	B	C
2"	4-1/4"	2-5/8"

PVC

PART NO.	DESCRIPTION	CTN QTY
D41007	2" Solvent outlet with SS strainer	20
D41009	2" Solvent outlet with PB strainer	20
D41008	2" No-caulk/solvent outlet with SS strainer	20

ABS

PART NO.	DESCRIPTION	CTN QTY
D41307	2" Solvent outlet with SS strainer	20
D41105	2" Solvent outlet with PB strainer	20

Snap-In Replacement Strainers

PART NO.	DESCRIPTION	CTN QTY
D40005	SS for solvent outlet drains	10
D41103	SS for no caulk/solvent drains	10
D41104	Snap-in for D41008	10
D40010	SN	10
D40003	PB	10

Shower Stall Drains with Receptor Base

Fits Over 2" Schedule 40 DWV Pipe

RECEPTOR BASE

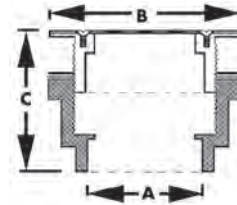

- Allows for secondary drainage
- Accepts knockout test cap for testing

A	B	C
2"	4-1/4"	2"

PVC

PART NO.	DESCRIPTION	CTN QTY
D41001	2" Pipe size with SS strainer	25
D41002	2" Pipe size with PB strainer	20
D41003	2" Pipe size with AB strainer	20
D41004	2" Pipe size with SN strainer	20

ABS

PART NO.	DESCRIPTION	CTN QTY
D41301	2" Pipe size with SS strainer	20
D41302	2" Pipe size with PB strainer	20
D41303	2" Pipe size with AB strainer	20

PVC - 2" Offset

PART NO.	DESCRIPTION	CTN QTY
D41600	2" Offset with SS strainer	20

ABS - 2" Offset

PART NO.	DESCRIPTION	CTN QTY
D41601	2" Offset with SS strainer	20

Replacement Strainers with Screws

PART NO.	DESCRIPTION	CTN QTY
D41101	SS replacement strainer with screws	1
D41102	PB replacement strainer with screws	1
D41106	AB replacement strainer with screws	1
D41107	SN replacement strainer with screws	1

General Purpose Drains

2" x 3" Fits Over 2" or Inside 3" Schedule 40 DWV Pipe

COVERALL TOPS



• Brass inserts

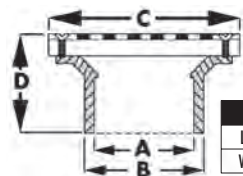

	A	B	C	D
Less rings: Over 2" pipe	Inside 3" pipe	4-1/4"	1-1/2"	
With rings: Over 2" pipe	Inside 3" pipe	4-1/2"	2-1/4"	

MADE IN THE
USA



PVC

PART NO.	DESCRIPTION	CTN QTY
D54001	with SS strainer	20
D54013	with NB strainer	20
D54014	with NB strainer with ring	20
D54002	with CP strainer	20
D54022	with CP strainer with ring	20
D54015	PB stamped strainer (PVD finish)	20
D54011	PB cast strainer	20
D54012	PB cast strainer with ring	20

ABS

PART NO.	DESCRIPTION	CTN QTY
D54301	with SS strainer	20
D54313	with NB strainer	20
D54314	with NB strainer with ring	20
D54302	with CP strainer	20
D54319	with CP strainer with ring	20
D54315	PB stamped str. (PVD finish)	20
D54311	PB cast strainer	20
D54312	PB cast strainer with ring	20

General Purpose Drains with Long Body

2" x 3" Fits Over 2" or Inside 3" Schedule 40 DWV Pipe

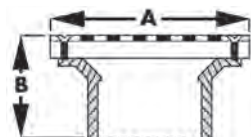

PART NO.	A	B
D54-001L	4-1/4"	2"
D54-002L	4-1/4"	2-1/8"
D54-013L	4-1/4"	2-1/8"
D54-014L	4-1/2"	2-1/4"

MADE IN THE
USA

PVC

PART NO.	DESCRIPTION	CTN QTY
D54001L	with SS strainer	20
D54002L	with CP Brass strainer	20
D54013L	with NB strainer	20
D54014L	with NB strainer with ring	20

General Purpose Drains

2" x 3" Fits Over 2" or Inside 3" Schedule 40 DWV Pipe
3" x 4" Fits Over 3" or Inside 4" Schedule 40 DWV Pipe
4" Fits Over 4" Schedule 40 DWV Pipe

MADE IN THE
USA

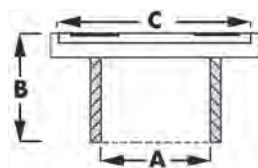

• Cast iron strainer for heavy trucking traffic areas

SIZE	A	B	C
2" x 3"	2-3/8" ID 3" OD	2-1/8"	4-3/4" ID 5-1/8" OD
3" x 4"	3-5/8" ID 4" OD	3-1/8"	4-5/8" ID 5-1/8" OD
4"	4-5/8" ID 5-1/16" OD	3-3/8"	5-3/8" ID 5-3/4" OD

PVC

PART NO.	DESCRIPTION	CTN QTY
D54016	2" x 3" with CI ring and strainer	1
D54126	3" x 4" with CI ring and strainer	1
D54136	4" with CI ring and strainer	1

ABS

PART NO.	DESCRIPTION	CTN QTY
D54316	2" x 3" with CI ring and strainer	1
D54326	3" x 4" with CI ring and strainer	1
D54336	4" with CI ring and strainer	1

General Purpose Drains

3" x 4" Fits Over 3" or Inside 4" DWV Pipe

COVERALL TOPS



• Brass inserts

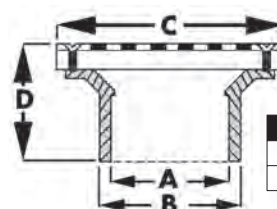

	A	B	C	D
Less rings: 3" socket	Inside 4" pipe	5-3/16"	2-3/8"	
With rings: 3" socket	Inside 4" pipe	5-1/2"	2-11/16"	

MADE IN THE
USA



PVC

PART NO.	DESCRIPTION	CTN QTY
D54100	with SS strainer	10
D54113	with NB strainer	10
D54114	with NB strainer with ring	10
D54101	with CP strainer	10
D54107	with CP strainer with ring	10
D54111	with PB strainer	10
D54112	with PB strainer with ring	10

ABS

PART NO.	DESCRIPTION	CTN QTY
D54400	with SS strainer	10
D54323	with NB strainer	10
D54324	with NB strainer with ring	10
D54401	with CP strainer	10
D54307	with CP strainer with ring	10
D54321	with PB strainer	10
D54322	with PB strainer with ring	10

General Purpose Drains

4" Fits Over 4" Schedule 40 DWV Pipe

COVERALL TOPS



MADE IN THE
USA

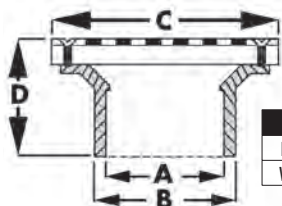

• Brass Inserts

	A	B	C	D
Less rings: Over 4" pipe	5"	6-3/16"	2-5/8"	
With rings: Over 4" pipe	5"	6-7/16"	2-3/4"	

PVC

PART NO.	DESCRIPTION	CTN QTY
D54104	with SS strainer	10
D54130	with NB strainer	10
D54132	with NB strainer with ring	10
D54102	with CP strainer	10
D54137	with CP strainer with ring	10
D54105	with PB strainer	10
D54131	with PB strainer with ring	10
D54133	with 7" PB square strainer	5
D54134	with 7" NB square strainer	5

ABS

PART NO.	DESCRIPTION	CTN QTY
D54304	with SS strainer	10
D54330	with NB strainer	10
D54332	with NB strainer with ring	10
D54305	with CP strainer	10
D54337	with CP strainer with ring	10
D54306	with PB strainer	10
D54331	with PB strainer with ring	10
D54333	with 7" PB square strainer	5
D54334	with 7" NB square strainer	5

8-1/2" Pan Heavy Duty Traffic Floor Drain

MADE IN THE
USA



- Floor sink, area drain, garbage drain, yard drain
- Full plastic 7-1/4" grate; 8-1/2" pan
- Sediment bucket option
- 3 sizes available

PVC

PART NO.	DESCRIPTION	CTN QTY
D49820	2" x 3"	1
D49821	3" x 4"	1
D49822	4"	1

ABS

PART NO.	DESCRIPTION	CTN QTY
D49823	2" x 3"	1
D49824	3" x 4"	1
D49825	4"	1

PVC - With Sediment Bucket

PART NO.	DESCRIPTION	CTN QTY
D49826	2" x 3"	1
D49827	3" x 4"	1
D49828	4"	1

ABS - With Sediment Bucket

PART NO.	DESCRIPTION	CTN QTY
D49829	2" x 3"	1
D49830	3" x 4"	1
D49831	4"	1

Sediment Bucket Only

PART NO.	DESCRIPTION	CTN QTY
D49924	Sediment bucket	1



Heavy Duty Traffic Floor Drains

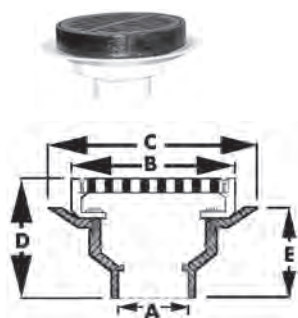

- Floor sink, area drain, garbage drain, yard drain
- 8-1/2" diameter grate
- Brass inserts
- Available with cast iron or plastic grate and ring

MADE IN THE **USA**



	A	B	C	D	E
Over 2" pipe	9"	11"	4-11/16"	3-5/16"	
Over 3" pipe	9"	11"	4-11/16"	3-5/16"	
Over 4" pipe	9"	11"	5-1/16"	3-5/16"	

PVC - Full Cast Iron Grate and Ring

PART NO.	DESCRIPTION	CTN QTY
D50092	2" drain	1
D50093	3" drain	1
D50094	4" drain	1
D50089	2" drain with CI sediment bucket	1
D50090	3" drain with CI sediment bucket	1
D50091	4" drain with CI sediment bucket	1

ABS - Full Cast Iron Grate and Ring

PART NO.	DESCRIPTION	CTN QTY
D50392	2" drain	1
D50393	3" drain	1
D50394	4" drain	1
D50389	2" drain with CI sediment bucket	1
D50390	3" drain with CI sediment bucket	1
D50391	4" drain with CI sediment bucket	1

PVC - Full Plastic Grate and Ring

PART NO.	DESCRIPTION	CTN QTY
D50177	2" drain	1
D50179	3" drain	1
D50181	4" drain	1
D50178	2" drain with debris bucket	1
D50180	3" drain with debris bucket	1
D50182	4" drain with debris bucket	1
D50682	6" drain with debris bucket	1

ABS - Full Plastic Grate and Ring

PART NO.	DESCRIPTION	CTN QTY
D50377	2" drain	1
D50379	3" drain	1
D50381	4" drain	1
D50378	2" drain with debris bucket	1
D50380	3" drain with debris bucket	1
D50382	4" drain with debris bucket	1
D50683	6" drain with debris bucket	1

PVC - Three-Quarter Plastic Grate and Ring

PART NO.	DESCRIPTION	CTN QTY
D50183	2" drain	1
D50184	3" drain	1
D50185	4" drain	1

ABS - Three-Quarter Plastic Grate and Ring

PART NO.	DESCRIPTION	CTN QTY
D50383	2" drain	1
D50384	3" drain	1
D50385	4" drain	1

PVC - Half Plastic Grate and Ring

PART NO.	DESCRIPTION	CTN QTY
D50186	2" drain	1
D50187	3" drain	1
D50188	4" drain	1

ABS - Half Plastic Grate and Ring

PART NO.	DESCRIPTION	CTN QTY
D50386	2" drain	1
D50387	3" drain	1
D50388	4" drain	1

PVC - Replacement Parts

PART NO.	DESCRIPTION	CTN QTY
D50904	Full plastic grate	1
D50906	Three-quarter plastic grate	1
D50908	Half plastic grate	1
D50910	Plastic sediment / debris bucket	1
D50905	CI sediment / debris bucket	1

ABS - Replacement Parts

PART NO.	DESCRIPTION	CTN QTY
D50905	Full plastic grate	1
D50907	Three-quarter plastic grate	1
D50909	Half plastic grate	1
D50911	Plastic sediment / debris bucket	1

All Plastic Snap-in Drains

Fits Into Schedule 40 DWV Pipe

MADE IN THE **USA**

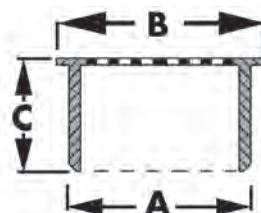

	A	B	C
Inside 2"	2-3/8"	1"	
Inside 3"	3-1/2"	1-3/4"	
Inside 4"	4-1/2"	2"	

PVC

PART NO.	DESCRIPTION	CTN QTY
D42002	2"	20
D42003	3"	20
D42004	4"	20

ABS

PART NO.	DESCRIPTION	CTN QTY
D42022	2"	20
D42023	3"	20
D42024	4"	20

Snap-in Drains w/ Stainless Steel Strainers

Fits Into Schedule 40 DWV Pipe

MADE IN THE USA

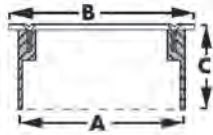

A	B	C
Inside 3" pipe	3-1/2"	2"
Inside 4" pipe	4-1/2"	2"

PVC

PART NO.	DESCRIPTION	CTN QTY
D54003	3"	20
D54004	4"	20

ABS

PART NO.	DESCRIPTION	CTN QTY
D54005	3"	20
D54006	4"	20

Snap-in Strainers

Fits Inside Pipe



• Stainless steel

PART NO.	DESCRIPTION	CTN/MSTR
D59001	3-1/8" strainer fits inside 2" pipe	10/200
D59002	4-1/8" strainer fits inside 3" pipe	10/200
D59003	5-1/8" strainer fits inside 4" pipe	10/100

Socket Ring

MADE IN THE USA

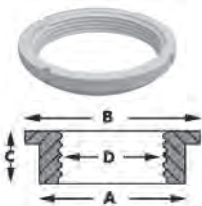

• Solvent welds into Schedule 40 hub to make threaded connection

A	B	C	D
2"	2-3/4"	1/2"	2" FIP
3"	4-1/16"	5/8"	3" FIP
4"	5-1/16"	5/8"	4" FIP

PVC

PART NO.	DESCRIPTION	CTN QTY
P48002	2"	20
P48003	3"	20
P48004	4"	20

ABS

PART NO.	DESCRIPTION	CTN QTY
P48102	2"	20
P48103	3"	20
P48104	4"	20

Utility Drains

MADE IN THE USA

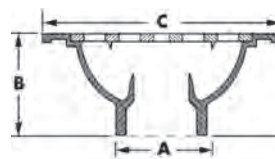

• Snap-in lid
• Use 2" coupling to connect 6" x 6" to 2" pipe

A	B	C	D
1-1/2" x 2"	2-3/8"	6"	4-9/16"
3" x 4"	3-7/16"	9"	7-11/16"
4"	4-9/16"	9"	7-11/16"
4" w/out stop	4-9/16"	9"	7-11/16"

PVC

PART NO.	DESCRIPTION	CTN QTY
D40020	6" x 6" w/pipe stop; 1-1/2" hub; 2" spigot	20
D40021	9" x 9" w/pipe stop; 3" hub; 4" spigot	10
D40023	9" x 9" w/pipe stop; 4" hub	10
D42019	9" x 9" with 4" hub	10

ABS

PART NO.	DESCRIPTION	CTN QTY
D42029	9" x 9" with 4" hub	10

Bell Traps

MADE IN THE USA

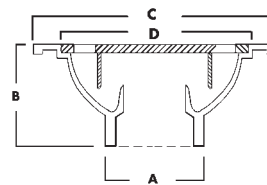

• Snap-in lid
• Molded bell in lid
• Use 2" coupling to convert 6" x 6" x 1-1/2" to 2" outlet

A	B	C	D
1-1/2" x 2"	2-3/8"	6"	4-9/16"
3" x 4"	4"	9"	7-3/4"
4"	4-1/2"	9"	7-3/4"

PVC

PART NO.	DESCRIPTION	CTN QTY
D42006	6" x 6" with 1-1/2" x 2" outlet	20
D42009	9" x 9" with 3" x 4" outlet	10
D42010	9" x 9" with 4" hub fit outlet	10

ABS

PART NO.	DESCRIPTION	CTN QTY
D42011	6" x 6" with 1-1/2" x 2" outlet	20
D42012	9" x 9" with 3" x 4" outlet	10
D42013	9" x 9" with 4" hub fit outlet	10

Accessories

PART NO.	DESCRIPTION	CTN QTY
D42007	Lid for the D42006	1
D42008	Lid for the D42009 and D42010	1
D42014	Lid for the D42011	1
D42015	Lid for the D42012 and D42013	1

Heavy Duty PVC Bell Traps with Hinged Lids

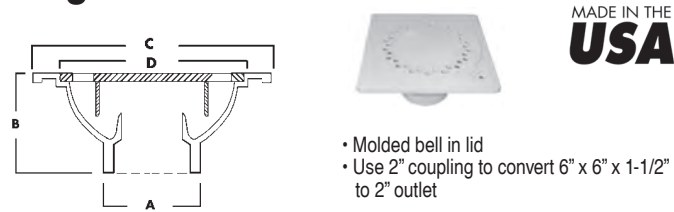

MADE IN THE **USA**

- Molded bell in lid
- Use 2" coupling to convert 6" x 6" x 1-1/2" to 2" outlet

A	B	C	D
1-1/2" x 2"	2-1/2"	6"	4-1/2"
3" x 4"	4-3/8"	9"	7-3/4"
4"	4-1/2"	9"	7-3/4"

PVC

PART NO.	DESCRIPTION	CTN QTY
D42006H	6" x 6" with 1-1/2" x 2" outlet	20
D42009H	9" x 9" with 3" x 4" outlet	10
D42010H	9" x 9" with 4" outlet	10

Accessories

PART NO.	DESCRIPTION	CTN QTY
D42007H	Lid for the D42006H	1
D42008H	Lid for the D42009H and D42010H	1

Floor Drains with Traps

2" Solvent Weld Outlet

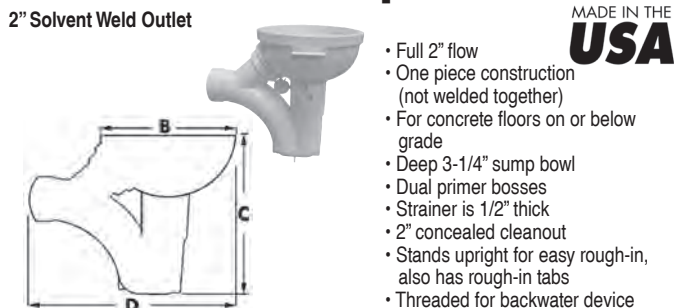

MADE IN THE **USA**

- Full 2" flow
- One piece construction (not welded together)
- For concrete floors on or below grade
- Deep 3-1/4" sump bowl
- Dual primer bosses
- Strainer is 1/2" thick
- 2" concealed cleanout
- Stands upright for easy rough-in, also has rough-in tabs
- Threaded for backwater device

PIPE SIZE	B	C	D
2" IPS	7-5/8"	10-7/8"	11-3/4"

PVC

PART NO.	DESCRIPTION	CTN QTY
D50200	with full plastic grate	12
D50208	with 7-1/2" NB strainer	12

ABS

PART NO.	DESCRIPTION	CTN QTY
D50600	with full plastic grate	12

PVC - Accessories

PART NO.	DESCRIPTION	CTN QTY
D50202	Full grate strainer	1
D50203	Three-quarter grate strainer	1
D50204	Half grate strainer	1

ABS - Accessories

PART NO.	DESCRIPTION	CTN QTY
D50205	Full grate strainer	1
D50206	Three-quarter grate strainer	1
D50207	Half grate strainer	1

Other Accessories

PART NO.	DESCRIPTION	CTN QTY
D50213	NB strainer	1
B06001	Plastic backwater device	1
B70499	Replacement ball	1

4-Way Area Drain

Fits 2" or 3" Pipe

MADE IN THE **USA**

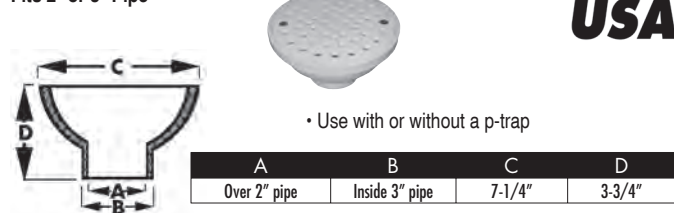

• Use with or without a p-trap

PVC

PART NO.	DESCRIPTION	CTN QTY
D50201	2" X 3"	15
D50220	2" X 3" without stop	15
B06010	Replacement strainer for D50201	1

ABS

PART NO.	DESCRIPTION	CTN QTY
D50601	2" X 3"	15
D50221	2" X 3" without stop	15
B06100	Replacement strainer for D50601	1

Area Drains

2" x 3" Fits Over 2" or Inside 3" Schedule 40 DWV Pipe
3" x 4" Fits Over 3" or Inside 4" Schedule 40 DWV Pipe

MADE IN THE **USA**

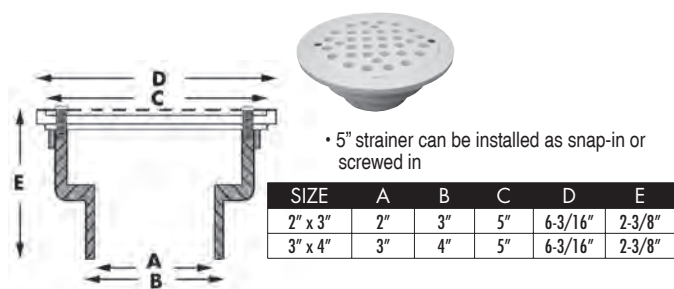

• 5" strainer can be installed as snap-in or screwed in

PVC

PART NO.	DESCRIPTION	CTN QTY
D40600	2" x 3"	12
D40601	3" x 4"	12
D40602	PVC Replacement Strainer	1

ABS

PART NO.	DESCRIPTION	CTN QTY
D40700	2" x 3"	12
D40701	3" x 4"	12
D40702	ABS Replacement Strainer	1

Backwater Valves

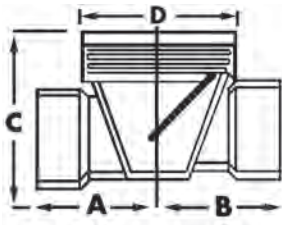

MADE IN THE
USA
NSF

- Sockets are Schedule 40 DWV
- Reduces backflow in drainage system
- Threaded access cover for easy inspection
- Magnetic strip for underground detection
- Flapper and cover have elastomeric gasket to ensure watertight seal
- Stepped construction encourages flow (minimum 1/4" per foot fall)
- The 1-1/2", 2" and 6" have UPC, SBCCI and CSA listings
- The 3" and 4" are NSF and UPC listed

A	B	C	D
1/2"	2-3/16"	2"	4"
2"	2-7/16"	3-7/8"	4"
3"	3-7/8"	5-1/2"	6"
4"	5-3/8"	6-3/4"	8"
6"	7-3/4"	9-1/4"	10-3/4"

PVC

PART NO.	DESCRIPTION	CTN QTY
B04150	1-1/2"	1
B04200	2"	1
B04300	3"	1
B04400	4"	1
B04600	6"	1
B04150K	1-1/2" with extension kit & CI lid	1
B04200K	2" with extension kit & CI lid	1
B04300K	3" with extension kit & CI lid	1
B04400K	4" with extension kit & CI lid	1
B04151K	1-1/2" with extension kit & plastic lid	1
B04201K	2" with extension kit & plastic lid	1
B04301K	3" with extension kit & plastic lid	1
B04401K	4" with extension kit & plastic lid	1

ABS

PART NO.	DESCRIPTION	CTN QTY
B05150	1-1/2"	1
B05200	2"	1
B05300	3"	1
B05400	4"	1
B05600	6"	1
B05150K	1-1/2" with extension kit & CI lid	1
B05200K	2" with extension kit & CI lid	1
B05300K	3" with extension kit & CI lid	1
B05400K	4" with extension kit & CI lid	1

Flapper w/Gasket for Backwater Valve



PART NO.	DESCRIPTION	CTN QTY
B04201	Fits 1-1/2" & 2" backwater valve	1
B04301	Fits 3" backwater valve	1
B04401	Fits 4" backwater valve	1

Extension Kit



- Kit includes cast iron top, 16" sleeve and adapter

PART NO.	DESCRIPTION	CTN QTY
B04303	3" complete kit w/CI lid	1
B04403	4" complete kit w/CI lid	1
B04304	3" complete kit w/plastic lid	1
B04404	4" complete kit w/plastic lid	1
BWV200	Ring adapter for 1-1/2" and 2"	1
BWV300	Ring adapter for 3"	1
BWV400	Ring adapter for 4"	1
B04006	6" CI lid for 3" (fits 6" pipe)	1
B04008	8" CI lid for 4" (fits 8" pipe)	1

Cast Iron Cover Marked "Water" for 6" PVC Pipe



- Covers 6" PVC and ABS pipe

PART NO.	DESCRIPTION	CTN QTY
B04007	For 6" Plastic Pipe	1

Condensate Traps

Manufactured of Schedule 40 DWV Pipe



- One-piece design

PART NO.	DESCRIPTION	CTN QTY
P15050	1/2" p-trap	100
P15075	3/4" p-trap	100
P15175	3/4" mini p-trap	250
R15050	1/2" running trap	100
R15075	3/4" running trap	100

Mushroom Vent Caps

Fits 3" or 4" Vent Stacks

MADE IN THE
USA



- Gray PVC construction
- Includes three installation screws

PART NO.	DESCRIPTION	CTN QTY
M05034	3" x 4"	20

Flat Top Vent Cap



- White PVC construction
- Fits 3" and 4" vent stacks
- Includes 2 set screws for securing cap

MADE IN THE
USA

PART NO.	DESCRIPTION	CTN QTY
M05134	Flat top vent cap	20

Plastic Over-Fitting Repair Fitting



- More efficient and less costly way to handle many common PVC re-piping problems
- Available in 1-1/2", 2", 3" and 4" PVC
- Compatible with all fittings
- Raised lettering on hub actually helps seal chemical bond
- Glues over the hub of a fitting on one end and is a 1-1/2" or 2" hub on the other end

MADE IN THE
USA

PVC

PART NO.	DESCRIPTION	CTN QTY
P22100	1-1/2"	1
P22200	2"	1
P22300	3"	1
P22400	4"	1

ABS

PART NO.	DESCRIPTION	CTN QTY
P22101	1-1/2"	1
P22201	2"	1

PVC Couplings

4" x 4" Connects 4" Schedule 40 DWV Pipe to 4" SDR



MADE IN THE
USA

PART NO.	DESCRIPTION	CTN QTY
C67440	4" DWV x 4" SDR	10

PVC Multi-Use Couplings



- Use to reduce or increase variety of sizes of Schedule 40 pipe

MADE IN THE
USA

PART NO.	DESCRIPTION	CTN QTY
C67230	2" x 3"	1
C67340	3" x 4"	1

Spigot Adapter



- 4" DWV x 4" SDR spigot

MADE IN THE
USA

PART NO.	DESCRIPTION	CTN QTY
C67445	4" DWV x 4" SDR spigot	1

ADJUST HEIGHT BEFORE & AFTER CONCRETE POUR!

**LevelBest
PVC Rough-In Adapter**

used for Cast Iron or PVC Drains & Cleanouts

- LevelBest can be used with most manufacturers' products! Industry Standard iron pipe size threads compatible with most adapter and drain bodies.
- LevelBest is the only product on the market that is compatible with most plastic and brass spuds used in the industry.
- LevelBest is the only product that includes the spacer ring that can be used with brass spuds.
- PVC, ABS or CAST IRON drains and cleanouts are compatible with LevelBest.
- LevelBest can be used with tile rings.



Removable Cap - Remove after concrete is poured

Optional Spacer - Included for brass spuds

LevelBest PVC Rough-in Adapter - Allows adjustment to floor level after concrete is poured

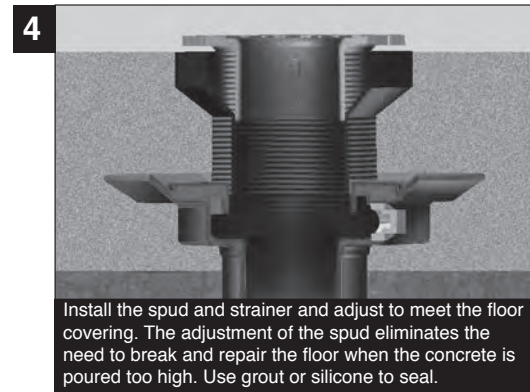
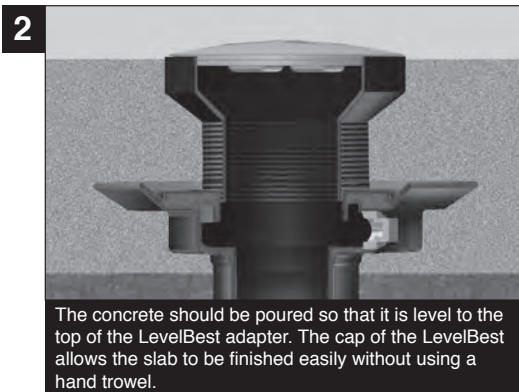
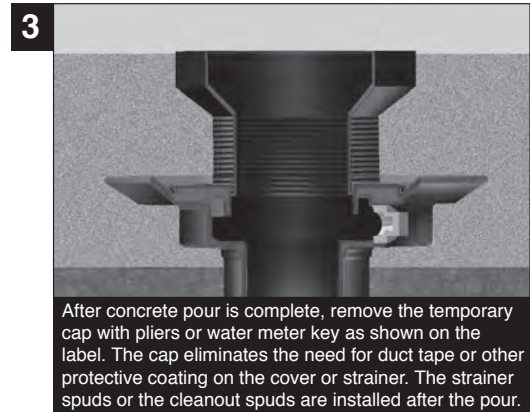
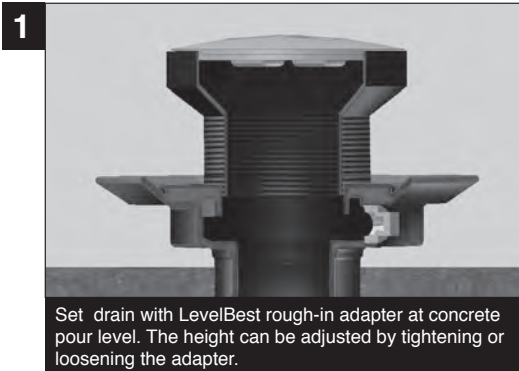

Adapter

Allows adjustment to floor level after concrete is poured!

MADE IN THE
USA



- PVC, ABS or Cast Iron drains compatible.
- Industry standard iron pipe size threads compatible with most adapter and drain bodies.
- Compatible with most plastic and brass spuds used in the industry
- Includes the spacer ring that can be used with brass spuds
- Can be used with tile rings.
- Drains marked with a **FF** can be built with components available on the "Fast Five Display" (See page 197)

PART NO.	DESCRIPTION	CTN QTY
D50448	3-1/2" x 3" x 6"	1
D50449	4" x 3-1/2" x 6"	1
FF D50450	4" x 3-1/2" x 5"	1
D50451	3-1/2" x 3" x 5"	1
D50452	Replacement Cap	1
D50453	Replacement Ring	1
D50454	Leveling Shim for 5" Strainer	1

Adapter with Spud & Strainer

Allows adjustment to floor level after concrete is poured!

MADE IN THE
USA



- PVC, ABS or Cast Iron drains compatible.
- Industry standard iron pipe size threads compatible with most adapter and drain bodies.
- Includes the spacer ring that can be used with brass spuds
- Can be used with tile rings.

PART NO.	SIZE	SPUD	STRAINER	CTN QTY
D50522	3-1/2"	3" Plastic	5" NB Round	1
D50523	3-1/2"	3" Metal	5" NB Round	1
D50520	4"	3-1/2" Plastic	5" NB Round	1
D50521	4"	3-1/2" Metal	5" NB Round	1
D50524	3-1/2"	3-1/2" Plastic	6" NB Round	1
D50526	4"	3-1/2" Plastic	6" NB Round	1

Adapter with Spud & Cleanout

Allows adjustment to floor level after concrete is poured!

MADE IN THE
USA



- PVC, ABS or Cast Iron drains compatible.
- Industry standard iron pipe size threads compatible with most adapter and drain bodies.
- Includes the spacer ring that can be used with brass spuds
- Can be used with tile rings.

PART NO.	SIZE	SPUD	COVER	CTN QTY
D50525	3-1/2"	3" Plastic	6" NB Round	1

Complete Pipe Fit Drain System

Allows adjustment to floor level after concrete is poured!

MADE IN THE
USA



- Includes the spacer ring that can be used with brass spuds
- Can be used with tile rings.
- Primer tapped with 1/2" IPS plug
- Drains marked with a **FF** can be built with components available on the "Fast Five Display" (See page 197)

PART NO.	PIPE SIZE	SPUD	STRAINER	CTN QTY
D50460	3" x 4"	3" Plastic	5" NB Round	1
D50461	3" x 4"	3" Metal	5" NB Round	1
D50473	3" x 4"	3" Plastic	6" NB Round	1
FF D50486	3" x 4"	3-1/2" Plastic	5" NB Round	1
D50469	3" x 4"	3" Plastic	6" NB Square	1
D50472	4"	3-1/2" Plastic	6" NB Round	1
D50470	4"	3-1/2" Plastic	5" NB Round	1
D50471	4"	3-1/2" Metal	5" NB Round	1
D50465	4"	3" Metal	5" NB Round	1
D50464	4"	3" Plastic	5" NB Round	1
D50474	4"	3" Plastic	6" NB Round	1

Complete Pipe Fit Cleanout System

Allows adjustment to floor level after concrete is poured!

MADE IN THE
USA



- Includes the spacer ring that can be used with brass spuds
- Can be used with tile rings.
- Primer tapped with 1/2" IPS plug
- Drains marked with a **FF** can be built with components available on the "Fast Five Display" (See page 197)

PART NO.	PIPE SIZE	SPUD	COVER	CTN QTY
C59242	3" x 4"	3" Plastic	5" NB Round	1
C59243	3" x 4"	3" Metal	5" NB Round	1
FF C59252	3" x 4"	3-1/2" Plastic	5" NB Round	1
D50481	3" x 4"	3" Plastic	6" NB Round	1
C59244	over 4"	3" Plastic	5" NB Round	1
C59245	over 4"	3" Metal	5" NB Round	1
C59250	over 4"	3-1/2" Plastic	5" NB Round	1
C59251	over 4"	3-1/2" Metal	5" NB Round	1
D50482	over 4"	3" Plastic	6" NB Round	1
D50480	over 4"	3-1/2" Plastic	6" NB Round	1

Complete Hub Fit Drain System

Allows adjustment to floor level after concrete is poured!

MADE IN THE
USA



- Includes the spacer ring that can be used with brass spuds
- Can be used with tile rings.

PART NO.	SIZE	SPUD	STRAINER	CTN QTY
D50462	4"	3" Plastic	5" NB Round	1
D50463	4"	3" Metal	5" NB Round	1

Complete Hub Fit Cleanout System

Allows adjustment to floor level after concrete is poured!

MADE IN THE **USA**



- Includes the spacer ring that can be used with brass spuds
- Can be used with tile rings.

PART NO.	SIZE	SPUD	COVER	CTN QTY
C59240	4"	3" Plastic	5" NB Round	1
C59241	4"	3" Metal	5" NB Round	1

Complete Heavy Duty Drain System

Allows adjustment to floor level after concrete is poured!

MADE IN THE **USA**



- Includes the spacer ring that can be used with brass spuds
- Can be used with tile rings.
- Completely adjustable; reversible clamping ring gains additional 1" height
- 8-1/2" Pan primer tapped with 1/2" plug
- Extra weep holes

PART NO.	PIPE SIZE	SPUD	STRAINER	CTN QTY
D49640	4"	3" Plastic	5" NB Round	1
D49641	4"	3" Metal	5" NB Round	1
D49646	4"	3-1/2" Plastic	5" NB Round	1
D49647	4"	3-1/2" Metal	5" NB Round	1
D49644	2" x 3"	3" Plastic	5" NB Round	1
D49645	2" x 3"	3" Metal	5" NB Round	1
D49650	2" x 3"	3-1/2" Plastic	5" NB Round	1
D49651	2" x 3"	3-1/2" Metal	5" NB Round	1
D49642	3" x 4"	3" Plastic	5" NB Round	1
D49643	3" x 4"	3" Metal	5" NB Round	1
D49648	3" x 4"	3-1/2" Plastic	5" NB Round	1
D49649	3" x 4"	3-1/2" Metal	5" NB Round	1
D50477	3"	3-1/2" Plastic	6" NB Round	1
D50479	4"	3-1/2" Plastic	6" NB Round	1

Complete Heavy Duty Slab Drain System

Allows adjustment to floor level after concrete is poured!

MADE IN THE **USA**



- Includes the spacer ring that can be used with brass spuds
- Can be used with tile rings.
- 8-1/2" Pan for applications where no clamping ring is required
- Primer tapped with 1/2" plug
- Completely adjustable

PART NO.	PIPE SIZE	SPUD	STRAINER	CTN QTY
D49656	2" x 3"	3" Plastic	5" NB Round	1
D49657	2" x 3"	3" Metal	5" NB Round	1
D49662	2" x 3"	3-1/2" Plastic	5" NB Round	1
D49663	2" x 3"	3-1/2" Metal	5" NB Round	1
D49654	3" x 4"	3" Plastic	5" NB Round	1
D49655	3" x 4"	3" Metal	5" NB Round	1
D49660	3" x 4"	3-1/2" Plastic	5" NB Round	1
D49661	3" x 4"	3-1/2" Metal	5" NB Round	1
D49652	4"	3" Plastic	5" NB Round	1
D49653	4"	3" Metal	5" NB Round	1
D49658	4"	3-1/2" Plastic	5" NB Round	1
D49659	4"	3-1/2" Metal	5" NB Round	1

Fast Five Drain Display

Display Part No. Q01555

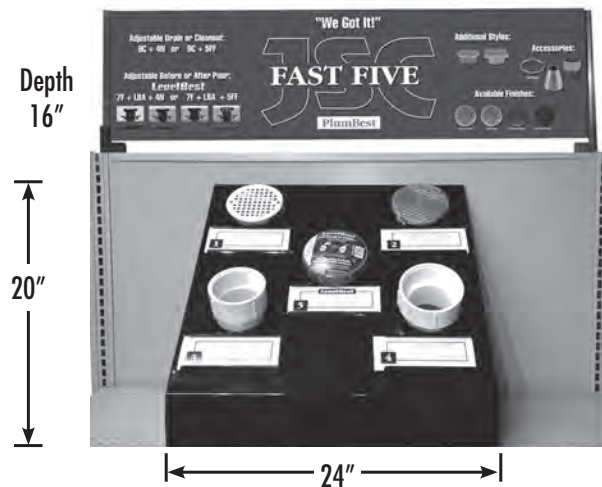

FITS SLOT #	PART NO.	SIZE	SPUD MATERIAL	STRAINER SIZE / MATERIAL	STRAINER DIAMETER	QTY
1	D56214	3-1/2"	Plastic	5" NB Strainer	Round	20
2	D59945	3-1/2"	Plastic	5" NB Cover	Round	20

FITS SLOT #	PART NO.	CONNECTION SIZE	BASE	SPUD SIZE	PRIMER TAP	QTY
3	D52451	3" x 4"	Pipe Fit	3 1/2"	with 1/2" plug	15
4	D52391	3" x 4"	Pipe Fit	4"	with 1/2" plug	10
5	D50450	4" x 3-1/2" x 5"	LevelBest Adpt.	3 1/2"	—	10
—	D49804	3" x 4"	Heavy Duty	3 1/2"	with 1/2" plug	5

Accessories

FITS SLOT #	PART NO.	DESCRIPTION	QTY
-	D60996	3-1/2" Metal spud with 5" NB Strainer	5
-	C60805	5" NB cast coverall strainer	5
-	C60503	5" NB cast cleanout cover	5
-	C60823	5" NB ring	5
-	F65400	4" Funnel	2

Inside Pipe Fit Drain



• Strainer is the same diameter as the pipe to provide full coverage every time!

MADE IN THE
USA

PART NO.	BASE	STRAINER	CTN QTY
D60130	3" PVC	3-1/2" NB Round	1
D60140	4" PVC	4-1/2" NB Round	1

Inside Pipe Fit Cleanout



• Cover is the same diameter as the pipe to provide full coverage every time!

MADE IN THE
USA

PART NO.	BASE	STRAINER	CTN QTY
C60172	3" PVC	3-1/2" NB Round	1
C60170	4" PVC	4-1/2" NB Round	1
C60171	4" PVC	4-1/2" Cast Iron Round	1

HOW IT WORKS!

Concrete Floor Application

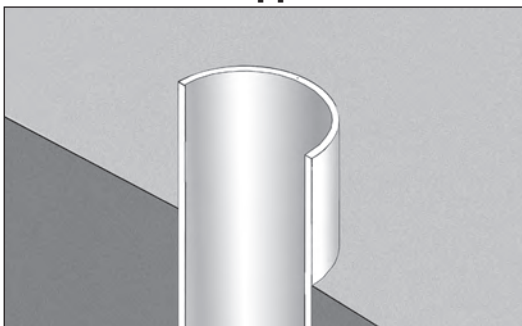

The concrete should be poured so that the pipe stack is above the finished surface.

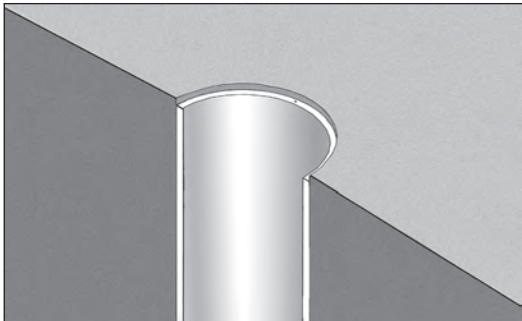

After concrete is complete, use a Plumbest EZ Stroke pipe saw to cut flush with concrete. Then, use a socket saver or inside pipe cutter to trim pipe 3/8" below concrete surface.

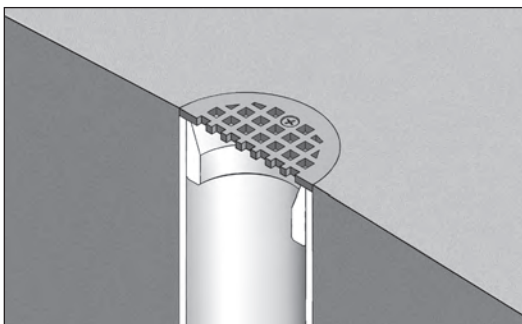

The inside pipe fit drain/cleanout can easily be glued into the pipe creating a level surface once the strainer is installed. No chisel or tape needed!

Tile Floor Application

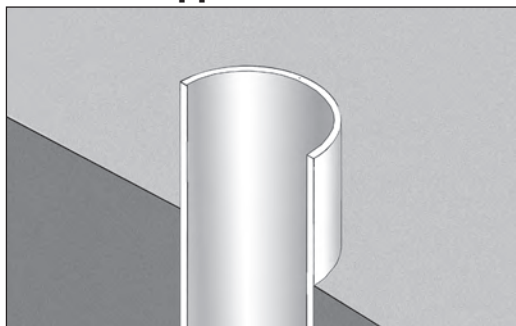

The concrete should be poured so that the pipe stack is above the finished surface.

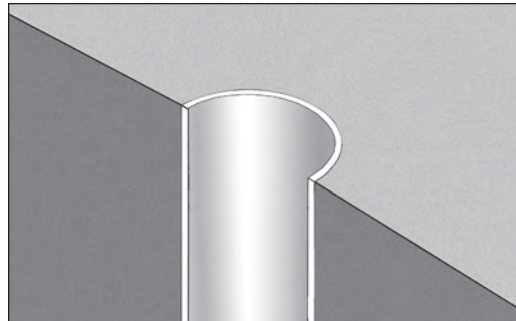

After concrete is complete, use a Plumbest EZ Stroke pipe saw to cut flush with concrete. The inside pipe fit drain/cleanout can easily be glued into the pipe.

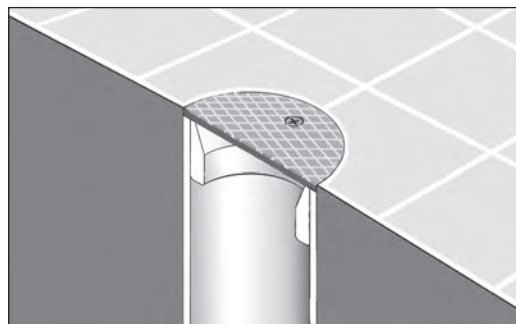

Lay tile to the edge of the cover or strainer. No chisel or tape needed!

E

Pipe Fit Base



PVC

PART NO.	PIPE SIZE	SCH 40 DWV PIPE	SPUD SIZE	CTN QTY
D52120	2"	over 2" w/PT	2"	20
D52012	2"	over 2" and inside 3"	2"	20
D52013	3"	over 3"	3"	10
D52450	3" x 4"	over 3" and inside 4" w/PT	3"	10
D52400	3" x 4"	over 3" and inside 4"	3-1/2"	10
D52451	3" x 4"	over 3" and inside 4" w/PT	3-1/2"	10
D52005	4"	over 4"	3-1/2"	10
D52452	4"	over 4" w/PT	3-1/2"	10
D52014	4"	over 4"	4"	10
D52453	4"	over 4" w/PT	4"	10

ABS

PART NO.	PIPE SIZE	SCH 40 DWV PIPE	SPUD SIZE	CTN QTY
D52112	2"	over 2" and inside 3"	2"	20
D52016	3"	over 3"	3"	10
D52460	3" x 4"	over 3" and inside 4" w/PT	3"	10
D52500	3" x 4"	over 3" and inside 4"	3-1/2"	10
D52461	3" x 4"	over 3" and inside 4" w/PT	3-1/2"	10
D52462	3" x 4"	over 3" and inside 4" w/PT	4"	10
D52105	4"	over 4"	3-1/2"	10
D52462	4"	over 4" w/PT	3-1/2"	10
D52017	4"	over 4"	4"	10
D52463	4"	over 4" w/PT	4"	10

Inside Pipe Fit Base



PVC

PART NO.	PIPE SIZE	SCH 40 DWV PIPE	SPUD SIZE	CTN QTY
D52023	3"	inside 3"	2"	1
D52004	4"	inside 4"	3"	1

ABS

PART NO.	PIPE SIZE	SCH 40 DWV PIPE	SPUD SIZE	CTN QTY
D52123	3"	inside 3"	2"	1
D52104	4"	inside 4"	3"	1

Hub Fit Bases



PVC

PART NO.	PIPE SIZE	SCH 40 DWV PIPE	SPUD SIZE	CTN QTY
D52003	4"	inside 4" hub	3-1/2"	1

ABS

PART NO.	PIPE SIZE	SCH 40 DWV PIPE	SPUD SIZE	CTN QTY
D52103	4"	inside 4" hub	3-1/2"	1

Heavy Duty Bases with Clamping Ring



- Completely adjustable; reversible clamping ring gains additional 1" height
- 8-1/2" Pan
- Gray PVC / Black ABS
- Extra weep holes
- Primer tapped with 1/2" plug



PVC

PART NO.	PIPE SIZE	SCH 40 DWV PIPE	SPUD SIZE	CTN QTY
D49800	2" x 3"	over 2" and inside 3"	3"	1
D49801	2" x 3"	over 2" and inside 3"	3-1/2"	1
D49802	2" x 3"	over 2" and inside 3"	4"	1
D49803	3" x 4"	over 3" and inside 4"	3"	1
D49804	3" x 4"	over 3" and inside 4"	3-1/2"	1
D49805	3" x 4"	over 3" and inside 4"	4"	1
D49806	4"	over 4"	3"	1
D49807	4"	over 4"	3-1/2"	1
D49808	4"	over 4"	4"	1

ABS

PART NO.	PIPE SIZE	SCH 40 DWV PIPE	SPUD SIZE	CTN QTY
D49810	2" x 3"	over 2" and inside 3"	3"	1
D49811	2" x 3"	over 2" and inside 3"	3-1/2"	1
D49812	2" x 3"	over 2" and inside 3"	4"	1
D49813	3" x 4"	over 3" and inside 4"	3"	1
D49814	3" x 4"	over 3" and inside 4"	3-1/2"	1
D49815	3" x 4"	over 3" and inside 4"	4"	1
D49816	4"	over 4"	3"	1
D49817	4"	over 4"	3-1/2"	1
D49818	4"	over 4"	4"	1

Slab Drain Bases



- 8-1/2" Pan for applications where no clamping ring is required
- Spud threads directly into base
- Primer tapped with 1/2" plug
- Gray PVC / Black ABS
- Completely adjustable

MADE IN THE
USA

PVC

PART NO.	PIPE SIZE	SCH 40 DWV PIPE	SPUD SIZE	CTN QTY
D49850	2" x 3"	over 2" and inside 3"	3"	1
D49851	2" x 3"	over 2" and inside 3"	3-1/2"	1
D49852	2" x 3"	over 2" and inside 3"	4"	1
D49853	3" x 4"	over 3" and inside 4"	3"	1
D49854	3" x 4"	over 3" and inside 4"	3-1/2"	1
D49855	3" x 4"	over 3" and inside 4"	4"	1
D49856	4"	over 4"	3"	1
D49857	4"	over 4"	3-1/2"	1
D49858	4"	over 4"	4"	1

ABS

PART NO.	PIPE SIZE	SCH 40 DWV PIPE	SPUD SIZE	CTN QTY
D49860	2" x 3"	over 2" and inside 3"	3"	1
D49861	2" x 3"	over 2" and inside 3"	3-1/2"	1
D49862	2" x 3"	over 2" and inside 3"	4"	1
D49863	3" x 4"	over 3" and inside 4"	3"	1
D49864	3" x 4"	over 3" and inside 4"	3-1/2"	1
D49865	3" x 4"	over 3" and inside 4"	4"	1
D49866	4"	over 4"	3"	1
D49867	4"	over 4"	3-1/2"	1
D49868	4"	over 4"	4"	1

Heavy Duty Bases



- 10" Pan
- Primer tapped, includes 1/2" plug
- Adjustable

MADE IN THE
USA



PVC

PART NO.	PIPE SIZE	SCH 40 DWV PIPE	SPUD SIZE	CTN QTY
D52202	2"	over 2"	3-1/2"	1
D52205	2"	over 2"	4"	1
D52203	3"	over 3"	3-1/2"	1
D52206	3"	over 3"	4"	1
D52204	4"	over 4"	3-1/2"	1
D52207	4"	over 4"	4"	1
D52216	6"	over 6"	3-1/2"	1
D52217	6"	over 6"	4"	1

ABS

PART NO.	PIPE SIZE	SCH 40 DWV PIPE	SPUD SIZE	CTN QTY
D52302	2"	over 2"	3-1/2"	1
D52305	2"	over 2"	4"	1
D52303	3"	over 3"	3-1/2"	1
D52306	3"	over 3"	4"	1
D52304	4"	over 4"	3-1/2"	1
D52307	4"	over 4"	4"	1
D52316	6"	over 6"	3-1/2"	1
D52317	6"	over 6"	4"	1

E

Round Strainers w/2" Plastic Spuds



PVC

PART NO.	IPS	STRAINER	CTN QTY
D50980	2"	4" SS	1
D50987	2"	4" CP	1
D50988	2"	4" CP with ring	1
D50985	2"	4" NB	1
D50986	2"	4" NB with ring	1
D50983	2"	4" PB cast	1
D50982	2"	4" PB stamped	1
D50984	2"	4" PB with ring	1

ABS

PART NO.	IPS	STRAINER	CTN QTY
D57980	2"	4" SS	1
D57987	2"	4" CP	1
D57988	2"	4" CP with ring	1
D57985	2"	4" NB	1
D57986	2"	4" NB with ring	1
D57983	2"	4" PB cast	1
D57982	2"	4" PB stamped	1
D57984	2"	4" PB with ring	1

Round Strainers w/3" Plastic Spuds



PVC

PART NO.	IPS	STRAINER	CTN QTY
D56105	3"	6" SS	1
D56205	3"	6" CP	1
D56210	3"	6" CP with ring	1
D56405	3"	6" NB	1
D56404	3"	6" NB with ring	1
D56305	3"	6" PB	1
D56304	3"	6" PB with ring	1

ABS

PART NO.	IPS	STRAINER	CTN QTY
D57105	3"	6" SS	1
D57205	3"	6" CP	1
D57210	3"	6" CP with ring	1
D57405	3"	6" NB	1
D57404	3"	6" NB with ring	1
D57305	3"	6" PB	1
D57304	3"	6" PB with ring	1

Round Strainers w/3-1/2" Plastic Spuds



PVC

PART NO.	IPS	STRAINER	CTN QTY
D56211	3-1/2"	5" SS	1
D56216	3-1/2"	5" CP	1
D56217	3-1/2"	5" CP with ring	1
D56214	3-1/2"	5" NB	1
D56215	3-1/2"	5" NB with ring	1
D56212	3-1/2"	5" PB	1
D56213	3-1/2"	5" PB with ring	1
D56106	3-1/2"	6" SS	1
D56206	3-1/2"	6" CP	1
D56209	3-1/2"	6" CP with ring	1
D56406	3-1/2"	6" NB	1
D56407	3-1/2"	6" NB with ring	1
D56306	3-1/2"	6" PB	1
D56307	3-1/2"	6" PB with ring	1

ABS

PART NO.	IPS	STRAINER	CTN QTY
D57211	3-1/2"	5" SS	1
D57216	3-1/2"	5" CP	1
D57217	3-1/2"	5" CP with ring	1
D57214	3-1/2"	5" NB	1
D57215	3-1/2"	5" NB with ring	1
D57212	3-1/2"	5" PB	1
D57213	3-1/2"	5" PB with ring	1
D57106	3-1/2"	6" SS	1
D57206	3-1/2"	6" CP	1
D57209	3-1/2"	6" CP with ring	1
D57406	3-1/2"	6" NB	1
D57407	3-1/2"	6" NB with ring	1
D57306	3-1/2"	6" PB	1
D57307	3-1/2"	6" PB with ring	1



Round Strainers w/4" Plastic Spuds



PVC			
PART NO.	IPS	STRAINER	CTN QTY
D56107	4"	6" SS	1
D56207	4"	6" CP	1
D56208	4"	6" CP with ring	1
D56408	4"	6" NB	1
D56409	4"	6" NB with ring	1
D56308	4"	6" PB	1
D56309	4"	6" PB with ring	1

ABS			
PART NO.	IPS	STRAINER	CTN QTY
D57107	4"	6" SS	1
D57207	4"	6" CP	1
D57208	4"	6" CP with ring	1
D57408	4"	6" NB	1
D57409	4"	6" NB with ring	1
D57308	4"	6" PB	1
D57309	4"	6" PB with ring	1

Round Strainers w/3-1/2" Metal Spuds



PART NO.	IPS	STRAINER	CTN/MSTR
D60986	3-1/2"	4" NB	1/40
D60987	3-1/2"	4" PB	1/40
D60990	3-1/2"	5" CP	1/40
D60996	3-1/2"	5" NB	1/40
D60991	3-1/2"	5" PB	1/40
D60992	3-1/2"	6" CP	1/20
D60997	3-1/2"	6" NB	1/20
D60993	3-1/2"	6" PB	1/20
D60994	3-1/2"	8" CP	1/10
D60998	3-1/2"	8" NB	1/10
D60995	3-1/2"	8" PB	1/10
D60999	3-1/2"	9" NB	1/12
D60989	3-1/2"	9" PB	1/12

Round Strainers w/2" Metal Spuds



PART NO.	IPS	STRAINER	CTN/MSTR
D60980	2"	4" SS	1/50
D60981	2"	4" CP	1/50
D60982	2"	4" PB	1/50
D60970	2"	6" CP	1/30
D60975	2"	6" PB	1/30

Round Strainers w/4" Metal Spuds



PART NO.	IPS	STRAINER	CTN/MSTR
D60958	4"	5" NB	1/30
D60959	4"	5" PB	1/30
D60940	4"	9" NB	1/8

Round Strainers w/3" Metal Spuds



PART NO.	IPS	STRAINER	CTN/MSTR
D60955	3"	5" NB	1/30
D60956	3"	5" PB	1/30
D60945	3"	8" NB	1/12

Replacement Strainers for Metal Spuds



PART NO.	DESCRIPTION	FINISH	CTN/MSTR
D60780	Fits D60-980	SS	1/200
D60781	Fits D60-981	CP	1/200
D60782	Fits D60-982	PB	1/200
D60790	Fits D60-990	CP	1/200
D60791	Fits D60-991	PB	1/50
D60792	Fits D60-992	CP	1/50
D60793	Fits D60-993	PB	1/50
D60795	Fits D60-995	PB	1/50
D60966	Fits D60-986	NB	1/50
D60967	Fits D60-987	PB	1/100
D60968	Fits D60-996	NB	1/50
D60969	Fits D60-997	NB	1/20

Square Strainers w/2" Plastic Spuds



PVC			
PART NO.	IPS	STRAINER	CTN QTY
D50989	2"	4" CP	1
D50990	2"	4" PB	1
ABS			
PART NO.	IPS	STRAINER	CTN QTY
D57989	2"	4" CP	1
D57990	2"	4" PB	1

7" Square Strainers w/4" Plastic Spuds



PVC			
PART NO.	IPS	STRAINER	CTN QTY
D56505	4"	5" NB	1
D56504	4"	5" PB	1
ABS			
PART NO.	IPS	STRAINER	CTN QTY
D57505	4"	5" NB	1
D57504	4"	5" PB	1

7" Square Strainers w/3" Plastic Spuds



PVC			
PART NO.	IPS	STRAINER	CTN QTY
D56501	3"	5" NB	1
D56500	3"	5" PB	1
ABS			
PART NO.	IPS	STRAINER	CTN QTY
D57501	3"	5" NB	1
D57500	3"	5" PB	1

Square Strainers w/3-1/2" Metal Spuds



PART NO.	IPS	STRAINER	CTN/MSTR
D60954	3-1/2"	5" CP	1/20
D60962	3-1/2"	5" NB	1/20
D60960	3-1/2"	5" PB	1/20
D60963	3-1/2"	6" NB	1/12
D60961	3-1/2"	6" PB	1/12

7" Square Strainers w/3-1/2" Plastic Spuds



PVC			
PART NO.	IPS	STRAINER	CTN QTY
D56503	3-1/2"	5" NB	1
D56502	3-1/2"	5" PB	1
ABS			
PART NO.	IPS	STRAINER	CTN QTY
D57503	3-1/2"	5" NB	1
D57502	3-1/2"	5" PB	1

Strainers



- 4" Fits 4-1/4" diameter drain and cleanout spuds, D50 (2" x 3") series shower drains and 2" x 3" general purpose drains
- 5" Fits 5" diameter drain and cleanout spuds and 3" x 4" General Purpose Drains
- 6" Fits 6-1/8" diameter drain and cleanout spuds and 4" General Purpose Drains

PART NO.	SIZE	DESCRIPTION	CTN/MSTR
C60809	4"	SS coverall	1/400
D54008	4"	SS fits inside plastic ring	1/100
C60806	4"	CP cast coverall	1/100
C60812	4"	CP cast square coverall	1/100
C60808	4"	NB cast coverall	1/100
C60807	4"	PB cast coverall	1/100
C60813	4"	PB cast square coverall	1/100
C60810	4"	PB PVD finish coverall	1/400
C60814	4"	SN coverall	1/100
D54010	4"	PB fits inside plastic ring	1/100
C60811	5"	SS coverall	1/200
D54108	5"	SS fits inside plastic ring	1/100
C60803	5"	CP cast coverall	1/30
D54109	5"	CP cast fits inside plastic ring	1/30
C60805	5"	NB cast coverall	1/30
C60804	5"	PB cast coverall	1/30
D59100	6"	SS coverall	1/30
C60800	6"	CP cast coverall	1/30
C60802	6"	NB cast coverall	1/30
C60801	6"	PB cast coverall	1/30

Covers



- 4" Fits 4-1/4" diameter drain and cleanout spuds, D50 (2" x 3") series shower drains and 2" x 3" general purpose drains
- 5" Fits 5" diameter drain and cleanout spuds and 3" x 4" General Purpose Drains
- 6" Fits 6-1/8" diameter drain and cleanout spuds and 4" General Purpose Drains

PART NO.	SIZE	DESCRIPTION	CTN/MSTR
C60504	4"	NB cast cleanout cover	1/50
C60505	4"	PB cast cleanout cover	1/50
C60503	5"	NB cast cleanout cover	1/50
C60502	5"	PB cast cleanout cover	1/50
C60501	6"	NB cast coverall	1/30
C60500	6"	PB cast coverall	1/30

Rings



- 4" Fits 4-1/4" diameter drain and cleanout spuds, D50 (2" x 3") series shower drains and 2" x 3" general purpose drains
- 5" Fits 5" diameter drain and cleanout spuds and 3" x 4" General Purpose Drains
- 6" Fits 6-1/8" diameter drain and cleanout spuds and 4" General Purpose Drains

PART NO.	SIZE	DESCRIPTION	CTN/MSTR
C60818	4"	CP ring	1/200
C60825	4"	NB ring	1/200
C60824	4"	PB ring	1/200
C60819	5"	CP ring	1/100
C60823	5"	NB ring	1/100
C60822	5"	PB ring	1/100
C60817	6"	CP ring	1/80
C60821	6"	NB ring	1/80
C60820	6"	PB ring	1/80

Spud Extension



- 2-1/2" - 4" extension for a 3-1/2" drain / cleanout spud
- Use on cast iron or PVC drain bodies when additional height is needed to offset inconsistent concrete pours

PART NO.	SIZE	DESCRIPTION	CTN QTY
D60979	3-1/2"	Spud extension	1

Funnels



- Supplied with screws
- Vandal-proof installation
- Fits virtually any floor/shower drain
- Funnel tapped for 10-24 screws which are supplied with washers

PART NO.	SIZE	DESCRIPTION	CTN QTY
F65400	4"	Funnel	1
F65600	6"	Funnel	1

3" x 4" Pipe Fit Base with 3-1/2" Plastic Spuds

5" Round Strainers

Fits Over 3" or Inside 4" Schedule 40 DWV Pipe

MADE IN THE USA

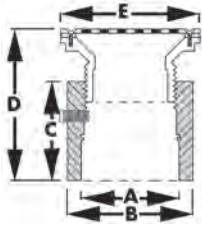

- SS strainers are .06" thick
- Polished Brass, Nickel Bronze and Chrome Plated strainers are 3/16" thick
- Strainers available in SS, PB, NB and CP
- Adjustable (see dimension D)
- Primer tapped, includes 1/2" plug

	A	B	C	D	E
Without ring	Over 3" pipe	Inside 4" pipe	4-1/2"	5-1/16" – 7-1/8"	5-3/16"
With ring	Over 3" pipe	Inside 4" pipe	4-1/2"	5-13/16" – 7-1/4"	5-1/2"

PVC

PART NO.	STRAINER	CTN QTY
D53428	5" SS	1
D53429	5" PB	1
D53430	5" PB with ring	1
D53431	5" NB	1
D53432	5" NB with ring	1
D53433	5" CP	1
D53434	5" CP with ring	1

ABS

PART NO.	STRAINER	CTN QTY
D53435	5" SS	1
D53436	5" PB	1
D53437	5" PB with ring	1
D53438	5" NB	1
D53439	5" NB with ring	1
D53440	5" CP	1
D53441	5" CP with ring	1

3" x 4" Pipe Fit Base with 3-1/2" Plastic Spuds

6" Square Tops and 5" Round Strainer

Fits Over 3" or Inside 4" Schedule 40 DWV Pipe

MADE IN THE USA

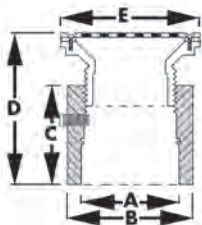

- Primer tapped, includes 1/2" plug
- Adjustable (see dimension D)

	A	B	C	D	E
Square top	Over 3" pipe	Inside 4" pipe	4-1/2"	5-3/4" – 7-1/8"	6"

PVC

PART NO.	STRAINER	CTN QTY
D59900	5" NB	1

3" x 4" Pipe Fit Base with 3-1/2" Plastic Spuds

6" Round Strainer

Fits Over 3" or Inside 4" Schedule 40 DWV Pipe

MADE IN THE USA

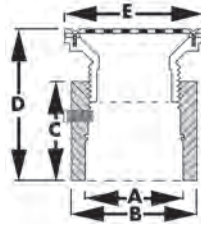

- SS strainers are .06" thick
- Polished Brass, Nickel Bronze and Chrome Plated strainers are 3/16" thick
- Strainers available in SS, PB, NB and CP
- Adjustable (see dimension D)
- Primer tapped, includes 1/2" plug

	A	B	C	D	E
Without ring	Over 3" pipe	Inside 4" pipe	4-1/2"	5-3/4" – 7-1/4"	6-1/8"
With ring	Over 3" pipe	Inside 4" pipe	4-1/2"	6-1/16" – 7-5/16"	6-1/2"

PVC

PART NO.	STRAINER	CTN QTY
D53020	6" SS	1
D53022	6" PB	1
D53074	6" PB with ring	1
D53072	6" NB	1
D53076	6" NB with ring	1
D53021	6" CP	1
D53284	6" CP with ring	1

ABS

PART NO.	STRAINER	CTN QTY
D53023	6" SS	1
D53025	6" PB	1
D53075	6" PB with ring	1
D53073	6" NB	1
D53077	6" NB with ring	1
D53024	6" CP	1
D53285	6" CP with ring	1

3" x 4" Pipe Fit Base with 3-1/2" Plastic Spuds

7" Square Tops and 5" Round Strainer

Fits Over 3" or Inside 4" Schedule 40 DWV Pipe

MADE IN THE USA

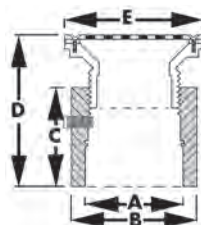

- Strainers are available in PB and NB
- Primer tapped, includes 1/2" plug
- Adjustable (see dimension D)

	A	B	C	D	E
Square top	Over 3" pipe	Inside 4" pipe	4-1/2"	5-15/16" – 7-3/8"	7"

PVC

PART NO.	STRAINER	CTN QTY
D53246	5" PB	1
D53248	5" NB	1

ABS

PART NO.	STRAINER	CTN QTY
D53247	5" PB	1
D53249	5" NB	1

3" x 4" Pipe Fit Base with 3-1/2" Metal Spuds

5", 6", 8" or 9" Round Strainer

Fits Over 3" or Inside 4" Schedule 40 DWV Pipe

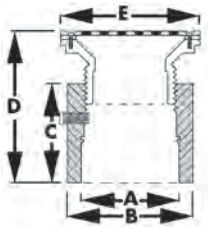

MADE IN THE USA



- Strainers are available in PB, NB and CP
- Primer tapped, includes 1/2" plug
- Adjustable (see dimension D)

	A	B	C	D	E
Metal spud	Over 3" pipe	Inside 4" pipe	4-1/2"	4-7/8" - 6-1/16"	5"
Metal spud	Over 3" pipe	Inside 4" pipe	4-1/2"	5-5/16" - 6-11/16"	6"
Metal spud	Over 3" pipe	Inside 4" pipe	4-1/2"	5-3/8" - 6-7/8"	8"
Metal spud	Over 3" pipe	Inside 4" pipe	4-1/2"	5-3/8" - 6-7/8"	9"

PVC

PART NO.	STRAINER	CTN QTY
D53027	5" PB	1
D53124	5" NB	1
D53026	5" CP	1
D53029	6" PB	1
D53125	6" NB	1
D53028	6" CP	1
D53031	8" PB	1
D53138	8" NB	1
D53030	8" CP	1
D53142	9" PB	1
D53140	9" NB	1

ABS

PART NO.	STRAINER	CTN QTY
D53033	5" PB	1
D53126	5" NB	1
D53032	5" CP	1
D53035	6" PB	1
D53127	6" NB	1
D53034	6" CP	1
D53037	8" PB	1
D53139	8" NB	1
D53036	8" CP	1
D53143	9" PB	1
D53141	9" NB	1

3" x 4" Pipe Fit Base with 3-1/2" Metal Spuds

5" or 6" Square Strainer

Fits Over 3" or Inside 4" Schedule 40 DWV Pipe

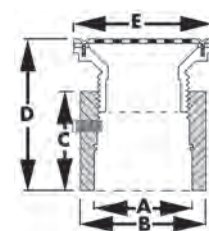

MADE IN THE USA



- Strainers are available in PB and NB
- Primer tapped, includes 1/2" plug
- Adjustable (see dimension D)

	A	B	C	D	E
Square top	Over 3" pipe	Inside 4" pipe	4-1/2"	5-3/4" - 7-1/8"	5" or 6"

PVC

PART NO.	STRAINER	CTN QTY
D53078	5" PB	1
D53082	5" NB	1
D53080	6" PB	1
D53084	6" NB	1

ABS

PART NO.	STRAINER	CTN QTY
D53079	5" PB	1
D53083	5" NB	1
D53081	6" PB	1
D53085	6" NB	1

4" Over Pipe Fit Base with 3-1/2" Plastic Spuds

5" Round Strainer

Fits Over 4" Schedule 40 DWV Pipe

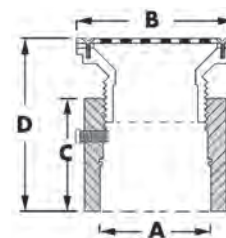

MADE IN THE USA



- Stainless steel strainers are .06" thick
- Strainers are available in SS, PB, NB and CP
- PB, NB and CP strainers are 3/16" thick
- Primer tapped, includes 1/2" plug
- Adjustable (see dimension D)

	A	B	C	D
Without ring	Over 4" pipe	5-3/16"	4-3/4"	6" - 7-3/8"
With ring	Over 4" pipe	5-1/2"	4-3/4"	6-1/8" - 7-1/2"

PVC

PART NO.	STRAINER	CTN QTY
D53414	5" SS	1
D53415	5" PB	1
D53416	5" PB with ring	1
D53417	5" NB	1
D53418	5" NB with ring	1
D53419	5" CP	1
D53420	5" CP with ring	1

ABS

PART NO.	STRAINER	CTN QTY
D53421	5" SS	1
D53422	5" PB	1
D53423	5" PB with ring	1
D53424	5" NB	1
D53425	5" NB with ring	1
D53426	5" CP	1
D53427	5" CP with ring	1

4" Over Pipe Fit Base with 3-1/2" Plastic Spuds

6" Round Strainer

Fits Over 4" Schedule 40 DWV Pipe

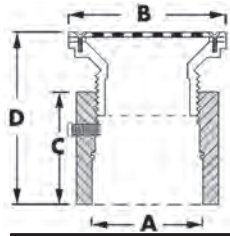

MADE IN THE USA



- Stainless steel strainers are .06" thick
- Strainers are available in SS, PB, NB and CP
- PB, NB and CP strainers are 3/16" thick
- Primer tapped, includes 1/2" plug
- Adjustable (see dimension D)

	A	B	C	D
Without ring	Over 4" pipe	6-1/8"	4-3/4"	6" - 7-1/2"
With ring	Over 4" pipe	6-1/2"	4-3/4"	6-1/4" - 7-5/8"

PVC

PART NO.	STRAINER	CTN QTY
D53040	6" SS	1
D53042	6" PB	1
D53088	6" PB with ring	1
D53086	6" NB	1
D53090	6" NB with ring	1
D53041	6" CP	1
D53282	6" CP with ring	1

ABS

PART NO.	STRAINER	CTN QTY
D53043	6" SS	1
D53045	6" PB	1
D53089	6" PB with ring	1
D53087	6" NB	1
D53091	6" NB with ring	1
D53044	6" CP	1
D53283	6" CP with ring	1

4" Over Pipe Fit Base with 3-1/2" Plastic Spuds

7" Square Top and 5" Round Strainer

Fits Over 4" Schedule 40 DWV Pipe

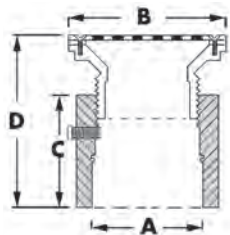

MADE IN THE USA



- Strainers are available in PB and NB
- Strainers are 3/16" thick
- Primer tapped, includes 1/2" plug
- Adjustable (see dimension D)

	A	B	C	D
Square	Over 4" pipe	7"	4-3/4"	5-1/2" - 6-7/8"

PVC

PART NO.	STRAINER	CTN QTY
D53250	5" PB	1
D53252	5" NB	1

ABS

PART NO.	STRAINER	CTN QTY
D53251	5" PB	1
D53253	5" NB	1

4" Over Pipe Fit Base with 3-1/2" Metal Spuds

5", 6", 8" or 9" Round Strainer

Fits Over 4" Schedule 40 DWV Pipe

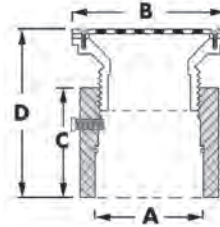

MADE IN THE USA



- Strainers are available in SS, PB, NB and CP
- PB, NB and CP strainers are 3/16" thick
- Primer tapped, includes 1/2" plug
- Adjustable (see dimension D)

	A	B	C	D
Round	Over 4" pipe	5-3/16"	4-3/4"	5-1/8" - 6-3/8"
Round	Over 4" pipe	6-3/16"	4-3/4"	5-5/16" - 6-5/8"
Round	Over 4" pipe	8"	4-3/4"	5-1/2" - 7"
Round	Over 4" pipe	9"	4-3/4"	5-1/2" - 7-1/8"

PVC

PART NO.	STRAINER	CTN QTY
D53047	5" PB	1
D53128	5" NB	1
D53046	5" CP	1
D53049	6" PB	1
D53129	6" NB	1
D53048	6" CP	1
D53051	8" PB	1
D53132	8" NB	1
D53050	8" CP	1
D53136	9" PB	1
D53134	9" NB	1

ABS

PART NO.	STRAINER	CTN QTY
D53053	5" PB	1
D53130	5" NB	1
D53052	5" CP	1
D53055	6" PB	1
D53131	6" NB	1
D53054	6" CP	1
D53057	8" PB	1
D53133	8" NB	1
D53056	8" CP	1
D53137	9" PB	1
D53135	9" NB	1

4" Over Pipe Fit Base with 3-1/2" Metal Spuds

5" or 6" Square Strainer

Fits Over 4" Schedule 40 DWV Pipe

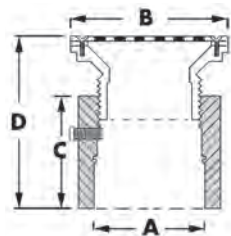

MADE IN THE **USA**



- Strainers are available in PB and NB
- Strainers are 3/16" thick
- Primer tapped, includes 1/2" plug
- Adjustable (see dimension D)

	A	B	C	D
Square	Over 4" pipe	5" or 6"	4-3/4"	5-5/16" — 6-5/8"

PVC

PART NO.	STRAINER	CTN QTY
D53092	5" PB	1
D53096	5" NB	1
D53094	6" PB	1
D53098	6" NB	1

ABS

PART NO.	STRAINER	CTN QTY
D53093	5" PB	1
D53097	5" NB	1
D53095	6" PB	1
D53099	6" NB	1

4" Over Pipe Fit Base with 4" Plastic Spuds

7" Square Top and 5" Round Strainer

Fits Over 4" Schedule 40 DWV Pipe

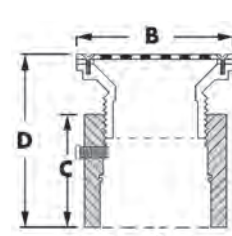

MADE IN THE **USA**



- Strainers are available in PB and NB
- Strainers are 3/16" thick
- Primer tapped, includes 1/2" plug
- Adjustable (see dimension D)

	A	B	C	D
Square	Over 4" pipe	7"	4-3/4"	6-1/16" — 7-3/8"

PVC

PART NO.	STRAINER	CTN QTY
D53267	5" PB	1
D53268	5" NB	1

ABS

PART NO.	STRAINER	CTN QTY
D53277	5" PB	1
D53278	5" NB	1

4" Over Pipe Fit Base with 4" Metal Spuds

5" Round Strainer

Fits Over 4" Schedule 40 DWV Pipe

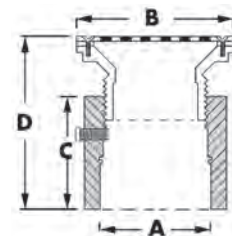

MADE IN THE **USA**



- Strainers are available in PB and NB
- Strainers are 3/16" thick
- Primer tapped, includes 1/2" plug
- Adjustable (see dimension D)

	A	B	C	D
Metal	Over 4" pipe	5"	4-3/4"	6-1/16" — 7-3/8"

PVC

PART NO.	STRAINER	CTN QTY
D53308	5" PB	4
D53304	5" NB	4

ABS

PART NO.	STRAINER	CTN QTY
D53309	5" PB	4
D53305	5" NB	4

4" Over Pipe Fit Base with 4" Plastic Spuds

6" Round Strainer

Fits Over 4" Schedule 40 DWV Pipe

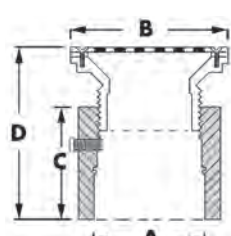

MADE IN THE **USA**



- Stainless steel strainers are .06" thick
- Strainers are available in SS, PB, NB and CP
- PB, NB and CP strainers are 3/16" thick
- Primer tapped, includes 1/2" plug
- Adjustable (see dimension D)

	A	B	C	D
Without ring	Over 4" pipe	6-1/8"	4-3/4"	6" — 7-3/16"
With ring	Over 4" pipe	6-1/2"	4-3/4"	6-1/8" — 7-5/16"

PVC

PART NO.	STRAINER	CTN QTY
D53262	6" SS	4
D53263	6" PB	4
D53264	6" PB with ring	4
D53265	6" NB	4
D53266	6" NB with ring	4
D53269	6" CP	4
D53286	6" CP with ring	4

ABS

PART NO.	STRAINER	CTN QTY
D53272	6" SS	4
D53273	6" PB	4
D53274	6" PB with ring	4
D53275	6" NB	4
D53276	6" NB with ring	4
D53279	6" CP	4
D53287	6" CP with ring	4

3" Over Pipe Fit Base with 3" Plastic Spuds

6" Round Strainer

Fits Over 3" Schedule 40 DWV Pipe

MADE IN THE USA

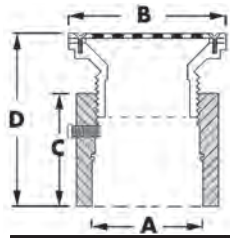

- Stainless steel strainers are .06" thick
- PB, NB and CP strainers are 3/16" thick
- Strainers are available in SS, PB, NB and CP
- Primer tapped, includes 1/2" plug

	A	B	C	D
Without ring	Over 3" pipe	6-1/8"	3-7/8"	4-13/16" – 5-3/4"
With ring	Over 3" pipe	6-1/2"	3-7/8"	4-15/16" – 5-13/16"

PVC

PART NO.	STRAINER	CTN QTY
D53100	6" SS	1
D53104	6" PB	1
D53108	6" PB with ring	1
D53106	6" NB	1
D53110	6" NB with ring	1
D53102	6" CP	1
D53288	6" CP with ring	1

ABS

PART NO.	STRAINER	CTN QTY
D53101	6" SS	1
D53105	6" PB	1
D53109	6" PB with ring	1
D53107	6" NB	1
D53111	6" NB with ring	1
D53103	6" CP	1
D53289	6" CP with ring	1

3" Over Pipe Fit Base with 3" Plastic Spuds

7" Square Top and 5" Round Strainer

Fits Over 3" Schedule 40 DWV Pipe

MADE IN THE USA

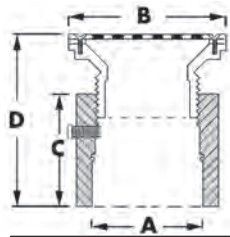

- Strainers are 3/16" thick
- Strainers are available in PB and NB
- Primer tapped, includes 1/2" plug

	A	B	C	D
Square	Over 3" pipe	7"	3-7/8"	4-13/16" – 6-1/8"

PVC

PART NO.	STRAINER	CTN QTY
D53258	5" PB	1
D53260	5" NB	1

ABS

PART NO.	STRAINER	CTN QTY
D53259	5" PB	1
D53261	5" NB	1

3" Over Pipe Fit Base with 3" Metal Spuds

5" Round Strainer

Fits Over 3" Schedule 40 DWV Pipe

MADE IN THE USA

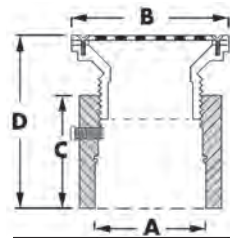

- PB, NB and CP strainers are 3/16" thick
- Strainers are available in PB and NB
- Primer tapped, includes 1/2" plug

	A	B	C	D
Metal spud	Over 3" pipe	5"	3-7/8"	4-15/16" – 5-3/4"

PVC

PART NO.	STRAINER	CTN QTY
D53312	5" PB	1
D53306	5" NB	1

ABS

PART NO.	STRAINER	CTN QTY
D53313	5" PB	1
D53307	5" NB	1

2" Over Pipe Fit Base with 2" Plastic Spuds

4" Round Strainer

Fits Over 2" Schedule 40 DWV Pipe

MADE IN THE USA

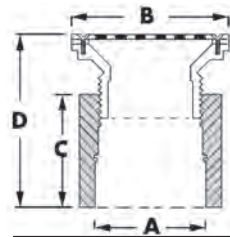

- Stainless steel strainers are .06" thick
- Strainers are available in SS, PB, NB and CP
- PB, NB and CP strainers are 3/16" thick
- Adjustable (see dimension D)

	A	B	C	D
Without ring	Over 2" pipe	4-1/4"	1-3/4"	3-3/8" – 3-13/16"
With ring	Over 2" pipe	4-1/4"	1-3/4"	3-1/2" – 3-7/8"

PVC

PART NO.	STRAINER	CTN QTY
D53190	4" SS	1
D53194	4" PB stamped	1
D53196	4" PB cast	1
D53200	4" PB with ring	1
D53198	4" NB	1
D53202	4" NB with ring	1
D53192	4" CP	1
D53290	4" CP with ring	1

ABS

PART NO.	STRAINER	CTN QTY
D53191	4" SS	1
D53195	4" PB stamped	1
D53197	4" PB cast	1
D53201	4" PB with ring	1
D53199	4" NB	1
D53203	4" NB with ring	1
D53193	4" CP	1
D53291	4" CP with ring	1

2" Over Pipe Fit Base with 2" Plastic Spuds

4" Square Strainer

Fits Over 2" Schedule 40 DWV Pipe

MADE IN THE
USA

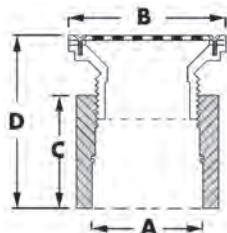

- Strainers are available in PB and CP
- Strainers are 3/16" thick
- Adjustable (see dimension D)

	A	B	C	D
Square	Over 2" pipe	4-1/4"	1-3/4"	3-3/16" – 3-11/16"

PVC

PART NO.	STRAINER	CTN QTY
D53298	4" PB	1
D53296	4" CP	1

ABS

PART NO.	STRAINER	CTN QTY
D53299	4" PB	1
D53297	4" CP	1

2" Over Pipe Fit Base with 2" Metal Spuds

4" and 6" Round Strainer

Fits Over 2" Schedule 40 DWV Pipe

MADE IN THE
USA

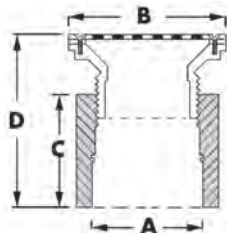

- Stainless steel strainers are .06" thick
- Strainers are available in SS, PB, NB and CP
- PB, NB and CP strainers are 3/16" thick
- Adjustable (see dimension D)

	A	B	C	D
Metal	Over 2" pipe	4-1/4" or 6"	1-3/4"	3-1/8" – 3-5/8"

PVC

PART NO.	STRAINER	CTN QTY
D53204	4" SS	1
D53208	4" PB	1
D53206	4" CP	1
D53218	6" PB	1
D53216	6" CP	1

ABS

PART NO.	STRAINER	CTN QTY
D53205	4" SS	1
D53209	4" PB	1
D53207	4" CP	1
D53219	6" PB	1
D53217	6" CP	1

4" Inside Pipe Fit Base with 3" Plastic Spuds

6" Round Strainer

Fits Inside 4" Schedule 40 DWV Pipe

MADE IN THE
USA

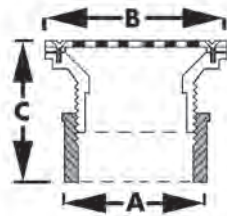

- Stainless steel strainers are .06" thick
- Strainers are available in SS, PB, NB and CP
- PB, NB and CP strainers are 3/16" thick
- Adjustable (see dimension C)

	A	B	C
Without ring	Inside 4" pipe	6-1/8"	3-13/16" – 4-5/8"
With ring	Inside 4" pipe	6-1/2"	4" – 4-13/16"

PVC

PART NO.	STRAINER	CTN QTY
D53230	6" SS	1
D53232	6" PB	1
D53238	6" PB with ring	1
D53234	6" NB	1
D53240	6" NB with ring	1
D53236	6" CP	1
D53292	6" CP with ring	1

ABS

PART NO.	STRAINER	CTN QTY
D53231	6" SS	1
D53233	6" PB	1
D53239	6" PB with ring	1
D53235	6" NB	1
D53241	6" NB with ring	1
D53237	6" CP	1
D53293	6" CP with ring	1

4" Inside Pipe Fit Base with 3" Metal Spuds

5" Round Strainer

Fits Inside 4" Schedule 40 DWV Pipe

MADE IN THE
USA

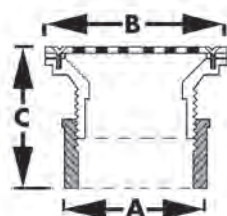

- Strainers are available in PB and NB
- Strainers are 3/16" thick
- Adjustable (see dimension C)

	A	B	C
Metal Spud	Inside 4" pipe	5"	2-5/8" – 3-1/2"

PVC

PART NO.	STRAINER	CTN QTY
D53314	5" PB	1
D53310	5" NB	1

ABS

PART NO.	STRAINER	CTN QTY
D53315	5" PB	1
D53311	5" NB	1

3" Inside Pipe Fit Base with 2" Plastic Spuds

4" Round Strainer

Fits Inside 3" Schedule 40 DWV Pipe

MADE IN THE USA

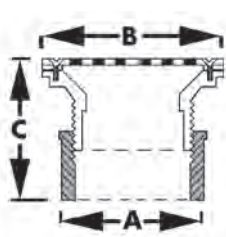

- Stainless steel strainers are .06" thick
- Strainers are available in SS, PB, NB and CP
- PB, NB and CP strainers are 3/16" thick
- Adjustable (see dimension C)

	A	B	C
Without ring	Inside 3" pipe	4-1/4"	2-5/8" – 3-7/8"
With ring	Inside 3" pipe	4-1/2"	2-11/16" – 4"

PVC

PART NO.	STRAINER	CTN QTY
D53150	4" SS	1
D53154	4" PB stamped	1
D53156	4" PB cast	1
D53160	4" PB with ring	1
D53158	4" NB	1
D53162	4" NB with ring	1
D53152	4" CP	1
D53294	4" CP with ring	1

ABS

PART NO.	STRAINER	CTN QTY
D53151	4" SS	1
D53155	4" PB stamped	1
D53157	4" PB cast	1
D53161	4" PB with ring	1
D53159	4" NB	1
D53163	4" NB with ring	1
D53153	4" CP	1
D53295	4" CP with ring	1

3" Inside Pipe Fit Base with 2" Plastic Spuds

4" Square Strainer

Fits Inside 3" Schedule 40 DWV Pipe

MADE IN THE USA

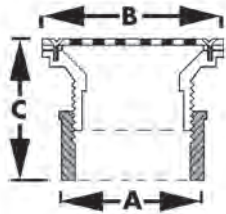

- Strainers are available in PB and CP
- Strainers are 3/16" thick
- Adjustable (see dimension C)

	A	B	C
Square	Inside 3" pipe	4-1/4"	2-1/2" – 3-13/16"

PVC

PART NO.	STRAINER	CTN QTY
D53300	4" CP	1
D53302	4" PB	1

ABS

PART NO.	STRAINER	CTN QTY
D53301	4" CP	1
D53303	4" PB	1

3" Inside Pipe Fit Base with 2" Metal Spuds

4" or 6" Round Strainer

Fits Inside 3" Schedule 40 DWV Pipe

MADE IN THE USA

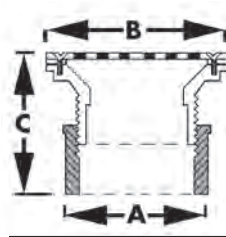

- Stainless steel strainers are .06" thick
- Strainers are available in SS, PB and CP
- PB and CP strainers are 3/16" thick
- Adjustable (see dimension C)

	A	B	C
Metal Spud	Inside 3" pipe	4-1/4" or 6"	2-7/16" – 3-3/4"

PVC

PART NO.	STRAINER	CTN QTY
D53180	4" SS	1
D53184	4" PB	1
D53182	4" CP	1
D53188	6" PB	1
D53186	6" CP	1

ABS

PART NO.	STRAINER	CTN QTY
D53181	4" SS	1
D53185	4" PB	1
D53183	4" CP	1
D53189	6" PB	1
D53187	6" CP	1

4" Hub Fit Base with 3-1/2" Plastic Spuds

5" Round Strainer

Fits Inside 4" Schedule 40 DWV Pipe

MADE IN THE USA

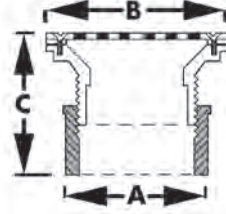

- Stainless steel strainers are .06" thick
- Strainers are available in SS, PB, NB and CP
- PB, NB and CP strainers are 3/16" thick
- Adjustable (see dimension C)

	A	B	C
Without ring	4" hub fit	5-3/16"	3" – 4-1/2"
With ring	4" hub fit	5-1/2"	3-1/8" – 4-5/8"

PVC

PART NO.	STRAINER	CTN QTY
D53400	5" SS	1
D53401	5" PB	1
D53402	5" PB with ring	1
D53403	5" NB	1
D53404	5" NB with ring	1
D53405	5" CP	1
D53406	5" CP with ring	1

ABS

PART NO.	STRAINER	CTN QTY
D53407	5" SS	1
D53408	5" PB	1
D53409	5" PB with ring	1
D53410	5" NB	1
D53411	5" NB with ring	1
D53412	5" CP	1
D53413	5" CP with ring	1

4" Hub Fit Base with 3-1/2" Plastic Spuds

6" Round Strainer

Fits Inside 4" Schedule 40 DWV Pipe

MADE IN THE
USA

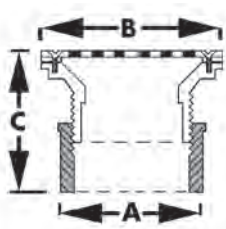

- Stainless steel strainers are .06" thick
- Strainers are available in SS, PB, NB and CP
- PB, NB and CP strainers are 3/16" thick
- Adjustable (see dimension C)

	A	B	C
Without ring	4" hub fit	6-1/8"	3-1/16" - 4-11/16"
With ring	4" hub fit	6-1/2"	3-1/4" - 4-3/4"

PVC

PART NO.	STRAINER	CTN QTY
D53017	6" SS	1
D53001	6" PB	1
D53060	6" PB with ring	1
D53058	6" NB	1
D53062	6" NB with ring	1
D53003	6" CP	1
D53280	6" CP with ring	1

ABS

PART NO.	STRAINER	CTN QTY
D53018	6" SS	1
D53002	6" PB	1
D53061	6" PB with ring	1
D53059	6" NB	1
D53063	6" NB with ring	1
D53004	6" CP	1
D53281	6" CP with ring	1

4" Hub Fit Base with 3-1/2" Metal Spuds

5" or 6" Round Strainer

Fits Inside 4" Schedule 40 DWV Pipe

MADE IN THE
USA

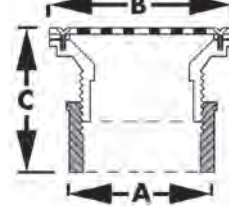

- Strainers are available in PB, NB and CP
- Strainers are 3/16" thick
- Adjustable (see dimension C)

	A	B	C
Round	5" hub fit	5-3/16"	2-3/8" - 3-5/8"
Round	6" hub fit	6-3/16"	2-5/8" - 4"
Round	4" hub fit	8"	2-7/8" - 4-1/2"
Round	4" hub fit	9"	2-7/8" - 4-1/2"

PVC

PART NO.	STRAINER	CTN QTY
D53005	5" PB	1
D53120	5" NB	1
D53011	5" CP	1
D53006	6" PB	1
D53121	6" NB	1
D53012	6" CP	1

ABS

PART NO.	STRAINER	CTN QTY
D53008	5" PB	1
D53122	5" NB	1
D53014	5" CP	1
D53009	6" PB	1
D53123	6" NB	1
D53015	6" CP	1

4" Hub Fit Base with 3-1/2" Metal Spuds

5" or 6" Square Strainer

Fits Inside 4" Schedule 40 DWV Pipe

MADE IN THE
USA

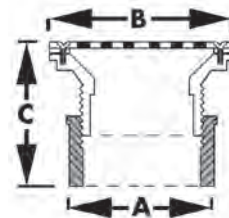

- Strainers are available in PB and NB
- Strainers are 3/16" thick
- Adjustable (see dimension C)

	A	B	C
Square	4" hub fit	5" or 6"	2-3/4" - 4-3/16"

PVC

PART NO.	STRAINER	CTN QTY
D53064	5" PB	4
D53068	5" NB	4
D53066	6" PB	4
D53070	6" NB	4

ABS

PART NO.	STRAINER	CTN QTY
D53065	5" PB	4
D53069	5" NB	4
D53067	6" PB	4
D53071	6" NB	4

4" Heavy Duty Drain Base with 3" Plastic Spuds

6" Round Strainer

Fits Over 4" Schedule 40 DWV Pipe

MADE IN THE
USA

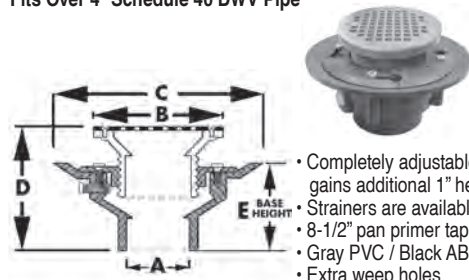

- Completely adjustable; reversible clamping ring gains additional 1" height
- Strainers are available in SS, PB, NB and CP
- 8-1/2" pan primer tapped with 1/2" plug
- Gray PVC / Black ABS
- Extra weep holes

	A	B	C	D	E
without ring (SS str.)	Over 4"	6-1/8"	8-9/16"	5-9/16" — 6-11/16"	4-1/4"
without ring	Over 4"	6-1/8"	8-9/16"	5-5/8" — 6-7/8"	4-1/4"
with ring	Over 4"	6-7/16"	8-9/16"	5-13/16" — 7"	4-1/4"

PVC

PART NO.	STRAINER	CTN QTY
D49201	6" SS	1
D49203	6" PB	1
D49205	6" PB with ring	1
D49207	6" NB	1
D49209	6" NB with ring	1
D49211	6" CP	1
D49213	6" CP with ring	1

ABS

PART NO.	STRAINER	CTN QTY
D49202	6" SS	1
D49204	6" PB	1
D49206	6" PB with ring	1
D49208	6" NB	1
D49210	6" NB with ring	1
D49212	6" CP	1
D49214	6" CP with ring	1

4" Heavy Duty Drain Base with 3" Metal Spuds

5" Round Strainer

Fits Over 4" Schedule 40 DWV Pipe

MADE IN THE
USA

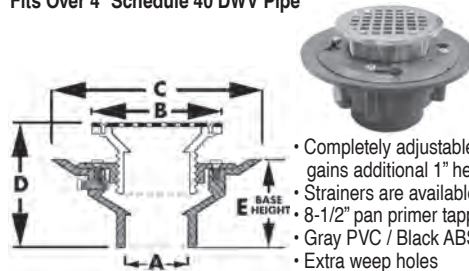

- Completely adjustable; reversible clamping ring gains additional 1" height
- Strainers are available in PB and NB
- 8-1/2" pan primer tapped with 1/2" plug
- Gray PVC / Black ABS
- Extra weep holes

	A	B	C	D	E
Metal	Over 4"	5-3/16"	8-9/16"	4-11/16" — 5-7/8"	4-1/4"

PVC

PART NO.	STRAINER	CTN QTY
D49219	5" PB	1
D49221	5" NB	1

ABS

PART NO.	STRAINER	CTN QTY
D49220	5" PB	1
D49222	5" NB	1

4" Heavy Duty Drain Base with 3-1/2" Plastic Spuds

5" Round Strainer

Fits Over 4" Schedule 40 DWV Pipe

MADE IN THE
USA

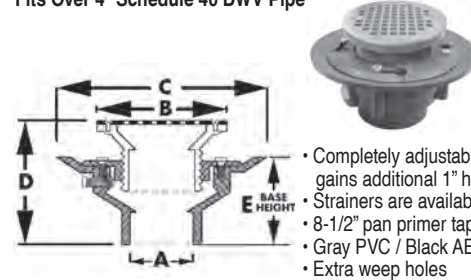

- Completely adjustable; reversible clamping ring gains additional 1" height
- Strainers are available in SS, PB, NB and CP
- 8-1/2" pan primer tapped with 1/2" plug
- Gray PVC / Black ABS
- Extra weep holes

	A	B	C	D	E
without ring (SS str.)	Over 4"	5-1/4"	8-9/16"	5-1/8" — 6-5/8"	4-1/4"
without ring	Over 4"	5-1/4"	8-9/16"	5-3/16" — 6-3/4"	4-1/4"
with ring	Over 4"	5-9/16"	8-9/16"	5-1/4" — 6-13/16"	4-1/4"

PVC

PART NO.	STRAINER	CTN QTY
D49223	5" SS	1
D49225	5" PB	1
D49227	5" PB with ring	1
D49229	5" NB	1
D49231	5" NB with ring	1
D49233	5" CP	1
D49235	5" CP with ring	1

ABS

PART NO.	STRAINER	CTN QTY
D49224	5" SS	1
D49226	5" PB	1
D49228	5" PB with ring	1
D49230	5" NB	1
D49232	5" NB with ring	1
D49234	5" CP	1
D49236	5" CP with ring	1

4" Heavy Duty Drain Base with 3-1/2" Plastic Spuds

6" Round Strainer

Fits Over 4" Schedule 40 DWV Pipe

MADE IN THE
USA

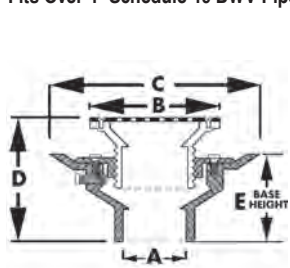

- Completely adjustable; reversible clamping ring gains additional 1" height
- Strainers are available in SS, PB, NB and CP
- 8-1/2" pan primer tapped with 1/2" plug
- Gray PVC / Black ABS
- Extra weep holes

	A	B	C	D	E
without ring (SS str.)	Over 4"	6-1/4"	8-9/16"	5-5/16" – 6-3/4"	4-1/4"
without ring	Over 4"	6-1/4"	8-9/16"	5-7/16" – 6-13/16"	4-1/4"
with ring	Over 4"	6-9/16"	8-9/16"	5-9/16" – 7"	4-1/4"

PVC

PART NO.	STRAINER	CTN QTY
D49237	6" SS	1
D49239	6" PB	1
D49241	6" PB with ring	1
D49243	6" NB	1
D49245	6" NB with ring	1
D49247	6" CP	1
D49249	6" CP with ring	1

ABS

PART NO.	STRAINER	CTN QTY
D49238	6" SS	1
D49240	6" PB	1
D49242	6" PB with ring	1
D49244	6" NB	1
D49246	6" NB with ring	1
D49248	6" CP	1
D49250	6" CP with ring	1

4" Heavy Duty Drain Base with 3-1/2" Metal Spuds

4", 5" or 6" Round Strainer

Fits Over 4" Schedule 40 DWV Pipe

MADE IN THE
USA

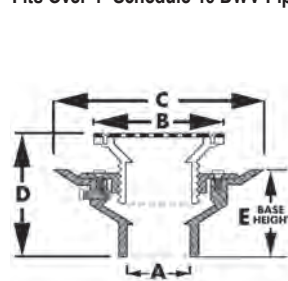

- Completely adjustable; reversible clamping ring gains additional 1" height
- Strainers are available in PB, NB and CP
- 8-1/2" pan primer tapped with 1/2" plug
- Gray PVC / Black ABS
- Extra weep holes

	A	B	C	D	E
4" metal	Over 4"	4-1/8"	8-9/16"	4-5/8" – 5-3/4"	4-1/4"
5" metal	Over 4"	5-3/16"	8-9/16"	4-5/8" – 5-13/16"	4-1/4"
6" metal	Over 4"	6-3/16"	8-9/16"	4-13/16" – 6-1/4"	4-1/4"

PVC

PART NO.	STRAINER	CTN QTY
D49251	4" PB	1
D49253	4" NB	1
D49255	5" PB	1
D49257	5" NB	1
D49259	5" CP	1
D49261	6" PB	1
D49263	6" NB	1
D49265	6" CP	1

ABS

PART NO.	STRAINER	CTN QTY
D49252	4" PB	1
D49254	4" NB	1
D49256	5" PB	1
D49258	5" NB	1
D49260	5" CP	1
D49262	6" PB	1
D49264	6" NB	1
D49266	6" CP	1

4" Heavy Duty Drain Base with 4" Plastic Spuds

6" Round Strainer

Fits Over 4" Schedule 40 DWV Pipe

MADE IN THE USA

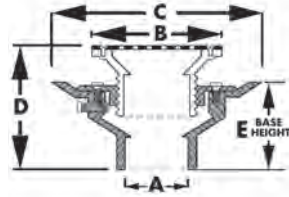

- Completely adjustable; reversible clamping ring gains additional 1" height
- Strainers are available in SS, PB, NB and CP
- 8-1/2" pan primer tapped with 1/2" plug
- Gray PVC / Black ABS
- Extra weep holes

	A	B	C	D	E
without ring (SS str.)	Over 4"	6-3/16"	8-9/16"	5-1/2" – 6-11/16"	4-1/4"
without ring	Over 4"	6-3/16"	8-9/16"	5-9/16" – 6-3/4"	4-1/4"
with ring	Over 4"	6-7/16"	8-9/16"	5-3/4" – 7"	4-1/4"

PVC

PART NO.	STRAINER	CTN QTY
D49277	6" SS	1
D49279	6" PB	1
D49281	6" PB with ring	1
D49283	6" NB	1
D49285	6" NB with ring	1
D49287	6" CP	1
D49289	6" CP with ring	1

ABS

PART NO.	STRAINER	CTN QTY
D49278	6" SS	1
D49280	6" PB	1
D49282	6" PB with ring	1
D49284	6" NB	1
D49286	6" NB with ring	1
D49288	6" CP	1
D49290	6" CP with ring	1

3" x 4" Heavy Duty Drain Base with 3" Plastic Spuds

6" Round Strainer

Fits Over 3" and Inside 4" Schedule 40 DWV Pipe

MADE IN THE USA

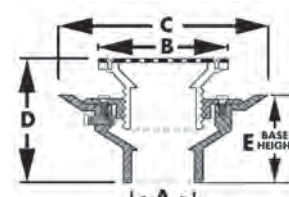

- Completely adjustable; reversible clamping ring gains additional 1" height
- Strainers are available in SS, PB, NB and CP
- 8-1/2" pan primer tapped with 1/2" plug
- Gray PVC / Black ABS
- Extra weep holes

	A	B	C	D	E
without ring (SS str.)	Over 3" Inside 4"	6-1/8"	8-9/16"	5-1/16" – 6-3/16"	5-3/16"
without ring	Over 3" Inside 4"	6-1/8"	8-9/16"	5-1/8" – 6-3/8"	5-3/16"
with ring	Over 3" Inside 4"	6-7/16"	8-9/16"	5-5/16" – 6-1/2"	5-3/16"

PVC

PART NO.	STRAINER	CTN QTY
D49101	6" SS	1
D49103	6" PB	1
D49105	6" PB with ring	1
D49107	6" NB	1
D49109	6" NB with ring	1
D49111	6" CP	1
D49113	6" CP with ring	1

ABS

PART NO.	STRAINER	CTN QTY
D49102	6" SS	1
D49104	6" PB	1
D49106	6" PB with ring	1
D49108	6" NB	1
D49110	6" NB with ring	1
D49112	6" CP	1
D49114	6" CP with ring	1

4" Heavy Duty Drain Base with 4" Metal Spuds

5" Round Strainer

Fits Over 4" Schedule 40 DWV Pipe

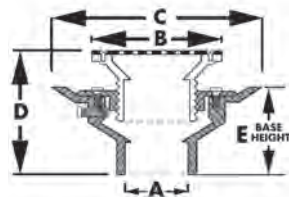

- Completely adjustable; reversible clamping ring gains additional 1" height
- Strainers are available in PB and NB
- 8-1/2" pan primer tapped with 1/2" plug
- Gray PVC / Black ABS
- Extra weep holes

	A	B	C	D	E
Metal	Over 4"	5-3/16"	8-9/16"	4-5/8" – 5-11/16"	4-1/4"

PVC

PART NO.	STRAINER	CTN QTY
D49295	5" PB	1
D49297	5" NB	1

ABS

PART NO.	STRAINER	CTN QTY
D49296	5" PB	1
D49298	5" NB	1

3" x 4" Heavy Duty Drain Base with 3" Metal Spuds

5" Round Strainer

Fits Over 3" and Inside 4" Schedule 40 DWV Pipe

MADE IN THE USA

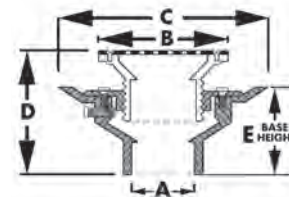

- Completely adjustable; reversible clamping ring gains additional 1" height
- Strainers are available in PB and NB
- 8-1/2" pan primer tapped with 1/2" plug
- Gray PVC / Black ABS
- Extra weep holes

	A	B	C	D	E
Metal	Over 3" Inside 4"	5-3/16"	8-9/16"	4-3/16" – 5-3/8"	5-3/16"

PVC

PART NO.	STRAINER	CTN QTY
D49119	5" PB	1
D49121	5" NB	1

ABS

PART NO.	STRAINER	CTN QTY
D49120	5" PB	1
D49122	5" NB	1

3" x 4" Heavy Duty Drain Base with 3-1/2" Plastic Spuds

5" Round Strainer

Fits Over 3" and Inside 4" Schedule 40 DWV Pipe

MADE IN THE
USA

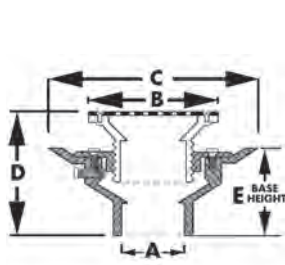

- Completely adjustable; reversible clamping ring gains additional 1" height
- Strainers are available in SS, PB, NB and CP
- 8-1/2" pan primer tapped with 1/2" plug
- Gray PVC / Black ABS
- Extra weep holes

	A	B	C	D	E
without ring (SS str.)	Over 3" Inside 4"	5-1/4"	8-9/16"	4-5/8" — 6-1/8"	5-1/4"
without ring	Over 3" Inside 4"	5-1/4"	8-9/16"	4-11/16" — 6-1/4"	5-1/4"
with ring	Over 3" Inside 4"	5-9/16"	8-9/16"	4-3/4" — 6-5/16"	5-1/4"

PVC

PART NO.	STRAINER	CTN QTY
D49123	5" SS	1
D49125	5" PB	1
D49127	5" PB with ring	1
D49129	5" NB	1
D49131	5" NB with ring	1
D49133	5" CP	1
D49135	5" CP with ring	1

ABS

PART NO.	STRAINER	CTN QTY
D49124	5" SS	1
D49126	5" PB	1
D49128	5" PB with ring	1
D49130	5" NB	1
D49132	5" NB with ring	1
D49134	5" CP	1
D49136	5" CP with ring	1

3" x 4" Heavy Duty Drain Base with 3-1/2" Plastic Spuds

6" Round Strainer

Fits Over 3" and Inside 4" Schedule 40 DWV Pipe

MADE IN THE
USA

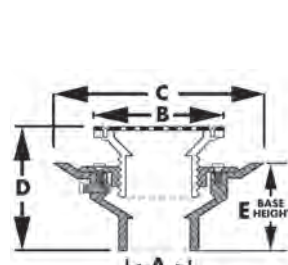

- Completely adjustable; reversible clamping ring gains additional 1" height
- Strainers are available in SS, PB, NB and CP
- 8-1/2" pan primer tapped with 1/2" plug
- Gray PVC / Black ABS
- Extra weep holes

	A	B	C	D	E
without ring (SS str.)	Over 3" Inside 4"	6-1/4"	8-9/16"	4-13/16" — 6-1/4"	5-1/4"
without ring	Over 3" Inside 4"	6-1/4"	8-9/16"	4-15/16" — 6-5/16"	5-1/4"
with ring	Over 3" Inside 4"	6-9/16"	8-9/16"	5-1/16" — 6-1/2"	5-1/4"

PVC

PART NO.	STRAINER	CTN QTY
D49137	6" SS	1
D49139	6" PB	1
D49141	6" PB with ring	1
D49143	6" NB	1
D49145	6" NB with ring	1
D49147	6" CP	1
D49149	6" CP with ring	1

ABS

PART NO.	STRAINER	CTN QTY
D49138	6" SS	1
D49140	6" PB	1
D49142	6" PB with ring	1
D49144	6" NB	1
D49146	6" NB with ring	1
D49148	6" CP	1
D49150	6" CP with ring	1

3" x 4" Heavy Duty Drain Base with 3-1/2" Metal Spuds

4", 5" or 6" Round Strainer

Fits Over 3" and Inside 4" Schedule 40 DWV Pipe

MADE IN THE USA

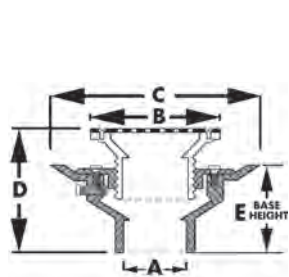

- Completely adjustable; reversible clamping ring gains additional 1" height
- Strainers are available in PB, NB and CP
- 8-1/2" pan primer tapped with 1/2" plug
- Gray PVC / Black ABS
- Extra weep holes

	A	B	C	D	E
4" metal	Over 3" Inside 4"	4-1/8"	8-9/16"	4-1/8" — 5-1/4"	5-1/4"
5" metal	Over 3" Inside 4"	5-3/16"	8-9/16"	4-1/8" — 5-5/16"	5-1/4"
6" metal	Over 3" Inside 4"	6-3/16"	8-9/16"	4-5/16" — 5-3/4"	5-1/4"

PVC

PART NO.	STRAINER	CTN QTY
D49151	4" PB	1
D49153	4" NB	1
D49155	5" PB	1
D49157	5" NB	1
D49159	5" CP	1
D49161	6" PB	1
D49163	6" NB	1
D49165	6" CP	1

ABS

PART NO.	STRAINER	CTN QTY
D49152	4" PB	1
D49154	4" NB	1
D49156	5" PB	1
D49158	5" NB	1
D49160	5" CP	1
D49162	6" PB	1
D49164	6" NB	1
D49166	6" CP	1

3" x 4" Heavy Duty Drain Base with 4" Plastic Spuds

6" Round Strainer

Fits Over 3" and Inside 4" Schedule 40 DWV Pipe

MADE IN THE USA

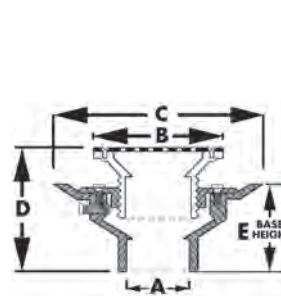

- Completely adjustable; reversible clamping ring gains additional 1" height
- Strainers are available in SS, PB, NB and CP
- 8-1/2" pan primer tapped with 1/2" plug
- Gray PVC / Black ABS
- Extra weep holes

	A	B	C	D	E
Without ring (SS str.)	Over 3" Inside 4"	6-3/16"	8-9/16"	5-1/16" — 6-3/16"	5-1/4"
Without ring	Over 3" Inside 4"	6-3/16"	8-9/16"	5-1/8" — 6-3/8"	5-1/4"
With ring	Over 3" Inside 4"	6-7/16"	8-9/16"	5-5/16" — 6-1/2"	5-1/4"

PVC

PART NO.	STRAINER	CTN QTY
D49177	6" SS	1
D49179	6" PB	1
D49181	6" PB with ring	1
D49183	6" NB	1
D49185	6" NB with ring	1
D49187	6" CP	1
D49189	6" CP with ring	1

ABS

PART NO.	STRAINER	CTN QTY
D49178	6" SS	1
D49180	6" PB	1
D49182	6" PB with ring	1
D49184	6" NB	1
D49186	6" NB with ring	1
D49188	6" CP	1
D49190	6" CP with ring	1

3" x 4" Heavy Duty Drain Base with 4" Metal Spuds

5" Round Strainer

Fits Over 3" and Inside 4" Schedule 40 DWV Pipe

MADE IN THE USA

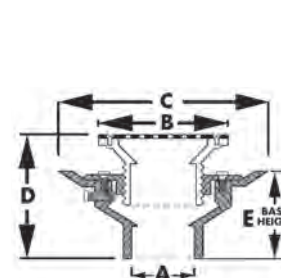

- Completely adjustable; reversible clamping ring gains additional 1" height
- Strainers are available in SS, PB, NB and CP
- 8-1/2" pan primer tapped with 1/2" plug
- Gray PVC / Black ABS
- Extra weep holes

	A	B	C	D	E
Metal	Over 3" Inside 4"	5-3/16"	8-9/16"	4-3/16" — 5-3/8"	5-1/4"

PVC

PART NO.	STRAINER	CTN QTY
D49195	5" PB	1
D49197	5" NB	1

ABS

PART NO.	STRAINER	CTN QTY
D49196	5" PB	1
D49198	5" NB	1

2" x 3" Heavy Duty Drain Base with 3" Plastic Spuds

6" Round Strainer

Fits Over 2" and Inside 3" Schedule 40 DWV Pipe

MADE IN THE
USA

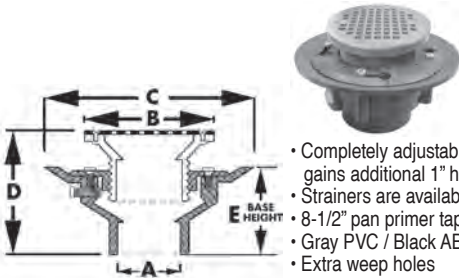

- Completely adjustable; reversible clamping ring gains additional 1" height
- Strainers are available in SS, PB, NB and CP
- 8-1/2" pan primer tapped with 1/2" plug
- Gray PVC / Black ABS
- Extra weep holes

	A	B	C	D	E
Without ring (SS str.)	Over 2" Inside 3"	6-1/8"	8-9/16"	5-1/16" — 6-3/16"	3-3/4"
Without ring	Over 2" Inside 3"	6-1/8"	8-9/16"	5-1/8" — 6-3/8"	3-3/4"
With ring	Over 2" Inside 3"	6-7/16"	8-9/16"	5-5/16" — 6-3/16"	3-3/4"

PVC

PART NO.	STRAINER	CTN QTY
D49001	6" SS	1
D49003	6" PB	1
D49005	6" PB with ring	1
D49007	6" NB	1
D49009	6" NB with ring	1
D49011	6" CP	1
D49013	6" CP with ring	1

ABS

PART NO.	STRAINER	CTN QTY
D49002	6" SS	1
D49004	6" PB	1
D49006	6" PB with ring	1
D49008	6" NB	1
D49010	6" NB with ring	1
D49012	6" CP	1
D49014	6" CP with ring	1

2" x 3" Heavy Duty Drain Base with 3" Metal Spuds

5" Round Strainer

Fits Over 2" and Inside 3" Schedule 40 DWV Pipe

MADE IN THE
USA

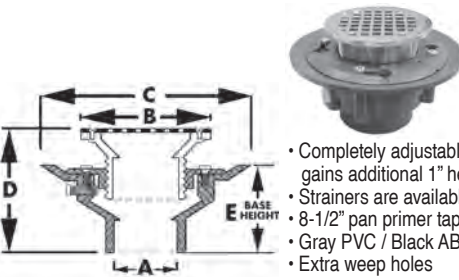

- Completely adjustable; reversible clamping ring gains additional 1" height
- Strainers are available in SS, PB, NB and CP
- 8-1/2" pan primer tapped with 1/2" plug
- Gray PVC / Black ABS
- Extra weep holes

	A	B	C	D	E
Metal	Over 2" Inside 3"	5-3/16"	8-9/16"	4-3/16" — 5-3/8"	3-3/4"

PVC

PART NO.	STRAINER	CTN QTY
D49019	5" PB	1
D49021	5" NB	1

ABS

PART NO.	STRAINER	CTN QTY
D49020	5" PB	1
D49022	5" NB	1

2" x 3" Heavy Duty Drain Base with 3-1/2" Plastic Spuds

5" Round Strainer

Fits Over 2" and Inside 3" Schedule 40 DWV Pipe

MADE IN THE
USA

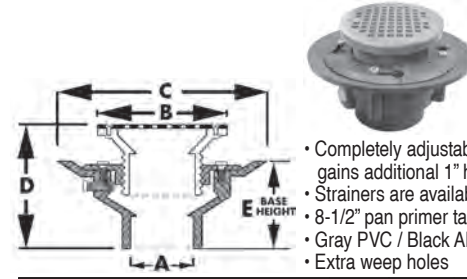

- Completely adjustable; reversible clamping ring gains additional 1" height
- Strainers are available in SS, PB, NB and CP
- 8-1/2" pan primer tapped with 1/2" plug
- Gray PVC / Black ABS
- Extra weep holes

	A	B	C	D	E
Without ring (SS str.)	Over 2" Inside 3"	5-1/4"	8-9/16"	4-5/8" — 6-1/8"	3-3/4"
Without ring	Over 2" Inside 3"	5-1/4"	8-9/16"	4-11/16" — 6-1/4"	3-3/4"
With ring	Over 2" Inside 3"	5-9/16"	8-9/16"	4-3/4" — 6-5/16"	3-3/4"

PVC

PART NO.	STRAINER	CTN QTY
D49023	5" SS	1
D49025	5" PB	1
D49027	5" PB with ring	1
D49029	5" NB	1
D49031	5" NB with ring	1
D49033	5" CP	1
D49035	5" CP with ring	1

ABS

PART NO.	STRAINER	CTN QTY
D49024	5" SS	1
D49026	5" PB	1
D49028	5" PB with ring	1
D49030	5" NB	1
D49032	5" NB with ring	1
D49034	5" CP	1
D49036	5" CP with ring	1

2" x 3" Heavy Duty Drain Base with 3-1/2" Plastic Spuds

6" Round Strainer

Fits Over 2" and Inside 3" Schedule 40 DWV Pipe

MADE IN THE
USA

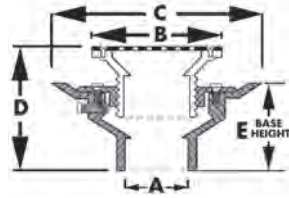

- Completely adjustable; reversible clamping ring gains additional 1" height
- Strainers are available in SS, PB, NB and CP
- 8-1/2" pan primer tapped with 1/2" plug
- Gray PVC / Black ABS
- Extra weep holes

	A	B	C	D	E
Without ring (SS str.)	Over 2" Inside 3"	6-1/4"	8-9/16"	4-13/16" — 6-1/4"	3-3/4"
Without ring	Over 2" Inside 3"	6-1/4"	8-9/16"	4-15/16" — 6-5/16"	3-3/4"
With ring	Over 2" Inside 3"	6-9/16"	8-9/16"	5-1/16" — 6-1/2"	3-3/4"

PVC

PART NO.	STRAINER	CTN QTY
D49037	6" SS	1
D49039	6" PB	1
D49041	6" PB with ring	1
D49043	6" NB	1
D49045	6" NB with ring	1
D49047	6" CP	1
D49049	6" CP with ring	1

ABS

PART NO.	STRAINER	CTN QTY
D49038	6" SS	1
D49040	6" PB	1
D49042	6" PB with ring	1
D49044	6" NB	1
D49046	6" NB with ring	1
D49048	6" CP	1
D49050	6" CP with ring	1

2" x 3" Heavy Duty Drain Base with 3-1/2" Metal Spuds

4", 5" or 6" Round Strainer

Fits Over 2" and Inside 3" Schedule 40 DWV Pipe

MADE IN THE
USA

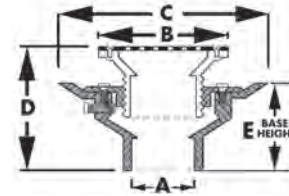

- Completely adjustable; reversible clamping ring gains additional 1" height
- Strainers are available in PB, NB and CP
- 8-1/2" pan primer tapped with 1/2" plug
- Gray PVC / Black ABS
- Extra weep holes

	A	B	C	D	E
4" metal	Over 2" Inside 3"	4-1/8"	8-9/16"	4-1/8" — 5-1/4"	3-3/4"
5" metal	Over 2" Inside 3"	5-3/16"	8-9/16"	4-1/8" — 5-5/16"	3-3/4"
6" metal	Over 2" Inside 3"	6-3/16"	8-9/16"	4-5/16" — 5-3/4"	3-3/4"

PVC

PART NO.	STRAINER	CTN QTY
D49051	4" PB	1
D49053	4" NB	1
D49055	5" PB	1
D49057	5" NB	1
D49059	5" CP	1
D49061	6" PB	1
D49063	6" NB	1
D49065	6" CP	1

ABS

PART NO.	STRAINER	CTN QTY
D49052	4" PB	1
D49054	4" NB	1
D49056	5" PB	1
D49058	5" NB	1
D49060	5" CP	1
D49062	6" PB	1
D49064	6" NB	1
D49066	6" CP	1

2" x 3" Heavy Duty Drain Base with 4" Plastic Spuds

6" Round Strainer

Fits Over 2" and Inside 3" Schedule 40 DWV Pipe

MADE IN THE
USA

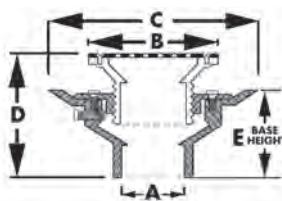

- Completely adjustable; reversible clamping ring gains additional 1" height
- Strainers are available in SS, PB, NB and CP
- 8-1/2" pan primer tapped with 1/2" plug
- Gray PVC / Black ABS
- Extra weep holes

	A	B	C	D	E
Without ring (SS str.)	Over 2" Inside 3"	6-3/16"	8-9/16"	5" - 6-3/16"	3-3/4"
Without ring	Over 2" Inside 3"	6-3/16"	8-9/16"	5-1/16" - 6-1/4"	3-3/4"

PVC

PART NO.	STRAINER	CTN QTY
D49077	6" SS	1
D49079	6" PB	1
D49081	6" PB with ring	1
D49083	6" NB	1
D49085	6" NB with ring	1
D49087	6" CP	1
D49089	6" CP with ring	1

ABS

PART NO.	STRAINER	CTN QTY
D49078	6" SS	1
D49080	6" PB	1
D49082	6" PB with ring	1
D49084	6" NB	1
D49086	6" NB with ring	1
D49088	6" CP	1
D49090	6" CP with ring	1

4" Heavy Duty Slab Drain Base with 3" Plastic Spuds

6" Round Strainer

Fits Over 4" Schedule 40 DWV Pipe

MADE IN THE
USA

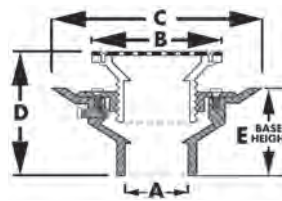

- 8-1/2" pan for applications where no clamping ring is required
- Strainers are available in SS, PB, NB and CP
- Spud threads directly into base
- Primer tapped with 1/2" plug
- Gray PVC / Black ABS
- Completely adjustable

	A	B	C	D	E
Without ring (SS str.)	Over 4"	6-1/8"	8-9/16"	5-5/16" - 6-3/8"	4-3/16"
Without ring	Over 4"	6-1/8"	8-9/16"	5-3/8" - 6-5/16"	4-3/16"
With ring	Over 4"	6-7/16"	8-9/16"	5-1/8" - 6-9/16"	4-3/16"

PVC

PART NO.	STRAINER	CTN QTY
D49501	6" SS	1
D49503	6" PB	1
D49505	6" PB with ring	1
D49507	6" NB	1
D49509	6" NB with ring	1
D49511	6" CP	1
D49513	6" CP with ring	1

ABS

PART NO.	STRAINER	CTN QTY
D49502	6" SS	1
D49504	6" PB	1
D49506	6" PB with ring	1
D49508	6" NB	1
D49510	6" NB with ring	1
D49512	6" CP	1
D49514	6" CP with ring	1

2" x 3" Heavy Duty Drain Base with 4" Metal Spuds

5" Round Strainer

Fits Over 2" and Inside 3" Schedule 40 DWV Pipe

MADE IN THE
USA

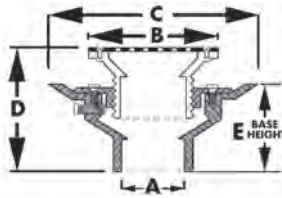

- Completely adjustable; reversible clamping ring gains additional 1" height
- Strainers are available in SS, PB, NB and CP
- 8-1/2" pan primer tapped with 1/2" plug
- Gray PVC / Black ABS
- Extra weep holes

	A	B	C	D	E
Metal	Over 2" Inside 3"	5-3/16"	8-9/16"	4-1/8" - 5-3/16"	3-3/4"

PVC

PART NO.	STRAINER	CTN QTY
D49095	5" PB	1
D49097	5" NB	1

ABS

PART NO.	STRAINER	CTN QTY
D49096	5" PB	1
D49098	5" NB	1

4" Heavy Duty Slab Drain Base with 3" Metal Spuds

5" Round Strainer

Fits Over 4" Schedule 40 DWV Pipe

MADE IN THE
USA

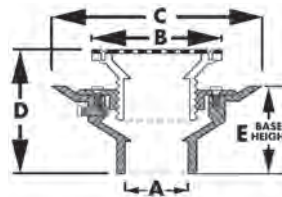

- 8-1/2" pan for applications where no clamping ring is required
- Strainers are available in PB and NB
- Spud threads directly into base
- Primer tapped with 1/2" plug
- Gray PVC / Black ABS
- Completely adjustable

	A	B	C	D	E
Metal	Over 4"	5-3/16"	8-9/16"	4-5/16" - 5-3/8"	4-3/16"

PVC

PART NO.	STRAINER	CTN QTY
D49519	5" PB	1
D49521	5" NB	1

ABS

PART NO.	STRAINER	CTN QTY
D49520	5" PB	1
D49522	5" NB	1

4" Heavy Duty Slab Drain Base with 3-1/2" Plastic Spuds

5" Round Strainer

Fits Over 4" Schedule 40 DWV Pipe



MADE IN THE
USA

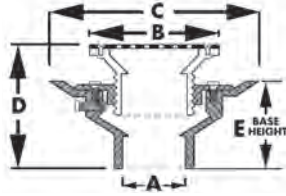

- 8-1/2" pan for applications where no clamping ring is required
- Strainers are available in SS, PB, NB and CP
- Spud threads directly into base
- Primer tapped with 1/2" plug
- Gray PVC / Black ABS
- Completely adjustable

	A	B	C	D	E
Without ring (SS str.)	Over 4"	5-1/4"	8-9/16"	5-1/4" — 6-7/16"	4-3/16"
Without ring	Over 4"	5-1/4"	8-9/16"	5-3/8" — 6-7/16"	4-3/16"
With ring	Over 4"	5-9/16"	8-9/16"	5-9/16" — 6-5/8"	4-3/16"

PVC

PART NO.	STRAINER	CTN QTY
D49523	5" SS	1
D49525	5" PB	1
D49527	5" PB with ring	1
D49529	5" NB	1
D49531	5" NB with ring	1
D49533	5" CP	1
D49535	5" CP with ring	1

ABS

PART NO.	STRAINER	CTN QTY
D49524	5" SS	1
D49526	5" PB	1
D49528	5" PB with ring	1
D49530	5" NB	1
D49532	5" NB with ring	1
D49534	5" CP	1
D49536	5" CP with ring	1

4" Heavy Duty Slab Drain Base with 3-1/2" Plastic Spuds

6" Round Strainer

Fits Over 4" Schedule 40 DWV Pipe



MADE IN THE
USA

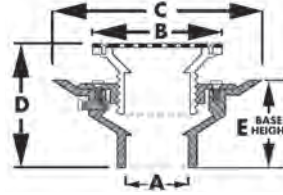

- 8-1/2" pan for applications where no clamping ring is required
- Strainers are available in SS, PB, NB and CP
- Spud threads directly into base
- Primer tapped with 1/2" plug
- Gray PVC / Black ABS
- Completely adjustable

	A	B	C	D	E
Without ring (SS str.)	Over 4"	6-1/4"	8-9/16"	5-3/8" — 6-7/16"	4-3/16"
Without ring	Over 4"	6-1/4"	8-9/16"	5-7/16" — 6-7/16"	4-3/16"
With ring	Over 4"	6-9/16"	8-9/16"	5-1/2" — 6-5/8"	4-3/16"

PVC

PART NO.	STRAINER	CTN QTY
D49537	6" SS	1
D49539	6" PB	1
D49541	6" PB with ring	1
D49543	6" NB	1
D49545	6" NB with ring	1
D49547	6" CP	1
D49549	6" CP with ring	1

ABS

PART NO.	STRAINER	CTN QTY
D49538	6" SS	1
D49540	6" PB	1
D49542	6" PB with ring	1
D49544	6" NB	1
D49546	6" NB with ring	1
D49548	6" CP	1
D49550	6" CP with ring	1

4" Heavy Duty Slab Drain Base with 3-1/2" Metal Spuds

4", 5" or 6" Round Strainer

Fits Over 4" Schedule 40 DWV Pipe

MADE IN THE
USA

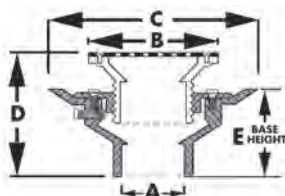

- 8-1/2" pan for applications where no clamping ring is required
- Strainers are available in PB, NB and CP
- Spud threads directly into base
- Primer tapped with 1/2" plug
- Gray PVC / Black ABS
- Completely adjustable

	A	B	C	D	E
4" metal	Over 4"	4-1/8"	8-9/16"	4-7/16" – 5-7/16"	4-3/16"
5" metal	Over 4"	5-3/16"	8-9/16"	4-5/16" – 5-7/16"	4-3/16"
6" metal	Over 4"	6-3/16"	8-9/16"	4-13/16" – 5-13/16"	4-3/16"

PVC

PART NO.	STRAINER	CTN QTY
D49551	4" PB	1
D49553	4" NB	1
D49555	5" PB	1
D49557	5" NB	1
D49559	5" CP	1
D49561	6" PB	1
D49563	6" NB	1
D49565	6" CP	1

ABS

PART NO.	STRAINER	CTN QTY
D49552	4" PB	1
D49554	4" NB	1
D49556	5" PB	1
D49558	5" NB	1
D49560	5" CP	1
D49562	6" PB	1
D49564	6" NB	1
D49566	6" CP	1

4" Heavy Duty Slab Drain Base with 4" Plastic Spuds

6" Round Strainer

Fits Over 4" Schedule 40 DWV Pipe

MADE IN THE
USA

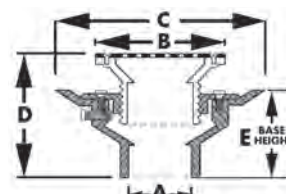

- 8-1/2" pan for applications where no clamping ring is required
- Strainers are available in SS, PB, NB and CP
- Spud threads directly into base
- Primer tapped with 1/2" plug
- Gray PVC / Black ABS
- Completely adjustable

	A	B	C	D	E
Without ring (SS str.)	Over 4"	6-3/16"	8-9/16"	5-3/8" – 6-3/8"	4-3/16"
Without ring	Over 4"	6-3/16"	8-9/16"	5-7/16" – 6-7/16"	4-3/16"
With ring	Over 4"	6-7/16"	8-9/16"	5-5/8" – 6-9/16"	4-3/16"

PVC

PART NO.	STRAINER	CTN QTY
D49577	6" SS	1
D49579	6" PB	1
D49581	6" PB with ring	1
D49583	6" NB	1
D49585	6" NB with ring	1
D49587	6" CP	1
D49589	6" CP with ring	1

ABS

PART NO.	STRAINER	CTN QTY
D49578	6" SS	1
D49580	6" PB	1
D49582	6" PB with ring	1
D49584	6" NB	1
D49586	6" NB with ring	1
D49588	6" CP	1
D49590	6" CP with ring	1

4" Heavy Duty Slab Drain Base with 4" Metal Spuds

5" Round Strainer

Fits Over 4" Schedule 40 DWV Pipe

MADE IN THE
USA

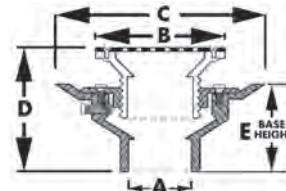

- 8-1/2" pan for applications where no clamping ring is required
- Strainers are available in PB and NB
- Spud threads directly into base
- Primer tapped with 1/2" plug
- Gray PVC / Black ABS
- Completely adjustable

	A	B	C	D	E
Metal	Over 4"	5-3/16"	8-9/16"	4-1/4" – 5-5/16"	4-3/16"

PVC

PART NO.	STRAINER	CTN QTY
D49595	5" PB	1
D49597	5" NB	1

ABS

PART NO.	STRAINER	CTN QTY
D49596	5" PB	1
D49598	5" NB	1

3" x 4" Heavy Duty Slab Drain Base with 3" Plastic Spuds

6" Round Strainer

Fits Over 3" and Inside 4" Schedule 40 DWV Pipe

MADE IN THE USA

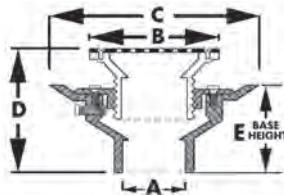

- 8-1/2" pan for applications where no clamping ring is required
- Strainers are available in SS, PB, NB and CP
- Spud threads directly into base
- Primer tapped with 1/2" plug
- Gray PVC / Black ABS
- Completely adjustable

	A	B	C	D	E
Without ring (SS str.)	Over 3" Inside 4"	6-1/8"	8-9/16"	5-1/16" – 6-1/16"	3-3/4"
Without ring	Over 3" Inside 4"	6-1/8"	8-9/16"	5-1/8" – 6-3/16"	3-3/4"
With ring	Over 3" Inside 4"	6-7/16"	8-9/16"	5-5/16" – 6-3/8"	3-3/4"

PVC

PART NO.	STRAINER	CTN QTY
D49401	6" SS	1
D49403	6" PB	1
D49405	6" PB with ring	1
D49407	6" NB	1
D49409	6" NB with ring	1
D49411	6" CP	1
D49413	6" CP with ring	1

ABS

PART NO.	STRAINER	CTN QTY
D49402	6" SS	1
D49404	6" PB	1
D49406	6" PB with ring	1
D49408	6" NB	1
D49410	6" NB with ring	1
D49412	6" CP	1
D49414	6" CP with ring	1

3" x 4" Heavy Duty Slab Drain Base with 3" Metal Spuds

5" Round Strainer

Fits Over 3" and Inside 4" Schedule 40 DWV Pipe

MADE IN THE USA

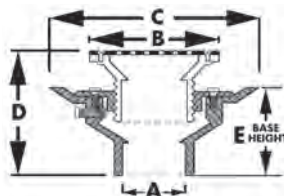

- 8-1/2" pan for applications where no clamping ring is required
- Strainers are available in PB and NB
- Spud threads directly into base
- Primer tapped with 1/2" plug
- Gray PVC / Black ABS
- Completely adjustable

	A	B	C	D	E
Metal	Over 3" Inside 4"	5-3/16"	8-9/16"	4-1/8" – 5-1/8"	3-3/4"

PVC

PART NO.	STRAINER	CTN QTY
D49419	5" PB	1
D49421	5" NB	1

ABS

PART NO.	STRAINER	CTN QTY
D49420	5" PB	1
D49422	5" NB	1

3" x 4" Heavy Duty Slab Drain Base with 3-1/2" Plastic Spuds

5" Round Strainer

Fits Over 3" and Inside 4" Schedule 40 DWV Pipe

MADE IN THE USA

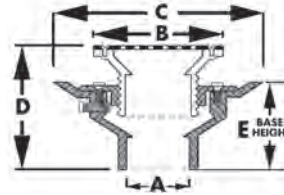

- 8-1/2" pan for applications where no clamping ring is required
- Strainers are available in SS, PB, NB and CP
- Spud threads directly into base
- Primer tapped with 1/2" plug
- Gray PVC / Black ABS
- Completely adjustable

	A	B	C	D	E
Without ring (SS str.)	Over 3" Inside 4"	5-1/4"	8-9/16"	5" – 6-1/8"	3-3/4"
Without ring	Over 3" Inside 4"	5-1/4"	8-9/16"	5-3/16" – 6-3/16"	3-3/4"
With ring	Over 3" Inside 4"	5-9/16"	8-9/16"	5-3/8" – 6-5/16"	3-3/4"

PVC

PART NO.	STRAINER	CTN QTY
D49423	5" SS	1
D49425	5" PB	1
D49427	5" PB with ring	1
D49429	5" NB	1
D49431	5" NB with ring	1
D49433	5" CP	1
D49435	5" CP with ring	1

ABS

PART NO.	STRAINER	CTN QTY
D49424	5" SS	1
D49426	5" PB	1
D49428	5" PB with ring	1
D49430	5" NB	1
D49432	5" NB with ring	1
D49434	5" CP	1
D49436	5" CP with ring	1

3" x 4" Heavy Duty Slab Drain Base with 3-1/2" Plastic Spuds

6" Round Strainer

Fits Over 3" and Inside 4" Schedule 40 DWV Pipe

MADE IN THE
USA

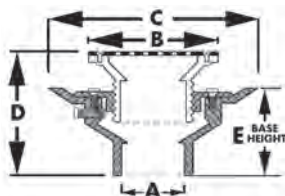

- 8-1/2" pan for applications where no clamping ring is required
- Strainers are available in SS, PB, NB and CP
- Spud threads directly into base
- Primer tapped with 1/2" plug
- Gray PVC / Black ABS
- Completely adjustable

	A	B	C	D	E
Without ring (SS str.)	Over 3" Inside 4"	6-1/4"	8-9/16"	5-1/16" — 6-1/16"	3-3/4"
Without ring	Over 3" Inside 4"	6-1/4"	8-9/16"	5-3/16" — 6-3/16"	3-3/4"
With ring	Over 3" Inside 4"	6-9/16"	8-9/16"	5-5/16" — 6-3/8"	3-3/4"

PVC

PART NO.	STRAINER	CTN QTY
D49437	6" SS	1
D49439	6" PB	1
D49441	6" PB with ring	1
D49443	6" NB	1
D49445	6" NB with ring	1
D49447	6" CP	1
D49449	6" CP with ring	1

ABS

PART NO.	STRAINER	CTN QTY
D49438	6" SS	1
D49440	6" PB	1
D49442	6" PB with ring	1
D49444	6" NB	1
D49446	6" NB with ring	1
D49448	6" CP	1
D49450	6" CP with ring	1

3" x 4" Heavy Duty Slab Drain Base with 3-1/2" Metal Spuds

4", 5", 6", 8" or 9" Round Strainer

Fits Over 3" and Inside 4" Schedule 40 DWV Pipe

MADE IN THE
USA

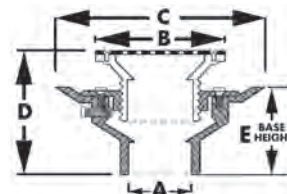

- 8-1/2" pan for applications where no clamping ring is required
- Strainers are available in PB, NB and CP
- Spud threads directly into base
- Primer tapped with 1/2" plug
- Gray PVC / Black ABS
- Completely adjustable

	A	B	C	D	E
4" round	Over 3" Inside 4"	4-1/8"	8-9/16"	4-1/8" — 5-1/16"	3-15/16"
5" round	Over 3" Inside 4"	5-3/16"	8-9/16"	4-1/8" — 5-1/4"	3-15/16"
6" round	Over 3" Inside 4"	6-3/16"	8-9/16"	4-9/16" — 5-7/16"	3-15/16"
8" round	Over 3" Inside 4"	8-1/8"	8-9/16"	5-1/16" — 6"	3-15/16"
9" round	Over 3" Inside 4"	9"	8-9/16"	5" — 6-1/8"	3-15/16"

PVC

PART NO.	STRAINER	CTN QTY
D49451	4" PB	1
D49453	4" NB	1
D49455	5" PB	1
D49457	5" NB	1
D49459	5" CP	1
D49461	6" PB	1
D49463	6" NB	1
D49465	6" CP	1
D49467	8" PB	1
D49469	8" NB	1
D49471	8" CP	1
D49473	9" PB	1
D49475	9" NB	1

ABS

PART NO.	STRAINER	CTN QTY
D49452	4" PB	1
D49454	4" NB	1
D49456	5" PB	1
D49458	5" NB	1
D49460	5" CP	1
D49462	6" PB	1
D49464	6" NB	1
D49466	6" CP	1
D49468	8" PB	1
D49470	8" NB	1
D49472	8" CP	1
D49474	9" PB	1
D49476	9" NB	1

3" x 4" Heavy Duty Slab Drain Base with 4" Plastic Spuds

6" Round Strainer

Fits Over 3" and Inside 4" Schedule 40 DWV Pipe

MADE IN THE USA

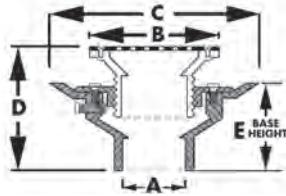

- 8-1/2" pan for applications where no clamping ring is required
- Strainers are available in SS, PB, NB and CP
- Spud threads directly into base
- Primer tapped with 1/2" plug
- Gray PVC / Black ABS
- Completely adjustable

	A	B	C	D	E
Without ring (SS str.)	Over 3" Inside 4"	6-3/16"	8-9/16"	5-1/16" — 6-1/8"	3-15/16"
Without ring	Over 3" Inside 4"	6-3/16"	8-9/16"	5-1/4" — 6-3/16"	3-15/16"
With ring	Over 3" Inside 4"	6-7/16"	8-9/16"	5-3/8" — 6-5/16"	3-15/16"

PVC

PART NO.	STRAINER	CTN QTY
D49477	6" SS	1
D49479	6" PB	1
D49481	6" PB with ring	1
D49483	6" NB	1
D49485	6" NB with ring	1
D49487	6" CP	1
D49489	6" CP with ring	1

ABS

PART NO.	STRAINER	CTN QTY
D49478	6" SS	1
D49480	6" PB	1
D49482	6" PB with ring	1
D49484	6" NB	1
D49486	6" NB with ring	1
D49488	6" CP	1
D49490	6" CP with ring	1

3" x 4" Heavy Duty Slab Drain Base with 4" Metal Spuds

5" Round Strainer

Fits Over 3" and Inside 4" Schedule 40 DWV Pipe

MADE IN THE USA

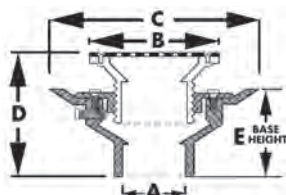

- 8-1/2" pan for applications where no clamping ring is required
- Strainers are available in PB and NB
- Spud threads directly into base
- Primer tapped with 1/2" plug
- Gray PVC / Black ABS
- Completely adjustable

	A	B	C	D	E
Metal	Over 3" Inside 4"	5-3/16"	8-9/16"	4" — 5-1/8"	3-15/16"

PVC

PART NO.	STRAINER	CTN QTY
D49495	5" PB	1
D49497	5" NB	1

ABS

PART NO.	STRAINER	CTN QTY
D49496	5" PB	1
D49498	5" NB	1

2" x 3" Heavy Duty Slab Drain Base with 3" Plastic Spuds

6" Round Strainer

Fits Over 2" and Inside 3" Schedule 40 DWV Pipe

MADE IN THE USA

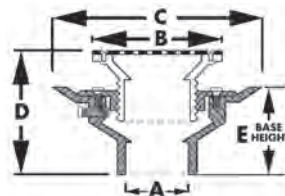

- 8-1/2" pan for applications where no clamping ring is required
- Strainers are available in SS, PB, NB and CP
- Spud threads directly into base
- Primer tapped with 1/2" plug
- Gray PVC / Black ABS
- Completely adjustable

	A	B	C	D	E
Without ring (SS str.)	Over 2" Inside 3"	6-1/8"	8-9/16"	4-15/16" — 5-7/8"	3-3/4"
Without ring	Over 2" Inside 3"	6-1/8"	8-9/16"	5" — 6"	3-3/4"
With ring	Over 2" Inside 3"	6-7/16"	8-9/16"	5-1/8" — 6-1/8"	3-3/4"

PVC

PART NO.	STRAINER	CTN QTY
D49301	6" SS	1
D49303	6" PB	1
D49305	6" PB with ring	1
D49307	6" NB	1
D49309	6" NB with ring	1
D49311	6" CP	1
D49313	6" CP with ring	1

ABS

PART NO.	STRAINER	CTN QTY
D49302	6" SS	1
D49304	6" PB	1
D49306	6" PB with ring	1
D49308	6" NB	1
D49310	6" NB with ring	1
D49312	6" CP	1
D49314	6" CP with ring	1

2" x 3" Heavy Duty Slab Drain Base with 3" Metal Spuds

5" Round Strainer

Fits Over 2" and Inside 3" Schedule 40 DWV Pipe

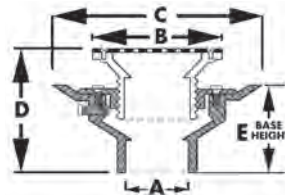

- 8-1/2" pan for applications where no clamping ring is required
- Strainers are available in PB and NB
- Spud threads directly into base
- Primer tapped with 1/2" plug
- Gray PVC / Black ABS
- Completely adjustable

	A	B	C	D	E
Metal	Over 2" Inside 3"	5-3/16"	8-9/16"	3-15/16" — 4-15/16"	3-3/4"

PVC

PART NO.	STRAINER	CTN QTY
D49319	5" PB	1
D49321	5" NB	1

ABS

PART NO.	STRAINER	CTN QTY
D49320	5" PB	1
D49322	5" NB	1

2" x 3" Heavy Duty Slab Drain Base with 3-1/2" Plastic Spuds

5" Round Strainer

Fits Over 2" and Inside 3" Schedule 40 DWV Pipe

MADE IN THE
USA

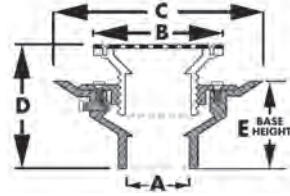

- 8-1/2" pan for applications where no clamping ring is required
- Strainers are available in SS, PB, NB and CP
- Spud threads directly into base
- Primer tapped with 1/2" plug
- Gray PVC / Black ABS
- Completely adjustable

	A	B	C	D	E
Without ring (SS str.)	Over 2" Inside 3"	5-1/4"	8-9/16"	4-3/4" - 6-1/16"	3-3/4"
Without ring	Over 2" Inside 3"	5-1/4"	8-9/16"	5" - 5-15/16"	3-3/4"
With ring	Over 2" Inside 3"	5-9/16"	8-9/16"	5-1/8" - 6-1/8"	3-3/4"

PVC

PART NO.	STRAINER	CTN QTY
D49323	5" SS	1
D49325	5" PB	1
D49327	5" PB with ring	1
D49329	5" NB	1
D49331	5" NB with ring	1
D49333	5" CP	1
D49335	5" CP with ring	1

ABS

PART NO.	STRAINER	CTN QTY
D49324	5" SS	1
D49326	5" PB	1
D49328	5" PB with ring	1
D49330	5" NB	1
D49332	5" NB with ring	1
D49334	5" CP	1
D49336	5" CP with ring	1

2" x 3" Heavy Duty Slab Drain Base with 3-1/2" Plastic Spuds

6" Round Strainer

Fits Over 2" and Inside 3" Schedule 40 DWV Pipe

MADE IN THE
USA

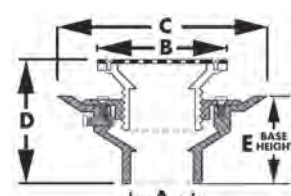

- 8-1/2" pan for applications where no clamping ring is required
- Strainers are available in SS, PB, NB and CP
- Spud threads directly into base
- Primer tapped with 1/2" plug
- Gray PVC / Black ABS
- Completely adjustable

	A	B	C	D	E
Without ring (SS str.)	Over 2" Inside 3"	6-1/4"	8-9/16"	5" - 6-1/16"	3-3/4"
Without ring	Over 2" Inside 3"	6-1/4"	8-9/16"	5-1/8" - 6"	3-3/4"
With ring	Over 2" Inside 3"	6-9/16"	8-9/16"	5-1/4" - 6-1/4"	3-3/4"

PVC

PART NO.	STRAINER	CTN QTY
D49337	6" SS	1
D49339	6" PB	1
D49341	6" PB with ring	1
D49343	6" NB	1
D49345	6" NB with ring	1
D49347	6" CP	1
D49349	6" CP with ring	1

ABS

PART NO.	STRAINER	CTN QTY
D49338	6" SS	1
D49340	6" PB	1
D49342	6" PB with ring	1
D49344	6" NB	1
D49346	6" NB with ring	1
D49348	6" CP	1
D49350	6" CP with ring	1

2" x 3" Heavy Duty Slab Drain Base with 3-1/2" Metal Spuds

4", 5" or 6" Round Strainer

Fits Over 2" and Inside 3" Schedule 40 DWV Pipe

MADE IN THE
USA

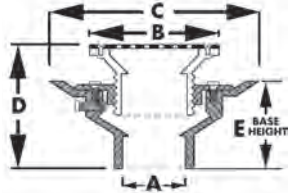

- 8-1/2" pan for applications where no clamping ring is required
- Strainers are available in PB, NB and CP
- Spud threads directly into base
- Primer tapped with 1/2" plug
- Gray PVC / Black ABS
- Completely adjustable

	A	B	C	D	E
4" without ring	Over 2" Inside 3"	4-1/8"	8-9/16"	48" - 4-15/16"	3-3/4"
5" without ring	Over 2" Inside 3"	5-3/16"	8-9/16"	4" - 5"	3-3/4"
6" without ring	Over 2" Inside 3"	6-3/16"	8-9/16"	4-7/16" - 5-1/2"	3-3/4"

PVC

PART NO.	STRAINER	CTN QTY
D49351	4" PB	1
D49353	4" NB	1
D49355	5" PB	1
D49357	5" NB	1
D49359	5" CP	1
D49361	6" PB	1
D49363	6" NB	1
D49365	6" CP	1

ABS

PART NO.	STRAINER	CTN QTY
D49352	4" PB	1
D49354	4" NB	1
D49356	5" PB	1
D49358	5" NB	1
D49360	5" CP	1
D49362	6" PB	1
D49364	6" NB	1
D49366	6" CP	1

2" x 3" Heavy Duty Slab Drain Base with 4" Plastic Spuds

6" Round Strainer

Fits Over 2" and Inside 3" Schedule 40 DWV Pipe

MADE IN THE
USA

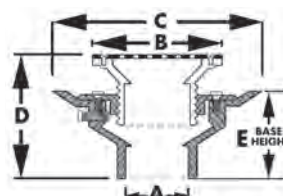

- 8-1/2" pan for applications where no clamping ring is required
- Strainers are available in SS, PB, NB and CP
- Spud threads directly into base
- Primer tapped with 1/2" plug
- Gray PVC / Black ABS
- Completely adjustable

	A	B	C	D	E
Without ring (SS str.)	Over 2" Inside 3"	6-3/16"	8-9/16"	5" - 5-15/16"	3-3/4"
Without ring	Over 2" Inside 3"	6-3/16"	8-9/16"	5" - 6"	3-3/4"
With ring	Over 2" Inside 3"	6-7/16"	8-9/16"	5-3/16" - 6-3/16"	3-3/4"

PVC

PART NO.	STRAINER	CTN QTY
D49377	6" SS	1
D49379	6" PB	1
D49381	6" PB with ring	1
D49383	6" NB	1
D49385	6" NB with ring	1
D49387	6" CP	1
D49389	6" CP with ring	1

ABS

PART NO.	STRAINER	CTN QTY
D49378	6" SS	1
D49380	6" PB	1
D49382	6" PB with ring	1
D49384	6" NB	1
D49386	6" NB with ring	1
D49388	6" CP	1
D49390	6" CP with ring	1

2" x 3" Heavy Duty Slab Drain Base with 4" Metal Spuds

5" Round Strainer

Fits Over 2" and Inside 3" Schedule 40 DWV Pipe

MADE IN THE
USA

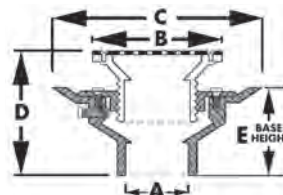

- 8-1/2" pan for applications where no clamping ring is required
- Strainers are available in PB and NB
- Spud threads directly into base
- Primer tapped with 1/2" plug
- Gray PVC / Black ABS
- Completely adjustable

	A	B	C	D	E
Metal	Over 2" Inside 3"	5-3/16"	8-9/16"	3-7/8" - 4-7/8"	3-3/4"

PVC

PART NO.	STRAINER	CTN QTY
D49395	5" PB	1
D49397	5" NB	1

ABS

PART NO.	STRAINER	CTN QTY
D49396	5" PB	1
D49398	5" NB	1

2" Heavy Duty Drain Base with 3-1/2" Plastic Spuds

5" Round Strainer

Fits Over 2" Schedule 40 DWV Pipe



MADE IN THE
USA

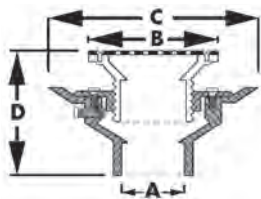

- 10" Pan
- Stainless steel strainers are .06" thick
- PB, NB and CP strainers are 3/16" thick
- Strainers are available in SS, PB, NB and CP
- Primer tapped with 1/2" plug

	A	B	C	D
Without ring	Over 2"	5-3/16"	11"	4-3/8" – 6"
With ring	Over 2"	5-1/2"	11"	4-1/2" – 6-1/8"

PVC

PART NO.	STRAINER	CTN QTY
D53442	5" SS	1
D53443	5" PB	1
D53444	5" PB with ring	1
D53445	5" NB	1
D53446	5" NB with ring	1
D53447	5" CP	1
D53448	5" CP with ring	1

ABS

PART NO.	STRAINER	CTN QTY
D53449	5" SS	1
D53450	5" PB	1
D53451	5" PB with ring	1
D53452	5" NB	1
D53453	5" NB with ring	1
D53454	5" CP	1
D53455	5" CP with ring	1

2" Heavy Duty Drain Base with 3-1/2" Plastic Spuds

6" Round Strainer

Fits Over 2" Schedule 40 DWV Pipe



MADE IN THE
USA

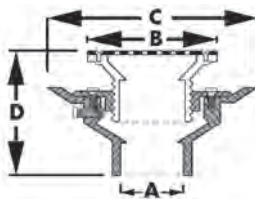

- 10" Pan
- Stainless steel strainers are .06" thick
- PB, NB and CP strainers are 3/16" thick
- Strainers are available in SS, PB, NB and CP
- Primer tapped with 1/2" plug
- Adjustable (see dimension D)

	A	B	C	D
Without ring	Over 2"	6-1/8"	11"	4-7/16" – 6-1/16"
With ring	Over 2"	6-1/2"	11"	4-1/2" – 6-1/4"

PVC

PART NO.	STRAINER	CTN QTY
D50037	6" SS	1
D50044	6" PB	1
D50050	6" PB with ring	1
D50047	6" NB	1
D50053	6" NB with ring	1
D50040	6" CP	1
D50278	6" CP with ring	1

ABS

PART NO.	STRAINER	CTN QTY
D51037	6" SS	1
D51044	6" PB	1
D51050	6" PB with ring	1
D51047	6" NB	1
D51053	6" NB with ring	1
D51040	6" CP	1
D51278	6" CP with ring	1

2" Heavy Duty Drain Base with 3-1/2" Metal Spuds

5" or 6" Round Strainer

Fits Over 2" Schedule 40 DWV Pipe

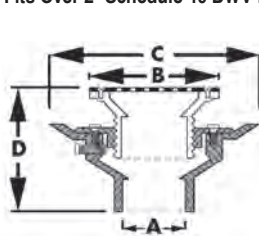

MADE IN THE
USA

- 10" Pan
- PB, NB and CP strainers are 3/16" thick
- Strainers are available in PB, NB and CP
- Primer tapped with 1/2" plug
- Adjustable (see dimension D)

	A	B	C	D
Metal	Over 2"	5" or 6"	11"	4-1/4" – 5-5/8"

PVC

PART NO.	STRAINER	CTN QTY
D50027	5" PB	1
D50060	5" NB	1
D50022	5" CP	1
D50028	6" PB	1
D50063	6" NB	1
D50023	6" CP	1

ABS

PART NO.	STRAINER	CTN QTY
D51027	5" PB	1
D51060	5" NB	1
D51022	5" CP	1
D51028	6" PB	1
D51063	6" NB	1
D51023	6" CP	1

2" Heavy Duty Drain Base with 3-1/2" Metal Spuds

5" or 6" Square Strainer

Fits Over 2" Schedule 40 DWV Pipe

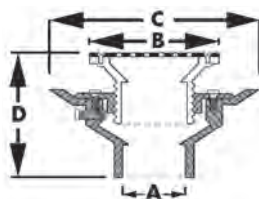

MADE IN THE
USA

- 10" Pan
- Strainers are available in PB and NB
- PB and NB strainers are 3/16" thick
- Primer tapped with 1/2" plug

	A	B	C	D
Square top	Over 2"	5" or 6"	11"	4-1/4" – 5-5/8"

PVC

PART NO.	STRAINER	CTN QTY
D50066	5" PB	1
D50072	5" NB	1
D50069	6" PB	1
D50075	6" NB	1

ABS

PART NO.	STRAINER	CTN QTY
D51066	5" PB	1
D51072	5" NB	1
D51069	6" PB	1
D51075	6" NB	1

3" Heavy Duty Drain Base with 3-1/2" Plastic Spuds

5" Round Strainer

Fits Over 3" Schedule 40 DWV Pipe

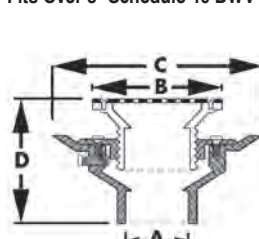

MADE IN THE
USA

- 10" Pan
- Stainless steel strainers are .06" thick
- PB, NB and CP strainers are 3/16" thick
- Strainers are available in SS, PB, NB and CP
- Primer tapped with 1/2" plug

	A	B	C	D
Without ring	Over 3"	5-3/16"	11"	4-3/8" – 6"
With ring	Over 3"	5-1/2"	11"	4-1/2" – 6-1/8"

PVC

PART NO.	STRAINER	CTN QTY
D53456	5" SS	1
D53457	5" PB	1
D53458	5" PB with ring	1
D53459	5" NB	1
D53460	5" NB with ring	1
D53461	5" CP	1
D53462	5" CP with ring	1

ABS

PART NO.	STRAINER	CTN QTY
D53463	5" SS	1
D53464	5" PB	1
D53465	5" PB with ring	1
D53466	5" NB	1
D53467	5" NB with ring	1
D53468	5" CP	1
D53469	5" CP with ring	1

3" Heavy Duty Drain Base with 3-1/2" Plastic Spuds

6" Round Strainer

Fits Over 3" Schedule 40 DWV Pipe



MADE IN THE
USA

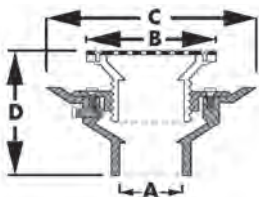

- 10" Pan
- Stainless steel strainers are .06" thick
- PB, NB and CP strainers are 3/16" thick
- Strainers are available in SS, PB, NB and CP
- Primer tapped with 1/2" plug

	A	B	C	D
Without ring	Over 3"	6-1/8"	11"	4-11/16" – 6-7/16"
With ring	Over 3"	6-1/2"	11"	4-3/4" – 6-1/2"

PVC

PART NO.	STRAINER	CTN QTY
D50038	6" SS	1
D50045	6" PB	1
D50051	6" PB with ring	1
D50048	6" NB	1
D50054	6" NB with ring	1
D50041	6" CP	1
D50279	6" CP with ring	1

ABS

PART NO.	STRAINER	CTN QTY
D51038	6" SS	1
D51045	6" PB	1
D51051	6" PB with ring	1
D51048	6" NB	1
D51054	6" NB with ring	1
D51041	6" CP	1
D51279	6" CP with ring	1

3" Heavy Duty Drain Base with 3-1/2" Metal Spuds

5", 6", 8" or 9" Round Strainer

Fits Over 3" Schedule 40 DWV Pipe



MADE IN THE
USA

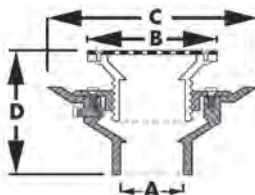

- 10" Pan
- Stainless steel strainers are .06" thick
- PB, NB and CP strainers are 3/16" thick
- Strainers are available in PB, NB and CP
- Primer tapped with 1/2" plug

	A	B	C	D
Metal	Over 3"	5", 6", 8" or 9"	11"	5" – 6-1/2"

PVC

PART NO.	STRAINER	CTN QTY
D50012	5" PB	1
D50061	5" NB	1
D50004	5" CP	1
D50013	6" PB	1
D50064	6" NB	1
D50005	6" CP	1
D50014	8" PB	1
D53144	8" NB	1
D50006	8" CP	1
D53148	9" PB	1
D53146	9" NB	1

ABS

PART NO.	STRAINER	CTN QTY
D51012	5" PB	1
D51061	5" NB	1
D51004	5" CP	1
D51013	6" PB	1
D51064	6" NB	1
D51005	6" CP	1
D51014	8" PB	1
D53145	8" NB	1
D51006	8" CP	1
D53149	9" PB	1
D53147	9" NB	1

3" Heavy Duty Drain Base with 3-1/2" Metal Spuds

5" or 6" Square Strainer

Fits Over 3" Schedule 40 DWV Pipe



MADE IN THE USA

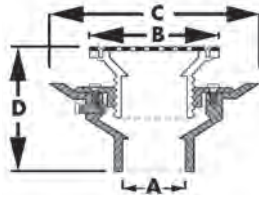

- 10" Pan
- Strainers are available in PB and NB
- PB and NB strainers are 3/16" thick
- Primer tapped with 1/2" plug

	A	B	C	D
Square top	Over 3"	5" or 6"	11"	5" - 6-1/2"

PVC

PART NO.	STRAINER	CTN QTY
D50067	5" PB	1
D50073	5" NB	1
D50070	6" PB	1
D50076	6" NB	1

ABS

PART NO.	STRAINER	CTN QTY
D51067	5" PB	1
D51073	5" NB	1
D51070	6" PB	1
D51076	6" NB	1

4" Heavy Duty Drain Base with 3-1/2" Plastic Spuds

5" Round Strainer

Fits Over 4" Schedule 40 DWV Pipe



MADE IN THE USA

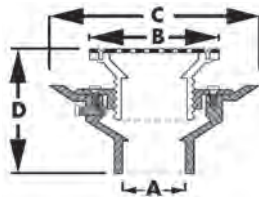

- 10" Pan
- Stainless steel strainers are .06" thick
- PB, NB and CP strainers are 3/16" thick
- Strainers are available in SS, PB, NB and CP
- Primer tapped with 1/2" plug

	A	B	C	D
Without ring	Over 4"	5-3/16"	11"	4-3/8" - 6"
With ring	Over 4"	5-1/2"	11"	4-1/2" - 6-1/8"

PVC

PART NO.	STRAINER	CTN QTY
D53470	5" SS	1
D53471	5" PB	1
D53472	5" PB with ring	1
D53473	5" NB	1
D53474	5" NB with ring	1
D53475	5" CP	1
D53476	5" CP with ring	1

ABS

PART NO.	STRAINER	CTN QTY
D53477	5" SS	1
D53478	5" PB	1
D53479	5" PB with ring	1
D53480	5" NB	1
D53481	5" NB with ring	1
D53482	5" CP	1
D53483	5" CP with ring	1

4" Heavy Duty Drain Base with 3-1/2" Plastic Spuds

6" Round Strainer

Fits Over 4" Schedule 40 DWV Pipe



MADE IN THE USA

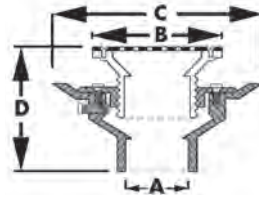

- 10" Pan
- Stainless steel strainers are .06" thick
- PB, NB and CP strainers are 3/16" thick
- Strainers are available in SS, PB, NB and CP
- Primer tapped with 1/2" plug

	A	B	C	D
Without ring	Over 4"	6-1/8"	11"	5-1/16" - 6-13/16"
With ring	Over 4"	6-1/2"	11"	5-1/4" - 6-15/16"

PVC

PART NO.	STRAINER	CTN QTY
D50039	6" SS	1
D50046	6" PB	1
D50052	6" PB with ring	1
D50049	6" NB	1
D50055	6" NB with ring	1
D50042	6" CP	1
D50280	6" CP with ring	1

ABS

PART NO.	STRAINER	CTN QTY
D51039	6" SS	1
D51046	6" PB	1
D51052	6" PB with ring	1
D51049	6" NB	1
D51055	6" NB with ring	1
D51042	6" CP	1
D51280	6" CP with ring	1

4" Heavy Duty Drain Base with 3-1/2" Metal Spuds

5" or 6" Round Strainer

Fits Over 4" Schedule 40 DWV Pipe



MADE IN THE
USA

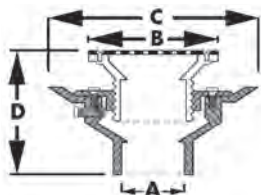

- 10" Pan
- Stainless steel strainers are .06" thick
- PB, NB and CP strainers are 3/16" thick
- Strainers are available in PB, NB and CP
- Primer tapped with 1/2" plug

	A	B	C	D
Metal	Over 4"	5" or 6"	11"	4-5/8" — 5-7/8"

PVC

PART NO.	STRAINER	CTN QTY
D50062	5" NB	1
D50015	5" PB	1
D50007	5" CP	1
D50065	6" NB	1
D50016	6" PB	1
D50008	6" CP	1

ABS

PART NO.	STRAINER	CTN QTY
D51062	5" NB	1
D51015	5" PB	1
D51007	5" CP	1
D51065	6" NB	1
D51016	6" PB	1
D51008	6" CP	1

2" Heavy Duty Drain Base with 4" Plastic Spuds

6" Round Strainer

Fits Over 2" Schedule 40 DWV Pipe



MADE IN THE
USA

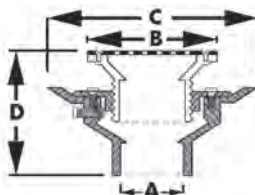

- 10" Pan
- Stainless steel strainers are .06" thick
- PB, NB and CP strainers are 3/16" thick
- Strainers are available in SS, PB, NB and CP
- Primer tapped with 1/2" plug

	A	B	C	D
Without ring	Over 2"	6-1/8"	11"	4-7/16" — 6-1/16"
With ring	Over 2"	6-1/2"	11"	4-1/2" — 6-1/4"

PVC

PART NO.	STRAINER	CTN QTY
D50340	6" SS	1
D50341	6" PB	1
D50342	6" PB with ring	1
D50343	6" NB	1
D50344	6" NB with ring	1
D50345	6" CP	1
D50346	6" CP with ring	1

ABS

PART NO.	STRAINER	CTN QTY
D51340	6" SS	1
D51341	6" PB	1
D51342	6" PB with ring	1
D51343	6" NB	1
D51344	6" NB with ring	1
D51345	6" CP	1
D51346	6" CP with ring	1

4" Heavy Duty Drain Base with 3-1/2" Metal Spuds

5" or 6" Square Strainer

Fits Over 4" Schedule 40 DWV Pipe



MADE IN THE
USA

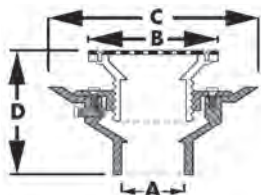

- 10" Pan
- Strainers are available in PB and NB
- PB and NB strainers are 3/16" thick
- Primer tapped with 1/2" plug

	A	B	C	D
Square top	Over 4"	5" or 6"	11"	4-5/8" — 5-7/8"

PVC

PART NO.	STRAINER	CTN QTY
D50068	5" PB	1
D50074	5" NB	1
D50071	6" PB	1
D50077	6" NB	1

ABS

PART NO.	STRAINER	CTN QTY
D51068	5" PB	1
D51074	5" NB	1
D51071	6" PB	1
D51077	6" NB	1

2" Heavy Duty Drain Base with 4" Metal Spuds

5" Round Strainer

Fits Over 2" Schedule 40 DWV Pipe



MADE IN THE
USA

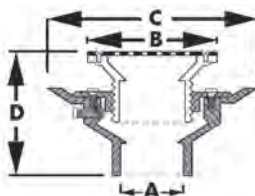

- 10" Pan
- Stainless steel strainers are .06" thick
- Strainers are 3/16" thick
- Strainers are available in PB and NB
- Primer tapped with 1/2" plug

	A	B	C	D
Metal	Over 2"	5"	11"	4-1/4" — 5-5/8"

PVC

PART NO.	STRAINER	CTN QTY
D50349	5" NB	1
D50350	5" PB	1

ABS

PART NO.	STRAINER	CTN QTY
D51349	5" NB	1
D51350	5" PB	1

3" Heavy Duty Drain Base with 4" Plastic Spuds

6" Round Strainer

Fits Over 3" Schedule 40 DWV Pipe



MADE IN THE **USA**

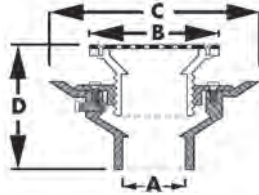

- 10" Pan
- Stainless steel strainers are .06" thick
- PB, NB and CP strainers are 3/16" thick
- Strainers are available in SS, PB, NB and CP
- Primer tapped with 1/2" plug

	A	B	C	D
Without ring	Over 3"	6-1/8"	4-5/8" – 6"	4-11/16" – 6-7/16"
With ring	Over 3"	6-1/2"	4-5/8" – 6"	4-3/4" – 6-1/2"

PVC

PART NO.	STRAINER	CTN QTY
D50351	6" SS	1
D50352	6" PB	1
D50353	6" PB with ring	1
D50354	6" NB	1
D50355	6" NB with ring	1
D50356	6" CP	1
D50357	6" CP with ring	1

ABS

PART NO.	STRAINER	CTN QTY
D51351	6" SS	1
D51352	6" PB	1
D51353	6" PB with ring	1
D51354	6" NB	1
D51355	6" NB with ring	1
D51356	6" CP	1
D51357	6" CP with ring	1

4" Heavy Duty Drain Base with 4" Plastic Spuds

6" Round Strainer

Fits Over 4" Schedule 40 DWV Pipe



MADE IN THE **USA**

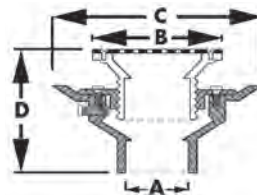

- 10" Pan
- Stainless steel strainers are .06" thick
- PB, NB and CP strainers are 3/16" thick
- Strainers are available in SS, PB, NB and CP
- Primer tapped with 1/2" plug

	A	B	C	D
Without ring	Over 4"	6-1/8"	11"	5-1/16" – 6-13/16"
With ring	Over 4"	6-1/2"	11"	5-1/4" – 6-15/16"

PVC

PART NO.	STRAINER	CTN QTY
D50362	6" SS	1
D50363	6" PB	1
D50364	6" PB with ring	1
D50365	6" NB	1
D50366	6" NB with ring	1
D50367	6" CP	1
D50368	6" CP with ring	1

ABS

PART NO.	STRAINER	CTN QTY
D51362	6" SS	1
D51363	6" PB	1
D51364	6" PB with ring	1
D51365	6" NB	1
D51366	6" NB with ring	1
D51367	6" CP	1
D51368	6" CP with ring	1

3" Heavy Duty Drain Base with 4" Metal Spuds

5" Round Strainer

Fits Over 3" Schedule 40 DWV Pipe



MADE IN THE **USA**

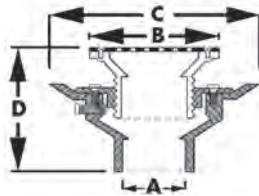

- 10" Pan
- Strainers are 3/16" thick
- Strainers are available in PB and NB
- Primer tapped with 1/2" plug
- Adjustable (see dimension D)

	A	B	C	D
Metal	Over 3"	5"	4-5/8" – 6"	5" – 6-1/2"

PVC

PART NO.	STRAINER	CTN QTY
D50361	5" PB	1
D50360	5" NB	1

ABS

PART NO.	STRAINER	CTN QTY
D51361	5" PB	1
D51360	5" NB	1

4" Heavy Duty Drain Base with 4" Metal Spuds

5" Round Strainer

Fits Over 4" Schedule 40 DWV Pipe



MADE IN THE **USA**

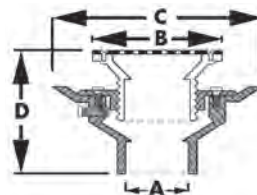

- 10" Pan
- Strainers are 3/16" thick
- Strainers are available in PB and NB
- Primer tapped with 1/2" plug
- Adjustable (see dimension D)

	A	B	C	D
Metal	Over 4"	5"	11"	4-5/8" – 5-7/8"

PVC

PART NO.	STRAINER	CTN QTY
D50372	5" PB	1
D50371	5" NB	1

ABS

PART NO.	STRAINER	CTN QTY
D51372	5" PB	1
D51371	5" NB	1

Internal Pipe Cleanout

Solvent Welds Into Schedule 40 DWV Pipe

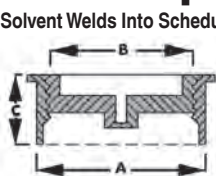

MADE IN THE USA

- Allows pipe to be cut flush with floor or wall
- Countersunk plug included

A	B	C
Inside 2"	1-1/2"	1"
Inside 3"	2-1/2"	1-1/8"
Inside 4"	3-1/2"	1-1/4"

PVC

PART NO.	PIPE SIZE	PLUG SIZE	OD	CTN QTY
C60106	2"	1-1/2" IPS	1-7/8"	10
C60007	3"	2-1/2" IPS	2-13/16"	10
C60008	4"	3-1/2" IPS	4"	50
C60116	2"	1-1/2" with insert	—	10
C60117	3"	2-1/2" with insert	—	10
C60118	4"	3-1/2" with insert	—	10

ABS

PART NO.	PIPE SIZE	PLUG SIZE	OD	CTN QTY
C60107	2"	1-1/2" IPS	1-7/8"	10
C60011	3"	2-1/2" IPS	2-13/16"	10
C60012	4"	3-1/2" IPS	4"	10

Heavy Duty Internal Pipe Cleanout

Solvent Welds Into Schedule 40 DWV Pipe

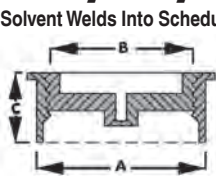

MADE IN THE USA

- Allows pipe to be cut flush with floor or wall
- Countersunk plug included

A	B	C
Inside 3"	2-1/4"	1-7/8"
Inside 4"	3-1/2"	2"

PVC

PART NO.	SIZE	PLUG SIZE	CTN QTY
C60207	3"	2" IPS	10
C60108	4"	3" IPS	10

ABS

PART NO.	SIZE	PLUG SIZE	CTN QTY
C60211	3"	2" IPS	10
C60112	4"	3" IPS	10

Hub/Fitting Cleanouts

Fits Inside 4" Schedule 40 DWV Fittings

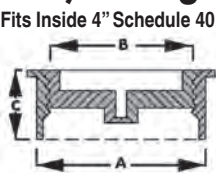

MADE IN THE USA

- 3-1/2" IPS countersunk plug
- Solvent welds into 4" fitting hubs

A	B	C
4-1/2"	3-7/8"	2-3/16"

PVC

PART NO.	DESCRIPTION	CTN QTY
C60009	4"	10

ABS

PART NO.	DESCRIPTION	CTN QTY
C60010	4"	10

Fit-Flush Cleanout

2" x 3" Fits Over 2" or Inside 3" Schedule 40 DWV Pipe
3" x 4" Fits Over 3" or Inside 4" Schedule 40 DWV Pipe

MADE IN THE USA

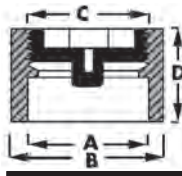

- Built-in stop
- Fits flush everytime

A	B	C	D
Over 2"	Inside 3"	2"	2"
Over 3"	Inside 4"	3"	2-1/2"

PVC

PART NO.	SIZE	PLUG SIZE	OD	CTN QTY
C61023	2" x 3"	2" IPS	2-3/8"	1
C61034	3" x 4"	3" IPS	3-1/2"	1
C61223	2" x 3"	2" IPS brass	2-3/8"	1
C61234	3" x 4"	3" IPS brass	3-1/2"	1
C61432	2" x 3"	2" with insert	2-3/8"	1
C61434	3" x 4"	3" with insert	3-1/2"	1

ABS

PART NO.	SIZE	PLUG SIZE	OD	CTN QTY
C61123	2" x 3"	2" IPS	2-3/8"	1
C61134	3" x 4"	3" IPS	3-1/2"	1

Countersunk Cleanout Plugs w/Insert



- White plastic
- With threaded brass insert for cleanout covers

MADE IN THE USA

PART NO.	DESCRIPTION	CTN QTY
P49915	1-1/2"	25
P49920	2"	25
P49925	2-1/2"	25
P49930	3"	25
P49935	3-1/2"	25
P49940	4"	25

Raised Head Cleanout Plugs



- White plastic

MADE IN THE USA

PART NO.	DESCRIPTION	CTN QTY
P49150	1-1/2"	50
P49200	2"	50
P49250	2-1/2"	25
P49350	3-1/2"	25
P49400	4"	10
P49600	6"	10

Countersunk Cleanout Plugs



- White plastic

MADE IN THE USA

PART NO.	DESCRIPTION	CTN QTY
P49015	1-1/2"	25
P49002	2"	25
P49025	2-1/2"	25
P49003	3"	25
P49035	3-1/2"	25
P49004	4"	25

4" PVC Hub Fit Cleanout with 3-1/2" Countersunk Brass Plug



- Fits flush
- Fits inside 4" hub or Schedule 40 DWV fitting

MADE IN THE USA

PART NO.	DESCRIPTION	CTN QTY
C61009	4" PVC hub fit cleanout	10

General Purpose Access Fittings

3" x 4" Fits Over 3" or Inside 4" Schedule 40 DWV Pipe
4" Fits Over 4" Schedule 40 DWV Pipe

MADE IN THE USA

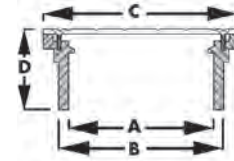

- For use with internal pipe cleanout, order separately

A	B	C	D
Over 3"	Inside 4"	5-3/16"	2-1/2"
Over 4"	—	6-1/8"	2-1/2"

General Purpose Cleanouts

3" x 4" Fits Over 3" or Inside 4" Schedule 40 DWV Pipe
4" Fits Over 4" Schedule 40 DWV Pipe

MADE IN THE USA

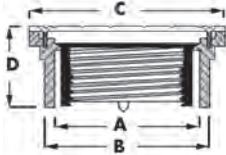

- Supplied with a combination test plug installed

A	B	C	D
Over 3"	Inside 4"	5-3/16"	2-1/2"
Over 4"	—	6-1/8"	2-1/2"

PVC

PART NO.	DESCRIPTION	CTN QTY
C60162	3" x 4" w/NB cover	5
C60165	3" x 4" w/NB cover & ring	5
C60160	3" x 4" w/PB cover	5
C60164	3" x 4" w/PB cover & ring	5
C60142	4" w/NB cover	5
C60146	4" w/NB cover & ring	5
C60140	4" w/PB cover	5
C60144	4" w/PB cover & ring	5

ABS

PART NO.	DESCRIPTION	CTN QTY
C60163	3" x 4" w/NB cover	5
C60167	3" x 4" w/NB cover & ring	5
C60161	3" x 4" w/PB cover	5
C60166	3" x 4" w/PB cover & ring	5
C60143	4" w/NB cover	5
C60147	4" w/NB cover & ring	5
C60141	4" w/PB cover	5
C60145	4" w/PB cover & ring	5

PVC

PART NO.	DESCRIPTION	CTN QTY
C60062	3" x 4" w/NB cover	5
C60065	3" x 4" w/NB cover & ring	5
C60060	3" x 4" w/PB cover	5
C60064	3" x 4" w/PB cover & ring	5
C60042	4" w/NB cover	5
C60046	4" w/NB cover & ring	5
C60040	4" w/PB cover	5
C60044	4" w/PB cover & ring	5

ABS

PART NO.	DESCRIPTION	CTN QTY
C60063	3" x 4" w/NB cover	5
C60067	3" x 4" w/NB cover & ring	5
C60061	3" x 4" w/PB cover	5
C60066	3" x 4" w/PB cover & ring	5
C60043	4" w/NB cover	5
C60047	4" w/NB cover & ring	5
C60041	4" w/PB cover	5
C60045	4" w/PB cover & ring	5

Snap-in Access Fittings

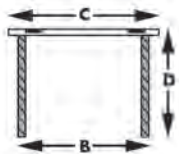

MADE IN THE
USA

A	B	C	D
3"	3-1/16"	3-1/2"	2"
4"	4"	4-1/2"	2"

PVC

PART NO.	DESCRIPTION	CTN QTY
C60013	3" with SS strainer	20
C60014	4" with SS strainer	20

E

Sewer Relief Plugs



- High-density construction
- Eliminates costly damages caused by sewer gas
- Spring-loaded to close automatically to eliminate sewer gas
- Made of ABS

MADE IN THE
USA

PART NO.	DESCRIPTION	CTN/MSTR
S25150	1-1/2"	1/50
S25200	2"	1/50
S25250	2-1/2"	1/100
S25300	3"	1/100
S25350	3-1/2"	1/100
S25400	4"	1/100

PVC Internal Cleanout w/SS Cover



MADE IN THE
USA

PART NO.	DESCRIPTION	CTN QTY
C60015	3" w/5" SS external wall cover	1
C60016	4" w/6" SS external wall cover	1

Saddle Tees and Kits



- Use bushing to reduce 2" unit to 1-1/2"
- Kits include V-bolts, nuts and washers
- Conversion kit also contains gasket mat for use with cast iron pipe
- Solvent branch

MADE IN THE
USA

PART NO.	DESCRIPTION	CTN QTY
S26014	3" x 2" Saddle tee only	20
S26015	4" x 2" Saddle tee only	10
S26016	4" x 3" Saddle tee only	10
S26017	4" x 4" Saddle tee only	10
S26004	3" x 2" Saddle tee kit less gasket	20
S26005	4" x 2" Saddle tee kit less gasket	10
S26006	4" x 3" Saddle tee kit less gasket	10
S26007	4" x 4" Saddle tee kit less gasket	10
S26009	3" x 2" Saddle tee conversion kit with gasket	20
S26010	4" x 2" Saddle tee conversion kit with gasket	10
S26011	4" x 3" Saddle tee conversion kit with gasket	10
S26012	4" x 4" Saddle tee conversion kit with gasket	10
S26008	6" x 7" x 1/4" closed cell foam gasket	20

Test Tee w/Plug



- Easy pop top test
- PVC Plug included
- Test up to 3 floors

MADE IN THE
USA

PART NO.	DESCRIPTION	CTN/MSTR
C67450	2"	1/10
C67451	3"	1/12

Round Covers w/2" Plastic Spuds



• Supplied with 2" IPS / 2-1/2" OD countersunk t-cone test plug



PVC

PART NO.	IPS	COVER	CTN/MSTR
D59920	2"	4" PB	1
D59921	2"	4" PB with ring	1
D59922	2"	4" NB	1
D59923	2"	4" NB with ring	1

ABS

PART NO.	IPS	COVER	CTN/MSTR
D59924	2"	4" PB	1
D59925	2"	4" PB with ring	1
D59926	2"	4" NB	1
D59927	2"	4" NB with ring	1

Round Covers w/3" Plastic Spuds



• Supplied with 2-1/2" IPS / 3" OD countersunk plug



PVC

PART NO.	IPS	COVER	CTN/MSTR
D59904	3"	6" PB	1
D59908	3"	6" PB with ring	1
D59905	3"	6" NB	1
D59909	3"	6" NB with ring	1

ABS

PART NO.	IPS	COVER	CTN/MSTR
D57904	3"	6" PB	1
D57908	3"	6" PB with ring	1
D57905	3"	6" NB	1
D57909	3"	6" NB with ring	1

Round Covers w/3" Metal Spuds



• Supplied with 2-1/2" IPS / 3" OD countersunk plug



PART NO.	IPS	COVER	CTN/MSTR
C37801	3"	5" PB	1/20
C37803	3"	5" NB	1/20
C37800	3"	5" CP	1/20

Round Covers w/3-1/2" Plastic Spuds



• Supplied with 3" IPS countersunk plug



PVC

PART NO.	IPS	COVER	CTN/MSTR
D59943	3-1/2"	5" PB	1
D59944	3-1/2"	5" PB with ring	1
D59945	3-1/2"	5" NB	1
D59946	3-1/2"	5" NB with ring	1
D59901	3-1/2"	6" PB	1
D59906	3-1/2"	6" PB with ring	1
D59902	3-1/2"	6" NB	1
D59907	3-1/2"	6" NB with ring	1

ABS

PART NO.	IPS	COVER	CTN/MSTR
D59947	3-1/2"	5" PB	1
D59948	3-1/2"	5" PB with ring	1
D59949	3-1/2"	5" NB	1
D59950	3-1/2"	5" NB with ring	1
D57901	3-1/2"	6" PB	1
D57906	3-1/2"	6" PB with ring	1
D57902	3-1/2"	6" NB	1
D57907	3-1/2"	6" NB with ring	1

Round Covers w/4" Plastic Spuds



• Supplied with 3" IPS countersunk plug



PVC

PART NO.	IPS	COVER	CTN/MSTR
D59914	4"	6" PB	1
D59915	4"	6" PB with ring	1
D59916	4"	6" NB	1
D59917	4"	6" NB with ring	1

ABS

PART NO.	IPS	COVER	CTN/MSTR
D57914	4"	6" PB	1
D57915	4"	6" PB with ring	1
D57916	4"	6" NB	1
D57917	4"	6" NB with ring	1

Round Covers w/3-1/2" Metal Spuds



• Supplied with 3-1/2" IPS countersunk plug



PART NO.	IPS	COVER	CTN/MSTR
C37811	3-1/2"	5" PB	1/18
C37810	3-1/2"	5" NB	1/18

Round Covers w/4" Metal Spuds



• Supplied with 3-1/2" IPS countersunk plug



PART NO.	IPS	COVER	CTN/MSTR
C37806	4"	5" PB	1/20
C37805	4"	5" NB	1/20

Round Covers w/4" Metal Spuds



• Supplied with 4" IPS countersunk plug



PART NO.	IPS	COVER	CTN/MSTR
C37808	4"	6" PB	1/8
C37807	4"	6" NB	1/8

Square Covers w/3" Plastic Spuds



• Supplied with 2-1/2" IPS / 3" OD countersunk plug

MADE IN THE
USA



PVC

PART NO.	IPS	COVER	CTN/MSTR
D59912	3"	7" PB	1
D59913	3"	7" NB	1

ABS

PART NO.	IPS	COVER	CTN/MSTR
D57912	3"	7" PB	1
D57913	3"	7" NB	1

Square Covers w/3-1/2" Plastic Spuds



• Supplied with 3" IPS countersunk plug

MADE IN THE
USA



PVC

PART NO.	IPS	COVER	CTN/MSTR
D59910	3-1/2"	7" PB	1
D59911	3-1/2"	7" NB	1

ABS

PART NO.	IPS	COVER	CTN/MSTR
D57910	3-1/2"	7" PB	1
D57911	3-1/2"	7" NB	1

Square Covers w/4" Plastic Spuds



• Supplied with 3" IPS countersunk plug

MADE IN THE
USA



PVC

PART NO.	IPS	COVER	CTN/MSTR
D59918	4"	7" PB	1
D59919	4"	7" NB	1

ABS

PART NO.	IPS	COVER	CTN/MSTR
D57918	4"	7" PB	1
D57919	4"	7" NB	1

4" Hub Fit Base with 3-1/2" Plastic Spuds

5" Round Cover

Fits Inside 4" Schedule 40 DWV Pipe

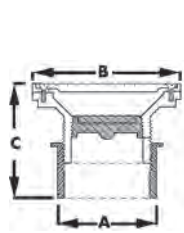

- Supplied with 3" IPS (3-1/2" OD) countersunk plug
- Covers available in PB and NB
- Covers are 3/16" thick
- Adjustable (see dimension C)

	A	B	C
Without ring	4" Hub fit	5-3/16"	3-1/8" - 4-5/8"
With ring	4" Hub fit	5-1/2"	3-5/16" - 4-13/16"

PVC

PART NO.	COVER	CTN QTY
C59200	5" PB	1
C59201	5" PB with ring	1
C59202	5" NB	1
C59203	5" NB with ring	1

ABS

PART NO.	COVER	CTN QTY
C59204	5" PB	1
C59205	5" PB with ring	1
C59206	5" NB	1
C59207	5" NB with ring	1

4" Hub Fit Base with 3-1/2" Plastic Spuds

6" Round Cover

Fits Inside 4" Schedule 40 DWV Pipe

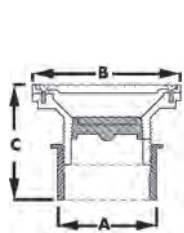

- Supplied with 3" IPS (3-1/2" OD) countersunk plug
- Covers available in PB and NB
- Covers are 3/16" thick
- Adjustable (see dimension C)

	A	B	C
Without ring	4" Hub fit	6-1/8"	3-1/8" - 4-5/8"
With ring	4" Hub fit	6-1/2"	3-5/16" - 4-13/16"

PVC

PART NO.	COVER	CTN QTY
C59001	6" PB	1
C59005	6" PB with ring	1
C59003	6" NB	1
C59007	6" NB with ring	1

ABS

PART NO.	COVER	CTN QTY
C59002	6" PB	1
C59006	6" PB with ring	1
C59004	6" NB	1
C59008	6" NB with ring	1

4" Hub Fit Base with 3-1/2" Plastic Spuds

7" Square Top

Fits Inside 4" Schedule 40 DWV Pipe

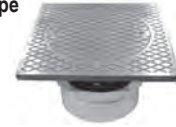
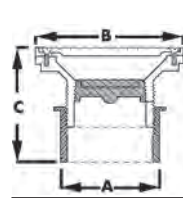

- Supplied with 3" IPS (3-1/2" OD) countersunk plug
- Covers available in PB and NB
- Covers are 3/16" thick
- Adjustable (see dimension C)

	A	B	C
Square	4" Hub fit	7"	3-3/8" - 4-15/16"

PVC

PART NO.	COVER	CTN QTY
C59050	7" PB	1
C59052	7" NB	1

ABS

PART NO.	COVER	CTN QTY
C59051	7" PB	1
C59053	7" NB	1

4" Hub Fit Base with 3-1/2" Metal Spuds

5" Round Cover

Fits Inside 4" Schedule 40 DWV Pipe

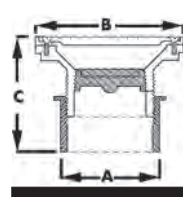

- Supplied with 3" IPS (3-1/2" OD) countersunk plug
- Covers available in PB and NB
- Covers are 3/16" thick
- Adjustable (see dimension C)

	A	B	C
Metal	4" Hub fit	5-3/16"	3-1/4" - 4-1/4"

PVC

PART NO.	COVER	CTN QTY
C59060	5" PB	1
C59062	5" NB	1

ABS

PART NO.	COVER	CTN QTY
C59061	5" PB	1
C59063	5" NB	1

3" x 4" Pipe Fit Base with 3-1/2" Plastic Spuds

5" Round Cover

Fits Over 3" or Inside 4" Schedule 40 DWV Pipe

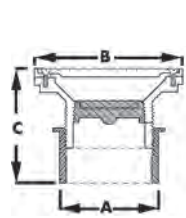

- Supplied with 3" IPS (3-1/2" OD) countersunk plug
- Covers available in PB and NB
- Covers are 3/16" thick
- Adjustable (see dimension D)

	A	B	C
Without ring	Over 3" Pipe Inside 4" Pipe	5-3/16"	3-1/8" - 4-5/8"
With ring	Over 3" Pipe Inside 4" Pipe	5-1/2"	3-5/16" - 4-13/16"

PVC

PART NO.	COVER	CTN QTY
C59216	5" PB	1
C59217	5" PB with ring	1
C59218	5" NB	1
C59219	5" NB with ring	1

ABS

PART NO.	COVER	CTN QTY
C59220	5" PB	1
C59221	5" PB with ring	1
C59222	5" NB	1
C59223	5" NB with ring	1

3" x 4" Pipe Fit Base with 3-1/2" Plastic Spuds

6" Round Cover

Fits Over 3" or Inside 4" Schedule 40 DWV Pipe

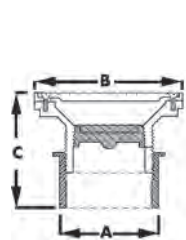

- Supplied with 3" IPS (3-1/2" OD) countersunk plug
- Covers available in PB and NB
- Covers are 3/16" thick
- Adjustable (see dimension D)

	A	B	C
Without ring	Over 3" Pipe Inside 4" Pipe	6-1/8"	3-1/8" - 4-5/8"
With ring	Over 3" Pipe Inside 4" Pipe	6-1/2"	3-5/16" - 4-13/16"

PVC

PART NO.	COVER	CTN QTY
C59010	6" PB	1
C59014	6" PB with ring	1
C59012	6" NB	1
C59016	6" NB with ring	1

ABS

PART NO.	COVER	CTN QTY
C59011	6" PB	1
C59015	6" PB with ring	1
C59013	6" NB	1
C59017	6" NB with ring	1

3" x 4" Pipe Fit Base with 3-1/2" Plastic Spuds

7" Square Top

Fits Over 3" or Inside 4" Schedule 40 DWV Pipe

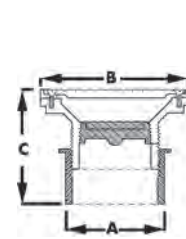

- Supplied with 3" IPS (3-1/2" OD) countersunk plug
- Covers available in PB and NB
- Covers are 3/16" thick
- Adjustable (see dimension D)

	A	B	C
Square	Over 3" Pipe Inside 4" Pipe	7"	5-15/16" - 7-1/2"

PVC

PART NO.	COVER	CTN QTY
C59054	7" PB	1
C59056	7" NB	1

ABS

PART NO.	COVER	CTN QTY
C59055	7" PB	1
C59057	7" NB	1

3" x 4" Pipe Fit Base with 3-1/2" Metal Spuds

5" Round Cover

Fits Over 3" or Inside 4" Schedule 40 DWV Pipe

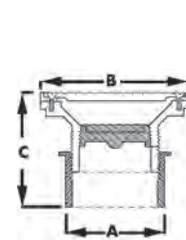

- Supplied with 3" IPS (3-1/2" OD) countersunk plug
- Covers available in PB and NB
- Covers are 3/16" thick
- Adjustable (see dimension D)

	A	B	C
Metal	Over 3" Pipe Inside 4" Pipe	5-3/16"	5-3/4" - 7"

PVC

PART NO.	COVER	CTN QTY
C59068	5" PB	1
C59070	5" NB	1

ABS

PART NO.	COVER	CTN QTY
C59069	5" PB	1
C59071	5" NB	1

4" Over Pipe Fit Base with 3-1/2" Plastic Spuds

5" Round Cover

Fits Over 4" Schedule 40 DWV Pipe

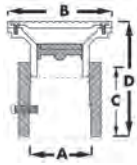

- Supplied with 3" IPS (3-1/2" OD) countersunk plug
- Covers available in PB and NB
- Covers are 3/16" thick
- Adjustable (see dimension D)

	A	B	C	D
Without ring	Over 4" Pipe	5-3/16"	4-1/4"	5-15/16" - 7-1/2"
With ring	Over 4" Pipe	5-1/2"	4-1/4"	6-1/16" - 7-5/8"

PVC

PART NO.	COVER	CTN QTY
C59208	5" PB	1
C59209	5" PB with ring	1
C59210	5" NB	1
C59211	5" NB with ring	1

ABS

PART NO.	COVER	CTN QTY
C59212	5" PB	1
C59213	5" PB with ring	1
C59214	5" NB	1
C59215	5" NB with ring	1

4" Over Pipe Fit Base with 3-1/2" Plastic Spuds

6" Round Cover

Fits Over 4" Schedule 40 DWV Pipe

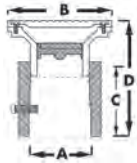

- Supplied with 3" IPS (3-1/2" OD) countersunk plug
- Covers available in PB and NB
- Covers are 3/16" thick
- Adjustable (see dimension D)

	A	B	C	D
Without ring	Over 4" Pipe	6-1/8"	4-1/4"	5-15/16" - 7-1/2"
With ring	Over 4" Pipe	6-1/2"	4-1/4"	6-1/16" - 7-5/8"

PVC

PART NO.	COVER	CTN QTY
C60001	6" PB	1
C60022	6" PB with ring	1
C60020	6" NB	1
C60024	6" NB with ring	1

ABS

PART NO.	COVER	CTN QTY
C60003	6" PB	1
C60023	6" PB with ring	1
C60021	6" NB	1
C60025	6" NB with ring	1

4" Over Pipe Fit Base with 3-1/2" Plastic Spuds

7" Square Cover

Fits Over 4" Schedule 40 DWV Pipe

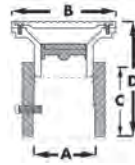

- Supplied with 3" IPS (3-1/2" OD) countersunk plug
- Covers available in PB and NB
- Covers are 3/16" thick
- Adjustable (see dimension D)

	A	B	C	D
Square	Over 4" Pipe	7"	4-1/4"	6-1/8" - 7-11/16"

PVC

PART NO.	COVER	CTN QTY
C60050	7" PB	1
C60052	7" NB	1

ABS

PART NO.	COVER	CTN QTY
C60051	7" PB	1
C60053	7" NB	1

4" Over Pipe Fit Base with 3-1/2" Metal Spuds

5" Round Cover

Fits Over 4" Schedule 40 DWV Pipe

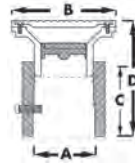

- Supplied with 3" IPS (3-1/2" OD) countersunk plug
- Covers available in PB and NB
- Covers are 3/16" thick
- Adjustable (see dimension D)

	A	B	C	D
Metal	Over 4" Pipe	5"	4-1/4"	6" - 7-1/16"

PVC

PART NO.	COVER	CTN QTY
C59064	5" PB	1
C59066	5" NB	1

ABS

PART NO.	COVER	CTN QTY
C59065	5" PB	1
C59067	5" NB	1

4" Over Pipe Fit Base with 4" Plastic Spuds

6" Round Cover

Fits Over 4" Schedule 40 DWV Pipe

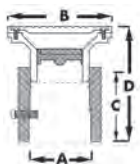

- Supplied with 3" IPS (3-1/2" OD) countersunk plug
- Covers available in PB and NB
- Covers are 3/16" thick
- Adjustable (see dimension D)

	A	B	C	D
Without ring	Over 4" Pipe	6"	4-3/4"	6-1/16" - 7-3/16"
With ring	Over 4" Pipe	6-1/8"	4-3/4"	6-1/8" - 7-1/4"

PVC

PART NO.	COVER	CTN QTY
C60070	6" PB	1
C60071	6" PB with ring	1
C60072	6" NB	1
C60073	6" NB with ring	1

ABS

PART NO.	COVER	CTN QTY
C60076	6" PB	1
C60077	6" PB with ring	1
C60078	6" NB	1
C60079	6" NB with ring	1

4" Over Pipe Fit Base with 4" Metal Spuds

5" or 6" Round Cover

Fits Over 4" Schedule 40 DWV Pipe

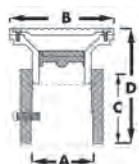

- 5" Supplied with 3" IPS (3-1/2" OD) countersunk plug
- 6" Supplied with 4" IPS plug
- Covers available in PB and NB
- Covers are 3/16" thick
- Adjustable (see dimension D)

	A	B	C	D
Metal	Over 4" Pipe	5"	4-3/4"	5" - 6"
Metal	Over 4" Pipe	6"	4-3/4"	5" - 6"

PVC

PART NO.	COVER	CTN QTY
C60082	5" NB	1
C60092	5" PB	1
C60094	6" NB	1
C60096	6" PB	1

ABS

PART NO.	COVER	CTN QTY
C60083	5" NB	1
C60095	6" NB	1
C60097	6" PB	1

4" Over Pipe Fit Base with 4" Plastic Spuds

7" Square Top

Fits Over 4" Schedule 40 DWV Pipe

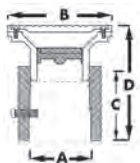

- Supplied with 3" IPS (3-1/2" OD) countersunk plug
- Covers available in PB and NB
- Covers are 3/16" thick
- Adjustable (see dimension D)

	A	B	C	D
Square	Over 4" Pipe	7"	4-3/4"	6-3/16" - 7-3/8"

PVC

PART NO.	COVER	CTN QTY
C60074	7" PB	1
C60075	7" NB	1

ABS

PART NO.	COVER	CTN QTY
C60080	7" PB	1
C60081	7" NB	1

3" Over Pipe Fit Base with 3" Plastic Spuds

6" Round Cover

Fits Over 3" Schedule 40 DWV Pipe

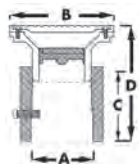

- Supplied with 2-1/2" IPS (3" OD) countersunk plug
- Covers are 3/16" thick
- Adjustable (see dimension D)

	A	B	C	D
Without ring	Over 3" Pipe	6-1/8"	4-1/2"	5-7/8" - 7-1/8"
With ring	Over 3" Pipe	6-1/2"	4-1/2"	6" - 7-3/16"

PVC

PART NO.	COVER	CTN QTY
C60026	6" PB	1
C60030	6" PB with ring	1
C60028	6" NB	1
C60032	6" NB with ring	1

ABS

PART NO.	COVER	CTN QTY
C60027	6" PB	1
C60031	6" PB with ring	1
C60029	6" NB	1
C60033	6" NB with ring	1

3" Over Pipe Fit Base with 3" Plastic Spuds

7" Square Top

Fits Over 3" Schedule 40 DWV Pipe

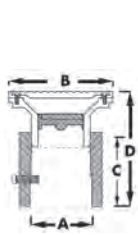

- Supplied with 2-1/2" IPS (3" OD) countersunk plug
- Covers are 3/16" thick
- Adjustable (see dimension D)

	A	B	C	D
Square	Over 3" Pipe	7"	4-1/2"	6" - 7-3/16"

PVC

PART NO.	COVER	CTN QTY
C60054	7" PB	1
C60056	7" NB	1

ABS

PART NO.	COVER	CTN QTY
C60055	7" PB	1
C60057	7" NB	1

3" Over Pipe Fit Base with 3" Metal Spuds

5" Round Cover

Fits Over 3" Schedule 40 DWV Pipe

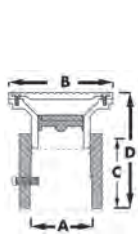

- Supplied with 2-1/2" IPS (3" OD) countersunk plug
- Covers are 3/16" thick
- Adjustable (see dimension D)

	A	B	C	D
Metal	Over 3" Pipe	5-3/16"	4-1/2"	5" - 6"

PVC

PART NO.	COVER	CTN QTY
C60086	5" PB	1
C60084	5" NB	1
C60088	5" CP	1

ABS

PART NO.	COVER	CTN QTY
C60087	5" PB	1
C60085	5" NB	1
C60089	5" CP	1

4" Inside Pipe Fit Base with 3" Plastic Spuds

6" Round Cover

Fits Inside 4" Schedule 40 DWV Pipe

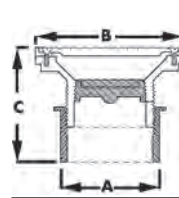

- Supplied with 3" IPS (3-1/2" OD) countersunk plug
- Covers available in PB and NB
- Covers are 3/16" thick
- Adjustable (see dimension D)

	A	B	C
Without ring	Inside 4" Pipe	6-1/8"	3-7/8" - 4-5/8"
With ring	Inside 4" Pipe	6-1/2"	4" - 4-3/4"

PVC

PART NO.	COVER	CTN QTY
C59020	6" PB	1
C59024	6" PB with ring	1
C59022	6" NB	1
C59026	6" NB with ring	1

ABS

PART NO.	COVER	CTN QTY
C59021	6" PB	1
C59025	6" PB with ring	1
C59023	6" NB	1
C59027	6" NB with ring	1

4" Inside Pipe Fit Base with 3" Plastic Spuds

7" Square Top

Fits Inside 4" Schedule 40 DWV Pipe

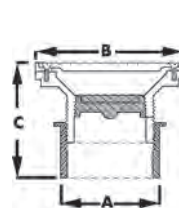

- Supplied with 3" IPS (3-1/2" OD) countersunk plug
- Covers available in PB and NB
- Covers are 3/16" thick
- Adjustable (see dimension D)

	A	B	C
Square	Inside 4" Pipe	7"	4" - 4-7/8"

PVC

PART NO.	COVER	CTN QTY
C59028	7" PB	1
C59030	7" NB	1

ABS

PART NO.	COVER	CTN QTY
C59029	7" PB	1
C59031	7" NB	1

4" Inside Pipe Fit Base with 3" Metal Spuds

5" Round Cover

Fits Inside 4" Schedule 40 DWV Pipe

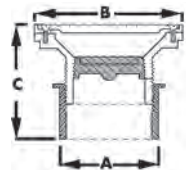

- Supplied with 3" IPS (3-1/2" OD) countersunk plug
- Covers available in PB, NB and CP
- Covers are 3/16" thick
- Adjustable (see dimension D)

	A	B	C
Metal	Inside 4" Pipe	5"	2-7/16" - 3-1/2"

PVC

PART NO.	COVER	CTN QTY
C59090	5" NB	1
C59092	5" PB	1
C59094	5" CP	1

ABS

PART NO.	COVER	CTN QTY
C59091	5" NB	1
C59093	5" PB	1
C59095	5" CP	1

2" x 3" Cleanouts w/2" Plastic Spud

4" Round Cover

Fits Over 2" or Inside 3" Schedule 40 DWV Pipe

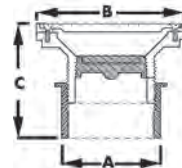

MADE IN THE
USA

- Supplied with 2" t-cone test plug installed
- Covers available in PB and NB

	A	B	C
Without ring	2"	4-1/4"	2-1/4"
With ring	2"	4-1/2"	2-3/8"

PVC

PART NO.	COVER	CTN QTY
C59096	4" PB	1
C59097	4" PB with ring	1
C59098	4" NB	1
C59099	4" NB with ring	1

ABS

PART NO.	COVER	CTN QTY
C59100	4" PB	1
C59101	4" PB with ring	1
C59102	4" NB	1
C59103	4" NB with ring	1

E

Round Slop Sinks

Fits Over 3" or Inside 4" Pipe

MADE IN THE USA

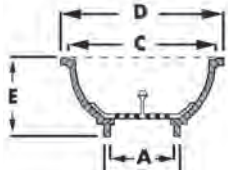

- 4-7/8" OD scoop strainer with stem for easy removal
- 12" diameter

A	B	C	D	E
3"	4"	11"	12"	6-3/8"

PART NO.	DESCRIPTION	CTN QTY
S55001	3" x 4" PVC sink and strainer	1
S55002	Replacement strainer	1

Floor Sinks

To Be Used with Coupling or Hub Kit

MADE IN THE USA

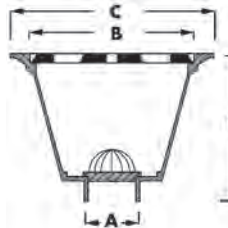

- 3/4" thick top grate in three styles
- 12" x 12" top flange

A	B	C	D
Inside 2" fitting	9-3/16"	12"	8"
Inside 3" fitting	9-3/16"	12"	8"
Inside 4" fitting	9-3/16"	12"	8"

PVC

PART NO.	DESCRIPTION	CTN QTY
S59002	2" sink only	1
S59003	3" sink only	1
S59004	4" sink only	1

ABS

PART NO.	DESCRIPTION	CTN QTY
S59302	2" sink only	1
S59303	3" sink only	1
S59304	4" sink only	1

Complete PVC Floor Sink Kits

MADE IN THE USA



- Includes sink, top grate and bottom strainer
- To be used with coupling or hub kit

PART NO.	DESCRIPTION	CTN QTY
S49042	2" – 1/2 top grate – dome bottom grate	1
S49052	2" – 3/4 top grate – dome bottom grate	1
S49062	2" – full top grate – dome bottom grate	1
S49072	2" – 1/2 top grate – flat bottom grate	1
S49082	2" – 3/4 top grate – flat bottom grate	1
S49092	2" – full top grate – flat bottom grate	1
S49043	3" – 1/2 top grate – dome bottom grate	1
S49053	3" – 3/4 top grate – dome bottom grate	1
S49063	3" – full top grate – dome bottom grate	1
S49073	3" – 1/2 top grate – flat bottom grate	1
S49083	3" – 3/4 top grate – flat bottom grate	1
S49093	3" – full top grate – flat bottom grate	1
S49044	4" – 1/2 top grate – dome bottom grate	1
S49054	4" – 3/4 top grate – dome bottom grate	1
S49064	4" – full top grate – dome bottom grate	1
S49074	4" – 1/2 top grate – flat bottom grate	1
S49084	4" – 3/4 top grate – flat bottom grate	1
S49094	4" – full top grate – flat bottom grate	1

Pipe Fit Floor Sinks

- 2" x 3" Fits Over 2" or Inside 3" Schedule 40 DWV Pipe
- 3" x 4" Fits Over 3" or Inside 4" Schedule 40 DWV Pipe
- 4" Fits Over 4" Schedule 40 DWV Pipe

MADE IN THE USA

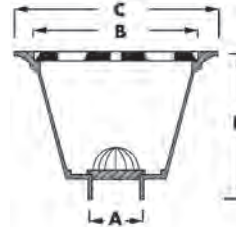

- 3/4" thick top grate in three styles
- 12" x 12" top flange
- Temp up to 180°

A	B	C	D
Over 2" Inside 3"	9-3/16"	12"	8"
Over 3" Inside 4"	9-3/16"	12"	8"
Over 4"	9-3/16"	12"	8"

PVC

PART NO.	DESCRIPTION	CTN QTY
S59102	2" x 3" sink only	1
S59103	3" x 4" sink only	1
S59104	4" sink only	1

ABS

PART NO.	DESCRIPTION	CTN QTY
S59402	2" x 3" sink only	1
S59403	3" x 4" sink only	1

Complete PVC Floor Sink Kits-Pipe Fit



• Includes sink, top grate and bottom strainer

PART NO.	DESCRIPTION	CTN QTY
S59042	2"x 3" - 1/2 top grate - dome bottom grate	1
S59052	2"x 3" - 3/4 top grate - dome bottom grate	1
S59062	2"x 3" - full top grate - dome bottom grate	1
S59072	2"x 3" - 1/2 top grate - flat bottom grate	1
S59082	2"x 3" - 3/4 top grate - flat bottom grate	1
S59092	2"x 3" - full top grate - flat bottom grate	1
S59043	3"x 4" - 1/2 top grate - dome bottom grate	1
S59053	3"x 4" - 3/4 top grate - dome bottom grate	1
S59063	3"x 4" - full top grate - dome bottom grate	1
S59073	3"x 4" - 1/2 top grate - flat bottom grate	1
S59083	3"x 4" - 3/4 top grate - flat bottom grate	1
S59093	3"x 4" - full top grate - flat bottom grate	1
S59044	4" - 1/2 top grate - dome bottom grate	1
S59054	4" - 3/4 top grate - dome bottom grate	1
S59064	4" - full top grate - dome bottom grate	1
S59074	4" - 1/2 top grate - flat bottom grate	1
S59084	4" - 3/4 top grate - flat bottom grate	1
S59094	4" - full top grate - flat bottom grate	1

Full Top Grate for Floor Sinks



• Accessories for all S49 and S59 series floor sinks

PVC		
PART NO.	DESCRIPTION	CTN QTY
S59010	Full top grate	10

ABS		
PART NO.	DESCRIPTION	CTN QTY
S59310	Full top grate	10

Three-Quarters Top Grate for Floor Sinks



• Accessories for all S49 and S59 series floor sinks

PVC		
PART NO.	DESCRIPTION	CTN QTY
S59011	3/4 top grate	10

ABS		
PART NO.	DESCRIPTION	CTN QTY
S59311	3/4 top grate	10

Half Top Grate for Floor Sinks



• Accessories for all S49 and S59 series floor sinks

PVC		
PART NO.	DESCRIPTION	CTN QTY
S59012	1/2 top grate	10

ABS		
PART NO.	DESCRIPTION	CTN QTY
S59312	1/2 top grate	10

Aluminum Dome Strainers for Floor Sinks



• Accessories for all S49 and S59 series floor sinks

PART NO.	DESCRIPTION	CTN QTY
S60002	2" aluminum dome bottom strainer	10
S60003	3" aluminum dome bottom strainer	10
S60004	4" aluminum dome bottom strainer	10

Flat Aluminum Bottom Strainer for Floor Sinks



• Accessories for all S49 and S59 series floor sinks

PART NO.	DESCRIPTION	CTN QTY
S60005	flat aluminum bottom strainer	10

Roof Drains w/Cast Iron Dome

Fits over Schedule 40 DWV Pipe



MADE IN THE
USA

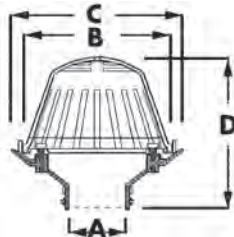

- Brass inserts in underside for underdeck clamps
- Dome has 50 square inches of free area

	A	B	C	D
Over 2" pipe	8-1/4"	11"	11"	9"
Over 3" pipe	8-1/4"	11"	11"	9"
Over 4" pipe	8-1/4"	11"	11"	9"
Over 6" pipe	8-1/4"	11"	11"	8"

PVC

PART NO.	DESCRIPTION	CTN QTY
R18001	2" cast iron dome	1
R18005	3" cast iron dome	1
R18006	4" cast iron dome	1
R18026	6" cast iron dome	1

ABS

PART NO.	DESCRIPTION	CTN QTY
R18009	2" cast iron dome	1
R18007	3" cast iron dome	1
R18008	4" cast iron dome	1

Accessories for Roof Drains

MADE IN THE
USA



PART NO.	DESCRIPTION	CTN QTY
R18011	2", 3" & 4" underdeck clamp	1
R18028	6" underdeck clamp	1
R18012	16" receiving pan	1
R18019	Plastic roof dome	1
R18020	Cast iron roof dome	1



Roof Drains w/Plastic Dome

Fits over Schedule 40 DWV Pipe



MADE IN THE
USA

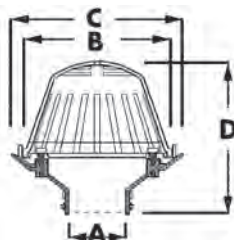

- Brass inserts in underside for underdeck clamps
- Dome has 50 square inches of free area

	A	B	C	D
Over 2" pipe	8-1/4"	11"	11"	8"
Over 3" pipe	8-1/4"	11"	11"	8"
Over 4" pipe	8-1/4"	11"	11"	8"
Over 6" pipe	8-1/4"	11"	11"	8"

PVC

PART NO.	DESCRIPTION	CTN QTY
R18013	2" plastic dome	1
R18014	3" plastic dome	1
R18015	4" plastic dome	1
R18027	6" plastic dome	1

ABS

PART NO.	DESCRIPTION	CTN QTY
R18016	2" plastic dome	1
R18017	3" plastic dome	1
R18018	4" plastic dome	1

SECTION F - CAST IRON

Closet Flanges & Accessories 250-251

Drain Bodies..... 252-253

Spuds & Strainers..... 254

Assembled Cast Iron Drains 255-262

Cleanout Bodies & Spuds..... 263-264

Cleanout Plugs 265-266

Cleanout Cover Plates..... 267

Assembled Cleanouts..... 268-270

Roof Drains..... 271

General Purpose Drains..... 272-273

Bell Traps..... 274

Floor & Cesspool Drains/Grates..... 275

Service Sinks & Accessories 276

Bar Grates/Sewer Strainers & Boxes 277

Vent Boxes/Caps/Backwater Valves 278

Test Tees & Closet Bends..... 279

Gas Burners/Log Lighter Valves/Accessories 280-281



The Exclusive Two Finger Flange

Patent #: 5,937,450



- Flush fit
- Redesigned to fit oblong horns
- Made of cast iron
- Pushes easily into cast iron or Schedule 40 DWV pipe
- No tear out or caulking required
- ASTM C-564 rubber gasket
- 3" x 2", 4" x 2" and 4" x 3": for areas with the bend close to the flange
- 3" x 4", 4" x 4" and 4" x 6": for areas without the bend close to the flange or broken pipe



PART NO.	DESCRIPTION	CTN QTY
C47320	3" x 2"	8
C47340	3" x 4"	4
C47420	4" x 2"	8
C47430	4" x 3"	4
C47440	4" x 4"	4
C47460	4" x 6"	2

Inside Caulk Closet Flange



- Notched and slotted
- Inside caulk connection



Service Weight

PART NO.	DESCRIPTION	CTN QTY
C41410	4" x 1"	10
C41411	4" x 1-1/2"	10
C41420	4" x 2"	8
C41421	4" x 2-1/2"	8
C41430	4" x 3"	6
C41440	4" x 4"	4
C41460	4" x 6"	2
Extra Heavy - 5" I.D. - NO BEAD		
C42421	4" x 2-1/2"	8
C42440	4" x 4"	4
C42460	4" x 6"	2

Inside Caulk Reducing Closet Flange



- Notched and slotted



PART NO.	DESCRIPTION	CTN QTY
C45433	4" inlet x 3" outlet x 3" depth	6

No Caulk Closet Flange w/Test Cap



- Slotted
- Stainless bolts and washers

PART NO.	DESCRIPTION	CTN QTY
C40425	4" x 2" No Caulk	8

"Code Blue" No Caulk Closet Flange



- Four stainless bolts and washers
- Neoprene gasket meets ASTM C564
- Ideal for both repair and new construction
- Easy to install- reduces installation time by 80%
- Push over cast iron or plastic pipe, anchor to floor and tighten bolts

Parts marked * are



PART NO.	DESCRIPTION	CTN QTY
C40320	3" pipe x 2" depth	8
C40420*	4" pipe x 2" depth	8
C40430*	4" pipe x 3" depth	4
C40440*	4" pipe x 4" depth	4

"Code Blue" No Caulk Closet Flange w/Test Cap



- Cut out neoprene test cap
- Stainless steel bolts



PART NO.	DESCRIPTION	CTN QTY
C40500	4" x 2"	8
C40503	3" x 3"	8

No Hub Closet Flange



- Notched and slotted

Parts marked * are



PART NO.	DESCRIPTION	CTN QTY
C46331*	3" x 3-1/2"	6
C46431	4" x 3-1/2"	6
C46351*	3" x 5-1/2"	6
C46451	4" x 5-1/2"	6

2" Offset Closet Flange



PART NO.	DESCRIPTION	CONNECTION	CTN QTY
C43440	4" x 4" x 2"	Inside Caulk	4
C43441	4" x 4" x 2"	No Hub	4

" Code Blue" 1" Offset Closet Flange



• 5/16" bolt slots



PART NO.	DESCRIPTION	CONNECTION	CTN QTY
C40640	4"	No Caulk	4

Four Way Offset Closet Flange



• 1-1/2" offset
• Internal clip allows 360° offset capability

PART NO.	DESCRIPTION	CONNECTION	CTN QTY
C44420	4" x 2"	Inside Caulk	8
C44440	4" x 4"	Inside Caulk	4

Brass Closet Flange



PART NO.	DESCRIPTION	CTN/MSTR
C49440	14 oz.	1/50
C49441	Deep seal 1-1/8"	1/40
C49442	16 oz.	1/50

Brass Four Way Offset Closet Flange



• Clip allows four way 1-1/2" offset
• For use with lead bends

PART NO.	DESCRIPTION	CTN/MSTR
C49421	4" x 2"	1/40

Closest Flange Repair Ring



• Securely attaches to concrete or wood sub-floor
• Replaces most closet rings
• Corrosion Resistant • Mounting ears offset by 1/8" to allow closet bolts to be installed

PART NO.	DESCRIPTION	CTN/MSTR
C85000	Closest flange repair ring	20/80

Gapper Flange



• Used to repair broken closet flanges
• Individually carded for easy display or bulk

PART NO.	DESCRIPTION	CTN/MSTR
C87100	Repair flange carded	24/240

Flange Support For Wood Floors



• Supports flange if floor has rotted or if rough-in hole is too large
• Easy to install- complete kit includes screws
• Cast iron fits 3" or 4" flange; plastic fits 3", 4" or 3" x 4" flange
• Individually carded

PART NO.	DESCRIPTION	CTN/MSTR
C01001	Flange support for plastic	1/50
C01002	Flange support for cast iron	1/50

Moss Bay Repair Flange



• For corroded and rusted toilet flanges
• Installs in minutes

PART NO.	DESCRIPTION	CTN/MSTR
C85500	Moss bay repair flange	1/50

Shower Drain Bodies w/Clamping Ring And Bolts



- Tongue and groove cast iron bolt down clamping ring
- Weep holes on both top and bottom for secondary drainage
- Inside caulk unit can be used with gasket to make unit no caulk
- For 2" IPS threaded tailpieces

PART NO.	SIZE	PAN	HEIGHT	CTN QTY
D60900	2" Inside Caulk	6-1/2"	2-1/2"	1
D60901	2" FIP	6-1/2"	2-1/2"	1
D60902	2" No Hub	6-1/2"	2-1/2"	1

"Code Blue" No Caulk (Mechanical Joint) Drain Bodies



- 1/2" Primer tapped with brass plug
- Supplied with stainless steel bolts
- Test plug included
- Tapped for 3-1/2" spud

PART NO.	SIZE	PAN	SPUD	HEIGHT	CTN QTY
D65002	2"	7"	3-1/2"	2-1/2"	1
D66002	2"	9"	3-1/2"	3-1/8"	1
D65003	3"	7"	3-1/2"	2-1/2"	1
D66003	3"	9"	3-1/2"	3-1/8"	1
D66004	4"	9"	3-1/2"	3-1/8"	1

Shower Drain Bodies w/Brass Threaded Clamping Ring

F



- Designed for lead pan showers
- Weep holes in clamping ring
- For 2" IPS threaded tailpieces

PART NO.	SIZE	PAN	HEIGHT	CTN QTY
D61800	2" FIP	6-3/8"	3-1/4"	1
D61801	2" No Hub	6-3/8"	3-1/4"	1
D61802	2" Inside Caulk	6-3/8"	3-1/4"	1

"Code Blue" No Hub Drain Bodies



- Tapped for 3-1/2" spud
- 1/2" Primer tapped with brass plug
- Supplied with stainless steel bolts

PART NO.	SIZE	PAN	SPUD	HEIGHT	CTN QTY
D65102	2"	7"	3-1/2"	2-1/2"	1
D66102	2"	9"	3-1/2"	3-1/8"	1
D65103	3"	7"	3-1/2"	2-1/2"	1
D66103	3"	9"	3-1/2"	3-1/4"	1
D65104	4"	7"	3-1/2"	2-1/2"	1
D66104	4"	9"	3-1/2"	3-1/8"	1

Heavy Duty Drain Bodies



- For use with heavy duty floor drains
- For 3-1/2" IPS threaded tailpieces

PART NO.	SIZE	PAN	HEIGHT	CTN QTY
D80097	3" No Hub	10-1/2"	3-1/2"	1
D80099	3" Inside Caulk	10-1/2"	3-1/2"	1
D80090	3" No Hub; 1/2 PT	10-1/2"	3-1/2"	1
D80096	4" No Hub	10-1/2"	3-1/2"	1
D80098	4" Inside Caulk	10-1/2"	3-1/2"	1
D80091	4" No Hub; 1/2 PT	10-1/2"	3-1/2"	1

"Code Blue" IPS Drain Bodies



- Tapped for 3-1/2" spud
- 1/2" Primer tapped with brass plug
- Supplied with stainless steel bolts

PART NO.	SIZE	PAN	SPUD	HEIGHT	CTN QTY
D65202	2"	7"	3-1/2"	2-1/2"	1
D66202	2"	9"	3-1/2"	3-1/8"	1
D65203	3"	7"	3-1/2"	2-1/2"	1
D66203	3"	9"	3-1/2"	3-1/8"	1
D66204	4"	9"	3-1/2"	3-1/8"	1

"Code Blue" No Caulk (Mechanical Joint) Slab Drain Bodies



- 1/2" Primer tap
- Less clamping ring
- Tapped for 3-1/2" spud

PART NO.	SIZE	PAN	SPUD	HEIGHT	CTN QTY
D67201	2"	7"	3-1/2"	3-3/8"	1

"Code Blue" No Hub Slab Drain Bodies



- Tapped for 3-1/2" spud
- 1/2" Primer tapped with brass plug
- Less clamping ring

PART NO.	SIZE	PAN	SPUD	HEIGHT	CTN QTY
D67200	2"	7"	3-1/2"	3-3/8"	1
D67300	3"	7"	3-1/2"	3-3/8"	1
D67400	4"	7"	3-1/2"	3-3/8"	1

"Code Blue" Push-On Drain Bodies



- Tapped for 3-1/2" spud
- 1/2" Primer tapped with brass plug
- Supplied with stainless steel bolts
- For PVC connections, you must replace with extra heavy Dual Tite gaskets

PART NO.	SIZE	PAN	SPUD	HEIGHT	CTN QTY
D66200	2"	9"	3-1/2"	3-3/4"	1
D66300	3"	9"	3-1/2"	3-3/4"	1
D66400	4"	9"	3-1/2"	3-3/4"	1

No Hub Base



- Use with CI strainers or covers for heavy trucking traffic
- Use with PB, NB, SS or CP strainers or covers for heavy pedestrian traffic

NOTE: 3" No hub will receive a 2" multi-tite gasket and therefore becomes a 2" push-on body. 4" No hub will receive a 3" multi-tite gasket.

PART NO.	NO HUB BASE x SPUD	HEIGHT	CTN QTY
D63300	3"x 3" IPS	4-1/4"	1
D63349	3"x 3-1/2" IPS	4-1/4"	1
D63350	4"X 3-1/2" IPS	4-1/4"	1
D63400	4"x 4" IPS	4-1/4"	1

Gasket Connection Base



- Supplied with Multi-Tite gasket
- Use with CI strainers or covers for heavy trucking traffic
- Use with PB, NB, SS or CP strainers or covers for heavy pedestrian traffic

PART NO.	S.V. BASE x SPUD	HEIGHT	CTN QTY
D62300	3"x 3" IPS	5-1/4"	1
D62349	3"x 3-1/2" IPS	5-1/4"	1
D62350	4"x 3-1/2" IPS	5-1/2"	1
D62400	4"x 4" IPS	5-1/2"	1

3-1/2" Spud Extension



- 2-1/2"-4" extension for a 3-1/2 drain/ cleanout spud
- Use on cast iron or PVC drain bodies when additional height is needed to offset inconsistent concrete pours

PART NO.	DESCRIPTION	CTN QTY
D60979	3-1/2" Spud Extension	1

Cast Iron Spuds w/Strainers For Heavy Duty Drain Bodies



- For use with heavy duty floor drains

2-1/2" IPS threaded throat for testing w/round strainer

PART NO.	SPUD	STRAINER	CTN QTY
D62130	3" IPS	4-9/16" CI	1
D62131	3" IPS	5" NB with ring	1
D62132	3" IPS	5" PB with ring	1

3" IPS threaded throat for testing with round strainer

PART NO.	SPUD	STRAINER	CTN QTY
D62135	3-1/2" IPS	5-1/2" CI	1
D62136	3-1/2" IPS	6" NB with ring	1
D62137	3-1/2" IPS	6" PB with ring	1

3-1/2" IPS threaded throat for testing w/round strainer

PART NO.	SPUD	STRAINER	CTN QTY
D62140	4" IPS	5-1/2" CI	1
D62141	4" IPS	6" NB with ring	1
D62142	4" IPS	6" PB with ring	1

Plastic Spuds w/Square Strainers & Tops for Heavy Duty Drain Bodies



- For use with heavy duty floor drains
- 5" round cover with 7" square top

PART NO.	SPUD	STRAINER	CTN QTY
D56500	3" IPS	PB	1
D56501	3" IPS	NB	1
D56502	3-1/2" IPS	PB	1
D56503	3-1/2" IPS	NB	1
D56504	4" IPS	PB	1
D56505	4" IPS	NB	1

Metal Spuds w/Strainers For Drain Bodies



- For use with floor drains

IPS Spud w/Round Strainer				
PART NO.	SIZE	STRAINER	SCREWS	CTN/MSTR
D60980	2"	4" SS stamped	2 (3-3/8")	1/50
D60981	2"	4" Chrome cast	2 (3-3/8")	1/50
D60982	2"	4" PB cast	2 (3-3/8")	1/50
D60970	2"	6" CP	2 (5")	1/30
D60975	2"	6" PB	2 (5")	1/30
D60955	3"	5" NB	3 (3-7/8")	1/30
D60956	3"	5" PB	3 (3-7/8")	1/30
D60986	3-1/2"	4" NB	2 (3-1/4")	1/40
D60987	3-1/2"	4" PB	2 (3-1/4")	1/40
D60990	3-1/2"	5" CP	3 (3-7/8")	1/40
D60991	3-1/2"	5" PB	3 (3-7/8")	1/40
D60996	3-1/2"	5" NB	3 (3-7/8")	1/40
D60997	3-1/2"	6" NB	3 (4-3/4")	1/20
D60992	3-1/2"	6" CP	2 (5")	1/20
D60993	3-1/2"	6" PB	2 (5")	1/20
D60994	3-1/2"	8" CP	4 (6-3/4")	1/10
D60995	3-1/2"	8" PB	4 (6-3/4")	1/10
D60998	3-1/2"	8" NB	4 (6-3/4")	1/10
D60989	3-1/2"	9" PB	4 (7-5/8")	1/12
D60999	3-1/2"	9" NB	4 (7-5/8")	1/12
D60958	4"	5" NB	3 (3-7/8")	1/30
D60959	4"	5" PB	3 (3-7/8")	1/30

3-1/2" IPS Metal Spud



PART NO.	SPUD	STRAINER	CTN/MSTR
D60986	3-1/2"	4" NB	1/40
D60987	3-1/2"	4" PB	1/40
Replacement Strainer			
D60966	Replacement Strainer for D60-986		50
D60967	Replacement Strainer for D60-987		100

Metal Spuds w/Strainers For Drain Bodies



- For use with floor drains

IPS Spud w/Square Strainer				
PART NO.	SIZE	STRAINER	SCREWS	CTN/MSTR
D60954	3-1/2"	5" CP	4 (3-7/8")	1/20
D60960	3-1/2"	5" PB	4 (3-7/8")	1/20
D60962	3-1/2"	5" NB	4 (3-7/8")	1/20
D60961	3-1/2"	6" PB	4 (4-7/8")	1/12
D60963	3-1/2"	6" NB	4 (4-7/8")	1/12

Funnels



- Vandal-proof installation
- Fits virtually any floor/ shower drain
- Funnel tapped for 10-24 screws which are supplied with washers

PART NO.	DESCRIPTION	CTN/MSTR
F65400	4" Funnel	1
F65600	6" Funnel	1/18

"Code Blue" EZ Test Shower Drains



- Includes cover plate and stainless steel screws

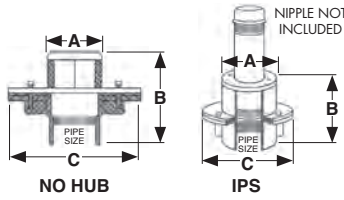

PIPE SIZE	A	B	C
1-1/2"	3-1/2"	4-1/4"	6"
2"	3-1/2"	4-1/4"	7"

PART NO.	SIZE	BASE	STRAINER	CTN/MSTR
D64150	1-1/2" IPS	6"	SS	1/4
D64202	2" IPS	6"	SS	1/4
D64012*	2" IPS	7"	SS	1/4
D64302*	2" No hub	6"	SS	1/4

"Code Blue" Roman Tub Drains



- 6" and 7" pans
- Non-adjustable
- Polished chrome, polished brass and satin nickel finishes with PVD protective finish

PART NO.	SIZE	BASE	FINISH	CTN QTY
D64800	2" IPS	7"	CP	1
D64801	2" No Caulk	7"	CP	1
D64802	2" IPS	6"	CP	1
D64803	2" No Caulk	6"	CP	1
D64804	2" IPS	7"	PB	1
D64805	2" No Caulk	7"	PB	1
D64806	2" IPS	6"	PB	1
D64807	2" No Caulk	6"	PB	1
D64808	2" IPS	7"	SN	1
D64809	2" No Caulk	7"	SN	1
D64810	2" IPS	6"	SN	1
D64811	2" No Caulk	6"	SN	1

"Code Blue" Shower Drains



- Includes cover plate and stainless steel screws
- No caulk includes built-in test plug

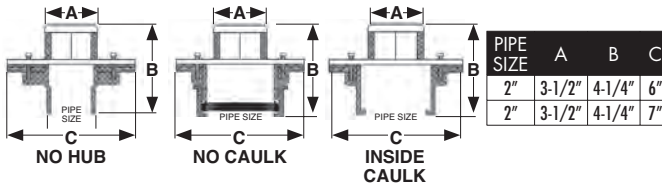

PIPE SIZE	A	B	C
2"	3-1/2"	4-1/4"	6"
2"	3-1/2"	4-1/4"	7"

PART NO.	SIZE	BASE	STRAINER	CTN/MSTR
D64502	2" No Caulk	6"	SS	1/4
D64002*	2" No Caulk	7"	SS	1/4
D64402	2" Inside Caulk	6"	SS	1/4
D64402G	D64-402 + Gasket	6"	SS	1/4
D64022*	2" No Hub	7"	SS	1/4

"Code Blue" Replacement Strainers



- Roman tub drains
- Fits non-adjustable "Code Blue" drains

PART NO.	DESCRIPTION	CTN/MSTR
D40000	Chrome plated	1/50
D40001	PB/PVD	1/50
D40002	Satin Nickel/PVD	1/50



- Regular Strainers
- Fits non-adjustable "Code Blue" drains
- Will not fit D64010 or D64011

PART NO.	DESCRIPTION	CTN/MSTR
D64000	2" SS	1
D64401	SS Crown	1
D64001	2" PB/PVD	1/100
D6400BN	Brushed Nickel	1/250
D6400RB	Oil Rubbed Bronze	1/250
D6400WB	Old World Bronze	1/250

"Code Blue" Non-Adjustable Drain



- With ABS base and cast iron top

PART NO.	TOP	BASE	CTN/MSTR
D64010	Cast Iron	ABS Base	1/4
D64011 (with test cap)	Cast Iron	ABS Base	1/4

2" Shower and Floor Drains



- Tongue and groove cast iron bolt down clamping ring
- Weep holes on both top and bottom for secondary drainage
- Inside caulk unit can be used with gasket to make unit no-caulk

2" IPS Brass Spud with 4" Round Strainer

PART NO.	SIZE	PAN	STRAINER	CTN	QTY
D60100	2" Inside Caulk	6-1/2"	SS	8	
D60102	2" FIP	6-1/2"	SS	8	
D60103	2" No Hub	6-1/2"	SS	8	
D60101	2" Gasket for inside caulk unit			1	

2" IPS Brass Spud with 4" Cast Brass Round Strainer

PART NO.	SIZE	PAN	STRAINER	CTN	QTY
D60201	2" Inside Caulk	6-1/2"	CP	8	
D60202	2" Inside Caulk	6-1/2"	PB	8	
D60203	2" FIP	6-1/2"	CP	8	
D60204	2" FIP	6-1/2"	PB	8	
D60205	2" No Hub	6-1/2"	CP	8	
D60206	2" No Hub	6-1/2"	PB	8	

2" IPS Brass Spud with 6" Cast Round Strainer

PART NO.	SIZE	PAN	STRAINER	CTN	QTY
D60211	2" Inside Caulk	6-1/2"	CP	1	
D60212	2" Inside Caulk	6-1/2"	PB	1	
D60207	2" FIP	6-1/2"	CP	1	
D60208	2" FIP	6-1/2"	PB	1	
D60209	2" No Hub	6-1/2"	CP	1	
D60210	2" No Hub	6-1/2"	PB	1	

2" IPS Brass Spud with 4" Cast Square Strainer

PART NO.	SIZE	PAN	STRAINER	CTN	QTY
D60400	2" Inside Caulk	6-1/2"	CP	1	
D60410	2" Inside Caulk	6-1/2"	PB	1	
D60402	2" FIP	6-1/2"	CP	1	
D60412	2" FIP	6-1/2"	PB	1	
D60403	2" No Hub	6-1/2"	CP	1	
D60413	2" No Hub	6-1/2"	PB	1	
D60499	2" Inside Caulk Push On	6-1/2"	CP	1	
D60498	2" Inside Caulk Push On	6-1/2"	PB	1	

2" Shower Drains With Brass Threaded Clamping Ring



- Designed for lead pan showers
- Weep holes in clamping ring

2" IPS Brass Spud With 4" Round Strainer

PART NO.	SIZE	PAN	STRAINER	CTN	QTY
D61101	2" IPS	6-1/2"	SS	4	
D61102	2" No Hub	6-1/2"	SS	4	
D61103	2" Inside Caulk	6-1/2"	SS	4	

2" IPS Brass Spud With 4" Cast Brass Round Strainer

PART NO.	SIZE	PAN	STRAINER	CTN	QTY
D61201	2" IPS	6-1/2"	CP	4	
D61202	2" No Hub	6-1/2"	CP	4	
D61203	2" Inside Caulk	6-1/2"	CP	4	

2" IPS Brass Spud With 6" Cast Brass Round Strainer

PART NO.	SIZE	PAN	STRAINER	CTN	QTY
D61301	2" IPS	6-1/2"	PB	4	
D61302	2" No Hub	6-1/2"	PB	4	
D61303	2" Inside Caulk	6-1/2"	PB	4	
D61850	Brass screw-down clamping ring			1	

F

2" "Code Blue" No Caulk (Mechanical Joint) Floor Drains



- 1/2" Primer tapped with brass plug
- Supplied with stainless steel bolts

3 1/2" IPS Spuds With 4", 5", or 6" Round Strainer

PART NO.	SIZE	PAN	STRAINER	HEIGHT	CTN QTY
D65661	2"	7"	4" NB	4" - 4 13/16"	1
D65662	2"	7"	4" PB	4" - 4 13/16"	1
D66681	2"	9"	4" NB	4" - 4 13/16"	1
D66682	2"	9"	4" PB	4" - 4 13/16"	1
D65500	2"	7"	5" NB	4" - 5"	1
D65501	2"	7"	5" PB	4" - 5"	1
D65502	2"	7"	5" CP	4" - 5"	1
D66500	2"	9"	5" NB	4" - 5"	1
D66501	2"	9"	5" PB	4" - 5"	1
D66502	2"	9"	5" CP	4" - 5"	1
D65503	2"	7"	6" NB	4 1/4" - 5 1/4"	1
D65504	2"	7"	6" PB	4 1/4" - 5 1/4"	1
D65505	2"	7"	6" CP	4 1/4" - 5 1/4"	1
D66503	2"	9"	6" NB	4 1/4" - 5 1/4"	1
D66504	2"	9"	6" PB	4 1/4" - 5 1/4"	1
D66505	2"	9"	6" CP	4 1/4" - 5 1/4"	1

3 1/2" IPS Spuds with 5" or 6" Square Strainer

PART NO.	SIZE	PAN	STRAINER	HEIGHT	CTN QTY
D65509	2"	7"	5" NB	4 1/4" - 5 1/4"	1
D65511	2"	7"	5" PB	4 1/4" - 5 1/4"	1
D66509	2"	9"	5" NB	4 1/4" - 5 1/4"	1
D66511	2"	9"	5" PB	4 1/4" - 5 1/4"	1
D65510	2"	7"	6" NB	4 1/4" - 5 1/4"	1
D65512	2"	7"	6" PB	4 1/4" - 5 1/4"	1
D66510	2"	9"	6" NB	4 1/4" - 5 1/4"	1
D66512	2"	9"	6" PB	4 1/4" - 5 1/4"	1

2" "Code Blue" (Mechanical Joint) No Caulk Slab Drain



- No Clamping Ring

3 1/2" Spud With 4", 5" or 6" Round Strainer

PART NO.	SIZE	PAN	STRAINER	HEIGHT	CTN QTY
D67001	2"	7"	4" NB	3 3/4" - 4 3/4"	1
D67002	2"	7"	4" PB	3 3/4" - 4 3/4"	1
D67003	2"	7"	5" NB	3 3/4" - 4 7/8"	1
D67004	2"	7"	5" PB	4" - 5 3/8"	1
D67005	2"	7"	5" CP	3 1/2" - 4 7/8"	1
D67006	2"	7"	6" NB	3 3/4" - 5 1/8"	1
D67007	2"	7"	6" PB	3 3/4" - 5 1/8"	1
D67008	2"	7"	6" CP	4" - 5 1/2"	1

2" "Code Blue" No Hub Floor Drain



- 1/2" Primer tapped with brass plug
- Supplied with stainless steel bolts

3 1/2" IPS Spuds with 4", 5" or 6" Round Strainer

PART NO.	SIZE	PAN	STRAINER	HEIGHT	CTN QTY
D66675	2"	9"	4" NB	3 3/4" - 4 5/8"	1
D66676	2"	9"	4" PB	3 3/4" - 4 5/8"	1
D65655	2"	7"	4" NB	3 3/4" - 4 7/16"	1
D65656	2"	7"	4" PB	3 3/4" - 4 7/16"	1
D65560	2"	7"	5" NB	2 7/8" - 4 1/2"	1
D65561	2"	7"	5" PB	2 7/8" - 4 1/2"	1
D65562	2"	7"	5" CP	2 7/8" - 4 1/2"	1
D66560	2"	9"	5" NB	3 1/2" - 5 1/8"	1
D66561	2"	9"	5" PB	3 1/2" - 5 1/8"	1
D66562	2"	9"	5" CP	3 1/2" - 5 1/8"	1
D65563	2"	7"	6" NB	4" - 5 1/4"	1
D65564	2"	7"	6" PB	4" - 5 1/4"	1
D65565	2"	7"	6" CP	4" - 5 1/4"	1
D66563	2"	9"	6" NB	3 5/8" - 5 5/8"	1
D66564	2"	9"	6" PB	3 5/8" - 5 5/8"	1
D66565	2"	9"	6" CP	3 5/8" - 5 5/8"	1

3 1/2" IPS Spuds with 5" or 6" Square Strainer

PART NO.	SIZE	PAN	STRAINER	HEIGHT	CTN QTY
D65569	2"	7"	5" NB	3 1/4" - 5 1/4"	1
D65571	2"	7"	5" PB	3 1/4" - 5 1/4"	1
D66569	2"	9"	5" NB	3 7/8" - 5 7/8"	1
D66571	2"	9"	5" PB	3 7/8" - 5 7/8"	1
D65570	2"	7"	6" NB	4" - 5 1/4"	1
D65572	2"	7"	6" PB	4" - 5 1/4"	1
D66570	2"	9"	6" NB	4 1/8" - 6 3/8"	1
D66572	2"	9"	6" PB	4 1/8" - 6 3/8"	1

2" "Code Blue" No Hub Slab Drain



- No Clamping Ring

3 1/2" Spud with 4", 5" or 6" Round Strainer

PART NO.	SIZE	PAN	STRAINER	HEIGHT	CTN QTY
D67016	2"	7"	4" NB	3 5/8" - 4 3/4"	1
D67017	2"	7"	4" PB	3 5/8" - 4 3/4"	1
D67018	2"	7"	5" NB	3 1/2" - 4 7/8"	1
D67019	2"	7"	5" PB	4" - 5 3/8"	1
D67020	2"	7"	5" CP	3 1/2" - 4 7/8"	1
D67021	2"	7"	6" NB	3 7/8" - 5"	1
D67022	2"	7"	6" PB	3 3/4" - 5"	1
D67023	2"	7"	6" CP	4" - 5 3/8"	1

3 1/2" Spud with 5" or 6" Square Strainer

PART NO.	SIZE	PAN	STRAINER	HEIGHT	CTN QTY
D67027	2"	7"	5" NB	3 3/4" - 5 1/8"	1
D67028	2"	7"	5" PB	3 3/4" - 5 1/8"	1
D67029	2"	7"	6" NB	4" - 5 3/16"	1
D67030	2"	7"	6" PB	4" - 5 3/16"	1

2" "Code Blue" IPS Floor Drain



- 1/2" Primer tapped with brass plug
- Supplied with stainless steel bolts

3 1/2" IPS Spuds with 4", 5" or 6" Round Strainer

PART NO.	SIZE	PAN	STRAINER	HEIGHT	CTN QTY
D66687	2"	9"	4" NB	3 1/4" - 4"	1
D66688	2"	9"	4" PB	3 1/4" - 4"	1
D65665	2"	7"	4" NB	3 3/16" - 4 3/16"	1
D65620	2"	7"	5" NB	2 7/8" - 4 1/2"	1
D65621	2"	7"	5" PB	2 7/8" - 4 1/2"	1
D65622	2"	7"	5" CP	2 7/8" - 4 1/2"	1
D66620	2"	9"	5" NB	3 1/2" - 5 1/8"	1
D66621	2"	9"	5" PB	3 1/2" - 5 1/8"	1
D66622	2"	9"	5" CP	3 1/2" - 5 1/8"	1
D65623	2"	7"	6" NB	3 1/2" - 4 1/2"	1
D65624	2"	7"	6" PB	3 1/2" - 4 1/2"	1
D65625	2"	7"	6" CP	3 1/2" - 4 1/2"	1
D66623	2"	9"	6" NB	3 5/8" - 5 5/8"	1
D66624	2"	9"	6" PB	3 5/8" - 5 5/8"	1
D66625	2"	9"	6" CP	3 5/8" - 5 5/8"	1

2" "Code Blue" Push-On Floor Drain



- With Clamping Ring
- Supplied with V96-002 gasket for 2" cast iron pipe

3 1/2" Stud with 4", 5" or 6" Round Strainer

PART NO.	SIZE	PAN	STRAINER	HEIGHT	CTN QTY
D66700	2"	9"	4" NB	4 5/8" - 5 1/2"	1
D66701	2"	9"	4" PB	4 5/8" - 5 1/2"	1
D66702	2"	9"	5" NB	4 5/8" - 5 1/2"	1
D66703	2"	9"	5" PB	5 3/16" - 6 1/8"	1
D66704	2"	9"	5" CP	4 3/4" - 5 1/2"	1
D66705	2"	9"	6" NB	4 7/8" - 5 3/4"	1
D66706	2"	9"	6" PB	4 7/8" - 5 3/4"	1
D66707	2"	9"	6" CP	5 1/4" - 6 1/4"	1

Bronze Shower Drains



- Heavy bronze body
- Suitable for residential and commercial installation
- 4-1/2" strainers in stainless steel or PVD polished brass
- Solid bronze strainer spuds in standard (1-1/2") or extra long (2-1/2") length
- 3 types of 2" connections

2" IPS Drain

PART NO.	SPUD	STRAINER	CTN QTY
D68510	Standard	SS	1
D68511	Standard	PB	1
D68512	Long Pattern	SS	1
D68513	Long Pattern	PB	1

2" Caulk Drain

PART NO.	SPUD	STRAINER	CTN QTY
D68610	Standard	SS	1
D68611	Standard	PB	1
D68612	Long Pattern	SS	1
D68613	Long Pattern	PB	1

2" Sweat Drain

PART NO.	SPUD	STRAINER	CTN QTY
D68710	Standard	SS	1
D68711	Standard	PB	1
D68712	Long Pattern	SS	1
D68713	Long Pattern	PB	1

Replacement Strainers

PART NO.	DESCRIPTION	CTN/MSTR
D68507	4 1/2" SS strainer with screws	100/400
D68508	4 1/2" PVD PB strainer with screws	100/400

3" Heavy Duty No Hub Floor/ Shower Drain



- Cast metal strainer and tailpiece
- Cast iron body

3 1/2" IPS Spuds with 5" or 6" Round Strainer

PART NO.	SIZE	PAN	STRAINER	HEIGHT	CTN QTY
D80200	3"	10"	5" CP	4 1/2" - 6 1/2"	1
D80201	3"	10"	5" PB	4 1/2" - 6 1/2"	1
D80212	3"	10"	5" NB	4 1/2" - 6 1/2"	1
D80202	3"	10"	6" CP	4 1/2" - 6 1/2"	1
D80203	3"	10"	6" PB	4 1/2" - 6 1/2"	1
D80213	3"	10"	6" NB	4 1/2" - 6 1/2"	1

3 1/2" IPS Spuds with 5" or 6" Square Strainer

PART NO.	SIZE	PAN	STRAINER	HEIGHT	CTN QTY
D80214	3"	10"	5" PB	4 1/2" - 6 1/2"	1
D80216	3"	10"	5" NB	4 1/2" - 6 1/2"	1
D80215	3"	10"	6" PB	4 1/2" - 6 1/2"	1
D80217	3"	10"	6" NB	4 1/2" - 6 1/2"	1

3" Heavy Duty Inside Caulk Floor/ Shower Drain



- Cast metal strainer and tailpiece
- Cast iron body

3 1/2" IPS Spud with 5", 6" or 8" Round Strainer

PART NO.	SIZE	PAN	STRAINER	HEIGHT	CTN QTY
D80100	3"	10"	5" CP	4 1/2" - 6 1/2"	1
D80101	3"	10"	5" PB	4 1/2" - 6 1/2"	1
D80112	3"	10"	5" NB	4 1/2" - 6 1/2"	1
D80102	3"	10"	6" CP	4 3/4" - 6 3/4"	1
D80103	3"	10"	6" PB	4 3/4" - 6 3/4"	1
D80113	3"	10"	6" NB	4 3/4" - 6 3/4"	1

3" "Code Blue" No Caulk (Mechanical Joint) Floor Drain



- 1/2" Primer tapped with brass plug
- Supplied with stainless steel bolts



3 1/2" IPS Spuds with 4", 5" or 6" Round Strainer

PART NO.	SIZE	PAN	STRAINER	HEIGHT	CTN QTY
D66683	3"	9"	4" NB	4" - 4 3/4"	1
D66684	3"	9"	4" PB	4" - 4 3/4"	1
D65663	3"	7"	4" NB	4" - 4 13/16"	1
D65664	3"	7"	4" PB	4" - 4 13/16"	1
D65520	3"	7"	5" NB	2 7/8" - 4 1/2"	1
D65521	3"	7"	5" PB	2 7/8" - 4 1/2"	1
D65522	3"	7"	5" CP	2 7/8" - 4 1/2"	1
D66520	3"	9"	5" NB	3-1/2" - 5-1/8"	1
D66521	3"	9"	5" PB	3-1/2" - 5-1/8"	1
D66522	3"	9"	5" CP	3-1/2" - 5-1/8"	1
D65523	3"	7"	6" NB	3" - 5"	1
D65524	3"	7"	6" PB	3" - 5"	1
D65525	3"	7"	6" CP	3" - 5"	1
D66523	3"	9"	6" NB	3-5/8" - 5-5/8"	1
D66524	3"	9"	6" PB	3-5/8" - 5-5/8"	1
D66525	3"	9"	6" CP	3-5/8" - 5-5/8"	1

3" "Code Blue" No Hub Slab Drain



- No Clamping Ring

3 1/2" Spud with 4", 5", 6", 8" or 9" Round Strainer

PART NO.	SIZE	PAN	STRAINER	HEIGHT	CTN QTY
D67031	3"	7"	4" NB	3 1/2" - 4 3/4"	1
D67032	3"	7"	4" PB	3 1/2" - 4 3/4"	1
D67033	3"	7"	5" NB	3 1/2" - 4 13/16"	1
D67034	3"	7"	5" PB	4" - 5 5/16"	1
D67035	3"	7"	5" CP	3 1/2" - 4 13/16"	1
D67036	3"	7"	6" NB	3 3/4" - 5"	1
D67037	3"	7"	6" PB	3 3/4" - 5"	1
D67038	3"	7"	6" CP	4" - 5 3/8"	1
D67039	3"	7"	8" NB	4 1/8" - 5 5/8"	1
D67040	3"	7"	8" PB	4 1/8" - 5 5/8"	1
D67041	3"	7"	8" CP	4 1/4" - 5 5/8"	1
D67042	3"	7"	9" NB	4 1/4" - 5 5/8"	1
D67043	3"	7"	9" PB	4 1/4" - 5 5/8"	1

3 1/2" Spud With 5" or 6" Square Strainer

PART NO.	SIZE	PAN	STRAINER	HEIGHT	CTN QTY
D67044	3"	7"	5" NB	3 3/4" - 5 1/16"	1
D67045	3"	7"	5" PB	3 7/8" - 5 1/16"	1
D67046	3"	7"	6" NB	4" - 5 1/4"	1
D67047	3"	7"	6" PB	4" - 5 1/4"	1

3" "Code Blue" No Hub Floor Drain



- 1/2" Primer tapped with brass plug
- Supplied with stainless steel bolts

3 1/2" IPS Spuds With 4", 5" or 6" Round Strainer

PART NO.	SIZE	PAN	STRAINER	HEIGHT	CTN QTY
D65657	3"	7"	4" NB	3 3/4" - 4 7/16"	1
D65658	3"	7"	4" PB	3 3/4" - 4 7/16"	1
D66677	3"	9"	4" NB	3 3/4" - 4 5/8"	1
D66678	3"	9"	4" PB	3 3/4" - 4 5/8"	1
D65580	3"	7"	5" NB	2 7/8" - 4 1/2"	1
D65581	3"	7"	5" PB	2 7/8" - 4 1/2"	1
D65582	3"	7"	5" CP	2 7/8" - 4 1/2"	1
D66580	3"	9"	5" NB	3 1/2" - 5 1/8"	1
D66581	3"	9"	5" PB	3 1/2" - 5 1/8"	1
D66582	3"	9"	5" CP	3 1/2" - 5 1/8"	1
D65583	3"	7"	6" NB	3" - 5"	1
D65584	3"	7"	6" PB	3" - 5"	1
D65585	3"	7"	6" CP	3" - 5"	1
D66583	3"	9"	6" NB	3 5/8" - 5 5/8"	1
D66584	3"	9"	6" PB	3 5/8" - 5 5/8"	1
D66585	3"	9"	6" CP	3 5/8" - 5 5/8"	1

3" "Code Blue" Push-On Floor Drain



- With Clamping Ring
- Supplied with V96-003 gasket for 3" cast iron pipe

3 1/2" Spuds with 4", 5" or 6" Round Strainer

PART NO.	SIZE	PAN	STRAINER	HEIGHT	CTN QTY
D66715	3"	9"	4" NB	4 3/4" - 5 5/8"	1
D66716	3"	9"	4" PB	4 3/4" - 5 5/8"	1
D66717	3"	9"	5" NB	4 3/4" - 5 5/8"	1
D66718	3"	9"	5" PB	5 3/8" - 6 1/4"	1
D66719	3"	9"	5" CP	4 3/4" - 5 5/8"	1
D66720	3"	9"	6" NB	5" - 6"	1
D66721	3"	9"	6" PB	5" - 6"	1
D66722	3"	9"	6" CP	5 3/8" - 6 3/8"	1

3" "Code Blue" IPS Floor Drain



- 1/2" Primer tapped with brass plug
- Supplied with stainless steel bolts

3 1/2" IPS Spuds with 4", 5" or 6" Round Strainer

PART NO.	SIZE	PAN	STRAINER	HEIGHT	CTN QTY
D66689	3"	9"	4" NB	3 1/4" x 4"	1
D66690	3"	9"	4" PB	3 1/4" x 4"	1
D65667	3"	7"	4" NB	3 3/16" - 4 13/16"	1
D65668	3"	7"	4" PB	3 3/16" - 4 13/16"	1
D65640	3"	7"	5" NB	2 7/8" - 4 1/2"	1
D65641	3"	7"	5" PB	2 7/8" - 4 1/2"	1
D65642	3"	7"	5" CP	2 7/8" - 4 1/2"	1
D66640	3"	9"	5" NB	3 1/2" - 5 1/8"	1
D66641	3"	9"	5" PB	3 1/2" - 5 1/8"	1
D66642	3"	9"	5" CP	3 1/2" - 5 1/8"	1
D65643	3"	7"	6" NB	3" - 5"	1
D65644	3"	7"	6" PB	3" - 5"	1
D65645	3"	7"	6" CP	3" - 5"	1
D66643	3"	9"	6" NB	3 5/8" - 5 5/8"	1
D66644	3"	9"	6" PB	3 5/8" - 5 5/8"	1
D66645	3"	9"	6" CP	3 5/8" - 5 5/8"	1

4" Heavy Duty No Hub Floor/ Shower Drain



- Cast metal strainer and tailpiece
- Cast iron body

3 1/2" IPS Spuds with 5", 6" or 8" Round Strainer

PART NO.	SIZE	PAN	STRAINER	HEIGHT	CTN QTY
D80206	4"	10"	5" CP	4 1/2" - 6 1/2"	1
D80207	4"	10"	5" PB	4 1/2" - 6 1/2"	1
D80218	4"	10"	5" NB	4 1/2" - 6 1/2"	1
D80208	4"	10"	6" CP	4 3/4" - 6 3/4"	1
D80209	4"	10"	6" PB	4 3/4" - 6 3/4"	1
D80219	4"	10"	6" NB	4 3/4" - 6 3/4"	1
D80210	4"	10"	8" CP	5" - 7"	1
D80211	4"	10"	8" PB	5" - 7"	1

3 1/2" IPS Spuds with 5" or 6" Square Strainer

PART NO.	SIZE	PAN	STRAINER	HEIGHT	CTN QTY
D80220	4"	10"	5" PB	4 1/2" - 6 1/2"	1
D80222	4"	10"	5" NB	4 1/2" - 6 1/2"	1
D80221	4"	10"	6" PB	4 3/4" - 6 3/4"	1
D80223	4"	10"	6" NB	4 3/4" - 6 3/4"	1

4" Heavy Duty Inside Caulk Floor/ Shower Drain



- Cast metal strainer or tailpiece
- Cast iron body

3 1/2" IPS Spuds with 5", 6", or 8" Round Strainer

PART NO.	SIZE	PAN	STRAINER	HEIGHT	CTN QTY
D80106	4"	10"	5" CP	4 1/2" - 6 1/2"	1
D80107	4"	10"	5" PB	4 1/2" - 6 1/2"	1
D80118	4"	10"	5" NB	4 1/2" - 6 1/2"	1
D80108	4"	10"	6" CP	4 3/4" - 6 3/4"	1
D80109	4"	10"	6" PB	4 3/4" - 6 3/4"	1
D80119	4"	10"	6" NB	4 3/4" - 6 3/4"	1

4" "Code Blue" No Caulk (Mechanical Joint) Floor Drain



- 1/2" Primer tapped with brass plug
- Supplied with stainless steel bolts

3 1/2" IPS Spuds with 4", 5" or 6" Round Strainer

PART NO.	SIZE	PAN	STRAINER	HEIGHT	CTN QTY
D66685	4"	9"	4" NB	4" - 4 7/8"	1
D66686	4"	9"	4" PB	4" - 4 7/8"	1
D66540	4"	9"	5" NB	3 1/2" - 5 1/8"	1
D66541	4"	9"	5" PB	3 1/2" - 5 1/8"	1
D66542	4"	9"	5" CP	3 1/2" - 5 1/8"	1
D66543	4"	9"	6" NB	3 5/8" - 5 5/8"	1
D66544	4"	9"	6" PB	3 5/8" - 5 5/8"	1
D66545	4"	9"	6" CP	3 5/8" - 5 5/8"	1

4" "Code Blue" IPS Floor Drain



- 1/2" Primer tapped with brass plug
- Supplied with stainless steel bolts

3 1/2" IPS Spuds with 4", 5" or 6" Round Strainer

PART NO.	SIZE	PAN	STRAINER	HEIGHT	CTN QTY
D66691	4"	9"	4" NB	3 1/4" - 4"	1
D66692	4"	9"	4" PB	3 1/4" - 4"	1
D66660	4"	9"	5" NB	3 1/2" - 5 1/8"	1
D66661	4"	9"	5" PB	3 1/2" - 5 1/8"	1
D66662	4"	9"	5" CP	3 1/2" - 5 1/8"	1
D66663	4"	9"	6" NB	3 5/8" - 5 5/8"	1
D66664	4"	9"	6" PB	3 5/8" - 5 5/8"	1
D66665	4"	9"	6" CP	3 5/8" - 5 5/8"	1

4" "Code Blue" No Hub Floor Drain



- 1/2" Primer tapped with brass plug
- Supplied with stainless steel bolts

3 1/2" IPS Spuds with 4", 5" or 6" Round Strainer

PART NO.	SIZE	PAN	STRAINER	HEIGHT	CTN QTY
D66679	4"	9"	4" NB	3 3/8" - 4 5/8"	1
D66680	4"	9"	4" PB	3 3/8" - 4 5/8"	1
D65659	4"	7"	4" NB	3 3/4" - 4 7/16"	1
D65660	4"	7"	4" PB	3 3/4" - 4 7/16"	1
D65600	4"	7"	5" NB	3 1/2" - 4 3/4"	1
D65601	4"	7"	5" PB	3 1/2" - 4 3/4"	1
D65602	4"	7"	5" CP	3 1/2" - 4 3/4"	1
D66600	4"	9"	5" NB	3 1/2" - 4 3/4"	1
D66601	4"	9"	5" PB	3 1/2" - 4 3/4"	1
D66602	4"	9"	5" CP	3 1/2" - 4 3/4"	1
D65603	4"	7"	6" NB	3 3/4" - 5"	1
D65604	4"	7"	6" PB	3 3/4" - 5"	1
D65605	4"	7"	6" CP	3 3/4" - 5"	1
D66603	4"	9"	6" NB	3 3/4" - 5"	1
D66604	4"	9"	6" PB	3 3/4" - 5"	1
D66605	4"	9"	6" CP	3 3/4" - 5"	1

4" "Code Blue" Push-On Floor Drain



- With clamping ring
- Supplied with V96-004 gasket for 4" cast iron pipe

3 1/2" Spuds with 4", 5" or 6" Round Strainer

PART NO.	SIZE	PAN	STRAINER	HEIGHT	CTN QTY
D66732	4"	9"	4" NB	4 3/4" - 5 1/2"	1
D66733	4"	9"	4" PB	4 3/4" - 5 1/2"	1
D66734	4"	9"	5" NB	4 3/4" - 5 5/8"	1
D66735	4"	9"	5" PB	5 1/4" - 6 3/16"	1
D66736	4"	9"	5" CP	4 3/4" - 5 5/8"	1
D66737	4"	9"	6" NB	5" - 6 1/8"	1
D66738	4"	9"	6" PB	5" - 6 1/8"	1
D66739	4"	9"	6" CP	5 3/8" - 6 3/8"	1

4" "Code Blue" No Hub Slab Drain



- No Clamping Ring

3 1/2" Spuds with 4", 5" or 6" Round Strainer

PART NO.	SIZE	PAN	STRAINER	HEIGHT	CTN QTY
D67048	4"	7"	4" NB	3 5/8" - 4 7/8"	1
D67049	4"	7"	4" PB	3 5/8" - 4 7/8"	1
D67050	4"	7"	5" NB	3 5/8" - 4 7/8"	1
D67051	4"	7"	5" PB	4" - 5 3/8"	1
D67052	4"	7"	5" CP	3 1/2" - 4 7/8"	1
D67053	4"	7"	6" NB	3 7/8" - 5 1/16"	1
D67054	4"	7"	6" PB	3 3/4" - 5 1/16"	1
D67055	4"	7"	6" CP	4" - 5 1/2"	1

No Hub Cleanout Bodies



PART NO.	PIPE SIZE	TAP SIZE	HEIGHT	CTN QTY
C37102	2" Body	1-1/2"	2-1/8"	10
C37103	3" Body	2-1/2"	2-1/8"	10
C37104	4" Body	3-1/2"	2-1/8"	10

Plain End Cast Iron Cleanout

Short Pattern Less Plug



• Fits flush with hub

PART NO.	PIPE SIZE	TAP SIZE	HEIGHT	CTN QTY
C37302	2"	1-1/2"	2-3/4"	12
C37303	3"	2-1/2"	3-1/2"	12
C37304	4"	3"	3"	8
C37314	4"	3-1/2"	3"	8

Plain End Cast Iron Cleanout

Long Pattern Less Plug



• Meets ASTM A-74

PART NO.	PIPE SIZE	TAP SIZE	HEIGHT	CTN QTY
C37002	2"	1-1/2"	2-3/4"	12
C37003	3"	2-1/2"	4"	12
C37004	4"	3"	4"	8
C37014	4"	3-1/2"	4"	8
C37005	5"	4"	3-1/2"	4
C37006	6"	5"	4"	2

No Hub Base



• Use with CI strainers or covers for heavy trucking traffic
 • Use with PB, NB, SS or CP strainers or covers for heavy pedestrian traffic

PART NO.	PIPE SIZE	TAP SIZE	HEIGHT	CTN QTY
D63300	3"	3" IPS	4-1/4"	1
D63349	3"	3-1/2 IPS	4-1/4"	1
D63350	4"	3-1/2 IPS	4-1/4"	1
D63400	4"	4" IPS	4-1/4"	1

Gasket Connection Base



• Use with CI strainers or covers for heavy trucking traffic
 • Use with PB, NB or CP strainers or covers for heavy pedestrian traffic
 • Supplied with multi-tite gasket

PART NO.	PIPE SIZE	TAP SIZE	HEIGHT	CTN QTY
D62300	3"	3" IPS	5"	1
D62349	3"	3-1/2" IPS	5-1/4"	1
D62350	4"	3-1/2" IPS	5-1/4"	1
D62400	4"	4" IPS	5-1/4"	1

Cast Iron Spuds w/Covers For Heavy Duty Cleanouts



• For use with heavy duty cleanouts

2-1/2" IPS Brass Plug with Round Cover

PART NO.	SIZE	COVER	CTN QTY
D62230	3"	5" CI	1
D62231	3"	5" NB with ring	1
D62232	3"	5" PB with ring	1

3" IPS Brass Plug with Round Cover

PART NO.	SIZE	COVER	CTN QTY
D62235	3-1/2"	5" CI	1
D62236	3-1/2"	6" NB with ring	1
D62237	3-1/2"	6" PB with ring	1

3-1/2" IPS Brass Plug with Round Cover

PART NO.	SIZE	COVER	CTN QTY
D62240	4"	5" CI	1
D62241	4"	6" NB with ring	1
D62242	4"	6" PB with ring	1

Plastic Spuds w/Covers & Tops for Heavy Duty Cleanouts



- For use with heavy duty cleanouts
- Round cover with 7" top

2-1/2" IPS Brass Plug with Square Top

PART NO.	SIZE	COVER	CTN QTY
D59912	3"	7" PB	1
D59913	3"	7" NB	1

3" IPS Brass Plug with Square Top

PART NO.	SIZE	COVER	CTN QTY
D59910	3-1/2"	7" PB	1
D59911	3-1/2"	7" NB	1

3-1/2" IPS Brass Plug with Square Top

PART NO.	SIZE	COVER	CTN QTY
D59918	4"	7" PB	1
D59919	4"	7" NB	1

Plastic Spuds w/Round Covers for Heavy Duty Cleanouts



- For use with heavy duty cleanouts

2-1/2" IPS Plastic Plug with Round Cover

PART NO.	SIZE	COVER	CTN QTY
D59904	3"	6" PB	1
D59908	3"	6" PB with ring	1
D59905	3"	6" NB	1
D59909	3"	6" NB with ring	1
D59940	3"	6" CI with ring	1

3" IPS Plastic Plug with Round Cover

PART NO.	SIZE	COVER	CTN QTY
D59943	3-1/2"	5" PB	1
D59944	3-1/2"	5" PB with ring	1
D59945	3-1/2"	5" NB	1
D59946	3-1/2"	5" NB with ring	1
D59901	3-1/2"	6" PB	1
D59906	3-1/2"	6" PB with ring	1
D59902	3-1/2"	6" NB	1
D59907	3-1/2"	6" NB with ring	1
D59941	3-1/2"	6" CI with ring	1
D59914	4"	6" PB	1
D59915	4"	6" PB with ring	1
D59916	4"	6" NB	1
D59917	4"	6" NB with ring	1
D59942	4"	6" CI with ring	1

Metal Spuds w/Covers for Heavy Duty Cleanouts



- For use with heavy duty cleanouts

2-1/2" IPS Brass Plug with Round Cover

PART NO.	SIZE	COVER	SCREWS	CENTER X CENTER	CTN/MSTR
C37803	3"	5" NB	3	3-7/8"	1/20
C37801	3"	5" PB	3	3-7/8"	1/20
C37800	3"	5" CP	3	3-7/8"	1/20

3-1/2" IPS Brass Plug with Round Cover

PART NO.	SIZE	COVER	SCREWS	CENTER X CENTER	CTN/MSTR
C37810	3-1/2"	5" NB	3	3-7/8"	1/18
C37811	3-1/2"	5" PB	3	3-7/8"	1/18
C37805	4"	5" NB	3	3-7/8"	1/20
C37806	4"	5" PB	3	3-7/8"	1/20

4" IPS Brass Countersunk Plug with Round Cover

PART NO.	SIZE	COVER	SCREWS	CENTER X CENTER	CTN/MSTR
C37807	4"	6" NB	2	4-7/8"	1/8
C37808	4"	6" PB	2	4-7/8"	1/8

New Orleans Code Brass Plugs



PART NO.	PLUG	O.D.	CTN QTY
P55150	1-1/2"	1-13/16"	100
P55250	2-1/2"	2-3/4"	100
P55300	3"	3-3/8"	60
P55350	3-1/2"	4"	80
P55500	5"	5-1/2"	30

Lead Fit-All Plug



- Cast iron cored
- Sizes are true measurement, not iron pipe size

PART NO.	PLUG	CTN/MSTR
P56200	2"	24/48
P56250	2-1/2"	24/48
P56300	3"	12/24
P56350	3-1/2"	12/24
P56400	4"	12/24
P56450	4-1/2"	12
P56500	5"	12
P56550	5-1/2"	12
P56600	6"	12

Southern Code Brass Plug



PART NO.	PLUG	O.D.	CTN QTY
P50100	1" Raised head	1-9/32"	200
P50125	1- 1/4" Raised head	1-5/8"	250
P50150	1-1/2" Raised head	1-7/8"	200
P51150	1-1/2" Countersunk	1-7/8"	200
P50200	2" Raised head	2-3/8"	200
P51200	2" Countersunk	2-3/8"	200
P50250	2-1/2" Raised head	2-7/8"	200
P51250	2-1/2" Countersunk	2-7/8"	200
P50300	3" Raised head	3-3/8"	120
P51300	3" Countersunk	3-3/8"	120
P50350	3-1/2" Raised head	3-7/8"	120
P51350	3-1/2" Countersunk	3-7/8"	120
P50400	4" Raised head	4-1/2"	90
P51400	4" Countersunk	4-1/2"	90
P50500	5" Raised head	5-1/2"	50
P51500	5" Countersunk	5-1/2"	50
P50600	6" Raised head	6-1/2"	30
P51600	6" Countersunk	6-1/2"	30
P50800	8" Raised head	8-1/2"	15
P51800	8" Countersunk	8-1/2"	15
P50999	10" Raised head	10-5/8"	10



Heavy Pattern Brass Plug



PART NO.	PLUG	O.D.	CTN QTY
P52150	1-1/2" Raised head	1-3/4"	150
P53150	1-1/2" Countersunk	1-3/4"	200
P52200	2" Raised head	2-3/8"	100
P53200	2" Countersunk	2-3/8"	200
P52250	2-1/2" Raised head	2-3/4"	100
P53250	2-1/2" Countersunk	2-3/4"	100
P52300	3" Raised head	3-1/2"	60
P53300	3" Countersunk	3-1/2"	120
P52350	3-1/2" Raised head	3-7/8"	40
P53350	3-1/2" Countersunk	3-7/8"	80
P52400	4" Raised head	4-3/8"	40
P53400	4" Countersunk	4-3/8"	60
P52500	5" Raised head	5-1/2"	30
P53500	5" Countersunk	5-1/2"	40

Code Pattern Plugs



• Meets ASTM A74-98

PART NO.	PLUG	CTN QTY
P59300	3" Raised head	50
P59333	3" Countersunk	50
P59350	3-1/2" Raised head	50
P59355	3-1/2" Countersunk	50
P59400	4" Raised head	50
P59444	4" Countersunk	50

Slotted Brass Plug With 1/4" Tap



• Tap is not through the plug

PART NO.	PLUG	CTN QTY
P58150	1-1/2"	150
P58200	2"	100
P58250	2-1/2"	80
P58300	3"	60
P58350	3-1/2"	40
P58400	4"	30

Brass Plug For Extension Cover

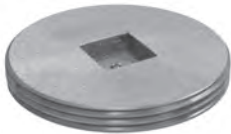

•Countersunk plug tapped 1/4-20

PART NO.	PLUG	O.D.	CTN QTY
P54150	1-1/2"	1-7/8"	200
P54200	2"	2-3/8"	200
P54250	2-1/2"	2-7/8"	100
P54300	3"	3-3/8"	100
P54350	3-1/2"	3-7/8"	100
P54400	4"	4-1/2"	80
P54500	5"	5-1/2"	40
P54600	6"	6-1/2"	30
P54800	8"	8-1/2"	20

Extension Cover Set



• Set includes stainless steel extension cover, brass countersunk plug and 1/4- 20 x 4" flat head machine screws
* Contains slotted plug

Wall Covers (24 gauge)

PART NO.	PLUG	COVER	CTN QTY
C92150	1-1/2"	3"	10
C92151*	1-1/2" slotted	3"	10
C92200	2"	4"	10
C92202*	2" slotted	4"	10
C92250	2-1/2"	5"	10
C92252*	2-1/2" slotted	5"	10
C92300	3"	5"	10
C92301	3"	6"	10
C92303*	3" slotted	6"	10
C92350	3-1/2"	6"	10
C92351	3-1/2"	7"	10
C92353*	3-1/2" slotted	7"	10
C92400	4"	7"	10
C92404*	4" slotted	7"	10
C92500	5"	8"	10
C92600	6"	8"	5
C92601	6"	10"	5
C92800	8"	10"	5

Floor Covers (16 gauge)

PART NO.	PLUG	COVER	CTN QTY
C93150	1-1/2"	3"	10
C93200	2"	4"	10
C93250	2-1/2"	5"	10
C93300	3"	5"	10
C93301	3"	6"	10
C93350	3-1/2"	6"	10
C93351	3-1/2"	7"	10
C93400	4"	7"	10
C93500	5"	8"	10

Stainless Steel Cleanout/ Extension Covers



Wall Mount (24 gauge)

PART NO.	SIZE	CTN/MSTR
C90300	3"	50/500
C90400	4"	25/200
C90500	5"	25/200
C90600	6"	25/100
C90700	7"	25/100
C90800	8"	25/100
C90999	10"	25/50

Floor Mount (16 gauge)

PART NO.	SIZE	CTN/MSTR
C91300	3"	25/200
C91400	4"	25/200
C91500	5"	25/200
C91600	6"	25/100
C91700	7"	25/100
C91800	8"	25/50
C91999	10"	25/50

Wall Mount With 4" Bolt (24 gauge)

PART NO.	SIZE	CTN QTY
C90013	3"	25
C90014	4"	25
C90015	5"	25
C90016	6"	25
C90017	7"	10
C90018	8"	10
C90019	10"	10

Floor Mount With 4" Bolt (16 gauge)

PART NO.	SIZE	CTN QTY
C91013	3"	25
C91014	4"	25
C91015	5"	25
C91016	6"	25
C91017	7"	10
C91018	8"	10
C91019	10"	10

Bolts For Extension/Cleanout Covers



• Flat slotted head plated machine screw

PART NO.	SIZE	CTN/MSTR
C90002	1/4"- 20 x 2-1/2"	100/1000
C90004	1/4"- 20 x 4"	100/1500
C90006	1/4"- 20 x 6"	100/1200

High Impact Plastic Cleanout Cover Plates



- Polished chrome or white matte finish
- Individually bagged with # 14 wood screw included

Flat Design

PART NO.	SIZE	CTN/MSTR
C94004	4-1/4" Chrome finish	25/200
C94005	5-1/4" Chrome finish	25/200
C94007	7-1/4" Chrome finish	25/200
C94009	9-1/4" Chrome finish	50/200
C95004	4-1/4" White finish	25/200
C95005	5-1/4" White finish	25/200
C95007	7-1/4" White finish	25/200
C95009	9-1/4" White finish	25/100

Bell Design

PART NO.	SIZE	CTN/MSTR
C96004	4-1/4" Chrome finish	25/200
C96005	5-1/4" Chrome finish	25/200
C96007	7-1/4" Chrome finish	25/200
C96009	9-1/4" Chrome finish	25/100
C97004	4-1/4" White finish	25/200
C97005	5-1/4" White finish	25/200
C97007	7-1/4" White finish	25/200
C97009	9-1/4" White finish	25/100

Trap Covers



• Stainless steel

PART NO.	DESCRIPTION	CTN/MSTR
C98001	5-3/4" Flat SS trap cover	150/300
C98002	5-3/4" Raised SS trap cover	50/200

Stainless Steel Dome Cover Plates



- High grade stainless steel
- Individually bagged with # 14 wood screw and 1/4" x 2-1/2" machine screw

PART NO.	DESCRIPTION	CTN/MSTR
C98014	4" SS dome cover plate	60/240
C98016	6" SS dome cover plate	50/150
C98018	8" SS dome cover plate	25/100

Push-On Cleanout



- Meets ASTM A74-98 and ASME A112.36.2M-91
- Cut pipe to desired level, lube gasket and push-on pipe, tap with lead hammer to seat, then install plug
- Schedule 40 unit fits plastic and extra heavy cast iron pipe

Less Gasket

PART NO.	PIPE SIZE	PLUG	HEIGHT	CTN QTY
C36003	3" SV	Raised head	3"	8
C36013	3" SV	Countersunk	3"	8
C36004	4" SV	Raised head	3"	8
C36014	4" SV	Countersunk	3"	8
C36024	4" Sch.40	Raised head	3"	8
C36034	4" Sch.40	Countersunk	3"	8
C36006	6" SV	Raised head	2-3/4"	4
C36016	6" SV	Countersunk	2-3/4"	4

With Gasket

PART NO.	PIPE SIZE	PLUG	HEIGHT	CTN QTY
C36104	4" SV	Raised head	3-1/4"	8
C36114	4" SV	Countersunk	3-1/4"	8
C36124	4" Sch.40	Raised head	3-1/4"	8
C36134	4" Sch.40	Countersunk	3-1/4"	8
C36106	6" SV	Raised head	3"	4
C36116	6" SV	Countersunk	3"	4

No Hub Cleanout With Plug



Southern Code Plug

PART NO.	PIPE SIZE	PLUG	HEIGHT	CTN QTY
C38402	2"	1-1/2" Raised Head	2-1/8"	10
C39402	2"	1-1/2" Countersunk	2-1/8"	10
C38403	3"	2-1/2" Raised Head	2-1/8"	10
C39403	3"	2-1/2" Countersunk	2-1/8"	10
C38404	4"	3-1/2" Raised Head	2-1/8"	10
C39404	4"	3-1/2" Countersunk	2-1/8"	10

Heavy Plug

PART NO.	PIPE SIZE	PLUG	HEIGHT	CTN QTY
C38502	2"	1-1/2" Raised Head	2-1/8"	10
C39502	2"	1-1/2" Countersunk	2-1/8"	10
C38503	3"	2-1/2" Raised Head	2-1/8"	10
C39503	3"	2-1/2" Countersunk	2-1/8"	10
C38504	4"	3-1/2" Raised Head	2-1/8"	10
C39504	4"	3-1/2" Countersunk	2-1/8"	10

New Orleans Code Plug

PART NO.	PIPE SIZE	PLUG	HEIGHT	CTN QTY
C40102	2"	1-1/2" Plug	2-1/4"	10
C40103	3"	2-1/2" Plug	2-1/4"	10
C40104	4"	3-1/2" Plug	2-1/4"	10

Plain End Cast Iron Cleanout-Short Pattern with Southern Code Plug



- Fits flush with hub

PART NO.	PIPE SIZE	PLUG	HEIGHT	CTN QTY
C38102	2"	1-1/2" Raised head	2-7/8"	10
C39102	2"	1-1/2" Countersunk	2-7/8"	10
C38103	3"	2-1/2" Raised head	3-5/8"	10
C39103	3"	2-1/2" Countersunk	3-5/8"	10
C38104	4"	3" Raised head	3"	10
C39104	4"	3" Countersunk	3"	10
C38114	4"	3-1/2" Raised head	3"	10
C39114	4"	3-1/2" Countersunk	3"	10

Plain End Cleanout Long Pattern



- For use with service weight (caulk into hub) or no-hub (use coupling)

With Southern Code Plug

PART NO.	PIPE SIZE	PLUG	HEIGHT	CTN QTY
C38002	2"	1-1/2" Raised (low sq.)	3-1/4"	12
C39002	2"	1-1/2" Countersunk	3-1/4"	12
C38003	3"	2-1/2" Raised (low sq.)	4"	12
C39003	3"	2-1/2" Countersunk	4"	12
C38004	4"	3" Raised head (low sq.)	4"	8
C39004	4"	3" Countersunk	4"	8
C38014	4"	3-1/2" Raised (low sq.)	4"	8
C39014	4"	3-1/2" Countersunk	4"	8
C38005	5"	4" Raised head (low sq.)	3-1/2"	4
C39005	5"	4" Countersunk	3-1/2"	4
C38006	6"	5" Raised head (low sq.)	4"	2
C39006	6"	5" Countersunk	4"	2

With Heavy Pattern Plug

PART NO.	PIPE SIZE	PLUG	HEIGHT	CTN QTY
C38202	2"	1-1/2" Raised head (hex)	3-1/4"	12
C39202	2"	1-1/2" Countersunk	3-1/4"	12
C38203	3"	2-1/2" Raised head (hex)	4"	12
C39203	3"	2-1/2" Countersunk	4"	12
C38204	4"	3" Raised head (hex)	4"	8
C39204	4"	3" Countersunk	4"	8
C38214	4"	3-1/2" Raised head (hex)	4"	8
C39214	4"	3-1/2" Countersunk	4"	8
C38205	5"	4" Raised head (hex)	3-1/2"	4
C39205	5"	4" Countersunk	3-1/2"	4
C38206	6"	5" Raised head (hex)	4"	2
C39206	6"	5" Countersunk	4"	2

Cleanout Ferrule With New Orleans Code Plug



Service Weight

PART NO.	PIPE SIZE	PLUG	HEIGHT	CTN QTY
C40002	2" SV	1-1/2"	3"	12
C40003	3" SV	2-1/2"	4"	12
C40004	4" SV	3 1/2"	4"	8
C40006	6" SV	5"	4"	2

Plumb Lock Adjustable Cleanout



- Supplied with Multi-Tite gasket
- Similar to Zurn Neo-Loc line

3" Spud with 3" Gasket Connection

PART NO.	PIPE SIZE	COVER	BODY HEIGHT	ADJ. HEIGHT	CTN QTY
D62330	3"	5" CI	5-1/4"	5-7/8" - 7"	1
D62333	3"	5" NB	5-1/4"	5-7/8" - 7"	1
D62334	3"	5" PB	5-1/4"	5-7/8" - 7"	1
D62335	3"	5" CP	5-1/4"	5-7/8" - 7"	1

4" Spud with 4" Gasket Connection

PART NO.	PIPE SIZE	COVER	BODY HEIGHT	ADJ. HEIGHT	CTN QTY
D62433	4"	5" NB	5-1/2"	6-1/8" - 7-1/4"	1
D62434	4"	5" PB	5-1/2"	6-1/8" - 7-1/4"	1
D62443	4"	5" NB w/4" plug	5-1/2"	6-1/8" - 7-1/4"	1
D62444	4"	5" PB w/4" plug	5-1/2"	6-1/8" - 7-1/4"	1

4" Spud with 6" Gasket Connection

PART NO.	PIPE SIZE	COVER	BODY HEIGHT	ADJ. HEIGHT	CTN QTY
D62601	6"	5" NB	3-1/4"	3-5/8" - 4-3/4"	1
D62602	6"	5" PB	3-1/4"	3-5/8" - 4-3/4"	1

No Hub Adjustable Cleanout



3" Spud

PART NO.	PIPE SIZE	COVER	BODY HEIGHT	ADJ. HEIGHT	CTN QTY
D63330	3"	5" CI	4 1/4"	4 7/8" - 6"	1
D63333	3"	5" NB	4 1/4"	4 7/8" - 6"	1
D63334	3"	5" PB	4 1/4"	4 7/8" - 6"	1
D63335	3"	5" CP	4 1/4"	4 7/8" - 6"	1

4" Spud

PART NO.	PIPE SIZE	COVER	BODY HEIGHT	ADJ. HEIGHT	CTN QTY
D63433	4"	5" NB	4 1/4"	4 7/8" - 6"	1
D63434	4"	5" PB	4 1/4"	4 7/8" - 6"	1

Adjustable- Plain End



- Cast iron top is for forklift or heavy trucking traffic
- Nickel bronze and polished brass tops are for heavy pedestrian traffic
- Satin finish on nickel bronze and polished brass ring and cover
- Cleanout body with brass plug
- Can also be caulked into hub

PART NO.	PIPE SIZE	COVER	ADJ. HEIGHT	CTN QTY
C33021	2"	5 1/4" CI w/ center screw	3 1/8" - 4 1/4"	1
C33022	2"	5 1/2" NB with ring	3" - 4 3/4"	1
C33023	2"	5 1/2" PB with ring	3" - 4 3/4"	1
C33031	3"	5 1/4" CI w/ center screw	4" - 5 3/4"	1
C33032	3"	5 1/2" NB with ring	4 1/4" - 6"	1
C33033	3"	5 1/2" PB with ring	4 1/4" - 6"	1
C33044	4"	6 3/16" CI w/ center screw	5 1/8" - 6 1/8"	1
C33045	4"	6 1/2" NB with ring	5 3/8" - 6 3/8"	1
C33046	4"	6 1/2" PB with ring	5 3/8" - 6 3/8"	1

Adjustable Push-On Cast Iron Pipe



- Supplied with gasket for cast iron pipe
- Cast iron top is for forklift or heavy trucking traffic
- Nickel bronze and polished brass tops are for heavy pedestrian traffic
- Cleanout body with brass plug

PART NO.	PIPE SIZE	COVER	ADJ. HEIGHT	CTN QTY
C33121	3"	5 1/4" CI w/ center screw	3 7/8" - 4 3/4"	1
C33122	3"	5 1/2" NB with ring	4 1/8" - 5"	1
C33123	3"	5 1/2" PB with ring	4 1/8" - 5"	1
C33144	4"	6 3/16" CI w/ center screw	4 7/8" - 5 3/4"	1
C33145	4"	6 1/2" NB with ring	5" - 6"	1
C33146	4"	6 1/2" PB with ring	5" - 6"	1

Adjustable Plastic Pipe Fit



- Cast iron top is for forklift or heavy trucking traffic
- Nickel bronze and polished brass tops are for heavy pedestrian traffic
- Satin finish on nickel bronze and polished brass ring and cover
- Cleanout body with plastic plug

PART NO.	HEIGHT ADJUSTMENT
C33221	2-7/8" – 3-7/8"
C33222	3-1/8" – 4-1/8"
C33223	3-1/8" – 4-1/8"
C33231	4" – 5"
C33232	4-1/4" – 5-1/4"
C33233	4-1/4" – 5-1/4"
C33244	5-1/8" – 6-1/4"
C33245	5-3/8" – 6-1/2"
C33246	5-3/8" – 6-1/2"

PART NO.	HEIGHT ADJUSTMENT
C33321	2-7/8" – 3-7/8"
C33322	3-1/8" – 4-1/8"
C33323	3-1/8" – 4-1/8"
C33331	4" – 5"
C33332	4-1/4" – 5-1/4"
C33333	4-1/4" – 5-1/4"
C33344	5-1/8" – 6-1/4"
C33345	5-3/8" – 6-1/2"
C33346	5-3/8" – 6-1/2"

PART NO.	SIZE	COVER	MATERIAL	CTN QTY
C33221	2"	5-1/4" CI w/ center screw	PVC	1
C33321	2"	5-1/4" CI w/ center screw	ABS	1
C33222	2"	5-1/2" NB with ring	PVC	1
C33322	2"	5-1/2" NB with ring	ABS	1
C33223	2"	5-1/2" PB with ring	PVC	1
C33323	2"	5-1/2" PB with ring	ABS	1
C33231	3"	5-1/4" CI w/ center screw	PVC	1
C33331	3"	5-1/4" CI w/ center screw	ABS	1
C33232	3"	5-1/2" NB with ring	PVC	1
C33332	3"	5-1/2" NB with ring	ABS	1
C33233	3"	5-1/2" PB with ring	PVC	1
C33333	3"	5-1/2" PB with ring	ABS	1
C33244	4"	6-3/16" CI w/ center screw	PVC	1
C33344	4"	6-3/16" CI w/ center screw	ABS	1
C33245	4"	6-1/2" NB with ring	PVC	1
C33345	4"	6-1/2" NB with ring	ABS	1
C33246	4"	6-1/2" PB with ring	PVC	1
C33346	4"	6-1/2" PB with ring	ABS	1

Adjustable Plastic Pipe Hub Fit



- Cast iron top is for forklift or heavy trucking traffic
- Nickel bronze and polished brass tops are for heavy pedestrian traffic
- Satin finish on nickel bronze and polished brass ring and cover
- Cleanout body with plastic plug

PART NO.	HEIGHT ADJUSTMENT
C33444	3" – 4-1/2"
C33445	3-1/4" – 4-3/4"
C33446	3-1/4" – 4-3/4"

PART NO.	HEIGHT ADJUSTMENT
C33544	3" – 4-1/2"
C33545	3-1/4" – 4-3/4"
C33546	3-1/4" – 4-3/4"

PART NO.	SIZE	COVER	MATERIAL	CTN QTY
C33444	4"	6-3/16" CI w/ center screw	PVC	1
C33544	4"	6-3/16" CI w/ center screw	ABS	1
C33445	4"	6-3/16" NB with ring	PVC	1
C33545	4"	6-3/16" NB with ring	ABS	1
C33446	4"	6-3/16" PB with ring	PVC	1
C33546	4"	6-3/16" PB with ring	ABS	1

Adjustable Access Cover



- Cast iron top is for forklift or heavy trucking traffic
- Designed to fit over 2", 3" and 4" plastic adapter, cast iron cleanout, ferrules and various drainage piping (2" x 3" fits 2" and 3" bodies)
- 3 set screws allow for vertical adjustment
- Nickel bronze and polished brass are satin finish

PART NO.	PIPE SIZE	COVER	HEIGHT	INSIDE C.O.	CTN QTY
C33001	2" & 3"	5-1/4" CI w/ center screw	2-1/8"	4-9/16"	1
C33002	2" & 3"	5-1/2" NB with ring	2-1/8"	4-9/16"	1
C33003	2" & 3"	5-1/2" PB with ring	2-1/8"	4-9/16"	1
C33004	4"	6-3/16" CI w/ center screw	2-5/8"	5-5/16"	1
C33005	4"	6-1/2" NB with ring	2-5/8"	5-5/16"	1
C33006	4"	6-1/2" PB with ring	2-5/8"	5-5/16"	1

Heavy Duty Adjustable Access Cover



- Scoriated cover
- Fits any 6" pipe
- Cast iron top is for forklift or heavy trucking traffic for up to 2000 lbs.
- 3 bolts secure the cleanout while puring concrete

PART NO.	PIPE SIZE	DESCRIPTION	HEIGHT	CTN QTY
C33088	6"	HDuty CI cleanout	3"	1

Heavy Duty Cleanout



- Scoriated cover
- Fits any 6" pipe
- 3 bolts secure the cleanout while puring concrete

PART NO.	PIPE SIZE	DESCRIPTION	HEIGHT	INSIDE C.O.	CTN QTY
D76005	6"	HDuty CI cleanout	5-3/8"	6-3/4"	1

Adjustable Floor Cleanout



- Adjusts 2-1/2"
- 4" cast iron body

PART NO.	PIPE SIZE	DESCRIPTION	HEIGHT	INSIDE C.O.	CTN QTY
A40001	4"	5" CP	5-1/4"	3-3/4"	1
A40002	4"	5" PB	5-1/4"	3-3/4"	1
A40003	4"	5" NB	5-1/4"	3-3/4"	1

Roof Drain with Cast Iron Dome



- 10" diameter pan
- Dome has 50 sq. Inches of drain area
- Cast iron dome

PART NO.	SIZE	PAN	DOMES	HEIGHT	CTN QTY
R19003	3" Inside caulk	10"	5-1/2"	8"	1
R19005	3" No Hub	10"	5-1/2"	8"	1
R19004	4" Inside caulk	10"	5-1/2"	8"	1
R19006	4" No Hub	10"	5-1/2"	8"	1
R18020	Cast iron roof dome		5-1/2"		1

"Code Blue" No Caulk (Mechanical Joint) Roof Drain with Square Pan



- 8 1/2" square pan
- Cast Iron dome and drain
- Supplied with stainless steel bolts

PART NO.	SIZE	STRAINER	HEIGHT	CTN QTY
R19102	2" No Caulk	8-1/2"	9-1/2"	1
R19103	3" No Caulk	8-1/2"	9-1/2"	1
R19104	4" No Caulk	8-1/2"	9-1/2"	1

"Code Blue" No Hub Side Outlet Roof Drain



PART NO.	SIZE	PAN	HEIGHT	CTN QTY
R19402	2"	8-1/2"	9-1/2"	1
R19403	3"	8-1/2"	9-1/2"	1
R19404	4"	8-1/2"	9-1/2"	1

"Code Blue" No Hub Roof Drain with Square Pan



- 8 1/2" square pan
- Cast Iron dome and drain
- Supplied with stainless steel bolts

PART NO.	SIZE	PAN	HEIGHT	CTN QTY
R19202	2" No Hub	8-1/2"	9-1/2"	1
R19203	3" No Hub	8-1/2"	9-3/4"	1
R19204	4" No Hub	8-1/2"	9-3/4"	1
R19206	6" No Hub	8-1/2"	9-3/4"	1

"Code Blue" No Hub Dual Roof Drains



- Supplied with stainless steel bolts

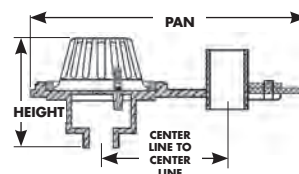

PIPE SIZE	CENTER TO CENTER	PAN	OVERALL SINGLE	HEIGHT DOUBLE
2"	8-1/2"	19"	8"	8-1/2"
3"	8-1/2"	19"	9-1/2"	10"
4"	8-1/2"	19"	10"	10-1/2"

Single Dome

PART NO.	SIZE	PAN	CTN QTY
R19302	2" No hub dual drain	19"	1
R19303	3" No hub dual drain	19"	1
R19304	4" No hub dual drain	19"	1

Double Dome

PART NO.	SIZE	PAN	CTN QTY
R19307	2" No hub dual dome drain	19"	1
R19305	3" No hub dual dome drain	19"	1
R19306	4" No hub dual dome drain	19"	1

Replacement Parts

PART NO.	SIZE	CTN QTY
R19099	Roof drain dome	1
R19100	Clamping ring	1

Area Drain



- Full waterway
- Lip secures strainer

DRAIN SPECS

SIZE	TOP WIDTH	OVERALL HEIGHT
2"	4-7/8"	3-1/4"
3"	6-3/16"	3-1/4"
4"	7-3/16"	3-1/4"

STRAINER SPECS

SIZE	A	B
2"	4-1/4"	4-1/4"
3"	5-3/8"	5-5/8"
4"	6-11/16"	6-11/16"

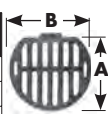

PART NO.	DESCRIPTION	CTN QTY
D76002	2" Inside caulk drain	8
D77002	2" No hub drain	8
D76012	2" Inside caulk CP area drain with strainer	8
D76092	2" Strainer only	1
D76003	3" Inside caulk drain	4
D77003	3" No hub drain	4
D76013	3" Inside caulk CP area drain with strainer	4
D76093	3" Strainer only	1
D76004	4" Inside caulk drain	4
D77004	4" No hub drain	4
D76014	4" Inside caulk CP area drain with strainer	4
D76094	4" Strainer only	1

St. Louis Drain



- Heavy duty loose set strainer
- Inside caulk

PART NO.	SIZE	CTN QTY
C72002	2" Inside caulk	8
C72003	3" Inside caulk	4
C72004	4" Inside caulk	2
C72093	6-1/4" OD Strainer	1

Inside Caulk Shower Stall Drains



- Designed for prefab shower stalls
- Snap in stainless steel strainer
- Fits 2" Schedule 40 and cast iron pipe
- Can be adapted to no-caulk with gasket
- 4 1/4" OD strainer

PART NO.	SIZE	STRAINER	CTN QTY
D40102	2"	SS	20
D40202	2"	PB	20
D60101	Gaskets to make unit no caulk		1

Cast Iron Gasket Connection Drain



- Supplied with Multi-Tite gasket
- Just lube gasket and push over S.V. or N.H. cast iron pipe
- NB and PB are for heavy pedestrian traffic areas

PART NO.	SIZE	STRAINER	CTN QTY
D62950	3"	5" NB with ring	1
D62951	3"	5" PB with ring	1
D62952	3"	4" CI	1
D62960	4"	6" NB with ring	1
D62961	4"	6" PB with ring	1
D62962	4"	5" CI	1

IPS Shower Stall Drain



- Designed for prefab shower stalls
- Snap in stainless steel strainer
- 4 1/4" O.D. strainer

PART NO.	SIZE	STRAINER	CTN QTY
D40104	1 1/2"	SS	36
D40204	1 1/2"	PB	20
D40103	2"	SS	36
D40203	2"	PB	20

Female Iron Pipe Shower Drain



- Cast brass body
- Stainless steel strainer

PART NO.	SIZE	BODY	STRAINER	CTN QTY
D40150	1 1/2"	Cast brass	SS	100
D40200	2"	Cast brass	SS	100

Kentucky Drain



- Inside caulk

PART NO.	DESCRIPTION	CTN QTY
C73003	3" Inside caulk drain	4
C73093	3" Strainer only	1
C73192	3" Drain with 2" hole in strainer	4
C73193	3" Strainer only with 2" hole	1
C73004	4" Inside caulk drain	4
C73094	4" Strainer only	1

Brass Inside Caulk Floor Drain



- For use where pan liner is not required
- Brass body

PART NO.	SIZE	BODY	STRAINER	CTN QTY
D76601	2"	Brass	SS	50

Combination Drain Trap



- Bolt-down clamping collar
- Weep holes and grooves in clamping flange

PART NO.	SIZE	STRAINER	CTN QTY
J60060	2" IPS	4" SS	1
J60061	2" IPS	4" CP brass	1
J60062	2" IPS	4" PB	1

Urinal Drain



- Brass body with stainless steel strainer

PART NO.	SIZE	BODY	STRAINER	CTN QTY
D45002	2" IPS	Brass	SS	40

Urinal Drain Flange Kit



- Kit includes all necessary hardware

PART NO.	DESCRIPTION	CTN QTY
F10005	2" IPS x 4-1/4"	50

Floor Drain With Trap



- Throat of drain is threaded for backwater device D70-500

Concealed Cleanout

PART NO.	DESCRIPTION	CTN QTY
D70001	2" Drain	1
D70011	2" Drain with backwater device	1
D70098	6 3/8" Cast iron strainer	1

Exposed Cleanout

D70020	2" Drain with backwater device	1
D70022	2" Drain with 1/2" PT	1
D71103	3" Drain - Backwater device not compatible	1
D70021	2" Drain with backwater device	1



Backwater Device



- Sleeve type
- Ball included

PART NO.	DESCRIPTION	CTN QTY
D70500	2" MIP brass body	50
B06001	2" MIP plastic body	50
B70499	2" Plastic ball	1300

Des Moines Pattern Floor Drain



- Bolt down lid
- Integral trap

PART NO.	DESCRIPTION	CTN QTY
D71003	3" with trap	1
D71004	Strainer for Des Moines	1

Inside Caulk Bell Trap



- Hinged lid
- Bell attached

PIPE SIZE	BODY	STRAINER	OUTLET HEIGHT	OVERALL HEIGHT
2"	6" x 6"	4-7/8"	1-3/4"	4-1/8"
3"	9" x 9"	6-3/4"	1-7/8"	4-7/8"
4"	12" x 12"	9-3/4"	1-3/4"	4-7/8"

PART NO.	SIZE	CTN QTY
D76202	6" x 6" x 2"	1
D76203	9" x 9" x 3"	1
D76204	12" x 12" x 4"	1

Strainers Less Hinge

PART NO.	SIZE	CTN QTY
D76205L	4-7/8" strainer for 6" x 6"	20
D76207L	6-3/4" strainer for 9" x 9"	20
D76209L	9-3/4" strainer for 12" x 12"	10

Cast Iron Bell With Nut And Bolt

PART NO.	SIZE	CTN QTY
D76256	Bell for 6" x 6"	20
D76259	Bell for 9" x 9"	20
D76252	Bell for 12" x 12"	10

No Hub Bell Trap



- Spigot outlet
- Hinged lid
- Bell attached

PIPE SIZE	BODY	STRAINER	OUTLET HEIGHT	OVERALL HEIGHT
2"	6" x 6"	4-7/8"	1-1/4"	3-1/4"
3"	9" x 9"	6-3/4"	1-1/2"	4-1/4"
4"	12" x 12"	9-3/4"	1-1/2"	4-7/8"

PART NO.	SIZE	CTN QTY
D76302	6" x 6" x 2"	1
D76303	9" x 9" x 3"	1
D76304	12" x 12" x 4"	1

Strainers Less Hinge

PART NO.	SIZE	CTN QTY
D76205L	4-7/8" strainer for 6" x 6"	20
D76207L	6-3/4" strainer for 9" x 9"	20
D76209L	9-3/4" strainer for 12" x 12"	10

Cast Iron Bell With Nut And Bolt

PART NO.	SIZE	CTN QTY
D76256	Bell for 6" x 6"	20
D76259	Bell for 9" x 9"	20
D76252	Bell for 12" x 12"	10

Spigot Outlet Bell Trap



- Loose lid
- Bell cast on

PIPE SIZE	BODY	STRAINER	OUTLET HEIGHT	OVERALL HEIGHT
2"	6" x 6"	4-7/8"	1-3/8"	3-1/2"
3"	9" x 9"	6-3/4"	1-1/2"	4-1/2"
4"	12" x 12"	9-3/4"	1-1/2"	4-7/8"

PART NO.	SIZE	CTN QTY
D76402	6" x 6" x 2"	1
D76403	9" x 9" x 3"	1
D76404	12" x 12" x 4"	1

Replacement Strainer With Cast-In Bell

PART NO.	SIZE	CTN QTY
D76412	4-7/8" cast-in bell for 6" x 6"	20
D76413	6-3/4" cast-in bell for 9" x 9"	20
D76414	9-3/4" cast-in bell for 12" x 12"	10

Pittsburgh Bell Trap



- Deep body
- 4" inside caulk

PIPE SIZE	BODY	STRAINER	OVERALL HEIGHT
4"	9" x 9"	6-3/4"	4-1/2"

PART NO.	SIZE	CTN QTY
B60994	9" x 9" x 4" Inside caulk less bell	1

Strainer Only (Loose Lid)

PART NO.	SIZE	CTN QTY
B60099	6-3/4" ID strainer	1

Heavy Duty Floor Drain



- 8-1/2" heavy duty cast iron grate
- Cast iron sediment bucket

No Hub Less Sediment Bucket

PART NO.	SIZE	PAN	GRATE	HEIGHT	CTN QTY
D79703	3"	10-1/2"	9" CI	5 1/4"	1
D79704	4"	10-1/2"	9" CI	5 1/4"	1

No Hub With Sediment Bucket

PART NO.	SIZE	PAN	GRATE	HEIGHT	CTN QTY
D79705	3"	10-1/2"	9" CI	5 1/4"	1
D79706	4"	10-1/2"	9" CI	5 1/4"	1

Inside Caulk Less Sediment Bucket

PART NO.	SIZE	PAN	GRATE	HEIGHT	CTN QTY
D79805	3"	10-1/2"	9" CI	5 1/4"	1
D79806	4"	10-1/2"	9" CI	5 1/4"	1

Inside Caulk With Sediment Bucket

PART NO.	SIZE	PAN	GRATE	HEIGHT	CTN QTY
D79803	3"	10-1/2"	9" CI	5 1/4"	1
D79804	4"	10-1/2"	9" CI	5 1/4"	1

Sediment Bucket

PART NO.	DESCRIPTION	CTN QTY
D50095	CI sediment bucket	1

"Code Blue" No Caulk (Mechanical Joint) Cesspool Drain



- Supplied with stainless steel bolts
- Includes test plug



PART NO.	SIZE	STRAINER	HEIGHT	CTN QTY
D76702	2"	6" CI	4 1/16"	1
D76703	3"	7" CI	4 1/16"	1
D76704	4"	8" CI	4 1/16"	1

"Code Blue" No Caulk (Mechanical Joint) Cesspool Drain Grate



PART NO.	DESCRIPTION	CTN QTY
D76705	Grate for D76-702	1
D76706	Grate for D76-703	1
D76707	Grate for D76-704	1

Caulk Cesspool with Recessed Grate



PART NO.	DESCRIPTION	CTN QTY
D76504	12" x 12" x 4"	1
D76519	Grate only	1

Rainleader Cesspool



- For areas requiring downspout, rainleader and cesspool drain
- Grate secured by screw
- 12-3/4" diameter pan fits over outlet

PART NO.	DESCRIPTION	CTN QTY
J60030	4" hub inlet x 4" spigot outlet	1

Square Cesspool Grate



PART NO.	DESCRIPTION	CTN QTY
D59156	6" x 6" square grate	10
D59158	8" x 8" square grate	5
D59160	10" x 10" square grate	2
D59162	12" x 12" square grate	2

Round Slop Sink, Hydrant Cesspool



- 2" IPS outlet
- Removable Strainer

PART NO.	DESCRIPTION	CTN QTY
S55100	2" IPS ink painted	1
S55101	2" IPS galvanized cast iron	1

Square Hydrant Cesspool



- Grate included
- Spigot outlet

PART NO.	DESCRIPTION	CTN QTY
S57034	11" x 11" x 4"	1
S57035	Grate only	1

Porcelain Coated Floor Sinks



- 12"x 12" white porcelain coated cast iron
- No hub and inside caulk
- Aluminum dome bottom strainer included

PART NO.	DESCRIPTION	CTN QTY
S55104	4" Inside caulk 6" deep	1
S55004	4" Inside caulk 8" deep	1
S55112	2" No hub 6" deep	1
S55113	3" No hub 6" deep	1
S55114	4" No hub 6" deep	1

Top Grates Only To Fit Floor Sinks



PART NO.	DESCRIPTION	CTN QTY
S55010	Full top grate	1
S55075	Three-quarter grate	1
S55050	Half grate	1

Aluminum Bottom Dome For Cast Iron Sink



- Fits all sizes porcelain coated cast iron sinks

BOTTOM OD	HEIGHT
5-3/8"	2-1/4"

PART NO.	DESCRIPTION	CTN QTY
S55115	Aluminum bottom dome- Fit All	10
S60002	2" Aluminum bottom dome	10
S60003	3" Aluminum bottom dome	10
S60004	4" Aluminum bottom dome	10

Plumlock Porcelain Floor Sink



- 12"x 12" white porcelain coated cast iron
- Aluminum dome strainer included
- Push-On Connection; gasket supplied

PART NO.	DESCRIPTION	CTN QTY
S55122	2" Plumlock Floor Sink- 6" deep	1
S55123	3" Plumlock Floor Sink- 6" deep	1
S55124	4" Plumlock Floor Sink- 6" deep	1

Plumlock Gasket For Cast Iron Or Schedule 40 Pipe Connectors



- Fits 12" x 12" white porcelain coated cast iron Plumlock Sinks

PART NO.	DESCRIPTION	CTN QTY
S55192	2" PlumLock Gasket	1
S55193	3" PlumLock Gasket	1
S55194	4" PlumLock Gasket	1

Service Sink Faucets



- Integral stops
- Integrated vacuum breaker
- Complete with all mounting hardware
- Meets ASSE 1001
- Front hook to hang bucket

PART NO.	DESCRIPTION	CTN/MSTR
S55349	Service sink faucet with lever handles	1/8
S55350	Service sink faucet w/cross handles	1/6
S55351	Cross handle stem repair kit for S55-350	1/100
S55352	Lever handle stem repair kit for S55-349	1/100
S55353	Integral stop repair kit for S55-349	1/100
S55354	Vacuum breaker repair kit (S5-349 or S55-350)	1/100

Trap Standard



- Cast iron body with white coating
- Chrome-plated brass strainer
- Fits American Standard, Kohler, Eljer and Crane cast iron service sinks

PART NO.	DESCRIPTION	CTN QTY
T00002	2" IPS	1
T00003	3" IPS	1
T00005	Base plated for trap standard	1
T00006	1-1/2" N.O. plug with gasket	1
T00009	Strainer and stud for trap standard	1

Mop Service Basin



- One-piece molded construction; 24" x 24" x 10"
- Crushed stone with polyester resin
- Supplied with 3" gasketed connection and stainless steel strainer

PART NO.	DESCRIPTION	CTN QTY
S55240	Mop service basin	1

Hose and Bracket for Service Sink



- Heavy duty 300# cloth-reinforced hose
- 5" x 3" stainless steel bracket with rubber grip
- 3/4" brass hose coupling at one end

PART NO.	DESCRIPTION	CTN QTY
M05001	Hose with bracket	1

Mop Hanger for Service Sink



- 24" x 3" stainless steel hanger with three rubber tool grips
- Anchors included

PART NO.	DESCRIPTION	CTN/MSTR
M05003	Mop hanger	1/25

Bar Grate



• For hub openings in soil pipe

Less Legs

PART NO.	SIZE	DIAMETER	CTN QTY
D59102	2"	2-3/4"	10
D59103	3"	3-3/4"	10
D59104	4"	4-7/8"	10
D59106	6"	6-7/8"	10
D59101	4"	4-7/8"	10

With Legs

PART NO.	SIZE	DIAMETER	CTN QTY
D59112	2"	2-3/4"	10
D59113	3"	3-3/4"	10
D59114	4"	4-7/8"	10

Perforated Sewer Strainer with Legs



• For hub openings in clay sewer pipe

PART NO.	SIZE	DIAMETER	CTN QTY
D59124	4"	5-1/2"	10
D59126	6"	7-3/8"	5
D59128	8"	10-1/8"	5
D59130	10"	12-1/4"	2
D59132	12"	14-1/4"	2

Sewer Box



• Sewer lid is marked "sewer"
 • Water lid is marked "water"
 • Plain lid is unmarked

PART NO.	DESCRIPTION	CTN QTY
S36006	8" water lid and ring	1
S36007	8" sewer lid	1
S36008	8" sewer lid and ring	1
S36090	8" plain lid	1
S36091	8" plain lid and ring	1
S36011	10" water lid and ring	1
S36009	10" sewer lid only	1
S36010	10" sewer lid and ring	1
S36095	10" plain lid	1
S36096	10" plain lid and ring	1

Water Access Box



• Lockable lid

PART NO.	DESCRIPTION	CTN QTY
J60026	6" x 6" x 2"	6

Perforated Vent Box



PART NO.	DESCRIPTION	CTN QTY
J60027	6" x 6" x 2"	6

Philadelphia Style Vent Box



• Strainer secured by overlapping lug and screw
 • Integral cast baffles

PART NO.	DESCRIPTION	CTN QTY
J60004	4" Inside caulk	1
J60094	Strainer Replacement	1

Fresh Air Inlet/ Floor Drain



PART NO.	DESCRIPTION	CTN QTY
J60007	3" Spigot	15
J60008	4" Spigot	15

Vent Cap



• Cast iron cap for 3" or 4" pipe

PART NO.	DESCRIPTION	CTN QTY
J60005	3" - 4" vent cap	10

Lockable Vent Cap



- Cast iron grate fits inside spigot end of pipe
- Secured with adjustable screw and clamp

PART NO.	DESCRIPTION	CTN QTY
J60010	4" cast iron vent cap	10

Brass Deck Plug



- Inside caulk
- Polished brass ring
- Cast brass body
- Skid-resistant scoriated lid

PART NO.	SIZE	CTN QTY
D28003	3"	12
D28004	4"	12

Blind Plugs



No Hub		
PART NO.	SIZE	CTN QTY
D59202	2"	10
D59203	3"	10
D59204	4"	8

Service Weight		
PART NO.	SIZE	CTN QTY
D59302	2"	10
D59303	3"	8
D59304	4"	4

Reading Style Cleanout



- 4" Inside caulk

PART NO.	DESCRIPTION	CTN QTY
J60012	Reading Cleanout	1

Plumbest Cast Iron Backwater Valves



- Reduces Backflow in drainage system
- All neoprene gaskets
- 300 series stainless bolts and washers
- Repairable in service
- Revolutionary design- that works!

Service Weight				
PART NO.	SIZE	LENGTH	HUB	CTN QTY
B01013	3"	10-3/4"	5-1/8"	1
B01014	4"	11-3/4"	6-1/2"	1
B01016	6"	12-3/4"	7-1/4"	1

No Hub				
PART NO.	SIZE	LENGTH	HUB	CTN QTY
B01002	2"	10-3/4"	—	1
B01003	3"	11-3/4"	—	1
B01004	4"	12-3/4"	—	1
B01006	6"	14-1/2"	—	1

Replacement Flappers		
PART NO.	DESCRIPTION	CTN QTY
B01017	2" bolt-in flapper and ring	1
B01018	3" bolt-in flapper and ring	1
B01019	4" bolt-in flapper and ring	1
B01020	6" bolt-in flapper and ring	1

Reading Style Vent



- 4" Inside caulk

PART NO.	DESCRIPTION	CTN QTY
J60011	Reading Vent	1

Test Tee



- Available with or without plug
- Plug is Southern Code

Service Weight Tee

PART NO.	DESCRIPTION	LENGTH	PLUG	CTN QTY
T55002	2"x 2" less plug	10-3/8"	2"	1
T55012	2"x 2" with plug	10-3/8"	2"	1
T55003	3"x 3" less plug	12-1/2"	3"	1
T55013	3"x 3" with plug	12-1/2"	3"	1
T55004	4"x 4" less plug	13-7/8"	4"	1
T55014	4"x 4" with plug	13-7/8"	4"	1

No Hub Tee

PART NO.	DESCRIPTION	LENGTH	PLUG	CTN QTY
T56002	2"x 2" less plug	6-3/8"	2"	1
T56012	2"x 2" with plug	6-3/8"	2"	1
T56003	3"x 3" less plug	7-3/4"	3"	1
T56013	3"x 3" with plug	7-3/4"	3"	1
T56004	4"x 4" less plug	8-7/8"	4"	1
T56014	4"x 4" with plug	8-7/8"	4"	1

Test Tee with Heavy Plug



Service Weight Tee With Heavy Plug

PART NO.	DESCRIPTION	LENGTH	PLUG	CTN QTY
T55022	2"x 2"	10-3/8"	2"	1
T55033	3"x 3"	12-1/2"	3"	1
T55044	4"x 4"	13-7/8"	4"	1

No Hub Tee With Heavy Plug

PART NO.	DESCRIPTION	LENGTH	PLUG	CTN QTY
T56022	2"x 2"	6-3/8"	2"	1
T56033	3"x 3"	7-3/4"	3"	1
T56044	4"x 4"	8-7/8"	4"	1

Cast Iron Single Vent Running Trap



PART NO.	DESCRIPTION	CTN QTY
T64540	5"x 4" single vent running trap	1

Tapped Saddle Tees



- U-bolt included

PART NO.	SIZE	CTN QTY
T21001	3"x 1 1/2"	1
T21002	3"x 2"	1
T21003	4"x 1 1/2"	1
T21004	4"x 2"	1
S26008	6" x 7" (1/4" thick) closed cell foam gasket	1

Repair Plate



- U-bolt included

PART NO.	DESCRIPTION	CTN QTY
T21062	2" Plate with u-bolt	1
T21063	3" Plate with u-bolt	1
T21064	4" Plate with u-bolt	1

F

"T" Burner Bar



- 12-1/4" long by 1-3/8" high, tapped 1/2" IPS in ends and bottom
- Supplied with two 1/2" plugs and close nipple orifice

PART NO.	DESCRIPTION	LENGTH	HEIGHT	CTN QTY
L75080	Natural Gas	12-1/4"	1-3/8"	10
L75180	LPG	12-1/4"	1-3/8"	10

Two Leg Burner



- Dimensions 14" long x 1-3/4" high x 2-1/4" wide
- Tapped 1/2" IPS on both ends and one leg
- Comes with two 1/2" IPS plugs and close nipple orifice
- Ledge over burner holes prevents clogging

PART NO.	DESCRIPTION	LENGTH	HEIGHT	CTN QTY
L75081	Natural Gas	14"	1-3/4"	10
L75181	LPG	14"	1-3/4"	10

Round Burner



- 1-3/4" high x 4 1/2" wide, tapped 1/2" IPS in bottom and sides
- Supplied with close nipple orifice and 1/2" plug

PART NO.	DESCRIPTION	WIDTH	HEIGHT	CTN QTY
L75086	Natural Gas	4-1/2"	1-3/4"	10
L75186	LPG	4-1/2"	1-3/4"	10

Rectangular Burner



- Dimensions 8-3/4" long x 1-1/2" high x 1-3/4" wide with 1/2" IPS inlet
- Supplied with close nipple orifice and removable lid
- Low Profile

PART NO.	DESCRIPTION	LENGTH	HEIGHT	CTN QTY
L75085	Natural Gas	8-3/4"	1-1/2"	10
L75185	LPG	8-3/4"	1-1/2"	10

Log Lighter Burner Bars



- Air mixing chamber
- Straight: 17" pipe plus 3" mixing chamber
- T-Pattern: Two 7" pipes plus 3" mixing chamber

PART NO.	DESCRIPTION	CTN QTY
L75091	Straight for natural gas	10
L75092	Straight for LPG	10
L75095	Tee for natural gas	10
L75096	Tee for LPG	10

Log Lighter Valves

- CSA design certified
- Zinc Escutcheon
- 1/4" Key included
- Individually tested (pressure test in open and closed position after installation)
- BTU rating: angle 188,000, straight 120,000
- To extend escutcheon use 1/2" pipe coupling and 1/2" pipe nipple

Standard Valve (7 turns open/close)



PART NO.	DESCRIPTION	CTN QTY
L75001	Chrome plated angle	25
L75002	Polished brass angle	25
L75006	Chrome plated straight	25
L75007	Polished brass straight	25

Ball Valve (1/4" turn)



PART NO.	DESCRIPTION	CTN QTY
L75040	Chrome plated angle	25
L75041	Polished brass angle	25
L75042	Chrome plated straight	25
L75043	Polished brass straight	25

Escutcheons Only

PART NO.	DESCRIPTION	CTN QTY
L75908	Chrome plated	1
L75909	Polished brass	1

Combo Log Lighter Valves



- Straight or angle pattern
- 5/16" key and brass plug for extra outlet included

PART NO.	DESCRIPTION	CTN QTY
L75009	Chrome plated	10
L75010	Polished brass	10

Log Lighter Valves with T-Burner



- Solid brass escutcheon, 1/4" key and close nipple orifice included
- Individually tested (pressure test open and closed after installation)
- Angle: 188,000 BTU/Straight: 120,000 BTU

PART NO.	DESCRIPTION	CTN QTY
L75406	Chrome plated angle natural gas	1
L75407	Polished brass angle natural gas	1
L75408	Chrome plated straight natural gas	1
L75409	Polished brass straight natural gas	1
L75400	Chrome plated angle LPG	1
L75401	Polished brass angle LPG	1
L75402	Chrome plated straight LPG	1
L75403	Polished brass straight LPG	1

Log Lighter Keys and Accessories

- 1/4" and 5/16" drives on keys

All Brass Keys



PART NO.	DESCRIPTION	CTN QTY
L75019	1/4"x 3"	200
L75020	5/16"x 3"	200
L75021	1/4"x 6"	240
L75023	5/16"x 6"	240
L75022	1/4"x 12"	100
L75024	5/16"x 12"	100

Die Cast Zinc Keys



PART NO.	DESCRIPTION	CTN QTY
L75017	1/4"x 3"	250
L75018	5/16"x 3"	250

Close Nipple Orifices



PART NO.	DESCRIPTION	CTN QTY
L75015	7/64" Orifice for natural gas	1
L75016	5/64" Orifice for LP gas	1

SECTION G - TOOLS..... 284-310



Tub And Shower Valve Wrench Set



- Complete set with handle includes: 21/32" x 27/32, 29/32" x 31/32", 1 1/32" x 1 3/32", 1 11/32" x 1 7/16"
- Plated steel

PART NO.	DESCRIPTION	CTN/MSTR
J40002	Valve wrench set	1/20
J40000	21/32" x 27/32" wrench only	20/100
J40001	1 1/32" x 1 3/32" wrench only	20/100
J40006	29/32" x 31/32" wrench only	20/100
J40008	1 11/32" x 1 7/16" wrench only	50

Garbage Disposal Wrench



- 1/2" steel
- 10" long

PART NO.	DESCRIPTION	CTN/MSTR
J40025	Disposal wrench	25/50

4-Way Key



Carded

- Plated steel
- For valve, faucet and sillcock sizes 1/4", 9/32", 5/16" and 11/32"

PART NO.	DESCRIPTION	CTN/MSTR
J40005	4-way key (carded)	50/100

No Hub Torque Wrench



Carded

- Automatic release at 60 in.lb.
- Built-in reversing lever
- Ratchets one way
- Chrome vanadium socket

PART NO.	DESCRIPTION	CTN/MSTR
T60060	No hub torque wrench (carded)	20/80

Mega Torque Wrench



- Slide down locking reversing feature
- Heavy duty construction with chrome vanadium sockets
- 60 lb. = 5/16" socket/80 lb = 3/8" socket

PART NO.	DESCRIPTION	CTN/MSTR
T60065	60 lb. - Mega Torque Wrench	15/60
T60080	80 lb. - Mega Torque Wrench with 3/8" Socket	15/60
T60081	80 lb. - Mega Torque Wrench with 5/16" Socket	1
T60066	5/16" Socket kit	1

Element Wrench



- Zinc plated steel
- For removing heater elements

PART NO.	DESCRIPTION	CTN/MSTR
J36100	Regular unit wrench	50/100
J36101	Heavy duty wrench	25/50

Sillcock Key



- Die cast
- 5/16" and 1/4"

PART NO.	DESCRIPTION	CTN/MSTR
J40003	1/4" Sillcock key	1/400
J40004	5/16" Sillcock key	1/400

14 Piece Folding Hex Key Wrench Set



- Chrome plated steel case
- Fourteen fractional U.S. sizes

PART NO.	DESCRIPTION	CTN/MSTR
J40015	Hex key wrench set (carded)	12/72

Basin Wrenches



B11010



B11012



B11011



B11013 Replacement Jaw

- Spring-hinged jaw
- Telescoping body allows for easier use in hard-to-reach areas
- Swivel head operates from either right or left side
- Use on hard-to-reach basin nuts, ballcocks and flush valves

PART NO.	DESCRIPTION	JAW	CTN/MSTR
B11010	10"-17" telescoping	1 1/4"	10/30
B11011	11 3/8" long non-telescoping	1 1/4"	10/40
B11012	9 1/2" - 16 1/2" telescoping	2"	15/30
B11013	Spring hinged replacement jaw for B11011	-	20/100

Radiator Spud Wrench



- Plated malleable iron
- For use as spud key and wrench

PART NO.	DESCRIPTION	CTN/MSTR
J40030	Radiator spud wrench	10/20

4-Way P.O. Plug Wrench



- For installing or removing basket strainers, tub drains and p.o. plugs

PART NO.	DESCRIPTION	CTN/MSTR
J40026	4-way p.o. plug wrench	20/60

4-Way Plug Wrench



PART NO.	DESCRIPTION	CTN/MSTR
J40040	4-way countersunk plug wrench	1/20

4-Way Countersunk Plug Wrench



- For installing or removing countersunk plugs

PART NO.	DESCRIPTION	CTN/MSTR
J40041	4-way countersunk plug wrench	5/15

6-Way Countersunk Plug Wrench



- 4 head sizes for square plugs
- 2 head sizes for slotted plugs
- Extra-strong iron construction

PART NO.	DESCRIPTION	CTN/MSTR
J40042	6-way wrench	1/20

Faucet Seat Repair Kit



Carded

- Reversible cone
- 4 sizes of cutters
- Hardened steel cutters smooth worn seats
- Saves repair costs; stops faucet drips
- Kit includes faucet washers and bibb screw

PART NO.	DESCRIPTION	CTN/MSTR
J40007	Faucet seat repair kit	12/120

Faucet Seat Wrench



- Tapered for use on all sizes and types of seats

PART NO.	DESCRIPTION	CTN/MSTR
S62001	Straight tapered wrench	100/200
S62002	Angle tapered wrench	20/60
S62003	Straight stepped wrench	100/200
S62004	Angle stepped wrench	20/60

Seat Wrench For Recessed Seats



- Works in hard-to-reach recessed seats

PART NO.	DESCRIPTION	CTN/MSTR
S62005	Seat wrench for recessed seats	1/100

Dual Kwik Tite Wrench



- Install stops easily
- Tightens 3/8" supply nuts

PART NO.	DESCRIPTION	CTN/MSTR
J40490	Dual Kwik Tie Wrench	15/60

Lavatory Nut Removal Tool



- Lightweight, high strength plastic
- For 7/8" metal or plastic hex nuts
- Extra long to reach mounting nuts on faucets, sprayers, and ballcocks

PART NO.	DESCRIPTION	CTN/MSTR
J40035	Lavatory Nut Removal Tool	1/50

Universal Drain Wrench



Carded

- 6" long
- Die cast aluminum
- Installs and removes tub drains and closet spuds
- Prevents damage to decorative finishes
- Use crescent wrench or screwdriver to turn tool

PART NO.	DESCRIPTION	CTN/MSTR
J45010	Universal drain wrench (carded)	12/48

Angle Compression Stop Wrench



- Fits 3/8" compression or 1/2" male IPS outlet threads on angle stops
- Protects finishes

PART NO.	DESCRIPTION	CTN/MSTR
J40491	Angle compression stop wrench	10/60

Extract-a-Drain Tub Drain Removal Tool



- Removes old or rusty drains - even drains with missing crossbars!
- Fits both 1 3/8" and 1 1/2" tub drains
- Jaws expand to firmly grip the inside of the drain
- Prevents damage to your tub's finish
- A wrench is the only other tool that you'll need to complete this job

PART NO.	DESCRIPTION	CTN/MSTR
J40018	Extract-a-drain tool	1/25

Compression Sleeve Puller



- Removes leaking compression sleeves without damaging walls
- Unique armless design - screws directly into compression nut for fast removal
- For 5/8" compression nuts
- Made in the U.S.A. (J40021)

PART NO.	DESCRIPTION	CTN/MSTR
J40021	Compression sleeve puller (carded)	1/35
J44661	Compression sleeve puller - 1/2" OD	10/40

Compression Sleeve Puller Adapter



- Converts any standard faucet handle puller to remove compression sleeves

PART NO.	DESCRIPTION	CTN QTY
J40013	Adapter	10

E-ZEE Pull Deluxe Faucet Handle Puller



- 4" bracket width
- Pulls all size handles
- Forged steel with case - hardened pin

PART NO.	DESCRIPTION	CTN/MSTR
J40012	E-ZEE pull deluxe faucet handle puller	25/50

Faucet Handle Pullers



- Plated steel
- Removes faucet and valve handles

PART NO.	DESCRIPTION	CTN/MSTR
J40010	Standard unit (carded)	25/50
J40011	Heavy duty impact unit	15/30

Quick Drain Wrench



- Installs no caulk shower drains quickly
- Provides tongue to seal drain

PART NO.	DESCRIPTION	CTN/MSTR
J40235	Quick Drain Wrench	10/60

Sink Drain Wrench



- Fits kitchen, bath & laundry tub basket strainers, "P" traps, wing nuts and tub drains
- Made in the U.S.A.

MADE IN THE USA

PART NO.	DESCRIPTION	CTN/MSTR
J40023	Sink drain wrench	1/24

Moen Stem And Cartridge Wrench



- Removes Moen stems and cartridges
- Works on plastic and brass faucet and shower valves

PART NO.	DESCRIPTION	CTN/MSTR
J45015	Stem and cartridge wrench (carded)	12/72

Adjustable Strainer And Spud Wrench



- Fits closet spuds, basket strainers, lock nuts and slip nuts
- Adjustment 7/8" to 3 1/8"
- Plated

PART NO.	DESCRIPTION	CTN/MSTR
J40022	Strainer & spud wrench	20/40

Spud Wrench



- For strainer, lock and slip nuts
- 1" - 3" capacity
- Heat treated forging

PART NO.	DESCRIPTION	CTN/MSTR
J40305	Spud wrench	20/40

Spud Wrench With Hinged Arm



PART NO.	DESCRIPTION	CTN/MSTR
J40306	Spud wrench with hinged arm	30/60

Spanner/Strainer Wrench



- Plated malleable iron
- Used for basket strainer jam nuts

PART NO.	DESCRIPTION	CTN/MSTR
J40024	Spanner/strainer wrench	25/50

Strainer Wrench



- For use on basket strainers and tub drains with cross bars
- Long handle for leverage
- Plated steel

PART NO.	DESCRIPTION	CTN/MSTR
J40028	Strainer wrench	20/60

Plumb Easy Sink Strainer Wrench



- Fits most basket strainers
- Installs and removes basket strainers with ease

PART NO.	DESCRIPTION	CTN/MSTR
J40128	Plumb Easy sink strainer wrench	4/32

Do All Plumbers Wrench



- Longer, more comfortable handle allows greater leverage for tightening or loosening locknuts
- Fits most standard size basket strainers including: Opella, Duo, Twist Lock and PB Duo. Use on any strainer which uses a standard 3 3/8" locknut
- Fits most shower stall drains
- Fits the following drain styles:
 - 2" Plastic No Caulk for plastic pipe
 - 2" Brass No Caulk for plastic pipe
 - 2" Receptor Base for plastic pipe
 - 2" Drop In style for plastic pipe

PART NO.	DESCRIPTION	CTN/MSTR
J40019	Do All plumbers wrench (Carded)	10/40

Heavy Duty Pipe Wrench



- Manufactured to U.S. Specification GGG-W651 Type II Class A
- Upper and lower jaws forged and tempered
- Nodular cast iron handle



PART NO.	ROTHENBERGER	LENGTH	CAPACITY	CTN QTY
J40065	7.0150	8"	1"	6
J40066	7.0151	10"	1 1/2"	6
J40067	7.0152	12"	2"	6
J40068	7.0153	14"	2"	4
J40069	7.0154	18"	2 1/2"	2
J40070	7.0155	24"	3"	4
J40105	7.0156	36"	5"	4

Aluminum Pipe Wrench



- Manufactured to U.S. Specification GGG-W651 Type I Class B
- Forged and tempered handle, bottom jaw and nut
- Alloy handle



PART NO.	ROTHENBERGER	LENGTH	CAPACITY	CTN QTY
J40071	7.0159	10"	1 1/2"	4
J40072	7.0160	14"	2"	6
J40073	7.0161	18"	2 1/2"	6
J40074	7.0162	24"	3"	6
J40106	7.0163	36"	5"	4

Adjustable Wrench



- Drop forged
- Chrome plated
- Manufactured to Federal Specification GGG-W-631-B Type I Class I



PART NO.	LENGTH	CAPACITY	CTN QTY
J40075	6"	13/16"	5
J40076	8"	15/16"	5
J40077	10"	1 3/16"	5
J40078	12"	1 3/8"	5
J40079	15"	1 3/8"	1

Curb Box Wrench



- For pentagon curb boxes
- Thin wall socket fits most boxes

PART NO.	DESCRIPTION	CTN/MSTR
M25900	Curb box wrench	1/100

Box Wrench



- For B and MC tanks

PART NO.	DESCRIPTION	CTN QTY
J40230	Box wrench	1

Bibb Seat Tool Set



- Set includes:
 - 3/8" x 7/16" ratcheting box wrench
 - small hex/large hex tapered bibb seat tool
 - small square/large square tapered bibb seat tool
 - small square /large square straight bibb seat tool

PART NO.	DESCRIPTION	CTN/MSTR
J40308	Bibb seat tool set	10/20

Strap Wrench



- For chrome fittings and nipples

PART NO.	DESCRIPTION	CTN/MSTR
J40307	7" strap wrench	25/50
J40311	11" strap wrench	8/24

Twist-Off Strap Tool



Carded

- Grips when wet
- Will not scratch
- High density polyethylene handle
- Heavy duty rubber strap

PART NO.	DESCRIPTION	CTN/MSTR
J40325	Twist-off Strap Tool(carded)	15/60

Hydrostatic Pressure Pump



- Maximum pressure 700 PSI
- 1/2" NPT hose connection
- Three gallon tank capacity



PART NO.	ROTHENBERGER	DESCRIPTION	CTN QTY
J40223	6.1004	Complete pressure pump unit	1
J40224	6.1313	0 - 700 PSI gauge	1
J40225	6.1300	Piston	1

RP 30 Hydrostatic Test Pump



- For quick pressure testing and/or air tight testing
- Ideal for use in small spaces
- Steel reinforced test hose
- Test up to 440 lbs
- No false reading from any bulging of the hose!



PART NO.	DESCRIPTION	CTN QTY
J40123	Hydrostatic Test Pump	1

High Pressure Hose with Fitting



- For hydrostatic pressure pump

PART NO.	DESCRIPTION	CTN QTY
J40198	High pressure hose with fitting	1

Air Pump



- Large diameter
- Heavy metal construction
- Pressure gauge included

PART NO.	DESCRIPTION	CTN/MSTR
P10001	Heavy duty pump	1/10

Economy Air Pump



PART NO.	DESCRIPTION	CTN/MSTR
P10002	1 1/2" x 18" air pump	1/12

Water Pump



- Excellent for draining water meter boxes
- High impact PVC; non-sparking; lightweight
- No priming necessary- removes 35 ounce/stroke
- Remove foot valve to clean

PART NO.	DESCRIPTION	CTN QTY
P13600	36" pump with 72" discharge hose	1

Copper Fitting Brush



- Carbon steel
- CARTON QUANTITIES ONLY

Wire Handle

Wooden Handle

Wire Handle			
PART NO.	ID	OD	CTN/MSTR
B28025	1/4"	3/8"	12/72
B28375	3/8"	1/2"	12/72
B28050	1/2"	5/8"	12/72
B28051	1/2"	5/8"	100-bulk
B28075	3/4"	7/8"	12/72
B28076	3/4"	7/8"	100-bulk
B28100	1"	1 1/8"	12/72
B28125	1 1/4"	1 3/8"	6/36
B28150	1 1/2"	1 5/8"	12/72
B28200	2"	2 1/8"	6/36
Wooden Handle			
PART NO.	ID	OD	CTN/MSTR
B29025	1/4"	3/8"	12/72
B29375	3/8"	1/2"	12/72
B29050	1/2"	5/8"	12/72
B29051	1/2"	5/8"	100-bulk
B29075	3/4"	7/8"	12/72
B29076	3/4"	7/8"	100-bulk
B29100	1"	1 1/8"	12/72
B29125	1 1/4"	1 3/8"	6/36
B29150	1 1/2"	1 5/8"	6/36
B29200	2"	2 1/8"	6/36

4-N-1 Copper Tube Fitting Brush



- Includes four long lasting high carbon steel brushes for 1 1/2" and 3/4" copper tube and fittings

PART NO.	DESCRIPTION	CTN/MSTR
B10004	Copper tube and fitting brush	1/10

Female Copper Tube Brush



- For cleaning copper tubing
- CARTON QUANTITIES ONLY

PART NO.	DESCRIPTION	CTN QTY
B29625	CTS OD 5/8" copper tube brush	6
B29875	CTS OD 7/8" copper tube brush	6
B29999	CTS OD 1 1/8" copper tube brush	6

Socket Savers



- Removes Schedule 40 plastic pipe
- Cuts ABS or PVC DWV pipe below slab
- Fits 1/2" variable speed power drill
- Carded for display

PART NO.	DESCRIPTION	CTN/MSTR
J44050	1/2" Socket Saver	36/144
J44075	3/4" Socket Saver	30/120
J44100	1" Socket Saver	24/96
J44150	1 1/2" Socket Saver	24/96
J44200	2" Socket Saver	12/72
J44300	3" Socket Saver	12/48
J44400	4" Socket Saver	20/40

Inside Pipe Cutter



- Cuts 2" and larger plastic pipe
- Fits electric drill

PART NO.	DESCRIPTION	CTN/MSTR
P70023	3" shaft with 2 blades	1/50
P70029	3 replacement blades	10

PlumBest E-Z Shear Inside Pipe Cutter



- Cuts PVC and ABS pipe
- High speed steel blade with zinc-plated shaft

PART NO.	DESCRIPTION	CTN/MSTR
J40830	E-Z shear inside pipe cutter	24/192
J40831	Two (2) E-Z shear replacement blades	1/100

PVC Pipe Cutters



- High carbon steel blades
- Repair kits includes all screws and springs needed to repair cutter
- Aluminum alloy handles
- Ratchet action

PART NO.	DESCRIPTION	CTN/MSTR
P70001	1" pipe cutter (carded)	10/50
P70005	1" replacement blade	25/300
P70015	1" repair kit	1/100

Heavy Duty PVC Pipe Cutters



- High carbon steel blades
- Repair kits includes all screws and springs needed to repair cutter
- Aluminum alloy handles

PART NO.	DESCRIPTION	CTN/MSTR
P70010	1" heavy duty pipe cutter (boxed)	1/60
P70011	1" heavy duty replacement blade	1/100
P70012	1" repair kit	1/100
P70002	2" pipe cutter (boxed)	1/20
P70006	2" replacement blade	1/100
P70016	2" repair kit	1/100

PVC One-Handed Pipe Cutters



- Easy one-handed ratchet cutting action
- Spring loaded blade
- Heat treated hardened steel blade for straighter cuts - longer life
- Contractor quality - great for plumbers, pool contractors, electricians, etc.
- Cuts up to 2" pipe (2 1/2" OD)

PART NO.	DESCRIPTION	CTN/MSTR
P70035	2" PVC One-handed pipe cutter	6/24
P70036	2" replacement blade	10/100

Professional PVC Pipe Cutter



- Rustproof
- Capacity to 1 1/4" diameter PVC
- The blade is non-electro nickel plated which ensures a sharper blade
- Locking hook can be used to deburr pipe

PART NO.	DESCRIPTION	CTN/MSTR
P70018	1 1/4" PVC pipe cutter (carded)	5/30
P70019	Replacement blade for P70018	10/100
P70020	Repair kit	10/100

Vinyl Tubing Cutter



- Plastic body
- Cuts up to 1" vinyl tubing

PART NO.	DESCRIPTION	CTN/MSTR
P70030	Vinyl tube cutter	12/72
P70031	Vinyl tube cutter replacement blade	1/50

Telescopic Tubing Cutter



- Extra wheel in handle
- Grooved roller
- 1/4" - 1 1/4" cutter
- Imported
- Built-in deburring tool

PART NO.	DESCRIPTION	CTN/MSTR
P70050	Telescopic tubing cutter	10/100
P70055	Replacement cutter wheel	1/100
P70056	Two (2) Replacement cutter wheels	50/100

Telescoping Tubing Cutter



- Enclosed feed mechanism
- Grooved rollers for close-to-flare cuts
- Anodized body for corrosion resistance
- Allows cut with shorter arc
- Fold-away reamer
- Spare cutter wheel stored in body



PART NO.	ROTHENBERGER	DESCRIPTION	CTN QTY
J40240	7.0010	1/8" - 1 1/8" O.D. capacity	1
J40241	7.0011	1/4" - 1 5/8" O.D. capacity	1
J40242	7.0007	Replacement cutter wheel	1
J40243	51250	Cutter wheel pin	1
J40244	51240	Cutter wheel pin retaining ring	1

Enclosed Feed Tube Cutter



- Extra cutter in knob
- Heavy duty one piece slide
- Polished rollers for easy rotation
- Cuts: Copper, brass, aluminum tubing, thin-wall conduit

PART NO.	DESCRIPTION	CTN/MSTR
P70064	1/8" x 1 3/16"	10/100
P70056	Two (2) Replacement cutter wheels	50/500

Quick Release Tubing Cutter



- Spring-loaded for quick size adjustment
- Spring cutter wheel in handle
- Imported

P70069 Carded

PART NO.	DESCRIPTION	CTN/MSTR
P70065	1/4" - 2" O.D. Capacity tubing cutter	6/48
P70069	Two (2) Replacement cutter wheels (carded)	1

Quick Release Tubing Cutter



- Spring-loaded ratchet allows for quick size adjustment and release
- Spare cutter wheel in handle



PART NO.	ROTHENBERGER	DESCRIPTION	CTN/MSTR
J40217	7.0030	1/4" - 2 5/8" heavy duty cutter	1
J40218	7.0005	Repl. cutter wheel for metal	1
J40219	7.0028	Repl. cutter wheel for plastic	1
J40228	7.0006	Cutter wheel screw	1/10

Economy Tube Cutter



- Screw-feed
- Zinc plated

PART NO.	DESCRIPTION	CTN/MSTR
P70066	1/8" - 1 1/8"	10/100
P70067	Replacement blades (slide blister)	50/500

Mini Tubing Cutter



PART NO.	ROTHENBERGER	DESCRIPTION	CTN/MSTR
J40213	7.0001	5/8" capacity tubing cutter	1/24
J40214	7.0002	7/8" capacity tubing cutter	1/24
J40215	7.0003	Replacement cutter wheel	1
J40228	7.0006	Cutter wheel screw	6/48

Mini Tubing Cutter



- 1/8" - 1/2" cutter

PART NO.	DESCRIPTION	CTN/MSTR
P70051	Mini tubing cutter - 1/8"-7/8"	20/200
P70060	Mini tubing cutter- 1/8" - 1 1/8"	25/100
P70067	Replacement blades (slide blister)	50/500

Mini Tubing Cutter



- Good for all soft metal tubing

PART NO.	DESCRIPTION	CTN/MSTR
P70052	Mini tubing cutter-1/8"-7/8" (uses P70055 repl. blade)	12/120
P70053	Mini tubing cutter- 1/8" - 1 1/8"	1
P70067	Replacement blades (slide blister)	50/500

Copper Tube Cutter



- Self-clamping and self-aligning
- Easy to use in close quarters
- Cuts copper and PVC quickly and easily

PART NO.	DESCRIPTION	CTN/MSTR
J40260	1/2" Copper tube cutter	10/100
J40261	3/4" Copper tube cutter	10/60
J40263	Replacement blades for J40260 & J40261	1

Ratcheting Handle Copper Tube Cutter



- Cuts multiple sizes of copper, aluminum tubing, and thin-wall conduit
- Long handle for more leverage

PART NO.	DESCRIPTION	CTN/MSTR
J40262	1/4"-3/4" Ratcheting handle copper tube cutter	6/48

E-Z Stroke Pipe Saw



- For smooth, fast, accurate cutting
- Tri-edge teeth are borazon wheel ground
- Pull-stroke cutting action
- Cuts plastic pipe and wood
- Replaceable blade

PART NO.	DESCRIPTION	CTN/MSTR
S49005	8" E-Z stroke pipe saw	10/100
S49006	8" Replacement blade	50/250
S49008	12" E-Z stroke pipe saw	10/100
S49007	12" Replacement blade	50/200

PlumBest Plastic Saw



- Die cast aluminum handle
- Quickly cuts PVC, ABS, wood, sheetrock, etc.
- Large comfortable grip
- Flame hardened blade
- 18" blade has 10 teeth/inch

PART NO.	DESCRIPTION	CTN QTY
S49001	18" PlumBest saw	6
S49002	18" Replacement blade	10
S49010	Handle only	10

Drywall Saw



- High quality carbon steel blade
- Great for sheetrock, wallboard, gypsum, plywood, wood and plastic pipe
- 6" 8 TPI aggressive tooth design ensures super sharp, fast & easy cut
- Comfortable grip with thumb stop for greater leverage
- Handy wrist strap

PART NO.	DESCRIPTION	CTN/MSTR
S49012	Drywall saw	1/10
S49013	Replacement blade	1/300

Jr. Plumber's Saw



- Die cast aluminum handle
- Case hardened steel blade
- Deburs as it cuts
- Cuts up to 4" PVC pipe
- 8 1/2" blade; 10 teeth/inch
- Unique nose teeth permit starting cuts on flat surfaces

PART NO.	DESCRIPTION	CTN QTY
S49004	Jr. Plumber's saw	1
S49000	8 1/2" Replacement blade	1

Hardwood 250 Speed Handsaw



- Great for hardwood and laminated wood
- Tri-edge and impulse hardened teeth for accurate rip, cross and slant cuts

PART NO.	DESCRIPTION	CTN QTY
S49200	Hardwood 250 Speed Handsaw	10/60
S49201	Replacement blade	50/100

Cable Saws

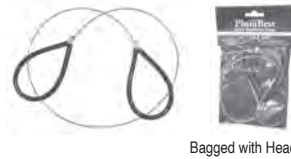

Bagged with Header

- For cutting PVC pipe
- For tight spots offering little clearance
- Fits easily into tool box and pocket
- Faster and easier than hacksaws in close quarters
- Individually bagged with header card

PART NO.	DESCRIPTION	CTN QTY
S49136	36" cable saws with display	36
S49148	48" cable saws with display	24
S49036	36" cable saw	1
S49048	48" cable saw	1

T-Handle Cable Saw



Bagged with Header

- For cutting PVC pipe
- Strong and comfortable t-handles
- Polybagged with header card
- Great for use in tight spots
- Long-lasting stainless steel cutting cable

PART NO.	DESCRIPTION	CTN QTY
S49236	36" cable saw	1

Close Quarters Hacksaw



S50060

S50062

- Nickel plated steel frame
- Cuts wood, plastic, brass, aluminum and steel

PART NO.	DESCRIPTION	CTN/MSTR
S50060	6" close quarters hacksaw	1/50
S50061	Replacement blades for S50060	5/800
S50062	6" adjustable hacksaw	12/144
S50063	Replacement blades for S50062	5/500

PlumBest Hacksaw



- Heavy square tubing and die cast construction
- Stores extra blades
- Blade tensioning adjustment
- Cuts flush with surface

PART NO.	DESCRIPTION	CTN/MSTR
S49003	Hacksaw with blade	6/36

Utility Knife



- Heavy duty construction
- Supplied with extra blade
- Coated case

PART NO.	DESCRIPTION	CTN/MSTR
K50041	Utility knife	12/120
K50042	Five replacement blades per pack	100/1000

Snap Knife



- Seven point snap-off blade
- Counter display box has 30 pcs.
- Replacement blades
- CARTON QUANTITIES ONLY
- 10 per tube, priced each

PART NO.	DESCRIPTION	CTN/MSTR
K50001	Snap knives with display box	30/300
K50002	7 point snap knife	40/480
K50003	7 point replacement blade	10/200

Deluxe Autolock Snap Knife



- Blade automatically locks into position
- Contoured shape for a more comfortable grip

PART NO.	DESCRIPTION	CTN QTY
K50005	Deluxe autolock snap knife	20/200

Fiberglass Handle Shovels



- STINGER SERIES - Fiberglass handle is 40% stronger than Federal Strength Test for long handle wood tools.
- Large steel collar adds maximum strength to handle/socket connection.
- Forward - turned step for secure foot placement

PART NO.	DESCRIPTION	AMES #	BUNDLE QTY
S49411	Long handle round point	SFGLR	6
S49412	Long handle square point	SFGLS	6
S49416	D-Handle 16" drain spade	SFGD16	6
S49413	Long handle 16" drain spade	SFGDSL	6

Premium Grade Wood Handle Shovels

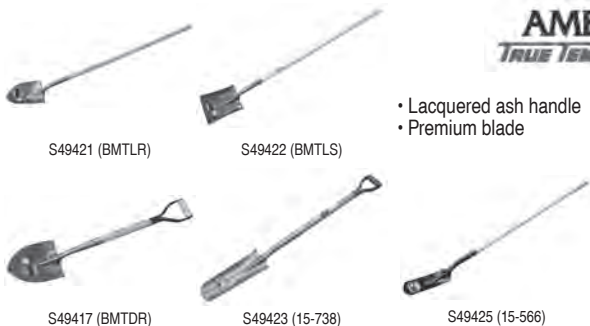

- Lacquered ash handle
- Premium blade

PART NO.	DESCRIPTION	AMES #	BUNDLE QTY
S49421	Long handle round point	BMTLR	6
S49422	Long handle square point	BMTLS	6
S49417	D-Handle round point	BMTDR	6
S49423	D-Handle 16" drain spade	15-738	6
S49425	LH trenching shovel 4" blade	15-566	6
S49427	LH trenching shovel 5" blade	15-567	6

Economy Shovels



PART NO.	DESCRIPTION	AMES #	BUNDLE QTY
S49431	Long handle round point	15-047	6
S49432	Long handle square point	15-049	6

Specialty Shovels



- KODIAK CUB - smaller design for easier use in tight spaces
- 16 gauge tempered steel blade
- Forward turned step
- 27" overall length

PART NO.	DESCRIPTION	AMES #	BUNDLE QTY
S49429	Compact utility shovel	15-663	6

Long Handle Round Point Fiberglass Shovel



- Long fiberglass handle
- Round point

PART NO.	DESCRIPTION	BUNDLE QTY
S49400	Long handle round point	6

Cold Chisels



- Designed for cutting cast iron or steel

PART NO.	DESCRIPTION	CTN/MSTR
J41002	1" wide x 8" regular length	1/24

Short Nose Caulking Tools



- For finishing lead joint

PART NO.	DESCRIPTION	CTN/MSTR
J41008	5/8" wide x 7 1/2" long	1/24

Inside Caulking Tools



- For finishing lead joint

PART NO.	DESCRIPTION	CTN/MSTR
J41009	5/8" wide x 7" long	1/24

Outside Caulking Tools



• For finishing lead joint

PART NO.	DESCRIPTION	CTN/MSTR
J41010	5/8" wide x 7" long	1/24

Broad Curve Nose Caulking Tools



• Used for packing Oakum tight
• For first pass on lead

PART NO.	DESCRIPTION	CTN/MSTR
J41011	5/8" wide x 8" x 1 1/2"	1/24

17 Pound Digging/Tamping Bar



• For digging holes, cutting roots or tamping

PART NO.	DESCRIPTION	CTN QTY
S49500	1" x 69" post hole digger	1

Slim Bar 360 Nail Puller



• 14" long
• Hang tab included

PART NO.	DESCRIPTION	CTN. QTY.
J40-400	Slim bar 360 nail puller	1

Utility Pry Bar



PART NO.	DESCRIPTION	CTN/MSTR
S49489	14" utility pry bar	1/5

Manhole Cover Lifter



• 25" long



PART NO.	DESCRIPTION	CTN/MSTR
S49490	Manhole cover lifter	1/10

Gooseneck Wrecking Bar



• Painted and polished
• Claw on end removes nails

PART NO.	DESCRIPTION	CTN/MSTR
S49501	30" wrecking bar	1/10

Striking Tools



• Made in the USA
• Hickory handles
• Long life - high quality

PART NO.	DESCRIPTION	CTN QTY
J40144	3 lb. engineers hammer	2
J40142	6 lb. sledgehammer	3
J40143	8 lb. sledgehammer	3

Pick Mattock



• Hardwood handle
• 5 pound head

PART NO.	DESCRIPTION	CTN/MSTR
J40141	5 lb. pick mattock with handle	1/4

Probing Rod



• Weather resistant fiberglass
• Eliminates danger of shock
• Tip is not replaceable

PART NO.	DESCRIPTION	CTN QTY
P27048	4'	5

Steel Probing Rod



• Stainless steel tips
• Cushion vinyl handle
• Welded steel construction

PART NO.	DESCRIPTION	CTN QTY
P27004	4'	5
P27005	5'	5
P27001	Stainless steel tip	5

Steel Probing Rod With Ball Point



Ballpoint Tip

• Steel shaft
• Vinyl handle for comfort
• Carbon steel ballpoint will not puncture soft pipe
• Tip is not replaceable

PART NO.	DESCRIPTION	CTN QTY
P27003	3' metal probing rod	1
P27040	4' metal probing rod	1

Water Meter Keys



- Rebar shaft and handle for greater strength
- Vinyl covered handle comfort

PART NO.	DIAMETER x LENGTH	BUNDLE QTY
M25127	1/2" x 27"	5
M25136	1/2" x 36"	5
M25148	1/2" x 48"	5
M25527	5/8" x 27"	5
M25536	5/8" x 36"	5
M25560	5/8" x 60"	5
M25736	3/4" x 36"	5
M25760	3/4" x 60"	5
M25772	3/4" x 72"	5
M25784	3/4" x 84"	5

Combo Water Meter Key



- Rebar shaft and handle for greater strength
- Vinyl covered handle comfort
- Combo lid key and meter key

PART NO.	SIZE	BUNDLE QTY
M25130	1/2" x 30"	5

Gate Valve Key



PART NO.	SIZE	CTN QTY
M25100	30"	5

Copper Sizing Tool



- For type "M" copper tubing
- Impact type to reround tube

PART NO.	DESCRIPTION	CTN/MSTR
J40750	1/2" Copper sizing tool	10/60
J40775	3/4" Copper sizing tool	10/40
J40800	1" Copper sizing tool	10/30

Copper Swedge Tool



J40375

J40369

- Use J40375 on 1/4", 5/16", 3/8", 1/2", and 5/8" copper tube
- Use J40369 on 5/8", 7/8", and 1 1/8" copper tube
- Heat-treated carbon steel
- Can also be used on soft copper, aluminum or any other thin-walled tubing

PART NO.	DESCRIPTION	CTN/MSTR
J40375	Copper swedge tool	25/100
J40369	Copper swedge tool (up to 1 1/8")	12/24

Polybutylene Crimping Tools



- Single crimp and combo tools
- Made in the USA
- Accurate and easy to use
- Unit can be calibrated in the field

MADE IN THE USA

PART NO.	DESCRIPTION	CTN QTY
J42002	1/2" regular crimping tool	1
J42003	3/4" regular crimping tool	1
J42004	1/2" - 3/4" combo crimping tool	1

Note: These tools cannot be returned for repair.

Pex Crimp Set



J40950

J40952

J40965

J40966

- For use on crimping PEX pipe with copper crimp rings and stainless steel bands

PART NO.	DESCRIPTION	CTN QTY
J40950	PEX crimp set with 3/8", 1/2", 3/4"	1
J40951	3/8" PEX crimp tool	1
J40952	1/2" PEX crimp tool	1
J40953	3/4" PEX crimp tool	1
J40954	1" PEX crimp tool	1
J40955	PEX crimp sizing tool	1
J40960	PEX crimp ring cutter	1
J40965	One hand PEX SS clamp tool	1
J40966	PEX SS clamp tool	1

Oetiker® 3-Handle Ratcheting Crimp Tool



- Tool will not release until clamp is properly closed
- Robust fastener with assist lever
- Single handed installation possible

MADE IN THE USA

PART NO.	DESCRIPTION	CTN QTY
J40967	3" hand crimp tool	1

Flaring Tool



- Makes smooth flare
- For O.D. sizes 3/16", 1/4", 5/16", 3/8", 1/2" and 5/8"

PART NO.	DESCRIPTION	CTN/MSTR
J40080	Bar flaring tool	6/24

Swing Release Flaring Tool



- 3/16" - 5/8" O.D.
- 45° single flare

PART NO.	DESCRIPTION	CTN/MSTR
J40220	45° flaring tool	1/12

Deburring Tool



- Easily removes burrs inside and outside of copper and plastic
- Handle stores spare blades

PART NO.	DESCRIPTION	CTN/MSTR
J40221	Deburring tool with blade	40/180
J40222	Replacement blade only	1

Nipple Extractor Sets



PART NO.	DESCRIPTION	CTN QTY
J40054	Nipple extractor set - 3/8", 1/2", 3/4"	1
J40055	Nipple extractor set - 3/8", 1/2", 3/4", 1"	1

Internal Pipe Nipple Extractors



- Heat treated and cad plated
- Removes or inserts nipples

PART NO.	DESCRIPTION	CTN/MSTR
J40050	3/8" nipple extractor	100/200
J40051	1/2" nipple extractor	20/120
J40052	3/4" nipple extractor	50/100
J40053	1" nipple extractor	25/50

Nipple And Screw Extractors



- Left hand spiral
- Removes nipples, bolts, and screws without thread damage

PART NO.	PIPE SIZE	DRILL SIZE	BOLT SIZE	CTN QTY
J41103	1/8"	1/4"	9/32" - 3/8"	1
J41104	1/4"	19/64"	3/8" - 5/8"	1
J41105	3/8"	13/32"	5/8" - 7/8"	1
J41106	1/2"	17/32"	7/8" - 1 1/8"	1
J41107	3/4"	13/16"	1 1/8" - 1 3/8"	1
J41108	1"	1 1/16"	1 3/8" - 2"	1

Carbide Tipped Masonry Drill Bit



PART NO.	REGULAR LENGTHS	SHANK SIZE	CTN QTY
S41349	5/32" x 4"	3/16"	1
S41351	3/16" x 4"	3/16"	1
S41350	1/4" x 4"	1/4"	1
S41352	5/16" x 4"	1/4"	1
S41353	3/8" x 6"	1/4"	1
S41354	7/16" x 6"	3/8"	1
S41355	1/2" x 6"	3/8"	1
S41356	9/16" x 6"	1/2"	1
S41357	5/8" x 6"	1/2"	1

Dual Auger Wood Bits

Screw Point



- Up to 1" for use in 3/8" or 1/2" power drill; 1" and up for use in 1/2"

PART NO.	DESCRIPTION	CTN QTY
B21625	5/8" x 6" long	1
B21075	3/4" x 6" long	1
B21087	7/8" x 6" long	1
B21100	1" x 6" long	1
B21112	1 1/8" x 6" long	1
B21125	1 1/4" x 6" long	1
B21150	1 1/2" x 6" long	1

Flat "Paddle" Wood Bits



PART NO.	SIZE	CTN QTY
B24375	3/8"	1
B24050	1/2"	1
B24056	9/16"	1
B24063	5/8"	1
B24075	3/4"	1
B24081	13/16"	1
B24088	7/8"	1
B24100	1"	1
B24113	1 1/8"	1
B24125	1 1/4"	1
B24150	1 1/2"	1

Straight Shank Drill Bits

- High speed steel
- Jobber's length

PART NO.	DESCRIPTION	CTN QTY
B20062	1/16" drill	1
B20078	5/64" drill	1
B20094	3/32" drill	1
B20109	7/64" drill	1
B20125	1/8" drill	1
B20141	9/64" drill	1
B20156	5/32" drill	1
B20172	11/64" drill	1
B20188	3/16" drill	1
B20203	13/64" drill	1
B20219	7/32" drill	1
B20234	15/64" drill	1
B20250	1/4" drill	1
B20266	17/64" drill	1
B20281	9/32" drill	1
B20297	19/64" drill	1
B20313	5/16" drill	1
B20328	21/64" drill (1/8" pipe tap)	1
B20344	11/32" drill	1
B20359	23/64" drill	1
B20375	3/8" drill	1
B20391	25/64" drill	1
B20406	13/32" drill	1
B20422	27/64" drill	1
B20438	7/16" drill (1/4" pipe tap)	1
B20453	29/64" drill	1
B20469	15/32" drill	1
B20484	31/64" drill	1
B20500	1/2" drill	1

Pipe Taps

- NPT
- High carbon steel

PART NO.	DESCRIPTION	CTN QTY
T41001	1/8" NPT pipe tap	1
T41002	1/4" NPT pipe tap	1
T41003	3/8" NPT pipe tap	1
T41004	1/2" NPT pipe tap	1
T41005	3/4" NPT pipe tap	1
T41006	1" NPT pipe tap	1
T41009	1 1/4" NPT pipe tap	1
T41007	1 1/2" NPT pipe tap	1
T41008	2" NPT pipe tap	1

PlumRule Tape Measure



- 1" locking blade with push button lock
- Offset fractions for easy reading
- Auto recoil; belt clip and wrist strap
- Red stud markings and joist markings

PART NO.	DESCRIPTION	CTN/MSTR
J40101	1" x 25' tape	6/48

Neon Precision Tape



- Sure grip case

PlumBest

PART NO.	DESCRIPTION	CTN/MSTR
J40086	1" x 25' neon orange tape	6/48
J40087	1" x 25' neon yellow tape	6/48

Long Tape



- Hook blade
- Pop-open handle

Starrett

PART NO.	DESCRIPTION	CTN/MSTR
J40088	3/8" x 50' tape	6/36
J40089	3/8" x 100' tape	6/24

Locking Measuring Tape



PlumBest

- Unbreakable chrome plated case
- Power return
- Double riveted tang
- Cushion stop
- Positive lock
- Yellow tape

Call Us for Private Labeling

PART NO.	DESCRIPTION	CTN/MSTR
J40046	1" x 25' tape	6/48
J40045	3/4" x 16' tape	12/144

Flint Striker



- Round file style
- Renewable flint
- Flints priced per pack of 5 renewals

PART NO.	DESCRIPTION	CTN/MSTR
J40048	Striker	25/200
J40049	Pack of 5 flint renewals	50/200

Three Flint Friction Lighter



- Flints priced per pack of 4 renewals
- CARTON QUANTITIES ONLY

PART NO.	DESCRIPTION	CTN/MSTR
J40047	Three flint friction lighter	6/48
J40044	Flint renewal unit (4/card)	1

PlumBest MAPP & Propane Cylinders



- Temperatures for burning: Propane 2300°, MAPP 3300°
- CARTON QUANTITIES ONLY
- LTL TRANSPORTATION ONLY
- NO UPS/FED EX

PART NO.	DESCRIPTION	CTN QTY
J40601	14.1 oz. Propane	12
J40600	16 oz. MAPP	12

Uniweld Torches



PART NO.	DESCRIPTION	CTN QTY
J40529	Hand torch with swivel tip and self-igniter	6
J40329	UT6 replacement tip for J40529	1
J40629	Hand torch with swivel tip	6
J40429	UT5 replacement tip for J40629	1

Pencil Flame Torch

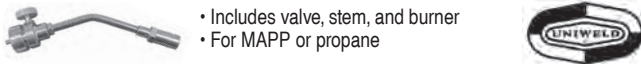

- Includes valve, stem, and burner
- For MAPP or propane

PART NO.	DESCRIPTION	CTN QTY
J40229	Pencil flame torch	1

Solder Shield Protective Blanket



- For use when combustible material is present during soldering
- 9" x 12" protection area
- Protects up to 2300°F for five minutes
- Smoke and odor free non-asbestos material
- Lends a clean, professional appearance to your work
- Durable woven ceramic holds up well in multiple uses

PART NO.	DESCRIPTION	CTN QTY
J40812	9" x 12" Solder shield	1

Flux Paste



- Meets ASTM B813
- Water flushable for faster rinsing from pipe lines
- Super detergent action cleans as it solders
- Non-acid, non-toxic, **lead-free**
- Contains no zinc chloride
- Use with all lead-free and common soft solders
- For use on copper, brass, galvanized iron, lead, zinc, tin, silver, nickel, mild steel, terne plate, and malleable iron
- Meets Mil. Spec. Mil-F-4995 Type II

PART NO.	DESCRIPTION	CTN QTY
S95102	4 oz. Flux Paste	48
S95106	4 oz. Flux Paste with brush in cap	48
S95103	1 lb. Flux Paste	24

Flux-Rite 90® Flux



- Meets ASTM B-813
- Water soluble for faster flushing from pipe lines
- Super detergent action cleans as it solders
- Non-acid, non-toxic and lead free
- Contains no zinc chloride
- Use with all lead free and common soft solders
- For use on most metal types

PART NO.	DESCRIPTION	CTN/MSTR
S95104	4 oz. Flux-Rite 90® Flux	1/24
S95105	1 lb. Flux-Rite 90® Flux	1/12

Phos-Copper Brazing Rod



- 92.9% copper/ 7.1% phos
- Tensile strength 91,000 PSI
- Self-fluxing
- Liquid 1460°F, solid 1310°F
- Working temp 1350°-1500°F
- 1 pound plastic tubes

PART NO.	DESCRIPTION	CTN/MSTR
J41021	1 lb. tube brazing rod	1/10

2% Silver Solder



- 91% copper/ 7% phos/ 2% silver
- Liquid 1450°F, solid 1190°F
- Meets AWS A5.8QQB-650 B Cup-6
- 1 pound plastic tubes

PART NO.	DESCRIPTION	CTN/MSTR
J41022	1 lb. tube 2% silver solder	1/10

5% Silver Solder



- 89% copper/ 6% phos/ 5% silver
- Meets AWS A5.8-81-BCup3 Fed QQB650B
- Liquid 1475°F, solid 1190°F
- Working temperature 1300°-1550°F
- 1 pound plastic tubes

PART NO.	DESCRIPTION	CTN/MSTR
J41023	1 lb. 5% silver solder	1/10

15% Silver Solder



- 80% copper/ 5% phos/ 15% silver
- Meets AWS A5.8-81-BC7P3 Fed QQB650B
- Liquid 1495°F, solid 1190°F
- Working temperature 1300°-1500°F
- 1 pound plastic tubes

PART NO.	DESCRIPTION	CTN/MSTR
J41024	1 lb. tube 15% silver solder	1/10

Freeze Fix Pipe Jackets



- Fast, easy way to freeze pipe up to 4"
- Saves time and money on pipe repairs
- Repairs can be made without draining the water out of the line

Quick Way to Freeze Pipes for Easy Repair!

PART NO.	DESCRIPTION	L x W	CTN QTY
J40801	3/8" - 3/4" jacket	8" x 4 1/2"	1
J40802	3/4" - 1 1/2" jacket	10 1/2" x 7"	1
J40803	1 1/2" - 3" jacket	14" x 8 1/2"	1
J40804	3" - 4" jacket	16" x 11"	1
J40805	8' hose and connectors for CO2 kit	-	1
J40806	Tee connector for CO2 freeze kit	-	1
J40807	Freeze fix carry bag	-	1
J40808	CO2 empty cylinder (20 lb. size)	-	1

Files



- Durable plastic handles
- Top quality alloy steel

PART NO.	DESCRIPTION	CTN/MSTR
J41201	8" mill bastard file with handle	1/4
J41202	10" mill bastard file with handle	1/4
J41205	12" half round file	1/4
J41206	14" half round file	1/4

Sure Sweat Dissolvable Pipe Plugs

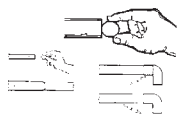

- Stop water from inside the pipe
- Dissolve safely and completely with water

PART NO.	DESCRIPTION	CTN/MSTR
H56050	1/2" kit (7 plugs per box)	1 box of 7/24
H56075	3/4" kit (5 plugs per box)	1 box of 5/24

Slip Jaw Pliers



- Plated finish
- Plastic grips

PART NO.	DESCRIPTION	CTN QTY
P60001	2 1/8" capacity / 10" long	5

Water Pump Pliers



- Drop forged vanadium steel; black epoxy powder coated
- Cushion grip
- Self-locking on pipe



PART NO.	ROTHENBERGER	LENGTH	CAPACITY	CTN QTY
J40210	7.0521	7"	1"	6
J40211	7.0522	10"	1 1/4"	6
J40212	7.0523	12"	1 1/2"	6

Griplock Tongue & Groove Water Pump Pliers



- Comfort grips



PART NO.	CHANNEL LOCK NO.	LENGTH	NO. ADJ.	CAPACITY	CTN QTY
J40410	GL10	10"	5	1 1/4"	5
J40411	GL12	12"	6	2 1/4"	5

"No Pinch" Pipe Wrench Pliers



- 10" comfort cushion grips
- Unique handle design prevents pinched fingers
- 1 3/4" jaw capacity
- Drop forged; plated finish

PART NO.	DESCRIPTION	CTN/MSTR
P60002	10" Pipe wrench pliers	4/40

10" Smooth Jaw Pliers



- 2 1/8" jaw opening
- Smooth jaws for non-arring surfaces (chrome, polished brass)
- Cushioned vinyl grips

PART NO.	DESCRIPTION	CTN/MSTR
P60003	10" Smooth jaw pliers	10/50

Tongue & Groove Pliers



- Right angle teeth
- Undercut tongue and groove-won't slip
- Comfort grips



PART NO.	CHANNEL LOCK NO.	LENGTH	NO. ADJ.	CAPACITY	CTN QTY
J40401	426	6 1/2"	5	7/8"	5
J40402	420	9 1/2"	5	1 1/2"	5
J40403	430	10"	7	2"	5
J40404	440	12"	7	2 1/4"	5
J40405	460	16"	8	4 1/4"	2

Curved Jaw Tongue & Groove Pliers



- Curved jaw for use on round stock and tubing
- Right angle teeth



PART NO.	CHANNEL LOCK NO.	LENGTH	NO. ADJ.	CAPACITY	CTN QTY
J40407	422	9 1/2"	5	1 1/2"	5
J40408	442	12"	7	2 1/4"	5

Smooth Jaw Tongue & Groove Pliers



- Smooth jaws for non-marring surfaces (PVC, chromes, etc.)
- Undercut tongue and groove-won't slip
- Comfort grips

CHANNEL LOCK

PART NO.	CHANNEL LOCK NO.	LENGTH	NO. ADJ.	CAPACITY	CTN QTY
J40406	415	10"	7	2"	5

4 in 1 Screwdriver



S41001 - 12 pk Display

- Alloy tool steel bits
- Ground and polished
- Heat treated for maximum strength
- High impact handle
- Floating ball bearing for tight fit

PART NO.	DESCRIPTION	CTN QTY
S41001	Phillips and slotted	12
S41002	Slotted bit for 4 in 1 or 6 in 1	1
S41003	Phillips bit for 4 in 1	1

6 in 1 Screwdriver



S41006 - 12 pk Display

- Shaft ends are 1/4" and 15/16" hex size for use as nut drivers
- Each bit has two sizes

PART NO.	DESCRIPTION	CTN QTY
S41006	6 in 1 screwdriver	12
S41002	Slotted bit for 4 in 1 or 6 in 1	1
S41007	Phillips bit for 6 in 1	1

Magnetic Power Nut Setters



- 1/4" hex shaft

PART NO.	DESCRIPTION	CTN QTY
S41300	1 3/4" long 1/4" head size	1
S41301	1 3/4" long 5/16" head size	1
S41302	2 9/16" long 1/4" head size	1
S41303	2 9/16" long 5/16" head size	1

Nut Driver



PART NO.	DESCRIPTION	CTN QTY
S06014	3/16" Nut driver	10
S06015	1/4" Nut driver	10
S06016	5/16" Nut driver	10
S06017	3/8" Nut driver	10
S06018	7/16" Nut driver	10
S06019	1/2" Nut driver	10

Bit Holders



- For insert type bits
- Magnetic

PART NO.	DESCRIPTION	CTN QTY
S41307	1/4" drive x 3" long	1

Phillips Bits



Insert Type

PART NO.	DESCRIPTION	CTN QTY
S41306	#2 point 1/4" hex 1" long	1

Long Insert Type

PART NO.	DESCRIPTION	CTN QTY
S41308	# 2 point 1/4" hex 11 5/16" long	1

100% Silicone Tub And Tile Sealant



J40197
J40199



J40200
J40201

- Ideal for tubs, sinks, toilets, showers and resetting loose tiles
- Warranted to last as long as the fixture
- Contains potent mildewcide
- CARTON QUANTITIES ONLY
- Application temperature range -10°F to 100°F
- Service temperature range -60°F to 400°F



PART NO.	DESCRIPTION	CTN QTY
J40199	2.8 oz. tube CLEAR caulk	12
J40197	2.8 oz. tube WHITE caulk	12
J40200	10.2 oz. tube CLEAR caulk	12
J40201	10.2 oz. tube WHITE caulk	12

PlumBest 100% Silicone Caulk



- Flexible, easy to use
- 50 year life
- CARTON QUANTITIES ONLY
- Will not stain or bleed
- Seal, bond or insulate



PART NO.	DESCRIPTION	CTN QTY
J40208	10.1 oz. tube CLEAR caulk	12
J40288	10.1 oz. tube WHITE caulk	12

25-Year Siliconized Acrylic Caulk



- Cleans up with water
- Paintable
- Will not stain or bleed
- CARTON QUANTITIES ONLY
- Application temperature range 40°F to 90°F
- Service temperature range 0°F to 200°F



PART NO.	DESCRIPTION	CTN QTY
J40202	10.1 oz. tube WHITE caulk	12

Acrylic Tub And Tile Caulk



- Long-lasting watertight seal around tubs, showers, and sinks
- Cleans up with water
- Odorless, mildew resistant
- Paintable
- CARTON QUANTITIES ONLY
- Application temperature range 40°F to 90°F
- Service temperature range 0°F to 200°F



PART NO.	DESCRIPTION	CTN QTY
J40203	5.5 oz. ALMOND caulk	12
J40204	5.5 oz. WHITE caulk	12
J40206	10.1 oz. WHITE caulk	12

Latex Caulk



- General purpose
- Dries quickly
- Will not stain or bleed
- Paintable
- CARTON QUANTITIES ONLY



PART NO.	DESCRIPTION	CTN QTY
J40207	10.1 oz. WHITE caulk	12

Hi-Temp 100% Red Silicone Caulk



- 100% silicone
- USDA approved, UL listed, meets NSF 51
- Temperature from 65°F to 650°F
- CARTON QUANTITIES ONLY



PART NO.	DESCRIPTION	CTN QTY
J40285	Hi-temp 100% silicone caulk	12

Caulking Gun



- 9" barrel
- Drop-in half barrel type
- Painted steel

PART NO.	DESCRIPTION	CTN QTY
C35090	Caulking gun	10

Professional Caulking Gun



- Parallel hex rod frame
- Seal puncture tool
- Thumb release
- E-Z thrust mechanism
- Spout cutter
- Ladder hook

PART NO.	DESCRIPTION	CTN QTY
C35091	Parallel hex rod caulking gun	12

Firestop 814+ Intumescent Firestopping Sealant



J40284



J40286

- Colored red for ease of inspection
- Fulfills residential and commercial firestopping code requirements
- Meets ASTM-E814/UL 1479 test standards
- Resumes integrity for 1 & 2 hour fire rated assemblies

PART NO.	DESCRIPTION	CTN QTY
J40284	5 gallons	1
J40286	10.3 oz. tube	12

Fire Seal-136 Firestopping Caulk



- Resumes integrity of fireblocks 1 & 2 family construction
- Meets ASTM-E136 test standards
- Fulfills all residential fireblocking code requirements

PART NO.	DESCRIPTION	CTN QTY
J40287	10.3 oz. tube	12

Putty Knives



PART NO.	DESCRIPTION	CTN/MSTR
K50015	1 1/4" putty knife	12/144
K50016	3" putty knife	12/144

PlumBest Handi-Plug



Counter Display

- Combination test plug and stub-out for drop eared ell
- No tools required - manual installation allows for no time wasted applying and removing thread tape after each use! Cost-effective, too!
- No thread seal required
- Reusable - long lasting
- Smooth at thread end for easy plastering
- Time and labor savings

PART NO.	DESCRIPTION	CTN QTY
H54050	1/2" MIP Handi-Plug	25

Handicap



- No tools required - manual installation allows for no time wasted applying and removing thread tape after each use! Cost-effective, too!
- Reusable - long lasting
- Caps and 1/2" male thread for testing

PART NO.	DESCRIPTION	CTN QTY
H54100	1/2" FIP Handicap	1

Lumber Crayon



- Fade-proof, waterproof and smear-proof
- Will work on wet or dry wood, metal and concrete
- 4 1/2" long by 1/2" diameter
- CARTON QUANTITIES ONLY

PART NO.	DESCRIPTION	CTN QTY
J40350	Black lumber crayon	12
J40351	Yellow lumber crayon	12
J40352	Red lumber crayon	12
J40353	Blue lumber crayon	12

Carpenters Pencil



- Flat black lead makes wood marking crisp and accurate
- Long-lasting and easy sharpening

PART NO.	DESCRIPTION	CTN QTY
J40360	Carpenters pencil	12

Marking Products



- High-performance industrial marking products
- Permanent paint
- Quick drying



PART NO.	DESCRIPTION	CTN QTY
J40330	Dura Ink 15 Marker Red	72
J40331	Dura Ink 15 Marker Black	72
J40332	Dura Ink 25 Marker Black	48
J40333	Dura Ink 55 Marker Red	48
J40334	Dura Ink 55 Marker Black	48
J40335	Dura Ink 200 Marker Black	24
J40336	Paint Marker White	48
J40337	Paint Marker Yellow	48
J40338	Paint Marker Red	48
J40339	Paint Marker Black	48
J40340	Paint Marker Blue	48
J40341	Paint Marker Display	1
J40342	Round Counter Display Black	1
J40343	Round Counter Display Red/Black	1

Industrial Choice Precision-Line Inverted Marking Paint



- Features a distance tip for easy-to-read, bright, vivid markings
- Marks more linear feet than the competition
- Virtually no overspray
- Fast-drying and non-clogging
- Can be applied down to 25°F
- Dries in 5 minutes or less
- Easy-to-use, spray through cap guaranteed not to clog
- "No Mess" spray tip keeps paint off finger
- Locking tip keeps tip from popping off
- Best resistance to premature chalking and fading
- CARTON QUANTITIES ONLY
- GROUND TRANSPORTATION ONLY

PART NO.	DESCRIPTION	CTN QTY
J40380	White marking point	12
J40381	Yellow marking point	12
J40382	Red marking point	12
J40383	Blue marking point	12
J40384	Green marking point	12
J40385	Orange marking point	12
J40387	Pink marking point	12

Paint Spotter Hand-Help Wand



- For quick, easy one-hand application of marking point

PART NO.	DESCRIPTION	CTN QTY
J40386	Paint spotter	1

PlumBest® Spray Weld



- Cleaner, Primer & Cement all-in-one!
- No Mess – No Waste
- Spray Any Angle
- Goes twice as far as brush and can method
- Work in a wider range of temperatures

PART NO.	DESCRIPTION	CTN. QTY.
S30800	11 oz. with purple primer	12
S30801	4.5 oz. with purple primer	12
S30802	11 oz. with clear primer	12
S30803	4.5 oz. with clear primer	12

Whitlam "Blue Magic" Pipe Joint Compound



- ORM-D
- NSF Approved
- Slow set
- Meets FED spec TT-S-1732
- Use on plastic and metal threads
- CARTON QUANTITIES ONLY

PART NO.	DESCRIPTION	CTN QTY
S95710	1/2 pint brush top can joint compound	24
S95711	1 pint brush top can joint compound	12
S96014	1/4 pint joint compound	24
S96016	1 quart pipe joint compound	12

Whitlam Seal Unyte



- Hard set
- Dark gray
- Semi-paste
- Use on all metal threaded connections and flanges

PART NO.	DESCRIPTION	CTN QTY
S95012	1/2 pint Whitlam seal unyte	24
S95014	1/4 pint Whitlam seal unyte	24
S96012	1 pint Whitlam seal unyte	12
S95016	1 quart Whitlam seal unyte	12

Whitlam "Select Unyte" Teflon Pipe Joint Compound



- ORM-D
- NSF Approved
- Soft set, white virgin teflon (PTFE)
- Use on plastic and metal threads
- For use on air, steam, petroleum, water, gas and chemical lines
- CARTON QUANTITIES ONLY

PART NO.	DESCRIPTION	CTN QTY
S95712	1/2 pint brush top can joint compound	24
S95713	1 pint brush top can joint compound	12

Whitlam "Green Blaster" Drain Opener



- ORM-D
- Dry granular composition for clearing grease, hair and other organic matter from drains
- Non-acid - safe for chrome, polished brass, plastic and fixtures
- Safe for septic tanks
- CARTON QUANTITIES ONLY
- GROUND TRANSPORTATION ONLY

PART NO.	DESCRIPTION	CTN QTY
S95714	1 lb. canister drain opener	24
S95715	2 lb. canister drain opener	12

Slic-tite® Heavy Duty Thread Sealing Compound



- Working pressures: to 10,000 psi (liquids), 3,000 (gases)
- Temp: -50°F to +500°F
- Use for threaded connections on steel, aluminum, brass, PVC, CPVC & ABS



PART NO.	DESCRIPTION	CTN QTY
S95011	8 fl. oz. Slic-tite® HD Thread Sealing Compound	24

Cool Gel®



- Protects surfaces and components from heat damage such as piping, drywall, and shower valves
- Used for any soldering or brazing job
- Safe, non-toxic, and harmless to the skin
- Will evaporate in 24-48 hrs. eliminating cleanup
- Unique gelling formula sticks to any surface without dripping or running off



PART NO.	DESCRIPTION	CTN QTY
S95100	1 qt. Cool Gel®	12
S95101	1 pt. Cool Gel®	24

Visu-Glow Leak Detector



- Fluorescent gas leak detector



PART NO.	DESCRIPTION	CTN QTY
S95200	8 oz. Visu-Glow Leak Detector	24

Floweazy Drain Cleaner



- Organic digester; biodegradable
- Dissolves grease, hair, sanitary napkins, sludge, soap and paper
- Environmentally safe
- CARTON QUANTITIES ONLY
- ORM-D (S95701/S95703)
- HAZMAT (S95705)

PART NO.	DESCRIPTION	CTN QTY
S95701	1 pint Floweazy drain cleaner	12
S95703	1 quart Floweazy drain cleaner	12
S95704	1/2 gallon Floweazy drain cleaner	6
S95705	1 gallon (HAZMAT) Floweazy drain cleaner	4

Drain King® Mini Snake



- Unclogs sinks, showers, bath drains & urinals
- Safe, easy to use
- No chemicals

PART NO.	DESCRIPTION	CTN. QTY.
D18190	Mini snake	36

A.C. Coil Cleaner



- No fumes
- Professional strength - non-corrosive citric acid formula
- Ready to use - No mixing, no measuring, no mess
- Convenient trigger sprayer
- Removes grease, oil and heavy soil deposits
- Color coded liquid for quick and easy product recognition
- CARTON QUANTITIES ONLY
- ORM-D

For Interior Coils

PART NO.	DESCRIPTION	CTN QTY
S95721	1 quart (RTU) A.C. Coil Cleaner	12

For Exterior Coils (also available as a concentrate)

PART NO.	DESCRIPTION	CTN QTY
S95722	1 gallon (Conc) Cond. Coil Cleaner	4
S95725	1 gallon (RTU) Cond. Coil Cleaner	4

Plumber's Faucet And Valve Grease



- Lubricates faucet stems, threads, o-rings, packing, gaskets
- Resists high temperatures
- Counter display
- CARTON QUANTITIES ONLY

PART NO.	DESCRIPTION	CTN QTY
S95709	2.0 fl.oz. tins in counter display	12

Plumber's Putty



- Use on sinks, strainers, faucets and other fixtures wherever a non-drying watertight seal is needed
- DO NOT USE ON MARBLE OR PLASTIC!!!
- Meets Federal Specification TT-P-1536
- CARTON QUANTITIES ONLY

PART NO.	DESCRIPTION	CTN QTY
P40014	14 oz. putty	24
P40080	5 lb. putty	6

Plumber's Epoxy Putty



- Seal leaks in sink traps, water tanks, pipe joints, drain leaks and radiators
- Stop leaks in pools and drain lines
- Repair cracked porcelain wall tiles, floor tiles and fixtures
- CARTON QUANTITIES ONLY

PART NO.	DESCRIPTION	CTN QTY
P40004	4 oz. Epoxy putty tubes in counter display	12

Plumber's Goop Adhesive



- 3.7 oz. tube
- Watertight bond for use on PVC, tile or porcelain
- CARTON QUANTITIES ONLY
- ORM-D

PART NO.	DESCRIPTION	CTN QTY
J45100	3.7 oz. tube plumber's goop adhesive	12

2CanCaddy™



- Grab and go handle
- Special velcro strap to keep cans organized and secure
- Works well with all size cans up to 32 oz.
- Made of extremely durable polymer
- Easily cleans, stain resistant and virtually indestructible
- Perfect for...Plumbers, Electricians, Painters & More

PART NO.	DESCRIPTION	CTN QTY
S95015	2CanCaddy™	12

Steel Nipple Caddy Tray



- Steel construction
- Baked epoxy finish
- Push away handles
- Nipple storage range (close-6")

PART NO.	SIZE	DIMENSIONS	CAPACITY	CTN/MSTR
N70050	1/2"	10 1/2" x 7" x 6 1/2"	77 pieces	1/8
N70075	3/4"	12 1/2" x 7" x 6 1/2"	66 pieces	1/8
N70016	1"	14 1/8" x 7 3/4" x 6 1/2"	50 pieces	1/6
N70020	1 1/4"	18" x 8" x 6 1/2"	40 pieces	1/8
N70024	1 1/2"	19 1/2" x 6 1/2" x 6 1/2"	30 pieces	1/8
N70032	2"	23 7/8" x 8 1/2" x 6 1/2"	27 pieces	1/4

1/2" & 3/4" Combo Nipple Caddy



- Holds 39 1/2" x close-6"
- Holds 33 3/4" x close-6"
- Steel construction with baked epoxy finish
- Fold over handle

PART NO.	DIMENSIONS	DESCRIPTION	CTN/MSTR
N70575	12 1/8" x 7" x 6 1/2"	Combo Caddy	1/8

Fitting Tote Tray



- Excellent for copper and PVC fittings
- Steel construction with baked epoxy finish
- Inside compartments measure 4 7/8" x 4 7/8" x 3 7/8"
- 8 compartments
- Fold over handle

PART NO.	DIMENSIONS	DESCRIPTION	CTN/MSTR
N70500	20" x 10 1/2" x 5"	Fitting Caddy	1/4

Plastic Nipple Caddy



- High impact plastic
- Strong and lightweight
- Will not rust or corrode
- Nipple storage range (close-6")

PART NO.	SIZE	DIMENSIONS	CAPACITY	CTN QTY
N70150	1/2"	11" x 7 1/2" x 6 1/2"	77 pieces	4
N70175	3/4"	13 1/4" x 7 7/8" x 6 1/2"	66 pieces	4
N70200	1"	14 3/4" x 8 1/8" x 6 1/2"	50 pieces	4
N70250	1 1/2"	21" x 7" x 6 1/2"	30 pieces	2
N70300	2"	23 1/4" x 8 1/2" x 6 1/2"	27 pieces	2

Utility Tote Tray



- Lightweight, durable, high impact plastic

PART NO.	DIMENSIONS	DESCRIPTION	CTN QTY
T60100	10" x 15" x 5"	Tote tray	12

Tool Totes



T60121



T60122



T60123



T60124

- High density polyethylene construction resistant to acids, chemicals, oils and glues
- Removable dividers
- Reinforced metal handle
- Made in the U.S.A.

MADE IN THE USA

PART NO.	DESCRIPTION	CTN QTY
T60121	12" x 24" x 6" deep tray with 4 dividers	5
T60122	9" x 15" x 5" deep tray with 4 dividers	10
T60123	9" x 15" x 3" deep tray with 4 dividers	10
T60124	12 1/2" x 18" x 4 1/2" deep tray	5
T60125	Extra dividers for T60121	4
T60126	Extra dividers for T60122	4
T60127	Extra dividers for T60123	4

Bucket Caddies



T60101 Red Bucket with Black Lid and Trays



T60103



T60104



T60108

- 5 gallon high-impact red plastic bucket holds 4 combinations of trays- 3 large; 6 small; 1 large with 4 small; and 2 large with 2 small
- All trays have 4 sections; use tray subdividers to increase small tray capacity up to 8 sections
- Tool apron fits 5 and 3 1/2" gallon buckets; apron straps on or can be permanently secured (hardware included)
- Made in the U.S.A.

MADE IN THE USA

PART NO.	DESCRIPTION	CTN QTY
T60101	5 gallon bucket with 6 small trays	8
T60102	5 gallon bucket with 1 large tray & 4 small trays	8
T60103	Large trays (4 1/2" deep)	3
T60104	Small trays (2 1/2" deep)	6
T60105	Lid for 5 gallon bucket	1
T60106	5 gallon bucket only	1
T60107	Subdividers for small trays (4 pack)	1
T60108	20-pocket tool apron	1
T60110	5 gallon bucket with 2 large and 2 small trays	1
T60111	5 gallon bucket with 3 large trays	1

Anti-Vibration Synthetic Leather Gloves



- Neoprene knuckle protection
- Flexible 4-way stretch
- Sure Grip™ reinforced thumb saddle
- Gel-padded Sure Grip™ patch palm
- Machine-washable Parity™

PART NO.	DESCRIPTION	CTN QTY
G50211	Pair synthetic leather gloves	72 pairs

Nitrile Gloves



- 3/4 coating offers more protection
- Micro foam nitril offers great grip
- Coating draws oil and water aside to allow for enhanced grip
- Good abrasion resistance
- Silicone free and Antibacterial

PART NO.	DESCRIPTION	CTN QTY
G50215	Pair nitrile gloves	144 pairs

Work Gloves

BROWN JERSEY GLOVE

- 100% Brown cotton
- One size fits all
- Knit wrist
- 8 ounce



G50200
G50210

LEATHER PALM WORK GLOVE

- Split leather palm, thumb, fingers and knuckle
- 100% cotton back and liner
- Safety cuff



G50204
G50214

COTTON GLOVES

with Rubber Grippers or Palms

- Durable 100% cotton canvas
- No-slip grip dots or rubber on palm and fingers
- One size fits all
- Knit wrist



G50205
G50206

DRIVERS' STYLE LEATHER GLOVES

- Durable and long lasting - conforms to your hand with time
- Grain leather glove
- Elastic cuff



G50208
G50218

• CARTON QUANTITIES ONLY

Carded for Display (Priced per Pair)

PART NO.	DESCRIPTION	CTN/MSTR
G50200	Brown cotton jersey	12/300
G50204	Leather palm low safety cuff	12/120
G50208	Drivers' style leather	12/120

Display Carton Display-Each pair carded (Priced per Pair)

PART NO.	DESCRIPTION	CTN/MSTR
G50210	Brown cotton jersey	216 pair
G50214	Leather palm low safety cuff	96 pair
G50218	Drivers' style leather	48 pair

Special Use Gloves-Bulk Only (Priced per Pair)

PART NO.	DESCRIPTION	CTN/MSTR
G50205	White cotton with rubber grippers	12/240
G50206	White cotton with rubber palms	12/240

All Purpose Latex Palm/Mesh Back Gloves



- Durable
- Excellent in wet conditions
- Protects hands during rugged jobs
- CARTON QUANTITIES ONLY

PART NO.	DESCRIPTION	CTN/MSTR
G50202	Latex palm/mesh back gloves	12/240

Vinyl Gloves



- 5 mil.
- One size fits all
- Lightly powdered
- 100 reversible gloves (50 pair)

PART NO.	DESCRIPTION	CTN/MSTR
G50250	100 vinyl gloves	1/10

Vinyl Disposable Gloves



- One size fits all
- Ready to Hang or Place on Shelf
- Rolled cuff
- Lightly powdered for easy on and off

PART NO.	DESCRIPTION	CTN/MSTR
G50251	20 pack disposable gloves	1/20

Nemesis® Safety Glasses



Display



- Soft-touch temples
- Light weight construction
- Single-lens wrap-around protection
- 99.9% UV resistant
- Meets ANSI Z87.1 + standards

Glasses

PART NO.	DESCRIPTION	CTN QTY
G30011	Nemesis® Clear	12
G30012	Nemesis® Smoke Mirror	12
G30013	Nemesis® Blue Mirror	12
G30014	Nemesis® Camo/Bronze	12

Display

PART NO.	DESCRIPTION	CTN QTY
G30000	Includes: 12 pair Smoke Mirror, 6 pair Blue Mirror, 6 pair Clear, Free Display	1
G30030	Includes: 12 pair Camo/Bronze, Free Display	1

Hellraiser Safety Glasses



Clear



Smoke



Blue Mirror

PART NO.	DESCRIPTION	CTN QTY
G30015	Hellraiser clear safety glasses	12
G30016	Hellraiser smoke safety glasses	12
G30017	Hellraiser blue mirror safety glasses	12

Visio Safety Glasses



- One-piece frame
- Adjustable temples
- Sleek, lightweight and comfortable
- Meets ANSI z87.1

PART NO.	DESCRIPTION	CTN QTY
G30003	Visio clear safety glasses	12
G30004	Visio blue mirror safety glasses	12
G30005	Visio silver indoor/outdoor glasses	12

Clear Safety Goggles



- Direct ventilation
- Economical protection

PART NO.	DESCRIPTION	CTN QTY
G30001	Clear safety glasses	200

Dust Masks



- 50 per box
- Disposable
- Non-toxic

PART NO.	DESCRIPTION	CTN/MSTR
G30021	Dust mask	1/20

Safety Hats



- Fits sizes 6 1/2- 8
- Meets ANSI z89.1 requirement
- Short peak design creates greater upward visibility
- Comfortable 4-point suspension with terrycloth sweatbands
- Low nape strap and rain trough features
- Universal slots to accommodate hearing, welding and face shield accessories

PART NO.	DESCRIPTION	CTN QTY
H40001	Yellow with 4-point pin lock suspension	12
H40002	White with 4-point pin lock suspension	12
H40003	Yellow with 4-point ratchet suspension	12
H40004	White with 4-point ratchet suspension	12

Knee Pads



- Lightweight and water-resistant
- Comfortable while kneeling, standing or walking
- Won't pinch or bind behind knee
- Soft, breathable inner lining for coolness and comfort
- Velcro closures on straps
- Heavy duty knee cap on K012000

PART NO.	DESCRIPTION	CTN QTY
K01120	Heavy duty foam economy	1 pair
K012000	Heavy duty knee cap	1 pair

Industrial Back Supports



- Adjustable, comfortable support promotes proper lifting techniques

PART NO.	DESCRIPTION	CTN QTY
S49601	Medium 33-38" waist	1
S49602	Large 39-44" waist	1
S49603	X-Large 45-49" waist	1

Ready Fit Corded Ear Plugs



- Display box included

PART NO.	DESCRIPTION	CTN QTY
E85000	Ready fit corded ear plugs	100

Hornet & Wasp Spray



- Long range spray- shoots a stream up to 20 feet, reaching nests far above ground, letting you keep a comfortable distance from the nest
- Contains no CFCs which deplete the ozone layer
- GROUND TRANSPORTATION ONLY
- CARTON QUANTITIES ONLY
- ORM-D

PART NO.	DESCRIPTION	CTN QTY
J40393	20 oz. can hornet & wasp spray	12

Protective Shoe Covers



- Fits easily over work shoes and boots
- Elastic top allows fit up to size 12
- Keeps dirt and grime outside
- Carton holds 200 pieces (100 pair)
- SOLD BY FULL CARTON OR 10 PAIR PACK

PART NO.	DESCRIPTION	CTN/MSTR
B05010	Protective shoe covers	1/10
B05011	Protective shoe covers (10 pair)	1/15

Shubee Shoe Covers



- Dark blue
- Fits easily over work shoes and boots
- Elastic top allows fit up to size 12
- Keeps dirt and grime outside
- Carton holds 150 pair

PART NO.	DESCRIPTION	CTN QTY
B05015	Shubee Shoe Covers	1

Disposable Coverall



- Tear and puncture resistant
- Use when comfort and coolness is a priority

PART NO.	DESCRIPTION	CTN/MSTR
B05020	Large disposable coverall	25
B05021	X-large disposable coverall	5/20

50 Pound UV Black Cable Tie



- Black UV rated for outdoor use
- UL Listed

PART NO.	DESCRIPTION	CTN QTY
J40116	7" long	100 per bag
J401167	11" long	100 per bag

Cable Ties



Natural Color



Black

- Standard size
- CARTON QUANTITIES ONLY
- Nylon

Natural Color		
PART NO.	DESCRIPTION	CTN/MSTR
J40107	7" long (1/16" - 1 3/4")	100/6600
J40111	11" regular (1/16" - 3")	100/18700
Black		
PART NO.	DESCRIPTION	CTN/MSTR
J40115	15" (5/16")	100/2300

Cable Tie Assortment



- 400 pieces in kit: 100 pieces of 11", 100 pieces of 7", 200 pieces of 4"

PART NO.	DESCRIPTION	CTN/MSTR
J40108	Cable tie assortment	1/10

Duct Straps



- HVAC application
- CARTON QUANTITIES ONLY
- Natural nylon
- Up to 10" diameter

PART NO.	DESCRIPTION	CTN QTY
J40134	34" Duct straps	50

Heavy Duty Utility Straps



- Made in the USA
- Plated S-hooks
- Meets or exceeds ASTM standards
- CARTON QUANTITIES ONLY
- Weather and wear resistant

MADE IN THE
USA

PART NO.	DESCRIPTION	CTN QTY
S20015	15" Heavy duty utility strap	25
S20021	21" Heavy duty utility strap	25
S20031	31" Heavy duty utility strap	25
S20041	41" Heavy duty utility strap	25

Ratchet Tie Down Strap



- 1" wide/400 lb. working load limit
- Comfort grip handles
- Weather and corrosion resistant
- PVC coated hooks that will not scratch
- Cut and abrasion resistant webbing

PART NO.	DESCRIPTION	CTN/MSTR
S20300	1" x 16' Ratchet tie down strap	1/4

Camouflage Strap With Hooks



- 1" wide/300 lb. working load limit
- 2 hooks included with each strap; pack of 4 ratchet straps

PART NO.	DESCRIPTION	CTN/MSTR
S20301	1" x 9' Camo strap with hooks	1/6

Ratchet Strap With Step Release J-Hooks



- 2" wide/ 3,333 lb. working load limit
- Step by step release action
- Gradually releases tension with double J-hook
- Flex grip handle

PART NO.	DESCRIPTION	CTN/MSTR
S20302	2" x 27' Ratchet strap with step release J-hooks	1/8

Cam Strap



- 1" wide / 750# test nylon straps
- All colored straps and threads are UV resistant
- Straps are secured by a heavy duty zinc plated metal cam buckle, which will not slip even in wet conditions
- Ideal for handling loads for all kinds of contractor needs
- Call for details about Cam Strap Display
- S20999 Display includes: One 2' x 2' peg board, Six peg hooks and reorder cards, 1 Display header card, Includes an assortment of 72 straps

PART NO.	DESCRIPTION	CTN/MSTR
S20100	1" x 2' Black	24/144
S20101	1" x 4' Red	24/144
S20102	1" x 6' Yellow	24/144
S20103	1" x 8' Green	24/144
S20104	1" x 10' Blue	24/144
S20105	1" x 12' Purple	24/144
S20106	1" x 20' Black	24/144
S20999	Cam Straps Display	1

Twin Packs

PART NO.	DESCRIPTION	CTN QTY
S20200	1" x 2' Black - Twin Pack	1
S20201	1" x 4' Red - Twin Pack	1
S20202	1" x 6' Yellow - Twin Pack	1
S20203	1" x 8' Green - Twin Pack	1
S20204	1" x 10' Blue - Twin Pack	1

3-N-1 Tubing Bender



- For 1/4", 5/16" or 3/8" tubing

PART NO.	DESCRIPTION	CTN/MSTR
T50001	3-N-1 tubing bender	10/20

Spring Tubing Bender



- Spring prevents collapse of the wall at bending point
- Allows fast free-form bending of soft copper and aluminum tube

PART NO.	DESCRIPTION	CTN QTY
J41030	3/8" spring tubing bender	1
J41031	1/2" spring tubing bender	1
J41032	5/8" spring tubing bender	1

WD-40® Lubricant



- Cleans
- Protects against rust and corrosion
- Lubricates
- ORM-D
- Penetrates stuck metal parts
- CARTON QUANTITIES ONLY
- Displaces moisture
- GROUND TRANSPORTATION ONLY

PART NO.	DESCRIPTION	CTN QTY
S95700	8 oz. can lubricant	12

Soap Stones And Holders



- ROUND- Pen size lightweight aluminum holder with built-in chuck
- FLAT- Stainless steel spring tension with locknut
- Soap stones sold in carton quantities only

PART NO.	DESCRIPTION	CTN QTY
J40060	Round soap stone holder	6
J40061	Flat soap stone holder	6
J40062	Round soap stone	144/box
J40063	Flat soap stone	144/box

Brass Plumb Bob



- Solid brass
- Removable tip

PART NO.	DESCRIPTION	CTN/MSTR
J42008	8 oz. brass plumb bob	10/80
J42012	12 oz. brass plumb bob	1

Garden Hoses



- G04001:
- 500 PSI burst strength
 - Kink-free construction
 - Heavy-duty solid brass nickel plated coupling
 - Built-in spring at faucet end to prevent hose damage
 - Nylon reinforced

- G04002 and G04000:
- 300 PSI burst strength
 - Solid brass couplings
 - Reinforced green nylon construction

PART NO.	DESCRIPTION	CTN QTY
G04001	5/8" x 60' (500 PSI) garden hose	6
G04002	5/8" x 50' (300 PSI) garden hose	6
G04000	5/8" x 75' (300 PSI) garden hose	6

Caution Tape



- Black print on safety yellow
- 3 mil thickness

PART NO.	DESCRIPTION	CTN/MSTR
J43300	3" x 300'	1/16
J43310	3" x 1000'	1/8

Gas Line Marking Labels



- Yellow self adhesive stickers
- Clearly identifies gas lines from other utility and water lines
- 100 labels per roll

PART NO.	DESCRIPTION	CTN/MSTR
J40481	2 PSI gas line stickers	1/100
J40482	Gas line stickers	1/100

E-Z Light



- Extendable for lighting flames from a distance
- Safe and convenient for torch, fireplace, or any hard-to-reach area

PART NO.	DESCRIPTION	CTN QTY
J40450	E-Z Light	1

E-Z Reach



- Extendable, magnetized arm for easy retrieval of small metal parts
- Great for shop or job site

PART NO.	DESCRIPTION	CTN QTY
J40451	E-Z Reach	1

24" Grab-It Tool



- Makes hard-to-reach areas accessible using retractable fingers

PART NO.	DESCRIPTION	CTN/MSTR
J40020	24" Grab-it tool	1/50

Steel Wool



- Packaged 16 pads per bag, 12 bags per carton
- Priced per bag

PART NO.	DESCRIPTION	CTN QTY
B29300	Size 00 steel wool	12
B29310	Size 0 steel wool	12

Plumber's Candle



PART NO.	DESCRIPTION	CTN QTY
J46118	1 1/8" x 5"	120

Copper Cleaning Pads



- Reusable
- Use wet or dry - will not clog
- Nylon impregnated fine maroon
- Good general cleaner for removing rust, corrosion, etc.
- Deoxidizes and cleans copper tube and fittings for soldering
- CARTON QUANTITIES ONLY

PART NO.	SIZE	CTN/MSTR
B29400	4" x 6 1/4" x 1/4"	10/710

Acid Brushes



- Tin handle
- CARTON QUANTITIES ONLY

PART NO.	SIZE	CTN/MSTR
B29700	3/8" x 6"	144/1728
B29701	1/2" x 6"	144/1428
B29702	9/16" x 6"	144/1008
B29699	1/4" x 3"	144/1428

Paint And Dope Brush



- Natural bristles
- CARTON QUANTITIES ONLY
- Ideal for use with pipe cleaners, thread cutting oil, paint, pipe dope

PART NO.	SIZE	CTN/MSTR
B29801	1"	36
B29802	2"	24/432

Wire Brush



- For cleaning rough surfaces
- Stiff steel wire bristle
- Polished hardwood handle
- CARTON QUANTITIES ONLY

PART NO.	SIZE	CTN/MSTR
B29900	1"	12/72

Lead Joint Runners



PART NO.	DESCRIPTION	CTN QTY
L42011	#1 - 2" - 4" pipe size	10
L42012	#2 - 4" - 6" pipe size	10
L42013	#3 - 6" - 10" pipe size	5
L42014	#4 - 10" - 14" pipe size	1
L42015	#5 - 16" - 20" pipe size	1
L42016	#6 - 20" - 24" pipe size	1
L42017	#7 - 24" - 30" pipe size	1
L42018	#8 - 30" - 36" pipe size	1
L42019	#9 - 36" - 42" pipe size	1
L42023	#10 - up to 48" pipe size	1

Torpedo Level



- Manufactured to rigid requirements
- Professional quality
- Aluminum construction
- Magnetic sides
- 7 1/2" length



PART NO.	DESCRIPTION	CTN/MSTR
J40100	Torpedo level	1/10

Plastic Magnetic Level



- Has front vial viewer
- Saves time and money
- Eliminates neck and back strain
- Internal aluminum frame for accuracy and strength
- Magnetic
- Integrated Euroslot hanging hole

PART NO.	DESCRIPTION	CTN/MSTR
J42101	10" Plastic magnetic level	1/6

Top Grade Gradient Level



- The ultimate plumbing level
- Set accurate slopes of 1 and 2 percent
- Includes conversion of pitch and slope
- Accuracy: 0.5mm/ M-0.029" on all vials
- Length: 60cm/24"
- U.S. patent 6,209,211

PART NO.	DESCRIPTION	CTN/MSTR
J42200	24" length gradient level	1/6

Industrial Swivel-Lite Flashlights



F20016



F20017

- Contractor grade construction
- Sure grip rubber handles

PART NO.	DESCRIPTION	CTN QTY
F20016	Flashlight for AA batteries	6
F20017	Flashlight for D batteries	6

Rayovac Floating Lantern & Battery



F20003



F20004



F20005

- 6-volt F20004 battery included
- Heavy duty battery priced each

PART NO.	DESCRIPTION	CTN QTY
F20003	Floating lantern with battery	6
F20004	6 volt spring top - battery only	12
F20005	6 volt screw top - battery only	4

Rayovac Industrial Flashlights



- Yellow flashlights with ring hangers

PART NO.	DESCRIPTION	CTN QTY
F20001	2 cell D size flashlight	6
F20002	3 cell D size flashlight	6

4 D/6 Volt Swivel-Lite



- Contractor grade construction
- Krypton bulb, spare bulb holder
- Floats in water (with beam up)
- Long range beam
- 45° swivel for hands-free use
- Comfort-grip handle, push-button switch
- No batteries included
- Can use 6V lantern battery for additional power

PART NO.	DESCRIPTION	CTN/MSTR
F20018	4D/ 6-Volt Swivel-Lite	1/6

Sportsman L.E.D. Head-Lite



- New technology unique 3-way hands-free L.E.D. system
- Close range use super white L.E.D., "Night vision" 2 super red L.E.D., Long range beam-krypton bulb
- Batteries last 20 times longer with L.E.D. bulbs than normal bulbs
- Rubber spot-flood reflector, head rotates 180° compact design, comfort-grip band
- Weatherproof, heavy duty construction

PART NO.	DESCRIPTION	CTN/MSTR
F20019	Sportsman L.E.D. Head-Lite	1/4

Rayovac Heavy Duty Industrial Batteries



- List price is for each battery
- PACK QUANTITIES ONLY

PART NO.	DESCRIPTION	CTN/MSTR
F20006	Heavy duty C batteries	6/72
F20007	Heavy duty D batteries	6/72

Rayovac Heavy Duty Alkaline Industrial Batteries



- List price is for each battery
- PACK QUANTITIES ONLY

PART NO.	DESCRIPTION	CTN/MSTR
F20012	AAA alkaline batteries	8/96
F20008	AA alkaline batteries	6/96
F20009	9 volt alkaline batteries	6/72
F20010	C alkaline batteries	6/72
F20011	D alkaline batteries	6/72

Cutting Oil



- Medium brown color

PART NO.	DESCRIPTION	CTN QTY
J45005	Premium all-purpose oil (gallon)	6

Wypall® Waterless Hand Wipes



- 10 x 12 pre-moistened towels; 50 count
- Lower price per tub
- Conveniently sized tub
- All of the towels can be used before they dry out
- CARTON QUANTITIES ONLY

PART NO.	DESCRIPTION	CTN QTY
B05007	50-count dispenser tub	8
B05008	Wypall display (32 tubs)	1

Wypall® Teri® Towels



- Strong and durable, wet or dry
- 125 reusable sheets per box-equivalent to 18 lbs. of rags
- Reinforced HYDROKNIT® provides extra scrubbing power
- CASE QUANTITIES ONLY



PART NO.	DESCRIPTION	CTN QTY
B05003	9 3/4" x 16 3/4" x 125 sheets	10

Wypall® Waterless Hand Wipes



- Full-sized pre-moistened hand towels- smooth for wiping on one side, tough for scrubbing on the other
- Natural d'limonene cleaning agent tough on grease, grime, ink & paint
- CASE QUANTITIES ONLY

PART NO.	DESCRIPTION	CTN QTY
B05002	12" x 12" x 75 sheets	6

Box of Rags



- Colored cotton sweatshirt material
- 100% recycled
- Pull out dispensing

PART NO.	DESCRIPTION	CTN QTY
B05001	4 lb. box of rags	1

Poly Sheeting



- Clear
- 4 mil super tough plastic
- Hundreds of uses
- Made in the U.S.A.



PART NO.	DESCRIPTION	CTN QTY
S08100	8' x 100' poly sheeting	1
S10100	10' x 100' poly sheeting	1

Cotton Plumbers Handy Towels



- 100% cotton heavy duty shop towels are washable, reusable & nonabrasive
- Ideal for cleaning hands, wiping spills, removing grime from tools & parts
- 12 towels per bag

PART NO.	DESCRIPTION	CTN QTY
B05004	Plumbers handy towels	12

Commercial Sponges



- Commercial grade cellulose sponges- made to last!
- Deeply textured top makes cleanup easier
- Made in the U.S.A.

MADE IN THE
USA

DIMENSIONS	
S50001	6-3/4" x 4-3/8" x 3/4"
S50002	8" x 4-1/2" x 3/4"

PART NO.	DESCRIPTION	CTN QTY
S50001	Medium Cellulose sponge	24
S50002	Large Cellulose sponge	24



Plastic Drop Cloth



- Medium duty 1 mil plastic
- Convenient pleat fold pack design
- Protects furniture, appliances and carpets

PART NO.	DESCRIPTION	CTN/MSTR
D50000	9' x 12' plastic drop cloth	1/48

Trash Bags



G02042



G02033

- Hundreds of uses
- Keep the jobsite clean

PART NO.	DESCRIPTION	CTN QTY
G02042	42 gallon 3 mil. / 10 per bag	6
G02033	33 gallon .95 mil / 40 per box	6

Spray Bottle



- Economical to use for leak testing when filled with soapy water
- Clear bottle with various color tints based on availability

PART NO.	DESCRIPTION	CTN/MSTR
B25001	16 oz. clear spray bottle	1/60

Garbage Disposal Cords



E25015
E25016

E25017
E25018

- 16/3 gauge wire

PART NO.	DESCRIPTION	CTN QTY
E25015	3' straight disposal cord	50
E25016	6' straight disposal cord	50
E25017	3' angle disposal cord	50
E25018	6' angle disposal cord	50

Garbage Disposal Wiring Kits



- Complete with 3 wire nuts and connector coupling
- 16/3 gauge wire
- Polybagged

PART NO.	DESCRIPTION	CTN QTY
E25115	Kit for 3' cord w/ straight plug	6
E25116	Kit for 6' cord w/ straight plug	6
E25117	Kit for 3' cord w/ angle plug	6
E25118	Kit for 6' cord w/ angle plug	6

Screw-On Wire Connectors



- Clamshell Packaging
- Ready to Hang!

PART NO.	DESCRIPTION	CTN QTY
E25125	Gray	100
E25126	Blue	100
E25127	Orange	100
E25128	Yellow	100
E25129	Red	50

Leak Alert Water Detector



- Loud alarm sounds with direct water contact
- Floats and signals for up to 72 hours
- Fully automatic operation - no wiring required
- Low battery indicator for optimum safety and performance

PART NO.	DESCRIPTION	CTN/MSTR
L95400	Leak alert water detector	1/12

GASKETS & COUPLINGS

Gaskets	312
Couplings	313
Import Couplings.....	314

Multi-Tite Gaskets



SERVICE WEIGHT



EXTRA HEAVY

- Multi rings on outside make this gasket the easiest to install
- Meets ASTM Standard C564
- CARTON QUANTITIES ONLY

Service Weight

PART NO.	SIZE	CTN QTY
V95002	2"	150
V95003	3"	75
V95004	4"	60
V95005	5"	30
V95006	6"	30
V95008	8"	20
V95010	10"	10
V95012	12"	10
V95015	15"	5

Extra Heavy

PART NO.	SIZE	CTN QTY
V94004	4"	60

Dual Tite Gaskets



SERVICE WEIGHT



EXTRA HEAVY

- Meets ASTM Standard C564
- CARTON QUANTITIES ONLY

Service Weight

PART NO.	SIZE	CTN QTY
V96002	2"	150
V96003	3"	75
V96004	4"	60
V96005	5"	30
V96006	6"	30
V96008	8"	20
V96010	10"	10
V96012	12"	10
V96015	15"	5

Extra Heavy

PART NO.	SIZE	CTN QTY
V97002	2"	150
V97003	3"	75
V97004	4"	60
V97005	5"	30
V97006	6"	30
V97008	8"	20
V97010	10"	10
V97012	12"	10
V97015	15"	5

Dual Tite Buna N "Nitrile" Gasket



PART NO.	SIZE	CTN QTY
V98002	2"	150
V98003	3"	75
V98004	4"	60
V98005	5"	30
V98006	6"	30
V98008	8"	20
V98010	10"	10
V98012	12"	10
V98015	15"	5

Pipe Lubricant



- Carton Quantities Only
- L95202 - ORM-D. Ships UPS Ground and Motor Freight ONLY

PART NO.	DESCRIPTION	CTN QTY
L95200	Quart lubricant	12
L95201	Gallon lubricant	4
L95202	Quart adhesive lube	4

GASKETS & COUPLINGS

No Hub Couplings



- Made in the U.S.A.
- Manufactured in accordance with CISPI Standard 310
- Gasket sleeve conforms to ASTM C564
- Screw is ASI 305 stainless steel



PART NO.	SIZE	CTN QTY	CTN / PALLET
U95001	1-1/2"	100	24
U95002	2"	100	24
U95003	3"	100	12
U95004	4"	100	12
U95005	5"	20	24
U95006	6"	25	18
U95008	8"	15	16
U95010	10"	12	16
U95012	12"	6	6
U95015	15"	6	6

PART NO.	SIZE	CTN QTY	CTN / PALLET
U95211	2" x 1-1/2"	100	24
U95320	3" x 2"	60	12
U95430	4" x 3"	60	8

No Hub Torque Wrench



- Automatic release at 60 in.lb.
- Ratchets one way
- Built-in reversing lever
- Chrome vanadium socket

PART NO.	DESCRIPTION	CTN/MSTR
T60060	No hub torque wrench	20/80

Mega Torque Wrench



- Heavy duty construction with chrome vanadium 5/16" or 3/8" sockets
- Socket kit includes screw and washer
- Slide down locking reversing feature

PART NO.	DESCRIPTION	CTN/MSTR
T60065	60 lb. - 5/16"	15/60
T60080	80lb. - 3/8"	15/60
T60081	80lb. - 5/16"	1
T60066	5/16" socket kit	1

Medium Duty No Hub Coupling



- Manufactured in accordance with CISPI Standard 310
- 9/16" stainless steel bands
- Stainless steel housing and shield
- 5/16" stainless steel screws
- 80 inch/lb. installation torque

PART NO.	DESCRIPTION	CTN QTY
U97001	1-1/2"	60
U97002	2"	75
U97003	3"	48
U97004	4"	48
U97005	5"	15
U97006	6"	15
U97008	8"	15
U97010	10"	12

Heavy Duty No Hub Couplings



- Manufactured in accordance with CISPI Standard 310
- 9/16" stainless steel bands
- Stainless steel housing and shield
- 3/8" stainless steel screws
- 80 inch/lb. installation torque

PART NO.	DESCRIPTION	CTN QTY
HDNHC1	1-1/2"	100
HDNHC2	2"	100
HDNHC3	3"	80
HDNHC4	4"	100
HDNHC5	5"	20
HDNHC6	6"	20
HDNHC8	8"	10
HDNHC10	10"	10

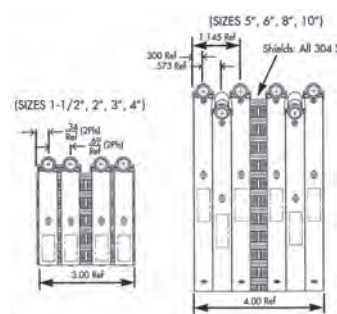

DESCRIPTION: Couplings consist of gasket and shield assemblies. The shield assemblies have four or six clamps depending on size. The clamps are fastened with eyelets to the bi-directional corrugated shield.

MATERIALS: Steels used in couplings are stainless steels. Shields, bands and housings are AISI 304. Screws and eyelets are ASI 305. Gaskets are neoprene rubber.

SPECIFICATIONS: Couplings conform to CISPI 310. Factory Mutual EN 1618. Couplings comply with ASTM C564, ASTM 1277, IAPMO file #3198, Commonwealth of Massachusetts CMR-248 and City of New York MEA 253-98-E. Gaskets are made from an elastomeric compound that meets the requirements of ASTM C564.

JSC PART #	COUPLING SIZE	INSTALLATION TORQUE	CLAMPS FOR COUPLING
HDN-HC1	1-1/2"	80	4
HDN-HC2	2"	80	4
HDN-HC3	3"	80	4
HDN-HC4	4"	80	4
HDN-HC5	5"	80	6
HDN-HC6	6"	80	6
HDN-HC8	8"	80	6
HDN-HC10	10"	80	6

Larger Hex Head Screw:
The new 3/8" hex head screw is designed to apply the full load of 80in/lbs. of insulation torque to the band/shield assembly.

Patented Bi-directional Shield Design: Our unique shield design employs bi-directional corrugations for maximum transfer of pressure from the clamps the gasket. This patented shield design adjusts to differences in the circumference and outside diameters for the pipes being joined. This eliminates gasket wrinkling and thereby eliminates leak paths. These parallel and transverse patterns on the gasket and pipe work to avoid pullout failures and provides a positive, reliable seal.

Specially Beaded Gaskets:
The heavy-duty coupling utilizes a specially beaded gasket that mates with the shield and clamping forces for superior sealing pressure and holding power. IDEAL gaskets comply with ASTM C564.

Floating Eyelet Design:
"Floating eyelets" fasten the clamps to the shield, allowing the clamp bond and shield to move independently. This freedom prevents the shield from crimping during tightening, which can lead to leakage later on.

Mechanical Interlocking Clamp Design: IDEAL clamps feature a one-piece screw housing that mechanically interlocks the housing to the band. This one-piece housing design eliminates leak paths that can occur in stacked or welded clamps.

Green Shield:
The distinctive green shield quickly identifies the newly re-engineered IDEAL Heavy-Duty Couplings.

GASKETS & COUPLINGS

Import No Hub Coupling



- Manufactured in accordance with CISPI Standard 310
- All stainless construction
- UPC listed
- Made in South Korea
- CARTON QUANTITIES ONLY



PART NO.	DESCRIPTION	CTN QTY
U99001	1-1/2"	200
U99002	2"	200
U99003	3"	150
U99004	4"	100
U99005	5"	60
U99006	6"	30
U99008	8"	15
U99010	10"	12
U99211	2" x 1-1/2"	200
U99320	3" x 2"	100

Import Heavy Duty No Hub Coupling



- Manufactured in accordance with CISPI Standard 310
- 9/16" stainless steel bands
- Stainless steel housing and shield
- 3/8" stainless steel screws
- 80 inch/lb. installation torque
- Made in South Korea



PART NO.	DESCRIPTION	CTN QTY
U99220	2"	75
U99330	3"	48
U99440	4"	48
U99550	5"	15
U99660	6"	15
U99880	8"	15
U99110	10"	10

GASKETS & COUPLINGS

SECTION T - TUBULAR

Chrome Plated 317-322

Rough Brass..... 323

PVC Plastic 324-327

ABS Plastic 328-329

Bath Wastes..... 330

Lav Drains & Pop Ups..... 331-332

Waste Connectors 333

Basket Strainers..... 334-335

Escutcheons 336



Chrome Plated Brass P-Traps



- Heavy zinc nuts
- Shallow escutcheon
- Less cleanout

PART NO.	SIZE	GAUGE	CTN/MSTR
P38001	1-1/4"	22	1/30
P38002	1-1/4"	20	1/30
P38003	1-1/4"	17	1/30
P38004	1-1/2"	22	1/30
P38005	1-1/2"	20	1/30
P38006	1-1/2"	17	1/30

Chrome Plated Brass P-Traps



- Brass nuts
- Shallow escutcheon
- Less cleanout

PART NO.	SIZE	GAUGE	CTN/MSTR
P38091	1-1/4"	22	1/30
P38007	1-1/4"	20	1/30
P38138	1-1/4" x 1-1/2"	17	1/30
P38092	1-1/4"	17	1/30
P38093	1-1/2"	22	1/30
P38008	1-1/2"	20	1/30
P38094	1-1/2"	17	1/30

Chrome Plated Brass P-Traps



- Brass nuts
- Box escutcheon
- Less cleanout

PART NO.	SIZE	GAUGE	CTN/MSTR
P38003B	1-1/4"	17	1/30
P38005B	1-1/2"	20	1/30
P38006B	1-1/2"	17	1/30

Chrome Plated Brass P-Traps



- Heavy zinc nuts
- With cleanout
- Bell escutcheon

PART NO.	SIZE	GAUGE	CTN/MSTR
P38002B	1-1/4"	20	1/30

Boston Style P-Trap



- Brass nuts
- With cleanout
- Box escutcheon

PART NO.	SIZE	GAUGE	CTN/MSTR
P38142	1-1/4" x 1-1/2"	17	1/30

Chrome Plated Brass P-Traps



- Zinc nuts
- Shallow escutcheon
- With cleanout

PART NO.	SIZE	GAUGE	CTN/MSTR
P38009	1-1/4"	20	1/30
P38009B (box esc.)	1-1/4"	20	1/30
P38011	1-1/2"	20	1/30

Chrome Plated Brass P-Traps



- Brass nuts
- Shallow escutcheon
- With cleanout

PART NO.	SIZE	GAUGE	CTN/MSTR
P38010	1-1/4"	17	1/30
P38012	1-1/2"	17	1/30

Chrome Plated Brass P-Traps



- Brass nuts
- Box escutcheon
- With cleanout

PART NO.	SIZE	GAUGE	CTN/MSTR
P38010B	1-1/4"	17	1/30
P38012B	1-1/2"	17	1/30

Chrome Plated Brass P-Traps



- Brass nuts
- With cleanout
- Semi- cast commercial
- Shallow escutcheon

PART NO.	SIZE	GAUGE	CTN/MSTR
J37124	1-1/4"	17	1/30
J37150	1-1/2"	17	1/30

Sink Trap w/Sweat Connection



- Brass nuts
- Box escutcheon
- With cleanout

PART NO.	SIZE	GAUGE	CTN/MSTR
P38140	1-1/2"	17	1/30

Sink Trap w/ABS Adapter



- Brass nuts
- Box escutcheon
- With cleanout

PART NO.	SIZE	GAUGE	CTN/MSTR
P38141	1-1/2"	17	1/20

Chrome Plated Brass S-Traps



- Zinc nuts
- Shallow escutcheon
- Less cleanout

PART NO.	SIZE	GAUGE	CTN/MSTR
P38013	1-1/4"	22	1/15
P38014	1-1/2"	22	1/15

T Chrome Plated Brass S-Traps



- Brass nuts
- Box escutcheon
- Less cleanout

PART NO.	SIZE	GAUGE	CTN/MSTR
P38095	1-1/4"	20	1/15
P38096	1-1/2"	20	1/15
P38137	1-1/4"	17	1/15
P38097	1-1/2"	17	1/50

Chrome Plated Brass J-Bend



- Heavy zinc nuts
- Slip Joint
- Less cleanout

PART NO.	SIZE	GAUGE	CTN/MSTR
P38015	1-1/4"	22	1/36
P38016	1-1/4"	20	1/36
P38017	1-1/4"	17	1/36
P38018	1-1/2"	22	1/36
P38019	1-1/2"	20	1/36
P38020	1-1/2"	17	1/36

Chrome Plated Brass J-Bend w/Cleanout



- Brass nuts
- Slip joint
- With cleanout

PART NO.	SIZE	GAUGE	CTN/MSTR
P38021	1-1/4"	17	1/36
P38022	1-1/2"	17	1/36

Chrome Plated Brass J-Bend w/Cleanout



- Heavy zinc nuts
- Slip joint
- Less cleanout

PART NO.	SIZE	GAUGE	CTN/MSTR
P38113	1-1/4"	20	1/60
P38114	1-1/2"	20	1/60

Chrome Plated Brass J-Bend



- Captured brass nuts
- Washer joint
- Less cleanout

PART NO.	SIZE	GAUGE	CTN/MSTR
P38107	1-1/4"	22	1/60
P38108	1-1/4"	20	1/60
P38109	1-1/4"	17	1/60
P38110	1-1/2"	22	1/60
P38111	1-1/2"	20	1/60
P38112	1-1/2"	17	1/60

Chrome Plated Brass L.A. Pattern Sink Trap



- P38099 and P38100 with cast brass elbows
- Brass nuts
- Less cleanout

PART NO.	SIZE	GAUGE	CTN/MSTR
P38098	1-1/2"	22	1/50
P38099	1-1/2"	20	1/50
P38100	1-1/2"	17	1/50

Chrome Plated Brass Repair Traps



- Heavy zinc nuts
- Less cleanout

PART NO.	SIZE	GAUGE	CTN/MSTR
P38101	1-1/4"	22	1/60
P38102	1-1/4"	20	1/60
P38103	1-1/2"	22	1/60
P38104	1-1/2"	20	1/60

Chrome Plated Brass Repair Traps



- Brass nuts
- Less cleanout

PART NO.	SIZE	GAUGE	CTN/MSTR
P38105	1-1/4"	17	1/60
P38106	1-1/2"	17	1/60

Milwaukee Style Trap



- Brass nuts
- 10" Arm
- Cast elbow
- With cleanout

PART NO.	SIZE	GAUGE	CTN/MSTR
P38129	1-1/2"	17	1/30

Sink Trap with PVC Adapter



- Box escutcheon
- PVC adapter
- Brass nuts
- With cleanout

PART NO.	SIZE	GAUGE	CTN/MSTR
P38130	1-1/2"	17	1/20

Chrome Brass P-Trap



- Bell escutcheon
- Brass nuts
- Less cleanout

PART NO.	SIZE	GAUGE	CTN/MSTR
P38150	1-1/4"	17	1/30

Brass Slip Joint End Outlet Tee Only



- Zinc nuts
- 4" Tailpiece
- No baffle

PART NO.	SIZE	GAUGE	CTN/MSTR
P38023	1-1/2"	22	1/50
P38024	1-1/2"	20	1/50

Brass Direct Connection End Outlet Waste



- Zinc nuts
- 4" Tailpiece
- No baffle

PART NO.	SIZE	GAUGE	CTN/MSTR
P38025	1-1/2" x 16"	22	1/20
P38026	1-1/2" x 16"	20	1/20

Brass Slip Joint End Outlet Waste



- Zinc nuts
- 4" Tailpiece
- No baffle

PART NO.	SIZE	GAUGE	CTN/MSTR
P38027	1-1/2" x 16"	22	1/20
P38028	1-1/2" x 16"	20	1/20

Brass Slip Joint Center Outlet Tee



- Zinc nuts
- 4" Tailpiece
- No baffle

PART NO.	SIZE	GAUGE	CTN/MSTR
P38029	1-1/2"	20	12/120

Brass Slip Joint Center Outlet Waste



- Zinc nuts
- 4" Tailpiece
- No baffle

PART NO.	SIZE	GAUGE	CTN/MSTR
P38030	1-1/2" x 16"	22	1/20
P38031	1-1/2" x 16"	20	1/20

Brass Direct Connection Center Outlet Waste



- Zinc nuts
- 4" Tailpiece
- No baffle

PART NO.	SIZE	GAUGE	CTN/MSTR
P38032	1-1/2" x 16"	22	1/20
P38033	1-1/2" x 16"	20	10/100

Brass Slip Joint Waste Arm



- Zinc nuts
- Bagged

PART NO.	SIZE	GAUGE	CTN/MSTR
P38034	1-1/4" x 6"	22	10/100
P38035	1-1/4" x 8"	22	10/50
P38036	1-1/4" x 12"	22	10/50
P38037	1-1/4" x 16"	22	10/50
P38038	1-1/2" x 8"	22	10/100
P38039	1-1/2" x 12"	22	10/50
P38040	1-1/2" x 16"	22	10/50
P38238	1-1/2" x 7"	17	10/50

Chrome Plated Brass Wall Bend



- Bagged

PART NO.	SIZE	GAUGE	CTN/MSTR
P38041	1-1/4" x 7"	22	10/100
P38042	1-1/4" x 7"	20	10/100
P38115	1-1/4" x 7-1/2"	17	10/100
P38043	1-1/2" x 7-1/2"	22	10/100
P38044	1-1/2" x 7-1/2"	20	10/100
P38116	1-1/2" x 7-1/2"	17	10/100

CP Brass Direct Connection Waste Arm



- Bagged

PART NO.	SIZE	GAUGE	CTN/MSTR
P38045	1-1/2" x 7"	22	10/100
P38117	1-1/2" x 15"	22	10/100
P38217	1-1/2" x 15"	17	1/25

Brass Slip Joint Double Offset



- Zinc nuts
- Bagged

PART NO.	SIZE	GAUGE	CTN/MSTR
P38046	1-1/4" x 12"	22	10/100
P38047	1-1/2" x 12"	22	10/50

Brass Sink Tailpiece



- Bagged

PART NO.	SIZE	GAUGE	CTN/MSTR
P38048	1-1/4" x 6"	22	10/100
P38049	1-1/4" x 8"	22	10/100
P38050	1-1/4" x 12"	22	10/100
P38051	1-1/4" x 6"	17	10/100
P38052	1-1/4" x 8"	17	10/100
P38053	1-1/4" x 12"	17	10/50
P38054	1-1/2" x 4"	22	10/100
P38055	1-1/2" x 6"	22	10/100
P38056	1-1/2" x 8"	22	10/100
P38057	1-1/2" x 12"	22	10/50
P38058	1-1/2" x 6"	17	10/100
P38059	1-1/2" x 8"	17	10/100
P38060	1-1/2" x 12"	17	10/50

Brass Double Flange Tailpiece



- Bagged

PART NO.	SIZE	GAUGE	CTN/MSTR
P38061	1-1/2" x 16"	22	10/50

Brass Direct Connect Dishwasher Tailpiece



- Zinc nut
- Bagged

PART NO.	SIZE	GAUGE	CTN/MSTR
P38063	1-1/2" x 6" w/3/4" branch	22	10/100
P38064	1-1/2" x 8" w/3/4" branch	22	10/50
P38163	1-1/2" x 6" w/1/2" branch	22	5/30
P38148	1-1/2" x 8" w/1/2" branch	22	10/100

Threaded Connection Dishwasher Tailpiece



PART NO.	SIZE	GAUGE	CTN/MSTR
P38166	1-1/2" x 6" w/1/2" branch	22	1/50

Slip Joint Tailpiece



- Zinc nut
- Bagged

PART NO.	SIZE	GAUGE	CTN/MSTR
P38164	1-1/2" x 8" w/3/4" branch	22	10/50
P38143	1-1/2" x 8" w/1/2" branch	22	10/50

Brass Double Slip Joint Extension Tube



- Zinc nuts
- Bagged

PART NO.	SIZE	GAUGE	CTN/MSTR
P38062	1-1/2" x 16"	22	10/50
P38162	1-1/4" x 16"	22	10/50

Chrome Plated Brass Slip Joint Extension Tube



- Zinc nut
- Bagged

PART NO.	SIZE	GAUGE	CTN/MSTR
P38065	1-1/4" x 6"	22	10/100
P38066	1-1/4" x 8"	22	10/100
P38067	1-1/4" x 12"	22	10/50
P38121	1-1/4" x 6"	20	10/100
P38122	1-1/4" x 8"	20	10/100
P38068	1-1/4" x 12"	20	10/50
P38118	1-1/4" x 6"	17	10/100
P38119	1-1/4" x 8"	17	10/100
P38120	1-1/4" x 12"	17	10/50
P38069	1-1/2" x 6"	22	10/100
P38070	1-1/2" x 8"	22	10/100
P38071	1-1/2" x 12"	22	25/50
P38123	1-1/2" x 6"	20	10/100
P38124	1-1/2" x 8"	20	10/100
P38125	1-1/2" x 12"	20	10/50
P38126	1-1/2" x 6"	17	10/100
P38127	1-1/2" x 8"	17	10/100
P38128	1-1/2" x 12"	17	10/50

Chrome Plated Closet Flush Elbow w/Nuts



- Zinc nuts
- Bagged

PART NO.	SIZE	GAUGE	CTN/MSTR
P38257	2" x 5" x 7"	20	1/25

Chrome Plated Disposer Kit



- Zinc nuts

PART NO.	SIZE	GAUGE	CTN/MSTR
P38165	1-1/2" x 13"	17	1/20

Brass Solder Extension Tube



PART NO.	SIZE	GAUGE	CTN/MSTR
P38072	1-1/4" x 6"	22	10/100
P38073	1-1/4" x 8"	22	10/100
P38074	1-1/4" x 12"	22	10/100
P38131	1-1/4" x 6"	20	10/100
P38132	1-1/4" x 8"	20	10/100
P38133	1-1/4" x 12"	20	10/100
P38075	1-1/2" x 6"	22	10/100
P38076	1-1/2" x 8"	22	10/100
P38077	1-1/2" x 12"	22	10/100
P38134	1-1/2" x 6"	20	10/100
P38135	1-1/2" x 8"	20	10/100
P38136	1-1/2" x 12"	20	10/100

Double Slip Fittings



- Zinc nuts
- Chrome plated brass
- 22 gauge

PART NO.	SIZE	DESCRIPTION	CTN/MSTR
T74001	1-1/4"	Coupling	10/100
T74002	1-1/2"	Coupling	10/100
T74003	1-1/4"	90° Ell	10/100
T74004	1-1/2"	90° Ell	10/100
T74005	1-1/4"	45° Ell	10/100
T74006	1-1/2"	45° Ell	10/100

Brass Threaded Extension Tube



• Bagged

PART NO.	SIZE	GAUGE	CTN/MSTR
P38078	1-1/4" x 6"	20	10/100
P38079	1-1/4" x 8"	20	10/100
P38080	1-1/4" x 12"	20	10/50
P38081	1-1/2" x 6"	20	10/100
P38082	1-1/2" x 8"	20	10/100
P38083	1-1/2" x 12"	20	10/50
P38084	1-1/4" x 6"	17	10/100
P38085	1-1/4" x 8"	17	10/100
P38086	1-1/4" x 12"	17	10/50
P38087	1-1/2" x 6"	17	10/100
P38088	1-1/2" x 8"	17	10/50
P38089	1-1/2" x 12"	17	10/50

Slip Joint Tee



- Zinc nuts
- Chrome plated satin finish cast brass

PART NO.	DESCRIPTION	CTN/MSTR
C74105	1-1/2" x 1-1/2" x 1-1/2"	10/60

Rough Brass P-Trap



- Less cleanout
- Deep flange
- Brass Nuts

PART NO.	SIZE	GAUGE	CTN/MSTR
P38406	1-1/2"	17	1/30

Slip Joint Extension Tube



- Brass nut

PART NO.	SIZE	GAUGE	CTN/MSTR
P38420	1-1/4" x 12"	17	10/50
P38428	1-1/2" x 12"	17	10/50

Rough Brass Direct Connection Waste Arm



PART NO.	SIZE	GAUGE	CTN/MSTR
P38444	1-1/2" x 7"	17	1/100
P38447	1-1/2" x 15"	17	1/50

Double Threaded Extension Tube



PART NO.	SIZE	GAUGE	CTN/MSTR
P38486	1-1/4" x 12"	17	10/100
P38489	1-1/2" x 12"	17	10/100

Rough Brass Flanged Tailpiece



PART NO.	SIZE	GAUGE	CTN/MSTR
P38454	1-1/2" x 4"	17	10/50
P38458	1-1/2" x 6"	17	10/100
P38459	1-1/2" x 8"	17	10/100
P38460	1-1/2" x 12"	17	10/50

Rough Brass Slip Joint Tailpiece w/ 1/2" Sweat Branch



- Brass nut

PART NO.	SIZE	GAUGE	CTN/MSTR
P38443	1-1/2" x 8"	17	1/50

T

PVC P-Trap



PART NO.	SIZE	CTN/MSTR
P37001	1-1/4"	25/100
P37002	1-1/2"	10/50

PVC P-Trap w/Marvel; PVC P-Trap w/Solvent Weld Marvel



• Master trap

PART NO.	SIZE	CTN/MSTR
P37003	1-1/2" slip joint	25/50
P37032	1-1/2" solvent weld	10/100

PVC Slip Joint Center Outlet Waste



• Baffle tee

PART NO.	SIZE	CTN/MSTR
P37004	1-1/2"	10/40

PVC Direct Connection Center Outlet Waste



• Baffle tee

PART NO.	SIZE	CTN/MSTR
P37005	1-1/2"	10/40

PVC Center Outlet Tee Only



- Baffle
- Tailpiece included
- May be used as slipjoint or direct connect

PART NO.	SIZE	CTN/MSTR
P37006	1-1/2"	25/100

PVC Slip Joint End Outlet Waste



• Baffle

PART NO.	SIZE	CTN/MSTR
P37007	1-1/2" x 16"	10/40
P37034	1-1/2" x 16" Adjustable arm	10/40

PVC Slip Joint End Outlet Waste



- 1/2" branch
- Adjustable arm

PART NO.	SIZE	CTN/MSTR
P37042	1-1/2"	10/40

PVC Direct Connection End Outlet Waste



• Baffle tee

PART NO.	SIZE	CTN/MSTR
P37008	1-1/2"	10/50
P37036	1-1/2" telescoping	10/50

PVC Slip Joint End Outlet Tee Only w/Baffle



• Baffle

PART NO.	SIZE	CTN/MSTR
P37009	1-1/2"	25/100

T

PVC Slip Joint S-Trap

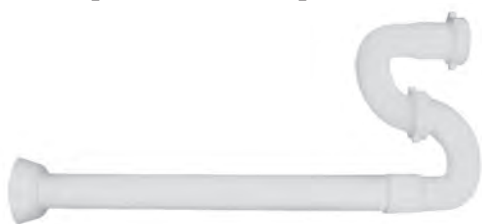

PART NO.	SIZE	CTN/MSTR
P37010	1-1/4"	15/60
P37011	1-1/2"	15/60

PVC Slip Joint Dishwasher Tailpiece



PART NO.	SIZE	CTN/MSTR
P37012	1-1/2" x 8" x 1/2"	1/25
P37030	1-1/2" x 8" x 3/4"	5/25

PVC Direct Connection Dishwasher Tailpiece



• Slip joint or direct connect

PART NO.	SIZE	CTN/MSTR
P37013	1-1/2" x 8" x 1/2"	5/25
P37031	1-1/2" x 8" x 3/4"	5/25

Universal End Outlet Waste w/Dishwasher Connection



- 1-1/2" tubular; 16" maximum adjustment
- Baffle tee
- Slip joint or direct connect

PART NO.	SIZE	CTN/MSTR
P37040	1/2" branch	10/60
P37041	3/4" branch	10/60

PVC Slip Joint Repair Trap



PART NO.	SIZE	CTN/MSTR
P37014	1-1/2"	1/80

PVC Slip Joint J-Bend



PART NO.	SIZE	CTN/MSTR
P37015	1-1/2"	10/60

PVC Slip Joint Waste Arm



PART NO.	SIZE	CTN/MSTR
P37016	1-1/2" x 16"	25/100

PVC Direct Connection Waste Arm



PART NO.	SIZE	CTN/MSTR
P37017	1-1/2" x 16"	10/100

PVC Slip Joint Extension Tube



PART NO.	SIZE	CTN/MSTR
P37018	1-1/2" x 16"	25/50
P37118	1-1/4" x 16"	10/100

PVC Double Flange Extension



PART NO.	SIZE	CTN/MSTR
P37019	1-1/2" x 16"	25/100
P37037	1-1/4" x 16"	10/100

PVC Slip Joint Extension Tube



PART NO.	SIZE	CTN/MSTR
P37020	1-1/4" x 6"	25/100
P37021	1-1/2" x 8"	25/100
P37022	1-1/2" x 12"	25/100

PVC Solvent Extension Tube



PART NO.	SIZE	CTN/MSTR
P37023	1-1/4" x 8"	25/100
P37024	1-1/2" x 6"	25/100
P37025	1-1/2" x 12"	25/100

PVC Flanged Tailpiece



PART NO.	SIZE	CTN/MSTR
P37026	1-1/2" x 6"	25/200
P37027	1-1/2" x 8"	25/200
P37028	1-1/2" x 12"	25/200
P37029	1-1/2" x 16"	25/100
P37038	1-1/4" x 12"	25/200

1-1/2" PVC Direct Connection Disposer Kit w/13" Arm



- Poly washers and wing nuts
- Disposer washer
- Baffle tee
- 6" Tailpiece

PART NO.	SIZE	CTN/MSTR
P37033	1-1/2" x 16"	10/50

1-1/2" PVC Direct Connection Disposer Kit w/Adjustable Arm



- Telescoping arm adjusts up to 16"
- Poly washers and wing nuts
- Disposer washer
- Baffle tee
- 6" tailpiece

PART NO.	SIZE	CTN/MSTR
P37035	1-1/2" x 16"	10/40

PVC Slip Joint Tee



PART NO.	SIZE	CTN QTY
P37400	1-1/2" with 1-1/4" washer	120

PVC Double Slip Fittings



PART NO.	SIZE	DESCRIPTION	CTN/MSTR
P37200	1-1/2"	Coupling	10/100
P37445	1-1/2"	45° Ell	1/100
P37490	1-1/2"	90° Ell	1/100

Chrome Plated PVC P-Trap



- Complete with nuts, washers, and escutcheon
- P36103 includes reducing washer

PART NO.	SIZE	CTN/MSTR
P36102	1-1/4"	1/50
P36103	1-1/2"	1/50

Polished Brass PVC P-Traps



- Slip joint
- Box escutcheon

PART NO.	SIZE	CTN/MSTR
P36101	1-1/2"	1/50

T

ABS P-Trap



PART NO.	SIZE	CTN/MSTR
P39001	1-1/4"	10/100
P39002	1-1/2"	10/50

ABS P-Trap w/Adapter



PART NO.	SIZE	CTN/MSTR
P39003	1-1/2" slip joint	1/50
P39032	1-1/2" solvent weld	10/50

ABS Slip-Joint Center Outlet



PART NO.	SIZE	CTN/MSTR
P39004	1-1/2"	10/40

ABS Direct Connection Center Outlet Waste



PART NO.	SIZE	CTN/MSTR
P39005	1-1/2"	10/40

ABS Slip-Joint Center Outlet



PART NO.	SIZE	CTN/MSTR
P39006	1-1/2"	10/100

ABS Slip-Joint End Outlet Waste



PART NO.	SIZE	CTN/MSTR
P39007	1-1/2" x 16"	20/40
P39034	1-1/2" x 16" adjustable	10/40

ABS Direct Connection End Outlet Waste



PART NO.	SIZE	CTN/MSTR
P39008	1-1/2"	20/40

ABS Slip Joint End Outlet Tee Only



PART NO.	SIZE	CTN/MSTR
P39009	1-1/2"	25/100

ABS S-Trap



PART NO.	SIZE	CTN/MSTR
P39010	1-1/4"	15/60
P39011	1-1/2"	15/60

ABS Slip Joint Dishwasher Tailpiece



PART NO.	SIZE	CTN/MSTR
P39012	1-1/2" x 8" x 1/2"	5/25
P39030	1-1/2" x 8" x 3/4"	5/25

ABS Direct Connection Dishwasher Tailpiece



PART NO.	SIZE	CTN/MSTR
P39013	1-1/2" x 8" x 1/2"	5/25
P39031	1-1/2" x 8" x 3/4"	5/25

ABS Repair Trap



PART NO.	SIZE	CTN/MSTR
P39014	1-1/2"	20/80

ABS Slip Joint J-Bend



PART NO.	SIZE	CTN/MSTR
P39015	1-1/2"	20/80

ABS Slip Joint Waste Arm



PART NO.	SIZE	CTN/MSTR
P39016	1-1/2" x 16"	25/100

ABS Direct Connection Waste Arm



PART NO.	SIZE	CTN/MSTR
P39017	1-1/2" x 16"	25/100

ABS Slip Joint Extension Tube



PART NO.	SIZE	CTN/MSTR
P39018	1-1/2" x 16"	10/50

ABS Double Flange Extension



PART NO.	SIZE	CTN/MSTR
P39019	1-1/2" x 16"	25/100

ABS Slip Joint Extension Tube



PART NO.	SIZE	CTN/MSTR
P39020	1-1/4" x 6"	10/100
P39021	1-1/2" x 8"	10/100
P39022	1-1/2" x 12"	25/100

1-1/2" ABS Direct Connection Disposer Kit



- Poly washer and wing nuts
- Disposer washer
- 6" Tailpiece

PART NO.	SIZE	CTN/MSTR
P39033	1-1/2" x 16"	10/50

1-1/2" ABS Direct Connection Disposer Kit w/Adjustable Arm



- Baffle tee
- 6" Tailpiece
- Disposer washer
- Poly washers and wing nuts
- Telescoping arm adjusts up to 16"

PART NO.	SIZE	CTN/MSTR
P39035	1-1/2" x 16"	1/40

ABS Universal End Outlet Waste w/Dishwasher Connection



- 1-1/2" tubular; 16" maximum adjustment
- Slip joint or direct connection
- Baffle tee

PART NO.	SIZE	CTN/MSTR
P39040	1/2" branch	10/40
P39041	3/4" branch	60

ABS Solvent Extension Tube

PART NO.	SIZE	CTN/MSTR
P39023	1-1/4" x 8"	25/100
P39024	1-1/2" x 6"	25/100
P39025	1-1/2" x 12"	25/100

ABS Flanged Tailpiece

PART NO.	SIZE	CTN/MSTR
P39026	1-1/2" x 6"	25/200
P39027	1-1/2" x 8"	25/200
P39028	1-1/2" x 12"	25/200
P39029	1-1/2" x 16"	25/100

Chrome Plated ABS P-Trap

- Slip joint connection
- Box pattern escutcheon

PART NO.	SIZE	CTN/MSTR
P36104	1-1/4"	10/50
P36105	1-1/2"	10/50

PVC & ABS Tubular Bath Waste Kits

- Heavy walled PVC and ABS tubular
- Available in polished chrome and pvd protected polished brass and satin nickel
- 2-hole face plates with wrap-around gaskets and tapped holes
- 1-1/2" IPS threaded drain shoe
- Overflow elbow designed to accommodate B07-202 test kit
- Wing nuts and poly washers
- Come packaged in individual box
- UPC listed

1-1/2" Lift And Turn Bath Waste Tubular Kit



PART NO.	FINISH	FACE PLATE	MATERIAL	CTN	QTY
P37500	CP	2-hole	PVC	20	
P39500	CP	2-hole	ABS	20	
P37502	SN	2-hole	PVC	20	
P39502	SN	2-hole	ABS	20	

1-1/2" Brass Friction Lift Bath Waste Tubular Kit



PART NO.	FINISH	FACE PLATE	MATERIAL	CTN	QTY
P37503	CP	2-hole	PVC	20	
P39503	CP	2-hole	ABS	20	
P37505	SN	2-hole	PVC	20	
P39505	SN	2-hole	ABS	20	

1-1/2" Brass Toe Touch Bath Waste Tubular Kit



PART NO.	FINISH	FACE PLATE	MATERIAL	CTN	QTY
P37506	CP	2-hole	PVC	20	
P39506	CP	2-hole	ABS	20	
P37508	SN	2-hole	PVC	20	
P39508	SN	2-hole	ABS	20	

1-1/2" Trip Lever Bath Waste Tubular Kit



PART NO.	FINISH	FACE PLATE	MATERIAL	CTN	QTY
P37509	CP	2-hole	PVC	20	
P39509	CP	2-hole	ABS	20	
P37511	SN	2-hole	PVC	20	
P39511	SN	2-hole	ABS	20	

PVC & ABS Tubular Cable Drive Bath Waste 1/2 Kits

- Available in polished chrome and pvd protected polished brass and satin nickel
- 1-1/2" IPS threaded drain shoe
- UPC listed

1-1/2"- 27" Cable Drive



PART NO.	FINISH	MATERIAL	CTN	QTY
P37512	CP	PVC	20	
P39512	CP	ABS	20	
P37514	SN	PVC	20	
P39514	SN	ABS	20	

1-1/2"- 35" Cable Drive



PART NO.	FINISH	MATERIAL	CTN	QTY
P37515	CP	PVC	20	
P39515	CP	ABS	20	
P37517	SN	PVC	20	
P39517	SN	ABS	20	

1-1/2"- 45" Cable Drive



PART NO.	FINISH	MATERIAL	CTN	QTY
P37518	CP	PVC	20	
P39518	CP	ABS	20	
P37520	SN	PVC	20	
P39520	SN	ABS	20	

T

Commercial Lav Drain



- Polished chrome plated brass
- 17 Gauge 1-1/4" tailpiece; 6" long
- Mack washer and brass locknut

PART NO.	SIZE	CTN/MSTR
D70100	1-1/4"	1/50

Handicap Style Lav Drain



- Polished chrome plated brass
- Twin 90° construction
- 17 Gauge 1-1/4" tailpiece; cast brass elbows
- Mack washer and brass locknut

PART NO.	SIZE	CTN/MSTR
D70101	1-1/4"	1/25

Commercial Handicap Drain w/Elbow



- Polished chrome plated brass; cast brass elbow
- Complete with gaskets and brass locknuts
- 1-1/4" Female thread

PART NO.	SIZE	CTN/MSTR
D70102	1-1/4"	1/25

Chrome Plated Brass Pop-Up Assembly



- All metal construction
- Tool free locknut and ballrod nut
- Boxed

PART NO.	DESCRIPTION	CTN/MSTR
P35001	CP pop-up assembly	1/50

Polished Brass Pop-Up Assembly



- PVD durable finish
- Tool free locknut and ballrod nut
- All metal construction
- 1-1/4" Tubular
- Boxed

PART NO.	DESCRIPTION	CTN/MSTR
P35002	PB pop-up assembly	1/50

ABS Pop Up Assembly



- Carded

PART NO.	DESCRIPTION	CTN/MSTR
P35004	Grey plastic	6/30

Chrome Plated ABS Pop Up Assembly



- Carded

PART NO.	DESCRIPTION	CTN/MSTR
P35005	Chrome plated plastic	6/30

Brass P.O. Plug Drain



- With chain and stopper

PART NO.	SIZE	CTN/MSTR
D70103	1-1/4"	1/50

Trap Primer Tailpiece



- 17 Gauge tubular chrome plated steel
- Sturdy one-piece construction eliminates leaks and cross-threading

PART NO.	SIZE	CTN/MSTR
T74010	1-1/4" x 8" threaded top	1/50
T74011	1-1/2" x 8" direct connection	1/50

Plastic Slip Joint Nut



- White
- CARTON QUANTITIES ONLY

PART NO.	SIZE	CTN/MSTR
T83150	1-1/2" with wings	100/1200
T85125	1-1/4" x 1-1/4"	100/1200
T85150	1-1/2" x 1-1/2"	100/1200

Plastic Slip Nut



- Replace fractured or stripped slip nuts without tubular disassembly
- Supplied with washer

PART NO.	SIZE	CTN/MSTR
T82125	1-1/4" Split nut	100/400
T82150	1-1/2" Split nut	100/400

Die Cast Zinc Slip Joint Nut



- Chrome plated
- CARTON QUANTITIES ONLY

PART NO.	IPS x SLIP TUBE	CTN/MSTR
T77125	1-1/4" x 1-1/4"	25/500
T77138	1-1/2" x 1-3/8"	25/300
T77150	1-1/2" x 1-1/2"	25/300
T77151	1-1/2" x 1-1/4"	25/300
T77152	2" x 1-1/2"	25/300
T77200	2" x 2"	25/200

Chrome Plated Brass Slip Joint Nut



- Chrome plated
- CARTON QUANTITIES ONLY

PART NO.	IPS x SLIP TUBE	CTN/MSTR
T78125	1-1/4" x 1-1/4"	25/400
T78150	1-1/2" x 1-1/2"	25/400
T78151	1-1/2" x 1-1/4"	25/400
T78152	2" x 1-1/2"	25/400
T78200	2" x 2"	25/400

Rough Brass Slip Joint Nut



- Heavy cast brass
- CARTON QUANTITIES ONLY

PART NO.	IPS x SLIP TUBE	CTN/MSTR
T84125	1-1/4" x 1-1/4"	25/300
T84150	1-1/2" x 1-1/2"	25/300
T84151	1-1/2" x 1-1/4"	25/300
T84200	2" x 2"	25/300

Die Cast Slip Joint Nut & Washer



- Chrome plated nut packed with square cut rubber washer
- CARTON QUANTITIES ONLY

PART NO.	SIZE	CTN QTY
T77014	1-1/4" x 1-1/4"	25
T77012	1-1/2" x 1-1/2"	25
T77013	1-1/2" x 1-1/4"	25
T77020	2" x 2"	25

Brass Slip Joint Nut & Washer



- Chrome plated nut packed with square cut rubber washer
- CARTON QUANTITIES ONLY

PART NO.	SIZE	CTN/MSTR
T78014	1-1/4" x 1-1/4"	25/400
T78012	1-1/2" x 1-1/2"	25/400
T78013	1-1/2" x 1-1/4"	25/400
T78020	2" x 2"	25/400

Square Cut Rubber Slip Joint Washer



• CARTON QUANTITIES ONLY

PART NO.	NUT x TUBE	CTN/MSTR
T79125	1-1/4" x 1-1/4"	100/5600
T79150	1-1/2" x 1-1/2"	100/5600
T79151	1-1/2" x 1-1/4"	100/5600
T79200	2" x 2"	100/2400
T79201	2" x 1-1/2"	100/2400
T79152	1-1/2" x 1-1/4" cloth inserted	100/1000

Poly Beveled Slip Joint Washer



• CARTON QUANTITIES ONLY

PART NO.	NUT x TUBE	CTN/MSTR
T80125	1-1/4" x 1-1/4"	100/5000
T80150	1-1/2" x 1-1/2"	100/5000
T80151	1-1/2" x 1-1/4"	100/5000
T80200	2" x 2"	100/5000

LDP Blue Slip Joint Washer Washer



• CARTON QUANTITIES ONLY

PART NO.	NUT x TUBE	CTN QTY
T80135	1-1/4" x 1-1/4"	100
T80160	1-1/2" x 1-1/2"	100

Flanged Poly Tailpiece Washer



• CARTON QUANTITIES ONLY

PART NO.	NUT x TUBE	CTN QTY
T81150	1-1/2" x 1-1/2"	100
T79152	1-1/2" x 1-1/4" cloth inserted	100

Marvel Rings



• Use on closet/urinal stub out adapter

PART NO.	FSWT x MIP	CTN/MSTR
B55004	1-1/4" SJ x 1-1/4" SWT	1/1000
B55005	1-1/2" SJ x 1-1/2" SWT	1/500
B55006	2" SJ x 2" SWT	1/500
B55007	1-1/2" SJ x 1-1/4" SWT	1/500

PVC Marvel Adapter



• Thread x Hub

PART NO.	SIZE	CTN QTY
P37000	1-1/2" PVC	100
P39000	1-1/2" ABS	100

Tray Plug



- Stainless steel body with die cast locknut
- Fits 1-1/2" bar sink
- Complete with washers and stopper

PART NO.	DESCRIPTION	CTN/MSTR
B02051	Tray Plug	1/100

FIP x SLIP Waste Connector



- Brass body ferrule and nut; OD is copper tubular dimension
- MIP units are combination female sweat

PART NO.	FIP x OD	CTN/MSTR
T75125	1-1/4" x 1-1/4"	12/72
T75150	1-1/2" x 1-1/2"	12/72
T75151	1-1/2" x 1-1/4"	12/72

MIP x SLIP Waste Connector



- Brass body ferrule and nut; OD is copper tubular dimension
- MIP units are combination female sweat

PART NO.	MIP x OD	CTN/MSTR
T76125	1-1/4" x 1-1/4"	12/72
T76150	1-1/2" x 1-1/2"	12/72
T76151	1-1/2" x 1-1/4"	12/72

Flexible Trap Drain Connector



PART NO.	DESCRIPTION	CTN/MSTR
T06001	Connects 1-1/4"- 1-1/2" tubular to 1-1/4"- 1-1/2" tubular	1/180
T06002	Connects 1" DWV or 1-1/2" CTS to 1-1/4"- 1-1/2" tubular	1/100
T06003	Connects 1-1/2" DWV or CTS to 1-1/4"- 1-1/2" tubular	1/100
T06004	Connects 2" DWV to 1-1/4"- 1-1/2" tubular	1/100

Duo Basket Strainer



- 4-1/2" diameter to fit 3-1/2" drilling
- All stainless steel with zinc locknut
- Basket with rolled edge

PART NO.	DESCRIPTION	CTN/MSTR
S14001	SS Duo Basket Strainer	1/50

Snap Lock Basket Strainer



- 4-1/2" diameter to fit 3-1/2" drilling
- All stainless steel with zinc locknut
- Ball bearing basket with rolled edge (less tailpiece)

PART NO.	DESCRIPTION	CTN/MSTR
S14005	Snap lock basket strainer	1/50

Flat Top Grid Strainer



- 4-1/2" diameter to fit 3-1/2" drilling
- All stainless steel with zinc locknut (less tailpiece)

PART NO.	DESCRIPTION	CTN/MSTR
S14002	Flat top grid strainer	1/24

Shallow Cup Duo Basket Strainer



- 4-1/2" diameter to fit 3-1/2" drilling
- All stainless steel with zinc locknut
- Basket with rolled edge (less tailpiece)

PART NO.	DESCRIPTION	CTN/MSTR
S14006	Shallow cup duo strainer	1/50

Twist & Lock Basket Strainer



- 4-1/2" diameter to fit 3-1/2" drilling
- Screw-in basket (less tailpiece)

PART NO.	DESCRIPTION	CTN/MSTR
S14003	Twist & lock basket strainer	1/50
S14103	Replacement basket	1/50

Stainless Steel Duo Basket Strainer



- Stainless steel body and basket
- Neoprene stopper
- Spring style snap-in basket

PART NO.	DESCRIPTION	CTN/MSTR
S14606	SS duo basket strainer	1/50

Stainless Steel Duo Post Style Basket Strainer



- Stainless steel body and basket
- Polished inner cup
- Compare to JB250SS
- CP zinc post and slip nut
- Heavy duty rubber gasket and zinc locknut

PART NO.	DESCRIPTION	CTN/MSTR
S14251	SS Duo post style basket strainer	1/50

CP Brass Duo Strainer



- Beveled stopper w/o-ring seal
- Brass slip joint nut and lock nut
- Compare to Kohler K8801

PART NO.	DESCRIPTION	CTN/MSTR
S14007	CP brass duo strainer	1/25

Deep Cup Basket Strainer



- 4-1/2" diameter to fit 3-1/2" drilling
- All stainless steel with zinc locknut
- Basket with rolled edge (less tailpiece)

PART NO.	DESCRIPTION	CTN/MSTR
S14004	Deep cup basket strainer	1/50

Chrome Plated Brass Duo Basket Strainer



- Chrome plated brass body with stainless steel basket
- Heavy duty construction
- Neoprene stopper

PART NO.	DESCRIPTION	CTN/MSTR
S14250	CP brass duo basket strainer	1/50

T

Quick Fit Stainless Steel Basket Strainer



- Minimizes installation time
- Triangle frame mounts to underside
- Fits virtually all sinks
- Durable stainless construction with brass nut
- For replacement basket use B03015

PART NO.	DESCRIPTION	CTN/MSTR
S14008	SS basket strainer	1/50

Stainless Steel Deep Cup Basket Strainer



- Stainless steel body and basket
- Neoprene stopper
- Spring style snap-in basket

PART NO.	DESCRIPTION	CTN/MSTR
S14014	SS cup basket strainer	1/50

Junior Duo Basket Strainer



- Stainless Steel body and basket with die cast locknut; 1-1/2" threads
- Complete with washers
- Fits 1-3/4" bar sink

PART NO.	DESCRIPTION	CTN/MSTR
B02050	Junior duo strainer	1/100
B02049	Replacement basket	100/500

Flat Duplex Strainer



- Stainless steel body and strainer with die cast locknut
- Complete with washers
- Fits 1-1/2" bar sink

PART NO.	DESCRIPTION	CTN/MSTR
B02052	Flat duplex strainer	1/100

Deep Junior Duo Basket Strainer



- For 2" and 2-1/2" deep outlets and bar sinks

PART NO.	DESCRIPTION	CTN/MSTR
B02102	2" Deep basket strainer	1/100
B02103	Replacement basket	1/250

Economy Replacement Basket Strainer



- ABS post
- Stainless steel basket

PART NO.	DESCRIPTION	CTN/MSTR
B03015	Replacement basket strainer	10/200

Fit-All Basket Strainer



- Stainless steel

PART NO.	DESCRIPTION	CTN/MSTR
B03010	Fit-all strainer	20/200

Snap N Lock Stainless Steel Basket Strainer



- Brass slip joint and lock nuts

PART NO.	DESCRIPTION	CTN/MSTR
S14010	Snap N Lock Stainless Steel Basket Strainer	1/50

Low Pattern-Tubular Sure Grip Escutcheons



- Chrome plated steel
- Carton quantities only

PART NO.	SIZE	FLANGE OD	CTN/MSTR
E03125	1-1/4" Tubular	2-7/8"	25/1200
E03150	1-1/2" Tubular	2-7/8"	25/1200
E03200	2" Tubular	3-1/2"	25/2500

Box Pattern-Tubular Sure Grip Escutcheons



- Chrome plated steel
- Carton quantities only

PART NO.	SIZE	FLANGE OD	CTN/MSTR
E04125	1-1/4" Tubular	3"	5/300
E04150	1-1/2" Tubular	3"	5/300
E04200	2" Tubular	3"	5/300

T

PVC DWV FITTINGS 339-346

Coupling

H x H



- Used to join straight lengths of pipe

PVC#	SIZE	MASTER CTN.
PFC114	1-1/4"	100
PFC115	1-1/2"	100
PFC120	2"	100
PFC130	3"	60
PFC140	4"	25
PFC160	6"	15

Repair Coupling

H x H



- Furnished without center stop so that stationary lengths of pipe can be spliced together

PVC#	SIZE	MASTER CTN.
PFC116	1-1/2"	25
PFC122	2"	25
PFC133	3"	10
PFC144	4"	5

Reducer Coupling

H x H



- Used to reduce or increase pipe sizes

PVC#	SIZE	MASTER CTN.
PFC121	2" x 1-1/2"	25
PFC131	3" x 1-1/2"	25
PFC132	3" x 2"	20
PFC142	4" x 2"	10
PFC143	4" x 3"	20

Flush Bushing

Spg x H



- Inserts into fitting hub to reduce to smaller pipe sizes

PVC#	SIZE	MASTER CTN.
PFB211	1-1/2" x 1-1/4"	50
PFB221	2" x 1-1/2"	100
PFB224	2" x 1-1/4"	70
PFB231	3" x 1-1/2"	20
PFB232	3" x 2"	30
PFB242	4" x 2"	30
PFB243	4" x 3"	30
PFB264	6" x 4"	10

Male Adapter

H x MPT



- Adapts to standard female pipe threads
- Teflon thread tape is recommended for threaded joints

PVC#	SIZE	MASTER CTN.
PMA414	1-1/4"	50
PMA415	1-1/2"	50
PMA420	2"	50
PMA430	3"	25
PMA440	4"	25

Female Adapter

H x FPT



- Adapts to standard male pipe threads
- Teflon thread tape is recommended for threaded joints

PVC#	SIZE	MASTER CTN.
PFA314	1-1/4"	100
PFA315	1-1/2"	100
PFA311	1-1/2" x 1-1/4"	100
PFA320	2"	100
PFA330	3"	30
PFA340	4"	10
PFA360	6"	10

Fitting C.O. Adapter, w/Plug

Spg x FPT



- Solvent welds into fitting hub to provide access to piping
- Teflon thread tape is recommended for threaded joints

PVC#	SIZE	MASTER CTN.
PFA615	1-1/2"	50
PFA620	2"	50
PFA630	3"	25
PFA640	4"	10

90 Deg Elbow

H x H



- Used to change direction in piping
- Sometimes called a "1/4 bend"

PVC#	SIZE	MASTER CTN.
PFL814	1-1/4"	100
PFL815	1-1/2"	100
PFL820	2"	50
PFL830	3"	25
PFL840	4"	10
PFL860	6"	5
PFL821	2" x 1-1/2"	20
PFL834	4" x 3"	20

45 Deg Street Elbow

Spg x Hub



- Used to change direction from a fitting hub to a pipe
- Sometimes called a "St. 1/8 bend"

PVC#	SIZE	MASTER CTN.
PSL715S	1-1/2" short turn	100
PSL716S	1-1/2" long turn	100
PSL720	2"	50
PSL730	3"	20
PSL740	4"	10
PSL760	6"	3

90 Deg Elbow w/Side Inlet

H x H x Spg/H



- Used to connect a branch line or vent at a change of direction in a larger vertical or horizontal pipe
- The inlet is constructed to accept a 2" fitting over its outside diameter or a 1-1/2" pipe into its inside diameter

PVC#	SIZE	MASTER CTN.
PFL131	3" x 2" Spg or 1-1/2" Hub	20

60 Deg Elbow

H x H



- Used to change direction in piping
- Sometimes called a "OK bend"

PVC#	SIZE	MASTER CTN.
PFL915	1-1/2"	40
PFL920	2"	25
PFL930	3"	20
PFL940	4"	10

90 Deg Street Elbow

Spg x H



- Used to change direction in piping
- Sometimes called a "street 1/4 bend"

PVC#	SIZE	MASTER CTN.
PSL916	1-1/2"	100
PSL926	2"	50
PSL936	3"	20
PSL946	4"	10

90 Deg Vent Elbow

H x H



- Used to change direction in the "dry" portion of vent piping where water flow is not a consideration

PVC#	SIZE	MASTER CTN.
PFL715	1-1/2"	20
PFL720	2"	30
PFL730	3"	10

90 Deg Long Sweep Elbow

H x H



- Used to change direction in piping
- Sometimes called a "long turn 1/4 bend"

PVC#	SIZE	MASTER CTN.
PFL815L	1-1/2"	50
PFL820L	2"	25
PFL830L	3"	10
PFL840L	4"	5

90 Deg Lowheel Inlet Elbow

H x H x Spg/H or H x H x H



- Used to connect a branch line or vent at a change of direction in a larger vertical or horizontal pipe
- The inlet is constructed to accept a 2" fitting over its outside diameter or a 1-1/2" pipe into its inside diameter

PVC#	SIZE	MASTER CTN.
PFL031	3" x 2" Spg or 1-1/2" Hub	25
PFL032	3" x 2" Hub	25

22 1/2 Deg Elbow

H x H



- Used to change direction in piping
- Sometimes called a "1/16 bend"

PVC#	SIZE	MASTER CTN.
PFL515	1-1/2"	50
PFL520	2"	25
PFL530	3"	20
PFL540	4"	15
PFL560	6"	3

Fitting C.O. Adapter

Spg x FPT



- Solvent welds into fitting hub and adapts to male threaded plug
- This fitting is a component part of "Fitting Cleanout w/ Threaded Plug"

PVC#	SIZE	MASTER CTN.
PFA614	1-1/2"	50
PFA619	2"	50
PFA629	3"	25
PFA639	4"	10
PFA659	6"	10

22 1/2 Deg Street Elbow

H x Spgt



- Used to change direction in piping
- Sometimes called a "St. 1/16 bend"

PVC#	SIZE	MASTER CTN.
PSL815	1-1/2"	50
PSL820	2"	25
PSL830	3"	20
PSL840	4"	10

Caps

Hub



- Used for permanently or temporarily capping pipe

PVC#	SIZE	MASTER CTN.
PHC151	1-1/2"	10
PHC152	2"	5
PHC153	3"	10
PHC154	4"	5

45 Deg Elbow

H x H



- Used to change direction in piping
- Sometimes called a "1/8 bend"

PVC#	SIZE	MASTER CTN.
PFL614	1-1/4"	100
PFL615	1-1/2"	100
PFL620	2"	50
PFL630	3"	20
PFL640	4"	10
PFL660	6"	3
PFL615S	1-1/2" short turn	100
PFL620S	2" short turn	100

Double 90 Deg Elbow

H x H x H



- Ideal for “back to back” sink or lavatory installations

PVC#	SIZE	MASTER CTN.
PDL716	1-1/2"	20
PDL736	3"	10
PDL722	2" x 1-1/2" x 1-1/2"	25

Double Fixture Tee

H x H x H x H



PVC#	SIZE	MASTER CTN.
PDT621	2" x 1-1/2" x 1-1/2" x 1-1/2"	20

Wye

H x H x H



- Used when connecting a branch line into a horizontal drain pipe
- Also used in conjunction with a “twist-lok” plug to provide a cleanout in a drain pipe

PVC#	SIZE	MASTER CTN.
PFY014	1-1/4"	35
PFY015	1-1/2"	50
PFY020	2"	25
PFY030	3"	25
PFY040	4"	5
PFY060	6"	4
PFY021	2" x 1-1/2"	25
PFY023	2" x 1-1/2" x 1-1/2"	25
PFY031	3" x 1-1/2"	15
PFY032	3" x 2"	25
PFY041	4" x 4" x 1-1/2"	10
PFY042	4" x 2"	10
PFY043	4" x 3"	10
PFY064	6" x 4"	5

Vent Tee

H x H x H



- Used primarily in seepage bed piping grids in conjunction with perforated pipe
- Used where flow characteristics are not a primary consideration

PVC#	SIZE	MASTER CTN.
PVT415	1-1/2"	10
PVT420	2"	10
PVT430	3"	10
PVT440	4"	10

Long Turn Tee Wye

H x H x H



- Used in some plumbing code areas to connect a branch line into a vertical drain pipe instead of a conventional tee fitting
- Also used to connect horizontal branch pipe approaching a horizontal drain pipe on the perpendicular

PVC#	SIZE	MASTER CTN.
PFY515L	1-1/2"	20
PFY520L	2"	10
PFY530L	3"	10
PFY540L	4"	5
PFY521	2" x 1-1/2"	20
PFY531	3" x 1-1/2"	10
PFY532	3" x 2"	10
PFY542	4" x 2"	10
PFY543	4" x 3"	5

Double Wye

All Hub



- Used to bring two branch lines into a horizontal drain pipe

PVC#	SIZE	MASTER CTN.
PDY415	1-1/2"	40
PDY420	2"	20
PDY430	3"	15
PDY440	4"	5
PDY442	4" x 4" x 2" x 2"	5
PDY443	4" x 4" x 3" x 3"	5

Cleanout Test Tee

H x H x FPT



- Used in conjunction with a threaded plug to provide a cleanout opening
- Teflon thread tape is recommended for joints

PVC#	SIZE	MASTER CTN.
PCT416	1-1/2"	20
PCT421	2"	20
PCT431	3"	10
PCT441	4"	10

w/Cleanout Plug

- Used at the base of a vertical drain pipe to provide a cleanout opening flush with the finished wall

PVC#	SIZE	MASTER CTN.
PCT315	1-1/2"	10
PCT320	2"	10
PCT330	3"	10
PCT340	4"	5

Sanitary Tee

H x H x H



- Used when connecting a branch line into a vertical drain pipe

PVC#	SIZE	MASTER CTN.
PST114	1-1/4"	25
PST115	1-1/2"	100
PST120	2"	35
PST130	3"	30
PST140	4"	5
PST160	6"	6
PST121	2" x 1-1/2"	50
PST122	2" x 1-1/2" x 2"	25
PST123	2" x 1-1/2" x 1-1/2"	25
PST131	3" x 1-1/2"	20
PST132	3" x 2"	10
PST141	4" x 1-1/2"	10
PST142	4" x 2"	10
PST143	4" x 3"	10
PST164	6" x 4"	6

Sanitary Tee Street

Spg x H x H



PVC#	SIZE	MASTER CTN.
PSS140	4"	10

Sanitary Tee w/Right Side Inlet

H x H x H x H



- This fitting provides for the connection of 2" vent or branch waste piping to a vertical pipe

PVC#	SIZE	MASTER CTN.
PST232	3" x 3" x 3" x 2"	10

Sanitary Tee w/Left Side Inlet

H x H x H x H



- This fitting provides for the connection of 2" vent or branch waste piping to a vertical pipe

PVC#	SIZE	MASTER CTN.
PSL132	3" x 3" x 3" x 2"	10

Sanitary Tee w/Right & Left Side Inlet

H x H x Spg/H x Spg/H



Sanitary Tee w/Right & Left Side Inlet

- Provides for the connection of 1-1/2" or 2" vent or branch waste piping to a vertical pipe as well as receiving the discharge of a water closet
- the inlets are constructed to accept a 2" fitting hub over their outside diameter or a 1-1/2" pipe into their inside diameter

PVC#	SIZE	MASTER CTN.
PSL031	3" x 3" x 3" x 1-1/2" / 2" x 1-1/2" / 2"	10

Sanitary Tee w/Right & Left Side Inlet

- Provides for the connection of 2" vent or branch waste piping to a vertical pipe as well as receive the discharge of a water closet

PVC#	SIZE	MASTER CTN.
PSL042	4" x 4" x 4" x 2" x 2"	5

Double Sanitary Tee

H x H x H x H



• Used to bring two branch lines into a vertical drain pipe

PVC#	SIZE	MASTER CTN.
PDT515	1-1/2"	25
PDT520	2"	20
PDT530	3"	20
PDT540	4"	4
PDT521	2" x 2" x 1-1/2" x 1-1/2"	15
PDT531	3" x 3" x 1-1/2" x 1-1/2"	20
PDT532	3" x 3" x 2" x 2"	10
PDT542	4" x 4" x 2" x 2"	5
PDT543	4" x 4" x 3" x 3"	5

Two-Way Cleanout Tee

H x H x H



• Used with a vertical pipe stack, this fitting provides for above ground level access to piping

PVC#	SIZE	MASTER CTN.
PTC633	3"	10
PTC644	4"	5

P-Trap LA Pattern w/Union

SJ x H



• Used to prevent the passage of sewer gas from the plumbing system into house through the plumbing fixture drain, when local code doesn't permit the use of slip coupled traps

PVC#	SIZE	MASTER CTN.
PPT715	1-1/2"	20

P-Trap w/Union

H x H



• Used to prevent the passage of sewer gas from the plumbing system into house through the plumbing fixture drain

PVC#	SIZE	MASTER CTN.
PPT315	1-1/2"	20
PPT320	2"	25

P-Trap w/Solvent Weld Joint

H x H



• Used to prevent the passage of sewer gas from the plumbing system into house through the plumbing fixture drain

PVC#	SIZE	MASTER CTN.
PPT515	1-1/2"	25
PPT520	2"	20
PPT530	3"	10
PPT540	4"	4

P-Trap w/Cleanout & Solvent Weld Joint

H x H



• Used to prevent the passage of sewer gas from the plumbing system into house through the plumbing fixture drain

PVC#	SIZE	MASTER CTN.
PPT415	1-1/2"	10
PPT420	2"	10

P-Trap U-Bend

H x H



• Bottom part of trap furnished without cleanout

PVC#	SIZE	MASTER CTN.
PPT015	1-1/2"	20
PPT020	2"	20
PPT030	3"	15
PPT040	4"	10

P-Trap Ell

Spg x H Short Sweep



• Used to change direction in the "dry" portion of vent piping where water flow is not a consideration

PVC#	SIZE	MASTER CTN.
PPT915S	1-1/2"	100
PPT920S	2"	20

PVC/DWV FITTINGS

Swivel Drum Trap

H x H



- PVC version of the old style bathtub "drum trap"
- Largely replaced today by the conventional 1-1/2" P-trap

PVC#	SIZE	MASTER CTN.
PDT715	3" x 6" x 1-1/2"	15

Female Trap Adapter w/Self Sealing Nut

H x SJT



- Utilized to adapt PVC pipe to tubular traps at wall or floor
- Utilizes special washer which seals to either 1-1/2" or 1-1/4" tubular products, reducing the number of SKU's needed in inventory
- This fitting solvent welds over a 1-1/2" DWV pipe
- Sometimes referred to as a "marvel"

PVC#	SIZE	MASTER CTN.
PTA215	1-1/2"	100
PTA221	1-1/2" x 1-1/2" or 1-1/4"	100
PTA223	1-1/2" x 1-1/4"	100

Male Trap Adapter less Washer & Nuts

Spg x MPT



- Adapts fitting hub to standard female pipe threads
- Teflon thread tape is recommended for threaded joints

PVC#	SIZE	MASTER CTN.
PTA415	1-1/2"	100
PTA420	2"	100

Male Trap Adapter w/Washer & Nuts

Spg x SJT



- Adapts PVC fitting hub to tubular traps in a wall or floor
- Utilizes special washer which seals to either 1-1/2" or 1-1/4" tubular products, reducing the number of SKU's needed in inventory
- This fitting solvent welds into a 1-1/2" DWV fitting hub
- Sometimes called a "marvel"

PVC#	SIZE	MASTER CTN.
PTA315	1-1/2"	50
PTA311	1-1/2" x 1-1/2" or 1-1/4"	75
PTA211	1-1/2" x 1-1/4"	50

Reducing Closet Bend

Spg x Hub



- Used to change direction in piping and size of pipe directly into fitting hub
- Usually a closet flange directly under a toilet
- Works well in tight space applications on second floors

PVC#	SIZE	MASTER CTN.
PCB934	4" x 3"	20

Expansion Joint

H x H



- To provide for expansion in straight vertical pipe runs exceeding 35 feet in length

PVC#	SIZE	MASTER CTN.
PEJ520	2"	15
PEJ530	3"	10
PEJ540	4"	10

Cast Iron No Hub Adapter

Spg x H



- Adapts no hub elastomer coupling to DWV spigot
- Provides a proper method of adapting from no-hub cast iron pipe utilizing the standard no-hub clamp ring

PVC#	SIZE	MASTER CTN.
PNH120	2"	100
PNH130	3"	20
PNH140	4"	10

Cast Iron Hub Adapter

Spg x H



- Adapts cast iron hub to DWV Spigot
- Can be joined to cast iron with Genova plastic lead or hot molten lead

PVC#	SIZE	MASTER CTN.
PHA520	2"	25
PHA521	2" x 1-1/2"	20
PHA530	3"	20
PHA540	4"	10
PHA543	4" x 3"	20

Cast Iron Spigot Adapter

H x H



- Adapts cast iron spigot to DWV spigot
- This fitting adapts Sch. 40 pipe to 4" cast iron spigot

PVC#	SIZE	MASTER CTN.
PSA730	3"	10
PSA740	4"	10

Adapter Coupling

Sewer H x DWV H



- Adapts sewer & drain spigot to DWV spigot

PVC#	SIZE	MASTER CTN.
PAC543	4" x 3"	20

Adaper Bushing

DWV Spg x Sewer H



- Adapts DWV hub to sewer & drain spigot

PVC#	SIZE	MASTER CTN.
PAB75340	4"	25

PVC/DWV
FITTINGS

Adapter Bushing

Sewer Spg x DWV H



- Adapts sewer & drain hub to DWV spigot

PVC#	SIZE	MASTER CTN.
PAB243	4" x 3"	20

BLACK & GALVANIZED MALLEABLES & PIPE NIPPLES

Black & Galvanized Malleable Fittings	349-354
Black & Galvanized Pipe Nipples	355-357
Black & Galvanized Readycut Pipe	358
Black & Galvanized Merchant Couplings	359

Hexagon Bushings

M x F, Concentric



BLACK PRT #	GALV. PRT #	SIZE	CTN QTY	MSTR QTY
B144-0007	G144-0007	1/4" x 1/8"	120	1,440
B144-0032	G144-0032	3/8" x 1/4"	75	900
B144-0033	G144-0033	3/8" x 1/8"	75	900
B144-0058	G144-0058	1/2" x 3/8"	100	1,200
B144-0059	G144-0059	1/2" x 1/4"	100	1,200
B144-0060	G144-0060	1/2" x 1/8"	100	1,200
B144-0107	G144-0107	3/4" x 1/2"	50	600
B144-0108	G144-0108	3/4" x 3/8"	50	600
B144-0109	G144-0109	3/4" x 1/4"	50	600
B144-0110	G144-0110	3/4" x 1/8"	50	600
B144-0159	G144-0159	1" x 3/4"	50	400
B144-0160	G144-0160	1" x 1/2"	50	400
B144-0161	G144-0161	1" x 3/8"	50	400
B144-0162	G144-0162	1" x 1/4"	50	400
B144-0222	G144-0222	1-1/4" x 1"	30	240
B144-0223	G144-0223	1-1/4" x 3/4"	30	240
B144-0224	G144-0224	1-1/4" x 1/2"	30	240
B144-0225	G144-0225	1-1/4" x 3/8"	30	240
B144-0226	G144-0226	1-1/4" x 1/4"	30	240
B144-0303	G144-0303	1-1/2" x 1-1/4"	25	150
B144-0304	G144-0304	1-1/2" x 1"	25	150
B144-0305	G144-0305	1-1/2" x 3/4"	25	150
B144-0306	G144-0306	1-1/2" x 1/2"	25	150
B144-0307	G144-0307	1-1/2" x 3/8"	25	150
B144-0308	G144-0308	1-1/2" x 1/4"	25	150
B144-0398	G144-0398	2" x 1-1/2"	20	120
B144-0399	G144-0399	2" x 1-1/4"	20	120
B144-0400	G144-0400	2" x 1"	20	120
B144-0401	G144-0401	2" x 3/4"	20	120
B144-0402	G144-0402	2" x 1/2"	20	120
B144-0403	G144-0403	2" x 3/8"	20	120
B144-0531	G144-0531	2-1/2" x 2"	15	60
B144-0532	G144-0532	2-1/2" x 1-1/2"	15	60
B144-0533	G144-0533	2-1/2" x 1-1/4"	15	60
B144-0534	G144-0534	2-1/2" x 1"	15	60
B144-0535	G144-0535	2-1/2" x 3/4"	15	60
B144-0536	G144-0536	2-1/2" x 1/2"	15	60
B144-0662	G144-0662	3" x 2-1/2"	12	48
B144-0663	G144-0663	3" x 2"	12	48
B144-0664	G144-0664	3" x 1-1/2"	12	48
B144-0665	G144-0665	3" x 1-1/4"	12	48
B144-0666	G144-0666	3" x 1"	12	48
B144-0667	—	3" x 3/4"	12	48
B144-0668	—	3" x 1/2"	12	48
B144-0790	G144-0790	3-1/2" x 3"	8	32
B144-0870	G144-0870	4" x 3"	5	20
B144-0871	G144-0871	4" x 2-1/2"	5	20
B144-0872	G144-0872	4" x 2"	5	20

Hexagon Bushings continued

BLACK PRT #	GALV. PRT #	SIZE	CTN QTY	MSTR QTY
B144-0873	G144-0873	4" x 1-1/2"	5	20
—	G144-0874	4" x 1-1/4"	5	20
B144-0875	G144-0875	4" x 1"	5	20
B144-1109	G144-1109	6" x 4"	4	8
B144-1111	G144-1111	6" x 3"	4	8

Cap



BLACK PRT #	GALV. PRT #	SIZE	CTN QTY	MSTR QTY
B155-0001	G155-0001	1/8"	120	1,440
B155-0002	G155-0002	1/4"	80	960
B155-0025	G155-0025	3/8"	60	720
B155-0050	G155-0050	1/2"	75	900
B155-0100	G155-0100	3/4"	40	480
B155-0150	G155-0150	1"	35	280
B155-0215	G155-0215	1-1/4"	25	200
B155-0295	G155-0295	1-1/2"	25	150
B155-0390	G155-0390	2"	18	108
B155-0520	G155-0520	2-1/2"	14	56
B155-0650	G155-0650	3"	12	36
B155-0860	G155-0860	4"	7	21
B155-0975	G155-0975	5"	8	16
B155-1100	G155-1100	6"	4	8

Extension Piece

M x F



BLACK PRT #	GALV. PRT #	SIZE	CTN QTY	MSTR QTY
B335-0050	G335-0050	1/2"	75	75
B335-0100	G335-0100	3/4"	40	320
B335-0150	G335-0150	1"	30	180
B335-0215	G335-0215	1-1/4"	30	120
B335-0295	G335-0295	1-1/2"	20	80
B335-0390	G335-0390	2"	15	60

BLACK & GALVANIZED
MALLEABLES/PIPE NIPPLES

Coupling, Banded

F x F



BLACK PRT #	GALV. PRT #	SIZE	CTN QTY	MSTR QTY
B165-0001	G165-0001	1/8"	70	840
B165-0002	G165-0002	1/4"	40	480
B165-0025	G165-0025	3/8"	50	600
B165-0050	G165-0050	1/2"	60	480
B165-0100	G165-0100	3/4"	50	300
B165-0150	G165-0150	1"	25	150
B165-0215	G165-0215	1-1/4"	32	128
B165-0295	G165-0295	1-1/2"	18	72
B165-0390	G165-0390	2"	12	48
B165-0520	G165-0520	2-1/2"	4	32
B165-0650	G165-0650	3"	12	24
B165-0860	G165-0860	4"	3	6
B165-1100	G165-1100	6"	3	6

Reducing Coupling, Banded

F x F, Concentric



BLACK PRT #	GALV. PRT #	SIZE	CTN QTY	MSTR QTY
B165-0007	G165-0007	1/4" x 1/8"	50	600
B165-0032	G165-0032	3/8" x 1/4"	30	360
B165-0033	G165-0033	3/8" x 1/8"	35	420
B165-0058	G165-0058	1/2" x 3/8"	40	480
B165-0059	G165-0059	1/2" x 1/4"	50	600
B165-0060	G165-0060	1/2" x 1/8"	50	600
B165-0107	G165-0107	3/4" x 1/2"	60	360
B165-0108	G165-0108	3/4" x 3/8"	30	360
B165-0109	G165-0109	3/4" x 1/4"	30	360
B165-0110	G165-0110	3/4" x 1/8"	35	0
B165-0159	G165-0159	1" x 3/4"	25	200
B165-0160	G165-0160	1" x 1/2"	40	240
B165-0161	G165-0161	1" x 3/8"	40	240
B165-0162	G165-0162	1" x 1/4"	45	220
B165-0222	G165-0222	1-1/4" x 1"	20	120
B165-0223	G165-0223	1-1/4" x 3/4"	25	150
B165-0224	G165-0224	1-1/4" x 1/2"	25	150
—	G165-0225	1-1/4" x 3/8"	25	150
B165-0303	G165-0303	1-1/2" x 1-1/4"	24	96
B165-0304	G165-0304	1-1/2" x 1"	25	100
B165-0305	G165-0305	1-1/2" x 3/4"	30	120
B165-0306	G165-0306	1-1/2" x 1/2"	20	120
B165-0307	G165-0307	1-1/2" x 3/8"	30	120
B165-0398	G165-0398	2" x 1-1/2"	12	72
B165-0399	G165-0399	2" x 1-1/4"	14	84
B165-0400	G165-0400	2" x 1"	14	84
B165-0401	G165-0401	2" x 3/4"	14	84
B165-0402	G165-0402	2" x 1/2"	14	84
B165-0531	G165-0531	2-1/2" x 2"	10	40
B165-0532	G165-0532	2-1/2" x 1-1/2"	10	40
B165-0533	G165-0533	2-1/2" x 1-1/4"	10	40
B165-0534	G165-0534	2-1/2" x 1"	10	40
B165-0535	G165-0535	2-1/2" x 3/4"	10	40
—	G165-0536	2-1/2" x 1/2"	10	40
B165-0662	G165-0662	3" x 2-1/2"	12	24
B165-0663	G165-0663	3" x 2"	8	32
B165-0664	G165-0664	3" x 1-1/2"	8	32
B165-0665	G165-0665	3" x 1-1/4"	8	32
B165-0666	G165-0666	3" x 1"	8	32
B165-0667	G165-0667	3" x 3/4"	8	32
—	G165-0668	3" x 1/2"	8	32
B165-0870	G165-0870	4" x 3"	6	18
B165-0871	G165-0871	4" x 2-1/2"	6	18
B165-0872	G165-0872	4" x 2"	6	18
B165-0873	G165-0873	4" x 1-1/2"	6	18
—	G165-0874	4" x 1-1/4"	6	18
B165-0875	G165-0875	4" x 1"	6	18
B165-1109	G165-1109	6" x 4"	4	8
B165-1111	G165-1111	6" x 3"	6	18

Cross, Banded

F x F x F x F



BLACK PRT #	GALV. PRT #	SIZE	CTN QTY	MSTR QTY
B195-0001	G195-0001	1/8"	30	360
B195-0002	G195-0002	1/4"	80	480
B195-0025	G195-0025	3/8"	50	300
B195-0050	G195-0050	1/2"	45	180
B195-0100	G195-0100	3/4"	30	120
B195-0150	G195-0150	1"	20	60
B195-0215	G195-0215	1-1/4"	20	40
B195-0295	G195-0295	1-1/2"	18	36
B195-0390	G195-0390	2"	10	20
B195-0520	G195-0520	2-1/2"	4	12
B195-0650	G195-0650	3"	4	8
—	G195-0860	4"	2	4

BLACK & GALVANIZED MALLEABLES/PIPE NIPPLES

90 Deg Reducing Elbow, Banded

F x F



BLACK PRT #	GALV. PRT #	SIZE	CTN QTY	MSTR QTY
B235-0007	G235-0007	1/4" x 1/8"	—	—
B235-0032	G235-0032	3/8" x 1/4"	60	720
B235-0058	G235-0058	1/2" x 3/8"	50	400
B235-0059	G235-0059	1/2" x 1/4"	40	480
B235-0060	G235-0060	1/2" x 1/8"	40	480
B235-0107	G235-0107	3/4" x 1/2"	40	240
B235-0108	G235-0108	3/4" x 3/8"	50	300
B235-0109	G235-0109	3/4" x 1/4"	40	320
B235-0159	G235-0159	1" x 3/4"	25	150
B235-0160	G235-0160	1" x 1/2"	30	180
B235-0161	G235-0161	1" x 3/8"	35	210
B235-0222	G235-0222	1-1/4" x 1"	20	80
B235-0223	G235-0223	1-1/4" x 3/4"	30	120
B235-0224	G235-0224	1-1/4" x 1/2"	35	140
B235-0303	G235-0303	1-1/2" x 1-1/4"	15	60
B235-0304	G235-0304	1-1/2" x 1"	20	80
B235-0305	G235-0305	1-1/2" x 3/4"	15	90
B235-0306	G235-0306	1-1/2" x 1/2"	25	100
B235-0398	G235-0398	2" x 1-1/2"	10	40
B235-0399	G235-0399	2" x 1-1/4"	10	40
B235-0400	G235-0400	2" x 1"	14	56
B235-0401	G235-0401	2" x 3/4"	15	60
B235-0402	G235-0402	2" x 1/2"	15	60
B235-0531	G235-0531	2-1/2" x 2"	12	24
B235-0532	G235-0532	2-1/2" x 1-1/2"	6	24
B235-0533	G235-0533	2-1/2" x 1-1/4"	6	24
B235-0534	G235-0534	2-1/2" x 1"	8	32
B235-0535	G235-0535	2-1/2" x 3/4"	10	40
B235-0536	—	2-1/2" x 1/2"	10	40
B235-0662	G235-0662	3" x 2-1/2"	4	16
B235-0663	G235-0663	3" x 2"	6	18
—	G235-0664	3" x 1-1/2"	5	20
B235-0870	G235-0870	4" x 3"	1	9
B235-0871	G235-0871	4" x 2-1/2"	4	8
B235-0872	G235-0872	4" x 2"	4	12

90 Deg Elbow, Banded

F x F



BLACK PRT #	GALV. PRT #	SIZE	CTN QTY	MSTR QTY
B235-0001	G235-0001	1/8"	50	600
B235-0002	G235-0002	1/4"	35	420
B235-0025	G235-0025	3/8"	45	540
B235-0050	G235-0050	1/2"	50	400
B235-0100	G235-0100	3/4"	35	210
B235-0150	G235-0150	1"	20	120
B235-0215	G235-0215	1-1/4"	20	80
B235-0295	G235-0295	1-1/2"	20	60
B235-0390	G235-0390	2"	8	32
B235-0520	G235-0520	2-1/2"	8	18
B235-0650	G235-0650	3"	7	14
B235-0860	G235-0860	4"	2	6
B235-0975	G235-0975	5"	2	4
B235-1100	G235-1100	6"	1	2

Side Outlet 90 Ell, Banded

F x F x F



BLACK PRT #	GALV. PRT #	SIZE	CTN QTY	MSTR QTY
B247-0215	—	1-1/4"	50	600

90 Street Ell, Banded

M x F



BLACK PRT #	GALV. PRT #	SIZE	CTN QTY	MSTR QTY
B254-0001	G254-0001	1/8"	60	720
B254-0002	G254-0002	1/4"	35	420
B254-0025	G254-0025	3/8"	40	480
B254-0050	G254-0050	1/2"	60	360
B254-0100	G254-0100	3/4"	35	210
B254-0150	G254-0150	1"	30	120
B254-0215	G254-0215	1-1/4"	25	75
B254-0295	G254-0295	1-1/2"	18	54
B254-0390	G254-0390	2"	10	30
B254-0520	G254-0520	2-1/2"	9	18
B254-0650	G254-0650	3"	—	14
B254-0860	G254-0860	4"	—	6

**BLACK & GALVANIZED
MALLEABLES/PIPE NIPPLES**

45 Deg Ell, Banded

F x F



BLACK PRT #	GALV. PRT #	SIZE	CTN QTY	MSTR QTY
B290-0001	G290-0001	1/8"	50	600
B290-0002	G290-0002	1/4"	30	360
B290-0025	G290-0025	3/8"	50	600
B290-0050	G290-0050	1/2"	50	400
B290-0100	G290-0100	3/4"	40	240
B290-0150	G290-0150	1"	20	120
B290-0215	G290-0215	1-1/4"	20	80
B290-0295	G290-0295	1-1/2"	15	60
B290-0390	G290-0390	2"	12	36
B290-0520	G290-0520	2-1/2"	—	27
B290-0650	G290-0650	3"	—	20
B290-0860	G290-0860	4"	—	6
B290-0975	—	5"	—	—
B290-1100	G290-1100	6"	—	—

45 Street Ell, Banded

M x F



BLACK PRT #	GALV. PRT #	SIZE	CTN QTY	MSTR QTY
B295-0001	G295-0001	1/8"	70	840
B295-0002	G295-0002	1/4"	40	480
B295-0025	G295-0025	3/8"	50	600
B295-0050	G295-0050	1/2"	75	450
B295-0100	G295-0100	3/4"	40	240
B295-0150	G295-0150	1"	25	150
B295-0215	G295-0215	1-1/4"	20	80
B295-0295	G295-0295	1-1/2"	20	60
B295-0390	G295-0390	2"	12	36
B295-0520	G295-0520	2-1/2"	—	25
B295-0650	G295-0650	3"	—	18
B295-0860	G295-0860	4"	—	7

BLACK & GALVANIZED
MALLEABLES/PIPE NIPPLES

Floor Flange



BLACK PRT #	GALV. PRT #	SIZE	CTN QTY	MSTR QTY
B355-0001	—	1/8"	—	—
B355-0002	G355-0002	1/4"	10	60
B355-0025	G355-0025	3/8"	25	150
B355-0050	G355-0050	1/2"	25	200
B355-0100	G355-0100	3/4"	20	160
B355-0150	G355-0150	1"	20	120
B355-0215	G355-0215	1-1/4"	15	90
B355-0295	G355-0295	1-1/2"	12	72
B355-0390	G355-0390	2"	8	48

Locknut/Backnut



BLACK PRT #	GALV. PRT #	SIZE	CTN QTY	MSTR QTY
—	G375-0001	1/8"	250	3,000
—	G375-0002	1/4"	125	1,500
—	G375-0025	3/8"	125	1,500
—	G375-0050	1/2"	100	1,200
—	G375-0100	3/4"	60	720
—	G375-0150	1"	60	480
—	G375-0215	1-1/4"	60	360
—	G375-0295	1-1/2"	45	270
—	G375-0390	2"	25	150
—	G375-0520	2-1/2"	14	84

Square Head Plug

M



BLACK PRT #	GALV. PRT #	SIZE	CTN QTY	MSTR QTY
B396-0001	G396-0001	1/8"	300	3,600
B396-0002	G396-0002	1/4"	150	1,800
B396-0025	G396-0025	3/8"	100	1,200
B396-0050	G396-0050	1/2"	50	600
B396-0100	G396-0100	3/4"	30	360
B396-0150	G396-0150	1"	20	240
B396-0215	G396-0215	1-1/4"	40	240
B396-0295	G396-0295	1-1/2"	30	180
B396-0390	G396-0390	2"	20	120
B396-0520	G396-0520	2-1/2"	8	64
B396-0650	G396-0650	3"	8	48
B396-0860	G396-0860	4"	8	16
B396-1100	G396-1100	6"	5	10

Tee, Banded

F x F x F



BLACK PRT #	GALV. PRT #	SIZE	CTN QTY	MSTR QTY
B460-0001	G460-0001	1/8"	80	960
B460-0002	G460-0002	1/4"	50	600
B460-0025	G460-0025	3/8"	45	360
B460-0050	G460-0050	1/2"	40	240
B460-0100	G460-0100	3/4"	35	140
B460-0150	G460-0150	1"	20	80
B460-0215	G460-0215	1-1/4"	14	56
B460-0295	G460-0295	1-1/2"	15	45
B460-0390	G460-0390	2"	10	30
B460-0520	G460-0520	2-1/2"	8	16
B460-0650	G460-0650	3"	6	12
B460-0860	G460-0860	4"	2	6
B460-0975	G460-0975	5"	2	2
B460-1100	G460-1100	6"	2	2

Reducing Tee, Banded

F x F x F



BLACK PRT #	GALV. PRT #	SIZE	CTN QTY	MSTR QTY
B460-0007	G460-0007	1/4" x 1/8"	25	300
B460-0032	G460-0032	3/8" x 1/4"	60	480
B460-0056	—	1/2" x 1"	40	160
B460-0057	G460-0057	1/2" x 3/4"	30	180
B460-0058	G460-0058	1/2" x 3/8"	45	270
B460-0059	G460-0059	1/2" x 1/4"	50	300
B460-0106	G460-0106	3/4" x 1"	20	120
B460-0107	G460-0107	3/4" x 1/2"	45	180
B460-0108	G460-0108	3/4" x 3/8"	45	180
B460-0109	G460-0109	3/4" x 1/4"	50	200
B460-0116	G460-0116	3/4" x 1/2" x 1"	35	140
B460-0117	G460-0117	3/4" x 1/2" x 3/4"	40	160
B460-0118	G460-0118	3/4" x 1/2" x 1/2"	30	180
B460-0156	—	1" x 2"	12	48
B460-0157	G460-0157	1" x 1-1/2"	15	60
B460-0158	—	1" x 1-1/4"	15	60
B460-0159	G460-0159	1" x 3/4"	25	100
B460-0160	G460-0160	1" x 1/2"	30	120
B460-0161	G460-0161	1" x 3/8"	20	120
B460-0162	G460-0162	1" x 1/4"	25	150
B460-0169	G460-0169	1" x 3/4" x 1"	15	90
B460-0170	G460-0170	1" x 3/4" x 3/4"	25	100
B460-0171	G460-0171	1" x 3/4" x 1/2"	25	100
B460-0180	G460-0180	1" x 1/2" x 1"	15	90
B460-0181	G460-0181	1" x 1/2" x 3/4"	30	120
B460-0182	G460-0182	1" x 1/2" x 1/2"	20	120
B460-0220	G460-0215	1-1/4" x 2	10	40
B460-0221	G460-0221	1-1/4" x 1-1/2"	14	56
B460-0222	G460-0222	1-1/4" x 1	16	64

Reducing Tee, Banded (continued)

BLACK PRT #	GALV. PRT #	SIZE	CTN QTY	MSTR QTY
B460-0223	G460-0223	1-1/4" x 3/4"	18	72
B460-0224	G460-0224	1-1/4" x 1/2"	20	80
B460-0225	G460-0225	1-1/4" x 3/8"	20	80
B460-0233	G460-0233	1-1/4" x 1" x 1-1/2"	1	1
B460-0234	G460-0234	1-1/4" x 1" x 1-1/4"	15	60
B460-0235	G460-0235	1-1/4" x 1" x 1	18	72
B460-0236	G460-0236	1-1/4" x 1" x 3/4"	18	72
B460-0237	G460-0237	1-1/4" x 1" x 1/2"	18	72
B460-0245	G460-0245	1-1/4" x 3/4" x 1-1/4"	15	60
B460-0246	G460-0246	1-1/4" x 3/4" x 1	20	80
B460-0247	G460-0247	1-1/4" x 3/4" x 3/4"	20	80
B460-0248	G460-0248	1-1/4" x 3/4" x 1/2"	25	100
B460-0256	G460-0256	1-1/4" x 1/2" x 1-1/4"	15	60
B460-0257	G460-0257	1-1/4" x 1/2" x 1	20	80
B460-0258	G460-0258	1-1/4" x 1/2" x 3/4"	25	100
B460-0259	G460-0259	1-1/4" x 1/2" x 1/2"	25	100
B460-0302	—	1-1/2" x 2	030	32
B460-0303	G460-0303	1-1/2" x 1-1/4"	15	45
B460-0304	G460-0304	1-1/2" x 1	13	52
B460-0305	G460-0305	1-1/2" x 3/4"	10	60
B460-0306	G460-0306	1-1/2" x 1/2"	18	72
B460-0307	G460-0307	1-1/2" x 3/8"	18	72
B460-0315	G460-0315	1-1/2" x 1-1/4" x 1-1/2"	10	40
B460-0316	G460-0316	1-1/2" x 1-1/4" x 1-1/4"	12	48
B460-0317	G460-0317	1-1/2" x 1-1/4" x 1	14	56
B460-0318	G460-0318	1-1/2" x 1-1/4" x 3/4"	16	64
B460-0319	G460-0319	1-1/2" x 1-1/4" x 1/2"	16	64
B460-0328	G460-0328	1-1/2" x 1" x 1-1/2"	14	56
B460-0329	G460-0329	1-1/2" x 1" x 1-1/4"	14	56
B460-0330	G460-0330	1-1/2" x 1" x 1	15	60
B460-0331	G460-0331	1-1/2" x 1" x 3/4"	15	60
—	G460-0332	1-1/2" x 1" x 1/2"	18	72
B460-0339	G460-0339	1-1/2" x 3/4" x 1-1/2"	12	48
B460-0340	G460-0340	1-1/2" x 3/4" x 1-1/4"	15	60
B460-0342	G460-0342	1-1/2" x 3/4" x 3/4"	18	72
B460-0343	G460-0343	1-1/2" x 3/4" x 1/2"	20	80
B460-0350	G460-0350	1-1/2" x 1/2" x 1-1/2"	12	48
B460-0351	—	1-1/2" x 1/2" x 1-1/4"	15	60
B460-0352	G460-0352	1-1/2" x 1/2" x 1	18	72
B460-0353	G460-0353	1-1/2" x 1/2" x 3/4"	1	1

**BLACK & GALVANIZED
MALLEABLES/PIPE NIPPLES**

Reducing Tee, Banded (continued)

BLACK PRT #	GALV. PRT #	SIZE	CTN QTY	MSTR QTY
B460-0354	—	1-1/2" x 1/2" x 1/2"	1	1
B460-0397	—	2" x 2-1/2"	8	16
B460-0398	G460-0398	2" x 1-1/2"	16	32
B460-0399	G460-0399	2" x 1-1/4"	8	32
B460-0400	G460-0400	2" x 1"	12	36
B460-0401	G460-0401	2" x 3/4"	10	40
B460-0402	G460-0402	2" x 1/2"	10	40
B460-0403	—	2" x 3/8"	10	40
B460-0413	G460-0413	2" x 1-1/2" x 2"	10	30
B460-0414	G460-0414	2" x 1-1/2" x 1-1/2"	8	32
B460-0415	G460-0415	2" x 1-1/2" x 1-1/4"	8	32
B460-0416	G460-0416	2" x 1-1/2" x 1"	10	40
B460-0417	G460-0417	2" x 1-1/2" x 3/4"	10	40
B460-0418	—	2" x 1-1/2" x 1/2"	10	40
B460-0429	G460-0429	2" x 1-1/4" x 2"	13	26
B460-0430	G460-0430	2" x 1-1/4" x 1-1/2"	8	32
B460-0431	G460-0431	2" x 1-1/4" x 1-1/4"	12	36
B460-0432	G460-0432	2" x 1-1/4" x 1"	10	40
B460-0444	G460-0444	2" x 1" x 2"	8	32
B460-0447	G460-0447	2" x 1" x 1"	12	48
B460-0457	G460-0457	2" x 3/4" x 2"	8	32
B460-0461	G460-0461	2" x 3/4" x 3/4"	12	48
B460-0470	G460-0470	2" x 1/2" x 2"	8	32
B460-0531	G460-0531	2-1/2" x 2"	4	16
B460-0532	G460-0532	2-1/2" x 1-1/2"	5	15
B460-0533	G460-0533	2-1/2" x 1-1/4"	10	20
B460-0534	G460-0534	2-1/2" x 1"	12	24
B460-0535	G460-0535	2-1/2" x 3/4"	12	24
B460-0536	G460-0536	2-1/2" x 1/2"	12	24
B460-0548	G460-0548	2-1/2" x 2" x 2-1/2"	1	16
B460-0549	G460-0549	2-1/2" x 2" x 2"	1	1
B460-0662	G460-0662	3" x 2-1/2"	6	12
B460-0663	G460-0663	3" x 2"	4	12
B460-0664	—	3" x 1-1/2"	4	12
B460-0665	G460-0665	3" x 1-1/4"	4	12
B460-0666	G460-0666	3" x 1"	5	15
B460-0667	G460-0667	3" x 3/4"	6	18
B460-0668	G460-0668	3" x 1/2"	6	18
B460-0870	G460-0870	4" x 3"	2	6
B460-0871	G460-0871	4" x 2-1/2"	2	6
B460-0872	G460-0872	4" x 2"	2	8
B460-0873	G460-0873	4" x 1-1/2"	2	8
B460-0874	G460-0874	4" x 1-1/4"	2	8
B460-0875	G460-0875	4" x 1"	2	8

BLACK & GALVANIZED MALLEABLES/PIPE NIPPLES

Street Tee, Banded

F x M x F



BLACK PRT #	GALV. PRT #	SIZE	CTN QTY	MSTR QTY
B486-0050	G486-0050	1/2"	40	240
B486-0100	G486-0100	3/4"	25	150
B486-0150	G486-0150	1"	20	80
B486-0215	G486-0215	1-1/4"	15	60
B486-0295	G486-0295	1-1/2"	12	36

Union, Brass to Iron Seat



BLACK PRT #	GALV. PRT #	SIZE	CTN QTY	MSTR QTY
B657-0001	G657-0001	1/8"	30	360
B657-0002	G657-0002	1/4"	20	240
B657-0025	G657-0025	3/8"	20	240
B657-0050	G657-0050	1/2"	50	200
B657-0100	G657-0100	3/4"	35	140
B657-0150	G657-0150	1"	20	80
B657-0215	G657-0215	1-1/4"	15	60
B657-0295	G657-0295	1-1/2"	10	40
B657-0390	G657-0390	2"	6	24
B657-0520	G657-0520	2-1/2"	4	16
B657-0650	G657-0650	3"	7	14
B657-0860	G657-0860	4"	7	7

Pipe Nipples



BLACK	GALVANIZED	SIZE	CTN QTY	MSTR QTY
30100	50100	1/8" X Close	25	600
30110	50110	1/8" X 10"	25	150
—	50111	1/8" X 11"	25	150
30112	50112	1/8" X 12"	25	150
30115	50115	1/8" X 1-1/2"	25	600
30120	50120	1/8" X 2"	25	600
30125	50125	1/8" X 2-1/2"	25	600
30130	50130	1/8" X 3"	25	600
30135	50135	1/8" X 3-1/2"	25	600
30140	50140	1/8" X 4"	25	600
30145	50145	1/8" X 4-1/2"	25	400
30150	50150	1/8" X 5"	25	400
30155	50155	1/8" X 5-1/2"	25	400
30160	50160	1/8" X 6"	25	400
30170	50170	1/8" X 7"	25	200
30180	50180	1/8" X 8"	25	200
30190	50190	1/8" X 9"	25	200
30200	50200	1/4" X Close	25	600
30210	50210	1/4" X 10"	25	150
30211	50211	1/4" X 11"	25	150
30212	50212	1/4" X 12"	25	150
30215	50215	1/4" X 1-1/2"	25	600
30220	50220	1/4" X 2"	25	600
30225	50225	1/4" X 2-1/2"	25	600
30230	50230	1/4" X 3"	25	600
30235	50235	1/4" X 3-1/2"	25	400
30240	50240	1/4" X 4"	25	400
30245	50245	1/4" X 4-1/2"	25	400
30250	50250	1/4" X 5"	25	300
30255	50255	1/4" X 5-1/2"	25	300
30260	50260	1/4" X 6"	25	300
30270	50270	1/4" X 7"	25	200
30280	50280	1/4" X 8"	25	200
30290	50290	1/4" X 9"	25	200
30300	50300	3/8" X Close	25	600
30310	50310	3/8" X 10"	25	100
30311	—	3/8" X 11"	25	100
30312	50312	3/8" X 12"	25	100
30314	—	3/8" X 14"	5	10
30315	50315	3/8" X 1-1/2"	25	600
30320	50320	3/8" X 2"	25	600
30325	50325	3/8" X 2-1/2"	25	400
30330	50330	3/8" X 3"	25	400
30335	50335	3/8" X 3-1/2"	25	400
30340	50340	3/8" X 4"	25	300
30345	50345	3/8" X 4-1/2"	25	300
30350	50350	3/8" X 5"	25	300
30355	50355	3/8" X 5-1/2"	25	200
30360	50360	3/8" X 6"	25	200
30370	50370	3/8" X 7"	25	200

BLACK	GALVANIZED	SIZE	CTN QTY	MSTR QTY
30380	50380	3/8" X 8"	25	150
30390	—	3/8" X 9"	25	150
30500	50500	1/2" X Close	25	600
30510	50510	1/2" X 10"	25	75
30511	50511	1/2" X 11"	25	75
30512	50512	1/2" X 12"	25	75
30515	50515	1/2" X 1-1/2"	25	600
30520	50520	1/2" X 2"	25	600
30525	50525	1/2" X 2-1/2"	25	400
30530	50530	1/2" X 3"	25	400
30535	50535	1/2" X 3-1/2"	25	300
30540	50540	1/2" X 4"	25	300
30545	50545	1/2" X 4-1/2"	25	200
30550	50550	1/2" X 5"	25	200
30555	50555	1/2" X 5-1/2"	25	200
30560	50560	1/2" X 6"	25	200
30570	50570	1/2" X 7"	25	100
30575	—	1/2" X 7-1/2"	25	100
30580	50580	1/2" X 8"	25	100
30590	50590	1/2" X 9"	25	100
30700	50700	3/4" X Close	25	400
30710	50710	3/4" X 10"	25	50
30711	50711	3/4" X 11"	25	50
30712	50712	3/4" X 12"	25	50
30715	50715	3/4" X 1-1/2"	25	400
30720	50720	3/4" X 2"	25	300
30725	50725	3/4" X 2-1/2"	25	300
30730	50730	3/4" X 3"	25	200
30735	50735	3/4" X 3-1/2"	25	200
30740	50740	3/4" X 4"	25	150
30745	50745	3/4" X 4-1/2"	25	150
30750	50750	3/4" X 5"	25	100
30755	50755	3/4" X 5-1/2"	25	100
30760	50760	3/4" X 6"	25	100
30765	—	3/4" X 6-1/2"	25	75
30770	50770	3/4" X 7"	25	75
30775	50775	3/4" X 7-1/2"	25	75
30780	50780	3/4" X 8"	25	75
30790	50790	3/4" X 9"	25	75
31000	51000	1" X Close	25	300
31010	51010	1" X 10"	25	50
31011	51011	1" X 11"	25	50
31012	51012	1" X 12"	25	50
31014	51014	1" X 14"	5	10
31020	51020	1" X 2"	25	200
31025	51025	1" X 2-1/2"	25	200
31030	51030	1" X 3"	25	150
31035	51035	1" X 3-1/2"	25	150
31040	51040	1" X 4"	25	100
31045	51045	1" X 4-1/2"	25	100
31050	51050	1" X 5"	25	100
31055	51055	1" X 5-1/2"	25	75
31060	51060	1" X 6"	25	75
31065	—	1" X 6-1/2"	25	50
31070	51070	1" X 7"	25	50
31075	—	1" X 7-1/2"	25	50
31080	51080	1" X 8"	25	50

**BLACK & GALVANIZED
MALLEABLES/PIPE NIPPLES**

BLACK	GALVANIZED	SIZE	CTN QTY	MSTR QTY
31085	—	1" X 8-1/2"	25	50
31090	51090	1" X 9"	25	50
31095	—	1" X 9-1/2"	25	50
31200	51200	1-1/4" X Close	25	150
31210	51210	1-1/4" X 10"	20	40
31211	51211	1-1/4" X 11"	20	40
31212	51212	1-1/4" X 12"	10	30
31213	—	1-1/4" X 13"	3	6
31214	—	1-1/4" X 14"	3	6
—	51215	1-1/4" X 1-1/2"	25	150
31220	51220	1-1/4" X 2"	25	150
31225	51225	1-1/4" X 2-1/2"	25	150
31230	51230	1-1/4" X 3"	25	100
31235	51235	1-1/4" X 3-1/2"	25	100
31240	51240	1-1/4" X 4"	25	100
31245	51245	1-1/4" X 4-1/2"	25	75
31250	51250	1-1/4" X 5"	25	75
31255	51255	1-1/4" X 5-1/2"	25	75
31260	51260	1-1/4" X 6"	25	50
31265	—	1-1/4" X 6-1/2"	25	50
31270	51270	1-1/4" X 7"	25	50
31280	51280	1-1/4" X 8"	25	50
31285	—	1-1/4" X 8-1/2"	25	30
31290	51290	1-1/4" X 9"	25	50
31295	—	1-1/4" X 9-1/2"	20	40
31500	51500	1-1/2" X Close	25	100
31510	51510	1-1/2" X 10"	30	30
31511	51511	1-1/2" X 11"	20	20
31512	51512	1-1/2" X 12"	20	20
31514	—	1-1/2" X 14"	3	6
31520	51520	1-1/2" X 2"	25	75
31525	51525	1-1/2" X 2-1/2"	25	75
31530	51530	1-1/2" X 3"	25	50
31535	51535	1-1/2" X 3-1/2"	25	50
31540	51540	1-1/2" X 4"	25	50
31545	51545	1-1/2" X 4-1/2"	25	50
31550	51550	1-1/2" X 5"	25	50
31555	51555	1-1/2" X 5-1/2"	25	50
31560	51560	1-1/2" X 6"	25	50
31570	51570	1-1/2" X 7"	20	40
31580	51580	1-1/2" X 8"	20	40
31590	51590	1-1/2" X 9"	10	30
32000	52000	2" X Close	25	75
32010	52010	2" X 10"	15	15
32011	52011	2" X 11"	15	15
32012	52012	2" X 12"	15	15
32013	—	2" X 13"	3	6
32025	52025	2" X 2-1/2"	25	50
32030	52030	2" X 3"	25	50
32035	52035	2" X 3-1/2"	25	50
32040	52040	2" X 4"	25	25
32045	52045	2" X 4-1/2"	25	25
32050	52050	2" X 5"	25	25
32055	52055	2" X 5-1/2"	25	25
32060	52060	2" X 6"	25	25
32065	—	2" X 6-1/2"	20	20
32070	52070	2" X 7"	20	20

BLACK	GALVANIZED	SIZE	CTN QTY	MSTR QTY
32075	—	2" X 7-1/2"	20	20
32080	52080	2" X 8"	20	20
32090	52090	2" X 9"	20	20
32500	52500	2-1/2" X Close	20	40
32510	52510	2-1/2" X 10"	10	10
32511	52511	2-1/2" X 11"	10	10
32512	52512	2-1/2" X 12"	10	10
32514	—	2-1/2" X 14"	3	6
32530	52530	2-1/2" X 3"	20	40
32535	52535	2-1/2" X 3-1/2"	30	30
32540	52540	2-1/2" X 4"	30	30
32545	52545	2-1/2" X 4-1/2"	30	30
32550	52550	2-1/2" X 5"	20	20
32555	52555	2-1/2" X 5-1/2"	20	20
32560	52560	2-1/2" X 6"	20	20
32565	—	2-1/2" X 6-1/2"	20	20
32570	52570	2-1/2" X 7"	20	20
32580	52580	2-1/2" X 8"	10	10
32590	52590	2-1/2" X 9"	10	10
33000	53000	3" X Close	30	30
33010	53010	3" X 10"	5	5
33011	53011	3" X 11"	5	5
33012	53012	3" X 12"	5	5
33030	53030	3" X 3"	20	20
33035	53035	3" X 3-1/2"	15	15
33040	53040	3" X 4"	15	15
33045	53045	3" X 4-1/2"	15	15
33050	53050	3" X 5"	15	15
33055	53055	3" X 5-1/2"	15	15
33060	53060	3" X 6"	10	10
33070	53070	3" X 7"	7	7
33080	53080	3" X 8"	7	7
33090	53090	3" X 9"	7	7
33500	—	3-1/2" X Close	20	20
33540	—	3-1/2" X 4"	10	10
33550	53550	3-1/2" X 5"	8	8
33555	—	3-1/2" X 5-1/2"	8	8
33580	—	3-1/2" X 8"	6	6
34000	54000	4" X Close	20	20
34010	54010	4" X 10"	4	4
34011	54011	4" X 11"	4	4
34012	54012	4" X 12"	4	4
34014	—	4" X 14"	2	2
34035	54035	4" X 3-1/2"	10	10
34040	54040	4" X 4"	10	10
34045	54045	4" X 4-1/2"	8	8
34050	54050	4" X 5"	8	8
34055	54055	4" X 5-1/2"	8	8
34060	54060	4" X 6"	8	8
34070	54070	4" X 7"	4	4
34080	54080	4" X 8"	4	4
34090	54090	4" X 9"	4	4
35000	—	5" X Close	1	5
35045	—	5" X 4-1/2"	1	5
35050	—	5" X 5"	1	5
35055	—	5" X 5-1/2"	1	5
35060	—	5" X 6"	1	5

**BLACK & GALVANIZED
MALEABLES/PIPE NIPPLES**

BLACK	GALVANIZED	SIZE	CTN QTY	MSTR QTY
35070	—	5" X 7"	1	5
35080	—	5" X 8"	1	5
36000	56000	6" X Close	1	5
36010	56010	6" X 10"	1	3
36011	56011	6" X 11"	1	3
36012	56012	6" X 12"	3	3
—	56040	6" X 4"	1	5
36045	56045	6" X 4-1/2"	1	5
—	56050	6" X 5"	1	5
36055	56055	6" X 5-1/2"	1	5
36060	56060	6" X 6"	1	5
36070	56070	6" X 7"	1	4
36080	56080	6" X 8"	1	4
36090	56090	6" X 9"	1	4
31210TOE	—	1-1/4" X 10"	20	40
31212TOE	—	1-1/4" X 12"	10	30

XHY Pipe Nipple				
BLACK	GALVANIZED	SIZE	CTN QTY	
40300	—	3/8" X Close	1	
40500	—	1/2" X Close	1	
40700	—	3/4" X Close	1	
41000	—	1" X Close	1	
41200	—	1-1/4" X Close	1	
41500	—	1-1/2" X Close	1	
42000	—	2" X Close	1	

Installation Kit				
BLACK	GALVANIZED	SIZE	CTN QTY	MSTR QTY
BI05	GI05	1/2"	1	1
BI07	GI07	3/4"	1	1
BI10	GI10	1"	1	1
BI12	GI12	1-1/4"	1	1
BI15	GI15	1-1/2"	1	1
BI20	GI20	2"	1	1

Ever Ready Kit				
BLACK	GALVANIZED	SIZE	CTN QTY	MSTR QTY
ERB05	ERG05	1/2"	1	1
ERB07	ERG07	3/4"	1	1

C-Assort				
BLACK	GALVANIZED	SIZE	CTN QTY	MSTR QTY
CB05	CG05	1/2"	1	1
CB07	CG07	3/4"	1	1
CB10	CG10	1"	1	1
CB12	CG12	1-1/4"	1	1
CB15	—	1-1/2"	1	1

A-Assort				
BLACK	GALVANIZED	SIZE	CTN QTY	MSTR QTY
AB05	AG05	1/2"	1	1
AB07	AG07	3/4"	1	1
AB10	AG10	1"	1	1

6-Pack Assort				
BLACK	GALVANIZED	SIZE	CTN QTY	MSTR QTY
605B	605G	1/2"	1	1
607B	607G	3/4"	1	1
610B	610G	1"	1	1

**BLACK & GALVANIZED
MALLEABLES/PIPE NIPPLES**

Readycut Pipe



BLACK	GALVANIZED	SIZE	CTN QTY	MSTR QTY
—	301 G0118	1/8" X 18"	5	10
300 B0218	301 G0218	1/4" X 18"	5	10
300 B0224	301 G0224	1/4" X 24"	5	10
300 B0230	301 G0230	1/4" X 30"	5	10
300 B0236	301 G0236	1/4" X 36"	5	10
300 B0248	301 G0248	1/4" X 48"	5	10
300 B0260	301 G0260	1/4" X 60"	5	10
300 B0272	—	1/4" X 72"	5	10
300 B0318	301 G0318	3/8" X 18"	5	10
300 B0324	301 G0324	3/8" X 24"	5	10
300 B0330	301 G0330	3/8" X 30"	5	10
300 B0336	301 G0336	3/8" X 36"	5	10
300 B0348	301 G0348	3/8" X 48"	5	10
300 B0360	301 G0360	3/8" X 60"	5	10
300 B0372	301 G0372	3/8" X 72"	5	10
300 B0518	301 G0518	1/2" X 18"	5	10
300 B0524	301 G0524	1/2" X 24"	5	10
300 B0530	301 G0530	1/2" X 30"	5	10
300 B0536	301 G0536	1/2" X 36"	5	10
300 B0542	301 G0542	1/2" X 42"	5	10
300 B0548	301 G0548	1/2" X 48"	5	10
300 B0554	—	1/2" X 54"	5	10
300 B0560	301 G0560	1/2" X 60"	5	10
300 B0572	301 G0572	1/2" X 72"	5	10
300 B0718	301 G0718	3/4" X 18"	5	10
300 B0724	301 G0724	3/4" X 24"	5	10
300 B0730	301 G0730	3/4" X 30"	5	10
300 B0736	301 G0736	3/4" X 36"	5	10
300 B0742	301 G0742	3/4" X 42"	5	10
300 B0748	301 G0748	3/4" X 48"	5	10
300 B0754	301 G0754	3/4" X 54"	5	10
300 B0760	301 G0760	3/4" X 60"	5	10
300 B0772	301 G0772	3/4" X 72"	5	10
300 B1018	301 G1018	1" X 18"	5	10
300 B1024	301 G1024	1" X 24"	5	10
300 B1030	301 G1030	1" X 30"	5	10
300 B1036	301 G1036	1" X 36"	5	10
300 B1042	301 G1042	1" X 42"	5	10
300 B1048	301 G1048	1" X 48"	5	10
300 B1054	—	1" X 54"	5	10
300 B1060	301 G1060	1" X 60"	3	6
300 B1066	—	1" X 66"	3	6
300 B1072	301 G1072	1" X 72"	3	6
300 B1218	301 G1218	1-1/4" X 18"	3	6
—	301 G1220	1-1/4" X 20"	3	6
300 B1224	301 G1224	1-1/4" X 24"	3	6
300 B1230	301 G1230	1-1/4" X 30"	3	6
300 B1236	301 G1236	1-1/4" X 36"	3	6
300 B1242	301 G1242	1-1/4" X 42"	3	6
300 B1248	301 G1248	1-1/4" X 48"	3	6
300 B1254	—	1-1/4" X 54"	3	6

**BLACK & GALVANIZED
MALEABLES/PIPE NIPPLES**

BLACK	GALVANIZED	SIZE	CTN QTY	MSTR QTY
300 B1260	301 G1260	1-1/4" X 60"	3	6
300 B1272	301 G1272	1-1/4" X 72"	3	6
300 B1518	301 G1518	1-1/2" X 18"	3	6
300 B1524	301 G1524	1-1/2" X 24"	3	6
300 B1530	301 G1530	1-1/2" X 30"	3	6
300 B1536	301 G1536	1-1/2" X 36"	3	6
300 B1548	301 G1548	1-1/2" X 48"	3	6
300 B1560	301 G1560	1-1/2" X 60"	3	6
300 B1572	301 G1572	1-1/2" X 72"	3	6
300 B2018	301 G2018	2" X 18"	3	6
300 B2024	301 G2024	2" X 24"	3	6
300 B2030	301 G2030	2" X 30"	3	6
300 B2036	301 G2036	2" X 36"	3	6
300 B2042	—	2" X 42"	3	6
300 B2048	301 G2048	2" X 48"	3	6
300 B2060	301 G2060	2" X 60"	3	6
300 B2072	301 G2072	2" X 72"	3	6
32518	52518	2-1/2" X 18"	3	6
32520	—	2-1/2" X 20"	3	6
32524	52524	2-1/2" X 24"	3	6
300 B2530	—	2-1/2" X 30"	3	6
300 B2560	—	2-1/2" X 60"	3	6
33018	301 G3018	3" X 18"	2	4
300 B3024	301 G3024	3" X 24"	2	4
300 B3036	—	3" X 36"	2	4
300 B4018	301 G4018	4" X 18"	2	2
34024	54024	4" X 24"	2	2
—	301 G4048	4" X 48"	2	2
300 B4060	—	4" X 60"	2	2

Standard Merchant Couplings

BLACK PART NO.	GALV. PART NO.	SIZE	CTN QTY
M301	M101	1/8"	100
M302	M102	1/4"	100
M303	M103	3/8"	100
M305	M105	1/2"	100
M307	M107	3/4"	50
M310	M110	1"	30
M312	M112	1-1/4"	25
M315	M115	1-1/2"	25
M320	M120	2"	20
M325	M125	2-1/2"	10
M330	M130	3"	10
M340	M140	4"	10

Standard Merchant Half Couplings

BLACK PART NO.	GALV. PART NO.	SIZE	CTN QTY
H305	H105	1/2"	8
H307	H107	3/4"	12
H310	H110	1"	18
H312	H112	1-1/4"	23
H315	H115	1-1/2"	32
H320	H120	2"	47

COPPER FITTINGS

Wrot/ACR Solder Fittings	362-369
Forged Brass/Cast Brass Pressure Fittings.....	370-373
Wrot DWV Solder Fittings.....	374-375
Cast DWV Solder Fittings.....	376-379
Cast Brass Flanges	380

Male Adapter

C x M



JSC #	LTC #	SIZE	CTN QTY	MSTR QTY
C75311	K151010001	1/8"	25	3000
C75312	K151010002	1/4"	25	1600
C75313	K151010025	3/8"	25	1000
C75314	K151010050	1/2"	25	600
C75315	K151010100	3/4"	25	250
C75316	K151010150	1"	10	150
C75317	K151010215	1 1/4"	110	110
C75318	K151010295	1 1/2"	65	65
C75319	K151010390	2"	38	38
C75320	K151010520	2 1/2"	48	48
C75321	K151010650	3"	36	36
C75322	K151010860	4"	12	12
C75323	K151010024	1/8" x 1/4"	25	2000
C75324	K151010007	1/4" x 1/8"	25	2000
C75325	K151010006	1/4" x 3/8"	25	750
C75326	K151010005	1/4" x 1/2"	25	600
C75327	K151010032	3/8" x 1/4"	25	750
C75329	K151010059	1/2" x 1/4"	25	1000
C75330	K151010058	1/2" x 3/8"	25	800
C75331	K151010057	1/2" x 3/4"	25	250
C75332	K151010056	1/2" x 1"	10	150
C75334	K151010092	5/8" x 3/4"	25	250
C75335	K151010107	3/4" x 1/2"	25	250
C75336	K151010106	3/4" x 1"	10	150
C75337	K151010160	1" x 1/2"	10	180
C75338	K151010159	1" x 3/4"	10	150
C75339	K151010158	1" x 1 1/4"	85	85
C75340	K151010157	1" x 1 1/2"	65	65
C75341	K151010223	1 1/4" x 3/4"	130	130
C75342	K151010222	1 1/4" x 1"	120	120
C75343	K151010221	1 1/4" x 1 1/2"	90	90
C75345	K151010304	1 1/2" x 1"	120	120
C75346	K151010303	1 1/2" x 1 1/4"	60	60
C75347	K151010302	1 1/2" x 2"	50	50
C75348	K151010399	2" x 1 1/4"	48	48
C75349	K151010398	2" x 1 1/2"	48	48
C75350	K151010531	2 1/2" x 2"	36	36

Female Adapter

C x F



JSC #	LTC #	SIZE	CTN QTY	MSTR QTY
C75111	K151050001	1/8"	25	1500
C75112	K151050002	1/4"	25	1000
C75113	K151050025	3/8"	25	800
C75114	K151050050	1/2"	25	450
C75115	K151050100	3/4"	25	200
C75116	K151050150	1"	10	140
C75117	K151050215	1 1/4"	80	80
C75118	K151050295	1 1/2"	60	60
C75119	K151050390	2"	36	36
C75120	K151050520	2 1/2"	48	48
C75121	K151050650	3"	28	28
C75122	K151050024	1/8" x 1/4"	25	1000
C75123	K151050006	1/4" x 3/8"	25	900
C75124	K151050032	3/8" x 1/4"	25	750
C75125	K151050031	3/8" x 1/2"	25	500
C75126	K151050060	1/2" x 1/8"	25	500
C75127	K151050059	1/2" x 1/4"	50	500
C75128	K151050058	1/2" x 3/8"	25	800
C75129	K151050057	1/2" x 3/4"	25	300
C75130	K151050056	1/2" x 1"	10	160
C75131	K151050093	5/8" x 1/2"	25	300
C75132	K151050092	5/8" x 3/4"	25	250
C75133	K151050107	3/4" x 1/2"	25	300
C75134	K151050106	3/4" x 1"	10	140
C75135	K151050160	1" x 1/2"	10	150
C75136	K151050159	1" x 3/4"	10	150
C75137	K151050158	1" x 1 1/4"	85	85
C75138	K151050223	1 1/4" x 3/4"	120	120
C75139	K151050222	1 1/4" x 1"	120	120
C75140	K151050221	1 1/4" x 1 1/2"	65	65
C75141	K151050303	1 1/2" x 1 1/4"	70	70
C75142	K151050302	1 1/2" x 2"	60	60
C75494	K151050398	2" x 1 1/2"	40	40

Fitting Male Adapter

Ftg x M



JSC #	LTC #	SIZE	CTN QTY	MSTR QTY
C75352	K151140025	3/8"	25	800
C75353	K151140050	1/2"	25	500
C75354	K151140057	1/2" x 3/4"	25	250
C75355	K151140100	3/4"	25	250
C75356	K151140150	1"	10	130
C75357	K151140215	1 1/4"	80	80
C75358	K151140295	1 1/2"	50	50
C75359	K151140390	2"	38	38

COPPER

Fitting Female Adapter

Ftg x F



JSC #	LTC #	SIZE	CTN QTY	MSTR QTY
C75392	K151150002	1/4"	25	1500
C75394	K151150050	1/2"	25	500
C75395	K151150100	3/4"	25	250
C75396	K151150150	1"	10	140
C75397	K151150215	1 1/4"	85	85
C75398	K151150295	1 1/2"	80	80
C75399	K151150390	2"	40	40
C75400	K151150058	1/2" x 3/8"	25	700
C75401	K151150057	1/2" x 3/4"	25	300

Flush Bushing

Ftg x F

JSC #	LTC #	SIZE	CTN QTY	MSTR QTY
C75375	K151420060	1/2" x 1/8"	25	1500

Coupling (Socket) w/Rolled Tube Stop

C x C



JSC #	LTC #	SIZE	CTN QTY	MSTR QTY
C75000	K151650001	1/8"	25	3000
C75001	K151650002	1/4"	25	2000
C75566	K151650015	5/16" OD	25	3000
C75002	K151650025	3/8"	25	1200
C75003	K151650050	1/2"	25	800
C75004	K151650090	5/8"	25	400
C75005	K151650100	3/4"	25	300
C75006	K151650150	1"	10	150
C75007	K151650215	1 1/4"	100	100
C75008	K151650295	1 1/2"	60	60
C75009	K151650390	2"	40	40
C75010	K151650520	2 1/2"	50	50
C75011	K151650650	3"	30	30
C75012	K151650780	3 1/2"	18	18
C75013	K151650860	4"	12	12
C75477	K151651100	6"	3	3
C75478	K151651225	8"	1	1

Reducing Coupling

C x C



JSC #	LTC #	SIZE	CTN QTY	MSTR QTY
C75069	K151650007	1/4" x 1/8"	25	2000
C75516	K151650008	1/4" OD x 3/16" OD	25	2000
C75070	K151650033	3/8" x 1/8"	25	800
C75071	K151650032	3/8" x 1/4"	25	800
C75073	K151650059	1/2" x 1/4"	25	800
C75074	K151650058	1/2" x 3/8"	25	800
C75075	K151650095	5/8" x 1/4"	25	500
C75076	K151650094	5/8" x 3/8"	25	500
C75077	K151650093	5/8" x 1/2"	25	500
C75078	K151650109	3/4" x 1/4"	25	400
C75079	K151650108	3/4" x 3/8"	25	400
C75080	K151650107	3/4" x 1/2"	25	350
C75081	K151650149	3/4" x 5/8"	25	350
C75517	K151650161	1" x 3/8"	10	200
C75082	K151650160	1" x 1/2"	10	200
C75083	K151651498	1" x 5/8"	10	180
C75084	K151650159	1" x 3/4"	10	160
C75085	K151650224	1 1/4" x 1/2"	100	100
C75086	K151650223	1 1/4" x 3/4"	100	100
C75087	K151650222	1 1/4" x 1"	100	100
C75088	K151650306	1 1/2" x 1/2"	100	100
C75089	K151650305	1 1/2" x 3/4"	100	100
C75090	K151650304	1 1/2" x 1"	100	100
C75091	K151650303	1 1/2" x 1 1/4"	100	100
C75092	K151650402	2" x 1/2"	50	50
C75093	K151650401	2" x 3/4"	50	50
C75094	K151650400	2" x 1"	50	50
C75095	K151650399	2" x 1 1/4"	50	50
C75096	K151650398	2" x 1 1/2"	50	50
C75097	K151650534	2 1/2" x 1"	30	30
C75098	K151650533	2 1/2" x 1 1/4"	30	30
C75099	K151650532	2 1/2" x 1 1/2"	30	30
C75100	K151650531	2 1/2" x 2"	30	30
C75101	K151650664	3" x 1 1/2"	20	20
C75102	K151650663	3" x 2"	20	20
C75103	K151650662	3" x 2 1/2"	15	15
C75104	K151650874	4" x 1 1/4"	20	20
C75105	K151650873	4" x 1 1/2"	20	20
C75106	K151650872	4" x 2"	18	18
C75107	K151650871	4" x 2 1/2"	18	18
C75108	K151650870	4" x 3"	18	18
C75109	K151651111	6" x 3"	4	4
C75110	K151651109	6" x 4"	4	4

COPPER

Coupling (Socket) w/Dimple Tube Stop

C x C



JSC #	LTC #	SIZE	CTN QTY	MSTR QTY
C75550	K151700001	1/8"	25	3000
C75551	K151700002	1/4"	25	2000
C75553	K151700025	3/8"	25	1200
C75554	K151700050	1/2"	25	800
C75555	K151700090	5/8"	25	400
C75556	K151700100	3/4"	25	300
C75557	K151700150	1"	10	150
C75558	K151700215	1 1/4"	100	100
C75559	K151700295	1 1/2"	60	60
C75580	K151700390	2"	40	40
C75581	K151700520	2 1/2"	50	50
C75582	K151700650	3"	30	30
C75583	K151700780	3 1/2"	25	25
C75564	K151700860	4"	12	12
C75565	K151700975	5"	6	6
C75586	K151701100	6"	4	4

Coupling (Socket) Less Tube Stop

C x C



JSC #	LTC #	SIZE	CTN QTY	MSTR QTY
C75412	K151720001	1/8"	25	3000
C75413	K151720002	1/4"	25	2000
C75414	K151720025	3/8"	25	1200
C75415	K151720050	1/2"	25	800
C75519	K151720090	5/8"	25	400
C75416	K151720100	3/4"	25	300
C75417	K151720150	1"	10	150
C75418	K151720215	1 1/4"	100	100
C75419	K151720295	1 1/2"	60	60
C75420	K151720390	2"	40	40
C75421	K151720520	2 1/2"	50	50
C75422	K151720650	3"	30	30
C75423	K151720860	4"	12	12
C75424	K151720975	5"	6	6

Crossover Coupling

C x C



JSC #	LTC #	SIZE	CTN QTY	MSTR QTY
C75548	K151670050	1/2"	10	180

Cap



JSC #	LTC #	SIZE	CTN QTY	MSTR QTY
C75055	K151540001	1/8"	25	3300
C75056	K151540002	1/4"	25	3000
C75057	K151540025	3/8"	25	2500
C75058	K151540050	1/2"	25	1400
C75059	K151540090	5/8"	25	850
C75060	K151540100	3/4"	25	500
C75061	K151540150	1"	10	300
C75062	K151540215	1 1/4"	200	200
C75063	K151540295	1 1/2"	140	140
C75064	K151540390	2"	60	60
C75065	K151540520	2 1/2"	30	30
C75066	K151540650	3"	20	20
C75067	K151540860	4"	25	25
C75068	K151541100	6"	5	5

90° Short Turn Ell

C x C



JSC #	LTC #	SIZE	CTN QTY	MSTR QTY
C75014	K152350001	1/8"	25	3000
C75015	K152350002	1/4"	25	1200
C75016	K152350025	3/8"	25	1000
C75030	K152350032	3/8" x 1/4"	25	800
C75017	K152350050	1/2"	100	800
C75031	K152350059	1/2" x 1/4"	25	500
C75018	K152350090	5/8"	25	300
C75520	K152350093	5/8" x 1/2"	25	300
C75019	K152350100	3/4"	25	250
C75033	K152350107	3/4" x 1/2"	25	200
C75020	K152350150	1"	10	100
C75034	K152350160	1" x 1/2"	10	80
C75035	K152350159	1" x 3/4"	10	80
C75021	K152350215	1 1/4"	50	50
C75522	K152350223	1 1/4" x 3/4"	50	50
C75036	K152350222	1 1/4" x 1"	50	50
C75022	K152350295	1 1/2"	35	35
C75037	K152350303	1 1/2" x 1 1/4"	35	35
C75023	K152350390	2"	17	17
C75038	K152350398	2" x 1 1/2"	17	17
C75024	K152350520	2 1/2"	20	20
C75025	K152350650	3"	13	13
C75523	K152350780	3 1/2"	25	25
C75026	K152350860	4"	6	6
C75027	K152350975	5"	2	2
C75028	K152351100	6"	1	1
C75029	K152351225	8"	1	1

COPPER

90° Intermediate Turn Ell

C x C

JSC #	LTC #	SIZE	CTN QTY	MSTR QTY
C75531	K152380090	5/8"	25	200

90° Long Turn Ell

C x C



JSC #	LTC #	SIZE	CTN QTY	MSTR QTY
C75481	K152420001	1/8"	25	2000
C75482	K152420002	1/4"	25	1200
C75540	K152420015	5/16" OD	25	1600
C75483	K152420025	3/8"	25	750
C75484	K152420050	1/2"	25	350
C75485	K152420090	5/8"	25	200
C75486	K152420100	3/4"	10	120
C75487	K152420150	1"	10	60
C75488	K152420215	1 1/4"	35	35
C75489	K152420295	1 1/2"	25	25
C75490	K152420390	2"	12	12
C75491	K152420520	2 1/2"	16	16
C75492	K152420650	3"	8	8
C75544	K152420860	4"	6	6

90° Short Turn Street Ell

Ftg x Ftg

JSC #	LTC #	SIZE	CTN QTY	MSTR QTY
C75535	K152670050	1/2"	25	500
C75536	K152670100	3/4"	25	250
C75537	K152670215	1 1/4"	35	35

90° Long Turn Street Ell

Ftg x C



JSC #	LTC #	SIZE	CTN QTY	MSTR QTY
C75403	K152720002	1/4"	25	1200
C75404	K152720025	3/8"	25	750
C75405	K152720050	1/2"	25	350
C75406	K152720090	5/8"	25	200
C75407	K152720100	3/4"	10	120
C75408	K152720150	1"	10	60
C75409	K152720215	1 1/4"	35	35
C75410	K152720295	1 1/2"	25	25
C75411	K152720390	2"	12	12
C75479	K152720520	2 1/2"	16	16
C75546	K152720860	4"	6	6

90° Short Turn Street Ell

Ftg x C



JSC #	LTC #	SIZE	CTN QTY	MSTR QTY
C75377	K152540002	1/4"	25	1200
C75378	K152540025	3/8"	25	1000
C75379	K152540050	1/2"	25	500
C75380	K152540090	5/8"	25	300
C75381	K152540100	3/4"	25	200
C75382	K152540150	1"	10	100
C75383	K152540215	1 1/4"	50	50
C75384	K152540295	1 1/2"	35	35
C75385	K152540390	2"	17	17
C75386	K152540520	2 1/2"	20	20
C75387	K152540650	3"	13	13
C75388	K152540860	4"	6	6

45° Ell

C x C



JSC #	LTC #	SIZE	CTN QTY	MSTR QTY
C75039	K152900001	1/8"	25	2000
C75040	K152900002	1/4"	25	2000
C75041	K152900025	3/8"	25	800
C75042	K152900050	1/2"	25	500
C75043	K152900090	5/8"	25	300
C75044	K152900100	3/4"	25	200
C75045	K152900150	1"	10	100
C75046	K152900215	1 1/4"	60	60
C75047	K152900295	1 1/2"	40	40
C75048	K152900390	2"	18	18
C75049	K152900520	2 1/2"	20	20
C75050	K152900650	3"	15	15
C75051	K152900860	4"	6	6
C75052	K152900975	5"	4	4
C75053	K152901100	6"	2	2

COPPER

45° Street Ell

Ftg x C



JSC #	LTC #	SIZE	CTN QTY	MSTR QTY
C75463	K152950002	1/4"	25	2000
C75464	K152950025	3/8"	25	800
C75465	K152950050	1/2"	25	500
C75466	K152950090	5/8"	25	300
C75467	K152950100	3/4"	25	200
C75468	K152950150	1"	10	100
C75469	K152950215	1 1/4"	60	60
C75470	K152950295	1 1/2"	40	40
C75471	K152950390	2"	18	18
C75472	K152950520	2 1/2"	20	20
C75473	K152950650	3"	15	15
C75474	K152950860	4"	6	6

Flush Bushing

Ftg x C



JSC #	LTC #	SIZE	CTN QTY	MSTR QTY
C75360	K151400007	1/4" x 1/8"	25	3300
C75361	K151400032	3/8" x 1/4"	25	2500
C75363	K151400058	1/2" x 3/8"	25	1500
C75362	K151400059	1/2" x 1/4"	25	1500
C75568	K151400108	3/4" x 3/8"	25	700
C75366	K151400107	3/4" x 1/2"	25	700
C75367	K151400149	3/4" x 5/8"	25	500
C75368	K151400160	1" x 1/2"	10	320
C75370	K151400159	1" x 3/4"	10	400
C75371	K151400223	1 1/4" x 3/4"	200	200
C75372	K151400222	1 1/4" x 1"	200	200
C75373	K151400303	1 1/2" x 1 1/4"	140	140
C75374	K151400398	2" x 1 1/2"	60	60

Fitting Plug



JSC #	LTC #	SIZE	CTN QTY	MSTR QTY
C75525	K153960050	1/2"	25	1400
C75527	K153960150	1"	10	300

Suction Line P-Trap

C x C



LTC #	SIZE	CTN QTY	MSTR QTY
K155330050	1/2"	5	60
K155330090	5/8"	5	60
K155330100	3/4"	5	40
K155330150	1"	3	15
K155330215	1 1/4"	2	10
K155330295	1 1/2"	2	6
K155330390	2"	1	4

COPPER

Fitting Reducer

Ftg x C



JSC #	LTC #	SIZE	CTN QTY	MSTR QTY
C75425	K154100007	1/4" x 1/8"	25	3300
C75427	K154100032	3/8" x 1/4"	25	1200
C75428	K154100059	1/2" x 1/4"	25	1000
C75429	K154100058	1/2" x 3/8"	25	1000
C75430	K154100094	5/8" x 3/8"	25	500
C75431	K154100093	5/8" x 1/2"	25	500
C75432	K154100109	3/4" x 1/4"	25	400
C75433	K154100108	3/4" x 3/8"	25	400
C75434	K154100107	3/4" x 1/2"	25	400
C75435	K154100149	3/4" x 5/8"	25	400
C75437	K154100160	1" x 1/2"	10	200
C75438	K154101498	1" x 5/8"	10	200
C75439	K154100159	1" x 3/4"	10	160
C75440	K154100224	1 1/4" x 1/2"	100	100
C75441	K154100223	1 1/4" x 3/4"	100	100
C75442	K154100222	1 1/4" x 1"	100	100
C75443	K154100306	1 1/2" x 1/2"	100	100
C75444	K154100305	1 1/2" x 3/4"	100	100
C75445	K154100304	1 1/2" x 1"	100	100
C75446	K154100303	1 1/2" x 1 1/4"	100	100
C75447	K154100402	2" x 1/2"	50	50
C75448	K154100401	2" x 3/4"	50	50
C75449	K154100400	2" x 1"	50	50
C75450	K154100399	2" x 1 1/4"	50	50
C75451	K154100398	2" x 1 1/2"	50	50
C75452	K154100534	2 1/2" x 1"	30	30
C75453	K154100533	2 1/2" x 1 1/4"	30	30
C75454	K154100532	2 1/2" x 1 1/2"	30	30
C75455	K154100531	2 1/2" x 2"	30	30
C75456	K154100665	3" x 1 1/4"	20	20
C75457	K154100664	3" x 1 1/2"	20	20
C75458	K154100663	3" x 2"	20	20
C75459	K154100662	3" x 2 1/2"	15	15
C75460	K154100872	4" x 2"	18	18
C75461	K154100871	4" x 2 1/2"	18	18
C75462	K154100870	4" x 3"	18	18
C75562	K154100869	4" x 3 1/2"	15	15
C75563	K154100983	5" x 4"	1	1

Union

C x C



JSC #	LTC #	SIZE	CTN QTY	MSTR QTY
C75500	K156570002	1/4"	25	500
C75501	K156570025	3/8"	25	400
C75502	K156570050	1/2"	25	200
C75503	K156570100	3/4"	25	100
C75504	K156570150	1"	10	70
C75505	K126570215	1 1/4"	50	50
C75506	K126570295	1 1/2"	30	30
C75507	K126570390	2"	18	18
C75508	K126570520	2 1/2"	8	8
C75509	K126570650	3"	6	6

U-Type Strap



LTC #	SIZE	CTN QTY	MSTR QTY
K159470001	1/8"	25	2000
K159470002	1/4"	100	1000
K159470025	3/8"	25	1300
K159470050	1/2"	25	1000
K159470090	5/8"	25	500
K159470100	3/4"	25	600
K159470150	1"	10	350
K159470215	1 1/4"	-	350
K159470295	1 1/2"	-	300
K159470390	2"	-	300

Tee

C x C x C



JSC #	LTC #	SIZE	CTN QTY	MSTR QTY
C75143	K154600001	1/8"	25	2000
C75144	K154600002	1/4"	25	1300
C75162	K154600007	1/4" x 1/4" x 1/8"	25	1300
C75163	K154600006	1/4" x 1/4" x 3/8"	25	1300
C75160	K154600013	1/4" x 1/8" x 1/8"	25	1500
C75161	K154600012	1/4" x 1/8" x 1/4"	25	1300
C75145	K154600025	3/8"	25	600
C75166	K154600041	3/8" x 1/4" x 1/4"	25	500
C75167	K154600033	3/8" x 3/8" x 1/8"	25	600
C75168	K154600032	3/8" x 3/8" x 1/4"	25	600
C75169	K154600031	3/8" x 3/8" x 1/2"	25	350
C75146	K154600050	1/2"	50	500
C75170	K154600075	1/2" x 1/4" x 1/2"	25	400
C75171	K154600068	1/2" x 3/8" x 1/4"	25	400
C75173	K154600066	1/2" x 3/8" x 1/2"	25	350
C75174	K154600060	1/2" x 1/2" x 1/8"	25	400
C75175	K154600059	1/2" x 1/2" x 1/4"	25	400
C75176	K154600058	1/2" x 1/2" x 3/8"	25	400
C75570	K154600087	1/2" x 1/2" x 5/8"	10	180
C75177	K154600057	1/2" x 1/2" x 3/4"	10	180
C75178	K154600056	1/2" x 1/2" x 1"	10	70
C75147	K154600090	5/8"	25	200
C75571	K154600095	5/8" x 5/8" x 1/4"	25	200
C75181	K154600092	5/8" x 5/8" x 3/4"	25	200
C75148	K154600100	3/4"	20	160
C75572	K154600127	3/4" x 3/8" x 1/2"	10	170
C75182	K154600118	3/4" x 1/2" x 1/2"	10	180
C75183	K154600117	3/4" x 1/2" x 3/4"	10	120
C75184	K154600109	3/4" x 3/4" x 1/4"	10	170
C75185	K154600108	3/4" x 3/4" x 3/8"	10	170
C75186	K154600107	3/4" x 3/4" x 1/2"	10	170
C75188	K154600106	3/4" x 3/4" x 1"	10	80
C75149	K154600150	1"	10	60
C75195	K154600161	1" x 1" x 3/8"	10	100
C75196	K154600160	1" x 1" x 1/2"	10	100
C75198	K154600159	1" x 1" x 3/4"	10	60
C75199	K154600158	1" x 1" x 1 1/4"	35	35
C75200	K154600157	1" x 1" x 1 1/2"	25	25
C75192	K154600171	1" x 3/4" x 1/2"	10	90
C75193	K154600170	1" x 3/4" x 3/4"	10	60
C75194	K154600169	1" x 3/4" x 1"	10	60
C75189	K154600182	1" x 1/2" x 1/2"	10	100
C75190	K154600181	1" x 1/2" x 3/4"	10	80
C75191	K154600180	1" x 1/2" x 1"	10	60
C75197	K154601498	1" x 1" x 5/8"	10	70
C75150	K154600215	1 1/4"	35	35
C75202	K154600256	1 1/4" x 1/2" x 1 1/4"	35	35
C75203	K154600248	1 1/4" x 3/4" x 1/2"	50	50
C75204	K154600247	1 1/4" x 3/4" x 3/4"	50	50
C75205	K154600246	1 1/4" x 3/4" x 1"	45	45

JSC #	LTC #	SIZE	CTN QTY	MSTR QTY
C75206	K154600245	1 1/4" x 3/4" x 1 1/4"	35	35
C75207	K154600237	1 1/4" x 1" x 1/2"	60	60
C75208	K154600236	1 1/4" x 1" x 3/4"	50	50
C75209	K154600235	1 1/4" x 1" x 1"	50	50
C75210	K154600234	1 1/4" x 1" x 1 1/4"	30	30
C75211	K154600224	1 1/4" x 1 1/4" x 1/2"	50	50
C75212	K154600223	1 1/4" x 1 1/4" x 3/4"	50	50
C75213	K154600222	1 1/4" x 1 1/4" x 1"	40	40
C75214	K154600221	1 1/4" x 1 1/4" x 1 1/2"	20	20
C75215	K154600220	1 1/4" x 1 1/4" x 2"	10	10
C75151	K154600295	1 1/2"	20	20
C75233	K154600306	1 1/2" x 1 1/2" x 1/2"	40	40
C75234	K154600305	1 1/2" x 1 1/2" x 3/4"	35	35
C75235	K154600304	1 1/2" x 1 1/2" x 1"	35	35
C75236	K154600303	1 1/2" x 1 1/2" x 1 1/4"	25	25
C75237	K154600302	1 1/2" x 1 1/2" x 2"	10	10
C75228	K154600319	1 1/2" x 1 1/4" x 1/2"	40	40
C75229	K154600318	1 1/2" x 1 1/4" x 3/4"	40	40
C75230	K154600317	1 1/2" x 1 1/4" x 1"	30	30
C75231	K154600316	1 1/2" x 1 1/4" x 1 1/4"	30	30
C75232	K154600315	1 1/2" x 1 1/4" x 1 1/2"	20	20
C75223	K154600332	1 1/2" x 1" x 1/2"	40	40
C75225	K154600331	1 1/2" x 1" x 3/4"	40	40
C75224	K154600330	1 1/2" x 1" x 1"	35	35
C75226	K154600329	1 1/2" x 1" x 1 1/4"	30	30
C75227	K154600328	1 1/2" x 1" x 1 1/2"	20	20
C75218	K154600343	1 1/2" x 3/4" x 1/2"	40	40
C75219	K154600342	1 1/2" x 3/4" x 3/4"	30	30
C75220	K154600341	1 1/2" x 3/4" x 1"	40	40
C75221	K154600340	1 1/2" x 3/4" x 1 1/4"	30	30
C75222	K154600339	1 1/2" x 3/4" x 1 1/2"	20	20
C75216	K154600352	1 1/2" x 1/2" x 1"	40	40
C75217	K154600350	1 1/2" x 1/2" x 1 1/2"	20	20
C75152	K154600390	2"	10	10
C75254	K154600402	2" x 2" x 1/2"	20	20
C75255	K154600401	2" x 2" x 3/4"	20	20
C75256	K154600400	2" x 2" x 1"	18	18
C75257	K154600399	2" x 2" x 1 1/4"	15	15
C75258	K154600398	2" x 2" x 1 1/2"	10	10
C75259	K154600397	2" x 2" x 2 1/2"	15	15
C75248	K154600418	2" x 1 1/2" x 1/2"	20	20
C75249	K154600417	2" x 1 1/2" x 3/4"	20	20
C75250	K154600416	2" x 1 1/2" x 1"	20	20
C75251	K154600415	2" x 1 1/2" x 1 1/4"	10	10
C75252	K154600414	2" x 1 1/2" x 1 1/2"	10	10
C75253	K154600413	2" x 1 1/2" x 2"	10	10
C75243	K154600433	2" x 1 1/4" x 3/4"	20	20
C75244	K154600432	2" x 1 1/4" x 1"	20	20
C75245	K154600431	2" x 1 1/4" x 1 1/4"	15	15
C75246	K154600430	2" x 1 1/4" x 1 1/2"	15	15
C75247	K154600429	2" x 1 1/4" x 2"	10	10
C75240	K154600447	2" x 1" x 1"	20	20
C75242	K154600444	2" x 1" x 2"	15	15
C75238	K154600470	2" x 1/2" x 2"	15	15
C75239	K154600457	2" x 3/4" x 2"	10	10
C75153	K154600520	2 1/2"	15	15
C75260	K154600608	2 1/2" x 3/4" x 2 1/2"	15	15

COPPER

JSC #	LTC #	SIZE	CTN QTY	MSTR QTY
C75261	K154600595	2 1/2" x 1" x 2 1/2"	15	15
C75262	K154600583	2 1/2" x 1 1/4" x 1 1/4"	20	20
C75263	K154600580	2 1/2" x 1 1/4" x 2 1/2"	15	15
C75573	K154600566	2 1/2" x 1 1/2" x 1 1/2"	15	15
C75574	K154600565	2 1/2" x 1 1/2" x 2"	15	15
C75264	K154600564	2 1/2" x 1 1/2" x 2 1/2"	15	15
C75265	K154600554	2 1/2" x 2" x 1/2"	20	20
C75266	K154600553	2 1/2" x 2" x 3/4"	20	20
C75267	K154600552	2 1/2" x 2" x 1"	20	20
C75268	K154600551	2 1/2" x 2" x 1 1/4"	20	20
C75269	K154600550	2 1/2" x 2" x 1 1/2"	20	20
C75270	K154600549	2 1/2" x 2" x 2"	15	15
C75271	K154600548	2 1/2" x 2" x 2 1/2"	15	15
C75272	K154600536	2 1/2" x 2 1/2" x 1/2"	25	25
C75273	K154600535	2 1/2" x 2 1/2" x 3/4"	25	25
C75274	K154600534	2 1/2" x 2 1/2" x 1"	25	25
C75275	K154600533	2 1/2" x 2 1/2" x 1 1/4"	20	20
C75276	K154600532	2 1/2" x 2 1/2" x 1 1/2"	20	20
C75277	K154600531	2 1/2" x 2 1/2" x 2"	15	15
C75154	K154600650	3"	10	10
C75575	K154600746	3" x 3/4" x 3"	10	10
C75281	K154600708	3" x 1 1/2" x 3"	10	10
C75282	K154600696	3" x 2" x 1 1/2"	10	10
C75283	K154600695	3" x 2" x 2"	15	15
C75285	K154600694	3" x 2" x 2 1/2"	10	10
C75286	K154600693	3" x 2" x 3"	10	10
C75576	K154600682	3" x 2 1/2" x 1"	15	15
C75288	K154600680	3" x 2 1/2" x 1 1/2"	15	15
C75289	K154600679	3" x 2 1/2" x 2"	15	15
C75290	K154600678	3" x 2 1/2" x 2 1/2"	10	10
C75291	K154600677	3" x 2 1/2" x 3"	10	10
C75292	K154600668	3" x 3" x 1/2"	10	10
C75293	K154600667	3" x 3" x 3/4"	20	20
C75294	K154600666	3" x 3" x 1"	20	20
C75295	K154600665	3" x 3" x 1 1/4"	15	15
C75296	K154600664	3" x 3" x 1 1/2"	15	15
C75297	K154600663	3" x 3" x 2"	13	13
C75298	K154600662	3" x 3" x 2 1/2"	10	10
C75155	K154600860	4"	5	5
C75299	K154600914	4" x 2" x 4"	4	4
C75300	K154600896	4" x 3" x 2 1/2"	4	4
C75301	K154600895	4" x 3" x 3"	5	5
C75302	K154600893	4" x 3" x 4"	5	5
C75303	K154600877	4" x 4" x 1/2"	5	5
C75304	K154600876	4" x 4" x 3/4"	8	8
C75305	K154600875	4" x 4" x 1"	8	8
C75306	K154600874	4" x 4" x 1 1/4"	8	8
C75307	K154600873	4" x 4" x 1 1/2"	8	8
C75308	K154600872	4" x 4" x 2"	6	6
C75309	K154600871	4" x 4" x 2 1/2"	5	5
C75310	K154600870	4" x 4" x 3"	5	5
C75156	K154600975	5"	2	2
C75157	K154601100	6"	1	1
C75577	K154601113	6" x 6" x 2"	2	2
C75578	K154601111	6" x 6" x 3"	1	1
C75579	K154601109	6" x 6" x 4"	2	2
C75158	K154601225	8"	1	1

Male Adapter

C x M

* Cast



LTC #	SIZE	CTN QTY	MSTR QTY
K101010050	1/2"	50	200
K101010057*	1/2" x 3/4"	25	250
K101010100	3/4"	25	150
K101010107*	3/4" x 1/2"	25	300
K101010105	3/4" x 1 1/4"	10	80
K101010150	1"	10	100
K101010215	1 1/4"	10	60
K101010295*	1 1/2"	10	50
K101010390*	2"	5	50
K101010520*	2 1/2"	-	20
K101010860*	4"	-	-

Hose Adapter

C x Hose Thd

* Cast



LTC #	SIZE	CTN QTY	MSTR QTY
K101020057*	1/2" x 3/4"	-	75

Female Adapter

C x F

* Cast



LTC #	SIZE	CTN QTY	MSTR QTY
K101050050	1/2"	50	400
K101050100	3/4"	25	150
K101050105	3/4" x 1 1/4"	10	80
K101050106*	3/4" x 1"	-	150
K101050150	1"	10	100
K101050157*	1" x 1 1/2"	-	40
K101050215*	1 1/4"	10	100
K101050295	1 1/2"	10	100
K101050390*	2"	-	24

Fitting Female Adapter

Ftg x F

* Cast



LTC #	SIZE	CTN QTY	MSTR QTY
K101150059	1/2" x 1/4"	50	500
K101150107*	3/4" x 1/2"	-	-

Drain Coupling w/ Cap

* Cast



LTC #	SIZE	CTN QTY	MSTR QTY
K101750050*	1/2"	10	200
K101750100*	3/4"	25	200

Cross

C x C x C x C

* Cast



LTC #	SIZE	CTN QTY	MSTR QTY
K101950050	1/2"	45	180
K101950100	3/4"	10	100
K101950150*	1"	5	100
K101950215*	1 1/4"	5	50
K101950390*	2"	-	25

90° Ell

C x C

* Cast



LTC #	SIZE	CTN QTY	MSTR QTY
K102350223	1 1/4" x 3/4"	10	60

90° Ell w/ Drain Cap

C x C

* Cast



LTC #	SIZE	CTN QTY	MSTR QTY
K102360050	1/2"	-	25

COPPER

90° Drop Ell

C x C

* Cast



LTC #	SIZE	CTN QTY	MSTR QTY
K102400100	3/4"	10	80
K102400150*	1"	-	-

90° Hi-Ear Ell

C x C



LTC #	SIZE	CTN QTY	MSTR QTY
K142400050	1/2"	25	250
K142400100	3/4"	10	100

90° Ell

C x M



LTC #	SIZE	CTN QTY	MSTR QTY
K102550025	3/8"	50	400
K102550050	1/2"	50	200
K102550057	1/2" x 3/4"	25	200
K102550058	1/2" x 3/8"	50	250
K102550100	3/4"	25	150
K102550107	3/4" x 1/2"	10	100
K102550150	1"	10	80
K102550215	1 1/4"	10	50
K102550295	1 1/2"	5	40
K102550390	2"	-	20

90° Hi-Ear Ell

C x F



LTC #	SIZE	CTN QTY	MSTR QTY
K142590050	1/2"	25	150
K142590100	3/4"	25	100

90° Flanged Sink Ell

C x F



LTC #	SIZE	CTN QTY	MSTR QTY
K102600050	1/2"	25	100

90° Ell

C x F

* Cast



LTC #	SIZE	CTN QTY	MSTR QTY
K102570050	1/2"	50	250
K102570057	1/2" x 3/4"	25	150
K102570058	1/2" x 3/8"	25	250
K102570100	3/4"	25	100
K102570107	3/4" x 1/2"	25	200
K102570150	1"	10	50
K102570160	1" x 1/2"	10	100
K102570215	1 1/4"	5	60
K102570295	1 1/2"	5	20
K102570390	2"	-	20

90° Drop Ell

C x F

* Cast



LTC #	SIZE	CTN QTY	MSTR QTY
K102590050	1/2"	25	200
K102590058	1/2" x 3/8"	25	200
K102590107	3/4" x 1/2"	25	100
K102590150*	1"	10	120

45° Ell

C x C

* Cast



LTC #	SIZE	CTN QTY	MSTR QTY
K102900860*	4"	-	5

Drop Tee

C x C x C



LTC #	SIZE	CTN QTY	MSTR QTY
K104670050	1/2"	25	250

Tee

C x C x F

* Cast



LTC #	SIZE	CTN QTY	MSTR QTY
K104800025	3/8"	50	500
K104800050	1/2"	25	200
K104800057	1/2" x 1/2" x 3/4"	25	200
K104800058	1/2" x 1/2" x 3/8"	25	200
K104800100	3/4"	10	100
K104800106	3/4" x 3/4" x 1"	25	50
K104800107	3/4" x 3/4" x 1/2"	25	100
K104800108	3/4" x 3/4" x 3/8"	-	-
K104800117	3/4" x 1/2" x 3/4"	25	100
K104800150	1"	5	60
K104800159	1" x 1" x 3/4"	10	80
K104800160	1" x 1" x 1/2"	10	100
K104800215*	1 1/4"	-	50
K104800222*	1 1/4" x 1 1/4" x 1"	-	25
K104800223	1 1/4" x 1 1/4" x 3/4"	10	50
K104800224	1 1/4" x 1 1/4" x 1/2"	10	50
K104800295	1 1/2"	-	25
K104800304	1 1/2" x 1 1/2" x 1"	5	40
K104800306	1 1/2" x 1 1/2" x 1/2"	5	40
K104800400	2" x 2" x 1"	-	25

Drop Tee

C x C x F



LTC #	SIZE	CTN QTY	MSTR QTY
K104820050	1/2"	25	150

Tee

C x F x C

* Cast



LTC #	SIZE	CTN QTY	MSTR QTY
K104920050	1/2"	25	300
K104920100	3/4"	10	100
K104920117	3/4" x 1/2" x 3/4"	25	100
K104920150*	1"	-	15
K104920169	1" x 3/4" x 1"	10	40
K104920180	1" x 1/2" x 1"	10	50

Baseboard Tee

C x F x C



LTC #	SIZE	CTN QTY	MSTR QTY
K104920081	1/2" x 1/8" x 1/2"	50	250
K104920143	3/4" x 1/8" x 3/4"	25	100
K104920206	1" x 1/8" x 1"	10	50
K104920283	1 1/4" x 1/8" x 1 1/4"	10	60

Tee

F x F x C

* Cast



LTC #	SIZE	CTN QTY	MSTR QTY
K104980050	1/2"	25	100
K104980100*	3/4"	-	25
K104980118	3/4" x 1/2" x 1/2"	10	100
K104980107	3/4" x 3/4" x 1/2"	10	100

45° Wye

C x C x C

* Cast



LTC #	SIZE	CTN QTY	MSTR QTY
K108400100	3/4"	-	120

Union

C x M



LTC #	SIZE	CTN QTY	MSTR QTY
K126610025	3/8"	25	300
K126610050	1/2"	25	200
K126610100	3/4"	10	100
K126610150	1"	10	50
K126610215	1 1/4"	5	30
K126610295	1 1/2"	-	50
K126610390	2"	-	25

Union

C x F



LTC #	SIZE	CTN QTY	MSTR QTY
K126650050	1/2"	25	200
K126650100	3/4"	25	100
K126650150	1"	10	100
K126650215	1 1/4"	5	40
K126650295	1 1/2"	-	50
K126650390	2"	-	25

Male Adapter

C x M



LTC #	SIZE	CTN QTY	MSTR QTY
161010295	1 1/2"	10	100
161010390	2"	5	100

Female Adapter

C x F



LTC #	SIZE	CTN QTY	MSTR QTY
161050215	1 1/4"	-	150
161050295	1 1/2"	10	100
161050390	2"	10	100

Test Cap



LTC #	SIZE	CTN QTY	MSTR QTY
161570050	1/2"	-	-
161570100	3/4"	-	-
161570150	1"	-	400
161570215	1 1/4"	50	600
161570295	1 1/2"	50	600
161570390	2"	50	100
161570650	3"	25	200

Tee

C x C x C



LTC #	SIZE	CTN QTY	MSTR QTY
164600390	2"	5	25
164600398	2" x 1 1/2"	5	50

Coupling w/Stop

C x C



LTC #	SIZE	CTN QTY	MSTR QTY
161650215	1 1/4"	25	250
161650295	1 1/2"	25	250
161650303	1 1/2" x 1 1/4"	25	300
161650390	2"	-	250
161650398	2" x 1 1/2"	10	100
161650399	2" x 1 1/4"	10	100
161650650	3"	-	80
161650663	3" x 2"	5	100
161650860	4"	-	36
161650872	4" x 2"	-	-

Coupling Less Stop

C x C



LTC #	SIZE	CTN QTY	MSTR QTY
161720215	1 1/4"	25	200
161720295	1 1/2"	25	200
161720390	2"	-	100
161720650	3"	-	-

90° Ell

C x C



LTC #	SIZE	CTN QTY	MSTR QTY
162350215	1 1/4"	25	100
162350295	1 1/2"	10	100
162350390	2"	5	50

90° Long Turn Ell

C x C



LTC #	SIZE	CTN QTY	MSTR QTY
162420295	1 1/2"	-	-
162420390	2"	-	-

COPPER

90° Street Ell

Ftg x C



LTC #	SIZE	CTN QTY	MSTR QTY
162540215	1 1/4"	-	200
162540295	1 1/2"	10	100
162540390	2"	50	50

45° Ell

C x C



LTC #	SIZE	CTN QTY	MSTR QTY
162900215	1 1/4"	25	200
162900295	1 1/2"	25	150
162900390	2"	5	5
162900650	3"	2	2

45° Street Ell

Ftg x C



LTC #	SIZE	CTN QTY	MSTR QTY
162950215	1 1/4"	10	10
162950295	1 1/2"	10	100
162950390	2"	5	50

Fitting Reducer

Ftg x C



LTC #	SIZE	CTN QTY	MSTR QTY
164100303	1 1/2" x 1 1/4"	25	250
164100398	2" x 1 1/2"	10	100
164100399	2" x 1 1/4"	-	-
164100663	3" x 2"	-	50
164100664	3" x 1 1/2"	5	50

Male Adapter

C x M



LTC #	SIZE	CTN QTY	MSTR QTY
K201010215	1 1/4"	10	300
K201010295	1 1/2"	10	100
K201010303	1 1/2" x 1 1/4"	75	75
K201010390	2"	60	60
K201010650	3"	-	20
K201010860	4"	-	20

Female Adapter

C x F



LTC #	SIZE	CTN QTY	MSTR QTY
K201050295	1 1/2"	10	150
K201050650	3"	-	25
K201050860	4"	-	20

Soil Pipe Adapter

C x Spigot



LTC #	SIZE	CTN QTY	MSTR QTY
K201100390	2"	50	50

Soil Pipe Adapter

C x No Hub



LTC #	SIZE	CTN QTY	MSTR QTY
K201120302	1 1/2" x 2"	-	50
K201120390	2"	50	50

Female Adapter

Ftg x F



LTC #	SIZE	CTN QTY	MSTR QTY
K201150295	1 1/2"	100	100
K201150390	2"	50	50

Trap Adapter

F x S_J



LTC #	SIZE	CTN QTY	MSTR QTY
K201200295	1 1/2"	-	10

Cap



LTC #	SIZE	CTN QTY	MSTR QTY
K201540295	1 1/2"	-	-

Fitting Cleanout

Ftg x Cleanout w/Plug



LTC #	SIZE	CTN QTY	MSTR QTY
K201610215	1 1/4"	120	120
K201610295	1 1/2"	-	100
K201610390	2"	60	60

Flush Fitting Cleanout

Ftg x Cleanout w/Plug



LTC #	SIZE	CTN QTY	MSTR QTY
K201620215	1 1/4"	-	25
K201620650	3"	25	25

90° Ell

C x C



LTC #	SIZE	CTN QTY	MSTR QTY
K202350303	1 1/2" x 1 1/4"	75	75
K202350398	2" x 1 1/2"	25	25
K202350650	3"	10	10
K202350860	4"	-	-

90° Street Ell

Ftg x C



LTC #	SIZE	CTN QTY	MSTR QTY
K202540650	3"	-	-
K202540860	4"	-	10

90° Ell

C x M



LTC #	SIZE	CTN QTY	MSTR QTY
K202550295	1 1/2"	50	50

90° Ell

C x F



LTC #	SIZE	CTN QTY	MSTR QTY
K202570295	1 1/2"	75	75

45° Ell

C x C



LTC #	SIZE	CTN QTY	MSTR QTY
K202900860	4"	-	-

45° Ell

Ftg x C



LTC #	SIZE	CTN QTY	MSTR QTY
K202950650	3"	-	25

22 1/2° Ell

C x C



LTC #	SIZE	CTN QTY	MSTR QTY
K203100215	1 1/4"	-	25
K203100295	1 1/2"	-	-
K203100390	2"	-	50

Return Bend

C x C

LTC #	SIZE	CTN QTY	MSTR QTY
K204180295	1 1/2"	-	-

Tee

C x C x C



LTC #	SIZE	CTN QTY	MSTR QTY
K204600215	1 1/4"	50	50
K204600295	1 1/2"	60	60
K204600390	2"	25	25
K204600398	2" x 1 1/2"	40	40
K204600414	2" x 1 1/2" x 1 1/2"	50	50

Double Tee

C x C x C x C



LTC #	SIZE	CTN QTY	MSTR QTY
K204650295	1 1/2"	25	25
K204650390	2"	-	25
K204650398	2" x 1 1/2"	-	-
K204650695	3" x 2"	-	15

Tee

C x C x F



LTC #	SIZE	CTN QTY	MSTR QTY
K204800295	1 1/2"	60	60
K204800390	2"	-	25

Test Tee

C x C x Cleanout w/Plug



LTC #	SIZE	CTN QTY	MSTR QTY
K204850295	1 1/2"	-	50
K204850390	2"	-	25

Double Long Turn T-Y

C x C x C x C



LTC #	SIZE	CTN QTY	MSTR QTY
K205220390	2"	-	25

Wye

C x C x C



LTC #	SIZE	CTN QTY	MSTR QTY
K208400215	1 1/4"	-	-
K208400295	1 1/2"	-	50
K208400303	1 1/2" x 1 1/4"	-	-
K208400390	2"	-	25
K208400398	2" x 1 1/2"	-	50
K208400399	2" x 1 1/4"	-	50
K208400413	2" x 1 1/2" x 2"	-	50
K208400650	3"	-	-
K208400664	3" x 3" x 1 1/2"	-	-

Double Wye

C x C x C x C



LTC #	SIZE	CTN QTY	MSTR QTY
K208450295	1 1/2"	-	50
K208450650	3"	-	10

P-Traps

C x C



LTC #	SIZE	CTN QTY	MSTR QTY
K245500295	1 1/2"	-	-
K245500390	2"	20	20

P-Traps w/Cleanout

C x C x Cleanout w/Plug



LTC #	SIZE	CTN QTY	MSTR QTY
K245510215	1 1/4"	-	50
K245510295	1 1/2"	20	20
K245510390	2"	-	25

COPPER

P-Trap

C x SJ



LTC #	SIZE	CTN QTY	MSTR QTY
K245540295	1 1/2"	-	25

P-Trap w/Union Joint LA Pattern

F x SJ



LTC #	SIZE	CTN QTY	MSTR QTY
K245560295	1 1/2"	-	-

125# Companion Flange w/A.S.M.E. Drilling

Copper Sweat



LTC #	SIZE	CTN QTY	MSTR QTY
K113420100	3/4"	30	30
K113420150	1"	50	50
K113420215	1 1/4"	45	45
K113420295	1 1/2"	24	24
K113420390	2"	15	15
K113420520	2 1/2"	12	12
K113420650	3"	6	6
K113420860	4"	6	6
K113421100	6"	2	2

150# Companion Flange w/A.S.M.E. Drilling

Copper Sweat



LTC #	SIZE	CTN QTY	MSTR QTY
K113450150	1"	20	20
K113450215	1 1/4"	30	30
K113450295	1 1/2"	20	20
K113450390	2"	15	15
K113450520	2 1/2"	5	5
K113450650	3"	6	6
K113450860	4"	3	3
K113451100	6"	2	2

- IAPMO & NSF-61 CERTIFICATIONS
- MEETS STRICT ANSI SPECS
- MATERIAL SPECIFICATIONS TO ASTM B88
- CARTON QUANTITIES ONLY

NOMINAL (I.D.) PLUMBING SIZE	REFRIGERATION (O.D.) HVAC SIZE
1/8"	1/4"
1/4"	3/8"
3/8"	1/2"
5/8"	3/4"
3/4"	7/8"
1"	1 1/8"
1 1/4"	1 3/8"
1 1/2"	1 5/8"
2"	2 1/8"
2 1/2"	2 5/8"
3"	3 1/8"
4"	4 1/8"

COPPER

SECTION M: MERCHANDISING

Pegboard Merchandising..... 383-387

Tilt Bin Merchandising 388-395

Gondola Merchandising 396-398

Drain Merchandising..... 399-400

Chemical Merchandising 401-403



PlumBest Tool Center

Display Part No. TB1100

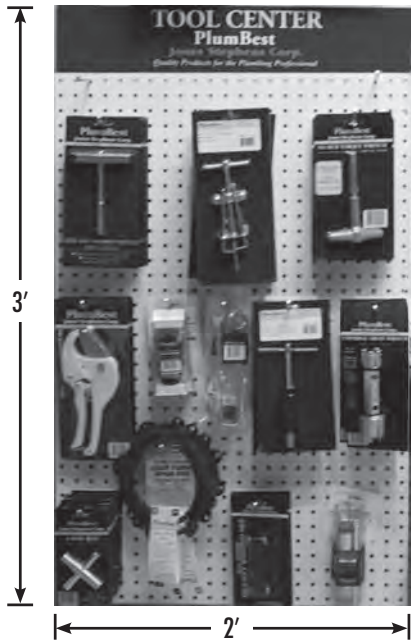

• 2' x 3' pegboard

PART NO.	DESCRIPTION	QTY
J45010	Universal Drain Wrench	5
J45015	Moen Cartridge Wrench	5
T60060	No Hub Torque Wrench	5
J40010	Faucet Handle Puller	5
J40015	Hex Key Set	5
J40048	Flint Striker	5
P70018	Professional PVC Cutter	5
J40021	Compression Sleeve Puller	5
J40005	4-Way Key	10
J40028	Strainer Wrench	5
C85000	Closet Flange Repair Ring	5
J40018	Extract-A-Drain	4

PlumBest Cutting Board

Display Part No. TB1200

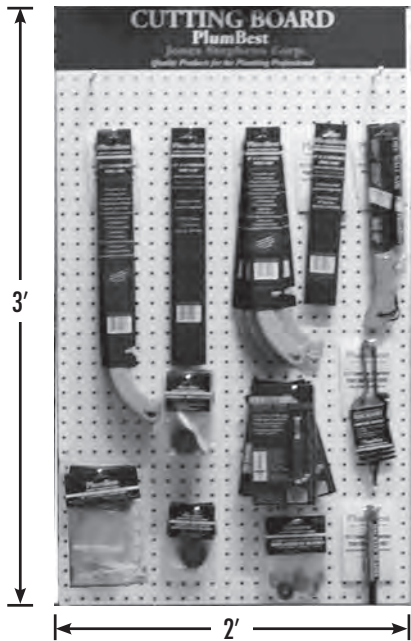

• 2' x 3' pegboard

PART NO.	DESCRIPTION	QTY
P70023	Inside Pipe Cutter	6
P70029	P70023 Replacement Blades	3
J40830	E-Z Shear Inside Pipe Cutter	6
J40831	J40830 Replacement Blades	3
S49008	12" E-Z Stroke Pipe Saw	6
S49007	12" E-Z Stroke Replacement Blade	6
S49236	T-Handle Cable Saw	6
S50060	Close Quarters Hacksaw	5
S49005	8" E-Z Stroke Pipe Saw	5
S49006	S49005 Replacement Blades	6
S50061	Close Quarters Hacksaw Blades	20
S49012	PlumBest Drywall Saw	6



PlumBest Socket Saver

Display Part No. TB1300

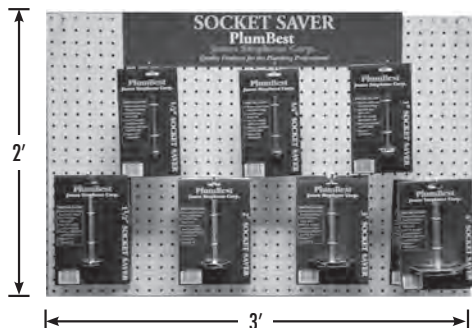

• 3' x 2' pegboard

PART NO.	DESCRIPTION	QTY
J44050	1/2" Socket Saver	4
J44075	3/4" Socket Saver	4
J44100	1" Socket Saver	4
J44150	1 1/2" Socket Saver	4
J44200	2" Socket Saver	4
J44300	3" Socket Saver	2
J44400	4" Socket Saver	2

PlumBest Tool Board

Display Part No. RTB100

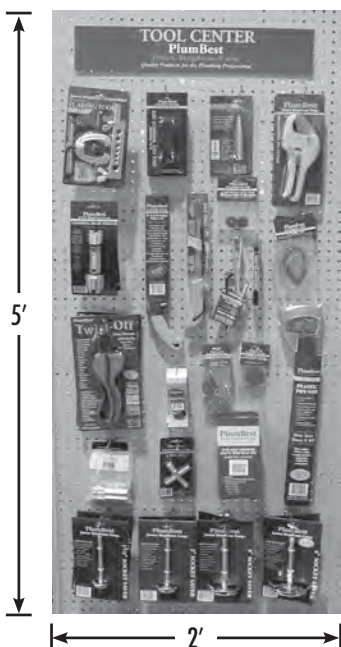

PART NO.	DESCRIPTION	QTY
J40002	Tub/Shower Valve Wrench Set	2
J40005	4-Way Key	2
J40015	Hex Key Set	2
J40018	Extract-A-Drain Tub Extraction Tool	2
J40054	Nipple Extractor Set	2
J40080	Flaring Tool	2
J40325	Twist-Off Strap Tool	2
J40830	E-Z Shear Inside Pipe Cutter	2
J40831	E-Z Shear Pipe Cutter Blades	2
J44150	1 1/2" Socket Saver	2
J44200	2" Socket Saver	2
J44300	3" Socket Saver	2
J44400	4" Socket Saver	2
J45010	Universal Drain Wrench	2
P70018	Professional PVC Pipe Cutter	2
P70023	Inside Pipe Cutter	2
P70029	Inside Pipe Cutter Blades	2
P70066	1/8" x 1 1/8" Tube Cutter	2
S49001	PlumBest Plastic Pipe Saw	2
S49005	8" E-Z Stroke Pipe Saw	2
S49012	PlumBest Drywall Saw	2
S49036	36" PVC Cable Saw	2
S50060	Close Quarters Hacksaw	2
S50061	Close Quarters Hacksaw Blades	2
T50001	3-N-1 Tubing Bender	2

PlumBest Tool Board

Display Part No. TB1600

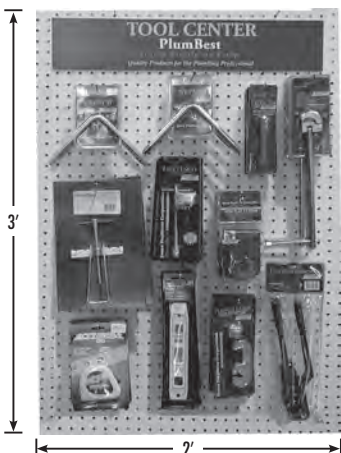

• 2' x 3' pegboard

PART NO.	DESCRIPTION	QTY
S62004	Angle Stepped Faucet Seat Wrench	6
S62002	Angle Tapered Faucet Seat Wrench	6
J40007	Faucet Seat Repair Kit	4
T50001	3-N-1 Tubing Bender	3
P70052	Mini Tube Cutter	6
P70066	Economy Tube Cutter	5
B11011	Telescoping Basin Wrench	6
J40012	E-Zee Pull Deluxe Faucet Handle Puller	6
J40051	Internal Pipe Nipple Extractors	6
J40101	Accu-Rule Tape Measure	4
J40100	Torpedo Level	6

Complete Tool Center

Display Part No. TB1700

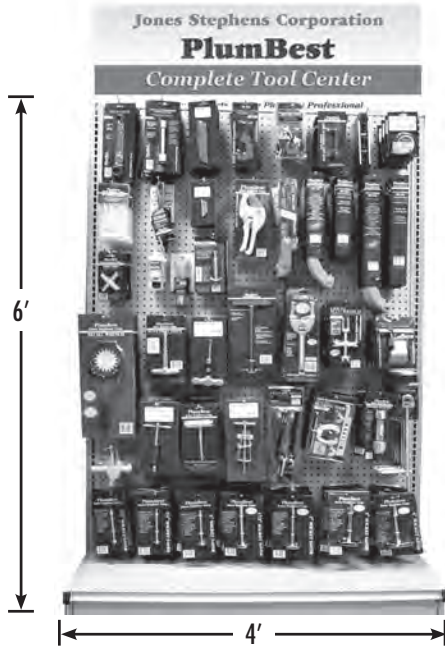

• 4' x 6' pegboard

PART NO.	DESCRIPTION	QTY
J45010	Universal Drain Wrench	5
J45015	Moen Cartridge Wrench	5
T60060	No Hub Torque Wrench	5
J40010	Faucet Handle Puller	5
J40015	Hex Key Set	5
J40048	Flint Striker	5
P70018	Professional PVC Cutter	5
J40021	Compression Sleeve Puller	3
J40042	6-Way Countersunk Plug Wrench	4
J40005	4-Way Key	10
S50060	6" Close Quarters Hacksaw	10
S50061	Close Quarters Hacksaw Blades	50
C85000	Closet Flange Repair Ring	5
P70023	Inside Pipe Cutter	6
P70029	Inside Pipe Cutter Blades	3
J40830	E-Z Shear Inside Pipe Cutter	6
J40831	E-Z Shear Inside Pipe Cutter Blade	3
S49008	12" E-Z Stroke Pipe Saw	6
S49007	12" E-Z Stroke Pipe Saw Blade	6
S49005	8" E-Z Stroke Pipe Saw	5
S49006	8" E-Z Stroke Pipe Saw Blade	5
S49012	PlumBest Drywall Saw	6
S49236	T-Handle Cable Saw	6
J40028	Strainer Wrench	5
J40018	Extract-A-Drain	5
J40019	Do All Plumbers Wrench	3
J40035	Lavatory Nut Removal Tool	5
J40260	1/2" Copper Tube Cutter	5
J40261	3/4" Copper Tube Cutter	5
J44050	1/2" Socket Saver	4
J44075	3/4" Socket Saver	4
J44100	1" Socket Saver	4
J44150	1 1/2" Socket Saver	4
J44200	2" Socket Saver	4
J44300	3" Socket Saver	2
J44400	4" Socket Saver	2



Utility Tie-Down Strap

Display Part No. S20001

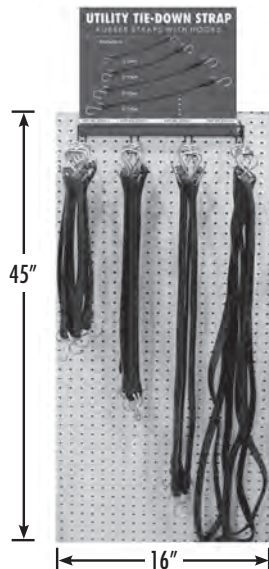

- Extra Heavy Duty
- American Trucker certified
- Weather and ozone resistant
- Made in the USA

MADE IN THE
USA

PART NO.	LENGTH	MAX STRETCH	QTY
S20015	15"	20"	25
S20021	21"	36"	25
S20031	31"	53"	25
S20041	41"	70"	25

Cam Straps

Display Part No. S20999

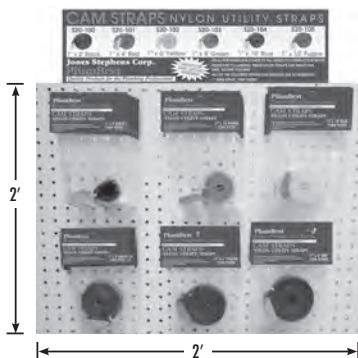

• 2' x 2' pegboard

PART NO.	DESCRIPTION	QTY
S20100	1" x 2' Black	12
S20101	1" x 4' Red	12
S20102	1" x 6' Yellow	12
S20103	1" x 8' Green	12
S20104	1" x 10' Blue	12
S20105	1" x 12' Purple	12

Work Gloves

• Display Rack and Display Box included

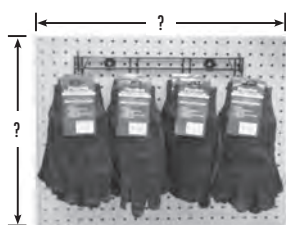

Display Rack



Display Box

Display Part No. G50210

PART NO.	DESCRIPTION	QTY
G50200	Brown Cotton Jersey	216 pair

Display Part No. G50214

PART NO.	DESCRIPTION	QTY
G50204	Leather Palm Low Safety Cuff	96 pair

Display Part No. G50218

PART NO.	DESCRIPTION	QTY
G50208	Drivers' Style Leather	48 pair

Stainless Steel Connectors Extended Assortment

Display Part No. SSC100

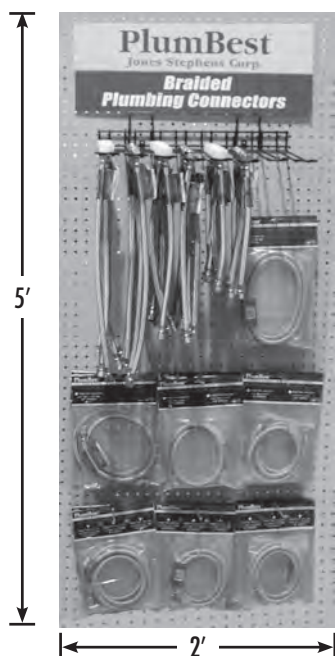

PART NO.	DESCRIPTION	QTY
S04201	3/8" OD x 1/2" FIP x 12" SS Faucet Con.	25
S04202	3/8" OD x 1/2" FIP x 16" SS Faucet Con.	12
S04203	3/8" OD x 1/2" FIP x 20" SS Faucet Con.	25
S04204	3/8" OD x 1/2" FIP x 30" SS Faucet Con.	5
S04217	3/8" OD x 7/8" BC x 12" SS Ballcock Con.	25
S04218	3/8" OD x 7/8" BC x 16" SS Ballcock Con.	12
S04219	3/8" OD x 7/8" BC x 20" SS Ballcock Con.	12
S04227	3/4" FH x 3/4" x 48" SS Washing Machine Con.	5
S04228	3/4" FH x 3/4" x 60" SS Washing Machine Con.	5
S04234	3/8" OD x 3/8" MIP x 60" SS Dishwasher Con.	5
S04237	1/2" OD x 3/8" MIP x 60" SS Dishwasher Con.	5
S04238	1/2" OD x 3/8" MIP x 72" SS Dishwasher Con.	5
S04232	1/2" OD x 1/4" OD x 84" SS Icemaker Con.	5
H99000	Flexible Connector Display Unit w/Header	1
TB1Hook	Additional Hooks	6

Stainless Steel Connectors Assortment

Display Part No. S04303

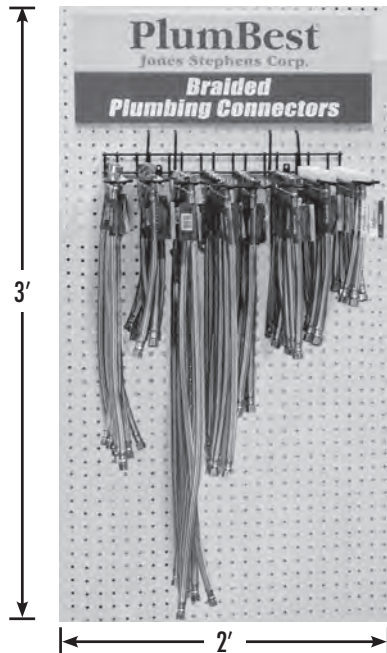

• CARTON QUANTITIES ONLY

PART NO.	DESCRIPTION	QTY
S04201	3/8" OD x 1/2" FIP x 12" SS Faucet Con.	8
S04202	3/8" OD x 1/2" FIP x 16" SS Faucet Con.	8
S04203	3/8" OD x 1/2" FIP x 20" SS Faucet Con.	8
S04204	3/8" OD x 1/2" FIP x 30" SS Faucet Con.	8
S04216	3/8" OD x 7/8" BC x 9" SS Ballcock Con.	7
S04217	3/8" OD x 7/8" BC x 12" SS Ballcock Con.	7
S04240	3/8" OD x 12" SS Delta Style Faucet Con.	12
S04242	3/8" OD x 20" SS Delta Style Faucet Con.	12
H99000	Flexible Connector Display Unit w/Header	1
TB1000	2' x 3' Peg Board	1

Complete Brass Assortment

Display Part No. Q01011

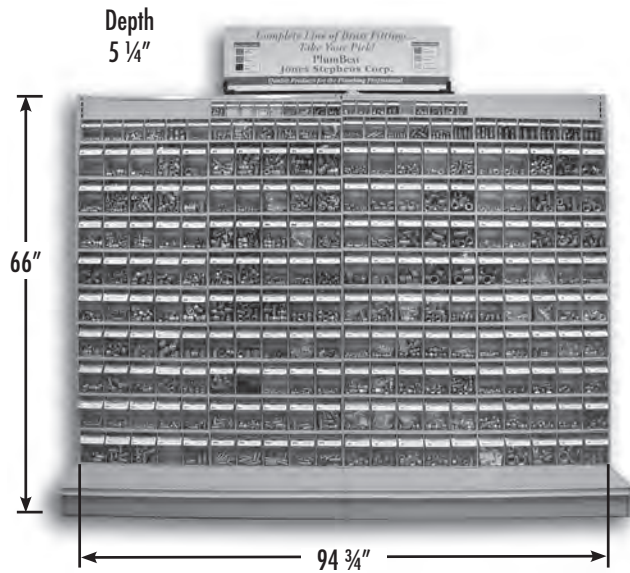

*Gondola Not Included

- Complete Brass assortment includes all 5 of the assortments (Q01012, Q01013, Q01014, Q01015, Q01016) plus the following items:
- Get 42 Multistore Bins FREE!
- Note: The items listed on this page are currently included in our complete brass assortment, but not as part of the individual assortment packages.

PART NO.	DESCRIPTION	QTY
N10442	1/4" OD x 1/8" MIP (Angle Needle Valve)	25
N15100	3/8" x Close CP Nipple	5
N15200	3/8" x 2" CP Nipple	5
N15400	3/8" x 4" CP Nipple	5
N16100	1/2" x Close CP Nipple	5
N16200	1/2" x 2" CP Nipple	5
N16400	1/2" x 4" CP Nipple	5
B50001	3/8" 90° CP Elbow	5
B50002	1/2" 90° CP Elbow	5
B50041	3/8" CP Coupling	5
B50042	1/2" CP Coupling	5
B50031	3/8" CP Tee	5
B50032	1/2" CP Tee	5
B10100	1/2" - 14 x 3/8" Regular Zamak Basin Nut	25
B10102	1/2" - 14 x 1/2" Regular Zamak Basin Nut	25
B10103	1/2" - 14 x 9/16" Regular Zamak Basin Nut	25
B10104	1/2" - 14 x 9/16" Regular Brass Basin Nut	25
B10105	1/2" - 14 x 1/2" White Faucet Nut	25
C74002	3/8" Compression Cap	25
C74011	7/8" OD Compression Sleeve	50
C74020	7/8" OD Compression Nut	50
C74031	1/2" x 3/8" Comp Reducing Union	25
C74093	5/8" OD x 5/8" OD (1/2" Sweat Adapter)	25
C74094	3/8" CP Compression Nut	25
C74096	1/4" OD Delrin Comp Sleeve	100
C74097	3/8" OD Delrin Comp Sleeve	100
C74098	1/2" OD Delrin Comp Sleeve	100
C74099	5/8" OD Delrin Comp Sleeve	25
C74100	1/4" Brass Insert	100
C74101	3/8" Brass Insert	100
C74102	1/2" Brass Insert	40
C74103	5/8" Brass Insert	25
S92001	Self-piercing Needle Valve Kit	10
T77125	1 1/4" x 1 1/4" CP Slip Joint Nut	25
T77150	1 1/2" x 1 1/2" CP Slip Joint Nut	25
T77151	1 1/2" x 1 1/4" CP Slip Joint Nut	25
C05080	5/8" x 1/2" Zinc Ballcock Coupling Nut	25
C05081	5/8" x 7/8" Brass Ballcock Coupling Nut	25
G20056	3/4" FGH Cap with Chain	10
A11001	1/4" FIP x 1/4" MIP Brass Air Cock with Lever Handle and Hex Shoulder	5
A11003	1/4" FIP x 1/4" MIP Brass Air Cock with Tee Handle and Hex Shoulder	5
A11004	1/4" FIP x 1/4" FIP Brass Air Cock with Lever Handle and Round Shoulder	5
A11005	1/4" FIP x 1/4" FIP Brass Air Cock	5
N01001	1/8" MIP Lever Handle Drain Cock	10
N01002	1/4" MIP Lever Handle Drain Cock	10
Q01005	5-unit Tilt Bin Display	36
Q01006	6-unit Tilt Bin Display	4
Q01009	9-unit Tilt Bin Display	2

Flare Fittings Assortment

Display Part No. Q01013

• Get 5 Multistore Bins FREE!

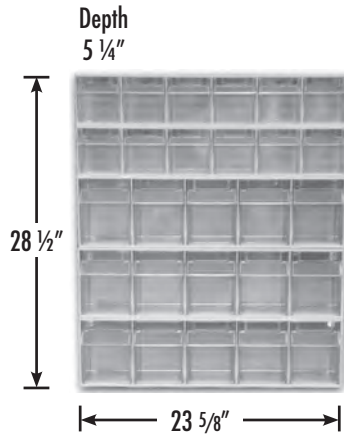

PART NO.	DESCRIPTION	QTY
F40002	1/4" Short Flare Nut	25
F40004	3/8" Short Flare Nut	50
F40005	1/2" Short Flare Nut	50
F40006	5/8" Short Flare Nut	25
F40020	3/8" Flare Cap	25
F40021	1/2" Flare Cap	25
F40023	1/4" Flare Union	25
F40025	3/8" Flare Union	25
F40026	1/2" Flare Union	25
F40027	5/8" Flare Union	10
F40035	3/8" Flare Tee	10
F40036	1/2" Flare Tee	10
F40048	3/8" Flare x 3/8" FIP Coupling	20
F40049	3/8" Flare x 1/2" FIP Coupling	20
F40052	1/2" Flare x 3/8" FIP Coupling	20
F40053	1/2" Flare x 1/2" FIP Coupling	20
F40055	5/8" Flare x 1/2" FIP Coupling	15
F40063	1/4" Flare x 1/8" MIP Half Union	20
F40064	1/4" Flare x 1/4" MIP Half Union	20
F40068	3/8" Flare x 1/4" MIP Half Union	20
F40069	3/8" Flare x 3/8" MIP Half Union	25
F40070	3/8" Flare x 1/2" MIP Half Union	25
F40073	1/2" Flare x 3/8" MIP Half Union	25
F40074	1/2" Flare x 1/2" MIP Half Union	25
F40076	5/8" Flare x 1/2" MIP Half Union	15
F40088	3/8" Flare x 3/8" MIP Elbow	10
Q01005	5-unit Tilt Bin Display	3
Q01006	6-unit Tilt Bin Display	2

Brass Flare Tube Fittings Assortment

Display Part No. Q01013R

• Get 5 Multistore Bins FREE!

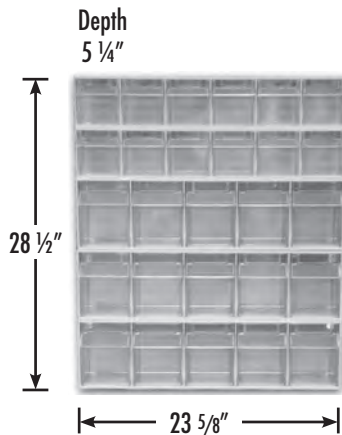

PART NO.	DESCRIPTION	QTY
F40002	1/4" Short Flare Nut	25
F40004	3/8" Short Flare Nut	50
F40005	1/2" Short Flare Nut	50
F40006	5/8" Short Flare Nut	25
F40020	3/8" Flare Cap	25
F40021	1/2" Flare Cap	25
F40023	1/4" Flare Union	25
F40025	3/8" Flare Union	25
F40026	1/2" Flare Union	25
F40027	5/8" Flare Union	10
F40035	3/8" Flare Tee	10
F40036	1/2" Flare Tee	10
F40048	3/8" OD x 3/8" FIP Coupling	20
F40049	3/8" OD x 1/2" FIP Coupling	20
F40052	1/2" OD x 3/8" FIP Coupling	20
F40053	1/2" OD x 1/2" FIP Coupling	20
F40055	5/8" OD x 1/2" FIP Coupling	15
F40063	1/4" OD x 1/8" MIP Half Union	20
F40064	1/4" OD x 1/4" MIP Half Union	20
F40068	3/8" OD x 1/4" MIP Half Union	20
F40069	3/8" OD x 3/8" MIP Half Union	25
F40070	3/8" OD x 1/2" MIP Half Union	25
F40073	1/2" OD x 3/8" MIP Half Union	25
F40074	1/2" OD x 1/2" MIP Half Union	25
F40076	5/8" OD x 1/2" MIP Half Union	15
F40088	3/8" OD x 3/8" MIP Elbow	10
F40092	1/2" OD x 1/2" MIP Elbow	10
Q01005	5-unit Tilt Bin Display	3
Q01006	6-unit Tilt Bin Display	2

Compression Fittings Assortment

Display Part No. Q01012

• Get 9 Multistore Bins FREE!

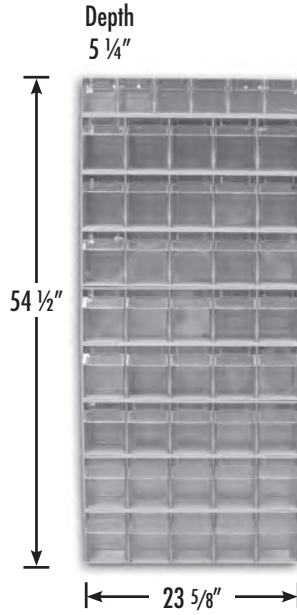

PART NO.	DESCRIPTION	QTY
C74005	1/4" OD Compression Sleeve	100
C74007	3/8" OD Compression Sleeve	100
C74008	1/2" OD Compression Sleeve	100
C74009	5/8" OD Compression Sleeve	100
C74014	1/4" OD Compression Sleeve	100
C74016	3/8" OD Compression Nut	100
C74017	1/2" OD Compression Nut	100
C74018	5/8" OD Compression Nut	100
C74023	1/4" OD Compression Union	50
C74025	3/8" OD Compression Union	100
C74026	1/2" OD Compression Union	50
C74027	5/8" OD Compression Union	50
C74029	7/8" OD Compression Union	25
C74030	3/8" x 1/4" Comp Reducing Union	25
C74031	1/2" x 3/8" Comp Reducing Union	25
C74032	5/8" x 3/8" Comp Reducing Union	25
C74034	1/4" OD Compression Tee	10
C74036	3/8" OD Compression Tee	20
C74038	1/2" OD Compression Tee	10
C74041	3/8" OD Compression Elbow	25
C74043	5/8" OD Compression Elbow	10
C74044	5/8" x 3/8" Compression Elbow	10
C74050	3/8" OD x 3/8" FIP Comp Union	25
C74051	3/8" OD x 1/2" FIP Comp Union	25
C74052	1/2" OD x 3/8" FIP Comp Union	25
C74053	1/2" OD x 1/2" FIP Comp Union	25
C74054	5/8" x OD x 1/2" FIP Comp Union	10
C74055	7/8" OD x 3/4" FIP Comp Union	10
C74058	1/4" OD x 1/8" MIP Comp Union	25
C74059	1/4" OD x 1/4" MIP Comp Union	25
C74060	1/4" OD x 3/8" MIP Comp Union	25
C74064	3/8" OD x 1/4" MIP Comp Union	25
C74065	3/8" OD x 3/8" MIP Comp Union	50
C74066	3/8" OD x 1/2" MIP Comp Union	50
C74069	1/2" OD x 3/8" MIP Comp Union	50
C74070	1/2" OD x 1/2" MIP Comp Union	50
C74071	5/8" OD x 1/2" MIP Comp Union	40
C74072	5/8" OD x 3/4" MIP Comp Union	25
C74073	7/8" OD x 3/4" MIP Comp Union	20
C74081	1/4" OD x 1/8" MIP Comp Elbow	25
C74082	1/4" OD x 1/4" MIP Comp Elbow	25
C74085	3/8" OD x 1/4" MIP Comp Elbow	25
C74086	3/8" OD x 3/8" MIP Comp Elbow	60
C74087	3/8" OD x 1/2" MIP Comp Elbow	25
C74088	1/2" OD x 3/8" MIP Comp Elbow	50
C74089	1/2" OD x 1/2" MIP Comp Elbow	25
Q01005	5-unit Tilt Bin Display	8
Q01006	6-unit Tilt Bin Display	1



Mini Compression Fittings Assortment

Display Part No. Q01030R

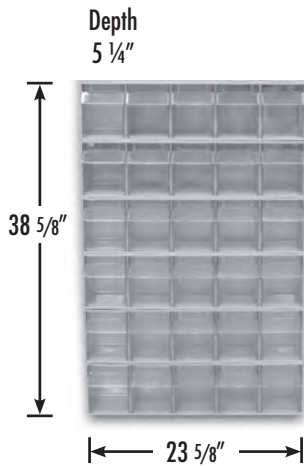

• Get 6 Multistore Bins FREE!

PART NO.	DESCRIPTION	QTY
C74096	1/4" OD Delrin Comp Sleeve	100
C74097	3/8" OD Delrin Comp Sleeve	100
C74098	1/2" OD Delrin Comp Sleeve	100
C74100	1/4" Brass Insert	100
C74101	3/8" Brass Insert	100
C74102	1/2" Brass Insert	40
C74005	1/4" OD Compression Sleeve	100
C74007	3/8" OD Compression Sleeve	100
C74008	1/2" OD Compression Sleeve	100
C74009	5/8" OD Compression Sleeve	100
C74016	3/8" OD Compression Nut	25
C74017	1/2" OD Compression Nut	25
C74023	1/4" OD Compression Nut	25
C74025	3/8" OD Compression Union	25
C74026	1/2" OD Compression Union	25
C74027	5/8" OD Compression Union	25
C74052	1/2" OD x 3/8" FIP Comp Union	25
C74059	1/4" OD x 1/4" MIP Comp Union	25
C74065	3/8" OD x 3/8" MIP Comp Union	25
C74070	1/2" OD x 1/2" MIP Comp Union	25
C74058	1/4" OD x 1/8" MIP Comp Union	25
C74064	3/8" OD x 1/4" MIP Comp Union	25
C74066	3/8" OD x 1/2" MIP Comp Union	25
C74069	1/2" OD x 3/8" MIP Comp Union	25
C74082	1/4" OD x 1/4" MIP Comp Elbow	25
C74086	3/8" OD x 3/8" MIP Comp Elbow	25
C74081	1/4" OD x 1/8" MIP Comp Elbow	25
C74085	3/8" OD x 1/4" MIP Comp Elbow	25
S92001	Self-piercing Needle Valve Kit	25
Q01005	5-unit Tilt Bin Display	6

Garden Hose Fitting Assortment

Display Part No. Q01014

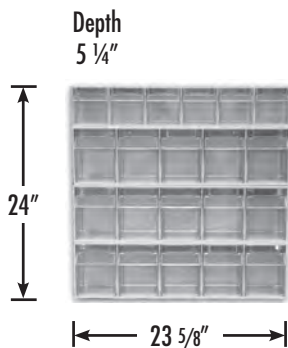

• Get 4 Multistore Bins FREE!

PART NO.	DESCRIPTION	QTY
G20002	3/4" MGH x 1/2" MIP	25
G20003	3/4" MGH x 3/4" MIP Tapped 1/2" FIP	25
G20008	3/4" MGH to 3/4" MGH	25
G20010	3/4" MGH x 1/2" FIP	10
G20011	3/4" MGH x 3/4" FIP	25
G20015	3/4" FGH x 1/2" MIP	10
G20016	3/4" FGH x 3/4" MIP	25
G20020	3/4" FGH x 1/2" FIP	10
G20021	3/4" FGH x 3/4" FIP	10
G20030	3/4" FGH Swivel	25
G20031	3/4" FGH x 1/2" FIP Swivel	25
G20032	3/4" FGH x 3/4" FIP Swivel	25
G20036	1/2" ID x 3/4" FGH Swivel Hose Barb	5
G20037	5/8" ID x 3/4" FGH Swivel Hose Barb	10
G20038	3/4" ID x 3/4" FGH Swivel Hose Barb	2
G20041	1/2" ID x 3/4" MGH Hose Barb	5
G20042	5/8" ID x 3/4" MGH Hose Barb	10
G20043	3/4" ID x 3/4" MGH Hose Barb	5
G20050	3/4" FGH x 3/4" MGH Wye	5
G20055	3/4" GH Cap	25
G20057	3/4" Hose Washer	200
Q01005	5-unit Tilt Bin Display	3
Q01006	6-unit Tilt Bin Display	1



Brass Hose Barb Assortment

Display Part No. Q01016

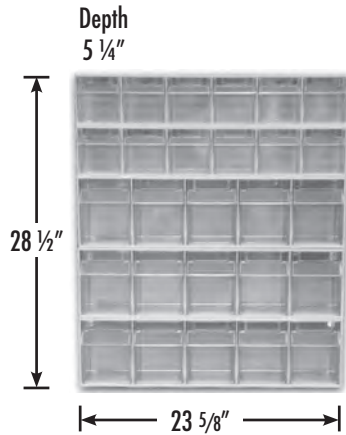

• Get 5 Multistore Bins FREE!

PART NO.	DESCRIPTION	QTY
G25032	3/16" ID x 1/8" MIP Hose Barb	10
G25042	1/4" ID x 1/8" MIP Hose Barb	10
G25044	1/4" ID x 1/4" MIP Hose Barb	24
G25046	1/4" ID x 3/8" MIP Hose Barb	10
G25048	1/4" ID x 1/2" MIP Hose Barb	10
G25052	5/16" ID x 1/8" MIP Hose Barb	10
G25054	5/16" ID x 1/4" MIP Hose Barb	10
G25064	3/8" ID x 1/4" MIP Hose Barb	20
G25066	3/8" ID x 3/8" MIP Hose Barb	30
G25068	3/8" ID x 1/2" MIP Hose Barb	10
G25084	1/2" ID x 1/4" MIP Hose Barb	25
G25086	1/2" ID x 3/8" MIP Hose Barb	15
G25088	1/2" ID x 1/2" MIP Hose Barb	40
G25106	5/8" ID x 3/8" MIP Hose Barb	20
G25108	5/8" ID x 1/2" MIP Hose Barb	25
G25101	5/8" ID x 3/4" MIP Hose Barb	25
G25121	3/4" ID x 3/4" MIP Hose Barb	10
G25128	3/4" ID x 1/2" MIP Hose Barb	5
G29004	1/4" ID Hose Splicer	100
G29005	5/16" ID Hose Splicer	100
G29006	3/8" ID Hose Splicer	95
G29008	1/2" ID Hose Splicer	70
G29010	5/8" ID Hose Splicer	50
N10544	1/4" OD x 1/4" OD St. Needle Valve	25
N10566	3/8" OD x 3/8" OD St. Needle Valve	25
N10642	1/4" OD x 1/8" MIP St. Needle Valve	25
N10664	3/8" OD x 1/4" MIP St. Needle Valve	25
Q01005	5-unit Tilt Bin Display	3
Q01006	6-unit Tilt Bin Display	2

Yellow Brass & Bronze Pipe Fittings

Display Part No. Q01015

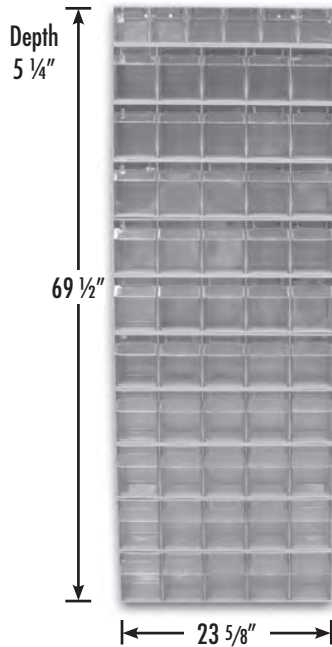

• Get 11 Multistore Bins FREE!

PART NO.	DESCRIPTION	QTY
B74001	1/8" 90° Pipe Elbow	10
B74002	1/4" 90° Pipe Elbow	10
B74003	3/8" 90° Pipe Elbow	10
B74004	1/2" 90° Pipe Elbow	20
B74005	3/4" 90° Pipe Elbow	20
B74006	1" 90° Pipe Elbow	5
P10012	1/8" Pipe Tee	10
B74082	1/4" Pipe Tee	10
B74083	3/8" Pipe Tee	5
B74084	1/2" Pipe Tee	10
B74085	3/4" Pipe Tee	10
B74086	1" Pipe Tee	10
P10032	1/8" Pipe Coupling	10
P10034	1/4" Pipe Coupling	10
B74123	3/8" Pipe Coupling	10
B74124	1/2" Pipe Coupling	20
B74125	3/4" Pipe Coupling	20
B74126	1" Pipe Coupling	10
P10082	1/8" Pipe Cap	10
P10084	1/4" Pipe Cap	10
P10086	3/8" Pipe Cap	10
B74184	1/2" Pipe Cap	25
B74185	3/4" Pipe Cap	25
B74186	1" Pipe Cap	10
P10092	1/8" Square Head Pipe Plug	25
P10094	1/4" Square Head Pipe Plug	50
P10096	3/8" Square Head Pipe Plug	25
B74284	1/2" Square Head Pipe Plug	30
B74285	3/4" Square Head Pipe Plug	30
B74286	1" Square Head Pipe Plug	10
P11042	1/4" x 1/8" Hex Bushing	25
P11062	3/8" x 1/8" Hex Bushing	25
P11064	3/8" x 1/4" Hex Bushing	20
P11084	1/2" x 1/4" Hex Bushing	20
P11086	1/2" x 3/8" Hex Bushing	50
P11124	3/4" x 1/4" Hex Bushing	10
P11128	3/4" x 1/2" Hex Bushing	50
B74212	1" x 1/2" Hex Bushing	20
B74213	1" x 3/4" Hex Bushing	25
P11202	1/8" x Close Pipe Nipple	25
P11204	1/4" x Close Pipe Nipple	25
P11206	3/8" x Close Pipe Nipple	25
P11208	1/2" x Close Pipe Nipple	25
N24000	3/4" x Close Pipe Nipple	25
N25000	1" x Close Pipe Nipple	10
P13232	1/8" x 2" Pipe Nipple	20
P13432	1/4" x 2" Pipe Nipple	20
P13632	3/8" x 2" Pipe Nipple	20
N23002	1/2" x 2" Pipe Nipple	25
N24002	3/4" x 2" Pipe Nipple	25
N25002	1" x 2" Pipe Nipple	10
P16002	1/8" 90° Street Elbow	10
P16004	1/4" 90° Street Elbow	10
B74023	3/8" 90° Street Elbow	10
B74024	1/2" 90° Street Elbow	10
Q01005	5-unit Tilt Bin Display	10
Q01006	6-unit Tilt Bin Display	1

Poly Insert Assortment

Display Part No. Q01027

• Get 10 Multistore Bins FREE!

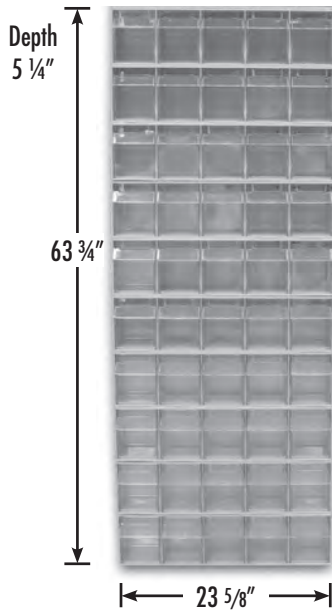

PART NO.	DESCRIPTION	QTY
I10001	1/2" Poly Insert x MIP Adapter	20
I10002	3/4" Poly Insert x MIP Adapter	25
I10003	1" Poly Insert x MIP Adapter	25
I10004	1 1/4" Poly Insert x MIP Adapter	15
I10005	1 1/2" Poly Insert x MIP Adapter	15
I10006	2" Poly Insert x MIP Adapter	10
I10007	1/2" Poly Insert x FIP Adapter	20
I10008	3/4" Poly Insert x FIP Adapter	20
I10009	1" Poly Insert x FIP Adapter	15
I10010	1 1/4" Poly Insert x FIP Adapter	40
I10011	1 1/2" Poly Insert Coupling	20
I10012	3/4" Poly Insert Coupling	25
I10013	1" Poly Insert Coupling	25
I10014	1 1/4" Poly Insert Coupling	15
I10015	1 1/2" Poly Insert Coupling	15
I10016	2" Poly Insert Coupling	10
I10017	3/4" x 1/2" Poly Insert Red Coupling	20
I10018	1" x 1/2" Poly Insert Red Coupling	10
I10019	1" x 3/4" Poly Insert Red Coupling	20
I10020	1 1/4" x 1" Poly Insert Red Coupling	20
I10021	1 1/2" x 1 1/4" Poly Insert Red Coupling	10
I10022	2" x 1 1/2" Poly Insert Red Coupling	5
I10023	1/2" Poly Insert Elbow	20
I10024	3/4" Poly Insert Elbow	25
I10025	1" Poly Insert Elbow	25
I10026	1 1/4" Poly Insert Elbow	15
I10027	1 1/2" Poly Insert Elbow	15
I10028	2" Poly Insert Elbow	10
I10029	1/2" Poly Insert Tee	20
I10030	3/4" Poly Insert Tee	25
I10031	1" Poly Insert Tee	25
I10032	1 1/4" Poly Insert Tee	15
I10033	1 1/2" Poly Insert Tee	15
I10034	2" Poly Insert Tee	10
I10035	1/2" Poly Insert x MIP Comb Elbow	20
I10036	3/4" Poly Insert x MIP Comb Elbow	20
I10037	1" Poly Insert x MIP Comb Elbow	15
I10038	1 1/4" Poly Insert x MIP Comb Elbow	10
I10039	1 1/2" Poly Insert x MIP Comb Elbow	10
I10040	3/4" MIP x 1/2" Poly Insert Adapter	20
I10041	1" MIP x 3/4" Poly Insert Adapter	15
I10042	1 1/4" MIP x 1" Poly Insert Adapter	10
I10043	3/4" x 3/4" 1/2" Poly Insert Red Tee	10
I10044	3/4" x 1/2" 1/2" Poly Insert Red Tee	10
I10045	1" x 1" x 1/2" Poly Insert Red Tee	10
I10046	1" x 1" x 3/4" Poly Insert Red Tee	10
I10047	1" x 3/4" x 3/4" Poly Insert Red Tee	10
I10048	1 1/2" x 1 1/2" x 1" Poly Insert Red Tee	10
I10049	2" x 2" x 1" Poly Insert Red Tee	5
Q01005	5-unit Tilt Bin Display	10



Drain & Flange Assortment (Bulk)

Display Part No. DFD100



*Gondola Not Included

PART NO.	DESCRIPTION	QTY
C40420	4" x 2" CI No Caulk Closet Flange	1
C4743P	4" x 3" PVC Two Finger Flange	1
C51340	3" x 4" PVC Flange Less Knockout	3
C53340	3" x 4" PVC Flange w/ Metal Ring, Less KO	2
C53342	3" x 4" PVC Adjustable Flange w/ Plastic Swivel Ring, Less KO	3
C54402	3" x 4" PVC Offset Adjustable Flange w/ Plastic Swivel Ring	1
C85000	Metal Closet Flange	2
C87100	Gapper Flange	2
C88001	Closet Flange Extender	2
D40003	4 1/4" PB Snap-in Strainer for No Caulk Drain	1
D40005	4 1/4" SS Snap-in Strainer for No Caulk Drain	2
D40101	2" No Caulk Shower Drain with SS Strainer	2
D40140	2" No Caulk Brass Shower Stall Drain	1
D40600	2" x 3" Area Drain	2
D40601	3" x 4" Area Drain	2
D41001	2" Shower Drain with Receptor Base	2
D41009	2" PVC Drop-In Shower Drain w/ PB Strainer	1
D42006H	6" x 6" PVC Bell Trap with Hinged Lid	2
D50001	2" x 3" PVC Shower/Floor Drain w/ SS Strainer	2
D54100	3" x 4" PVC General Purpose Drain w/ SS Strainer	2
D59001	2" SS Push-in Strainer	2
D59002	3" SS Push-in Strainer	2
D59003	4" SS Push-in Strainer	2
S26004	3" x 2" PVC Saddle Tee Kit	2
S26005	4" x 2" PVC Saddle Tee Kit	2



C4743P



C53342



C85000



C87100



D40005



D40140



D50001

Plumbing Specialties Display

Display Part No. Q01018

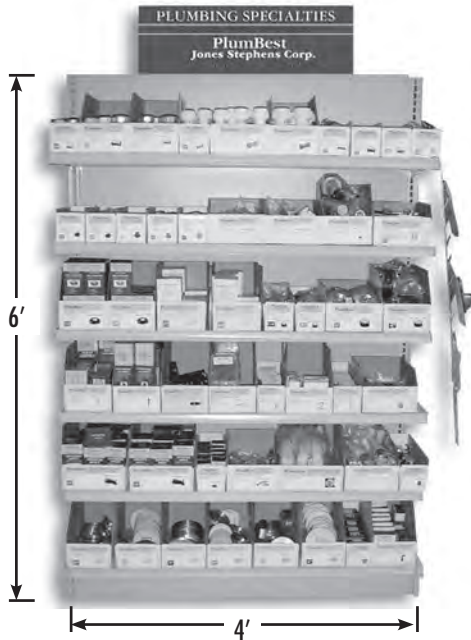

PART NO.	DESCRIPTION	QTY
C11050	1/2" IPS Galvanized Compression Coupling	10
C11075	3/4" IPS Galvanized Compression Coupling	10
C11100	1" IPS Galvanized Compression Coupling	10
C12050	1/2" IPS PVC Compression Coupling	12
C12075	3/4" IPS PVC Compression Coupling	10
C12100	1" IPS PVC Compression Coupling	10
C15050	1/2" CTS (3/8" IPS) Bronze Compression Coupling	10
C15075	3/4" CTS (1/2" IPS) Bronze Compression Coupling	10
D06753	3/4" MIP x 3" Dielectric Nipple	20
R60050	1/2" IPS / 3/4" CTS SS Repair Clamp	8
D06050	1/2" FIP x 1/2" SWEAT (5/8" OD) Dielectric Union	15
D06075	3/4" FIP x 3/4" SWEAT (7/8" OD) Dielectric Union	15
C27134	1" x 3/4" Urinal Spud	15
C27125	1 1/4" Closet Spud	12
C27150	1 1/2" Closet Spud	10
C02011	1/4" x 2 1/4" BP Closet Bolts/Round Washer	50 pair
T01001	Fit-All CP Tank Trip Lever with 9" Brass Arm	20
C05070	Douglas Plastic Flush Valve with SS Chain	6
R60075	3/4" x 6" SS Repair Clamp	8
E01050	1/2" CTS (5/8" OD) CP Low Pattern Escutcheon	200
E01075	3/4" CTS (7/8" OD) CP Low Pattern Escutcheon	200
F01050	1/2" CTS 5/8" OD F&C Plate - Light Gauge	108
F01075	3/4" CTS - 7/8" OD F&C Plate - Light Gauge	108
T31001	1 1/2" Economy Test Plug	16
T31002	2" Economy Test Plug	12
T31003	3" Economy Test Plug	12
T31004	4" Economy Test Plug	10
P35001	CP Brass Pop-Up	6
D70100	CP Commercial Grid Lav Drain	6
D10001	Dishwasher Connection with 2 Worm Gear Clamps	20
A33002	#10 x 1 1/4" Anchor Kit	6
J66300	300 PSI Water Test Gauge	6
G64030	30 lb. Gas Test Gauge Assembly	6
G60030	30 PSI 2" Pressure Gauge	10
C90600	6" SS Cleanout Cover	25
D01001	1/2" FIP CP Diverter Spout (nose)	8
D01004	1/2" CTS CP Diverter Spout (slip)	8
S01004	CP 1 5/8" Deluxe Die Cast Shower Head	10
S01044	1/2" x 6" CP Shower Arm and SS Flange	10
S92025	1/4" x 25' Icemaker Kit Poly Tubing	8
A10001	Air Gap	10
B10201	1 3/4" OD Cock Hole Cover	25
P51300	3" Countersunk Southern Code Brass Plug	15
P51350	3 1/2" Countersunk Southern Code Brass Plug	15
P51400	4" Countersunk Southern Code Brass Plug	15
P50300	3" Raised Head Southern Code Brass Plug	15
P50350	3 1/2" Raised Head Southern Code Brass Plug	15
P50400	4" Raised Head Southern Code Brass Plug	15
B02050	SS Junior Duo Basket Strainer	6
K52001	Kitchen Faucet Spray Head Only	10
C04004	Carded Blue Vinyl Flapper	12
C87100	Gapper Repair Flange	12
Q01010	4' Gondola with Five Shelves	1

PVC Plastic Specialties

Display Part No. Q01017

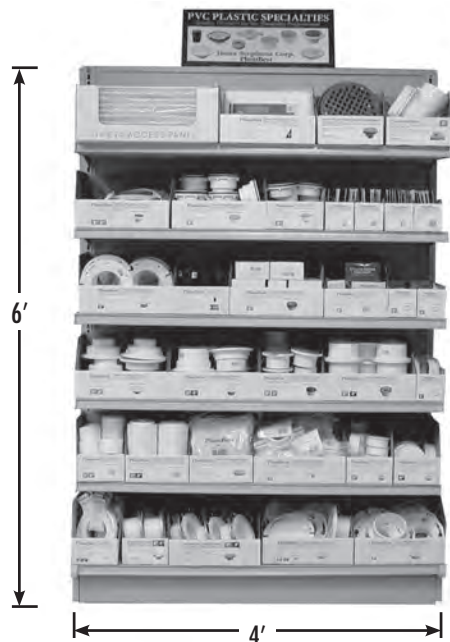

A04006



D41001



C4743P



H21050



C88001



C51340

PART NO.	DESCRIPTION	QTY
A05014	14" x 14" Snap-Ease Access Panel	10
A04006	6" x 9" Access Panel	10
D49827	8 1/2" Heavy Duty Traffic Floor Drain w/ Sediment Bucket	2
B04300	3" Backwater Valve	2
D50001	2" x 3" PVC Shower Drain w/ SS Strainer	8
D41001	2" PVC Shower Drain with SS Strainer & Receptor Base	15
D41600	2" PVC Offset Shower Stall Drain with SS Strainer	5
D41102	Polished Brass Replacement Strainer	5
C60810	4 1/4" SS Stamped Coverall Replacement Strainer	5
D40003	4 1/4" PB Snap-in Replacement Strainer	5
C60809	4 1/4" SS Stamped Coverall Replacement Strainer	5
C4743P	3" x 3" PVC Plastic Two Finger Flange	6
P21150	Provent	20
D40101	2" PVC NC Shower Drain with SS Strainer	15
D40140	2" PVC NC Shower Drain with SS Strainer - Brass Body	12
P48002	2" Socket Ring	20
P48003	3" Socket Ring	15
P48004	4" Socket Ring	10
D40600	2" x 3" PVC General Purpose Area Drain	6
D40601	3" x 4" PVC General Purpose Area Drain	6
D54001	2" x 3" PVC Drain with SS Strainer	12
D54100	3" x 4" PVC Drain with SS Strainer	10
C61023	2" x 3" Fit Flush Cleanout with 2" IPS plug - 2 3/8" OD	10
C61034	3" x 4" Fit Flush Cleanout with 3" IPS plug - 3 1/2" OD	10
H21050	50' Plastic Hanger Tape	10
F10002	2" Adjustable Urinal Flange Kit Socket Fit	10
C60007	3" PVC Internal Pipe Cleanout Fitting	10
C60008	4" Internal Pipe Cleanout Fitting	10
C88001	1/2" Closet Flange Extender	10
C57034	3" x 4" PVC Closet Flange with SS Ring and KO	4
C50340	3" x 4" PVC Closet Flange with KO	8
C51340	3" x 4" PVC Closet Flange w/o KO	8
C57134	3" x 4" PVC Closet Flange with SS Ring w/o KO	8
-	Zip Strip for Hanging Carded Items	1

"Code Blue" Light Commercial Cast Iron

Display Part No. Q01031



Drain Spuds

FITS SLOT #	PART NO.	IPS SIZE	SPUD MATERIAL	STRAINER SIZE / MATERIAL	STRAINER DIAMETER	QTY
4R	D60986	3 1/2"	Metal	4" NB	Round	6
2A	D60990	3 1/2"	Metal	5" CP	Round	6
3B	D60991	3 1/2"	Metal	5" PB	Round	6
4B	D60996	3 1/2"	Metal	5" NB	Round	6
5KK	C37810	3 1/2"	Metal	5" NB	Round	6

No Hub Drain Bodies

FITS SLOT #	PART NO.	IPS SIZE	PAN	SPUD	HEIGHT	QTY
X37	D67200	2"	7"	3 1/2"	3 3/8"	6
X6	D65102	2"	7"	3 1/2"	2 1/2"	6

Cess Pool Drain

FITS SLOT #	PART NO.	SIZE	STRAINER SIZE / MATERIAL	SPUD	HEIGHT	QTY
X18	D76703	3"	7" CI	Round	4 1/16"	4

No Caulk Drain Bodies

FITS SLOT #	PART NO.	SIZE	PAN	SPUD	HEIGHT	QTY
X1	D65002	2"	7"	3 1/2"	2 1/2"	6

Gasket Connection Base

FITS SLOT #	PART NO.	S.V. BASE x SPUD	HEIGHT	QTY
10K	D62350	4" x 3 1/2" IPS	5 1/2"	6

Accessories

FITS SLOT #	PART NO.	DESCRIPTION	QTY
-	D65103	3" NH drain base with clamp ring	6

Recommended Items For Residential Display

Display Part No. Q01002

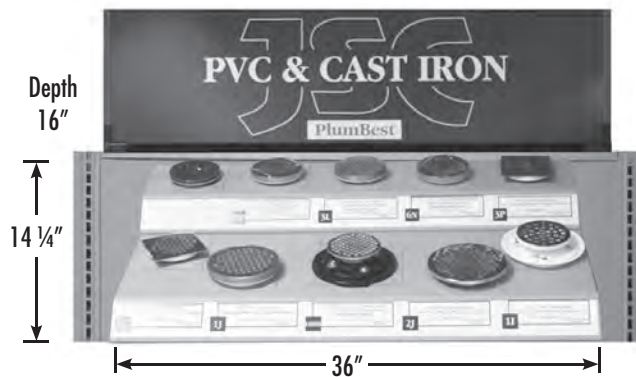

FITS SLOT #	PART NO.	IPS SIZE	SPUD MATERIAL	STRAINER/COVER SIZE / MATERIAL	STRAINER DIAMETER	QTY
2H	D60981	2"	Metal	4" CP	Round	6
3L	D60982	2"	Metal	4" PB	Round	6
2K	D50989	2"	Plastic	4" CP	Square	6
3P	D50990	2"	Plastic	4" PB	Square	6
2J	D60970	2"	Metal	6" CP	Round	6
1D	D40140	2"	Brass	SS	Round	12
10HH	D60103	2"	Cast Iron	4" SS	Round	6
1I	D50001	2" x 3"	Plastic	Bolt down 4" SS	Round	6
6N	D54022	2" x 3"	Plastic	4" CP with ring	Round	6
1J	D54112	3" x 4"	Plastic	4" PB with ring	Round	6
-	D40003	-	-	PB repl. strainer	Round	6
-	D40005	-	-	SS repl. strainer	Round	6
-	D40009	-	-	White Plastic repl. strainer	Round	6



Recommended Items For PVC Display

Display Part No. Q01000



FITS SLOT #	PART NO.	SIZE	SPUD MATERIAL	STRAINER SIZE / MATERIAL	STRAINER DIAMETER	QTY
1M	D56211		Plastic	5" SS	Round	6
2AA	D56216		Plastic	5" CP	Round	6
3S	D56212		Plastic	5" PB	Round	6
4N	D56214		Plastic	5" NB	Round	6
5FF	D59945		Plastic	5" NB	Round	6
4B	D60996		Metal	5" NB	Round	6

FITS SLOT #	PART NO.	CONNECTION SIZE	BASE MATERIAL	SPUD SIZE	PRIMER TAP	QTY
7	D52003	4"	Hub Fit	3 1/2"	-	6
8	D49804	3" x 4"	HD	3 1/2"	with 1/2" plug	10
9C	D52451	3" x 4"	Pipe Fit	3 1/2"	with 1/2" plug	12
10B	D52452	4"	Over Pipe Fit	3 1/2"	with 1/2" plug	6

Accessories

FITS SLOT #	PART NO.	DESCRIPTION	QTY
-	D49801	2" x 3" HD drain base w/ 3 1/2" spud size and primer tap	6
-	C60822	5" PB ring	6
-	C60823	5" NB ring	6
-	C60819	5" CP ring	6

Fast Five Drain Display

Display Part No. Q01555

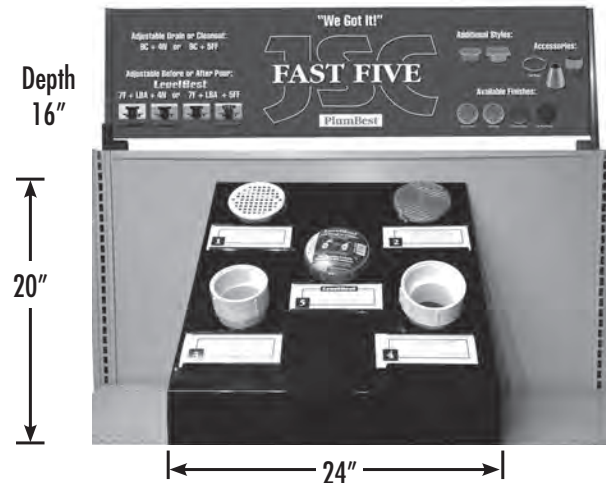

FITS SLOT #	PART NO.	SIZE	SPUD MATERIAL	STRAINER SIZE / MATERIAL	STRAINER DIAMETER	QTY
1	D56214	3-1/2"	Plastic	5" NB Strainer	Round	20
2	D59945	3-1/2"	Plastic	5" NB Cover	Round	20

FITS SLOT #	PART NO.	CONNECTION SIZE	BASE	SPUD SIZE	PRIMER TAP	QTY
3	D52451	3" x 4"	Pipe Fit	3 1/2"	with 1/2" plug	15
4	D52391	3" x 4"	Pipe Fit	4"	with 1/2" plug	10
5	D50450	4" x 3-1/2" x 5"	LevelBest Adpt.	3 1/2"	—	10
—	D49804	3" x 4"	Heavy Duty	3 1/2"	with 1/2" plug	5

Accessories

FITS SLOT #	PART NO.	DESCRIPTION	QTY
-	D60996	3-1/2" Metal spud with 5" NB Strainer	5
-	C60805	5" NB cast coverall strainer	5
-	C60503	5" NB cast cleanout cover	5
-	C60823	5" NB ring	5
-	F65400	4" Funnel	2

Floweasay Drain Opener

Display Part No. S95994

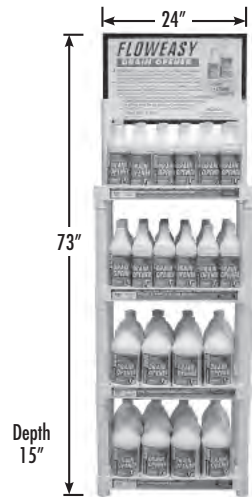

S95703 Quart



S95704 Half Gallon

PART NO.	DESCRIPTION	QTY
S95703	Floweasay Drain Opener (Quart)	72 + 12 FREE
S95704	Floweasay Drain Opener (1/2 Gallon)	24
S95900	4 Shelf White Plastic Display Rack w/Header	1

Floweasay Drain Opener

Display Part No. S95995

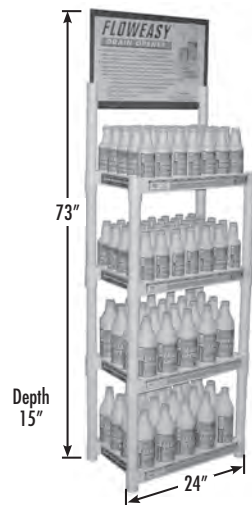

PART NO.	DESCRIPTION	QTY
S95701	Floweasay Drain Opener (Pint)	96
S95703	Floweasay Drain Opener (Quart)	48
S95900	4 Shelf White Plastic Display Rack w/Header	1

Floweasay Drain Opener

Display Part No. S95920



PART NO.	DESCRIPTION	QTY
S95701	Floweasay Drain Opener (Pint)	48 + 6 FREE
S95703	Floweasay Drain Opener (Quart)	24
S95704	Floweasay Drain Opener (1/2 Gallon)	12
S95900	White Plastic Display Rack w/Header	1



Floweasay Drain Opener (36 qt)

Display Part No. S95968



PART NO.	DESCRIPTION	QTY
S95703	Floweasay Drain Opener (Quart)	36
S95900	White Plastic Display Rack w/Header	1

Floweasay Drain Opener

Display Part No. S95999

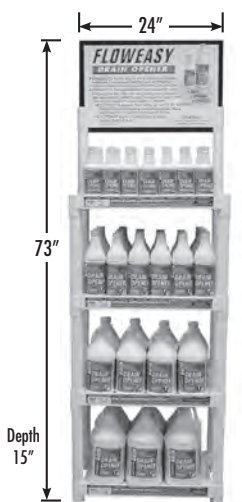

PART NO.	DESCRIPTION	QTY
S95701	Floweasay Drain Opener (Pint)	36
S95703	Floweasay Drain Opener (Quart)	24
S95704	Floweasay Drain Opener (1/2 Gallon)	12
S95705	Floweasay Drain Opener (Gallon)	8
S95900	4 Shelf White Plastic Display Rack w/Header	1

Coil Cleaner

Display Part No. Q01COIL



PART NO.	DESCRIPTION	QTY
S95721	A.C. Coil Cleaner (Quart/RTU)	24
S95722	Condenser Coil Cleaner (Gallon/Concentrate)	8
S95725	Condenser Coil Cleaner (Gallon/RTU)	8
S95900	White Plastic Display Rack w/Header	1

Wypall® Waterless Handwipes

Display Part No. B05008



B05007

PART NO.	DESCRIPTION	QTY
B05007	50-count Dispenser Tub	32

Heating & Cooling Maintenance Assort.

Display Part No. S95967



PART NO.	DESCRIPTION	QTY
S95721	AC (Inside) Coil Cleaner Ready-to-Use	12
S95722	AC (Outside) Coil Cleaner Concentrate	8
S95725	AC (Outside) Coil Cleaner Ready-to-Use	8
S95732	PlumBest Electrical Lubricant	12
S95734	Clear-A-Line Condensate Line Treatment	12
S95736	Spritz Gas Leak Detector	12
S95738	Pan-Gel Condensation Pan Tablet	12
S95900	4 Shelf White Plastic Display Rack w/Header	1



PART NO.	PG #	PART NO.	PG #	PART NO.	PG #	PART NO.	PG #
30100	355	30725	355	32012	356	35080	357
30110	355	30730	355	32013	356	36000	357
30112	355	30735	355	32025	356	36010	357
30115	355	30740	355	32030	356	36011	357
30120	355	30745	355	32035	356	36012	357
30125	355	30750	355	32040	356	36045	357
30130	355	30755	355	32045	356	36055	357
30135	355	30760	355	32050	356	36060	357
30140	355	30765	355	32055	356	36070	357
30145	355	30770	355	32060	356	36080	357
30150	355	30775	355	32065	356	36090	357
30155	355	30780	355	32070	356	40300	357
30160	355	30790	355	32075	356	40500	357
30170	355	31000	355	32080	356	40700	357
30180	355	31010	355	32090	356	41000	357
30190	355	31011	355	32500	356	41200	357
30200	355	31012	355	32510	356	41500	357
30210	355	31014	355	32511	356	42000	357
30211	355	31020	355	32512	356	50100	355
30212	355	31025	355	32514	356	50110	355
30215	355	31030	355	32518	358	50111	355
30220	355	31035	355	32520	358	50112	355
30225	355	31040	355	32524	358	50115	355
30230	355	31045	355	32530	356	50120	355
30235	355	31050	355	32535	356	50125	355
30240	355	31055	355	32540	356	50130	355
30245	355	31060	355	32545	356	50135	355
30250	355	31065	355	32550	356	50140	355
30255	355	31070	355	32555	356	50145	355
30260	355	31075	355	32560	356	50150	355
30270	355	31080	355	32565	356	50155	355
30280	355	31085	356	32570	356	50160	355
30290	355	31090	356	32580	356	50170	355
30300	355	31095	356	32590	356	50180	355
30310	355	31200	356	33000	356	50190	355
30311	355	31210	356	33010	356	50200	355
30312	355	31211	356	33011	356	50210	355
30314	355	31212	356	33012	356	50211	355
30315	355	31213	356	33018	358	50212	355
30320	355	31214	356	33030	356	50215	355
30325	355	31220	356	33035	356	50220	355
30330	355	31225	356	33040	356	50225	355
30335	355	31230	356	33045	356	50230	355
30340	355	31235	356	33050	356	50235	355
30345	355	31240	356	33055	356	50240	355
30350	355	31245	356	33060	356	50245	355
30355	355	31250	356	33070	356	50250	355
30360	355	31255	356	33080	356	50255	355
30370	355	31260	356	33090	356	50260	355
30380	355	31265	356	33500	356	50270	355
30390	355	31270	356	33540	356	50280	355
30500	355	31280	356	33550	356	50290	355
30510	355	31285	356	33555	356	50300	355
30511	355	31290	356	33580	356	50310	355
30512	355	31295	356	34000	356	50312	355
30515	355	31500	356	34010	356	50315	355
30520	355	31510	356	34011	356	50320	355
30525	355	31511	356	34012	356	50325	355
30530	355	31512	356	34014	356	50330	355
30535	355	31514	356	34024	358	50335	355
30540	355	31520	356	34035	356	50340	355
30545	355	31525	356	34040	356	50345	355
30550	355	31530	356	34045	356	50350	355
30555	355	31535	356	34050	356	50355	355
30560	355	31540	356	34055	356	50360	355
30570	355	31545	356	34060	356	50370	355
30575	355	31550	356	34070	356	50380	355
30580	355	31555	356	34080	356	50500	355
30590	355	31560	356	34090	356	50510	355
30700	355	31570	356	35000	356	50511	355
30710	355	31580	356	35045	356	50512	355
30711	355	31590	356	35050	356	50515	355
30712	355	32000	356	35055	356	50520	355
30715	355	32010	356	35060	356	50525	355
30720	355	32011	356	35070	357	50530	355

PART NO.	PG #	PART NO.	PG #	PART NO.	PG #	PART NO.	PG #
50535	355	51580	356	161010390	374	300 B0748	358
50540	355	51590	356	161050215	374	300 B0754	358
50545	355	52000	356	161050295	374	300 B0760	358
50550	355	52010	356	161050390	374	300 B0772	358
50555	355	52011	356	161570050	374	300 B1018	358
50560	355	52012	356	161570100	374	300 B1024	358
50570	355	52025	356	161570150	374	300 B1030	358
50580	355	52030	356	161570215	374	300 B1036	358
50590	355	52035	356	161570295	374	300 B1042	358
50700	355	52040	356	161570390	374	300 B1048	358
50710	355	52045	356	161570650	374	300 B1054	358
50711	355	52050	356	161650215	374	300 B1060	358
50712	355	52055	356	161650295	374	300 B1066	358
50715	355	52060	356	161650303	374	300 B1072	358
50720	355	52070	356	161650390	374	300 B1218	358
50725	355	52080	356	161650398	374	300 B1224	358
50730	355	52090	356	161650399	374	300 B1230	358
50735	355	52500	356	161650650	374	300 B1236	358
50740	355	52510	356	161650663	374	300 B1242	358
50745	355	52511	356	161650860	374	300 B1248	358
50750	355	52512	356	161650872	374	300 B1254	358
50755	355	52518	358	161720215	374	300 B1260	358
50760	355	52524	358	161720295	374	300 B1272	358
50770	355	52530	356	161720390	374	300 B1518	358
50775	355	52535	356	161720650	374	300 B1524	358
50780	355	52540	356	162350215	374	300 B1530	358
50790	355	52545	356	162350295	374	300 B1536	358
51000	355	52550	356	162350390	374	300 B1548	358
51010	355	52555	356	162420295	374	300 B1560	358
51011	355	52560	356	162420390	374	300 B1572	358
51012	355	52570	356	162540215	375	300 B2018	358
51014	355	52580	356	162540295	375	300 B2024	358
51020	355	52590	356	162540390	375	300 B2030	358
51025	355	53000	356	162900215	375	300 B2036	358
51030	355	53010	356	162900295	375	300 B2042	358
51035	355	53011	356	162900390	375	300 B2048	358
51040	355	53012	356	162900650	375	300 B2060	358
51045	355	53030	356	162950215	375	300 B2072	358
51050	355	53035	356	162950295	375	300 B2530	358
51055	355	53040	356	162950390	375	300 B2560	358
51060	355	53045	356	164100303	375	300 B3024	358
51070	355	53050	356	164100398	375	300 B3036	358
51080	355	53055	356	164100399	375	300 B4018	358
51090	356	53060	356	164100663	375	300 B4060	358
51200	356	53070	356	164100664	375	301 G0118	358
51210	356	53080	356	164600390	374	301 G0218	358
51211	356	53090	356	164600398	374	301 G0224	358
51212	356	53550	356	300 B0218	358	301 G0230	358
51215	356	54000	356	300 B0224	358	301 G0236	358
51220	356	54010	356	300 B0230	358	301 G0248	358
51225	356	54011	356	300 B0236	358	301 G0260	358
51230	356	54012	356	300 B0248	358	301 G0318	358
51235	356	54024	358	300 B0260	358	301 G0324	358
51240	356	54035	356	300 B0272	358	301 G0330	358
51245	356	54040	356	300 B0318	358	301 G0336	358
51250	356	54045	356	300 B0324	358	301 G0348	358
51255	356	54050	356	300 B0330	358	301 G0360	358
51260	356	54055	356	300 B0336	358	301 G0372	358
51270	356	54060	356	300 B0348	358	301 G0518	358
51280	356	54070	356	300 B0360	358	301 G0524	358
51290	356	54080	356	300 B0372	358	301 G0530	358
51500	356	54090	356	300 B0518	358	301 G0536	358
51510	356	56000	357	300 B0524	358	301 G0542	358
51511	356	56010	357	300 B0530	358	301 G0548	358
51512	356	56011	357	300 B0536	358	301 G0560	358
51520	356	56012	357	300 B0542	358	301 G0572	358
51525	356	56040	357	300 B0548	358	301 G0718	358
51530	356	56045	357	300 B0554	358	301 G0724	358
51535	356	56050	357	300 B0560	358	301 G0730	358
51540	356	56055	357	300 B0572	358	301 G0736	358
51545	356	56060	357	300 B0718	358	301 G0742	358
51550	356	56070	357	300 B0724	358	301 G0748	358
51555	356	56080	357	300 B0730	358	301 G0754	358
51560	356	56090	357	300 B0736	358	301 G0760	358
51570	356	161010295	374	300 B0742	358	301 G0772	358

PART NO.	PG #	PART NO.	PG #	PART NO.	PG #	PART NO.	PG #
301 G1018	358	A01036	67	AG10	357	B03001B	3
301 G1024	358	A01037	67	B00001	115	B03003	3
301 G1030	358	A01040	68	B00002	116	B03003B	3
301 G1036	358	A01041	68	B00003	115	B03004	3
301 G1042	358	A01050	67	B00004	115	B03004B	3
301 G1048	358	A01051	67	B00005	115	B03005	3
301 G1060	358	A01060	67	B00006	116	B03005B	3
301 G1072	358	A01061	67	B00007	116	B03010	64, 335
301 G1218	358	A01062	67	B00008	116	B03015	64, 335
301 G1220	358	A01900	67	B00009	116	B03400	3
301 G1224	358	A01901	67	B00010	116	B03401	3
301 G1230	358	A04006	91, 398	B00011	116	B03405	3
301 G1236	358	A04012	91	B00013	116	B03406	3
301 G1242	358	A05008	91	B00014	116	B03407	3
301 G1248	358	A05014	91, 398	B00015	116	B03408	3
301 G1260	358	A05027	91	B00016	116	B04006	193
301 G1272	358	A10001	5, 58,	B00017	116	B04007	193
301 G1518	358		397	B00018	116	B04008	193
301 G1524	358	A10002	5	B00019	116	B04150	193
301 G1530	358	A10003	5	B00020	116	B04150K	193
301 G1536	358	A10004	5	B00021	115	B04151K	193
301 G1548	358	A10005	5	B00022	115	B04200	193
301 G1560	358	A10006	5	B00023	115	B04200K	193
301 G1572	358	A10010	5	B00024	116	B04201	193
301 G2018	358	A10011	5	B00025	115	B04201K	193
301 G2024	358	A10015	5	B01002	278	B04300	193, 398
301 G2030	358	A10017	5	B01003	278	B04300K	193
301 G2036	358	A10018	5	B01004	278	B04301	193
301 G2048	358	A10019	5	B01006	278	B04301K	193
301 G2060	358	A10100	58	B01013	278	B04303	193
301 G2072	358	A10150	58	B01014	278	B04304	193
301 G3018	358	A10200	58	B01016	278	B04400	193
301 G3024	358	A10901	58	B01017	278	B04400K	193
301 G4018	358	A11001	166, 388	B01018	278	B04401	193
301 G4048	358	A11002	166	B01019	278	B04401K	193
31210TOE	357	A11003	166, 388	B01020	278	B04403	193
31212TOE	357	A11004	166, 388	B02001	3	B04404	193
605B	357	A11005	166, 388	B02003	3	B04600	193
605G	357	A11006	166	B02004	3	B05001	309
607B	357	A11007	166	B02005	3	B05002	309
607G	357	A11008	166	B02008	3	B05003	309
610B	357	A11011	166	B02049	65, 335	B05004	310
610G	357	A11016	166	B02050	3, 65,	B05007	309, 403
A01001	66	A11017	166		335, 397	B05008	309, 403
A01002	66	A33001	122	B02051	66, 333	B05010	305
A01003	66	A33002	122, 397	B02052	65, 335	B05011	305
A01004	66	A33005	122	B02060	66	B05015	305
A01005	66	A33010	122	B02100	3	B05020	305
A01006	66	A40001	270	B02101	3	B05021	305
A01007	66	A40002	270	B02102	3, 65,	B05150	193
A01008	66	A40003	270		335	B05150K	193
A01010	66	A95001	177	B02103	65, 335	B05200	193
A01011	67	A95002	177	B02301	3	B05200K	193
A01012	67	A95003	177	B02303	3	B05300	193
A01013	67	A95004	177	B02304	3	B05300K	193
A01014	67	A95005	177	B02305	3	B05400	193
A01015	67	A95006	177	B02400	3	B05400K	193
A01016	67	A95007	177	B02401	3	B05600	193
A01017	67	A95008	177	B02404	3	B05900	96
A01018	67	A95009	177	B02405	3	B05901	96
A01019	23	A95010	177	B02406	3	B05910	96
A01020	67	A95011	177	B02407	3	B05911	96
A01021	67	A95014	177	B02408	3	B05920	96
A01022	67	A97001	178	B0240BN	3	B05921	96
A01023	67	A97002	178	B0240BS	3	B05922	96
A01024	67	A97004	178	B0240PN	3	B05923	96
A01026	67	A97007	178	B0240PS	3	B05924	96
A01027	67	A97009	178	B0240RB	3	B05925	96
A01029	67	A97011	178	B0240WB	3	B05926	96
A01030	68	AB05	357	B0250BN	3	B05927	96
A01031	68	AB07	357	B0250NP	3	B05928	96
A01032	68	AB10	357	B0250RB	3	B06001	192, 273
A01033	68	AG05	357	B0250WB	3	B06010	192
A01034	68	AG07	357	B03001	3	B06100	192
A01035	68					B07001	52

PART NO.	PG #	PART NO.	PG #	PART NO.	PG #	PART NO.	PG #
B07002	52	B07114	17, 53	B0715PS	18	B0753BN	16
B07003	52	B07114S	49	B0715PW	18	B0753NP	16
B07004	52	B07115	17, 53	B0715RB	18	B0753RB	16
B07005	52	B07116	17, 53	B0715WB	18	B0753WB	16
B07006	52	B07117	17, 53	B07160	18, 53	B0754BN	17
B07007	52	B0711AB	17	B07161	18, 53	B0754NP	17
B07008	52	B0711AL	17	B0716AB	18	B0754RB	17
B07010	16, 53	B0711AN	17	B0716AL	18	B0754WB	17
B07011	16, 53	B0711BI	17	B0716AN	18	B0755BN	17
B07012	17, 53	B0711BL	17	B0716BI	18	B0755NP	17
B07013	17, 53	B0711BN	17	B0716BL	18	B0755RB	17
B07014	16, 53	B0711BS	17	B0716BN	18	B0755WB	17
B07015	16, 53	B0711NP	17	B0716BS	18	B08060	16
B07016	17, 53	B0711PN	17	B0716NP	18	B08071	54
B07017	17, 53	B0711PS	17	B0716PN	18	B0811AB	17
B07020	52	B0711PW	17	B0716PS	18	B0811AL	17
B07021	52	B0711RB	17	B0716PW	18	B0811AN	17
B07022	52	B0711WB	17	B0716RB	18	B0811BI	17
B07023	52	B07120	52	B0716WB	18	B0811BL	17
B07024	52	B07121	52	B07170	55	B0811BN	17
B07025	52	B07122	52	B07171	54	B0811BS	17
B07027	52	B07123	52	B07172	55	B0811NP	17
B07030	16, 53	B07124	52	B07173	54	B0811PN	17
B07031	16, 53	B07125	52	B0717AB	17	B0811PS	17
B07032	17, 53	B07126	52	B0717AL	17	B0811PW	17
B07033	17, 53	B07127	52	B0717AN	17	B0811RB	17
B07034	16, 53	B07130	17, 53	B0717BI	17	B0811WB	17
B07035	16, 53	B07131	17, 53	B0717BL	17	B0813AB	17
B07036	17, 53	B07132	18, 53	B0717BN	17	B0813AL	17
B07037	17, 53	B07133	18, 53	B0717BS	17	B0813AN	17
B07038	52	B07134	17, 53	B0717NP	17	B0813BI	17
B07039	52	B07135	17, 53	B0717PN	17	B0813BL	17
B07040	52	B07136	18, 53	B0717PS	17	B0813BN	17
B07041	52	B07137	18, 53	B0717PW	17	B0813NP	17
B07042	52	B07138	52	B0717RB	17	B0813PN	17
B07043	52	B07139	52	B0717WB	17	B0813PS	17
B07044	52	B0713AB	17	B0718AB	18	B0813PW	17
B07045	52	B0713AL	17	B0718AN	18	B0813RB	17
B07046	52	B0713AN	17	B0718BI	18	B0813WB	17
B07047	52	B0713BI	17	B0718BL	18	B0815AB	18
B07048	52	B0713BL	17	B0718BN	18	B0815AL	18
B07049	52	B0713BN	17	B0718NP	18	B0815AN	18
B07050	53	B0713NP	17	B0718PN	18	B0815BI	18
B07051	53	B0713PN	17	B0718PS	18	B0815BL	18
B07052	16, 53	B0713PS	17	B0718PW	18	B0815BN	18
B07053	16, 53	B0713PW	17	B0718RB	18	B0815NP	18
B07054	16, 53	B0713RB	17	B0718WB	18	B0815PN	18
B07055	16, 53	B0713WB	17	B07200	54	B0815PS	18
B07056	53	B07140	52	B07201	54	B0815PW	18
B07057	53	B07141	52	B07202	54	B0815RB	18
B07058	16, 53	B07142	52	B07203	54	B0815WB	18
B07059	16, 53	B07143	52	B07210	54	B0816AB	18
B07060	16, 53	B07144	52	B07219	49	B0816AL	18
B07061	53	B07146	52	B07220T	49	B0816AN	18
B07070	55	B07147	52	B07221T	49	B0816BI	18
B07071	54	B07148	52	B07374	54	B0816BL	18
B07072	55	B07149	52	B07375	54	B0816BN	18
B07073	54	B07150	53	B07376	54	B0816BS	18
B07074	54	B07151	53	B07377	54	B0816NP	18
B07075	54	B07152	18, 53	B07470	55	B0816PN	18
B07076	54	B07153	18, 53	B07472	55	B0816PS	18
B07077	54	B07154	18, 53	B07476	55	B0816PW	18
B07101	52	B07155	18, 53	B07477	55	B0816RB	18
B07102	52	B07156	53	B0750BN	16	B0816WB	18
B07103	52	B07157	53	B0750NP	16	B0817AB	17
B07104	52	B07158	18, 53	B0750RB	16	B0817AL	17
B07105	52	B07159	18, 53	B0750WB	16	B0817AN	17
B07106	52	B0715AB	18	B0751BN	16	B0817BI	17
B07107	52	B0715AL	18	B0751NP	16	B0817BL	17
B07108	52	B0715AN	18	B0751RB	16	B0817BN	17
B07110	17, 53	B0715BI	18	B0751WB	16	B0817BS	17
B07111	17, 53	B0715BL	18	B0752BN	16	B0817NP	17
B07111S	49	B0715BN	18	B0752NP	16	B0817PN	17
B07112	17, 53	B0715NP	18	B0752RB	16	B0817PS	17
B07113	17, 53	B0715PN	18	B0752WB	16	B0817PW	17

PART NO.	PG #	PART NO.	PG #	PART NO.	PG #	PART NO.	PG #
B0817RB	17	B12430	95	B165-0058	350	B20266	296
B0817WB	17	B12640	95	B165-0059	350	B20281	296
B0818AB	18	B144-0007	349	B165-0060	350	B20297	296
B0818AN	18	B144-0032	349	B165-0100	350	B20313	296
B0818BI	18	B144-0033	349	B165-0107	350	B20328	296
B0818BL	18	B144-0058	349	B165-0108	350	B20344	296
B0818BN	18	B144-0059	349	B165-0109	350	B20359	296
B0818NP	18	B144-0060	349	B165-0110	350	B20375	296
B0818PN	18	B144-0107	349	B165-0150	350	B20391	296
B0818PS	18	B144-0108	349	B165-0159	350	B20406	296
B0818PW	18	B144-0109	349	B165-0160	350	B20422	296
B0818RB	18	B144-0110	349	B165-0161	350	B20438	296
B0818WB	18	B144-0159	349	B165-0162	350	B20453	296
B0850BN	16	B144-0160	349	B165-0215	350	B20469	296
B0850NP	16	B144-0161	349	B165-0222	350	B20484	296
B0850RB	16	B144-0162	349	B165-0223	350	B20500	296
B0850WB	16	B144-0222	349	B165-0224	350	B21075	295
B0851BN	16	B144-0223	349	B165-0295	350	B21087	295
B0851NP	16	B144-0224	349	B165-0303	350	B21100	295
B0851RB	16	B144-0225	349	B165-0304	350	B21112	295
B0851WB	16	B144-0226	349	B165-0305	350	B21125	295
B0852BN	16	B144-0303	349	B165-0306	350	B21150	295
B0852NP	16	B144-0304	349	B165-0307	350	B21625	295
B0852RB	16	B144-0305	349	B165-0390	350	B235-0001	351
B0852WB	16	B144-0306	349	B165-0398	350	B235-0002	351
B0853BN	16	B144-0307	349	B165-0399	350	B235-0007	351
B0853NP	16	B144-0308	349	B165-0400	350	B235-0025	351
B0853RB	16	B144-0398	349	B165-0401	350	B235-0032	351
B0853WB	16	B144-0399	349	B165-0402	350	B235-0050	351
B0854BN	17	B144-0400	349	B165-0520	350	B235-0058	351
B0854NP	17	B144-0401	349	B165-0531	350	B235-0059	351
B0854RB	17	B144-0402	349	B165-0532	350	B235-0060	351
B0854WB	17	B144-0403	349	B165-0533	350	B235-0100	351
B0855BN	17	B144-0531	349	B165-0534	350	B235-0107	351
B0855NP	17	B144-0532	349	B165-0535	350	B235-0108	351
B0855RB	17	B144-0533	349	B165-0650	350	B235-0109	351
B0855WB	17	B144-0534	349	B165-0662	350	B235-0150	351
B10004	288	B144-0535	349	B165-0663	350	B235-0159	351
B10080	58	B144-0536	349	B165-0664	350	B235-0160	351
B10081	58	B144-0662	349	B165-0665	350	B235-0161	351
B10090	58	B144-0663	349	B165-0666	350	B235-0215	351
B10091	58	B144-0664	349	B165-0667	350	B235-0222	351
B10092	58	B144-0665	349	B165-0860	350	B235-0223	351
B10093	58	B144-0666	349	B165-0870	350	B235-0224	351
B10094	58	B144-0667	349	B165-0871	350	B235-0295	351
B10100	59, 388	B144-0668	349	B165-0872	350	B235-0303	351
B10102	59, 388	B144-0790	349	B165-0873	350	B235-0304	351
B10103	59, 388	B144-0870	349	B165-0875	350	B235-0305	351
B10104	59, 388	B144-0871	349	B165-1100	350	B235-0306	351
B10105	59, 388	B144-0872	349	B165-1109	350	B235-0390	351
B10110	58	B144-0873	349	B165-1111	350	B235-0398	351
B10111	58	B144-0875	349	B195-0001	350	B235-0399	351
B10195	57	B144-1109	349	B195-0002	350	B235-0400	351
B10200	62	B144-1111	349	B195-0025	350	B235-0401	351
B10201	62, 397	B155-0001	349	B195-0050	350	B235-0402	351
B10202	62	B155-0002	349	B195-0100	350	B235-0520	351
B10203	62	B155-0025	349	B195-0150	350	B235-0531	351
B1020AB	4	B155-0050	349	B195-0215	350	B235-0532	351
B1020AL	4	B155-0100	349	B195-0295	350	B235-0533	351
B1020AN	4	B155-0150	349	B195-0390	350	B235-0534	351
B1020BI	4	B155-0215	349	B195-0520	350	B235-0535	351
B1020BL	4	B155-0295	349	B195-0650	350	B235-0536	351
B1020BN	4	B155-0390	349	B20062	296	B235-0650	351
B1020NP	4	B155-0520	349	B20078	296	B235-0662	351
B1020PN	4	B155-0650	349	B20094	296	B235-0663	351
B1020PS	4	B155-0860	349	B20109	296	B235-0860	351
B1020PW	4	B155-0975	349	B20125	296	B235-0870	351
B1020RB	4	B155-1100	349	B20141	296	B235-0871	351
B1020WB	4	B165-0001	350	B20156	296	B235-0872	351
B11010	284	B165-0002	350	B20172	296	B235-0975	351
B11011	284, 384	B165-0007	350	B20188	296	B235-1100	351
B11012	284	B165-0025	350	B20203	296	B24050	295
B11013	284	B165-0032	350	B20219	296	B24056	295
B12210	95	B165-0033	350	B20234	296	B24063	295
B12320	95	B165-0050	350	B20250	296	B24075	295

PART NO	PAGE	PART NO	PAGE	PART NO	PAGE	PART NO.	PG #
PART NO.	PG #	PART NO.	PG #	PART NO.	PG #		
B24081	295	B29702	308	B45217	77	B460-0342	353
B24088	295	B29801	308	B45218	77	B460-0343	353
B24100	295	B29802	308	B45220	77	B460-0350	353
B24113	295	B29875	288	B460-0001	353	B460-0351	353
B24125	295	B29900	308	B460-0002	353	B460-0352	353
B24150	295	B29999	288	B460-0007	353	B460-0353	353
B24375	295	B335-0050	349	B460-0025	353	B460-0354	354
B25001	310	B335-0100	349	B460-0032	353	B460-0390	353
B254-0001	351	B335-0150	349	B460-0050	353	B460-0397	354
B254-0002	351	B335-0215	349	B460-0056	353	B460-0398	354
B254-0025	351	B335-0295	349	B460-0057	353	B460-0399	354
B254-0050	351	B335-0390	349	B460-0058	353	B460-0400	354
B254-0100	351	B355-0001	352	B460-0059	353	B460-0401	354
B254-0150	351	B355-0002	352	B460-0100	353	B460-0402	354
B254-0215	351	B355-0025	352	B460-0106	353	B460-0403	354
B254-0295	351	B355-0050	352	B460-0107	353	B460-0413	354
B254-0390	351	B355-0100	352	B460-0108	353	B460-0414	354
B254-0520	351	B355-0150	352	B460-0109	353	B460-0415	354
B254-0650	351	B355-0215	352	B460-0116	353	B460-0416	354
B254-0860	351	B355-0295	352	B460-0117	353	B460-0417	354
B28025	288	B355-0390	352	B460-0118	353	B460-0418	354
B28050	288	B396-0001	352	B460-0150	353	B460-0429	354
B28051	288	B396-0002	352	B460-0156	353	B460-0430	354
B28075	288	B396-0025	352	B460-0157	353	B460-0431	354
B28076	288	B396-0050	352	B460-0158	353	B460-0432	354
B28100	288	B396-0100	352	B460-0159	353	B460-0444	354
B28125	288	B396-0150	352	B460-0160	353	B460-0447	354
B28150	288	B396-0215	352	B460-0161	353	B460-0457	354
B28200	288	B396-0295	352	B460-0162	353	B460-0461	354
B28375	288	B396-0390	352	B460-0169	353	B460-0470	354
B290-0001	352	B396-0520	352	B460-0170	353	B460-0520	353
B290-0002	352	B396-0650	352	B460-0171	353	B460-0531	354
B290-0025	352	B396-0860	352	B460-0180	353	B460-0532	354
B290-0050	352	B396-1100	352	B460-0181	353	B460-0533	354
B290-0100	352	B40000	61	B460-0182	353	B460-0534	354
B290-0150	352	B40001	62	B460-0215	353	B460-0535	354
B290-0215	352	B40002	62	B460-0220	353	B460-0536	354
B290-0295	352	B40003	62	B460-0221	353	B460-0548	354
B290-0390	352	B40004	62	B460-0222	353	B460-0549	354
B290-0520	352	B40005	62	B460-0223	353	B460-0650	353
B290-0650	352	B40006	62	B460-0224	353	B460-0662	354
B290-0860	352	B40007	62	B460-0225	353	B460-0663	354
B290-0975	352	B40008	62	B460-0233	353	B460-0664	354
B290-1100	352	B40009	62	B460-0234	353	B460-0665	354
B29025	288	B40010	62	B460-0235	353	B460-0666	354
B29050	288	B40011	62	B460-0236	353	B460-0667	354
B29051	288	B40012	62	B460-0237	353	B460-0668	354
B29075	288	B40013	62	B460-0245	353	B460-0860	353
B29076	288	B40014	62	B460-0246	353	B460-0870	354
B29100	288	B40015	62	B460-0247	353	B460-0871	354
B29125	288	B40017	62	B460-0248	353	B460-0872	354
B29150	288	B40018	62	B460-0256	353	B460-0873	354
B29200	288	B40019	62	B460-0257	353	B460-0874	354
B29300	307	B40020	62	B460-0258	353	B460-0875	354
B29310	307	B40021	62	B460-0259	353	B460-0975	353
B29375	288	B40023	62	B460-0295	353	B460-1100	353
B29400	308	B40024	62	B460-0302	353	B486-0050	354
B295-0001	352	B40025	62	B460-0303	353	B486-0100	354
B295-0002	352	B40026	62	B460-0304	353	B486-0150	354
B295-0025	352	B40027	62	B460-0305	353	B486-0215	354
B295-0050	352	B40028	62	B460-0306	353	B486-0295	354
B295-0100	352	B40030	62	B460-0307	353	B49001	47
B295-0150	352	B40031	62	B460-0315	353	B49002	47
B295-0215	352	B40032	62	B460-0316	353	B49010	47
B295-0295	352	B40033	62	B460-0317	353	B49011	47
B295-0390	352	B40034	62	B460-0318	353	B49012	47
B295-0520	352	B40035	62	B460-0319	353	B49013	47
B295-0650	352	B40036	62	B460-0328	353	B49020	7, 46
B295-0860	352	B45010	62	B460-0329	353	B49021	7, 46
B29625	288	B45014	62	B460-0330	353	B49022	7, 46
B29699	308	B45200	77	B460-0331	353	B50001	154, 388
B29700	308	B45215	77	B460-0339	353	B50002	154, 388
B29701	308	B45216	77	B460-0340	353	B50002LF	154
						B50003	154
						B50003LF	154

PART NO.	PG #	PART NO.	PG #	PART NO.	PG #	PART NO.	PG #
B50004	154	B5112RB	13	B60099	274	B67211	168
B50011	154	B5112WB	13	B60100	169	B67212	168
B50011LF	154	B5114AP	13	B60125	169	B67213	168
B50012	154	B5114BB	13	B60150	169	B67214	168
B50012LF	154	B5114BN	13	B60200	169	B67215	168
B50013	154	B5114NP	13	B60250	169	B67216	168
B50013LF	154	B5114PB	13	B60300	169	B67217	168
B50014	154	B5114PN	13	B60375	169	B67218	168
B50031	154, 388	B5114PS	13	B60400	169	B67219	168
B50032	154, 388	B5114RB	13	B60610	169	B67312	168
B50032LF	154	B5114WB	13	B60650	169	B67313	168
B50033	154	B5155AB	13	B60675	169	B67315	168
B50033LF	154	B5155AL	13	B60710	169	B67316	168
B50034	154	B5155AN	13	B60750	169	B67317	168
B50041	155, 388	B5155AP	13	B60775	169	B67375	167
B50042	155, 388	B5155BB	13	B60950	171	B67937	167
B50042LF	155	B5155BI	13	B60975	171	B67975	167
B50043	155	B5155BL	13	B60994	274	B68001	167
B50043LF	155	B5155BN	13	B61050	169	B68050	167
B50044	155	B5155BS	13	B61075	169	B68058	167
B50044LF	155	B5155NP	13	B61100	169	B68375	167
B50051	155	B5155PS	13	B61125	169	B69050	167
B50052	155	B5155PW	13	B61150	169	B69121	167
B50052LF	155	B5155RB	13	B61200	169	B70001	4
B50072	155	B5155WB	13	B63050	139	B70003	4
B50073	155	B5156AP	13	B63075	139	B70004	4
B50073LF	155	B5156BB	13	B63100	139	B70006	4
B50074	155	B5156BN	13	B64050	167	B70007	4
B50075	155	B5156NP	13	B64075	167	B70008	4
B50081	155	B5156PS	13	B64100	167	B70009	4
B50082	155	B5156RB	13	B64125	167	B70012	4
B50082LF	155	B5156WB	13	B64150	167	B70013	4
B50083	155	B5160AP	12	B64200	167	B70014	4
B50083LF	155	B5160BB	12	B64375	167	B70017	4
B50084	155	B5160BN	12	B64450	167	B70020	4
B50091	155	B5160BS	12	B64475	167	B70499	192, 273
B50092	155	B5160NP	12	B65050	167	B74001	149, 394
B50092LF	155	B5160PN	12	B65075	167	B74002	149, 394
B50093	154	B5160PS	12	B65100	167	B74002LF	149
B50094	154	B5160RB	12	B65375	167	B74003	149, 394
B50094LF	154	B5160WB	12	B657-0001	354	B74003LF	149
B50095	155	B5161AP	12	B657-0002	354	B74004	149, 394
B50096	155	B5161BB	12	B657-0025	354	B74004LF	149
B50096LF	155	B5161BN	12	B657-0050	354	B74005	149, 394
B50097	155	B5161NP	12	B657-0100	354	B74005LF	149
B50097LF	155	B5161PS	12	B657-0150	354	B74006	149, 394
B50098	154	B5161RB	12	B657-0215	354	B74006LF	149
B50098LF	154	B5161WB	12	B657-0295	354	B74007	149
B50099	155	B55000	61	B657-0390	354	B74008	149
B50099LF	155	B55001	61	B657-0520	354	B74008LF	149
B50100	155	B55002	61	B657-0650	354	B74009	149
B50101	155	B55003	61	B657-0860	354	B74009LF	149
B50103	154	B55004	61, 333	B66050	167	B74010	149
B51001	12	B55005	61, 333	B66075	167	B74011	149
B51002	12	B55006	61, 333	B66100	167	B74012	149
B51003	12	B55007	61, 333	B66375	167	B74021	149
B51004	13	B55008	61	B67050	167	B74022	149
B51005	13, 54	B55009	61	B67100	168	B74023	149, 394
B51006	54	B55050	61	B67101	168	B74024	149, 394
B51007	13, 54	B55100	61	B67102	168	B74024LF	149
B51008	54	B55101	61	B67103	168	B74025	149
B51009	54	B55103	61	B67104	168	B74025LF	149
B51010	12, 54	B55104	61	B67105	168	B74026	149
B51011	54	B55150	47	B67106	168	B74026LF	149
B51014	13, 54	B59000	171	B67200	168	B74027	149
B51015	13, 54	B59001	170	B67201	168	B74028	149
B51019	12, 54	B59002	170	B67202	168	B74029	149
B51020	12, 54	B59050	171	B67203	168	B74030	149
B5112AP	13	B59075	171	B67204	168	B74031	149
B5112BB	13	B59100	171	B67205	168	B74032	149
B5112BI	13	B60001	46	B67206	168	B74041	149
B5112BN	13	B60002	46	B67207	168	B74042	149
B5112BS	13	B60025	169	B67208	168	B74043	149
B5112NP	13	B60050	169	B67209	168	B74044	149
B5112PW	13	B60075	169	B67210	168	B74044LF	149

PART NO.	PG #	PART NO.	PG #	PART NO.	PG #	PART NO.	PG #
B74045	149	B74144	151	B74220LF	153	B74328	152
B74045LF	149	B74144LF	151	B74221	153	B74329	152
B74046	149	B74145	151	B74222	153	B74330	152
B74046LF	149	B74145LF	151	B74222LF	153	B74331	152
B74047	149	B74146	151	B74223	153	B74331LF	152
B74048	149	B74147	151	B74223LF	153	B74332	152
B74049	149	B74148	151	B74224	153	B74340	149
B74050	149	B74148LF	151	B74224LF	153	B74341	149
B74051	149	B74149	151	B74225	153	B74341LF	149
B74052	149	B74150	151	B74226	153	B74342	149
B74061	150	B74150LF	151	B74227	153	B74343	149
B74062	150	B74151	151	B74228	153	B74344	149
B74063	150	B74152	151	B74228LF	153	B74344LF	149
B74064	150	B74152LF	151	B74229	153	B74345	149
B74065	150	B74153	151	B74229LF	153	B74345LF	149
B74066	150	B74153LF	151	B74230	153	B74346	149
B74067	150	B74154	151	B74231	153	B74347	149
B74067LF	150	B74154LF	151	B74231LF	153	B74348	149
B74068	150	B74155	151	B74232	153	B74354	150
B74069	150	B74156	151	B74232LF	153	B74354LF	150
B74081	150	B74157	151	B74233	153	B74355	150
B74082	150, 394	B74158	151	B74234	153	B74356	150
B74082LF	150	B74159	151	B74235	153	B74357	150
B74083	150, 394	B74160	151	B74235LF	153	B74358	150
B74083LF	150	B74161	151	B74261	150	B74358LF	150
B74084	150, 394	B74161LF	151	B74262	150	B74359	150
B74084LF	150	B74162	151	B74263	150	B74359LF	150
B74085	150, 394	B74163	151	B74264	150	B74360	150
B74085LF	150	B74164	151	B74264LF	150	B74361	150
B74086	150, 394	B74181	151	B74265	150	B74362	150
B74086LF	150	B74182	151	B74265LF	150	B74363	150
B74087	150	B74183	151	B74266	150	B74364	150
B74087LF	150	B74183LF	151	B74266LF	150	B74365	150
B74088	150	B74184	151, 394	B74267	150	B74365LF	150
B74088LF	150	B74184LF	151	B74267LF	150	B74366	150
B74089	150	B74185	151, 394	B74268	150	B74367	150
B74090	150	B74185LF	151	B74269	150	B74367LF	150
B74090LF	150	B74186	151, 394	B74269LF	150	B74368	150
B74091	150	B74186LF	151	B74270	150	B74368LF	150
B74092	150	B74187	151	B74271	150	B74369	150
B74101	152	B74188	151	B74272	150	B74369LF	150
B74102	152	B74189	151	B74284	152, 394	B74370	152
B74103	152	B74190	151	B74284LF	152	B74380	151
B74104	152	B74191	151	B74285	152, 394	B74381	151
B74105	152	B74192	151	B74285LF	152	B74382	151
B74106	152	B74200	153	B74286	152, 394	B74383	151
B74107	152	B74201	153	B74286LF	152	B74384	151
B74107LF	152	B74202	153	B74287	152	B74385	151
B74108	152	B74203	153	B74288	152	B74386	149
B74108LF	152	B74203LF	153	B74289	152	B74387	149
B74109	152	B74204	153	B74290	152	B74388	149
B74121	151	B74204LF	153	B74291	152	B74389	149
B74122	151	B74205	153	B74292	152	B74390	149
B74123	151, 394	B74205LF	153	B74301	152	B74391	149
B74123LF	151	B74206	153	B74302	152	B74392	150
B74124	151, 394	B74207	153	B74303	152	B74393	150
B74124LF	151	B74207LF	153	B74304	152	B74394	150
B74125	151, 394	B74208	153	B74304LF	152	B74395LF	150
B74125LF	151	B74209	153	B74305	152	B74397	150
B74126	151, 394	B74209LF	153	B74305LF	152	B74400	152
B74126LF	151	B74210	153	B74306	152	B90050	169
B74127	151	B74211	153	B74306LF	152	B90075	169
B74127LF	151	B74212	153, 394	B74307	152	B90100	169
B74128	151	B74212LF	153	B74308	152	B90125	169
B74128LF	151	B74213	153, 394	B74309	152	B90150	169
B74129	151	B74213LF	153	B74310	152	B90200	169
B74129LF	151	B74214	153	B74311	152	B90250	169
B74130	151	B74215	153	B74312	152	B90300	169
B74131	151	B74216	153	B74321	152	B90400	169
B74132	151	B74217	153	B74322	152	B91050	169
B74132LF	151	B74217LF	153	B74323	152	B91075	169
B74140	151	B74218	153	B74324	152	B91100	169
B74141	151	B74218LF	153	B74325	152	B91125	169
B74142	151	B74219	153	B74326	152	B91150	169
B74143	151	B74220	153	B74327	152		

PART NO.	PG #	PART NO.	PG #	PART NO.	PG #	PART NO.	PG #
B91200	169	C02034	39	C02995	41	C05052	36
B91250	169	C02034B	40	C02996	41	C05053	36
B91300	169	C02040	41	C02997	41	C05054	36
B91400	169	C02041	41	C02998	41	C05056	36
B92050	169	C02045	41	C02999	41	C05057	36
B92075	169	C02046	41	C03200	41	C05070	37, 397
B95150	170	C02050	38	C03201	41	C05071	37
B95200	170	C02075	42	C03202	41	C05080	58, 388
BI05	357	C02100	41	C03203	41	C05081	58, 388
BI07	357	C02103	41	C03210	41	C05082	58
BI10	357	C02104	41	C03211	41	C05200	37
BI12	357	C02105	41	C03212	41	C06001	5
BI15	357	C02106	41	C03213	41	C06002	5
BI20	357	C02200	41	C03240	41	C06004	4
BIN004	128	C02201	41	C03250	41	C06005	4
BIN005	128	C02202	41	C03251	41	C06006	4
BIN008	128	C02203	41	C03252	41	C06007	4
BIN012	128	C02210	41	C03253	41	C06008	4
BO718AL	18	C02211	41	C03260	42	C06011	4
BO818AL	18	C02300	41	C03265	42	C06013	4
BOX006	128	C02301	41	C03270	42	C06014	4
BOX008	128	C02302	41	C03271	42	C06016	4
BOX011	128	C02303	41	C03272	42	C06017	4
BOX012	128	C02310	41	C03280	42	C06018	4
BWV200	193	C02311	41	C03300	42	C06020	5
BWV300	193	C02401	39	C03301	42	C06021	5
BWV400	193	C02402	39	C03302	42	C06024	5
C01001	251	C02403	39	C03303	42	C09000	120
C01002	251	C02404	39	C03304	42	C09001	120
C02000	39	C02405	39	C03305	42	C09002	120
C02000B	40	C02421	39	C03306	42	C09003	121
C02001	39	C02422	39	C03800	42	C11050	91, 397
C02001B	40	C02423	39	C03801	42	C11075	91, 397
C02002	39	C02424	39	C03803	42	C11100	91, 397
C02002B	40	C02800	40	C03804	42	C11125	91
C02003	39	C02801	40	C03805	42	C11150	91
C02003B	40	C02802	40	C03807	42	C11200	91
C02004	39	C02803	40	C03810	42	C11250	91
C02004B	40	C02804	40	C04000	34	C11300	91
C02005	39	C02805	40	C04001	34	C11400	91
C02005B	40	C02807	40	C04002	34	C12050	92, 397
C02010	39	C02808	40	C04004	34, 397	C12075	92, 397
C02010B	40	C02809	40	C04005	34	C12100	92, 397
C02011	39, 397	C02810	40	C04006	34	C12125	92
C02011B	40	C02811	40	C04007	34	C12150	92
C02012	39	C02812	40	C04008	34	C12200	92
C02012B	40	C02813	40	C04010	34	C12250	92
C02013	39	C02814	40	C04011	34	C12300	92
C02013B	40	C02815	40	C04013	35	C12400	92
C02014	39	C02820	40	C04014	34	C12600	92
C02014B	40	C02821	40	C04015	35	C13050	92
C02015	39	C02822	40	C04016	35	C13075	92
C02015B	40	C02823	40	C04017	35	C14050	91
C02020	39	C02824	40	C04019	33	C14075	91
C02020B	40	C02825	40	C04020	33	C14100	91
C02021	39	C02830	40	C04021	33	C14205	91
C02021B	40	C02832	40	C04024	34	C14206	91
C02022	39	C02850	40	C04025	34	C14207	91
C02022B	40	C02851	40	C04027	35	C15050	91, 397
C02023	39	C02852	40, 42	C04028	34	C15075	91, 397
C02023B	40	C02853	40	C04029	34	C15100	91
C02024	39	C02860	40	C04030	33	C15125	91
C02024B	40	C02861	40	C04031	33	C15150	91
C02025	39	C02862	40	C04032	35	C15151	91
C02025B	40	C02863	40	C04033	35	C15200	91
C02029	39	C02864	40	C04034	35	C15201	91
C02029B	40	C02865	40	C05040	34	C15300	91
C02030	39	C02900	40	C05041	34	C15301	91
C02030B	40	C02901	40	C05042	36	C15302	91
C02031	39	C02987	41	C05045	36	C15303	91
C02031B	40	C02989	41	C05046	36	C15304	91
C02032	39	C02990	39	C05047	36	C15305	91
C02032B	40	C02992	41	C05048	36	C15306	91
C02033	39	C02993	41	C05049	36	C15307	91
C02033B	40	C02994	41	C05051	36	C16050	92

PART NO.	PG #	PART NO.	PG #	PART NO.	PG #	PART NO.	PG #
C16075	92	C33046	269	C38005	268	C47320	250
C17050	92	C33088	270	C38006	268	C4733A	181
C17075	92	C33121	269	C38014	268	C4733P	181
C17100	92	C33122	269	C38102	268	C47340	250
C17125	92	C33123	269	C38103	268	C47420	250
C17150	92	C33144	269	C38104	268	C47430	250
C17200	92	C33145	269	C38114	268	C4743A	181
C19050	92	C33146	269	C38202	268	C4743P	181, 396,
C19051	92	C33221	270	C38203	268		398
C19075	92	C33222	270	C38204	268	C47440	250
C25000	100	C33223	270	C38205	268	C47460	250
C25001	100	C33231	270	C38206	268	C49421	251
C25002	100	C33232	270	C38214	268	C49440	251
C25003	100	C33233	270	C38402	268	C49441	251
C25010	100	C33244	270	C38403	268	C49442	251
C25011	100	C33245	270	C38404	268	C50300	180
C25012	100	C33246	270	C38502	268	C50301	180
C25013	100	C33321	270	C38503	268	C50302	181
C25020	100	C33322	270	C38504	268	C50303	181
C25021	100	C33323	270	C39002	268	C50304	181
C25022	100	C33331	270	C39003	268	C50305	181
C27125	35, 397	C33332	270	C39004	268	C50306	181
C27126	35	C33333	270	C39005	268	C50307	181
C27127	35	C33344	270	C39006	268	C50308	181
C27134	35, 397	C33345	270	C39014	268	C50309	181
C27150	35, 397	C33346	270	C39102	268	C50340	180, 398
C27150A	35	C33444	270	C39103	268	C50341	180
C27200	35	C33445	270	C39104	268	C50400	180
C27201	35	C33446	270	C39114	268	C51150	182
C27202	35	C33544	270	C39202	268	C51300	180
C27301	35	C33545	270	C39203	268	C51301	180
C27302	35	C33546	270	C39204	268	C51302	183
C27303	35	C35090	300	C39205	268	C51303	183
C27304	35	C35091	300	C39206	268	C51340	180, 396,
C27305	35	C36003	268	C39214	268		398
C27308	35	C36004	268	C39402	268	C51341	180
C27309	35	C36006	268	C39403	268	C51350	180
C27310	35	C36013	268	C39404	268	C51351	180
C27321	35	C36014	268	C39502	268	C51400	180
C27322	35	C36016	268	C39503	268	C51401	180
C27323	35	C36024	268	C39504	268	C51402	183
C27324	35	C36034	268	C40002	269	C51403	183
C27325	35	C36104	268	C40003	269	C51450	180
C27328	35	C36106	268	C40004	269	C51451	180
C29123	121	C36114	268	C40006	269	C52150	182
C29124	121	C36116	268	C40102	268	C52340	180
C29126	121	C36124	268	C40103	268	C52341	180
C29150	121	C36134	268	C40104	268	C52342	181
C29200	121	C37002	263	C40320	250	C52343	181
C30050	170	C37003	263	C40420	250, 396	C52400	180
C30075	170	C37004	263	C40425	250	C52401	180
C30100	170	C37005	263	C40430	250	C52402	181
C30125	170	C37006	263	C40440	250	C52403	181
C30150	170	C37014	263	C40500	250	C53340	180, 396
C30200	170	C37102	263	C40503	250	C53341	180
C31050	170	C37103	263	C40640	251	C53342	181, 396
C31075	170	C37104	263	C41410	250	C53343	181
C31100	170	C37302	263	C41411	250	C53400	180
C31125	170	C37303	263	C41420	250	C53401	180
C31150	170	C37304	263	C41421	250	C53402	181
C31200	170	C37314	263	C41430	250	C53403	181
C33001	270	C37800	237, 264	C41440	250	C53600	181
C33002	270	C37801	237, 264	C41460	250	C53601	181
C33003	270	C37803	237, 264	C42421	250	C53700	181
C33004	270	C37805	238, 264	C42440	250	C53701	181
C33005	270	C37806	238, 264	C42460	250	C54150	181
C33006	270	C37807	238, 264	C43440	251	C54340	182
C33021	269	C37808	238, 264	C43441	251	C54341	182
C33022	269	C37810	237, 264,	C44420	251	C54342	182
C33023	269		399	C44440	251	C54343	182
C33031	269	C37811	237, 264	C45433	250	C54400	182
C33032	269	C38002	268	C46331	250	C54401	182
C33033	269	C38003	268	C46351	250	C54402	181, 396
C33044	269	C38004	268	C46431	250	C54403	181
C33045	269			C46451	250		

PART NO.	PG #	PART NO.	PG #	PART NO.	PG #	PART NO.	PG #
C55043	182	C59098	244	C60053	241	C60803	22, 204
C55143	182	C59099	244	C60054	243	C60804	22, 204
C56100	124	C59100	244	C60055	243	C60805	204, 400
C57034	180, 398	C59101	244	C60056	243	C60806	21, 204
C57040	180	C59102	244	C60057	243	C60807	22, 204
C57134	180, 398	C59103	244	C60060	235	C60808	204
C57140	180	C59200	239	C60061	235	C60809	204, 398
C57234	180	C59201	239	C60062	235	C60810	21, 204, 398
C57236	180	C59202	239	C60063	235	C60811	204
C57334	180	C59203	239	C60064	235	C60812	204
C57434	180	C59204	239	C60065	235	C60813	22, 204
C58034	180	C59205	239	C60066	235	C60814	21, 204
C58040	180	C59206	239	C60067	235	C60817	204
C58134	180	C59207	239	C60070	242	C60818	204
C58140	180	C59208	241	C60071	242	C60819	204, 400
C58234	180	C59209	241	C60072	242	C60820	204
C58236	180	C59210	241	C60073	242	C60821	204
C58334	180	C59211	241	C60074	242	C60822	204, 400
C58434	180	C59212	241	C60075	242	C60823	204, 400
C59001	239	C59213	241	C60076	242	C60824	204
C59002	239	C59214	241	C60077	242	C60825	204
C59003	239	C59215	241	C60078	242	C6083BN	22
C59004	239	C59216	240	C60079	242	C6083NP	22
C59005	239	C59217	240	C60080	242	C6083RB	22
C59006	239	C59218	240	C60081	242	C6083WB	22
C59007	239	C59219	240	C60082	242	C6084BN	22
C59008	239	C59220	240	C60083	242	C6084NP	22
C59010	240	C59221	240	C60084	243	C6084RB	22
C59011	240	C59222	240	C60085	243	C6084WB	22
C59012	240	C59223	240	C60086	243	C6087BN	22
C59013	240	C59240	197	C60087	243	C6087NP	22
C59014	240	C59241	197	C60088	243	C6087RB	22
C59015	240	C59242	196	C60089	243	C6087WB	22
C59016	240	C59243	196	C60092	242	C6089AB	21
C59017	240	C59244	196	C60094	242	C6089AL	21
C59020	243	C59245	196	C60095	242	C6089AN	21
C59021	243	C59250	196	C60096	242	C6089BI	21
C59022	243	C59251	196	C60097	242	C6089BL	21
C59023	243	C60001	241	C60106	234	C6089BN	21
C59024	243	C60003	241	C60107	234	C6089NP	21
C59025	243	C60007	234, 398	C60108	234	C6089PN	21
C59026	243	C60008	234, 398	C60112	234	C6089PS	21
C59027	243	C60009	234	C60116	234	C6089PW	21
C59028	243	C60010	234	C60117	234	C6089RB	21
C59029	243	C60011	234	C60118	234	C6089WB	21
C59030	243	C60012	234	C60140	235	C61009	235
C59031	243	C60013	236	C60141	235	C61023	234, 398
C59050	239	C60014	236	C60142	235	C61034	234, 398
C59051	239	C60015	236	C60143	235	C61123	234
C59052	239	C60016	236	C60144	235	C61134	234
C59053	239	C60020	241	C60145	235	C61223	234
C59054	240	C60021	241	C60146	235	C61234	234
C59055	240	C60022	241	C60147	235	C61432	234
C59056	240	C60023	241	C60160	235	C61434	234
C59057	240	C60024	241	C60161	235	C67230	194
C59060	239	C60025	241	C60162	235	C67340	194
C59061	239	C60026	242	C60163	235	C67440	194
C59062	239	C60027	242	C60164	235	C67445	194
C59063	239	C60028	242	C60165	235	C67450	236
C59064	241	C60029	242	C60166	235	C67451	236
C59065	241	C60030	242	C60167	235	C72002	272
C59066	241	C60031	242	C60170	198	C72003	272
C59067	241	C60032	242	C60171	198	C72004	272
C59068	240	C60033	242	C60172	198	C72093	272
C59069	240	C60040	235	C60207	234	C73003	272
C59070	240	C60041	235	C60211	234	C73004	272
C59071	240	C60042	235	C60500	204	C73093	272
C59090	244	C60043	235	C60501	204	C73094	272
C59091	244	C60044	235	C60502	204	C73192	272
C59092	244	C60045	235	C60503	204, 400	C73193	272
C59093	244	C60046	235	C60504	204	C74001	131
C59094	244	C60047	235	C60505	204	C74002	131, 388
C59095	244	C60050	241	C60800	204	C74003	131
C59096	244	C60051	241	C60801	204		
C59097	244	C60052	241	C60802	204		

PART NO.	PG #	PART NO.	PG #	PART NO.	PG #	PART NO.	PG #
C74004	131	C74051	132, 391	C74089LF	133	C74156	132
C74005	131, 391, 392	C74051LF	132	C74090	133	C74157	132
C74006	131	C74052	132, 391, 392	C74091	132	C74158	133
C74007	131, 391, 392	C74052LF	132	C74092	132	C75000	363
C74008	131, 391, 392	C74053	132, 391	C74093	132, 388	C75001	363
C74009	131, 391, 392	C74053LF	132	C74094	133, 388	C75002	363
C74010	131	C74054	132, 391	C74095	133	C75003	363
C74011	131, 388	C74054LF	132	C74096	131, 388, 392	C75004	363
C74012	131	C74055	132, 391	C74097	131, 388, 392	C75005	363
C74013	131	C74055LF	132	C74098	131, 388, 392	C75006	363
C74014	131, 391	C74056	132	C74099	131, 388	C75007	363
C74015	131	C74057	132	C74100	131, 388, 392	C75008	363
C74016	131, 391, 392	C74058	132, 391, 392	C74101	131, 388, 392	C75009	363
C74017	131, 391, 392	C74058LF	132	C74102	131, 388, 392	C75010	363
C74018	131, 391	C74059	132, 391, 392	C74103	131, 388	C75011	363
C74019	131	C74059LF	132	C74104	131	C75012	363
C74020	131, 388	C74060	132, 391	C74105	60, 322	C75013	363
C74021	131	C74060LF	132	C74106	131	C75014	364
C74022	131, 392	C74061	132	C74107	131	C75015	364
C74023	131, 391	C74062	132	C74108	131	C75016	364
C74023LF	131	C74063	132	C74109	132	C75017	364
C74024	131	C74064	132, 391, 392	C74110	132	C75018	364
C74025	131, 391, 392	C74064LF	132	C74111	132	C75019	364
C74025LF	131	C74065	132, 391, 392	C74112	132	C75020	364
C74026	131, 391, 392	C74065LF	132	C74113	132	C75021	364
C74026LF	131	C74066	132, 391, 392	C74114	132	C75022	364
C74027	131, 391, 392	C74066LF	132	C74115	132	C75023	364
C74027LF	131	C74067	132	C74116	132	C75024	364
C74028	131	C74068	132	C74117	132	C75025	364
C74029	131, 391	C74069	132, 391, 392	C74118	132	C75026	364
C74029LF	131	C74069LF	132	C74119	132	C75027	364
C74030	131, 391	C74070	132, 391, 392	C74120	132	C75028	364
C74030LF	131	C74070LF	132	C74121	132	C75029	364
C74031	131, 391	C74071	132, 391	C74122	132	C75030	364
C74031LF	131	C74071LF	132	C74123	132	C75031	364
C74032	131, 391	C74072	132, 391	C74124	132	C75033	364
C74032LF	131	C74072LF	132	C74125	132	C75034	364
C74033	131	C74073	132, 391	C74126	132	C75035	364
C74034	131, 391	C74073LF	132	C74127	133	C75036	364
C74034LF	131	C74074	133	C74128	133	C75037	364
C74035	131	C74075	133	C74129	133	C75038	364
C74036	131, 391	C74076	133	C74130	133	C75039	365
C74036LF	131	C74077	133	C74131	133	C75040	365
C74037	131	C74078	133	C74132	133	C75041	365
C74038	131, 391	C74079	133	C74133	133	C75042	365
C74038LF	131	C74080	133	C74134	133	C75043	365
C74039	131	C74081	133, 391, 392	C74135	133	C75044	365
C74039LF	131	C74081LF	133	C74136	133	C75045	365
C74040	132	C74082	133, 391, 392	C74137	133	C75046	365
C74041	132, 391	C74082LF	133	C74138	133	C75047	365
C74041LF	132	C74083	133	C74139	133	C75048	365
C74042	132	C74084	133	C74140	133	C75049	365
C74042LF	132	C74085	133, 391, 392	C74141	133	C75050	365
C74043	132, 391	C74085LF	133	C74142	133	C75051	365
C74043LF	132	C74086	133, 391, 392	C74143	133	C75052	365
C74044	132, 391	C74086LF	133	C74144	133	C75053	365
C74044LF	132	C74087	133, 391	C74145	131	C75055	364
C74045	132	C74087LF	133	C74146	132	C75056	364
C74046	132	C74088	133, 391	C74147	131	C75057	364
C74047	132	C74088LF	133	C74148	133	C75058	364
C74048	132	C74089	133, 391	C74149	132	C75059	364
C74049	132			C74150	132	C75060	364
C74050	132, 391			C74151	131	C75061	364
C74050LF	132			C74152	131	C75062	364
				C74153	131	C75063	364
				C74154	131	C75064	364
				C74155	131	C75065	364
						C75066	364
						C75067	364
						C75068	364
						C75069	363
						C75070	363
						C75071	363
						C75072	363
						C75073	363
						C75074	363

PART NO.	PG #	PART NO.	PG #	PART NO.	PG #	PART NO.	PG #
C75075	363	C75150	368	C75233	368	C75314	362
C75076	363	C75151	368	C75234	368	C75315	362
C75077	363	C75152	368	C75235	368	C75316	362
C75078	363	C75153	368	C75236	368	C75317	362
C75079	363	C75154	369	C75237	368	C75318	362
C75080	363	C75155	369	C75238	368	C75319	362
C75081	363	C75156	369	C75239	368	C75320	362
C75082	363	C75157	369	C75240	368	C75321	362
C75083	363	C75158	369	C75242	368	C75322	362
C75084	363	C75160	368	C75243	368	C75323	362
C75085	363	C75161	368	C75244	368	C75324	362
C75086	363	C75162	368	C75245	368	C75325	362
C75087	363	C75163	368	C75246	368	C75326	362
C75088	363	C75166	368	C75247	368	C75327	362
C75089	363	C75167	368	C75248	368	C75329	362
C75090	363	C75168	368	C75249	368	C75330	362
C75091	363	C75169	368	C75250	368	C75331	362
C75092	363	C75170	368	C75251	368	C75332	362
C75093	363	C75171	368	C75252	368	C75334	362
C75094	363	C75173	368	C75253	368	C75335	362
C75095	363	C75174	368	C75254	368	C75336	362
C75096	363	C75175	368	C75255	368	C75337	362
C75097	363	C75176	368	C75256	368	C75338	362
C75098	363	C75177	368	C75257	368	C75339	362
C75099	363	C75178	368	C75258	368	C75340	362
C75100	363	C75181	368	C75259	368	C75341	362
C75101	363	C75182	368	C75260	368	C75342	362
C75102	363	C75183	368	C75261	369	C75343	362
C75103	363	C75184	368	C75262	369	C75345	362
C75104	363	C75185	368	C75263	369	C75346	362
C75105	363	C75186	368	C75264	369	C75347	362
C75106	363	C75188	368	C75265	369	C75348	362
C75107	363	C75189	368	C75266	369	C75349	362
C75108	363	C75190	368	C75267	369	C75350	362
C75109	363	C75191	368	C75268	369	C75352	362
C75110	363	C75192	368	C75269	369	C75353	362
C75111	362	C75193	368	C75270	369	C75354	362
C75112	362	C75194	368	C75271	369	C75355	362
C75113	362	C75195	368	C75272	369	C75356	362
C75114	362	C75196	368	C75273	369	C75357	362
C75115	362	C75197	368	C75274	369	C75358	362
C75116	362	C75198	368	C75275	369	C75359	362
C75117	362	C75199	368	C75276	369	C75360	366
C75118	362	C75200	368	C75277	369	C75361	366
C75119	362	C75202	368	C75281	369	C75362	366
C75120	362	C75203	368	C75282	369	C75363	366
C75121	362	C75204	368	C75283	369	C75366	366
C75122	362	C75205	368	C75285	369	C75367	366
C75123	362	C75206	368	C75286	369	C75368	366
C75124	362	C75207	368	C75288	369	C75370	366
C75125	362	C75208	368	C75289	369	C75371	366
C75126	362	C75209	368	C75290	369	C75372	366
C75127	362	C75210	368	C75291	369	C75373	366
C75128	362	C75211	368	C75292	369	C75374	366
C75129	362	C75212	368	C75293	369	C75377	365
C75130	362	C75213	368	C75294	369	C75378	365
C75131	362	C75214	368	C75295	369	C75379	365
C75132	362	C75215	368	C75296	369	C75380	365
C75133	362	C75216	368	C75297	369	C75381	365
C75134	362	C75217	368	C75298	369	C75382	365
C75135	362	C75218	368	C75299	369	C75383	365
C75136	362	C75219	368	C75300	369	C75384	365
C75137	362	C75220	368	C75301	369	C75385	365
C75138	362	C75221	368	C75302	369	C75386	365
C75139	362	C75222	368	C75303	369	C75387	365
C75140	362	C75223	368	C75304	369	C75388	365
C75141	362	C75224	368	C75305	369	C75392	363
C75142	362	C75225	368	C75306	369	C75394	363
C75143	368	C75226	368	C75307	369	C75395	363
C75144	368	C75227	368	C75308	369	C75396	363
C75145	368	C75228	368	C75309	369	C75397	363
C75146	368	C75229	368	C75310	369	C75398	363
C75147	368	C75230	368	C75311	362	C75399	363
C75148	368	C75231	368	C75312	362	C75400	363
C75149	368	C75232	368	C75313	362	C75401	363

PART NO.	PG #	PART NO.	PG #	PART NO.	PG #	PART NO.	PG #
C75403	365	C75483	365	C76014	139	C76513	141
C75404	365	C75484	365	C76015	139	C76513LF	142
C75405	365	C75485	365	C76016	139	C76514	141
C75406	365	C75486	365	C76017	139	C76514LF	142
C75407	365	C75487	365	C76018	139	C76515	141
C75408	365	C75488	365	C76019	139	C76515LF	142
C75409	365	C75489	365	C76020	139	C76516	141
C75410	365	C75490	365	C76021	139	C76516LF	142
C75411	365	C75491	365	C76022	139	C76520	141, 142
C75412	364	C75492	365	C76023	139	C76521	141, 142
C75413	364	C75494	362	C76024	139	C76522	141, 142
C75414	364	C75500	367	C76025	139	C76530	141
C75415	364	C75501	367	C76027	139	C76531	141
C75416	364	C75502	367	C76028	139	C76532	141
C75417	364	C75503	367	C76029	139	C76550	141
C75418	364	C75504	367	C76030	139	C76551	141
C75419	364	C75505	367	C76034	139	C76553	141
C75420	364	C75506	367	C76035	139	C76554	141
C75421	364	C75507	367	C76036	139	C76555	141
C75422	364	C75508	367	C76037	139	C76556	141
C75423	364	C75509	367	C76038	139	C76557	141
C75424	364	C75516	363	C76041	139	C76558	141
C75425	367	C75517	363	C76042	139	C76561	141
C75427	367	C75519	364	C76043	139	C76562	141
C75428	367	C75520	364	C76044	139	C76563	141
C75429	367	C75522	364	C76047	139	C76570	141
C75430	367	C75523	364	C76048	139	C76571	141
C75431	367	C75525	366	C76049	139	C76605	109
C75432	367	C75527	366	C76050	139	C76606	109
C75433	367	C75531	365	C76051	139	C76607	109
C75434	367	C75535	365	C76055	139	C76608	109
C75435	367	C75536	365	C76056	139	C76612	109
C75437	367	C75537	365	C76057	139	C76613	109
C75438	367	C75540	365	C76060	139	C76614	109
C75439	367	C75544	365	C76061	139	C76615	109
C75440	367	C75546	365	C76065	140	C76616	109
C75441	367	C75550	364	C76066	140	C76617	109
C75442	367	C75551	364	C76067	140	C76700	140
C75443	367	C75553	364	C76070	140	C76701	140
C75444	367	C75554	364	C76071	140	C76702	140
C75445	367	C75555	364	C76072	140	C76703	140
C75446	367	C75556	364	C76073	140	C76704	140
C75447	367	C75557	364	C76074	140	C76705	140
C75448	367	C75558	364	C76075	140	C76706	140
C75449	367	C75559	364	C76076	140	C76707	140
C75450	367	C75562	367	C76077	140	C76708	140
C75451	367	C75563	367	C76079	140	C76709	140
C75452	367	C75564	364	C76080	140	C76710	140
C75453	367	C75565	364	C76081	140	C76711	140
C75454	367	C75566	363	C76500	141	C76712	140
C75455	367	C75568	366	C76500LF	142	C76720	140
C75456	367	C75570	368	C76501	141	C76722	140
C75457	367	C75571	368	C76501LF	142	C76723	140
C75458	367	C75572	368	C76502	141	C76727	140
C75459	367	C75573	369	C76502LF	142	C76740	140
C75460	367	C75574	369	C76503	141	C76741	140
C75461	367	C75575	369	C76503LF	142	C76800	143
C75462	367	C75576	369	C76504	141	C76801	143
C75463	366	C75577	369	C76504LF	142	C76802	143
C75464	366	C75578	369	C76505	141	C76803	143
C75465	366	C75579	369	C76505LF	142	C76804	143
C75466	366	C75580	364	C76506	141	C76805	143
C75467	366	C75581	364	C76506LF	142	C76806	143
C75468	366	C75582	364	C76507	141	C76807	143
C75469	366	C75583	364	C76507LF	142	C76808	143
C75470	366	C75586	364	C76508	141	C76809	143
C75471	366	C76001	139	C76508LF	142	C76810	143
C75472	366	C76002	139	C76509	141	C76811	143
C75473	366	C76003	139	C76509LF	142	C76812	143
C75474	366	C76004	139	C76510	141	C76813	143
C75477	363	C76005	139	C76510LF	142	C76814	144
C75478	363	C76008	139	C76511	141	C76815	144
C75479	365	C76009	139	C76511LF	142	C76816	144
C75481	365	C76010	139	C76512	141	C76817	144
C75482	365	C76013	139	C76512LF	142	C76818	144

PART NO.	PG #	PART NO.	PG #	PART NO.	PG #	PART NO.	PG #
C76819	144	C85000	183, 251,	C93500	266	D01025	11, 47
C76820	144		383, 385,	C94004	267	D01026	11, 48
C76821	144		396	C94005	267	D01027	11, 48
C76822	144	C85500	251	C94007	267	D01028	48
C76823	144	C87100	183, 251,	C94009	267	D01029	48
C76824	144		396, 397	C95004	267	D01030	11, 47
C76825	144	C88001	183, 396,	C95005	267	D01031	11, 47
C76826	144		398	C95007	267	D01032	11, 48
C76827	144	C88002	183	C95009	267	D01035	48
C76828	144	C88050	183	C96004	267	D01040	47
C76829	144	C88500	183	C96005	267	D01041	47
C76830	144	C88500C	183	C96007	267	D01042	47
C76831	144	C88501	183	C96009	267	D01050	11
C76832	144	C88502	183	C97004	267	D01050BN	11
C76833	144	C88501	183	C97005	267	D01050RB	11
C76834	144	C88600	183	C97007	267	D01050WB	11
C76835	144	C89500	183	C97009	267	D02001	120
C76836	144	C89600	183	C98001	120, 267	D02002	58, 120
C76837	144	C90002	267	C98002	120, 267	D03001	10
C76838	144	C90004	267	C98014	267	D03002	10
C76839	144	C90006	267	C98016	267	D03004	10
C76840	145	C90013	267	C98018	267	D03010	10
C76841	145	C90014	267	CB05	357	D03011	10
C76842	145	C90015	267	CB07	357	D03015	10
C76843	145	C90016	267	CB10	357	D03016	10
C76844	145	C90017	267	CB12	357	D03020	10
C76845	145	C90018	267	CB15	357	D04001	98
C76846	145	C90019	267	CB2001	39	D04002	98
C76847	145	C90300	267	CB2002	39	D04003	98
C76848	145	C90400	267	CB2003	39	D04004	98
C76849	145	C90500	267	CB2004	39	D04005	97
C76850	145	C90600	267, 397	CB2005	39	D04008	97
C76851	145	C90700	267	CB2011	39	D04009	97
C76852	145	C90800	267	CB2012	39	D04010	97
C76853	145	C90999	267	CB2013	39	D04012	97
C76854	145	C91013	267	CB2014	39	D04013	98
C76855	145	C91014	267	CB2015	39	D04014	98
C76856	145	C91015	267	CB2021	39	D04015	98
C76857	145	C91016	267	CB2022	39	D04016	98
C76858	145	C91017	267	CB2023	39	D04017	98
C76859	145	C91018	267	CB2024	39	D04018	98
C76860	145	C91019	267	CB2025	39	D04019	98
C76861	145	C91300	267	CB2030	39	D04020	98
C76862	145	C91400	267	CB2031	39	D04021	98
C76863	146	C91500	267	CB2032	39	D04022	98
C76864	146	C91600	267	CB2033	39	D04023	97
C76865	146	C91700	267	CB2034	39	D04024	97
C76866	146	C91800	267	CB2040	41	D04025	97
C76867	146	C91999	267	CB2041	41	D04026	97
C76868	146	C92150	266	CB2045	41	D04027	98
C76869	146	C92151	266	CB2046	41	D04028	98
C76870	146	C92200	266	CG05	357	D04031	98
C76871	146	C92202	266	CG07	357	D04032	98
C76872	146	C92250	266	CG10	357	D04033	98
C76873	146	C92252	266	CG12	357	D04034	98
C76874	146	C92300	266	CJ1002	99	D04035	98
C76875	146	C92301	266	CJ1003	38	D04036	98
C76876	146	C92303	266	D01001	47, 397	D04050	98
C76877	146	C92350	266	D01002	47	D04051	98
C76878	146	C92351	266	D01003	47	D04053	98
C76879	146	C92353	266	D01004	47, 397	D04054	98
C76880	146	C92400	266	D01005	48	D04055	98
C76881	146	C92404	266	D01008	47	D04056	98
C76882	146	C92500	266	D01009	47	D04057	98
C76883	146	C92600	266	D01010	11, 47	D04058	98
C76884	146	C92601	266	D01011	11, 47	D04059	98
C76885	146	C92800	266	D01015	11, 47	D04060	98
C76886	146	C93150	266	D01016	11, 48	D04062	98
C76887	146	C93200	266	D01017	11, 48	D04064	97
C76888	146	C93250	266	D01018	11, 48	D06005	108
C76889	146	C93300	266	D01020	11, 48	D06050	108, 397
C76890	146	C93301	266	D01021	11, 48	D06075	108, 397
C76891	146	C93350	266	D01022	48	D06100	108
C76892	146	C93351	266	D01023	48	D06125	108
C76893	146	C93400	266	D01024	11, 47	D06150	108

PART NO.	PG #	PART NO.	PG #	PART NO.	PG #	PART NO.	PG #
D06200	108	D40101	187, 396,	D45000	65	D49087	220
D06250	108		398	D45001	65	D49088	220
D06300	108	D40102	272	D45002	273	D49089	220
D06350	108	D40103	272	D49001	218	D49090	220
D06400	108	D40104	272	D49002	218	D49095	220
D06450	109	D40140	187, 396,	D49003	218	D49096	220
D06500	109		398, 399	D49004	218	D49097	220
D06510	109	D40150	272	D49005	218	D49098	220
D06525	109	D40151	187	D49006	218	D49101	215
D06550	109	D40200	272	D49007	218	D49102	215
D06600	109	D40201	187	D49008	218	D49103	215
D06650	109	D40202	272	D49009	218	D49104	215
D06700	109	D40203	272	D49010	218	D49105	215
D06750	108	D40204	272	D49011	218	D49106	215
D06753	109, 397	D40240	187	D49012	218	D49107	215
D06755	108	D40401	187	D49013	218	D49108	215
D06800	109	D40440	187	D49014	218	D49109	215
D06801	109	D40600	192, 396,	D49019	218	D49110	215
D06802	109		398	D49020	218	D49111	215
D06803	109	D40601	192, 396,	D49021	218	D49112	215
D06804	109		398	D49022	218	D49113	215
D06805	109	D40602	192	D49023	218	D49114	215
D06850	109	D40700	192	D49024	218	D49119	215
D06875	109	D40701	192	D49025	218	D49120	215
D06900	109	D40702	192	D49026	218	D49121	215
D06901	109	D41001	187, 396,	D49027	218	D49122	215
D06902	109		398	D49028	218	D49123	216
D06903	109	D41002	187	D49029	218	D49124	216
D08001	96	D41003	187	D49030	218	D49125	216
D10001	96, 397	D41004	187	D49031	218	D49126	216
D10625	96	D41007	187	D49032	218	D49127	216
D10875	96	D41008	187	D49033	218	D49128	216
D10900	97	D41009	187, 396	D49034	218	D49129	216
D18000	95	D41101	22, 187	D49035	218	D4912BN	21
D18001	94	D41102	22, 187,	D49036	218	D4912NP	21
D18002	94		398	D49037	219	D4912RB	21
D18034	94	D41103	187	D49038	219	D4912WB	21
D18060	94	D41104	187	D49039	219	D49130	216
D18062	66	D41105	187	D49040	219	D49131	216
D18063	66	D41106	187	D49041	219	D49132	216
D18186	94	D41107	22, 187	D49042	219	D49133	216
D18190	302	D4110BN	22	D49043	219	D49134	216
D18340	94	D4110NP	22	D49044	219	D49135	216
D18400	94	D4110RB	22	D49045	219	D49136	216
D18401	94	D4110WB	22	D49046	219	D49137	216
D18402	94	D41301	187	D49047	219	D49138	216
D18501	94	D41302	187	D49048	219	D49139	216
D18560	94	D41303	187	D49049	219	D49140	216
D18750	94	D41307	187	D49050	219	D49141	216
D18850	94	D41600	187, 398	D49051	219	D49142	216
D28003	278	D41601	187	D49052	219	D49143	216
D28004	278	D42002	190	D49053	219	D49144	216
D40000	50, 255	D42003	190	D49054	219	D49145	216
D40001	50, 255	D42004	190	D49055	21, 219	D49146	216
D40002	50, 255	D42006	191	D49056	219	D49147	216
D40003	21, 187,	D42006H	192, 396	D49057	21, 219	D49148	216
	396, 398,	D42007	191	D49058	219	D49149	216
	399	D42007H	192	D49059	21, 219	D49150	216
D40004	21, 187	D42008	191	D49060	219	D49151	217
D40005	21, 187,	D42008H	192	D49061	219	D49152	217
	396, 399	D42009	191	D49062	219	D49153	217
D40006	187	D42009H	192	D49063	219	D49154	217
D40007	187	D42010	191	D49064	219	D49155	21, 217
D40008	187	D42010H	192	D49065	219	D49156	217
D40009	187, 399	D42011	191	D49066	219	D49157	21, 217
D40010	21, 187	D42012	191	D49077	220	D49158	217
D40020	191	D42013	191	D49078	220	D49159	21, 217
D40021	191	D42014	191	D49079	220	D49160	217
D40023	191	D42015	191	D49080	220	D49161	217
D4005BN	21	D42019	191	D49081	220	D49162	217
D4005NP	21	D42022	190	D49082	220	D49163	217
D4005RB	21	D42023	190	D49083	220	D49164	217
D4005WB	21	D42024	190	D49084	220	D49165	217
		D42029	191	D49085	220	D49166	217
				D49086	220	D49177	217

PART NO.	PG #	PART NO.	PG #	PART NO.	PG #	PART NO.	PG #
D49178	217	D49263	214	D49358	227	D49453	224
D49179	217	D49264	214	D49359	227	D49454	224
D49180	217	D49265	214	D49360	227	D49455	224
D49181	217	D49266	214	D49361	227	D49456	224
D49182	217	D49277	215	D49362	227	D49457	224
D49183	217	D49278	215	D49363	227	D49458	224
D49184	217	D49279	215	D49364	227	D49459	224
D49185	217	D49280	215	D49365	227	D49460	224
D49186	217	D49281	215	D49366	227	D49461	224
D49187	217	D49282	215	D49377	227	D49462	224
D49188	217	D49283	215	D49378	227	D49463	224
D49189	217	D49284	215	D49379	227	D49464	224
D49190	217	D49285	215	D49380	227	D49465	224
D49195	217	D49286	215	D49381	227	D49466	224
D49196	217	D49287	215	D49382	227	D49467	224
D49197	217	D49288	215	D49383	227	D49468	224
D49198	217	D49289	215	D49384	227	D49469	224
D49201	213	D49290	215	D49385	227	D49470	224
D49202	213	D49295	215	D49386	227	D49471	224
D49203	213	D49296	215	D49387	227	D49472	224
D49204	213	D49297	215	D49388	227	D49473	224
D49205	213	D49298	215	D49389	227	D49474	224
D49206	213	D49301	225	D49390	227	D49475	224
D49207	213	D49302	225	D49395	227	D49476	224
D49208	213	D49303	225	D49396	227	D49477	225
D49209	213	D49304	225	D49397	227	D49478	225
D49210	213	D49305	225	D49398	227	D49479	225
D49211	213	D49306	225	D49401	223	D49480	225
D49212	213	D49307	225	D49402	223	D49481	225
D49213	213	D49308	225	D49403	223	D49482	225
D49214	213	D49309	225	D49404	223	D49483	225
D49219	213	D49310	225	D49405	223	D49484	225
D49220	213	D49311	225	D49406	223	D49485	225
D49221	213	D49312	225	D49407	223	D49486	225
D49222	213	D49313	225	D49408	223	D49487	225
D49223	213	D49314	225	D49409	223	D49488	225
D49224	213	D49319	225	D49410	223	D49489	225
D49225	213	D49320	225	D49411	223	D49490	225
D49226	213	D49321	225	D49412	223	D49495	225
D49227	213	D49322	225	D49413	223	D49496	225
D49228	213	D49323	226	D49414	223	D49497	225
D49229	213	D49324	226	D49419	223	D49498	225
D49230	213	D49325	226	D49420	223	D49501	220
D49231	213	D49326	226	D49421	223	D49502	220
D49232	213	D49327	226	D49422	223	D49503	220
D49233	213	D49328	226	D49423	223	D49504	220
D49234	213	D49329	226	D49424	223	D49505	220
D49235	213	D49330	226	D49425	223	D49506	220
D49236	213	D49331	226	D49426	223	D49507	220
D49237	214	D49332	226	D49427	223	D49508	220
D49238	214	D49333	226	D49428	223	D49509	220
D49239	214	D49334	226	D49429	223	D49510	220
D49240	214	D49335	226	D49430	223	D49511	220
D49241	214	D49336	226	D49431	223	D49512	220
D49242	214	D49337	226	D49432	223	D49513	220
D49243	214	D49338	226	D49433	223	D49514	220
D49244	214	D49339	226	D49434	223	D49519	220
D49245	214	D49340	226	D49435	223	D49520	220
D49246	214	D49341	226	D49436	223	D49521	220
D49247	214	D49342	226	D49437	224	D49522	220
D49248	214	D49343	226	D49438	224	D49523	221
D49249	214	D49344	226	D49439	224	D49524	221
D49250	214	D49345	226	D49440	224	D49525	221
D49251	214	D49346	226	D49441	224	D49526	221
D49252	214	D49347	226	D49442	224	D49527	221
D49253	214	D49348	226	D49443	224	D49528	221
D49254	214	D49349	226	D49444	224	D49529	221
D49255	214	D49350	226	D49445	224	D49530	221
D49256	214	D49351	227	D49446	224	D49531	221
D49257	214	D49352	227	D49447	224	D49532	221
D49258	214	D49353	227	D49448	224	D49533	221
D49259	214	D49354	227	D49449	224	D49534	221
D49260	214	D49355	227	D49450	224	D49535	221
D49261	214	D49356	227	D49451	224	D49536	221
D49262	214	D49357	227	D49452	224	D49537	221

PART NO.	PG #	PART NO.	PG #	PART NO.	PG #	PART NO.	PG #
D49538	221	D49804	199, 400	D5001NP	20	D50182	190
D49539	221	D49805	199	D5001RB	20	D50183	190
D49540	221	D49806	199	D5001WB	20	D50184	190
D49541	221	D49807	199	D50022	229	D50185	190
D49542	221	D49808	199	D50023	229	D50186	190
D49543	221	D49810	199	D50027	229	D50187	190
D49544	221	D49811	199	D50028	229	D50188	190
D49545	221	D49812	199	D50037	228	D50200	192
D49546	221	D49813	199	D50038	230	D50201	192
D49547	221	D49814	199	D50039	231	D50202	192
D49548	221	D49815	199	D50040	228	D50203	192
D49549	221	D49816	199	D50041	230	D50204	192
D49550	221	D49817	199	D50042	231	D50205	192
D49551	222	D49818	199	D50044	228	D50206	192
D49552	222	D49820	189	D50045	230	D50207	192
D49553	222	D49821	189	D50046	231	D50208	192
D49554	222	D49822	189	D50047	228	D50213	192
D49555	222	D49823	189	D50048	230	D50220	192
D49556	222	D49824	189	D50049	231	D50221	192
D49557	222	D49825	189	D50050	228	D50278	228
D49558	222	D49826	189	D50051	230	D50279	230
D49559	222	D49827	189, 398	D50052	231	D50280	231
D49560	222	D49828	189	D50053	228	D50301	185
D49561	222	D49829	189	D50054	230	D50302	185
D49562	222	D49830	189	D50055	231	D50310	185
D49563	222	D49831	189	D50060	229	D50311	185
D49564	222	D4984BN	21	D50061	230	D50330	185
D49565	222	D4984NP	21	D50062	232	D50331	185
D49566	222	D4984RB	21	D50063	229	D50332	185
D49577	222	D4984WB	21	D50064	230	D50333	185
D49578	222	D49850	200	D50065	232	D50334	185
D49579	222	D49851	200	D50066	229	D50335	185
D49580	222	D49852	200	D50067	231	D50340	232
D49581	222	D49853	200	D50068	232	D50341	232
D49582	222	D49854	200	D50069	229	D50342	232
D49583	222	D49855	200	D50070	231	D50343	232
D49584	222	D49856	200	D50071	232	D50344	232
D49585	222	D49857	200	D50072	229	D50345	232
D49586	222	D49858	200	D50073	231	D50346	232
D49587	222	D49860	200	D50074	232	D50349	232
D49588	222	D49861	200	D50075	229	D50350	232
D49589	222	D49862	200	D50076	231	D50351	233
D49590	222	D49863	200	D50077	232	D50352	233
D49595	222	D49864	200	D50089	190	D50353	233
D49596	222	D49865	200	D50090	190	D50354	233
D49597	222	D49866	200	D50091	190	D50355	233
D49598	222	D49867	200	D50092	190	D50356	233
D49640	197	D49868	200	D50093	190	D50357	233
D49641	197	D4991BN	21	D50094	190	D50360	233
D49642	197	D4991NP	21	D50095	190, 275	D50361	233
D49643	197	D4991RB	21	D50101	185	D50362	233
D49644	197	D4991WB	21	D50102	185	D50363	233
D49645	197	D49924	189	D50111	20, 185	D50364	233
D49646	197	D4996BN	21	D50120	185	D50365	233
D49647	197	D4996NP	21	D50121	185	D50366	233
D49648	197	D4996RB	21	D50122	185	D50367	233
D49649	197	D4996WB	21	D50123	185	D50368	233
D49650	197	D50000	310	D50124	185	D50371	233
D49651	197	D50001	185, 396,	D50125	186	D50372	233
D49652	197		398, 399	D50126	186	D50377	190
D49653	197	D50002	185	D50130	185	D50378	190
D49654	197	D50004	230	D50131	185	D50379	190
D49655	197	D50005	230	D50132	185	D50380	190
D49656	197	D50006	230	D50133	185	D50381	190
D49657	197	D50007	232	D50134	185	D50382	190
D49658	197	D50008	232	D50135	185	D50383	190
D49659	197	D50010	185	D50152	185	D50384	190
D49660	197	D50011	185	D50153	185	D50385	190
D49661	197	D50012	230	D50161	185	D50386	190
D49662	197	D50013	230	D50162	185	D50387	190
D49663	197	D50014	230	D50177	190	D50388	190
D49800	199	D50015	232	D50178	190	D50389	190
D49801	199, 400	D50016	232	D50179	190	D50390	190
D49802	199	D5001BN	20	D50180	190	D50391	190
D49803	199			D50181	190	D50392	190

PART NO.	PG #	PART NO.	PG #	PART NO.	PG #	PART NO.	PG #
D50393	190	D5087RB	20	D51072	229	D52463	199
D50394	190	D5087WB	20	D51073	231	D52500	199
D50401	185	D50887	20	D51074	232	D53001	212
D50402	185	D50888	20	D51075	229	D53002	212
D50411	185	D5088BN	20	D51076	231	D53003	212
D50448	196	D5088RB	20	D51077	232	D53004	212
D50449	196	D5088WB	20	D51278	228	D53005	212
D50450	196, 400	D50904	190	D51279	230	D53006	212
D50451	196	D50905	190	D51280	231	D53008	212
D50452	196	D50906	190	D51340	232	D53009	212
D50453	196	D50907	190	D51341	232	D53011	212
D50454	196	D50908	190	D51342	232	D53012	212
D50460	196	D50909	190	D51343	232	D53014	212
D50461	196	D50910	190	D51344	232	D53015	212
D50462	196	D50911	190	D51345	232	D53017	212
D50463	196	D50942	20	D51346	232	D53018	212
D50464	196	D5094BN	20	D51349	232	D53020	205
D50465	196	D5094RB	20	D51350	232	D53021	205
D50469	196	D5094WB	20	D51351	233	D53022	205
D50470	196	D50980	201	D51352	233	D53023	205
D50471	196	D50982	201	D51353	233	D53024	205
D50472	196	D50983	201	D51354	233	D53025	205
D50473	196	D50984	201	D51355	233	D53026	206
D50474	196	D50985	201	D51356	233	D53027	206
D50477	197	D50986	201	D51357	233	D53028	206
D50479	197	D50987	201	D51360	233	D53029	206
D50480	196	D50988	201	D51361	233	D53030	206
D50481	196	D50989	203	D51362	233	D53031	206
D50482	196	D50990	203, 399	D51363	233	D53032	206
D50486	196	D50998	185	D51364	233	D53033	206
D50500	186	D50PLP	185	D51365	233	D53034	206
D50501	186	D51004	230	D51366	233	D53035	206
D50502	186	D51005	230	D51367	233	D53036	206
D50510	186	D51006	230	D51368	233	D53037	206
D50511	186	D51007	232	D51371	233	D53040	207
D50520	196	D51008	232	D51372	233	D53041	207
D50521	196	D51012	230	D52003	199, 400	D53042	207
D50522	196	D51013	230	D52004	199	D53043	207
D50523	196	D51014	230	D52005	199	D53044	207
D50524	196	D51015	232	D52012	199	D53045	207
D50525	196	D51016	232	D52013	199	D53046	207
D50526	196	D51022	229	D52014	199	D53047	207
D50600	192	D51023	229	D52016	199	D53048	207
D50601	192	D51027	229	D52017	199	D53049	207
D50682	190	D51028	229	D52023	199	D53050	207
D50683	190	D51037	228	D52103	199	D53051	207
D50700	186	D51038	230	D52104	199	D53052	207
D50701	186	D51039	231	D52105	199	D53053	207
D50702	186	D51040	228	D52112	199	D53054	207
D50703	186	D51041	230	D52120	199	D53055	207
D50704	186	D51042	231	D52123	199	D53056	207
D50705	186	D51044	228	D52202	200	D53057	207
D50706	186	D51045	230	D52203	200	D53058	212
D50707	186	D51046	231	D52204	200	D53059	212
D50708	186	D51047	228	D52205	200	D53060	212
D50709	186	D51048	230	D52206	200	D53061	212
D50710	186	D51049	231	D52207	200	D53062	212
D50711	186	D51050	228	D52216	200	D53063	212
D50712	186	D51051	230	D52217	200	D53064	212
D50713	186	D51052	231	D52302	200	D53065	212
D50714	186	D51053	228	D52303	200	D53066	212
D50715	186	D51054	230	D52304	200	D53067	212
D50720	186	D51055	231	D52305	200	D53068	212
D50721	186	D51060	229	D52306	200	D53069	212
D50722	186	D51061	230	D52307	200	D53070	212
D50723	186	D51062	232	D52316	200	D53071	212
D50724	186	D51063	229	D52317	200	D53072	205
D50725	186	D51064	230	D52400	199	D53073	205
D50726	186	D51065	232	D52450	199	D53074	205
D50727	186	D51066	229	D52451	199, 400	D53075	205
D50800	185	D51067	231	D52452	199, 400	D53076	205
D50802	185	D51068	232	D52453	199	D53077	205
D50830	185	D51069	229	D52460	199	D53078	206
D50832	185	D51070	231	D52461	199	D53079	206
D5087BN	20	D51071	232	D52462	199	D53080	206

PART NO.	PG #	PART NO.	PG #	PART NO.	PG #	PART NO.	PG #
D53081	206	D53180	211	D53281	212	D53440	205
D53082	206	D53181	211	D53282	207	D53441	205
D53083	206	D53182	211	D53283	207	D53442	228
D53084	206	D53183	211	D53284	205	D53443	228
D53085	206	D53184	211	D53285	205	D53444	228
D53086	207	D53185	211	D53286	208	D53445	228
D53087	207	D53186	211	D53287	208	D53446	228
D53088	207	D53187	211	D53288	209	D53447	228
D53089	207	D53188	211	D53289	209	D53448	228
D53090	207	D53189	211	D53290	209	D53449	228
D53091	207	D53190	209	D53291	209	D53450	228
D53092	208	D53191	209	D53292	210	D53451	228
D53093	208	D53192	209	D53293	210	D53452	228
D53094	208	D53193	209	D53294	211	D53453	228
D53095	208	D53194	209	D53295	211	D53454	228
D53096	208	D53195	209	D53296	210	D53455	228
D53097	208	D53196	209	D53297	210	D53456	229
D53098	208	D53197	209	D53298	210	D53457	229
D53099	208	D53198	209	D53299	210	D53458	229
D53100	209	D53199	209	D53300	211	D53459	229
D53101	209	D53200	209	D53301	211	D53460	229
D53102	209	D53201	209	D53302	211	D53461	229
D53103	209	D53202	209	D53303	211	D53462	229
D53104	209	D53203	209	D53304	208	D53463	229
D53105	209	D53204	210	D53305	208	D53464	229
D53106	209	D53205	210	D53306	209	D53465	229
D53107	209	D53206	210	D53307	209	D53466	229
D53108	209	D53207	210	D53308	208	D53467	229
D53109	209	D53208	210	D53309	208	D53468	229
D53110	209	D53209	210	D53310	210	D53469	229
D53111	209	D53216	210	D53311	210	D53470	231
D53120	212	D53217	210	D53312	209	D53471	231
D53121	212	D53218	210	D53313	209	D53472	231
D53122	212	D53219	210	D53314	210	D53473	231
D53123	212	D53230	210	D53315	210	D53474	231
D53124	206	D53231	210	D53400	211	D53475	231
D53125	206	D53232	210	D53401	211	D53476	231
D53126	206	D53233	210	D53402	211	D53477	231
D53127	206	D53234	210	D53403	211	D53478	231
D53128	207	D53235	210	D53404	211	D53479	231
D53129	207	D53236	210	D53405	211	D53480	231
D53130	207	D53237	210	D53406	211	D53481	231
D53131	207	D53238	210	D53407	211	D53482	231
D53132	207	D53239	210	D53408	211	D53483	231
D53133	207	D53240	210	D53409	211	D54001	188, 398
D53134	207	D53241	210	D53410	211	D54001L	188
D53135	207	D53246	205	D53411	211	D54002	188
D53136	207	D53247	205	D53412	211	D54002L	188
D53137	207	D53248	205	D53413	211	D54003	191
D53138	206	D53249	205	D53414	206	D54004	191
D53139	206	D53250	207	D53415	206	D54005	191
D53140	206	D53251	207	D53416	206	D54006	191
D53141	206	D53252	207	D53417	206	D54008	204
D53142	206	D53253	207	D53418	206	D54010	22, 204
D53143	206	D53258	209	D53419	206	D54011	188
D53144	230	D53259	209	D53420	206	D54012	188
D53145	230	D53260	209	D53421	206	D54013	188
D53146	230	D53261	209	D53422	206	D54013L	188
D53147	230	D53262	208	D53423	206	D54014	188
D53148	230	D53263	208	D53424	206	D54014L	188
D53149	230	D53264	208	D53425	206	D54015	188
D53150	211	D53265	208	D53426	206	D54016	188
D53151	211	D53266	208	D53427	206	D54022	188, 399
D53152	211	D53267	208	D53428	205	D54100	188, 396,
D53153	211	D53268	208	D53429	205		398
D53154	211	D53269	208	D53430	205	D54101	188
D53155	211	D53272	208	D53431	205	D54102	189
D53156	211	D53273	208	D53432	205	D54104	189
D53157	211	D53274	208	D53433	205	D54105	189
D53158	211	D53275	208	D53434	205	D54107	188
D53159	211	D53276	208	D53435	205	D54108	204
D53160	211	D53277	208	D53436	205	D54109	204
D53161	211	D53278	208	D53437	205	D54111	188
D53162	211	D53279	208	D53438	205	D54112	188, 399
D53163	211	D53280	212	D53439	205		

PART NO.	PG #	PART NO.	PG #	PART NO.	PG #	PART NO.	PG #
D54113	188	D56505	203, 254	D59124	277	D60403	256
D54114	188	D57105	201	D59126	277	D60410	256
D54126	188	D57106	201	D59128	277	D60412	256
D54130	189	D57107	202	D59130	277	D60413	256
D54131	189	D57205	201	D59132	277	D60498	256
D54132	189	D57206	201	D59156	275	D60499	256
D54133	189	D57207	202	D59158	275	D60780	202
D54134	189	D57208	202	D59160	275	D60781	202
D54136	188	D57209	201	D59162	275	D60782	202
D54137	189	D57210	201	D59202	278	D60790	202
D54301	188	D57211	201	D59203	278	D60791	202
D54302	188	D57212	201	D59204	278	D60792	202
D54304	189	D57213	201	D59302	278	D60793	202
D54305	189	D57214	201	D59303	278	D60794	202
D54306	189	D57215	201	D59304	278	D60795	202
D54307	188	D57216	201	D59900	205	D6084BN	22
D54311	188	D57217	201	D59901	237, 264	D6084NP	22
D54312	188	D57304	201	D59902	237, 264	D6084RB	22
D54313	188	D57305	201	D59904	237, 264	D6084WB	22
D54314	188	D57306	201	D59905	237, 264	D60900	252
D54315	188	D57307	201	D59906	237, 264	D60901	252
D54316	188	D57308	202	D59907	237, 264	D60902	252
D54319	188	D57309	202	D59908	237, 264	D6091BN	22
D54321	188	D57404	201	D59909	237, 264	D6091NP	22
D54322	188	D57405	201	D59910	238, 264	D6091RB	22
D54323	188	D57406	201	D59911	238, 264	D6091WB	22
D54324	188	D57407	201	D59912	238, 264	D60940	202
D54326	188	D57408	202	D59913	238, 264	D60942	20
D54330	189	D57409	202	D59914	237, 264	D60945	202
D54331	189	D57500	203	D59915	237, 264	D6094BN	20
D54332	189	D57501	203	D59916	237, 264	D6094NP	20
D54333	189	D57502	203	D59917	237, 264	D6094PB	20
D54334	189	D57503	203	D59918	238, 264	D6094RB	20
D54336	188	D57504	203	D59919	238, 264	D6094WB	20
D54337	189	D57505	203	D59920	237	D60954	20, 203, 254
D54400	188	D57901	237	D59921	237	D60955	202, 254
D54401	188	D57902	237	D59922	237	D60956	202, 254
D56105	201	D57904	237	D59923	237	D60958	202, 254
D56106	201	D57905	237	D59924	237	D60959	202, 254
D56107	202	D57906	237	D59925	237	D60960	20, 203, 254
D56205	201	D57907	237	D59926	237	D60961	203, 254
D56206	201	D57908	237	D59927	237	D60962	20, 203, 254
D56207	202	D57909	237	D59940	264	D60963	203, 254
D56208	202	D57910	238	D59941	264	D60966	202, 254
D56209	201	D57911	238	D59942	264	D60967	202, 254
D56210	201	D57912	238	D59943	238, 264	D60968	202
D56211	22, 201, 400	D57913	238	D59944	237, 264	D60969	202
D56212	22, 201, 400	D57914	237	D59945	237, 264, 400	D6096BN	20
D56213	201	D57915	237	D59946	237, 264	D6096NP	20
D56214	22, 201, 400	D57916	237	D59947	237	D6096RB	20
D56215	201	D57917	237	D59948	237	D6096WB	20
D56216	22, 201, 400	D57918	238	D59949	237	D60970	202, 254, 399
D56217	201	D57919	238	D59950	237	D60975	202, 254
D56304	201	D57980	201	D60100	256	D60978	185
D56305	201	D57982	201	D60101	256, 272	D60979	204
D56306	201	D57983	201	D60102	256	D60980	20, 202, 254
D56307	201	D57984	201	D60103	256, 399	D60981	20, 202, 254, 399
D56308	202	D57985	201	D60130	198	D60982	20, 202, 254, 399
D56309	202	D57986	201	D60140	198	D60986	202, 254, 399
D56404	201	D57987	201	D60201	256	D60987	202, 254
D56405	201	D57988	201	D60202	256	D60989	202, 254, 399
D56406	201	D57989	203	D60203	256	D6098BN	20
D56407	201	D57990	203	D60204	256	D6098NP	20
D56408	202	D59001	191, 396	D60205	256	D6098RB	20
D56409	202	D59002	191, 396	D60206	256		
D56500	203, 254	D59003	191, 396	D60207	256		
D56501	203, 254	D59100	204	D60208	256		
D56502	203, 254	D59101	277	D60209	256		
D56503	203, 254	D59102	277	D60210	256		
D56504	203, 254	D59103	277	D60211	256		
		D59104	277	D60212	256		
		D59106	277	D60400	256		
		D59112	277	D60402	256		
		D59113	277				
		D59114	277				

PART NO.	PG #	PART NO.	PG #	PART NO.	PG #	PART NO.	PG #
D6098WB	20	D63400	253, 263	D65604	262	D66584	260
D60990	20, 202, 254, 399	D63433	269	D65605	262	D66585	260
D60991	20, 202, 254, 399	D63434	269	D65620	258	D66600	262
D60992	202, 254	D64000	22, 255	D65621	258	D66601	262
D60993	202, 254	D64001	22, 255	D65622	258	D66602	262
D60994	202, 254	D64002	255	D65623	258	D66603	262
D60995	202, 254	D6400BN	22, 255	D65624	258	D66604	262
D60996	22, 202, 254, 399, 400	D6400RB	22, 255	D65625	258	D66605	262
D60997	202, 254	D6400WB	22, 255	D65640	260	D66620	258
D60998	202, 254	D64010	255	D65641	260	D66621	258
D60999	202, 254	D64011	255	D65642	260	D66622	258
D61101	256	D64012	255	D65643	260	D66623	258
D61102	256	D64022	255	D65644	260	D66624	258
D61103	256	D64150	255	D65645	260	D66625	258
D61201	256	D64202	255	D65655	257	D66640	260
D61202	256	D64302	255	D65656	257	D66641	260
D61203	256	D64401	22, 255	D65657	260	D66642	260
D61301	256	D64402	255	D65658	260	D66643	260
D61302	256	D64402G	255	D65659	262	D66644	260
D61303	256	D64502	255	D65660	262	D66645	260
D61800	252	D64800	255	D65661	257	D66660	261
D61801	252	D64801	255	D65662	257	D66661	261
D61802	252	D64802	255	D65663	259	D66662	261
D61850	256	D64803	255	D65664	259	D66663	261
D62130	253	D64804	255	D65665	258	D66664	261
D62131	253	D64805	255	D65666	260	D66665	261
D62132	253	D64806	255	D65668	260	D66675	257
D62135	253	D64807	255	D66002	252	D66676	257
D62136	253	D64808	255	D66003	252	D66677	260
D62137	253	D64809	255	D66004	252	D66678	260
D62140	253	D64810	255	D66102	252	D66679	262
D62141	253	D64811	255	D66103	252	D66680	262
D62142	253	D65002	252, 399	D66104	252	D66681	257
D62230	263	D65003	252	D66200	253	D66682	257
D62231	263	D65102	252, 399	D66202	252	D66683	259
D62232	263	D65103	252, 399	D66203	252	D66684	259
D62233	263	D65104	252	D66204	252	D66685	261
D62235	263	D65202	252	D66300	253	D66686	261
D62236	263	D65203	252	D66400	253	D66687	258
D62237	263	D65500	257	D66500	257	D66688	258
D62240	263	D65501	257	D66501	257	D66689	260
D62241	263	D65502	257	D66502	257	D66690	260
D62242	263	D65503	257	D66503	257	D66691	261
D62300	253, 263	D65504	257	D66504	257	D66692	261
D62330	269	D65505	257	D66505	257	D66700	258
D62333	269	D65509	257	D66509	257	D66701	258
D62334	269	D65510	257	D66510	257	D66702	258
D62335	269	D65511	257	D66511	257	D66703	258
D62349	253, 263	D65512	257	D66512	257	D66704	258
D62350	253, 263, 399	D65520	259	D66520	259	D66705	258
D62400	253, 263	D65521	259	D66521	259	D66706	258
D62433	269	D65522	259	D66522	259	D66707	258
D62434	269	D65523	259	D66523	259	D66715	260
D62443	269	D65524	259	D66524	259	D66716	260
D62444	269	D65525	259	D66525	259	D66717	260
D62601	269	D65560	257	D66540	261	D66718	260
D62602	269	D65561	257	D66541	261	D66719	260
D62950	272	D65562	257	D66542	261	D66720	260
D62951	272	D65563	257	D66543	261	D66721	260
D62952	272	D65564	257	D66544	261	D66722	260
D62960	272	D65565	257	D66545	261	D66732	262
D62961	272	D65569	257	D66560	257	D66733	262
D62962	272	D65570	257	D66561	257	D66734	262
D63300	253, 263	D65571	257	D66562	257	D66735	262
D63330	269	D65572	257	D66563	257	D66736	262
D63333	269	D65580	260	D66564	257	D66737	262
D63334	269	D65581	260	D66565	257	D66738	262
D63335	269	D65582	260	D66569	257	D66739	262
D63349	253, 263	D65583	260	D66570	257	D67001	257
D63350	253, 263	D65584	260	D66571	257	D67002	257
		D65585	260	D66572	257	D67003	257
		D65600	262	D66580	260	D67004	257
		D65601	262	D66581	260	D67005	257
		D65602	262	D66582	260	D67006	257
		D65603	262	D66583	260	D67007	257

PART NO.	PG #	PART NO.	PG #	PART NO.	PG #	PART NO.	PG #
D67008	257	D70205	6	D80201	259	E0705WB	23
D67016	258	D7020BN	6	D80202	259	E07375	69
D67017	258	D7020RB	6	D80203	259	E08125	69
D67018	258	D7020WB	6	D80206	261	E0812BN	23
D67019	258	D70500	273	D80207	261	E0812PB	23
D67020	258	D71003	273	D80208	261	E0812RB	23
D67021	258	D71004	273	D80209	261	E0812WB	23
D67022	258	D71103	273	D80210	261	E08138	69
D67023	258	D76002	272	D80211	261	E08150	69
D67027	258	D76003	272	D80212	259	E0815BN	23
D67028	258	D76004	272	D80213	259	E0815PB	23
D67029	258	D76005	270	D80214	259	E0815RB	23
D67030	258	D76012	272	D80215	259	E0815WB	23
D67031	259	D76013	272	D80216	259	E09050	92
D67032	259	D76014	272	D80217	259	E09075	92
D67033	259	D76092	272	D80218	261	E09100	92
D67034	259	D76093	272	D80219	261	E09125	92
D67035	259	D76094	272	D80220	261	E09150	92
D67036	259	D76202	274	D80221	261	E09200	92
D67037	259	D76203	274	D80222	261	E09250	92
D67038	259	D76204	274	D80223	261	E09300	92
D67039	259	D76205L	274	DFD100	396	E09400	92
D67040	259	D76207L	274	E01049	70	E10150	95
D67041	259	D76209L	274	E01050	69, 397	E10200	95
D67042	259	D76252	274	E0105BN	23	E10300	95
D67043	259	D76256	274	E0105RB	23	E10400	95
D67044	259	D76259	274	E0105WB	23	E15050	70
D67045	259	D76302	274	E01074	70	E15052	70
D67046	259	D76303	274	E01075	69, 397	E15075	70
D67047	259	D76304	274	E01100	69	E15375	70
D67048	262	D76402	274	E01125	69	E16050	70
D67049	262	D76403	274	E01150	69	E16075	70
D67050	262	D76404	274	E01375	69	E16150	70
D67051	262	D76412	274	E02050	69	E16151	70
D67052	262	D76413	274	E0205BN	23	E16200	70
D67053	262	D76414	274	E0205RB	23	E16375	70
D67054	262	D76504	275	E0205WB	23	E25015	310
D67055	262	D76519	275	E02075	69	E25016	310
D67200	253, 399	D76601	273	E02100	69	E25017	310
D67201	253	D76702	275	E02125	69	E25018	310
D67300	253	D76703	275, 399	E02150	69	E25115	310
D67400	253	D76704	275	E02152	69	E25116	310
D68507	258	D76705	275	E02200	69	E25117	310
D68508	258	D76706	275	E02375	69	E25118	310
D68510	258	D76707	275	E03125	69, 336	E25125	310
D68511	258	D77002	272	E03150	69, 336	E25126	310
D68512	258	D77003	272	E03200	69, 336	E25127	310
D68513	258	D77004	272	E03225	70	E25128	310
D68610	258	D79703	275	E03250	70	E25129	310
D68611	258	D79704	275	E04125	69, 336	E80050	23
D68612	258	D79705	275	E0412BN	23	E81050	23
D68613	258	D79706	275	E0412RB	23	E81375	23
D68710	258	D79803	275	E0412WB	23	E82125	23
D68711	258	D79804	275	E04150	69, 336	E82150	23
D68712	258	D79805	275	E0415BN	23	E85000	305
D68713	258	D79806	275	E0415RB	23	ERB05	357
D70001	273	D80090	252	E0415WB	23	ERB07	357
D70011	273	D80091	252	E04200	69, 336	ERG05	357
D70020	273	D80096	252	E05125	69	ERG07	357
D70021	273	D80097	252	E05150	69	F01050	70, 397
D70022	273	D80098	252	E06050	69	F01075	70, 397
D70098	273	D80099	252	E0605BN	23	F01100	70
D70100	57, 331, 397	D80100	259	E0605PB	23	F01125	70
D70101	57, 331	D80101	259	E0605RB	23	F01150	70
D70102	57, 331	D80102	259	E0605WB	23	F01375	70
D70103	57, 331	D80103	259	E06075	69	F02050	70
D70104	57	D80106	261	E06100	69	F02075	70
D70105	6, 57	D80107	261	E06125	69	F02100	70
D7010BN	6	D80108	261	E06150	69	F02125	70
D7010NP	6	D80109	261	E06375	69	F02150	70
D7010PB	6	D80112	259	E07025	69	F02200	70
D7010RB	6	D80113	259	E07050	69	F02375	70
D7010WB	6	D80118	261	E0705BN	23	F03050	70
		D80119	261	E0705PB	23	F03075	70
		D80200	259	E0705RB	23	F03100	70

PART NO.	PG #	PART NO.	PG #	PART NO.	PG #	PART NO.	PG #
F03125	70	F160126	115	F33101	123	F40023	134, 389, 390
F03150	70	F16016	115	F33102	123	F40024	134
F03200	70	F160183	115	F33103	123	F40025	134, 389, 390
F03250	70	F160184	115	F33104	123	F40026	134, 389, 390
F03300	70	F160186	115	F33105	123	F40027	134, 389, 390
F03375	70	F160243	115	F33106	123	F40028	134
F04050	70	F160246	115	F33107	123	F40029	134
F04075	70	F160363	115	F33108	123	F40030	134
F04100	70	F160393	115	F33109	123	F40031	134
F04125	70	F163186	115	F33110	123	F40032	134
F04150	70	F163246	115	F33111	123	F40033	134
F04200	70	F165181	115	F33112	123	F40034	134
F04250	70	F165186	115	F33113	123	F40035	134, 389, 390
F04300	70	F180032	115	F33114	123	F40036	134, 389, 390
F04350	70	F18009	114	F33115	123	F40037	134
F04375	70	F18012	114	F33116	123	F40038	134
F04400	70	F18018	114	F33120	123	F40039	134
F04500	70	F18024	114	F33121	123	F40040	134
F04600	70	F18309	115	F33122	123	F40041	134
F04800	70	F18312	115	F33123	123	F40042	135
F04999	70	F18318	115	F33124	123	F40043	135
F06050	71	F18324	115	F33125	123	F40044	135
F06075	71	F20001	309	F33126	123	F40045	135
F06099	71	F20002	309	F33127	123	F40046	135
F06100	71	F20003	308	F33128	123	F40047	135
F06124	71	F20004	308	F33129	123	F40048	135, 389, 390
F06125	71	F20005	308	F33130	123	F40049	135, 389, 390
F06150	71	F20006	309	F33131	123	F40050	135
F06200	71	F20007	309	F33132	123	F40051	135
F06201	71	F20008	309	F33140	122	F40052	135, 389, 390
F06250	71	F20009	309	F33141	122	F40053	135, 389, 390
F06251	71	F20010	309	F33142	122	F40054	135
F06300	71	F20011	309	F33143	122	F40055	135, 389, 390
F06301	71	F20012	309	F33144	122	F40056	135
F06351	71	F20016	308	F33300	122	F40057	135
F06375	71	F20017	308	F33301	122	F40058	135
F06400	71	F20018	309	F33302	122	F40059	135
F06401	71	F20019	309	F33303	122	F40060	135
F06500	71	F33009	122	F39001	77	F40061	135
F06600	71	F33010	122	F39002	77	F40062	135
F06800	71	F33011	122	F39004	77	F40063	135, 389, 390
F07050	71	F33012	122	F39005	77	F40064	135, 389, 390
F07075	71	F33013	122	F39010	78	F40065	135
F07099	71	F33014	122	F39700	57	F40066	135
F07100	71	F33030	122	F39800	57	F40067	135
F07124	71	F33031	122	F40001	134	F40068	135, 389, 390
F07125	71	F33032	122	F40002	134, 389, 390	F40069	135, 389, 390
F07150	71	F33033	122	F40003	134	F40070	135, 389, 390
F07200	71	F33034	122	F40004	134, 389, 390	F40071	135
F07201	71	F33035	122	F40005	134, 389, 390	F40072	135
F07300	71	F33036	122	F40006	134, 389, 390	F40073	135, 389, 390
F07375	71	F33037	122	F40007	134	F40074	135, 389, 390
F08050	23	F33038	122	F40008	134	F40075	135
F08124	23	F33039	122	F40009	134		
F08150	23	F33040	122	F40010	134		
F08375	23	F33041	122	F40011	134		
F10001	182	F33060	123	F40012	134		
F10002	182, 398	F33061	123	F40013	134		
F10003	182	F33062	123	F40014	134		
F10004	182	F33063	123	F40015	134		
F10005	273	F33064	123	F40016	134		
F11001	182	F33065	123	F40017	134		
F11002	182	F33066	123	F40018	134		
F11003	182	F33067	123	F40019	134		
F11004	182	F33068	123	F40020	134, 389, 390		
F12009	114	F33069	123	F40021	134, 389, 390		
F12012	114	F33080	123	F40022	134		
F12018	114	F33081	123				
F12024	114	F33082	123				
F14012	115	F33083	123				
F160063	115	F33094	123				
F160093	115	F33095	123				
F160094	115	F33096	123				
F16012	115	F33097	123				
F160123	115	F33098	123				

PART NO.	PG #	PART NO.	PG #	PART NO.	PG #	PART NO.	PG #
F40076	135, 389, 390	F481012	136	G12132	55	G14012	173
F40077	135	F48108	136	G12136	55	G14016	173
F40078	135	F65400	204, 254, 400	G12142	55	G14020	173
F40079	135	F65600	204, 254	G12148	55	G14024	173
F40080	135	G02033	310	G12212	55	G14028	173
F40081	135	G02042	310	G12216	55	G14032	173
F40082	135	G04000	307	G12218	55	G14036	173
F40083	135	G04001	307	G12224	55	G14040	173
F40084	135	G04002	307	G12230	55	G14044	173
F40085	135	G04004	171	G12232	55	G14048	173
F40086	135	G08004	172	G12236	55	G14052	173
F40087	135	G08006	172	G12242	55	G14056	173
F40088	135, 389, 390	G08008	172	G12248	55	G14064	173
F40089	135	G08012	172	G12312	56	G14072	173
F40090	135	G08016	172	G12316	56	G14080	173
F40091	135	G08016	172	G12318	56	G14088	173
F40092	135, 390	G08020	172	G12324	56	G14096	173
F40093	135	G08024	172	G12330	56	G14104	173
F40094	135	G09004	172	G12332	56	G144-0007	349
F40095	134	G09006	172	G12336	56	G144-0032	349
F40096	134	G09008	172	G12342	56	G144-0033	349
F40097	134	G09012	172	G12348	56	G144-0058	349
F40098	134	G09016	172	G12998	56	G144-0059	349
F40100	134	G09020	172	G12999	56	G144-0060	349
F40101	135	G09024	172	G13001	43	G144-0107	349
F40102	135	G10006	172	G13002	43	G144-0108	349
F40103	135	G10008	172	G13003	43	G144-0109	349
F40104	135	G10010	172	G13004	43	G144-0110	349
F40105	135	G10012	172	G13005	43	G144-0159	349
F40106	135	G10016	172	G13012	55	G144-0160	349
F40107	135	G10020	172	G13016	55	G144-0161	349
F40108	135	G10024	172	G13018	55	G144-0162	349
F40109	135	G10032	172	G13024	55	G144-0222	349
F40110	135	G10036	172	G13030	55	G144-0223	349
F40111	135	G10040	172	G13032	55	G144-0224	349
F40112	135	G10052	172	G13036	55	G144-0225	349
F40113	135	G10072	172	G13042	55	G144-0226	349
F40114	135	G10080	172	G13048	55	G144-0303	349
F40115	135	G10104	172	G13112	55	G144-0304	349
F40116	135	G11006	172	G13116	55	G144-0305	349
F40117	135	G11008	172	G13118	55	G144-0306	349
F40118	135	G11010	172	G13124	55	G144-0307	349
F40119	134	G11012	172	G13130	55	G144-0308	349
F40120	134	G11016	172	G13132	55	G144-0398	349
F40121	135	G11020	172	G13136	55	G144-0399	349
F40122	135	G11024	172	G13142	55	G144-0400	349
F40123	134	G11028	172	G13148	55	G144-0401	349
F40124	134	G11032	172	G13212	55	G144-0402	349
F40125	134	G11036	172	G13216	55	G144-0403	349
F40126	134	G11040	172	G13218	55	G144-0403	349
F40127	134	G11044	172	G13224	55	G144-0531	349
F40128	135	G11048	172	G13230	55	G144-0532	349
F40131	134	G11052	172	G13232	55	G144-0533	349
F40132	134	G11056	172	G13236	55	G144-0534	349
F40133	134	G11064	172	G13242	55	G144-0535	349
F40135	135	G11072	172	G13248	55	G144-0536	349
F401516	136	G11080	172	G13248	55	G144-0662	349
F41001	136	G11088	172	G13312	56	G144-0663	349
F41002	136	G11096	172	G13316	56	G144-0664	349
F41003	136	G11104	172	G13318	56	G144-0665	349
F41004	136	G12012	55	G13324	56	G144-0666	349
F41005	136	G12016	55	G13330	56	G144-0790	349
F41006	136	G12018	55	G13332	56	G144-0870	349
F41007	136	G12024	55	G13336	56	G144-0871	349
F41008	136	G12030	55	G13342	56	G144-0872	349
F41009	136	G12032	55	G13348	56	G144-0873	349
F41010	136	G12036	55	G13500	36	G144-0874	349
F41011	136	G12042	55	G13516	36	G144-0875	349
F41012	136	G12048	55	G13534	36	G144-1109	349
F41013	136	G12112	55	G13601	36	G144-1111	349
F411516	136	G12116	55	G13616	36	G15002	173
F461012	136	G12118	55	G13634	36	G15003	173
F46108	136	G12124	55	G13638	36	G15004	173
		G12130	55	G14006	173	G15006	173
				G14008	173	G15008	173
				G14010	173	G155-0001	349

PART NO.	PG #	PART NO.	PG #	PART NO.	PG #	PART NO.	PG #
G155-0002	349	G165-0535	350	G20038	156, 392	G235-0534	351
G155-0025	349	G165-0536	350	G20040	157	G235-0535	351
G155-0050	349	G165-0650	350	G20041	157, 392	G235-0650	351
G155-0100	349	G165-0662	350	G20042	157, 392	G235-0662	351
G155-0150	349	G165-0663	350	G20043	157, 392	G235-0663	351
G155-0215	349	G165-0664	350	G20045	157	G235-0664	351
G155-0295	349	G165-0665	350	G20047	157	G235-0860	351
G155-0390	349	G165-0666	350	G20050	157, 392	G235-0870	351
G155-0520	349	G165-0667	350	G20051	157	G235-0871	351
G155-0650	349	G165-0668	350	G20052	157	G235-0872	351
G155-0860	349	G165-0860	350	G20053	157	G235-0975	351
G155-0975	349	G165-0870	350	G20054	157	G235-1100	351
G155-1100	349	G165-0871	350	G20055	157, 392	G24004	158
G16008	173	G165-0872	350	G20056	157, 388	G24006	158
G16010	173	G165-0873	350	G20057	157, 392	G25022	158
G16012	173	G165-0874	350	G20057R	157	G25032	158, 393
G16016	173	G165-0875	350	G20058	171	G25034	158
G16020	173	G165-1100	350	G20060	157	G25042	158, 393
G16024	173	G165-1109	350	G20086	74	G25044	158, 393
G16028	173	G165-1111	350	G20102	156	G25046	158, 393
G16032	173	G17025	165	G20103	156	G25048	158, 393
G16036	173	G17037	165	G20108	156	G25052	158, 393
G16040	173	G17050	165	G20110	156	G25054	158, 393
G16044	173	G17075	165	G20111	156	G25056	158
G16048	173	G17100	165	G20115	156	G25062	158
G16052	173	G17125	165	G20116	156	G25064	158, 393
G16056	173	G17150	165	G20120	156	G25066	158, 393
G16064	173	G17200	165	G20121	156	G25068	158, 393
G16072	173	G18025	165	G20130	156	G25084	158, 393
G16080	173	G18037	165	G20131	156	G25086	158, 393
G16088	173	G18050	165	G20132	156	G25088	158, 393
G16096	173	G18075	165	G20136	157	G25101	158, 393
G16104	173	G18100	165	G20137	157	G25106	158, 393
G165-0001	350	G18125	165	G20138	157	G25108	158, 393
G165-0002	350	G18150	165	G20141	157	G25121	158, 393
G165-0007	350	G18200	165	G20142	157	G25128	158, 393
G165-0025	350	G19025	165	G20143	157	G25161	158
G165-0032	350	G19037	165	G20150	157	G25169	158
G165-0033	350	G19050	165	G20155	157	G254-0001	351
G165-0050	350	G19075	165	G235-0001	351	G254-0002	351
G165-0058	350	G19100	165	G235-0002	351	G254-0025	351
G165-0059	350	G19125	165	G235-0007	351	G254-0050	351
G165-0060	350	G19150	165	G235-0025	351	G254-0100	351
G165-0100	350	G19200	165	G235-0032	351	G254-0150	351
G165-0107	350	G195-0001	350	G235-0050	351	G254-0215	351
G165-0108	350	G195-0002	350	G235-0058	351	G254-0295	351
G165-0109	350	G195-0025	350	G235-0059	351	G254-0390	351
G165-0110	350	G195-0050	350	G235-0060	351	G254-0520	351
G165-0150	350	G195-0100	350	G235-0100	351	G254-0650	351
G165-0159	350	G195-0150	350	G235-0107	351	G254-0860	351
G165-0160	350	G195-0215	350	G235-0108	351	G25612	158
G165-0161	350	G195-0295	350	G235-0109	351	G25812	158
G165-0162	350	G195-0390	350	G235-0150	351	G26022	158
G165-0215	350	G195-0520	350	G235-0159	351	G26032	158
G165-0222	350	G195-0650	350	G235-0160	351	G26034	158
G165-0223	350	G195-0860	350	G235-0161	351	G26042	158
G165-0224	350	G20002	156, 392	G235-0215	351	G26044	158
G165-0225	350	G20003	156, 392	G235-0222	351	G26046	158
G165-0295	350	G20004	156	G235-0223	351	G26052	158
G165-0303	350	G20005	156	G235-0224	351	G26054	158
G165-0304	350	G20006	157	G235-0295	351	G26056	158
G165-0305	350	G20008	156, 392	G235-0303	351	G26062	158
G165-0306	350	G20010	156, 392	G235-0304	351	G26064	158
G165-0307	350	G20011	156, 392	G235-0305	351	G26066	158
G165-0390	350	G20015	156, 392	G235-0306	351	G26068	158
G165-0398	350	G20016	156, 392	G235-0390	351	G26084	158
G165-0399	350	G20017	156	G235-0398	351	G26086	158
G165-0400	350	G20020	156, 392	G235-0399	351	G26088	158
G165-0401	350	G20021	156, 392	G235-0400	351	G26121	158
G165-0402	350	G20030	156, 392	G235-0401	351	G26161	158
G165-0520	350	G20031	156, 392	G235-0402	351	G27042	158
G165-0531	350	G20032	156, 392	G235-0520	351	G27044	158
G165-0532	350	G20035	156	G235-0531	351	G27054	158
G165-0533	350	G20036	156, 392	G235-0532	351	G27062	158
G165-0534	350	G20037	156, 392	G235-0533	351	G27064	158

PART NO.	PG #	PART NO.	PG #	PART NO.	PG #	PART NO.	PG #
G27066	158	G375-0215	352	G460-0319	353	G50251	304
G27068	158	G375-0295	352	G460-0328	353	G51001	174
G27084	158	G375-0390	352	G460-0329	353	G51002	174
G27086	158	G375-0520	352	G460-0330	353	G51003	174
G27088	158	G396-0001	352	G460-0331	353	G51004	174
G27106	158	G396-0002	352	G460-0332	353	G51005	174
G27108	158	G396-0025	352	G460-0339	353	G51006	174
G28044	158	G396-0050	352	G460-0340	353	G51008	174
G28066	158	G396-0100	352	G460-0342	353	G51010	174
G28088	158	G396-0150	352	G460-0343	353	G51012	174
G290-0001	352	G396-0215	352	G460-0350	353	G51013	174
G290-0002	352	G396-0295	352	G460-0352	353	G51015	174
G290-0025	352	G396-0390	352	G460-0353	353	G51025	174
G290-0050	352	G396-0520	352	G460-0390	353	G51035	174
G290-0100	352	G396-0650	352	G460-0398	354	G51050	174
G290-0150	352	G396-0860	352	G460-0399	354	G51075	174
G290-0215	352	G396-1100	352	G460-0400	354	G51102	175
G290-0295	352	G460-0001	353	G460-0401	354	G51103	175
G290-0390	352	G460-0002	353	G460-0402	354	G51104	175
G290-0520	352	G460-0007	353	G460-0413	354	G51105	175
G290-0650	352	G460-0025	353	G460-0414	354	G51106	175
G290-0860	352	G460-0032	353	G460-0415	354	G51108	175
G290-1100	352	G460-0050	353	G460-0416	354	G51110	175
G29003	158	G460-0057	353	G460-0417	354	G51112	175
G29004	158, 393	G460-0058	353	G460-0429	354	G51125	175
G29005	158, 393	G460-0059	353	G460-0430	354	G51135	175
G29006	158, 393	G460-0100	353	G460-0431	354	G52001	174
G29008	158, 393	G460-0106	353	G460-0432	354	G52002	174
G29010	158, 393	G460-0107	353	G460-0444	354	G52003	174
G295-0001	352	G460-0108	353	G460-0447	354	G52004	174
G295-0002	352	G460-0109	353	G460-0457	354	G52005	174
G295-0025	352	G460-0116	353	G460-0461	354	G52006	174
G295-0050	352	G460-0117	353	G460-0470	354	G52008	174
G295-0100	352	G460-0118	353	G460-0520	353	G52010	174
G295-0150	352	G460-0150	353	G460-0531	354	G52012	174
G295-0215	352	G460-0157	353	G460-0532	354	G52013	174
G295-0295	352	G460-0159	353	G460-0533	354	G52015	174
G295-0390	352	G460-0160	353	G460-0534	354	G52025	174
G295-0520	352	G460-0161	353	G460-0535	354	G52035	174
G295-0650	352	G460-0162	353	G460-0536	354	G52075	174
G295-0860	352	G460-0169	353	G460-0548	354	G52102	175
G30000	304	G460-0170	353	G460-0549	354	G52103	175
G30001	304	G460-0171	353	G460-0650	353	G52104	175
G30003	304	G460-0180	353	G460-0662	354	G52105	175
G30004	304	G460-0181	353	G460-0663	354	G52106	175
G30005	304	G460-0182	353	G460-0665	354	G52108	175
G30011	304	G460-0215	353	G460-0666	354	G52110	175
G30012	304	G460-0221	353	G460-0667	354	G52115	175
G30013	304	G460-0222	353	G460-0668	354	G52125	175
G30014	304	G460-0223	353	G460-0860	353	G53001	174
G30015	304	G460-0224	353	G460-0870	354	G53002	174
G30016	304	G460-0225	353	G460-0871	354	G53003	174
G30017	304	G460-0233	353	G460-0872	354	G53004	174
G30021	304	G460-0234	353	G460-0873	354	G53005	174
G30030	304	G460-0235	353	G460-0874	354	G53006	174
G335-0050	349	G460-0236	353	G460-0875	354	G53008	174
G335-0100	349	G460-0237	353	G460-0975	353	G53010	174
G335-0150	349	G460-0245	353	G460-1100	353	G53012	174
G335-0215	349	G460-0246	353	G486-0050	354	G53013	174
G335-0295	349	G460-0247	353	G486-0100	354	G53015	174
G335-0390	349	G460-0248	353	G486-0150	354	G53025	174
G355-0002	352	G460-0256	353	G486-0215	354	G53035	174
G355-0025	352	G460-0257	353	G486-0295	354	G53050	174
G355-0050	352	G460-0258	353	G50200	304, 386	G53075	174
G355-0100	352	G460-0259	353	G50202	304	G53101	175
G355-0150	352	G460-0295	353	G50204	304, 386	G53102	175
G355-0215	352	G460-0303	353	G50205	304	G53103	175
G355-0295	352	G460-0304	353	G50206	304	G53104	175
G355-0390	352	G460-0305	353	G50208	304, 386	G53105	175
G375-0001	352	G460-0306	353	G50210	304	G53106	175
G375-0002	352	G460-0307	353	G50211	303	G53108	175
G375-0025	352	G460-0315	353	G50214	304	G53110	175
G375-0050	352	G460-0316	353	G50215	303	G53113	175
G375-0100	352	G460-0317	353	G50218	304	G53115	175
G375-0150	352	G460-0318	353	G50250	304	G53125	175

PART NO.	PG #	PART NO.	PG #	PART NO.	PG #	PART NO.	PG #
G53203	175	G61160	111	G70022	79	G70141	80
G53204	175	G61200	111	G70023	79	G70142	80
G53206	175	G61300	111	G70024	79	G70143	80
G53215	175	G62030	111	G70025	79	G70144	80
G53225	175	G62060	111	G70026	79	G70145	80
G54001	174	G62100	111	G70027	79	G70146	80
G54002	174	G62200	111	G70028	79	G70147	80
G54003	174	G62300	111	G70029	79	G70148	80
G54004	174	G63001	112	G70030	79	G70149	80
G54005	174	G64000	112	G70031	79	G70150	80
G54006	174	G64001	112	G70032	79	G70151	80
G54008	174	G64002	112	G70033	79	G70152	80
G54010	174	G64004	112	G70034	79	G70153	80
G54012	174	G64005	112	G70035	79	G70154	80
G54013	174	G64015	112	G70036	79	G70155	80
G54015	174	G64020	112	G70037	79	G70200	80
G54025	174	G64030	112, 397	G70038	79	G70201	80
G54035	174	G64055	111	G70039	79	G70202	80
G54075	174	G64060	112	G70040	79	G70203	80
G54102	175	G64100	112	G70041	79	G70204	80
G54103	175	G64101	112	G70042	79	G70205	80
G54104	175	G64155	112	G70043	79	G70206	80
G54105	175	G64160	112	G70044	79	G70207	80
G54106	175	G64200	112	G70045	79	G70208	80
G54108	175	G64300	112	G70046	79	G70209	80
G54110	175	G64301	112	G70047	79	G70210	80
G54112	175	G64333	112	G70048	79	G70211	80
G54115	175	G65055	111	G70049	79	G70212	80
G54125	175	G65155	112	G70050	79	G70213	80
G54202	175	G657-0001	354	G70051	79	G70214	80
G54203	175	G657-0002	354	G70052	79	G70215	80
G54204	175	G657-0025	354	G70053	79	G70216	80
G54205	175	G657-0050	354	G70054	79	G70217	80
G54206	175	G657-0100	354	G70055	79	G70218	80
G54208	175	G657-0150	354	G70100	79	G70219	80
G54210	175	G657-0215	354	G70101	79	G70220	80
G54212	175	G657-0295	354	G70102	79	G70221	80
G54215	175	G657-0390	354	G70103	79	G70222	80
G54225	175	G657-0520	354	G70104	79	G70223	80
G55001	176	G657-0650	354	G70105	79	G70224	80
G55002	176	G657-0860	354	G70106	79	G70225	80
G55003	176	G66000	112	G70107	79	G70226	80
G55004	176	G66002	112	G70108	79	G70227	80
G55005	176	G66015	112	G70109	79	G70228	80
G55014	176	G66030	112	G70110	79	G70229	80
G55016	176	G66060	112	G70111	79	G70230	80
G55018	176	G66100	112	G70112	79	G70231	80
G55116	176	G67000	112	G70113	79	G70232	80
G55118	176	G67002	112	G70114	79	G70233	80
G55150	175	G67015	112	G70115	79	G70234	80
G55200	175	G67030	112	G70116	79	G70235	80
G55250	175	G67060	112	G70117	79	G70236	80
G55300	175	G67100	112	G70118	79	G70237	80
G55350	175	G70000	79	G70119	79	G70300	81
G55400	175	G70001	79	G70120	79	G70301	81
G55450	175	G70002	79	G70121	79	G70302	81
G55500	175	G70003	79	G70122	79	G70303	81
G55550	175	G70004	79	G70123	80	G70304	81
G55600	175	G70005	79	G70124	80	G70305	81
G60000	111	G70006	79	G70125	80	G70306	81
G60001	111	G70007	79	G70126	80	G70307	81
G60005	111	G70008	79	G70127	80	G70308	81
G60015	111	G70009	79	G70128	80	G70309	81
G60030	111, 397	G70010	79	G70129	80	G70310	81
G60055	111	G70011	79	G70130	80	G70311	81
G60060	111	G70012	79	G70131	80	G70312	81
G60100	111	G70013	79	G70132	80	G70313	81
G60160	111	G70014	79	G70133	80	G70314	81
G60200	111	G70015	79	G70134	80	G70315	81
G60300	111	G70016	79	G70135	80	G70316	81
G61005	112	G70017	79	G70136	80	G70317	81
G61015	111	G70018	79	G70137	80	G70318	81
G61030	111	G70019	79	G70138	80	G70319	81
G61060	111	G70020	79	G70139	80	G70320	81
G61100	111	G70021	79	G70140	80	G70321	81

PART NO.	PG #	PART NO.	PG #	PART NO.	PG #	PART NO.	PG #
G70322	81	G71059	82	G71154	83	G71249	84
G70323	81	G71060	82	G71155	83	G71250	84
G70324	81	G71061	82	G71156	83	G71251	84
G70325	81	G71062	82	G71157	83	G71252	84
G70326	81	G71063	82	G71158	83	G71253	84
G70327	81	G71064	82	G71159	83	G71254	84
G70328	81	G71065	82	G71160	83	G71255	84
G70329	81	G71066	82	G71161	83	G71256	84
G70330	81	G71067	82	G71162	83	G71257	84
G70331	81	G71068	82	G71163	83	G71258	84
G70332	81	G71069	82	G71164	83	G71259	84
G70333	81	G71070	82	G71165	83	G71260	84
G70334	81	G71071	82	G71166	83	G71261	84
G70335	81	G71072	82	G71167	83	G71262	84
G70336	81	G71073	82	G71168	83	G71263	84
G70337	81	G71074	82	G71169	83	G71264	84
G71000	81	G71075	82	G71170	83	G71265	84
G71001	81	G71076	82	G71171	83	G71266	84
G71002	81	G71077	82	G71172	83	G71267	84
G71003	81	G71078	82	G71173	83	G71300	84
G71004	81	G71079	82	G71174	83	G71304	84
G71005	81	G71100	82	G71175	83	G71305	84
G71006	81	G71101	82	G71176	83	G71307	84
G71007	81	G71102	82	G71177	83	G71308	84
G71008	81	G71103	82	G71178	83	G71312	84
G71009	81	G71104	82	G71179	83	G71313	84
G71010	81	G71105	82	G71200	83	G71315	84
G71011	81	G71106	82	G71201	83	G71316	84
G71012	81	G71107	82	G71202	83	G71320	84
G71013	81	G71108	82	G71203	83	G71321	84
G71014	81	G71109	82	G71204	83	G71323	84
G71015	81	G71110	82	G71205	83	G71324	84
G71016	81	G71111	82	G71206	83	G71328	84
G71017	81	G71112	82	G71207	83	G71329	84
G71018	81	G71113	82	G71208	83	G71331	84
G71019	81	G71114	82	G71209	83	G71332	84
G71020	81	G71115	82	G71210	83	G71336	84
G71021	81	G71116	82	G71211	83	G71337	84
G71022	81	G71117	82	G71212	83	G71339	84
G71023	81	G71118	82	G71213	83	G71340	84
G71024	81	G71119	82	G71214	83	G71344	84
G71025	81	G71120	82	G71215	83	G71345	84
G71026	81	G71121	82	G71216	83	G71347	84
G71027	81	G71122	82	G71217	83	G71348	84
G71028	81	G71123	82	G71218	83	G71352	84
G71029	81	G71124	82	G71219	83	G71353	84
G71030	81	G71125	82	G71220	83	G71356	84
G71031	81	G71126	82	G71221	83	G71360	84
G71032	81	G71127	82	G71222	83	G71361	84
G71033	81	G71128	82	G71223	83	G71401	87
G71034	81	G71129	82	G71224	83	G71402	87
G71035	81	G71130	82	G71225	83	G71403	87
G71036	81	G71131	82	G71226	83	G71404	87
G71037	81	G71132	82	G71227	83	G72000	85
G71038	81	G71133	82	G71228	83	G72001	85
G71039	81	G71134	82	G71229	83	G72002	85
G71040	81	G71135	82	G71230	83	G72003	85
G71041	81	G71136	82	G71231	83	G72004	85
G71042	81	G71137	82	G71232	83	G72005	85
G71043	81	G71138	82	G71233	83	G72006	85
G71044	81	G71139	82	G71234	83	G72007	85
G71045	81	G71140	82	G71235	83	G72008	85
G71046	82	G71141	82	G71236	83	G72009	85
G71047	82	G71142	82	G71237	83	G72010	85
G71048	82	G71143	83	G71238	83	G72011	85
G71049	82	G71144	83	G71239	83	G72012	85
G71050	82	G71145	83	G71240	83	G72013	85
G71051	82	G71146	83	G71241	83	G72014	85
G71052	82	G71147	83	G71242	83	G72015	85
G71053	82	G71148	83	G71243	83	G72016	85
G71054	82	G71149	83	G71244	84	G72017	85
G71055	82	G71150	83	G71245	84	G72018	85
G71056	82	G71151	83	G71246	84	G72019	85
G71057	82	G71152	83	G71247	84	G72020	85
G71058	82	G71153	83	G71248	84	G72021	85

PART NO.	PG #	PART NO.	PG #	PART NO.	PG #	PART NO.	PG #
G72022	85	G72130	86	G72333	87	H14050	124
G72023	85	G72131	86	G72334	87	H14075	124
G72024	85	G72132	86	G72335	87	H14100	124
G72025	85	G72133	86	G73101	88	H14125	124
G72026	85	G72134	86	G73108	88	H14150	124
G72027	85	G72135	86	G73115	88	H14200	124
G72028	85	G72136	86	G73122	88	H14250	124
G72029	85	G72137	86	G73129	88	H14300	124
G72030	85	G72138	86	G74103	88	H14350	124
G72031	85	G72139	86	G74105	88	H14400	124
G72032	85	G72140	86	G74111	88	H15001	118
G72033	85	G72141	86	G74113	88	H15050	118
G72034	85	G72142	86	G74119	88	H15075	118
G72035	85	G72143	86	G74121	88	H15100	118
G72036	85	G72144	86	G74127	88	H15125	118
G72037	85	G72145	86	G74129	88	H15150	118
G72038	85	G72146	86	G74135	88	H15200	118
G72039	85	G72147	86	G74137	88	H16038	118
G72040	85	G72148	86	GI05	357	H16050	118
G72041	85	G72149	86	GI07	357	H16075	118
G72042	85	G72150	86	GI10	357	H16100	118
G72043	85	G72151	86	GI12	357	H17050	124
G72044	85	G72152	86	GI15	357	H17075	124
G72045	85	G72153	86	GI20	357	H17100	124
G72046	85	G72154	86	H10052	117	H17125	124
G72047	85	G72155	86	H10054	117	H17150	124
G72048	85	G72200	87	H10056	117	H17200	124
G72049	85	G72201	87	H10058	117	H17250	124
G72050	85	G72202	87	H10072	117	H17300	124
G72051	85	G72203	87	H10074	117	H17350	124
G72052	85	G72204	87	H10076	117	H17400	124
G72053	85	G72205	87	H10078	117	H18050	118
G72054	85	G72206	87	H10080	117	H18075	118
G72055	85	G72207	87	H10106	117	H20001	119
G72056	85	G72208	87	H10108	117	H20002	119
G72057	85	G72209	87	H10110	117	H20003	119
G72058	85	G72210	87	H10126	117	H20005	119
G72059	85	G72211	87	H10128	117	H20006	119
G72060	85	G72212	87	H10156	117	H20007	119
G72061	85	G72213	87	H10158	117	H20010	119
G72062	85	G72214	87	H10208	117	H20011	119
G72063	85	G72215	87	H105	359	H20012	119
G72064	85	G72216	87	H107	359	H20100	119
G72065	85	G72217	87	H110	359	H20150	119
G72066	85	G72218	87	H11054	117	H20500	119
G72100	86	G72219	87	H11056	117	H21010	119
G72101	86	G72220	87	H11058	117	H21025	119
G72102	86	G72221	87	H11074	117	H21050	119, 398
G72103	86	G72222	87	H11076	117	H21100	119
G72104	86	G72223	87	H11078	117	H21101	119
G72105	86	G72224	87	H11080	117	H21200	119
G72106	86	G72225	87	H11106	117	H22050	118
G72107	86	G72226	87	H11108	117	H22075	118
G72108	86	G72227	87	H11126	117	H23050	117
G72109	86	G72228	87	H11156	117	H24038	118
G72110	86	G72229	87	H112	359	H24050	118
G72111	86	G72230	87	H11208	117	H24075	118
G72112	86	G72231	87	H11210	117	H24100	118
G72113	86	G72300	87	H115	359	H25050	118
G72114	86	G72302	87	H120	359	H25075	118
G72115	86	G72304	87	H12054	117	H25100	118
G72116	86	G72306	87	H12056	117	H26050	118
G72117	86	G72308	87	H12074	117	H26075	118
G72118	86	G72310	87	H12076	117	H26100	118
G72119	86	G72312	87	H12106	117	H26125	118
G72120	86	G72314	87	H13038	118	H26150	118
G72121	86	G72316	87	H13050	118	H26200	118
G72122	86	G72318	87	H13075	118	H27050	119
G72123	86	G72320	87	H13100	118	H27075	119
G72124	86	G72322	87	H13125	118	H27100	119
G72125	86	G72324	87	H13150	118	H28050	119
G72126	86	G72326	87	H13200	118	H28075	119
G72127	86	G72328	87	H13250	118	H28100	119
G72128	86	G72330	87	H13300	118	H28125	119
G72129	86	G72332	87	H13400	118	H28150	119

PART NO.	PG #	PART NO.	PG #	PART NO.	PG #	PART NO.	PG #
H28200	119	H68200	125	I10010	161, 395	I12008	162
H29000	119	H68250	125	I10011	161, 395	I12009	162
H29010	119	H68300	125	I10012	161, 395	I12010	162
H30001	117	H68350	125	I10013	161, 395	I12011	162
H30002	117	H68400	125	I10014	161, 395	I12012	162
H30003	117	H68500	125	I10015	161, 395	I12013	162
H30004	117	H68600	125	I10016	161, 395	I12014	162
H30011	117	H68800	125	I10017	161, 395	I12015	162
H30022	117	H69050	125	I10018	161, 395	I12016	162
H30033	117	H69075	125	I10019	161, 395	I12017	162
H30044	117	H69100	125	I10020	161, 395	I12018	162
H305	359	H69150	125	I10021	161, 395	I13001	163
H307	359	H69200	125	I10022	161, 395	I13002	163
H310	359	H69250	125	I10023	161, 395	I13003	163
H312	359	H69300	125	I10024	161, 395	I13004	163
H315	359	H69400	125	I10025	161, 395	I13005	163
H320	359	H70050	125	I10026	161, 395	I13006	163
H40001	305	H70075	125	I10027	161, 395	I13007	163
H40002	305	H70100	125	I10028	161, 395	I13008	163
H40003	305	H70125	125	I10029	161, 395	I13009	163
H40004	305	H70150	125	I10030	161, 395	I13010	163
H54001	68	H70200	125	I10031	161, 395	I13011	163
H54002	68	H70250	125	I10032	161, 395	I13012	163
H54003	68	H70300	125	I10033	161, 395	I13013	163
H54010	68	H70350	125	I10034	161, 395	I13014	163
H54011	68	H70400	125	I10035	161, 395	I13015	163
H54012	68	H72050	125	I10036	161, 395	I13016	163
H54013	68	H72075	125	I10037	161, 395	I13017	163
H54014	68	H72100	125	I10038	161, 395	I13018	163
H54015	68	H72125	125	I10039	161, 395	I13019	163
H54017	68	H72150	125	I10040	161, 395	I13020	163
H54018	68	H72200	125	I10041	161, 395	I13021	163
H54025	69	H72250	125	I10042	161, 395	I13022	163
H54026	69	H72300	125	I10043	161, 395	I13023	163
H54027	69	H72375	125	I10044	161, 395	I13024	163
H54028	69	H72400	125	I10045	161, 395	I13025	163
H54029	69	H73050	125	I10046	161, 395	I13026	163
H54030	68	H73075	125	I10047	161, 395	I13027	163
H54040	69	H73100	125	I10048	161, 395	I13028	163
H54041	69	H73125	125	I10049	161, 395	I13029	163
H54050	300	H73150	125	I11001	160	I13030	163
H54060	69	H73200	125	I11002	160	I13031	163
H54061	69	H73375	125	I11003	160	I13032	163
H54100	300	H80050	125	I11004	160	I13033	163
H56050	298	H80375	125	I11005	160	I13034	163
H56075	298	H81050	125	I11006	160	I13035	163
H60050	124	H81375	125	I11007	160	I13036	163
H60075	124	H82050	125	I11008	160	I13037	163
H60375	124	H82375	125	I11009	160	I13038	163
H60625	124	H83050	124	I11010	160	I13039	163
H65050	124	H83075	124	I11011	160	I13040	163
H65075	124	H83100	124	I11012	160	I13041	163
H65100	124	H84050	124	I11013	160	I13042	163
H65125	124	H84075	124	I11014	160	I50058	107
H65150	124	H84100	124	I11015	160	I50075	107
H65200	124	H85050	124	I11016	160	I50078	107
H65250	124	H85075	124	I11017	160	I50118	107
H65300	124	H85100	124	I11018	160	I50138	107
H65400	124	HDNHC1	313	I11019	160	I50158	107
H65500	124	HDNHC10	313	I11020	160	I50178	107
H65600	124	HDNHC2	313	I11021	160	I50218	107
H66050	124	HDNHC3	313	I11022	160	I50238	107
H66075	124	HDNHC4	313	I11023	160	I50258	107
H66100	124	HDNHC5	313	I11024	160	I51058	107
H66125	124	HDNHC6	313	I11025	160	I51078	107
H66150	124	HDNHC8	313	I11026	160	I51118	107
H66200	124	I10001	161, 395	I11027	160	I51138	107
H66250	124	I10002	161, 395	I11028	160	I51158	107
H66300	124	I10003	161, 395	I12001	162	I51178	107
H66400	124	I10004	161, 395	I12002	162	I51218	107
H68050	125	I10005	161, 395	I12003	162	I51238	107
H68075	125	I10006	161, 395	I12004	162	I51258	107
H68100	125	I10007	161, 395	I12005	162	I52034	107
H68125	125	I10008	161, 395	I12006	162	I52058	107
H68150	125	I10009	161, 395	I12007	162	I52078	107

PART NO.	PG #	PART NO.	PG #	PART NO.	PG #	PART NO.	PG #
152118	107	160078	103	181034	104	J04016	97
152138	107	160118	103	181038	104	J04104	96
152158	107	160138	103	181050	104	J04105	96
152178	107	160158	103	181058	104	J04106	96
152218	107	160200	103	181078	104	J04204	97
152238	107	160218	103	181118	104	J04205	97
152258	107	160250	103	181138	104	J04206	97
152318	107	160258	103	181150	104	J04250	97
152358	107	160300	103	181158	104	J34712	109
153038	107	160318	103	181200	104	J34715	109
153050	107	160350	103	181218	104	J34718	109
153058	107	161038	103	181250	104	J34724	109
153075	107	161050	103	181258	104	J34800	110
153078	107	161058	103	181300	104	J34970	111
153118	107	161075	103	181318	104	J34975	111
153138	107	161078	103	181358	104	J34980	111
153158	107	161118	103	181400	104	J35712	109
153178	107	161138	103	181418	104	J35715	109
153218	107	161158	103	182034	104	J35718	109
153238	107	161200	103	182038	104	J35724	109
153258	107	161218	103	182050	104	J36018	110
153312	107	161250	103	182058	104	J36022	110
153318	107	161258	103	182078	104	J36024	110
153358	107	161300	103	182118	104	J36026	110
153412	107	161318	103	182138	104	J36030	110
153418	107	161350	103	182150	104	J36100	284
154050	107	161358	103	182158	104	J36101	284
154058	107	161418	103	182200	104	J36118	109
154075	107	161450	103	182218	104	J36124	109
154078	107	162038	103	182250	104	J36130	109
154118	107	162050	103	182258	104	J36136	109
154138	107	162058	103	182300	104	J36148	109
154158	107	162075	103	182318	104	J36200	110
154178	107	162078	103	182358	104	J36250	110
154218	107	162118	103	182400	104	J36300	110
154258	107	162138	103	182418	104	J36400	110
155058	107	162158	103	183034	104	J36712	109
155075	107	162200	103	183058	104	J36715	109
155078	107	162218	103	183078	104	J36718	109
155118	107	162250	103	183118	104	J36724	109
155138	107	162258	103	183138	104	J37022	110
155158	107	162300	103	183150	104	J37024	110
155178	107	162318	103	183158	104	J37026	110
155218	107	162350	103	183200	104	J37028	110
155258	107	162358	103	183218	104	J37030	110
156058	107	162418	103	183250	104	J37124	57,317
156075	107	162450	103	183258	104	J37150	57,317
156078	107	163058	103	183300	104	J38020	110
156118	107	163075	103	183318	104	J38022	110
156138	107	163078	103	183358	104	J38024	110
156158	107	163118	103	183418	104	J38026	110
156218	107	163138	103	1A1050	108	J38030	110
157058	107	163158	103	1A1100	108	J38712	109
157078	107	163200	103	1A2050	108	J38715	109
157115	107	163218	103	1A2100	108	J38718	109
157118	107	163250	103	1INT001	108	J38724	109
157138	107	163258	103	1INT002	108	J39019	110
157158	107	163300	103	1IPC004	108	J39023	110
157178	107	163318	103	1J01001	96	J39027	110
157218	107	163350	103	1J01050	117	J39030	110
157238	107	163358	103	1J01051	117	J39712	109
157258	107	180034	104	1J01052	117	J39715	109
159050	108	180038	104	1J01053	117	J39718	109
159075	108	180050	104	1J01057	117	J39724	109
159100	108	180058	104	1J01075	117	1J40000	284
159125	108	180078	104	1J01077	117	1J40001	284
159150	108	180118	104	1J01100	117	1J40002	284, 384
159175	108	180138	104	1J01150	118	1J40003	284
159200	108	180150	104	1J01200	118	1J40004	284
159225	108	180158	104	1J01300	118	1J40005	284, 383,
160025	103	180200	104	1J01400	118		384, 385
160038	103	180218	104	1J04004	96	1J40006	284
160050	103	180250	104	1J04005	96	1J40007	285, 384
160058	103	180258	104	1J04006	96	1J40008	284
160075	103	180318	104	1J04012	97		

PART NO.	PG #	PART NO.	PG #	PART NO.	PG #	PART NO.	PG #
J40010	286, 383, 385	J40134	306	J40352	300	J40830	289, 383, 384, 385
J40011	286	J40141	293	J40353	300	J40831	289, 383, 384, 385
J40012	286, 384	J40142	293	J40360	300		
J40013	286	J40143	293	J40369	294		
J40015	284, 383, 384, 385	J40144	293	J40375	294	J40950	294
J40018	285, 383, 384, 385	J40150	61	J40380	301	J40951	294
J40019	287, 385	J40151	61	J40381	301	J40952	294
J40020	307	J40153	61	J40382	301	J40953	294
J40021	286, 383, 385	J40197	299	J40383	301	J40954	294
J40022	286	J40198	288	J40384	301	J40955	294
J40023	286	J40199	299	J40385	301	J40960	294
J40024	286	J40200	299	J40386	301	J40965	294
J40025	284	J40201	299	J40387	301	J40966	294
J40026	285	J40202	299	J40393	305	J40967	294
J40028	287, 383, 385	J40203	300	J40400	293	J41002	292
J40030	284	J40204	300	J40401	298	J41008	292
J40035	285	J40206	300	J40402	298	J41009	292
J40040	285	J40207	300	J40403	298	J41010	293
J40041	285	J40208	299	J40404	298	J41011	293
J40042	285, 385	J40210	298	J40405	298	J41021	297
J40044	296	J40211	298	J40406	299	J41022	297
J40045	296	J40212	298	J40407	298	J41023	297
J40046	296	J40213	290	J40408	298	J41024	297
J40047	296	J40214	290	J40410	298	J41030	306
J40048	296, 383, 385	J40215	290	J40411	298	J41031	306
J40049	296	J40217	290	J40429	297	J41032	306
J40050	295	J40218	290	J40450	307	J41103	295
J40051	295, 384	J40219	290	J40451	307	J41104	295
J40052	295	J40220	295	J40481	307	J41105	295
J40053	295	J40221	295	J40482	307	J41106	295
J40054	295, 384	J40222	295	J40490	285	J41107	295
J40055	295	J40223	288	J40491	285	J41108	295
J40060	307	J40224	288	J40500	113	J41201	298
J40061	307	J40225	288	J40501	113	J41202	298
J40062	307	J40228	290	J40502	113	J41205	298
J40063	307	J40229	297	J40503	113	J41206	298
J40065	287	J40230	287	J40505	113	J42002	294
J40066	287	J40235	286	J40506	113	J42003	294
J40067	287	J40240	290	J40510	113	J42004	294
J40068	287	J40241	290	J40511	113	J42008	307
J40069	287	J40242	290	J40529	297	J42012	307
J40070	287	J40243	290	J40550	112	J42101	308
J40071	287	J40244	290	J40551	112	J42200	308
J40072	287	J40260	290	J40553	111	J43300	307
J40073	287	J40261	290	J40554	111	J43310	307
J40074	287	J40262	290	J40555	111	J44050	289, 384, 385
J40075	287	J40263	290	J40556	111	J44075	289, 384, 385
J40076	287	J40284	300	J40557	111	J44100	289, 384, 385
J40077	287	J40285	300	J40558	112	J44150	289, 384, 385
J40078	287	J40286	300	J40560	112	J44200	289, 384, 385
J40079	287	J40287	300	J40561	113	J44300	289, 384, 385
J40080	294, 384	J40288	299	J40562	113	J44400	289, 384, 385
J40086	296	J40305	286	J40563	113	J44661	286
J40087	296	J40306	286	J40600	297	J45005	309
J40088	296	J40307	287	J40601	297	J45010	285, 383, 384, 385
J40089	296	J40308	287	J40629	297	J45015	286, 383, 385
J40100	308, 384	J40311	287	J40700	113	J45100	303
J40101	296, 384	J40325	287, 384	J40701	113	J46118	307
J40105	287	J40329	297	J40702	113	J60004	277
J40106	287	J40330	301	J40703	113	J60005	277
J40107	305	J40331	301	J40704	113	J60007	277
J40108	306	J40332	301	J40705	113	J60008	277
J40111	305	J40333	301	J40750	294	J60010	278
J40115	305	J40334	301	J40775	294	J60011	278
J40116	305	J40335	301	J40800	294		
J401167	305	J40336	301	J40801	298		
J40123	288	J40337	301	J40802	298		
J40128	287	J40338	301	J40803	298		
		J40339	301	J40804	298		
		J40340	301	J40805	298		
		J40341	301	J40806	298		
		J40342	301	J40807	298		
		J40343	301	J40808	298		
		J40350	300	J40812	297		
		J40351	300				

PART NO.	PG #	PART NO.	PG #	PART NO.	PG #	PART NO.	PG #
J60012	278	K104800057	372	K151010005	362	K151140390	362
J60026	277	K104800058	372	K151010006	362	K151150002	363
J60027	277	K104800100	372	K151010007	362	K151150050	363
J60030	275	K104800106	372	K151010024	362	K151150057	363
J60060	273	K104800107	372	K151010025	362	K151150058	363
J60061	273	K104800108	372	K151010032	362	K151150100	363
J60062	273	K104800117	372	K151010050	362	K151150150	363
J60094	277	K104800150	372	K151010056	362	K151150215	363
J66300	111, 397	K104800159	372	K151010057	362	K151150295	363
J66301	111	K104800160	372	K151010058	362	K151150390	363
K01120	305	K104800215	372	K151010059	362	K151400007	366
K012000	305	K104800222	372	K151010092	362	K151400032	366
K101010050	370	K104800223	372	K151010100	362	K151400058	366
K101010057	370	K104800224	372	K151010106	362	K151400059	366
K101010100	370	K104800295	372	K151010107	362	K151400107	366
K101010105	370	K104800304	372	K151010150	362	K151400108	366
K101010107	370	K104800306	372	K151010157	362	K151400149	366
K101010150	370	K104800400	372	K151010158	362	K151400159	366
K101010215	370	K104820050	372	K151010159	362	K151400160	366
K101010295	370	K104920050	372	K151010160	362	K151400222	366
K101010390	370	K104920081	372	K151010215	362	K151400223	366
K101010520	370	K104920100	372	K151010221	362	K151400303	366
K101010860	370	K104920117	372	K151010222	362	K151400398	366
K101020057	370	K104920143	372	K151010223	362	K151540001	364
K101050050	370	K104920150	372	K151010295	362	K151540002	364
K101050100	370	K104920169	372	K151010302	362	K151540025	364
K101050105	370	K104920180	372	K151010303	362	K151540050	364
K101050106	370	K104920206	372	K151010304	362	K151540090	364
K101050150	370	K104920283	372	K151010390	362	K151540100	364
K101050157	370	K104980050	372	K151010398	362	K151540150	364
K101050215	370	K104980100	372	K151010399	362	K151540215	364
K101050295	370	K104980107	372	K151010520	362	K151540295	364
K101050390	370	K104980118	372	K151010531	362	K151540390	364
K101150059	370	K108400100	372	K151010650	362	K151540520	364
K101150107	370	K113420100	380	K151010860	362	K151540650	364
K101750050	370	K113420150	380	K151050001	362	K151540860	364
K101750100	370	K113420215	380	K151050002	362	K151541100	364
K101950050	370	K113420295	380	K151050006	362	K151650001	363
K101950100	370	K113420390	380	K151050024	362	K151650002	363
K101950150	370	K113420520	380	K151050025	362	K151650007	363
K101950215	370	K113420650	380	K151050031	362	K151650008	363
K101950390	370	K113420860	380	K151050032	362	K151650015	363
K102350223	370	K113421100	380	K151050050	362	K151650025	363
K102360050	370	K113450150	380	K151050056	362	K151650032	363
K102400100	371	K113450215	380	K151050057	362	K151650033	363
K102400150	371	K113450295	380	K151050058	362	K151650050	363
K102550025	371	K113450390	380	K151050059	362	K151650058	363
K102550050	371	K113450520	380	K151050060	362	K151650059	363
K102550057	371	K113450650	380	K151050092	362	K151650090	363
K102550058	371	K113450860	380	K151050093	362	K151650093	363
K102550100	371	K113451100	380	K151050100	362	K151650094	363
K102550107	371	K126570215	367	K151050106	362	K151650095	363
K102550150	371	K126570295	367	K151050107	362	K151650100	363
K102550215	371	K126570390	367	K151050150	362	K151650107	363
K102550295	371	K126570520	367	K151050158	362	K151650108	363
K102550390	371	K126570650	367	K151050159	362	K151650109	363
K102570050	371	K126610025	373	K151050160	362	K151650149	363
K102570057	371	K126610050	373	K151050215	362	K151650150	363
K102570058	371	K126610100	373	K151050221	362	K151650159	363
K102570100	371	K126610150	373	K151050222	362	K151650160	363
K102570107	371	K126610215	373	K151050223	362	K151650161	363
K102570150	371	K126610295	373	K151050295	362	K151650215	363
K102570160	371	K126610390	373	K151050302	362	K151650222	363
K102570215	371	K126650050	373	K151050303	362	K151650223	363
K102570295	371	K126650100	373	K151050390	362	K151650224	363
K102570390	371	K126650150	373	K151050398	362	K151650295	363
K102590050	371	K126650215	373	K151050520	362	K151650303	363
K102590058	371	K126650295	373	K151050650	362	K151650304	363
K102590107	371	K126650390	373	K151140025	362	K151650305	363
K102590150	371	K142400050	371	K151140050	362	K151650306	363
K102600050	371	K142400100	371	K151140057	362	K151650390	363
K102900860	371	K142590050	371	K151140100	362	K151650398	363
K104670050	372	K142590100	371	K151140150	362	K151650399	363
K104800025	372	K151010001	362	K151140215	362	K151650400	363
K104800050	372	K151010002	362	K151140295	362	K151650401	363

PART NO.	PG #	PART NO.	PG #	PART NO.	PG #	PART NO.	PG #
K151650402	363	K152350860	364	K154100032	367	K154600169	368
K151650520	363	K152350975	364	K154100058	367	K154600170	368
K151650531	363	K152351100	364	K154100059	367	K154600171	368
K151650532	363	K152351225	364	K154100093	367	K154600180	368
K151650533	363	K152380090	365	K154100094	367	K154600181	368
K151650534	363	K152420001	365	K154100107	367	K154600182	368
K151650650	363	K152420002	365	K154100108	367	K154600215	368
K151650662	363	K152420015	365	K154100109	367	K154600220	368
K151650663	363	K152420025	365	K154100149	367	K154600221	368
K151650664	363	K152420050	365	K154100159	367	K154600222	368
K151650780	363	K152420090	365	K154100160	367	K154600223	368
K151650860	363	K152420100	365	K154100222	367	K154600224	368
K151650870	363	K152420150	365	K154100223	367	K154600234	368
K151650871	363	K152420215	365	K154100224	367	K154600235	368
K151650872	363	K152420295	365	K154100303	367	K154600236	368
K151650873	363	K152420390	365	K154100304	367	K154600237	368
K151650874	363	K152420520	365	K154100305	367	K154600245	368
K151651100	363	K152420650	365	K154100306	367	K154600246	368
K151651109	363	K152420860	365	K154100398	367	K154600247	368
K151651111	363	K152540002	365	K154100399	367	K154600248	368
K151651225	363	K152540025	365	K154100400	367	K154600256	368
K151651498	363	K152540050	365	K154100401	367	K154600295	368
K151700001	364	K152540090	365	K154100402	367	K154600302	368
K151700002	364	K152540100	365	K154100531	367	K154600303	368
K151700025	364	K152540150	365	K154100532	367	K154600304	368
K151700050	364	K152540215	365	K154100533	367	K154600305	368
K151700090	364	K152540295	365	K154100534	367	K154600306	368
K151700100	364	K152540390	365	K154100662	367	K154600315	368
K151700150	364	K152540520	365	K154100663	367	K154600316	368
K151700215	364	K152540650	365	K154100664	367	K154600317	368
K151700295	364	K152540860	365	K154100665	367	K154600318	368
K151700390	364	K152670050	365	K154100869	367	K154600319	368
K151700520	364	K152670100	365	K154100870	367	K154600328	368
K151700650	364	K152670215	365	K154100871	367	K154600329	368
K151700780	364	K152720002	365	K154100872	367	K154600330	368
K151700860	364	K152720025	365	K154100983	367	K154600331	368
K151700975	364	K152720050	365	K154101498	367	K154600332	368
K151701100	364	K152720090	365	K154600001	368	K154600339	368
K151720001	364	K152720100	365	K154600002	368	K154600340	368
K151720002	364	K152720150	365	K154600006	368	K154600341	368
K151720025	364	K152720215	365	K154600007	368	K154600342	368
K151720050	364	K152720295	365	K154600012	368	K154600343	368
K151720090	364	K152720390	365	K154600013	368	K154600350	368
K151720100	364	K152720520	365	K154600025	368	K154600352	368
K151720150	364	K152720860	365	K154600031	368	K154600390	368
K151720215	364	K152900001	365	K154600032	368	K154600397	368
K151720295	364	K152900002	365	K154600033	368	K154600398	368
K151720390	364	K152900025	365	K154600041	368	K154600399	368
K151720520	364	K152900050	365	K154600050	368	K154600400	368
K151720650	364	K152900090	365	K154600056	368	K154600401	368
K151720860	364	K152900100	365	K154600057	368	K154600402	368
K151720975	364	K152900150	365	K154600058	368	K154600413	368
K152350001	364	K152900215	365	K154600059	368	K154600414	368
K152350002	364	K152900295	365	K154600060	368	K154600415	368
K152350025	364	K152900390	365	K154600066	368	K154600416	368
K152350032	364	K152900520	365	K154600068	368	K154600417	368
K152350050	364	K152900650	365	K154600075	368	K154600418	368
K152350059	364	K152900860	365	K154600087	368	K154600429	368
K152350090	364	K152900975	365	K154600090	368	K154600430	368
K152350093	364	K152901100	365	K154600092	368	K154600431	368
K152350100	364	K152950002	366	K154600095	368	K154600432	368
K152350107	364	K152950025	366	K154600100	368	K154600433	368
K152350150	364	K152950050	366	K154600106	368	K154600444	368
K152350159	364	K152950090	366	K154600107	368	K154600447	368
K152350160	364	K152950100	366	K154600108	368	K154600457	368
K152350215	364	K152950150	366	K154600109	368	K154600470	368
K152350222	364	K152950215	366	K154600117	368	K154600520	368
K152350223	364	K152950295	366	K154600118	368	K154600531	369
K152350295	364	K152950390	366	K154600127	368	K154600532	369
K152350303	364	K152950520	366	K154600150	368	K154600533	369
K152350390	364	K152950650	366	K154600157	368	K154600534	369
K152350398	364	K152950860	366	K154600158	368	K154600535	369
K152350520	364	K153960050	366	K154600159	368	K154600536	369
K152350650	364	K153960150	366	K154600160	368	K154600548	369
K152350780	364	K154100007	367	K154600161	368	K154600549	369

PART NO.	PG #	PART NO.	PG #	PART NO.	PG #	PART NO.	PG #
K154600550	369	K201010303	376	K52003	63	L75085	280
K154600551	369	K201010390	376	K52004	63	L75086	280
K154600552	369	K201010650	376	K52005	63	L75091	280
K154600553	369	K201010860	376	K52010	4, 63	L75092	280
K154600554	369	K201050295	376	K52011	4	L75095	280
K154600564	369	K201050650	376	K52013	4	L75096	280
K154600565	369	K201050860	376	K52014	4	L75180	280
K154600566	369	K201100390	376	K52016	4	L75181	280
K154600580	369	K201120302	376	K52017	4	L75185	280
K154600583	369	K201120390	376	K53001	63	L75186	280
K154600595	369	K201150295	376	K53002	63	L75400	281
K154600608	368	K201150390	376	K53003	63	L75401	281
K154600650	369	K201200295	376	K53004	63	L75402	281
K154600662	369	K201540295	376	K53005	63	L75403	281
K154600663	369	K201610215	376	K53006	63	L75406	281
K154600664	369	K201610295	376	K53007	63	L75407	281
K154600665	369	K201610390	376	K53008	63	L75408	281
K154600666	369	K201620215	376	K53055	63	L75409	281
K154600667	369	K201620650	376	K53056	63	L75908	280
K154600668	369	K202350303	377	K53057	63	L75909	280
K154600677	369	K202350398	377	K53058	63	L95200	312
K154600678	369	K202350650	377	K53060	63	L95201	312
K154600679	369	K202350860	377	K53077	63	L95202	312
K154600680	369	K202540650	377	K55006	63	L95400	310
K154600682	369	K202540860	377	K55007	63	M05001	78, 122,
K154600693	369	K202550295	377	L40001	120		276
K154600694	369	K202570295	377	L40002	120	M05003	78, 122,
K154600695	369	K202900860	377	L42006	120		276
K154600696	369	K202950650	377	L42008	120	M05005	78, 122
K154600708	369	K203100215	377	L42011	308	M05034	193
K154600746	369	K203100295	377	L42012	308	M05134	194
K154600860	369	K203100390	377	L42013	308	M06001	126
K154600870	369	K204180295	377	L42014	308	M06002	126
K154600871	369	K204600215	377	L42015	308	M06006	127
K154600872	369	K204600295	377	L42016	308	M06007	127
K154600873	369	K204600390	377	L42017	308	M06010	127
K154600874	369	K204600398	377	L42018	308	M07001	126
K154600875	369	K204600414	377	L42019	308	M07002	126
K154600876	369	K204650295	378	L42023	308	M101	359
K154600877	369	K204650390	378	L42052	120	M102	359
K154600893	369	K204650398	378	L42102	120	M103	359
K154600895	369	K204650695	378	L42103	120	M105	359
K154600896	369	K204800295	378	L42104	120	M107	359
K154600914	369	K204800390	378	L47001	77	M110	359
K154600975	369	K204850295	378	L47004	77	M112	359
K154601100	369	K204850390	378	L56020	64	M115	359
K154601109	369	K205220390	378	L56021	64	M120	359
K154601111	369	K208400215	378	L56023	64	M12001	126
K154601113	369	K208400295	378	L56024	64	M12002	126
K154601225	369	K208400303	378	L56025	64	M12003	126
K154601498	368	K208400390	378	L56026	64	M12004	127
K155330050	366	K208400398	378	L56027	64	M12005	126, 127
K155330090	366	K208400399	378	L65001	63	M12006	126, 127
K155330100	366	K208400413	378	L75001	280	M12007	127
K155330150	366	K208400650	378	L75002	280	M12008	127
K155330215	366	K208400664	378	L75006	280	M12009	126
K155330295	366	K208450295	378	L75007	280	M12022	126
K155330390	366	K208450650	378	L75009	281	M12085	126
K156570002	367	K245500295	378	L75010	281	M12100	126
K156570025	367	K245500390	378	L75015	281	M125	359
K156570050	367	K245510215	378	L75016	281	M130	359
K156570100	367	K245510295	378	L75017	281	M140	359
K156570150	367	K245510390	378	L75018	281	M15001	127
K159470001	367	K245540295	379	L75019	281	M15002	127
K159470002	367	K245560295	379	L75020	281	M15004	127
K159470025	367	K50001	292	L75021	281	M15005	127
K159470050	367	K50002	292	L75022	281	M15006	127
K159470090	367	K50003	292	L75023	281	M15009	127
K159470100	367	K50005	292	L75024	281	M20058	126
K159470150	367	K50015	300	L75040	280	M20075	126
K159470215	367	K50016	300	L75041	280	M20100	126
K159470295	367	K50041	291	L75042	280	M20101	126
K159470390	367	K50042	291	L75043	280	M20581	126
K201010215	376	K52001	63, 397	L75080	280	M20751	126
K201010295	376	K52002	63	L75081	280		

PART NO.	PG #	PART NO.	PG #	PART NO.	PG #	PART NO.	PG #
M25100	294	N12006	159	N18300	154	N23016	147
M25127	294	N14001	159	N18400	154	N23018	147
M25130	294	N14002	159	N18500	154	N23020	147
M25136	294	N14003	159	N18600	154	N23022	147, 394
M25148	294	N14004	159	N20000	147	N2306BN	24
M25527	294	N14005	159	N20001	147	N2306RB	24
M25536	294	N14006	159	N20002	147	N2306WB	24
M25560	294	N14007	159	N20003	147	N2310BN	24
M25736	294	N14008	159	N20004	147	N2310PB	24
M25760	294	N14009	159	N20005	147	N2310RB	24
M25772	294	N14010	159	N20006	147	N2310WB	24
M25784	294	N14011	159	N20007	147	N24000	147, 394
M25900	126, 287	N14012	159	N20008	147	N24001	147
M301	359	N14013	159	N20009	147	N24002	147, 394
M302	359	N14014	159	N20010	147	N24003	147
M303	359	N14015	159	N20012	147	N24004	147
M305	359	N14016	159	N20014	147	N24005	147
M307	359	N14017	159	N20016	147	N24006	147
M310	359	N14018	159	N20018	147	N24007	147
M312	359	N14019	159	N20020	147	N24008	147
M315	359	N15001	159	N20022	147	N24009	147
M320	359	N15100	154, 388	N21000	147	N24010	147
M325	359	N15150	154	N21001	147	N24012	147
M330	359	N15200	154, 388	N21002	147	N24014	147
M340	359	N15250	154	N21003	147	N24016	147
N01001	166, 388	N15300	154	N21004	147	N24018	147
N01002	166, 388	N15350	154	N21005	147	N24020	147
N01010	165	N15400	154, 388	N21006	147	N24022	147
N01011	165	N15450	154	N21007	147	N25000	147, 394
N01014	165	N15500	154	N21008	147	N25002	147, 394
N01027	165	N15550	154	N21009	147	N25003	147
N01028	165	N15600	154	N21010	147	N25004	147
N01029	165	N15900	154	N21012	147	N25005	147
N01032	166	N15918	154	N21014	147	N25006	147
N01033	166	N15924	154	N21016	147	N25007	147
N01034	166	N15936	154	N21018	147	N25008	147
N01035	166	N15948	154	N21020	147	N25009	147
N01038	164	N15960	154	N21022	147	N25010	147
N01039	164	N15972	154	N22000	147	N25012	147
N06001	159	N16100	154, 388	N22001	147	N25014	147
N07001	159	N16150	154	N22002	147	N25016	147
N09001	159	N16200	154, 388	N22003	147	N25018	147
N09002	159	N16250	154	N22004	147	N25020	147
N10001	159	N16300	154	N22005	147	N25022	148
N10002	159	N16350	154	N22006	147	N27000	148
N10003	159	N16400	154, 388	N22007	147	N27002	148
N10004	159	N16450	154	N22008	147	N27003	148
N10005	159	N16500	154	N22009	147	N27004	148
N10006	159	N16550	154	N22010	147	N27005	148
N10007	159	N16600	154	N22012	147	N27006	148
N10008	159	N16900	154	N22014	147	N27007	148
N10244	164	N16918	154	N22016	147	N27008	148
N10266	164	N16924	154	N22018	147	N27009	148
N10442	164, 388	N16936	154	N22020	147	N27010	148
N10444	164	N16948	154	N22022	147	N27012	148
N10464	164	N16960	154	N2206BN	24	N27014	148
N10544	164, 393	N16972	154	N2206RB	24	N27016	148
N10566	164, 393	N17050	24	N2206WB	24	N27018	148
N10642	164, 393	N17100	154	N2210BN	24	N27020	148
N10644	164	N17150	154	N2210PB	24	N27022	148
N10664	164, 393	N17200	154	N2210RB	24	N28000	148
N10944	164	N17250	154	N2210WB	24	N28002	148
N11001	159	N17300	154	N23000	147	N28003	148
N11002	159	N17350	154	N23001	147	N28004	148
N11003	159	N17375	24	N23002	147	N28005	148
N11004	159	N17400	154	N23003	147	N28006	148
N11005	159	N17450	154	N23004	147	N28007	148
N11006	159	N17500	154	N23005	147	N28008	148
N11007	159	N17550	154	N23006	147	N28009	148
N11008	159	N17600	154	N23007	147	N28010	148
N12001	159	N18001	159	N23008	147	N28012	148
N12002	159	N18002	159	N23009	147	N28014	148
N12003	159	N18100	154	N23010	147	N28016	148
N12004	159	N18200	154	N23012	147	N28018	148
N12005	159	N18250	154	N23014	147	N28020	148

PART NO.	PG #	PART NO.	PG #	PART NO.	PG #	PART NO.	PG #
N28022	148	O15007	120	P12212	138	P3500WB	6
N29000	148	O25199	61	P12328	138	P35033	6
N29003	148	O25200	61	P12342	138	P3503BN	6
N29004	148	O25202	36	P12362	138	P3503RB	6
N29005	148	O25203	36	P12364	138	P3503WB	6
N29006	148	O25204	36	P12384	138	P35041	56
N29007	148	O25205	36	P12386	138	P35050	15, 16
N29008	148	O25206	36	P12402	137	P35051	15
N29009	148	O25207	36	P12404	137	P35052	15
N29010	148	O25208	36	P12406	137	P35053	15
N29012	148	O25209	36	P12408	137	P35055	15
N29014	148	O25210	36	P13224	138	P35056	15, 49
N29016	148	O25302	36	P13232	138, 394	P35057	49
N29018	148	O25303	36	P13424	138	P35058	15
N29020	148	O25304	36	P13432	138, 394	P35060	15, 49
N29022	148	O25305	36	P13600	288	P35061	15, 49
N30000	148	O25306	36	P13624	138	P35062	15, 49
N30004	148	O25307	36	P13632	138, 394	P35063	15, 49
N30005	148	O25308	36	P13986	137	P35064	15, 49
N30006	148	O25309	36	P15050	193	P35065	15
N30007	148	O25310	36	P15075	193	P35066	16, 49
N30008	148	P10001	288	P15175	193	P35067	16, 49
N30009	148	P10002	288	P16002	137, 394	P35068	15, 16
N30010	148	P10012	137, 394	P16004	137, 394	P35070	14, 50
N31000	148	P10014	137	P16006	137	P35071	14
N31004	148	P10016	137	P16008	137	P35072	15
N31005	148	P10018	137	P19042	137	P35073	15
N31006	148	P10032	137, 394	P19062	137	P35077	49
N31007	148	P10034	137, 394	P19064	137	P35125	50
N31008	148	P10036	137	P19082	137	P35150	50
N31009	148	P10038	137	P19084	137	P35158	50
N31010	148	P10082	137, 394	P19086	137	P35159	66
N61010	133	P10084	137, 394	P19128	137	P35160	50
N62006	133	P10086	137, 394	P20002	137	P35161	50
N62008	133	P10088	137	P20004	137	P35162	66
N62010	133	P10092	137, 394	P20006	137	P35163	66
N62086	133	P10094	137, 394	P20008	137	P35165	66
N62106	133	P10096	137, 394	P20092	138	P35166	66
N62108	133	P10098	137	P20094	138	P35167	66
N65106	133	P10312	137	P20096	138	P35170	14, 50
N66066	133	P10452	137	P20098	138	P35171	14
N66068	133	P10454	137	P21100	58	P35172	14
N66086	133	P10812	137	P21101	58	P35175	50
N66088	133	P10912	137	P21102	58	P35180	65
N66610	133	P11042	138, 394	P21103	58	P3560AB	16
N68066	133	P11062	138, 394	P21104	58	P3560AL	16
N68068	133	P11064	138, 394	P21107	58	P3560AN	16
N68086	133	P11082	138	P21150	57, 398	P3560BI	16
N68088	133	P11084	138, 394	P22100	194	P3560BL	16
N69066	133	P11086	138, 394	P22101	194	P3560BN	16
N69068	133	P11102	138	P22200	194	P3560BS	16
N69086	133	P11104	138	P22201	194	P3560NP	16
N69088	133	P11106	138	P22300	194	P3560PN	16
N70016	303	P11108	138	P22400	194	P3560PS	16
N70020	303	P11122	138	P27001	293	P3560PW	16
N70024	303	P11124	138, 394	P27003	293	P3560RB	16
N70032	303	P11126	138	P27004	293	P3560WB	16
N70050	303	P11128	138, 394	P27005	293	P35610	15, 16
N70066	133	P11202	138, 394	P27040	293	P35611	15, 16
N70068	133	P11204	138, 394	P27048	293	P35612	15
N70075	303	P11206	138, 394	P3450BN	6	P35613	15
N70086	133	P11208	138, 394	P3450CP	6	P35614	15
N70088	133	P11212	138	P3450RB	6	P35615	14
N70150	303	P11928	138	P35000	56	P35616	12
N70175	303	P11964	138	P35001	6, 56,	P3561AB	16
N70200	303	P11986	138		331, 397	P3561AL	16
N70250	303	P12102	137	P35002	6, 331	P3561AN	16
N70300	303	P12104	137	P35003	6, 56	P3561BI	16
N70500	303	P12106	137	P35004	56, 331	P3561BL	16
N70575	303	P12108	137	P35005	56, 331	P3561BN	16
N78064	164	P12112	137	P3500BN	6	P3561BS	16
O15001	120	P12202	138	P3500NP	6	P3561NP	16
O15002	120	P12204	138	P3500PB	6	P3561PN	16
O15003	120	P12206	138	P3500RB	6	P3561PS	16
O15006	120	P12208	138			P3561PW	16

PART NO.	PG #	PART NO.	PG #	PART NO.	PG #	PART NO.	PG #
P3561RB	16	P36102	57, 326	P37514	330	P38019	318
P3561WB	16	P36103	57, 326	P37515	330	P38020	318
P3562AB	15	P36104	329	P37517	330	P38021	318
P3562AL	15	P36105	329	P37518	330	P38022	318
P3562AN	15	P36125	6	P3751AB	19	P38023	319
P3562BI	15	P36150	6	P3751AL	19	P38024	319
P3562BL	15	P37000	333	P3751AN	19	P38025	319
P3562BN	15	P37001	324	P3751BI	19	P38026	319
P3562BS	15	P37002	324	P3751BL	19	P38027	319
P3562NP	15	P37003	324	P3751BN	19	P38028	319
P3562PN	15	P37004	324	P3751BS	19	P38029	319
P3562PS	15	P37005	324	P3751NP	19	P38030	319
P3562PW	15	P37006	324	P3751PN	19	P38031	319
P3562RB	15	P37007	324	P3751PS	19	P38032	320
P3562WB	15	P37008	324	P3751PW	19	P38033	320
P3563AB	15	P37009	324	P3751RB	19	P38034	320
P3563AL	15	P37010	325	P3751WB	19	P38035	320
P3563AN	15	P37011	325	P37520	330	P38036	320
P3563BI	15	P37012	325	P3752AB	19	P38037	320
P3563BL	15	P37013	325	P3752AL	19	P38038	320
P3563BN	15	P37014	325	P3752AN	19	P38039	320
P3563BS	15	P37015	325	P3752BI	19	P38040	320
P3563NP	15	P37016	325	P3752BL	19	P38041	320
P3563PN	15	P37017	325	P3752BN	19	P38042	320
P3563PS	15	P37018	325	P3752NP	19	P38043	320
P3563PW	15	P37019	325	P3752PN	19	P38044	320
P3563RB	15	P37020	326	P3752PS	19	P38045	320
P3563WB	15	P37021	326	P3752PW	19	P38046	320
P3565AB	14	P37022	326	P3752RB	19	P38047	320
P3565AL	14	P37023	326	P3752WB	19	P38048	320
P3565AN	14	P37024	326	P37550	19	P38049	320
P3565BI	14	P37025	326	P3755BN	19	P38050	320
P3565BL	14	P37026	326	P3755NP	19	P38051	320
P3565BN	14	P37027	326	P3755PB	19	P38052	320
P3565BS	14	P37028	326	P3755RB	19	P38053	320
P3565NP	14	P37029	326	P3755WB	19	P38054	320
P3565PN	14	P37030	325	P3755WH	19	P38055	320
P3565PS	14	P37031	325	P3761AB	19	P38056	320
P3565PW	14	P37032	324	P3761AL	19	P38057	320
P3565RB	14	P37033	326	P3761AN	19	P38058	320
P3565WB	14	P37034	324	P3761BI	19	P38059	320
P3566AB	14	P37035	326	P3761BL	19	P38060	320
P3566AL	14	P37036	324	P3761BN	19	P38061	320
P3566AN	14	P37037	325	P3761BS	19	P38062	321
P3566BI	14	P37038	326	P3761NP	19	P38063	320
P3566BL	14	P37040	325	P3761PN	19	P38064	320
P3566BN	14	P37041	325	P3761PS	19	P38065	321
P3566BS	14	P37042	324	P3761PW	19	P38066	321
P3566NP	14	P37118	325	P3761RB	19	P38067	321
P3566PN	14	P37200	326	P3761WB	19	P38068	321
P3566PS	14	P37400	326	P38001	317	P38069	321
P3566PW	14	P37445	326	P38002	317	P38070	321
P3566RB	14	P37490	326	P38002B	317	P38071	321
P3566WB	14	P37500	18, 330	P38003	317	P38072	322
P35900	56	P37502	18, 330	P38003B	317	P38073	322
P35901	56	P37503	19, 330	P38004	317	P38074	322
P35902	56	P37505	19, 330	P38005	317	P38075	322
P35904	56	P37506	19, 330	P38005B	317	P38076	322
P35905	56	P37508	19, 330	P38006	317	P38077	322
P35906	56	P37509	19, 330	P38006B	317	P38078	322
P35907	56	P3750AB	18	P38007	317	P38079	322
P35908	56	P3750AL	18	P38008	317	P38080	322
P35909	56	P3750AN	18	P38009	317	P38081	322
P35910	56	P3750BI	18	P38009B	317	P38082	322
P35911	56	P3750BL	18	P38010	317	P38083	322
P35912	56	P3750BN	18	P38010B	317	P38084	322
P35913	56	P3750BS	18	P38011	317	P38085	322
P35920	6	P3750NP	18	P38012	317	P38086	322
P35921	6	P3750PN	18	P38012B	317	P38087	322
P35922	6	P3750PS	18	P38013	318	P38088	322
P36002	50	P3750PW	18	P38014	318	P38089	322
P36003	50	P3750RB	18	P38015	318	P38091	317
P36004	50	P3750WB	18	P38016	318	P38092	317
P36100	6	P37511	19, 330	P38017	318	P38093	317
P36101	6, 326	P37512	330	P38018	318	P38094	317

PART NO.	PG #	PART NO.	PG #	PART NO.	PG #	PART NO.	PG #
P38095	318	P3892RB	6	P3951PS	19	P51500	265
P38096	318	P3892WB	6	P3951PW	19	P51600	265
P38097	318	P39000	333	P3951RB	19	P51800	265
P38098	318	P39001	327	P3951WB	19	P52150	265
P38099	318	P39002	327	P39520	330	P52200	265
P38100	318	P39003	327	P3952AB	19	P52250	265
P38101	319	P39004	327	P3952AL	19	P52300	265
P38102	319	P39005	327	P3952AN	19	P52350	265
P38103	319	P39006	327	P3952BI	19	P52400	265
P38104	319	P39007	327	P3952BL	19	P52500	265
P38105	319	P39008	327	P3952BN	19	P53150	265
P38106	319	P39009	327	P3952NP	19	P53200	265
P38107	318	P39010	327	P3952PN	19	P53250	265
P38108	318	P39011	327	P3952PS	19	P53300	265
P38109	318	P39012	327	P3952PW	19	P53350	265
P38110	318	P39013	328	P3952RB	19	P53400	265
P38111	318	P39014	328	P3952WB	19	P53500	265
P38112	318	P39015	328	P3961AB	19	P54150	266
P38113	318	P39016	328	P3961AL	19	P54200	266
P38114	318	P39017	328	P3961AN	19	P54250	266
P38115	320	P39018	328	P3961BI	19	P54300	266
P38116	320	P39019	328	P3961BL	19	P54350	266
P38117	320	P39020	328	P3961BN	19	P54400	266
P38118	321	P39021	328	P3961BS	19	P54500	266
P38119	321	P39022	328	P3961NP	19	P54600	266
P38120	321	P39023	329	P3961PN	19	P54800	266
P38121	321	P39024	329	P3961PS	19	P55150	265
P38122	321	P39025	329	P3961PW	19	P55250	265
P38123	321	P39026	329	P3961RB	19	P55300	120, 265
P38124	321	P39027	329	P3961WB	19	P55350	265
P38125	321	P39028	329	P40004	302	P55500	265
P38126	321	P39029	329	P40014	302	P56200	265
P38127	321	P39030	327	P40080	302	P56250	265
P38128	321	P39031	328	P48002	191, 398	P56300	265
P38129	319	P39032	327	P48003	191, 398	P56350	265
P38130	319	P39033	328	P48004	191, 398	P56400	265
P38131	322	P39034	327	P48102	191	P56450	265
P38132	322	P39035	328	P48103	191	P56500	265
P38133	322	P39040	328	P48104	191	P56550	265
P38134	322	P39041	328	P49002	234	P56600	265
P38135	322	P39500	18, 330	P49003	234	P56600	265
P38136	322	P39502	18, 330	P49004	234	P58150	266
P38137	318	P39503	19, 330	P49015	234	P58200	266
P38138	317	P39505	19, 330	P49025	234	P58250	266
P38140	318	P39506	19, 330	P49035	234	P58300	266
P38141	318	P39508	19, 330	P49035	234	P58350	266
P38142	317	P39509	19, 330	P49150	234	P58400	266
P38143	321	P3950AB	18	P49200	234	P59300	266
P38148	320	P3950AL	18	P49250	234	P59333	266
P38150	319	P3950AN	18	P49350	234	P59350	266
P38162	321	P3950BI	18	P49400	234	P59355	266
P38163	320	P3950BL	18	P49600	234	P59400	266
P38164	321	P3950BN	18	P49915	234	P59444	266
P38165	321	P3950BS	18	P49920	234	P60001	298
P38166	321	P3950NP	18	P49925	234	P60002	298
P3819BN	6	P3950PN	18	P49930	234	P60003	298
P3819RB	6	P3950PS	18	P49935	234	P70001	289
P38217	320	P3950PW	18	P49940	234	P70002	289
P38238	320	P3950RB	18	P50100	265	P70005	289
P38257	321	P3950WB	18	P50125	265	P70006	289
P38406	323	P39511	19, 330	P50150	265	P70010	289
P38420	323	P39512	330	P50200	265	P70011	289
P38428	323	P39514	330	P50250	265	P70012	289
P38443	323	P39515	330	P50300	265, 397	P70015	289
P38444	323	P39517	330	P50350	265, 397	P70016	289
P38447	323	P39518	330	P50400	265, 397	P70018	289, 383,
P38454	323	P3951AB	19	P50500	265		384, 385
P38458	323	P3951AL	19	P50600	265	P70019	289
P38459	323	P3951AN	19	P50800	265	P70020	289
P38460	323	P3951BI	19	P50999	265	P70023	289, 383,
P38486	323	P3951BL	19	P51150	265		384, 385
P38489	323	P3951BN	19	P51200	265	P70029	289, 383,
P3892BN	6	P3951BS	19	P51250	265		384, 385
P3892NP	6	P3951NP	19	P51300	265, 397	P70030	289
P3892PB	6	P3951PN	19	P51350	265, 397	P70031	289
				P51400	265, 397		

PART NO.	PG #	PART NO.	PG #	PART NO.	PG #	PART NO.	PG #
P70035	289	PFC116	339	PHA543	345	PVT420	342
P70036	289	PFC120	339	PHC151	341	PVT430	342
P70050	289	PFC121	339	PHC152	341	PVT440	342
P70051	290	PFC122	339	PHC153	341	Q01000	400
P70052	290, 384	PFC130	339	PHC154	341	Q01002	399
P70053	290	PFC131	339	PMA414	339	Q01011	388
P70055	289	PFC132	339	PMA415	339	Q01012	391
P70056	289, 290	PFC133	339	PMA420	339	Q01013	389
P70060	290	PFC140	339	PMA430	339	Q01013R	390
P70064	290	PFC142	339	PMA440	339	Q01014	392
P70065	290	PFC143	339	PNH120	345	Q01015	394
P70066	290, 384	PFC144	339	PNH130	345	Q01016	393
P70067	290	PFC160	339	PNH140	345	Q01017	398
P70069	290	PFL031	341	PPT015	344	Q01018	397
PAB243	346	PFL032	341	PPT020	344	Q01027	395
PAB75340	346	PFL131	340	PPT030	344	Q01030R	392
PAC543	346	PFL515	341	PPT040	344	Q01031	399
PCB934	345	PFL520	341	PPT315	344	Q01555	400
PCT315	343	PFL530	341	PPT320	344	Q01COIL	402
PCT320	343	PFL540	341	PPT415	344	R15050	193
PCT330	343	PFL560	341	PPT420	344	R15075	193
PCT340	343	PFL614	341	PPT515	344	R15100	121
PCT416	343	PFL615	341	PPT520	344	R15101	121
PCT421	343	PFL615S	341	PPT530	344	R15107	121
PCT431	343	PFL620	341	PPT540	344	R15108	121
PCT441	343	PFL620S	341	PPT715	344	R15109	121
PDL716	342	PFL630	341	PPT915S	344	R15202	108
PDL722	342	PFL640	341	PPT920S	344	R15204	108
PDL736	342	PFL660	341	PSA730	346	R15206	108
PDT515	344	PFL715	340	PSA740	346	R16100	121
PDT520	344	PFL720	340	PSL031	343	R16101	121
PDT521	344	PFL730	340	PSL042	343	R16107	121
PDT530	344	PFL814	340	PSL132	343	R16108	121
PDT531	344	PFL815	340	PSL715S	340	R18001	247
PDT532	344	PFL815L	340	PSL716S	340	R18005	247
PDT540	344	PFL820	340	PSL720	340	R18006	247
PDT542	344	PFL820L	340	PSL730	340	R18007	247
PDT543	344	PFL821	340	PSL740	340	R18008	247
PDT621	342	PFL830	340	PSL760	340	R18009	247
PDT715	345	PFL830L	340	PSL815	341	R18011	247
PDY415	342	PFL834	340	PSL820	341	R18012	247
PDY420	342	PFL840	340	PSL830	341	R18013	247
PDY430	342	PFL840L	340	PSL840	341	R18014	247
PDY440	342	PFL860	340	PSL916	340	R18015	247
PDY442	342	PFL915	340	PSL926	340	R18016	247
PDY443	342	PFL920	340	PSL936	340	R18017	247
PEJ520	345	PFL930	340	PSL946	340	R18018	247
PEJ530	345	PFL940	340	PSS140	343	R18019	247
PEJ540	345	PFY014	342	PST114	343	R18020	247, 271
PFA311	339	PFY015	342	PST115	343	R18026	247
PFA314	339	PFY020	342	PST120	343	R18027	247
PFA315	339	PFY021	342	PST121	343	R18028	247
PFA320	339	PFY023	342	PST122	343	R19003	271
PFA330	339	PFY030	342	PST123	343	R19004	271
PFA340	339	PFY031	342	PST130	343	R19005	271
PFA360	339	PFY032	342	PST131	343	R19006	271
PFA614	341	PFY040	342	PST132	343	R19099	271
PFA615	340	PFY041	342	PST140	343	R19100	271
PFA619	341	PFY042	342	PST141	343	R19102	271
PFA620	340	PFY043	342	PST142	343	R19103	271
PFA629	341	PFY060	342	PST143	343	R19104	271
PFA630	340	PFY064	342	PST160	343	R19202	271
PFA639	341	PFY515L	342	PST164	343	R19203	271
PFA640	340	PFY520L	342	PST232	343	R19204	271
PFA659	341	PFY521	342	PTA211	345	R19206	271
PFB211	339	PFY530L	342	PTA215	345	R19302	271
PFB221	339	PFY531	342	PTA221	345	R19303	271
PFB224	339	PFY532	342	PTA223	345	R19304	271
PFB231	339	PFY540L	342	PTA311	345	R19305	271
PFB232	339	PFY542	342	PTA315	345	R19306	271
PFB242	339	PFY543	342	PTA415	345	R19307	271
PFB243	339	PHA520	345	PTA420	345	R19402	271
PFB264	339	PHA521	345	PTC633	344	R19403	271
PFC114	339	PHA530	345	PTC644	344	R19404	271
PFC115	339	PHA540	345	PVT415	342	R20001	169

PART NO.	PG #	PART NO.	PG #	PART NO.	PG #	PART NO.	PG #
R20002	169	S01042	45	S0185WB	7	S04032	75
R20003	169	S01044	45, 397	S0186BN	7	S04101	75
R30050	91	S01045	45	S0186RB	7	S04102	75
R30075	91	S01049	45	S0186WB	7	S04103	75
R30100	91	S01050	47	S0187BN	7	S04104	75
R30125	91	S01051	9	S0187RB	7	S04105	75
R30150	91	S01052	9	S0187WB	7	S04106	75
R30200	91	S01053	9	S0188BN	8	S04107	75
R30250	91	S01055	8	S0188RB	8	S04108	75
R30300	91	S01056	9	S0188WB	8	S04121	75
R30375	91	S01057	9	S0189BN	8	S04123	75
R30400	91	S01058	9	S0189RB	8	S04124	75
R30600	91	S01060	45	S0189WB	8	S04125	75
R40150	121	S01061	45	S0192BN	8	S04127	75
R40200	121	S01070	7, 46	S0192RB	8	S04128	75
R40300	121	S01071	7	S0192WB	8	S04200	73
R40400	121	S01072	7	S0193BN	8	S04201	73, 386, 387
R45150	121	S01073	7	S0193RB	8	S04202	73, 386, 387
R45200	121	S01080	45	S0193WB	8	S04203	73, 386, 387
R45300	121	S01084	7	S0194BN	8	S04204	73, 386, 387
R45400	121	S01085	7	S0194RB	8	S04205	73
R50150	121	S01086	7	S0194WB	8	S04206	73
R50200	121	S01087	7	S0195BN	8	S04207	73
R50300	121	S01088	8	S0195RB	8	S04208	73
R50400	121	S01089	8	S0195WB	8	S04209	73
R57150	121	S01090	8	S0196BN	8	S04210	73
R57200	121	S01091	8	S0196RB	8	S04211	73
R57300	121	S01092	8	S0196WB	8	S04212	73
R57400	121	S01093	8	S02015	44	S04213	73
R60001	126	S01094	8	S02016	44	S04214	73
R60002	126	S01095	8	S02055	44	S04215	73
R60003	126	S01096	8	S02056	44	S04216	73, 387
R60004	126	S01151	9	S02057	44	S04217	73, 386, 387
R60050	91, 397	S01152	9	S02058	44	S04218	73, 386
R60075	91, 397	S01153	9	S02059	44	S04219	73, 386
R60100	91	S01155	8	S02066	44	S04220	73
R60125	91	S01156	9	S02069	44	S04221	73
R60150	91	S01157	9	S02070	44	S04222	73
R60200	91	S01158	9	S02071	44	S04223	73
R60250	91	S01184	7	S02072	44	S04224	73
R60300	91	S01185	7	S02073	44	S04225	73
R60375	91	S01186	7	S02074	44	S04226	73
R60400	91	S01187	7	S02100	45	S04227	73, 386
R60600	91	S0130BN	9	S02150	44	S04228	73, 386
R70150	121	S0130RB	9	S02151	44	S04229	73
R70200	121	S0130WB	9	S02152	44	S04230	73
R70300	121	S0132BN	9	S02190	10, 44	S04231	73
R70400	121	S0132RB	9	S02191	10	S04232	73, 386
RTB100	384	S0132WB	9	S02193	10, 44	S04233	74
S01001	44	S0151BN	9	S02290	10	S04234	74, 386
S01002	44	S0151RB	9	S02291	10	S04235	74
S01003	44	S0151WB	9	S02293	10	S04236	74
S01004	44, 397	S0152BN	9	S02300	44	S04237	74, 386
S01005	44	S0152RB	9	S02999	56	S04238	74, 386
S01008	44	S0152WB	9	S03009	7	S04239	74
S01009	44	S0153BN	9	S03030	9	S04240	74, 387
S01010	7, 44	S0153RB	9	S03032	9	S04241	74
S01013	44	S0153WB	9	S03040	10	S04242	74, 387
S01014	44	S0155BN	8	S03051	7	S04243	74
S01015	44	S0155RB	8	S03151	7	S04244	74
S01016	45	S0155WB	8	S03152	7	S04245	74
S0101BN	7	S0156BN	9	S03220	49	S04246	74
S0101RB	7	S0156RB	9	S03222	49	S04247	74
S0101WB	7	S0156WB	9	S04020	26, 75	S04248	74
S01020	45	S0157BN	9	S04021	75	S04249	74
S01025	45	S0157RB	9	S04022	26, 75	S04250	74
S01030	9, 45	S0157WB	9	S04023	75	S04255	73
S01032	9, 45	S0158BN	9	S04024	75	S04260	74
S01035	9, 45	S0158RB	9	S04025	75	S04268	74
S01036	9	S0158WB	9	S04026	75		
S01037	9	S0184BN	7	S04027	26, 75		
S01038	9, 45	S0184RB	7	S04028	75		
S01039	45	S0184WB	7	S04029	26, 75		
S01040	45	S0185BN	7	S04030	75		
S01041	45	S0185RB	7	S04031	75		

PART NO.	PG #	PART NO.	PG #	PART NO.	PG #	PART NO.	PG #
S04269	74	S10069	46	S10267	76	S14007	3, 64,
S04270	74	S10070	46	S10275	76		334
S04275	74	S10071	46	S10280	76	S14008	65, 335
S04276	74	S10072	46	S10300	76	S14010	64, 335
S04280	73	S10073	46	S10301	76	S14011	64
S04285	73	S10074	46	S10302	76	S14014	65, 335
S04303	387	S10075	46	S10303	76	S14030	65
S04350	110	S10076	46	S10310	76	S1407BN	3
S04351	110	S10077	46	S10311	76	S1407NP	3
S04352	110	S10078	46	S10312	76	S1407RB	3
S04353	110	S10079	47	S10313	76	S1407WB	3
S04354	110	S10080	46	S10314	76	S14103	64, 334
S04355	110	S10081	46	S10315	76	S14250	65, 334
S04356	110	S10082	46	S10316	76	S14251	65, 334
S04357	110	S10083	46	S10317	76	S14606	65, 334
S04358	110	S10100	309	S10318	76	S16003	114
S04359	110	S10200	76	S10319	76	S16005	114
S04360	110	S10201	76	S10320	76	S16006	114
S04361	110	S10202	76	S1034BN	26	S16009	114
S04400	74	S10203	25, 76	S1034CP	26	S16012	114
S04401	74	S10204	76	S1034RB	26	S16018	114
S04402	74	S10205	76	S10351	26	S16024	114
S04403	74	S10206	25, 76	S1035AP	26	S163566	114
S04404	74	S10207	76	S1035BB	26	S180032	114
S04405	74	S10208	76	S1035BN	26	S20001	385
S04406	74	S10209	76	S1035CP	26	S20009	114
S04407	74	S10210	24, 76	S1035PS	26	S20012	114
S04408	74	S10211	76	S1035RB	26	S20015	306, 385
S04409	74	S10212	76	S1035WB	26	S20021	306, 385
S04410	74	S10213	76	S10361	26	S20031	306, 385
S04411	74	S10214	25, 76	S1036AP	26	S20041	306, 385
S04412	74	S10215	76	S1036BB	26	S20100	306, 385
S04413	74	S10216	76	S1036BN	26	S20101	306, 385
S04414	74	S10217	76	S1036CP	26	S20102	306, 385
S04415	74	S10218	76	S1036PS	26	S20103	306, 385
S04416	74	S10219	76	S1036RB	26	S20104	306, 385
S04417	74	S10220	76	S1036WB	26	S20105	306, 385
S04418	74	S10221	76	S10371	25	S20106	306
S04419	74	S10222	76	S1037AP	25	S20200	306
S04420	74	S10223	76	S1037BB	25	S20201	306
S04421	74	S10224	76	S1037BN	25	S20202	306
S04422	74	S10225	76	S1037CP	25	S20203	306
S04423	74	S10226	76	S1037PS	25	S20204	306
S04424	74	S10227	76	S1037RB	25	S20300	306
S04430	74	S10228	76	S1037WB	25	S20301	306
S04440	74	S10229	76	S10381	25	S20302	306
S04450	74	S10230	76	S1038AP	25	S20999	306, 386
S04455	74	S10231	76	S1038BB	25	S22001	100
S05100	78	S10232	76	S1038BN	25	S22002	100
S05101	78	S10233	76	S1038CP	25	S22003	100
S05102	78	S10234	76	S1038PS	25	S22004	100
S05105	77	S10235	76	S1038RB	25	S22005	100
S06014	299	S10236	76	S1038WB	25	S22006	100
S06015	299	S10237	76	S1039BN	25	S25150	236
S06016	299	S10238	76	S1039CP	25	S25200	236
S06017	299	S10239	76	S1039RB	25	S25250	236
S06018	299	S10240	76	S1135BN	26	S25300	236
S06019	299	S10241	76	S1135RB	26	S25350	236
S08003	77	S10242	76	S1136BN	26	S25400	236
S08008	77	S10243	76	S1136RB	26	S26001	95
S08012	77	S10244	76	S1137BN	25	S26002	95
S08018	77	S10247	76	S1137RB	25	S26003	95
S08020	4, 63	S10248	76	S1138BN	25	S26004	236, 396
S08030	77	S10249	76	S1138RB	25	S26005	236, 396
S08031	77	S10250	76	S12005	43	S26006	236
S08032	77	S10251	76	S13130	43	S26007	236
S08100	309	S10252	76	S13140	43	S26008	236, 279
S10020	4	S10253	76	S13240	43	S26009	236
S10021	4	S10260	76	S14001	64, 334	S26010	236
S10022	4	S10261	76	S14002	64, 334	S26011	236
S10023	4	S10262	76	S14003	64, 334	S26012	236
S10024	4	S10263	76	S14004	65, 334	S26014	236
S10025	4	S10264	76	S14005	64, 334	S26015	236
S10067	46	S10265	76	S14006	64, 334	S26016	236
S10068	46	S10266	76				

PART NO.	PG #	PART NO.	PG #	PART NO.	PG #	PART NO.	PG #
S26017	236	S4222RB	24	S49200	291	S59002	245
S26100	95	S4222WB	24	S49201	291	S59003	245
S27001	95	S43021	24	S49236	291, 383,	S59004	245
S27002	95	S4302BN	24		385	S59010	246
S30012	122	S4302PB	24	S49400	292	S59011	246
S30024	122	S4302RB	24	S49411	292	S59012	246
S30800	301	S4302WB	24	S49412	292	S59042	246
S30801	301	S43031	24	S49413	292	S59043	246
S30802	301	S4303BN	24	S49416	292	S59044	246
S30803	301	S4303PB	24	S49417	292	S59052	246
S33001	114	S4303RB	24	S49421	292	S59053	246
S33002	114	S4303WB	24	S49422	292	S59054	246
S33003	114	S4312BN	25	S49423	292	S59062	246
S33004	114	S4312PN	25	S49425	292	S59063	246
S33005	114	S4312RB	25	S49427	292	S59064	246
S33006	114	S4312WB	25	S49429	292	S59072	246
S33007	114	S4314BN	25	S49431	292	S59073	246
S33010	114	S4314PN	25	S49432	292	S59074	246
S33011	114	S4314RB	25	S49489	293	S59082	246
S33012	114	S4314WB	25	S49490	293	S59083	246
S33013	114	S44002	25	S49500	293	S59084	246
S33014	114	S44003	25	S49501	293	S59092	246
S33016	114	S44005	25	S49601	305	S59093	246
S33021	114	S4401BN	26	S49602	305	S59094	246
S33022	114	S4401RB	26	S49603	305	S59102	245
S33023	114	S4401WB	26	S50001	310	S59103	245
S33318	114	S4402BN	26	S50002	310	S59104	245
S33518	114	S4402RB	26	S50060	291, 383,	S59302	245
S36006	277	S4402WB	26		384, 385	S59303	245
S36007	277	S4403BN	26	S50061	291, 383,	S59304	245
S36008	277	S4403RB	26		384, 385	S59310	246
S36009	277	S4403WB	26			S59311	246
S36010	277	S4405BN	26	S50062	291	S59312	246
S36011	277	S4405RB	26	S50063	291	S59402	245
S36090	277	S4405WB	26	S51001	100	S59403	245
S36091	277	S49000	291	S51002	100	S60002	246, 276
S36095	277	S49001	291, 384	S55001	245	S60003	246, 276
S36096	277	S49002	291	S55002	245	S60004	246, 276
S41001	299	S49003	291	S55004	276	S60005	246
S41002	299	S49004	291	S55010	276	S62001	285
S41003	299	S49005	291, 383,	S55050	276	S62002	285, 384
S41006	299		384, 385	S55075	276	S62003	285
S41007	299	S49006	291, 383,	S55100	275	S62004	285, 384
S41300	299		385	S55101	275	S62005	285
S41301	299			S55104	276	S62100	71
S41302	299	S49007	291, 383,	S55112	276	S62101	71
S41303	299		385	S55113	276	S62304	71
S41306	299	S49008	291, 383,	S55114	276	S63200	71
S41307	299		385	S55115	276	S63300	71
S41308	299	S49010	291	S55122	276	S63400	71
S41349	295	S49012	291, 383,	S55123	276	S92001	164, 388,
S41350	295		384, 385	S55124	276		392
S41351	295	S49013	291	S55192	276	S92025	164, 397
S41352	295	S49036	291, 384	S55193	276	S92030	164
S41353	295	S49042	245	S55194	276	S92031	164
S41354	295	S49043	245	S55240	276	S95011	302
S41355	295	S49044	245	S55349	78, 276	S95012	301
S41356	295	S49048	291	S55350	78, 276	S95014	301
S41357	295	S49052	245	S55351	78, 276	S95015	303
S42031	24	S49053	245	S55352	78, 276	S95016	301
S4203BN	24	S49054	245	S55353	78, 276	S95100	302
S4203PB	24	S49062	245	S55354	78, 276	S95101	302
S4203RB	24	S49063	245	S55902	38, 184	S95102	297
S4203WB	24	S49064	245	S55903	38, 184	S95103	297
S4211BN	24	S49072	245	S55950	38, 184	S95104	297
S4211PN	24	S49073	245	S55951	38, 184	S95105	297
S4211RB	24	S49074	245	S55952	39, 184	S95106	297
S4211WB	24	S49082	245	S55953	39, 184	S95200	302
S4213BN	25	S49083	245	S57034	275	S95700	307
S4213PN	25	S49084	245	S57035	275	S95701	302, 401,
S4213RB	25	S49092	245	S58050	63		402
S4213WB	25	S49093	245	S58051	63	S95703	302, 401,
S42220	24	S49094	245	S58052	63		402
S4222BN	24	S49136	291	S58053	63		
S4222PB	24	S49148	291	S58101	63		

PART NO.	PG #	PART NO.	PG #	PART NO.	PG #	PART NO.	PG #
S95704	302, 401, 402	T01042	32	T05012	12, 48	T18202	99
S95705	302, 402	T01043	27	T05013	14, 48	T19118	99
S95709	302	T01044	27	T05015	12	T19119	99
S95710	301	T01045	27	T05021	14, 48	T19122	99
S95711	301	T01048	32	T05023	49	T19125	99
S95712	301	T01049	27	T05024	15, 49	T19222	99
S95713	301	T01050	32	T05025	48	T19342	99
S95714	302	T01051	28	T05026	48	T19345	99
S95715	302	T01052	28	T05029	48	T20020	99
S95721	302, 402, 403	T01053	28	T0521AB	14	T20023	99
S95722	302, 402, 403	T01060	32	T0521AL	14	T20030	99
S95725	302, 402, 403	T01061	27	T0521AN	14	T20040	99
S95732	403	T01062	32	T0521BI	14	T20041	99
S95734	403	T01064	32	T0521BL	14	T20050	99
S95736	403	T01065	27	T0521BN	14	T20200	99
S95738	403	T01066	33	T0521BS	14	T21001	279
S95920	401	T01067	28	T0521NP	14	T21002	279
S95967	403	T01068	32	T0521PN	14	T21003	279
S95968	402	T01070	32	T0521PS	14	T21004	279
S95994	401	T01071	27	T0521PW	14	T21062	279
S95995	401	T01072	33	T0521RB	14	T21063	279
S95999	402	T01073	28	T0521WB	14	T21064	279
S96012	301	T01074	32	T06001	95, 333	T25250	113
S96014	301	T01075	27	T06002	95, 333	T25312	113
S96016	301	T01080	33	T06003	95, 333	T25375	113
S99100	45	T01081	33	T06004	95, 333	T25500	113
S994050	45	T0108BN	28	T06025	95	T25625	113
S995040	45	T0108NP	28	T06050	95	T26000	113
S996050	45	T0108RB	28	T06200	95	T26124	113
S996080	45	T0108WB	28	T06250	95	T26125	113
SSC100	386	T01099	32	T06300	95	T26186	113
T00002	276	T01100	27, 33	T06320	95	T26187	113
T00003	276	T01101	27	T06400	95	T26250	113
T00005	276	T01102	27	T06430	95	T26252	113
T00006	276	T01103	27	T06600	95	T26312	113
T00009	276	T01181	28	T06640	95	T26313	113
T01000	28	T01200	32	T06800	95	T26375	113
T01001	32, 397	T01201	32	T07150	95	T26376	113
T01002	32	T01330	28	T07200	95	T26377	113
T01003	27	T0133BN	28	T07300	95	T26498	113
T01004	27	T0133NP	28	T07400	95	T26500	113
T01005	32	T0133RB	28	T08003	12	T26625	113
T01006	27	T0133WB	28	T08004	12	T26626	113
T01007	27	T02005	38	T08012	12	T26750	113
T01008	27	T02020	37	T08013	12	T26875	113
T0100BN	28	T02021	37	T08021	14	T27125	114
T0100NP	28	T02022	37	T08112	12	T27188	114
T0100PB	28	T02023	37	T08113	12	T27250	114
T0100RB	28	T02024	37	T0812BN	12	T27313	114
T0100WB	28	T02025	34	T0812NP	12	T27375	114
T01010	33	T02026	37	T0812RB	12	T27438	114
T01012	33	T02027	37	T0812WB	12	T27500	114
T01015	28	T02028	36	T0813BN	14	T27625	114
T01016	33	T02035	37	T0813NP	14	T30002	94
T01017	28	T02036	37	T0813PW	14	T30034	94
T01020	33	T02037	37	T0813RB	14	T30046	94
T01021	28	T02038	37	T0813WB	14	T30068	94
T0102BN	28	T02039	37	T10014	49	T30102	94
T0102NP	28	T02050	38	T10016	49	T30203	94
T0102RB	28	T02051	38	T10216	49	T30304	94
T0102WB	28	T02052	38	T12001	119	T31000	92
T01030	32	T02053	38	T12006	125	T31001	92, 397
T01031	27	T02060	38	T12010	125	T31002	92, 397
T01032	27	T02062	38	T12050	126	T31003	92, 397
T01033	27	T02064	38	T12106	125	T31004	92, 397
T01034	32	T02065	38	T12110	125	T31006	92
T01035	28	T02066	37	T16002	99	T32001	93
T01036	28	T02067	38	T16004	99	T32002	93
T01037	28	T02075	37	T16100	99	T32003	93
T01040	33	T03008	37	T17002	99	T32004	93
		T04001	27	T17004	99	T32006	93
		T05002	14, 48	T17101	99	T32008	93
		T05003	12, 48	T17102	99	T32011	93
		T05010	48	T17104	99	T32022	93
		T05011	14, 48	T18201	99	T32033	93

PART NO.	PG #	PART NO.	PG #	PART NO.	PG #	PART NO.	PG #
T32044	93	T45012	94	T73815	10, 72	T85150	58, 332
T33001	94	T45150	94	T73816	10, 72	T86050	60
T33002	94	T45200	94	T73817	10, 72	T86052	60
T33003	94	T45300	94	T73818	10, 72	T86053	60
T33004	94	T45400	94	T74001	60, 322	T86054	60
T33152	93	T45600	94	T74002	60, 322	T86055	60
T33200	94	T45800	94	T74003	60, 322	TB1100	383
T33300	94	T46200	94	T74004	60, 322	TB1200	383
T33304	93	T46300	94	T74005	60, 322	TB1300	384
T33400	94	T46400	94	T74006	60, 322	TB1600	384
T34001	93	T50001	306, 384	T74010	57, 332	TB1700	385
T34002	93	T55002	279	T74011	57, 332	U95001	313
T34003	93	T55003	279	T75000	60	U95002	313
T34004	93	T55004	279	T75001	60	U95003	313
T34006	93	T55012	279	T75125	60, 333	U95004	313
T34008	93	T55013	279	T75150	60, 333	U95005	313
T34012	93	T55014	279	T75151	60, 333	U95006	313
T34013	93	T55022	279	T75250	60	U95008	313
T34014	93	T55033	279	T76125	60, 333	U95010	313
T34150	93	T55044	279	T76150	60, 333	U95012	313
T34200	93	T56002	279	T76151	60, 333	U95015	313
T34300	93	T56003	279	T76250	60	U95211	313
T34350	93	T56004	279	T77012	59, 332	U95320	313
T34400	93	T56012	279	T77013	59, 332	U95430	313
T35001	93	T56013	279	T77014	59, 332	U97001	313
T35002	93	T56014	279	T77020	59, 332	U97002	313
T35003	93	T56022	279	T77125	59, 332,	U97003	313
T35004	93	T56033	279		388	U97004	313
T35201	93	T56044	279	T77138	59, 332	U97005	313
T35202	93	T60000	119	T77150	59, 332,	U97006	313
T35203	93	T60001	119		388	U97008	313
T35204	93	T60002	120	T77151	59, 332,	U97010	313
T35206	93	T60003	120		388	U99001	314
T36150	93	T60005	120	T77152	59, 332	U99002	314
T36200	93	T60006	120	T77200	59, 332	U99003	314
T36300	93	T60060	284, 313,	T78012	59, 332	U99004	314
T36400	93		383, 385	T78013	59, 332	U99005	314
T36600	93	T60065	284, 313	T78014	59, 332	U99006	314
T37001	93	T60066	284, 313	T78020	59, 332	U99008	314
T37002	93	T60080	284, 313	T78125	59, 332	U99010	314
T37003	93	T60081	284, 313	T78150	59, 332	U99110	314
T37004	93	T60100	303	T78151	59, 332	U99211	314
T37006	93	T60101	303	T78152	59, 332	U99220	314
T37008	93	T60102	303	T78200	59, 332	U99320	314
T38006	125	T60103	303	T79000	59	U99330	314
T38010	125	T60104	303	T79125	59, 333	U99440	314
T38038	126	T60105	303	T79150	59, 333	U99550	314
T38106	125	T60106	303	T79151	59, 333	U99660	314
T38110	125	T60107	303	T79152	60, 333	U99880	314
T39002	93	T60108	303	T79200	59, 333	V94004	312
T39003	93	T60110	303	T79201	59, 333	V95002	312
T39004	93	T60111	303	T80125	59, 333	V95003	312
T39006	93	T60121	303	T80135	333	V95004	312
T39008	93	T60122	303	T80150	59, 333	V95005	312
T39010	93	T60123	303	T80151	59, 333	V95006	312
T39012	93	T60124	303	T80160	333	V95008	312
T40001	128	T60125	303	T80200	59, 333	V95010	312
T40002	128	T60126	303	T81150	60, 333	V95012	312
T40003	128	T60127	303	T82125	59, 332	V95015	312
T40004	128	T64540	279	T82150	59, 332	V96002	312
T40005	128	T73001	10, 72	T83150	58, 332	V96003	312
T40007	128	T73002	10, 72	T84125	59, 332	V96004	312
T40008	128	T73003	10, 72	T84150	59, 332	V96005	312
T41001	296	T73004	10, 72	T84151	59, 332	V96006	312
T41002	296	T73125	133	T84200	59, 332	V96008	312
T41003	296	T73138	133	T85050	60	V96010	312
T41004	296	T73150	133	T85051	60	V96012	312
T41005	296	T73175	133	T85052	60	V96015	312
T41006	296	T73200	133	T85053	60	V97002	312
T41007	296	T73300	24	T85054	60	V97003	312
T41008	296	T7330BN	24	T85055	60	V97004	312
T41009	296	T7330PB	24	T85056	36	V97005	312
T45002	94	T7330RB	24	T85057	36	V97006	312
T45003	94	T7330WB	24	T85125	58, 332	V97008	312
T45010	94					V97010	312

PART NO.	PG #
V97012	312
V97015	312
V98002	312
V98003	312
V98004	312
V98005	312
V98006	312
V98008	312
V98010	312
V98012	312
V98015	312

2CanCaddy™	301	Air Gap	58
3' Chrome Plated Brass Cover Tubes	133	Dishwasher Kit	58
3-N-1 Tubing Bender	304	Air Pump	288
4-Way	284	Economy	288
Countersunk Plug Wrench	285	Air Vent, Plumb Aire	58
Key	284	American Standard	37
Plug Wrench	285	Ballcock Repair Parts	37
P.O. Plug Wrench	283	Seat Disc Tank Ball	34
6-Way Countersunk Plug Wrench	285	Anchor Bolt Kit	122
45 Deg Ell, Banded	352	Angle Compression Stop Wrench	285
45° Elbow	137, 149, 152, 154	Angle Stop	24-26
45° Street Elbow	137, 148	Aqualine Replacement Handles	68
45 Street Ell, Banded	352	Area Drain	192
90 Deg Elbow, Banded	351	Assembly	56
90 Deg Reducing Elbow, Banded	351	ABS Pop-Up	56
90° Elbow	137, 149, 152, 154	Brass Pop-up	56
90° Male Elbow	137	Brass Pop-up, Replacement Parts	56
90° Street Elbow	137, 149, 152, 154	Chrome Plated ABS Pop-Up	56
90 Street Ell, Banded	351	Delta Style Spray	63
A		Lift & Lock Pop-Up	56
Access Fittings	235	B	
Snap-in Access Fittings	236	Backflow Preventer	170
Access Panel	91	Backflow Preventer/Sewer Stopper	71
Plastic	91	Back Supports, Industrial	303
Snap-Ease	91	Backwater Valve	193
A.C. Coil Cleaner	300	Bags, Trash	308
Acid Brushes	306	Ballcock	58
Acrylic Tub And Tile Caulk	298	And Flush Valve Repair Parts for Mansfield	38
Adapter Bushing	344	Coupling Nut And Locknut	58
Adapter	61, 339, 341, 343	Mansfield Style	37
Faucet	68	Mansfield Style, With Float Rod	37
Faucet To Garden Hose	68	Repair Parts For American Standard	37
Female Adapter	339	Repair Parts For Coast	37
Fitting C.O. Adapter, w/Plug	340	Repair Parts For Fluidmaster	38
Male Adapter	339	Repair Parts For Hoover/Amerline	38
No Hub Adapter	343	Repair Parts For Kohler	38
Spigot Adapter	344	Ball Valves	167
Sweat Male	61	Bar	291
Adapter Coupling	344	Digging/Tamping	291
Adapters		Gooseneck Wrecking	291
Female	362, 370, 374, 376	Utility Pry	291
Fitting Female	363, 370	Bar Plug, Brass	66
Fitting Male	362	Bar Tap Faucet	2
Hose	370	Basin	50, 59
Male	362, 370, 374, 376	And Tub Stopper	50
Soil Pipe	376	Cock Locknut	58
Adhesive, Plumber's Goop	301	Crumb Cups	66
Aerator	23	Faucet	77
Aerators	66	Self-Closing and Shower Valve	78
Chicago Style Faucet	67	Nut	59
Counter Display	67	Basket Strainer	58, 64, 334, 335
Non-Slotted .5 GPM	67	ABS Body And Post	65
Non-Slotted Full Flow	66	Chrome Plated Brass Duo	65
Non-Slotted Reduced Flow	67	Deep Cup	65
Six Pack Tubes For Counter Display	67	Deep Junior Duo	65
Slotted 2.2 GPM Flow	66	Duo	64
Slotted Full Flow	66	Economy Replacement	64
Snap Fitting	67	Junior Duo	65
Swivel Spray	67	Locknuts And Washers	58
Vandal-Proof	67	Quick Fit Stainless Steel	65

Shallow Cup Duo.....	64	Brass Float Rod.....	36
Stainless Steel Deep Cup.....	65	Brass Hose Barb.....	391
Stainless Steel Duo.....	65	Assortment.....	391
Twist And Lock.....	64	Brass Nipples.....	24
Basket Strainers.....	1	Brass Overflow Tube.....	36
Bathcocks.....	47	Brass Plumb Bob.....	305
Bath Drain.....	15–16, 49	Brass P.O. Plug Drain.....	57
Adapter Bushing.....	49	Brass Saddle Clamp.....	164
Lift And Turn.....	49	Brass Wells.....	113
Toe Touch.....	49	Bronze Locknuts.....	149
Bath Kits.....	52	Bronze & Yellow Brass Pipe Fittings.....	392
Schedule 40 Direct Waste.....	52	Brush.....	288
With One-Hole Face Plates.....	52	4-N-1 Copper Tube Fitting.....	288
With Two-Hole Face Plates.....	52	Acid.....	306
Bathroom Fan Vent Kit.....	98	Copper Fitting.....	288
Bath Supplies, Offset.....	46	Female Copper Tube.....	288
Bathtub Protectors.....	49	Paint And Dope.....	306
Bath Waste 1/2 Kits.....	330	Wire.....	306
Bath Waste Kits.....	53, 330	Bubbler.....	77
Conversion.....	54	Drinking Fountain.....	77
Rough-In, Schedule 40.....	54	Drinking Fountain With Face Guard.....	77
Rough-In, Schedule 40 With Test Kits.....	55	Retrofit Kit.....	77
Schedule 40 Bath Waste.....	53	Bucket Caddies.....	301
With One-Hole Face Plates.....	53	Bushing.....	47, 153
With Two-Hole Face Plates.....	53	Adapter, For Bath Drain.....	49
Batteries.....	307	Brass Trap.....	47
Rayovac.....	307	Twin Elbow And Face.....	47
Heavy Duty Alkaline Industrial.....	307	Bushing for Qwik Tees and Qwik Elbows.....	95
Heavy Duty Industrial.....	307	Buttons.....	69
Bell Reducer.....	137	Faucet Index.....	69
Bell Trap.....	191–192	Single Handle Replacement.....	69
Bibb Seat Tool Set.....	287	C	
Bit.....	297	Cable Drive Full Kit.....	19
Holders.....	297	Cable Ties.....	303
Phillips.....	297	Assortment.....	304
Bore O-Ring.....	95	Caddies, Bucket.....	301
Bottle, Spray.....	308	Camouflage Strap With Hooks.....	304
Boxes.....	126	Cam Strap.....	304
Bin.....	126	Cam Straps.....	386
Cardboard Tub.....	126	Candle, Plumber's.....	305
Plastic Tub.....	126	Cap.....	134, 137, 149, 155, 349, 364, 153
Shipping.....	126	Test.....	374
Box of Rags.....	307	Caps.....	341
Box Wrench.....	287	Carpenters Pencil.....	298
Bracket		Carrier Nuts and Washer Set.....	122
Carrier.....	115	Cast Iron, "Code Blue" Light Commercial.....	399
Extruded Hole Copper Plated.....	114	Caulk.....	297
Extruded Notches Copper Plated.....	114	Acrylic Tub And Tile.....	298
Flat Copper Plated.....	115	Hi-Temp Red Silicone.....	298
Galvanized.....	115, 116	Latex.....	298
Galvanized-CPVC.....	116	PlumBest Silicone.....	297
Galvanized L.....	116	Siliconized Acrylic.....	297
Galvanized Lockright.....	116	Caulking Tools.....	290, 298
Galvanized Lockright Pipe-CPVC.....	116	Broad Curve Nose.....	291
Holdrite.....	114	Gun.....	298
Water Closet-Copper Clad.....	116	Gun, Professional.....	298
Brass Assortment, Complete.....	388	Inside.....	290
Brass Compression Insert.....	131	Outside.....	293
Brass Drain Extension.....	185	Short Nose.....	290
Brass Flare Tube Fittings Assortment.....	390	Caution Tape.....	305

Ceiling Flange.....	125	Closet Supply.....	25–26
Ceiling Plates, Floor and.....	70	Closet Wedge Shims.....	184
Flexible.....	69	Coast Ballcock Repair Parts.....	37
Center Outlet.....	327	“Code Blue” Light Commercial Cast Iron.....	399
Center Outlet Tee.....	319	Coil Cleaner.....	402
Center Outlet Waste.....	320, 327	Coil Cleaner, A.C.....	300
Check Valves.....	170	Commercial.....	57
Chisels.....	290	Grid Drain Without Overflow Holes.....	57
Cold.....	290	Handicap Drain With Elbow.....	57
Chrome Elbow.....	133	Lav Drain.....	57
Chrome Plated.....		Commercial Drain Base.....	199–200
Compression Connector.....	133	Heavy Duty Bases.....	200
Compression Elbow.....	133	Heavy Duty Bases with Clamping Ring.....	199
Compression x Sweat Adapter.....	133	Hub Fit Bases.....	199
Chrome Plated Nipples & Pipe Lengths.....	154	Inside Pipe Fit Base.....	199
Chrome Union.....	133	Pipe Fit Base.....	199
Cleanout And Relief Valve.....	71	Slab Drain Bases.....	200
Sewer.....	71	Commercial Drain Spuds and Strainers.....	201–202
Sewer Popper™.....	71	Commercial Sponges.....	308
Cleanout Bodies.....	263	Commercial Spuds and Strainers.....	201–204
Cleanout Covers.....	267	Companion Flanges, Cast Brass.....	
Cleanout Plugs.....	234, 265–266	125# w/A.S.M.E. Drilling.....	380
Countersunk Cleanout Plugs.....	234	150# w/A.S.M.E. Drilling.....	380
Raised Head Cleanout Plugs.....	234	Complete Brass Assortment.....	388
Cleanouts.....	234–236	Compression Branch Tee.....	130
Fit-Flush Cleanout.....	234	Compression Cap.....	131
General Purpose Cleanouts.....	235	Compression Connector.....	130, 132
Heavy Duty Internal Pipe Cleanout.....	234	Compression Coupling.....	91
Hub Fit Base.....	239	Bronze.....	91
Hub Fit Cleanout with Countersunk Brass Plug.....	235	CPVC.....	92
Hub/Fitting Cleanouts.....	234	Malleable Iron.....	91
Inside Pipe Fit Base.....	241	PVC.....	92
Internal Cleanout w/SS Cover.....	236	Compression Elbow.....	130, 132
Internal Pipe Cleanout.....	234	Compression Fittings Assortment.....	391
Over Pipe Fit Base.....	241–244	Compression Nut.....	133
Pipe Fit Base.....	240–241	Chrome Plated Compression Nut.....	133
Cleanout Spuds.....	263–264	Compression Nuts.....	131
Cleanout Tee.....	344	Compression Sleeve.....	131
Close Nipple.....	138	Compression Sleeve Puller.....	286
Closet Bend.....	343	Adapter.....	286
Closet Bolts.....	38	Compression Tee.....	92, 129, 131
“Bucket Of Bolts”.....	39	Malleable Iron.....	92
Bulk Packed.....	40	PVC.....	92
Component Parts.....	40	Compression Union.....	129, 131
Custom Packed.....	39	Compression x Sweat Adapter.....	130
Elite Packs.....	41	Condensate Trap.....	193
Enduro.....	38	Conduit Hangers.....	124
Enduro Jar Display.....	38	Connectors.....	
Snap-Off.....	41	Stainless Steel, Assortment.....	387
With Tinnerman Nuts.....	39	Stainless Steel, Extended Assortment.....	386
Closet Flange.....	180–182, 250, 251	Connectors, Gas (see Gas Connectors).....	79
Closet Flange Extender.....	183	Connector, Waste.....	60
Closet Flange Extension Kit.....	183	Conversion Kit - 2 hole.....	13–14
Closet Flange Repair Ring.....	251	Conversion Kit - One hole.....	12
Closet Flange Spacer Kit.....	183	Conversion Kits.....	54
Closet Flush Elbow.....	321	Bath Waste.....	54
Closet Screws.....	41	With Cross Bar.....	54
Closet Spuds.....	35	Cool Gel®.....	300
Friction Rings.....	35	Cooling & Heating Maintenance Assort.....	403
Washers.....	35	Copper.....	288

4-N-1 Tube Fitting Brush 288
 Cleaning Pads 306
 Female Tube Brush 288
 Fitting Brush 288
 Sizing Tool 292
 Swedge Tool 292
Copper Pipe Hangers - Bell & Milford Types 122
Copper Refill Tube 36
Corded Square Head Plug 150
Countersunk Plug 138, 150
Coupling 137, 153, 153
Coupling, Banded 350
Coupling/ Reducer 149
Couplings
 Crossover 364
 Drain, with Cap 370
 Less Stop 374
 Reducing 363
 With Stop 374
Cover 62
 Cock Hole 62
 Plastic Faucet Hole 62
 Repair Plates, Stainless Steel 70
Coverall, Disposable 303
Cover Plates 10
Crimping Tools 292
 Pex Crimp Set 292
 Polybutylene 292
Cross 150, 150
Cross, Banded 350
Cross Handle Self Closing Valve 77
Crumb Cups, Sink and Basin 66
Curb Box Wrench 287
Curved Jaw Tongue & Groove Pliers 296
Cutting Board 383
Cutting Oil 307
D
Deburring Tool 293
Decorative Hose And Spray 2
Decorative Ring for Tub Spouts & Diverter 11
Delex Replacement Handles 68
Delrin Compression Sleeve 131
Delta 68
 Faucet Index Buttons 69
 Replacement Handles 68
Dielectric Union 108
 Flanged 106
 Gasket and Insert 109
Digging/Tamping Bar 291
Dishwasher Repair 96
 Dishwasher Drain Connector 96
 Dishwasher Hose 96
Dishwasher Tailpiece 327, 328
Dispenser Faucet 2
Dispenser, Soap and Lotion 63
Disposable 302
 Coverall 303
 Vinyl Gloves 302
Disposal Assembly 1
Disposer Kit 321, 328

Disposer Kit w/13" Arm 326
Disposer Kit w/Adjustable Arm 326, 328
Diverter Spout 10-11
Diverter Spouts 47
 Add-A-Shower 46
 And Extensions 47
 Chrome Plated 47
 Chrome Plated Slip-On, With Polished Brass Knob 48
Do All Plumbers Wrench 287
Double Flange Extension 328
Double Offset 320
Double Slip Fittings 60, 322, 326
Drain Bodies 252, 253
Drain Cleaner, Floweasy 300
Drain Cock 166
Drain & Flange Assortment (Bulk) 396
Drain King 94
Drain Opener 300
 Floweasy 300
 Whitlam "Green Blaster" 300
Drain, Three Prong Protector 66
Drill Bits 293
 Carbide Tipped Masonry 293
 Straight Shank 294
Drinking Fountain 77
 Bubbler and Cartridge 77
 Bubbler With Face Guard 77
 Self-Closing 77
Drop Cloth, Plastic 308
Drop Ear 61
 Elbow 61
 Transition Elbow 61
Drop-In Concrete Anchor 124
Dryer Repair 97
 Aluminum Ducting 98
 Flexible Aluminum 98
 Flexible Aluminum Foil 98
 Proflex Aluminum Foil 98
 Aluminum Elbow and Pipe 98
 Flexible Duct Connector Kit 98
 Increaser/Decreaser 98
 Vent 97
 Aluminum Hood 97
 Clamp for Dryer Vent Kit 95
 Complete Dryer Vent Kit 97
 Dryer Vent Hood 97
 Dryer Vent Hose 98
 Dryer Vent Kit w/Louvered Hood 98
 Indoor Dryer Vent Kit 98
 Louvered Dryer Vent Hood 97
 Metal Clamp for Dryer Vent 98
 White Back Collar for Dryer Vent Kits 97
Duct Straps 304
Duo Strainer 1
Dust Masks 302
E
Ear Plugs, Ready Fit Corded 303
Earthquake Strap 119
Elbow 340, 339, 341
Eljer Replacement Handles 68

Ells		
22 1/2°	377	
45°	365, 369, 375	
Street	366, 375	
90°	370, 371, 374, 377	
Drop	371	
Flanged Sink	371	
Hi-Ear	371	
Long Turn	374	
Short Turn Street	365	
Street	375, 377	
with Drain Cap	368	
End Outlet Tee Only	319, 327	
End Outlet Waste	319, 327	
Escutcheons	23, 69, 336	
Plastic Shallow Flange	70	
Poly Bagged	70	
Sure Grip	69	
Expansion Coupling	92	
PVC Expansion Coupling	92	
Expansion Joint	343	
Extension Hose	94	
Extension Piece	150, 349	
Extension Tube	6, 321, 322, 323, 326, 328	
Extract-a-Drain Tub Drain Removal Tool	285	
E-Z	305	
Light	305	
Reach	305	
E-Z Anchor/Self-Drilling Wall Board	122	
F		
Face Bushing	138	
Face Plate Gasket And Shoe Gasket	48	
Faceplate Screws	14	
Faucet	62, 285	
Adapters	68	
Bar Tap	62	
Basin	77	
Self-Closing and Shower Valve	78	
Index Buttons	69	
Laundry Tray	77	
Long Reach Bar Tap	62	
Seat Repair Kit	285	
Seat Wrench	285	
Seat Wrench For Recessed Seats	285	
Service Sink	78	
Single Kitchen Sink	77	
Wall Mount Sink	77	
Faucet And Valve Grease, Plumber's	300	
Faucet Handle Pullers	286	
E-ZEE Pull Deluxe	286	
Faucet Hole Cover	2-3	
Faucet Hole Cover, Plastic	62	
Faucet Seats Kit	62	
Faucet To Garden Hose Adapters	68	
Female Copper Tube Brush	288	
Female Flare Swivel	134	
F.H.A. Strap	114	
Galvanized Steel	114	
F.H.A. Tub Hanger	117	
Files	296	
Fire Seal-136 Firestopping Caulk	298	
Firestop 814+ Intumescent Firestopping Sealant	298	
Fit-All	50	
Basket Strainer	64	
Kitchen Hose And Spray	63	
Replacement Handles	68	
Stopper	50	
Fitting Cleanout	376	
Fitting Cleanout, Flush	376	
Fitting Plug	366	
Fitting Reducer	375	
Fittings Assortment	390	
Brass Flare Tube	390	
Compression	391	
Garden Hose	390	
Mini Compression	392	
Fittings, Double Slip	60	
Flange & Drain Assortment (Bulk)	396	
Flanged Tailpiece	323, 326, 329	
Flanges	44	
Jumbo Shower Bar	44	
Shower Arm	45	
Shower Rod	44	
Flange Support	251	
Flappers	34	
2 Way, with Separate Trunion	34	
Carded Blue Vinyl	34	
Jumbo ToTo Style	34	
Flare Elbow	135	
Flare Fittings Assortment	389	
Flare Tees	134	
Flare Union	134	
Flare x FIP Coupling	135	
Flare x MIP Branch Tee	134	
Flare x MIP Half Union	135	
Flaring Tools	292	
Swing Release	295	
Flashlights	306	
Industrial Swivel-Lite	306	
Rayovac Industrial	307	
Flexible Discharge Hose	119	
Flexible Drain Trap	96	
Flexible Floor And Ceiling Plates	23	
Flexible PVC Saddle Fitting	95	
Flexible Transition Coupling	95	
Flexible Trap Drain Connector	95, 333	
Flint Striker	294	
Three Flint Friction Lighter	294	
Flip-It	50	
Tub Stopper	50	
Flip-It Conversion Kit	14	
Flip-It Tub Stopper	14	
Float, Ball	34	
Floating Lantern & Battery	306	
Floor & Ceiling Plates	70	
Flexible	69	
Floor Drain	192	
Floor Drains	257-262	
Floor Flange	352	
Floor/ Shower	259, 261	

Floor Sinks	245	5/8" OD with Fittings.....	81
Aluminum Dome Strainers		Gas Heater Valves	167
for Floor Sinks.....	246	Gasket	48, 174
Complete PVC Floor Sink Kits.....	245	Asbestos- Free Full Face Gasket.....	174
Complete PVC Floor Sink Kits-Pipe Fit.....	246	Asbestos- Free Ring Gasket.....	174
Flat Aluminum Bottom Strainer		Face Plate.....	48
for Floor Sinks.....	246	Red Rubber Full Face Gasket.....	174
Full Top Grate for Floor Sinks.....	246	Red Rubber Ring Gasket.....	174
Half Top Grate for Floor Sinks.....	246	Shoe.....	48
Round Slop Sinks.....	245	Tank to Bowl.....	42
Three-Quarters Top Grate for Floor Sinks.....	246	Wax.....	43
Floweazy Drain Cleaner	300	Gasket Kits	175
Floweazy Drain Opener	401	Gas Line Marking Labels	305
Flush Bushing	339, 363	Gas Range Fittings	136
Flush Fitting Cleanout	376	Gas Shut-Off Valve	165
Flush Valve	36	Gate Valve Key	292
Douglas.....	37	Gear Clamps	
Mansfield #210.....	37	"68" Series Stainless.....	173
Pipe Support.....	57	Full Size.....	172
Shank Washer.....	36	Micro Size.....	172
Flux Paste	295	General Purpose Drain	188-189
Flux-Rite 90® Flux	295	Glasses, Safety	302
Foundation and Roof Coating	119	Hellraiser.....	302
Freeze Fix Pipe Jackets	296	Nemesis.....	302
Friction Rings	60	Visio.....	302
Brass.....	60	Gloves	302
Closet Spud.....	35	All Purpose Latex Palm/Mesh Back.....	302
Full Clamp	118	Vinyl.....	302
Full Port Ball Valves	167	Vinyl Disposable.....	302
Funnels	254	Work.....	302
G		Gloves, Work	386
Galvanized Insert Fittings	162	Goggles, Clear Safety	302
Gapper Flange	183, 251	Grab Bar	55
Garbage Disposal	66, 308	Fastening Systems.....	56
Cords.....	308	With Concealed Snap-On Flange.....	55, 56
Splash Guard.....	66	With Exposed Flange.....	55
Stopper.....	66	Grab-It Tool	305
Wiring Kits.....	308	Gradient Level, Top Grade	306
Wrench.....	284	Grid Drain	49
Garden Hose Fitting Assortment	390	Chrome Plated Body With Screw.....	49
Garden Hose Fittings	156, 157	Commercial, Without Overflow Holes.....	57
Garden Hoses	305	Grid Strainer	334
Gas Ball Valves	167	Griplock Tongue & Groove Water Pump Pliers	296
Gas Connectors	79	H	
Black Coated.....	88	Hacksaw	289
1/2" OD.....	88	Close Quarters.....	289
3/8" OD.....	88	PlumBest.....	289
Coated.....	79	Half Clamp	118
1/2" OD with Ball Valves.....	87	Handicap	298
1/2" OD with Fittings.....	86	Handi-Plug, PlumBest	298
3/8" OD with Ball Valves.....	81	Hand Wipes, Wypall Waterless	307
3/8" OD with Fittings.....	79	Hangers	64
5/8" OD with Ball Valves.....	84	Adjustable Lavatory.....	64
5/8" OD with Fittings.....	82	Lavatory.....	64
Uncoated.....	79	Mop, for Service Sink.....	78
1/2" OD with Ball Valves.....	87	Sink.....	64
1/2" OD with Fittings.....	85	Hats, Safety	303
3/8" OD with Ball Valves.....	80	Head-Lite, Sportsman L.E.D.	307
3/8" OD with Fittings.....	79	Heating & Cooling Maintenance Assort	403
5/8" OD with Ball Valves.....	83	Heavy Duty Commercial Drain	213-233

Hexagon Bushings.....	349	LACO.....	99, 295
HEX Brushing.....	151	Cool Gel®.....	300
HEX Bushing.....	138	Flux Paste.....	295
HEX Head Plug.....	137	Flux-Rite 90® Flux.....	295
HEX Nipple.....	138	Marking Products.....	299
Hex Nut.....	123	Slic-tite® Heavy Duty Thread Sealing Compound.....	300
Hinged Split Ring.....	125	Slic-tite® High Density Thread Sealants.....	99
Hi-Temp Red Silicone Caulk.....	298	Visu-Glow Leak Detector.....	300
Hornet & Wasp Spray.....	303	Latex Caulk.....	298
Hose.....	288	Lavatory.....	63
Garden.....	305	Adjustable Hanger.....	64
High Pressure with Fitting.....	288	Hangers.....	64
Hose And Spray.....	63	Legs.....	63
Kitchen (Fit All).....	63	Lavatory Nut Removal Tool.....	285
Rinse-Quik.....	63	Lav Drain.....	6, 57
Hose Barb Fittings.....	158	Commercial.....	57
Hose Bibb.....	171	Handicap Style.....	57
Hose Bibb Reducer.....	171	Lav Supply Tubes.....	26
Hose Faucet Anchor.....	171	Lead Ingot.....	120
Hose Grip Clothes Washer Connector.....	96	Lead Joint Runners.....	306
Hub Fit Commercial Drain.....	211–212	Lead Melting Pot.....	120
Hydrostatic Pressure Pump.....	288	Lead Pouring Ladle.....	120
RP 30.....	288	Lead Wool.....	118
I		Leak Alert Water Detector.....	308
Icemaker Boxes.....	96	Leak Detector, Visu-Glow.....	300
With Hammer Arrester.....	96	LevelBest.....	195–197
With Valves.....	96	Levels	
Icemaker Or Humidifier Kit.....	164	Plastic Magnetic.....	306
Industrial Back Supports.....	303	Top Grade Gradient.....	306
Insert for CPVC.....	116	Torpedo.....	306
Inside Pipe Fit Cleanout.....	198	Lift Wire.....	36
Inside Pipe Fit Commercial Drain.....	210–211	Brass.....	36
Inside Pipe Fit Drain.....	198	Brass Guide.....	36
In-Sink-Erator Rubber Hush Cushion.....	66	Light Commercial Cast Iron, "Code Blue".....	399
Instant Sealant.....	120	Locknut.....	58
Insulating/Suspension Clamp.....	118	Ballcock Coupling Nut And.....	58
Insulation Protective Coating.....	108	Basin Cock.....	58
J		Basket Strainer, And Washers.....	58
J-Bend.....	318, 328	Lock Nut.....	138
J-Bend w/Cleanout.....	318	Locknut/Backnut.....	352
J-Hook.....	117	Long Flare Nut.....	134
Drive.....	117	Long Nipple.....	138
For CTS Water System.....	117	Long Sweep Elbow.....	340
For Drain Pipe System.....	116	Lotion And Soap Dispenser.....	2
K		Lubricant, WD-40®.....	305
Key.....	284	Lugs, Sink.....	63
4-Way.....	284	Lumber Crayon.....	298
Sillcock.....	284	M	
Kit.....	61	Magnetic.....	297
Assorted Washer.....	61	Plastic Level.....	306
O-Ring.....	61	Power Nut Setters.....	297
Solid Brass Bibb Screw Assortment.....	61	Torpedo Level.....	306
Undermount Sink Installation.....	63	Mansfield Style.....	37
Knee Pads.....	303	Ballcock.....	37
Knives.....	289	Ballcock and Flush Valve Repair Parts.....	38
Deluxe Autolock Snap.....	292	Ballcock With Float Rod.....	37
Putty.....	298	MAPP Gas Cylinders.....	295
Snap.....	292	Marking Labels, Gas Line.....	305
Utility.....	289	Marking Paint, Industrial Choice Precision-Line Inverted.....	299
L		Marvel Adapter.....	333

Marvel Rings	333	Peerless	68
Marvel Rings, Sweat Male Adapter	61	Faucet Index Buttons	69
Merchant Couplings	359	Replacement Handles	68
Metal Stud Insulator	116	Perforated Hanger Iron	119
Metal Stud Pipe Insulator	117	PEX 90° Ell	139
Milwaukee Style Trap	319	PEX 90° Ell Swivel Plastic Nut	139
Mini Compression Fittings Assortment	392	Pex Adapter	140
Mixer Hose	97	PEX Adapter	139
Mixet Replacement Handles	68	Pex Coupling	140
Moen	69	PEX Couplings	139
Replacement Handles	69	PEX Crimp Ring	140
Single Handle Replacement Buttons	69	PEX Drop Ear 90° Ell	140
Mop Hanger for Service Sink	120	Pex Elbow	140
Moss Bay Repair Flange	251	PEX Equal Tee	139
N		PEX Plug	137, 140
Nails	116	PEX Sweat Adapter	139
Copper Clad Nail	116	PEX Swivel Plastic Nut	139
Copper Coated J-Nails	116	Pex Tee	138, 140
Needle Valve for Pressure Gauge	112	PEX Tee	139
Nipple Caddy		Phillips Bits	297
Combo	301	Pick	291
Plastic	301	Mattock	291
Steel Tray	301	Pigtail Syphon	111
Nipple Extractors	293	Pilot Line Breakaway Nut	131
And Screw Extractors	293	Pipe Bracket	
Internal Pipe	293	Carrier	115
Sets	293	Extruded Hole Copper Plated	114
Non-Adjustable Drain	255	Extruded Notches Copper Plated	114
"No Pinch" Pipe Wrench Pliers	296	Flat Copper Plated	115
Nut	58	For Water Closet-Copper Clad	116
Basin	59	Galvanized	115
Plastic Lavatory Supply	59	Galvanized-CPVC	116
Plastic Slip Joint	58	Galvanized L	116
Split	59	Galvanized Lockright	116
Nut Driver	297	Galvanized Lockright-CPVC	116
Nut Setters, Magnetic Power	297	Holdrite	114
Nylon Garden Hose Fittings	159	Pipe Cutters	289
Nylon Hose Barb Fittings	159	Heavy Duty PVC	289
Nylon Insert Adapters	160	Inside	289
O		PlumBest E-Z Shear Inside	289
Oakum	118	Professional PVC	289
Oetiker PEX Stainless Steel Clamp	140	PVC	289
Offset Bath Supplies	7	PVC One-Handed	289
Oil, Cutting	307	Pipe Fit Commercial Drain	203–204
One-Hole Schedule 40 Half Kit	16–17	Pipe Fittings	392
O-Ring Kit And Pick	61	Yellow Brass & Bronze	392
Overflow Plates	48	Pipe Hanger	115
Overflow Plates - One hole	12	Schedule 40	115
Over Pipe Fit Commercial Drain	206–210	Pipe Hook	115
P		"Copper Boy"	117
Packing	118	Plastic Coated	115
Candle Wick	118	Pipe Insulation	
Graphite	118	Double Stick	107
Pads	303	Insulation Protective Coating	108
Copper Cleaning	306	Insulation Tape	108
Knee	303	Poly	
Paint	299	Double Stick Pipe Insulation	107
And Dope Brush	306	Semi-Slit Pipe Insulation	107
Marking, Industrial Choice Precision-Line Inverted	299	Rubber	104
Spotter Hand-Help Wand	299	Double Stick Rubber Pipe Insulation	104

Seamless Rubber Pipe Insulation	103	Gas Test Gauge	110
Semi-Slit	107	Gas Test Gauge Assembly	112
Pipe Insulator	117	Gas Testing Equipment	109
Metal Stud	117	Liquid Filled	111
Pipe Jackets, Freeze Fix	296	Needle Valve	112
Pipe Joint Compound	299	Pressure Gauge	111
Whitlam "Blue Magic"	299	Sillcock/Water or Gas Test Gauge Assembly	110
Whitlam "Select Unyte" Teflon	299	Test Gauge Assembly	110
Pipe Nipple Black	355, 356, 357, 359	Tridicator	112
Pipe Plugs, Sure Sweat Dissolvable	296	Vacuum Gauge	112
Pipe Sleeving	100	Water Test Gauge	111
Pipe Strap	118	Pressure Snubber	112
Pipe Support, Flush Valve	57	Primer for Pipe Wrap Tape	99
Pipe Taps	294	Propane Cylinders	295
Pipe Wrench	287	Protector, Three Prong Drain	66
Aluminum	287	Provent	55
Heavy Duty	287	PTFE Thread Seal Tape	99
Plastic Drop Cloth	308	P-Trap	6, 57, 319, 323, 326, 327, 329, 342, 344
Plastic Flow Restrictor	45	Chrome Plated PVC	57
Plastic Hanger Tape	119	Commercial, with Cleanout	57
Plastic Magnetic Level	306	P-Trap w/Adapter	327
Plastic Push On Fittings	143	Rough Brass P-Trap	323
Pliers	296	P-Traps	317, 376, 379
Curved Jaw Tongue & Groove	296	Suction Line	366
Pipe Wrench, "No Pinch"	296	With Cleanout	376
Slip Jaw	296	With Union Joint LA Pattern	379
Smooth Jaw	296	Pumps	288
Smooth Jaw Tongue & Groove	297	Air	288
Tongue & Groove	296	Economy Air	288
Water Pump	296	Hydrostatic Pressure	288
Water Pump, Griplock Tongue & Groove	296	RP 30 Hydrostatic Test	288
Plug	66, 134, 153, 155	Water	288
Brass Bar	66	Putty	298
Tray	66	Knives	298
Plug, Fitting	366	Plumber's	300
Plumb Aire Air Vent	58	Plumber's Epoxy	300
Plumb Bob, Brass	305	PVC Display, Recommended Items For	400
Plumber's	300	PVC Plastic Specialties	398
Candle	305	PVC Shower Pan Liner Cement	45
Cotton Handy Towels	308	Q	
Epoxy Putty	300	Qwik Elbow	95
Faucet And Valve Grease	300	Qwik Tee	95
Goop Adhesive	301	R	
Putty	300	Radiant Seal Sponge Rubber Closet Gasket	43
Plumbing Connectors	73	Radiator Coin Key Air Valve And Key	169
Braided Nylon	74	Radiator Spud Wrench	284
Flexible Stainless-Steel	73	Rags, Box of	307
Plumbing Specialties Display	397	Ratchet Strap	304
PlumBite Push On Fittings	141, 140	Tie Down	304
Plumbjet	94	With Step Release J-Hooks	304
Plunger	94	Rayovac	306
Force Cup	94	Batteries	307
Professional Force Cup Display	95	Heavy Duty Alkaline Industrial	307
Poly Insert Assortment	393	Heavy Duty Industrial	307
Poly Insert Fittings	161	Floating Lantern & Battery	306
Poly Sheeting	307	Industrial Flashlights	307
Pop-Up Assembly	6	Readycut Pipe Black	358
Pressure Gauges	112	Ready Fit CorDED Ear Plugs	303
Gas	110	Red Brass Insert Fittings	163
Gas Test Assembly	112	Red Brass Pipe Nipples	147

Red Rubber Sheet Packing/Gasket Material..... 176
 Reducer..... 153
 Reducer Coupling..... 339
 Reducing Coupling, Banded..... 350
 Reducing Tee, Banded..... 353, 354
 Relief Valve, Cleanout And..... 71
 Sewer..... 71
 Sewer Popper™..... 71
Removal Tool..... 285
 Extract-a-Drain Tub Drain..... 285
 Lavatory Nut..... 285
Repair Clamp..... 91
 Stainless Steel..... 91
Repair Coupling..... 339
Repair Flange..... 251
Repair Trap..... 328
Repair Traps..... 319
Replacement Basket Strainer..... 1
Replacement Clamp For Flexible Couplings..... 173
Replacement Handles..... 68
 Aqualine..... 68
 Delex..... 68
 Delta..... 68
 Eljer..... 68
 Fit-All..... 68
 Mixet..... 68
 Moen..... 69
 Peerless..... 68
 Sears..... 68
 Stanadyne..... 69
 Valley..... 68
Replacement Strainers..... , 255, 20
 For Roman Tub Drains..... , 20
 Regular Strainers..... , 20
Residential Display, Recommended Items For..... 399
Return Bend..... 375
Rinse-Quik Hose and Spray..... 63
Riser Clamp..... 123
Rod..... 291
 Probing..... 291
 Steel Probing..... 291
 Steel Probing, with Ball Point..... 291
Rod Coupling Nut..... 124
Roman Tub Drains..... 255
Roof Drains..... 247
 Accessories for Roof Drains..... 247
 Roof Drains w/Cast Iron Dome..... 247
 Roof Drains w/Plastic Dome..... 247
Roof Flashing..... 121
 All Neoprene..... 121
 Aluminum..... 121
 Galvanized..... 121
 Lead..... 121
 Neo-poly..... 121
 Roofrite..... 121
 Roofrite Hi-Heat Silicone..... 119
Rosettes..... 58
Rubber Hush Cushion, In-Sink-Erator..... 66
Run-Off Tube..... 109

S
Saddle Tees and Kits..... 236
Safety..... 302
 Glasses..... 302
 Hellraiser..... 302
 Nemesis..... 302
 Visio..... 302
 Goggles, Clear..... 302
 Hats..... 303
Sand Cloth..... 100
 Flexible Open Mesh..... 100
 Open Mesh..... 100
 Waterproof Aluminum Oxide..... 100
 Water Resistant..... 100
Sanitary Tee..... 343
Sanitray Tee..... 341
Satin Brass Air Cock..... 166
Saws..... 291
 Cable..... 291
 Close Quarters Hacksaw..... 289
 Drywall..... 291
 E-Z Stroke Pipe..... 291
 Hardwood 250 Speed Handsaw..... 291
 Jr. Plumber's..... 291
 PlumBest Hacksaw..... 289
 PlumBest Plastic..... 291
 T-Handle Cable..... 289
Screw and Nipple Extractors..... 293
Screwdrivers..... 297
 4 in 1..... 297
 6 in 1..... 297
Screws..... 122
 Drill Point Tech Screw..... 123
 Flat Phillips Head Brass Wood Screw..... 122
 Hex Head Lag Screw..... 122
 Hex Head Tapping Screw..... 121
 Phillips Head Wood Screw..... 122
Screws, Solid Brass Bibb Assortment Kit..... 61
Sealant, Silicone Tub And Tile..... 297
Sears Replacement Handles..... 68
Service Sink Repair..... 120
 Hose and Hose Bracket..... 120
 Mop Hanger..... 120
Sewage Ejector/Sump Pump Check Valve..... 119
Sewer Relief Plugs..... 236
Sewer Stopper/Backflow Preventer..... 71
Sheeting, Poly..... 307
Shims
 Closet Wedge Shims..... 38
 Flexible Super Shims..... 39
 Rigid Super Shims..... 39
Shoe Covers..... 303
 Protective..... 303
 Shubee..... 303
Shoe Gasket and Face Plate Gasket..... 48
Short Flare Nut..... 134
Shovels..... 290
 Economy..... 290
 Fiberglass Handle..... 290
 Long Handle Round Point Fiberglass..... 290

Premium Grade Wood Handle.....	290	Mop Hanger.....	78
Specialty.....	290	Single Kitchen Sink Faucet.....	77
Shower.....	45	Undermount Installation Kit.....	63
Curtain Pin.....	45	Wall Mount Faucet.....	77
Diverter Valve.....	46	Sink Trap.....	318, 319
Pan Liner.....	45	L.A. Pattern Sink Trap.....	318
Pan Liner Cement, PVC.....	45	Sink Trap w/ABS Adapter.....	318
Utility.....	47	Sink Trap w/Sweat Connection.....	318
Shower, Add-A.....	46	Slab Drain.....	257, 258, 259, 262
Accessories.....	46	Sleeves.....	24
Code Pattern.....	46	Slip Jaw Pliers.....	296
Complete Unit.....	46	Slip Joint.....	59
Diverter Spout & Riser.....	46	Cone, Washer.....	60
D-Style.....	46	Nut.....	59
Less Oval Shower Rod.....	46	Nut And Washer.....	59
Shower and Floor Drains.....	256	Rough Brass, Nut.....	59
Shower Arm.....	8-9, 45	Tee.....	60
And Flange with Set Screw.....	45	Washer.....	59
And Kits.....	45	Slip Joint Nut.....	332
Flange.....	45	Slip Joint Nut & Washer.....	332
Heavy Adjustable.....	45	Slip Nut.....	332
Plastic.....	45	Slip-On Plastic Cap.....	93
Shower Arm Flange.....	10	Smooth Jaw Pliers.....	296
Shower Curtain Pin.....	45	Tongue & Groove.....	297
Shower Curtain Rod.....	10	Snap-in Drain.....	190-191
Shower Diverter Valve.....	7	Snap-in Strainers.....	21
Shower Drain.....	20-21	Soap And Lotion Dispenser, Chrome Plated.....	63
Shower Drains.....	255, 256, 258	Soap Stones And Holders.....	305
Shower Elbow, Brass For Fiberglass Shower Stall.....	47	Socket Ring.....	191
Shower/Floor Drain.....	185-186	Socket Saver.....	384
Shower Head.....	7-8, 44	Socket Savers.....	289
Adjustable Massage.....	45	Solder.....	295
Adjustable Plastic.....	45	Phos-Copper Brazing Rod.....	295
Brass Aerating Water Saver.....	44	Shield Protective Blanket.....	295
Deluxe.....	44	Silver.....	295
Octagonal.....	45	Solid Square Head Plug.....	150
Vandal Proof.....	44	Solvent Extension Tube.....	329
Shower Rod.....	44	Space Heater Fittings.....	136
Adjustable Aluminum.....	44	Spacer.....	43
Aluminum.....	44	Air Gap.....	58
Aluminum, with Holders.....	44	Closet Bend.....	43
Contoured.....	44	Foam.....	43
Shower Rod Flange.....	7	Styrofoam Closet Flange.....	43
Shower Stall Drain.....	187	Spanner/Strainer Wrench.....	286
Side Outlet 90 Ell, Banded.....	351	Splash Guard, Garbage Disposal.....	66
Silicone.....	297	Split Nut.....	59
Caulk.....	297	Sponge Closet Gaskets.....	36
Tub And Tile Sealant.....	297	Sponges, Commercial.....	308
Siliconized Acrylic Caulk.....	297	Sportsman L.E.D. Head-Lite.....	307
Sillcock Key.....	284	Spouts.....	47
Sink.....	63	Diverter.....	47
Connection Washer.....	59	Telescoping Tub.....	48
Crumb Cups.....	66	Tub.....	48
Hangers.....	64	Spray.....	63
Kitchen Stopper.....	66	Delta Style Assembly.....	63
Laundry Tray Faucet.....	77	Kitchen (Fit All).....	63
Lugs.....	63	Rinse-Quik.....	63
Service.....	78	Spray Bottle.....	308
Faucet.....	78	Spring Tubing Bender.....	304
Hose & Hose Bracket.....	78	Spud.....	286

Adjustable, Strainer and.....	286	Street Tee, Banded.....	354
Wrench.....	286	Stretch Wrap.....	100
Wrench With Hinged Arm.....	286	Film and Dispenser.....	100
Spud and Strainer.....	20–22	Striking Tools.....	291
Round Strainers with Plastic Spuds.....	201	Stud Guard.....	114
Spuds.....	253–254	Interlocking.....	114
Square Head Plug.....	137, 352	Stud Protectors and Plate.....	114
Stainless Steel Connectors.....	386	Stud Shoe.....	114
Assortment.....	387	Super Shims.....	184
Extended Assortment.....	386	Supply Nut, Plastic Lavatory.....	59
Stanadyne.....	69	Supply Stops.....	76
Replacement Handles.....	69	Supply Tubes.....	75
Single Handle Replacement Buttons.....	69	Chrome Plated Flexible Basin.....	75
Standard Two-Hole Schedule 40 Half Kit.....	17–18	Chrome Plated Flexible Tank.....	75
Standard Waste Overflow.....	49	Flexible Tank.....	75
One-Hole.....	49	PEX.....	75
Two-Hole.....	49	PEX With Ferrule.....	73
Steel Wool.....	305	Sure Sweat Dissolvable Pipe Plugs.....	296
Stopper.....	50	Sweat Male Adapter/Marvel Rings.....	61
Basin And Tub.....	50	Swimming Pool Valves.....	170
Fit-All.....	50	Swivel Drum Trap.....	345
Flip-It Tub.....	50	Swivel-Lite.....	306
Garbage Disposal.....	66	4 D/6 Volt.....	307
Kitchen Sink.....	66	Industrial Flashlights.....	306
Pop-Up Basin.....	50	Swivel Ring.....	124
Stove Bolt with Nut.....	122	T	
Straight Stop.....	24–26	Tailpiece.....	320
Strainer.....	64, 286	Brass Direct Connect Dishwasher	
ABS Body And Post Basket.....	65	Tailpiece.....	320
Adjustable, and Spud.....	286	Brass Double Flange Tailpiece.....	320
Beehive Urinal, Cast Brass.....	65	Brass Sink Tailpiece.....	320
Chrome Plated Brass Duo Basket.....	65	Slip Joint Tailpiece.....	321
Deep Cup Basket.....	65	Slip Joint Tailpiece w/1/2" Sweat Branch.....	323
Deep Junior Duo Basket.....	65	Threaded Connection Dishwasher	
Duo Basket.....	64	Tailpiece.....	321
Duo, CP Brass.....	64	Trap Primer Tailpiece.....	332
Economy Replacement Basket.....	64	Tamping/Digging Bar.....	291
Fit-All Basket.....	64	Tank.....	33
Flat Duplex.....	65	Ball and Seat Discs.....	33
Flat Top Grid.....	64	Cover, Toilet Tank.....	38
Flexible Hair.....	65	Tank to Bowl.....	41
Junior Duo Basket.....	65	Bolt Set.....	41
Plumb Easy Sink Wrench.....	287	Components.....	42
Quick Fit Stainless Steel Basket.....	65	Gasket.....	42
Shallow Cup Duo Basket.....	64	Offset Bolts.....	42
Stainless Steel Deep Cup Basket.....	65	Set.....	41
Stainless Steel Duo Basket.....	65	Tank to Bowl Bolt Kit.....	42
Twist And Lock Basket.....	64	For American Standard.....	42
Wrench.....	285	For Mansfield.....	42
S-Trap.....	327	Tri-Bolt Tank.....	42
Straps.....	304	Tri-Tank, American Standard.....	42
Cam.....	304, 386	Tank Trip Lever.....	
Camouflage, with Hooks.....	304	American Standard.....	32
Duct.....	304	Crane.....	32
Heavy Duty Utility.....	304	Eljer.....	33
Ratchet Tie Down.....	304	Eljer Touch Flush Assembly.....	33
Ratchet, with Step Release J-Hooks.....	304	Fit-All Economy.....	32
Utility Tie-Down.....	385	Fit-All Front Mount.....	32
S-Traps.....	318	Fit-All Heavy Duty.....	32
Strap Wrench.....	287	Fit-All Premium.....	32

Fit-All Side Mount	32	Dial	111
Kohler	33	Hot Water/Refrigerant Line	111
Mansfield	33	Pocket Test	113
ToTo Chrome Plated	33	Weksler Industrial Multi-Angle	111
Ultrafit	33	Threaded Steel Rod.....	125
Universal Rundle/Sears	33	Thread Sealants, Slic-tite® High Density	99
Western Pottery	33	Thread Sealing Compound, Slic-tite® Heavy Duty	300
Tank Trip Levers.....	27–28	Tissue Rollers.....	57
Tape.....	99	Toggle Bolt	121
Box Sealing	99	Tongue & Groove Pliers.....	296
Duct	99	Tool Board.....	384
Electrical	99	Tool Center	383
Insulation	108	Top Grade Gradient Level.....	306
Pipe Wrap	99	Torches.....	295
Domestic Pipe Wrap Tape	99	Pencil Flame	295
Imported Pipe Wrap Tape	99	Uniweld	295
Primer for Pipe Wrap Tape	99	Torpedo Level	306
Self-Fusing	99	Totes	301
Thread Seal	99	Fitting Tray	301
PTFE Thread Seal Tape	99	Tool	301
PTFE Yellow Gas Line Thread Seal Tape	99	Utility Tray	301
Slic-tite® High Density Thread Sealants.....	99	Towels.....	307
Thread Seal Tape Jar Display	99	Cotton Plumbers Handy	308
Tape, Caution.....	305	Wypall Teri	307
Tape Measure	294	Traffic Floor Drain	189–190
Locking	294	Trap Adapter	345
Long.....	294	Trap Cover.....	120
Neon Precision	294	Drum.....	120
PlumbRule.....	294	Trap Primer Tailpiece.....	57
T-Cone Cleanout Repair Plugs.....	93	Trash Bags.....	308
Tee.....	137, 150, 154, 322, 326, 152, 342	Tray Plug.....	66, 333
Tee, Banded	353	Trip Lever Trim	54
Tee Plug	94	Tub and Basin Stopper	50
Inflatable.....	94	Tub And Shower Valve Wrench Set	284
Tees	368, 372, 374, 375	Tub Drain	
Baseboard	372	Friction Lift	49
Double.....	378	Roman.....	50
Double Long Turn T-Y	378	Tubing.....	113
Drop	372	Clear Vinyl.....	113
Test	378	Natural Polyethylene	113
Test Cap.....	93	Soft Aluminum	112
Flexible PVC	93	Tubing Benders.....	304
Knockout.....	94	3-N-1	304
PVC Dual Fit	93	Spring.....	304
PVC Test Cap.....	93	Tubing Cutter.....	289
Slip-On Plastic	93	Copper.....	290
Techno Test Plug.....	93	Economy	290
Test Plug	92, 93	Mini	290
Cast Iron	93	Quick Release	290
Economy.....	92	Ratcheting Handle Copper.....	290
“Plum-Tite” Mechanical	93	Telescoping.....	290
Pneumatic	94	Vinyl.....	289
Pneumatic-Hydraulic	94	Tub Spouts.....	48
T-Cone	93	Chrome Plated	48
Two Stage Long.....	94	Telescoping.....	48
Test Tee w/Plug	236	TubSpouts.....	10–11
Texas Pattern Gas Ball Valve	167	Tub Trip Levers With Spring	48
Thermometer.....	111	Tub Trip Lever with Spring	12
Bi-Metal Dial	113	Tubular Bath Waste Full Kit	19
Brass Wells.....	113	Turnout Bend Support for PEX.....	116

Twine 119
 Binder Sisal 118
 Mason's Nylon 119
Twist To Lock Plastic Fittings 141
Two-Hole Pipe Clamp 117
Two-Hole Schedule 40 Full Kit 17-18
U
Union 148, 155, 367, 153
Union, Brass to Iron Seat 354
Universal Beam Clamp 122
Universal Copper Thermocouple 107
Universal Drain Wrench 285
Urinal
 Strainer, Cast Brass Beehive 65
Urinal Flange 182
Urinal Flange Kits 180
Utility Drain 191
Utility Pry Bar 291
Utility Tie-Down Strap 385
U-Type Strap 367
V
Valley 68
 Replacement Handles 68
Vent Cap 193-194
Vent Elbow 340
Vessel Drain 6
Vinyl Gloves 302
 Disposable 302
W
Wall Bend 320
Washer 36, 333
 Aqua Seal 36
 Assorted Kit 61
 Basket Strainer 58
 Beveled Ballcock Shank 36
 Beveled Bibb 36
 Beveled Slip Joint Washer 333
 Cone Slip Joint 60
 Flanged Poly Tailpiece 60
 Flanged Poly Tailpiece Washer 333
 Flat Bibb 36
 Rubber Slip Joint Washer 333
 Sink Connection 59
 Slip Joint 59
Washers 123
 Flat 123
 Zinc Plated Fender 123
Washing Machine Repair 96
 Boxes 96
 with Hammer Arrester 96
 with Valves 96
 Hoses 97
 Drain 97
 Fit-All Drain 97
 Mixer 97
 Washing Machine 96
 Pan 97
 Washing Machine 97
Wasp & Hornet Spray 303
Waste And Overflow 54

Aluminum Bar 54
 Test Kits 54
Waste Arm 320, 323, 328
Waste Connector 60, 333
Waste w/Dishwasher Connection 328
Water Detector, Leak Alert 308
Water Hammer Arresters 177, 176
Water Heater Repair 109
 Connector 109
 Stainless Steel Water Heater 108
 Water Heater 109
 Pan 110
 Adapter 110
 Galvanized 110
 Safety 110
 Water Heater 110
 Stand 110
 Stand-rite 110
 Water Heater Stand 110
Water Meter Keys 292
 Combo 292
 Gate Valve Key 292
Water Meter Repair 124
 Gasket Only for Water Meter Couplings 124
 Water Meter Box Keys and Covers 124
 Water Meter Coupling Complete 124
Water Pump 288
 Pliers 296
Water Supply Tubes 25
Water Volume Control 45
Wax Gaskets 43
Waxless Gasket 183
WD-40® Lubricant 305
Wet-R-Dri Roofing Cement 120
Whitlam 299
 "Blue Magic" Pipe Joint Compound 299
 "Green Blaster" Drain Opener 300
 Seal Unyte 299
 "Select Unyte" Teflon Pipe Joint Compound 299
Wire Brush 306
Wire Connectors, Screw-On 308
Wood Bits 293
 Dual Auger 293
 Flat "Paddle" 293
Wool, Steel 305
Work Gloves 302, 386
Wrench
 4-Way Countersunk Plug 285
 4-Way Plug 285
 4-Way P.O. Plug 283
 6-Way Countersunk Plug 285
 Adjustable 287
 Adjustable Strainer And Spud 286
 Aluminum Pipe 287
 Angle Compression Stop 285
 Box 287
 Curb Box 287
 Do All Plumbers 287
 Dual Kwik Tie 285
 Element 284

Faucet Seat	285
Garbage Disposal.....	284
Heavy Duty Pipe.....	287
Mega Torque.....	284
Moen Stem And Cartridge.....	286
No Hub Torque	284
Plumb Easy Sink Strainer.....	287
Quick Drain.....	286
Radiator Spud	284
Seat, for Recessed Seats	285
Set.....	284
14 Piece Folding Hex Key Wrench.....	284
Tub And Shower Valve Wrench.....	284
Sink Drain	286
Spanner/Strainer	286
Spud	286
Spud With Hinged Arm.....	286
Strainer.....	285
Strap.....	287
Universal Drain.....	285
Wye.....	340, 342, 376
45°	372
Double.....	376
Wypall	307
Teri Towels.....	307
Waterless Hand Wipes.....	307
Wypall Waterless Handwipes.....	403
Y	
Yellow Brass & Bronze Pipe Fittings	392
Z	
Zinc Plated Clevis Hanger.....	123