



VOLUME VII



A World and Main company

Final Touch

JSC DECORATIVE LINE™

PAGES 1-28

The Final Touch collection of decorative kitchen and bath accessories from Jones Stephens includes over 1,200 products ranging from escutcheons, strainers and drains to hose sprayers, diverter spouts and showerheads. This premier collection is offered in over 16 trend-forward colors and finishes designed and engineered to match all of today's popular kitchen and bath manufacturers' faucets and fixtures. We invite you to turn the pages and explore our expansive line of decorative accessories.

FINISH SWATCHES



BRUSHED NICKEL (BN)



OIL RUBBED BRONZE (RB)



OLD WORLD BRONZE (WB)



POLISHED STAINLESS (PS)



POLISHED NICKEL (PN)



SATIN NICKEL (SN)



BRUSHED BRONZE (BB)



BRUSHED STAINLESS (BS)



ANTIQUE NICKEL (AN)



ANTIQUE PEWTER (AP)



ANTIQUE BRASS (AB)



POLISHED BRASS (PB)



POLAR WHITE (PW)



BISCUIT (BI)



ALMOND (AL)



BLACK (BL)

Note: Actual product finishes may slightly vary from swatches shown above.

SECTION A - DECORATIVE -Page 1

In the decorative section, you will find our FINAL TOUCH line of products. We offer a variety of decorative bath and kitchen items available in eighteen special finishes.

A**SECTION B - SPECIALTIES AND REPAIR - Page 29**

The Specialties and Repair section contains all of the items that you will need for your basic plumbing and repair needs.

B**SECTION C - MISC. PLUMBING SPECIALTIES - Page 83**

Our misc. plumbing specialties section covers a wide range of items from basic plumbing items such as water heater stands, access panels and compression couplings to water meter boxes and pipe insulation.

C**SECTION D - FITTINGS AND VALVES - Page 123**

In the fittings and valves section you will find our large variety of brass fittings, nylon fittings, push on fittings, PEX fittings, ball valves and much, much more.

D**SECTION E - COMMERCIAL / RESIDENTIAL PLASTICS - Page 169**

This section is full of assembled coverall drains and cleanouts that have both plastic and metal spuds with a variety of different strainer and cover diameters and finishes. You will also find residential plastics such as shower drains, roof drains and floor sinks.

E**SECTION F - CAST IRON - Page 237**

This section contains all of our cast iron products such as closet flanges, drains, "Code Blue" drains, and cleanouts.

F**SECTION G - TOOLS - Page 273**

Our tool section has hand tools, plumbing tools, cutting tools, shovels, measuring tools, caulk, chemicals and safety equipment.

G**GASKETS AND COUPLINGS - Page 311**

Here you will find our compression gaskets and no hub couplings.

H&I**SECTION T: TUBULAR - Page 317**

This section contains all of our chrome plated, rough brass, PVC and ABS plastic tubular products as well as lav drains and pop-up assemblies.

T**PVC/DWV FITTINGS - Page 339**

We offer a wide variety of PVC/DWV fittings including couplings, adapters, elbows, p-traps and bushings.

**PVC
DWV****BLACK AND GALVANIZED MALLEABLES/PIPE NIPPLES - Page 349**

In this section you will find our black and galvanized malleable fittings, pipe nipples, readycut pipe and merchant couplings.

BG**COPPER - Page 363**

Our copper section contains a large variety of fittings including wrot/ACR fittings, forged brass/cast brass pressure fittings, wrot DWV solder fittings, cast DWV solder fittings and cast brass flanges.

CF**SECTION TS: JONES STEPHENS TOILET SEATS - Page 381**

Jones Stephens toilet seats combine aesthetics with innovation, ensuring that they're of the highest quality. That's one reason we're a leading manufacturer of commercial, residential, hospitality, and multi-family dwelling toilet seats.

TS**SECTION MRO: CONTRACTOR SPECIALTIES & MRO PRODUCTS - Page 393**

These pages carry more than the widest possible range of plumbing supplies. They include the products your customers typically need on the jobsite, everyday items such as work lights... and gloves, and trash bags, and extension cords, and locksets, and caulk, and so much more.

MRO**SECTION M: MERCHANDISING - Page 413**

We have a wide range of merchandising displays to fit your needs. We have peg board, tilt bin, and free standing options available.

M

You Need It...We Got It



CORE ITEMS

9 Specialty Categories • 1,300 Associated Items

You Need It.

With over 18,000 SKU's, we understand that shopping Jones Stephens' catalog can be a little perplexing. In fact, we've heard it over and over and we took it to heart! We simplified your selection by identifying 134 CORE items that Jones Stephens HAS that you absolutely NEED! **We didn't get rid of anything**; we just simplified the buying process for you! We identified the core items that you are more than likely already buying and listed the associated items for each.

They Want It.

Associated items are the every day items that not only you, but they (your customers) ask for. Here's an example: our C27150 – 1-½ Closet Spud is a core item which has 16 associated products. The associated list outlines other sizes and styles that maybe you didn't know Jones Stephens offers, but should have in stock.

We Got It.

You already buy these core products, but unless you're buying from Jones Stephens, you probably can't get them all from ONE company. Jones Stephens offers a consolidation advantage with all 134 core items being competitively priced. With no minimums, fast shipping and the best customer service around, we're determined to make your customer experience with Jones Stephens a great one!

Save Time. Save Money. Save Freight.

We Got It – Call Jones Stephens.

You Need It items are designated with our logo “” throughout this catalog.

SECTION A - DECORATIVE

Decorative Kitchen 3-5
Decorative Bathroom 6-28

Disposal Assembly



- Fits In-Sink-Erator
- Also acts as a basket strainer
- All stainless steel construction
- Positive stopper
- Clamshell or box package

PART NO.	BOX	FINISH	CTN/MSTR
B03004	B03004B	Almond	5/20
B03003	B03003B	Biscuit	5/20
B03005	B03005B	Flat Black	5/20
B03408	—	Brushed Nickel	5/20
B03401	—	Brushed Stainless	5/20
B03406	—	Oil Rubbed Bronze	5/20
B03407	—	Old World Bronze	5/20
B03001	B03001B	Polar White	5/20
B03405	—	Polished Nickel (PVD)	5/20
B03400	—	Polished Stainless	5/20

Basket Strainer



- Simple to install, operate and maintain
- Stainless steel flange and basket
- Positive seal
- Clamshell packaging

PART NO.	FINISH	CTN/MSTR
B02004	Almond	5/20
B02404	Antique Nickel	5/20
B02003	Biscuit	5/20
B02005	Black	5/20
B02408	Brushed Nickel	5/20
B02401	Brushed Stainless	5/20
B02406	Oil Rubbed Bronze	5/20
B02407	Old World Bronze	5/20
B02001	Polar White	5/20
B02405	Polished Nickel (PVD)	5/20
B02400	Polished Stainless	5/20

Replacement Basket Strainer



PART NO.	FINISH	FITS PART NO.	CTN/MSTR
B02304	Almond	B02004	10/40
B02303	Biscuit	B02003	10/40
B02305	Black	B02005	10/40
B0240BN	Brushed Nickel	B02408	10/40
B0240BS	Brushed Stainless	B02401	10/40
B0240RB	Oil Rubbed Bronze	B02406	10/40
B0240WB	Old World Bronze	B02407	10/40
B02301	Polar White	B02001	10/40
B0240PN	Polished Nickel	B02405	10/40
B0240PS	Polished Stainless	B02400	10/40

Items marked with the Jones Stephens logo are "You Need It... We Got It" Items.

Polished Brass Basket Strainer



- Metal construction

PART NO.	FINISH	CTN/MSTR
B02008	Polished Brass	1/50

ASAP Basket Strainer



- Ideal for quick installation
- Can be installed in less than one minute
- Brass slip nut
- Galvanized retaining ring and locking ring
- Durable stainless steel construction

PART NO.	FINISH	CTN/MSTR
S14009	Chrome Plated	1/24
S1409BN	Brushed Nickel	1/24

Disposal Assembly and Stopper



- Fits In-Sink-Erator
- Metal construction
- Matches well with S14 Duo Strainer Series

PART NO.	FINISH	CTN QTY
B03050	Polished Chrome	5/20
B0350BN	Brushed Nickel	5/20
B0350RB	Oil Rubbed Bronze	5/20
B0350WB	Old World Bronze	5/20

Duo Strainer



- Cast brass

PART NO.	FINISH	CTN QTY
S14007	Chrome Plated	1
S1407BN	Brushed Nickel (PVD)	1
S1407RB	Oil Rubbed Bronze	1
S1407WB	Old World Bronze	1
S1407NP	Pearl Nickel	1

Junior Duo Basket Strainer

A



- Complete with nuts and washers

PART NO.	FINISH	CTN/MSTR
B02050	Chrome Plated	1/100
B0250BN	Brushed Nickel	10/80
B0250RB	Oil Rubbed Bronze	10/80
B0250WB	Old World Bronze	10/80
B0250NP	Pearl Nickel	10/80
B02100	Polished Brass	10/80

Deep Junior Duo Basket Strainer



- Polished brass body
- Complete with nuts and washers
- For 2" and 2-1/2" outlets

PART NO.	FINISH	CTN QTY
B02102	Chrome Plated	1
B02101	Polished Brass	1

Hose And Spray



- Blister card packaging with 1/4" universal coupling adapter
- Hose is white

PART NO.	FINISH	CTN/MSTR
K52011	Biscuit	12/24
K52013	Black	12/24
K52014	Brushed Nickel	12/24
K52016	Oil Rubbed Bronze	12/24
K52017	Old World Bronze	12/24
K52010	Polar White	1/100

Bar Tap Faucet with Rotating Spout



- 9-1/2" high
- Can be used with reverse osmosis
- 1/4" to 3/8" O.D. adapter
- Handle can be installed side or front mount
- Spout rotates
- 5" reach

PART NO.	FINISH	CTN/MSTR
B70030	Chrome Plated	1/40
B70031	Brushed Nickel	1/40
B70032	Oil Rubbed Bronze	1/40
B70033	Old World Bronze	1/40
B70045	Threaded shank extension kit	1/200

Dispenser Faucet



- 9-1/2" high
- Can be used with reverse osmosis
- Ceramic cartridge
- Quarter-turn handle
- Sleek European design
- For use with cold water only
- Manufactured of Celcon- will not crack, chip or peel
- Blister card packaging with 1/4" and 3/8" adapters

PART NO.	FINISH	CTN QTY
B70013	Almond	1
B70012	Biscuit	1
B70020	Black body gold spout	1
B70017	White body chrome spout	1

Bar Tap Faucet



- 6-1/2" high
- Can be used with reverse osmosis
- All brass construction
- 1/2" connection
- Epoxy coated
- 1/4" inlet; 1-3/4" escutcheon
- Blister card packaging
- Lead Free

PART NO.	FINISH	CTN/MSTR
B45010	Chrome	1/36
B70009	Biscuit	6/36
B70003	Black	6/36
B70008	Brushed Nickel	6/36
B70007	Oil Rubbed Bronze	6/36
B70004	Old World Bronze	6/36
B70001	Polar White	6/36
B70006	Polished Brass	6/36

Lotion And Soap Dispenser with Brass Pump



- 2" spout
- All brass pump
- Seven ounce poly bottle
- Blister card packaging

PART NO.	FINISH	CTN QTY
S08020	Chrome	1
S10022	Biscuit	1
S10023	Black	1
S10025	Brushed Nickel (PVD)	1
S10024	Oil Rubbed Bronze	1
S10021	Polar White	1
S10020	Polished Brass	1

Faucet Hole Cover



- Wing nut included
- 1-3/4" diameter top

PART NO.	FINISH	MATERIAL	CTN/MSTR
B1020AL	Almond	Stainless Steel	12/250
B1020AB	Antique Brass	Brass	12/250
B1020AN	Antique Nickel	Brass	12/144
B1020BI	Biscuit	Stainless Steel	12/250
B1020BL	Black	Stainless Steel	12/144
B1020BN	Brushed Nickel (PVD)	Brass	12/144
B1020RB	Oil Rubbed Bronze	Brass	12/144
B1020WB	Old World Bronze	Brass	12/144
B1020NP	Pearl Nickel (PVD)	Brass	12/250
B1020PW	Polar White	Stainless Steel	12/250
B1020PN	Polished Nickel	Brass	12/250
B1020PS	Polished Stainless (PVD)	Brass	12/250

Celcon Faucet Hole Cover



- Molded Celcon- will not crack, chip or peel
- Blister card packaging
- 1-3/4" diameter top

PART NO.	FINISH	CTN/MSTR
C06011	Chrome	12/96
C06007	Almond	12/96
C06006	Biscuit	12/96
C06008	Black	12/96
C06014	Brushed Nickel	12/96
C06016	Oil Rubbed Bronze	12/96
C06013	Old World Bronze	12/96
C06017	Pearl Nickel (PVD)	12/96
C06004	Polar White	12/96
C06018	Polished Nickel (PVD)	12/96

ABS Faucet Hole Cover



- Screw down type
- Fit all
- Made of ABS Plastic
- 1-3/4" diameter top; 3" length

PART NO.	FINISH	CTN QTY
C06002	Almond	1
C06001	Polar White	1

Brass Faucet Hole Cover



- Heavy duty brass construction
- 1-3/4" diameter top

PART NO.	FINISH	CTN/MSTR
C06021	Brushed Stainless	12/144
C06024	Polished Nickel	12/144
C06020	Polished Stainless	12/144

A

Air Gap



- Protects dishwasher from sewage backflow
- UPC listed

PART NO.	FINISH	CTN/MSTR
A10001	Chrome Plated	36/72
A10011	Polar White	1/50
A10010	Polished Brass	1/50

Air Gap Cover



- Replaces chrome cover on most air gaps
- Blister card packaging

PART NO.	FINISH	CTN QTY
A10015	Chrome	1
A10005	Almond	1
A10004	Biscuit	1
A10006	Black	1
A10018	Brushed Nickel	1
A10003	Euro White	1
A10017	Oil Rubbed Bronze	1
A10019	Old World Bronze	1
A10002	Polar White	1

A

Lav Pop-Up Drain with Overflow



- For vessel sinks 1-1/2" drain hole
- 18 gauge
- With 4" drain body and 8" brass tailpiece
- Decorative finish covers all metal parts including tailpiece and lock nut.
- Tailpiece opening - 1-1/4" OD

PART NO.	FINISH	CTN/MSTR
P35033	Chrome Plated	3/12
P3503BN	Brushed Nickel	3/12
P3503RB	Oil Rubbed Bronze	3/12
P3503WB	Old World Bronze	3/12

Lav Pop-Up Drain without Overflow



- For vessel sinks 1-1/2" drain hole
- 18 gauge
- With 4" drain body and 8" brass tailpiece
- Decorative finish covers all metal parts including tailpiece and lock nut.
- Tailpiece opening - 1-1/4" OD

PART NO.	FINISH	CTN/MSTR
P35044	Chrome Plated	3/12
P3504BN	Brushed Nickel	3/12
P3504RB	Oil Rubbed Bronze	3/12
P3504WB	Old World Bronze	3/12

Lav Grid Drain without Overflow



- For vessel sinks 1-1/2" drain hole
- 18 gauge
- With 4" drain body and 8" brass tailpiece
- Decorative finish covers all metal parts including tailpiece and lock nut
- Tailpiece opening - 1-1/4" OD

PART NO.	FINISH	CTN/MSTR
D70205	Chrome Plated	3/12
D7020BN	Brushed Nickel	3/12
D7020RB	Oil Rubbed Bronze	3/12
D7020WB	Old World Bronze	3/12

Lav Grid Drain with Overflow



- For vessel sinks 1-1/2" drain hole
- 18 gauge
- With 4" drain body and 8" brass tailpiece
- Decorative finish covers all metal parts including tailpiece and lock nut
- Tailpiece opening - 1-1/4" OD

PART NO.	FINISH	CTN/MSTR
D70210	Chrome Plated	3/12
D7021BN	Brushed Nickel	3/12
D7021RB	Oil Rubbed Bronze	3/12
D7021WB	Old World Bronze	3/12

Pop-Up Assembly with Overflow



- All metal construction
- Tool free locknut and ballrod nut
- 1-1/4" tubular
- 17 gauge
- Boxed

PART NO.	FINISH	CTN QTY
P35001	Chrome Plated (PVD)	25
P35002	Polished Brass (PVD)	10

Replacement Parts

PART NO.	DESCRIPTION	CTN QTY
P35920	Plunger	25
P35921	Flange	25
P35922	Lift Rod	25

Lav Lift and Turn Drain without Overflow



- For vessel sinks
- With 3" drain body and 4-3/4" brass tailpiece
- Blister card packaging
- Tailpiece opening- 1-1/4" OD

PART NO.	FINISH	CTN/MSTR
P35003	Chrome Plated	1/50
P3500BN	Brushed Nickel (PVD)	5/30
P3500RB	Oil Rubbed Bronze	5/30
P3500WB	Old World Bronze	5/30
P3500NP	Pearl Nickel (PVD)	5/30
P3500PB	Polished Brass	5/30

Lav Grid Drain without Overflow



- For vessel sinks
- With 2-1/4" drain body and 6" (5-7/8") brass tailpiece
- Blister card packaging
- Tailpiece opening- 1-1/4" OD

PART NO.	FINISH	CTN QTY
D70105	Chrome Plated	1
D7010BN	Brushed Nickel	5
D7010RB	Oil Rubbed Bronze	5
D7010WB	Old World Bronze	5
D7010NP	Pearl Nickel	5
D7010PB	Polished Brass	5

Brass Tubular P-Trap



- 17 gauge
- Brass slip joint nut and rubber washers

PART NO.	FINISH	OD	CTN QTY
P3892BN	Brushed Nickel	1-1/4"	1
P3892RB	Oil Rubbed Bronze	1-1/4"	1
P3892WB	Old World Bronze	1-1/4"	1
P3892NP	Pearl Nickel	1-1/4"	1
P36125	Polished Brass	1-1/4"	12
P36150	Polished Brass	1-1/2"	12
P3892PB	Polished Brass (PVD)	1-1/4"	1

Brass Tubular P-Trap with Box Escutcheon



- 17 gauge
- Brass slip joint nut and rubber washers

PART NO.	FINISH	OD	CTN QTY
P3450CP	Chrome Plated	1-1/4"	1
P3450BN	Brushed Nickel	1-1/4"	1
P3450RB	Oil Rubbed Bronze	1-1/4"	1

Polished Brass Finished P-Trap



- Complete with nuts, washers and box escutcheon
- Plastic

PART NO.	FINISH	SIZE	CTN QTY
P36100	Polished Brass	1-1/4"	1
P36101	Polished Brass	1-1/2"	1

Slip Joint Extension Tube



- 17 gauge
- Brass slip joint nut and rubber washers

PART NO.	FINISH	SIZE	CTN QTY
P3819BN	Brushed Nickel	1-1/4" x 8"	1
P3819RB	Oil Rubbed Bronze	1-1/4" x 8"	1

Offset Bath Supplies



- Chrome plated
- 1/2" supply tubes
- All hardware needed for connection included

PART NO.	DESCRIPTION	CTN QTY
B49020	Single offset (pair)	6
B49021	Double offset (pair)	6
B49022	Replacement nuts, washers and escutcheons	6

Polished Brass Shower Rod Flange with Set Screws



- Includes: two flanges, two set screws and four wood screws

PART NO.	FINISH	CTN QTY
S03152	Shower Rod Flange	1

Polished Brass Jiffy Rod Flange



- Die Cast

PART NO.	FINISH	CTN QTY
S03151	Metal Jiffy Rod Flange	1

Shower Diverter Valve



- Installs between arm and shower head
- Allows usage of hand-held shower or shower head
- Not a positive shut off

PART NO.	FINISH	CTN QTY
S01070	Chrome Plated	1
S01071	Brushed Nickel	1
S01072	Oil Rubbed Bronze	1
S01073	Old World Bronze	1

3" Adjustable Shower Head



- 2.5 GPM
- Solid Brass

PART NO.	FINISH	CTN QTY
S01010	Chrome Plated	1
S0101BN	Brushed Nickel	1
S0101RB	Oil Rubbed Bronze	1
S0101WB	Old World Bronze	1

Polished Brass Shower Head & Kit



- Shower head is solid brass with PVD finish
- Adjustable
- 2.5 GPM at 80 psi

PART NO.	DESCRIPTION	CTN QTY
S03009	2-1/4" face adjustable	1
S03051	Kit includes arm & flange w/set screws	1

Round Classic Shower Head



- 1/2" swivel connection
- 2.5 GPM at 80 PSI

5" Round			
PART NO.	FINISH	SIZE	CTN QTY
S01087	Chrome Plated	5"	1
S0187BN	Brushed Nickel	5"	1
S0187RB	Oil Rubbed Bronze	5"	1
S0187WB	Old World Bronze	5"	1
S01187	Polished Brass	5"	1

Round Shower Head with Metal Tips



- 1/2" swivel connection
- 2.5 GPM at 80 PSI
- Metal tips

6" Round			
PART NO.	FINISH	SIZE	CTN QTY
S01084	Chrome Plated	6"	1
S0184BN	Brushed Nickel (PVD)	6"	1
S0184RB	Oil Rubbed Bronze	6"	1
S0184WB	Old World Bronze	6"	1
S01184	Polished Brass (PVD)	6"	1

8" Round			
PART NO.	FINISH	SIZE	CTN QTY
S01085	Chrome Plated	8"	1
S0185BN	Brushed Nickel (PVD)	8"	1
S0185RB	Oil Rubbed Bronze	8"	1
S0185WB	Old World Bronze	8"	1
S01185	Polished Brass (PVD)	8"	1

10" Round			
PART NO.	FINISH	SIZE	CTN QTY
S01086	Chrome Plated	10"	1
S0186BN	Brushed Nickel (PVD)	10"	1
S0186RB	Oil Rubbed Bronze	10"	1
S0186WB	Old World Bronze	10"	1
S01186	Polished Brass (PVD)	10"	1

A Round Rain Style Shower Head with Dimples



- 1/2" swivel connection
- 2.5 GPM at 80 PSI

5" Round			
PART NO.	FINISH	SIZE	CTN QTY
S01088	Chrome Plated	5"	1
S0188BN	Brushed Nickel	5"	1
S0188RB	Oil Rubbed Bronze	5"	1
S0188WB	Old World Bronze	5"	1

8" Round			
PART NO.	FINISH	SIZE	CTN QTY
S01089	Chrome Plated	8"	1
S0189BN	Brushed Nickel	8"	1
S0189RB	Oil Rubbed Bronze	8"	1
S0189WB	Old World Bronze	8"	1

Round Shower Head with Gold Tips



- Chrome plated body with gold tips (removable)
- 2.5 GPM at 80 PSI

5" Round			
PART NO.	FINISH	SIZE	CTN QTY
S01090	Chrome Plated with gold tips	5"	20

9" Round			
PART NO.	FINISH	SIZE	CTN QTY
S01091	Chrome Plated with gold tips	9"	12

Shower Head with Rubber Tips



- 2.5 GPM at 80 PSI
- Chrome & Brushed Nickel finishes have grey tips
- Oil Rubbed Bronze & Old World Bronze finishes have black tips

10" Round			
PART NO.	FINISH	SIZE	CTN QTY
S01096	Chrome Plated	10"	1
S0196BN	Brushed Nickel	10"	1
S0196RB	Oil Rubbed Bronze	10"	1
S0196WB	Old World Bronze	10"	1



- 2.5 GPM at 80 PSI
- Chrome & Brushed Nickel finishes have grey tips
- Oil Rubbed Bronze & Old World Bronze finishes have black tips

8" Round			
PART NO.	FINISH	SIZE	CTN QTY
S01092	Chrome Plated	8"	1
S0192BN	Brushed Nickel	8"	1
S0192RB	Oil Rubbed Bronze	8"	1
S0192WB	Old World Bronze	8"	1

10" Round			
PART NO.	FINISH	SIZE	CTN QTY
S01093	Chrome Plated	10"	1
S0193BN	Brushed Nickel	10"	1
S0193RB	Oil Rubbed Bronze	10"	1
S0193WB	Old World Bronze	10"	1



- 2.5 GPM at 80 PSI
- Chrome & Brushed Nickel finishes have grey tips
- Oil Rubbed Bronze & Old World Bronze finishes have black tips

8" Square			
PART NO.	FINISH	SIZE	CTN QTY
S01094	Chrome Plated	8"	1
S0194BN	Brushed Nickel	8"	1
S0194RB	Oil Rubbed Bronze	8"	1
S0194WB	Old World Bronze	8"	1

10" Square			
PART NO.	FINISH	SIZE	CTN QTY
S01095	Chrome Plated	10"	1
S0195BN	Brushed Nickel	10"	1
S0195RB	Oil Rubbed Bronze	10"	1
S0195WB	Old World Bronze	10"	1

S-Shaped Shower Arm



- 18" length
- Adds 12" to height
- 1/2" female threads
- Fixed escutcheon

PART NO.	FINISH	SIZE	CTN QTY
S01055	Chrome Plated	1/2" x 18"	1
S0155BN	Brushed Nickel	1/2" x 18"	1
S0155RB	Oil Rubbed Bronze	1/2" x 18"	1
S0155WB	Old World Bronze	1/2" x 18"	1
S01155	Polished Brass (PVD)	1/2" x 18"	1

S-Shaped Shower Arm



- Chrome plated brass
- 8" or 10" length

PART NO.	FINISH	SIZE	CTN QTY
S01035	Chrome Plated	8"	1
S01038	Chrome Plated	10"	1

Ceiling Mount Shower Arm



- 1/2" female threads
- Fixed escutcheon

1/2" x 6"

PART NO.	FINISH	SIZE	CTN QTY
S01051	Chrome Plated	1/2" x 6"	10
S0151BN	Brushed Nickel	1/2" x 6"	10
S0151RB	Oil Rubbed Bronze	1/2" x 6"	10
S0151WB	Old World Bronze	1/2" x 6"	10
S01151	Polished Brass (PVD)	1/2" x 6"	10

1/2" x 12"

PART NO.	FINISH	SIZE	CTN QTY
S01052	Chrome Plated	1/2" x 12"	10
S0152BN	Brushed Nickel	1/2" x 12"	10
S0152RB	Oil Rubbed Bronze	1/2" x 12"	10
S0152WB	Old World Bronze	1/2" x 12"	10
S01152	Polished Brass (PVD)	1/2" x 12"	10

1/2" x 18"

PART NO.	FINISH	SIZE	CTN QTY
S01053	Chrome Plated	1/2" x 18"	10
S0153BN	Brushed Nickel	1/2" x 18"	10
S0153RB	Oil Rubbed Bronze	1/2" x 18"	10
S0153WB	Old World Bronze	1/2" x 18"	10
S01153	Polished Brass (PVD)	1/2" x 18"	10

90° Shower Arm with Flange



- 18" length
- 1/2" female threads
- Fixed escutcheon

PART NO.	FINISH	SIZE	CTN QTY
S01056	Chrome Plated	1/2" x 18"	1
S0156BN	Brushed Nickel	1/2" x 18"	1
S0156RB	Oil Rubbed Bronze	1/2" x 18"	1
S0156WB	Old World Bronze	1/2" x 18"	1
S01156	Polished Brass	1/2" x 18"	1

Raised Bend Shower Arm



- 18" length
- 1/2" female threads
- Fixed escutcheon

PART NO.	FINISH	SIZE	CTN QTY
S01057	Chrome Plated	1/2" x 18"	1
S0157BN	Brushed Nickel	1/2" x 18"	1
S0157RB	Oil Rubbed Bronze	1/2" x 18"	1
S0157WB	Old World Bronze	1/2" x 18"	1
S01157	Polished Brass (PVD)	1/2" x 18"	1

Double Offset Shower Arm



- 18" length
- 1/2" female threads
- Adds 12" to height
- Fixed escutcheon

PART NO.	FINISH	SIZE	CTN QTY
S01058	Chrome Plated	1/2" x 18"	1
S0158BN	Brushed Nickel	1/2" x 18"	1
S0158RB	Oil Rubbed Bronze	1/2" x 18"	1
S0158WB	Old World Bronze	1/2" x 18"	1
S01158	Polished Brass (PVD)	1/2" x 18"	1

Shower Arm



- Fits E02 series escutcheons

6"

PART NO.	FINISH	SIZE	CTN QTY
S01030	Chrome Plated	6"	1
S0130BN	Brushed Nickel	6"	1
S0130RB	Oil Rubbed Bronze	6"	1
S0130WB	Old World Bronze	6"	1

8"

PART NO.	FINISH	SIZE	CTN QTY
S01032	Chrome Plated	8"	1
S0132BN	Brushed Nickel	8"	1
S0132RB	Oil Rubbed Bronze	8"	1
S0132WB	Old World Bronze	8"	1

Polished Brass Shower Arm



- Fits E81050 escutcheon

PART NO.	FINISH	SIZE	CTN/MSTR
S03030	Polished Brass	1/2" x 6"	20/200
S03032	Polished Brass	1/2" x 8"	20/200
S01036	Polished Brass	1/2" x 8" s-shaped	10/80
S01037	Polished Brass	1/2" x 10" s-shaped	10/60

Contoured Shower Curtain Rod

A

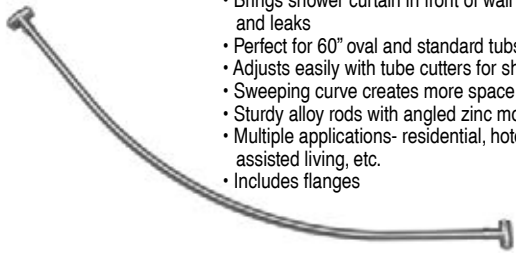

- Brings shower curtain in front of wall to prevent gaps and leaks
- Perfect for 60" oval and standard tubs
- Adjusts easily with tube cutters for shower walls
- Sweeping curve creates more space in center of tub
- Sturdy alloy rods with angled zinc mounting brackets
- Multiple applications- residential, hotel, motel, assisted living, etc.
- Includes flanges

PART NO.	FINISH	CTN/MSTR
S02190	Chrome Plated	1/12
S02193	Satin Nickel	1/1

Flanges

PART NO.	FINISH	CTN/MSTR
S02290	Chrome flanges (Fits S02190)	1/1
S02293	Satin Nickel flanges (Fits S02193)	1/1

Cover Plates

- Mirrored acrylic
- Conceals damaged/cracked tiles
- Fits all standard bath/shower fittings
- No tools required-use silicone caulk
- DO NOT use abrasive cleaners



PART NO.	DESCRIPTION	SIZE	CTN/MSTR
T73001	Tub spout model	3-1/2" diameter	1/300
T73002	One handle model	8" x 14"	1/100
T73003	Two handle model	6" x 14"	1/40
T73004	Three handle model	6" x 14"	1/36

Polished Stainless Steel Repair Cover Plates

- 1, 2 or 3 hole design to fit multitude of valves
- Polished stainless steel finish
- Easily attaches with silicone caulk; 1-hole has brackets and screw
- 7-1/4" x 13" long



PART NO.	# OF HOLES	DIAMETER	CTN QTY
T73815	1	5-1/8"	1
T73816	2	1-3/8"	1
T73817	3	1-3/8"	1
T73818	1	3-3/4"	1

Polished Brass Shower Arm Flange

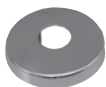

- Die cast with a set screw
- Poly bagged

PART NO.	DESCRIPTION	CTN/MSTR
S03040	1/2" with set screw	20/400

Polished Brass Tub Spouts



- 8-1/2"
- PVD durable finish
- All brass
- Boxed

PART NO.	DESCRIPTION	MATERIAL	CONNECTION	CTN/MSTR
D03016	3/4" x 1/2" x 8-1/2"	Brass	Base	1/20



- Brass plated zamak
- Boxed

PART NO.	DESCRIPTION	MATERIAL	CONNECTION	CTN/MSTR
D03020	1/2" FIP	Zamak	Nose	1/50

Polished Brass Diverter Spouts



- Brass plated zamak
- Boxed

PART NO.	DESCRIPTION	MATERIAL	CONNECTION	CTN/MSTR
D03001	1/2" FIP	Zamak	Nose	1/50



- Brass plated zamak
- Boxed

PART NO.	DESCRIPTION	MATERIAL	CONNECTION	CTN/MSTR
D03002	3/4" x 1/2" FIP	Zamak	Base	1/50



- Brass plated zamak
- Boxed

PART NO.	DESCRIPTION	MATERIAL	CONNECTION	CTN/MSTR
D03004	1/2" CTS (5/8" OD) Slip-on with hex key	Zamak	Base	1/50



- Brass plated zamak
- Boxed

PART NO.	DESCRIPTION	MATERIAL	CONNECTION	CTN/MSTR
D03010	3/4" x 1/2" FIP with 1/2" top connection for hand-held shower	Zamak	Base	1/50



- Brass plated zamak
- Boxed

PART NO.	DESCRIPTION	MATERIAL	CONNECTION	CTN/MSTR
D03011	3/4" x 1/2" FIP with 1/2" bottom connection for hand-held shower	Zamak	Base	1/50



- 8-1/2"
- PVD durable finish
- All brass
- Boxed

PART NO.	DESCRIPTION	MATERIAL	CONNECTION	CTN/MSTR
D03015	3/4" x 1/2" x 8-1/2" long	Brass	Base	1/20

Chrome Plated Diverter Spouts and Extensions



- Chrome plated Brass
- 8-1/2" One piece diverter spout
- All brass
- Boxed

PART NO.	DESCRIPTION	MATERIAL	CONNECTION	CTN/MSTR
D01015	3/4" x 1/2" FIP	Brass	Base	1/20

Extension Only



- All brass

PART NO.	DESCRIPTION	MATERIAL	CTN/MSTR
D01030	3" extension only	CP Brass	1/100
D01031	4-3/4" extension only	CP Brass	1/80



- Chrome plated Zamak
- Diverter spout for hand held shower

PART NO.	DESCRIPTION	MATERIAL	CONNECTION	CTN/MSTR
D01010	3/4" x 1/2" FIP top connection	Zamak	Base	1/10
D01011	3/4" x 1/2" MIP lower connection	Zamak	Base	1/50

7" Chrome Plated Diverter Spout



- Chrome plated Zamak
- Longer length for today's larger tubs
- CTS unit comes with hex key

PART NO.	MATERIAL	CONNECTION	CTN/MSTR
D01024	CP Zamak	1/2" FIP Nose	1/50
D01025	CP Zamak	1/2" CTS Nose	1/25

Chrome Plated Diverter Spout with Polished Brass Knob



- Brass plated Zamak
- Boxed

PART NO.	DESCRIPTION	MATERIAL	CONNECTION	CTN/MSTR
D01032	CP slip on diverter with PB knob	Zamak	Base	1/50

7" Chrome Plated Tub Spout



- CTS unit comes with hex key
- Longer length for today's larger tubs
- Chrome plated zamak

PART NO.	MATERIAL	CONNECTION	CTN/MSTR
D01026	CP Zamak	1/2" FIP Nose	1/50
D01027	CP Zamak	1/2" CTS Slide	1/25

Chrome Plated Tub Spouts



- Chrome plated Zamak
- CTS unit comes with hex key

PART NO.	MATERIAL	CONNECTION	CTN/MSTR
D01020	CP Zamak	1/2" FIP Nose	1/50
D01021	CP Zamak	1/2" CTS SlideBase	1/50



- Chrome plated Brass
- 8-1/2" One piece diverter spout

PART NO.	MATERIAL	CONNECTION	CTN/MSTR
D01016	CP Brass	3/4" x 1/2" FIP Base	1/20

9" Chrome Plated Tub and Diverter Spout



- Chrome plated brass
- One piece design
- 1/2" nose connection
- Solid brass construction

PART NO.	MATERIAL	CONNECTION	CTN/MSTR
D01017	CP Brass	1/2" FIP Nose	1/12
D01018	CP Brass	1/2" FIP Nose	1/12

Decorative Diverter Spout



- 1/2" CTS Slide connection

PART NO.	MATERIAL	CONNECTION	CTN/MSTR
D0104BN	Brushed Nickel Zamak	1/2" CTS Nose	1/50
D0104RB	Oil Rubbed Bronze Zamak	1/2" CTS Slide	1/50
D0104WB	Old World Bronze Zamak	1/2" CTS Slide	1/50

Ring for Tub Spouts and Diverter



- Adds decorative touch to any tub spout or diverter
- Fits between the wall and the tub spout or diverter
- 3-5/16" OD 2-3/8" ID

PART NO.	FINISH	CTN QTY
D01050	Chrome Plated	1
D01050BN	Brushed Nickel	1
D01050RB	Oil Rubbed Bronze	1
D01050WB	Old World Bronze	1

A

Trip Lever with Spring



- Includes screws

PART NO.	FINISH	# OF HOLES	CTN/MSTR
T05003	Chrome Plated	2	25/200
T08003	Polished Brass	2	25/200
T08004	Polished Brass (PVD)	2	1/100

Overflow Plates



- Includes screws

PART NO.	FINISH	# OF HOLES	CTN QTY
T05012	Chrome Plated	1	25
T0812BN	Brushed Nickel	1	1
T0812RB	Oil Rubbed Bronze	1	1
T0812WB	Old World Bronze	1	1
T0812NP	Pearl Nickel	1	1
T08012	Polished Brass	1	1
T08112	Polished Brass (PVD)	1	1
T08013	Polished Brass	2	1
T08113	Polished Brass (PVD)	2	1
P35616	Satin Nickel	2	1
T05015	White	2	1

Polished Brass Lift and Turn Bath Waste Conversion Kits



- Converts regular bath waste to polished brass
- Fits 1-3/8" or 1-1/2" waste elbows
- Includes drain, bushing, faceplate, and 2 screws
- Blister card packaging

PART NO.	SIZE	# OF HOLES	CTN QTY
B51003	1/2" and 1-3/8"	2	12
B51020	1/2" and 1-3/8"	1	12

Lift and Turn Conversion Kit



- 1- hole faceplate
- 1-3/8" drain with bushing
- Includes drain, bushing, face plate, aluminum adapter bar and screws
- Blister card packaging

PART NO.	FINISH	# OF HOLES	CTN QTY
B51019	Chrome Plated	1	1
B5160AP	Antique Pewter	1	1
B5160BB	Brushed Bronze	1	1
B5160BN	Brushed Nickel	1	1
B5160BS	Brushed Stainless	1	1
B5160RB	Oil Rubbed Bronze	1	1
B5160WB	Old World Bronze	1	1
B5160PN	Polished Nickel	1	1
B5160PS	Polished Stainless	1	1

Ⓢ Items marked with the Jones Stephens logo are "You Need It... We Got It" Items.

Toe Touch Conversion Kit



- 1- hole faceplate
- 1-3/8" drain with bushing, screw and faceplate
- Includes drain, bushing, face plate, aluminum adapter bar and screws
- Clamshell packaging

PART NO.	FINISH	# OF HOLES	CTN QTY
B51010	Chrome Plated	1	1
B5161AP	Antique Pewter	1	1
B5161BB	Brushed Bronze	1	1
B5161BN	Brushed Nickel	1	1
B5161RB	Oil Rubbed Bronze	1	1
B5161WB	Old World Bronze	1	1
B5161PS	Polished Stainless	1	1

Lift and Turn Conversion Kit



- 2-hole faceplate
- 1-3/8" drain with bushing, 2 screws and faceplate
- Clamshell packaging - B5155BNB and B5155WBB are boxed

PART NO.	FINISH	# OF HOLES	CTN QTY
B51005	Chrome Plated	2	6
B5155AL	Almond	2	1
B5155AB	Antique Brass	2	1
B5155AN	Antique Nickel	2	1
B5155AP	Antique Pewter	2	1
B5155BI	Biscuit	2	1
B5155BL	Black	2	1
B5155BB	Brushed Bronze	2	1
B5155BN	Brushed Nickel	2	1
B5155BS	Brushed Stainless	2	1
B5155RB	Oil Rubbed Bronze	2	1
B5155WB	Old World Bronze	2	1
B5155PW	Polar White	2	1
B5155PS	Polished Stainless	2	1
B51004	Satin Nickel	2	1
B5155BNB	Brushed Nickel (boxed)	2	1
B5155WBB	Old World Bronze (boxed)	2	1

Toe Touch Conversion Kit



- 2-hole faceplate
- Fits 1-3/8" or 1-1/2" waste elbows
- Includes drain, bushing, faceplate and 2 screws
- Clamshell packaging

PART NO.	FINISH	# OF HOLES	CTN QTY
B51007	Chrome Plated	2	1
B5156AP	Antique Pewter	2	1
B5156BB	Brushed Bronze	2	1
B5156BN	Brushed Nickel	2	1
B5156RB	Oil Rubbed Bronze	2	1
B5156WB	Old World Bronze	2	1
B5156PS	Polished Stainless	2	1

Trip Lever Conversion Kit



- Fits 1-3/8" or 1-1/2" waste elbows
- Includes drain, bushing, faceplate and 2 screws
- Clamshell packaging

PART NO.	FINISH	# OF HOLES	CTN QTY
B51015	Chrome Plated	2	1
B5112AP	Antique Pewter	2	1
B5112BI	Biscuit	2	1
B5112BB	Brushed Bronze	2	1
B5112BN	Brushed Nickel	2	1
B5112BS	Brushed Stainless	2	1
B5112RB	Oil Rubbed Bronze	2	1
B5112WB	Old World Bronze	2	1
B5112PW	Polar White	2	1

Trip Lever Trim Only



- 2-hole faceplate
- Includes springs, faceplate, 2 screws and strainer
- Clamshell packaging

PART NO.	FINISH	# OF HOLES	CTN QTY
B51014	Chrome Plated	2	1
B5114AP	Antique Pewter	2	1
B5114BB	Brushed Bronze	2	1
B5114BN	Brushed Nickel	2	1
B5114RB	Oil Rubbed Bronze	2	1
B5114WB	Old World Bronze	2	1
B5114PB	Polished Brass	2	1
B5114PN	Polished Nickel	2	1
B5114PS	Polished Stainless	2	1

Trip Lever Faceplate and Handle



- Less screws

PART NO.	FINISH	# OF HOLES	CTN QTY
T05002	Chrome Plated	2	1
P3566AL	Almond	2	1
P3566AB	Antique Brass	2	1
P3566AN	Antique Nickel	2	1
P3566BI	Biscuit	2	1
P3566BL	Black	2	1
P3566BN	Brushed Nickel	2	1
P3566BS	Brushed Stainless	2	1
P3566RB	Oil Rubbed Bronze	2	1
P3566WB	Old World Bronze	2	1
P3566PW	Polar White	2	1
P3566PN	Polished Nickel	2	1
P3566PS	Polished Stainless	2	1

2-Hole Overflow Faceplate



- Includes screws

PART NO.	FINISH	# OF HOLES	CTN QTY
T05013	Chrome Plated	2	1
T0813BN	Brushed Nickel	2	1
T0813RB	Oil Rubbed Bronze	2	1
T0813WB	Old World Bronze	2	1
T0813PW	Polar White	2	1

Waste and Overflow Faceplate Only



- Less screws

PART NO.	FINISH	# OF HOLES	CTN QTY
T05011	Chrome Plated	2	1
P3565AL	Almond	2	1
P3565AB	Antique Brass	2	1
P3565AN	Antique Nickel	2	1
P3565BI	Biscuit	2	1
P3565BL	Black	2	1
P3565BN	Brushed Nickel	2	1
P3565BS	Brushed Stainless	2	1
P3565RB	Oil Rubbed Bronze	2	1
P3565WB	Old World Bronze	2	1
P3565PW	Polar White	2	1
P3565PN	Polished Nickel	2	1
P3565PS	Polished Stainless	2	1

Waste and Overflow Faceplate Screws



PART NO.	FINISH	SIZE	CTN/MSTR
T05021	Chrome Plated	1/4" x 2"	100/1000
T0521AL	Almond	1/4" x 2"	1/1
T0521AB	Antique Brass	1/4" x 2"	1/1
T0521AN	Antique Nickel	1/4" x 2"	1/1
T0521BI	Biscuit	1/4" x 2"	1/1
T0521BL	Black	1/4" x 2"	1/1
T0521BN	Brushed Nickel	1/4" x 2"	1/1
T0521BS	Brushed Stainless	1/4" x 2"	1/1
T0521RB	Oil Rubbed Bronze	1/4" x 2"	1/1
T0521WB	Old World Bronze	1/4" x 2"	1/1
T0521PW	Polar White	1/4" x 2"	1/1
T0521PN	Polished Nickel	1/4" x 2"	1/1
T0521PS	Polished Stainless	1/4" x 2"	1/1
T08021	Polished Brass	1/4" x 2"	50/2000
P35615	Satin Nickel	1/4" x 2"	1/25

Flip-It Conversion Kit

A



- No tools needed for installation
- Open or close with a flip of the toe
- Fits most popular tub drains (assorted o-ring included)
- One piece construction Delrin and ABS

PART NO.	FINISH	# OF HOLES	CTN/MSTR
P35170	Chrome Plated	1	1/1
P35172	Brushed Nickel	1	1/1
P35171	Polished Brass	1	1/1

Flip-It Bath Tub Stopper



- No tools needed for installation
- Open or close with a flip of the toe
- Fits most popular tub drains (assorted o-ring included)
- One piece construction Delrin and ABS

PART NO.	FINISH	CTN/MSTR
P35070	Chrome Plated	100/200
P35071	Polished Brass	1/100

Bath Drains



PART NO.	FINISH	DESCRIPTION	CTN/MSTR
P35061	Chrome Plated	1-3/8" Lift and Turn	1/100
P35051	Polished Brass	1-3/8" Lift and Turn	1/100
P35060	Chrome Plated	1-1/2" Lift and Turn	1/100
P35050	Polished Brass	1-1/2" Lift and Turn	1/100
P35065	White	1-1/2" Lift and Turn	1/100



PART NO.	FINISH	DESCRIPTION	CTN/MSTR
P35063	Chrome Plated	1-3/8" Toe Touch	1/100
P35053	Polished Brass	1-3/8" Toe Touch	1/100
P35062	Chrome Plated	1-1/2" Toe Touch	1/100
P35052	Polished Brass	1-1/2" Toe Touch	1/100



PART NO.	FINISH	DESCRIPTION	CTN/MSTR
P35056	Chrome Plated	5/16" Toe Touch Cartridge	1/300
P35055	Polished Brass	5/16" Toe Touch Cartridge	1/1



- 1-3/8" are fine threads
- 1-1/2" are course threads

PART NO.	DESCRIPTION	CTN/MSTR
T05024	1-3/8" female- 1-1/2" male bushing	50/300

Polished Brass/Satin Nickel Bath Drains



- PVD durable finish

PART NO.	FINISH	DESCRIPTION	CTN QTY
P35072	Polished Brass (PVD)	1-1/2" Lift and Turn	1
P35073	Polished Brass (PVD)	1-1/2" Toe Touch	1
P35068	Polished Brass (PVD)	1-1/2" Friction Lift	1
P35058	Polished Brass (PVD)	3/8" Toe Touch Replacement	1
P35610	Satin Nickel (PVD)	1-1/2" Lift and Turn	1
P35611	Satin Nickel (PVD)	1-1/2" Friction Lift	1
P35612	Satin Nickel (PVD)	1-1/2" Toe Touch	1
P35613	Satin Nickel (PVD)	1-1/2" Trip Lever	1
P35614	Satin Nickel (PVD)	1-1/2" Cable Drive	1

Toe Touch Bath Drain



- 1-1/2" drain
- Course thread

PART NO.	FINISH	CTN QTY
P35062	Chrome Plated	1
P3562AL	Almond	1
P3562AB	Antique Brass	1
P3562AN	Antique Nickel	1
P3562BI	Biscuit	1
P3562BL	Black	1
P3562BN	Brushed Nickel	1
P3562BS	Brushed Stainless	1
P3562RB	Oil Rubbed Bronze	1
P3562WB	Old World Bronze	1
P3562PW	Polar White	1
P3562PN	Polished Nickel	1
P3562PS	Polished Stainless	1

Trip Lever Body, Grid and Screw



- 1-1/2" drain
- Course thread

PART NO.	FINISH	CTN QTY
P35064	Chrome Plated	1
P3563AL	Almond	1
P3563AB	Antique Brass	1
P3563AN	Antique Nickel	1
P3563BI	Biscuit	1
P3563BL	Black	1
P3563BN	Brushed Nickel	1
P3563BS	Brushed Stainless	1
P3563RB	Oil Rubbed Bronze	1
P3563WB	Old World Bronze	1
P3563PW	Polar White	1
P3563PN	Polished Nickel	1
P3563PS	Polished Stainless	1

Lift and Turn Bath Drain



- Solid Brass
- Body and stopper
- 1-1/2" drain
- Course thread

PART NO.	FINISH	CTN QTY
P35066	Chrome Plated	1
P3560AL	Almond	1
P3560AB	Antique Brass	1
P3560AN	Antique Nickel	1
P3560BI	Biscuit	1
P3560BL	Black	1
P3560BN	Brushed Nickel	1
P3560BS	Brushed Stainless	1
P3560RB	Oil Rubbed Bronze	1
P3560WB	Old World Bronze	1
P3560PW	Polar White	1
P35050	Polished Brass	1
P3560PN	Polished Nickel	1
P3560PS	Polished Stainless	1
P35610	Satin Nickel	1

Friction Lift Bath Drain



- Solid Brass
- 1-1/2" drain
- Course thread

PART NO.	FINISH	CTN QTY
P35067	Chrome Plated	1
P3561AL	Almond	1
P3561AB	Antique Brass	1
P3561AN	Antique Nickel	1
P3561BI	Biscuit	1
P3561BL	Black	1
P3561BN	Brushed Nickel	1
P3561BS	Brushed Stainless	1
P3561RB	Oil Rubbed Bronze	1
P3561WB	Old World Bronze	1
P3561PW	Polar White	1
P35068	Polished Brass	1
P3561PN	Polished Nickel	1
P3561PS	Polished Stainless	1
P35611	Satin Nickel	1

Standard 1-Hole Schedule 40 Lift and Turn Bath Waste Kits

A



- 1-hole faceplate

Half Kit

PVC#	ABS#	FINISH	CTN QTY
B07010	B07011	Chrome Plated	1
B0750BN	B0850BN	Brushed Nickel	1
B0750RB	B0850RB	Oil Rubbed Bronze	1
B0750WB	B0850WB	Old World Bronze	1
B07014	B07015	Polished Brass	1



- 1-hole faceplate

Full Kit

PVC#	ABS#	FINISH	CTN QTY
B07030	B07031	Chrome Plated	1
B0751BN	B0851BN	Brushed Nickel	1
B0751RB	B0851RB	Oil Rubbed Bronze	1
B0751WB	B0851WB	Old World Bronze	1
B07034	B07035	Polished Brass	1

Standard 1-Hole Schedule 40 Friction Lift Bath Waste Kits



- 1-hole faceplate

Half Kit

PVC#	ABS#	FINISH	CTN QTY
B07052	B07053	Chrome Plated	1
B0752BN	B0852BN	Brushed Nickel	1
B0752RB	B0852RB	Oil Rubbed Bronze	1
B0752WB	B0852WB	Old World Bronze	1
B07054	B07055	Polished Brass	1



- 1-hole faceplate

Full Kit

PVC#	ABS#	FINISH	CTN QTY
B07058	B07059	Chrome Plated	1
B0753BN	B0853BN	Brushed Nickel	1
B0753RB	B0853RB	Oil Rubbed Bronze	1
B0753WB	B0853WB	Old World Bronze	1
B07060	B08060	Polished Brass	1

A Standard 1-Hole Schedule 40 Toe Touch Bath Waste Kits



• 1-hole faceplate

Half Kit			
PVC#	ABS#	FINISH	CTN QTY
B07012	B07013	Chrome Plated	24
B0754BN	B0854BN	Brushed Nickel	1
B0754RB	B0854RB	Oil Rubbed Bronze	1
B0754WB	B0854WB	Old World Bronze	1
B07016	B07017	Polished Brass	1



• 1-hole faceplate

Full Kit			
PVC#	ABS#	FINISH	CTN QTY
B07032	B07033	Chrome Plated	1
B0755BN	B0855BN	Brushed Nickel	1
B0755RB	B0855RB	Oil Rubbed Bronze	1
B0755WB	B0855WB	Old World Bronze	1
B0755NP	B0855NP	Pearl Nickel	1
B07036	B07037	Polished Brass	1

Standard 2-Hole Schedule 40 Lift and Turn Bath Waste Kits



• 2-hole faceplate

Half Kit			
PVC#	ABS#	FINISH	CTN QTY
B07110	B07111	Chrome Plated	1
B0711AL	B0811AL	Almond	1
B0711AB	B0811AB	Antique Brass	1
B0711AN	B0811AN	Antique Nickel	1
B0711BI	B0811BI	Biscuit	1
B0711BL	B0811BL	Black	1
B0711BN	B0811BN	Brushed Nickel	1
B0711BS	B0811BS	Brushed Stainless	1
B0711RB	B0811RB	Oil Rubbed Bronze	1
B0711WB	B0811WB	Old World Bronze	1
B0711PW	B0811PW	Polar White	1
B07114	B07115	Polished Brass	1
B0711PN	B0811PN	Polished Nickel	1
B0711PS	B0811PS	Polished Stainless	1



• 2-hole faceplate

Full Kit			
PVC#	ABS#	FINISH	CTN QTY
B07130	B07131	Chrome Plated	1
B0713AL	B0813AL	Almond	1
B0713AB	B0813AB	Antique Brass	1
B0713AN	B0813AN	Antique Nickel	1
B0713BI	B0813BI	Biscuit	1
B0713BL	B0813BL	Black	1
B0713BN	B0813BN	Brushed Nickel	1
B0713RB	B0813RB	Oil Rubbed Bronze	1
B0713WB	B0813WB	Old World Bronze	1
B0713PW	B0813PW	Polar White	1
B07134	B07135	Polished Brass	1
B0713PN	B0813PN	Polished Nickel	1
B0713PS	B0813PS	Polished Stainless	1

Standard 2-Hole Schedule 40 Toe Touch Bath Waste Kits



• 2-hole faceplate

Half Kit			
PVC#	ABS#	FINISH	CTN QTY
B07112	B07113	Chrome Plated	1
B0717AL	B0817AL	Almond	1
B0717AB	B0817AB	Antique Brass	1
B0717AN	B0817AN	Antique Nickel	1
B0717BI	B0817BI	Biscuit	1
B0717BL	B0817BL	Black	1
B0717BN	B0817BN	Brushed Nickel	1
B0717BS	B0817BS	Brushed Stainless	1
B0717RB	B0817RB	Oil Rubbed Bronze	1
B0717WB	B0817WB	Old World Bronze	1
B0717PW	B0817PW	Polar White	1
B07116	B07117	Polished Brass	1
B0717PN	B0817PN	Polished Nickel	1
B0717PS	B0817PS	Polished Stainless	1



• 2-hole faceplate

Full Kit			
PVC#	ABS#	FINISH	CTN QTY
B07158	B07159	Chrome Plated	1
B0716AL	B0816AL	Almond	1
B0716AB	B0816AB	Antique Brass	1
B0716AN	B0816AN	Antique Nickel	1
B0716BI	B0816BI	Biscuit	1
B0716BL	B0816BL	Black	1
B0716BN	B0816BN	Brushed Nickel	1
B0716BS	B0816BS	Brushed Stainless	1
B0716RB	B0816RB	Oil Rubbed Bronze	1
B0716WB	B0816WB	Old World Bronze	1
B0716PW	B0816PW	Polar White	1
B07160	B07161	Polished Brass	1
B0716PN	B0816PN	Polished Nickel	1
B0716PS	B0816PS	Polished Stainless	1

Standard 2-Hole Schedule 40 Friction Lift Bath Waste Kits



• 2-hole faceplate

Half Kit			
PVC#	ABS#	FINISH	CTN QTY
B07152	B07153	Chrome Plated	1
B0715AL	B0815AL	Almond	1
B0715AB	B0815AB	Antique Brass	1
B0715AN	B0815AN	Antique Nickel	1
B0715BI	B0815BI	Biscuit	1
B0715BL	B0815BL	Black	1
B0715BN	B0815BN	Brushed Nickel	1
B0715RB	B0815RB	Oil Rubbed Bronze	1
B0715WB	B0815WB	Old World Bronze	1
B0715PW	B0815PW	Polar White	1
B07154	B07155	Polished Brass	1
B0715PN	B0815PN	Polished Nickel	1
B0715PS	B0815PS	Polished Stainless	1



• 2-hole faceplate

Full Kit			
PVC#	ABS#	FINISH	CTN QTY
B07132	B07133	Chrome Plated	1
B0718AL	B0818AL	Almond	1
B0718AB	B0818AB	Antique Brass	1
B0718AN	B0818AN	Antique Nickel	1
B0718BI	B0818BI	Biscuit	1
B0718BL	B0818BL	Black	1
B0718BN	B0818BN	Brushed Nickel	1
B0718RB	B0818RB	Oil Rubbed Bronze	1
B0718WB	B0818WB	Old World Bronze	1
B0718PW	B0818PW	Polar White	1
B07136	B07137	Polished Brass	1
B0718PN	B0818PN	Polished Nickel	1
B0718PS	B0818PS	Polished Stainless	1

Tubular Lift and Turn Bath Waste Kits

A



• 2-hole faceplate

Full Kit			
PVC#	ABS#	FINISH	CTN QTY
P37500	P39500	Chrome Plated	1
P3750AL	P3950AL	Almond	1
P3750AB	P3950AB	Antique Brass	1
P3750AN	P3950AN	Antique Nickel	1
P3750BI	P3950BI	Biscuit	1
P3750BL	P3950BL	Black	1
P3750BN	P3950BN	Brushed Nickel	1
P3750BS	P3950BS	Brushed Stainless	1
P3750RB	P3950RB	Oil Rubbed Bronze	1
P3750WB	P3950WB	Old World Bronze	1
P3750PW	P3950PW	Polar White	1
P3750PN	P3950PN	Polished Nickel	1
P3750PS	P3950PS	Polished Stainless	1
P37502	P39502	Satin Nickel	1

Tubular Toe Touch Bath Waste Kits



• 2-hole faceplate

Full Kit			
PVC#	ABS#	FINISH	CTN QTY
P37506	P39506	Chrome Plated	1
P3752AL	P3952AL	Almond	1
P3752AB	P3952AB	Antique Brass	1
P3752AN	P3952AN	Antique Nickel	1
P3752BI	P3952BI	Biscuit	1
P3752BL	P3952BL	Black	1
P3752BN	P3952BN	Brushed Nickel	1
P3752RB	P3952RB	Oil Rubbed Bronze	1
P3752WB	P3952WB	Old World Bronze	1
P3752PW	P3952PW	Polar White	1
P3752PN	P3952PN	Polished Nickel	1
P3752PS	P3952PS	Polished Stainless	1
P37508	P39508	Satin Nickel	1

Tubular Friction Lift Bath Waste Kits



• 2-hole faceplate

Full Kit			
PVC#	ABS#	FINISH	CTN QTY
P37503	P39503	Chrome Plated	1
P3751AL	P3951AL	Almond	1
P3751AB	P3951AB	Antique Brass	1
P3751AN	P3951AN	Antique Nickel	1
P3751BI	P3951BI	Biscuit	1
P3751BL	P3951BL	Black	1
P3751BN	P3951BN	Brushed Nickel	1
P3751BS	P3951BS	Brushed Stainless	1
P3751RB	P3951RB	Oil Rubbed Bronze	1
P3751WB	P3951WB	Old World Bronze	1
P3751PW	P3951PW	Polar White	1
P3751PN	P3951PN	Polished Nickel	1
P3751PS	P3951PS	Polished Stainless	1
P37505	P39505	Satin Nickel	1

Tubular Trip Lever Bath Waste Kits



• 2-hole faceplate

Full Kit			
PVC#	ABS#	FINISH	CTN QTY
P37509	P39509	Chrome Plated	1
P3761AL	P3961AL	Almond	1
P3761AB	P3961AB	Antique Brass	1
P3761AN	P3961AN	Antique Nickel	1
P3761BI	P3961BI	Biscuit	1
P3761BL	P3961BL	Black	1
P3761BN	P3961BN	Brushed Nickel	1
P3761BS	P3961BS	Brushed Stainless	1
P3761RB	P3961RB	Oil Rubbed Bronze	1
P3761WB	P3961WB	Old World Bronze	1
P3761PW	P3961PW	Polar White	1
P3761PN	P3961PN	Polished Nickel	1
P3761PS	P3961PS	Polished Stainless	1
P37511	P39511	Satin Nickel	1

27" Cable Drive Bath Waste Kits



- 1-1/2" Schedule 40 Cable Drive

Full Kit		
PVC#	FINISH	CTN QTY
P37550	Chrome Plated	1
P3755BN	Brushed Nickel	1
P3755RB	Oil Rubbed Bronze	1
P3755WB	Old World Bronze	1
P3755PB	Polished Brass	1
P3755WH	White	1

2" Metal Spud with 4-1/4" Round Strainer



- All brass spud & strainer
- Works with shower drain base D50001

PART NO.	FINISH	CTN QTY
D60981	Chrome Plated	1
D6098BN	Brushed Nickel	1
D6098RB	Oil Rubbed Bronze	1
D6098WB	Old World Bronze	1
D6098NP	Pearl Nickel	1
D60982	Polished Brass	1
D60980	Stainless Steel	1

3-1/2" Metal Spud with 5" Square Strainer



- All brass spud & strainer
- Works with shower drain base D49804/D49801

PART NO.	FINISH	CTN QTY
D60954	Chrome Plated	1
D6096BN	Brushed Nickel	1
D60962	Nickel Bronze	3
D6096RB	Oil Rubbed Bronze	1
D6096WB	Old World Bronze	1
D6096NP	Pearl Nickel	1
D60960	Polished Brass	2

2" Brass Spud with 4" Square Strainer



- All brass spud & strainer
- Grout ring
- Works with shower drain base D50001

PART NO.	FINISH	CTN QTY
D60942	Chrome Plated	1
D6094BN	Brushed Nickel	1
D6094RB	Oil Rubbed Bronze	1
D6094WB	Old World Bronze	1
D6094NP	Pearl Nickel	1
D6094PB	Polished Brass	1

2" PVC Spud with 4-1/4" Stamped Square Strainer



PART NO.	FINISH	CTN QTY
D5087BN	Brushed Nickel	1
D5087RB	Oil Rubbed Bronze	1
D5087WB	Old World Bronze	1
D50887	Stainless Steel	1

2" x 3" Shower Drain with 2" Brass Spud and 4-1/4" Square Strainer



- All brass spud and strainer
- Grout ring

PART NO.	FINISH	CTN QTY
D50942	Chrome Plated	1
D5094BN	Brushed Nickel	1
D5094RB	Oil Rubbed Bronze	1
D5094WB	Old World Bronze	1

A

2" x 3" Shower Drain with 2" Spud and Snap-in 4" Square Strainer



- No screws
- Four prong installation
- Plastic spud

PART NO.	FINISH	CTN QTY
D5088BN	Brushed Nickel	1
D5088RB	Oil Rubbed Bronze	1
D5088WB	Old World Bronze	1
D50888	Stainless Steel	1

2" x 3" Shower Drain with 2" Spud and 4-1/4" Round Strainer



- Flow rate - 3.102 GPM
- Metal Spud

PART NO.	FINISH	CTN QTY
D50111	Chrome Plated (cast brass)	1
D5001BN	Brushed Nickel (cast brass)	1
D5001RB	Oil Rubbed Bronze (cast brass)	1
D5001WB	Old World Bronze (cast brass)	1
D5001NP	Pearl Nickel (cast brass)	1

2" x 3" Heavy Duty PVC Shower Drain with 3-1/2" Spud and 5" Round Cast Brass Strainer



- PVC spud
- Round strainer
- For multi-head showers
- Flow rate - 15.260 GPM
- Primer tapped

PART NO.	FINISH	CTN QTY
D49059	Chrome Plated	1
D4912BN	Brushed Nickel	1
D49057	Nickel Bronze	1
D4912RB	Oil Rubbed Bronze	1
D4912WB	Old World Bronze	1
D4912NP	Pearl Nickel	1
D49055	Polished Brass	1

3" x 4" Heavy Duty PVC Shower Drain with 3-1/2" Spud and 5" Round Strainer



- Metal spud
- Round strainer
- For multi-head showers
- Flow rate - 15.260 GPM
- Primer tapped

PART NO.	FINISH	CTN QTY
D49159	Chrome Plated	1
D4991BN	Brushed Nickel	1
D49157	Nickel Bronze	1
D4991RB	Oil Rubbed Bronze	1
D4991WB	Old World Bronze	1
D4991NP	Pearl Nickel	1
D49155	Polished Brass	1

3" x 4" Heavy Duty PVC Shower Drain with 3-1/2" Spud and 5" Square Strainer



- Metal spud
- Square strainer
- For multi-head showers
- Flow rate - 15.260 GPM
- Primer tapped

PART NO.	FINISH	CTN QTY
D4996BN	Brushed Nickel	1
D4996RB	Oil Rubbed Bronze	1
D4996WB	Old World Bronze	1
D4996NP	Pearl Nickel	1

3" x 4" Heavy Duty PVC Shower Drain with 3-1/2" Plastic Spud and 5" Round Cast Brass Strainer



- PVC spud
- Round strainer
- For multi-head showers
- Flow rate - 15.260 GPM
- Primer tapped

PART NO.	FINISH	CTN QTY
D4984BN	Brushed Nickel	1
D4984RB	Oil Rubbed Bronze	1
D4984WB	Old World Bronze	1
D4984NP	Pearl Nickel	1

4-1/4" Round Stamped Strainer



- Includes screws
- Fits D50001 tile shower drain
- Blister packaging
- Center to center screwholes- 3-3/8"

PART NO.	FINISH	CTN/MSTR
C60806	Chrome Plated	1/100
C6089AL	Almond	20/400
C6089AB	Antique Brass	20/400
C6089AN	Antique Nickel	20/400
C6089BI	Biscuit	20/400
C6089BL	Black	20/400
C6089BN	Brushed Nickel	20/200
C6089RB	Oil Rubbed Bronze	20/200
C6089WB	Old World Bronze	20/200
C6089NP	Pearl Nickel	20/400
C6089PW	Polar White	20/400
C60810	Polished Brass (PVD)	20/400
C6089PN	Polished Nickel	20/400
C6089PS	Polished Stainless	20/200
C60814	Satin Nickel	1/100

4-1/4" Round Snap-in Strainer



- For no caulk fiberglass shower stalls
- Fits D40101, D40140 and D50001
- Blister packaging
- Snap-in prong to snap-in prong - 3"

PART NO.	FINISH	CTN QTY
D4005BN	Brushed Nickel	20/200
D4005RB	Oil Rubbed Bronze	1/1
D4005WB	Old World Bronze	1/1
D4005NP	Pearl Nickel	1/1
D40003	Polished Brass (PVD)	50/250
D40010	Satin Nickel	20/200
D40005	Stainless Steel	1/200
D40004	White	50/200

4-1/4" Round Cast Brass Heavy Duty Strainer



- Includes screws
- Fits D50001 tile shower drain
- Center to center screwholes- 3-3/8"

PART NO.	FINISH	CTN QTY
C6087BN	Brushed Nickel	1
C6087RB	Oil Rubbed Bronze	1
C6087WB	Old World Bronze	1
C6087NP	Pearl Nickel	1
C60807	Polished Brass (PVD)	10

4-1/4" Square Cast Brass Heavy Duty Strainer



- Includes fine and coarse threaded screws
- Fits D50001 tile shower drain
- Center to center screwholes- 3-3/8"

PART NO.	FINISH	CTN QTY
C6083BN	Brushed Nickel	1
C6083RB	Oil Rubbed Bronze	1
C6083WB	Old World Bronze	1
C6083NP	Pearl Nickel	1
C60813	Polished Brass (PVD)	10

5.196" Round Cast Brass Heavy Duty Strainer



- Includes screws
- Fits any drain with 3-1/2" PVC spud
- Center to center screwholes- 4-3/8"

PART NO.	FINISH	CTN QTY
C60803	Chrome Plated	1
C6084BN	Brushed Nickel	1
C6084RB	Oil Rubbed Bronze	1
C6084WB	Old World Bronze	1
C6084NP	Pearl Nickel	1
C60804	Polished Brass	1

"Code Blue" Round Replacement Strainer



- Includes screws
- Fits non-adjustable "Code Blue" drains

PART NO.	DESCRIPTION	CTN/MSTR
D64000	2" SS	1/50
D64401	SS Crown	1/100
D64001	2" PB (PVD)	1/100
D6400BN	Brushed Nickel	1/250
D6400RB	Oil Rubbed Bronze	1/250
D6400WB	Old World Bronze	1/250

4" Round Shower Drain Strainer



- Includes screws
- Stamped to fit inside plastic ring
- Center to center screwholes- 3.362"

PART NO.	FINISH	CTN QTY
D54010	Polished Brass (PVD)	10

A

4-1/4" Round Strainer with Screws for Fiberglass Shower Stalls



- Fits D41001 and D41600
- Tapping screws included
- Blister card packaging
- Center to center screwholes- 2-5/8"

PART NO.	FINISH	CTN QTY
D4110BN	Brushed Nickel	20/200
D4110RB	Oil Rubbed Bronze	20/200
D4110WB	Old World Bronze	20/200
D4110NP	Pearl Nickel	125/250
D41102	Polished Brass (PVD)	50/250
D41107	Satin Nickel	50/250
D41101	Stainless Steel	50/250

4-1/4" Stamped Square Strainer



- Fits D5088 series drains
- Snap-in
- Coverall

PART NO.	FINISH	CTN QTY
C6088BN	Brushed Nickel	10/100
C6088RB	Oil Rubbed Bronze	10/100
C6088WB	Old World Bronze	10/100

3-1/2" PVC Spud with 5" Round Strainer



- Fits drain bases tapped for 3-1/2" spuds

PART NO.	FINISH	CTN QTY
D56216	Chrome Plated	1
D6084BN	Brushed Nickel	1
D56214	Nickel Bronze	1
D6084RB	Oil Rubbed Bronze	1
D6084WB	Old World Bronze	1
D6084NP	Pearl Nickel	1
D56212	Polished Brass	1
D56211	Stainless Steel	1

3-1/2" Metal Spud with 5" Round Strainer



- All brass
- Fits drain bases tapped for 3-1/2" spuds

PART NO.	FINISH	CTN/MSTR
D60990	Chrome Plated	1/40
D6091BN	Brushed Nickel	1/40
D60996	Nickel Bronze	1/30
D6091RB	Oil Rubbed Bronze	1/40
D6091WB	Old World Bronze	1/40
D6091NP	Pearl Nickel	1/40
D60991	Polished Brass	1/40

Escutcheons



Low Pattern - Copper Tube Size

PART NO.	FINISH	SIZE	FLANGE OD	CTN QTY
E0105BN	Brushed Nickel	1/2" CTS (5/8" OD)	2-1/2"	1
E0105RB	Oil Rubbed Bronze	1/2" CTS (5/8" OD)	2-1/2"	1
E0105WB	Old World Bronze	1/2" CTS (5/8" OD)	2-1/2"	1

Low Pattern - Iron Pipe Size

PART NO.	FINISH	SIZE	FLANGE OD	CTN QTY
E0205BN	Brushed Nickel	1/2" IPS	2-1/2"	1
E0205RB	Oil Rubbed Bronze	1/2" IPS	2-1/2"	1
E0205WB	Old World Bronze	1/2" IPS	2-1/2"	1

Box Pattern - Tubular

PART NO.	FINISH	SIZE	FLANGE OD	CTN QTY
E0412BN	Brushed Nickel	1-1/4" Tubular	3"	1
E0412RB	Oil Rubbed Bronze	1-1/4" Tubular	3"	1
E0412WB	Old World Bronze	1-1/4" Tubular	3"	1
E0415BN	Brushed Nickel	1-1/2" Tubular	3"	1
E0415RB	Oil Rubbed Bronze	1-1/2" Tubular	3"	1
E0415WB	Old World Bronze	1-1/2" Tubular	3"	1

Bell Pattern - Copper Tube Size

PART NO.	FINISH	SIZE	FLANGE OD	CTN QTY
E0705BN	Brushed Nickel	1/2" CTS (5/8" OD)	2-3/8"	1
E0705RB	Oil Rubbed Bronze	1/2" CTS (5/8" OD)	2-3/8"	1
E0705WB	Old World Bronze	1/2" CTS (5/8" OD)	2-3/8"	1
E0705PB	Polished Brass	1/2" CTS (5/8" OD)	2-3/8"	1

Bell Pattern - Iron Pipe Size

PART NO.	FINISH	SIZE	FLANGE OD	CTN QTY
E0605BN	Brushed Nickel	1/2" IPS	2-3/8"	1
E0605RB	Oil Rubbed Bronze	1/2" IPS	2-3/8"	1
E0605WB	Old World Bronze	1/2" IPS	2-3/8"	1
E0605PB	Polished Brass	1/2" IPS	2-3/8"	1

Bell Pattern - Tubular

PART NO.	FINISH	SIZE	FLANGE OD	CTN QTY
E0812BN	Brushed Nickel	1-1/4" Tubular	3"	1
E0812RB	Oil Rubbed Bronze	1-1/4" Tubular	3"	1
E0812WB	Old World Bronze	1-1/4" Tubular	3"	1
E0812PB	Polished Brass	1-1/4" Tubular	3"	1
E0815BN	Brushed Nickel	1-1/2" Tubular	3"	1
E0815RB	Oil Rubbed Bronze	1-1/2" Tubular	3"	1
E0815WB	Old World Bronze	1-1/2" Tubular	3"	1
E0815PB	Polished Brass	1-1/2" Tubular	3"	1

Polished Brass Escutcheon



• Low Patten

PART NO.	DESCRIPTION	CTN/MSTR
E80050	1/2" CTS (5/8" OD)	500/1000
E80075	3/4" CTS (7/8" OD)	500/1000
E81375	3/8" IPS	500/1000
E81050	1/2" IPS	500/1000



• Box Patten

PART NO.	DESCRIPTION	CTN/MSTR
E82125	1-1/4" OD tubular	100/200
E82150	1-1/2" OD tubular	100/200

Polished Brass Finish Flexible Floor and Ceiling Plate



• Plastic

PART NO.	DESCRIPTION	CTN QTY
F08375	3/8" IPS or 1/2" CTS	12
F08050	1/2" IPS or 3/4" CTS	12
F08124	1-1/4" CTS	12
F08150	1-1/2" IPS	12

Non-Slotted Full Flow Aerator



• Dual threads (15/16 -27 male x 55/64 -27 female)

PART NO.	FINISH	CTN QTY
A01019	Polished Brass	1

Brass Nipple



• Lead Free

3/8" x 4"

PART NO.	FINISH	SIZE	CTN/MSTR
N2206BN	Brushed Nickel (PVD)	3/8" x 4"	25/200
N2206RB	Oil Rubbed Bronze	3/8" x 4"	25/200
N2206WB	Old World Bronze	3/8" x 4"	25/200
N17375	Polished Brass	3/8" x 4"	25/200

3/8" x 6"

PART NO.	FINISH	SIZE	CTN/MSTR
N2210BN	Brushed Nickel (PVD)	3/8" x 6"	25/100
N2210RB	Oil Rubbed Bronze	3/8" x 6"	25/100
N2210WB	Old World Bronze	3/8" x 6"	25/100
N2210PB	Polished Brass	3/8" x 6"	25/100

1/2" x 4"

PART NO.	FINISH	SIZE	CTN/MSTR
N2306BN	Brushed Nickel (PVD)	1/2" x 4"	25/200
N2306RB	Oil Rubbed Bronze	1/2" x 4"	25/200
N2306WB	Old World Bronze	1/2" x 4"	25/200
N17050	Polished Brass	1/2" x 4"	25/200

1/2" x 6"

PART NO.	FINISH	SIZE	CTN/MSTR
N2310BN	Brushed Nickel (PVD)	1/2" x 6"	25/100
N2310RB	Oil Rubbed Bronze	1/2" x 6"	25/100
N2310WB	Old World Bronze	1/2" x 6"	25/100
N2310PB	Polished Brass	1/2" x 6"	25/100

Sleeves



• Fits over 1/2" CTS
• Brass

PART NO.	FINISH	SIZE	CTN QTY
T73300	Chrome	1/2" x 3-1/2"	1
T7330BN	Brushed Nickel (PVD)	1/2" x 3-1/2"	1
T7330RB	Oil Rubbed Bronze	1/2" x 3-1/2"	1
T7330WB	Old World Bronze	1/2" x 3-1/2"	1
T7330PB	Polished Brass (PVD)	1/2" x 3-1/2"	1

Quarter Turn Angle Stop with 5" Sweat Extension and Escutcheon



• Bell escutcheon
• 3/8" OD x 1/2" sweat connection
• Includes hot, cold and blank buttons

PART NO.	FINISH	CTN QTY
S42220	Chrome Plated	1
S4222BN	Brushed Nickel	1
S4222RB	Oil Rubbed Bronze	1
S4222WB	Old World Bronze	1
S4222PB	Polished Brass	1

Quarter Turn Angle Stop

A



- Cross handle
- Includes hot, cold and blank buttons

1/2" FIP x 3/8" OD

PART NO.	FINISH	SIZE	CTN QTY
S42021	Chrome Plated	1/2" FIP x 3/8" OD	1
S4202BN	Brushed Nickel	1/2" FIP x 3/8" OD	1
S4202RB	Oil Rubbed Bronze	1/2" FIP x 3/8" OD	1
S4202WB	Old World Bronze	1/2" FIP x 3/8" OD	1
S4202PB	Polished Brass (PVD)	1/2" FIP x 3/8" OD	1

5/8" OD x 3/8" OD

PART NO.	FINISH	SIZE	CTN QTY
S42031	Chrome Plated	5/8" OD x 3/8" OD	1
S4203BN	Brushed Nickel	5/8" OD x 3/8" OD	1
S4203RB	Oil Rubbed Bronze	5/8" OD x 3/8" OD	1
S4203WB	Old World Bronze	5/8" OD x 3/8" OD	1
S4203PB	Polished Brass	5/8" OD x 3/8" OD	1



- Oval handle
- UPC Listed



3/8" OD x 3/8" OD

PART NO.	FINISH	SIZE	CTN QTY
S4212BN	Brushed Nickel	3/8" OD x 3/8" OD	20/100
S4212RB	Oil Rubbed Bronze	3/8" OD x 3/8" OD	20/100
S4212WB	Old World Bronze	3/8" OD x 3/8" OD	20/100

Quarter Turn Straight Stop



- Cross handle
- Includes hot, cold and blank buttons

1/2" FIP x 3/8" OD

PART NO.	FINISH	SIZE	CTN QTY
S43021	Chrome Plated	1/2" FIP x 3/8" OD	1
S4302BN	Brushed Nickel	1/2" FIP x 3/8" OD	1
S4302RB	Oil Rubbed Bronze	1/2" FIP x 3/8" OD	1
S4302WB	Old World Bronze	1/2" FIP x 3/8" OD	1
S4302PB	Polished Brass (PVD)	1/2" FIP x 3/8" OD	1

5/8" OD x 3/8" OD

PART NO.	FINISH	SIZE	CTN QTY
S43031	Chrome Plated	5/8" OD x 3/8" OD	1
S4303BN	Brushed Nickel	5/8" OD x 3/8" OD	1
S4303RB	Oil Rubbed Bronze	5/8" OD x 3/8" OD	1
S4303WB	Old World Bronze	5/8" OD x 3/8" OD	1
S4303PB	Polished Brass (PVD)	5/8" OD x 3/8" OD	1



- Oval handle
- UPC Listed



3/8" FIP x 3/8" OD

PART NO.	FINISH	SIZE	CTN QTY
S4311BN	Brushed Nickel	3/8" FIP x 3/8" OD	20/100
S4311RB	Oil Rubbed Bronze	3/8" FIP x 3/8" OD	20/100
S4311WB	Old World Bronze	3/8" FIP x 3/8" OD	20/100

Multi-Turn Compression Angle Stop



PART NO.	FINISH	SIZE	CTN QTY
S10210	Chrome Plated	5/8" COMP x 3/8" COMP	1
S4211BN	Brushed Nickel	5/8" COMP x 3/8" COMP	20
S4211RB	Oil Rubbed Bronze	5/8" COMP x 3/8" COMP	20
S4211WB	Old World Bronze	5/8" COMP x 3/8" COMP	20
S4211PN	Polished Nickel	5/8" COMP x 3/8" COMP	20
S10203	Chrome Plated	1/2" FIP x 3/8" COMP	1
S4213BN	Brushed Nickel	1/2" FIP x 3/8" COMP	20
S4213RB	Oil Rubbed Bronze	1/2" FIP x 3/8" COMP	20
S4213WB	Old World Bronze	1/2" FIP x 3/8" COMP	20
S4213PN	Polished Nickel	1/2" FIP x 3/8" COMP	20

Multi-Turn Compression Straight Stop



PART NO.	FINISH	SIZE	CTN QTY
S10214	Chrome Plated	5/8" COMP x 3/8" COMP	1
S4312BN	Brushed Nickel	5/8" COMP x 3/8" COMP	20
S4312RB	Oil Rubbed Bronze	5/8" COMP x 3/8" COMP	20
S4312WB	Old World Bronze	5/8" COMP x 3/8" COMP	20
S4312PN	Polished Nickel	5/8" COMP x 3/8" COMP	20
S10206	Chrome Plated	1/2" FIP x 3/8" COMP	1
S4314BN	Brushed Nickel	1/2" FIP x 3/8" COMP	20
S4314RB	Oil Rubbed Bronze	1/2" FIP x 3/8" COMP	20
S4314WB	Old World Bronze	1/2" FIP x 3/8" COMP	20
S4314PN	Polished Nickel	1/2" FIP x 3/8" COMP	20

Closest Supply and Stop Kit



- Supply and multi-turn stop
- 1/2" CTS Escutcheon

3/8" x 20" Closet Supply and 3/8" x 5/8" Angle Stop Kit

PART NO.	FINISH	CTN QTY
S1037CP	Chrome	1
S1037AP	Antique Pewter	1
S1037BB	Brushed Bronze	1
S1037BN	Brushed Nickel	1
S1037RB	Oil Rubbed Bronze	1
S1037WB	Old World Bronze	1
S10371	Polished Brass	1
S1037PS	Polished Stainless	1

3/8" x 20" Closet Supply and 3/8" x 5/8" Straight Stop Kit

PART NO.	FINISH	CTN QTY
S1038CP	Chrome Plated	1
S1038AP	Antique Pewter	1
S1038BB	Brushed Bronze	1
S1038BN	Brushed Nickel	1
S1038RB	Oil Rubbed Bronze	1
S1038WB	Old World Bronze	1
S10381	Polished Brass	1
S1038PS	Polished Stainless	1

3/8" x 20" Closet Supply and 1/2" x 3/8" Angle Stop Kit

PART NO.	FINISH	CTN QTY
S1039CP	Chrome Plated	1
S1039BN	Brushed Nickel	1
S1039RB	Oil Rubbed Bronze	1

3/8" x 20" Closet Supply and 5/8" x 3/8" Angle Stop Kit

PART NO.	FINISH	CTN QTY
S1137BN	Brushed Nickel	1
S1137RB	Oil Rubbed Bronze	1

3/8" x 20" Closet Supply and 5/8" x 3/8" Straight Stop Kit

PART NO.	FINISH	CTN QTY
S1138BN	Brushed Nickel	1
S1138RB	Oil Rubbed Bronze	1

Lavatory Supply and Stop Kit

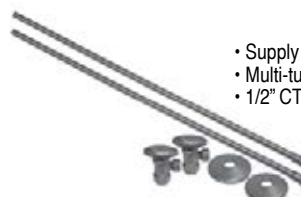

- Supply (2 pieces)
- Multi-turn stop (2 pieces)
- 1/2" CTS escutcheon (2 pieces)

3/8" x 20" Lavatory Supply and 3/8" x 5/8" Angle Stop Kit

PART NO.	FINISH	CTN QTY
S1036AP	Antique Pewter	1
S1036BB	Brushed Bronze	1
S1036BN	Brushed Nickel	1
S1036RB	Oil Rubbed Bronze	1
S1036WB	Old World Bronze	1
S10361	Polished Brass	1
S1036PS	Polished Stainless	1

3/8" x 20" Lavatory Supply and 3/8" x 5/8" Straight Stop Kit

PART NO.	FINISH	CTN QTY
S1035AP	Antique Pewter	1
S1035BB	Brushed Bronze	1
S1035BN	Brushed Nickel	1
S1035RB	Oil Rubbed Bronze	1
S1035WB	Old World Bronze	1
S10351	Polished Brass	1
S1035PS	Polished Stainless	1

3/8" x 20" Lavatory Supply and 1/2" x 3/8" Angle Stop Kit

PART NO.	FINISH	CTN QTY
S1034BN	Brushed Nickel	1
S1034RB	Oil Rubbed Bronze	1

3/8" x 20" Lavatory Supply and 5/8" x 3/8" Angle Stop Kit

PART NO.	FINISH	CTN QTY
S1136BN	Brushed Nickel	1
S1136RB	Oil Rubbed Bronze	1

3/8" x 20" Lavatory Supply and 5/8" x 3/8" Straight Stop Kit

PART NO.	FINISH	CTN QTY
S1135BN	Brushed Nickel	1
S1135RB	Oil Rubbed Bronze	1

Polished Brass Water Supply Tubes

A



• Bullnose rigid supply tube

PART NO.	DESCRIPTION	CTN QTY
S44002	3/8" x 20" Basin Tube	12
S44003	3/8" x 12" Tank Tube	12
S44005	3/8" x 20" Tank Tube	12

Lavatory Supply Tubes



• Basin supply
• Bullnose rigid supply tube

3/8" x 12"

PART NO.	FINISH	SIZE	CTN QTY
S04020	Chrome Plated	3/8" x 12"	100
S4401BN	Brushed Nickel	3/8" x 12"	1
S4401RB	Oil Rubbed Bronze	3/8" x 12"	1
S4401WB	Old World Bronze	3/8" x 12"	1

3/8" x 20"

PART NO.	FINISH	SIZE	CTN QTY
S04022	Chrome Plated	3/8" x 20"	100
S4402BN	Brushed Nickel	3/8" x 20"	1
S4402RB	Oil Rubbed Bronze	3/8" x 20"	1
S4402WB	Old World Bronze	3/8" x 20"	1

Closet Supply Tubes

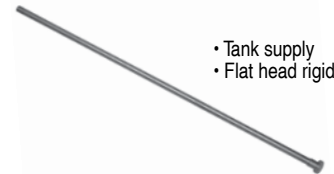

• Tank supply
• Flat head rigid supply tube

3/8" x 12"

PART NO.	FINISH	SIZE	CTN QTY
S04027	Chrome Plated	3/8" x 12"	100
S4403BN	Brushed Nickel	3/8" x 12"	1
S4403RB	Oil Rubbed Bronze	3/8" x 12"	1
S4403WB	Old World Bronze	3/8" x 12"	1

3/8 x 20"

PART NO.	FINISH	SIZE	CTN QTY
S04029	Chrome Plated	3/8" x 20"	100
S4405BN	Brushed Nickel	3/8" x 20"	1
S4405RB	Oil Rubbed Bronze	3/8" x 20"	1
S4405WB	Old World Bronze	3/8" x 20"	1

Ultrafit Tank Trip Lever - Replaces 96% of All Tank Levers



- PATENTED
- New shapable arm bends to fit the needed arm angle
- Arm can be cut to fit 4", 6" or 8" lengths for customized fit
- Heavy duty plastic handle comes in a variety of finishes
- Sturdy plastic arm, spud and nut
- Blister card packaging

PART NO.	FINISH	CTN/MSTR
T01100	Chrome Plated	1/200
T01101	Polished Brass	1/200
T01102	White	1/200
T01103	Bone	1/200
T04001	Display for UltraFit Tank levers 12 each of above	1/1

Tank Trip Levers



• Front mount
• 8" arm

PART NO.	DESCRIPTION	FINISH	CTN QTY
T01003	Brass arm with metal spud and nut	PB Metal	25
T01004	Brass plated arm with metal spud and nut	AB Metal	25
T01007	Brass arm with metal spud and nut	Satin Nickel	1



• Front mount
• 8" arm

PART NO.	DESCRIPTION	FINISH	CTN QTY
T01061	Brass plated arm with plastic spud and nut / universal fit	PB Metal	25



• Front mount
• 8" arm

PART NO.	DESCRIPTION	FINISH	CTN QTY
T01006	Brass arm with metal spud and nut / universal fit	PB Metal	25
T01008	Brass arm with die cast nut	Satin Nickel	1



• Side mount
• 8" arm

PART NO.	DESCRIPTION	FINISH	CTN/MSTR
T01071	Side mount push button brass arm with plastic spud and nut	PB ABS	25/50
T01075	Front mount push button brass arm with plastic spud and nut	PV ABS	25/50

Tank Trip Levers for American Standard*



- Front mount
- 9-1/2" arm

PART NO.	DESCRIPTION	FINISH	CTN QTY
T01065	Brass arm with metal spud and nut. Offset for thick walls	PB Metal	25



- Front mount
- 8" arm

PART NO.	DESCRIPTION	FINISH	CTN QTY
T01049	Neo 28° combo with plastic arm, spud and nut	PB ABS	1



- Front mount
- 6" arm

PART NO.	DESCRIPTION	FINISH	CTN QTY
T01043	45° arm for Cadet 2* plastic arm, spud and nut	PB ABS	25
T01044	45° arm with Cadet 2* plastic arm, spud and nut	White ABS	25
T01045	45° arm with Cadet 2* plastic arm, spud and nut	Bone ABS	25



- Front mount
- 4" arm

PART NO.	DESCRIPTION	FINISH	CTN QTY
T01031	Plastic arm, spud and nut for beaded chain	PB ABS	25
T01032	Plastic arm, spud and nut for beaded chain	White ABS	25
T01033	Plastic arm, spud and nut for beaded chain	Bone ABS	25



- Front mount
- 6" arm

PART NO.	DESCRIPTION	FINISH	CTN QTY
T01051	Plastic arm, spud and nut for Plebe* and Cadet*	PB ABS	25
T01052	Plastic arm, spud and nut for Plebe* and Cadet*	White ABS	25
T01053	Plastic arm, spud and nut for Pleve* and Cadet*	Bone ABS	25

* The manufacturers' names are used only to describe whose products the tank levers will fit. The tank levers are not manufactured by those companies.

Tank Trip Levers for Crane*



- Front mount
- 8" arm

PART NO.	DESCRIPTION	FINISH	CTN QTY
T01035	Plastic arm, spud and nut	PB ABS	25
T01036	Plastic arm, spud and nut	White ABS	25
T01037	Plastic arm, spud and nut	Bone ABS	25

* The manufacturers' names are used only to describe whose products the tank levers will fit. The tank levers are not manufactured by those companies.

Tank Trip Levers for Eljer*



- Side mount
- 9" arm

PART NO.	DESCRIPTION	FINISH	CTN QTY
T01021	Brass arm with non-crack nylon spud and nut	PB Metal	25



- Side mount
- 8" brass arm

PART NO.	FINISH	CTN QTY
T0102BN	Brushed Nickel	1
T0102RB	Oil Rubbed Bronze	1
T0102WB	Old World Bronze	1
T0102NP	Pearl Nickel	1

* The manufacturers' names are used only to describe whose products the tank levers will fit. The tank levers are not manufactured by those companies.

Tank Trip Levers for Kohler*



- Side mount
- 8" brass arm

PART NO.	FINISH	CTN QTY
T0108BN	Brushed Nickel	1
T0108NP	Pearl Nickel	1
T0108RB	Oil Rubbed Bronze	1
T0108WB	Old World Bronze	1
T01181	Polished Brass	1



- Front mount
- 8" arm

PART NO.	DESCRIPTION	FINISH	CTN/MSTR
T01017	Wellworth/Barrington Lite new style / side mount 1.6 gal. unit replacement	PB Metal	1/125
T01015	Cast brass arm with metal spud and nut	PB Metal	1/125

* The manufacturers' names are used only to describe whose products the tank levers will fit. The tank levers are not manufactured by those companies.

Tank Trip Lever for Mansfield*



- Front mount
- 9" arm

PART NO.	DESCRIPTION	FINISH	CTN QTY
T01073	#41* plastic arm, spud and nut	PB ABS	25

* The manufacturers' names are used only to describe whose products the tank levers will fit. The tank levers are not manufactured by those companies.

A

Tank Trip Levers for ToTo*



- Side mount
- 10" brass arm
- Plastic spud and nut

PART NO.	FINISH	CTN QTY
T018BN	Brushed Nickel	1/30
T018RB	Oil Rubbed Bronze	1/30
T018WB	Old World Bronze	1/30

* The manufacturers' names are used only to describe whose products the tank levers will fit. The tank levers are not manufactured by those companies.

Tank Trip Levers for Universal Rundle/Sears*



- Front mount
- 8" arm

PART NO.	DESCRIPTION	FINISH	CTN QTY
T01067	Brass arm with plastic spud and nut fits Universal Rundle/Sears*	PB Metal	25

* The manufacturers' names are used only to describe whose products the tank levers will fit. The tank levers are not manufactured by those companies.

Universal Tank Trip Levers



- Front mount
- 8" arm
- Brass handle and arm

PART NO.	FINISH	CTN QTY
T01000	Chrome Plated	1
T0100BN	Brushed Nickel	1
T0100RB	Oil Rubbed Bronze	1
T0100WB	Old World Bronze	1
T0100NP	Pearl Nickel	1
T0100PB	Polished Brass	1



- Can be used as a front mount or side mount
- 8" adjustable arm

PART NO.	FINISH	CTN/MSTR
T01330	Chrome	10/50
T0133BN	Brushed Nickel	10/50
T0133RB 	Oil Rubbed Bronze	10/50
T0133WB	Old World Bronze	10/50
T0133NP	Pearl Nickel	10/50



- Front mount
- 8" arm
- Elite, heavy duty

PART NO.	FINISH	CTN/MSTR
T0105BN	Brushed Nickel	10/50
T0105RB	Oil Rubbed Bronze	10/50
T0105WB	Old World Bronze	10/50

 Items marked with the Jones Stephens logo are "You Need It... We Got It" Items.

SECTION B - SPECIALTIES & REPAIR

Toilet Repairs 31-43
Kitchen & Bath 44-70
Plumbing Connectors/Supply Stops 71-73
Drinking Fountain Bubbler/Sink Faucets & Accessories 74-75
Gas Connectors 76-82



TANK LEVER TO TANK REFERENCE CHART

MFR.	PART NO.	FINISH	SECTION PAGE NO.	TANK STYLE
American Standard*	T01030	CP ABS	B2	Glenwall with vent #4049.177 Compack with vent #4052.346 Norwall with vent #4041.091
	T01031	PB ABS	DECORATIVE (SECT. A)	
	T01032 T01033	White ABS Bone ABS		
	T01042	CPS ABS	B2	Cadet II #4072 Cadet #4029 Cadet II #4014 Ellisse #4075 High Hamilton - 1 pc. #2096 Hamilton - 1 pc. #2092
	T01043	PB ABS	DECORATIVE (SECT. A)	Carlyle #2010.031 New Cadet line
	T01044	White ABS		
	T01045	Bone ABS		
	T01048	CPS ABS	B2	Glenwall #2093 Cadet #2108 Cadet #2109 Cadet #2120 Cadet #2124 Plebe #2131 Plebe #2138 Plebe #2139 Plebe Aquameter
	T01049	PB ABS	DECORATIVE (SECT. A)	
	T01050	CPS ABS	B2	
	T01051	PB ABS	DECORATIVE (SECT. A)	Old style, thick walled
	T01052	White ABS		
	T01053	Bone ABS		
	T01064	CP Metal	B2	
	T01065	PB Metal	DECORATIVE (SECT. A)	
Crane*	T01034	CPS ABS	B2	Galaxy New Galaxy Sante Fe Avon Antigua
Eljer*	T01020	CP Metal	B3	New Emblem
	T01021	PB Metal	DECORATIVE (SECT. A)	
Kohler*	T01010	CP Metal	B3	Wellworth*/Barrington* - Old Style
	T01012	CP Metal	B3	
	T01015	PB Metal	DECORATIVE (SECT. A)	Kohler 9400
	T01016	CP Metal	B3	Wellworth*/Barrington Lite* - Old Style
	T01017	PB Metal	DECORATIVE (SECT. A)	
Mansfield*	T01040	CPS ABS	B3	Mansfield #35 Mansfield #51 Mansfield #8 Mansfield #16 Mansfield #35LT
	T01073	PB ABS	DECORATIVE (SECT. A)	
	T01072	CP Metal	B3	Mansfield old style #42
	T01041	PB Metal	DECORATIVE (SECT. A)	
Universal Rundle*/Sears*	T01066	CP Metal	B3	Saturn 4012 Low Boy 4445
	T01067	PB Metal	DECORATIVE (SECT. A)	

*The manufacturers' names are used only to describe whose products the tank levers will fit. The tank levers are not manufactured by those companies.



Fit-All Tank Trip Lever

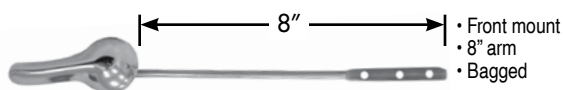

PART NO.	FINISH	DESCRIPTION	CTN/MSTR
T01001	CP Metal	Brass arm with metal spud and nut	25/200
T01002	CP Metal	Brass plated arm with metal spud and nut	25/200
T01200	CP Metal	Aluminum arm with zinc spud and nut	25/200
T01201	CP Metal	Aluminum arm with plastic spud and nut	25/200
T01099	Zinc	Replacement spud nut	1/25

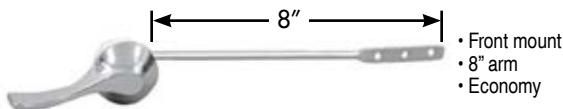

PART NO.	FINISH	DESCRIPTION	CTN/MSTR
T01060	CP Metal	Brass plated arm with plastic spud and nut/ universal fit	25/200

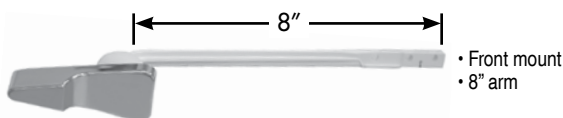

PART NO.	FINISH	DESCRIPTION	CTN/MSTR
T01062	CP ABS	Plastic arm, spud and nut/ universal fit	25/125

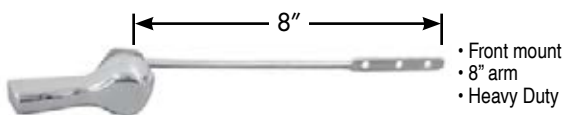

PART NO.	FINISH	DESCRIPTION	CTN/MSTR
T01005	CP Metal	Brass arm with metal spud and nut/ universal fit	25/150

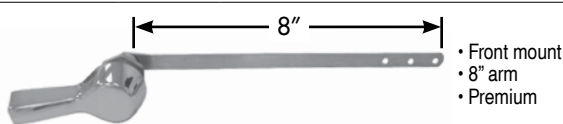

PART NO.	FINISH	DESCRIPTION	CTN/MSTR
T01068	CP Metal	Flat brass arm with metal spud and nut/ universal fit	25/200

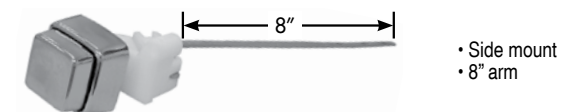

PART NO.	FINISH	DESCRIPTION	CTN/MSTR
T01070	CP ABS	Push button brass arm with plastic spud and nut/ universal fit	25/50

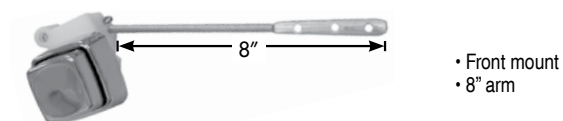

PART NO.	FINISH	DESCRIPTION	CTN/MSTR
T01074	CP ABS	Push button brass arm with plastic spud and nut/ universal fit	25/50

Tank Trip Levers for American Standard*

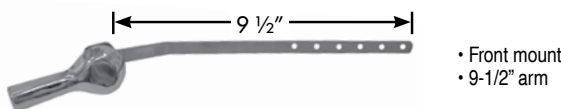

PART NO.	FINISH	DESCRIPTION	CTN/MSTR
T01064	CP Metal	Brass arm with metal spud and nut offset for thick tank walls	25/150

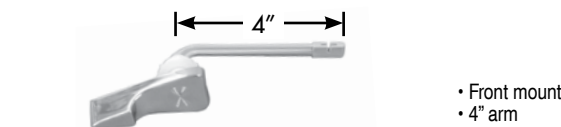

PART NO.	FINISH	DESCRIPTION	CTN/MSTR
T01030	CP ABS	Plastic arm, spud and nut for beaded chain	25/250

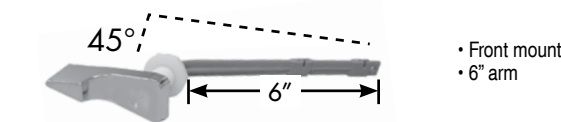

PART NO.	FINISH	DESCRIPTION	CTN/MSTR
T01042	CP ABS	45° arm for Cadet 2* plastic arm, spud and nut	1/200

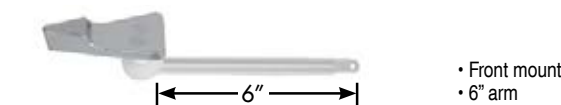

PART NO.	FINISH	DESCRIPTION	CTN/MSTR
T01050	CP ABS	Plastic arm, spud and nut for Plebe* and Cadet*	1/25

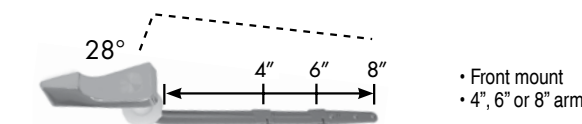

PART NO.	FINISH	DESCRIPTION	CTN/MSTR
T01048	CP ABS	Neo 28° combo with plastic arm, spud and nut	1/200

* The manufacturers' names are used only to describe whose products the tank levers will fit. The tank levers are not manufactured by those companies.

Tank Trip Lever for Crane*

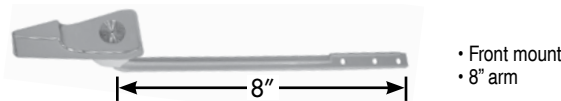

PART NO.	FINISH	DESCRIPTION	CTN QTY
T01034	CP ABS	Plastic arm, spud and nut	25/250

* The manufacturers' names are used only to describe whose products the tank levers will fit. The tank levers are not manufactured by those companies.

Items marked with the Jones Stephens logo are "You Need It... We Got It" Items.

Tank Trip Lever for Eljer*

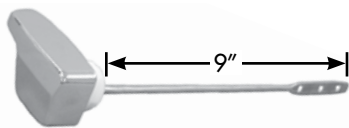

- Side mount
- 9" arm

PART NO.	FINISH	DESCRIPTION	CTN/ MSTR
T01020	CP Metal	Brass arm with non-crack nylon spud and nut	25/200

* The manufacturers' names are used only to describe whose products the tank levers will fit. The tank levers are not manufactured by those companies.

Tank Trip Levers for Kohler*

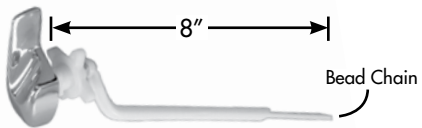

- Side mount
- 8" arm

PART NO.	FINISH	DESCRIPTION	CTN/ MSTR
T01010	CP Metal	Wellworth*/Barrington* Old style/Plastic arm (less bead hook), spud and nut	25/125
T01016	CP Metal	Wellworth*/Barrington Pressure Lite® New style/ 1.6 gal. unit replacement Plastic arm, spud and nut	25/125

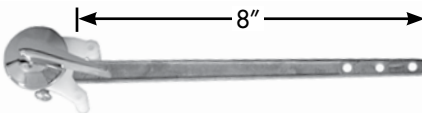

- Front mount
- 8" arm

PART NO.	FINISH	DESCRIPTION	CTN/ MSTR
T01012	CP Metal	Cast brass arm with metal spud and nut	25/125

* The manufacturers' names are used only to describe whose products the tank levers will fit. The tank levers are not manufactured by those companies.

Tank Trip Levers for Mansfield*



- Front mount
- 9" arm

PART NO.	FINISH	DESCRIPTION	CTN/ MSTR
T01040	CP ABS	#41* Plastic arm, spud and nut	1/25



- Front mount
- 10" arm

PART NO.	FINISH	DESCRIPTION	CTN/ MSTR
T01072	CP Metal	#42* Brass arm with plastic spud and nut	25/100

* The manufacturers' names are used only to describe whose products the tank levers will fit. The tank levers are not manufactured by those companies.

Tank Trip Lever for Universal Rundle*/Sears*

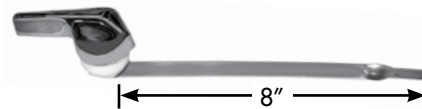

- Front mount
- 8" arm

PART NO.	FINISH	DESCRIPTION	CTN/ MSTR
T01066	CP Metal	Brass arm with plastic spud and nut	25/200

* The manufacturers' names are used only to describe whose products the tank levers will fit. The tank levers are not manufactured by those companies.

Ultrafit Tank Trip Lever



- Bagged
- Patented!
- Heavy Duty plastic arm, spud and nut
- Display Available- Part No. T04001
- Shapeable arm bends to fit the needed arm angle
- Arm can be cut to 4", 6" or 8" lengths for customized fit
- Fits American Standard*, Eljer*, Kohler*, Mansfield* and ToTo*

PART NO.	FINISH	DESCRIPTION	CTN/ MSTR
T01100	CP ABS	Ultrafit tank lever	25/200

* The manufacturers' names are used only to describe whose products the tank levers will fit. The tank levers are not manufactured by those companies.

Tank Trip Lever for Western Pottery*



- Side mount
- 10" arm

PART NO.	FINISH	DESCRIPTION	CTN/ MSTR
T01080	CP Metal	Brass arm with plastic spud and nut	25/200

* The manufacturers' names are used only to describe whose products the tank levers will fit. The tank levers are not manufactured by those companies.

Tank Trip Lever for ToTo*



- Side mount
- 10" arm

PART NO.	FINISH	DESCRIPTION	CTN/ MSTR
T01081	CP Metal	Brass arm with plastic spud and nut	25/200

* The manufacturers' names are used only to describe whose products the tank levers will fit. The tank levers are not manufactured by those companies.

Eljer* Touch Flush* Assembly



- Complete with tank, lever, chain, ball and arm
- CARTON QUANTITIES ONLY

PART NO.	DESCRIPTION	CTN/MSTR
C04019	Touch Flush assembly	1/5

* The manufacturers' names are used only to describe whose products the products will fit.

Tank Ball and Seat Disc



- Rubber
- New boxing to protect shape of units
- Rated to 160°F
- CARTON QUANTITIES ONLY

PART NO.	DESCRIPTION	CTN QTY
C04020	Eljer* tank ball for touch flush	1/10
C04021	Fit-All tank ball less guide	1/10
C04030	2-1/4" - 2-5/8" Tri-seal tank ball	1/100
C04031	3" Tri-seal tank ball	1/100

* The manufacturers' names are used only to describe whose products the products will fit.

American Standard* Seat Disc Tank Ball



- For small tilt flush valves
- Units are in a plastic housing to protect the shape of the seats
- CARTON QUANTITIES ONLY

PART NO.	DESCRIPTION	CTN/MSTR
C04024	Screw-on unit black	1/25
C04025	Snap-on unit black	1/25
T02025	Combo seat disc, snap-on and screw-on	1/25

* The manufacturers' names are used only to describe whose products the products will fit.

Float Ball



- Fits 1/4" rod
- Made of high density poly
- CARTON QUANTITIES ONLY ON THE C05041

PART NO.	DESCRIPTION	CTN/MSTR
C05040	Plastic 4" x 5"	1/24
C05041	Copper 4" x 5"	12/72

Flappers



- High grade vinyl construction
- New boxing to protect shape of units

PART NO.	DESCRIPTION	CTN/MSTR
C04005	3 way with strap (fits plastic, brass and old Crane* 57 flush valves)	25/100
C04006	3 way with stainless chain and strap (fits plastic, brass and old Crane* 57 flush valves)	25/100
C04007	Standard unit with 9" chain and strap	1/10
C04008	Kohler* unit with 8" chain	50/200
C04010	Crane* unit with 9" chain	50/200
C04011	Eljer* original unit with rigid arms and foam cone with beaded chain	1/10

* The manufacturers' names are used only to describe whose products the products will fit.

Kohler* Rialto™ Flapper



- 5 year warranty
- Blister carded for easy display
- Made from high grade chlorazone
- Resists chemicals and toilet tank cleaners

PART NO.	DESCRIPTION	FITS KOHLER* MODELS	CTN/MSTR
C04028	Kohler Flapper 2010 BP	Rialto, San Raphael, Santa Martine and Rosario	12/72
C04029	Sharkfin Flapper 2012 BP	Rialto, San Raphael, Santa Rosa, Revival and Gabrielle	12/72

* The manufacturers' names are used only to describe whose products the products will fit.

2 Way Flapper with Separate Trunion



- Siliconized chemical resistant material
- Stainless steel chain

PART NO.	DESCRIPTION	CTN/MSTR
C04002	2 way flapper	1/10

Carded Blue Vinyl Flapper



- 5 year warranty on flapper life
- Chemical resistant
- Individually carded
- Soft body replacement flapper
- 9" stainless steel chain and hook

PART NO.	DESCRIPTION	CTN/MSTR
C04004	Carded blue fit-all vinyl flapper	25/100

Jumbo ToTo* Style Flapper



PART NO.	DESCRIPTION	CTN/MSTR
C04000	Blue flapper (Power Gravity)	1/10
C04001	Red flapper (G-Max)	1/10

* The manufacturers' names are used only to describe whose products the products will fit.

Blue Vinyl Flapper



- 5 Year Warranty
- Chemical Resistant
- Fits most plastic flush valves
- Easily installed- no collar to cut
- 9" stainless steel chain and hook
- CARTON QUANTITIES ONLY



PART NO.	DESCRIPTION	CTN/MSTR
C04014	Blue vinyl flapper	1/80

Red Korky® Plus Flapper



- 5 Year Warranty
- Chemical Resistant
- Individually carded in cartons of 12



PART NO.	DESCRIPTION	CTN/MSTR
C04016	Red Korky® Plus (2001BP)	12/72

Items marked with the Jones Stephens logo are "You Need It...We Got It" Items.

Korky® Plus Ultra Water Saver Flapper



- 5-year manufacturer's warranty
- The most universal 2" flapper
- Adjusts to match OEM performance in all tank sizes including 1.28, 1.6, 3.5 and 5+ gpf toilets
- Adjusts to save water in any tank size
- Korky® red Chorazone® rubber resists chlorine



PART NO.	DESCRIPTION	CTN/MSTR
C04038	Korky® Plus ultra water saver flapper (100BP)	1/12

Korky® Flapper



C04032

- C04032 Fits Kohler® Class Five™ Flapper
- Larger 3 1/4" replacement flapper
 - Replaces Kohler® No. 1016546 & 1042313
 - Engineered materials resist chlorine



C04033

- C04033 Fits Eljer® Titan™ Flapper
- Replaces Eljer® No. 495-6077-00
 - Engineered materials chlorine



C04034

- C04034 Fits American Standard® Cadet 3® Flapper
- Replaces American Standard® No. 738920-0070P
 - Engineered materials resist chlorine

PART NO.	DESCRIPTION	CTN/MSTR
C04032	Fits Kohler® Class Five™ flapper (3010BP)	1/5
C04033	Fits Eljer® Titan™ flapper (3030BP)	1/5
C04034	Fits American Standard® Cadet 3® flapper (3040BP)	1/5

* The manufacturers' names are used only to describe whose products the products will fit.

The Original Korky® Flapper



- No tank centering
- Assures a positive seal
- Easy fingertip operation
- Individually carded cartons
- Eliminates lift wire misalignment
- Chemical resistant in areas with poor water quality



PART NO.	DESCRIPTION	CTN/MSTR
C04015	(54 BP)	12/72
C04017	Fits Kohler® (58 BP)	10/100

* The manufacturers' names are used only to describe whose products the products will fit.

Korky® Plus 3 Universal Flapper



- 5-year manufacturer's warranty
- Universal design fits large 3" flush valves
- Adjusts to match OEM performance for all 3" flapper-based systems
- Korky® red Chorazone® rubber resists chlorine



PART NO.	DESCRIPTION	CTN/MSTR
C04039	Korky® Plus 3 universal toilet flapper (3060BP)	1/5

Ⓢ Items marked with the Jones Stephens logo are "You Need It... We Got It" Items.

Korky® 1.6 Adjustable Flapper



- Chemical resistant
- Easy to install and adjust
- Individually carded in cartons of 12
- Flush volume changes with just a twist
- Can be used as a water saving device
- Adjustable sealing ball for precise water control
- Universal design fits most popular brands of 1.6 toilets



PART NO.	DESCRIPTION	CTN/MSTR
C04027	Korky® 1.6 adjustable flapper (16BP)	12/72

Korky® Plus Adjustable Flapper



- Adjust flush volume with movable float on chain
- Slide the float up for water savings or down for increased flush volume
- Korky® red Chorazone® rubber resists chlorine



PART NO.	DESCRIPTION	CTN/MSTR
C04013	Korky® Plus adjustable flapper (2004BP)	1/12

Closet Spud



- Cast brass
- Includes spud washer and metal friction ring

PART NO.	DESCRIPTION	CTN/MSTR
C27125	1-1/4" closet spud	25/100
C27150 Ⓢ	1-1/2" closet spud	25/100
C27200	2" closet spud	25/75
C27201	2" x 1-1/4" closet spud	25/100
C27202	2" x 1-1/2" closet spud	25/75
C27127	1-1/2" x 1-1/4" closet spud	25/100
C27150A	1-1/2" (For American Standard*) closet spud	25/100

* The manufacturers' names are used only to describe whose products the products will fit.

Urinal Spud



- Cast brass
- Includes spud washer and metal friction ring

PART NO.	DESCRIPTION	CTN/MSTR
C27134	1" x 3/4" urinal spud	25/200
C27126	1-1/4" x 3/4" urinal spud	25/125
C27310	1-1/2" x 3/4" urinal spud	25/100

Closet Spud Washer



- CARTON QUANTITIES ONLY

PART NO.	DESCRIPTION	CTN/MSTR
C27301	1-1/4" closet spud washer	25/500
C27302	1-1/2" closet spud washer	25/500
C27303	2" closet spud washer	25/500
C27304	2" x 1-1/4" closet spud washer	25/500
C27305	2" x 1-1/2" closet spud washer	25/500
C27308	1" x 3/4" closet spud washer	25/1000
C27309	1-1/4" x 3/4" closet spud washer	25/500

B

Closet Spud Friction Ring



- Zinc plated
- CARTON QUANTITIES ONLY

PART NO.	DESCRIPTION	CTN/MSTR
C27321	1-1/4" friction ring	25/1000
C27322	1-1/2" friction ring	25/1000
C27323	2" friction ring	25/500
C27324	2" x 1-1/4" friction ring	25/500
C27325	2" x 1-1/2" friction ring	25/500
C27328	1" x 3/4" friction ring	25/500

Flush Valve Shank Washer



- 3-1/16" OD x 2-1/4" ID
- Rubber

PART NO.	DESCRIPTION	CTN/MSTR
T02028	3/8" Height flush valve shank washer	1/100

Aqua Seal Washer



- Rubber
- American Standard* Top Hat Washer

PART NO.	DESCRIPTION	CTN/MSTR
T85057	Aqua seal washer	1/100

* The manufacturers' names are used only to describe whose products the products will fit.

Beveled Ballcock Shank Washer



- Rubber
- 1 3/4" OD x 15/16" ID

PART NO.	DESCRIPTION	CTN/MSTR
T85056	1/2" beveled ballcock shank washer	1/100

Flat Bibb Washer



- EPDM rubber
- Priced per carton
- 100 pieces per carton

PART NO.	SIZE	TRADE SIZE	OD	CTN/MSTR
O25202	1/4"	00	1/2"	1
O25203	1/4"	0	17/32"	1
O25204	1/4"	1/4	9/16"	1
O25205	1/4"	1/4L	19/32"	1
O25206	3/8"	3/8	5/8"	1
O25207	3/8"	3/8M	21/32"	1
O25208	3/8"	3/8L	11/16"	1
O25209	1/2"	1/2	3/4"	1
O25210	1/2"	1/2L	25/32"	1

Beveled Bibb Washer



- Priced per carton
- 100 pieces per carton
- Rubber

PART NO.	SIZE	TRADE SIZE	OD	CTN/MSTR
O25302	1/4"	00	1/2"	1
O25303	1/4"	0	17/32"	1
O25304	1/4"	1/4	9/16"	1
O25305	1/4"	1/4L	19/32"	1
O25306	3/8"	3/8	5/8"	1
O25307	3/8"	3/8M	21/32"	1
O25308	3/8"	3/8L	11/16"	1
O25309	1/2"	1/2	3/4"	1
O25310	1/2"	1/2L	25/32"	1

Sponge Closet Gaskets



- All have 2 bolt holes
- 5-1/2" center-to-center

G13500

G13534

G13634

PART NO.	OD x ID x THICKNESS	CTN/MSTR
G13534	5-3/8" x 3-1/2" x 3/4"	10/200
G13516	5-3/8" x 3-1/2" x 9/16"	10/232
G13634	6-3/4" x 3-1/2" x 3/4"	10/80
G13601	6-3/4" x 3-1/2" x 1"	10/80
G13616	6-3/4" x 3-1/2" x 9/16"	10/80
G13638	6-3/4" x 3-1/2" x 3/8"	10/80
G13500	4-3/8" x 2-7/8" x 1/2" wall hung urinal	10/225

Brass Lift Wire Guide



- Fit-All
- CARTON QUANTITIES ONLY

C05056

C05057

PART NO.	DESCRIPTION	CTN/MSTR
C05056	Adjustable heavy pattern	25/500
C05057	Standard split ring	25/500

Brass Lift Wire



- CARTON QUANTITIES ONLY

PART NO.	DESCRIPTION	CTN/MSTR
C05045	4 1/2" lower	25/2000
C05046	5" lower	25/2000
C05047	5 1/2" lower	25/2000
C05048	8" upper	25/1000
C05049	9" upper	25/1000

Copper Refill Tube



- 1/2" IPS
- CARTON QUANTITIES ONLY

PART NO.	DESCRIPTION	CTN/MSTR
C05051	9" refill tube	25/1000

Brass Float Rod



- CARTON QUANTITIES ONLY

PART NO.	DESCRIPTION	CTN/MSTR
C05052	1/4"x 8" float rod	25/1000
C05053	1/4"x 10" float rod	25/1000
C05054	1/4"x 12" float rod	25/1000

Brass Overflow Tube



- 22 gauge

PART NO.	DESCRIPTION	CTN/MSTR
C05042	1" x 1 1/8" x 10" overflow tube	1/200

Mansfield* Style Ballcock



- All brass
- Compound lever

PART NO.	DESCRIPTION	CTN/MSTR
T02075	Brass ballcock	1/50

* The manufacturers' names are used only to describe whose products the products will fit.

Mansfield* Style Ballcock With Float Rod



- Genuine Mansfield ballcock

PART NO.	DESCRIPTION	CTN/MSTR
T03008	Ballcock with float rod #08	1/20

* The manufacturers' names are used only to describe whose products the products will fit.

Mansfield* Flush Valve #210



- Water saver
- 3.5 gal. toilets
- Instant shut-off
- Won't rust or corrode

PART NO.	DESCRIPTION	CTN/MSTR
T02066	Flush valve	1/50

* The manufacturers' names are used only to describe whose products the products will fit.

Douglas Flush Valve



C05070



C05071

- Bagged
- Brass unit includes split guide
- Plastic unit includes flapper tank ball
- Includes locknut, beveled washer

PART NO.	DESCRIPTION	CTN/MSTR
C05070	Plastic with stainless steel chain	1/50
C05071	Brass	1/40

Korky® Universal 3" Valve Seal



- 5-year manufacturer's warranty
- Replacement seals for tower style flush valves
- Fits Kohler® Class Five™ & Class Six™
- Fits American Standard® Champio® 3
- Korky® red Chorazone® rubber resists chlorine



PART NO.	DESCRIPTION	CTN/MSTR
C05085	Korky® universal 3" valve seal	1/5

* The manufacturers' names are used only to describe whose products the products will fit.

Korky® Flush Valve Seal for Champion® 4



- 5-year manufacturer's warranty
- Replaces American Standard® No. 7301111-0070A
- Korky® red Chorazone® rubber resists chlorine



PART NO.	DESCRIPTION	CTN/MSTR
C05086	Korky® flush valve seal for Champion® 4	1/5

* The manufacturers' names are used only to describe whose products the products will fit.

Korky® QuietFill Valve



- 5 year guarantee
- Resists chlorine



PART NO.	DESCRIPTION	CTN/MSTR
C05200	Korky® QuietFill valve (5282)	1/24

Integral Float Fill Valve



- Fits most toilets
- Replace all of the complicated mechanisms with this simple kit
- Adjustable height from 9" to 13"
- Adjustable float for adjustable water height
- Similar to Fluidmaster® 400A

PART NO.	DESCRIPTION	KORKY #	CTN/MSTR
T02070	Integral float fill valve	528Z	1/12

* The manufacturers' names are used only to describe whose products the products will fit.

American Standard* Toilet Repair Parts

B



PART NO.	DESCRIPTION	CTN/MSTR
T02020	#5 (33642-07) old style low profile actuator unit, black, with disc, chain, clip and grommet	25/50
T02021	#6 (72880-07) old style high profile actuator unit, complete, black, with disc, chain, clip and grommet	25/50
T02022	#4 (8162-07) old style high profile actuator unit with legs, for one piece low boy*with brass flush valves, complete, black with disc, chain, clip, grommet and legs	25/50
T02023	#4 (70711-07) old style Cadet* water saver actuator unit, white with blue cap complete with disc, chain, clip and grommet	50/100
T02024	Chain kit complete for all actuator units (American Standard* 8321-07) 8" chain	50/500
T02026	#4 (47107-07) new style complete flush valve unit, white, short actuator	1/5
T02027	#5 (47089-07) complete flush valve tall black for standard two-piece closets	50/100

* The manufacturers' names are used only to describe whose products the products will fit.

Ballcock Repair Parts for American Standard*



PART NO.	DESCRIPTION	CTN/MSTR
T02035	7307 cap and plunger with seat, new style	1/10
T02036	N3010 ballcock plunger with thumb hole	1/10

* The manufacturers' names are used only to describe whose products the products will fit.

Ballcock Repair Parts for Coast*



PART NO.	DESCRIPTION	CTN/MSTR
T02037	Coast 1B1*, 1B1P*, standard large head kit with 3 screws	1/10
T02038	Coast 1B1A*, smaller head kit with 3 screws	1/10
T02039	Coast 1B1X*, Kohler*, UR*, Eljer*, Briggs*, American Standard*, kits with 3 screws, high and low boy	1/10

* The manufacturers' names are used only to describe whose products the products will fit.

Ballcock Repair Parts for Amerline*/Hoov-R-Line*



PART NO.	DESCRIPTION	CTN/MSTR
T02050	Standard kit with 4 screws	1/25

* The manufacturers' names are used only to describe whose products the products will fit.

Ballcock Repair Parts for Kohler*



PART NO.	DESCRIPTION	CTN/MSTR
T02051	Black plunger with cap and seal	1/10

* The manufacturers' names are used only to describe whose products the products will fit.

Ballcock Repair Parts for Fluidmaster*



PART NO.	DESCRIPTION	CTN/MSTR
T02052	Diaphragm N/S heavy duty white for hard water and chloramines (Ref. 242F)	1/10
T02053	Standard black diaphragm (Ref. 242)	1/10

* The manufacturers' names are used only to describe whose products the products will fit.

Mansfield* Ballcock and Flush Valve Repair Parts



* Original Mansfield* parts

PART NO.	DESCRIPTION	CTN/MSTR
T02060	03, 09, XQ-16 ballcock repair kit	1/10
T02062	08 ballcock repair kit	1/10
T02064	208/209 flush valve diaphragm	10/50
T02065	210/211 flush valve seal	10/700

* The manufacturers' names are used only to describe whose products the products will fit.

Dual Flush Toilet Kit



- Simple to install
- Save water with every flush!
- Push one way to rinse liquid
- Push the other way to flush solids

PART NO.	DESCRIPTION	CTN/MSTR
T02067	Dual flush toilet kit	1/40

Toilet Tank Cover



- Fit-All
- White plastic
- Fits most tanks with outside dimensions of 21-1/8" x 7-3/8" or less

PART NO.	DESCRIPTION	CTN/MSTR
T02005	White	1/1

Enduro Closet Bolt



- Never Rusts
- Space age material
- Fits all closet flange styles
- Withstands over 1,000 PSI
- CARTON QUANTITIES ONLY

PART NO.	DESCRIPTION	CTN/MSTR
C02050	5/16" x 2-1/2" closet bolt	50 pairs/500 pairs



- 50 pairs per display

PART NO.	DESCRIPTION	CTN/MSTR
CJ1003	5/16" x 2-1/2" closet bolt display	1/1

Flexible and Rigid Super Shims



- Stackable
- Rigid, can be driven
- Flexible, can be trimmed
- Priced per bag
- 10 per bag

MADE IN THE USA

PART NO.	DESCRIPTION	CTN/MSTR
S55950	1-1/8" x 1-15/16" x 1/4" flexible	1 bag of 10/400
S55951	1-1/8" x 1-15/16" x 1/4" rigid	1 bag of 10/400



- 200 super shims packaged in a convenient refillable "candy bowl" counter display
- Priced per display

PART NO.	DESCRIPTION	CTN/MSTR
S55952	200 Flexible super shims	1/1
S55953	200 Rigid super shims	1/1

Closet Wedge Shims



- Stackable
- 3/8" width x 1-3/8" length x 5/16" height
- Easily trimmed to desired height
- Priced per bag

MADE IN THE USA

PART NO.	DESCRIPTION	CTN/MSTR
S55902	100 shims poly bagged	1/1



- Priced per display

PART NO.	DESCRIPTION	CTN/MSTR
S55903	1000 shims counter display	1/1

Items marked with the Jones Stephens logo are "You Need It...We Got It" Items.

"Bucket Of Bolts"



- Attractive counter/shelf display
- Closet bolts are custom packed (2 bolts, nuts, and washers per bag)

Brass Plated Bolts, Zinc Plated Washers and Acorn Nuts

PART NO.	SIZE	WASHER	CTN/MSTR
CB2001	1/4" x 2-1/4"	Oval	50 pairs/1
CB2011	1/4" x 2-1/4"	Round	50 pairs/1
CB2002	1/4" x 3-1/2"	Oval	50 pairs/1
CB2012	1/4" x 3-1/2"	Round	50 pairs/1
CB2003	5/16" x 1-3/4"	Oval	50 pairs/1
CB2013	5/16" x 1-3/4"	Round	50 pairs/1
CB2004	5/16" x 2-1/4"	Oval	50 pairs/1
CB2014	5/16" x 2-1/4"	Round	50 pairs/1
CB2005	5/16" x 3-1/2"	Oval	50 pairs/1
CB2015	5/16" x 3-1/2"	Round	50 pairs/1

Brass Bolts, Stainless Washers and Nickel Plated Acorn Nuts

PART NO.	SIZE	WASHER	CTN/MSTR
CB2021	1/4" x 2-1/4"	Oval	50 pairs/1
CB2030	1/4" x 2-1/4"	Round	50 pairs/1
CB2022	1/4" x 3-1/2"	Oval	50 pairs/1
CB2031	1/4" x 3-1/2"	Round	50 pairs/1
CB2023	5/16" x 1-3/4"	Oval	50 pairs/1
CB2032	5/16" x 1-3/4"	Round	50 pairs/1
CB2024	5/16" x 2-1/4"	Oval	50 pairs/1
CB2033	5/16" x 2-1/4"	Round	50 pairs/1
CB2025	5/16" x 3-1/2"	Oval	50 pairs/1
CB2034	5/16" x 3-1/2"	Round	50 pairs/1

Closet Bolts with Tinnerman Nuts



- Two each bolts, nuts, round washers and tinnerman nuts per bag
- CARTON QUANTITIES ONLY

Brass Plated Bolts, Zinc Plated Washers and Tinnerman Nuts

PART NO.	SIZE	CTN/MSTR
C02401	1/4" x 2-1/4"	50 pairs/400
C02402	1/4" x 3-1/2"	50 pairs/200
C02403	5/16" x 1-3/4"	50 pairs/200
C02404	5/16" x 2-1/4"	50 pairs/200
C02405	5/16" x 3-1/2"	50 pairs/200

Brass Bolts, Stainless Washers and Nickel Plated Tinnerman Nuts

PART NO.	SIZE	CTN/MSTR
C02421	1/4" x 2-1/4"	50 pairs/400
C02990	1/4" x 3-1/2"	50 pairs/200
C02422	5/16" x 1-3/4"	50 pairs/400
C02423	5/16" x 2-1/4"	50 pairs/400
C02424	5/16" x 3-1/2"	50 pairs/200

Closet Bolts



- Closet bolts are custom packed (2 bolts, nuts, and washers per bag)
- CARTON QUANTITIES ONLY

Brass Plated Bolts, Zinc Plated Washers and Acorn Nuts

PART NO.	SIZE	WASHER	CTN/MSTR
C02000	1/4" x 1-3/4"	Oval	50 pairs/400
C02010	1/4" x 1-3/4"	Round	50 pairs/400
C02001	1/4" x 2-1/4"	Oval	50 pairs/400
C02011	1/4" x 2-1/4"	Round	50 pairs/400
C02002	1/4" x 3-1/2"	Oval	50 pairs/400
C02012	1/4" x 3-1/2"	Round	50 pairs/200
C02003	5/16" x 1-3/4"	Oval	50 pairs/400
C02013	5/16" x 1-3/4"	Round	50 pairs/400
C02004	5/16" x 2-1/4"	Oval	50 pairs/200
C02014	5/16" x 2-1/4"	Round	50 pairs/200
C02005	5/16" x 3-1/2"	Oval	50 pairs/200
C02015	5/16" x 3-1/2"	Round	50 pairs/200

Brass Bolts, Stainless Washers, Nickel Plated Acorn Nuts

PART NO.	SIZE	WASHER	CTN/MSTR
C02020	1/4" x 1-3/4"	Oval	50 pairs/400
C02029	1/4" x 1-3/4"	Round	50 pairs/200
C02021	1/4" x 2-1/4"	Oval	50 pairs/400
C02030	1/4" x 2-1/4"	Round	50 pairs/400
C02022	1/4" x 3-1/2"	Oval	50 pairs/200
C02031	1/4" x 3-1/2"	Round	50 pairs/200
C02023	5/16" x 1-3/4"	Oval	50 pairs/200
C02032	5/16" x 1-3/4"	Round	50 pairs/200
C02024	5/16" x 2-1/4"	Oval	50 pairs/200
C02033	5/16" x 2-1/4"	Round	50 pairs/200
C02025	5/16" x 3-1/2"	Oval	50 pairs/200
C02034	5/16" x 3-1/2"	Round	50 pairs/200

Closet Bolts



- Bulk Packed - One each bolt, nut, washer and acorn nut per bag
- CARTON QUANTITIES ONLY

Brass Plated Bolts, Zinc Plated Washers and Acorn Nuts

PART NO.	SIZE	WASHER	CTN/MSTR
C02000B	1/4" x 1-3/4"	Oval	100 each/400
C02010B	1/4" x 1-3/4"	Round	100 each/400
C02001B	1/4" x 2-1/4"	Oval	100 each/400
C02011B	1/4" x 2-1/4"	Round	100 each/400
C02002B	1/4" x 3-1/2"	Oval	100 each/400
C02012B	1/4" x 3-1/2"	Round	100 each/400
C02003B	5/16" x 1-3/4"	Oval	100 each/400
C02013B	5/16" x 1-3/4"	Round	100 each/400
C02004B	5/16" x 2-1/4"	Oval	100 each/400
C02014B	5/16" x 2-1/4"	Round	100 each/400
C02005B	5/16" x 3-1/2"	Oval	100 each/400
C02015B	5/16" x 3-1/2"	Round	100 each/400

Brass Bolts, Stainless Washers and Nickel Plated Acorn Nuts

PART NO.	SIZE	WASHER	CTN/MSTR
C02020B	1/4" x 1-3/4"	Oval	100 each/400
C02029B	1/4" x 1-3/4"	Round	100 each/400
C02021B	1/4" x 2-1/4"	Oval	100 each/400
C02030B	1/4" x 2-1/4"	Round	100 each/400
C02022B	1/4" x 3-1/2"	Oval	100 each/400
C02031B	1/4" x 3-1/2"	Round	100 each/400
C02023B	5/16" x 1-3/4"	Oval	100 each/400
C02032B	5/16" x 1-3/4"	Round	100 each/400
C02024B	5/16" x 2-1/4"	Oval	100 each/400
C02033B	5/16" x 2-1/4"	Round	100 each/400
C02025B	5/16" x 3-1/2"	Oval	100 each/400
C02034B	5/16" x 3-1/2"	Round	100 each/400

Items marked with the Jones Stephens logo are "You Need It... We Got It" Items.

Closest Bolt Component Parts



PART NO.	DESCRIPTION	CTN/MSTR
C02800	1/4" x 1-3/4" brass plated closet bolt	100/1200
C02801	1/4" x 2-1/4" brass plated closet bolt	100/1200
C02802	1/4" x 3-1/2" brass plated closet bolt	100/700
C02803	5/16" x 1-3/4" brass plated closet bolt	100/700
C02804	5/16" x 2-1/4" brass plated closet bolt	100/800
C02805	5/16" x 3-1/2" brass plated closet bolt	100/500
C02820	1/4" x 1-3/4" brass closet bolt	100/1500
C02821	1/4" x 2-1/4" brass closet bolt	100/1200
C02822	1/4" x 3-1/2" brass closet bolt	100/700
C02823	5/16" x 1-3/4" brass closet bolt	100/1000
C02824	5/16" x 2-1/4" brass closet bolt	100/800
C02825	5/16" x 3-1/2" brass closet bolt	100/500
C02830	1/4" x 2-1/4" brass snap-off closet bolt	100/1000
C02832	5/16" x 2-1/4" brass snap-off closet bolt	100/800
C02808	1/4" x 2-1/2" brass plated closet screw	100/1000
C02815	1/4" x 3-1/2" brass plated closet screw	100/1000
C02811	5/16" x 2-1/2" brass plated closet screw	100/700
C02812	1/4" x 2-1/2" brass closet screw	100/800
C02813	1/4" x 3-1/2" brass closet screw	100/1000
C02814	5/16" x 2-1/2" brass closet screw	100/1000
C02807	5/16" tinnerman nut	100/3500
C02860	1/4" x 7/16" nickel plated open acorn nut	100/5000
C02861	1/4" x 7/16" zinc plated open acorn nut	100/5000
C02862	5/16" x 9/16" nickel plated open acorn nut	100/3000
C02863	5/16" x 9/16" zinc plated open acorn nut	100/3000
C02809	1/4" x 7/16" zinc plated closed acorn nut	100/2500
C02810	5/16" x 9/16" zinc plated closed acorn nut	100/4000
C02900	1/4" nickel plated closed acorn nut	100/2500
C02901	5/16" nickel plated closed acorn nut	100/4000
C02864	1/4" brass open acorn nut	100/2500
C02865	5/16" brass open acorn nut	100/4000
C02850	Oval stainless steel washer	100/5000
C02851	Oval zinc plated washer	100/4000
C02852	Round stainless steel washer	100/5000
C02853	Round zinc plated washer	100/5000

Items marked with the Jones Stephens logo are "You Need It... We Got It" Items.

Snap-Off Closet Bolts



- Closet bolts are custom packed (2 bolts, nuts, and washers per bag)
- Available boxed or in counter display ("Bucket of Bolts")

PART NO.	SIZE	WASHER	CTN/MSTR
C02040	1/4" x 2-1/4"	Oval	50 pairs/400
C02045	1/4" x 2-1/4"	Round	50 pairs/400
C02041	5/16" x 2-1/4"	Oval	50 pairs/200
C02046	5/16" x 2-1/4"	Round	50 pairs/200



• Priced per display

PART NO.	SIZE	WASHER	CTN QTY
CB2040	1/4" x 3-1/2"	Oval	50 pairs
CB2045	1/4" x 3-1/2"	Round	50 pairs
CB2041	5/16" x 1-3/4"	Oval	50 pairs
CB2046	5/16" x 1-3/4"	Round	50 pairs

Closest Bolt - Elite Packs



• CARTON QUANTITIES ONLY

Packed with 4 Acorn Nuts and 4 Round Washers

PART NO.	DESCRIPTION	CTN/MSTR
C02989	5/16" x 1-3/4" brass plated bolts	50 pairs/400
C02999	1/4" x 2-1/4" brass plated bolts	50 pairs/400
C02998	1/4" x 2-1/4" solid brass bolts	50 pairs/400
C02997	1/4" x 3-1/2" brass plated bolts	50 pairs/200
C02996	1/4" x 3-1/2" solid brass bolts	50 pairs/200
C02992	1/4" x 2-1/4" solid brass bolts	50 pairs/400
C02993	5/16" x 2-1/4" brass plated bolts	50 pairs/200

Packed with 2 Acorn Nuts, 2 Hex Nuts, and 4 Round Washers

PART NO.	DESCRIPTION	CTN/MSTR
C02995	1/4" x 2-1/4" brass plated bolts	50 pairs/400
C02994	1/4" x 2-1/4" solid brass bolts	50 pairs/400

Packed with 2 Acorn Nuts, 2 Hex Nuts, 4 Round Washers, and 2 Tinnerman Nuts

PART NO.	DESCRIPTION	CTN/MSTR
C02987	1/4" x 2-1/4" solid brass bolts	50 pairs/400

Closest Bolt Cap



- Plastic
- CARTON QUANTITIES ONLY

Bulk Packed - Priced Per Cap and Washer

PART NO.	DESCRIPTION	CTN/MSTR
C02100	Oval white (less washer)	100/900
C02105	Round white (with washer)	100/2000
C02106	Round bone (with washer)	100/4000

Custom Packed - Priced Per Bag of Two Each

PART NO.	DESCRIPTION	CTN/MSTR
C02103	Round white (with washer)	50 pairs/50
C02104	Round bone (with washer)	50 pairs/50

B

Closet Screws



- Two each screws, nuts, and washers per bag
- CARTON QUANTITIES ONLY

B

Brass Plated Bolts, Stainless Washers and Nickel Plated Acorn Nuts

PART NO.	SIZE	WASHER	CTN/MSTR
C02200	1/4" x 2-1/2"	Oval	50 pairs/200
C02210	1/4" x 2-1/2"	Round	50 pairs/400
C02203	1/4" x 3-1/2"	Oval	50 pairs/200
C02202	1/4" x 3-1/2"	Round	50 pairs/200
C02211	5/16" x 2-1/2"	Oval	50 pairs/200
C02201	5/16" x 2-1/2"	Round	50 pairs/200

Brass Bolts, Stainless Washers and Nickel Plated Acorn Nuts

PART NO.	SIZE	WASHER	CTN/MSTR
C02300	1/4" x 2-1/2"	Oval	50 pairs/400
C02310	1/4" x 2-1/2"	Round	50 pairs/400
C02303	1/4" x 3-1/2"	Oval	50 pairs/200
C02302	1/4" x 3-1/2"	Round	50 pairs/400
C02311	5/16" x 2-1/2"	Oval	50 pairs/200
C02301	5/16" x 2-1/2"	Round	50 pairs/200

Tank to Bowl Set



- Universal fit sponge rubber gasket
- Domed poly wingnut fits into china, eliminating bottom washer
- CARTON QUANTITIES ONLY

PART NO.	DESCRIPTION	BOLT	CTN QTY
C03250	5/16" x 3"	Brass Plated	50 pairs
C03251	5/16" x 3" with gasket	Brass Plated	25 pairs
C03252	5/16" x 3"	Brass	25 pairs
C03253	5/16" x 3" with gasket	Brass	25 pairs

Tank to Bowl Bolt Set



- Universal fit sponge rubber gasket
- CARTON QUANTITIES ONLY

With Wing Nut

PART NO.	DESCRIPTION	BOLT	CTN/MSTR
C03200	5/16" x 3"	Brass Plated	50 pairs/200
C03201	5/16" x 3" with gasket	Brass Plated	25 pairs/200
C03202	5/16" x 3"	Brass	50 pairs/200
C03203	5/16" x 3" with gasket	Brass	25 pairs/200

With Hex Nut

PART NO.	DESCRIPTION	BOLT	CTN/MSTR
C03210	5/16" x 3"	Brass Plated	50 pairs/200
C03211	5/16" x 3" with gasket	Brass Plated	25 pairs/200
C03212	5/16" x 3"	Brass	50 pairs/200
C03213	5/16" x 3" with gasket	Brass	25 pairs/100

With Hex Nut and Wing Nut

PART NO.	DESCRIPTION	BOLT	CTN/MSTR
C03240	5/16" x 3"	Brass	50 pairs/100

Tank to Bowl Bolt Kit for Mansfield*



- Includes 3 brass plated bolts, 3 hex nuts, 3 round washers, 1 sponge rubber gasket, 1 ballcock coupling nut and 3 cloth inserted washers
- 3" bolt

PART NO.	DESCRIPTION	CTN/MSTR
C03260	Mansfield* kit	1/25

* The manufacturers' names are used only to describe whose products the products will fit.

Tank to Bowl Bolt Kit for Gerber*



- Includes 2 brass bolts, 2 hex nuts, 4 round washers, 1 sponge rubber gasket and 4 cloth inserted washers

PART NO.	DESCRIPTION	CTN/MSTR
C03265	Gerber* kit	1/25

* The manufacturers' names are used only to describe whose products the products will fit.

Tank to Bowl Bolt Kit for American Standard*



- Includes 2 bolts, 4 nuts, 4 round washers and 1 sponge rubber gasket

PART NO.	DESCRIPTION	CTN/MSTR
C03270	American Standard* kit (brass plated bolts)	1/25

C03271	American Standard* kit (brass bolts)	1/25
--------	--------------------------------------	------

* The manufacturers' names are used only to describe whose products the products will fit.

Tri-Tank to Bowl Bolt Kit for American Standard*



- Includes 3 brass plated bolts, 6 hex nuts, 6 round washers, 1 sponge rubber gasket and 6 cloth inserted washers

PART NO.	DESCRIPTION	CTN/MSTR
C03272	American Standard* tank to bowl bolt kit	1/25

* The manufacturers' names are used only to describe whose products the products will fit.

Tri-Bolt Tank to Bowl Bolt Set



- For units requiring 3-bolt attachment
- Custom packed with 3 brass bolts, 6 round washers, 6 hex nuts and 6 cloth inserted washers

PART NO.	DESCRIPTION	CTN/MSTR
C03280	5/16" x 3"	1/25

Offset Tank to Bowl Bolts



- All brass
- Rubber washers
- 2" maximum adjustment

PART NO.	DESCRIPTION	CTN/MSTR
C02075	Offset tank to bowl bolts	50/200

Items marked with the Jones Stephens logo are "You Need It... We Got It" Items.

Tank to Bowl Components



PART NO.	DESCRIPTION	CTN/MSTR
C03800	5/16"-18 x 3" brass plated tank bolt	100/500
C03801	5/16"-18 x 3" brass tank bolt	100/500
C03803	5/16"-18 brass plated forged wing nut	100/500
C03804	5/16"-18 brass plated heavy hex jam nut	100/5500
C03805	5/16"-18 brass heavy hex jam nut	100/5000
C03807	5/16" acetal tank bowl wing nut	100/3500
C03810	Cloth inserted washer	10/100
C02852	Stainless steel washer	100

Tank to Bowl Gaskets



- Close coupled tank to bowl gaskets
- Beveled sponge rubber material
- CARTON QUANTITIES ONLY

Universal Fit-All

PART NO.	DESCRIPTION	CTN/MSTR
C03300	2-1/4" ID x 3-3/8" OD x 11/16" thick	25/1000

Kohler* (fits Alamo and other Kohler* integral units with two piece closets)

PART NO.	DESCRIPTION	CTN/MSTR
C03301	2-1/2" ID x 3-3/4" OD x 3/4" thick	25/1000

Eljer* (rubber)

PART NO.	DESCRIPTION	CTN/MSTR
C03302	2-5/16" ID x 3-1/8" OD x 3/8" thick	25/1000

American Standard Cadet*, Kohler*, Crane*, Borg Warner*

PART NO.	DESCRIPTION	CTN/MSTR
C03303	2-1/8" ID x 3-1/2" OD x 1-1/4" thick	25/300

Crane*

PART NO.	DESCRIPTION	CTN/MSTR
C03304	2-1/8" ID x 3-1/4" OD x 1-1/16" thick	25/300

Gerber* (free standing late models)

PART NO.	DESCRIPTION	CTN/MSTR
C03305	2-1/8" ID x 3-1/4" OD x 1-3/16" thick	25/300

Mansfield*

PART NO.	DESCRIPTION	CTN/MSTR
C03306	2-1/2" ID x 3-5/8" OD x 3/4" thick	25/200

* The manufacturers' names are used only to describe whose products the products will fit.

Wax Gaskets



- Boxed
- CARTON QUANTITIES ONLY

PART NO.	DESCRIPTION	CTN/MSTR
G13001	Full size standard wax gasket	1/48
G13002	Gasket with plastic flange	1/24
G13003	Urinal gasket- fits 2" outlet	1/12
G13004	Jumbo wax gasket	1/12

Radiant Seal Sponge Rubber Closet Gasket



- Neoprene
- Easy installation
- Unaffected by radiant heat
- Seals effectively with uneven floors

PART NO.	DESCRIPTION	CTN/MSTR
G13005	3-3/4" ID x 5-1/8" OD x 1/2" thick	1/150

Closet Bend Spacer



- Fit-all
- Eliminates the need to chip out concrete
- 6" OD x 4" high (fits 3" and 4" waste lines)
- Keeps poured concrete away from waste lines and closet bends
- Replaces styrofoam, styrene coverings, coffee cans and duct tape
- Outside is plastic, inside is foam
- CARTON QUANTITIES ONLY

PART NO.	DESCRIPTION	CTN QTY
S12005	Closet bend spacer	18

Styrofoam Closet Flange Spacer



- Eliminates needless chipping of concrete
- Styrofoam breaks away or melts with flame
- CARTON QUANTITIES ONLY

PART NO.	DESCRIPTION	CTN QTY
S13130	3" Flange spacer	120
S13140	4" Flange spacer	120

Foam Spacer



- Foam closet bend protector
- CARTON QUANTITIES ONLY

PART NO.	DESCRIPTION	CTN QTY
S13240	4"x 4" foam spacer	60

B

Shower Rod Flanges



- Flanges fit 15/16" and 1" OD rod
- Mount to wall

PART NO.	DESCRIPTION	CTN/MSTR
S02150	Jiffy flange chrome plated plastic	1/200
S02151	Jiffy flange chrome die cast zinc	1/100
S02152	Chrome flanges with screws (bagged)	50/500

Jumbo Shower Bar Flange



PART NO.	DESCRIPTION	CTN/MSTR
S02300	Jumbo shower bar flange	1/50

Contoured Shower Rod



- Brings shower curtain in front of wall to prevent gaps and leaks
- Perfect for 60° oval or standard tubs
- Adjusts easily with tube cutter for shorter walls
- Sweeping curve increases space in center of oval tubs
- Sturdy alloy rods with zinc angled mounting brackets
- Multiple applications - residential, hotel, motel, assisted living, etc.

PART NO.	DESCRIPTION	CTN/MSTR
S02190	Chrome plated	1/12
S02193	Satin Nickel	1

Flanges

PART NO.	FINISH	CTN QTY
S02290	Chrome flanges (Fits S02190)	1
S02293	Satin Nickel flanges (Fits S02193)	1

Aluminum Shower Rod



- 1" OD - .025 wall (22 gauge)
- Individually wrapped
- Can be cut
- CARTON QUANTITIES ONLY

PART NO.	DESCRIPTION	CTN QTY
S02055	5' rod	50
S02015	5' rod	10
S02056	6' rod	50
S02016	6' rod	10

Aluminum Shower Rod with Holders



- 1" OD - .025 wall (22 gauge)
- Individually wrapped rods and holders boxed together
- CARTON QUANTITIES ONLY

PART NO.	DESCRIPTION	CTN QTY
S02057	5' rod with plastic Jiffy flange	50
S02058	5' rod with die cast Jiffy flange	50
S02059	5' rod with chrome flange and screws	50
S02071	5' rod with chrome flange and screws (10 pack)	10
S02072	6' rod with chrome flange and screws (10 pack)	10
S02073	5' rod with plastic Jiffy flange (10 pack)	10
S02074	6' rod with plastic Jiffy flange (10 pack)	10

Adjustable Aluminum Shower Rod



- Sturdy, self-supporting rod with plastic ends
- 1" OD/.025 wall (22 gauge)
- Expandable from 58" to 61" or 69" to 73"
- Individually wrapped
- CARTON QUANTITIES ONLY

PART NO.	DESCRIPTION	CTN QTY
S02070	Adjustable shower rod 58" - 61"	50
S02066	Adjustable shower rod 69" - 73"	50
S02069	Adjustable shower rod 58" - 61" (10 pack)	10

Deluxe Shower Head



- Chrome plated die cast zinc
- 2.5 gpm flow rate
- Brass ball

PART NO.	DESCRIPTION	CTN/MSTR
S01004	Chrome plated deluxe shower head	1/100

Shower Heads



Plastic



Die cast



Brass

- 2.5 gpm flow rate

Plastic

PART NO.	DESCRIPTION	CTN/MSTR
S01001	2" Chrome with plastic ball	1/100
S01002	2" White with plastic ball	1/200
S01003	2" Chrome with brass ball	1/100

Die Cast

PART NO.	DESCRIPTION	CTN/MSTR
S01005	2" Chrome- adjustable	1/100

Brass

PART NO.	DESCRIPTION	CTN/MSTR
S01008	1-3/4" Chrome- adjustable	1/50
S01009	2-1/8" Chrome- adjustable	1/50
S01010	3" Chrome- adjustable	1/20

Items marked with the Jones Stephens logo are "You Need It... We Got It" Items.

Brass Aerating Water Saver Shower Head



Chrome

Chrome with Shutoff

- Permanent built-in water restrictor
- Mixes air and water for invigorating spray
- Restricts water to 2-2.5 gpm, depending on water pressure

PART NO.	DESCRIPTION	CTN/MSTR
S01013	1" Chrome	50/200
S01014	1" Chrome with shutoff	50/200

Vandal Proof Shower Head



- 2.5 gpm flow rate
- Chrome plated plastic
- Brass ball
- Spray adjusts from coarse to fine
- Secures with set screw, hex key included

PART NO.	DESCRIPTION	CTN/MSTR
S01015	Chrome plated plastic shower head	1/100

Adjustable Plastic Shower Head



- Chrome plated plastic
- 1.5 gpm flow rate
- Brass ball

PART NO.	DESCRIPTION	CTN/MSTR
S01016	Chrome plated adjustable plastic shower head	1/100

Adjustable Massage Shower Head



- Chrome plated plastic
- 2.5 gpm flow rate
- Brass ball

PART NO.	DESCRIPTION	CTN/MSTR
S01020	Chrome plated adjustable massage plastic shower head	1/100

Octagonal Shower Head



- 2.5 gpm flow rate
- Brass ball

PART NO.	DESCRIPTION	CTN/MSTR
S01025	Chrome plated octagonal shower head	10/50

Shower Arms and Kits



Shower Arm

Shower Arm with Flange

"S" Style Shower Arm

- Chrome plated stainless steel arms

PART NO.	DESCRIPTION	CTN/MSTR
S01030	6" Arm only	1/200
S01032	8" Arm only	1/100
S01044	6" Arm and stainless steel flange	1/25
S01045	8" Arm and stainless steel flange	1/100
S01035	8" "S" shaped arm	10/80
S01038	10" "S" shaped arm	25/50

Heavy Adjustable Shower Arm



- Chrome plated brass
- 10" length
- Locking wing nut adjustment

PART NO.	DESCRIPTION	CTN/MSTR
S01039	1/2" x 10" adjustable	10/50

Shower Arm and Flange with Set Screw



- 1/2" x 6" shower arm

PART NO.	DESCRIPTION	CTN/MSTR
S01042	6" Shower arm and flange with set screw	1/25

Plastic Shower Arm



- 1/2" x 6" chrome-plated plastic with flange

PART NO.	DESCRIPTION	CTN/MSTR
S01049	Plastic shower arm and flange	1/200

Shower Arm Flange



S01041

S01040

PART NO.	DESCRIPTION	CTN/MSTR
S01040	Chrome flange with set screw (2-1/2" OD)	40/400
S01041	Stainless steel flange (2-1/2" OD)	50/2000

Shower Curtain Pin



- CARTON QUANTITY ONLY

PART NO.	DESCRIPTION	CTN/MSTR
S02100	Shower curtain pin	500/2000

Shower Pan Liner



- 40 mil thickness flexible gray PVC
- Meets ASTM D4551
- UPC listed
- PVC
- Marked in 6 inch increments for easy measurements
- Treated to prevent the growth of fungus, molds and mildew
- FREIGHT LINE ONLY

PART NO.	DESCRIPTION	CTN QTY
S994050	4' x 50' shower pan liner	1
S995040	5' x 40' shower pan liner	1
S996050	6' x 50' shower pan liner	1
S996080	5' x 80' shower pan liner	1

PVC Shower Pan Liner Cement



- 3 year shelf life
- Not for PE liner use
- Instant contact strength
- CARTON QUANTITY ONLY

PART NO.	DESCRIPTION	CTN QTY
S99100	Shower pan liner cement (pint)	12

Water Volume Control



- 1/2" female x 1/2" male IPS
- Allows reduced water flow (does not shut water completely off)

PART NO.	DESCRIPTION	CTN/MSTR
S01060	Chrome-brass	50/200
S01061	Chrome-plastic	1/500

Plastic Flow Restrictor



- 2.5 GPM
- Fits most heads

PART NO.	DESCRIPTION	CTN/MSTR
S01080	Shower head flow restrictor	1/1000

54" D-Style Add-A-Shower

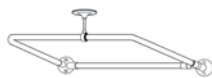

- Heavy duty jumbo flanges
- 61" riser with shower head
- Standard bathcock (3 3/8" centers)
- 54" x 27" chrome plated brass shower rod (1" diameter)
- Non-adjustable

PART NO.	DESCRIPTION	CTN/MSTR
S10083	54" x 27" D-Style Add-A-Shower	1/5

Add-A-Shower Complete Unit



- Bathcock with diverter spout
- Chrome plated plastic shower head
- 61" rise with 12" rod and riser support
- 24" x 42" rectangular aluminum shower rod with 36" ceiling rod and support

PART NO.	DESCRIPTION	CTN/MSTR
S10070	Complete unit with S10080 diverter	1/5
S10069	Complete unit with S10074 diverter	1/5

Complete Add-A-Shower

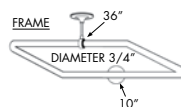

- Rectangular frame
- Aluminum shower rod
- Bathcock with diverter spout
- 3/8" mounting brackets included
- 61" riser with 10" rod and riser support

PART NO.	DESCRIPTION	CTN/MSTR
S10067	Shower with 24" x 42" frame	1/5
S10068	24" x 42" Frame only	1

Add-A-Shower less Oval Shower Rod



- 61" riser and wall support
- Bathcock with diverter spout
- Chrome plated plastic shower head
- Includes bushings (P11986)

PART NO.	DESCRIPTION	CTN/MSTR
S10072	Complete unit	1/10

Add-A-Shower Diverter Spout & Riser

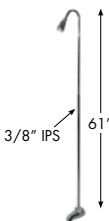

- Diverter valve
- 61" riser with wall support
- Chrome plated plastic shower head
- Includes 1" wall bracket (S10077)
- S10081 replacement diverter

PART NO.	DESCRIPTION	CTN/MSTR
S10071	Spout and riser	1/10

Add-A-Shower Code Pattern

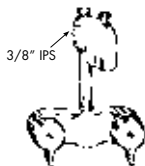

PART NO.	DESCRIPTION	CTN QTY
S10074	Code pattern anti-syphon diverter bathcock	1

Add-A-Shower Accessories

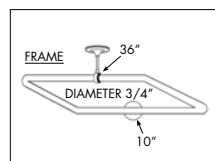

PART NO.	DESCRIPTION	CTN/MSTR
S10075	24" x 42" rectangle shower rod	1/10
B60001	Wall bracket and rod holder with 12" rod (can be cut to fit)	1/100
B60002	Ceiling bracket and rod holder with standard size 36" rod	1/100
S10073	48" ceiling rod only	1
S10080	Replacement bathcock assembly	1/12
S10081	Diverter spout only for S10071 (base connection)	1/50
S10077	Wall bracket for S10071	1/200
S10078	Diverter spout with 65" riser	1/10
S10082	61" CP brass riser only	1/20
S10076	61" CP brass riser with shower head	1/10

Shower Diverter Valve



- Installs between arm and shower head
- Allows usage of hand-held personal shower or shower head

PART NO.	DESCRIPTION	CTN/MSTR
S01070	Chrome push button- brass	1/5

Offset Bath Supplies



B49020

B49021

- Chrome plated
- 1/2" supply tubes
- All hardware needed for connection included

PART NO.	DESCRIPTION	CTN/MSTR
B49020	Single offset (pair)	1/25
B49021	Double offset (pair)	1/25
B49022	Replacement nuts, washers and escutcheons	1/25

Utility Shower



- 21" galvanized riser
- Top or bottom connection
- Chrome plated brass body with shower head and soap dish
- Combination 1/2" threaded or sweat connection union inlets on 3" centers
- Use S10080 for replacement bathcock assembly

PART NO.	DESCRIPTION	CTN/MSTR
S10079	Utility shower	1/6

Bathcocks for Clawfoot Tubs



B49001



B49002



B49010

- Chrome plated brass body
- Replaceable stem and seat
- 3 3/8" centers and 3/4" threaded inlets

PART NO.	DESCRIPTION	CTN/MSTR
B49001	"O" pattern with slip-on spout	1/48
B49002	Code pattern with goose neck spout	1/48
B49010	Coupling elbows (pair) chrome plated 3/4" bath-cock threads x 1/2" male IPS	6/60
B49011	Code spout only	10/300
B49012	Hot repair kit (handle, stem and seat)	1/100
B49013	Cold repair kit (handle, stem and seat)	1/100

Brass Trap Bushing



- Heavy pattern/cast
- 1-1/2" sweat x 1-1/2" IPS
- Knurled end for ease of tightening
- 3/4" length

PART NO.	DESCRIPTION	CTN/MSTR
B55150	1-1/2" SWT x 1-1/2" MIP	1/250

Twin Elbow and Face Bushings



FIP x FIP



MIP x FIP

- Brass

PART NO.	DESCRIPTION	CTN/MSTR
D01040	3/4" FIP x 1/2" FIP twin elbow	1/144
D01041	3/4" MIP x 1/2" FIP face bushing	1/1000
D01042	1/2" MIP x 3/8" FIP face bushing	1/40

Brass Shower Elbow for Fiberglass Shower Stall



- Outlet 1/2" FIP
- Secures tub spout nipple
- Secures shower arm to stall
- Lock nuts secure ell to fiberglass wall
- Requires 1-1/8" hole through fiberglass wall
- Combination inlet 1/2" female sweat or 1/2" threaded

PART NO.	DESCRIPTION	CTN/MSTR
S01050	Brass elbow	6/144

7" Chrome Plated Diverter Spout

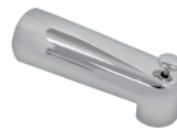

- Longer length for today's larger tubs
- CTS unit comes with hex key

PART NO.	SIZE	CONNECTION	CTN/MSTR
D01024	7"	1/2" FIP Nose	1/50
D01025	7"	1/2" CTS Slide	1/25

Chrome Plated Slip-On Diverter Spout with Polished Brass Knob



- Hex key included
- Polished brass knob
- Standard 5 1/2" diverter spout
- 1/2" CTS slip-on connection with set screw

PART NO.	DESCRIPTION	CTN/MSTR
D01032	Slip-on diverter spout with PB knob	1/50

Chrome Plated Diverter Spouts and Extensions

B



- Zamak
- D01004 Meets IAPMO and California Energy Commission approval
- Use P11928 replacement bushing
- Boxed

PART NO.	DESCRIPTION	MATERIAL	CONNECTION	CTN/MSTR
D01001	1/2" FIP	Zamak	Nose	1/50

D01004	1/2" CTS Slide with hex key	Zamak	Base	1/50
--------	-----------------------------	-------	------	------



- Brass plated zamak
- D01002 Meets IAPMO and California Energy Commission approval
- Use P11928 replacement bushing
- Boxed

PART NO.	DESCRIPTION	MATERIAL	CONNECTION	CTN/MSTR
D01002	3/4" x 1/2" FIP	Zamak	Base	1/50

D01003	3/4" x 1/2" FIP	Brass	Base	1/50
--------	-----------------	-------	------	------



- All brass
- Chrome plated brass
- 8-1/2" One piece diverter spout
- Boxed

PART NO.	DESCRIPTION	MATERIAL	CONNECTION	CTN/MSTR
D01015	3/4" x 1/2" FIP	Brass	Base	1/20



- Chrome plated zamak
- Two piece diverter spout
- Boxed

PART NO.	DESCRIPTION	MATERIAL	CONNECTION	CTN
D01008	8-1/4" two piece	Zamak	—	1

D01009	10-1/8" two piece	Zamak	—	1
--------	-------------------	-------	---	---

Extension Only



- All brass

PART NO.	DESCRIPTION	MATERIAL	CTN/MSTR
D01030	3" extension only	CP Brass	1/100

D01031	4-3/4" extension only	CP Brass	1/80
--------	-----------------------	----------	------



- Chrome plated zamak
- Diverter spout for hand held shower

PART NO.	DESCRIPTION	MATERIAL	CONNECTION	CTN QTY
D01010	3/4" x 1/2" FIP top connection	Zamak	Base	10

D01011	3/4" x 1/2" MIP lower connection	Zamak	Base	50
--------	----------------------------------	-------	------	----

Tub Spouts



D01020
D01021



D01016



D01028
D01029

Chrome Plated Zamak Slide Connection with Hex Key

PART NO.	DESCRIPTION	CONNECTION	MATERIAL	CTN/MSTR
D01020	1/2" FIP	Nose	CP Zamak	1/50

D01021	1/2" CTS slide connection	Base	CP Zamak	1/50
--------	---------------------------	------	----------	------

8 1/2" One Piece Chrome Plated Brass

PART NO.	DESCRIPTION	CONNECTION	MATERIAL	CTN/MSTR
D01016	3/4" x 1/2" FIP	Base	CP brass	1/20

Two Piece Chrome Plated

PART NO.	DESCRIPTION	CONNECTION	MATERIAL	CTN QTY
D01028	8" two piece	Nose	Zamak	1

D01029	10" two piece	Nose	Zamak	1
--------	---------------	------	-------	---

Telescoping Tub and Diverter Spout



D01022



D01023

- 5 1/2" overall length
- Adjustment up to 1" to accommodate various rough-ins

PART NO.	DESCRIPTION	CTN/MSTR
----------	-------------	----------

D01022	1/2" x 3/4" tub spout	1/50
--------	-----------------------	------

D01023	1/2" x 3/4" diverter spout	1/50
--------	----------------------------	------

9" Chrome Plated Tub Spout



D01017



D01018

- Solid brass construction
- One piece design
- 1/2" FIP nose connection

PART NO.	DESCRIPTION	CTN/MSTR
----------	-------------	----------

D01017	9" chrome plated brass diverter spout	1/12
--------	---------------------------------------	------

D01018	9" chrome plated brass tub spout	1/12
--------	----------------------------------	------

7" Chrome Plated Tub Spout



- Longer length for today's larger tubs
- CTS unit comes with hex key

PART NO.	SIZE	CONNECTION	CTN/MSTR
----------	------	------------	----------

D01026	7"	1/2" FIP Nose	1/50
--------	----	---------------	------

D01027	7"	1/2" CTS Slide	1/25
--------	----	----------------	------

Items marked with the Jones Stephens logo are "You Need It... We Got It" Items.

Tub Spouts



Solid Brass

Zinc

Solid brass

PART NO.	SIZE	CONNECTION	CTN/MSTR
D01005	3/4" x 1/2"	Base	1/40

Zinc

PART NO.	SIZE	CONNECTION	CTN/MSTR
D01035	1/2" x 3/4"	Base	1/25

Overflow Plates

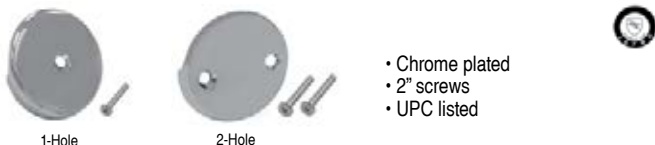

1-Hole

2-Hole

- Chrome plated
- 2" screws
- UPC listed

PART NO.	DESCRIPTION	# OF HOLES	CTN/MSTR
T05012	1-hole with screw	1	20/200
T05013	2-hole with screws	2	20/200
T05010	1-hole less screw	1	20/200
T05011	2-hole less screw	2	20/200
T05021	1/4" x 2" chrome plated screw	—	100/1000

Trip Levers With Spring



Round

- Chrome plated
- Coil-type spring
- 2" screws

PART NO.	DESCRIPTION	CTN/MSTR
T05002	Round trip lever less screws	25/200
T05003	Round trip lever with 2" screws	25/200
T05021	1/4" x 2" chrome plated screw	500/2000

Face Plate Gasket and Shoe Gasket



T05025

T05026

PART NO.	DESCRIPTION	CTN/MSTR
T05025	Beveled face plate gasket 2 1/8" ID x 3 3/16" OD- 9/16"-3/16" thick	25/300
T05026	Shoe gasket 1 3/4" ID x 2 5/8" OD - 3/32" thick	25/50

Wraparound Sponge Rubber Face Plate Gasket



- Grips top elbow for easy installation

PART NO.	DESCRIPTION	CTN/MSTR
T05029	Wraparound sponge rubber face gasket	25/500

#15 Plumb Kit



- Stainless steel flange (S01041)
- 1/2" x 6" chrome plated brass shower arm (S01030)
- Chrome plated plastic shower head with brass ball (S01003)

PART NO.	DESCRIPTION	CTN/MSTR
S03220	#15 Plumb kit	1/25

#51 Plumb Kit



- Chrome plated flange with set screw (S01040)
- 1/2" x 6" chrome plated brass shower arm (S01030)
- Chrome plated die cast adjustable shower head (S01005)

PART NO.	DESCRIPTION	CTN/MSTR
S03222	#51 Plumb kit	1/25

Bathtub Protectors



- High impact plastic
- Fluted side walls and foam bottom
- MOTOR FREIGHT (LTL) ONLY
- CARTON QUANTITIES ONLY

For Steel Tubs

PART NO.	DESCRIPTION	CTN QTY
T10014	14" deep x 60" long x 30" wide (steel tubs)	35
T10016	16" deep x 60" long x 42" wide (oval tubs)	25
T10216	16" deep x 60" long x 30" wide (cast iron tubs)	35

Adapter Bushing for Bath Drain



- Brass bushing

PART NO.	DESCRIPTION	CTN/MSTR
T05023	Kohler* Bushing	50/200
T05024	1-1/2" MIP x 1-3/8" FIP	50/300

* The manufacturers' names are used only to describe whose products the products will fit.

Standard Waste and 1-Hole Overflow



- Half kit with chrome plated lift and turn
- 2-hole test kit converts to 1-hole face plate

PART NO.	DESCRIPTION	MATERIAL	CTN/MSTR
B07220T	Waste and overflow kit	PVC	1/24
B07221T	Waste and overflow kit	ABS	1/24

Standard Waste and 2-Hole Overflow



- Half kit with satin nickel lift and turn
- 2-hole face plate

PART NO.	DESCRIPTION	MATERIAL	CTN/MSTR
B07111S	Waste and overflow kit	PVC	1/24
B07114S	Waste and overflow kit	ABS	1/24

Standard Waste and Overflow

B



- Full kit with chrome plated friction lift
- Includes bar
- 1-hole face plate

PART NO.	DESCRIPTION	MATERIAL	CTN/MSTR
B07219	Waste and overflow kit	PVC	1/10

Bath Drains



- 2-11/16" OD
- P35061 and P35060 have a zinc body, P35066 is brass

PART NO.	FINISH	DESCRIPTION	CTN/MSTR
P35061	Chrome Plated	1-3/8" (1-5/8" thread OD) lift and turn	1/100
P35060	Chrome Plated	1-1/2" (1-7/8" thread OD) lift and turn	1/100
P35066	Chrome Plated	1-1/2" (1-7/8" thread OD) lift and turn	1/100



- Chrome plated zinc

PART NO.	FINISH	DESCRIPTION	CTN/MSTR
P35067	Chrome Plated	1-1/2" friction lift	1/100
P35077	Chrome Plated	1-3/8" friction lift	1/50



- Chrome plated zinc
- Includes screw

PART NO.	FINISH	DESCRIPTION	CTN/MSTR
P35064	Chrome Plated	1-1/2" grid	1/100



- Chrome plated zinc

PART NO.	FINISH	DESCRIPTION	CTN/MSTR
P35063	Chrome Plated	1-3/8" (1-5/8" OD thread) toe touch	1/100
P35062	Chrome Plated	1-1/2" (1-7/8" OD thread) toe touch	1/100



- Replacement cartridge for P35063 and P35062

PART NO.	FINISH	DESCRIPTION	CTN/MSTR
P35056	Chrome Plated	5/16" toe touch cartridge	1/300
P35057	Chrome Plated	5/16" toe touch cartridge	1/250



- 1-3/8" are fine threads
- 1-1/2" are course threads

PART NO.	DESCRIPTION	CTN QTY
T05023	Kohler* Bushing	50/300
T05024	1-3/8" female- 1-1/2" male bushing	1

* The manufacturers' names are used only to describe whose products the products will fit.

Roman Tub Drain



- Solid brass construction
- Screws are included
- U-shaped handle design
- Designed to fit D64 series "Code Blue" drains

PART NO.	FINISH	CTN/MSTR
D40000	Chrome Plated	1/50
D40001	Polished Brass (PVD)	1/50
D40002	Satin Nickel (PVD)	1/50

Basin and Bath Stopper



- White hollow rubber with rustproof ring

PART NO.	TRADE SIZE	TOP	BOTTOM	CTN/MSTR
P35125	1 1/4"	1 3/8"	1 3/16"	100/500
P35150	1 1/2"	1 5/8"	1 3/8"	100/500
P35158	1 5/8"	1 25/32"	1 19/32"	100/500
P35175	1 3/4"	1 55/64"	1 11/16"	100/500

Fit-All Stopper



Part No.	Top	Bottom
P35160	1-1/2"	7/8"
P35161	3"	1-1/2"

- White rubber construction

PART NO.	DESCRIPTION	CTN/MSTR
P35160	1"- 1-3/8" basin stopper	100/500
P35161	1-1/2"- 2" bath tub or laundry tub stopper	100/500

Pop-Up Basin Stopper



P36002



P36003



P36004

PART NO.	DESCRIPTION	CTN/MSTR
P36002	Delta* pop-up basin stopper	50/200
P36003	Price-Pfister* pop-up stopper	10/500
P36004	Moen* pop-up basin stopper	1/200

* The manufacturers' names are used only to describe whose products the products will fit.

Flip-It Bath Stopper



- One piece construction of Derlin and ABS
- No tools needed for installation
- Open or close with a flip of the toe
- Fits most popular tub drains (assorted o-rings included)

PART NO.	DESCRIPTION	CTN/MSTR
P35070	Chrome plated flip-it stopper	100/200



- No bending or stooping necessary to operate
- Open or close with a flip of the toe
- Fits most popular tub drains

PART NO.	DESCRIPTION	CTN QTY
P35170	Chrome plated flip-it conversion kit	1

Schedule 40 Bath Waste Kits - Expanded Views

*See pages 22 - 23 for a complete list of available Schedule 40 Bath Waste Kits

Standard **1-Hole** Schedule 40 Bath Waste Kits

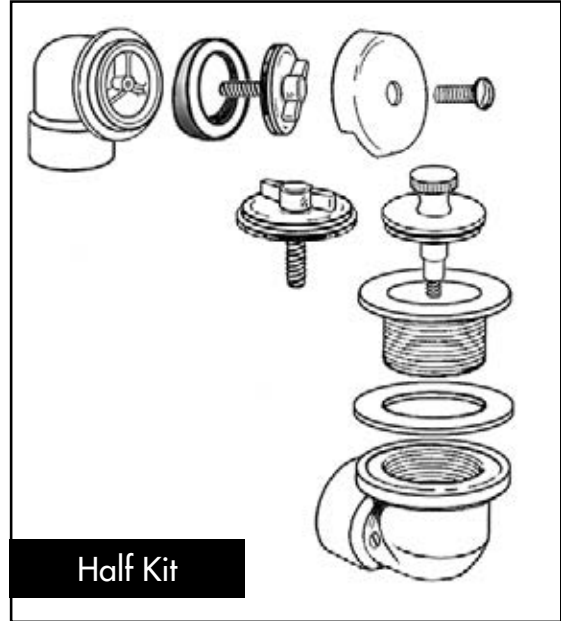
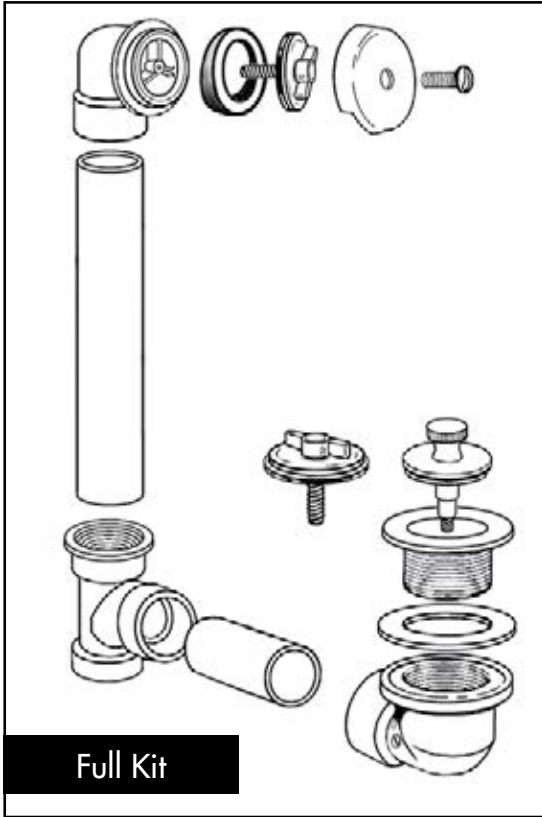

B

Standard **2-Hole** Schedule 40 Bath Waste Kits

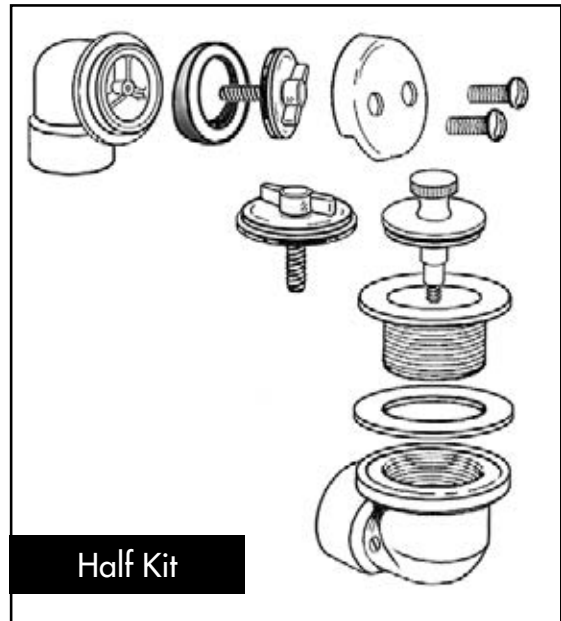
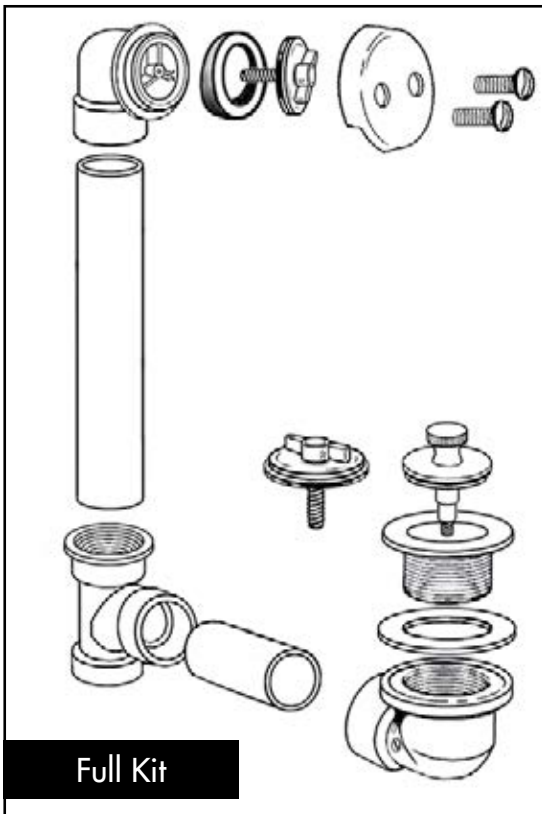

T-Waste 1-Hole Schedule 40 Bath Waste Kits

For use in apartments, motels, hotels - anywhere with back to back baths



T-Waste Kit Benefits:

- Direct access to trap from tub
- Direct waste much less likely to clog
- Solvent weld = homogeneous
- Code required for back to back installation
- Never needs access through walls or ceilings

- NO ACCESS PANEL NEEDED!
- 1-hole face plates
- Bolt holes on top elbows are pre-threaded
- All drains 3/8" thread size for testing
- UPC listed

Note: Please use suffix "T" when ordering any waste and overflow kit to have test kit included. Add \$4.99 to list price. When a complete kit with a 2-hole test kit is ordered, a 1-hole face plate with aluminum conversion bar will be supplied.



Half Kit - Lift and Turn Drain



Half Kit - Toe Touch Drain

T-Waste Half Kit- No Pipe Or Elbow

PART NO.	MATERIAL	DESCRIPTION	# HOLES	CTN/MSTR
B07038	PVC	CP brass lift and turn	1	1/24
B07001	PVC	CP lift and turn	1	1/24
B07005	PVC	PB lift and turn	1	1/24
B07003	PVC	CP toe touch	1	1/24
B07007	PVC	PB toe touch	1	1/24
B07040	PVC	CP friction lift	1	1/24
B07042	PVC	PB friction lift	1	1/24
B07006	ABS	PB lift and turn	1	1/24
B07039	ABS	CP brass lift and turn	1	1/24
B07002	ABS	CP lift and turn	1	1/24
B07004	ABS	CP toe touch	1	1/24
B07008	ABS	PB toe touch	1	1/24
B07041	ABS	CP friction lift	1	1/24
B07043	ABS	PB friction lift	1	1/24



Full Kit - Lift and Turn Drain



Full Kit - Toe Touch Drain

T-Waste Full Kit- Includes Pipe and 90° Elbow

PART NO.	MATERIAL	DESCRIPTION	# HOLES	CTN/MSTR
B07044	PVC	CP brass lift and turn	1	1/10
B07020	PVC	CP lift and turn	1	1/10
B07024	PVS	PB lift and turn	1	1/10
B07022	PVC	CP toe touch	1	1/10
B07046	PVC	CP friction lift	1	1/10
B07048	PVC	PB friction lift	1	1/10
B07045	ABS	CP brass lift and turn	1	1/10
B07021	ABS	CP lift and turn	1	1/10
B07025	ABS	PB lift and turn	1	1/10
B07023	ABS	CP toe touch	1	1/10
B07027	ABS	PB toe touch	1	1/10
B07047	ABS	CP friction lift	1	1/10
B07049	ABS	PB friction lift	1	1/10

T-Waste 2-Hole Schedule 40 Bath Waste Kits

For use in apartments, motels, hotels - anywhere with back to back baths



T-Waste Kit Benefits:

- Direct access to trap from tub
- Direct waste much less likely to clog
- Solvent weld = homogeneous
- Code required for back to back installation
- Never needs access through walls or ceilings

- NO ACCESS PANEL NEEDED!
- 2-hole face plates
- Bolt holes on top elbow are pre-threaded
- All drains 3/8" thread size for testing
- UPC listed

Note: Please use suffix "T" when ordering any waste and overflow kit to have test kit included. Add \$4.99 to list price. When a complete kit with a 2-hole test kit is ordered, a 1-hole face plate with aluminum conversion bar will be supplied.



Half Kit - Lift and Turn Drain



Half Kit - Toe Touch Drain

T-Waste Half Kit- No Pipe Or Elbow

PART NO.	MATERIAL	DESCRIPTION	# HOLES	CTN/MSTR
B07138	PVC	CP brass lift and turn	2	1/24
B07101	PVC	CP lift and turn	2	1/24
B07105	PVC	PB lift and turn	2	1/24
B07103	PVC	CP toe touch	2	1/24
B07107	PVC	PB toe touch	2	1/24
B07140	PVC	CP friction lift	2	1/24
B07142	PVC	PB friction lift	2	1/24
B07139	ABS	CP brass lift and turn	2	1/24
B07102	ABS	CP lift and turn	2	1/24
B07106	ABS	PB lift and turn	2	1/24
B07104	ABS	CP toe touch	2	1/24
B07108	ABS	PB toe touch	2	1/24
B07141	ABS	CP friction lift	2	1/24
B07143	ABS	PB friction lift	2	1/24



Full Kit - Lift and Turn Drain



Full Kit - Toe Touch Drain

T-Waste Full Kit- Includes Pipe and 90° Elbow

PART NO.	MATERIAL	DESCRIPTION	# HOLES	CTN/MSTR
B07144	PVC	CP brass lift and turn	2	1/10
B07120	PVC	CP lift and turn	2	1/10
B07124	PVC	PB lift and turn	2	1/10
B07122	PVC	CP toe touch	2	1/10
B07126	PVC	PB toe touch	2	1/10
B07146	PVC	CP friction lift	2	1/10
B07148	PVC	PB friction lift	2	1/10
B07121	ABS	CP lift and turn	2	1/10
B07125	ABS	PB lift and turn	2	1/10
B07123	ABS	CP toe touch	2	1/10
B07127	ABS	PB toe touch	2	1/10
B07147	ABS	CP friction lift	2	1/10
B07149	ABS	PB friction lift	2	1/10

Standard 1-Hole Schedule 40 Bath Waste Kits

- 1-hole face plates
- Bolt holes on top elbows are pre-threaded
- All drains 3/8" thread size for testing
- UPC listed



Note: Please use suffix "T" when ordering any waste and overflow kit to have test kit included. Add \$4.99 to list price. When a complete kit with a 2-hole test kit is ordered, a 1-hole face plate with aluminum conversion bar will be supplied.



Half Kit - Lift and Turn Drain



Half Kit - Toe Touch Drain

Standard Half Kit- No Pipe or Tee

PART NO.	MATERIAL	DESCRIPTION	# HOLES	CTN/MSTR
B07050	PVC	CP brass lift and turn	1	1/24
B07010	PVC	CP lift and turn	1	1/24
B07014	PVC	PB lift and turn	1	1/24
B07012	PVC	CP toe touch	1	1/24
B07016	PVC	PB toe touch	1	1/24
B07052	PVC	CP friction lift	1	1/24
B07054	PVC	PB friction lift	1	1/24
B07051	ABS	CP brass lift and turn	1	1/24
B07011	ABS	CP lift and turn	1	1/24
B07015	ABS	PB lift and turn	1	1/24
B07013	ABS	CP toe touch	1	1/24
B07017	ABS	PB toe touch	1	1/24
B07053	ABS	CP friction lift	1	1/24
B07055	ABS	PB friction lift	1	1/24



Half Kit - Lift and Turn Drain



Half Kit - Toe Touch Drain

Standard Full Kit- Includes Pipe and Tee

PART NO.	MATERIAL	DESCRIPTION	# HOLES	CTN/MSTR
B07056	PVC	CP brass lift and turn	1	1/10
B07030	PVC	CP lift and turn	1	1/10
B07034	PVC	PB lift and turn	1	1/10
B07032	PVC	CP toe touch	1	1/10
B07036	PVC	PB toe touch	1	1/10
B07058	PVC	CP friction lift	1	1/10
B07060	PVC	PB friction lift	1	1/10
B07057	ABS	CP brass lift and turn	1	1/10
B07031	ABS	CP lift and turn	1	1/10
B07035	ABS	PB lift and turn	1	1/10
B07033	ABS	CP toe touch	1	1/10
B07037	ABS	PB toe touch	1	1/10
B07059	ABS	CP friction lift	1	1/10
B07061	ABS	PB friction lift	1	1/10

Standard 2-Hole Schedule 40 Bath Waste Kits

- 2-hole face plates
- Bolt holes on top elbow are pre-threaded
- All drains 3/8" thread size for testing
- UPC listed



Note: Please use suffix "T" when ordering any waste and overflow kit to have test kit included. Add \$4.99 to list price. When a complete kit with a 2-hole test kit is ordered, a 1-hole face plate with aluminum conversion bar will be supplied.



Half Kit - Lift and Turn Drain



Half Kit - Toe Touch Drain

Standard Half Kit- No Pipe or Tee

PART NO.	MATERIAL	DESCRIPTION	# HOLES	CTN/MSTR
B07150	PVC	CP brass lift and turn	2	1/24
B07110	PVC	CP lift and turn	2	1/24
B07114	PVC	PB lift and turn	2	1/24
B07112	PVC	CP toe touch	2	1/24
B07116	PVC	PB toe touch	2	1/24
B07152	PVC	CP friction lift	2	1/24
B07154	PVC	PB friction lift	2	1/24
B07151	ABS	CP brass lift and turn	2	1/24
B07111	ABS	CP lift and turn	2	1/24
B07115	ABS	PB lift and turn	2	1/24
B07113	ABS	CP toe touch	2	1/24
B07117	ABS	PB toe touch	2	1/24
B07153	ABS	CP friction lift	2	1/24
B07155	ABS	PB friction lift	2	1/24



Half Kit - Lift and Turn Drain



Half Kit - Toe Touch Drain

Standard Full Kit- Includes Pipe and Tee

PART NO.	MATERIAL	DESCRIPTION	# HOLES	CTN/MSTR
B07156	PVC	CP brass lift and turn	2	1/10
B07130	PVC	CP lift and turn	2	1/10
B07134	PVC	PB lift and turn	2	1/10
B07132	PVC	CP toe touch	2	1/10
B07136	PVC	PB toe touch	2	1/10
B07158	PVC	CP friction lift	2	1/10
B07160	PVC	PB friction lift	2	1/10
B07157	ABS	CP brass lift and turn	2	1/10
B07131	ABS	CP lift and turn	2	1/10
B07135	ABS	PB lift and turn	2	1/10
B07133	ABS	CP toe touch	2	1/10
B07137	ABS	PB toe touch	2	1/10
B07159	ABS	CP friction lift	2	1/10
B07161	ABS	PB friction lift	2	1/10

Items marked with the Jones Stephens logo are "You Need It...We Got It" Items.

Bath Waste and Overflow Test Kit



• Drain thread size is 3/8"

PART NO.	DESCRIPTION	CTN/MSTR
B07201	1-hole kit without screws or plate	1/200
B07202	2-hole kit includes screws and plate	1/200

Aluminum Bar for Waste and Overflow



- Holds overflow ell to tub
- Converts 2-hole faceplate to 1-hole faceplate

PART NO.	DESCRIPTION	CTN/MSTR
B07200	Aluminum bar with 2 screws	1/500
B07203	1-hole overflow face plate with aluminum bar	1

Bath Waste Trim Kits



- Chrome plated
- Includes overflow plate, screws and stopper

PART NO.	DESCRIPTION	# HOLES	CTN QTY
B07071	Trim kit with lift and turn stopper	1	1
B07073	Trim kit with friction lift stopper	1	1
B07171	Trim kit with lift and turn stopper	2	1
B07173	Trim kit with friction lift stopper	2	1

Polished Brass Face Plate Trim Kit



- Overflow plate, screws and lift and turn stopper
- PVD finish

PART NO.	DESCRIPTION	# HOLES	CTN QTY
B08071	1-hole face plate trim kit	1	1

Conversion Kit with Cross Bar



- 1-3/8" chrome plated zinc drain
- Includes cross bar
- 1-hole face plate
- Includes bushing for 1-1/2" installation

PART NO.	DESCRIPTION	CTN/MSTR
B51019	CP lift and turn conversion kit	6/36
B51020	PB lift and turn conversion kit	1/12
B07210	CP friction lift conversion kit	1/1

Trip Lever Trim Only



- Chrome plated
- 2-hole faceplate
- Includes springs, faceplate, 2 screws and strainer
- Clamshell packaging

PART NO.	DESCRIPTION	# HOLES	CTN/MSTR
B51014	Chrome plated trip lever trim only	2	5/25

Trip Lever Conversion Kit



- Chrome plated
- Fits 1-3/8" or 1-1/2" waste elbows
- Includes drain, bushing, faceplate and 2 screws
- Clamshell packaging

PART NO.	DESCRIPTION	# HOLES	CTN/MSTR
B51015	Chrome plated trip lever conversion kit	2	5/25

Bath Waste Conversion Kits



- B51006, B51008, B51011 are 1-1/2" kits
- All others are 1-1/2"x 1-3/8" and include bushings
- Carded for display

PART NO.	DESCRIPTION	# HOLES	CTN/MSTR
B51005	CP lift and turn kit	2	6/36
B51006	White lift and turn kit	2	1/1
B51007	CP toe touch kit	2	1/1
B51008	CP friction lift kit	2	1/1
B51009	CP lift and turn kit	1	1/1
B51010	CP toe touch kit	1	1/1
B51011	CP friction lift kit	1	1/1

Schedule 40 Bath Waste Rough-In Kit



1-Hole Rough In Kit B07070

- Chrome plated drain body
- Standard rough-in kit

PART NO.	MATERIAL	DESCRIPTION	# HOLES	CTN QTY
B07074	PVC	Lift and turn drain body	1	1
B07374	ABS	Lift and turn drain body	1	1
B07075	PVC	Friction lift drain body	1	1
B07375	ABS	Friction lift drain body	1	1
B07076	PVC	Lift and turn drain body	2	1
B07376	ABS	Lift and turn drain body	2	1
B07077	PVC	Friction lift drain body	2	1
B07377	ABS	Friction lift drain body	2	1

Schedule 40 Bath Waste Rough-In Kits with Test Kit



Two-Hole Rough In Kit B07170

- Chrome plated drain body
- Standard rough-in kit
- Includes test kit

PART NO.	MATERIAL	DESCRIPTION	# HOLES	CTN QTY
B07070	PVC	Lift and turn drain body	1	1
B07470	ABS	Lift and turn drain body	1	1
B07072	PVC	Friction lift drain body	1	1
B07472	ABS	Friction lift drain body	1	1
B07170	PVC	Lift and turn drain body	2	1
B07476	ABS	Lift and turn drain body	2	1
B07172	PVC	Friction lift drain body	2	1
B07477	ABS	Friction lift drain body	2	1

Plunge Right



- Easily unplug a clogged drain
- Eliminates use of a rag to plug overflow
- Seal allows for full utilization of pressure to remove clog
- Reusable

PART NO.	DESCRIPTION	# HOLES	CTN/MSTR
J40016	2-Hole plunge right	2	1
J40017	1-Hole plunge right	1	1

Grab Bar with Exposed Flange



Satin Finish



Peened Finish

- 18 gauge stainless steel
- Meets 900 lb. downward pull when installed properly
- Meets federal specification WW-P-541/8B, Amendment 1, 16 April 1990
- Meets ANSI 117.1 and all ADA Code requirements
- Meets federal specifications for FHA, VA hospital, private construction
- Individually bagged with stainless steel mounting screws

Satin Finish

PART NO.	DESCRIPTION	FINISH	CTN/MSTR
G12012	1-1/4" x 12"	Satin	1/5
G12016	1-1/4" x 16"	Satin	1/5
G12018	1-1/4" x 18"	Satin	1/5
G12024	1-1/4" x 24"	Satin	1/5
G12030	1-1/4" x 30"	Satin	1/5
G12032	1-1/4" x 32"	Satin	1/5
G12036	1-1/4" x 36"	Satin	1/5
G12042	1-1/4" x 42"	Satin	1/5
G12048	1-1/4" x 48"	Satin	1/5
G13012	1-1/2" x 12"	Satin	1/5
G13016	1-1/2" x 16"	Satin	1/5
G13018	1-1/2" x 18"	Satin	1/5
G13024	1-1/2" x 24"	Satin	1/5
G13030	1-1/2" x 30"	Satin	1/5
G13032	1-1/2" x 32"	Satin	1/5
G13036	1-1/2" x 36"	Satin	1/5
G13042	1-1/2" x 42"	Satin	1/5
G13048	1-1/2" x 48"	Satin	1/5

Peened Finish

PART NO.	DESCRIPTION	FINISH	CTN/MSTR
G12212	1-1/4" x 12"	Peened	1/5
G12216	1-1/4" x 16"	Peened	1/5
G12218	1-1/4" x 18"	Peened	1/5
G12224	1-1/4" x 24"	Peened	1/5
G12230	1-1/4" x 30"	Peened	1/5
G12232	1-1/4" x 32"	Peened	1/5
G12236	1-1/4" x 36"	Peened	1/5
G12242	1-1/4" x 42"	Peened	1/5
G12248	1-1/4" x 48"	Peened	1/5
G13212	1-1/2" x 12"	Peened	1/5
G13216	1-1/2" x 16"	Peened	1/5
G13218	1-1/2" x 18"	Peened	1/5
G13224	1-1/2" x 24"	Peened	1/5
G13230	1-1/2" x 30"	Peened	1/5
G13232	1-1/2" x 32"	Peened	1/5
G13236	1-1/2" x 36"	Peened	1/5
G13242	1-1/2" x 42"	Peened	1/5
G13248	1-1/2" x 48"	Peened	1/5

Ⓢ Items marked with the Jones Stephens logo are "You Need It... We Got It" Items.

Grab Bar with Concealed Snap-On Flange



Satin Finish



Peened Finish

- 18 gauge stainless steel
- Meets 900 lb. downward pull when installed properly
- Meets federal specification WW-P-541/8B, Amendment 1, 16 April 1990
- Meets ANSI 117.1 and all ADA Code requirements
- Meets federal specifications for FHA, VA hospital, private construction
- Individually bagged with stainless steel mounting screws

Satin Finish

PART NO.	DESCRIPTION	FINISH	CTN/MSTR
G12112	1-1/4" x 12"	Satin	1/5
G12116	1-1/4" x 16"	Satin	1/5
G12118	1-1/4" x 18"	Satin	1/5
G12124	1-1/4" x 24"	Satin	1/5
G12130	1-1/4" x 30"	Satin	1/5
G12132	1-1/4" x 32"	Satin	1/5
G12136	1-1/4" x 36"	Satin	1/5
G12142	1-1/4" x 42"	Satin	1/5
G12148	1-1/4" x 48"	Satin	1/5
G13112	1-1/2" x 12"	Satin	1/5
G13116	1-1/2" x 16"	Satin	1/5
G13118	1-1/2" x 18"	Satin	1/5
G13124	1-1/2" x 24"	Satin	1/5
G13130	1-1/2" x 30"	Satin	1/5
G13132	1-1/2" x 32"	Satin	1/5
G13136	1-1/2" x 36"	Satin	1/5
G13142	1-1/2" x 42"	Satin	1/5
G13148	1-1/2" x 48"	Satin	1/5

Peened Finish

PART NO.	DESCRIPTION	FINISH	CTN/MSTR
G12312	1-1/4" x 12"	Peened	1/5
G12316	1-1/4" x 16"	Peened	1/5
G12318	1-1/4" x 18"	Peened	1/5
G12324	1-1/4" x 24"	Peened	1/5
G12330	1-1/4" x 30"	Peened	1/5
G12332	1-1/4" x 32"	Peened	1/5
G12336	1-1/4" x 36"	Peened	1/5
G12342	1-1/4" x 42"	Peened	1/5
G12348	1-1/4" x 48"	Peened	1/5
G13312	1-1/2" x 12"	Peened	1/5
G13316	1-1/2" x 16"	Peened	1/5
G13318	1-1/2" x 18"	Peened	1/5
G13324	1-1/2" x 24"	Peened	1/5
G13330	1-1/2" x 30"	Peened	1/5
G13332	1-1/2" x 32"	Peened	1/5
G13336	1-1/2" x 36"	Peened	1/5
G13342	1-1/2" x 42"	Peened	1/5
G13348	1-1/2" x 48"	Peened	1/5

Grab Bar Fastening System



- Made of stainless steel
- Will hold up to 1000 lbs. per grab bar
- Blocking/studs are not required

PART NO.	DESCRIPTION	CTN/MSTR
G12999	Commercial grab bar wing lt	1/60

Brass Pop-up Assembly/Replacement Parts

B



- All metal construction
- Tool free locknut and ballrod top
- 17 gauge

PART NO.	DESCRIPTION	CTN/MSTR
P35001	Chrome-brass	1/50
Replacement Parts		
PART NO.	DESCRIPTION	CTN/MSTR
P35041	1-1/4" mack gasket	1/500
P35900	Universal plastic plunger with CP brass cap	1/25
P35901	CP brass flange	16/800
P35902	Flat rubber washer	1/25
P35904	Polyethylene washer	1/1000
P35905	Brass locknut	1/25
P35906	CP brass drain body	1/250
P35907	CP brass tailpiece	1/250
P35908	Stainless steel lift rod	1/500
P35909	Steel clevis with thumb screw	1/25
P35910	Stainless steel spring clip	1/2000
P35911	CP brass ball nut	1/600
P35912	CP steel ball rod with plastic all (6-3/8" long)	1/150
P35913	Friction washer - under nut (not visible)	1/600

Lav Lift and Lock Pop-Up Drain



- Chrome plated

PART NO.	DESCRIPTION	CTN/MSTR
P35000	CP lift and lock pop-up (with overflow holes)	1/50
P35003	CP lift and lock pop-up (without overflow holes)	1/50

ABS Lav Pop-Up Assembly



- Carded

PART NO.	DESCRIPTION	CTN/MSTR
P35004	Grey plastic	1/30

Chrome Plated ABS Lav Pop-Up Assembly



- Carded

PART NO.	DESCRIPTION	CTN/MSTR
P35005	Chrome plated plastic	1/30

Items marked with the Jones Stephens logo are "You Need It...We Got It" Items.

Brass Lav P.O. Plug Drain



- With chain and stopper
- With overflow
- 17 gauge

PART NO.	DESCRIPTION	CTN/MSTR
D70103	1-1/4" P.O. plug drain	1/50

Trap Primer Tailpiece



- Chrome plated 17 gauge tubular
- Sturdy one-piece construction eliminates leaks and cross-threading
- 3/4" compression nut

PART NO.	DESCRIPTION	CTN/MSTR
T74010	1-1/4" x 8" - threaded top	1/50
T74011	1-1/2" x 8" - slip joint top direct connection	1/50

Handicap Style Lav Grid Drain



- Polished chrome plated brass
- Twin 90° construction
- Mack washer and brass locknut
- 17 gauge 1-1/4" tailpiece; cast brass elbows
- Without overflow

PART NO.	DESCRIPTION	CTN/MSTR
D70101	Handicap style lav grid drain	1/25
D70104	Handicap style lav grid drain with one piece tubular elbow	1/25

Commercial Handicap Style Lav Grid Drain with Elbow



- Polished chrome plated brass; cast brass elbow
- 1-1/4" female thread
- Complete with gaskets and brass locknut

PART NO.	DESCRIPTION	CTN/MSTR
D70102	Handicap style lav grid drain with elbow	1/48

Commercial Lav Grid Drain without Overflow Holes



- Chrome plated
- 17 gauge
- For vessel sinks

PART NO.	DESCRIPTION	CTN/MSTR
D70105	Chrome plated grid drain	1/50

Commercial Lav Grid Drain



- Stainless steel
- Mack washer and brass locknut
- 17 gauge 1-1/4" tailpiece; 6" long

PART NO.	DESCRIPTION	CTN/MSTR
D70100	Commercial lav drain	1/50

Commercial P-Trap with Cleanout



- Chrome plated
- Brass nuts
- 17 gauge semi-cast p-trap
- 17 gauge tubular wall bend
- Carded

PART NO.	DESCRIPTION	CTN/MSTR
J37124	1-1/4" OD with cleanout	1/12
J37150	1-1/2" OD with cleanout	1/12

Chrome Plated PVC P-Trap



- Complete with nuts, washers and escutcheon

PART NO.	DESCRIPTION	CTN/MSTR
P36102	1-1/4" p-trap	1/50
P36103	1-1/2" p-trap	1/50

Flush Valve Pipe Support



- Chrome plated split ring type
- 1-1/2" OD size
- 5" center of pipe to wall
- Mounting hardware included

PART NO.	DESCRIPTION	CTN/MSTR
F39800	1-1/2" x 5" pipe support	5/50
F39700	1-1/2" x 3 1/2" pipe support	10/100

Tissue Roller



- CARTON QUANTITIES ONLY

PART NO.	DESCRIPTION	CTN/MSTR
B10195	Fit-All white plastic	50/200

Provent



- Manufactured housing and RV's only
- Automatic anti-siphon trap vent used as secondary venting
- Must be located at least 60" above trap arm
- Two individually protected fixtures may be connected to same 1-1/2" drain
- Three or more fixtures must be drained by 2" line
- Simply hand tighten, no thread seal needed
- Water closet must have main stack to outside
- Must be installed in accessible location with free flow air
- Do not install in sealed wall cavity
- 1-1/2" MPT threads

PART NO.	DESCRIPTION	CTN/MSTR
P21150	1-1/2" Provent	1/200

Air Gap



- Prevents sewage backflow by breaking siphoning action in drain line
- White polypro body with chrome plated ABS top
- UPC listed



PART NO.	DESCRIPTION	CTN QTY
A10001	Air gap	36/72

Items marked with the Jones Stephens logo are "You Need It... We Got It" Items.

Air Gap Spacer



PART NO.	DESCRIPTION	CTN/MSTR
A10901	Air gap spacer	1/25

Air Gap Dishwasher Kit



- Contains air gap, 24" dishwasher hose (7/8"), and 2 gear clamps
- Poly bagged and labeled

PART NO.	DESCRIPTION	CTN/MSTR
A10100	Air gap installation pack	1/10
A10200	Air gap installation pack-white	1/10
A10150	Air gap deluxe pack (includes dishwasher elbow and vacuum breaker)	1/10

Plumb Aire Air Vent



Adapter

- Up to 160 fixture units
- May be exposed to temperatures ranging from -40° + 150°F
- No protective cover required when installed per code specifications
- Back pressure rated to 20 PSI

PART NO.	DESCRIPTION	MATERIAL	CTN/MSTR
P21100	Plumb Aire vent- 1-1/2"x 2"	PVC	1/20
P21101	Plumb Aire vent with adapter	PVC	1/20
P21102	Plumb Aire vent - 1-1/2"x 2"	ABS	1/20
P21103	Plumb Aire vent with adapter	ABS	1/20

Adapter for Air Inlet Valve

PART NO.	DESCRIPTION	MATERIAL	CTN/MSTR
P21104	Adapter for air inlet valve	PVC	1/20
P21107	Adapter for air inlet valve	ABS	1/20

Rosettes



B10110



B10111

- CARTON QUANTITIES ONLY

PART NO.	DESCRIPTION	CTN/MSTR
B10110	Shallow pattern (zinc plated)	25/5000
B10111	Deep pattern (zinc plated)	25/1000

Basin Cock Locknut



B10080



B10081

- CARTON QUANTITIES ONLY

PART NO.	DESCRIPTION	MATERIAL	CTN/MSTR
B10080	1/2"- 14 hex locknut	Zamak	25/1000
B10081	1/2"- 14 flanged hex locknut	Zamak	25/750

Basket Strainer Locknuts & Washers



Locknut



Rubber Washer



Friction Washer

- Die cast zinc
- CARTON QUANTITIES ONLY

PART NO.	DESCRIPTION	CTN/MSTR
B10090	1-1/2" locknut	25/350
B10091	2" locknut	25/350
B10092	3-3/8" locknut for 4" duo strainer	25/350
B10093	3-3/8" heavy pattern locknut for 4" duo strainer	25/100
B10094	Basket strainer rubber washer (4-7/16" OD)	25/300

Fiber Friction Washer

PART NO.	DESCRIPTION	CTN/MSTR
D02002	Basket strainer friction washer (4-3/16" OD) [fiber friction washer]	1/100

Ballcock Coupling Nut and Locknut



- CARTON QUANTITIES ONLY

PART NO.	DESCRIPTION	CTN/MSTR
C05080	5/8" x 1/2" 7 threads zinc die cast	25/500
C05081	5/8" x 7/8" brass	20/400
C05082	15/16"- 14 locknut	25/500

Plastic Slip Joint Nut



WINGS MAKE
INSTALLATION
EASIER!

- White
- CARTON QUANTITIES ONLY (T85125 and T85150)

PART NO.	DESCRIPTION	CTN/MSTR
T83150	1-1/2" with wings	100/1200
T85125	1-1/4" x 1-1/4"	100/1200
T85150	1-1/2" x 1-1/2"	100/1200

Basin Nut



- CARTON QUANTITIES ONLY

PART NO.	DESCRIPTION	MATERIAL	CTN/MSTR
B10100	1/2" - 14 x 3/8"	Zamak	25/500
B10102	1/2" - 14 x 1/2"	Zamak	25/500
B10103	1/2" - 14 x 9/16"	Zamak	25/500
B10104	1/2" - 14 x 9/16"	Brass	25/1000

Lavatory Supply Nut



- Wing nut design
- CARTON QUANTITIES ONLY

PART NO.	DESCRIPTION	MATERIAL	CTN/MSTR
B10105	1/2" - 14 x 1/2" white lavatory nut	plastic	25/1100

Ⓢ Items marked with the Jones Stephens logo are "You Need It...We Got It" Items.

Sink Connection Washer



- CARTON QUANTITIES ONLY

PART NO.	DESCRIPTION	CTN/MSTR
T79000	1-3/4" x 1-3/8" x 1/8"	100/1000

Split Nut



- Replace fractured or stripped slip nuts without tubular disassembly
- Supplied with washer

PART NO.	DESCRIPTION	CTN/MSTR
T82125	1-1/4" split nut	100/400
T82150	1-1/2" split nut	100/400

Slip Joint Nut



- CARTON QUANTITIES ONLY

PART NO.	IPS x SLIP TUBE	MATERIAL	CTN/MSTR
T77125	1-1/4" x 1-1/4"	Die Cast Zinc	25/500
T77138	1-1/2" x 1-3/8"	Die Cast Zinc	400/800
T77150	1-1/2" x 1-1/2"	Die Cast Zinc	25/300
T77151	1-1/2" x 1-1/4"	Die Cast Zinc	25/300
T77152	2" x 1-1/2"	Die Cast Zinc	25/300
T77200	2" x 2"	Die Cast Zinc	25/200
T78125	1-1/4" x 1-1/4"	Chrome Plated Brass	200/400
T78150	1-1/2" x 1-1/2"	Chrome Plated Brass	200/400
T78151	1-1/2" x 1-1/4"	Chrome Plated Brass	200/400
T78152	2" x 1-1/2"	Chrome Plated Brass	125/250
T78200	2" x 2"	Chrome Plated Brass	25/250

Rough Brass Slip Joint Nut



- Heavy cast brass
- CARTON QUANTITIES ONLY

PART NO.	IPS x SLIP TUBE	MATERIAL	CTN/MSTR
T84125	1-1/4" x 1-1/4"	Cast Brass	25/300
T84150	1-1/2" x 1-1/2"	Cast Brass	25/300
T84151	1-1/2" x 1-1/4"	Cast Brass	25/300
T84200	2" x 2"	Cast Brass	25/300

Slip Joint Washer



• CARTON QUANTITIES ONLY

Square Cut Rubber

Poly Beveled

Square Cut

PART NO.	NUT x TUBE	MATERIAL	CTN/MSTR
T79125	1-1/4" x 1-1/4"	Black Rubber	100/5600
T79150	1-1/2" x 1-1/2"	Black Rubber	100/5600
T79151	1-1/2" x 1-1/4"	Black Rubber	100/5600
T79200	2" x 2"	Black Rubber	100/2400
T79201	2" x 1-1/2"	Black Rubber	100/2400

Beveled

PART NO.	NUT x TUBE	MATERIAL	CTN/MSTR
T80125	1-1/4" x 1-1/4"	Blue Rubber	100/5000
T80150	1-1/2" x 1-1/2"	Blue Rubber	100/5000
T80151	1-1/2" x 1-1/4"	Blue Rubber	100/5000
T80200	2" x 2"	Blue Rubber	100/5000

Slip Joint Nut and Washer



• Chrome plated nut packed with square cut rubber washer
• CARTON QUANTITIES ONLY

Die Cast Nut

Brass Nut

Die Cast Nut

PART NO.	DESCRIPTION	MATERIAL	CTN/MSTR
T77014	1-1/4" x 1-1/4"	Die Cast	25/500
T77012	1-1/2" x 1-1/2"	Die Cast	25/500
T77013	1-1/2" x 1-1/4"	Die Cast	25/500
T77020	2" x 2"	Die Cast	25/500

Brass Nut

PART NO.	DESCRIPTION	MATERIAL	CTN/MSTR
T78014	1-1/4" x 1-1/4"	Brass	25/400
T78012	1-1/2" x 1-1/2"	Brass	200/400
T78013	1-1/2" x 1-1/4"	Brass	200/400
T78020	2" x 2"	Brass	25/400

Cone Slip Joint Washer



• Black rubber
• CARTON QUANTITIES ONLY

T85052

T85053

T85054

T85055

PART NO.	NUT	TUBE	OD x ID	CTN/MSTR
T85050	1/2"	3/8"	23/32" x 3/8"	100/1600
T85051	1/2"	3/8" threaded	23/32" x 3/8"	100/1600
T85052	1/2"	7/16" or 1/2"	5/8" x 7/16"	100/1600
T85053	Ballcock supply -		3/4" x 7/16"	100/1600
T85054	Ballcock supply -		13/16" x 11/32"	100/1600
T85055	Upper bath supply -		27/32" x 7/16"	100/1600

Ⓢ Items marked with the Jones Stephens logo are "You Need It... We Got It" Items.

Brass Friction Rings



• CARTON QUANTITIES ONLY

PART NO.	NUT	TUBE	OD x ID	CTN QTY
T86050	1/2"	3/8"	21/32" x 25/64"	100
T86052	1/2"	7/16"	21/32" x 29/64"	100
T86053	Ballcock	1/2"	13/16" x 17/32"	100
T86054	Ballcock	3/8"	13/16" x 25/64"	100
T86055	Ballcock	7/16"	13/16" x 15/32"	100

Flanged Poly Tailpiece Washer



• CARTON QUANTITIES ONLY

PART NO.	NUT x TUBE	CTN QTY
T81150	1 1/2" x 1 1/2"	100
T79152	1 1/2" x 1 1/4" cloth inserted	100

Waste Connector



• Brass body ferrule and nut
• MIP units are combination female sweat

FIP x SLIP

PART NO.	DESCRIPTION	CTN/MSTR
T75125	1-1/4" FIP x 1-1/4" OD	12/72
T75150	1-1/2" FIP x 1-1/2" OD	12/72
T75151	1-1/2" FIP x 1-1/4" OD	12/72
T75250	1-1/2" FIP x 1-1/2" OD with poly washer	12/72

MIP x SLIP

PART NO.	DESCRIPTION	CTN/MSTR
T76125	1-1/4" MIP x 1-1/4" OD	12/72
T76150 Ⓢ	1-1/2" MIP x 1-1/2" OD	12/72
T76151	1-1/2" MIP x 1-1/4" OD	12/72
T76250	1-1/2" MIP x 1-1/2" OD with poly washer	12/72

Brass Compression Ring

PART NO.	DESCRIPTION	CTN/MSTR
T75000	1-1/4" OD	1/1000
T75001	1-1/2" OD	1/1000

Double Slip Fittings



Coupling



90° Ell



45° Ell

- Chrome plated brass
- 22 gauge

PART NO.	DESCRIPTION	CTN/MSTR
T74001	1-1/4" coupling	10/100
T74002	1-1/2" coupling	10/100
T74003	1-1/4" 90° elbow	10/100
T74004	1-1/2" 90° elbow	10/100
T74005	1-1/4" 45° elbow	10/100
T74006	1-1/2" 45° elbow	10/100

Slip Joint Tee



- Chrome plated satin finish cast brass
- Compression ends

PART NO.	DESCRIPTION	CTN/MSTR
C74105	1-1/2" x 1-1/2" x 1-1/2" tee	10/60

90° Drop Ear Elbow



- Cast brass
- Lead Free

PART NO.	DESCRIPTION	CTN/MSTR
B55100LF	1/2" FIP x 1/2" FIP	45/180
B55103LF	1/2" FSWT x 1/2" FSWT	1/100
B55050	1/2" FIP x 1/2" FSWT	60/240

Sweat Male Adapter and Marvel Adapter



Sweat Male Adapter



Marvel Adapter

- Use on tub spout elbow or closet/urinal stub out adapter

Sweat Male Adapter		
PART NO.	FSWT x MIP	CTN/MSTR
B55001	1/2" x 1/2"	1/1000
B55002	3/4" x 3/4"	1/1000
B55003	1" SJ x 1" SWT	1/1000
Marvel Adapter		
PART NO.	FSWT x MIP	CTN/MSTR
B55004	1 1/4" SJ x 1 1/4" SWT	1/1000
B55005	1 1/2" SJ x 1 1/2" SWT	1/500
B55006	2" SJ x 2" SWT	1/500
B55007	1 1/2" SJ x 1 1/4" SWT	1/500
B55008	1 1/2" SJ x 1 1/2" Tubular	1/500
B55009	1 1/4" SJ x 1 1/4" Tubular	1/500

Assorted Washer Kit



- 210 pieces packaged in reusable plastic case
- Available with flat or beveled washers
- Contains: 40-00, 40-0, 40-1/4, 30-1/4 large, 20-3/8, 20-3/8 medium, 10-3/8 large, 10-1/2 large

PART NO.	DESCRIPTION	CTN/MSTR
J40150	Beveled washer kit	12/24
J40151	Flat washer kit - assorted colors	12/24

O-Ring Kit and Pick



O25200

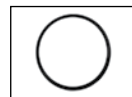

O25199

MADE IN THE USA

- Packed in resealable plastic case with fitting chart on lid
- Manufactured from nitrile compound
- Made in the USA

PART NO.	DESCRIPTION	CTN/MSTR
O25200	200 pc plumbers pack	12/24
O25199	O-ring pick	1/25

Solid Brass Bibb Screw Assortment Kit



- 208 pieces packaged in reusable plastic case
- Contains: 3/8" x 6-32, 1/2" x 6-32, 3/8" x 8-32, 1/2" x 8-32, 3/8" x 10-24, 1/2" x 6-24, 3/8" x 10-32, 1/2" x 10-32

PART NO.	DESCRIPTION	CTN/MSTR
J40153	Bibb screw assortment	10/40

Faucet Seat Kit



- Reusable compartment box with seat guide on inside cover
- Contains all 36 seats
- Made in the USA

MADE IN THE USA

PART NO.	DESCRIPTION	CTN/MSTR
B40000	144-piece faucet seat kit (36 different parts)	1/4

Items marked with the Jones Stephens logo are "You Need It... We Got It" Items.

Faucet Seats

- All brass
- Made in the USA

MADE IN THE
USA



PART NO.	FITS BRAND/SIZE	CTN/MSTR
B40001	Speakman* 9/16" x 28 x 3/8"	1/100
B40003	Speakman* 7/16" x 27 x 11/32"	1/100
B40002	American Standard* 7/16" x 24 x 13/32"	1/100
B40004	American Standard* 9/16" x 24" x 3/8"	1/100
B40012	American Standard* 1/2" x 20 x 3/8"	1/100
B40013	American Standard* 1/2" x 20 x 7/16"	1/100
B40021	American Standard* 9/16" x 18 x 3/8"	1/100
B40031	American Standard* 1/2" x 20 x 5/8"	1/100
B40005	Price Pfister* 1/2" x 20" x 3/8"	1/100
B40006	Price Pfister* .65" x 18 x 3/8"	1/100
B40007	Briggs*, Republic* 1/2" x 24 x 7/16"	1/100
B40008	Briggs*, Republic* 9/16" x 20 x 3/8"	1/100
B40023	Briggs* 5/8" x 20 x 13/16"	1/100
B40035	Briggs*, Republic* 5/8" x 24 x 7/16"	1/100
B40009	Repal* 9/16" x 28 x 11/32"	1/100
B40010	Eljer* 1/2" x 27 x 1/2"	1/100
B40026	Eljer* 1/2" x 20 x 3/8"	1/100
B40011	Kohler* 1/2" x 27 x 3/8"	1/100
B40028	Kohler* 1/2" x 27 x .318"	1/100
B40027	Kohler* Push-In x .348"	1/100
B40014	Central Brass* 9/16" x 27 x 13/32"	1/100
B40018	Central Brass* 1/2" x 24 x .418"	1/100
B40019	Central Brass* 5/8" x 24 x 23/32"	1/100
B40015	Sterling* 1/2" x 24 x 3/8"	1/100
B40017	Universal* 17/32" x 24 x 3/8"	1/100
B40020	Gerber* 5/8" x 20 x 27/64"	1/100
B40024	Dick Brothers* 1/2" x 27 x 13/32"	1/100
B40025	Indiana Brass* 1/2" x 27 x 13/32"	1/100
B40034	Indiana Brass* 9/16" x 27 x 5/8"	1/100
B40030	Union Brass* 5/8" x 18 x 5/16"	1/100
B40033	Union Brass* 5/8" x 18 x 29/32"	1/100
B40032	Sayco* 1/2" x 20 x 5/16"	1/100
B40036	Steamway* 1/2" x 24 x 11/32"	1/100

* The manufacturers' names are used only to describe whose products the products will fit.

Faucet Hole Cover

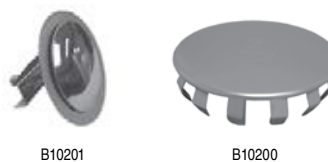

- Stainless steel
- CARTON QUANTITIES ONLY

PART NO.	DESCRIPTION	CTN/MSTR
B10201	1-3/4" OD with washer	25/500
B10202	2" OD with washer	25/500
B10200	1-1/2" snap-in	25/1200

Long Reach Bar Tap Faucet



- 1/4" connection
- 10" meets NSF 61.9
- Can be used with reverse osmosis
- Lead Free

PART NO.	DESCRIPTION	CTN/MSTR
B45014	Long reach bar tap faucet	5/50

Bar Tap Faucet



- Chrome plated brass
- Meets NSF standard 61.9
- 1/4" compression inlet connection
- Individually bagged
- Kit includes: stem, spring, 2 "o" rings and black handle
- Lead Free

PART NO.	DESCRIPTION	CTN/MSTR
B45010	1/4" connection	1/36

Kitchen Hose and Spray (Fit All)



- Reinforced hose with universal coupling adapter
- Individually boxed for display
- Automatic off
- Replacement for thumb controlled sink spray

PART NO.	DESCRIPTION	CTN/MSTR
K52001	Head only	1/200
K52002	Head, hose and adapter	1/50
K52003	4' hose and adapter	1/100
K52004	Hose guide	1/500
K52010	White hose and spray	1/100
K52005	White head only	50/200

Rinse-Quik Hose And Spray



MADE IN THE
USA

- Individually boxed
- Made in the USA

B

Complete Spray Head Assembly Spray Head Pet Sprayer

PART NO.	DESCRIPTION	RQ #	CTN/MSTR
K53001	Black complete spray assembly	(MR4224)	1/50
K53005	White complete spray assembly	(MR-4224WH)	1/50
K53006	Black spray assembly with 1/4" female swivel nut to fit Delta* faucet	(MR422-4C)	1/50
K53002	Black spray head only w/ chrome ring	(MR4-22)	1/100
K53003	4' hose only	(MR-4)	1/50
K53004	Hose guide	(MR-200)	1/10
K53007	Replacement hose for Delta*	(MR4C)	1/100
K53008	White spray head only w/ chrome ring	(MR422WH)	1/100
K53056	Black spray head with black ring	(MR427)	1/100
K53057	White spray head assembly	(MR4274WH)	1/100
K53058	White spray head with white ring	(MR427WH)	1/100
K53055	Black spray head assembly	(MR42474)	1
K53077	Black spray head assembly with 6' hose	-	1
K53060	Pet sprayer (off-white)	(MR421)	1

* The manufacturers' names are used only to describe whose products the products will fit.

Delta* Style Spray Assembly



- 4' hose and 1/4" female swivel nut
- Replaces Delta* style thumb-controlled sink sprays and hoses

PART NO.	DESCRIPTION	CTN/MSTR
K55006	Spray assembly	1/50
K55007	Replacement hose only	1/50

* The manufacturers' names are used only to describe whose products the products will fit.

Chrome Plated Soap and Lotion Dispenser



- All brass pump
- Large 7 oz. capacity bottle

PART NO.	DESCRIPTION	CTN/MSTR
S08020	Chrome plated dispenser	1/50

Sink Lugs



- Four lugs bagged with screws
- PRICED PER BAG

PART NO.	DESCRIPTION	CTN/MSTR
S58050	Combo clip for counters 5/8"- 1-1/8" thick	1/100
S58052	E-lug for counters 3/8"- 1/2" thick	1/100
S58051	Adjustable clips for counters 3/4"- 2-3/4" thick	1/100
S58053	KT lug with bolt	1/100

Items marked with the Jones Stephens logo are "You Need It... We Got It" Items.

Undermount Sink Installation Kit



- Includes 4 each brackets, brass inserts, washers, bolts and wing nuts
- PRICED PER BAG

PART NO.	DESCRIPTION	CTN/MSTR
S58101	Undermount kit	50/100

Lavatory Legs



- Chrome plated
- Fits vitreous china, steel or cast iron lavatories
- Total length ranges from 31-1/2" to 32-3/4" extended
- Can be cut
- Sold in pairs

PART NO.	DESCRIPTION	CTN/MSTR
L65001	27" legs	1/20

Lavatory and Sink Hangers



• Wall mount

PART NO.	DESCRIPTION	CTN/MSTR
L56020	Cast iron (for cast iron or vitreous china)	1/24
L56026	Pair cast iron hangers (for cast iron or vitreous china)	1/12
L56023	Steel 10" centers (one piece)	50/100
L56024	7" stamped steel lavatory hanger	50/25
L56025	3-way steel lavatory bracket pair	1 pair/25

Adjustable Lavatory Hanger



- Durable cast iron
- Adjusts from 10-1/2" to 16"
- For iron, lugs fit into pockets
- For china, remove side lugs

PART NO.	DESCRIPTION	CTN/MSTR
L56027	Lav hanger	1/14

Economy Replacement Basket Strainer



- ABS post
- Stainless steel basket

PART NO.	DESCRIPTION	CTN/MSTR
B03015	Replacement basket	1/200

Fit-All Basket Strainer



- Stainless steel
- Rubber stopper

PART NO.	DESCRIPTION	CTN/MSTR
B03010	Fit-All strainer	1/200

Duo Basket Strainer



- All stainless steel with zinc locknut
- 4-1/2" diameter to fit 3-1/2" drilling
- Basket with rolled edge

PART NO.	DESCRIPTION	CTN/MSTR
S14001	SS duo strainer	1/50

Flat Top Grid Strainer



- All stainless steel with zinc locknut (less tailpiece)
- 4-1/2" diameter to fit 3-1/2" drilling

PART NO.	DESCRIPTION	CTN/MSTR
S14002	Flat grid strainer	1/24

Snap Lock Basket Strainer



- All stainless steel
- 4-1/2" diameter to fit 3-1/2" drilling
- Ball bearing basket with rolled edge (less tailpiece)

PART NO.	DESCRIPTION	CTN/MSTR
S14005	Snap lock basket strainer with zinc locknut	1/50
S14010	Snap lock basket strainer with brass locknut	1/50

Shallow Cup Duo Basket Strainer



- 4-1/2" diameter to fit 3-1/2" drilling
- All stainless steel with zinc locknut
- Basket with rolled edge (less tailpiece)

PART NO.	DESCRIPTION	CTN/MSTR
S14006	Shallow cup duo strainer	1/50

Chrome Plated Brass Duo Strainer



PART NO.	DESCRIPTION	CTN/MSTR
S14007	CP brass duo strainer	1/25
S14011	Replacement strainer	1/150

Twist and Lock Basket Strainer



- All stainless steel with zinc locknut
- 4-1/2" diameter to fit 3-1/2" drilling
- Screw-in basket (less tailpiece)

PART NO.	DESCRIPTION	CTN/MSTR
S14003	Twist and lock basket strainer	1/50
S14103	Twist and lock replacement basket	1/200

Deep Cup Basket Strainer



- All stainless steel with zinc locknut
- 4-1/2" diameter to fit 3-1/2" drilling
- Basket with rolled edge (less tailpiece)

PART NO.	DESCRIPTION	CTN/MSTR
S14004	Deep cup basket strainer	1/50

Quick Fit Stainless Steel Basket Strainer



- Durable stainless construction with brass nut
- Minimizes installation time
- Triangle frame mounts to underside
- Fits virtually all sinks
- For replacement basket use B03015

PART NO.	DESCRIPTION	CTN/MSTR
S14008	Quick fit basket strainer	1/50

Chrome Plated ASAP Basket Strainer



- Durable stainless construction with brass slip nut
- Ideal for quick installation
- Can be installed in less than one minute
- Galvanized retaining ring
- Galvanized locking ring

PART NO.	DESCRIPTION	CTN/MSTR
S14009	ASAP basket strainer vbc cc c cccc c	1/24

Chrome Plated Brass Duo Basket Strainer



- Chrome plated brass body with stainless steel basket
- Heavy Duty construction
- Neoprene stopper

PART NO.	DESCRIPTION	CTN/MSTR
S14250	CP brass duo basket strainer	1/50

Stainless Steel Duo Basket Strainer



- Stainless steel body and basket
- Chrome plated zinc post and slip nut
- Polished inner cup
- Heavy duty rubber gasket and zinc locknut

PART NO.	DESCRIPTION	CTN/MSTR
S14251	SS duo post style basket strainer	1/50

Stainless Steel Basket Strainer



- Stainless steel body and locknut
- Neoprene stopper
- Spring style snap-in basket
- Compares to DB 14

PART NO.	DESCRIPTION	CTN/MSTR
S14014	SS cup basket strainer	1/50

Stainless Steel Duo Basket Strainer



- Stainless steel body and locknut
- Neoprene stopper
- Spring style snap-in basket

PART NO.	DESCRIPTION	CTN/MSTR
S14606	SS duo basket strainer	1/50

ABS Body and Post Basket Strainer



- Plastic nut

PART NO.	DESCRIPTION	CTN/MSTR
S14030	ABS body and post basket strainer	1/50

Items marked with the Jones Stephens logo are "You Need It...We Got It" Items.

Deep Junior Duo Basket Strainer



B02102



B02103

- For 2" and 2-1/2" deep outlets and bar sinks

PART NO.	DESCRIPTION	CTN/MSTR
B02102	2" deep basket strainer	1/100
B02103	Replacement strainer	1/250

Junior Duo Basket Strainer



B02050



B02049

- Stainless steel body and basket with die cast locknut; 1-1/2" threads
- Complete with washers
- Fits 1-3/4" bar sink

PART NO.	DESCRIPTION	CTN/MSTR
B02050	Junior duo strainer	1/100
B02049	Replacement basket	100/500

Flat Duplex Strainer



- Stainless steel body and strainer with die cast locknut
- Complete with washers
- Fits 1-3/4" bar sink

PART NO.	DESCRIPTION	CTN/MSTR
B02052	Flat duplex strainer	1/100

Cast Brass Beehive Urinal Strainer



- Chrome plated brass strainer and body
- Brass locknut
- 2" caulk connection

PART NO.	DESCRIPTION	CTN/MSTR
D45000	Cast brass beehive urinal strainer	1/30
D45001	Replacement top with screws for D45000	1/100

Flexible Hair Strainer



- Soft rubber flexible strainer fits neatly over drain

PART NO.	DESCRIPTION	CTN/MSTR
P35180	Flexible hair strainer	1/1000

1" Brass Bar Plug



- Cast brass
- Includes ground seat plug

PART NO.	DESCRIPTION	CTN/MSTR
B02060	1" x 3" bar plug	1/50

Tray Plug



- Stainless steel body with die cast locknut
- Fits 1-1/2" bar sink
- Complete with washers and stoppers

PART NO.	DESCRIPTION	CTN/MSTR
B02051	Tray plug	1/100

In-Sink-Erator Rubber Hush Cushion



- Black

PART NO.	DESCRIPTION	CTN/MSTR
P35159	Rubber hush cushion	1/500

Kitchen Sink and Garbage Disposal Stopper



- Vinyl construction
- Flanged to fit all sizes

PART NO.	DESCRIPTION	CTN/MSTR
P35162	Sink stopper	1/50

Garbage Disposal Splash Guard



- Snap-fit reinforced ring
- Fits all disposal brands

PART NO.	DESCRIPTION	CTN/MSTR
P35163	Rubber fit-all splash guard	1/200

Three Prong Drain Protector



- Aluminum

PART NO.	DESCRIPTION	CTN QTY
D18062	1 5/8" drain protector	1/2500
D18063	1 7/8" drain protector	1/500

Sink and Basin Crumb Cup



- Nickel plated brass

PART NO.	DESCRIPTION	CTN/MSTR
P35165	1 1/2" crumb cup with post	1/500
P35166	1" crumb cup	1/1000
P35167	1 3/8" crumb cup	1/160

Items marked with the Jones Stephens logo are "You Need It...We Got It" Items.

Slotted Full Flow Aerators



Male Thread



Female Thread



Dual Thread

- Chrome plated brass
- Non-corrosive mixing chamber
- Individually bagged
- 4.5 gpm
- Lead Free

PART NO.	DESCRIPTION	CTN/MSTR
A01001	15/16"-27 male thread	25/600
A01002	55/64"-27 female thread	25/600
A01003	Dual threads (15/16"-27 male x 55/64"-27 female)	25/2000

Slotted Reduced Flow Aerator



- NSF listed santoprene washer
- 2.2 gpm
- Meets ANSI A-112.18M
- Easily cleaned
- Individually bagged
- Lead Free

PART NO.	DESCRIPTION	CTN/MSTR
A01004	Dual threads (15/16"-27 male x 55/64"-27 female)	25/600

Non-Slotted Full Flow Aerators



Male Thread



Female Thread



Dual Thread

- Individually bagged
- 4.5 GPM
- Lead Free

PART NO.	DESCRIPTION	CTN/MSTR
A01005	15/16"-27 male thread	25/600
A01006	55/64"-27 female thread	25/600
A01007	13/16"-27 male thread	25/600
A01008	3/4"-27 female thread	25/600
A01010	Dual threads (15/16"-27 male x 55/64"-27 female)	25/600

Non-Slotted Reduced Flow Aerators



Male Thread



Female Thread



Dual Thread

- Meets ANSI A-112.18M
- Individually bagged
- Lead Free

PART NO.	DESCRIPTION	CTN/MSTR
A01011	15/16"-27 male thread 2.2 gpm	25/600
A01012	55/64"-27 female thread 2.2 gpm	25/600
A01013	Dual threads 2.2 gpm (15/16"-27 male x 55/64"-27 female)	25/600
A01050	Dual threads 2.0 gpm (15/16"-27 male x 55/64"-27 female)	25/600
A01051	Dual threads 1.5 gpm (15/16"-27 male x 55/64"-27 female)	25/600

Items marked with the Jones Stephens logo are "You Need It... We Got It" Items.

Non-Slotted Reduced Flow Aerator



- Individually bagged
- 0.5 gpm
- Lead Free

PART NO.	DESCRIPTION	CTN/MSTR
A01037	Dual thread (15/16"-27 male x 55/64"-27 female)	25/600

Chicago Style Faucet Aerator



- Individually bagged
- Lead Free

PART NO.	DESCRIPTION	CTN/MSTR
A01062	Non-slotted full flow (55/64"-27 female thread)	1/600

Aerator Six Pack Tubes for Counter Display



- Dual threads are 15/16"-27 male x 55/64"-27 female
- Six aerators per tube; priced per display
- Lead Free

Six Aerators per Tube

PART NO.	DESCRIPTION	CTN/MSTR
A01020	Slotted full flow (A01003)	Tube of 6/200
A01021	Slotted 2.2 gpm (A01004)	Tube of 6/200
A01022	Non-slotted full flow (A01010)	Tube of 6/200
A01023	Non-slotted 2.2 gpm (A01013)	Tube of 6/200
A01061	Non-slotted 2.0 gpm (A01050)	Tube of 6/200

Aerator Counter Display



- Dual threads are 15/16"-27 male x 55/64"-27 female
- 24 tubes per display box, six aerators per tube
- 144 pieces per display; priced per display
- Lead Free

Display

PART NO.	DESCRIPTION	CTN/MSTR
A01015	Slotted full flow (A01003)	1/5
A01016	Slotted 2.2 gpm (A01004)	1/5
A01017	Non-slotted full flow (A01010)	1/5
A01018	Non-slotted 2.2 gpm (A01013)	1/5
A01060	Non-slotted 2.0 gpm (A01050)	1/5

Spring-Flo Faucet Aerator



- Dual thread
- Fully compliant with California AB1953 and Vermont S152
- Lead Free

PART NO.	DESCRIPTION	CTN QTY
A01900	Slotted 2.2 gpm Spring-Flo display	24 tubes of 6
A01901	Slotted 2.2 gpm Spring-Flo	1 tube of 6

Snap Fitting



A01029



A01036

• Aerated

PART NO.	DESCRIPTION	CTN/MSTR
A01029	Dual thread (15/16"-27 male x 55/64"-27 female x aerated snap fitting)	1/300
A01036	Nonplated brass snap coupler x 3/4" GHT for use with A01029 as a quick-disconnect unit	1/300

Swivel Spray Aerator



- Individually bagged
- Brass coupling nut
- Unit reverts to non-splash mode when water is turned off
- 2.2 gpm; 60 psi

PART NO.	DESCRIPTION	CTN/MSTR
A01014	Dual thread (15/16"-27 male x 55/64"-27 female)	12/72

Vandal-Proof Aerators



Male



Female

- Special key wrench included
- Prevents unauthorized removal

PART NO.	DESCRIPTION	CTN QTY
A01024	15/16"-27 male full flow	1/600
A01026	15/16"-27 male 2.0 gpm	1/600
A01027	55/64"-27 female 2.0 gpm	1/25

Faucet Adapters



A01030



A01032

• These parts are not OEM



A01033



A01035

To Fit Delta*, American Standard* Style

PART NO.	DESCRIPTION	CTN/MSTR
A01030	CP brass 15/16"-27 male x 55/64"-27 male threads	1/25
A01031	Plastic 15/16"-27 male x 55/64"-27 male threads	1/300

To Fit Price Pfister*, Kohler* Style

PART NO.	DESCRIPTION	CTN/MSTR
A01032	CP brass female 3/4"-27 x 55/64"-27 male threads	1/300

To Fit Kohler*, Union*, Savoy* Style

PART NO.	DESCRIPTION	CTN/MSTR
A01033	CP brass male 13/16"-27 x 55/64"-27 male threads	1/300
A01034	Plastic male 13/16"-27 x 55/64"-27 male threads	1/500

To Fit Chicago* Style

PART NO.	DESCRIPTION	CTN/MSTR
A01035	CP brass female 13/16"-24 x 55/64"-27 male threads	1/500

* The manufacturers' names are used only to describe whose products the products will fit.

Faucet To Garden Hose Adapters



- Chrome plated brass
- Lead Free

PART NO.	DESCRIPTION	CTN/MSTR
A01040	Dual threads 15/16"-27 male x 55/64"-27 female x 3/4" MGH	1/600
A01041	Dual threads 15/16"-27 male x 55/64"-27 female x 3/4" MGH and 55/64"-27 male	1/600

* The manufacturers' names are used only to describe whose products the products will fit.

Fit-All Replacement Handles



Cross Pattern



Lever Pattern



Acrylic

- Vise grip design allows units to fit all types of stems, including rounded
- Each pair individually bagged

PART NO.	DESCRIPTION	CTN/MSTR
H54001	Cross pattern	5/100
H54002	Lever pattern	5/100
H54003	Acrylic	5/100

Delta*/Peerless* Replacement Handles



H54010



H54011



H54012

- Includes button and screw

PART NO.	DESCRIPTION	CTN/MSTR
H54010	Single layer crystal handle for all lav faucets using 212* ball	1/5
H54011	Single layer crystal handle offset broach for tub and shower valves using 212* ball	1/5
H54012	Single layer crystal tub handle for Scald Guard*	1/5

* The manufacturers' names are used only to describe whose products the products will fit.

Delex*/Peerless* Replacement Handles



H54013



H54014



H54015

- Includes button and screws

PART NO.	DESCRIPTION	CTN/MSTR
H54013	Two chrome plated canopy handles for center set	1/5
H54014	Two crystal handles for center set new style	1/5
H54015	Two crystal handles for wide spread lav and tub and shower valves	1/5

* The manufacturers' names are used only to describe whose products the products will fit.

Mixet* Replacement Handles



H54017



H54018

- Includes screw

PART NO.	DESCRIPTION	CTN/MSTR
H54017	Clear outer handle (MRH-CLR*)	1/5
H54018	Clear inner handle (MTH-CLR*)	1/5

* The manufacturers' names are used only to describe whose products the products will fit.

Valley*/Aqualine*/Eljer*/Sears* Replacement Handles



- New style crystal handle
- Complete with button and screw

PART NO.	DESCRIPTION	CTN/MSTR
H54030	Crystal single handle	1/5

* The manufacturers' names are used only to describe whose products the products will fit.

Moen*/Stanadyne* Replacement Handles



H54025



H54026



H54027



H54028



H54029

- Complete with button and screw
- Teardrop* replaces both round and Teardrop* handles

PART NO.	DESCRIPTION	CTN/MSTR
H54025	Crystal Teardrop* single lav handle shallow broach	1/5
H54026	Crystal Teardrop* single tub handle deep broach	1/5
H54027	Round crystal single lav handle shallow broach	1/5
H54028	Round crystal single tub handle deep broach	1/5
H54029	Chrome plated cap and cover for single handle kitchen faucet	1/5

* The manufacturers' names are used only to describe whose products the products will fit.

Delta*/Peerless* Faucet Index Buttons



H54040



H54041

- Single handle models

PART NO.	DESCRIPTION	CTN/MSTR
H54040	Old style crystal button for lav and tub and shower valve 1" OD	5/35
H54041	New large style crystal button for lav and tub and shower valve 1-1/2" OD	5/35

* The manufacturers' names are used only to describe whose products the products will fit.

Moen*/Stanadyne* Single Handle Replacement Buttons



H54060



H54061

PART NO.	DESCRIPTION	CTN/MSTR
H54060	Button for new style Teardrop* crystal handle	1/5
H54061	Button for round crystal handle lav and tub and shower valve	1/5

* The manufacturers' names are used only to describe whose products the products will fit.

Sure Grip Escutcheons



Low Pattern



Box Pattern



Bell Pattern

- Chrome plated steel
- CARTON QUANTITIES ONLY

Low-Pattern- Copper Tube Size

PART NO.	SIZE	FLANGE OD	CTN QTY
E01375	3/8" CTS (1/2" OD)	2-1/2"	25/2000
E01050	1/2" CTS (5/8" OD)	2-1/2"	25/2000
E01075	3/4" CTS (7/8" OD)	2-1/2"	25/2000
E01100	1" CTS (1-1/8" OD)	2-7/8"	25/2000
E01125	1-1/4" CTS (1-3/8" OD)	2-7/8"	25/1200
E01150	1-1/2" CTS (1-5/8" OD)	2-7/8"	25/1200

Low-Pattern- Iron Pipe Size

PART NO.	SIZE	FLANGE OD	CTN QTY
E02375	3/8" IPS	2-1/2"	25/2000
E02050	1/2" IPS	2-1/2"	25/2000
E02075	3/4" IPS	2-1/2"	25/2000
E02100	1" IPS	2-7/8"	25/1200
E02125	1-1/4" IPS	2-7/8"	25/1200
E02150	1-1/2" IPS	3"	25/1200
E02152	1-1/2" IPS	3-1/2"	25/1200
E02200	2" IPS	3-1/2"	25/1200

Low Pattern- Tubular

PART NO.	SIZE	FLANGE OD	CTN QTY
E03125	1-1/4" Tubular	2-7/8"	25/1200
E03150	1-1/2" Tubular	2-7/8"	25/1200
E03200	2" Tubular	3-1/2"	25/1200

Box Pattern- Tubular

PART NO.	SIZE	FLANGE OD	CTN QTY
E04125	1-1/4" Tubular	3"	5/300
E04150	1-1/2" Tubular	3"	5/300
E04200	2" Tubular	3"	5/300

Box Pattern- Iron Pipe Size

PART NO.	SIZE	FLANGE OD	CTN QTY
E05125	1-1/4" IPS	3"	5/300
E05150	1-1/2" IPS	3"	5/300

Bell Pattern- Iron Pipe Size

PART NO.	SIZE	FLANGE OD	CTN QTY
E06375	3/8" IPS	2-3/8"	25/1000
E06050	1/2" IPS	2-3/8"	25/1000
E06075	3/4" IPS	2-3/8"	25/1000
E06100	1" IPS	3"	25/1000
E06125	1-1/4" IPS	3"	25/1000
E06150	1-1/2" IPS	3"	25/1000

Bell Pattern- Copper Tube Size

PART NO.	SIZE	FLANGE OD	CTN QTY
E07025	1/4" CTS (3/8" OD)	2-3/8"	25/1000
E07375	3/8" CTS (1/2" OD)	2-3/8"	25/1000
E07050	1/2" CTS (5/8" OD)	2-3/8"	25/1000

Bell Pattern- Tubular

PART NO.	SIZE	FLANGE OD	CTN QTY
E08125	1-1/4" OD Tubular	3"	25/1000
E08138	1-3/8" OD Tubular	3"	25/1000
E08150	1-1/2" OD Tubular	3"	25/1000

Ⓢ Items marked with the Jones Stephens logo are "You Need It... We Got It" Items.

Plastic Shallow Flange Escutcheons



- Corrosion-proof, indestructible, high-density polyethylene
- Tight fit
- Low cost
- CARTON QUANTITIES ONLY

B

Copper Tube Size

PART NO.	SIZE	COLOR	CTN QTY
E15375	1/2" OD (3/8" CTS)	White	50 per bag
E15050	5/8" OD (1/2" CTS)	White	50 per bag
E15052	5/8" OD (1/2" CTS)	Almond	50 per bag
E15075	7/8" OD (3/4" CTS)	White	50 per bag

Iron Pipe Size

PART NO.	SIZE	COLOR	CTN QTY
E16375	3/8" IPS	White	50 per bag
E16050	1/2" IPS	White	50 per bag
E16075	3/4" IPS	White	50 per bag
E16150	1-1/2" IPS	White	50 per bag
E16151	1-1/2" IPS	Almond	50 per bag
E16200	2" IPS	White	50 per bag

Tubular

PART NO.	SIZE	COLOR	CTN QTY
E03225	1-1/4" Tubular	White	50 per bag
E03250	1-1/2" Tubular	White	50 per bag

Poly Bagged Escutcheons



- Chrome plated steel
- 50 per bag
- CARTON QUANTITIES ONLY

PART NO.	DESCRIPTION	CTN/MSTR
E01049	1/2" CTS (5/8" O.D.)	500/2000
E01074	3/4" CTS (7/8" O.D.)	50/2000

Floor & Ceiling Plates



- Chrome plated
- Boxed
- CARTON QUANTITIES ONLY

Light 24 Gauge- Copper Tube Size

PART NO.	SIZE	FLANGE OD	CTN QTY
F01375	3/8" CTS (1/2" OD)	2-1/2"	12/576
F01050	1/2" CTS (5/8" OD)	2-5/8"	12/576
F01075	3/4" CTS (7/8" OD)	2-27/32"	12/576
F01100	1" CTS (1-1/8" OD)	3-9/32"	12/576
F01125	1-1/4" CTS (1-3/8" OD)	3-5/8"	12/576
F01150	1-1/2" CTS (1-5/8" OD)	3-15/16"	12/576

Light 24 Gauge- Iron Pipe Size

PART NO.	SIZE	FLANGE OD	CTN QTY
F02375	3/8" IPS	2-1/2"	12/576
F02050	1/2" IPS	2-5/8"	12/576
F02075	3/4" IPS	2-27/32"	12/576
F02100	1" IPS	3-9/32"	12/576
F02125	1-1/4" IPS	3-5/8"	12/576
F02150	1-1/2" IPS	3-15/16"	12/576
F02200	2" IPS	4-3/8"	12/576

Heavy 21 Gauge with Springs- Copper Tube Size

PART NO.	SIZE	FLANGE OD	CTN QTY
F03375	3/8" CTS (1/2" OD)	2-1/8"	12/480
F03050	1/2" CTS (5/8" OD)	2-7/16"	12/480
F03075	3/4" CTS (7/8" OD)	2-21/32"	12/480
F03100	1" CTS (1-1/8" OD)	2-27/32"	12/480
F03125	1-1/4" CTS (1-3/8" OD)	3-9/32"	12/240
F03150	1-1/2" CTS (1-5/8" OD)	3-5/8"	12/240
F03200	2" CTS (2-1/8" OD)	4-3/16"	12/240
F03250	2-1/2" CTS (2-5/8" OD)	4-15/16"	6/240
F03300	3" CTS (3-1/8" OD)	5-3/16"	6/240

Heavy 21 Gauge with Springs- Iron Pipe Size

PART NO.	SIZE	FLANGE OD	CTN QTY
F04375	3/8" IPS	2-1/2"	12/480
F04050	1/2" IPS	2-5/8"	12/480
F04075	3/4" IPS	2-27/32"	12/480
F04100	1" IPS	3-9/32"	12/480
F04125	1-1/4" IPS	3-5/8"	12/240
F04150	1-1/2" IPS	3-15/16"	12/240
F04200	2" IPS	4-3/8"	12/240
F04250	2-1/2" IPS	5-7/32"	6/120
F04300	3" IPS	5-29/32"	6/120
F04350	3-1/2" IPS	6-9/16"	6/120
F04400	4" IPS	7-3/16"	6/120
F04500	5" IPS	8-7/8"	1/60
F04600	6" IPS	10"	1/60
F04800	8" IPS	13"	1/48
F04999	10" IPS	15"	1/48

Flexible Floor and Ceiling Plates



- Chrome plated
- CARTON QUANTITIES ONLY

Chrome Plated Plastic

PART NO.	IPS	CTS	FLANGE OD	CTN/MSTR
F06375	3/8"	1/2"	2.572	12/1080
F06050	1/2"	3/4"	2.787	12/1080
F06075	3/4"	-	2.997	12/1440
F06099	-	1"	3.077	12/1080
F06100	1"	-	3.210	12/1440
F06124	-	1-1/4"	3.308	12/1440
F06125	1-1/4"	1-1/2"	3.580	12/1200
F06150	1-1/2"	-	3.900	12/1200
F06200	2"	-	4.450	12/720
F06201	-	2"	4.205	12/720
F06250	2-1/2"	-	5.313	12/600
F06251	-	2-1/2"	4.688	12/600
F06300	3"	-	5.875	12/480
F06301	-	3"	5.375	12/240
F06351	-	3-1/2"	5.875	12/240
F06400	4"	-	6.781	12/240
F06401	-	4"	6.344	12/240
F06500	5"	-	8.531	6/240
F06600	6"	-	9.688	6/120
F06800	8"	-	13.000	6/96

White Plastic

PART NO.	IPS	CTS	FLANGE OD	CTN/MSTR
F07375	3/8"	1/2"	2.572	12/1080
F07050	1/2"	3/4"	2.787	12/1080
F07075	3/4"	-	2.997	12/1440
F07099	-	1"	3.077	12/1080
F07100	1"	-	3.210	12/1440
F07124	-	1-1/4"	3.308	12/1440
F07125	1-1/4"	1-1/2"	3.580	12/1200
F07150	1-1/2"	-	3.900	12/1200
F07200	2"	-	4.450	12/720
F07201	-	2"	4.205	12/720
F07300	3"	-	5.825	12/480

Sewer Relief Valve and Cleanout

- Releases waste to outside of buildings in the event of sewer line blockage, preventing costly damage due to sewage backflow or overflow.
- Applicable in residential, commercial, or industrial settings- any structure connected to sewer lines or septic tanks
- Patent #4,475,571
- Meets ASTM specifications
- Automatic unlock and re-lock
- Vandal- resistant
- Safe in yard or high traffic areas
- Solvent welds over 4" Schedule 40 DWV pipe
- Removable lid provides full access to cleanout
- May be used to replace existing exterior cleanouts
- Easily adaptable to new or existing sewer lines
- Water and waste swirl in bowl until blockage is cleared

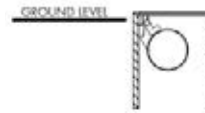

Locked in Normal Position

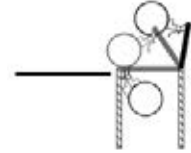

Opens When Overflow Occurs

PART NO.	DESCRIPTION	CTN QTY
S62100	PVC sewer relief valve	1
S62101	ABS sewer relief valve	1

Sewer Stopper/ Backflow Preventer



- Use inside drain line to help guard against backups
- Creates seal in pipe to reduce sewer gases
- Secures into place with set screws
- Compression fit

PART NO.	DESCRIPTION	MATERIAL	CTN/MSTR
S63200	2" sewer stopper	ZP Steel	1/100
S63300	3" sewer stopper	Brass	1/80
S63400	4" sewer stopper	Brass	1/60

Got To Have It!

Sewer Popper™ Cleanout and Relief Valve

- Automatic pop-up releases sewage overflow outside the house
- Prevents thousands of dollars in property damages
- Eliminates health hazards associated with sewage overflow
- Vandal- and tamper-resistant center
- Threaded for 3" or 4" pipe or tapped together
- Constructed of white PVC
- Threaded unit can be used with PVC or ABS tapped together
- For cast iron pipe, use standard no hub clamp
- Meets Southern Building Code Section 301.10, Principle No.10
- Patent No. 5,209,257

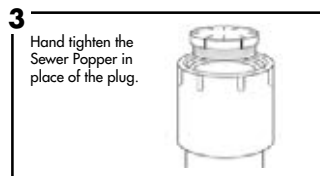
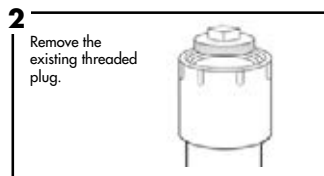
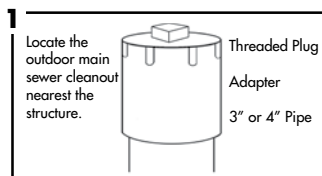

PART NO.	DESCRIPTION	CTN/MSTR
S62304	3"x 4" Sewer Popper™	1/6

Items marked with the Jones Stephens logo are "You Need It...We Got It" Items.

Cover Plates

- Mirrored acrylic
- Conceals damaged/cracked tiles
- Fits all standard bath/shower fittings
- No tools required- use silicone caulk
- DO NOT use abrasive cleaners



B

T73001

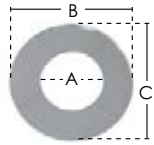

A	B	C	THICKNESS
1-11/16"	3-1/2"	3-1/2"	1/8"

T73002

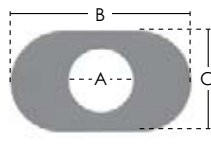

A	B	C	THICKNESS
5"	14"	8"	1/8"

T73003

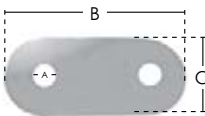

A	B	C	THICKNESS
1-3/4"	14"	6"	1/8"

T73004

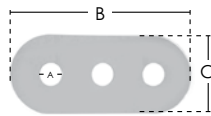

A	B	C	THICKNESS
1-3/4"	14"	6"	1/8"

PART NO.	DESCRIPTION	SIZE	CTN/MSTR
T73001	Tub spout model	3-1/2" diameter	1/300
T73002	One handle model	8" x 14"	1/100
T73003	Two handle model	6" x 14"	1/40
T73004	Three handle model	6" x 14"	1/36

Stainless Steel Repair Cover Plates



- Polished stainless steel finish
- 1, 2 or 3 hole design to fit multitude of valves
- Easily attaches with silicone caulk; 1-hole has brackets and screw
- 7-1/4" x 13" long

PART NO.	# OF HOLES	DIAMETER	CTN/MSTR
T73815	1	5-1/8"	20/40
T73816	2	1-3/8"	20/40
T73817	3	1-3/8"	20/40
T73818	1	3-3/4"	20/40

Items marked with the Jones Stephens logo are "You Need It...We Got It" Items.

Flexible Stainless Steel Plumbing Connectors



- Reliable, trouble-free service Inner core of non-toxic polymer withstands temperatures of 33°F (1°C) to 174°F (99°C)
- Leak proof seal- High quality outer braid of stainless steel and exclusive crimp-on fittings for maximum performance
- Quick and easy installation- No special tools; no soldering
- No pipe bending- Flexible connectors simplify installation, even in cramped spaces
- Chrome plated nut
- UPC listed
- Lead Free

Faucet

PART NO.	OD x FIP	LENGTH	CTN/MSTR
S04200	3/8" x 1/2"	9	25/100
S04201	3/8" x 1/2"	12	25/100
S04202	3/8" x 1/2"	16	25/100
S04203	3/8" x 1/2"	20	25/100
S04204	3/8" x 1/2"	30	25/50
S04205	3/8" x 1/2"	36	25/100
S04206	1/2" x 1/2"	12	25/100
S04207	1/2" x 1/2"	16	25/100
S04208	1/2" x 1/2"	20	25/100
S04209	1/2" x 1/2"	30	25/50
S04210	1/2" x 1/2"	36	25/100

Faucet

PART NO.	FIP x FIP	LENGTH	CTN/MSTR
S04211	1/2" x 1/2"	12	25/100
S04212	1/2" x 1/2"	16	25/175
S04213	1/2" x 1/2"	20	25/100
S04214	1/2" x 1/2"	30	25/50
S04215	1/2" x 1/2"	36	25/50

Flexible Stainless Steel Plumbing Connectors



- Reliable, trouble-free service Inner core of non-toxic polymer withstands temperatures of 33°F (1°C) to 174°F (99°C)
- Leak proof seal- High quality outer braid of stainless steel and exclusive crimp-on fittings for maximum performance
- Quick and easy installation- No special tools; no soldering
- No pipe bending- Flexible connectors simplify installation, even in cramped spaces
- UPC listed
- Lead Free

Ballcock

PART NO.	OD x BC	LENGTH	CTN QTY
S04216	3/8" x 7/8"	9	25/100
S04217	3/8" x 7/8"	12	25/100
S04218	3/8" x 7/8"	16	25/100
S04219	3/8" x 7/8"	20	25/100
S04220	1/2" x 7/8"	9	25/100
S04221	1/2" x 7/8"	12	25/100
S04222	1/2" x 7/8"	16	25/100
S04223	1/2" x 7/8"	20	25/100
S04255	3/8" x 7/8" w/ brass nut	12	25/100

Ballcock

PART NO.	FIP x BC	LENGTH	CTN QTY
S04224	1/2" x 7/8"	9	25/100
S04225	1/2" x 7/8"	12	25/100
S04226	1/2" x 7/8"	20	25/100

Ballcock

PART NO.	FLARE x BC	LENGTH	CTN QTY
S04280	1/2" x 7/8"	20	25/100
S04285	3/8" x 7/8"	20	25/50

Washing Machine

PART NO.	FEM HOSE x FEM HOSE	LENGTH	CTN QTY
S04227	3/4" x 3/4"	48	5/50
S04228	3/4" x 3/4"	60	5/175
S04229	3/4" x 3/4"	72	5/50

Icemaker

PART NO.	OD x OD	LENGTH	CTN QTY
S04230	1/4" x 1/4"	12	5/50
S04231	1/4" x 1/4"	60	5/50
S04232	1/4" x 1/4"	84	5/50

Items marked with the Jones Stephens logo are "You Need It...We Got It" Items.

Flexible Stainless Steel Plumbing Connectors



- Reliable, trouble-free service Inner core of non-toxic polymer withstands temperatures of 33°F (1°C) to 174°F (81°C); burst pressure 1,000 PSI
- Leak proof seal- High quality outer braid of stainless steel and exclusive crimp-on fittings for maximum performance
- Quick and easy installation- No special tools; no soldering
- No pipe bending- Flexible connectors simplify installation, even in cramped spaces
- Chrome plated nut
- UPC listed
- Lead Free

Dishwasher with 90° Elbow

PART NO.	OD x MIP	LENGTH	CTN/MSTR
S04233	3/8" x 3/8"	48	25/50
S04234	3/8" x 3/8"	60	25/50
S04235	3/8" x 3/8"	72	25/50
S04237	1/2" x 3/8"	60	25/50
S04238	1/2" x 3/8"	72	25/50

Dishwasher

PART NO.	OD x OD	LENGTH	CTN/MSTR
S04236	1/2" x 3/8"	48	25/50
S04260	3/8" x 3/8"	48	25/50
S04268	3/8" x 3/8"	12	25/100
S04269	3/8" x 3/8"	16	25/100
S04270	3/8" x 3/8"	20	25/100

SS "Delta" Style Faucet

PART NO.	OD x COMP FITTING	LENGTH	CTN/MSTR
S04239	3/8" x 3/8"	9	25/100
S04240	3/8" x 3/8"	12	25/100
S04241	3/8" x 3/8"	16	25/100
S04242	3/8" x 3/8"	20	25/100
S04243	3/8" x 3/8"	30	25/50
S04244	3/8" x 3/8"	36	25/100

Texas Style Faucet

PART NO.	FL x OD	LENGTH	CTN/MSTR
S04245	3/8" x 3/8"	9	25/100
S04246	3/8" x 3/8"	12	25/100
S04247	3/8" x 3/8"	16	25/100
S04248	3/8" x 3/8"	20	25/100
S04249	3/8" x 3/8"	30	25/50
S04250	3/8" x 3/8"	36	25/100

Stainless Steel Dishwasher Connection with Garden Hose Fitting and 90° Elbow



- Use to connect Whirlpool*, Maytag*, Amana*, Kitchen Aid* and Jenn-Air* dishwashers manufactured after September 2009

PART NO.	DESCRIPTION	CTN QTY
S04275	3/8" OD x 3/8" MIP x 60"	1
S04276	3/8" OD x 3/8" MIP x 72"	1
G20086LF	Garden Hose Ftg & 90 only - 3/4" FGHT x 3/8" OD Comp	1

* The manufacturers' names are used only to describe whose products the products will fit.

Braided Nylon Plumbing Connectors



- Reliable, economy style connectors
- Temperature rated 173° (82°C)
- Burst pressure is 450 PSI
- Chrome plated nut
- UPC listed
- Lead Free

Faucet

PART NO.	OD x FIP	LENGTH	CTN/MSTR
S04400	3/8" x 1/2"	9	25/100
S04401	3/8" x 1/2"	12	25/100
S04402	3/8" x 1/2"	16	25/100
S04403	3/8" x 1/2"	20	25/100
S04404	3/8" x 1/2"	30	25/50
S04405	1/2" x 1/2"	12	25/100
S04406	1/2" x 1/2"	16	25/100
S04407	1/2" x 1/2"	20	25/150
S04408	1/2" x 1/2"	30	25/100

Faucet

PART NO.	FIP x FIP	LENGTH	CTN/MSTR
S04409	1/2" x 1/2"	12	25/100
S04410	1/2" x 1/2"	16	25/100
S04411	1/2" x 1/2"	20	25/100
S04440	1/2" x 1/2"	36	25/100

Faucet

PART NO.	COMP x FIP	LENGTH	CTN/MSTR
S04450	3/8" x 1/2"	24	25/100
S04455	3/8" x 1/2"	36	25/50

Delta

PART NO.	OD x COMP FITTING	LENGTH	CTN/MSTR
S04412	3/8" x 3/8"	12	25/100
S04413	3/8" x 3/8"	20	25/100

Toilet

PART NO.	OD x BC	LENGTH	CTN/MSTR
S04414	3/8" x 7/8"	9	25/100
S04415	3/8" x 7/8"	12	25/100
S04416	3/8" x 7/8"	16	25/100
S04417	3/8" x 7/8"	20	25/100
S04418	1/2" x 7/8"	9	25/100
S04419	1/2" x 7/8"	12	25/200
S04420	1/2" x 7/8"	16	25/100
S04421	1/2" x 7/8"	20	25/100

Toilet

PART NO.	FIP x BC	LENGTH	CTN/MSTR
S04422	1/2" x 7/8"	9	25/100
S04423	1/2" x 7/8"	12	25/100
S04424	1/2" x 7/8"	20	25/100

Dishwasher with 90° Elbow

PART NO.	OD x MIP	LENGTH	CTN/MSTR
S04430	3/8" x 3/8"	72	10/40

PEX Supply Tube (3/8" OD)



- Rated 100 psi at 180°F
- Resistant to corrosion and damage due to freezing
- NSF listed material

PART NO.	DESCRIPTION	CTN/MSTR
S04101	3/8" x 12" Basin	10/325
S04102	3/8" x 15" Basin	10/250
S04103	3/8" x 20" Basin	10/150
S04104	3/8" x 30" Basin	10/200
S04108	3/8" x 36" Basin	10/200
S04105	3/8" x 12" Tank	10/300
S04106	3/8" x 15" Tank	10/250
S04107	3/8" x 20" Tank	10/175

PEX Supply Tube with Ferrule



- Supplied with ferrule (3/8" compression sleeve)
- Rated 100 PSI at 180°
- NSF listed material

PART NO.	DESCRIPTION	CTN/MSTR
S04121	3/8" x 12 Basin	10/100
S04123	3/8" x 20 Basin	10/100
S04124	3/8" x 30 Basin	10/100
S04128	3/8" x 36 Basin	10/100
S04125	3/8" x 12 Tank	10/100
S04127	3/8" x 20 Tank	10/100

Chrome Plated Flexible Basin Supply Tube



- Lead Free

PART NO.	DESCRIPTION	CTN/MSTR
S04020	3/8" x 12" Basin	1/500
S04021	3/8" x 16" Basin	1/400
S04022	3/8" x 20" Basin	1/300
S04023	3/8" x 30" Basin	1/200
S04024	3/8" x 36" Basin	1/200
S04025	1/2" x 12" Basin	1/200
S04026	1/2" x 20" Basin	1/200

Chrome Plated Flexible Supply Tube with Rubber Nose



- Chrome plated
- With rubber nose
- Lead Free

PART NO.	DESCRIPTION	CTN/MSTR
S04027	3/8" x 12" Tank	1/500
S04028	3/8" x 16" Tank	1/300
S04029	3/8" x 20" Tank	1/300
S04030	1/2" x 12" Tank	1/50



- Chrome plated
- With rubber nose cone
- Lead Free

PART NO.	DESCRIPTION	CTN/MSTR
S04031	3/8" x 12" Basin	1/100
S04032	3/8" x 20" Basin	1/100

Items marked with the Jones Stephens logo are "You Need It...We Got It" Items.

Chrome Plated Brass Multi-Turn Supply Stop



- cUPC listed
- Lead Free

PART NO.	DESCRIPTION	CTN QTY
S10338	3/8 FIP x 3/8 OD Angle	1/200
S10321	1/2 FIP x 1/4 OD Angle	1/200
S10300	1/2 FIP x 3/8 OD Angle	1/200
S10302	1/2 FIP x 3/8 OD Straight	1/200
S10323	3/8 OD x 3/8 OD Straight	1/200
S10324	5/8 OD x 1/4 OD Angle	1/200
S10301	5/8 OD x 3/8 OD Angle	1/200
S10303	5/8 OD x 3/8 OD Straight	1/200
S10316	5/8 OD x 1/2 OD Straight	1/200
S10325	1/2 Sweat x 3/8 OD Angle	1/200
S10326	1/2 Sweat x 3/8 OD Straight	1/200
S10335	1/2 PEX x 1/4 OD Angle	1/200
S10318	1/2 PEX x 3/8 OD Angle	1/200
S10337	1/2 PEX x 3/8 OD Straight	1/200
S10319	1/2 CPVC x 3/8 OD Straight	1/200
S10320	1/2 CPVC x 3/8 OD Angle	1/200

Chrome Plated Brass Quarter Turn Supply Stop



- cUPC listed
- Lead Free

PART NO.	DESCRIPTION	CTN QTY
S10339	3/8 FIP x 3/8 OD Angle	24/144
S10327	3/8 FIP x 3/8 OD Straight	1/200
S10328	1/2 FIP x 1/4 OD Angle	1/200
S10310	1/2 FIP x 3/8 OD Angle	1/200
S10312	1/2 FIP x 3/8 OD Straight	1/200
S10330	3/8 OD x 3/8 OD Straight	1/200
S10317	5/8 OD x 1/4 OD Angle	1/200
S10311	5/8 OD x 3/8 OD Angle	1/200
S10313	5/8 OD x 3/8 OD Straight	1/200
S10331	1/2 Sweat x 3/8 OD Angle	1/200
S10332	1/2 Sweat x 3/8 OD Straight	1/200
S10333	5/8 OD x 3/8 OD x 3/8 OD Dual	1/200
S10334	5/8 OD x 3/8 OD x 1/4 OD Dual	1/200
S10336	1/2 PEX x 1/4 OD Angle	1/150
S10314	1/2 PEX x 3/8 OD Angle	1/144
S10315	1/2 PEX x 3/8 OD Straight	1/144
S10340	1/2 x 3/8 OD Angle Wirsbo® style	25/200
S10341	1/2 x 3/8 OD Straight Wirsbo® style	25/200

Chrome Plated Brass Easy Connect Tee



- Brass
- Attaches to outlet of stop valve to give you 2 outlets
- Lead Free

PART NO.	DESCRIPTION	CTN/MSTR
C74250LF	3/8" F Comp x 3/8" M Comp x 3/8" M Comp	5/25
C74251LF	3/8" F Comp x 3/8" M Comp x 1/4" M Comp	5/25

Chrome Plated Quarter Turn Repair Stop Valve



- Attach to outlet of broken valve to give you another valve
- AB1953 compliant
- Lead Free

PART NO.	DESCRIPTION	CTN/MSTR
S10355	3/8" F Comp x 3/8" M Comp x 3/8" M Comp	5/25

Drinking Fountain Bubbler and Cartridge



- Chrome plated brass body
- 3/8" FIP connection
- Stainless steel cartridge
- Lead Free

PART NO.	DESCRIPTION	CTN/MSTR
B45215	CP brass bubbler with stainless steel cartridge	1/40
B45216	Stainless steel replacement cartridge	100/500

Drinking Fountain Bubbler with Face Guard



Flexible Water Shield

- Chrome plated brass body
- Equipped with unique neo-poly water shield to prevent injuries to teeth, gums and face
- Tamper proof design requires 5/16" hex key to remove/ replace water shield for cleaning
- B45218 Kit includes new water shield, washer, and retainer nut
- Lead Free

PART NO.	DESCRIPTION	CTN/MSTR
B45216	Stainless steel replacement cartridge	100/500
B45217	Chrome plated brass bubbler	1/40
B45218	Polymer water shield kit	1/120

Self-Closing Drinking Fountain



- Chrome plated brass
- Mildew resistant
- Perfect for schools
- Stainless steel cartridge
- 1/2" Female pipe threads
- Lead Free

PART NO.	DESCRIPTION	CTN/MSTR
B45200	Drinking fountain	1/25

Retrofit Bubbler Kit



- Replaces fountain on china fixtures
- Contains bubbler 1/2" x 3/8" x 3 1/2" nipple, rosette flange, locknut, coupling nut and 1 3/4" faucet cover
- All metal
- Lead Free

PART NO.	DESCRIPTION	CTN/MSTR
B45220	Drinking fountain	1/20

Cross Handle Self Closing Valve



- Chrome plated
- Heavy brass construction

PART NO.	DESCRIPTION	CTN/MSTR
S05105	1/2" FIP self closing valve	25/50

Chrome Plated Single Sink Bibb



- Chrome plated bodies and tee handles
- Replaceable washers

PART NO.	INLET	FLANGE	CTN/MSTR
S08003	1/2" FIP	Fixed (3/4" hose outlet)	12/72

Wall Mount Sink Faucet



- Chrome plated with soap dish mounted on body
- 8" center to center
- Adjustable 1/2" female threaded eccentric couplings
- Replaceable seats and stems
- Meets NSF standard 61.9
- Lead Free

PART NO.	DESCRIPTION	CTN/MSTR
S08008	8" tubular spout	1/12
S08012	12" tubular spout	1/12
S08030	Hot repair kit (handle, stem and seat)	1/100
S08031	Cold repair kit (handle, stem and seat)	1/100
S08032	Union repair kit (union assembly)	1/50

Lead Free

PART NO.	DESCRIPTION	CTN/MSTR
S08018	8" tubular spout - Lead Free	1/20

Laundry Tray Faucet



A01006

- Supplied with garden hose adapter and A01006 aerator
- Can be used either way with either adapter or aerator
- Meets Detroit Code
- Lead Free

PART NO.	DESCRIPTION	CTN/MSTR
L47001	Chrome laundry tray faucet	1/24
L47004	With gooseneck spout	1/24

Basin Faucet



Heavy Pattern



Standard Pattern

- Chrome plated
- Replaceable seats and stems
- Furnished with hot and cold buttons
- Meets NSF standard 61.9
- Lead Free

PART NO.	DESCRIPTION	CTN/MSTR
F39001	Heavy pattern with aerator	1/30
F39002	Standard pattern	1/50
F39004	Repair kit for F39002 series (Handle, seat, stem and buttons)	1/100
F39005	Repair kit for F39001 series (Handles, seat, stem and buttons)	1/150

Self-Closing Basin Faucet and Shower Valve



Self-Closing Basin Faucet



Shower Valve with Pull Chain

- Chrome plated heavy duty pattern
- Deluxe aerator
- 1/2" FIP connection
- Replaceable stem, cam and spring mechanism
- Shower valves ideal for urinals when used with standpipe assembly

PART NO.	DESCRIPTION	CTN/MSTR
F39010	Basin Faucet	1/36
S05100	Shower valve with pull chain (7" chain)	1/50
S05102	Standpipe assembly for urinal with escutcheon	1/100
S05101	Repair kit (stem and cam mechanism)	1/10

Items marked with the Jones Stephens logo are "You Need It... We Got It" Items.

Service Sink Faucets

B



Lever Handles



Cross Handles



S55352

- Integral stops; 1/4 turn for S55349
- Complete with all mounting hardware
- Integrated vacuum breaker (ASSE 1001)
- Front hook to hang bucket

PART NO.	DESCRIPTION	CTN/MSTR
S55349	Service sink faucet with lever handles	1/8
S55350	Service sink faucet with cross handles	1/6
S55351	Hot and cold cross handle stem repair kit for S55350	1/100
S55352	Lever handle and stem repair kit S55349	1/50
S55353	Integral stop repair kit for S55350	1/100
S55354	Vacuum breaker repair kit for S55350	1/100

Hose and Hose Bracket for Service Sink



- Heavy duty 300 PSI cloth-reinforced hose
- 3/4" brass hose coupling at one end
- 5" x 3" stainless steel bracket with rubber grips

PART NO.	DESCRIPTION	CTN/MSTR
M05001	30" hose with bracket	1
M05005	Bracket only	1/100

Mop Hanger for Service Sink

- 24" x 3" stainless steel hanger with three rubber tool grips
- Anchors included



PART NO.	DESCRIPTION	CTN/MSTR
M05003	Mop hanger	1/25

3/8" OD Uncoated with Fittings



- Durable stainless steel 304
- Corrugation extends all the way to the fitting for increased tubing flexibility
- CSA Design certified domestically and internationally for indoor and outdoor use
- 100% leak tested to ensure safety and quality and a product you can trust
- Quality flared end fittings to create a metal to metal seal in critical applications
- Corrosion resistant

B

PART NO.	DESCRIPTION	CTN QTY
G70000	1/2" MIP x 1/2" MIP x 12"	1/25
G70001	1/2" FIP x 1/2" FIP x 12"	1/25
G70002	3/8" FIP x 3/8" FIP x 12"	1/25
G70003	1/2" FIP x 1/2" MIP x 12"	1/25
G70004	1/2" FIP x 3/8" MIP x 12"	1/25
G70005	3/8" FIP x 1/2" MIP x 12"	1/25
G70006	3/8" FIP x 3/8" MIP x 12"	1/25
G70007	1/2" MIP x 1/2" MIP x 18"	1/25
G70008	1/2" FIP x 1/2" FIP x 18"	1/25
G70009	3/8" FIP x 3/8" FIP x 18"	1/25
G70010	1/2" FIP x 1/2" MIP x 18"	1/25
G70011	1/2" FIP x 3/8" MIP x 18"	1/25
G70012	3/8" FIP x 1/2" MIP x 18"	1/25
G70013	3/8" FIP x 3/8" MIP x 18"	1/25
G70014	1/2" MIP x 1/2" MIP x 24"	1/25
G70015	1/2" FIP x 1/2" FIP x 24"	1/25
G70016	3/8" FIP x 3/8" FIP x 24"	1/25
G70017	1/2" FIP x 1/2" MIP x 24"	1/25
G70018	1/2" FIP x 3/8" MIP x 24"	1/25
G70019	3/8" FIP x 1/2" MIP x 24"	1/25
G70020	3/8" FIP x 3/8" MIP x 24"	1/25
G70021	1/2" MIP x 1/2" MIP x 30"	1/25
G70022	1/2" FIP x 1/2" FIP x 30"	1/25
G70023	3/8" FIP x 3/8" FIP x 30"	1/25
G70024	1/2" FIP x 1/2" MIP x 30"	1/25
G70025	1/2" FIP x 3/8" MIP x 30"	1/25
G70026	3/8" FIP x 1/2" MIP x 30"	1/25
G70027	3/8" FIP x 3/8" MIP x 30"	1/25
G70028	1/2" MIP x 1/2" MIP x 36"	1/25
G70029	1/2" FIP x 1/2" FIP x 36"	1/25
G70030	3/8" FIP x 3/8" FIP x 36"	1/25
G70031	1/2" FIP x 1/2" MIP x 36"	1/25
G70032	1/2" FIP x 3/8" MIP x 36"	1/25
G70033	3/8" FIP x 1/2" MIP x 36"	1/25
G70034	3/8" FIP x 3/8" MIP x 36"	1/25
G70035	1/2" MIP x 1/2" MIP x 48"	1/25
G70036	1/2" FIP x 1/2" FIP x 48"	1/25
G70037	3/8" FIP x 3/8" FIP x 48"	1/25
G70038	1/2" FIP x 1/2" MIP x 48"	1/25
G70039	1/2" FIP x 3/8" MIP x 48"	1/25
G70040	3/8" FIP x 1/2" MIP x 48"	1/25
G70041	3/8" FIP x 3/8" MIP x 48"	1/25
G70042	1/2" MIP x 1/2" MIP x 60"	1/25
G70043	1/2" FIP x 1/2" FIP x 60"	1/25
G70044	3/8" FIP x 3/8" FIP x 60"	1/25
G70045	1/2" FIP x 1/2" MIP x 60"	1/25

3/8" OD Uncoated with Fittings (cont.)



- Durable stainless steel 304
- Corrugation extends all the way to the fitting for increased tubing flexibility
- CSA Design certified domestically and internationally for indoor and outdoor use
- 100% leak tested to ensure safety and quality and a product you can trust
- Quality flared end fittings to create a metal to metal seal in critical applications
- Corrosion resistant

PART NO.	DESCRIPTION	CTN QTY
G70046	1/2" FIP x 3/8" MIP x 60"	1/25
G70047	3/8" FIP x 1/2" MIP x 60"	1/25
G70048	3/8" FIP x 3/8" MIP x 60"	1/25
G70049	1/2" MIP x 1/2" MIP x 72"	1/25
G70050	1/2" FIP x 1/2" FIP x 72"	1/25
G70051	3/8" FIP x 3/8" FIP x 72"	1/25
G70052	1/2" FIP x 1/2" MIP x 72"	1/25
G70053	1/2" FIP x 3/8" MIP x 72"	1/25
G70054	3/8" FIP x 1/2" MIP x 72"	1/25
G70055	3/8" FIP x 3/8" MIP x 72"	1/25

3/8" OD Yellow Coated with Fittings



- Durable stainless steel 304
- Corrugation extends all the way to the fitting for increased tubing flexibility
- CSA Design certified domestically and internationally for indoor and outdoor use
- 100% leak tested to ensure safety and quality and a product you can trust
- Quality flared end fittings to create a metal to metal seal in critical applications
- Coated connectors add additional safety in highly corrosive environments or in areas where caustic chemicals are located
- Corrosion resistant

PART NO.	DESCRIPTION	CTN QTY
G70100	1/2" MIP x 1/2" MIP x 12"	1/25
G70101	1/2" FIP x 1/2" FIP x 12"	1/25
G70102	3/8" FIP x 3/8" FIP x 12"	1/25
G70103	1/2" FIP x 1/2" MIP x 12"	1/25
G70104	1/2" FIP x 3/8" MIP x 12"	1/25
G70105	3/8" FIP x 1/2" MIP x 12"	1/25
G70106	3/8" FIP x 3/8" MIP x 12"	1/25
G70107	1/2" MIP x 1/2" MIP x 18"	1/25
G70108	1/2" FIP x 1/2" FIP x 18"	1/25
G70109	3/8" FIP x 3/8" FIP x 18"	1/25
G70110	1/2" FIP x 1/2" MIP x 18"	1/25
G70111	1/2" FIP x 3/8" MIP x 18"	1/25
G70112	3/8" FIP x 1/2" MIP x 18"	1/25
G70113	3/8" FIP x 3/8" MIP x 18"	1/25
G70114	1/2" MIP x 1/2" MIP x 24"	1/25
G70115	1/2" FIP x 1/2" FIP x 24"	1/25
G70116	3/8" FIP x 3/8" FIP x 24"	1/25
G70117	1/2" FIP x 1/2" MIP x 24"	1/25
G70118	1/2" FIP x 3/8" MIP x 24"	1/25
G70119	3/8" FIP x 1/2" MIP x 24"	1/25
G70120	3/8" FIP x 3/8" MIP x 24"	1/25
G70121	1/2" MIP x 1/2" MIP x 30"	1/25
G70122	1/2" FIP x 1/2" FIP x 30"	1/25

3/8" OD Yellow Coated with Fittings (cont.)



- Durable stainless steel 304
- Corrugation extends all the way to the fitting for increased tubing flexibility
- CSA Design certified domestically and internationally for indoor and outdoor use
- 100% leak tested to ensure safety and quality and a product you can trust
- Quality flared end fittings to create a metal to metal seal in critical applications
- Coated connectors add additional safety in highly corrosive environments or in areas where caustic chemicals are located
- Corrosion resistant

PART NO.	DESCRIPTION	CTN QTY
G70123	3/8" FIP x 3/8" FIP x 30"	1/25
G70124	1/2" FIP x 1/2" MIP x 30"	1/25
G70125	1/2" FIP x 3/8" MIP x 30"	1/25
G70126	3/8" FIP x 1/2" MIP x 30"	1/25
G70127	3/8" FIP x 3/8" MIP x 30"	1/25
G70128	1/2" MIP x 1/2" MIP x 36"	1/25
G70129	1/2" FIP x 1/2" FIP x 36"	1/25
G70130	3/8" FIP x 3/8" FIP x 36"	1/25
G70131	1/2" FIP x 1/2" MIP x 36"	1/25
G70132	1/2" FIP x 3/8" MIP x 36"	1/25
G70133	3/8" FIP x 1/2" MIP x 36"	1/25
G70134	3/8" FIP x 3/8" MIP x 36"	1/25
G70135	1/2" MIP x 1/2" MIP x 48"	1/25
G70136	1/2" FIP x 1/2" FIP x 48"	1/25
G70137	3/8" FIP x 3/8" FIP x 48"	1/25
G70138	1/2" FIP x 1/2" MIP x 48"	1/25
G70139	1/2" FIP x 3/8" MIP x 48"	1/25
G70140	3/8" FIP x 1/2" MIP x 48"	1/25
G70141	3/8" FIP x 3/8" MIP x 48"	1/25
G70142	1/2" MIP x 1/2" MIP x 60"	1/25
G70143	1/2" FIP x 1/2" FIP x 60"	1/25
G70144	3/8" FIP x 3/8" FIP x 60"	1/25
G70145	1/2" FIP x 1/2" MIP x 60"	1/25
G70146	1/2" FIP x 3/8" MIP x 60"	1/25
G70147	3/8" FIP x 1/2" MIP x 60"	1/25
G70148	3/8" FIP x 3/8" MIP x 60"	1/25
G70149	1/2" MIP x 1/2" MIP x 72"	1/25
G70150	1/2" FIP x 1/2" FIP x 72"	1/25
G70151	3/8" FIP x 3/8" FIP x 72"	1/25
G70152	1/2" FIP x 1/2" MIP x 72"	1/25
G70153	1/2" FIP x 3/8" MIP x 72"	1/25
G70154	3/8" FIP x 1/2" MIP x 72"	1/25
G70155	3/8" FIP x 3/8" MIP x 72"	1/25

3/8" OD Uncoated with Ball Valve



- Durable stainless steel 304
- Corrugation extends all the way to the fitting for increased tubing flexibility
- CSA Design certified domestically and internationally for indoor and outdoor use
- 100% leak tested to ensure safety and quality and a product you can trust
- Quality flared end fittings to create a metal to metal seal in critical applications
- Corrosion resistant

PART NO.	DESCRIPTION	CTN QTY
G70200	3/8" MIP x 1/2" FIP Ball x 12"	1/25
G70201	1/2" MIP x 1/2" FIP Ball x 12"	1/25
G70202	1/2" FIP x 1/2" FIP Ball x 12"	1/25
G70203	3/8" FIP x 1/2" FIP Ball x 12"	1/25
G70204	3/8" MIP x 1/2" FIP Ball x 18"	1/25
G70205	1/2" MIP x 1/2" FIP Ball x 18"	1/25
G70206	1/2" FIP x 1/2" FIP Ball x 18"	1/25
G70207	3/8" FIP x 1/2" FIP Ball x 18"	1/25
G70208	3/8" MIP x 1/2" FIP Ball x 24"	1/25
G70209	1/2" MIP x 1/2" FIP Ball x 24"	1/25
G70210	1/2" FIP x 1/2" FIP Ball x 24"	1/25
G70211	3/8" FIP x 1/2" FIP Ball x 24"	1/25
G70212	3/8" MIP x 1/2" FIP Ball x 30"	1/25
G70213	1/2" MIP x 1/2" FIP Ball x 30"	1/25
G70214	1/2" FIP x 1/2" FIP Ball x 30"	1/25
G70215	3/8" FIP x 1/2" FIP Ball x 30"	1/25
G70216	3/8" MIP x 1/2" FIP Ball x 36"	1/25
G70217	1/2" MIP x 1/2" FIP Ball x 36"	1/25
G70218	1/2" FIP x 1/2" FIP Ball x 36"	1/25
G70219	3/8" FIP x 1/2" FIP Ball x 36"	1/25
G70220	3/8" MIP x 1/2" FIP Ball x 48"	1/25
G70221	1/2" MIP x 1/2" FIP Ball x 48"	1/25
G70222	1/2" FIP x 1/2" FIP Ball x 48"	1/25
G70223	3/8" FIP x 1/2" FIP Ball x 48"	1/25
G70224	3/8" MIP x 1/2" FIP Ball x 60"	1/25
G70225	1/2" MIP x 1/2" FIP Ball x 60"	1/25
G70226	1/2" FIP x 1/2" FIP Ball x 60"	1/25
G70227	3/8" FIP x 1/2" FIP Ball x 60"	1/25
G70228	3/8" MIP x 1/2" FIP Ball x 72"	1/25
G70229	1/2" MIP x 1/2" FIP Ball x 72"	1/25
G70230	1/2" FIP x 1/2" FIP Ball x 72"	1/25
G70231	3/8" FIP x 1/2" FIP Ball x 72"	1/25
G70232	1/2" MIP x 1/2" FIP Angle Ball x 48"	1/25
G70233	3/8" FIP x 1/2" FIP Angle Ball x 48"	1/25
G70234	1/2" MIP x 1/2" FIP Angle Ball x 60"	1/25
G70235	3/8" FIP x 1/2" FIP Angle Ball x 60"	1/25
G70236	1/2" MIP x 1/2" FIP Angle Ball x 72"	1/25
G70237	3/8" FIP x 1/2" FIP Angle Ball x 72"	1/25

B

5/8" OD Uncoated with Fittings



B

- Durable stainless steel 304
- Corrugation extends all the way to the fitting for increased tubing flexibility
- CSA Design certified domestically and internationally for indoor and outdoor use
- 100% leak tested to ensure safety and quality and a product you can trust
- Quality flared end fittings to create a metal to metal seal in critical applications
- Corrosion resistant

PART NO.	DESCRIPTION	CTN QTY
G71000	3/4" MIP x 3/4" MIP x 12"	1/25
G71001	3/4" MIP x 1/2" MIP x 12"	1/25
G71002	1/2" MIP x 1/2" MIP x 12"	1/25
G71003	3/4" FIP x 3/4" FIP x 12"	1/25
G71004	3/4" FIP x 1/2" FIP x 12"	1/25
G71005	1/2" FIP x 1/2" FIP x 12"	1/25
G71006	1/2" FIP x 3/4" MIP x 12"	1/25
G71007	3/4" FIP x 3/4" MIP x 12"	1/25
G71008	3/4" FIP x 1/2" MIP x 12"	1/25
G71009	1/2" FIP x 1/2" MIP x 12"	1/25
G71010	3/4" MIP x 3/4" MIP x 18"	1/25
G71011	3/4" MIP x 1/2" MIP x 18"	1/25
G71012	1/2" MIP x 1/2" MIP x 18"	1/25
G71013	3/4" FIP x 3/4" FIP x 18"	1/25
G71014	3/4" FIP x 1/2" FIP x 18"	1/25
G71015	1/2" FIP x 1/2" FIP x 18"	1/25
G71016	1/2" FIP x 3/4" MIP x 18"	1/25
G71017	3/4" FIP x 3/4" MIP x 18"	1/25
G71018	3/4" FIP x 1/2" MIP x 18"	1/25
G71019	1/2" FIP x 1/2" MIP x 18"	1/25
G71020	3/4" MIP x 3/4" MIP x 24"	1/25
G71021	3/4" MIP x 1/2" MIP x 24"	1/25
G71022	1/2" MIP x 1/2" MIP x 24"	1/25
G71023	3/4" FIP x 3/4" FIP x 24"	1/25
G71024	3/4" FIP x 1/2" FIP x 24"	1/25
G71025	1/2" FIP x 1/2" FIP x 24"	1/25
G71026	1/2" FIP x 3/4" MIP x 24"	1/25
G71027	3/4" FIP x 3/4" MIP x 24"	1/25
G71028	3/4" FIP x 1/2" MIP x 24"	1/25
G71029	1/2" FIP x 1/2" MIP x 24"	1/25
G71030	3/4" MIP x 3/4" MIP x 30"	1/25
G71031	3/4" MIP x 1/2" MIP x 30"	1/25
G71032	1/2" MIP x 1/2" MIP x 30"	1/25
G71033	3/4" FIP x 3/4" FIP x 30"	1/25
G71034	3/4" FIP x 1/2" FIP x 30"	1/25
G71035	1/2" FIP x 1/2" FIP x 30"	1/25
G71036	1/2" FIP x 3/4" MIP x 30"	1/25
G71037	3/4" FIP x 3/4" MIP x 30"	1/25
G71038	3/4" FIP x 1/2" MIP x 30"	1/25
G71039	1/2" FIP x 1/2" MIP x 30"	1/25
G71040	3/4" MIP x 3/4" MIP x 36"	1/25
G71041	3/4" MIP x 1/2" MIP x 36"	1/25
G71042	1/2" MIP x 1/2" MIP x 36"	1/25
G71043	3/4" FIP x 3/4" FIP x 36"	1/25
G71044	3/4" FIP x 1/2" FIP x 36"	1/25
G71045	1/2" FIP x 1/2" FIP x 36"	1/25

5/8" OD Uncoated with Fittings (cont.)



- Durable stainless steel 304
- Corrugation extends all the way to the fitting for increased tubing flexibility
- CSA Design certified domestically and internationally for indoor and outdoor use
- 100% leak tested to ensure safety and quality and a product you can trust
- Quality flared end fittings to create a metal to metal seal in critical applications
- Corrosion resistant

PART NO.	DESCRIPTION	CTN QTY
G71046	1/2" FIP x 3/4" MIP x 36"	1/25
G71047	3/4" FIP x 3/4" MIP x 36"	1/25
G71048	3/4" FIP x 1/2" MIP x 36"	1/25
G71049	1/2" FIP x 1/2" MIP x 36"	1/25
G71050	3/4" MIP x 3/4" MIP x 48"	1/25
G71051	3/4" MIP x 1/2" MIP x 48"	1/25
G71052	1/2" MIP x 1/2" MIP x 48"	1/25
G71053	3/4" FIP x 3/4" FIP x 48"	1/25
G71054	3/4" FIP x 1/2" FIP x 48"	1/25
G71055	1/2" FIP x 1/2" FIP x 48"	1/25
G71056	1/2" FIP x 3/4" MIP x 48"	1/25
G71057	3/4" FIP x 3/4" MIP x 48"	1/25
G71058	3/4" FIP x 1/2" MIP x 48"	1/25
G71059	1/2" FIP x 1/2" MIP x 48"	1/25
G71060	3/4" MIP x 3/4" MIP x 60"	1/25
G71061	3/4" MIP x 1/2" MIP x 60"	1/25
G71062	1/2" MIP x 1/2" MIP x 60"	1/25
G71063	3/4" FIP x 3/4" FIP x 60"	1/25
G71064	3/4" FIP x 1/2" FIP x 60"	1/25
G71065	1/2" FIP x 1/2" FIP x 60"	1/25
G71066	1/2" FIP x 3/4" MIP x 60"	1/25
G71067	3/4" FIP x 3/4" MIP x 60"	1/25
G71068	3/4" FIP x 1/2" MIP x 60"	1/25
G71069	1/2" FIP x 1/2" MIP x 60"	1/25
G71070	3/4" MIP x 3/4" MIP x 72"	1/25
G71071	3/4" MIP x 1/2" MIP x 72"	1/25
G71072	1/2" MIP x 1/2" MIP x 72"	1/25
G71073	3/4" FIP x 3/4" FIP x 72"	1/25
G71074	3/4" FIP x 1/2" FIP x 72"	1/25
G71075	1/2" FIP x 1/2" FIP x 72"	1/25
G71076	1/2" FIP x 3/4" MIP x 72"	1/25
G71077	3/4" FIP x 3/4" MIP x 72"	1/25
G71078	3/4" FIP x 1/2" MIP x 72"	1/25
G71079	1/2" FIP x 1/2" MIP x 72"	1/25

5/8" OD Yellow Coated with Fittings



- Durable stainless steel 304
- Corrugation extends all the way to the fitting for increased tubing flexibility
- CSA Design certified domestically and internationally for indoor and outdoor use
- 100% leak tested to ensure safety and quality and a product you can trust
- Quality flared end fittings to create a metal to metal seal in critical applications
- Coated connectors add additional safety in highly corrosive environments or in areas where caustic chemicals are located
- Corrosion resistant

5/8" OD Yellow Coated with Fittings (cont.)



- Durable stainless steel 304
- Corrugation extends all the way to the fitting for increased tubing flexibility
- CSA Design certified domestically and internationally for indoor and outdoor use
- 100% leak tested to ensure safety and quality and a product you can trust
- Quality flared end fittings to create a metal to metal seal in critical applications
- Coated connectors add additional safety in highly corrosive environments or in areas where caustic chemicals are located
- Corrosion resistant

B

PART NO.	DESCRIPTION	CTN QTY
G71100	3/4" MIP x 3/4" MIP x 12"	1/25
G71101	3/4" MIP x 1/2" MIP x 12"	1/25
G71102	1/2" MIP x 1/2" MIP x 12"	1/25
G71103	3/4" FIP x 3/4" FIP x 12"	1/25
G71104	3/4" FIP x 1/2" FIP x 12"	1/25
G71105	1/2" FIP x 1/2" FIP x 12"	1/25
G71106	1/2" FIP x 3/4" MIP x 12"	1/25
G71107	3/4" FIP x 3/4" MIP x 12"	1/25
G71108	3/4" FIP x 1/2" MIP x 12"	1/25
G71109	1/2" FIP x 1/2" MIP x 12"	1/25
G71110	3/4" MIP x 3/4" MIP x 18"	1/25
G71111	3/4" MIP x 1/2" MIP x 18"	1/25
G71112	1/2" MIP x 1/2" MIP x 18"	1/25
G71113	3/4" FIP x 3/4" FIP x 18"	1/25
G71114	3/4" FIP x 1/2" FIP x 18"	1/25
G71115	1/2" FIP x 1/2" FIP x 18"	1/25
G71116	1/2" FIP x 3/4" MIP x 18"	1/25
G71117	3/4" FIP x 3/4" MIP x 18"	1/25
G71118	3/4" FIP x 1/2" MIP x 18"	1/25
G71119	1/2" FIP x 1/2" MIP x 18"	1/25
G71120	3/4" MIP x 3/4" MIP x 24"	1/25
G71121	3/4" MIP x 1/2" MIP x 24"	1/25
G71122	1/2" MIP x 1/2" MIP x 24"	1/25
G71123	3/4" FIP x 3/4" FIP x 24"	1/25
G71124	3/4" FIP x 1/2" FIP x 24"	1/25
G71125	1/2" FIP x 1/2" FIP x 24"	1/25
G71126	1/2" FIP x 3/4" MIP x 24"	1/25
G71127	3/4" FIP x 3/4" MIP x 24"	1/25
G71128	3/4" FIP x 1/2" MIP x 24"	1/25
G71129	1/2" FIP x 1/2" MIP x 24"	1/25
G71130	3/4" MIP x 3/4" MIP x 30"	1/25
G71131	3/4" MIP x 1/2" MIP x 30"	1/25
G71132	1/2" MIP x 1/2" MIP x 30"	1/25
G71133	3/4" FIP x 3/4" FIP x 30"	1/25
G71134	3/4" FIP x 1/2" FIP x 30"	1/25
G71135	1/2" FIP x 1/2" FIP x 30"	1/25
G71136	1/2" FIP x 3/4" MIP x 30"	1/25
G71137	3/4" FIP x 3/4" MIP x 30"	1/25
G71138	3/4" FIP x 1/2" MIP x 30"	1/25
G71139	1/2" FIP x 1/2" MIP x 30"	1/25
G71140	3/4" MIP x 3/4" MIP x 36"	1/25
G71141	3/4" MIP x 1/2" MIP x 36"	1/25
G71142	1/2" MIP x 1/2" MIP x 36"	1/25

PART NO.	DESCRIPTION	CTN QTY
G71143	3/4" FIP x 3/4" FIP x 36"	1/25
G71144	3/4" FIP x 1/2" FIP x 36"	1/25
G71145	1/2" FIP x 1/2" FIP x 36"	1/25
G71146	1/2" FIP x 3/4" MIP x 36"	1/25
G71147	3/4" FIP x 3/4" MIP x 36"	1/25
G71148	3/4" FIP x 1/2" MIP x 36"	1/25
G71149	1/2" FIP x 1/2" MIP x 36"	1/25
G71150	3/4" MIP x 3/4" MIP x 48"	1/25
G71151	3/4" MIP x 1/2" MIP x 48"	1/25
G71152	1/2" MIP x 1/2" MIP x 48"	1/25
G71153	3/4" FIP x 3/4" FIP x 48"	1/25
G71154	3/4" FIP x 1/2" FIP x 48"	1/25
G71155	1/2" FIP x 1/2" FIP x 48"	1/25
G71156	1/2" FIP x 3/4" MIP x 48"	1/25
G71157	3/4" FIP x 3/4" MIP x 48"	1/25
G71158	3/4" FIP x 1/2" MIP x 48"	1/25
G71159	1/2" FIP x 1/2" MIP x 48"	1/25
G71160	3/4" MIP x 3/4" MIP x 60"	1/25
G71161	3/4" MIP x 1/2" MIP x 60"	1/25
G71162	1/2" MIP x 1/2" MIP x 60"	1/25
G71163	3/4" FIP x 3/4" FIP x 60"	1/25
G71164	3/4" FIP x 1/2" FIP x 60"	1/25
G71165	1/2" FIP x 1/2" FIP x 60"	1/25
G71166	1/2" FIP x 3/4" MIP x 60"	1/25
G71167	3/4" FIP x 3/4" MIP x 60"	1/25
G71168	3/4" FIP x 1/2" MIP x 60"	1/25
G71169	1/2" FIP x 1/2" MIP x 60"	1/25
G71170	3/4" MIP x 3/4" MIP x 72"	1/25
G71171	3/4" MIP x 1/2" MIP x 72"	1/25
G71172	1/2" MIP x 1/2" MIP x 72"	1/25
G71173	3/4" FIP x 3/4" FIP x 72"	1/25
G71174	3/4" FIP x 1/2" FIP x 72"	1/25
G71175	1/2" FIP x 1/2" FIP x 72"	1/25
G71176	1/2" FIP x 3/4" MIP x 72"	1/25
G71177	3/4" FIP x 3/4" MIP x 72"	1/25
G71178	3/4" FIP x 1/2" MIP x 72"	1/25
G71179	1/2" FIP x 1/2" MIP x 72"	1/25

1/2" OD Yellow Coated with Fittings



B

- Durable stainless steel 304
- Corrugation extends all the way to the fitting for increased tubing flexibility
- CSA Design certified domestically and internationally for indoor and outdoor use
- 100% leak tested to ensure safety and quality and a product you can trust
- Quality flared end fittings to create a metal to metal seal in critical applications
- Coated connectors add additional safety in highly corrosive environments or in areas where caustic chemicals are located
- Corrosion resistant

PART NO.	DESCRIPTION	CTN QTY
G72100	1/2" MIP x 1/2" MIP x 12"	1/25
G72101	1/2" MIP x 3/8" MIP x 12"	1/25
G72102	3/8" MIP x 3/8" MIP x 12"	1/25
G72103	1/2" FIP x 1/2" FIP x 12"	1/25
G72104	1/2" FIP x 3/8" FIP x 12"	1/25
G72105	1/2" FIP x 1/2" MIP x 12"	1/25
G72106	1/2" FIP x 3/8" MIP x 12"	1/25
G72107	3/8" FIP x 1/2" MIP x 12"	1/25
G72108	1/2" MIP x 1/2" MIP x 18"	1/25
G72109	1/2" MIP x 3/8" MIP x 18"	1/25
G72110	3/8" MIP x 3/8" MIP x 18"	1/25
G72111	1/2" FIP x 1/2" FIP x 18"	1/25
G72112	1/2" FIP x 3/8" FIP x 18"	1/25
G72113	1/2" FIP x 1/2" MIP x 18"	1/25
G72114	1/2" FIP x 3/8" MIP x 18"	1/25
G72115	3/8" FIP x 1/2" MIP x 18"	1/25
G72116	1/2" MIP x 1/2" MIP x 24"	1/25
G72117	1/2" MIP x 3/8" MIP x 24"	1/25
G72118	3/8" MIP x 3/8" MIP x 24"	1/25
G72119	1/2" FIP x 1/2" FIP x 24"	1/25
G72120	1/2" FIP x 3/8" FIP x 24"	1/25
G72121	1/2" FIP x 1/2" MIP x 24"	1/25
G72122	1/2" FIP x 3/8" MIP x 24"	1/25
G72123	3/8" FIP x 1/2" MIP x 24"	1/25
G72124	1/2" MIP x 1/2" MIP x 30"	1/25
G72125	1/2" MIP x 3/8" MIP x 30"	1/25
G72126	3/8" MIP x 3/8" MIP x 30"	1/25
G72127	1/2" FIP x 1/2" FIP x 30"	1/25
G72128	1/2" FIP x 3/8" FIP x 30"	1/25
G72129	1/2" FIP x 1/2" MIP x 30"	1/25
G72130	1/2" FIP x 3/8" MIP x 30"	1/25
G72131	3/8" FIP x 1/2" MIP x 30"	1/25
G72132	1/2" MIP x 1/2" MIP x 36"	1/25
G72133	1/2" MIP x 3/8" MIP x 36"	1/25
G72134	3/8" MIP x 3/8" MIP x 36"	1/25
G72135	1/2" FIP x 1/2" FIP x 36"	1/25
G72136	1/2" FIP x 3/8" FIP x 36"	1/25
G72137	1/2" FIP x 1/2" MIP x 36"	1/25
G72138	1/2" FIP x 3/8" MIP x 36"	1/25
G72139	3/8" FIP x 1/2" MIP x 36"	1/25
G72140	1/2" MIP x 1/2" MIP x 48"	1/25
G72141	1/2" MIP x 3/8" MIP x 48"	1/25
G72142	3/8" MIP x 3/8" MIP x 48"	1/25
G72143	1/2" FIP x 1/2" FIP x 48"	1/25
G72144	1/2" FIP x 3/8" FIP x 48"	1/25
G72145	1/2" FIP x 1/2" MIP x 48"	1/25

1/2" OD Yellow Coated with Fittings (cont.)



- Durable stainless steel 304
- Corrugation extends all the way to the fitting for increased tubing flexibility
- CSA Design certified domestically and internationally for indoor and outdoor use
- 100% leak tested to ensure safety and quality and a product you can trust
- Quality flared end fittings to create a metal to metal seal in critical applications
- Coated connectors add additional safety in highly corrosive environments or in areas where caustic chemicals are located
- Corrosion resistant

PART NO.	DESCRIPTION	CTN QTY
G72146	1/2" FIP x 3/8" MIP x 48"	1/25
G72147	3/8" FIP x 1/2" MIP x 48"	1/25
G72148	1/2" MIP x 1/2" MIP x 60"	1/25
G72149	1/2" MIP x 3/8" MIP x 60"	1/25
G72150	3/8" MIP x 3/8" MIP x 60"	1/25
G72151	1/2" FIP x 1/2" FIP x 60"	1/25
G72152	1/2" FIP x 3/8" FIP x 60"	1/25
G72153	1/2" FIP x 1/2" MIP x 60"	1/25
G72154	1/2" FIP x 3/8" MIP x 60"	1/25
G72155	3/8" FIP x 1/2" MIP x 60"	1/25

1/2" OD Yellow Coated with Ball Valve



- Durable stainless steel 304
- Corrugation extends all the way to the fitting for increased tubing flexibility
- CSA Design certified domestically and internationally for indoor and outdoor use
- 100% leak tested to ensure safety and quality and a product you can trust
- Quality flared end fittings to create a metal to metal seal in critical applications
- Coated connectors add additional safety in highly corrosive environments or in areas where caustic chemicals are located
- Corrosion resistant

PART NO.	DESCRIPTION	CTN QTY
G72300	1/2" MIP x 1/2" FIP Ball x 12"	1/25
G72302	1/2" FIP x 1/2" FIP Ball x 12"	1/25
G72304	1/2" MIP x 1/2" FIP Ball x 18"	1/25
G72306	1/2" FIP x 1/2" FIP Ball x 18"	1/25
G72308	1/2" MIP x 1/2" FIP Ball x 24"	1/25
G72310	1/2" FIP x 1/2" FIP Ball x 24"	1/25
G72312	1/2" MIP x 1/2" FIP Ball x 30"	1/25
G72314	1/2" FIP x 1/2" FIP Ball x 30"	1/25
G72316	1/2" MIP x 1/2" FIP Ball x 36"	1/25
G72318	1/2" FIP x 1/2" FIP Ball x 36"	1/25
G72320	1/2" MIP x 1/2" FIP Ball x 48"	1/25
G72322	1/2" FIP x 1/2" FIP Ball x 48"	1/25
G72324	1/2" MIP x 1/2" FIP Ball x 60"	1/25
G72326	1/2" FIP x 1/2" FIP Ball x 60"	1/25
G72328	1/2" MIP x 1/2" FIP Ball x 72"	1/25
G72330	1/2" FIP x 1/2" FIP Ball x 72"	1/25
G72332	1/2" MIP x 1/2" FIP Angle Ball x 24"	1/25
G72333	1/2" MIP x 1/2" FIP Angle Ball x 36"	1/25
G72334	1/2" MIP x 1/2" FIP Angle Ball x 48"	1/25
G72335	1/2" MIP x 1/2" FIP Angle Ball x 72"	1/25

1" OD Yellow Coated with Fittings



- Durable stainless steel 304
- Corrugation extends all the way to the fitting for increased tubing flexibility
- CSA Design certified domestically and internationally for indoor and outdoor use
- 100% leak tested to ensure safety and quality and a product you can trust
- Quality flared end fittings to create a metal to metal seal in critical applications
- Coated connectors add additional safety in highly corrosive environments or in areas where caustic chemicals are located
- Corrosion resistant

PART NO.	DESCRIPTION	CTN QTY
G71401	3/4" MIP x 3/4" FIP x 18"	1/25
G71402	3/4" MIP x 3/4" FIP x 24"	1/25
G71403	3/4" MIP x 3/4" MIP x 18"	1/25
G71404	3/4" MIP x 3/4" MIP x 24"	1/25

1/2" OD Black Coated



- Durable stainless steel 304
- For use with gas logs
- Corrugation extends all the way to the fitting for increased tubing flexibility
- CSA Design certified domestically and internationally for indoor and outdoor use
- 100% leak tested to ensure safety and quality and a product you can trust
- Quality flared end fittings to create a metal to metal seal in critical applications
- Coated connectors add additional safety in highly corrosive environments or in areas where caustic chemicals are located.
- Corrosion resistant

PART NO.	DESCRIPTION	CTN QTY
G74103	1/2" FIP x 1/2" FIP x 12"	1/25
G74105	1/2" FIP x 1/2" MIP x 12"	1/25
G74111	1/2" FIP x 1/2" FIP x 18"	1/25
G74113	1/2" FIP x 1/2" MIP x 18"	1/25
G74119	1/2" FIP x 1/2" FIP x 24"	1/25
G74121	1/2" FIP x 1/2" MIP x 24"	1/25
G74127	1/2" FIP x 1/2" FIP x 30"	1/25
G74129	1/2" FIP x 1/2" MIP x 30"	1/25
G74135	1/2" FIP x 1/2" FIP x 36"	1/25
G74137	1/2" FIP x 1/2" MIP x 36"	1/25

3/8" OD Black Coated



- Durable stainless steel 304
- For use with gas logs
- Corrugation extends all the way to the fitting for increased tubing flexibility
- CSA Design certified domestically and internationally for indoor and outdoor use
- 100% leak tested to ensure safety and quality and a product you can trust
- Quality flared end fittings to create a metal to metal seal in critical applications
- Coated connectors add additional safety in highly corrosive environments or in areas where caustic chemicals are located.
- Corrosion resistant

PART NO.	DESCRIPTION	CTN QTY
G73101	1/2" FIP x 1/2" FIP x 12"	1/25
G73108	1/2" FIP x 1/2" FIP x 18"	1/25
G73115	1/2" FIP x 1/2" FIP x 24"	1/25
G73122	1/2" FIP x 1/2" FIP x 30"	1/25
G73129	1/2" FIP x 1/2" FIP x 36"	1/25

Nominal Connector Series (I.D. Inches)	Straight Length Capacity - Ptu Per Hr (W) 0.64 Sp Gr. 1000 Btu Per Cu Ft (37.2 MJ Per Cu Meter) Gas at @ 0.5 inch Water Column (124 Pa) Pressure Drop		
	12"	24"	36"
1/4	48000	40000	33400
3/8	102000	85000	71000
1/2	180000	150000	125000

NOTE: When using 0.2 inch water column pressure drop, capacity can be determined by multiplying the figures above by 0.632.

SECTION C - MISC. PLUMBING SPECIALTIES

Repair 85-86

Test Caps & Plugs 87-88

Flexible Transition Couplings 89

Dishwasher/Washing Machine Parts 90

Dryer Vents..... 91-92

Tape..... 93

Pipe Sleeving/Sand Cloth 94

Rubber Insulation 95-98

Poly Insulation..... 99-101

Insulation Tools/Dielectric Union..... 102

Water Heater Connectors..... 103

Water Heater Supplies..... 104

Pressure Gauges 105-106

Tubing 107

Stud Guards 108-110

Hooks & Nails..... 111

Pipe Strap/Clamps..... 112

Hanger Tape/Packing..... 113

Lead Supplies/Roofing Repair 114

Service Sink Repair 115

Bolts & Screws 116

Washers/Clamps 117

Conduit Hanger 118

Water Meter Supplies 119

Meter Boxes..... 120-121

Boxes 121



Snap-Ease Access Panel



- Constructed of high-impact white ABS
- Can be painted or wallpapered
- Easily installed to eliminate unsightly drywall repairs
- Provides for future access to plumbing or wiring behind wall
- 5/8" depth

PART NO.	DESCRIPTION	CTN/MSTR
A04006	6" x 9" access panel	10/80
A05008	8" x 8" access panel	1/10
A05014	14" x 14" access panel	10/30
A05027	14" x 27" access panel	1/6

Plastic Access Panel



- Beveled edges
- Indented screw holes in corners

PART NO.	DESCRIPTION	CTN/MSTR
A04012	12" x 12" access panel	1/20

Stainless Steel Repair Clamp



Two Bolt



One Bolt

- Plated lug, carriage bolt and nuts for corrosion protection
- 301 stainless steel clamp with neoprene gaskets for up to 180°F
- Long neck carriage bolts for easy installation

PART NO.	DESCRIPTION	IPS/SCH 40	CTS NOM	CTN/MSTR
R30375	3" one bolt	3/8"	1/2"	6/72
R30050	3" one bolt	1/2"	3/4"	6/72
R30075	3" one bolt	3/4"	1"	6/72
R30100	3" one bolt	1"	1-1/4"	6/72
R30125	3" one bolt	1-1/4"	1-1/2"	6/72
R30150	3" one bolt	1-1/2"	-	6/72
R30200	3" one bolt	2"	-	6/72
R30250	3" one bolt	2-1/2"	-	6/48
R30300	3" one bolt	3"	-	6/36
R30400	3" one bolt	4"	-	6/24
R30600	3" one bolt	6"	-	1/36
R60375	6" two bolt	3/8"	1/2"	6/36
R60050	6" two bolt	1/2"	3/4"	6/36
R60075	6" two bolt	3/4"	1"	6/36
R60100	6" two bolt	1"	1-1/4"	6/36
R60125	6" two bolt	1-1/4"	1-1/2"	6/36
R60150	6" two bolt	1-1/2"	-	6/36
R60200	6" two bolt	2"	-	6/36
R60250	6" two bolt	2-1/2"	-	6/24
R60300	6" two bolt	3"	-	6/24
R60400	6" two bolt	4"	-	6/24
R60600	6" two bolt	6"	-	1/20

Items marked with the Jones Stephens logo are "You Need It... We Got It" Items.

Malleable Iron Compression Coupling



- Long pattern
- EPDM gaskets
- Metal friction ring
- Maximum 125 PSI at 120°F
- Pipe ends must be restrained
- Fits both IPS and Schedule 40 pipe
- Galvanized for corrosion protection

PART NO.	IPS	BODY LENGTH	CTN/MSTR
C11050	1/2"	3-3/8"	1/42
C11075	3/4"	3-5/8"	1/32
C11100	1"	3-7/8"	1/24
C11125	1-1/4"	4-1/8"	1/18
C11150	1-1/2"	4-5/16"	1/15
C11200	2"	4-1/2"	1/12
C11250	2-1/2"	6-3/4"	1/4
C11300	3"	7"	1/4
C11400	4"	8-1/8"	1/2

Bronze Compression Coupling



- EPDM gaskets
- Bronze coated brass bodies and nuts
- Maximum 125 PSI at temperatures up to 180°F
- Pipe ends must be restrained on both ends
- For use on galvanized pipe and copper tubing
- Lead Free

PART NO.	DESCRIPTION	CTS	IPS	CTN/MSTR
C14205	3" length	1/2"	3/8"	1/120
C14206	3" length	3/4"	1/2"	12/120
C14207	3" length	1"	3/4"	12/72
C15300	5" length	1/2"	3/8"	1/96
C15301	5" length	3/4"	1/2"	12/72
C15302	5" length	1"	3/4"	12/48
C15303	5" length	1-1/4"	1"	12/48
C15304	5" length	1-1/2"	1-1/4"	12/36
C15305	5" length	-	1-1/2"	12/36
C15306	5" length	2"	-	1/30
C15307	5" length	-	2"	12/24

PVC Compression Coupling



- For use on cold water lines only
- Ribbed body and nuts for gripping
- Fits IPS and Schedule 40 pipe
- EPDM gaskets
- 150 PSI at 73°F
- Pipe ends must be restrained

PART NO.	IPS	BODY LENGTH	CTN/MSTR
C12050	1/2"	3-3/4"	30/120
C12075	3/4"	3-15/16"	30/120
C12100	1"	4-3/4"	25/100
C12125	1-1/4"	5-3/16"	25/100
C12150	1-1/2"	5-3/8"	15/60
C12200	2"	6"	6/24
C12250	2-1/2"	7-7/8"	3/12
C12300	3"	8"	2/8
C12400	4"	12"	2/8
C12600	6"	11-1/8"	1/4

PVC Expansion Coupling



• Rated 200 PSI

PART NO.	IPS	BODY LENGTH	CTN/MSTR
E09050	1/2"	5-3/4"	1/160
E09075	3/4"	6-3/4"	1/120
E09100	1"	7-3/4"	1/54
E09125	1-1/4"	9"	1/40
E09150	1-1/2"	10"	1/35
E09200	2"	10-1/2"	1/24
E09250	2-1/2"	13"	1/3
E09300	3"	14-1/2"	1/3
E09400	4"	14-1/2"	1/3

CPVC Compression Coupling



- For use on hot water lines
- 100 PSI at temperatures up to 180°F
- Tubing sizes copper and plastic tubing
- EPDM gaskets
- Ribbed body and nuts for gripping
- Pipe ends must be restrained

PART NO.	TUBING SIZE	CTN/MSTR
C13050	1/2" (5/8" OD)	20/360
C13075	3/4" (7/8" OD)	20/240

Malleable Iron Compression Tee



- Galvanized for corrosion protection
- Metal friction ring
- Compression tees must be restrained on both ends
- Fits both IPS and Schedule 40 pipe
- EPDM gaskets
- FIP branch
- 125 PSI at 120°F

PART NO.	SIZE	CTN/MSTR
C16050	1/2"	1/12
C16075	3/4"	1/12

Bronze Compression Tee



- FIP branch
- EPDM gaskets
- Pipe ends must be restrained
- Bronze coated brass bodies and nuts
- Maximum 125 PSI at temperatures up to 180°F
- For use on galvanized pipe and copper tubing (check sizes)

PART NO.	CTS	IPS	BRANCH	CTN/MSTR
C19050	1/2"	3/8"	1/2" FIP	1/112
C19051	3/4"	1/2"	1/2" FIP	1/96
C19075	3/4"	1/2"	3/4" FIP	1/96

PVC Compression Tee



- For use on cold water lines only
- Ribbed body and nuts for gripping
- Fits both IPS and Schedule 40 pipe
- EPDM gaskets
- 150 PSI at 73°F
- Threaded branch

PART NO.	SIZE	CTN/MSTR
C17050	1/2"	25/100
C17075	3/4"	1/90
C17100	1"	15/60
C17125	1-1/4"	1/40
C17150	1-1/2"	1/30
C17200	2"	1/20

Economy Test Plug



- Galvanized steel flanges
- Fits cast iron and plastic pipe
- Neoprene rubber gasket

PART NO.	PIPE SIZE	CTN/MSTR
T31001	1-1/2"	24/192
T31002	2"	24/96
T31003	3"	24/48
T31004	4"	24/48
T31006	6"	4/16
T31000	Replacement wing nut	1/5000

Combination Test Plug



Raised Head



Countersunk

- Test up to three floors at once
- Combination test plug and cleanout
- Fits Schedule 40 DWV pipe
- Positive sealing
- No metal parts to rust

PART NO.	DESCRIPTION	CTN/MSTR
T34001	1-1/2" raised head	1/392
T34002	2" raised head	1/288
T34003	3" raised head	1/200
T34004	4" raised head	1/128
T34006	6" raised head	1/54
T34008	8" raised head	1/24
T34012	2" countersunk	1/288
T34013	3" countersunk	1/200
T34014	4" countersunk	1/128

T-Cone Cleanout Repair Plugs



- Easily repairs damaged or corroded metal or plastic cleanout threads

PART NO.	PIPE SIZE	THREAD ID	CTN/MSTR
T34150	1-1/2"	1.780	1/50
T34200	2"	2.255	1/50
T34300	3"	3.375	1/50
T34350	3-1/2"	3.900	1/50
T34400	4"	4.336	1/50

Items marked with the Jones Stephens logo are "You Need It... We Got It" Items.

“Plum-Tite” Mechanical Test Plugs



- High density plastic construction
- Neoprene gasket
- Extra large wingnut
- Rust and corrosion proof

PART NO.	PIPE SIZE	CTN/MSTR
T37001	1-1/2"	10/200
T37002	2"	10/150
T37003	3"	10/40
T37004	4"	10/40
T37006	6"	5/20
T37008	8"	5/10

Cast Iron Test Plug



- Maximum 10 PSI
- To test cast iron soil pipe drainage systems
- Cold water ONLY

PART NO.	PIPE SIZE	CTN QTY
T39002	2"	1
T39003	3"	1
T39004	4"	1
T39006	6"	1
T39008	8"	1
T39010	10"	1
T39012	12"	1

Flexible PVC Test Cap



- Reinforced top
- 5/16" hex screw with screwdriver slot
- Fits both cast iron and plastic pipe

PART NO.	PIPE SIZE	CTN/MSTR
T32001	1-1/2"	24/288
T32002	2"	24/288
T32003	3"	24/144
T32004	4"	1/50
T32006	6"	1/24
T32008	8"	1/16
T32011	1-1/2"	1/200
T32022	2"	1/100
T32033	3"	1/50
T32044	4"	1/50

PVC Dual Fit Test Cap



- Each cap fits two sizes of Schedule 40 pipe
- CARTON QUANTITIES ONLY

PART NO.	PIPE SIZE	CTN QTY
T33152	1-1/2" and 2"	100
T33304	3" and 4"	25

Slip-On Plastic Cap



- DWV protection cap
- Protects from debris during construction
- Orange

PART NO.	SIZE	CTN/MSTR
T36150	1-1/2"	300
T36200	2"	200
T36300	3"	75
T36400	4"	1/45
T36600	6"	1/25

Techno Test Plug Cap



- Heavy duty PVC, high pressure tested over six stories
- Easily solvent cemented over end of DWV pipe
- Will not clog or go down pipe
- CARTON QUANTITIES ONLY

PART NO.	DESCRIPTION	CTN QTY
T35001	1-1/2" DWV	100
T35002	2" DWV	100
T35003	3" DWV	50
T35004	4" DWV	25

PVC Test Cap



- Easily solvent cemented over end of DWV pipe
- CARTON QUANTITIES ONLY

PART NO.	DESCRIPTION	CTN/MSTR
T35201	1-1/2" PVC Test Cap	100/1000
T35202	2" PVC Test Cap	100/1000
T35203	3" PVC Test Cap	50/250
T35204	4" PVC Test Cap	25/250
T35206	6" PVC Test Cap	1/100

Knockout Test Cap



- For use in plastic waste and drain pipe
- Disposable
- CARTON QUANTITIES ONLY

PART NO.	PIPE SIZE	CTN/MSTR
T33001	1-1/2"	100/5000
T33002	2"	100/1900
T33003	3"	50
T33004	4"	50/3600

Items marked with the Jones Stephens logo are "You Need It...We Got It" Items.

Pneumatic Test Plug



- All units smaller than 8" are supplied with chain and ring
- All units 8" or larger are supplied with a removable eye bolt
- For use with cast iron, PVC, ABS, copper, clay and concrete pipe
- Made in the USA

MADE IN THE USA

Regular

PART NO.	NOM. PIPE SIZE	MAX AIR PRESSURE	MAX TEST PRESSURE	MAX HEAD	CTN/MSTR
T45150	1-1/4" - 1-1/2"	40 PSI	5 PSI	30'	1/6
T45200	2"	40 PSI	5 PSI	30'	1/6
T45300	3"	35 PSI	5 PSI	30'	1/6
T45400	4"	30 PSI	5 PSI	30'	1/4
T45600	6"	25 PSI	5 PSI	30'	1
T45800	8"	25 PSI	15 PSI	40'	1
T45010	10"	25 PSI	15 PSI	40'	1
T45012	12"	25 PSI	15 PSI	40'	1

Long - 23"

PART NO.	NOM. PIPE SIZE	MAX AIR PRESSURE	MAX TEST PRESSURE	MAX HEAD	CTN QTY
T46200	2"	45 PSI	5 PSI	30'	1
T46300	3"	35 PSI	5 PSI	30'	1
T46400	4"	30 PSI	5 PSI	30'	1

Pneumatic-Hydraulic Test Plug



- Uses either water or air
- Temperature range 30° - 200°F
- User safe; cannot be overinflated
- Individually tested for 24 hours to insure proper operation
- Using water, stack can be filled and plugged from same position
- Made in the USA

MADE IN THE USA

PART NO.	PIPE SIZE	MFG PART NO.	CTN/MSTR
T30002	1-1/4" - 2"	WATP 2	1/6
T30034	3 - 4"	WATP 3-4	1/10
T30046	4 - 6"	WATP 4-6	1
T30068	5" - 8"	WATP 6-8	1
T30102	10" - 12"	WATP 10-12	1

Two Stage Long Test Plug



- Two stage deflation allows access pipe to remain sealed while water clears drain line

PART NO.	PIPE SIZE	MFG PART NO.	CTN QTY
T30203	2" - 3"	DDO203	1
T30304	3" - 4"	DDO304	1

Inflatable Tee Plug



Inflated Test Plug

- Body is high quality natural rubber
- Top is made from high impact ABS plastic
- Threads directly into test tee
- Threads into both CI and plastic pipe

PART NO.	DESCRIPTION	CTN/MSTR
T33200	2" Inflatable tee plug	6/36
T33300	3" Inflatable tee plug	1/6
T33400	4" Inflatable tee plug	1/6

Drain King®



- Insert in drain line opening and turn water on
- Automatically seals drain and powerful water pulses loosen and clear drain
- Brass on each end

PART NO.	PIPE SIZE	DK NO.	CTN/MSTR
D18501	1" - 2"	D501	1/12
D18186	1-1/2" - 3"	D186	12/144
D18034	3" - 4"	H34	1/6
D18750	3" - 6"	D750	1/6
D18850	6" - 10"	D850	1
D18560	1" - 2" with drain adapter	H560	1/5
D18340	1-1/2" - 3" with 10" hose and faucet adapter	PE60	1/12
D18060	Drain adapter	PE60	1/12

Plumbjet



- Attaches to garden hose
- All natural
- Environmentally safe

PART NO.	PIPE SIZE	DK NO.	CTN/MSTR
D18400	1" - 2"	D501	10/60
D18401	1-1/2" - 3"	D186	10/60

Extension Hose



- For pneumatic test plug
- Can be used in tandem

PART NO.	DESCRIPTION	CTN QTY
T45002	2' extension hose	1
T45003	3' extension hose	1

Force Cup Plunger



- Highest quality rubber
- Supplied with handle

PART NO.	DESCRIPTION	CTN/MSTR
D18001	5 1/2" diameter (red rubber)	1/48
D18002	6" professional style (black rubber)	1/24

Professional Force Cup Display



Cloghopper Display

- Highest quality rubber
- Supplied with handle
- Attractive point of purchase display
- Display box contains 30 rubber plungers
- CARTON QUANTITIES ONLY

PART NO.	DESCRIPTION	CTN QTY
D18000	Rubber plungers and display box	30

Flexible PVC Saddle Fitting



Tee Pattern



Wye Pattern

- Provided with stainless steel clamp on inlet
- Includes stainless steel clamps on saddle to fit up to 12" clay pipe
- Extension clamps may be used for larger pipe sizes

Tee Pattern

PART NO.	DESCRIPTION	CTN/MSTR
S26001	6" plastic-12" clay saddle x 4" Sch.40 CI or SDR35 inlet	1
S26002	6" plastic - 12" clay saddle x 6" Sch.40 CI or SDR35 inlet	1

Wye Pattern

PART NO.	DESCRIPTION	CTN QTY
S27001	6" plastic - 12" clay saddle x 4" Sch. 40 cast iron or SDR35 inlet	1
S27002	6" plastic - 12" clay saddle x 6" Sch. 40 cast iron or SDR35 inlet	1

Replacement Clamp

PART NO.	DESCRIPTION	CTN/MSTR
S26100	4"-12" gear clamp	1/100

Flexible Trap Drain Connector



PART NO.	DESCRIPTION	CTN/MSTR
T06001	Connects 1-1/4" - 1 1/2" tubular to 1-1/4" - 1-1/2" tubular	1/180
T06002	Connects 1" DWV or 1-1/2" CTS to 1-1/4" - 1-1/2" tubular	1/100
T06003	Connects 1-1/2" DWV or CTS to 1-1/4" - 1-1/2" tubular	1/100
T06004	Connects 2" DWV to 1-1/4" - 1-1/2" tubular	1/100

Flexible Transition Coupling



T06320



T06400

- Flexible PVC
- For use on PVC, DWV and CI pipe
- Stainless steel clamps and housing
- UPC listed

PART NO.	DESCRIPTION	CTN/MSTR
T06025	1-1/4" PL + CI to PL + CI	1/300
T06050	1-1/2" PL + CI to PL + CI	1/150
T06200	2" PL + CI to PL + CI	1/105
T06250	2" x 1-1/2" PL + CI to PL + CI	1/105
T06300	3" PL + CI to PL + CI	1/60
T06320	3" x 2" PL + CI to PL + CI	1/80
T06400	4" PL + CI to PL + CI	1/36
T06430	4" x 3" PL + CI to PL + CI	1/44
T06600	6" PL + CI to PL + CI	1/12
T06640	6" x 4" PL + CI to PL + CI	1/15
T06800	8" PL + CI to PL + CI	1/6

Items marked with the Jones Stephens logo are "You Need It...We Got It" Items.

Bore O-Ring



PART NO.	DESCRIPTION	CTN/MSTR
B12640	6" bore x 4" plastic or cast iron	1/60

Qwik Tee



PART NO.	DESCRIPTION	CTN/MSTR
T07150	1-1/2" x 1-1/2" x 1-1/2" tee	1/50
T07200	2" x 2" x 2" tee	1/20
T07300	3" x 3" x 3" tee	1/20
T07400	4" x 4" x 4" tee	1/6

Qwik Elbow



- Flexible

PART NO.	DESCRIPTION	CTN/MSTR
E10150	1-1/2" x 1-1/2" elbow	1/50
E10200	2" x 2" elbow	1/20
E10300	3" x 3" elbow	1/20
E10400	4" x 4" elbow	1/6

Bushing for Qwik Tees and Qwik Elbows



PART NO.	DESCRIPTION	CTN/MSTR
B12210	2" x 1-1/2" bushing	1/24
B12320	3" x 2" bushing	1/24
B12430	4" x 3" bushing	1/24

Hose Grip Clothes Washer Connector



- Fits 1-1/2" or 2" standpipe
- Fits 1" - 1-7/16" drain hose
- Securely holds drain hose in standpipe

PART NO.	DESCRIPTION	CTN/MSTR
D08001	Drain hose connector	1/100

Flexible Drain Trap



- J-bend

PART NO.	DESCRIPTION	CTN QTY
J01001	1-1/4" or 1-1/2" tubular trap j-bend	1/20

Washing Machine Box with Valves



- Long shank MIP valve
- White box with valve installed
- Combo 1-1/2" or 2" drain

B05900

B05901

PART NO.	DESCRIPTION	CTN/MSTR
B05900	Offset drain	1/10
B05901	Center drain	1/10

Washing Machine Boxes with Hammer Arrester



B05920

B05921

B05922



B05923

B05924

- 1/4 Turn valves or lever handle mixer valve

Dual Drain

PART NO.	DESCRIPTION	CTN/MSTR
B05920	1/4 Turn valve with solder connection	1/10
B05921	1/4 Turn valve with CPVC connection	1/10
B05922	Single lever handle with solder connection	1/10

Center Drain

PART NO.	DESCRIPTION	CTN/MSTR
B05923	1/4 Turn valve with solder connection	1/10
B05924	1/4 Turn valve with CPVC connection	1/10

Replacement Frame

PART NO.	DESCRIPTION	CTN/MSTR
B05927	Replacement frame for washer box	1/10
B05928	Replacement frame for icemaker box	1/10

Icemaker Boxes with Hammer Arrester



- 1/4 Turn valve

B05925

B05926

PART NO.	DESCRIPTION	CTN/MSTR
B05925	Icemaker box with Solder connection	1/10
B05926	Icemaker box with CPVC connection	1/10

Icemaker Boxes with Valves



- White box with valve installed
- CARTON QUANTITIES ONLY

PART NO.	DESCRIPTION	CTN/MSTR
B05910	Icemaker box with brass valve	1/10
B05911	Icemaker box with Flowguard all CPVC icemaker valve	1/10

Dishwasher Hose



- EPDM material with single spiral reinforcement
- 5/8" connects dishwasher pump to airgap inlet or dishwasher tailpiece
- 7/8" connects airgap outlet to branch tailpiece or disposal
- Resists kinking
- Marked per foot
- -40°F to +180°F
- IAPMO/UPC listed; meets ANSI, AHAM-DWI specifications



PART NO.	SIZE	WP	BURST PRESSURE	CTN QTY
D10625	5/8" ID x 50'	90	200	1
D10875	7/8" ID x 50'	70	100	1

Dishwasher Drain Connector



- 410 Stainless steel clamps
- Includes two worm gear clamps

PART NO.	DESCRIPTION	CTN/MSTR
D10001	Universal connector	50/200

Washing Machine Hose



Straight Female



With 90° Elbow

- 3/8" ID rubber for hot or cold use
- Bagged with washers
- Standard female hose threads
- Bursting pressure 800 lbs. per sq. inch

PART NO.	DESCRIPTION	CTN/MSTR
J04104	4' with 90° elbow	1/12
J04105	5' with 90° elbow	1/12
J04106	6' with 90° elbow	1/12
J04004	4' straight female	1/12
J04005	5' straight female	1/12
J04006	6' straight female	1/12

Washing Machine Hose



- Industrial quality
- 1/2" ID EPDM rubber for hot and cold use
- Polyester yarn reinforcement
- 3/4" female hose ends
- Temp. rating -40°F to +190°F
- Stamped brass ends and crimps
- 200 PSI working pressure
- Bagged with washers

PART NO.	DESCRIPTION	CTN/MSTR
J04204	4' washing machine hose	1/12
J04205	5' washing machine hose	1/12
J04206	6' washing machine hose	1/12

Mixer Hose



- High pressure hose; 12" arms
- Individually bagged

PART NO.	DESCRIPTION	CTN/MSTR
J04012	Mixer hose	1/12

Items marked with the Jones Stephens logo are "You Need It... We Got It" Items.

Fit-All Drain Hose for Washing Machine



- 3 size step down 3/4", 7/8" and 1" for drain lines
- Individually bagged

PART NO.	DESCRIPTION	CTN/MSTR
J04016	5' fit-all drain hose	1/12

Washing Machine Drain Hose



- Rubber

PART NO.	DESCRIPTION	CTN QTY
D10900	1" x 50' roll	1

Washing Machine Pan



- 2-1/2" deep heavy gauge plastic pan
- White
- 1" adapter
- CARTON QUANTITIES ONLY

PART NO.	DESCRIPTION	CTN/MSTR
J04250	27" x 29" with side mount drain	1/5

Dryer Vent Hood



- PVC hood
- Weather proof 12" aluminum extension
- Pre-punched mounting holes
- CARTON QUANTITIES ONLY

PART NO.	DESCRIPTION	CTN/MSTR
D04012	4" dryer vent hood	1/12

Aluminum Vent Hood



- For clothes dryers or exhaust fans
- Complete with damper and flange plate

PART NO.	DESCRIPTION	CTN/MSTR
D04023	3" aluminum vent hood	1/12
D04024	4" aluminum vent hood	1/12

Louvered Dryer Vent Hood



- Includes hood, aluminum pipe and collar

PART NO.	DESCRIPTION	CTN/MSTR
D04025	4" white hood assembly	1/12
D04026	4" brown hood assembly	1/12

White Back Collar for Dryer Vent Kits



PART NO.	DESCRIPTION	CTN/MSTR
D04064	White back collar	1/6

Items marked with the Jones Stephens logo are "You Need It...We Got It" Items.

Complete Dryer Vent Kit



- Kit includes hose, vent and 2 plastic clamps
- PVC hood
- Weather proof 12" aluminum extension
- Pre-punched mounting holes
- 12" aluminum extension, pre-punched mounting holes

PART NO.	DESCRIPTION	CTN/MSTR
D04005	4" x 5' vent kit	1/10
D04008	4" x 8' vent kit	1/10
D04009	4" x 8' flex aluminum duct with louvered hood and two metal clamps	1/6
D04010	4" clamp only	1/10

Clamp for Dryer Vent Kit



PART NO.	DESCRIPTION	CTN/MSTR
D04010	4" clamp only	1/10

Metal Clamp for Dryer Vent



- Heavy duty all metal design
- Excellent for use with metal ducting

PART NO.	DESCRIPTION	CTN/MSTR
D04015	3" metal clamp	1/12
D04016	4" metal clamp	1/12
D04017	5" metal clamp	1/12
D04018	6" metal clamp	1/12

Aluminum Elbow and Pipe



- All aluminum

PART NO.	DESCRIPTION	CTN/MSTR
D04013	3" x 90° swivel elbow	1/12
D04014	3" x 24" aluminum pipe	1/25
D04027	4" x 90° swivel elbow	1/12
D04028	4" x 24" aluminum pipe	1/25

Flexible Duct Connector Kit



- Connects flexible ducting
- Extends exhaust collar of clothes dryer

PART NO.	DESCRIPTION	CTN/MSTR
D04019	4" duct connector kit	1/6

Increaser/Reducer



- Connects 3" to 4" ducting or 4" ducting to 3" exhaust collar

PART NO.	DESCRIPTION	CTN/MSTR
D04021	3"-4" plastic increaser/reducer	1/6
D04022	4"-3" aluminum reducer	1/6
D04055	3"-4" aluminum increaser	1/6

Flexible Aluminum Ducting



- Ideal for exhausting clothes dryers
- Bendable to any configuration
- No fire or UL ratings

PART NO.	DESCRIPTION	CTN/MSTR
D04031	3" x 8' aluminum ducting	1/14
D04032	4" x 8' aluminum ducting	1/9
D04033	5" x 8' aluminum ducting	1/6
D04034	6" x 8' aluminum ducting	1/3
D04053	3" x 25' aluminum ducting	1/10
D04054	4" x 25' aluminum ducting	1/6

Proflex Aluminum Foil Ducting



- Flexible, fire resistant
- Will not support combustion
- Wire reinforced

PART NO.	DESCRIPTION	CTN/MSTR
D04058	4" x 5' Proflex aluminum foil ducting	1/12
D04059	4" x 8' Proflex aluminum foil ducting	1/12
D04060	4" x 50' Proflex aluminum foil ducting	1

Flexible Aluminum Foil Ducting



- Ideal for exhausting clothes dryers and bathroom fans
- Will not support combustion
- No fire or UL ratings

PART NO.	DESCRIPTION	CTN/MSTR
D04056	4" x 25' aluminum foil ducting	1
D04057	4" x 8' aluminum foil ducting	1/12

Dryer Vent Hose



- Wire-reinforced vinyl

PART NO.	DESCRIPTION	CTN/MSTR
D04020	4" x 20' (boxed)	1/5
D04051	4" x 5' (bagged)	1/12

Dryer Vent Kit with Louvered Hood



- Includes vinyl hose, aluminum pipe, collar, clamps and louvered hood

PART NO.	DESCRIPTION	CTN/MSTR
D04001	4" x 5' with white hood	1/10
D04002	4" x 5' with brown hood	1/10
D04003	4" x 8' with white hood	1/10
D04004	4" x 8' with brown hood	1/10

Bathroom Fan Vent Kit



- Contains the following parts for 3" and 4" wall type exhaust fans: 4" x 5' flexible vinyl ducting, clamps, 4" louvered vent, 3"-4" foam increaser

PART NO.	DESCRIPTION	CTN/MSTR
D04035	Bathroom fan vent kit	1/10
D04050	4" x 50' vinyl hose only (boxed)	1
D04062	3" x 50' vinyl hose only (boxed)	1

Indoor Dryer Vent Kit



- Use on electric clothes dryers when outside venting is not possible
- Recirculates warm, moist air
- Specially designed lint reservoir

PART NO.	DESCRIPTION	CTN/MSTR
D04036	Indoor dryer vent kit	1/6

Domestic Pipe Wrap Tape



- Both sides have adhesive
- CARTON QUANTITIES ONLY

PART NO.	COLOR	SIZE	THICKNESS	CTN QTY
T16002	yellow	2" x 100'	12 mil.	24
T16004	yellow	4" x 100'	12 mil.	12
T17002	black	2" x 100'	12 mil.	24
T17004	black	4" x 100'	12 mil.	12

Imported Pipe Wrap Tape



- Black tape with PVC backing
- UPC listed
- CARTON QUANTITIES ONLY



PART NO.	SIZE	THICKNESS	CTN QTY
T17101	1" x 100'	10 mil.	48
T17102	2" x 100'	10 mil.	24
T17104	4" x 100'	10 mil.	12
T18201	1" x 100'	20 mil.	48
T18202	2" x 100'	20 mil.	24

Primer for Pipe Wrap Tape



- Maximizes tape performance
- Final step in preparing steel surfaces for taping
- Can more than double adhesion of corrosion tapes to cleaned steel
- CARTON QUANTITIES ONLY
- MOTOR FREIGHT ONLY / FLAMMABLE

PART NO.	DESCRIPTION	CTN QTY
T16100	Quart	12

Items marked with the Jones Stephens logo are "You Need It...We Got It" Items.

Electrical Tape



- Blacky vinyl
- Individually wrapped
- UL listed
- CARTON QUANTITIES ONLY



PART NO.	DESCRIPTION	CTN/MSTR
T20030	3/4" x 60' electrical tape	10/250

Slic-tite® High Density Thread Sealant



- Thickness 4 mil
- Provides a highly resistant seal on pipe threads for all types of service
- Non-toxic
- Permits easy disassembly, even after years of service
- Sealing temperature: -450°F to 550°F (-268°C to 288°C)
- Pressures: to 2,000 PSI (136 BAR)
- Meets Mil. Spec T-27730A



PART NO.	DESCRIPTION	CTN/MSTR
T19118	1/2" x 600"	12/36
T19119	3/4" x 600"	12/72

PTFE Thread Seal Tape

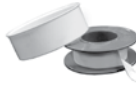

- Thickness 3 mil. plus
- Temperature range is 500°F to +650°F
- Withstands pressure up to 5000 PSI
- Meets U.S. government military specification MIL-T27730A

PART NO.	DESCRIPTION	CTN/MSTR
T19122	1/2" x 260"	100/500
T19125	1/2" x 520"	50/350
T19342	3/4" x 260"	50/350
T19345	3/4" x 520"	50/350

Thread Seal Tape Jar Display

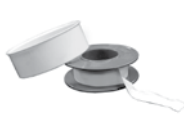

- Withstands pressure up to 5000 PSI
- Temperatures to +650°F
- Thickness 3 mil. plus
- Meets U.S. MILSPEC T27730A

PART NO.	DESCRIPTION	CTN QTY
CJ1002	1/2" x 260" Teflon tape	1

PTFE Yellow Gas Line Thread Seal Tape



- 0035 mil
- Temperature range is -450°F to +500°F
- Withstands pressure up to 5000 PSI
- Meets U.S. government military specification MIL-T27730A
- UL listed

PART NO.	DESCRIPTION	CTN/MSTR
T19222	1/2" x 260"	100/500

Duct Tape



- Premium grade, waterproof non-elastic reinforced cloth
- Pressure sensitive; vapor and flame resistant
- CARTON QUANTITIES ONLY

PART NO.	DESCRIPTION	THICKNESS	CTN QTY
T20020	2" x 60 yds (gray)	8.5 mil.	24
T20023	2" x 60 yds (black)	10 mil.	24

Box Sealing Tape



PART NO.	DESCRIPTION	CTN/MSTR
T20040	2" x 55 yds	36
T20041	2" x 110 yds	36
T20050	Dispenser only	1/24

Stretch Wrap

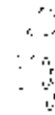

- Use instead of tape to bind packages or parts
- Protects products from dirt and moisture
- Can be used on palletted shipments or small orders
- Great for wrapping lengths of pipe
- CARTON QUANTITIES ONLY

PART NO.	DESCRIPTION	GAUGE	CTN QTY
S51120	3" x 700'	120	18
S51080	3" x 1000'	80	18

Stretch Wrap Film and Dispenser



- Secures packages to pallets
- Reduces lost packages
- Retards moisture
- Lowers handling costs
- Wrapping is priced per carton - no broken cartons

PART NO.	DESCRIPTION	CTN QTY
S51001	80 gauge wrap 18" x 1500' (4 rolls)	1
S51002	Hand dispenser only	1

Pipe Sleeving



- Underground sleeving protects against lime reaction in concrete
- Allows expansion and contraction of pipe, minimizing stress
- Individually boxed; color-coded (red for hot, blue for cold)
- IAPMO listed

PART NO.	PIPE SIZE	THICKNESS	COLOR	LENGTH	CTN/MSTR
S22001	1/2"-1"	6 mil	Red	200'	1/20
S22002	1/2"-1"	6 mil	Blue	200'	1/20
S22003	1/2"-1"	10 mil	Red	100'	1/20
S22004	1/2"-1"	10 mil	Blue	100'	1/20
S22005	1/2"-1"	25 mil	Red	100'	1/20
S22006	1/2"-1"	25 mil	Blue	100'	1/20

Waterproof Aluminum Oxide



- Dispenser box
- 100% waterproof
- Wet cut
- 120 grit

PART NO.	DESCRIPTION	CTN/MSTR
C25020	1-1/2" x 5 yds	1/50
C25021	1-1/2" x 10 yds	1/50
C25022	1-1/2" x 25 yds	1/25

Water Resistant Sand Cloth



- Dispenser box
- Water resistant aluminum oxide
- 120 grit abrasive cloth for cleaning pipe and fittings

PART NO.	DESCRIPTION	CTN/MSTR
C25000	1-1/2" x 2 yds	1/50
C25001	1-1/2" x 5 yds	1/50
C25002	1-1/2" x 10 yds	1/50
C25003	1-1/2" x 25 yds	1/25

Open Mesh



- Dispenser box
- 100% waterproof
- Polyester on both sides
- 180 grit with large holes for aggressive sanding
- Can be exposed to water and solvents indefinitely without breakdown

PART NO.	DESCRIPTION	CTN/MSTR
C25010	1-1/2" x 5 yds	1/50
C25011	1-1/2" x 10 yds	1/50

Flexible Open Mesh



- Dispenser box
- 100% waterproof
- Polyester on both sides
- 180 grit
- Smaller holes for finer sanding

PART NO.	DESCRIPTION	CTN/MSTR
C25012	1-1/2" x 5 yds	1/50
C25013	1-1/2" x 10 yds	1/50

SEAMLESS RUBBER

Pipe Insulation

Flexible Closed Cell Insulation



DESCRIPTION

Seamless Rubber Pipe Insulation is an environmentally friendly, CFC-free, flexible elastomeric thermal insulation.

APPLICATIONS

Seamless Rubber Pipe Insulation is used to retard heat gain and prevent condensation or frost formation on refrigerant lines, cold water plumbing, and chilled water systems. It also retards heat flow for hot water plumbing, liquid heating, dual temperature piping, and many solar systems.

Seamless Rubber is recommended for applications ranging from -70°F to 220° F (-57° C to 104° C). The expanded closed cell structure makes Seamless Rubber an efficient insulator and an effective moisture vapor retarder.

Due to its unique microwave curing process, Seamless Rubber has a very tough skin which withstands tearing, rough handling, and severe environmental conditions, and yet is quite flexible for easy installation.

Seamless Rubber has superior cold weather flexibility.

INSTALLATION

With a factory-applied coating of talc on the smooth inner surface, Seamless Rubber slides easily over pipe or tubing for quick installation. When applied to existing lines, tubing is slit lengthwise and snapped into place. (Slitting can be done on the job with a sharp knife. All seams and butt joints should be sealed with Seamless Rubber Contact Adhesive, making sure both surfaces to be joined are coated with adhesive.

OUTDOOR APPLICATIONS

Outdoor applications require UV Protective Coating. For best appearance, two coats are recommended.

UNDERGROUND

For buried lines above the water table, use a clean fill such as sand (3"-5" layer) to protect Seamless Rubber before backfilling. It is recommended that materials to be buried are properly sealed at all seams and butt joints with Contact Adhesive. For optimum performance, the lines should be encased in a conduit to protect them from problems associated with ground water.

RESISTANCE TO MOISTURE VAPOR FLOW

The closed-cell structure of Seamless Rubber effectively retards the flow of moisture vapor, and is considered a low transmittance vapor retarder. For most applications, Seamless Rubber needs no additional protection. Additional vapor barrier protection may be necessary for Seamless Rubber when

installed on low temperature surfaces or where it is exposed to continuous high humidity.

FLAME AND SMOKE RATING

Seamless Rubber Pipe Insulation in wall thicknesses of 1" (25 mm) and below has a flame spread rating of 25 or less and a smoke development rating of 50 or less as tested by ASTM E 84 Method of Testing entitled: "Surface Burning Characteristics of Building Materials."

Numerical flammability ratings alone may not define the performance of products under actual fire conditions. They are provided only for us in the selection of products to meet limits specified, when compared to a known standard.

SPECIFICATION COMPLIANCE

ASTM C 534 Type 1 (Tubing)
ASTM D 1056-91-2C1
MEA 186-86-M Vol. IV (New York City)
USDA Requirements

UL 94-5V Flammability Classification (Recognition No. E55475)
Complies with requirements of CAN/ULC S102-M88
ASTM E 84 1" 25/50-tested according to UL 723 and NFPA 255

Meets requirements of NFPA 90A Sect. 2.3.3 for Supplementary Materials for Air Distribution Systems

NFPA No. 101 Class A Rating
Meets requirements of UL 181 sections 11.0 and 16.0

MIL-P-15280, For T (Tubing)

PHYSICAL PROPERTIES		SEAMLESS RUBBER INSULATION	TEST METHODS
Thermal Conductivity (K)	90° F (32° C) Mean Temp	.282 (.041)	ASTM C 177
BTU -in/hr-Ft2 - °F (W/mK)	75° F (24° C) Mean Temp	.277 (.040)	ASTM C 177
	50° F (10° C) Mean Temp	.270 (.039)	ASTM C 177
Operating Temperature Range	Upper	200° F (104° C)	
Flexible to -100° F (-73° C)	Lower	-70° F (-57° C)	
Water Vapor Permeability Dry Cup. Perm-In		.10	ASTM E 96
Water Absorption % weight gain		5%	ASTM D 1056
Ozone Resistant		Pass	ASTM D 1171
Chemical/Solvent Resistance		Good	
Mildew Resistance/Air Erosion		Pass	UL 181

THICKNESS RECOMMENDATIONS* - TO CONTROL CONDENSATION

PIPE SIZE	LINE TEMP		LINE TEMP		LINE TEMP		LINE TEMP	
	50° F	10° C	35° F	2° C	0° F	-18° C	-20° F	-29° C
Normal Conditions (Max 85°F, 29°C - 70% R.H.)								
3/8" ID thru 1-3/8" ID	3/8"	10 mm	1/2"	13 mm	3/4"	19 mm	1"	25 mm
Over 1-3/8" thru 3" IPS	3/8"	10 mm	1/2"	13 mm	1"	25 mm	1"	25 mm
Over 3" IPS thru 4" IPS**	1/2"	13 mm	1/2"	13 mm	1"	25 mm	1-1/4"	32 mm
Over 4" IPS	1/2"	13 mm	3/4"	19 mm	1"	25 mm	1-1/4"	32 mm
Mild Conditions (Max 80°F, 26°C - 50% R.H.)								
3/8" ID thru 2-1/8" ID	3/8"	10 mm	3/8"	10 mm	1/2"	13 mm	1/2"	13 mm
Over 2-1/8" thru 3" IPS	3/8"	10 mm	3/8"	10 mm	1/2"	13 mm	3/4"	19 mm
Over 3" IPS thru 4" IPS**	1/2"	13 mm	1/2"	13 mm	3/4"	19 mm	3/4"	19 mm
Over 4" IPS	1/2"	13 mm	1/2"	13 mm	3/4"	19 mm	3/4"	19 mm
Severe Conditions (Max 90°F, 32°C - 80% R.H.)								
3/8" ID thru 1-1/8" ID	3/4"	19 mm	3/4"	19 mm	1-1/4"	32 mm	1-1/4"	32 mm
Over 1-1/8" ID thru 4" IPS	3/4"	19 mm	1"	25 mm	1-1/2"	38 mm	1-1/2"	38 mm
Over 4" IPS	3/4"	19 mm	1-1/4"	32 mm	1-3/4"	44 mm	2"	50 mm

Seamless Rubber in thickness notes within the specified temperature ranges will prevent condensation on indoor piping under design conditions defined below. Thickness recommendations above 1" can be sleeved to achieve thickness desired.

Normal: Maximum severity of indoor conditions seldom exceed 85° F (29° C) and 70% R.H. in United States.

Mild: Typical conditions are most air-conditioned spaces and arid climates.

Severe: Generally found in areas which excessive moisture is introduced or in poorly ventilated areas where the temperature may be depressed below the ambient. Under conditions of high humidity, additional thickness of insulation may be required.

**Available: Nom. 1/2" or Nom. 3/4" thickness only

SEAMLESS RUBBER "R" VALUES PER SQUARE FOOT					
Pipe OD or Nominal Insulation ID		R Value 3/8" (10 mm) Wall	R Value 1/2" (13 mm) Wall	R Value 3/4" (19 mm) Wall	R Value 1" (25 mm) Wall
3/8"	10 mm	2.3	3.1	4.7	-
1/2"	13 mm	2.2	2.9	4.7	7.6
5/8"	16 mm	2.1	2.7	4.6	7.1
3/4"	19 mm	2.0	2.6	4.6	6.7
7/8"	22 mm	1.9	2.7	4.6	6.5
1-1/8"	29 mm	1.8	2.6	4.6	5.1
1-3/8"	35 mm	1.8	2.7	4.4	5.8
1-1/2" IPS	-	2.0	2.6	4.3	5.5
1-5/8"	41 mm	2.1	2.7	4.3	5.5
2-1/8"	54 mm	1.9	2.6	4.0	5.2
2" IPS	-	2.0	2.7	4.1	5.2
2-1/2" IPS	64 mm	1.9	2.6	3.9	5.0
2-5/8"	67 mm	2.0	2.7	4.0	5.1
3-1/8"	79 mm	1.9	2.5	3.8	4.9
3" IPS	-	2.0	2.8	3.9	5.0
3-5/8"	92 mm	-	2.6	3.7	-
4-1/8"	105 mm	-	2.6	3.7	-
4" IPS	-	-	2.8	3.9	-
5" IPS	-	1.9	2.6	3.9	-
6" IPS	-	-	2.4	3.6	-
8" IPS	-	-	2.4	3.6	-

Note: "R" factors were calculated from using the K factor of .277 (75°F, 24°C mean temp) and nominal wall thickness is each case. Lower operating temperatures will result in improved R values.

C

Seamless Rubber Pipe Insulation



- Environmentally friendly
- 4 Wall thicknesses: 3/8", 1/2", 3/4" and 1"
- Sizes range from 3/8" ID to 4" IPS
- Sizes not listed are special order. Allow two weeks for delivery.
- CFC-free
- Color - Black with blue ink
- Easy installation, flexible
- CARTON QUANTITIES ONLY

3/8" Wall Thickness

PART NO.	COPPER OD	IPS/PVC	FT/BOX
I60025	1/4"	-	630'
I60038	3/8"	-	612'
I60050	1/2"	1/4"	432'
I60058	5/8"	3/8"	378'
I60075	3/4"	-	342'
I60078	7/8"	1/2"	288'
I60118	1-1/8"	-	216'
I60138	1-3/8"	-	168'
I60158	1-5/8"	1-1/4"	150'
I60200	-	1-1/2"	120'
I60218	2-1/8"	-	96'
I60250	-	2"	84'
I60258	2-5/8"	-	72'
I60300	-	2-1/2"	60'
I60318	3-1/8"	-	60'
I60350	-	3"	48'

1/2" Wall Thickness

PART NO.	COPPER OD	IPS/PVC	FT/BOX
I61038	3/8"	-	456'
I61050	1/2"	1/4"	360'
I61058	5/8"	3/8"	324'
I61075	3/4"	-	270'
I61078	7/8"	1/2"	228'
I61118	1-1/8"	-	156'
I61138	1-3/8"	-	120'
I61158	1-5/8"	1-1/4"	114'
I61200	-	1-1/2"	114'
I61218	2-1/8"	-	102'
I61250	-	2"	66'
I61258	2-5/8"	-	60'
I61300	-	2-1/2"	48'
I61318	3-1/8"	-	48'
I61350	-	3"	36'
I61358	3-5/8"	-	36'
I61418	4-1/8"	-	24'
I61450	-	4"	24'

Seamless Rubber Pipe Insulation



- Environmentally friendly
- 4 Wall thicknesses: 3/8", 1/2", 3/4" and 1"
- Sizes range from 3/8" ID to 4" IPS
- Sizes not listed are special order. Allow two weeks for delivery.
- CFC-free
- Color - Black with blue ink
- Easy installation, flexible
- CARTON QUANTITIES ONLY

3/4" Wall Thickness

PART NO.	COPPER OD	IPS/PVC	FT/BOX
I62038	3/8"	-	294'
I62050	1/2"	1/4"	228'
I62058	5/8"	3/8"	180'
I62075	3/4"	-	144'
I62078	7/8"	1/2"	126'
I62118	1-1/8"	-	90'
I62138	1-3/8"	-	78'
I62158	1-5/8"	1-1/4"	72'
I62200	-	1-1/2"	66'
I62218	2-1/8"	-	60'
I62250	-	2"	48'
I62258	2-5/8"	-	42'
I62300	-	2-1/2"	36'
I62318	3-1/8"	-	36'
I62350	-	3"	30'
I62358	3-5/8"	-	30'
I62418	4-1/8"	-	24'
I62450	-	4"	24'

1" Wall Thickness

PART NO.	COPPER OD	IPS/PVC	FT/BOX
I63058	5/8"	3/8"	108'
I63075	3/4"	-	108'
I63078	7/8"	1/2"	90'
I63118	1-1/8"	-	66'
I63138	1-3/8"	-	60'
I63158	1-5/8"	1-1/2"	54'
I63200	-	1-1/2"	42'
I63218	2-1/8"	-	42'
I63250	-	2"	36'
I63258	2-5/8"	-	36'
I63300	-	2-1/2"	36'
I63318	3-1/8"	-	30'
I63350	-	3"	30'
I63358	3-5/8"	-	30'

C

Double Stick Rubber Pipe Insulation



- Environmentally friendly
- 4 Wall thicknesses: 3/8", 1/2", 3/4" and 1"
- Sizes range from 3/8" ID to 4" IPS
- Split with adhesive on both sides
- CFC-free
- Color - Black with blue ink
- Easy installation, flexible
- CARTON QUANTITIES ONLY

3/8" Wall Thickness

PART NO.	COPPER OD	IPS/PVC	FT/BOX
I80038	3/8"	3/8"	570'
I80050	1/2"	1/2"	402'
I80058	5/8"	5/8"	348'
I80034	3/4"	3/4"	318'
I80078	7/8"	7/8"	288'
I80118	1-1/8"	1-1/8"	216'
I80138	1-3/8"	1-3/8"	150'
I80150	1-1/2" IPS	1-1/2" IPS	120'
I80158	1 5/8"	1 5/8"	132'
I80200	2" IPS	2" IPS	78'
I80218	2 1/8"	2 1/8"	78'
I80250	2-1/2" IPS	2-1/2" IPS	60'
I80258	2-5/8"	2-5/8"	72'
I80318	3-1/8"	3-1/8"	60'

1/2" Wall Thickness

PART NO.	COPPER OD	IPS/PVC	FT/BOX
I81038	3/8"	3/8"	420'
I81050	1/2"	1/2"	312'
I81058	5/8"	5/8"	312'
I81034	3/4"	3/4"	270'
I81078	7/8"	7/8"	216'
I81118	1-1/8"	1-1/8"	150'
I81138	1-3/8"	1-3/8"	120'
I81150	1-1/2" IPS	1-1/2" IPS	108'
I81158	1 5/8"	1 5/8"	108'
I81200	2" IPS	2" IPS	60'
I81218	2-1/8"	2-1/8"	60'
I81250	2-1/2" IPS	2-1/2" IPS	48'
I81258	2-5/8"	2-5/8"	60'
I81300	3" IPS	3" IPS	36'
I81318	3-1/8"	3-1/8"	48'
I81358	3-5/8"	3-5/8"	36'
I81400	4" IPS	4" IPS	24'
I81418	4-1/8"	4-1/8"	24'

Double Stick Rubber Pipe Insulation



- Environmentally friendly
- 4 Wall thicknesses: 3/8", 1/2", 3/4" and 1"
- Sizes range from 3/8" ID to 4" IPS
- Split with adhesive on both sides
- CFC-free
- Color - Black with blue ink
- Easy installation, flexible
- CARTON QUANTITIES ONLY

3/4" Wall Thickness

PART NO.	COPPER OD	IPS/PVC	FT/BOX
I82038	3/8"	3/8"	258'
I82050	1/2"	1/2"	192'
I82058	5/8"	5/8"	180'
I82034	3/4"	3/4"	120'
I82078	7/8"	7/8"	126'
I82118	1-1/8"	1-1/8"	90'
I82138	1-3/8"	1-3/8"	78'
I82150	1-1/2" IPS	1-1/2" IPS	66'
I82158	1-5/8"	1-5/8"	72'
I82200	2" IPS	2" IPS	48'
I82218	2-1/8"	2-1/8"	60'
I82250	2-1/2" IPS	2-1/2" IPS	36'
I82258	2-5/8"	2-5/8"	42'
I82300	3" IPS	3" IPS	30'
I82318	3-1/8"	3-1/8"	36'
I82358	3-5/8"	3-5/8"	30'
I82400	4" IPS	4" IPS	24'
I82418	4-1/8"	4-1/8"	24'

1" Wall Thickness

PART NO.	COPPER OD	IPS/PVC	FT/BOX
I83058	5/8"	5/8"	108'
I83034	3/4"	3/4"	78'
I83078	7/8"	7/8"	78'
I83118	1-1/8"	1-1/8"	66'
I83138	1-3/8"	1-3/8"	60'
I83150	1-1/2" IPS	1-1/2" IPS	42'
I83158	1-5/8"	1-5/8"	42'
I83200	2" IPS	2" IPS	36'
I83218	2-1/8"	2-1/8"	42'
I83250	2-1/2" IPS	2-1/2" IPS	36'
I83258	2-5/8"	2-5/8"	36'
I83300	3" IPS	3" IPS	30'
I83318	3-1/8"	3-1/8"	30'
I83358	3-5/8"	3-5/8"	30'
I83418	4-1/8"	4-1/8"	18'

CLOSED CELL Pipe Insulation

C



DESCRIPTION

Closed Cell Pipe Insulation is a flexible and easy-to-apply tubing product available in Semi-Slit and Self-Sealing styles. These chemically inert pipe insulations are specially formulated to retard heat gain and their closed-cell structures allow them to function as efficient insulators. The Self-Sealing version has yellow self-seal release liner that is both easy to see and peel.

APPLICATIONS

To reduce unwanted heat loss or heat gain, control condensation, decrease plumbing noise and maximize energy savings. They can be used on hot and cold water lines, refrigeration lines, air conditioning lines; line set tubing, condenser coils, and connection and distribution lines.

Closed Cell Pipe Insulation has low thermal conductivity and a very low water vapor transmission rate. This low density product demonstrates excellent thermal, physical and chemical resistant properties, and has a broad service temperature range between -90° F and 180° F (-68° C and 82° C). It can be installed in commercial, industrial, and residential insulation projects.

INSTALLATION

Closed Cell Pipe Insulation is installed by sliding the stick over pipe or tubing. For existing lines, the insulation should be slit lengthwise and fitted over the pipe. When in place, make sure all seams are adhered with contact adhesive and pressed together to form a seal. The Self-Sealing version does not require adhesive. Fittings can be fabricated from miter-cut tubular sections. Closed Cell Pipe Insulation is easily cut with a sharp knife.

OUTDOOR APPLICATIONS

Outdoor applications require a protective coating (high quality exterior acrylic latex paint) for optimum performance. For best appearance, two coats are recommended.

UNDERGROUND

For buried lines above the water table, use a clean fill such as sand (3"-5" layer) to protect Closed Cell Pipe Insulation before backfilling. It is recommended that all materials to be buried are properly sealed at all seams and butt joints with Contact Adhesive. For optimum performance, the lines should be encased in conduit to protect them from problems associated with ground water.

RESISTANCE TO MOISTURE VAPOR FLOW

The closed-cell structure effectively retards the flow of moisture vapor, and is considered a low transmittance vapor retarder. For most applications, Closed Cell Pipe Insulation needs no additional protection.

Additional vapor barrier protection may be necessary for Closed Cell Pipe Insulation when installed on low temperature surfaces or where it is exposed to continuous high humidity.

FLAME AND SMOKE RATING

Closed Cell Pipe Insulation in wall thicknesses of 1" (25mm) and below has a flame spread rating of 25 or less and a smoke development rating of 50 or less as tested by ASTM E 84; CAN/ULC-S102.2-M88 Method of Testing entitled: "Surface Burning Characteristics of Building Materials."

Numerical flammability ratings alone may not define the performance of products under actual fire conditions. They are provided only for use in the selection of products to meet limits specified, when compared to a known standard.

SPECIFICATION COMPLIANCE

Complies with requirements of:

ASTM E 84; CAN/ULC S102.2

ASTM D 1622

ASTM D 1171

ASTM C 177 or C518

ASTM E 96

PHYSICAL DATA	PROPERTIES	TEST METHODS
Material	Closed Cell Polyolefin	-
Color	Charcoal	-
Upper Use Limit	180°F (82°C) constant	-
Lower Use Limit	-90°F (-68°C)	-
Density	1.5 lbs/ft ³	ASTM D 1622
Ozone Resistant	Good	ASTM D 1171
Thermal Conductivity (K)	at 75° F (24°C) Mean Temp	ASTM C 177 or C 518
BTU-in/hr-ft ² - F° (W/m-K)	0.230 (0.033)	-
Water Absorption	0.02% by Volume	ASTM E 96
Flame Speed	Less than 25	ASTM E 84; CAN/ULC-S102.2-M88
Smoke Classification	Less than 50	ASTM E 84; CAN/ULC-S102.2-M88

THICKNESS RECOMMENDATIONS* - TO CONTROL CONDENSATION								
PIPE SIZE	LINE TEMP		LINE TEMP		LINE TEMP		LINE TEMP	
	50° F	10° C	35° F	2° C	0° F	-18° C	-20° F	-29° C
Normal Conditions (Max 85°F, 29°C - 70% R.H.)								
3/8" ID thru 1-3/8" ID	3/8"	10 mm	1/2"	13 mm	3/4"	19 mm	1"	25 mm
Over 1-3/8" thru 3" IPS	3/8"	10 mm	1/2"	13 mm	1"	25 mm	1"	25 mm
Over 3" IPS thru 4" IPS**	3/8"	10 mm	1/2"	13 mm	1"	25 mm	1"	25 mm
Over 4" IPS	1/2"	13 mm	3/4"	19 mm	1"	25 mm	1-1/4"	32 mm
Mild Conditions (Max 80°F, 26°C - 50% R.H.)								
3/8" ID thru 2-1/8" ID	3/8"	10 mm	3/8"	10 mm	3/8"	10 mm	1/2"	13 mm
Over 2-1/8" thru 3" IPS	3/8"	10 mm	3/8"	10 mm	3/8"	10 mm	1/2"	13 mm
Over 3" IPS thru 4" IPS**	3/8"	10 mm	3/8"	10 mm	1/2"	13 mm	3/4"	19 mm
Over 4" IPS	3/8"	10 mm	1/2"	13 mm	1/2"	13 mm	3/4"	19 mm
Severe Conditions (Max 90°F, 32°C - 80% R.H.)								
3/8" ID thru 1-1/8" ID	3/4"	19 mm	3/4"	19 mm	1-1/4"	32 mm	1-1/4"	32 mm
Over 1-1/8" ID thru 4" IPS	3/4"	19 mm	1"	25 mm	1-1/2"	38 mm	1-1/2"	38 mm
Over 4" IPS	3/4"	19 mm	1"	25 mm	1-1/2"	38 mm	2"	50 mm

Closed Cell Pipe Insulation in thickness notes within the specified temperature ranges will prevent condensation on indoor piping under design conditions defined below. Thickness recommendations above 1" can be sleeved to achieve thickness desired.

Normal: Maximum severity of indoor conditions seldom exceed 85° F (29° C) and 70% R.H. in United States.

Mild: Typical conditions are most air-conditioned spaces and arid climates.

Severe: Generally found in areas which excessive moisture is introduced or in poorly ventilated areas where the temperature may be depressed below the ambient. Under conditions of high humidity, additional thickness of insulation may be required.

**Available: Nom. 1/2" or Nom. 3/4" thickness only

CLOSED CELL "R" VALUES PER SQUARE FOOT					
Pipe OD or Nominal Insulation ID		R Value 3/8" (10 mm) Wall	R Value 1/2" (13 mm) Wall	R Value 3/4" (19 mm) Wall	R Value 1" (25 mm) Wall
3/8"	10 mm	2.687	3.844	-	-
1/2"	13 mm	2.490	3.582	6.027	-
5/8"	16 mm	2.357	3.375	5.653	8.189
3/4"	19 mm	2.680	3.223	5.374	7.767
7/8"	22 mm	2.187	3.107	5.155	7.435
1-1/8"	29 mm	2.082	4.835	4.835	6.941
1-3/8"	35 mm	2.011	2.822	4.610	6.588
1-5/8"	41 mm	1.959	2.737	4.420	6.323
1-7/8"	-	1.920	2.672	4.313	6.115
2-1/8"	54 mm	1.889	2.620	4.209	5.948
2-3/8"	-	1.864	2.578	4.124	5.810
2-5/8"	67 mm	1.844	2.544	4.053	5.695
2-7/8"	-	1.827	2.514	3.993	5.596
3-1/8"	79 mm	1.812	2.490	3.942	5.512
3-1/2"	-	-	2.459	3.877	5.404
3-5/8"	92 mm	-	2.449	-	5.373
4"	105 mm	-	2.425	-	-
4-1/8"	-	-	2.418	-	5.264
4-1/2"	-	-	2.399	-	5.196

Note: "R" factors were calculated from using the K factor of .230 (75°F, 24°C mean temp) and nominal wall thickness is each case. Lower operating temperatures will result in improved R values.

Semi-Slit Pipe Insulation



- 100% closed cell polyethylene
- For outdoor use, paint with a high quality exterior acrylic latex paint
- UPS shippable cartons - CARTON QUANTITIES ONLY

SPECIFICATIONS:
 Density: 1.5 lbs./cubic foot; Mold growth: None;
 Temperature Range: -90° to 180°F; Flame/Smoke:
 25/50; Water vapor permeability: less than .02
 inches; Ozone resistance: Good

3/8" Wall Thickness

PART NO.	NOMINAL ID	R VALUES	CTS	IPS	FT/BOX
I50058	5/8"	2.357	1/2"	3/8"	408'
I50075	3/4"	2.680	5/8"	-	360'
I50078	7/8"	2.187	3/4"	1/2"	300'
I50118	1-1/8"	2.082	1"	3/4"	240'
I50138	1-3/8"	2.011	1-1/4"	1"	192'
I50158	1-5/8"	1.959	1-1/2"	1-1/4"	132'
I50178	2"	1.920	-	1-1/2"	108'
I50218	2-1/8"	1.889	2"	-	90'
I50238	2-3/8"	1.864	-	2"	90'
I50258	2-5/8"	1.844	2-1/2"	-	72'

1/2" Wall Thickness

PART NO.	NOMINAL ID	R VALUES	CTS	IPS	FT/BOX
I51058	5/8"	3.375	1/2"	3/8"	306'
I51078	7/8"	3.107	3/4"	1/2"	240'
I51118	1-1/8"	4.835	1"	3/4"	180'
I51138	1-3/8"	2.822	1-1/4"	1"	150'
I51158	1-5/8"	2.737	1-1/2"	1-1/4"	120'
I51178	2"	2.672	-	1-1/2"	90'
I51218	2-1/8"	2.620	2"	-	84'
I51238	2-3/8"	2.578	-	2"	66'
I51258	2-5/8"	2.544	2-1/2"	-	60'

3/4" Wall Thickness

PART NO.	NOMINAL ID	R VALUES	CTS	IPS	FT/BOX
I54050	1/2"	6.027	3/8"	1/4"	204'
I54058	5/8"	5.653	1/2"	3/8"	180'
I54075	3/4"	5.374	5/8"	1/2"	168'
I54078	7/8"	5.155	3/4"	-	156'
I54118	1-1/8"	4.835	1"	-	102'
I54138	1-3/8"	4.610	1-1/4"	1"	90'
I54158	1-5/8"	4.420	1-1/2"	1-1/4"	84'
I54178	2"	4.313	-	1-1/2"	66'
I54218	2-1/8"	4.209	2"	-	54'
I54258	2-5/8"	4.053	2-1/2"	-	48'

1" Wall Thickness

PART NO.	NOMINAL ID	R VALUES	CTS	IPS	FT/BOX
I55058	5/8"	8.189	1/2"	3/8"	108'
I55075	3/4"	7.767	5/8"	1/2"	102'
I55078	7/8"	7.435	3/4"	-	90'
I55118	1-1/8"	6.941	1"	-	90'
I55138	1-3/8"	6.588	1-1/4"	1"	72'
I55158	1-5/8"	6.323	1-1/2"	1-1/4"	60'
I55178	2"	6.115	-	1-1/2"	54'
I55218	2-1/8"	5.948	2"	-	48'
I55258	2-5/8"	5.695	2-1/2"	-	42'

Self-Sealing Pipe Insulation



- 100% closed cell polyethylene
- Complete seal on hot or cold pipe
- Two strips of self-adhesive seal easily at any length
- UPS shippable cartons - CARTON QUANTITIES ONLY



SPECIFICATIONS:
 Density: 1.5 lbs./cubic foot; Mold growth: None;
 Temperature Range: -90° to 180°F; Flame/Smoke:
 25/50; Water vapor permeability: less than .02
 inches; Ozone resistance: Good

3/8" Wall Thickness

PART NO.	NOMINAL ID	R VALUES	CTS	IPS	FT/BOX
I52058	5/8"	2.357	1/2"	3/8"	408'
I52034	3/4"	2.680	5/8"	-	360'
I52078	7/8"	2.187	3/4"	1/2"	300'
I52118	1-1/8"	2.082	1"	3/4"	240'
I52138	1-3/8"	2.011	1-1/4"	1"	192'
I52158	1-5/8"	1.959	1-1/2"	1-1/4"	132'
I52178	2"	1.920	-	1-1/2"	108'
I52218	2-1/8"	1.889	2"	-	90'
I52238	2-3/8"	1.864	-	2"	90'
I52258	2-5/8"	1.844	2-1/2"	-	72'
I52318	3-1/8"	1.812	3"	-	54'
I52358	3-5/8"	-	-	-	42'

1/2" Wall Thickness

PART NO.	NOMINAL ID	R VALUES	CTS	IPS	FT/BOX
I53038	3/8"	3.844	1/4"	-	444'
I53050	1/2"	3.582	3/8"	1/4"	360'
I53058	5/8"	3.375	1/2"	3/8"	306'
I53075	3/4"	3.223	3/4"	1/2"	270'
I53078	7/8"	3.107	3/4"	1/2"	240'
I53118	1-1/8"	4.835	1"	3/4"	180'
I53138	1-3/8"	2.822	1-1/4"	1"	150'
I53158	1-5/8"	2.737	1-1/2"	1-1/4"	120'
I53178	2"	2.672	-	1-1/2"	90'
I53218	2-1/8"	2.620	2"	-	84'
I53238	2-3/8"	2.578	-	2"	66'
I53258	2-5/8"	2.544	2-1/2"	-	60'
I53318	3-1/8"	2.490	3"	-	48'
I53312	3-1/2"	2.459	-	3"	42'
I53358	3-5/8"	2.449	3-1/2"	-	42'
I53418	4-1/8"	2.418	4"	-	30'
I53412	4-1/2"	2.399	-	4"	30'

3/4" Wall Thickness

PART NO.	NOMINAL ID	R VALUES	CTS	IPS	FT/BOX
I56058	5/8"	5.653	1/2"	3/8"	180'
I56075	3/4"	5.374	5/8"	1/2"	168'
I56078	7/8"	5.155	3/4"	1/2"	156'
I56118	1-1/8"	4.835	1"	3/4"	102'
I56138	1-3/8"	4.610	1-1/4"	1"	90'
I56158	1-5/8"	4.420	1-1/2"	1-1/4"	84'
I56218	2-1/8"	4.209	2"	-	54'

1" Wall Thickness

PART NO.	NOMINAL ID	R VALUES	CTS	IPS	FT/BOX
I57058	5/8"	8.189	1/2"	3/8"	108'
I57078	7/8"	7.435	3/4"	1/2"	90'
I57115	3/4"	7.767	5/8"	-	102'
I57118	1-1/8"	6.941	1"	-	90'
I57138	1-3/8"	6.588	1-1/4"	1"	72'
I57158	1-5/8"	6.323	1-1/2"	1-1/4"	60'
I57178	2"	6.115	-	1-1/2"	54'
I57218	2-1/8"	5.948	2"	-	56'
I57238	2-3/8"	5.810	-	2"	42'
I57258	2-5/8"	5.695	2-1/2"	-	36'

Poly Pipe Insulation Tees and Elbows



- 100% closed cell polyethylene
- Complete seal on hot or cold pipe
- Two strips of self-adhesive to seal easily
- UPS shippable cartons - CARTON QUANTITIES ONLY



SPECIFICATIONS:

Density: 1.5 lbs./cubic foot; Mold growth: None;
Temperature Range: -90° to 180°F; Flame/Smoke:
25/50; Water vapor permeability: less than .02
inches; Ozone resistance: Good

PART NO.	DESCRIPTION	WALL THICKNESS	CTN/MSTR
159050	1/2" tee	3/8"	1/16
159075	3/4" tee	3/8"	1/12
159100	1" tee	3/8"	1/12
159125	1-1/4" tee	3/8"	1/8
159150	1/2" elbow	3/8"	1/32
159175	3/4" elbow	3/8"	1/20
159200	1" elbow	3/8"	1/16
159225	1-1/4" elbow	3/8"	1/12

Insulation Contact Adhesive



- Brush top cans
- For use with rubber insulation only
- MOTOR FREIGHT ONLY/FLAMMABLE
- CARTON QUANTITIES ONLY

PART NO.	DESCRIPTION	CTN QTY
IA1050	Fast tack 1/2 pint	48
IA1100	Fast tack 1 pint	24
IA2050	Slow tack 1/2 pint	48
IA2100	Slow tack 1 pint	24

Insulation Protective Coating



- Clear

PART NO.	DESCRIPTION	CTN QTY
IPC004	1 gallon	4

Insulation Tape



- Gray
- Adhesive only on one side

PART NO.	DESCRIPTION	CTN QTY
INT001	1/8" x 2" x 30' cork tape	12
INT002	1/8" x 2" x 30' tape	12

Flanged Dielectric Union



- Temperature range: 180°F at 200 PSI
- Maximum temperature 200°F

PART NO.	FIP x COPPER SWEAT	CTN/MSTR
D06250	2-1/2" x 2-1/2"	1/4
D06300	3" x 3"	1/4
D06400	4" x 4"	1/2

Thermal Expansion Tank



- Designed for the protection of potable hot water systems
- Install between the backflow preventer and the water heater

SPECIFICATIONS:

Factory pre-charge: 40psi
System connection: 304 Stainless Steel
Diaphragm: Butyl Rubber
Liner Material: Food Grade Polypropylene
Max. Operating Temperature: 200°F
Max. Operating Pressure: 150psi

PART NO.	DESCRIPTION	CTN. QTY.	PALLET QTY.
R15202	2 gallon tank	1	150
R15204	4-1/2 gallon tank	1	80

Dual Port Self Cleaning Thermal Expansion Tank



- Designed for the protection of potable hot water systems
- Install between the backflow preventer and the water heater

SPECIFICATIONS:

Factory pre-charge: 15psi
System connection: 304 Stainless Steel
Diaphragm: Butyl Rubber
Liner Material: Food Grade Polypropylene
Max. Operating Temperature: 200°F
Max. Operating Pressure: 150psi

PART NO.	DESCRIPTION	CTN. QTY.	PALLET QTY.
R15206	2 gallon tank	1	150

Water Heater Grounding Kit



- Kit includes 2 bare bronze clamps
- Fits 1/2" to 1" pipe
- 6 gauge copper wire

PART NO.	DESCRIPTION	CTN QTY
J36500	Kit with 12" copper wire	6
J36501	Kit with 24" copper wire	6

Dielectric Union



Female x Sweat



Male x Sweat

- Zinc plated forged steel
- Prevents electrolysis or galvanic action when connecting dissimilar metals
- Residential or commercial use
- Solder ends conform to ANSI B16.19
- EPDM washer, ABS fiber sleeve
- Threads conform to ANSI B2.1
- Pressure rated at 250 PSI at 180°F
- Lead Free

Female x Sweat			
PART NO.	FIP x COPPER SWEAT	OD	CTN/MSTR
D06050	1/2" x 1/2"	5/8"	24/144
D06075	3/4" x 3/4"	7/8"	24/96
D06100	1" x 1"	1-1/8"	12/96
D06125	1-1/4" x 1-1/4"	1-3/8"	6/48
D06150	1-1/2" x 1-1/2"	1-5/8"	6/48
D06200	2" x 2"	2-1/8"	6/18

Reducing			
PART NO.	FIP x COPPER SWEAT	OD	CTN/MSTR
D06350	3/4" x 1/2"	5/8"	24/96

Male x Sweat			
PART NO.	MIP x COPPER SWEAT	OD	CTN/MSTR
D06005	1/2" x 1/2"	7/8"	24/96
D06750	3/4" x 3/4"	7/8"	24/96

Reducing			
PART NO.	MIP x COPPER SWEAT	OD	CTN/MSTR
D06755	3/4" x 1/2"	5/8"	24/72

Items marked with the Jones Stephens logo are "You Need It... We Got It" Items.

Universal Copper Thermocouple



- All copper with brass fittings
- Adaptable to 5 different pilot valves
- Kit includes 2 clips and nuts
- Individually carded

PART NO.	DESCRIPTION	CTN/MSTR
J36118	18" copper thermocouple	10/100
J36124	24" copper thermocouple	10/100
J36130	30" copper thermocouple	1/10
J36136	36" copper thermocouple	1/10
J36148	48" copper thermocouple	1/10

Gasket and Insert for Dielectric Union



Insert



Gasket

- For water
- 200°F temperature rating
- CARTON QUANTITIES ONLY

PART NO.	DESCRIPTION	CTN QTY
D06800	1/2" insert	1/1
D06801	3/4" insert	1/500
D06802	1" insert	1/100
D06803	1-1/4" insert	1/1
D06804	1-1/2" insert	1/1
D06805	2" insert	1/1
D06850	1/2" gasket	1/1000
D06875	3/4" gasket (EPDM rubber)	1/1000
D06900	1" gasket	1/1000
D06901	1-1/4" gasket	1/1000
D06902	1-1/2" gasket	1/1000
D06903	2" gasket	1/1000

Dielectric Nipple



- Electroplated steel casing with non-corrosion thermoplastic lining• 180° maximum temperature
- Prevents corrosion, lime and scale buildup
- Adds years of life to any water system
- For use on water heaters, dishwashers, water filtration systems

PART NO.	SIZE	CTN/MSTR
D06753	3/4" MIP x 3" length	50/100
D06450	1/2" MIP x 3" length	50/100
D06500	1" MIP x 3" length	25/50
D06510	1" MIP x 4" length	25/50
D06525	1-1/4" MIP x 4" length	25/50
D06550	1-1/2" MIP x 4" length	5/25
D06600	2" MIP x 4" length	5/25
D06650	2-1/2" MIP x 6" length	5/10
D06700	3" MIP x 6" length	5/10

Items marked with the Jones Stephens logo are "You Need It... We Got It" Items.

Corrugated Water Heater Connector

- Corrugated for easy flex on water heaters and softeners
- Includes rubber washers

Copper



PART NO.	FPT x LENGTH	CTN/MSTR
J34712	3/4" x 12"	1/50
J34715	3/4" x 15"	1/50
J34718	3/4" x 18"	1/50
J34724	3/4" x 24"	1/50

PART NO.	FIP x SWT x LENGTH	CTN/MSTR
J35712	3/4" x 3/4" x 12"	25/50
J35715	3/4" x 3/4" x 15"	25/50
J35718	3/4" x 3/4" x 18"	25/50
J35724	3/4" x 3/4" x 24"	25/50

PART NO.	FIP x MIP x LENGTH	CTN/MSTR
J36712	3/4" x 3/4" x 12"	1/25
J36715	3/4" x 3/4" x 15"	1/25
J36718	3/4" x 3/4" x 18"	1/25
J36724	3/4" x 3/4" x 24"	1/25

Stainless Steel



PART NO.	MIP x FIP x LENGTH	CTN/MSTR
J38712	3/4" x 3/4" x 12"	25/50
J38715	3/4" x 3/4" x 15"	25/50
J38718	3/4" x 3/4" x 18"	25/50
J38724	3/4" x 3/4" x 24"	25/50

PART NO.	FIP x FIP x LENGTH	CTN/MSTR
J39712	3/4" x 3/4" x 12"	25/50
J39715	3/4" x 3/4" x 15"	25/50
J39718	3/4" x 3/4" x 18"	25/50
J39724	3/4" x 3/4" x 24"	25/50

Braided Stainless Steel Water Heater Connector

- UPC listed
- Lead Free



PART NO.	FIP x LENGTH	CTN/MSTR
S04350	3/4" x 12"	10/40
S04351	3/4" x 18"	10/40
S04352	3/4" x 24"	10/40

PART NO.	FIP x COMP x LENGTH	CTN/MSTR
S04353	3/4" x 3/4" x 12"	10/40
S04354	3/4" x 3/4" x 18"	10/40
S04355	3/4" x 3/4" x 24"	10/40

PART NO.	FIP x MIP x LENGTH	CTN/MSTR
S04356	3/4" x 3/4" x 12"	10/40
S04357	3/4" x 3/4" x 18"	10/40
S04358	3/4" x 3/4" x 24"	10/40

PART NO.	MIP x COMP x LENGTH	CTN/MSTR
S04359	3/4" x 3/4" x 12"	10/40
S04360	3/4" x 3/4" x 18"	10/50

Water Heater Stand



- Galvanized
- Snap-in legs
- Easy to assemble
- Rating approval at 2,000 lbs. static weight

PART NO.	DESCRIPTION	CTN/MSTR
J36200	18" square x 17" high water heater stand	1/4

C

Water Heater Stand



- 3/4 tubular steel construction
- No assembly required
- Non-rust paint
- 800 lbs. static weight

PART NO.	DESCRIPTION	CTN QTY
J36300	25-1/2" x 19" high water heater stand	1
J36250	28-3/8" x 18-3/16" high water heater stand	1

Stand-Rite Water Heater Stand



- 14 gauge galvanized steel
- Lab tested
- Heavy Duty
- Corrosion resistant
- Top 21.5" x 21.5"
- Rated up to 650 pounds
- For water heaters up to 65 gallons
- Includes mounting clips for securing to wall/floor
- Quick assembly

PART NO.	DESCRIPTION	CTN QTY
J36400	Water heater stand	1

Water Heater Safety Pan



- High impact plastic
- 1" pan adapter (J34800) included
- 2-1/2" depth
- Southern Building Code and natural gas approved
- CARTON QUANTITIES ONLY

PART NO.	BOTTOM ID	TOP ID	CTN/MSTR
J36018	19"	20-1/2"	1/20
J36022	22"	22-1/2"	1/20
J36024	24"	25-1/2"	1/20
J36026	26"	27-1/2"	1/10
J36030	30"	31-1/2"	1/5

Galvanized Hot Water Heater Pan



- 24 gauge
- Flared sides
- 1" pan adapter (J34800) included

PART NO.	DESCRIPTION	CTN QTY
J37022	22" x 22" x 4" water heater pan	1
J37024	24" x 24" x 4" water heater pan	1
J37026	26" x 26" x 4" water heater pan	1
J37028	28" x 28" x 4" water heater pan	1
J37030	30" x 30" x 4" water heater pan	1

Water Heater Pan



Seamless Galvanized Corner



- Seamless galvanized water heater pans are folded not welded
- 1" pan adapter (J34800) included
- One piece stamped aluminum .032 mil (20 gauge)
- Aluminum pans comply with SBCCI, sec. 1213.7

PART NO.	DESCRIPTION	CTN/MSTR
J38020	20" round water heater pan (aluminum)	1/10
J38022	22" round water heater pan (aluminum)	1/10
J38024	24" round water heater pan (aluminum)	1/10
J38026	26" round water heater pan (aluminum)	1/10
J38030	30" round water heater pan (aluminum)	1/5
J39019	19" seamless water heater pan (galvanized)	1
J39023	23" seamless water heater pan (galvanized)	1
J39027	27" seamless water heater pan (galvanized)	1
J39030	30" seamless water heater pan (galvanized)	1

Water Heater Pan Adapter



- 1" PVC
- Washer and locknut
- Fits all Jones Stephens pans

PART NO.	DESCRIPTION	CTN/MSTR
J34800	1" Adapter	1/25

Run-Off Tube



- For water heaters
- Electroplated fittings
- 230°F temperature rating
- Hand tighten to T and P valve
- UL listed
- J34970 is sold in CARTON QUANTITIES ONLY



PART NO.	DESCRIPTION	CTN/MSTR
J34975	3/4" NPT x 60" side mount	1/100
J34980	3/4" NPT top mount	1/25
J34970	3/4" NPT x 60" side mount	12/12

Gas Testing Equipment



- Large 4" face
- Class 1A gauge
- 5 lb. gas test gauge/15 lb. gas test gauge
- 1/10 # increments
- Inches of mercury scale
- External set hand
- Bellows design
- 1/4 NPT connection
- Gauge meets all requirements of the City of Houston code Word 94-108, Section 1204.3.2, revised January 18, 2001
- ALL SALES FINAL; NO WARRANTY; NO RETURN

PART NO.	DESCRIPTION	CTN/MSTR
G60055	15 lb. gas test gauge only	1/20
G60005	5 lb. gas test gauge only	1/20

Liquid Filled Pressure Gauge



- Polished 304 stainless steel case with vent plug
- 2-1/2" face (glass)
- +/- 1.5% accuracy
- Glycerin filled for use where vibration or pressure pulsation occur
- -50 to 150°F operating temperature
- 1/4" NPT bottom connection

PART NO.	DESCRIPTION	CTN/MSTR
J40553	0-30 PSI	1/50
J40554	0-60 PSI	1/50
J40555	0-100 PSI	1/50
J40556	0-200 PSI	1/50
J40557	0-300 PSI	1/50

Pressure Gauge



- Steel case
- Shatterproof face
- 1/4" MIP brass lower connection
- Applicable with air, water, oil and gas - anything which does not attack brass
- Not for use on oxygen service
- Individually boxed
- Class 2.5-2% accuracy

PART NO.	FACE SIZE	PRESSURE RATING	CTN/MSTR
G60015	2"	15 PSI	1/100
G60030	2"	30 PSI	1/100
G60060	2"	60 PSI	1/100
G60100	2"	100 PSI	1/100
G60160	2"	160 PSI	1/100
G60200	2"	200 PSI	1/100
G60300	2"	300 PSI	1/100
G61015	2-1/2"	15 PSI	1/100
G61030	2-1/2"	30 PSI	1/60
G61060	2-1/2"	60 PSI	1/100
G61100	2-1/2"	100 PSI	1/100
G61160	2-1/2"	160 PSI	1/100
G61200	2-1/2"	200 PSI	1/100
G61300	2-1/2"	300 PSI	1/100
G62030	3-1/2"	30 PSI	1/50
G62060	3-1/2"	60 PSI	1/50
G62100	3-1/2"	100 PSI	1/50
G62200	3-1/2"	200 PSI	1/50
G62300	3-1/2"	300 PSI	1/50

Pigtail Syphon



G60000



G60001

- Steel construction
- For use with gauges on steam line
- 1/4" MPT x 1/4" MPT

PART NO.	DESCRIPTION	CTN/MSTR
G60000	Straight	20/200
G60001	90° Angle	10/200

Items marked with the Jones Stephens logo are "You Need It...We Got It" Items.

Water Test Gauge



- Steel case with 2-1/2" shatterproof face
- Individually boxed
- 3/4" female brass hose connection

PART NO.	DESCRIPTION	CTN/MSTR
J66300	300 PSI	1/50
J66301	300 PSI with indicator arm	1/50
J66302	160 PSI with indicator arm	1/50

Sillcock/Water or Gas Test Gauge Assembly



- Steel case with 2" shatterproof face
- Brass air valve
- Individually boxed
- Adapts to 3/4" male garden hose or 3/4" MIP
- Comes with garden hose adapter

PART NO.	DESCRIPTION	CTN/MSTR
G64101	200 PSI	1/50

5 Pound Gas Test Gauge



- 1/4" NPT
- 2-1/2" diaphragm
- 1/10 # increments
- For building code inspection

PART NO.	DESCRIPTION	CTN/MSTR
G61005	5 lb. gas test gauge	1/100

Gas Test Gauge



- 2" steel case gauge on 15 lb.
- 5 lb. is marked in 1/10 lb. increments
- 15 lbs. is marked in 1/10 lb. increments
- Plated body with 3/4" FIP inlet
- 2 1/2" diaphragm on 5 lb.
- Adapts to 3/4" MPT
- Brass air valve
- Individually boxed

PART NO.	DESCRIPTION	CTN/MSTR
G64015	15 lb. gas test gauge assembly	1/50
G64005	5 lb. gas test gauge assembly	1/50

Test Gauge Assembly



- Bell type

PART NO.	DESCRIPTION	CTN/MSTR
G66015	15# x 3/4" FIP	1/50
G66030	30# x 3/4" FIP	1/50
G66060	60# x 3/4" FIP	1/50
G66100	100# x 3/4" FIP	1/24
G67015	15# x 1" FIP	1/50
G67030	30# x 1" FIP	1/50
G67060	60# x 1" FIP	1/50
G67100	100# x 1" FIP	1/100
G66000	3/4" Bell body (less air valve)	1/100
G66002	3/4" Bell body (with air valve)	1/100
G67000	1" Bell body (less air valve)	1/59
G67002	1" Bell body (with air valve)	1/80

Gas Test Gauge Assembly



- 4" face and pressure snubber
- Regulates air to an even flow
- Over pressurization will void the warranty
- Protects the diaphragm from compressed air damage
- Class 1A gauge

PART NO.	DESCRIPTION	CTN/MSTR
G64155	5 lb. test gauge assembly	1/20
G65155	15 lb. test gauge assembly	1/20

C

Gas Test Gauge Assembly



- Steel case with 2" shatterproof face
- Adapts to 3/4" MPT
- Plated body with 3/4" FIP inlet
- Brass air valve
- Individually boxed

PART NO.	DESCRIPTION	CTN/MSTR
G64030	30 PSI	1/50
G64060	60 PSI	1/50
G64100	100 PSI	1/50
G64160	160 PSI	1/50
G64200	200 PSI	1/50
G64333	300 PSI	1/50
G64000	1/4" air valve and cap	50/500
G64001	Gas test body only	1/100
G64002	1/8" air valve and cap	500/1000
G64020	Gas test body and air valve assembly	1/100

Tridicator



- 0-55 PSI
- 70°F to 250°F temperature range
- Back mount

PART NO.	DESCRIPTION	CTN/MSTR
J40550	2 1/2" face angle 2 1/4" stem (1/4" NPT)	1/50
J40551	2 1/2" face angle 2 1/2" stem (1/4" NPT)	1/50
J40558	2 1/2" face angle 1" stem (1/4" NPT)	1/50
J40560	3 1/2" face angle 2 3/4" stem (1/2" NPT)	1/50

Dual Scale Boiler Gauge



- 0-75 PSI
- 1/4" MIP connection
- -60-320° F, 20-160° C
- Center back mount
- 3-1/2" face

PART NO.	DESCRIPTION	CTN/MSTR
J40575	Dual scale boiler gauge	1/100

Vacuum Gauge



- 1/4" brass lower connection
- -30 to 0 inch Hg
- Black steel case with bronze internals
- 2" face

PART NO.	DESCRIPTION	CTN/MSTR
G63001	Vacuum gauge	1/100

Items marked with the Jones Stephens logo are "You Need It...We Got It" Items.

Pressure Snubber



- Bronze body and core
- Use on lines with noticeable pressure changes/oscillations
- 1000 PSI maximum

PART NO.	DESCRIPTION	CTN/MSTR
G64300	1/4" NPT for air or gas	1/500
G64301	1/4" NPT for oil, steam or water	1/200

Needle Valve for Pressure Gauge



- Brass body, seat, stem and handle
- 1/4" NPT
- 300°F maximum temperature
- Female x female
- Teflon packing
- 2000 PSI

PART NO.	DESCRIPTION	CTN/MSTR
G64004	1/4" needle valve	1/125

Hot Water/Refrigerant Line Thermometer

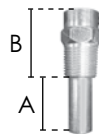

- Straight or angle pattern
- Steel or brass well included
- 40°-280°F x 5°F (5-120°C x 2°C)
- 1/2" NPT; 1" stem

PART NO.	DESCRIPTION	DIM (A)	DIM (B)	CTN/MSTR
J40500	Straight pattern with steel well	1"	1/2" NPT	1/50
J40501	Straight pattern with brass well	1"	1/2" NPT	1/50
J40502	Angle pattern with steel well	1"	1/2" NPT	1/50
J40503	Angle pattern with brass well	1"	1/2" NPT	1/50

Dial Thermometer



- 2-1/2" face
- 5° increments
- Dual scale: 40°-240°/0°-120°C
- Brass wells/removable thermometers
- Thermometers are not supplied with wells

PART NO.	DESCRIPTION	CTN/MSTR
J40702	3/4" SWT connection	1/50
J40703	1/2" MIP connection	1/100
J40704	3/4" SWT well	1/100
J40705	1/2" MIP well	1/100

Weksler Industrial Multi-Angle Thermometer

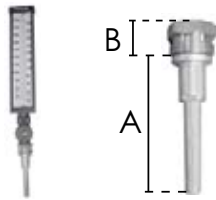

- Must have well - no well provided; order wells separately
- 9° scale, red-reading mercury tubes
- Molded cyclocac case with glass window
- Adjustable to any angle
- Accurate to +/- one scale division
- Must have well

PART NO.	DESCRIPTION	DIM (A)	DIM (B)	CTN/MSTR
J40505	Hot water 30°-240°F	3-1/2" stem	1" NPSM	1/50
J40506	Cold water 0°-120°F	3-1/2" stem	1" NPSM	1/25
J40510	Standard brass well	2-1/2" stem	3/4" NPT	1/100
J40511	Extended well	1-3/4" stem	3/4" NPT	1/100

Bi-Metal Dial Thermometer

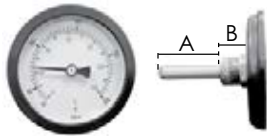

- For commercial or home heating systems
- 1/2" NPT
- 20°-240°F temperature range
- 3" dial in steel case
- Angle has back connection; straight has bottom connection

PART NO.	DESCRIPTION	DIM (A)	DIM (B)	CTN/MSTR
J40561	Angle outlet with brass well	1-1/8" stem	1/2" NPT	1/50
J40562	Straight outlet with brass well	2-3/8" stem	1/2" NPT	1/50



- Solid brass construction
- 1-1/2" stem
- 1/2" MPT x 1/4" FPT threads

PART NO.	DESCRIPTION	CTN/MSTR
J40563	Brass well for J40562	1/200

Pocket Test Thermometer



- 2% accuracy for hot and cold
- Pocket clip on sheath; 5" stem

PART NO.	DESCRIPTION	CTN/MSTR
J40700	Cold thermometer (-40° to 160°F)	1/80
J40701	Hot thermometer (0° to 220°F)	1/80

Natural Polyethylene Tubing



- Non-toxic, 100% virgin material
- 100' coils in dispenser box
- FDA grade
- -40°F to +135°F
- Low density

PART NO.	OD	ID	PSI	WALL	CTN QTY
T25250	1/4"	.170"	120	.040	100'
T25312	5/16"	.187"	150	.040	100'
T25375	3/8"	.250"	125	.062	100'
T25500	1/2"	.375"	95	.062	100'
T25625	5/8"	.500"	75	.500	100'

Items marked with the Jones Stephens logo are "You Need It...We Got It" Items.

Clear Vinyl Tubing



- 75 duro clear
- -5°F to +125°F
- Self-dispensing cartons
- FDA grade

PART NO.	OD	ID	WALL	WPPSI	CTN QTY
T26124	3/16"	1/8"	1/32"	50	100'
T26125	1/4"	1/8"	1/16"	80	100'
T26186	1/4"	3/16"	1/32"	40	100'
T26187	5/16"	3/16"	1/16"	60	100'
T26250	3/8"	1/4"	1/16"	55	100'
T26252	1/2"	1/4"	1/8"	90	100'
T26312	7/16"	5/16"	1/16"	50	100'
T26313	1/2"	5/16"	3/32"	60	100'
T26375	1/2"	3/8"	1/16"	45	100'
T26376	9/16"	3/8"	3/32"	55	100'
T26377	5/8"	3/8"	1/8"	65	100'
T26498	5/8"	1/2"	1/16"	30	100'
T26500	3/4"	1/2"	1/8"	45	100'
T26626	3/4"	5/8"	1/16"	30	100'
T26625	7/8"	5/8"	1/8"	40	100'
T26750	1"	3/4"	1/8"	35	100'
T26875	1 1/8"	7/8"	1/8"	30	50'
T26000	1 1/4"	1"	1/8"	28	50'

Soft Aluminum Tubing



- 50' coils
- Alloy 3003-0, ASTM B-483

PART NO.	OD	WALL	CTN/MSTR
T27125	1/8"	.025	1/10
T27188	3/16"	.028	1/10
T27250	1/4"	.032	1/10
T27313	5/16"	.035	1/10
T27375	3/8"	.035	1/10
T27438	7/16"	.035	1/10
T27500	1/2"	.035	1/10
T27625	5/8"	.035	1/10

Stud Protectors and Plate



- Protects piping and wiring from nails
- CARTON QUANTITIES ONLY

PART NO.	DESCRIPTION	GAUGE	CTN QTY
S33001	1-1/2" x 6"	18	100
S33002	1-1/2" x 3"	18	100
S33003	5" x 8" (not self nailed)	16	50
S33005	1-1/2" x 6"	16	100
S33006	1-1/2" x 5"	18	100
S33010	1-1/2" x 6"	22	100
S33011	1-1/2" x 3"	22	100
S33012	3-1/2" x 6" (not self nailed)	16	100

Interlocking Stud Guard



- CARTON QUANTITIES ONLY

PART NO.	DESCRIPTION	GAUGE	CTN QTY
S33004	1-1/2" x 6"	20	100
S33007	1-1/2" x 6"	16	100
S33016	3-1/2" x 6"	16	25

Stud Shoe



- 18 gauge galvanized
- 4 nail holes on each side
- Pipe opening accommodates 2" IPS or smaller pipe
- Stud/joist reinforcement when drilling or notching for pipe runs
- CARTON QUANTITIES ONLY

PART NO.	DESCRIPTION	CTN QTY
S33021	Single stud shoe	50
S33022	Double stud shoe	25
S33023	Triple stud shoe	10

Stud Guard



- 6 holes, 2 nailers
- Self-nailing
- Protects pipes
- CARTON QUANTITIES ONLY

PART NO.	DESCRIPTION	GAUGE	CTN QTY
S33013	5" x 8" stud guard	16	25



- CARTON QUANTITIES ONLY

PART NO.	DESCRIPTION	GAUGE	CTN QTY
S33318	3-1/2" x 18" stud guard	16	25



- 20 holes
- CARTON QUANTITIES ONLY

PART NO.	DESCRIPTION	GAUGE	CTN QTY
S33518	5" x 18" stud guard	16	25

Stud Guard



S180032



S16006



S163566

- CARTON QUANTITIES ONLY

Self Nailing Stud Guard with 2 Holes Centered

PART NO.	SIZE	GAUGE	CTN QTY
S180032	1-1/2" x 3"	18	200

2 Hole Stud Guard

PART NO.	SIZE	GAUGE	CTN QTY
S16006	1-1/2" x 6"	16	100

6 Hole Stud Guard

PART NO.	SIZE	GAUGE	CTN QTY
S163566	3-1/2" x 6"	16	25

Self Nailed Stud Guard

PART NO.	SIZE	GAUGE	CTN QTY
S16009	1-1/2" x 9"	16	100
S16012	1-1/2" x 12"	16	100
S16018	1-1/2" x 18"	16	50
S16024	1-1/2" x 24"	16	25
S20012	1-1/2" x 12"	20	100
S20009	1-1/2" x 9"	20	100
S16005	1-1/2" x 5"	16	100
S16003	1-1/2" x 3"	16	100

F.H.A. Strap - Galvanized Steel



- Tie plates
- CARTON QUANTITIES ONLY

PART NO.	SIZE	GAUGE	CTN QTY
F12009	1-1/2" x 9"	12	50
F18009	1-1/2" x 9"	18	100
F12012	1-1/2" x 12"	12	50
F18012	1-1/2" x 12"	18	100
F12018	1-1/2" x 18"	12	50
F18018	1-1/2" x 18"	18	100
F12024	1-1/2" x 24"	12	50
F18024	1-1/2" x 24"	18	100

F.H.A. Strap



- CARTON QUANTITIES ONLY

PART NO.	SIZE	GAUGE	CTN QTY
F18309	3" x 9"	18	50
F18312	3" x 12"	18	50
F18318	3" x 18"	18	50
F18324	3" x 24"	18	50

Items marked with the Jones Stephens logo are "You Need It...We Got It" Items.

F.H.A. Strap

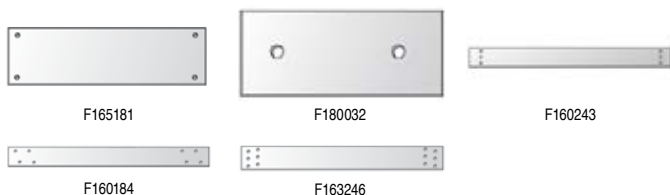

• CARTON QUANTITIES ONLY

One Hole in Each Corner

PART NO.	SIZE	GAUGE	CTN QTY
F165181	5" x 18"	16	15

2 Holes

PART NO.	SIZE	GAUGE	CTN QTY
F180032	1-1/2" x 3"	18	200

3 Holes Vertically Aligned

PART NO.	SIZE	GAUGE	CTN QTY
F160123	1-1/2" x 12"	16	50
F160183	1-1/2" x 18"	16	50
F160243	1-1/2" x 24"	16	50
F160363	3" x 6"	16	50
F160393	3" x 9"	16	50
F160063	1-1/2" x 6"	16	50
F160093	1-1/2" x 9"	16	50

Standard F.H.A. with 4 Offset Holes

PART NO.	SIZE	GAUGE	CTN QTY
F14012	1-1/2" x 12"	14	50
F16012	1-1/2" x 12"	16	50
F160184	1-1/2" x 18"	16	50
F160094	1-1/2" x 9"	16	50

Standard F.H.A. with 6 Offset Holes

PART NO.	SIZE	GAUGE	CTN QTY
F160126	1-1/2" x 12"	16	50
F16016	1-1/2" x 16"	16	50
F160186	1-1/2" x 18"	16	50
F160246	1-1/2" x 24"	16	50
F163186	3" x 18"	16	50
F163246	3" x 24"	16	50
F165186	5" x 18"	16	15

Galvanized Bracket

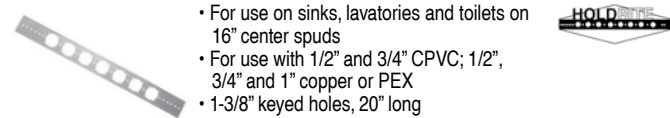

- For use on sinks, lavatories and toilets on 16" center spuds
- For use with 1/2" and 3/4" CPVC; 1/2", 3/4" and 1" copper or PEX
- 1-3/8" keyed holes, 20" long
- Use with B00016, B00017, B00018 and B00013
- CARTON QUANTITIES ONLY

PART NO.	DESCRIPTION	HR #	CTN QTY
B00001	1/2" - 1" x 20"	103-18	50

Flat Copper Plated Bracket



- For use on sinks, lavatories or other fixtures
- Use for 1/2" copper pipe
- CARTON QUANTITIES ONLY



PART NO.	DESCRIPTION	HR #	CTN QTY
B00003	1/2" x 20"	101-18	50
B00021	1/2" x 26"	101-26	50

Flat Copper Plated Bracket



- For use on water heater connections
- Use for 3/4" and 1" copper pipe
- CARTON QUANTITIES ONLY



PART NO.	DESCRIPTION	HR #	CTN QTY
B00004	3/4" - 1" x 20"	102-18	50

Flat Copper Plated Bracket



- For use on 1/2", 3/4" or 1" copper pipe
- CARTON QUANTITIES ONLY



PART NO.	DESCRIPTION	HR #	CTN QTY
B00005	1/2" - 1" x 20"	107-18	50

Flat Copper Plated Bracket



- Copper-Bonded™ steel
- For support of 1/2" and 3/4" pipes on 4" or 8" centers
- Positions copper water supplies for sinks, water closets, and other fixtures
- 25 lb. load rating
- CARTON QUANTITIES ONLY



PART NO.	DESCRIPTION	HR #	CTN QTY
B00025	1/2" - 3/4" x 20"	150-20	50

Copper Plated Carrier Bracket



- Secures 1" stub out at 11-1/2" above the rim
- CARTON QUANTITIES ONLY



PART NO.	DESCRIPTION	HR #	CTN QTY
B00022	Carrier Bracket	114-C	6
B00023	Carrier Bracket	114-R	6

Pipe Bracket



- 150 lb. load capacity
- Can attach to stud or directly to wall



PART NO.	DESCRIPTION	HR #	CTN QTY
B00024	Pipe Bracket	V2	25

Items marked with the Jones Stephens logo are "You Need It...We Got It" Items.

Extruded Hole Copper Plated Bracket



- For use on 1/2", 3/4" or 1" copper pipe
- Extruded holes
- CARTON QUANTITIES ONLY



PART NO.	DESCRIPTION	HR #	CTN QTY
B00006	1/2" - 1" x 20"	108-20	50
B00019	1/2" - 1" x 26"	108-26	50

C

Extruded Notches Copper Plated Bracket



- For use on 1/2", 3/4" or 1" copper pipe
- Extruded holes
- CARTON QUANTITIES ONLY



PART NO.	DESCRIPTION	HR #	CTN QTY
B00007	1/2" - 3/4" x 20"	140	50

Galvanized Lockright Pipe Bracket for CPVC



- For use on sinks or lavatories using CPVC
- 20 gauge galvanized steel with 1" holes on 2" centers
- Use with B00014 and B00015
- CARTON QUANTITIES ONLY



PART NO.	DESCRIPTION	HR #	CTN QTY
B00008	1/2" - 3/4" x 20"	601-20	50

Galvanized Lockright Bracket



- CARTON QUANTITIES ONLY



PART NO.	DESCRIPTION	HR #	CTN QTY
B00020	1/2" - 3/4" x 26"	601-26	50

Copper Plated Bracket for Water Closet



- For use on 1/2" copper pipe
- For use with water closets or hose bibbs
- CARTON QUANTITIES ONLY



PART NO.	DESCRIPTION	HR #	CTN QTY
B00002	1/2"	109-N-6	50

Galvanized L Bracket for PEX



- For use with PEX on overhead and side runs
- Use with B00013, B00016, B00017 and B00018 inserts
- CARTON QUANTITIES ONLY



PART NO.	DESCRIPTION	HR #	CTN QTY
B00009	Bracket with 1 3/8" keyed holes-PEX	709L	50

Galvanized Bracket



- For use on lavatories and toilets
- Use with B00013, B00016, B00017 and B00018 inserts
- CARTON QUANTITIES ONLY



PART NO.	DESCRIPTION	HR #	CTN QTY
B00010	Bracket with 1 3/8" keyed holes-PEX	709	50

18 Gauge Galvanized Bracket for CPVC



- For use on residential toilets or hose bibbs
- Use with B00014 or B00015 inserts
- CARTON QUANTITIES ONLY



PART NO.	DESCRIPTION	HR #	CTN QTY
B00011	Bracket with 1" hole	609-N-6	50

Turnout Bend Support for PEX



- PEX turnout bend support for potable water installations
- CARTON QUANTITIES ONLY



PART NO.	DESCRIPTION	HR #	CTN QTY
B00013	3/8" - 1/2"	704	25/100

Insert for CPVC



- Fire retardant plastic
- CARTON QUANTITIES ONLY



PART NO.	DESCRIPTION	HR #	CTN QTY
B00014	1/2" insert	604	100

Metal Stud Insulator



- Fire retardant plastic
- Use for copper pipe
- CARTON QUANTITIES ONLY



PART NO.	DESCRIPTION	HR #	CTN QTY
B00016	1/2" insulator	404-R	100
B00017	3/4" insulator	405-R	100
B00018	1" insulator	406-R	100

Schedule 40 Pipe Hanger



- Alternating screw and nail holes
- Load rating 250# max

PART NO.	DESCRIPTION	CTN QTY
H30001	1-1/2" galvanized pipe hanger	50
H30002	2" galvanized pipe hanger	50
H30003	3" galvanized pipe hanger	50
H30004	4" galvanized pipe hanger	50
H30011	1-1/2" vinyl coated pipe hanger	100
H30022	2" vinyl coated pipe hanger	50
H30033	3" vinyl coated pipe hanger	50
H30044	4" vinyl coated pipe hanger	50

Plastic Coated Pipe Hook



- Steel pipe hook with plastic insulation
- Coated black

PART NO.	DESCRIPTION	CTN QTY
H12054	1/2" x 4" pipe hook	50/1000
H12056	1/2" x 6" pipe hook	50/1000
H12074	3/4" x 4" pipe hook	50/1000
H12076	3/4" x 6" pipe hook	50/1000
H12106	1" x 6" pipe hook	50/1000

"Copper Boy" Pipe Hook



- CARTON QUANTITIES ONLY

PART NO.	DESCRIPTION	CTN/MSTR
H10052	1/2" x 2-1/2" copper clad pipe hook	50/2200
H10072	3/4" x 2-1/2" copper clad pipe hook	50/500

Drive J-Hook



- Copper clad
- CARTON QUANTITIES ONLY

PART NO.	DESCRIPTION	CTN QTY
H23050	1/2" x 3/4" CTS drive j-hook	100

Pipe Hook



Plain Steel



Copper Clad

- 10 gauge
- CARTON QUANTITIES ONLY

PART NO.	SIZE	MATERIAL	CTN QTY
H10054	1/2" x 4"	Plain Steel	50/500
H10056	1/2" x 6"	Plain Steel	50/500
H10058	1/2" x 8"	Plain Steel	50/500
H10074	3/4" x 4"	Plain Steel	50/500
H10076	3/4" x 6"	Plain Steel	50/500
H10078	3/4" x 8"	Plain Steel	50/500
H10080	3/4" x 10"	Plain Steel	50/500
H10106	1" x 6"	Plain Steel	50/500
H10108	1" x 8"	Plain Steel	50/500
H10110	1" x 10"	Plain Steel	50/500
H10126	1-1/4" x 6"	Plain Steel	50/500
H10128	1-1/4" x 8"	Plain Steel	50/500
H10156	1-1/2" x 6"	Plain Steel	50/500
H10158	1-1/2" x 8"	Plain Steel	50/500
H10208	2" x 8"	Plain Steel	50/500
H11054	1/2" x 4"	Copper Clad	50/500
H11056	1/2" x 6"	Copper Clad	50/500
H11058	1/2" x 8"	Copper Clad	50/500
H11074	3/4" x 4"	Copper Clad	50/500
H11076	3/4" x 6"	Copper Clad	50/500
H11078	3/4" x 8"	Copper Clad	50/500
H11080	3/4" x 10"	Copper Clad	50/500
H11106	1" x 6"	Copper Clad	50/500
H11108	1" x 8"	Copper Clad	50/500
H11126	1-1/4" x 6"	Copper Clad	50/500
H11156	1-1/2" x 6"	Copper Clad	50/500
H11208	2" x 8"	Copper Clad	50/500
H11210	2" x 10"	Copper Clad	50/500

J-Hook for CTS Water System



- Fabricated of durable ABS plastic
- Nail holes on all four sides - nails are included!
- No heat distortion even at 250°
- Eliminates corrosion and electrolysis on copper pipe
- FULL BAG QUANTITIES ONLY

Baby J-Hooks

PART NO.	DESCRIPTION	BAG/CTN QTY
J01050	1/2" CTS x 4" length	25/300
J01075	3/4" CTS x 4" length	25/300
J01100	1" CTS x 4" length	25/200

Long Baby J-Hooks

PART NO.	DESCRIPTION	BAG/CTN QTY
J01057	1/2" CTS x 7-1/2" length	25/200
J01077	3/4" CTS x 7-1/2" length	25/200

Double J-Hooks

PART NO.	DESCRIPTION	BAG/CTN QTY
J01051	1/2" CTS x 1/2" CTS x 4" length	25/200
J01052	1/2" CTS x 3/4" CTS x 4" length	25/200
J01053	3/4" CTS x 3/4" CTS x 4" length	25/200

J-Hook for Drain Pipe System



- Fabricated of durable ABS plastic
- Nails included
- Reduces installation time
- Glueable with universal cement
- Designed for PVC and ABS pipe
- Calibrated for 1/8" fall per foot - no more measuring & adjusting for fall
- UPC listed
- FULL BAG QUANTITIES ONLY



PART NO.	DESCRIPTION	BAG/CTN QTY
J01150	1 1/2" DWV x 7" length	25/300
J01200	2" DWV x 7" length	25/300
J01300	3" DWV x 7" length	25/300
J01400	4" DWV x 7" length	25/300

Pipe Strap



- Priced each
- CARTON QUANTITIES ONLY

PART NO.	SIZE	MATERIAL	# HOLES	CTN QTY
H13038	3/8" IPS	Galvanized	2	200
H13050	1/2" IPS	Galvanized	2	150
H13075	3/4" IPS	Galvanized	2	50
H13100	1" IPS	Galvanized	2	50
H13125	1-1/4" IPS	Galvanized	2	50
H13150	1-1/2" IPS	Galvanized	2	25
H13200	2" IPS	Galvanized	2	25
H13250	2-1/2" IPS	Galvanized	2	25
H13300	3" IPS	Galvanized	2	10
H13400	4" IPS	Galvanized	2	10
H15050	1/2" CTS	Copper Clad	2	100
H15075	3/4" CTS	Copper Clad	2	100
H15100	1" CTS	Copper Clad	2	100
H15125	1-1/4" CTS	Copper Clad	2	100
H15150	1-1/2" CTS	Copper Clad	2	100
H15200	2" CTS	Copper Clad	2	100
H16038	3/8" CTS	Solid Copper	2	100
H16050	1/2" CTS	Solid Copper	2	100
H16075	3/4" CTS	Solid Copper	2	100
H16100	1" CTS	Solid Copper	2	100
H18050	1/2" IPS	Galvanized	1	100
H18075	3/4" IPS	Galvanized	1	100

Copper Clad Nail



- CARTON QUANTITIES ONLY

PART NO.	DESCRIPTION	CTN/MSTR
H15001	1-1/4" copper clad nail	200/2000

Copper Coated J-Nails



- CARTON QUANTITIES ONLY

PART NO.	DESCRIPTION	CTN/MSTR
H22050	1/2" copper coated j-nail	100/1300
H22075	3/4" copper coated j-nail	100/1300

Full Clamp



- Plastic clamp with preloaded nail for copper, CPVC, polybutylene tubing
- CARTON QUANTITIES ONLY

PART NO.	TUBING SIZE	CTN/MSTR
H25050	1/2"	100/4000
H25075	3/4"	50/2000
H25100	1"	25/1025

Half Clamp



- Plastic clamp with preloaded nail for copper, CPVC, polybutylene tubing
- CARTON QUANTITIES ONLY

PART NO.	TUBING SIZE	CTN/MSTR
H24038	3/8"	100/7500
H24050	1/2"	50/1000
H24075	3/4"	50/1000
H24100	1"	50/2000

Insulating/Suspension Clamp



- Plastic insulating and suspension clamp in one
- Eliminates noise from tubing expansion and contraction
- For copper, CPVC and polybutylene tubing
- CARTON QUANTITIES ONLY

PART NO.	TUBING SIZE	CTN/MSTR
H26050	1/2"	50/1000
H26075	3/4"	50/1000
H26100	1"	50/600
H26125	1 1/4"	50/500
H26150	1 1/2"	25/500
H26200	2"	25/350

Pipe Insulator



- Plastic insulator eliminates noise from expansion and contraction
- For copper, CPVC and polybutylene tubing
- Drill hole size 1 3/8"
- UPC listed
- CARTON QUANTITIES ONLY



PART NO.	TUBING SIZE	CTN/MSTR
H27050	1/2"	25/1000
H27075	3/4"	25/1000
H27100	1"	25/1000

Items marked with the Jones Stephens logo are "You Need It...We Got It" Items.

2-Hole Pipe Clamp



- Plastic clamp eliminates noise from tubing expansion and contraction
- Supports copper, CPVC and polybutylene tubing
- CARTON QUANTITIES ONLY

PART NO.	TUBING SIZE	CTN/MSTR
H28050	1/2"	100/1000
H28075	3/4"	100/1000
H28100	1"	50/500
H28125	1 1/4"	50/750
H28150	1 1/2"	25/500
H28200	2"	25/250

F.H.A. Tub Hanger



- 12 gauge galvanized steel
- Adjustable on stud
- CARTON QUANTITIES ONLY

PART NO.	DESCRIPTION	CTN QTY
T12001	Tub Hanger	100

Metal Stud Pipe Insulator



PART NO.	DESCRIPTION	CTN/MSTR
H29000	3/8", 1/2", 3/4"	50/500
H29010	1"	50/500

Earthquake Strap



- Holes are spread 1" apart on center

PART NO.	SIZE	GAUGE	CTN QTY
H20500	2" x 10'	22	10

Perforated Hanger Iron



- Alternating holes (bolt and nail)
- CARTON QUANTITIES ONLY

PART NO.	DESCRIPTION	GAUGE	CTN QTY
H20001	3/4" x 10' galvanized	20 (heavy)	50 rolls
H20002	3/4" x 10' galvanized	24 (medium)	50 rolls
H20003	3/4" x 10' galvanized	28 (light)	50 rolls
H20005	3/4" x 50' galvanized	20 (heavy)	10 rolls
H20006	3/4" x 50' galvanized	24 (medium)	10 rolls
H20007	3/4" x 50' galvanized	28 (light)	10 rolls
H20010	3/4" x 100' galvanized	20 (heavy)	5 rolls
H20011	3/4" x 100' galvanized	24 (medium)	10 rolls
H20012	3/4" x 100' galvanized	28 (light)	10 rolls
H20100	3/4" x 10' copper clad	22 (heavy)	50 rolls
H20150	3/4" x 50' copper clad	22 (heavy)	10 rolls

Items marked with the Jones Stephens logo are "You Need It...We Got It" Items.

Plastic Hanger Tape



- Flexible, non-conductive polypropylene
- 3/4" wide, .050 thick
- 1/8" diameter holes every 3/4"
- 125 lb. ultimate load ASTM A-370-77
- Can be cut with scissors or utility knife
- Uses: pipe hanger, duct hanger and tubing utility strapping

PART NO.	DESCRIPTION	CTN/MSTR
H21010	10' roll poly bagged	1/200
H21025	25' roll poly bagged	1/50
H21050	50' roll poly bagged	1/20
H21100	100' roll poly bagged	1/30
H21101	100' roll dispenser box	1/25

Plastic Hanger Tape



- 125# max load
- 1/8" diameter holes every 3/4"
- 2" wide; .05 thickness; cuts with scissors

PART NO.	DESCRIPTION	CTN/MSTR
H21200	2" x 100' hanger tape	1/5

Nylon Line Reel



- Twisted nylon
- Carded

PART NO.	DESCRIPTION	CTN/MSTR
J40125	#18 x 270' nylon line reel	6/36

Mason's Nylon Twine



- Twisted yellow twine
- Approximately 165 lb. break strength

PART NO.	DESCRIPTION	CTN/MSTR
T60001	#18 x 225' nylon twine	24/192
T60000	#18 x 1100' nylon twine	12/72

10 lb. Tying Twine with Dispenser Box



- 650/1
- 10 lbs.
- Includes dispenser box

PART NO.	DESCRIPTION	CTN/MSTR
T60004	10 lb. dispenser	1/1

Candle Wick Packing



- Medium packing in 2 ounce balls

PART NO.	DESCRIPTION	CTN/MSTR
T60003	Candle wick packing	12/396

Graphite Packing



- Non-asbestos material in resealable spools
- Up to 150°F

PART NO.	DESCRIPTION	CTN/MSTR
T60005	1/8" diameter x 12' spool	12/120
T60006	1/4" diameter x 8' spool	12/120

C Oakum



- The original Oakum with benonite-expands over 10 times when wet
- Baled in coils or cut length for easy use
- No tar in brown oakum
- CARTON QUANTITIES ONLY (except 1 lb. bags)

PART NO.	DESCRIPTION	INNER PACK	CTN/MSTR
O15001	Brown random cut	10 - 5 lb. bags	1
O15002	White 3/8" cord	6 - 10 lb. coils	1
O15003	White 3/8" cord (27" cut length)	10 - 5 lb. bags	1
O15006	Brown random cut	1 lb. bags	1/20
O15007	White 3/8" cord (27" cut length)	1 lb. bags	1/20

Lead Wool



- Five pound box

PART NO.	DESCRIPTION	CTN/MSTR
L40001	5 lbs. lead wool	1/10

Lead Ingot



L42002



L42052

PART NO.	DESCRIPTION	CTN QTY
L40002	25 lbs. (Handle with four 5 lb. plugs)	1
L42052	5 lbs.	1

Lead Melting Pot



- Wire handle

PART NO.	DESCRIPTION	CTN QTY
L42006	6" depth pot	1
L42008	8" depth pot	1

Lead Pouring Ladle



- Wrought steel

PART NO.	DESCRIPTION	CTN/MSTR
L42102	3" ladle	1/100
L42103	3-1/2" ladle	1/50
L42104	4" ladle	1/50

Drum Trap Cover



- Flanged, plated die cast
- Cover supplied with gasket
- D02002 - CARTON QUANTITIES ONLY

PART NO.	DESCRIPTION	CTN/MSTR
D02001	Cover and gasket	25/100
D02002	Gasket only	25/100
P55300	Rough brass cover	1/60

Trap Covers



C98001



C98002

- Stainless steel

PART NO.	DESCRIPTION	CTN/MSTR
C98001	5-3/4" flat SS trap cover	150/300
C98002	5-3/4" raised SS trap cover	50/200

Wet-R-Dri Roofing Cement



- All-weather plastic
- Chemically fortified to bond to water-covered, damp or dry surfaces
- Great for emergency repairs under wet conditions

PART NO.	DESCRIPTION	CTN/MSTR
C09000	5 gallon can	1/1
C09001	1 gallon can	1/6
C09002	10.5 ounce cartridge	1/12

Foundation and Roof Coating



- Non-fibered liquid damp-proof seal
- All weather plastic
- Chemically fortified to bond to water covered, damp or dry surfaces
- Great for emergency repairs under wet conditions

PART NO.	DESCRIPTION	CTN/MSTR
C09003	1 gallon can	1/6

Sewage Ejector/Sump Pump Check Valve



- Couplings are sized for IPS ID hose
- Combination unit for 1-1/2" and 1-1/4" IPS, 1-1/2" copper

PART NO.	DESCRIPTION	CTN/MSTR
C29150	1-1/2" slip x 1-1/2" slip	1/50
C29200	2" slip x 2" slip	1/50
C29126	1-1/4" slip x 1-1/2" slip	1/50

Flexible Discharge Hose



- Ideal for sump pumps, centrifugal pumps, and submersible pumps
- Kits include 24' hose, threaded adapter and steel clamp

PART NO.	DESCRIPTION	CTN/MSTR
C29123	1-1/2" flex discharge hose kit	1/5
C29124	1-1/4" flex discharge hose kit	1/5

Roofite® Hi-Heat Silicone Flashing



- Silicone range is designed for high temperature applications up to 390°F
- Ideal for corrugated metal roofs
- Can be used on flat roofs
- Pipe diameter markings
- For plumbing, heating, air conditioning, electrical or exhaust vents
- Pleated cone adjusts to any pitch up to 45° F
- Ozone and UV resistant

PART NO.	DESCRIPTION	CTN/MSTR
R16100	0" - 2-3/4"	1/25
R16101	2" - 6-1/8"	1/20
R16107	6" - 10-1/32"	1/10
R16108	9-1/2" - 14-3/4"	1/10

Roofite® Roof Flashing



- Made of EPDM with flexible aluminum base
- -30°F to +250°F
- Ideal for corrugated metal roofs
- Can be used on flat roofs
- Pipe diameter markings
- For plumbing, heating, air conditioning, electrical or exhaust vents
- Pleated cone adjusts to any pitch
- Ozone and UV resistant

PART NO.	DESCRIPTION	CTN/MSTR
R15109	0" - 1-1/4"	1/20
R15100	0" - 2-3/4" pipe	1/20
R15101	2" - 6-1/8" pipe	1/20
R15107	6" - 10-1/32" pipe	1/10
R15108	9-1/2" - 14-3/4" pipe	1/10

Galvanized Roof Flashing



- Double seal neoprene collar
- UPC listed, BOCA ad SBCCI approved



PART NO.	DESCRIPTION	FLANGE	CTN/MSTR
R40150	1-1/4" and 1-1/2"	8-3/4" x 12-1/2"	1/12
R40200	2"	8-3/4" x 12-1/2"	1/12
R40300	3"	10-3/4" x 14-1/2"	1/12
R40400	4"	12" x 16"	1/12

Aluminum Roof Flashing



- Double seal neoprene collar

PART NO.	DESCRIPTION	FLANGE	CTN/MSTR
R45150	1-1/4" and 1-1/2"	8-3/4" x 12-1/2"	1/12
R45200	2"	8-3/4" x 12-1/2"	1/12
R45300	3"	10-3/4" x 14-1/2"	1/12
R45400	4"	12" x 16"	1/12

All Neoprene Roof Flashing



- Double seal neoprene collar

PART NO.	DESCRIPTION	FLANGE	CTN/MSTR
R50150	1-1/4" and 1-1/2"	9" x 11-3/8"	1/20
R50200	2"	9" x 11-3/8"	1/20
R50300	3"	10" x 13-1/4"	1/20
R50400	4"	12" x 14-3/4"	1/20

Neo-poly Roof Flashing



- Poly vinyl base
- Neoprene collar

PART NO.	DESCRIPTION	FLANGE	CTN/MSTR
R57150	1-1/4" and 1-1/2"	9-1/4" x 13"	1/12
R57200	2"	9-1/4" x 13"	1/12
R57300	3"	11-1/8" x 15"	1/12
R57400	4"	12" x 15-1/2"	1/12

Lead Roof Flashing



- Southeastern Code
- 2-1/2 pounds
- Multi-pitch from flat to 7/12"
- CARTON QUANTITIES ONLY

PART NO.	SIZE	FLANGE	CTN QTY
R70150	1-1/2"	8-1/2" x 10-1/2"	12
R70200	2"	8-1/2" x 10-1/2"	12
R70300	3"	10-1/2" x 11-1/2"	6
R70400	4"	10-1/2" x 11-1/4"	6

Instant Sealant



- Flame resistant
- Fills holes and cracks
- Deadens sound
- Insulates against air conditioning and heat loss
- Prevents passage of dirt, water and insects
- Both 12 and 24 oz. cans spray in any position
- UPS GROUND AND MOTOR FREIGHT ONLY
- CARTON QUANTITIES ONLY

PART NO.	DESCRIPTION	CTN QTY
S30012	12 oz. cans	12
S30024	24 oz. cans	12

Hose and Hose Bracket for Service Sink



- Heavy duty 300 cloth-reinforced 5/8" rubber hose (2-1/2" long)
- 3/4" brass hose coupling at one end
- 5" x 3" stainless steel bracket with rubber grip

PART NO.	DESCRIPTION	CTN/MSTR
M05001	Hose with bracket	1/1
M05005	Bracket only	1/100

Mop Hanger for Service Sink



- 24" x 3" stainless steel hanger with three rubber tool grips
- Anchors included

PART NO.	DESCRIPTION	CTN/MSTR
M05003	Mop hanger	1/5

Stove Bolt with Nut



- Zinc plated
- CARTON QUANTITIES ONLY

PART NO.	SIZE	CTN QTY
F33009	3/16" x 3/4"	100
F33010	1/4" x 3/4"	100
F33011	1/4" x 1"	100
F33012	1/4" x 1-1/4"	100
F33013	1/4" x 1-1/2"	100
F33014	1/4" x 2"	100

Flat Phillips Head Brass Wood Screw



- Solid brass construction
- Flat Phillips head
- CARTON QUANTITIES ONLY

PART NO.	SIZE	CTN QTY
F33300	#12 x 1-1/4"	100
F33301	#12 x 1-1/2"	100
F33302	#12 x 2"	100
F33303	#14 x 1-1/4"	100

Phillips Head Wood Screw



- Zinc plated
- CARTON QUANTITIES ONLY

PART NO.	SIZE	CTN QTY
F33030	#10 x 1-1/2"	100
F33031	#12 x 1"	100
F33032	#12 x 1-1/4"	100
F33033	#12 x 1-1/2"	100
F33034	#12 x 2"	100
F33035	#12 x 2-1/2"	100
F33036	#12 x 3"	100
F33037	#14 x 1-1/4"	100
F33038	#14 x 1-1/2"	100
F33039	#14 x 2"	100
F33040	#14 x 2-1/2"	100
F33041	#14 x 3"	100

Hex Head Lag Screw



- CARTON QUANTITIES ONLY

PART NO.	SIZE	CTN QTY
F33140	3/8" x 1"	100
F33141	3/8" x 1-1/2"	100
F33142	3/8" x 2"	100
F33143	3/8" x 2-1/2"	50
F33144	3/8" x 3"	50

E-Z Anchor/Self-Drilling Wall Board



- Die cast zinc
- Installs with #2 Phillips screwdriver
- CARTON QUANTITIES ONLY

PART NO.	DESCRIPTION	CTN QTY
A33010	E-Z Anchor with 1-1/4" screws	10

Toggle Bolt



Toggle Bolt



Toggle Wing

- Zinc plated
- Spring loaded wing
- CARTON QUANTITIES ONLY

PART NO.	DESCRIPTION	CTN QTY
F33060	3/16" x 4" toggle bolt	50
F33061	1/4" x 3" toggle bolt only	50
F33062	1/4" x 4" toggle bolt only	50
F33063	1/4" x 6" toggle bolt only	50
F33064	3/8" x 4" toggle bolt only	50
F33065	3/8" x 6" toggle bolt only	50
F33066	3/16" toggle wing only	100
F33067	1/4" toggle wing only	100
F33068	3/8" toggle wing only	100
F33069	1/2" toggle wing only	100

Items marked with the Jones Stephens logo are "You Need It...We Got It" Items.

Hex Head Tapping Screw



- Zinc plated
- CARTON QUANTITIES ONLY

PART NO.	SIZE	CTN QTY
F33101	#7 x 1/2"	100
F33102	#7 x 1/2"	1000
F33103	#8 x 1/2"	100
F33104	#8 x 1/2"	1000
F33105	#8 x 3/4"	100
F33106	#8 x 3/4"	1000
F33107	#8 x 1"	100
F33108	#8 x 1"	500
F33109	#8 x 1-1/2"	50
F33110	#8 x 1-1/2"	500
F33111	#8 x 2"	50
F33112	#8 x 2"	250
F33113	#10 x 3/4"	100
F33114	#10 x 3/4"	1000
F33115	#10 x 1"	100
F33116	#10 x 1"	500

Drill Point Tech Screw



- CARTON QUANTITIES ONLY

PART NO.	SIZE	CTN QTY
F33120	#8 x 1/2"	100
F33121	#8 x 1/2"	500
F33122	#8 x 3/4"	100
F33123	#8 x 3/4"	500
F33124	#10 x 3/4"	100
F33125	#10 x 3/4"	500
F33126	#10 x 1"	100
F33127	#10 x 1"	500
F33128	#10 x 1-1/2"	100
F33129	#12 x 3/4"	100
F33130	#12 x 1"	100
F33131	#12 x 1-1/2"	100
F33132	#12 x 2"	100

Hex Nut



- Zinc plated
- CARTON QUANTITIES ONLY

PART NO.	SIZE	CTN QTY
F33080	1/4" - 20	100
F33081	5/16" - 18	100
F33082	3/8" - 16	100
F33083	1/2" - 13	50

Items marked with the Jones Stephens logo are "You Need It...We Got It" Items.

Anchor Bolt Kit



- Includes anchors, hex head screws and drill bit

PART NO.	SIZE	PIECES	DRILL BIT	CTN/MSTR
A33001	#8 x 1"	100	3/16"	1/50
A33002	#10 x 1-1/4"	100	1/4"	1/36
A33005	#14 x 1-1/2"	50	5/16"	1/36

Hollow Wall Anchor Kit



- 100 pieces
- 4 sizes and styles
- Anchors, screws and toggle bolts
- Reclosable, reusable, divided plastic container

PART NO.	DESCRIPTION	CTN/MSTR
A33006	100 piece hollow wall anchor kit	12/72

Fender Washer



- Zinc plated
- CARTON QUANTITIES ONLY

PART NO.	SIZE	OD	CTN QTY
F33098	1/4"	1-1/2"	100
F33096	3/8"	1-1/2"	100
F33097	1/2"	2"	100

Flat Washer



- Zinc plated
- CARTON QUANTITIES ONLY

PART NO.	SIZE	OD	CTN QTY
F33094	3/8"	1"	100
F33095	1/2"	1-3/8"	100

Carrier Nuts and Washer Set



- 4 chrome plated nuts and zinc washers
- 5/8 - 11 threads
- Much lower cost than specification companies

PART NO.	DESCRIPTION	CTN/MSTR
C56100	Carrier nuts and washer set (4-pack)	1/100

Universal Beam Clamp



- 3/8" UNC bolt thread
- Steel set screw

PART NO.	SIZE	ROD SIZE	CTN QTY
H60375	3/8"	3/8"	25
H60050	1/2"	1/2"	25
H60625	5/8"	5/8"	25
H60075	3/4"	3/4"	25

Copper Pipe Hanger - Bell & Milford Types



Bell Type

Milford Type

• Copper clad

PART NO.	DESCRIPTION	CTN/MSTR
H83050 	1/2" bell type	25/500
H83075	3/4" bell type	25/500
H83100	1" bell type	25/500
H84050	1/2" x 6" milford type	25
H84075	3/4" x 6" milford type	25
H84100	1" x 6" milford type	25
H85050	1/2" x 12" milford type	25
H85075	3/4" x 12" milford type	25
H85100	1" x 12" milford type	25

Conduit Hanger



• Packed with bolts and nuts
• CARTON QUANTITIES ONLY

Zinc Plated				
PART NO.	CODE NO.	RIGID	THIN WALL	CTN QTY
H14050	0	1/2"-3/8"	1/2"	100
H14075	1	3/4"	3/4"	50
H14100	2	1"	1"	50
H14125	3	1-1/4"	-	50
H14150	4	1-1/2"	1-1/2"	25
H14200	5	2"	2"	25
H14250	6	2-1/2"	-	10
H14300	7	3"	-	10
H14350	8	3-1/2"	-	10
H14400	9	4"	-	10

Copper Plated				
PART NO.	CODE NO.	RIGID	THIN WALL	CTN QTY
H17050	0	1/2"-3/8"	1/2"	100
H17075	1	3/4"	3/4"	100
H17100	2	1"	1"	50
H17125	3	1-1/4"	-	50
H17150	4	1-1/2"	1-1/2"	25
H17200	5	2"	2"	25
H17250	6	2-1/2"	-	25
H17300	7	3"	-	25
H17350	8	3-1/2"	-	25
H17400	9	4"	-	25

Swivel Ring



• Supplied with nuts

Zinc Plated			
PART NO.	SIZE	ROD SIZE	CTN QTY
H65050	1/2"	3/8"	25
H65075	3/4"	3/8"	25
H65100	1"	3/8"	25
H65125	1-1/4"	3/8"	25
H65150	1-1/2"	3/8"	25
H65200	2"	1/2"	20
H65250	2-1/2"	1/2"	20
H65300	3"	1/2"	10
H65400	4"	1/2"	10
H65500	5"	1/2"	5
H65600	6"	1/2"	5

Copper Plated			
PART NO.	SIZE	ROD SIZE	CTN QTY
H66050	1/2"	3/8"	25
H66075	3/4"	3/8"	25
H66100	1"	3/8"	25
H66125	1-1/4"	3/8"	25
H66150	1-1/2"	3/8"	25
H66200	2"	1/2"	20
H66250	2-1/2"	1/2"	20
H66300	3"	1/2"	10
H66400	4"	1/2"	10

Zinc Plated Clevis Hanger



Standard - 401# Steel			
PART NO.	SIZE	ROD SIZE	CTN QTY
H68050	1/2"	3/8"	25
H68075	3/4"	3/8"	25
H68100	1"	3/8"	25
H68125	1-1/4"	3/8"	25
H68150	1-1/2"	3/8"	25
H68200	2"	3/8"	20
H68250	2-1/2"	1/2"	20
H68300	3"	1/2"	10
H68350	3-1/2"	1/2"	10
H68400	4"	5/8"	10
H68500	5"	5/8"	5
H68600	6"	3/4"	5
H68800	8"	7/8"	5

Light Duty - 400# Steel			
PART NO.	SIZE	ROD SIZE	CTN QTY
H69050	1/2"	3/8"	25
H69075	3/4"	3/8"	25
H69100	1"	3/8"	25
H69150	1-1/2"	3/8"	25
H69200	2"	3/8"	20
H69250	2-1/2"	1/2"	20
H69300	3"	1/2"	10
H69400	4"	5/8"	10

 Items marked with the Jones Stephens logo are "You Need It... We Got It" Items.

Riser Clamp



• For Schedule 40 iron pipe only - Not for soil pipe

PART NO.	SIZE	OVERALL WIDTH	CTN QTY
H70050	1/2"	9-3/8"	25
H70075	3/4"	9-3/8"	25
H70100	1"	9-3/8"	25
H70125	1-1/4"	10"	25
H70150	1-1/2"	10-3/8"	25
H70200	2"	10-7/8"	25
H70250	2-1/2"	11-1/4"	25
H70300	3"	11-3/4"	10
H70350	3-1/2"	13-1/4"	10
H70400	4"	13-1/2"	10

Hinged Split Ring



Zinc Plated for Iron Pipe

PART NO.	SIZE	ROD SIZE	CTN QTY
H72375	3/8"	3/8"	25
H72050	1/2"	3/8"	25
H72075	3/4"	3/8"	25
H72100	1"	3/8"	25
H72125	1-1/4"	3/8"	25
H72150	1-1/2"	3/8"	25
H72200	2"	3/8"	20
H72250	2-1/2"	1/2"	20
H72300	3"	1/2"	10
H72400	4"	1/2"	10

Copper Plated for Copper Tube

PART NO.	SIZE	ROD SIZE	CTN QTY
H73375	3/8"	3/8"	25
H73050	1/2"	3/8"	25
H73075	3/4"	3/8"	25
H73100	1"	3/8"	25
H73125	1-1/4"	3/8"	25
H73150	1-1/2"	3/8"	25
H73200	2"	3/8"	10

Ceiling Flange

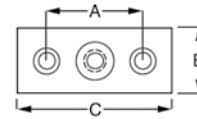

DIMENSIONS		
A	B	C
2"	1-3/8"	2-3/4"

PART NO.	SIZE	CTN QTY
H80375	3/8" plain finish (black)	25
H80050	1/2" plain finish (black)	25
H81375	3/8" zinc finish (galvanized)	25
H81050	1/2" zinc finish (galvanized)	25
H82375	3/8" copper finish	25
H82050	1/2" copper finish	25

Threaded Steel Rod



• Priced per rod
• CARTON QUANTITIES ONLY

PART NO.	DESCRIPTION	CTN QTY
T38006	3/8" x 6' plain finish (black)	25
T38010	3/8" x 10' plain finish (black)	25
T12006	1/2" x 6' plain finish (black)	12
T12010	1/2" x 10' plain finish (black)	12
T38106	3/8" x 6' zinc finish (galvanized)	25
T38110	3/8" x 10' zinc finish (galvanized)	25
T12106	1/2" x 6' zinc finish (galvanized)	12
T12110	1/2" x 10' zinc finish (galvanized)	12

Drop-In Concrete Anchor



• Priced per rod
• CARTON QUANTITIES ONLY

PART NO.	DESCRIPTION	CTN/MSTR
T38038	3/8" drop-in anchor	100/900
T12050	1/2" drop-in anchor	50/500

Rod Coupling Nut



• Hex, zinc plated, carbon steel

PART NO.	DESCRIPTION	CTN/MSTR
R60001	1/4" x 7/8" rod coupling nut	50/1000
R60002	3/8" x 1-3/4" rod coupling nut	50/1000
R60003	1/2" x 1-3/4" rod coupling nut	50/1000
R60004	5/8" x 2-1/8" rod coupling nut	50/200

Water Meter Box Keys and Covers



M07001 M07002 M25900

• All brass

PART NO.	DESCRIPTION	CTN/MSTR
M07001	Meter box key	1/100
M07002	Combination key and wrench	1/50
M25900	Penta head meter box and roadway box wrench	1/100



M25900 bottom view

Water Meter Coupling Complete



• Heavy cast brass
• Complete with gasket
• Lead Free

PART NO.	SIZE	NPSM	LENGTH	NPT	CTN/MSTR
M20058	1/2"	3/4"	2-3/8"	1/2"	25/100
M20075	3/4"	1"	2-1/2"	3/4"	1/100
M20100	1"	1-1/4"	2-5/8"	1"	1/100

Gasket Only for Water Meter Couplings



• 3/32" thick
• CARTON QUANTITIES ONLY

PART NO.	DESCRIPTION	CTN QTY
M20581	5/8" gasket for coupling	25
M20751	3/4" gasket for coupling	25
M20101	1" gasket for coupling	25

10" Economy Plastic Water Meter Box

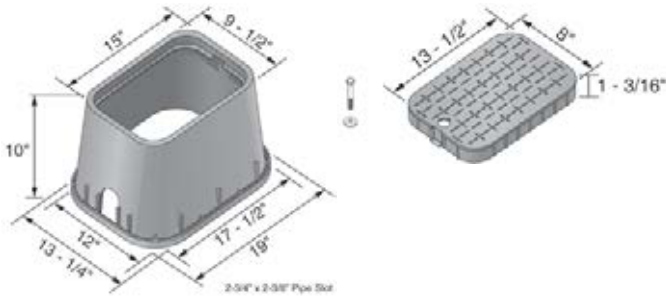

• Snap-in green lid
• 96 per pallet
• Drop in reader cover

PART NO.	DESCRIPTION	CTN/MSTR
M06001	10" rectangular box and green lid	1/96
M06002	10" green snap-in lid only	1

Note: All items shown are for non-vehicular applications. Concrete and asphalt installations are not recommended for plastic parts.

Ⓢ Items marked with the Jones Stephens logo are "You Need It... We Got It" Items.

12" Plastic Water Meter Box

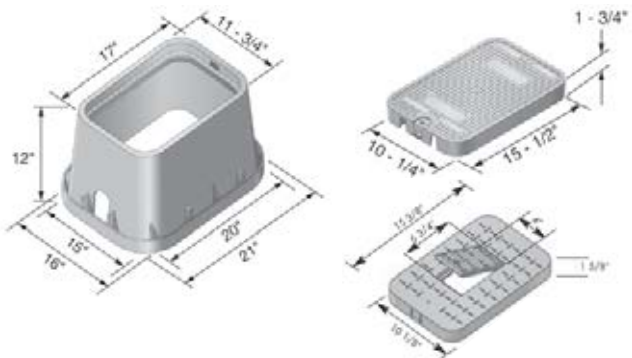

PART NO.	DESCRIPTION	CTN/MSTR
M12001	12" box and solid green lid	1/72
M12002	12" box and black reader lid	1/72
M12022	12" box and black lid marked "sewer"	1/72
M12003	6" extension	1/42
M12005	12" solid green lid only	1
M12006	12" black reader lid only	1
M12009	12" box and solid black lid	1/72

Note: All items shown are for non-vehicular applications. Concrete and asphalt installations are not recommended for plastic parts.

12" Plastic Water Meter Box with Solid Cast Iron Lid

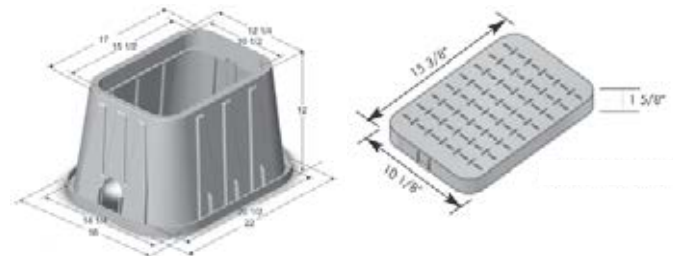

• Drop in solid lid

PART NO.	DESCRIPTION	CTN/MSTR
M12100	12" box with black solid cast iron lid	1/72
M12085	Black cast iron lid only	1

Note: All items shown are for non-vehicular applications. Concrete and asphalt installations are not recommended for plastic parts.

12" Plastic Standard Water Meter Box with Plastic Lid and Cast Iron Reader

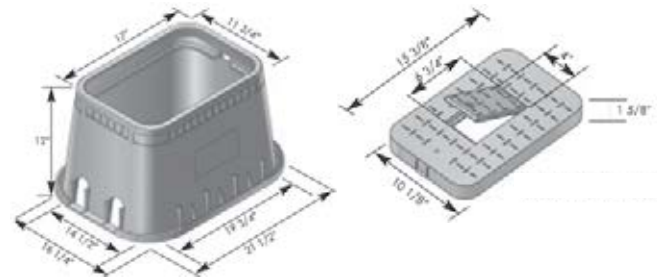

• 72 per pallet
• Drop in reader lid

PART NO.	DESCRIPTION	CTN/MSTR
M12004	12" box with plastic lid & black cast iron reader	1/72

Note: All items shown are for non-vehicular applications. Concrete and asphalt installations are not recommended for plastic parts.

12" Plastic Irrigation Box

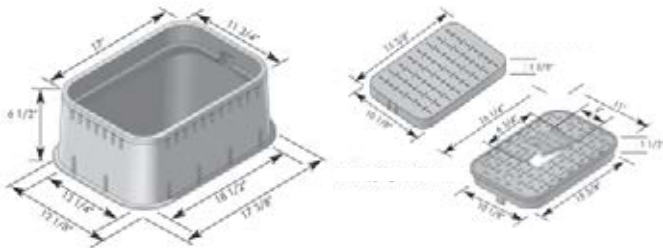

- 6" deep
- Drop in solid lid or overlapping reader lid available

PART NO.	DESCRIPTION	CTN QTY
M12007	12" box with green lid	1
M12005	12" solid green lid only	1
M12006	12" black reader lid only	1

Note: All items shown are for non-vehicular applications. Concrete and asphalt installations are not recommended for plastic parts.

15" Jumbo Water Meter Box

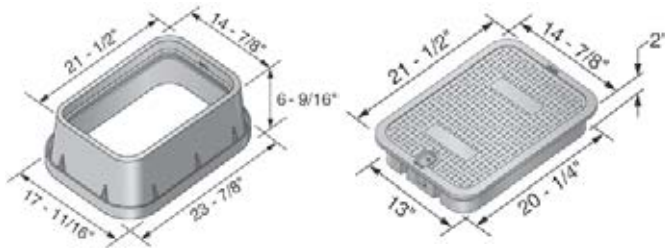

PART NO.	DESCRIPTION	CTN/MSTR
M15001	15" box and green solid lid	1/48
M15009	6" extension for M15001	1/36
M15002	15" box and black reader lid	1/48
M15004	15" solid green lid only	1
M15005	15" black reader lid only	1
M15006	6" extension with solid green lid	1

Note: All items shown are for non-vehicular applications. Concrete and asphalt installations are not recommended for plastic parts.

6" Residential Valve Box

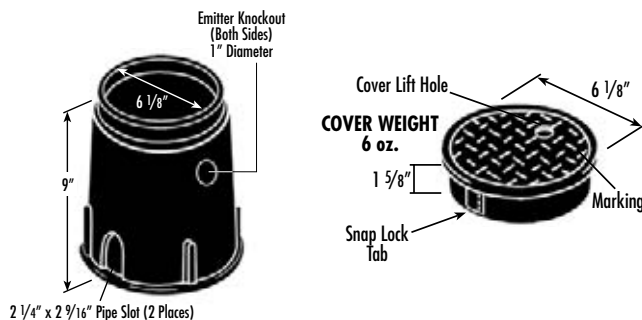

- 9" deep
- Snap-in green lid
- Overlapping cover keeps dirt or grass from between body and lid
- Valve box can be extended with any 6" plastic or iron pipe

PART NO.	DESCRIPTION	CTN/MSTR
M06006	6" valve box with green lid	1/36
M06007	6" green snap-in lid only	1

Note: All items shown are for non-vehicular applications. Concrete and asphalt installations are not recommended for plastic parts.

10" Round Valve Box

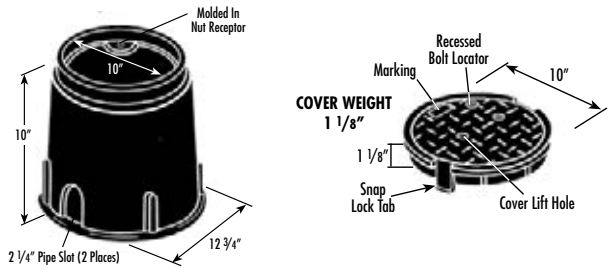

- Snap-in green lid
- Overlapping cover keeps dirt or grass from between body and lid
- 96 per pallet

PART NO.	DESCRIPTION	CTN/MSTR
M06010	10" round body and snap-in green lid	1/96

Note: All items shown are for non-vehicular applications. Concrete and asphalt installations are not recommended for plastic parts.

Shipping Boxes



- 32 ECT board test
- Kraft (brown)
- 200 pound burst strength
- BUNDLE QUANTITIES ONLY

PART NO.	SIZE	CTN/MSTR
BOX012	12-3/4"L x 12-3/4"W x 13-1/2"D	1/20
BOX011	11-1/8"L x 11-1/8"W x 9-1/8"D	1/20
BOX008	8"L x 8"W x 8"D	1/20
BOX006	6"L x 6"W x 8"D	1/20

Bin Boxes



PART NO.	SIZE	CTN/MSTR
BIN004	4"L x 12"W x 6-5/8"D	1/20
BIN005	5-1/4"L x 11-3/4"W x 6"D	1/20
BIN008	8"L x 12-1/4"W x 7-1/2"D	1/20
BIN012	12"L x 12-3/8"W x 7-1/2"D	1/20

Plastic Tub Box



PART NO.	SIZE	CTN QTY
T40001	13"L x 13"W x 7"D	1
T40002	12"L x 8-1/8"W x 6-1/2"D	1

Cardboard Tub Box



PART NO.	SIZE	CTN/MSTR
T40003	12"L x 8"W x 8-1/2"D wax coated	1/10
T40004	14-1/2"L x 11-5/16"W x 6"D wax coated	1/10
T40005	15"L x 12"W x 9"D non-coated	1/10
T40007	12"L x 12"W x 9"D non-coated	1/10
T40008	12"L x 12"W x 12"D non-coated	1/10

SECTION D - FITTINGS & VALVES

Brass Compression Fittings	125-126
Chrome Plated Compression Fittings	126
45° Flare Tube Fittings	127-128
Space Heater & Gas Range Fittings	129
Yellow Brass Pipe Fittings	130-131
PEX Fittings	132-134
Push On Fittings	135-139
Red Brass Pipe Fittings	140-141
Bronze Pipe Fittings	142-143
Chrome Plated Pipe Nipples & Fittings	144-145
Brass Garden Hose Fittings	146-147
Brass Hose Barbs	148
Nylon Fittings.....	149-150
Poly Insert Fittings.....	151
Red Brass Insert Fittings.....	152
Galvanized Insert Fittings.....	153
Brass Needle Valves	154
Shut-Off Valves	155
Drain Cocks/Air Cocks.....	156
Ball Valves	157-160
Valves	161
Hose Bibbs	162
Gear Clamps	163-164
Flange Connection Gaskets & Kits	165-166
Rubber Sheet/Gasket Material	167
Water Hammer Arresters	168

D

Compression Cap

Style 61C



PART NO.	TUBE SIZE	CTN/MSTR
C74001	1/4"	500/1000
C74002	3/8"	500/1000
C74147	1/2"	1
C74155	5/8"	1

Compression Sleeve

Style 60



PART NO.	TUBE SIZE	CTN/MSTR
C74003	1/8"	1
C74004	3/16"	1
C74005	1/4"	1
C74006	5/16"	1
C74007	3/8"	10000
C74151	7/16"	1
C74008	1/2"	1
C74009	5/8"	2000/4000
C74010	3/4"	100/1000
C74011	7/8"	1

Compression Nut

Style 61



• CARTON QUANTITIES ONLY

PART NO.	TUBE SIZE	CTN/MSTR
C74012	1/8"	200
C74013	3/16"	100
C74014	1/4"	500/2000
C74015	5/16"	25
C74016	3/8"	1/2000
C74152	7/16"	10
C74017	1/2"	1
C74018	5/8"	100/400
C74019	3/4"	1
C74020	7/8"	1

Delrin Compression Sleeve

Style 60P



• CARTON QUANTITIES ONLY

PART NO.	TUBE SIZE	CTN/MSTR
C74096	1/4"	100
C74097	3/8"	100
C74098	1/2"	100
C74099	5/8"	50

Compression Insert

Style 63P



• Lead Free

PART NO.	TUBE SIZE	CTN/MSTR
C74100LF	1/4"	100/5000
C74101LF	3/8"	1000/9000
C74102LF	1/2"	50
C74103LF	5/8"	100/3000

Compression Union

Style 62



• Lead Free

PART NO.	TUBE SIZE	CTN/MSTR
C74021LF	1/8"	100/1000
C74022LF	3/16"	1
C74023LF	1/4"	100/500
C74025LF	3/8"	250/500
C74026LF	1/2"	20/260
C74027LF	5/8"	20/200
C74029LF	7/8"	50/100
C74030LF	3/8" x 1/4"	1/500
C74031LF	1/2" x 3/8"	50/300
C74032LF	5/8" x 3/8"	100/400
C74033LF	5/8" x 1/2"	25/200

Compression Tee

Style 64



• Lead Free

PART NO.	TUBE SIZE	CTN/MSTR
C74034LF	1/4"	1/500
C74036LF	3/8"	125/250
C74037LF	3/8" x 3/8" x 1/4"	1/300
C74038LF	1/2"	1/150
C74039LF	5/8"	50/100

Compression x FIP Branch Tee

Style 78



• Lead Free

PART NO.	TUBE x FIP	CTN/MSTR
C74091LF	3/8" x 1/8"	1

Compression x Sweat Adapter

Style 666



• Lead Free

PART NO.	TUBE x OD	CTN/MSTR
C74093LF	3/8" x 5/8" (1/2" swt)	100/250

Compression x FIP Connector

Style 66



• Lead Free

PART NO.	TUBE x FIP	CTN/MSTR
C74045LF	1/4" x 1/8"	250/1000
C74046LF	1/4" x 1/4"	50/500
C74113LF	1/4" x 3/8"	250/500
C74114LF	1/4" x 1/2"	100/400
C74048LF	3/8" x 1/8"	1
C74049LF	3/8" x 1/4"	50/500
C74050LF	3/8" x 3/8"	100/400
C74051LF	3/8" x 1/2"	100/400
C74052LF	1/2" x 3/8"	1
C74053LF	1/2" x 1/2"	1
C74054LF	5/8" x 1/2"	1
C74118LF	5/8" x 3/4"	1/100
C74055LF	7/8" x 3/4"	10/150

Compression x MIP Connector

Style 68



• Lead Free

PART NO.	TUBE x MIP	CTN/MSTR
C74121LF	1/8" x 1/8"	1
C74058LF	1/4" x 1/8"	100/1000
C74059LF	1/4" x 1/4"	50/600
C74060LF	1/4" x 3/8"	50/500
C74123LF	1/4" x 1/2"	125/500
C74063LF	3/8" x 1/8"	1
C74064LF	3/8" x 1/4"	200/800
C74065LF	3/8" x 3/8"	100/400
C74066LF	3/8" x 1/2"	100/400
C74067LF	3/8" x 3/4"	20/200
C74068LF	1/2" x 1/4"	50/500
C74069LF	1/2" x 3/8"	10/250
C74070LF	1/2" x 1/2"	100/400
C74146LF	5/8" x 3/8"	50/200
C74071LF	5/8" x 1/2"	50/200
C74072LF	5/8" x 3/4"	20/200
C74149LF	7/8" x 1/2"	20/200
C74073LF	7/8" x 3/4"	1

Compression Elbow

Style 65



• Lead Free

PART NO.	TUBE SIZE	CTN/MSTR
C74040LF	1/4"	1
C74041LF	3/8"	50/300
C74042LF	1/2"	50/200
C74043LF	5/8"	50/100
C74044LF	5/8" x 3/8"	100/400
C74112LF	7/8"	1

Compression x FIP Elbow

Style 70



• Lead Free

PART NO.	TUBE x FIP	CTN/MSTR
C74078LF	3/8" x 1/2"	20/250
C74131LF	1/2" x 3/8"	1

Compression x MIP Elbow

Style 69



• Lead Free

PART NO.	TUBE x MIP	CTN/MSTR
C74081LF	1/4" x 1/8"	1
C74082LF	1/4" x 1/4"	50/700
C74135LF	1/4" x 3/8"	1
C74136LF	1/4" x 1/2"	1
C74085LF	3/8" x 1/4"	50/500
C74086LF	3/8" x 3/8"	20/300
C74087LF	3/8" x 1/2"	100/400
C74088LF	1/2" x 3/8"	1
C74089LF	1/2" x 1/2"	50/300
C74090LF	5/8" x 1/2"	10/250

Pilot Line Breakaway Nut



• Lead Free

PART NO.	DESCRIPTION	CTN/MSTR
C74158LF	1/4" OD	1

Chrome Plated Compression Union

• Lead Free



PART NO.	TUBE SIZE	CTN/MSTR
N62006LF	3/8"	250/500
N62086LF	1/2" x 3/8"	100/400
N62106LF	5/8" x 3/8"	50/200

Chrome Plated Compression Elbow



• Lead Free

PART NO.	TUBE SIZE	CTN/MSTR
N65106LF	5/8" x 3/8"	50/200

Chrome Plated Compression x FIP Connector



• Lead Free

PART NO.	TUBE x FIP	CTN/MSTR
N66066LF	3/8" x 3/8"	200/800
N66068LF	3/8" x 1/2"	100/400
N66088LF	1/2" x 1/2"	125/250

Chrome Plated Compression x MIP Connector



• Lead Free

PART NO.	TUBE x MIP	CTN/MSTR
N68066LF	3/8" x 3/8"	125/500
N68068LF	3/8" x 1/2"	100/400
N68088LF	1/2" x 1/2"	30/300

Chrome Plated Compression x Sweat Adapter



• Lead Free

PART NO.	TUBE x OD	CTN/MSTR
N66610LF	3/8" x 5/8" (1/2" swt)	100/200

Chrome Plated Compression x FIP Elbow



• Lead Free

PART NO.	TUBE x FIP	CTN/MSTR
N70066LF	3/8" x 3/8"	100/400
N70068LF	3/8" x 1/2"	100/400
N70086LF	1/2" x 3/8"	100/400

Chrome Plated Compression x MIP Elbow



• Lead Free

PART NO.	TUBE x MIP	CTN/MSTR
N69066LF	3/8" x 3/8"	100/400
N69068LF	3/8" x 1/2"	100/400

3' Chrome Plated Brass Cover Tubes



• Plain ends (no threads)
• 20 gauge

PART NO.	DESCRIPTION	CTN/MSTR
T73125	1-1/4" OD x 3' tube	1/25
T73138	1-3/8" OD x 3' tube	1/25
T73150	1-1/2" OD x 3' tube	1/25
T73175	1-3/4" OD x 3' tube	1/25
T73200	2" OD x 3' tube	1/20

Short Flare Nut

Style 41S



PART NO.	TUBE SIZE	CTN/MSTR
F40001	3/16"	1
F40002	1/4"	100/1200
F40003	5/16"	1
F40004	3/8"	100/2000
F40005	1/2"	10/200
F40006	5/8"	5/200
F40007	3/4"	1
F40126	7/8"	1

Long Flare Nut

Style 141L



PART NO.	TUBE SIZE	CTN/MSTR
F40008	3/8"	1
F40131	1/4"	1
F40132	1/2"	1
F40133	5/8"	1

Short Forged Flare Nut

Style 141S



PART NO.	TUBE SIZE	CTN/MSTR
F40009	1/4"	1
F40010	3/8"	1
F40011	1/2"	5/200
F40012	5/8"	5/200
F40013	3/8"x 1/4"	1
F40014	1/2"x 3/8"	1
F40119	5/8"x 1/2"	1

Flare Plug

Style 39



PART NO.	TUBE SIZE	CTN/MSTR
F40015	1/4"	1
F40016	3/8"	90/960
F40017	1/2"	50/500
F40018	5/8"	1

Flare Cap

Style 40



PART NO.	TUBE SIZE	CTN/MSTR
F40019	1/4"	1
F40098	5/16"	1
F40020	3/8"	100
F40021	1/2"	100/500
F40022	5/8"	40/480

Flare Tee

Style 44



PART NO.	TUBE SIZE	CTN/MSTR
F40033	1/4"	1
F40034	5/16"	1
F40035	3/8"	10/200
F40036	1/2"	10/200
F40037	5/8"	5/200
F40124	3/4"	1
F40038	3/8"x 3/8"x 1/4"	1
F40039	1/2"x 1/2"x 3/8"	1
F40120	5/8"x 5/8"x 1/2"	1

Flare x MIP Branch Tee

Style 45



PART NO.	TUBE x MIP	CTN/MSTR
F40040	3/8"x 1/4"	1
F40041	3/8"x 3/8"	1

Female Flare Swivel

Style 70



PART NO.	TUBE SIZE	CTN/MSTR
F40125	1/4"	1
F40095	3/8"	100/400
F40096	1/2"	20/250
F40097	5/8"	10/150

Flare Union

Style 42



PART NO.	TUBE SIZE	CTN/MSTR
F40123	3/16"	1
F40023	1/4"	1
F40024	5/16"	1
F40025	3/8"	50/400
F40026	1/2"	10/200
F40027	5/8"	10/200
F40100	3/4"	10/150
F40127	7/8"	1
F40028	3/8"x 1/4"	1
F40029	1/2"x 1/4"	1
F40030	1/2"x 3/8"	10/200
F40031	5/8"x 3/8"	1
F40032	5/8"x 1/2"	1

Flare x MIP Half Union

Style 48



PART NO.	TUBE x MIP	CTN/MSTR
F40062	3/16" x 1/8"	1
F40063	1/4" x 1/8"	1
F40064	1/4" x 1/4"	10/200
F40107	1/4" x 3/8"	1
F40108	1/4" x 1/2"	1
F40065	5/16" x 1/8"	1
F40066	5/16" x 1/4"	1
F40067	3/8" x 1/8"	1
F40068	3/8" x 1/4"	50/500
F40069	3/8" x 3/8"	10/200
F40070	3/8" x 1/2"	10/200
F40071	3/8" x 3/4"	20/240
F40072	1/2" x 1/4"	1
F40073	1/2" x 3/8"	10/200
F40074	1/2" x 1/2"	10/200
F40075	1/2" x 3/4"	10/200
F40109	5/8" x 3/8"	1
F40076	5/8" x 1/2"	20/300
F40077	5/8" x 3/4"	20/200
F40110	3/4" x 1/2"	1
F40112	3/4" x 3/4"	1
F40122	7/8" x 3/4"	1

D

Flare Elbow

Style 55



PART NO.	TUBE SIZE	CTN/MSTR
F40078	1/4"	1
F40079	3/8"	1
F40080	1/2"	10/250
F40081	5/8"	1

Flare x FIP Elbow

Style 50



PART NO.	TUBE x FIP	CTN/MSTR
F40104	1/4" x 1/4"	1
F40105	1/4" x 3/8"	1
F40056	3/8" x 1/4"	1
F40057	3/8" x 3/8"	1
F40058	3/8" x 1/2"	1
F40059	1/2" x 3/8"	1
F40060	1/2" x 1/2"	1
F40061	5/8" x 1/2"	1
F40106	5/8" x 3/4"	1
F40135	1/2" x 3/4"	1/200

Flare x FIP Coupling

Style 46



PART NO.	TUBE x FIP	CTN/MSTR
F40042	1/4" x 1/8"	1
F40043	1/4" x 1/4"	1
F40117	1/4" x 3/8"	1
F40118	1/4" x 1/2"	1
F40044	5/16" x 1/8"	1
F40045	5/16" x 1/4"	1
F40047	3/8" x 1/4"	1
F40048	3/8" x 3/8"	30/300
F40049	3/8" x 1/2"	10/200
F40050	3/8" x 3/4"	1
F40051	1/2" x 1/4"	1
F40052	1/2" x 3/8"	30/300
F40053	1/2" x 1/2"	10/200
F40054	1/2" x 3/4"	20/240
F40055	5/8" x 1/2"	10/200
F40101	5/8" x 3/4"	1
F40102	3/4" x 1/2"	1
F40103	3/4" x 3/4"	1
F40121	7/8" x 3/4"	1

Flare x MIP Elbow

Style 49



PART NO.	TUBE x MIP	CTN/MSTR
F40082	1/4" x 1/8"	1
F40083	1/4" x 1/4"	1
F40113	1/4" x 3/8"	1
F40084	5/16" x 1/8"	1
F40085	5/16" x 1/4"	1
F40086	3/8" x 1/8"	1
F40087	3/8" x 1/4"	1
F40088	3/8" x 3/8"	32/384
F40089	3/8" x 1/2"	20/300
F40090	3/8" x 3/4"	1
F40091	1/2" x 3/8"	10/200
F40114	1/2" x 1/4"	1
F40092	1/2" x 1/2"	10/200
F40093	1/2" x 3/4"	1
F40128	5/8" x 3/8"	1
F40094	5/8" x 1/2"	1
F40115	5/8" x 3/4"	1
F40111	3/4" x 1/2"	1
F40116	3/4" x 3/4"	1

Space Heater Fittings

Nut



• 9/16"-24 Fine threaded flare

PART NO.	OD	CTN/MSTR
F41001	3/8"	1
F41002	3/8"x 1/4"	1

Cap



• 9/16"-24 Fine threaded flare

PART NO.	OD	CTN/MSTR
F41003	3/8"	1

Union



• 9/16"-24 Fine threaded flare

PART NO.	OD	CTN/MSTR
F41008	3/8"	1

Female Coupling



• 9/16"-24 Fine threaded flare

PART NO.	OD x FIP	CTN/MSTR
F41004	3/8"x 3/8"	1
F41005	3/8"x 1/2"	1

Male Half Union



• 9/16"-24 Fine threaded flare

PART NO.	OD x MIP	CTN/MSTR
F41006	3/8"x 3/8"	1
F41007	3/8"x 1/2"	1

Tee



• 9/16"-24 Fine threaded flare

PART NO.	OD	CTN/MSTR
F41009	3/8"	1/100

Female Elbow



• 9/16"-24 Fine threaded flare

PART NO.	OD x FIP	CTN/MSTR
F41011	3/8" x 1/2"	1

Male Elbow



• 9/16"-24 Fine threaded flare

PART NO.	OD x MIP	CTN/MSTR
F41012	3/8" x 3/8"	1
F41013	3/8" x 1/2"	1

Gas Range Fittings

Flare x Male



PART NO.	OD x MIP	CTN/MSTR
F48108	5/8" (15/16-16) x 1/2"	1
F481012	5/8" (15/16-16) x 3/4"	1

Flare x Female



PART NO.	OD x FIP	CTN/MSTR
F46108	5/8" (15/16-16) x 1/2"	1
F461012	5/8" (15/16-16) x 3/4"	1

Flare Cap & Nut



PART NO.	SIZE	CTN/MSTR
F401516 (cap)	15/16"	1
F411516 (nut)	15/16"	1

D

Yellow Brass 90° Elbow



PART NO.	IPT	CTN/MSTR
P20002	1/8"	1
P20004	1/4"	1
P20006	3/8"	1
P20008	1/2"	1

Yellow Brass 90° Male Elbow

D



PART NO.	IPT	CTN/MSTR
P13986	1/2"	1

Yellow Brass 90° Street Elbow



PART NO.	IPT	CTN/MSTR
P16002	1/8"	1
P16004	1/4"	200/600
P16006	3/8"	1
P16008	1/2"	1

Yellow Brass 45° Elbow



PART NO.	IPT	CTN/MSTR
P10452	1/8"	1
P10454	1/4"	1

Yellow Brass 45° Street Elbow



PART NO.	IPT	CTN/MSTR
P12402	1/8"	1
P12404	1/4"	1
P12406	3/8"	1
P12408	1/2"	1

Yellow Brass Tee



PART NO.	IPT	CTN/MSTR
P10012	1/8"	1
P10014	1/4"	1
P10016	3/8"	1
P10018	1/2"	1

Yellow Brass Bell Reducer



PART NO.	IPT	CTN/MSTR
P19042	1/4" x 1/8"	1
P19062	3/8" x 1/8"	1
P19064	3/8" x 1/4"	1
P19082	1/2" x 1/8"	1
P19084	1/2" x 1/4"	1
P19086	1/2" x 3/8"	1
P19128	3/4" x 1/2"	1

Yellow Brass Coupling



PART NO.	IPT	CTN/MSTR
P10032	1/8"	1
P10034	1/4"	1
P10036	3/8"	1
P10038	1/2"	1
P10312	3/4"	1

Yellow Brass Cap



PART NO.	IPT	CTN/MSTR
P10082	1/8"	1
P10084	1/4"	1
P10086	3/8"	1
P10088	1/2"	1
P10812	3/4"	1

Yellow Brass Square Head Plug



PART NO.	IPT	CTN/MSTR
P10092	1/8"	1
P10094	1/4"	84/1008
P10096	3/8"	1
P10098	1/2"	1
P10912	3/4"	1

Yellow Brass HEX Head Plug



PART NO.	IPT	CTN/MSTR
P12102	1/8"	1
P12104	1/4"	1
P12106	3/8"	1
P12108	1/2"	1
P12112	3/4"	1

Yellow Brass Countersunk Plug



PART NO.	IPT	CTN/MSTR
P20092	1/8"	1
P20094	1/4"	1
P20096	3/8"	1
P20098	1/2"	1

Yellow Brass Lock Nut



PART NO.	IPT	CTN/MSTR
P11102	1/8"	1
P11104	1/4"	1
P11106	3/8"	1
P11108	1/2"	1

Yellow Brass HEX Bushing



PART NO.	IPT	CTN/MSTR
P11042	1/4" x 1/8"	1
P11062	3/8" x 1/8"	1
P11064	3/8" x 1/4"	90/1080
P11082	1/2" x 1/8"	40/320
P11084	1/2" x 1/4"	40/400
P11086	1/2" x 3/8"	40/480
P11122	3/4" x 1/8"	1
P11124	3/4" x 1/4"	1
P11126	3/4" x 3/8"	40/240
P11128	3/4" x 1/2"	1/400

Yellow Brass Face Bushing



PART NO.	IPT	CTN/MSTR
P11964	3/8" x 1/4"	1
P11986	1/2" x 3/8"	1
P11928	3/4" x 1/2"	1

Yellow Brass Close Nipple



PART NO.	IPT	CTN/MSTR
P11202	1/8"	1
P11204	1/4"	1
P11206	3/8"	1
P11208	1/2"	1
P11212	3/4"	1

Yellow Brass Long Nipple



PART NO.	IPT	CTN/MSTR
P13224	1/8" x 1-1/2"	1
P13232	1/8" x 2"	1
P13424	1/4" x 1-1/2"	1
P13432	1/4" x 2"	1
P13624	3/8" x 1-1/2"	1
P13632	3/8" x 2"	1

Yellow Brass HEX Nipple



PART NO.	IPT	CTN/MSTR
P12202	1/8"	1
P12204	1/4"	1
P12206	3/8"	50/450
P12208	1/2"	1
P12212	3/4"	1
P12342	1/4" x 1/8"	1
P12362	3/8" x 1/8"	1
P12364	3/8" x 1/4"	1
P12384	1/2" x 1/4"	1
P12386	1/2" x 3/8"	1
P12328	3/4" x 1/2"	1/200

D

Brass PEX Coupling



• Lead Free

PART NO.	SIZE	CTN/MSTR
C76001LF	1/2"	100/1000
C76002LF	3/4"	50/500
C76003LF	1"	50/300
C76004LF	3/4" x 1/2"	50/500
C76005LF	1" x 3/4"	25/250

Brass PEX 90° Elbow

D



• Lead Free

PART NO.	SIZE	CTN/MSTR
C76008LF	1/2"	100/500
C76009LF	3/4"	50/250
C76010LF	1"	25/100

Brass PEX x MIP 90° Elbow



• Lead Free

PART NO.	SIZE	CTN/MSTR
C76013LF	1/2" x 1/2"	25/100

Brass PEX Equal Tee



• Lead Free

PART NO.	SIZE	CTN/MSTR
C76014LF	1/2"	50/500
C76015LF	3/4"	50/250
C76016LF	1"	25/100

Brass PEX Tee



• Lead Free

PART NO.	SIZE	CTN/MSTR
C76017LF	1/2" x 1/2" x 3/4"	50/250
C76018LF	3/4" x 1/2" x 1/2"	50/250
C76019LF	3/4" x 1/2" x 3/4"	25/250
C76020LF	3/4" x 3/4" x 1/2"	25/250
C76021LF	1" x 3/4" x 3/4"	25/100
C76022LF	1" x 1" x 1/2"	25/100
C76023LF	1" x 1" x 3/4"	25/100

Brass PEX x Female Sweat Adapter



• Lead Free

PART NO.	PEX x FSF	CTN/MSTR
C76027LF	1/2" x 1/2"	100/500
C76028LF	3/4" x 3/4"	50/250
C76029LF	1/2" x 3/4"	25/250
C76030LF	1" x 1"	25/200

Brass PEX x Male Adapter



• Lead Free

PART NO.	PEX x MIP	CTN/MSTR
C76034LF	1/2" x 1/2"	25/400
C76035LF	1/2" x 3/4"	25/200
C76036LF	3/4" x 3/4"	50/250
C76037LF	1" x 1"	50/250
C76038LF	1" x 3/4"	25/100

Brass PEX x FIP Female Adapter



• Lead Free

PART NO.	PEX x FIP	CTN/MSTR
C76041LF	1/2" x 1/2"	50/250
C76042LF	1/2" x 3/4"	50/200
C76043LF	3/4" x 3/4"	25/200
C76044LF	1" x 1"	25/250

Brass PEX x Male Sweat Adapter



• Lead Free

PART NO.	PEX x MALE	CTN/MSTR
C76047LF	3/8" x 1/2"	50/500
C76048LF	1/2" x 1/2"	50/500
C76049LF	1/2" x 3/4"	25/100
C76050LF	3/4" x 3/4"	50/250
C76051LF	1" x 1"	25/100

Brass PEX x FIP 90° Elbow with Swivel Plastic Nut



• Lead Free

PART NO.	PEX x FIP	CTN/MSTR
C76060LF	1/2" x 1/2"	50/200

Brass PEX Ball Valve



• Lead Free

PART NO.	PEX x PEX	CTN/MSTR
B63050LF	1/2"	10/100
B63075LF	3/4"	10/100
B63100LF	1"	6/48

Brass PEX Plug



• Lead Free

PART NO.	PEX x FIP	CTN/MSTR
C76065LF	1/2"	100/1000
C76066LF	3/4"	100/500
C76067LF	1"	25/250

Brass PEX Crimp Ring



PART NO.	PEX x FIP	CTN/MSTR
C76070	3/8"	100/2000
C76071	1/2"	100/2000
C76072	3/4"	100/1000
C76073	1"	100/1000

Brass PEX x FIP Drop Ear 90° Elbow



- Lead Free

PART NO.	PEX x FIP	CTN/MSTR
C76080LF	1/2" x 1/2"	25/200
C76081LF	3/4" x 1/2"	25/200
C76079LF	1/2" x 1/2"	25/200

Oetiker PEX Stainless Steel Clamp



- The original patented PEX assembly clamp designated by ASTM F 2098
- Ingenious stepless design provides uniform compression for a 360° watertight seal
- Available for 3/8", 1/2", 3/4" and 1" ASTM F 876/877 pex tubing sizes
- Specified for use with ASTM F 1807 and F 2159 insert fittings

TECHNICAL DATA

APPLICATION:
PLUMBING & HYDRONIC
HEATING
HOT AND COLD WATER

MAXIMUM OPERATING
TEMPERATURE: 180°F

MAXIMUM OPERATING
PRESSURE (PSI): 100

MATERIAL: STAINLESS
STEEL UNS S304000

PART NO.	SIZE	CTN/MSTR
C76074	3/8"	100/2000
C76075	1/2"	100/2000
C76076	3/4"	50/2000
C76077	1"	50/1300

White Plastic PEX Equal Tee



- Listed by Warnock Hersey
- Meets ASTM F2159, F877 and CSA B1375
- Will not rust or corrode
- Unaffected by household cleaners and chemicals
- Smooth interior for better water flow
- Resists scale build-up
- Lead Free

PART NO.	SIZE	CTN/MSTR
C76700	1/2"	50/400
C76701	3/4"	25/200

White Plastic PEX Reducing Tee



- Listed by Warnock Hersey
- Meets ASTM F2159, F877 and CSA B1375
- Will not rust or corrode
- Unaffected by household cleaners and chemicals
- Smooth interior for better water flow
- Resists scale build-up
- Lead Free

PART NO.	SIZE	CTN/MSTR
C76709	1/2" x 1/2" x 3/4"	25/300
C76710	3/4" x 1/2" x 1/2"	25/300
C76711	3/4" x 1/2" x 3/4"	25/300
C76712	3/4" x 3/4" x 1/2"	25/300

White Plastic PEX Elbow



- Listed by Warnock Hersey
- Meets ASTM F2159, F877 and CSA B1375
- Will not rust or corrode
- Unaffected by household cleaners and chemicals
- Smooth interior for better water flow
- Resists scale build-up
- Lead Free

PART NO.	SIZE	CTN/MSTR
C76702	1/2"	50/500
C76703	3/4"	25/350
C76720	1"	10/150

White Plastic PEX Coupling



- Listed by Warnock Hersey
- Meets ASTM F2159, F877 and CSA B1375
- Will not rust or corrode
- Unaffected by household cleaners and chemicals
- Smooth interior for better water flow
- Resists scale build-up
- Lead Free

PART NO.	SIZE	CTN/MSTR
C76704	1/2"	50/1000
C76705	3/4"	50/600
C76706	3/4" x 1/2"	50/600
C76722	1"	25/200
C76723	1" x 3/4"	25/300

White Plastic PEX Adapter



- Listed by Warnock Hersey
- Meets ASTM F2159, F877 and CSA B1375
- Will not rust or corrode
- Unaffected by household cleaners and chemicals
- Smooth interior for better water flow
- Resists scale build-up
- Lead Free

PART NO.	PEX x MPT	CTN/MSTR
C76707	1/2" x 1/2"	50/500
C76708	3/4" x 3/4"	25/300
C76727	1" x 1"	10/150

White Plastic PEX Plug



- Listed by Warnock Hersey
- Meets ASTM F2159, F877 and CSA B1375
- Will not rust or corrode
- Unaffected by household cleaners and chemicals
- Smooth interior for better water flow
- Resists scale build-up
- Lead Free

PART NO.	SIZE	CTN/MSTR
C76740	1/2"	100/2000
C76741	3/4"	100/1000

Black Plastic PEX Equal Tee



- Listed by Warnock Hersey
- Meets ASTM F2159, F877 and CSA B1375
- Will not rust or corrode
- Unaffected by household cleaners and chemicals
- Smooth interior for better water flow
- Resists scale build-up
- Lead Free

PART NO.	SIZE	CTN/MSTR
C76762	1/2"	50/400
C76763	3/4"	50/200

Black Plastic PEX Reducing Tee

D



- Listed by Warnock Hersey
- Meets ASTM F2159, F877 and CSA B1375
- Will not rust or corrode
- Unaffected by household cleaners and chemicals
- Smooth interior for better water flow
- Resists scale build-up
- Lead Free

PART NO.	SIZE	CTN/MSTR
C76764	1/2" x 1/2" x 3/4"	25/300
C76765	3/4" x 1/2" x 1/2"	25/300
C76766	3/4" x 1/2" x 3/4"	25/300
C76767	3/4" x 3/4" x 1/2"	25/300

Black Plastic PEX Elbow



- Listed by Warnock Hersey
- Meets ASTM F2159, F877 and CSA B1375
- Will not rust or corrode
- Unaffected by household cleaners and chemicals
- Smooth interior for better water flow
- Resists scale build-up
- Lead Free

PART NO.	SIZE	CTN/MSTR
C76751	1/2"	50/500
C76752	3/4"	50/350
C76753	1"	50/150

Black Plastic PEX Coupling



- Listed by Warnock Hersey
- Meets ASTM F2159, F877 and CSA B1375
- Will not rust or corrode
- Unaffected by household cleaners and chemicals
- Smooth interior for better water flow
- Resists scale build-up
- Lead Free

PART NO.	SIZE	CTN/MSTR
C76754	1/2"	50/1000
C76755	3/4"	50/600
C76756	3/4" x 1/2"	50/600
C76757	1"	50/200
C76758	1" x 3/4"	50/300

Black Plastic PEX Adapter



- Listed by Warnock Hersey
- Meets ASTM F2159, F877 and CSA B1375
- Will not rust or corrode
- Unaffected by household cleaners and chemicals
- Smooth interior for better water flow
- Resists scale build-up
- Lead Free

PART NO.	PEX x MPT	CTN/MSTR
C76759	1/2" x 1/2"	25/500
C76760	3/4" x 3/4"	25/300
C76761	1" x 1"	25/150

Black Plastic PEX Plug



- Listed by Warnock Hersey
- Meets ASTM F2159, F877 and CSA B1375
- Will not rust or corrode
- Unaffected by household cleaners and chemicals
- Smooth interior for better water flow
- Resists scale build-up
- Lead Free

PART NO.	SIZE	CTN/MSTR
C76768	1/2"	100/2000
C76769	3/4"	100/1000

PlumBite Push On Fittings

- Heat free method for joining Copper, CPVC and PEX tube and are designed to save time and money on installations
- To make an effective joint with PEX tube, the included liner must be used. (DO NOT SUBSTITUTE with other manufacturer's liner.)
- Push fit
- Reduced installation time
- Ideal for service and repair
- "O-ring" design for leak free seals
- EPDM O-ring seal
- 316 Stainless steel retaining ring
- Designed for use with ASTM B88 hard drawn and annealed copper tube, type K, L, or M, in the 1/2" through 3/4" size range; CPVC water tube per ASTM D2846/2846M and PEX tube that meets the requirements of ASTM F876 & F877
- Operate at temperatures from 0° to 250°F at a maximum working pressure of 200 PSI
- Sold in bag quantity only

Type of Service	System Operating Conditions
FLUIDS	
Hot and Cold Potable Water	32°F to 200°F, max. 200 PSI
Potable Water System Flushing	Compliant with major plumbing codes
Chilled Water w/Corrosion Inhibitors	0°F to 250°F, max 200 PSI
	Ethylene Glycol - 50% max. concentration Propylene Glycol - 50% max. concentration
Hydronic Heating	0°F to 250°F, max 200 concentration
	Ethylene Glycol - 50% max. concentration Propylene Glycol - 50% max. concentration
Rainwater/Greywater	32° F to 250°F, max. 200 PSI

Coupling



• Lead Free

PART NO.	SIZE	CTN/MSTR
C76500LF	1/2"	5/100
C76501LF	3/4"	5/100

Reducer Coupling



• Lead Free

PART NO.	SIZE	CTN/MSTR
C76502LF	3/4" x 1/2"	15/60

Adapter C x F



• Lead Free

PART NO.	SIZE	CTN/MSTR
C76503LF	1/2"	10/100
C76504LF	3/4"	20/60
C76553LF	1"	5/100

Adapter C x M



• Lead Free

PART NO.	SIZE	CTN/MSTR
C76505LF	1/2"	10/200
C76506LF	3/4"	5/100

90° Elbow



• Lead Free

PART NO.	SIZE	CTN/MSTR
C76507LF	1/2"	10/150
C76508LF	3/4"	5/80

Drop Ear 90° Elbow C x F



• Lead Free

PART NO.	SIZE	CTN/MSTR
C76509LF	1/2"	10/100

Tee



• Lead Free

PART NO.	SIZE	CTN/MSTR
C76510LF	1/2"	10/100
C76511LF	3/4"	10/100
C76512LF	3/4" x 3/4" x 1/2"	5/50
C76513LF	3/4" x 1/2" x 3/4"	5/50
C76514LF	3/4" x 1/2" x 1/2"	5/50

Cap



• Lead Free

PART NO.	SIZE	CTN/MSTR
C76515LF	1/2"	10/200
C76516LF	3/4"	5/150

Ball Valve



• Lead Free

PART NO.	SIZE	CTN/MSTR
C76561LF	1/2"	10/60
C76562LF	3/4"	10/40

Repair Coupling



• Lead Free

PART NO.	SIZE	CTN/MSTR
C76530LF	1/2"	5/70
C76531LF	3/4"	5/70
C76532LF	1"	5/40

Supply Stop



• Lead Free

PART NO.	SIZE	CTN QTY
C76570LF	Straight 1/2" x 3/8"OD	1/120
C76571LF	Angle 1/2" x 3/8"OD	1/120

Removal Tool



PART NO.	SIZE	CTN QTY
C76520	1/2"	1/500
C76521	3/4"	5/250
C76522	1"	5/200

Twist To Lock Plastic Fittings

- Reduced installation time
- Ideal for service and repair
- "O-ring" design for leak-free seals
- Working temps and pressure:
180PSI@68°F, 100PSI@150°F, 45PSI@180°F

INSTRUCTIONS FOR USE

To Connect: Squarely cut tubing or pipe to desired length, removing all burrs. Push fitting onto the end of tube or pipe. Fitting will grip before it seals. Ensure that tubing or pipe is pushed into the fitting until the end is fully seated into the internal tube stop.



D To Lock Fitting: Twist the screw cap until colored line is no longer visible.



Plastic inserts are required for plastic pipe connections in heating installations. It is recommended to use pipe inserts for plastic pipe connections in standard residential plumbing (hot and cold water) installations.

Drop Ear Elbow CTS



PART NO.	SIZE	CTN/MSTR
C76800	1/2"	3/144

Enlarger Connector CTS STACK x CTS



PART NO.	SIZE	CTN/MSTR
C76801	3/4" x 1"	3/120

Female Adapter CTS x FIP



PART NO.	SIZE	CTN/MSTR
C76802	1/2" x 1/2"	3/321
C76803	1/2" x 3/4"	3/480
C76804	3/4" x 3/4"	3/216
C76805	1" x 1"	3/36

Female Garden Hose Adapter CTS x FGH



PART NO.	SIZE	CTN/MSTR
C76806	1/2" x 3/4"	3/168

Male Adapter CTS x MIP



PART NO.	SIZE	CTN/MSTR
C76807	1/2" x 1/2"	3/330
C76808	1/2" x 3/4"	3/282
C76809	3/4" x 3/4"	3/192

Male Elbow CTS x MIP



PART NO.	SIZE	CTN/MSTR
C76810	1/2" x 1/2"	3/168

Reducing Connector CTS x CTS Stem



PART NO.	SIZE	CTN/MSTR
C76811	1/2" x 3/4"	3/300

Swivel Elbow Union CTS x FIP



PART NO.	SIZE	CTN/MSTR
C76812	1/2" x 1/2"	3/160

Swivel Union Connector CTS x BC



PART NO.	SIZE	CTN/MSTR
C76813	1/2" x BC	3/300

Tube End Stop CTS



PART NO.	SIZE	CTN/MSTR
C76814	1/2"	3/336
C76815	3/4"	3/640
C76816	1"	3/135

Tube Elbow Union CTS x CTS Stem



PART NO.	SIZE	CTN/MSTR
C76817	1/2" x 1/2"	3/345
C76818	3/4" x 3/4"	3/180

Elbow Union CTS x CTS



PART NO.	SIZE	CTN/MSTR
C76819	1/2"	3/480
C76820	3/4"	3/60
C76821	1"	3/138

Tube Tee Union Connector CTS x CTS x CTS Stem



PART NO.	SIZE	CTN/MSTR
C76822	1/2" x 1/2" x 1/2"	3/180

Stack Tube Tee Union CTS



PART NO.	SIZE	CTN/MSTR
C76823	1/2"	3/195
C76824	3/4"	3/102

Union Connector CTS x CTS



PART NO.	SIZE	CTN/MSTR
C76825	3/8"	3/351
C76826	1/2" x 5/8"	3/528
C76827	1/2"	3/480
C76828	3/4" x 1/2"	3/330
C76829	3/4"	3/288
C76830	1" x 3/4"	3/180
C76831	1"	3/165

Tee Union CTS x CTS x CTS



PART NO.	SIZE	CTN/MSTR
C76832	1/2"	3/150
C76833	3/4" x 3/4" x 1/2"	3/180
C76834	3/4"	3/90
C76835	1"	3/78
C76836	1" x 3/4" x 3/4"	3/81
C76837	3/4" x 1/2" x 1/2"	3/180

Hand Valve Union Connector CTS x CTS



PART NO.	SIZE	CTN/MSTR
C76838	1/2"	3/210
C76839	3/4"	3/120

D

Plastic Push On Fittings

- Quick and easy installation
- Very durable and fatigue resistant
- Manufactured from safe, non-toxic materials meeting the requirements of the US FDA, WRAS, ANSI/NSF-51, 61 and SK Zert
- All connections can be assembled and disassembled repeatedly



1. Cut the part of the tube to be inserted into the fitting to plane the end.
2. Make sure to use a clean tube without any foreign material or cracks.



3. When inserting the tube, remove any obstructions before fully inserting the tube. Make sure the tube is fully inserted.

4. Inserting the tube into the fitting only takes moderate force. The tube or fitting should not be scratched or damaged in the process, as this is the main cause for water leaks later on.



5. To make sure that the fitting is properly connected to the tube, pull it once. After pulling, insert a spanner under the collet and push the tube into the fitting once more for a complete insertion.



6. When no play is desired for the fitting and tube, use our company's LC to eliminate the play of the fitting.



7. Make sure to completely eliminate pressure before disassembling the fitting.

8. When disassembling the tube, push the clip in direction to the main assembly and then pull the tube out for easy disassembling.

9. Fittings and tubes can be reused.

Straight Needle Valve CTS x MIP



PART NO.	SIZE	CTN/MSTR
C76840	1/4" x 1/4"	400/1600
C76841	3/8" x 3/8"	100/400

Straight Needle Valve CTS



PART NO.	SIZE	CTN/MSTR
C76842	1/4"	100/400
C76843	3/8"	150/600

Angle Valve CTS x FIP



PART NO.	SIZE	CTN/MSTR
C76844	1/4" x 1/4"	300/1200
C76845	3/8" x 3/8"	100/400

Straight Valve CTS x MIP



PART NO.	SIZE	CTN/MSTR
C76846	1/4" x 1/4"	50/600
C76847	3/8" x 3/8"	100/400

Straight Valve CTS x CTS



PART NO.	SIZE	CTN/MSTR
C76848	1/4"	150/600
C76849	3/8"	100/400

End Cap CTS



PART NO.	SIZE	CTN/MSTR
C76850	1/4"	500/3600
C76851	3/8"	600/2400
C76852	1/2"	400/1600

Plug CTS



PART NO.	SIZE	CTN/MSTR
C76853	1/4"	600/2400
C76854	3/8"	1000/4000
C76855	1/2"	500/2000

Union & Reducing Union CTS x CTS



PART NO.	SIZE	CTN/MSTR
C76856	1/4"	700/2800
C76857	3/8" x 1/4"	250/1000
C76858	3/8" x 3/8"	250/1000
C76859	1/2" x 3/8"	200/800

Bulkhead Union CTS x CTS



PART NO.	SIZE	CTN/MSTR
C76860	1/4" x 1/4"	200/800
C76861	3/8" x 3/8"	200/800
C76862	1/2" x 3/8"	100/400

Tee & Reducing Tee CTS x CTS x CTS



PART NO.	SIZE	CTN/MSTR
C76863	1/4"	400/1600
C76864	3/8" x 3/8" x 1/4"	200/800
C76865	3/8"	150/600
C76866	1/2" x 1/2" x 3/8"	100/400
C76867	1/2"	100/400

Elbow CTS x MIP



PART NO.	SIZE	CTN/MSTR
C76884	1/4" x 1/8"	800/3200
C76885	1/4" x 1/4"	600/2400
C76886	1/4" x 3/8"	500/2000
C76887	3/8" x 1/4"	800/3200
C76888	3/8" x 3/8"	300/1200

Elbow & Reducing Elbow CTS x CTS



PART NO.	SIZE	CTN/MSTR
C76868	1/4"	700/2800
C76869	3/8"	300/1200
C76870	1/2"	150/600

Elbow Adapter CTS x CTS Stem



PART NO.	SIZE	CTN/MSTR
C76889	1/4" x 1/4"	500/2000
C76890	3/8" x 3/8"	200/800

Coupling CTS x FIP



PART NO.	SIZE	CTN/MSTR
C76871	1/4" x 1/8"	400/1600
C76872	1/4" x 1/4"	600/2400
C76873	3/8" x 1/4"	300/1200

Connector CTS Stem x Tube ID



PART NO.	SIZE	CTN/MSTR
C76891	3/8" x 3/8"	800/3200
C76892	3/8" x 1/2"	200/800
C76893	1/2" x 1/2"	400/1600

Kitchen Faucet Adapter Tee FIP x MIP x CTS



PART NO.	SIZE	CTN/MSTR
C76874	1/2" x 1/2" x 1/4"	100/400
C76875	1/2" x 1/2" x 3/8"	100/400

Connector CTS x MIP



PART NO.	SIZE	CTN/MSTR
C76876	1/4" x 1/8"	800/3200
C76877	1/4" x 1/4"	800/3200
C76878	1/4" x 3/8"	600/2400
C76879	3/8" x 1/4"	400/1600
C76880	3/8" x 3/8"	400/1600
C76881	3/8" x 1/2"	200/800
C76882	1/2" x 3/8"	300/1200
C76883	1/2" x 1/2"	200/800

Red Brass Pipe Nipples - Lead Free



• Meets ASTM B687

PART NO.	IPT	CTN/MSTR
N20000	1/8" x close	200/800
N20001	1/8" x 1-1/2"	200/800
N20002	1/8" x 2"	200/800
N20003	1/8" x 2-1/2"	200/800
N20004	1/8" x 3"	200/800
N20005	1/8" x 3-1/2"	100/400
N20006	1/8" x 4"	100/400
N20007	1/8" x 4-1/2"	100/400
N20008	1/8" x 5"	100/400
N20009	1/8" x 5-1/2"	100/400
N20010	1/8" x 6"	100/400
N20012	1/8" x 7"	1/400
N20014	1/8" x 8"	1/400
N20016	1/8" x 9"	1/300
N20018	1/8" x 10"	1/300
N20020	1/8" x 11"	1/300
N20022	1/8" x 12"	1/200
N21000	1/4" x close	150/600
N21001	1/4" x 1-1/2"	100/800
N21002	1/4" x 2"	100/800
N21003	1/4" x 2-1/2"	100/800
N21004	1/4" x 3"	50/400
N21005	1/4" x 3-1/2"	50/400
N21006	1/4" x 4"	50/200
N21007	1/4" x 4-1/2"	50/200
N21008	1/4" x 5"	40/320
N21009	1/4" x 5-1/2"	40/320
N21010	1/4" x 6"	40/320
N21012	1/4" x 7"	1/150
N21014	1/4" x 8"	1/150
N21016	1/4" x 9"	1/100
N21018	1/4" x 10"	1/100
N21020	1/4" x 11"	1/100
N21022	1/4" x 12"	1/100
N22000	3/8" x close	100/400
N22001	3/8" x 1-1/2"	100/400
N22002	3/8" x 2"	80/320
N22003	3/8" x 2-1/2"	80/320
N22004	3/8" x 3"	50/200
N22005	3/8" x 3-1/2"	40/320
N22006	3/8" x 4"	40/320
N22007	3/8" x 4-1/2"	35/280
N22008	3/8" x 5"	30/120
N22009	3/8" x 5-1/2"	30/120
N22010	3/8" x 6"	30/120
N22012	3/8" x 7"	1/160
N22014	3/8" x 8"	1/160
N22016	3/8" x 9"	1/120
N22018	3/8" x 10"	1/120

Red Brass Pipe Nipples cont...

PART NO.	IPT	CTN/MSTR
N22020	3/8" x 11"	1/120
N22022	3/8" x 12"	1/110
N23000	1/2" x close	75/600
N23001	1/2" x 1-1/2"	60/480
N23002	1/2" x 2"	50/200
N23003	1/2" x 2-1/2"	35/280
N23004	1/2" x 3"	35/280
N23005	1/2" x 3-1/2"	25/100
N23006	1/2" x 4"	25/100
N23007	1/2" x 4-1/2"	25/100
N23008	1/2" x 5"	25/100
N23009	1/2" x 5-1/2"	25/100
N23010	1/2" x 6"	25/100
N23012	1/2" x 7"	1/100
N23014	1/2" x 8"	1/100
N23016	1/2" x 9"	1/100
N23018	1/2" x 10"	1/100
N23020	1/2" x 11"	1/100
N23022	1/2" x 12"	1/100
N24000	3/4" x close	40/320
N24001	3/4" x 1-1/2"	30/240
N24002	3/4" x 2"	30/240
N24003	3/4" x 2-1/2"	25/200
N24004	3/4" x 3"	25/100
N24005	3/4" x 3-1/2"	35/140
N24006	3/4" x 4"	35/140
N24007	3/4" x 4-1/2"	30/120
N24008	3/4" x 5"	30/120
N24009	3/4" x 5-1/2"	25/100
N24010	3/4" x 6"	25/100
N24012	3/4" x 7"	1/65
N24014	3/4" x 8"	1/65
N24016	3/4" x 9"	1/45
N24018	3/4" x 10"	1/45
N24020	3/4" x 11"	1/45
N24022	3/4" x 12"	1/45
N25000	1" x close	25/200
N25002	1" x 2"	25/200
N25003	1" x 2-1/2"	40/160
N25004	1" x 3"	40/160
N25005	1" x 3-1/2"	25/100
N25006	1" x 4"	25/100
N25007	1" x 4-1/2"	25/100
N25008	1" x 5"	20/80
N25009	1" x 5-1/2"	10/40
N25010	1" x 6"	10/40
N25012	1" x 7"	1/40
N25014	1" x 8"	1/40
N25016	1" x 9"	1/30
N25018	1" x 10"	1/30
N25020	1" x 11"	1/30

Red Brass Pipe Nipples cont...

PART NO.	IPT	CTN/MSTR
N25022	1" x 12"	1/30
N27000	1-1/4" x close	25/100
N27002	1-1/4" x 2"	25/100
N27003	1-1/4" x 2-1/2"	10/80
N27004	1-1/4" x 3"	10/80
N27005	1-1/4" x 3-1/2"	1/40
N27006	1-1/4" x 4"	10/40
N27007	1-1/4" x 4-1/2"	10/40
N27008	1-1/4" x 5"	10/40
N27009	1-1/4" x 5-1/2"	10/40
N27010	1-1/4" x 6"	10/40
N27012	1-1/4" x 7"	1/25
N27014	1-1/4" x 8"	1/25
N27016	1-1/4" x 9"	1/20
N27018	1-1/4" x 10"	1/20
N27020	1-1/4" x 11"	1/20
N27022	1-1/4" x 12"	1/20
N28000	1-1/2" x close	25/100
N28002	1-1/2" x 2"	20/80
N28003	1-1/2" x 2-1/2"	15/60
N28004	1-1/2" x 3"	15/60
N28005	1-1/2" x 3-1/2"	15/60
N28006	1-1/2" x 4"	15/60
N28007	1-1/2" x 4-1/2"	15/60
N28008	1-1/2" x 5"	10/40
N28009	1-1/2" x 5-1/2"	10/40
N28010	1-1/2" x 6"	10/40
N28012	1-1/2" x 7"	1/20
N28014	1-1/2" x 8"	1/20
N28016	1-1/2" x 9"	1/15
N28018	1-1/2" x 10"	1/15
N28020	1-1/2" x 11"	1/15
N28022	1-1/2" x 12"	1/15
N29000	2" x close	15/60
N29003	2" x 2-1/2"	10/40
N29004	2" x 3"	10/40
N29005	2" x 3-1/2"	10/40
N29006	2" x 4"	10/40
N29007	2" x 4-1/2"	10/40
N29008	2" x 5"	1/25
N29009	2" x 5-1/2"	1/25
N29010	2" x 6"	1/25
N29012	2" x 7"	1/10
N29014	2" x 8"	1/10

Red Brass Pipe Nipples cont...

PART NO.	IPT	CTN/MSTR
N29016	2" x 9"	1/10
N29018	2" x 10"	1/10
N29020	2" x 11"	1/10
N29022	2" x 12"	1/10
N30000	2-1/2" x close	1/40
N30004	2-1/2" x 3"	1/40
N30005	2-1/2" x 3-1/2"	1/20
N30006	2-1/2" x 4"	1/20
N30007	2-1/2" x 4-1/2"	1/20
N30008	2-1/2" x 5"	1/20
N30009	2-1/2" x 5-1/2"	1/20
N30010	2-1/2" x 6"	1/20
N31000	3" x close	1/20
N31004	3" x 3"	1/20
N31005	3" x 3-1/2"	1/10
N31006	3" x 4"	1/10
N31007	3" x 4-1/2"	1/10
N31008	3" x 5"	1/10
N31009	3" x 5-1/2"	1/10
N31010	3" x 6"	1/10

D

Bronze 90° Elbow



• Lead Free

PART NO.	SIZE	CTN/MSTR
B74001LF	1/8"	150/600
B74002LF	1/4"	100/400
B74003LF	3/8"	75/300
B74004LF	1/2"	50/200
B74005LF	3/4"	25/100
B74006LF	1"	1/80
B74007LF	1-1/4"	1/50
B74008LF	1-1/2"	1/35
B74009LF	2"	1/20
B74343LF	3/4" x 1/2"	30/120
B74344LF	1" x 1/2"	1
B74345LF	1" x 3/4"	25/100
B74347LF	1-1/2" x 1-1/4"	1/40

SPECIFICATIONS:
ANSI B16.15
ANSI B2.1 (PIPE THREADS)
FED WW-P-460
FED WW-U-516
150 PSI @400°F WSP
225 PSI WOG@ -20°F / 150°F

D

Bronze 90° Street Elbow



• Lead Free

PART NO.	SIZE	CTN/MSTR
B74021LF	1/8"	200/800
B74022LF	1/4"	100/400
B74023LF	3/8"	60/240
B74024LF	1/2"	50/200
B74025LF	3/4"	25/100
B74026LF	1"	1/50
B74027LF	1-1/4"	1/40
B74028LF	1-1/2"	1/35
B74029LF	2"	1/20

Bronze 45° Elbow



• Lead Free

PART NO.	SIZE	CTN/MSTR
B74042LF	1/4"	1
B74044LF	1/2"	50/200
B74045LF	3/4"	25/100
B74046LF	1"	1/90

Bronze 45° Street Elbow



• Lead Free

PART NO.	SIZE	CTN/MSTR
B74066LF	1"	1/80
B74067LF	1-1/4"	1/50

Bronze Union



• Lead Free

PART NO.	SIZE	CTN/MSTR
B74262LF	1/4"	60/240
B74263LF	3/8"	30/120
B74264LF	1/2"	25/100
B74265LF	3/4"	20/80
B74266LF	1"	1/50
B74267LF	1-1/4"	1/35
B74268LF	1-1/2"	1/25
B74269LF	2"	1/18

Bronze Tee



• Lead Free

PART NO.	SIZE	CTN/MSTR
B74081LF	1/8"	120/480
B74082LF	1/4"	75/300
B74083LF	3/8"	50/200
B74084LF	1/2"	25/100
B74085LF	3/4"	1/85
B74086LF	1"	1/35
B74087LF	1-1/4"	1/35
B74088LF	1-1/2"	1/24
B74089LF	2"	1/15
B74090LF	2-1/2"	8
B74354LF	1/2" x 3/8"	35
B74395LF	3/4" x 1/4"	25/100
B74396LF	3/4" x 3/8"	25/100
B74358LF	3/4" x 1/2" x 3/4"	1/100
B74359LF	3/4" x 1/2"	25/100
B74365LF	1" x 3/4"	1/70
B74369LF	1-1/4" x 3/4"	1/35
B74367LF	1-1/2" x 1-1/4"	1
B74368LF	2" x 1-1/2"	1/15

Bronze Cap



• Lead Free

PART NO.	SIZE	CTN/MSTR
B74181LF	1/8"	1
B74182LF	1/4"	200/800
B74183LF	3/8"	150/600
B74184LF	1/2"	100/400
B74185LF	3/4"	50/200
B74186LF	1"	40/160
B74187LF	1-1/4"	1/100
B74188LF	1-1/2"	1/100
B74189LF	2"	1/70

Bronze Locknut



PART NO.	SIZE	CTN/MSTR
B74380LF	1/2"	150/600
B74381	3/4"	90/360
B74382	1"	60/240
B74383	1-1/4"	1
B74384	1-1/2"	1

Bronze Coupling/ Reducer



• Lead Free

PART NO.	SIZE	CTN/MSTR
B74121LF	1/8"	200/800
B74122LF	1/4"	150/600
B74123LF	3/8"	100/400
B74124LF	1/2"	50/200
B74125LF	3/4"	5/100
B74126LF	1"	1/100
B74127LF	1-1/4"	1/175
B74128LF	1-1/2"	1/50
B74129LF	2"	1/30
B74132LF	4"	1/6
B74140LF	1/4" x 1/8"	150/600
B74142LF	3/8" x 1/4"	90/360
B74144LF	1/2" x 1/4"	75/300
B74145LF	1/2" x 3/8"	70/280
B74148LF	3/4" x 1/2"	45/180
B74150LF	1" x 3/4"	25/100
B74152LF	1-1/4" x 3/4"	1/90
B74153LF	1-1/4" x 1"	1/80
B74154LF	1-1/2" x 1/2"	1
B74155LF	1-1/2" x 3/4"	1/80
B74156LF	1-1/2" x 1"	1/65
B74157LF	1-1/2" x 1-1/4"	60
B74160LF	2" x 1-1/4"	1/40
B74161LF	2" x 1-1/2"	1/35

Bronze Extension Piece



• Lead Free

PART NO.	SIZE	CTN/MSTR
B74370LF	3/4"	40/160

Bronze Cored Square Head Plug



• Lead Free

PART NO.	SIZE	CTN/MSTR
B74284LF	1/2"	150/600
B74285LF	3/4"	100/400
B74286LF	1"	50/200
B74287LF	1-1/4"	140
B74288LF	1-1/2"	120
B74289LF	2"	1/75

Bronze Solid Square Head Plug



• Lead Free

PART NO.	SIZE	CTN/MSTR
B74301LF	1/8"	1
B74302LF	1/4"	1/690
B74303LF	3/8"	1/310
B74304LF	1/2"	100/400
B74305LF	3/4"	50/200
B74306LF	1"	35/140

Bronze Countersunk Plug



• Lead Free

PART NO.	SIZE	CTN/MSTR
B74331LF	3"	1/32

Bronze Cross



• Lead Free

PART NO.	SIZE	CTN/MSTR
B74104LF	1/2"	25/100
B74105LF	3/4"	1/60
B74107LF	1-1/4"	1/24
B74108LF	1-1/2"	1/22

Bronze HEX Bushing



• Lead Free

PART NO.	SIZE	CTN/MSTR
B74200LF	1/4" x 1/8"	1
B74201LF	3/8" x 1/8"	250/1000
B74202LF	3/8" x 1/4"	250/1000
B74203LF	1/2" x 1/8"	150/600
B74204LF	1/2" x 1/4"	150/600
B74205LF	1/2" x 3/8"	1/1000
B74206LF	3/4" x 1/8"	75/300
B74207LF	3/4" x 1/4"	80/320
B74208LF	3/4" x 3/8"	85/340
B74209LF	3/4" x 1/2"	90/360
B74210LF	1" x 1/4"	50/200
B74212LF	1" x 1/2"	50/200
B74213LF	1" x 3/4"	50/200
B74216LF	1-1/4" x 1/2"	1/120
B74217LF	1-1/4" x 3/4"	1/120
B74218LF	1-1/4" x 1"	1/120
B74220LF	1-1/2" x 3/8"	1
B74222LF	1-1/2" x 3/4"	1/85
B74223LF	1-1/2" x 1"	1/115
B74224LF	1-1/2" x 1-1/4"	1/120
B74228LF	2" x 3/4"	1/60
B74229LF	2" x 1"	1/60
B74230LF	2" x 1-1/4"	1/65
B74231LF	2" x 1-1/2"	1/65
B74232LF	2-1/2" x 2"	1/40
B74235LF	4" x 3"	1/12

Chrome Plated Nipples/Pipe Lengths



• Lead Free

PART NO.	SIZE	CTN/MSTR
N15100	3/8" x close	50/400
N15150	3/8" x 1-1/2"	25/400
N15200	3/8" x 2"	50/400
N15250	3/8" x 2-1/2"	50/300
N15300	3/8" x 3"	50/300
N15350	3/8" x 3-1/2"	50/200
N15400	3/8" x 4"	25/100
N15450	3/8" x 4-1/2"	50/200
N15500	3/8" x 5"	50/200
N15550	3/8" x 5-1/2"	25/100
N15600	3/8" x 6"	25/100
N15900	3/8" x 12"	25/50
N15948	3/8" x 48"	1/10
N15972	3/8" x 72"	1/10
N16100	1/2" x close	50/400
N16150	1/2" x 1-1/2"	50/400
N16200	1/2" x 2"	50/400
N16250	1/2" x 2-1/2"	75/300
N16300	1/2" x 3"	75/300
N16350	1/2" x 3-1/2"	50/200
N16400	1/2" x 4"	25/100
N16450	1/2" x 4-1/2"	25/100
N16500	1/2" x 5"	1
N16550	1/2" x 5-1/2"	25/100
N16600	1/2" x 6"	25/100
N16900	1/2" x 12"	10/50
N16918	1/2" x 18"	1/10
N16924	1/2" x 24"	1/10
N16936	1/2" x 36"	1/10
N16948	1/2" x 48"	1/10
N17100	3/4" x close	50/100
N17150	3/4" x 1-1/2"	50/200
N17300	3/4" x 3"	1/30
N17400	3/4" x 4"	25/100
N17600	3/4" x 6"	25/100
N18100	1" x close	20/200
N18200	1" x 2"	20/200
N18250	1" x 2-1/2"	20/100
N18300	1" x 3"	25/100
N18400	1" x 4"	25/100
N18500	1" x 5"	10/50
N18600	1" x 6"	10/50

Chrome Plated 90° Elbow



• Lead Free

PART NO.	SIZE	CTN/MSTR
B50001LF	3/8"	25/100
B50002LF	1/2"	50/200
B50003LF	3/4"	25/100
B50004LF	1"	25/100

Chrome Plated 90° Street Elbow



• Lead Free

PART NO.	SIZE	CTN/MSTR
B50094LF	1/2"	25/100
B50098LF	3/4"	25/100
B50103LF	1"	1/50

Chrome Plated 45° Elbow



• Lead Free

PART NO.	SIZE	CTN/MSTR
B50011LF	3/8"	25/100
B50012LF	1/2"	50/200
B50013LF	3/4"	25/100

Chrome Plated Tee



• Lead Free

PART NO.	SIZE	CTN/MSTR
B50031LF	3/8"	50/200
B50032LF	1/2"	50/100
B50033LF	3/4"	1/85

Chrome Plated Coupling



• Lead Free

PART NO.	SIZE	CTN/MSTR
B50041LF	3/8"	25/400
B50042LF	1/2"	50/200
B50043LF	3/4"	25/100
B50044LF	1"	25/100

Chrome Plated Reducer



• Lead Free

PART NO.	SIZE	CTN/MSTR
B50051LF	1/2"x 3/8"	70/280
B50052LF	3/4"x 1/2"	45/180

D

Chrome Plated Bushing



• Lead Free

PART NO.	SIZE	CTN/MSTR
B50072LF	1/2"x 3/8"	50/200
B50073LF	3/4"x 1/2"	90/360

Chrome Plated Union



• Lead Free

PART NO.	SIZE	CTN/MSTR
B50092LF	1/2"	25/100
B50097LF	3/4"	20/80
B50100LF	1"	50

Chrome Plated Plug



• Lead Free

PART NO.	SIZE	CTN/MSTR
B50096LF	1/2"	100/400
B50099LF	3/4"	1

Chrome Plated Cap



• Lead Free

PART NO.	SIZE	CTN/MSTR
B50081LF	3/8"	150/600
B50082LF	1/2"	100/400
B50083LF	3/4"	50/200

D

Male Hose To Male Pipe



PART NO.	MHT x MPT	CTN/MSTR
G20002	3/4" x 1/2"	20/200
G20003	3/4" x 3/4" (1/2" FIP tap)	20/200
G20004	3/4" x 1/2" (1/2" SWT)	50/200

Male Hose To Male Pipe - Lead Free



PART NO.	MHT x MPT	CTN/MSTR
G20102	3/4" x 1/2"	1/40
G20103	3/4" x 3/4" (1/2" FIP tap)	50/200

Male Hose To Male Hose



PART NO.	MHT x MHT	CTN/MSTR
G20008	3/4" x 3/4" (1/2" FIP tap)	20/200

Male Hose To Male Hose - Lead Free



PART NO.	MHT x MHT	CTN. QTY.
G20108	3/4" x 3/4" (1/2" FIP tap)	1/40

Male Hose To Female Pipe



PART NO.	MHT x FPT	CTN/MSTR
G20010	3/4" x 1/2"	100/500
G20011	3/4" x 3/4"	20/200

Male Hose To Female Pipe - Lead Free



PART NO.	MHT x FPT	CTN/MSTR
G20110	3/4" x 1/2"	1/40
G20111	3/4" x 3/4"	1/40

Female Hose To Male Pipe



PART NO.	FHT x MPT	CTN/MSTR
G20005	3/4" x 1/2" (1/2" SWT)	
G20015	3/4" x 1/2"	50/250
G20016	3/4" x 3/4"	50/250
G20017	3/4" x 3/4" (1/2" FIP tap)	50/200

Female Hose To Male Pipe - Lead Free



PART NO.	FHT x MPT	CTN/MSTR
G20115	3/4" x 1/2"	50/200
G20116	3/4" x 3/4"	1/40

Female Hose To Female Pipe



PART NO.	FHT x FPT	CTN/MSTR
G20020	3/4" x 1/2"	50/200
G20021	3/4" x 3/4"	50/200

Female Hose To Female Pipe - Lead Free



PART NO.	FHT x FPT	CTN/MSTR
G20120	3/4" x 1/2"	1/40
G20121	3/4" x 3/4"	1/40

Female Hose To Female Hose Swivel



PART NO.	FHT x FHT	CTN/MSTR
G20030	3/4" x 3/4"	20/200

Female Hose To Female Hose Swivel - Lead Free



PART NO.	FHT x FHT	CTN/MSTR
G20130	3/4" x 3/4"	1/40

Female Hose To Female Pipe Swivel



PART NO.	FHT x FPT	CTN/MSTR
G20031	3/4" x 1/2"	20/200
G20032	3/4" x 3/4"	125/250

Female Hose To Female Pipe Swivel - Lead Free



PART NO.	FHT x FPT	CTN/MSTR
G20131	3/4" x 1/2"	1/40
G20132	3/4" x 3/4"	1/40

Hose Barb To Female Hose Swivel



PART NO.	HB x FHT	CTN/MSTR
G20035	3/8" x 3/4"	140
G20036	1/2" x 3/4"	20/245
G20037	5/8" x 3/4"	1
G20038	3/4" x 3/4"	1

Hose Barb To Female Hose Swivel - Lead Free



PART NO.	HB x FHT	CTN/MSTR
G20136	1/2" x 3/4"	50/200
G20137	5/8" x 3/4"	50/200
G20138	3/4" x 3/4"	50/200

Hose Barb To Male Hose



PART NO.	HB x MHT	CTN/MSTR
G20040	3/8" x 3/4"	1
G20041	1/2" x 3/4"	50/200
G20042	5/8" x 3/4"	1/200
G20043	3/4" x 3/4"	50/200

Hose Barb To Male Hose - Lead Free



PART NO.	HB x MHT	CTN/MSTR
G20141	1/2" x 3/4"	50/200
G20142	5/8" x 3/4"	50/200
G20143	3/4" x 3/4"	50/200

Male Pipe To Female Hose Swivel



PART NO.	MPT x FHT	CTN/MSTR
G20045	1/4" x 3/4"	1
G20047	1/2" x 3/4"	50/200

Hose WYE



PART NO.	DESCRIPTION	CTN/MSTR
G20050	3/4" x 3/4"	20/200

Hose WYE - Lead Free



PART NO.	DESCRIPTION	CTN/MSTR
G20150	3/4" x 3/4"	1/100

Garden Hose Shut Off



• Buna-N seals

PART NO.	DESCRIPTION	CTN/MSTR
G20051	Dual shut off/green ABS	100
G20052	Single shut off/green ABS	1/200
G20053	Brass hose with shut off "wye"	15/60
G20054	CP die cast with shut off "wye"	20/100

Garden Hose Cap



PART NO.	FHT	CTN/MSTR
G20055	3/4"	100/600
G20056	3/4" with chain	1/500

Garden Hose Cap - Lead Free



PART NO.	FHT	CTN/MSTR
G20155	3/4" with washer	1/500

Garden Hose Washer



PART NO.	SIZE	CTN/MSTR
G20057	3/4" vinyl	1/5000
G20057R	3/4" red rubber	1/2500

Garden Hose Filter Washer



PART NO.	SIZE	CTN/MSTR
G20060	3/4"	2000

Evaporation Cooler Drain



PART NO.	MHT x FPT	CTN/MSTR
G20006	3/4" x 1/2"	25/200

Hose Barb To Male Pipe

• Barb refers to hose I.D.



PART NO.	BARB x MPT	CTN/MSTR
G25022	1/8" x 1/8"	1
G25032	3/16" x 1/8"	1
G25034	3/16" x 1/4"	1
G25042	1/4" x 1/8"	1
G25044	1/4" x 1/4"	1
G25046	1/4" x 3/8"	1
G25048	1/4" x 1/2"	1
G25052	5/16" x 1/8"	500/1000
G25054	5/16" x 1/4"	1
G25056	5/16" x 3/8"	1
G25062	3/8" x 1/8"	1
G25064	3/8" x 1/4"	1
G25066	3/8" x 3/8"	1
G25068	3/8" x 1/2"	50/500
G25612	3/8" x 3/4"	1
G25084	1/2" x 1/4"	1
G25086	1/2" x 3/8"	1
G25088	1/2" x 1/2"	350
G25812	1/2" x 3/4"	1
G25106	5/8" x 3/8"	250/500
G25108	5/8" x 1/2"	1
G25101	5/8" x 3/4"	1
G25128	3/4" x 1/2"	1
G25121	3/4" x 3/4"	200
G25161	1" x 3/4"	1
G25169	1" x 1"	1

D

Hose Barb To Female Pipe

• Barb refers to hose I.D.



PART NO.	BARB x FPT	CTN/MSTR
G26022	1/8" x 1/8"	1
G26032	3/16" x 1/8"	1
G26034	3/16" x 1/4"	1
G26042	1/4" x 1/8"	1
G26044	1/4" x 1/4"	1
G26046	1/4" x 3/8"	1
G26052	5/16" x 1/8"	1
G26054	5/16" x 1/4"	1
G26056	5/16" x 3/8"	1
G26062	3/8" x 1/8"	1
G26064	3/8" x 1/4"	1
G26066	3/8" x 3/8"	1
G26068	3/8" x 1/2"	100/200
G26084	1/2" x 1/4"	1
G26086	1/2" x 3/8"	1
G26088	1/2" x 1/2"	1
G26121	3/4" x 3/4"	1
G26161	1" x 3/4"	1

Hose Barb To Male Pipe Elbow

• Barb refers to hose I.D.



PART NO.	BARB x MPT	CTN/MSTR
G27042	1/4" x 1/8"	1
G27044	1/4" x 1/4"	1
G27054	5/16" x 1/4"	1
G27062	3/8" x 1/8"	1
G27064	3/8" x 1/4"	1
G27066	3/8" x 3/8"	1
G27068	3/8" x 1/2"	1
G27084	1/2" x 1/4"	1
G27086	1/2" x 3/8"	1
G27088	1/2" x 1/2"	1
G27106	5/8" x 3/8"	1
G27108	5/8" x 1/2"	1

Barb To Barb Hose Splicers

• Barb refers to hose I.D.



PART NO.	BARB	CTN/MSTR
G29003	3/16"	1
G29004	1/4"	1
G29005	5/16"	250/1000
G29006	3/8"	100/800
G29008	1/2"	1
G29010	5/8"	1

Hose Barb To Female Ball End Swivel

• Barb refers to hose I.D.



PART NO.	BARB x NPSM	CTN/MSTR
G28044	1/4" x 1/4"	1
G28066	3/8" x 3/8"	1
G28088	1/2" x 1/2"	1

Hose Barb Tee

• Barb refers to hose I.D.



PART NO.	BARB x BARB X BARB	CTN/MSTR
G24004	1/4"	1
G24006	3/8"	1

Nylon Hose Barb Splicer



• Barb refers to hose I.D.

PART NO.	BARB x BARB	CTN/MSTR
N10001	1/8" x 1/8"	10/100
N10002	1/4" x 1/4"	10/100
N10003	5/16" x 5/16"	10/100
N10004	3/8" x 3/8"	10/100
N10005	1/2" x 1/2"	10/100
N10006	5/8" x 5/8"	10/100
N10007	3/4" x 3/4"	10/100
N10008	1" x 1"	5/50

Nylon Hose Barb Tee



• Barb refers to hose I.D.

PART NO.	BARB x BARB	CTN/MSTR
N11001	1/8" x 1/8" x 1/8"	10/100
N11002	1/4" x 1/4" x 1/4"	10/100
N11003	3/8" x 3/8" x 3/8"	10/100
N11004	1/2" x 1/2" x 3/8"	10/100
N11005	1/2" x 1/2" x 1/2"	10/100
N11006	5/8" x 5/8" x 5/8"	10/100
N11007	3/4" x 3/4" x 3/4"	10/100
N11008	1" x 1" x 1"	5/50

Nylon Hose Barb Elbow



• Barb refers to hose I.D.

PART NO.	BARB x BARB	CTN/MSTR
N12001	1/4" x 1/4"	10/100
N12002	3/8" x 3/8"	10/100
N12003	1/2" x 1/2"	10/100
N12004	5/8" x 5/8"	10/100
N12005	3/4" x 3/4"	10/100
N12006	1" x 1"	5/50

Nylon Garden Hose Cap



PART NO.	FHT	CTN/MSTR
N06001	3/4"	10/100

Nylon Female Hose Barb Adapter



• Barb refers to hose I.D.

PART NO.	BARB x FPT	CTN/MSTR
N15001	1/2" x 1/2"	10/100

Nylon Hose Barb Adapter



• Barb refers to hose I.D.

PART NO.	MPT x BARB	CTN/MSTR
N14001	1/4" x 1/4"	10/100
N14002	1/4" x 3/8"	10/100
N14003	3/8" x 1/4"	10/100
N14004	3/8" x 3/8"	10/100
N14005	3/8" x 1/2"	10/100
N14006	1/2" x 1/4"	10/100
N14007	1/2" x 3/8"	10/100
N14008	1/2" x 1/2"	10/100
N14009	1/2" x 5/8"	10/100
N14010	1/2" x 3/4"	10/100
N14011	3/4" x 3/8"	10/100
N14012	3/4" x 1/2"	10/100
N14013	3/4" x 5/8"	10/100
N14014	3/4" x 3/4"	10/100
N14015	3/4" x 1"	5/50
N14016	1" x 1/2"	5/50
N14017	1" x 5/8"	5/50
N14018	1" x 3/4"	5/50
N14019	1" x 1"	5/50

Nylon Male Garden Hose To Female Pipe



PART NO.	MHT x FPT	CTN/MSTR
N18001	3/4" x 1/2"	10/100
N18002	3/4" x 3/4"	10/100

Nylon Male Garden Hose To Male Pipe



PART NO.	MHT x MPT	CTN/MSTR
N09001	3/4" x 1/2"	10/100
N09002	3/4" x 3/4"	10/100

Nylon Female Garden Hose To Female Pipe



PART NO.	FHT x FPT	CTN/MSTR
N07001	3/4" x 1/2"	10/100

Nylon Male Insert Adapter



- For flexible polyethylene plastic pipe
- NSF listed

NSF

PART NO.	SIZE	CTN/MSTR
I11001	1/2"	10/100
I11002	3/4"	10/100
I11003	1"	10/100
I11004	1-1/4"	10/100
I11005	1-1/2"	10/100
I11006	2"	10/100

D

Nylon Insert Coupling



- For flexible polyethylene plastic pipe
- NSF listed

NSF

PART NO.	SIZE	CTN/MSTR
I11007	1/2"	10/100
I11008	3/4"	10/100
I11009	1"	10/100
I11010	1-1/4"	10/100
I11011	1-1/2"	10/100
I11012	2"	10/100

Nylon Insert Elbow



- For flexible polyethylene plastic pipe
- NSF listed

NSF

PART NO.	SIZE	CTN/MSTR
I11013	1/2"	10/100
I11014	3/4"	10/100
I11015	1"	10/100
I11016	1-1/4"	10/100
I11017	1-1/2"	10/100
I11018	2"	5/50

Nylon Insert Tee



- For flexible polyethylene plastic pipe
- NSF listed

NSF

PART NO.	SIZE	CTN/MSTR
I11019	1/2"	10/100
I11020	3/4"	10/100
I11021	1"	10/100
I11022	1-1/4"	10/100
I11023	1-1/2"	10/100
I11024	2"	5/50

Nylon Insert Combination Elbow



- For flexible polyethylene plastic pipe
- NSF listed

NSF

PART NO.	SIZE	CTN. QTY.
I11025	1/2"	10/100
I11026	3/4"	10/100
I11027	1"	10/100
I11028	1-1/4"	10/100

Poly Male Insert Adapter



- For flexible polyethylene plastic pipe
- NSF listed



PART NO.	SIZE	CTN/MSTR
I10001	1/2"	10/100
I10002	3/4"	10/250
I10003	1"	10/160
I10004	1-1/4"	10/80
I10005	1-1/2"	5/60
I10006	2"	5/40

Poly Female Insert Adapter



- For flexible polyethylene plastic pipe
- NSF listed



PART NO.	SIZE	CTN/MSTR
I10007	1/2"	10/400
I10008	3/4"	10/250
I10009	1"	10/160
I10010	1-1/4"	10/80

Poly Insert Coupling



- For flexible polyethylene plastic pipe
- NSF listed



PART NO.	SIZE	CTN/MSTR
I10011	1/2"	10/400
I10012	3/4"	10/250
I10013	1"	10/160
I10014	1-1/4"	10/80
I10015	1-1/2"	5/60
I10016	2"	5/40

Poly Reducing Insert Coupling



- For flexible polyethylene plastic pipe
- NSF listed



PART NO.	SIZE	CTN/MSTR
I10017	3/4" x 1/2"	10/300
I10018	1" x 1/2"	10/220
I10019	1" x 3/4"	10/220
I10020	1-1/4" x 1"	10/100
I10021	1-1/2" x 1-1/4"	5/15
I10022	2" x 1-1/2"	5/15

Poly Male Insert Reducer



- For flexible polyethylene plastic pipe
- NSF listed



PART NO.	SIZE	CTN/MSTR
I10040	3/4" x 1/2"	10/300
I10041	1" x 3/4"	10/220
I10042	1-1/4" x 1"	10/100

Poly Insert Elbow



- For flexible polyethylene plastic pipe
- NSF listed



PART NO.	SIZE	CTN/MSTR
I10023	1/2"	10/300
I10024	3/4"	10/180
I10025	1"	10/100
I10026	1-1/4"	5/60
I10027	1-1/2"	5/40
I10028	2"	5/25

Poly Insert Tee



- For flexible polyethylene plastic pipe
- NSF listed



PART NO.	SIZE	CTN/MSTR
I10029	1/2"	10/180
I10030	3/4"	10/100
I10031	1"	10/60
I10032	1-1/4"	5/40
I10033	1-1/2"	5/30
I10034	2"	5/15

Poly Insert x MIP Combination Elbow



- For flexible polyethylene plastic pipe
- NSF listed



PART NO.	SIZE	CTN/MSTR
I10035	1/2"	10/300
I10036	3/4"	10/200
I10037	1"	10/100
I10038	1-1/4"	5/50
I10039	1-1/2"	5/50

Poly Insert Reducing Tee



- For flexible polyethylene plastic pipe
- NSF listed



PART NO.	SIZE	CTN/MSTR
I10043	3/4" x 3/4" x 1/2"	1
I10044	3/4" x 1/2" x 1/2"	1
I10045	1" x 1" x 1/2"	1
I10046	1" x 1" x 3/4"	1
I10047	1" x 3/4" x 3/4"	1
I10048	1-1/2" x 1-1/2" x 1"	1
I10049	2" x 2" x 1"	1

Red Brass Male Insert Adapter



• For flexible polyethylene plastic pipe

PART NO.	SIZE	CTN/MSTR
I13001LF	1/2"	10/200
I13002LF	3/4"	10/200
I13003LF	1"	10/100
I13004LF	1 1/4"	10/100
I13005LF	1 1/2"	10/60
I13006LF	2"	5/40

Red Brass Insert Coupling



• For flexible polyethylene plastic pipe

PART NO.	SIZE	CTN/MSTR
I13016LF	3/4"	1/100
I13017LF	1"	1/100
I13018LF	1 1/4"	1/100
I13019LF	1 1/2"	1/100
I13020LF	2"	10/100

D Red Brass Male Insert Reducer



• For flexible polyethylene plastic pipe

PART NO.	INSERT x MPT	CTN/MSTR
I13007LF	1" x 3/4"	1/100

Red Brass Insert Tee



• For flexible polyethylene plastic pipe

PART NO.	SIZE	CTN/MSTR
I13021LF	3/4"	1/100
I13022LF	1"	1/100
I13023LF	1 1/4"	10/50

Red Brass Female Insert Adapter



• For flexible polyethylene plastic pipe

PART NO.	SIZE	CTN/MSTR
I13010LF	3/4"	10/100
I13011LF	1"	1/200
I13012LF	1 1/4"	1/100
I13013LF	1 1/2"	1

Red Brass Insert Elbow



• For flexible polyethylene plastic pipe

PART NO.	SIZE	CTN/MSTR
I13024LF	3/4"	1/100
I13025LF	1"	1/100
I13026LF	1 1/4"	1/50

Red Brass Insert x MIP 90° Elbow



• For flexible polyethylene plastic pipe

PART NO.	INSERT	MIP	CTN/MSTR
I13031LF	3/4"	3/4"	1/100
I13032LF	1"	3/4"	1/100
I13033LF	1"	1"	10/100

Red Brass Insert Male Rope Adapter



• For flexible polyethylene plastic pipe

PART NO.	SIZE	CTN/MSTR
I13027LF	1"	1/100
I13029LF	1"x 1 1/4"	1/100

Red Brass Insert x Sweat Adapters



• For flexible polyethylene plastic pipe

PART NO.	INSERT	SWEAT	CTN/MSTR
I13036LF	3/4"	3/4"	10/100
I13037LF	1"	1"	10/200

Steel Male Insert Adapter



• For flexible polyethylene plastic pipe

PART NO.	SIZE	CTN/MSTR
I12001	1/2"	25/100
I12002	3/4"	25/100
I12003	1"	20/120
I12004	1-1/4"	20/80
I12005	1-1/2"	10/100
I12006	2"	10/40

Steel Female Insert Adapter



• For flexible polyethylene plastic pipe

PART NO.	SIZE	CTN/MSTR
I12007	1/2"	1
I12008	3/4"	1
I12009	1"	10/30
I12010	1-1/4"	1
I12011	1-1/2"	10
I12012	2"	1

Steel Insert Coupling



• For flexible polyethylene plastic pipe

PART NO.	SIZE	CTN/MSTR
I12013	1/2"	1
I12014	3/4"	1/25
I12015	1"	1/20
I12016	1-1/4"	1/20
I12017	1-1/2"	10/60
I12018	2"	10

INSERT FITTINGS VS HOSE BARBS?

Insert Fittings only fit polyethylene plastic pipe (water service pipe).

Hose Barbs are designed to fit the inside diameter of various rubber hose sizes.

Both types of fittings are normally secured with hose gear clamps.

Brass Angle Compression Needle Valve



PART NO.	COMP x MIP	CTN/MSTR
N10442LF	1/4" x 1/8"	50/500
N10444LF	1/4" x 1/4"	1

Brass Straight Compression Needle Valve



PART NO.	COMP x COMP	CTN/MSTR
N10544LF	1/4" x 1/4"	150/300
N10566LF	3/8" x 3/8"	25/250

Brass Straight Compression Needle Valve



PART NO.	COMP x MIP	CTN/MSTR
N10664LF	3/8" x 1/4"	1

Brass Pipe Needle Valve



PART NO.	FIP x FIP	CTN/MSTR
N10944LF	1/4" x 1/4"	1

Brass Saddle Clamp



- Fits up to 3/4" iron pipe
- Fits up to 1" hard copper
- Unassembled

PART NO.	FPT	CTN/MSTR
N01038	1/8"	1

Brass Saddle Clamp With Valve



- Fits up to 3/4" iron pipe
- Fits up to 1" hard copper
- Unassembled

PART NO.	OD	CTN/MSTR
N01039	1/4"	1

Self Piercing Valve



- 1/4" OD compression outlet
- Fits 3/8" to 1.315" OD tube
- Lead Free

PART NO.	TUBE SIZE	CTN/MSTR
S92001	1/4"	50/100

Icemaker Or Humidifier Kit



- 1/4" tubing
- Self piercing valve
- Brass fittings
- Lead Free



PART NO.	TUBE SIZE	CTN/MSTR
S92025	1/4" x 25' poly tubing	1/10
S92030	1/4" x 25' copper tubing	1/10
S92031	1/4" x 15' copper tubing	1/10

**We Got It -
Gas Shut-Off Valve**

- Rated at 2 PSIG
- Cast bronze plug style

MADE IN THE
USA



Lever Handle

G17025	1/4"	25
G17037	3/8"	1
G17050	1/2"	1
G17075	3/4"	1
G17100	1"	1
G17125	1-1/4"	1
G17150	1-1/2"	10
G17200	2"	5



Square Head

G18025	1/4"	1
G18037	3/8"	1
G18050	1/2" AGA	50
G18075	3/4" AGA	50
G18100	1"	25
G18125	1-1/4"	1
G18150	1-1/2"	10
G18200	2"	5



Flat/Tee Head

G19025	1/4"	1
G19037	3/8"	1
G19050	1/2" AGA	50
G19075	3/4" AGA	1
G19100	1"	25
G19125	1-1/4"	15
G19150	1-1/2"	10
G19200	2"	5

Flare x Flare



• 30 PSI

PART NO.	SIZE	CTN/MSTR
N01014	3/8"	1

Female Pipe x Female Pipe



• 30 PSI

PART NO.	SIZE	CTN/MSTR
N01010	1/8"	1
N01011	1/4"	1

Female Pipe x Male Pipe



• 30 PSI

PART NO.	SIZE	CTN/MSTR
N01027	1/8"	1
N01028	1/4"	1
N01029	3/8"	1

Drain Cock Tee Handle with Bibb



• Hose x Male IPT

PART NO.	SIZE	CTN/MSTR
N01032	1/4"	1/500

Drain Cock External Seat



PART NO.	SIZE	CTN/MSTR
N01033	1/8"	1/1000
N01034	1/4"	1/1000
N01035	3/8"	5/200

Drain Cock



PART NO.	SIZE	CTN/MSTR
N01001	1/8"	1
N01002	1/4"	1

Satin Brass Air Cock Female x Male Lever Handle HEX Shoulder



• Spring bottoms

PART NO.	SIZE	CTN/MSTR
A11011	1/8" x 1/8"	1/100
A11001	1/4" x 1/4"	100/200

Satin Brass Air Cock Male x Spigot Tee Handle HEX Shoulder



• Spring bottoms

PART NO.	SIZE	CTN/MSTR
A11002	1/4" x spigot	100/200

Satin Brass Air Cock Female x Male Tee Handle HEX Shoulder



• Spring bottoms

PART NO.	SIZE	CTN/MSTR
A11003	1/4" x 1/4"	1/200

Satin Brass Air Cock Female x Female Lever Handle Round Shoulder



• Spring bottoms

PART NO.	SIZE	CTN/MSTR
A11004	1/4" x 1/4"	1/100

Satin Brass Air Cock Female x Female Tee Handle HEX Shoulder



• Spring bottoms

PART NO.	SIZE	CTN/MSTR
A11005	1/4" x 1/4"	1/200

Satin Brass Air Cock Female x Female Tee Handle Round Shoulder



• Spring bottoms

PART NO.	SIZE	CTN/MSTR
A11016	1/8" x 1/8"	1/50
A11006	1/4" x 1/4"	100/200

Satin Brass Air Cock Female x Female Lever Handle HEX Shoulder



• Spring bottoms

PART NO.	SIZE	CTN/MSTR
A11017	1/8" x 1/8"	1/100
A11007	1/4" x 1/4"	1/100

Satin Brass Air Cock Female x Male Tee Handle Round Shoulder



• Spring bottoms

PART NO.	SIZE	CTN/MSTR
A11008	1/4" x 1/4"	100/200

Gas Ball Valve

- Forged brass body
- 3/8" x 3/4" one piece body
- 1"-2" two-piece body with plated steel handle
- Chrome plated brass ball
- Temperatures up to 175°F
- Threaded ends comply with ANSI B2.1
- CSA- certified for use with natural, manufactured, mixed, liquefied petroleum and LP gas/air mixtures up to 2 PSIG
- UL listed 757x (1/2" and 3/4")
- Made in Italy



Lever Handle, Female x Female



PART NO.	SIZE	CTN/MSTR
B64375	3/8" FIP	10/100
B64050	1/2" FIP	10/100
B64075	3/4" FIP	10/100
B64100	1" FIP	6/36
B64125	1 1/4" FIP	4/24
B64150	1 1/2" FIP	4/16
B64200	2" FIP	2/10

Tee Handle, Female x Female



PART NO.	SIZE	CTN/MSTR
B65375	3/8" FIP	10/100
B65050	3/8" FIP	10/100
B65075	3/4" FIP	10/100
B65100	1" FIP	6/36

Square Head, Female x Female



PART NO.	SIZE	CTN/MSTR
B66375	3/8" FIP	10/100
B66050	1/2" FIP	10/100
B66075	3/4" FIP	10/100

Two-Piece Gas Ball Valve

- Forged brass body
- Two-piece body
- Chrome plated brass ball
- Temperatures up to 125° F
- CSA- certified for use with natural, manufactured, mixed liquefied petroleum and L.P. gas/air mixtures up to 2 PSIG
- Made in Italy



PART NO.	SIZE	CTN/MSTR
B64450	1/2"	10/50
B64475	3/4"	10/50

Texas Pattern Gas Ball Valve

- One-piece forged body
- Lever handle
- Female IPS x hose end x 1/8" MIP
- CSA- certified for use with natural, manufactured, mixed liquefied petroleum and L.P. gas/air mixtures up to 2 PSIG
- Made in Italy



PART NO.	SIZE	CTN/MSTR
B69121	1/2" FIP x 1/8" MIP	10/100

Lever Handle Gas Ball Valve

- Forged brass body
- One piece body construction
- 3/4" Chrome plated forged brass ball
- Temperatures up to 175°F
- Threaded ends comply with ANSI B2.1
- CSA- certified for use with natural, manufactured, mixed, liquefied petroleum and LP gas/air mixtures up to 2 PSIG
- Made in Italy



Flare x Female



PART NO.	SIZE	CTN/MSTR
B67375	3/8" flare x 1/2" FIP	10/100
B67050	1/2" flare x 1/2" FIP	10/100
B67937	15/16" flare x 1/2" FIP	10/100
B67975	15/16" flare x 3/4" FIP	10/100

Flare x Male



PART NO.	SIZE	CTN/MSTR
B68001	1/2" flare x 1/2" MIP	10/100

Flare x Flare



PART NO.	SIZE	CTN/MSTR
B68375	3/8" flare x 3/8" flare	10/100
B68050	1/2" flare x 1/2" flare	10/100
B68058	5/8" flare x 5/8" flare	10/100

Gas Heater Valve

- Forged brass body
- One piece body construction
- Chrome plated forged brass ball
- Temperatures up to 175°F
- 9/16" - 24 Fine Thread Flare (for 3/8" tube)
- CSA certified for use with natural, manufactured, mixed, liquefied petroleum and LP gas/air mixtures up to 2 PSIG
- Made in Italy



PART NO.	SIZE	CTN/MSTR
B69050	9/16"-24 x 1/2" FIP	10/100

Brass Gas Ball Valve

- Two-piece forged brass body with chrome plated brass ball
- Double O-ring packing
- PTFE Seats
- 1/4 turn aluminum handle
- 1/2 PSI for indoor appliance connections per ANSI Z21.15/CGA 9.1
- Blowout-proof stem
- 5 PSI for indoor shutoff per CGA 91-002 & ASME B16.44
- CSA Listed



Female x Female		
PART NO.	SIZE	CTN/MSTR
B67100	1/2" FIP x 1/2" FIP	1/160
B67101	3/4" FIP x 3/4" FIP	1/100



Flare x Female		
PART NO.	SIZE	CTN/MSTR
B67102	3/8" FL x 1/2" FIP	1/160
B67103	1/2" FL x 1/2" FIP	1/160

Flare x Male		
PART NO.	SIZE	CTN/MSTR
B67104	1/2" FL x 1/2" MIP	1/160

Flare		
PART NO.	SIZE	CTN/MSTR
B67105	3/8" FL x 3/8" FL	1/160
B67106	1/2" FL x 1/2" FL	1/160

- Full-port design
- Forged brass body up to 4"
- Chrome plated brass ball
- Adjustable packing nut
- Non-sticking teflon seats
- 1/4 turn zinc plated steel handle
- 600 PSI, WOG (water, oil, gas)
- Working steam pressure: 150 PSI
- Blowout-proof stem
- Teflon packing for safety against leakage
- UPC Listed
- Lead Free



Threaded		
PART NO.	SIZE	CTN/MSTR
B67200	3/8"	20/100
B67201	1/2"	50/100
B67202	3/4"	30/60
B67203	1"	20/40
B67204	1-1/4"	12/24
B67205	1-1/2"	9/18
B67206	2"	6/12



Sweat		
PART NO.	SIZE	CTN/MSTR
B67208	1/2"	50/100
B67209	3/4"	30/60
B67210	1"	20/40
B67211	1-1/4"	12/24
B67212	1-1/2"	9/18
B67213	2"	6/12

Brass Ball & Waste Valve

- Full-port with waste design
- Forged brass body
- Chrome plated brass ball
- Adjustable packing nut
- Non-sticking teflon seats
- 1/4 turn zinc plated steel handle
- 600 PSI, WOG (water, oil, gas)
- Working steam pressure: 150 PSI
- Blowout-proof stem
- Teflon packing for safety against leakage
- NSF61 certified
- UPC Listed
- Lead Free



Sweat		
PART NO.	SIZE	CTN/MSTR
B67214	1/2"	10/60
B67215	3/4"	10/60
B67216	1"	5/40



Threaded		
PART NO.	SIZE	CTN/MSTR
B67217	1/2"	10/60
B67218	3/4"	10/60
B67219	1"	5/40

Brass Stop Valve

- Cast brass body
- Cast iron handle
- 125 PSI WOG to 100° F
- Maximum Temperature 180°F
- Lead Free



Threaded		
PART NO.	SIZE	CTN/MSTR
B67312	1/2"	6/48
B67313	3/4"	6/48



Stop & Waste Valve Threaded		
PART NO.	SIZE	CTN/MSTR
B67315	3/4"	10/100



Sweat		
PART NO.	SIZE	CTN/MSTR
B67316	1/2"	6/48
B67317	3/4"	10/100

Brass Broiler Drain Valve

- Forged brass body
- Copper or threads to hose
- Cast iron handle
- Non-sticking teflon seats
- 125 PSI WOG to 100°F
- Maximum Temperature 180°F
- UPC Listed



Male		
PART NO.	SIZE	CTN/MSTR
B67320	1/2" MIP x 3/4" MHT	10/100
B67321	3/4" MIP x 3/4" MHT	10/100

- Forged brass body
- Threads to hose
- Cast iron handle
- 125 PSI WOG to 100°F
- Maximum Temperature 180°F



Female		
PART NO.	SIZE	CTN/MSTR
B67322	1/2" FIP x 3/4" MHT	10/100
B67323	3/4" FIP x 3/4" MHT	10/100

PVC Ball Valve Solvent End

- One piece body construction
- Standard port
- EPDM seats and o-rings
- Working pressure 150 psi at 73°F
- Quarter turn operation
- Not for compressed air
- Ideal for swimming pools, irrigation and water supply uses
- Solvent ends comply with ASTM D 2466
- Threaded ends comply with ANSI B2.1
- For cold water lines
- Large flow opening



PART NO.	SIZE	CTN/MSTR
B90050	1/2"	1/162
B90075	3/4"	1/80
B90100	1"	1/84
B90125	1-1/4"	1/50
B90150	1-1/2"	1/50
B90200	2"	1/24
B90250	2-1/2"	1/15
B90300	3"	1/2
B90400	4"	1/1

PVC Ball Valve with Threaded Ends

- One-piece body construction
- Standard port
- EPDM seats and o-rings
- Working pressure 150 psi at 73°F
- Quarter turn operation
- Not for compressed air
- Ideal for swimming pools, irrigation and water supply uses
- Solvent ends comply with ASTM D 2466
- Threaded ends comply with ANSI B2.1
- For cold water lines
- Large flow opening



PART NO.	SIZE	CTN/MSTR
B91050	1/2"	1/162
B91075	3/4"	25/100
B91100	1"	1/84
B91125	1-1/4"	1/60
B91150	1-1/2"	1/40
B91200	2"	6/24
B91250	2-1/2"	1/16
B91300	3"	1/10
B91400	4"	1/1

CPVC Ball Valve

- Standard port
- For use on CPVC tubing size (OD)
- Teflon seats
- EPDM o-rings
- One piece body construction
- Large flow opening
- For hot or cold water lines up to 100 PSI at temperature up to 180°F
- Solvent ends comply with ASTM D2846
- Quarter turn operation
- NSF listed



PART NO.	SIZE	CTN/MSTR
B92050	1/2" (5/8" OD)	10/100
B92075	3/4" (7/8" OD)	10/100

Items marked with the Jones Stephens logo are "You Need It... We Got It" Items.

Radiator Coin Key Air Valve And Key



- 1/8" threads
- 125 PSI
- CARTON QUANTITIES ONLY

PART NO.	DESCRIPTION	CTN/MSTR
R20001	Vent valve with key	50/500
R20002	Key only	100/5000
R20003	Valve only	100/1000

Angle Air Valve



- Use on radiators in room with thermostat or on radiators that effect the thermostat

PART NO.	DESCRIPTION	CTN/MSTR
R20104	#4 1/8"	12/144

- Use on radiators near the boiler and in warm room

PART NO.	DESCRIPTION	CTN/MSTR
R20105	#5 1/8"	12/144

- Use on radiators furthest from the boiler (i.e. 3rd floor)

PART NO.	DESCRIPTION	CTN/MSTR
R20107	#C 1/8"	12/144

- Use on radiators needing a lot of venting (i.e. long branches or extra long radiators)

PART NO.	DESCRIPTION	CTN/MSTR
R20108	#D 1/8"	12/144

Straight Air Valve



- Use on radiators furthest from the boiler (i.e. 3rd floor)

PART NO.	DESCRIPTION	CTN/MSTR
R20109	#C 1/8"	12/144

- Use on radiators needing a lot of venting (i.e. long branches or extra long radiators)

PART NO.	DESCRIPTION	CTN/MSTR
R20110	#D 1/8"	12/144

- Use on radiators furthest from the boiler (i.e. 3rd floor)

PART NO.	DESCRIPTION	CTN/MSTR
R20111	#C 1/4"	12/144

- Use on radiators needing a lot of venting (i.e. long branches or extra long radiators)

PART NO.	DESCRIPTION	CTN/MSTR
R20112	#D 1/4"	12/144

- Used at end of short main or main running to warm side of building

PART NO.	DESCRIPTION	CTN/MSTR
R20113	3/4" x 1/2"	12/144

Bronze Steam Radiator Angle Valve



PART NO.	DESCRIPTION	CTN/MSTR
R20005	1/2"	10/60
R20006	3/4"	6/48
R20007	1"	4/36
R20008	1-1/4"	2/24
R20009	1-1/2"	2/18

Angle Steam Vent



• Use on one-pipe steam systems - at the radiator

PART NO.	DESCRIPTION	CTN/MSTR
R20100	1/8"	12/144

Straight Steam Vent

D



• Use on one-pipe steam systems - at the radiator

PART NO.	DESCRIPTION	CTN/MSTR
R20101	1/8"	12/144
R20102	1/4"	12/144

Radiator Angle Air Valve



PART NO.	DESCRIPTION	CTN/MSTR
R20150	1/8"	12/144
R20151	1/8" adjustable	12/144

Radiator Straight Air Valve



R20152
R20153



R20154

PART NO.	DESCRIPTION	CTN/MSTR
R20152	1/8"	12/144
R20153	1/8" adjustable	12/144
R20154	3/4" x 1/2"	12/144

3 Screw Radiator Valve Handle



• Fit-all

PART NO.	DESCRIPTION	CTN/MSTR
J40032	3 screw handle	25/500

4-N-1 Radiator Valve Handle



• Fit-all

PART NO.	DESCRIPTION	CTN/MSTR
J40033	4-n-1 handle	25/500

Single Union PVC Swimming Pool Valve



- Teflon seats
- 150 psi working pressure
- EPDM o-rings seal on union end
- Suitable for swimming pools, spas and plumbing
- Full port
- Solvent ends

PART NO.	SIZE	CTN/MSTR
B95150	1-1/2"	8/32
B95200	2"	5/20

Dual Check Backflow Preventer



- Female by female
- Forged brass body
- 150 psi
- Acetyl-resin check modules
- Stainless steel spring
- 180° F maximum temperature
- Lead Free

PART NO.	SIZE	CTN/MSTR
B59001	3/4"	1/100
B59002	1"	1/25

Inline PVC Check Valve



- Stainless steel spring
- EPDM seats
- Maintenance-free operation
- .5 psi required to open unit
- 200 psi static pressure rating at 77°F
- Use anywhere to stop backflow and siphoning
- Suitable for swimming pools, hot tubs, spas and solar installations

Solvent Ends

PART NO.	SIZE	CTN/MSTR
C30050	1/2"	30/120
C30075	3/4"	30/120
C30100	1"	16/64
C30125	1-1/4"	12/48
C30150	1-1/2"	8/32
C30200	2"	4/16

Threaded Ends



PART NO.	SIZE	CTN/MSTR
C31050	1/2"	30/120
C31075	3/4"	30/120
C31100	1"	16/64
C31125	1-1/4"	12/48
C31150	1-1/2"	8/32
C31200	2"	4/16

Forged Brass Hose Bibb



- Hard chrome ball
- Quarter-turn operation
- Teflon seats
- T-handle

PART NO.	SIZE	CTN/MSTR
B60950	1/2"	10/100
B60975	3/4"	10/100

Cast Brass Hose Bibb

D



- Lead Free

PART NO.	MIP x MALE HOSE	CTN/MSTR
B59050	1/2" x 3/4"	10/100
B59075	3/4" x 3/4"	10/100
B59100	1" x 1"	6/36

Economy Hose Bibb Vacuum Breaker



- Brass
- 3/4" hose thread
- Vandal-proof breakoff screw
- ASSE 1011

PART NO.	DESCRIPTION	CTN/MSTR
G04004	Economy Vacuum Breaker	20/200
G04003LF	Economy Vacuum Breaker - Lead Free	20/200

Hose Faucet Anchor



- Long lasting solution to loosen exterior faucets
- Works with any wall material (brick, concrete, vinyl siding or stucco)
- For repair or new home applications
- Fits all exterior or faucet water lines
- Corrosion free

PART NO.	DESCRIPTION	CTN/MSTR
B59000	Hose faucet anchor	1/100

Micro Size Gear Clamp

- CARTON QUANTITIES ONLY
- 5/16" band
- Made in USA

MADE IN THE
USA

Part Stainless



PART NO.	TRADE SIZE	SIZE	CTN/MSTR
G08004	4	1/4" - 5/8"	10/1000
G08006	6	5/16" - 7/8"	10/1000
G08008	8	3/8" - 1"	10/500
G08012	12	1/2" - 1-1/4"	10/500
G08016	16	1/2" - 1-1/2"	10/500
G08020	20	3/4" - 1-3/4"	10/500
G08024	24	1" - 2"	10/500

All Stainless



PART NO.	TRADE SIZE	SIZE	CTN/MSTR
G09004	4	1/4" - 5/8"	10/1000
G09006	6	5/16" - 7/8"	10/1000
G09008	8	1/2" - 1"	10/500
G09012	12	1/2" - 1-1/4"	10/500
G09016	16	1/2" - 1-1/2"	10/500
G09020	20	3/4" - 1-3/4"	10/500
G09024	24	1" - 2"	10/500

Ⓢ Items marked with the Jones Stephens logo are "You Need It...We Got It" Items.

Full Size Gear Clamp

- CARTON QUANTITIES ONLY
- 1/2" band
- Made in USA

MADE IN THE
USA

Part Stainless



PART NO.	TRADE SIZE	SIZE	CTN/MSTR
G10006	6	3/8" - 7/8"	10/200
G10008	8	7/16" - 1"	10/200
G10010	10	1/2" - 1-1/16"	10/500
G10012	12	1/2" - 1-1/4"	10/500
G10016	16	3/4" - 1-1/2"	10/500
G10020	20	3/4" - 1-3/4"	10/500
G10024	24	1" - 2"	10/500
G10032	32	1-1/2" - 2-1/2"	10/500
G10036	36	7/8" - 2-3/4"	10/500
G10040	40	1-1/8" - 3"	10/200
G10052	52	1-7/8" - 3-3/4"	10/100
G10072	72	3-1/8" - 5"	10/100
G10080	80	3-5/8" - 5-1/2"	10/100
G10104	104	5" - 7"	10/100

All Stainless



PART NO.	TRADE SIZE	SIZE	CTN/MSTR
G11006	6	3/8" - 7/8"	10/200
G11008	8	7/16" - 1"	10/200
G11010	10	1/2" - 1-1/16"	10/500
G11012	12	1/2" - 1-1/4"	10/500
G11016 Ⓢ	16	11/16" - 1-1/2"	10/500
G11020	20	3/4" - 1-3/4"	10/500
G11024	24	1" - 2"	10/500
G11028	28	1-5/16" - 2-1/4"	10/500
G11032	32	1-9/16" - 2-1/2"	10/500
G11036	36	7/8" - 2-3/4"	10/500
G11040	40	1-1/8" - 3"	10/200
G11044	44	2-1/4" - 3 1/4"	10/200
G11048	48	1-5/8" - 3-1/2"	10/200
G11052	52	1-7/8" - 3-3/4"	10/200
G11056	56	2-1/8" - 4"	10/100
G11064	64	2-1/2" - 4-1/2"	10/100
G11072	72	3" - 5"	10/100
G11080	80	3-1/2" - 5-1/2"	10/100
G11088	88	4" - 6"	10/100
G11096	96	4-3/4" - 6-1/2"	10/100
G11104	104	5" - 7"	10/100

D

“68” Series Stainless Steel Gear Clamp

- 9/16" band
- All stainless, 300 grade construction
- Ideal for well drilling and applications requiring marine grade stainless clamps
- CARTON QUANTITIES ONLY
- Made in USA

MADE IN THE
USA



PART NO.	TRADE SIZE	SIZE	CTN/MSTR
G14006	6	3/8" - 7/8"	10/200
G14008	8	7/16" - 1"	10/200
G14010	10	1/2" - 1-1/16"	10/500
G14012	12	1/2" - 1-1/4"	10/500
G14016	16	11/16" - 1-1/2"	10/500
G14020	20	3/4" - 1-3/4"	10/500
G14024	24	1" - 2"	10/500
G14028	28	1-1/4" - 2-1/4"	10/500
G14032	32	1-1/2" - 2-1/2"	10/500
G14036	36	1-3/4" - 2-3/4"	10/200
G14040	40	1-1/8" - 3"	10/200
G14044	44	2-1/4" - 3-1/4"	10/200
G14048	48	1-5/8" - 3-1/2"	10/200
G14052	52	1-7/8" - 3-3/4"	10/100
G14056	56	2-1/8" - 4"	10/100
G14064	64	2-1/2" - 4-1/2"	10/100
G14072	72	3" - 5"	10/100
G14080	80	3-1/2" - 5-1/2"	10/100
G14088	88	4" - 6"	10/100
G14096	96	4-1/2" - 6-1/2"	10/100
G14104	104	5" - 7"	10/100

Replacement Clamp For Flexible Coupling

- CARTON QUANTITIES ONLY
- Made in USA

MADE IN THE
USA



PART NO.	DESCRIPTION	CTN/MSTR
G15002	2" Replacement clamp	10/200
G15003	3" Replacement clamp	10/100
G15004	4" Replacement clamp	10/100
G15006	6" Replacement clamp	1/100
G15008	8" Replacement clamp	1/50

D

Stainless Steel Gear Clamp

- 9/16" band
- All stainless
- Hanging bag
- CARTON QUANTITIES ONLY



PART NO.	TRADE SIZE	SIZE	CTN/MSTR
G16006	6	3/8" - 7/8"	200/2000
G16008	8	7/16" - 1"	100/1000
G16010	10	1/2" - 1-1/16"	100/1000
G16012	12	1/2" - 1-1/4"	100/1000
G16016	16	11/16" - 1-1/2"	100/1000
G16020	20	3/4" - 1-3/4"	100/1000
G16024	24	1" - 2"	1
G16028	28	1-1/4" - 2-1/4"	100/1000
G16032	32	1-1/2" - 2-1/2"	100/1000
G16036	36	1-3/4" - 2-3/4"	100/1000
G16040	40	1-1/8" - 3"	100/500
G16044	44	2-1/4" - 3-1/4"	100/500
G16048	48	1-5/8" - 3-1/2"	100/500
G16052	52	1-7/8" - 3-3/4"	100/500
G16056	56	2-1/8" - 4"	100/500
G16064	64	2-1/2" - 4-1/2"	100/500
G16072	72	3" - 5"	1
G16080	80	3-1/2" - 5-1/2"	50/200
G16088	88	4" - 6"	50/250
G16096	96	4-1/2" - 6-1/2"	50
G16104	104	5" - 7"	50/250

Asbestos-Free Full Face Gasket



- Meets ASTM F152, F36A and F146
- 1/16" thick
- Temperature rating of 750°F
- Manufactured of Garlock 4401

PART NO.	SIZE	LBS.
G54075	3/4"	150
G54001	1"	150
G54013	1-1/4"	150
G54015	1-1/2"	150
G54002	2"	150
G54025	2-1/2"	150
G54003	3"	150
G54035	3-1/2"	150
G54004	4"	150
G54005	5"	150
G54006	6"	150
G54008	8"	150
G54010	10"	150
G54012	12"	150

Red Rubber Full Face Gasket



- Meets ASTM D1330
- 1/16" thick
- Temperature rating of 350° F

PART NO.	SIZE	LBS.
G51050	1/2"	150
G51075	3/4"	150
G51001	1"	150
G51013	1-1/4"	150
G51015	1-1/2"	150
G51002	2"	150
G51025	2-1/2"	150
G51003	3"	150
G51035	3-1/2"	150
G51004	4"	150
G51005	5"	150
G51006	6"	150
G51008	8"	150
G51010	10"	150
G51012	12"	150

Asbestos-Free Ring Gasket



- Meets ASTM F152, F36A and F146
- 1/16" thick
- Temperature rating of 750°F
- Manufacture of Garlock 4401

PART NO.	SIZE	LBS.
G53050	1/2"	150
G53075	3/4"	150
G53001	1"	150
G53013	1-1/4"	150
G53015	1-1/2"	150
G53002	2"	150
G53025	2-1/2"	150
G53003	3"	150
G53035	3-1/2"	150
G53004	4"	150
G53005	5"	150
G53006	6"	150
G53008	8"	150
G53010	10"	150
G53012	12"	150

Red Rubber Ring Gasket



- Meets ASTM D1330
- 1/16" thick
- Temperature rating of 350° F

PART NO.	SIZE	LBS.
G52075	3/4"	150
G52001	1"	150
G52013	1-1/4"	150
G52015	1-1/2"	150
G52002	2"	150
G52025	2-1/2"	150
G52003	3"	150
G52035	3-1/2"	150
G52004	4"	150
G52005	5"	150
G52006	6"	150
G52008	8"	150
G52010	10"	150
G52012	12"	150

Asbestos-Free Full Face Gasket



- Meets ASTM F152, F36A and F146
- Gaskets are 1/16" thick
- ASTM A307 hex bolts and heavy hex nuts
- Constructed of Garlock 4401

PART NO.	PIPE SIZE	BOLT SIZE	BOLTS/ KIT
G54115	1-1/2"	1/2" x 2-1/4"	4
G54102	2"	5/8" x 2-3/4"	4
G54125	2-1/2"	5/8" x 3"	4
G54103	3"	5/8" x 3"	4
G54104	4"	5/8" x 3"	8
G54105	5"	3/4" x 3-1/4"	8
G54106	6"	3/4" x 3-1/4"	8
G54108	8"	3/4" x 3-1/2"	8
G54110	10"	7/8" x 3-3/4"	12
G54112	12"	7/8" x 4"	12

D

Asbestos-Free Ring Gasket Kit



- Meets ASTM F152, F36A and F146
- Gaskets are 1/16" thick
- ASTM A307 hex bolts and heavy hex nuts
- Constructed of Garlock 4401

PART NO.	PIPE SIZE	BOLT SIZE	BOLTS/ KIT
G53101	1"	1/2" x 2"	4
G53113	1-1/4"	1/2" x 2-1/4"	4
G53115	1-1/2"	1/2" x 2-1/4"	4
G53102	2"	5/8" x 2-3/4"	4
G53125	2-1/2"	5/8" x 3"	4
G53103	3"	5/8" x 3"	4
G53104	4"	5/8" x 3"	8
G53105	5"	3/4" x 3-1/4"	8
G53106	6"	3/4" x 3-1/4"	8
G53108	8"	3/4" x 3-1/2"	8
G53110	10"	7/8" x 3-3/4"	12

Red Rubber Full Face Gasket Kit



- Meets ASTM D1330
- Gaskets are 1/16" thick
- ASTM A307 hex bolts and heavy hex nuts

PART NO.	PIPE SIZE	BOLT SIZE	BOLTS/ KIT
G51102	2"	5/8" x 2-3/4"	4
G51125	2-1/2"	5/8" x 3"	4
G51103	3"	5/8" x 3"	4
G51135	3-1/2"	5/8" x 3"	8
G51104	4"	5/8" x 3"	8
G51105	5"	3/4" x 3-1/4"	8
G51106	6"	3/4" x 3-1/4"	8
G51108	8"	3/4" x 3-1/2"	8
G51110	10"	7/8" x 3-3/4"	12
G51112	12"	7/8" x 4"	12

Red Rubber Ring Gasket Kit



- Meets ASTM D1330
- Gaskets are 1/16" thick
- ASTM A307 hex bolts and heavy hex nuts

PART NO.	PIPE SIZE	BOLT SIZE	BOLTS/ KIT
G52115	1-1/2"	1/2" x 2-1/4"	4
G52102	2"	5/8" x 2-3/4"	4
G52125	2-1/2"	5/8" x 3"	4
G52103	3"	5/8" x 3"	4
G52104	4"	5/8" x 3"	8
G52105	5"	3/4" x 3-1/4"	8
G52106	6"	3/4" x 3-1/4"	8
G52108	8"	3/4" x 3-1/2"	8
G52110	10"	7/8" x 3-3/4"	12

Insulation Kit with Poly Sleeves



- Use with flange connection kits
- To form dielectric connection use fiber washers

PART NO.	SIZE	#SLEEVES	#WASHERS
G55150	1-1/2"	4	8
G55200	2"	4	8
G55250	2-1/2"	4	8
G55300	3"	4	8
G55350	4"	8	16
G55400	5"	8	16
G55450	6"	8	16
G55500	8"	8	16
G55550	10"	12	24
G55600	12"	12	24

Asbestos-Free Ring Gasket Kit with Insulation Kit



PART NO.	PIPE SIZE	BOLT SIZE	BOLTS/ KIT
G53203	3"	5/8" x 3"	4
G53204	4"	5/8" x 3"	8
G53206	6"	3/4" x 3-1/4"	8
G53215	1-1/2"	1/2" x 2-1/4"	4
G53225	2-1/2"	5/8" x 3"	4

Asbestos-Free Full Face Gasket Kit with Insulation Kit



PART NO.	PIPE SIZE	BOLT SIZE	BOLTS/ KIT
G54215	1-1/2"	1/2" x 2-1/4"	4
G54202	2"	5/8" x 2-3/4"	4
G54225	2-1/2"	5/8" x 3"	4
G54203	3"	5/8" x 3"	4
G54204	4"	5/8" x 3"	8
G54205	5"	3/4" x 3-1/4"	8
G54206	6"	3/4" x 3-1/4"	8
G54208	8"	3/4" x 3-1/2"	8
G54210	10"	7/8" x 3-3/4"	12
G54212	12"	7/8" x 4"	12

Red Rubber Sheet Packing/Gasket Material

- Priced per roll (approximately 100 pounds)
- FULL ROLLS ONLY



PART NO.	DESCRIPTION	CTN QTY
G55016	1/16"x 36"x 60'	1 roll
G55018	1/8"x 36"x 30'	1 roll
G55014	1/4"x 36"x 15'	1 roll

Red Rubber Sheet Packing/Gasket Material

D



- Single 3'x 5' sheet

PART NO.	MATERIAL	THICKNESS	CTN QTY
G55116	Red Rubber (1 sheet)	1/16"	1 roll/
G55118	Red Rubber (1 sheet)	1/8"	1 roll

Gasket and Washer Materials



- Make your own gaskets and washers
- 6"x 6" square in hanging display bag

PART NO.	MATERIAL	THICKNESS	CTN QTY
G55001	Red Rubber (1 sheet)	1/16"	1
G55002	Black Fiber (1 sheet)	1/32"	1
G55003	Cork/Rubber (1 sheet)	1/16"	1
G55004	Combo (1 sheet of each)	—	1

Circulator Flange Gasket Pair



- SOLD IN PAIRS ONLY

PART NO.	DESCRIPTION	CTN QTY
G55005	Circulator Flange Gasket	1

Water Hammer Arresters

- Maximum working temp: 250°F
- Maximum working pressure: 300psi
- Burst pressure: 2900psi
- Poly Bagged
- UPC Listed
- Lead Free



FIXTURE	TYPE OF SUPPLY CONTROL	PUBLIC			PRIVATE		
		TOTAL	C.W.	H.W.	TOTAL	C.W.	H.W.
Water Closet	Flush Valve	10	10	--	6	6	--
Water Closet	Flush Tank	5	5	--	3	3	--
Pedestal Urinal	Flush Valve	10	10	--	--	--	--
Stall or Wall Unit	Flush Valve	5	5	--	--	--	--
Stall or Wall Unit	Flush Tank	3	3	--	--	--	1
Lavatory	Faucet	2	1-1/2	1-1/2	1	1	1-1/2
Bath tub	Faucet	4	2	3	2	1-1/2	1-1/2
Shower Head	Mixing Valve	4	2	3	2	1	2
Bathroom Group	Flush Valve Closet	--	--	--	8	8	3
Bathroom Group	Flush Tank Closet	--	--	--	6	6	3
Separate Shower	Mixing Valve	--	--	--	2	1	2
Service Sink	Faucet	3	3	3	--	--	--
Laundry Tubs (3)	Faucet	--	--	--	3	3	3
Combination Fixture	Faucet	--	--	--	3	3	3

Now apply the total fixture units to Table B to obtain your PDI size value.

PDI SIZE ARRESTER:	AA	A	B	C	D	E	F
FIXTURE UNITS:	1-5	1-11	12-32	33-60	61-113	114-154	155-330
THREAD SIZE:	1/2	1/2	3/4	3/4	1	1	1
CATALOG NUMBER:	ALL A97 SERIES						

MIP AA



PART NO.	SIZE	CTN/MSTR
A97001	1/2"	1

MSWT AA



PART NO.	SIZE	CTN/MSTR
A97002	1/2"	1

CPVC AA



PART NO.	SIZE	CTN/MSTR
A97004	1/2"	1

PEX TEE AA



PART NO.	SIZE	CTN/MSTR
A97007	1/2"	1

OD TEE AA

















PART NO.	SIZE	CTN/MSTR
A97009	3/8"	1

MHT x FHS AA



PART NO.	SIZE	CTN/MSTR
A97011	3/4"	1

SECTION E - COMMERCIAL & RESIDENTIAL PLASTICS

Closet Flanges and Accessories	172-176	
Residential Drains	177-180	
LevelBest Drainage and Cleanout System.....	181-183	
Commercial Drains.....	184-209	
Commercial Pipe/Hub Fit Adapter Drains.....	184-190	
8-1/2" Pan Commercial Drains.....	191-197	
8-1/2" Commercial Slab Drains.....	198-204	
10" Pan Heavy Duty Commercial Drains	205-209	
Commercial Drain Bases.....	210-211	
Commercial Spuds and Strainers.....	214-215	
General Purpose/Utility Drains.....	216-220	
Inside Pipe Fit Drains and Cleanouts	221	
Residential and Light Commercial Cleanouts.....	222-224	
Commercial Cleanouts.....	225-228	
Cleanout Spuds.....	229-230	
Floor Sinks and Accessories	231-232	
Backwater Valves and Accessories.....	233-234	
Roof Drains.....	235	



It's a New Wave in Water Conservation

THE GREEN DRAIN

Waterless Trap Seal

•PREVENTS•

the spread of different dangerous bacterias that can cause potential health hazards.

•ELIMINATES•

the need to frequently pour primer and fresh water down the drain.

•SAVES•

a significant amount of time, water, costs and energy.

- UNLIKE COMPETITORS -

Requires NO caulk or expensive installation tool.
Easy to install & easy to remove - NO pliers needed.
Durable - will not break during installation or removal.
Seals tight - NO leaking!



PART NO.	DESCRIPTION	CTN/MSTR
P24001	2" Waterless Trap Seal	1/96
P24002	3" Waterless Trap Seal	1/96
P24003	3-1/2" Waterless Trap Seal	1/96
P24004	4" Waterless Trap Seal	1/96

Scan for
Demo Video



TRADITIONAL FLOOR DRAIN TECHNOLOGY POSES A VARIETY OF PROBLEMS IN TERMS OF MAINTENANCE AND SAFETY, BUT THE GREEN DRAIN SOLVES THESE MAJOR PROBLEMS IN A BIG WAY:

- **Sewer odors often cause a nasty smell in buildings from floor drains.** The Green Drain's one-way valve eliminates those nasty odors, while still keeping the drain fully functional at all times.
- **Traditional floor drains could quickly become a doorway for pests such as flies, cockroaches and rodents.** However, the Green Drain has a silicon skirt attached, preventing pests from getting in.
- **Traditional drain trap primers need to be replaced often and are a pain to replace.** The Green Drain takes mere seconds to install and also acts as a barrier trap protection device.
- **Traditional drains require consistent chemical treatments as part of their maintenance.** The Green Drain eliminates the need for chemical applications, making it better on the environment.

Adjust height BEFORE & AFTER concrete pour!

**LevelBest
PVC Rough-In Adapter**

used for Cast Iron or PVC Drains & Cleanouts

- LevelBest can be used with most manufacturers' products! Industry Standard iron pipe size threads compatible with most adapter and drain bodies.
- LevelBest is the only product on the market that is compatible with most plastic and brass spuds used in the industry.
- LevelBest is the only product that includes the spacer ring that can be used with brass spuds.
- PVC, ABS or CAST IRON drains and cleanouts are compatible with LevelBest.
- LevelBest can be used with tile rings.



Removable Cap - Remove after concrete is poured

Optional Spacer - Included for brass spuds

LevelBest PVC Rough-in Adapter - Allows adjustment to floor level after concrete is poured

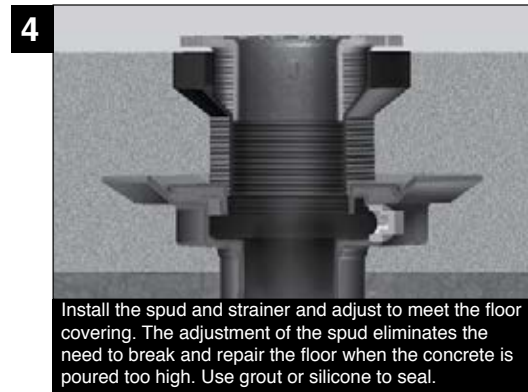
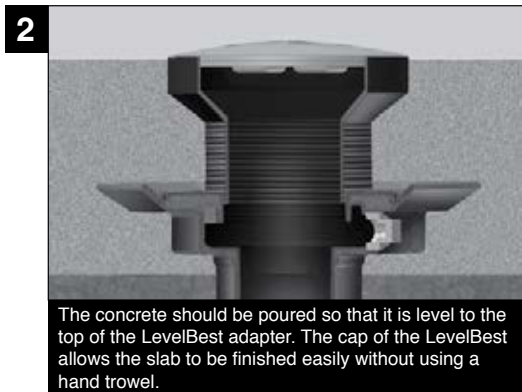
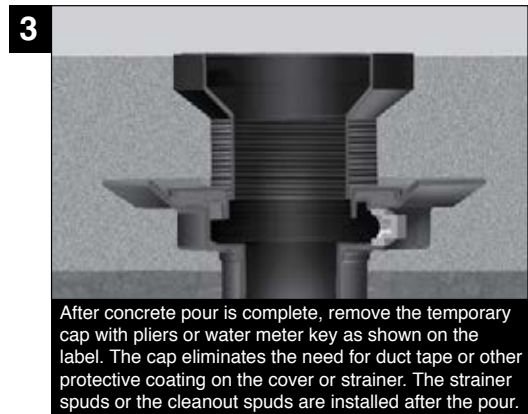
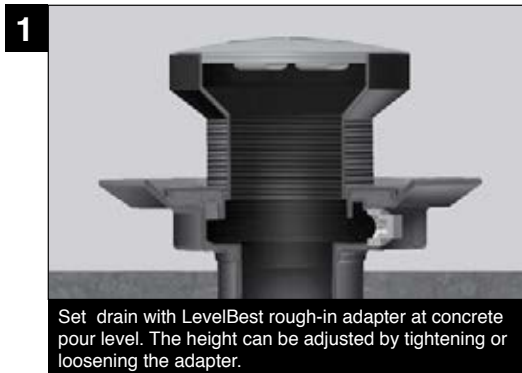

Plumbfit Closet Flange

3" x 4" Fits Flush with Floor
3" Fits Inside 3" Schedule 40 DWV Pipe



- Long shank
- 6 screw holes
- Extra-thick flange with short slots for extra strength
- For 3" units cut pipe 1/8" below floor and remove concrete so unit will fit flush
- 3" has 4 closet bolt slots



PVC		
PART NO.	DESCRIPTION	CTN QTY
C51300	3" less knockout	20
C50300	3" with knockout	20
C51340	3" x 4" less knockout	20
C50340	3" x 4" with knockout	20

ABS		
PART NO.	DESCRIPTION	CTN QTY
C51301	3" less knockout	20
C50301	3" with knockout	20
C51341	3" x 4" less knockout	20
C50341	3" x 4" with knockout	20

Plumbfit Closet Flange

Fits Over 4" Schedule 40 DWV Pipe



- Long shank
- 6 screw holes
- Extra thick flange with short slots for extra strength



PVC		
PART NO.	DESCRIPTION	CTN QTY
C51400	4" less knockout	20
C50400	4" with knockout	20

ABS		
PART NO.	DESCRIPTION	CTN QTY
C51401	4" less knockout	20

Plumbfit Closet Flange with Metal Ring

3" x 4" Fits Over 3" or Inside 4" Schedule 40 DWV Pipe
4" Fits Over 4" Schedule 40 DWV Pipe



- Adjustable metal ring
- 2 radial slots for closet bolts



PVC		
PART NO.	DESCRIPTION	CTN QTY
C53340	3" x 4" less knockout	20
C52340	3" x 4" with knockout	20
C53400	4" less knockout	20
C52400	4" with knockout	20

ABS		
PART NO.	DESCRIPTION	CTN QTY
C53341	3" x 4" less knockout	20
C52341	3" x 4" with knockout	20
C53401	4" less knockout	20
C52401	4" with knockout	20

Plumbfit Closet Flange with Stainless Steel Ring

3" Fits Inside 3" Schedule 40 DWV Pipe
3" x 4" Fits Over 3" or Inside 4" Schedule 40 DWV Pipe
4" Fits Over 4" Schedule 40 DWV Pipe



- Exclusive 400 grade stainless with plumb fit bodies
- Radial slots for closet bolts; 6 screw holes
- For Schedule 40 DWV pipe



PVC		
PART NO.	DESCRIPTION	CTN QTY
C57234	3" less knockout; 4" long shank	20
C57236	3" less knockout; 6" long shank	20
C57134	3" x 4" less knockout	20
C57034	3" x 4" with knockout	20
C57334	3" x 4" less knockout; 6" long shank	20
C57040	4" with knockout	20
C57140	4" less knockout	20

ABS		
PART NO.	DESCRIPTION	CTN QTY
C58234	3" less knockout; 4" long shank	20
C58236	3" less knockout; 6" long shank	20
C58134	3" x 4" less knockout	20
C58034	3" x 4" with knockout	20
C58334	3" x 4" less knockout; 6" long shank	20
C58040	4" with knockout	20
C58140	4" less knockout	20

Spigot Fit Closet Flange



- Extra-thick flange with short slots for extra strength
- 6 screw holes
- Flush fit



PVC		
PART NO.	DESCRIPTION	CTN QTY
C51350	3" less knockout	20
C51450	4" less knockout	20

ABS		
PART NO.	DESCRIPTION	CTN QTY
C51351	3" less knockout	20
C51451	4" less knockout	20

Items marked with the Jones Stephens logo are "You Need It... We Got It" Items.

Plumbfit Closet Flange with Adjustable Ring

Fits Over 3" and Inside 4" Schedule 40 DWV Pipe



- 6" long shank
- Can be cut to desired length
- Swivel rings

MADE IN THE
USA

PVC

PART NO.	DESCRIPTION	CTN QTY
C53600	3" x 4" with metal ring	10
C53700	3" x 4" with plastic ring	10

ABS

PART NO.	DESCRIPTION	CTN QTY
C53601	3" x 4" with metal ring	10
C53701	3" x 4" with plastic ring	10

3" Closet Flange with Adjustable Ring

Fits Inside 3" Schedule 40 DWV



- Adjustable swivel rings
- Flush fit

MADE IN THE
USA

PVC

PART NO.	DESCRIPTION	BARREL SIZE	CTN QTY
C50302	3" with metal ring	4"	10
C50306	3" with plastic ring	4"	10
C50304	3" with metal ring	6"	10
C50308	3" with plastic ring	6"	10

ABS

PART NO.	DESCRIPTION	BARREL SIZE	CTN QTY
C50303	3" with metal ring	4"	10
C50307	3" with plastic ring	4"	10
C50305	3" with metal ring	6"	10
C50309	3" with plastic ring	6"	10

Plastic Two Finger Flange



- Fits flush
- Patent #: 5,937,450
- Will fit oblong horns
- Pushes easily into 3" or 4" cast iron or Schedule 40 DWV pipe
- ASTM C-564 rubber gasket

MADE IN THE
USA

NSF

White Plastic

PART NO.	DESCRIPTION	CTN QTY
C4733P	3" x 3"	6
C4743P	4" x 3"	6

Black Plastic

PART NO.	DESCRIPTION	CTN QTY
C4733A	3" x 3"	6
C4743A	4" x 3"	6

Items marked with the Jones Stephens logo are "You Need It... We Got It" Items.

Closet Flange with 3-1/2" Extended Threads



MADE IN THE
USA

PVC

PART NO.	DESCRIPTION	CTN/MSTR
C54150	with 3-1/2" extended threads	20

Plumbfit Closet Flange with Plastic Swivel Ring

3" x 4" Fits Over 3" or Inside 4" Schedule 40 DWV Pipe
4" Fits Over Schedule 40 DWV Pipe



- Plastic ring will not deteriorate
- 360° rotation
- 2 radial slots and 2 grooved slots for closet bolts
- 6 screw holes for securing to floor

MADE IN THE
USA

NSF

PVC

PART NO.	DESCRIPTION	CTN QTY
C53342	3" x 4" less knockout	20
C54402	3" x 4" offset less knockout	20
C52342	3" x 4" with knockout	6
C52402	4" with knockout	10
C53402	4" less knockout	10

ABS

PART NO.	DESCRIPTION	CTN QTY
C53343	3" x 4" less knockout	20
C54403	3" x 4" offset less knockout	20
C52343	3" x 4" with knockout	20
C52403	4" with knockout	10
C53403	4" less knockout	10

45° Closet Flange

Fits Over 3" DWV with a 4" Sweep



- CSA certified
- With plastic swivel ring
- More versatile than an offset closet flange
- Provides unlimited offset when used in conjunction with a socket x socket 45° elbow



PVC

PART NO.	DESCRIPTION	CTN QTY
C55043	3" x 4" with plastic ring	20

ABS

PART NO.	DESCRIPTION	CTN QTY
C55143	3" x 4" with plastic ring	20

Offset Plumbfit Closet Flange with Stainless Steel Ring

3" x 4" Fits Over 3" or Inside 4" Schedule 40 DWV Pipe



- Exclusive 400 grade stainless with plumbfit bodies
- Radial slots for closet bolts; 6 screw holes
- 2" offset



PVC		
PART NO.	DESCRIPTION	CTN QTY
C57434	3" x 4" offset less knockout	20

ABS		
PART NO.	DESCRIPTION	CTN QTY
C58434	3" x 4" offset less knockout	20

Offset Closet Flange

Fits Over 3" or Inside 4" Schedule 40 DWV Pipe



- 2" offset
- 4 closet bolt slots and 2 mounting screw holes



PVC		
PART NO.	DESCRIPTION	CTN QTY
C54340	3" x 4" offset less knockout	20

ABS		
PART NO.	DESCRIPTION	CTN QTY
C54341	3" x 4" offset less knockout	20

Offset Closet Flange with Metal Ring

Fits Over 3" or Inside 4" Schedule 40 DWV Pipe



- 2" offset
- Adjustable metal ring
- 2 radial slots for closet bolts



PVC		
PART NO.	DESCRIPTION	CTN QTY
C54400	3" x 4" offset less knockout	20

ABS		
PART NO.	DESCRIPTION	CTN QTY
C54401	3" x 4" offset less knockout	20

4-Way Offset Closet Flange

Fits Over 3" or Inside 4" Schedule 40 DWV Pipe



- 2" offset
- 1-13/16" barrel depth



PVC		
PART NO.	DESCRIPTION	CTN QTY
C54342	3" x 4" offset less knockout	20

ABS		
PART NO.	DESCRIPTION	CTN QTY
C54343	3" x 4" offset less knockout	20

3" Over Schedule 30 Pipe Closet Flange



PVC		
PART NO.	DESCRIPTION	CTN QTY
C51150	3" less knockout	20
C52150	3" with knockout	20

Adjustable Urinal Flange Kit

Socket Fits Over 2" Schedule 40 DWV Pipe

Spigot Fits Inside Hub of Fitting



- 3-1/4" - 7" flange mounting centers
- Kits include bolts, nuts, washers and gasket

	A	B	C	D
Spigot	2-3/8"	1-13/16"	7"	1-11/16"
Socket/Hub	2-11/16"	1-1/2"	7"	1-11/16"

PVC		
PART NO.	DESCRIPTION	CTN QTY
F10001	2" spigot outlet	20
F10002	2" socket/hub outlet	20

ABS		
PART NO.	DESCRIPTION	CTN QTY
F11001	2" spigot outlet	20
F11002	2" socket/hub outlet	20

Radial Fit Urinal Flange Kit



- Permits parallel alignment using radial slots
- Adjusts to 4" to 6" centers
- Socket and spigot connections
- Kit includes bolts, nuts, washers and gasket

PVC		
PART NO.	DESCRIPTION	CTN QTY
F10003	2" with socket connection	1
F10004	2" with spigot connection	1

ABS		
PART NO.	DESCRIPTION	CTN QTY
F11003	2" with socket connection	1
F11004	2" with spigot connection	1

Closet Flange Extender



- Stackable to desired height
- For raising floor height when adding ceramic tile or hardwood

PVC		
PART NO.	DESCRIPTION	CTN QTY
C88001	1/2" thick	20
C88501	1/4" thick	20

Items marked with the Jones Stephens logo are "You Need It...We Got It" Items.

Waxless Gasket



- Reusable
- Seals closet flange without using wax

MADE IN THE
USA

PART NO.	DESCRIPTION	CTN QTY
C88002	Waxless gasket	1

Closet Flange Ring



- Fits over 3" or 4" PVC
- Converts 3" and 4" PVC pipe into a toilet ready application

MADE IN THE
USA

PVC

PART NO.	DESCRIPTION	CTN QTY
C51302	3" ring	10
C51402	4" ring	10

ABS

PART NO.	DESCRIPTION	CTN QTY
C51303	3" ring	10
C51403	4" ring	10

Closet Flange Repair Ring



- Securely attaches to concrete or wood sub-floor
- Replaces most closet rings
- Corrosion resistant
- Mounting ears offset by 1/8" to allow closet bolts to be installed

PART NO.	DESCRIPTION	CTN /MSTR
C85000	Closet flange repair ring	20/80

Set-Rite® Closet Flange Spacer Kit



- Code Approved: Water and Gas tight seal!
- Raises existing toilet flange from 1/4" up to 1-5/8"
- Kit includes yellow extender, 4 spacers, gasket & 6 stainless steel screws

PART NO.	DESCRIPTION	CTN QTY
C89500	Extender kit	5

Set-Rite® Closet Flange Spacer Kit



- Set your flange height right the first time!
- Install under the flange during rough-in
- Kit includes 4 spacers: 3/4", 1/2", 1/4" & 1/8"

PART NO.	DESCRIPTION	CTN QTY
C89600	Spacer kit	12

Closet Flange Spacer Kit



- Reusable toilet seal gasket
- For repair or correction of problems resulting from installation errors or remodeling projects
- Complete kit includes: 2 gaskets, 1/2" spacer, 1/4" x 3-1/2" closet bolt kit, 2 plastic shims

MADE IN THE
USA

PART NO.	DESCRIPTION	CTN/MSTR
C88600	Spacer kit	1/10

Complete Closet Flange Extension Kit with Gaskets



- Useful when overlaying, replacing or tiling bathroom floors
- Two 3-1/2" closet bolts with washers and nuts
- Anchors toilet bolts when closet ring is broken
- No caulking required
- Has built-in gaskets
- One 1/4" flange & one 1/2" flange

MADE IN THE
USA

PART NO.	DESCRIPTION	CTN QTY
C88500	Complete kit	10
C88502	Kit less bolts	10

Complete Closet Flange Extension Kit with Caulk



- Three 1/4" extenders for easy adjustment
- Two 3-1/2" closet bolts with washers and nuts
- Adhesive caulk and all hardware included

MADE IN THE
USA

PART NO.	DESCRIPTION	CTN QTY
C88500C	Complete kit	10

Closet Flange Extension Kit



- No mastic necessary between pieces as with stackable units
- Heavy solid plastic construction
- Two 3-1/2" closet bolts with washers and nuts
- Packaged in display header bag
- One 1/2" flange

MADE IN THE
USA

PART NO.	DESCRIPTION	CTN QTY
C88050	1/2" extension kit	10

Gapper Flange



- Used to repair broken closet flanges
- Individually carded for easy display or bulk

PART NO.	DESCRIPTION	CTN/MSTR
C87100	Repair flange	24/240

Items marked with the Jones Stephens logo are "You Need It...We Got It" Items.

Flexible and Rigid Super Shims



- Stackable
- Rigid, can be driven
- Flexible, can be trimmed
- **Priced per bag**
- 10 per bag

MADE IN THE
USA

PART NO.	DESCRIPTION	CTN/MSTR
S55950	1-1/8" x 1-15/16" x 1/4" flexible	1 bag of 10
S55951	1-1/8" x 1-15/16" x 1/4" rigid	1 bag of 10

Flexible Super Shims



- 200 Flexible super shims packaged in a convenient refillable "candy bowl" counter display
- **Priced per display**

MADE IN THE
USA

PART NO.	DESCRIPTION	CTN QTY
S55952	200 Flexible super shims	1 bowl of 200

Rigid Super Shims



- 200 Rigid super shims packaged in a convenient refillable "candy bowl" counter display
- **Priced per display**

MADE IN THE
USA

PART NO.	DESCRIPTION	CTN QTY
S55953	200 Rigid super shims	1 bowl of 200

Closet Wedge Shims



- Stackable
- 3/8" width x 1-3/8" length x 5/16" height
- Easily trimmed to desired height
- **Priced per bag or display**

MADE IN THE
USA

PART NO.	DESCRIPTION	CTN/MSTR
S55902	100 shims poly bagged	1 bag of 100
S55903	1000 shims counter display	1 bowl of 1000

PVC and ABS Residential Shower/Floor Drains

Pages 177-180

SIZES: 2", 2" x 3"



For use in
residential applications.

2" x 3" Shower/Floor Drain

Fits Over 2" or Inside 3" Schedule 40 DWV Pipe

MADE IN THE
USA



- Low profile for first and second floor installations
- Beveled edge allows for recessed installation
- Reversible clamping ring for additional 1/2" height adjustment
- Brass inserts ensure secure clamping of membrane
- Dual weeps holes
- Recessed sump area for added drainage
- D50001 UPC Listed

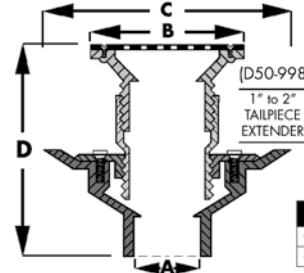

	A	B	C	D
Over 2" pipe	4-1/4"	6-1/2"	3-1/4" - 4-3/8"	
Over 3" pipe	4-1/4"	6-1/2"	3-1/4" - 4-3/8"	

PVC

PART NO.	STRAINER	REPL. STRAINER	CTN QTY
D50001	4" SS	C60809	20
D50002	4" PB	C60810	20
D50132	4" PB cast	C60807	20
D50133	4" PB cast w/ring	C60807/C60824	20
D50130	4" NB cast	C60808	20
D50131	4" NB cast w/ring	C60808/C60825	20
D50011	4" CP cast	C60806	20
D50010	4" CP cast w/ring	C60806/C60818	20
D50134	4" CP cast square	C60812	20
D50135	4" PB cast square	C60813	20
D50120	PT and 4" SS	C60809	1
D50121	PT and 4" PB	C60810	1
D50122	PT and 4" PB cast	C60807	1
D50123	PT and 4" CP cast	C60806	1
D50124	4" CP cast	C60808	1

ABS

PART NO.	STRAINER	REPL. STRAINER	CTN QTY
D50301	4" SS	C60809	20
D50302	4" PB	C60810	20
D50332	4" PB cast	C60807	20
D50333	4" PB cast w/ring	C60807/C60824	20
D50330	24" NB cast	C60808	20
D50331	4" NB cast w/ring	C60808/C60825	20
D50311	4" CP cast	C60806	20
D50310	4" CP cast w/ring	C60806/C60818	20
D50334	4" CP cast square	C60812	20
D50335	4" PB cast square	C60813	20

Items marked with the Jones Stephens logo are "You Need It...We Got It" Items.

2" x 3" Shower/Floor Drain with Square Strainer

Fits Over 2" or Inside 3" Schedule 40 DWV Pipe

MADE IN THE **USA**



- Low profile for first and second floor installations
- Beveled edge allows for recessed installation
- Reversible clamping ring for additional 1/2" height adjustment
- Brass inserts ensure secure clamping of membrane
- Dual weeps holes
- Recessed sump area for added drainage

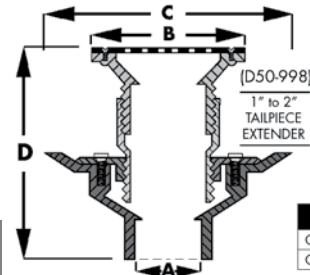

• Use **D50998** Tailpiece Extension (listed below) when additional height is needed.

A	B	C	D
Over 2" pipe	4-1/4"	6-1/2"	3-1/4" - 4-3/8"
Over 3" pipe	4-1/4"	6-1/2"	3-1/4" - 4-3/8"

PVC

PART NO.	STRAINER	CTN QTY
D50141	4" NB square	20

2" x 3" Shower Drain with 2" Spud and Snap-in 4" Square Strainer



- No screws
- Four prong installation
- Plastic spud

PART NO.	STRAINER	CTN QTY
D5088BN	4" BN square	1
D5088RB	4" RB square	1
D5088WB	4" WB square	1
D50888	4" SS square	1

Tailpiece Extension



- Use when additional height is needed
- Compensates for thick shower bases

MADE IN THE **USA**

PART NO.	DESCRIPTION	CTN QTY
D50998	1" - 2" tailpiece extension	1

Brass Drain Extension



- 2" MIP x 2" FIP for 2" drain spuds
- Use when additional height is required to overcome inconsistent concrete pours
- Height extension from 1-1/2" to 3-1/2"
- Solid brass construction

PART NO.	DESCRIPTION	CTN QTY
D60978	Brass drain extension	1

2" x 3" Shower/Floor Drain with Brass Tailpiece

Fits Over 2" or Inside 3" Schedule 40 DWV Pipe

MADE IN THE **USA**



- Low profile for first and second floor installations
- Beveled edge allows for recessed installation
- Reversible clamping ring for additional 1/2" height adjustment
- Brass inserts ensure secure clamping of membrane
- Dual weeps holes
- Recessed sump area for added drainage

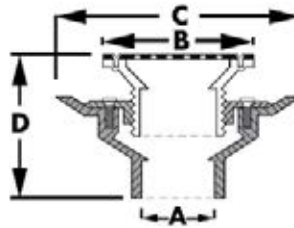

A	B	C	D
Over 2" pipe	4-1/4"	6-1/2"	3-1/4" - 4-3/8"
Over 3" pipe	4-1/4"	6-1/2"	3-1/4" - 4-3/8"

PVC

PART NO.	STRAINER	REPL. STRAINER	CTN QTY
D50101	4" SS round	D60780	20
D50111	4" CP round	D60781	20
D50102	4" PB round	D60782	20
D50800	6" CP round	-	20
D50802	6" PB round	-	20
D50161	4" CP square	C60812	20
D50152	4" PB square	C60813	20
D5001BN	4" BN round	-	1
D5001RB	4" RB round	-	1
D5001WB	4" WB round	-	1
D5001NP	4" NP round	-	1

ABS

PART NO.	STRAINER	REPL. STRAINER	CTN QTY
D50401	4" SS round	D60780	20
D50411	4" CP round	D60781	20
D50402	4" PB round	D60782	20
D50830	6" CP round	-	20
D50832	6" PB round	-	20
D50162	4" CP square	C60812	20
D50153	4" PB square	C60813	20

2" Shower/Floor Drain with Brass Tailpiece

Fits Over 2" Schedule 40 DWV Pipe



MADE IN THE
USA

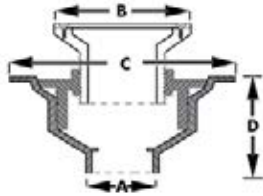

- Overall top
- Brass tailpiece
- Screw-down clamping ring has weep holes for secondary drainage

A	B	C	D
Over 2" pipe	4-1/8" or 6"	7"	3-5/8" - 5-1/4"

PVC

PART NO.	STRAINER	CTN QTY
D50710	4" SS round	10
D50712	4" PB round	10
D50711	4" CP round	10
D50721	6" PB round	10
D50720	6" CP round	10

ABS

PART NO.	STRAINER	CTN QTY
D50713	4" SS round	10
D50715	4" PB round	10
D50714	4" CP round	10
D50723	6" PB round	10
D50722	6" CP round	10

2" x 3" "Perfect Low Profile" Drain

Fits Over 2" or Inside 3" PVC Schedule 40 DWV Pipe

MADE IN THE
USA

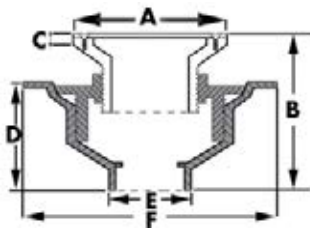

- 3" total height; perfect for multiple stories
- Reversible clamping ring, stainless steel strainer

A	B	C	D	E	F
4-1/4"	MIN: 3" - MAX: 4-1/4"	3/8"	2"	ID: 2-3/8" OD: 3-1/16"	6-5/8"

PVC

PART NO.	STRAINER	CTN QTY
D50PLP	4" SS round	20

2" x 3" PVC Low Profile Drain

MADE IN THE
USA

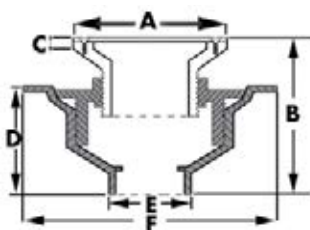

- Primer tapped

A	B	C	D	E	F
4-1/4"	MIN: 3" - MAX: 4-1/4"	3/8"	2"	ID: 2-3/8" OD: 3-1/16"	6-5/8"

PVC

PART NO.	STRAINER	CTN QTY
D50125	4" SS round	1
D50126	4" NB round cast	1

Items marked with the Jones Stephens logo are "You Need It... We Got It" Items.

2" Shower/Floor Drain with Plastic Tailpiece

Fits Over 2" Schedule 40 DWV Pipe



MADE IN THE
USA

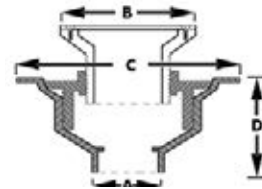

- Overall top
- Plastic tailpiece
- Screw-down clamping ring has weep holes for secondary drainage

A	B	C	D
Over 2" pipe	4-1/4"	7"	3-5/8" - 5-1/8"
With Ring	4-1/4"	7"	3-3/4" - 5-1/4"

PVC

PART NO.	STRAINER	CTN QTY
D50700	4" SS round	10
D50702	4" PB round	10
D50708	4" PB round cast	10
D50709	4" PB round with ring	10
D50701	4" CP round	10
D50706	4" NB round	10
D50707	4" NB round with ring	10

ABS

PART NO.	STRAINER	CTN QTY
D50703	4" SS round	10
D50705	4" PB round	10
D50726	4" PB round cast	10
D50727	4" PB round with ring	10
D50704	4" CP round	10
D50724	4" NB round	10
D50725	4" NB round with ring	10

2" No Caulk Shower Drain

Pushes Over 2" DWV Pipe

MADE IN THE
USA

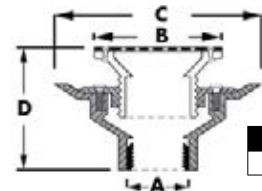

- Overall top
- Tongue-and-grooved beveled clamping ring
- Brass inserts
- Supplied with gasket

A	B	C	D
2" no caulk	4-1/4"	6-1/2"	3-1/2" - 4-3/4"

PVC - PLASTIC TAILPIECE

PART NO.	STRAINER	CTN QTY
D50500	4" SS round	10
D50510	4" CP round	10

PVC - BRASS TAILPIECE

PART NO.	STRAINER	CTN QTY
D50501	4" SS round	10
D50502	4" PB round	10
D50511	4" CP round	10

2" No Caulk Shower Stall Drain

Fits Over 2" Schedule 40 DWV Pipe

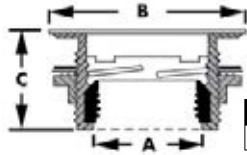

- Overall top
- Snap-in strainer
- Wrench included
- For 2" CTS order gasket separately
- D40140 UPC Listed

A	B	C
2"	4-1/4"	2"

Plastic Body

PART NO.	STRAINER	CTN QTY
D40101	4" SS round	20
D40151	4" White plastic round	20
D40201	4" PB round	25
D40401	4" White epoxy coated SS round	10

Brass Body

PART NO.	STRAINER	CTN QTY
D40140	4" SS round	20
D40240	4" PB round	36
D40440	4" White epoxy coated SS round	10

Snap-In Replacement Strainers

PART NO.	DESCRIPTION	CTN QTY
D40005	SS round replacement strainer for solvent outlet drains	1
D40003	PB round replacement strainer	50
D40004	White epoxy coated SS replacement strainer	50
D40006	Replacement wrench key	1
D40007	2" Schedule 40 DWV gasket	1
D40008	2" CTS replacement gasket	1
D40009	White plastic round replacement strainer	1
D40010	SN replacement strainer	20

2" Drop-In Shower Stall Drain

Fits Over 2" Schedule 40 DWV Pipe

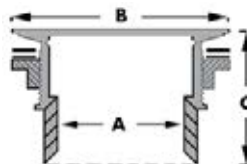

- Drain body drops through shower base
- Locknut tightens from underside
- Snap-in strainer

A	B	C
2"	4-1/4"	2-5/8"

PVC

PART NO.	DESCRIPTION	STRAINER	CTN QTY
D41007	Solvent outlet	4" SS	25
D41009	Solvent outlet	4" PB	20
D41008	No-caulk/solvent outlet	4" SS	20

ABS

PART NO.	DESCRIPTION	STRAINER	CTN QTY
D41307	Solvent outlet	4" SS	25
D41105	Solvent outlet	4" PB	20

Snap-In Replacement Strainers

PART NO.	DESCRIPTION	CTN QTY
D40005	SS for solvent outlet drains	10
D41103	SS for no caulk/solvent drains	10
D41104	Snap-in for D41008	10
D40010	SN	10
D40003	PB	10

Items marked with the Jones Stephens logo are "You Need It... We Got It" Items.

2" Shower Stall Drain with Receptor Base

Fits Over 2" Schedule 40 DWV Pipe

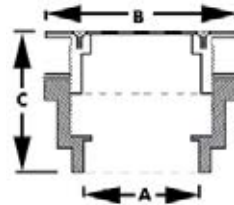

- Allows for secondary drainage
- Accepts knockout test cap for testing
- 3" OD threads

A	B	C
2"	4-1/4"	2"

PVC

PART NO.	STRAINER	CTN QTY
D41001	4" SS round	25
D41002	4" PB round	20
D41003	4" AB round	20
D41004	4" SN round	20

ABS

PART NO.	STRAINER	CTN QTY
D41301	4" SS round	20
D41302	4" PB round	20
D41303	4" AB round	20

PVC - 2" Offset

PART NO.	STRAINER	CTN QTY
D41600	4" SS round	25

ABS - 2" Offset

PART NO.	STRAINER	CTN QTY
D41601	4" SS round	25

Replacement Strainers with Screws

PART NO.	DESCRIPTION	CTN/MSTR
D41101	SS round replacement strainer with screws	50/250
D41102	PB round replacement strainer with screws	50/250
D41106	AB round replacement strainer with screws	50/250
D41107	SN round replacement strainer with screws	50/250

PVC LevelBest Drainage and Cleanout System

Pages 181-183

SIZES: 2" x 3", 3", 3" x 4", 4"



For use in applications where adjustments after the concrete pour are required.

Adapter

Allows adjustment to floor level after concrete is poured!

MADE IN THE
USA



- PVC, ABS or Cast Iron drains compatible
- Industry standard iron pipe size threads compatible with most adapter and drain bodies
- Compatible with most plastic and brass spuds used in the industry
- Includes the spacer ring that can be used with brass spuds
- Can be used with tile rings

PART NO.	DESCRIPTION	CTN QTY
D50448	3-1/2" x 3" x 6"	1
D50449	4" x 3-1/2" x 6"	1
D50450	4" x 3-1/2" x 5"	1
D50451	3-1/2" x 3" x 5"	1
D50452	Replacement cap	1
D50453	Replacement ring	1
D50454	Leveling shim for 5" strainer	1

3" x 4" PVC Base with 3-1/2" Adapter

Allows adjustment to floor level after concrete is poured!

MADE IN THE
USA



- PVC, ABS or Cast Iron drains compatible
- Industry standard iron pipe size threads compatible with most adapter and drain bodies
- Includes the spacer ring that can be used with brass spuds
- Can be used with tile rings
- Primer tapped with 1/2" IPS plug

PART NO.	DESCRIPTION	CTN QTY
D50440	3" x 4" PVC base with 3-1/2" LevelBest adapter	1

Adapter with Spud and Strainer

Allows adjustment to floor level after concrete is poured!

MADE IN THE
USA



- PVC, ABS or Cast Iron drains compatible
- Industry standard iron pipe size threads compatible with most adapter and drain bodies
- Includes the spacer ring that can be used with brass spuds
- Can be used with tile rings

PART NO.	SIZE	SPUD	STRAINER	CTN QTY
D50522	3-1/2"	3" Plastic	5" NB Round	1
D50523	3-1/2"	3" Metal	5" NB Round	1
D50520	4"	3-1/2" Plastic	5" NB Round	1
D50521	4"	3-1/2" Metal	5" NB Round	1
D50524	3-1/2"	3-1/2" Plastic	6" NB Round	1
D50526	4"	3-1/2" Plastic	6" NB Round	1

Adapter with Spud and Cleanout

Allows adjustment to floor level after concrete is poured!

MADE IN THE
USA



- PVC, ABS or Cast Iron drains compatible
- Industry standard iron pipe size threads compatible with most adapter and drain bodies
- Includes the spacer ring that can be used with brass spuds
- Can be used with tile rings

PART NO.	PIPE SIZE	SPUD	COVER	CTN QTY
D50525	3-1/2"	3" Plastic	6" NB Round	1

Complete Hub Fit Drain System

Allows adjustment to floor level after concrete is poured!

MADE IN THE
USA



- Includes the spacer ring that can be used with brass spuds
- Can be used with tile rings

PART NO.	PIPE SIZE	SPUD	STRAINER	CTN QTY
D50462	4"	3" Plastic	5" NB Round	1
D50463	4"	3" Metal	5" NB Round	1

Complete Pipe Fit Drain System

Allows adjustment to floor level after concrete is poured!

MADE IN THE
USA



- Includes the spacer ring that can be used with brass spuds
- Can be used with tile rings
- Primer tapped with 1/2" IPS plug

PART NO.	PIPE SIZE	SPUD	STRAINER	CTN QTY
D50460	3" x 4"	3" Plastic	5" NB Round	1
D50461	3" x 4"	3" Metal	5" NB Round	1
D50473	3" x 4"	3" Plastic	6" NB Round	1
D50486	3" x 4"	3-1/2" Plastic	5" NB Round	1
D50469	3" x 4"	3" Plastic	6" NB Square	1
D50472	4"	3-1/2" Plastic	6" NB Round	1
D50470	4"	3-1/2" Plastic	5" NB Round	1
D50471	4"	3-1/2" Metal	5" NB Round	1
D50465	4"	3" Metal	5" NB Round	1
D50464	4"	3" Plastic	5" NB Round	1
D50474	4"	3" Plastic	6" NB Round	1

Complete Hub Fit Cleanout System

Allows adjustment to floor level after concrete is poured!

MADE IN THE
USA



- Includes the spacer ring that can be used with brass spuds
- Can be used with tile rings

PART NO.	PIPE SIZE	SPUD	COVER	CTN QTY
C59240	4"	3" Plastic	5" NB Round	1
C59241	4"	3" Metal	5" NB Round	1

Complete Pipe Fit Cleanout System

Allows adjustment to floor level after concrete is poured!

MADE IN THE
USA



- Includes the spacer ring that can be used with brass spuds
- Can be used with tile rings

PART NO.	PIPE SIZE	SPUD	COVER	CTN QTY
C59242	3" x 4"	3" Plastic	5" NB Round	1
C59243	3" x 4"	3" Metal	5" NB Round	1
C59252	3" x 4"	3-1/2" Plastic	5" NB Round	1
D50481	3" x 4"	3" Plastic	6" NB Round	1
C59244	4"	3" Plastic	5" NB Round	1
C59245	4"	3" Metal	5" NB Round	1
C59250	4"	3-1/2" Plastic	5" NB Round	1
C59251	4"	3-1/2" Metal	5" NB Round	1
D50482	4"	3" Plastic	6" NB Round	1
D50480	4"	3-1/2" Plastic	6" NB Round	1

Complete Heavy Duty Drain System

Allows adjustment to floor level after concrete is poured!

MADE IN THE
USA



- Includes the spacer ring that can be used with brass spuds
- Can be used with tile rings
- Completely adjustable; reversible clamping ring gains additional 1" height
- 8-1/2" Pan primer tapped with 1/2" plug
- Extra weep holes

PART NO.	PIPE SIZE	SPUD	STRAINER	CTN QTY
D49640	4"	3" Plastic	5" NB Round	1
D49641	4"	3" Metal	5" NB Round	1
D49646	4"	3-1/2" Plastic	5" NB Round	1
D49647	4"	3-1/2" Metal	5" NB Round	1
D49644	2" x 3"	3" Plastic	5" NB Round	1
D49645	2" x 3"	3" Metal	5" NB Round	1
D49650	2" x 3"	3-1/2" Plastic	5" NB Round	1
D49651	2" x 3"	3-1/2" Metal	5" NB Round	1
D49642	3" x 4"	3" Plastic	5" NB Round	1
D49643	3" x 4"	3" Metal	5" NB Round	1
D49648	3" x 4"	3-1/2" Plastic	5" NB Round	1
D49649	3" x 4"	3-1/2" Metal	5" NB Round	1
D50477	3"	3-1/2" Plastic	6" NB Round	1
D50479	4"	3-1/2" Plastic	6" NB Round	1

Ⓢ Items marked with the Jones Stephens logo are "You Need It... We Got It" Items.

Complete Heavy Duty Slab Drain System

Allows adjustment to floor level after concrete is poured!

MADE IN THE
USA



- Includes the spacer ring that can be used with brass spuds
- Can be used with tile rings
- 8-1/2" Pan for applications where no clamping ring is required
- Primer tapped with 1/2" plug
- Completely adjustable

PART NO.	PIPE SIZE	SPUD	STRAINER	CTN QTY
D49656	2" x 3"	3" Plastic	5" NB Round	1
D49657	2" x 3"	3" Metal	5" NB Round	1
D49662	2" x 3"	3-1/2" Plastic	5" NB Round	1
D49663	2" x 3"	3-1/2" Metal	5" NB Round	1
D49654	3" x 4"	3" Plastic	5" NB Round	1
D49655	3" x 4"	3" Metal	5" NB Round	1
D49660	3" x 4"	3-1/2" Plastic	5" NB Round	1
D49661	3" x 4"	3-1/2" Metal	5" NB Round	1
D49652	4"	3" Plastic	5" NB Round	1
D49653	4"	3" Metal	5" NB Round	1
D49658	4"	3-1/2" Plastic	5" NB Round	1
D49659	4"	3-1/2" Metal	5" NB Round	1

E

3" x 4" Pipe Fit Base with 3-1/2" Plastic Spud

Fits Over 3" or Inside 4" Schedule 40 DWV Pipe

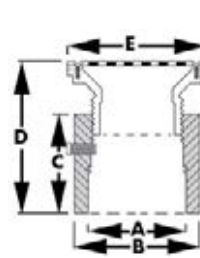

- Strainers available in SS, PB, NB and CP
- SS strainers are .06" thick
- PB, NB and CP strainers are 3/16" thick
- Primer tapped, includes 1/2" plug
- Adjustable (see dimension D)

STRAINER	A	B	C	D	E
5" round	Over 3" pipe	Inside 4" pipe	4-1/2"	5-1/16" - 7-1/8"	5-3/16"
5" round with ring	Over 3" pipe	Inside 4" pipe	4-1/2"	5-13/16" - 7-1/4"	5-1/2"
6" round	Over 3" pipe	Inside 4" pipe	4-1/2"	5-3/4" - 7-1/4"	6-1/8"
6" round with ring	Over 3" pipe	Inside 4" pipe	4-1/2"	6-1/16" - 7-5/16"	6-1/2"
6" square	Over 3" pipe	Inside 4" pipe	4-1/2"	5-3/4" - 7-1/8"	6"
7" square	Over 3" pipe	Inside 4" pipe	4-1/2"	5-15/16" - 7-3/8"	7"

PVC

PART NO.	STRAINER	CTN QTY
D53428	5" SS round	1
D53429	5" PB round	1
D53430	5" PB round with ring	1
D53431	5" NB round	1
D53432	5" NB round with ring	1
D53433	5" CP round	1
D53434	5" CP round with ring	1
D53020	6" SS round	1
D53022	6" PB round	1
D53074	6" PB round with ring	1
D53072	6" NB round	1
D53076	6" NB round with ring	1
D53021	6" CP round	1
D53284	6" CP round with ring	1
D59900	5" NB round with 6" square top	1
D53246	5" PB round with 7" square top	1
D53248	5" NB round with 7" square top	1

ABS

PART NO.	STRAINER	CTN QTY
D53435	5" SS round	1
D53436	5" PB round	1
D53437	5" PB round with ring	1
D53438	5" NB round	1
D53439	5" NB round with ring	1
D53440	5" CP round	1
D53441	5" CP round with ring	1
D53023	6" SS round	1
D53025	6" PB round	1
D53075	6" PB round with ring	1
D53073	6" NB round	1
D53077	6" NB round with ring	1
D53024	6" CP round	1
D53285	6" CP round with ring	1
D53247	5" PB round with 7" square top	1
D53249	5" NB round with 7" square top	1

PVC and ABS Commercial Pipe/Hub Fit Adapter Drains

Pages 184-190

SIZES: 2", 3", 3" x 4", 4"



For use in applications where a membrane is not required.

E

3" x 4" Pipe Fit Base with 3-1/2" Metal Spud

Fits Over 3" or Inside 4" Schedule 40 DWV Pipe

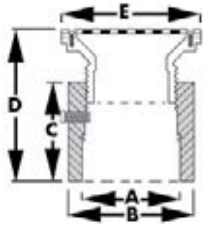

MADE IN THE **USA**
NSF

- Strainers are available in PB, NB and CP
- Primer tapped, includes 1/2" plug
- Adjustable (see dimension D)

STRAINER	A	B	C	D	E
5" round	Over 3" pipe	Inside 4" pipe	4-1/2"	4-7/8" — 6-1/16"	5"
6" round	Over 3" pipe	Inside 4" pipe	4-1/2"	5-5/16" — 6-11/16"	6"
8" round	Over 3" pipe	Inside 4" pipe	4-1/2"	5-3/8" — 6-7/8"	8"
9" round	Over 3" pipe	Inside 4" pipe	4-1/2"	5-3/8" — 6-7/8"	9"
5" or 6" square top	Over 3" pipe	Inside 4" pipe	4-1/2"	5-3/4" — 7-1/8"	5" or 6"

PVC

PART NO.	STRAINER	CTN QTY
D53027	5" PB round	1
D53124	5" NB round	1
D53026	5" CP round	1
D53029	6" PB round	1
D53125	6" NB round	1
D53028	6" CP round	1
D53031	8" PB round	1
D53138	8" NB round	1
D53030	8" CP round	1
D53142	9" PB round	1
D53140	9" NB round	1
D53078	5" PB square	1
D53082	5" NB square	1
D53080	6" PB square	1
D53084	6" NB square	1

ABS

PART NO.	STRAINER	CTN QTY
D53033	5" PB round	1
D53126	5" NB round	1
D53032	5" CP round	1
D53035	6" PB round	1
D53127	6" NB round	1
D53034	6" CP round	1
D53037	8" PB round	1
D53139	8" NB round	1
D53036	8" CP round	1
D53143	9" PB round	1
D53141	9" NB round	1
D53079	5" PB square	1
D53083	5" NB square	1
D53081	6" PB square	1
D53085	6" NB square	1

2" Over Pipe Fit Base with 2" Plastic Spud

Fits Over 2" Schedule 40 DWV Pipe

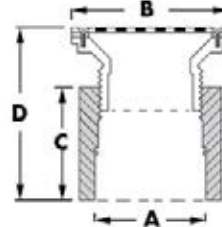

MADE IN THE **USA**

- Strainers are available in SS, PB, NB and CP
- Stainless steel strainers are .06" thick
- PB, NB and CP strainers are 3/16" thick
- Adjustable (see dimension D)

STRAINER	A	B	C	D
4" round	Over 2" pipe	4-1/4"	1-3/4"	3-3/8" — 3-13/16"
4" round with ring	Over 2" pipe	4-1/4"	1-3/4"	3-1/2" — 3-7/8"
4" square	Over 2" pipe	4-1/4"	1-3/4"	3-3/16" — 3-11/16"

PVC

PART NO.	STRAINER	CTN QTY
D53190	4" SS round	1
D53194	4" PB round stamped	1
D53196	4" PB round cast	1
D53200	4" PB round with ring	1
D53198	4" NB round	1
D53202	4" NB round with ring	1
D53192	4" CP round	1
D53290	4" CP round with ring	1
D53298	4" PB square	1
D53296	4" CP square	1

ABS

PART NO.	STRAINER	CTN QTY
D53191	4" SS round	1
D53195	4" PB round stamped	1
D53197	4" PB round cast	1
D53201	4" PB round with ring	1
D53199	4" NB round	1
D53203	4" NB round with ring	1
D53193	4" CP round	1
D53291	4" CP round with ring	1
D53299	4" PB square	1
D53297	4" CP square	1

2" Over Pipe Fit Base with 2" Metal Spud

Fits Over 2" Schedule 40 DWV Pipe

MADE IN THE
USA

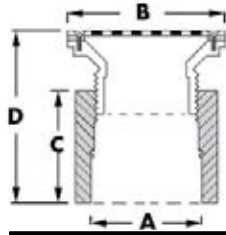

- Strainers are available in SS, PB and CP
- Stainless steel strainers are .06" thick
- PB, NB and CP strainers are 3/16" thick
- Adjustable (see dimension D)

STRAINER	A	B	C	D
4" round	Over 2" pipe	4-1/4"	1-3/4"	3-1/8" - 3-5/8"
6" round	Over 2" pipe	6"	1-3/4"	3-1/8" - 3-5/8"

PVC

PART NO.	STRAINER	CTN QTY
D53204	4" SS round	1
D53208	4" PB round	1
D53206	4" CP round	1
D53218	6" PB round	1
D53216	6" CP round	1

ABS

PART NO.	STRAINER	CTN QTY
D53205	4" SS round	1
D53209	4" PB round	1
D53207	4" CP round	1
D53219	6" PB round	1
D53217	6" CP round	1

3" Over Pipe Fit Base with 3" Plastic Spud

Fits Over 3" Schedule 40 DWV Pipe

MADE IN THE
USA

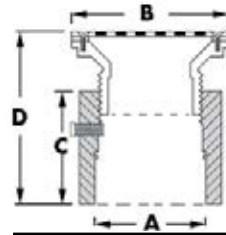

- Strainers are available in SS, PB, NB and CP
- Stainless steel strainers are .06" thick
- PB, NB and CP strainers are 3/16" thick
- Primer tapped, includes 1/2" plug
- Adjustable (see dimension D)

STRAINER	A	B	C	D
6" round	Over 3" pipe	6-1/8"	3-7/8"	4-13/16" - 5-3/4"
6" round with ring	Over 3" pipe	6-1/2"	3-7/8"	4-15/16" - 5-13/16"
7" square	Over 3" pipe	7"	3-7/8"	4-13/16" - 6-1/8"

PVC

PART NO.	STRAINER	CTN QTY
D53100	6" SS round	1
D53104	6" PB round	1
D53108	6" PB round with ring	1
D53106	6" NB round	1
D53110	6" NB round with ring	1
D53102	6" CP round	1
D53288	6" CP round with ring	1
D53258	5" PB round with 7" square top	1
D53260	5" NB round with 7" square top	1

ABS

PART NO.	STRAINER	CTN QTY
D53101	6" SS round	1
D53105	6" PB round	1
D53109	6" PB round with ring	1
D53107	6" NB round	1
D53111	6" NB round with ring	1
D53103	6" CP round	1
D53289	6" CP round with ring	1
D53259	5" PB round with 7" square top	1
D53261	5" NB round with 7" square top	1

3" Over Pipe Fit Base with 3" Metal Spud

Fits Over 3" Schedule 40 DWV Pipe

MADE IN THE
USA

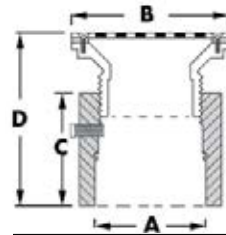

- Strainers are available in PB and NB
- PB and NB strainers are 3/16" thick
- Primer tapped, includes 1/2" plug
- Adjustable (see dimension D)

STRAINER	A	B	C	D
5" round	Over 3" pipe	5"	3-7/8"	4-15/16" - 5-3/4"

PVC

PART NO.	STRAINER	CTN QTY
D53312	5" PB round	1
D53306	5" NB round	1

ABS

PART NO.	STRAINER	CTN QTY
D53313	5" PB round	1
D53307	5" NB round	1

4" Over Pipe Fit Base with 3-1/2" Plastic Spud

Fits Over 4" Schedule 40 DWV Pipe

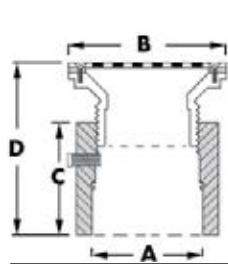

MADE IN THE USA
NSF CM

- Strainers are available in SS, PB, NB and CP
- Stainless steel strainers are .06" thick
- PB, NB and CP strainers are 3/16" thick
- Primer tapped, includes 1/2" plug
- Adjustable (see dimension D)

STRAINER	A	B	C	D
5" round	Over 4" pipe	5-3/16"	4-3/4"	6" - 7-3/8"
5" round with ring	Over 4" pipe	5-1/2"	4-3/4"	6-1/8" - 7-1/2"
6" round	Over 4" pipe	6-1/8"	4-3/4"	6" - 7-1/2"
6" round with ring	Over 4" pipe	6-1/2"	4-3/4"	6-1/4" - 7-5/8"
7" square	Over 4" pipe	7"	4-3/4"	5-1/2" - 6-7/8"

PVC

PART NO.	STRAINER	CTN QTY
D53414	5" SS round	1
D53415	5" PB round	1
D53416	5" PB round with ring	1
D53417	5" NB round	1
D53418	5" NB round with ring	1
D53419	5" CP round	1
D53420	5" CP round with ring	1
D53040	6" SS round	1
D53042	6" PB round	1
D53088	6" PB round with ring	1
D53086	6" NB round	1
D53090	6" NB round with ring	1
D53041	6" CP round	1
D53282	6" CP round with ring	1
D53250	5" PB round with 7" square top	1
D53252	5" NB round with 7" square top	1

ABS

PART NO.	STRAINER	CTN QTY
D53421	5" SS round	1
D53422	5" PB round	1
D53423	5" PB round with ring	1
D53424	5" NB round	1
D53425	5" NB round with ring	1
D53426	5" CP round	1
D53427	5" CP round with ring	1
D53043	6" SS round	1
D53045	6" PB round	1
D53089	6" PB round with ring	1
D53087	6" NB round	1
D53091	6" NB round with ring	1
D53044	6" CP round	1
D53283	6" CP round with ring	1
D53251	5" PB round with 7" square top	1
D53253	5" NB round with 7" square top	1

4" Over Pipe Fit Base with 3-1/2" Metal Spud

Fits Over 4" Schedule 40 DWV Pipe

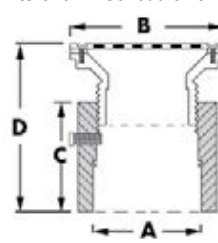

MADE IN THE USA
NSF CM

- Strainers are available in SS, PB, NB and CP
- PB, NB and CP strainers are 3/16" thick
- Primer tapped, includes 1/2" plug
- Adjustable (see dimension D)

STRAINER	A	B	C	D
5" round	Over 4" pipe	5-3/16"	4-3/4"	5-1/8" - 6-3/8"
6" round	Over 4" pipe	6-3/16"	4-3/4"	5-5/16" - 6-5/8"
8" round	Over 4" pipe	8"	4-3/4"	5-1/2" - 7"
9" round	Over 4" pipe	9"	4-3/4"	5-1/2" - 7-1/8"
5" or 6" square	Over 4" pipe	5" or 6"	4-3/4"	5-5/16" - 6-5/8"

PVC

PART NO.	STRAINER	CTN QTY
D53047	5" PB round	1
D53128	5" NB round	1
D53046	5" CP round	1
D53049	6" PB round	1
D53129	6" NB round	1
D53048	6" CP round	1
D53051	8" PB round	1
D53132	8" NB round	1
D53050	8" CP round	1
D53136	9" PB round	1
D53134	9" NB round	1
D53092	5" PB square	1
D53096	5" NB square	1
D53094	6" PB square	1
D53098	6" NB square	1

ABS

PART NO.	STRAINER	CTN QTY
D53053	5" PB round	1
D53130	5" NB round	1
D53052	5" CP round	1
D53055	6" PB round	1
D53131	6" NB round	1
D53054	6" CP round	1
D53057	8" PB round	1
D53133	8" NB round	1
D53056	8" CP round	1
D53137	9" PB round	1
D53135	9" NB round	1
D53093	5" PB square	1
D53097	5" NB square	1
D53095	6" PB square	1
D53099	6" NB square	1

4" Over Pipe Fit Base with 4" Plastic Spud

Fits Over 4" Schedule 40 DWV Pipe



- Strainers are available in SS, PB, NB and CP
- Stainless steel strainers are .06" thick
- PB, NB and CP strainers are 3/16" thick
- Primer tapped, includes 1/2" plug
- Adjustable (see dimension D)

STRAINER	A	B	C	D
6" round	Over 4" pipe	6-1/8"	4-3/4"	6" - 7-3/16"
6" round with ring	Over 4" pipe	6-1/2"	4-3/4"	6-1/8" - 7-5/16"
7" square	Over 4" pipe	7"	4-3/4"	6-1/16" - 7-3/8"

PVC

PART NO.	STRAINER	CTN QTY
D53262	6" SS round	4
D53263	6" PB round	4
D53264	6" PB round with ring	4
D53265	6" NB round	4
D53266	6" NB round with ring	4
D53269	6" CP round	4
D53286	6" CP round with ring	4
D53267	5" PB round with 7" square top	1
D53268	5" NB round with 7" square top	1

ABS

PART NO.	STRAINER	CTN QTY
D53272	6" SS round	4
D53273	6" PB round	4
D53274	6" PB round with ring	4
D53275	6" NB round	4
D53276	6" NB round with ring	4
D53279	6" CP round	4
D53287	6" CP round with ring	4
D53277	5" PB round with 7" square top	1
D53278	5" NB round with 7" square top	1

4" Over Pipe Fit Base with 4" Metal Spud

Fits Over 4" Schedule 40 DWV Pipe



- Strainers are available in PB and NB
- Strainers are 3/16" thick
- Primer tapped, includes 1/2" plug
- Adjustable (see dimension D)

STRAINER	A	B	C	D
5" round	Over 4" pipe	5"	4-3/4"	6-1/16" - 7-3/8"

PVC

PART NO.	STRAINER	CTN QTY
D53308	5" PB round	4
D53304	5" NB round	4

ABS

PART NO.	STRAINER	CTN QTY
D53309	5" PB round	4
D53305	5" NB round	4

3" Inside Pipe Fit Base with 2" Plastic Spud

Fits Inside 3" Schedule 40 DWV Pipe



- Strainers are available in SS, PB, NB and CP
- Stainless steel strainers are .06" thick
- PB, NB and CP strainers are 3/16" thick
- Adjustable (see dimension C)

STRAINER	A	B	C
4" round	Inside 3" pipe	4-1/4"	2-5/8" - 3-7/8"
4" round with ring	Inside 3" pipe	4-1/2"	2-11/16" - 4"
4" square	Inside 3" pipe	4-1/4"	2-1/2" - 3-13/16"

PVC

PART NO.	STRAINER	CTN QTY
D53150	4" SS round	1
D53154	4" PB round stamped	1
D53156	4" PB round cast	1
D53160	4" PB round with ring	1
D53158	4" NB round	1
D53162	4" NB round with ring	1
D53152	4" CP round	1
D53294	4" CP round with ring	1
D53300	4" CP square	1
D53302	4" PB square	1

ABS

PART NO.	STRAINER	CTN QTY
D53151	4" SS round	1
D53155	4" PB round stamped	1
D53157	4" PB round cast	1
D53161	4" PB round with ring	1
D53159	4" NB round	1
D53163	4" NB round with ring	1
D53153	4" CP round	1
D53295	4" CP round with ring	1
D53301	4" CP square	1
D53303	4" PB square	1

3" Inside Pipe Fit Base with 2" Metal Spuds

Fits Inside 3" Schedule 40 DWV Pipe

MADE IN THE
USA

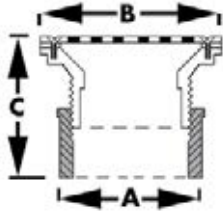

- Strainers are available in SS, PB and CP
- Stainless steel strainers are .06" thick
- PB and CP strainers are 3/16" thick
- Adjustable (see dimension C)

STRAINER	A	B	C
4" or 6" round	Inside 3" pipe	4-1/4" or 6"	2-7/16" - 3-3/4"

PVC

PART NO.	STRAINER	CTN QTY
D53180	4" SS	1
D53184	4" PB	1
D53182	4" CP	1
D53188	6" PB	1
D53186	6" CP	1

ABS

PART NO.	STRAINER	CTN QTY
D53181	4" SS	1
D53185	4" PB	1
D53183	4" CP	1
D53189	6" PB	1
D53187	6" CP	1

4" Inside Pipe Fit Base with 3" Plastic Spud

Fits Inside 4" Schedule 40 DWV Pipe

MADE IN THE
USA

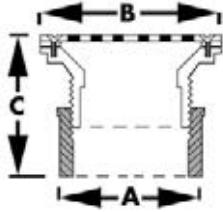

- Strainers are available in SS, PB, NB and CP
- Stainless steel strainers are .06" thick
- PB, NB and CP strainers are 3/16" thick
- Adjustable (see dimension C)

STRAINER	A	B	C
6" round	Inside 4" pipe	6-1/8"	3-13/16" - 4-5/8"
6" round with ring	Inside 4" pipe	6-1/2"	4" - 4-13/16"

PVC

PART NO.	STRAINER	CTN QTY
D53230	6" SS round	1
D53232	6" PB round	1
D53238	6" PB round with ring	1
D53234	6" NB round	1
D53240	6" NB round with ring	1
D53236	6" CP round	1
D53292	6" CP round with ring	1

ABS

PART NO.	STRAINER	CTN QTY
D53231	6" SS round	1
D53233	6" PB round	1
D53239	6" PB round with ring	1
D53235	6" NB round	1
D53241	6" NB round with ring	1
D53237	6" CP round	1
D53293	6" CP round with ring	1

4" Inside Pipe Fit Base with 3" Metal Spud

Fits Inside 4" Schedule 40 DWV Pipe

MADE IN THE
USA

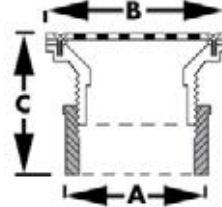

- Strainers are available in PB and NB
- Strainers are 3/16" thick
- Adjustable (see dimension C)

STRAINER	A	B	C
5" round	Inside 4" pipe	5"	2-5/8" - 3-1/2"

PVC

PART NO.	STRAINER	CTN QTY
D53314	5" PB round	1
D53310	5" NB round	1

ABS

PART NO.	STRAINER	CTN QTY
D53315	5" PB round	1
D53311	5" NB round	1

4" Hub Fit Base with 3-1/2" Plastic Spud

Fits Inside 4" Schedule 40 DWV Pipe

MADE IN THE **USA**

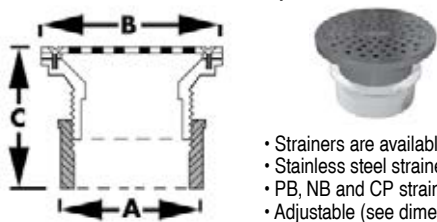

- Strainers are available in SS, PB, NB and CP
- Stainless steel strainers are .06" thick
- PB, NB and CP strainers are 3/16" thick
- Adjustable (see dimension C)

STRAINER	A	B	C
5" round	4" hub fit	5-3/16"	3" - 4-1/2"
5" round with ring	4" hub fit	5-1/2"	3-1/8" - 4-5/8"
6" round	4" hub fit	6-1/8"	3-1/16" - 4-11/16"
6" round with ring	4" hub fit	6-1/2"	3-1/4" - 4-3/4"

PVC

PART NO.	STRAINER	CTN QTY
D53400	5" SS round	1
D53401	5" PB round	1
D53402	5" PB round with ring	1
D53403	5" NB round	1
D53404	5" NB round with ring	1
D53405	5" CP round	1
D53406	5" CP round with ring	1
D53017	6" SS round	1
D53001	6" PB round	1
D53060	6" PB round with ring	1
D53058	6" NB round	1
D53062	6" NB round with ring	1
D53003	6" CP round	1
D53280	6" CP round with ring	1

ABS

PART NO.	STRAINER	CTN QTY
D53407	5" SS round	1
D53408	5" PB round	1
D53409	5" PB round with ring	1
D53410	5" NB round	1
D53411	5" NB round with ring	1
D53412	5" CP round	1
D53413	5" CP round with ring	1
D53018	6" SS round	1
D53002	6" PB round	1
D53061	6" PB round with ring	1
D53059	6" NB round	1
D53063	6" NB round with ring	1
D53004	6" CP round	1
D53281	6" CP round with ring	1

4" Hub Fit Base with 3-1/2" Metal Spud

Fits Inside 4" Schedule 40 DWV Pipe

MADE IN THE **USA**



- Strainers are available in PB, NB and CP
- Strainers are 3/16" thick
- Adjustable (see dimension C)

STRAINER	A	B	C
5" round	5" hub fit	5-3/16"	2-3/8" - 3-5/8"
6" round	6" hub fit	6-3/16"	2-5/8" - 4"
5" or 6" square	4" hub fit	5" or 6"	2-3/4" - 4-3/16"

PVC

PART NO.	STRAINER	CTN QTY
D53005	5" PB round	1
D53120	5" NB round	1
D53011	5" CP round	1
D53006	6" PB round	1
D53121	6" NB round	1
D53012	6" CP round	1
D53064	5" PB square	4
D53068	5" NB square	4
D53066	6" PB square	4
D53070	6" NB square	4

ABS

PART NO.	STRAINER	CTN QTY
D53008	5" PB round	1
D53122	5" NB round	1
D53014	5" CP round	1
D53009	6" PB round	1
D53123	6" NB round	1
D53015	6" CP round	1
D53065	5" PB square	4
D53069	5" NB square	4
D53067	6" PB square	4
D53071	6" NB square	4

E

PVC and ABS 8-1/2" Pan Commercial Drains

Pages 191-197

SIZES: 2" x 3", 3" x 4", 4"



For use in applications where a membrane is required.

2" x 3" Drain Base with 3" Plastic Spud

Fits Over 2" and Inside 3" Schedule 40 DWV Pipe

MADE IN THE
USA

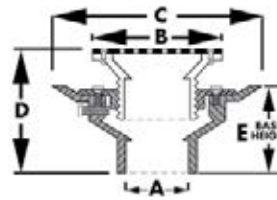

- Completely adjustable; reversible clamping ring gains additional 1" height
- Strainers are available in SS, PB, NB and CP
- 8-1/2" pan primer tapped with 1/2" plug
- Gray PVC or Black ABS
- Extra weep holes

STRAINER	A	B	C	D	E
6" round stainless steel	Over 2" Inside 3"	6-1/8"	8-9/16"	5-1/16" - 6-3/16"	3-3/4"
6" round	Over 2" Inside 3"	6-1/8"	8-9/16"	5-1/8" - 6-3/8"	3-3/4"
6" with ring	Over 2" Inside 3"	6-7/16"	8-9/16"	5-5/16" - 6-3/16"	3-3/4"

PVC

PART NO.	STRAINER	CTN QTY
D49001	6" SS round	1
D49003	6" PB round	1
D49005	6" PB round with ring	1
D49007	6" NB round	1
D49009	6" NB round with ring	1
D49011	6" CP round	1
D49013	6" CP round with ring	1

ABS

PART NO.	STRAINER	CTN QTY
D49002	6" SS round	1
D49004	6" PB round	1
D49006	6" PB round with ring	1
D49008	6" NB round	1
D49010	6" NB round with ring	1
D49012	6" CP round	1
D49014	6" CP round with ring	1

2" x 3" Drain Base with 3" Metal Spud

Fits Over 2" and Inside 3" Schedule 40 DWV Pipe

MADE IN THE
USA

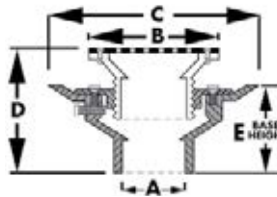

- Completely adjustable; reversible clamping ring gains additional 1" height
- Strainers are available in PB and NB
- 8-1/2" pan primer tapped with 1/2" plug
- Gray PVC or Black ABS
- Extra weep holes

STRAINER	A	B	C	D	E
5" round	Over 2" Inside 3"	5-3/16"	8-9/16"	4-3/16" - 5-3/8"	3-3/4"

PVC

PART NO.	STRAINER	CTN QTY
D49019	5" PB round	1
D49021	5" NB round	1

ABS

PART NO.	STRAINER	CTN QTY
D49020	5" PB round	1
D49022	5" NB round	1

2" x 3" Drain Base with 3-1/2" Plastic Spud

Fits Over 2" and Inside 3" Schedule 40 DWV Pipe

MADE IN THE
USA

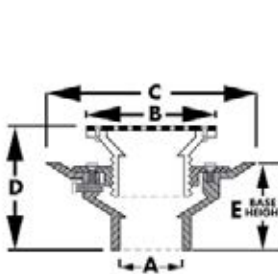

- Completely adjustable; reversible clamping ring gains additional 1" height
- Strainers are available in SS, PB, NB and CP
- 8-1/2" pan primer tapped with 1/2" plug
- Gray PVC or Black ABS
- Extra weep holes

STRAINER	A	B	C	D	E
5" round stainless steel	Over 2" Inside 3"	5-1/4"	8-9/16"	4-5/8" — 6-1/8"	3-3/4"
5" round	Over 2" Inside 3"	5-1/4"	8-9/16"	4-11/16" — 6-1/4"	3-3/4"
5" round with ring	Over 2" Inside 3"	5-9/16"	8-9/16"	4-3/4" — 6-5/16"	3-3/4"
6" round stainless steel	Over 2" Inside 3"	6-1/4"	8-9/16"	4-13/16" — 6-1/4"	3-3/4"
6" round	Over 2" Inside 3"	6-1/4"	8-9/16"	4-15/16" — 6-5/16"	3-3/4"
6" round with ring	Over 2" Inside 3"	6-9/16"	8-9/16"	5-1/16" — 6-1/2"	3-3/4"

PVC

PART NO.	STRAINER	CTN QTY
D49023	5" SS round	1
D49025	5" PB round	1
D49027	5" PB round with ring	1
D49029	5" NB round	1
D49031	5" NB round with ring	1
D49033	5" CP round	1
D49035	5" CP round with ring	1
D49037	6" SS round	1
D49039	6" PB round	1
D49041	6" PB round with ring	1
D49043	6" NB round	1
D49045	6" NB round with ring	1
D49047	6" CP round	1
D49049	6" CP round with ring	1

ABS

PART NO.	STRAINER	CTN QTY
D49024	5" SS round	1
D49026	5" PB round	1
D49028	5" PB round with ring	1
D49030	5" NB round	1
D49032	5" NB round with ring	1
D49034	5" CP round	1
D49036	5" CP round with ring	1
D49038	6" SS round	1
D49040	6" PB round	1
D49042	6" PB round with ring	1
D49044	6" NB round	1
D49046	6" NB round with ring	1
D49048	6" CP round	1
D49050	6" CP round with ring	1

2" x 3" Drain Base with 3-1/2" Metal Spud

Fits Over 2" and Inside 3" Schedule 40 DWV Pipe

MADE IN THE
USA

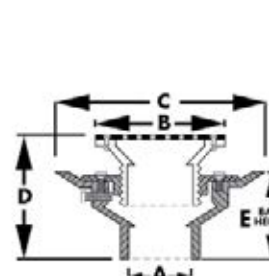

- Completely adjustable; reversible clamping ring gains additional 1" height
- Strainers are available in PB, NB and CP
- 8-1/2" pan primer tapped with 1/2" plug
- Gray PVC or Black ABS
- Extra weep holes

STRAINER	A	B	C	D	E
4" round	Over 2" Inside 3"	4-1/8"	8-9/16"	4-1/8" — 5-1/4"	3-3/4"
5" round	Over 2" Inside 3"	5-3/16"	8-9/16"	4-1/8" — 5-5/16"	3-3/4"
6" round	Over 2" Inside 3"	6-3/16"	8-9/16"	4-5/16" — 5-3/4"	3-3/4"

PVC

PART NO.	STRAINER	CTN QTY
D49051	4" PB round	1
D49053	4" NB round	1
D49055	5" PB round	1
D49057	5" NB round	1
D49059	5" CP round	1
D49061	6" PB round	1
D49063	6" NB round	1
D49065	6" CP round	1

ABS

PART NO.	STRAINER	CTN QTY
D49052	4" PB round	1
D49054	4" NB round	1
D49056	5" PB round	1
D49058	5" NB round	1
D49060	5" CP round	1
D49062	6" PB round	1
D49064	6" NB round	1
D49066	6" CP round	1

2" x 3" Drain Base with 4" Plastic Spud

Fits Over 2" and Inside 3" Schedule 40 DWV Pipe

MADE IN THE
USA

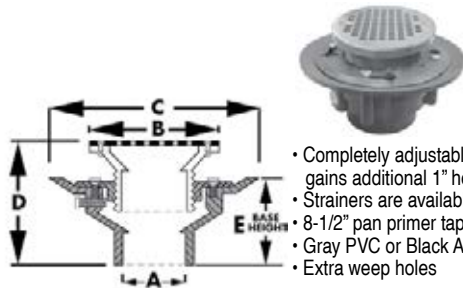

- Completely adjustable; reversible clamping ring gains additional 1" height
- Strainers are available in SS, PB, NB and CP
- 8-1/2" pan primer tapped with 1/2" plug
- Gray PVC or Black ABS
- Extra weep holes

STRAINER	A	B	C	D	E
6" round stainless steel	Over 2" Inside 3"	6-3/16"	8-9/16"	5" - 6-3/16"	3-3/4"
6" round	Over 2" Inside 3"	6-3/16"	8-9/16"	5-1/16" - 6-1/4"	3-3/4"

PVC

PART NO.	STRAINER	CTN QTY
D49077	6" SS round	1
D49079	6" PB round	1
D49081	6" PB round with ring	1
D49083	6" NB round	1
D49085	6" NB round with ring	1
D49087	6" CP round	1
D49089	6" CP round with ring	1

ABS

PART NO.	STRAINER	CTN QTY
D49078	6" SS round	1
D49080	6" PB round	1
D49082	6" PB round with ring	1
D49084	6" NB round	1
D49086	6" NB round with ring	1
D49088	6" CP round	1
D49090	6" CP round with ring	1

2" x 3" Drain Base with 4" Metal Spuds

Fits Over 2" and Inside 3" Schedule 40 DWV Pipe

MADE IN THE
USA

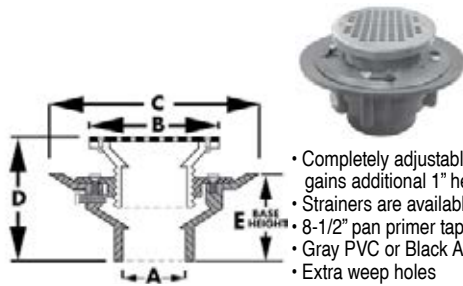

- Completely adjustable; reversible clamping ring gains additional 1" height
- Strainers are available in SS, PB, NB and CP
- 8-1/2" pan primer tapped with 1/2" plug
- Gray PVC or Black ABS
- Extra weep holes

STRAINER	A	B	C	D	E
5" round	Over 2" Inside 3"	5-3/16"	8-9/16"	4-1/8" - 5-3/16"	3-3/4"

PVC

PART NO.	STRAINER	CTN QTY
D49095	5" PB	1
D49097	5" NB	1

ABS

PART NO.	STRAINER	CTN QTY
D49096	5" PB	1
D49098	5" NB	1

3" x 4" Drain Base with 3" Plastic Spud

Fits Over 3" and Inside 4" Schedule 40 DWV Pipe

MADE IN THE
USA

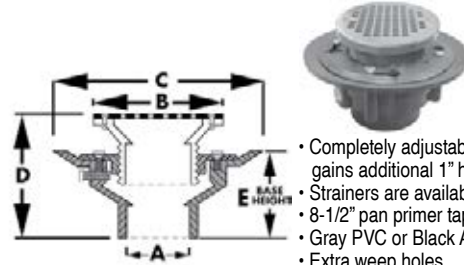

- Completely adjustable; reversible clamping ring gains additional 1" height
- Strainers are available in SS, PB, NB and CP
- 8-1/2" pan primer tapped with 1/2" plug
- Gray PVC or Black ABS
- Extra weep holes

STRAINER	A	B	C	D	E
6" round stainless steel	Over 3" Inside 4"	6-1/8"	8-9/16"	5-1/16" - 6-3/16"	5-3/16"
6" round	Over 3" Inside 4"	6-1/8"	8-9/16"	5-1/8" - 6-3/8"	5-3/16"
6" round with ring	Over 3" Inside 4"	6-7/16"	8-9/16"	5-5/16" - 6-1/2"	5-3/16"

PVC

PART NO.	STRAINER	CTN QTY
D49101	6" SS round	1
D49103	6" PB round	1
D49105	6" PB round with ring	1
D49107	6" NB round	1
D49109	6" NB round with ring	1
D49111	6" CP round	1
D49113	6" CP round with ring	1

ABS

PART NO.	STRAINER	CTN QTY
D49102	6" SS round	1
D49104	6" PB round	1
D49106	6" PB round with ring	1
D49108	6" NB round	1
D49110	6" NB round with ring	1
D49112	6" CP round	1
D49114	6" CP round with ring	1

3" x 4" Drain Base with 3" Metal Spud

Fits Over 3" and Inside 4" Schedule 40 DWV Pipe

MADE IN THE
USA

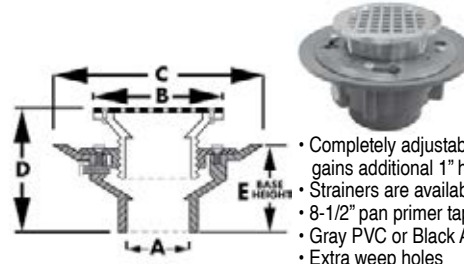

- Completely adjustable; reversible clamping ring gains additional 1" height
- Strainers are available in PB and NB
- 8-1/2" pan primer tapped with 1/2" plug
- Gray PVC or Black ABS
- Extra weep holes

STRAINER	A	B	C	D	E
5" round	Over 3" Inside 4"	5-3/16"	8-9/16"	4-3/16" - 5-3/8"	5-3/16"

PVC

PART NO.	STRAINER	CTN QTY
D49119	5" PB round	1
D49121	5" NB round	1

ABS

PART NO.	STRAINER	CTN QTY
D49120	5" PB round	1
D49122	5" NB round	1

3" x 4" Drain Base with 3-1/2" Plastic Spud

Fits Over 3" and Inside 4" Schedule 40 DWV Pipe

MADE IN THE
USA

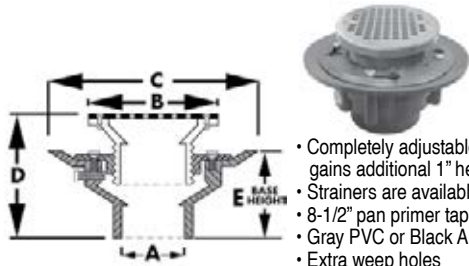

- Completely adjustable; reversible clamping ring gains additional 1" height
- Strainers are available in SS, PB, NB and CP
- 8-1/2" pan primer tapped with 1/2" plug
- Gray PVC or Black ABS
- Extra weep holes

STRAINER	A	B	C	D	E
5" round stainless steel	Over 3" Inside 4"	5-1/4"	8-9/16"	4-5/8" — 6-1/8"	5-1/4"
5" round	Over 3" Inside 4"	5-1/4"	8-9/16"	4-11/16" — 6-1/4"	5-1/4"
5" round with ring	Over 3" Inside 4"	5-9/16"	8-9/16"	4-3/4" — 6-5/16"	5-1/4"
6" round stainless steel	Over 3" Inside 4"	6-1/4"	8-9/16"	4-13/16" — 6-1/4"	5-1/4"
6" round	Over 3" Inside 4"	6-1/4"	8-9/16"	4-15/16" — 6-5/16"	5-1/4"
6" round with ring	Over 3" Inside 4"	6-9/16"	8-9/16"	5-1/16" — 6-1/2"	5-1/4"

PVC

PART NO.	STRAINER	CTN QTY
D49123	5" SS round	1
D49125	5" PB round	1
D49127	5" PB round with ring	1
D49129	5" NB round	1
D49131	5" NB round with ring	1
D49133	5" CP round	1
D49135	5" CP round with ring	1
D49137	6" SS round	1
D49139	6" PB round	1
D49141	6" PB round with ring	1
D49143	6" NB round	1
D49145	6" NB round with ring	1
D49147	6" CP round	1
D49149	6" CP round with ring	1

ABS

PART NO.	STRAINER	CTN QTY
D49124	5" SS round	1
D49126	5" PB round	1
D49128	5" PB round with ring	1
D49130	5" NB round	1
D49132	5" NB round with ring	1
D49134	5" CP round	1
D49136	5" CP round with ring	1
D49138	6" SS round	1
D49140	6" PB round	1
D49142	6" PB round with ring	1
D49144	6" NB round	1
D49146	6" NB round with ring	1
D49148	6" CP round	1
D49150	6" CP round with ring	1

3" x 4" Drain Base with 3-1/2" Metal Spud

Fits Over 3" and Inside 4" Schedule 40 DWV Pipe

MADE IN THE
USA

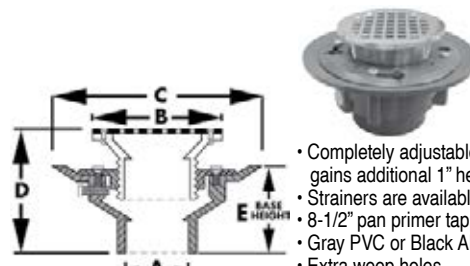

- Completely adjustable; reversible clamping ring gains additional 1" height
- Strainers are available in PB, NB and CP
- 8-1/2" pan primer tapped with 1/2" plug
- Gray PVC or Black ABS
- Extra weep holes

STRAINER	A	B	C	D	E
4" round	Over 3" Inside 4"	4-1/8"	8-9/16"	4-1/8" — 5-1/4"	5-1/4"
5" round	Over 3" Inside 4"	5-3/16"	8-9/16"	4-1/8" — 5-5/16"	5-1/4"
6" round	Over 3" Inside 4"	6-3/16"	8-9/16"	4-5/16" — 5-3/4"	5-1/4"

PVC

PART NO.	STRAINER	CTN QTY
D49151	4" PB round	1
D49153	4" NB round	1
D49155	5" PB round	1
D49157	5" NB round	1
D49159	5" CP round	1
D49161	6" PB round	1
D49163	6" NB round	1
D49165	6" CP round	1

ABS

PART NO.	STRAINER	CTN QTY
D49152	4" PB round	1
D49154	4" NB round	1
D49156	5" PB round	1
D49158	5" NB round	1
D49160	5" CP round	1
D49162	6" PB round	1
D49164	6" NB round	1
D49166	6" CP round	1

E

3" x 4" Drain Base with 4" Plastic Spud

Fits Over 3" and Inside 4" Schedule 40 DWV Pipe

MADE IN THE USA

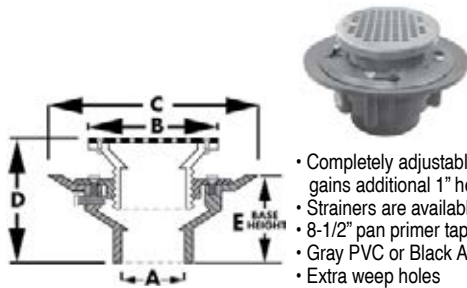

- Completely adjustable; reversible clamping ring gains additional 1" height
- Strainers are available in SS, PB, NB and CP
- 8-1/2" pan primer tapped with 1/2" plug
- Gray PVC or Black ABS
- Extra weep holes

STRAINER	A	B	C	D	E
6" round stainless steel	Over 3" Inside 4"	6-3/16"	8-9/16"	5-1/16" - 6-3/16"	5-1/4"
6" round	Over 3" Inside 4"	6-3/16"	8-9/16"	5-1/8" - 6-3/8"	5-1/4"
6" round with ring	Over 3" Inside 4"	6-7/16"	8-9/16"	5-5/16" - 6-1/2"	5-1/4"

PVC

PART NO.	STRAINER	CTN QTY
D49177	6" SS round	1
D49179	6" PB round	1
D49181	6" PB round with ring	1
D49183	6" NB round	1
D49185	6" NB round with ring	1
D49187	6" CP round	1
D49189	6" CP round with ring	1

ABS

PART NO.	STRAINER	CTN QTY
D49178	6" SS round	1
D49180	6" PB round	1
D49182	6" PB round with ring	1
D49184	6" NB round	1
D49186	6" NB round with ring	1
D49188	6" CP round	1
D49190	6" CP round with ring	1

3" x 4" Drain Base with 4" Metal Spud

Fits Over 3" and Inside 4" Schedule 40 DWV Pipe

MADE IN THE USA

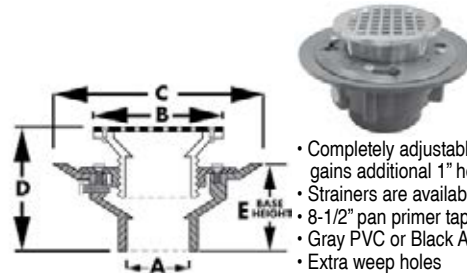

- Completely adjustable; reversible clamping ring gains additional 1" height
- Strainers are available in PB and NB
- 8-1/2" pan primer tapped with 1/2" plug
- Gray PVC or Black ABS
- Extra weep holes

STRAINER	A	B	C	D	E
5" round	Over 3" Inside 4"	5-3/16"	8-9/16"	4-3/16" - 5-3/8"	5-1/4"

PVC

PART NO.	STRAINER	CTN QTY
D49195	5" PB round	1
D49197	5" NB round	1

ABS

PART NO.	STRAINER	CTN QTY
D49196	5" PB round	1
D49198	5" NB round	1

4" Drain Base with 3" Plastic Spud

Fits Over 4" Schedule 40 DWV Pipe

MADE IN THE USA

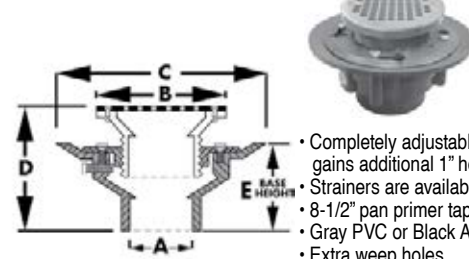

- Completely adjustable; reversible clamping ring gains additional 1" height
- Strainers are available in SS, PB, NB and CP
- 8-1/2" pan primer tapped with 1/2" plug
- Gray PVC or Black ABS
- Extra weep holes

STRAINER	A	B	C	D	E
6" round stainless steel	Over 4"	6-1/8"	8-9/16"	5-9/16" - 6-11/16"	4-1/4"
6" round	Over 4"	6-1/8"	8-9/16"	5-5/8" - 6-7/8"	4-1/4"
6" round with ring	Over 4"	6-7/16"	8-9/16"	5-13/16" - 7"	4-1/4"

PVC

PART NO.	STRAINER	CTN QTY
D49201	6" SS round	1
D49203	6" PB round	1
D49205	6" PB round with ring	1
D49207	6" NB round	1
D49209	6" NB round with ring	1
D49211	6" CP round	1
D49213	6" CP round with ring	1

ABS

PART NO.	STRAINER	CTN QTY
D49202	6" SS round	1
D49204	6" PB round	1
D49206	6" PB round with ring	1
D49208	6" NB round	1
D49210	6" NB round with ring	1
D49212	6" CP round	1
D49214	6" CP round with ring	1

4" Drain Base with 3" Metal Spud

Fits Over 4" Schedule 40 DWV Pipe

MADE IN THE USA

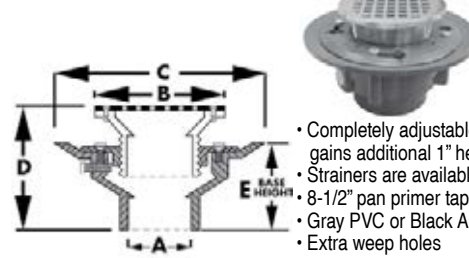

- Completely adjustable; reversible clamping ring gains additional 1" height
- Strainers are available in PB and NB
- 8-1/2" pan primer tapped with 1/2" plug
- Gray PVC or Black ABS
- Extra weep holes

STRAINER	A	B	C	D	E
5" round	Over 4"	5-3/16"	8-9/16"	4-11/16" - 5-7/8"	4-1/4"

PVC

PART NO.	STRAINER	CTN QTY
D49219	5" PB round	1
D49221	5" NB round	1

ABS

PART NO.	STRAINER	CTN QTY
D49220	5" PB round	1
D49222	5" NB round	1

4" Drain Base with 3-1/2" Plastic Spud

Fits Over 4" Schedule 40 DWV Pipe

MADE IN THE
USA

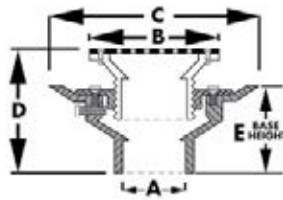

- Completely adjustable; reversible clamping ring gains additional 1" height
- Strainers are available in SS, PB, NB and CP
- 8-1/2" pan primer tapped with 1/2" plug
- Gray PVC or Black ABS

STRAINER	A	B	C	D	E
5" round stainless steel	Over 4"	5-1/4"	8-9/16"	5-1/8" - 6-5/8"	4-1/4"
5" round	Over 4"	5-1/4"	8-9/16"	5-3/16" - 6-3/4"	4-1/4"
5" round with ring	Over 4"	5-9/16"	8-9/16"	5-1/4" - 6-13/16"	4-1/4"
6" round stainless steel	Over 4"	6-1/4"	8-9/16"	5-5/16" - 6-3/4"	4-1/4"
6" round	Over 4"	6-1/4"	8-9/16"	5-7/16" - 6-13/16"	4-1/4"
6" round with ring	Over 4"	6-9/16"	8-9/16"	5-9/16" - 7"	4-1/4"

PVC

PART NO.	STRAINER	CTN QTY
D49223	5" SS round	1
D49225	5" PB round	1
D49227	5" PB round with ring	1
D49229	5" NB round	1
D49231	5" NB round with ring	1
D49233	5" CP round	1
D49235	5" CP round with ring	1
D49237	6" SS round	1
D49239	6" PB round	1
D49241	6" PB round with ring	1
D49243	6" NB round	1
D49245	6" NB round with ring	1
D49247	6" CP round	1
D49249	6" CP round with ring	1

ABS

PART NO.	STRAINER	CTN QTY
D49224	5" SS round	1
D49226	5" PB round	1
D49228	5" PB round with ring	1
D49230	5" NB round	1
D49232	5" NB round with ring	1
D49234	5" CP round	1
D49236	5" CP round with ring	1
D49238	6" SS round	1
D49240	6" PB round	1
D49242	6" PB round with ring	1
D49244	6" NB round	1
D49246	6" NB round with ring	1
D49248	6" CP round	1
D49250	6" CP round with ring	1

4" Drain Base with 3-1/2" Metal Spud

Fits Over 4" Schedule 40 DWV Pipe

MADE IN THE
USA

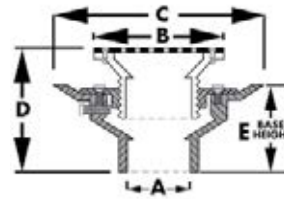

- Completely adjustable; reversible clamping ring gains additional 1" height
- Strainers are available in PB, NB and CP
- 8-1/2" pan primer tapped with 1/2" plug
- Gray PVC or Black ABS
- Extra weep holes

STRAINER	A	B	C	D	E
4" round	Over 4"	4-1/8"	8-9/16"	4-5/8" - 5-3/4"	4-1/4"
5" round	Over 4"	5-3/16"	8-9/16"	4-5/8" - 5-13/16"	4-1/4"
6" round	Over 4"	6-3/16"	8-9/16"	4-13/16" - 6-1/4"	4-1/4"

PVC

PART NO.	STRAINER	CTN QTY
D49251	4" PB round	1
D49253	4" NB round	1
D49255	5" PB round	1
D49257	5" NB round	1
D49259	5" CP round	1
D49261	6" PB round	1
D49263	6" NB round	1
D49265	6" CP round	1

ABS

PART NO.	STRAINER	CTN QTY
D49252	4" PB round	1
D49254	4" NB round	1
D49256	5" PB round	1
D49258	5" NB round	1
D49260	5" CP round	1
D49262	6" PB round	1
D49264	6" NB round	1
D49266	6" CP round	1

4" Drain Base with 4" Plastic Spud

Fits Over 4" Schedule 40 DWV Pipe



MADE IN THE
USA

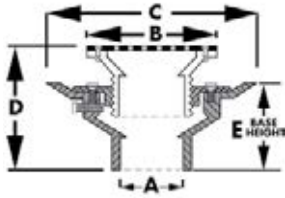

- Completely adjustable; reversible clamping ring gains additional 1" height
- Strainers are available in SS, PB, NB and CP
- 8-1/2" pan primer tapped with 1/2" plug
- Gray PVC or Black ABS
- Extra weep holes

STRAINER	A	B	C	D	E
6" round stainless steel	Over 4"	6-3/16"	8-9/16"	5-1/2" - 6-11/16"	4-1/4"
6" round	Over 4"	6-3/16"	8-9/16"	5-9/16" - 6-3/4"	4-1/4"
6" round with ring	Over 4"	6-7/16"	8-9/16"	5-3/4" - 7"	4-1/4"

PVC

PART NO.	STRAINER	CTN QTY
D49277	6" SS round	1
D49279	6" PB round	1
D49281	6" PB round with ring	1
D49283	6" NB round	1
D49285	6" NB round with ring	1
D49287	6" CP round	1
D49289	6" CP round with ring	1

ABS

PART NO.	STRAINER	CTN QTY
D49278	6" SS round	1
D49280	6" PB round	1
D49282	6" PB round with ring	1
D49284	6" NB round	1
D49286	6" NB round with ring	1
D49288	6" CP round	1
D49290	6" CP round with ring	1

4" Drain Base with 4" Metal Spud

Fits Over 4" Schedule 40 DWV Pipe



MADE IN THE
USA

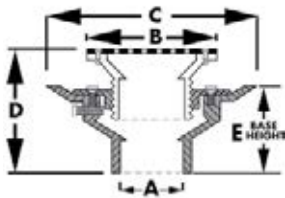

- Completely adjustable; reversible clamping ring gains additional 1" height
- Strainers are available in PB and NB
- 8-1/2" pan primer tapped with 1/2" plug
- Gray PVC or Black ABS
- Extra weep holes

STRAINER	A	B	C	D	E
5" round	Over 4"	5-3/16"	8-9/16"	4-5/8" - 5-11/16"	4-1/4"

PVC

PART NO.	STRAINER	CTN QTY
D49295	5" PB round	1
D49297	5" NB round	1

ABS

PART NO.	STRAINER	CTN QTY
D49296	5" PB round	1
D49298	5" NB round	1

E

PVC and ABS 8-1/2" Pan Commercial Slab Drains

Pages 198-204

SIZES: 2" x 3", 3" x 4", 4"



For use in applications where a membrane is not required.

2" x 3" Slab Drain Base with 3" Plastic Spud

Fits Over 2" and Inside 3" Schedule 40 DWV Pipe

MADE IN THE USA

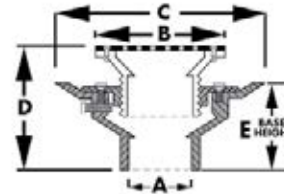

- Completely adjustable
- 8-1/2" pan for applications where no clamping ring is required
- Strainers are available in SS, PB, NB and CP
- Spud threads directly into base
- Primer tapped with 1/2" plug
- Gray PVC or Black ABS

STRAINER	A	B	C	D	E
6" round stainless steel	Over 2" Inside 3"	6-1/8"	8-9/16"	4-15/16" - 5-7/8"	3-3/4"
6" round	Over 2" Inside 3"	6-1/8"	8-9/16"	5" - 6"	3-3/4"
6" round with ring	Over 2" Inside 3"	6-7/16"	8-9/16"	5-1/8" - 6-1/8"	3-3/4"

PVC

PART NO.	STRAINER	CTN QTY
D49301	6" SS round	1
D49303	6" PB round	1
D49305	6" PB round with ring	1
D49307	6" NB round	1
D49309	6" NB round with ring	1
D49311	6" CP round	1
D49313	6" CP round with ring	1

ABS

PART NO.	STRAINER	CTN QTY
D49302	6" SS round	1
D49304	6" PB round	1
D49306	6" PB round with ring	1
D49308	6" NB round	1
D49310	6" NB round with ring	1
D49312	6" CP round	1
D49314	6" CP round with ring	1

2" x 3" Slab Drain Base with 3" Metal Spud

Fits Over 2" and Inside 3" Schedule 40 DWV Pipe

MADE IN THE USA

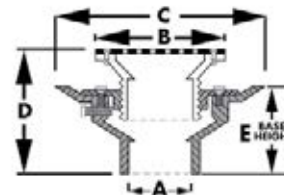

- Completely adjustable
- 8-1/2" pan for applications where no clamping ring is required
- Strainers are available in PB and NB
- Spud threads directly into base
- Primer tapped with 1/2" plug
- Gray PVC or Black ABS

STRAINER	A	B	C	D	E
5" round	Over 2" Inside 3"	5-3/16"	8-9/16"	3-15/16" - 4-15/16"	3-3/4"

PVC

PART NO.	STRAINER	CTN QTY
D49319	5" PB round	1
D49321	5" NB round	1

ABS

PART NO.	STRAINER	CTN QTY
D49320	5" PB round	1
D49322	5" NB round	1

2" x 3" Slab Drain Base with 3-1/2" Plastic Spud

Fits Over 2" and Inside 3" Schedule 40 DWV Pipe

MADE IN THE
USA

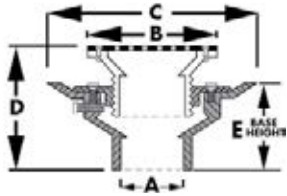

- Completely adjustable
- 8-1/2" pan for applications where no clamping ring is required
- Strainers are available in SS, PB, NB and CP
- Spud threads directly into base
- Primer tapped with 1/2" plug
- Gray PVC or Black ABS

STRAINER	A	B	C	D	E
5" round stainless steel	Over 2" Inside 3"	5-1/4"	8-9/16"	4-3/4" - 6-1/16"	3-3/4"
5" round	Over 2" Inside 3"	5-1/4"	8-9/16"	5" - 5-15/16"	3-3/4"
5" round with ring	Over 2" Inside 3"	5-9/16"	8-9/16"	5-1/8" - 6-1/8"	3-3/4"
6" round stainless steel	Over 2" Inside 3"	6-1/4"	8-9/16"	5" - 6-1/16"	3-3/4"
6" round	Over 2" Inside 3"	6-1/4"	8-9/16"	5-1/8" - 6"	3-3/4"
6" round with ring	Over 2" Inside 3"	6-9/16"	8-9/16"	5-1/4" - 6-1/4"	3-3/4"

PVC

PART NO.	STRAINER	CTN QTY
D49323	5" SS round	1
D49325	5" PB round	1
D49327	5" PB round with ring	1
D49329	5" NB round	1
D49331	5" NB round with ring	1
D49333	5" CP round	1
D49335	5" CP round with ring	1
D49337	6" SS round	1
D49339	6" PB round	1
D49341	6" PB round with ring	1
D49343	6" NB round	1
D49345	6" NB round with ring	1
D49347	6" CP round	1
D49349	6" CP round with ring	1

ABS

PART NO.	STRAINER	CTN QTY
D49324	5" SS round	1
D49326	5" PB round	1
D49328	5" PB round with ring	1
D49330	5" NB round	1
D49332	5" NB round with ring	1
D49334	5" CP round	1
D49336	5" CP round with ring	1
D49338	6" SS round	1
D49340	6" PB round	1
D49342	6" PB round with ring	1
D49344	6" NB round	1
D49346	6" NB round with ring	1
D49348	6" CP round	1
D49350	6" CP round with ring	1

2" x 3" Slab Drain Base with 3-1/2" Metal Spud

Fits Over 2" and Inside 3" Schedule 40 DWV Pipe

MADE IN THE
USA

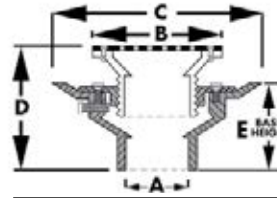

- Completely adjustable
- 8-1/2" pan for applications where no clamping ring is required
- Strainers are available in PB, NB and CP
- Spud threads directly into base
- Primer tapped with 1/2" plug
- Gray PVC or Black ABS

STRAINER	A	B	C	D	E
4" round	Over 2" Inside 3"	4-1/8"	8-9/16"	4 8" - 4-15/16"	3-3/4"
5" round	Over 2" Inside 3"	5-3/16"	8-9/16"	4" - 5"	3-3/4"
6" round	Over 2" Inside 3"	6-3/16"	8-9/16"	4-7/16" - 5-1/2"	3-3/4"

PVC

PART NO.	STRAINER	CTN QTY
D49351	4" PB round	1
D49353	4" NB round	1
D49355	5" PB round	1
D49357	5" NB round	1
D49359	5" CP round	1
D49361	6" PB round	1
D49363	6" NB round	1
D49365	6" CP round	1

ABS

PART NO.	STRAINER	CTN QTY
D49352	4" PB round	1
D49354	4" NB round	1
D49356	5" PB round	1
D49358	5" NB round	1
D49360	5" CP round	1
D49362	6" PB round	1
D49364	6" NB round	1
D49366	6" CP round	1

2"x 3" Slab Drain Base with 4" Plastic Spud

Fits Over 2" and Inside 3" Schedule 40 DWV Pipe

MADE IN THE **USA**

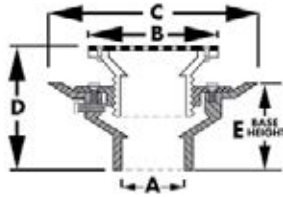

- Completely adjustable
- 8-1/2" pan for applications where no clamping ring is required
- Strainers are available in SS, PB, NB and CP
- Spud threads directly into base
- Primer tapped with 1/2" plug
- Gray PVC or Black ABS

STRAINER	A	B	C	D	E
6" round stainless steel	Over 2" Inside 3"	6-3/16"	8-9/16"	5" - 5-15/16"	3-3/4"
6" round	Over 2" Inside 3"	6-3/16"	8-9/16"	5" - 6"	3-3/4"
6" round with ring	Over 2" Inside 3"	6-7/16"	8-9/16"	5-3/16" - 6-3/16"	3-3/4"

PVC

PART NO.	STRAINER	CTN QTY
D49377	6" SS round	1
D49379	6" PB round	1
D49381	6" PB round with ring	1
D49383	6" NB round	1
D49385	6" NB round with ring	1
D49387	6" CP round	1
D49389	6" CP round with ring	1

ABS

PART NO.	STRAINER	CTN QTY
D49378	6" SS round	1
D49380	6" PB round	1
D49382	6" PB round with ring	1
D49384	6" NB round	1
D49386	6" NB round with ring	1
D49388	6" CP round	1
D49390	6" CP round with ring	1

3"x 4" Slab Drain Base with 3" Plastic Spud

Fits Over 3" and Inside 4" Schedule 40 DWV Pipe

MADE IN THE **USA**

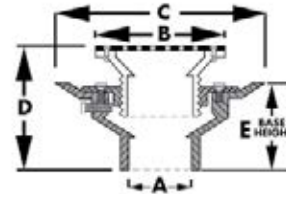

- Completely adjustable
- 8-1/2" pan for applications where no clamping ring is required
- Strainers are available in SS, PB, NB and CP
- Spud threads directly into base
- Primer tapped with 1/2" plug
- Gray PVC or Black ABS

STRAINER	A	B	C	D	E
6" round stainless steel	Over 3" Inside 4"	6-1/8"	8-9/16"	5-1/16" - 6-1/16"	3-3/4"
6" round	Over 3" Inside 4"	6-1/8"	8-9/16"	5-1/8" - 6-3/16"	3-3/4"
6" round with ring	Over 3" Inside 4"	6-7/16"	8-9/16"	5-5/16" - 6-3/8"	3-3/4"

PVC

PART NO.	STRAINER	CTN QTY
D49401	6" SS round	1
D49403	6" PB round	1
D49405	6" PB round with ring	1
D49407	6" NB round	1
D49409	6" NB round with ring	1
D49411	6" CP round	1
D49413	6" CP round with ring	1

ABS

PART NO.	STRAINER	CTN QTY
D49402	6" SS round	1
D49404	6" PB round	1
D49406	6" PB round with ring	1
D49408	6" NB round	1
D49410	6" NB round with ring	1
D49412	6" CP round	1
D49414	6" CP round with ring	1

2"x 3" Slab Drain Base with 4" Metal Spud

Fits Over 2" and Inside 3" Schedule 40 DWV Pipe

MADE IN THE **USA**

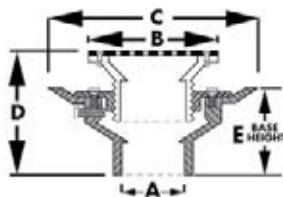

- Completely adjustable
- 8-1/2" pan for applications where no clamping ring is required
- Strainers are available in PB and NB
- Spud threads directly into base
- Primer tapped with 1/2" plug
- Gray PVC or Black ABS

STRAINER	A	B	C	D	E
5" round	Over 2" Inside 3"	5-3/16"	8-9/16"	3-7/8" - 4-7/8"	3-3/4"

PVC

PART NO.	STRAINER	CTN QTY
D49395	5" PB round	1
D49397	5" NB round	1

ABS

PART NO.	STRAINER	CTN QTY
D49396	5" PB round	1
D49398	5" NB round	1

3"x 4" Slab Drain Base with 3" Metal Spud

Fits Over 3" and Inside 4" Schedule 40 DWV Pipe

MADE IN THE **USA**

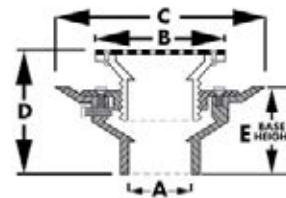

- Completely adjustable
- 8-1/2" pan for applications where no clamping ring is required
- Strainers are available in PB and NB
- Spud threads directly into base
- Primer tapped with 1/2" plug
- Gray PVC or Black ABS

STRAINER	A	B	C	D	E
5" round	Over 3" Inside 4"	5-3/16"	8-9/16"	4-1/8" - 5-1/8"	3-3/4"

PVC

PART NO.	STRAINER	CTN QTY
D49419	5" PB round	1
D49421	5" NB round	1

ABS

PART NO.	STRAINER	CTN QTY
D49420	5" PB round	1
D49422	5" NB round	1

3"x 4" Slab Drain Base with 3-1/2" Plastic Spud

Fits Over 3" and Inside 4" Schedule 40 DWV Pipe

MADE IN THE
USA

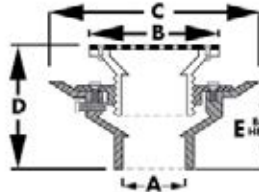

- Completely adjustable
- 8-1/2" pan for applications where no clamping ring is required
- Strainers are available in SS, PB, NB and CP
- Spud threads directly into base
- Primer tapped with 1/2" plug
- Gray PVC or Black ABS

STRAINER	A	B	C	D	E
5" round stainless steel	Over 3" Inside 4"	5-1/4"	8-9/16"	5" - 6-1/8"	3-3/4"
5" round	Over 3" Inside 4"	5-1/4"	8-9/16"	5-3/16" - 6-3/16"	3-3/4"
5" round with ring	Over 3" Inside 4"	5-9/16"	8-9/16"	5-3/8" - 6-5/16"	3-3/4"
6" round stainless steel	Over 3" Inside 4"	6-1/4"	8-9/16"	5-1/16" - 6-1/16"	3-3/4"
6" round	Over 3" Inside 4"	6-1/4"	8-9/16"	5-3/16" - 6-3/16"	3-3/4"
6" round with ring	Over 3" Inside 4"	6-9/16"	8-9/16"	5-5/16" - 6-3/8"	3-3/4"

PVC

PART NO.	STRAINER	CTN QTY
D49423	5" SS round	1
D49425	5" PB round	1
D49427	5" PB round with ring	1
D49429	5" NB round	1
D49431	5" NB round with ring	1
D49433	5" CP round	1
D49435	5" CP round with ring	1
D49437	6" SS round	1
D49439	6" PB round	1
D49441	6" PB round with ring	1
D49443	6" NB round	1
D49445	6" NB round with ring	1
D49447	6" CP round	1
D49449	6" CP round with ring	1

ABS

PART NO.	STRAINER	CTN QTY
D49424	5" SS round	1
D49426	5" PB round	1
D49428	5" PB round with ring	1
D49430	5" NB round	1
D49432	5" NB round with ring	1
D49434	5" CP round	1
D49436	5" CP round with ring	1
D49438	6" SS round	1
D49440	6" PB round	1
D49442	6" PB round with ring	1
D49444	6" NB round	1
D49446	6" NB round with ring	1
D49448	6" CP round	1
D49450	6" CP round with ring	1

3"x 4" Slab Drain Base with 3-1/2" Metal Spud

Fits Over 3" and Inside 4" Schedule 40 DWV Pipe

MADE IN THE
USA

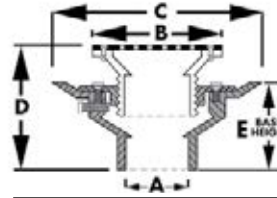

- Completely adjustable
- 8-1/2" pan for applications where no clamping ring is required
- Strainers are available in PB, NB and CP
- Spud threads directly into base
- Primer tapped with 1/2" plug
- Gray PVC or Black ABS

STRAINER	A	B	C	D	E
4" round	Over 3" Inside 4"	4-1/8"	8-9/16"	4-1/8" - 5-1/16"	3-15/16"
5" round	Over 3" Inside 4"	5-3/16"	8-9/16"	4-1/8" - 5-1/4"	3-15/16"
6" round	Over 3" Inside 4"	6-3/16"	8-9/16"	4-9/16" - 5-7/16"	3-15/16"
8" round	Over 3" Inside 4"	8-1/8"	8-9/16"	5-1/16" - 6"	3-15/16"
9" round	Over 3" Inside 4"	9"	8-9/16"	5" - 6-1/8"	3-15/16"

PVC

PART NO.	STRAINER	CTN QTY
D49451	4" PB round	1
D49453	4" NB round	1
D49455	5" PB round	1
D49457	5" NB round	1
D49459	5" CP round	1
D49461	6" PB round	1
D49463	6" NB round	1
D49465	6" CP round	1
D49467	8" PB round	1
D49469	8" NB round	1
D49471	8" CP round	1
D49473	9" PB round	1
D49475	9" NB round	1

ABS

PART NO.	STRAINER	CTN QTY
D49452	4" PB round	1
D49454	4" NB round	1
D49456	5" PB round	1
D49458	5" NB round	1
D49460	5" CP round	1
D49462	6" PB round	1
D49464	6" NB round	1
D49466	6" CP round	1
D49468	8" PB round	1
D49470	8" NB round	1
D49472	8" CP round	1
D49474	9" PB round	1
D49476	9" NB round	1

3"x 4" Slab Drain Base with 4" Plastic Spud

Fits Over 3" and Inside 4" Schedule 40 DWV Pipe

MADE IN THE **USA**

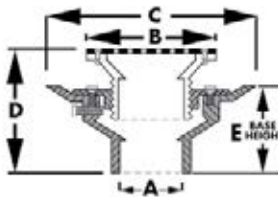

- Completely adjustable
- 8-1/2" pan for applications where no clamping ring is required
- Strainers are available in SS, PB, NB and CP
- Spud threads directly into base
- Primer tapped with 1/2" plug
- Gray PVC or Black ABS

STRAINER	A	B	C	D	E
6" round stainless steel	Over 3" Inside 4"	6-3/16"	8-9/16"	5-1/16" - 6-1/8"	3-15/16"
6" round	Over 3" Inside 4"	6-3/16"	8-9/16"	5-1/4" - 6-3/16"	3-15/16"
6" round with ring	Over 3" Inside 4"	6-7/16"	8-9/16"	5-3/8" - 6-5/16"	3-15/16"

PVC

PART NO.	STRAINER	CTN QTY
D49477	6" SS round	1
D49479	6" PB round	1
D49481	6" PB round with ring	1
D49483	6" NB round	1
D49485	6" NB round with ring	1
D49487	6" CP round	1
D49489	6" CP round with ring	1

ABS

PART NO.	STRAINER	CTN QTY
D49478	6" SS round	1
D49480	6" PB round	1
D49482	6" PB round with ring	1
D49484	6" NB round	1
D49486	6" NB round with ring	1
D49488	6" CP round	1
D49490	6" CP round with ring	1

3"x 4" Slab Drain Base with 4" Metal Spud

Fits Over 3" and Inside 4" Schedule 40 DWV Pipe

MADE IN THE **USA**

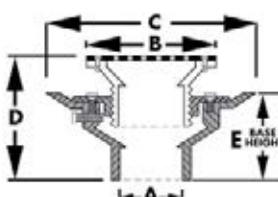

- Completely adjustable
- 8-1/2" pan for applications where no clamping ring is required
- Strainers are available in PB and NB
- Spud threads directly into base
- Primer tapped with 1/2" plug
- Gray PVC or Black ABS

STRAINER	A	B	C	D	E
5" round	Over 3" Inside 4"	5-3/16"	8-9/16"	4" - 5-1/8"	3-15/16"

PVC

PART NO.	STRAINER	CTN QTY
D49495	5" PB round	1
D49497	5" NB round	1

ABS

PART NO.	STRAINER	CTN QTY
D49496	5" PB round	1
D49498	5" NB round	1

4" Slab Drain Base with 3" Plastic Spud

Fits Over 4" Schedule 40 DWV Pipe

MADE IN THE **USA**

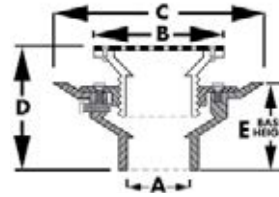

- Completely adjustable
- 8-1/2" pan for applications where no clamping ring is required
- Strainers are available in SS, PB, NB and CP
- Spud threads directly into base
- Primer tapped with 1/2" plug
- Gray PVC or Black ABS

STRAINER	A	B	C	D	E
6" round stainless steel	Over 4"	6-1/8"	8-9/16"	5-5/16" - 6-3/8"	4-3/16"
6" round	Over 4"	6-1/8"	8-9/16"	5-3/8" - 6-5/16"	4-3/16"
6" round with ring	Over 4"	6-7/16"	8-9/16"	5-1/8" - 6-9/16"	4-3/16"

PVC

PART NO.	STRAINER	CTN QTY
D49501	6" SS round	1
D49503	6" PB round	1
D49505	6" PB round with ring	1
D49507	6" NB round	1
D49509	6" NB round with ring	1
D49511	6" CP round	1
D49513	6" CP round with ring	1

ABS

PART NO.	STRAINER	CTN QTY
D49502	6" SS round	1
D49504	6" PB round	1
D49506	6" PB round with ring	1
D49508	6" NB round	1
D49510	6" NB round with ring	1
D49512	6" CP round	1
D49514	6" CP round with ring	1

4" Slab Drain Base with 3" Metal Spud

Fits Over 4" Schedule 40 DWV Pipe

MADE IN THE **USA**

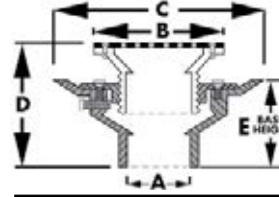

- Completely adjustable
- 8-1/2" pan for applications where no clamping ring is required
- Strainers are available in PB and NB
- Spud threads directly into base
- Primer tapped with 1/2" plug
- Gray PVC or Black ABS

STRAINER	A	B	C	D	E
5" round	Over 4"	5-3/16"	8-9/16"	4-5/16" - 5-3/8"	4-3/16"

PVC

PART NO.	STRAINER	CTN QTY
D49519	5" PB round	1
D49521	5" NB round	1

ABS

PART NO.	STRAINER	CTN QTY
D49520	5" PB round	1
D49522	5" NB round	1

4" Slab Drain Base with 3-1/2" Plastic Spud

Fits Over 4" Schedule 40 DWV Pipe

MADE IN THE
USA

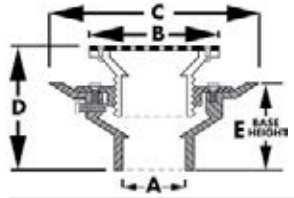

- Completely adjustable
- 8-1/2" pan for applications where no clamping ring is required
- Strainers are available in SS, PB, NB and CP
- Spud threads directly into base
- Primer tapped with 1/2" plug
- Gray PVC or Black ABS

STRAINER	A	B	C	D	E
5" round stainless steel	Over 4"	5-1/4"	8-9/16"	5-1/4" - 6-7/16"	4-3/16"
5" round	Over 4"	5-1/4"	8-9/16"	5-3/8" - 6-7/16"	4-3/16"
5" round with ring	Over 4"	5-9/16"	8-9/16"	5-9/16" - 6-5/8"	4-3/16"
6" round stainless steel	Over 4"	6-1/4"	8-9/16"	5-3/8" - 6-7/16"	4-3/16"
6" round	Over 4"	6-1/4"	8-9/16"	5-7/16" - 6-7/16"	4-3/16"
6" round with ring	Over 4"	6-9/16"	8-9/16"	5-1/2" - 6-5/8"	4-3/16"

PVC

PART NO.	STRAINER	CTN QTY
D49523	5" SS round	1
D49525	5" PB round	1
D49527	5" PB round with ring	1
D49529	5" NB round	1
D49531	5" NB round with ring	1
D49533	5" CP round	1
D49535	5" CP round with ring	1
D49537	6" SS round	1
D49539	6" PB round	1
D49541	6" PB round with ring	1
D49543	6" NB round	1
D49545	6" NB round with ring	1
D49547	6" CP round	1
D49549	6" CP round with ring	1

ABS

PART NO.	STRAINER	CTN QTY
D49524	5" SS round	1
D49526	5" PB round	1
D49528	5" PB round with ring	1
D49530	5" NB round	1
D49532	5" NB round with ring	1
D49534	5" CP round	1
D49536	5" CP round with ring	1
D49538	6" SS round	1
D49540	6" PB round	1
D49542	6" PB round with ring	1
D49544	6" NB round	1
D49546	6" NB round with ring	1
D49548	6" CP round	1
D49550	6" CP round with ring	1

4" Slab Drain Base with 3-1/2" Metal Spud

Fits Over 4" Schedule 40 DWV Pipe

MADE IN THE
USA

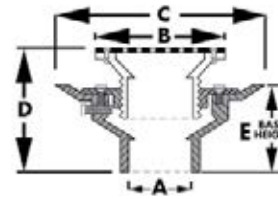

- Completely adjustable
- 8-1/2" pan for applications where no clamping ring is required
- Strainers are available in PB, NB and CP
- Spud threads directly into base
- Primer tapped with 1/2" plug
- Gray PVC or Black ABS

STRAINER	A	B	C	D	E
4" round	Over 4"	4-1/8"	8-9/16"	4-7/16" - 5-7/16"	4-3/16"
5" round	Over 4"	5-3/16"	8-9/16"	4-5/16" - 5-7/16"	4-3/16"
6" round	Over 4"	6-3/16"	8-9/16"	4-13/16" - 5-13/16"	4-3/16"

PVC

PART NO.	STRAINER	CTN QTY
D49551	4" PB round	1
D49553	4" NB round	1
D49555	5" PB round	1
D49557	5" NB round	1
D49559	5" CP round	1
D49561	6" PB round	1
D49563	6" NB round	1
D49565	6" CP round	1

ABS

PART NO.	STRAINER	CTN QTY
D49552	4" PB round	1
D49554	4" NB round	1
D49556	5" PB round	1
D49558	5" NB round	1
D49560	5" CP round	1
D49562	6" PB round	1
D49564	6" NB round	1
D49566	6" CP round	1

4" Slab Drain Base with 4" Plastic Spud

Fits Over 4" Schedule 40 DWV Pipe

MADE IN THE
USA

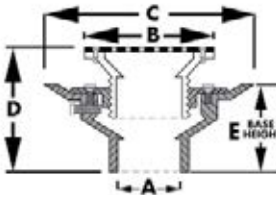

- Completely adjustable
- 8-1/2" pan for applications where no clamping ring is required
- Strainers are available in SS, PB, NB and CP
- Spud threads directly into base
- Primer tapped with 1/2" plug
- Gray PVC or Black ABS

STRAINER	A	B	C	D	E
6" round stainless steel	Over 4"	6-3/16"	8-9/16"	5-3/8" — 6-3/8"	4-3/16"
6" round	Over 4"	6-3/16"	8-9/16"	5-7/16" — 6-7/16"	4-3/16"
6" round with ring	Over 4"	6-7/16"	8-9/16"	5-5/8" — 6-9/16"	4-3/16"

PVC

PART NO.	STRAINER	CTN QTY
D49577	6" SS round	1
D49579	6" PB round	1
D49581	6" PB round with ring	1
D49583	6" NB round	1
D49585	6" NB round with ring	1
D49587	6" CP round	1
D49589	6" CP round with ring	1

ABS

PART NO.	STRAINER	CTN QTY
D49578	6" SS round	1
D49580	6" PB round	1
D49582	6" PB round with ring	1
D49584	6" NB round	1
D49586	6" NB round with ring	1
D49588	6" CP round	1
D49590	6" CP round with ring	1

4" Slab Drain Base with 4" Metal Spud

Fits Over 4" Schedule 40 DWV Pipe

MADE IN THE
USA

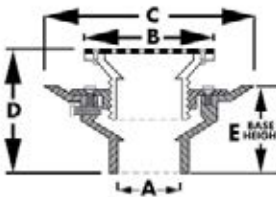

- Completely adjustable
- 8-1/2" pan for applications where no clamping ring is required
- Strainers are available in PB and NB
- Spud threads directly into base
- Primer tapped with 1/2" plug
- Gray PVC or Black ABS

STRAINER	A	B	C	D	E
5" round	Over 4"	5-3/16"	8-9/16"	4-1/4" — 5-5/16"	4-3/16"

PVC

PART NO.	STRAINER	CTN QTY
D49595	5" PB round	1
D49597	5" NB round	1

ABS

PART NO.	STRAINER	CTN QTY
D49596	5" PB round	1
D49598	5" NB round	1

PVC and ABS 10" Pan Commercial Drains

Pages 205-209

SIZES: 2", 3", 4"



For use in applications where a membrane is required.

2" Heavy Duty Drain Base with 3-1/2" Plastic Spud

Fits Over 2" Schedule 40 DWV Pipe

MADE IN THE
USA

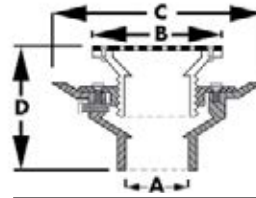

- 10" Pan
- Strainers are available in SS, PB, NB and CP
- Stainless steel strainers are .06" thick
- PB, NB and CP strainers are 3/16" thick
- Primer tapped with 1/2" plug
- Adjustable (see dimension D)

STRAINER	A	B	C	D
5" round	Over 2"	5-3/16"	11"	4-3/8" - 6"
5" round with ring	Over 2"	5-1/2"	11"	4-1/2" - 6-1/8"
6" round	Over 2"	6-1/8"	11"	4-7/16" - 6-1/16"
6" round with ring	Over 2"	6-1/2"	11"	4-1/2" - 6-1/4"

PVC

PART NO.	STRAINER	CTN QTY
D53442	5" SS round	1
D53443	5" PB round	1
D53444	5" PB round with ring	1
D53445	5" NB round	1
D53446	5" NB round with ring	1
D53447	5" CP round	1
D53448	5" CP round with ring	1
D50037	6" SS round	1
D50044	6" PB round	1
D50050	6" PB round with ring	1
D50047	6" NB round	1
D50053	6" NB round with ring	1
D50040	6" CP round	1
D50278	6" CP round with ring	1

ABS

PART NO.	STRAINER	CTN QTY
D53449	5" SS round	1
D53450	5" PB round	1
D53451	5" PB round with ring	1
D53452	5" NB round	1
D53453	5" NB round with ring	1
D53454	5" CP round	1
D53455	5" CP round with ring	1
D51037	6" SS round	1
D51044	6" PB round	1
D51050	6" PB round with ring	1
D51047	6" NB round	1
D51053	6" NB round with ring	1
D51040	6" CP round	1
D51278	6" CP round with ring	1

E

2" Heavy Duty Drain Base with 3-1/2" Metal Spud

Fits Over 2" Schedule 40 DWV Pipe

MADE IN THE USA

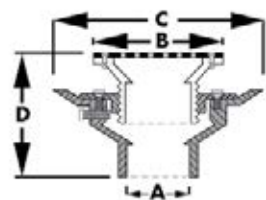

- 10" Pan
- Strainers are available in PB, NB and CP
- PB, NB and CP strainers are 3/16" thick
- Primer tapped with 1/2" plug
- Adjustable (see dimension D)

STRAINER	A	B	C	D
5" or 6" round	Over 2"	5" or 6"	11"	4-1/4" - 5-5/8"
5" or 6" square	Over 2"	5" or 6"	11"	4-1/4" - 5-5/8"

PVC

PART NO.	STRAINER	CTN QTY
D50027	5" PB round	1
D50060	5" NB round	1
D50022	5" CP round	1
D50028	6" PB round	1
D50063	6" NB round	1
D50023	6" CP round	1
D50066	5" PB square	1
D50072	5" NB square	1
D50069	6" PB square	1
D50075	6" NB square	1

ABS

PART NO.	STRAINER	CTN QTY
D51027	5" PB round	1
D51060	5" NB round	1
D51022	5" CP round	1
D51028	6" PB round	1
D51063	6" NB round	1
D51023	6" CP round	1
D51066	5" PB square	1
D51072	5" NB square	1
D51069	6" PB square	1
D51075	6" NB square	1

2" Heavy Duty Drain Base with 4" Plastic Spud

Fits Over 2" Schedule 40 DWV Pipe

MADE IN THE USA

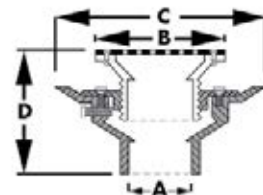

- 10" Pan
- Strainers are available in SS, PB, NB and CP
- Stainless steel strainers are .06" thick
- PB, NB and CP strainers are 3/16" thick
- Primer tapped with 1/2" plug
- Adjustable (see dimension D)

STRAINER	A	B	C	D
6" round	Over 2"	6-1/8"	11"	4-7/16" - 6-1/16"
6" round with ring	Over 2"	6-1/2"	11"	4-1/2" - 6-1/4"

PVC

PART NO.	STRAINER	CTN QTY
D50340	6" SS round	1
D50341	6" PB round	1
D50342	6" PB round with ring	1
D50343	6" NB round	1
D50344	6" NB round with ring	1
D50345	6" CP round	1
D50346	6" CP round with ring	1

ABS

PART NO.	STRAINER	CTN QTY
D51340	6" SS round	1
D51341	6" PB round	1
D51342	6" PB round with ring	1
D51343	6" NB round	1
D51344	6" NB round with ring	1
D51345	6" CP round	1
D51346	6" CP round with ring	1

2" Heavy Duty Drain Base with 4" Metal Spud

Fits Over 2" Schedule 40 DWV Pipe

MADE IN THE USA

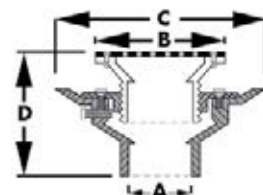

- 10" Pan
- Strainers are available in PB and NB
- Strainers are 3/16" thick
- Primer tapped with 1/2" plug
- Adjustable (see dimension D)

STRAINER	A	B	C	D
5" round	Over 2"	5"	11"	4-1/4" - 5-5/8"

PVC

PART NO.	STRAINER	CTN QTY
D50349	5" NB round	1
D50350	5" PB round	1

ABS

PART NO.	STRAINER	CTN QTY
D51349	5" NB round	1
D51350	5" PB round	1

3" Heavy Duty Drain Base with 3-1/2" Plastic Spud

Fits Over 3" Schedule 40 DWV Pipe

MADE IN THE USA

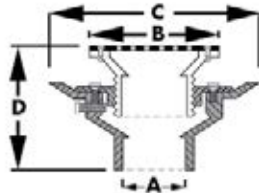

- 10" Pan
- Strainers are available in SS, PB, NB and CP
- Stainless steel strainers are .06" thick
- PB, NB and CP strainers are 3/16" thick
- Primer tapped with 1/2" plug
- Adjustable (see dimension D)

STRAINER	A	B	C	D
5" round	Over 3"	5-3/16"	11"	4-3/8" - 6"
5" round with ring	Over 3"	5-1/2"	11"	4-1/2" - 6-1/8"
6" round	Over 3"	6-1/8"	11"	4-11/16" - 6-7/16"
6" round with ring	Over 3"	6-1/2"	11"	4-3/4" - 6-1/2"

PVC

PART NO.	STRAINER	CTN QTY
D53456	5" SS round	1
D53457	5" PB round	1
D53458	5" PB round with ring	1
D53459	5" NB round	1
D53460	5" NB round with ring	1
D53461	5" CP round	1
D53462	5" CP round with ring	1
D50038	6" SS round	1
D50045	6" PB round	1
D50051	6" PB round with ring	1
D50048	6" NB round	1
D50054	6" NB round with ring	1
D50041	6" CP round	1
D50279	6" CP round with ring	1

ABS

PART NO.	STRAINER	CTN QTY
D53463	5" SS round	1
D53464	5" PB round	1
D53465	5" PB round with ring	1
D53466	5" NB round	1
D53467	5" NB round with ring	1
D53468	5" CP round	1
D53469	5" CP round with ring	1
D51038	6" SS round	1
D51045	6" PB round	1
D51051	6" PB round with ring	1
D51048	6" NB round	1
D51054	6" NB round with ring	1
D51041	6" CP round	1
D51279	6" CP round with ring	1

3" Heavy Duty Drain Base with 3-1/2" Metal Spud

Fits Over 3" Schedule 40 DWV Pipe

MADE IN THE USA

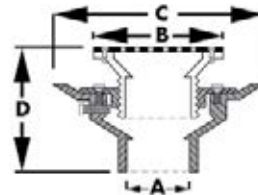

- 10" Pan
- Strainers are available in PB, NB and CP
- PB, NB and CP strainers are 3/16" thick
- Primer tapped with 1/2" plug
- Adjustable (see dimension D)

STRAINER	A	B	C	D
5", 6", 8" or 9" round	Over 3"	5", 6", 8" or 9"	11"	5" - 6-1/2"
5" or 6" square	Over 3"	5" or 6"	11"	5" - 6-1/2"

PVC

PART NO.	STRAINER	CTN QTY
D50012	5" PB round	1
D50061	5" NB round	1
D50004	5" CP round	1
D50013	6" PB round	1
D50064	6" NB round	1
D50005	6" CP round	1
D50014	8" PB round	1
D53144	8" NB round	1
D50006	8" CP round	1
D53148	9" PB round	1
D53146	9" NB round	1
D50067	5" PB square	1
D50073	5" NB square	1
D50070	6" PB square	1
D50076	6" NB square	1

ABS

PART NO.	STRAINER	CTN QTY
D51012	5" PB round	1
D51061	5" NB round	1
D51004	5" CP round	1
D51013	6" PB round	1
D51064	6" NB round	1
D51005	6" CP round	1
D51014	8" PB round	1
D53145	8" NB round	1
D51006	8" CP round	1
D53149	9" PB round	1
D53147	9" NB round	1
D51067	5" PB square	1
D51073	5" NB square	1
D51070	6" PB square	1
D51076	6" NB square	1

Items marked with the Jones Stephens logo are "You Need It... We Got It" Items.

3" Heavy Duty Drain Base with 4" Plastic Spud

Fits Over 3" Schedule 40 DWV Pipe

MADE IN THE USA

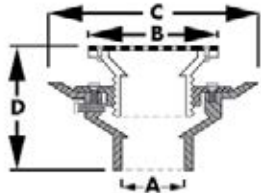

- 10" Pan
- Strainers are available in SS, PB, NB and CP
- Stainless steel strainers are .06" thick
- PB, NB and CP strainers are 3/16" thick
- Primer tapped with 1/2" plug
- Adjustable (see dimension D)

STRAINER	A	B	C	D
6" round	Over 3"	6-1/8"	4-5/8" - 6"	4-11/16" - 6-7/16"
6" round with ring	Over 3"	6-1/2"	4-5/8" - 6"	4-3/4" - 6-1/2"

PVC

PART NO.	STRAINER	CTN QTY
D50351	6" SS round	1
D50352	6" PB round	1
D50353	6" PB round with ring	1
D50354	6" NB round	1
D50355	6" NB round with ring	1
D50356	6" CP round	1
D50357	6" CP round with ring	1

ABS

PART NO.	STRAINER	CTN QTY
D51351	6" SS round	1
D51352	6" PB round	1
D51353	6" PB round with ring	1
D51354	6" NB round	1
D51355	6" NB round with ring	1
D51356	6" CP round	1
D51357	6" CP round with ring	1

3" Heavy Duty Drain Base with 4" Metal Spud

Fits Over 3" Schedule 40 DWV Pipe

MADE IN THE USA

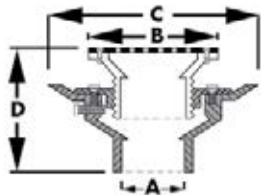

- 10" Pan
- Strainers are available in PB and NB
- Strainers are 3/16" thick
- Primer tapped with 1/2" plug
- Adjustable (see dimension D)

STRAINER	A	B	C	D
5" round	Over 3"	5"	4-5/8" - 6"	5" - 6-1/2"

PVC

PART NO.	STRAINER	CTN QTY
D50361	5" PB round	1
D50360	5" NB round	1

ABS

PART NO.	STRAINER	CTN QTY
D51361	5" PB round	1
D51360	5" NB round	1

4" Heavy Duty Drain Base with 3-1/2" Plastic Spud

Fits Over 4" Schedule 40 DWV Pipe

MADE IN THE USA

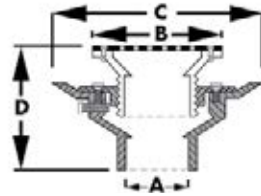

- 10" Pan
- Strainers are available in SS, PB, NB and CP
- Stainless steel strainers are .06" thick
- PB, NB and CP strainers are 3/16" thick
- Primer tapped with 1/2" plug
- Adjustable (see dimension D)

STRAINER	A	B	C	D
5" round	Over 4"	5-3/16"	11"	4-3/8" - 6"
5" round with ring	Over 4"	5-1/2"	11"	4-1/2" - 6-1/8"
6" round	Over 4"	6-1/8"	11"	5-1/16" - 6-13/16"
6" round with ring	Over 4"	6-1/2"	11"	5-1/4" - 6-15/16"

PVC

PART NO.	STRAINER	CTN QTY
D53470	5" SS round	1
D53471	5" PB round	1
D53472	5" PB round with ring	1
D53473	5" NB round	1
D53474	5" NB round with ring	1
D53475	5" CP round	1
D53476	5" CP round with ring	1
D50039	6" SS round	1
D50046	6" PB round	1
D50052	6" PB round with ring	1
D50049	6" NB round	1
D50055	6" NB round with ring	1
D50042	6" CP round	1
D50280	6" CP round with ring	1

ABS

PART NO.	STRAINER	CTN QTY
D53477	5" SS round	1
D53478	5" PB round	1
D53479	5" PB round with ring	1
D53480	5" NB round	1
D53481	5" NB round with ring	1
D53482	5" CP round	1
D53483	5" CP round with ring	1
D51039	6" SS round	1
D51046	6" PB round	1
D51052	6" PB round with ring	1
D51049	6" NB round	1
D51055	6" NB round with ring	1
D51042	6" CP round	1
D51280	6" CP round with ring	1

4" Heavy Duty Drain Base with 3-1/2" Metal Spud

Fits Over 4" Schedule 40 DWV Pipe

MADE IN THE USA

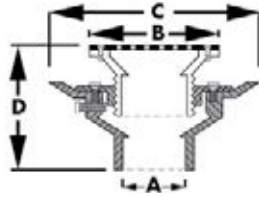

- 10" Pan
- Strainers are available in PB, NB and CP
- PB, NB and CP strainers are 3/16" thick
- Primer tapped with 1/2" plug
- Adjustable (see dimension D)

STRAINER	A	B	C	D
5" or 6" round	Over 4"	5" or 6"	11"	4-5/8" - 5-7/8"
5" or 6" square	Over 4"	5" or 6"	11"	4-5/8" - 5-7/8"

PVC

PART NO.	STRAINER	CTN QTY
D50062	5" NB round	1
D50015	5" PB round	1
D50007	5" CP round	1
D50065	6" NB round	1
D50016	6" PB round	1
D50008	6" CP round	1
D50068	5" PB square	1
D50074	5" NB square	1
D50071	6" PB square	1
D50077	6" NB square	1

ABS

PART NO.	STRAINER	CTN QTY
D51062	5" NB round	1
D51015	5" PB round	1
D51007	5" CP round	1
D51065	6" NB round	1
D51016	6" PB round	1
D51008	6" CP round	1
D51068	5" PB square	1
D51074	5" NB square	1
D51071	6" PB square	1
D51077	6" NB square	1

4" Heavy Duty Drain Base with 4" Plastic Spud

Fits Over 4" Schedule 40 DWV Pipe

MADE IN THE USA

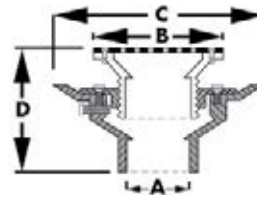

- 10" Pan
- Strainers are available in SS, PB, NB and CP
- Stainless steel strainers are .06" thick
- PB, NB and CP strainers are 3/16" thick
- Primer tapped with 1/2" plug
- Adjustable (see dimension D)

STRAINER	A	B	C	D
6" round	Over 4"	6-1/8"	11"	5-1/16" - 6-13/16"
6" round with ring	Over 4"	6-1/2"	11"	5-1/4" - 6-15/16"

PVC

PART NO.	STRAINER	CTN QTY
D50362	6" SS round	1
D50363	6" PB round	1
D50364	6" PB round with ring	1
D50365	6" NB round	1
D50366	6" NB round with ring	1
D50367	6" CP round	1
D50368	6" CP round with ring	1

ABS

PART NO.	STRAINER	CTN QTY
D51362	6" SS round	1
D51363	6" PB round	1
D51364	6" PB round with ring	1
D51365	6" NB round	1
D51366	6" NB round with ring	1
D51367	6" CP round	1
D51368	6" CP round with ring	1

4" Heavy Duty Drain Base with 4" Metal Spud

Fits Over 4" Schedule 40 DWV Pipe

MADE IN THE USA

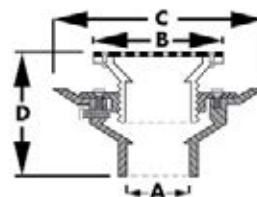

- 10" Pan
- Strainers are available in PB and NB
- Strainers are 3/16" thick
- Primer tapped with 1/2" plug
- Adjustable (see dimension D)

STRAINER	A	B	C	D
5" round	Over 4"	5"	11"	4-5/8" - 5-7/8"

PVC

PART NO.	STRAINER	CTN QTY
D50372	5" PB round	1
D50371	5" NB round	1

ABS

PART NO.	STRAINER	CTN QTY
D51372	5" PB round	1
D51371	5" NB round	1

PVC and ABS Commercial Drain Components

Pages 210-215

SIZES: 2", 2" x 3", 3", 3-1/2",
3" x 4", 4"



For use in commercial applications.

Pipe Fit Base

- 2" Fits Over 2" Schedule 40 DWV Pipe
- 3" Fits Over 3" Schedule 40 DWV Pipe
- 3" x 4" Fits Over 3" or Inside 4" Schedule 40 DWV Pipe
- 4" Fits Over 4" Schedule 40 DWV Pipe



PVC

PART NO.	PIPE SIZE	SPUD	CTN QTY
D52120	2" with PT	2"	20
D52012	2"	2"	20
D52450	3" x 4" with PT	3"	10
D52400	3" x 4"	3-1/2"	10
D52451	3" x 4" with PT	3-1/2"	10
D52005	4"	3-1/2"	10
D52452	4" with PT	3-1/2"	10
D52014	4"	4"	10
D52453	4" with PT	4"	10

ABS

PART NO.	PIPE SIZE	SPUD SIZE	CTN QTY
D52112	2"	2"	20
D52016	3"	3"	10
D52460	3" x 4" with PT	3"	10
D52500	3" x 4"	3-1/2"	10
D52461	3" x 4" with PT	3-1/2"	10
D52105	4"	3-1/2"	10
D52462	4" with PT	3-1/2"	10
D52017	4"	4"	10
D52463	4" with PT	4"	10

Inside Pipe Fit Base

- 3" Fits Over 3" Schedule 40 DWV Pipe
- 4" Fits Over 4" Schedule 40 DWV Pipe



PVC

PART NO.	PIPE SIZE	SPUD	CTN QTY
D52023	3"	2"	1
D52004	4"	3"	1

ABS

PART NO.	PIPE SIZE	SPUD	CTN QTY
D52123	3"	2"	1
D52104	4"	3"	1

Hub Fit Base

4" Fits Inside 4" Hub Schedule 40 DWV Pipe



PVC			
PART NO.	PIPE SIZE	SPUD	CTN QTY
D52003	4"	3-1/2"	1
ABS			
PART NO.	PIPE SIZE	SPUD	CTN QTY
D52103	4"	3-1/2"	1

Heavy Duty Base with Clamping Ring

2" x 3" Fits Over 2" or Inside 3" Schedule 40 DWV Pipe
3" x 4" Fits Over 3" or Inside 4" Schedule 40 DWV Pipe
4" Fits Over 4" Schedule 40 DWV Pipe



- Completely adjustable; reversible clamping ring gains additional 1" height
- 8-1/2" Pan
- Extra weep holes
- Primer tapped with 1/2" plug
- Gray PVC or Black ABS

PVC			
PART NO.	PIPE SIZE	SPUD	CTN QTY
D49800	2" x 3"	3"	1
D49801	2" x 3"	3-1/2"	1
D49802	2" x 3"	4"	1
D49803	3" x 4"	3"	1
D49804	3" x 4"	3-1/2"	1
D49805	3" x 4"	4"	1
D49806	4"	3"	1
D49807	4"	3-1/2"	1
D49808	4"	4"	1
ABS			
PART NO.	PIPE SIZE	SPUD	CTN QTY
D49810	2" x 3"	3"	1
D49811	2" x 3"	3-1/2"	1
D49812	2" x 3"	4"	1
D49813	3" x 4"	3"	1
D49814	3" x 4"	3-1/2"	1
D49815	3" x 4"	4"	1
D49816	4"	3"	1
D49817	4"	3-1/2"	1
D49818	4"	4"	1

Slab Drain Base

2" x 3" Fits Over 2" or Inside 3" Schedule 40 DWV Pipe
3" x 4" Fits Over 3" or Inside 4" Schedule 40 DWV Pipe
4" Fits Over 4" Schedule 40 DWV Pipe



- Completely adjustable
- 8-1/2" Pan for applications where no clamping ring is required
- Spud threads directly into base
- Primer tapped with 1/2" plug
- Gray PVC or Black ABS

PVC			
PART NO.	PIPE SIZE	SPUD	CTN QTY
D49850	2" x 3"	3"	1
D49851	2" x 3"	3-1/2"	1
D49852	2" x 3"	4"	1
D49853	3" x 4"	3"	1
D49854	3" x 4"	3-1/2"	1
D49855	3" x 4"	4"	1
D49856	4"	3"	1
D49857	4"	3-1/2"	1
D49858	4"	4"	1
ABS			
PART NO.	PIPE SIZE	SPUD	CTN QTY
D49860	2" x 3"	3"	1
D49861	2" x 3"	3-1/2"	1
D49862	2" x 3"	4"	1
D49863	3" x 4"	3"	1
D49864	3" x 4"	3-1/2"	1
D49865	3" x 4"	4"	1
D49866	4"	3"	1
D49867	4"	3-1/2"	1
D49868	4"	4"	1

Heavy Duty Base

2" Fits Over 2" Schedule 40 DWV Pipe
3" Fits Over 3" Schedule 40 DWV Pipe
4" Fits Over 4" Schedule 40 DWV Pipe
6" Fits Over 6" Schedule 40 DWV Pipe



- 10" Pan
- Primer tapped with 1/2" plug
- Adjustable

PVC			
PART NO.	PIPE SIZE	SPUD	CTN QTY
D52202	2"	3-1/2"	1
D52205	2"	4"	1
D52203	3"	3-1/2"	1
D52206	3"	4"	1
D52204	4"	3-1/2"	1
D52207	4"	4"	1
D52216	6"	3-1/2"	1
D52217	6"	4"	1
ABS			
PART NO.	PIPE SIZE	SPUD	CTN QTY
D52302	2"	3-1/2"	1
D52305	2"	4"	1
D52303	3"	3-1/2"	1
D52306	3"	4"	1
D52304	4"	3-1/2"	1
D52307	4"	4"	1
D52316	6"	3-1/2"	1
D52317	6"	4"	1

2" Plastic Spud with Round Strainer



PVC			
PART NO.	IPS	STRAINER	CTN QTY
D50980	2"	4" SS	1
D50987	2"	4" CP	1
D50988	2"	4" CP with ring	1
D50985	2"	4" NB	1
D50986	2"	4" NB with ring	1
D50983	2"	4" PB cast	1
D50982	2"	4" PB stamped	1
D50984	2"	4" PB with ring	1

ABS			
PART NO.	IPS	STRAINER	CTN QTY
D57980	2"	4" SS	1
D57987	2"	4" CP	1
D57988	2"	4" CP with ring	1
D57985	2"	4" NB	1
D57986	2"	4" NB with ring	1
D57983	2"	4" PB cast	1
D57982	2"	4" PB stamped	1
D57984	2"	4" PB with ring	1

3" Plastic Spud with Round Strainer



PVC			
PART NO.	IPS	STRAINER	CTN QTY
D56105	3"	6" SS	1
D56205	3"	6" CP	1
D56210	3"	6" CP with ring	1
D56405	3"	6" NB	1
D56404	3"	6" NB with ring	1
D56305	3"	6" PB	1
D56304	3"	6" PB with ring	1

ABS			
PART NO.	IPS	STRAINER	CTN QTY
D57105	3"	6" SS	1
D57205	3"	6" CP	1
D57210	3"	6" CP with ring	1
D57405	3"	6" NB	1
D57404	3"	6" NB with ring	1
D57305	3"	6" PB	1
D57304	3"	6" PB with ring	1

2" Metal Spud with Round Strainer



PART NO.	IPS	STRAINER	CTN/MSTR
D60980	2"	4" SS	1/50
D60981	2"	4" CP	1/50
D60982	2"	4" PB	1/50
D60970	2"	6" CP	1/30
D60975	2"	6" PB	1/30

3" Metal Spud with Round Strainer



PART NO.	IPS	STRAINER	CTN/MSTR
D60955	3"	5" NB	1/30
D60956	3"	5" PB	1/30
D60945	3"	8" NB	1/12

2" Plastic Spud with Square Strainer



PVC			
PART NO.	IPS	STRAINER	CTN QTY
D50989	2"	4" CP	1
D50990	2"	4" PB	1

ABS			
PART NO.	IPS	STRAINER	CTN QTY
D57989	2"	4" CP	1
D57990	2"	4" PB	1

3" Plastic Spud with 7" Square Top and Round Strainer



PVC			
PART NO.	IPS	STRAINER	CTN QTY
D56501	3"	5" NB	1
D56500	3"	5" PB	1

ABS			
PART NO.	IPS	STRAINER	CTN QTY
D57501	3"	5" NB	1
D57500	3"	5" PB	1

3-1/2" Plastic Spud with Round Strainer



PVC			
PART NO.	IPS	STRAINER	CTN QTY
D56211	3-1/2"	5" SS	1
D56216	3-1/2"	5" CP	1
D56217	3-1/2"	5" CP with ring	1
D56214	3-1/2"	5" NB	1
D56215	3-1/2"	5" NB with ring	1
D56212	3-1/2"	5" PB	1
D56213	3-1/2"	5" PB with ring	1
D56106	3-1/2"	6" SS	1
D56206	3-1/2"	6" CP	1
D56209	3-1/2"	6" CP with ring	1
D56406	3-1/2"	6" NB	1
D56407	3-1/2"	6" NB with ring	1
D56306	3-1/2"	6" PB	1
D56307	3-1/2"	6" PB with ring	1

ABS			
PART NO.	IPS	STRAINER	CTN QTY
D57211	3-1/2"	5" SS	1
D57216	3-1/2"	5" CP	1
D57217	3-1/2"	5" CP with ring	1
D57214	3-1/2"	5" NB	1
D57215	3-1/2"	5" NB with ring	1
D57212	3-1/2"	5" PB	1
D57213	3-1/2"	5" PB with ring	1
D57106	3-1/2"	6" SS	1
D57206	3-1/2"	6" CP	1
D57209	3-1/2"	6" CP with ring	1
D57406	3-1/2"	6" NB	1
D57407	3-1/2"	6" NB with ring	1
D57306	3-1/2"	6" PB	1
D57307	3-1/2"	6" PB with ring	1

3-1/2" Metal Spud with Round Strainer



PART NO.	IPS	STRAINER	CTN/MSTR
D60986	3-1/2"	4" NB	1/40
D60987	3-1/2"	4" PB	1/40
D60990	3-1/2"	5" CP	1/40
D60996	3-1/2"	5" NB	1/40
D60991	3-1/2"	5" PB	1/40
D60992	3-1/2"	6" CP	1/20
D60997	3-1/2"	6" NB	1/20
D60993	3-1/2"	6" PB	1/20
D60994	3-1/2"	8" CP	1/10
D60998	3-1/2"	8" NB	1/12
D60995	3-1/2"	8" PB	1/10
D60999	3-1/2"	9" NB	1/12
D60989	3-1/2"	9" PB	1/12

3-1/2" Metal Spud with Square Strainer



PART NO.	IPS	STRAINER	CTN/MSTR
D60954	3-1/2"	5" CP	1/20
D60962	3-1/2"	5" NB	1/20
D60960	3-1/2"	5" PB	1/20
D60963	3-1/2"	6" NB	1/12
D60961	3-1/2"	6" PB	1/12

3-1/2" Plastic Spud with 7" Square Top and Round Strainer



PVC			
PART NO.	IPS	STRAINER	CTN QTY
D56503	3-1/2"	5" NB	1
D56502	3-1/2"	5" PB	1

ABS			
PART NO.	IPS	STRAINER	CTN QTY
D57503	3-1/2"	5" NB	1
D57502	3-1/2"	5" PB	1

4" Plastic Spud with Round Strainer



PVC			
PART NO.	IPS	STRAINER	CTN QTY
D56107	4"	6" SS	1
D56207	4"	6" CP	1
D56208	4"	6" CP with ring	1
D56408	4"	6" NB	1
D56409	4"	6" NB with ring	1
D56308	4"	6" PB	1
D56309	4"	6" PB with ring	1

ABS			
PART NO.	IPS	STRAINER	CTN QTY
D57107	4"	6" SS	1
D57207	4"	6" CP	1
D57208	4"	6" CP with ring	1
D57408	4"	6" NB	1
D57409	4"	6" NB with ring	1
D57308	4"	6" PB	1
D57309	4"	6" PB with ring	1

4" Metal Spud with Round Strainer



PART NO.	IPS	STRAINER	CTN/MSTR
D60958	4"	5" NB	1/30
D60959	4"	5" PB	1/30
D60940	4"	9" NB	1/8

4" Plastic Spud with 7" Square Top and Round Strainer



PVC			
PART NO.	IPS	STRAINER	CTN QTY
D56505	4"	5" NB	1
D56504	4"	5" PB	1
ABS			
PART NO.	IPS	STRAINER	CTN QTY
D57505	4"	5" NB	1
D57504	4"	5" PB	1

Replacement Strainer for Metal Spud



- Round
- Includes screws

PART NO.	FINISH	SIZE	CTN/MSTR
D60780	Stainless Steel	4" stamped	100/400
D60781	Chrome Plated	4"	1/200
D60782	Polished Brass	4"	1/200
D60967	Polished Brass	4"	1/100
D60966	Nickel Bronze	4"	1/50
D60790	Chrome Plated	5"	1/150
D60791	Polished Brass	5"	1/50
D60968	Nickel Bronze	5"	1/50
D60792	Chrome Plated	6"	1/50
D60793	Polished Brass	6"	1/50
D60969	Nickel Bronze	6"	1/50
D60795	Polished Brass	8"	1/30

Strainers/Coveralls



- 4" Fits 4-1/4" diameter drain and cleanout spuds, D50 (2" x 3") series shower drains and 2" x 3" General Purpose Drains
- 5" Fits 5" diameter drain and cleanout spuds and 3" x 4" General Purpose Drains
- 6" Fits 6-1/8" diameter drain and cleanout spuds and 4" General Purpose Drains
- Includes screws

Round			
PART NO.	SIZE	DESCRIPTION	CTN/MSTR
C60809	4"	SS coverall	100/400
D54008	4"	SS fits inside plastic ring	100/400
C60806	4"	CP cast coverall	1/100
C60808	4"	NB cast coverall	1/100
C60807	4"	PB cast coverall	1/100
C60810	4"	PB PVD finish coverall	1/400
C60814	4"	SN coverall	100/400
D54010	4"	PB fits inside plastic ring	1/100
C60811	5"	SS coverall	50/200
D54108	5"	SS fits inside plastic ring	60/240
C60803	5"	CP cast coverall	1/50
C60805	5"	NB cast coverall	1/50
C60804	5"	PB cast coverall	1/50
D59100	6"	SS coverall	1/125
C60800	6"	CP cast coverall	1/50
C60802	6"	NB cast coverall	1/50
C60801	6"	PB cast coverall	1/50

Square			
PART NO.	SIZE	DESCRIPTION	CTN/MSTR
C60888	4"	SS stamped square coverall	1/100
C60812	4"	CP cast square coverall	1/100
C60813	4"	PB cast square coverall	1/100
C60810	4"	PB PVD finish coverall	1/400

Rings



- 4" Fits 4-1/4" diameter drain and cleanout spuds, D50 (2" x 3") series shower drains and 2" x 3" General Purpose Drains
- 5" Fits 5" diameter drain and cleanout spuds and 3" x 4" General Purpose Drains
- 6" Fits 6-1/8" diameter drain and cleanout spuds and 4" General Purpose Drains

PART NO.	SIZE	DESCRIPTION	CTN/MSTR
C60818	4"	CP ring	1/200
C60825	4"	NB ring	1/200
C60824	4"	PB ring	1/200
C60819	5"	CP ring	1/100
C60823	5"	NB ring	1/100
C60822	5"	PB ring	1/100
C60817	6"	CP ring	1/80
C60821	6"	NB ring	1/80
C60820	6"	PB ring	1/80

Spud Extension



- 2-1/2" - 4" extension for a 3-1/2" drain / cleanout spud
- Use on cast iron or PVC drain bodies when additional height is needed to offset inconsistent concrete pours

PART NO.	SIZE	DESCRIPTION	CTN/MSTR
D60979	3-1/2"	Spud extension	1/12

Funnels



- Supplied with screws
- Vandal-proof installation
- Fits virtually any floor/shower drain
- Funnel tapped for 10-24 screws which are supplied with washers

PART NO.	SIZE	DESCRIPTION	CTN QTY
F65400	4"	Funnel	1
F65600	6"	Funnel	1

E

Got To Have It!

The Green Drain Waterless Trap Seal

- Prevents the spread of different dangerous bacteria that can cause potential heal hazards
- Eliminates the need to frequently pour primer and fresh water down the drain
- Saves a significant amount of time, water, costs and energy

- Requires no caulk or expensive installation tool
- Easy to install and easy to remove - no pliers needed
- Durable - will not break during installation or removal
- Seals tight - no leaking!

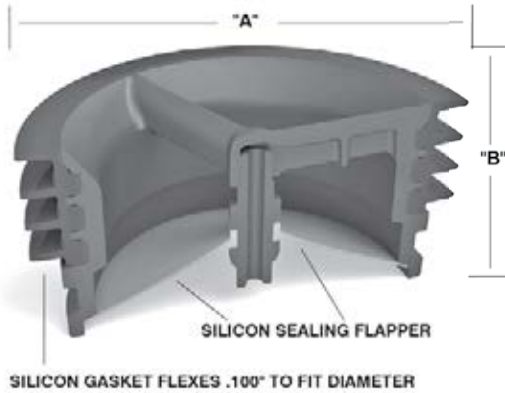

MODEL NUMBER	"A" (PIPE SIZE)	"B" (HEIGHT)
P24001	2" (51)	2" (51)
P24002	3" (76)	2" (51)
P24003	3 1/2" (89)	2" (51)
P24004	4" (102)	2" (51)

PART NO.	DESCRIPTION	CTN/MSTR
P24001	2" waterless trap seal	1/96
P24002	3" waterless trap seal	1/96
P24003	3-1/2" waterless trap seal	1/96
P24004	4" waterless trap seal	1/96

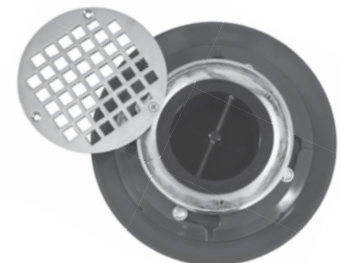

Items marked with the Jones Stephens logo are "You Need It... We Got It" Items.

PVC and ABS General Purpose/Utility Drains

Pages 216-220

SIZES: 2", 2" x 3", 3", 3" x 4", 4"



For use in residential and commercial applications.

2" x 3" General Purpose Drain

2" x 3" Fits Over 2" or Inside 3" Schedule 40 DWV Pipe

MADE IN THE
USA

NSF

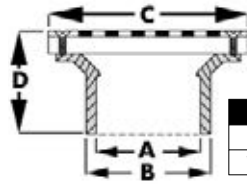

- Coverall tops
- Brass inserts

	A	B	C	D
Less rings: Over 2" pipe		Inside 3" pipe	4-1/4"	1-1/2"
With rings: Over 2" pipe		Inside 3" pipe	4-1/2"	2-1/4"

PVC

PART NO.	STRAINER	CTN QTY
D54001	4" SS round	20
D54013	4" NB round	20
D54014	4" NB round with ring	20
D54002	4" CP round	20
D54022	4" CP round with ring	20
D54015	4" PB round stamped (PVD)	20
D54011	4" PB round cast	20
D54012	4" PB round cast with ring	20

ABS

PART NO.	STRAINER	CTN QTY
D54301	4" SS round	20
D54313	4" NB round	20
D54314	4" NB round with ring	20
D54302	4" CP round	20
D54319	4" CP round with ring	20
D54315	4" PB round stamped (PVD)	20
D54311	4" PB round cast	20
D54312	4" PB round cast with ring	20

2" x 3" General Purpose Drain with Long Body

2" x 3" Fits Over 2" or Inside 3" Schedule 40 DWV Pipe

MADE IN THE
USA

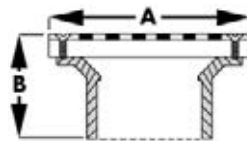

PART NO.	A	B
D54001L	4-1/4"	2"
D54002L	4-1/4"	2-1/8"
D54013L	4-1/4"	2-1/8"
D54014L	4-1/2"	2-1/4"

PVC

PART NO.	DESCRIPTION	CTN QTY
D54001L	4" SS round	20
D54002L	4" CP brass round	20
D54013L	4" NB round	20
D54014L	4" NB round with ring	20

General Purpose Drain with Cast Iron Strainer

2" x 3" Fits Over 2" or Inside 3" Schedule 40 DWV Pipe
 3" x 4" Fits Over 3" or Inside 4" Schedule 40 DWV Pipe
 4" Fits Over 4" Schedule 40 DWV Pipe

MADE IN THE
USA

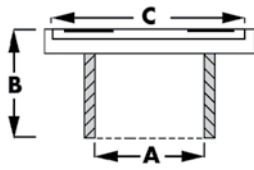

• Cast iron strainer for heavy trucking traffic areas

SIZE	A	B	C
2" x 3"	2-3/8" ID 3" OD	2-1/8"	4-3/4" ID 5-1/8" OD
3" x 4"	3-5/8" ID 4" OD	3-1/8"	4-5/8" ID 5-1/8" OD
4"	4-5/8" ID 5-1/16" OD	3-3/8"	5-3/8" ID 5-3/4" OD

PVC

PART NO.	SIZE	STRAINER	CTN QTY
D54016	2" x 3"	CI with ring	1
D54126	3" x 4"	CI with ring	1
D54136	4"	CI with ring	1

ABS

PART NO.	SIZE	STRAINER	CTN QTY
D54316	2" x 3"	CI with ring	1
D54326	3" x 4"	CI with ring	1
D54336	4"	CI with ring	1

3" x 4" General Purpose Drain

3" x 4" Fits Over 3" or Inside 4" DWV Pipe

MADE IN THE
USA

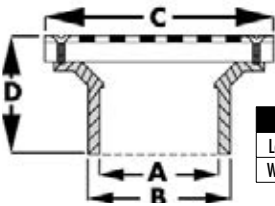

• Coverall tops
• Brass inserts

A	B	C	D
Less rings: 3" socket	Inside 4" pipe	5-3/16"	2-3/8"
With rings: 3" socket	Inside 4" pipe	5-1/2"	2-11/16"

PVC

PART NO.	STRAINER	CTN QTY
D54100	5" SS round	10
D54113	5" NB round	10
D54114	5" NB round with ring	10
D54101	5" CP round	10
D54107	5" CP round with ring	10
D54111	5" PB round	10
D54112	5" PB round with ring	10

ABS

PART NO.	STRAINER	CTN QTY
D54400	5" SS round	10
D54323	5" NB round	10
D54324	5" NB round with ring	10
D54401	5" CP round	10
D54307	5" CP round with ring	10
D54321	5" PB round	10
D54322	5" PB round with ring	10

4" General Purpose Drain

4" Fits Over 4" Schedule 40 DWV Pipe

MADE IN THE
USA

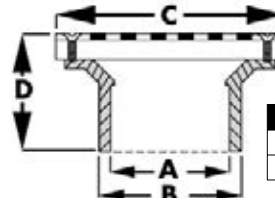

• Coverall tops
• Brass Inserts

	A	B	C	D
Less rings: Over 4" pipe	5"	6-3/16"	2-5/8"	
With rings: Over 4" pipe	5"	6-7/16"	2-3/4"	

PVC

PART NO.	STRAINER	CTN QTY
D54104	6" SS round	10
D54130	6" NB round	10
D54132	6" NB round with ring	10
D54102	6" CP round	10
D54137	6" CP round with ring	10
D54105	6" PB round	10
D54131	6" PB round with ring	10
D54133	7" PB square	5
D54134	7" NB square	5

ABS

PART NO.	STRAINER	CTN QTY
D54304	6" SS round	10
D54330	6" NB round	10
D54332	6" NB round with ring	10
D54305	6" CP round	10
D54337	6" CP round with ring	10
D54306	6" PB round	10
D54331	6" PB round with ring	10
D54333	7" PB square	5
D54334	7" NB square	5

8-1/2" Pan Heavy Duty Traffic Floor Drain

MADE IN THE
USA



• Floor sink, area drain, garbage drain, yard drain
• Full plastic 7-1/4" grate; 8-1/2" pan
• Sediment bucket option

PVC

PART NO.	DESCRIPTION	CTN QTY
D49820	2" x 3" drain	1
D49821	3" x 4" drain	1
D49822	4" drain	1
D49826	2" x 3" drain (with sediment bucket)	1
D49827	3" x 4" drain (with sediment bucket)	1
D49828	4" drain (with sediment bucket)	1

ABS

PART NO.	DESCRIPTION	CTN QTY
D49823	2" x 3" drain	1
D49824	3" x 4" drain	1
D49825	4" drain	1
D49829	2" x 3" drain (with sediment bucket)	1
D49830	3" x 4" drain (with sediment bucket)	1
D49831	4" drain (with sediment bucket)	1

Sediment Bucket Only

PART NO.	DESCRIPTION	CTN QTY
D49924	Sediment bucket	1

Heavy Duty Traffic Floor Drain

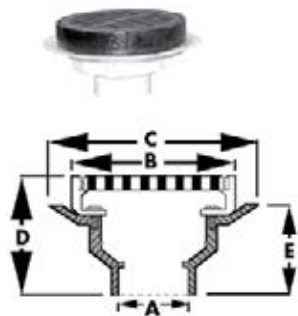

- Floor sink, area drain, garbage drain, yard drain
- 8-1/2" diameter grate
- Brass inserts
- Available with cast iron or plastic grate and ring
- Includes 1/2" primer tap



	A	B	C	D	E
Over 2" pipe	9"	11"	4-11/16"	3-5/16"	
Over 3" pipe	9"	11"	4-11/16"	3-5/16"	
Over 4" pipe	9"	11"	5-1/16"	3-5/16"	

PVC - Full Cast Iron Grate and Ring

PART NO.	DESCRIPTION	CTN QTY
D50092	2" drain	1
D50093	3" drain	1
D50094	4" drain	1
D50089	2" drain with CI sediment bucket	1
D50090	3" drain with CI sediment bucket	1
D50091	4" drain with CI sediment bucket	1

ABS - Full Cast Iron Grate and Ring

PART NO.	DESCRIPTION	CTN QTY
D50392	2" drain	1
D50393	3" drain	1
D50394	4" drain	1
D50389	2" drain with CI sediment bucket	1
D50390	3" drain with CI sediment bucket	1
D50391	4" drain with CI sediment bucket	1

PVC - Full Plastic Grate and Ring

PART NO.	DESCRIPTION	CTN QTY
D50177	2" drain	1
D50179	3" drain	1
D50181	4" drain	1
D50178	2" drain with plastic debris bucket	1
D50180	3" drain with plastic debris bucket	1
D50182	4" drain with plastic debris bucket	1
D50682	6" drain with plastic debris bucket	1

ABS - Full Plastic Grate and Ring

PART NO.	DESCRIPTION	CTN QTY
D50377	2" drain	1
D50379	3" drain	1
D50381	4" drain	1
D50378	2" drain with plastic debris bucket	1
D50380	3" drain with plastic debris bucket	1
D50382	4" drain with plastic debris bucket	1
D50683	6" drain with plastic debris bucket	1

PVC - Three-Quarter Plastic Grate and Ring

PART NO.	DESCRIPTION	CTN QTY
D50183	2" drain	1
D50184	3" drain	1
D50185	4" drain	1

ABS - Three-Quarter Plastic Grate and Ring

PART NO.	DESCRIPTION	CTN QTY
D50383	2" drain	1
D50384	3" drain	1
D50385	4" drain	1

PVC - Half Plastic Grate and Ring

PART NO.	DESCRIPTION	CTN QTY
D50186	2" drain	1
D50187	3" drain	1
D50188	4" drain	1

ABS - Half Plastic Grate and Ring

PART NO.	DESCRIPTION	CTN QTY
D50386	2" drain	1
D50387	3" drain	1
D50388	4" drain	1

PVC - Replacement Parts

PART NO.	DESCRIPTION	CTN QTY
D50904	Full plastic grate	1
D50906	Three-quarter plastic grate	1
D50908	Half plastic grate	1
D50910	Plastic debris bucket	1
D50095	CI sediment bucket	1

ABS - Replacement Parts

PART NO.	DESCRIPTION	CTN QTY
D50905	Full plastic grate	1
D50907	Three-quarter plastic grate	1
D50909	Half plastic grate	1
D50911	Plastic debris bucket	1

All Plastic Snap-In Drain

Fits Into Schedule 40 DWV Pipe

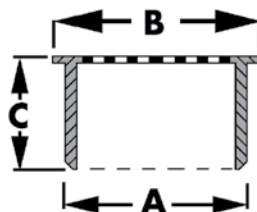

	A	B	C
Inside 2"		2-3/8"	1"
Inside 3"		3-1/2"	1-3/4"
Inside 4"		4-1/2"	2"

PVC

PART NO.	DESCRIPTION	CTN QTY
D42002	2" snap-in drain	20
D42003	3" snap-in drain	20
D42004	4" snap-in drain	20

ABS

PART NO.	DESCRIPTION	CTN QTY
D42022	2" snap-in drain	20
D42023	3" snap-in drain	20
D42024	4" snap-in drain	20

Snap-In Drain with Stainless Steel Strainer

Fits Into Schedule 40 DWV Pipe

MADE IN THE
USA

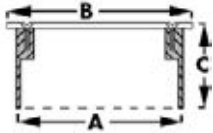

A	B	C
Inside 3" pipe	3-1/2"	2"
Inside 4" pipe	4-1/2"	2"

PVC

PART NO.	DESCRIPTION	CTN QTY
D54003	3" snap-in drain	20
D54004	4" snap-in drain	20

ABS

PART NO.	DESCRIPTION	CTN QTY
D54005	3" snap-in drain	20
D54006	4" snap-in drain	20

Snap-In Strainer

Fits Inside Pipe



• Stainless steel

PART NO.	DESCRIPTION	CTN/MSTR
D59001	3-1/8" strainer fits inside 2" pipe	10/200
D59002	4-1/8" strainer fits inside 3" pipe	10/200
D59003	5-1/8" strainer fits inside 4" pipe	10/100

Socket Ring

MADE IN THE
USA

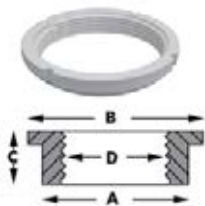

• Solvent welds into Schedule 40 hub to make threaded connection

A	B	C	D
2"	2-3/4"	1/2"	2" FIP
3"	4-1/16"	5/8"	3" FIP
4"	5-1/16"	5/8"	4" FIP

PVC

PART NO.	DESCRIPTION	CTN QTY
P48002	2" socket ring	20
P48003	3" socket ring	20
P48004	4" socket ring	20

ABS

PART NO.	DESCRIPTION	CTN QTY
P48102	2" socket ring	20
P48103	3" socket ring	20
P48104	4" socket ring	20

Utility Drain

MADE IN THE
USA

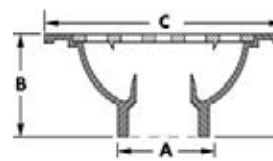

- Snap-in lid
- Use 2" coupling to connect 6" x 6" to 2" pipe

A	B	C	D
1-1/2" x 2"	2-3/8"	6"	4-9/16"
3" x 4"	3-7/16"	9"	7-11/16"
4"	4-9/16"	9"	7-11/16"
4" w/out stop	4-9/16"	9"	7-11/16"

PVC

PART NO.	DESCRIPTION	CTN QTY
D40020	6" x 6" with pipe stop; 1-1/2" hub; 2" spigot	20
D40021	9" x 9" with pipe stop; 3" hub; 4" spigot	10
D40023	9" x 9" with pipe stop; 4" hub	10
D42019	9" x 9" with 4" hub	10

ABS

PART NO.	DESCRIPTION	CTN QTY
D42029	9" x 9" with 4" hub	10

Bell Trap

MADE IN THE
USA

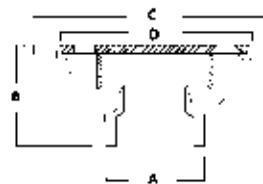

- Snap-in lid
- Molded bell in lid
- Use 2" coupling to convert 6" x 6" x 1-1/2" to 2" outlet

A	B	C	D
1-1/2" x 2"	2-3/8"	6"	4-9/16"
3" x 4"	4"	9"	7-3/4"
4"	4-1/2"	9"	7-3/4"

PVC

PART NO.	DESCRIPTION	CTN QTY
D42006	6" x 6" with 1-1/2" x 2" outlet	20
D42009	9" x 9" with 3" x 4" outlet	10
D42010	9" x 9" with 4" hub fit outlet	10

ABS

PART NO.	DESCRIPTION	CTN QTY
D42011	6" x 6" with 1-1/2" x 2" outlet	20
D42012	9" x 9" with 3" x 4" outlet	10
D42013	9" x 9" with 4" hub fit outlet	10

PVC Accessories

PART NO.	DESCRIPTION	CTN QTY
D42007	Lid for the D42006	1
D42008	Lid for the D42009 and D42010	1

ABS Accessories

PART NO.	DESCRIPTION	CTN QTY
D42014	Lid for the D42011	1
D42015	Lid for the D42012 and D42013	1

Heavy Duty PVC Bell Trap with Hinged Lid

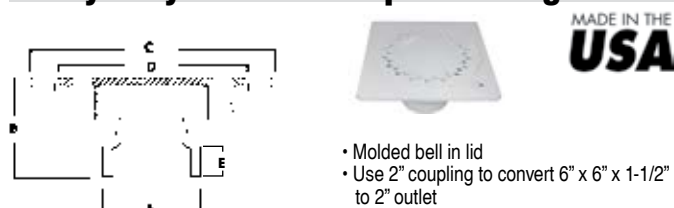

A	B	C	D	E
1-1/2" x 2"	2-1/2"	6"	4-1/2"	3/4"
3" x 4"	4-3/8"	9"	7-3/4"	3/4"
4"	4-1/2"	9"	7-3/4"	3/4"

PVC

PART NO.	DESCRIPTION	CTN QTY
D42006H	6" x 6" with 1-1/2" x 2" outlet	20
D42009H	9" x 9" with 3" x 4" outlet	10
D42010H	9" x 9" with 4" outlet	10

Accessories

PART NO.	DESCRIPTION	CTN QTY
D42007H	Lid for the D42006H	1
D42008H	Lid for the D42009H and D42010H	1

Floor Drain with Trap

2" Solvent Weld Outlet

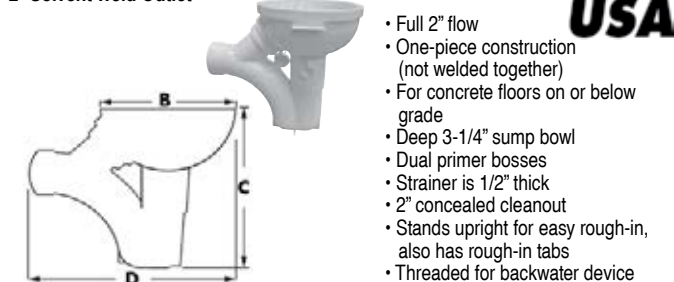

PIPE SIZE	B	C	D
2" IPS	7-5/8"	10-7/8"	11-3/4"

PVC

PART NO.	DESCRIPTION	CTN QTY
D50200	2" with full plastic grate	12
D50208	2" with 7-1/2" NB strainer	12

ABS

PART NO.	DESCRIPTION	CTN QTY
D50600	2" with full plastic grate	12

PVC - Accessories

PART NO.	DESCRIPTION	CTN QTY
D50202	Full grate strainer	1
D50203	Three-quarter grate strainer	1
D50204	Half grate strainer	1

ABS - Accessories

PART NO.	DESCRIPTION	CTN QTY
D50205	Full grate strainer	1
D50206	Three-quarter grate strainer	1
D50207	Half grate strainer	1

Other Accessories

PART NO.	DESCRIPTION	CTN QTY
D50213	NB strainer	1
B06001	Plastic backwater device	1
B70499	Replacement ball	1

4-Way Area Drain

Fits 2" or 3" Pipe

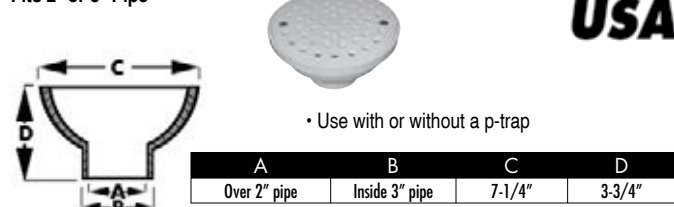

PVC

PART NO.	DESCRIPTION	CTN QTY
D50201	2" x 3" area drain	15
D50220	2" x 3" area drain without stop	15
B06010	Replacement strainer for D50201	1

ABS

PART NO.	DESCRIPTION	CTN QTY
D50601	2" x 3" area drain	15
D50221	2" x 3" area drain without stop	15
B06100	Replacement strainer for D50601	1

Area Drain

2" x 3" Fits Over 2" or Inside 3" Schedule 40 DWV Pipe
3" x 4" Fits Over 3" or Inside 4" Schedule 40 DWV Pipe

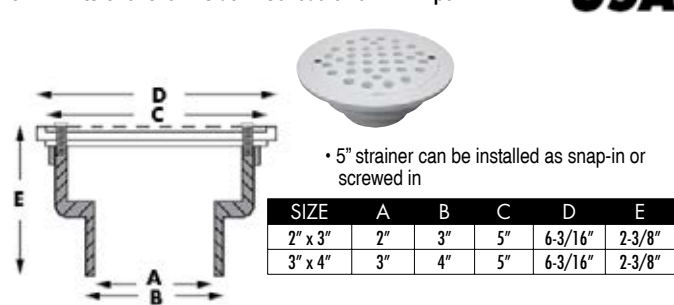

PVC

PART NO.	DESCRIPTION	CTN QTY
D40600	2" x 3" area drain	12
D40601	3" x 4" area drain	12
D40602	PVC replacement strainer	1

ABS

PART NO.	DESCRIPTION	CTN QTY
D40700	2" x 3" area drain	12
D40701	3" x 4" area drain	12
D40702	ABS replacement strainer	1

PVC Inside Pipe Fit Drains and Cleanouts

Page 221

SIZES: 3", 4"



For use in applications where adjustments after the concrete pour are required.

Items marked with the Jones Stephens logo are "You Need It...We Got It" Items.

Inside Pipe Fit Drain



• Strainer is the same diameter as the pipe to provide full coverage every time!

MADE IN THE
USA

PART NO.	BASE	STRAINER	CTN QTY
D60130	3" PVC	3-1/2" NB Round	1
D60140	4" PVC	4-1/2" NB Round	1

Inside Pipe Fit Cleanout



• Cover is the same diameter as the pipe to provide full coverage every time!

MADE IN THE
USA

PART NO.	BASE	COVER	CTN QTY
C60172	3" PVC	3-1/2" NB Round	1
C60170 	4" PVC	4-1/2" NB Round	1
C60171	4" PVC	4-1/2" Cast Iron Round	1

HOW IT WORKS!

Concrete Floor Application

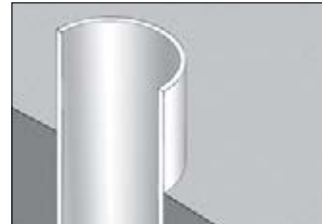

The concrete should be poured so that the pipe stack is above the finished surface.



After concrete is complete, use a Plumbest EZ Stroke pipe saw to cut flush with concrete. Then, use a socket saver or inside pipe cutter to trim pipe 3/8" below concrete surface.



The inside pipe fit drain/cleanout can easily be glued into the pipe creating a level surface once the strainer is installed. No chisel or tape needed!

Tile Floor Application

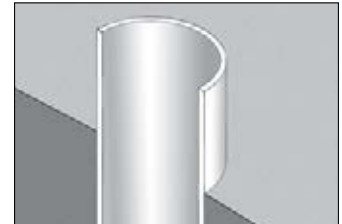

The concrete should be poured so that the pipe stack is above the finished surface.

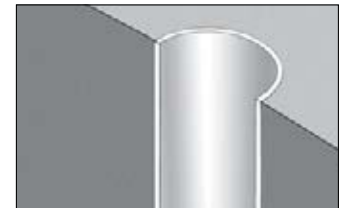

After concrete is complete, use a Plumbest EZ Stroke pipe saw to cut flush with concrete. The inside pipe fit drain/cleanout can easily be glued into the pipe.



Lay tile to the edge of the cover or strainer. No chisel or tape needed!

PVC and ABS Residential and Light Commercial Cleanouts

Pages 222-224

**SIZES: 1-1/2", 2", 2-1/2", 2"x 3",
3", 3-1/2", 3"x 4", 4"**



For use in residential and light commercial applications.

Internal Pipe Cleanout

Solvent Welds Into Schedule 40 DWV Pipe

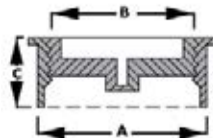

MADE IN THE USA

- Allows pipe to be cut flush with floor or wall
- Countersunk plug included

A	B	C
Inside 2"	1-1/2"	1"
Inside 3"	2-1/2"	1-1/8"
Inside 4"	3-1/2"	1-1/4"

PVC

PART NO.	PIPE SIZE	PLUG SIZE	OD	CTN QTY
C60106	2"	1-1/2" IPS	1-7/8"	10
C60007	3"	2-1/2" IPS	2-13/16"	10
C60008	4"	3-1/2" IPS	4"	50
C60116	2"	1-1/2" with insert	—	10
C60117	3"	2-1/2" with insert	—	10
C60118	4"	3-1/2" with insert	—	10

ABS

PART NO.	PIPE SIZE	PLUG SIZE	OD	CTN QTY
C60107	2"	1-1/2" IPS	1-7/8"	10
C60011	3"	2-1/2" IPS	2-13/16"	10
C60012	4"	3-1/2" IPS	4"	10

Heavy Duty Internal Pipe Cleanout

Solvent Welds Into Schedule 40 DWV Pipe

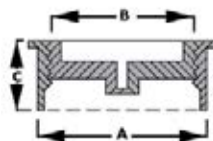

MADE IN THE USA

- Allows pipe to be cut flush with floor or wall
- Countersunk plug included

A	B	C
Inside 3"	2-1/4"	1-7/8"
Inside 4"	3-1/2"	2"

PVC

PART NO.	SIZE	PLUG SIZE	CTN QTY
C60207	3"	2" IPS	10
C60108	4"	3" IPS	10

ABS

PART NO.	SIZE	PLUG SIZE	CTN QTY
C60211	3"	2" IPS	10
C60112	4"	3" IPS	10

Hub/Fitting Cleanout

Fits Inside 4" Schedule 40 DWV Fittings

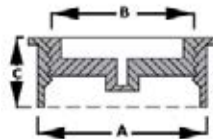

MADE IN THE USA

- 3-1/2" IPS countersunk plug
- Solvent welds into 4" fitting hubs

A	B	C
4-1/2"	3-7/8"	2-3/16"

PVC

PART NO.	DESCRIPTION	CTN QTY
C60009	4" hub/fitting cleanout	10

ABS

PART NO.	DESCRIPTION	CTN QTY
C60010	4" hub/fitting cleanout	10

Fit-Flush Cleanout

2" x 3" Fits Over 2" or Inside 3" Schedule 40 DWV Pipe
 3" x 4" Fits Over 3" or Inside 4" Schedule 40 DWV Pipe

MADE IN THE
USA

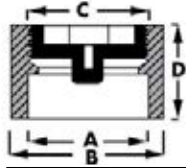

- Built-in stop
- Fits flush everytime

A	B	C	D
Over 2"	Inside 3"	2"	2"
Over 3"	Inside 4"	3"	2-1/2"

PVC

PART NO.	SIZE	PLUG SIZE	OD	CTN QTY
C61023	2" x 3"	2" IPS	2-3/8"	1
C61034	3" x 4"	3" IPS	3-1/2"	1
C61223	2" x 3"	2" IPS brass	2-3/8"	1
C61234	3" x 4"	3" IPS brass	3-1/2"	1
C61432	2" x 3"	2" with insert	2-3/8"	1
C61434	3" x 4"	3" with insert	3-1/2"	1

ABS

PART NO.	SIZE	PLUG SIZE	OD	CTN QTY
C61123	2" x 3"	2" IPS	2-3/8"	1
C61134	3" x 4"	3" IPS	3-1/2"	1

Countersunk Cleanout Plug with Insert



- White plastic
- With threaded brass insert for cleanout covers

MADE IN THE
USA

PART NO.	DESCRIPTION	CTN QTY
P49915	1-1/2" countersunk cleanout plug	25
P49920	2" countersunk cleanout plug	25
P49925	2-1/2" countersunk cleanout plug	25
P49930	3" countersunk cleanout plug	25
P49935	3-1/2" countersunk cleanout plug	25
P49940	4" countersunk cleanout plug	25

Raised Head Cleanout Plug



- White plastic

MADE IN THE
USA

PART NO.	DESCRIPTION	CTN QTY
P49150	1-1/2" raised head cleanout plug	50
P49200	2" raised head cleanout plug	50
P49250	2-1/2" raised head cleanout plug	25
P49350	3-1/2" raised head cleanout plug	25
P49600	6" raised head cleanout plug	10

Countersunk Cleanout Plug



- White plastic

MADE IN THE
USA

PART NO.	DESCRIPTION	CTN QTY
P49015	1-1/2" countersunk cleanout plug	25
P49002	2" countersunk cleanout plug	25
P49025	2-1/2" countersunk cleanout plug	25
P49003	3" countersunk cleanout plug	25
P49035	3-1/2" countersunk cleanout plug	25
P49004	4" countersunk cleanout plug	25

Drainable Cleanout Test Plug

MADE IN THE
USA

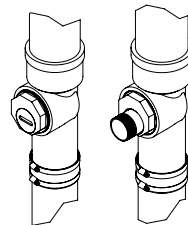

With nipple installed

- PVC
- 4" IPS thread size; 2" IPS thread size for drain plug and spout
- Threads into any plastic or cast iron cleanout, or test tee that accepts 4" threads
- Add nipple to create drainage spout
- Easy installation; can be installed horizontal or vertical
- Drain the line without coming in contact with waste!
- Reduce distance between technician and blockage - shorter sewer rods!
- Search for another access is not needed!

PART NO.	DESCRIPTION	CTN QTY
P48400	4" drainable cleanout test plug	1/72

4" PVC Hub Fit Cleanout with 3-1/2" Countersunk Brass Plug

MADE IN THE
USA



- Fits flush
- Fits inside 4" hub or Schedule 40 DWV fitting

PART NO.	DESCRIPTION	CTN QTY
C61009	4" PVC hub fit cleanout	10

General Purpose Cleanout

3" x 4" Fits Over 3" or Inside 4" Schedule 40 DWV Pipe
 4" Fits Over 4" Schedule 40 DWV Pipe

MADE IN THE
USA

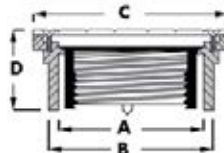

- Supplied with a combination test plug installed

A	B	C	D
Over 3"	Inside 4"	5-3/16"	2-1/2"
Over 4"	—	6-1/8"	2-1/2"

PVC

PART NO.	DESCRIPTION	CTN QTY
C60162	3" x 4" with NB cover	5
C60165	3" x 4" with NB cover & ring	5
C60160	3" x 4" with PB cover	5
C60164	3" x 4" with PB cover & ring	5
C60142	4" with NB cover	5
C60146	4" with NB cover & ring	5
C60140	4" with PB cover	5
C60144	4" with PB cover & ring	5

ABS

PART NO.	DESCRIPTION	CTN QTY
C60163	3" x 4" with NB cover	5
C60167	3" x 4" with NB cover & ring	5
C60161	3" x 4" with PB cover	5
C60166	3" x 4" with PB cover & ring	5
C60143	4" with NB cover	5
C60147	4" with NB cover & ring	5
C60141	4" with PB cover	5
C60145	4" with PB cover & ring	5

General Purpose Access Fitting

3" x 4" Fits Over 3" or Inside 4" Schedule 40 DWV Pipe
4" Fits Over 4" Schedule 40 DWV Pipe

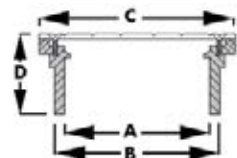

• For use with internal pipe cleanout, order separately

MADE IN THE USA

A	B	C	D
Over 3"	Inside 4"	5-3/16"	2-1/2"
Over 4"	—	6-1/8"	2-1/2"

PVC

PART NO.	DESCRIPTION	CTN QTY
C60062	3" x 4" with NB cover	5
C60065	3" x 4" with NB cover & ring	5
C60060	3" x 4" with PB cover	5
C60064	3" x 4" with PB cover & ring	5
C60042	4" with NB cover	5
C60046	4" with NB cover & ring	5
C60040	4" with PB cover	5
C60044	4" with PB cover & ring	5

ABS

PART NO.	DESCRIPTION	CTN QTY
C60063	3" x 4" with NB cover	5
C60067	3" x 4" with NB cover & ring	5
C60061	3" x 4" with PB cover	5
C60066	3" x 4" with PB cover & ring	5
C60043	4" with NB cover	5
C60047	4" with NB cover & ring	5
C60041	4" with PB cover	5
C60045	4" with PB cover & ring	5

Snap-in Access Fitting

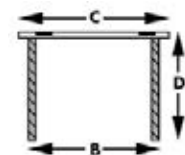

MADE IN THE USA

A	B	C	D
3"	3-1/16"	3-1/2"	2"
4"	4"	4-1/2"	2"

PVC

PART NO.	DESCRIPTION	CTN QTY
C60013	3" with SS strainer	20
C60014	4" with SS strainer	20

Sewer Relief Plug



- High-density construction
- Eliminates costly damages caused by sewer back-up
- Spring-loaded to close automatically to eliminate sewer gas
- Made of ABS

MADE IN THE USA

PART NO.	DESCRIPTION	CTN/MSTR
S25150	1-1/2" sewer relief plug	1/50
S25200	2" sewer relief plug	1/50
S25250	2-1/2" sewer relief plug	1/100
S25300	3" sewer relief plug	1/100
S25350	3-1/2" sewer relief plug	1/100
S25400	4" sewer relief plug	1/100

Test Tee with Plug



- Easy pop top test
- PVC plug included
- Test up to 3 floors

MADE IN THE USA

PART NO.	DESCRIPTION	CTN/MSTR
C67450	2" test tee	1/10
C67451	3" test tee	1/12

PVC Internal Cleanout with SS Cover



PART NO.	DESCRIPTION	CTN QTY
C60015	3" with 5" SS external wall cover	1
C60016	4" with 6" SS external wall cover	1

Saddle Tees and Kits



- Use bushing to reduce 2" unit to 1-1/2"
- Kits include V-bolts, nuts and washers
- Conversion kit also contains gasket mat for use with cast iron pipe
- Solvent branch

MADE IN THE USA

PART NO.	DESCRIPTION	CTN QTY
S26014	3" x 2" Saddle tee only	20
S26015	4" x 2" Saddle tee only	10
S26016	4" x 3" Saddle tee only	10
S26017	4" x 4" Saddle tee only	10
S26004	3" x 2" Saddle tee kit less gasket	20
S26005	4" x 2" Saddle tee kit less gasket	10
S26006	4" x 3" Saddle tee kit less gasket	10
S26007	4" x 4" Saddle tee kit less gasket	10
S26009	3" x 2" Saddle tee conversion kit with gasket	20
S26010	4" x 2" Saddle tee conversion kit with gasket	10
S26011	4" x 3" Saddle tee conversion kit with gasket	10
S26012	4" x 4" Saddle tee conversion kit with gasket	10
S26008	6" x 7" x 1/4" closed cell foam gasket	20

PVC and ABS Adjustable Commercial Cleanouts

Pages 225-228

SIZES: 2" x 3", 3", 3" x 4", 4"



For use in applications
where height adjustments
are necessary.

4" Hub Fit Base with 3-1/2" Plastic Spud

Fits Inside 4" Schedule 40 DWV Pipe



- Supplied with 3" IPS (3-1/2" OD) countersunk plug
- Covers available in PB and NB
- Covers are 3/16" thick
- Adjustable (see dimension C)

COVER	A	B	C
5" round	4" Hub fit	5-3/16"	3-1/8" - 4-5/8"
5" round with ring	4" Hub fit	5-1/2"	3-5/16" - 4-13/16"
6" round	4" Hub fit	6-1/8"	3-1/8" - 4-5/8"
6" round with ring	4" Hub fit	6-1/2"	3-5/16" - 4-13/16"
7" square	4" Hub fit	7"	3-3/8" - 4-15/16"

PVC

PART NO.	COVER	CTN QTY
C59200	5" PB round	1
C59201	5" PB round with ring	1
C59202	5" NB round	1
C59203	5" NB round with ring	1
C59001	6" PB round	1
C59005	6" PB round with ring	1
C59003	6" NB round	1
C59007	6" NB round with ring	1
C59050	7" PB square	1
C59052	7" NB square	1

ABS

PART NO.	COVER	CTN QTY
C59204	5" PB round	1
C59205	5" PB round with ring	1
C59206	5" NB round	1
C59207	5" NB round with ring	1
C59002	6" PB round	1
C59006	6" PB round with ring	1
C59004	6" NB round	1
C59008	6" NB round with ring	1
C59051	7" PB square	1
C59053	7" NB square	1

4" Hub Fit Base with 3-1/2" Metal Spud

Fits Inside 4" Schedule 40 DWV Pipe



- Supplied with 3" IPS (3-1/2" OD) countersunk plug
- Covers available in PB and NB
- Covers are 3/16" thick
- Adjustable (see dimension C)

COVER	A	B	C
5" round	4" Hub fit	5-3/16"	3-1/4" - 4-1/4"

PVC

PART NO.	COVER	CTN QTY
C59060	5" PB round	1
C59062	5" NB round	1

ABS

PART NO.	COVER	CTN QTY
C59061	5" PB round	1
C59063	5" NB round	1

3" x 4" Pipe Fit Base with 3-1/2" Plastic Spud

Fits Over 3" or Inside 4" Schedule 40 DWV Pipe

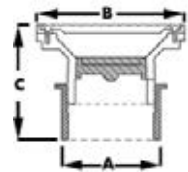

- Supplied with 3" IPS (3-1/2" OD) countersunk plug
- Covers available in PB and NB
- Covers are 3/16" thick
- Adjustable (see dimension D)

COVER	A	B	C
5" round	Over 3" Pipe Inside 4" Pipe	5-3/16"	3-1/8" - 4-5/8"
5" round with ring	Over 3" Pipe Inside 4" Pipe	5-1/2"	3-5/16" - 4-13/16"
6" round	Over 3" Pipe Inside 4" Pipe	6-1/8"	3-1/8" - 4-5/8"
6" round with ring	Over 3" Pipe Inside 4" Pipe	6-1/2"	3-5/16" - 4-13/16"
7" square	Over 3" Pipe Inside 4" Pipe	7"	5-15/16" - 7-1/2"

PVC

PART NO.	COVER	CTN QTY
C59216	5" PB round	1
C59217	5" PB round with ring	1
C59218	5" NB round	1
C59219	5" NB round with ring	1
C59010	6" PB round	1
C59014	6" PB round with ring	1
C59012	6" NB round	1
C59016	6" NB round with ring	1
C59054	7" PB square	1
C59056	7" NB square	1

ABS

PART NO.	COVER	CTN QTY
C59220	5" PB round	1
C59221	5" PB round with ring	1
C59222	5" NB round	1
C59223	5" NB round with ring	1
C59011	6" PB round	1
C59015	6" PB round with ring	1
C59013	6" NB round	1
C59017	6" NB round with ring	1
C59055	7" PB square	1
C59057	7" NB square	1

3" x 4" Pipe Fit Base with 3-1/2" Metal Spud

Fits Over 3" or Inside 4" Schedule 40 DWV Pipe

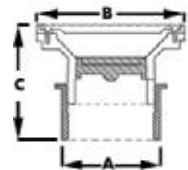

- Supplied with 3" IPS (3-1/2" OD) countersunk plug
- Covers available in PB and NB
- Covers are 3/16" thick
- Adjustable (see dimension D)

COVER	A	B	C
5" round	Over 3" Pipe Inside 4" Pipe	5-3/16"	5-3/4" - 7"

PVC

PART NO.	COVER	CTN QTY
C59068	5" PB round	1
C59070	5" NB round	1

ABS

PART NO.	COVER	CTN QTY
C59069	5" PB round	1
C59071	5" NB round	1

4" Over Pipe Fit Base with 3-1/2" Plastic Spud

Fits Over 4" Schedule 40 DWV Pipe

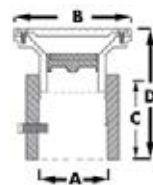

- Supplied with 3" IPS (3-1/2" OD) countersunk plug
- Covers available in PB and NB
- Covers are 3/16" thick
- Adjustable (see dimension D)

COVER	A	B	C	D
5" round	Over 4" Pipe	5-3/16"	4-1/4"	5-15/16" - 7-1/2"
5" round with ring	Over 4" Pipe	5-1/2"	4-1/4"	6-1/16" - 7-5/8"
6" round	Over 4" Pipe	6-1/8"	4-1/4"	5-15/16" - 7-1/2"
6" round with ring	Over 4" Pipe	6-1/2"	4-1/4"	6-1/16" - 7-5/8"
7" square	Over 4" Pipe	7"	4-1/4"	6-1/8" - 7-11/16"

PVC

PART NO.	COVER	CTN QTY
C59208	5" PB round	1
C59209	5" PB round with ring	1
C59210	5" NB round	1
C59211	5" NB round with ring	1
C60001	6" PB round	1
C60022	6" PB round with ring	1
C60020	6" NB round	1
C60024	6" NB round with ring	1
C60050	7" PB square	1
C60052	7" NB square	1

ABS

PART NO.	COVER	CTN QTY
C59212	5" PB round	1
C59213	5" PB round with ring	1
C59214	5" NB round	1
C59215	5" NB round with ring	1
C60003	6" PB round	1
C60023	6" PB round with ring	1
C60021	6" NB round	1
C60025	6" NB round with ring	1
C60051	7" PB square	1
C60053	7" NB square	1

4" Over Pipe Fit Base with 3-1/2" Metal Spud

Fits Over 4" Schedule 40 DWV Pipe

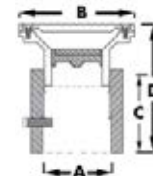

- Supplied with 3" IPS (3-1/2" OD) countersunk plug
- Covers available in PB and NB
- Covers are 3/16" thick
- Adjustable (see dimension D)

COVER	A	B	C	D
5" round	Over 4" Pipe	5"	4-1/4"	6" - 7-1/16"

PVC

PART NO.	COVER	CTN QTY
C59064	5" PB round	1
C59066	5" NB round	1

ABS

PART NO.	COVER	CTN QTY
C59065	5" PB round	1
C59067	5" NB round	1

4" Over Pipe Fit Base with 4" Plastic Spud

Fits Over 4" Schedule 40 DWV Pipe

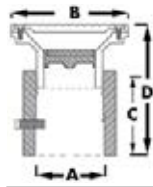

- Supplied with 3" IPS (3-1/2" OD) countersunk plug
- Covers available in PB and NB
- Covers are 3/16" thick
- Adjustable (see dimension D)

COVER	A	B	C	D
6" round	Over 4" Pipe	6"	4-3/4"	6-1/16" - 7-3/16"
6" round with ring	Over 4" Pipe	6-1/8"	4-3/4"	6-1/8" - 7-1/4"
7" square	Over 4" Pipe	7"	4-3/4"	6-3/16" - 7-3/8"

PVC

PART NO.	COVER	CTN QTY
C60070	6" PB round	1
C60071	6" PB round with ring	1
C60072	6" NB round	1
C60073	6" NB round with ring	1
C60074	7" PB square	1
C60075	7" NB square	1

ABS

PART NO.	COVER	CTN QTY
C60076	6" PB round	1
C60077	6" PB round with ring	1
C60078	6" NB round	1
C60079	6" NB round with ring	1
C60080	7" PB square	1
C60081	7" NB square	1

4" Over Pipe Fit Base with 4" Metal Spud

Fits Over 4" Schedule 40 DWV Pipe

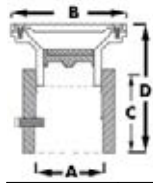

- 5" Supplied with 3" IPS (3-1/2" OD) countersunk plug
- 6" Supplied with 4" IPS plug
- Covers available in PB and NB
- Covers are 3/16" thick
- Adjustable (see dimension D)

COVER	A	B	C	D
5" round	Over 4" Pipe	5"	4-3/4"	5" - 6"
6" round	Over 4" Pipe	6"	4-3/4"	5" - 6"

PVC

PART NO.	COVER	CTN QTY
C60082	5" NB round	1
C60092	5" PB round	1
C60094	6" NB round	1
C60096	6" PB round	1

ABS

PART NO.	COVER	CTN QTY
C60083	5" NB round	1
C60095	6" NB round	1
C60097	6" PB round	1

3" Over Pipe Fit Base with 3" Plastic Spud

Fits Over 3" Schedule 40 DWV Pipe

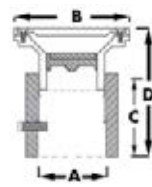

- Supplied with 2-1/2" IPS (3" OD) countersunk plug
- Covers available in PB and NB
- Covers are 3/16" thick
- Adjustable (see dimension D)

COVER	A	B	C	D
6" round	Over 3" Pipe	6-1/8"	4-1/2"	5-7/8" - 7-1/8"
6" round with ring	Over 3" Pipe	6-1/2"	4-1/2"	6" - 7-3/16"
7" square	Over 3" Pipe	7"	4-1/2"	6" - 7-3/16"

PVC

PART NO.	COVER	CTN QTY
C60026	6" PB round	1
C60030	6" PB round with ring	1
C60028	6" NB round	1
C60032	6" NB round with ring	1
C60054	7" PB square	1
C60056	7" NB square	1

ABS

PART NO.	COVER	CTN QTY
C60027	6" PB round	1
C60031	6" PB round with ring	1
C60029	6" NB round	1
C60033	6" NB round with ring	1
C60055	7" PB square	1
C60057	7" NB square	1

3" Over Pipe Fit Base with 3" Metal Spud

Fits Over 3" Schedule 40 DWV Pipe

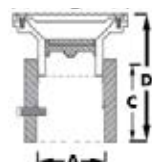

- Supplied with 2-1/2" IPS (3" OD) countersunk plug
- Covers available in PB, NB and CP
- Covers are 3/16" thick
- Adjustable (see dimension D)

COVER	A	B	C	D
5" round	Over 3" Pipe	5-3/16"	4-1/2"	5" - 6"

PVC

PART NO.	COVER	CTN QTY
C60086	5" PB round	1
C60084	5" NB round	1
C60088	5" CP round	1

ABS

PART NO.	COVER	CTN QTY
C60087	5" PB round	1
C60085	5" NB round	1
C60089	5" CP round	1

4" Inside Pipe Fit Base with 3" Plastic Spud

Fits Inside 4" Schedule 40 DWV Pipe

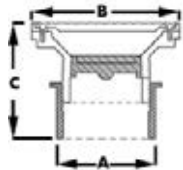

- Supplied with 3" IPS (3-1/2" OD) countersunk plug
- Covers available in PB and NB
- Covers are 3/16" thick
- Adjustable (see dimension D)

COVER	A	B	C
6" round	Inside 4" Pipe	6-1/8"	3-7/8" - 4-5/8"
6" round with ring	Inside 4" Pipe	6-1/2"	4" - 4-3/4"
7" square	Inside 4" Pipe	7"	4" - 4-7/8"

PVC

PART NO.	COVER	CTN QTY
C59020	6" PB round	1
C59024	6" PB round with ring	1
C59022	6" NB round	1
C59026	6" NB round with ring	1
C59028	7" PB square	1
C59030	7" NB square	1

ABS

PART NO.	COVER	CTN QTY
C59021	6" PB round	1
C59025	6" PB round with ring	1
C59023	6" NB round	1
C59027	6" NB round with ring	1
C59029	7" PB square	1
C59031	7" NB square	1

2" x 3" Cleanout with 2" Plastic Spud

Fits Over 2" or Inside 3" Schedule 40 DWV Pipe

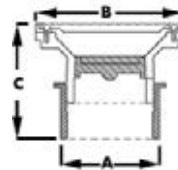

- Supplied with 2" t-cone test plug installed
- Covers available in PB and NB

COVER	A	B	C
4" round	2"	4-1/4"	2-1/4"
4" round with ring	2"	4-1/2"	2-3/8"

PVC

PART NO.	COVER	CTN QTY
C59096	4" PB round	1
C59097	4" PB round with ring	1
C59098	4" NB round	1
C59099	4" NB round with ring	1

ABS

PART NO.	COVER	CTN QTY
C59100	4" PB round	1
C59101	4" PB round with ring	1
C59102	4" NB round	1
C59103	4" NB round with ring	1

4" Inside Pipe Fit Base with 3" Metal Spud

Fits Inside 4" Schedule 40 DWV Pipe

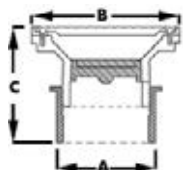

- Supplied with 3" IPS (3-1/2" OD) countersunk plug
- Covers available in PB, NB and CP
- Covers are 3/16" thick
- Adjustable (see dimension D)

COVER	A	B	C
5" round	Inside 4" Pipe	5"	2-7/16" - 3-1/2"

PVC

PART NO.	COVER	CTN QTY
C59090	5" NB round	1
C59092	5" PB round	1
C59094	5" CP round	1

ABS

PART NO.	COVER	CTN QTY
C59091	5" NB round	1
C59093	5" PB round	1
C59095	5" CP round	1

PVC and ABS Commercial Cleanout Components

Pages 229-230

SIZES: 2", 3", 3-1/2", 4"

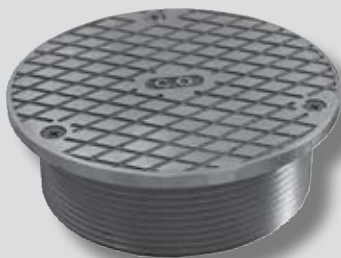

For use in
commercial applications.

2" Plastic Spud with Round Cover



• Supplied with 2" IPS / 2-1/2" OD
countersunk t-cone test plug



PVC

PART NO.	IPS	COVER	CTNMSTR
D59920	2"	4" PB	1
D59921	2"	4" PB with ring	1
D59922	2"	4" NB	1
D59923	2"	4" NB with ring	1

ABS

PART NO.	IPS	COVER	CTNMSTR
D59924	2"	4" PB	1
D59925	2"	4" PB with ring	1
D59926	2"	4" NB	1
D59927	2"	4" NB with ring	1

3" Plastic Spud with Round Cover



• Supplied with 2-1/2" IPS / 3" OD
countersunk plug



PVC

PART NO.	IPS	COVER	CTNMSTR
D59904	3"	6" PB	1
D59908	3"	6" PB with ring	1
D59905	3"	6" NB	1
D59909	3"	6" NB with ring	1

ABS

PART NO.	IPS	COVER	CTNMSTR
D57904	3"	6" PB	1
D57908	3"	6" PB with ring	1
D57905	3"	6" NB	1
D57909	3"	6" NB with ring	1

3" Metal Spud with Round Cover



• Supplied with 2-1/2" IPS / 3" OD
countersunk plug



PART NO.	IPS	COVER	CTNMSTR
C37801	3"	5" PB	1/20
C37803	3"	5" NB	1/20
C37800	3"	5" CP	1/20

3" Plastic Spud with Square Cover



• Supplied with 2-1/2" IPS / 3" OD
countersunk plug



PVC

PART NO.	IPS	COVER	CTNMSTR
D59912	3"	7" PB	1
D59913	3"	7" NB	1

ABS

PART NO.	IPS	COVER	CTNMSTR
D57912	3"	7" PB	1
D57913	3"	7" NB	1

3-1/2" Plastic Spud with Round Cover



• Supplied with 3" IPS countersunk plug



PVC			
PART NO.	IPS	COVER	CTNMSTR
D59943	3-1/2"	5" PB	1
D59944	3-1/2"	5" PB with ring	1
D59945	3-1/2"	5" NB	1
D59946	3-1/2"	5" NB with ring	1
D59901	3-1/2"	6" PB	1
D59906	3-1/2"	6" PB with ring	1
D59902	3-1/2"	6" NB	1
D59907	3-1/2"	6" NB with ring	1

ABS			
PART NO.	IPS	COVER	CTNMSTR
D59947	3-1/2"	5" PB	1
D59948	3-1/2"	5" PB with ring	1
D59949	3-1/2"	5" NB	1
D59950	3-1/2"	5" NB with ring	1
D57901	3-1/2"	6" PB	1
D57906	3-1/2"	6" PB with ring	1
D57902	3-1/2"	6" NB	1
D57907	3-1/2"	6" NB with ring	1

4" Plastic Spud with Round Cover



• Supplied with 3" IPS countersunk plug



PVC			
PART NO.	IPS	COVER	CTNMSTR
D59914	4"	6" PB	1
D59915	4"	6" PB with ring	1
D59916	4"	6" NB	1
D59917	4"	6" NB with ring	1

ABS			
PART NO.	IPS	COVER	CTNMSTR
D57914	4"	6" PB	1
D57915	4"	6" PB with ring	1
D57916	4"	6" NB	1
D57917	4"	6" NB with ring	1

4" Metal Spud with Round Cover



• 5" Cover supplied with 3-1/2" IPS countersunk plug
• 6" Cover supplied with 4" IPS countersunk plug



PART NO.	IPS	COVER	CTNMSTR
C37806	4"	5" PB	1/20
C37805	4"	5" NB	1/20
C37808	4"	6" PB	1/8
C37807	4"	6" NB	1/8

3-1/2" Metal Spud with Round Cover



• Supplied with 3-1/2" IPS countersunk plug



PART NO.	IPS	COVER	CTNMSTR
C37811	3-1/2"	5" PB	1/18
C37810	3-1/2"	5" NB	1/18

3-1/2" Plastic Spud with Square Cover



• Supplied with 3" IPS countersunk plug



PVC			
PART NO.	IPS	COVER	CTNMSTR
D59910	3-1/2"	7" PB	1
D59911	3-1/2"	7" NB	1

ABS			
PART NO.	IPS	COVER	CTNMSTR
D57910	3-1/2"	7" PB	1
D57911	3-1/2"	7" NB	1

4" Plastic Spud with Square Cover



• Supplied with 3" IPS countersunk plug



PVC			
PART NO.	IPS	COVER	CTNMSTR
D59918	4"	7" PB	1
D59919	4"	7" NB	1

ABS			
PART NO.	IPS	COVER	CTNMSTR
D57918	4"	7" PB	1
D57919	4"	7" NB	1

Covers



• 4" Fits 4-1/4" diameter drain and cleanout spuds, D50 (2" x 3") series shower drains and 2" x 3" General Purpose Drains
• 5" Fits 5" diameter drain and cleanout spuds and 3" x 4" General Purpose Drains
• 6" Fits 6-1/8" diameter drain and cleanout spuds and 4" General Purpose Drains
• Includes screws

PART NO.	SIZE	DESCRIPTION	CTNMSTR
C60504	4"	NB cast cleanout cover	1/50
C60505	4"	PB cast cleanout cover	1/50
C60503	5"	NB cast cleanout cover	1/50
C60502	5"	PB cast cleanout cover	1/50
C60501	6"	NB cast cleanout cover	1/30
C60500	6"	PB cast cleanout cover	1/30

Round Slop Sink

Fits Over 3" or Inside 4" Pipe

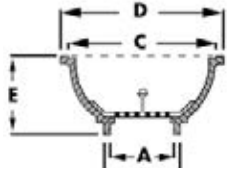

MADE IN THE USA

- 4-7/8" OD scoop strainer with stem for easy removal
- 12" diameter

A	B	C	D	E
3"	4"	11"	12"	6-3/8"

PART NO.	DESCRIPTION	CTN QTY
S55001	3" x 4" PVC sink and strainer	1
S55002	Replacement strainer	1

Floor Sink

To Be Used with Coupling or Hub Kit

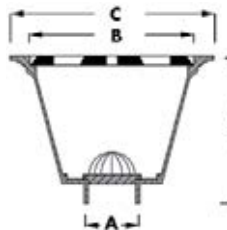

MADE IN THE USA



- 3/4" thick top grate in three styles
- 12" x 12" top flange

A	B	C	D
Inside 2" fitting	9-3/16"	12"	8"
Inside 3" fitting	9-3/16"	12"	8"
Inside 4" fitting	9-3/16"	12"	8"

PVC

PART NO.	DESCRIPTION	CTN QTY
S59002	2" sink only	1
S59003	3" sink only	1
S59004	4" sink only	1

ABS

PART NO.	DESCRIPTION	CTN QTY
S59302	2" sink only	1
S59303	3" sink only	1
S59304	4" sink only	1

Complete PVC Floor Sink Kit



MADE IN THE USA



- Includes sink, top grate and bottom strainer
- To be used with coupling or hub kit

PART NO.	DESCRIPTION	CTN QTY
S49042	2" - 1/2 top grate - dome bottom grate	1
S49052	2" - 3/4 top grate - dome bottom grate	1
S49062	2" - full top grate - dome bottom grate	1
S49072	2" - 1/2 top grate - flat bottom grate	1
S49082	2" - 3/4 top grate - flat bottom grate	1
S49092	2" - full top grate - flat bottom grate	1
S49043	3" - 1/2 top grate - dome bottom grate	1
S49053	3" - 3/4 top grate - dome bottom grate	1
S49063	3" - full top grate - dome bottom grate	1
S49073	3" - 1/2 top grate - flat bottom grate	1
S49083	3" - 3/4 top grate - flat bottom grate	1
S49093	3" - full top grate - flat bottom grate	1
S49044	4" - 1/2 top grate - dome bottom grate	1
S49054	4" - 3/4 top grate - dome bottom grate	1
S49064	4" - full top grate - dome bottom grate	1
S49074	4" - 1/2 top grate - flat bottom grate	1
S49084	4" - 3/4 top grate - flat bottom grate	1
S49094	4" - full top grate - flat bottom grate	1

Pipe Fit Floor Sink

2" x 3" Fits Over 2" or Inside 3" Schedule 40 DWV Pipe

3" x 4" Fits Over 3" or Inside 4" Schedule 40 DWV Pipe

4" Fits Over 4" Schedule 40 DWV Pipe

MADE IN THE USA

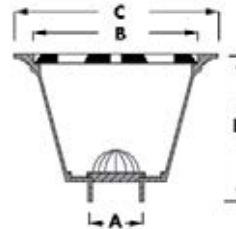

- 3/4" thick top grate in three styles
- 12" x 12" top flange
- Temp up to 180°

A	B	C	D
Over 2" Inside 3"	9-3/16"	12"	8"
Over 3" Inside 4"	9-3/16"	12"	8"
Over 4"	9-3/16"	12"	8"

PVC

PART NO.	DESCRIPTION	CTN QTY
S59102	2" x 3" sink only	1
S59103	3" x 4" sink only	1
S59104	4" sink only	1

ABS

PART NO.	DESCRIPTION	CTN QTY
S59402	2" x 3" sink only	1
S59403	3" x 4" sink only	1

Complete PVC Floor Sink Kit-Pipe Fit



• Includes sink, top grate and bottom strainer

PART NO.	DESCRIPTION	CTN QTY
S59042	2"x 3" - 1/2 top grate - dome bottom grate	1
S59052	2"x 3" - 3/4 top grate - dome bottom grate	1
S59062	2"x 3" - full top grate - dome bottom grate	1
S59072	2"x 3" - 1/2 top grate - flat bottom grate	1
S59082	2"x 3" - 3/4 top grate - flat bottom grate	1
S59092	2"x 3" - full top grate - flat bottom grate	1
S59043	3"x 4" - 1/2 top grate - dome bottom grate	1
S59053	3"x 4" - 3/4 top grate - dome bottom grate	1
S59063	3"x 4" - full top grate - dome bottom grate	1
S59073	3"x 4" - 1/2 top grate - flat bottom grate	1
S59083	3"x 4" - 3/4 top grate - flat bottom grate	1
S59093	3"x 4" - full top grate - flat bottom grate	1
S59044	4" - 1/2 top grate - dome bottom grate	1
S59054	4" - 3/4 top grate - dome bottom grate	1
S59064	4" - full top grate - dome bottom grate	1
S59074	4" - 1/2 top grate - flat bottom grate	1
S59084	4" - 3/4 top grate - flat bottom grate	1
S59094	4" - full top grate - flat bottom grate	1

Half Top Grate for Floor Sink



• Accessories for all S49 and S59 series floor sinks

PVC		
PART NO.	DESCRIPTION	CTN QTY
S59012	1/2 top grate	10

ABS		
PART NO.	DESCRIPTION	CTN QTY
S59312	1/2 top grate	10

Aluminum Dome Strainer for Floor Sink



• Accessories for all S49 and S59 series floor sinks

PART NO.	DESCRIPTION	CTN QTY
S60002	2" aluminum dome bottom strainer	10
S60003	3" aluminum dome bottom strainer	10
S60004	4" aluminum dome bottom strainer	10

Full Top Grate for Floor Sink



• Accessories for all S49 and S59 series floor sinks

PVC		
PART NO.	DESCRIPTION	CTN QTY
S59010	Full top grate	10

ABS		
PART NO.	DESCRIPTION	CTN QTY
S59310	Full top grate	10

Flat Aluminum Bottom Strainer for Floor Sink



• Accessories for all S49 and S59 series floor sinks

PART NO.	DESCRIPTION	CTN QTY
S60005	Flat aluminum bottom strainer	10

Three-Quarters Top Grate for Floor Sink



• Accessories for all S49 and S59 series floor sinks

PVC		
PART NO.	DESCRIPTION	CTN QTY
S59011	3/4 top grate	10

ABS		
PART NO.	DESCRIPTION	CTN QTY
S59311	3/4 top grate	10

Backwater Valve

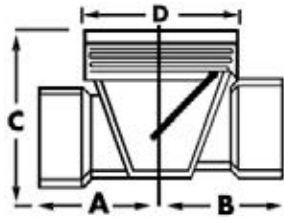

MADE IN THE USA
NSF

- Sockets are Schedule 40 DWV
- Reduces backflow in drainage system
- Threaded access cover for easy inspection
- Magnetic strip for underground detection
- Flapper and cover have elastomeric gasket to ensure watertight seal
- Stepped construction encourages flow (minimum 1/4" per foot fall)
- The 1-1/2", 2" and 6" have UPC, SBCCI and CSA listings
- The 3" and 4" are NSF and UPC listed

A	B	C	D
1/2"	2-3/16"	2"	4"
2"	2-7/16"	3-7/8"	4"
3"	3-7/8"	5-1/2"	6"
4"	5-3/8"	6-3/4"	8"
6"	7-3/4"	9-1/4"	10-3/4"

PVC

PART NO.	DESCRIPTION	CTN QTY
B04150	1-1/2" backwater valve	1
B04200	2" backwater valve	1
B04300	3" backwater valve	1
B04400	4" backwater valve	1
B04600	6" backwater valve	1

ABS

PART NO.	DESCRIPTION	CTN QTY
B05150	1-1/2" backwater valve	1
B05200	2" backwater valve	1
B05300	3" backwater valve	1
B05400	4" backwater valve	1
B05600	6" backwater valve	1



- Extension kit includes 16" sleeve, lid and adapter
- Sockets are Schedule 40 DWV
- Reduces backflow in drainage system
- Threaded access cover for easy inspection
- Magnetic strip for underground detection
- Flapper and cover have elastomeric gasket to ensure watertight seal
- Stepped construction encourages flow (minimum 1/4" per foot fall)
- The 1-1/2", 2" and 6" have UPC, SBCCI and CSA listings
- The 3" and 4" are NSF and UPC listed

MADE IN THE USA
NSF

PVC

PART NO.	DESCRIPTION	CTN QTY
B04150K	1-1/2" with extension kit & CI lid	1
B04200K	2" with extension kit & CI lid	1
B04300K	3" with extension kit & CI lid	1
B04400K	4" with extension kit & CI lid	1
B04151K	1-1/2" with extension kit & plastic lid	1
B04201K	2" with extension kit & plastic lid	1
B04301K	3" with extension kit & plastic lid	1
B04401K	4" with extension kit & plastic lid	1

ABS

PART NO.	DESCRIPTION	CTN QTY
B05150K	1-1/2" with extension kit & CI lid	1
B05200K	2" with extension kit & CI lid	1
B05300K	3" with extension kit & CI lid	1
B05400K	4" with extension kit & CI lid	1

Items marked with the Jones Stephens logo are "You Need It... We Got It" Items.

Flapper with Gasket for Backwater Valve



PART NO.	DESCRIPTION	CTN QTY
B04201	Fits 1-1/2" & 2" backwater valve	1
B04301	Fits 3" backwater valve	1
B04401	Fits 4" backwater valve	1

Extension Kit



- Kit includes cast iron top, 16" sleeve and adapter

MADE IN THE USA

PART NO.	DESCRIPTION	CTN QTY
B04303	3" complete kit with CI lid	1
B04403	4" complete kit with CI lid	1
B04304	3" complete kit with plastic lid	1
B04404	4" complete kit with plastic lid	1
BWV200	Ring adapter for 1-1/2" and 2"	1
BWV300	Ring adapter for 3"	1
BWV400	Ring adapter for 4"	1
B04006	6" CI lid for 3" (fits 6" pipe)	1
B04008	8" CI lid for 4" (fits 8" pipe)	1

Cover for PVC and ABS Pipe



- Covers 6" or 8" PVC and ABS pipe

PART NO.	DESCRIPTION	CTN QTY
B04007	6" plastic lid marked "water" (fits 6" pipe)	1
B04006	6" cast iron lid marked "sewer" (fits 6" pipe)	1
B04008	8" cast iron lid "sewer" (fits 8" pipe)	1

Condensate Trap



- Manufactured of Schedule 40 DWV pipe
- One-piece design

PART NO.	DESCRIPTION	CTN QTY
P15050	1/2" p-trap	100
P15075	3/4" p-trap	100
P15175	3/4" mini p-trap	250
R15050	1/2" running trap	100
R15075	3/4" running trap	100

Mushroom Vent Cap

Fits 3" or 4" Vent Stacks

MADE IN THE
USA



- Gray PVC construction
- Includes three installation screws

PART NO.	DESCRIPTION	CTN QTY
M05034	3" x 4" mushroom vent cap	20

Flat Top Vent Cap

MADE IN THE
USA



- White PVC construction
- Fits 3" and 4" vent stacks
- Includes 2 set screws for securing cap

PART NO.	DESCRIPTION	CTN QTY
M05134	Flat top vent cap	20

PVC Coupling

Connects 4" Schedule 40 DWV Pipe to 4" SDR

MADE IN THE
USA



PART NO.	DESCRIPTION	CTN QTY
C67440	4" DWV x 4" SDR coupling	10

PVC Multi-Use Coupling

MADE IN THE
USA



- Use to reduce or increase variety of sizes of Schedule 40 pipe

PART NO.	DESCRIPTION	CTN QTY
C67230	2" x 3" coupling	1
C67340	3" x 4" coupling	1

Spigot Adapter

MADE IN THE
USA



PART NO.	DESCRIPTION	CTN QTY
C67445	4" DWV x 4" SDR spigot	1

Plastic Over-Fitting Repair Fitting

MADE IN THE
USA



- More efficient and less costly way to handle many common PVC re-piping problems
- Available in 1-1/2", 2", 3" and 4" PVC
- Compatible with all fittings
- Raised lettering on hub actually helps seal chemical bond
- Glues over the hub of a fitting on one end and is a 1-1/2" or 2" hub on the other end

PVC

PART NO.	DESCRIPTION	CTN QTY
P22100	1-1/2" repair fitting	1
P22200	2" repair fitting	1
P22300	3" repair fitting	1
P22400	4" repair fitting	1

ABS

PART NO.	DESCRIPTION	CTN QTY
P22101	1-1/2" repair fitting	1
P22201	2" repair fitting	1

E

We Got It -

Roof Drain with Cast Iron Dome

Fits over Schedule 40 DWV Pipe



MADE IN THE
USA

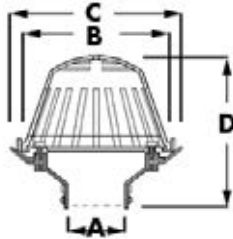

- Brass inserts in underside for underdeck clamps
- Dome has 50 square inches of free area

	A	B	C	D
Over 2" pipe		8-1/4"	11"	9"
Over 3" pipe		8-1/4"	11"	9"
Over 4" pipe		8-1/4"	11"	9"
Over 6" pipe		8-1/4"	11"	8"

PVC

PART NO.	DESCRIPTION	CTN QTY
R18001	2" cast iron dome	1
R18005	3" cast iron dome	1
R18006	4" cast iron dome	1
R18026	6" cast iron dome	1

ABS

PART NO.	DESCRIPTION	CTN QTY
R18009	2" cast iron dome	1
R18007	3" cast iron dome	1
R18008	4" cast iron dome	1

Accessories for Roof Drains



MADE IN THE
USA

PART NO.	DESCRIPTION	CTN QTY
R18011	2", 3" & 4" underdeck clamp	1
R18028	6" underdeck clamp	10
R18012	16" plastic receiving pan	1
R18019	Plastic roof dome	1
R18020	Cast iron roof dome	1



Roof Drain with Plastic Dome

Fits over Schedule 40 DWV Pipe



MADE IN THE
USA

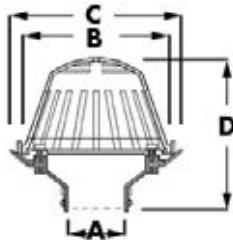

- Brass inserts in underside for underdeck clamps
- Dome has 50 square inches of free area

	A	B	C	D
Over 2" pipe		8-1/4"	11"	8"
Over 3" pipe		8-1/4"	11"	8"
Over 4" pipe		8-1/4"	11"	8"
Over 6" pipe		8-1/4"	11"	8"

PVC

PART NO.	DESCRIPTION	CTN QTY
R18013	2" plastic dome	1
R18014	3" plastic dome	1
R18015	4" plastic dome	1
R18027	6" plastic dome	1

ABS

PART NO.	DESCRIPTION	CTN QTY
R18016	2" plastic dome	1
R18017	3" plastic dome	1
R18018	4" plastic dome	1

SECTION F - CAST IRON

Closet Flanges and Accessories 239-240

Residential Shower/Floor Drains 241-243

Assembled Cast Iron Drains 244-248

Drain Bodies..... 249-250

Spuds and Strainers 250-251

General Purpose Drains..... 252-253

Assembled Cleanouts..... 254-257

Cleanout Bodies and Spuds..... 258-259

Cleanout Plugs 260-261

Cleanout Cover Plates..... 262

Bell Traps..... 263

Floor and Cesspool Drains/Grates 264

Service Sinks and Accessories 265

Roof Drains..... 266

Bar Grates/Sewer Strainers and Boxes 267

Vent Boxes/Caps/Backwater Valves 268

Test Tees and Closet Bends 269

Gas Burners/Log Lighter Valves/Accessories 270-271

F

Cast Iron Two Finger Flange



- Patent #: 5,937,450
- Flush fit
- Redesigned to fit oblong horns
- Made of cast iron
- Pushes easily into cast iron or Schedule 40 DWV pipe
- No tear out or caulking required
- ASTM C-564 rubber gasket
- 3" x 2", 4" x 2" and 4" x 3": for areas with the bend close to the flange
- 3" x 4", 4" x 4" and 4" x 6": for areas without the bend close to the flange or broken pipe



PART NO.	DESCRIPTION	CTN QTY
C47320	3" x 2" CI two finger flange	8
C47340	3" x 4" CI two finger flange	4
C47420	4" x 2" CI two finger flange	8
C47430	4" x 3" CI two finger flange	4
C47440	4" x 4" CI two finger flange	4
C47460	4" x 6" CI two finger flange	2

Inside Caulk Closet Flange



- Notched and slotted
- Inside caulk connection



Service Weight

PART NO.	DESCRIPTION	CTN QTY
C41410	4" x 1" inside caulk	10
C41411	4" x 1-1/2" inside caulk	10
C41420	4" x 2" inside caulk	8
C41421	4" x 2-1/2" inside caulk	8
C41430	4" x 3" inside caulk	6
C41440	4" x 4" inside caulk	4
C41460	4" x 6" inside caulk	2
Extra Heavy - 5" I.D. - NO BEAD		
C42421	4" x 2-1/2" inside caulk	8
C42440	4" x 4" inside caulk	4
C42460	4" x 6" inside caulk	2

Inside Caulk Reducing Closet Flange



- Notched and slotted
- Inside caulk connection



PART NO.	DESCRIPTION	CTN QTY
C45433	4" inlet x 3" outlet x 3" depth	6

No Caulk Closet Flange with Test Cap



- Slotted
- Stainless bolts and washers

PART NO.	DESCRIPTION	CTN QTY
C40425	4" x 2" no caulk	8

Code Blue No Caulk Closet Flange



- Four stainless bolts and washers
- Neoprene gasket meets ASTM C564
- Ideal for both repair and new construction
- Easy to install- reduces installation time by 80%
- Push over cast iron or plastic pipe, anchor to floor and tighten bolts
- C40420, C40430, and C40440 are UPC listed

Parts marked * are



PART NO.	DESCRIPTION	CTN QTY
C40320	3" pipe x 2" depth	8
C40420*	4" pipe x 2" depth	8
C40430*	4" pipe x 3" depth	4
C40440*	4" pipe x 4" depth	4

Code Blue No Caulk Closet Flange with Test Cap



- Cut out neoprene test cap
- Stainless steel bolts



PART NO.	DESCRIPTION	CTN QTY
C40500	4" x 2" no caulk	8
C40503	3" x 3" no caulk	8

No Hub Closet Flange



- Notched and slotted
- C46331 and C46351 are UPC listed

Parts marked * are



PART NO.	DESCRIPTION	CTN QTY
C46331*	3" x 3-1/2" no hub	6
C46431	4" x 3-1/2" no hub	6
C46351*	3" x 5-1/2" no hub	6
C46451	4" x 5-1/2" no hub	6

Items marked with the Jones Stephens logo are "You Need It... We Got It" Items.

2" Offset Closet Flange



PART NO.	DESCRIPTION	CTN QTY
C43440	4" x 4" x 2" inside caulk	4
C43441	4" x 4" x 2" no hub	4

Code Blue 1" Offset Closet Flange



• 5/16" bolt slots

F

PART NO.	DESCRIPTION	CTN QTY
C40640	4" no caulk	4

Four Way Offset Closet Flange



• 1-1/2" offset
• Internal clip allows 360° offset capability

PART NO.	DESCRIPTION	CTN QTY
C44420	4 "x 2" inside caulk	8
C44440	4" x 4" inside caulk	4

Brass Closet Flange



PART NO.	DESCRIPTION	CTN/MSTR
C49440	14 oz.	1/50
C49441	Deep seal 1-1/8"	1/40
C49442	16 oz.	1/50

Brass Four Way Offset Closet Flange



• Clip allows four way 1-1/2" offset
• For use with lead bends

PART NO.	DESCRIPTION	CTN/MSTR
C49421	4" x 2" 4-way offset closet flange	1/40

Closet Flange Repair Ring



• Securely attaches to concrete or wood sub-floor
• Replaces most closet rings
• Corrosion resistant
• Mounting ears offset by 1/8" to allow closet bolts to be installed

PART NO.	DESCRIPTION	CTN/MSTR
C85000	Closet flange repair ring	20/80

Moss Bay Repair Flange



• For corroded and rusted toilet flanges
• Installs in minutes
• Galvanized

PART NO.	DESCRIPTION	CTN/MSTR
C85500	Moss bay repair flange	1/50

Gapper Flange



• Used to repair broken closet flanges
• Individually carded

PART NO.	DESCRIPTION	CTN/MSTR
C87100	Repair flange (carded)	24/240

Flange Support for Wood Floors



• Supports flange if floor has rotted or if rough-in hole is too large
• Easy to install- complete kit includes screws
• Cast iron fits 3" or 4" flange; plastic fits 3", 4" or 3"x 4" flange
• Individually carded

PART NO.	DESCRIPTION	CTN/MSTR
C01001	Flange support for plastic (carded)	1/50
C01002	Flange support for cast iron (carded)	1/50

Items marked with the Jones Stephens logo are "You Need It...We Got It" Items.

Cast Iron Residential Shower/Floor Drains

Pages 241-243

SIZES: 1-1/2", 2"



For use in
residential applications.

1-1/2" or 2" Code Blue EZ Test Shower Drain



- Includes cover plate and stainless steel screws
- D64012 and D64302 are UPC approved
- Nipple not included

Parts marked

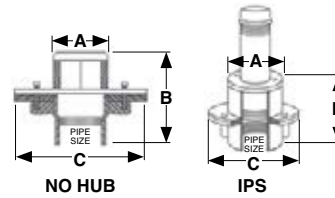

PIPE SIZE	A	B	C
1-1/2"	3-1/2"	4-1/4"	6"
2"	3-1/2"	4-1/4"	7"

PART NO.	SIZE	BASE	STRAINER	CTN/MSTR
D64150	1-1/2" IPS	6"	SS	1/4
D64202	2" IPS	6"	SS	1/4
D64012*	2" IPS	7"	SS	1/4
D64302*	2" no hub	6"	SS	1/4

2" Code Blue Shower Drain



- Includes cover plate and stainless steel screws
- No caulk includes built-in test plug
- D64002 and D64022 are UPC approved

Parts marked

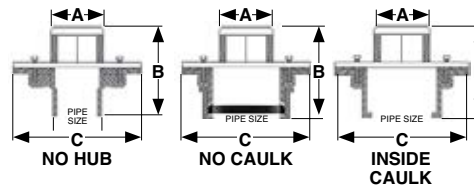

PIPE SIZE	A	B	C
2"	3-1/2"	4-1/4"	6"
2"	3-1/2"	4-1/4"	7"

PART NO.	SIZE	BASE	STRAINER	CTN/MSTR
D64502	2" no caulk	6"	SS	1/4
D64002*	2" no caulk	7"	SS	1/4
D64402	2" inside caulk	6"	SS	1/4
D64402G	D64402 + gasket	6"	SS	1/4
D64022*	2" no hub	7"	SS	1/4

Items marked with the Jones Stephens logo are "You Need It... We Got It" Items.

2" Code Blue Roman Tub Drain



- 6" and 7" pans
- Non-adjustable

PART NO.	SIZE	BASE	FINISH	CTN QTY
D64800	2" IPS	7"	CP (PVD)	1
D64801	2" no caulk	7"	CP (PVD)	1
D64802	2" IPS	6"	CP (PVD)	1
D64803	2" no caulk	6"	CP (PVD)	1
D64804	2" IPS	7"	PB (PVD)	1
D64805	2" no caulk	7"	PB (PVD)	1
D64806	2" IPS	6"	PB (PVD)	1
D64807	2" no caulk	6"	PB (PVD)	1
D64808	2" IPS	7"	SN (PVD)	1
D64809	2" no caulk	7"	SN (PVD)	1
D64810	2" IPS	6"	SN (PVD)	1
D64811	2" no caulk	6"	SN (PVD)	1

F Code Blue Replacement Strainer



- Roman tub drains
- Fits non-adjustable Code Blue drains

PART NO.	DESCRIPTION	CTN/MSTR
D40000	CP strainer	1/50
D40001	PB (PVD) strainer	1/50
D40002	SN (PVD) strainer	1/50



- Regular strainer
- Fits non-adjustable Code Blue drains
- Will not fit D64010 or D64011
- Includes screws

PART NO.	DESCRIPTION	CTN/MSTR
D64000	2" SS	1/50
D64401	2" SS crown	1/400
D64001	2" PB (PVD)	1/100
D6400BN	2" Brushed Nickel	1/250
D6400RB	2" Oil Rubbed Bronze	1/250
D6400WB	2" Old World Bronze	1/250

2" Code Blue Non-Adjustable Drain



- With ABS base and cast iron top

PART NO.	TOP	BASE	CTN/MSTR
D64010	Cast Iron	ABS base	1/8
D64011 (with test cap)	Cast Iron	ABS base	1/8

Ⓢ Items marked with the Jones Stephens logo are "You Need It... We Got It" Items.

2" Shower/Floor Drain



- Brass spud
- 6-1/2" pan
- Tongue and groove cast iron bolt down clamping ring
- Weep holes on both top and bottom for secondary drainage
- Inside caulk unit can be used with gasket to make unit no-caulk

PART NO.	SIZE	STRAINER	CTN QTY
D60100	2" inside caulk	4" SS round	8
D60102	2" FIP	4" SS round	8
D60103	2" no hub	4" SS round	8
D60201	2" inside caulk	4" CP cast round	8
D60202	2" inside caulk	4" PB cast round	8
D60203	2" FIP	4" CP cast round	8
D60204	2" FIP	4" PB cast round	8
D60205 Ⓢ	2" no hub	4" CP cast round	8
D60206	2" no hub	4" PB cast round	8
D60211	2" inside caulk	6" CP cast round	1
D60212	2" inside caulk	6" PB cast round	1
D60207	2" FIP	6" CP cast round	1
D60208	2" FIP	6" PB cast round	1
D60209	2" no hub	6" CP cast round	1
D60210	2" no hub	6" PB cast round	1
D60400	2" inside caulk	4" CP cast square	1
D60410	2" inside caulk	4" PB cast square	1
D60402	2" FIP	4" CP cast square	1
D60412	2" FIP	4" PB cast square	1
D60403	2" no hub	4" CP cast square	1
D60413	2" no hub	4" PB cast square	1
D60499	2" inside caulk push on	4" CP cast square	1
D60498	2" inside caulk push on	4" PB cast square	1
D60101	2" gasket for inside caulk unit		1

2" Shower Drain with Brass Threaded Clamping Ring



- Brass spud
- 6-1/2" pan
- Designed for lead pan showers
- Weep holes in clamping ring

PART NO.	SIZE	STRAINER	CTN QTY
D61101	2" IPS	4" SS round	4
D61102	2" no hub	4" SS round	4
D61103	2" inside caulk	4" SS round	4
D61201	2" IPS	4" CP cast brass round	4
D61202	2" no hub	4" CP cast brass round	4
D61203	2" inside caulk	4" CP cast brass round	4
D61301	2" IPS	6" PB cast brass round	4
D61302	2" no hub	6" PB cast brass round	4
D61303	2" inside caulk	6" PB cast brass round	4
D61850	Brass screw-down clamping ring		1

2" Shower Drain Base with Clamping Ring and Bolts



- 6-1/2" pan; 2-1/2" height
- Tongue and groove cast iron bolt down clamping ring
- Weep holes on both top and bottom for secondary drainage
- Inside caulk unit can be used with gasket to make unit no caulk
- For 2" IPS threaded tailpieces

PART NO.	SIZE	HEIGHT	CTN QTY
D60900	2" inside caulk	2-1/2"	1
D60901	2" FIP	2-1/2"	1
D60902	2" no hub	2-1/2"	1

2" Shower Drain Base with Brass Threaded Clamping Ring



- 6-3/8" pan; 3-1/4" height
- Designed for lead pan showers
- Weep holes in clamping ring
- For 2" IPS threaded tailpieces

PART NO.	SIZE	CTN QTY
D61800	2" FIP	1
D61801	2" no hub	1
D61802	2" inside caulk	1

F

Cast Iron Commercial Drains

Pages 244-248

F

SIZES: 2", 3", 4"



For use in
commercial applications.

2" Code Blue No Caulk (Mechanical Joint) Floor Drain



- 1/2" Primer tapped with brass plug
- Supplied with stainless steel bolts
- UPC listed

PART NO.	PAN	STRAINER	HEIGHT	CTN QTY
D65661	7"	4" NB round	4" - 4-13/16"	1
D65662	7"	4" PB round	4" - 4-13/16"	1
D66681	9"	4" NB round	4" - 4-13/16"	1
D66682	9"	4" PB round	4" - 4-13/16"	1
D65500	7"	5" NB round	4" - 5"	1
D65501	7"	5" PB round	4" - 5"	1
D65502	7"	5" CP round	4" - 5"	1
D66500	9"	5" NB round	4" - 5"	1
D66501	9"	5" PB round	4" - 5"	1
D66502	9"	5" CP round	4" - 5"	1
D65503	7"	6" NB round	4-1/4" - 5-1/4"	1
D65504	7"	6" PB round	4-1/4" - 5-1/4"	1
D65505	7"	6" CP round	4-1/4" - 5-1/4"	1
D66503	9"	6" NB round	4-1/4" - 5-1/4"	1
D66504	9"	6" PB round	4-1/4" - 5-1/4"	1
D66505	9"	6" CP round	4-1/4" - 5-1/4"	1
D65509	7"	5" NB square	4-1/4" - 5-1/4"	1
D65511	7"	5" PB square	4-1/4" - 5-1/4"	1
D66509	9"	5" NB square	4-1/4" - 5-1/4"	1
D66511	9"	5" PB square	4-1/4" - 5-1/4"	1
D65510	7"	6" NB square	4-1/4" - 5-1/4"	1
D65512	7"	6" PB square	4-1/4" - 5-1/4"	1
D66510	9"	6" NB square	4-1/4" - 5-1/4"	1
D66512	9"	6" PB square	4-1/4" - 5-1/4"	1

2" Code Blue (Mechanical Joint) No Caulk Slab Drain



- No Clamping Ring

PART NO.	PAN	STRAINER	HEIGHT	CTN QTY
D67001	7"	4" NB round	3-3/4" - 4-3/4"	1
D67002	7"	4" PB round	3-3/4" - 4-3/4"	1
D67003	7"	5" NB round	3-3/4" - 4-7/8"	1
D67004	7"	5" PB round	4" - 5-3/8"	1
D67005	7"	5" CP round	3-1/2" - 4-7/8"	1
D67006	7"	6" NB round	3-3/4" - 5-1/8"	1
D67007	7"	6" PB round	3-3/4" - 5-1/8"	1
D67008	7"	6" CP round	4" - 5-1/2"	1

2" Code Blue No Hub Floor Drain



- 1/2" Primer tapped with brass plug
- Supplied with stainless steel bolts
- UPC listed

3 1/2" IPS Spud with 4", 5" or 6" Round Strainer

PART NO.	PAN	STRAINER	HEIGHT	CTN QTY
D66675	9"	4" NB round	3-3/4" - 4-5/8"	1
D66676	9"	4" PB round	3-3/4" - 4-5/8"	1
D65655	7"	4" NB round	3-3/4" - 4-7/16"	1
D65656	7"	4" PB round	3-3/4" - 4-7/16"	1
D65560	7"	5" NB round	2-7/8" - 4-1/2"	1
D65561	7"	5" PB round	2-7/8" - 4-1/2"	1
D65562	7"	5" CP round	2-7/8" - 4-1/2"	1
D66560	9"	5" NB round	3-1/2" - 5-1/8"	1
D66561	9"	5" PB round	3-1/2" - 5-1/8"	1
D66562	9"	5" CP round	3-1/2" - 5-1/8"	1
D65563	7"	6" NB round	4" - 5-1/4"	1
D65564	7"	6" PB round	4" - 5-1/4"	1
D65565	7"	6" CP round	4" - 5-1/4"	1
D66563	9"	6" NB round	3-5/8" - 5-5/8"	1
D66564	9"	6" PB round	3-5/8" - 5-5/8"	1
D66565	9"	6" CP round	3-5/8" - 5-5/8"	1
D65569	7"	5" NB square	3-1/4" - 5-1/4"	1
D65571	7"	5" PB square	3-1/4" - 5-1/4"	1
D66569	9"	5" NB square	3-7/8" - 5-7/8"	1
D66571	9"	5" PB square	3-7/8" - 5-7/8"	1
D65570	7"	6" NB square	4" - 5-1/4"	1
D65572	7"	6" PB square	4" - 5-1/4"	1
D66570	9"	6" NB square	4-1/8" - 6-3/8"	1
D66572	9"	6" PB square	4-1/8" - 6-3/8"	1

2" Code Blue No Hub Slab Drain



- No clamping ring

PART NO.	PAN	STRAINER	HEIGHT	CTN QTY
D67016	7"	4" NB round	3-5/8" - 4-3/4"	1
D67017	7"	4" PB round	3-5/8" - 4-3/4"	1
D67018	7"	5" NB round	3-1/2" - 4-7/8"	1
D67019	7"	5" PB round	4" - 5-3/8"	1
D67020	7"	5" CP round	3-1/2" - 4-7/8"	1
D67021	7"	6" NB round	3-7/8" - 5"	1
D67022	7"	6" PB round	3-3/4" - 5"	1
D67023	7"	6" CP round	4" - 5-3/8"	1
D67027	7"	5" NB square	3-3/4" - 5-1/8"	1
D67028	7"	5" PB square	3-3/4" - 5-1/8"	1
D67029	7"	6" NB square	4" - 5-3/16"	1
D67030	7"	6" PB square	4" - 5-3/16"	1

2" Code Blue IPS Floor Drain



- 1/2" Primer tapped with brass plug
- Supplied with stainless steel bolts
- UPC listed

PART NO.	PAN	STRAINER	HEIGHT	CTN QTY
D66687	9"	4" NB round	3-1/4" - 4"	1
D66688	9"	4" PB round	3-1/4" - 4"	1
D65665	7"	4" NB round	3-3/16" - 4-3/16"	1
D65620	7"	5" NB round	2-7/8" - 4-1/2"	1
D65621	7"	5" PB round	2-7/8" - 4-1/2"	1
D65622	7"	5" CP round	2-7/8" - 4-1/2"	1
D66620	9"	5" NB round	3-1/2" - 5-1/8"	1
D66621	9"	5" PB round	3-1/2" - 5-1/8"	1
D66622	9"	5" CP round	3-1/2" - 5-1/8"	1
D65623	7"	6" NB round	3-1/2" - 4-1/2"	1
D65624	7"	6" PB round	3-1/2" - 4-1/2"	1
D65625	7"	6" CP round	3-1/2" - 4-1/2"	1
D66623	9"	6" NB round	3-5/8" - 5-5/8"	1
D66624	9"	6" PB round	3-5/8" - 5-5/8"	1
D66625	9"	6" CP round	3-5/8" - 5-5/8"	1

2" Code Blue Push-On Floor Drain



- With clamping ring
- Supplied with V96002 gasket for 2" cast iron pipe

PART NO.	PAN	STRAINER	HEIGHT	CTN QTY
D66700	9"	4" NB round	4-5/8" - 5-1/2"	1
D66701	9"	4" PB round	4-5/8" - 5-1/2"	1
D66702	9"	5" NB round	4-5/8" - 5-1/2"	1
D66703	9"	5" PB round	5-3/16" - 6-1/8"	1
D66704	9"	5" CP round	4-3/4" - 5-1/2"	1
D66705	9"	6" NB round	4-7/8" - 5-3/4"	1
D66706	9"	6" PB round	4-7/8" - 5-3/4"	1
D66707	9"	6" CP round	5-1/4" - 6-1/4"	1

2" Bronze Shower Drain



- Heavy bronze body
- Suitable for residential and commercial installation
- 4-1/2" strainers in stainless steel or PVD polished brass
- Solid bronze strainer spuds in standard (1-1/2") or long pattern (2-1/2") length
- 3 types of 2" connections

2" IPS Drain

PART NO.	SPUD	STRAINER	CTN QTY
D68510	Standard	4-1/2" SS round	1
D68511	Standard	4-1/2" PB (PVD) round	1
D68512	Long pattern	4-1/2" SS round	1
D68513	Long pattern	4-1/2" PB (PVD) round	1

2" Caulk Drain

PART NO.	SPUD	STRAINER	CTN QTY
D68610	Standard	4-1/2" SS round	1
D68611	Standard	4-1/2" PB (PVD) round	1
D68612	Long pattern	4-1/2" SS round	1
D68613	Long pattern	4-1/2" PB (PVD) round	1

2" Sweat Drain

PART NO.	SPUD	STRAINER	CTN QTY
D68710	Standard	4-1/2" SS round	1
D68711	Standard	4-1/2" PB (PVD) round	1
D68712	Long pattern	4-1/2" SS round	1
D68713	Long pattern	4-1/2" PB (PVD) round	1

Replacement Strainers

PART NO.	DESCRIPTION	CTN/MSTR
D68507	4 1/2" SS strainer with screws	100/400
D68508	4 1/2" (PVD) PB strainer with screws	100/400

3" Heavy Duty No Hub Floor/Shower Drain



- Cast metal strainer and tailpiece
- Cast iron body

PART NO.	PAN	STRAINER	HEIGHT	CTN QTY
D80200	10"	5" CP round	4-1/2" - 6-1/2"	1
D80201	10"	5" PB round	4-1/2" - 6-1/2"	1
D80212	10"	5" NB round	4-1/2" - 6-1/2"	1
D80202	10"	6" CP round	4-1/2" - 6-1/2"	1
D80203	10"	6" PB round	4-1/2" - 6-1/2"	1
D80213	10"	6" NB round	4-1/2" - 6-1/2"	1
D80214	10"	5" PB square	4-1/2" - 6-1/2"	1
D80216	10"	5" NB square	4-1/2" - 6-1/2"	1
D80215	10"	6" PB square	4-1/2" - 6-1/2"	1
D80217	10"	6" NB square	4-1/2" - 6-1/2"	1

3" Heavy Duty Inside Caulk Floor/Shower Drain



- Cast metal strainer and tailpiece
- Cast iron body

PART NO.	PAN	STRAINER	HEIGHT	CTN QTY
D80100	10"	5" CP round	4-1/2" - 6-1/2"	1
D80101	10"	5" PB round	4-1/2" - 6-1/2"	1
D80112	10"	5" NB round	4-1/2" - 6-1/2"	1
D80102	10"	6" CP round	4-3/4" - 6-3/4"	1
D80103	10"	6" PB round	4-3/4" - 6-3/4"	1
D80113	10"	6" NB round	4-3/4" - 6-3/4"	1

3" Code Blue No Caulk (Mechanical Joint) Floor Drain



- 1/2" Primer tapped with brass plug
- Supplied with stainless steel bolts
- UPC listed



PART NO.	PAN	STRAINER	HEIGHT	CTN QTY
D66683	9"	4" NB round	4" - 4-3/4"	1
D66684	9"	4" PB round	4" - 4-3/4"	1
D65663	7"	4" NB round	4" - 4-13/16"	1
D65664	7"	4" PB round	4" - 4-13/16"	1
D65520	7"	5" NB round	2-7/8" - 4-1/2"	1
D65521	7"	5" PB round	2-7/8" - 4-1/2"	1
D65522	7"	5" CP round	2-7/8" - 4-1/2"	1
D66520	9"	5" NB round	3-1/2" - 5-1/8"	1
D66521	9"	5" PB round	3-1/2" - 5-1/8"	1
D66522	9"	5" CP round	3-1/2" - 5-1/8"	1
D65523	7"	6" NB round	3" - 5"	1
D65524	7"	6" PB round	3" - 5"	1
D65525	7"	6" CP round	3" - 5"	1
D66523	9"	6" NB round	3-5/8" - 5-5/8"	1
D66524	9"	6" PB round	3-5/8" - 5-5/8"	1
D66525	9"	6" CP round	3-5/8" - 5-5/8"	1

3" Code Blue No Hub Slab Drain



- No clamping ring

PART NO.	PAN	STRAINER	HEIGHT	CTN QTY
D67031	7"	4" NB round	3-1/2" - 4-3/4"	1
D67032	7"	4" PB round	3-1/2" - 4-3/4"	1
D67033	7"	5" NB round	3-1/2" - 4-13/16"	1
D67034	7"	5" PB round	4" - 5-5/16"	1
D67035	7"	5" CP round	3-1/2" - 4-13/16"	1
D67036	7"	6" NB round	3-3/4" - 5"	1
D67037	7"	6" PB round	3-3/4" - 5"	1
D67038	7"	6" CP round	4" - 5-3/8"	1
D67039	7"	8" NB round	4-1/8" - 5-5/8"	1
D67040	7"	8" PB round	4-1/8" - 5-5/8"	1
D67041	7"	8" CP round	4-1/4" - 5-5/8"	1
D67042	7"	9" NB round	4-1/4" - 5-5/8"	1
D67043	7"	9" PB round	4-1/4" - 5-5/8"	1
D67044	7"	5" NB square	3-3/4" - 5-1/16"	1
D67045	7"	5" PB square	3-7/8" - 5-1/16"	1
D67046	7"	6" NB square	4" - 5-1/4"	1
D67047	7"	6" PB square	4" - 5-1/4"	1

3" Code Blue No Hub Floor Drain



- 1/2" Primer tapped with brass plug
- Supplied with stainless steel bolts
- UPC listed



PART NO.	PAN	STRAINER	HEIGHT	CTN QTY
D65657	7"	4" NB round	3-3/4" - 4-7/16"	1
D65658	7"	4" PB round	3-3/4" - 4-7/16"	1
D66677	9"	4" NB round	3-3/4" - 4-5/8"	1
D66678	9"	4" PB round	3-3/4" - 4-5/8"	1
D65580	7"	5" NB round	2-7/8" - 4-1/2"	1
D65581	7"	5" PB round	2-7/8" - 4-1/2"	1
D65582	7"	5" CP round	2-7/8" - 4-1/2"	1
D66580	9"	5" NB round	3-1/2" - 5-1/8"	1
D66581	9"	5" PB round	3-1/2" - 5-1/8"	1
D66582	9"	5" CP round	3-1/2" - 5-1/8"	1
D65583	7"	6" NB round	3" - 5"	1
D65584	7"	6" PB round	3" - 5"	1
D65585	7"	6" CP round	3" - 5"	1
D66583	9"	6" NB round	3-5/8" - 5-5/8"	1
D66584	9"	6" PB round	3-5/8" - 5-5/8"	1
D66585	9"	6" CP round	3-5/8" - 5-5/8"	1

Items marked with the Jones Stephens logo are "You Need It...We Got It" Items.

3" Code Blue IPS Floor Drain



- 1/2" Primer tapped with brass plug
- Supplied with stainless steel bolts
- UPC listed



PART NO.	PAN	STRAINER	HEIGHT	CTN QTY
D66689	9"	4" NB round	3-1/4" x 4"	1
D66690	9"	4" PB round	3-1/4" x 4"	1
D65667	7"	4" NB round	3-3/16" - 4-13/16"	1
D65668	7"	4" PB round	3-3/16" - 4-13/16"	1
D65640	7"	5" NB round	2-7/8" - 4-1/2"	1
D65641	7"	5" PB round	2-7/8" - 4-1/2"	1
D65642	7"	5" CP round	2-7/8" - 4-1/2"	1
D66640	9"	5" NB round	3-1/2" - 5-1/8"	1
D66641	9"	5" PB round	3-1/2" - 5-1/8"	1
D66642	9"	5" CP round	3-1/2" - 5-1/8"	1
D65643	7"	6" NB round	3" - 5"	1
D65644	7"	6" PB round	3" - 5"	1
D65645	7"	6" CP round	3" - 5"	1
D66643	9"	6" NB round	3-5/8" - 5-5/8"	1
D66644	9"	6" PB round	3-5/8" - 5-5/8"	1
D66645	9"	6" CP round	3-5/8" - 5-5/8"	1

3" Code Blue Push-On Floor Drain



- With clamping ring
- Supplied with V96003 gasket for 3" cast iron pipe

PART NO.	PAN	STRAINER	HEIGHT	CTN QTY
D66715	9"	4" NB round	4-3/4" - 5-5/8"	1
D66716	9"	4" PB round	4-3/4" - 5-5/8"	1
D66717	9"	5" NB round	4-3/4" - 5-5/8"	1
D66718	9"	5" PB round	5-3/8" - 6-1/4"	1
D66719	9"	5" CP round	4-3/4" - 5-5/8"	1
D66720	9"	6" NB round	5" - 6"	1
D66721	9"	6" PB round	5" - 6"	1
D66722	9"	6" CP round	5-3/8" - 6-3/8"	1

4" Heavy Duty No Hub Floor/Shower Drain



- Cast metal strainer and tailpiece
- Cast iron body

PART NO.	PAN	STRAINER	HEIGHT	CTN QTY
D80206	10"	5" CP round	4-1/2" - 6-1/2"	1
D80207	10"	5" PB round	4-1/2" - 6-1/2"	1
D80218	10"	5" NB round	4-1/2" - 6-1/2"	1
D80208	10"	6" CP round	4-3/4" - 6-3/4"	1
D80209	10"	6" PB round	4-3/4" - 6-3/4"	1
D80219	10"	6" NB round	4-3/4" - 6-3/4"	1
D80210	10"	8" CP round	5" - 7"	1
D80211	10"	8" PB round	5" - 7"	1
D80220	10"	5" PB square	4-1/2" - 6-1/2"	1
D80222	10"	5" NB square	4-1/2" - 6-1/2"	1
D80221	10"	6" PB square	4-3/4" - 6-3/4"	1
D80223	10"	6" NB square	4-3/4" - 6-3/4"	1

4" Heavy Duty Inside Caulk Floor/Shower Drain



- Cast metal strainer and tailpiece
- Cast iron body

PART NO.	PAN	STRAINER	HEIGHT	CTN QTY
D80106	10"	5" CP round	4-1/2" - 6-1/2"	1
D80107	10"	5" PB round	4-1/2" - 6-1/2"	1
D80118	10"	5" NB round	4-1/2" - 6-1/2"	1
D80108	10"	6" CP round	4-3/4" - 6-3/4"	1
D80109	10"	6" PB round	4-3/4" - 6-3/4"	1
D80119	10"	6" NB round	4-3/4" - 6-3/4"	1

4" Code Blue No Caulk (Mechanical Joint) Floor Drain



- 1/2" Primer tapped with brass plug
- Supplied with stainless steel bolts
- UPC listed



PART NO.	PAN	STRAINER	HEIGHT	CTN QTY
D66685	9"	4" NB round	4" - 4-7/8"	1
D66686	9"	4" PB round	4" - 4-7/8"	1
D66540	9"	5" NB round	3-1/2" - 5-1/8"	1
D66541	9"	5" PB round	3-1/2" - 5-1/8"	1
D66542	9"	5" CP round	3-1/2" - 5-1/8"	1
D66543	9"	6" NB round	3-5/8" - 5-5/8"	1
D66544	9"	6" PB round	3-5/8" - 5-5/8"	1
D66545	9"	6" CP round	3-5/8" - 5-5/8"	1

4" Code Blue IPS Floor Drain



- 1/2" Primer tapped with brass plug
- Supplied with stainless steel bolts
- UPC listed



PART NO.	PAN	STRAINER	HEIGHT	CTN QTY
D66691	9"	4" NB round	3-1/4" - 4"	1
D66692	9"	4" PB round	3-1/4" - 4"	1
D66660	9"	5" NB round	3-1/2" - 5 1/8"	1
D66661	9"	5" PB round	3-1/2" - 5-1/8"	1
D66662	9"	5" CP round	3-1/2" - 5-1/8"	1
D66663	9"	6" NB round	3-5/8" - 5-5/8"	1
D66664	9"	6" PB round	3-5/8" - 5-5/8"	1
D66665	9"	6" CP round	3-5/8" - 5-5/8"	1

4" Code Blue No Hub Floor Drain



- 1/2" Primer tapped with brass plug
- Supplied with stainless steel bolts
- UPC listed



PART NO.	PAN	STRAINER	HEIGHT	CTN QTY
D66679	9"	4" NB round	3-3/8" - 4-5/8"	1
D66680	9"	4" PB round	3-3/8" - 4-5/8"	1
D65659	7"	4" NB round	3-3/4" - 4-7/16"	1
D65660	7"	4" PB round	3-3/4" - 4-7/16"	1
D65600	7"	5" NB round	3-1/2" - 4-3/4"	1
D65601	7"	5" PB round	3-1/2" - 4-3/4"	1
D65602	7"	5" CP round	3-1/2" - 4-3/4"	1
D66600	9"	5" NB round	3-1/2" - 4-3/4"	1
D66601	9"	5" PB round	3-1/2" - 4-3/4"	1
D66602	9"	5" CP round	3-1/2" - 4-3/4"	1
D65603	7"	6" NB round	3-3/4" - 5"	1
D65604	7"	6" PB round	3-3/4" - 5"	1
D65605	7"	6" CP round	3-3/4" - 5"	1
D66603	9"	6" NB round	3-3/4" - 5"	1
D66604	9"	6" PB round	3-3/4" - 5"	1
D66605	9"	6" CP round	3-3/4" - 5"	1

4" Code Blue No Hub Slab Drain



- No clamping ring

PART NO.	PAN	STRAINER	HEIGHT	CTN QTY
D67048	7"	4" NB round	3-5/8" - 4-7/8"	1
D67049	7"	4" PB round	3-5/8" - 4-7/8"	1
D67050	7"	5" NB round	3-5/8" - 4-7/8"	1
D67051	7"	5" PB round	4" - 5-3/8"	1
D67052	7"	5" CP round	3-1/2" - 4-7/8"	1
D67053	7"	6" NB round	3-7/8" - 5-1/16"	1
D67054	7"	6" PB round	3-3/4" - 5-1/16"	1
D67055	7"	6" CP round	4" - 5-1/2"	1

4" Code Blue Push-On Floor Drain



- With clamping ring
- Supplied with V96004 gasket for 4" cast iron pipe

PART NO.	PAN	STRAINER	HEIGHT	CTN QTY
D66732	9"	4" NB round	4-3/4" - 5-1/2"	1
D66733	9"	4" PB round	4-3/4" - 5-1/2"	1
D66734	9"	5" NB round	4-3/4" - 5-5/8"	1
D66735	9"	5" PB round	5-1/4" - 6-3/16"	1
D66736	9"	5" CP round	4-3/4" - 5-5/8"	1
D66737	9"	6" NB round	5" - 6-1/8"	1
D66738	9"	6" PB round	5" - 6-1/8"	1
D66739	9"	6" CP round	5-3/8" - 6-3/8"	1

Cast Iron Commercial Drain Components

Pages 249-251

SIZES: 2", 3", 3-1/2", 4"



For use in
commercial applications.

Heavy Duty Drain Base



- For use with heavy duty floor drains
- For 3-1/2" IPS threaded tailpieces

PART NO.	SIZE	PAN	HEIGHT	CTN QTY
D80097	3" no hub	10-1/2"	3-1/2"	1
D80099	3" inside caulk	10-1/2"	3-1/2"	1
D80090	3" no hub; 1/2 PT	10-1/2"	3-1/2"	1
D80096	4" no hub	10-1/2"	3-1/2"	1
D80098	4" inside caulk	10-1/2"	3-1/2"	1
D80091	4" no hub; 1/2 PT	10-1/2"	3-1/2"	1

Code Blue No Caulk (Mechanical Joint) Drain Base



- 1/2" Primer tapped with brass plug
- Supplied with stainless steel bolts
- Test plug included
- Tapped for 3-1/2" spud

PART NO.	SIZE	PAN	SPUD	HEIGHT	CTN QTY
D65002	2"	7"	3-1/2"	2-1/2"	1
D66002	2"	9"	3-1/2"	3-1/8"	1
D65003	3"	7"	3-1/2"	2-1/2"	1
D66003	3"	9"	3-1/2"	3-1/8"	1
D66004	4"	9"	3-1/2"	3-1/8"	1

Code Blue No Hub Drain Base



- Tapped for 3-1/2" spud
- 1/2" Primer tapped with brass plug
- Supplied with stainless steel bolts

PART NO.	SIZE	PAN	SPUD	HEIGHT	CTN QTY
D65102	2"	7"	3-1/2"	2-1/2"	1
D66102	2"	9"	3-1/2"	3-1/8"	1
D65103	3"	7"	3-1/2"	2-1/2"	1
D66103	3"	9"	3-1/2"	3-1/4"	1
D65104	4"	7"	3-1/2"	2-1/2"	1
D66104	4"	9"	3-1/2"	3-1/8"	1

Code Blue Drain Base



- Tapped for 3-1/2" spud
- 1/2" Primer tapped with brass plug
- Supplied with stainless steel bolts

PART NO.	SIZE	PAN	SPUD	HEIGHT	CTN QTY
D65202	2" IPS	7"	3-1/2"	2-1/2"	1
D66202	2" IPS	9"	3-1/2"	3-1/8"	1
D65203	3" IPS	7"	3-1/2"	2-1/2"	1
D66203	3" IPS	9"	3-1/2"	3-1/8"	1
D66204	4" IPS	9"	3-1/2"	3-1/8"	1

Code Blue No Caulk (Mechanical Joint) Slab Drain Base



- 1/2" primer tap with brass plug
- Less clamping ring
- Tapped for 3-1/2" spud

PART NO.	SIZE	PAN	SPUD	HEIGHT	CTN QTY
D67201	2"	7"	3-1/2"	3-3/8"	1

Code Blue No Hub Slab Drain Base



- 1/2" primer tap with brass plug
- Less clamping ring
- Tapped for 3-1/2" spud

PART NO.	SIZE	PAN	SPUD	HEIGHT	CTN QTY
D67200	2"	7"	3-1/2"	3-3/8"	1
D67300	3"	7"	3-1/2"	3-3/8"	1
D67400	4"	7"	3-1/2"	3-3/8"	1

Code Blue Push-On Drain Base



- 1/2" primer tapped with brass plug
- Tapped for 3-1/2" spud
- Supplied with stainless steel bolts
- For PVC connections, you must replace with extra heavy Dual Tite gaskets

PART NO.	SIZE	PAN	SPUD	HEIGHT	CTN QTY
D66200	2"	9"	3-1/2"	3-3/4"	1
D66300	3"	9"	3-1/2"	3-3/4"	1
D66400	4"	9"	3-1/2"	3-3/4"	1

No Hub Base



- Use with CI strainers or covers for heavy trucking traffic
- Use with PB, NB, SS or CP strainers or covers for heavy pedestrian traffic

NOTE: 3" No hub will receive a 2" multi-tite gasket and therefore becomes a 2" push-on body. 4" No hub will receive a 3" multi-tite gasket.

PART NO.	NO HUB BASE x SPUD	HEIGHT	CTN QTY
D63300	3"x 3" IPS	4-1/4"	1
D63349	3"x 3-1/2" IPS	4-1/4"	1
D63350	4"X 3-1/2" IPS	4-1/4"	1
D63400	4"x 4" IPS	4-1/4"	1

Gasket Connection Base



- Supplied with Multi-Tite gasket
- Use with CI strainers or covers for heavy trucking traffic
- Use with PB, NB, SS or CP strainers or covers for heavy pedestrian traffic

PART NO.	S.V. BASE x SPUD	HEIGHT	CTN QTY
D62300	3"x 3" IPS	5-1/4"	1
D62349	3"x 3-1/2" IPS	5-1/4"	1
D62350	4"x 3-1/2" IPS	5-1/2"	1
D62400	4"x 4" IPS	5-1/2"	1

3-1/2" Spud Extension



- 2-1/2"-4" extension for a 3-1/2 drain/cleanout spud
- Use on cast iron or PVC drain bodies when additional height is needed to offset inconsistent concrete pours

PART NO.	DESCRIPTION	CTN QTY
D60979	3-1/2" spud extension	1

Cast Iron Spud with Round Strainer for Heavy Duty Drain Base



- For use with heavy duty floor drains

2-1/2" IPS threaded throat for testing with round strainer

PART NO.	SPUD	STRAINER	CTN QTY
D62130	3" IPS	4-9/16" CI	1
D62131	3" IPS	5" NB with ring	1
D62132	3" IPS	5" PB with ring	1

3" IPS threaded throat for testing with round strainer

PART NO.	SPUD	STRAINER	CTN QTY
D62135	3-1/2" IPS	5-1/2" CI	1
D62136	3-1/2" IPS	6" NB with ring	1
D62137	3-1/2" IPS	6" PB with ring	1

3-1/2" IPS threaded throat for testing with round strainer

PART NO.	SPUD	STRAINER	CTN QTY
D62140	4" IPS	5-1/2" CI	1
D62141	4" IPS	6" NB with ring	1
D62142	4" IPS	6" PB with ring	1

Plastic Spud with Square Strainer and Top for Heavy Duty Drain Base



- For use with heavy duty floor drains
- 5" round cover with 7" square top

PART NO.	IPS	STRAINER	CTN QTY
D56500	3"	5" PB	1
D56501	3"	5" NB	1
D56502	3-1/2"	5" PB	1
D56503	3-1/2"	5" NB	1
D56504	4"	5" PB	1
D56505	4"	5" NB	1

3-1/2" Metal Spud with Round Strainer



• For use with floor drains

PART NO.	IPS	STRAINER	CTN/MSTR
D60986	3-1/2"	4" NB	1/40
D60987	3-1/2"	4" PB	1/40
Replacement Strainer			
D60966	Replacement strainer for D60986		1/50
D60967	Replacement strainer for D60987		1/100

3-1/2" Metal Spud with Square Strainer



• For use with floor drains

PART NO.	IPS	STRAINER	SCREWS	CTN/MSTR
D60954	3-1/2"	5" CP	4 (3-7/8")	1/20
D60960	3-1/2"	5" PB	4 (3-7/8")	1/20
D60962	3-1/2"	5" NB	4 (3-7/8")	1/20
D60961	3-1/2"	6" PB	4 (4-7/8")	1/12
D60963	3-1/2"	6" NB	4 (4-7/8")	1/12

Metal Spud with Round Strainer



• For use with floor drains

PART NO.	IPS	STRAINER	SCREWS	CTN/MSTR
D60980	2"	4" SS stamped	2 (3-3/8")	1/50
D60981	2"	4" Chrome cast	2 (3-3/8")	1/50
D60982	2"	4" PB cast	2 (3-3/8")	1/50
D60970	2"	6" CP	2 (5")	1/30
D60975	2"	6" PB	2 (5")	1/30
D60955	2"	5" NB	3 (3-7/8")	1/30
D60956	3"	5" PB	3 (3-7/8")	1/30
D60986	3-1/2"	4" NB	2 (3-1/4")	1/40
D60987	3-1/2"	4" PB	2 (3-1/4")	1/40
D60990	3-1/2"	5" CP	3 (3-7/8")	1/40
D60991	3-1/2"	5" PB	3 (3-7/8")	1/40
D60996	3-1/2"	5" NB	3 (3-7/8")	1/30
D60997	3-1/2"	6" NB	3 (4-3/4")	1/20
D60992	3-1/2"	6" CP	2 (5")	1/20
D60993	3-1/2"	6" PB	2 (5")	1/20
D60994	3-1/2"	8" CP	4 (6-3/4")	1/10
D60995	3-1/2"	8" PB	4 (6-3/4")	1/10
D60998	3-1/2"	8" NB	4 (6-3/4")	1/12
D60989	3-1/2"	9" PB	4 (7-5/8")	1/12
D60999	3-1/2"	9" NB	4 (7-5/8")	1/12
D60958	4"	5" NB	3 (3-7/8")	1/30
D60959	4"	5" PB	3 (3-7/8")	1/30

Ⓢ Items marked with the Jones Stephens logo are "You Need It... We Got It" Items.

Funnel



- Vandal-proof installation
- Fits virtually any floor/shower drain
- Funnel tapped for 10-24 screws which are supplied with washers

PART NO.	DESCRIPTION	CTN/MSTR
F65400	4" funnel	1
F65600	6" funnel	1/18

The Green Drain Waterless Trap Seal



- Requires NO caulk or expensive installation tool
- Easy to install and easy to remove - NO pliers needed
- Durable - will not break during installation or removal
- Seals tight - NO leaking

PART NO.	DESCRIPTION	CTN/MSTR
P24001	2" waterless trap seal	1/96
P24002	3" waterless trap seal	1/96
P24003 Ⓢ	3-1/2" waterless trap seal	1/96
P24004	4" waterless trap seal	1/96

F

Cast Iron General Purpose/Utility Drains

Pages 252-253

SIZES: 1-1/2", 2", 3", 4"



For use in residential and commercial applications.

F

Area Drain



- Full waterway
- Lip secures strainer

DRAIN SPECS

SIZE	TOP WIDTH	OVERALL HEIGHT
2"	4-7/8"	3-1/4"
3"	6-3/16"	3-1/4"
4"	7-3/16"	3-1/4"

STRAINER SPECS

SIZE	A	B
2"	4-1/4"	4-1/4"
3"	5-3/8"	5-5/8"
4"	6-11/16"	6-11/16"

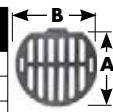

PART NO.	DESCRIPTION	CTN QTY
D76002	2" inside caulk drain	8
D77002	2" no hub drain	8
D76012	2" inside caulk CP area drain with strainer	8
D76092	2" strainer only	1
D76003	3" inside caulk drain	4
D77003	3" no hub drain	4
D76013	3" inside caulk CP area drain with strainer	4
D76093	3" strainer only	1
D76004	4" inside caulk drain	4
D77004	4" no hub drain	4
D76014	4" inside caulk CP area drain with strainer	4
D76094	4" strainer only	1

Cast Iron Gasket Connection Drain



- Supplied with Multi-Tite gasket
- Just lube gasket and push over S.V. or N.H. cast iron pipe
- NB and PB are for heavy pedestrian traffic areas

PART NO.	SIZE	STRAINER	CTN QTY
D62950	3"	5" NB round with ring	1
D62951	3"	5" PB round with ring	1
D62952	3"	4" CI round	1
D62960	4"	6" NB round with ring	1
D62961	4"	6" PB round with ring	1
D62962	4"	5" CI round	1

Kentucky Drain



- Inside caulk

PART NO.	DESCRIPTION	CTN QTY
C73003	3" inside caulk drain	4
C73093	3" strainer only	1
C73192	3" drain with 2" hole in strainer	4
C73193	3" strainer only with 2" hole	1
C73004	4" inside caulk drain	4
C73094	4" strainer only	1

St. Louis Drain



- Heavy duty loose set strainer
- Inside caulk

PART NO.	DESCRIPTION	CTN QTY
C72002	2" inside caulk	8
C72003	3" inside caulk	4
C72004	4" inside caulk	2
C72093	6-1/4" OD round strainer	1

Inside Caulk Shower Stall Drain



- Designed for prefab shower stalls
- Snap in stainless steel strainer
- Fits 2" Schedule 40 and cast iron pipe
- Can be adapted to no caulk with gasket
- 4-1/4" OD strainer

PART NO.	DESCRIPTION	STRAINER	CTN QTY
D40102	2" inside caulk	4" SS round	36
D40202	2" inside caulk	4" PB round	20
D60101	Gasket to make unit no caulk		1

IPS Shower Stall Drain



- Designed for prefab shower stalls
- Snap in stainless steel strainer
- 4-1/4" O.D. strainer

PART NO.	SIZE	STRAINER	CTN QTY
D40104	1-1/2"	4" SS round	36
D40204	1-1/2"	4" PB round	20
D40103	2"	4" SS round	36
D40203	2"	4" PB round	20

FIP Shower Stall Drain



- Cast brass body
- Stainless steel strainer

PART NO.	SIZE	BODY	STRAINER	CTN QTY
D40150	1-1/2"	Cast brass	SS round	100
D40200	2"	Cast brass	SS round	100

Brass Inside Caulk Floor Drain



- For use where pan liner is not required
- Brass body

PART NO.	DESCRIPTION	BODY	STRAINER	CTN QTY
D76601	2" inside caulk	Brass	SS round	50

Urinal Drain



- Brass body with stainless steel strainer

PART NO.	DESCRIPTION	CTN QTY
D45002	2" IPS	40

Urinal Drain Flange Kit



- Brass
- Kit includes all necessary hardware
- Center-to-center for bolt holes is 4-1/4"

PART NO.	DESCRIPTION	CTN QTY
F10005	2" IPS x 4-1/4"	50

Combination Drain Trap



- Bolt-down clamping collar
- Weep holes and grooves in clamping flange

PART NO.	DESCRIPTION	STRAINER	CTN QTY
J60060	2" IPS	4" SS round	1
J60061	2" IPS	4" CP brass round	1
J60062	2" IPS	4" PB round	1

Floor Drain with Trap



- Throat of drain is threaded for backwater device D70500

Concealed Cleanout

PART NO.	DESCRIPTION	CTN QTY
D70001	2" drain	1
D70011	2" drain with backwater device	1
D70098	6-3/8" cast iron strainer	1

Exposed Cleanout

D70020	2" drain with backwater device	1
D70022	2" drain with 1/2" PT	1
D71103	3" drain - backwater device not compatible	1
D70021	2" drain with backwater device	1

Des Moines Pattern Floor Drain



- Bolt down lid
- Integral trap

PART NO.	DESCRIPTION	CTN QTY
D71003	3" with trap	1
D71004	Strainer for Des Moines (screws not included)	1

Backwater Device



- Sleeve type
- Ball included

PART NO.	DESCRIPTION	CTN QTY
D70500	2" MIP brass body	50
B06001	2" MIP plastic body	50
B70499	2" plastic ball	1300

Cast Iron Commercial Cleanouts

Pages 254-257

F

SIZES: 2", 3", 4", 6"



For use in applications
where height adjustments
are necessary.

Push-On Cleanout



- Meets ASTM A74-98 and ASME A112.36.2M-91
- Cut pipe to desired level, lube gasket and push-on pipe, tap with lead hammer to seat, then install plug
- Schedule 40 unit fits plastic and extra heavy cast iron pipe

Less Gasket

PART NO.	PIPE SIZE	PLUG	HEIGHT	CTN QTY
C36003	3" SV	2-1/2" raised head	3"	8
C36013	3" SV	2-1/2" countersunk	3"	8
C36004	4" SV	3-1/2" raised head	3"	8
C36014	4" SV	3-1/2" countersunk	3"	8
C36024	4" Sch.40	3-1/2" raised head	3"	8
C36034	4" Sch.40	3-1/2" countersunk	3"	8
C36006	6" SV	4" raised head	2-3/4"	4
C36016	6" SV	4" countersunk	2-3/4"	4

With Gasket

PART NO.	PIPE SIZE	PLUG	HEIGHT	CTN QTY
C36104	4" SV	3-1/2" raised head	3-1/4"	8
C36114	4" SV	3-1/2" countersunk	3-1/4"	8
C36124	4" Sch.40	3-1/2" raised head	3-1/4"	8
C36134	4" Sch.40	3-1/2" countersunk	3-1/4"	8
C36106	6" SV	4" raised head	3"	4
C36116	6" SV	4" countersunk	3"	4

No Hub Cleanout with Plug



Southern Code Plug

PART NO.	PIPE SIZE	PLUG	HEIGHT	CTN QTY
C38402	2"	1-1/2" raised head	2-1/8"	10
C39402	2"	1-1/2" countersunk	2-1/8"	10
C38403	3"	2-1/2" raised head	2-1/8"	10
C39403	3"	2-1/2" countersunk	2-1/8"	10
C38404	4"	3-1/2" raised head	2-1/8"	10
C39404	4"	3-1/2" countersunk	2-1/8"	10

Heavy Plug

PART NO.	PIPE SIZE	PLUG	HEIGHT	CTN QTY
C38502	2"	1-1/2" raised head	2-1/8"	10
C39502	2"	1-1/2" countersunk	2-1/8"	10
C38503	3"	2-1/2" raised head	2-1/8"	10
C39503	3"	2-1/2" countersunk	2-1/8"	10
C38504	4"	3-1/2" raised head	2-1/8"	10
C39504	4"	3-1/2" countersunk	2-1/8"	10

New Orleans Code Plug

PART NO.	PIPE SIZE	PLUG	HEIGHT	CTN QTY
C40102	2"	1-1/2" plug	2-1/4"	10
C40103	3"	2-1/2" plug	2-1/4"	10
C40104	4"	3-1/2" plug	2-1/4"	10

Plain End Cast Iron Cleanout- Short Pattern with Southern Code Plug



• Fits flush with hub

PART NO.	PIPE SIZE	PLUG	HEIGHT	CTN QTY
C38102	2"	1-1/2" raised head	2-7/8"	10
C39102	2"	1-1/2" countersunk	2-7/8"	10
C38103	3"	2-1/2" raised head	3-5/8"	10
C39103	3"	2-1/2" countersunk	3-5/8"	10
C38104	4"	3" raised head	3"	10
C39104	4"	3" countersunk	3"	10
C38114	4"	3-1/2" raised head	3"	10
C39114	4"	3-1/2" countersunk	3"	10

Plain End Cleanout Long Pattern



• For use with service weight (caulk into hub) or no-hub (use coupling)

With Southern Code Plug

PART NO.	PIPE SIZE	PLUG	HEIGHT	CTN QTY
C38002	2"	1-1/2" raised head (low sq.)	3-1/4"	12
C39002	2"	1-1/2" countersunk	3-1/4"	12
C38003	3"	2-1/2" raised head (low sq.)	4"	12
C39003	3"	2-1/2" countersunk	4"	12
C38004	4"	3" raised head (low sq.)	4"	8
C39004	4"	3" countersunk	4"	8
C38014	4"	3-1/2" raised head (low sq.)	4"	8
C39014	4"	3-1/2" countersunk	4"	8
C38005	5"	4" raised head (low sq.)	3-1/2"	4
C39005	5"	4" countersunk	3-1/2"	4
C38006	6"	5" raised head (low sq.)	4"	2
C39006	6"	5" countersunk	4"	2

With Heavy Pattern Plug

PART NO.	PIPE SIZE	PLUG	HEIGHT	CTN QTY
C38202	2"	1-1/2" raised head (hex)	3-1/4"	12
C39202	2"	1-1/2" countersunk	3-1/4"	12
C38203	3"	2-1/2" raised head (hex)	4"	12
C39203	3"	2-1/2" countersunk	4"	12
C38204	4"	3" raised head (hex)	4"	8
C39204	4"	3" countersunk	4"	8
C38214	4"	3-1/2" raised head (hex)	4"	8
C39214	4"	3-1/2" countersunk	4"	8
C38205	5"	4" raised head (hex)	3-1/2"	4
C39205	5"	4" countersunk	3-1/2"	4
C38206	6"	5" raised head (hex)	4"	2
C39206	6"	5" countersunk	4"	2

Cleanout Ferrule with New Orleans Code Plug



• Service weight

PART NO.	PIPE SIZE	PLUG	HEIGHT	CTN QTY
C40002	2" SV	1-1/2"	3"	12
C40003	3" SV	2-1/2"	4"	12
C40004	4" SV	3 1/2"	4"	8
C40006	6" SV	5"	4"	2

Plumb Lock Adjustable Cleanout



• Supplied with Multi-Tite gasket
• Similar to Zurn Neo-Loc line

3" Spud with 3" Gasket Connection

PART NO.	PIPE SIZE	COVER	BODY HEIGHT	ADJ. HEIGHT	CTN QTY
D62330	3"	5" CI round	5-1/4"	5-7/8" - 7"	1
D62333	3"	5" NB round	5-1/4"	5-7/8" - 7"	1
D62334	3"	5" PB round	5-1/4"	5-7/8" - 7"	1
D62335	3"	5" CP round	5-1/4"	5-7/8" - 7"	1

4" Spud with 4" Gasket Connection

PART NO.	PIPE SIZE	COVER	BODY HEIGHT	ADJ. HEIGHT	CTN QTY
D62433	4"	5" NB round	5-1/2"	6-1/8" - 7-1/4"	1
D62434	4"	5" PB round	5-1/2"	6-1/8" - 7-1/4"	1
D62443	4"	5" NB round w/4" plug	5-1/2"	6-1/8" - 7-1/4"	1
D62444	4"	5" PB round w/4" plug	5-1/2"	6-1/8" - 7-1/4"	1

4" Spud with 6" Gasket Connection

PART NO.	PIPE SIZE	COVER	BODY HEIGHT	ADJ. HEIGHT	CTN QTY
D62601	6"	5" NB round	3-1/4"	3-5/8" - 4-3/4"	1
D62602	6"	5" PB round	3-1/4"	3-5/8" - 4-3/4"	1

No Hub Adjustable Cleanout



3" Spud					
PART NO.	PIPE SIZE	COVER	BODY HEIGHT	ADJ. HEIGHT	CTN QTY
D63330	3"	5" CI round	4-1/4"	4-7/8" - 6"	1
D63333	3"	5" NB round	4-1/4"	4-7/8" - 6"	1
D63334	3"	5" PB round	4-1/4"	4-7/8" - 6"	1
D63335	3"	5" CP round	4-1/4"	4-7/8" - 6"	1

4" Spud					
PART NO.	PIPE SIZE	COVER	BODY HEIGHT	ADJ. HEIGHT	CTN QTY
D63433	4"	5" NB round	4-1/4"	4-7/8" - 6"	1
D63434	4"	5" PB round	4-1/4"	4-7/8" - 6"	1

Adjustable Plain End Cleanout



- CI cover is for forklift or heavy trucking traffic
- NB and PB covers are for heavy pedestrian traffic
- Cleanout body with brass plug
- Can also be caulked into hub

PART NO.	PIPE SIZE	COVER	ADJ. HEIGHT	CTN QTY
C33021	2"	5 1/4" CI round with center screw	3-1/8" - 4-1/4"	1
C33022	2"	5 1/2" NB round with ring	3" - 4-3/4"	1
C33023	2"	5 1/2" PB round with ring	3" - 4-3/4"	1
C33031	3"	5 1/4" CI round with center screw	4" - 5-3/4"	1
C33032	3"	5 1/2" NB round with ring	4-1/4" - 6"	1
C33033	3"	5 1/2" PB round with ring	4-1/4" - 6"	1
C33044	4"	6 3/16" CI with center screw	5-1/8" - 6-1/8"	1
C33045	4"	6 1/2" NB round with ring	5-3/8" - 6-3/8"	1
C33046	4"	6 1/2" PB round with ring	5-3/8" - 6-3/8"	1

Adjustable Push-On Cleanout for Cast Iron Pipe



- Supplied with gasket for cast iron pipe
- CI cover is for forklift or heavy trucking traffic
- NB and PB covers are for heavy pedestrian traffic
- Cleanout body with brass plug

PART NO.	PIPE SIZE	COVER	ADJ. HEIGHT	CTN QTY
C33121	3"	5 1/4" CI round with center screw	3-7/8" - 4-3/4"	1
C33122	3"	5 1/2" NB round with ring	4-1/8" - 5"	1
C33123	3"	5 1/2" PB round with ring	4-1/8" - 5"	1
C33144	4"	6 3/16" CI round with center screw	4-7/8" - 5-3/4"	1
C33145	4"	6 1/2" NB round with ring	5" - 6"	1
C33146	4"	6 1/2" PB round with ring	5" - 6"	1

Adjustable Cleanout for Plastic Pipe



- CI cover is for forklift or heavy trucking traffic
- NB and PB covers are for heavy pedestrian traffic
- Cleanout body with plastic plug

PART NO.	HEIGHT ADJUSTMENT	PART NO.	HEIGHT ADJUSTMENT
C33221	2-7/8" - 3-7/8"	C33321	2-7/8" - 3-7/8"
C33222	3-1/8" - 4-1/8"	C33322	3-1/8" - 4-1/8"
C33223	3-1/8" - 4-1/8"	C33323	3-1/8" - 4-1/8"
C33231	4" - 5"	C33331	4" - 5"
C33232	4-1/4" - 5-1/4"	C33332	4-1/4" - 5-1/4"
C33233	4-1/4" - 5-1/4"	C33333	4-1/4" - 5-1/4"
C33244	5-1/8" - 6-1/4"	C33344	5-1/8" - 6-1/4"
C33245	5-3/8" - 6-1/2"	C33345	5-3/8" - 6-1/2"
C33246	5-3/8" - 6-1/2"	C33346	5-3/8" - 6-1/2"

PART NO.	SIZE	COVER	MATERIAL	CTN QTY
C33221	2"	5-1/4" CI round with center screw	PVC	1
C33321	2"	5-1/4" CI round with center screw	ABS	1
C33222	2"	5-1/2" NB round with ring	PVC	1
C33322	2"	5-1/2" NB round with ring	ABS	1
C33223	2"	5-1/2" PB round with ring	PVC	1
C33323	2"	5-1/2" PB round with ring	ABS	1
C33231	3"	5-1/4" CI round with center screw	PVC	1
C33331	3"	5-1/4" CI round with center screw	ABS	1
C33232	3"	5-1/2" NB round with ring	PVC	1
C33332	3"	5-1/2" NB round with ring	ABS	1
C33233	3"	5-1/2" PB round with ring	PVC	1
C33333	3"	5-1/2" PB round with ring	ABS	1
C33244	4"	6-3/16" CI round with center screw	PVC	1
C33344	4"	6-3/16" CI round with center screw	ABS	1
C33245	4"	6-1/2" NB round with ring	PVC	1
C33345	4"	6-1/2" NB round with ring	ABS	1
C33246	4"	6-1/2" PB round with ring	PVC	1
C33346	4"	6-1/2" PB round with ring	ABS	1

Adjustable Cleanout for Plastic Pipe Hub



- CI cover is for forklift or heavy trucking traffic
- NB and PB covers are for heavy pedestrian traffic
- Cleanout body with plastic plug

PART NO.	HEIGHT ADJUSTMENT	PART NO.	HEIGHT ADJUSTMENT
C33444	3" - 4-1/2"	C33544	3" - 4-1/2"
C33445	3-1/4" - 4-3/4"	C33545	3-1/4" - 4-3/4"
C33446	3-1/4" - 4-3/4"	C33546	3-1/4" - 4-3/4"

PART NO.	SIZE	COVER	MATERIAL	CTN QTY
C33444	4"	6-3/16" CI round with center screw	PVC	1
C33544	4"	6-3/16" CI round with center screw	ABS	1
C33445	4"	6-3/16" NB round with ring	PVC	1
C33545	4"	6-3/16" NB round with ring	ABS	1
C33446	4"	6-3/16" PB round with ring	PVC	1
C33546	4"	6-3/16" PB round with ring	ABS	1

Adjustable Access Cover



- CI cover is for forklift or heavy trucking traffic
- NB and PB covers are for heavy pedestrian traffic
- Designed to fit over 2", 3" and 4" plastic adapter, cast iron cleanout, ferrules and various drainage piping (2" x 3" fits 2" and 3" bodies)
- 3 set screws allow for vertical adjustment

PART NO.	PIPE SIZE	COVER	HEIGHT	INSIDE C.O.	CTN QTY
C33001	2" & 3"	5-1/4" CI round with center screw	2-1/8"	4-9/16"	1
C33002	2" & 3"	5-1/2" NB round with ring	2-1/8"	4-9/16"	1
C33003	2" & 3"	5-1/2" PB round with ring	2-1/8"	4-9/16"	1
C33004	4"	6-3/16" CI round with center screw	2-5/8"	5-5/16"	1
C33005	4"	6-1/2" NB round with ring	2-5/8"	5-5/16"	1
C33006	4"	6-1/2" PB round with ring	2-5/8"	5-5/16"	1

Adjustable Floor Cleanout



- Adjusts 2-1/2"
- 4" cast iron body

PART NO.	PIPE SIZE	COVER	HEIGHT	INSIDE C.O.	CTN QTY
A40001	4"	5" CP	5-1/4"	3-3/4"	1
A40002	4"	5" PB	5-1/4"	3-3/4"	1
A40003	4"	5" NB	5-1/4"	3-3/4"	1

Heavy Duty Adjustable Access Cover



- Scoriated cover
- Fits any 6" pipe
- CI top is for forklift or heavy trucking traffic for up to 2000 lbs.
- 3 bolts secure the cleanout while puring concrete

PART NO.	PIPE SIZE	DESCRIPTION	HEIGHT	CTN QTY
C33088	6"	CI cleanout	3"	1

Heavy Duty Cleanout



- Scoriated cover
- Fits any 6" pipe
- 3 bolts secure the cleanout while puring concrete

PART NO.	PIPE SIZE	DESCRIPTION	HEIGHT	INSIDE C.O.	CTN QTY
D76005	6"	CI cleanout	5-3/8"	6-3/4"	1

Items marked with the Jones Stephens logo are "You Need It...We Got It" Items.



Cast Iron Commercial Cleanout Components

Pages 258-259

F

SIZES: 2", 3", 3-1/2", 4", 5", 6"

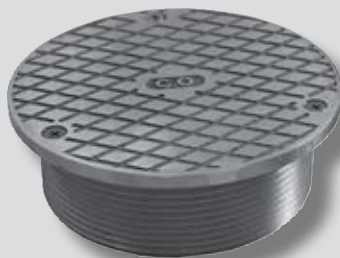

For use in
commercial applications.

No Hub Cleanout Body



PART NO.	PIPE SIZE	TAP SIZE	HEIGHT	CTN QTY
C37102	2" Body	1-1/2"	2-1/8"	10
C37103	3" Body	2-1/2"	2-1/8"	10
C37104	4" Body	3-1/2"	2-1/8"	10

Plain End Cast Iron Cleanout



- Short pattern less plug
- Fits flush with hub

PART NO.	PIPE SIZE	TAP SIZE	HEIGHT	CTN QTY
C37302	2"	1-1/2"	2-3/4"	12
C37303	3"	2-1/2"	3-1/2"	12
C37304	4"	3"	3"	8
C37314	4"	3-1/2"	3"	8

Plain End Cast Iron Cleanout



- Long pattern less plug
- Meets ASTM A-74

PART NO.	PIPE SIZE	TAP SIZE	HEIGHT	CTN QTY
C37002	2"	1-1/2"	2-3/4"	12
C37003	3"	2-1/2"	4"	12
C37004	4"	3"	4"	8
C37014	4"	3-1/2"	4"	8
C37005	5"	4"	3-1/2"	4
C37006	6"	5"	4"	2

No Hub Base



- Use with CI strainers or covers for heavy trucking traffic
- Use with PB, NB, SS or CP strainers or covers for heavy pedestrian traffic

PART NO.	PIPE SIZE	TAP SIZE	HEIGHT	CTN QTY
D63300	3"	3" IPS	4-1/4"	1
D63349	3"	3-1/2 IPS	4-1/4"	1
D63350	4"	3-1/2 IPS	4-1/4"	1
D63400	4"	4" IPS	4-1/4"	1

Gasket Connection Base



- Use with CI strainers or covers for heavy trucking traffic
- Use with PB, NB or CP strainers or covers for heavy pedestrian traffic
- Supplied with multi-tite gasket

PART NO.	PIPE SIZE	TAP SIZE	HEIGHT	CTN QTY
D62300	3"	3" IPS	5"	1
D62349	3"	3-1/2" IPS	5-1/4"	1
D62350	4"	3-1/2" IPS	5-1/4"	1
D62400	4"	4" IPS	5-1/4"	1

Cast Iron Spud with Cover for Heavy Duty Cleanout



- For use with heavy duty cleanouts

2-1/2" IPS Brass Plug with Round Cover

PART NO.	SIZE	COVER	CTN QTY
D62230	3"	5" CI round	1
D62231	3"	5" NB round with ring	1
D62232	3"	5" PB round with ring	1

3" IPS Brass Plug with Round Cover

PART NO.	SIZE	COVER	CTN QTY
D62235	3-1/2"	5" CI round	1
D62236	3-1/2"	6" NB round with ring	1
D62237	3-1/2"	6" PB round with ring	1

3-1/2" IPS Brass Plug with Round Cover

PART NO.	SIZE	COVER	CTN QTY
D62240	4"	5" CI round	1
D62241	4"	6" NB round with ring	1
D62242	4"	6" PB round with ring	1

Plastic Spud with Cover and Square Top for Heavy Duty Cleanout



- For use with heavy duty cleanouts
- Round cover with 7" square top

2-1/2" IPS Brass Plug with Square Top

PART NO.	SIZE	COVER	CTN QTY
D59912	3"	7" PB square	1
D59913	3"	7" NB square	1

3" IPS Brass Plug with Square Top

PART NO.	SIZE	COVER	CTN QTY
D59910	3-1/2"	7" PB square	1
D59911	3-1/2"	7" NB square	1

3-1/2" IPS Brass Plug with Square Top

PART NO.	SIZE	COVER	CTN QTY
D59918	4"	7" PB square	1
D59919	4"	7" NB square	1

Plastic Spud with Round Cover for Heavy Duty Cleanout



- For use with heavy duty cleanouts



2-1/2" IPS Plastic Plug with Round Cover

PART NO.	SIZE	COVER	CTN QTY
D59904	3"	6" PB round	1
D59908	3"	6" PB round with ring	1
D59905	3"	6" NB round	1
D59909	3"	6" NB round with ring	1
D59940	3"	6" CI round with ring	1

3" IPS Plastic Plug with Round Cover

PART NO.	SIZE	COVER	CTN QTY
D59943	3-1/2"	5" PB round	1
D59944	3-1/2"	5" PB round with ring	1
D59945	3-1/2"	5" NB round	1
D59946	3-1/2"	5" NB round with ring	1
D59901	3-1/2"	6" PB round	1
D59906	3-1/2"	6" PB round with ring	1
D59902	3-1/2"	6" NB round	1
D59907	3-1/2"	6" NB round with ring	1
D59941	3-1/2"	6" CI round with ring	1
D59914	4"	6" PB round	1
D59915	4"	6" PB round with ring	1
D59916	4"	6" NB round	1
D59917	4"	6" NB round with ring	1
D59942	4"	6" CI round with ring	1

Metal Spud with Round Cover for Heavy Duty Cleanout



- For use with heavy duty cleanouts

2-1/2" IPS Brass Plug with Round Cover

PART NO.	SIZE	COVER	SCREWS	CENTER X CENTER	CTN/MSTR
C37803	3"	5" NB round	3	3-7/8"	1/20
C37801	3"	5" PB round	3	3-7/8"	1/20
C37800	3"	5" CP round	3	3-7/8"	1/20

3-1/2" IPS Brass Plug with Round Cover

PART NO.	SIZE	COVER	SCREWS	CENTER X CENTER	CTN/MSTR
C37810	3-1/2"	5" NB round	3	3-7/8"	1/18
C37811	3-1/2"	5" PB round	3	3-7/8"	1/18
C37805	4"	5" NB round	3	3-7/8"	1/20
C37806	4"	5" PB round	3	3-7/8"	1/20

4" IPS Brass Countersunk Plug with Round Cover

PART NO.	SIZE	COVER	SCREWS	CENTER X CENTER	CTN/MSTR
C37807	4"	6" NB round	2	4-7/8"	1/8
C37808	4"	6" PB round	2	4-7/8"	1/8

New Orleans Code Brass Plug



PART NO.	DESCRIPTION	O.D.	CTN QTY
P55150	1-1/2"	1-13/16"	200
P55250	2-1/2"	2-3/4"	100
P55300	3"	3-3/8"	60
P55350	3-1/2"	4"	80
P55500	5"	5-1/2"	30

Lead Fit-All Plug



- Cast iron cored
- Sizes are true measurement, not iron pipe size

PART NO.	DESCRIPTION	CTN/MSTR
P56200	2"	24/48
P56250	2-1/2"	24/48
P56300	3"	12/24
P56350	3-1/2"	12/24
P56400	4"	12/24
P56450	4-1/2"	12/12
P56500	5"	12/12
P56550	5-1/2"	12/12
P56600	6"	12/12

Southern Code Brass Plug



PART NO.	DESCRIPTION	O.D.	CTN QTY
P50100	1" raised head	1-9/32"	200
P50125	1- 1/4" raised head	1-5/8"	250
P50150	1-1/2" raised head	1-7/8"	200
P51150	1-1/2" countersunk	1-7/8"	200
P50200	2" raised head	2-3/8"	200
P51200	2" countersunk	2-3/8"	200
P50250	2-1/2" raised head	2-7/8"	200
P51250	2-1/2" countersunk	2-7/8"	200
P50300	3" raised head	3-3/8"	120
P51300	3" countersunk	3-3/8"	120
P50350	3-1/2" raised head	3-7/8"	90
P51350	3-1/2" countersunk	3-7/8"	120
P50400	4" raised head	4-1/2"	90
P51400	4" countersunk	4-1/2"	90
P50500	5" raised head	5-1/2"	50
P51500	5" countersunk	5-1/2"	50
P50600	6" raised head	6-1/2"	30
P51600	6" countersunk	6-1/2"	30
P50800	8" raised head	8-1/2"	15
P51800	8" countersunk	8-1/2"	15
P50999	10" raised head	10-5/8"	10

Heavy Pattern Brass Plug



PART NO.	DESCRIPTION	O.D.	CTN QTY
P52150	1-1/2" raised head	1-3/4"	100
P53150	1-1/2" countersunk	1-3/4"	200
P52200	2" raised head	2-3/8"	100
P53200	2" countersunk	2-3/8"	200
P52250	2-1/2" raised head	2-3/4"	60
P53250	2-1/2" countersunk	2-3/4"	100
P52300	3" raised head	3-1/2"	60
P53300	3" countersunk	3-1/2"	120
P52350	3-1/2" raised head	3-7/8"	60
P53350	3-1/2" countersunk	3-7/8"	80
P52400	4" raised head	4-3/8"	40
P53400	4" countersunk	4-3/8"	60
P52500	5" raised head	5-1/2"	30
P53500	5" countersunk	5-1/2"	40

Items marked with the Jones Stephens logo are "You Need It... We Got It" Items.

Code Pattern Plug



• Meets ASTM A74-98

PART NO.	DESCRIPTION	CTN QTY
P59300	3" raised head	50
P59333	3" countersunk	50
P59350	3-1/2" raised head	50
P59355	3-1/2" countersunk	50
P59400	4" raised head	50
P59444	4" countersunk	50

Slotted Brass Plug with 1/4" Tap



• Tap is not through the plug

PART NO.	DESCRIPTION	CTN QTY
P58150	1-1/2" slotted	150
P58200	2" slotted	100
P58250	2-1/2" slotted	80
P58300	3" slotted	60
P58350	3-1/2" slotted	40
P58400	4" slotted	30

Brass Plug For Extension Cover



•Countersunk plug tapped 1/4-20

PART NO.	DESCRIPTION	O.D.	CTN QTY
P54150	1-1/2" countersunk	1-7/8"	200
P54200	2" countersunk	2-3/8"	200
P54250	2-1/2" countersunk	2-7/8"	150
P54300	3" countersunk	3-3/8"	100
P54350	3-1/2" countersunk	3-7/8"	100
P54400	4" countersunk	4-1/2"	80
P54500	5" countersunk	5-1/2"	40
P54600	6" countersunk	6-1/2"	30
P54800	8" countersunk	8-1/2"	12

Extension Cover Set



• Set includes stainless steel extension cover, brass countersunk or slotted plug and 1/4- 20 x 4" flat head machine screws

Wall Cover (24 gauge)

PART NO.	PLUG	COVER	CTN QTY
C92150	1-1/2" countersunk	3"	10
C92151	1-1/2" slotted	3"	10
C92200	2" countersunk	4"	10
C92202	2" slotted	4"	10
C92250	2-1/2" countersunk	5"	10
C92252	2-1/2" slotted	5"	10
C92300	3" countersunk	5"	10
C92301	3" countersunk	6"	10
C92303	3" slotted	6"	10
C92350	3-1/2" countersunk	6"	10
C92351	3-1/2" countersunk	7"	10
C92353	3-1/2" slotted	7"	10
C92400	4" countersunk	7"	10
C92404	4" slotted	7"	10
C92500	5" countersunk	8"	10
C92600	6" countersunk	8"	5
C92601	6" countersunk	10"	5
C92800	8" countersunk	10"	5

Floor Cover (16 gauge)

PART NO.	PLUG	COVER	CTN QTY
C93150	1-1/2" countersunk	3"	10
C93200	2" countersunk	4"	10
C93250	2-1/2" countersunk	5"	10
C93300	3" countersunk	5"	10
C93301	3" countersunk	6"	10
C93350	3-1/2" countersunk	6"	10
C93351	3-1/2" countersunk	7"	10
C93400	4" countersunk	7"	10
C93500	5" countersunk	8"	10

Stainless Steel Cleanout/Extension Cover



- Beveled edge
- 1500°F fire rating

Wall Mount (24 gauge)

PART NO.	SIZE	CTN/MSTR
C90300	3"	50/500
C90400	4"	25/200
C90500	5"	25/200
C90600 	6"	25/100
C90700	7"	25/100
C90800	8"	25/100
C90999	10"	25/50

Floor Mount (16 gauge)

PART NO.	SIZE	CTN/MSTR
C91300	3"	25/200
C91400	4"	25/200
C91500	5"	25/200
C91600	6"	25/100
C91700	7"	25/100
C91800	8"	25/50
C91999	10"	25/50

Wall Mount With 4" Bolt (24 gauge)

PART NO.	SIZE	CTN QTY
C90013	3"	25/200
C90014	4"	25/200
C90015	5"	25/200
C90016	6"	25/100
C90017	7"	25/100
C90018	8"	25/100
C90019	10"	25/50

Floor Mount With 4" Bolt (16 gauge)

PART NO.	SIZE	CTN QTY
C91013	3"	25/150
C91014	4"	25/150
C91015	5"	25/100
C91016	6"	25/75
C91017	7"	25/50
C91018	8"	25/50
C91019	10"	10/30

Bolts for Cleanout/Extension Covers



- Flat slotted head plated machine screw

PART NO.	SIZE	CTN/MSTR
C90002	1/4"- 20 x 2-1/2"	100/1000
C90004	1/4"- 20 x 4"	100/1500
C90006	1/4"- 20 x 6"	100/1200

High Impact Plastic Cleanout Cover Plate



- Polished chrome or white matte finish
- Individually bagged with # 14 wood screw included

Flat Design

PART NO.	SIZE	CTN/MSTR
C94004	4-1/4" Chrome finish	25/200
C94005	5-1/4" Chrome finish	25/200
C94007	7-1/4" Chrome finish	25/200
C94009	9-1/4" Chrome finish	25/100
C95004	4-1/4" White finish	25/200
C95005	5-1/4" White finish	25/200
C95007	7-1/4" White finish	25/200
C95009	9-1/4" White finish	25/100

Bell Design

PART NO.	SIZE	CTN/MSTR
C96004	4-1/4" Chrome finish	25/200
C96005	5-1/4" Chrome finish	25/200
C96007	7-1/4" Chrome finish	25/200
C96009	9-1/4" Chrome finish	25/100
C97004	4-1/4" White finish	25/200
C97005 	5-1/4" White finish	25/200
C97007	7-1/4" White finish	25/200
C97009	9-1/4" White finish	25/100

Trap Cover



- Stainless steel

PART NO.	DESCRIPTION	CTN/MSTR
C98001	5-3/4" Flat SS trap cover	150/300
C98002	5-3/4" Raised SS trap cover	50/200

Stainless Steel Dome Cover Plate



- 1-3/4" depth
- 1500°F fire rating
- High grade stainless steel
- Individually bagged with # 14 wood screw and 1/4" x 2-1/2" machine screw

PART NO.	DESCRIPTION	CTN/MSTR
C98014	4" SS dome cover plate	60/240
C98016	6" SS dome cover plate	50/150
C98018	8" SS dome cover plate	50/100

 Items marked with the Jones Stephens logo are "You Need It... We Got It" Items.

Inside Caulk Bell Trap



- Hinged lid
- Bell attached

PIPE SIZE	BODY	STRAINER	OUTLET HEIGHT	OVERALL HEIGHT
2"	6" x 6"	4-7/8"	1-3/4"	4-1/8"
3"	9" x 9"	6-3/4"	1-7/8"	4-7/8"
4"	12" x 12"	9-3/4"	1-3/4"	4-7/8"

PART NO.	DESCRIPTION	CTN QTY
D76202	6" x 6" x 2"	1
D76203	9" x 9" x 3"	1
D76204	12" x 12" x 4"	1

Strainers less Hinge

PART NO.	DESCRIPTION	CTN QTY
D76205L	4-7/8" strainer for 6" x 6"	20
D76207L	6-3/4" strainer for 9" x 9"	20
D76209L	9-3/4" strainer for 12" x 12"	10

Cast Iron Bell with Nut and Bolt

PART NO.	SIZE	CTN QTY
D76256	Bell for 6" x 6"	20
D76259	Bell for 9" x 9"	20
D76252	Bell for 12" x 12"	10

No Hub Bell Trap



- Spigot outlet
- Hinged lid
- Bell attached

PIPE SIZE	BODY	STRAINER	OUTLET HEIGHT	OVERALL HEIGHT
2"	6" x 6"	4-7/8"	1-1/4"	3-1/4"
3"	9" x 9"	6-3/4"	1-1/2"	4-1/4"
4"	12" x 12"	9-3/4"	1-1/2"	4-7/8"

PART NO.	DESCRIPTION	CTN QTY
D76302	6" x 6" x 2"	1
D76303	9" x 9" x 3"	1
D76304	12" x 12" x 4"	1

Strainers less Hinge

PART NO.	DESCRIPTION	CTN QTY
D76205L	4-7/8" strainer for 6" x 6"	20
D76207L	6-3/4" strainer for 9" x 9"	20
D76209L	9-3/4" strainer for 12" x 12"	10

Cast Iron Bell with Nut and Bolt

PART NO.	DESCRIPTION	CTN QTY
D76256	Bell for 6" x 6"	20
D76259	Bell for 9" x 9"	20
D76252	Bell for 12" x 12"	10

Spigot Outlet Bell Trap



- Loose lid
- Bell cast on

PIPE SIZE	BODY	STRAINER	OUTLET HEIGHT	OVERALL HEIGHT
2"	6" x 6"	4-7/8"	1-3/8"	3-1/2"
3"	9" x 9"	6-3/4"	1-1/2"	4-1/2"
4"	12" x 12"	9-3/4"	1-1/2"	4-7/8"

PART NO.	DESCRIPTION	CTN QTY
D76402	6" x 6" x 2"	1
D76403	9" x 9" x 3"	1
D76404	12" x 12" x 4"	1

Replacement Strainer with Cast-In Bell

PART NO.	DESCRIPTION	CTN QTY
D76412	4-7/8" cast-in bell for 6" x 6"	20
D76413	6-3/4" cast-in bell for 9" x 9"	20
D76414	9-3/4" cast-in bell for 12" x 12"	10

Pittsburgh Bell Trap



- Deep body
- 4" inside caulk

PIPE SIZE	BODY	STRAINER	OVERALL HEIGHT
4"	9" x 9"	6-3/4"	4-1/2"

PART NO.	DESCRIPTION	CTN QTY
B60994	9" x 9" x 4" Inside Caulk less bell	1

Strainer Only (Loose Lid)

PART NO.	DESCRIPTION	CTN QTY
B60099	6-3/4" ID strainer	1

F

Heavy Duty Floor Drain



- 8-1/2" heavy duty cast iron grate
- Cast iron sediment bucket

No Hub less Sediment Bucket

PART NO.	SIZE	PAN	GRATE	HEIGHT	CTN QTY
D79703	3"	10-1/2"	9" CI	5 1/4"	1
D79704	4"	10-1/2"	9" CI	5 1/4"	1

No Hub with Sediment Bucket

PART NO.	SIZE	PAN	GRATE	HEIGHT	CTN QTY
D79705	3"	10-1/2"	9" CI	5 1/4"	1
D79706	4"	10-1/2"	9" CI	5 1/4"	1

Inside Caulk less Sediment Bucket

PART NO.	SIZE	PAN	GRATE	HEIGHT	CTN QTY
D79805	3"	10-1/2"	9" CI	5 1/4"	1
D79806	4"	10-1/2"	9" CI	5 1/4"	1

Inside Caulk with Sediment Bucket

PART NO.	SIZE	PAN	GRATE	HEIGHT	CTN QTY
D79803	3"	10-1/2"	9" CI	5 1/4"	1
D79804	4"	10-1/2"	9" CI	5 1/4"	1

Sediment Bucket

PART NO.	DESCRIPTION	CTN QTY
D50095	CI sediment bucket	1

Code Blue No Caulk (Mechanical Joint) Cesspool Drain



- Supplied with stainless steel bolts
- Includes test plug
- UPC listed



PART NO.	SIZE	STRAINER	HEIGHT	CTN QTY
D76702	2"	6" CI	4 1/16"	1
D76703	3"	7" CI	4 1/16"	1
D76704	4"	8" CI	4 1/16"	1



- 3/4" Thick

PART NO.	DESCRIPTION	CTN QTY
D76705	Grate for D76702	1
D76706	Grate for D76703	1
D76707	Grate for D76704	1

Caulk Cesspool with Recessed Grate



PART NO.	DESCRIPTION	CTN QTY
D76504	12" x 12" x 4"	1
D76519	Grate only	1

Rainleader Cesspool



- For areas requiring downspout, rainleader and cesspool drain
- Grate secured by screw
- 12-3/4" diameter pan fits over outlet

PART NO.	DESCRIPTION	CTN QTY
J60030	4" hub inlet x 4" spigot outlet	1

Square Cesspool Grate



PART NO.	DESCRIPTION	CTN QTY
D59156	6" x 6" square grate	10
D59158	8" x 8" square grate	5
D59160	10" x 10" square grate	2
D59162	12" x 12" square grate	2

Round Slop Sink, Hydrant Cesspool



- 2" IPS outlet
- Removable Strainer

PART NO.	DESCRIPTION	CTN QTY
S55100	2" IPS ink painted	1
S55101	2" IPS galvanized cast iron	1

Square Hydrant Cesspool



- Grate included
- Spigot outlet

PART NO.	DESCRIPTION	CTN QTY
S57034	11" x 11" x 4"	1
S57035	Grate only	1

Porcelain Coated Floor Sink



- 12" x 12" white porcelain coated cast iron
- No hub and inside caulk
- Aluminum dome bottom strainer included

PART NO.	DESCRIPTION	CTN QTY
S55104	4" inside caulk 6" deep	1
S55004	4" inside caulk 8" deep	1
S55112	2" no hub 6" deep	1
S55113	3" no hub 6" deep	1
S55114	4" no hub 6" deep	1

Top Grates Only To Fit Floor Sinks



PART NO.	DESCRIPTION	CTN QTY
S55010	Full top grate	1
S55075	Three-quarter top grate	1
S55050	Half top grate	1

Aluminum Bottom Dome For Cast Iron Sink



- Fits all sizes porcelain coated cast iron sinks

BOTTOM OD	HEIGHT
5-3/8"	2-1/4"

PART NO.	DESCRIPTION	CTN QTY
S55115	Aluminum bottom dome- Fit All	1
S60002	2" aluminum bottom dome	10
S60003	3" aluminum bottom dome	10
S60004	4" aluminum bottom dome	10

Plumlock Porcelain Floor Sink



- 12" x 12" white porcelain coated cast iron
- Aluminum dome strainer included
- Push-On Connection; gasket supplied

PART NO.	DESCRIPTION	CTN QTY
S55122	2" Plumlock floor sink- 6" deep	1
S55123	3" Plumlock floor sink- 6" deep	1
S55124	4" Plumlock floor sink- 6" deep	1

Plumlock Gasket for Cast Iron Or Schedule 40 Pipe Connectors



- Fits 12" x 12" white porcelain coated cast iron Plumlock Sinks

PART NO.	DESCRIPTION	CTN QTY
S55192	2" PlumLock gasket	1
S55193	3" PlumLock gasket	1
S55194	4" PlumLock gasket	1

Service Sink Faucet



- Chrome plated
- Integral stops
- Integrated vacuum breaker
- Complete with all mounting hardware
- Meets ASSE 1001
- Front hook to hang bucket

PART NO.	DESCRIPTION	CTN/MSTR
S55349	Service sink faucet with lever handles	1/8
S55350	Service sink faucet w/cross handles	1/6
S55351	Cross handle stem repair kit for S55350	1/100
S55352	Lever handle stem repair kit for S55349	1/100
S55353	Integral stop repair kit for S55349	1/100
S55354	Vacuum breaker repair kit (S55349 or S55350)	1/100

Trap Standard



- Cast iron body with white coating
- Chrome plated brass strainer
- Fits American Standard*, Kohler*, Eljer* and Crane* cast iron service sinks

PART NO.	DESCRIPTION	CTN QTY
T00002	2" IPS	1
T00003	3" IPS	1
T00005	Base plate for trap standard	1
T00006	1-1/2" N.O. plug with gasket	1
T00009	Strainer and stud for trap standard	1

* The manufacturers' names are used only to describe whose products the products will fit.

Mop Service Basin



- One-piece molded construction; 24" x 24" x 10"
- Crushed stone with polyester resin
- Supplied with 3" gasketed connection and stainless steel strainer

PART NO.	DESCRIPTION	CTN QTY
S55240	Mop service basin	1

Hose and Bracket for Service Sink



- Heavy duty 300# cloth-reinforced hose
- 5" x 3" stainless steel bracket with rubber grip
- 3/4" brass hose coupling at one end

PART NO.	DESCRIPTION	CTN QTY
M05001	Hose with bracket	1

Mop Hanger for Service Sink



- 24" x 3" stainless steel hanger with three rubber tool grips
- Anchors included

PART NO.	DESCRIPTION	CTN/MSTR
M05003	Mop hanger	1/25

Roof Drain with Cast Iron Dome



- 10" diameter pan
- Dome has 50 sq. Inches of drain area
- Cast iron dome

PART NO.	SIZE	PAN	DOMES	HEIGHT	CTN QTY
R19003	3" inside caulk	10"	5-1/2"	8"	1
R19005	3" no hub	10"	5-1/2"	8"	1
R19004	4" inside caulk	10"	5-1/2"	8"	1
R19006	4" no hub	10"	5-1/2"	8"	1
R18020	Cast iron roof dome		5-1/2"		1

Code Blue No Hub Roof Drain with Square Pan



- 8 1/2" square pan
- Cast iron dome and drain
- Supplied with stainless steel bolts
- UPC listed



PART NO.	SIZE	PAN	HEIGHT	CTN QTY
R19202	2" No Hub	8-1/2"	9-1/2"	1
R19203	3" No Hub	8-1/2"	9-3/4"	1
R19204	4" No Hub	8-1/2"	9-3/4"	1
R19206	6" No Hub	8-1/2"	9-3/4"	1

Code Blue No Caulk (Mechanical Joint) Roof Drain with Square Pan



- 8 1/2" square pan
- Cast iron dome and drain
- Supplied with stainless steel bolts
- UPC listed



PART NO.	SIZE	STRAINER	HEIGHT	CTN QTY
R19102	2" no caulk	8-1/2"	9-1/2"	1
R19103	3" no caulk	8-1/2"	9-1/2"	1
R19104	4" no caulk	8-1/2"	9-1/2"	1

Code Blue No Hub Dual Roof Drain



- Supplied with stainless steel bolts
- Overflow
- UPC listed

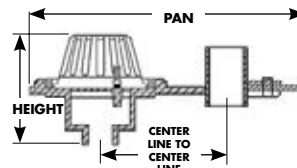

PIPE SIZE	CENTER TO CENTER	PAN	OVERALL HEIGHT SINGLE	OVERALL HEIGHT DOUBLE
2"	8-1/2"	19"	8"	8-1/2"
3"	8-1/2"	19"	9-1/2"	10"
4"	8-1/2"	19"	10"	10-1/2"

Single Dome

PART NO.	SIZE	PAN	CTN QTY
R19302	2" no hub dual drain	19"	1
R19303	3" no hub dual drain	19"	1
R19304	4" no hub dual drain	19"	1

Double Dome

PART NO.	SIZE	PAN	CTN QTY
R19307	2" no hub dual dome drain	19"	1
R19305	3" no hub dual dome drain	19"	1
R19306	4" no hub dual dome drain	19"	1

Replacement Parts

PART NO.	SIZE	CTN QTY
R19099	Roof drain dome	1
R19100	Clamping ring	1

Code Blue No Hub Side Outlet Roof Drain with Square Pan



PART NO.	SIZE	PAN	HEIGHT	CTN QTY
R19402	2"	8-1/2"	9-1/2"	1
R19403	3"	8-1/2"	9-1/2"	1
R19404	4"	8-1/2"	9-1/2"	1

Bar Grate



• For hub openings in soil pipe

PART NO.	DESCRIPTION	DIAMETER	CTN QTY
D59102	2" (less legs)	2-3/4"	10
D59103	3" (less legs)	3-1/2"	10
D59104	4" (less legs)	4-7/8"	10
D59106	6" (less legs)	6-7/8"	10
D59101	4" (less legs)	4-7/8"	10
D59112	2" (with legs)	2-3/4"	10
D59113	3" (with legs)	3-3/4"	10
D59114	4" (with legs)	4-7/8"	10

Perforated Sewer Strainer with Legs



• For hub openings in clay sewer pipe

PART NO.	DESCRIPTION	DIAMETER	CTN QTY
D59124	4" sewer strainer	5-1/2"	10
D59126	6" sewer strainer	7-3/8"	5
D59128	8" sewer strainer	10-1/8"	5
D59130	10" sewer strainer	12-1/4"	2
D59132	12" sewer strainer	14-1/4"	2

Sewer Box



• Sewer lid is marked "sewer"
• Water lid is marked "water"
• Plain lid is unmarked

PART NO.	DESCRIPTION	CTN QTY
S36006	8" water lid and ring	1
S36007	8" sewer lid	1
S36008	8" sewer lid and ring	1
S36090	8" plain lid	1
S36091	8" plain lid and ring	1
S36011	10" water lid and ring	1
S36009	10" sewer lid only	1
S36010	10" sewer lid and ring	1
S36095	10" plain lid	1
S36096	10" plain lid and ring	1

Ohio Style Grate



• Cast iron grate

PART NO.	DESCRIPTION	CTN QTY
J60005	6" Ohio style grate	1

Water Access Box



• Lockable lid

PART NO.	DESCRIPTION	CTN QTY
J60026	6" x 6" x 2" water access box	6

Perforated Vent Box



PART NO.	DESCRIPTION	CTN QTY
J60027	6" x 6" x 2" perforated vent box	6

Philadelphia Style Vent Box



• Strainer secured by overlapping lug and screw
• Integral cast baffles

PART NO.	DESCRIPTION	CTN QTY
J60004	4" inside caulk	1
J60094	Replacement strainer	1

Fresh Air Inlet/Floor Drain



PART NO.	DESCRIPTION	CTN QTY
J60007	3" spigot	15
J60008	4" spigot	15

Vent Cap



• Cast iron cap for 3" or 4" pipe

PART NO.	DESCRIPTION	CTN QTY
J60005	3" - 4" vent cap	10

Lockable Vent Cap



- Cast iron grate fits inside spigot end of pipe
- Secured with adjustable screw and clamp

PART NO.	DESCRIPTION	CTN QTY
J60010	4" cast iron vent cap	10

Brass Deck Plug



- Inside caulk
- Polished brass ring
- Cast brass body
- Skid-resistant scoriated lid

PART NO.	DESCRIPTION	CTN QTY
D28003	3" deck plug	20
D28004	4" deck plug	12

F

Blind Plugs



No Hub		
PART NO.	DESCRIPTION	CTN QTY
D59202	2" blind plug	10
D59203	3" blind plug	10
D59204	4" blind plug	8
Service Weight		
PART NO.	DESCRIPTION	CTN QTY
D59302	2" blind plug	10
D59303	3" blind plug	8
D59304	4" blind plug	4

Reading Style Cleanout



- 4" Inside caulk

PART NO.	DESCRIPTION	CTN QTY
J60012	Reading cleanout	1

Cast Iron Backwater Valves



- Reduces backflow in drainage system
- All neoprene gaskets
- 300 series stainless bolts and washers
- Repairable in service
- Revolutionary design- that works!
- UPC listed

Service Weight				
PART NO.	SIZE	LENGTH	HUB	CTN QTY
B01013	3"	10-3/4"	5-1/8"	1
B01014	4"	11-3/4"	6-1/2"	1
B01016	6"	12-3/4"	7-1/4"	1
No Hub				
PART NO.	SIZE	LENGTH	HUB	CTN QTY
B01002	2"	10-3/4"	—	1
B01003	3"	11-3/4"	—	1
B01004	4"	12-3/4"	—	1
B01006	6"	14-1/2"	—	1
Replacement Flappers				
PART NO.	DESCRIPTION	CTN QTY		
B01017	2" bolt-in flapper and ring	1		
B01018	3" bolt-in flapper and ring	1		
B01019	4" bolt-in flapper and ring	1		
B01020	6" bolt-in flapper and ring	1		

Reading Style Vent



- 4" Inside caulk

PART NO.	DESCRIPTION	CTN QTY
J60011	Reading vent	1

Items marked with the Jones Stephens logo are "You Need It... We Got It" Items.

Test Tee



- Available with or without plug
- Plug is Southern Code

Service Weight Tee

PART NO.	DESCRIPTION	LENGTH	PLUG	CTN QTY
T55002	2"x 2" less plug	10-3/8"	2"	1
T55012	2"x 2" with plug	10-3/8"	2"	1
T55003	3"x 3" less plug	12-1/2"	3"	1
T55013	3"x 3" with plug	12-1/2"	3"	1
T55004	4"x 4" less plug	13-7/8"	4"	1
T55014	4"x 4" with plug	13-7/8"	4"	1

No Hub Tee

PART NO.	DESCRIPTION	LENGTH	PLUG	CTN QTY
T56002	2"x 2" less plug	6-3/8"	2"	1
T56012	2"x 2" with plug	6-3/8"	2"	1
T56003	3"x 3" less plug	7-3/4"	3"	1
T56013	3"x 3" with plug	7-3/4"	3"	1
T56004	4"x 4" less plug	8-7/8"	4"	1
T56014	4"x 4" with plug	8-7/8"	4"	1

Test Tee with Heavy Plug



Service Weight Tee

PART NO.	DESCRIPTION	LENGTH	PLUG	CTN QTY
T55022	2"x 2" with plug	10-3/8"	2"	1
T55033	3"x 3" with plug	12-1/2"	3"	1
T55044	4"x 4" with plug	13-7/8"	4"	1

No Hub Tee

PART NO.	DESCRIPTION	LENGTH	PLUG	CTN QTY
T56022	2"x 2" with plug	6-3/8"	2"	1
T56033	3"x 3" with plug	7-3/4"	3"	1
T56044	4"x 4" with plug	8-7/8"	4"	1

Cast Iron Single Vent Running Trap



PART NO.	DESCRIPTION	CTN QTY
T64540	5"x 4" single vent running trap	1

Tapped Saddle Tee



- U-bolt included

PART NO.	DESCRIPTION	CTN QTY
T21001	3"x 1 1/2"	1
T21002	3"x 2"	1
T21003	4"x 1 1/2"	1
T21004	4"x 2"	1
S26008	6" x 7" (1/4" thick) closed cell foam gasket	1

Repair Plate



- U-bolt included

PART NO.	DESCRIPTION	CTN QTY
T21062	2" plate with u-bolt	1
T21063	3" plate with u-bolt	1
T21064	4" plate with u-bolt	1



“T” Burner Bar



- 12-1/4" long by 1-3/8" high, tapped 1/2" IPS in ends and bottom
- Supplied with two 1/2" plugs and close nipple orifice

PART NO.	DESCRIPTION	LENGTH	HEIGHT	CTN QTY
L75080	Natural Gas	12-1/4"	1-3/8"	10
L75180	LPG	12-1/4"	1-3/8"	10

Two Leg Burner



- Dimensions 14" long x 1-3/4" high x 2-1/4" wide
- Tapped 1/2" IPS on both ends and one leg
- Comes with two 1/2" IPS plugs and close nipple orifice
- Ledge over burner holes prevents clogging

PART NO.	DESCRIPTION	LENGTH	HEIGHT	CTN QTY
L75081	Natural Gas	14"	1-3/4"	10
L75181	LPG	14"	1-3/4"	10

Round Burner



- 1-3/4" high x 4 1/2" wide, tapped 1/2" IPS in bottom and sides
- Supplied with close nipple orifice and 1/2" plug

PART NO.	DESCRIPTION	WIDTH	HEIGHT	CTN QTY
L75086	Natural Gas	4-1/2"	1-3/4"	10
L75186	LPG	4-1/2"	1-3/4"	10

Rectangular Burner



- Dimensions 8-3/4" long x 1-1/2" high x 1-3/4" wide with 1/2" IPS inlet
- Supplied with close nipple orifice and removable lid
- Low profile

PART NO.	DESCRIPTION	LENGTH	HEIGHT	CTN QTY
L75085	Natural Gas	8-3/4"	1-1/2"	10
L75185	LPG	8-3/4"	1-1/2"	10

Log Lighter Burner Bar



- Air mixing chamber
- Straight: 17" pipe plus 3" mixing chamber
- T-Pattern: Two 7" pipes plus 3" mixing chamber

PART NO.	DESCRIPTION	CTN QTY
L75091	Straight for natural gas	10
L75092	Straight for LPG	10
L75095	T-pattern for natural gas	10
L75096	T-pattern for LPG	10

Log Lighter Valves

- CSA design certified
- Zinc escutcheon
- 1/4" Key included
- Individually tested (pressure test in open and closed position after installation)
- BTU rating: angle 188,000, straight 120,000
- To extend escutcheon use 1/2" pipe coupling and 1/2" pipe nipple

Standard Valve (7 turns open/close)



PART NO.	DESCRIPTION	CTN QTY
L75001	Chrome plated angle	36
L75002	Polished brass angle	36
L75006	Chrome plated straight	36
L75007	Polished brass straight	36

Ball Valve (1/4" turn)



PART NO.	DESCRIPTION	CTN QTY
L75040	Chrome plated angle	36
L75041	Polished brass angle	36
L75042	Chrome plated straight	36
L75043	Polished brass straight	36

Escutcheons Only

PART NO.	DESCRIPTION	CTN QTY
L75908	Chrome plated	36
L75909	Polished brass	36

Items marked with the Jones Stephens logo are "You Need It... We Got It" Items.

2-Way Combo Log Lighter Valve



- Straight or angle pattern
- 5/16" key and brass plug for extra outlet included

PART NO.	DESCRIPTION	CTN QTY
L75009	Chrome plated	10
L75010	Polished brass	10

Log Lighter Valve with T-Burner



- Solid brass escutcheon, 1/4" key and close nipple orifice included
- Individually tested (pressure test open and closed after installation)
- Angle: 188,000 BTU/Straight: 120,000 BTU

PART NO.	DESCRIPTION	CTN QTY
L75406	Chrome plated angle natural gas	1
L75407	Polished brass angle natural gas	1
L75408	Chrome plated straight natural gas	1
L75409	Polished brass straight natural gas	1
L75400	Chrome plated angle LPG	1
L75401	Polished brass angle LPG	1
L75402	Chrome plated straight LPG	1
L75403	Polished brass straight LPG	1

Log Lighter Keys and Accessories

- 1/4" and 5/16" drives on keys



PART NO.	DESCRIPTION	MATERIAL	CTN QTY
L75019	1/4"x 3"	Brass	200
L75020	5/16"x 3"	Brass	200
L75021	1/4"x 6"	Brass	240
L75023	5/16"x 6"	Brass	240
L75022	1/4"x 12"	Brass	100
L75024	5/16"x 12"	Brass	100



PART NO.	DESCRIPTION	MATERIAL	CTN QTY
L75017	1/4"x 3"	Die cast zinc	250
L75018	5/16"x 3"	Die cast zinc	250

Close Nipple Orifices



PART NO.	DESCRIPTION	CTN QTY
L75015	7/64" Orifice for natural gas	1
L75016	5/64" Orifice for LP gas	1

F

SECTION G - TOOLS..... 275-310

G

Tub and Shower Valve Wrench Set



- Plated steel
- Complete set with handle includes: 21/32" x 27/32", 29/32" x 31/32", 1-1/32" x 1-3/32", 1-11/32" x 1-7/16", 1-5/32" x 1-9/32"

PART NO.	DESCRIPTION	CTN/MSTR
J40002	Valve wrench set	1/20
J40000	21/32" x 27/32" wrench only	20/100
J40001	1-1/32" x 1-3/32" wrench only	20/100
J40006	29/32" x 31/32" wrench only	50/100
J40008	1-11/32" x 1-7/16" wrench only	1/100

Garbage Disposal Wrench



- 1/2" steel
- 10" long

PART NO.	DESCRIPTION	CTN/MSTR
J40025	Disposal wrench	25/50

4-Way Key



- Plated steel
- For valve, faucet and sillcock sizes 1/4", 9/32", 5/16" and 11/32"
- Carded

PART NO.	DESCRIPTION	CTN/MSTR
J40005	4-way key	25/100

No Hub Torque Wrench



- For 5/16"
- Automatic release at 60 in.lb.
- Built-in reversing lever
- Ratchets one way
- Chrome vanadium socket
- Carded

PART NO.	DESCRIPTION	CTN/MSTR
T60060	No hub torque wrench	20/80

Mega Torque Wrench



- Slide down locking reversing feature
- Heavy duty construction with chrome vanadium sockets

PART NO.	DESCRIPTION	CTN/MSTR
T60065	60 lb. - Mega torque wrench with 5/16" socket	15/60
T60080	80 lb. - Mega torque wrench with 3/8" socket	15/60
T60081	80 lb. - Mega torque wrench with 5/16" socket	15/60
T60066	5/16" Socket kit	15/60

Element Wrench



- Zinc plated steel
- 1-1/2" ID - 1-3/4" OD
- For removing heater elements

PART NO.	DESCRIPTION	CTN/MSTR
J36100	Regular unit wrench	25/100
J36101	Heavy duty wrench	25/50

Sillcock Key



- Die cast
- 5/16" and 1/4"

PART NO.	DESCRIPTION	CTN/MSTR
J40003	1/4" Sillcock key	1/400
J40004	5/16" Sillcock key	1/400

14 Piece Folding Hex Key Wrench Set



- Chrome plated steel case
- Fourteen fractional U.S. sizes
- Carded

PART NO.	DESCRIPTION	CTN/MSTR
J40015	Hex key wrench set	12/72

Basin Wrench



B11010



B11012



B11011



B11013 Replacement Jaw

- Spring-hinged jaw
- Telescoping body allows for easier use in hard-to-reach areas
- Swivel head operates from either right or left side
- Use on hard-to-reach basin nuts, ballcocks and flush valves
- B11013 is carded

PART NO.	DESCRIPTION	JAW	CTN/MSTR
B11010	10" - 17" telescoping	1-1/4"	10/30
B11011	11-3/8" long non-telescoping	1-1/4"	20/40
B11012	9-1/2" - 16-1/2" telescoping	2"	15/30
B11013	Spring hinged replacement jaw for B11011	-	20/100

Radiator Spud Wrench



- Plated malleable iron
- For use as spud key and wrench

PART NO.	DESCRIPTION	CTN/MSTR
J40030	Radiator spud wrench	10/20

Items marked with the Jones Stephens logo are "You Need It... We Got It" Items.

3-N-1 Radiator Repair Tool



- Steel
- For re-tapping and reaming out radiators
- Carded

PART NO.	DESCRIPTION	CTN/MSTR
J40034	3-N-1 radiator repair tool	6/72

4-Way P.O. Plug Wrench



- For installing or removing basket strainers, tub drains and P.O. plugs

PART NO.	DESCRIPTION	CTN/MSTR
J40026	4-way P.O. plug wrench	20/60

4-Way Plug Wrench



PART NO.	DESCRIPTION	CTN/MSTR
J40040	4-way countersunk plug wrench	1/20

4-Way Countersunk Plug Wrench



- For installing or removing countersunk plugs

PART NO.	DESCRIPTION	CTN/MSTR
J40041	4-way countersunk plug wrench	5/15

6-Way Countersunk Plug Wrench



- 4 head sizes for square plugs
- 2 head sizes for slotted plugs
- Extra-strong iron construction

PART NO.	DESCRIPTION	CTN/MSTR
J40042	6-way wrench	1/20

Faucet Seat Repair Kit



- Reversible cone
- 4 sizes of cutters
- Hardened steel cutters smooth worn seats
- Saves repair costs; stops faucet drips
- Kit includes faucet washers and bibb screw
- Carded

PART NO.	DESCRIPTION	CTN/MSTR
J40007	Faucet seat repair kit	12/120

Faucet Seat Wrench



- Tapered for use on all sizes and types of seats

PART NO.	DESCRIPTION	CTN/MSTR
S62001	Straight tapered wrench	100/200
S62002	Angle tapered wrench	20/60
S62003	Straight stepped wrench	100/200
S62004	Angle stepped wrench	20/60

Seat Wrench for Recessed Seats



- Works in hard-to-reach recessed seats

PART NO.	DESCRIPTION	CTN/MSTR
S62005	Seat wrench for recessed seats	50/100

Dual Kwik Tite Wrench



- Install stops easily
- Tightens 3/8" supply nuts
- Carded

PART NO.	DESCRIPTION	CTN/MSTR
J40490	Dual kwik tite wrench	10/60

Lavatory Nut Removal Tool



- Lightweight, high strength plastic
- For 7/8" metal or plastic hex nuts
- Extra long to reach mounting nuts on faucets, sprayers, and ballcocks
- Bagged

PART NO.	DESCRIPTION	CTN/MSTR
J40035	Lavatory nut removal tool	10/50

Universal Drain Wrench



- 6" long
- Die cast aluminum
- Installs and removes tub drains and closet spuds
- Prevents damage to decorative finishes
- Use crescent wrench or screwdriver to turn tool
- Carded

PART NO.	DESCRIPTION	CTN/MSTR
J45010	Universal drain wrench	12/48

Angle Compression Stop Wrench



- Fits 3/8" compression or 1/2" male IPS outlet threads on angle stops
- Protects finishes
- Carded

PART NO.	DESCRIPTION	CTN/MSTR
J40491	Angle compression stop wrench	10/60

Extract-a-Drain Tub Drain Removal Tool



- Removes old or rusty drains - even drains with missing crossbars!
- Fits both 1-3/8" and 1-1/2" tub drains
- Jaws expand to firmly grip the inside of the drain
- Prevents damage to your tub's finish
- A wrench is the only other tool that you'll need to complete this job

PART NO.	DESCRIPTION	CTN/MSTR
J40018	Extract-a-drain tool	1/50

Compression Sleeve Puller



- Removes leaking compression sleeves without damaging walls
- Unique armless design - screws directly into compression nut for fast removal
- For 5/8" compression nuts
- Made in the USA (J40021)
- Carded

MADE IN THE USA

PART NO.	DESCRIPTION	CTN/MSTR
J40021	Compression sleeve puller	1/35
J44661	Compression sleeve puller - 1/2" OD	10/40

Compression Sleeve Puller Adapter



- Converts any standard faucet handle puller to remove compression sleeves

PART NO.	DESCRIPTION	CTN/MSTR
J40013	Adapter	50/100

E-ZEE Pull Deluxe Faucet Handle Puller



- 4" bracket width
- Pulls all size handles
- Forged steel with case - hardened pin

PART NO.	DESCRIPTION	CTN/MSTR
J40012	E-ZEE pull deluxe faucet handle puller	25/50

Faucet Handle Puller



J40010



J40011

- Plated steel
- Removes faucet and valve handles
- J40010 is carded

PART NO.	DESCRIPTION	CTN/MSTR
J40010	Standard unit (carded)	25/50
J40011	Heavy duty impact unit	15/30

Quick Drain Wrench



- Installs no caulk shower drains quickly
- Provides tongue to seal drain

PART NO.	DESCRIPTION	CTN/MSTR
J40235	Quick drain wrench	10/60

Sink Drain Wrench



- Fits kitchen, bath & laundry tub basket strainers, p-traps, wing nuts and tub drains
- Made in the USA

MADE IN THE USA

PART NO.	DESCRIPTION	CTN/MSTR
J40023	Sink drain wrench	1/24

Moen Stem and Cartridge Wrench



- Removes Moen stems and cartridges
- Works on plastic and brass faucet and shower valves
- Carded

PART NO.	DESCRIPTION	CTN/MSTR
J45015	Stem and cartridge wrench	12/72

Adjustable Strainer and Spud Wrench



- Plated
- Fits closet spuds, basket strainers, lock nuts and slip nuts
- Adjustment 7/8" to 3-1/8"

PART NO.	DESCRIPTION	CTN/MSTR
J40022	Strainer & spud wrench	20/40

Spud Wrench



- For strainer, lock and slip nuts
- 1" - 3" capacity
- Heat treated forging

PART NO.	DESCRIPTION	CTN/MSTR
J40305	Spud wrench	20/40

Spud Wrench with Hinged Arm



PART NO.	DESCRIPTION	CTN/MSTR
J40306	Spud wrench with hinged arm	30/60

Spanner/Strainer Wrench



- Plated malleable iron
- Used for basket strainer jam nuts

PART NO.	DESCRIPTION	CTN/MSTR
J40024	Spanner/strainer wrench	25/50

Strainer Wrench



- Plated steel
- For use on basket strainers and tub drains with cross bars
- Long handle for leverage

PART NO.	DESCRIPTION	CTN/MSTR
J40028	Strainer wrench	20/60

Plumb Easy Sink Strainer Wrench



- Fits most basket strainers
- Installs and removes basket strainers with ease

PART NO.	DESCRIPTION	CTN/MSTR
J40128	Plumb Easy sink strainer wrench	4/32

Do All Plumbers Wrench



- Longer, more comfortable handle allows greater leverage for tightening or loosening locknuts
- Fits most standard size basket strainers including: Opella, Duo, Twist Lock and PB Duo. Use on any strainer which uses a standard 3-3/8" locknut
- Fits most shower stall drains
- Fits the following drain styles:
 - 2" Plastic No Caulk for plastic pipe
 - 2" Brass No Caulk for plastic pipe
 - 2" Receptor Base for plastic pipe
 - 2" Drop In style for plastic pipe
- Carded

PART NO.	DESCRIPTION	CTN/MSTR
J40019	Do All plumbers wrench	10/40

Heavy Duty Pipe Wrench



- Manufactured to U.S. Specification GGG-W651 Type II Class A
- Upper and lower jaws forged and tempered
- Nodular cast iron handle



PART NO.	LENGTH	CAPACITY	ROTHENBERGER	CTN QTY
J40065	8"	1"	70150	6
J40066	10"	1-1/2"	70151	6
J40067	12"	2"	70152	6
J40068	14"	2"	70153	4
J40069	18"	2-1/2"	70154	2
J40070	24"	3"	70155	4
J40105	36"	5"	70156	4

Aluminum Pipe Wrench



- Manufactured to U.S. Specification GGG-W651 Type I Class B
- Forged and tempered handle, bottom jaw and nut
- Alloy handle



PART NO.	LENGTH	CAPACITY	ROTHENBERGER	CTN QTY
J40071	10"	1-1/2"	70159	4
J40072	14"	2"	70160	6
J40073	18"	2-1/2"	70161	6
J40074	24"	3"	70162	6
J40106	36"	5"	70163	4

Adjustable Wrench



- Manufactured to Federal Specification GGG-W-631-B Type I Class I
- Drop forged
- Chrome plated



PART NO.	LENGTH	CAPACITY	CHANNELLOCK	CTN QTY
J40075	6"	13/16"	806W	5
J40076	8"	15/16"	808W	5
J40077	10"	1-3/16"	810W	5
J40078	12"	1-3/8"	812W	5
J40079	15"	1-3/8"	815	1

Curb Box Wrench



- For pentagon curb boxes
- Thin wall socket fits most boxes

PART NO.	DESCRIPTION	CTN/MSTR
M25900	Curb box wrench	1/100

Box Wrench



- For B and MC tanks

PART NO.	DESCRIPTION	CTN QTY
J40230	Box wrench	1

Bibb Seat Tool Set



- Set includes:
 - 3/8" x 7/16" ratcheting box wrench
 - Small hex/large hex tapered bibb seat tool
 - Small square/large square tapered bibb seat tool
 - Small square/large square straight bibb seat tool
 - Sleeved pouch

PART NO.	DESCRIPTION	CTN/MSTR
J40308	Bibb seat tool set	20/40

Strap Wrench



- For chrome fittings and nipples

PART NO.	DESCRIPTION	CTN/MSTR
J40307	7" strap wrench	25/50
J40311	11" strap wrench	12/24

Twist-Off Strap Tool



- Grips when wet
- Will not scratch
- High density polyethylene handle
- Heavy duty rubber strap
- Carded

PART NO.	DESCRIPTION	CTN/MSTR
J40325	Twist-off strap tool	15/60

Hydrostatic Pressure Pump



- Maximum pressure 700 PSI
- 1/2" NPT hose connection
- Three gallon tank capacity



PART NO.	DESCRIPTION	ROTHENBERGER	CTN QTY
J40223	Complete pressure pump unit	6.1004	1
J40224	0 - 700 PSI gauge	6.1313	1
J40225	Piston	6.1300	1

RP 30 Hydrostatic Test Pump



- For quick pressure testing and/or air tight testing
- Ideal for use in small spaces
- Steel reinforced test hose
- Test up to 440 lbs
- 500 PSI
- No false reading from any bulging of the hose!



PART NO.	DESCRIPTION	ROTHENBERGER	CTN QTY
J40123	Hydrostatic test pump	RP 30	1

High Pressure Hose with Fitting



- For hydrostatic pressure pump

PART NO.	DESCRIPTION	CTN QTY
J40198	High pressure hose with fitting	1

Air Pump



- Large diameter
- Heavy metal construction
- Pressure gauge included

PART NO.	DESCRIPTION	CTN/MSTR
P10001	Heavy duty pump	1/10

Economy Air Pump



PART NO.	DESCRIPTION	CTN/MSTR
P10002	1-1/2" x 18" air pump	1/12

Water Pump



- Excellent for draining water meter boxes
- High impact PVC; non-sparking; lightweight
- No priming necessary- removes 35 ounce/stroke
- Remove foot valve to clean

PART NO.	DESCRIPTION	CTN QTY
P13600	36" pump with 72" discharge hose	1

4-N-1 Copper Tube Fitting Brush



- Includes four long lasting high carbon steel brushes for 1-1/2" and 3/4" copper tube and fittings

PART NO.	DESCRIPTION	CTN/MSTR
B10004	Copper tube and fitting brush	1/10

Female Copper Tube Brush



- For cleaning copper tubing
- CARTON QUANTITIES ONLY

PART NO.	DESCRIPTION	CTN QTY
B29625	CTS OD 5/8" copper tube brush	6
B29875	CTS OD 7/8" copper tube brush	6
B29999	CTS OD 1-1/8" copper tube brush	6

Copper Fitting Brush



- Carbon steel
- CARTON QUANTITIES ONLY

Wire Handle			
PART NO.	ID	OD	CTN/MSTR
B28025	1/4"	3/8"	12/72
B28375	3/8"	1/2"	12/72
B28050	1/2"	5/8"	12/72
B28051	1/2"	5/8"	100-bulk
B28075	3/4"	7/8"	12/72
B28076	3/4"	7/8"	100-bulk
B28100	1"	1-1/8"	12/72
B28125	1-1/4"	1-3/8"	6/36
B28150	1-1/2"	1-5/8"	12/72
B28200	2"	2-1/8"	6/36
Wooden Handle			
PART NO.	ID	OD	CTN/MSTR
B29025	1/4"	3/8"	12/72
B29375	3/8"	1/2"	12/72
B29050	1/2"	5/8"	12/72
B29051	1/2"	5/8"	100-bulk
B29075	3/4"	7/8"	12/72
B29076	3/4"	7/8"	100-bulk
B29100	1"	1-1/8"	12/72
B29125	1-1/4"	1-3/8"	6/36
B29150	1-1/2"	1-5/8"	6/36
B29200	2"	2-1/8"	6/36

Socket Savers



- Removes Schedule 40 plastic pipe
- Cuts ABS or PVC DWV pipe below slab
- Fits 1/2" variable speed power drill
- Carded

PART NO.	DESCRIPTION	CTN/MSTR
J44050	1/2" Socket Saver	36/144
J44075	3/4" Socket Saver	30/120
J44100	1" Socket Saver	24/96
J44150	1-1/2" Socket Saver	24/96
J44200	2" Socket Saver	12/72
J44300	3" Socket Saver	12/48
J44400	4" Socket Saver	20/40

Items marked with the Jones Stephens logo are "You Need It... We Got It" Items.

Inside Pipe Cutter



- Cuts 2" and larger plastic pipe
- Fits electric drill

PART NO.	DESCRIPTION	CTN/MSTR
P70023	3" shaft with 2 blades	1/50
P70029	(3) replacement blades	10

EZY Grind Pipe Cutter



- Made from tool steel
- Replaceable diamond blade
- Suitable for portable power drills
- 1/4" hex shank, fits all drill chucks
- Guided cutting motion
- Pre-set depth of cut
- Cuts PVC and ABS pipe
- A fast and safe way to cut pipes at or below floor level

PART NO.	DESCRIPTION	CTN/MSTR
J40650	Pipe cutter for 3" - 4" plastic DWV pipe	1/1
J40652	Replacement blade for 3" - 4" pipe cutter (2 pack)	1/1
J40651	Pipe cutter for 1-1/2" - 2" plastic DWV pipe	1/1
J40653	Replacement blade for 1-1/2" - 2" pipe cutter (2 pack)	1/1

E-Z Shear Inside Pipe Cutter



- Cuts PVC and ABS pipe
- High speed steel blade with zinc-plated shaft

PART NO.	DESCRIPTION	CTN/MSTR
J40830	E-Z shear inside pipe cutter	24/192
J40831	(2) E-Z shear replacement blades	1/100

PVC Pipe Cutter



- High carbon steel blades
- Repair kits includes all screws and springs needed to repair cutter
- Aluminum alloy handles
- Ratchet action
- P70001 is carded

PART NO.	DESCRIPTION	CTN/MSTR
P70001	1" pipe cutter	10/50
P70005	Replacement blade	50/300
P70015	1" repair kit	1/100

Heavy Duty PVC Pipe Cutter



- High carbon steel blades
- Repair kit includes all screws and springs needed to repair cutter
- Aluminum alloy handles

PART NO.	DESCRIPTION	CTN/MSTR
P70010	1" heavy duty pipe cutter (boxed)	1/60
P70011	1" heavy duty replacement blade	1/100
P70012	1" repair kit	1/100
P70002	2" pipe cutter (boxed)	1/20
P70006	2" replacement blade	1/100
P70016	2" repair kit	1/100

PVC One-Handed Pipe Cutter



- Easy one-handed ratchet cutting action
- Spring loaded blade
- Heat treated hardened steel blade for straighter cuts - longer life
- Contractor quality - great for plumbers, pool contractors, electricians, etc.
- Cuts up to 2" pipe (2-1/2" OD)
- P70035 is carded

PART NO.	DESCRIPTION	CTN/MSTR
P70035	2" PVC one-handed pipe cutter	6/24
P70036	Replacement blade	25/50

Professional PVC Pipe Cutter



- Rustproof
- Capacity to 1-1/4" diameter PVC
- The blade is non-electro nickel plated which ensures a sharper blade
- Locking hook can be used to deburr pipe
- P70018 and P70019 are carded

PART NO.	DESCRIPTION	CTN/MSTR
P70018	1-1/4" PVC pipe cutter	5/30
P70019	Replacement blade	10/100
P70020	Repair kit (spring and screws)	10/100

Vinyl Tubing Cutter



- Plastic body
- Cuts up to 1" vinyl tubing

PART NO.	DESCRIPTION	CTN/MSTR
P70030	Vinyl tube cutter	12/72
P70031	Replacement blade	50/500

Telescopic Tubing Cutter



- Extra wheel in handle
- Grooved roller
- 1/4" - 1-1/4" cutter
- Imported
- Built-in deburring tool

PART NO.	DESCRIPTION	CTN/MSTR
P70050	Telescopic tubing cutter	10/100
P70055	Replacement cutter wheel	1/100
P70056	(2) Replacement cutter wheels	50/500

Telescoping Tubing Cutter



- Enclosed feed mechanism
- Grooved rollers for close-to-flare cuts
- Anodized body for corrosion resistance
- Allows cut with shorter arc
- Fold-away reamer
- Spare cutter wheel stored in body



PART NO.	DESCRIPTION	ROTHENBERGER	CTN	QTY
J40240	1/8" - 1-1/8" O.D. capacity	70010	1	
J40241	1/4" - 1-5/8" O.D. capacity	70011	1	
J40242	Replacement cutter wheel	70007	1	
J40243	Cutter wheel pin	51250	1	
J40244	Cutter wheel pin retaining ring	51240	1	

Ⓢ Items marked with the Jones Stephens logo are "You Need It... We Got It" Items.

Enclosed Feed Tube Cutter



Retractable
Deburring
Blade

- Extra cutter in knob
- Heavy duty one piece slide
- Polished rollers for easy rotation
- Cuts: copper, brass, aluminum tubing, thin-wall conduit
- P70056 is carded

PART NO.	DESCRIPTION	CTN/MSTR
P70064	1/8" x 1-3/16"	10/60
P70056	(2) Replacement cutter wheels	50/500

Quick Release Tubing Cutter



- Spring-loaded for quick size adjustment
- Spring cutter wheel in handle
- Imported
- P70069 is carded

PART NO.	DESCRIPTION	CTN/MSTR
P70065	1/4" - 2" O.D. Capacity tubing cutter	6/48
P70069	(2) Replacement cutter wheels	50/500

Quick Release Tubing Cutter



- Spring-loaded ratchet allows for quick size adjustment and release
- Spare cutter wheel in handle



PART NO.	DESCRIPTION	ROTHENBERGER	CTN/MSTR
J40217	1/4" - 2 5/8" heavy duty cutter	7.0030	1
J40218	Repl. cutter wheel for metal	7.0005	1
J40219	Repl. cutter wheel for plastic	7.0028	1
J40228	Cutter wheel screw	7.0006	1/10

Economy Tube Cutter



- Screw-feed
- Zinc plated

PART NO.	DESCRIPTION	CTN/MSTR
P70066	1/8" - 1-1/8"	10/60
P70067	(2) Replacement blades (slide blister)	50/500

Ratcheting Handle Copper Tube Cutter



- Cuts multiple sizes of copper, aluminum tubing, and thin-wall conduit
- Long handle for more leverage

PART NO.	DESCRIPTION	CTN/MSTR
J40262	1/4"-3/4" Ratcheting handle copper tube cutter	6/48

Mini Tubing Cutter



PART NO.	DESCRIPTION	ROTHENBERGER	CTN/MSTR
J40213	5/8" capacity tubing cutter	7.0001	1/24
J40214	7/8" capacity tubing cutter	7.0002	1/24
J40215	Replacement cutter wheel	7.0003	1
J40228	Cutter wheel screw	7.0006	6/48

Items marked with the Jones Stephens logo are "You Need It...We Got It" Items.

Mini Tubing Cutter



- Good for all soft metal tubing
- P70052 is carded

PART NO.	DESCRIPTION	CTN/MSTR
P70051	Mini tubing cutter - 1/8"-7/8"	20/200
P70052	Mini tubing cutter-1/8"-7/8" (uses P70055 repl. blade)	1/100
P70053	Mini tubing cutter- 1/8" - 1-1/8"	1/80
P70060	(2) Replacement blades (bulk)	25/250
P70067	(2) Replacement blades (slide blister)	50/500

Copper Tube Cutter



- Self-clamping and self-aligning
- Easy to use in close quarters
- Cuts copper and PVC quickly and easily
- J40260 and J40261 are carded

PART NO.	DESCRIPTION	CTN/MSTR
J40260	1/2" Copper tube cutter	10/100
J40261	3/4" Copper tube cutter	10/60
J40263	(2) Replacement blades for J40260 and J40261	50/500

Plastic Saw



- Die cast aluminum handle
- Quickly cuts PVC, ABS, wood, sheetrock, etc.
- Large comfortable grip
- Flame hardened blade
- Blade has 10 teeth/inch

PART NO.	DESCRIPTION	CTN/MSTR
S49001	18" Saw	1/6
S49002	Replacement blade	50/100
S49010	Handle only	20/100

Drywall Saw



- High quality carbon steel blade
- Great for sheetrock, wallboard, gypsum, plywood, wood and plastic pipe
- 6" 8 TPI aggressive tooth design ensures super sharp, fast & easy cut
- Comfortable grip with thumb stop for greater leverage
- Handy wrist strap

PART NO.	DESCRIPTION	CTN/MSTR
S49012	Drywall saw	1/10
S49013	Replacement blade	1/300

Jr. Plumber's Saw



- Die cast aluminum handle
- Case hardened steel blade
- Deburs as it cuts
- Cuts up to 4" PVC pipe
- 8-1/2" blade; 10 teeth/inch
- Unique nose teeth permit starting cuts on flat surfaces

PART NO.	DESCRIPTION	CTN QTY
S49004	Jr. Plumber's saw	1
S49000	Replacement blade	1

Hardwood 250 Speed Handsaw



- Great for hardwood and laminated wood
- Tri-edge and impulse hardened teeth for accurate rip, cross and slant cuts

PART NO.	DESCRIPTION	CTN QTY
S49200	Hardwood 250 speed handsaw	10/60
S49201	Replacement blade	50/100

Cable Saw

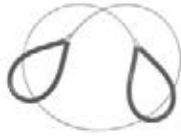

- For cutting PVC pipe
- For tight spots offering little clearance
- Fits easily into tool box and pocket
- Faster and easier than hacksaws in close quarters
- Individually bagged with header card

PART NO.	DESCRIPTION	CTN QTY
S49136	36" cable saw display	36
S49148	48" cable saw display	24
S49036	36" cable saw	1
S49048	48" cable saw	1

T-Handle Cable Saw



- For cutting PVC pipe
- Strong and comfortable t-handles
- Great for use in tight spots
- Long-lasting stainless steel cutting cable
- Polybagged with header card

PART NO.	DESCRIPTION	CTN QTY
S49236	36" cable saw	1

Close Quarters Hacksaw



- Nickel plated steel frame
- Cuts wood, plastic, brass, aluminum and steel

PART NO.	DESCRIPTION	CTN/MSTR
S50060	6" close quarters hacksaw	1/50
S50061	(5) Replacement blades for S50060	5/800
S50062	6" adjustable hacksaw	12/144
S50063	(5) Replacement blades for S50062	5/1000

Hacksaw



- Heavy square tubing and die cast construction
- Stores extra blades
- Blade tensioning adjustment
- Cuts flush with surface

PART NO.	DESCRIPTION	CTN/MSTR
S49003	Hacksaw with blade	6/36

Snap Knife



- 8 point snap-off blade
- Counter display box has 30 pcs.
- 10 per tube, priced each
- CARTON QUANTITIES ONLY

PART NO.	DESCRIPTION	CTN/MSTR
K50001	Snap knives display box	30/300
K50002	8 point snap knife	40/480
K50003	8 point replacement blade	10/200

Deluxe Autolock Snap Knife



- Blade automatically locks into position
- Contoured shape for a more comfortable grip

PART NO.	DESCRIPTION	CTN QTY
K50005	Deluxe autolock snap knife	20/200

Utility Knife



- Heavy duty construction
- Supplied with extra blade
- Coated case

PART NO.	DESCRIPTION	CTN/MSTR
K50041	Utility knife	12/120
K50042	(5) Replacement blades	100/1000

Heavy Duty Utility Knife - Carded



- Safety orange color
- Solid east metal
- Retractable
- Blade included
- Carded

PART NO.	DESCRIPTION	CTN QTY
K50046	Heavy duty utility knife	12/144
K50043	Utility knife replacement blades with dispenser (100/pk)	6/36

Got To Have It!

E-Z Stroke Pipe Saw

- For smooth, fast, accurate cutting
- Tri-edge teeth are borazon wheel ground
- Pull-stroke cutting action
- Cuts plastic pipe and wood
- Replaceable blade



PART NO.	DESCRIPTION	CTN/MSTR
S49005	8" E-Z stroke pipe saw	10/100
S49006	8" Replacement blade	50/250
S49008	12" E-Z stroke pipe saw	10/100
S49007	12" Replacement blade	50/200



Items marked with the Jones Stephens logo are "You Need It... We Got It" Items.

Fiberglass Handle Shovel



- STINGER SERIES - Fiberglass handle is 40% stronger than Federal Strength Test for long handle wood tools.
- Large steel collar adds maximum strength to handle/socket connection.
- Forward - turned step for secure foot placement

PART NO.	DESCRIPTION	AMES #	BUNDLE QTY
S49411	Long handle round point	SFGLR	6
S49412	Long handle square point	SFGLS	6
S49416	D-Handle 16" drain spade	SFGD16	6
S49413	Long handle 16" drain spade	SFGDSL	6

Premium Grade Wood Handle Shovel



- Lacquered ash handle
- Premium blade

PART NO.	DESCRIPTION	AMES #	BUNDLE QTY
S49421	Long handle round point	BMTLR	6
S49422	Long handle square point	BMTLS	6
S49417	D-Handle round point	BMTDR	6
S49423	D-Handle 16" drain spade	15-738	6
S49425	LH trenching shovel 4" blade	15-566	6
S49427	LH trenching shovel 5" blade	15-567	6

Economy Grade Wood Handle Shovel

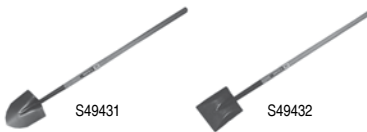

PART NO.	DESCRIPTION	AMES #	BUNDLE QTY
S49431	Long handle round point	15-047	6
S49432	Long handle square point	15-049	6

Economy Grade Wood Handle Shovel



PART NO.	DESCRIPTION	BUNDLE QTY
S49401	Long handle round point	6
S49402	Long handle square point	6

Specialty Shovel



- KODIAK CUB - smaller design for easier use in tight spaces
- 16 gauge tempered steel blade
- Forward turned step
- 27" overall length

PART NO.	DESCRIPTION	AMES #	BUNDLE QTY
S49429	Compact utility shovel	15-663	6

Long Handle Round Point Fiberglass Shovel



- Long fiberglass handle
- Round point

PART NO.	DESCRIPTION	BUNDLE QTY
S49400	Long handle round point	12

Combination Snow Pusher/Shovel



- 18" x 14" poly blade
- Deep rib molded, non-stick poly blade
- Heavy duty

PART NO.	DESCRIPTION	CTN/MSTR
S49430	Combination snow pusher/shovel	1/6

Poly Blade Snow Shovel



- 21" deep rib molded, non-stick poly blade
- High impact blade
- Lightweight
- 48" heavy duty handle

PART NO.	DESCRIPTION	CTN/MSTR
S49434	Poly blade snow shovel	1/6

D-Grip Poly Blade Snow Shovel



- 18" x 14" high-impact, non-stick poly blade
- Lightweight
- 48" heavy duty handle

PART NO.	DESCRIPTION	CTN/MSTR
S49433	D-grip poly blade snow shovel	1/6

44" Telescopic Snow Brush



- Great for trucks and SUV's!
- Combination snow brush, scraper, and squeegee
- Extra thick bristles
- Aluminum handle

PART NO.	DESCRIPTION	CTN/MSTR
S80201	44" telescopic snow brush	1/24

12" Cushion Grip Snow Scraper



- Display box included
- 24 scrapers; priced each
- High impact plastic
- Wide scraping surface
- CARTON QUANTITIES ONLY

PART NO.	DESCRIPTION	CTN/MSTR
S80200	12" cushion grip snow scraper display	1/24

Pointing Trowel with Wood Handle



- Fine grained hardwood handle

PART NO.	DESCRIPTION	CTN/MSTR
B29500	5" pointing trowel with wood handle	12/120
B29501	7" pointing trowel with wood handle	12/72

Cold Chisel



- Designed for cutting cast iron or steel

PART NO.	DESCRIPTION	CTN/MSTR
J41002	1" wide x 8" regular length	1/24

G Short Nose Caulking Tool



- For finishing lead joint

PART NO.	DESCRIPTION	CTN/MSTR
J41008	5/8" wide x 7-1/2" long	1/24

Inside Caulking Tool



- For finishing lead joint

PART NO.	DESCRIPTION	CTN/MSTR
J41009	5/8" wide x 7" long	1/24

Outside Caulking Tool



- For finishing lead joint

PART NO.	DESCRIPTION	CTN/MSTR
J41010	5/8" wide x 7" long	1/24

Broad Curve Nose Caulking Tool



- Used for packing Oakum tight
- For first pass on lead

PART NO.	DESCRIPTION	CTN/MSTR
J41011	5/8" wide x 8" x 1-1/2"	1/24

17 Pound Digging/Tamping Bar



- For digging holes, cutting roots or tamping

PART NO.	DESCRIPTION	CTN QTY
S49500	1" x 69" post hole digger	1

Slim Bar 360 Nail Puller



- 14" long
- Hang tab included

PART NO.	DESCRIPTION	CTN. QTY.
J40400	Slim bar 360 nail puller	1

Utility Pry Bar



PART NO.	DESCRIPTION	CTN/MSTR
S49489	14" utility pry bar	1/5

Manhole Cover Lifter



- 25" long



PART NO.	DESCRIPTION	CTN/MSTR
S49490	Manhole cover lifter	1/10

Gooseneck Wrecking Bar



- Painted and polished
- Claw on end removes nails



PART NO.	DESCRIPTION	CTN/MSTR
S49501	30" wrecking bar	1/10

Striking Tools



- Hickory handles
- Long life - high quality
- Made in the USA



PART NO.	DESCRIPTION	CTN QTY
J40144	3 lb. engineers hammer	2
J40142	6 lb. sledgehammer	3
J40143	8 lb. sledgehammer	3

Pick Mattock



- Hardwood handle
- 5 pound head



PART NO.	DESCRIPTION	CTN/MSTR
J40141	5 lb. pick mattock with handle	1/4

Probing Rod



- Weather resistant fiberglass
- Eliminates danger of shock
- Tip is not replaceable

PART NO.	DESCRIPTION	CTN QTY
P27048	4' probing rod	5

Steel Probing Rod



- Stainless steel tips
- Cushion vinyl handle
- Welded steel construction

PART NO.	DESCRIPTION	CTN QTY
P27004	4' steel probing rod	5
P27005	5' steel probing rod	5
P27001	Stainless steel tip	5

Steel Probing Rod with Ball Point



Ballpoint Tip

- Steel shaft
- Vinyl handle for comfort
- Carbon steel ballpoint will not puncture soft pipe
- Tip is not replaceable

PART NO.	DESCRIPTION	CTN QTY
P27003	3' metal probing rod	1
P27040	4' metal probing rod	1

Water Meter Key



- Rebar shaft and handle for greater strength
- Vinyl covered handle comfort
- Diameter x Length

PART NO.	DESCRIPTION	BUNDLE QTY
M25127	1/2" x 27" meter key	5
M25136	1/2" x 36" meter key	5
M25148	1/2" x 48" meter key	5
M25527	5/8" x 27" meter key	5
M25536	5/8" x 36" meter key	5
M25560	5/8" x 60" meter key	5
M25736	3/4" x 36" meter key	5
M25760	3/4" x 60" meter key	5
M25772	3/4" x 72" meter key	5
M25784	3/4" x 84" meter key	5

Items marked with the Jones Stephens logo are "You Need It... We Got It" Items.

Combo Water Meter Key



- Rebar shaft and handle for greater strength
- Vinyl covered handle comfort
- Combo lid key and meter key
- Diameter x Length

PART NO.	DESCRIPTION	BUNDLE QTY
M25130	1/2" x 30" meter key	5

Gate Valve Key



PART NO.	DESCRIPTION	CTN QTY
M25100	30" gate valve key	5

Copper Sizing Tool



- For type "M" copper tubing
- Impact type to reround tube

PART NO.	DESCRIPTION	CTN/MSTR
J40750	1/2" Copper sizing tool	10/60
J40775	3/4" Copper sizing tool	10/40
J40800	1" Copper sizing tool	10/30

Copper Swedge Tool

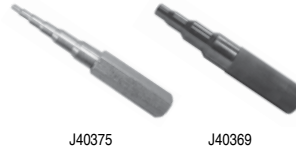

J40375

J40369

- Use J40375 on 1/4", 5/16", 3/8", 1/2", and 5/8" copper tube
- Use J40369 on 5/8", 7/8", and 1 1/8" copper tube
- Heat-treated carbon steel
- Can also be used on soft copper, aluminum or any other thin-walled tubing

PART NO.	DESCRIPTION	CTN/MSTR
J40375	Copper swedge tool	25/100
J40369	Copper swedge tool (up to 1 1/8")	12/24

Polybutylene Crimping Tools



- Single crimp and combo tools
- Accurate and easy to use
- Unit can be calibrated in the field
- Made in the USA



PART NO.	DESCRIPTION	CTN QTY
J42002	1/2" regular crimping tool	1
J42003	3/4" regular crimping tool	1
J42004	1/2" - 3/4" combo crimping tool	1

Note: These tools cannot be returned for repair.

Oetiker® 3-Handle Ratcheting Crimp Tool



- Tool will not release until clamp is properly closed
- Robust fastener with assist lever
- Single handed installation possible
- Made in the USA



PART NO.	DESCRIPTION	CTN QTY
J40967	3" hand crimp tool	1

Pex Crimp Set



J40950



J40952



J40965



J40966

- For use on crimping PEX pipe with copper crimp rings and stainless steel bands

PART NO.	DESCRIPTION	CTN QTY
J40950	PEX crimp set with 3/8", 1/2", 3/4" heads	1
J40951	3/8" PEX crimp tool	1
J40952	1/2" PEX crimp tool	1
J40953	3/4" PEX crimp tool	1
J40954	1" PEX crimp tool	1
J40955	PEX crimp sizing tool	1
J40960	PEX crimp ring cutter	1
J40965	One hand PEX SS clamp tool	1
J40966	PEX SS clamp tool	1

Flaring Tool



- Makes smooth flare
- For O.D. sizes 3/16", 1/4", 5/16", 3/8", 1/2" and 5/8"

PART NO.	DESCRIPTION	CTN/MSTR
J40080	Bar flaring tool	6/24

Swing Release Flaring Tool



- 3/16" - 5/8" O.D.
- 45° single flare

PART NO.	DESCRIPTION	CTN/MSTR
J40220	45° flaring tool	1/12

Deburring Tool



- Easily removes burrs inside and outside of copper and plastic
- Handle stores spare blades

PART NO.	DESCRIPTION	CTN/MSTR
J40221	Deburring tool with blade	40/180
J40222	Replacement blade	1/1

Nipple Extractor Set



PART NO.	DESCRIPTION	CTN/MSTR
J40054	Nipple extractor set - 3/8", 1/2", 3/4"	20/40
J40055	Nipple extractor set - 3/8", 1/2", 3/4", 1"	1/1

Internal Pipe Nipple Extractor



- Heat treated and cad plated
- Removes or inserts nipples

PART NO.	DESCRIPTION	CTN/MSTR
J40050	3/8" nipple extractor	100/200
J40051	1/2" nipple extractor	20/120
J40052	3/4" nipple extractor	50/100
J40053	1" nipple extractor	25/50

Nipple and Screw Extractor



- Left hand spiral
- Removes nipples, bolts, and screws without thread damage

PART NO.	PIPE SIZE	DRILL SIZE	BOLT SIZE	CTN QTY
J41103	1/8"	1/4"	9/32" - 3/8"	1
J41104	1/4"	19/64"	3/8" - 5/8"	1
J41105	3/8"	13/32"	5/8" - 7/8"	1
J41106	1/2"	17/32"	7/8" - 1-1/8"	1
J41107	3/4"	13/16"	1-1/8" - 1-3/8"	1
J41108	1"	1-1/16"	1-3/8" - 2"	1

Carbide Tipped Masonry Drill Bit



PART NO.	REGULAR LENGTHS	SHANK SIZE	CTN QTY
S41349	5/32" x 4"	3/16"	1
S41351	3/16" x 4"	3/16"	1
S41350	1/4" x 4"	1/4"	1
S41352	5/16" x 4"	1/4"	1
S41353	3/8" x 6"	1/4"	1
S41354	7/16" x 6"	3/8"	1
S41355	1/2" x 6"	3/8"	1
S41356	9/16" x 6"	1/2"	1
S41357	5/8" x 6"	1/2"	1

Masonry Drill Bit



- Carded

PART NO.	DESCRIPTION	CTN/MSTR
S41348	1/8" masonry drill bit	6/48
S41364	3/16" masonry drill bit	6/48
S41450	1/4" masonry drill bit	6/48
S41452	5/16" masonry drill bit	6/48
S41453	3/8" masonry drill bit	6/48
S41455	1/2" masonry drill bit	6/48

Dual Auger Wood Drill Bit



- Screw point
- Up to 1" for use in 3/8" or 1/2" power drill; 1" and up for use in 1/2"

PART NO.	DESCRIPTION	CTN QTY
B21625	5/8" x 6" long	1
B21075	3/4" x 6" long	1
B21087	7/8" x 6" long	1
B21100	1" x 6" long	1
B21112	1-1/8" x 6" long	1
B21125	1-1/4" x 6" long	1
B21150	1-1/2" x 6" long	1

Flat "Paddle" Wood Drill Bit



PART NO.	DESCRIPTION	CTN QTY
B24375	3/8" flat paddle wood bit	1
B24050	1/2" flat paddle wood bit	1
B24056	9/16" flat paddle wood bit	1
B24063	5/8" flat paddle wood bit	1
B24075	3/4" flat paddle wood bit	1
B24081	13/16" flat paddle wood bit	1
B24088	7/8" flat paddle wood bit	1
B24100	1" flat paddle wood bit	1
B24113	1-1/8" flat paddle wood bit	1
B24125	1-1/4" flat paddle wood bit	1
B24150	1-1/2" flat paddle wood bit	1

Wood Spade Drill Bit



- Carded

PART NO.	DESCRIPTION	CTN/MSTR
B24250	1/2" wood spade drill bit	6/48
B24263	5/8" wood spade drill bit	6/48
B24175	3/4" wood spade drill bit	6/48
B24188	7/8" wood spade drill bit	6/144
B24200	1" wood spade drill bit	6/48
B24213	1-1/8" wood spade drill bit	6/48
B24225	1-1/4" wood spade drill bit	6/48
B24251	1-1/2" wood spade drill bit	6/48

Straight Shank Drill Bit



- High speed steel
- Jobber's length

PART NO.	DESCRIPTION	CTN QTY
B20062	1/16" drill	1
B20078	5/64" drill	1
B20094	3/32" drill	1
B20109	7/64" drill	1
B20125	1/8" drill	1
B20141	9/64" drill	1
B20156	5/32" drill	1
B20172	11/64" drill	1
B20188	3/16" drill	1
B20203	13/64" drill	1
B20219	7/32" drill	1
B20234	15/64" drill	1
B20250	1/4" drill	1
B20266	17/64" drill	1
B20281	9/32" drill	1
B20297	19/64" drill	1
B20313	5/16" drill	1
B20328	21/64" drill (1/8" pipe tap)	1
B20344	11/32" drill	1
B20359	23/64" drill	1
B20375	3/8" drill	1
B20391	25/64" drill	1
B20406	13/32" drill	1
B20422	27/64" drill	1
B20438	7/16" drill (1/4" pipe tap)	1
B20453	29/64" drill	1
B20469	15/32" drill	1
B20484	31/64" drill	1
B20500	1/2" drill	1

G

Pipe Tap



- NPT
- High carbon steel

PART NO.	DESCRIPTION	CTN QTY
T41001	1/8" NPT pipe tap	1
T41002	1/4" NPT pipe tap	1
T41003	3/8" NPT pipe tap	1
T41004	1/2" NPT pipe tap	1
T41005	3/4" NPT pipe tap	1
T41006	1" NPT pipe tap	1
T41009	1-1/4" NPT pipe tap	1
T41007	1-1/2" NPT pipe tap	1
T41008	2" NPT pipe tap	1

Locking Measuring Tape



- 33 ft.
- Extra heavy duty rubber case
- Power locking

PART NO.	DESCRIPTION	CTN/MSTR
J40084	1-1/4" x 33' tape measure	1/15

PlumbRule Measuring Tape

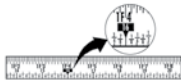

- 1" locking blade with push button lock
- Offset fractions for easy reading
- Auto recoil; belt clip and wrist strap
- Red stud markings and joist markings

PART NO.	DESCRIPTION	CTN/MSTR
J40101	1" x 25' tape	6/48

Neon Precision Measuring Tape



- Sure grip case

PART NO.	DESCRIPTION	CTN/MSTR
J40086	1" x 25' neon orange tape	6/48
J40087	1" x 25' neon yellow tape	6/48

Long Measuring Tape



- Hook blade
- Pop-open handle

Starrett

PART NO.	DESCRIPTION	CTN/MSTR
J40088	3/8" x 50' tape	6/36
J40089	3/8" x 100' tape	6/24

Locking Measuring Tape



- Unbreakable chrome plated case
- Power return
- Double riveted tang
- Cushion stop
- Positive lock
- Yellow tape
- Carded

PART NO.	DESCRIPTION	CTN/MSTR
J40046	1" x 25' tape	6/48
J40045	3/4" x 16' tape	12/144

Power Locking Measuring Tape



- Positive thumb lock
- Chrome plated case
- Smooth power return
- Stainless belt clip
- True zero blade hook
- P.R. approved

PART NO.	DESCRIPTION	CTN/MSTR
J40346	1" x 25' tape	6/36
J40345	3/4" x 16' tape	6/36

Brass Plumb Bob



- Solid brass
- Removable tip

PART NO.	DESCRIPTION	CTN/MSTR
J42008	8 oz. brass plumb bob	10/80
J42012	12 oz. brass plumb bob	1/50

Blue Chalk Line Set



- Metal body reel
- 4 oz. chalk
- Carded

PART NO.	DESCRIPTION	CTN/MSTR
J40124	100' blue chalk line set	6/36

Nylon Line Reel



- Twisted nylon
- Carded

PART NO.	DESCRIPTION	CTN/MSTR
J40125	#18 x 270' nylon line reel	6/36

Soap Stone and Holder



- ROUND- Pen size lightweight aluminum holder with built-in chuck
- FLAT- Stainless steel spring tension with locknut
- J40062 and J40063 sold in CARTON QUANTITIES ONLY

PART NO.	DESCRIPTION	CTN QTY
J40060	Round soap stone holder	6
J40061	Flat soap stone holder	6
J40062	Round soap stone	144/box
J40063	Flat soap stone	144/box

Flint Striker



- Round file style
- Renewable flint
- Flint priced per pack of 5 renewals

PART NO.	DESCRIPTION	CTN/MSTR
J40048	Striker	25/200
J40049	(5) flint renewals	50/200

Three Flint Friction Lighter



- Flint priced per pack of 4 renewals
- CARTON QUANTITIES ONLY

PART NO.	DESCRIPTION	CTN/MSTR
J40047	Three flint friction lighter	6/48
J40044	Flint renewal unit (4/card)	1

MAPP and Propane Cylinders



- Temperatures for burning: Propane 2300°, MAPP 3300°
- LTL TRANSPORTATION ONLY
- NO UPS/FED EX
- CARTON QUANTITIES ONLY

PART NO.	DESCRIPTION	CTN QTY
J40601	14.1 oz. Propane	12
J40600	14.1 oz. MAPP	12

Uniweld® Torch



• For MAPP or propane

PART NO.	DESCRIPTION	CTN QTY
J40529	Hand torch with swivel tip and self-igniter	20
J40329	UT6 replacement tip for J40529	1
J40629	Hand torch with swivel tip	20
J40429	UT5 replacement tip for J40629	1

Uniweld® Pencil Flame Torch

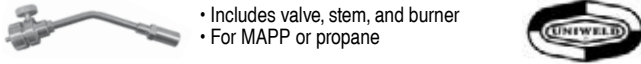

• Includes valve, stem, and burner
• For MAPP or propane

PART NO.	DESCRIPTION	CTN QTY
J40229	Pencil flame torch	1

Solid Brass Pencil Torch for Propane Only

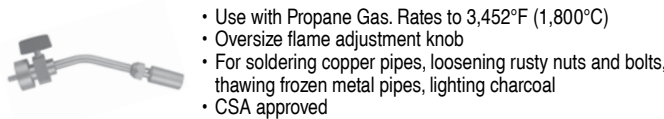

- Use with Propane Gas. Rates to 3,452°F (1,800°C)
- Oversize flame adjustment knob
- For soldering copper pipes, loosening rusty nuts and bolts, thawing frozen metal pipes, lighting charcoal
- CSA approved

PART NO.	DESCRIPTION	CTN/MSTR
J40430	Solid brass pencil torch for propane only	6/48

Self Igniting Torch for Propane Only

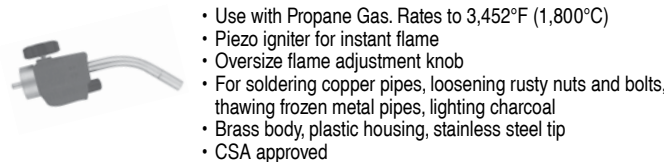

- Use with Propane Gas. Rates to 3,452°F (1,800°C)
- Piezo igniter for instant flame
- Oversize flame adjustment knob
- For soldering copper pipes, loosening rusty nuts and bolts, thawing frozen metal pipes, lighting charcoal
- Brass body, plastic housing, stainless steel tip
- CSA approved

PART NO.	DESCRIPTION	CTN/MSTR
J40431	Self igniting torch for propane only	6/48

Self Igniting Hand Torch for MAPP or Propane

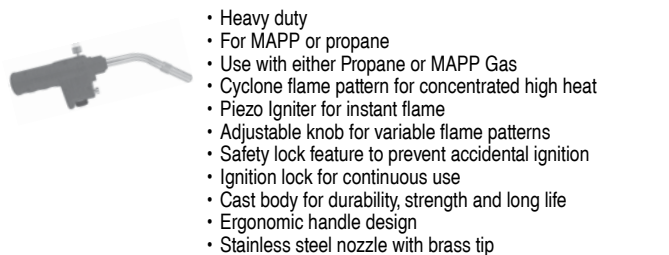

- Heavy duty
- For MAPP or propane
- Use with either Propane or MAPP Gas
- Cyclone flame pattern for concentrated high heat
- Piezo Igniter for instant flame
- Adjustable knob for variable flame patterns
- Safety lock feature to prevent accidental ignition
- Ignition lock for continuous use
- Cast body for durability, strength and long life
- Ergonomic handle design
- Stainless steel nozzle with brass tip

PART NO.	DESCRIPTION	CTN/MSTR
J40432	Self igniting hand torch for MAPP or propane	4/24

Solder Shield Protective Blanket

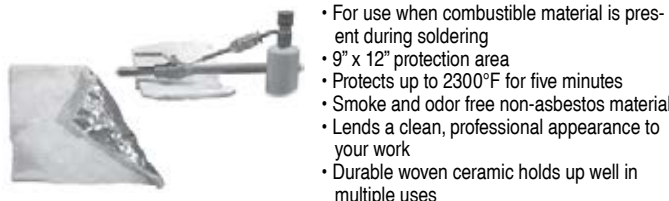

- For use when combustible material is present during soldering
- 9" x 12" protection area
- Protects up to 2300°F for five minutes
- Smoke and odor free non-asbestos material
- Lends a clean, professional appearance to your work
- Durable woven ceramic holds up well in multiple uses

PART NO.	DESCRIPTION	CTN QTY
J40812	9" x 12" Solder shield	1

Flux Paste



- Meets ASTM B813
- Water flushable for faster rinsing from pipe lines
- Super detergent action cleans as it solders
- Non-acid, non-toxic, **lead free**
- Contains no zinc chloride
- Use with all lead-free and common soft solders
- For use on copper, brass, galvanized iron, lead, zinc, tin, silver, nickel, mild steel, terne plate, and malleable iron
- Meets Mil. Spec. Mil-F-4995 Type II



PART NO.	DESCRIPTION	CTN QTY
S95102	4 oz. Flux paste	48
S95106	4 oz. Flux paste with brush in cap	48
S95103	1 lb. Flux paste	24

Flux-Rite 90® Flux



- Meets ASTM B-813
- Water soluble for faster flushing from pipe lines
- Super detergent action cleans as it solders
- Non-acid, non-toxic and lead free
- Contains no zinc chloride
- Use with all lead free and common soft solders
- For use on most metal types



PART NO.	DESCRIPTION	CTN/MSTR
S95104	4 oz. Flux-Rite 90® flux	1/24
S95105	1 lb. Flux-Rite 90® flux	1/12

Phos-Copper Brazing Rod



- 92.9% copper/ 7.1% phos
- Tensile strength 91,000 PSI
- Self-fluxing
- Liquid 1460°F, solid 1310°F
- Working temp 1350°-1500°F
- 1 pound plastic tubes

PART NO.	DESCRIPTION	CTN/MSTR
J41021	1 lb. tube brazing rod	1/10

2% Silver Solder



- 91% copper/ 7% phos/ 2% silver
- Liquid 1450°F, solid 1190°F
- Meets AWS A5.8QQB-650 B Cup-6
- 1 pound plastic tubes

PART NO.	DESCRIPTION	CTN/MSTR
J41022	1 lb. tube 2% silver solder	1/10

5% Silver Solder



- 89% copper/ 6% phos/ 5% silver
- Meets AWS A5.8-81-BCup3 Fed QQB650B
- Liquid 1475°F, solid 1190°F
- Working temperature 1300°-1550°F
- 1 pound plastic tubes

PART NO.	DESCRIPTION	CTN/MSTR
J41023	1 lb. 5% silver solder	1/10

15% Silver Solder



- 80% copper/ 5% phos/ 15% silver
- Meets AWS A5.8-81-BC7P3 Fed QQB650B
- Liquid 1495°F, solid 1190°F
- Working temperature 1300°-1500°F
- 1 pound plastic tubes

PART NO.	DESCRIPTION	CTN/MSTR
J41024	1 lb. tube 15% silver solder	1/10

Freeze Fix Pipe Jacket



- Fast, easy way to freeze pipe up to 4"
- Saves time and money on pipe repairs
- Repairs can be made without draining the water out of the line

Quick Way to Freeze Pipes for Easy Repair!

PART NO.	DESCRIPTION	L x W	CTN QTY
J40801	3/8" - 3/4" jacket	8" x 4-1/2"	1
J40802	3/4" - 1-1/2" jacket	10-1/2" x 7"	1
J40803	1-1/2" - 3" jacket	14" x 8-1/2"	1
J40804	3" - 4" jacket	16" x 11"	1
J40805	8' hose and connectors for CO2 kit	-	1
J40806	Tee connector for CO2 freeze kit	-	1
J40807	Freeze fix carry bag	-	1
J40808	CO2 empty cylinder (20 lb. size)	-	1

Files



- Durable plastic handles
- Top quality alloy steel

PART NO.	DESCRIPTION	CTN/MSTR
J41201	8" mil bastard file with handle	1/4
J41202	10" mil bastard file with handle	1/4
J41205	12" half round file	1/4
J41206	14" half round file	1/4

8" Half Round Bastard File



- High speed steel plastic molded handle
- Carded double blister

PART NO.	DESCRIPTION	CTN/MSTR
J41210	8" half round bastard file	6/36

Sure Sweat Dissolvable Pipe Plug

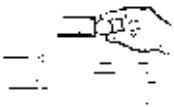

- Stop water from inside the pipe
- Dissolve safely and completely with water

PART NO.	DESCRIPTION	CTN/MSTR
H56050	1/2" kit (7 plugs per box)	1 box of 7/24
H56075	3/4" kit (5 plugs per box)	1 box of 5/24

Slip Jaw Pliers



- Plated finish
- Plastic grips

PART NO.	DESCRIPTION	CTN QTY
P60001	2-1/8" capacity / 10" long	5

Water Pump Pliers



- Drop forged vanadium steel; black epoxy powder coated
- Cushion grip
- Self-locking on pipe



PART NO.	LENGTH	CAPACITY	ROTHENBERGER	CTN QTY
J40210	7"	1"	7.0521	6
J40211	10"	1-1/4"	7.0522	6
J40212	12"	1-1/2"	7.0523	6

Griplock Tongue and Groove Water Pump Pliers



- Comfort grips



PART NO.	LENGTH	NO. ADJ.	CAPACITY	CHANNEL LOCK NO.	CTN QTY
J40410	10"	5	1-1/4"	GL10	5
J40411	12"	6	2-1/4"	GL12	5

"No Pinch" Pipe Wrench Pliers



- 10" comfort cushion grips
- Unique handle design prevents pinched fingers
- 1-3/4" jaw capacity
- Drop forged; plated finish

PART NO.	DESCRIPTION	CTN/MSTR
P60002	10" Pipe wrench pliers	4/40

10" Smooth Jaw Pliers



- 2-1/8" jaw opening
- Smooth jaws for non-arrng surfaces (chrome, polished brass)
- Cushioned vinyl grips

PART NO.	DESCRIPTION	CTN/MSTR
P60003	10" Smooth jaw pliers	10/50

Tongue and Groove Pliers



- Right angle teeth
- Undercut tongue and groove- won't slip
- Comfort grips



PART NO.	LENGTH	NO. ADJ.	CAPACITY	CHANNEL LOCK NO.	CTN QTY
J40401	6-1/2"	5	7/8"	426	5
J40402	9-1/2"	5	1-1/2"	420	5
J40403	10"	7	2"	430	5
J40404	12"	7	2-1/4"	440	5
J40405	16"	8	4-1/4"	460	2

Curved Jaw Tongue and Groove Pliers



- Curved jaw for use on round stock and tubing
- Right angle teeth

CHANNEL LOCK

PART NO.	LENGTH	NO. ADJ.	CAPACITY	CHANNEL LOCK NO.	CTN QTY
J40407	9-1/2"	5	1-1/2"	422	5
J40408	12"	7	2-1/4"	442	5

Smooth Jaw Tongue and Groove Pliers



- Smooth jaws for non-marring surfaces (PVC, chromes, etc.)
- Undercut tongue and groove-won't slip
- Comfort grips

CHANNEL LOCK

PART NO.	LENGTH	NO. ADJ.	CAPACITY	CHANNEL LOCK NO.	CTN QTY
J40406	10"	7	2"	415	5

4 in 1 Screwdriver



S41001 - 12 pk Display

- Alloy tool steel bits
- Ground and polished
- Heat treated for maximum strength
- High impact handle
- Floating ball bearing for tight fit

PART NO.	DESCRIPTION	CTN QTY
S41001	Phillips and slotted display	12
S41002	Slotted bit for 4 in 1 or 6 in 1	1
S41003	Phillips bit for 4 in 1	1

6 in 1 Screwdriver



S41006 - 12 pk Display

- Shaft ends are 1/4" and 15/16" hex size for use as nut drivers
- Each bit has two sizes

PART NO.	DESCRIPTION	CTN QTY
S41006	6 in 1 screwdriver display	12
S41002	Slotted bit for 4 in 1 or 6 in 1	1
S41007	Phillips bit for 6 in 1	1

Magnetic Power Nut Setters



- 1/4" hex shaft

PART NO.	DESCRIPTION	CTN QTY
S41300	1-3/4" long 1/4" head size	1
S41301	1-3/4" long 5/16" head size	1
S41302	2-9/16" long 1/4" head size	1
S41303	2-9/16" long 5/16" head size	1

Nut Driver



PART NO.	DESCRIPTION	CTN QTY
S06014	3/16" Nut driver	10
S06015	1/4" Nut driver	10
S06016	5/16" Nut driver	10
S06017	3/8" Nut driver	10
S06018	7/16" Nut driver	10
S06019	1/2" Nut driver	10

Hollow Shaft Nut Driver



- Drop forged steel
- Color coded handle
- Carded

PART NO.	DESCRIPTION	CTN/MSTR
S06117	3/8" hollow shaft nut driver	6/36
S06115	1/4" hollow shaft nut driver	6/36
S06116	5/16" hollow shaft nut driver	6/36



- 7 pc. set includes 3/16", 1/4", 5/16", 11/32", 3/8", 7/16", and 1/2" nut drivers
- Carded

PART NO.	DESCRIPTION	CTN/MSTR
S06021	7 piece hollow shaft nut driver set	6/36

Bit Holder



- For insert type bits
- Magnetic

PART NO.	DESCRIPTION	CTN QTY
S41307	1/4" drive x 3" long	1

Phillips Bit



PART NO.	DESCRIPTION	CTN QTY
S41306	#2 point 1/4" hex 1" insert type	1
S41308	# 2 point 1/4" hex 11 5/16" long insert type	1

100% Silicone Tub and Tile Sealant



J40197
J40199



J40200
J40201

- Ideal for tubs, sinks, toilets, showers and resetting loose tiles
- Warranted to last as long as the fixture
- Contains potent mildewcide
- Application temperature range -10°F to 100°F
- Service temperature range -60°F to 400°F
- CARTON QUANTITIES ONLY



PART NO.	DESCRIPTION	CTN QTY
J40199	2.8 oz. tube CLEAR caulk	12
J40197	2.8 oz. tube WHITE caulk	12
J40200	10.2 oz. tube CLEAR caulk	12
J40201	10.2 oz. tube WHITE caulk	12

100% Silicone Caulk



- Flexible, easy to use
- 50 year life
- Will not stain or bleed
- Seal, bond or insulate
- CARTON QUANTITIES ONLY

PART NO.	DESCRIPTION	CTN QTY
J40208	10.1 oz. tube CLEAR caulk	12
J40288	10.1 oz. tube WHITE caulk	12

25-Year Siliconized Acrylic Caulk



- Cleans up with water
- Paintable
- Will not stain or bleed
- Application temperature range 40°F to 90°F
- Service temperature range 0°F to 200°F
- CARTON QUANTITIES ONLY



PART NO.	DESCRIPTION	CTN QTY
J40202	10.1 oz. tube WHITE caulk	12

Acrylic Tub and Tile Caulk



- Long-lasting watertight seal around tubs, showers, and sinks
- Cleans up with water
- Odorless, mildew resistant
- Paintable
- Application temperature range 40°F to 90°F
- Service temperature range 0°F to 200°F
- CARTON QUANTITIES ONLY



PART NO.	DESCRIPTION	CTN QTY
J40203	5.5 oz. almond caulk	12
J40204	10.1 oz. white caulk	12
J40206	5.5 oz. white caulk	12

Latex Caulk



- General purpose
- Dries quickly
- Will not stain or bleed
- Paintable
- CARTON QUANTITIES ONLY



PART NO.	DESCRIPTION	CTN QTY
J40207	10.1 oz. white caulk	12

Hi-Temp 100% Red Silicone Caulk



- 100% silicone
- USDA approved, UL listed, meets NSF 51
- Temperature from 65°F to 650°F
- CARTON QUANTITIES ONLY



PART NO.	DESCRIPTION	CTN QTY
J40285	Hi-temp 100% silicone caulk	12

DAP® KWIK SEAL® Kitchen and Bath Adhesive Caulk



- Bonds like a glue and seals like a caulk
- Durable, watertight seal
- Excellent adhesion and flexibility
- Tools easy
- Cured caulk is mildew resistant
- Paintable
- Easy water clean-up
- CARTON QUANTITIES ONLY



PART NO.	DESCRIPTION	CTN QTY
DAP18001	5.5 oz. white caulk	12
DAP18032	10.1 oz. white caulk	12

DAP® KWIK SEAL PLUS® Premium Kitchen and Bath Adhesive Sealant with Antimicrobial Product Protection



- Premium adhesive caulk with antimicrobial product protection
- Siliconized latex
- Durable, watertight seal
- Excellent adhesion and flexibility
- Paintable
- Easy water clean-up
- CARTON QUANTITIES ONLY



PART NO.	DESCRIPTION	CTN QTY
DAP18526	5.5 oz. white caulk	12

DAP® Polyurethane Fireblock Foam Sealant



- Quickly fill and seal large gaps around vents, pipes, ducts and wires; and at wall-to-floor or ceiling-to-floor joints
- For use in Type V residential construction
- Bright orange foam for easy code identification
- Expands 2-1/2 to 3 times its dispensed size
- 1 can of this expanding foam yields up to 15 large caulk tubes
- CARTON QUANTITIES ONLY



PART NO.	DESCRIPTION	CTN QTY
DAP44242	12 oz. orange sealant	9

DAP® ALEX PLUS® Acrylic Latex Caulk Plus Silicone



- Superior quality, multi-purpose
- Highly flexible and durable
- Excellent adhesion
- Cured caulk is mildew resistant
- Interior/exterior use
- Paintable
- Easy water clean-up
- CARTON QUANTITIES ONLY



PART NO.	DESCRIPTION	CTN QTY
DAP18152	10.1 oz. white caulk	12

Items marked with the Jones Stephens logo are "You Need It... We Got It" Items.

DAP® Kitchen and Bath 100% Silicone Rubber Sealant



- Long-lasting flexibility
- Excellent adhesion
- Watertight seal around non-porous surfaces, such as ceramic tile and plumbing fixtures
- Safe for incidental food contact
- Cured sealant is mildew resistant
- CARTON QUANTITIES ONLY



PART NO.	DESCRIPTION	CTN QTY
DAP08640	10.1 oz. white sealant	12

DAP® All-Purpose 100% Silicone Rubber Sealant



- Long-lasting flexibility
- Excellent adhesion
- Weatherproof, watertight seal
- Resists cracking, crumbling and chalking
- Interior/exterior use
- CARTON QUANTITIES ONLY



PART NO.	DESCRIPTION	CTN QTY
DAP00683	2.8 oz. white sealant	12
DAP00684	2.8 oz. clear sealant	12
DAP08641	10.1 oz. clear sealant	12

Caulking Gun



- 9" barrel
- Drop-in half barrel type
- Painted steel

PART NO.	DESCRIPTION	CTN QTY
C35090	Caulking gun	10

Stop Flow™ Style Parallel Smooth Hex Rod Caulking Gun



- For standard cartridge
- Perfectly balanced
- Deep milled cut teeth built in spout cutter
- Nozzle clean out tool
- D-ring and wrist strap ladder hook

PART NO.	DESCRIPTION	CTN/MSTR
C35092	Stop Flow™ style parallel smooth hex rod caulk gun	1/12

Professional Caulking Gun



- Parallel hex rod frame
- Seal puncture tool
- Thumb release
- E-Z thrust mechanism
- Spout cutter
- Ladder hook

PART NO.	DESCRIPTION	CTN QTY
C35091	Parallel hex rod caulk gun	12

Firestop 814+ Intumescent Firestopping Sealant



J40284



J40286

- Colored red for ease of inspection
- Fulfills residential and commercial firestopping code requirements
- Meets ASTM-E814/UL 1479 test standards
- Resumes integrity for 1 & 2 hour fire rated assemblies

PART NO.	DESCRIPTION	CTN QTY
J40284	5 gallons	1
J40286	10.3 oz. tube	12

Fire Seal-136 Firestopping Caulk



- Resumes integrity of fireblocks 1 & 2 family construction
- Meets ASTM-E136 test standards
- Fulfills all residential fireblocking code requirements

PART NO.	DESCRIPTION	CTN QTY
J40287	10.3 oz. tube	12

Handicap



- No tools required - manual installation allows for no time wasted applying and removing thread tape after each use! Cost-effective, too!
- Reusable - long lasting
- Caps and 1/2" male thread for testing

PART NO.	DESCRIPTION	CTN QTY
H54100	1/2" FIP Handicap	1

Got To Have It!

Handi-Plug Combination Test Plug and Stub-Out

- Combination test plug and stub-out for drop eared elbow
- No tools required - manual installation allows for no time wasted applying and removing thread tape after each use! Cost-effective, too!
- No thread seal required
- Reusable - long lasting
- Smooth at thread end for easy plastering
- Time and labor savings



PART NO.	DESCRIPTION	CTN/MSTR
H54050	1/2" MIP Handi-Plug	25
H54051	Handi-Plug counter display	1

Items marked with the Jones Stephens logo are "You Need It...We Got It" Items.

Marking Products

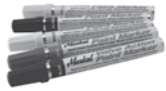

- High-performance industrial marking products
- Permanent paint
- Quick drying

LA·CO®

PART NO.	DESCRIPTION	CTN QTY
J40330	Red Dura-Ink® 15 marker	72
J40331	Black Dura-Ink® 15 marker	72
J40332	Black Dura-Ink® 25 marker	48
J40333	Red Dura-Ink® 55 marker	48
J40334	Black Dura-Ink® 55 marker	48
J40335	Black Dura-Ink® 200 marker	24
J40336	White paint marker	48
J40337	Yellow paint marker	48
J40338	Red paint marker	48
J40339	Black paint marker	48
J40340	Blue paint marker	48
J40341	Paint marker display yellow, white, and black	1
J40343	Round counter display red and black	1

Industrial Choice Precision-Line Inverted Marking Paint

G



- Features a distance tip for easy-to-read, bright, vivid markings
- Marks more linear feet than the competition
- Virtually no overspray
- Fast-drying and non-clogging
- Can be applied down to 25°F
- Dries in 5 minutes or less
- Easy-to-use, spray through cap guaranteed not to clog
- "No Mess" spray tip keeps paint off finger
- Locking tip keeps tip from popping off
- Best resistance to premature chalking and fading
- GROUND TRANSPORTATION ONLY
- CARTON QUANTITIES ONLY

PART NO.	DESCRIPTION	CTN QTY
J40380	White marking paint	12
J40381	Yellow marking paint	12
J40382	Red marking paint	12
J40383	Blue marking paint	12
J40384	Green marking paint	12
J40385 	Orange marking paint	12
J40387	Pink marking paint	12

Paint Spotter Hand-Help Wand



- For quick, easy one-hand application of marking point
- Non-adjustable

PART NO.	DESCRIPTION	CTN QTY
J40386	Paint spotter	1

Acid Brush



- Tin handle
- CARTON QUANTITIES ONLY

PART NO.	DESCRIPTION	CTN/MSTR
B29700	3/8" x 6" acid brush	144/1728
B29701	1/2" x 6" acid brush	144/1428
B29702	9/16" x 6" acid brush	144/1008
B29699	1/4" x 3" acid brush	144/1428

Chip Brush



- Natural bristles
- Ideal for use with pipe cleaners, thread cutting oil, paint, pipe dope
- CARTON QUANTITIES ONLY

PART NO.	DESCRIPTION	CTN/MSTR
B29801	1" chip brush	36
B29802	2" chip brush	24/432

Chip Brush



- Pure 100% natural white color bristle
- Epoxy set bristles for lasting durability
- Can be used with all paints, glue, and stains
- Interior/exterior
- Smooth natural wood handles

PART NO.	DESCRIPTION	CTN/MSTR
B29805	1-1/2" chip brush	36/864
B29806	2" chip brush	36/864
B29807	3" chip brush	12/432
B29808	4" chip brush	12/288

Long Handle Wire Brush with Scraper



- Long bent handle
- 3x19 rows
- For removing rust and corrosion from metals, roughing-up wood and brushing loose stucco surfaces
- Oil tempered carbon steel wire tynes
- Smooth sanded hardwood block

PART NO.	DESCRIPTION	CTN/MSTR
B29901	Long handle wire brush with scraper	12/144

Shoe Handle Wire Brush with Scraper



- Shoe handle
- 4x16 rows
- For removing rust and corrosion from metals, roughing-up wood and brushing loose stucco surfaces
- Oil tempered carbon steel wire tynes
- Smooth sanded hardwood block

PART NO.	DESCRIPTION	CTN/MSTR
B29902	Shoe handle wire brush with scraper	12/144

 Items marked with the Jones Stephens logo are "You Need It... We Got It" Items.

Wire Brush



- For cleaning rough surfaces
- Stiff steel wire bristle
- Polished hardwood handle
- CARTON QUANTITIES ONLY

PART NO.	DESCRIPTION	CTN/MSTR
B29900	1" wire brush	12/72

Mini Scraper with 5 Replacement Blades



PART NO.	DESCRIPTION	CTN/MSTR
K50045	Mini scraper with 5 replacement blades	6/36

5 in 1 Painters Tool



- Solid plastic handle
- Mirror finish tempered high carbon steel blade
- Precision ground
- Full tang
- Professional grade

PART NO.	DESCRIPTION	CTN/MSTR
K50011	5 in 1 painters tool	10/100

Putty Knife



PART NO.	DESCRIPTION	CTN/MSTR
K50015	1-1/4" putty knife	12/144
K50020	1-1/2" putty knife	10/100
K50017	2" putty knife	10/100
K50016	3" putty knife	12/144
K50018	4" putty knife	10/50

Clip Point Putty Knife



- Solid plastic handle
- Mirror finish tempered high carbon steel blade
- Precision ground
- Full tang
- Professional grade

PART NO.	DESCRIPTION	CTN/MSTR
K50012	Clip point putty knife	10/100

Spray Weld



- Cleaner, Primer & Cement all-in-one!
- No Mess – No Waste
- Spray any angle
- Goes twice as far as brush and can method
- Work in a wider range of temperatures

PART NO.	DESCRIPTION	CTN. QTY.
S30800	11 oz. with purple primer	12
S30801	4.5 oz. with purple primer	12
S30802	11 oz. with clear primer	12
S30803	4.5 oz. with clear primer	12

Whitlam "Blue Magic" Pipe Joint Compound



- ORM-D
- NSF listed
- Slow set
- Meets FED spec TTS-1732
- Use on plastic and metal threads
- GROUND TRANSPORTATION ONLY
- CARTON QUANTITIES ONLY



PART NO.	DESCRIPTION	CTN QTY
S95710	1/2 pint brush top can joint compound	24
S95711	1 pint brush top can joint compound	12
S96014	1/4 pint joint compound	24
S96016	1 quart pipe joint compound	12

Whitlam Seal Unyte



- Hard set
- Dark gray
- Semi-paste
- Use on all metal threaded connections and flanges

PART NO.	DESCRIPTION	CTN QTY
S95012	1/2 pint Whitlam seal unyte	24
S95014	1/4 pint Whitlam seal unyte	24
S96012	1 pint Whitlam seal unyte	12
S95016	1 quart Whitlam seal unyte	12

Whitlam "Select Unyte" Teflon Pipe Joint Compound



- ORM-D
- NSF listed
- Soft set, white virgin teflon (PTFE)
- Use on plastic and metal threads
- For use on air, steam, petroleum, water, gas and chemical lines
- GROUND TRANSPORTATION ONLY
- CARTON QUANTITIES ONLY



PART NO.	DESCRIPTION	CTN QTY
S95712	1/2 pint brush top can joint compound	24
S95713	1 pint brush top can joint compound	12

Slic-tite® Heavy Duty Thread Sealing Compound



- Working pressures: to 10,000 psi (liquids), 3,000 (gases)
- Temp: -50°F to +500°F
- Use for threaded connections on steel, aluminum, brass, PVC, CPVC & ABS



PART NO.	DESCRIPTION	CTN QTY
S95011	8 fl. oz. Slic-tite® HD thread sealing compound	24
S95010	Pint Slic-tite® HD thread sealing compound	24

Cool Gel®



- Protects surfaces and components from heat damage such as piping, drywall, and shower valves
- Used for any soldering or brazing job
- Safe, non-toxic, and harmless to the skin
- Will evaporate in 24-48 hrs. eliminating cleanup
- Unique gelling formula sticks to any surface without dripping or running off



PART NO.	DESCRIPTION	CTN QTY
S95100	1 qt. Cool Gel®	12
S95101	1 pt. Cool Gel®	24

Visu-Glow Leak Detector

G



- Fluorescent gas leak detector



PART NO.	DESCRIPTION	CTN QTY
S95200	8 oz. Visu-Glow leak detector	24

Liquid Lightning Pro Drain Opener



- Organic digester; biodegradable
- Dissolves grease, hair, sanitary napkins, sludge, soap and paper
- Environmentally safe
- ORM-D (S95701/S95793) GROUND TRANSPORTATION ONLY
- HAZMAT (S95794/S95795) LIGHT TRUCK LOAD ONLY
- CARTON QUANTITIES ONLY

PART NO.	DESCRIPTION	CTN QTY
S95701	1 pint drain opener	12
S95793	1 quart drain opener	12
S95794	1/2 gallon drain opener (HAZMAT)	6
S95795	1 gallon drain opener (HAZMAT)	4

Whitlam "Green Blaster" Drain Opener



- ORM-D
- Dry granular composition for clearing grease, hair and other organic matter from drains
- Non-acid - safe for chrome, polished brass, plastic and fixtures
- Safe for septic tanks
- GROUND TRANSPORTATION ONLY
- CARTON QUANTITIES ONLY

PART NO.	DESCRIPTION	CTN QTY
S95714	1 lb. canister drain opener	24
S95715	2 lb. canister drain opener	12

Drain King® Mini Snake



- Unclogs sinks, showers, bath drains & urinals
- Safe, easy to use
- No chemicals

PART NO.	DESCRIPTION	CTN. QTY.
D18190	Mini snake	36

Cloth Inserted Plunger Disc



- Cloth inserted rubber

PART NO.	DESCRIPTION	CTN/MSTR
D18052	3" cloth inserted plunger disc	5/30
D18051	4" cloth inserted plunger disc	5/30
D18050	Plunger disc holder	30/300

Plumber's Faucet and Valve Grease



- Lubricates faucet stems, threads, o-rings, packing, gaskets
- Resists high temperatures
- Counter display
- CARTON QUANTITIES ONLY

PART NO.	DESCRIPTION	CTN QTY
S95709	2.0 fl.oz. tins in counter display	12

Plumber's Putty



- Use on sinks, strainers, faucets and other fixtures wherever a non-drying watertight seal is needed
- DO NOT USE ON MARBLE OR PLASTIC!!!
- Meets Federal Specification TT-P-1536
- CARTON QUANTITIES ONLY

PART NO.	DESCRIPTION	CTN QTY
P40014	14 oz. putty	24
P40080	5 lb. putty	6

Plumber's Epoxy Putty



- Seal leaks in sink traps, water tanks, pipe joints, drain leaks and radiators
- Stop leaks in pools and drain lines
- Repair cracked porcelain wall tiles, floor tiles and fixtures
- CARTON QUANTITIES ONLY

PART NO.	DESCRIPTION	CTN QTY
P40004	4 oz. Epoxy putty tubes in counter display	12

Plumber's Goop Adhesive



- 3.7 oz. tube
- Watertight bond for use on PVC, tile or porcelain
- ORM-D
- GROUND TRANSPORTATION ONLY
- CARTON QUANTITIES ONLY

PART NO.	DESCRIPTION	CTN QTY
J45100	3.7 oz. tube plumber's goop adhesive	12

Items marked with the Jones Stephens logo are "You Need It... We Got It" Items.

2CanCaddy™



- Grab and go handle
- Special velcro strap to keep cans organized and secure
- Works well with all size cans up to 32 oz.
- Made of extremely durable polymer
- Easily cleans, stain resistant and virtually indestructible
- Perfect for Plumbers, Electricians, Painters & more

PART NO.	DESCRIPTION	CTN QTY
S95015	2CanCaddy™	12

20 Compartment Parts Box



- Includes extra dividers to increase the amount of compartments

PART NO.	DESCRIPTION	CTN/MSTR
T60130	20 compartment parts box	1/6

Steel Nipple Caddy Tray



- Steel construction
- Baked epoxy finish
- Push away handles
- Nipple storage range (close-6")

PART NO.	SIZE	DIMENSIONS	CAPACITY	CTN/MSTR
N70050	1/2"	10-1/2" x 7" x 6-1/2"	77 pieces	1/8
N70075	3/4"	12-1/2" x 7" x 6-1/2"	66 pieces	1/8
N70016	1"	14-1/8" x 7-3/4" x 6-1/2"	50 pieces	1/6
N70020	1-1/4"	18" x 8" x 6-1/2"	40 pieces	1/8
N70024	1-1/2"	19-1/2" x 6-1/2" x 6-1/2"	30 pieces	1/8
N70032	2"	23-7/8" x 8-1/2" x 6-1/2"	27 pieces	1/4

1/2" & 3/4" Combo Nipple Caddy



- Holds 39 1/2" x close-6"
- Holds 33 3/4" x close-6"
- Steel construction with baked epoxy finish
- Fold over handle

PART NO.	DESCRIPTION	DIMENSIONS	CTN/MSTR
N70575	Combo Caddy	12 1/8" x 7" x 6 1/2"	1/8

Fitting Tote Tray



- Excellent for copper and PVC fittings
- Steel construction with baked epoxy finish
- Inside compartments measure 4-7/8" x 4-7/8" x 3-7/8"
- 8 compartments
- Fold over handle

PART NO.	DESCRIPTION	DIMENSIONS	CTN/MSTR
N70500	Fitting Caddy	20" x 10-1/2" x 5"	1/4

Plastic Nipple Caddy



- High impact plastic
- Strong and lightweight
- Will not rust or corrode
- Nipple storage range (close-6")

PART NO.	SIZE	DIMENSIONS	CAPACITY	CTN QTY
N70150	1/2"	11" x 7-1/2" x 6-1/2"	77 pieces	4
N70175	3/4"	13-1/4" x 7-7/8" x 6-1/2"	66 pieces	4
N70200	1"	14-3/4" x 8-1/8" x 6-1/2"	50 pieces	4
N70250	1-1/2"	21" x 7" x 6-1/2"	30 pieces	2
N70300	2"	23-1/4" x 8-1/2" x 6-1/2"	27 pieces	2

Utility Tote Tray



- Lightweight, durable, high impact plastic

PART NO.	DESCRIPTION	DIMENSIONS	CTN QTY
T60100	Tote tray	10" x 15" x 5"	12

Tool Totes



T60121



T60122



T60123



T60124

- High density polyethylene construction resistant to acids, chemicals, oils and glues
- Removable dividers
- Reinforced metal handle
- Made in the USA

MADE IN THE USA

PART NO.	DESCRIPTION	CTN QTY
T60121	12" x 24" x 6" deep tray with 4 dividers	5
T60122	9" x 15" x 5" deep tray with 4 dividers	10
T60123	9" x 15" x 3" deep tray with 4 dividers	10
T60124	12-1/2" x 18" x 4-1/2" deep tray	5
T60125	Extra divider for T60121	4
T60126	Extra divider for T60122	4
T60127	Extra divider for T60123	4

Bucket Caddies



T60101



T60103



T60104



T60108

- 5 gallon high-impact red plastic bucket holds 4 combinations of trays- 3 large; 6 small; 1 large with 4 small; and 2 large with 2 small
- All trays have 4 sections; use tray subdividers to increase small tray capacity up to 8 sections
- Tool apron fits 5 and 3 1/2" gallon buckets; apron straps on or can be permanently secured (hardware included)
- Made in the USA

MADE IN THE USA

PART NO.	DESCRIPTION	CTN QTY
T60101	5 gallon bucket with 6 small trays	8
T60102	5 gallon bucket with 1 large tray & 4 small trays	8
T60103	Large trays (4-1/2" deep)	3
T60104	Small trays (2-1/2" deep)	6
T60105	Lid for 5 gallon bucket	1
T60106	5 gallon bucket only	1
T60107	Subdividers for small trays (4 pack)	1
T60108	20-pocket tool apron	1
T60110	5 gallon bucket with 2 large and 2 small trays	1
T60111	5 gallon bucket with 3 large trays	1

Items marked with the Jones Stephens logo are "You Need It...We Got It" Items.

Anti-Vibration Synthetic Leather Gloves



- Neoprene knuckle protection
- Flexible 4-way stretch
- Sure Grip™ reinforced thumb saddle
- Gel-padded Sure Grip™ patch palm
- Machine-washable Parity™
- CARTON QUANTITIES ONLY

PART NO.	DESCRIPTION	CTN QTY
G50211	Pair synthetic leather gloves	12 pairs

Nitrile Gloves



- 3/4 coating offers more protection
- Micro foam nitril offers great grip
- Coating draws oil and water aside to allow for enhanced grip
- Good abrasion resistance
- Silicone free and antibacterial
- CARTON QUANTITIES ONLY

PART NO.	DESCRIPTION	CTN QTY
G50215	Pair nitrile gloves	12 pairs

Polyester Nitrile Dipped Palm Gloves



- 100% polyester
- Large/X-large
- Pair
- Knit wrist to keep out dirt

PART NO.	DESCRIPTION	CTN/MSTR
G50225	Polyester nitrile dipped palm gloves	12/144

Blue Nitrile Gloves



- Powdered
- Priced per box
- 100 per box (50 pair)

PART NO.	DESCRIPTION	CTN/MSTR
G50230	Blue nitrile gloves - size large/XL	1/10
G50231	Blue nitrile gloves - size medium/large	1/10

All Purpose Latex Palm/Mesh Back Gloves



- Durable
- Excellent in wet conditions
- Protects hands during rugged jobs
- CARTON QUANTITIES ONLY

PART NO.	DESCRIPTION	CTN/MSTR
G50202	Latex palm/mesh back gloves	12/240

Disposable Blue Latex Gloves



- 14 mil
- Priced per box
- 50 per box
- Powder free
- Examination grade
- Large

PART NO.	DESCRIPTION	CTN/MSTR
G50212	Disposable blue latex gloves	1/10

Industrial Rubber Gloves



- Extra heavy
- Large
- Pair
- Rolled cuffs
- CARTON QUANTITIES ONLY

PART NO.	DESCRIPTION	CTN/MSTR
G50223	14" smooth hands, 30 mil	12/72
G50220	18" rough hands, 25 mil	10/60

Brown Jersey Gloves



- 100% brown cotton
- One size fits all
- Knit wrist
- 8 ounce
- Priced per pair
- CARTON QUANTITIES ONLY

PART NO.	DESCRIPTION	CTN/MSTR
G50200	 Brown cotton jersey glove (carded)	12/300
G50210	Brown cotton jersey glove (display)	216 pair

Economy Brown Jersey Gloves



- Made of cotton
- Large
- Close fitting knit wrist
- Comfortable
- Straight thumb
- Full size
- Priced per pair
- CARTON QUANTITIES ONLY

PART NO.	DESCRIPTION	CTN/MSTR
G50300	Economy brown cotton jersey glove (carded)	12/144

White Canvas Work Gloves



- Canvas
- Knit wrists
- Large/X-large
- CARTON QUANTITIES ONLY

PART NO.	DESCRIPTION	CTN/MSTR
G50228	White canvas work gloves	12/144

White Cotton Gloves with Grippers



- Durable 100% cotton canvas
- No-slip grip on palm
- One size fits all
- Knit wrist
- Priced per pair
- CARTON QUANTITIES ONLY

PART NO.	DESCRIPTION	CTN/MSTR
G50205	White cotton gloves with rubber dots (bulk)	12/240
G50206	White cotton gloves with rubber palms (bulk)	12/240
G50229	White cotton gloves with PVC dots (carded)	12/144

 Items marked with the Jones Stephens logo are "You Need It... We Got It" Items.

Leather Palm Work Gloves



- Split leather palm, thumb, fingers and knuckles
- 100% Cotton back and liner
- Safety cuff
- Priced per pair
- CARTON QUANTITIES ONLY

PART NO.	DESCRIPTION	CTN/MSTR
G50204	Leather palm low safety cuff (carded)	12/120
G50214	Leather palm low safety cuff (display)	96 pair

Drivers' Style Leather Gloves



- Durable and long lasting - conforms to your hand with time
- Grain leather glove
- Elastic cuff
- Priced per pair
- CARTON QUANTITIES ONLY

PART NO.	DESCRIPTION	CTN/MSTR
G50208	Drivers' style leather (carded)	12/120
G50218	Drivers' style leather (display)	48 pair

Vinyl Gloves



- 5 mil.
- One size fits all
- Lightly powdered
- 100 reversible gloves (50 pair)

PART NO.	DESCRIPTION	CTN/MSTR
G50250	100 vinyl gloves	1/10

Disposable Vinyl Gloves



- One size fits all
- Rolled cuff
- Lightly powdered for easy on and off
- Ready to hang or place on shelf

PART NO.	DESCRIPTION	CTN/MSTR
G50251	20 pack disposable gloves	1/20



- One size fits all
- Non-powdered
- Non-sterile
- Heavy duty
- Multi-purpose
- Carded

PART NO.	DESCRIPTION	CTN/MSTR
G50302	8 pack disposable gloves	12/72

Nemesis® Safety Glasses



Display



- Soft-touch temples
- Light weight construction
- Single-lens wrap-around protection
- 99.9% UV resistant
- Meets ANSI Z87.1 + standards
- G30030 is CARTON QUANTITIES ONLY

PART NO.	DESCRIPTION	CTN QTY
G30011	Nemesis® clear glasses	12
G30012	Nemesis® smoke mirror glasses	12
G30013	Nemesis® blue mirror glasses	12
G30014	Nemesis® camo/bronze glasses	12
G30000	Display includes: 12 pair smoke mirror, 6 pair blue mirror, 6 pair clear, free display	1
G30030	Dispenser box: 12 pair camo/bronze	1

Hellraiser Safety Glasses



Clear



Smoke



Blue Mirror

PART NO.	DESCRIPTION	CTN QTY
G30015	Hellraiser clear safety glasses	12
G30016	Hellraiser smoke safety glasses	12
G30017	Hellraiser blue mirror safety glasses	12

Visio Safety Glasses



- One-piece frame
- Adjustable temples
- Sleek, lightweight and comfortable
- Meets ANSI z87.1

PART NO.	DESCRIPTION	CTN QTY
G30003	Visio clear safety glasses	12
G30004	Visio blue mirror safety glasses	12
G30005	Visio silver indoor/outdoor glasses	12

Clear Safety Goggles



- Direct ventilation
- Economical protection

PART NO.	DESCRIPTION	CTN QTY
G30001	Clear safety glasses	200

Dust Mask



- 50 per box
- Disposable
- Non-toxic

PART NO.	DESCRIPTION	CTN/MSTR
G30021	Dust mask	1/20

Safety Hat



- Fits sizes 6 1/2- 8
- Meets ANSI z89.1 requirement
- Short peak design creates greater upward visibility
- Comfortable 4-point suspension with terrycloth sweatbands
- Low nape strap and rain trough features
- Universal slots to accommodate hearing, welding and face shield accessories

PART NO.	DESCRIPTION	CTN QTY
H40001	Yellow with 4-point pin lock suspension	12
H40002	White with 4-point pin lock suspension	12
H40003	Yellow with 4-point ratchet suspension	12
H40004	White with 4-point ratchet suspension	12

Knee Pads



K01120

K01200

- Lightweight and water-resistant
- Comfortable while kneeling, standing or walking
- Won't pinch or bind behind knee
- Soft, breathable inner lining for coolness and comfort
- Velcro closures on straps

PART NO.	DESCRIPTION	CTN QTY
K01120	Heavy duty foam economy	1 pair
K01200	Heavy duty knee cap	1 pair

Ready Fit Corded Ear Plugs

G



- Display box included

PART NO.	DESCRIPTION	CTN QTY
E85000	Ready fit corded ear plugs	100 pair

Hornet and Wasp Spray



- Long range spray- shoots a stream up to 20 feet, reaching nests far above ground, letting you keep a comfortable distance from the nest
- Contains no CFCs which deplete the ozone layer
- GROUND TRANSPORTATION ONLY
- ORM-D
- CARTON QUANTITIES ONLY

PART NO.	DESCRIPTION	CTN QTY
J40393	20 oz. can hornet & wasp spray	12

Protective Shoe Covers



- Fits easily over work shoes and boots
- Elastic top allows fit up to size 12
- Keeps dirt and grime outside
- Carton holds 200 pieces (100 pair)
- SOLD BY FULL CARTON OR 10 PAIR PACK

PART NO.	DESCRIPTION	CTN/MSTR
B05010	Protective shoe covers	1/10
B05011	Protective shoe covers (10 pair)	1/15

Shubee Shoe Covers



- Dark blue
- Fits easily over work shoes and boots
- Elastic top allows fit up to size 12
- Keeps dirt and grime outside
- Carton holds 150 pair

PART NO.	DESCRIPTION	CTN QTY
B05015	Shubee shoe covers	1

Disposable Coverall



- Tear and puncture resistant
- Use when comfort and coolness is a priority

PART NO.	DESCRIPTION	CTN/MSTR
B05020	Large disposable coverall	25
B05021	X-large disposable coverall	5/20

50 Pound UV Black Cable Tie



- Black UV rated for outdoor use
- UL Listed



PART NO.	DESCRIPTION	CTN QTY
J40116	7" long cable ties	100 per bag
J40117	11" long cable ties	100 per bag

Nylon Cable Ties



Natural Color



Black

- Standard size
- Nylon
- CARTON QUANTITIES ONLY

PART NO.	DESCRIPTION	CTN/MSTR
J40107	7" long (1/16" - 1-3/4") natural	100/6600
J40111	11" regular (1/16" - 3") natural	100/18700
J40115	15" (5/16") black	100/2300

Heat and UV Stabilized Nylon Cable Ties



- Heat & UV stabilized nylon-66
- Priced per bag of 100

PART NO.	DESCRIPTION	CTN/MSTR
J40433	4" 18lb. natural cable ties	12/72
J40434	6" 18lb. natural cable ties	12/72
J40435	8" 40lb. natural cable ties	12/72
J40436	11" 50lb. natural cable ties	12/72
J40437	14" 50lb. natural cable ties	12/72
J40438	17" 50lb. natural cable ties	12/72
J40443	4" 18lb. black cable ties	12/72
J40444	6" 18lb. black cable ties	12/72
J40445	8" 40lb. black cable ties	12/72
J40446	11" 50lb. black cable ties	12/72
J40447	14" 50lb. black cable ties	12/72
J40448	17" 50lb. black cable ties	12/72

Duct Straps



- HVAC application
- Natural nylon
- Up to 10" diameter
- CARTON QUANTITIES ONLY

PART NO.	DESCRIPTION	CTN QTY
J40134	34" Duct straps	50

Heavy Duty Utility Strap



- Plated S-hooks
- Meets or exceeds ASTM standards
- Weather and wear resistant
- Made in the USA
- CARTON QUANTITIES ONLY

MADE IN THE USA

PART NO.	DESCRIPTION	CTN QTY
S20015	15" Heavy duty utility strap	25
S20021	21" Heavy duty utility strap	25
S20031	31" Heavy duty utility strap	25
S20041	41" Heavy duty utility strap	25

Ratchet Tie Down Strap



- 1" wide/400 lb. working load limit
- Comfort grip handles
- Weather and corrosion resistant
- PVC coated hooks that will not scratch
- Cut and abrasion resistant webbing

PART NO.	DESCRIPTION	CTN/MSTR
S20300	1" x 16' Ratchet tie down strap	1/4

Camouflage Strap with Hooks



- 1" wide/300 lb. working load limit
- 2 hooks included with each strap; pack of 4 ratchet straps

PART NO.	DESCRIPTION	CTN/MSTR
S20301	1" x 9' Camo strap with hooks	1/6

Ratchet Strap with Step Release J-Hooks



- 2" wide/ 3,333 lb. working load limit
- Step by step release action
- Gradually releases tension with double J-hook
- Flex grip handle

PART NO.	DESCRIPTION	CTN/MSTR
S20302	2" x 27' Ratchet strap with step release J-hooks	1/8

Cam Straps



- 1" wide / 750# test nylon straps
- All colored straps and threads are UV resistant
- Straps are secured by a heavy duty zinc plated metal cam buckle, which will not slip even in wet conditions
- Ideal for handling loads for all kinds of contractor needs

PART NO.	DESCRIPTION	CTN/MSTR
S20100	1" x 2' Black single pack	24/144
S20101	1" x 4' Red single pack	24/144
S20102	1" x 6' Yellow single pack	24/144
S20103	1" x 8' Green single pack	24/144
S20104	1" x 10' Blue single pack	24/144
S20105	1" x 12' Purple single pack	24/144
S20106	1" x 20' Black single pack	24/72
S20200	1" x 2' Black - twin pack	1
S20201	1" x 4' Red - twin pack	1
S20202	1" x 6' Yellow - twin pack	1
S20203	1" x 8' Green - twin pack	1
S20204	1" x 10' Blue - twin pack	1

3-N-1 Tubing Bender



- For 1/4", 5/16" or 3/8" tubing

PART NO.	DESCRIPTION	CTN/MSTR
T50001	3-N-1 tubing bender	10/20

Spring Tubing Bender



- Spring prevents collapse of the wall at bending point
- Allows fast free-form bending of soft copper and aluminum tube

PART NO.	DESCRIPTION	CTN/MSTR
J41030	3/8" spring tubing bender	1/200
J41031	1/2" spring tubing bender	1/100
J41032	5/8" spring tubing bender	1/100

WD-40® Lubricant



- Cleans
- Protects against rust and corrosion
- Lubricates
- Penetrates stuck metal parts
- Displaces moisture
- ORM-D
- GROUND TRANSPORTATION ONLY
- CARTON QUANTITIES ONLY

PART NO.	DESCRIPTION	CTN QTY
S95700	8 oz. can lubricant	12
S95800	8 oz. can lubricant low VOC for California	12

Items marked with the Jones Stephens logo are "You Need It... We Got It" Items.

Commercial Premium Rubber Hose



PART NO.	DESCRIPTION	CTN/MSTR
G04005	5/8" x 25' commercial premium rubber hose	1/1
G04006	5/8" x 50' commercial premium rubber hose	1/1

Contractor Grade Rubber Hose



- Contractor grade
- Reinforced rubber
- Heavy duty brass coupling

PART NO.	DESCRIPTION	CTN/MSTR
G04025	3/4" x 25' contractor grade rubber hose	1/4
G04026	3/4" x 50' contractor grade rubber hose	1/2

Garden Hose



- G04001:
- 500 PSI burst strength
 - Kink-free construction
 - Heavy-duty solid brass nickel plated coupling
 - Built-in spring at faucet end to prevent hose damage
 - Nylon reinforced
- G04002 and G04000:
- 300 PSI burst strength
 - Solid brass couplings
 - Reinforced green nylon construction

PART NO.	DESCRIPTION	CTN QTY
G04001	5/8" x 60' (500 PSI) garden hose	6
G04002	5/8" x 50' (300 PSI) garden hose	6
G04000	5/8" x 75' (300 PSI) garden hose	6

Insulated Hose Nozzle



- Heavy duty with threaded end
- Soft comfort grip
- Carded

PART NO.	DESCRIPTION	CTN/MSTR
G04030	Insulated hose nozzle	12/72

4" Brass Hose Nozzle



- Twist to adjust spray
- Carded

PART NO.	DESCRIPTION	CTN/MSTR
G04031	4" brass hose nozzle	12/72

Caution Tape



- Black print on safety yellow
- 3 mil thickness
- Non-stick

PART NO.	DESCRIPTION	CTN/MSTR
J43300	3" x 300' caution tape	1/16
J43310	3" x 1000' caution tape	1/8

Gas Line Marking Labels



- Yellow self adhesive stickers
- Clearly identifies gas lines from other utility and water lines
- 100 labels per roll

PART NO.	DESCRIPTION	CTN/MSTR
J40481	2 PSI gas line stickers	1/100
J40482	Gas line stickers	1/100

E-Z Light



- Extendable for lighting flames from a distance
- Safe and convenient for torch, fireplace, or any hard-to-reach area

PART NO.	DESCRIPTION	CTN QTY
J40450	E-Z light	1

E-Z Reach



- Extendable, magnetized arm for easy retrieval of small metal parts
- Great for shop or job site

PART NO.	DESCRIPTION	CTN/MSTR
J40451	E-Z reach	24/240

24" Grab-It Tool



- Makes hard-to-reach areas accessible using retractable fingers

PART NO.	DESCRIPTION	CTN/MSTR
J40020	24" Grab-it tool	1/50

Steel Wool



- Packaged 16 pads per bag, 12 bags per carton
- Priced per bag

PART NO.	DESCRIPTION	CTN QTY
B29300	Size 00 steel wool	12
B29310	Size 0 steel wool	12

Items marked with the Jones Stephens logo are "You Need It... We Got It" Items.

Copper Cleaning Pad



- Reusable
- Use wet or dry - will not clog
- Nylon impregnated fine maroon
- Good general cleaner for removing rust, corrosion, etc.
- Deoxidizes and cleans copper tube and fittings for soldering
- CARTON QUANTITIES ONLY

PART NO.	DESCRIPTION	CTN/MSTR
B29400	4" x 6-1/4" x 1/4" cleaning pad	10/710

Lead Joint Runner



PART NO.	DESCRIPTION	CTN QTY
L42011	#1 - 2" - 4" pipe size	10
L42012	#2 - 4" - 6" pipe size	10
L42013	#3 - 6" - 10" pipe size	5
L42014	#4 - 10" - 14" pipe size	1
L42015	#5 - 16" - 20" pipe size	1
L42016	#6 - 20" - 24" pipe size	1
L42017	#7 - 24" - 30" pipe size	1
L42018	#8 - 30" - 36" pipe size	1
L42019	#9 - 36" - 42" pipe size	1
L42023	#10 - up to 48" pipe size	1

7-1/2" Torpedo Level



- Manufactured to rigid requirements
- Professional quality
- Aluminum construction
- Magnetic sides



PART NO.	DESCRIPTION	CTN/MSTR
J40100	7-1/2" torpedo level	1/10

9" Torpedo Level with Magnetic Strip



- Top read window simplifies readings in confined areas
- High impact ABS plastic frame
- Full length magnetic edge on one side
- Carded

PART NO.	DESCRIPTION	CTN/MSTR
J40102	9" torpedo level with magnetic strip	6/36

Plastic Magnetic Level



- Has front vial viewer
- Saves time and money
- Eliminates neck and back strain
- Internal aluminum frame for accuracy and strength
- Magnetic
- Integrated Euroslot hanging hole

PART NO.	DESCRIPTION	CTN/MSTR
J42101	10" Plastic magnetic level	1/6

Top Grade Gradient Level



- The ultimate plumbing level
- Set accurate slopes of 1 and 2 percent
- Includes conversion of pitch and slope
- Accuracy: 0.5mm/ M-0.029" on all vials
- Length: 60cm/24"
- U.S. patent 6,209,211

PART NO.	DESCRIPTION	CTN/MSTR
J42200	24" length gradient level	1/6

Industrial Swivel-Lite Flashlight



F20016



F20017

- Contractor grade construction
- Sure grip rubber handles

PART NO.	DESCRIPTION	CTN QTY
F20016	Flashlight for AA batteries	6
F20017	Flashlight for D batteries	6

Rayovac Floating Lantern and Battery



F20003



F20004



F20005

- 6-volt F20004 battery included
- Heavy duty battery priced each

PART NO.	DESCRIPTION	CTN QTY
F20003	Floating lantern with battery	6
F20004	6 volt spring top - battery only	12
F20005	6 volt screw top - battery only	4

Rayovac Industrial Flashlight



- Yellow flashlights with ring hangers

PART NO.	DESCRIPTION	CTN QTY
F20001	2 cell D size flashlight	6
F20002	3 cell D size flashlight	6

4 D/6 Volt Swivel-Lite



- Contractor grade construction
- Krypton bulb, spare bulb holder
- Floats in water (with beam up)
- Long range beam
- 45° swivel for hands-free use
- Comfort-grip handle, push-button switch
- No batteries included
- Can use 6V lantern battery for additional power

PART NO.	DESCRIPTION	CTN/MSTR
F20018	4D/ 6-Volt Swivel-Lite	1/6

Sportsman LED Head-Lite



- New technology unique 3-way hands-free L.E.D. system
- Close range use super white L.E.D., "Night vision" 2 super red L.E.D., Long range beam-krypton bulb
- Batteries last 20 times longer with L.E.D. bulbs than normal bulbs
- Rubber spot-flood reflector, head rotates 180° compact design, comfort-grip band
- Weatherproof, heavy duty construction

PART NO.	DESCRIPTION	CTN/MSTR
F20019	Sportsman LED head-lite	1/4

8 LED Flashlight



- With magnifying lenses
- Push button switch
- Impact resistant
- Comfort grip
- Handy strap
- Uses 3 AAA batteries (included)

PART NO.	DESCRIPTION	CTN/MSTR
F20052	8 LED flashlight	6/48

24 LED Twist Light



- (2) 12 LED super bright lights
- Versatile flexible body
- Removable heads to use as single flashlights
- Use for emergencies, repairs and more!
- Uses 6 AAA batteries - 3 per side (not included)

PART NO.	DESCRIPTION	CTN/MSTR
F20050	24 LED twist light	1/6

1 Watt LED Flashlight



- With adjustable beam
- Narrow to wide focus
- Aluminum body
- Wrist strap
- 3 light options: high, low and safety flash
- Uses 3 AAA batteries (not included)

PART NO.	DESCRIPTION	CTN/MSTR
F20054	1 watt LED flashlight with adjustable beam	6/48

3 Watt LED Flashlight



- Aluminum body
- Large easy grip
- 3 light options: high, low and safety flash
- Uses 3 AAA batteries (not included)

PART NO.	DESCRIPTION	CTN/MSTR
F20053	3 watt LED flashlight	6/48

5 Watt LED Flashlight



- Aluminum body
- Includes charger
- 3 light options: high, low and safety flash
- Rechargeable lithium ion battery (included)

PART NO.	DESCRIPTION	CTN/MSTR
F20055	5 watt LED flashlight with charger	6/48

27 LED Utility Light



- With magnetic back and folding swivel hook
- 24 LED light
- 3 LED flashlight
- Push button switch
- Uses 3 AAA batteries (included)
- Display contains 12 lights
- CARTON QUANTITIES ONLY

PART NO.	DESCRIPTION	CTN/MSTR
F20051	27 LED utility light display	12/48

Portable Halogen Work Light



- 6 ft. grounded
- 500 watt
- Power cord
- Adjustable frame

PART NO.	DESCRIPTION	CTN/MSTR
E25250	500 watt halogen light	1/6
H500X2	(2) replacement bulbs - RSC base T3 (J-type)	12/144

Clamp-On Light



- Reflector lamp for general shop and industrial applications
- 8" shade, 6 ft. cord
- On/Off switch
- Use 75 watt max type "A" bulb (not included)
- Boxed

PART NO.	DESCRIPTION	CTN/MSTR
E25251	Clamp-on light with 8" shade	1/4

Orange Trouble Light



- Industrial quality
- 25 ft. 16/3 SJT cord
- 3-prong side outlets
- Metal cage

PART NO.	DESCRIPTION	CTN/MSTR
E25021	Orange trouble light with metal cage	1/12

Orange Extension Cord



- Safety orange color
- Heavy duty
- Outdoor/grounded
- ETL Listed

PART NO.	DESCRIPTION	CTN QTY
E25000	16/3 SJT 15 ft. extension cord	6/24
E25001	16/3 SJT 25 ft. extension cord	6/24
E25002	16/3 SJT 50 ft. extension cord	6/12
E25004	16/3 SJT 100 ft. extension cord	1/6
E25005	12/3 SJT 25 ft. extension cord	1/8
E25006	12/3 SJT 50 ft. extension cord	1/6
E25007	12/3 SJT 100 ft. extension cord	1/4
E25040	14/3 SJT 25 ft. extension cord	1/12
E25041	14/3 SJT 50 ft. extension cord	1/8
E25042	14/3 SJT 100 ft. extension cord	1/4

Round Extension Cord Power Block



- 14/3 SJT
- 15 AMP
- 125 V
- ETL Listed



PART NO.	DESCRIPTION	CTN QTY
E25010	3 ft. round extension cord block	12/48

Grey Appliance Cord



- Heavy duty
- 15 AMP
- 3 wire
- ETL Listed



PART NO.	DESCRIPTION	CTN QTY
E25200	14/3 SPT-3 3 ft. extension cord	10/50
E25201	14/3 SPT-3 6 ft. extension cord	10/50
E25202	14/3 SPT-3 9 ft. extension cord	5/25
E25203	14/3 SPT-3 12 ft. extension cord	5/25
E25204	14/3 SPT-3 15 ft. extension cord	5/25

Outlet Adapter



- Converts 3 prong cord to 2 prong
- ETL Listed



PART NO.	DESCRIPTION	CTN QTY
E25320	3 to 2 prong outlet adapter	1/500

6 Outlet Power Strip with Surge Protector



- Indoor use only
- Reset button
- Hi-impact, Hi-strength plastic
- Lighted On/Off switch
- ETL Listed



PART NO.	DESCRIPTION	CTN QTY
E25300	6 outlet, 90 joules	1/12
E25301	6 outlet, 735 joules	3/18

7 Outlet Power Strip with Surge Protector



- Indoor use only
- Outlets spaced apart for large AC adapters
- 3' long
- 14/3 AWG
- Grounded cord
- Lighted On/Off switch
- ETL Listed



PART NO.	DESCRIPTION	CTN QTY
E25302	7 outlet, 300 joules	1/12

GFCI Safety Outlet



- LED trip indicator
- Side and back wired
- Tamper resistant
- Wall planes included
- Boxed
- ETL Listed



PART NO.	DESCRIPTION	CTN QTY
E26001	15 AMP ivory safety outlet	6/24
E26002	15 AMP white safety outlet	6/24
E26003	20 AMP ivory safety outlet	6/24
E26004	20 AMP white safety outlet	6/24

Rayovac® Industrial Batteries



- Priced per battery
- PACK QUANTITIES ONLY

PART NO.	DESCRIPTION	CTN/MSTR
F20006	Heavy duty C batteries	6/72
F20007	Heavy duty D batteries	6/72
F20012	AAA alkaline batteries	8/96
F20008	AA alkaline batteries	8/96
F20009	9 volt alkaline batteries	6/72
F20010	C alkaline batteries	6/72
F20011	D alkaline batteries	6/72

Duracell® Alkaline Batteries



- Priced per pack
- Carded
- PACK QUANTITIES ONLY

PART NO.	DESCRIPTION	CTN/MSTR
F20020	AAA alkaline batteries - 2 pack	1/50
F20021	AAA alkaline batteries - 4 pack	1/50
F20022	AA alkaline batteries - 2 pack	1/50
F20023	AA alkaline batteries - 4 pack	1/50
F20024	C alkaline batteries - 2 pack	1/30
F20025	D alkaline batteries - 2 pack	1/48
F20026	9 volt alkaline battery	1/50

Cutting Oil



- Medium brown color

PART NO.	DESCRIPTION	CTN QTY
J45005	Premium all-purpose oil (gallon)	6

Heavy Duty Big Wipes



- 80 count tub
- Wipe size is 8" x 12"
- Lint free
- Removes paint, glue, oil, sealants, grease and grime
- Dermatologically tested, plus vitamin E and aloe vera added
- Dual sided, scrubs and cleans

PART NO.	DESCRIPTION	CTN QTY
B05050	Heavy duty big wipes, 80 count tub	1/8

Wypall® Waterless Hand Wipes



- 10 x 12 pre-moistened towels; 50 count
- Lower price per tub
- Conveniently sized tub
- All of the towels can be used before they dry out
- CARTON QUANTITIES ONLY

PART NO.	DESCRIPTION	CTN QTY
B05007	50-count dispenser tub	8
B05008	Wypall display (32 tubs)	1

Wypall® Waterless Hand Wipes



- Full-sized pre-moistened hand towels- smooth for wiping on one side, tough for scrubbing on the other
- Natural d'limonene cleaning agent tough on grease, grime, ink & paint
- CASE QUANTITIES ONLY

PART NO.	DESCRIPTION	CTN QTY
B05002	12" x 12" x 75 sheets	6

Wypall® Teri® Towels



- Strong and durable, wet or dry
- 125 reusable sheets per box-equivalent to 18 lbs. of rags
- Reinforced HYDROKNIT® provides extra scrubbing power
- CASE QUANTITIES ONLY



PART NO.	DESCRIPTION	CTN QTY
B05003	9 3/4" x 16 3/4" x 125 sheets	10

Cotton Plumbers Handy Towels



- 100% cotton heavy duty shop towels are washable, reusable & nonabrasive
- Ideal for cleaning hands, wiping spills, removing grime from tools & parts
- 12 towels per bag

PART NO.	DESCRIPTION	CTN QTY
B05004	Plumbers handy towels	12

Cotton Terry Cloth Towels



- 100% cotton
- 14" x 17"
- Waxes, dries and polishes
- Super soft

PART NO.	DESCRIPTION	CTN/MSTR
B05025	Terry cloth towels, 3 pack	1/10
B05026	Terry cloth towels, 8 pack	1/12

Box of Rags



- Colored cotton sweatshirt material
- 100% recycled
- Pull out dispensing
- Multi-colored

PART NO.	DESCRIPTION	CTN QTY
B05001	4 lb. box of rags	1

Poly Sheeting



- Clear
- 4 mil super tough plastic
- Hundreds of uses
- Made in the USA



PART NO.	DESCRIPTION	CTN QTY
S08100	8' x 100' poly sheeting	1
S10100	10' x 100' poly sheeting	1

Commercial Sponge



- Commercial grade cellulose sponges- made to last!
- Deeply textured top makes cleanup easier
- Made in the USA



DIMENSIONS	
S50001	6-3/4" x 4-3/8" x 3/4"
S50002	8" x 4-1/2" x 3/4"

PART NO.	DESCRIPTION	CTN QTY
S50001	Medium cellulose sponge	24
S50002	Large cellulose sponge	24

Plastic Drop Cloth



- Medium duty 1 mil plastic
- Convenient pleat fold pack design
- Protects furniture, appliances and carpets

PART NO.	DESCRIPTION	CTN/MSTR
D50000	9' x 12' plastic drop cloth	1/48

Cotton Canvas Drop Cloth



- 8 oz.
- Absorbs and traps spills
- Washable and reusable

PART NO.	DESCRIPTION	CTN/MSTR
G02010	6' x 9' cotton canvas drop cloth	1/6
G02011	9' x 12' cotton canvas drop cloth	1/4

Trash Bags



- 2'8" x 4'2"
- 20 bags per box
- 42 gallon
- 3 mil

PART NO.	DESCRIPTION	CTN/MSTR
G02042	42 gallon trash bags	1/6

Spray Bottle



- Economical to use for leak testing when filled with soapy water
- Clear bottle with various color tints based on availability

PART NO.	DESCRIPTION	CTN/MSTR
B25001	16 oz. clear spray bottle	1/60

Angle Broom

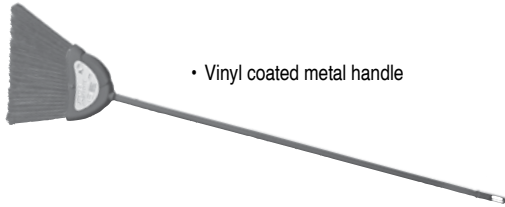

- Vinyl coated metal handle

PART NO.	DESCRIPTION	CTN/MSTR
B29850	Large plastic angle broom	1/12
B29851	Small plastic angle broom	1/24

13" Jumbo Plastic Dust Pan



- Clip on
- All plastic
- Assorted colors
- Rubber edge

PART NO.	DESCRIPTION	CTN/MSTR
B29852	13" jumbo plastic dust pan	1/12

Urinal Screen and Refills



- 4 oz. scented deodorant block
- Cherry scent
- S95251 is priced each and sold in CARTON QUANTITIES ONLY

PART NO.	DESCRIPTION	CTN/MSTR
S95250	Urinal screen	12/72
S95251	4 oz. cherry scent refills for urinal screen, 12 piece	12/72

100 lb. Capacity Broadcast Spreader



- Fast 3 step assembly
- Up to 17,500 sq. ft. coverage
- Stainless steel gears, axle, agitator and linkage
- Heavy duty coated steel frame
- Rust/corrosion proof hopper
- X-Large 12.5" pneumatic tires
- Flow regulator on handle
- Comes with preinstalled deflectors to customize spread pattern

PART NO.	DESCRIPTION	CTN/MSTR
S44000	100 lb. capacity broadcast spreader	1/1

WordLock® 4 Dial Utility Padlock



- High security
- Heavy duty
- Brass color
- Resettable
- 1-1/2" shackle
- Clamshell pack

PART NO.	DESCRIPTION	CTN/MSTR
L26006	4 dial utility padlock	3/12

WordLock® 4 Dial Discus Lock



- Patented design
- Resettable
- Stainless steel body with rubber bumper
- Weatherproof
- ASTM rated to the highest standards
- Clamshell pack

PART NO.	DESCRIPTION	CTN/MSTR
L26007	4 dial discus lock	6/48

WordLock® Stor-More Key Safe™



- More space than traditional key safes - can hold larger items
- Can hold keys, key fobs, credit cards and much more
- Mounts on door or wall
- 10,000 possible combinations
- Resettable
- Reinforced stainless steel body to withstand sawing and hammering
- Clamshell pack

PART NO.	DESCRIPTION	CTN/MSTR
L26008	Key safe	3/12

WordLock® Loop and Lock™ with MatchKey



- 8 ft.
- Ultimate utility cable lock
- Heavy duty flexible steel cable
- Integrated lock head means no padlocks to lose
- Ideal for securing ladders and other tools
- Key color matches cable color
- Word on key matches word on lock
- Unique key shape
- Carded

PART NO.	DESCRIPTION	CTN/MSTR
L26005	8 ft. black Loop and Lock with matchkey	4/16

Shielded Protected Shackleless Lock with Keys



- Includes 3 keys
- Hasp sold separately (L26012)
- No shackle
- 2-7/8"
- Large chrome plated solid steel body
- Removable cylinder
- Compare with American 2000® series
- Boxed

PART NO.	DESCRIPTION	CTN/MSTR
L26011	Shielded protected shackleless lock with keys	6/24
L26012	Hasp only	1/16

4 Dial Combination Padlock



- Heavy duty, solid brass
- Resettable
- Hardened shackle
- Shackle height is 1"
- Clamshell pack

PART NO.	DESCRIPTION	CTN/MSTR
L26015	4 dial combination padlock	6/48

Square Body Steel Padlock with Keys



- Includes 3 keys
- Shackle height is 1.1"
- Solid steel body
- Hardened chrome plated steel cylinder, guard plate and security nut
- Double steel ball bearing locks shackle on both heel and toe
- Clamshell pack

PART NO.	DESCRIPTION	CTN/MSTR
L26016	1-3/4" square body steel padlock	6/24

Round Body Steel Padlock with Keys



- Includes 3 keys
- Shackle height is 1.25"
- Solid steel body
- Hardened chrome plated steel cylinder, guard plate and security nut
- Double steel ball bearing locks shackle on both heel and toe
- Clamshell pack

PART NO.	DESCRIPTION	CTN/MSTR
L26017	2-5/8" round body steel padlock	6/24

4' Steel Hardened Security Chain



- 4' x 3/8"
- Hardened to resist cutting
- Canvas cover
- Square link
- Sleeve pack

PART NO.	DESCRIPTION	CTN/MSTR
L26018	4" steel hardened security chain	1/6

Flexible Cable Lock



- Weatherproof
- 7 x 7 strands
- 2 loop
- Vinyl coated

PART NO.	DESCRIPTION	CTN/MSTR
L26009	6' x 5/16" clear flexible cable lock	12/48
L26010	14' x 3/8" black flexible cable lock	6/24

Laminated Padlock with Keys



- Includes 2 keys
- Laminated
- Hardened steel shackle
- Shackle height is 1"
- Precision engineered double locking
- Brass pin cylinder - 5 PIN
- Protective bumper
- Clamshell pack

PART NO.	DESCRIPTION	CTN/MSTR
L26001	1-1/2" standard shackle padlock with keys	6/72
L26003	1-3/4" standard shackle padlock with keys	12/72



- Includes 2 keys
- Laminated
- Hardened steel shackle
- Shackle height is 2-1/4"
- Precision engineered double locking
- Brass pin cylinder - 5 PIN
- Protective bumper
- Clamshell pack

PART NO.	DESCRIPTION	CTN/MSTR
L26002	1-1/2" long shackle padlock with keys	6/72
L26004	1-3/4" long shackle padlock with keys	6/72

Ceramic Heater



- Ceramic heating element
- Fan forced
- Three settings: 750/1500 watts, fan only
- Adjustable thermostat
- Safety tip-over switch
- Box: 6.6" x 5.6" x 10"

PART NO.	DESCRIPTION	CTN/MSTR
H90100	Ceramic heater	1/6

Shop Heater



- Fan forced wire element
- Three settings: 750/1500 watts, fan only
- Adjustable thermostat
- Wide stable base and adjustable tilt
- All metal body
- Long 6 ft. cord
- Padded carry handle
- Box: 10" x 7" x 11.5"

PART NO.	DESCRIPTION	CTN/MSTR
H90101	Shop heater	1/4

Garbage Disposal Cord



- 16/3 gauge wire

E25015
E25016

E25017
E25018

PART NO.	DESCRIPTION	CTN QTY
E25015	3' straight disposal cord	50
E25016	6' straight disposal cord	50
E25017	3' angle disposal cord	50
E25018	6' angle disposal cord	50

Garbage Disposal Wiring Kit



- Complete with 3 wire nuts and connector coupling
- 16/3 gauge wire
- Polybagged

PART NO.	DESCRIPTION	CTN QTY
E25115	Kit for 3' cord with straight plug	6
E25116	Kit for 6' cord with straight plug	6
E25117	Kit for 3' cord with angle plug	6
E25118	Kit for 6' cord with angle plug	6

Screw-On Wire Connector



- Clamshell packaging
- Ready to hang!

PART NO.	DESCRIPTION	CTN QTY
E25125	Gray	100
E25126	Blue	100
E25127	Orange	100
E25128	Yellow	45
E25129	Red	45

Leak Alert Water Detector



- Loud alarm sounds with direct water contact
- Floats and signals for up to 72 hours
- Fully automatic operation - no wiring required
- Low battery indicator for optimum safety and performance

PART NO.	DESCRIPTION	CTN/MSTR
L95400	Leak alert water detector	1/12

Carbon Monoxide Alarm



- Electrochemical CO sensor
- Loud 85 decibels
- Silence and test button
- Low battery indicator

PART NO.	DESCRIPTION	CTN/MSTR
L95500	Carbon monoxide alarm	1/6

G

GASKETS AND COUPLINGS

Gaskets 313
Couplings 314
Import Couplings..... 315



Multi-Tite Gasket



SERVICE WEIGHT



EXTRA HEAVY

- Multi rings on outside make this gasket the easiest to install
- Meets ASTM Standard C564

Service Weight

PART NO.	SIZE	CTN/MSTR
V95002	2"	1/150
V95003	3"	1/75
V95004	4"	1/60
V95005	5"	1/30
V95006	6"	1/30
V95008	8"	1/20
V95010	10"	1/10
V95012	12"	1/10
V95015	15"	1/5

Extra Heavy

PART NO.	SIZE	CTN/MSTR
V94004	4"	1/60

Dual Tite Gasket



SERVICE WEIGHT



EXTRA HEAVY

- Meets ASTM Standard C564

Service Weight

PART NO.	SIZE	CTN/MSTR
V96002	2"	1/150
V96003	3"	1/75
V96004	4"	1/60
V96005	5"	1/30
V96006	6"	1/30
V96008	8"	1/20
V96010	10"	1/10
V96012	12"	1/10
V96015	15"	1/5

Extra Heavy

PART NO.	SIZE	CTN/MSTR
V97002	2"	1/150
V97003	3"	1/75
V97004	4"	1/60
V97005	5"	1/30
V97006	6"	1/30
V97008	8"	1/20
V97010	10"	1/10
V97012	12"	1/10
V97015	15"	1/5

Dual Tite Buna N "Nitrile" Gasket



PART NO.	SIZE	CTN QTY
V98002	2"	1/150
V98003	3"	1/75
V98004	4"	1/60
V98005	5"	1/30
V98006	6"	1/30
V98008	8"	1/20
V98010	10"	1/10
V98012	12"	1/10
V98015	15"	1/5

Pipe Lubricant



- L95202 - ORM-D. Ships UPS Ground and Motor Freight ONLY
- CARTON QUANTITIES ONLY

PART NO.	DESCRIPTION	CTN QTY
L95200	Quart lubricant	12/12
L95201	Gallon lubricant	4/4
L95202	Quart adhesive lube	12/12

H&I

No Hub Coupling



- Manufactured in accordance with CISPI Standard 310
- Gasket sleeve conforms to ASTM C564
- Screw is ASI 305 stainless steel

MADE IN THE USA

PART NO.	SIZE	CTN/MSTR
U95001	1-1/2"	1/100
U95002	2"	1/100
U95003	3"	1/100
U95004	4"	1/100
U95005	5"	1/20
U95006	6"	1/20
U95008	8"	1/10
U95010	10"	1/10
U95012	12"	1/12
U95015	15"	1/6
U95211	2" x 1-1/2"	1/100
U95320	3" x 2"	1/100
U95430	4" x 3"	1/60

No Hub Torque Wrench



- Automatic release at 60 in.lb.
- Ratchets one way
- Built-in reversing lever
- Chrome vanadium socket

PART NO.	DESCRIPTION	CTN/MSTR
T60060	No hub torque wrench	20/80

H&I Mega Torque Wrench



- Heavy duty construction with chrome vanadium 5/16" or 3/8" sockets
- Socket kit includes screw and washer
- Slide down locking reversing feature

PART NO.	DESCRIPTION	CTN/MSTR
T60065	60 lb. - 5/16"	15/60
T60080	80 lb. - 3/8"	15/60
T60081	80 lb. - 5/16"	15/60
T60066	5/16" socket kit	15/60

Medium Duty No Hub Coupling



- Manufactured in accordance with CISPI Standard 310
- 9/16" stainless steel bands
- Stainless steel housing and shield
- 5/16" stainless steel screws
- 80 inch/lb. installation torque
- UPC listed

MADE IN THE USA

PART NO.	SIZE	CTN/MSTR
U97001	1-1/2"	1/60
U97002	2"	1/75
U97003	3"	1/48
U97004	4"	1/48
U97005	5"	1/15
U97006	6"	1/15
U97008	8"	1/15
U97010	10"	1/12

Heavy Duty No Hub Coupling



- Manufactured in accordance with CISPI Standard 310
- 9/16" stainless steel bands
- Stainless steel housing and shield
- 3/8" stainless steel screws
- 80 inch/lb. installation torque
- UPC listed

MADE IN THE USA

PART NO.	SIZE	CTN/MSTR
HDNHC1	1-1/2"	1/60
HDNHC2	2"	1/75
HDNHC3	3"	1/48
HDNHC4	4"	1/48
HDNHC5	5"	1/15
HDNHC6	6"	1/15
HDNHC8	8"	1/15
HDNHC10	10"	1/12

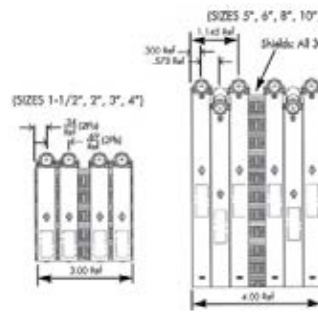

DESCRIPTION: Couplings consist of gasket and shield assemblies. The shield assemblies have four or six clamps depending on size. The clamps are fastened with eyelets to the bi-directional corrugated shield.

MATERIALS: Steels used in couplings are stainless steels. Shields, bands and housings are AISI 304. Screws and eyelets are ASI 305. Gaskets are neoprene rubber.

SPECIFICATIONS: Couplings conform to CISPI 310. Factory Mutual EN 1618. Couplings comply with ASTM C564, ASTM 1277, IAPMO file #3198, Commonwealth of Massachusetts CMR-248 and City of New York MEA 253-98-E. Gaskets are made from an elastomeric compound that meets the requirements of ASTM C564.

COUPLING SIZE	INSTALLATION TORQUE	CLAMPS FOR COUPLING
1-1/2"	80	4
2"	80	4
3"	80	4
4"	80	4
5"	80	6
6"	80	6
8"	80	6
10"	80	6



Larger Hex Head Screw: The new 3/8" hex head screw is designed to apply the full load of 80in/lbs. of insulation torque to the band/shield assembly.

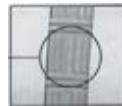

Patented Bi-directional Shield Design: Our unique shield design employs bi-directional corrugations for maximum transfer of pressure from the clamps the gasket. This patented shield design adjusts to differences in the circumference and outside diameters for the pipes being joined. This eliminates gasket wrinkling and thereby eliminates leak paths. These parallel and transverse patterns on the gasket and pipe work to avoid pullout failures and provides a positive, reliable seal.



Specially Beaded Gaskets: The heavy-duty coupling utilizes a specially beaded gasket that mates with the shield and clamping forces for superior sealing pressure and holding power. IDEAL gaskets comply with ASTM C564.



Floating Eyelet Design: "Floating eyelets" fasten the clamps to the shield, allowing the clamp band and shield to move independently. This freedom prevents the shield from crimping during tightening, which can lead to leakage later on.



Mechanical Interlocking Clamp Design: IDEAL clamps feature a one-piece screw housing that mechanically interlocks the housing to the band. This one-piece housing design eliminates leak paths that can occur in staked or welded clamps.



Green Shield: The distinctive green shield quickly identifies the newly re-engineered IDEAL Heavy-Duty Couplings.

Import No Hub Coupling



- Manufactured in accordance with CISPI Standard 310
- All stainless construction
- UPC listed



PART NO.	SIZE	CTN/MSTR
U99001	1-1/2"	1/100
U99002	2"	1/100
U99003	3"	1/100
U99004	4"	1/100
U99005	5"	1/40
U99006	6"	1/30
U99008	8"	1/15
U99010	10"	1/12
U99211	2" x 1-1/2"	1/100
U99320	3" x 2"	1/100

Import Heavy Duty No Hub Coupling



- Manufactured in accordance with CISPI Standard 310
- 9/16" stainless steel bands
- Stainless steel housing and shield
- 3/8" stainless steel screws
- 80 inch/lb. installation torque
- UPC listed



PART NO.	DESCRIPTION	CTN/MSTR
U99220	2"	1/75
U99330	3"	1/48
U99440	4"	1/48
U99550	5"	1/15
U99660	6"	1/15
U99880	8"	1/15
U99110	10"	1/10



SECTION T - TUBULAR

Chrome Plated	319-324
Rough Brass.....	325
PVC Plastic	326-328
ABS Plastic	329-331
Bath Wastes.....	332
Lav Drains & Pop Ups.....	333-334
Connectors	335
Basket Strainers.....	336-337
Escutcheons	338

Chrome Plated Brass P-Trap



- Shallow escutcheon
- Less cleanout
- UPC listed



PART NO.	SIZE	GAUGE	CTN/MSTR
P38001	1-1/4"	22	1/30
P38002	1-1/4"	20	1/30
P38003	1-1/4"	17	1/30
P38004	1-1/2"	22	1/30
P38005	1-1/2"	20	1/30
P38006	1-1/2"	17	1/30

Chrome Plated Brass P-Trap



- Brass nuts
- Shallow escutcheon
- Less cleanout
- UPC listed



PART NO.	SIZE	GAUGE	CTN/MSTR
P38091	1-1/4"	22	1/30
P38007	1-1/4"	20	1/30
P38138	1-1/4" x 1-1/2"	17	1/30
P38092	1-1/4"	17	1/30
P38093	1-1/2"	22	1/30
P38008	1-1/2"	20	1/30
P38094	1-1/2"	17	1/30

Chrome Plated Brass P-Trap



- Brass nuts
- Box escutcheon
- Less cleanout
- UPC listed



PART NO.	SIZE	GAUGE	CTN/MSTR
P38003B	1-1/4"	17	1/30
P38005B	1-1/2"	20	1/30
P38006B	1-1/2"	17	1/30

Chrome Plated Brass P-Trap



- Heavy zinc nuts
- Bell escutcheon
- With cleanout
- UPC listed



PART NO.	SIZE	GAUGE	CTN/MSTR
P38002B	1-1/4"	20	1/30

Chrome Plated Brass P-Trap



- Zinc nuts
- Shallow escutcheon
- With cleanout
- UPC listed



PART NO.	SIZE	GAUGE	CTN/MSTR
P38009	1-1/4"	20	1/30
P38009B (box esc.)	1-1/4"	20	1/30
P38011	1-1/2"	20	1/30

Chrome Plated Brass P-Trap



- Brass nuts
- Shallow escutcheon
- With cleanout
- UPC listed



PART NO.	SIZE	GAUGE	CTN/MSTR
P38010	1-1/4"	17	1/30
P38012	1-1/2"	17	1/30

Chrome Plated Brass P-Trap



- Brass nuts
- Box escutcheon
- With cleanout
- UPC listed



PART NO.	SIZE	GAUGE	CTN/MSTR
P38010B	1-1/4"	17	1/30
P38012B	1-1/2"	17	1/30

Chrome Plated Brass P-Trap



- Brass nuts
- Semi-cast commercial
- Shallow escutcheon
- With cleanout
- UPC listed



PART NO.	SIZE	GAUGE	CTN/MSTR
J37124	1-1/4"	17	1/30
J37150	1-1/2"	17	1/30

Chrome Plated Brass P-Trap



- Brass nuts
- Bell escutcheon
- Less cleanout
- UPC listed



PART NO.	SIZE	GAUGE	CTN/MSTR
P38150	1-1/4"	17	1/30

Chrome Plated Boston Style P-Trap



- Brass nuts
- Box escutcheon
- With cleanout
- UPC listed



PART NO.	SIZE	GAUGE	CTN/MSTR
P38142	1-1/4" x 1-1/2"	17	1/30

Chrome Plated Milwaukee Style Trap



- Brass nuts
- 10" Arm
- Cast elbow
- With cleanout
- UPC listed



PART NO.	SIZE	GAUGE	CTN/MSTR
P38129	1-1/2"	17	1/30

Chrome Plated Sink Trap with Sweat Connection



- Brass nuts
- Box escutcheon
- With cleanout
- UPC listed



PART NO.	SIZE	GAUGE	CTN/MSTR
P38140	1-1/2"	17	1/30

Chrome Plated Sink Trap with PVC Adapter



- Brass nuts
- PVC adapter
- Box escutcheon
- With cleanout
- UPC listed



PART NO.	SIZE	GAUGE	CTN/MSTR
P38130	1-1/2"	17	1/20

Chrome Plated Sink Trap with ABS Adapter



- Brass nuts
- Box escutcheon
- With cleanout
- UPC listed



PART NO.	SIZE	GAUGE	CTN/MSTR
P38141	1-1/2"	17	1/20

Chrome Plated Brass S-Trap



- Zinc nuts
- Shallow escutcheon
- Less cleanout
- UPC listed



PART NO.	SIZE	GAUGE	CTN/MSTR
P38013	1-1/4"	22	1/15
P38014	1-1/2"	22	1/15

Chrome Plated Brass S-Trap



- Brass nuts
- Box escutcheon
- Less cleanout
- UPC listed



PART NO.	SIZE	GAUGE	CTN/MSTR
P38095	1-1/4"	20	1/15
P38096	1-1/2"	20	1/15
P38137	1-1/4"	17	1/15
P38097	1-1/2"	17	1/50

Chrome Plated Brass J-Bend



- Heavy zinc nuts
- Slip Joint
- Less cleanout
- UPC listed



PART NO.	SIZE	GAUGE	CTN/MSTR
P38015	1-1/4"	22	1/36
P38016	1-1/4"	20	1/36
P38017	1-1/4"	17	1/36
P38018	1-1/2"	22	1/36
P38019	1-1/2"	20	1/36
P38020	1-1/2"	17	1/36



- Captured brass nuts
- Washer joint
- Less cleanout
- UPC listed



PART NO.	SIZE	GAUGE	CTN/MSTR
P38107	1-1/4"	22	1/60
P38108	1-1/4"	20	1/60
P38109	1-1/4"	17	1/60
P38110	1-1/2"	22	1/60
P38111	1-1/2"	20	1/60
P38112	1-1/2"	17	1/60

T

Chrome Plated Brass J-Bend with Cleanout



- Brass nuts
- Slip joint
- With cleanout
- UPC listed



PART NO.	SIZE	GAUGE	CTN/MSTR
P38021	1-1/4"	17	1/36
P38022	1-1/2"	17	1/36



- Heavy zinc nuts
- Slip joint
- With cleanout
- UPC listed



PART NO.	SIZE	GAUGE	CTN/MSTR
P38113	1-1/4"	20	1/60
P38114	1-1/2"	20	1/60

Chrome Plated Brass L.A. Pattern Sink Trap



- P38099 and P38100 with cast brass elbows
- Brass nuts
- Less cleanout
- UPC listed



PART NO.	SIZE	GAUGE	CTN/MSTR
P38098	1-1/2"	22	1/50
P38099	1-1/2"	20	1/50
P38100	1-1/2"	17	1/50

Chrome Plated Brass Repair Trap



- Brass nuts
- Less cleanout
- UPC listed



PART NO.	SIZE	GAUGE	CTN/MSTR
P38105	1-1/4"	17	1/60
P38106	1-1/2"	17	1/60



- Heavy zinc nuts
- Less cleanout
- UPC listed



PART NO.	SIZE	GAUGE	CTN/MSTR
P38101	1-1/4"	22	1/60
P38102	1-1/4"	20	1/60
P38103	1-1/2"	22	1/60
P38104	1-1/2"	20	1/60

Chrome Plated Brass Slip Joint End Outlet Tee



- Zinc nuts
- 4" Tailpiece
- No baffle
- UPC listed



PART NO.	SIZE	GAUGE	CTN/MSTR
P38023	1-1/2"	22	1/50
P38024	1-1/2"	20	1/50

Chrome Plated Brass Direct Connection End Outlet Waste



- Zinc nuts
- 4" Tailpiece
- No baffle
- UPC listed



PART NO.	SIZE	GAUGE	CTN/MSTR
P38025	1-1/2" x 16"	22	1/20
P38026	1-1/2" x 16"	20	1/20

Chrome Plated Brass Slip Joint End Outlet Waste



- Zinc nuts
- 4" Tailpiece
- No baffle
- UPC listed



PART NO.	SIZE	GAUGE	CTN/MSTR
P38027	1-1/2" x 16"	22	1/20
P38028	1-1/2" x 16"	20	1/20

Chrome Plated Brass Slip Joint Center Outlet Tee



- Zinc nuts
- 4" Tailpiece
- No baffle
- UPC listed



PART NO.	SIZE	GAUGE	CTN/MSTR
P38029	1-1/2"	20	12/120

Chrome Plated Brass Slip Joint Center Outlet Waste



- Zinc nuts
- 4" Tailpiece
- No baffle
- UPC listed



PART NO.	SIZE	GAUGE	CTN/MSTR
P38030	1-1/2" x 16"	22	1/20
P38031	1-1/2" x 16"	20	1/20

Chrome Plated Brass Direct Connection Center Outlet Waste



- Zinc nuts
- 4" Tailpiece
- No baffle
- UPC listed



PART NO.	SIZE	GAUGE	CTN/MSTR
P38032	1-1/2" x 16"	22	1/20
P38033	1-1/2" x 16"	20	10/100

Chrome Plated Brass Slip Joint Waste Arm



- Zinc nuts
- Bagged
- UPC listed



PART NO.	SIZE	GAUGE	CTN/MSTR
P38034	1-1/4" x 6"	22	10/100
P38035	1-1/4" x 8"	22	10/50
P38036	1-1/4" x 12"	22	10/50
P38037	1-1/4" x 16"	22	10/50
P38038	1-1/2" x 8"	22	10/100
P38039	1-1/2" x 12"	22	10/50
P38040	1-1/2" x 16"	22	10/50
P38238	1-1/2" x 7"	17	10/50

Chrome Plated Brass Wall Bend



- Bagged
- UPC listed



PART NO.	SIZE	GAUGE	CTN/MSTR
P38041	1-1/4" x 7"	22	10/100
P38042	1-1/4" x 7"	20	10/100
P38115	1-1/4" x 7-1/2"	17	10/100
P38043	1-1/2" x 7-1/2"	22	10/100
P38044	1-1/2" x 7-1/2"	20	10/100
P38116	1-1/2" x 7-1/2"	17	10/100

Chrome Plated Brass Direct Connection Waste Arm



- Bagged
- UPC listed



PART NO.	SIZE	GAUGE	CTN/MSTR
P38045	1-1/2" x 7"	22	10/100
P38117	1-1/2" x 15"	22	10/100
P38217	1-1/2" x 15"	17	1/25

Chrome Plated Brass Slip Joint Double Offset



- Zinc nuts
- Bagged
- UPC listed



PART NO.	SIZE	GAUGE	CTN/MSTR
P38046	1-1/4" x 12"	22	10/100
P38047	1-1/2" x 12"	22	10/50

Chrome Plated Brass Sink Tailpiece



- Bagged
- UPC listed



PART NO.	SIZE	GAUGE	CTN/MSTR
P38048	1-1/4" x 6"	22	10/100
P38049	1-1/4" x 8"	22	10/100
P38050	1-1/4" x 12"	22	10/100
P38051	1-1/4" x 6"	17	10/100
P38052	1-1/4" x 8"	17	10/100
P38053	1-1/4" x 12"	17	10/50
P38054	1-1/2" x 4"	22	10/100
P38055	1-1/2" x 6"	22	10/100
P38056	1-1/2" x 8"	22	10/100
P38057	1-1/2" x 12"	22	10/50
P38058	1-1/2" x 6"	17	10/100
P38059	1-1/2" x 8"	17	10/100
P38060	1-1/2" x 12"	17	10/50

Chrome Plated Brass Double Flange Tailpiece



- Bagged
- UPC listed



PART NO.	SIZE	GAUGE	CTN/MSTR
P38061	1-1/2" x 16"	22	10/50

T

Chrome Plated Brass Double Slip Joint Extension Tube



- Zinc nuts
- Bagged
- UPC listed



PART NO.	SIZE	GAUGE	CTN/MSTR
P38062	1-1/2" x 16"	22	10/50
P38162	1-1/4" x 16"	22	10/50

Chrome Plated Brass Slip Joint Extension Tube



- Zinc nut
- Bagged
- UPC listed



PART NO.	SIZE	GAUGE	CTN/MSTR
P38065	1-1/4" x 6"	22	10/100
P38066	1-1/4" x 8"	22	10/100
P38067	1-1/4" x 12"	22	10/50
P38121	1-1/4" x 6"	20	10/100
P38122	1-1/4" x 8"	20	10/100
P38068	1-1/4" x 12"	20	10/50
P38118	1-1/4" x 6"	17	10/100
P38119	1-1/4" x 8"	17	10/100
P38120	1-1/4" x 12"	17	10/50
P38069	1-1/2" x 6"	22	10/100
P38070	1-1/2" x 8"	22	10/100
P38071	1-1/2" x 12"	22	25/50
P38123	1-1/2" x 6"	20	10/100
P38124	1-1/2" x 8"	20	10/100
P38125	1-1/2" x 12"	20	10/50
P38126	1-1/2" x 6"	17	10/100
P38127	1-1/2" x 8"	17	10/100
P38128	1-1/2" x 12"	17	10/50

Chrome Plated Brass Solder Extension Tube



- UPC listed



PART NO.	SIZE	GAUGE	CTN/MSTR
P38072	1-1/4" x 6"	22	10/100
P38073	1-1/4" x 8"	22	10/100
P38074	1-1/4" x 12"	22	10/100
P38131	1-1/4" x 6"	20	10/100
P38132	1-1/4" x 8"	20	10/100
P38133	1-1/4" x 12"	20	10/100
P38075	1-1/2" x 6"	22	10/100
P38076	1-1/2" x 8"	22	10/100
P38077	1-1/2" x 12"	22	10/100
P38134	1-1/2" x 6"	20	10/100
P38135	1-1/2" x 8"	20	10/100
P38136	1-1/2" x 12"	20	10/100

Chrome Plated Brass Threaded Extension Tube



- Bagged
- Threaded both ends
- UPC listed



PART NO.	SIZE	GAUGE	CTN/MSTR
P38078	1-1/4" x 6"	20	10/100
P38079	1-1/4" x 8"	20	10/100
P38080	1-1/4" x 12"	20	10/50
P38081	1-1/2" x 6"	20	10/100
P38082	1-1/2" x 8"	20	10/100
P38083	1-1/2" x 12"	20	10/50
P38084	1-1/4" x 6"	17	10/100
P38085	1-1/4" x 8"	17	10/100
P38086	1-1/4" x 12"	17	10/50
P38087	1-1/2" x 6"	17	10/100
P38088	1-1/2" x 8"	17	10/50
P38089	1-1/2" x 12"	17	10/50

Chrome Plated Brass Direct Connect Dishwasher Tailpiece



- Zinc nut
- Bagged
- UPC listed



PART NO.	SIZE	GAUGE	CTN/MSTR
P38063	1-1/2" x 6" with 3/4" branch	22	10/100
P38064	1-1/2" x 8" with 3/4" branch	22	10/50
P38163	1-1/2" x 6" with 1/2" branch	22	5/30
P38148	1-1/2" x 8" with 1/2" branch	22	10/100

Chrome Plated Threaded Connection Dishwasher Tailpiece



- UPC listed



PART NO.	SIZE	GAUGE	CTN/MSTR
P38166	1-1/2" x 6" with 1/2" branch	22	1/50

Chrome Plated Slip Joint Dishwasher Tailpiece



- Zinc nut
- Bagged
- UPC listed



PART NO.	SIZE	GAUGE	CTN/MSTR
P38164	1-1/2" x 8" with 3/4" branch	22	10/50
P38143	1-1/2" x 8" with 1/2" branch	22	10/50

Chrome Plated Closet Flush Elbow



- Includes rubber slip joint washers
- Zinc nuts
- Bagged
- UPC listed



PART NO.	SIZE	GAUGE	CTN/MSTR
P38257	2" x 5" x 7"	20	1/25

Chrome Plated Disposer Kit



- Zinc nuts
- UPC listed



PART NO.	SIZE	GAUGE	CTN/MSTR
P38165	1-1/2" x 13"	17	1/20

Chrome Plated Slip Joint Tee



- Zinc nuts
- Chrome plated satin finish cast brass

PART NO.	DESCRIPTION	CTN/MSTR
C74105	1-1/2" x 1-1/2" x 1-1/2"	10/60

Chrome Plated Double Slip Fittings



- Zinc nuts
- Chrome plated brass
- 22 gauge

PART NO.	DESCRIPTION	SIZE	CTN/MSTR
T74001	Coupling	1-1/4"	10/100
T74002	Coupling	1-1/2"	10/100
T74003	90° Ellbow	1-1/4"	10/100
T74004	90° Ellbow	1-1/2"	10/100
T74005	45° Ellbow	1-1/4"	10/100
T74006	45° Ellbow	1-1/2"	10/100

Items marked with the Jones Stephens logo are "You Need It... We Got It" Items.

Rough Brass P-Trap



- Brass nuts
- Deep flange
- Less cleanout
- UPC listed



PART NO.	SIZE	GAUGE	CTN/MSTR
P38406	1-1/2"	17	1/30

Rough Brass Direct Connection Waste Arm



- UPC listed



PART NO.	SIZE	GAUGE	CTN/MSTR
P38444	1-1/2" x 7"	17	1/100
P38447	1-1/2" x 15"	17	1/50

Rough Brass Flanged Tailpiece



- UPC listed



PART NO.	SIZE	GAUGE	CTN/MSTR
P38454	1-1/2" x 4"	17	10/50
P38458	1-1/2" x 6"	17	10/100
P38459	1-1/2" x 8"	17	10/100
P38460	1-1/2" x 12"	17	10/50

Rough Brass Slip Joint Tailpiece with 1/2" Sweat Branch



- Brass nut
- UPC listed



PART NO.	SIZE	GAUGE	CTN/MSTR
P38443	1-1/2" x 8"	17	1/50

Rough Brass Slip Joint Extension Tube



- Brass nut
- UPC listed



PART NO.	SIZE	GAUGE	CTN/MSTR
P38420	1-1/4" x 12"	17	10/50
P38428	1-1/2" x 12"	17	10/50

Rough Brass Double Threaded Extension Tube



- UPC listed



PART NO.	SIZE	GAUGE	CTN/MSTR
P38486	1-1/4" x 12"	17	10/100
P38489	1-1/2" x 12"	17	10/100

Rough Brass Bath Waste and Overflow Kit



- Full kit
- Chrome plated brass drain
- Die cast face plate

PART NO.	GAUGE	DESCRIPTION	# HOLES	CTN/MSTR
B07310	20	1-3/8" with chain and stopper	2	1/12
B07311	20	1-1/2" with chain and stopper	2	1/10



- Full kit
- Chrome plated brass drain
- Die cast face plate

PART NO.	GAUGE	DESCRIPTION	# HOLES	CTN/MSTR
B07312	20	1-1/2" with trip lever	2	1/12

T

PVC P-Trap



- UPC listed



PART NO.	SIZE	CTN/MSTR
P37001	1-1/4"	25/100
P37002	1-1/2"	10/50

PVC P-Trap with Solvent Weld Marvel



- Master trap
- UPC listed



PART NO.	SIZE	CTN/MSTR
P37003	1-1/2" slip joint	25/50
P37032	1-1/2" solvent weld	10/100

PVC Slip Joint Center Outlet Waste



- Baffle tee
- UPC listed



PART NO.	SIZE	CTN/MSTR
P37004	1-1/2"	10/40

PVC Direct Connection Center Outlet Waste



- Baffle tee
- UPC listed



PART NO.	SIZE	CTN/MSTR
P37005	1-1/2"	10/40

PVC Center Outlet Tee



- Baffle
- Tailpiece included
- May be used as slipjoint or direct connect
- UPC listed



PART NO.	SIZE	CTN/MSTR
P37006	1-1/2"	25/100

PVC Slip Joint End Outlet Waste



- Baffle
- UPC listed



PART NO.	SIZE	CTN/MSTR
P37007	1-1/2" x 16"	10/40
P37034	1-1/2" x 16" Adjustable arm	10/40

PVC Slip Joint End Outlet Waste



- 1/2" branch
- Adjustable arm
- With dishwasher tailpiece
- UPC listed



PART NO.	SIZE	CTN/MSTR
P37042	1-1/2"	10/40

PVC Direct Connection End Outlet Waste



- Baffle
- UPC listed



PART NO.	SIZE	CTN/MSTR
P37008	1-1/2"	10/50
P37036	1-1/2" telescoping	10/50

PVC Slip Joint End Outlet Tee Only with Baffle



- Baffle
- UPC listed



PART NO.	SIZE	CTN/MSTR
P37009	1-1/2"	25/100

T

PVC Slip Joint S-Trap



• UPC listed



PART NO.	SIZE	CTN/MSTR
P37010	1-1/4"	15/60
P37011	1-1/2"	15/60

PVC Slip Joint Dishwasher Tailpiece



• UPC listed



PART NO.	SIZE	CTN/MSTR
P37012	1-1/2" x 8" x 1/2"	1/25
P37030	1-1/2" x 8" x 3/4"	5/25

PVC Direct Connection Dishwasher Tailpiece



• May be used as slip joint or direct connect
• UPC listed



PART NO.	SIZE	CTN/MSTR
P37013	1-1/2" x 8" x 1/2"	5/25
P37031	1-1/2" x 8" x 3/4"	5/25

Universal End Outlet Waste with Dishwasher Connection



• 1-1/2" tubular; 16" maximum adjustment
• Baffle tee
• May be used as slip joint or direct connect
• UPC listed



PART NO.	SIZE	CTN/MSTR
P37040	1/2" branch	10/60
P37041	3/4" branch	10/60

PVC Slip Joint Repair Trap



• UPC listed



PART NO.	SIZE	CTN/MSTR
P37014	1-1/2"	1/80

PVC Slip Joint J-Bend



• UPC listed



PART NO.	SIZE	CTN/MSTR
P37015	1-1/2"	10/60

PVC Slip Joint Waste Arm



• UPC listed



PART NO.	SIZE	CTN/MSTR
P37016	1-1/2" x 16"	25/100

PVC Direct Connection Waste Arm



• UPC listed



PART NO.	SIZE	CTN/MSTR
P37017	1-1/2" x 16"	10/100

PVC Slip Joint Extension Tube



• UPC listed



PART NO.	SIZE	CTN/MSTR
P37018	1-1/2" x 16"	25/50
P37118	1-1/4" x 16"	10/100

PVC Double Flange Extension



• UPC listed



PART NO.	SIZE	CTN/MSTR
P37019	1-1/2" x 16"	25/100
P37037	1-1/4" x 16"	10/100

PVC Slip Joint Extension Tube



• UPC listed



PART NO.	SIZE	CTN/MSTR
P37020	1-1/4" x 6"	25/100
P37021	1-1/2" x 8"	25/100
P37022	1-1/2" x 12"	25/100

PVC Solvent Extension Tube



• UPC listed



PART NO.	SIZE	CTN/MSTR
P37023	1-1/4" x 8"	25/100
P37024	1-1/2" x 6"	25/100
P37025	1-1/2" x 12"	25/100

PVC Flanged Tailpiece



• UPC listed



PART NO.	SIZE	CTN/MSTR
P37026	1-1/2" x 6"	25/200
P37027	1-1/2" x 8"	25/200
P37028	1-1/2" x 12"	25/200
P37029	1-1/2" x 16" double flanged	25/100
P37038	1-1/4" x 12"	25/200

PVC Direct Connection Disposer Kit with 13" Arm



- Poly washers and wing nuts
- Disposer washer
- Baffle tee
- 6" Tailpiece
- UPC listed



PART NO.	SIZE	CTN/MSTR
P37033	1-1/2" x 16"	10/50

PVC Slip Joint Double Offset Tailpiece



- Slip joint on both ends
- UPC Listed



PART NO.	SIZE	CTN/MSTR
P37150	1/2"	1/40

1-1/2" PVC Direct Connection Disposer Kit with Adjustable Arm



- Telescoping arm adjusts up to 16"
- Poly washers and wing nuts
- Disposer washer
- Baffle tee
- 6" tailpiece

PART NO.	SIZE	CTN/MSTR
P37035	1-1/2" x 16"	10/40

PVC Slip Joint Tee



PART NO.	SIZE	CTN QTY
P37400	1-1/2" with 1-1/4" washer	120

PVC Double Slip Fittings



PART NO.	DESCRIPTION	SIZE	CTN/MSTR
P37200	Coupling	1-1/2"	10/100
P37445	45° Elbow	1-1/2"	1/100
P37490	90° Elbow	1-1/2"	1/100

T

Chrome Plated PVC P-Trap



- Complete with nuts, washers, and box escutcheon
- P36103 includes reducing washer

PART NO.	SIZE	CTN/MSTR
P36102	1-1/4"	1/50
P36103	1-1/2"	1/50

Polished Brass PVC P-Trap



- Slip joint
- Box escutcheon

PART NO.	SIZE	CTN/MSTR
P36101	1-1/2"	1/50

ABS P-Trap



- UPC listed

PART NO.	SIZE	CTN/MSTR
P39001	1-1/4"	10/100
P39002	1-1/2"	10/50

ABS P-Trap with Adapter



- Master trap
- UPC listed

PART NO.	SIZE	CTN/MSTR
P39003	1-1/2" slip joint	1/50
P39032	1-1/2" solvent weld	10/50

ABS Slip-Joint Center Outlet Waste



- UPC listed

PART NO.	SIZE	CTN/MSTR
P39004	1-1/2"	10/40

ABS Direct Connection Center Outlet Waste



- Tailpiece included
- May be used as slip joint or direct connect
- UPC listed

PART NO.	SIZE	CTN/MSTR
P39005	1-1/2"	10/40

ABS Slip-Joint Center Outlet Tee



- UPC listed

PART NO.	SIZE	CTN/MSTR
P39006	1-1/2"	10/100

ABS Slip-Joint End Outlet Waste



- UPC listed

PART NO.	SIZE	CTN/MSTR
P39007	1-1/2" x 16"	20/40
P39034	1-1/2" x 16" adjustable	10/40

ABS Direct Connection End Outlet Waste



- UPC listed

PART NO.	SIZE	CTN/MSTR
P39008	1-1/2"	20/40

ABS Slip Joint End Outlet Tee



- UPC listed

PART NO.	SIZE	CTN/MSTR
P39009	1-1/2"	25/100

ABS S-Trap



• UPC listed



PART NO.	SIZE	CTN/MSTR
P39010	1-1/4"	15/60
P39011	1-1/2"	15/60

ABS Slip Joint Dishwasher Tailpiece



• UPC listed



PART NO.	SIZE	CTN/MSTR
P39012	1-1/2" x 8" x 1/2"	5/25
P39030	1-1/2" x 8" x 3/4"	5/25

ABS Direct Connection Dishwasher Tailpiece



• UPC listed



PART NO.	SIZE	CTN/MSTR
P39013	1-1/2" x 8" x 1/2"	5/25
P39031	1-1/2" x 8" x 3/4"	5/25

ABS Slip Joint Repair Trap



• UPC listed



PART NO.	SIZE	CTN/MSTR
P39014	1-1/2"	20/80

ABS Slip Joint J-Bend



• UPC listed



PART NO.	SIZE	CTN/MSTR
P39015	1-1/2"	20/80

ABS Slip Joint Waste Arm



• UPC listed



PART NO.	SIZE	CTN/MSTR
P39016	1-1/2" x 16"	25/100

ABS Direct Connection Waste Arm



• UPC listed



PART NO.	SIZE	CTN/MSTR
P39017	1-1/2" x 16"	25/100

ABS Slip Joint Extension Tube



• UPC listed



PART NO.	SIZE	CTN/MSTR
P39018	1-1/2" x 16"	10/50

ABS Double Flange Extension



• UPC listed



PART NO.	SIZE	CTN/MSTR
P39019	1-1/2" x 16"	25/100

ABS Slip Joint Extension Tube



• UPC listed



PART NO.	SIZE	CTN/MSTR
P39020	1-1/4" x 6"	10/100
P39021	1-1/2" x 8"	10/100
P39022	1-1/2" x 12"	25/100

1-1/2" ABS Direct Connection Disposer Kit



- Poly washer and wing nuts
- Disposer washer
- 6" Tailpiece
- UPC listed



PART NO.	SIZE	CTN/MSTR
P39033	1-1/2" x 16"	10/50

T

1-1/2" ABS Direct Connection Disposer Kit with Adjustable Arm



- Baffle tee
- 6" Tailpiece
- Disposer washer
- Poly washers and wing nuts
- Telescoping arm adjusts up to 16"
- UPC listed

PART NO.	SIZE	CTN/MSTR
P39035	1-1/2" x 16"	1/40

ABS Universal End Outlet Waste with Dishwasher Connection



- 1-1/2" tubular; 16" maximum adjustment
- Slip joint or direct connection
- Baffle tee
- UPC listed

PART NO.	SIZE	CTN/MSTR
P39040	1/2" branch	10/40
P39041	3/4" branch	60

ABS Solvent Extension Tube



- UPC listed

PART NO.	SIZE	CTN/MSTR
P39023	1-1/4" x 8"	25/100
P39024	1-1/2" x 6"	25/100
P39025	1-1/2" x 12"	25/100

ABS Flanged Tailpiece



- UPC listed

PART NO.	SIZE	CTN/MSTR
P39026	1-1/2" x 6"	25/200
P39027	1-1/2" x 8"	25/200
P39028	1-1/2" x 12"	25/200
P39029	1-1/2" x 16"	25/100

Chrome Plated ABS P-Trap



- Slip joint connection
- Box escutcheon
- UPC listed

PART NO.	SIZE	CTN/MSTR
P36104	1-1/4"	10/50
P36105	1-1/2"	10/50

T

PVC and ABS Tubular Bath Waste Kits

- Heavy walled PVC and ABS tubular
- Available in CP and PVD protected SN
- 2-hole face plates with wrap-around gaskets and tapped holes
- 1-1/2" IPS threaded drain shoe
- Overflow elbow designed to accommodate B07202 test kit
- Wing nuts and poly washers
- Come packaged in individual box
- UPC listed



1-1/2" Lift and Turn Bath Waste Tubular Kit



PART NO.	FINISH	FACE PLATE	MATERIAL	CTN	QTY
P37500	CP	2-hole	PVC	20	
P39500	CP	2-hole	ABS	20	
P37502	SN (PVD)	2-hole	PVC	20	
P39502	SN (PVD)	2-hole	ABS	20	

1-1/2" Brass Friction Lift Bath Waste Tubular Kit



PART NO.	FINISH	FACE PLATE	MATERIAL	CTN	QTY
P37503	CP	2-hole	PVC	20	
P39503	CP	2-hole	ABS	20	
P37505	SN (PVD)	2-hole	PVC	20	
P39505	SN (PVD)	2-hole	ABS	20	

1-1/2" Brass Toe Touch Bath Waste Tubular Kit



PART NO.	FINISH	FACE PLATE	MATERIAL	CTN	QTY
P37506	CP	2-hole	PVC	20	
P39506	CP	2-hole	ABS	20	
P37508	SN (PVD)	2-hole	PVC	20	
P39508	SN (PVD)	2-hole	ABS	20	

1-1/2" Trip Lever Bath Waste Tubular Kit



PART NO.	FINISH	FACE PLATE	MATERIAL	CTN	QTY
P37509	CP	2-hole	PVC	20	
P39509	CP	2-hole	ABS	20	
P37511	SN (PVD)	2-hole	PVC	20	
P39511	SN (PVD)	2-hole	ABS	20	

PVC and ABS Tubular Cable Drive Bath Waste 1/2 Kits

- Available in CP and PVD protected SN
- 1-1/2" IPS threaded drain shoe
- UPC listed



1-1/2"- 27" Cable Drive



PART NO.	FINISH	MATERIAL	CTN	QTY
P37512	CP	PVC	20	
P39512	CP	ABS	20	
P37514	SN (PVD)	PVC	20	
P39514	SN (PVD)	ABS	20	

1-1/2"- 35" Cable Drive



PART NO.	FINISH	MATERIAL	CTN	QTY
P37515	CP	PVC	20	
P39515	CP	ABS	20	
P37517	SN (PVD)	PVC	20	
P39517	SN (PVD)	ABS	20	

1-1/2"- 45" Cable Drive



PART NO.	FINISH	MATERIAL	CTN	QTY
P37518	CP	PVC	20	
P39518	CP	ABS	20	
P37520	SN (PVD)	PVC	20	

T

Commercial Lav Grid Drain



- Polished chrome plated brass
- Mack washer and brass locknut
- 17 Gauge 1-1/4" tailpiece; 6" long

PART NO.	DESCRIPTION	CTN/MSTR
D70100	Commercial lav drain	1/50

Handicap Style Lav Grid Drain



- Polished chrome plated brass
- Twin 90° construction
- 17 Gauge 1-1/4" tailpiece; cast brass elbows
- Mack washer and brass locknut

PART NO.	DESCRIPTION	CTN/MSTR
D70101	Handicap style lav grid drain	1/25

Commercial Handicap Style Lav Grid Drain with Elbow



- Polished chrome plated brass; cast brass elbow
- 1-1/4" female thread
- Complete with gaskets and brass locknut

PART NO.	DESCRIPTION	CTN/MSTR
D70102	Handicap style lav grid drain with elbow	1/48

Chrome Plated Brass Pop-Up Assembly



- All metal construction
- Tool free locknut and ballrod nut
- With overflow holes
- Boxed

PART NO.	DESCRIPTION	CTN/MSTR
P35001	CP pop-up assembly	1/50

Polished Brass Pop-Up Assembly



- PVD durable finish
- Tool free locknut and ballrod nut
- All metal construction
- 1-1/4" Tubular
- Boxed

PART NO.	DESCRIPTION	CTN/MSTR
P35002	PB (PVD) pop-up assembly	1/50

ABS Lav Pop-Up Assembly



- Carded

PART NO.	DESCRIPTION	CTN/MSTR
P35004	Grey plastic	1/30

Chrome Plated ABS Lav Pop-Up Assembly



- Carded

PART NO.	DESCRIPTION	CTN/MSTR
P35005	Chrome plated plastic	1/30

Brass P.O. Plug Lav Drain



- With chain and stopper

PART NO.	DESCRIPTION	CTN/MSTR
D70103	P.O. plug drain	1/50

Chrome Plated Trap Primer Tailpiece



- 17 Gauge tubular chrome plated steel
- Sturdy one-piece construction eliminates leaks and cross-threading

PART NO.	SIZE	CTN/MSTR
T74010	1-1/4" x 8" threaded top	1/50
T74011	1-1/2" x 8" direct connection	1/50

Plastic Slip Joint Nut



- White
- CARTON QUANTITIES ONLY

PART NO.	SIZE	CTN/MSTR
T83150	1-1/2" with wings	100/1200
T85125	1-1/4" x 1-1/4"	100/1200
T85150	1-1/2" x 1-1/2"	100/1200

Plastic Slip Nut



- Replace fractured or stripped slip nuts without tubular disassembly
- Supplied with washer

PART NO.	SIZE	CTN/MSTR
T82125	1-1/4" Split nut	100/400
T82150	1-1/2" Split nut	100/400

Chrome Plated Die Cast Zinc Slip Joint Nut



- Chrome plated
- CARTON QUANTITIES ONLY

PART NO.	IPS x SLIP TUBE	CTN/MSTR
T77125	1-1/4" x 1-1/4"	25/500
T77138	1-1/2" x 1-3/8"	400/800
T77150	1-1/2" x 1-1/2"	25/300
T77151	1-1/2" x 1-1/4"	25/300
T77152	2" x 1-1/2"	25/300
T77200	2" x 2"	25/200

Chrome Plated Brass Slip Joint Nut



- Chrome plated
- CARTON QUANTITIES ONLY

PART NO.	IPS x SLIP TUBE	CTN/MSTR
T78125	1-1/4" x 1-1/4"	200/400
T78150	1-1/2" x 1-1/2"	200/400
T78151	1-1/2" x 1-1/4"	200/400
T78152	2" x 1-1/2"	125/250
T78200	2" x 2"	25/250

Rough Brass Slip Joint Nut



- Heavy cast brass
- CARTON QUANTITIES ONLY

PART NO.	IPS x SLIP TUBE	CTN/MSTR
T84125	1-1/4" x 1-1/4"	25/300
T84150	1-1/2" x 1-1/2"	25/300
T84151	1-1/2" x 1-1/4"	25/300
T84200	2" x 2"	25/300

Chrome Plated Die Cast Slip Joint Nut and Washer



- Chrome plated nut packed with square cut rubber washer
- CARTON QUANTITIES ONLY

PART NO.	SIZE	CTN QTY
T77014	1-1/4" x 1-1/4"	25
T77012	1-1/2" x 1-1/2"	25
T77013	1-1/2" x 1-1/4"	25
T77020	2" x 2"	25

Chrome Plated Brass Slip Joint Nut and Washer



- Chrome plated nut packed with square cut rubber washer
- CARTON QUANTITIES ONLY

PART NO.	SIZE	CTN/MSTR
T78014	1-1/4" x 1-1/4"	25/400
T78012	1-1/2" x 1-1/2"	200/400
T78013	1-1/2" x 1-1/4"	200/400
T78020	2" x 2"	25/400

Square Cut Rubber Slip Joint Washer



• CARTON QUANTITIES ONLY

PART NO.	NUT x TUBE	CTN/MSTR
T79125	1-1/4" x 1-1/4"	100/5600
T79150	1-1/2" x 1-1/2"	100/5600
T79151	1-1/2" x 1-1/4"	100/5600
T79200	2" x 2"	100/2400
T79201	2" x 1-1/2"	100/2400
T79152	1-1/2" x 1-1/4" cloth inserted	100/1000

Poly Beveled Slip Joint Washer



• CARTON QUANTITIES ONLY

PART NO.	NUT x TUBE	CTN/MSTR
T80125	1-1/4" x 1-1/4"	100/5000
T80150	1-1/2" x 1-1/2"	100/5000
T80151	1-1/2" x 1-1/4"	100/5000
T80200	2" x 2"	100/5000

LDP Blue Slip Joint Washer



• CARTON QUANTITIES ONLY

PART NO.	NUT x TUBE	CTN QTY
T80135	1-1/4" x 1-1/4"	100
T80160	1-1/2" x 1-1/2"	100

Flanged Poly Tailpiece Washer



• CARTON QUANTITIES ONLY

PART NO.	NUT x TUBE	CTN QTY
T81150	1-1/2" x 1-1/2"	100
T79152	1-1/2" x 1-1/4" cloth inserted	100

Marvel Ring



• Use on closet/urinal stub out adapter

PART NO.	FSWT x MIP	CTN/MSTR
B55004	1-1/4" SJ x 1-1/4" SWT	1/1000
B55005	1-1/2" SJ x 1-1/2" SWT	1/500
B55006	2" SJ x 2" SWT	1/500
B55007	1-1/2" SJ x 1-1/4" SWT	1/500

PVC Marvel Adapter



• Thread x Hub

PART NO.	SIZE	CTN QTY
P37000	1-1/2" PVC	100
P39000	1-1/2" ABS	100

Tray Plug



- Stainless steel body with die cast locknut
- Fits 1-1/2" bar sink
- Complete with washers and stopper

PART NO.	DESCRIPTION	CTN/MSTR
B02051	Tray plug	1/100

FIP x SLIP Waste Connector



- Brass body ferrule and nut; OD is copper tubular dimension
- MIP units are combination female sweat
- With stop

PART NO.	FIP x OD	CTN/MSTR
T75125	1-1/4" x 1-1/4"	12/72
T75150	1-1/2" x 1-1/2"	12/72
T75151	1-1/2" x 1-1/4"	12/72

MIP x SLIP Waste Connector



- Brass body ferrule and nut; OD is copper tubular dimension
- MIP units are combination female sweat
- With stop

PART NO.	MIP x OD	CTN/MSTR
T76125	1-1/4" x 1-1/4"	12/72
T76150	1-1/2" x 1-1/2"	12/72
T76151	1-1/2" x 1-1/4"	12/72

Flexible Trap Drain Connector



PART NO.	DESCRIPTION	CTN/MSTR
T06001	Connects 1-1/4" - 1-1/2" tubular to 1-1/4" - 1-1/2" tubular	1/180
T06002	Connects 1" DWV or 1-1/2" CTS to 1-1/4" - 1-1/2" tubular	1/100
T06003	Connects 1-1/2" DWV or CTS to 1-1/4" - 1-1/2" tubular	1/100
T06004	Connects 2" DWV to 1-1/4" - 1-1/2" tubular	1/100

Duo Basket Strainer



- 4-1/2" diameter to fit 3-1/2" drilling
- All stainless steel with zinc locknut
- Basket with rolled edge

PART NO.	DESCRIPTION	CTN/MSTR
S14001	SS duo basket strainer	1/50

Snap Lock Basket Strainer



- 4-1/2" diameter to fit 3-1/2" drilling
- All stainless steel with zinc locknut
- Ball bearing basket with rolled edge (less tailpiece)

PART NO.	DESCRIPTION	CTN/MSTR
S14005	Snap lock basket strainer	1/50

Flat Top Grid Strainer



- 4-1/2" diameter to fit 3-1/2" drilling
- All stainless steel with zinc locknut (less tailpiece)

PART NO.	DESCRIPTION	CTN/MSTR
S14002	Flat top grid strainer	1/24

Shallow Cup Duo Basket Strainer



- 4-1/2" diameter to fit 3-1/2" drilling
- All stainless steel with zinc locknut
- Basket with rolled edge (less tailpiece)

PART NO.	DESCRIPTION	CTN/MSTR
S14006	Shallow cup duo strainer	1/50

Twist & Lock Basket Strainer



- 4-1/2" diameter to fit 3-1/2" drilling
- Screw-in basket (less tailpiece)

PART NO.	DESCRIPTION	CTN/MSTR
S14003	Twist & lock basket strainer	1/50
S14103	Replacement basket	10/200

Stainless Steel Duo Basket Strainer



- Stainless steel body and basket
- Neoprene stopper
- Spring style snap-in basket

PART NO.	DESCRIPTION	CTN/MSTR
S14606	SS duo basket strainer	1/50

Stainless Steel Duo Post Style Basket Strainer



- Stainless steel body and basket
- Polished inner cup
- Compare to JB250SS
- CP zinc post and slip nut
- Heavy duty rubber gasket and zinc locknut

PART NO.	DESCRIPTION	CTN/MSTR
S14251	SS Duo post style basket strainer	1/50

Chrome Plated Brass Duo Basket Strainer



- Beveled stopper w/o-ring seal
- Brass slip joint nut and lock nut
- Compare to Kohler K8801

PART NO.	DESCRIPTION	CTN/MSTR
S14007	CP brass duo basket strainer	1/25

Deep Cup Basket Strainer



- 4-1/2" diameter to fit 3-1/2" drilling
- All stainless steel with zinc locknut
- Basket with rolled edge (less tailpiece)

PART NO.	DESCRIPTION	CTN/MSTR
S14004	Deep cup basket strainer	1/50

Chrome Plated Brass Duo Basket Strainer



- Chrome plated brass body with stainless steel basket
- Heavy duty construction
- Neoprene stopper

PART NO.	DESCRIPTION	CTN/MSTR
S14250	CP brass duo basket strainer	1/50

T

Quick Fit Stainless Steel Basket Strainer



- Minimizes installation time
- Triangle frame mounts to underside
- Fits virtually all sinks
- Durable stainless construction with brass nut
- For replacement basket use B03015

PART NO.	DESCRIPTION	CTN/MSTR
S14008	SS basket strainer	1/50

Stainless Steel Deep Cup Basket Strainer



- Stainless steel body and basket
- Neoprene stopper
- Spring style snap-in basket

PART NO.	DESCRIPTION	CTN/MSTR
S14014	SS cup basket strainer	1/50

Junior Duo Basket Strainer



- Stainless steel body and basket with die cast locknut; 1-1/2" threads
- Complete with washers
- Fits 1-3/4" bar sink

PART NO.	DESCRIPTION	CTN/MSTR
B02050	Junior duo basket strainer	1/100
B02049	Replacement basket	100/500

Flat Duplex Strainer



- Stainless steel body and strainer with die cast locknut
- Complete with washers
- Fits 1-3/4" bar sink

PART NO.	DESCRIPTION	CTN/MSTR
B02052	Flat duplex strainer	1/100

Deep Junior Duo Basket Strainer



- For 2" and 2-1/2" deep outlets and bar sinks

PART NO.	DESCRIPTION	CTN/MSTR
B02102	2" Deep basket strainer	1/100
B02103	Replacement basket	1/250

Economy Replacement Basket Strainer



- ABS post
- Stainless steel basket

PART NO.	DESCRIPTION	CTN/MSTR
B03015	Replacement basket strainer	10/200

Fit-All Basket Strainer



- Stainless steel

PART NO.	DESCRIPTION	CTN/MSTR
B03010	Fit-all basket strainer	20/200

Snap N Lock Stainless Steel Basket Strainer



- Brass slip joint and lock nuts

PART NO.	DESCRIPTION	CTN/MSTR
S14010	Snap N Lock stainless steel basket strainer	1/50

Chrome Plated ASAP Basket Strainer



- Durable stainless construction with brass slip nut
- Ideal for quick installation
- Can be installed in less than one minute
- Galvanized retaining ring
- Galvanized locking ring

PART NO.	DESCRIPTION	CTN/MSTR
S14009	ASAP basket strainer	1/24

Low Pattern-Tubular Sure Grip Escutcheon



- Chrome plated steel
- CARTON QUANTITIES ONLY

PART NO.	SIZE	FLANGE OD	CTN/MSTR
E03125	1-1/4" Tubular	2-7/8"	25/1200
E03150	1-1/2" Tubular	2-7/8"	25/1200
E03200	2" Tubular	3-1/2"	25/400

Box Pattern-Tubular Sure Grip Escutcheon



- Chrome plated steel
- CARTON QUANTITIES ONLY

PART NO.	SIZE	FLANGE OD	CTN/MSTR
E04125	1-1/4" Tubular	3"	5/300
E04150	1-1/2" Tubular	3"	5/300
E04200	2" Tubular	3"	5/300

PVC DWV FITTINGS 341-348

**PVC
DWV**

Coupling

H x H



- Used to join straight lengths of pipe

PART NO.	SIZE	MASTER CTN.
PFC114	1-1/4"	100
PFC115	1-1/2"	100
PFC120	2"	100
PFC130	3"	60
PFC140	4"	25
PFC160	6"	15

Repair Coupling

H x H



- Furnished without center stop so that stationary lengths of pipe can be spliced together

PART NO.	SIZE	MASTER CTN.
PFC116	1-1/2"	25
PFC122	2"	25
PFC133	3"	10
PFC144	4"	5

Reducer Coupling

H x H



- Used to reduce or increase pipe sizes

PART NO.	SIZE	MASTER CTN.
PFC121	2" x 1-1/2"	25
PFC131	3" x 1-1/2"	25
PFC132	3" x 2"	20
PFC142	4" x 2"	10
PFC143	4" x 3"	20

Flush Bushing

Spg x H



- Inserts into fitting hub to reduce to smaller pipe sizes

PART NO.	SIZE	MASTER CTN.
PFB211	1-1/2" x 1-1/4"	50
PFB221	2" x 1-1/2"	100
PFB224	2" x 1-1/4"	70
PFB231	3" x 1-1/2"	20
PFB232	3" x 2"	30
PFB242	4" x 2"	30
PFB243	4" x 3"	30
PFB264	6" x 4"	10

Male Adapter

H x MPT



- Adapts to standard female pipe threads
- Teflon thread tape is recommended for threaded joints

PART NO.	SIZE	MASTER CTN.
PMA414	1-1/4"	50
PMA415	1-1/2"	50
PMA420	2"	50
PMA430	3"	25
PMA440	4"	25

Female Adapter

H x FPT



- Adapts to standard male pipe threads
- Teflon thread tape is recommended for threaded joints

PART NO.	SIZE	MASTER CTN.
PFA314	1-1/4"	100
PFA315	1-1/2"	100
PFA311	1-1/2" x 1-1/4"	100
PFA320	2"	100
PFA330	3"	30
PFA340	4"	10
PFA360	6"	10

**PVC
DWV**

Fitting C.O. Adapter with Plug

Spg x FPT



- Solvent welds into fitting hub to provide access to piping
- Teflon thread tape is recommended for threaded joints

PART NO.	SIZE	MASTER CTN.
PFA615	1-1/2"	50
PFA620	2"	50
PFA630	3"	25
PFA640	4"	10

45° Street Elbow

Spg x H



- Used to change direction from a fitting hub to a pipe
- Sometimes called a "Street 1/8 bend"

PART NO.	SIZE	MASTER CTN.
PSL715S	1-1/2" short turn	100
PSL716S	1-1/2" long turn	100
PSL720	2"	50
PSL730	3"	20
PSL740	4"	10
PSL760	6"	3

60° Elbow

H x H



- Used to change direction in piping
- Sometimes called a "OK bend"

PART NO.	SIZE	MASTER CTN.
PFL915	1-1/2"	40
PFL920	2"	25
PFL930	3"	20
PFL940	4"	10

90° Vent Elbow

H x H



- Used to change direction in the "dry" portion of vent piping where water flow is not a consideration

PART NO.	SIZE	MASTER CTN.
PFL715	1-1/2"	20
PFL720	2"	30
PFL730	3"	10

90° Elbow

H x H



- Used to change direction in piping
- Sometimes called a "1/4 bend"

PART NO.	SIZE	MASTER CTN.
PFL814	1-1/4"	100
PFL815	1-1/2"	100
PFL820	2"	50
PFL830	3"	25
PFL840	4"	10
PFL860	6"	5
PFL821	2" x 1-1/2"	20
PFL834	4" x 3"	20

90° Elbow with Side Inlet

H x H x Spg/H



- Used to connect a branch line or vent at a change of direction in a larger vertical or horizontal pipe
- The inlet is constructed to accept a 2" fitting over its outside diameter or a 1-1/2" pipe into its inside diameter

PART NO.	SIZE	MASTER CTN.
PFL131	3" x 2" Spg or 1-1/2" Hub	20

90° Street Elbow

Spg x H



- Used to change direction in piping
- Sometimes called a "street 1/4 bend"

PART NO.	SIZE	MASTER CTN.
PSL916	1-1/2"	100
PSL926	2"	50
PSL936	3"	20
PSL946	4"	10

90° Long Sweep Elbow

H x H



- Used to change direction in piping
- Sometimes called a "long turn 1/4 bend"

PART NO.	SIZE	MASTER CTN.
PFL815L	1-1/2"	50
PFL820L	2"	25
PFL830L	3"	10
PFL840L	4"	5

90° Lowheel Inlet Elbow

H x H x Spg/H or H x H x H



- Used to connect a branch line or vent at a change of direction in a larger vertical or horizontal pipe
- The inlet is constructed to accept a 2" fitting over its outside diameter or a 1-1/2" pipe into its inside diameter

PART NO.	SIZE	MASTER CTN.
PFL031	3" x 2" Spg or 1-1/2" Hub	25
PFL032	3" x 2" Hub	25

Fitting C.O. Adapter

Spg x FPT



- Solvent welds into fitting hub and adapts to male threaded plug
- This fitting is a component part of "Fitting Cleanout with Threaded Plug"

PART NO.	SIZE	MASTER CTN.
PFA614	1-1/2"	50
PFA619	2"	50
PFA629	3"	25
PFA639	4"	10
PFA659	6"	10

Cap

Hub



- Used for permanently or temporarily capping pipe

PART NO.	SIZE	MASTER CTN.
PHC151	1-1/2"	10
PHC152	2"	5
PHC153	3"	10
PHC154	4"	5

22-1/2° Elbow

H x H



- Used to change direction in piping
- Sometimes called a "1/16 bend"

PART NO.	SIZE	MASTER CTN.
PFL515	1-1/2"	50
PFL520	2"	25
PFL530	3"	20
PFL540	4"	15
PFL560	6"	3

22-1/2° Street Elbow

H x Spg



- Used to change direction in piping
- Sometimes called a "Street 1/16 bend"

PART NO.	SIZE	MASTER CTN.
PSL815	1-1/2"	50
PSL820	2"	25
PSL830	3"	20
PSL840	4"	10

45° Elbow

H x H



- Used to change direction in piping
- Sometimes called a "1/8 bend"

PART NO.	SIZE	MASTER CTN.
PFL614	1-1/4"	100
PFL615	1-1/2"	100
PFL620	2"	50
PFL630	3"	20
PFL640	4"	10
PFL660	6"	3
PFL615S	1-1/2" short turn	100
PFL620S	2" short turn	100

Double 90° Elbow

H x H x H



- Ideal for “back to back” sink or lavatory installations

PART NO.	SIZE	MASTER CTN.
PDL716	1-1/2"	20
PDL736	3"	10
PDL722	2" x 1-1/2" x 1-1/2"	25

Wye

H x H x H



- Used when connecting a branch line into a horizontal drain pipe
- Also used in conjunction with a “twist-lok” plug to provide a cleanout in a drain pipe

PART NO.	SIZE	MASTER CTN.
PFY014	1-1/4"	35
PFY015	1-1/2"	50
PFY020	2"	25
PFY030	3"	25
PFY040	4"	5
PFY060	6"	4
PFY021	2" x 1-1/2"	25
PFY023	2" x 1-1/2" x 1-1/2"	25
PFY031	3" x 1-1/2"	15
PFY032	3" x 2"	25
PFY041	4" x 4" x 1-1/2"	10
PFY042	4" x 2"	10
PFY043	4" x 3"	10
PFY064	6" x 4"	5

PVC
DWV

Double Wye

H x H x H x H



- Used to bring two branch lines into a horizontal drain pipe

PART NO.	SIZE	MASTER CTN.
PDY415	1-1/2"	40
PDY420	2"	20
PDY430	3"	15
PDY440	4"	5
PDY442	4" x 4" x 2" x 2"	5
PDY443	4" x 4" x 3" x 3"	5

Double Fixture Tee

H x H x H x H



PART NO.	SIZE	MASTER CTN.
PDT621	2" x 1-1/2" x 1-1/2" x 1-1/2"	20

Vent Tee

H x H x H



- Used primarily in seepage bed piping grids in conjunction with perforated pipe
- Used where flow characteristics are not a primary consideration

PART NO.	SIZE	MASTER CTN.
PVT415	1-1/2"	10
PVT420	2"	10
PVT430	3"	10
PVT440	4"	10

Long Turn Tee Wye

H x H x H



- Used in some plumbing code areas to connect a branch line into a vertical drain pipe instead of a conventional tee fitting
- Also used to connect horizontal branch pipe approaching a horizontal drain pipe on the perpendicular

PART NO.	SIZE	MASTER CTN.
PFY515L	1-1/2"	20
PFY520L	2"	10
PFY530L	3"	10
PFY540L	4"	5
PFY521	2" x 1-1/2"	20
PFY531	3" x 1-1/2"	10
PFY532	3" x 2"	10
PFY542	4" x 2"	10
PFY543	4" x 3"	5

Cleanout Test Tee

H x H x FPT



- Used in conjunction with a threaded plug to provide a cleanout opening
- Teflon thread tape is recommended for threaded joints

PART NO.	SIZE	MASTER CTN.
PCT416	1-1/2"	20
PCT421	2"	20
PCT431	3"	10
PCT441	4"	10

Cleanout Test Tee with Cleanout Plug

H x H x FPT



- Used at the base of a vertical drain pipe to provide a cleanout opening flush with the finished wall

PART NO.	SIZE	MASTER CTN.
PCT315	1-1/2"	10
PCT320	2"	10
PCT330	3"	10
PCT340	4"	5

Sanitary Tee

H x H x H



- Used when connecting a branch line into a vertical drain pipe

PART NO.	SIZE	MASTER CTN.
PST114	1-1/4"	25
PST115	1-1/2"	100
PST120	2"	35
PST130	3"	30
PST140	4"	5
PST160	6"	6
PST121	2" x 1-1/2"	50
PST122	2" x 1-1/2" x 2"	25
PST123	2" x 1-1/2" x 1-1/2"	25
PST131	3" x 1-1/2"	20
PST132	3" x 2"	10
PST141	4" x 1-1/2"	10
PST142	4" x 2"	10
PST143	4" x 3"	10
PST164	6" x 4"	6

Sanitary Tee Street

Spg x H x H



PART NO.	SIZE	MASTER CTN.
PSS140	4"	10

Sanitary Tee with Right Side Inlet

H x H x H x H



- This fitting provides for the connection of 2" vent or branch waste piping to a vertical pipe

PART NO.	SIZE	MASTER CTN.
PST232	3" x 3" x 3" x 2"	10

Sanitary Tee with Left Side Inlet

H x H x H x H



- This fitting provides for the connection of 2" vent or branch waste piping to a vertical pipe

PART NO.	SIZE	MASTER CTN.
PSL132	3" x 3" x 3" x 2"	10

Sanitary Tee with Right and Left Side Inlet

H x H x Spg/H x Spg/H



Sanitary Tee with Right and Left Side Inlet

- Provides for the connection of 1-1/2" or 2" vent or branch waste piping to a vertical pipe as well as receiving the discharge of a water closet
- The inlets are constructed to accept a 2" fitting hub over their outside diameter or a 1-1/2" pipe into their inside diameter

PART NO.	SIZE	MASTER CTN.
PSL031	3" x 3" x 3" x 1-1/2" / 2" x 1-1/2" / 2"	10

Sanitary Tee with Right and Left Side Inlet

- Provides for the connection of 2" vent or branch waste piping to a vertical pipe as well as receive the discharge of a water closet

PART NO.	SIZE	MASTER CTN.
PSL042	4" x 4" x 4" x 2" x 2"	5

PVC DWV

Double Sanitary Tee

H x H x H x H



• Used to bring two branch lines into a vertical drain pipe

PART NO.	SIZE	MASTER CTN.
PDT515	1-1/2"	25
PDT520	2"	20
PDT530	3"	20
PDT540	4"	4
PDT521	2" x 2" x 1-1/2" x 1-1/2"	15
PDT531	3" x 3" x 1-1/2" x 1-1/2"	20
PDT532	3" x 3" x 2" x 2"	10
PDT542	4" x 4" x 2" x 2"	5
PDT543	4" x 4" x 3" x 3"	5

Two-Way Cleanout Tee

H x H x H



• Used with a vertical pipe stack, this fitting provides for above ground level access to piping

PART NO.	SIZE	MASTER CTN.
PTC633	3"	10
PTC644	4"	5

P-Trap LA Pattern with Union

SJ x H

PVC DWV



• Used to prevent the passage of sewer gas from the plumbing system into house through the plumbing fixture drain, when local code doesn't permit the use of slip coupled traps

PART NO.	SIZE	MASTER CTN.
PPT715	1-1/2"	20

P-Trap with Union

H x H



• Used to prevent the passage of sewer gas from the plumbing system into house through the plumbing fixture drain

PART NO.	SIZE	MASTER CTN.
PPT315	1-1/2"	20
PPT320	2"	25

P-Trap with Solvent Weld Joint

H x H



• Used to prevent the passage of sewer gas from the plumbing system into house through the plumbing fixture drain

PART NO.	SIZE	MASTER CTN.
PPT515	1-1/2"	25
PPT520	2"	20
PPT530	3"	10
PPT540	4"	4

P-Trap with Cleanout and Solvent Weld Joint

H x H



• Used to prevent the passage of sewer gas from the plumbing system into house through the plumbing fixture drain

PART NO.	SIZE	MASTER CTN.
PPT415	1-1/2"	10
PPT420	2"	10

P-Trap U-Bend

H x H



• Bottom part of trap furnished without cleanout

PART NO.	SIZE	MASTER CTN.
PPT015	1-1/2"	20
PPT020	2"	20
PPT030	3"	15
PPT040	4"	10

P-Trap Elbow

Spg x H Short Sweep



• Used to change direction in the "dry" portion of vent piping where water flow is not a consideration

PART NO.	SIZE	MASTER CTN.
PPT915S	1-1/2"	100
PPT920S	2"	20

Swivel Drum Trap

H x H



- PVC version of the old style bathtub "drum trap"
- Largely replaced today by the conventional 1-1/2" P-trap

PART NO.	SIZE	MASTER CTN.
PDT715	3" x 6" x 1-1/2"	15

Female Trap Adapter with Self Sealing Nut

H x SJT



- Utilized to adapt PVC pipe to tubular traps at wall or floor
- Utilizes special washer which seals to either 1-1/2" or 1-1/4" tubular products, reducing the number of SKU's needed in inventory
- This fitting solvent welds over a 1-1/2" DWV pipe
- Sometimes referred to as a "marvel"

PART NO.	SIZE	MASTER CTN.
PTA215	1-1/2"	100
PTA221	1-1/2" x 1-1/2" or 1-1/4"	100
PTA223	1-1/2" x 1-1/4"	100

Male Trap Adapter less Washer and Nuts

Spg x MPT



- Adapts fitting hub to standard female pipe threads
- Teflon thread tape is recommended for threaded joints

PART NO.	SIZE	MASTER CTN.
PTA415	1-1/2" (less washer)	100
PTA420	2" (less washer)	100

Male Trap Adapter with Washer and Nuts

Spg x SJT



- Adapts PVC fitting hub to tubular traps in a wall or floor
- Utilizes special washer which seals to either 1-1/2" or 1-1/4" tubular products, reducing the number of SKU's needed in inventory
- This fitting solvent welds into a 1-1/2" DWV fitting hub
- Sometimes called a "marvel"

PART NO.	SIZE	MASTER CTN.
PTA315	1-1/2" (with washer)	50
PTA311	1-1/2" x 1-1/2" or 1-1/4" (with washer)	75
PTA211	1-1/2" x 1-1/4" (with washer)	50

Reducing Closet Bend

Spg x H



- Used to change direction in piping and size of pipe directly into fitting hub
- Usually a closet flange directly under a toilet
- Works well in tight space applications on second floors

PART NO.	SIZE	MASTER CTN.
PCB934	4" x 3"	20

Expansion Joint

H x H



- To provide for expansion in straight vertical pipe runs exceeding 35 feet in length

PART NO.	SIZE	MASTER CTN.
PEJ520	2"	15
PEJ530	3"	10
PEJ540	4"	10

Cast Iron No Hub Adapter

Spg x H



- Adapts no hub elastomer coupling to DWV spigot
- Provides a proper method of adapting from no-hub cast iron pipe utilizing the standard no-hub clamp ring

PART NO.	SIZE	MASTER CTN.
PNH120	2"	100
PNH130	3"	20
PNH140	4"	10

PVC DWV

Cast Iron Hub Adapter

Spg x H



- Adapts cast iron hub to DWV Spigot
- Can be joined to cast iron with Genova plastic lead or hot molten lead

PART NO.	SIZE	MASTER CTN.
PHA520	2"	25
PHA521	2" x 1-1/2"	20
PHA530	3"	20
PHA540	4"	10
PHA543	4" x 3"	20

Cast Iron Spigot Adapter

H x H



- Adapts cast iron spigot to DWV spigot
- This fitting adapts Sch. 40 pipe to 4" cast iron spigot

PART NO.	SIZE	MASTER CTN.
PSA730	3"	10
PSA740	4"	10

Adapter Coupling

Sewer H x DWV H



- Adapts sewer & drain spigot to DWV spigot

PART NO.	SIZE	MASTER CTN.
PAC543	4" x 3"	20

Adapter Bushing

DWV Spg x Sewer H



- Adapts DWV hub to sewer & drain spigot

PART NO.	SIZE	MASTER CTN.
PAB75340	4"	25

**PVC
DWV**

Adapter Bushing

Sewer Spg x DWV H



- Adapts sewer & drain hub to DWV spigot

PART NO.	SIZE	MASTER CTN.
PAB243	4" x 3"	20

BLACK & GALVANIZED MALLEABLES & PIPE NIPPLES

Black and Galvanized Malleable Fittings.....	351-356
Black and Galvanized Pipe Nipples.....	357-359
Black and Galvanized Readycut Pipe.....	360
Black and Galvanized Merchant Couplings.....	361

BG

HEX Bushing

M x F, Concentric



- CSA
- UL listed
- FM
- NSF 61-4 and AB1953
- Meets ASTM A197, ASME B16.3, and ASTM A153



BLACK PART #	GALV. PART #	SIZE	CTN/MSTR
B144-0007	G144-0007	1/4" x 1/8"	120/1,440
B144-0032	G144-0032	3/8" x 1/4"	75/900
B144-0033	G144-0033	3/8" x 1/8"	75/900
B144-0058	G144-0058	1/2" x 3/8"	100/1,200
B144-0059	G144-0059	1/2" x 1/4"	100/1,200
B144-0060	G144-0060	1/2" x 1/8"	100/1,200
B144-0107	G144-0107	3/4" x 1/2"	50/600
B144-0108	G144-0108	3/4" x 3/8"	50/600
B144-0109	G144-0109	3/4" x 1/4"	50/600
B144-0110	G144-0110	3/4" x 1/8"	50/600
B144-0159	G144-0159	1" x 3/4"	50/400
B144-0160	G144-0160	1" x 1/2"	50/400
B144-0161	G144-0161	1" x 3/8"	50/400
B144-0162	G144-0162	1" x 1/4"	50/400
B144-0222	G144-0222	1-1/4" x 1"	30/240
B144-0223	G144-0223	1-1/4" x 3/4"	30/240
B144-0224	G144-0224	1-1/4" x 1/2"	30/240
B144-0225	G144-0225	1-1/4" x 3/8"	30/240
B144-0226	G144-0226	1-1/4" x 1/4"	30/240
B144-0303	G144-0303	1-1/2" x 1-1/4"	25/150
B144-0304	G144-0304	1-1/2" x 1"	25/150
B144-0305	G144-0305	1-1/2" x 3/4"	25/150
B144-0306	G144-0306	1-1/2" x 1/2"	25/150
B144-0307	G144-0307	1-1/2" x 3/8"	25/150
B144-0308	G144-0308	1-1/2" x 1/4"	25/150
B144-0398	G144-0398	2" x 1-1/2"	20/120
B144-0399	G144-0399	2" x 1-1/4"	20/120
B144-0400	G144-0400	2" x 1"	20/120
B144-0401	G144-0401	2" x 3/4"	20/120
B144-0402	G144-0402	2" x 1/2"	20/120
B144-0403	G144-0403	2" x 3/8"	20/120
B144-0531	G144-0531	2-1/2" x 2"	15/60
B144-0532	G144-0532	2-1/2" x 1-1/2"	15/60
B144-0533	G144-0533	2-1/2" x 1-1/4"	15/60
B144-0534	G144-0534	2-1/2" x 1"	15/60
B144-0535	G144-0535	2-1/2" x 3/4"	15/60
B144-0536	G144-0536	2-1/2" x 1/2"	15/60
B144-0662	G144-0662	3" x 2-1/2"	12/48
B144-0663	G144-0663	3" x 2"	12/48
B144-0664	G144-0664	3" x 1-1/2"	12/48
B144-0665	G144-0665	3" x 1-1/4"	12/48
B144-0666	G144-0666	3" x 1"	12/48
B144-0667	—	3" x 3/4"	12/48
B144-0790	G144-0790	3-1/2" x 3"	8/32
B144-0870	G144-0870	4" x 3"	5/20
B144-0871	G144-0871	4" x 2-1/2"	5/20
B144-0872	G144-0872	4" x 2"	5/20
B144-0873	G144-0873	4" x 1-1/2"	5/20
B144-0875	G144-0875	4" x 1"	5/20
B144-1109	G144-1109	6" x 4"	4/8
B144-1111	G144-1111	6" x 3"	4/8

Cap



- CSA
- UL listed
- FM
- NSF 61-4 and AB1953
- Meets ASTM A197, ASME B16.3, and ASTM A153



BLACK PART #	GALV. PART #	SIZE	CTN/MSTR
B155-0001	G155-0001	1/8"	120/1,440
B155-0002	G155-0002	1/4"	80/960
B155-0025	G155-0025	3/8"	60/720
B155-0050	G155-0050	1/2"	75/600
B155-0100	G155-0100	3/4"	40/320
B155-0150	G155-0150	1"	35/200
B155-0215	G155-0215	1-1/4"	25/160
B155-0295	G155-0295	1-1/2"	25/108
B155-0390	G155-0390	2"	18/72
B155-0520	G155-0520	2-1/2"	14/56
B155-0650	G155-0650	3"	12/36
B155-0860	G155-0860	4"	7/21
B155-0975	G155-0975	5"	8/16
B155-1100	G155-1100	6"	4/8

Extension Piece

M x F



- CSA
- UL listed
- FM
- NSF 61-4 and AB1953
- Meets ASTM A197, ASME B16.3, and ASTM A153



BLACK PART #	GALV. PART #	SIZE	CTN/MSTR
B335-0050	G335-0050	1/2"	75/600
B335-0100	G335-0100	3/4"	40/320
B335-0150	G335-0150	1"	30/180
B335-0215	G335-0215	1-1/4"	30/120
B335-0295	G335-0295	1-1/2"	20/80
B335-0390	G335-0390	2"	15/60

BG

Coupling, Banded

F x F



- CSA
- UL listed
- FM
- NSF 61-4 and AB1953
- Meets ASTM A197, ASME B16.3, and ASTM A153



BLACK PART #	GALV. PART #	SIZE	CTN/MSTR
B165-0001	G165-0001	1/8"	70/840
B165-0002	G165-0002	1/4"	40/480
B165-0025	G165-0025	3/8"	50/600
B165-0050	G165-0050	1/2"	60/480
B165-0100	G165-0100	3/4"	50/300
B165-0150	G165-0150	1"	25/150
B165-0215	G165-0215	1-1/4"	32/128
B165-0295	G165-0295	1-1/2"	18/72
B165-0390	G165-0390	2"	12/48
B165-0520	G165-0520	2-1/2"	4/32
B165-0650	G165-0650	3"	12/24
B165-0860	G165-0860	4"	3/12
B165-1100	G165-1100	6"	3/6

Reducing Coupling, Banded

F x F, Concentric



- CSA
- UL listed
- FM
- NSF 61-4 and AB1953
- Meets ASTM A197, ASME B16.3, and ASTM A153



BLACK PART #	GALV. PART #	SIZE	CTN/MSTR
B165-0007	G165-0007	1/4" x 1/8"	50/600
B165-0032	G165-0032	3/8" x 1/4"	30/360
B165-0033	G165-0033	3/8" x 1/8"	35/420
B165-0058	G165-0058	1/2" x 3/8"	40/480
B165-0059	G165-0059	1/2" x 1/4"	50/600
B165-0060	G165-0060	1/2" x 1/8"	50/600
B165-0107	G165-0107	3/4" x 1/2"	60/360
B165-0108	G165-0108	3/4" x 3/8"	30/360
B165-0109	G165-0109	3/4" x 1/4"	30/360
B165-0110	G165-0110	3/4" x 1/8"	35/420
B165-0159	G165-0159	1" x 3/4"	25/200
B165-0160	G165-0160	1" x 1/2"	40/240
B165-0161	G165-0161	1" x 3/8"	40/240
B165-0162	G165-0162	1" x 1/4"	45/270
B165-0222	G165-0222	1-1/4" x 1"	20/120
B165-0223	G165-0223	1-1/4" x 3/4"	25/150
B165-0224	G165-0224	1-1/4" x 1/2"	25/150
B165-0303	G165-0303	1-1/2" x 1-1/4"	24/96
B165-0304	G165-0304	1-1/2" x 1"	25/100
B165-0305	G165-0305	1-1/2" x 3/4"	30/120
B165-0306	G165-0306	1-1/2" x 1/2"	20/120
B165-0307	G165-0307	1-1/2" x 3/8"	30/120
B165-0398	G165-0398	2" x 1-1/2"	12/72
B165-0399	G165-0399	2" x 1-1/4"	14/72
B165-0400	G165-0400	2" x 1"	14/84
B165-0401	G165-0401	2" x 3/4"	14/84
B165-0402	G165-0402	2" x 1/2"	14/84
B165-0531	G165-0531	2-1/2" x 2"	10/40
B165-0532	G165-0532	2-1/2" x 1-1/2"	10/40
B165-0533	G165-0533	2-1/2" x 1-1/4"	10/40
B165-0534	G165-0534	2-1/2" x 1"	10/40
B165-0535	—	2-1/2" x 3/4"	10/40
B165-0662	G165-0662	3" x 2-1/2"	12/24
B165-0663	G165-0663	3" x 2"	8/32
B165-0664	G165-0664	3" x 1-1/2"	8/32
B165-0665	G165-0665	3" x 1-1/4"	8/32
B165-0666	G165-0666	3" x 1"	8/32
B165-0870	G165-0870	4" x 3"	6/12
B165-0871	G165-0871	4" x 2-1/2"	6/18
B165-0872	G165-0872	4" x 2"	6/12
B165-0873	G165-0873	4" x 1-1/2"	6/18
B165-1109	G165-1109	6" x 4"	4/8

Cross, Banded

F x F x F x F



- CSA
- UL listed
- FM
- NSF 61-4 and AB1953
- Meets ASTM A197, ASME B16.3, and ASTM A153



BLACK PART #	GALV. PART #	SIZE	CTN/MSTR
B195-0002	G195-0002	1/4"	80/480
B195-0025	G195-0025	3/8"	50/300
B195-0050	G195-0050	1/2"	45/180
B195-0100	G195-0100	3/4"	30/120
B195-0150	G195-0150	1"	20/60
B195-0215	G195-0215	1-1/4"	20/40
B195-0295	G195-0295	1-1/2"	18/36
—	G195-0390	2"	10/20

BG

90° Reducing Elbow, Banded

F x F



- CSA
- UL listed
- FM
- NSF 61-4 and AB1953
- Meets ASTM A197, ASME B16.3, and ASTM A153



BLACK PART #	GALV. PART #	SIZE	CTN/MSTR
B235-0007	G235-0007	1/4" x 1/8"	1/480
B235-0032	G235-0032	3/8" x 1/4"	60/720
B235-0058	G235-0058	1/2" x 3/8"	50/400
B235-0059	G235-0059	1/2" x 1/4"	40/480
B235-0060	G235-0060	1/2" x 1/8"	40/480
B235-0107	G235-0107	3/4" x 1/2"	40/240
B235-0108	G235-0108	3/4" x 3/8"	50/300
B235-0109	G235-0109	3/4" x 1/4"	40/320
B235-0159	G235-0159	1" x 3/4"	25/150
B235-0160	G235-0160	1" x 1/2"	30/180
B235-0222	G235-0222	1-1/4" x 1"	20/80
B235-0223	G235-0223	1-1/4" x 3/4"	30/120
B235-0224	G235-0224	1-1/4" x 1/2"	35/140
B235-0303	G235-0303	1-1/2" x 1-1/4"	15/60
B235-0304	G235-0304	1-1/2" x 1"	20/80
B235-0305	G235-0305	1-1/2" x 3/4"	15/90
B235-0306	G235-0306	1-1/2" x 1/2"	25/100
B235-0398	G235-0398	2" x 1-1/2"	10/40
B235-0399	G235-0399	2" x 1-1/4"	10/40
B235-0400	G235-0400	2" x 1"	14/56
B235-0401	G235-0401	2" x 3/4"	15/60
B235-0402	G235-0402	2" x 1/2"	15/60
B235-0531	G235-0531	2-1/2" x 2"	12/24
B235-0532	G235-0532	2-1/2" x 1-1/2"	6/24
B235-0533	G235-0533	2-1/2" x 1-1/4"	6/40
B235-0662	G235-0662	3" x 2-1/2"	4/16
B235-0663	G235-0663	3" x 2"	6/18

90° Elbow, Banded

F x F



- CSA
- UL listed
- FM
- NSF 61-4 and AB1953
- Meets ASTM A197, ASME B16.3, and ASTM A153



BLACK PART #	GALV. PART #	SIZE	CTN/MSTR
B235-0001	G235-0001	1/8"	50/600
B235-0002	G235-0002	1/4"	35/420
B235-0025	G235-0025	3/8"	45/540
B235-0050	G235-0050	1/2"	50/400
B235-0100	G235-0100	3/4"	35/210
B235-0150	G235-0150	1"	20/120
B235-0215	G235-0215	1-1/4"	20/80
B235-0295	G235-0295	1-1/2"	20/60
B235-0390	G235-0390	2"	8/32
B235-0520	G235-0520	2-1/2"	8/18
B235-0650	G235-0650	3"	7/14
B235-0860	G235-0860	4"	2/6
B235-0975	G235-0975	5"	2/4
B235-1100	G235-1100	6"	1/2

90° Street Elbow, Banded

M x F



- CSA
- UL listed
- FM
- NSF 61-4 and AB1953
- Meets ASTM A197, ASME B16.3, and ASTM A153



BLACK PART #	GALV. PART #	SIZE	CTN/MSTR
B254-0001	G254-0001	1/8"	60/720
B254-0002	G254-0002	1/4"	35/420
B254-0025	G254-0025	3/8"	40/480
B254-0050	G254-0050	1/2"	60/360
B254-0100	G254-0100	3/4"	35/210
B254-0150	G254-0150	1"	30/120
B254-0215	G254-0215	1-1/4"	25/75
B254-0295	G254-0295	1-1/2"	18/54
B254-0390	G254-0390	2"	10/30
B254-0520	G254-0520	2-1/2"	9/18
B254-0650	G254-0650	3"	1/14
B254-0860	G254-0860	4"	1/6

BG

45° Elbow, Banded

F x F



- CSA
- UL listed
- FM
- NSF 61-4 and AB1953
- Meets ASTM A197, ASME B16.3, and ASTM A153



BLACK PART #	GALV. PART #	SIZE	CTN/MSTR
B290-0001	G290-0001	1/8"	50/600
B290-0002	G290-0002	1/4"	30/360
B290-0025	G290-0025	3/8"	50/600
B290-0050	G290-0050	1/2"	50/400
B290-0100	G290-0100	3/4"	40/240
B290-0150	G290-0150	1"	20/120
B290-0215	G290-0215	1-1/4"	20/80
B290-0295	G290-0295	1-1/2"	15/60
B290-0390	G290-0390	2"	12/36
B290-0520	G290-0520	2-1/2"	1/27
B290-0650	G290-0650	3"	1/20
B290-0860	G290-0860	4"	1/6

45° Street Elbow, Banded

M x F



- CSA
- UL listed
- FM
- NSF 61-4 and AB1953
- Meets ASTM A197, ASME B16.3, and ASTM A153



BLACK PART #	GALV. PART #	SIZE	CTN/MSTR
B295-0001	G295-0001	1/8"	70/840
B295-0002	G295-0002	1/4"	40/480
B295-0025	G295-0025	3/8"	50/600
B295-0050	G295-0050	1/2"	75/450
B295-0100	G295-0100	3/4"	40/240
B295-0150	G295-0150	1"	25/150
B295-0215	G295-0215	1-1/4"	20/80
B295-0295	G295-0295	1-1/2"	20/60
B295-0390	G295-0390	2"	12/36
B295-0520	G295-0520	2-1/2"	1/24
B295-0650	G295-0650	3"	1/18
B295-0860	G295-0860	4"	1/7

Floor Flange



- CSA
- UL listed
- FM
- NSF 61-4 and AB1953
- Meets ASTM A197, ASME B16.3, and ASTM A153



BLACK PART #	GALV. PART #	SIZE	CTN/MSTR
B355-0025	G355-0025	3/8"	25/150
B355-0050	G355-0050	1/2"	25/100
B355-0100	G355-0100	3/4"	20/80
B355-0150	G355-0150	1"	20/60
B355-0215	G355-0215	1-1/4"	15/60
B355-0295	G355-0295	1-1/2"	12/48
B355-0390	G355-0390	2"	8/32

Locknut/Backnut



- CSA
- UL listed
- FM
- NSF 61-4 and AB1953
- Meets ASTM A197, ASME B16.3, and ASTM A153



BLACK PART #	GALV. PART #	SIZE	CTN/MSTR
—	G375-0001	1/8"	250/3000
—	G375-0002	1/4"	125/1500
—	G375-0025	3/8"	125/1500
—	G375-0050	1/2"	100/1200
—	G375-0100	3/4"	60/720
—	G375-0150	1"	60/480
—	G375-0215	1-1/4"	60/360
—	G375-0295	1-1/2"	45/270
—	G375-0390	2"	25/150

Square Head Plug

M



- Cored
- CSA
- UL listed
- FM
- NSF 61-4 and AB1953
- Meets ASTM A197, ASME B16.3, and ASTM A153



BLACK PART #	GALV. PART #	SIZE	CTN/MSTR
B396-0001	G396-0001	1/8"	300/3600
B396-0002	G396-0002	1/4"	150/1800
B396-0025	G396-0025	3/8"	100/1200
B396-0050	G396-0050	1/2"	50/600
B396-0100	G396-0100	3/4"	30/360
B396-0150	G396-0150	1"	20/240
B396-0215	G396-0215	1-1/4"	40/240
B396-0295	G396-0295	1-1/2"	30/180
B396-0390	G396-0390	2"	20/120
B396-0520	G396-0520	2-1/2"	8/64
B396-0650	G396-0650	3"	8/48
B396-0860	G396-0860	4"	8/16
B396-1100	G396-1100	6"	5/10

BG

Tee, Banded

F x F x F



- CSA
- UL listed
- FM
- NSF 61-4 and AB1953
- Meets ASTM A197, ASME B16.3, and ASTM A153



BLACK PART #	GALV. PART #	SIZE	CTN/MSTR
B460-0001	G460-0001	1/8"	80/960
B460-0002	G460-0002	1/4"	50/600
B460-0025	G460-0025	3/8"	45/360
B460-0050	G460-0050	1/2"	40/240
B460-0100	G460-0100	3/4"	35/140
B460-0150	G460-0150	1"	20/80
B460-0215	G460-0215	1-1/4"	14/56
B460-0295	G460-0295	1-1/2"	15/45
B460-0390	G460-0390	2"	10/30
B460-0520	G460-0520	2-1/2"	8/16
B460-0650	G460-0650	3"	6/12
B460-0860	G460-0860	4"	2/6
B460-1100	G460-1100	6"	2/2

Reducing Tee, Banded

F x F x F



- CSA
- UL listed
- FM
- NSF 61-4 and AB1953
- Meets ASTM A197, ASME B16.3, and ASTM A153



BLACK PART #	GALV. PART #	SIZE	CTN/MSTR
B460-0007	G460-0007	1/4" x 1/8"	25/300
B460-0032	—	3/8" x 1/4"	60/300
B460-0056	—	1/2" x 1"	40/160
B460-0057	G460-0057	1/2" x 3/4"	30/180
B460-0058	G460-0058	1/2" x 3/8"	45/270
B460-0059	G460-0059	1/2" x 1/4"	50/300
B460-0106	G460-0106	3/4" x 1"	20/120
B460-0107	G460-0107	3/4" x 1/2"	45/180
B460-0108	G460-0108	3/4" x 3/8"	45/180
B460-0109	G460-0109	3/4" x 1/4"	50/200
B460-0116	G460-0116	3/4" x 1/2" x 1"	35/140
B460-0117	G460-0117	3/4" x 1/2" x 3/4"	40/160
B460-0118	G460-0118	3/4" x 1/2" x 1/2"	30/180
B460-0157	G460-0157	1" x 1-1/2"	15/60
B460-0158	—	1" x 1-1/4"	15/60
B460-0159	G460-0159	1" x 3/4"	25/100
B460-0160	G460-0160	1" x 1/2"	30/120
B460-0161	G460-0161	1" x 3/8"	20/120
B460-0162	G460-0162	1" x 1/4"	25/150
B460-0169	G460-0169	1" x 3/4" x 1"	15/90
B460-0170	G460-0170	1" x 3/4" x 3/4"	25/100
B460-0171	G460-0171	1" x 3/4" x 1/2"	25/120
B460-0180	G460-0180	1" x 1/2" x 1"	15/90
B460-0181	G460-0181	1" x 1/2" x 3/4"	30/120
B460-0182	G460-0182	1" x 1/2" x 1/2"	20/120
B460-0220	G460-0215	1-1/4" x 2"	14/56
B460-0221	G460-0221	1-1/4" x 1-1/2"	14/56
B460-0222	G460-0222	1-1/4" x 1"	16/64
B460-0223	G460-0223	1-1/4" x 3/4"	18/72
B460-0224	G460-0224	1-1/4" x 1/2"	20/80
B460-0234	G460-0234	1-1/4" x 1" x 1-1/4"	15/60
B460-0235	G460-0235	1-1/4" x 1" x 1"	18/72
B460-0236	G460-0236	1-1/4" x 1" x 3/4"	18/72

Reducing Tee, Banded (cont.)

BLACK PART #	GALV. PART #	SIZE	CTN/MSTR
B460-0237	G460-0237	1-1/4" x 1" x 1/2"	18/72
B460-0245	G460-0245	1-1/4" x 3/4" x 1-1/4"	15/60
B460-0246	G460-0246	1-1/4" x 3/4" x 1"	20/80
B460-0247	G460-0247	1-1/4" x 3/4" x 3/4"	20/80
B460-0248	G460-0248	1-1/4" x 3/4" x 1/2"	25/100
B460-0256	G460-0256	1-1/4" x 1/2" x 1-1/4"	15/60
B460-0257	G460-0257	1-1/4" x 1/2" x 1"	20/80
B460-0258	G460-0258	1-1/4" x 1/2" x 3/4"	25/50
B460-0259	G460-0259	1-1/4" x 1/2" x 1/2"	25/50
B460-0302	—	1-1/2" x 2"	15/45
B460-0303	G460-0303	1-1/2" x 1-1/4"	15/45
B460-0304	G460-0304	1-1/2" x 1"	13/52
B460-0305	G460-0305	1-1/2" x 3/4"	10/60
B460-0306	G460-0306	1-1/2" x 1/2"	18/72
B460-0315	G460-0315	1-1/2" x 1-1/4" x 1-1/2"	10/40
B460-0316	G460-0316	1-1/2" x 1-1/4" x 1-1/4"	12/48
B460-0317	G460-0317	1-1/2" x 1-1/4" x 1"	14/56
B460-0318	G460-0318	1-1/2" x 1-1/4" x 3/4"	16/64
B460-0319	G460-0319	1-1/2" x 1-1/4" x 1/2"	16/64
B460-0328	G460-0328	1-1/2" x 1" x 1-1/2"	14/56
B460-0329	G460-0329	1-1/2" x 1" x 1-1/4"	14/56
B460-0330	G460-0330	1-1/2" x 1" x 1"	15/60
B460-0331	G460-0331	1-1/2" x 1" x 3/4"	15/60
B460-0339	G460-0339	1-1/2" x 3/4" x 1-1/2"	12/48
B460-0340	G460-0340	1-1/2" x 3/4" x 1-1/4"	15/60
B460-0342	G460-0342	1-1/2" x 3/4" x 3/4"	15/60
B460-0350	G460-0350	1-1/2" x 1/2" x 1-1/2"	12/48
B460-0398	G460-0398	2" x 1-1/2"	16/32
B460-0399	G460-0399	2" x 1-1/4"	8/32
B460-0400	G460-0400	2" x 1"	12/36
B460-0401	G460-0401	2" x 3/4"	10/40
B460-0402	G460-0402	2" x 1/2"	10/40
B460-0413	G460-0413	2" x 1-1/2" x 2"	10/30
B460-0414	G460-0414	2" x 1-1/2" x 1-1/2"	8/32
B460-0415	G460-0415	2" x 1-1/2" x 1-1/4"	8/32
B460-0416	G460-0416	2" x 1-1/2" x 1"	10/40
B460-0417	G460-0417	2" x 1-1/2" x 3/4"	10/40
B460-0429	G460-0429	2" x 1-1/4" x 2"	13/26
B460-0430	G460-0430	2" x 1-1/4" x 1-1/2"	8/32
B460-0431	G460-0431	2" x 1-1/4" x 1-1/4"	12/36
B460-0444	G460-0444	2" x 1" x 2"	8/32
B460-0447	G460-0447	2" x 1" x 1"	12/48
B460-0457	G460-0457	2" x 3/4" x 2"	8/32
B460-0470	G460-0470	2" x 1/2" x 2"	8/32
B460-0531	G460-0531	2-1/2" x 2"	4/16
B460-0532	G460-0532	2-1/2" x 1-1/2"	5/15
B460-0533	G460-0533	2-1/2" x 1-1/4"	10/20
B460-0534	G460-0534	2-1/2" x 1"	12/24
B460-0535	G460-0535	2-1/2" x 3/4"	12/24
B460-0536	G460-0536	2-1/2" x 1/2"	12/24
B460-0662	G460-0662	3" x 2-1/2"	6/12
B460-0663	G460-0663	3" x 2"	4/12
B460-0664	—	3" x 1-1/2"	4/12
B460-0665	G460-0665	3" x 1-1/4"	4/12
B460-0666	G460-0666	3" x 1"	5/15
B460-0667	G460-0667	3" x 3/4"	6/18
B460-0668	—	3" x 1/2"	6/18
B460-0870	G460-0870	4" x 3"	2/6
B460-0871	G460-0871	4" x 2-1/2"	2/6
B460-0872	G460-0872	4" x 2"	2/8
B460-0873	G460-0873	4" x 1-1/2"	2/8

BG

Street Tee, Banded

F x M x F



- CSA
- UL listed
- FM
- NSF 61-4 and AB1953
- Meets ASTM A197, ASME B16.3, and ASTM A153



BLACK PART #	GALV. PART #	SIZE	CTN/MSTR
B486-0050	G486-0050	1/2"	40/240
B486-0100	G486-0100	3/4"	25/150
B486-0150	G486-0150	1"	20/80
B486-0215	—	1-1/4"	15/60

Union



- Brass to iron seat
- CSA
- UL listed
- FM
- NSF 61-4 and AB1953
- Meets ASTM A197, ASME B16.3, and ASTM A153



BLACK PART #	GALV. PART #	SIZE	CTN/MSTR
B657-0001	G657-0001	1/8"	30/360
B657-0002	G657-0002	1/4"	20/240
B657-0025	G657-0025	3/8"	20/240
B657-0050	G657-0050	1/2"	50/200
B657-0100	G657-0100	3/4"	35/140
B657-0150	G657-0150	1"	20/80
B657-0215	G657-0215	1-1/4"	15/60
B657-0295	G657-0295	1-1/2"	10/40
B657-0390	G657-0390	2"	6/24
B657-0520	G657-0520	2-1/2"	4/16
B657-0650	G657-0650	3"	7/14
B657-0860	G657-0860	4"	7/7

BG

Pipe Nipples



BLACK PART #	GALV. PART #	SIZE	CTN/MSTR
30100	50100	1/8" x Close	25/400
30110	50110	1/8" x 10"	25/200
—	50111	1/8" x 11"	25/200
30112	50112	1/8" x 12"	25/200
30115	50115	1/8" x 1-1/2"	25/400
30120	50120	1/8" x 2"	25/400
30125	50125	1/8" x 2-1/2"	25/400
30130	50130	1/8" x 3"	25/400
30135	50135	1/8" x 3-1/2"	25/400
30140	50140	1/8" x 4"	25/400
30145	50145	1/8" x 4-1/2"	25/400
30150	50150	1/8" x 5"	25/400
30155	50155	1/8" x 5-1/2"	25/400
30160	50160	1/8" x 6"	25/400
30170	50170	1/8" x 7"	25/200
30180	50180	1/8" x 8"	25/200
30190	50190	1/8" x 9"	25/200
30200	50200	1/4" x Close	25/400
30210	50210	1/4" x 10"	25/200
30211	50211	1/4" x 11"	25/200
30212	50212	1/4" x 12"	25/200
30215	50215	1/4" x 1-1/2"	25/400
30220	50220	1/4" x 2"	25/400
30225	50225	1/4" x 2-1/2"	25/400
30230	50230	1/4" x 3"	25/400
30235	50235	1/4" x 3-1/2"	25/400
30240	50240	1/4" x 4"	25/400
30245	50245	1/4" x 4-1/2"	25/400
30250	50250	1/4" x 5"	25/400
30255	50255	1/4" x 5-1/2"	25/400
30260	50260	1/4" x 6"	25/400
30270	50270	1/4" x 7"	25/200
30280	50280	1/4" x 8"	25/200
30290	50290	1/4" x 9"	25/200
30300	50300	3/8" x Close	25/400
30310	50310	3/8" x 10"	25/100
30311	—	3/8" x 11"	25/100
30312	50312	3/8" x 12"	25/100
30314	—	3/8" x 14"	5/100
30315	50315	3/8" x 1-1/2"	25/400
30320	50320	3/8" x 2"	25/400
30325	50325	3/8" x 2-1/2"	25/400
30330	50330	3/8" x 3"	25/400
30335	50335	3/8" x 3-1/2"	25/400
30340	50340	3/8" x 4"	25/400
30345	50345	3/8" x 4-1/2"	25/400
30350	50350	3/8" x 5"	25/300
30355	50355	3/8" x 5-1/2"	25/300
30360	50360	3/8" x 6"	25/300
30370	50370	3/8" x 7"	25/150
30380	50380	3/8" x 8"	25/150
30390	—	3/8" x 9"	25/100
30500	50500	1/2" x Close	25/400

Pipe Nipples (cont.)

BLACK PART #	GALV. PART #	SIZE	CTN/MSTR
30510	50510	1/2" x 10"	25/100
30511	50511	1/2" x 11"	25/100
30512	50512	1/2" x 12"	25/100
30515	50515	1/2" x 1-1/2"	25/400
30520	50520	1/2" x 2"	25/400
30525	50525	1/2" x 2-1/2"	25/300
30530	50530	1/2" x 3"	25/300
30535	50535	1/2" x 3-1/2"	25/300
30540	50540	1/2" x 4"	25/200
30545	50545	1/2" x 4-1/2"	25/200
30550	50550	1/2" x 5"	25/200
30555	50555	1/2" x 5-1/2"	25/200
30560	50560	1/2" x 6"	25/200
30570	50570	1/2" x 7"	25/100
30575	—	1/2" x 7-1/2"	25/100
30580	50580	1/2" x 8"	25/100
30590	50590	1/2" x 9"	25/100
30700	50700	3/4" x Close	25/400
30710	50710	3/4" x 10"	25/50
30711	50711	3/4" x 11"	25/50
30712	50712	3/4" x 12"	25/50
30715	50715	3/4" x 1-1/2"	25/400
30720	50720	3/4" x 2"	25/300
30725	50725	3/4" x 2-1/2"	25/300
30730	50730	3/4" x 3"	25/200
30735	50735	3/4" x 3-1/2"	25/200
30740	50740	3/4" x 4"	25/150
30745	50745	3/4" x 4-1/2"	25/150
30750	50750	3/4" x 5"	25/100
30755	50755	3/4" x 5-1/2"	25/100
30760	50760	3/4" x 6"	25/100
30765	—	3/4" x 6-1/2"	25/75
30770	50770	3/4" x 7"	25/75
30775	50775	3/4" x 7-1/2"	25/75
30780	50780	3/4" x 8"	25/75
30790	50790	3/4" x 9"	25/50
31000	51000	1" x Close	25/200
31010	51010	1" x 10"	25/50
31011	51011	1" x 11"	25/50
31012	51012	1" x 12"	25/50
31014	51014	1" x 14"	5/25
31020	51020	1" x 2"	25/200
31025	51025	1" x 2-1/2"	25/150
31030	51030	1" x 3"	25/150
31035	51035	1" x 3-1/2"	25/100
31040	51040	1" x 4"	25/100
31045	51045	1" x 4-1/2"	25/100
31050	51050	1" x 5"	25/75
31055	51055	1" x 5-1/2"	25/75
31060	51060	1" x 6"	25/50
31065	—	1" x 6-1/2"	25/50
31070	51070	1" x 7"	25/50
31075	—	1" x 7-1/2"	25/50
31080	51080	1" x 8"	25/50
31090	51090	1" x 9"	25/50
31200	51200	1-1/4" x Close	25/100
31210	51210	1-1/4" x 10"	20/40
31211	51211	1-1/4" x 11"	20/40
31212	51212	1-1/4" x 12"	10/30



Pipe Nipples (cont.)

BLACK PART #	GALV. PART #	SIZE	CTN/MSTR
31213	—	1-1/4" x 13"	3/30
31214	—	1-1/4" x 14"	3/30
31220	51220	1-1/4" x 2"	25/100
31225	51225	1-1/4" x 2-1/2"	25/100
31230	51230	1-1/4" x 3"	25/100
31235	51235	1-1/4" x 3-1/2"	25/50
31240	51240	1-1/4" x 4"	25/50
31245	51245	1-1/4" x 4-1/2"	25/50
31250	51250	1-1/4" x 5"	25/50
31255	51255	1-1/4" x 5-1/2"	25/50
31260	51260	1-1/4" x 6"	25/50
31265	—	1-1/4" x 6-1/2"	25/50
31270	51270	1-1/4" x 7"	25/50
31280	51280	1-1/4" x 8"	25/50
31285	—	1-1/4" x 8-1/2"	25/30
31290	51290	1-1/4" x 9"	25/50
31295	—	1-1/4" x 9-1/2"	20/40
31500	51500	1-1/2" x Close	25/100
31510	51510	1-1/2" x 10"	15/30
31511	51511	1-1/2" x 11"	15/30
31512	51512	1-1/2" x 12"	15/30
31514	—	1-1/2" x 14"	3/6
31520	51520	1-1/2" x 2"	25/100
31525	51525	1-1/2" x 2-1/2"	25/50
31530	51530	1-1/2" x 3"	25/50
31535	51535	1-1/2" x 3-1/2"	25/50
31540	51540	1-1/2" x 4"	25/50
31545	51545	1-1/2" x 4-1/2"	25/50
31550	51550	1-1/2" x 5"	25/50
31555	51555	1-1/2" x 5-1/2"	25/50
31560	51560	1-1/2" x 6"	25/50
31570	51570	1-1/2" x 7"	20/40
31580	51580	1-1/2" x 8"	20/40
31590	51590	1-1/2" x 9"	10/20
32000	52000	2" x Close	25/50
32010	52010	2" x 10"	15/30
32011	52011	2" x 11"	15/30
32012	52012	2" x 12"	15/30
32013	—	2" x 13"	3/6
32025	52025	2" x 2-1/2"	25/50
32030	52030	2" x 3"	25/50
32035	52035	2" x 3-1/2"	25/50
32040	52040	2" x 4"	25/50
32045	52045	2" x 4-1/2"	25/50
32050	52050	2" x 5"	25/50
32055	52055	2" x 5-1/2"	25/50
32060	52060	2" x 6"	25/50
32065	—	2" x 6-1/2"	20/20
32070	52070	2" x 7"	20/20
32075	—	2" x 7-1/2"	20/20
32080	52080	2" x 8"	20/20
32090	52090	2" x 9"	20/20
32500	52500	2-1/2" x Close	20/40
32510	52510	2-1/2" x 10"	10/10
32511	52511	2-1/2" x 11"	10/10
32512	52512	2-1/2" x 12"	10/10
32514	—	2-1/2" x 14"	3/6
32530	52530	2-1/2" x 3"	20/40

Pipe Nipples (cont.)

BLACK PART #	GALV. PART #	SIZE	CTN/MSTR
32535	52535	2-1/2" x 3-1/2"	30/30
32540	52540	2-1/2" x 4"	30/30
32545	52545	2-1/2" x 4-1/2"	30/30
32550	52550	2-1/2" x 5"	20/20
32555	52555	2-1/2" x 5-1/2"	20/20
32560	52560	2-1/2" x 6"	20/20
32565	—	2-1/2" x 6-1/2"	20/20
32570	52570	2-1/2" x 7"	20/20
32580	52580	2-1/2" x 8"	10/10
32590	52590	2-1/2" x 9"	10/10
33000	53000	3" x Close	30/30
33010	53010	3" x 10"	5/5
33011	53011	3" x 11"	5/5
33012	53012	3" x 12"	5/5
33030	53030	3" x 3"	20/20
33035	53035	3" x 3-1/2"	15/15
33040	53040	3" x 4"	15/15
33045	53045	3" x 4-1/2"	15/15
33050	53050	3" x 5"	15/15
33055	53055	3" x 5-1/2"	15/15
33060	53060	3" x 6"	10/10
33070	53070	3" x 7"	7/7
33080	53080	3" x 8"	7/7
33090	53090	3" x 9"	7/7
33500	—	3-1/2" x Close	20/20
33540	—	3-1/2" x 4"	10/10
33550	53550	3-1/2" x 5"	8/8
33555	—	3-1/2" x 5-1/2"	8/8
33580	—	3-1/2" x 8"	6/6
34000	54000	4" x Close	20/20
34010	54010	4" x 10"	4/4
34011	54011	4" x 11"	4/4
34012	54012	4" x 12"	4/4
34014	—	4" x 14"	2/2
34035	54035	4" x 3-1/2"	10/10
34040	54040	4" x 4"	10/10
34045	54045	4" x 4-1/2"	8/8
34050	54050	4" x 5"	8/8
34055	54055	4" x 5-1/2"	8/8
34060	54060	4" x 6"	8/8
34070	54070	4" x 7"	4/4
34080	54080	4" x 8"	4/4
34090	54090	4" x 9"	4/4
35000	—	5" x Close	1/4
35045	—	5" x 4-1/2"	1/5
35050	—	5" x 5"	1/4
35055	—	5" x 5-1/2"	1/5
35060	—	5" x 6"	1/4
35070	—	5" x 7"	1/4
35080	—	5" x 8"	1/4
36000	56000	6" x Close	1/4
36010	56010	6" x 10"	1/3
36011	56011	6" x 11"	1/3
36012	56012	6" x 12"	3/3
36045	56045	6" x 4-1/2"	1/2
—	56050	6" x 5"	1/5
36055	56055	6" x 5-1/2"	1/2
36060	56060	6" x 6"	1/2

BG

Pipe Nipples (cont.)

BLACK PART #	GALV. PART #	SIZE	CTN/MSTR
36070	56070	6" x 7"	1/4
36080	56080	6" x 8"	1/4
36090	56090	6" x 9"	1/4
31210TOE	—	1-1/4" x 10"	20/40
31212TOE	—	1-1/4" x 12"	10/30

XHY Pipe Nipple

BLACK PART #	GALV. PART #	SIZE	CTN QTY
40300	—	3/8" x Close	1/400
40500	—	1/2" x Close	1/400
40700	—	3/4" x Close	1/400
41000	—	1" x Close	1/200
41200	—	1-1/4" x Close	1/100
42000	—	2" x Close	1/50

Installation Kit

BLACK PART #	GALV. PART #	SIZE	CTN/MSTR
BI05	GI05	1/2"	1/1
BI07	GI07	3/4"	1/1
BI10	GI10	1"	1/1
BI12	GI12	1-1/4"	1/1
BI15	GI15	1-1/2"	1/1
BI20	GI20	2"	1/1

Ever Ready Kit

BLACK PART #	GALV. PART #	SIZE	CTN/MSTR
ERB05	ERG05	1/2"	1/1
ERB07	ERG07	3/4"	1/1

C-Assort

BLACK PART #	GALV. PART #	SIZE	CTN/MSTR
CB05	CG05	1/2"	1/1
CB07	CG07	3/4"	1/1
CB10	CG10	1"	1/1
CB12	CG12	1-1/4"	1/1
CB15	—	1-1/2"	1/1

A-Assort

BLACK PART #	GALV. PART #	SIZE	CTN/MSTR
AB05	AG05	1/2"	1/1
AB07	AG07	3/4"	1/1
AB10	AG10	1"	1/1

6-Pack Assort

BLACK PART #	GALV. PART #	SIZE	CTN/MSTR
605B	605G	1/2"	1/1
607B	607G	3/4"	1/1
610B	610G	1"	1/1



Readycut Pipe



BLACK PART #	GALV. PART #	SIZE	CTN QTY	CTN/MSTR
—	301 G0118	1/8" x 18"	5	5/10
300 B0218	301 G0218	1/4" x 18"	5	5/10
300 B0224	301 G0224	1/4" x 24"	5	5/10
300 B0230	301 G0230	1/4" x 30"	5	5/10
300 B0236	301 G0236	1/4" x 36"	5	5/10
300 B0248	301 G0248	1/4" x 48"	5	5/10
300 B0260	301 G0260	1/4" x 60"	5	5/10
300 B0272	—	1/4" x 72"	5	5/10
300 B0318	301 G0318	3/8" x 18"	5	5/10
300 B0324	301 G0324	3/8" x 24"	5	5/10
300 B0330	301 G0330	3/8" x 30"	5	5/10
300 B0336	301 G0336	3/8" x 36"	5	5/10
300 B0348	301 G0348	3/8" x 48"	5	5/10
300 B0360	301 G0360	3/8" x 60"	5	5/10
300 B0372	301 G0372	3/8" x 72"	5	5/10
300 B0518	301 G0518	1/2" x 18"	5	5/10
300 B0524	301 G0524	1/2" x 24"	5	5/10
300 B0530	301 G0530	1/2" x 30"	5	5/10
300 B0536	301 G0536	1/2" x 36"	5	5/10
300 B0542	301 G0542	1/2" x 42"	5	5/10
300 B0548	301 G0548	1/2" x 48"	5	5/10
300 B0554	—	1/2" x 54"	5	5/10
300 B0560	301 G0560	1/2" x 60"	5	5/10
300 B0572	301 G0572	1/2" x 72"	5	5/10
300 B0718	301 G0718	3/4" x 18"	5	5/10
300 B0724	301 G0724	3/4" x 24"	5	5/10
300 B0730	301 G0730	3/4" x 30"	5	5/10
300 B0736	301 G0736	3/4" x 36"	5	5/10
300 B0742	301 G0742	3/4" x 42"	5	5/10
300 B0748	301 G0748	3/4" x 48"	5	5/10
300 B0754	301 G0754	3/4" x 54"	5	5/10
300 B0760	301 G0760	3/4" x 60"	5	5/10
300 B0772	301 G0772	3/4" x 72"	5	5/10
300 B1018	301 G1018	1" x 18"	5	5/10
300 B1024	301 G1024	1" x 24"	5	5/10
300 B1030	301 G1030	1" x 30"	5	5/10
300 B1036	301 G1036	1" x 36"	5	5/10
300 B1042	301 G1042	1" x 42"	5	5/10
300 B1048	301 G1048	1" x 48"	5	5/10
300 B1054	—	1" x 54"	5	5/10
300 B1060	301 G1060	1" x 60"	3	3/6
300 B1066	—	1" x 66"	3	3/6
300 B1072	301 G1072	1" x 72"	3	3/6
300 B1218	301 G1218	1-1/4" x 18"	3	3/6
—	301 G1220	1-1/4" x 20"	3	3/6
300 B1224	301 G1224	1-1/4" x 24"	3	3/6
300 B1230	301 G1230	1-1/4" x 30"	3	3/6
300 B1236	301 G1236	1-1/4" x 36"	3	3/6
300 B1242	301 G1242	1-1/4" x 42"	3	3/6
300 B1248	301 G1248	1-1/4" x 48"	3	3/6

Readycut Pipe (cont.)

BLACK PART #	GALV. PART #	SIZE	CTN QTY	CTN/MSTR
300 B1254	—	1-1/4" x 54"	3	3/6
300 B1260	301 G1260	1-1/4" x 60"	3	3/6
300 B1272	301 G1272	1-1/4" x 72"	3	3/6
300 B1518	301 G1518	1-1/2" x 18"	3	3/6
300 B1524	301 G1524	1-1/2" x 24"	3	3/6
300 B1530	301 G1530	1-1/2" x 30"	3	3/6
300 B1536	301 G1536	1-1/2" x 36"	3	3/6
300 B1548	301 G1548	1-1/2" x 48"	3	3/6
300 B1560	301 G1560	1-1/2" x 60"	3	3/6
300 B1572	301 G1572	1-1/2" x 72"	3	3/6
300 B2018	301 G2018	2" x 18"	3	3/6
300 B2024	301 G2024	2" x 24"	3	3/6
300 B2030	301 G2030	2" x 30"	3	3/6
300 B2036	301 G2036	2" x 36"	3	3/6
300 B2042	—	2" x 42"	3	3/6
300 B2048	301 G2048	2" x 48"	3	3/6
300 B2060	301 G2060	2" x 60"	3	3/6
300 B2072	301 G2072	2" x 72"	3	3/6
32518	52518	2-1/2" x 18"	3	3/6
32520	—	2-1/2" x 20"	3	3/6
32524	52524	2-1/2" x 24"	3	3/6
300 B2530	—	2-1/2" x 30"	3	3/6
300 B2560	—	2-1/2" x 60"	3	3/6
33018	301 G3018	3" x 18"	2	2/4
300 B3024	301 G3024	3" x 24"	2	2/4
300 B3036	—	3" x 36"	2	2/4
300 B4018	301 G4018	4" x 18"	2	2/2
34024	54024	4" x 24"	2	2/2
—	301 G4048	4" x 48"	2	2/2
300 B4060	—	4" x 60"	2	2/2

BG

Standard Merchant Coupling



BLACK PART #	GALV. PART #	SIZE	CTN/MSTR
M301	M101	1/8"	100/600
M302	M102	1/4"	100/500
M303	M103	3/8"	100/300
M305	M105	1/2"	100/250
M307	M107	3/4"	50/150
M310	M110	1"	30/100
M312	M112	1-1/4"	25/70
M315	M115	1-1/2"	25/60
M320	M120	2"	20/40
M325	M125	2-1/2"	10/20
M330	M130	3"	10/10
M340	M140	4"	10/5

Standard Merchant Half Coupling



BLACK PART #	SIZE	CTN/MSTR
H305	1/2"	1/500
H307	3/4"	1/300
H310	1"	1/200
H312	1-1/4"	1/140
H320	2"	1/80

BG

COPPER FITTINGS

Wrot/ACR Solder Fittings	365-372
Forged Brass/Cast Pressure Fittings	373-374
Wrot DWV Solder Fittings.....	375-376
Cast DWV Solder Fittings.....	377-379
Cast Brass Flanges	380

Wrot Male Adapter

C x M



PART #	ALT #	SIZE	CTN/MSTR
C75311	K151010001	1/8"	25/3000
C75312	K151010002	1/4"	25/1600
C75313	K151010025	3/8"	25/1000
C75314	K151010050	1/2"	25/600
C75315	K151010100	3/4"	25/250
C75316	K151010150	1"	10/150
C75317	K151010215	1-1/4"	110/110
C75318	K151010295	1-1/2"	65/65
C75319	K151010390	2"	38/38
C75320	K151010520	2-1/2"	48/48
C75321	K151010650	3"	36/36
C75322	K151010860	4"	12/12
C75323	K151010024	1/8" x 1/4"	25/2000
C75324	K151010007	1/4" x 1/8"	25/2000
C75325	K151010006	1/4" x 3/8"	25/750
C75326	K151010005	1/4" x 1/2"	25/600
C75327	K151010032	3/8" x 1/4"	25/750
C75328	K151010031	3/8" x 1/2"	25/500
C75329	K151010059	1/2" x 1/4"	25/1000
C75330	K151010058	1/2" x 3/8"	25/800
C75331	K151010057	1/2" x 3/4"	25/250
C75332	K151010056	1/2" x 1"	10/150
C75334	K151010092	5/8" x 3/4"	25/250
C75335	K151010107	3/4" x 1/2"	25/250
C75336	K151010106	3/4" x 1"	10/150
C75337	K151010160	1" x 1/2"	10/180
C75338	K151010159	1" x 3/4"	10/150
C75339	K151010158	1" x 1-1/4"	85/85
C75340	K151010157	1" x 1-1/2"	65/65
C75341	K151010223	1-1/4" x 3/4"	130/130
C75342	K151010222	1-1/4" x 1"	120/120
C75343	K151010221	1-1/4" x 1-1/2"	90/90
C75345	K151010304	1-1/2" x 1"	120/120
C75346	K151010303	1-1/2" x 1-1/4"	60/60
C75347	K151010302	1-1/2" x 2"	50/50
C75348	K151010399	2" x 1-1/4"	48/48
C75349	K151010398	2" x 1-1/2"	48/48
C75350	K151010531	2-1/2" x 2"	36/36

Wrot Female Adapter

C x F



PART #	ALT #	SIZE	CTN/MSTR
C75111	K151050001	1/8"	25/1500
C75112	K151050002	1/4"	25/1000
C75113	K151050025	3/8"	25/800
C75114	K151050050	1/2"	25/450
C75115	K151050100	3/4"	25/200
C75116	K151050150	1"	10/140
C75117	K151050215	1-1/4"	80/80
C75118	K151050295	1-1/2"	60/60
C75119	K151050390	2"	36/36
C75120	K151050520	2-1/2"	48/48
C75121	K151050650	3"	30/30
C75122	K151050024	1/8" x 1/4"	25/1000
C75123	K151050006	1/4" x 3/8"	25/900
C75124	K151050032	3/8" x 1/4"	25/750
C75125	K151050031	3/8" x 1/2"	25/500
C75126	K151050060	1/2" x 1/8"	25/500
C75127	K151050059	1/2" x 1/4"	25/500
C75128	K151050058	1/2" x 3/8"	25/800
C75129	K151050057	1/2" x 3/4"	25/300
C75130	K151050056	1/2" x 1"	10/160
C75131	K151050093	5/8" x 1/2"	25/300
C75132	K151050092	5/8" x 3/4"	25/250
C75133	K151050107	3/4" x 1/2"	25/300
C75134	K151050106	3/4" x 1"	10/140
C75135	K151050160	1" x 1/2"	10/150
C75136	K151050159	1" x 3/4"	10/150
C75137	K151050158	1" x 1-1/4"	85/85
C75138	K151050223	1-1/4" x 3/4"	120/120
C75139	K151050222	1-1/4" x 1"	120/120
C75140	K151050221	1-1/4" x 1-1/2"	65/65
C75141	K151050303	1-1/2" x 1-1/4"	70/70
C75142	K151050302	1-1/2" x 2"	60/60
C75494	K151050398	2" x 1-1/2"	40/40

Wrot Fitting Male Adapter

Ftg x M



PART #	ALT #	SIZE	CTN/MSTR
C75352	K151140025	3/8"	25/800
C75353	K151140050	1/2"	25/500
C75354	K151140057	1/2" x 3/4"	25/250
C75355	K151140100	3/4"	25/250
C75356	K151140150	1"	10/130
C75357	K151140215	1-1/4"	80/80
C75358	K151140295	1-1/2"	50/50
C75359	K151140390	2"	38/38

CF

Wrot Fitting Female Adapter

Ftg x F



PART #	ALT #	SIZE	CTN/MSTR
C75392	K151150002	1/4"	25/1500
C75394	K151150050	1/2"	25/500
C75395	K151150100	3/4"	25/250
C75396	K151150150	1"	10/140
C75397	K151150215	1-1/4"	85/85
C75398	K151150295	1-1/2"	80/80
C75399	K151150390	2"	40/40
C75400	K151150058	1/2" x 3/8"	25/700
C75401	K151150057	1/2" x 3/4"	25/300

Wrot Flush Bushing

Ftg x F



PART #	ALT #	SIZE	CTN/MSTR
C75375	K151420060	1/2" x 1/8"	25/1500

Wrot Coupling (Socket) with Rolled Tube Stop

C x C



PART #	ALT #	SIZE	CTN/MSTR
C75000	K151650001	1/8"	25/3000
C75001	K151650002	1/4"	25/2000
C75566	K151650015	5/16" OD	25/3000
C75002	K151650025	3/8"	25/1200
C75003	K151650050	1/2"	25/800
C75004	K151650090	5/8"	25/400
C75005	K151650100	3/4"	25/300
C75006	K151650150	1"	10/150
C75007	K151650215	1-1/4"	100/100
C75008	K151650295	1-1/2"	60/60
C75009	K151650390	2"	40/40
C75010	K151650520	2-1/2"	50/50
C75011	K151650650	3"	30/30
C75012	K151650780	3-1/2"	18/18
C75013	K151650860	4"	20/20
C75477	K151651100	6"	3/3
C75478	K151651225	8"	1/1

Wrot Reducing Coupling

C x C



PART #	ALT #	SIZE	CTN/MSTR
C75069	K151650007	1/4" x 1/8"	25/2000
C75516	K151650008	1/4" OD x 3/16" OD	25/2000
C75070	K151650033	3/8" x 1/8"	25/800
C75071	K151650032	3/8" x 1/4"	25/800
C75073	K151650059	1/2" x 1/4"	25/800
C75074	K151650058	1/2" x 3/8"	25/800
C75075	K151650095	5/8" x 1/4"	25/500
C75076	K151650094	5/8" x 3/8"	25/500
C75077	K151650093	5/8" x 1/2"	25/500
C75078	K151650109	3/4" x 1/4"	25/400
C75079	K151650108	3/4" x 3/8"	25/400
C75080	K151650107	3/4" x 1/2"	25/350
C75081	K151650149	3/4" x 5/8"	25/350
C75517	K151650161	1" x 3/8"	10/200
C75082	K151650160	1" x 1/2"	10/200
C75083	K151651498	1" x 5/8"	10/180
C75084	K151650159	1" x 3/4"	10/160
C75085	K151650224	1-1/4" x 1/2"	100/100
C75086	K151650223	1-1/4" x 3/4"	100/100
C75087	K151650222	1-1/4" x 1"	100/100
C75088	K151650306	1-1/2" x 1/2"	100/100
C75089	K151650305	1-1/2" x 3/4"	100/100
C75090	K151650304	1-1/2" x 1"	100/100
C75091	K151650303	1-1/2" x 1-1/4"	100/100
C75092	K151650402	2" x 1/2"	50/50
C75093	K151650401	2" x 3/4"	50/50
C75094	K151650400	2" x 1"	50/50
C75095	K151650399	2" x 1-1/4"	50/50
C75096	K151650398	2" x 1-1/2"	50/50
C75097	K151650534	2-1/2" x 1"	30/30
C75098	K151650533	2-1/2" x 1-1/4"	30/30
C75099	K151650532	2-1/2" x 1-1/2"	30/30
C75100	K151650531	2-1/2" x 2"	30/30
C75101	K151650664	3" x 1-1/2"	20/20
C75102	K151650663	3" x 2"	20/20
C75103	K151650662	3" x 2-1/2"	15/15
C75104	K151650874	4" x 1-1/4"	20/20
C75105	K151650873	4" x 1-1/2"	20/20
C75106	K151650872	4" x 2"	18/18
C75107	K151650871	4" x 2-1/2"	18/18
C75108	K151650870	4" x 3"	18/18
C75109	K151651111	6" x 3"	4/4
C75110	K151651109	6" x 4"	4/4

CF

Wrot Coupling (Socket) with Dimple Tube Stop

C x C

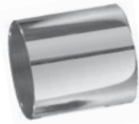

PART #	ALT #	SIZE	CTN/MSTR
C75550	K151700001	1/8"	25/3000
C75551	K151700002	1/4"	25/2000
C75553	K151700025	3/8"	25/1200
C75554	K151700050	1/2"	25/800
C75555	K151700090	5/8"	25/400
C75556	K151700100	3/4"	25/300
C75557	K151700150	1"	10/150
C75558	K151700215	1-1/4"	100/100
C75559	K151700295	1-1/2"	60/60
C75580	K151700390	2"	40/40
C75581	K151700520	2-1/2"	50/50
C75582	K151700650	3"	30/30
C75583	K151700780	3-1/2"	25/25
C75564	K151700860	4"	12/12
C75565	K151700975	5"	6/6
C75586	K151701100	6"	3/3

Wrot Coupling (Socket) less Tube Stop

C x C

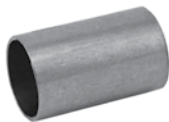

PART #	ALT #	SIZE	CTN/MSTR
C75412	K151720001	1/8"	25/3000
C75413	K151720002	1/4"	25/2000
C75414	K151720025	3/8"	25/1200
C75415	K151720050	1/2"	25/800
C75519	K151720090	5/8"	25/400
C75416	K151720100	3/4"	25/300
C75417	K151720150	1"	10/150
C75418	K151720215	1-1/4"	100/100
C75419	K151720295	1-1/2"	60/60
C75420	K151720390	2"	40/40
C75421	K151720520	2-1/2"	50/50
C75422	K151720650	3"	30/30
C75423	K151720860	4"	12/12
C75424	K151720975	5"	6/6

Wrot Crossover Coupling

C x C



PART #	ALT #	SIZE	CTN/MSTR
C75548	K151670050	1/2"	180/180

Wrot Cap



PART #	ALT #	SIZE	CTN/MSTR
C75055	K151540001	1/8"	25/3300
C75056	K151540002	1/4"	25/3000
C75057	K151540025	3/8"	25/2500
C75058	K151540050	1/2"	25/1400
C75059	K151540090	5/8"	25/850
C75060	K151540100	3/4"	25/500
C75061	K151540150	1"	10/300
C75062	K151540215	1-1/4"	200/200
C75063	K151540295	1-1/2"	140/140
C75064	K151540390	2"	60/60
C75065	K151540520	2-1/2"	30/30
C75066	K151540650	3"	20/20
C75067	K151540860	4"	25/25
C75068	K151541100	6"	5/5

Wrot 90° Short Turn Elbow

C x C



PART #	ALT #	SIZE	CTN/MSTR
C75014	K152350001	1/8"	25/3000
C75015	K152350002	1/4"	25/1200
C75016	K152350025	3/8"	25/1000
C75030	K152350032	3/8" x 1/4"	25/800
C75017	K152350050	1/2"	25/500
C75031	K152350059	1/2" x 1/4"	25/500
C75018	K152350090	5/8"	25/300
C75520	K152350093	5/8" x 1/2"	25/300
C75019	K152350100	3/4"	25/200
C75033	K152350107	3/4" x 1/2"	25/200
C75020	K152350150	1"	10/100
C75034	K152350160	1" x 1/2"	10/80
C75035	K152350159	1" x 3/4"	10/80
C75021	K152350215	1-1/4"	50/50
C75522	K152350223	1-1/4" x 3/4"	50/50
C75036	K152350222	1-1/4" x 1"	50/50
C75022	K152350295	1-1/2"	35/35
C75037	K152350303	1-1/2" x 1-1/4"	35/35
C75023	K152350390	2"	17/17
C75038	K152350398	2" x 1-1/2"	17/17
C75024	K152350520	2-1/2"	20/20
C75025	K152350650	3"	13/13
C75523	K152350780	3-1/2"	7/7
C75026	K152350860	4"	6/6
C75027	K152350975	5"	2/2
C75028	K152351100	6"	1/1
C75029	K152351225	8"	1/1

CF

Wrot 90° Long Turn Elbow

C x C



PART #	ALT #	SIZE	CTN/MSTR
C75481	K152420001	1/8"	25/2000
C75482	K152420002	1/4"	25/1200
C75540	K152420015	5/16" OD	25/1600
C75483	K152420025	3/8"	25/750
C75484	K152420050	1/2"	25/350
C75485	K152420090	5/8"	25/200
C75486	K152420100	3/4"	10/120
C75487	K152420150	1"	10/60
C75488	K152420215	1-1/4"	35/35
C75489	K152420295	1-1/2"	25/25
C75490	K152420390	2"	12/12
C75491	K152420520	2-1/2"	16/16
C75492	K152420650	3"	8/8
C75544	K152420860	4"	4/4

Wrot 90° Short Turn Street Elbow

Ftg x C



PART #	ALT #	SIZE	CTN/MSTR
C75377	K152540002	1/4"	25/1200
C75378	K152540025	3/8"	25/1000
C75379	K152540050	1/2"	25/500
C75380	K152540090	5/8"	25/300
C75381	K152540100	3/4"	25/200
C75382	K152540150	1"	10/100
C75383	K152540215	1-1/4"	50/50
C75384	K152540295	1-1/2"	35/35
C75385	K152540390	2"	17/17
C75386	K152540520	2-1/2"	20/20
C75387	K152540650	3"	13/13
C75388	K152540860	4"	25/1200

CF

Wrot 90° Short Turn Street Elbow

Ftg x Ftg



PART #	ALT #	SIZE	CTN/MSTR
C75535	K152670050	1/2"	25/500
C75536	K152670100	3/4"	25/250
C75537	K152670215	1-1/4"	35/35

Wrot 90° Long Turn Street Elbow

Ftg x C



PART #	ALT #	SIZE	CTN/MSTR
C75403	K152720002	1/4"	25/1200
C75404	K152720025	3/8"	25/750
C75405	K152720050	1/2"	25/350
C75406	K152720090	5/8"	25/200
C75407	K152720100	3/4"	10/120
C75408	K152720150	1"	10/60
C75409	K152720215	1-1/4"	35/35
C75410	K152720295	1-1/2"	25/25
C75411	K152720390	2"	12/12
C75479	K152720520	2-1/2"	16/16
C75546	K152720860	4"	6/6

Wrot 45° Elbow

C x C



PART #	ALT #	SIZE	CTN/MSTR
C75039	K152900001	1/8"	25/2000
C75040	K152900002	1/4"	25/2000
C75041	K152900025	3/8"	25/800
C75042	K152900050	1/2"	25/500
C75043	K152900090	5/8"	25/300
C75044	K152900100	3/4"	25/200
C75045	K152900150	1"	10/100
C75046	K152900215	1-1/4"	60/60
C75047	K152900295	1-1/2"	40/40
C75048	K152900390	2"	18/18
C75049	K152900520	2-1/2"	20/20
C75050	K152900650	3"	15/15
C75051	K152900860	4"	6/6
C75052	K152900975	5"	4/4
C75053	K152901100	6"	2/2

Wrot 45° Street Elbow

Ftg x C



PART #	ALT #	SIZE	CTNMSTR
C75463	K152950002	1/4"	25/2000
C75464	K152950025	3/8"	25/800
C75465	K152950050	1/2"	25/500
C75466	K152950090	5/8"	25/300
C75467	K152950100	3/4"	25/200
C75468	K152950150	1"	10/100
C75469	K152950215	1-1/4"	60/60
C75470	K152950295	1-1/2"	40/40
C75471	K152950390	2"	18/18
C75472	K152950520	2-1/2"	20/20
C75473	K152950650	3"	15/15
C75474	K152950860	4"	6/6

Wrot Flush Bushing

Ftg x C



PART #	ALT #	SIZE	CTNMSTR
C75360	K151400007	1/4" x 1/8"	25/3300
C75361	K151400032	3/8" x 1/4"	25/2500
C75363	K151400058	1/2" x 3/8"	25/1500
C75362	K151400059	1/2" x 1/4"	25/1500
C75568	K151400108	3/4" x 3/8"	25/700
C75366	K151400107	3/4" x 1/2"	25/700
C75367	K151400149	3/4" x 5/8"	25/500
C75368	K151400160	1" x 1/2"	10/320
C75370	K151400159	1" x 3/4"	10/300
C75371	K151400223	1-1/4" x 3/4"	200/200
C75372	K151400222	1-1/4" x 1"	200/200
C75373	K151400303	1-1/2" x 1-1/4"	140/140
C75374	K151400398	2" x 1-1/2"	60/60

Wrot Fitting Plug



PART #	ALT #	SIZE	CTNMSTR
C75525	K153960050	1/2"	25/1400
C75527	K153960150	1"	10/300

Wrot Suction Line P-Trap

C x C



PART #	SIZE	CTNMSTR
K155330050	1/2"	5/60
K155330090	5/8"	5/60
K155330100	3/4"	40/40
K155330150	1"	3/15
K155330215	1-1/4"	2/10
K155330295	1-1/2"	2/6
K155330390	2"	1/4

CF

Wrot Fitting Reducer

Ftg x C



PART #	ALT #	SIZE	CTN/MSTR
C75425	K154100007	1/4" x 1/8"	25/3300
C75427	K154100032	3/8" x 1/4"	25/1200
C75428	K154100059	1/2" x 1/4"	25/1000
C75429	K154100058	1/2" x 3/8"	25/1000
C75430	K154100094	5/8" x 3/8"	25/500
C75431	K154100093	5/8" x 1/2"	25/500
C75432	K154100109	3/4" x 1/4"	25/400
C75433	K154100108	3/4" x 3/8"	25/400
C75434	K154100107	3/4" x 1/2"	25/400
C75435	K154100149	3/4" x 5/8"	25/400
C75437	K154100160	1" x 1/2"	10/200
C75438	K154101498	1" x 5/8"	10/200
C75439	K154100159	1" x 3/4"	10/160
C75440	K154100224	1-1/4" x 1/2"	100/100
C75441	K154100223	1-1/4" x 3/4"	100/100
C75442	K154100222	1-1/4" x 1"	100/100
C75443	K154100306	1-1/2" x 1/2"	100/100
C75444	K154100305	1-1/2" x 3/4"	100/100
C75445	K154100304	1-1/2" x 1"	100/100
C75446	K154100303	1-1/2" x 1-1/4"	100/100
C75447	K154100402	2" x 1/2"	50/50
C75448	K154100401	2" x 3/4"	50/50
C75449	K154100400	2" x 1"	50/50
C75450	K154100399	2" x 1-1/4"	50/50
C75451	K154100398	2" x 1-1/2"	50/50
C75452	K154100534	2-1/2" x 1"	30/30
C75453	K154100533	2-1/2" x 1-1/4"	30/30
C75454	K154100532	2-1/2" x 1-1/2"	30/30
C75455	K154100531	2-1/2" x 2"	30/30
C75456	K154100665	3" x 1-1/4"	20/20
C75457	K154100664	3" x 1-1/2"	20/20
C75458	K154100663	3" x 2"	20/20
C75459	K154100662	3" x 2-1/2"	15/15
C75460	K154100872	4" x 2"	18/18
C75461	K154100871	4" x 2-1/2"	18/18
C75462	K154100870	4" x 3"	18/18
C75562	K154100869	4" x 3-1/2"	15/15
C75563	K154100983	5" x 4"	12/12

Union

C x C



PART #	ALT #	SIZE	CTN/MSTR
C75502	K156570050	1/2"	25/200
C75503	K156570100	3/4"	25/100
C75504	K156570150	1"	10/70
C75505	K126570215	1-1/4"	50/50
C75506	K126570295	1-1/2"	30/30
C75507	K126570390	2"	18/18
C75508	K126570520	2-1/2"	8/8
C75509	K126570650	3"	6/6

U-Type Strap



PART #	SIZE	CTN/MSTR
K159470001	1/8"	25/2000
K159470002	1/4"	25/1500
K159470025	3/8"	25/1300
K159470050	1/2"	25/1000
K159470090	5/8"	25/500
K159470100	3/4"	25/600
K159470150	1"	10/350
K159470215	1-1/4"	1/350
K159470295	1-1/2"	300/300
K159470390	2"	300/300

CF

Wrot Tee

C x C x C



PART #	ALT #	SIZE	CTN/MSTR
C75143	K154600001	1/8"	25/2000
C75144	K154600002	1/4"	25/1300
C75162	K154600007	1/4" x 1/4" x 1/8"	25/1300
C75163	K154600006	1/4" x 1/4" x 3/8"	25/1300
C75160	K154600013	1/4" x 1/8" x 1/8"	25/1500
C75161	K154600012	1/4" x 1/8" x 1/4"	25/1300
C75145	K154600025	3/8"	25/600
C75166	K154600041	3/8" x 1/4" x 1/4"	25/500
C75167	K154600033	3/8" x 3/8" x 1/8"	25/600
C75168	K154600032	3/8" x 3/8" x 1/4"	25/600
C75169	K154600031	3/8" x 3/8" x 1/2"	25/350
C75146	K154600050	1/2"	50/500
C75170	K154600075	1/2" x 1/4" x 1/2"	25/400
C75171	K154600068	1/2" x 3/8" x 1/4"	25/400
C75173	K154600066	1/2" x 3/8" x 1/2"	25/350
C75174	K154600060	1/2" x 1/2" x 1/8"	25/400
C75175	K154600059	1/2" x 1/2" x 1/4"	25/400
C75176	K154600058	1/2" x 1/2" x 3/8"	25/400
C75570	K154600087	1/2" x 1/2" x 5/8"	10/180
C75177	K154600057	1/2" x 1/2" x 3/4"	10/180
C75178	K154600056	1/2" x 1/2" x 1"	10/70
C75147	K154600090	5/8"	25/200
C75571	K154600095	5/8" x 5/8" x 1/4"	25/200
C75181	K154600092	5/8" x 5/8" x 3/4"	25/200
C75148	K154600100	3/4"	20/160
C75572	K154600127	3/4" x 3/8" x 1/2"	10/170
C75182	K154600118	3/4" x 1/2" x 1/2"	10/180
C75183	K154600117	3/4" x 1/2" x 3/4"	10/120
C75184	K154600109	3/4" x 3/4" x 1/4"	10/170
C75185	K154600108	3/4" x 3/4" x 3/8"	10/170
C75186	K154600107	3/4" x 3/4" x 1/2"	10/170
C75188	K154600106	3/4" x 3/4" x 1"	10/80
C75149	K154600150	1"	10/60
C75195	K154600161	1" x 1" x 3/8"	10/100
C75196	K154600160	1" x 1" x 1/2"	10/100
C75198	K154600159	1" x 1" x 3/4"	10/60
C75199	K154600158	1" x 1" x 1-1/4"	35/35
C75200	K154600157	1" x 1" x 1-1/2"	25/25
C75192	K154600171	1" x 3/4" x 1/2"	10/60
C75193	K154600170	1" x 3/4" x 3/4"	10/60
C75194	K154600169	1" x 3/4" x 1"	10/60
C75189	K154600182	1" x 1/2" x 1/2"	10/100
C75190	K154600181	1" x 1/2" x 3/4"	10/80
C75191	K154600180	1" x 1/2" x 1"	10/60
C75197	K154601498	1" x 1" x 5/8"	10/70
C75150	K154600215	1-1/4"	35/35
C75202	K154600256	1-1/4" x 1/2" x 1-1/4"	35/35
C75203	K154600248	1-1/4" x 3/4" x 1/2"	50/50
C75204	K154600247	1-1/4" x 3/4" x 3/4"	50/50
C75205	K154600246	1-1/4" x 3/4" x 1"	45/45

PART #	ALT #	SIZE	CTN/MSTR
C75206	K154600245	1-1/4" x 3/4" x 1-1/4"	35/35
C75207	K154600237	1-1/4" x 1" x 1/2"	60/60
C75208	K154600236	1-1/4" x 1" x 3/4"	50/50
C75209	K154600235	1-1/4" x 1" x 1"	50/50
C75210	K154600234	1-1/4" x 1" x 1-1/4"	30/30
C75211	K154600224	1-1/4" x 1-1/4" x 1/2"	50/50
C75212	K154600223	1-1/4" x 1-1/4" x 3/4"	50/50
C75213	K154600222	1-1/4" x 1-1/4" x 1"	40/40
C75214	K154600221	1-1/4" x 1-1/4" x 1-1/2"	20/20
C75215	K154600220	1-1/4" x 1-1/4" x 2"	10/10
C75151	K154600295	1-1/2"	20/20
C75233	K154600306	1-1/2" x 1-1/2" x 1/2"	40/40
C75234	K154600305	1-1/2" x 1-1/2" x 3/4"	35/35
C75235	K154600304	1-1/2" x 1-1/2" x 1"	35/35
C75236	K154600303	1-1/2" x 1-1/2" x 1-1/4"	25/25
C75237	K154600302	1-1/2" x 1-1/2" x 2"	10/10
C75228	K154600319	1-1/2" x 1-1/4" x 1/2"	10/40
C75229	K154600318	1-1/2" x 1-1/4" x 3/4"	40/40
C75230	K154600317	1-1/2" x 1-1/4" x 1"	30/30
C75231	K154600316	1-1/2" x 1-1/4" x 1-1/4"	30/30
C75232	K154600315	1-1/2" x 1-1/4" x 1-1/2"	20/20
C75223	K154600332	1-1/2" x 1" x 1/2"	40/40
C75225	K154600331	1-1/2" x 1" x 3/4"	40/40
C75224	K154600330	1-1/2" x 1" x 1"	35/35
C75226	K154600329	1-1/2" x 1" x 1-1/4"	30/30
C75227	K154600328	1-1/2" x 1" x 1-1/2"	20/20
C75218	K154600343	1-1/2" x 3/4" x 1/2"	40/40
C75219	K154600342	1-1/2" x 3/4" x 3/4"	30/30
C75220	K154600341	1-1/2" x 3/4" x 1"	40/40
C75221	K154600340	1-1/2" x 3/4" x 1-1/4"	30/30
C75222	K154600339	1-1/2" x 3/4" x 1-1/2"	20/20
C75216	K154600352	1-1/2" x 1/2" x 1"	40/40
C75217	K154600350	1-1/2" x 1/2" x 1-1/2"	20/20
C75152	K154600390	2"	10/10
C75254	K154600402	2" x 2" x 1/2"	20/20
C75255	K154600401	2" x 2" x 3/4"	20/20
C75256	K154600400	2" x 2" x 1"	18/18
C75257	K154600399	2" x 2" x 1-1/4"	15/15
C75258	K154600398	2" x 2" x 1-1/2"	10/10
C75259	K154600397	2" x 2" x 2-1/2"	15/15
C75248	K154600418	2" x 1-1/2" x 1/2"	20/20
C75249	K154600417	2" x 1-1/2" x 3/4"	20/20
C75250	K154600416	2" x 1-1/2" x 1"	20/20
C75251	K154600415	2" x 1-1/2" x 1-1/4"	10/10
C75252	K154600414	2" x 1-1/2" x 1-1/2"	15/15
C75253	K154600413	2" x 1-1/2" x 2"	10/10
C75243	K154600433	2" x 1-1/4" x 3/4"	20/20
C75244	K154600432	2" x 1-1/4" x 1"	20/20
C75245	K154600431	2" x 1-1/4" x 1-1/4"	15/15
C75246	K154600430	2" x 1-1/4" x 1-1/2"	15/15
C75247	K154600429	2" x 1-1/4" x 2"	10/10
C75240	K154600447	2" x 1" x 1"	20/20
C75242	K154600444	2" x 1" x 2"	15/15
C75238	K154600470	2" x 1/2" x 2"	15/15
C75239	K154600457	2" x 3/4" x 2"	10/10
C75153	K154600520	2-1/2"	15/15
C75260	K154600608	2-1/2" x 3/4" x 2-1/2"	15/15

CF

PART #	ALT #	SIZE	CTN/MSTR
C75261	K154600595	2-1/2" x 1" x 2-1/2"	15/15
C75262	K154600583	2-1/2" x 1-1/4" x 1-1/4"	20/20
C75263	K154600580	2-1/2" x 1-1/4" x 2-1/2"	15/15
C75573	K154600566	2-1/2" x 1-1/2" x 1-1/2"	10/10
C75574	K154600565	2-1/2" x 1-1/2" x 2"	15/15
C75264	K154600564	2-1/2" x 1-1/2" x 2-1/2"	15/15
C75265	K154600554	2-1/2" x 2" x 1/2"	20/20
C75266	K154600553	2-1/2" x 2" x 3/4"	20/20
C75267	K154600552	2-1/2" x 2" x 1"	20/20
C75268	K154600551	2-1/2" x 2" x 1-1/4"	20/20
C75269	K154600550	2-1/2" x 2" x 1-1/2"	20/20
C75270	K154600549	2-1/2" x 2" x 2"	15/15
C75271	K154600548	2-1/2" x 2" x 2-1/2"	15/15
C75272	K154600536	2-1/2" x 2-1/2" x 1/2"	25/25
C75273	K154600535	2-1/2" x 2-1/2" x 3/4"	25/25
C75274	K154600534	2-1/2" x 2-1/2" x 1"	25/25
C75275	K154600533	2-1/2" x 2-1/2" x 1-1/4"	20/20
C75276	K154600532	2-1/2" x 2-1/2" x 1-1/2"	20/20
C75277	K154600531	2-1/2" x 2-1/2" x 2"	15/15
C75154	K154600650	3"	10/10
C75575	K154600746	3" x 3/4" x 3"	10/10
C75281	K154600708	3" x 1-1/2" x 3"	8/8
C75282	K154600696	3" x 2" x 1-1/2"	10/10
C75283	K154600695	3" x 2" x 2"	15/15
C75285	K154600694	3" x 2" x 2-1/2"	10/10
C75286	K154600693	3" x 2" x 3"	10/10
C75576	K154600682	3" x 2-1/2" x 1"	25/25
C75288	K154600680	3" x 2-1/2" x 1-1/2"	15/15
C75289	K154600679	3" x 2-1/2" x 2"	15/15
C75290	K154600678	3" x 2-1/2" x 2-1/2"	10/10
C75291	K154600677	3" x 2-1/2" x 3"	10/10
C75292	K154600668	3" x 3" x 1/2"	10/10
C75293	K154600667	3" x 3" x 3/4"	20/20
C75294	K154600666	3" x 3" x 1"	20/20
C75295	K154600665	3" x 3" x 1-1/4"	15/15
C75296	K154600664	3" x 3" x 1-1/2"	15/15
C75297	K154600663	3" x 3" x 2"	13/13
C75298	K154600662	3" x 3" x 2-1/2"	10/10
C75155	K154600860	4"	5/5
C75299	K154600914	4" x 2" x 4"	4/4
C75300	K154600896	4" x 3" x 2-1/2"	5/5
C75301	K154600895	4" x 3" x 3"	5/5
C75302	K154600893	4" x 3" x 4"	5/5
C75303	K154600877	4" x 4" x 1/2"	5/5
C75304	K154600876	4" x 4" x 3/4"	8/8
C75305	K154600875	4" x 4" x 1"	8/8
C75306	K154600874	4" x 4" x 1-1/4"	8/8
C75307	K154600873	4" x 4" x 1-1/2"	8/8
C75308	K154600872	4" x 4" x 2"	6/6
C75309	K154600871	4" x 4" x 2-1/2"	5/5
C75310	K154600870	4" x 4" x 3"	5/5
C75156	K154600975	5"	2/2
C75157	K154601100	6"	1/1
C75577	K154601113	6" x 6" x 2"	2/2
C75578	K154601111	6" x 6" x 3"	2/2
C75579	K154601109	6" x 6" x 4"	2/2
C75158	K154601225	8"	1/1

CF

Brass Male Adapter

C x M



PART NO.	SIZE	CTN/MSTR
K101010050	1/2"	50/200
K101010100	3/4"	25/150
K101010105	3/4" x 1-1/4"	10/80
K101010295	1-1/2" cast	10/50
K101010390	2" cast	5/50

Brass Female Adapter

C x F



PART NO.	SIZE	CTN/MSTR
K101050100	3/4"	25/150
K101050157	1" x 1-1/2" cast	1/40
K101050215	1-1/4" cast	10/100
K101050390	2" cast	1/24

Brass Fitting Female Adapter

Ftg x F



PART NO.	SIZE	CTN/MSTR
K101150059	1/2" x 1/4"	50/500

Brass Drain Coupling with Cap

C x C



PART NO.	SIZE	CTN/MSTR
K101750100	3/4" cast	25/200

Brass 90° Flanged Sink Elbow

C x F



PART NO.	SIZE	CTN/MSTR
K102600050	1/2"	25/100

Brass 90° Hi-Ear Elbow

C x C



PART NO.	SIZE	CTN/MSTR
K142400050	1/2"	25/250
K142400100	3/4"	10/100

C x F



PART NO.	SIZE	CTN/MSTR
K102590050	1/2"	25/200
K102590058	1/2" x 3/8"	25/200

C x F



PART NO.	SIZE	CTN/MSTR
K142590050	1/2"	25/150
K142590100	3/4"	25/100

Brass 90° Elbow

C x M



PART NO.	SIZE	CTN/MSTR
K102550050	1/2"	50/200
K102550058	1/2" x 3/8"	50/250
K102550100	3/4"	25/150
K102550150	1"	10/80

C x F



PART NO.	SIZE	CTN/MSTR
K102570050	1/2"	50/250
K102570058	1/2" x 3/8"	25/250
K102570100	3/4"	25/100
K102570107	3/4" x 1/2"	25/200
K102570150	1"	10/50
K102570160	1" x 1/2"	10/100

CF

Brass Drop Tee

C x C x C



PART NO.	SIZE	CTN/MSTR
K104670050	1/2"	25/250

C x C x F



PART NO.	SIZE	CTN/MSTR
K104820050	1/2"	25/150

Brass Tee

C x C x F



PART NO.	SIZE	CTN/MSTR
K104800050	1/2"	25/200
K104800057	1/2" x 1/2" x 3/4"	25/200
K104800058	1/2" x 1/2" x 3/8"	25/200
K104800100	3/4"	10/100
K104800107	3/4" x 3/4" x 1/2"	25/100
K104800159	1" x 1" x 3/4"	10/80
K104800160	1" x 1" x 1/2"	10/100
K104800215	1-1/4" cast	1/50
K104800222	1-1/4" x 1-1/4" x 1" cast	1/25
K104800223	1-1/4" x 1-1/4" x 3/4"	10/50
K104800224	1-1/4" x 1-1/4" x 1/2"	10/50

C x F x C



PART NO.	SIZE	CTN/MSTR
K104920050	1/2"	25/300
K104920100	3/4"	10/100

CF

F x F x C



PART NO.	SIZE	CTN/MSTR
K104980118	3/4" x 1/2" x 1/2"	10/100

Brass Baseboard Tee

C x F x C



PART NO.	SIZE	CTN/MSTR
K104920143	3/4" x 1/8" x 3/4"	25/100

Brass Union

C x M



PART NO.	SIZE	CTN/MSTR
K126610050	1/2"	25/200
K126610100	3/4"	10/100
K126610150	1"	10/50
K126610215	1-1/4"	5/30
K126610295	1-1/2"	1/50
K126610390	2"	1/25

C x F



PART NO.	SIZE	CTN/MSTR
K126650050	1/2"	25/200
K126650100	3/4"	25/100
K126650150	1"	10/100
K126650215	1-1/4"	5/40
K126650295	1-1/2"	1/50

Wrot DWV Male Adapter

C x M



PART NO.	SIZE	CTN/MSTR
161010295	1-1/2"	10/100
161010390	2"	5/100

Wrot DWV Female Adapter

C x F



PART NO.	SIZE	CTN/MSTR
161050215	1-1/4"	150/150
161050295	1-1/2"	10/100
161050390	2"	10/100

Wrot DWV Test Cap



PART NO.	SIZE	CTN/MSTR
161570050	1/2"	1/1
161570100	3/4"	1/1
161570150	1"	400/400
161570215	1-1/4"	50/600
161570295	1-1/2"	50/600
161570390	2"	50/100
161570650	3"	25/200

Wrot DWV Tee

C x C x C



PART NO.	SIZE	CTN/MSTR
164600390	2"	16/16
164600398	2" x 1-1/2"	5/50

Wrot DWV Coupling with Stop

C x C



PART NO.	SIZE	CTN/MSTR
161650215	1-1/4"	25/250
161650295	1-1/2"	130/130
161650303	1-1/2" x 1-1/4"	25/300
161650390	2"	250/250
161650398	2" x 1-1/2"	10/100
161650399	2" x 1-1/4"	10/100
161650650	3"	80/80
161650663	3" x 2"	5/100
161650860	4"	36/36
161650872	4" x 2"	1/1

Wrot DWV Coupling less Stop

C x C



PART NO.	SIZE	CTN/MSTR
161720215	1-1/4"	25/200
161720295	1-1/2"	25/200
161720390	2"	100/100
161720650	3"	1/1

Wrot DWV 90° Elbow

C x C



PART NO.	SIZE	CTN/MSTR
162350215	1-1/4"	80/80
162350295	1-1/2"	40/40
162350390	2"	20/20

Wrot DWV 90° Long Turn Elbow

C x C



PART NO.	SIZE	CTN/MSTR
162420295	1-1/2"	1/1
162420390	2"	1/1

CF

Wrot DWV 90° Street Elbow

Ftg x C



PART NO.	SIZE	CTN/MSTR
162540215	1-1/4"	200/200
162540295	1-1/2"	50/50
162540390	2"	50/50

Wrot DWV 45° Elbow

C x C



PART NO.	SIZE	CTN/MSTR
162900215	1-1/4"	120/120
162900295	1-1/2"	60/60
162900390	2"	30/30
162900650	3"	2/2

Wrot DWV 45° Street Elbow

Ftg x C



PART NO.	SIZE	CTN/MSTR
162950215	1-1/4"	120/120
162950295	1-1/2"	60/60
162950390	2"	30/30

Wrot DWV Fitting Reducer

Ftg x C



PART NO.	SIZE	CTN/MSTR
164100303	1-1/2" x 1-1/4"	25/250
164100398	2" x 1-1/2"	10/100
164100399	2" x 1-1/4"	1/1
164100663	3" x 2"	1/50
164100664	3" x 1-1/2"	5/50

CF

Cast DWV Male Adapter

C x M



PART NO.	SIZE	CTN/MSTR
K201010215	1-1/4"	10/300
K201010295	1-1/2"	10/100
K201010390	2"	60/60
K201010650	3"	1/20

Cast DWV Female Adapter

C x F



PART NO.	SIZE	CTN/MSTR
K201050295	1-1/2"	10/150
K201050650	3"	1/25
K201050860	4"	1/20

Ftg x F



PART NO.	SIZE	CTN/MSTR
K201150295	1-1/2"	100/100

Cast DWV Soil Pipe Adapter

C x Spg



PART NO.	SIZE	CTN/MSTR
K201100390	2"	50/50

Cast DWV Trap Adapter

F x SJ



PART NO.	SIZE	CTN/MSTR
K201200295	1-1/2"	1/10

Cast DWV Cap



PART NO.	SIZE	CTN/MSTR
K201540295	1-1/2"	1/1

Cast DWV Fitting Cleanout

Ftg x Cleanout with Plug



PART NO.	SIZE	CTN/MSTR
K201610215	1-1/4"	120/120
K201610295	1-1/2"	1/100
K201610390	2"	60/60

Cast DWV Flush Fitting Cleanout

Ftg x Cleanout with Plug



PART NO.	SIZE	CTN/MSTR
K201620215	1-1/4"	25/25
K201620650	3"	25/25

Cast DWV 90° Elbow

C x C



PART NO.	SIZE	CTN/MSTR
K202350303	1-1/2" x 1-1/4"	75/75
K202350398	2" x 1-1/2"	25/25
K202350650	3"	10/10
K202350860	4"	1/1

CF

Cast DWV 90° Elbow

C x M



PART NO.	SIZE	CTN/MSTR
K202550295	1-1/2"	50/50

Cast DWV 90° Street Elbow

Ftg x C



PART NO.	SIZE	CTN/MSTR
K202540650	3"	1/1
K202540860	4"	1/10

Cast DWV 45° Elbow

C x C



PART NO.	SIZE	CTN/MSTR
K202900860	4"	1/1

Ftg x C



PART NO.	SIZE	CTN/MSTR
K202950650	3"	1/25

CF

Cast DWV 22-1/2° Elbow

C x C



PART NO.	SIZE	CTN/MSTR
K203100215	1-1/4"	1/25
K203100295	1-1/2"	1/1
K203100390	2"	1/50

Cast DWV Tee

C x C x C



PART NO.	SIZE	CTN/MSTR
K204600215	1-1/4"	50/50
K204600295	1-1/2"	60/60
K204600390	2"	25/25
K204600398	2" x 1-1/2"	40/40
K204600414	2" x 1-1/2" x 1-1/2"	50/50

C x C x F



PART NO.	SIZE	CTN/MSTR
K204800295	1-1/2"	60/60

Cast DWV Test Tee

C x C x Cleanout with Plug



PART NO.	SIZE	CTN/MSTR
K204850295	1-1/2"	1/50
K204850390	2"	1/25

Cast DWV Double Tee

C x C x C x C



PART NO.	SIZE	CTN/MSTR
K204650295	1-1/2"	25/25
K204650390	2"	1/25
K204650398	2" x 1-1/2"	1/1
K204650695	3" x 2"	1/15

Cast DWV Wye

C x C x C



PART NO.	SIZE	CTN/MSTR
K208400215	1-1/4"	1/1
K208400295	1-1/2"	1/50
K208400303	1-1/2" x 1-1/4"	1/1
K208400390	2"	1/25
K208400398	2" x 1-1/2"	1/50
K208400399	2" x 1-1/4"	1/50
K208400413	2" x 1-1/2" x 2"	1/50
K208400650	3"	1/1
K208400664	3" x 3" x 1-1/2"	1/1

Cast DWV Double Wye

C x C x C x C



PART NO.	SIZE	CTN/MSTR
K208450295	1-1/2"	1/50
K208450650	3"	1/10

Cast DWV Double Long Turn Tee-Wye

C x C x C x C



PART NO.	SIZE	CTN/MSTR
K205220390	2"	1/25

Cast DWV P-Trap

C x C



PART NO.	SIZE	CTN/MSTR
K245500295	1-1/2"	1/1
K245500390	2"	1/20

C x SJ



PART NO.	SIZE	CTN/MSTR
K245540295	1-1/2"	1/25

Cast DWV P-Trap with Cleanout

C x C x Cleanout with Plug



PART NO.	SIZE	CTN/MSTR
K245510215	1-1/4"	1/50
K245510295	1-1/2"	20/20
K245510390	2"	1/25

CF

125# Cast Brass Companion Flange with A.S.M.E. Drilling

Copper Sweat



PART NO.	SIZE	CTN/MSTR
K113420215	1-1/4"	45/45
K113420520	2-1/2"	12/12
K113420650	3"	6/6
K113420860	4"	6/6

150# Cast Brass Companion Flange with A.S.M.E. Drilling

Copper Sweat



PART NO.	SIZE	CTN/MSTR
K113450390	2"	15/15
K113450650	3"	6/6
K113450860	4"	3/3

CF

- IAPMO & NSF-61 CERTIFICATIONS
- MEETS STRICT ANSI SPECS
- MATERIAL SPECIFICATIONS TO ASTM B88
- CARTON QUANTITIES ONLY

NOMINAL PLUMBING TO REFRIGERATION HVAC

NOMINAL (I.D.) PLUMBING SIZE	REFRIGERATION (O.D.) HVAC SIZE
1/8"	1/4"
1/4"	3/8"
3/8"	1/2"
5/8"	3/4"
3/4"	7/8"
1"	1-1/8"
1-1/4"	1-3/8"
1-1/2"	1-5/8"
2"	2-1/8"
2-1/2"	2-5/8"
3"	3-1/8"
4"	4-1/8"

JONES STEPHENS TOILET SEATS

Wood Seats 383-385

Plastic Seats 387-390

Soft Seats 391

Acrylic Seats..... 392

Replacement Hardware 392

TS

Premium Molded Wood

- Durable molded wood
- Stainless steel pintel on C023 and C024 seats
- Adjustable
- QuicKlean® adjustable hinges on specified models
- EZ Close® feature on specified models
- Multi-coat high gloss enamel paint
- Beveled lid
- Four color-matched bumpers
- Color-matched hinges

- Stainless steel screws
- Non-skid rubberized pads
- Corrosion resistant mounting hardware

IDEAL FOR:

- Manufactured Housing
- Residential
- Apartments
- Condos



NOTE: Existing standard hinges will change to QuicKlean® upon depletion of existing inventory.

With Color-Matched QuicKlean® Hinges - Closed Front with Cover

ROUND	ELONGATED	SEAT / HINGE COLOR
C023WD00	C024WD00	White / White
C023WD01	C024WD01	Bone / Bone
C023WD02	C024WD02	Biscuit / Biscuit
C023WD04	C024WD04	Cotton White / Cotton White

See inside back cover for available seat and hinge color swatches.



NOTE: Existing standard hinges will change to QuicKlean® upon depletion of existing inventory.

Anti-Microbial with Metal Finish QuicKlean® Hinges - Closed Front with Cover

ROUND	ELONGATED	SEAT / HINGE COLOR
C3B4R300AMCH	—	White / Chrome Finish
C3B4R300AMBN	C3B4E300AMBN	White / Brushed Nickel Finish
C3B4R300AMAB	—	White / Antique Brass Finish

See inside back cover for available seat and hinge color swatches.



EZ Close® Anti-Microbial with Metal Finish Hinges - Closed Front with Cover

ROUND	ELONGATED	SEAT / HINGE COLOR
C3B4R2S00AMCH	C3B4E2S00AMCH	White / Chrome Finish

See inside back cover for available seat and hinge color swatches.

Premium Molded Wood (cont.)



For Vortens® Toilets - Closed Front with Cover

ROUND	ELONGATED	SEAT / HINGE COLOR
—	U300V00	White / White
—	U300V01	Bone / Bone
—	U300V02	Biscuit / Biscuit

See inside back cover for available seat and hinge color swatches.

* The manufacturer's names are used only to describe which toilets the seats will fit. The seats are not manufactured by those companies.

Deluxe Molded Wood

- Durable molded wood
- Adjustable
- QuicKlean® adjustable hinges on specified models
- EZ Close® feature on specified models
- Multi-coat high gloss enamel paint
- Beveled lid
- Four color-matched bumpers
- Color-matched hinges
- Stainless steel screws
- Non-skid rubberized pads
- Corrosion resistant mounting hardware

IDEAL FOR:

- Manufactured Housing
- Offices
- Residential
- Apartments
- Condos
- Restaurants
- Dormitories



With Plastic Color-Matched Hinges - Closed Front with Cover

ROUND	ELONGATED	SEAT / HINGE COLOR
C013WD00	C014WD00 	White / White
C013WD01	C014WD01	Bone / Bone
C013WD02	C014WD02	Biscuit / Biscuit
C013WD03	C014WD03	Almond / Almond
C013WD04	C014WD04	Cotton White / Cotton White
C3B4R220	C014WD20	Venetian Pink / Venetian Pink
C3B4R230	C014WD30	Fawn Beige / Fawn Beige
C3B4R240	C014WD40	Dresden Blue / Dresden Blue
C3B4R245	C014WD45	Regency Blue / Regency Blue
C3B4R250	C014WD50	Citron Yellow / Citron Yellow
C3B4R253	C014WD53	Harvest Gold / Harvest Gold
C3B4R258	C014WD58	Avocado / Avocado
C3B4R280	C014WD80	Silver / Silver
C3B4R290	C014WD90	Black / Black

See inside back cover for available seat and hinge color swatches.

 Items marked with the Jones Stephens logo are "You Need It... We Got It" Items.

Deluxe Molded Wood (cont.)

- Durable molded wood
- Adjustable
- QuicKlean® adjustable hinges on specified models
- EZ Close® feature on specified models
- Multi-coat high gloss enamel paint
- Beveled lid
- Four color-matched bumpers
- Color-matched hinges
- Stainless steel screws
- Non-skid rubberized pads
- Corrosion resistant mounting hardware

IDEAL FOR:

- Manufactured Housing
- Offices
- Residential
- Apartments
- Condos
- Restaurants
- Dormitories



Hinge Color Matched to Seat

With International Hinges - Closed Front with Cover

ROUND	ELONGATED	SEAT / HINGE COLOR
C013WD00INT	—	White / White

See inside back cover for available seat and hinge color swatches.



Decorative Metal Hinges

Anti-Microbial with Decorative Metal Hinges - Closed Front with Cover

ROUND	ELONGATED	SEAT / HINGE COLOR
C013WD00CH	C014WD00CH	White / Chrome
C3B4R200CHWP	—	White / Chrome and White Powder Coated
C013WD00BN	C014WD00BN	White / Brushed Nickel
C3B4R200WP	—	White / White Powder Coated
C3B4R201BN	—	Bone / Brushed Nickel
C3B4R290CH	C3B4E290CH	Black / Chrome

See inside back cover for available seat and hinge color swatches.



Hinge Color Matched to Seat

EZ Close®

EZ Close® with Plastic Color-Matched Hinges - Closed Front with Cover

ROUND	ELONGATED	SEAT / HINGE COLOR
C013WDS00	C014WDS00	White / White
C013WDS01	C014WDS01	Bone / Bone

See inside back cover for available seat and hinge color swatches.

Deluxe Molded Wood (cont.)



Hinge Color Matched to Seat

With Plastic Color-Matched Hinges - Open Front with Cover

ROUND	ELONGATED	SEAT / HINGE COLOR
C013WDO00	C014WDO00	White / White

See inside back cover for available seat and hinge color swatches.



Decorative Metal Hinges

Sculpted with Decorative Metal Hinges - Closed Front with Cover

ROUND	ELONGATED	SEAT / HINGE COLOR
C3B4R400CH	—	White Bead Board / Chrome

See inside back cover for available seat and hinge color swatches.



Hinge Color Matched to Seat

Square Front for Eljer® New Emblem™ Toilets with Plastic Color-Matched Hinges - Closed Square Front with Cover

ROUND	ELONGATED	SEAT / HINGE COLOR
C049WDO	C050WDO0	White / White

See inside back cover for available seat and hinge color swatches.

Standard Molded Wood

- Durable molded wood
- Multi-coat high gloss enamel paint
- Color-matched hinges and bumpers
- Stainless steel screws
- Corrosion resistant mounting hardware

IDEAL FOR:

- Manufactured Housing
- Residential
- Apartments
- Condos



Hinge Color Matched to Seat

With Plastic Color-Matched Hinges - Closed Front with Cover

ROUND	ELONGATED	SEAT / HINGE COLOR
C001WD00	C002WD00	White / White
C001WD01	C002WD01	Bone / Bone

See inside back cover for available seat and hinge color swatches.

TS

Utility Molded Wood

- Durable molded wood
- Adjustable
- Multi-coat high gloss enamel paint
- Color-matched hinges and bumpers
- Stainless steel screws
- Non-skid rubberized pads
- Corrosion resistant mounting hardware

IDEAL FOR:

- Manufactured Housing
- Residential
- Apartments
- Condos



With Plastic Color-Matched Hinges - Closed Front with Cover

ROUND	ELONGATED	SEAT / HINGE COLOR
U003WD00	U004WD00	White / White

See inside back cover for available seat and hinge color swatches.

Decorative Piano Finish, Solid Bamboo

- Sealed with 1 mil of high gloss polyurethane
- Four color-matched bumpers
- Corrosion resistant mounting hardware

IDEAL FOR:

- Manufactured Housing
- Residential
- Apartments
- Condos



With Decorative Metal Hinges - Closed Front with Cover

ROUND	ELONGATED	SEAT / HINGE COLOR
C3B2R220BN	C3B2E220BN	Natural Bamboo / Brushed Nickel

See inside back cover for available seat and hinge color swatches.

Decorative Piano Finish, Solid Oak

- Solid oak construction
- Sealed with 1 mil of high gloss polyurethane
- PVD hinge
- Four color-matched bumpers
- Corrosion resistant mounting hardware

IDEAL FOR:

- Manufactured Housing
- Residential
- Apartments
- Condos



Anti-Microbial with Decorative Metal Hinges - Closed Front with Cover

ROUND	ELONGATED	SEAT / HINGE COLOR
C2B1R16CH	C2B1E16CH	Mahogany Finish / Chrome
C2B1R16BR	C2B1E16BR	Mahogany Finish / Brass
C2B1R16BN	C2B1E16BN	Mahogany Finish / Brushed Nickel
C2B1R17CH	C2B1E17CH	Natural Oak / Chrome
C2B1R17BR	C2B1E17BR	Natural Oak / Brass
C2B1R17BN	C2B1E17BN	Natural Oak / Brushed Nickel
C2B1R18CH	C2B1E18CH	Dark Brown Finish / Chrome
C2B1R18BN	C2B1E18BN	Dark Brown Finish / Brushed Nickel
C2B1R19CH	C2B1E19CH	Walnut Finish / Chrome
C2B1R19BN	C2B1E19BN	Walnut Finish / Brushed Nickel

See inside back cover for available seat and hinge color swatches.

Decorative Natural Finish, Solid Oak

- EZ Close® feature on specified models
- Sealed with polyurethane
- Four color-matched bumpers
- Corrosion resistant mounting hardware

IDEAL FOR:

- Manufactured Housing
- Residential
- Apartments
- Condos



With Decorative Metal Hinges - Closed Front with Cover

ROUND	ELONGATED	SEAT / HINGE COLOR
C3B2R117CH	—	Light Oak Finish / Chrome
C3B2R117BR	C3B2E117BR	Light Oak Finish / Brass
C3B2R117BN	C3B2E117BN	Light Oak Finish / Brushed Nickel
C3B2R118CH	C3B2E118CH	Dark Brown Finish / Chrome
C3B2R118BN	C3B2E118BN	Dark Brown Finish / Brushed Nickel
—	C3B2E115BN	Cherry Finish / Brushed Nickel

See inside back cover for available seat and hinge color swatches.



EZ Close® with Decorative Metal Hinges - Closed Front with Cover

ROUND	ELONGATED	SEAT / HINGE COLOR
C2B1RS19CH	C2B1ES19CH	Natural Black Walnut / Chrome

See inside back cover for available seat and hinge color swatches.

Premium Residential Plastic

- Injection molded durable polypropylene plastic with UV protection
- QuicKlean® adjustable hinges on specified models
- EZ Close® feature on specified models
- Beveled lid
- Four molded-in color-matched bumpers
- Color-matched hinges
- Non-skid rubberized pads
- Corrosion resistant mounting hardware

IDEAL FOR:

- Manufactured Housing
- Residential
- Apartments
- Condos
- Schools
- Offices
- Hotels
- Restaurants
- Dormitories



NOTE: Existing standard hinges will change to QuicKlean® upon depletion of existing inventory.

EZ Close® with Color-Matched QuicKlean® Hinges - Closed Front with Cover

ROUND	ELONGATED	SEAT / HINGE COLOR
C1606S00	C2200S00	White / White
C1606S01	C2200S01	Bone / Bone
C1606S02	C2200S02	Biscuit / Biscuit
C1606S03	C2200S03	Almond / Almond
C1606S04	C2200S04	Cotton White / Cotton White
C1606S20	C2200S20	Venetian Pink / Venetian Pink
C1606S30	C2200S30	Fawn Beige / Fawn Beige
C1606S40	C2200S40	Dresden Blue / Dresden Blue
C1606S45	C2200S45	Regency Blue / Regency Blue
C1606S50	C2200S50	Citron Yellow / Citron Yellow
C1606S53	C2200S53	Harvest Gold / Harvest Gold
C1606S58	C2200S58	Avocado / Avocado
C1606S80	C2200S80	Silver / Silver
C1606S90	C2200S90	Black / Black

See inside back cover for available seat and hinge color swatches.



NOTE: Existing standard hinges will change to QuicKlean® upon depletion of existing inventory.

With Color-Matched QuicKlean® Hinges - Closed Front with Cover

ROUND	ELONGATED	SEAT / HINGE COLOR
C160600	C220000	White / White
C160601	C220001	Bone / Bone
C160602	C220002	Biscuit / Biscuit

See inside back cover for available seat and hinge color swatches.

TS

Premium Residential Plastic (cont.)



NOTE: Existing standard hinges will change to QuicKlean® upon depletion of existing inventory.

EZ Close® with Color-Matched QuicKlean® Hinges - Closed Front with Cover

ROUND	ELONGATED	SEAT / HINGE COLOR
C3B3RSL00	C3B3ESL00	White / White

6 Pack EZ Close® w/Color-Matched QuicKlean® Hinges - Closed Front w/Cover

ROUND	ELONGATED	SEAT / HINGE COLOR
C3B3RSL00	C3B3ESL00	White / White

See inside back cover for available seat and hinge color swatches.

Deluxe Residential Plastic

- Injection molded durable polypropylene plastic with UV protection
- QuicKlean® adjustable hinges on specified models
- EZ Close® feature on specified models
- Adjustable
- Four molded-in bumpers
- Color-matched hinges and bumpers
- Non-skid rubberized pads
- Corrosion resistant mounting hardware

IDEAL FOR:

- Manufactured Housing
- Residential
- Apartments
- Condos
- Offices
- Portable Toilets



Hinge Color Matched to Seat

With Color-Matched Hinges - Closed Front with Cover

ROUND	ELONGATED	SEAT / HINGE COLOR
C104100	C104200	White / White
C104101	C104201	Bone / Bone
C104102	C104202	Biscuit / Biscuit
C104120	C104220	Venetian Pink / Venetian Pink
C104140	C104240	Dresden Blue / Dresden Blue
C104190	C104290	Black / Black

See inside back cover for available seat and hinge color swatches.



NOTE: Existing standard hinges will change to QuicKlean® upon depletion of existing inventory.

EZ Close® with Color-Matched QuicKlean® Hinges - Closed Front with Cover

ROUND	ELONGATED	SEAT / HINGE COLOR
C1210S00	C1211S00	White / White
C1210S01	C1211S01	Bone / Bone
C1210S02	C1211S02	Biscuit / Biscuit

See inside back cover for available seat and hinge color swatches.

Items marked with the Jones Stephens logo are "You Need It...We Got It" Items.

Deluxe Residential Plastic (cont.)



Hinge Color Matched to Seat

With Color-Matched Hinges - Open Front with Cover

ROUND	ELONGATED	SEAT / HINGE COLOR
—	C1042000	White / White

See inside back cover for available seat and hinge color swatches.



Hinge Color Matched to Seat

Euro Design with Color-Matched Hinges and Telescoping Cover to Conceal Entire Ring - Closed Front with Cover

ROUND	ELONGATED	SEAT / HINGE COLOR
C3B3R200	C3B3E200	White / White

See inside back cover for available seat and hinge color swatches.



Hinge Color Matched to Seat

Square Front for Eljer® New Emblem™ Toilets with Color-Matched Hinges - Closed Square Front with Cover

ROUND	ELONGATED	SEAT / HINGE COLOR
—	C105000	White / White
—	C105001	Bone / Bone

See inside back cover for available seat and hinge color swatches.



Hinge Color Matched to Seat

EZ Close®

EZ Close® Square Front for Eljer® New Emblem™ Toilets with Color-Matched Hinges - Closed Square Front with Cover

ROUND	ELONGATED	SEAT / HINGE COLOR
—	C1050S00	White / White
—	C1050S01	Bone / Bone

See inside back cover for available seat and hinge color swatches.

Standard Residential Plastic

- Injection molded durable polypropylene plastic with UV protection
- QuickKlean® adjustable hinges on specified models
- EZ Close® feature on specified models
- Adjustable
- Four molded-in color-matched bumpers
- Color-matched hinges
- Non-skid rubberized pads
- Corrosion resistant mounting hardware

IDEAL FOR:

- Manufactured Housing
- Residential
- Apartments
- Condos
- Schools
- Offices
- Hotels
- Restaurants
- Dormitories
- Portable Toilets



Hinge Color Matched to Seat

With Color-Matched Hinges - Closed Front with Cover

ROUND	ELONGATED	SEAT / HINGE COLOR
C803200	C803300	White / White
C803201	C803301	Bone / Bone
—	C803302	Biscuit / Biscuit

See inside back cover for available seat and hinge color swatches.



Hinge Color Matched to Seat

EZ Close®

QuickKlean®

NOTE: Existing standard hinges will change to QuickKlean® upon depletion of existing inventory.

EZ Close® with Color-Matched QuickKlean® Hinges - Closed Front with Cover

ROUND	ELONGATED	SEAT / HINGE COLOR
C1006S00	C1007S00	White / White
—	C1007S02	Bone / Bone

See inside back cover for available seat and hinge color swatches.

Adult/Juvenile Residential Plastic

- Injection molded durable polypropylene plastic with UV protection
- EZ Close®
- Adjustable
- Four molded-in color-matched bumpers
- Color-matched hinges
- Non-skid rubberized pads
- Corrosion resistant mounting hardware
- Extra thick support ring for increased strength

- Adult/juvenile seat design for children and adults eliminates the need to install and remove training seat
- Juvenile seat held in place with magnet

IDEAL FOR:

- Manufactured Housing
- Residential
- Apartments
- Condos
- Schools

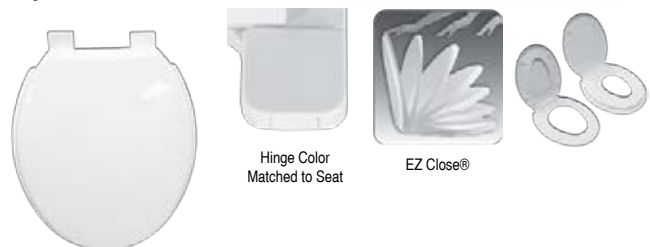

Hinge Color Matched to Seat

EZ Close®

TS

EZ Close® with Color-Matched Hinges - Closed Front with Cover

ROUND	ELONGATED	SEAT / HINGE COLOR
C3B3RJS00	C3B3EJS00	White / White

See inside back cover for available seat and hinge color swatches.

Builder Grade Residential Plastic

- Injection molded durable polypropylene plastic with UV protection
- Adjustable
- Four molded-in color-matched bumpers
- Color-matched hinges
- Non-skid rubberized pads
- Corrosion resistant mounting hardware
- Truck packs available on specified models (Box of 10 individually shrink wrapped seats separated by cardboard slats)

IDEAL FOR:

- Manufactured Housing
- Residential
- Apartments
- Condos
- Offices
- Portable Toilets



With Color-Matched Hinges - Closed Front with Cover

ROUND	ELONGATED	SEAT / HINGE COLOR
C101000	C101100	White / White
C101001	C101101	Bone / Bone
C101002	C101102	Biscuit / Biscuit

Truck Pack

ROUND	ELONGATED	SEAT / HINGE COLOR
C1010TK00	C1011TK00	White / White

See inside back cover for available seat and hinge color swatches.

Utility Grade Residential Plastic

- Injection molded durable polypropylene plastic with UV protection
- Adjustable
- Four molded-in color-matched bumpers
- Color-matched hinges
- Corrosion resistant mounting hardware
- Truck packs available on specified models (Box of 10 individually shrink wrapped seats separated by cardboard slats)

IDEAL FOR:

- Manufactured Housing
- Apartments
- Condos
- Portable Toilets



With Color-Matched Hinges - Closed Front with Cover

ROUND	ELONGATED	SEAT / HINGE COLOR
U100500	U100600	White / White
U100700	U100800	White / White

Truck Pack

ROUND	ELONGATED	SEAT / HINGE COLOR
U1007TK00	U1008TK00	White / White

See inside back cover for available seat and hinge color swatches.

Extra Heavy Duty Commercial Plastic

- Injection molded durable polypropylene plastic with UV protection
- Anti-microbial on specified models
- External color-matched check hinge
- Four molded-in color-matched bumpers
- Extra heavy duty weight and posture curve design
- Ergonomic design
- 304 grade stainless steel hinge post and hardware
- Anti-skid rubberized bushings
- Concealed hinges

IDEAL FOR:

- Service Stations
- Public Restrooms
- Hospitals
- Hotels
- Assisted Living
- Offices
- Correctional Institutes
- Park Facilities
- Schools
- Stadiums
- Airports



With Color-Matched Check Hinge - Open Front less Cover

ROUND	ELONGATED	SEAT / HINGE COLOR
—	C110C00	White / White

Anti-Microbial with Color-Matched Check Hinge - Open Front less Cover

ROUND	ELONGATED	SEAT / HINGE COLOR
—	C110CAM00	White / White

See inside back cover for available seat and hinge color swatches.

Heavy Duty Commercial Plastic

- Injection molded durable polypropylene plastic with UV protection
- Anti-microbial on specified models
- External color-matched check hinge
- Four molded-in color-matched bumpers
- Heavy duty weight
- 304 grade stainless steel hinge post and hardware
- Anti-skid rubberized bushings
- Concealed hinges
- Self-sustaining feature available on specified models

IDEAL FOR:

- Service Stations
- Public Restrooms
- Hospitals
- Hotels
- Assisted Living
- Offices
- Correctional Institutes
- Park Facilities
- Schools
- Stadiums
- Airports



With Color-Matched Check Hinge - Open Front less Cover

ROUND	ELONGATED	SEAT / HINGE COLOR
—	C108C00	White / White

With Color-Matched Self-Sustaining Check Hinge - Open Front less Cover

ROUND	ELONGATED	SEAT / HINGE COLOR
—	C108SSC00	White / White

Anti-Microbial with Color-Matched Self-Sustaining Check Hinge - Open Front less Cover

ROUND	ELONGATED	SEAT / HINGE COLOR
—	C108SSCAM00	White / White

See inside back cover for available seat and hinge color swatches.

TS

Items marked with the Jones Stephens logo are "You Need It...We Got It" Items.

Deluxe Commercial Plastic

- Injection molded durable polypropylene plastic with UV protection
- External color-matched check hinge with exception of C106CEZ00
- Four molded-in color-matched bumpers
- 304 grade stainless steel hinge post and hardware
- Anti-skid rubberized bushings
- Concealed hinges
- Self-sustaining
- Fire retardant on specified models
- EZ Close® feature on specified models
- Anti-microbial on specified models

IDEAL FOR:

- Service Stations
- Public Restrooms
- Hospitals
- Hotels
- Assisted Living
- Offices
- Correctional Institutes
- Park Facilities
- Schools
- Stadiums
- Airports



With Color-Matched Check Hinge - Open Front less Cover

ROUND	ELONGATED	SEAT / HINGE COLOR
C105C00	C106C00	White / White
—	C106C90	Black / Black

With Color-Matched Self-Sustaining Check Hinge - Open Front less Cover

ROUND	ELONGATED	SEAT / HINGE COLOR
C105SSC00	C106SSC00	White / White
—	C106SSC01	Bone / Bone
—	C106SSC02	Biscuit / Biscuit
C105SSC90	C106SSC90	Black / Black

Anti-Microbial with Color-Matched Self-Sustaining Check Hinge - Open Front less Cover

ROUND	ELONGATED	SEAT / HINGE COLOR
—	C106SSCAM00	White / White
—	C106SSCAM90	Black / Black

Anti-Microbial and Fire Retardant with Color-Matched Self-Sustaining Check Hinge - Open Front less Cover

ROUND	ELONGATED	SEAT / HINGE COLOR
—	C106SSCAMFR0	White / White

See inside back cover for available seat and hinge color swatches.

Standard Commercial Plastic

- Injection molded durable polypropylene plastic with UV protection
- External color-matched check hinge
- Four molded-in color-matched bumpers
- Anti-skid rubberized bushings
- Concealed hinges

IDEAL FOR:

- Portable Toilets
- Hospitals
- Assisted Living



With Color-Matched Check Hinge, Plastic and Stainless Steel Hardware - Open Front less Cover

ROUND	ELONGATED	SEAT / HINGE COLOR
—	C106CHPM00	White / White

See inside back cover for available seat and hinge color swatches.

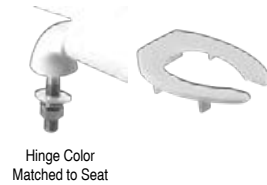

With Color-Matched Check Hinge, Plastic and Stainless Steel Hardware - Open Front less Cover

ROUND	ELONGATED	SEAT / HINGE COLOR
—	C106CHPM00	White / White

See inside back cover for available seat and hinge color swatches.

Got To Have It!

Deluxe Commercial Plastic EZ Close® with Chrome Plated Check Hinge - Open Front less Cover

- Injection molded durable polypropylene plastic with UV protection
- External color-matched check hinge with exception of C106CEZ00
- Four molded-in color-matched bumpers
- 304 grade stainless steel hinge post and hardware
- Anti-skid rubberized bushings
- Concealed hinges
- Self-sustaining
- Fire retardant on specified models
- EZ Close® feature on specified models
- Anti-microbial on specified models



Chrome Plated Check Hinge



EZ Close®



TS

ROUND	ELONGATED	SEAT / HINGE COLOR
—	C106CEZ00	White / Chrome

See inside back cover for available seat and hinge color swatches.

Items marked with the Jones Stephens logo are "You Need It...We Got It" Items.

Commercial Baby Bowl Plastic

- Injection molded durable polypropylene plastic with UV protection
- External color-matched check hinge
- Four molded-in color-matched bumpers
- 304 grade stainless steel hinge post and hardware
- Anti-skid rubberized bushings
- Concealed hinges

- Self-sustaining
- Anti-microbial

IDEAL FOR:

- Schools
- Public Family Restrooms



Anti-Microbial with Color-Matched Self-Sustaining Check Hinge - Open Front less Cover

ROUND	ELONGATED	SEAT / HINGE COLOR
C100BBSCAM0	—	White / White

See inside back cover for available seat and hinge color swatches.

Premium Commercial/Institutional Plastic

- Injection molded durable polypropylene plastic with UV protection
- EZ Close® feature on specified models
- Adjustable
- Four molded-in color-matched bumpers
- Color-matched hinges
- Corrosion resistant mounting hardware
- Anti-skid rubberized pads
- Fire retardant on specified models
- Stainless steel posts
- Anti-microbial on specified models

IDEAL FOR:

- Public Restrooms
- Hospitals
- Hotels
- Offices
- Schools
- Airports
- Restaurants
- Dormitories



With Color-Matched Hinges - Open Front with Cover

ROUND	ELONGATED	SEAT / HINGE COLOR
—	C2200O00	White / White

With Color-Matched Hinges and Stainless Steel Hinge Posts - Open Front with Cover

ROUND	ELONGATED	SEAT / HINGE COLOR
—	C2200O00HPSS	White / White

With Color-Matched Hinges and Stainless Steel Hinge Posts - Closed Front with Cover

ROUND	ELONGATED	SEAT / HINGE COLOR
C1606HPSS00	C2200HPSS00	White / White
—	C2200HPSS90	Black / Black

Anti-Microbial and Fire Retardant with Color-Matched Hinges and Stainless Steel Hinge Posts - Closed Front with Cover

ROUND	ELONGATED	SEAT / HINGE COLOR
—	C2200HPSSAMF	White / White

See inside back cover for available seat and hinge color swatches.

Premium Commercial/Institutional Plastic (cont.)



EZ Close® with Color-Matched Hinges - Open Front with Cover

ROUND	ELONGATED	SEAT / HINGE COLOR
C1606OS00	C2200OS00	White / White

EZ Close® Anti-Microbial with Color-Matched Hinges and Stainless Steel Hinge Posts - Open Front with Cover

ROUND	ELONGATED	SEAT / HINGE COLOR
—	C2200OS00HPSSAM	White / White

See inside back cover for available seat and hinge color swatches.

Premium Heavy Duty Commercial Plastic

- Injection molded durable polypropylene plastic with UV protection
- EZ Close® feature on specified models
- QuickKlean® adjustable hinges on specified models
- Adjustable
- Four molded-in color-matched bumpers
- Color-matched hinges
- Corrosion resistant mounting hardware
- Stainless steel pintels
- Anti-skid rubberized pads
- Stainless steel posts

IDEAL FOR:

- Public Restrooms
- Offices
- Airports
- Manufactured Housing
- Portable Toilets
- Residential
- Condos
- Apartments



With Color-Matched Hinges - Closed Front with Cover

ROUND	ELONGATED	SEAT / HINGE COLOR
C801800	—	White / White

See inside back cover for available seat and hinge color swatches.



NOTE: Existing standard hinges will change to QuickKlean® upon depletion of existing inventory.

EZ Close® with Color-Matched QuickKlean® Hinges - Closed Front with Cover

ROUND	ELONGATED	SEAT / HINGE COLOR
—	C8019S00	White / White

With Color-Matched Hinges and Stainless Steel Hinge Posts - Closed Front with Cover

ROUND	ELONGATED	SEAT / HINGE COLOR
—	C8019OS00	White / White

See inside back cover for available seat and hinge color swatches.

TS

Light Duty Commercial Plastic

- Injection molded durable polypropylene plastic with UV protection
- Adjustable
- Four molded-in color-matched bumpers
- Color-matched hinges
- Corrosion resistant mounting hardware
- Extra large pintels
- Anti-skid rubberized pads

IDEAL FOR:

- Public Restrooms
- Schools
- Portable Toilets
- Airports
- Restaurants
- Hotels
- Dormitories
- Offices



Hinge Color Matched to Seat

With Color-Matched Hinges - Open Front with Cover

ROUND	ELONGATED	SEAT / HINGE COLOR
C8032000	C8033000	White / White



Hinge Color Matched to Seat

Contemporary Style with Color-Matched Hinges - Open Front with Cover

ROUND	ELONGATED	SEAT / HINGE COLOR
—	C102C00	White / White

See inside back cover for available seat and hinge color swatches.

Specialty Plastic

- ADA compliant with 2" lift
- Fits round or elongated bowls
- Durable plastic construction
- Designed for use in hospitals or public restrooms

IDEAL FOR:

- Hospitals
- Assisted Living
- Airports



Stainless Steel Hinge

Big John - Closed Front with Cover

ROUND	ELONGATED	SEAT / HINGE COLOR
24456461W	24456461W	White / Stainless Steel
24456462CR	24456462CR	Biscuit / Stainless Steel

Big John - Open Front with Cover

ROUND	ELONGATED	SEAT / HINGE COLOR
24452633W	24452633W	White / Stainless Steel

Big John - Closed Front less Cover

ROUND	ELONGATED	SEAT / HINGE COLOR
24452634W	24452634W	White / Stainless Steel

See inside back cover for available seat and hinge color swatches.

Specialty Plastic (cont.)



Big John Wall Hung Support - 1000 pounds

ROUND	ELONGATED	COLOR
612011919	612011919	White with Gray Trim

Standard and Deluxe Soft Seats

- Standard is constructed using high density vinyl
- Deluxe is constructed using heavy duty embossed vinyl
- UV paint color protection
- QuicKlean® adjustable hinges on specified models
- Color-matched hinges
- Four color-matched bumpers
- Adjustable
- Non-skid rubberized pads
- Corrosion resistant mounting hardware

IDEAL FOR:

- Manufactured Housing
- Apartments
- Condos
- Residential



Hinge Color Matched to Seat



QuicKlean®

NOTE: Existing standard hinges will change to QuicKlean® upon depletion of existing inventory.

Standard with Plastic Insert and Color-Matched QuicKlean® Hinges - Closed Front with Cover

ROUND	ELONGATED	SEAT / HINGE COLOR
C5C5R100	—	White / White

Deluxe Anti-Microbial with Solid Wood Core and Color-Matched QuicKlean® Hinges - Closed Front with Cover

ROUND	ELONGATED	SEAT / HINGE COLOR
C3B5R200	C3B5E200	White / White
C3B5R201	C3B5E201	Bone / Bone
C3B5R290	—	Black / Black
C3B5R221	—	Pink / Pink
C3B5R242	—	Blue / Blue
C3B5R260	—	Forest Green / Forest Green
C3B5R270	—	Claret / Claret
C3B5R200	C3B5E200	White / White

See inside back cover for available seat and hinge color swatches.



Decorative Metal Hinges

Deluxe Anti-Microbial with Solid Wood Core and Decorative Metal Hinge - Closed Front with Cover

ROUND	ELONGATED	SEAT / HINGE COLOR
C3B5R200CH	C3B5E200CH	White / Chrome

See inside back cover for available seat and hinge color swatches.

Designer Acrylic

- Clear acrylic
- Life-like embedded objects
- Corrosion resistant mounting hardware
- Four clear bumpers

IDEAL FOR:

- Manufactured Housing
- Apartments
- Condos
- Residential



Decorative Metal Hinges

Aquarium with Decorative Metal Hinges - Closed Front with Cover

ROUND	ELONGATED	SEAT / HINGE COLOR
C2B6R9AQCH	—	Aquarium / Chrome

See inside back cover for available seat and hinge color swatches.



Decorative Metal Hinges

Seahorse with Decorative Metal Hinges - Closed Front with Cover

ROUND	ELONGATED	SEAT / HINGE COLOR
C2B6R9SHCH	—	Seahorse / Chrome

See inside back cover for available seat and hinge color swatches.

Replacement Hardware



C200HPSS



C200HEX

Hinge Post Hardware

PART NO.	DESCRIPTION	MATERIAL
C200HPSS	For all top mounts except C001WD, C002WD, C1005	Stainless Steel
C200HEX	Hinge post hardware for all top mounts except C001WD, C002WD, C1005	White Plastic



C306CHPSS00



C406CHPSS00

Hinge Post Hardware

PART NO.	DESCRIPTION	MATERIAL
C306CHPSS00	Hinge pack for check hinge toilet seat (white only)	304 Stainless
C406SSCHPSS00	Hinge pack for self-sustaining check hinge toilet seat (white only)	304 Stainless

TS

CONTRACTOR SPECIALTIES AND MRO PRODUCTS

Plumbing 397

Cleaning Supplies 397-398

Safety..... 398-401

Outdoor 401-402

Contractor Tools 403-405

Electrical..... 405-408

Security 408-409

Merchandise Peg Boards 409-412

 Toilet Repair 409

 Hardware..... 410

 Security 410

 Gloves 411

 Cable Ties 411

 Wall and Counter Repair..... 412

 Flashlights..... 421

MRO

IT TAKES MORE THAN PLUMBING SUPPLIES TO FINISH A PLUMBING PROJECT.

A day on the job requires specialty items—along with gloves, trash bags, work lights, and more.

**Order contractor
specialty items
and MRO
products for:**

- PLUMBING
- CLEANING
- SAFETY
- OUTDOOR
- TOOLS
- ELECTRICAL
- SECURITY



At Jones Stephens, we know plumbers. That's why these pages carry more than the widest possible range of plumbing supplies. They include the products your customers typically need on the jobsite, everyday items such as work lights.... and gloves, and trash bags, and extension cords, and locksets, and caulk, and so much more.

So as you're picking the plumbing supplies your customers are looking for—be sure to order the items they need to finish the job. They'll thank you. And you'll thank us.

Integral Float Fill Valve



- Fits most toilets
- Replace all of the complicated mechanisms with this simple kit
- Adjustable height from 9" to 13"
- Adjustable float for adjustable water height
- Similar to Fluidmaster®* 400A

PART NO.	DESCRIPTION	CTN/MSTR
T02070	Integral float fill valve	1/12

* The manufacturers' names are used only to describe whose products the products will fit.

Hollow Wall Anchor Kit



- 100 pieces
- 4 sizes and styles
- Anchors, screws and toggle bolts
- Reclosable, reusable, divided plastic container

PART NO.	DESCRIPTION	CTN/MSTR
A33006	100 piece hollow wall anchor kit	12/72

The Green Drain Waterless Trap Seal



- Requires NO caulk or expensive installation tool
- Easy to install and easy to remove - NO pliers needed
- Durable - will not break during installation or removal
- Seals tight - NO leaking

PART NO.	DESCRIPTION	CTN/MSTR
P24001	2" waterless trap seal	1/96
P24002	3" waterless trap seal	1/96
P24003	3-1/2" waterless trap seal	1/96
P24004	4" waterless trap seal	1/96

13" Jumbo Plastic Dust Pan



- Clip on
- All plastic
- Assorted colors
- Rubber edge

PART NO.	DESCRIPTION	CTN/MSTR
B29852	13" jumbo plastic dust pan	1/12

Angle Broom

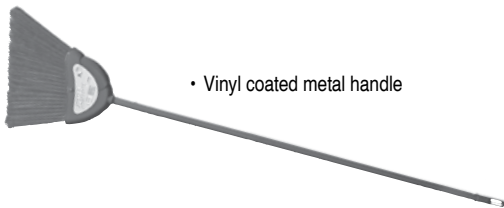

- Vinyl coated metal handle

PART NO.	DESCRIPTION	CTN/MSTR
B29850	Large plastic angle broom	1/12
B29851	Small plastic angle broom	1/24

Items marked with the Jones Stephens logo are "You Need It...We Got It" Items.

Cotton Terry Cloth Towels



- 100% cotton
- 14" x 17"
- Waxes, dries and polishes
- Super soft

PART NO.	DESCRIPTION	CTN/MSTR
B05025	Terry cloth towels, 3 pack	1/10
B05026	Terry cloth towels, 8 pack	1/12

Wypall® Teri® Towels



- Strong and durable, wet or dry
- 125 reusable sheets per box-equivalent to 18 lbs. of rags
- Reinforced HYDROKNIT® provides extra scrubbing power
- CASE QUANTITIES ONLY

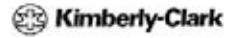

PART NO.	DESCRIPTION	CTN QTY
B05003	9-3/4" x 16-3/4" x 125 sheets	10

Box of Rags



- Colored cotton sweatshirt material
- 100% recycled
- Pull out dispensing
- Multi-colored

PART NO.	DESCRIPTION	CTN QTY
B05001	4 lb. box of rags	1

Cotton Plumbers Handy Towels



- 100% cotton heavy duty shop towels are washable, reusable & nonabrasive
- Ideal for cleaning hands, wiping spills, removing grime from tools & parts
- 12 towels per bag

PART NO.	DESCRIPTION	CTN QTY
B05004	Plumbers handy towels	12

Plastic Drop Cloth



- Medium duty 1 mil plastic
- Convenient pleat fold pack design
- Protects furniture, appliances and carpets

PART NO.	DESCRIPTION	CTN/MSTR
D50000	9' x 12' plastic drop cloth	1/48

Cotton Canvas Drop Cloth



- 8 oz.
- Absorbs and traps spills
- Washable and reusable

PART NO.	DESCRIPTION	CTN/MSTR
G02010	6' x 9' cotton canvas drop cloth	1/6
G02011	9' x 12' cotton canvas drop cloth	1/4

Urinal Screen and Refills



- 4 oz. scented deodorant block
- Cherry scent
- S95251 is priced each and sold in CARTON QUANTITIES ONLY

PART NO.	DESCRIPTION	CTN/MSTR
S95250	Urinal screen	12/72
S95251	4 oz. cherry scent refills for urinal screen, 12 piece	12/72

Commercial Sponge



MADE IN THE **USA**

- Commercial grade cellulose sponges- made to last!
- Deeply textured top makes cleanup easier
- Made in the USA

DIMENSIONS	
S50001	6-3/4" x 4-3/8" x 3/4"
S50002	8" x 4-1/2" x 3/4"

PART NO.	DESCRIPTION	CTN QTY
S50001	Medium cellulose sponge	24
S50002	Large cellulose sponge	24

Spray Bottle



- Economical to use for leak testing when filled with soapy water
- Clear bottle with various color tints based on availability

PART NO.	DESCRIPTION	CTN/MSTR
B25001	16 oz. clear spray bottle	1/60

Heavy Duty Big Wipes



- 80 count tub
- Wipe size is 8" x 12"
- Lint free
- Removes paint, glue, oil, sealants, grease and grime
- Dermatologically tested, plus vitamin E and aloe vera added
- Dual sided, scrubs and cleans

PART NO.	DESCRIPTION	CTN QTY
B05050	Heavy duty big wipes, 80 count tub	1/8

Wypall® Waterless Hand Wipes



Kimberly-Clark

- 10 x 12 pre-moistened towels; 50 count
- Lower price per tub
- Conveniently sized tub
- All of the towels can be used before they dry out
- CARTON QUANTITIES ONLY

PART NO.	DESCRIPTION	CTN QTY
B05007	50-count dispenser tub	8
B05008	Wypall display (32 tubs)	1

Wypall® Waterless Hand Wipes



Kimberly-Clark

- Full-sized pre-moistened hand towels- smooth for wiping on one side, tough for scrubbing on the other
- Natural d'limonene cleaning agent tough on grease, grime, ink & paint
- CASE QUANTITIES ONLY

PART NO.	DESCRIPTION	CTN QTY
B05002	12" x 12" x 75 sheets	6

Disposable Vinyl Gloves



- One size fits all
- Rolled cuff
- Lightly powdered for easy on and off
- Ready to hang or place on shelf

PART NO.	DESCRIPTION	CTN/MSTR
G50251	20 pack disposable gloves	1/20



- One size fits all
- Non-powdered
- Non-sterile
- Heavy duty
- Multi-purpose
- Carded

PART NO.	DESCRIPTION	CTN/MSTR
G50302	8 pack disposable gloves	12/72

Blue Nitrile Gloves



- Powdered
- Priced per box
- 100 per box (50 pair)

PART NO.	DESCRIPTION	CTN/MSTR
G50230	Blue nitrile gloves - size large/XL	1/10
G50231	Blue nitrile gloves - size medium/large	1/10

Disposable Blue Latex Gloves



- 14 mil
- Priced per box
- 50 per box
- Powder free
- Examination grade
- Large

PART NO.	DESCRIPTION	CTN/MSTR
G50212	Disposable blue latex gloves	1/10

MRO

All Purpose Latex Palm/Mesh Back Gloves



- Durable
- Excellent in wet conditions
- Protects hands during rugged jobs
- CARTON QUANTITIES ONLY

PART NO.	DESCRIPTION	CTN/MSTR
G50202	Latex palm/mesh back gloves (carded)	12/240

Vinyl Gloves



- 5 mil.
- One size fits all
- Lightly powdered
- 100 reversible gloves (50 pair)

PART NO.	DESCRIPTION	CTN/MSTR
G50250	100 vinyl gloves	1/10

Industrial Rubber Gloves



- Extra heavy
- Large
- Pair
- Rolled cuffs
- CARTON QUANTITIES ONLY

PART NO.	DESCRIPTION	CTN/MSTR
G50223	14" smooth hands, 30 mil	12/72
G50220	18" rough hands, 25 mil	10/60

White Canvas Work Gloves



- Canvas
- Knit wrist
- Large/X-large
- CARTON QUANTITIES ONLY

PART NO.	DESCRIPTION	CTN/MSTR
G50228	White canvas work gloves (carded)	12/144

White Cotton Gloves with Grippers



- Durable 100% cotton canvas
- No-slip grip on palm
- One size fits all
- Knit wrist
- Priced per pair
- CARTON QUANTITIES ONLY

PART NO.	DESCRIPTION	CTN/MSTR
G50205	White cotton gloves with rubber dots (bulk)	12/240
G50206	White cotton gloves with rubber palms (bulk)	12/240
G50229	White cotton gloves with PVC dots (carded)	12/144

Polyester Nitrile Dipped Palm Gloves



- 100% polyester
- Large/X-large
- Pair
- Knit wrist to keep out dirt

PART NO.	DESCRIPTION	CTN/MSTR
G50225	Polyester nitrile dipped palm gloves (carded)	12/144

Ⓢ Items marked with the Jones Stephens logo are "You Need It...We Got It" Items.

Nitrile Gloves



- 3/4 coating offers more protection
- Micro foam nitrile offers great grip
- Coating draws oil and water aside to allow for enhanced grip
- Good abrasion resistance
- Silicone free and antibacterial
- CARTON QUANTITIES ONLY

PART NO.	DESCRIPTION	CTN QTY
G50215	Pair nitrile gloves	12 pairs

Leather Palm Work Gloves



- Split leather palm, thumb, fingers and knuckles
- 100% Cotton back and liner
- Safety cuff
- Priced per pair
- CARTON QUANTITIES ONLY

PART NO.	DESCRIPTION	CTN/MSTR
G50204	Leather palm low safety cuff (carded)	12/120

Drivers' Style Leather Gloves



- Durable and long lasting - conforms to your hand with time
- Grain leather glove
- Elastic cuff
- Priced per pair
- CARTON QUANTITIES ONLY

PART NO.	DESCRIPTION	CTN/MSTR
G50208	Drivers' style leather (carded)	12/120

Economy Brown Jersey Gloves



- Made of cotton
- Large
- Close fitting knit wrist
- Comfortable
- Straight thumb
- Full size
- Priced per pair
- CARTON QUANTITIES ONLY

PART NO.	DESCRIPTION	CTN/MSTR
G50300	Economy brown cotton jersey glove (carded)	12/144

Brown Jersey Gloves



- 100% brown cotton
- One size fits all
- Knit wrist
- 8 ounce
- Priced per pair
- CARTON QUANTITIES ONLY

PART NO.	DESCRIPTION	CTN/MSTR
G50200 Ⓢ	Brown cotton jersey glove (carded)	12/300

Carbon Monoxide Alarm



- Electrochemical CO sensor
- Loud 85 decibels
- Silence and test button
- Low battery indicator

PART NO.	DESCRIPTION	CTN/MSTR
L95500	Carbon monoxide alarm	1/6

Protective Shoe Covers



- Fits easily over work shoes and boots
- Elastic top allows fit up to size 12
- Keeps dirt and grime outside
- Carton holds 200 pieces (100 pair)
- SOLD BY FULL CARTON OR 10 PAIR PACK

PART NO.	DESCRIPTION	CTN/MSTR
B05010	Protective shoe covers (100 pair)	1/10
B05011	Protective shoe covers (10 pair)	1/15

Shubee Shoe Covers



- Dark blue
- Fits easily over work shoes and boots
- Elastic top allows fit up to size 12
- Keeps dirt and grime outside
- Carton holds 150 pair

PART NO.	DESCRIPTION	CTN QTY
B05015	Shubee shoe covers	1

Disposable Coverall



- Tear and puncture resistant
- Use when comfort and coolness is a priority

PART NO.	DESCRIPTION	CTN/MSTR
B05020	Large disposable coverall	25
B05021	X-large disposable coverall	5/20

Dust Mask



- 50 per box
- Disposable
- Non-toxic

PART NO.	DESCRIPTION	CTN/MSTR
G30021	Dust mask	1/20

Safety Hat



- Fits sizes 6 1/2- 8
- Meets ANSI z89.1 requirement
- Short peak design creates greater upward visibility
- Comfortable 4-point suspension with terry cloth sweatbands
- Low nape strap and rain trough features
- Universal slots to accommodate hearing, welding and face shield accessories

PART NO.	DESCRIPTION	CTN QTY
H40001	Yellow with 4-point pin lock suspension	12
H40002	White with 4-point pin lock suspension	12
H40003	Yellow with 4-point ratchet suspension	12
H40004	White with 4-point ratchet suspension	12

Knee Pads



- Lightweight and water-resistant
- Comfortable while kneeling, standing or walking
- Won't pinch or bind behind knee
- Soft, breathable inner lining for coolness and comfort
- Velcro closures on straps

PART NO.	DESCRIPTION	CTN QTY
K01120	Heavy duty foam economy	1 pair
K012000	Heavy duty knee cap	1 pair

Ready Fit Corded Ear Plugs



- Display box included

PART NO.	DESCRIPTION	CTN QTY
E85000	Ready fit corded ear plugs	100 pair

Nemesis® Safety Glasses



Display



- Soft-touch temples
- Light weight construction
- Single-lens wrap-around protection
- 99.9% UV resistant
- Meets ANSI Z87.1 + standards

PART NO.	DESCRIPTION	CTN QTY
G30011	Nemesis® clear glasses	12
G30012	Nemesis® smoke mirror glasses	12
G30013	Nemesis® blue mirror glasses	12
G30014	Nemesis® camo/bronze glasses	12
G30000	Display includes: 12 pair smoke mirror, 6 pair blue mirror, 6 pair clear, free display	1
G30030	Dispenser box: 12 pair camo/bronze	1

Hellraiser Safety Glasses



Clear



Smoke



Blue Mirror

PART NO.	DESCRIPTION	CTN QTY
G30015	Hellraiser clear safety glasses	12
G30016	Hellraiser smoke safety glasses	12
G30017	Hellraiser blue mirror safety glasses	12

Visio Safety Glasses



- One-piece frame
- Adjustable temples
- Sleek, lightweight and comfortable
- Meets ANSI z87.1

PART NO.	DESCRIPTION	CTN QTY
G30003	Visio clear safety glasses	12
G30004	Visio blue mirror safety glasses	12
G30005	Visio silver indoor/outdoor glasses	12

Clear Safety Goggles



- Direct ventilation
- Economical protection

PART NO.	DESCRIPTION	CTN QTY
G30001	Clear safety glasses	200

Caution Tape



- Black print on safety yellow
- 3 mil thickness
- Non-stick

PART NO.	DESCRIPTION	CTN/MSTR
J43300	3" x 300' caution tape	1/16
J43310	3" x 1000' caution tape	1/8

Insulated Hose Nozzle



- Heavy duty with threaded end
- Soft comfort grip
- Carded

PART NO.	DESCRIPTION	CTN/MSTR
G04030	Insulated hose nozzle	12/72

4" Brass Hose Nozzle



- Twist to adjust spray
- Carded

PART NO.	DESCRIPTION	CTN/MSTR
G04031	4" brass hose nozzle	12/72

Contractor Grade Rubber Hose



- Contractor grade
- Reinforced rubber
- Heavy duty brass coupling

PART NO.	DESCRIPTION	CTN/MSTR
G04025	3/4" x 25' contractor grade rubber hose	1/4
G04026	3/4" x 50' contractor grade rubber hose	1/2

Commercial Premium Rubber Hose



PART NO.	DESCRIPTION	CTN/MSTR
G04005	5/8" x 25' commercial premium rubber hose	1/1
G04006	5/8" x 50' commercial premium rubber hose	1/1

Garden Hose



- G04001:
- 500 PSI burst strength
 - Kink-free construction
 - Heavy-duty solid brass nickel plated coupling
 - Built-in spring at faucet end to prevent hose damage
 - Nylon reinforced
- G04002 and G04000:
- 300 PSI burst strength
 - Solid brass couplings
 - Reinforced green nylon construction

PART NO.	DESCRIPTION	CTN QTY
G04001	5/8" x 60' (500 PSI) garden hose	6
G04002	5/8" x 50' (300 PSI) garden hose	6
G04000	5/8" x 75' (300 PSI) garden hose	6

12" Cushion Grip Snow Scraper



- Display box included
- 24 scrapers; priced each
- High impact plastic
- Wide scraping surface
- CARTON QUANTITIES ONLY

PART NO.	DESCRIPTION	CTN/MSTR
S80200	12" cushion grip snow scraper display	1/24

44" Telescopic Snow Brush



- Great for trucks and SUV's!
- Combination snow brush, scraper, and squeegee
- Extra thick bristles
- Aluminum handle

PART NO.	DESCRIPTION	CTN/MSTR
S80201	44" telescopic snow brush	1/24

Combination Snow Pusher/Shovel



- 18" x 14" poly blade
- Deep rib molded, non-stick poly blade
- Heavy duty

PART NO.	DESCRIPTION	CTN/MSTR
S49430	Combination snow pusher/shovel	1/6

Items marked with the Jones Stephens logo are "You Need It...We Got It" Items.

Poly Blade Snow Shovel



- 21" deep rib molded, non-stick poly blade
- High impact blade
- Lightweight
- 48" heavy duty handle

PART NO.	DESCRIPTION	CTN/MSTR
S49434	Poly blade snow shovel	1/6

D-Grip Poly Blade Snow Shovel



- 18" x 14" high-impact, non-stick poly blade
- Lightweight
- 48" heavy duty handle

PART NO.	DESCRIPTION	CTN/MSTR
S49433	D-grip poly blade snow shovel	1/6

Economy Grade Wood Handle Shovel



PART NO.	DESCRIPTION	BUNDLE QTY
S49401	Long handle round point	6
S49402	Long handle square point	6

Fiberglass Handle Shovel



- STINGER SERIES - Fiberglass handle is 40% stronger than Federal Strength Test for long handle wood tools.
- Large steel collar adds maximum strength to handle/socket connection.
- Forward - turned step for secure foot placement

PART NO.	DESCRIPTION	AMES #	BUNDLE QTY
S49411	Long handle round point	SFGLR	6
S49412	Long handle square point	SFGLS	6

100 lb. Capacity Broadcast Spreader



- Fast 3 step assembly
- Up to 17,500 sq. ft. coverage
- Stainless steel gears, axle, agitator and linkage
- Heavy duty coated steel frame
- Rust/corrosion proof hopper
- X-Large 12.5" pneumatic tires
- Flow regulator on handle
- Comes with preinstalled deflectors to customize spread pattern

PART NO.	DESCRIPTION	CTN/MSTR
S44000	100 lb. capacity broadcast spreader	1/1

Hornet and Wasp Spray



- Long range spray- shoots a stream up to 20 feet, reaching nests far above ground, letting you keep a comfortable distance from the nest
- Contains no CFCs which deplete the ozone layer
- GROUND TRANSPORTATION ONLY
- ORM-D
- CARTON QUANTITIES ONLY

PART NO.	DESCRIPTION	CTN QTY
J40393	20 oz. can hornet & wasp spray	12

Hollow Shaft Nut Driver



- Drop forged steel
- Color coded handle
- Carded

PART NO.	DESCRIPTION	CTN/MSTR
S06117	3/8" hollow shaft nut driver	6/36
S06115	1/4" hollow shaft nut driver	6/36
S06116	5/16" hollow shaft nut driver	6/36



- 7 pc. set includes 3/16", 1/4", 5/16", 11/32", 3/8", 7/16", and 1/2" nut drivers
- Carded

PART NO.	DESCRIPTION	CTN/MSTR
S06021	7 piece hollow shaft nut driver set	6/36

Blue Chalk Line Set



- Metal body reel
- 4 oz. chalk
- Carded

PART NO.	DESCRIPTION	CTN/MSTR
J40124	100' blue chalk line set	6/36

Nylon Line Reel



- Twisted nylon
- Carded

PART NO.	DESCRIPTION	CTN/MSTR
J40125	#18 x 270' nylon line reel	6/36

10 lb. Tying Twine with Dispenser Box



- 650/1
- 10 lbs.
- Includes dispenser box

PART NO.	DESCRIPTION	CTN/MSTR
T60004	10 lb. dispenser	1/1

8" Half Round Bastard File



- High speed steel plastic molded handle
- Carded double blister

PART NO.	DESCRIPTION	CTN/MSTR
J41210	8" half round bastard file	6/36

Heavy Duty Utility Knife - Carded



- Safety orange color
- Solid east metal
- Retractable
- Blade included
- Carded

PART NO.	DESCRIPTION	CTN QTY
K50046	Heavy duty utility knife	12/144
K50043	Utility knife replacement blades with dispenser (100/pk)	6/36

Mini Scraper with 5 Replacement Blades



PART NO.	DESCRIPTION	CTN/MSTR
K50045	Mini scraper with 5 replacement blades	6/36

20 Compartment Parts Box



- Includes extra dividers to increase the amount of compartments

PART NO.	DESCRIPTION	CTN/MSTR
T60130	20 compartment parts box	1/6

5 in 1 Painters Tool



- Solid plastic handle
- Mirror finish tempered high carbon steel blade
- Precision ground
- Full tang
- Professional grade

PART NO.	DESCRIPTION	CTN/MSTR
K50011	5 in 1 painters tool	10/100

Putty Knife



PART NO.	DESCRIPTION	CTN/MSTR
K50015	1-1/4" putty knife	12/144
K50020	1-1/2" putty knife	10/100
K50017	2" putty knife	10/100
K50016	3" putty knife	12/144
K50018	4" putty knife	10/50

Clip Point Putty Knife



- Solid plastic handle
- Mirror finish tempered high carbon steel blade
- Precision ground
- Full tang
- Professional grade

PART NO.	DESCRIPTION	CTN/MSTR
K50012	Clip point putty knife	10/100

Chip Brush



- Pure 100% natural white color bristle
- Epoxy set bristles for lasting durability
- Can be used with all paints, glues, and stains
- Interior/exterior
- Smooth natural wood handles

PART NO.	DESCRIPTION	CTN/MSTR
B29805	1-1/2" chip brush	36/864
B29806	2" chip brush	36/864
B29807	3" chip brush	12/432
B29808	4" chip brush	12/288

Long Handle Wire Brush with Scraper



- Long bent handle
- 3x19 rows
- For removing rust and corrosion from metals, roughing-up wood and brushing loose stucco surfaces
- Oil tempered carbon steel wire tynes
- Smooth sanded hardwood block

PART NO.	DESCRIPTION	CTN/MSTR
B29901	Long handle wire brush with scraper	12/144

Shoe Handle Wire Brush with Scraper



- Shoe handle
- 4x16 rows
- For removing rust and corrosion from metals, roughing-up wood and brushing loose stucco surfaces
- Oil tempered carbon steel wire tines
- Smooth sanded hardwood block

PART NO.	DESCRIPTION	CTN/MSTR
B29902	Shoe handle wire brush with scraper	12/144

Ceramic Heater



- Ceramic heating element
- Fan forced
- Three settings: 750/1500 watts, fan only
- Adjustable thermostat
- Safety tip-over switch
- Box: 6.6" x 5.6" x 10"

PART NO.	DESCRIPTION	CTN/MSTR
H90100	Ceramic heater	1/6

Shop Heater



- Fan forced wire element
- Three settings: 750/1500 watts, fan only
- Adjustable thermostat
- Wide stable base and adjustable tilt
- All metal body
- Long 6 ft. cord
- Padded carry handle
- Box: 10" x 7" x 11.5"

PART NO.	DESCRIPTION	CTN/MSTR
H90101	Shop heater	1/4

Heat and UV Stabilized Nylon Cable Ties



- Heat & UV stabilized nylon-66
- Priced per bag of 100

PART NO.	DESCRIPTION	CTN/MSTR
J40433	4" 18lb. natural cable ties	12/72
J40434	6" 18lb. natural cable ties	12/72
J40435	8" 40lb. natural cable ties	12/72
J40436	11" 50lb. natural cable ties	12/72
J40437	14" 50lb. natural cable ties	12/72
J40438	17" 50lb. natural cable ties	12/72
J40443	4" 18lb. black cable ties	12/72
J40444	6" 18lb. black cable ties	12/72
J40445	8" 40lb. black cable ties	12/72
J40446	11" 50lb. black cable ties	12/72
J40447	14" 50lb. black cable ties	12/72
J40448	17" 50lb. black cable ties	12/72

Nylon Cable Ties



Natural Color



Black

- Standard size
- Nylon
- CARTON QUANTITIES ONLY

PART NO.	DESCRIPTION	CTN/MSTR
J40107	7" long (1/16" - 1-3/4") natural	100/6600
J40115	15" (5/16") black	100/2300

Pointing Trowel with Wood Handle



- Fine grained hardwood handle

PART NO.	DESCRIPTION	CTN/MSTR
B29500	5" pointing trowel with wood handle	12/120
B29501	7" pointing trowel with wood handle	12/72

Masonry Drill Bit



- Carded

PART NO.	DESCRIPTION	CTN/MSTR
S41348	1/8" masonry drill bit	6/48
S41364	3/16" masonry drill bit	6/48
S41450	1/4" masonry drill bit	6/48
S41452	5/16" masonry drill bit	6/48
S41453	3/8" masonry drill bit	6/48
S41455	1/2" masonry drill bit	6/48

Wood Spade Drill Bit



- Carded

PART NO.	DESCRIPTION	CTN/MSTR
B24250	1/2" wood spade drill bit	6/48
B24263	5/8" wood spade drill bit	6/48
B24175	3/4" wood spade drill bit	6/48
B24188	7/8" wood spade drill bit	6/144
B24200	1" wood spade drill bit	6/48
B24213	1-1/8" wood spade drill bit	6/48
B24225	1-1/4" wood spade drill bit	6/48
B24251	1-1/2" wood spade drill bit	6/48

MRO

9" Torpedo Level with Magnetic Strip



- Top read window simplifies readings in confined areas
- High impact ABS plastic frame
- Full length magnetic edge on one side
- Carded

PART NO.	DESCRIPTION	CTN/MSTR
J40102	9" torpedo level with magnetic strip	6/36

Locking Measuring Tape



- 33 ft.
- Extra heavy duty rubber case
- Power locking

PART NO.	DESCRIPTION	CTN/MSTR
J40084	1-1/4" x 33' tape measure	1/15

Power Locking Measuring Tape



- Positive thumb lock
- Chrome plated case
- Smooth power return
- Stainless belt clip
- True zero blade hook
- P.R. approved

PART NO.	DESCRIPTION	CTN/MSTR
J40346	1" x 25' tape	6/36
J40345	3/4" x 16' tape	6/36

Caulking Gun



- 9" barrel
- Drop-in half barrel type
- Painted steel

PART NO.	DESCRIPTION	CTN QTY
C35090	Caulking gun	10

Stop Flow™ Style Parallel Smooth Hex Rod Caulking Gun



- For standard cartridge
- Perfectly balanced
- Deep milled cut teeth built in spout cutter
- Nozzle clean out tool
- D-ring and wrist strap ladder hook

PART NO.	DESCRIPTION	CTN/MSTR
C35092	Stop Flow™ style parallel smooth hex rod caulking gun	1/12

100% Silicone Caulk



- Flexible, easy to use
- 50 year life
- Will not stain or bleed
- Seal, bond or insulate
- CARTON QUANTITIES ONLY

PART NO.	DESCRIPTION	CTN QTY
J40208	10.1 oz. tube CLEAR caulk	12
J40288	10.1 oz. tube WHITE caulk	12

Items marked with the Jones Stephens logo are "You Need It... We Got It" Items.

Trash Bags



- 2'8" x 4'2"
- 20 bags per box
- 42 gallon
- 3 mil

PART NO.	DESCRIPTION	CTN/MSTR
G02042	42 gallon trash bags	1/6

Duct Tape



- Premium grade, waterproof non-elastic reinforced cloth
- Pressure sensitive; vapor and flame resistant
- CARTON QUANTITIES ONLY

PART NO.	DESCRIPTION	THICKNESS	CTN QTY
T20020	2" x 60 yds (gray)	8.5 mil.	24
T20023	2" x 60 yds (black)	10 mil.	24

Box Sealing Tape



PART NO.	DESCRIPTION	CTN/MSTR
T20040	2" x 55 yds	36
T20041	2" x 110 yds	36
T20050	Dispenser only	1/24

WD-40® Lubricant



- Cleans
- Protects against rust and corrosion
- Lubricates
- Penetrates stuck metal parts
- Displaces moisture
- ORM-D
- GROUND TRANSPORTATION ONLY
- CARTON QUANTITIES ONLY

PART NO.	DESCRIPTION	CTN QTY
S95700	8 oz. can lubricant	12
S95800	8 oz. can lubricant low VOC for California	12

Orange Extension Cord



- Safety orange color
- Heavy duty
- Outdoor/grounded
- ETL Listed



PART NO.	DESCRIPTION	CTN QTY
E25000	16/3 SJT 15 ft. extension cord	6/24
E25001	16/3 SJT 25 ft. extension cord	6/24
E25002	16/3 SJT 50 ft. extension cord	6/12
E25004	16/3 SJT 100 ft. extension cord	1/6
E25005	12/3 SJT 25 ft. extension cord	1/8
E25006	12/3 SJT 50 ft. extension cord	1/6
E25007	12/3 SJT 100 ft. extension cord	1/4
E25040	14/3 SJT 25 ft. extension cord	1/12
E25041	14/3 SJT 50 ft. extension cord	1/8
E25042	14/3 SJT 100 ft. extension cord	1/4

MRO

Round Extension Cord Power Block



- 14/3 SJT
- 15 AMP
- 125 V
- ETL Listed



PART NO.	DESCRIPTION	CTN QTY
E25010	3 ft. round extension cord block	12/48

Outlet Adapter



- Converts 3 prong cord to 2 prong
- ETL Listed



PART NO.	DESCRIPTION	CTN QTY
E25320	3 to 2 prong outlet adapter	1/500

6 Outlet Power Strip with Surge Protector



- Indoor use only
- Reset button
- Hi-impact, Hi-strength plastic
- Lighted On/Off switch
- ETL Listed



PART NO.	DESCRIPTION	CTN QTY
E25300	6 outlet, 90 joules	1/12
E25301	6 outlet, 735 joules	3/18

7 Outlet Power Strip with Surge Protector



- Indoor use only
- Outlets spaced apart for large AC adapters
- 3' long
- 14/3 AWG
- Grounded cord
- Lighted On/Off switch
- ETL Listed



PART NO.	DESCRIPTION	CTN QTY
E25302	7 outlet, 300 joules	1/12

Portable Halogen Work Light



- 6 ft. grounded
- 500 watt
- Power cord
- Adjustable frame

PART NO.	DESCRIPTION	CTN/MSTR
E25250	500 watt halogen light	1/6
H500X2	(2) replacement bulbs - RSC base T3 (J-type)	12/144

Clamp-On Light



- Reflector lamp for general shop and industrial applications
- 8" shade, 6 ft. cord
- On/Off switch
- Use 75 watt max type "A" bulb (not included)
- Boxed



PART NO.	DESCRIPTION	CTN/MSTR
E25251	Clamp-on light with 8" shade	1/4

Orange Trouble Light



- Industrial quality
- 25 ft. 16/3 SJT cord
- 3-prong side outlets
- Metal cage

PART NO.	DESCRIPTION	CTN/MSTR
E25021	Orange trouble light with metal cage	1/12

8 LED Flashlight



- With magnifying lenses
- Push button switch
- Impact resistant
- Comfort grip
- Handy strap
- Uses 3 AAA batteries (included)

PART NO.	DESCRIPTION	CTN/MSTR
F20052	8 LED flashlight	6/48

24 LED Twist Light



- (2) 12 LED super bright lights
- Versatile flexible body
- Removable heads to use as single flashlights
- Use for emergencies, repairs and more!
- Uses 6 AAA batteries - 3 per side (not included)

PART NO.	DESCRIPTION	CTN/MSTR
F20050	24 LED twist light	1/6

1 Watt LED Flashlight



- With adjustable beam
- Narrow to wide focus
- Aluminum body
- Wrist strap
- 3 light options: high, low and safety flash
- Uses 3 AAA batteries (not included)

PART NO.	DESCRIPTION	CTN/MSTR
F20054	1 watt LED flashlight with adjustable beam	6/48

MRO

3 Watt LED Flashlight



- Aluminum body
- Large easy grip
- 3 light options: high, low and safety flash
- Uses 3 AAA batteries (not included)

PART NO.	DESCRIPTION	CTN/MSTR
F20053	3 watt LED flashlight	6/48

5 Watt LED Flashlight



- Aluminum body
- Includes charger
- 3 light options: high, low and safety flash
- Rechargeable lithium ion battery (included)

PART NO.	DESCRIPTION	CTN/MSTR
F20055	5 watt LED flashlight with charger	6/48

27 LED Utility Light



- With magnetic back and folding swivel hook
- 24 LED light
- 3 LED flashlight
- Push button switch
- Uses 3 AAA batteries (included)
- Display contains 12 lights
- CARTON QUANTITIES ONLY

PART NO.	DESCRIPTION	CTN/MSTR
F20051	27 LED utility light display	12/48

Industrial Swivel-Lite Flashlight



F20016



F20017

- Contractor grade construction
- Sure grip rubber handles

PART NO.	DESCRIPTION	CTN QTY
F20016	Flashlight for AA batteries	6
F20017	Flashlight for D batteries	6

Rayovac Floating Lantern and Battery



F20003



F20004



F20005

- 6-volt F20004 battery included
- Heavy duty battery priced each

PART NO.	DESCRIPTION	CTN QTY
F20003	Floating lantern with battery	6
F20004	6 volt spring top - battery only	12
F20005	6 volt screw top - battery only	4

Rayovac Industrial Flashlight



- Yellow flashlights with ring hangers

PART NO.	DESCRIPTION	CTN QTY
F20001	2 cell D size flashlight	6
F20002	3 cell D size flashlight	6

4 D/6 Volt Swivel-Lite



- Contractor grade construction
- Krypton bulb, spare bulb holder
- Floats in water (with beam up)
- Long range beam
- 45° swivel for hands-free use
- Comfort-grip handle, push-button switch
- No batteries included
- Can use 6V lantern battery for additional power

PART NO.	DESCRIPTION	CTN/MSTR
F20018	4D/ 6-Volt Swivel-Lite	1/6

Sportsman LED Head-Lite



- New technology unique 3-way hands-free L.E.D. system
- Close range use super white L.E.D., "Night vision" 2 super red L.E.D., Long range beam-krypton bulb
- Batteries last 20 times longer with L.E.D. bulbs than normal bulbs
- Rubber spot-flood reflector, head rotates 180° compact design, comfort-grip band
- Weatherproof, heavy duty construction

PART NO.	DESCRIPTION	CTN/MSTR
F20019	Sportsman LED head-lite	1/4

Duracell® Alkaline Batteries



- Priced per pack
- Carded
- PACK QUANTITIES ONLY

PART NO.	DESCRIPTION	CTN/MSTR
F20020	AAA alkaline batteries - 2 pack	1/50
F20021	AAA alkaline batteries - 4 pack	1/50
F20022	AA alkaline batteries - 2 pack	1/50
F20023	AA alkaline batteries - 4 pack	1/50
F20024	C alkaline batteries - 2 pack	1/30
F20025	D alkaline batteries - 2 pack	1/48
F20026	9 volt alkaline battery	1/50

Rayovac® Industrial Batteries



- Priced per battery
- PACK QUANTITIES ONLY

PART NO.	DESCRIPTION	CTN/MSTR
F20006	Heavy duty C batteries	6/72
F20007	Heavy duty D batteries	6/72
F20004	6 volt spring top - battery only	12/12
F20005	6 volt screw top - battery only	4/4
F20012	AAA alkaline batteries	8/96
F20008	AA alkaline batteries	8/96
F20009	9 volt alkaline batteries	6/72
F20010	C alkaline batteries	6/72
F20011	D alkaline batteries	6/72

Laminated Padlock with Keys



- Includes 2 keys
- Laminated
- Hardened steel shackle
- Shackle height is 1"
- Precision engineered double locking
- Brass pin cylinder - 5 PIN
- Protective bumper
- Clamshell pack

PART NO.	DESCRIPTION	CTN/MSTR
L26001	1-1/2" standard shackle padlock with keys	6/72
L26003	1-3/4" standard shackle padlock with keys	12/72



- Includes 2 keys
- Laminated
- Hardened steel shackle
- Shackle height is 2-1/4"
- Precision engineered double locking
- Brass pin cylinder - 5 PIN
- Protective bumper
- Clamshell pack

PART NO.	DESCRIPTION	CTN/MSTR
L26002	1-1/2" long shackle padlock with keys	6/72
L26004	1-3/4" long shackle padlock with keys	6/72

WordLock® 4 Dial Utility Padlock



- High security
- Heavy duty
- Brass color
- Resettable
- 1-1/2" shackle
- Clamshell pack

WordLock®

PART NO.	DESCRIPTION	CTN/MSTR
L26006	4 dial utility padlock	3/12

WordLock® 4 Dial Discus Lock



- Patented design
- Resettable
- Stainless steel body with rubber bumper
- Weatherproof
- ASTM rated to the highest standards
- Clamshell pack

WordLock®

PART NO.	DESCRIPTION	CTN/MSTR
L26007	4 dial discus lock	6/48

WordLock® Stor-More Key Safe™



- More space than traditional key safes - can hold larger items
- Can hold keys, key fobs, credit cards and much more
- Mounts on door or wall
- 10,000 possible combinations
- Resettable
- Reinforced stainless steel body to withstand sawing and hammering
- Clamshell pack

WordLock®

PART NO.	DESCRIPTION	CTN/MSTR
L26008	Key safe	3/12

WordLock® Loop and Lock™ with MatchKey



- 8 ft.
- Ultimate utility cable lock
- Heavy duty flexible steel cable
- Integrated lock head means no padlocks to lose
- Ideal for securing ladders and other tools
- Key color matches cable color
- Word on key matches word on lock
- Unique key shape
- Carded

WordLock®

PART NO.	DESCRIPTION	CTN/MSTR
L26005	8 ft. black Loop and Lock with matchkey	4/16

Flexible Cable Lock



- Weatherproof
- 7 x 7 strands
- 2 loop
- Vinyl coated

PART NO.	DESCRIPTION	CTN/MSTR
L26009	6' x 5/16" clear flexible cable lock	12/48
L26010	14' x 3/8" black flexible cable lock	6/24

Shielded Protected Shackleless Lock with Keys



- Includes 3 keys
- Hasp sold separately (L26012)
- No shackle
- 2-7/8"
- Large chrome plated solid steel body
- Removable cylinder
- Compare with American 2000® series
- Boxed

PART NO.	DESCRIPTION	CTN/MSTR
L26011	Shielded protected shackleless lock with keys	6/24
L26012	Hasp only	1/16

MRO

4 Dial Combination Padlock



- Heavy duty, solid brass
- Resettable
- Hardened shackle
- Shackle height is 1"
- Clamshell pack

PART NO.	DESCRIPTION	CTN/MSTR
L26015	4 dial combination padlock	6/48

Round Body Steel Padlock with Keys



- Includes 3 keys
- Shackle height is 1.25"
- Solid steel body
- Hardened chrome plated steel cylinder, guard plate and security nut
- Double steel ball bearing locks shackle on both heel and toe
- Clamshell pack

PART NO.	DESCRIPTION	CTN/MSTR
L26017	2-5/8" round body steel padlock	6/24

Square Body Steel Padlock with Keys



- Includes 3 keys
- Shackle height is 1.1"
- Solid steel body
- Hardened chrome plated steel cylinder, guard plate and security nut
- Double steel ball bearing locks shackle on both heel and toe
- Clamshell pack

PART NO.	DESCRIPTION	CTN/MSTR
L26016	1-3/4" square body steel padlock	6/24

4' Steel Hardened Security Chain



- 4' x 3/8"
- Hardened to resist cutting
- Canvas cover
- Square link
- Sleeve pack

PART NO.	DESCRIPTION	CTN/MSTR
L26018	4" steel hardened security chain	1/6



Toliet Repair

Display Part No. TB5000



- 2' x 2' white pegboard
- Includes header, peg hooks, reorder tags, and planogram

* Note: Some items on this board are not listed in the MRO section of the catalog.

PART NO.	DESCRIPTION	QTY
T02070	Integral float fill valve	6
T01001*	Chrome plated fit-all tank trip lever with 8" brass arm	8
S04216*	9" flexible stainless steel connector - 3/8" OD x 7/8" BC	10
S04415	12" braided nylon connector - 3/8" OD x 7/8" BC	10
S04217* 	12" flexible stainless steel connector - 3/8" OD x 7/8" BC	10
S04222*	16" flexible stainless steel connector - 1/2" OD x 7/8" BC	10
S04219*	20" flexible stainless steel connector - 3/8" OD x 7/8" BC	10
C04004*	Carded blue fit-all vinyl flapper	8
C85000* 	Closet flange repair ring	6
C87100* 	Repair flange	6

 Items marked with the Jones Stephens logo are "You Need It...We Got It" Items.

Hardware

Display Part No. TB5100



- 2' x 2' white pegboard
- Includes header, peg hooks, reorder tags, and planogram

PART NO.	DESCRIPTION	QTY
B24250	1/2" wood spade drill bit	4
B24263	5/8" wood spade drill bit	4
B24175	3/4" wood spade drill bit	4
B24188	7/8" wood spade drill bit	4
B24200	1" wood spade drill bit	4
B24213	1-1/8" wood spade drill bit	4
B24225	1-1/4" wood spade drill bit	4
B24251	1-1/2" wood spade drill bit	4
K50043	Heavy duty utility knife replacement blades with dispenser	6
K50046	Heavy duty utility knife	8
S41452	5/16" masonry drill bit	4
S41453	3/8" masonry drill bit	4
S41455	1/2" masonry drill bit	4
S41348	1/8" masonry drill bit	4
S41364	3/16" masonry drill bit	4
S41450	1/4" masonry drill bit	4
S06021	7 piece hollow shaft nut driver set	4
J40345	3/4" x 16' measuring tape	4
J40346	1" x 25' measuring tape	4
J40102	9" torpedo level with magnetic strip	6

Security

Display Part No. TB5200



- 2' x 2' white pegboard
- Includes header, peg hooks, reorder tags, and planogram

PART NO.	DESCRIPTION	QTY
L26001	1-1/2" standard shackle padlock with keys	4
L26003	1-3/4" standard shackle padlock with keys	4
L26004	1-3/4" long shackle padlock with keys	4
L26015	4 dial combination padlock	4
L26008	Stor-More Key Safe®	2
L26016	1-3/4" square body steel padlock	4
L26017	2-5/8" round body steel padlock	4
L26010	14' x 3/8" black flexible cable lock	4
L26005	8 ft. black Loop and Lock™ with matchkey	4
L26007	4 dial discus lock	4
L26018	4" steel hardened security chain	2

MRO

Gloves

Display Part No. TB5300



- 2' x 2' white pegboard
- Includes header, peg hooks, reorder tags, and planogram

PART NO.	DESCRIPTION	QTY
G50223	14" industrial smooth hands rubber gloves, 30 mil	8
G50204	Leather palm low safety cuff gloves	12
G50300	Economy brown cotton jersey gloves	12
G50229	White cotton gloves with PVC dots	12
G50228	White canvas work gloves	12
G50225	Polyester nitrile dipped palm gloves	12
G50302	8 pack disposable gloves	16

Cable Ties

Display Part No. TB5400



- 2' x 2' white pegboard
- Includes header, peg hooks, reorder tags, and planogram

PART NO.	DESCRIPTION	QTY
J40438	17" 50lb. natural cable ties	6
J40437	14" 50lb. natural cable ties	6
J40435	8" 40lb. natural cable ties	8
J40434	6" 18lb. natural cable ties	8
J40447	14" 50lb. black cable ties	6
J40448	17" 50lb. black cable ties	6
J40444	6" 18lb. black cable ties	8
J40445	8" 40lb. black cable ties	8

Wall and Counter Repair

Display Part No. TB5500



- 2' x 2' white pegboard
- Includes header, peg hooks, reorder tags, and planogram

PART NO.	DESCRIPTION	QTY
C35090	Caulking gun	6
C35092	Stop Flow™ style parallel smooth hex rod caulking gun	6
K50020	1-1/2" putty knife	6
B29902	Shoe handle wire brush with scraper	6
B29901	Long handle wire brush with scraper	6
B29805	1-1/2" chip brush	6
B29806	2" chip brush	6
B29807	3" chip brush	6
B29808	4" chip brush	6
K50018	4" putty knife	6
K50012	Clip point putty knife	6
K50011	5 in 1 painters tool	6

Flashlights

Display Part No. TB5600



- 2' x 2' white pegboard
- Includes header, peg hooks, reorder tags, and planogram

PART NO.	DESCRIPTION	QTY
F20054	1 watt LED flashlight with adjustable beam	4
F20055	5 watt LED flashlight with charger	4
F20001	2 cell D size flashlight	4
F20017	Industrial swivel-lite D size flashlight	4
F20053	3 watt LED flashlight	4
F20052	8 LED flashlight	4
F20019	Sportsman LED head-lite	6
F20003	Floating lantern with battery	4

MERCHANDISING

Wrench and Pliers..... 415

Cutting Tools 415

Specialty Tools 416

Saws 416

Straps and Gloves 417

Socket Savers..... 417

Toilet Repair..... 418

Hardware..... 418

Security 419

Gloves..... 419

Cable Ties..... 420

Wall and Counter Repair 420

Flashlights..... 421

Complete Tool Spinner..... 421

Liquid Lightning Pro Drain Opener..... 422

Wypall® Waterless Hand Wipes..... 422

The Green Drain 422

Complete Brass Assortment - Lead Free..... 423

Flare Fittings 424

Compression Fittings..... 425

Garden Hose Fittings - Lead Free..... 426

Brass Hose Barbs 427

Yellow Brass and Bronze Fittings - Lead Free 428

Poly Inserts 429

Wrench and Pliers

Display Part No. TB4000



- 2' x 2' white pegboard
- Includes header, peg hooks, reorder tags, and planogram



PART NO.	DESCRIPTION	QTY
J40021	Compression sleeve puller	6
J40035	Lavatory nut removal tool	6
P60001	Slip jaw pliers (2-1/8" capacity / 10" long)	6
J40019	Do All plumbers wrench	6
J45010	Universal drain wrench	6
J40491	Angle compression stop wrench	6
J40490	Dual kwik tite wrench	6
T60060	 No hub torque wrench	6

Cutting Tools

Display Part No. TB4100



- 2' x 2' white pegboard
- Includes header, peg hooks, reorder tags, and planogram

PART NO.	DESCRIPTION	QTY
P70035	2" PVC one-handed pipe cutter	6
P70018	 1-1/4" PVC pipe cutter	6
J40260	 1/2" Copper tube cutter	6
J40261	3/4" Copper tube cutter	6
P70019	1-1/4" PVC pipe cutter replacement blade	6
P70052	Mini tubing cutter-1/8"-7/8" (uses P70055 repl. blade)	6
P70067	Mini tubing cutter replacement blades (2)	6
P70056	Enclosed feed tube cutter replacement cutter wheels (2)	6
P70064	Enclosed feed tube cutter (1/8" x 1-3/16")	6

 Items marked with the Jones Stephens logo are "You Need It...We Got It" Items.

Specialty Tools

Display Part No. TB4200



- 2' x 2' white pegboard
- Includes header, peg hooks, reorder tags, and planogram

PART NO.	DESCRIPTION	QTY
J40080	Bar flaring tool	6
J40830	E-Z shear inside pipe cutter	6
J40026	4-way P.O. plug wrench	6
J45015	Stem and cartridge wrench	6
B11010	Basin wrench (10"-17" telescoping)	6
J40021	Compression sleeve puller	6
J40010	Faucet handle puller standard unit	6
J40018	Extract-a-drain tool	6
J40015	Hex key wrench set	6

Saws

Display Part No. TB4300



- 2' x 2' white pegboard
- Includes header, peg hooks, reorder tags, and planogram

PART NO.	DESCRIPTION	QTY
S49008	12" E-Z stroke pipe saw	6
S49007	12" E-Z stroke pipe saw replacement blade	6
S49200	Hardwood 250 speed handsaw	6
S49005	8" E-Z stroke pipe saw	6
S49006	8" E-Z stroke pipe saw replacement blade	6
S49036	36" cable saw	6
S50060	6" close quarters hacksaw	6
S49236	36" T-handle cable saw	6
S50061	6" close quarters hacksaw replacement blades (5)	6

Straps and Gloves

Display Part No. TB4400



- 2' x 2' white pegboard
- Includes header, peg hooks, reorder tags, and planogram

PART NO.	DESCRIPTION	QTY
S20100	1" x 2' black single pack	6
S20101	1" x 4' red single pack	6
S20102	1" x 6' yellow single pack	6
G50200	 Brown cotton jersey glove	6
S20103	1" x 8' green single pack	6
S20104	1" x 10' blue single pack	6
S20105	1" x 12' purple single pack	6
G50204	Leather palm low safety cuff glove	6

Socket Savers

Display Part No. TB4500



- 2' x 2' white pegboard
- Includes header, peg hooks, reorder tags, and planogram

PART NO.	DESCRIPTION	QTY
J44050	1/2" socket saver	6
J44075	3/4" socket saver	6
J44100	1" socket saver	6
J44150	1-1/2" socket saver	6
J44200	2" socket saver	6
J44300	 3" socket saver	6
J44400	4" socket saver	6



 Items marked with the Jones Stephens logo are "You Need It...We Got It" Items.

Toliet Repair

Display Part No. TB5000



- 2' x 2' white pegboard
- Includes header, peg hooks, reorder tags, and planogram
- * Note: Some items on this board are not listed in the MRO section of the catalog.

PART NO.	DESCRIPTION	QTY
T02070	Integral float fill valve	6
T01001*	Chrome plated fit-all tank trip lever with 8" brass arm	8
S04216*	9" flexible stainless steel connector - 3/8" OD x 7/8" BC	10
S04415	12" braided nylon connector - 3/8" OD x 7/8" BC	10
S04217* 	12" flexible stainless steel connector - 3/8" OD x 7/8" BC	10
S04222*	16" flexible stainless steel connector - 1/2" OD x 7/8" BC	10
S04219*	20" flexible stainless steel connector - 3/8" OD x 7/8" BC	10
C04004*	Carded blue fit-all vinyl flapper	8
C85000* 	Closet flange repair ring	6
C87100* 	Repair flange	6

Hardware

Display Part No. TB5100



- 2' x 2' white pegboard
- Includes header, peg hooks, reorder tags, and planogram

PART NO.	DESCRIPTION	QTY
B24250	1/2" wood spade drill bit	4
B24263	5/8" wood spade drill bit	4
B24175	3/4" wood spade drill bit	4
B24188	7/8" wood spade drill bit	4
B24200	1" wood spade drill bit	4
B24213	1-1/8" wood spade drill bit	4
B24225	1-1/4" wood spade drill bit	4
B24251	1-1/2" wood spade drill bit	4
K50043	Heavy duty utility knife replacement blades with dispenser	6
K50046	Heavy duty utility knife	8
S41452	5/16" masonry drill bit	4
S41453	3/8" masonry drill bit	4
S41455	1/2" masonry drill bit	4
S41348	1/8" masonry drill bit	4
S41364	3/16" masonry drill bit	4
S41450	1/4" masonry drill bit	4
S06021	7 piece hollow shaft nut driver set	4
J40345	3/4" x 16' measuring tape	4
J40346	1" x 25' measuring tape	4
J40102	9" torpedo level with magnetic strip	6

Security

Display Part No. TB5200



- 2' x 2' white pegboard
- Includes header, peg hooks, reorder tags, and planogram

PART NO.	DESCRIPTION	QTY
L26001	1-1/2" standard shackle padlock with keys	4
L26003	1-3/4" standard shackle padlock with keys	4
L26004	1-3/4" long shackle padlock with keys	4
L26015	4 dial combination padlock	4
L26008	Stor-More Key Safe®	2
L26016	1-3/4" square body steel padlock	4
L26017	2-5/8" round body steel padlock	4
L26010	14' x 3/8" black flexible cable lock	4
L26005	8 ft. black Loop and Lock™ with matchkey	4
L26007	4 dial disc lock	4
L26018	4" steel hardened security chain	2

Gloves

Display Part No. TB5300



- 2' x 2' white pegboard
- Includes header, peg hooks, reorder tags, and planogram

PART NO.	DESCRIPTION	QTY
G50223	14" industrial smooth hands rubber gloves, 30 mil	8
G50204	Leather palm low safety cuff gloves	12
G50300	Economy brown cotton jersey gloves	12
G50229	White cotton gloves with PVC dots	12
G50228	White canvas work gloves	12
G50225	Polyester nitrile dipped palm gloves	12
G50302	8 pack disposable gloves	16

Cable Ties

Display Part No. TB5400



- 2' x 2' white pegboard
- Includes header, peg hooks, reorder tags, and planogram

PART NO.	DESCRIPTION	QTY
J40438	17" 50lb. natural cable ties	6
J40437	14" 50lb. natural cable ties	6
J40435	8" 40lb. natural cable ties	8
J40434	6" 18lb. natural cable ties	8
J40447	14" 50lb. black cable ties	6
J40448	17" 50lb. black cable ties	6
J40444	6" 18lb. black cable ties	8
J40445	8" 40lb. black cable ties	8

Wall and Counter Repair

Display Part No. TB5500



- 2' x 2' white pegboard
- Includes header, peg hooks, reorder tags, and planogram

PART NO.	DESCRIPTION	QTY
C35090	Caulking gun	6
C35092	Stop Flow™ style parallel smooth hex rod caulking gun	6
K50020	1-1/2" putty knife	6
B29902	Shoe handle wire brush with scraper	6
B29901	Long handle wire brush with scraper	6
B29805	1-1/2" chip brush	6
B29806	2" chip brush	6
B29807	3" chip brush	6
B29808	4" chip brush	6
K50018	4" putty knife	6
K50012	Clip point putty knife	6
K50011	5 in 1 painters tool	6

Flashlights

Display Part No. TB5600



- 2' x 2' white pegboard
- Includes header, peg hooks, reorder tags, and planogram

PART NO.	DESCRIPTION	QTY
F20054	1 watt LED flashlight with adjustable beam	4
F20055	5 watt LED flashlight with charger	4
F20001	2 cell D size flashlight	4
F20017	Industrial swivel-lite D size flashlight	4
F20053	3 watt LED flashlight	4
F20052	8 LED flashlight	4
F20019	Sportsman LED head-lite	6
F20003	Floating lantern with battery	4

Complete Tool Spinner

Display Part No. TOOLSPIN



- Spinner display
- Includes header, peg hooks, reorder tags, and planogram

PART NO.	DESCRIPTION	QTY
J44050	1/2" socket saver	6
J44100	1" socket saver	6
J44150	1-1/2" socket saver	6
J44200	2" socket saver	6
J44300	3" socket saver	6
J44400	4" socket saver	6
S49008	12" E-Z stroke pipe saw	6
S49007	12" E-Z stroke pipe saw replacement blade	6
S49005	8" E-Z stroke pipe saw	6
S49006	8" E-Z stroke pipe saw replacement blade	6
P70035	2" PVC one-handed pipe cutter	6
P70019	1-1/4" PVC pipe cutter replacement blade	6
P70018	1-1/4" PVC pipe cutter	6
S49001	18" plastic saw	6
P70052	Mini tubing cutter-1/8"-7/8" (uses P70055 repl. blade)	6
J40260	1/2" Copper tube cutter	6
J40261	3/4" Copper tube cutter	6
J40830	E-Z shear inside pipe cutter	6
J40831	E-Z shear replacement blades (2)	6
J40010	Faucet handle puller standard unit	6
J40262	1/4"-3/4" Ratcheting handle copper tube cutter	6
P70064	Enclosed feed tube cutter (1/8" x 1-3/16")	6
J45010	Universal drain wrench	6
J40080	Bar flaring tool	6
J40075	6" adjustable wrench	6
J40490	Dual kwik tite wrench	6
J40491	Angle compression stop wrench	6
T60060	No hub torque wrench	6
J45015	Stem and cartridge wrench	6
J40026	4-way P.O. plug wrench	6
J40019	Do All plumbers wrench	6
J40035	Lavatory nut removal tool	6
J40235	Quick drain wrench	6
T50001	3-N-1 tubing bender	6

Items marked with the Jones Stephens logo are "You Need It...We Got It" Items.

Liquid Lightning Pro Drain Opener

Display Part No. LLPRODISP



- Blue metal rack and header included

PART NO.	DESCRIPTION	QTY
S95701	1 pint drain opener	48
S95793	1 quart drain opener	96

Wypall® Waterless Hand Wipes



- 10 x 12 pre-moistened towels; 50 count
- Lower price per tub
- Conveniently sized tub
- All of the towels can be used before they dry out
- CARTON QUANTITIES ONLY

PART NO.	DESCRIPTION	CTN QTY
B05007	50-count dispenser tub	8
B05008	Wypall display (32 tubs)	1

The Green Drain

Display Part No. Q00200



- Metal display
- Header included

PART NO.	DESCRIPTION	QTY
Q00200	Green Drain display	1

Complete Brass Assortment - Lead Free

Display Part No. Q01011LF

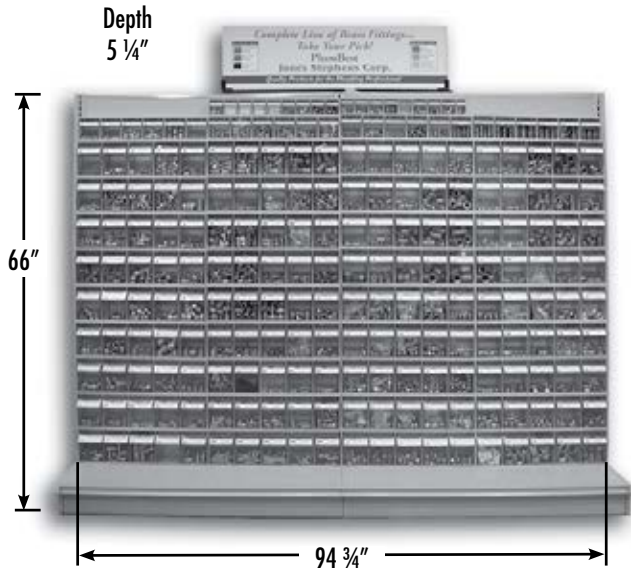

*Gondola Not Included

- Complete Brass assortment includes all 5 of the assortments (Q01012LF, Q01013, Q01014LF, Q01015LF, Q01016) plus the following items:
- Get 42 Multistore Bins FREE!
- NOTE: Parts noted with " * " comply with the 2014 U.S. Safe Drinking Water Act. Some part numbers have not changed.

PART NO.	DESCRIPTION	QTY
* N10442	1/4" OD x 1/8" MIP (Angle Needle Valve)	25
* N15100	3/8" x Close CP Nipple	5
* N15200	3/8" x 2" CP Nipple	5
* N15400	3/8" x 4" CP Nipple	5
* N16100	1/2" x Close CP Nipple	5
* N16200	1/2" x 2" CP Nipple	5
* N16400	1/2" x 4" CP Nipple	5
* B50001LF	3/8" 90° CP Elbow	5
* B50002LF	1/2" 90° CP Elbow	5
* B50041LF	3/8" CP Coupling	5
* B50042LF	1/2" CP Coupling	5
* B50031LF	3/8" CP Tee	5
* B50032LF	1/2" CP Tee	5
* B10100	1/2" - 14 x 3/8" Regular Zamak Basin Nut	25
* B10102	1/2" - 14 x 1/2" Regular Zamak Basin Nut	25
* B10103	1/2" - 14 x 9/16" Regular Zamak Basin Nut	25
* B10104	1/2" - 14 x 9/16" Regular Brass Basin Nut	25
* B10105	1/2" - 14 x 1/2" White Faucet Nut	25
* C74002LF	3/8" Compression Cap	25
* C74011	7/8" OD Compression Sleeve	50
* C74020	7/8" OD Compression Nut	50
* C74031LF	1/2" x 3/8" Comp Reducing Union	25
* C74093LF	5/8" OD x 5/8" OD (1/2" Sweat Adapter)	25
* C74094	3/8" CP Compression Nut	25
* C74096	1/4" OD Delrin Comp Sleeve	100
* C74097	3/8" OD Delrin Comp Sleeve	100
* C74098	1/2" OD Delrin Comp Sleeve	100
* C74099	5/8" OD Delrin Comp Sleeve	25
* C74100LF	1/4" Brass Insert	100
* C74101LF	3/8" Brass Insert	100
* C74102LF	1/2" Brass Insert	40
* C74103LF	5/8" Brass Insert	25
* S92001	Self-piercing Needle Valve Kit	10
T77125	1 1/4" x 1 1/4" CP Slip Joint Nut	25
T77150	1 1/2" x 1 1/2" CP Slip Joint Nut	25
T77151	1 1/2" x 1 1/4" CP Slip Joint Nut	25
* C05080	5/8" x 1/2" Zinc Ballcock Coupling Nut	25
* C05081	5/8" x 7/8" Brass Ballcock Coupling Nut	25
* G20056	3/4" FGH Cap with Chain	10
A11001	1/4" FIP x 1/4" MIP Brass Air Cock with Lever Handle and Hex Shoulder	5
A11003	1/4" FIP x 1/4" MIP Brass Air Cock with Tee Handle and Hex Shoulder	5
A11004	1/4" FIP x 1/4" FIP Brass Air Cock with Lever Handle and Round Shoulder	5
A11005	1/4" FIP x 1/4" FIP Brass Air Cock	5
* N01001	1/8" MIP Lever Handle Drain Cock	10
* N01002	1/4" MIP Lever Handle Drain Cock	10
Q01005	5-unit Tilt Bin Display	36
Q01006	6-unit Tilt Bin Display	4
Q01009	9-unit Tilt Bin Display	2

Flare Fittings

Display Part No. Q01013

• Get 5 Multistore Bins FREE!

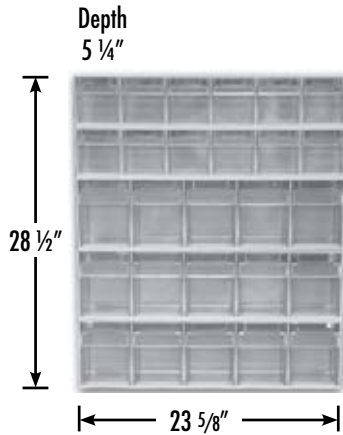

PART NO.	DESCRIPTION	QTY
F40002	1/4" Short Flare Nut	25
F40004	3/8" Short Flare Nut	50
F40005	1/2" Short Flare Nut	50
F40006	5/8" Short Flare Nut	25
F40020	3/8" Flare Cap	25
F40021	1/2" Flare Cap	25
F40023	1/4" Flare Union	25
F40025	3/8" Flare Union	25
F40026	1/2" Flare Union	25
F40027	5/8" Flare Union	10
F40035	3/8" Flare Tee	10
F40036	1/2" Flare Tee	10
F40048	3/8" Flare x 3/8" FIP Coupling	20
F40049	3/8" Flare x 1/2" FIP Coupling	20
F40052	1/2" Flare x 3/8" FIP Coupling	20
F40053	1/2" Flare x 1/2" FIP Coupling	20
F40055	5/8" Flare x 1/2" FIP Coupling	15
F40063	1/4" Flare x 1/8" MIP Half Union	20
F40064	1/4" Flare x 1/4" MIP Half Union	20
F40068	3/8" Flare x 1/4" MIP Half Union	20
F40069	3/8" Flare x 3/8" MIP Half Union	25
F40070	3/8" Flare x 1/2" MIP Half Union	25
F40073	1/2" Flare x 3/8" MIP Half Union	25
F40074	1/2" Flare x 1/2" MIP Half Union	25
F40076	5/8" Flare x 1/2" MIP Half Union	15
F40088	3/8" Flare x 3/8" MIP Elbow	10
Q01005	5-unit Tilt Bin Display	3
Q01006	6-unit Tilt Bin Display	2

Compression Fittings - Lead Free

Display Part No. Q01012LF

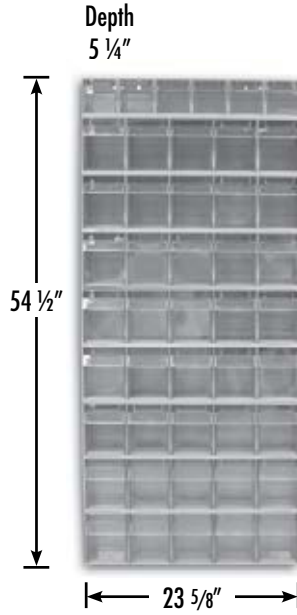

• Get 9 Multistore Bins FREE!

NOTE: Parts noted with "*" comply with the 2014 U.S. Safe Drinking Water Act. Some part numbers have not changed.

PART NO.	DESCRIPTION	QTY
* C74005	1/4" OD Compression Sleeve	100
* C74007	3/8" OD Compression Sleeve	100
* C74008	1/2" OD Compression Sleeve	100
* C74009	5/8" OD Compression Sleeve	100
* C74014	1/4" OD Compression Sleeve	100
* C74016	3/8" OD Compression Nut	100
* C74017	1/2" OD Compression Nut	100
* C74018	5/8" OD Compression Nut	100
* C74023LF	1/4" OD Compression Union	50
* C74025LF	3/8" OD Compression Union	100
* C74026LF	1/2" OD Compression Union	50
* C74027LF	5/8" OD Compression Union	50
* C74029LF	7/8" OD Compression Union	25
* C74030LF	3/8" x 1/4" Comp Reducing Union	25
* C74031LF	1/2" x 3/8" Comp Reducing Union	25
* C74032LF	5/8" x 3/8" Comp Reducing Union	25
* C74034LF	1/4" OD Compression Tee	10
* C74036LF	3/8" OD Compression Tee	20
* C74038LF	1/2" OD Compression Tee	10
* C74041LF	3/8" OD Compression Elbow	25
* C74043LF	5/8" OD Compression Elbow	10
* C74044LF	5/8" x 3/8" Compression Elbow	10
* C74050LF	3/8" OD x 3/8" FIP Comp Union	25
* C74051LF	3/8" OD x 1/2" FIP Comp Union	25
* C74052LF	1/2" OD x 3/8" FIP Comp Union	25
* C74053LF	1/2" OD x 1/2" FIP Comp Union	25
* C74054LF	5/8" x OD x 1/2" FIP Comp Union	10
* C74055LF	7/8" OD x 3/4" FIP Comp Union	10
* C74058LF	1/4" OD x 1/8" MIP Comp Union	25
* C74059LF	1/4" OD x 1/4" MIP Comp Union	25
* C74060LF	1/4" OD x 3/8" MIP Comp Union	25
* C74064LF	3/8" OD x 1/4" MIP Comp Union	25
* C74065LF	3/8" OD x 3/8" MIP Comp Union	50
* C74066LF	3/8" OD x 1/2" MIP Comp Union	50
* C74069LF	1/2" OD x 3/8" MIP Comp Union	50
* C74070LF	1/2" OD x 1/2" MIP Comp Union	50
* C74071LF	5/8" OD x 1/2" MIP Comp Union	40
* C74072LF	5/8" OD x 3/4" MIP Comp Union	25
* C74073LF	7/8" OD x 3/4" MIP Comp Union	20
* C74081LF	1/4" OD x 1/8" MIP Comp Elbow	25
* C74082LF	1/4" OD x 1/4" MIP Comp Elbow	25
* C74085LF	3/8" OD x 1/4" MIP Comp Elbow	25
* C74086LF	3/8" OD x 3/8" MIP Comp Elbow	60
* C74087LF	3/8" OD x 1/2" MIP Comp Elbow	25
* C74088LF	1/2" OD x 3/8" MIP Comp Elbow	50
* C74089LF	1/2" OD x 1/2" MIP Comp Elbow	25
Q01005	5-unit Tilt Bin Display	8
Q01006	6-unit Tilt Bin Display	1

Garden Hose Fittings - Lead Free

Display Part No. Q01014LF

• Get 4 Multistore Bins FREE!

NOTE: Parts noted with "*" comply with the 2014 U.S. Safe Drinking Water Act. Some part numbers have not changed.

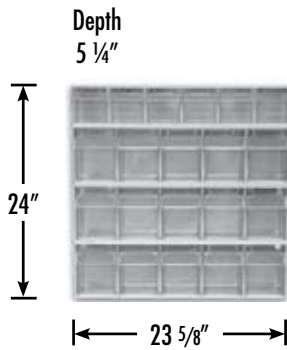

PART NO.	DESCRIPTION	QTY
* G20102	3/4" MGH x 1/2" MIP	25
* G20103	3/4" MGH x 3/4" MIP Tapped 1/2" FIP	25
* G20108	3/4" MGH to 3/4" MGH	25
* G20110	3/4" MGH x 1/2" FIP	10
* G20111	3/4" MGH x 3/4" FIP	25
* G20115	3/4" FGH x 1/2" MIP	10
* G20116	3/4" FGH x 3/4" MIP	25
* G20120	3/4" FGH x 1/2" FIP	10
* G20121	3/4" FGH x 3/4" FIP	10
* G20130	3/4" FGH Swivel	25
* G20131	3/4" FGH x 1/2" FIP Swivel	25
* G20132	3/4" FGH x 3/4" FIP Swivel	25
* G20136	1/2" ID x 3/4" FGH Swivel Hose Barb	5
* G20137	5/8" ID x 3/4" FGH Swivel Hose Barb	10
* G20138	3/4" ID x 3/4" FGH Swivel Hose Barb	2
* G20141	1/2" ID x 3/4" MGH Hose Barb	5
* G20142	5/8" ID x 3/4" MGH Hose Barb	10
* G20143	3/4" ID x 3/4" MGH Hose Barb	5
* G20150	3/4" FGH x 3/4" MGH Wye	5
* G20155	3/4" GH Cap	25
* G20057	3/4" Hose Washer	200
Q01005	5-unit Tilt Bin Display	3
Q01006	6-unit Tilt Bin Display	1

Brass Hose Barbs

Display Part No. Q01016

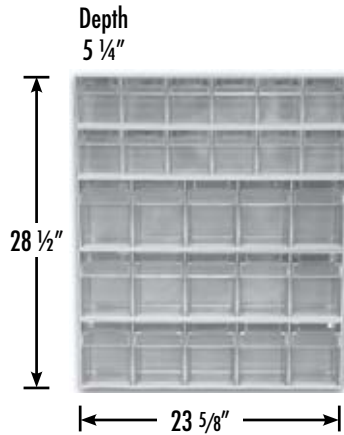

• Get 5 Multistore Bins FREE!

PART NO.	DESCRIPTION	QTY
G25032	3/16" ID x 1/8" MIP Hose Barb	10
G25042	1/4" ID x 1/8" MIP Hose Barb	10
G25044	1/4" ID x 1/4" MIP Hose Barb	24
G25046	1/4" ID x 3/8" MIP Hose Barb	10
G25048	1/4" ID x 1/2" MIP Hose Barb	10
G25052	5/16" ID x 1/8" MIP Hose Barb	10
G25054	5/16" ID x 1/4" MIP Hose Barb	10
G25064	3/8" ID x 1/4" MIP Hose Barb	20
G25066	3/8" ID x 3/8" MIP Hose Barb	30
G25068	3/8" ID x 1/2" MIP Hose Barb	10
G25084	1/2" ID x 1/4" MIP Hose Barb	25
G25086	1/2" ID x 3/8" MIP Hose Barb	15
G25088	1/2" ID x 1/2" MIP Hose Barb	40
G25106	5/8" ID x 3/8" MIP Hose Barb	20
G25108	5/8" ID x 1/2" MIP Hose Barb	25
G25101	5/8" ID x 3/4" MIP Hose Barb	25
G25121	3/4" ID x 3/4" MIP Hose Barb	10
G25128	3/4" ID x 1/2" MIP Hose Barb	5
G29004	1/4" ID Hose Splicer	100
G29005	5/16" ID Hose Splicer	100
G29006	3/8" ID Hose Splicer	95
G29008	1/2" ID Hose Splicer	70
G29010	5/8" ID Hose Splicer	50
N10544	1/4" OD x 1/4" OD St. Needle Valve	25
N10566	3/8" OD x 3/8" OD St. Needle Valve	25
N10642	1/4" OD x 1/8" MIP St. Needle Valve	25
N10664	3/8" OD x 1/4" MIP St. Needle Valve	25
Q01005	5-unit Tilt Bin Display	3
Q01006	6-unit Tilt Bin Display	2

Yellow Brass and Bronze Pipe Fittings - Lead Free

Display Part No. Q01015LF

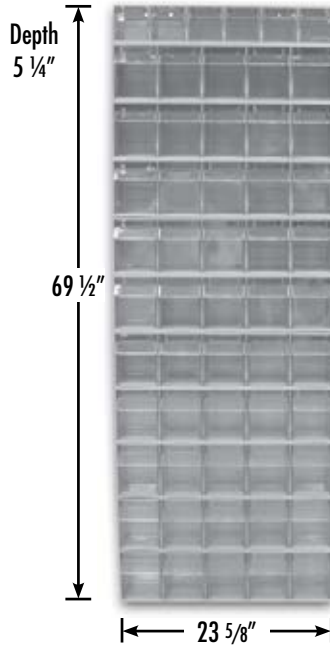

* Get 11 Multistore Bins FREE!

NOTE: Parts noted with "*" comply with the 2014 U.S. Safe Drinking Water Act. Some part numbers have not changed.

PART NO.	DESCRIPTION	QTY
* B74343LF	1/8" 90° Pipe Elbow	10
* B74002LF	1/4" 90° Pipe Elbow	10
* B74003LF	3/8" 90° Pipe Elbow	10
* B74004LF	1/2" 90° Pipe Elbow	20
* B74005LF	3/4" 90° Pipe Elbow	20
* B74006LF	1" 90° Pipe Elbow	5
P10012	1/8" Pipe Tee	10
* B74082LF	1/4" Pipe Tee	10
* B74083LF	3/8" Pipe Tee	5
* B74084LF	1/2" Pipe Tee	10
* B74085LF	3/4" Pipe Tee	10
* B74086LF	1" Pipe Tee	10
P10032	1/8" Pipe Coupling	10
P10034	1/4" Pipe Coupling	10
* B74123LF	3/8" Pipe Coupling	10
* B74124LF	1/2" Pipe Coupling	20
* B74125LF	3/4" Pipe Coupling	20
* B74126LF	1" Pipe Coupling	10
P10082	1/8" Pipe Cap	10
P10084	1/4" Pipe Cap	10
P10086	3/8" Pipe Cap	10
* B74184LF	1/2" Pipe Cap	25
* B74185LF	3/4" Pipe Cap	25
* B74186LF	1" Pipe Cap	10
P10092	1/8" Square Head Pipe Plug	25
P10094	1/4" Square Head Pipe Plug	50
P10096	3/8" Square Head Pipe Plug	25
* B74284LF	1/2" Square Head Pipe Plug	30
* B74285LF	3/4" Square Head Pipe Plug	30
* B74286LF	1" Square Head Pipe Plug	10
P11042	1/4" x 1/8" Hex Bushing	25
P11062	3/8" x 1/8" Hex Bushing	25
P11064	3/8" x 1/4" Hex Bushing	20
P11084	1/2" x 1/4" Hex Bushing	20
P11086	1/2" x 3/8" Hex Bushing	50
P11124	3/4" x 1/4" Hex Bushing	10
P11128	3/4" x 1/2" Hex Bushing	50
* B74212LF	1" x 1/2" Hex Bushing	20
* B74213LF	1" x 3/4" Hex Bushing	25
P11202	1/8" x Close Pipe Nipple	25
P11204	1/4" x Close Pipe Nipple	25
P11206	3/8" x Close Pipe Nipple	25
P11208	1/2" x Close Pipe Nipple	25
* N24000	3/4" x Close Pipe Nipple	25
* N25000	1" x Close Pipe Nipple	10
P13232	1/8" x 2" Pipe Nipple	20
P13432	1/4" x 2" Pipe Nipple	20
P13632	3/8" x 2" Pipe Nipple	20
* N23002	1/2" x 2" Pipe Nipple	25
* N24002	3/4" x 2" Pipe Nipple	25
* N25002	1" x 2" Pipe Nipple	10
P16002	1/8" 90° Street Elbow	10
P16004	1/4" 90° Street Elbow	10
* B74023LF	3/8" 90° Street Elbow	10
* B74024LF	1/2" 90° Street Elbow	10
Q01005	5-unit Tilt Bin Display	10
Q01006	6-unit Tilt Bin Display	1

Poly Inserts

Display Part No. Q01027

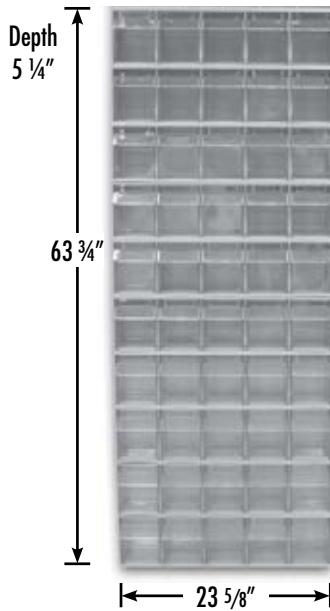

• Get 10 Multistore Bins FREE!

PART NO.	DESCRIPTION	QTY
I10001	1/2" Poly Insert x MIP Adapter	20
I10002	3/4" Poly Insert x MIP Adapter	25
I10003	1" Poly Insert x MIP Adapter	25
I10004	1 1/4" Poly Insert x MIP Adapter	15
I10005	1 1/2" Poly Insert x MIP Adapter	15
I10006	2" Poly Insert x MIP Adapter	10
I10007	1/2" Poly Insert x FIP Adapter	20
I10008	3/4" Poly Insert x FIP Adapter	20
I10009	1" Poly Insert x FIP Adapter	15
I10010	1 1/4" Poly Insert x FIP Adapter	40
I10011	1 1/2" Poly Insert Coupling	20
I10012	3/4" Poly Insert Coupling	25
I10013	1" Poly Insert Coupling	25
I10014	1 1/4" Poly Insert Coupling	15
I10015	1 1/2" Poly Insert Coupling	15
I10016	2" Poly Insert Coupling	10
I10017	3/4" x 1/2" Poly Insert Red Coupling	20
I10018	1" x 1/2" Poly Insert Red Coupling	10
I10019	1" x 3/4" Poly Insert Red Coupling	20
I10020	1 1/4" x 1" Poly Insert Red Coupling	20
I10021	1 1/2" x 1 1/4" Poly Insert Red Coupling	10
I10022	2" x 1 1/2" Poly Insert Red Coupling	5
I10023	1/2" Poly Insert Elbow	20
I10024	3/4" Poly Insert Elbow	25
I10025	1" Poly Insert Elbow	25
I10026	1 1/4" Poly Insert Elbow	15
I10027	1 1/2" Poly Insert Elbow	15
I10028	2" Poly Insert Elbow	10
I10029	1/2" Poly Insert Tee	20
I10030	3/4" Poly Insert Tee	25
I10031	1" Poly Insert Tee	25
I10032	1 1/4" Poly Insert Tee	15
I10033	1 1/2" Poly Insert Tee	15
I10034	2" Poly Insert Tee	10
I10035	1/2" Poly Insert x MIP Comb Elbow	20
I10036	3/4" Poly Insert x MIP Comb Elbow	20
I10037	1" Poly Insert x MIP Comb Elbow	15
I10038	1 1/4" Poly Insert x MIP Comb Elbow	10
I10039	1 1/2" Poly Insert x MIP Comb Elbow	10
I10040	3/4" MIP x 1/2" Poly Insert Adapter	20
I10041	1" MIP x 3/4" Poly Insert Adapter	15
I10042	1 1/4" MIP x 1" Poly Insert Adapter	10
I10043	3/4" x 3/4" 1/2" Poly Insert Red Tee	10
I10044	3/4" x 1/2" 1/2" Poly Insert Red Tee	10
I10045	1" x 1" x 1/2" Poly Insert Red Tee	10
I10046	1" x 1" x 3/4" Poly Insert Red Tee	10
I10047	1" x 3/4" x 3/4" Poly Insert Red Tee	10
I10048	1 1/2" x 1 1/2" x 1" Poly Insert Red Tee	10
I10049	2" x 2" x 1" Poly Insert Red Tee	5
Q01005	5-unit Tilt Bin Display	10

Numbers

2CanCaddy™ 297
3' Chrome Plated Brass Cover Tubes 126
3-N-1
 Radiator Repair Tool 276
 Tubing Bender 301
4-Way
 Countersunk Plug Wrench 276
 Key 275
 Plug Wrench 276
 P.O. Plug Wrench 276, 416, 421
6-Way Countersunk Plug Wrench 276
8-1/2" Pan Commercial Drains 191
45° Flare Tube Fittings
 Female Flare Swivel 127
 Flare Cap 127
 Flare Elbow 128
 Flare Plug 127
 Flare Tee 127
 Flare Union 127
 Flare x FIP Coupling 128
 Flare x MIP Branch Tee 127
 Flare x MIP Half Union 128
 Long Flare Nut 127
 Short Flare Nut 127
 Short Forged Flare Nut 127

A

Access Fittings

General Purpose 224
 Snap-in Access Fittings 224

Access Panel

Plastic 85
 Snap-Ease 85

Acid Brushes 294

Acrylic Tub And Tile Caulk 292

Actuator Unit

for American Standard 38

Adapter Bushing 348

Adapter

Black Plastic PEX 134
 Brass Compression 125
 Brass Hose Barb 148
 Brass PEX 132
 Cast DWV 377
 Cast Iron Spigot, PVC DWV 348
 Faucet 66
 Faucet To Garden Hose 66
 Female Adapter 341
 Female, PVC DWV 341
 Fitting C.O. Adapter, w/Plug 342
 Forged Brass/Cast Pressure 373
 Garden Hose, Twist To Lock 136
 Hub Adapter for Cast Iron, PVC DWV 347
 Insert, Galvanized 153
 Insert Male Rope, Red Brass 152
 Insert, Nylon 150
 Insert, Poly 151
 Insert, Red Brass 152
 Male Adapter 341
 Male, PVC DWV 341
 No Hub Adapter 347
 No Hub for Cast Iron, PVC DWV 347
 Nylon 149

PlumBite 135
 Soil Pipe 377
 Spigot Adapter 348
 Sweat Male 60
 Trap 59
 Twist To Lock 136
 White Plastic PEX 133
 Wrot DWV 375
 Wrot Female, Copper 365
 Wrot Male, Copper 365

Adhesive, Plumber's Goop 296

Aerator

Chicago Style Faucet 65
 Counter Display 65
 Non-Slotted .5 GPM 65
 Non-Slotted Full Flow 65
 Non-Slotted Reduced Flow 65
 Six Pack Tubes For Counter Display 65
 Slotted 2.2 GPM Flow 65
 Slotted Full Flow 65
 Slotted Reduced Flow 65
 Snap Fitting 66
 Spring-Flo 65
 Swivel Spray 66
 Vandal-Proof 66

Air Cock 156

Air Gap

Chrome Plated ABS 57
 Cover 5
 Decorative 5
 Dishwasher Kit 57
 Spacer 57

Air Pump

Economy 279

Air Valve 159, 160

Air Vent, Plumb Aire 57

Aluminum Bar for Waste and Overflow 54

Anchor

Drop-In Concrete 119

Anchor Bolt Kit 117, 397

Angle Air Valve 159

Angle Compression Stop Wrench 276

Angle Steam Vent 160

Angle Stop 23-25

Angle Valve

Plastic Push On 138

Appliance Cord 305

Aqualine Replacement Handles 67

Aqua Seal Washer 36

Area Drain 220

Assembly

ABS Pop-Up 56
 Brass Pop-up 6, 56
 Brass Pop-up, Replacement Parts 56
 Chrome Plated ABS Pop-Up 56
 Delta Style Spray 62
 Lift & Lock Pop-Up 56

B

Backflow Preventer 161

Backflow Preventer/Sewer Stopper 69

Backnut Black Malleable 354

Backwater Valve

Flat Top Vent Cap 234

Mushroom Vent Cap	234	Snap N Lock Stainless Steel	337
Plastic Over-Fitting Repair Fitting	234	Stainless Steel	63
PVC Coupling	234	Stainless Steel Deep Cup	63, 337
Spigot Adapter	234	Stainless Steel Duo	63, 336
Cast Iron	268	Stainless Steel Duo Post Style	336
Extension Kit	233	Twist And Lock	63
Flapper with Gasket	233	Twist & Lock	336
Bags, Trash	307	Bastard File	290
Ballcock		Bathcock	
And Flush Valve Repair Parts for Mansfield	38	for Clawfoot Tub	47
Coupling Nut And Locknut	58	Repair Kit	47
Mansfield Style	37	Bath Drain	14-15, 49, 50-51
Mansfield Style, With Float Rod	37	Adapter Bushing	49
Repair Parts for American Standard	38	Bathroom Fan Vent Kit	92
Repair Parts For American Standard	38	Bath Supplies, Offset	47
Repair Parts for Amerline/Hoov-R-Line	38	Bathtub Protector	49
Repair Parts for Coast	38	Bathtub Protectors	49
Repair Parts For Coast	38	Bath Waste	
Repair Parts for Fluidmaster	38	ABS Tubular	332
Repair Parts For Fluidmaster	38	and Overflow Test Kit	54
Repair Parts For Hoover/Amerline	38	Cable Drive, ABS Tubular	332
Repair Parts for Kohler	38	Cable Drive, PVC Tubular	332
Repair Parts For Kohler	38	Conversion Kit	54
Repair Parts for Mansfield	38	PVC Tubular	332
Ball Valve		Rough Brass	325
Brass Broiler Drain Valve	158	Rough-In, Schedule 40	54
Brass PEX	132	Rough-In, Schedule 40 With Test Kit	54
CPVC	159	Schedule 40 Kit	52, 53
Gas	157	Trim Kit	54
Gas Heater	157	Batteries	305
Gas, Texas Pattern	157	Bell Reducer	130
PlumBite	135	Bell Trap	
PVC	159	Inside Caulk, Cast Iron	263
Bar		No Hub, Cast Iron	263
Digging/Tamping	284	Pittsburgh, Cast Iron	263
Gooseneck Wrecking	284	Spigot Outlet, Cast Iron	263
Utility Pry	284	Bibb Seat Tool Set	278
Bar Plug, Brass	64	Bit	
Bar Tap Faucet	4, 61	Holders	291
Basin		Phillips	291
And Tub Stopper	50	Blue Chalk Line Set	288
Cock Locknut	57	Boiler Gauge	
Crumb Cups	64	Dual Scale	106
Faucet	74	Bolt	
Self-Closing and Shower Valve	74	Stove Bolt with Nut	116
Nut58		Toggle Bolt	116
Basket Strainer		Bore O-Ring	89
ABS Body And Post	63	Bottle, Spray	307
ASAP, Chrome Plated	63	Box Cutter	403
Chrome Plated ASAP	337	Boxes	
Chrome Plated Brass Duo	63, 336	20 Compartment Parts	297
Decorative	3	Bin	121
Deep Cup	63, 336	Cardboard Tub	121
Deep Junior Duo	64, 337	Plastic Tub	121
Duo	63, 336	Shipping	121
Flat Duplex	337	Box of Rags	306
Flat Top Grid	63, 336	Box Wrench	278
Junior Duo	64, 337	Bracket	
Locknuts And Washers	58	Carrier	109
Quick Fit Stainless Steel	63, 337	Extruded Hole Copper Plated	110
Replacement Strainer	62, 337	Extruded Notches Copper Plated	110
Shallow Cup Duo	63, 336	Flat Copper Plated	109
Snap Lock	63, 336		

Galvanized 109, 110
 Galvanized-CPVC 110
 Galvanized L 110
 Galvanized Lockright 110
 Galvanized Lockright Pipe-CPVC 110
 Pipe 109
 Water Closet-Copper Clad 110

Brass Float Rod 37
Brass Hose Barb 427
Brass Lift Wire Guide 36
Brass Needle Valves 154
Brass Nipples 23
Brass Overflow Tube 37
Brass Plumb Bob 288
Brass P.O. Plug Drain 56
Brass Saddle Clamp 154
Brazing Rod 289
Broadcast Spreader 307
Bronze Locknuts 142
Bronze Pipe Fittings
 Bushing 143
 Cap 142
 Coupling/ Reducer 143
 Cross 143
 Elbow 142
 Extension Piece 143
 Locknut 142
 Plug 143
 Tee 142
 Union 142

Bronze & Yellow Brass Pipe Fittings 428
Broom 307, 397
Brush
 4-N-1 Copper Tube Fitting 279
 Acid 294
 Chip 294
 Copper Fitting 279
 Female Copper Tube 279
 Long Handle Wire with Scraper 294
 Paint And Dope 294
 Shoe Handle Wire with Scraper 294
 Wire 295

Bubbler
 Drinking Fountain 74
 Drinking Fountain With Face Guard 74
 Retrofit Kit 74

Bucket Caddies 297
Bushing
 Adapter 348
 Adapter, For Bath Drain 49
 Brass Trap 47
 Bronze 143
 Chrome Plated 145
 Flush 341
 HEX, Black Malleable 351
 HEX, Yellow Brass 131
 Twin Elbow And Face 47
 Wrot Flush, Copper 366, 369
 Yellow Brass 131

Bushing for Qwik Tees and Qwik Elbows 89
Buttons
 Faucet Index 67
 Single Handle Replacement 67

C

Cable Drive Full Kit 19
Cable Lock 308
Cable Ties 300, 404
Caddies
 1/2" & 3/4" Combo Nipple 297
 2CanCaddy 297
 Bucket 297
 Fitting Tote Tray 297
 Plastic Nipple 297
 Steel Nipple Tray 297
 Tool Totes 297
 Utility Tote Tray 297

Camouflage Strap With Hooks 301
Cam Strap 301
Canvas Drop Cloth 306, 397
Cap
 45° Flare Tube Fitting 127
 Black Malleable 351
 Brass Compression 125
 Bronze 142
 Cast DWV 377
 Chrome Plated 145
 Garden Hose, Nylon 149
 Plastic Push On 138
 PlumBite 135
 PVC DWV 343
 Space Heater Fitting 129
 Test 375
 Test, Wrot DWV 375
 Wrot, Copper 367
 Yellow Brass 130

Carbon Monoxide Alarm 309, 400
Cardboard Box
 Bin Boxes 121
 Shipping Boxes 121
 Tub Box 121

Carrier Nuts and Washer Set 117
Cast Iron Commercial Drain Components 249
Caulk
 100% Silicone 292
 Acrylic Tub And Tile 292
 DAP ALEX PLUS Acrylic Latex Caulk Plus Silicone 292
 DAP KWIK SEAL Kitchen and Bath Adhesive 292
 Fire Seal-136 Firestopping 293
 Gun 293
 Hi-Temp Red Silicone 292
 Latex 292
 Siliconized Acrylic 292

Caulking Tools
 Broad Curve Nose 284
 Gun 293, 405
 Gun, Professional 293
 Inside 284
 Outside 284
 Short Nose 284

Caution Tape 302, 401
Ceiling Flange 119
Ceiling Plates, Floor and 68
 Flexible 69

Center Outlet Tee
 Chrome Plated Brass 321
 PVC 326

Center Outlet Waste		
ABS	329	
Chrome Plated Brass	322	
PVC	326	
Ceramic Heater	308	
Chalk Line Set	288	
Check Valves	161	
Chip Brush	294	
Chisels		
Cold	284	
Chrome Elbow	126	
Chrome Plated Brass		
End Outlet Tee	321	
Chrome Plated Compression Fittings		
3' Chrome Plated Brass Cover Tubes	126	
Connector	126	
Elbow	126	
Pilot Line Breakaway Nut	126	
Sweat Adapter	126	
Union	126	
Chrome Plated Nipples & Pipe Lengths	144	
Chrome Plated Pipe Fittings		
Bushing	145	
Cap	145	
Coupling	144	
Elbow	144	
Plug	145	
Reducer	144	
Tee	144	
Union	145	
Chrome Plated Sink Trap with ABS Adapter	320	
Chrome Union	126	
Clamp		
2-Hole Pipe	113	
Full	112	
Half	112	
Insulating/Suspension	112	
Oetiker, PEX	133	
Stainless Steel Repair Clamp	85	
Universal Beam Clamp	117	
Clamp-On Light	304	
Cleanout		
Cast DWV	377	
Test Tee, PVC DWV	345	
Two-Way Tee, PVC DWV	346	
Cleanout And Relief Valve		
Sewer	69	
Cleanout Bodies	258	
Cleanout Covers	262	
Cleanout Plugs		
Countersunk Cleanout Plugs	223	
Drainable Cleanout Test Plug	223	
Raised Head Cleanout Plugs	223	
Cleanouts		
Commercial		
Access Cover Adjustable, Cast Iron	257	
Adjustable, Cast Iron	256	
Adjustable Floor, Cast Iron	257	
Cleanout Ferrule, Cast Iron	255	
Components		
Gasket Connection Base, Cast Iron	259	
Metal Spud with Round Cover	229, 230, 259	
No Hub Base, Cast Iron	258	
No Hub Cleanout Body, Cast Iron	258	
Plain End Cleanout, Cast Iron	258	
Plastic Spud with Cover and Square Top	259	
Plastic Spud with Round Cover	229, 230, 259	
Plastic Spud with Square Cover	229, 230	
Spud with Cover, Cast Iron	259	
Replacement Covers	230	
Heavy Duty, Cast Iron	257	
Hub Fit Base	225	
Inside Pipe Fit	228	
No Hub Adjustable, Cast Iron	256	
No Hub, Cast Iron	254	
Over Pipe Fit	226	
Pipe Fit	226	
Plain End Adjustable, Cast Iron	256	
Plain End, Cast Iron	255	
Plumb Lock Adjustable, Cast Iron	255	
Push-On Adjustable, Cast Iron	256	
Push-On, Cast Iron	254	
Countersunk Plug with Insert	223	
Cover	262	
Dome Cover Plate	262	
Fit-Flush	223	
Fit-Flush Cleanout	223	
General Purpose	223	
General Purpose Access Fitting	224	
General Purpose Cleanouts	223	
Heavy Duty	222	
Heavy Duty Internal Pipe Cleanout	222	
Hub Fit	223	
Hub Fit Cleanout with Countersunk Brass Plug	223	
Hub/Fitting	222	
Hub/Fitting Cleanouts	222	
Inside Pipe Fit	221	
Internal Cleanout w/SS Cover	224	
Internal Pipe	222	
Internal Pipe Cleanout	222	
Internal with SS Cover	224	
Plug		
Code Pattern	261	
New Orleans Code	260	
Extension Cover Set	261	
for Extension Cover	261	
Heavy Pattern	260	
Lead Fit-All	260	
Slotted	261	
Southern Code	260	
Sewer Relief Plug	224	
Snap-in Access Fitting	224	
Test Tee with Plug	224	
Trap Cover	262	
Cleanout Spuds	259	
Cleanout Tee	346	
Close Nipple	131	
Closet Bend, PVC DWV	347	
Closet Bolts		
Bulk Packed	40	
Cap	41	
Component Parts	41	
Custom Packed	40	
Display Bucket	39	
Elite Packs	41	
Enduro	39	

Snap-Off 41
with Tinnerman Nuts 39

Closet Flange

4-Way Offset 174
Brass 240
Brass Four Way Offset 240
Code Blue 239, 240
Extender 174
Extension Kit 175
Flange Support for Wood Floors 240
Gapper Flange 240
Gapper Repair Flange 175
Inside Caulk 239
No Caulk 239
No Hub 239
Offset 174, 240
Over Schedule 30 Pipe 174
Plumbfit 174
Repair Flange 240
Repair Ring 175, 240
Ring 175
Set-Rite Spacer Kit 175
Spacer Kit 175
Two Finger Flange 239
Urinal Flange 174

Closet Flange Extender 174

Closet Flange Extension Kit 175

Closet Flange Repair Ring 240

Closet Flush Elbow 324

Closet Screws 42

Closet Spud

Friction Ring 36
Washer 35

Closet Supply 25-26

Closet Wedge Shims 39, 176

Cloth Inserted Plunger Disc 296

Coast Ballcock Repair Parts 38

Combination Padlock 308

Commercial Cleanouts, Adjustable 225

Commercial Cleanouts, Residential and Light 222

Commercial Drain Base

Heavy Duty Bases 211
Heavy Duty Bases with Clamping Ring 211
Hub Fit Bases 211
Inside Pipe Fit Base 210
Pipe Fit Base 210
Slab Drain Bases 211

Commercial Pipe/Hub Fit Adapter Drains 184

Commercial Sponges 306, 398

Companion Flanges, Cast Brass

125# w/A.S.M.E. Drilling 380
150# w/A.S.M.E. Drilling 380

Complete Brass Assortment 423

Complete Brass Assortment - Lead Free 423

Compression Branch Tee 125

Compression Cap 125

Compression Connector 125

Compression Coupling

Bronze 85
CPVC 86
Malleable Iron 85
PVC 85

Compression Elbow 126

Compression Fittings Assortment 425

Compression Nuts 125

Compression Sleeve 125

Compression Sleeve Puller 277

Adapter 277

Compression Tee

Bronze 86
PVC 86

Compression Union 125

Compression x Sweat Adapter 125

Condensate Trap 233

Conduit Hangers 118

Connector

Brass Compression 125, 126
Flexible Trap Drain 89, 335
Gas 76
Hose Grip Clothes Washer 89
Plastic Push On 139
Screw-On Wire 309
Twist To Lock 136
Waste 59, 335

Contoured Shower Rod 44

Conversion Kit - 2 hole 12-13

Conversion Kit - One hole 12

Conversion Kits

Bath Waste 12, 13, 14, 50, 54
With Cross Bar 54

Cool Gel® 296

Copper Fittings, Tools for 279

4-N-1 Tube Fitting Brush 279
Cleaning Pads 303
Female Tube Brush 279
Fitting Brush 279
Sizing Tool 285
Swedge Tool 285

Copper Pipe Hangers - Bell & Milford Types 118

Copper Refill Tube 36

Copper Sizing Tool 285

Corded Square Head Plug 143

Cotton Canvas Drop Cloth 306

Coupling

45° Flare Tube 128
Banded, Black Malleable 352
Black Plastic PEX 134
Brass PEX 132
Bronze 143
Chrome Plated 144
Compression 85
CPVC Compression 86
Crossover 367
Drain, with Cap 373, 374
Flexible Transition 89
Forged Brass/Cast Pressure 373
Heavy Duty No Hub 314
Import Heavy Duty No Hub 315
Import No Hub 315
Insert, Galvanized 153
Insert, Nylon 150
Insert, Poly. 151
Insert, Red Brass 152
Medium Duty No Hub 314
Merchant, Black Malleable 361

No Hub	314	PVC	328
Plastic Push On	139	Disposer Kit w/13" Arm	328
PlumBite	135	Disposer Kit w/Adjustable Arm	328, 331
PVC DWV	341	Disposer Kit with Adjustable Arm	
PVC Expansion	86	PVC	328
Reducing, Banded Black Malleable	352	Dissolvable Pipe Plug	290
White Plastic PEX	133	Diverter Spout	
Wrot DWV	375	7" Chrome Plated	47
Wrot Reducing, Copper	366	Add-A-Shower	46
Yellow Brass	130	Chrome Plated	47, 48
Coverall, Disposable	300, 400	Chrome Plated Slip-On, With Polished Brass Knob	47
Coveralls, Replacement	214	Decorative	10, 11
Cover Plates	10, 70	Extension	48
Cover, Toilet Tank	39	Slip-On	47
Cover Tubes		Do All Plumbers Wrench	278
Brass Compression	126	Double Flange Extension	
Crimping Tools		ABS	330
Pex Crimp Set	286	PVC	328
Polybutylene	285	Double Flange Tailpiece	
Crimp Ring		Chrome Plated Brass	322
Brass PEX	133	Double Offset	
Crimp Set	286	Chrome Plated Brass	322
Cross		Double Offset Tailpiece	
Banded, Black Malleable	352	PVC	328
Bronze	143	Double Slip Fittings	
Cross, Banded	352	Chrome Plated	60, 324
Cross Handle Self Closing Valve	74	PVC	328
Crumb Cups, Sink and Basin	64	Drainable Cleanout Test Plug	223
Curb Box Wrench	278	Drain Bodies	250
Curved Jaw Tongue & Groove Pliers	291	Drain Cleaner, Floweasy	296
Cutting Oil	306	Drain Cock	156
D		Drain King	88
DAP Caulk and Sealant	292	Drain Opener	
Deburring Tool	286	Drain King Mini Snake	296
Delex Replacement Handles	66	Liquid Lightning Pro	296, 422
Delrin Compression Sleeve	125	Whitlam "Green Blaster"	296
Delta		Drains	
Faucet Index Buttons	67	4-Way Area Drain	220
Replacement Handles	66	Bell Trap	219
Dielectric Union		Bell Trap with Hinged Lid	220
Flanged	102	Brass Inside Caulk Floor	253
Gasket and Insert	103	Bronze Shower	246
Digging/Tamping Bar	284	Cast Iron Commercial Drains	244
Discus Lock	307	Caulk Cesspool with Recessed Grate, Cast Iron	264
Dishwasher Connection		Commercial	210
PVC	327	Components	214
Dishwasher Kit	57	Coveralls	214
Dishwasher Repair		Funnels	215
Dishwasher Drain Connector	90	Green Drain Waterless Trap Seal	215
Dishwasher Hose	90	Heavy Duty Base	211
Dishwasher Tailpiece		Heavy Duty Base with Clamping Ring	211
ABS	330	Hub Fit Base	211
Chrome Plated Brass	324	Inside Pipe Fit Base	210
PVC	327	Metal Spud with Round Strainer	212, 213, 214
Dispenser Faucet	4	Metal Spud with Square Strainer	213
Dispenser, Soap and Lotion	62	Pipe Fit Base	210
Disposable		Plastic Spud with 7" Square Top and Round Strainer ..	212, 213, 214
Coverall	300, 400	Plastic Spud with Round Strainer	212, 213
Vinyl Gloves	299, 398	Plastic Spud with Square Strainer	212
Disposal Assembly	3	Replacement Strainer for Metal Spud	214
Disposer Kit		Rings	214
ABS	330	Slab Drain Base	211
Chrome Plated	324	Spud Extension	215

Strainers 214

Inside Pipe Fit 188, 189

Over Pipe Fit 185, 186, 187

Pipe Fit 184, 185

Slab Drain with 8-1/2" Pan 198, 199, 200, 201, 202, 203, 204

with 8-1/2" Pan 191, 192, 193, 194, 195, 196, 197

with 10" Pan 205, 206, 207, 208, 209

Components

Gasket Connection Base, Cast Iron 250

Heavy Duty Drain Base, Cast Iron 249

IPS Drain Base, Code Blue 249

Metal Spud with Round Strainer 251

Metal Spud with Square Strainer 251

No Caulk Mechanical Joint Drain Base, Code Blue 249

No Caulk Mechanical Joint Slab Drain Base, Code Blue 250

No Hub Base, Cast Iron 250

No Hub Drain Base, Code Blue 249

No Hub Slab Drain Base 250

Plastic Spud with Square Strainer 250

Push-On Drain Base, Code Blue 250

Spud Extension, Cast Iron 250

Spud with Round Strainer, Cast Iron 250

Floor Drain with Trap 220

General Purpose

Area Drain 220

Area Drain, Cast Iron 252

Backwater Device 253

Combination Drain Trap 253

Des Moines Pattern Floor Drain 253

Floor Drain with Trap 253

Gasket Connection Drain, Cast Iron 252

Heavy Duty Traffic Floor Drain 217, 218

Kentucky Drain, Cast Iron 252

Plastic Snap-In 218

Snap-In 219

Snap-In Strainer 219

Socket Ring 219

St. Louis Drain, Cast Iron 253

Urinal Drain Flange Kit 253

with Long Body 216

Inside Caulk Floor/Shower, Heavy Duty 246, 248

Inside Pipe Fit 221

IPS Floor, Code Blue 247, 248

IPS Floor Drain, Code Blue 245

No Caulk Floor Drain, Code Blue 244

No Caulk Mechanical Joint Cesspool, Code Blue 264

No Caulk Mechanical Joint Floor, Code Blue 246, 248

No Caulk Slab Mechanical Joint, Code Blue 244

No Hub Floor, Code Blue 247, 248

No Hub Floor Drain, Code Blue 245

No Hub Floor/Shower, Heavy Duty 246, 247

No Hub Slab, Code Blue 247, 248

No Hub Slab Drain, Code Blue 245

Non-Adjustable, Code Blue 242

Push-On Floor, Code Blue 245, 247, 248

Rainleader Cesspool, Cast Iron 264

Replacement Strainer, Code Blue 242

Roman Tub, Code Blue 242

Roman Tub Replacement Strainer, Code Blue 242

Roof Drain, Code Blue 266

Roof Drains, Accessories for 235

Roof Drain with Cast Iron Dome 235, 266

Roof Drain with Plastic Dome 235

Round Slop Sink, Hydrant Cesspool, Cast Iron 264

Shower 242, 243

FIP 253

Inside Caulk 253

IPS 253

Square Cesspool Grate, Cast Iron 264

Square Hydrant Cesspool, Cast Iron 264

Utility 219

Drain, Three Prong Protector 64

Dresser Coupling 85, 86

Drill Bits

Carbide Tipped Masonry 286

Dual Auger Wood 287

Flat "Paddle" Wood 287

Masonry 286

Straight Shank 287

Wood Spade 287

Drinking Fountain

Bubbler and Cartridge 74

Bubbler With Face Guard 74

Cross Handle Self Closing Valve 74

Retrofit Bubbler Kit 74

Self-Closing 74

Drop Cloth 306, 397

Drop Cord Light 304

Drop Ear Elbow 60

Drop-In Concrete Anchor 119

Dryer Repair

Aluminum Ducting

Flexible Aluminum 92

Flexible Aluminum Foil 92

Proflex Aluminum Foil 92

Aluminum Elbow and Pipe 91

Flexible Duct Connector Kit 91

Increaser/Decreaser 91

Vent

Aluminum Hood 91

Clamp for Dryer Vent Kit 91

Complete Dryer Vent Kit 91

Dryer Vent Hood 91

Dryer Vent Hose 92

Dryer Vent Kit w/Louvered Hood 92

Indoor Dryer Vent Kit 92

Louvered Dryer Vent Hood 91

Metal Clamp for Dryer Vent 91

White Back Collar for Dryer Vent Kits 91

Dual Flush Toilet Kit 38

Ducting

Flexible Aluminum 92

Proflex Aluminum Foil 92

Duct Straps 301

Duo Basket Strainer

Chrome Plated 63

Deep Junior 4

Junior 4

Stainless Steel 63

Duracell® Alkaline Batteries 305

Dust Masks 299, 400

Dust Pan 307, 397

E

Ear Plugs, Ready Fit Corded 300, 400

Earthquake Strap 113

Elbow	
45° Flare Tube	128
Banded, Black Malleable	354
Black Plastic PEX	134
Brass Compression	126
Brass Hose Barb	148
Brass PEX	132
Bronze	142
Cast DWV	377, 378
Chrome Plated	144
Double, PVC DWV	344
Drop Ear	60
Drop Ear, Brass PEX	133
Flanged Sink, Forged Brass/Cast Pressure	373
Forged Brass/Cast Pressure	373
Hi-Ear, Forged Brass/Cast Pressure	373
Insert, Nylon	150
Insert, Poly	151
Insert, Red Brass	152
Nylon	149
Plastic Push On	139
PlumBite	135
P-Trap, PVC DWV	346
PVC DWV	342
Qwik	89
Reducing, Banded Black Malleable	353
Space Heater Fitting	129
Twist To Lock	136
Union, Twist To Lock	137
White Plastic PEX	133
Wrot, Copper	367
Wrot DWV	375
Yellow Brass	130
Eljer Replacement Handles	67
Enclosed Feed Tube Cutter	280
End Outlet Tee	
ABS	329
End Outlet Tee Only	321, 329
End Outlet Waste	
ABS	329
Chrome Plated Brass	321
PVC	326
Engineers Hammer	284
Escutcheon	338
Escutcheons	
Plastic Shallow Flange	68
Poly Bagged	68
Sure Grip	67
Expansion Coupling	
PVC	86
PVC Expansion Coupling	86
Expansion Joint	347
Expansion Tank	102
Extension Cord	304
Extension Cord Power Block	305
Extension Hose	88
Extension Piece	
Black Malleable	351
Bronze	143
Extension Tube	
ABS	330, 331
Chrome Plated Brass	323
Decorative	7
PVC	327, 328
Rough Brass	325
Extract-a-Drain Tub Drain Removal Tool	277
EZY Grind Pipe Cutter	280
E-Z	
Light	302
Reach	302
Anchor/Self-Drilling Wall Board	116
Shear Inside Pipe Cutter	280
F	
Face Bushing	47, 131
Face Plate Gasket	49
Faucet	
Adapters	66
Bar Tap	61
Basin	74
Self-Closing and Shower Valve	74
Index Buttons	67
Laundry Tray	74
Long Reach Bar Tap	61
Seat Repair Kit	276
Seat Wrench	276
Seat Wrench For Recessed Seats	276
Service Sink	75
Wall Mount Sink	74
Faucet And Valve Grease, Plumber's	296
Faucet Handle Pullers	
E-ZEE Pull Deluxe	277
Faucet Hole Cover	5, 61
Faucet Seat	61
Faucet Seat Kit	60
Faucet To Garden Hose Adapters	66
Female Copper Tube Brush	279
Female Coupling	
Space Heater Fitting	129
Female Flare Swivel	127
F.H.A. Strap	
Galvanized Steel	108
F.H.A. Tub Hanger	113
Files	290
Fill Valve	397
Integral Float	37
Korky	37
Fire Seal-136 Firestopping Caulk	293
Firestop 814+ Intumescent Firestopping Sealant	293
Fit-All	
Basket Strainer	62
Kitchen Hose And Spray	61
Replacement Handles	66
Stopper	50
Fitting Cleanout	377
Fitting Cleanout, Flush	377
Fitting Plug	369
Fitting Reducer	376
Fittings Assortment	
Compression	425
Garden Hose	426
Fittings, Double Slip	60
Flange	
Cast Brass	380
Jumbo Shower Bar	44
Shower Arm	45
Shower Rod	44

Flange Connection Gasket 165

Flanged Tailpiece

 ABS 331

 PVC 328

 Rough Brass 325

Flange Support 240

Flapper 34, 35

 2 Way, with Separate Trunion 34

 Carded Blue Vinyl 34

 Jumbo ToTo Style 34

 Korky 34

Flare Elbow 128

Flare Fittings Assortment 424

Flare Tees 127

Flare Union 127

Flare x FIP Coupling 128

Flare x MIP Branch Tee 127

Flare x MIP Half Union 128

Flaring Tools 286

 Swing Release 286

Flashlight 304

Flashlights 303, 407

Flat Duplex Strainer 64

Flat Top Vent Cap 234

Flexible Discharge Hose 115

Flexible Drain Trap 89

Flexible Floor And Ceiling Plates 23

Flexible PVC Saddle Fitting 89

Flexible Transition Coupling 89

Flexible Trap Drain Connector 89, 335

Flint Striker 288

Flip-It 50

Flip-It Conversion Kit 14

Flip-It Tub Stopper 14

Float Ball 34

Floating Lantern & Battery 303, 407

Float Rod 37

Floor & Ceiling Plates

 Flexible Plastic 69

 Heavy 21 Gauge 68

 Light 24 Gauge 68

Floor Flange, Black Malleable 354

Floor Sink

 Aluminum Bottom Dome For Cast Iron Sink 265

 Plumlock Porcelain 265

 Porcelain Coated 265

Floor Sinks

 Aluminum Dome Strainers
 for Floor Sinks 232

 Complete PVC Floor Sink Kits 231

 Complete PVC Floor Sink Kits-Pipe Fit 232

 Flat Aluminum Bottom Strainer
 for Floor Sinks 232

 Full Top Grate for Floor Sinks 232

 Half Top Grate for Floor Sinks 232

 Round Slop Sink 231

 Three-Quarters Top Grate for Floor Sinks 232

Flow Restrictor 46

Flush Bushing, PVC DWV 341

Flush Fitting Cleanout 377

Flush Valve

 Douglas 37

 Dual Flush Kit 38

 for American Standard 38

 Mansfield #210 37

 Pipe Support 57

 Repair Parts for Mansfield 38

 Shank Washer 36

Flux Paste 289

Flux-Rite 90® Flux 289

Foundation and Roof Coating 114

Freeze Fix Pipe Jackets 290

Friction Ring

 Brass 59

 Closet Spud 36

Full Clamp 112

Funnels 251

Funnels, for Shower/Floor Drains 215

G

Galvanized Insert Fittings

 Insert Adapter 153

 Insert Coupling 153

Gapper Flange 175, 240

Garbage Disposal

 Cords 309

 Splash Guard 64

 Stopper 64

 Wiring Kits 309

 Wrench 275

Garbage Disposal Wiring Kit 309

Garden Hose Fitting Assortment 426

Garden Hose Fittings

 Adpater 146

 Cap 147

 Evaporation Cooler Drain 147

 Filter Washer 147

 Hose Barb 146

 Shut Off 147

 Swivel 146

 Washer 147

 WYE 147

Garden Hoses 302, 401

Gas Ball Valve 157, 158

Gas Burners

 2-Way Combo Log Lighter Valve 271

 Log Lighter Burner Bar 270

 Log Lighter Keys and Accessories 271

 Log Lighter Valves 270

 Log Lighter Valve with T-Burner 271

 Rectangular Burner 270

 Round Burner 270

 "™" Burner Bar 270

 Two Leg Burner 270

Gas Connectors

 Black Coated 81

 1/2" OD 81

 3/8" OD 81

 Coated 76

 1/2" OD with Ball Valves 80

 1/2" OD with Fittings 80

 3/8" OD with Fittings 76

 5/8" OD with Fittings 79

 Uncoated 76

 3/8" OD with Ball Valves 77

 3/8" OD with Fittings 76

 5/8" OD with Fittings 78

Gas Heater Valves	157	Grid Strainer	336
Gasket		Griplock Tongue & Groove Water Pump Pliers	290
Asbestos- Free Full Face Gasket	165	H	
Asbestos- Free Ring Gasket	165	Hacksaw	282
Circulator Flange Gasket Pair	167	Hair Strainer	64
Dual Tite	313	Half Clamp	112
Dual Tite Buna N "Nitrile"	313	Handicap	293
Face Plate	49	Handi-Plug	293
Materials	167	Handle	
Multi-Tite	313	3 Screw Radiator Valve Handle	160
Radiant Seal Sponge Rubber Closet Gasket	43	4-N-1 Radiator Valve Handle	160
Red Rubber Full Face Gasket	165	Hand Torch	289
Red Rubber Ring Gasket	165	Hand Wipes	306, 398, 422
Shoe	49	Handy Foam	116
Sponge Closet	36	Hangers	
Tank to Bowl	43	Adjustable Lavatory	62
Wax	43	Lavatory	62
Gasket Kits	166	Mop, for Service Sink	75
Gasket Material	167	Sink	62
Gas Line Marking Labels	302	Hard Hat	300
Gas Range Fittings	129	Hats, Safety	300, 400
Gas Shut-Off Valve	155	Head Light	303
Gate Valve Key	285	Head-Lite, Sportsman L.E.D.	303, 407
Gear Clamps		Heater	
"68" Series Stainless	164	Ceramic	308
Full Size	163	Shop	309
Micro Size	163	Heavy Duty Big Wipes	306
Replacement Clamp For Flexible Coupling	164	Heavy Duty Commercial Drain	195-209
Stainless Steel	164	Hexagon Bushings	351
General Purpose Drain	216-217	HEX Brushing	143
General Purpose/Utility Drains	216	HEX Bushing	131
Glasses, Safety	299, 400	HEX Head Plug	130
Hellraiser	299, 400	HEX Nipple	131
Nemesis	299, 400	Hex Nut	117
Visio	299, 401	Hinged Split Ring	119
Gloves		Hi-Temp Red Silicone Caulk	292
All Purpose Latex Palm/Mesh Back	298, 399	Hornet & Wasp Spray	300, 402
Anti-Vibration Synthetic Leather	298	Hose	
Blue Nitrile	298, 398	Dryer Vent	92
Brown Jersey	298, 399	Extension	88
Disposable Blue Latex	298, 398	for Service Sink	116
Drivers' Style Leather	299, 399	Garden	302, 401
Economy Brown Jersey	298, 399	High Pressure with Fitting	279
Industrial Rubber	298	Hose and Spray	
Leather Palm Work	299, 399	Decorative	4
Nitrile	298	Kitchen (Fit All)	61
Polyester Nitrile Dipped Palm	298	Rinse-Quik	62
Vinyl	299, 398	Hose Barb	
Vinyl Disposable	299	Adapter	148
White Canvas Work	298	Elbow	148
White Cotton with Grippers	298	Splicers	148
Goggles, Clear Safety	299, 401	Swivel	148
Grab Bar		Tee	148
Fastening System	55	Hose Barb Fittings	148
With Concealed Snap-On Flange	55	Hose Bibb	162
With Exposed Flange	55	Hose Bracket	
Grab-It Tool	302	for Service Sink	116
Gradient Level	303	Hose Faucet Anchor	162
Gradient Level, Top Grade	303	Hose Grip Clothes Washer Connector	89
Green Drain Waterless Trap Seal	215, 397	Hose Nozzle	302, 401
Grid Drain		Hub Fit Adapter Drains	184
Commercial Lav	56, 333	Hub Fit Commercial Drain	190-191
Handicap Style Lav	56, 333	Humidifier Kit	154

Hydrostatic Pressure Pump 278, 279

I

Icemaker Boxes

 With Hammer Arrester 90

 With Valves 90

Icemaker Or Humidifier Kit 154

Insert

 Brass Compression 125

Insert for CPVC 110

Inside Pipe Fit Cleanout 221

Inside Pipe Fit Commercial Drain 189-190

Inside Pipe Fit Drain 221

Inside Pipe Fit Drains and Cleanouts 221

In-Sink-Erator Rubber Hush Cushion 64

Instant Sealant 116

Insulating/Suspension Clamp 112

Insulation Protective Coating 102

Intergral Float Fill Valve 37

J

J-Bend

 ABS 330

 Chrome Plated Brass 320

 PVC 327

J-Bend w/Cleanout 321

J-Hook

 Drive 111

 For CTS Water System 111

 For Drain Pipe System 112

Joint Compound

 Slic-tite Heavy Duty Thread Sealing 296

 Spray Weld 295

 Whitlam "Blue Magic" Pipe 295

 Whitlam Seal Unyte 295

 Whitlam "Select Unyte" Teflon Pipe 295

Joint Runner 303

Jumbo Shower Bar Flange 44

K

Key 275

 4-Way 275

 Sillcock 275

Key Safe 307

Kit

 Assorted Washer 60

 O-Ring 60

 Solid Brass Bibb Screw Assortment 60

 Undermount Sink Installation 62

Kitchen Hose and Spray 61

Kitchen Hose And Spray 62

Knee Pads 300, 400

Knives

 Deluxe Autolock Snap 282

 Snap 282

 Utility 282, 403

Korky 35

L

LACO

 Cool Gel® 296

 Flux Paste 289

 Flux-Rite 90® Flux 289

 Marking Products 294

 Slic-tite® Heavy Duty Thread Sealing Compound 296

 Slic-tite® High Density Thread Sealants 93

 Visu-Glow Leak Detector 296

Latex Caulk 292

Lavatory

 Adjustable Hanger 62

 Hangers 62

 Legs 62

Lavatory Nut Removal Tool 276

Lav Drain 6, 56

 Commercial 56

 Decorative 56

 Handicap Style 56

Lav Supply Tubes 26

Lead Ingot 114

Lead Joint Runners 303

Lead Melting Pot 114

Lead Pouring Ladle 114

Lead Wool 114

Leak Alert Water Detector 309

Leak Detector 296

Leak Detector, Visu-Glow 296

Level 303

LevelBest 171

LevelBest Drainage and Cleanout System

 Adapter 181

 Adapter with Spud and Cleanout 182

 Adapter with Spud and Strainer 181

 Complete Heavy Duty Drain System 182

 Complete Heavy Duty Slab Drain System 183

 Complete Hub Fit Cleanout System 182

 Complete Hub Fit Drain System 182

 Complete Pipe Fit Cleanout System 182

 Complete Pipe Fit Drain System 182

 Drain Base with Adapter 181

Levels

 Plastic Magnetic 303

 Top Grade Gradient 303

 Torpedo 303, 405

Lift Wire

 Brass 36

 Brass Guide 36

Lift Wire Guide 36

Liquid Lightning Pro Drain Opener 296, 422

Lock

 4 Dial Combination Padlock 308

 4' Steel Hardened Security Chain 308

 Flexible Cable Lock 308

 Laminated Padlock with Keys 308

 Round Body Steel Padlock with Keys 308

 Shielded Protected Shackleless Lock with Keys 308

 Square Body Steel Padlock with Keys 308

 WordLock 4 Dial Discus Lock 307

 WordLock 4 Dial Utility Padlock 307

 WordLock Loop and Lock™ with MatchKey 307

 WordLock Stor-More Key Safe™ 307

Locknut

 Ballcock Coupling Nut And 58

 Basin Cock 57

 Basket Strainer, And Washers 58

 Black Malleable 354

 Bronze 142

Lock Nut 131

Locknut/Backnut 354

Long Flare Nut 127

Long Nipple	131	Mushroom Vent Cap	234
Long Sweep Elbow	342	N	
Loop and Lock	307	Nail Puller	284
Lotion And Soap Dispenser	4	Nails	
Lubricant		Copper Clad Nail	112
Cutting Oil	306	Copper Coated J-Nails	112
WD-40®	301, 405	Needle Valve for Pressure Gauge	106
Lugs, Sink	62	Nipple	
M		Chrome Plated	144
Magnetic		Red Brass	140
Plastic Level	303	Yellow Brass	131
Power Nut Setters	291	Nipple Caddy	
Torpedo Level	303, 405	Combo	297
Manhole Cover Lifter	284	Plastic	297
Mansfield Style		Steel Tray	297
Ballcock	37	Nipple Extractor	286
Ballcock and Flush Valve Repair Parts	38	And Screw Extractors	286
Ballcock With Float Rod	37	Internal Pipe	286
MAPP Cylinders	288	Sets	286
Markers	294	No Hub Torque Wrench	314
Marking Labels, Gas Line	302	Non-Adjustable Drain	242
Marking Paint	294	"No Pinch" Pipe Wrench Pliers	290
Marking Paint, Industrial Choice Precision-Line Inverted	294	Nut	
Marvel Adapter	60, 335	45° Flare Tube Fitting	127
Marvel Ring	335	Basin	58
Marvel Rings	335	Brass Compression	125
Marvel Rings, Sweat Male Adapter	60	Carrier Nuts and Washer Set	117
Measuring Tape		Chrome Plated Brass Slip Joint	58
Locking	287, 288, 405	Chrome Plated Die Cast Zinc Slip Joint	334
Long	288	Die Cast Zinc Slip Joint	58
Neon Precision	288	Driver	291
PlumbRule	288	Hex Nut	117
Mega Torque Wrench	314	Lavatory Supply	58
Merchandising		Lock, Yellow Brass	131
Brass Hose Barbs	427	Plastic Slip Joint	58, 334
Cable Ties	411, 420	Rod Coupling	119
Complete Brass Assortment - Lead Free	423	Rough Brass Slip Joint	58, 334
Complete Tool Spinner	421	Setters	291
Compression Fittings - Lead Free	425	Space Heater Fitting	129
Flare Fittings	424	Split	58
Flashlights	412, 421	Stove Bolt with Nut	116
Garden Hose Fittings - Lead Free	426	Nut Driver	291
Gloves	411, 419	Nut Setters, Magnetic Power	291
Hardware	410, 418	Nylon Fittings	
Liquid Lightning Pro Drain Opener	422	Adapter	149
Poly Inserts	429	Elbow	149
Security	410, 419	Garden Hose Cap	149
Toilet Repair Board	409	Hose Barb Adapter	149
Wall and Counter Repair	412, 420	Insert Adapter	150
Wypall Waterless Hand Wipes	422	Insert Combination Elbow	150
Yellow Brass and Bronze Pipe Fittings - Lead Free	428	Insert Coupling	150
Merchant Couplings	361	Insert Elbow	150
Metal Stud Insulator	110	Insert Tee	150
Metal Stud Pipe Insulator	113	Splicer	149
Meter Key	285	Tee	149
Milwaukee Style Trap	320	Nylon Garden Hose Fittings	149
Mixer Hose	90	Nylon Hose Barb Fittings	149
Mixet Replacement Handles	66	Nylon Insert Adapters	150
Moen		Nylon Line Reel	113, 288
Replacement Handles	67	O	
Single Handle Replacement Buttons	67	Oakum	114
Mop Hanger for Service Sink	116	Oetiker PEX Stainless Steel Clamp	133
Moss Bay Repair Flange	240	Offset Bath Supplies	7, 47

Offset Tank to Bowl Bolts 42

Oil 306

Oil, Cutting 306

One-Hole Schedule 40 Half Kit 15-16, 52-53, 53-54

O-Ring

 Bore 89

 Kit And Pick 60

Outlet Adapter 305

Outlet Tee, PVC 326

Overflow Plate 49

Overflow Plates 49

Overflow Plates - One hole 12

Overflow Tube 37

Over Pipe Fit Commercial Drain 187-191

P

Packing

 Candle Wick 113

 Graphite 114

Padlock 307

Pads

 Copper Cleaning 303

 Knee 300, 400

Paint

 5 in 1 Painters Tool 295

 Marking, Industrial Choice Precision-Line Inverted 294

 Spotter Hand-Help Wand 294

Paint Holder 294

Pantry Faucet 61

Peerless

 Faucet Index Buttons 67

 Replacement Handles 66

Pencil Flame Torch 289

Pencil Torch 289

"Perfect Low Profile" Shower Drain 179

Perforated Hanger Iron 113

PEX Fittings

 Adapter 132, 133, 134

 Ball Valve 132

 Coupling 132, 133, 134

 Crimp Ring 133

 Elbow 132, 133, 134

 Plug 132, 133, 134

 Tee 132, 133, 134

Phillips Bits 291

Pick Mattock 285

Pigtail Syphon 105

Pilot Line Breakaway Nut 126

Pipe

 Lubricant 313

 Readycut, Black Malleable 360

Pipe Bracket

 Carrier 109

 Extruded Hole Copper Plated 110

 Extruded Notches Copper Plated 110

 Flat Copper Plated 109

 For Water Closet-Copper Clad 110

 Galvanized 109

 Galvanized-CPVC 110

 Galvanized L 110

 Galvanized Lockright 110

 Galvanized Lockright-CPVC 110

Pipe Cutters

 Heavy Duty PVC 280

 Inside 280

 Professional PVC 280

 PVC 280

 PVC One-Handed 280

Pipe Fit Adapter Drains 184

Pipe Fit Commercial Drain 184-185

Pipe Fittings, Yellow Brass & Bronze 428

Pipe Hanger

 Conduit Hanger 118

 Copper - Bell & Milford Types 118

 Schedule 40 111

Pipe Hook

 "Copper Boy" 111

 Plastic Coated 111

Pipe Insulation

 Double Stick 101

 Insulation Protective Coating 102

 Insulation Tape 102

 Poly

 Double Stick Pipe Insulation 101

 Semi-Slit Pipe Insulation 101

 Tees and Elbows 102

 Rubber

 Double Stick Rubber Pipe Insulation 98

 Seamless Rubber Pipe Insulation 97

 Semi-Slit 101

Pipe Insulator

 Metal Stud 113

Pipe Jacket 290

Pipe Jackets, Freeze Fix 290

Pipe Joint Compound

 Whitlam "Blue Magic" 295

 Whitlam "Select Unyte" Teflon 295

Pipe Lubricant 313

Pipe Nipple Black 357, 358, 359, 360

Pipe Nipple Extractor 286

Pipe Nipples

 Black Malleable 357

 Chrome Plated 144

 Red Brass 140

Pipe Plug 290

Pipe Plugs, Sure Sweat Dissolvable 290

Pipe Sleeveing 94

Pipe Strap 112

Pipe Support, Flush Valve 57

Pipe Taps 287

Pipe Wrap Tape 92

Pipe Wrench

 Aluminum 278

 Heavy Duty 278

Plastic Access Panel 85

Plastic Drop Cloth 306, 397

Plastic Flow Restrictor 46

Plastic Hanger Tape 113

Plastic Magnetic Level 303

Plastic Push On Fittings 138

Pliers

 Curved Jaw Tongue & Groove 291

 Pipe Wrench, "No Pinch" 290

 Slip Jaw 290

 Smooth Jaw 290

 Smooth Jaw Tongue & Groove 291

 Tongue & Groove 290

Water Pump	290	Gas Test Assembly	106
Water Pump, Griplock Tongue & Groove	290	Gas Test Gauge	105
Plug		Gas Test Gauge Assembly	106
45° Flare Tube Fitting	127	Gas Testing Equipment	104
Black Plastic PEX	134	Liquid Filled	105
Brass Bar	64	Needle Valve	106
Brass PEX	132	Pressure Gauge	105
Bronze	143	Sillcock/Water or Gas Test Gauge Assembly	105
Chrome Plated	145	Test Gauge Assembly	105
Fitting C.O. Adapter with Plug	342	Tridicator	106
Handi-	293	Vacuum Gauge	106
Plastic Push On	138	Water Test Gauge	105
Square Head, Black Malleable	354	Pressure Snubber	106
Sure Sweat Dissolvable Pipe Plug	290	Primer for Pipe Wrap Tape	92
Tray	64, 335	Propane Cylinders	288
White Plastic PEX	133	Protective Blanket	289
Wrot, Copper	369	Protector, Three Prong Drain	64
Yellow Brass	130	Provent	57
Plug Drain, Brass P.O.	56	PTFE Thread Seal Tape	93
Plug, Fitting	369	P-Trap	
Plumb Aire Air Vent	57	ABS	329
Plumb Bob	288	ABS, Chrome Plated	331
Plumb Bob, Brass	288	ABS Plastic	329
Plumber's	296	Boston Style	320
Cotton Handy Towels	306, 397	Brass Tubular	6
Epoxy Putty	296	Cast DWV	379
Faucet And Valve Grease	296	Chrome Plated	320
Goop Adhesive	296	Chrome Plated ABS	329, 331
Putty	296	Chrome Plated Boston Style	320
Plumbing Connectors		Chrome Plated Brass	319
Braided Nylon	72	Chrome Plated Milwaukee Style	320
Flexible Stainless Steel	71, 72	Chrome Plated PVC	57
PlumbBite Push On Fittings	135	Chrome Plated Sink Trap with PVC Adapter	320
Plumbjet	88	Chrome Plated Sink Trap with Sweat Connection	320
Plumb Kit	49	Commercial	57
Plunger		Commercial, with Cleanout	57
Force Cup	88	Elbow	346
Professional Force Cup Display	88	LA Pattern with Union	346
Plunge Right	55	Milwaukee Style	320
Pointing Trowel	284	P-Trap w/Adapter	329
Poly Fittings		PVC	326
Combination Elbow	151	PVC, Chrome Plated	329
Insert Adapter	151	PVC DWV	346
Insert Coupling	151	PVC, Polished Brass	329
Insert Elbow	151	PVC with Solvent Weld Marvel	326
Insert Reducer	151	Rough Brass	325
Insert Tee	151	Rough Brass P-Trap	325
Poly Insert Assortment	429	Suction Line	369
Poly Insert Fittings	151	U-Bend	346
Poly Sheeting	306	with ABS Adapter	320
P.O. Plug Lav Drain	333	With Cleanout	379
Pop-Up Assembly		with PVC Adapter	320
ABS	56, 333	with Solvent Weld Joint	346
Brass	56	with Sweat Connection	320
Chrome Plated ABS	56, 333	with Union	346
Chrome Plated Brass	333	Wrot Suction Line, Copper	369
Polished Brass	333	Pumps	
Replacement Parts	56	Air	279
Pop-Up Drain, Lav Lift and Lock	56	Economy Air	279
Portable Halogen Work Light	304	Hydrostatic Pressure	278
Power Strip	305	RP 30 Hydrostatic Test	279
Pressure Gauges		Water	279
Gas	105		

Push On Fittings

Plastic

Angle Valve 138
 Cap 138
 Connector 139
 Coupling 139
 Elbow 139
 Needle Valve 138
 Plug 138
 Straight Valve 138
 Tee 139
 Union 138

PlumBite

Adapter 135
 Ball Valve 135
 Cap 135
 Coupling 135
 Elbow 135
 Removal Tool 135
 Supply Stop 135
 Tee 135

Twist To Lock

Connector 136
 Coupling 136
 Elbow 136
 Tube End Stop 137
 Union 137

Putty

Plumber's 296
 Plumber's Epoxy 296

Putty Knife

..... 295

PVC Shower Pan Liner Cement

..... 45

Q

Qwik Elbow

..... 89

Qwik Tee

..... 89

R

Radiant Seal Sponge Rubber Closet Gasket

..... 43

Radiator Accessories

..... 159, 160

Radiator Angle Air Valve

..... 160

Radiator Angle Valve

..... 159

Radiator Coin Key Air Valve And Key

..... 159

Radiator Spud Wrench

..... 275

Radiator Straight Air Valve

..... 160

Radiator Valve Handle

..... 160

Rags

..... 306, 397

Rags, Box of

..... 306, 397

Ratchet Strap

Tie Down 301

With Step Release J-Hooks 301

Rayovac

Batteries 305, 408

Heavy Duty Industrial 305, 408

Floating Lantern & Battery 303, 407

Industrial Flashlights 303, 407

Readycut Pipe

Black Malleable 360

Readycut Pipe Black

..... 360

Ready Fit Corded Ear Plugs

..... 300, 400

Red Brass Insert Fittings

Insert Adapter 152

Insert Coupling 152

Insert Elbow 152

Insert Male Rope Adapter 152

Insert Reducer 152

Insert Tee 152

Insert x MIP 90° Elbow 152

Insert x Sweat Adapters 152

Red Brass Pipe Nipples 140

Red Rubber Sheet Packing/Gasket Material 167

Reducer

Bell, Yellow Brass 130

Bronze 143

Chrome Plated 144

Insert, Poly 151

Insert, Red Brass 152

Wrot DWV 376

Wrot Fitting, Copper 370

Reducer Coupling, PVC DWV 341

Reducing Coupling, Banded 352

Reducing Tee, Banded 355

Refill Tube 36

Relief Valve, Cleanout And

Sewer 69

Removal Tool

Extract-a-Drain Tub Drain 277

Lavatory Nut 276

PlumBite 135

Repair Clamp

Stainless Steel 85

Repair Coupling

PVC DWV 341

Repair Cover Plates 70

Repair Fitting 234

Repair Flange 240

Repair Plate 269

Repair Plug 86

Repair Trap

ABS 330

Chrome Plated Brass 321

PVC 327

Replacement Basket Strainer 3

Replacement Clamp For Flexible Couplings 164

Replacement Handles

Aqualine 67

Delex 66

Delta 66

Eljer 67

Fit-All 66

Mixet 66

Moen 67

Peerless 66

Sears 67

Stanadyne 67

Valley 67

Replacement Strainer for Metal Spud 214

Replacement Strainers 21, 180, 214, 242, 246

For Roman Tub Drains 21, 242

Restrictor 46

Rings, for Drain and Cleanout Spuds 214

Rinse-Quik Hose and Spray 62

Riser Clamp 119

Rod

Probing 285

Steel Probing 285

Steel Probing, with Ball Point 285

Rod Coupling Nut 119

Roman Tub Drains	242	6 in 1	291
Roof Drains		Screw-On Wire Connector	309
Accessories for Roof Drains	235	Screws	
Roof Drains w/Cast Iron Dome	235	Anchor Bolt Kit	117
Roof Drains w/Plastic Dome	235	Drill Point Tech Screw	117
Roof Flashing		E-Z Anchor/Self-Drilling Wall Board	116
All Neoprene	115	Flat Phillips Head Brass Wood Screw	116
Aluminum	115	Hex Head Lag Screw	116
Galvanized	115	Hex Head Tapping Screw	117
Lead	115	Hollow Wall Anchor Kit	117
Neo-poly	115	Phillips Head Wood Screw	116
Roofrite	115	Screws, Solid Brass Bibb Assortment Kit	60
Roofrite Hi-Heat Silicone	115	Sealant	
Rosettes	57	100% Silicone Tub and Tile	292
Rough Brass Tubular	325	DAP All-Purpose 100% Silicone Rubber	293
Rough-In Kit	54	DAP Kitchen and Bath 100% Silicone Rubber	293
Rubber Hose	302, 401	DAP KWIK SEAL PLUS Premium Kitchen and Bath Adhesive	292
Rubber Hush Cushion, In-Sink-Erator	64	DAP Polyurethane Fireblock Foam	292
Rubber Sheet	167	Firestop 814+ Intumescent Firestopping	293
Running Trap	269	Instant	116
Run-Off Tube	104	Silicone Tub And Tile	292
S		Slic-tite High Density Thread	93
Saddle Tees and Kits	224	Sears Replacement Handles	67
Saddle Tee, Tapped	269	Seat Disc	34
Safety		Seat Disc and Tank Ball	
Carbon Monoxide Alarm	309, 400	for American Standard	34
Disposable Coverall	300, 400	Security Chain	308
Dust Mask	299, 400	Service Sink	
Glasses	299, 400	Faucet	265
Hellraiser	299, 400	Hose and Bracket	265
Nemesis	299, 400	Mop Hanger	265
Visio	299, 401	Mop Service Basin	265
Goggles	401	Trap Standard	265
Goggles, Clear	299, 401	Service Sink Repair	
Hats	300, 400	Faucet	75
Hornet and Wasp Spray	300, 402	Hose and Hose Bracket	116
Knee Pads	300, 400	Mop Hanger	116
Leak Alert Water Detector	309	Sewage Ejector/Sump Pump Check Valve	114
Outlet	305	Sewer Popper	69
Protective Shoe Covers	300, 400	Sewer Relief Plugs	224
Ready Fit Corded Ear Plugs	300, 400	Sewer Relief Valve and Cleanout	69
Shubee Shoe Covers	300, 400	Sewer Stopper/Backflow Preventer	69
Safety Outlet	305	Shackleless Lock	308
Sand Cloth		Sheeting, Poly	306
Flexible Open Mesh	94	Sheet Packing	167
Open Mesh	94	Shims	
Waterproof Aluminum Oxide	94	Closet Wedge	176
Water Resistant	94	Closet Wedge Shims	39
Sanitary Tee	345	Flexible	176
Sanitray Tee	345	Rigid	176
Satin Brass Air Cock	156	Shoe Covers	
Saws		Protective	300, 400
Cable	282	Shubee	300, 400
Close Quarters Hacksaw	282	Shoe Gasket	49
Drywall	281	Shop Heater	309
Hardwood 250 Speed Handsaw	282	Short Flare Nut	127
Jr. Plumber's	281	Shovels	
PlumBest Plastic	281	Economy	283, 402
T-Handle Cable	282	Fiberglass Handle	283, 402
Scraper	295	Long Handle Round Point Fiberglass	283
Screw and Nipple Extractors	286	Premium Grade Wood Handle	283
Screwdrivers		Snow	402
4 in 1	291	Specialty	283

Shower, Add-A- 46
 Accessories 46
 Code Pattern 46
 Complete Unit 46
 Diverter Spout & Riser 46
 D-Style 46
 Less Oval Shower Rod 46
Shower and Floor Drains 242
Shower Arm
 And Kits 45
 Decorative 8, 9
 Flange 45
 Heavy Adjustable 45
 Plastic 45
 with Flange and Set Screw 45
Shower Arm Flange 10
Shower Curtain Pin 45
Shower Curtain Rod 10, 44
Shower Diverter Valve 7, 47
Shower Drain 19–20, 177, 178, 179, 180
Shower Drains 241, 243, 246
Shower Elbow, Brass For Fiberglass Shower Stall 47
Shower/Floor Drain 177–178, 178–179
Shower Head
 Adjustable Massage 45
 Adjustable Plastic 45
 Brass 44
 Brass Aerating Water Saver 45
 Decorative 7, 8
 Deluxe 44
 Die Cast 44
 Octagonal 45
 Plastic 44
 Vandal Proof 45
Shower Pan Liner 45
Shower Pan Liner Cement 45
Shower Pan Liner Cement, PVC 45
Shower Rod
 Adjustable Aluminum 44
 Aluminum 44
 Aluminum, with Holders 44
 Contoured 44
Shower Rod Flange 7, 44
Shower Stall Drain 180
Shower Utility 47
Shower Valve 74
Shut-Off Valve, Gas 155
Shut-Off Valves 155
Silicone
 Caulk 292, 405
 Tub And Tile Sealant 292
Siliconized Acrylic Caulk 292
Sillcock Key 275
Sink
 Basin Faucet 74
 Connection Washer 58
 Crumb Cups 64
 Hangers 62
 Kitchen Stopper 64
 Laundry Tray Faucet 74
 Lugs 62
 Self-Closing Basin Faucet 74
 Service 75

Hose & Hose Bracket 75
 Mop Hanger 75
 Single Sink Bibb 74
 Undermount Installation Kit 62
 Wall Mount Faucet 74
Sink Tailpiece
 Chrome Plated Brass 322
Sink Trap
 L.A. Pattern 321
 L.A. Pattern Sink Trap 321
 Sink Trap w/ABS Adapter 320
 Sink Trap w/Sweat Connection 320
Slab Drain 244, 245, 247, 248
Sledgehammer 284
Sleeve
 Brass Compression 125
Slip Jaw Pliers 290
Slip Joint
 Cone, Washer 59
 Nut 58, 334
 Nut And Washer 59
 Rough Brass, Nut 58
 Tee 60, 328
 Washer 59, 334
Slip Nut 334
Slip-On Plastic Cap 87
Smooth Jaw Pliers
 10" 290
 Tongue & Groove 291
Snake, Drain King Mini Snake 296
Snap-Ease Access Panel 85
Snap-in Drain 218–219
Snap-in Strainers 21
Snow Brush 283, 401
Snow Pusher/Shovel 283, 401
Snow Scraper 284, 401
Snow Shovel 283, 402
Soap And Lotion Dispenser, Chrome Plated 62
Soap Stones And Holders 288
Socket Ring 219
Socket Savers 279
Solder
 Phos-Copper Brazing Rod 289
 Shield Protective Blanket 289
 Silver 289
Solder Extension Tube
 Chrome Plated Brass 323
Solid Square Head Plug 143
Solvent Extension Tube
 ABS 331
 PVC 328
Space Heater Fittings 129
Spacer
 Air Gap 57
 Closet Bend 43
 Foam 43
 Styrofoam Closet Flange 43
Spanner/Strainer Wrench 277
Splash Guard, Garbage Disposal 64
Splicer, Nylon 149
Split Nut 58
Sponge 306, 398
Sponge Closet Gaskets 36

Sponges, Commercial	306, 398	Quick Fit Stainless Steel Basket	63
Sportsman L.E.D. Head-Lite	303, 407	Shallow Cup Duo Basket	63
Spouts		Stainless Steel Deep Cup Basket	63
Telescoping Tub	48	Stainless Steel Duo Basket	63
Tub	48	Twist And Lock Basket	63
Spray		Wrench	277
Delta Style Assembly	62	Strainers, Replacement	214
Kitchen (Fit All)	61	Strap	
Rinse-Quik	62	U-Type, Copper	370
Spray Assembly	62	S-Trap	
Spray Bottle	307, 398	ABS	330
Spray Paint	294	Chrome Plated Brass	320
Spray Weld	295	PVC	327
Spreader	307, 402	Straps	
Spring Tubing Bender	301	Cam	301
Spud		Camouflage, with Hooks	301
Adjustable, Strainer and	277	Duct	301
Wrench	277	Heavy Duty Utility	301
Wrench With Hinged Arm	277	Ratchet Tie Down	301
Spud and Strainer	19-21	Ratchet, with Step Release J-Hooks	301
Spud Extension, for Drains and Cleanouts	215	S-Traps	320
Spuds	250-251	Strap Wrench	278
Square Head Plug	130, 354	Street Tee, Banded	356
Stanadyne		Stretch Wrap	
Replacement Handles	67	Film and Dispenser	93
Single Handle Replacement Buttons	67	Striking Tools	284
Standard Two-Hole Schedule 40 Half Kit	16-17	Stud Guard	
Standard Waste and Overflow		2 Hole	108
1-Hole Full Kit	50	6 Hole	108
1-Hole Half Kit	49	20-holes	108
2-Hole Half Kit	49	Interlocking	108
Steam Vent	160	Self Nailing	108
Steel Padlock	308	Stud Protectors and Plate	108
Steel Wool	302	Stud Shoe	108
Stopper		Super Shims	176
Basin And Tub	50	Supply and Stop Kit	
Fit-All	50	Closet	25
Flip-It Tub	50	Lavatory	25
Garbage Disposal	64	Supply Stop	
Kitchen Sink	64	Easy Connect Tee	73
Pop-Up Basin	50	Multi-Turn	24, 73
Stove Bolt with Nut	116	PlumBite	135
Straight Air Valve	159	Quarter Turn	24, 73
Straight Needle Valve		Repair Stop Valve	73
Plastic Push On	138	Supply Tubes	
Straight Steam Vent	160	Closet	26
Straight Stop	24-26	Flexible Basin	73
Strainer		Flexible with Rubber Nose	73
ABS Body And Post Basket	63	Lavatory	26
Adjustable, and Spud	277	PEX	73
Beehive Urinal, Cast Brass	64	PEX With Ferrule	73
Chrome Plated Brass Duo Basket	63	Sure Grip Escutcheon	338
Deep Cup Basket	63	Sure Sweat Dissolvable Pipe Plugs	290
Deep Junior Duo Basket	64	Surge Protector	305
Duo Basket	63	Sweat Male Adapter	60
Duo, CP Brass	63	Sweat Male Adapter/Marvel Rings	60
Economy Replacement Basket	62	Swimming Pool Valves	161
Fit-All Basket	62	Swivel, 45° Flare Tube Fitting	127
Flat Duplex	64	Swivel Drum Trap	347
Flat Top Grid	63	Swivel-Lite	303, 407
Flexible Hair	64	4 D/6 Volt	303, 407
Junior Duo Basket	64	Industrial Flashlights	303, 407
Plumb Easy Sink Wrench	278	Swivel Ring	118

T

Tailpiece

ABS 331
 Brass Direct Connect Dishwasher 324
 Brass Double Flange 322
 Brass Sink 322
 Slip Joint Tailpiece 324
 Slip Joint Tailpiece w/1/2" Sweat Branch 325
 Threaded Connection Dishwasher
 Tailpiece 324
 Trap Primer 56
 Trap Primer Tailpiece 334

Tailpiece Extension 178

Tamping Bar 284

Tamping/Digging Bar 284

Tank Ball 34

Tank to Bowl

Bolt Kit for American Standard 42
 Bolt Kit for Gerber 42
 Bolt Kit for Mansfield 42
 Bolt Set 42
 Components 43
 Gasket 43
 Offset Bolts 42
 Offset Tank to Bowl Bolts 42
 Set 42
 Tri-Bolt Tank to Bowl Bolt Set 42
 Tri-Tank to Bowl Bolt Kit for American Standard 42

Tank to Bowl Bolt Kit

For American Standard 42
 For Mansfield 42
 Tri-Bolt Tank 42
 Tri-Tank, American Standard 42

Tank Trip Lever

Eljer Touch Flush Assembly 33
 Fit-All 32
 for American Standard 27, 32
 for Crane 32
 for Eljer 27, 33
 for Kohler 27, 33
 for Mansfield 33
 for ToTo 28, 33
 for Universal Rundle/Sears 28, 33
 for Western Pottery 33
 Ultrafit 26, 33
 Universal 28

Tape

Box Sealing 93, 405
 Caution 302, 401
 Duct 93, 405
 Electrical 93
 Gas Line Marking Labels 302
 Insulation 102
 Pipe Wrap
 Domestic Pipe Wrap Tape 92
 Imported Pipe Wrap Tape 92
 Primer for Pipe Wrap Tape 92
 Thread Seal
 PTFE Thread Seal Tape 93
 PTFE Yellow Gas Line Thread Seal Tape 93
 Slic-tite® High Density Thread Sealants 93
 Thread Seal Tape Jar Display 93

Tape Measure

Locking 287, 288, 405
 Long 288
 Neon Precision 288
 PlumbRule 288

T-Cone Cleanout Repair Plugs 86

Tee

45° Flare Tube Fitting 127
 Banded 355
 Banded, Black Malleable 355
 Baseboard 374
 Black Plastic PEX 134
 Brass Compression 125
 Brass Hose Barb 148
 Brass PEX 132
 Bronze 142
 Bronze Compression 86
 Cast DWV 378
 Chrome Plated 144
 Double 378
 Double, Cast DWV 378
 Double Long Turn T-Y 379
 Double Sanitary, PVC DWV 346
 Drop 374
 Forged Brass/Cast Pressure 374
 Insert, Nylon 150
 Insert, Poly 151
 Insert, Red Brass 152
 Nylon 149
 Plastic Push On 139
 PlumBite 135
 PVC Compression 86
 PVC DWV 344
 Qwik 89
 Reducing, Banded Black Malleable 355
 Sanitary, PVC DWV 345
 Slip Joint 60
 Space Heater Fitting 129
 Street, Banded Black Malleable 356
 Test 378
 Tubular, Chrome Plated 324
 White Plastic PEX 133
 Wrot, Copper 371
 Wrot DWV 375
 Yellow Brass 130

Tee Plug, Inflatable 88

Test Cap

Flexible PVC 87
 Knockout 87
 PVC Dual Fit 87
 PVC Test Cap 87
 Slip-On Plastic 87
 Techno Test Plug 87
 Wrot DWV 375

Test Gauge

5 Pound Gas 105
 Assembly 105
 Gas 105
 Gas Test Gauge Assembly 106
 Gas Testing Equipment 104
 Liquid Filled Pressure Gauge 105
 Pressure Gauge 105
 Sillcock/Water or Gas Test Gauge Assembly 105

Tridicator	106	Torches	
Water	105	Pencil Flame	289
Test Plug		Uniweld	289
Cast Iron	87	Torpedo Level	303, 405
Combination	86	Torque Wrench	314
Economy	86	Totes	
"Plum-Tite" Mechanical	87	2CanCaddy	297
Pneumatic	88	20 Compartment Parts Box	297
Pneumatic-Hydraulic	88	Bucket Caddies	297
T-Cone	86	Combo Nipple Caddy	297
Two Stage Long	88	Fitting Tote Tray	297
Test Tee, Cast DWV	378	Fitting Tray	297
Test Tee, Cast Iron	269	Plastic Nipple Caddy	297
Test Tee with Plug	224, 269	Steel Nipple Caddy Tray	297
Test Tee w/Plug	224	Tool	297
Texas Pattern Gas Ball Valve	157	Utility Tote Tray	297
The Green Drain Waterless Trap Seal	215	Utility Tray	297
Thermometer		Towels	
Bi-Metal Dial	107	Cotton Plumbers Handy	306, 397
Dial	106	Wypall Teri	306, 397
Hot Water/Refrigerant Line	106	Traffic Floor Drain	217-218
Pocket Test	107	Transition Coupling, Flexible	89
Weksler Industrial Multi-Angle	107	Trap Adapter	347
Threaded Extension Tube, Chrome Plated Brass	323	Trap Adapters	59
Threaded Steel Rod	119	Trap Bushing	47
Thread Sealants, Slic-tite® High Density	93	Trap Cover, Drum	114
Thread Sealing Compound, Slic-tite® Heavy Duty	296	Trap Primer Tailpiece	56, 334
Thread Seal Tape		Trash Bags	307, 405
PTFE	93	Tray Plug	64, 335
PTFE Yellow Gas Line	93	Tridicator	106
Tissue Roller	57	Trip Lever	
Toggle Bolt	116	Trim	54
Toilet Seat		with Spring	49
Adult/Juvenile Residential Plastic	387	Trouble Light	304
Builder Grade Residential Plastic	388	Trowel	284
Commercial Baby Bowl Plastic	390	Tub And Shower Valve Wrench Set	275
Decorative Natural Finish, Solid Oak	385	Tubing	
Decorative Piano Finish, Solid Bamboo	385	Clear Vinyl	107
Decorative Piano Finish, Solid Oak	385	Natural Polyethylene	107
Deluxe Commercial Plastic	389	Soft Aluminum	107
Deluxe Molded Wood	383	Tubing Benders	
Deluxe Residential Plastic	386	3-N-1	301
Designer Acrylic	392	Spring	301
Extra Heavy Duty Commercial Plastic	388	Tubing Cutter	
Heavy Duty Commercial Plastic	388	Copper	281
Light Duty Commercial Plastic	391	Economy	281
Premium Commercial/Institutional Plastic	390	Mini	281
Premium Heavy Duty Commercial Plastic	390	Quick Release	281
Premium Molded Wood	383	Ratcheting Handle Copper	281
Premium Residential Plastic	386	Telescoping	280
Replacement Hardware	392	Vinyl	280
Specialty Plastic	391	Tub Spout	
Standard and Deluxe Soft Seats	391	Chrome Plated	48
Standard Commercial Plastic	389	Solid Brass	49
Standard Molded Wood	384	Telescoping	48
Standard Residential Plastic	387	Zinc	49
Utility Grade Residential Plastic	388	TubSpouts	10-11
Utility Molded Wood	385	Tubular Bath Waste Full Kit	18
Toilet Repair Board	418	Tundra Pipe Insulation	99-102
Tongue & Groove Pliers	290	Turnout Bend Support for PEX	110
Top Grade Gradient Level	303	Twine	
Top Hat Washer	36	10 lb. Tying Twine with Dispenser Box	113
		Binder Sisal	113, 403

Mason's Nylon 113

Twin Elbow Bushing 47

Twist Light 304

Twist-Off Strap Tool 278

Twist To Lock Plastic Fittings 136

U

U-Bend

PVC DWV 346

Union

45° Flare Tube 128

45° Flare Tube Fitting 127

Black Malleable 356

Brass Compression 125

Bronze 142

Chrome Plated 145

Copper 370

Forged Brass/Cast Pressure 374

Plastic Push On 138

Space Heater Fitting 129

Stack Tube Tee, Twist To Lock 137

Twist To Lock 136

Union, Brass to Iron Seat 356

Universal Beam Clamp 117

Universal Copper Thermocouple 103

Universal Drain Wrench 276

Urinal

Flange 174

Flange Kits 174

Screen 307, 398

Spud 35

Strainer, Cast Brass Beehive 64

Utility

Drain 219

Knife 403

Light 304

Pry Bar 284

Shower 47

Strap 301

V

Vacuum Gauge 106

Valve, Plastic Push On 138

Valve Grease 296

Valve Key 285

Valve Seal

Korky 37

Korky for Champion 4 37

Vent Cap 234

Vent Elbow 342

Vinyl Gloves

Disposable 299, 398

W

Wall Bend, Chrome Plated Brass 322

Washer 335

Aqua Seal 36

Assorted Kit 60

Basket Strainer 58

Beveled Ballcock Shank 36

Beveled Bibb 36

Beveled Slip Joint Washer 335

Carrier Nuts and Washer Set 117

Cone Slip Joint 59

Fender 117

Flanged Poly Tailpiece 59, 335

Flanged Poly Tailpiece Washer 335

Flat 117

Flat Bibb 36

LDP Blue Slip Joint 335

Materials 167

Poly Beveled Slip Joint 335

Rubber Slip Joint Washer 335

Sink Connection 58

Slip Joint 59

Square Cut Rubber Slip Joint 335

Top Hat 36

Washing Machine Repair

Boxes 90

with Hammer Arrestor 90

with Valves 90

Hoses

Drain 91

Fit-All Drain 91

Mixer 90

Washing Machine 90

Pan 91

Wasp & Hornet Spray 300, 402

Waste And Overflow 54

Aluminum Bar 54

Test Kits 54

Waste Arm

ABS 330

Chrome Plated Brass 322

PVC 327

Rough Brass 325

Waste Connector 59, 335

Waste w/Dishwasher Connection 331

Water Detector 309

Water Detector, Leak Alert 309

Water Dispenser 4

Water Hammer Arresters 168

Water Heater Repair

Connector 103

Braided Stainless Steel 103

Corrugated Copper 103

Corrugated Stainless Steel 103

Dielectric Nipple 103

Dielectric Union 102

Gasket and Insert for Dielectric Union 103

Pan 104

Adapter 104

Galvanized 104

Safety 104

Water Heater 104

Run-Off Tube 104

Stand 104

Stand-rite 104

Water Heater Stand 104

Thermal Expansion Tank 102

Universal Copper Thermocouple 103

Waterless Trap Seal 215

Water Meter Keys 285

Combo 285

Gate Valve Key 285

Water Meter Repair

Gasket Only for Water Meter Couplings 120

Irrigation Box 121

Round Valve Box 121

Water Meter Box 120
 Water Meter Box Keys and Covers 120
 Water Meter Coupling Complete 120
Water Pump 279
 Pliers 290
Water Supply Tubes 26
Water Tank 102
Water Volume Control 46
Water Volume Restrictor 46
Wax Gaskets 43
Waxless Gasket 175
WD-40® Lubricant 301, 405
Wet-R-Dri Roofing Cement 114
Whitlam
 "Blue Magic" Pipe Joint Compound 295
 "Green Blaster" Drain Opener 296
 Seal Unyte 295
 "Select Unyte" Teflon Pipe Joint Compound 295
Wire Brush 294, 295
Wire Connectors, Screw-On 309
Wood Bits
 Dual Auger 287
 Flat "Paddle" 287
Wool, Steel 302
WordLock 307
Work Light 304
Wrecking Bar 284
Wrench
 4-Way Countersunk Plug 276
 4-Way Plug 276
 4-Way P.O. Plug 276
 6-Way Countersunk Plug 276
 Adjustable 278
 Adjustable Strainer And Spud 277
 Aluminum Pipe 278
 Angle Compression Stop 276
 Box 278
 Curb Box 278
 Do All Plumbers 278
 Dual Kwik Tie 276
 Element 275
 Faucet Seat 276
 Garbage Disposal 275
 Heavy Duty Pipe 278
 Mega Torque 275
 Moen Stem And Cartridge 277
 No Hub Torque 275
 Plumb Easy Sink Strainer 278
 Quick Drain 277
 Radiator Spud 275
 Seat, for Recessed Seats 276
 Set 275
 14 Piece Folding Hex Key Wrench 275
 Tub And Shower Valve Wrench 275
 Sink Drain 277
 Spanner/Strainer 277
 Spud 277
 Spud With Hinged Arm 277
 Strainer 277
 Strap 278
 Universal Drain 276
Wye
 Cast DWV 379

Double 379
 Double, Cast DWV 379
 PVC DWV 344
Wypall
 Teri Towels 306, 397
 Waterless Hand Wipes 306, 398, 422
Y
Yellow Brass & Bronze Pipe Fittings 428
Yellow Brass Pipe Fittings
 Bell Reducer 130
 Bushing 131
 Coupling 130
 Elbow 130
 Lock Nut 131
 Nipple 131
 Plug 130, 131
 Tee 130
Z
Zinc Plated Clevis Hanger 118
Zip Ties 300

<u>PART NO.</u>	<u>PG #</u>	<u>PART NO.</u>	<u>PG #</u>	<u>PART NO.</u>	<u>PG #</u>	<u>PART NO.</u>	<u>PG #</u>
30100	357	30700	357	31545	358	34024	360
30110	357	30710	357	31550	358	34035	358
30112	357	30711	357	31555	358	34040	358
30115	357	30712	357	31560	358	34045	358
30120	357	30715	357	31570	358	34050	358
30125	357	30720	357	31580	358	34055	358
30130	357	30725	357	31590	358	34060	358
30135	357	30730	357	32000	358	34070	358
30140	357	30735	357	32010	358	34080	358
30145	357	30740	357	32011	358	34090	358
30150	357	30745	357	32012	358	35000	358
30155	357	30750	357	32013	358	35045	358
30160	357	30755	357	32025	358	35050	358
30170	357	30760	357	32030	358	35055	358
30180	357	30765	357	32035	358	35060	358
30190	357	30770	357	32040	358	35070	358
30200	357	30775	357	32045	358	35080	358
30210	357	30780	357	32050	358	36000	358
30211	357	30790	357	32055	358	36010	358
30212	357	31000	357	32060	358	36011	358
30215	357	31010	357	32065	358	36012	358
30220	357	31011	357	32070	358	36045	358
30225	357	31012	357	32075	358	36055	358
30230	357	31014	357	32080	358	36060	358
30235	357	31020	357	32090	358	36070	359
30240	357	31025	357	32500	358	36080	359
30245	357	31030	357	32510	358	36090	359
30250	357	31035	357	32511	358	40300	359
30255	357	31040	357	32512	358	40500	359
30260	357	31045	357	32514	358	40700	359
30270	357	31050	357	32518	360	41000	359
30280	357	31055	357	32520	360	41200	359
30290	357	31060	357	32524	360	42000	359
30300	357	31065	357	32530	358	50100	357
30310	357	31070	357	32535	358	50110	357
30311	357	31075	357	32540	358	50111	357
30312	357	31080	357	32545	358	50112	357
30314	357	31090	357	32550	358	50115	357
30315	357	31200	357	32555	358	50120	357
30320	357	31210	357	32560	358	50125	357
30325	357	31211	357	32565	358	50130	357
30330	357	31212	357	32570	358	50135	357
30335	357	31213	358	32580	358	50140	357
30340	357	31214	358	32590	358	50145	357
30345	357	31220	358	33000	358	50150	357
30350	357	31225	358	33010	358	50155	357
30355	357	31230	358	33011	358	50160	357
30360	357	31235	358	33012	358	50170	357
30370	357	31240	358	33018	360	50180	357
30380	357	31245	358	33030	358	50190	357
30390	357	31250	358	33035	358	50200	357
30500	357	31255	358	33040	358	50210	357
30510	357	31260	358	33045	358	50211	357
30511	357	31265	358	33050	358	50212	357
30512	357	31270	358	33055	358	50215	357
30515	357	31280	358	33060	358	50220	357
30520	357	31285	358	33070	358	50225	357
30525	357	31290	358	33080	358	50230	357
30530	357	31295	358	33090	358	50235	357
30535	357	31500	358	33500	358	50240	357
30540	357	31510	358	33540	358	50245	357
30545	357	31511	358	33550	358	50250	357
30550	357	31512	358	33555	358	50255	357
30555	357	31514	358	33580	358	50260	357
30560	357	31520	358	34000	358	50270	357
30570	357	31525	358	34010	358	50280	357
30575	357	31530	358	34011	358	50290	357
30580	357	31535	358	34012	358	50300	357
30590	357	31540	358	34014	358	50310	357

PART NO.	PG #	PART NO.	PG #	PART NO.	PG #	PART NO.	PG #
50312	357	51220	358	53060	358	162950295	376
50315	357	51225	358	53070	358	162950390	376
50320	357	51230	358	53080	358	164100303	376
50325	357	51235	358	53090	358	164100398	376
50330	357	51240	358	53550	358	164100399	376
50335	357	51245	358	54000	358	164100663	376
50340	357	51250	358	54010	358	164100664	376
50345	357	51255	358	54011	358	164600390	375
50350	357	51260	358	54012	358	164600398	375
50355	357	51270	358	54024	360	612011919	391
50360	357	51280	358	54035	358	S49005	416
50370	357	51290	358	54040	358	S49006	416
50380	357	51500	358	54045	358	S49007	416
50500	357	51510	358	54050	358	S49008	416
50510	357	51511	358	54055	358	S49036	416
50511	357	51512	358	54060	358	S49200	416
50512	357	51520	358	54070	358	S49236	416
50515	357	51525	358	54080	358	S50060	416
50520	357	51530	358	54090	358	S50061	416
50525	357	51535	358	56000	358	24452633W	391
50530	357	51540	358	56010	358	24452634W	391
50535	357	51545	358	56011	358	24456461W	391
50540	357	51550	358	56012	358	24456462CR	391
50545	357	51555	358	56045	358	300 B0218	360
50550	357	51560	358	56050	358	300 B0224	360
50555	357	51570	358	56055	358	300 B0230	360
50560	357	51580	358	56060	358	300 B0236	360
50570	357	51590	358	56070	359	300 B0248	360
50580	357	52000	358	56080	359	300 B0260	360
50590	357	52010	358	56090	359	300 B0272	360
50700	357	52011	358	161010295	375	300 B0318	360
50710	357	52012	358	161010390	375	300 B0324	360
50711	357	52025	358	161050215	375	300 B0330	360
50712	357	52030	358	161050295	375	300 B0336	360
50715	357	52035	358	161050390	375	300 B0348	360
50720	357	52040	358	161570050	375	300 B0360	360
50725	357	52045	358	161570100	375	300 B0372	360
50730	357	52050	358	161570150	375	300 B0518	360
50735	357	52055	358	161570215	375	300 B0524	360
50740	357	52060	358	161570295	375	300 B0530	360
50745	357	52070	358	161570390	375	300 B0536	360
50750	357	52080	358	161570650	375	300 B0542	360
50755	357	52090	358	161650215	375	300 B0548	360
50760	357	52500	358	161650295	375	300 B0554	360
50770	357	52510	358	161650303	375	300 B0560	360
50775	357	52511	358	161650390	375	300 B0572	360
50780	357	52512	358	161650398	375	300 B0718	360
50790	357	52518	360	161650399	375	300 B0724	360
51000	357	52524	360	161650650	375	300 B0730	360
51010	357	52530	358	161650663	375	300 B0736	360
51011	357	52535	358	161650860	375	300 B0742	360
51012	357	52540	358	161650872	375	300 B0748	360
51014	357	52545	358	161720215	375	300 B0754	360
51020	357	52550	358	161720295	375	300 B0760	360
51025	357	52555	358	161720390	375	300 B0772	360
51030	357	52560	358	161720650	375	300 B1018	360
51035	357	52570	358	162350215	375	300 B1024	360
51040	357	52580	358	162350295	375	300 B1030	360
51045	357	52590	358	162350390	375	300 B1036	360
51050	357	53000	358	162420295	375	300 B1042	360
51055	357	53010	358	162420390	375	300 B1048	360
51060	357	53011	358	162540215	376	300 B1054	360
51070	357	53012	358	162540295	376	300 B1060	360
51080	357	53030	358	162540390	376	300 B1066	360
51090	357	53035	358	162900215	376	300 B1072	360
51200	357	53040	358	162900295	376	300 B1218	360
51210	357	53045	358	162900390	376	300 B1224	360
51211	357	53050	358	162900650	376	300 B1230	360
51212	357	53055	358	162950215	376	300 B1236	360

PART NO.	PG #	PART NO.	PG #	PART NO.	PG #	PART NO.	PG #
300 B1242	360	301 G1236	360	A01060	65	B00013	110
300 B1248	360	301 G1242	360	A01061	65	B00014	110
300 B1254	360	301 G1248	360	A01062	65	B00016	110
300 B1260	360	301 G1260	360	A01900	65	B00017	110
300 B1272	360	301 G1272	360	A01901	65	B00018	110
300 B1518	360	301 G1518	360	A04006	85	B00019	110
300 B1524	360	301 G1524	360	A04012	85	B00020	110
300 B1530	360	301 G1530	360	A05008	85	B00021	109
300 B1536	360	301 G1536	360	A05014	85	B00022	109
300 B1548	360	301 G1548	360	A05027	85	B00023	109
300 B1560	360	301 G1560	360	A10001	5	B00024	109
300 B1572	360	301 G1572	360	A10001	57	B00025	109
300 B2018	360	301 G2018	360	A10002	5	B01002	268
300 B2024	360	301 G2024	360	A10003	5	B01003	268
300 B2030	360	301 G2030	360	A10004	5	B01004	268
300 B2036	360	301 G2036	360	A10005	5	B01006	268
300 B2042	360	301 G2048	360	A10006	5	B01013	268
300 B2048	360	301 G2060	360	A10010	5	B01014	268
300 B2060	360	301 G2072	360	A10011	5	B01016	268
300 B2072	360	301 G3018	360	A10015	5	B01017	268
300 B2530	360	301 G3024	360	A10017	5	B01018	268
300 B2560	360	301 G4018	360	A10018	5	B01019	268
300 B3024	360	301 G4048	360	A10019	5	B01020	268
300 B3036	360	31210TOE	359	A10100	57	B02001	3
300 B4018	360	31212TOE	359	A10150	57	B02003	3
300 B4060	360	605B	359	A10200	57	B02004	3
301 G0118	360	605G	359	A10901	57	B02005	3
301 G0218	360	607B	359	A11001	156, 423	B02008	3
301 G0224	360	607G	359	A11002	156	B02049	64, 337
301 G0230	360	610B	359	A11003	156, 423	B02050	64, 337
301 G0236	360	610G	359	A11004	156, 423	B02051	64, 335
301 G0248	360	A01001	65	A11005	156, 423	B02052	64, 337
301 G0260	360	A01002	65	A11006	156	B02060	64
301 G0318	360	A01003	65	A11007	156	B02100	4
301 G0324	360	A01004	65	A11008	156	B02101	4
301 G0330	360	A01005	65	A11011	156	B02102	4, 64, 337
301 G0336	360	A01006	65	A11016	156	B02103	64, 337
301 G0348	360	A01007	65	A11017	156	B02301	3
301 G0360	360	A01008	65	A33001	117	B02303	3
301 G0372	360	A01010	65	A33002	117	B02304	3
301 G0518	360	A01011	65	A33005	117	B02305	3
301 G0524	360	A01012	65	A33006	117, 397	B02400	3
301 G0530	360	A01013	65	A33010	116	B02401	3
301 G0536	360	A01014	66	A40001	257	B02404	3
301 G0542	360	A01015	65	A40002	257	B02405	3
301 G0548	360	A01016	65	A40003	257	B02406	3
301 G0560	360	A01017	65	A97001	168	B02407	3
301 G0572	360	A01018	65	A97002	168	B02408	3
301 G0718	360	A01019	23	A97004	168	B0240BN	3
301 G0724	360	A01020	65	A97007	168	B0240BS	3
301 G0730	360	A01021	65	A97009	168	B0240PN	3
301 G0736	360	A01022	65	A97011	168	B0240PS	3
301 G0742	360	A01023	65	AB05	359	B0240RB	3
301 G0748	360	A01024	66	AB07	359	B0240WB	3
301 G0754	360	A01026	66	AB10	359	B0250BN	4
301 G0760	360	A01027	66	AG05	359	B0250NP	4
301 G0772	360	A01029	66	AG07	359	B0250RB	4
301 G1018	360	A01030	66	AG10	359	B0250WB	4
301 G1024	360	A01031	66	B00001	109	B03001	3
301 G1030	360	A01032	66	B00002	110	B03003	3
301 G1036	360	A01033	66	B00003	109	B03004	3
301 G1042	360	A01034	66	B00004	109	B03005	3
301 G1048	360	A01035	66	B00005	109	B03010	62, 337
301 G1060	360	A01036	66	B00006	110	B03015	62, 337
301 G1072	360	A01037	65	B00007	110	B03050	3
301 G1218	360	A01040	66	B00008	110	B03400	3
301 G1220	360	A01041	66	B00009	110	B03401	3
301 G1224	360	A01050	65	B00010	110	B03405	3
301 G1230	360	A01051	65	B00011	110	B03406	3

<u>PART NO.</u>	<u>PG #</u>	<u>PART NO.</u>	<u>PG #</u>	<u>PART NO.</u>	<u>PG #</u>	<u>PART NO.</u>	<u>PG #</u>
B03407	3	B07003	52	B07110	16	B07158	17, 53
B03408	3	B07004	52	B07110	53	B07159	17, 53
B0350BN	3	B07005	52	B07111	16, 53	B0715AB	17
B0350RB	3	B07006	52	B07111S	49	B0715AL	17
B0350WB	3	B07007	52	B07112	17, 53	B0715AN	17
B04006	233	B07008	52	B07113	17, 53	B0715BI	17
B04007	233	B07010	15, 53	B07114	16, 53	B0715BL	17
B04008	233	B07011	15, 53	B07114S	49	B0715BN	17
B04150	233	B07012	16, 53	B07115	16, 53	B0715PN	17
B04150K	233	B07013	16, 53	B07116	17, 53	B0715PS	17
B04151K	233	B07014	15, 53	B07117	17, 53	B0715PW	17
B04200	233	B07015	15, 53	B0711AB	16	B0715FRB	17
B04200K	233	B07016	16, 53	B0711AL	16	B0715WB	17
B04201	233	B07017	16, 53	B0711AN	16	B07160	17, 53
B04201K	233	B07020	52	B0711BI	16	B07161	17, 53
B04300	233	B07021	52	B0711BL	16	B0716AB	17
B04300K	233	B07022	52	B0711BN	16	B0716AL	17
B04301	233	B07023	52	B0711BS	16	B0716AN	17
B04301K	233	B07024	52	B0711PN	16	B0716BI	17
B04303	233	B07025	52	B0711PS	16	B0716BL	17
B04304	233	B07027	52	B0711PW	16	B0716BN	17
B04400	233	B07030	15, 53	B0711RB	16	B0716BS	17
B04400K	233	B07031	15, 53	B0711WB	16	B0716PN	17
B04401	233	B07032	16, 53	B07120	52	B0716PS	17
B04401K	233	B07033	16, 53	B07121	52	B0716PW	17
B04403	233	B07034	15, 53	B07122	52	B0716RB	17
B04404	233	B07035	15, 53	B07123	52	B0716WB	17
B04600	233	B07036	16, 53	B07124	52	B07170	54
B05001	306, 397	B07037	16, 53	B07125	52	B07171	54
B05002	306, 398	B07038	52	B07126	52	B07172	54
B05003	306, 397	B07039	52	B07127	52	B07173	54
B05004	306, 397	B07040	52	B07130	16, 53	B0717AB	17
B05007	306, 398, 422	B07041	52	B07131	16, 53	B0717AL	17
B05008	306, 398, 422	B07042	52	B07132	17, 53	B0717AN	17
B05010	300, 400	B07043	52	B07133	17, 53	B0717BI	17
B05011	300, 400	B07044	52	B07134	16, 53	B0717BL	17
B05015	300, 400	B07045	52	B07135	16, 53	B0717BN	17
B05020	300, 400	B07046	52	B07136	17, 53	B0717BS	17
B05021	300, 400	B07047	52	B07137	17, 53	B0717PN	17
B05025	306, 397	B07048	52	B07138	52	B0717PS	17
B05026	306, 397	B07049	52	B07139	52	B0717PW	17
B05050	306, 398	B07050	53	B0713AB	16	B0717RB	17
B05150	233	B07051	53	B0713AL	16	B0717WB	17
B05150K	233	B07052	15, 53	B0713AN	16	B0718AB	17
B05200	233	B07053	15, 53	B0713BI	16	B0718AN	17
B05200K	233	B07054	15, 53	B0713BL	16	B0718BI	17
B05300	233	B07055	15, 53	B0713BN	16	B0718BL	17
B05300K	233	B07056	53	B0713PN	16	B0718BN	17
B05400	233	B07057	53	B0713PS	16	B0718PN	17
B05400K	233	B07058	15, 53	B0713PW	16	B0718PS	17
B05600	233	B07059	15, 53	B0713RB	16	B0718PW	17
B05900	90	B07060	15, 53	B0713WB	16	B0718RB	17
B05901	90	B07061	53	B07140	52	B0718WB	17
B05910	90	B07070	54	B07141	52	B07200	54
B05911	90	B07071	54	B07142	52	B07201	54
B05920	90	B07072	54	B07143	52	B07202	54
B05921	90	B07073	54	B07144	52	B07203	54
B05922	90	B07074	54	B07146	52	B07210	54
B05923	90	B07075	54	B07147	52	B07219	50
B05924	90	B07076	54	B07148	52	B07220T	49
B05925	90	B07077	54	B07149	52	B07221T	49
B05926	90	B07101	52	B07150	53	B07310	325
B05927	90	B07102	52	B07151	53	B07311	325
B05928	90	B07103	52	B07152	17, 53	B07312	325
B06001	220, 253	B07104	52	B07153	17, 53	B07374	54
B06010	220	B07105	52	B07154	17, 53	B07375	54
B06100	220	B07106	52	B07155	17, 53	B07376	54
B07001	52	B07107	52	B07156	53	B07377	54
B07002	52	B07108	52	B07157	53	B07470	54

PART NO.	PG #	PART NO.	PG #	PART NO.	PG #	PART NO.	PG #
B07472	54	B0816WB	17	B1020PN	5	B155-0150	351
B07476	54	B0817AB	17	B1020PS	5	B155-0215	351
B07477	54	B0817AL	17	B1020PW	5	B155-0295	351
B0750BN	15	B0817AN	17	B1020RB	5	B155-0390	351
B0750RB	15	B0817BI	17	B1020WB	5	B155-0520	351
B0750WB	15	B0817BL	17	B11010	275, 416	B155-0650	351
B0751BN	15	B0817BN	17	B11011	275	B155-0860	351
B0751RB	15	B0817BS	17	B11012	275	B155-0975	351
B0751WB	15	B0817PN	17	B11013	275	B155-1100	351
B0752BN	15	B0817PS	17	B12210	89	B165-0001	352
B0752RB	15	B0817PW	17	B12320	89	B165-0002	352
B0752WB	15	B0817RB	17	B12430	89	B165-0007	352
B0753BN	15	B0817WB	17	B12640	89	B165-0025	352
B0753RB	15	B0818AB	17	B144-0007	351	B165-0032	352
B0753WB	15	B0818AN	17	B144-0032	351	B165-0033	352
B0754BN	16	B0818BI	17	B144-0033	351	B165-0050	352
B0754RB	16	B0818BL	17	B144-0058	351	B165-0058	352
B0754WB	16	B0818BN	17	B144-0059	351	B165-0059	352
B0755BN	16	B0818PN	17	B144-0060	351	B165-0060	352
B0755NP	16	B0818PS	17	B144-0107	351	B165-0100	352
B0755RB	16	B0818PW	17	B144-0108	351	B165-0107	352
B0755WB	16	B0818RB	17	B144-0109	351	B165-0108	352
B08060	15	B0818WB	17	B144-0110	351	B165-0109	352
B08071	54	B0850BN	15	B144-0159	351	B165-0110	352
B0811AB	16	B0850RB	15	B144-0160	351	B165-0150	352
B0811AL	16	B0850WB	15	B144-0161	351	B165-0159	352
B0811AN	16	B0851BN	15	B144-0162	351	B165-0160	352
B0811BI	16	B0851RB	15	B144-0222	351	B165-0161	352
B0811BL	16	B0851WB	15	B144-0223	351	B165-0162	352
B0811BN	16	B0852BN	15	B144-0224	351	B165-0215	352
B0811BS	16	B0852RB	15	B144-0225	351	B165-0222	352
B0811PN	16	B0852WB	15	B144-0226	351	B165-0223	352
B0811PS	16	B0853BN	15	B144-0303	351	B165-0224	352
B0811PW	16	B0853RB	15	B144-0304	351	B165-0295	352
B0811RB	16	B0853WB	15	B144-0305	351	B165-0303	352
B0811WB	16	B0854BN	16	B144-0306	351	B165-0304	352
B0813AB	16	B0854RB	16	B144-0307	351	B165-0305	352
B0813AL	16	B0854WB	16	B144-0308	351	B165-0306	352
B0813AN	16	B0855BN	16	B144-0398	351	B165-0307	352
B0813BI	16	B0855NP	16	B144-0399	351	B165-0390	352
B0813BL	16	B0855RB	16	B144-0400	351	B165-0398	352
B0813BN	16	B0855WB	16	B144-0401	351	B165-0399	352
B0813PN	16	B10004	279	B144-0402	351	B165-0400	352
B0813PS	16	B10080	57	B144-0403	351	B165-0401	352
B0813PW	16	B10081	57	B144-0531	351	B165-0402	352
B0813RB	16	B10090	58	B144-0532	351	B165-0520	352
B0813WB	16	B10091	58	B144-0533	351	B165-0531	352
B0815AB	17	B10092	58	B144-0534	351	B165-0532	352
B0815AL	17	B10093	58	B144-0535	351	B165-0533	352
B0815AN	17	B10094	58	B144-0536	351	B165-0534	352
B0815BI	17	B10100	58, 423	B144-0662	351	B165-0535	352
B0815BL	17	B10102	58, 423	B144-0663	351	B165-0650	352
B0815BN	17	B10103	58, 423	B144-0664	351	B165-0662	352
B0815PN	17	B10104	423	B144-0665	351	B165-0663	352
B0815PS	17	B10104	58	B144-0666	351	B165-0664	352
B0815PW	17	B10105	58, 423	B144-0667	351	B165-0665	352
B0815RB	17	B10110	57	B144-0790	351	B165-0666	352
B0815WB	17	B10111	57	B144-0870	351	B165-0860	352
B0816AB	17	B10195	57	B144-0871	351	B165-0870	352
B0816AL	17	B10200	61	B144-0872	351	B165-0871	352
B0816AN	17	B10201	61	B144-0873	351	B165-0872	352
B0816BI	17	B10202	61	B144-0875	351	B165-0873	352
B0816BL	17	B1020AB	5	B144-1109	351	B165-1100	352
B0816BN	17	B1020AL	5	B144-1111	351	B165-1109	352
B0816BS	17	B1020AN	5	B155-0001	351	B195-0002	352
B0816PN	17	B1020BI	5	B155-0002	351	B195-0025	352
B0816PS	17	B1020BL	5	B155-0025	351	B195-0050	352
B0816PW	17	B1020BN	5	B155-0050	351	B195-0100	352
B0816RB	17	B1020NP	5	B155-0100	351	B195-0150	352

PART NO.	PG #	PART NO.	PG #	PART NO.	PG #	PART NO.	PG #
B195-0215	352	B235-0520	353	B29100	279	B40002	61
B195-0295	352	B235-0531	353	B29125	279	B40003	61
B20062	287	B235-0532	353	B29150	279	B40004	61
B20078	287	B235-0533	353	B29200	279	B40005	61
B20094	287	B235-0650	353	B29300	302	B40006	61
B20109	287	B235-0662	353	B29310	302	B40007	61
B20125	287	B235-0663	353	B29375	279	B40008	61
B20141	287	B235-0860	353	B29400	303	B40009	61
B20156	287	B235-0975	353	B295-0001	354	B40010	61
B20172	287	B235-1100	353	B295-0002	354	B40011	61
B20188	287	B24050	287	B295-0025	354	B40012	61
B20203	287	B24056	287	B295-0050	354	B40013	61
B20219	287	B24063	287	B295-0100	354	B40014	61
B20234	287	B24075	287	B295-0150	354	B40015	61
B20250	287	B24081	287	B295-0215	354	B40017	61
B20266	287	B24088	287	B295-0295	354	B40018	61
B20281	287	B24100	287	B295-0390	354	B40019	61
B20297	287	B24113	287	B295-0520	354	B40020	61
B20313	287	B24125	287	B295-0650	354	B40021	61
B20328	287	B24150	287	B295-0860	354	B40023	61
B20344	287	B24175	287, 404, 410, 418	B29500	284, 404	B40024	61
B20359	287	B24188	287, 404, 410, 418	B29501	284, 404	B40025	61
B20375	287	B24200	287, 404, 410, 418	B29625	279	B40026	61
B20391	287	B24213	287, 404, 410, 418	B29699	294	B40027	61
B20406	287	B24225	287, 404, 410, 418	B29700	294	B40028	61
B20422	287	B24250	287, 404, 410, 418	B29701	294	B40030	61
B20438	287	B24251	287, 404, 410, 418	B29702	294	B40031	61
B20453	287	B24263	287, 404, 410, 418	B29801	294	B40032	61
B20469	287	B24375	287	B29802	294	B40033	61
B20484	287	B25001	307, 398	B29805	294, 403, 412, 420	B40034	61
B20500	287	B254-0001	353	B29806	294, 403, 412, 420	B40035	61
B21075	287	B254-0002	353	B29807	294, 403, 412, 420	B40036	61
B21087	287	B254-0025	353	B29808	294, 403, 412, 420	B45010	4, 61
B21100	287	B254-0050	353	B29850	307, 397	B45014	61
B21112	287	B254-0100	353	B29851	307, 397	B45200	74
B21125	287	B254-0150	353	B29852	307, 397	B45215	74
B21150	287	B254-0215	353	B29875	279	B45216	74
B21625	287	B254-0295	353	B29900	295	B45217	74
B235-0001	353	B254-0390	353	B29901	294, 403, 412, 420	B45218	74
B235-0002	353	B254-0520	353	B29902	294, 404, 412, 420	B45220	74
B235-0007	353	B254-0650	353	B29999	279	B460-0001	355
B235-0025	353	B254-0860	353	B335-0050	351	B460-0002	355
B235-0032	353	B28025	279	B335-0100	351	B460-0007	355
B235-0050	353	B28050	279	B335-0150	351	B460-0025	355
B235-0058	353	B28051	279	B335-0215	351	B460-0032	355
B235-0059	353	B28075	279	B335-0295	351	B460-0050	355
B235-0060	353	B28076	279	B335-0390	351	B460-0056	355
B235-0100	353	B28100	279	B355-0025	354	B460-0057	355
B235-0107	353	B28125	279	B355-0050	354	B460-0058	355
B235-0108	353	B28150	279	B355-0100	354	B460-0059	355
B235-0109	353	B28200	279	B355-0150	354	B460-0100	355
B235-0150	353	B28375	279	B355-0215	354	B460-0106	355
B235-0159	353	B290-0001	354	B355-0295	354	B460-0107	355
B235-0160	353	B290-0002	354	B355-0390	354	B460-0108	355
B235-0215	353	B290-0025	354	B396-0001	354	B460-0109	355
B235-0222	353	B290-0050	354	B396-0002	354	B460-0116	355
B235-0223	353	B290-0100	354	B396-0025	354	B460-0117	355
B235-0224	353	B290-0150	354	B396-0050	354	B460-0118	355
B235-0295	353	B290-0215	354	B396-0100	354	B460-0150	355
B235-0303	353	B290-0295	354	B396-0150	354	B460-0157	355
B235-0304	353	B290-0390	354	B396-0215	354	B460-0158	355
B235-0305	353	B290-0520	354	B396-0295	354	B460-0159	355
B235-0306	353	B290-0650	354	B396-0390	354	B460-0160	355
B235-0390	353	B290-0860	354	B396-0520	354	B460-0161	355
B235-0398	353	B29025	279	B396-0650	354	B460-0162	355
B235-0399	353	B29050	279	B396-0860	354	B460-0169	355
B235-0400	353	B29051	279	B396-1100	354	B460-0170	355
B235-0401	353	B29075	279	B40000	60	B460-0171	355
B235-0402	353	B29076	279	B40001	61	B460-0180	355

PART NO.	PG #	PART NO.	PG #	PART NO.	PG #	PART NO.	PG #
B460-0181	355	B460-0666	355	B5112PW	13	B60975	162
B460-0182	355	B460-0667	355	B5112RB	13	B60994	263
B460-0215	355	B460-0668	355	B5112WB	13	B63050LF	132
B460-0220	355	B460-0860	355	B5114AP	13	B63075LF	132
B460-0221	355	B460-0870	355	B5114BB	13	B63100LF	132
B460-0222	355	B460-0871	355	B5114BN	13	B64050	157
B460-0223	355	B460-0872	355	B5114PB	13	B64075	157
B460-0224	355	B460-0873	355	B5114PN	13	B64100	157
B460-0234	355	B460-1100	355	B5114PS	13	B64125	157
B460-0235	355	B486-0050	356	B5114RB	13	B64150	157
B460-0236	355	B486-0100	356	B5114WB	13	B64200	157
B460-0237	355	B486-0150	356	B5155AB	12	B64375	157
B460-0245	355	B486-0215	356	B5155AL	12	B64450	157
B460-0246	355	B49001	47	B5155AN	12	B64475	157
B460-0247	355	B49002	47	B5155AP	12	B65050	157
B460-0248	355	B49010	47	B5155BB	12	B65075	157
B460-0256	355	B49011	47	B5155BI	12	B65100	157
B460-0257	355	B49012	47	B5155BL	12	B65375	157
B460-0258	355	B49013	47	B5155BN	12	B657-0001	356
B460-0259	355	B49020	7, 47	B5155BNB	12	B657-0002	356
B460-0295	355	B49021	7, 47	B5155BS	12	B657-0025	356
B460-0302	355	B49022	7, 47	B5155PS	12	B657-0050	356
B460-0303	355	B50001LF	144, 423	B5155PW	12	B657-0100	356
B460-0304	355	B50002LF	144, 423	B5155RB	12	B657-0150	356
B460-0305	355	B50003LF	144	B5155WB	12	B657-0215	356
B460-0306	355	B50004LF	144	B5155WBB	12	B657-0295	356
B460-0315	355	B50011LF	144	B5156AP	12	B657-0390	356
B460-0316	355	B50012LF	144	B5156BB	12	B657-0520	356
B460-0317	355	B50013LF	144	B5156BN	12	B657-0650	356
B460-0318	355	B50031LF	144, 423	B5156PS	12	B657-0860	356
B460-0319	355	B50032LF	144, 423	B5156RB	12	B66050	157
B460-0328	355	B50033LF	144	B5156WB	12	B66075	157
B460-0329	355	B50041LF	144, 423	B5160AP	12	B66375	157
B460-0330	355	B50042LF	144, 423	B5160BB	12	B67050	157
B460-0331	355	B50043LF	144	B5160BN	12	B67100	158
B460-0339	355	B50044LF	144	B5160BS	12	B67101	158
B460-0340	355	B50051LF	144	B5160PN	12	B67102	158
B460-0342	355	B50052LF	144	B5160PS	12	B67103	158
B460-0350	355	B50072LF	145	B5160RB	12	B67104	158
B460-0390	355	B50073LF	145	B5160WB	12	B67105	158
B460-0398	355	B50081LF	145	B5161AP	12	B67106	158
B460-0399	355	B50082LF	145	B5161BB	12	B67200	158
B460-0400	355	B50083LF	145	B5161BN	12	B67201	158
B460-0401	355	B50092LF	145	B5161PS	12	B67202	158
B460-0402	355	B50094LF	144	B5161RB	12	B67203	158
B460-0413	355	B50096LF	145	B5161WB	12	B67204	158
B460-0414	355	B50097LF	145	B55001	60	B67205	158
B460-0415	355	B50098LF	144	B55002	60	B67206	158
B460-0416	355	B50099LF	145	B55003	60	B67208	158
B460-0417	355	B50100LF	145	B55004	60, 335	B67209	158
B460-0429	355	B50103LF	144	B55005	60, 335	B67210	158
B460-0430	355	B51003	12	B55006	60, 335	B67211	158
B460-0431	355	B51004	12	B55007	60, 335	B67212	158
B460-0444	355	B51005	12, 54	B55008	60	B67213	158
B460-0447	355	B51006	54	B55009	60	B67214	158
B460-0457	355	B51007	12, 54	B55050	60	B67215	158
B460-0470	355	B51008	54	B55100LF	60	B67216	158
B460-0520	355	B51009	54	B55103LF	60	B67217	158
B460-0531	355	B51010	12, 54	B55150	47	B67218	158
B460-0532	355	B51011	54	B59000	162	B67219	158
B460-0533	355	B51014	13, 54	B59001	161	B67312	158
B460-0534	355	B51015	13, 54	B59002	161	B67313	158
B460-0535	355	B51019	12, 54	B59050	162	B67315	158
B460-0536	355	B51020	12, 54	B59075	162	B67316	158
B460-0650	355	B5112AP	13	B59100	162	B67317	158
B460-0662	355	B5112BB	13	B60001	46	B67320	158
B460-0663	355	B5112BI	13	B60002	46	B67321	158
B460-0664	355	B5112BN	13	B60099	263	B67322	158
B460-0665	355	B5112BS	13	B60950	162	B67323	158

PART NO.	PG #	PART NO.	PG #	PART NO.	PG #	PART NO.	PG #
B67375	157	B74140LF	143	B74331LF	143	C013WD00INT	384
B67937	157	B74142LF	143	B74343LF	142, 428	C013WDO00	384
B67975	157	B74144LF	143	B74344LF	142	C013WDS00	384
B68001	157	B74145LF	143	B74345LF	142	C013WDS01	384
B68050	157	B74148LF	143	B74347LF	142	C014WD00	383
B68058	157	B74150LF	143	B74354LF	142	C014WD00BN	384
B68375	157	B74152LF	143	B74358LF	142	C014WD00CH	384
B69050	157	B74153LF	143	B74359LF	142	C014WD01	383
B69121	157	B74154LF	143	B74365LF	142	C014WD02	383
B70001	4	B74155LF	143	B74367LF	142	C014WD03	383
B70003	4	B74156LF	143	B74368LF	142	C014WD04	383
B70004	4	B74157LF	143	B74369LF	142	C014WD20	383
B70006	4	B74160LF	143	B74370LF	143	C014WD30	383
B70007	4	B74161LF	143	B74380LF	142	C014WD40	383
B70008	4	B74181LF	142	B74381	142	C014WD45	383
B70009	4	B74182LF	142	B74382	142	C014WD50	383
B70012	4	B74183LF	142	B74383	142	C014WD53	383
B70013	4	B74184LF	142, 428	B74384	142	C014WD58	383
B70017	4	B74185LF	142, 428	B74395LF	142	C014WD80	383
B70020	4	B74186LF	142, 428	B74396LF	142	C014WD90	383
B70499	220, 253	B74187LF	142	B90050	159	C014WDO00	384
B74001LF	142	B74188LF	142	B90075	159	C014WDS00	384
B74002LF	142, 428	B74189LF	142	B90100	159	C014WDS01	384
B74003LF	142, 428	B74200LF	143	B90125	159	C02000	40
B74004LF	142, 428	B74201LF	143	B90150	159	C02000B	40
B74005LF	142, 428	B74202LF	143	B90200	159	C02001	40
B74006LF	142, 428	B74203LF	143	B90250	159	C02001B	40
B74007LF	142	B74204LF	143	B90300	159	C02002	40
B74008LF	142	B74205LF	143	B90400	159	C02002B	40
B74009LF	142	B74206LF	143	B91050	159	C02003	40
B74021LF	142	B74207LF	143	B91075	159	C02003B	40
B74022LF	142	B74208LF	143	B91100	159	C02004	40
B74023LF	142, 428	B74209LF	143	B91125	159	C02004B	40
B74024LF	142, 428	B74210LF	143	B91150	159	C02005	40
B74025LF	142	B74212LF	143, 428	B91200	159	C02005B	40
B74026LF	142	B74213LF	143, 428	B91250	159	C02010	40
B74027LF	142	B74216LF	143	B91300	159	C02010B	40
B74028LF	142	B74217LF	143	B91400	159	C02011	40
B74029LF	142	B74218LF	143	B92050	159	C02011B	40
B74042LF	142	B74220LF	143	B92075	159	C02012	40
B74044LF	142	B74222LF	143	B95150	161	C02012B	40
B74045LF	142	B74223LF	143	B95200	161	C02013	40
B74046LF	142	B74224LF	143	BI05	359	C02013B	40
B74066LF	142	B74228LF	143	BI07	359	C02014	40
B74067LF	142	B74229LF	143	BI10	359	C02014B	40
B74081LF	142	B74230LF	143	BI12	359	C02015	40
B74082LF	142, 428	B74231LF	143	BI15	359	C02015B	40
B74083LF	142, 428	B74232LF	143	BI20	359	C02020	40
B74084LF	142, 428	B74235LF	143	BIN004	121	C02020B	40
B74085LF	142, 428	B74262LF	142	BIN005	121	C02021	40
B74086LF	142, 428	B74263LF	142	BIN008	121	C02021B	40
B74087LF	142	B74264LF	142	BIN012	121	C02022	40
B74088LF	142	B74265LF	142	BO718AL	17	C02022B	40
B74089LF	142	B74266LF	142	BO818AL	17	C02023	40
B74090LF	142	B74267LF	142	BOX006	121	C02023B	40
B74104LF	143	B74268LF	142	BOX008	121	C02024	40
B74105LF	143	B74269LF	142	BOX011	121	C02024B	40
B74107LF	143	B74284LF	143, 428	BOX012	121	C02025	40
B74108LF	143	B74285LF	143, 428	BWV200	233	C02025B	40
B74121LF	143	B74286LF	143, 428	BWV300	233	C02029	40
B74122LF	143	B74287LF	143	BWV400	233	C02029B	40
B74123LF	143, 428	B74288LF	143	C001WD00	384	C02030	40
B74124LF	143, 428	B74289LF	143	C001WD01	384	C02030B	40
B74125LF	143, 428	B74301LF	143	C002WD00	384	C02031	40
B74126LF	143, 428	B74302LF	143	C002WD01	384	C02031B	40
B74127LF	143	B74303LF	143	C01001	240	C02032	40
B74128LF	143	B74304LF	143	C01002	240	C02032B	40
B74129LF	143	B74305LF	143	C013WD00BN	384	C02033	40
B74132LF	143	B74306LF	143	C013WD00CH	384	C02033B	40

PART NO.	PG #	PART NO.	PG #	PART NO.	PG #	PART NO.	PG #
C02034	40	C02860	41	C04021	34	C104100	386
C02034B	40	C02861	41	C04024	34	C104101	386
C02040	41	C02862	41	C04025	34	C104102	386
C02041	41	C02863	41	C04027	35	C104120	386
C02045	41	C02864	41	C04028	34	C104140	386
C02046	41	C02865	41	C04029	34	C104190	386
C02050	39	C02900	41	C04030	34	C104200	386
C02075	42	C02901	41	C04031	34	C104201	386
C02100	41	C02987	41	C04032	35	C104202	386
C02103	41	C02989	41	C04033	35	C104220	386
C02104	41	C02990	39	C04034	35	C104240	386
C02105	41	C02992	41	C04038	35	C104290	386
C02106	41	C02993	41	C04039	35	C1042O00	387
C02200	42	C02994	41	C049WD0	384	C105000	387
C02201	42	C02995	41	C05040	34	C105001	387
C02202	42	C02996	41	C05041	34	C1050S00	387
C02203	42	C02997	41	C05042	37	C1050S01	387
C02210	42	C02998	41	C05045	36	C105C00	389
C02211	42	C02999	41	C05046	36	C105SSC00	389
C02300	42	C03200	42	C05047	36	C105SSC90	389
C02301	42	C03201	42	C05048	36	C106C00	389
C02302	42	C03202	42	C05049	36	C106C90	389
C02303	42	C03203	42	C05051	36	C106CEZ00	389
C02310	42	C03210	42	C05052	37	C106CHPM00	389
C02311	42	C03211	42	C05053	37	C106SSC00	389
C023WD00	383	C03212	42	C05054	37	C106SSC01	389
C023WD01	383	C03213	42	C05056	36	C106SSC02	389
C023WD02	383	C03240	42	C05057	36	C106SSC90	389
C023WD04	383	C03250	42	C05070	37	C106SSCAM00	389
C02401	39	C03251	42	C05071	37	C106SSCAM90	389
C02402	39	C03252	42	C05080	58, 423	C106SSCAMFRO	389
C02403	39	C03253	42	C05081	58, 423	C108C00	388
C02404	39	C03260	42	C05082	58	C108SSC00	388
C02405	39	C03265	42	C05085	37	C108SSCAM00	388
C02421	39	C03270	42	C05086	37	C11050	85
C02422	39	C03271	42	C050WD00	384	C11075	85
C02423	39	C03272	42	C05200	37	C110C00	388
C02424	39	C03280	42	C06001	5	C110CAM00	388
C024WD00	383	C03300	43	C06002	5	C11100	85
C024WD01	383	C03301	43	C06004	5	C11125	85
C024WD02	383	C03302	43	C06006	5	C11150	85
C024WD04	383	C03303	43	C06007	5	C11200	85
C02800	41	C03304	43	C06008	5	C11250	85
C02801	41	C03305	43	C06011	5	C11300	85
C02802	41	C03306	43	C06013	5	C11400	85
C02803	41	C03800	43	C06014	5	C12050	85
C02804	41	C03801	43	C06016	5	C12075	85
C02805	41	C03803	43	C06017	5	C12100	85
C02807	41	C03804	43	C06018	5	C1210S00	386
C02808	41	C03805	43	C06020	5	C1210S01	386
C02809	41	C03807	43	C06021	5	C1210S02	386
C02810	41	C03810	43	C06024	5	C1211S00	386
C02811	41	C04000	34	C09000	114	C1211S01	386
C02812	41	C04001	34	C09001	114	C1211S02	386
C02813	41	C04002	34	C09002	114	C12125	85
C02814	41	C04004	34, 409, 418	C09003	114	C12150	85
C02815	41	C04005	34	C1006S00	387	C12200	85
C02820	41	C04006	34	C1007S00	387	C12250	85
C02821	41	C04007	34	C1007S02	387	C12300	85
C02822	41	C04008	34	C100BBSSCAM0	390	C12400	85
C02823	41	C04010	34	C101000	388	C12600	85
C02824	41	C04011	34	C101001	388	C13050	86
C02825	41	C04013	35	C101002	388	C13075	86
C02830	41	C04014	34	C1010TK00	388	C14205	85
C02832	41	C04015	35	C101100	388	C14206	85
C02850	41	C04016	34	C101101	388	C14207	85
C02851	41	C04017	35	C101102	388	C15300	85
C02852	41, 43	C04019	33	C1011TK00	388	C15301	85
C02853	41	C04020	34	C102C00	391	C15302	85

PART NO.	PG #	PART NO.	PG #	PART NO.	PG #	PART NO.	PG #
C15303	85	C25013	94	C33001	257	C37102	258
C15304	85	C25020	94	C33002	257	C37103	258
C15305	85	C25021	94	C33003	257	C37104	258
C15306	85	C25022	94	C33004	257	C37302	258
C15307	85	C27125	35	C33005	257	C37303	258
C16050	86	C27126	35	C33006	257	C37304	258
C160600	386	C27127	35	C33021	256	C37314	258
C160601	386	C27134	35	C33022	256	C37800	229, 259
C160602	386	C27150	35	C33023	256	C37801	229, 259
C1606HPSS00	390	C27150A	35	C33031	256	C37803	229, 259
C1606OS00	390	C27200	35	C33032	256	C37805	230, 259
C1606S00	386	C27201	35	C33033	256	C37806	230, 259
C1606S01	386	C27202	35	C33044	256	C37807	230, 259
C1606S02	386	C27301	35	C33045	256	C37808	230, 259
C1606S03	386	C27302	35	C33046	256	C37810	230, 259
C1606S04	386	C27303	35	C33088	257	C37811	230, 259
C1606S20	386	C27304	35	C33121	256	C38002	255
C1606S30	386	C27305	35	C33122	256	C38003	255
C1606S40	386	C27308	35	C33123	256	C38004	255
C1606S45	386	C27309	35	C33144	256	C38005	255
C1606S50	386	C27310	35	C33145	256	C38006	255
C1606S53	386	C27321	36	C33146	256	C38014	255
C1606S58	386	C27322	36	C33221	256	C38102	255
C1606S80	386	C27323	36	C33222	256	C38103	255
C1606S90	386	C27324	36	C33223	256	C38104	255
C16075	86	C27325	36	C33231	256	C38114	255
C17050	86	C27328	36	C33232	256	C38202	255
C17075	86	C29123	115	C33233	256	C38203	255
C17100	86	C29124	115	C33244	256	C38204	255
C17125	86	C29126	114	C33245	256	C38205	255
C17150	86	C29150	114	C33246	256	C38206	255
C17200	86	C29200	114	C33321	256	C38214	255
C19050	86	C2B1E16BN	385	C33322	256	C38402	254
C19051	86	C2B1E16BR	385	C33323	256	C38403	254
C19075	86	C2B1E16CH	385	C33331	256	C38404	254
C200HEX	392	C2B1E17BN	385	C33332	256	C38502	254
C200HPSS	392	C2B1E17BR	385	C33333	256	C38503	254
C220000	386	C2B1E17CH	385	C33344	256	C38504	254
C220001	386	C2B1E18BN	385	C33345	256	C39002	255
C220002	386	C2B1E18CH	385	C33346	256	C39003	255
C2200HPSS00	390	C2B1E19BN	385	C33444	256	C39004	255
C2200HPSS90	390	C2B1E19CH	385	C33445	256	C39005	255
C2200HPSSAMF	390	C2B1ES19CH	385	C33446	256	C39006	255
C2200C00	390	C2B1R16BN	385	C33544	256	C39014	255
C2200C00HPSS	390	C2B1R16BR	385	C33545	256	C39102	255
C2200OS00	390	C2B1R16CH	385	C33546	256	C39103	255
C2200OS00HPS-SAM	390	C2B1R17BN	385	C35090	293, 405, 412, 420	C39104	255
C2200S00	386	C2B1R17BR	385	C35091	293	C39114	255
C2200S01	386	C2B1R17CH	385	C35092	293, 405, 412, 420	C39202	255
C2200S02	386	C2B1R18BN	385	C36003	254	C39203	255
C2200S03	386	C2B1R18CH	385	C36004	254	C39204	255
C2200S04	386	C2B1R19BN	385	C36006	254	C39205	255
C2200S20	386	C2B1R19CH	385	C36013	254	C39206	255
C2200S30	386	C2B1RS19CH	385	C36014	254	C39214	255
C2200S40	386	C2B6R9AQCH	392	C36016	254	C39402	254
C2200S45	386	C2B6R9SHCH	392	C36024	254	C39403	254
C2200S50	386	C30050	161	C36034	254	C39404	254
C2200S53	386	C30075	161	C36104	254	C39502	254
C2200S58	386	C30100	161	C36106	254	C39503	254
C2200S80	386	C30125	161	C36114	254	C39504	254
C2200S90	386	C30150	161	C36116	254	C3B2E115BN	385
C25000	94	C30200	161	C36124	254	C3B2E117BN	385
C25001	94	C306CHPSS00	392	C36134	254	C3B2E117BR	385
C25002	94	C31050	161	C37002	258	C3B2E118BN	385
C25003	94	C31075	161	C37003	258	C3B2E118CH	385
C25010	94	C31100	161	C37004	258	C3B2E220BN	385
C25011	94	C31125	161	C37005	258	C3B2R117BN	385
C25012	94	C31150	161	C37006	258	C3B2R117BR	385
		C31200	161	C37014	258	C3B2R117CH	385

PART NO.	PG #	PART NO.	PG #	PART NO.	PG #	PART NO.	PG #
C3B2R118BN	385	C4733P	173	C54403	173	C59091	228
C3B2R118CH	385	C47340	239	C55043	173	C59092	228
C3B2R220BN	385	C47420	239	C55143	173	C59093	228
C3B3E200	387	C47430	239	C56100	117	C59094	228
C3B3EJS00	387	C4743A	173	C57034	172	C59095	228
C3B3ESL00	386	C4743P	173	C57040	172	C59096	228
C3B3R200	387	C47440	239	C57134	172	C59097	228
C3B3RJS00	387	C47460	239	C57140	172	C59098	228
C3B3RSL00	386	C49421	240	C57234	172	C59099	228
C3B4E290CH	384	C49440	240	C57236	172	C59100	228
C3B4E2S00AMCH	383	C49441	240	C57334	172	C59101	228
C3B4E300AMBN	383	C49442	240	C57434	174	C59102	228
C3B4R200CHWP	384	C50300	172	C58034	172	C59103	228
C3B4R200WP	384	C50301	172	C58040	172	C59200	225
C3B4R201BN	384	C50302	173	C58134	172	C59201	225
C3B4R290CH	384	C50303	173	C58140	172	C59202	225
C3B4R2S00AMCH	383	C50304	173	C58234	172	C59203	225
C3B4R300AMAB	383	C50305	173	C58236	172	C59204	225
C3B4R300AMBN	383	C50306	173	C58334	172	C59205	225
C3B4R300AMCH	383	C50307	173	C58434	174	C59206	225
C3B4R400CH	384	C50308	173	C59001	225	C59207	225
C3B5E200	391	C50309	173	C59002	225	C59208	226
C3B5E200CH	391	C50340	172	C59003	225	C59209	226
C3B5E201	391	C50341	172	C59004	225	C59210	226
C3B5R200	391	C50400	172	C59005	225	C59211	226
C3B5R200CH	391	C51150	174	C59006	225	C59212	226
C3B5R201	391	C51300	172	C59007	225	C59213	226
C3B5R221	391	C51301	172	C59008	225	C59214	226
C3B5R242	391	C51302	175	C59010	226	C59215	226
C3B5R260	391	C51303	175	C59011	226	C59216	226
C3B5R270	391	C51340	172	C59012	226	C59217	226
C3B5R290	391	C51341	172	C59013	226	C59218	226
C40002	255	C51350	172	C59014	226	C59219	226
C40003	255	C51351	172	C59015	226	C59220	226
C40004	255	C51400	172	C59016	226	C59221	226
C40006	255	C51401	172	C59017	226	C59222	226
C40102	254	C51402	175	C59020	228	C59223	226
C40103	254	C51403	175	C59021	228	C59240	182
C40104	254	C51450	172	C59022	228	C59241	182
C40320	239	C51451	172	C59023	228	C59242	182
C40420	239	C52150	174	C59024	228	C59243	182
C40425	239	C52340	172	C59025	228	C59244	182
C40430	239	C52341	172	C59026	228	C59245	182
C40440	239	C52342	173	C59027	228	C59250	182
C40500	239	C52343	173	C59028	228	C59251	182
C40503	239	C52400	172	C59029	228	C59252	182
C40640	240	C52401	172	C59030	228	C5C5R100	391
C406SCHPSS00	392	C52402	173	C59031	228	C60001	226
C41410	239	C52403	173	C59050	225	C60003	226
C41411	239	C53340	172	C59051	225	C60007	222
C41420	239	C53341	172	C59052	225	C60008	222
C41421	239	C53342	173	C59053	225	C60009	222
C41430	239	C53343	173	C59054	226	C60010	222
C41440	239	C53400	172	C59055	226	C60011	222
C41460	239	C53401	172	C59056	226	C60012	222
C42421	239	C53402	173	C59057	226	C60013	224
C42440	239	C53403	173	C59060	225	C60014	224
C42460	239	C53600	173	C59061	225	C60015	224
C43440	240	C53601	173	C59062	225	C60016	224
C43441	240	C53700	173	C59063	225	C60020	226
C44420	240	C53701	173	C59064	226	C60021	226
C44440	240	C54150	173	C59065	226	C60022	226
C45433	239	C54340	174	C59066	226	C60023	226
C46331	239	C54341	174	C59067	226	C60024	226
C46351	239	C54342	174	C59068	226	C60025	226
C46431	239	C54343	174	C59069	226	C60026	227
C46451	239	C54400	174	C59070	226	C60027	227
C47320	239	C54401	174	C59071	226	C60028	227
C4733A	173	C54402	173	C59090	228	C60029	227

PART NO.	PG #	PART NO.	PG #	PART NO.	PG #	PART NO.	PG #
C60030	227	C60161	223	C61034	223	C74050LF	125, 425
C60031	227	C60162	223	C61123	223	C74051LF	125, 425
C60032	227	C60163	223	C61134	223	C74052LF	125, 425
C60033	227	C60164	223	C61223	223	C74053LF	125, 425
C60040	224	C60165	223	C61234	223	C74054LF	125, 425
C60041	224	C60166	223	C61432	223	C74055LF	125, 425
C60042	224	C60167	223	C61434	223	C74058LF	126, 425
C60043	224	C60170	221	C67230	234	C74059LF	126, 425
C60044	224	C60171	221	C67340	234	C74060LF	126, 425
C60045	224	C60172	221	C67440	234	C74063LF	126
C60046	224	C60207	222	C67445	234	C74064LF	126, 425
C60047	224	C60211	222	C67450	224	C74065LF	126, 425
C60050	226	C60500	230	C67451	224	C74066LF	126, 425
C60051	226	C60501	230	C72002	253	C74067LF	126
C60052	226	C60502	230	C72003	253	C74068LF	126
C60053	226	C60503	230	C72004	253	C74069LF	126, 425
C60054	227	C60504	230	C72093	253	C74070LF	126, 425
C60055	227	C60505	230	C73003	252	C74071LF	126, 425
C60056	227	C60800	214	C73004	252	C74072LF	126, 425
C60057	227	C60801	214	C73093	252	C74073LF	126, 425
C60060	224	C60802	214	C73094	252	C74078LF	126
C60061	224	C60803	21, 214	C73192	252	C74081LF	126, 425
C60062	224	C60804	21, 214	C73193	252	C74082LF	126, 425
C60063	224	C60805	214	C74001	125	C74085LF	126, 425
C60064	224	C60806	21, 214	C74002	125	C74086LF	126, 425
C60065	224	C60807	21, 214	C74002LF	423	C74087LF	126, 425
C60066	224	C60808	214	C74003	125	C74088LF	126, 425
C60067	224	C60809	214	C74004	125	C74089LF	126, 425
C60070	227	C60810	21, 214	C74005	125, 425	C74090LF	126
C60071	227	C60811	214	C74006	125	C74091LF	125
C60072	227	C60812	214	C74007	125, 425	C74093LF	125, 423
C60073	227	C60813	21, 214	C74008	125, 425	C74094	423
C60074	227	C60814	21, 214	C74009	125, 425	C74096	125, 423
C60075	227	C60817	214	C74010	125	C74097	125, 423
C60076	227	C60818	214	C74011	125, 423	C74098	125, 423
C60077	227	C60819	214	C74012	125	C74099	125, 423
C60078	227	C60820	214	C74013	125	C74100LF	125, 423
C60079	227	C60821	214	C74014	125, 425	C74101LF	125, 423
C60080	227	C60822	214	C74015	125	C74102LF	125, 423
C60081	227	C60823	214	C74016	125, 425	C74103LF	125, 423
C60082	227	C60824	214	C74017	125, 425	C74105	60, 324
C60083	227	C60825	214	C74018	125, 425	C74112LF	126
C60084	227	C6083BN	21	C74019	125	C74113LF	125
C60085	227	C6083NP	21	C74020	125, 423	C74114LF	125
C60086	227	C6083RB	21	C74021LF	125	C74118LF	125
C60087	227	C6083WB	21	C74022LF	125	C74121LF	126
C60088	227	C6084BN	21	C74023LF	125, 425	C74123LF	126
C60089	227	C6084NP	21	C74025LF	125, 425	C74131LF	126
C60092	227	C6084RB	21	C74026LF	125, 425	C74135LF	126
C60094	227	C6084WB	21	C74027LF	125, 425	C74136LF	126
C60095	227	C6087BN	21	C74029LF	125, 425	C74146LF	126
C60096	227	C6087NP	21	C74030LF	125, 425	C74147	125
C60097	227	C6087RB	21	C74031LF	125, 423, 425	C74149LF	126
C60106	222	C6087WB	21	C74032LF	125, 425	C74151	125
C60107	222	C60888	214	C74033LF	125	C74152	125
C60108	222	C6089AB	21	C74034LF	125, 425	C74155	125
C60112	222	C6089AL	21	C74036LF	125, 425	C74158LF	126
C60116	222	C6089AN	21	C74037LF	125	C74250LF	73
C60117	222	C6089BI	21	C74038LF	125, 425	C74251LF	73
C60118	222	C6089BL	21	C74039LF	125	C75000	366
C60140	223	C6089BN	21	C74040LF	126	C75001	366
C60141	223	C6089NP	21	C74041LF	126, 425	C75002	366
C60142	223	C6089PN	21	C74042LF	126	C75003	366
C60143	223	C6089PS	21	C74043LF	126, 425	C75004	366
C60144	223	C6089PW	21	C74044LF	126, 425	C75005	366
C60145	223	C6089RB	21	C74045LF	125	C75006	366
C60146	223	C6089WB	21	C74046LF	125	C75007	366
C60147	223	C61009	223	C74048LF	125	C75008	366
C60160	223	C61023	223	C74049LF	125	C75009	366

PART NO.	PG #	PART NO.	PG #	PART NO.	PG #	PART NO.	PG #
C75010	366	C75082	366	C75151	371	C75228	371
C75011	366	C75083	366	C75152	371	C75229	371
C75012	366	C75084	366	C75153	371	C75230	371
C75013	366	C75085	366	C75154	372	C75231	371
C75014	367	C75086	366	C75155	372	C75232	371
C75015	367	C75087	366	C75156	372	C75233	371
C75016	367	C75088	366	C75157	372	C75234	371
C75017	367	C75089	366	C75158	372	C75235	371
C75018	367	C75090	366	C75160	371	C75236	371
C75019	367	C75091	366	C75161	371	C75237	371
C75020	367	C75092	366	C75162	371	C75238	371
C75021	367	C75093	366	C75163	371	C75239	371
C75022	367	C75094	366	C75166	371	C75240	371
C75023	367	C75095	366	C75167	371	C75242	371
C75024	367	C75096	366	C75168	371	C75243	371
C75025	367	C75097	366	C75169	371	C75244	371
C75026	367	C75098	366	C75170	371	C75245	371
C75027	367	C75099	366	C75171	371	C75246	371
C75028	367	C75100	366	C75173	371	C75247	371
C75029	367	C75101	366	C75174	371	C75248	371
C75030	367	C75102	366	C75175	371	C75249	371
C75031	367	C75103	366	C75176	371	C75250	371
C75033	367	C75104	366	C75177	371	C75251	371
C75034	367	C75105	366	C75178	371	C75252	371
C75035	367	C75106	366	C75181	371	C75253	371
C75036	367	C75107	366	C75182	371	C75254	371
C75037	367	C75108	366	C75183	371	C75255	371
C75038	367	C75109	366	C75184	371	C75256	371
C75039	368	C75110	366	C75185	371	C75257	371
C75040	368	C75111	365	C75186	371	C75258	371
C75041	368	C75112	365	C75188	371	C75259	371
C75042	368	C75113	365	C75189	371	C75260	371
C75043	368	C75114	365	C75190	371	C75261	372
C75044	368	C75115	365	C75191	371	C75262	372
C75045	368	C75116	365	C75192	371	C75263	372
C75046	368	C75117	365	C75193	371	C75264	372
C75047	368	C75118	365	C75194	371	C75265	372
C75048	368	C75119	365	C75195	371	C75266	372
C75049	368	C75120	365	C75196	371	C75267	372
C75050	368	C75121	365	C75197	371	C75268	372
C75051	368	C75122	365	C75198	371	C75269	372
C75052	368	C75123	365	C75199	371	C75270	372
C75053	368	C75124	365	C75200	371	C75271	372
C75055	367	C75125	365	C75202	371	C75272	372
C75056	367	C75126	365	C75203	371	C75273	372
C75057	367	C75127	365	C75204	371	C75274	372
C75058	367	C75128	365	C75205	371	C75275	372
C75059	367	C75129	365	C75206	371	C75276	372
C75060	367	C75130	365	C75207	371	C75277	372
C75061	367	C75131	365	C75208	371	C75281	372
C75062	367	C75132	365	C75209	371	C75282	372
C75063	367	C75133	365	C75210	371	C75283	372
C75064	367	C75134	365	C75211	371	C75285	372
C75065	367	C75135	365	C75212	371	C75286	372
C75066	367	C75136	365	C75213	371	C75288	372
C75067	367	C75137	365	C75214	371	C75289	372
C75068	367	C75138	365	C75215	371	C75290	372
C75069	366	C75139	365	C75216	371	C75291	372
C75070	366	C75140	365	C75217	371	C75292	372
C75071	366	C75141	365	C75218	371	C75293	372
C75073	366	C75142	365	C75219	371	C75294	372
C75074	366	C75143	371	C75220	371	C75295	372
C75075	366	C75144	371	C75221	371	C75296	372
C75076	366	C75145	371	C75222	371	C75297	372
C75077	366	C75146	371	C75223	371	C75298	372
C75078	366	C75147	371	C75224	371	C75299	372
C75079	366	C75148	371	C75225	371	C75300	372
C75080	366	C75149	371	C75226	371	C75301	372
C75081	366	C75150	371	C75227	371	C75302	372

PART NO.	PG #	PART NO.	PG #	PART NO.	PG #	PART NO.	PG #
C75303	372	C75379	368	C75455	370	C75563	370
C75304	372	C75380	368	C75456	370	C75564	367
C75305	372	C75381	368	C75457	370	C75565	367
C75306	372	C75382	368	C75458	370	C75566	366
C75307	372	C75383	368	C75459	370	C75568	369
C75308	372	C75384	368	C75460	370	C75570	371
C75309	372	C75385	368	C75461	370	C75571	371
C75310	372	C75386	368	C75462	370	C75572	371
C75311	365	C75387	368	C75463	369	C75573	372
C75312	365	C75388	368	C75464	369	C75574	372
C75313	365	C75392	366	C75465	369	C75575	372
C75314	365	C75394	366	C75466	369	C75576	372
C75315	365	C75395	366	C75467	369	C75577	372
C75316	365	C75396	366	C75468	369	C75578	372
C75317	365	C75397	366	C75469	369	C75579	372
C75318	365	C75398	366	C75470	369	C75580	367
C75319	365	C75399	366	C75471	369	C75581	367
C75320	365	C75400	366	C75472	369	C75582	367
C75321	365	C75401	366	C75473	369	C75583	367
C75322	365	C75403	368	C75474	369	C75586	367
C75323	365	C75404	368	C75477	366	C76001LF	132
C75324	365	C75405	368	C75478	366	C76002LF	132
C75325	365	C75406	368	C75479	368	C76003LF	132
C75326	365	C75407	368	C75481	368	C76004LF	132
C75327	365	C75408	368	C75482	368	C76005LF	132
C75328	365	C75409	368	C75483	368	C76008LF	132
C75329	365	C75410	368	C75484	368	C76009LF	132
C75330	365	C75411	368	C75485	368	C76010LF	132
C75331	365	C75412	367	C75486	368	C76013LF	132
C75332	365	C75413	367	C75487	368	C76014LF	132
C75334	365	C75414	367	C75488	368	C76015LF	132
C75335	365	C75415	367	C75489	368	C76016LF	132
C75336	365	C75416	367	C75490	368	C76017LF	132
C75337	365	C75417	367	C75491	368	C76018LF	132
C75338	365	C75418	367	C75492	368	C76019LF	132
C75339	365	C75419	367	C75494	365	C76020LF	132
C75340	365	C75420	367	C75502	370	C76021LF	132
C75341	365	C75421	367	C75503	370	C76022LF	132
C75342	365	C75422	367	C75504	370	C76023LF	132
C75343	365	C75423	367	C75505	370	C76027LF	132
C75345	365	C75424	367	C75506	370	C76028LF	132
C75346	365	C75425	370	C75507	370	C76029LF	132
C75347	365	C75427	370	C75508	370	C76030LF	132
C75348	365	C75428	370	C75509	370	C76034LF	132
C75349	365	C75429	370	C75516	366	C76035LF	132
C75350	365	C75430	370	C75517	366	C76036LF	132
C75352	365	C75431	370	C75519	367	C76037LF	132
C75353	365	C75432	370	C75520	367	C76038LF	132
C75354	365	C75433	370	C75522	367	C76041LF	132
C75355	365	C75434	370	C75523	367	C76042LF	132
C75356	365	C75435	370	C75525	369	C76043LF	132
C75357	365	C75437	370	C75527	369	C76044LF	132
C75358	365	C75438	370	C75535	368	C76047LF	132
C75359	365	C75439	370	C75536	368	C76048LF	132
C75360	369	C75440	370	C75537	368	C76049LF	132
C75361	369	C75441	370	C75540	368	C76050LF	132
C75362	369	C75442	370	C75544	368	C76051LF	132
C75363	369	C75443	370	C75546	368	C76060LF	132
C75366	369	C75444	370	C75548	367	C76065LF	132
C75367	369	C75445	370	C75550	367	C76066LF	132
C75368	369	C75446	370	C75551	367	C76067LF	132
C75370	369	C75447	370	C75553	367	C76070	133
C75371	369	C75448	370	C75554	367	C76071	133
C75372	369	C75449	370	C75555	367	C76072	133
C75373	369	C75450	370	C75556	367	C76073	133
C75374	369	C75451	370	C75557	367	C76074	133
C75375	366	C75452	370	C75558	367	C76075	133
C75377	368	C75453	370	C75559	367	C76076	133
C75378	368	C75454	370	C75562	370	C76077	133

<u>PART NO.</u>	<u>PG #</u>	<u>PART NO.</u>	<u>PG #</u>	<u>PART NO.</u>	<u>PG #</u>	<u>PART NO.</u>	<u>PG #</u>
C76079LF	133	C76800	136	C76869	139	C91015	262
C76080LF	133	C76801	136	C76870	139	C91016	262
C76081LF	133	C76802	136	C76871	139	C91017	262
C76500LF	135	C76803	136	C76872	139	C91018	262
C76501LF	135	C76804	136	C76873	139	C91019	262
C76502LF	135	C76805	136	C76874	139	C91300	262
C76503LF	135	C76806	136	C76875	139	C91400	262
C76504LF	135	C76807	136	C76876	139	C91500	262
C76505LF	135	C76808	136	C76877	139	C91600	262
C76506LF	135	C76809	136	C76878	139	C91700	262
C76507LF	135	C76810	136	C76879	139	C91800	262
C76508LF	135	C76811	136	C76880	139	C91999	262
C76509LF	135	C76812	136	C76881	139	C92150	261
C76510LF	135	C76813	136	C76882	139	C92151	261
C76511LF	135	C76814	137	C76883	139	C92200	261
C76512LF	135	C76815	137	C76884	139	C92202	261
C76513LF	135	C76816	137	C76885	139	C92250	261
C76514LF	135	C76817	137	C76886	139	C92252	261
C76515LF	135	C76818	137	C76887	139	C92300	261
C76516LF	135	C76819	137	C76888	139	C92301	261
C76520	135	C76820	137	C76889	139	C92303	261
C76521	135	C76821	137	C76890	139	C92350	261
C76522	135	C76822	137	C76891	139	C92351	261
C76530LF	135	C76823	137	C76892	139	C92353	261
C76531LF	135	C76824	137	C76893	139	C92400	261
C76532LF	135	C76825	137	C801800	390	C92404	261
C76553LF	135	C76826	137	C8019OS00	390	C92500	261
C76561LF	135	C76827	137	C8019S00	390	C92600	261
C76562LF	135	C76828	137	C803200	387	C92601	261
C76570LF	135	C76829	137	C803201	387	C92800	261
C76571LF	135	C76830	137	C8032O00	391	C93150	261
C76700	133	C76831	137	C803300	387	C93200	261
C76701	133	C76832	137	C803301	387	C93250	261
C76702	133	C76833	137	C803302	387	C93300	261
C76703	133	C76834	137	C8033O00	391	C93301	261
C76704	133	C76835	137	C85000	240	C93350	261
C76705	133	C76836	137	C85000	175, 409, 418	C93351	261
C76706	133	C76837	137	C85500	240	C93400	261
C76707	133	C76838	137	C87100	240	C93500	261
C76708	133	C76839	137	C87100	175, 409, 418	C94004	262
C76709	133	C76840	138	C88001	174	C94005	262
C76710	133	C76841	138	C88002	175	C94007	262
C76711	133	C76842	138	C88050	175	C94009	262
C76712	133	C76843	138	C88500	175	C95004	262
C76720	133	C76844	138	C88500C	175	C95005	262
C76722	133	C76845	138	C88501	174	C95007	262
C76723	133	C76846	138	C88502	175	C95009	262
C76727	133	C76847	138	C88600	175	C96004	262
C76740	133	C76848	138	C89500	175	C96005	262
C76741	133	C76849	138	C89600	175	C96007	262
C76751	134	C76850	138	C90002	262	C96009	262
C76752	134	C76851	138	C90004	262	C97004	262
C76753	134	C76852	138	C90006	262	C97005	262
C76754	134	C76853	138	C90013	262	C97007	262
C76755	134	C76854	138	C90014	262	C97009	262
C76756	134	C76855	138	C90015	262	C98001	114, 262
C76757	134	C76856	138	C90016	262	C98002	114, 262
C76758	134	C76857	138	C90017	262	C98014	262
C76759	134	C76858	138	C90018	262	C98016	262
C76760	134	C76859	138	C90019	262	C98018	262
C76761	134	C76860	138	C90300	262	CB05	359
C76762	134	C76861	138	C90400	262	CB07	359
C76763	134	C76862	138	C90500	262	CB10	359
C76764	134	C76863	139	C90600	262	CB12	359
C76765	134	C76864	139	C90700	262	CB15	359
C76766	134	C76865	139	C90800	262	CB2001	39
C76767	134	C76866	139	C90999	262	CB2002	39
C76768	134	C76867	139	C91013	262	CB2003	39
C76769	134	C76868	139	C91014	262	CB2004	39

PART NO.	PG #	PART NO.	PG #	PART NO.	PG #	PART NO.	PG #
CB2005	39	D03011	10	D06800	103	D40401	180
CB2011	39	D03015	10	D06801	103	D40440	180
CB2012	39	D03016	10	D06802	103	D40600	220
CB2013	39	D03020	10	D06803	103	D40601	220
CB2014	39	D04001	92	D06804	103	D40602	220
CB2015	39	D04002	92	D06805	103	D40700	220
CB2021	39	D04003	92	D06850	103	D40701	220
CB2022	39	D04004	92	D06875	103	D40702	220
CB2023	39	D04005	91	D06900	103	D41001	180
CB2024	39	D04008	91	D06901	103	D41002	180
CB2025	39	D04009	91	D06902	103	D41003	180
CB2030	39	D04010	91	D06903	103	D41004	180
CB2031	39	D04012	91	D08001	89	D41007	180
CB2032	39	D04013	91	D10001	90	D41008	180
CB2033	39	D04014	91	D10625	90	D41009	180
CB2034	39	D04015	91	D10875	90	D41101	22, 180
CB2040	41	D04016	91	D10900	91	D41102	22, 180
CB2041	41	D04017	91	D18000	88	D41103	180
CB2045	41	D04018	91	D18001	88	D41104	180
CB2046	41	D04019	91	D18002	88	D41105	180
CG05	359	D04020	92	D18034	88	D41106	180
CG07	359	D04021	91	D18050	296	D41107	22, 180
CG10	359	D04022	91	D18051	296	D4110BN	22
CG12	359	D04023	91	D18052	296	D4110NP	22
CJ1002	93	D04024	91	D18060	88	D4110RB	22
CJ1003	39	D04025	91	D18062	64	D4110WB	22
D01001	48	D04026	91	D18063	64	D41301	180
D01002	48	D04027	91	D18186	88	D41302	180
D01003	48	D04028	91	D18190	296	D41303	180
D01004	48	D04031	92	D18340	88	D41307	180
D01005	49	D04032	92	D18400	88	D41600	180
D01008	48	D04033	92	D18401	88	D41601	180
D01009	48	D04034	92	D18501	88	D42002	218
D01010	11, 48	D04035	92	D18560	88	D42003	218
D01011	11, 48	D04036	92	D18750	88	D42004	218
D01015	11, 48	D04050	92	D18850	88	D42006	219
D01016	11, 48	D04051	92	D28003	268	D42006H	220
D01017	11, 48	D04053	92	D28004	268	D42007	219
D01018	11, 48	D04054	92	D40000	50, 242	D42007H	220
D01020	11, 48	D04055	91	D40001	50, 242	D42008	219
D01021	11, 48	D04056	92	D40002	50, 242	D42008H	220
D01022	48	D04057	92	D40003	21, 180	D42009	219
D01023	48	D04058	92	D40004	21, 180	D42009H	220
D01024	11, 47	D04059	92	D40005	21, 180	D42010	219
D01025	11, 47	D04060	92	D40006	180	D42010H	220
D01026	11, 48	D04062	92	D40007	180	D42011	219
D01027	11, 48	D04064	91	D40008	180	D42012	219
D01028	48	D06005	102	D40009	180	D42013	219
D01029	48	D06050	102	D40010	21, 180	D42014	219
D01030	11, 48	D06075	102	D40020	219	D42015	219
D01031	11, 48	D06100	102	D40021	219	D42019	219
D01032	11, 47	D06125	102	D40023	219	D42022	218
D01035	49	D06150	102	D4005BN	21	D42023	218
D01040	47	D06200	102	D4005NP	21	D42024	218
D01041	47	D06250	102	D4005RB	21	D42029	219
D01042	47	D06300	102	D4005WB	21	D45000	64
D0104BN	11	D06350	102	D40101	180	D45001	64
D0104RB	11	D06400	102	D40102	253	D45002	253
D0104WB	11	D06450	103	D40103	253	D49001	191
D01050	11	D06500	103	D40104	253	D49002	191
D01050BN	11	D06510	103	D40140	180	D49003	191
D01050RB	11	D06525	103	D40150	253	D49004	191
D01050WB	11	D06550	103	D40151	180	D49005	191
D02001	114	D06600	103	D40200	253	D49006	191
D02002	58, 114	D06650	103	D40201	180	D49007	191
D03001	10	D06700	103	D40202	253	D49008	191
D03002	10	D06750	102	D40203	253	D49009	191
D03004	10	D06753	103	D40204	253	D49010	191
D03010	10	D06755	102	D40240	180	D49011	191

<u>PART NO.</u>	<u>PG #</u>	<u>PART NO.</u>	<u>PG #</u>	<u>PART NO.</u>	<u>PG #</u>	<u>PART NO.</u>	<u>PG #</u>
D49012	191	D49101	193	D49180	195	D49259	196
D49013	191	D49102	193	D49181	195	D49260	196
D49014	191	D49103	193	D49182	195	D49261	196
D49019	191	D49104	193	D49183	195	D49262	196
D49020	191	D49105	193	D49184	195	D49263	196
D49021	191	D49106	193	D49185	195	D49264	196
D49022	191	D49107	193	D49186	195	D49265	196
D49023	192	D49108	193	D49187	195	D49266	196
D49024	192	D49109	193	D49188	195	D49277	197
D49025	192	D49110	193	D49189	195	D49278	197
D49026	192	D49111	193	D49190	195	D49279	197
D49027	192	D49112	193	D49195	195	D49280	197
D49028	192	D49113	193	D49196	195	D49281	197
D49029	192	D49114	193	D49197	195	D49282	197
D49030	192	D49119	193	D49198	195	D49283	197
D49031	192	D49120	193	D49201	195	D49284	197
D49032	192	D49121	193	D49202	195	D49285	197
D49033	192	D49122	193	D49203	195	D49286	197
D49034	192	D49123	194	D49204	195	D49287	197
D49035	192	D49124	194	D49205	195	D49288	197
D49036	192	D49125	194	D49206	195	D49289	197
D49037	192	D49126	194	D49207	195	D49290	197
D49038	192	D49127	194	D49208	195	D49295	197
D49039	192	D49128	194	D49209	195	D49296	197
D49040	192	D49129	194	D49210	195	D49297	197
D49041	192	D4912BN	20	D49211	195	D49298	197
D49042	192	D4912NP	20	D49212	195	D49301	198
D49043	192	D4912RB	20	D49213	195	D49302	198
D49044	192	D4912WB	20	D49214	195	D49303	198
D49045	192	D49130	194	D49219	195	D49304	198
D49046	192	D49131	194	D49220	195	D49305	198
D49047	192	D49132	194	D49221	195	D49306	198
D49048	192	D49133	194	D49222	195	D49307	198
D49049	192	D49134	194	D49223	196	D49308	198
D49050	192	D49135	194	D49224	196	D49309	198
D49051	192	D49136	194	D49225	196	D49310	198
D49052	192	D49137	194	D49226	196	D49311	198
D49053	192	D49138	194	D49227	196	D49312	198
D49054	192	D49139	194	D49228	196	D49313	198
D49055	20, 192	D49140	194	D49229	196	D49314	198
D49056	192	D49141	194	D49230	196	D49319	198
D49057	20, 192	D49142	194	D49231	196	D49320	198
D49058	192	D49143	194	D49232	196	D49321	198
D49059	20, 192	D49144	194	D49233	196	D49322	198
D49060	192	D49145	194	D49234	196	D49323	199
D49061	192	D49146	194	D49235	196	D49324	199
D49062	192	D49147	194	D49236	196	D49325	199
D49063	192	D49148	194	D49237	196	D49326	199
D49064	192	D49149	194	D49238	196	D49327	199
D49065	192	D49150	194	D49239	196	D49328	199
D49066	192	D49151	194	D49240	196	D49329	199
D49077	193	D49152	194	D49241	196	D49330	199
D49078	193	D49153	194	D49242	196	D49331	199
D49079	193	D49154	194	D49243	196	D49332	199
D49080	193	D49155	20, 194	D49244	196	D49333	199
D49081	193	D49156	194	D49245	196	D49334	199
D49082	193	D49157	20, 194	D49246	196	D49335	199
D49083	193	D49158	194	D49247	196	D49336	199
D49084	193	D49159	20, 194	D49248	196	D49337	199
D49085	193	D49160	194	D49249	196	D49338	199
D49086	193	D49161	194	D49250	196	D49339	199
D49087	193	D49162	194	D49251	196	D49340	199
D49088	193	D49163	194	D49252	196	D49341	199
D49089	193	D49164	194	D49253	196	D49342	199
D49090	193	D49165	194	D49254	196	D49343	199
D49095	193	D49166	194	D49255	196	D49344	199
D49096	193	D49177	195	D49256	196	D49345	199
D49097	193	D49178	195	D49257	196	D49346	199
D49098	193	D49179	195	D49258	196	D49347	199

PART NO.	PG #	PART NO.	PG #	PART NO.	PG #	PART NO.	PG #
D49348	199	D49437	201	D49512	202	D49642	182
D49349	199	D49438	201	D49513	202	D49643	182
D49350	199	D49439	201	D49514	202	D49644	182
D49351	199	D49440	201	D49519	202	D49645	182
D49352	199	D49441	201	D49520	202	D49646	182
D49353	199	D49442	201	D49521	202	D49647	182
D49354	199	D49443	201	D49522	202	D49648	182
D49355	199	D49444	201	D49523	203	D49649	182
D49356	199	D49445	201	D49524	203	D49650	182
D49357	199	D49446	201	D49525	203	D49651	182
D49358	199	D49447	201	D49526	203	D49652	183
D49359	199	D49448	201	D49527	203	D49653	183
D49360	199	D49449	201	D49528	203	D49654	183
D49361	199	D49450	201	D49529	203	D49655	183
D49362	199	D49451	201	D49530	203	D49656	183
D49363	199	D49452	201	D49531	203	D49657	183
D49364	199	D49453	201	D49532	203	D49658	183
D49365	199	D49454	201	D49533	203	D49659	183
D49366	199	D49455	201	D49534	203	D49660	183
D49377	200	D49456	201	D49535	203	D49661	183
D49378	200	D49457	201	D49536	203	D49662	183
D49379	200	D49458	201	D49537	203	D49663	183
D49380	200	D49459	201	D49538	203	D49800	211
D49381	200	D49460	201	D49539	203	D49801	211
D49382	200	D49461	201	D49540	203	D49802	211
D49383	200	D49462	201	D49541	203	D49803	211
D49384	200	D49463	201	D49542	203	D49804	211
D49385	200	D49464	201	D49543	203	D49805	211
D49386	200	D49465	201	D49544	203	D49806	211
D49387	200	D49466	201	D49545	203	D49807	211
D49388	200	D49467	201	D49546	203	D49808	211
D49389	200	D49468	201	D49547	203	D49810	211
D49390	200	D49469	201	D49548	203	D49811	211
D49395	200	D49470	201	D49549	203	D49812	211
D49396	200	D49471	201	D49550	203	D49813	211
D49397	200	D49472	201	D49551	203	D49814	211
D49398	200	D49473	201	D49552	203	D49815	211
D49401	200	D49474	201	D49553	203	D49816	211
D49402	200	D49475	201	D49554	203	D49817	211
D49403	200	D49476	201	D49555	203	D49818	211
D49404	200	D49477	202	D49556	203	D49820	217
D49405	200	D49478	202	D49557	203	D49821	217
D49406	200	D49479	202	D49558	203	D49822	217
D49407	200	D49480	202	D49559	203	D49823	217
D49408	200	D49481	202	D49560	203	D49824	217
D49409	200	D49482	202	D49561	203	D49825	217
D49410	200	D49483	202	D49562	203	D49826	217
D49411	200	D49484	202	D49563	203	D49827	217
D49412	200	D49485	202	D49564	203	D49828	217
D49413	200	D49486	202	D49565	203	D49829	217
D49414	200	D49487	202	D49566	203	D49830	217
D49419	200	D49488	202	D49577	204	D49831	217
D49420	200	D49489	202	D49578	204	D4984BN	20
D49421	200	D49490	202	D49579	204	D4984NP	20
D49422	200	D49495	202	D49580	204	D4984RB	20
D49423	201	D49496	202	D49581	204	D4984WB	20
D49424	201	D49497	202	D49582	204	D49850	211
D49425	201	D49498	202	D49583	204	D49851	211
D49426	201	D49501	202	D49584	204	D49852	211
D49427	201	D49502	202	D49585	204	D49853	211
D49428	201	D49503	202	D49586	204	D49854	211
D49429	201	D49504	202	D49587	204	D49855	211
D49430	201	D49505	202	D49588	204	D49856	211
D49431	201	D49506	202	D49589	204	D49857	211
D49432	201	D49507	202	D49590	204	D49858	211
D49433	201	D49508	202	D49595	204	D49860	211
D49434	201	D49509	202	D49597	204	D49861	211
D49435	201	D49510	202	D49640	182	D49862	211
D49436	201	D49511	202	D49641	182	D49863	211

<u>PART NO.</u>	<u>PG #</u>	<u>PART NO.</u>	<u>PG #</u>	<u>PART NO.</u>	<u>PG #</u>	<u>PART NO.</u>	<u>PG #</u>
D49864	211	D50074	209	D50340	206	D50479	182
D49865	211	D50075	206	D50341	206	D50480	182
D49866	211	D50076	207	D50342	206	D50481	182
D49867	211	D50077	209	D50343	206	D50482	182
D49868	211	D50089	218	D50344	206	D50486	182
D4991BN	20	D50090	218	D50345	206	D50500	179
D4991NP	20	D50091	218	D50346	206	D50501	179
D4991RB	20	D50092	218	D50349	206	D50502	179
D4991WB	20	D50093	218	D50350	206	D50510	179
D49924	217	D50094	218	D50351	208	D50511	179
D4996BN	20	D50095	218, 264	D50352	208	D50520	181
D4996NP	20	D50101	178	D50353	208	D50521	181
D4996RB	20	D50102	178	D50354	208	D50522	181
D4996WB	20	D50111	20, 178	D50355	208	D50523	181
D50000	306, 397	D50120	177	D50356	208	D50524	181
D50001	177	D50121	177	D50357	208	D50525	182
D50002	177	D50122	177	D50360	208	D50526	181
D50004	207	D50123	177	D50361	208	D50600	220
D50005	207	D50124	177	D50362	209	D50601	220
D50006	207	D50125	179	D50363	209	D50682	218
D50007	209	D50126	179	D50364	209	D50683	218
D50008	209	D50130	177	D50365	209	D50700	179
D50010	177	D50131	177	D50366	209	D50701	179
D50011	177	D50132	177	D50367	209	D50702	179
D50012	207	D50133	177	D50368	209	D50703	179
D50013	207	D50134	177	D50371	209	D50704	179
D50014	207	D50135	177	D50372	209	D50705	179
D50015	209	D50141	178	D50377	218	D50706	179
D50016	209	D50152	178	D50378	218	D50707	179
D5001BN	20, 178	D50153	178	D50379	218	D50708	179
D5001NP	20, 178	D50161	178	D50380	218	D50709	179
D5001RB	20, 178	D50162	178	D50381	218	D50710	179
D5001WB	20, 178	D50177	218	D50382	218	D50711	179
D50022	206	D50178	218	D50383	218	D50712	179
D50023	206	D50179	218	D50384	218	D50713	179
D50027	206	D50180	218	D50385	218	D50714	179
D50028	206	D50181	218	D50386	218	D50715	179
D50037	205	D50182	218	D50387	218	D50720	179
D50038	207	D50183	218	D50388	218	D50721	179
D50039	208	D50184	218	D50389	218	D50722	179
D50040	205	D50185	218	D50390	218	D50723	179
D50041	207	D50186	218	D50391	218	D50724	179
D50042	208	D50187	218	D50392	218	D50725	179
D50044	205	D50188	218	D50393	218	D50726	179
D50045	207	D50200	220	D50394	218	D50727	179
D50046	208	D50201	220	D50401	178	D50800	178
D50047	205	D50202	220	D50402	178	D50802	178
D50048	207	D50203	220	D50411	178	D50830	178
D50049	208	D50204	220	D50440	181	D50832	178
D50050	205	D50205	220	D50448	181	D5087BN	19
D50051	207	D50206	220	D50449	181	D5087RB	19
D50052	208	D50207	220	D50450	181	D5087WB	19
D50053	205	D50208	220	D50451	181	D50887	19
D50054	207	D50213	220	D50452	181	D50888	20, 178
D50055	208	D50220	220	D50453	181	D5088BN	20, 178
D50060	206	D50221	220	D50454	181	D5088RB	20, 178
D50061	207	D50278	205	D50460	182	D5088WB	20, 178
D50062	209	D50279	207	D50461	182	D50904	218
D50063	206	D50280	208	D50462	182	D50905	218
D50064	207	D50301	177	D50463	182	D50906	218
D50065	209	D50302	177	D50464	182	D50907	218
D50066	206	D50310	177	D50465	182	D50908	218
D50067	207	D50311	177	D50469	182	D50909	218
D50068	209	D50330	177	D50470	182	D50910	218
D50069	206	D50331	177	D50471	182	D50911	218
D50070	207	D50332	177	D50472	182	D50942	19
D50071	209	D50333	177	D50473	182	D5094BN	19
D50072	206	D50334	177	D50474	182	D5094RB	19
D50073	207	D50335	177	D50477	182	D5094WB	19

PART NO.	PG #	PART NO.	PG #	PART NO.	PG #	PART NO.	PG #
D50980	212	D51344	206	D53008	190	D53083	185
D50982	212	D51345	206	D53009	190	D53084	185
D50983	212	D51346	206	D53011	190	D53085	185
D50984	212	D51349	206	D53012	190	D53086	187
D50985	212	D51350	206	D53014	190	D53087	187
D50986	212	D51351	208	D53015	190	D53088	187
D50987	212	D51352	208	D53017	190	D53089	187
D50988	212	D51353	208	D53018	190	D53090	187
D50989	212	D51354	208	D53020	184	D53091	187
D50990	212	D51355	208	D53021	184	D53092	187
D50998	178	D51356	208	D53022	184	D53093	187
D50PLP	179	D51357	208	D53023	184	D53094	187
D51004	207	D51360	208	D53024	184	D53095	187
D51005	207	D51361	208	D53025	184	D53096	187
D51006	207	D51362	209	D53026	185	D53097	187
D51007	209	D51363	209	D53027	185	D53098	187
D51008	209	D51364	209	D53028	185	D53099	187
D51012	207	D51365	209	D53029	185	D53100	186
D51013	207	D51366	209	D53030	185	D53101	186
D51014	207	D51367	209	D53031	185	D53102	186
D51015	209	D51368	209	D53032	185	D53103	186
D51016	209	D51371	209	D53033	185	D53104	186
D51022	206	D51372	209	D53034	185	D53105	186
D51023	206	D52003	211	D53035	185	D53106	186
D51027	206	D52004	210	D53036	185	D53107	186
D51028	206	D52005	210	D53037	185	D53108	186
D51037	205	D52012	210	D53040	187	D53109	186
D51038	207	D52014	210	D53041	187	D53110	186
D51039	208	D52016	210	D53042	187	D53111	186
D51040	205	D52017	210	D53043	187	D53120	190
D51041	207	D52023	210	D53044	187	D53121	190
D51042	208	D52103	211	D53045	187	D53122	190
D51044	205	D52104	210	D53046	187	D53123	190
D51045	207	D52105	210	D53047	187	D53124	185
D51046	208	D52112	210	D53048	187	D53125	185
D51047	205	D52120	210	D53049	187	D53126	185
D51048	207	D52123	210	D53050	187	D53127	185
D51049	208	D52202	211	D53051	187	D53128	187
D51050	205	D52203	211	D53052	187	D53129	187
D51051	207	D52204	211	D53053	187	D53130	187
D51052	208	D52205	211	D53054	187	D53131	187
D51053	205	D52206	211	D53055	187	D53132	187
D51054	207	D52207	211	D53056	187	D53133	187
D51055	208	D52216	211	D53057	187	D53134	187
D51060	206	D52217	211	D53058	190	D53135	187
D51061	207	D52302	211	D53059	190	D53136	187
D51062	209	D52303	211	D53060	190	D53137	187
D51063	206	D52304	211	D53061	190	D53138	185
D51064	207	D52305	211	D53062	190	D53139	185
D51065	209	D52306	211	D53063	190	D53140	185
D51066	206	D52307	211	D53064	190	D53141	185
D51067	207	D52316	211	D53065	190	D53142	185
D51068	209	D52317	211	D53066	190	D53143	185
D51069	206	D52400	210	D53067	190	D53144	207
D51070	207	D52450	210	D53068	190	D53145	207
D51071	209	D52451	210	D53069	190	D53146	207
D51072	206	D52452	210	D53070	190	D53147	207
D51073	207	D52453	210	D53071	190	D53148	207
D51074	209	D52460	210	D53072	184	D53149	207
D51075	206	D52461	210	D53073	184	D53150	188
D51076	207	D52462	210	D53074	184	D53151	188
D51077	209	D52463	210	D53075	184	D53152	188
D51278	205	D52500	210	D53076	184	D53153	188
D51279	207	D53001	190	D53077	184	D53154	188
D51280	208	D53002	190	D53078	185	D53155	188
D51340	206	D53003	190	D53079	185	D53156	188
D51341	206	D53004	190	D53080	185	D53157	188
D51342	206	D53005	190	D53081	185	D53158	188
D51343	206	D53006	190	D53082	185	D53159	188

PART NO.	PG #	PART NO.	PG #	PART NO.	PG #	PART NO.	PG #
D53160	188	D53269	188	D53424	187	D54010	21, 214
D53161	188	D53272	188	D53425	187	D54011	216
D53162	188	D53273	188	D53426	187	D54012	216
D53163	188	D53274	188	D53427	187	D54013	216
D53180	189	D53275	188	D53428	184	D54013L	216
D53181	189	D53276	188	D53429	184	D54014	216
D53182	189	D53277	188	D53430	184	D54014L	216
D53183	189	D53278	188	D53431	184	D54015	216
D53184	189	D53279	188	D53432	184	D54016	217
D53185	189	D53280	190	D53433	184	D54022	216
D53186	189	D53281	190	D53434	184	D54100	217
D53187	189	D53282	187	D53435	184	D54101	217
D53188	189	D53283	187	D53436	184	D54102	217
D53189	189	D53284	184	D53437	184	D54104	217
D53190	185	D53285	184	D53438	184	D54105	217
D53191	185	D53286	188	D53439	184	D54107	217
D53192	185	D53287	188	D53440	184	D54108	214
D53193	185	D53288	186	D53441	184	D54111	217
D53194	185	D53289	186	D53442	205	D54112	217
D53195	185	D53290	185	D53443	205	D54113	217
D53196	185	D53291	185	D53444	205	D54114	217
D53197	185	D53292	189	D53445	205	D54126	217
D53198	185	D53293	189	D53446	205	D54130	217
D53199	185	D53294	188	D53447	205	D54131	217
D53200	185	D53295	188	D53448	205	D54132	217
D53201	185	D53296	185	D53449	205	D54133	217
D53202	185	D53297	185	D53450	205	D54134	217
D53203	185	D53298	185	D53451	205	D54136	217
D53204	186	D53299	185	D53452	205	D54137	217
D53205	186	D53300	188	D53453	205	D54301	216
D53206	186	D53301	188	D53454	205	D54302	216
D53207	186	D53302	188	D53455	205	D54304	217
D53208	186	D53303	188	D53456	207	D54305	217
D53209	186	D53304	188	D53457	207	D54306	217
D53216	186	D53305	188	D53458	207	D54307	217
D53217	186	D53306	186	D53459	207	D54311	216
D53218	186	D53307	186	D53460	207	D54312	216
D53219	186	D53308	188	D53461	207	D54313	216
D53230	189	D53309	188	D53462	207	D54314	216
D53231	189	D53310	189	D53463	207	D54315	216
D53232	189	D53311	189	D53464	207	D54316	217
D53233	189	D53312	186	D53465	207	D54319	216
D53234	189	D53313	186	D53466	207	D54321	217
D53235	189	D53314	189	D53467	207	D54322	217
D53236	189	D53315	189	D53468	207	D54323	217
D53237	189	D53400	190	D53469	207	D54324	217
D53238	189	D53401	190	D53470	208	D54326	217
D53239	189	D53402	190	D53471	208	D54330	217
D53240	189	D53403	190	D53472	208	D54331	217
D53241	189	D53404	190	D53473	208	D54332	217
D53246	184	D53405	190	D53474	208	D54333	217
D53247	184	D53406	190	D53475	208	D54334	217
D53248	184	D53407	190	D53476	208	D54336	217
D53249	184	D53408	190	D53477	208	D54337	217
D53250	187	D53409	190	D53478	208	D54400	217
D53251	187	D53410	190	D53479	208	D54401	217
D53252	187	D53411	190	D53480	208	D56105	212
D53253	187	D53412	190	D53481	208	D56106	213
D53258	186	D53413	190	D53482	208	D56107	213
D53259	186	D53414	187	D53483	208	D56205	212
D53260	186	D53415	187	D54001	216	D56206	213
D53261	186	D53416	187	D54001L	216	D56207	213
D53262	188	D53417	187	D54002	216	D56208	213
D53263	188	D53418	187	D54002L	216	D56209	213
D53264	188	D53419	187	D54003	219	D56210	212
D53265	188	D53420	187	D54004	219	D56211	22, 213
D53266	188	D53421	187	D54005	219	D56212	22, 213
D53267	188	D53422	187	D54006	219	D56213	213
D53268	188	D53423	187	D54008	214		

PART NO.	PG #	PART NO.	PG #	PART NO.	PG #	PART NO.	PG #
D56214	22, 213	D57915	230	D59940	259	D60960	19, 213, 251
D56215	213	D57916	230	D59941	259	D60961	213, 251
D56216	22, 213	D57917	230	D59942	259	D60962	19, 213, 251
D56217	213	D57918	230	D59943	230, 259	D60963	213, 251
D56304	212	D57919	230	D59944	230, 259	D60966	214, 251
D56305	212	D57980	212	D59945	230, 259	D60967	214, 251
D56306	213	D57982	212	D59946	230, 259	D60968	214
D56307	213	D57983	212	D59947	230	D60969	214
D56308	213	D57984	212	D59948	230	D6096BN	19
D56309	213	D57985	212	D59949	230	D6096NP	19
D56404	212	D57986	212	D59950	230	D6096RB	19
D56405	212	D57987	212	D60100	242	D6096WB	19
D56406	213	D57988	212	D60101	242, 253	D60970	212, 251
D56407	213	D57989	212	D60102	242	D60975	212, 251
D56408	213	D57990	212	D60103	242	D60978	178
D56409	213	D59001	219	D60130	221	D60979	215, 250
D56500	212, 250	D59002	219	D60140	221	D60980	19, 212, 251
D56501	212, 250	D59003	219	D60201	242	D60981	19, 212, 251
D56502	213, 250	D59100	214	D60202	242	D60982	19, 212, 251
D56503	213, 250	D59101	267	D60203	242	D60986	213, 251
D56504	214, 250	D59102	267	D60204	242	D60987	213, 251
D56505	214, 250	D59103	267	D60205	242	D60989	213, 251
D57105	212	D59104	267	D60206	242	D6098BN	19
D57106	213	D59106	267	D60207	242	D6098NP	19
D57107	213	D59112	267	D60208	242	D6098RB	19
D57205	212	D59113	267	D60209	242	D6098WB	19
D57206	213	D59114	267	D60210	242	D60990	22, 213, 251
D57207	213	D59124	267	D60211	242	D60991	22, 213, 251
D57208	213	D59126	267	D60212	242	D60992	213, 251
D57209	213	D59128	267	D60400	242	D60993	213, 251
D57210	212	D59130	267	D60402	242	D60994	213, 251
D57211	213	D59132	267	D60403	242	D60995	213, 251
D57212	213	D59156	264	D60410	242	D60996	22, 213, 251
D57213	213	D59158	264	D60412	242	D60997	213, 251
D57214	213	D59160	264	D60413	242	D60998	213, 251
D57215	213	D59162	264	D60498	242	D60999	213, 251
D57216	213	D59202	268	D60499	242	D61101	243
D57217	213	D59203	268	D60780	214	D61102	243
D57304	212	D59204	268	D60781	214	D61103	243
D57305	212	D59302	268	D60782	214	D61201	243
D57306	213	D59303	268	D60790	214	D61202	243
D57307	213	D59304	268	D60791	214	D61203	243
D57308	213	D59900	184	D60792	214	D61301	243
D57309	213	D59901	230, 259	D60793	214	D61302	243
D57404	212	D59902	230, 259	D60795	214	D61303	243
D57405	212	D59904	229, 259	D6084BN	22	D61800	243
D57406	213	D59905	229, 259	D6084NP	22	D61801	243
D57407	213	D59906	230, 259	D6084RB	22	D61802	243
D57408	213	D59907	230, 259	D6084WB	22	D61850	243
D57409	213	D59908	229, 259	D60900	243	D62130	250
D57500	212	D59909	229, 259	D60901	243	D62131	250
D57501	212	D59910	230, 259	D60902	243	D62132	250
D57502	213	D59911	230, 259	D6091BN	22	D62135	250
D57503	213	D59912	229, 259	D6091NP	22	D62136	250
D57504	214	D59913	229, 259	D6091RB	22	D62137	250
D57505	214	D59914	230, 259	D6091WB	22	D62140	250
D57901	230	D59915	230, 259	D60940	214	D62141	250
D57902	230	D59916	230, 259	D60942	19	D62142	250
D57904	229	D59917	230, 259	D60945	212	D62230	259
D57905	229	D59918	230, 259	D6094BN	19	D62231	259
D57906	230	D59919	230, 259	D6094NP	19	D62232	259
D57907	230	D59920	229	D6094PB	19	D62235	259
D57908	229	D59921	229	D6094RB	19	D62236	259
D57909	229	D59922	229	D6094WB	19	D62237	259
D57910	230	D59923	229	D60954	19, 213, 251	D62240	259
D57911	230	D59924	229	D60955	212, 251	D62241	259
D57912	229	D59925	229	D60956	212, 251	D62242	259
D57913	229	D59926	229	D60958	214, 251	D62300	250, 259
D57914	230	D59927	229	D60959	214, 251	D62330	255

PART NO.	PG #	PART NO.	PG #	PART NO.	PG #	PART NO.	PG #
D62333	255	D65505	244	D66400	250	D66681	244
D62334	255	D65509	244	D66500	244	D66682	244
D62335	255	D65510	244	D66501	244	D66683	246
D62349	250, 259	D65511	244	D66502	244	D66684	246
D62350	250, 259	D65512	244	D66503	244	D66685	248
D62400	250, 259	D65520	246	D66504	244	D66686	248
D62433	255	D65521	246	D66505	244	D66687	245
D62434	255	D65522	246	D66509	244	D66688	245
D62443	255	D65523	246	D66510	244	D66689	247
D62444	255	D65524	246	D66511	244	D66690	247
D62601	255	D65525	246	D66512	244	D66691	248
D62602	255	D65560	245	D66520	246	D66692	248
D62950	252	D65561	245	D66521	246	D66700	245
D62951	252	D65562	245	D66522	246	D66701	245
D62952	252	D65563	245	D66523	246	D66702	245
D62960	252	D65564	245	D66524	246	D66703	245
D62961	252	D65565	245	D66525	246	D66704	245
D62962	252	D65569	245	D66540	248	D66705	245
D63300	250, 258	D65570	245	D66541	248	D66706	245
D63330	256	D65571	245	D66542	248	D66707	245
D63333	256	D65572	245	D66543	248	D66715	247
D63334	256	D65580	247	D66544	248	D66716	247
D63335	256	D65581	247	D66545	248	D66717	247
D63349	250, 258	D65582	247	D66560	245	D66718	247
D63350	250, 258	D65583	247	D66561	245	D66719	247
D63400	250, 258	D65584	247	D66562	245	D66720	247
D63433	256	D65585	247	D66563	245	D66721	247
D63434	256	D65600	248	D66564	245	D66722	247
D64000	21, 242	D65601	248	D66565	245	D66732	248
D64001	21, 242	D65602	248	D66569	245	D66733	248
D64002	241	D65603	248	D66570	245	D66734	248
D6400BN	21, 242	D65604	248	D66571	245	D66735	248
D6400RB	21, 242	D65605	248	D66572	245	D66736	248
D6400WB	21, 242	D65620	245	D66580	247	D66737	248
D64010	242	D65621	245	D66581	247	D66738	248
D64011	242	D65622	245	D66582	247	D66739	248
D64012	241	D65623	245	D66583	247	D67001	244
D64022	241	D65624	245	D66584	247	D67002	244
D64150	241	D65625	245	D66585	247	D67003	244
D64202	241	D65640	247	D66600	248	D67004	244
D64302	241	D65641	247	D66601	248	D67005	244
D64401	21, 242	D65642	247	D66602	248	D67006	244
D64402	241	D65643	247	D66603	248	D67007	244
D64402G	241	D65644	247	D66604	248	D67008	244
D64502	241	D65645	247	D66605	248	D67016	245
D64800	242	D65655	245	D66620	245	D67017	245
D64801	242	D65656	245	D66621	245	D67018	245
D64802	242	D65657	247	D66622	245	D67019	245
D64803	242	D65658	247	D66623	245	D67020	245
D64804	242	D65659	248	D66624	245	D67021	245
D64805	242	D65660	248	D66625	245	D67022	245
D64806	242	D65661	244	D66640	247	D67023	245
D64807	242	D65662	244	D66641	247	D67027	245
D64808	242	D65663	246	D66642	247	D67028	245
D64809	242	D65664	246	D66643	247	D67029	245
D64810	242	D65665	245	D66644	247	D67030	245
D64811	242	D65667	247	D66645	247	D67031	247
D65002	249	D65668	247	D66660	248	D67032	247
D65003	249	D66002	249	D66661	248	D67033	247
D65102	249	D66003	249	D66662	248	D67034	247
D65103	249	D66004	249	D66663	248	D67035	247
D65104	249	D66102	249	D66664	248	D67036	247
D65202	249	D66103	249	D66665	248	D67037	247
D65203	249	D66104	249	D66675	245	D67038	247
D65500	244	D66200	250	D66676	245	D67039	247
D65501	244	D66202	249	D66677	247	D67040	247
D65502	244	D66203	249	D66678	247	D67041	247
D65503	244	D66204	249	D66679	248	D67042	247
D65504	244	D66300	250	D66680	248	D67043	247

PART NO.	PG #	PART NO.	PG #	PART NO.	PG #	PART NO.	PG #
D67044	247	D76209L	263	D80220	247	E0812BN	22
D67045	247	D76252	263	D80221	247	E0812PB	22
D67046	247	D76256	263	D80222	247	E0812RB	22
D67047	247	D76259	263	D80223	247	E0812WB	22
D67048	248	D76302	263	DAP00683	293	E08138	67
D67049	248	D76303	263	DAP00684	293	E08150	67
D67050	248	D76304	263	DAP08641	293	E0815BN	22
D67051	248	D76402	263	DAP18001	292	E0815PB	22
D67052	248	D76403	263	DAP18032	292	E0815RB	22
D67053	248	D76404	263	DAP18152	292	E0815WB	22
D67054	248	D76412	263	DAP18526	292	E09050	86
D67055	248	D76413	263	DAP44242	292	E09075	86
D67200	250	D76414	263	DAP8640	293	E09100	86
D67201	250	D76504	264	E01049	68	E09125	86
D67300	250	D76519	264	E01050	67	E09150	86
D67400	250	D76601	253	E0105BN	22	E09200	86
D68507	246	D76702	264	E0105RB	22	E09250	86
D68508	246	D76703	264	E0105WB	22	E09300	86
D68510	246	D76704	264	E01074	68	E09400	86
D68511	246	D76705	264	E01075	67	E10150	89
D68512	246	D76706	264	E01100	67	E10200	89
D68513	246	D76707	264	E01125	67	E10300	89
D68610	246	D77002	252	E01150	67	E10400	89
D68611	246	D77003	252	E01375	67	E15050	68
D68612	246	D77004	252	E02050	67	E15052	68
D68613	246	D79703	264	E0205BN	22	E15075	68
D68710	246	D79704	264	E0205RB	22	E15375	68
D68711	246	D79705	264	E0205WB	22	E16050	68
D68712	246	D79706	264	E02075	67	E16075	68
D68713	246	D79803	264	E02100	67	E16150	68
D70001	253	D79804	264	E02125	67	E16151	68
D70011	253	D79805	264	E02150	67	E16200	68
D70020	253	D79806	264	E02152	67	E16375	68
D70021	253	D80090	249	E02200	67	E25000	304, 405
D70022	253	D80091	249	E02375	67	E25001	304, 405
D70098	253	D80096	249	E03125	67, 338	E25002	304, 405
D70100	56, 333	D80097	249	E03150	67, 338	E25004	304, 405
D70101	56, 333	D80098	249	E03200	67, 338	E25005	304, 405
D70102	56, 333	D80099	249	E03225	68	E25006	304, 405
D70103	56, 333	D80100	246	E03250	68	E25007	304, 405
D70104	56	D80101	246	E04125	67, 338	E25010	305, 406
D70105	6, 56	D80102	246	E0412BN	22	E25015	309
D7010BN	6	D80103	246	E0412RB	22	E25016	309
D7010NP	6	D80106	248	E0412WB	22	E25017	309
D7010PB	6	D80107	248	E04150	67, 338	E25018	309
D7010RB	6	D80108	248	E0415BN	22	E25021	304, 406
D7010WB	6	D80109	248	E0415RB	22	E25040	304, 405
D70205	6	D80112	246	E0415WB	22	E25041	304, 405
D7020BN	6	D80113	246	E04200	67, 338	E25042	304, 405
D7020RB	6	D80118	248	E05125	67	E25115	309
D7020WB	6	D80119	248	E05150	67	E25116	309
D70500	253	D80200	246	E06050	67	E25117	309
D71003	253	D80201	246	E0605BN	22	E25118	309
D71004	253	D80202	246	E0605PB	22	E25125	309
D71103	253	D80203	246	E0605RB	22	E25126	309
D76002	252	D80206	247	E0605WB	22	E25127	309
D76003	252	D80207	247	E06075	67	E25128	309
D76004	252	D80208	247	E06100	67	E25129	309
D76005	257	D80209	247	E06125	67	E25200	305
D76012	252	D80210	247	E06150	67	E25201	305
D76013	252	D80211	247	E06375	67	E25202	305
D76014	252	D80212	246	E07025	67	E25203	305
D76092	252	D80213	246	E07050	67	E25204	305
D76093	252	D80214	246	E0705BN	22	E25250	304, 406
D76094	252	D80215	246	E0705PB	22	E25251	304, 406
D76202	263	D80216	246	E0705RB	22	E25300	305, 406
D76203	263	D80217	246	E0705WB	22	E25301	305, 406
D76204	263	D80218	247	E07375	67	E25302	305, 406
D76207L	263	D80219	247	E08125	67	E25320	305, 406

PART NO.	PG #	PART NO.	PG #	PART NO.	PG #	PART NO.	PG #
E26001	305	F06500	69	F20011	305, 408	F33114	117
E26002	305	F06600	69	F20012	305, 408	F33115	117
E26003	305	F06800	69	F20016	303, 407	F33116	117
E26004	305	F07050	69	F20017	303, 407, 412, 421	F33120	117
E80050	23	F07075	69	F20018	303, 407	F33121	117
E80075	23	F07099	69	F20019	303, 407, 412, 421	F33122	117
E81050	23	F07100	69	F20020	305, 407	F33123	117
E81375	23	F07124	69	F20021	305, 407	F33124	117
E82125	23	F07125	69	F20022	305, 407	F33125	117
E82150	23	F07150	69	F20023	305, 407	F33126	117
E85000	300, 400	F07200	69	F20024	305, 407	F33127	117
ERB05	359	F07201	69	F20025	305, 407	F33128	117
ERB07	359	F07300	69	F20026	305, 407	F33129	117
ERG05	359	F07375	69	F20050	304, 406	F33130	117
ERG07	359	F08050	23	F20051	407	F33131	117
F01050	68	F08124	23	F20052	304, 406, 412, 421	F33132	117
F01075	68	F08150	23	F20053	304, 407, 412, 421	F33140	116
F01100	68	F08375	23	F20054	304, 406, 412, 421	F33141	116
F01125	68	F10001	174	F20055	304, 407, 412, 421	F33142	116
F01150	68	F10002	174	F33009	116	F33143	116
F01375	68	F10003	174	F33010	116	F33144	116
F02050	68	F10004	174	F33011	116	F33300	116
F02075	68	F10005	253	F33012	116	F33301	116
F02100	68	F11001	174	F33013	116	F33302	116
F02125	68	F11002	174	F33014	116	F33303	116
F02150	68	F11003	174	F33030	116	F39001	74
F02200	68	F11004	174	F33031	116	F39002	74
F02375	68	F12009	108	F33032	116	F39004	74
F03050	68	F12012	108	F33033	116	F39005	74
F03075	68	F12018	108	F33034	116	F39010	74
F03100	68	F12024	108	F33035	116	F39700	57
F03125	68	F14012	109	F33036	116	F39800	57
F03150	68	F160063	109	F33037	116	F40001	127
F03200	68	F160093	109	F33038	116	F40002	127, 424
F03250	68	F160094	109	F33039	116	F40003	127
F03300	68	F16012	109	F33040	116	F40004	127, 424
F03375	68	F160123	109	F33041	116	F40005	127, 424
F04050	68	F160126	109	F33060	116	F40006	127, 424
F04075	68	F16016	109	F33061	116	F40007	127
F04100	68	F160183	109	F33062	116	F40008	127
F04125	68	F160184	109	F33063	116	F40009	127
F04150	68	F160186	109	F33064	116	F40010	127
F04200	68	F160243	109	F33065	116	F40011	127
F04250	68	F160246	109	F33066	116	F40012	127
F04300	68	F160363	109	F33067	116	F40013	127
F04350	68	F160393	109	F33068	116	F40014	127
F04375	68	F163186	109	F33069	116	F40015	127
F04400	68	F163246	109	F33080	117	F40016	127
F04500	68	F165181	109	F33081	117	F40017	127
F04600	68	F165186	109	F33082	117	F40018	127
F04800	68	F180032	109	F33083	117	F40019	127
F04999	68	F18009	108	F33094	117	F40020	127, 424
F06050	69	F18012	108	F33095	117	F40021	127, 424
F06075	69	F18018	108	F33096	117	F40022	127
F06099	69	F18024	108	F33097	117	F40023	127, 424
F06100	69	F18309	108	F33098	117	F40024	127
F06124	69	F18312	108	F33101	117	F40025	127, 424
F06125	69	F18318	108	F33102	117	F40026	127, 424
F06150	69	F18324	108	F33103	117	F40027	127, 424
F06200	69	F20001	303, 407, 412, 421	F33104	117	F40028	127
F06201	69	F20002	303, 407	F33105	117	F40029	127
F06250	69	F20003	303, 407, 412, 421	F33106	117	F40030	127
F06251	69	F20004	303, 407, 408	F33107	117	F40031	127
F06300	69	F20005	303, 407, 408	F33108	117	F40032	127
F06301	69	F20006	305, 408	F33109	117	F40033	127
F06351	69	F20007	305, 408	F33110	117	F40034	127
F06375	69	F20008	305, 408	F33111	117	F40035	127, 424
F06400	69	F20009	305, 408	F33112	117	F40036	127, 424
F06401	69	F20010	305, 408	F33113	117	F40037	127

PART NO.	PG #	PART NO.	PG #	PART NO.	PG #	PART NO.	PG #
F40038	127	F40109	128	G09020	163	G12332	55
F40039	127	F40110	128	G09024	163	G12336	55
F40040	127	F40111	128	G10006	163	G12342	55
F40041	127	F40112	128	G10008	163	G12348	55
F40042	128	F40113	128	G10010	163	G12999	55
F40043	128	F40114	128	G10012	163	G13001	43
F40044	128	F40115	128	G10016	163	G13002	43
F40045	128	F40116	128	G10020	163	G13003	43
F40047	128	F40117	128	G10024	163	G13004	43
F40048	128, 424	F40118	128	G10032	163	G13005	43
F40049	128, 424	F40119	127	G10036	163	G13012	55
F40050	128	F40120	127	G10040	163	G13016	55
F40051	128	F40121	128	G10052	163	G13018	55
F40052	128, 424	F40122	128	G10072	163	G13024	55
F40053	128, 424	F40123	127	G10080	163	G13030	55
F40054	128	F40124	127	G10104	163	G13032	55
F40055	128, 424	F40125	127	G11006	163	G13036	55
F40056	128	F40126	127	G11008	163	G13042	55
F40057	128	F40127	127	G11010	163	G13048	55
F40058	128	F40128	128	G11012	163	G13112	55
F40059	128	F40131	127	G11016	163	G13116	55
F40060	128	F40132	127	G11020	163	G13118	55
F40061	128	F40133	127	G11024	163	G13124	55
F40062	128	F40135	128	G11028	163	G13130	55
F40063	128, 424	F401516	129	G11032	163	G13132	55
F40064	128, 424	F41002	129	G11036	163	G13136	55
F40065	128	F41003	129	G11040	163	G13142	55
F40066	128	F41004	129	G11044	163	G13148	55
F40067	128	F41005	129	G11048	163	G13212	55
F40068	128, 424	F41006	129	G11052	163	G13216	55
F40069	128, 424	F41007	129	G11056	163	G13218	55
F40070	128, 424	F41008	129	G11064	163	G13224	55
F40071	128	F41009	129	G11072	163	G13230	55
F40072	128	F41011	129	G11080	163	G13232	55
F40073	128, 424	F41012	129	G11088	163	G13236	55
F40074	128, 424	F41013	129	G11096	163	G13242	55
F40075	128	F411516	129	G11104	163	G13248	55
F40076	128, 424	F461012	129	G12012	55	G13312	55
F40077	128	F46108	129	G12016	55	G13316	55
F40078	128	F481012	129	G12018	55	G13318	55
F40079	128	F48108	129	G12024	55	G13324	55
F40080	128	F65400	215, 251	G12030	55	G13330	55
F40081	128	F65600	215, 251	G12032	55	G13332	55
F40082	128	G02010	306, 397	G12036	55	G13336	55
F40083	128	G02011	306, 397	G12042	55	G13342	55
F40084	128	G02042	307, 405	G12048	55	G13348	55
F40085	128	G04000	302, 401	G12112	55	G13500	36
F40086	128	G04001	302, 401	G12116	55	G13516	36
F40087	128	G04002	302, 401	G12118	55	G13534	36
F40088	128, 424	G04003LF	162	G12124	55	G13601	36
F40089	128	G04004	162	G12130	55	G13616	36
F40090	128	G04005	302, 401	G12132	55	G13634	36
F40091	128	G04006	302, 401	G12136	55	G13638	36
F40092	128	G04025	302, 401	G12142	55	G14006	164
F40093	128	G04026	302, 401	G12148	55	G14008	164
F40094	128	G04030	302, 401	G12212	55	G14010	164
F40095	127	G04031	302, 401	G12216	55	G14012	164
F40096	127	G08004	163	G12218	55	G14016	164
F40097	127	G08006	163	G12224	55	G14020	164
F40098	127	G08008	163	G12230	55	G14024	164
F40100	127	G08012	163	G12232	55	G14028	164
F40101	128	G08016	163	G12236	55	G14032	164
F40102	128	G08020	163	G12242	55	G14036	164
F40103	128	G08024	163	G12248	55	G14040	164
F40104	128	G09004	163	G12312	55	G14044	164
F40105	128	G09006	163	G12316	55	G14048	164
F40106	128	G09008	163	G12318	55	G14052	164
F40107	128	G09012	163	G12324	55	G14056	164
F40108	128	G09016	163	G12330	55	G14064	164

PART NO.	PG #
G14072	164
G14080	164
G14088	164
G14096	164
G14104	164
G144-0007	351
G144-0032	351
G144-0033	351
G144-0058	351
G144-0059	351
G144-0060	351
G144-0107	351
G144-0108	351
G144-0109	351
G144-0110	351
G144-0159	351
G144-0160	351
G144-0161	351
G144-0162	351
G144-0222	351
G144-0223	351
G144-0224	351
G144-0225	351
G144-0226	351
G144-0303	351
G144-0304	351
G144-0305	351
G144-0306	351
G144-0307	351
G144-0308	351
G144-0398	351
G144-0399	351
G144-0400	351
G144-0401	351
G144-0402	351
G144-0403	351
G144-0531	351
G144-0532	351
G144-0533	351
G144-0534	351
G144-0535	351
G144-0536	351
G144-0662	351
G144-0663	351
G144-0664	351
G144-0665	351
G144-0666	351
G144-0790	351
G144-0870	351
G144-0871	351
G144-0872	351
G144-0873	351
G144-0875	351
G144-1109	351
G144-1111	351
G15002	164
G15003	164
G15004	164
G15006	164
G15008	164
G155-0001	351
G155-0002	351
G155-0025	351
G155-0050	351
G155-0100	351
G155-0150	351
G155-0215	351
G155-0295	351
G155-0390	351

PART NO.	PG #
G155-0520	351
G155-0650	351
G155-0860	351
G155-0975	351
G155-1100	351
G16006	164
G16008	164
G16010	164
G16012	164
G16016	164
G16020	164
G16024	164
G16028	164
G16032	164
G16036	164
G16040	164
G16044	164
G16048	164
G16052	164
G16056	164
G16064	164
G16072	164
G16080	164
G16088	164
G16096	164
G16104	164
G165-0001	352
G165-0002	352
G165-0007	352
G165-0025	352
G165-0032	352
G165-0033	352
G165-0050	352
G165-0058	352
G165-0059	352
G165-0060	352
G165-0100	352
G165-0107	352
G165-0108	352
G165-0109	352
G165-0110	352
G165-0150	352
G165-0159	352
G165-0160	352
G165-0161	352
G165-0162	352
G165-0215	352
G165-0222	352
G165-0223	352
G165-0224	352
G165-0295	352
G165-0303	352
G165-0304	352
G165-0305	352
G165-0306	352
G165-0307	352
G165-0390	352
G165-0398	352
G165-0399	352
G165-0400	352
G165-0401	352
G165-0402	352
G165-0520	352
G165-0531	352
G165-0532	352
G165-0533	352
G165-0534	352
G165-0650	352
G165-0662	352

PART NO.	PG #
G165-0663	352
G165-0664	352
G165-0665	352
G165-0666	352
G165-0860	352
G165-0870	352
G165-0871	352
G165-0872	352
G165-0873	352
G165-1100	352
G165-1109	352
G17025	155
G17037	155
G17050	155
G17075	155
G17100	155
G17125	155
G17150	155
G17200	155
G18025	155
G18037	155
G18050	155
G18075	155
G18100	155
G18125	155
G18150	155
G18200	155
G19025	155
G19037	155
G19050	155
G19075	155
G19100	155
G19125	155
G19150	155
G19200	155
G195-0002	352
G195-0025	352
G195-0050	352
G195-0100	352
G195-0150	352
G195-0215	352
G195-0295	352
G195-0390	352
G20002	146
G20003	146
G20004	146
G20005	146
G20006	147
G20008	146
G20010	146
G20011	146
G20015	146
G20016	146
G20017	146
G20020	146
G20021	146
G20030	146
G20031	146
G20032	146
G20035	146
G20036	146
G20037	146
G20038	146
G20040	147
G20041	147
G20042	147
G20043	147
G20045	147
G20047	147

PART NO.	PG #
G20050	147
G20051	147
G20052	147
G20053	147
G20054	147
G20055	147
G20056	147, 423
G20057	147
G20057R	147
G20060	147
G20086LF	72
G20102	146, 426
G20103	146, 426
G20108	146, 426
G20110	146, 426
G20111	146, 426
G20115	146, 426
G20116	146, 426
G20120	146, 426
G20121	146, 426
G20130	146, 426
G20131	146, 426
G20132	146, 426
G20136	146, 426
G20137	147, 426
G20138	147, 426
G20141	147, 426
G20142	147, 426
G20143	147, 426
G20150	147, 426
G20155	147, 426
G20157	426
G235-0001	353
G235-0002	353
G235-0007	353
G235-0025	353
G235-0032	353
G235-0050	353
G235-0058	353
G235-0059	353
G235-0060	353
G235-0100	353
G235-0107	353
G235-0108	353
G235-0109	353
G235-0150	353
G235-0159	353
G235-0160	353
G235-0215	353
G235-0222	353
G235-0223	353
G235-0224	353
G235-0295	353
G235-0303	353
G235-0304	353
G235-0305	353
G235-0306	353
G235-0390	353
G235-0398	353
G235-0399	353
G235-0400	353
G235-0401	353
G235-0402	353
G235-0520	353
G235-0531	353
G235-0532	353
G235-0533	353
G235-0650	353
G235-0662	353

<u>PART NO.</u>	<u>PG #</u>	<u>PART NO.</u>	<u>PG #</u>	<u>PART NO.</u>	<u>PG #</u>	<u>PART NO.</u>	<u>PG #</u>
G235-0663	353	G27084	148	G375-0100	354	G460-0316	355
G235-0860	353	G27086	148	G375-0150	354	G460-0317	355
G235-0975	353	G27088	148	G375-0215	354	G460-0318	355
G235-1100	353	G27106	148	G375-0295	354	G460-0319	355
G24004	148	G27108	148	G375-0390	354	G460-0328	355
G24006	148	G28044	148	G396-0001	354	G460-0329	355
G25022	148	G28066	148	G396-0002	354	G460-0330	355
G25032	148, 427	G28088	148	G396-0025	354	G460-0331	355
G25034	148	G290-0001	354	G396-0050	354	G460-0339	355
G25042	148, 427	G290-0002	354	G396-0100	354	G460-0340	355
G25044	148, 427	G290-0025	354	G396-0150	354	G460-0342	355
G25046	148, 427	G290-0050	354	G396-0215	354	G460-0350	355
G25048	148, 427	G290-0100	354	G396-0295	354	G460-0390	355
G25052	148, 427	G290-0150	354	G396-0390	354	G460-0398	355
G25054	148, 427	G290-0215	354	G396-0520	354	G460-0399	355
G25056	148	G290-0295	354	G396-0650	354	G460-0400	355
G25062	148	G290-0390	354	G396-0860	354	G460-0401	355
G25064	148, 427	G290-0520	354	G396-1100	354	G460-0402	355
G25066	148, 427	G290-0650	354	G460-0001	355	G460-0413	355
G25068	148, 427	G290-0860	354	G460-0002	355	G460-0414	355
G25084	148, 427	G29003	148	G460-0007	355	G460-0415	355
G25086	148, 427	G29004	148, 427	G460-0025	355	G460-0416	355
G25088	148, 427	G29005	148, 427	G460-0050	355	G460-0417	355
G25101	148, 427	G29006	148, 427	G460-0057	355	G460-0429	355
G25106	148, 427	G29008	148, 427	G460-0058	355	G460-0430	355
G25108	148, 427	G29010	148, 427	G460-0059	355	G460-0431	355
G25121	148, 427	G295-0001	354	G460-0100	355	G460-0444	355
G25128	148, 427	G295-0002	354	G460-0106	355	G460-0447	355
G25161	148	G295-0025	354	G460-0107	355	G460-0457	355
G25169	148	G295-0050	354	G460-0108	355	G460-0470	355
G254-0001	353	G295-0100	354	G460-0109	355	G460-0520	355
G254-0002	353	G295-0150	354	G460-0116	355	G460-0531	355
G254-0025	353	G295-0215	354	G460-0117	355	G460-0532	355
G254-0050	353	G295-0295	354	G460-0118	355	G460-0533	355
G254-0100	353	G295-0390	354	G460-0150	355	G460-0534	355
G254-0150	353	G295-0520	354	G460-0157	355	G460-0535	355
G254-0215	353	G295-0650	354	G460-0159	355	G460-0536	355
G254-0295	353	G295-0860	354	G460-0160	355	G460-0650	355
G254-0390	353	G30000	299, 400	G460-0161	355	G460-0662	355
G254-0520	353	G30001	299, 401	G460-0162	355	G460-0663	355
G254-0650	353	G30003	299, 401	G460-0169	355	G460-0665	355
G254-0860	353	G30004	299, 401	G460-0170	355	G460-0666	355
G25612	148	G30005	299, 401	G460-0171	355	G460-0667	355
G25812	148	G30011	299, 400	G460-0180	355	G460-0860	355
G26022	148	G30012	299, 400	G460-0181	355	G460-0870	355
G26032	148	G30013	299, 400	G460-0182	355	G460-0871	355
G26034	148	G30014	299, 400	G460-0215	355	G460-0872	355
G26042	148	G30015	299, 400	G460-0221	355	G460-0873	355
G26044	148	G30016	299, 400	G460-0222	355	G460-1100	355
G26046	148	G30017	299, 400	G460-0223	355	G486-0050	356
G26052	148	G30021	299, 400	G460-0224	355	G486-0100	356
G26054	148	G30030	299, 400	G460-0234	355	G486-0150	356
G26056	148	G335-0050	351	G460-0235	355	G50200	298, 399, 417
G26062	148	G335-0100	351	G460-0236	355	G50202	298, 399
G26064	148	G335-0150	351	G460-0237	355	G50204	299, 399, 411, 417, 419
G26066	148	G335-0215	351	G460-0245	355	G50205	298, 399
G26068	148	G335-0295	351	G460-0246	355	G50206	298, 399
G26084	148	G335-0390	351	G460-0247	355	G50208	299, 399
G26086	148	G355-0025	354	G460-0248	355	G50210	298
G26088	148	G355-0050	354	G460-0256	355	G50211	298
G26121	148	G355-0100	354	G460-0257	355	G50212	298, 398
G26161	148	G355-0150	354	G460-0258	355	G50214	299
G27042	148	G355-0215	354	G460-0259	355	G50215	298, 399
G27044	148	G355-0295	354	G460-0295	355	G50218	299
G27054	148	G355-0390	354	G460-0303	355	G50220	298, 399
G27062	148	G375-0001	354	G460-0304	355	G50223	298, 399, 411, 419
G27064	148	G375-0002	354	G460-0305	355	G50225	298, 399, 411, 419
G27066	148	G375-0025	354	G460-0306	355	G50228	298, 399, 411, 419
G27068	148	G375-0050	354	G460-0315	355		

PART NO.	PG #
G50229	298, 399, 411, 419
G50230	298, 398
G50231	298, 398
G50250	299, 399
G50251	299, 399
G50300	298, 399, 411, 419
G50302	299, 398, 411, 419
G51001	165
G51002	165
G51003	165
G51004	165
G51005	165
G51006	165
G51008	165
G51010	165
G51012	165
G51013	165
G51015	165
G51025	165
G51035	165
G51050	165
G51075	165
G51102	166
G51103	166
G51104	166
G51105	166
G51106	166
G51108	166
G51110	166
G51112	166
G51125	166
G51135	166
G52001	165
G52002	165
G52003	165
G52004	165
G52005	165
G52006	165
G52008	165
G52010	165
G52012	165
G52013	165
G52015	165
G52025	165
G52035	165
G52075	165
G52102	166
G52103	166
G52104	166
G52105	166
G52106	166
G52108	166
G52110	166
G52115	166
G52125	166
G53001	165
G53002	165
G53003	165
G53004	165
G53005	165
G53006	165
G53008	165
G53010	165
G53012	165
G53013	165
G53015	165
G53025	165
G53035	165
G53050	165

PART NO.	PG #
G53075	165
G53101	166
G53102	166
G53103	166
G53104	166
G53105	166
G53106	166
G53108	166
G53110	166
G53113	166
G53115	166
G53125	166
G53203	166
G53204	166
G53206	166
G53215	166
G53225	166
G54001	165
G54002	165
G54003	165
G54004	165
G54005	165
G54006	165
G54008	165
G54010	165
G54012	165
G54013	165
G54015	165
G54025	165
G54035	165
G54075	165
G54102	166
G54103	166
G54104	166
G54105	166
G54106	166
G54108	166
G54110	166
G54112	166
G54115	166
G54125	166
G54202	166
G54203	166
G54204	166
G54205	166
G54206	166
G54208	166
G54210	166
G54212	166
G54215	166
G54225	166
G55001	167
G55002	167
G55003	167
G55004	167
G55005	167
G55014	167
G55016	167
G55018	167
G55116	167
G55118	167
G55150	166
G55200	166
G55250	166
G55300	166
G55350	166
G55400	166
G55450	166
G55500	166

PART NO.	PG #
G55550	166
G55600	166
G60000	105
G60001	105
G60005	104
G60015	105
G60030	105
G60055	104
G60060	105
G60100	105
G60160	105
G60200	105
G60300	105
G61005	105
G61015	105
G61030	105
G61060	105
G61100	105
G61160	105
G61200	105
G61300	105
G62030	105
G62060	105
G62100	105
G62200	105
G62300	105
G63001	106
G64000	106
G64001	106
G64002	106
G64004	106
G64005	105
G64015	105
G64020	106
G64030	106
G64060	106
G64100	106
G64101	105
G64155	106
G64160	106
G64200	106
G64300	106
G64301	106
G64333	106
G65155	106
G657-0001	356
G657-0002	356
G657-0025	356
G657-0050	356
G657-0100	356
G657-0150	356
G657-0215	356
G657-0295	356
G657-0390	356
G657-0520	356
G657-0650	356
G657-0860	356
G66000	105
G66002	105
G66015	105
G66030	105
G66060	105
G66100	105
G67000	105
G67002	105
G67015	105
G67030	105
G67060	105
G67100	105

PART NO.	PG #
G70000	76
G70001	76
G70002	76
G70003	76
G70004	76
G70005	76
G70006	76
G70007	76
G70008	76
G70009	76
G70010	76
G70011	76
G70012	76
G70013	76
G70014	76
G70015	76
G70016	76
G70017	76
G70018	76
G70019	76
G70020	76
G70021	76
G70022	76
G70023	76
G70024	76
G70025	76
G70026	76
G70027	76
G70028	76
G70029	76
G70030	76
G70031	76
G70032	76
G70033	76
G70034	76
G70035	76
G70036	76
G70037	76
G70038	76
G70039	76
G70040	76
G70041	76
G70042	76
G70043	76
G70044	76
G70045	76
G70046	76
G70047	76
G70048	76
G70049	76
G70050	76
G70051	76
G70052	76
G70053	76
G70054	76
G70055	76
G70100	76
G70101	76
G70102	76
G70103	76
G70104	76
G70105	76
G70106	76
G70107	76
G70108	76
G70109	76
G70110	76
G70111	76
G70112	76

PART NO.	PG #	PART NO.	PG #	PART NO.	PG #	PART NO.	PG #
G70113	76	G70226	77	G71057	78	G71146	79
G70114	76	G70227	77	G71058	78	G71147	79
G70115	76	G70228	77	G71059	78	G71148	79
G70116	76	G70229	77	G71060	78	G71149	79
G70117	76	G70230	77	G71061	78	G71150	79
G70118	76	G70231	77	G71062	78	G71151	79
G70119	76	G70232	77	G71063	78	G71152	79
G70120	76	G70233	77	G71064	78	G71153	79
G70121	76	G70234	77	G71065	78	G71154	79
G70122	76	G70235	77	G71066	78	G71155	79
G70123	77	G70236	77	G71067	78	G71156	79
G70124	77	G70237	77	G71068	78	G71157	79
G70125	77	G71000	78	G71069	78	G71158	79
G70126	77	G71001	78	G71070	78	G71159	79
G70127	77	G71002	78	G71071	78	G71160	79
G70128	77	G71003	78	G71072	78	G71161	79
G70129	77	G71004	78	G71073	78	G71162	79
G70130	77	G71005	78	G71074	78	G71163	79
G70131	77	G71006	78	G71075	78	G71164	79
G70132	77	G71007	78	G71076	78	G71165	79
G70133	77	G71008	78	G71077	78	G71166	79
G70134	77	G71009	78	G71078	78	G71167	79
G70135	77	G71010	78	G71079	78	G71168	79
G70136	77	G71011	78	G71100	79	G71169	79
G70137	77	G71012	78	G71101	79	G71170	79
G70138	77	G71013	78	G71102	79	G71171	79
G70139	77	G71014	78	G71103	79	G71172	79
G70140	77	G71015	78	G71104	79	G71173	79
G70141	77	G71016	78	G71105	79	G71174	79
G70142	77	G71017	78	G71106	79	G71175	79
G70143	77	G71018	78	G71107	79	G71176	79
G70144	77	G71019	78	G71108	79	G71177	79
G70145	77	G71020	78	G71109	79	G71178	79
G70146	77	G71021	78	G71110	79	G71179	79
G70147	77	G71022	78	G71111	79	G71401	81
G70148	77	G71023	78	G71112	79	G71402	81
G70149	77	G71024	78	G71113	79	G71403	81
G70150	77	G71025	78	G71114	79	G71404	81
G70151	77	G71026	78	G71115	79	G72100	80
G70152	77	G71027	78	G71116	79	G72101	80
G70153	77	G71028	78	G71117	79	G72102	80
G70154	77	G71029	78	G71118	79	G72103	80
G70155	77	G71030	78	G71119	79	G72104	80
G70200	77	G71031	78	G71120	79	G72105	80
G70201	77	G71032	78	G71121	79	G72106	80
G70202	77	G71033	78	G71122	79	G72107	80
G70203	77	G71034	78	G71123	79	G72108	80
G70204	77	G71035	78	G71124	79	G72109	80
G70205	77	G71036	78	G71125	79	G72110	80
G70206	77	G71037	78	G71126	79	G72111	80
G70207	77	G71038	78	G71127	79	G72112	80
G70208	77	G71039	78	G71128	79	G72113	80
G70209	77	G71040	78	G71129	79	G72114	80
G70210	77	G71041	78	G71130	79	G72115	80
G70211	77	G71042	78	G71131	79	G72116	80
G70212	77	G71043	78	G71132	79	G72117	80
G70213	77	G71044	78	G71133	79	G72118	80
G70214	77	G71045	78	G71134	79	G72119	80
G70215	77	G71046	78	G71135	79	G72120	80
G70216	77	G71047	78	G71136	79	G72121	80
G70217	77	G71048	78	G71137	79	G72122	80
G70218	77	G71049	78	G71138	79	G72123	80
G70219	77	G71050	78	G71139	79	G72124	80
G70220	77	G71051	78	G71140	79	G72125	80
G70221	77	G71052	78	G71141	79	G72126	80
G70222	77	G71053	78	G71142	79	G72127	80
G70223	77	G71054	78	G71143	79	G72128	80
G70224	77	G71055	78	G71144	79	G72129	80
G70225	77	G71056	78	G71145	79	G72130	80

PART NO.	PG #	PART NO.	PG #	PART NO.	PG #	PART NO.	PG #
G72131	80	H10058	111	H17250	118	H54001	66
G72132	80	H10072	111	H17300	118	H54002	66
G72133	80	H10074	111	H17350	118	H54003	66
G72134	80	H10076	111	H17400	118	H54010	66
G72135	80	H10078	111	H18050	112	H54011	66
G72136	80	H10080	111	H18075	112	H54012	66
G72137	80	H10106	111	H20001	113	H54013	66
G72138	80	H10108	111	H20002	113	H54014	66
G72139	80	H10110	111	H20003	113	H54015	66
G72140	80	H10126	111	H20005	113	H54017	66
G72141	80	H10128	111	H20006	113	H54018	66
G72142	80	H10156	111	H20007	113	H54025	67
G72143	80	H10158	111	H20010	113	H54026	67
G72144	80	H10208	111	H20011	113	H54027	67
G72145	80	H11054	111	H20012	113	H54028	67
G72146	80	H11056	111	H20100	113	H54029	67
G72147	80	H11058	111	H20150	113	H54030	67
G72148	80	H11074	111	H20500	113	H54040	67
G72149	80	H11076	111	H21010	113	H54041	67
G72150	80	H11078	111	H21025	113	H54050	293
G72151	80	H11080	111	H21050	113	H54051	293
G72152	80	H11106	111	H21100	113	H54060	67
G72153	80	H11108	111	H21101	113	H54061	67
G72154	80	H11126	111	H21200	113	H54100	293
G72155	80	H11156	111	H22050	112	H56050	290
G72300	80	H11208	111	H22075	112	H56075	290
G72302	80	H11210	111	H23050	111	H60050	117
G72304	80	H12054	111	H24038	112	H60075	117
G72306	80	H12056	111	H24050	112	H60375	117
G72308	80	H12074	111	H24075	112	H60625	117
G72310	80	H12076	111	H24100	112	H65050	118
G72312	80	H12106	111	H25050	112	H65075	118
G72314	80	H13038	112	H25075	112	H65100	118
G72316	80	H13050	112	H25100	112	H65125	118
G72318	80	H13075	112	H26050	112	H65150	118
G72320	80	H13100	112	H26075	112	H65200	118
G72322	80	H13125	112	H26100	112	H65250	118
G72324	80	H13150	112	H26125	112	H65300	118
G72326	80	H13200	112	H26150	112	H65400	118
G72328	80	H13250	112	H26200	112	H65500	118
G72330	80	H13300	112	H27050	112	H65600	118
G72332	80	H13400	112	H27075	112	H66050	118
G72333	80	H14050	118	H27100	112	H66075	118
G72334	80	H14075	118	H28050	113	H66100	118
G72335	80	H14100	118	H28075	113	H66125	118
G73101	81	H14125	118	H28100	113	H66150	118
G73108	81	H14150	118	H28125	113	H66200	118
G73115	81	H14200	118	H28150	113	H66250	118
G73122	81	H14250	118	H28200	113	H66300	118
G73129	81	H14300	118	H29000	113	H66400	118
G74103	81	H14350	118	H29010	113	H68050	118
G74105	81	H14400	118	H30001	111	H68075	118
G74111	81	H15001	112	H30002	111	H68100	118
G74113	81	H15050	112	H30003	111	H68125	118
G74119	81	H15075	112	H30004	111	H68150	118
G74121	81	H15100	112	H30011	111	H68200	118
G74127	81	H15125	112	H30022	111	H68250	118
G74129	81	H15150	112	H30033	111	H68300	118
G74135	81	H15200	112	H30044	111	H68350	118
G74137	81	H16038	112	H305	361	H68400	118
GI05	359	H16050	112	H307	361	H68500	118
GI07	359	H16075	112	H310	361	H68600	118
GI10	359	H16100	112	H312	361	H68800	118
GI12	359	H17050	118	H320	361	H69050	118
GI15	359	H17075	118	H40001	300, 400	H69075	118
GI20	359	H17100	118	H40002	300, 400	H69100	118
H10052	111	H17125	118	H40003	300, 400	H69150	118
H10054	111	H17150	118	H40004	300, 400	H69200	118
H10056	111	H17200	118	H500X2	304, 406	H69250	118

PART NO.	PG #	PART NO.	PG #	PART NO.	PG #	PART NO.	PG #
H69300	118	I10016	151, 429	I12008	153	I52318	101
H69400	118	I10017	151, 429	I12009	153	I52358	101
H70050	119	I10018	151, 429	I12010	153	I53038	101
H70075	119	I10019	151, 429	I12011	153	I53050	101
H70100	119	I10020	151, 429	I12012	153	I53058	101
H70125	119	I10021	151, 429	I12013	153	I53075	101
H70150	119	I10022	151, 429	I12014	153	I53078	101
H70200	119	I10023	151, 429	I12015	153	I53118	101
H70250	119	I10024	151, 429	I12016	153	I53138	101
H70300	119	I10025	151, 429	I12017	153	I53158	101
H70350	119	I10026	151, 429	I12018	153	I53178	101
H70400	119	I10027	151, 429	I13001LF	152	I53218	101
H72050	119	I10028	151, 429	I13002LF	152	I53238	101
H72075	119	I10029	151, 429	I13003LF	152	I53258	101
H72100	119	I10030	151, 429	I13004LF	152	I53312	101
H72125	119	I10031	151, 429	I13005LF	152	I53318	101
H72150	119	I10032	151, 429	I13006LF	152	I53358	101
H72200	119	I10033	151, 429	I13007LF	152	I53412	101
H72250	119	I10034	151, 429	I13010LF	152	I53418	101
H72300	119	I10035	151, 429	I13011LF	152	I54050	101
H72375	119	I10036	151, 429	I13012LF	152	I54058	101
H72400	119	I10037	151, 429	I13013LF	152	I54075	101
H73050	119	I10038	151, 429	I13016LF	152	I54078	101
H73075	119	I10039	151, 429	I13017LF	152	I54118	101
H73100	119	I10040	151, 429	I13018LF	152	I54138	101
H73125	119	I10041	151, 429	I13019LF	152	I54158	101
H73150	119	I10042	151, 429	I13020LF	152	I54178	101
H73200	119	I10043	151, 429	I13021LF	152	I54218	101
H73375	119	I10044	151, 429	I13022LF	152	I54258	101
H80050	119	I10045	151, 429	I13023LF	152	I55058	101
H80375	119	I10046	151, 429	I13024LF	152	I55075	101
H81050	119	I10047	151, 429	I13025LF	152	I55078	101
H81375	119	I10048	151, 429	I13026LF	152	I55118	101
H82050	119	I10049	151, 429	I13027LF	152	I55138	101
H82375	119	I11001	150	I13029LF	152	I55158	101
H83050	118	I11002	150	I13031LF	152	I55178	101
H83075	118	I11003	150	I13032LF	152	I55218	101
H83100	118	I11004	150	I13033LF	152	I55258	101
H84050	118	I11005	150	I13036LF	152	I56058	101
H84075	118	I11006	150	I13037LF	152	I56075	101
H84100	118	I11007	150	I50058	101	I56078	101
H85050	118	I11008	150	I50075	101	I56118	101
H85075	118	I11009	150	I50078	101	I56138	101
H85100	118	I11010	150	I50118	101	I56158	101
H90100	308, 404	I11011	150	I50138	101	I56218	101
H90101	309, 404	I11012	150	I50158	101	I57058	101
HDNHC1	314	I11013	150	I50178	101	I57078	101
HDNHC10	314	I11014	150	I50218	101	I57115	101
HDNHC2	314	I11015	150	I50238	101	I57118	101
HDNHC3	314	I11016	150	I50258	101	I57138	101
HDNHC4	314	I11017	150	I51058	101	I57158	101
HDNHC5	314	I11018	150	I51078	101	I57178	101
HDNHC6	314	I11019	150	I51118	101	I57218	101
HDNHC8	314	I11020	150	I51138	101	I57238	101
I10001	151, 429	I11021	150	I51158	101	I57258	101
I10002	151, 429	I11022	150	I51178	101	I59050	102
I10003	151, 429	I11023	150	I51218	101	I59075	102
I10004	151, 429	I11024	150	I51238	101	I59100	102
I10005	151, 429	I11025	150	I51258	101	I59125	102
I10006	151, 429	I11026	150	I52034	101	I59150	102
I10007	151, 429	I11027	150	I52058	101	I59175	102
I10008	151, 429	I11028	150	I52078	101	I59200	102
I10009	151, 429	I12001	153	I52118	101	I59225	102
I10010	151, 429	I12002	153	I52138	101	I60025	97
I10011	151, 429	I12003	153	I52158	101	I60038	97
I10012	151, 429	I12004	153	I52178	101	I60050	97
I10013	151, 429	I12005	153	I52218	101	I60058	97
I10014	151, 429	I12006	153	I52238	101	I60075	97
I10015	151, 429	I12007	153	I52258	101	I60078	97

PART NO.	PG #	PART NO.	PG #	PART NO.	PG #	PART NO.	PG #
160118	97	180200	98	J01075	111	J39019	104
160138	97	180218	98	J01077	111	J39023	104
160158	97	180250	98	J01100	111	J39027	104
160200	97	180258	98	J01150	112	J39030	104
160218	97	180318	98	J01200	112	J39712	103
160250	97	181034	98	J01300	112	J39715	103
160258	97	181038	98	J01400	112	J39718	103
160300	97	181050	98	J04004	90	J39724	103
160318	97	181058	98	J04005	90	J40000	275
160350	97	181078	98	J04006	90	J40001	275
161038	97	181118	98	J04012	90	J40002	275
161050	97	181138	98	J04016	91	J40003	275
161058	97	181150	98	J04104	90	J40004	275
161075	97	181158	98	J04105	90	J40005	275
161078	97	181200	98	J04106	90	J40006	275
161118	97	181218	98	J04204	90	J40007	276
161138	97	181250	98	J04205	90	J40008	275
161158	97	181258	98	J04206	90	J40010	277, 416, 421
161200	97	181300	98	J04250	91	J40011	277
161218	97	181318	98	J34712	103	J40012	277
161250	97	181358	98	J34715	103	J40013	277
161258	97	181400	98	J34718	103	J40015	275, 416
161300	97	181418	98	J34724	103	J40016	55
161318	97	182034	98	J34800	104	J40017	55
161350	97	182038	98	J34970	104	J40018	277, 416
161358	97	182050	98	J34975	104	J40019	278, 415, 421
161418	97	182058	98	J34980	104	J40020	302
161450	97	182078	98	J35712	103	J40021	277, 415, 416
162038	97	182118	98	J35715	103	J40022	277
162050	97	182138	98	J35718	103	J40023	277
162058	97	182150	98	J35724	103	J40024	277
162075	97	182158	98	J36018	104	J40025	275
162078	97	182200	98	J36022	104	J40026	276, 416, 421
162118	97	182218	98	J36024	104	J40028	277
162138	97	182250	98	J36026	104	J40030	275
162158	97	182258	98	J36030	104	J40032	160
162200	97	182300	98	J36100	275	J40033	160
162218	97	182318	98	J36101	275	J40034	276
162250	97	182358	98	J36118	103	J40035	276, 415, 421
162258	97	182400	98	J36124	103	J40040	276
162300	97	182418	98	J36130	103	J40041	276
162318	97	183034	98	J36136	103	J40042	276
162350	97	183058	98	J36148	103	J40044	288
162358	97	183078	98	J36200	104	J40045	288
162418	97	183118	98	J36250	104	J40046	288
162450	97	183138	98	J36300	104	J40047	288
163058	97	183150	98	J36400	104	J40048	288
163075	97	183158	98	J36500	102	J40049	288
163078	97	183200	98	J36501	102	J40050	286
163118	97	183218	98	J36712	103	J40051	286
163138	97	183250	98	J36715	103	J40052	286
163158	97	183258	98	J36718	103	J40053	286
163200	97	183300	98	J36724	103	J40054	286
163218	97	183318	98	J37022	104	J40055	286
163250	97	183358	98	J37024	104	J40060	288
163258	97	183418	98	J37026	104	J40061	288
163300	97	1A1050	102	J37028	104	J40062	288
163318	97	1A1100	102	J37030	104	J40063	288
163350	97	1A2050	102	J37124	57, 319	J40065	278
163358	97	1A2100	102	J37150	57, 319	J40066	278
180034	98	INT001	102	J38020	104	J40067	278
180038	98	INT002	102	J38022	104	J40068	278
180050	98	IPC004	102	J38024	104	J40069	278
180058	98	J01001	89	J38026	104	J40070	278
180078	98	J01050	111	J38030	104	J40071	278
180118	98	J01051	111	J38712	103	J40072	278
180138	98	J01052	111	J38715	103	J40073	278
180150	98	J01053	111	J38718	103	J40074	278
180158	98	J01057	111	J38724	103	J40075	278, 421

PART NO.	PG #	PART NO.	PG #	PART NO.	PG #	PART NO.	PG #
J40076	278	J40262	281, 421	J40481	302	J41031	301
J40077	278	J40263	281	J40482	302	J41032	301
J40078	278	J40284	293	J40490	276, 415, 421	J41103	286
J40079	278	J40285	292	J40491	276, 415, 421	J41104	286
J40080	286, 416, 421	J40286	293	J40500	106	J41105	286
J40084	287, 405	J40287	293	J40501	106	J41106	286
J40086	288	J40288	292, 405	J40502	106	J41107	286
J40087	288	J40305	277	J40503	106	J41108	286
J40088	288	J40306	277	J40505	107	J41201	290
J40089	288	J40307	278	J40506	107	J41202	290
J40100	303	J40308	278	J40510	107	J41205	290
J40101	288	J40311	278	J40511	107	J41206	290
J40102	303, 405, 410, 418	J40325	278	J40529	289	J41210	290, 403
J40105	278	J40329	289	J40550	106	J42002	285
J40106	278	J40330	294	J40551	106	J42003	285
J40107	300, 404	J40331	294	J40553	105	J42004	285
J40111	300	J40332	294	J40554	105	J42008	288
J40115	300, 404	J40333	294	J40555	105	J42012	288
J40116	300	J40334	294	J40556	105	J42101	303
J40117	300	J40335	294	J40557	105	J42200	303
J40123	279	J40336	294	J40558	106	J43300	302, 401
J40124	288, 402	J40337	294	J40560	106	J43310	302, 401
J40125	113, 288, 402	J40338	294	J40561	107	J44050	279, 417, 421
J40128	278	J40339	294	J40562	107	J44075	279, 417
J40134	301	J40340	294	J40563	107	J44100	279, 417, 421
J40141	285	J40341	294	J40575	106	J44150	279, 417, 421
J40142	284	J40343	294	J40600	288	J44200	279, 417, 421
J40143	284	J40345	288, 405, 410, 418	J40601	288	J44300	279, 417, 421
J40144	284	J40346	288, 405, 410, 418	J40629	289	J44400	279, 417, 421
J40150	60	J40369	285	J40700	107	J44661	277
J40151	60	J40375	285	J40701	107	J45005	306
J40153	60	J40380	294	J40702	106	J45010	276, 415, 421
J40197	292	J40381	294	J40703	106	J45015	277, 416, 421
J40198	279	J40382	294	J40704	106	J45100	296
J40199	292	J40383	294	J40705	106	J60004	267
J40200	292	J40384	294	J40750	285	J60005	267
J40201	292	J40385	294	J40775	285	J60007	267
J40202	292	J40386	294	J40800	285	J60008	267
J40203	292	J40387	294	J40801	290	J60010	268
J40204	292	J40393	300, 402	J40802	290	J60011	268
J40206	292	J40400	284	J40803	290	J60012	268
J40207	292	J40401	290	J40804	290	J60026	267
J40208	292, 405	J40402	290	J40805	290	J60027	267
J40210	290	J40403	290	J40806	290	J60030	264
J40211	290	J40404	290	J40807	290	J60060	253
J40212	290	J40405	290	J40808	290	J60061	253
J40213	281	J40406	291	J40812	289	J60062	253
J40214	281	J40407	291	J40830	280, 416, 421	J60094	267
J40215	281	J40408	291	J40831	280, 421	J66300	105
J40217	281	J40410	290	J40950	286	J66301	105
J40218	281	J40411	290	J40951	286	J66302	105
J40219	281	J40429	289	J40952	286	K01120	300, 400
J40220	286	J40430	289	J40953	286	K012000	300, 400
J40221	286	J40431	289	J40954	286	K101010050	373
J40222	286	J40432	289	J40955	286	K101010100	373
J40223	278	J40433	300, 404	J40960	286	K101010105	373
J40224	278	J40434	300, 404, 411, 420	J40965	286	K101010295	373
J40225	278	J40435	300, 404, 411, 420	J40966	286	K101010390	373
J40228	281	J40436	300, 404	J40967	285	K101050100	373
J40229	289	J40437	300, 404, 411, 420	J41002	284	K101050157	373
J40230	278	J40438	300, 404, 411, 420	J41008	284	K101050215	373
J40235	277, 421	J40443	300, 404	J41009	284	K101050390	373
J40240	280	J40444	300, 404, 411, 420	J41010	284	K101150059	373
J40241	280	J40445	300, 404, 411, 420	J41011	284	K101750100	373
J40242	280	J40446	300, 404	J41021	289	K102550050	373
J40243	280	J40447	300, 404, 411, 420	J41022	289	K102550058	373
J40244	280	J40448	300, 404, 411, 420	J41023	289	K102550100	373
J40260	281, 415, 421	J40450	302	J41024	289	K102550150	373
J40261	281, 415, 421	J40451	302	J41030	301	K102570050	373

PART NO.	PG #	PART NO.	PG #	PART NO.	PG #	PART NO.	PG #
K102570058	373	K151010107	365	K151150295	366	K151650520	366
K102570100	373	K151010150	365	K151150390	366	K151650531	366
K102570107	373	K151010157	365	K151400007	369	K151650532	366
K102570150	373	K151010158	365	K151400032	369	K151650533	366
K102570160	373	K151010159	365	K151400058	369	K151650534	366
K102590050	373	K151010160	365	K151400059	369	K151650650	366
K102590058	373	K151010215	365	K151400107	369	K151650662	366
K102600050	373	K151010221	365	K151400108	369	K151650663	366
K104670050	374	K151010222	365	K151400149	369	K151650664	366
K104800050	374	K151010223	365	K151400159	369	K151650780	366
K104800057	374	K151010295	365	K151400160	369	K151650860	366
K104800058	374	K151010302	365	K151400222	369	K151650870	366
K104800100	374	K151010303	365	K151400223	369	K151650871	366
K104800107	374	K151010304	365	K151400303	369	K151650872	366
K104800159	374	K151010390	365	K151400398	369	K151650873	366
K104800160	374	K151010398	365	K151420060	366	K151650874	366
K104800215	374	K151010399	365	K151540001	367	K151651100	366
K104800222	374	K151010520	365	K151540002	367	K151651109	366
K104800223	374	K151010531	365	K151540025	367	K151651111	366
K104800224	374	K151010650	365	K151540050	367	K151651225	366
K104820050	374	K151010860	365	K151540090	367	K151651498	366
K104920050	374	K151050001	365	K151540100	367	K151670050	367
K104920100	374	K151050002	365	K151540150	367	K151700001	367
K104920143	374	K151050006	365	K151540215	367	K151700002	367
K104980118	374	K151050024	365	K151540295	367	K151700025	367
K113420215	380	K151050025	365	K151540390	367	K151700050	367
K113420520	380	K151050031	365	K151540520	367	K151700090	367
K113420650	380	K151050032	365	K151540650	367	K151700100	367
K113420860	380	K151050050	365	K151540860	367	K151700150	367
K113450390	380	K151050056	365	K151541100	367	K151700215	367
K113450650	380	K151050057	365	K151650001	366	K151700295	367
K113450860	380	K151050058	365	K151650002	366	K151700390	367
K126570215	370	K151050059	365	K151650007	366	K151700520	367
K126570295	370	K151050060	365	K151650008	366	K151700650	367
K126570390	370	K151050092	365	K151650015	366	K151700780	367
K126570520	370	K151050093	365	K151650025	366	K151700860	367
K126570650	370	K151050100	365	K151650032	366	K151700975	367
K126610050	374	K151050106	365	K151650033	366	K151701100	367
K126610100	374	K151050107	365	K151650050	366	K151720001	367
K126610150	374	K151050150	365	K151650058	366	K151720002	367
K126610215	374	K151050158	365	K151650059	366	K151720025	367
K126610295	374	K151050159	365	K151650090	366	K151720050	367
K126610390	374	K151050160	365	K151650093	366	K151720090	367
K126650050	374	K151050215	365	K151650094	366	K151720100	367
K126650100	374	K151050221	365	K151650095	366	K151720150	367
K126650150	374	K151050222	365	K151650100	366	K151720215	367
K126650215	374	K151050223	365	K151650107	366	K151720295	367
K126650295	374	K151050295	365	K151650108	366	K151720390	367
K142400050	373	K151050302	365	K151650109	366	K151720520	367
K142400100	373	K151050303	365	K151650149	366	K151720650	367
K142590050	373	K151050390	365	K151650150	366	K151720860	367
K142590100	373	K151050398	365	K151650159	366	K151720975	367
K151010001	365	K151050520	365	K151650160	366	K152350001	367
K151010002	365	K151050650	365	K151650161	366	K152350002	367
K151010005	365	K151140025	365	K151650215	366	K152350025	367
K151010006	365	K151140050	365	K151650222	366	K152350032	367
K151010007	365	K151140057	365	K151650223	366	K152350050	367
K151010024	365	K151140100	365	K151650224	366	K152350059	367
K151010025	365	K151140150	365	K151650295	366	K152350090	367
K151010031	365	K151140215	365	K151650303	366	K152350093	367
K151010032	365	K151140295	365	K151650304	366	K152350100	367
K151010050	365	K151140390	365	K151650305	366	K152350107	367
K151010056	365	K151150002	366	K151650306	366	K152350150	367
K151010057	365	K151150050	366	K151650390	366	K152350159	367
K151010058	365	K151150057	366	K151650398	366	K152350160	367
K151010059	365	K151150058	366	K151650399	366	K152350215	367
K151010092	365	K151150100	366	K151650400	366	K152350222	367
K151010100	365	K151150150	366	K151650401	366	K152350223	367
K151010106	365	K151150215	366	K151650402	366	K152350295	367

PART NO.	PG #	PART NO.	PG #	PART NO.	PG #	PART NO.	PG #
K152350303	367	K152950100	369	K154600090	371	K154600414	371
K152350390	367	K152950150	369	K154600092	371	K154600415	371
K152350398	367	K152950215	369	K154600095	371	K154600416	371
K152350520	367	K152950295	369	K154600100	371	K154600417	371
K152350650	367	K152950390	369	K154600106	371	K154600418	371
K152350780	367	K152950520	369	K154600107	371	K154600429	371
K152350860	367	K152950650	369	K154600108	371	K154600430	371
K152350975	367	K152950860	369	K154600109	371	K154600431	371
K152351100	367	K153960050	369	K154600117	371	K154600432	371
K152351225	367	K153960150	369	K154600118	371	K154600433	371
K152420001	368	K154100007	370	K154600127	371	K154600444	371
K152420002	368	K154100032	370	K154600150	371	K154600447	371
K152420015	368	K154100058	370	K154600157	371	K154600457	371
K152420025	368	K154100059	370	K154600158	371	K154600470	371
K152420050	368	K154100093	370	K154600159	371	K154600520	371
K152420090	368	K154100094	370	K154600160	371	K154600531	372
K152420100	368	K154100107	370	K154600161	371	K154600532	372
K152420150	368	K154100108	370	K154600169	371	K154600533	372
K152420215	368	K154100109	370	K154600170	371	K154600534	372
K152420295	368	K154100149	370	K154600171	371	K154600535	372
K152420390	368	K154100159	370	K154600180	371	K154600536	372
K152420520	368	K154100160	370	K154600181	371	K154600548	372
K152420650	368	K154100222	370	K154600182	371	K154600549	372
K152420860	368	K154100223	370	K154600215	371	K154600550	372
K152540002	368	K154100224	370	K154600220	371	K154600551	372
K152540025	368	K154100303	370	K154600221	371	K154600552	372
K152540050	368	K154100304	370	K154600222	371	K154600553	372
K152540090	368	K154100305	370	K154600223	371	K154600554	372
K152540100	368	K154100306	370	K154600224	371	K154600564	372
K152540150	368	K154100398	370	K154600234	371	K154600565	372
K152540215	368	K154100399	370	K154600235	371	K154600566	372
K152540295	368	K154100400	370	K154600236	371	K154600580	372
K152540390	368	K154100401	370	K154600237	371	K154600583	372
K152540520	368	K154100402	370	K154600245	371	K154600595	372
K152540650	368	K154100531	370	K154600246	371	K154600608	371
K152540860	368	K154100532	370	K154600247	371	K154600650	372
K152670050	368	K154100533	370	K154600248	371	K154600662	372
K152670100	368	K154100534	370	K154600256	371	K154600663	372
K152670215	368	K154100662	370	K154600295	371	K154600664	372
K152720002	368	K154100663	370	K154600302	371	K154600665	372
K152720025	368	K154100664	370	K154600303	371	K154600666	372
K152720050	368	K154100665	370	K154600304	371	K154600667	372
K152720090	368	K154100869	370	K154600305	371	K154600668	372
K152720100	368	K154100870	370	K154600306	371	K154600677	372
K152720150	368	K154100871	370	K154600315	371	K154600678	372
K152720215	368	K154100872	370	K154600316	371	K154600679	372
K152720295	368	K154100983	370	K154600317	371	K154600680	372
K152720390	368	K154101498	370	K154600318	371	K154600682	372
K152720520	368	K154600001	371	K154600319	371	K154600693	372
K152720860	368	K154600002	371	K154600328	371	K154600694	372
K152900001	368	K154600006	371	K154600329	371	K154600695	372
K152900002	368	K154600007	371	K154600330	371	K154600696	372
K152900025	368	K154600012	371	K154600331	371	K154600708	372
K152900050	368	K154600013	371	K154600332	371	K154600746	372
K152900090	368	K154600025	371	K154600339	371	K154600860	372
K152900100	368	K154600031	371	K154600340	371	K154600870	372
K152900150	368	K154600032	371	K154600341	371	K154600871	372
K152900215	368	K154600033	371	K154600342	371	K154600872	372
K152900295	368	K154600041	371	K154600343	371	K154600873	372
K152900390	368	K154600050	371	K154600350	371	K154600874	372
K152900520	368	K154600056	371	K154600352	371	K154600875	372
K152900650	368	K154600057	371	K154600390	371	K154600876	372
K152900860	368	K154600058	371	K154600397	371	K154600877	372
K152900975	368	K154600059	371	K154600398	371	K154600893	372
K152901100	368	K154600060	371	K154600399	371	K154600895	372
K152950002	369	K154600066	371	K154600400	371	K154600896	372
K152950025	369	K154600068	371	K154600401	371	K154600914	372
K152950050	369	K154600075	371	K154600402	371	K154600975	372
K152950090	369	K154600087	371	K154600413	371	K154601100	372

PART NO.	PG #	PART NO.	PG #	PART NO.	PG #	PART NO.	PG #
K154601109	372	K208400390	379	L26015	308, 409, 410, 419	L75408	271
K154601111	372	K208400398	379	L26016	308, 409, 410, 419	L75409	271
K154601113	372	K208400399	379	L26017	308, 409, 410, 419	L75908	270
K154601225	372	K208400413	379	L26018	308, 409, 410, 419	L75909	270
K154601498	371	K208400650	379	L40001	114	L95200	313
K155330050	369	K208400664	379	L40002	114	L95201	313
K155330090	369	K208450295	379	L42006	114	L95202	313
K155330100	369	K208450650	379	L42008	114	L95400	309
K155330150	369	K245500295	379	L42011	303	L95500	309, 400
K155330215	369	K245500390	379	L42012	303	M05001	75, 116, 265
K155330295	369	K245510215	379	L42013	303	M05003	75, 116, 265
K155330390	369	K245510295	379	L42014	303	M05005	75, 116
K156570050	370	K245510390	379	L42015	303	M05034	234
K156570100	370	K245540295	379	L42016	303	M05134	234
K156570150	370	K50001	282	L42017	303	M06001	120
K159470001	370	K50002	282	L42018	303	M06002	120
K159470002	370	K50003	282	L42019	303	M06006	121
K159470025	370	K50005	282	L42023	303	M06007	121
K159470050	370	K50011	295, 403, 412, 420	L42052	114	M06010	121
K159470090	370	K50012	295, 403, 412, 420	L42102	114	M07001	120
K159470100	370	K50015	295, 403	L42103	114	M07002	120
K159470150	370	K50016	295, 403	L42104	114	M101	361
K159470215	370	K50017	295, 403	L47001	74	M102	361
K159470295	370	K50018	295, 403, 412, 420	L47004	74	M103	361
K159470390	370	K50020	295, 403, 412, 420	L56020	62	M105	361
K201010215	377	K50041	282	L56023	62	M107	361
K201010295	377	K50042	282	L56024	62	M110	361
K201010390	377	K50043	282, 403, 410, 418	L56025	62	M112	361
K201010650	377	K50045	295, 403	L56026	62	M115	361
K201050295	377	K50046	282, 403, 410, 418	L56027	62	M120	361
K201050650	377	K52001	61	L65001	62	M12001	120
K201050860	377	K52002	61	L75001	270	M12002	120
K201100390	377	K52003	61	L75002	270	M12003	120
K201150295	377	K52004	61	L75006	270	M12004	120
K201200295	377	K52005	61	L75007	270	M12005	120, 121
K201540295	377	K52010	4, 61	L75009	271	M12006	120, 121
K201610215	377	K52011	4	L75010	271	M12007	121
K201610295	377	K52013	4	L75015	271	M12009	120
K201610390	377	K52014	4	L75016	271	M12022	120
K201620215	377	K52016	4	L75017	271	M12085	120
K201620650	377	K52017	4	L75018	271	M12100	120
K202350303	377	K53001	62	L75019	271	M125	361
K202350398	377	K53002	62	L75020	271	M130	361
K202350650	377	K53003	62	L75021	271	M140	361
K202350860	377	K53004	62	L75022	271	M15001	121
K202540650	378	K53005	62	L75023	271	M15002	121
K202540860	378	K53006	62	L75024	271	M15004	121
K202550295	378	K53007	62	L75040	270	M15005	121
K202900860	378	K53008	62	L75041	270	M15006	121
K202950650	378	K53055	62	L75042	270	M15009	121
K203100215	378	K53056	62	L75043	270	M20058	120
K203100295	378	K53057	62	L75080	270	M20075	120
K203100390	378	K53058	62	L75081	270	M20100	120
K204600215	378	K53060	62	L75085	270	M20101	120
K204600295	378	K53077	62	L75086	270	M20581	120
K204600390	378	K55006	62	L75091	270	M20751	120
K204600398	378	K55007	62	L75092	270	M25100	285
K204600414	378	L26001	308, 408, 410, 419	L75095	270	M25127	285
K204650295	378	L26002	308, 408	L75096	270	M25130	285
K204650390	378	L26003	308, 408, 410, 419	L75180	270	M25136	285
K204650398	378	L26004	308, 408, 410, 419	L75181	270	M25148	285
K204650695	378	L26005	307, 408, 410, 419	L75185	270	M25527	285
K204800295	378	L26006	307, 408	L75186	270	M25536	285
K204850295	378	L26007	307, 408, 410, 419	L75400	271	M25560	285
K204850390	378	L26008	307, 408, 410, 419	L75401	271	M25736	285
K205220390	379	L26009	308, 408	L75402	271	M25760	285
K208400215	379	L26010	308, 408, 410, 419	L75403	271	M25772	285
K208400295	379	L26011	308, 408	L75406	271	M25784	285
K208400303	379	L26012	308, 408	L75407	271	M25900	120, 278

PART NO.	PG #	PART NO.	PG #	PART NO.	PG #	PART NO.	PG #
M301	361	N14007	149	N20009	140	N2310BN	23
M302	361	N14008	149	N20010	140	N2310PB	23
M303	361	N14009	149	N20012	140	N2310RB	23
M305	361	N14010	149	N20014	140	N2310WB	23
M307	361	N14011	149	N20016	140	N24000	140, 428
M310	361	N14012	149	N20018	140	N24001	140
M312	361	N14013	149	N20020	140	N24002	140, 428
M315	361	N14014	149	N20022	140	N24003	140
M320	361	N14015	149	N21000	140	N24004	140
M325	361	N14016	149	N21001	140	N24005	140
M330	361	N14017	149	N21002	140	N24006	140
M340	361	N14018	149	N21003	140	N24007	140
N01001	156, 423	N14019	149	N21004	140	N24008	140
N01002	156, 423	N15001	149	N21005	140	N24009	140
N01010	155	N15100	144, 423	N21006	140	N24010	140
N01011	155	N15150	144	N21007	140	N24012	140
N01014	155	N15200	144, 423	N21008	140	N24014	140
N01027	155	N15250	144	N21009	140	N24016	140
N01028	155	N15300	144	N21010	140	N24018	140
N01029	155	N15350	144	N21012	140	N24020	140
N01032	156	N15400	144, 423	N21014	140	N24022	140
N01033	156	N15450	144	N21016	140	N25000	140, 428
N01034	156	N15500	144	N21018	140	N25002	140, 428
N01035	156	N15550	144	N21020	140	N25003	140
N01038	154	N15600	144	N21022	140	N25004	140
N01039	154	N15900	144	N22000	140	N25005	140
N06001	149	N15948	144	N22001	140	N25006	140
N07001	149	N15972	144	N22002	140	N25007	140
N09001	149	N16100	144, 423	N22003	140	N25008	140
N09002	149	N16150	144	N22004	140	N25009	140
N10001	149	N16200	144, 423	N22005	140	N25010	140
N10002	149	N16250	144	N22006	140	N25012	140
N10003	149	N16300	144	N22007	140	N25014	140
N10004	149	N16350	144	N22008	140	N25016	140
N10005	149	N16400	144, 423	N22009	140	N25018	140
N10006	149	N16450	144	N22010	140	N25020	140
N10007	149	N16500	144	N22012	140	N25022	141
N10008	149	N16550	144	N22014	140	N27000	141
N10442	423	N16600	144	N22016	140	N27002	141
N10442LF	154	N16900	144	N22018	140	N27003	141
N10444LF	154	N16918	144	N22020	140	N27004	141
N10544	427	N16924	144	N22022	140	N27005	141
N10544LF	154	N16936	144	N2206BN	23	N27006	141
N10566	427	N16948	144	N2206RB	23	N27007	141
N10566LF	154	N17050	23	N2206WB	23	N27008	141
N10642	427	N17100	144	N2210BN	23	N27009	141
N10664	427	N17150	144	N2210PB	23	N27010	141
N10664LF	154	N17300	144	N2210RB	23	N27012	141
N10944LF	154	N17375	23	N2210WB	23	N27014	141
N11001	149	N17400	144	N23000	140	N27016	141
N11002	149	N17600	144	N23001	140	N27018	141
N11003	149	N18001	149	N23002	140, 428	N27020	141
N11004	149	N18002	149	N23003	140	N27022	141
N11005	149	N18100	144	N23004	140	N28000	141
N11006	149	N18200	144	N23005	140	N28002	141
N11007	149	N18250	144	N23006	140	N28003	141
N11008	149	N18300	144	N23007	140	N28004	141
N12001	149	N18400	144	N23008	140	N28005	141
N12002	149	N18500	144	N23009	140	N28006	141
N12003	149	N18600	144	N23010	140	N28007	141
N12004	149	N20000	140	N23012	140	N28008	141
N12005	149	N20001	140	N23014	140	N28009	141
N12006	149	N20002	140	N23016	140	N28010	141
N14001	149	N20003	140	N23018	140	N28012	141
N14002	149	N20004	140	N23020	140	N28014	141
N14003	149	N20005	140	N23022	140	N28016	141
N14004	149	N20006	140	N2306BN	23	N28018	141
N14005	149	N20007	140	N2306RB	23	N28020	141
N14006	149	N20008	140	N2306WB	23	N28022	141

PART NO.	PG #	PART NO.	PG #	PART NO.	PG #	PART NO.	PG #
N29000	141	O25204	36	P12208	131	P35001	6, 56, 333
N29003	141	O25205	36	P12212	131	P35002	6, 333
N29004	141	O25206	36	P12328	131	P35003	6, 56
N29005	141	O25207	36	P12342	131	P35004	56, 333
N29006	141	O25208	36	P12362	131	P35005	56, 333
N29007	141	O25209	36	P12364	131	P3500BN	6
N29008	141	O25210	36	P12384	131	P3500NP	6
N29009	141	O25302	36	P12386	131	P3500PB	6
N29010	141	O25303	36	P12402	130	P3500RB	6
N29012	141	O25304	36	P12404	130	P3500WB	6
N29014	141	O25305	36	P12406	130	P35033	6
N29016	141	O25306	36	P12408	130	P3503BN	6
N29018	141	O25307	36	P13224	131	P3503RB	6
N29020	141	O25308	36	P13232	131, 428	P3503WB	6
N29022	141	O25309	36	P13424	131	P35041	56
N30000	141	O25310	36	P13432	131, 428	P35044	6
N30004	141	P10001	279	P13600	279	P3504BN	6
N30005	141	P10002	279	P13624	131	P3504RB	6
N30006	141	P10012	130, 428	P13632	131, 428	P3504WB	6
N30007	141	P10014	130	P13986	130	P35050	14, 15
N30008	141	P10016	130	P15050	233	P35051	14
N30009	141	P10018	130	P15075	233	P35052	14
N30010	141	P10032	130, 428	P15175	233	P35053	14
N31000	141	P10034	130, 428	P16002	130, 428	P35055	14
N31004	141	P10036	130	P16004	130, 428	P35056	14, 50
N31005	141	P10038	130	P16006	130	P35057	50
N31006	141	P10082	130, 428	P16008	130	P35058	14
N31007	141	P10084	130, 428	P19042	130	P35060	14, 50
N31008	141	P10086	130, 428	P19062	130	P35061	14, 50
N31009	141	P10088	130	P19064	130	P35062	14, 50
N31010	141	P10092	130, 428	P19082	130	P35063	14, 50
N62006LF	126	P10094	130, 428	P19084	130	P35064	14, 50
N62086LF	126	P10096	130, 428	P19086	130	P35065	14
N62106LF	126	P10098	130	P19128	130	P35066	15, 50
N65106LF	126	P10312	130	P20002	130	P35067	15, 50
N66066LF	126	P10452	130	P20004	130	P35068	14, 15
N66068LF	126	P10454	130	P20006	130	P35070	14, 50
N66088LF	126	P10812	130	P20008	130	P35071	14
N66610LF	126	P10912	130	P20092	131	P35072	14
N68066LF	126	P11042	131, 428	P20094	131	P35073	14
N68068LF	126	P11062	131, 428	P20096	131	P35077	50
N68088LF	126	P11064	131, 428	P20098	131	P35125	50
N69066LF	126	P11082	131	P21100	57	P35150	50
N69068LF	126	P11084	131, 428	P21101	57	P35158	50
N70016	297	P11086	131, 428	P21102	57	P35159	64
N70020	297	P11102	131	P21103	57	P35160	50
N70024	297	P11104	131	P21104	57	P35161	50
N70032	297	P11106	131	P21107	57	P35162	64
N70050	297	P11108	131	P21150	57	P35163	64
N70066LF	126	P11122	131	P22100	234	P35165	64
N70068LF	126	P11124	131, 428	P22101	234	P35166	64
N70075	297	P11126	131	P22200	234	P35167	64
N70086LF	126	P11128	131, 428	P22201	234	P35170	14, 50
N70150	297	P11202	131, 428	P22300	234	P35171	14
N70175	297	P11204	131, 428	P22400	234	P35172	14
N70200	297	P11206	131, 428	P24001	170, 215, 251, 397	P35175	50
N70250	297	P11208	131, 428	P24002	170, 215, 251, 397	P35180	64
N70300	297	P11212	131	P24003	170, 215, 251, 397	P3560AB	15
N70500	297	P11928	131	P24004	170, 215, 251, 397	P3560AL	15
N70575	297	P11964	131	P27001	285	P3560AN	15
O15001	114	P11986	131	P27003	285	P3560BI	15
O15002	114	P12102	130	P27004	285	P3560BL	15
O15003	114	P12104	130	P27005	285	P3560BN	15
O15006	114	P12106	130	P27040	285	P3560BS	15
O15007	114	P12108	130	P27048	285	P3560PN	15
O25199	60	P12112	130	P3450BN	6	P3560PS	15
O25200	60	P12202	131	P3450CP	6	P3560PW	15
O25202	36	P12204	131	P3450RB	6	P3560RB	15
O25203	36	P12206	131	P35000	56	P3560WB	15

PART NO.	PG #	PART NO.	PG #	PART NO.	PG #	PART NO.	PG #
P35610	14, 15	P35902	56	P37200	328	P3761RB	18
P35611	14, 15	P35904	56	P37400	328	P3761WB	18
P35612	14	P35905	56	P37445	328	P38001	319
P35613	14	P35906	56	P37490	328	P38002	319
P35614	14	P35907	56	P37500	18, 332	P38002B	319
P35615	13	P35908	56	P37502	18, 332	P38003	319
P35616	12	P35909	56	P37503	18, 332	P38003B	319
P3561AB	15	P35910	56	P37505	18, 332	P38004	319
P3561AL	15	P35911	56	P37506	18, 332	P38005	319
P3561AN	15	P35912	56	P37508	18, 332	P38005B	319
P3561BI	15	P35913	56	P37509	18, 332	P38006	319
P3561BL	15	P35920	6	P3750AB	18	P38006B	319
P3561BN	15	P35921	6	P3750AL	18	P38007	319
P3561BS	15	P35922	6	P3750AN	18	P38008	319
P3561PN	15	P36002	50	P3750BI	18	P38009	319
P3561PS	15	P36003	50	P3750BL	18	P38009B	319
P3561PW	15	P36004	50	P3750BN	18	P38010	319
P3561RB	15	P36100	6	P3750BS	18	P38010B	319
P3561WB	15	P36101	6, 329	P3750PN	18	P38011	319
P3562AB	14	P36102	57, 329	P3750PS	18	P38012	319
P3562AL	14	P36103	57, 329	P3750PW	18	P38012B	319
P3562AN	14	P36104	331	P3750RB	18	P38013	320
P3562BI	14	P36105	331	P3750WB	18	P38014	320
P3562BL	14	P36125	6	P37511	18, 332	P38015	320
P3562BN	14	P36150	6	P37512	332	P38016	320
P3562BS	14	P37000	335	P37514	332	P38017	320
P3562PN	14	P37001	326	P37515	332	P38018	320
P3562PS	14	P37002	326	P37517	332	P38019	320
P3562PW	14	P37003	326	P37518	332	P38020	320
P3562RB	14	P37004	326	P3751AB	18	P38021	321
P3562WB	14	P37005	326	P3751AL	18	P38022	321
P3563AB	14	P37006	326	P3751AN	18	P38023	321
P3563AL	14	P37007	326	P3751BI	18	P38024	321
P3563AN	14	P37008	326	P3751BL	18	P38025	321
P3563BI	14	P37009	326	P3751BN	18	P38026	321
P3563BL	14	P37010	327	P3751BS	18	P38027	321
P3563BN	14	P37011	327	P3751PN	18	P38028	321
P3563BS	14	P37012	327	P3751PS	18	P38029	321
P3563PN	14	P37013	327	P3751PW	18	P38030	322
P3563PS	14	P37014	327	P3751RB	18	P38031	322
P3563PW	14	P37015	327	P3751WB	18	P38032	322
P3563RB	14	P37016	327	P37520	332	P38033	322
P3563WB	14	P37017	327	P3752AB	18	P38034	322
P3565AB	13	P37018	327	P3752AL	18	P38035	322
P3565AL	13	P37019	328	P3752AN	18	P38036	322
P3565AN	13	P37020	328	P3752BI	18	P38037	322
P3565BI	13	P37021	328	P3752BL	18	P38038	322
P3565BL	13	P37022	328	P3752BN	18	P38039	322
P3565BN	13	P37023	328	P3752PN	18	P38040	322
P3565BS	13	P37024	328	P3752PS	18	P38041	322
P3565PN	13	P37025	328	P3752PW	18	P38042	322
P3565PS	13	P37026	328	P3752RB	18	P38043	322
P3565PW	13	P37027	328	P3752WB	18	P38044	322
P3565RB	13	P37028	328	P37550	19	P38045	322
P3565WB	13	P37029	328	P3755BN	19	P38046	322
P3566AB	13	P37030	327	P3755PB	19	P38047	322
P3566AL	13	P37031	327	P3755RB	19	P38048	322
P3566AN	13	P37032	326	P3755WB	19	P38049	322
P3566BI	13	P37033	328	P3755WH	19	P38050	322
P3566BL	13	P37034	326	P3761AB	18	P38051	322
P3566BN	13	P37035	328	P3761AL	18	P38052	322
P3566BS	13	P37036	326	P3761AN	18	P38053	322
P3566PN	13	P37037	328	P3761BI	18	P38054	322
P3566PS	13	P37038	328	P3761BL	18	P38055	322
P3566PW	13	P37040	327	P3761BN	18	P38056	322
P3566RB	13	P37041	327	P3761BS	18	P38057	322
P3566WB	13	P37042	326	P3761PN	18	P38058	322
P35900	56	P37118	327	P3761PS	18	P38059	322
P35901	56	P37150	328	P3761PW	18	P38060	322

PART NO.	PG #	PART NO.	PG #	PART NO.	PG #	PART NO.	PG #
P38061	322	P38131	323	P39028	331	P3961WB	18
P38062	323	P38132	323	P39029	331	P40004	296
P38063	324	P38133	323	P39030	330	P40014	296
P38064	324	P38134	323	P39031	330	P40080	296
P38065	323	P38135	323	P39032	329	P48002	219
P38066	323	P38136	323	P39033	330	P48003	219
P38067	323	P38137	320	P39034	329	P48004	219
P38068	323	P38138	319	P39035	331	P48102	219
P38069	323	P38140	320	P39040	331	P48103	219
P38070	323	P38141	320	P39041	331	P48104	219
P38071	323	P38142	320	P39500	18, 332	P48400	223
P38072	323	P38143	324	P39502	18, 332	P49002	223
P38073	323	P38148	324	P39503	18, 332	P49003	223
P38074	323	P38150	319	P39505	18, 332	P49004	223
P38075	323	P38162	323	P39506	18, 332	P49015	223
P38076	323	P38163	324	P39508	18, 332	P49025	223
P38077	323	P38164	324	P39509	18, 332	P49035	223
P38078	323	P38165	324	P3950AB	18	P49150	223
P38079	323	P38166	324	P3950AL	18	P49200	223
P38080	323	P3819BN	7	P3950AN	18	P49250	223
P38081	323	P3819RB	7	P3950BI	18	P49350	223
P38082	323	P38217	322	P3950BL	18	P49600	223
P38083	323	P38238	322	P3950BN	18	P49915	223
P38084	323	P38257	324	P3950BS	18	P49920	223
P38085	323	P38406	325	P3950PN	18	P49925	223
P38086	323	P38420	325	P3950PS	18	P49930	223
P38087	323	P38428	325	P3950PW	18	P49935	223
P38088	323	P38443	325	P3950RB	18	P49940	223
P38089	323	P38444	325	P3950WB	18	P50100	260
P38091	319	P38447	325	P39511	18, 332	P50125	260
P38092	319	P38454	325	P39512	332	P50150	260
P38093	319	P38458	325	P39514	332	P50200	260
P38094	319	P38459	325	P39515	332	P50250	260
P38095	320	P38460	325	P39517	332	P50300	260
P38096	320	P38486	325	P39518	332	P50350	260
P38097	320	P38489	325	P3951AB	18	P50400	260
P38098	321	P3892BN	6	P3951AL	18	P50500	260
P38099	321	P3892NP	6	P3951AN	18	P50600	260
P38100	321	P3892PB	6	P3951BI	18	P50800	260
P38101	321	P3892RB	6	P3951BL	18	P50999	260
P38102	321	P3892WB	6	P3951BN	18	P51150	260
P38103	321	P39000	335	P3951BS	18	P51200	260
P38104	321	P39001	329	P3951PN	18	P51250	260
P38105	321	P39002	329	P3951PS	18	P51300	260
P38106	321	P39003	329	P3951PW	18	P51350	260
P38107	320	P39004	329	P3951RB	18	P51400	260
P38108	320	P39005	329	P3951WB	18	P51500	260
P38109	320	P39006	329	P3952AB	18	P51600	260
P38110	320	P39007	329	P3952AL	18	P51800	260
P38111	320	P39008	329	P3952AN	18	P52150	260
P38112	320	P39009	329	P3952BI	18	P52200	260
P38113	321	P39010	330	P3952BL	18	P52250	260
P38114	321	P39011	330	P3952BN	18	P52300	260
P38115	322	P39012	330	P3952PN	18	P52350	260
P38116	322	P39013	330	P3952PS	18	P52400	260
P38117	322	P39014	330	P3952PW	18	P52500	260
P38118	323	P39015	330	P3952RB	18	P53150	260
P38119	323	P39016	330	P3952WB	18	P53200	260
P38120	323	P39017	330	P3961AB	18	P53250	260
P38121	323	P39018	330	P3961AL	18	P53300	260
P38122	323	P39019	330	P3961AN	18	P53350	260
P38123	323	P39020	330	P3961BI	18	P53400	260
P38124	323	P39021	330	P3961BL	18	P53500	260
P38125	323	P39022	330	P3961BN	18	P54150	261
P38126	323	P39023	331	P3961BS	18	P54200	261
P38127	323	P39024	331	P3961PN	18	P54250	261
P38128	323	P39025	331	P3961PS	18	P54300	261
P38129	320	P39026	331	P3961PW	18	P54350	261
P38130	320	P39027	331	P3961RB	18	P54400	261

<u>PART NO.</u>	<u>PG #</u>	<u>PART NO.</u>	<u>PG #</u>	<u>PART NO.</u>	<u>PG #</u>	<u>PART NO.</u>	<u>PG #</u>
P54500	261	PCT340	345	PFL131	342	PMA440	341
P54600	261	PCT416	345	PFL515	343	PNH120	347
P54800	261	PCT421	345	PFL520	343	PNH130	347
P55150	260	PCT431	345	PFL530	343	PNH140	347
P55250	260	PCT441	345	PFL540	343	PPT015	346
P55300	114, 260	PDL716	344	PFL560	343	PPT020	346
P55350	260	PDL722	344	PFL614	343	PPT030	346
P55500	260	PDL736	344	PFL615	343	PPT040	346
P56200	260	PDT515	346	PFL615S	343	PPT315	346
P56250	260	PDT520	346	PFL620	343	PPT320	346
P56300	260	PDT521	346	PFL620S	343	PPT415	346
P56350	260	PDT530	346	PFL630	343	PPT420	346
P56400	260	PDT531	346	PFL640	343	PPT515	346
P56450	260	PDT532	346	PFL660	343	PPT520	346
P56500	260	PDT540	346	PFL715	342	PPT530	346
P56550	260	PDT542	346	PFL720	342	PPT540	346
P56600	260	PDT543	346	PFL730	342	PPT715	346
P58150	261	PDT621	344	PFL814	342	PPT915S	346
P58200	261	PDT715	347	PFL815	342	PPT920S	346
P58250	261	PDY415	344	PFL815L	342	PSA730	348
P58300	261	PDY420	344	PFL820	342	PSA740	348
P58350	261	PDY430	344	PFL820L	342	PSL031	345
P58400	261	PDY440	344	PFL821	342	PSL042	345
P59300	261	PDY442	344	PFL830	342	PSL132	345
P59333	261	PDY443	344	PFL830L	342	PSL715S	342
P59350	261	PEJ520	347	PFL834	342	PSL716S	342
P59355	261	PEJ530	347	PFL840	342	PSL720	342
P59400	261	PEJ540	347	PFL840L	342	PSL730	342
P59444	261	PFA311	341	PFL860	342	PSL740	342
P60001	290, 415	PFA314	341	PFL915	342	PSL760	342
P60002	290	PFA315	341	PFL920	342	PSL815	343
P60003	290	PFA320	341	PFL930	342	PSL820	343
P70001	280	PFA330	341	PFL940	342	PSL830	343
P70002	280	PFA340	341	PFY014	344	PSL840	343
P70005	280	PFA360	341	PFY015	344	PSL916	342
P70006	280	PFA614	343	PFY020	344	PSL926	342
P70010	280	PFA615	342	PFY021	344	PSL936	342
P70011	280	PFA619	343	PFY023	344	PSL946	342
P70012	280	PFA620	342	PFY030	344	PSS140	345
P70015	280	PFA629	343	PFY031	344	PST114	345
P70016	280	PFA630	342	PFY032	344	PST115	345
P70018	280, 415, 421	PFA639	343	PFY040	344	PST120	345
P70019	280, 415, 421	PFA640	342	PFY041	344	PST121	345
P70020	280	PFA659	343	PFY042	344	PST122	345
P70023	280	PFB211	341	PFY043	344	PST123	345
P70029	280	PFB221	341	PFY060	344	PST130	345
P70030	280	PFB224	341	PFY064	344	PST131	345
P70031	280	PFB231	341	PFY515L	344	PST132	345
P70035	280, 415, 421	PFB232	341	PFY520L	344	PST140	345
P70036	280	PFB242	341	PFY521	344	PST141	345
P70050	280	PFB243	341	PFY530L	344	PST142	345
P70051	281	PFB264	341	PFY531	344	PST143	345
P70052	281, 415, 421	PFC114	341	PFY532	344	PST160	345
P70053	281	PFC115	341	PFY540L	344	PST164	345
P70055	280	PFC116	341	PFY542	344	PST232	345
P70056	281, 415	PFC120	341	PFY543	344	PTA211	347
P70060	281	PFC121	341	PHA520	347	PTA215	347
P70064	281, 415, 421	PFC122	341	PHA521	347	PTA221	347
P70065	281	PFC130	341	PHA530	347	PTA223	347
P70066	281	PFC131	341	PHA540	347	PTA311	347
P70067	281, 415	PFC132	341	PHA543	347	PTA315	347
P70069	281	PFC133	341	PHC151	343	PTA415	347
PAB243	348	PFC140	341	PHC152	343	PTA420	347
PAB75340	348	PFC142	341	PHC153	343	PTC633	346
PAC543	348	PFC143	341	PHC154	343	PTC644	346
PCB934	347	PFC144	341	PMA414	341	PVT415	344
PCT315	345	PFC160	341	PMA415	341	PVT420	344
PCT320	345	PFL031	343	PMA420	341	PVT430	344
PCT330	345	PFL032	343	PMA430	341	PVT440	344

PART NO.	PG #
Q00200	422
Q01005	423, 424, 425, 426, 427, 428, 429
Q01006	423, 424, 425, 426, 427, 428
Q01009	423
R15050	233
R15075	233
R15100	115
R15101	115
R15107	115
R15108	115
R15109	115
R15202	102
R15204	102
R15206	102
R16100	115
R16101	115
R16107	115
R16108	115
R18001	235
R18005	235
R18006	235
R18007	235
R18008	235
R18009	235
R18011	235
R18012	235
R18013	235
R18014	235
R18015	235
R18016	235
R18017	235
R18018	235
R18019	235
R18020	235, 266
R18026	235
R18027	235
R18028	235
R19003	266
R19004	266
R19005	266
R19006	266
R19099	266
R19100	266
R19102	266
R19103	266
R19104	266
R19202	266
R19203	266
R19204	266
R19206	266
R19302	266
R19303	266
R19304	266
R19305	266
R19306	266
R19307	266
R19402	266
R19403	266
R19404	266
R20001	159
R20002	159
R20003	159
R20005	159
R20006	159
R20007	159
R20008	159
R20009	159

PART NO.	PG #
R20100	160
R20101	160
R20102	160
R20104	159
R20105	159
R20107	159
R20108	159
R20109	159
R20110	159
R20111	159
R20112	159
R20113	159
R20150	160
R20151	160
R20152	160
R20153	160
R20154	160
R30050	85
R30075	85
R30100	85
R30125	85
R30150	85
R30200	85
R30250	85
R30300	85
R30375	85
R30400	85
R30600	85
R40150	115
R40200	115
R40300	115
R40400	115
R45150	115
R45200	115
R45300	115
R45400	115
R50150	115
R50200	115
R50300	115
R50400	115
R57150	115
R57200	115
R57300	115
R57400	115
R60001	119
R60002	119
R60003	119
R60004	119
R60050	85
R60075	85
R60100	85
R60125	85
R60150	85
R60200	85
R60250	85
R60300	85
R60375	85
R60400	85
R60600	85
R70150	115
R70200	115
R70300	115
R70400	115
S01001	44
S01002	44
S01003	44
S01004	44
S01005	44
S01008	44

PART NO.	PG #
S01009	44
S01010	7, 44
S01013	45
S01014	45
S01015	45
S01016	45
S0101BN	7
S0101RB	7
S0101WB	7
S01020	45
S01025	45
S01030	9, 45
S01032	9, 45
S01035	9, 45
S01036	9
S01037	9
S01038	9, 45
S01039	45
S01040	45
S01041	45
S01042	45
S01044	45
S01045	45
S01049	45
S01050	47
S01051	9
S01052	9
S01053	9
S01055	8
S01056	9
S01057	9
S01058	9
S01060	46
S01061	46
S01070	7, 47
S01071	7
S01072	7
S01073	7
S01080	46
S01084	7
S01085	7
S01086	7
S01087	7
S01088	8
S01089	8
S01090	8
S01091	8
S01092	8
S01093	8
S01094	8
S01095	8
S01096	8
S01151	9
S01152	9
S01153	9
S01155	8
S01156	9
S01157	9
S01158	9
S01184	7
S01185	7
S01186	7
S01187	7
S0130BN	9
S0130RB	9
S0130WB	9
S0132BN	9
S0132RB	9
S0132WB	9

PART NO.	PG #
S0151BN	9
S0151RB	9
S0151WB	9
S0152BN	9
S0152RB	9
S0152WB	9
S0153BN	9
S0153RB	9
S0153WB	9
S0155BN	8
S0155RB	8
S0155WB	8
S0156BN	9
S0156RB	9
S0156WB	9
S0157BN	9
S0157RB	9
S0157WB	9
S0158BN	9
S0158RB	9
S0158WB	9
S0184BN	7
S0184RB	7
S0184WB	7
S0185BN	7
S0185RB	7
S0185WB	7
S0186BN	7
S0186RB	7
S0186WB	7
S0187BN	7
S0187RB	7
S0187WB	7
S0188BN	8
S0188RB	8
S0188WB	8
S0189BN	8
S0189RB	8
S0189WB	8
S0192BN	8
S0192RB	8
S0192WB	8
S0193BN	8
S0193RB	8
S0193WB	8
S0194BN	8
S0194RB	8
S0194WB	8
S0195BN	8
S0195RB	8
S0195WB	8
S0196BN	8
S0196RB	8
S0196WB	8
S02015	44
S02016	44
S02055	44
S02056	44
S02057	44
S02058	44
S02059	44
S02066	44
S02069	44
S02070	44
S02071	44
S02072	44
S02073	44
S02074	44
S02100	45

PART NO.	PG #	PART NO.	PG #	PART NO.	PG #	PART NO.	PG #
S02150	44	S04225	71	S04423	72	S10318	73
S02151	44	S04226	71	S04424	72	S10319	73
S02152	44	S04227	71	S04430	72	S10320	73
S02190	10, 44	S04228	71	S04440	72	S10321	73
S02193	10, 44	S04229	71	S04450	72	S10323	73
S02290	10, 44	S04230	71	S04455	72	S10324	73
S02293	10, 44	S04231	71	S05100	74	S10325	73
S02300	44	S04232	71	S05101	74	S10326	73
S03009	7	S04233	72	S05102	74	S10327	73
S03030	9	S04234	72	S05105	74	S10328	73
S03032	9	S04235	72	S06014	291	S10330	73
S03040	10	S04236	72	S06015	291	S10331	73
S03051	7	S04237	72	S06016	291	S10332	73
S03151	7	S04238	72	S06017	291	S10333	73
S03152	7	S04239	72	S06018	291	S10334	73
S03220	49	S04240	72	S06019	291	S10335	73
S03222	49	S04241	72	S06021	291, 402, 410, 418	S10336	73
S04020	26, 73	S04242	72	S06115	291, 402	S10337	73
S04021	73	S04243	72	S06116	291, 402	S10338	73
S04022	26, 73	S04244	72	S06117	291, 402	S10339	73
S04023	73	S04245	72	S08003	74	S10340	73
S04024	73	S04246	72	S08008	74	S10341	73
S04025	73	S04247	72	S08012	74	S1034BN	25
S04026	73	S04248	72	S08018	74	S1034RB	25
S04027	26, 73	S04249	72	S08020	4, 62	S10351	25
S04028	73	S04250	72	S08030	74	S10355	73
S04029	26, 73	S04255	71	S08031	74	S1035AP	25
S04030	73	S04260	72	S08032	74	S1035BB	25
S04031	73	S04268	72	S08100	306	S1035BN	25
S04032	73	S04269	72	S10020	4	S1035PS	25
S04101	73	S04270	72	S10021	4	S1035RB	25
S04102	73	S04275	72	S10022	4	S1035WB	25
S04103	73	S04276	72	S10023	4	S10361	25
S04104	73	S04280	71	S10024	4	S1036AP	25
S04105	73	S04285	71	S10025	4	S1036BB	25
S04106	73	S04350	103	S10067	46	S1036BN	25
S04107	73	S04351	103	S10068	46	S1036PS	25
S04108	73	S04352	103	S10069	46	S1036RB	25
S04121	73	S04353	103	S10070	46	S1036WB	25
S04123	73	S04354	103	S10071	46	S10371	25
S04124	73	S04355	103	S10072	46	S1037AP	25
S04125	73	S04356	103	S10073	46	S1037BB	25
S04127	73	S04357	103	S10074	46	S1037BN	25
S04128	73	S04358	103	S10075	46	S1037CP	25
S04200	71	S04359	103	S10076	46	S1037PS	25
S04201	71	S04360	103	S10077	46	S1037RB	25
S04202	71	S04400	72	S10078	46	S1037WB	25
S04203	71	S04401	72	S10079	47	S10381	25
S04204	71	S04402	72	S10080	46	S1038AP	25
S04205	71	S04403	72	S10081	46	S1038BB	25
S04206	71	S04404	72	S10082	46	S1038BN	25
S04207	71	S04405	72	S10083	46	S1038CP	25
S04208	71	S04406	72	S10100	306	S1038PS	25
S04209	71	S04407	72	S10203	24	S1038RB	25
S04210	71	S04408	72	S10206	24	S1038WB	25
S04211	71	S04409	72	S10210	24	S1039BN	25
S04212	71	S04410	72	S10214	24	S1039CP	25
S04213	71	S04411	72	S10300	73	S1039RB	25
S04214	71	S04412	72	S10301	73	S1135BN	25
S04215	71	S04413	72	S10302	73	S1135RB	25
S04216	71, 409, 418	S04414	72	S10303	73	S1136BN	25
S04217	71, 409, 418	S04415	72, 409, 418	S10310	73	S1136RB	25
S04218	71	S04416	72	S10311	73	S1137BN	25
S04219	71, 409, 418	S04417	72	S10312	73	S1137RB	25
S04220	71	S04418	72	S10313	73	S1138BN	25
S04221	71	S04419	72	S10314	73	S1138RB	25
S04222	71, 409, 418	S04420	72	S10315	73	S12005	43
S04223	71	S04421	72	S10316	73	S13130	43
S04224	71	S04422	72	S10317	73	S13140	43

PART NO.	PG #	PART NO.	PG #	PART NO.	PG #	PART NO.	PG #
S13240	43	S26004	224	S41356	286	S4405WB	26
S14001	63, 336	S26005	224	S41357	286	S49000	281
S14002	63, 336	S26006	224	S41364	286, 404, 410, 418	S49001	281, 421
S14003	336	S26007	224	S41450	286, 404, 410, 418	S49002	281
S14003	63	S26008	224, 269	S41452	286, 404, 410, 418	S49003	282
S14004	336	S26009	224	S41453	286, 404, 410, 418	S49004	281
S14004	63	S26010	224	S41455	286, 404, 410, 418	S49005	282
S14005	63, 336	S26011	224	S42021	24	S49005	421
S14006	63, 336	S26012	224	S4202BN	24	S49006	282, 421
S14007	3, 63, 336	S26014	224	S4202PB	24	S49007	282, 421
S14008	63, 337	S26015	224	S4202RB	24	S49008	282
S14009	3, 63, 337	S26016	224	S4202WB	24	S49008	421
S14010	63, 337	S26017	224	S42031	24	S49010	281
S14011	63	S26100	89	S4203BN	24	S49012	281
S14014	63, 337	S27001	89	S4203PB	24	S49013	281
S14030	63	S27002	89	S4203RB	24	S49036	282
S1407BN	3	S30012	116	S4203WB	24	S49042	231
S1407NP	3	S30024	116	S4211BN	24	S49043	231
S1407RB	3	S30800	295	S4211PN	24	S49044	231
S1407WB	3	S30801	295	S4211RB	24	S49048	282
S1409BN	3	S30802	295	S4211WB	24	S49052	231
S14103	63, 336	S30803	295	S4212BN	24	S49053	231
S14250	63, 336	S33001	108	S4212RB	24	S49054	231
S14251	63, 336	S33002	108	S4212WB	24	S49062	231
S14606	63, 336	S33003	108	S4213BN	24	S49063	231
S16003	108	S33004	108	S4213PN	24	S49064	231
S16005	108	S33005	108	S4213RB	24	S49072	231
S16006	108	S33006	108	S4213WB	24	S49073	231
S16009	108	S33007	108	S42220	23	S49074	231
S16012	108	S33010	108	S4222BN	23	S49082	231
S16018	108	S33011	108	S4222PB	23	S49083	231
S16024	108	S33012	108	S4222RB	23	S49084	231
S163566	108	S33013	108	S4222WB	23	S49092	231
S180032	108	S33016	108	S43021	24	S49093	231
S20009	108	S33021	108	S4302BN	24	S49094	231
S20012	108	S33022	108	S4302PB	24	S49136	282
S20015	301	S33023	108	S4302RB	24	S49148	282
S20021	301	S33318	108	S4302WB	24	S49200	282
S20031	301	S33518	108	S43031	24	S49201	282
S20041	301	S36006	267	S4303BN	24	S49236	282
S20100	301, 417	S36007	267	S4303PB	24	S49400	283
S20101	301, 417	S36008	267	S4303RB	24	S49401	283, 402
S20102	301, 417	S36009	267	S4303WB	24	S49402	283, 402
S20103	301, 417	S36010	267	S4311BN	24	S49411	283, 402
S20104	301, 417	S36011	267	S4311RB	24	S49412	283, 402
S20105	301, 417	S36090	267	S4311WB	24	S49413	283
S20106	301	S36091	267	S4312BN	24	S49416	283
S20200	301	S36095	267	S4312PN	24	S49417	283
S20201	301	S36096	267	S4312RB	24	S49421	283
S20202	301	S41001	291	S4312WB	24	S49422	283
S20203	301	S41002	291	S4314BN	24	S49423	283
S20204	301	S41003	291	S4314PN	24	S49425	283
S20300	301	S41006	291	S4314RB	24	S49427	283
S20301	301	S41007	291	S4314WB	24	S49429	283
S20302	301	S41300	291	S44000	307, 402	S49430	283, 401
S22001	94	S41301	291	S44002	26	S49431	283
S22002	94	S41302	291	S44003	26	S49432	283
S22003	94	S41303	291	S44005	26	S49433	283, 402
S22004	94	S41306	291	S4401BN	26	S49434	283, 402
S22005	94	S41307	291	S4401RB	26	S49489	284
S22006	94	S41308	291	S4401WB	26	S49490	284
S25150	224	S41348	286, 404, 410, 418	S4402BN	26	S49500	284
S25200	224	S41349	286	S4402RB	26	S49501	284
S25250	224	S41350	286	S4402WB	26	S50001	306, 398
S25300	224	S41351	286	S4403BN	26	S50002	306, 398
S25350	224	S41352	286	S4403RB	26	S50060	282
S25400	224	S41353	286	S4403WB	26	S50061	282
S26001	89	S41354	286	S4405BN	26	S50062	282
S26002	89	S41355	286	S4405RB	26	S50063	282

PART NO.	PG #	PART NO.	PG #	PART NO.	PG #	PART NO.	PG #
S51001	93	S59104	231	T00005	265	T0108RB	27
S51002	93	S59302	231	T00006	265	T0108WB	27
S51080	93	S59303	231	T00009	265	T01099	32
S51120	93	S59304	231	T01000	28	T01100	26, 33
S55001	231	S59310	232	T01001	409, 418	T01101	26
S55002	231	S59311	232	T01001	32	T01102	26
S55004	265	S59312	232	T01002	32	T01103	26
S55010	265	S59402	231	T01003	26	T01181	27
S55050	265	S59403	231	T01004	26	T01200	32
S55075	265	S60002	232, 265	T01005	32	T01201	32
S55100	264	S60003	232, 265	T01006	26	T01330	28
S55101	264	S60004	232, 265	T01007	26	T0133BN	28
S55104	265	S60005	232	T01008	26	T0133NP	28
S55112	265	S62001	276	T01008BN	28	T0133RB	28
S55113	265	S62002	276	T0100NP	28	T0133WB	28
S55114	265	S62003	276	T0100PB	28	T018BN	28
S55115	265	S62004	276	T0100RB	28	T018RB	28
S55122	265	S62005	276	T0100WB	28	T018WB	28
S55123	265	S62100	69	T01010	33	T02005	39
S55124	265	S62101	69	T01012	33	T02020	38
S55192	265	S62304	69	T01015	27	T02021	38
S55193	265	S63200	69	T01016	33	T02022	38
S55194	265	S63300	69	T01017	27	T02023	38
S55240	265	S63400	69	T01020	33	T02024	38
S55349	75, 265	S80200	284, 401	T01021	27	T02025	34
S55350	75, 265	S80201	283, 401	T0102BN	27	T02026	38
S55351	75, 265	S92001	154, 423	T0102NP	27	T02027	38
S55352	75, 265	S92025	154	T0102RB	27	T02028	36
S55353	75, 265	S92030	154	T0102WB	27	T02035	38
S55354	75, 265	S92031	154	T01030	32	T02036	38
S55902	39, 176	S95010	296	T01031	27	T02037	38
S55903	39, 176	S95011	296	T01032	27	T02038	38
S55950	39, 176	S95012	295	T01033	27	T02039	38
S55951	39, 176	S95014	295	T01034	32	T02050	38
S55952	39, 176	S95015	297	T01035	27	T02051	38
S55953	39, 176	S95016	295	T01036	27	T02052	38
S57034	264	S95100	296	T01037	27	T02053	38
S57035	264	S95101	296	T01040	33	T02060	38
S58050	62	S95102	289	T01042	32	T02062	38
S58051	62	S95103	289	T01043	27	T02064	38
S58052	62	S95104	289	T01044	27	T02065	38
S58053	62	S95105	289	T01045	27	T02066	37
S58101	62	S95106	289	T01048	32	T02067	38
S59002	231	S95200	296	T01049	27	T02070	37, 397, 409, 418
S59003	231	S95250	307, 398	T01050	32	T02075	37
S59004	231	S95251	307, 398	T01051	27	T03008	37
S59010	232	S95700	301, 405	T01052	27	T04001	26
S59011	232	S95701	296, 422	T01053	27	T05002	13, 49
S59012	232	S95709	296	T0105BN	28	T05003	12, 49
S59042	232	S95710	295	T0105RB	28	T05010	49
S59043	232	S95711	295	T0105WB	28	T05011	49
S59044	232	S95712	295	T01060	32	T05012	12, 49
S59052	232	S95713	295	T01061	26	T05013	13, 49
S59053	232	S95714	296	T01062	32	T05015	12
S59054	232	S95715	296	T01064	32	T05021	13, 49
S59062	232	S95793	296, 422	T01065	27	T05023	49, 50
S59063	232	S95794	296	T01066	33	T05024	14, 49, 50
S59064	232	S95795	296	T01067	28	T05025	49
S59072	232	S95800	301, 405	T01068	32	T05026	49
S59073	232	S96012	295	T01070	32	T05029	49
S59074	232	S96014	295	T01071	26	T0521AB	13
S59082	232	S96016	295	T01072	33	T0521AL	13
S59083	232	S99100	45	T01073	27	T0521AN	13
S59084	232	S994050	45	T01074	32	T0521BI	13
S59092	232	S995040	45	T01075	26	T0521BL	13
S59093	232	S996050	45	T01080	33	T0521BN	13
S59094	232	S996080	45	T01081	33	T0521BS	13
S59102	231	T00002	265	T0108BN	27	T0521PN	13
S59103	231	T00003	265	T0108NP	27	T0521PS	13

PART NO.	PG #	PART NO.	PG #	PART NO.	PG #	PART NO.	PG #
T0521PW	13	T21001	269	T33400	88	T45300	88
T0521RB	13	T21002	269	T34001	86	T45400	88
T0521WB	13	T21003	269	T34002	86	T45600	88
T06001	89, 335	T21004	269	T34003	86	T45800	88
T06002	89, 335	T21062	269	T34004	86	T46200	88
T06003	89, 335	T21063	269	T34006	86	T46300	88
T06004	89, 335	T21064	269	T34008	86	T46400	88
T06025	89	T25250	107	T34012	86	T50001	301, 421
T06050	89	T25312	107	T34013	86	T55002	269
T06200	89	T25375	107	T34014	86	T55003	269
T06250	89	T25500	107	T34150	86	T55004	269
T06300	89	T25625	107	T34200	86	T55012	269
T06320	89	T26000	107	T34300	86	T55013	269
T06400	89	T26124	107	T34350	86	T55014	269
T06430	89	T26125	107	T34400	86	T55022	269
T06600	89	T26186	107	T35001	87	T55033	269
T06640	89	T26187	107	T35002	87	T55044	269
T06800	89	T26250	107	T35003	87	T56002	269
T07150	89	T26252	107	T35004	87	T56003	269
T07200	89	T26312	107	T35201	87	T56004	269
T07300	89	T26313	107	T35202	87	T56012	269
T07400	89	T26375	107	T35203	87	T56013	269
T08003	12	T26376	107	T35204	87	T56014	269
T08004	12	T26377	107	T35206	87	T56022	269
T08012	12	T26498	107	T36150	87	T56033	269
T08013	12	T26500	107	T36200	87	T56044	269
T08021	13	T26625	107	T36300	87	T60000	113
T08112	12	T26626	107	T36400	87	T60001	113
T08113	12	T26750	107	T36600	87	T60003	113
T0812BN	12	T26875	107	T37001	87	T60004	113, 403
T0812NP	12	T27125	107	T37002	87	T60005	114
T0812RB	12	T27188	107	T37003	87	T60006	114
T0812WB	12	T27250	107	T37004	87	T60060	275
T0813BN	13	T27313	107	T37006	87	T60060	415, 421
T0813PW	13	T27375	107	T37008	87	T60065	275, 314
T0813RB	13	T27438	107	T38006	119	T60066	275, 314
T0813WB	13	T27500	107	T38010	119	T60080	275, 314
T10014	49	T27625	107	T38038	119	T60081	275, 314
T10016	49	T30002	88	T38106	119	T60100	297
T10216	49	T30034	88	T38110	119	T60101	297
T12001	113	T30046	88	T39002	87	T60102	297
T12006	119	T30068	88	T39003	87	T60103	297
T12010	119	T30102	88	T39004	87	T60104	297
T12050	119	T30203	88	T39006	87	T60105	297
T12106	119	T30304	88	T39008	87	T60106	297
T12110	119	T31000	86	T39010	87	T60107	297
T16002	92	T31001	86	T39012	87	T60108	297
T16004	92	T31002	86	T40001	121	T60110	297
T16100	92	T31003	86	T40002	121	T60111	297
T17002	92	T31004	86	T40003	121	T60121	297
T17004	92	T31006	86	T40004	121	T60122	297
T17101	92	T32001	87	T40005	121	T60123	297
T17102	92	T32002	87	T40007	121	T60124	297
T17104	92	T32003	87	T40008	121	T60125	297
T18201	92	T32004	87	T41001	287	T60126	297
T18202	92	T32006	87	T41002	287	T60127	297
T19118	93	T32008	87	T41003	287	T60130	297, 403
T19119	93	T32011	87	T41004	287	T64540	269
T19122	93	T32022	87	T41005	287	T73001	10, 70
T19125	93	T32033	87	T41006	287	T73002	10, 70
T19222	93	T32044	87	T41007	287	T73003	10, 70
T19342	93	T33001	87	T41008	287	T73004	10, 70
T19345	93	T33002	87	T41009	287	T73125	126
T20020	93, 405	T33003	87	T45002	88	T73138	126
T20023	93, 405	T33004	87	T45003	88	T73150	126
T20030	93	T33152	87	T45010	88	T73175	126
T20040	93, 405	T33200	88	T45012	88	T73200	126
T20041	93, 405	T33300	88	T45150	88	T73300	23
T20050	93, 405	T33304	87	T45200	88	T7330BN	23

<u>PART NO.</u>	<u>PG #</u>	<u>PART NO.</u>	<u>PG #</u>	<u>PART NO.</u>	<u>PG #</u>
T7330PB	23	T85052	59	V95010	313
T7330RB	23	T85053	59	V95012	313
T7330WB	23	T85054	59	V95015	313
T73815	10	T85055	59	V96002	313
T73815	70	T85056	36	V96003	313
T73816	10, 70	T85057	36	V96004	313
T73817	10, 70	T85125	58, 334	V96005	313
T73818	10, 70	T85150	58, 334	V96006	313
T74001	60, 324	T86050	59	V96008	313
T74002	60, 324	T86052	59	V96010	313
T74003	60, 324	T86053	59	V96012	313
T74004	60, 324	T86054	59	V96015	313
T74005	60, 324	T86055	59	V97002	313
T74006	60, 324	U003WD00	385	V97003	313
T74010	56, 334	U004WD00	385	V97004	313
T74011	56, 334	U100500	388	V97005	313
T75000	59	U100600	388	V97006	313
T75001	59	U100700	388	V97008	313
T75125	59, 335	U1007TK00	388	V97010	313
T75150	59, 335	U100800	388	V97012	313
T75151	59, 335	U1008TK00	388	V97015	313
T75250	59	U300V00	383	V98002	313
T76125	59, 335	U300V01	383	V98003	313
T76150	335	U300V02	383	V98004	313
T76150	59	U95001	314	V98005	313
T76151	59, 335	U95002	314	V98006	313
T76250	59	U95003	314	V98008	313
T77012	59, 334	U95004	314	V98010	313
T77013	59, 334	U95005	314	V98012	313
T77014	59, 334	U95006	314	V98015	313
T77020	59, 334	U95008	314	J40650	280
T77125	58, 334, 423	U95010	314	J40651	280
T77138	58, 334	U95012	314	J40652	280
T77150	58, 334, 423	U95015	314	J40653	280
T77151	58, 334, 423	U95211	314		
T77152	58, 334	U95320	314		
T77200	58, 334	U95430	314		
T78012	59, 334	U97001	314		
T78013	59, 334	U97002	314		
T78014	59, 334	U97003	314		
T78020	59, 334	U97004	314		
T78125	58, 334	U97005	314		
T78150	58, 334	U97006	314		
T78151	58, 334	U97008	314		
T78152	58, 334	U97010	314		
T78200	58, 334	U99001	315		
T79000	58	U99002	315		
T79125	59, 335	U99003	315		
T79150	59, 335	U99004	315		
T79151	59, 335	U99005	315		
T79152	59, 335	U99006	315		
T79200	59, 335	U99008	315		
T79201	59, 335	U99010	315		
T80125	59, 335	U99110	315		
T80135	335	U99211	315		
T80150	59, 335	U99220	315		
T80151	59, 335	U99320	315		
T80160	335	U99330	315		
T80200	59, 335	U99440	315		
T81150	59, 335	U99550	315		
T82125	58, 334	U99660	315		
T82150	58, 334	U99880	315		
T83150	58, 334	V94004	313		
T84125	58, 334	V95002	313		
T84150	58, 334	V95003	313		
T84151	58, 334	V95004	313		
T84200	58, 334	V95005	313		
T85050	59	V95006	313		
T85051	59	V95008	313		

Jones Stephens Toilet Seats

Pages 381-392



Fit. Form. Function. Jones Stephens toilet seats combine aesthetics with innovation, ensuring that they're of the highest quality. That's one reason we're now the leading manufacturer of commercial, residential, hospitality, and multi-family dwelling toilet seats. We're also progressive. We now offer more than 200 SKUs in 14 colors, not to mention EZ-Close® seats, adjustable products, and a patent-pending QuicKlean® hinge.

Equally important, Jones Stephens toilet seats fit all of the most popular toilets, meet all North American ANSI standards, and pass our own uncompromising series of inspections.

As part of Hardware Holdings, Jones Stephens leverages Handy Hardware and HBC Home & Hardware to bring you more than 35,000 plumbing items, along with contractor and MRO specialty products such as gloves, trash bags, extension cords, locksets, and more.

Wood Seats (page 383-385)

AVAILABLE FEATURES



QuicKlean®



EZ Close®

AVAILABLE HINGE OPTIONS



QuicKlean®
Plastic or
Metal Finish



Decorative
Metal



Hinge Color
Matched
to Seat

AVAILABLE COLORS

White -00	Bone -01	Biscuit -02	Almond -03	Cotton White -04	Venetian Pink -20	Fawn Beige -30	Dresden Blue -40
Regency Blue -45	Citron Yellow -50	Harvest Gold -53	Avocado -58	Silver -80	Black -90	Mahogany Finish -16	Natural Finish -17
Dark Brown Finish -18	Walnut Finish -19	Natural Bamboo Finish -220	Light Oak Finish -117	Dark Brown Finish -118	Cherry Finish -115	Natural Black Walnut Finish -19	

Plastic Seats (page 387-390)

AVAILABLE FEATURES



QuicKlean®



EZ Close®

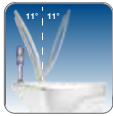

Self-Sustaining

AVAILABLE HINGE OPTIONS



QuicKlean®
Plastic or
Metal Finish



Hinge Color
Matched
to Seat



Color-matched
Check Hinge

AVAILABLE COLORS

White -00	Bone -01	Biscuit -02	Almond -03	Cotton White -04	Venetian Pink -20	Fawn Beige -30	Dresden Blue -40
Regency Blue -45	Citron Yellow -50	Harvest Gold -53	Avocado -58	Silver -80	Black -90		

Soft Seats (page 391)

AVAILABLE FEATURES



QuicKlean®

AVAILABLE HINGE OPTIONS



QuicKlean®
Plastic or
Metal Finish



Decorative
Metal

AVAILABLE COLORS

White -00	Bone -01	Black -90	Pink -21	Blue -42	Forest Green -60	Claret -70

Acrylic Seats (page 392)

AVAILABLE HINGE OPTIONS



Decorative
Metal

AVAILABLE COLORS

Aquarium -AQ	Seahorse -SH

You Need It. We Got It.

Jones Stephens brings over twenty years of expertise to the design, manufacture, and quality of our products. Our sales team offers a deep understanding of the local business climate as well as our products; our regional sales managers spend their time visiting customers, testing new products, and analyzing industry trends. Equally important, Jones Stephens's customer service team dedicates itself to managing your account, so you can concentrate on your customers instead of your supplier.

- ⑤ More than 18,000 SKUs in over 15 product categories – in stock.
You need it. We got it!
- ⑤ A one-stop plumbing shop, including hundreds of plumbing specialty items your customers need to finish the job
- ⑤ Fast and accurate shipping – orders ship in 24 hours with 99% accuracy
- ⑤ Friendly and helpful customer service representatives who know our products and your company
- ⑤ Our deep sourcing capabilities mean competitive pricing for you
- ⑤ No order minimums – you can order by the piece, case, pallet, truckload, or container

