

DECORATIVE - page 1

Decorative bath and kitchen items available in over sixteen special finishes. (see inside front cover for finish swatches)

A**FAUCETS AND BATH ACCESSORIES - page 27**

Contemporary and classic designed kitchen, bath, tub, and shower faucets along with replacement parts and bath accessories.

FAU**SPECIALTIES AND REPAIR - page 37**

Basic plumbing and repair needs, including tank trip levers, tub and diverter spouts, bath waste kits, plumbing connectors, gas connectors, and more.

B**MISC. PLUMBING SPECIALTIES - page 89**

Wide range of items from basic plumbing items such as water heater stands, access panels and compression couplings to water meter boxes and pipe insulation.

C**FITTINGS AND VALVES - page 131**

Brass fittings, nylon fittings, push on fittings, PEX fittings, ball valves and more.

D**COMMERCIAL / RESIDENTIAL PLASTICS - page 171**

Assembled coverall drains and cleanouts that have both plastic and metal spuds with a variety of different strainer and cover diameters and finishes. Residential plastics such as shower drains, roof drains and floor sinks.

E**CAST IRON - page 237**

Cast iron products such as closet flanges, drains, "Code Blue" drains, and cleanouts.

F**TOOLS - page 273**

Hand tools, plumbing tools, cutting tools, shovels, measuring tools, caulk, and chemicals.

G**GASKETS AND COUPLINGS - page 305**

Compression gaskets and no hub couplings.

H&I**TUBULAR - page 311**

Chrome plated, rough brass, PVC and ABS plastic tubular products as well as lav drains and pop-up assemblies.

T**PVC/DWV FITTINGS - page 333**

PVC/DWV fittings including couplings, adapters, elbows, p-traps and bushings.

**PVC
DWV****BLACK AND GALVANIZED MALLEABLES/PIPE NIPPLES - page 343**

Black and galvanized malleable fittings, pipe nipples, readycut pipe and merchant couplings.

BG**COPPER - page 353**

Wrot/ACR fittings, forged brass/cast brass pressure fittings, wrot DWV solder fittings, cast DWV solder fittings and cast brass flanges.

CF**TOILET SEATS - page 373**

Commercial, residential, hospitality, and multi-family dwelling toilet seats.

TS**PRODUCT INDEX - page 385****PRODUCT
INDEX****PART NUMBER INDEX - page 405****PART #
INDEX**

DECORATIVE

Decorative Kitchen 3-5
Decorative Bathroom 6-26

Disposal Assembly



- Fits In-Sink-Erator
- Also acts as a basket strainer
- Stainless steel flange and basket
- Positive stopper

PART NO.	BOX	FINISH	CTN/MSTR
B03004	B03004B	Almond	5/20
B03003	B03003B	Biscuit	5/20
B03005	B03005B	Flat Black	5/20
B03408	—	Brushed Nickel	5/20
B03401	—	Brushed Stainless	5/20
B03406	—	Oil Rubbed Bronze	5/20
B03407	—	Old World Bronze	5/20
B03001	B03001B	Polar White	5/20
B03405	—	Polished Nickel (PVD)	5/20
B03400	—	Polished Stainless	5/20

Basket Strainer



- Simple to install, operate and maintain
- Stainless steel flange and basket
- Positive seal

PART NO.	FINISH	CTN/MSTR
B02004	Almond	5/20
B02404	Antique Nickel	5/20
B02003	Biscuit	5/20
B02005	Black	5/20
B02408	Brushed Nickel	5/20
B02401	Brushed Stainless	5/20
B02406	Oil Rubbed Bronze	5/20
B02407	Old World Bronze	5/20
B02001	Polar White	5/20
B02405	Polished Nickel (PVD)	5/20
B02400	Polished Stainless	5/20

Replacement Basket Strainer



- Simple to operate and maintain
- Positive seal

PART NO.	FINISH	FITS PART NO.	CTN/MSTR
B02304	Almond	B02004	10/40
B02303	Biscuit	B02003	10/40
B02305	Black	B02005	10/40
B0240BN	Brushed Nickel	B02408	10/40
B0240BS	Brushed Stainless	B02401	10/40
B0240RB	Oil Rubbed Bronze	B02406	10/40
B0240WB	Old World Bronze	B02407	10/40
B02301	Polar White	B02001	10/40
B0240PN	Polished Nickel	B02405	10/40
B0240PS	Polished Stainless	B02400	10/40

Items marked with the Jones Stephens logo are "You Need It... We Got It" Items.

Polished Brass Basket Strainer



- Metal construction
- Simple to install, operate, and maintain
- Positive seal

PART NO.	FINISH	CTN/MSTR
B02008	Polished Brass	1/50

Disposal Assembly and Stopper



- Fits In-Sink-Erator
- Metal construction
- Matches well with S14 Duo Strainer Series

PART NO.	FINISH	CTN/MSTR
B03050	Polished Chrome	5/20
B0350BN	Brushed Nickel	5/20
B0350RB	Oil Rubbed Bronze	5/20
B0350WB	Old World Bronze	5/20
F05001	Polished Brass flange only	5/20
S45001	Polished Brass stopper only	5/20

Duo Strainer



- Cast brass

PART NO.	FINISH	CTN/MSTR
S14007	Chrome Plated	1/25
S1407BN	Brushed Nickel (PVD)	1/25
S1407RB	Oil Rubbed Bronze	1/25
S1407WB	Old World Bronze	1/25

Junior Duo Basket Strainer



- Stainless steel body and basket with die cast locknut; 1-1/2" threads
- Complete with washers
- Fits 1-3/4" bar sink

PART NO.	FINISH	CTN/MSTR
B02050	Chrome Plated	1/100
B0250BN	Brushed Nickel	10/80
B0250RB	Oil Rubbed Bronze	10/80
B0250WB	Old World Bronze	10/80
B02100	Polished Brass	10/80

A

Deep Junior Duo Basket Strainer



B02102



B02103

- For 2" and 2-1/2" deep outlets and bar sinks

PART NO.	FINISH	CTN/MSTR
B02102	Chrome Plated	1/100
B02101	Polished Brass	1/1
B02103	Chrome Plated (replacement strainer only)	1/250

Hose and Spray



- 1/4" universal coupling adapter
- Hose is white

PART NO.	FINISH	CTN/MSTR
K52011	Biscuit	12/24
K52013	Black	12/24
K52014	Brushed Nickel	12/24
K52016	Oil Rubbed Bronze	12/24
K52017	Old World Bronze	12/24
K52010	Polar White	1/100

Bar Tap Faucet with Rotating Spout



- 9-1/2" high
- Can be used with reverse osmosis
- 1/4" to 3/8" O.D. adapter
- Handle can be installed side or front mount
- Spout rotates
- 5" reach

PART NO.	FINISH	CTN/MSTR
B70030	Chrome Plated	1/40
B70031	Brushed Nickel	1/40
B70032	Oil Rubbed Bronze	1/40
B70033	Old World Bronze	1/40
B70045	Threaded shank extension kit	1/200

Bar Tap Faucet



- 6-1/2" high
- Can be used with reverse osmosis
- All brass construction
- 1/2" connection
- Epoxy coated
- 1/4" inlet; 1-3/4" escutcheon
- Lead Free

PART NO.	FINISH	CTN/MSTR
B45010	Chrome	1/36
B70009	Biscuit	6/36
B70003	Black	6/36
B70008	Brushed Nickel	6/36
B70007	Oil Rubbed Bronze	6/36
B70004	Old World Bronze	6/36
B70001	Polar White	6/36
B70006	Polished Brass	6/36

Lotion and Soap Dispenser with Brass Pump



- 2" spout
- All brass pump
- 7 ounce poly bottle

PART NO.	FINISH	CTN/MSTR
S08020	Chrome	1/50
S10022	Biscuit	1/1
S10023	Black	1/1
S10025	Brushed Nickel (PVD)	1/1
S10024	Oil Rubbed Bronze	1/1
S10021	Polar White	1/1
S10020	Polished Brass	1/1

Faucet Hole Cover



- Wing nut included
- 1-3/4" diameter top

PART NO.	FINISH	MATERIAL	CTN/MSTR
B1020AL	Almond	Stainless Steel	12/250
B1020AB	Antique Brass	Brass	12/250
B1020AN	Antique Nickel	Brass	12/144
B1020BI	Biscuit	Stainless Steel	12/250
B1020BL	Black	Stainless Steel	12/144
B1020BN	Brushed Nickel (PVD)	Brass	12/144
B1020RB	Oil Rubbed Bronze	Brass	12/144
B1020WB	Old World Bronze	Brass	12/144
B1020PW	Polar White	Stainless Steel	12/250
B1020PN	Polished Nickel	Brass	12/250
B1020PS	Polished Stainless (PVD)	Brass	12/250

Celcon Faucet Hole Cover



- Molded Celcon- will not crack, chip or peel
- 1-3/4" diameter top

PART NO.	FINISH	CTN/MSTR
C06011	Chrome	12/96
C06007	Almond	12/96
C06006	Biscuit	12/96
C06008	Black	12/96
C06014	Brushed Nickel	12/96
C06016	Oil Rubbed Bronze	12/96
C06013	Old World Bronze	12/96
C06004	Polar White	12/96
C06018	Polished Nickel (PVD)	12/96

ABS Faucet Hole Cover



- Screw down
- Fit all
- Made of ABS Plastic
- 1-3/4" diameter top; 3" length

PART NO.	FINISH	CTN/MSTR
C06002	Almond	1/1
C06001	Polar White	1/1

Brass Faucet Hole Cover



- Heavy duty brass construction
- 1-3/4" diameter top

PART NO.	FINISH	CTN/MSTR
C06021	Brushed Stainless	12/144
C06024	Polished Nickel	12/144
C06020	Polished Stainless	12/144

Air Gap



- Prevents sewage backflow by breaking siphoning action in drain line
- White polypro body with chrome plated ABS top
- UPC listed

PART NO.	FINISH	CTN/MSTR
A10001	Chrome Plated	36/72
A10011	Polar White	1/50
A10010	Polished Brass	1/50

Items marked with the Jones Stephens logo are "You Need It... We Got It" Items.

Air Gap Cover



- Replaces chrome cover on most air gaps

PART NO.	FINISH	CTN/MSTR
A10015	Chrome	1/1
A10004	Biscuit	1/1
A10018	Brushed Nickel	6/18
A10017	Oil Rubbed Bronze	6/72
A10019	Old World Bronze	6/72
A10002	Polar White	1/1

A

Lav Pop-Up Drain with Overflow



- For vessel sinks 1-1/2" drain hole
- 18 gauge
- With 4" drain body and 8" brass tailpiece
- Decorative finish covers all metal parts including tailpiece and lock nut
- Tailpiece opening - 1-1/4" OD

PART NO.	FINISH	CTN/MSTR
P35033	Chrome Plated	3/12
P3503BN	Brushed Nickel	3/12
P3503RB	Oil Rubbed Bronze	3/12
P3503WB	Old World Bronze	3/12

Lav Pop-Up Drain without Overflow



- For vessel sinks 1-1/2" drain hole
- 18 gauge
- With 4" drain body and 8" brass tailpiece
- Decorative finish covers all metal parts including tailpiece and lock nut
- Tailpiece opening - 1-1/4" OD

PART NO.	FINISH	CTN/MSTR
P35044	Chrome Plated	3/12
P3504BN	Brushed Nickel	3/12
P3504RB	Oil Rubbed Bronze	3/12
P3504WB	Old World Bronze	3/12

Lav Grid Drain without Overflow



- For vessel sinks 1-1/2" drain hole
- 18 gauge
- With 4" drain body and 8" brass tailpiece
- Decorative finish covers all metal parts including tailpiece and lock nut
- Tailpiece opening - 1-1/4" OD

PART NO.	FINISH	CTN/MSTR
D70205	Chrome Plated	3/12
D7020BN	Brushed Nickel	3/12
D7020RB	Oil Rubbed Bronze	3/12
D7020WB	Old World Bronze	3/12

Lav Grid Drain with Overflow



- For vessel sinks 1-1/2" drain hole
- 18 gauge
- With 4" drain body and 8" brass tailpiece
- Decorative finish covers all metal parts including tailpiece and lock nut
- Tailpiece opening - 1-1/4" OD

PART NO.	FINISH	CTN/MSTR
D70210	Chrome Plated	3/12
D7021BN	Brushed Nickel	3/12
D7021RB	Oil Rubbed Bronze	3/12
D7021WB	Old World Bronze	3/12

Lav Pop-Up Assembly with Overflow



- All metal construction
- Tool free locknut and ballrod nut
- 1-1/4" tubular
- 17 gauge

PART NO.	FINISH	CTN/MSTR
P35001	Chrome Plated	1/25
P35002	Polished Brass (PVD)	1/10

Replacement Parts

PART NO.	DESCRIPTION	CTN/MSTR
P35920	Plunger	1/25
P35921	Flange	1/25
P35922	Lift Rod	1/25

Lav Lift and Turn Drain without Overflow



- For vessel sinks
- With 3" drain body and 4-3/4" brass tailpiece
- Tailpiece opening- 1-1/4" OD

PART NO.	FINISH	CTN/MSTR
P35003	Chrome Plated	1/50
P3500BN	Brushed Nickel (PVD)	5/30
P3500RB	Oil Rubbed Bronze	5/30
P3500WB	Old World Bronze	5/30
P3500PB	Polished Brass	5/30

Lav Grid Drain without Overflow



- For vessel sinks
- With 2-1/4" drain body and 6" (5-7/8") brass tailpiece
- Tailpiece opening- 1-1/4" OD

PART NO.	FINISH	CTN/MSTR
D70105	Chrome Plated	1/50
D7010BN	Brushed Nickel	1/25
D7010RB	Oil Rubbed Bronze	1/25
D7010WB	Old World Bronze	1/25
D7010PB	Polished Brass	1/25

Brass Tubular P-Trap



- 17 gauge
- Brass slip joint nut and rubber washers

PART NO.	FINISH	OD	CTN/MSTR
P3892BN	Brushed Nickel	1-1/4"	1/30
P3892RB	Oil Rubbed Bronze	1-1/4"	1/30
P3892WB	Old World Bronze	1-1/4"	1/30
P36125	Polished Brass	1-1/4"	1/30
P36150	Polished Brass	1-1/2"	1/30
P3892PB	Polished Brass (PVD)	1-1/4"	1/30

Brass Tubular P-Trap with Box Escutcheon



- 17 gauge
- Brass slip joint nut and rubber washers

PART NO.	FINISH	OD	CTN/MSTR
P3450CP	Chrome Plated	1-1/4"	1/1
P3450BN	Brushed Nickel	1-1/4"	1/1
P3450RB	Oil Rubbed Bronze	1-1/4"	1/1

Slip Joint Extension Tube



- 17 gauge
- Brass slip joint nut and rubber washers

PART NO.	FINISH	SIZE	CTN/MSTR
P3819BN	Brushed Nickel	1-1/4" x 8"	1/100
P3819RB	Oil Rubbed Bronze	1-1/4" x 8"	1/100

Offset Bath Supplies



- Chrome plated
- 1/2" supply tubes
- All hardware needed for connection included

PART NO.	DESCRIPTION	CTN/MSTR
B49020	Single offset (pair)	1/6
B49021	Double offset (pair)	1/6
B49022	Replacement nuts, washers and escutcheons	1/6

Polished Brass Shower Rod Flange with Set Screws



- Includes: two flanges, two set screws and four wood screws

PART NO.	FINISH	CTN/MSTR
S03152	Polished Brass	1/1

Shower Diverter Valve



- Installs between arm and shower head
- Allows usage of hand-held shower or shower head
- Not a positive shut off

PART NO.	FINISH	CTN/MSTR
S01070	Chrome Plated	1/100
S01071	Brushed Nickel	1/100
S01072	Oil Rubbed Bronze	1/100
S01073	Old World Bronze	1/100

S-Shaped Shower Arm



- 18" length
- Adds 12" to height
- 1/2" female threads
- Fixed escutcheon

PART NO.	FINISH	SIZE	CTN/MSTR
S01055	Chrome Plated	1/2" x 18"	1/10
S0155BN	Brushed Nickel	1/2" x 18"	1/10
S0155RB	Oil Rubbed Bronze	1/2" x 18"	1/10
S0155WB	Old World Bronze	1/2" x 18"	1/10
S01155	Polished Brass (PVD)	1/2" x 18"	1/10

S-Shaped Shower Arm



- 8" or 10" length
- 1/2" male threads

PART NO.	FINISH	SIZE	CTN/MSTR
S01035	Chrome Plated	8"	1/80
S01038	Chrome Plated	10"	1/50

Ceiling Mount Shower Arm



- 1/2" female threads
- Fixed escutcheon

1/2" x 6"			
PART NO.	FINISH	SIZE	CTN/MSTR
S01051	Chrome Plated	1/2" x 6"	1/10
S0151BN	Brushed Nickel	1/2" x 6"	1/10
S0151RB	Oil Rubbed Bronze	1/2" x 6"	1/10
S0151WB	Old World Bronze	1/2" x 6"	1/10
S01151	Polished Brass (PVD)	1/2" x 6"	1/10

1/2" x 12"			
PART NO.	FINISH	SIZE	CTN/MSTR
S01052	Chrome Plated	1/2" x 12"	1/10
S0152BN	Brushed Nickel	1/2" x 12"	1/10
S0152RB	Oil Rubbed Bronze	1/2" x 12"	1/10
S0152WB	Old World Bronze	1/2" x 12"	1/10
S01152	Polished Brass (PVD)	1/2" x 12"	1/10

1/2" x 18"			
PART NO.	FINISH	SIZE	CTN/MSTR
S01053	Chrome Plated	1/2" x 18"	1/10
S0153BN	Brushed Nickel	1/2" x 18"	1/10
S0153RB	Oil Rubbed Bronze	1/2" x 18"	1/10
S0153WB	Old World Bronze	1/2" x 18"	1/10
S01153	Polished Brass (PVD)	1/2" x 18"	1/10

90° Shower Arm with Flange



- 18" length
- 1/2" female threads
- Fixed escutcheon

PART NO.	FINISH	SIZE	CTN/MSTR
S01056	Chrome Plated	1/2" x 18"	1/20
S0156BN	Brushed Nickel	1/2" x 18"	1/20
S0156RB	Oil Rubbed Bronze	1/2" x 18"	1/20
S0156WB	Old World Bronze	1/2" x 18"	1/20
S01156	Polished Brass	1/2" x 18"	1/20

Raised Bend Shower Arm



- 18" length
- 1/2" female threads
- Fixed escutcheon

PART NO.	FINISH	SIZE	CTN/MSTR
S01057	Chrome Plated	1/2" x 18"	1/20
S0157BN	Brushed Nickel	1/2" x 18"	1/20
S0157RB	Oil Rubbed Bronze	1/2" x 18"	1/20
S0157WB	Old World Bronze	1/2" x 18"	1/20
S01157	Polished Brass (PVD)	1/2" x 18"	1/20

Double Offset Shower Arm

A



- 18" length
- 1/2" female threads
- Adds 12" to height
- Fixed escutcheon

PART NO.	FINISH	SIZE	CTN/MSTR
S01058	Chrome Plated	1/2" x 18"	1/10
S0158BN	Brushed Nickel	1/2" x 18"	1/10
S0158RB	Oil Rubbed Bronze	1/2" x 18"	1/10
S0158WB	Old World Bronze	1/2" x 18"	1/10
S01158	Polished Brass (PVD)	1/2" x 18"	1/10

Shower Arm



- Fits E02 series escutcheons

6"

PART NO.	FINISH	SIZE	CTN/MSTR
S01030	Chrome Plated	6"	1/200
S0130BN	Brushed Nickel	6"	1/200
S0130RB	Oil Rubbed Bronze	6"	1/200
S0130WB	Old World Bronze	6"	1/200

8"

PART NO.	FINISH	SIZE	CTN/MSTR
S01032	Chrome Plated	8"	1/100
S0132BN	Brushed Nickel	8"	1/100
S0132RB	Oil Rubbed Bronze	8"	1/100
S0132WB	Old World Bronze	8"	1/100

Polished Brass Shower Arm



- Fits E81050 escutcheon

PART NO.	FINISH	SIZE	CTN/MSTR
S03030	Polished Brass	1/2" x 6"	20/200
S03032	Polished Brass	1/2" x 8"	20/200
S01036	Polished Brass	1/2" x 8" s-shaped	10/80
S01037	Polished Brass	1/2" x 10" s-shaped	10/60

Contoured Shower Curtain Rod

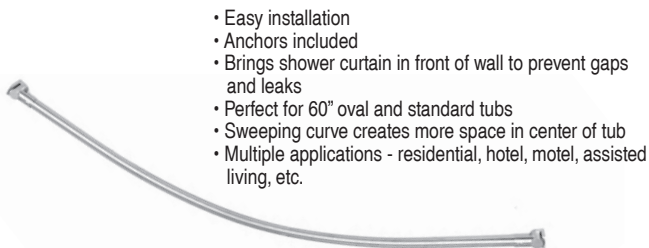

- Easy installation
- Anchors included
- Brings shower curtain in front of wall to prevent gaps and leaks
- Perfect for 60" oval and standard tubs
- Sweeping curve creates more space in center of tub
- Multiple applications - residential, hotel, motel, assisted living, etc.

PART NO.	FINISH	CTN/MSTR
S02197	Chrome Plated	1/1
S02198	Brushed Nickel	1/2

Items marked with the Jones Stephens logo are "You Need It... We Got It" Items.

Polished Brass Shower Arm Flange



- Die cast with a set screw
- Poly bagged

PART NO.	DESCRIPTION	CTN/MSTR
S03040	1/2" with set screw	20/400

Cover Plates

- Mirrored acrylic
- Conceals damaged/cracked tiles
- Fits all standard bath/shower fittings
- No tools required- use silicone caulk
- DO NOT use abrasive cleaners

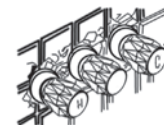

ASSEMBLED IN USA



PART NO.	DESCRIPTION	SIZE	CTN/MSTR
T73001	Tube spout model	3-1/2" diameter	1/300
T73002	One handle model	8" x 14"	1/100
T73003	Two handle model	6" x 14"	1/40
T73004	Three handle model	6" x 14"	1/36

Stainless Steel Repair Cover Plates

- 1, 2 or 3 hole design to fit multitude of valves
- Polished stainless steel finish
- Easily attaches with silicone caulk; 1-hole has brackets and screw
- 7-1/4" x 13" long



PART NO.	# OF HOLES	DIAMETER	CTN/MSTR
T73815	1	5-1/8"	1/40
T73816	2	1-3/8"	1/40
T73817	3	1-3/8"	1/40
T73818	1	3-3/4"	1/40

Chrome Plated Tub Spouts



- Chrome plated Zamak
- CTS unit comes with hex key

PART NO.	DESCRIPTION	CONNECTION	CTN/MSTR
D01020	1/2" FIP	Nose	1/50
D01021	1/2" CTS	SlideBase	1/50



- Chrome plated brass
- 8-1/2" One piece diverter spout

PART NO.	DESCRIPTION	CONNECTION	CTN/MSTR
D01016	3/4" x 1/2" FIP	Base	1/20

9" Chrome Plated Tub and Diverter Spout



- Chrome plated brass
- One piece design
- 1/2" nose connection
- Solid brass construction

PART NO.	DESCRIPTION	CONNECTION	CTN/MSTR
D01017	1/2" FIP	Nose	1/12
D01018	1/2" FIP	Nose	1/12

Polished Brass Tub Spouts



- 8-1/2"
- PVD durable finish
- All brass
- Boxed

PART NO.	DESCRIPTION	CONNECTION	CTN/MSTR
D03016	3/4" x 1/2" x 8-1/2"	Base	1/20



- Brass plated zamak
- Boxed

PART NO.	DESCRIPTION	CONNECTION	CTN/MSTR
D03020	1/2" FIP	Nose	1/50

Polished Brass Diverter Spouts



- Brass plated zamak
- Boxed

PART NO.	DESCRIPTION	CONNECTION	CTN/MSTR
D03001	1/2" FIP	Nose	1/50



- Brass plated zamak
- Boxed

PART NO.	DESCRIPTION	CONNECTION	CTN/MSTR
D03002	3/4" x 1/2" FIP	Base	1/50



- Brass plated zamak
- Boxed

PART NO.	DESCRIPTION	CONNECTION	CTN/MSTR
D03004	1/2" CTS (5/8" OD) Slip-on with hex key	Base	1/50



- Brass plated zamak
- Boxed

PART NO.	DESCRIPTION	CONNECTION	CTN/MSTR
D03010	3/4" x 1/2" FIP with 1/2" top connection for hand-held shower	Base	1/50



- Brass plated zamak
- Boxed

PART NO.	DESCRIPTION	CONNECTION	CTN/MSTR
D03011	3/4" x 1/2" FIP with 1/2" bottom connection for hand-held shower	Base	1/50



- 8-1/2"
- PVD durable finish
- All brass
- Boxed

PART NO.	DESCRIPTION	CONNECTION	CTN/MSTR
D03015	3/4" x 1/2" x 8-1/2" long	Base	1/20

Chrome Plated Diverter Spouts and Extensions



- Chrome plated brass
- 8-1/2" One piece diverter spout
- All brass
- Boxed

PART NO.	DESCRIPTION	CONNECTION	CTN/MSTR
D01015	3/4" x 1/2" FIP	Base	1/20

Extension Only



- Chrome plated brass

PART NO.	DESCRIPTION	CTN/MSTR
D01030	3" extension only	1/100
D01031	4-3/4" extension only	1/80



- Chrome plated Zamak
- Diverter spout for hand held shower

PART NO.	DESCRIPTION	CONNECTION	CTN/MSTR
D01010	3/4" x 1/2" FIP top connection	Base	1/10
D01011	3/4" x 1/2" MIP lower connection	Base	1/50

7" Chrome Plated Diverter Spout



- Chrome plated Zamak
- Longer length for today's larger tubs
- CTS unit comes with hex key

PART NO.	DESCRIPTION	CONNECTION	CTN/MSTR
D01024	1/2" FIP	Nose	1/50
D01025	1/2" CTS	Slide	1/25

Chrome Plated Diverter Spout with Polished Brass Knob



- Brass plated Zamak
- Boxed

PART NO.	DESCRIPTION	CONNECTION	CTN/MSTR
D01032	CP slip on diverter with PB knob	Base	1/50

7" Chrome Plated Tub Spout



- CTS unit comes with hex key
- Longer length for today's larger tubs
- Chrome plated Zamak

PART NO.	DESCRIPTION	CONNECTION	CTN/MSTR
D01026	1/2" FIP	Nose	1/50
D01027	1/2" CTS	Slide	1/25

A

Decorative Diverter Spout



- Zamak
- 1/2" CTS Slide connection

PART NO.	FINISH	CONNECTION	CTN/MSTR
D0104BN	Brushed Nickel	1/2" CTS Nose	1/50
D0104RB	Oil Rubbed Bronze	1/2" CTS Slide	1/50
D0104WB	Old World Bronze	1/2" CTS Slide	1/50

Ring for Tub Spouts and Diverter



- Adds decorative touch to any tub spout or diverter
- Fits between the wall and the tub spout or diverter
- 3-5/16" OD - 2-3/8" ID

PART NO.	FINISH	CTN/MSTR
D01050	Chrome Plated	1/200
D01050BN	Brushed Nickel	1/200
D01050RB	Oil Rubbed Bronze	1/200
D01050WB	Old World Bronze	1/200

Polished Brass Lift and Turn Bath Waste Conversion Kit



- Converts regular bath waste to polished brass
- Fits 1-3/8" or 1-1/2" waste elbows
- Includes drain, bushing, faceplate, and screws
- Blister card packaging

PART NO.	SIZE	# OF HOLES	CTN/MSTR
B51003	1/2" and 1-3/8"	2	1/12
B51020	1/2" and 1-3/8"	1	1/12

Lift and Turn Conversion Kit



- 1-hole faceplate
- 1-3/8" drain with bushing
- Includes drain, bushing, faceplate, aluminum adapter bar and screws
- Blister card packaging

PART NO.	FINISH	# OF HOLES	CTN/MSTR
B51019	Chrome Plated	1	1/36
B5160AP	Antique Pewter	1	1/36
B5160BB	Brushed Bronze	1	1/36
B5160BN	Brushed Nickel	1	1/36
B5160BS	Brushed Stainless	1	1/36
B5160RB	Oil Rubbed Bronze	1	1/36
B5160WB	Old World Bronze	1	1/36
B5160PN	Polished Nickel	1	1/36
B5160PS	Polished Stainless	1	1/36

Toe Touch Conversion Kit



- 1-hole faceplate
- 1-3/8" drain with bushing, screw, aluminum adapter bar, and faceplate
- Clamshell packaging

PART NO.	FINISH	# OF HOLES	CTN/MSTR
B51010	Chrome Plated	1	1/25
B5161AP	Antique Pewter	1	1/25
B5161BB	Brushed Bronze	1	1/25
B5161BN	Brushed Nickel	1	1/25
B5161RB	Oil Rubbed Bronze	1	1/25
B5161WB	Old World Bronze	1	1/25
B5161PS	Polished Stainless	1	1/25

Lift and Turn Conversion Kit



- 2-hole faceplate
- 1-3/8" drain with bushing, 2 screws and faceplate

PART NO.	FINISH	# OF HOLES	CTN/MSTR
B51005	Chrome Plated	2	1/25
B5155AL	Almond	2	1/25
B5155AB	Antique Brass	2	1/25
B5155AN	Antique Nickel	2	1/25
B5155AP	Antique Pewter	2	1/25
B5155BI	Biscuit	2	1/25
B5155BL	Black	2	1/25
B5155BB	Brushed Bronze	2	1/25
B5155BN	Brushed Nickel	2	1/25
B5155BS	Brushed Stainless	2	1/25
B5155RB	Oil Rubbed Bronze	2	1/25
B5155WB	Old World Bronze	2	1/25
B5155PW	Polar White	2	1/25
B5155PS	Polished Stainless	2	1/25
B51004	Satin Nickel	2	1/25
B5155BNB	Brushed Nickel (boxed)	2	1/25
B5155WBB	Old World Bronze (boxed)	2	1/25

Toe Touch Conversion Kit



- 2-hole faceplate
- Fits 1-3/8" or 1-1/2" waste elbows
- Includes drain, bushing, faceplate and 2 screws

PART NO.	FINISH	# OF HOLES	CTN/MSTR
B51007	Chrome Plated	2	1/25
B5156AP	Antique Pewter	2	1/25
B5156BB	Brushed Bronze	2	1/25
B5156BN	Brushed Nickel	2	1/25
B5156RB	Oil Rubbed Bronze	2	1/25
B5156WB	Old World Bronze	2	1/25
B5156PS	Polished Stainless	2	1/25

Items marked with the Jones Stephens logo are "You Need It... We Got It" Items.

Trip Lever Conversion Kit



- 2-hole faceplate
- Fits 1-3/8" or 1-1/2" waste elbows
- Includes drain, bushing, faceplate and 2 screws

PART NO.	FINISH	# OF HOLES	CTN/MSTR
B51015	Chrome Plated	2	1/25
B5112AP	Antique Pewter	2	1/25
B5112BI	Biscuit	2	1/25
B5112BB	Brushed Bronze	2	1/25
B5112BN	Brushed Nickel	2	1/25
B5112BS	Brushed Stainless	2	1/25
B5112RB	Oil Rubbed Bronze	2	1/25
B5112WB	Old World Bronze	2	1/25
B5112PW	Polar White	2	1/25

Flip-It Conversion Kit



- No tools needed for installation
- Open or close with a flip of the toe
- Fits most popular tub drains (assorted o-ring included)
- One piece construction Delrin and ABS

PART NO.	FINISH	# OF HOLES	CTN/MSTR
P35170	Chrome Plated	1	1/5
P35172	Brushed Nickel	1	1/5
P35171	Polished Brass	1	1/5

Trip Lever Trim Only



- 2-hole faceplate
- Includes springs, faceplate, 2 screws and strainer

PART NO.	FINISH	# OF HOLES	CTN/MSTR
B51014	Chrome Plated	2	1/25
B5114AP	Antique Pewter	2	1/25
B5114BB	Brushed Bronze	2	1/25
B5114BN	Brushed Nickel	2	1/25
B5114RB	Oil Rubbed Bronze	2	1/25
B5114WB	Old World Bronze	2	1/25
B5114PB	Polished Brass	2	1/25
B5114PN	Polished Nickel	2	1/25
B5114PS	Polished Stainless	2	1/25

Trip Lever Faceplate and Handle



- 2-hole faceplate
- Less screws

PART NO.	FINISH	# OF HOLES	CTN/MSTR
T05002	Chrome Plated	2	1/200
P3566AL	Almond	2	1/100
P3566AB	Antique Brass	2	1/100
P3566AN	Antique Nickel	2	1/100
P3566BI	Biscuit	2	1/100
P3566BL	Black	2	1/100
P3566BN	Brushed Nickel	2	1/100
P3566BS	Brushed Stainless	2	1/100
P3566RB	Oil Rubbed Bronze	2	1/100
P3566WB	Old World Bronze	2	1/100
P3566PW	Polar White	2	1/100
P3566PN	Polished Nickel	2	1/100
P3566PS	Polished Stainless	2	1/100

Trip Lever with Spring



- Includes screws

PART NO.	FINISH	# OF HOLES	CTN/MSTR
T05003	Chrome Plated	2	25/200
T08003	Polished Brass	2	25/200
T08004	Polished Brass (PVD)	2	1/100

1-Hole Overflow Faceplates



- Includes screws

PART NO.	FINISH	# OF HOLES	CTN/MSTR
T05012	Chrome Plated	1	25/200
T0812BN	Brushed Nickel	1	1/100
T0812RB	Oil Rubbed Bronze	1	1/100
T0812WB	Old World Bronze	1	1/100
T08012	Polished Brass (PVD)	1	1/200
T08013	Polished Brass	2	1/200
T08113	Polished Brass (PVD)	2	1/200
P35616	Satin Nickel	2	1/50

2-Hole Overflow Faceplate

A



• Includes screws

PART NO.	FINISH	# OF HOLES	CTN/MSTR
T05013	Chrome Plated	2	1/200
T0813BN	Brushed Nickel	2	1/1
T0813RB	Oil Rubbed Bronze	2	1/1
T0813WB	Old World Bronze	2	1/1
T0813PW	Polar White	2	1/1

Overflow Faceplate Only



• 2-hole faceplate
• Less screws

PART NO.	FINISH	# OF HOLES	CTN/MSTR
T05011	Chrome Plated	2	1/200
P3565AL	Almond	2	1/50
P3565AB	Antique Brass	2	1/50
P3565AN	Antique Nickel	2	1/50
P3565BI	Biscuit	2	1/50
P3565BL	Black	2	1/50
P3565BN	Brushed Nickel	2	1/50
P3565BS	Brushed Stainless	2	1/50
P3565RB	Oil Rubbed Bronze	2	1/50
P3565WB	Old World Bronze	2	1/50
P3565PW	Polar White	2	1/50
P3565PN	Polished Nickel	2	1/50
P3565PS	Polished Stainless	2	1/50

Waste and Overflow Faceplate Screws



• For P3566 and P3565 series faceplates

PART NO.	FINISH	SIZE	CTN/MSTR
T05021	Chrome Plated	1/4" x 2"	100/1000
T0521AL	Almond	1/4" x 2"	1/300
T0521AB	Antique Brass	1/4" x 2"	1/300
T0521AN	Antique Nickel	1/4" x 2"	1/300
T0521BI	Biscuit	1/4" x 2"	1/300
T0521BL	Black	1/4" x 2"	1/300
T0521BN	Brushed Nickel	1/4" x 2"	1/300
T0521BS	Brushed Stainless	1/4" x 2"	1/300
T0521RB	Oil Rubbed Bronze	1/4" x 2"	1/300
T0521WB	Old World Bronze	1/4" x 2"	1/300
T0521PW	Polar White	1/4" x 2"	1/300
T0521PN	Polished Nickel	1/4" x 2"	1/300
T0521PS	Polished Stainless	1/4" x 2"	1/300
T08021	Polished Brass	1/4" x 2"	50/2000
P35615	Satin Nickel	1/4" x 2"	1/25

Bath Drains



• 2-11/16" OD
• P35061 and P35060 have a zinc body

PART NO.	FINISH	DESCRIPTION	CTN/MSTR
P35061	Chrome Plated	1-3/8" Lift and Turn	1/100
P35051	Polished Brass (PVD)	1-3/8" Lift and Turn	1/100
P35060	Chrome Plated	1-1/2" Lift and Turn	1/100
P35050	Polished Brass (PVD)	1-1/2" Lift and Turn	1/100
P35065	White	1-1/2" Lift and Turn	1/100



PART NO.	FINISH	DESCRIPTION	CTN/MSTR
P35063	Chrome Plated	1-3/8" Toe Touch	1/100
P35062	Chrome Plated	1-1/2" Toe Touch	1/100
P35052	Polished Brass	1-1/2" Toe Touch	1/100



• P35056 is replacement cartridge for P35063 and P35062
• P35055 is replacement cartridge for P35052

PART NO.	FINISH	DESCRIPTION	CTN/MSTR
P35056	Chrome Plated	5/16" Toe Touch Cartridge	1/300
P35055	Polished Brass	5/16" Toe Touch Cartridge	1/300



• 1-3/8" are fine threads
• 1-1/2" are coarse threads

PART NO.	DESCRIPTION	CTN/MSTR
T05024	1-3/8" female- 1-1/2" male bushing	50/300

Polished Brass/Satin Nickel Bath Drains



• PVD durable finish

PART NO.	FINISH	DESCRIPTION	CTN/MSTR
P35072	Polished Brass (PVD)	1-1/2" Lift and Turn	1/100
P35073	Polished Brass (PVD)	1-1/2" Toe Touch	1/50
P35068	Polished Brass (PVD)	1-1/2" Friction Lift	1/50
P35058	Polished Brass (PVD)	3/8" Toe Touch Replacement	1/100
P35610	Satin Nickel (PVD)	1-1/2" Lift and Turn	1/50
P35611	Satin Nickel (PVD)	1-1/2" Friction Lift	1/50
P35612	Satin Nickel (PVD)	1-1/2" Toe Touch	1/50
P35613	Satin Nickel (PVD)	1-1/2" Trip Lever	1/50
P35614	Satin Nickel (PVD)	1-1/2" Cable Drive	1/50

Toe Touch Bath Drain



- 1-1/2" drain
- Coarse thread

PART NO.	FINISH	CTN/MSTR
P35062	Chrome Plated	1/100
P3562AL	Almond	1/50
P3562AB	Antique Brass	1/50
P3562AN	Antique Nickel	1/50
P3562BI	Biscuit	1/50
P3562BL	Black	1/50
P3562BN	Brushed Nickel	1/50
P3562BS	Brushed Stainless	1/50
P3562RB	Oil Rubbed Bronze	1/50
P3562WB	Old World Bronze	1/50
P3562PW	Polar White	1/50
P3562PN	Polished Nickel	1/50
P3562PS	Polished Stainless	1/50

Lift and Turn Bath Drain



- Body and stopper
- 1-1/2" drain
- Coarse thread

PART NO.	FINISH	CTN/MSTR
P35066	Chrome Plated	1/100
P3560AL	Almond	1/50
P3560AB	Antique Brass	1/50
P3560AN	Antique Nickel	1/50
P3560BI	Biscuit	1/50
P3560BL	Black	1/50
P3560BN	Brushed Nickel	1/50
P3560BS	Brushed Stainless	1/50
P3560RB	Oil Rubbed Bronze	1/50
P3560WB	Old World Bronze	1/50
P3560PW	Polar White	1/50
P35050	Polished Brass (PVD)	1/100
P3560PN	Polished Nickel	1/50
P3560PS	Polished Stainless	1/50
P35610	Satin Nickel	1/50

A

Trip Lever Body, Grid and Screw



- 1-1/2" drain
- Coarse thread

PART NO.	FINISH	CTN/MSTR
P35064	Chrome Plated	1/100
P3563AL	Almond	1/50
P3563AB	Antique Brass	1/50
P3563AN	Antique Nickel	1/50
P3563BI	Biscuit	1/50
P3563BL	Black	1/50
P3563BN	Brushed Nickel	1/50
P3563BS	Brushed Stainless	1/50
P3563RB	Oil Rubbed Bronze	1/50
P3563WB	Old World Bronze	1/50
P3563PW	Polar White	1/50
P3563PN	Polished Nickel	1/50
P3563PS	Polished Stainless	1/50

Friction Lift Bath Drain



- 1-1/2" drain
- Coarse thread

PART NO.	FINISH	CTN/MSTR
P35067	Chrome Plated	1/100
P3561AL	Almond	1/50
P3561AB	Antique Brass	1/50
P3561AN	Antique Nickel	1/50
P3561BI	Biscuit	1/50
P3561BL	Black	1/50
P3561BN	Brushed Nickel	1/50
P3561BS	Brushed Stainless	1/50
P3561RB	Oil Rubbed Bronze	1/50
P3561WB	Old World Bronze	1/50
P3561PW	Polar White	1/50
P35068	Polished Brass (PVD)	1/50
P3561PN	Polished Nickel	1/50
P3561PS	Polished Stainless	1/50
P35611	Satin Nickel	1/50

Flip-It Bath Tub Stopper



- No tools needed for installation
- Open or close with a flip of the toe
- Fits most popular tub drains (assorted o-ring included)
- One piece construction Delrin and ABS

PART NO.	FINISH	CTN/MSTR
P35070	Chrome Plated	100/200
P35071	Polished Brass	1/100

A Standard 1-Hole Schedule 40 Lift and Turn Bath Waste Kits



- 1-hole faceplate
- Bolt holes on top elbows are pre-threaded
- All drains 3/8" thread size for testing

Half Kit			
PVC#	ABS#	FINISH	CTN/MSTR
B07010	B07011	Chrome Plated	1/1
B0750BN	B0850BN	Brushed Nickel	1/1
B0750RB	B0850RB	Oil Rubbed Bronze	1/1
B0750WB	B0850WB	Old World Bronze	1/1
B07014	B07015	Polished Brass	1/1



- 1-hole faceplate
- Bolt holes on top elbows are pre-threaded
- All drains 3/8" thread size for testing

Full Kit			
PVC#	ABS#	FINISH	CTN/MSTR
B07030	B07031	Chrome Plated	1/1
B0751BN	B0851BN	Brushed Nickel	1/1
B0751RB	B0851RB	Oil Rubbed Bronze	1/1
B0751WB	B0851WB	Old World Bronze	1/1
B07034	B07035	Polished Brass	1/1

Standard 1-Hole Schedule 40 Toe Touch Bath Waste Kits



- 1-hole faceplate
- Bolt holes on top elbows are pre-threaded
- All drains 3/8" thread size for testing

Half Kit			
PVC#	ABS#	FINISH	CTN/MSTR
B07012	B07013	Chrome Plated	1/24
B0754BN	B0854BN	Brushed Nickel	1/1
B0754RB	B0854RB	Oil Rubbed Bronze	1/1
B07016	—	Polished Brass	1/1



- 1-hole faceplate
- Bolt holes on top elbows are pre-threaded
- All drains 3/8" thread size for testing

Full Kit			
PVC#	ABS#	FINISH	CTN/MSTR
B07032	B07033	Chrome Plated	1/1
B0755BN	B0855BN	Brushed Nickel	1/1
B0755RB	B0855RB	Oil Rubbed Bronze	1/1
B0755WB	B0855WB	Old World Bronze	1/1
B0755NP	—	Pearl Nickel	1/1
B07036	B07037	Polished Brass	1/1

Standard 1-Hole Schedule 40 Friction Lift Bath Waste Kits



- 1-hole faceplate
- Bolt holes on top elbows are pre-threaded
- All drains 3/8" thread size for testing

Half Kit			
PVC#	ABS#	FINISH	CTN/MSTR
B07052	B07053	Chrome Plated	1/1
B0752BN	B0852BN	Brushed Nickel	1/1
B0752RB	B0852RB	Oil Rubbed Bronze	1/1
B0752WB	B0852WB	Old World Bronze	1/1
B07054	B07055	Polished Brass	1/1



- 1-hole faceplate
- Bolt holes on top elbows are pre-threaded
- All drains 3/8" thread size for testing

Full Kit			
PVC#	ABS#	FINISH	CTN/MSTR
B07058	B07059	Chrome Plated	1/1
B0753BN	B0853BN	Brushed Nickel	1/1
B0753RB	B0853RB	Oil Rubbed Bronze	1/1
B0753WB	B0853WB	Old World Bronze	1/1
B07060	B07061	Polished Brass	1/1

Standard 2-Hole Schedule 40 Lift and Turn Bath Waste Kits



- 2-hole faceplate
- Bolt holes on top elbow are pre-threaded
- All drains 3/8" thread size for testing

Half Kit			
PVC#	ABS#	FINISH	CTN/MSTR
B07110	B07111	Chrome Plated	1/1
B0711AL	B0811AL	Almond	1/1
B0711AB	B0811AB	Antique Brass	1/1
B0711AN	B0811AN	Antique Nickel	1/1
B0711BI	B0811BI	Biscuit	1/1
B0711BL	B0811BL	Black	1/1
B0711BN	B0811BN	Brushed Nickel	1/1
B0711BS	B0811BS	Brushed Stainless	1/1
B0711RB	B0811RB	Oil Rubbed Bronze	1/1
B0711WB	B0811WB	Old World Bronze	1/1
B0711PW	B0811PW	Polar White	1/1
B07114	B07115	Polished Brass	1/1
B0711PN	B0811PN	Polished Nickel	1/1
B0711PS	B0811PS	Polished Stainless	1/1



- 2-hole faceplate
- Bolt holes on top elbow are pre-threaded
- All drains 3/8" thread size for testing

Full Kit			
PVC#	ABS#	FINISH	CTN/MSTR
B07130	B07131	Chrome Plated	1/1
B0713AL	B0813AL	Almond	1/1
B0713AB	B0813AB	Antique Brass	1/1
B0713AN	B0813AN	Antique Nickel	1/1
B0713BI	B0813BI	Biscuit	1/1
B0713BL	B0813BL	Black	1/1
B0713BN	B0813BN	Brushed Nickel	1/1
B0713BS	—	Brushed Stainless	1/1
B0713RB	B0813RB	Oil Rubbed Bronze	1/1
B0713WB	B0813WB	Old World Bronze	1/1
B0713PW	B0813PW	Polar White	1/1
B07134	B07135	Polished Brass	1/1
B0713PN	B0813PN	Polished Nickel	1/1
B0713PS	B0813PS	Polished Stainless	1/1

Standard 2-Hole Schedule 40 Toe Touch Bath Waste Kits

A



- 2-hole faceplate
- Bolt holes on top elbow are pre-threaded
- All drains 3/8" thread size for testing

Half Kit			
PVC#	ABS#	FINISH	CTN/MSTR
B07112	B07113	Chrome Plated	1/1
B0717AL	B0817AL	Almond	1/1
B0717AB	B0817AB	Antique Brass	1/1
B0717AN	—	Antique Nickel	1/1
B0717BI	B0817BI	Biscuit	1/1
B0717BL	B0817BL	Black	1/1
B0717BN	B0817BN	Brushed Nickel	1/1
B0717BS	B0817BS	Brushed Stainless	1/1
B0717RB	B0817RB	Oil Rubbed Bronze	1/1
B0717WB	B0817WB	Old World Bronze	1/1
B0717PW	B0817PW	Polar White	1/1
B07116	B07117	Polished Brass	1/1
B0717PN	B0817PN	Polished Nickel	1/1
B0717PS	B0817PS	Polished Stainless	1/1



- 2-hole faceplate
- Bolt holes on top elbow are pre-threaded
- All drains 3/8" thread size for testing

Full Kit			
PVC#	ABS#	FINISH	CTN/MSTR
B07158	B07159	Chrome Plated	1/1
B0716AL	B0816AL	Almond	1/1
B0716AB	B0816AB	Antique Brass	1/1
B0716AN	B0816AN	Antique Nickel	1/1
B0716BI	B0816BI	Biscuit	1/1
B0716BL	B0816BL	Black	1/1
B0716BN	B0816BN	Brushed Nickel	1/1
B0716BS	B0816BS	Brushed Stainless	1/1
B0716RB	B0816RB	Oil Rubbed Bronze	1/1
B0716WB	B0816WB	Old World Bronze	1/1
B0716PW	B0816PW	Polar White	1/1
B07160	B07161	Polished Brass	1/1
B0716PN	B0816PN	Polished Nickel	1/1
B0716PS	B0816PS	Polished Stainless	1/1

A Standard 2-Hole Schedule 40 Friction Lift Bath Waste Kits



- 2-hole faceplate
- Bolt holes on top elbow are pre-threaded
- All drains 3/8" thread size for testing

Half Kit			
PVC#	ABS#	FINISH	CTN/MSTR
B07152	B07153	Chrome Plated	1/1
B0715AL	B0815AL	Almond	1/1
B0715AB	B0815AB	Antique Brass	1/1
B0715AN	B0815AN	Antique Nickel	1/1
B0715BI	B0815BI	Biscuit	1/1
B0715BL	B0815BL	Black	1/1
B0715BN	B0815BN	Brushed Nickel	1/1
B0715BS	—	Brushed Stainless	1/1
B0715RB	B0815RB	Oil Rubbed Bronze	1/1
B0715WB	B0815WB	Old World Bronze	1/1
B0715PW	B0815PW	Polar White	1/1
B07154	B07155	Polished Brass	1/1
B0715PN	B0815PN	Polished Nickel	1/1
B0715PS	B0815PS	Polished Stainless	1/1



- 2-hole faceplate
- Bolt holes on top elbow are pre-threaded
- All drains 3/8" thread size for testing

Full Kit			
PVC#	ABS#	FINISH	CTN/MSTR
B07132	B07133	Chrome Plated	1/1
B0718AL	B0818AL	Almond	1/1
B0718AB	B0818AB	Antique Brass	1/1
B0718AN	B0818AN	Antique Nickel	1/1
B0718BI	B0818BI	Biscuit	1/1
B0718BL	B0818BL	Black	1/1
B0718BN	B0818BN	Brushed Nickel	1/1
B0718BS	B0817BS	Brushed Stainless	1/1
B0718RB	B0818RB	Oil Rubbed Bronze	1/1
B0718WB	B0818WB	Old World Bronze	1/1
B0718PW	B0818PW	Polar White	1/1
B07136	B07137	Polished Brass	1/1
B0718PN	B0818PN	Polished Nickel	1/1
B0718PS	B0818PS	Polished Stainless	1/1

Tubular Lift and Turn Bath Waste Kits



- 2-hole faceplate
- Heavy walled PVC tubular
- 1-1/2" IPS threaded drain shoe
- Overflow elbow designed to accommodate B07202 test kit

Full Kit			
PVC#	ABS#	FINISH	CTN/MSTR
P37500	P39500	Chrome Plated	1/20
P3750AL	P3950AL	Almond	1/1
P3750AB	P3950AB	Antique Brass	1/1
P3750AN	P3950AN	Antique Nickel	1/1
P3750BI	P3950BI	Biscuit	1/1
P3750BL	P3950BL	Black	1/1
P3750BN	P3950BN	Brushed Nickel	1/1
P3750BS	P3950BS	Brushed Stainless	1/1
P3750RB	P3950RB	Oil Rubbed Bronze	1/1
P3750WB	P3950WB	Old World Bronze	1/1
P3750PW	P3950PW	Polar White	1/1
P3750PN	P3950PN	Polished Nickel	1/1
P3750PS	P3950PS	Polished Stainless	1/1
P37502	P39502	Satin Nickel	1/20

Tubular Friction Lift Bath Waste Kits



- 2-hole faceplate
- Heavy walled PVC tubular
- 1-1/2" IPS threaded drain shoe
- Overflow elbow designed to accommodate B07202 test kit

Full Kit			
PVC#	ABS#	FINISH	CTN/MSTR
P37503	P39503	Chrome Plated	1/20
P3751AL	P3951AL	Almond	1/1
P3751AB	P3951AB	Antique Brass	1/1
P3751AN	P3951AN	Antique Nickel	1/1
P3751BI	P3951BI	Biscuit	1/1
P3751BL	P3951BL	Black	1/1
P3751BN	P3951BN	Brushed Nickel	1/1
P3751BS	P3951BS	Brushed Stainless	1/1
P3751RB	P3951RB	Oil Rubbed Bronze	1/1
P3751WB	P3951WB	Old World Bronze	1/1
P3751PW	P3951PW	Polar White	1/1
P3751PN	P3951PN	Polished Nickel	1/1
P3751PS	P3951PS	Polished Stainless	1/1
P37505	P39505	Satin Nickel	1/20

Tubular Toe Touch Bath Waste Kits



- 2-hole faceplate
- Heavy walled PVC tubular
- 1-1/2" IPS threaded drain shoe
- Overflow elbow designed to accommodate B07202 test kit

Full Kit			
PVC#	ABS#	FINISH	CTN/MSTR
P37506	P39506	Chrome Plated	1/20
P3752AL	P3952AL	Almond	1/1
P3752AB	P3952AB	Antique Brass	1/1
P3752AN	P3952AN	Antique Nickel	1/1
P3752BI	P3952BI	Biscuit	1/1
P3752BL	P3952BL	Black	1/1
P3752BN	P3952BN	Brushed Nickel	1/1
P3752RB	P3952RB	Oil Rubbed Bronze	1/1
P3752WB	P3952WB	Old World Bronze	1/1
P3752PW	P3952PW	Polar White	1/1
P3752PN	P3952PN	Polished Nickel	1/1
P3752PS	P3952PS	Polished Stainless	1/1
P37508	P39508	Satin Nickel	1/20

Tubular Trip Lever Bath Waste Kits



- 2-hole faceplate
- Heavy walled PVC tubular
- 1-1/2" IPS threaded drain shoe
- Overflow elbow designed to accommodate B07202 test kit

Full Kit			
PVC#	ABS#	FINISH	CTN/MSTR
P37509	P39509	Chrome Plated	1/20
P3761AL	P3961AL	Almond	1/1
P3761AB	P3961AB	Antique Brass	1/1
P3761AN	P3961AN	Antique Nickel	1/1
P3761BI	P3961BI	Biscuit	1/1
P3761BL	P3961BL	Black	1/1
P3761BN	P3961BN	Brushed Nickel	1/1
P3761BS	—	Brushed Stainless	1/1
P3761RB	P3961RB	Oil Rubbed Bronze	1/1
P3761WB	P3961WB	Old World Bronze	1/1
P3761PW	P3961PW	Polar White	1/1
P3761PN	P3961PN	Polished Nickel	1/1
P3761PS	P3961PS	Polished Stainless	1/1
P37511	P39511	Satin Nickel	1/20

27" Cable Drive Bath Waste Kits



- 1-1/2" Schedule 40 Cable Drive

Full Kit		
PVC#	FINISH	CTN/MSTR
P37550	Chrome Plated	1/10
P3755BN	Brushed Nickel	1/10
P3755RB	Oil Rubbed Bronze	1/10
P3755WB	Old World Bronze	1/10
P3755PB	Polished Brass	1/10
P3755WH	White	1/10

2" Metal Spud with 4-1/4" Round Strainer



- All brass spud & strainer
- Works with shower drain base D50001

PART NO.	FINISH	CTN/MSTR
D60981	Chrome Plated	1/50
D6098BN	Brushed Nickel	1/50
D6098RB	Oil Rubbed Bronze	1/50
D6098WB	Old World Bronze	1/50
D60982	Polished Brass	1/50
D60980	Stainless Steel	1/50

3-1/2" Metal Spud with 5" Square Strainer

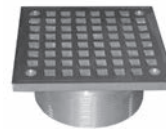

- All brass spud & strainer
- Works with shower drain base D49804/D49801

PART NO.	FINISH	CTN/MSTR
D60954	Chrome Plated	1/20
D6096BN	Brushed Nickel	1/20
D60962	Nickel Bronze	1/20
D6096RB	Oil Rubbed Bronze	1/20
D6096WB	Old World Bronze	1/20
D60960	Polished Brass	1/20

A

2" Brass Spud with 4" Square Strainer



- All brass spud & strainer
- Grout ring
- Works with shower drain base D50001

PART NO.	FINISH	CTN/MSTR
D60942	Chrome Plated	1/27
D6094BN	Brushed Nickel	1/27
D6094RB	Oil Rubbed Bronze	1/27
D6094WB	Old World Bronze	1/27
D6094PB	Polished Brass	1/27

2" PVC Spud with 4-1/4" Stamped Square Strainer



- Snap-in strainer

PART NO.	FINISH	CTN/MSTR
D5087BN	Brushed Nickel	1/1
D5087RB	Oil Rubbed Bronze	1/1
D5087WB	Old World Bronze	1/1
D50887	Stainless Steel	1/1

2" x 3" Shower Drain with 2" Brass Spud and 4-1/4" Square Strainer



- All brass spud and strainer
- Grout ring

ASSEMBLED IN
USA

PART NO.	FINISH	CTN/MSTR
D50942	Chrome Plated	1/1
D5094BN	Brushed Nickel	1/1
D5094RB	Oil Rubbed Bronze	1/1
D5094WB	Old World Bronze	1/1

2" x 3" Shower Drain with 2" Spud and 4" Square Snap-in Strainer



- No screws
- Four prong installation
- Plastic spud

ASSEMBLED IN
USA

PART NO.	FINISH	CTN/MSTR
D5088BN	Brushed Nickel	1/1
D5088RB	Oil Rubbed Bronze	1/1
D5088WB	Old World Bronze	1/1
D50888	Stainless Steel	1/1

2" x 3" Shower Drain with 2" Spud and 4-1/4" Round Strainer



- Flow rate - 3.102 GPM
- Cast brass strainer
- Metal spud

ASSEMBLED IN
USA

PART NO.	FINISH	CTN/MSTR
D50111	Chrome Plated	1/1
D5001BN	Brushed Nickel	1/1
D5001RB	Oil Rubbed Bronze	1/1
D5001WB	Old World Bronze	1/1

2" x 3" Heavy Duty PVC Shower Drain with 3-1/2" Spud and 5" Round Cast Brass Strainer



- PVC spud
- Round strainer
- For multi-head showers
- Flow rate - 15.260 GPM
- Primer tapped

ASSEMBLED IN
USA

PART NO.	FINISH	CTN/MSTR
D49059	Chrome Plated	1/1
D4912BN	Brushed Nickel	1/1
D49057	Nickel Bronze	1/1
D4912RB	Oil Rubbed Bronze	1/1
D4912WB	Old World Bronze	1/1
D49055	Polished Brass	1/1

3" x 4" Heavy Duty PVC Shower Drain with 3-1/2" Spud and 5" Round Strainer



- Metal spud
- Round strainer
- For multi-head showers
- Flow rate - 15.260 GPM
- Primer tapped

ASSEMBLED IN
USA

PART NO.	FINISH	CTN/MSTR
D49159	Chrome Plated	1/1
D4991BN	Brushed Nickel	1/1
D49157	Nickel Bronze	1/1
D4991RB	Oil Rubbed Bronze	1/1
D4991WB	Old World Bronze	1/1
D49155	Polished Brass	1/1

3" x 4" Heavy Duty PVC Shower Drain with 3-1/2" Spud and 5" Square Strainer



- Metal spud
- Square strainer
- For multi-head showers
- Flow rate - 15.260 GPM
- Primer tapped

ASSEMBLED IN
USA

PART NO.	FINISH	CTN/MSTR
D4996BN	Brushed Nickel	1/1
D4996RB	Oil Rubbed Bronze	1/1
D4996WB	Old World Bronze	1/1

3" x 4" Heavy Duty PVC Shower Drain with 3-1/2" Plastic Spud and 5" Round Cast Brass Strainer



- PVC spud
- Round strainer
- For multi-head showers
- Flow rate - 15.260 GPM
- Primer tapped

ASSEMBLED IN
USA

PART NO.	FINISH	CTN/MSTR
D4984BN	Brushed Nickel	1/1
D4984RB	Oil Rubbed Bronze	1/1
D4984WB	Old World Bronze	1/1

2" No Caulk Shower Stall Drain with 4-1/4" Round Snap-in Strainer



- Wrench included
- For 2" CTS order gasket separately

PART NO.	FINISH	CTN/MSTR
D4010BN	Brushed Nickel	1/1
D4010RB	Oil Rubbed Bronze	1/1
D4010WB	Old World Bronze	1/1

4-1/4" Round Stamped Strainer



- Includes screws
- Fits D50001 tile shower drain
- Blister packaging
- Center to center screwholes- 3-3/8"

PART NO.	FINISH	CTN/MSTR
C60806	Chrome Plated	1/100
C6089AL	Almond	20/400
C6089AB	Antique Brass	20/400
C6089AN	Antique Nickel	20/400
C6089BI	Biscuit	20/400
C6089BL	Black	20/400
C6089BN	Brushed Nickel	20/200
C6089RB	Oil Rubbed Bronze	20/200
C6089WB	Old World Bronze	20/200
C6089PW	Polar White	20/400
C60810	Polished Brass (PVD)	20/400
C6089PN	Polished Nickel	20/400
C6089PS	Polished Stainless	20/200
C60814	Satin Nickel	1/100

4-1/4" Round Snap-in Strainer



- For no caulk fiberglass shower stalls
- Fits D40101, D40140 and D50001
- Snap-in prong to snap-in prong - 3"
- Blister packaging

PART NO.	FINISH	CTN/MSTR
D4005BN	Brushed Nickel	20/200
D4005RB	Oil Rubbed Bronze	1/200
D4005WB	Old World Bronze	1/200
D40003	Polished Brass (PVD)	50/250
D40010	Satin Nickel	20/200
D40005	Stainless Steel	1/200
D40004	White	50/200

4-1/4" Square Snap-in Strainer



- Fits D5088 series drains
- Stamped
- Coverall

PART NO.	FINISH	CTN/MSTR
C60888	Chrome Plated	1/100
C6088BN	Brushed Nickel	10/100
C6088RB	Oil Rubbed Bronze	10/100
C6088WB	Old World Bronze	10/100

4-1/4" Round Cast Brass Heavy Duty Strainer



- Includes screws
- Fits D50001 tile shower drain
- Center to center screwholes- 3-3/8"

PART NO.	FINISH	CTN/MSTR
C6087BN	Brushed Nickel	1/100
C6087RB	Oil Rubbed Bronze	1/100
C6087WB	Old World Bronze	1/100
C60807	Polished Brass (PVD)	1/100

4-1/4" Square Cast Brass Heavy Duty Strainer



- Includes fine and coarse threaded screws
- Fits D50001 tile shower drain
- Center to center screwholes- 3-3/8"

PART NO.	FINISH	CTN/MSTR
C6083BN	Brushed Nickel	1/100
C6083RB	Oil Rubbed Bronze	1/100
C6083WB	Old World Bronze	1/100
C60813	Polished Brass (PVD)	1/100

5.196" Round Cast Brass Heavy Duty Strainer

A



- Includes screws
- Fits any drain with 3-1/2" PVC spud
- Center to center screwholes- 4-3/8"

PART NO.	FINISH	CTN/MSTR
C60803	Chrome Plated	1/50
C6084BN	Brushed Nickel	1/30
C6084RB	Oil Rubbed Bronze	1/30
C6084WB	Old World Bronze	1/30
C60804	Polished Brass	1/50

"Code Blue" Round Replacement Strainer

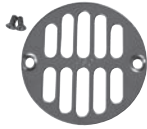

- Includes screws
- Fits non-adjustable "Code Blue" drains

PART NO.	DESCRIPTION	CTN/MSTR
D64000	2" SS	1/50
D64401	SS Crown	1/100
D64001	2" Polished Brass (PVD)	1/100
D6400BN	Brushed Nickel	1/250
D6400RB	Oil Rubbed Bronze	1/250
D6400WB	Old World Bronze	1/250

4" Round Strainer



- Includes screws
- Stamped to fit inside plastic ring
- Center to center screwholes- 3.362"

PART NO.	FINISH	CTN/MSTR
D54010	Polished Brass (PVD)	1/400

4-1/4" Round Strainer with Screws for Fiberglass Shower Stalls



- Fits D41001 and D41600
- Tapping screws included
- Center to center screwholes- 2-5/8"

PART NO.	FINISH	CTN/MSTR
D4110BN	Brushed Nickel	20/200
D4110RB	Oil Rubbed Bronze	20/200
D4110WB	Old World Bronze	20/200
D4110PN	Polished Nickel	20/200
D41102	Polished Brass (PVD)	50/250
D41107	Satin Nickel	50/250
D41101	Stainless Steel	50/250

3-1/2" PVC Spud with 5" Round Strainer



- Fits drain bases tapped for 3-1/2" spuds

PART NO.	FINISH	CTN/MSTR
D56216	Chrome Plated	1/1
D6084BN	Brushed Nickel	1/1
D56214	Nickel Bronze	1/1
D6084RB	Oil Rubbed Bronze	1/1
D6084WB	Old World Bronze	1/1
D56212	Polished Brass	1/1
D56211	Stainless Steel	1/1

3-1/2" Metal Spud with 5" Round Strainer



- All brass
- Fits drain bases tapped for 3-1/2" spuds

PART NO.	FINISH	CTN/MSTR
D60990	Chrome Plated	1/40
D6091BN	Brushed Nickel	1/40
D60996	Nickel Bronze	1/30
D6091RB	Oil Rubbed Bronze	1/40
D6091WB	Old World Bronze	1/40
D60991	Polished Brass	1/40

Polished Brass Escutcheon



- Low Patten

PART NO.	DESCRIPTION	CTN/MSTR
E80050	1/2" CTS (5/8" OD)	25/1000
E80075	3/4" CTS (7/8" OD)	25/1000
E81375	3/8" IPS	25/1000
E81050	1/2" IPS	25/1000

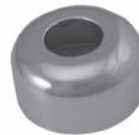

- Box Patten

PART NO.	DESCRIPTION	CTN/MSTR
E82125	1-1/4" OD tubular	25/200
E82150	1-1/2" OD tubular	25/200

Escutcheons



Low Pattern - Copper Tube Size

PART NO.	FINISH	SIZE	FLANGE OD	CTN/MSTR
E0105BN	Brushed Nickel	1/2" CTS (5/8" OD)	2-1/2"	1/200
E0105RB	Oil Rubbed Bronze	1/2" CTS (5/8" OD)	2-1/2"	1/200
E0105WB	Old World Bronze	1/2" CTS (5/8" OD)	2-1/2"	1/200

Low Pattern - Iron Pipe Size

PART NO.	FINISH	SIZE	FLANGE OD	CTN/MSTR
E0205BN	Brushed Nickel	1/2" IPS	2-1/2"	1/300
E0205RB	Oil Rubbed Bronze	1/2" IPS	2-1/2"	1/300
E0205WB	Old World Bronze	1/2" IPS	2-1/2"	1/300

Box Pattern - Tubular

PART NO.	FINISH	SIZE	FLANGE OD	CTN/MSTR
E0412BN	Brushed Nickel	1-1/4" Tubular	3"	1/100
E0412RB	Oil Rubbed Bronze	1-1/4" Tubular	3"	1/100
E0412WB	Old World Bronze	1-1/4" Tubular	3"	1/100
E0415BN	Brushed Nickel	1-1/2" Tubular	3"	1/100
E0415RB	Oil Rubbed Bronze	1-1/2" Tubular	3"	1/100
E0415WB	Old World Bronze	1-1/2" Tubular	3"	1/100

Bell Pattern - Copper Tube Size

PART NO.	FINISH	SIZE	FLANGE OD	CTN/MSTR
E0705BN	Brushed Nickel	1/2" CTS (5/8" OD)	2-3/8"	1/100
E0705RB	Oil Rubbed Bronze	1/2" CTS (5/8" OD)	2-3/8"	1/100
E0705WB	Old World Bronze	1/2" CTS (5/8" OD)	2-3/8"	1/100
E0705PB	Polished Brass	1/2" CTS (5/8" OD)	2-3/8"	1/100

Bell Pattern - Iron Pipe Size

PART NO.	FINISH	SIZE	FLANGE OD	CTN/MSTR
E0605BN	Brushed Nickel	1/2" IPS	2-3/8"	1/100
E0605RB	Oil Rubbed Bronze	1/2" IPS	2-3/8"	1/100
E0605WB	Old World Bronze	1/2" IPS	2-3/8"	1/100
E0605PB	Polished Brass	1/2" IPS	2-3/8"	1/100

Bell Pattern - Tubular

PART NO.	FINISH	SIZE	FLANGE OD	CTN/MSTR
E0812BN	Brushed Nickel	1-1/4" Tubular	3"	1/100
E0812RB	Oil Rubbed Bronze	1-1/4" Tubular	3"	1/100
E0812WB	Old World Bronze	1-1/4" Tubular	3"	1/100
E0812PB	Polished Brass	1-1/4" Tubular	3"	1/100
E0815BN	Brushed Nickel	1-1/2" Tubular	3"	1/100
E0815RB	Oil Rubbed Bronze	1-1/2" Tubular	3"	1/100
E0815WB	Old World Bronze	1-1/2" Tubular	3"	1/100
E0815PB	Polished Brass	1-1/2" Tubular	3"	1/100

Polished Brass Finish Flexible Floor and Ceiling Plate

A



• Plastic

PART NO.	DESCRIPTION	CTN/MSTR
F08375	3/8" IPS or 1/2" CTS	12/1080
F08050	1/2" IPS or 3/4" CTS	12/1080
F08124	1-1/4" CTS	12/1440
F08150	1-1/2" IPS	12/1200

Non-Slotted Full Flow Aerator



• Dual threads (15/16 -27 male x 55/64 -27 female)

PART NO.	FINISH	CTN/MSTR
A01019	Polished Brass	1/500

Brass Nipple



• Lead free

3/8" x 4"

PART NO.	FINISH	SIZE	CTN/MSTR
N2206BN	Brushed Nickel (PVD)	3/8" x 4"	25/200
N2206RB	Oil Rubbed Bronze	3/8" x 4"	25/200
N2206WB	Old World Bronze	3/8" x 4"	25/200
N17375	Polished Brass	3/8" x 4"	25/200

3/8" x 6"

PART NO.	FINISH	SIZE	CTN/MSTR
N2210BN	Brushed Nickel (PVD)	3/8" x 6"	25/100
N2210RB	Oil Rubbed Bronze	3/8" x 6"	25/100
N2210PB	Polished Brass	3/8" x 6"	25/100

1/2" x 4"

PART NO.	FINISH	SIZE	CTN/MSTR
N2306BN	Brushed Nickel (PVD)	1/2" x 4"	25/200
N2306RB	Oil Rubbed Bronze	1/2" x 4"	25/200
N2306WB	Old World Bronze	1/2" x 4"	25/200
N17050	Polished Brass	1/2" x 4"	25/200

1/2" x 6"

PART NO.	FINISH	SIZE	CTN/MSTR
N2310BN	Brushed Nickel (PVD)	1/2" x 6"	25/100
N2310RB	Oil Rubbed Bronze	1/2" x 6"	25/100
N2310WB	Old World Bronze	1/2" x 6"	25/100
N2310PB	Polished Brass	1/2" x 6"	25/100

Sleeves

A



- Fits over 1/2" CTS
- Brass

PART NO.	FINISH	SIZE	CTN/MSTR
T73300	Chrome	1/2" x 3-1/2"	1/200
T7330BN	Brushed Nickel (PVD)	1/2" x 3-1/2"	1/200
T7330RB	Oil Rubbed Bronze	1/2" x 3-1/2"	1/200
T7330WB	Old World Bronze	1/2" x 3-1/2"	1/200
T7330PB	Polished Brass (PVD)	1/2" x 3-1/2"	1/200

Quarter Turn Angle Stop with 5" Sweat Extension and Escutcheon



- Bell escutcheon
- 3/8" OD x 1/2" sweat connection
- Includes hot, cold and blank buttons

PART NO.	FINISH	CTN/MSTR
S42220	Chrome Plated	1/50
S4222BN	Brushed Nickel	1/50
S4222RB	Oil Rubbed Bronze	1/50
S4222WB	Old World Bronze	1/50

Quarter Turn Angle Stop



- Cross handle
- Includes hot, cold and blank buttons
- UPC Listed



1/2" FIP x 3/8" OD

PART NO.	FINISH	SIZE	CTN/MSTR
S42021	Chrome Plated	1/2" FIP x 3/8" OD	20/100
S4202BN	Brushed Nickel	1/2" FIP x 3/8" OD	20/100
S4202RB	Oil Rubbed Bronze	1/2" FIP x 3/8" OD	20/100
S4202WB	Old World Bronze	1/2" FIP x 3/8" OD	20/100
S4202PB	Polished Brass (PVD)	1/2" FIP x 3/8" OD	20/100

5/8" OD x 3/8" OD

PART NO.	FINISH	SIZE	CTN/MSTR
S42031	Chrome Plated	5/8" OD x 3/8" OD	20/100
S4203BN	Brushed Nickel	5/8" OD x 3/8" OD	20/100
S4203RB	Oil Rubbed Bronze	5/8" OD x 3/8" OD	20/100
S4203WB	Old World Bronze	5/8" OD x 3/8" OD	20/100
S4203PB	Polished Brass	5/8" OD x 3/8" OD	20/100



- Oval handle
- UPC Listed



3/8" OD x 3/8" OD

PART NO.	FINISH	SIZE	CTN/MSTR
S4212BN	Brushed Nickel	3/8" OD x 3/8" OD	20/100
S4212RB	Oil Rubbed Bronze	3/8" OD x 3/8" OD	20/100
S4212WB	Old World Bronze	3/8" OD x 3/8" OD	20/100

Quarter Turn Straight Stop



- Cross handle
- Includes hot, cold and blank buttons
- UPC Listed



1/2" FIP x 3/8" OD

PART NO.	FINISH	SIZE	CTN/MSTR
S43021	Chrome Plated	1/2" FIP x 3/8" OD	20/100
S4302BN	Brushed Nickel	1/2" FIP x 3/8" OD	20/100
S4302RB	Oil Rubbed Bronze	1/2" FIP x 3/8" OD	20/100
S4302WB	Old World Bronze	1/2" FIP x 3/8" OD	20/100
S4302PB	Polished Brass (PVD)	1/2" FIP x 3/8" OD	20/100

5/8" OD x 3/8" OD

PART NO.	FINISH	SIZE	CTN/MSTR
S43031	Chrome Plated	5/8" OD x 3/8" OD	20/100
S4303BN	Brushed Nickel	5/8" OD x 3/8" OD	20/100
S4303RB	Oil Rubbed Bronze	5/8" OD x 3/8" OD	20/100
S4303WB	Old World Bronze	5/8" OD x 3/8" OD	20/100
S4303PB	Polished Brass (PVD)	5/8" OD x 3/8" OD	20/100



- Oval handle
- UPC Listed



3/8" FIP x 3/8" OD

PART NO.	FINISH	SIZE	CTN/MSTR
S4311BN	Brushed Nickel	3/8" FIP x 3/8" OD	20/100
S4311RB	Oil Rubbed Bronze	3/8" FIP x 3/8" OD	20/100
S4311WB	Old World Bronze	3/8" FIP x 3/8" OD	20/100

Multi-Turn Compression Angle Stop



- UPC Listed



PART NO.	FINISH	SIZE	CTN/MSTR
S4211BN	Brushed Nickel	5/8" COMP x 3/8" COMP	20/100
S4211RB	Oil Rubbed Bronze	5/8" COMP x 3/8" COMP	20/100
S4211WB	Old World Bronze	5/8" COMP x 3/8" COMP	20/100
S4213BN	Brushed Nickel	1/2" FIP x 3/8" COMP	20/100
S4213RB	Oil Rubbed Bronze	1/2" FIP x 3/8" COMP	20/100
S4213WB	Old World Bronze	1/2" FIP x 3/8" COMP	20/100

Multi-Turn Compression Straight Stop



- UPC Listed



PART NO.	FINISH	SIZE	CTN/MSTR
S4312BN	Brushed Nickel	5/8" COMP x 3/8" COMP	20/100
S4312RB	Oil Rubbed Bronze	5/8" COMP x 3/8" COMP	20/100
S4312WB	Old World Bronze	5/8" COMP x 3/8" COMP	20/100
S4314BN	Brushed Nickel	1/2" FIP x 3/8" COMP	20/100
S4314RB	Oil Rubbed Bronze	1/2" FIP x 3/8" COMP	20/100
S4314WB	Old World Bronze	1/2" FIP x 3/8" COMP	20/100

Closest Supply and Stop Kit



- Supply and multi-turn stop
- 1/2" CTS escutcheon

3/8" x 20" Closet Supply and 3/8" x 5/8" Angle Stop Kit

PART NO.	FINISH	CTN/MSTR
S1037CP	Chrome	1/1
S1037AP	Antique Pewter	1/1
S1037BB	Brushed Bronze	1/1
S1037BN	Brushed Nickel	1/1
S1037RB	Oil Rubbed Bronze	1/1
S1037WB	Old World Bronze	1/1
S10371	Polished Brass	1/1
S1037PS	Polished Stainless	1/1

3/8" x 20" Closet Supply and 3/8" x 5/8" Straight Stop Kit

PART NO.	FINISH	CTN/MSTR
S1038CP	Chrome Plated	1/1
S1038AP	Antique Pewter	1/1
S1038BB	Brushed Bronze	1/1
S1038BN	Brushed Nickel	1/1
S1038RB	Oil Rubbed Bronze	1/1
S1038WB	Old World Bronze	1/1
S10381	Polished Brass	1/1
S1038PS	Polished Stainless	1/1

3/8" x 20" Closet Supply and 1/2" x 3/8" Angle Stop Kit

PART NO.	FINISH	CTN/MSTR
S1039CP	Chrome Plated	1/1
S1039BN	Brushed Nickel	1/1
S1039RB	Oil Rubbed Bronze	1/1

3/8" x 20" Closet Supply and 5/8" x 3/8" Angle Stop Kit

PART NO.	FINISH	CTN/MSTR
S1137BN	Brushed Nickel	1/1
S1137RB	Oil Rubbed Bronze	1/1

3/8" x 20" Closet Supply and 5/8" x 3/8" Straight Stop Kit

PART NO.	FINISH	CTN/MSTR
S1138BN	Brushed Nickel	1/1
S1138RB	Oil Rubbed Bronze	1/1

Lavatory Supply and Stop Kit

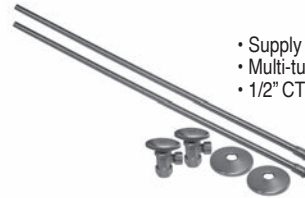

- Supply (2 pieces)
- Multi-turn stop (2 pieces)
- 1/2" CTS escutcheon (2 pieces)

3/8" x 20" Lavatory Supply and 3/8" x 5/8" Angle Stop Kit

PART NO.	FINISH	CTN/MSTR
S1036AP	Antique Pewter	1/25
S1036BN	Brushed Nickel	1/25
S1036RB	Oil Rubbed Bronze	1/25
S1036WB	Old World Bronze	1/25
S10361	Polished Brass	1/25

3/8" x 20" Lavatory Supply and 3/8" x 5/8" Straight Stop Kit

PART NO.	FINISH	CTN/MSTR
S1035AP	Antique Pewter	1/25
S1035BB	Brushed Bronze	1/25
S1035BN	Brushed Nickel	1/25
S1035RB	Oil Rubbed Bronze	1/25
S1035WB	Old World Bronze	1/25
S10351	Polished Brass	1/25
S1035PS	Polished Stainless	1/25

3/8" x 20" Lavatory Supply and 1/2" x 3/8" Angle Stop Kit

PART NO.	FINISH	CTN/MSTR
S1034BN	Brushed Nickel	1/1
S1034RB	Oil Rubbed Bronze	1/1

3/8" x 20" Lavatory Supply and 5/8" x 3/8" Angle Stop Kit

PART NO.	FINISH	CTN/MSTR
S1136BN	Brushed Nickel	1/1
S1136RB	Oil Rubbed Bronze	1/1

3/8" x 20" Lavatory Supply and 5/8" x 3/8" Straight Stop Kit

PART NO.	FINISH	CTN/MSTR
S1135BN	Brushed Nickel	1/1
S1135RB	Oil Rubbed Bronze	1/1

Polished Brass Water Supply Tube



- Bullnose rigid supply tube
- Lead free

PART NO.	DESCRIPTION	CTN/MSTR
S44002	3/8" x 20" basin tube	1/100
S44003	3/8" x 12" tank tube	1/200
S44005	3/8" x 20" tank tube	1/100

Lavatory Supply Tubes

A



- Basin supply
- Bullnose rigid supply tube

3/8" x 12"

PART NO.	FINISH	SIZE	CTN/MSTR
S04020	Chrome Plated	3/8" x 12"	1/100
S4401BN	Brushed Nickel	3/8" x 12"	1/100
S4401RB	Oil Rubbed Bronze	3/8" x 12"	1/100
S4401WB	Old World Bronze	3/8" x 12"	1/100

3/8" x 20"

PART NO.	FINISH	SIZE	CTN/MSTR
S04022	Chrome Plated	3/8" x 20"	1/100
S4402BN	Brushed Nickel	3/8" x 20"	1/100
S4402RB	Oil Rubbed Bronze	3/8" x 20"	1/100
S4402WB	Old World Bronze	3/8" x 20"	1/100

Closet Supply Tubes



- Tank supply
- Flat head rigid supply tube

3/8" x 12"

PART NO.	FINISH	SIZE	CTN/MSTR
S04027	Chrome Plated	3/8" x 12"	1/100
S4403BN	Brushed Nickel	3/8" x 12"	1/100
S4403RB	Oil Rubbed Bronze	3/8" x 12"	1/100
S4403WB	Old World Bronze	3/8" x 12"	1/100

3/8 x 20"

PART NO.	FINISH	SIZE	CTN/MSTR
S04029	Chrome Plated	3/8" x 20"	1/100
S4405BN	Brushed Nickel	3/8" x 20"	1/100
S4405RB	Oil Rubbed Bronze	3/8" x 20"	1/100
S4405WB	Old World Bronze	3/8" x 20"	1/100

Ultrafit Tank Trip Lever



- PATENTED
- New shapable arm bends to fit the needed arm angle
- Arm can be cut to fit 4", 6" or 8" lengths for customized fit
- Heavy duty plastic handle comes in a variety of finishes
- Sturdy plastic arm, spud and nut

PART NO.	FINISH	CTN/MSTR
T01100	Chrome Plated	1/200
T01101	Polished Brass	1/200
T01102	White	1/200
T01103	Bone	1/200
T04001	Display for UltraFit Tank levers 12 each of above	1/1

Tank Trip Levers



- Front mount
- 8" arm

PART NO.	DESCRIPTION	FINISH	CTN/MSTR
T01003	Brass arm with metal spud and nut	PB Metal	25/200
T01004	Brass plated arm with metal spud and nut	AB Metal	25/200
T01007	Brass arm with metal spud and nut	Satin Nickel	25/200



- Front mount
- 8" arm

PART NO.	DESCRIPTION	FINISH	CTN/MSTR
T01061	Brass plated arm with plastic spud and nut / universal fit	PB Metal	25/200



- Front mount
- 8" arm

PART NO.	DESCRIPTION	FINISH	CTN/MSTR
T01006	Brass arm with metal spud and nut / universal fit	PB Metal	25/200
T01008	Brass arm with die cast nut	Satin Nickel	25/200



- Side mount
- 8" arm

PART NO.	DESCRIPTION	FINISH	CTN/MSTR
T01071	Side mount push button brass arm with plastic spud and nut	PB ABS	25/50
T01075	Front mount push button brass arm with plastic spud and nut	PB ABS	25/50

Tank Trip Levers for Crane*



- Front mount
- 8" arm

PART NO.	DESCRIPTION	FINISH	CTN/MSTR
T01035	Plastic arm, spud and nut	PB ABS	1/25
T01036	Plastic arm, spud and nut	White ABS	1/25
T01037	Plastic arm, spud and nut	Bone ABS	1/25

* The manufacturers' names are used only to describe whose products the tank levers will fit. The tank levers are not manufactured by those companies.

Tank Trip Lever for Mansfield*



- Front mount
- 9" arm

PART NO.	DESCRIPTION	FINISH	CTN/MSTR
T01073	#41* plastic arm, spud and nut	PB ABS	25/200

* The manufacturers' names are used only to describe whose products the tank levers will fit. The tank levers are not manufactured by those companies.

Tank Trip Levers for ToTo*



- Side mount
- 10" brass arm
- Plastic spud and nut

PART NO.	FINISH	CTN/MSTR
T018BN	Brushed Nickel	1/30
T018RB	Oil Rubbed Bronze	1/30
T018WB	Old World Bronze	1/30

* The manufacturers' names are used only to describe whose products the tank levers will fit. The tank levers are not manufactured by those companies.

Tank Trip Levers for American Standard*



- Front mount
- 9-1/2" arm

PART NO.	DESCRIPTION	FINISH	CTN/MSTR
T01065	Brass arm with metal spud and nut. Offset for thick walls	PB Metal	25/150



- Front mount
- 8" arm

PART NO.	DESCRIPTION	FINISH	CTN/MSTR
T01049	Neo 28° combo with plastic arm, spud and nut	PB ABS	1/25



- Front mount
- 6" arm

PART NO.	DESCRIPTION	FINISH	CTN/MSTR
T01043	45° arm for Cadet 2* plastic arm, spud and nut	PB ABS	1/25
T01044	45° arm with Cadet 2* plastic arm, spud and nut	White ABS	1/25
T01045	45° arm with Cadet 2* plastic arm, spud and nut	Bone ABS	1/25



- Front mount
- 4" arm

PART NO.	DESCRIPTION	FINISH	CTN/MSTR
T01031	Plastic arm, spud and nut for beaded chain	PB ABS	1/25
T01032	Plastic arm, spud and nut for beaded chain	White ABS	1/25
T01033	Plastic arm, spud and nut for beaded chain	Bone ABS	1/25



- Front mount
- 6" arm

PART NO.	DESCRIPTION	FINISH	CTN/MSTR
T01051	Plastic arm, spud and nut for Plebe* and Cadet*	PB ABS	1/25
T01052	Plastic arm, spud and nut for Plabe* and Cadet*	White ABS	1/25
T01053	Plastic arm, spud and nut or Pleve* and Cadet*	Bone ABS	1/25

* The manufacturers' names are used only to describe whose products the tank levers will fit. The tank levers are not manufactured by those companies.

Tank Trip Levers for Eljer*



- Side mount
- 9" arm

PART NO.	DESCRIPTION	FINISH	CTN/MSTR
T01021	Brass arm with non-crack nylon spud and nut	PB Metal	25/150



- Side mount
- 8" brass arm

PART NO.	FINISH	CTN/MSTR
T0102BN	Brushed Nickel	1/50
T0102RB	Oil Rubbed Bronze	1/50
T0102WB	Old World Bronze	1/50

* The manufacturers' names are used only to describe whose products the tank levers will fit. The tank levers are not manufactured by those companies.

Ⓢ Items marked with the Jones Stephens logo are "You Need It... We Got It" Items.

Tank Trip Levers for Kohler*



- Side mount
- 8" brass arm

PART NO.	FINISH	CTN/MSTR
T0108BN	Brushed Nickel	1/50
T0108RB	Oil Rubbed Bronze	1/50
T0108WB	Old World Bronze	1/50
T01181	Polished Brass	1/50



- Front mount
- 8" arm

PART NO.	DESCRIPTION	FINISH	CTN/MSTR
T01017	Wellworth/Barrington Lite new style / side mount 1.6 gal. unit replacement	PB Metal	1/125
T01015	Cast brass arm with metal spud and nut	PB Metal	1/125

* The manufacturers' names are used only to describe whose products the tank levers will fit. The tank levers are not manufactured by those companies.

Universal Tank Trip Levers



- Front mount
- 8" arm
- Brass handle and arm

PART NO.	FINISH	CTN/MSTR
T01000	Chrome Plated	6/24
T0100BN	Brushed Nickel	6/24
T0100RB	Oil Rubbed Bronze	6/24
T0100WB	Old World Bronze	6/24
T0100PB	Polished Brass	6/24



- Can be used as a front mount or side mount
- 8" adjustable arm

PART NO.	FINISH	CTN/MSTR
T01330	Chrome	10/50
T0133BN	Brushed Nickel	10/50
T0133RB Ⓢ	Oil Rubbed Bronze	10/50
T0133WB	Old World Bronze	10/50



- Front mount
- 8" arm
- Elite, heavy duty

PART NO.	FINISH	CTN/MSTR
T0105BN	Brushed Nickel	10/50
T0105RB	Oil Rubbed Bronze	10/50
T0105WB	Old World Bronze	10/50

FAUCETS & BATH ACCESSORIES

Kitchen Faucets	29-30
Bathroom Faucets	30-31
Tub and Shower Faucets	31-33
Specialty Faucets	33
Bath Accessories	34-35

FAU

FAUCETS & BATH ACCESSORIES

Volos • Priana • Contractor's Choice

Introducing three collections of faucets and bath accessories from Jones Stephens. All of our collections are ideal for single family, multi-family and hospitality projects.

Volos COLLECTION

For a more modern style, the **Volos Collection** has sharp lines that complement contemporary and modern interior designs.



Priana COLLECTION

The **Priana Collection** offers a simple design with familiar traditional details and clean lines.



Contractor's Choice COLLECTION

The **Contractor's Choice Collection** offers a full line of fittings for any kitchen or bath application.



finishes
AVAILABLE

Chrome Plated

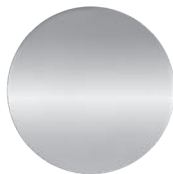

Brushed Nickel



Oil Rubbed Bronze

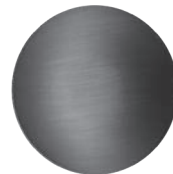

Stainless Steel



Volos Kitchen Faucets

- Ceramic cartridge
- Use with baseplate for 8" 3-hole installation
- Use without baseplate for 1-hole installation
- Max flow rate 1.8 GPM (6.8 LPM) at 60PSI (ASME A112.18.1M)
- Integral stainless steel braided supply lines with 3/8" COMP connection
- Includes matching soap/lotion dispenser
- Boxed
- Limited lifetime warranty

- Meets or exceeds the following:
- ANSI/ASME A112.18.1M
 - ANSI/NSF 61-Sec.9
 - IAPMO/CUPC



Hi-Arc Pull-Down Faucet

PART NO.	FINISH	CTN/MSTR
1559260	Chrome Plated	1/6
1559263	Stainless Steel	1/6



Spring Neck Pull-Down Faucet

PART NO.	FINISH	CTN/MSTR
1559270	Chrome Plated	1/6
1559273	Stainless Steel	1/6

Priana Kitchen Faucets

- Ceramic cartridge
- Use with baseplate for 8" 3-hole installation
- Use without baseplate for 1-hole installation
- Max flow rate 1.8 GPM (6.8 LPM) at 60PSI (ASME A112.18.1M)
- Integral stainless steel braided supply lines with 3/8" COMP connection
- Includes matching soap/lotion dispenser
- Boxed
- Limited lifetime warranty

- Meets or exceeds the following:
- ANSI/ASME A112.18.1M
 - ANSI/NSF 61-Sec.9
 - IAPMO/CUPC
 - ADA Compliant



Priana Hi-Arc Pull-Down Faucet

PART NO.	FINISH	CTN/MSTR
1559060	Chrome Plated	1/6
1559063	Stainless Steel	1/6

Priana Kitchen Faucets (cont.)

- Ceramic cartridge
- Use with baseplate for 8" 3-hole installation
- Use without baseplate for 1-hole installation
- Max flow rate 1.8 GPM (6.8 LPM) at 60PSI (ASME A112.18.1M)
- Integral stainless steel braided supply lines with 3/8" COMP connection
- Includes matching soap/lotion dispenser
- Boxed
- Limited lifetime warranty

- Meets or exceeds the following:
- ANSI/ASME A112.18.1M
 - ANSI/NSF 61-Sec.9
 - IAPMO/CUPC
 - ADA Compliant



Spring Neck Pull-Down Faucet

PART NO.	FINISH	CTN/MSTR
1559070	Chrome Plated	1/6
1559073	Stainless Steel	1/6



Pull-Out Faucet

PART NO.	FINISH	CTN/MSTR
1559020	Chrome Plated	1/6
1559023	Stainless Steel	1/6

FAU

Contractor's Choice Kitchen Faucets

- Fits 8" center
- 1.8 GPM
- Limited lifetime warranty

- Meets or exceeds the following:
- ANSI/ASME A112.18.1M
 - ANSI/NSF 61-Sec.9
 - IAPMO/CUPC
 - ADA Compliant



Single Handle Faucet with Spray

PART NO.	FINISH	CTN/MSTR
1558010	Chrome Plated	1/6

- 1/2" MPT copper inlets
- Ball style cartridge and POM waterways
- Install with or without spray



- Metal threaded shaft
- Install with or without spray

Two Handle High Spout Faucet with Spray

PART NO.	FINISH	CTN/MSTR
1558030	Chrome Plated	1/6
1558031	Stainless Steel	1/6

Contractor's Choice Kitchen Faucets (cont.)

- Fits 8" center
- 1.8 GPM
- Limited lifetime warranty

- Meets or exceeds the following:
- ANSI/ASME A112.18.1M
 - ANSI/NSF 61-Sec.9
 - IAPMO/CUPC
 - ADA Compliant



- 1/2" MPT copper inlets
- 1/4-Turn washerless stems and POM waterways
- Install with or without spray

Two Handle Faucet with Spray

PART NO.	FINISH	CTN/MSTR
1558001	Chrome Plated	1/6
1558002	Stainless Steel	1/6



- 1/2" MPT copper inlets
- Ball style cartridge and POM waterways

Single Handle Faucet with Spray

PART NO.	FINISH	CTN/MSTR
1550110	Chrome Plated	1/12

Volos Bathroom Faucets

- Ceramic cartridge
- Matching pop-up
- Max flow rate 1.2 GPM (4.5 LPM) at 60PSI (ASME.A112.18.1M)
- Boxed
- Limited lifetime warranty

- Meets or exceeds the following:
- ANSI/ASME A112.18.1M
 - ANSI/NSF 61-Sec.9
 - IAPMO/CUPC



- Three mounting holes
- Fits 4" center
- Metal threaded shafts

Two Handle High Spout Faucet with Pop-up

PART NO.	FINISH	CTN/MSTR
1559230	Chrome Plated	1/6
1559231	Brushed Nickel	1/6



- Three mounting holes
- Metal threaded shafts

Two Handle Wide Spread Faucet with Pop-up

PART NO.	FINISH	CTN/MSTR
1559250	Chrome Plated	1/6
1559251	Brushed Nickel	1/6

Volos Bathroom Faucets (cont.)

- Ceramic cartridge
- Matching pop-up
- Max flow rate 1.2 GPM (4.5 LPM) at 60PSI (ASME.A112.18.1M)
- Boxed
- Limited lifetime warranty

- Meets or exceeds the following:
- ANSI/ASME A112.18.1M
 - ANSI/NSF 61-Sec.9
 - IAPMO/CUPC



- Single hole
- Integral stainless steel braided supply lines with 3/8" COMP connection

Single Handle Faucet with Pop-up

PART NO.	FINISH	CTN/MSTR
1559240	Chrome Plated	1/6
1559241	Brushed Nickel	1/6

Priana Bathroom Faucets

- Ceramic cartridge
- Matching pop-up
- Max flow rate 1.2 GPM (4.5 LPM) at 60PSI (ASME.A112.18.1M)
- Boxed
- Limited lifetime warranty

- Meets or exceeds the following:
- ANSI/ASME A112.18.1M
 - ANSI/NSF 61-Sec.9
 - IAPMO/CUPC
 - ADA Compliant



- Single hole
- Fits 4" center
- Metal threaded shafts

Two Handle Faucet with Pop-up

PART NO.	FINISH	CTN/MSTR
1559000	Chrome Plated	1/6
1559001	Brushed Nickel	1/6
1559002	Oil Rubbed Bronze	1/6



- Three mounting holes
- Metal threaded shafts

Two Handle Wide Spread Faucet with Pop-up

PART NO.	FINISH	CTN/MSTR
1559050	Chrome Plated	1/6
1559051	Brushed Nickel	1/6
1559052	Oil Rubbed Bronze	1/6



- Three mounting holes
- Fits 4" center
- Metal threaded shafts

Two Handle High Spout Faucet with Pop-up

PART NO.	FINISH	CTN/MSTR
1559030	Chrome Plated	1/6
1559031	Brushed Nickel	1/6
1559032	Oil Rubbed Bronze	1/6

Priana Bathroom Faucets (cont.)

- Ceramic cartridge
- Matching pop-up
- Max flow rate 1.2 GPM (4.5 LPM) at 60PSI (ASME.A112.18.1M)
- Boxed
- Limited lifetime warranty

- Meets or exceeds the following:
- ANSI/ASME A112.18.1M
 - ANSI/NSF 61-Sec.9
 - IAPMO/CUPC
 - ADA Compliant



- Single hole
- Integral stainless steel braided supply lines with 3/8" COMP connection

Single Handle Faucet with Pop-up

PART NO.	FINISH	CTN/MSTR
1559040	Chrome Plated	1/6
1559041	Brushed Nickel	1/6
1559042	Oil Rubbed Bronze	1/6

Contractor's Choice Bathroom Faucets

- Fits 4" center
- 1.2 GPM
- Limited lifetime warranty

- Meets or exceeds the following:
- ANSI/ASME A112.18.1M
 - ANSI/NSF 61-Sec.9
 - IAPMO/CUPC
 - ADA Compliant (excludes 1550601)



- Three mounting holes
- Metal threaded shafts
- Ball style cartridge and POM waterways, metal cover

Single Handle Faucet with Pop-up

PART NO.	FINISH	CTN/MSTR
1559010	Chrome Plated	1/6
1559011	Brushed Nickel	1/6
1559012	Oil Rubbed Bronze	1/6



- Three mounting holes
- 1/2" MPT copper inlets
- Metal handle and body

Single Handle Faucet with Stainless Steel Pop-up

PART NO.	FINISH	CTN/MSTR
1550203	Chrome Plated	1/12



- Three mounting holes
- Metal threaded shafts
- POM waterways, metal cover, acrylic handles

Two Handle Rounded Body Faucet with Pop-up

PART NO.	FINISH	CTN/MSTR
1550601	Chrome Plated	1/12

Contractor's Choice Bathroom Faucets (cont.)

- Fits 4" center
- 1.2 GPM
- Limited lifetime warranty

- Meets or exceeds the following:
- ANSI/ASME A112.18.1M
 - ANSI/NSF 61-Sec.9
 - IAPMO/CUPC
 - ADA Compliant (excludes 1550601)



- Three mounting holes
- Metal threaded shafts
- POM waterways, metal cover, acrylic handles

Two Handle Handicap Faucet with Grid Drain

PART NO.	FINISH	CTN/MSTR
1550301	Chrome Plated	1/12

Volos Tub/Shower Faucets

- Use with rough-in valve 1559900, 1559901, or 1559902 (sold separately)
- Max flow rate 1.8 GPM (6.8 LPM) at 80PSI (ASME.A112.18.1M)
- Boxed
- Limited lifetime warranty

- Meets or exceeds the following:
- ANSI/ASME A112.18.1M
 - ANSI/NSF 61-Sec.9
 - IAPMO/CUPC



- Rain shower head, shower arm and tub spout
- 10-7/16" shower arm

Tub/Shower Faucet with Rain Shower Head, Trim Only

PART NO.	FINISH	CTN/MSTR
1559280	Chrome Plated	1/6
1559281	Brushed Nickel	1/6



- Rain shower head and shower arm
- 10-7/16" shower arm

Shower Faucet with Rain Shower Head, Trim Only

PART NO.	FINISH	CTN/MSTR
1559290	Chrome Plated	1/6
1559291	Brushed Nickel	1/6

Priana Tub/Shower Faucets

- Use with rough-in valve 1559900, 1559901, or 1559902 (sold separately)
 - Max flow rate 1.8 GPM (6.8 LPM) at 80PSI (ASME.A112.18.1M)
 - Boxed
 - Limited lifetime warranty
- Meets or exceeds the following:
- ANSI/ASME A112.18.1M
 - ANSI/NSF 61-Sec.9
 - IAPMO/CUPC
 - ADA Compliant



• Shower head, shower arm and tub spout

Tub/Shower Faucet, Trim Only		
PART NO.	FINISH	CTN/MSTR
1559080	Chrome Plated	1/6
1559081	Brushed Nickel	1/6
1559082	Oil Rubbed Bronze	1/6



• Shower head and shower arm

Shower Faucet, Trim Only		
PART NO.	FINISH	CTN/MSTR
1559090	Chrome Plated	1/6
1559091	Brushed Nickel	1/6
1559092	Oil Rubbed Bronze	1/6

Contractor's Choice Tub/Shower Faucets

- Fits 8" center (unless noted)
 - 1.8 GPM
 - Brass compression stems and replaceable seats
 - Limited lifetime warranty
- Meets or exceeds the following:
- IAPMO/CUPC



• Tub spout, bell escutcheons, shower head and arm

Three Handle Tub/Shower Faucet		
PART NO.	FINISH	CTN/MSTR
1855050	Chrome Plated	1/10

Contractor's Choice Tub/Shower Faucets (cont.)

- Fits 8" center (unless noted)
 - 1.8 GPM
 - Brass compression stems and replaceable seats
 - Limited lifetime warranty
- Meets or exceeds the following:
- IAPMO/CUPC



• Tub spout, bell escutcheons, shower head and arm

Three Handle Tub/Shower Faucet, Heavy Pattern		
PART NO.	FINISH	CTN/MSTR
1855051	Chrome Plated	1/6



• Acrylic handles
• Tub spout, bell escutcheons, shower head and arm

Three Handle Tub/Shower Faucet		
PART NO.	FINISH	CTN/MSTR
1855055	Chrome Plated	1/10



• Tub diverter spout, bell escutcheons, shower head and arm

Two Handle Tub/Shower Faucet		
PART NO.	FINISH	CTN/MSTR
1854030	Chrome Plated	1/10



• Acrylic handles
• Tub diverter spout, bell escutcheons, shower head and arm

Three Handle Tub/Shower Faucet		
PART NO.	FINISH	CTN/MSTR
1854015	Chrome Plated	1/10

Contractor's Choice Tub/Shower Faucets (cont.)

- Fits 8" center (unless noted)
- 1.8 GPM
- Brass compression stems and replaceable seats
- Limited lifetime warranty

Meets or exceeds the following:
• IAPMO/CUPC



- Bell escutcheons, shower head and arm

Two Handle Stall Shower Faucet

PART NO.	FINISH	CTN/MSTR
1850022	Chrome Plated	1/12



- Bell escutcheons, shower head and arm

Two Handle Shower Faucet

PART NO.	FINISH	CTN/MSTR
1854010	Chrome Plated	1/12



- Acrylic handles
- Bell escutcheons, shower head and arm

Two Handle Shower Faucet

PART NO.	FINISH	CTN/MSTR
1854035	Chrome Plated	1/10

Tub/Shower Valves, Rough-In

- Universal valve accepts all Jones Stephens trim kits for tub/shower and shower only installations
- Bath tub port can be plugged for shower only installations
- Integral stop valves on the hot and cold supply lines
- Includes plaster ring to assist in installation and to protect the valve during construction

Meets or exceeds the following:
• ANSI/ASME A112.18.1M
• ANSI/NSF 61-Sec.9
• IAPMO/CUPC



- Shower head, shower arm and tub spout
- ADA Compliant

1559900 1559901 1559902

PART NO.	DESCRIPTION	CTN/MSTR
1559900	1/2" NPT	1/6
1559901	Crimp PEX F1807	1/6
1559902	Expansion PEX F1960	1/6

Contractor's Choice Specialty Faucets

- Fits 4" center (Excludes 1828010)
- Limited lifetime warranty

Meets or exceeds the following:
• ANSI/ASME A112.18.1M
• ANSI/NSF 61-Sec.9
• IAPMO/CUPC
• ADA Compliant



- POM cartridge and waterways
- Metal threaded shaft
- Stainless steel spout
- 1.8 GPM

Two Handle Gooseneck Bar Faucet

PART NO.	FINISH	CTN/MSTR
1822025	Chrome Plated	1/12
1822026	Brushed Nickel	1/12



- Fits 3 hole laundry sinks
- Non-metallic construction
- Pull out spray head
- 1.8 GPM

Pull-Out Laundry Tray Faucet

PART NO.	FINISH	CTN/MSTR
1836015	Chrome Plated	1/12



- POM cartridge and waterways
- Metal threaded shaft
- 1.2 GPM

Two Handle Handicap Laundry Tray Faucet

PART NO.	FINISH	CTN/MSTR
1836050	Chrome Plated	1/12



- Solid brass body, chrome plated handles
- Top supply with 1/2" IPS unions
- 1/4 turn stems
- Includes garden hose adapter
- 1.2 GPM

Two Handle Laundry Tray Faucet, Top Supply

PART NO.	FINISH	CTN/MSTR
1828010	Rough Brass	1/12

Volos Bath Accessories

- Furnished with mounting brackets, heavy duty drywall anchors and screws
- Boxed



24" Towel Bar		
PART NO.	FINISH	CTN/MSTR
97900	Chrome Plated	1/10
97901	Brushed Nickel	1/10



18" Towel Bar		
PART NO.	FINISH	CTN/MSTR
97910	Chrome Plated	1/10
97911	Brushed Nickel	1/10



Towel Ring		
PART NO.	FINISH	CTN/MSTR
97920	Chrome Plated	5/20
97921	Brushed Nickel	5/20



Toilet Paper Holder		
PART NO.	FINISH	CTN/MSTR
97940	Chrome Plated	5/20
97941	Brushed Nickel	5/20



Robe Hook		
PART NO.	FINISH	CTN/MSTR
97930	Chrome Plated	5/20
97931	Brushed Nickel	5/20

Priana Bath Accessories

- Furnished with mounting brackets, heavy duty drywall anchors and screws
- Boxed



24" Towel Bar		
PART NO.	FINISH	CTN/MSTR
97950	Chrome Plated	1/10
97951	Brushed Nickel	1/10
97952	Oil Rubbed Bronze	1/10



18" Towel Bar		
PART NO.	FINISH	CTN/MSTR
97960	Chrome Plated	1/10
97961	Brushed Nickel	1/10
97962	Oil Rubbed Bronze	1/10



Towel Ring		
PART NO.	FINISH	CTN/MSTR
97970	Chrome Plated	5/20
97971	Brushed Nickel	5/20
97972	Oil Rubbed Bronze	5/20



Toilet Paper Holder		
PART NO.	FINISH	CTN/MSTR
97980	Chrome Plated	5/20
97981	Brushed Nickel	5/20
97982	Oil Rubbed Bronze	5/20



Robe Hook		
PART NO.	FINISH	CTN/MSTR
97990	Chrome Plated	5/20
97991	Brushed Nickel	5/20
97992	Oil Rubbed Bronze	5/20

FAU

Contractor's Choice Bath Accessories

- Furnished with mounting brackets, heavy duty drywall anchors and screws
- Concealed screws
- Boxed



- 3/4"
- Zinc

Towel Bar Brackets

PART NO.	FINISH	CTN/MSTR
97180	Chrome Plated	5/50
97170	Brushed Nickel	5/50



- Bar only
- Polished stainless

18" Towel Bar

PART NO.	FINISH	CTN/MSTR
97960	Chrome Plated	1/10
97961	Brushed Nickel	1/10
97962	Oil Rubbed Bronze	1/10



- 3/8" diameter ring
- Zinc

Towel Ring

PART NO.	FINISH	CTN/MSTR
62062	Chrome Plated	6/96
62070	Brushed Nickel	6/96



- Spring loaded white plastic roller
- Zinc

Toilet Paper Holder

PART NO.	FINISH	CTN/MSTR
97187	Chrome Plated	6/96
36214	Brushed Nickel	6/96



- 3/8" diameter ring
- Zinc

Double Robe Hook

PART NO.	FINISH	CTN/MSTR
97897	Chrome Plated	1/50
97896	Brushed Nickel	1/50

FAU

SECTION B - SPECIALTIES & REPAIR

Toilet Repairs	39-51
Kitchen & Bath	52-77
Plumbing Connectors	78-80
Supply Stops	80-81
Sink Faucets	81-82
Drinking Fountain Bubbler	82
Gas Connectors	83-87

B

TANK LEVER TO TANK REFERENCE CHART

MFR.	PART NO.	FINISH	SECTION PAGE NO.	TANK STYLE
American Standard*	T01030	CP ABS	B2	Glenwall with vent #4049.177 Compack with vent #4052.346 Norwall with vent #4041.091
	T01031	PB ABS	DECORATIVE (SECT. A)	
	T01032 T01033	White ABS Bone ABS		
	T01042	CPS ABS	B2	Cadet II #4072 Cadet #4029 Cadet II #4014 Ellisse #4075 High Hamilton - 1 pc. #2096 Hamilton - 1 pc. #2092
	T01043	PB ABS	DECORATIVE (SECT. A)	Carlyle #2010.031 New Cadet line
	T01044	White ABS		
	T01045	Bone ABS		
	T01048	CPS ABS	B2	Glenwall #2093 Cadet #2108 Cadet #2109 Cadet #2120 Cadet #2124 Plebe #2131 Plebe #2138 Plebe #2139 Plebe Aquameter
	T01049	PB ABS	DECORATIVE (SECT. A)	
	T01050	CPS ABS	B2	
	T01051	PB ABS	DECORATIVE (SECT. A)	Old style, thick walled
	T01052	White ABS		
T01053	Bone ABS			
	T01064	CP Metal	B2	
	T01065	PB Metal	DECORATIVE (SECT. A)	
Crane*	T01034	CPS ABS	B2	Galaxy New Galaxy Sante Fe Avon Antigua
Eljer*	T01020	CP Metal	B3	New Emblem
	T01021	PB Metal	DECORATIVE (SECT. A)	
Kohler*	T01010	CP Metal	B3	Wellworth*/Barrington* - Old Style
	T01012	CP Metal	B3	
	T01015	PB Metal	DECORATIVE (SECT. A)	Kohler 9400
	T01016	CP Metal	B3	Wellworth*/Barrington Lite* - Old Style
	T01017	PB Metal	DECORATIVE (SECT. A)	
Mansfield*	T01040	CPS ABS	B3	Mansfield #35 Mansfield #51 Mansfield #8 Mansfield #16 Mansfield #35LT
	T01073	PB ABS	DECORATIVE (SECT. A)	
	T01072	CP Metal	B3	Mansfield old style #42
	T01041	PB Metal	DECORATIVE (SECT. A)	
Universal Rundle*/Sears*	T01066	CP Metal	B3	Saturn 4012 Low Boy 4445
	T01067	PB Metal	DECORATIVE (SECT. A)	

*The manufacturers' names are used only to describe whose products the tank levers will fit. The tank levers are not manufactured by those companies.



Fit-All Tank Trip Lever



PART NO.	DESCRIPTION	FINISH	CTN/ MSTR
T01001	Brass arm with metal spud and nut	CP Metal	25/200
T01002	Brass plated arm with metal spud and nut	CP Metal	25/200
T01200	Aluminum arm with zinc spud and nut	CP Metal	25/200
T01201	Aluminum arm with plastic spud and nut	CP Metal	25/200
T01099	Replacement spud nut	Zinc	1/25

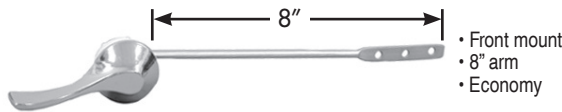

PART NO.	DESCRIPTION	FINISH	CTN/ MSTR
T01060	Brass plated arm with plastic spud and nut/universal fit	CP Metal	25/200

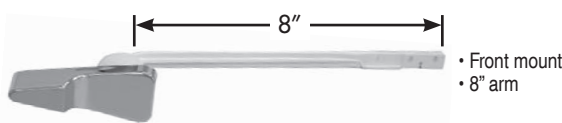

PART NO.	DESCRIPTION	FINISH	CTN/ MSTR
T01062	Plastic arm, spud and nut/universal fit	CP ABS	25/125

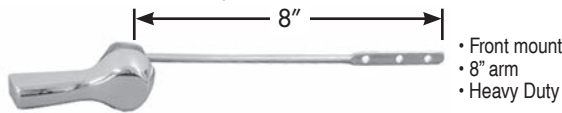

PART NO.	DESCRIPTION	FINISH	CTN/ MSTR
T01005	Brass arm with metal spud and nut/universal fit	CP Metal	25/150

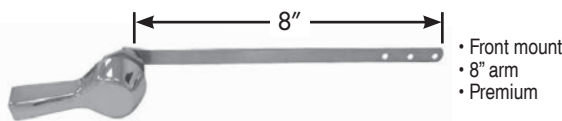

PART NO.	DESCRIPTION	FINISH	CTN/ MSTR
T01068	Flat brass arm with metal spud and nut/universal fit	CP Metal	25/200

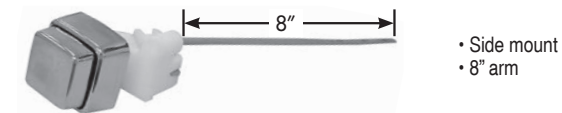

PART NO.	DESCRIPTION	FINISH	CTN/ MSTR
T01070	Push button brass arm with plastic spud and nut/universal fit	CP ABS	25/50

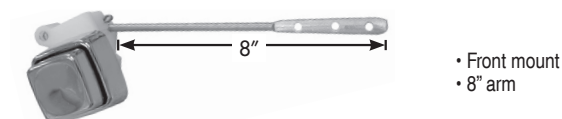

PART NO.	DESCRIPTION	FINISH	CTN/ MSTR
T01074	Push button brass arm with plastic spud and nut/universal fit	CP ABS	25/50

Tank Trip Levers for American Standard*

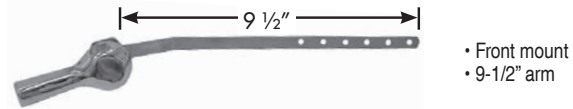

PART NO.	DESCRIPTION	FINISH	CTN/ MSTR
T01064	Brass arm with metal spud and nut offset for thick tank walls	CP Metal	25/150

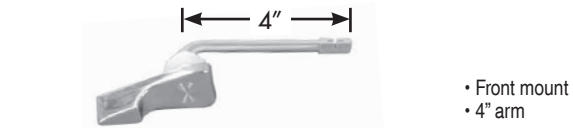

PART NO.	DESCRIPTION	FINISH	CTN/ MSTR
T01030	Plastic arm, spud and nut for beaded chain	CP ABS	25/250

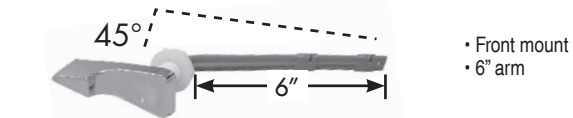

PART NO.	DESCRIPTION	FINISH	CTN/ MSTR
T01042	45° arm for Cadet 2* plastic arm, spud and nut	CP ABS	1/200

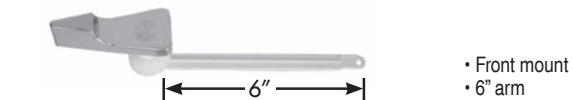

PART NO.	DESCRIPTION	FINISH	CTN/ MSTR
T01050	Plastic arm, spud and nut for Plebe* and Cadet*	CP ABS	1/25

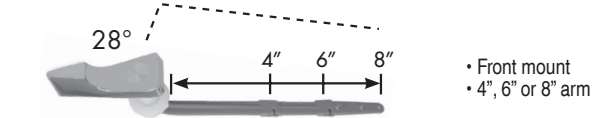

PART NO.	DESCRIPTION	FINISH	CTN/ MSTR
T01048	Neo 28° combo with plastic arm, spud and nut	CP ABS	1/200

* The manufacturers' names are used only to describe whose products the tank levers will fit. The tank levers are not manufactured by those companies.

Tank Trip Lever for Crane*

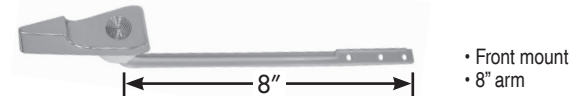

PART NO.	DESCRIPTION	FINISH	CTN/ MSTR
T01034	Plastic arm, spud and nut	CP ABS	25/250

* The manufacturers' names are used only to describe whose products the tank levers will fit. The tank levers are not manufactured by those companies.

Tank Trip Lever for Eljer*

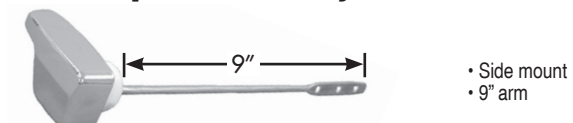

PART NO.	DESCRIPTION	FINISH	CTN/ MSTR
T01020	Brass arm with non-crack nylon spud and nut	CP Metal	25/200

* The manufacturers' names are used only to describe whose products the tank levers will fit. The tank levers are not manufactured by those companies.

Items marked with the Jones Stephens logo are "You Need It... We Got It" Items.

Tank Trip Levers for Kohler*

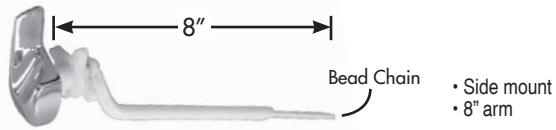

PART NO.	DESCRIPTION	FINISH	CTN/ MSTR
T01010	Wellworth*/Barrington* Old style/ Plastic arm (less bead hook), spud and nut	CP Metal	25/125
T01016	Wellworth*/Barrington Pressure Lite** New style/ 1.6 gal. unit replacement Plastic arm, spud and nut	CP Metal	25/125



PART NO.	DESCRIPTION	FINISH	CTN/ MSTR
T01012	Cast brass arm with metal spud and nut	CP Metal	25/125

* The manufacturers' names are used only to describe whose products the tank levers will fit. The tank levers are not manufactured by those companies.

Tank Trip Levers for Mansfield*

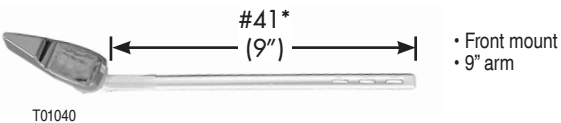

PART NO.	DESCRIPTION	FINISH	CTN/ MSTR
T01040	#41* Plastic arm, spud and nut	CP ABS	1/25

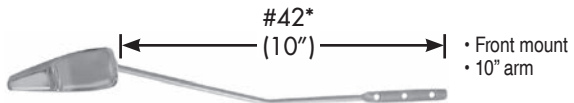

PART NO.	DESCRIPTION	FINISH	CTN/ MSTR
T01072	#42* Brass arm with plastic spud and nut	CP Metal	25/100

* The manufacturers' names are used only to describe whose products the tank levers will fit. The tank levers are not manufactured by those companies.

Tank Trip Lever for Universal Rundle*/Sears*

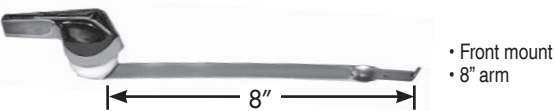

PART NO.	DESCRIPTION	FINISH	CTN/ MSTR
T01066	Brass arm with plastic spud and nut	CP Metal	25/200

* The manufacturers' names are used only to describe whose products the tank levers will fit. The tank levers are not manufactured by those companies.

Ultrafit Tank Trip Lever

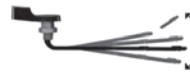

- Bagged
- Patented!
- Heavy Duty plastic arm, spud and nut
- Display Available- Part No. T04001
- Shapeable arm bends to fit the needed arm angle
- Arm can be cut to 4", 6" or 8" lengths for customized fit
- Fits American Standard*, Eljer*, Kohler*, Mansfield* and ToTo*

PART NO.	DESCRIPTION	FINISH	CTN/MSTR
T01100	Ultrafit tank lever	CP ABS	25/200

* The manufacturers' names are used only to describe whose products the tank levers will fit. The tank levers are not manufactured by those companies.

Tank Trip Lever for Western Pottery*



- Side mount
- 10" arm

PART NO.	DESCRIPTION	FINISH	CTN/MSTR
T01080	Brass arm with plastic spud and nut	CP Metal	25/200

* The manufacturers' names are used only to describe whose products the tank levers will fit. The tank levers are not manufactured by those companies.

Tank Trip Lever for ToTo*



- Side mount
- 10" arm

PART NO.	DESCRIPTION	FINISH	CTN/MSTR
T01081	Brass arm with plastic spud and nut	CP Metal	25/200

* The manufacturers' names are used only to describe whose products the tank levers will fit. The tank levers are not manufactured by those companies.

Eljer* Touch Flush* Assembly



- Complete with tank, lever, chain, ball and arm
- CARTON QUANTITIES ONLY

PART NO.	DESCRIPTION	FINISH	CTN/MSTR
C04019	Touch Flush assembly	CP ABS	1/5

* The manufacturers' names are used only to describe whose products the products will fit.

Tank Ball and Seat Disc



- Rubber
- New boxing to protect shape of units
- Rated to 160°F
- CARTON QUANTITIES ONLY

PART NO.	DESCRIPTION	CTN/MSTR
C04020	Eljer* tank ball for touch flush	1/10
C04021	Fit-All tank ball less guide	1/10
C04030	2-1/4" - 2-5/8" Tri-seal tank ball	1/100
C04031	3" Tri-seal tank ball	1/100

* The manufacturers' names are used only to describe whose products the products will fit.

American Standard* Seat Disc Tank Ball



C04024



T02025

- For small tilt flush valves
- Units are in a plastic housing to protect the shape of the seats
- CARTON QUANTITIES ONLY

PART NO.	DESCRIPTION	CTN/MSTR
C04024	Screw-on unit black	1/25
C04025	Snap-on unit black	1/25
T02025	Combo seat disc, snap-on and screw-on	1/25

* The manufacturers' names are used only to describe whose products the products will fit.

Float Ball



- Fits 1/4" rod
- Made of high density poly
- CARTON QUANTITIES ONLY ON THE C05041

PART NO.	DESCRIPTION	CTN/MSTR
C05040	Plastic 4" x 5"	1/24
C05041	Copper 4" x 5"	12/72

Flappers



C04005



C04006



C04007



C04008



C04010



C04011

- High grade vinyl construction
- New boxing to protect shape of units

PART NO.	DESCRIPTION	CTN/MSTR
C04005	3 way with strap (fits plastic, brass and old Crane* 57 flush valves)	25/100
C04006	3 way with stainless chain and strap (fits plastic, brass and old Crane* 57 flush valves)	25/100
C04007	Standard unit with 9" chain and strap	1/10
C04008	Kohler* unit with 8" chain	50/200
C04010	Crane* unit with 9" chain	50/200
C04011	Eljer* original unit with rigid arms and foam cone with beaded chain	1/10

* The manufacturers' names are used only to describe whose products the products will fit.

Jumbo ToTo* Style Flapper



PART NO.	DESCRIPTION	CTN/MSTR
C04000	Blue flapper (Power Gravity)	1/10
C04001	Red flapper (G-Max)	1/10

* The manufacturers' names are used only to describe whose products the products will fit.

Kohler* Rialto™ Flapper



C04028



C04029

MADE IN THE USA
LAVELLE

- 5 year warranty
- Blister carded for easy display
- Made from high grade chlorazone
- Resists chemicals and toilet tank cleaners

PART NO.	DESCRIPTION	FITS KOHLER* MODELS	CTN/MSTR
C04028	Kohler Flapper 2010 BP	Rialto, San Raphael, Santa Martine and Rosario	12/72
C04029	Sharkfin Flapper 2012 BP	Rialto, San Raphael, Santa Rosa, Revival and Gabrielle	12/72

* The manufacturers' names are used only to describe whose products the products will fit.

2 Way Flapper with Separate Trunion



- Siliconized chemical resistant material
- Stainless steel chain

PART NO.	DESCRIPTION	CTN/MSTR
C04002	2 way flapper	1/10

Carded Blue Vinyl Flapper



- 5 year warranty on flapper life
- Chemical resistant
- Individually carded
- Soft body replacement flapper
- 9" stainless steel chain and hook

PART NO.	DESCRIPTION	CTN/MSTR
C04004	Carded blue fit-all vinyl flapper	25/100

Blue Vinyl Flapper



- 5 year warranty
- Chemical resistant
- Fits most plastic flush valves
- Easily installed- no collar to cut
- 9" stainless steel chain and hook
- CARTON QUANTITIES ONLY

MADE IN THE USA
LAVELLE

PART NO.	DESCRIPTION	CTN/MSTR
C04014	Blue vinyl flapper	1/80

Red Korcky® Plus Flapper



- 5 year warranty
- Chemical resistant
- Individually carded in cartons of 12

MADE IN THE USA
LAVELLE

PART NO.	DESCRIPTION	CTN/MSTR
C04016	Red Korcky® Plus (2001BP)	12/72

Korky® Plus Ultra Water Saver Flapper



- 5-year manufacturer's warranty
- The most universal 2" flapper
- Adjusts to match OEM performance in all tank sizes including 1.28, 1.6, 3.5 and 5+ gpf toilets
- Adjusts to save water in any tank size
- Korky® red Chorazone® rubber resists chlorine



PART NO.	DESCRIPTION	CTN/MSTR
C04038	Korky® Plus ultra water saver flapper (100BP)	1/12

Korky® Flapper



C04032

- C04032 Fits Kohler®* Class Five™ Flapper
- Larger 3 1/4" replacement flapper
 - Replaces Kohler®* No. 1016546 & 1042313
 - Engineered materials resist chlorine



C04033

- C04033 Fits Eljer®*Titan™ Flapper
- Replaces Eljer®* No. 495-6077-00
 - Engineered materials resist chlorine



C04034

- C04034 Fits American Standard®* Cadet 3® Flapper
- Replaces American Standard®* No. 738920-0070P
 - Engineered materials resist chlorine

PART NO.	DESCRIPTION	CTN/MSTR
C04032	Fits Kohler®* Class Five™ flapper (3010BP)	1/5
C04033	Fits Eljer®*Titan™ flapper (3030BP)	1/5
C04034	Fits American Standard®* Cadet 3® flapper (3040BP)	1/5

* The manufacturers' names are used only to describe whose products the products will fit.

The Original Korky® Flapper



- No tank centering
- Assures a positive seal
- Easy fingertip operation
- Individually carded cartons
- Eliminates lift wire misalignment
- Chemical resistant in areas with poor water quality



PART NO.	DESCRIPTION	CTN/MSTR
C04015	(54 BP)	12/72
C04017	Fits Kohler®* (58 BP)	10/100

* The manufacturers' names are used only to describe whose products the products will fit.

Korky® Plus 3 Universal Flapper



- 5-year manufacturer's warranty
- Universal design fits large 3" flush valves
- Adjusts to match OEM performance for all 3" flapper-based systems
- Korky® red Chorazone® rubber resists chlorine



PART NO.	DESCRIPTION	CTN/MSTR
C04039	Korky® Plus 3 universal toilet flapper (3060BP)	1/5

Ⓢ Items marked with the Jones Stephens logo are "You Need It...We Got It" Items.

Korky® 1.6 Adjustable Flapper



- Chemical resistant
- Easy to install and adjust
- Individually carded in cartons of 12
- Flush volume changes with just a twist
- Can be used as a water saving device
- Adjustable sealing ball for precise water control
- Universal design fits most popular brands of 1.6 toilets



PART NO.	DESCRIPTION	CTN/MSTR
C04027	Korky® 1.6 adjustable flapper (16BP)	12/72

Korky® Plus Adjustable Flapper



- Adjust flush volume with movable float on chain
- Slide the float up for water savings or down for increased flush volume
- Korky® red Chorazone® rubber resists chlorine



PART NO.	DESCRIPTION	CTN/MSTR
C04013	Korky® Plus adjustable flapper (2004BP)	1/12

Closet Spud



- Cast brass
- Includes spud washer and metal friction ring

PART NO.	DESCRIPTION	CTN/MSTR
C27125	1-1/4" closet spud	25/100
C27150 Ⓢ	1-1/2" closet spud	25/100
C27200	2" closet spud	25/75
C27201	2" x 1-1/4" closet spud	25/100
C27202	2" x 1-1/2" closet spud	25/75
C27127	1-1/2" x 1-1/4" closet spud	25/100
C27150A	1-1/2" (For American Standard*) closet spud	25/100

* The manufacturers' names are used only to describe whose products the products will fit.

Urinal Spud



- Cast brass
- Includes spud washer and metal friction ring

PART NO.	DESCRIPTION	CTN/MSTR
C27134	1" x 3/4" urinal spud	25/200
C27126	1-1/4" x 3/4" urinal spud	25/125
C27310	1-1/2" x 3/4" urinal spud	25/100

Closet Spud Washer



- Rubber
- CARTON QUANTITIES ONLY

PART NO.	DESCRIPTION	CTN/MSTR
C27301	1-1/4" closet spud washer	25/500
C27302	1-1/2" closet spud washer	25/500
C27303	2" closet spud washer	25/500
C27304	2" x 1-1/4" closet spud washer	25/500
C27305	2" x 1-1/2" closet spud washer	25/500
C27308	1" x 3/4" closet spud washer	25/1000
C27309	1-1/4" x 3/4" closet spud washer	25/500

Closet Spud Friction Ring



- Zinc plated
- CARTON QUANTITIES ONLY

PART NO.	DESCRIPTION	CTN/MSTR
C27321	1-1/4" friction ring	25/1000
C27322	1-1/2" friction ring	25/1000
C27323	2" friction ring	25/500
C27324	2" x 1-1/4" friction ring	25/500
C27325	2" x 1-1/2" friction ring	25/500
C27328	1" x 3/4" friction ring	25/500

Flush Valve Shank Washer



- Rubber
- 3-1/16" OD x 2-1/4" ID

PART NO.	DESCRIPTION	CTN/MSTR
T02028	3/8" Height flush valve shank washer	1/100

Aqua Seal Washer



- Rubber
- American Standard* Top Hat Washer
- CARTON QUANTITIES ONLY

PART NO.	DESCRIPTION	CTN/MSTR
T85057	Aqua seal washer	1/100

* The manufacturers' names are used only to describe whose products the products will fit.

Beveled Ballcock Shank Washer



- Rubber
- 1 3/4" OD x 15/16" ID

PART NO.	DESCRIPTION	CTN/MSTR
T85056	1/2" beveled ballcock shank washer	1/100

Flat Bibb Washer



- EPDM rubber
- Priced per carton
- 100 pieces per carton

PART NO.	SIZE	TRADE SIZE	OD	CTN/MSTR
O25202	1/4"	00	1/2"	1/100
O25203	1/4"	0	17/32"	1/100
O25204	1/4"	1/4	9/16"	1/100
O25205	1/4"	1/4L	19/32"	1/100
O25206	3/8"	3/8	5/8"	1/100
O25207	3/8"	3/8M	21/32"	1/100
O25208	3/8"	3/8L	11/16"	1/100
O25209	1/2"	1/2	3/4"	1/100
O25210	1/2"	1/2L	25/32"	1/100

Beveled Bibb Washer



- Rubber
- Priced per carton
- 100 pieces per carton
- CARTON QUANTITIES ONLY

PART NO.	SIZE	TRADE SIZE	OD	CTN/MSTR
O25302	1/4"	00	1/2"	1/100
O25303	1/4"	0	17/32"	1/100
O25304	1/4"	1/4	9/16"	1/100
O25305	1/4"	1/4L	19/32"	1/100
O25306	3/8"	3/8	5/8"	1/100
O25307	3/8"	3/8M	21/32"	1/100
O25308	3/8"	3/8L	11/16"	1/100
O25309	1/2"	1/2	3/4"	1/100
O25310	1/2"	1/2L	25/32"	1/100

Sponge Closet Gasket



- All have 2 bolt holes
- 5-1/2" center-to-center

G13500

G13534

G13634

PART NO.	OD x ID x THICKNESS	CTN/MSTR
G13534	5-3/8" x 3-1/2" x 3/4"	10/200
G13516	5-3/8" x 3-1/2" x 9/16"	10/232
G13634	6-3/4" x 3-1/2" x 3/4"	10/80
G13601	6-3/4" x 3-1/2" x 1"	10/80
G13616	6-3/4" x 3-1/2" x 9/16"	10/80
G13638	6-3/4" x 3-1/2" x 3/8"	10/80
G13500	4-3/8" x 2-7/8" x 1/2" wall hung urinal	10/225

Brass Lift Wire Guide



- Fit-All
- CARTON QUANTITIES ONLY

C05056

C05057

PART NO.	DESCRIPTION	CTN/MSTR
C05056	Adjustable heavy pattern	25/500
C05057	Standard split ring	25/500

Brass Lift Wire



- CARTON QUANTITIES ONLY

PART NO.	DESCRIPTION	CTN/MSTR
C05045	4 1/2" lower	25/1000
C05046	5" lower	25/1000
C05047	5 1/2" lower	25/1000
C05048	8" upper	25/1000
C05049	9" upper	25/1000

Copper Refill Tube



- 1/2" IPS
- CARTON QUANTITIES ONLY

PART NO.	DESCRIPTION	CTN/MSTR
C05051	9" refill tube	25/1000

Brass Float Rod



- CARTON QUANTITIES ONLY

PART NO.	DESCRIPTION	CTN/MSTR
C05052	1/4" x 8" float rod	25/500
C05053	1/4" x 10" float rod	25/500
C05054	1/4" x 12" float rod	25/500

Brass Overflow Tube



- 22 gauge

PART NO.	DESCRIPTION	CTN/MSTR
C05042	1" x 1 1/8" x 10" overflow tube	1/200

Mansfield* Style Ballcock



- All brass
- Compound lever

PART NO.	DESCRIPTION	CTN/MSTR
T02075	Brass ballcock	1/50

* The manufacturers' names are used only to describe whose products the products will fit.

Mansfield* Style Ballcock with Float Rod



- Genuine Mansfield ballcock

PART NO.	DESCRIPTION	CTN/MSTR
T03008	Ballcock with float rod #08	1/20

* The manufacturers' names are used only to describe whose products the products will fit.

Mansfield* Flush Valve #210



- Water saver
- 3.5 gal. toilets
- Instant shut-off
- Won't rust or corrode

PART NO.	DESCRIPTION	CTN/MSTR
T02066	Flush valve	1/50

* The manufacturers' names are used only to describe whose products the products will fit.

Douglas Flush Valve



C05070



C05071

- Brass unit includes split guide
- Plastic unit includes flapper tank ball
- Includes locknut, beveled washer
- Bagged

PART NO.	DESCRIPTION	CTN/MSTR
C05070	Plastic with stainless steel chain	1/50
C05071	Brass	1/50

Korky® Universal 3" Valve Seal



- 5-year manufacturer's warranty
- Replacement seals for tower style flush valves
- Fits Kohler® Class Five™ & Class Six™
- Fits American Standard® Champio® 3
- Korky® red Chorazone® rubber resists chlorine

MADE IN THE USA LAVELLE

PART NO.	DESCRIPTION	CTN/MSTR
C05085	Korky® universal 3" valve seal	1/5

* The manufacturers' names are used only to describe whose products the products will fit.

Korky® Flush Valve Seal for Champion® 4



- 5-year manufacturer's warranty
- Replaces American Standard® No. 7301111-0070A
- Korky® red Chorazone® rubber resists chlorine

MADE IN THE USA LAVELLE

PART NO.	DESCRIPTION	CTN/MSTR
C05086	Korky® flush valve seal for Champion® 4	1/5

* The manufacturers' names are used only to describe whose products the products will fit.

Korky® QuietFill Valve



- 5 year guarantee
- Resists chlorine

MADE IN THE USA LAVELLE

PART NO.	DESCRIPTION	CTN/MSTR
C05200	Korky® QuietFill valve (5282)	1/24

Integral Float Fill Valve



- Fits most toilets
- Replace all of the complicated mechanisms with this simple kit
- Adjustable height from 9" to 13"
- Adjustable float for adjustable water height
- Similar to Fluidmaster® 400A
- Similar to Korky 528Z

PART NO.	DESCRIPTION	CTN/MSTR
T02070	Integral float fill valve	1/12

* The manufacturers' names are used only to describe whose products the products will fit.

American Standard* Toilet Repair Parts



PART NO.	DESCRIPTION	CTN/MSTR
T02020	#5 (33642-07) old style low profile actuator unit, black, with disc, chain, clip and grommet	25/50
T02021	#6 (72880-07) old style high profile actuator unit, complete, black, with disc, chain, clip and grommet	25/50
T02022	#4 (8162-07) old style high profile actuator unit with legs, for one piece low boy*with brass flush valves, complete, black with disc, chain, clip, grommet and legs	25/50
T02023	#4 (70711-07) old style Cadet* water saver actuator unit, white with blue cap complete with disc, chain, clip and grommet	50/100
T02024	Chain kit complete for all actuator units (American Standard* 8321-07) 8" chain	50/500
T02026	#4 (47107-07) new style complete flush valve unit, white, short actuator	1/5
T02027	#5 (47089-07) complete flush valve tall black for standard two-piece closets	50/100

* The manufacturers' names are used only to describe whose products the products will fit.

Ballcock Repair Parts for American Standard*



PART NO.	DESCRIPTION	CTN/MSTR
T02035	7307 cap and plunger with seat, new style	1/10
T02036	N3010 ballcock plunger with thumb hole	1/10

* The manufacturers' names are used only to describe whose products the products will fit.

Ballcock Repair Parts for Coast*



PART NO.	DESCRIPTION	CTN/MSTR
T02037	Coast 1B1*, 1B1P*, standard large head kit with 3 screws	1/10
T02038	Coast 1B1A*, smaller head kit with 3 screws	1/10
T02039	Coast 1B1X*, Kohler*, UR*, Eljer*, Briggs*, American Standard*, kits with 3 screws, high and low boy	1/10

* The manufacturers' names are used only to describe whose products the products will fit.

Ballcock Repair Parts for Amerline*/Hoov-R-Line*



PART NO.	DESCRIPTION	CTN/MSTR
T02050	Standard kit with 4 screws	1/25

* The manufacturers' names are used only to describe whose products the products will fit.

Ballcock Repair Parts for Kohler*



PART NO.	DESCRIPTION	CTN/MSTR
T02051	Black plunger with cap and seal	1/10

* The manufacturers' names are used only to describe whose products the products will fit.

Ballcock Repair Parts for Fluidmaster*



PART NO.	DESCRIPTION	CTN/MSTR
T02052	Diaphragm N/S heavy duty white for hard water and chloramines (Ref. 242F)	1/10
T02053	Standard black diaphragm (Ref. 242)	1/10

* The manufacturers' names are used only to describe whose products the products will fit.

Mansfield* Ballcock and Flush Valve Repair Parts



• Original Mansfield* parts

PART NO.	DESCRIPTION	CTN/MSTR
T02062	08 ballcock repair kit	1/10
T02064	208/209 flush valve diaphragm	10/50
T02065	210/211 flush valve seal	10/700

* The manufacturers' names are used only to describe whose products the products will fit.

Dual Flush Toilet Kit



- Simple to install
- Save water with every flush!
- Push one way to rinse liquid
- Push the other way to flush solids

PART NO.	DESCRIPTION	CTN/MSTR
T02067	Dual flush toilet kit	1/40

Toilet Tank Cover



- Fit-All
- White plastic
- Fits most tanks with outside dimensions of 21-1/8" x 7-3/8" or less

PART NO.	DESCRIPTION	CTN/MSTR
T02005	White tank cover	1/1

Enduro Closet Bolt



- Never Rusts
- Space age material
- Fits all closet flange styles
- Withstands over 1,000 PSI
- CARTON QUANTITIES ONLY

PART NO.	DESCRIPTION	CTN/MSTR
C02050	5/16" x 2-1/2" closet bolt	50 pairs/500 pairs



- Priced per display
- 50 closet bolts packaged in a convenient refillable counter display

PART NO.	DESCRIPTION	CTN/MSTR
CJ1003	5/16" x 2-1/2" closet bolt display	1/1

Flexible and Rigid Super Shims



- Stackable
- Rigid, can be driven
- Flexible, can be trimmed
- Priced per bag
- 10 per bag

MADE IN THE
USA

PART NO.	DESCRIPTION	CTN/MSTR
S55950	1-1/8" x 1-15/16" x 1/4" flexible	1 bag of 10/400
S55951	1-1/8" x 1-15/16" x 1/4" rigid	1 bag of 10/400



- 200 super shims packaged in a convenient refillable counter display
- Priced per display

PART NO.	DESCRIPTION	CTN/MSTR
S55952	Flexible super shims display	1/1
S55953	Rigid super shims display	1/1

Closet Wedge Shims



- Stackable
- 3/8" width x 1-3/8" length x 5/16" height
- Easily trimmed to desired height
- Priced per bag
- 100 per bag

MADE IN THE
USA

PART NO.	DESCRIPTION	CTN/MSTR
S55902	Closet wedge shims	1/1



- 1000 shims packaged in a convenient refillable counter display
- Priced per display

PART NO.	DESCRIPTION	CTN/MSTR
S55903	Closet wedge shims display	1/1

Items marked with the Jones Stephens logo are "You Need It...We Got It" Items.

"Bucket Of Bolts"



- Attractive counter/shelf display
- Closet bolts are custom packed (2 bolts, nuts, and washers per bag)

Brass Plated Bolts, Zinc Plated Washers and Zinc Plated Acorn Nuts

PART NO.	SIZE	WASHER	CTN/MSTR
CB2001	1/4" x 2-1/4"	Oval	50 pairs/1
CB2011	1/4" x 2-1/4"	Round	50 pairs/1
CB2002	1/4" x 3-1/2"	Oval	50 pairs/1
CB2012	1/4" x 3-1/2"	Round	50 pairs/1
CB2003	5/16" x 1-3/4"	Oval	50 pairs/1
CB2013	5/16" x 1-3/4"	Round	50 pairs/1
CB2004	5/16" x 2-1/4"	Oval	50 pairs/1
CB2014	5/16" x 2-1/4"	Round	50 pairs/1
CB2005	5/16" x 3-1/2"	Oval	50 pairs/1
CB2015	5/16" x 3-1/2"	Round	50 pairs/1

Brass Bolts, Stainless Washers and Nickel Plated Acorn Nuts

PART NO.	SIZE	WASHER	CTN/MSTR
CB2021	1/4" x 2-1/4"	Oval	50 pairs/1
CB2030	1/4" x 2-1/4"	Round	50 pairs/1
CB2022	1/4" x 3-1/2"	Oval	50 pairs/1
CB2031	1/4" x 3-1/2"	Round	50 pairs/1
CB2023	5/16" x 1-3/4"	Oval	50 pairs/1
CB2032	5/16" x 1-3/4"	Round	50 pairs/1
CB2024	5/16" x 2-1/4"	Oval	50 pairs/1
CB2033	5/16" x 2-1/4"	Round	50 pairs/1
CB2025	5/16" x 3-1/2"	Oval	50 pairs/1
CB2034	5/16" x 3-1/2"	Round	50 pairs/1

Closet Bolts with Tinnerman Nuts



- Two each bolts, nuts, round washers and tinnerman nuts per bag
- CARTON QUANTITIES ONLY

Brass Plated Bolts, Zinc Plated Washers and Zinc Plated Tinnerman Nuts

PART NO.	SIZE	CTN/MSTR
C02401	1/4" x 2-1/4"	50 pairs/400
C02402	1/4" x 3-1/2"	50 pairs/200
C02403	5/16" x 1-3/4"	50 pairs/200
C02404	5/16" x 2-1/4"	50 pairs/200
C02405	5/16" x 3-1/2"	50 pairs/200

Brass Bolts, Stainless Washers and Nickel Plated Tinnerman Nuts

PART NO.	SIZE	CTN/MSTR
C02421	1/4" x 2-1/4"	50 pairs/400
C02990	1/4" x 3-1/2"	50 pairs/200
C02422	5/16" x 1-3/4"	50 pairs/400
C02423	5/16" x 2-1/4"	50 pairs/400
C02424	5/16" x 3-1/2"	50 pairs/200

B

Closet Bolts



- Closet bolts are custom packed (2 bolts, nuts, and washers per bag)
- CARTON QUANTITIES ONLY

Brass Plated Bolts, Zinc Plated Washers and Zinc Plated Acorn Nuts

PART NO.	SIZE	WASHER	CTN/MSTR
C02000	1/4" x 1-3/4"	Oval	50 pairs/400
C02010	1/4" x 1-3/4"	Round	50 pairs/400
C02001	1/4" x 2-1/4"	Oval	50 pairs/400
C02011	1/4" x 2-1/4"	Round	50 pairs/400
C02002	1/4" x 3-1/2"	Oval	50 pairs/400
C02012	1/4" x 3-1/2"	Round	50 pairs/200
C02003	5/16" x 1-3/4"	Oval	50 pairs/400
C02013	5/16" x 1-3/4"	Round	50 pairs/400
C02004	5/16" x 2-1/4"	Oval	50 pairs/200
C02014	5/16" x 2-1/4"	Round	50 pairs/200
C02005	5/16" x 3-1/2"	Oval	50 pairs/200
C02015	5/16" x 3-1/2"	Round	50 pairs/200

Brass Bolts, Stainless Washers, Nickel Plated Acorn Nuts

PART NO.	SIZE	WASHER	CTN/MSTR
C02020	1/4" x 1-3/4"	Oval	50 pairs/400
C02029	1/4" x 1-3/4"	Round	50 pairs/200
C02021	1/4" x 2-1/4"	Oval	50 pairs/400
C02030	1/4" x 2-1/4"	Round	50 pairs/400
C02022	1/4" x 3-1/2"	Oval	50 pairs/200
C02031	1/4" x 3-1/2"	Round	50 pairs/200
C02023	5/16" x 1-3/4"	Oval	50 pairs/200
C02032	5/16" x 1-3/4"	Round	50 pairs/200
C02024	5/16" x 2-1/4"	Oval	50 pairs/200
C02033	5/16" x 2-1/4"	Round	50 pairs/200
C02025	5/16" x 3-1/2"	Oval	50 pairs/200
C02034	5/16" x 3-1/2"	Round	50 pairs/200

Closet Bolts



- Bulk Packed - One each bolt, nut, washer and acorn nut per bag
- CARTON QUANTITIES ONLY

Brass Plated Bolts, Zinc Plated Washers and Zinc Plated Acorn Nuts

PART NO.	SIZE	WASHER	CTN/MSTR
C02000B	1/4" x 1-3/4"	Oval	100 each/400
C02010B	1/4" x 1-3/4"	Round	100 each/400
C02001B	1/4" x 2-1/4"	Oval	100 each/400
C02011B	1/4" x 2-1/4"	Round	100 each/400
C02002B	1/4" x 3-1/2"	Oval	100 each/400
C02012B	1/4" x 3-1/2"	Round	100 each/400
C02003B	5/16" x 1-3/4"	Oval	100 each/400
C02004B	5/16" x 2-1/4"	Oval	100 each/400
C02014B	5/16" x 2-1/4"	Round	100 each/400
C02005B	5/16" x 3-1/2"	Oval	100 each/400
C02015B	5/16" x 3-1/2"	Round	100 each/400

Brass Bolts, Stainless Washers and Nickel Plated Acorn Nuts

PART NO.	SIZE	WASHER	CTN/MSTR
C02020B	1/4" x 1-3/4"	Oval	100 each/400
C02029B	1/4" x 1-3/4"	Round	100 each/400
C02021B	1/4" x 2-1/4"	Oval	100 each/400
C02030B	1/4" x 2-1/4"	Round	100 each/400
C02022B	1/4" x 3-1/2"	Oval	100 each/400
C02031B	1/4" x 3-1/2"	Round	100 each/400
C02023B	5/16" x 1-3/4"	Oval	100 each/400
C02032B	5/16" x 1-3/4"	Round	100 each/400
C02024B	5/16" x 2-1/4"	Oval	100 each/400
C02033B	5/16" x 2-1/4"	Round	100 each/400
C02025B	5/16" x 3-1/2"	Oval	100 each/400
C02034B	5/16" x 3-1/2"	Round	100 each/400

Items marked with the Jones Stephens logo are "You Need It... We Got It" Items.

Closest Bolt Component Parts



Closest Bolt



Closest Screw



Tinnerman Nut

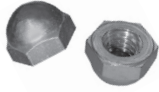

Closed Acorn Nut



Open Acorn Nut



Oval Washer



Round Washer

PART NO.	DESCRIPTION	CTN/MSTR
C02800	1/4" x 1-3/4" brass plated closet bolt	100/1200
C02801	1/4" x 2-1/4" brass plated closet bolt	100/1200
C02802	1/4" x 3-1/2" brass plated closet bolt	100/700
C02803	5/16" x 1-3/4" brass plated closet bolt	100/700
C02804	5/16" x 2-1/4" brass plated closet bolt	100/800
C02805	5/16" x 3-1/2" brass plated closet bolt	100/500
C02820	1/4" x 1-3/4" brass closet bolt	100/1500
C02821	1/4" x 2-1/4" brass closet bolt	100/1200
C02822	1/4" x 3-1/2" brass closet bolt	100/700
C02823	5/16" x 1-3/4" brass closet bolt	100/1000
C02824	5/16" x 2-1/4" brass closet bolt	100/800
C02825	5/16" x 3-1/2" brass closet bolt	100/500
C02830	1/4" x 2-1/4" brass snap-off closet bolt	100/1000
C02832	5/16" x 2-1/4" brass snap-off closet bolt	100/800
C02808	1/4" x 2-1/2" brass plated closet screw	100/1000
C02815	1/4" x 3-1/2" brass plated closet screw	100/1000
C02811	5/16" x 2-1/2" brass plated closet screw	100/700
C02812	1/4" x 2-1/2" brass closet screw	100/800
C02813	1/4" x 3-1/2" brass closet screw	100/1000
C02814	5/16" x 2-1/2" brass closet screw	100/1000
C02806	1/4" tinnerman nut	100/3500
C02807	5/16" tinnerman nut	100/3500
C02860	1/4" x 7/16" nickel plated open acorn nut	100/5000
C02861	1/4" x 7/16" zinc plated open acorn nut	100/5000
C02862	5/16" x 9/16" nickel plated open acorn nut	100/3000
C02863	5/16" x 9/16" zinc plated open acorn nut	100/3000
C02809	1/4" x 7/16" zinc plated closed acorn nut	100/2500
C02810	5/16" x 9/16" zinc plated closed acorn nut	100/4000
C02900	1/4" nickel plated closed acorn nut	100/2500
C02901	5/16" nickel plated closed acorn nut	100/4000
C02864	1/4" brass open acorn nut	100/2500
C02865	5/16" brass open acorn nut	100/4000
C02850	Oval stainless steel washer	100/5000
C02851	Oval zinc plated washer	100/4000
C02852	Round stainless steel washer	100/5000
C02853	Round zinc plated washer	100/5000

Items marked with the Jones Stephens logo are "You Need It... We Got It" Items.

Snap-Off Closet Bolts



- 2 bolts, nuts, and washers per bag
- Available boxed or in counter display

PART NO.	SIZE	WASHER	CTN/MSTR
C02040	1/4" x 2-1/4"	Oval	50 pairs/400
C02045	1/4" x 2-1/4"	Round	50 pairs/400
C02041	5/16" x 2-1/4"	Oval	50 pairs/200
C02046	5/16" x 2-1/4"	Round	50 pairs/200



- 50 pairs packaged in a convenient refillable counter display
- Priced per display

PART NO.	SIZE	WASHER	CTN/MSTR
CB2040	1/4" x 2-1/4"	Oval	50 pairs/1
CB2045	1/4" x 2-1/4"	Round	50 pairs/1
CB2041	5/16" x 2-1/4"	Oval	50 pairs/1
CB2046	5/16" x 2-1/4"	Round	50 pairs/1

Closest Bolt - Elite Packs



- CARTON QUANTITIES ONLY

Packed with 4 Acorn Nuts and 4 Round Washers

PART NO.	DESCRIPTION	CTN/MSTR
C02989	5/16" x 1-3/4" brass plated bolts	50 pairs/400
C02999	1/4" x 2-1/4" brass plated bolts	50 pairs/400
C02998	1/4" x 2-1/4" solid brass bolts	50 pairs/400
C02997	1/4" x 3-1/2" brass plated bolts	50 pairs/200
C02996	1/4" x 3-1/2" solid brass bolts	50 pairs/200
C02992	1/4" x 2-1/4" solid brass bolts	50 pairs/400
C02993	5/16" x 2-1/4" brass plated bolts	50 pairs/200

Packed with 2 Acorn Nuts, 2 Hex Nuts, and 4 Round Washers

PART NO.	DESCRIPTION	CTN/MSTR
C02995	1/4" x 2-1/4" brass plated bolts	50 pairs/400
C02994	1/4" x 2-1/4" solid brass bolts	50 pairs/400

Packed with 2 Acorn Nuts, 2 Hex Nuts, 4 Round Washers, and 2 Tinnerman Nuts

PART NO.	DESCRIPTION	CTN/MSTR
C02987	1/4" x 2-1/4" solid brass bolts	50 pairs/400

Closest Bolt Cap



Oval Cap

Round Cap

- Plastic
- Priced per bag
- CARTON QUANTITIES ONLY

One Cap and Washer Per Bag

PART NO.	DESCRIPTION	CTN/MSTR
C02100	Oval white (less washer)	100/900
C02105	Round white (with washer)	100/2000
C02106	Round bone (with washer)	100/4000

Two Caps and Washers Per Bag

PART NO.	DESCRIPTION	CTN/MSTR
C02103	Round white (with washer)	50 pairs/50
C02104	Round bone (with washer)	50 pairs/50

B

Closet Screws



- Two each screws, nuts, and washers per bag
- CARTON QUANTITIES ONLY

With Round Washer

With Oval Washer

Brass Plated Bolts, Stainless Washers and Nickel Plated Acorn Nuts

PART NO.	SIZE	WASHER	CTN/MSTR
C02200	1/4" x 2-1/2"	Oval	50 pairs/200
C02210	1/4" x 2-1/2"	Round	50 pairs/400
C02203	1/4" x 3-1/2"	Oval	50 pairs/200
C02202	1/4" x 3-1/2"	Round	50 pairs/200
C02211	5/16" x 2-1/2"	Oval	50 pairs/200
C02201	5/16" x 2-1/2"	Round	50 pairs/200

Brass Bolts, Stainless Washers and Nickel Plated Acorn Nuts

PART NO.	SIZE	WASHER	CTN/MSTR
C02300	1/4" x 2-1/2"	Oval	50 pairs/400
C02310	1/4" x 2-1/2"	Round	50 pairs/400
C02303	1/4" x 3-1/2"	Oval	50 pairs/200
C02302	1/4" x 3-1/2"	Round	50 pairs/400
C02311	5/16" x 2-1/2"	Oval	50 pairs/200
C02301	5/16" x 2-1/2"	Round	50 pairs/200

Tank to Bowl Set



- Universal fit sponge rubber gasket
- Domed poly wingnut fits into china, eliminating bottom washer
- CARTON QUANTITIES ONLY

PART NO.	DESCRIPTION	BOLT	CTN/MSTR
C03250	5/16" x 3"	Brass Plated	25/200 (pairs)
C03251	5/16" x 3" with gasket	Brass Plated	25/200 (pairs)
C03252	5/16" x 3"	Brass	25/200 (pairs)
C03253	5/16" x 3" with gasket	Brass	25/200 (pairs)

Tank to Bowl Bolt Set



- Universal fit sponge rubber gasket
- CARTON QUANTITIES ONLY

With Wing Nut

PART NO.	DESCRIPTION	BOLT	CTN/MSTR
C03200	5/16" x 3"	Brass Plated	50 pairs/200
C03201	5/16" x 3" with gasket	Brass Plated	25 pairs/200
C03202	5/16" x 3"	Brass	50 pairs/200
C03203	5/16" x 3" with gasket	Brass	25 pairs/200

With Hex Nut

PART NO.	DESCRIPTION	BOLT	CTN/MSTR
C03210	5/16" x 3"	Brass Plated	50 pairs/200
C03211	5/16" x 3" with gasket	Brass Plated	25 pairs/200
C03212	5/16" x 3"	Brass	50 pairs/200
C03213	5/16" x 3" with gasket	Brass	25 pairs/100

With Hex Nut and Wing Nut

PART NO.	DESCRIPTION	BOLT	CTN/MSTR
C03240	5/16" x 3"	Brass	50 pairs/100

Tank to Bowl Bolt Kit for Mansfield*



- Includes 3 brass plated bolts, 3 hex nuts, 3 round washers, 1 sponge rubber gasket, 1 ballcock coupling nut and 3 cloth inserted washers
- 3" bolt

PART NO.	DESCRIPTION	CTN/MSTR
C03260	Mansfield* kit	1/25

* The manufacturers' names are used only to describe whose products the products will fit.

Tank to Bowl Bolt Kit for Gerber*



- Includes 2 brass bolts, 2 hex nuts, 4 round washers, 1 sponge rubber gasket and 4 cloth inserted washers

PART NO.	DESCRIPTION	CTN/MSTR
C03265	Gerber* kit	1/25

* The manufacturers' names are used only to describe whose products the products will fit.

Tank to Bowl Bolt Kit for American Standard*



- Includes 2 bolts, 4 nuts, 4 round washers and 1 sponge rubber gasket

PART NO.	DESCRIPTION	CTN/MSTR
C03270	American Standard* kit (brass plated bolts)	1/25

C03271	American Standard* kit (brass bolts)	1/25
--------	--------------------------------------	------

* The manufacturers' names are used only to describe whose products the products will fit.

Tri-Tank to Bowl Bolt Kit for American Standard*



- Includes 3 brass plated bolts, 6 hex nuts, 6 round washers, 1 sponge rubber gasket and 6 cloth inserted washers

PART NO.	DESCRIPTION	CTN/MSTR
C03272	American Standard* kit	1/25

* The manufacturers' names are used only to describe whose products the products will fit.

Tri-Bolt Tank to Bowl Bolt Set



- For units requiring 3-bolt attachment
- 3 brass bolts, 6 round washers, 6 hex nuts and 6 cloth inserted washers

PART NO.	DESCRIPTION	CTN/MSTR
C03280	5/16" x 3" bolt set	1/25

Offset Tank to Bowl Bolts



- All brass
- Rubber washers
- 2" maximum adjustment

PART NO.	DESCRIPTION	CTN/MSTR
C02075	Offset tank to bowl bolts	50/200

Items marked with the Jones Stephens logo are "You Need It... We Got It" Items.

Tank to Bowl Components

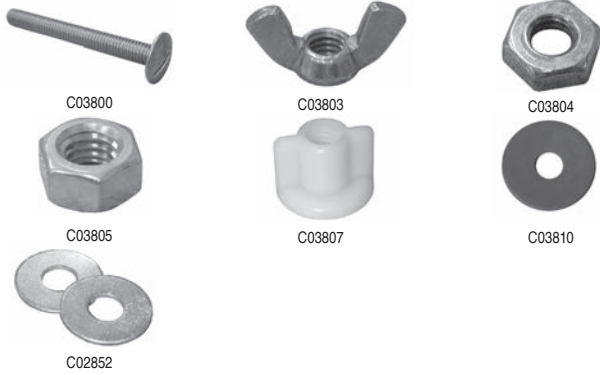

PART NO.	DESCRIPTION	CTN/MSTR
C03800	5/16"-18 x 3" brass plated tank bolt	100/500
C03801	5/16"-18 x 3" brass tank bolt	100/500
C03803	5/16"-18 brass plated forged wing nut	100/500
C03804	5/16"-18 brass plated heavy hex jam nut	100/5500
C03805	5/16"-18 brass heavy hex jam nut	100/5000
C03807	5/16" acetal tank bowl wing nut	100/3500
C03810	Cloth inserted washer	10/100
C02852	Stainless steel washer	100/5000

Tank to Bowl Gaskets



- Close coupled tank to bowl gaskets
- Beveled sponge rubber material
- CARTON QUANTITIES ONLY

Universal Fit-All

PART NO.	DESCRIPTION	CTN/MSTR
C03300	2-1/4" ID x 3-3/8" OD x 11/16" thick	25/1000

Kohler* (fits Alamo and other Kohler* integral units with two piece closets)

PART NO.	DESCRIPTION	CTN/MSTR
C03301	2-1/2" ID x 3-3/4" OD x 3/4" thick	25/1000

Eljer* (rubber)

PART NO.	DESCRIPTION	CTN/MSTR
C03302	2-5/16" ID x 3-1/8" OD x 3/8" thick	25/1000

American Standard Cadet*, Kohler*, Crane*, Borg Warner*

PART NO.	DESCRIPTION	CTN/MSTR
C03303	2-1/8" ID x 3-1/2" OD x 1-1/4" thick	25/300

Crane*

PART NO.	DESCRIPTION	CTN/MSTR
C03304	2-1/8" ID x 3-1/4" OD x 1-1/16" thick	25/300

Gerber* (free standing late models)

PART NO.	DESCRIPTION	CTN/MSTR
C03305	2-1/8" ID x 3-1/4" OD x 1-3/16" thick	25/300

Mansfield*

PART NO.	DESCRIPTION	CTN/MSTR
C03306	2-1/2" ID x 3-5/8" OD x 3/4" thick	25/200

* The manufacturers' names are used only to describe whose products the products will fit.

Wax Gaskets

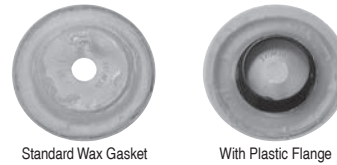

- Boxed
- CARTON QUANTITIES ONLY

PART NO.	DESCRIPTION	CTN/MSTR
G13001	Full size standard wax gasket	1/48
G13002	Wax gasket with plastic flange	1/24
G13003	Wax urinal gasket- fits 2" outlet	1/12
G13004	Jumbo wax gasket	1/12
G13006	Jumbo wax gasket with plastic flange	1/12

Radiant Seal Sponge Rubber Closet Gasket



- Neoprene
- Easy installation
- Unaffected by radiant heat
- Seals effectively with uneven floors

PART NO.	DESCRIPTION	CTN/MSTR
G13005	3-3/4" ID x 5-1/8" OD x 1/2" thick	1/150

Closet Bend Spacer



- Fit-all
- Eliminates the need to chip out concrete
- 6" OD x 4" high (fits 3" and 4" waste lines)
- Keeps poured concrete away from waste lines and closet bends
- Replaces styrofoam, styrene coverings, coffee cans and duct tape
- Outside is plastic, inside is foam
- CARTON QUANTITIES ONLY

PART NO.	DESCRIPTION	CTN/MSTR
S12005	Closet bend spacer	18/18

Styrofoam Closet Flange Spacer



- Eliminates needless chipping of concrete
- Styrofoam breaks away or melts with flame
- CARTON QUANTITIES ONLY

PART NO.	DESCRIPTION	CTN/MSTR
S13130	3" Flange spacer	120/120
S13140	4" Flange spacer	120/120

Foam Spacer



- Foam closet bend protector
- CARTON QUANTITIES ONLY

PART NO.	DESCRIPTION	CTN/MSTR
S13240	4"x 4" foam spacer	60/60

B

Shower Rod Flanges



- Flanges fit 15/16" and 1" OD rod
- Mount to wall

PART NO.	DESCRIPTION	CTN/MSTR
S02150	Jiffy flange chrome plated plastic	1/200
S02151	Jiffy flange chrome die cast zinc	1/100
S02152	Chrome flanges with screws (bagged)	50/500

Jumbo Shower Bar Flange



PART NO.	DESCRIPTION	CTN/MSTR
S02300	Jumbo shower bar flange	1/50

Contoured Shower Rod

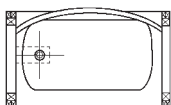

- Brings shower curtain in front of wall to prevent gaps and leaks
- Perfect for 60° oval or standard tubs
- Adjusts easily with tube cutter for shorter walls
- Sweeping curve increases space in center of oval tubs
- Sturdy alloy rods with zinc angled mounting brackets
- Multiple applications - residential, hotel, motel, assisted living, etc.



PART NO.	DESCRIPTION	CTN/MSTR
S02190	Chrome Plated shower rod	1/12
S02193	Satin Nickel shower rod	1/6

Flanges

PART NO.	DESCRIPTION	CTN/MSTR
S02290	Chrome flanges (Fits S02190)	1/1
S02293	Satin Nickel flanges (Fits S02193)	1/1



- Easy installation
- Anchors included
- Brings shower curtain in front of wall to prevent gaps and leaks

PART NO.	DESCRIPTION	CTN/MSTR
S02197	Chrome Plated	1/1
S02198	Brushed Nickel	1/2

Aluminum Shower Rod



- 1" OD - .025 wall (22 gauge)
- Individually wrapped
- Can be cut
- CARTON QUANTITIES ONLY

PART NO.	DESCRIPTION	CTN QTY
S02055	5' rod	1/50
S02015	5' rod	1/10
S02056	6' rod	1/50
S02016	6' rod	1/10

Aluminum Shower Rod with Holders



- 1" OD - .025 wall (22 gauge)
- Individually wrapped rods and holders boxed together
- CARTON QUANTITIES ONLY

PART NO.	DESCRIPTION	CTN QTY
S02057	5' rod with plastic Jiffy flange	1/50
S02058	5' rod with die cast Jiffy flange	1/50
S02059	5' rod with chrome flange and screws	1/50
S02071	5' rod with chrome flange and screws (10 pack)	1/10
S02072	6' rod with chrome flange and screws (10 pack)	1/10
S02073	5' rod with plastic Jiffy flange (10 pack)	1/10
S02074	6' rod with plastic Jiffy flange (10 pack)	1/10

Adjustable Aluminum Shower Rod



- Sturdy, self-supporting rod with plastic ends
- 1" OD/.025 wall (22 gauge)
- Expandable from 58" to 61" or 69" to 73"
- Individually wrapped
- CARTON QUANTITIES ONLY

PART NO.	DESCRIPTION	CTN QTY
S02070	Adjustable shower rod 58" - 61"	1/50
S02066	Adjustable shower rod 69" - 73"	1/50
S02069	Adjustable shower rod 58" - 61" (10 pack)	1/10

Deluxe Shower Head



- Chrome plated die cast zinc
- 2.5 gpm flow rate
- Brass ball

PART NO.	DESCRIPTION	CTN/MSTR
S01004	Chrome plated deluxe shower head	1/100

Shower Heads



Plastic



Die cast



Brass

- 2.5 gpm flow rate

Plastic

PART NO.	DESCRIPTION	CTN/MSTR
S01001	2" Chrome with plastic ball	1/100
S01002	2" White with plastic ball	1/200
S01003	2" Chrome with brass ball	1/100

Die Cast

PART NO.	DESCRIPTION	CTN/MSTR
S01005	2" Chrome- adjustable	1/100

Brass

PART NO.	DESCRIPTION	CTN/MSTR
S01008	1-3/4" Chrome- adjustable	1/50
S01009	2-1/8" Chrome- adjustable	1/50
S01010	3" Chrome- adjustable	1/20

Brass Aerating Water Saver Shower Head



S01013



S01014

- Permanent built-in water restrictor
- Mixes air and water for invigorating spray
- Restricts water to 2-2.5 GPM, depending on water pressure

PART NO.	DESCRIPTION	CTN/MSTR
S01013	1" Chrome	50/200
S01014	1" Chrome with shutoff	50/200

Items marked with the Jones Stephens logo are "You Need It...We Got It" Items.

Vandal Proof Shower Head



- Chrome plated plastic
- 2.5 GPM flow rate
- Brass ball
- Spray adjusts from coarse to fine
- Secures with set screw, hex key included

PART NO.	DESCRIPTION	CTN/MSTR
S01015	Chrome plated plastic shower head	1/100

Adjustable Plastic Shower Head



- Chrome plated plastic
- 1.5 GPM flow rate
- Brass ball

PART NO.	DESCRIPTION	CTN/MSTR
S01016	Chrome plated adjustable plastic shower head	1/100

Adjustable Massage Shower Head



- Chrome plated plastic
- 2.5 GPM flow rate
- Brass ball

PART NO.	DESCRIPTION	CTN/MSTR
S01020	Chrome plated adjustable massage plastic shower head	1/100

Octagonal Shower Head



- 2.5 GPM flow rate
- Brass ball

PART NO.	DESCRIPTION	CTN/MSTR
S01025	Chrome plated octagonal shower head	10/50

Shower Arms and Kits



Shower Arm

Shower Arm with Flange

"S" Style Shower Arm

- Chrome plated stainless steel arms

PART NO.	DESCRIPTION	CTN/MSTR
S01030	6" Arm only	1/200
S01032	8" Arm only	1/100
S01044	6" Arm and stainless steel flange	1/25
S01045	8" Arm and stainless steel flange	1/100
S01035	8" "S" shaped arm	10/80
S01038	10" "S" shaped arm	25/50

Heavy Adjustable Shower Arm



- Chrome plated brass
- 10" length
- Locking wing nut adjustment

PART NO.	DESCRIPTION	CTN/MSTR
S01039	1/2" x 10" adjustable	10/50

Shower Arm and Flange with Set Screw



- 1/2" x 6" shower arm

PART NO.	DESCRIPTION	CTN/MSTR
S01042	6" Shower arm and flange with set screw	1/150

Plastic Shower Arm



- 1/2" x 6" chrome-plated plastic with flange

PART NO.	DESCRIPTION	CTN/MSTR
S01049	6" Plastic shower arm and flange	1/200

Shower Arm Flange



S01041

S01040

PART NO.	DESCRIPTION	CTN/MSTR
S01040	Chrome flange with set screw (2-1/2" OD)	40/400
S01041	Stainless steel flange (2-1/2" OD)	50/2000

Shower Curtain Pin



- CARTON QUANTITIES ONLY

PART NO.	DESCRIPTION	CTN/MSTR
S02100	Shower curtain pin	500/2000

Shower Pan Liner

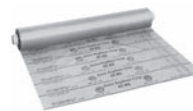

- 40 mil thickness flexible gray PVC
- Meets ASTM D4551
- PVC
- Marked in 6 inch increments for easy measurements
- Treated to prevent the growth of fungus, molds and mildew
- UPC listed
- FREIGHT LINE ONLY



PART NO.	DESCRIPTION	CTN/MSTR
S994050	4' x 50' shower pan liner	1/1
S995040	5' x 40' shower pan liner	1/1
S996050	6' x 50' shower pan liner	1/1
S996080	5' x 80' shower pan liner	1/1

PVC Shower Pan Liner Cement



- 3 year shelf life
- Not for PE liner use
- Instant contact strength
- CARTON QUANTITIES ONLY

PART NO.	DESCRIPTION	CTN/MSTR
S99100	Shower pan liner cement (pint)	12/12

Water Volume Control



- 1/2" female x 1/2" male IPS
- Allows reduced water flow (does not shut water completely off)

PART NO.	DESCRIPTION	CTN/MSTR
S01060	Chrome-brass water volume control	50/200
S01061	Chrome-plastic water volume control	1/500

Plastic Flow Restrictor



- 2.5 GPM
- Fits most heads

PART NO.	DESCRIPTION	CTN/MSTR
S01080	Shower head flow restrictor	1/1000

54" D-Style Add-A-Shower

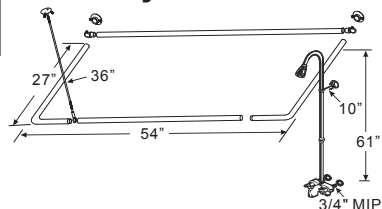

- Heavy duty jumbo flanges
- 61" riser with shower head
- Standard bathcock (3 3/8" centers)
- 54" x 27" chrome plated aluminum shower rod (1" diameter)
- Non-adjustable

PART NO.	DESCRIPTION	CTN/MSTR
S10083	54" x 27" D-Style Add-A-Shower	1/5

Add-A-Shower Complete Unit

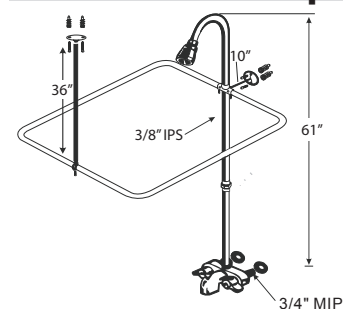

- Bathcock with diverter spout
- Chrome plated plastic shower head
- 61" rise with 10" rod and riser support
- 24" x 42" rectangular aluminum shower rod with 36" ceiling rod and support

PART NO.	DESCRIPTION	CTN/MSTR
S10070	Complete unit with S10080 diverter	1/5
S10069	Complete unit with S10074 diverter	1/5

Complete Add-A-Shower

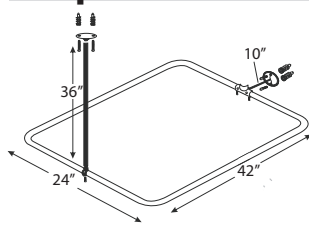

- Rectangular frame
- Aluminum shower rod
- Bathcock with diverter spout
- 3/8" mounting brackets included
- 61" riser with 10" rod and riser support

PART NO.	DESCRIPTION	CTN/MSTR
S10068	24" x 42"	1/5

Add-A-Shower less Oval Shower Rod

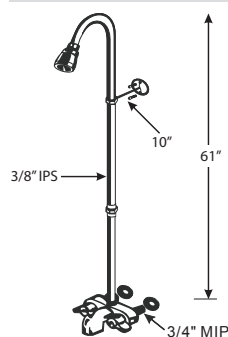

- 61" riser and wall support
- Bathcock with diverter spout
- Chrome plated plastic shower head
- Includes bushings (P11986)

PART NO.	DESCRIPTION	CTN/MSTR
S10072	Complete unit less oval shower rod	1/10

Add-A-Shower Diverter Spout and Riser

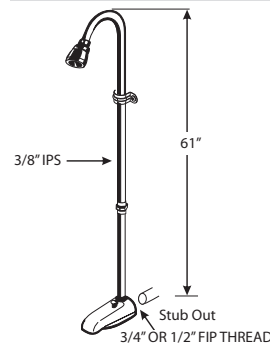

- Diverter valve
- 61" riser with wall support
- Chrome plated plastic shower head
- Includes 1" wall bracket (S10077)
- S10081 replacement diverter with base connection

PART NO.	DESCRIPTION	CTN/MSTR
S10071	Spout and riser	1/10

Add-A-Shower Code Pattern Diverter



PART NO.	DESCRIPTION	CTN/MSTR
S10074	Code pattern anti-syphon diverter bathcock	1/12

Add-A-Shower Accessories

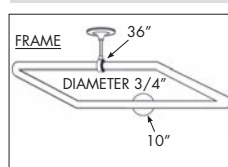

PART NO.	DESCRIPTION	CTN/MSTR
S10075	24" x 42" rectangle shower rod	1/10
B60001	Wall bracket and rod holder with 12" rod (can be cut to fit)	1/100
B60002	Ceiling bracket and rod holder with standard size 36" rod	1/100
S10073	48" ceiling rod only	1/10
S10080	Replacement bathcock assembly	1/12
S10081	Diverter spout only for S10071 (base connection)	1/50
S10077	1" Wall bracket for S10071	1/200
S10078	Diverter spout with 65" riser	1/10
S10082	61" CP brass riser only	1/20
S10076	61" CP brass riser with shower head	1/10

Shower Diverter Valve



- Installs between arm and shower head
- Allows usage of hand-held personal shower or shower head

PART NO.	DESCRIPTION	CTN/MSTR
S01070	Chrome push button- brass	1/5

Offset Bath Supplies



B49020



B49021

- Chrome plated
- 1/2" supply tubes
- All hardware needed for connection included

PART NO.	DESCRIPTION	CTN/MSTR
B49020	Single offset (pair)	1/25
B49021	Double offset (pair)	1/25
B49022	Replacement nuts, washers and escutcheons	1/25

Utility Shower



- 21" galvanized riser
- Top or bottom connection
- Chrome plated brass body with shower head and soap dish
- Combination 1/2" threaded or sweat connection union inlets on 3" centers
- Use S10080 for replacement bathcock assembly

PART NO.	DESCRIPTION	CTN/MSTR
S10079	Utility shower	1/6

Bathcocks for Clawfoot Tubs



B49001



B49002



B49010

- Chrome plated brass body
- Replaceable stem and seat
- 3 3/8" centers and 3/4" threaded inlets

PART NO.	DESCRIPTION	CTN/MSTR
B49001	"O" pattern with slip-on spout	1/48
B49002	Code pattern with goose neck spout	1/48
B49010	Coupling elbows (pair) chrome plated 3/4" bath-cock threads x 1/2" male IPS	6/60
B49011	Code spout only	10/300
B49012	Hot repair kit (handle, stem and seat)	1/100
B49013	Cold repair kit (handle, stem and seat)	1/100

Brass Trap Bushing



- Heavy pattern/cast
- 1-1/2" sweat x 1-1/2" IPS
- Knurled end for ease of tightening
- 3/4" length

PART NO.	DESCRIPTION	CTN/MSTR
B55150	1-1/2" SWT x 1-1/2" MIP	1/250

Twin Elbow and Face Bushings



D01040



D01041/042

- Brass

PART NO.	DESCRIPTION	CTN/MSTR
D01040	3/4" FIP x 1/2" FIP twin elbow	20/100
D01041	3/4" MIP x 1/2" FIP face bushing	25/100
D01042	1/2" MIP x 3/8" FIP face bushing	25/100

Brass Shower Elbow for Fiberglass Shower Stall



- Outlet 1/2" FIP
- Secures tub spout nipple
- Secures shower arm to stall
- Lock nuts secure ell to fiberglass wall
- Requires 1-1/8" hole through fiberglass wall
- Combination inlet 1/2" female sweat or 1/2" threaded

PART NO.	DESCRIPTION	CTN/MSTR
S01050	Brass elbow	6/144

7" Chrome Plated Diverter Spout



- Longer length for today's larger tubs
- CTS unit comes with hex key

PART NO.	SIZE	CONNECTION	CTN/MSTR
D01024	7"	1/2" FIP Nose	1/50
D01025	7"	1/2" CTS Slide	1/25

Chrome Plated Slip-On Diverter Spout with Polished Brass Knob



- Hex key included
- Polished brass knob
- Standard 5 1/2" diverter spout
- 1/2" CTS slip-on connection with set screw

PART NO.	DESCRIPTION	CTN/MSTR
D01032	Slip-on diverter spout with PB knob	1/50

Chrome Plated Diverter Spouts and Extensions



- Chrome plated Zamak
- D01004 Meets IAPMO and California Energy Commission approval
- Use P11928 replacement bushing
- Boxed

PART NO.	DESCRIPTION	CONNECTION	CTN/MSTR
D01001	1/2" FIP	Nose	1/50
D01004	1/2" CTS Slide with hex key	Base	1/50



- Chrome plated Zamak
- D01002 Meets IAPMO and California Energy Commission approval
- Use P11928 replacement bushing
- Boxed

PART NO.	DESCRIPTION	CONNECTION	CTN/MSTR
D01002	3/4" x 1/2" FIP	Base	1/50



- Chrome plated brass
- D01002 Meets IAPMO and California Energy Commission approval
- Use P11928 replacement bushing
- Boxed

PART NO.	DESCRIPTION	CONNECTION	CTN/MSTR
D01003	3/4" x 1/2" FIP	Base	1/50



- Chrome plated brass
- 8-1/2" One piece diverter spout
- Boxed

PART NO.	DESCRIPTION	CONNECTION	CTN/MSTR
D01015	3/4" x 1/2" FIP	Base	1/20



- Chrome plated zamak
- Two piece diverter spout
- Boxed

PART NO.	DESCRIPTION	CONNECTION	CTN/MSTR
D01008	8-1/4" two piece	—	1/1
D01009	10-1/8" two piece	—	1/1

Extension Only



- Chrome plated brass

PART NO.	DESCRIPTION	CTN/MSTR
D01030	3" extension only	1/100
D01031	4-3/4" extension only	1/80



- Chrome plated Zamak
- Diverter spout for hand held shower

PART NO.	DESCRIPTION	CONNECTION	CTN/MSTR
D01010	3/4" x 1/2" FIP top connection	Base	1/10
D01011	3/4" x 1/2" MIP lower connection	Base	1/50

Tub Spouts



D01020
D01021

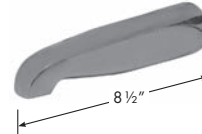

D01016



D01028
D01029

- Chrome plated zamak

Chrome Plated Zamak Slide Connection with Hex Key

PART NO.	DESCRIPTION	CONNECTION	CTN/MSTR
D01020	1/2" FIP	Nose	1/50
D01021	1/2" CTS slide connection	Base	1/50

8 1/2" One Piece Chrome Plated Brass

PART NO.	DESCRIPTION	CONNECTION	CTN/MSTR
D01016	3/4" x 1/2" FIP	Base	1/20

Two Piece Chrome Plated

PART NO.	DESCRIPTION	CONNECTION	CTN/MSTR
D01028	8" two piece	Nose	1/1
D01029	10" two piece	Nose	1/1

Telescoping Tub and Diverter Spout



D01022



D01023

- 5 1/2" overall length
- Adjustment up to 1" to accommodate various rough-ins

PART NO.	DESCRIPTION	CONNECTION	CTN/MSTR
D01022	1/2" x 3/4" tub spout	Base	1/50
D01023	1/2" x 3/4" diverter spout	Base	1/50

9" Chrome Plated Tub Spout



D01017



D01018

- Solid brass construction
- One piece design
- 1/2" FIP nose connection

PART NO.	DESCRIPTION	CONNECTION	CTN/MSTR
D01017	9" diverter spout	Base	1/12
D01018	9" tub spout	Base	1/12

7" Chrome Plated Tub Spout



- Longer length for today's larger tubs
- CTS unit comes with hex key

PART NO.	SIZE	CONNECTION	CTN/MSTR
D01026	7"	1/2" FIP Nose	1/50
D01027	7"	1/2" CTS Slide	1/25

Tub Spouts



- Solid brass

Solid brass

PART NO.	SIZE	CONNECTION	CTN/MSTR
D01005	3/4" x 1/2"	Base	1/40

Items marked with the Jones Stephens logo are "You Need It... We Got It" Items.

Overflow Plates

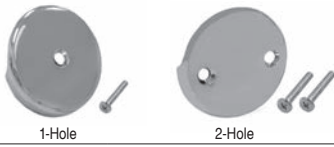

- Chrome plated
- 2" screws
- UPC listed



PART NO.	DESCRIPTION	# OF HOLES	CTN/MSTR
T05012	1-hole with screw	1	20/200
T05013	2-hole with screws	2	20/200
T05010	1-hole less screw	1	20/200
T05011	2-hole less screw	2	20/200
T05021	1/4" x 2" chrome plated screw	—	100/1000

Trip Lever With Spring



- Chrome plated
- Coil-type spring
- 2" screws

PART NO.	DESCRIPTION	CTN/MSTR
T05002	Round trip lever less screws	25/200
T05003	Round trip lever with 2" screws	25/200
T05021	1/4" x 2" chrome plated screw	500/2000

Faceplate Gasket and Shoe Gasket



T05025



T05026

- CARTON QUANTITIES ONLY

PART NO.	DESCRIPTION	CTN/MSTR
T05025	Beveled faceplate gasket 2 1/8" ID x 3 3/16" OD- 9/16"-3/16" thick	25/300
T05026	Shoe gasket 1 3/4" ID x 2 5/8" OD - 3/32" thick	25/50

Wraparound Sponge Rubber Faceplate Gasket



- Grips top elbow for easy installation

PART NO.	DESCRIPTION	CTN/MSTR
T05029	Wraparound sponge rubber face gasket	25/500

#15 Plumb Kit



- Stainless steel flange (S01041)
- 1/2" x 6" chrome plated brass shower arm (S01030)
- Chrome plated plastic shower head with brass ball (S01003)

PART NO.	DESCRIPTION	CTN/MSTR
S03220	#15 Plumb kit	1/25

#51 Plumb Kit



- Chrome plated flange with set screw (S01040)
- 1/2" x 6" chrome plated brass shower arm (S01030)
- Chrome plated die cast adjustable shower head (S01005)

PART NO.	DESCRIPTION	CTN/MSTR
S03222	#51 Plumb kit	1/25

Bathtub Protector



- High impact plastic
- Fluted side walls and foam bottom
- MOTOR FREIGHT (LTL) ONLY
- CARTON QUANTITIES ONLY

PART NO.	DESCRIPTION	CTN QTY
T10014	14" deep x 60" long x 30" wide (steel tubs)	35
T10016	16" deep x 60" long x 42" wide (oval tubs)	25
T10216	16" deep x 60" long x 30" wide (cast iron tubs)	35

Adapter Bushing for Bath Drain



- Brass bushing

PART NO.	DESCRIPTION	CTN/MSTR
T05023	Kohler* bushing	50/200
T05024	1-1/2" MIP x 1-3/8" FIP bushing	50/300

* The manufacturers' names are used only to describe whose products the products will fit.

Standard Waste and 1-Hole Overflow



- Half kit with chrome plated lift and turn
- 2-hole test kit converts to 1-hole faceplate

PART NO.	DESCRIPTION	MATERIAL	CTN/MSTR
B07220T	Waste and overflow kit	PVC	1/24
B07221T	Waste and overflow kit	ABS	1/24

Standard Waste and 2-Hole Overflow



- Half kit with satin nickel lift and turn
- 2-hole faceplate

PART NO.	DESCRIPTION	MATERIAL	CTN/MSTR
B07114S	Waste and overflow kit	PVC	1/24
B07111S	Waste and overflow kit	ABS	1/24

Standard Waste and Overflow



- Full kit with chrome plated friction lift
- Includes bar
- 1-hole faceplate

PART NO.	DESCRIPTION	MATERIAL	CTN/MSTR
B07219	Waste and overflow kit	PVC	1/10

Bath Drains



- Chrome plated
- 2-11/16" OD
- P35061 and P35060 have a zinc body, P35066 is brass

PART NO.	DESCRIPTION	CTN/MSTR
P35061	1-3/8" (1-5/8" thread OD) lift and turn	1/100
P35060	1-1/2" (1-7/8" thread OD) lift and turn	1/100
P35066	1-1/2" (1-7/8" thread OD) lift and turn	1/100



- Chrome plated zinc

PART NO.	DESCRIPTION	CTN/MSTR
P35067	1-1/2" friction lift	1/100
P35077	1-3/8" friction lift	1/50



- Chrome plated zinc
- Includes screw

PART NO.	DESCRIPTION	CTN/MSTR
P35064	1-1/2" grid	1/100



- Chrome plated zinc

PART NO.	DESCRIPTION	CTN/MSTR
P35063	1-3/8" (1-5/8" OD thread) toe touch	1/100
P35062	1-1/2" (1-7/8" OD thread) toe touch	1/100



- Chrome plated
- Replacement cartridge for P35063 and P35062

PART NO.	DESCRIPTION	CTN/MSTR
P35056	5/16" toe touch cartridge	1/300
P35057	5/16" toe touch cartridge	1/250



- 1-3/8" are fine threads
- 1-1/2" are course threads

PART NO.	DESCRIPTION	CTN/MSTR
T05023	Kohler* bushing	50/300
T05024	1-3/8" female- 1-1/2" male bushing	1/1

* The manufacturers' names are used only to describe whose products the products will fit.

Quick Cover-Up Tub Stopper



- Chrome plated
- Oversized stopper covers the entire tub drain
- Easily installs without the use of tools

PART NO.	DESCRIPTION	CTN/MSTR
P35260	Quick cover-up tub stopper	6/24

Roman Tub Drain



- Solid brass construction
- Screws are included
- U-shaped handle design
- Designed to fit D64 series "Code Blue" drains

PART NO.	DESCRIPTION	CTN/MSTR
D40000	Chrome Plated roman tub drain	1/50
D40001	Polished Brass (PVD) roman tub drain	1/50
D40002	Satin Nickel (PVD) roman tub drain	1/50

Basin and Bath Stopper



- White hollow rubber with rustproof ring

PART NO.	TRADE SIZE	TOP	BOTTOM	CTN/MSTR
P35125	1-1/4"	1-3/8"	1-3/16"	100/500
P35150	1-1/2"	1-5/8"	1-3/8"	100/500
P35158	1-5/8"	1-25/32"	1-19/32"	100/500
P35175	1-3/4"	1-55/64"	1-11/16"	100/500

Fit-All Stopper



Part No.	Top	Bottom
P35160	1-1/2"	7/8"
P35161	3"	1-1/2"

- White rubber construction

PART NO.	DESCRIPTION	CTN/MSTR
P35160	1"- 1-3/8" basin stopper	100/500
P35161	1-1/2"- 2" bath tub or laundry tub stopper	100/500

Pop-Up Basin Stopper



P36002



P36003



P36004

- Chrome plated

PART NO.	DESCRIPTION	CTN/MSTR
P36002	Delta* pop-up basin stopper	50/200
P36003	Price-Pfister* pop-up stopper	10/500
P36004	Moen* pop-up basin stopper	1/200

* The manufacturers' names are used only to describe whose products the products will fit.

Flip-It Bath Stopper



- One piece construction of Derlin and ABS
- No tools needed for installation
- Open or close with a flip of the toe
- Fits most popular tub drains (assorted o-rings included)

PART NO.	DESCRIPTION	CTN/MSTR
P35070	Chrome plated flip-it stopper	100/200



- No bending or stooping necessary to operate
- Open or close with a flip of the toe
- Fits most popular tub drains

PART NO.	DESCRIPTION	CTN/MSTR
P35170	Chrome plated flip-it conversion kit	1/25

T-Waste 1-Hole Schedule 40 Bath Waste Kits

For use in apartments, motels, hotels - anywhere with back to back baths



T-Waste Kit Benefits:

- Direct access to trap from tub
- Direct waste much less likely to clog
- Solvent weld = homogeneous
- Code required for back to back installation
- Never needs access through walls or ceilings

- No access panel needed
- 1-hole faceplate
- Bolt holes on top elbows are pre-threaded
- All drains 3/8" thread size for testing
- UPC listed

Note: Please use suffix "T" when ordering any waste and overflow kit to have test kit included. When a complete kit with a 2-hole test kit is ordered, a 1-hole faceplate with aluminum conversion bar will be supplied.



Half Kit - Lift and Turn Drain



Half Kit - Toe Touch Drain

T-Waste Half Kit- No Pipe Or Elbow

PART NO.	MATERIAL	DESCRIPTION	# HOLES	CTN/MSTR
B07038	PVC	CP brass lift and turn	1	1/24
B07001	PVC	CP lift and turn	1	1/24
B07005	PVC	PB lift and turn	1	1/24
B07003	PVC	CP toe touch	1	1/24
B07007	PVC	PB toe touch	1	1/24
B07040	PVC	CP friction lift	1	1/24
B07042	PVC	PB friction lift	1	1/24
B07006	ABS	PB lift and turn	1	1/24
B07039	ABS	CP brass lift and turn	1	1/24
B07002	ABS	CP lift and turn	1	1/24
B07004	ABS	CP toe touch	1	1/24
B07008	ABS	PB toe touch	1	1/24
B07041	ABS	CP friction lift	1	1/24
B07043	ABS	PB friction lift	1	1/24



Full Kit - Lift and Turn Drain



Full Kit - Toe Touch Drain

T-Waste Full Kit- Includes Pipe and 90° Elbow

PART NO.	MATERIAL	DESCRIPTION	# HOLES	CTN/MSTR
B07044	PVC	CP brass lift and turn	1	1/10
B07020	PVC	CP lift and turn	1	1/10
B07024	PVC	PB lift and turn	1	1/10
B07022	PVC	CP toe touch	1	1/10
B07046	PVC	CP friction lift	1	1/10
B07048	PVC	PB friction lift	1	1/10
B07045	ABS	CP brass lift and turn	1	1/10
B07021	ABS	CP lift and turn	1	1/10
B07025	ABS	PB lift and turn	1	1/10
B07023	ABS	CP toe touch	1	1/10
B07027	ABS	PB toe touch	1	1/10
B07047	ABS	CP friction lift	1	1/10
B07049	ABS	PB friction lift	1	1/10

T-Waste 2-Hole Schedule 40 Bath Waste Kits

For use in apartments, motels, hotels - anywhere with back to back baths



T-Waste Kit Benefits:

- Direct access to trap from tub
- Direct waste much less likely to clog
- Solvent weld = homogeneous
- Code required for back to back installation
- Never needs access through walls or ceilings

- No access panel needed
- 2-hole faceplate
- Bolt holes on top elbow are pre-threaded
- All drains 3/8" thread size for testing
- UPC listed

Note: Please use suffix "T" when ordering any waste and overflow kit to have test kit included. When a complete kit with a 2-hole test kit is ordered, a 1-hole faceplate with aluminum conversion bar will be supplied.



Half Kit - Lift and Turn Drain



Half Kit - Toe Touch Drain

T-Waste Half Kit- No Pipe Or Elbow

PART NO.	MATERIAL	DESCRIPTION	# HOLES	CTN/MSTR
B07138	PVC	CP brass lift and turn	2	1/24
B07101	PVC	CP lift and turn	2	1/24
B07105	PVC	PB lift and turn	2	1/24
B07103	PVC	CP toe touch	2	1/24
B07107	PVC	PB toe touch	2	1/24
B07140	PVC	CP friction lift	2	1/24
B07142	PVC	PB friction lift	2	1/24
B07139	ABS	CP brass lift and turn	2	1/24
B07102	ABS	CP lift and turn	2	1/24
B07106	ABS	PB lift and turn	2	1/24
B07104	ABS	CP toe touch	2	1/24
B07108	ABS	PB toe touch	2	1/24
B07141	ABS	CP friction lift	2	1/24
B07143	ABS	PB friction lift	2	1/24



Full Kit - Lift and Turn Drain



Full Kit - Toe Touch Drain

T-Waste Full Kit- Includes Pipe and 90° Elbow

PART NO.	MATERIAL	DESCRIPTION	# HOLES	CTN/MSTR
B07144	PVC	CP brass lift and turn	2	1/10
B07120	PVC	CP lift and turn	2	1/10
B07124	PVC	PB lift and turn	2	1/10
B07122	PVC	CP toe touch	2	1/10
B07126	PVC	PB toe touch	2	1/10
B07146	PVC	CP friction lift	2	1/10
B07148	PVC	PB friction lift	2	1/10
B07148	PVC	PB friction lift	2	1/10
B07121	ABS	CP lift and turn	2	1/10
B07125	ABS	PB lift and turn	2	1/10
B07123	ABS	CP toe touch	2	1/10
B07127	ABS	PB toe touch	2	1/10
B07147	ABS	CP friction lift	2	1/10
B07149	ABS	PB friction lift	2	1/10

Standard 1-Hole Schedule 40 Bath Waste Kits

- 1-hole faceplate
- Bolt holes on top elbows are pre-threaded
- All drains 3/8" thread size for testing
- UPC listed



Note: Please use suffix "T" when ordering any waste and overflow kit to have test kit included. When a complete kit with a 2-hole test kit is ordered, a 1-hole faceplate with aluminum conversion bar will be supplied.



Half Kit - Lift and Turn Drain



Half Kit - Toe Touch Drain

Standard Half Kit- No Pipe or Tee

PART NO.	MATERIAL	DESCRIPTION	# HOLES	CTN/MSTR
B07050	PVC	CP brass lift and turn	1	1/24
B07010	PVC	CP lift and turn	1	1/24
B07014	PVC	PB lift and turn	1	1/24
B07012	PVC	CP toe touch	1	1/24
B07016	PVC	PB toe touch	1	1/24
B07052	PVC	CP friction lift	1	1/24
B07054	PVC	PB friction lift	1	1/24
B07051	ABS	CP brass lift and turn	1	1/24
B07011	ABS	CP lift and turn	1	1/24
B07015	ABS	PB lift and turn	1	1/24
B07013	ABS	CP toe touch	1	1/24
B07017	ABS	PB toe touch	1	1/24
B07053	ABS	CP friction lift	1	1/24
B07055	ABS	PB friction lift	1	1/24



Full Kit - Lift and Turn Drain



Full Kit - Toe Touch Drain

Standard Full Kit- Includes Pipe and Tee

PART NO.	MATERIAL	DESCRIPTION	# HOLES	CTN/MSTR
B07056	PVC	CP brass lift and turn	1	1/10
B07030	PVC	CP lift and turn	1	1/10
B07034	PVC	PB lift and turn	1	1/10
B07032	PVC	CP toe touch	1	1/10
B07036	PVC	PB toe touch	1	1/10
B07058	PVC	CP friction lift	1	1/10
B07060	PVC	PB friction lift	1	1/10
B07057	ABS	CP brass lift and turn	1	1/10
B07031	ABS	CP lift and turn	1	1/10
B07035	ABS	PB lift and turn	1	1/10
B07033	ABS	CP toe touch	1	1/10
B07037	ABS	PB toe touch	1	1/10
B07059	ABS	CP friction lift	1	1/10
B07061	ABS	PB friction lift	1	1/10

Items marked with the Jones Stephens logo are "You Need It...We Got It" Items.

Standard 2-Hole Schedule 40 Bath Waste Kits

- 2-hole faceplate
- Bolt holes on top elbow are pre-threaded
- All drains 3/8" thread size for testing
- UPC listed



Note: Please use suffix "T" when ordering any waste and overflow kit to have test kit included. When a complete kit with a 2-hole test kit is ordered, a 1-hole faceplate with aluminum conversion bar will be supplied.



Half Kit - Lift and Turn Drain



Half Kit - Toe Touch Drain

Standard Half Kit- No Pipe or Tee

PART NO.	MATERIAL	DESCRIPTION	# HOLES	CTN/MSTR
B07150	PVC	CP brass lift and turn	2	1/24
B07110	PVC	CP lift and turn	2	1/24
B07114	PVC	PB lift and turn	2	1/24
B07112	PVC	CP toe touch	2	1/24
B07116	PVC	PB toe touch	2	1/24
B07152	PVC	CP friction lift	2	1/24
B07154	PVC	PB friction lift	2	1/24
B07151	ABS	CP brass lift and turn	2	1/24
B07111	ABS	CP lift and turn	2	1/24
B07115	ABS	PB lift and turn	2	1/24
B07113	ABS	CP toe touch	2	1/24
B07117	ABS	PB toe touch	2	1/24
B07153	ABS	CP friction lift	2	1/24
B07155	ABS	PB friction lift	2	1/24



Full Kit - Lift and Turn Drain



Full Kit - Toe Touch Drain

Standard Full Kit- Includes Pipe and Tee

PART NO.	MATERIAL	DESCRIPTION	# HOLES	CTN/MSTR
B07156	PVC	CP brass lift and turn	2	1/10
B07130	PVC	CP lift and turn	2	1/10
B07134	PVC	PB lift and turn	2	1/10
B07132	PVC	CP toe touch	2	1/10
B07136	PVC	PB toe touch	2	1/10
B07158	PVC	CP friction lift	2	1/10
B07160	PVC	PB friction lift	2	1/10
B07157	ABS	CP brass lift and turn	2	1/10
B07131	ABS	CP lift and turn	2	1/10
B07135	ABS	PB lift and turn	2	1/10
B07133	ABS	CP toe touch	2	1/10
B07137	ABS	PB toe touch	2	1/10
B07159	ABS	CP friction lift	2	1/10
B07161	ABS	PB friction lift	2	1/10

Bath Waste and Overflow Test Kit



• Drain thread size is 3/8"

PART NO.	DESCRIPTION	CTN/MSTR
B07201	1-hole kit without screws or plate	1/200
B07202	2-hole kit includes screws and plate	1/200

Aluminum Bar for Waste and Overflow



- Holds overflow elbow to tub
- Converts 2-hole faceplate to 1-hole faceplate

PART NO.	DESCRIPTION	CTN/MSTR
B07200	Aluminum bar with 2 screws	1/500
B07203	1-hole overflow faceplate with aluminum bar	1/1

Chrome Plated Trim Kits



- Chrome plated
- Includes overflow plate, screws and stopper

PART NO.	DESCRIPTION	# HOLES	CTN/MSTR
B07071	Trim kit with lift and turn stopper	1	1/1
B07073	Trim kit with friction lift stopper	1	1/1
B07171	Trim kit with lift and turn stopper	2	1/1
B07173	Trim kit with friction lift stopper	2	1/1

Polished Brass Trim Kit



- PVD finish
- Includes overflow plate, screws and lift and turn stopper

PART NO.	DESCRIPTION	# HOLES	CTN/MSTR
B08071	1-hole faceplate trim kit	1	1/1

Conversion Kit with Cross Bar



- 1-3/8" chrome plated zinc drain
- Includes cross bar
- 1-hole faceplate
- Includes bushing for 1-1/2" installation

PART NO.	DESCRIPTION	CTN/MSTR
B51019	CP lift and turn conversion kit	6/36
B51020	PB lift and turn conversion kit	1/12
B07210	CP friction lift conversion kit	1/1

Trip Lever Trim Only



- Chrome plated
- 2-hole faceplate
- Includes springs, faceplate, 2 screws and strainer
- Clamshell packaging

PART NO.	DESCRIPTION	# HOLES	CTN/MSTR
B51014	Chrome plated trip lever trim only	2	5/25

Trip Lever Conversion Kit



- Chrome plated
- Fits 1-3/8" or 1-1/2" waste elbows
- Includes drain, bushing, faceplate and 2 screws
- Clamshell packaging

PART NO.	DESCRIPTION	# HOLES	CTN/MSTR
B51015	Chrome plated trip lever conversion kit	2	5/25

Bath Waste Conversion Kits



- B51006, B51008, B51011 are 1-1/2" kits
- All others are 1-1/2"x 1-3/8" and include bushings
- Carded for display

PART NO.	DESCRIPTION	# HOLES	CTN/MSTR
B51005	CP lift and turn kit	2	1/25
B51006	White lift and turn kit	2	1/25
B51007	CP toe touch kit	2	1/25
B51008	CP friction lift kit	2	1/25
B51009	CP lift and turn kit	1	1/25
B51010	CP toe touch kit	1	1/25
B51011	CP friction lift kit	1	1/25

Schedule 40 Bath Waste Rough-In Kit



- Chrome plated drain body
- Standard rough-in kit

PART NO.	MATERIAL	DESCRIPTION	# HOLES	CTN/MSTR
B07074	PVC	Lift and turn drain body	1	1/1
B07374	ABS	Lift and turn drain body	1	1/1
B07075	PVC	Friction lift drain body	1	1/1
B07375	ABS	Friction lift drain body	1	1/1
B07076	PVC	Lift and turn drain body	2	1/1
B07376	ABS	Lift and turn drain body	2	1/1
B07077	PVC	Friction lift drain body	2	1/1
B07377	ABS	Friction lift drain body	2	1/1

Schedule 40 Bath Waste Rough-In Kits with Test Kit



- Chrome plated drain body
- Standard rough-in kit
- Includes test kit and aluminum bar with screws

PART NO.	MATERIAL	DESCRIPTION	# HOLES	CTN/MSTR
B07070	PVC	Lift and turn drain body	1	1/1
B07470	ABS	Lift and turn drain body	1	1/1
B07072	PVC	Friction lift drain body	1	1/1
B07472	ABS	Friction lift drain body	1	1/1
B07170	PVC	Lift and turn drain body	2	1/1
B07476	ABS	Lift and turn drain body	2	1/1
B07172	PVC	Friction lift drain body	2	1/1
B07477	ABS	Friction lift drain body	2	1/1

Plunge Right



- Easily unplug a clogged drain
- Eliminates use of a rag to plug overflow
- Seal allows for full utilization of pressure to remove clog
- Reusable

PART NO.	DESCRIPTION	# HOLES	CTN/MSTR
J40016	2-Hole plunge right	2	1/1
J40017	1-Hole plunge right	1	1/1

Grab Bar with Exposed Flange



Satin Finish



Peened Finish

- 18 gauge stainless steel
- Meets 900 lb. downward pull when installed properly
- Meets federal specification WW-P-541/8B, Amendment 1, 16 April 1990
- Meets ANSI 117.1 and all ADA Code requirements
- Meets federal specifications for FHA, VA hospital, private construction
- Individually bagged with stainless steel mounting screws

Satin Finish

PART NO.	DESCRIPTION	FINISH	CTN/MSTR
G12012	1-1/4" x 12"	Satin	1/5
G12016	1-1/4" x 16"	Satin	1/5
G12018	1-1/4" x 18"	Satin	1/5
G12024	1-1/4" x 24"	Satin	1/5
G12030	1-1/4" x 30"	Satin	1/5
G12032	1-1/4" x 32"	Satin	1/5
G12036	1-1/4" x 36"	Satin	1/5
G12042	1-1/4" x 42"	Satin	1/5
G12048	1-1/4" x 48"	Satin	1/5
G13012	1-1/2" x 12"	Satin	1/5
G13016	1-1/2" x 16"	Satin	1/5
G13018	1-1/2" x 18"	Satin	1/5
G13024	1-1/2" x 24"	Satin	1/5
G13030	1-1/2" x 30"	Satin	1/5
G13032	1-1/2" x 32"	Satin	1/5
G13036	1-1/2" x 36"	Satin	1/5
G13042	1-1/2" x 42"	Satin	1/5
G13048	1-1/2" x 48"	Satin	1/5

Peened Finish

PART NO.	DESCRIPTION	FINISH	CTN/MSTR
G12212	1-1/4" x 12"	Peened	1/5
G12216	1-1/4" x 16"	Peened	1/5
G12218	1-1/4" x 18"	Peened	1/5
G12224	1-1/4" x 24"	Peened	1/5
G12230	1-1/4" x 30"	Peened	1/5
G12232	1-1/4" x 32"	Peened	1/5
G12236	1-1/4" x 36"	Peened	1/5
G12242	1-1/4" x 42"	Peened	1/5
G12248	1-1/4" x 48"	Peened	1/5
G13212	1-1/2" x 12"	Peened	1/5
G13216	1-1/2" x 16"	Peened	1/5
G13218	1-1/2" x 18"	Peened	1/5
G13224	1-1/2" x 24"	Peened	1/5
G13230	1-1/2" x 30"	Peened	1/5
G13232	1-1/2" x 32"	Peened	1/5
G13236	1-1/2" x 36"	Peened	1/5
G13242	1-1/2" x 42"	Peened	1/5
G13248	1-1/2" x 48"	Peened	1/5

Grab Bar with Concealed Snap-On Flange



Satin Finish



Peened Finish

- 18 gauge stainless steel
- Meets 900 lb. downward pull when installed properly
- Meets federal specification WW-P-541/8B, Amendment 1, 16 April 1990
- Meets ANSI 117.1 and all ADA Code requirements
- Meets federal specifications for FHA, VA hospital, private construction
- Individually bagged with stainless steel mounting screws

Satin Finish

PART NO.	DESCRIPTION	FINISH	CTN/MSTR
G12112	1-1/4" x 12"	Satin	1/5
G12116	1-1/4" x 16"	Satin	1/5
G12118	1-1/4" x 18"	Satin	1/5
G12124	1-1/4" x 24"	Satin	1/5
G12130	1-1/4" x 30"	Satin	1/5
G12132	1-1/4" x 32"	Satin	1/5
G12136	1-1/4" x 36"	Satin	1/5
G12142	1-1/4" x 42"	Satin	1/5
G12148	1-1/4" x 48"	Satin	1/5
G13112	1-1/2" x 12"	Satin	1/5
G13116	1-1/2" x 16"	Satin	1/5
G13118	1-1/2" x 18"	Satin	1/5
G13124	1-1/2" x 24"	Satin	1/5
G13130	1-1/2" x 30"	Satin	1/5
G13132	1-1/2" x 32"	Satin	1/5
G13136	1-1/2" x 36"	Satin	1/5
G13142	1-1/2" x 42"	Satin	1/5
G13148	1-1/2" x 48"	Satin	1/5

Peened Finish

PART NO.	DESCRIPTION	FINISH	CTN/MSTR
G12312	1-1/4" x 12"	Peened	1/5
G12316	1-1/4" x 16"	Peened	1/5
G12318	1-1/4" x 18"	Peened	1/5
G12324	1-1/4" x 24"	Peened	1/5
G12330	1-1/4" x 30"	Peened	1/5
G12332	1-1/4" x 32"	Peened	1/5
G12336	1-1/4" x 36"	Peened	1/5
G12342	1-1/4" x 42"	Peened	1/5
G12348	1-1/4" x 48"	Peened	1/5
G13312	1-1/2" x 12"	Peened	1/5
G13316	1-1/2" x 16"	Peened	1/5
G13318	1-1/2" x 18"	Peened	1/5
G13324	1-1/2" x 24"	Peened	1/5
G13330	1-1/2" x 30"	Peened	1/5
G13332	1-1/2" x 32"	Peened	1/5
G13336	1-1/2" x 36"	Peened	1/5
G13342	1-1/2" x 42"	Peened	1/5
G13348	1-1/2" x 48"	Peened	1/5

Grab Bar Fastening System



- Made of stainless steel
- Will hold up to 1000 lbs. per grab bar
- Blocking/studs are not required

PART NO.	DESCRIPTION	CTN/MSTR
G12999	Commercial grab bar wing lt	1/60

Items marked with the Jones Stephens logo are "You Need It... We Got It" Items.

Brass Pop-Up Assembly/Replacement Parts



- All metal construction
- Tool free locknut and ballrod top
- 17 gauge

PART NO.	DESCRIPTION	CTN/MSTR
P35001	Chrome-brass	1/50

Replacement Parts

PART NO.	DESCRIPTION	CTN/MSTR
P35041	1-1/4" mack gasket	1/500
P35900	Universal plastic plunger with CP brass cap	1/25
P35901	CP stainless steel flange	16/800
P35902	Flat rubber washer	1/25
P35904	Polyethylene washer	1/1000
P35905	Brass locknut	1/25
P35906	CP brass drain body	1/250
P35907	CP brass tailpiece	1/250
P35908	Stainless steel lift rod	1/500
P35909	Steel clevis with thumb screw	1/25
P35910	Stainless steel spring clip	1/2000
P35911	CP brass ball nut	1/600
P35912	CP steel ball rod with plastic all (6-3/8" long)	1/150
P35913	Friction washer - under nut (not visible)	1/600

Lav Lift and Lock Pop-Up Drain



- For vessel sinks
- With 3" drain body and 4-3/4" brass tailpiece
- Tailpiece opening- 1-1/4" OD

PART NO.	DESCRIPTION	CTN/MSTR
P35000	CP lift and lock pop-up (with overflow holes)	1/50
P35003	CP lift and lock pop-up (without overflow holes)	1/50

ABS Lav Pop-Up Assembly



- Carded

PART NO.	DESCRIPTION	CTN/MSTR
P35004	Grey plastic	1/30

Chrome Plated ABS Lav Pop-Up Assembly



- Carded

PART NO.	DESCRIPTION	CTN/MSTR
P35005	Chrome plated plastic	1/30

Items marked with the Jones Stephens logo are "You Need It...We Got It" Items.

Brass Lav P.O. Plug Drain



- With chain and stopper
- With overflow
- 17 gauge

PART NO.	DESCRIPTION	CTN/MSTR
D70103	1-1/4" P.O. plug drain	1/50

Trap Primer Tailpiece



- Chrome plated 17 gauge tubular
- Sturdy one-piece construction eliminates leaks and cross-threading
- 3/4" compression nut

PART NO.	DESCRIPTION	CTN/MSTR
T74010	1-1/4" x 8" - threaded top	1/50
T74011	1-1/2" x 8" - slip joint top direct connection	1/50

Handicap Style Lav Grid Drain



- Polished chrome plated brass
- Twin 90° construction
- Mack washer and brass locknut
- 17 gauge 1-1/4" tailpiece; cast brass elbows
- With overflow
- UPC listed



PART NO.	DESCRIPTION	CTN/MSTR
D70101	Handicap style lav grid drain	1/25
D70104	Handicap style lav grid drain with one piece tubular elbow	1/25

Commercial Handicap Style Lav Grid Drain with Elbow



- Polished chrome plated brass; cast brass elbow
- 1-1/4" female thread
- Complete with gaskets and brass locknut

PART NO.	DESCRIPTION	CTN/MSTR
D70102	Handicap style lav grid drain with elbow	1/48

Commercial Lav Grid Drain without Overflow



- For vessel sinks
- With 2-1/4" drain body and 6" (5-7/8") brass tailpiece
- Tailpiece opening- 1-1/4" OD

PART NO.	DESCRIPTION	CTN/MSTR
D70105	Chrome plated grid drain	1/50

Commercial Lav Grid Drain



- Chrome plated brass drain with stainless steel tailpiece
- Mack washer and brass locknut
- 17 gauge 1-1/4" tailpiece; 6" long

PART NO.	DESCRIPTION	CTN/MSTR
D70100	Commercial lav drain	1/50

Commercial P-Trap with Cleanout



- Chrome plated
- Brass nuts
- 17 gauge semi-cast p-trap
- 17 gauge tubular wall bend
- cUPC listed



PART NO.	DESCRIPTION	CTN/MSTR
J37124	1-1/4" OD with cleanout	1/12
J37150	1-1/2" OD with cleanout	1/12

Chrome Plated PVC P-Trap



- Complete with nuts, washers and escutcheon

PART NO.	DESCRIPTION	CTN/MSTR
P36102	1-1/4" p-trap	1/50
P36103	1-1/2" p-trap	1/50

Flush Valve Pipe Support



- Chrome plated split ring type
- 1-1/2" OD size
- 5" center of pipe to wall
- Mounting hardware included

PART NO.	DESCRIPTION	CTN/MSTR
F39800	1-1/2" x 5" pipe support	10/50
F39700	1-1/2" x 3 1/2" pipe support	10/50

Tissue Roller



- Plastic
- CARTON QUANTITIES ONLY

PART NO.	DESCRIPTION	CTN/MSTR
B10195	Fit-All white plastic	50/200

Provent



- Manufactured housing and RV's only
- Automatic anti-siphon trap vent used as secondary venting
- Must be located at least 60" above trap arm
- Two individually protected fixtures may be connected to same 1-1/2" drain
- Three or more fixtures must be drained by 2" line
- Simply hand tighten, no thread seal needed
- Water closet must have main stack to outside
- Must be installed in accessible location with free flow air
- Do not install in sealed wall cavity
- 1-1/2" MPT threads

PART NO.	DESCRIPTION	CTN/MSTR
P21150	1-1/2" Provent	1/200

Air Gap



- Prevents sewage backflow by breaking siphoning action in drain line
- White polypro body with chrome plated ABS top
- UPC listed



PART NO.	DESCRIPTION	CTN/MSTR
A10001	Air gap	36/72

Items marked with the Jones Stephens logo are "You Need It... We Got It" Items.

Air Gap Cover



- Replaces chrome cover on most air gaps
- Blister card packaging

PART NO.	FINISH	CTN/MSTR
A10015	Chrome	1/1

Air Gap Spacer



PART NO.	DESCRIPTION	CTN/MSTR
A10901	Air gap spacer	1/25

Air Gap Dishwasher Kit



- Contains air gap, 24" dishwasher hose (7/8"), and 2 gear clamps
- Poly bagged

PART NO.	DESCRIPTION	CTN/MSTR
A10100	Air gap installation pack	1/10
A10200	Air gap installation pack-white	1/10
A10150	Air gap deluxe pack (includes dishwasher elbow and vacuum breaker)	1/10

Plumb Aire Air Vent



- Up to 160 fixture units
- May be exposed to temperatures ranging from -40° + 150°F
- No protective cover required when installed per code specifications
- Back pressure rated to 20 PSI

PART NO.	DESCRIPTION	MATERIAL	CTN/MSTR
P21100	Plumb Aire vent- 1-1/2"x 2"	PVC	1/20
P21101	Plumb Aire vent with adapter	PVC	1/20
P21102	Plumb Aire vent - 1-1/2"x 2"	ABS	1/20
P21103	Plumb Aire vent with adapter	ABS	1/20

Adapter for Air Inlet Valve

PART NO.	DESCRIPTION	MATERIAL	CTN/MSTR
P21104	Adapter for air inlet valve	PVC	1/20
P21107	Adapter for air inlet valve	ABS	1/20

Rosettes



B10110



B10111

- Install between bottom of counter and faucet nut to spread loads
- CARTON QUANTITIES ONLY

PART NO.	DESCRIPTION	CTN/MSTR
B10110	Shallow pattern (zinc plated)	25/5000
B10111	Deep pattern (zinc plated)	25/1000

Basin Cock Locknut



• CARTON QUANTITIES ONLY

B10080

B10081

PART NO.	DESCRIPTION	MATERIAL	CTN/MSTR
B10080	1/2" - 14 hex locknut	Zamak	25/1000
B10081	1/2" - 14 flanged hex locknut	Zamak	25/750

B

Basket Strainer Locknuts and Washers



Locknut



Rubber Washer



Friction Washer

• Die cast zinc
• CARTON QUANTITIES ONLY (Except D02002)

PART NO.	DESCRIPTION	CTN/MSTR
B10090	1-1/2" locknut	25/350
B10091	2" locknut	25/350
B10092	3-3/8" locknut for 4" duo strainer	25/350
B10093	3-3/8" heavy pattern locknut for 4" duo strainer	25/100
B10094	Basket strainer rubber washer (4-7/16" OD)	25/300
D02002	Basket strainer friction washer (4-3/16" OD) [fiber friction washer]	1/100

Ballcock Coupling Nut and Locknut



• CARTON QUANTITIES ONLY

PART NO.	DESCRIPTION	CTN/MSTR
C05080	5/8" x 1/2" 7 threads zinc die cast	25/500
C05081	5/8" x 7/8" brass	20/400
C05082	15/16" - 14 locknut	25/500

Plastic Slip Joint Nut



• White plastic
• Wings make installation easier
• CARTON QUANTITIES ONLY (T85125 and T85150)

PART NO.	DESCRIPTION	CTN/MSTR
T83150	1-1/2" slip joint nut with wings	100/1200
T85125	1-1/4" x 1-1/4" slip joint nut	100/1200
T85150	1-1/2" x 1-1/2" slip joint nut	100/1200

Basin Nut



• CARTON QUANTITIES ONLY

PART NO.	DESCRIPTION	MATERIAL	CTN/MSTR
B10100	1/2" - 14 x 3/8" basin nut	Zamak	25/500
B10102	1/2" - 14 x 1/2" basin nut	Zamak	25/500
B10103	1/2" - 14 x 9/16" basin nut	Zamak	25/500
B10104	1/2" - 14 x 9/16" basin nut	Brass	10/500

Items marked with the Jones Stephens logo are "You Need It... We Got It" Items.

Sink Connection Washer



• CARTON QUANTITIES ONLY

PART NO.	DESCRIPTION	CTN/MSTR
T79000	1-3/4" x 1-3/8" x 1/8" washer	100/1000

Split Nut



• Replace fractured or stripped slip nuts without tubular disassembly
• Supplied with washer

PART NO.	DESCRIPTION	CTN/MSTR
T82125	1-1/4" split nut	100/400
T82150	1-1/2" split nut	100/400

Slip Joint Nut



• CARTON QUANTITIES ONLY

PART NO.	IPS x SLIP TUBE	MATERIAL	CTN/MSTR
T77125	1-1/4" x 1-1/4"	Die Cast Zinc	25/500
T77138	1-1/2" x 1-3/8"	Die Cast Zinc	25/800
T77150	1-1/2" x 1-1/2"	Die Cast Zinc	25/300
T77151	1-1/2" x 1-1/4"	Die Cast Zinc	25/300
T77152	2" x 1-1/2"	Die Cast Zinc	25/300
T77200	2" x 2"	Die Cast Zinc	25/200
T78125	1-1/4" x 1-1/4"	Chrome Plated Brass	200/400
T78150	1-1/2" x 1-1/2"	Chrome Plated Brass	200/400
T78151	1-1/2" x 1-1/4"	Chrome Plated Brass	200/400
T78152	2" x 1-1/2"	Chrome Plated Brass	125/250
T78200	2" x 2"	Chrome Plated Brass	25/250

Rough Brass Slip Joint Nut



• Heavy cast brass
• CARTON QUANTITIES ONLY

PART NO.	IPS x SLIP TUBE	MATERIAL	CTN/MSTR
T84125	1-1/4" x 1-1/4"	Cast Brass	25/300
T84150	1-1/2" x 1-1/2"	Cast Brass	25/300
T84151	1-1/2" x 1-1/4"	Cast Brass	25/300
T84200	2" x 2"	Cast Brass	25/300

Lavatory Supply Nut



• White
• Wing nut design
• CARTON QUANTITIES ONLY

PART NO.	DESCRIPTION	MATERIAL	CTN/MSTR
B10105	1/2" - 14 x 1/2" lavatory nut	Plastic	25/1100

Slip Joint Washer



Square Cut Rubber

Beveled

• CARTON QUANTITIES ONLY

Square Cut

PART NO.	NUT x TUBE	MATERIAL	CTN/MSTR
T79125	1-1/4" x 1-1/4"	Black Rubber	100/5600
T79150	1-1/2" x 1-1/2"	Black Rubber	100/5600
T79151	1-1/2" x 1-1/4"	Black Rubber	100/5600
T79200	2" x 2"	Black Rubber	100/2400
T79201	2" x 1-1/2"	Black Rubber	100/2400

Beveled

PART NO.	NUT x TUBE	MATERIAL	CTN/MSTR
T80125	1-1/4" x 1-1/4"	White Poly	100/5000
T80135	1-1/4" x 1-1/4"	Blue TPR	100/5000
T80150	1-1/2" x 1-1/2"	White Poly	100/5000
T80160	1-1/2" x 1-1/2"	Blue TPR	100/5000
T80151	1-1/2" x 1-1/4"	Blue TPR	100/5000
T80200	2" x 2"	White Poly	100/5000

Slip Joint Nut and Washer

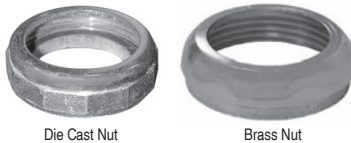

Die Cast Nut

Brass Nut

• Chrome plated nut packed with square cut rubber washer
• CARTON QUANTITIES ONLY

Die Cast Nut

PART NO.	DESCRIPTION	MATERIAL	CTN/MSTR
T77014	1-1/4" x 1-1/4"	Die Cast	25/500
T77012	1-1/2" x 1-1/2"	Die Cast	25/500
T77013	1-1/2" x 1-1/4"	Die Cast	25/500
T77020	2" x 2"	Die Cast	25/500

Brass Nut

PART NO.	DESCRIPTION	MATERIAL	CTN/MSTR
T78014	1-1/4" x 1-1/4"	Brass	25/400
T78012	1-1/2" x 1-1/2"	Brass	25/400
T78013	1-1/2" x 1-1/4"	Brass	25/400
T78020	2" x 2"	Brass	25/400

Cone Slip Joint Washer

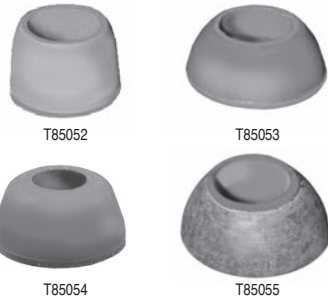

T85052

T85053

T85054

T85055

• Black rubber
• CARTON QUANTITIES ONLY

PART NO.	NUT	TUBE	OD x ID	CTN/MSTR
T85050	1/2"	3/8"	23/32" x 3/8"	100/1600
T85051	1/2"	3/8" threaded	23/32" x 3/8"	100/1600
T85052	1/2"	7/16" or 1/2"	5/8" x 7/16"	100/1600
T85053	Ballcock supply	-	3/4" x 7/16"	100/1600
T85054	Ballcock supply	-	13/16" x 11/32"	100/1600
T85055	Upper bath supply	-	27/32" x 7/16"	100/1600

Items marked with the Jones Stephens logo are "You Need It... We Got It" Items.

Brass Friction Rings



• CARTON QUANTITIES ONLY

PART NO.	NUT	TUBE	OD x ID	CTN/MSTR
T86050	1/2"	3/8"	21/32" x 25/64"	100/100
T86052	1/2"	7/16"	21/32" x 29/64"	100/100
T86053	Ballcock	1/2"	13/16" x 17/32"	100/100
T86054	Ballcock	3/8"	13/16" x 25/64"	100/100
T86055	Ballcock	7/16"	13/16" x 15/32"	100/100

Flanged Tailpiece Washer



• CARTON QUANTITIES ONLY

PART NO.	NUT x TUBE	MATERIAL	CTN/MSTR
T81150	1 1/2" x 1 1/2"	Poly	100/100
T79152	1 1/2" x 1 1/4" cloth inserted	Rubber	100/100

Waste Connector



FIP x SLIP



MIP x SLIP



Brass Compression Ring

• Brass body ferrule and nut
• MIP units are combination female sweat

FIP x SLIP

PART NO.	DESCRIPTION	CTN/MSTR
T75125	1-1/4" FIP x 1-1/4" OD	12/72
T75150	1-1/2" FIP x 1-1/2" OD	12/72
T75151	1-1/2" FIP x 1-1/4" OD	12/72
T75250	1-1/2" FIP x 1-1/2" OD with poly washer	12/72

MIP x SLIP

PART NO.	DESCRIPTION	CTN/MSTR
T76125	1-1/4" MIP x 1-1/4" OD	12/72
T76150	1-1/2" MIP x 1-1/2" OD	12/72
T76151	1-1/2" MIP x 1-1/4" OD	12/72
T76250	1-1/2" MIP x 1-1/2" OD with poly washer	12/72

Brass Compression Ring

PART NO.	DESCRIPTION	CTN/MSTR
T75000	1-1/4" OD	1/1000
T75001	1-1/2" OD	1/1000

Double Slip Fittings



Coupling



90° Elbow



45° Elbow

• Chrome plated brass
• 22 gauge

PART NO.	DESCRIPTION	CTN/MSTR
T74001	1-1/4" coupling	10/100
T74002	1-1/2" coupling	10/100
T74003	1-1/4" 90° elbow	10/100
T74004	1-1/2" 90° elbow	10/100
T74005	1-1/4" 45° elbow	10/100
T74006	1-1/2" 45° elbow	10/100

Slip Joint Tee



- Chrome plated satin finish cast brass
- Compression ends

PART NO.	DESCRIPTION	CTN/MSTR
C74105	1-1/2" x 1-1/2" x 1-1/2" tee	10/60

90° Drop Ear Elbow

B



- Cast brass
- Lead free

PART NO.	DESCRIPTION	CTN/MSTR
B55100LF	1/2" FIP x 1/2" FIP elbow	45/180
B55101LF	1/2" FIP x 1/2" CPVC elbow	45/180
B55103LF	1/2" FSWT x 1/2" FSWT elbow	1/100
B55050	1/2" FIP x 1/2" FSWT elbow	60/240

Sweat Male Adapter and Marvel Adapter



- Use on tub spout elbow or closet/urinal stub out adapter
- Brass

Sweat Male Adapter

PART NO.	FSWT x MIP	CTN/MSTR
B55001	1/2" x 1/2"	1/1000
B55002	3/4" x 3/4"	1/1000
B55003	1" SJ x 1" SWT	1/1000

Marvel Adapter

PART NO.	FSWT x MIP	CTN/MSTR
B55004	1 1/4" SJ x 1 1/4" SWT	1/1000
B55005	1 1/2" SJ x 1 1/2" SWT	1/500
B55006	2" SJ x 2" SWT	1/500
B55007	1 1/2" SJ x 1 1/4" SWT	1/500
B55008	1 1/2" SJ x 1 1/2" Tubular	1/500
B55009	1 1/4" SJ x 1 1/4" Tubular	1/500

Assorted Washer Kit



- 210 pieces packaged in reusable plastic case
- Available with flat or beveled washers
- Contains: 40-00, 40-0, 40-1/4, 30-1/4 large, 20-3/8, 20-3/8 medium, 10-3/8 large, 10-1/2 large

PART NO.	DESCRIPTION	CTN/MSTR
J40150	Beveled washer kit	12/24
J40151	Flat washer kit - assorted colors	12/24

O-Ring Kit and Pick

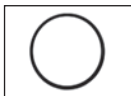

O25199

- Packed in resealable plastic case with fitting chart on lid
- Manufactured from nitrile compound

PART NO.	DESCRIPTION	CTN/MSTR
O25200	200 pc plumbers pack	12/24
ORA225	225 pc plumbers pack	1/24
O25199	O-ring pick	1/25

Items marked with the Jones Stephens logo are "You Need It... We Got It" Items.

Solid Brass Bibb Screw Assortment Kit



- 208 pieces packaged in reusable plastic case
- Contains: 3/8" x 6-32, 1/2" x 6-32, 3/8" x 8-32, 1/2" x 8-32, 3/8" x 10-24, 1/2" x 6-24, 3/8" x 10-32, 1/2" x 10-32

PART NO.	DESCRIPTION	CTN/MSTR
J40153	Bibb screw assortment	10/40

Faucet Seat Kit



- Reusable compartment box with seat guide on inside cover
- Contains all 36 seats
- Made in the USA

MADE IN THE USA

PART NO.	DESCRIPTION	CTN/MSTR
B40000	144-piece faucet seat kit (36 different parts)	1/4

Faucet Seats



MADE IN THE USA

- All brass
- Made in the USA

PART NO.	FITS BRAND/SIZE	CTN/MSTR
B40001	Speakman* 9/16" x 28 x 3/8"	1/100
B40003	Speakman* 7/16" x 27 x 11/32"	1/100
B40002	American Standard* 7/16" x 24 x 13/32"	1/100
B40004	American Standard* 9/16" x 24" x 3/8"	1/100
B40012	American Standard* 1/2" x 20 x 3/8"	1/100
B40013	American Standard* 1/2" x 20 x 7/16"	1/100
B40021	American Standard* 9/16" x 18 x 3/8"	1/100
B40005	Price Pfister* 1/2" x 20" x 3/8"	1/100
B40006	Price Pfister* .65" x 18 x 3/8"	1/100
B40007	Briggs*, Republic* 1/2" x 24 x 7/16"	1/100
B40008	Briggs*, Republic* 9/16" x 20 x 3/8"	1/100
B40023	Briggs* 5/8" x 20 x 13/16"	1/100
B40035	Briggs*, Republic* 5/8" x 24 x 7/16"	1/100
B40009	Repal* 9/16" x 28 x 11/32"	1/100
B40010	Eljer* 1/2" x 27 x 1/2"	1/100
B40026	Eljer* 1/2" x 20 x 3/8"	1/100
B40011	Kohler* 1/2" x 27 x 3/8"	1/100
B40028	Kohler* 1/2" x 27 x .318"	1/100
B40027	Kohler* Push-In x .348"	1/100
B40014	Central Brass* 9/16" x 27 x 13/32"	1/100
B40018	Central Brass* 1/2" x 24 x .418"	1/100
B40019	Central Brass* 5/8" x 24 x 23/32"	1/100
B40015	Sterling* 1/2" x 24 x 3/8"	1/100
B40017	Universal* 17/32" x 24 x 3/8"	1/100
B40020	Gerber* 5/8" x 20 x 27/64"	1/100
B40024	Dick Brothers* 1/2" x 27 x 13/32"	1/100
B40025	Indiana Brass* 1/2" x 27 x 13/32"	1/100
B40034	Indiana Brass* 9/16" x 27 x 5/8"	1/100
B40030	Union Brass* 5/8" x 18 x 5/16"	1/100
B40033	Union Brass* 5/8" x 18 x 29/32"	1/100
B40032	Sayco* 1/2" x 20 x 5/16"	1/100
B40036	Steamway* 1/2" x 24 x 11/32"	1/100

* The manufacturers' names are used only to describe whose products the products will fit.

Faucet Hole Cover



B10201



B10200

- Stainless steel
- CARTON QUANTITIES ONLY

PART NO.	DESCRIPTION	CTN/MSTR
B10201	1-3/4" OD with washer	25/500
B10202	2" OD with washer	25/500
B10200	1-1/2" snap-in	25/1200

Long Reach Bar Tap Faucet



- 1/4" connection
- 10" meets NSF 61.9
- Can be used with reverse osmosis
- Lead free

PART NO.	DESCRIPTION	CTN/MSTR
B45014	Long reach bar tap faucet	5/50

Bar Tap Faucet



- Chrome plated brass
- Meets NSF standard 61.9
- 1/4" compression inlet connection
- Kit includes: stem, spring, 2 "o" rings and black handle
- Lead Free
- Individually bagged

PART NO.	DESCRIPTION	CTN/MSTR
B45010	1/4" connection	1/36

Delta* Style Spray Assembly



K55006



K55007

- 4' hose and 1/4" female swivel nut
- Replaces Delta* style thumb-controlled sink sprays and hoses

PART NO.	DESCRIPTION	CTN/MSTR
K55006	Spray assembly	1/50
K55007	Replacement hose only	1/50

* The manufacturers' names are used only to describe whose products the products will fit.

Kitchen Hose and Spray (Fit All)



K52001



K52002

- Reinforced hose with universal coupling adapter
- Automatic off
- Replacement for thumb controlled sink spray
- Individually boxed for display



K52004



K52010

PART NO.	DESCRIPTION	CTN/MSTR
K52001	Head only	1/200
K52002	Head, hose and adapter	1/50
K52003	4' hose and adapter	1/100
K52004	Hose guide	1/500
K52010	White hose and spray	1/100
K52005	White head only	50/200

Ⓢ Items marked with the Jones Stephens logo are "You Need It... We Got It" Items.

Rinse-Quik Hose and Spray



Complete Spray Head Assembly



Spray Head



Pet Sprayer

MADE IN THE
USA

- Individually boxed
- Made in the USA

PART NO.	DESCRIPTION	RQ #	CTN/MSTR
K53001	Black complete spray assembly	(MR4224)	1/50
K53005	White complete spray assembly	(MR4224WH)	1/50
K53006	Black spray assembly with 1/4" female swivel nut to fit Delta* faucet	(MR422-4C)	1/50
K53002	Black spray head only w/ chrome ring	(MR4-22)	1/100
K53003	4' hose only	(MR-4)	1/50
K53004	Hose guide	(MR-200)	1/10
K53007	Replacement hose for Delta*	(MR4C)	1/100
K53008	White spray head only w/ chrome ring	(MR422WH)	1/100
K53056	Black spray head with black ring	(MR427)	1/100
K53057	White spray head assembly	(MR4274WH)	1/100
K53058	White spray head with white ring	(MR427WH)	1/100
K53055	Black spray head assembly	(MR42474)	1/1
K53077	Black spray head assembly with 6' hose	-	1/1
K53060	Pet sprayer (off-white)	(MR421)	1/1

* The manufacturers' names are used only to describe whose products the products will fit.

Chrome Plated Soap and Lotion Dispenser



- 2" spout
- All brass pump
- 7 ounce poly bottle

PART NO.	DESCRIPTION	CTN/MSTR
S08020	Chrome plated dispenser	1/50

Sink Lugs



S58050



S58052



S58051



S58053

- Four lugs bagged with screws
- Priced per bag

PART NO.	DESCRIPTION	CTN/MSTR
S58050	Combo clip for counters 5/8"- 1-1/8" thick	1/100
S58052	E-lug for counters 3/8"- 1/2" thick	1/100
S58051	Adjustable clips for counters 3/4"- 2-3/4" thick	1/100
S58053	KT lug with bolt	1/100

Undermount Sink Installation Kit



- Includes 4 each brackets, brass inserts, washers, bolts and wing nuts
- Priced per bag

PART NO.	DESCRIPTION	CTN/MSTR
S58101	Undermount kit	50/100

Lavatory Legs



- Chrome plated
- Fits vitreous china, steel or cast iron lavatories
- Total length ranges from 31-1/2" to 32-3/4" extended
- Can be cut
- Priced per pair

PART NO.	DESCRIPTION	CTN/MSTR
L65001	27" legs	1/20

B

Lavatory and Sink Hangers



L56020



L56026

• Wall mount



L56023



L56024

PART NO.	DESCRIPTION	CTN/MSTR
L56020	Cast iron (for cast iron or vitreous china)	1/24
L56026	Pair cast iron hangers (for cast iron or vitreous china)	1/12
L56023	Steel 10" centers (one piece)	50/100
L56024	7" stamped steel lavatory hanger	50/25

Adjustable Lavatory Hanger



- Durable cast iron
- Adjusts from 10-1/2" to 16"
- For iron, lugs fit into pockets
- For china, remove side lugs

PART NO.	DESCRIPTION	CTN/MSTR
L56027	Lav hanger	1/14

Economy Replacement Basket Strainer



- ABS post
- Stainless steel basket

PART NO.	DESCRIPTION	CTN/MSTR
B03015	Replacement basket	1/200

Fit-All Basket Strainer



- Stainless steel
- Rubber stopper

PART NO.	DESCRIPTION	CTN/MSTR
B03010	Fit-All strainer	1/200

Duo Basket Strainer



- All stainless steel with zinc locknut
- 4-1/2" diameter to fit 3-1/2" drilling
- Basket with rolled edge
- UPC listed



PART NO.	DESCRIPTION	CTN/MSTR
S14001	SS duo strainer	1/50

Flat Top Grid Strainer



- All stainless steel with zinc locknut (less tailpiece)
- 4-1/2" diameter to fit 3-1/2" drilling
- UPC listed



PART NO.	DESCRIPTION	CTN/MSTR
S14002	Flat grid strainer	1/24

Snap Lock Basket Strainer



- All stainless steel
- 4-1/2" diameter to fit 3-1/2" drilling
- Ball bearing basket with rolled edge (less tailpiece)

PART NO.	DESCRIPTION	CTN/MSTR
S14005	Snap lock basket strainer with zinc locknut	1/50
S14010	Snap lock basket strainer with brass locknut	1/50

Shallow Cup Duo Basket Strainer



- 4-1/2" diameter to fit 3-1/2" drilling
- All stainless steel with zinc locknut
- Basket with rolled edge (less tailpiece)
- UPC listed



PART NO.	DESCRIPTION	CTN/MSTR
S14006	Shallow cup duo strainer	1/50

Chrome Plated Brass Duo Strainer



PART NO.	DESCRIPTION	CTN/MSTR
S14007	CP brass duo strainer	1/25
S14011	Replacement strainer	1/150

Twist and Lock Basket Strainer



- All stainless steel with zinc locknut
- 4-1/2" diameter to fit 3-1/2" drilling
- Screw-in basket (less tailpiece)
- UPC listed



PART NO.	DESCRIPTION	CTN/MSTR
S14003	Twist and lock basket strainer	1/24
S14103	Twist and lock replacement basket	1/200

Deep Cup Basket Strainer



- All stainless steel with zinc locknut
- 4-1/2" diameter to fit 3-1/2" drilling
- Basket with rolled edge (less tailpiece)
- UPC listed



PART NO.	DESCRIPTION	CTN/MSTR
S14004	Deep cup basket strainer	1/24

Quick Fit Stainless Steel Basket Strainer



- Durable stainless construction with brass nut
- Minimizes installation time
- Triangle frame mounts to underside
- Fits virtually all sinks
- For replacement basket use B03015
- UPC listed



PART NO.	DESCRIPTION	CTN/MSTR
S14008	Quick fit basket strainer	1/50

Chrome Plated ASAP Basket Strainer



- Durable stainless construction with brass slip nut
- Ideal for quick installation
- Can be installed in less than one minute
- Galvanized retaining ring
- Galvanized locking ring

PART NO.	DESCRIPTION	CTN/MSTR
S14009	ASAP basket strainer	1/24

Ⓢ Items marked with the Jones Stephens logo are "You Need It... We Got It" Items.

Chrome Plated Brass Duo Basket Strainer



- Chrome plated brass body with stainless steel basket
- Heavy duty construction
- Neoprene stopper
- UPC listed



PART NO.	DESCRIPTION	CTN/MSTR
S14250	CP brass duo basket strainer	1/24

Stainless Steel Duo Basket Strainer



- Stainless steel body and basket
- Chrome plated zinc post and slip nut
- Polished inner cup
- Heavy duty rubber gasket and zinc locknut
- UPC listed



PART NO.	DESCRIPTION	CTN/MSTR
S14251	SS duo post style basket strainer	1/50

Stainless Steel Basket Strainer



- Stainless steel body and locknut
- Neoprene stopper
- Spring style snap-in basket
- Compares to DB 14
- UPC listed



PART NO.	DESCRIPTION	CTN/MSTR
S14014	SS cup basket strainer	1/50

Stainless Steel Duo Basket Strainer



- Stainless steel body and locknut
- Neoprene stopper
- Spring style snap-in basket
- UPC listed



PART NO.	DESCRIPTION	CTN/MSTR
S14606	SS duo basket strainer	1/50

ABS Body and Post Basket Strainer



- Plastic nut

PART NO.	DESCRIPTION	CTN/MSTR
S14030	ABS body and post basket strainer	1/50

Deep Junior Duo Basket Strainer



B02102



B02103

- For 2" and 2-1/2" deep outlets and bar sinks

PART NO.	DESCRIPTION	CTN/MSTR
B02102	2" deep basket strainer	1/100
B02103	Replacement strainer	1/250

Junior Duo Basket Strainer



B02050



B02049

- Stainless steel body and basket with die cast locknut; 1-1/2" threads
- Complete with washers
- Fits 1-3/4" bar sink

PART NO.	DESCRIPTION	CTN/MSTR
B02050	Junior duo strainer	1/100
B02049	Replacement basket	100/500

Items marked with the Jones Stephens logo are "You Need It... We Got It" Items.

Flat Duplex Strainer



- Stainless steel body and strainer with die cast locknut
- Complete with washers
- Fits 1-3/4" bar sink

PART NO.	DESCRIPTION	CTN/MSTR
B02052	Flat duplex strainer	1/100

Cast Brass Beehive Urinal Strainer



- Chrome plated brass strainer and body
- Brass locknut
- 2" caulk connection

PART NO.	DESCRIPTION	CTN/MSTR
D45000	Cast brass beehive urinal strainer	1/30
D45001	Replacement top with screws for D45000	1/100

Flexible Hair Strainer



- Soft rubber flexible strainer fits neatly over drain

PART NO.	DESCRIPTION	CTN/MSTR
P35180	Flexible hair strainer	1/1000

1" Brass Bar Plug



- Cast brass
- Includes ground seat plug

PART NO.	DESCRIPTION	CTN/MSTR
B02060	1" x 3" bar plug	1/50

Tray Plug



- Stainless steel body with die cast locknut
- Fits 1-1/2" bar sink
- Complete with washers and stoppers

PART NO.	DESCRIPTION	CTN/MSTR
B02051	Tray plug	1/100

Rubber Hush Cushion



- Black
- Fits In-Sink-Erator

PART NO.	DESCRIPTION	CTN/MSTR
P35159	Rubber hush cushion	1/500

Kitchen Sink and Garbage Disposal Stopper



- Vinyl construction
- Flanged to fit all sizes

PART NO.	DESCRIPTION	CTN/MSTR
P35162	Sink stopper	1/50

Garbage Disposal Splash Guard



- Rubber
- Snap-fit reinforced ring
- Fits all disposal brands

PART NO.	DESCRIPTION	CTN/MSTR
P35163	Rubber fit-all splash guard	1/200

Three Prong Drain Protector



- Stainless steel

PART NO.	DESCRIPTION	CTN QTY
D18062	1 5/8" drain protector	1/2500
D18063	1 7/8" drain protector	1/500

Sink and Basin Crumb Cup



- Stainless steel

PART NO.	DESCRIPTION	CTN/MSTR
P35165	1 1/2" crumb cup with post	1/500
P35166	1" crumb cup	1/1000
P35167	1 3/8" crumb cup	1/160

Slotted Full Flow Aerators



Male Thread



Female Thread



Dual Thread

- Chrome plated brass
- Non-corrosive mixing chamber
- 4.5 GPM
- Individually bagged
- Lead free

PART NO.	DESCRIPTION	CTN/MSTR
A01001	15/16"-27 male thread	25/600
A01002	55/64"-27 female thread	25/600
A01003	Dual threads (15/16"-27 male x 55/64"-27 female)	25/2000

Slotted Reduced Flow Aerator



- NSF listed santoprene washer
- 2.2 GPM
- Meets ANSI A-112.18M
- Individually bagged
- Lead free

PART NO.	DESCRIPTION	CTN/MSTR
A01004	Dual threads (15/16"-27 male x 55/64"-27 female)	25/600

Non-Slotted Full Flow Aerators



Male Thread



Female Thread



Dual Thread

- 4.5 GPM
- Individually bagged
- Lead free

PART NO.	DESCRIPTION	CTN/MSTR
A01005	15/16"-27 male thread	25/600
A01006	55/64"-27 female thread	25/600
A01007	13/16"-27 male thread	25/600
A01008	3/4"-27 female thread	25/600
A01010	Dual threads (15/16"-27 male x 55/64"-27 female)	25/600

Items marked with the Jones Stephens logo are "You Need It... We Got It" Items.

Non-Slotted Reduced Flow Aerators



Male Thread



Female Thread



Dual Thread

- Meets ANSI A-112.18M
- Individually bagged
- Lead free

PART NO.	DESCRIPTION	CTN/MSTR
A01011	15/16"-27 male thread 2.2 GPM	25/600
A01012	55/64"-27 female thread 2.2 GPM	25/600
A01013	Dual threads 2.2 GPM (15/16"-27 male x 55/64"-27 female)	25/600
A01050	Dual threads 2.0 GPM (15/16"-27 male x 55/64"-27 female)	25/600
A01051	Dual threads 1.5 GPM (15/16"-27 male x 55/64"-27 female)	25/600

Non-Slotted Reduced Flow Aerator



- 0.5 GPM
- Individually bagged
- Lead free

PART NO.	DESCRIPTION	CTN/MSTR
A01037	Dual thread (15/16"-27 male x 55/64"-27 female)	25/600

Chicago Style Faucet Aerator



- Individually bagged
- Lead free

PART NO.	DESCRIPTION	CTN/MSTR
A01062	Non-slotted full flow (55/64"-27 female thread)	1/600

Aerator Six Pack Tubes



- Dual threads are 15/16"-27 male x 55/64"-27 female
- Six aerators per tube
- Priced per tube
- Lead free

PART NO.	DESCRIPTION	CTN/MSTR
A01020	Slotted full flow (A01003)	Tube of 6/200
A01021	Slotted 2.2 GPM (A01004)	Tube of 6/200
A01022	Non-slotted full flow (A01010)	Tube of 6/200
A01023	Non-slotted 2.2 GPM (A01013)	Tube of 6/200
A01061	Non-slotted 2.0 GPM (A01050)	Tube of 6/200

Aerator Counter Display



- Dual threads are 15/16"-27 male x 55/64"-27 female
- 24 tubes per display box, six aerators per tube
- 144 pieces per display; priced per display
- Lead free

PART NO.	DESCRIPTION	CTN/MSTR
A01015	Slotted full flow with dual threads 4.5 GPM (A01003)	1/5
A01016	Slotted reduced flow with dual threads 2.2 GPM (A01004)	1/5
A01017	Non-slotted full flow with dual threads 4.5 GPM (A01010)	1/5
A01018	Non-slotted with dual threads 2.2 GPM (A01013)	1/5
A01060	Non-slotted with dual threads 2.0 GPM (A01050)	1/5

Spring-Flo Faucet Aerator



- Dual thread
- Fully compliant with California AB1953 and Vermont S152
- Lead free

MADE IN THE **USA**

PART NO.	DESCRIPTION	CTN/MSTR
A01900	Slotted 2.2 GPM Spring-Flo display	1/1
A01901	Slotted 2.2 GPM Spring-Flo	Tube of 6/24

Snap Fitting



A01029



A01036

- Aerated
- 2.5 GPM

PART NO.	DESCRIPTION	CTN/MSTR
A01029	Dual thread (15/16"-27 male x 55/64"-27 female x aerated snap fitting)	1/300
A01036	Nonplated brass snap coupler x 3/4" GHT for use with A01029 as a quick-disconnect unit	1/300

Swivel Spray Aerator



- Brass coupling nut
- Unit reverts to non-splash mode when water is turned off
- 2.2 GPM; 60 PSI
- Individually bagged

PART NO.	DESCRIPTION	CTN/MSTR
A01014	Dual thread (15/16"-27 male x 55/64"-27 female)	36/72

Vandal-Proof Aerators



Male



Female

- Special key wrench included
- Prevents unauthorized removal

PART NO.	DESCRIPTION	CTN/MSTR
A01024	15/16"-27 male full flow	1/600
A01026	15/16"-27 male 2.0 GPM	1/600
A01027	55/64"-27 female 2.0 GPM	1/25

Faucet to Garden Hose Adapters



- Chrome plated brass
- Lead free

PART NO.	DESCRIPTION	CTN/MSTR
A01040	Dual threads 15/16"-27 male x 55/64"-27 female x 3/4" MGH	1/600
A01041	Dual threads 15/16"-27 male x 55/64"-27 female x 3/4" MGH and 55/64"-27 male	1/600

Faucet Adapters



A01030



A01032



A01033



A01035

• These parts are not OEM

To Fit Delta*, American Standard* Style

PART NO.	DESCRIPTION	CTN/MSTR
A01030	CP brass 15/16"-27 male x 55/64"-27 male threads	1/25
A01031	Plastic 15/16"-27 male x 55/64"-27 male threads	1/300

To Fit Price Pfister*, Kohler* Style

PART NO.	DESCRIPTION	CTN/MSTR
A01032	CP brass female 3/4"-27 x 55/64"-27 male threads	1/300

To Fit Kohler*, Union*, Savoy* Style

PART NO.	DESCRIPTION	CTN/MSTR
A01033	CP brass male 13/16"-27 x 55/64"-27 male threads	1/300
A01034	Plastic male 13/16"-27 x 55/64"-27 male threads	1/500

To Fit Chicago* Style

PART NO.	DESCRIPTION	CTN/MSTR
A01035	CP brass female 13/16"-24 x 55/64"-27 male threads	1/500

* The manufacturers' names are used only to describe whose products the products will fit.

Fit-All Replacement Handles



Cross Pattern



Lever Pattern



Acrylic

- Vise grip design allows units to fit all types of stems, including rounded
- Each pair individually bagged

PART NO.	DESCRIPTION	CTN/MSTR
H54001	Cross pattern handles	5/100
H54002	Lever pattern handles	5/100
H54003	Acrylic handles	5/100



C384



C382



C406



C406A

PART NO.	DESCRIPTION	CTN/MSTR
C384	Chrome Plated hot & cold handles for compression tub/shower faucets (Pair)	6/72
C382	Chrome Plated diverter handle for tub/shower faucet	6/72
C406	Chrome Plated H & C handles for heavy tub/shower (Pair)	6/72
C406A	Chrome Plated diverter handle for heavy tub/shower	6/72

Delta*/Peerless* Replacement Handles



H54010



H54011



H54012

• Includes button and screw

PART NO.	DESCRIPTION	CTN/MSTR
H54010	Single lever crystal handle for all lav faucets using 212* ball	1/5
H54011	Single lever crystal handle offset broach for tub and shower valves using 212* ball	1/5
H54012	Single lever crystal tub handle for Scald Guard*	1/5

* The manufacturers' names are used only to describe whose products the products will fit.



H54013



H54014



H54015

• Includes button and screws

PART NO.	DESCRIPTION	CTN/MSTR
H54013	Two chrome plated canopy handles for center set	1/5
H54014	Two crystal handles for center set new style	1/5
H54015	Two crystal handles for wide spread lav and tub and shower valves	1/5

* The manufacturers' names are used only to describe whose products the products will fit.

Mixet* Replacement Handles



H54017



H54018

• Includes screw

PART NO.	DESCRIPTION	CTN/MSTR
H54017	Clear outer handle (MRH-CLR*)	1/5
H54018	Clear inner handle (MTH-CLR*)	1/5

* The manufacturers' names are used only to describe whose products the products will fit.

Valley*/Aqualine*/Eljer*/Sears* Replacement Handles



• New style crystal handle
• Complete with button and screw

PART NO.	DESCRIPTION	CTN/MSTR
H54030	Crystal single handle	1/5

* The manufacturers' names are used only to describe whose products the products will fit.

Moen*/Stanadyne* Replacement Handles



H54025



H54026



H54027



H54028



H54029

• Complete with button and screw
• Teardrop* replaces both round and Teardrop* handles

PART NO.	DESCRIPTION	CTN/MSTR
H54025	Crystal Teardrop* single lav handle shallow broach	1/5
H54026	Crystal Teardrop* single tub handle deep broach	1/5
H54027	Round crystal single lav handle shallow broach	1/5
H54028	Round crystal single tub handle deep broach	1/5
H54029	Chrome plated cap and cover for single handle kitchen faucet	1/5

* The manufacturers' names are used only to describe whose products the products will fit.

Delta*/Peerless* Faucet Index Buttons



H54040



H54041

• Single handle models

PART NO.	DESCRIPTION	CTN/MSTR
H54040	Old style crystal button for lav and tub and shower valve 1" OD	5/35
H54041	New large style crystal button for lav and tub and shower valve 1-1/2" OD	5/35

* The manufacturers' names are used only to describe whose products the products will fit.

Moen*/Stanadyne* Single Handle Replacement Buttons



H54060



H54061

PART NO.	DESCRIPTION	CTN/MSTR
H54060	Button for new style Teardrop* crystal handle	1/5
H54061	Button for round crystal handle lav and tub and shower valve	1/5

* The manufacturers' names are used only to describe whose products the products will fit.

Replacement Handles for Lavatory and Kitchen Faucets



660001
660011



660041
660042
660071
660081

PART NO.	DESCRIPTION	CTN/MSTR
660001	Chrome Plated handles for kitchen and bathroom faucets (Pair)	1/25
660011	Satin Nickel handles for kitchen and bathroom faucets (Pair)	1/25
660041	Chrome Plated single handle for bathroom faucet	1/25
660042	Satin Nickel single handle for bathroom faucet	1/25
660071	Chrome Plated single handle for kitchen faucet	1/25
660081	Satin Nickel single handle for kitchen faucet	1/25

Ceramic Cartridge for Kitchen Faucets



• Plastic square-broached stem
• Stem is internally threaded for handle screw
• Marked "DL02GJ"
• Fits 1558040, 1558060, 1558061, 1558070, 1558071, 1558072, 1558020, and 1558021

PART NO.	DESCRIPTION	CTN/MSTR
660143	Replacement cartridge for kitchen	1/25

Ceramic Cartridge for Tub/Shower Faucets

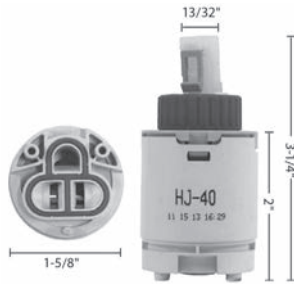

- Plastic square-broached stem
- Adjustable lock-nut reinforcer
- Stem is internally threaded for handle screw
- Scald guard pressure balanced
- Marked "HJ-40"
- Fits 1550221 and 1550222

PART NO.	DESCRIPTION	CTN/MSTR
1550223	Replacement cartridge for tub/shower	1/50

Stem and Seats for Two Handle Faucets



- Also fits some Glacier Bay®, Premier®, and ProPlus® faucets

PART NO.	DESCRIPTION	CTN/MSTR
C1742C	Stem and seat for two handle - Cold	4/48
C1742H	Stem and seat for two handle - Hot	4/48

* The manufacturers' names are used only to describe whose products the products will fit.

Replacement Handles for Classic Faucets

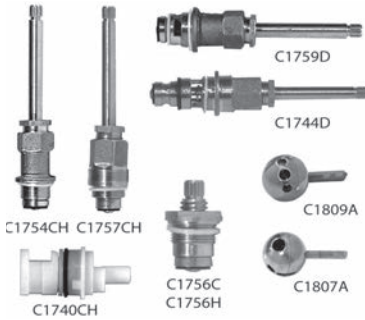

- Stems come together with seats

PART NO.	DESCRIPTION	CTN/MSTR
C1807A	Stainless steel ball for single handle kitchen faucet	6/144
C1809A	Stainless steel ball for single handle bathroom faucet	6/144
C1756C	Cold stem for heavy kitchen and bathroom faucet	4/48
C1756H	Hot stem for heavy kitchen and bathroom faucet	4/48
C1754CH	Stem for compression tub/shower faucet	4/48
C1757CH	Stem for heavy tub/shower faucet	4/48
C1759D	Diverter stem for compression tub/shower faucet	4/48
C1744D	Diverter stem for heavy tub/shower faucet	4/48
C1740CH	Stem, seat, and spring for washerless faucet	4/48

Poly Bagged Escutcheons



- Chrome plated steel
- 50 per bag
- CARTON QUANTITIES ONLY

PART NO.	DESCRIPTION	CTN/MSTR
E01049	1/2" CTS (5/8" O.D.)	50/2000
E01074	3/4" CTS (7/8" O.D.)	50/2000

Items marked with the Jones Stephens logo are "You Need It... We Got It" Items.

Sure Grip Escutcheons



Low Pattern



Box Pattern



Bell Pattern

- Chrome plated steel
- CARTON QUANTITIES ONLY

Low-Pattern- Copper Tube Size

PART NO.	SIZE	FLANGE OD	CTN/MSTR
E01375	3/8" CTS (1/2" OD)	2-1/2"	25/2000
E01050	1/2" CTS (5/8" OD)	2-1/2"	25/2000
E01075	3/4" CTS (7/8" OD)	2-1/2"	25/2000
E01100	1" CTS (1-1/8" OD)	2-7/8"	25/2000
E01125	1-1/4" CTS (1-3/8" OD)	2-7/8"	25/1200
E01150	1-1/2" CTS (1-5/8" OD)	2-7/8"	25/1200

Low-Pattern- Iron Pipe Size

PART NO.	SIZE	FLANGE OD	CTN/MSTR
E02375	3/8" IPS	2-1/2"	25/2000
E02050	1/2" IPS	2-1/2"	25/2000
E02075	3/4" IPS	2-1/2"	25/2000
E02100	1" IPS	2-7/8"	25/1200
E02125	1-1/4" IPS	2-7/8"	25/1200
E02150	1-1/2" IPS	3"	25/1200
E02152	1-1/2" IPS	3-1/2"	25/600
E02200	2" IPS	3-1/2"	25/1200

Low Pattern- Tubular

PART NO.	SIZE	FLANGE OD	CTN/MSTR
E03125	1-1/4" Tubular	2-7/8"	25/1200
E03150	1-1/2" Tubular	2-7/8"	25/1200
E03200	2" Tubular	3-1/2"	25/1200

Box Pattern- Tubular

PART NO.	SIZE	FLANGE OD	CTN/MSTR
E04125	1-1/4" Tubular	3"	5/300
E04150	1-1/2" Tubular	3"	5/300
E04200	2" Tubular	3"	5/300

Box Pattern- Iron Pipe Size

PART NO.	SIZE	FLANGE OD	CTN/MSTR
E05125	1-1/4" IPS	3"	5/300
E05150	1-1/2" IPS	3"	5/300

Bell Pattern- Iron Pipe Size

PART NO.	SIZE	FLANGE OD	CTN/MSTR
E06375	3/8" IPS	2-3/8"	25/1000
E06050	1/2" IPS	2-3/8"	25/1000
E06075	3/4" IPS	2-3/8"	25/1000
E06100	1" IPS	3"	25/1000
E06125	1-1/4" IPS	3"	25/1000
E06150	1-1/2" IPS	3"	25/1000

Bell Pattern- Copper Tube Size

PART NO.	SIZE	FLANGE OD	CTN/MSTR
E07025	1/4" CTS (3/8" OD)	2-3/8"	25/1000
E07375	3/8" CTS (1/2" OD)	2-3/8"	25/1000
E07050	1/2" CTS (5/8" OD)	2-3/8"	25/1000

Bell Pattern- Tubular

PART NO.	SIZE	FLANGE OD	CTN/MSTR
E08125	1-1/4" OD Tubular	3"	25/1000
E08138	1-3/8" OD Tubular	3"	25/1000
E08150	1-1/2" OD Tubular	3"	25/1000

Plastic Shallow Flange Escutcheons



- Corrosion-proof, indestructible, high-density polyethylene
- Tight fit
- CARTON QUANTITIES ONLY

Copper Tube Size

PART NO.	SIZE	COLOR	CTN/MSTR
E15375	1/2" OD (3/8" CTS)	White	50/1000
E15050	5/8" OD (1/2" CTS)	White	50/1000
E15052	5/8" OD (1/2" CTS)	Almond	50/1000
E15075	7/8" OD (3/4" CTS)	White	50/1000

Iron Pipe Size

PART NO.	SIZE	COLOR	CTN/MSTR
E16375	3/8" IPS	White	50/1000
E16050	1/2" IPS	White	50/1000
E16075	3/4" IPS	White	50/1000
E16150	1-1/2" IPS	White	50/800
E16151	1-1/2" IPS	Almond	50/800
E16200	2" IPS	White	50/800

Tubular

PART NO.	SIZE	COLOR	CTN/MSTR
E03225	1-1/4" Tubular	White	25/25
E03250	1-1/2" Tubular	White	50/300

Flexible Floor and Ceiling Plates



- Chrome plated
- CARTON QUANTITIES ONLY

Chrome Plated Plastic

PART NO.	IPS	CTS	FLANGE OD	CTN/MSTR
F06375	3/8"	1/2"	2.572	12/1080
F06050	1/2"	3/4"	2.787	12/1080
F06075	3/4"	-	2.997	12/1440
F06099	-	1"	3.077	12/1080
F06100	1"	-	3.210	12/1440
F06124	-	1-1/4"	3.308	12/1440
F06125	1-1/4"	1-1/2"	3.580	12/1200
F06150	1-1/2"	-	3.900	12/1200
F06200	2"	-	4.450	12/720
F06201	-	2"	4.205	12/720
F06250	2-1/2"	-	5.313	12/600
F06251	-	2-1/2"	4.688	12/600
F06300	3"	-	5.875	12/480
F06301	-	3"	5.375	12/240
F06351	-	3-1/2"	5.875	12/240
F06400	4"	-	6.781	12/240
F06401	-	4"	6.344	12/240
F06500	5"	-	8.531	6/240
F06600	6"	-	9.688	6/120
F06800	8"	-	13.000	6/96

White Plastic

PART NO.	IPS	CTS	FLANGE OD	CTN/MSTR
F07375	3/8"	1/2"	2.572	12/1080
F07050	1/2"	3/4"	2.787	12/1080
F07075	3/4"	-	2.997	12/1440
F07099	-	1"	3.077	12/1080
F07100	1"	-	3.210	12/1440
F07124	-	1-1/4"	3.308	12/1440
F07125	1-1/4"	1-1/2"	3.580	12/1200
F07150	1-1/2"	-	3.900	12/1200
F07200	2"	-	4.450	12/720
F07201	-	2"	4.205	12/720
F07300	3"	-	5.825	12/480

Items marked with the Jones Stephens logo are "You Need It... We Got It" Items.

Floor and Ceiling Plates



- Chrome plated
- Boxed
- CARTON QUANTITIES ONLY

Light 24 Gauge- Copper Tube Size

PART NO.	SIZE	FLANGE OD	CTN/MSTR
F01375	3/8" CTS (1/2" OD)	2-1/2"	12/576
F01050	1/2" CTS (5/8" OD)	2-5/8"	12/576
F01075	3/4" CTS (7/8" OD)	2-27/32"	12/576
F01100	1" CTS (1-1/8" OD)	3-9/32"	12/576
F01125	1-1/4" CTS (1-3/8" OD)	3-5/8"	12/576
F01150	1-1/2" CTS (1-5/8" OD)	3-15/16"	12/576

Light 24 Gauge- Iron Pipe Size

PART NO.	SIZE	FLANGE OD	CTN/MSTR
F02375	3/8" IPS	2-1/2"	12/576
F02050	1/2" IPS	2-5/8"	12/576
F02075	3/4" IPS	2-27/32"	12/576
F02100	1" IPS	3-9/32"	12/576
F02125	1-1/4" IPS	3-5/8"	12/576
F02150	1-1/2" IPS	3-15/16"	12/576
F02200	2" IPS	4-3/8"	12/576

Heavy 21 Gauge with Springs- Copper Tube Size

PART NO.	SIZE	FLANGE OD	CTN/MSTR
F03375	3/8" CTS (1/2" OD)	2-1/8"	12/480
F03050	1/2" CTS (5/8" OD)	2-7/16"	12/480
F03075	3/4" CTS (7/8" OD)	2-21/32"	12/480
F03100	1" CTS (1-1/8" OD)	2-27/32"	12/480
F03125	1-1/4" CTS (1-3/8" OD)	3-9/32"	12/240
F03150	1-1/2" CTS (1-5/8" OD)	3-5/8"	12/240
F03200	2" CTS (2-1/8" OD)	4-3/16"	12/240
F03250	2-1/2" CTS (2-5/8" OD)	4-15/16"	6/240
F03300	3" CTS (3-1/8" OD)	5-3/16"	6/240

Heavy 21 Gauge with Springs- Iron Pipe Size

PART NO.	SIZE	FLANGE OD	CTN/MSTR
F04375	3/8" IPS	2-1/2"	12/480
F04050	1/2" IPS	2-5/8"	12/480
F04075	3/4" IPS	2-27/32"	12/480
F04100	1" IPS	3-9/32"	12/480
F04125	1-1/4" IPS	3-5/8"	12/240
F04150	1-1/2" IPS	3-15/16"	12/240
F04200	2" IPS	4-3/8"	12/240
F04250	2-1/2" IPS	5-7/32"	6/120
F04300	3" IPS	5-29/32"	6/120
F04350	3-1/2" IPS	6-9/16"	6/120
F04400	4" IPS	7-3/16"	6/120
F04500	5" IPS	8-7/8"	12/60
F04600	6" IPS	10"	12/60
F04800	8" IPS	13"	6/48
F04999	10" IPS	15"	1/48

Stainless Steel Repair Cover Plates



- Polished stainless steel finish
- 1, 2 or 3 hole design to fit multitude of valves
- Easily attaches with silicone caulk; 1-hole has brackets and screw
- 7-1/4" x 13" long

PART NO.	# OF HOLES	DIAMETER	CTN/MSTR
T73815	1	5-1/8"	20/40
T73816	2	1-3/8"	20/40
T73817	3	1-3/8"	20/40
T73818	1	3-3/4"	20/40

Cover Plates

- Mirrored acrylic
- Conceals damaged/cracked tiles
- Fits all standard bath/shower fittings
- No tools required- use silicone caulk
- DO NOT use abrasive cleaners

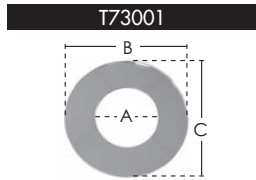

A	B	C	THICKNESS
1-11/16"	3-1/2"	3-1/2"	1/8"

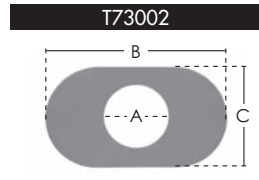

A	B	C	THICKNESS
5"	14"	8"	1/8"

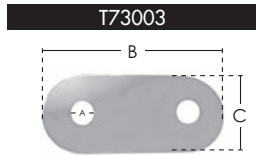

A	B	C	THICKNESS
1-3/4"	14"	6"	1/8"

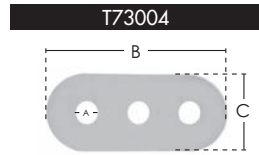

A	B	C	THICKNESS
1-3/4"	14"	6"	1/8"

PART NO.	DESCRIPTION	SIZE	CTN/MSTR
T73001	Tub spout model	3-1/2" diameter	1/300
T73002	One handle model	8" x 14"	1/100
T73003	Two handle model	6" x 14"	1/40
T73004	Three handle model	6" x 14"	1/36

Sewer Relief Valve and Cleanout

MADE IN THE **USA**

- Releases waste to outside of buildings in the event of sewer line blockage, preventing costly damage due to sewage backflow or overflow.
- Applicable in residential, commercial, or industrial settings- any structure connected to sewer lines or septic tanks
- Patent #4,475,571
- Meets ASTM specifications
- Automatic unlock and re-lock
- Vandal- resistant
- Safe in yard or high traffic areas
- Solvent welds over 4" Schedule 40 DWV pipe
- Removable lid provides full access to cleanout
- May be used to replace existing exterior cleanouts
- Easily adaptable to new or existing sewer lines
- Water and waste swirl in bowl until blockage is cleared

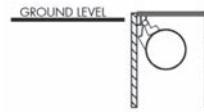

Locked in Normal Position

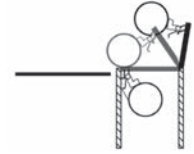

Opens When Overflow Occurs

PART NO.	DESCRIPTION	CTN/MSTR
S62100	PVC sewer relief valve	1/1
S62101	ABS sewer relief valve	1/1

Sewer Stopper/ Backflow Preventer



- Use inside drain line to help guard against backups
- Creates seal in pipe to reduce sewer gases
- Secures into place with set screws
- Compression fit

PART NO.	DESCRIPTION	MATERIAL	CTN/MSTR
S63200	2" sewer stopper	ZP Steel	1/100
S63300	3" sewer stopper	Brass	1/80
S63400	4" sewer stopper	Brass	1/60

Got To Have It!

Sewer Popper™ Cleanout and Relief Valve

- Automatic pop-up releases sewage overflow outside the house
- Prevents thousands of dollars in property damages
- Eliminates health hazards associated with sewage overflow
- Vandal- and tamper-resistant center
- Threaded for 3" or 4" pipe

- Constructed of white PVC
- Threaded unit can be used with PVC or ABS
- For cast iron pipe, use standard no hub clamp
- Meets Southern Building Code Section 301.10, Principle No.10
- Patent No. 5,209,257

MADE IN THE **USA**

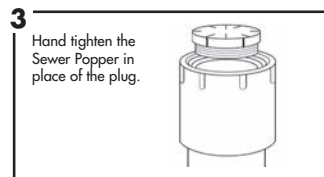
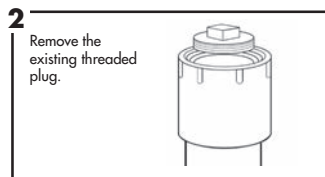
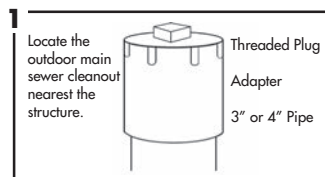

PART NO.	DESCRIPTION	CTN/MSTR
S62304	3" x 4" Sewer Popper™	1/6

Items marked with the Jones Stephens logo are "You Need It...We Got It" Items.

Flexible Stainless Steel Plumbing Connectors



B

- Reliable, trouble-free service inner core of non-toxic polymer withstands temperatures of 33°F (1°C) to 174°F (99°C)
- Leak proof seal- High quality outer braid of stainless steel and exclusive crimp-on fittings for maximum performance
- Quick and easy installation- No special tools; no soldering
- No pipe bending- Flexible connectors simplify installation, even in cramped spaces
- Chrome plated brass nut
- UPC listed
- Lead free

Faucet			
PART NO.	OD x FIP	LENGTH	CTN/MSTR
S04200	3/8" x 1/2"	9	25/100
S04201	3/8" x 1/2"	12	25/100
S04202	3/8" x 1/2"	16	25/100
S04203	3/8" x 1/2"	20	25/100
S04204	3/8" x 1/2"	30	25/50
S04205	3/8" x 1/2"	36	25/100
S04206	1/2" x 1/2"	12	25/100
S04207	1/2" x 1/2"	16	25/100
S04208	1/2" x 1/2"	20	25/100
S04209	1/2" x 1/2"	30	25/50
S04210	1/2" x 1/2"	36	25/100

Faucet			
PART NO.	FIP x FIP	LENGTH	CTN/MSTR
S04211	1/2" x 1/2"	12	25/100
S04212	1/2" x 1/2"	16	25/175
S04213	1/2" x 1/2"	20	25/100
S04214	1/2" x 1/2"	30	25/50
S04215	1/2" x 1/2"	36	25/50

- Reliable, trouble-free service inner core of non-toxic polymer withstands temperatures of 33°F (1°C) to 174°F (81°C); burst pressure 1,000 PSI
- Leak proof seal- High quality outer braid of stainless steel and exclusive crimp-on fittings for maximum performance
- Quick and easy installation- No special tools; no soldering
- No pipe bending- Flexible connectors simplify installation, even in cramped spaces
- Chrome plated brass nut
- UPC listed
- Lead free

SS "Delta" Style Faucet			
PART NO.	OD x COMP FITTING	LENGTH	CTN/MSTR
S04239	3/8" x 3/8"	9	25/100
S04240	3/8" x 3/8"	12	25/100
S04241	3/8" x 3/8"	16	25/100
S04242	3/8" x 3/8"	20	25/100
S04243	3/8" x 3/8"	30	25/50
S04244	3/8" x 3/8"	36	25/100

Texas Style Faucet			
PART NO.	FL x OD	LENGTH	CTN/MSTR
S04245	3/8" x 3/8"	9	25/100
S04246	3/8" x 3/8"	12	25/100
S04247	3/8" x 3/8"	16	25/100
S04248	3/8" x 3/8"	20	25/100
S04249	3/8" x 3/8"	30	25/50
S04250	3/8" x 3/8"	36	25/100

Flexible Stainless Steel Plumbing Connectors



- Reliable, trouble-free service inner core of non-toxic polymer withstands temperatures of 33°F (1°C) to 174°F (99°C)
- Leak proof seal- High quality outer braid of stainless steel and exclusive crimp-on fittings for maximum performance
- Quick and easy installation- No special tools; no soldering
- No pipe bending- Flexible connectors simplify installation, even in cramped spaces
- UPC listed
- Lead free

Ballcock			
PART NO.	OD x BC	LENGTH	CTN/MSTR
S04216	3/8" x 7/8"	9	25/100
S04217	3/8" x 7/8"	12	25/100
S04218	3/8" x 7/8"	16	25/100
S04219	3/8" x 7/8"	20	25/100
S04220	1/2" x 7/8"	9	25/100
S04221	1/2" x 7/8"	12	25/100
S04222	1/2" x 7/8"	16	25/100
S04223	1/2" x 7/8"	20	25/100
S04255	3/8" x 7/8" w/ brass nut	12	25/100
S04288	3/8" x 7/8" w/ brass nut	20	10/50

Ballcock			
PART NO.	FIP x BC	LENGTH	CTN/MSTR
S04224	1/2" x 7/8"	9	25/100
S04225	1/2" x 7/8"	12	25/100
S04226	1/2" x 7/8"	20	25/100

Ballcock			
PART NO.	FLARE x BC	LENGTH	CTN/MSTR
S04280	1/2" x 7/8"	20	25/100
S04285	3/8" x 7/8"	20	25/50

Washing Machine			
PART NO.	FEM HOSE x FEM HOSE	LENGTH	CTN/MSTR
S04261	3/4" x 3/4"	12	25/100
S04227	3/4" x 3/4"	48	5/50
S04228	3/4" x 3/4"	60	5/175
S04229	3/4" x 3/4"	72	5/50

Icemaker			
PART NO.	OD x OD	LENGTH	CTN/MSTR
S04230	1/4" x 1/4"	12	5/50
S04231	1/4" x 1/4"	60	5/50
S04232	1/4" x 1/4"	84	5/50

Items marked with the Jones Stephens logo are "You Need It... We Got It" Items.

Flexible Stainless Steel Plumbing Connectors



- Reliable, trouble-free service inner core of non-toxic polymer withstands temperatures of 33°F (1°C) to 174°F (81°C); burst pressure 1,000 PSI
- Leak proof seal- High quality outer braid of stainless steel and exclusive crimp-on fittings for maximum performance
- Quick and easy installation- No special tools; no soldering
- No pipe bending- Flexible connectors simplify installation, even in cramped spaces
- Chrome plated brass nut
- UPC listed
- Lead free

Dishwasher with 90° Elbow

PART NO.	OD x MIP	LENGTH	CTN/MSTR
S04233	3/8" x 3/8"	48	25/50
S04234	3/8" x 3/8"	60	25/50
S04235	3/8" x 3/8"	72	25/50
S04236	1/2" x 3/8"	48	25/50
S04237	1/2" x 3/8"	60	25/50
S04238	1/2" x 3/8"	72	25/50

Dishwasher

PART NO.	OD x OD	LENGTH	CTN/MSTR
S04260	3/8" x 3/8"	48	25/50
S04268	3/8" x 3/8"	12	25/100
S04269	3/8" x 3/8"	16	25/100
S04270	3/8" x 3/8"	20	25/100

Stainless Steel Dishwasher Connection with Garden Hose Fitting and 90° Elbow



- Use to connect Whirlpool*, Maytag*, Amana*, Kitchen Aid* and Jenn-Air* dishwashers manufactured after September 2009

PART NO.	DESCRIPTION	CTN/MSTR
S04275	3/8" OD x 3/8" MIP x 60"	1/1
S04276	3/8" OD x 3/8" MIP x 72"	1/1
S04267	3/4" FHT x 60" with long 90° end	1/15
G20086LF	Garden Hose Ftg & 90 only - 3/4" FGHT x 3/8" OD Comp	1/1

* The manufacturers' names are used only to describe whose products the products will fit.

Braided Nylon Plumbing Connectors



- Reliable, economy style connectors
- Temperature rated 173° (82°C)
- Burst pressure is 450 PSI
- Chrome plated nut
- UPC listed
- Lead free

Faucet

PART NO.	OD x FIP	LENGTH	CTN/MSTR
S04400	3/8" x 1/2"	9	25/100
S04401	3/8" x 1/2"	12	25/100
S04402	3/8" x 1/2"	16	25/100
S04403	3/8" x 1/2"	20	25/100
S04404	3/8" x 1/2"	30	25/50
S04405	1/2" x 1/2"	12	25/100
S04406	1/2" x 1/2"	16	25/100
S04407	1/2" x 1/2"	20	25/150
S04408	1/2" x 1/2"	30	25/100

Faucet

PART NO.	FIP x FIP	LENGTH	CTN/MSTR
S04409	1/2" x 1/2"	12	25/100
S04410	1/2" x 1/2"	16	25/100
S04411	1/2" x 1/2"	20	25/100
S04440	1/2" x 1/2"	36	25/100

Faucet

PART NO.	COMP x FIP	LENGTH	CTN/MSTR
S04450	3/8" x 1/2"	24	25/100
S04455	3/8" x 1/2"	36	25/50

Delta*

PART NO.	OD x COMP FITTING	LENGTH	CTN/MSTR
S04412	3/8" x 3/8"	12	25/100
S04413	3/8" x 3/8"	20	25/100

Toilet

PART NO.	OD x BC	LENGTH	CTN/MSTR
S04414	3/8" x 7/8"	9	25/100
S04415	3/8" x 7/8"	12	25/100
S04416	3/8" x 7/8"	16	25/100
S04417	3/8" x 7/8"	20	25/100
S04418	1/2" x 7/8"	9	25/100
S04419	1/2" x 7/8"	12	25/200
S04420	1/2" x 7/8"	16	25/100
S04421	1/2" x 7/8"	20	25/100

Toilet

PART NO.	FIP x BC	LENGTH	CTN/MSTR
S04422	1/2" x 7/8"	9	25/100
S04423	1/2" x 7/8"	12	25/100
S04424	1/2" x 7/8"	20	25/100

Dishwasher with 90° Elbow

PART NO.	OD x MIP	LENGTH	CTN/MSTR
S04430	3/8" x 3/8"	72	10/40

* The manufacturers' names are used only to describe whose products the products will fit.

PEX Supply Tube (3/8" OD)



- Rated 100 PSI at 180°F
- Resistant to corrosion and damage due to freezing
- NSF listed material

PART NO.	DESCRIPTION	CTN/MSTR
S04101	3/8" x 12" Basin	10/325
S04102	3/8" x 15" Basin	10/250
S04103	3/8" x 20" Basin	10/150
S04104	3/8" x 30" Basin	10/200
S04108	3/8" x 36" Basin	10/200
S04105	3/8" x 12" Tank	10/300
S04106	3/8" x 15" Tank	10/250
S04107	3/8" x 20" Tank	10/175

PEX Supply Tube with Ferrule



- Supplied with ferrule (3/8" compression sleeve)
- Rated 100 PSI at 180°
- NSF listed material

PART NO.	DESCRIPTION	CTN/MSTR
S04121	3/8" x 12 Basin	10/100
S04123	3/8" x 20 Basin	10/100
S04124	3/8" x 30 Basin	10/100
S04128	3/8" x 36 Basin	10/100
S04125	3/8" x 12 Tank	10/100
S04127	3/8" x 20 Tank	10/100

Chrome Plated Flexible Basin Supply Tube



- Lead free

PART NO.	DESCRIPTION	CTN/MSTR
S04020	3/8" x 12" Basin	1/500
S04021	3/8" x 15" Basin	1/400
S04022	3/8" x 20" Basin	1/300
S04023	3/8" x 30" Basin	1/200
S04024	3/8" x 36" Basin	1/200
S04025	1/2" x 12" Basin	1/200
S04026	1/2" x 20" Basin	1/200

Chrome Plated Flexible Supply Tube with Plastic Nose



- Chrome plated
- With plastic nose
- Lead free

PART NO.	DESCRIPTION	CTN/MSTR
S04027	3/8" x 12" Tank	1/500
S04028	3/8" x 16" Tank	1/300
S04029	3/8" x 20" Tank	1/300
S04030	1/2" x 12" Tank	1/50



- Chrome plated
- With plastic nose cone
- Lead free

PART NO.	DESCRIPTION	CTN/MSTR
S04031	3/8" x 12" Basin	1/200
S04032	3/8" x 20" Basin	1/100

Rough Brass Easy Connect Tee



- Brass
- Attaches to outlet of stop valve to give you 2 outlets
- Lead free

PART NO.	DESCRIPTION	CTN/MSTR
C74250LF	3/8" F Comp x 3/8" M Comp x 3/8" M Comp	5/25
C74251LF	3/8" F Comp x 3/8" M Comp x 1/4" M Comp	5/25

Chrome Plated Quarter Turn Repair Stop Valve



- Attach to outlet of broken valve to give you another valve
- AB1953 compliant
- Lead free

PART NO.	DESCRIPTION	CTN/MSTR
S10355	3/8" F Comp x 3/8" M Comp x 3/8" M Comp	5/25

Chrome Plated Brass Multi-Turn Supply Stop



- cUPC listed
- Lead free

PART NO.	DESCRIPTION	CTN/MSTR
S10338	3/8 FIP x 3/8 OD Angle	1/200
S10321	1/2 FIP x 1/4 OD Angle	1/200
S10300	1/2 FIP x 3/8 OD Angle	1/200
S10302	1/2 FIP x 3/8 OD Straight	1/200
S10324	5/8 OD x 1/4 OD Angle	1/200
S10301	5/8 OD x 3/8 OD Angle	1/200
S10323	3/8 OD x 3/8 OD Straight	1/200
S10303	5/8 OD x 3/8 OD Straight	1/200
S10316	5/8 OD x 1/2 OD Straight	1/200
S10325	1/2 Sweat x 3/8 OD Angle	1/200
S10326	1/2 Sweat x 3/8 OD Straight	1/200
S10419	1/2" SWT x 3/8" OD Angle, Rough Brass	10/200
S10422	1/2" SWT x 3/8" OD Straight, Rough Brass	10/200
S10335	1/2 PEX x 1/4 OD Angle	1/200
S10318	1/2 PEX x 3/8 OD Angle	1/200
S10412	1/2" PEX x 1/4" OD Straight	10/200
S10337	1/2 PEX x 3/8 OD Straight	1/200
S10319	1/2 CPVC x 3/8 OD Straight	1/200
S10320	1/2 CPVC x 3/8 OD Angle	1/200
S10408	1/2" SWT x 3/8" OD Angle with Loose Key	10/200
S10410	1/2" FIP x 3/8" OD x 1/4" OD 3-Way	10/200
S10411	1/2" FIP x 3/8" OD x 3/8" OD 3-Way	10/200
S10420	1/2" SWT x 3/8" OD x 1/4" OD 3-Way, Rough Brass	10/200
S10421	1/2" SWT x 3/8" OD x 3/8" OD 3-Way, Rough Brass	10/200

Items marked with the Jones Stephens logo are "You Need It... We Got It" Items.

Chrome Plated Brass Quarter Turn Supply Stop



- cUPC listed
- Lead free

PART NO.	DESCRIPTION	CTN/MSTR
S10339	3/8 FIP x 3/8 OD Angle	24/144
S10328	1/2 FIP x 1/4 OD Angle	1/200
S10310	1/2 FIP x 3/8 OD Angle	1/200
S10327	3/8 FIP x 3/8 OD Straight	1/200
S10312	1/2 FIP x 3/8 OD Straight	1/200
S10317	5/8 OD x 1/4 OD Angle	1/200
S10311	5/8 OD x 3/8 OD Angle	1/200
S10330	3/8 OD x 3/8 OD Straight	1/200
S10417	5/8" OD x 1/4" OD Straight	10/200
S10313	5/8 OD x 3/8 OD Straight	1/200
S10331	1/2 Sweat x 3/8 OD Angle	1/200
S10332	1/2 Sweat x 3/8 OD Straight	1/200
S10418	1/2" SWT x 1/4" OD Angle	10/200
S10336	1/2 PEX x 1/4 OD Angle	1/150
S10314	1/2 PEX x 3/8 OD Angle	1/144
S10315	1/2 PEX x 3/8 OD Straight	1/144
S10340	1/2 x 3/8 OD Angle Wirsbo® style	10/200
S10341	1/2 x 3/8 OD Straight Wirsbo® style	10/200
S10406	1/2" PEX F1960 x 1/4" OD Angle	10/200
S10407	1/2" PEX F1960 x 1/4" OD Straight	10/200
S10401	1/2" CPVC x 3/8" COMP Angle	10/200
S10402	1/2" CPVC x 1/4" COMP Straight	10/200
S10403	1/2" CPVC x 3/8" COMP Straight	10/200
S10416	1/2" Push On x 7/8" Toilet with 12" Connector	10/50
S10414	1/2" Push On x 1/2" Faucet with 18" Connector	10/50
S10409	1/2" SWT x 3/8" OD Angle with Loose Key	10/200
C76571LF	1/2" Push On x 3/8" COMP Angle	1/120
C76570LF	1/2" Push On x 3/8" COMP Straight	1/120
S10423	1/2" SWT x 3/8" OD Angle with 5" Extension and Escutcheon	10/50
S10424	1/2" SWT x 3/8" OD Straight with 5" Extension and Escutcheon	10/50
S10333	5/8" OD x 3/8" OD x 3/8" OD Angle, 3-Way	10/200
S10334	5/8" OD x 3/8" OD x 1/4" OD Angle, 3-Way	10/200
S10404	5/8" OD x 3/8" OD x 1/4" OD Dual Valve	10/100
S10405	5/8" OD x 3/8" OD x 3/8" OD Dual Valve	10/100
S10400	Replacement Handle for Quarter Turn Stop Valve	10/200

Cross Handle Self Closing Valve



- Chrome plated
- Heavy brass construction

PART NO.	DESCRIPTION	CTN/MSTR
S05105	1/2" FIP self closing valve	25/50

Chrome Plated Single Sink Bibb



- Chrome plated bodies and tee handles
- Replaceable washers

PART NO.	INLET	FLANGE	CTN/MSTR
S08003	1/2" FIP	Fixed (3/4" hose outlet)	12/72

Wall Mount Sink Faucet



- Chrome plated with soap dish mounted on body
- 8" center to center
- Adjustable 1/2" female threaded eccentric couplings
- Replaceable seats and stems
- Meets NSF standard 61.9
- Lead free

PART NO.	DESCRIPTION	CTN/MSTR
S08008	8" tubular spout	1/12
S08012	12" tubular spout	1/12
S08030	Hot repair kit (handle, stem and seat)	1/100
S08031	Cold repair kit (handle, stem and seat)	1/100
S08032	Union repair kit (union assembly)	1/50

Laundry Tray Faucet



A01006

- Supplied with garden hose adapter and A01006 aerator
- Can be used either way with either adapter or aerator
- Meets Detroit Code
- Lead free

PART NO.	DESCRIPTION	CTN/MSTR
L47001	Chrome laundry tray faucet	1/24
L47004	With gooseneck spout	1/24

Basin Faucet



Heavy Pattern



Standard Pattern

- Chrome plated
- Replaceable seats and stems
- Furnished with hot and cold buttons
- Meets NSF standard 61.9
- Lead free

PART NO.	DESCRIPTION	CTN/MSTR
F39001	Heavy pattern with aerator	1/30
F39002	Standard pattern	1/50
F39004	Repair kit for F39002 series (Handle, seat, stem and buttons)	1/100
F39005	Repair kit for F39001 series (Handles, seat, stem and buttons)	1/150

Self-Closing Basin Faucet and Shower Valve



Self-Closing Basin Faucet



Shower Valve with Pull Chain

- Chrome plated heavy duty pattern
- Deluxe aerator
- 1/2" FIP connection
- Replaceable stem, cam and spring mechanism
- Shower valves ideal for urinals when used with standpipe assembly

PART NO.	DESCRIPTION	CTN/MSTR
F39010	Basin faucet	1/36
S05100 	Shower valve with pull chain (7" chain)	1/50
S05102	Tailpiece assembly for S05100 with nut and flange	1/100
S05101	Repair kit (stem and cam mechanism)	1/10

Service Sink Faucet



Lever Handles



Cross Handles

- Integral stops; 1/4 turn for S55349
- Complete with all mounting hardware
- Integrated vacuum breaker (ASSE 1001)
- Front hook to hang bucket

PART NO.	DESCRIPTION	CTN/MSTR
S55349	Service sink faucet with lever handles	1/8
S55350	Service sink faucet with cross handles	1/6
S55352	Lever handle and stem repair kit S55349	1/50
S55353	Integral stop repair kit for S55350	1/100
S55354	Vacuum breaker repair kit for S55350	1/100

Hose and Hose Bracket for Service Sink



- Heavy duty 300 PSI cloth-reinforced hose
- 3/4" brass hose coupling at one end
- 5" x 3" stainless steel bracket with rubber grips

PART NO.	DESCRIPTION	CTN/MSTR
M05001	30" hose with bracket	1/1
M05005	Bracket only	1/100

Mop Hanger for Service Sink

- 24" x 3" stainless steel hanger with three rubber tool grips
- Anchors included



PART NO.	DESCRIPTION	CTN/MSTR
M05003	Mop hanger	1/25

Drinking Fountain Bubbler and Cartridge



- Chrome plated brass body
- 3/8" FIP connection
- Stainless steel cartridge
- Lead free

PART NO.	DESCRIPTION	CTN/MSTR
B45215 	CP brass bubbler with stainless steel cartridge	1/40
B45216	Stainless steel replacement cartridge	100/500

Drinking Fountain Bubbler with Face Guard



Flexible Water Shield

- Chrome plated brass body
- Equipped with unique neo-poly water shield to prevent injuries to teeth, gums and face
- Tamper proof design requires 5/16" hex key to remove/ replace water shield for cleaning
- B45218 Kit includes water shield, washer, and retainer nut
- Lead free

PART NO.	DESCRIPTION	CTN/MSTR
B45216	Stainless steel replacement cartridge	100/500
B45217	Chrome plated brass bubbler	1/40
B45218	Polymer water shield kit	1/120

Self-Closing Drinking Fountain



- Chrome plated brass
- Mildew resistant
- Perfect for schools
- Stainless steel cartridge
- 1/2" Female pipe threads
- Lead free

PART NO.	DESCRIPTION	CTN/MSTR
B45200	Drinking fountain	1/25

Retrofit Bubbler Kit



- Replaces fountain on china fixtures
- Contains bubbler 1/2" x 3/8" x 3-1/2" nipple, rosette flange, locknut, coupling nut and 1-3/4" faucet cover
- All metal
- Lead free

PART NO.	DESCRIPTION	CTN/MSTR
B45220	Drinking fountain	1/20

3/8" OD (1/4" ID) Uncoated with Fittings



- Durable stainless steel 304
- Corrugation extends all the way to the fitting for increased tubing flexibility
- CSA Design certified domestically and internationally for indoor and outdoor use
- 100% leak tested to ensure safety and quality and a product you can trust
- Quality flared end fittings to create a metal to metal seal in critical applications
- Corrosion resistant

PART NO.	DESCRIPTION	CTN/MSTR
G70000	1/2" MIP x 1/2" MIP x 12"	1/25
G70001	1/2" FIP x 1/2" FIP x 12"	1/25
G70002	3/8" FIP x 3/8" FIP x 12"	1/25
G70003	1/2" FIP x 1/2" MIP x 12"	1/25
G70004	1/2" FIP x 3/8" MIP x 12"	1/25
G70005	3/8" FIP x 1/2" MIP x 12"	1/25
G70006	3/8" FIP x 3/8" MIP x 12"	1/25
G70007	1/2" MIP x 1/2" MIP x 18"	1/25
G70008	1/2" FIP x 1/2" FIP x 18"	1/25
G70009	3/8" FIP x 3/8" FIP x 18"	1/25
G70010	1/2" FIP x 1/2" MIP x 18"	1/25
G70011	1/2" FIP x 3/8" MIP x 18"	1/25
G70012	3/8" FIP x 1/2" MIP x 18"	1/25
G70013	3/8" FIP x 3/8" MIP x 18"	1/25
G70014	1/2" MIP x 1/2" MIP x 24"	1/25
G70015	1/2" FIP x 1/2" FIP x 24"	1/25
G70016	3/8" FIP x 3/8" FIP x 24"	1/25
G70017	1/2" FIP x 1/2" MIP x 24"	1/25
G70018	1/2" FIP x 3/8" MIP x 24"	1/25
G70019	3/8" FIP x 1/2" MIP x 24"	1/25
G70020	3/8" FIP x 3/8" MIP x 24"	1/25
G70021	1/2" MIP x 1/2" MIP x 30"	1/25
G70022	1/2" FIP x 1/2" FIP x 30"	1/25
G70023	3/8" FIP x 3/8" FIP x 30"	1/25
G70024	1/2" FIP x 1/2" MIP x 30"	1/25
G70025	1/2" FIP x 3/8" MIP x 30"	1/25
G70026	3/8" FIP x 1/2" MIP x 30"	1/25
G70027	3/8" FIP x 3/8" MIP x 30"	1/25
G70028	1/2" MIP x 1/2" MIP x 36"	1/25
G70029	1/2" FIP x 1/2" FIP x 36"	1/25
G70030	3/8" FIP x 3/8" FIP x 36"	1/25
G70031	1/2" FIP x 1/2" MIP x 36"	1/25
G70032	1/2" FIP x 3/8" MIP x 36"	1/25
G70033	3/8" FIP x 1/2" MIP x 36"	1/25
G70034	3/8" FIP x 3/8" MIP x 36"	1/25
G70035	1/2" MIP x 1/2" MIP x 48"	1/25
G70036	1/2" FIP x 1/2" FIP x 48"	1/25
G70037	3/8" FIP x 3/8" FIP x 48"	1/25
G70038	1/2" FIP x 1/2" MIP x 48"	1/25
G70039	1/2" FIP x 3/8" MIP x 48"	1/25
G70040	3/8" FIP x 1/2" MIP x 48"	1/25
G70041	3/8" FIP x 3/8" MIP x 48"	1/25
G70042	1/2" MIP x 1/2" MIP x 60"	1/25
G70043	1/2" FIP x 1/2" FIP x 60"	1/25
G70044	3/8" FIP x 3/8" FIP x 60"	1/25
G70045	1/2" FIP x 1/2" MIP x 60"	1/25

3/8" OD (1/4" ID) Uncoated with Fittings (cont.)



- Durable stainless steel 304
- Corrugation extends all the way to the fitting for increased tubing flexibility
- CSA Design certified domestically and internationally for indoor and outdoor use
- 100% leak tested to ensure safety and quality and a product you can trust
- Quality flared end fittings to create a metal to metal seal in critical applications
- Corrosion resistant

PART NO.	DESCRIPTION	CTN/MSTR
G70046	1/2" FIP x 3/8" MIP x 60"	1/25
G70047	3/8" FIP x 1/2" MIP x 60"	1/25
G70048	3/8" FIP x 3/8" MIP x 60"	1/25
G70049	1/2" MIP x 1/2" MIP x 72"	1/25
G70050	1/2" FIP x 1/2" FIP x 72"	1/25
G70051	3/8" FIP x 3/8" FIP x 72"	1/25
G70052	1/2" FIP x 1/2" MIP x 72"	1/25
G70053	1/2" FIP x 3/8" MIP x 72"	1/25
G70054	3/8" FIP x 1/2" MIP x 72"	1/25
G70055	3/8" FIP x 3/8" MIP x 72"	1/25

3/8" OD (1/4" ID) Yellow Coated with Fittings



- Durable stainless steel 304
- Corrugation extends all the way to the fitting for increased tubing flexibility
- CSA Design certified domestically and internationally for indoor and outdoor use
- 100% leak tested to ensure safety and quality and a product you can trust
- Quality flared end fittings to create a metal to metal seal in critical applications
- Coated connectors add additional safety in highly corrosive environments or in areas where caustic chemicals are located
- Corrosion resistant

PART NO.	DESCRIPTION	CTN/MSTR
G70100	1/2" MIP x 1/2" MIP x 12"	1/25
G70101	1/2" FIP x 1/2" FIP x 12"	1/25
G70102	3/8" FIP x 3/8" FIP x 12"	1/25
G70103	1/2" FIP x 1/2" MIP x 12"	1/25
G70104	1/2" FIP x 3/8" MIP x 12"	1/25
G70105	3/8" FIP x 1/2" MIP x 12"	1/25
G70106	3/8" FIP x 3/8" MIP x 12"	1/25
G70107	1/2" MIP x 1/2" MIP x 18"	1/25
G70108	1/2" FIP x 1/2" FIP x 18"	1/25
G70109	3/8" FIP x 3/8" FIP x 18"	1/25
G70110	1/2" FIP x 1/2" MIP x 18"	1/25
G70111	1/2" FIP x 3/8" MIP x 18"	1/25
G70112	3/8" FIP x 1/2" MIP x 18"	1/25
G70113	3/8" FIP x 3/8" MIP x 18"	1/25
G70114	1/2" MIP x 1/2" MIP x 24"	1/25
G70115	1/2" FIP x 1/2" FIP x 24"	1/25
G70116	3/8" FIP x 3/8" FIP x 24"	1/25
G70117	1/2" FIP x 1/2" MIP x 24"	1/25
G70118	1/2" FIP x 3/8" MIP x 24"	1/25
G70119	3/8" FIP x 1/2" MIP x 24"	1/25
G70120	3/8" FIP x 3/8" MIP x 24"	1/25
G70121	1/2" MIP x 1/2" MIP x 30"	1/25
G70122	1/2" FIP x 1/2" FIP x 30"	1/25

3/8" OD (1/4" ID) Yellow Coated with Fittings (cont.)



- Durable stainless steel 304
- Corrugation extends all the way to the fitting for increased tubing flexibility
- CSA Design certified domestically and internationally for indoor and outdoor use
- 100% leak tested to ensure safety and quality and a product you can trust
- Quality flared end fittings to create a metal to metal seal in critical applications
- Coated connectors add additional safety in highly corrosive environments or in areas where caustic chemicals are located
- Corrosion resistant

B

PART NO.	DESCRIPTION	CTN/MSTR
G70123	3/8" FIP x 3/8" FIP x 30"	1/25
G70124	1/2" FIP x 1/2" MIP x 30"	1/25
G70125	1/2" FIP x 3/8" MIP x 30"	1/25
G70126	3/8" FIP x 1/2" MIP x 30"	1/25
G70127	3/8" FIP x 3/8" MIP x 30"	1/25
G70128	1/2" MIP x 1/2" MIP x 36"	1/25
G70129	1/2" FIP x 1/2" FIP x 36"	1/25
G70130	3/8" FIP x 3/8" FIP x 36"	1/25
G70131	1/2" FIP x 1/2" MIP x 36"	1/25
G70132	1/2" FIP x 3/8" MIP x 36"	1/25
G70133	3/8" FIP x 1/2" MIP x 36"	1/25
G70134	3/8" FIP x 3/8" MIP x 36"	1/25
G70135	1/2" MIP x 1/2" MIP x 48"	1/25
G70136	1/2" FIP x 1/2" FIP x 48"	1/25
G70137	3/8" FIP x 3/8" FIP x 48"	1/25
G70138	1/2" FIP x 1/2" MIP x 48"	1/25
G70139	1/2" FIP x 3/8" MIP x 48"	1/25
G70140	3/8" FIP x 1/2" MIP x 48"	1/25
G70141	3/8" FIP x 3/8" MIP x 48"	1/25
G70142	1/2" MIP x 1/2" MIP x 60"	1/25
G70143	1/2" FIP x 1/2" FIP x 60"	1/25
G70144	3/8" FIP x 3/8" FIP x 60"	1/25
G70145	1/2" FIP x 1/2" MIP x 60"	1/25
G70146	1/2" FIP x 3/8" MIP x 60"	1/25
G70147	3/8" FIP x 1/2" MIP x 60"	1/25
G70148	3/8" FIP x 3/8" MIP x 60"	1/25
G70149	1/2" MIP x 1/2" MIP x 72"	1/25
G70150	1/2" FIP x 1/2" FIP x 72"	1/25
G70151	3/8" FIP x 3/8" FIP x 72"	1/25
G70152	1/2" FIP x 1/2" MIP x 72"	1/25
G70153	1/2" FIP x 3/8" MIP x 72"	1/25
G70154	3/8" FIP x 1/2" MIP x 72"	1/25
G70155	3/8" FIP x 3/8" MIP x 72"	1/25

5/8" OD (1/2" ID) Uncoated with Fittings



- Durable stainless steel 304
- Corrugation extends all the way to the fitting for increased tubing flexibility
- CSA Design certified domestically and internationally for indoor and outdoor use
- 100% leak tested to ensure safety and quality and a product you can trust
- Quality flared end fittings to create a metal to metal seal in critical applications
- Corrosion resistant

PART NO.	DESCRIPTION	CTN/MSTR
G71000	3/4" MIP x 3/4" MIP x 12"	1/25
G71001	3/4" MIP x 1/2" MIP x 12"	1/25
G71002	1/2" MIP x 1/2" MIP x 12"	1/25
G71003	3/4" FIP x 3/4" FIP x 12"	1/25
G71004	3/4" FIP x 1/2" FIP x 12"	1/25
G71005	1/2" FIP x 1/2" FIP x 12"	1/25
G71006	1/2" FIP x 3/4" MIP x 12"	1/25
G71007	3/4" FIP x 3/4" MIP x 12"	1/25
G71008	3/4" FIP x 1/2" MIP x 12"	1/25
G71009	1/2" FIP x 1/2" MIP x 12"	1/25
G71010	3/4" MIP x 3/4" MIP x 18"	1/25
G71011	3/4" MIP x 1/2" MIP x 18"	1/25
G71012	1/2" MIP x 1/2" MIP x 18"	1/25
G71013	3/4" FIP x 3/4" FIP x 18"	1/25
G71014	3/4" FIP x 1/2" FIP x 18"	1/25
G71015	1/2" FIP x 1/2" FIP x 18"	1/25
G71016	1/2" FIP x 3/4" MIP x 18"	1/25
G71017	3/4" FIP x 3/4" MIP x 18"	1/25
G71018	3/4" FIP x 1/2" MIP x 18"	1/25
G71019	1/2" FIP x 1/2" MIP x 18"	1/25
G71020	3/4" MIP x 3/4" MIP x 24"	1/25
G71021	3/4" MIP x 1/2" MIP x 24"	1/25
G71022	1/2" MIP x 1/2" MIP x 24"	1/25
G71023	3/4" FIP x 3/4" FIP x 24"	1/25
G71024	3/4" FIP x 1/2" FIP x 24"	1/25
G71025	1/2" FIP x 1/2" FIP x 24"	1/25
G71026	1/2" FIP x 3/4" MIP x 24"	1/25
G71027	3/4" FIP x 3/4" MIP x 24"	1/25
G71028	3/4" FIP x 1/2" MIP x 24"	1/25
G71029	1/2" FIP x 1/2" MIP x 24"	1/25
G71031	3/4" MIP x 1/2" MIP x 30"	1/25
G71032	1/2" MIP x 1/2" MIP x 30"	1/25
G71033	3/4" FIP x 3/4" FIP x 30"	1/25
G71034	3/4" FIP x 1/2" FIP x 30"	1/25
G71035	1/2" FIP x 1/2" FIP x 30"	1/25
G71036	1/2" FIP x 3/4" MIP x 30"	1/25
G71037	3/4" FIP x 3/4" MIP x 30"	1/25
G71038	3/4" FIP x 1/2" MIP x 30"	1/25
G71039	1/2" FIP x 1/2" MIP x 30"	1/25
G71040	3/4" MIP x 3/4" MIP x 36"	1/25
G71041	3/4" MIP x 1/2" MIP x 36"	1/25
G71042	1/2" MIP x 1/2" MIP x 36"	1/25
G71043	3/4" FIP x 3/4" FIP x 36"	1/25
G71044	3/4" FIP x 1/2" FIP x 36"	1/25
G71045	1/2" FIP x 1/2" FIP x 36"	1/25

5/8" OD (1/2" ID) Uncoated with Fittings (cont.)



- Durable stainless steel 304
- Corrugation extends all the way to the fitting for increased tubing flexibility
- CSA Design certified domestically and internationally for indoor and outdoor use
- 100% leak tested to ensure safety and quality and a product you can trust
- Quality flared end fittings to create a metal to metal seal in critical applications
- Corrosion resistant

PART NO.	DESCRIPTION	CTN/MSTR
G71046	1/2" FIP x 3/4" MIP x 36"	1/25
G71047	3/4" FIP x 3/4" MIP x 36"	1/25
G71048	3/4" FIP x 1/2" MIP x 36"	1/25
G71049	1/2" FIP x 1/2" MIP x 36"	1/25
G71050	3/4" MIP x 3/4" MIP x 48"	1/25
G71051	3/4" MIP x 1/2" MIP x 48"	1/25
G71052	1/2" MIP x 1/2" MIP x 48"	1/25
G71053	3/4" FIP x 3/4" FIP x 48"	1/25
G71054	3/4" FIP x 1/2" FIP x 48"	1/25
G71055	1/2" FIP x 1/2" FIP x 48"	1/25
G71056	1/2" FIP x 3/4" MIP x 48"	1/25
G71057	3/4" FIP x 3/4" MIP x 48"	1/25
G71058	3/4" FIP x 1/2" MIP x 48"	1/25
G71059	1/2" FIP x 1/2" MIP x 48"	1/25
G71060	3/4" MIP x 3/4" MIP x 60"	1/25
G71061	3/4" MIP x 1/2" MIP x 60"	1/25
G71062	1/2" MIP x 1/2" MIP x 60"	1/25
G71063	3/4" FIP x 3/4" FIP x 60"	1/25
G71064	3/4" FIP x 1/2" FIP x 60"	1/25
G71066	1/2" FIP x 3/4" MIP x 60"	1/25
G71067	3/4" FIP x 3/4" MIP x 60"	1/25
G71068	3/4" FIP x 1/2" MIP x 60"	1/25
G71069	1/2" FIP x 1/2" MIP x 60"	1/25
G71070	3/4" MIP x 3/4" MIP x 72"	1/25
G71071	3/4" MIP x 1/2" MIP x 72"	1/25
G71072	1/2" MIP x 1/2" MIP x 72"	1/25
G71074	3/4" FIP x 1/2" FIP x 72"	1/25
G71075	1/2" FIP x 1/2" FIP x 72"	1/25
G71076	1/2" FIP x 3/4" MIP x 72"	1/25
G71077	3/4" FIP x 3/4" MIP x 72"	1/25
G71078	3/4" FIP x 1/2" MIP x 72"	1/25
G71079	1/2" FIP x 1/2" MIP x 72"	1/25

5/8" OD (1/2" ID) Yellow Coated with Fittings



- Durable stainless steel 304
- Corrugation extends all the way to the fitting for increased tubing flexibility
- CSA Design certified domestically and internationally for indoor and outdoor use
- 100% leak tested to ensure safety and quality and a product you can trust
- Quality flared end fittings to create a metal to metal seal in critical applications
- Coated connectors add additional safety in highly corrosive environments or in areas where caustic chemicals are located
- Corrosion resistant

PART NO.	DESCRIPTION	CTN/MSTR
G71100	3/4" MIP x 3/4" MIP x 12"	1/25
G71102	1/2" MIP x 1/2" MIP x 12"	1/25
G71103	3/4" FIP x 3/4" FIP x 12"	1/25
G71104	3/4" FIP x 1/2" FIP x 12"	1/25
G71105	1/2" FIP x 1/2" FIP x 12"	1/25
G71106	1/2" FIP x 3/4" MIP x 12"	1/25
G71107	3/4" FIP x 3/4" MIP x 12"	1/25
G71108	3/4" FIP x 1/2" MIP x 12"	1/25
G71109	1/2" FIP x 1/2" MIP x 12"	1/25
G71110	3/4" MIP x 3/4" MIP x 18"	1/25
G71111	3/4" MIP x 1/2" MIP x 18"	1/25
G71112	1/2" MIP x 1/2" MIP x 18"	1/25
G71113	3/4" FIP x 3/4" FIP x 18"	1/25
G71114	3/4" FIP x 1/2" FIP x 18"	1/25
G71115	1/2" FIP x 1/2" FIP x 18"	1/25
G71116	1/2" FIP x 3/4" MIP x 18"	1/25
G71117	3/4" FIP x 3/4" MIP x 18"	1/25
G71118	3/4" FIP x 1/2" MIP x 18"	1/25
G71119	1/2" FIP x 1/2" MIP x 18"	1/25
G71120	3/4" MIP x 3/4" MIP x 24"	1/25
G71121	3/4" MIP x 1/2" MIP x 24"	1/25
G71122	1/2" MIP x 1/2" MIP x 24"	1/25
G71123	3/4" FIP x 3/4" FIP x 24"	1/25
G71124	3/4" FIP x 1/2" FIP x 24"	1/25
G71125	1/2" FIP x 1/2" FIP x 24"	1/25
G71126	1/2" FIP x 3/4" MIP x 24"	1/25
G71127	3/4" FIP x 3/4" MIP x 24"	1/25
G71128	3/4" FIP x 1/2" MIP x 24"	1/25
G71129	1/2" FIP x 1/2" MIP x 24"	1/25
G71130	3/4" MIP x 3/4" MIP x 30"	1/25
G71131	3/4" MIP x 1/2" MIP x 30"	1/25
G71132	1/2" MIP x 1/2" MIP x 30"	1/25
G71133	3/4" FIP x 3/4" FIP x 30"	1/25
G71134	3/4" FIP x 1/2" FIP x 30"	1/25
G71135	1/2" FIP x 1/2" FIP x 30"	1/25
G71136	1/2" FIP x 3/4" MIP x 30"	1/25
G71137	3/4" FIP x 3/4" MIP x 30"	1/25
G71138	3/4" FIP x 1/2" MIP x 30"	1/25
G71139	1/2" FIP x 1/2" MIP x 30"	1/25
G71140	3/4" MIP x 3/4" MIP x 36"	1/25
G71141	3/4" MIP x 1/2" MIP x 36"	1/25
G71142	1/2" MIP x 1/2" MIP x 36"	1/25

B

5/8" OD (1/2" ID) Yellow Coated with Fittings (cont.)



- Durable stainless steel 304
- Corrugation extends all the way to the fitting for increased tubing flexibility
- CSA Design certified domestically and internationally for indoor and outdoor use
- 100% leak tested to ensure safety and quality and a product you can trust
- Quality flared end fittings to create a metal to metal seal in critical applications
- Coated connectors add additional safety in highly corrosive environments or in areas where caustic chemicals are located
- Corrosion resistant

B

PART NO.	DESCRIPTION	CTN/MSTR
G71143	3/4" FIP x 3/4" FIP x 36"	1/25
G71144	3/4" FIP x 1/2" FIP x 36"	1/25
G71145	1/2" FIP x 1/2" FIP x 36"	1/25
G71146	1/2" FIP x 3/4" MIP x 36"	1/25
G71147	3/4" FIP x 3/4" MIP x 36"	1/25
G71148	3/4" FIP x 1/2" MIP x 36"	1/25
G71149	1/2" FIP x 1/2" MIP x 36"	1/25
G71150	3/4" MIP x 3/4" MIP x 48"	1/25
G71151	3/4" MIP x 1/2" MIP x 48"	1/25
G71152	1/2" MIP x 1/2" MIP x 48"	1/25
G71153	3/4" FIP x 3/4" FIP x 48"	1/25
G71154	3/4" FIP x 1/2" FIP x 48"	1/25
G71155	1/2" FIP x 1/2" FIP x 48"	1/25
G71156	1/2" FIP x 3/4" MIP x 48"	1/25
G71157	3/4" FIP x 3/4" MIP x 48"	1/25
G71158	3/4" FIP x 1/2" MIP x 48"	1/25
G71159	1/2" FIP x 1/2" MIP x 48"	1/25
G71160	3/4" MIP x 3/4" MIP x 60"	1/25
G71161	3/4" MIP x 1/2" MIP x 60"	1/25
G71162	1/2" MIP x 1/2" MIP x 60"	1/25
G71167	3/4" FIP x 3/4" MIP x 60"	1/25
G71168	3/4" FIP x 1/2" MIP x 60"	1/25
G71169	1/2" FIP x 1/2" MIP x 60"	1/25
G71170	3/4" MIP x 3/4" MIP x 72"	1/25
G71172	1/2" MIP x 1/2" MIP x 72"	1/25
G71173	3/4" FIP x 3/4" FIP x 72"	1/25
G71174	3/4" FIP x 1/2" FIP x 72"	1/25
G71176	1/2" FIP x 3/4" MIP x 72"	1/25
G71177	3/4" FIP x 3/4" MIP x 72"	1/25
G71179	1/2" FIP x 1/2" MIP x 72"	1/25

1/2" OD (3/8" ID) Yellow Coated with Fittings



- Durable stainless steel 304
- Corrugation extends all the way to the fitting for increased tubing flexibility
- CSA Design certified domestically and internationally for indoor and outdoor use
- 100% leak tested to ensure safety and quality and a product you can trust
- Quality flared end fittings to create a metal to metal seal in critical applications
- Coated connectors add additional safety in highly corrosive environments or in areas where caustic chemicals are located
- Corrosion resistant

PART NO.	DESCRIPTION	CTN/MSTR
G72100	1/2" MIP x 1/2" MIP x 12"	1/25
G72101	1/2" MIP x 3/8" MIP x 12"	1/25
G72102	3/8" MIP x 3/8" MIP x 12"	1/25
G72103	1/2" FIP x 1/2" FIP x 12"	1/25
G72104	1/2" FIP x 3/8" FIP x 12"	1/25
G72105	1/2" FIP x 1/2" MIP x 12"	1/25
G72107	3/8" FIP x 1/2" MIP x 12"	1/25
G72108	1/2" MIP x 1/2" MIP x 18"	1/25
G72109	1/2" MIP x 3/8" MIP x 18"	1/25
G72110	3/8" MIP x 3/8" MIP x 18"	1/25
G72111	1/2" FIP x 1/2" FIP x 18"	1/25
G72112	1/2" FIP x 3/8" FIP x 18"	1/25
G72113	1/2" FIP x 1/2" MIP x 18"	1/25
G72114	1/2" FIP x 3/8" MIP x 18"	1/25
G72115	3/8" FIP x 1/2" MIP x 18"	1/25
G72116	1/2" MIP x 1/2" MIP x 24"	1/25
G72117	1/2" MIP x 3/8" MIP x 24"	1/25
G72118	3/8" MIP x 3/8" MIP x 24"	1/25
G72119	1/2" FIP x 1/2" FIP x 24"	1/25
G72120	1/2" FIP x 3/8" FIP x 24"	1/25
G72121	1/2" FIP x 1/2" MIP x 24"	1/25
G72122	1/2" FIP x 3/8" MIP x 24"	1/25
G72123	3/8" FIP x 1/2" MIP x 24"	1/25
G72124	1/2" MIP x 1/2" MIP x 30"	1/25
G72126	3/8" MIP x 3/8" MIP x 30"	1/25
G72127	1/2" FIP x 1/2" FIP x 30"	1/25
G72128	1/2" FIP x 3/8" FIP x 30"	1/25
G72129	1/2" FIP x 1/2" MIP x 30"	1/25
G72130	1/2" FIP x 3/8" MIP x 30"	1/25
G72131	3/8" FIP x 1/2" MIP x 30"	1/25
G72132	1/2" MIP x 1/2" MIP x 36"	1/25
G72133	1/2" MIP x 3/8" MIP x 36"	1/25
G72134	3/8" MIP x 3/8" MIP x 36"	1/25
G72135	1/2" FIP x 1/2" FIP x 36"	1/25
G72136	1/2" FIP x 3/8" FIP x 36"	1/25
G72137	1/2" FIP x 1/2" MIP x 36"	1/25
G72140	1/2" MIP x 1/2" MIP x 48"	1/25
G72141	1/2" MIP x 3/8" MIP x 48"	1/25
G72142	3/8" MIP x 3/8" MIP x 48"	1/25
G72143	1/2" FIP x 1/2" FIP x 48"	1/25
G72144	1/2" FIP x 3/8" FIP x 48"	1/25

1/2" OD (3/8" ID) Yellow Coated with Fittings (cont.)



- Durable stainless steel 304
- Corrugation extends all the way to the fitting for increased tubing flexibility
- CSA Design certified domestically and internationally for indoor and outdoor use
- 100% leak tested to ensure safety and quality and a product you can trust
- Quality flared end fittings to create a metal to metal seal in critical applications
- Coated connectors add additional safety in highly corrosive environments or in areas where caustic chemicals are located
- Corrosion resistant

PART NO.	DESCRIPTION	CTN/MSTR
G72146	1/2" FIP x 3/8" MIP x 48"	1/25
G72147	3/8" FIP x 1/2" MIP x 48"	1/25
G72148	1/2" MIP x 1/2" MIP x 60"	1/25
G72149	1/2" MIP x 3/8" MIP x 60"	1/25
G72150	3/8" MIP x 3/8" MIP x 60"	1/25
G72151	1/2" FIP x 1/2" FIP x 60"	1/25
G72152	1/2" FIP x 3/8" FIP x 60"	1/25
G72153	1/2" FIP x 1/2" MIP x 60"	1/25
G72154	1/2" FIP x 3/8" MIP x 60"	1/25
G72155	3/8" FIP x 1/2" MIP x 60"	1/25

1" OD (3/4" ID) Yellow Coated with Fittings



- Durable stainless steel 304
- Corrugation extends all the way to the fitting for increased tubing flexibility
- CSA Design certified domestically and internationally for indoor and outdoor use
- 100% leak tested to ensure safety and quality and a product you can trust
- Quality flared end fittings to create a metal to metal seal in critical applications
- Coated connectors add additional safety in highly corrosive environments or in areas where caustic chemicals are located
- Corrosion resistant

PART NO.	DESCRIPTION	CTN/MSTR
G71401	3/4" MIP x 3/4" FIP x 18"	1/25
G71402	3/4" MIP x 3/4" FIP x 24"	1/25
G76001	3/4" MIP x 3/4" MIP x 12"	1/25
G71403	3/4" MIP x 3/4" MIP x 18"	1/25
G71404	3/4" MIP x 3/4" MIP x 24"	1/25
G76041	3/4" MIP x 3/4" MIP x 36"	1/25
G76051	3/4" MIP x 3/4" MIP x 48"	1/25
G76002	3/4" FIP x 3/4" MIP x 12"	1/25
G76042	3/4" FIP x 3/4" MIP x 36"	1/25
G76052	3/4" FIP x 3/4" MIP x 48"	1/25
G76062	3/4" FIP x 3/4" MIP x 60"	1/25
G76072	3/4" FIP x 3/4" MIP x 72"	1/25
G76005	1" FIP x 1" MIP x 12"	1/25
G76015	1" FIP x 1" MIP x 18"	1/25
G76025	1" FIP x 1" MIP x 24"	1/25
G76045	1" FIP x 1" MIP x 36"	1/25
G76003	3/4" FIP x 3/4" FIP x 12"	1/25
G76013	3/4" FIP x 3/4" FIP x 18"	1/25
G76023	3/4" FIP x 3/4" FIP x 24"	1/25
G76043	3/4" FIP x 3/4" FIP x 36"	1/25
G76053	3/4" FIP x 3/4" FIP x 48"	1/25
G76073	3/4" FIP x 3/4" FIP x 72"	1/25

1/2" OD (3/8" ID) Black Coated



- Durable stainless steel 304
- For use with gas logs
- Corrugation extends all the way to the fitting for increased tubing flexibility
- CSA Design certified domestically and internationally for indoor and outdoor use
- 100% leak tested to ensure safety and quality and a product you can trust
- Quality flared end fittings to create a metal to metal seal in critical applications
- Coated connectors add additional safety in highly corrosive environments or in areas where caustic chemicals are located.
- Corrosion resistant

PART NO.	DESCRIPTION	CTN/MSTR
G74103	1/2" FIP x 1/2" FIP x 12"	1/25
G74105	1/2" FIP x 1/2" MIP x 12"	1/25
G74111	1/2" FIP x 1/2" FIP x 18"	1/25
G74113	1/2" FIP x 1/2" MIP x 18"	1/25
G74119	1/2" FIP x 1/2" FIP x 24"	1/25
G74121	1/2" FIP x 1/2" MIP x 24"	1/25
G74127	1/2" FIP x 1/2" FIP x 30"	1/25
G74129	1/2" FIP x 1/2" MIP x 30"	1/25
G74135	1/2" FIP x 1/2" FIP x 36"	1/25
G74137	1/2" FIP x 1/2" MIP x 36"	1/25

3/8" OD (1/4" ID) Black Coated



- Durable stainless steel 304
- For use with gas logs
- Corrugation extends all the way to the fitting for increased tubing flexibility
- CSA Design certified domestically and internationally for indoor and outdoor use
- 100% leak tested to ensure safety and quality and a product you can trust
- Quality flared end fittings to create a metal to metal seal in critical applications
- Coated connectors add additional safety in highly corrosive environments or in areas where caustic chemicals are located.
- Corrosion resistant

PART NO.	DESCRIPTION	CTN/MSTR
G73101	1/2" FIP x 1/2" FIP x 12"	1/25
G73108	1/2" FIP x 1/2" FIP x 18"	1/25
G73115	1/2" FIP x 1/2" FIP x 24"	1/25
G73122	1/2" FIP x 1/2" FIP x 30"	1/25
G73129	1/2" FIP x 1/2" FIP x 36"	1/25

Nominal Connector Series (I.D. Inches)	Straight Length Capacity - Ptu Per Hr (W) 0.64 Sp Gr. 1000 Btu Per Cu Ft (37.2 MJ Per Cu Meter) Gas at @ 0.5 inch Water Column (1.24 Pa) Pressure Drop		
	12"	24"	36"
1/4	48000	40000	33400
3/8	102000	85000	71000
1/2	180000	150000	125000

NOTE: When using 0.2 inch water column pressure drop, capacity can be determined by multiplying the figures above by 0.632.

MISC. PLUMBING SPECIALTIES

Repair 91-92

Test Caps & Plugs 92-94

Plungers 94

Flexible Transition Couplings 95

Dishwasher 96

Washing Machine Parts 96-97

Dryer Vents 97-98

Tape 99

Stretch Wrap 100

Pipe Sleeving 100

Sand Cloth 100

Rubber Pipe Insulation 101-105

Poly Pipe Insulation 106-108

Insulation Tools 109

Water Heater Supplies 109-111

Pressure Gauges 111-113

Themometers 113-114

Tubing 114

Stud Guards 115-116

Stub Outs 116-118

Pipe Brackets 118-119

Pipe Hooks 119-120

Pipe Hangers & Clamps 120-122

Lead Supplies 122-123

Roofing Repair 123-124

Service Sink Repair 124

Bolts/Screws 125

Washers/Clamps/Hangers 126-127

Water Meter Supplies 128

Meter Boxes 129-130

Boxes 130

C

*Published December 2019

Snap-Ease Access Panel



- Constructed of high-impact white ABS
- Can be painted or wallpapered
- Easily installed to eliminate unsightly drywall repairs
- Provides for future access to plumbing or wiring behind wall
- 5/8" depth

PART NO.	DESCRIPTION	CTN/MSTR
A04006	6" x 9" access panel	10/80
A05008	8" x 8" access panel	1/10
A05014	14" x 14" access panel	10/30
A05027	14" x 27" access panel	1/6

Spring Loaded Plastic Access Panel



- Quick and easy installation
- Can be painted or wallpapered
- No framing needed
- Spring loaded clips make removal simple

PART NO.	DESCRIPTION	CTN/MSTR
A06008	8" x 8" access panel	1/25
A06014	14" x 14" access panel	1/25

Plastic Access Panel



- Beveled edges
- Indented screw holes in corners

PART NO.	DESCRIPTION	CTN/MSTR
A04012	12" x 12" access panel	1/25

Stainless Steel Repair Clamp



Two Bolt

One Bolt

- Plated lug, carriage bolt and nuts for corrosion protection
- 301 stainless steel clamp with neoprene gaskets for up to 180°F
- Long neck carriage bolts for easy installation

PART NO.	DESCRIPTION	IPS/SCH 40	CTS NOM	CTN/MSTR
R30375	3" one bolt	3/8"	1/2"	6/72
R30050	3" one bolt	1/2"	3/4"	6/72
R30075	3" one bolt	3/4"	1"	6/72
R30100	3" one bolt	1"	1-1/4"	6/72
R30125	3" one bolt	1-1/4"	1-1/2"	6/72
R30150	3" one bolt	1-1/2"	-	6/72
R30200	3" one bolt	2"	-	6/72
R30250	3" one bolt	2-1/2"	-	6/48
R30300	3" one bolt	3"	-	6/36
R30400	3" one bolt	4"	-	6/24
R30600	3" one bolt	6"	-	1/36
R60375	6" two bolt	3/8"	1/2"	6/36
R60050	6" two bolt	1/2"	3/4"	6/36
R60075	6" two bolt	3/4"	1"	6/36
R60100	6" two bolt	1"	1-1/4"	6/36
R60125	6" two bolt	1-1/4"	1-1/2"	6/36
R60150	6" two bolt	1-1/2"	-	6/36
R60200	6" two bolt	2"	-	6/36
R60250	6" two bolt	2-1/2"	-	6/24
R60300	6" two bolt	3"	-	6/24
R60400	6" two bolt	4"	-	6/24
R60600	6" two bolt	6"	-	1/20

Items marked with the Jones Stephens logo are "You Need It...We Got It" Items.

Malleable Iron Compression Coupling



- Long pattern
- EPDM gaskets
- Metal friction ring
- Maximum 125 PSI at 120°F
- Pipe ends must be restrained
- Fits both IPS and Schedule 40 pipe
- Galvanized for corrosion protection

PART NO.	IPS	BODY LENGTH	CTN/MSTR
C11050	1/2"	3-3/8"	1/42
C11075	3/4"	3-5/8"	1/32
C11100	1"	3-7/8"	1/24
C11125	1-1/4"	4-1/8"	1/18
C11150	1-1/2"	4-5/16"	1/15
C11200	2"	4-1/2"	1/12
C11250	2-1/2"	6-3/4"	1/4
C11300	3"	7"	1/4
C11400	4"	8-1/8"	1/2

Bronze Compression Coupling



- EPDM gaskets
- Bronze coated brass bodies and nuts
- Maximum 125 PSI at temperatures up to 180°F
- Pipe ends must be restrained on both ends
- For use on galvanized pipe and copper tubing
- Lead Free

PART NO.	DESCRIPTION	CTS	IPS	CTN/MSTR
C14205	3" length	1/2"	3/8"	12/120
C14206	3" length	3/4"	1/2"	12/120
C14207	3" length	1"	3/4"	12/72
C15300	5" length	1/2"	3/8"	12/96
C15301	5" length	3/4"	1/2"	12/72
C15302	5" length	1"	3/4"	12/48
C15303	5" length	1-1/4"	1"	12/48
C15304	5" length	1-1/2"	1-1/4"	12/36
C15305	5" length	-	1-1/2"	12/36
C15306	5" length	2"	-	12/36
C15307	5" length	-	2"	12/24

PVC Compression Coupling



- For use on cold water lines only
- Ribbed body and nuts for gripping
- Fits IPS and Schedule 40 pipe
- EPDM gaskets
- 150 PSI at 73°F
- Pipe ends must be restrained

PART NO.	IPS	BODY LENGTH	CTN/MSTR
C12050	1/2"	3-3/4"	30/120
C12075	3/4"	3-15/16"	30/120
C12100	1"	4-3/4"	25/100
C12125	1-1/4"	5-3/16"	25/100
C12150	1-1/2"	5-3/8"	15/60
C12200	2"	6"	6/24
C12250	2-1/2"	7-7/8"	3/12
C12300	3"	8"	2/8
C12400	4"	12"	2/8
C12600	6"	11-1/8"	1/4

PVC Expansion Coupling



• Rated 200 PSI

PART NO.	IPS	BODY LENGTH	CTN/MSTR
E09050	1/2"	5-3/4"	1/160
E09075	3/4"	6-3/4"	1/120
E09100	1"	7-3/4"	1/54
E09125	1-1/4"	9"	1/40
E09150	1-1/2"	10"	1/35
E09200	2"	10-1/2"	1/24
E09250	2-1/2"	13"	1/3
E09300	3"	14-1/2"	1/3
E09400	4"	14-1/2"	1/3

CPVC Compression Coupling



- For use on hot water lines
- 100 PSI at temperatures up to 180°F
- Tubing sizes copper and plastic tubing
- EPDM gaskets
- Ribbed body and nuts for gripping
- Pipe ends must be restrained
- NSF 61 listed



PART NO.	TUBING SIZE	CTN/MSTR
C13050	1/2" (5/8" OD)	20/360
C13075	3/4" (7/8" OD)	20/240

Bronze Compression Tee



- FIP branch
- EPDM gaskets
- Pipe ends must be restrained
- Bronze coated brass bodies and nuts
- Maximum 125 PSI at temperatures up to 180°F
- For use on galvanized pipe and copper tubing (check sizes)

PART NO.	CTS	IPS	BRANCH	CTN/MSTR
C19050	1/2"	3/8"	1/2" FIP	1/112
C19051	3/4"	1/2"	1/2" FIP	1/96
C19075	3/4"	1/2"	3/4" FIP	1/96

PVC Compression Tee



- For use on cold water lines only
- Ribbed body and nuts for gripping
- Fits both IPS and Schedule 40 pipe
- EPDM gaskets
- 150 PSI at 73°F
- Threaded branch

PART NO.	SIZE	CTN/MSTR
C17050	1/2"	25/100
C17075	3/4"	15/90
C17100	1"	15/60
C17125	1-1/4"	1/40
C17150	1-1/2"	1/30
C17200	2"	1/20

Economy Test Plug



- Galvanized steel flanges
- Fits cast iron and plastic pipe
- Neoprene rubber gasket

PART NO.	PIPE SIZE	CTN/MSTR
T31001	1-1/2"	24/192
T31002	2"	24/96
T31003	3"	24/48
T31004	4"	24/48
T31006	6"	4/16
T31000	Replacement wing nut	1/5000

Combination Test Plug



Raised Head



Countersunk

- Test up to three floors at once
- Combination test plug and cleanout
- Fits Schedule 40 DWV pipe
- Positive sealing
- No metal parts to rust

PART NO.	DESCRIPTION	CTN/MSTR
T34001	1-1/2" raised head	1/392
T34002	2" raised head	1/288
T34003	3" raised head	1/200
T34004	4" raised head	1/128
T34006	6" raised head	1/54
T34008	8" raised head	1/24
T34012	2" countersunk	1/288
T34013	3" countersunk	1/200
T34014	4" countersunk	1/128

T-Cone Cleanout Repair Plugs



- Easily repairs damaged or corroded metal or plastic cleanout threads

PART NO.	PIPE SIZE	THREAD ID	CTN/MSTR
T34150	1-1/2"	1.780	1/50
T34200	2"	2.255	1/50
T34300	3"	3.375	1/50
T34350	3-1/2"	3.900	1/50
T34400	4"	4.336	1/50

"Plum-Tite" Mechanical Test Plugs



- High density plastic construction
- Neoprene gasket
- Extra large wingnut
- Rust and corrosion proof

PART NO.	PIPE SIZE	CTN/MSTR
T37001	1-1/2"	10/200
T37002	2"	10/150
T37003	3"	10/40
T37004	4"	10/40
T37006	6"	5/20
T37008	8"	5/10

Items marked with the Jones Stephens logo are "You Need It... We Got It" Items.

Cast Iron Test Plug



- Maximum 10 PSI
- To test cast iron soil pipe drainage systems
- Cold water ONLY

PART NO.	PIPE SIZE	CTN/MSTR
T39002	2"	1/40
T39003	3"	1/20
T39004	4"	1/12
T39006	6"	1/6
T39008	8"	1/2
T39010	10"	1/2
T39012	12"	1/1

Flexible PVC Test Cap



- Reinforced top
- 5/16" hex screw with screwdriver slot
- Fits both cast iron and plastic pipe

PART NO.	PIPE SIZE	CTN/MSTR
T32001	1-1/2" standard	20/160
T32002	2" standard	24/288
T32003	3" standard	24/144
T32004	4" standard	1/50
T32006	6" standard	1/24
T32008	8" standard	1/16
T32011	1-1/2" heavy duty	1/200
T32022	2" heavy duty	1/100
T32033	3" heavy duty	1/50
T32044	4" heavy duty	1/50

PVC Dual Fit Test Cap



- Each cap fits two sizes of Schedule 40 pipe
- CARTON QUANTITIES ONLY

PART NO.	PIPE SIZE	CTN/MSTR
T33152	1-1/2" and 2"	100/100
T33304	3" and 4"	25/25

Slip-On Plastic Cap



- DWV protection cap
- Protects from debris during construction
- Orange

PART NO.	PIPE SIZE	CTN/MSTR
T36150	1-1/2"	1/300
T36200	2"	1/200
T36300	3"	1/75
T36400	4"	1/45
T36600	6"	1/25

Techno Test Cap



- Heavy duty PVC, high pressure tested over six stories
- Easily solvent cemented over end of DWV pipe
- Will not clog or go down pipe
- CARTON QUANTITIES ONLY

PART NO.	PIPE SIZE	CTN/MSTR
T35001	1-1/2" DWV	100/100
T35002	2" DWV	100/100
T35003	3" DWV	50/50
T35004	4" DWV	25/25

PVC Test Cap



- Easily solvent cemented over end of DWV pipe
- CARTON QUANTITIES ONLY

PART NO.	PIPE SIZE	CTN/MSTR
T35201	1-1/2" PVC	100/1000
T35202	2" PVC	100/1000
T35203	3" PVC	50/250
T35204	4" PVC	25/250
T35206	6" PVC	10/100

Knockout Test Cap



- For use in plastic waste and drain pipe
- Disposable
- CARTON QUANTITIES ONLY

PART NO.	PIPE SIZE	CTN/MSTR
T33001	1-1/2"	100/5000
T33002	2"	100/5000
T33003	3"	50/2400
T33004	4"	50/1200

Pneumatic Test Plug



Regular

Long

- All units smaller than 8" are supplied with chain and ring
- All units 8" or larger are supplied with a removable eye bolt
- For use with cast iron, PVC, ABS, copper, clay and concrete pipe
- Made in the USA

MADE IN THE
USA

Regular						
PART NO.	NOM. PIPE SIZE	MAX AIR PRESSURE	MAX TEST PRESSURE	MAX HEAD	CTN/MSTR	
T45600	6"	25 PSI	5 PSI	30'	1/1	
T45800	8"	25 PSI	15 PSI	40'	1/1	
T45010	10"	25 PSI	15 PSI	40'	1/1	
T45012	12"	25 PSI	15 PSI	40'	1/1	
Long - 23"						
PART NO.	NOM. PIPE SIZE	MAX AIR PRESSURE	MAX TEST PRESSURE	MAX HEAD	CTN/MSTR	
T46200	2"	45 PSI	5 PSI	30'	1/1	
T46300	3"	35 PSI	5 PSI	30'	1/1	
T46400	4"	30 PSI	5 PSI	30'	1/1	

Items marked with the Jones Stephens logo are "You Need It... We Got It" Items.

Pneumatic Test Plug with Chain



- Compact design allows easy access, even in a cleanout tee
- Pressure relief has no moving parts to fail or malfunction
- Rubber body is molded as one-piece with no seams or bonded parts
- Pressure exhausts out of the top of the plug not into test area
- Works in place of "standard" pneumatic plugs
- Multiple sealing ribs in the center portion of the plug for positive sealing
- Made in the USA

MADE IN THE **USA**

PART NO.	PIPE SIZE	CTN/MSTR
T45151	1.10" - 1.75"	1/12
T45201	1.75" - 2.25"	1/12
T45301	2.25" - 3.25"	1/12
T45401	3.25" - 4.25"	1/12

Pneumatic-Hydraulic Test Plug



- Uses either water or air
- Temperature range 30° - 200°F
- User safe; cannot be overinflated
- Individually tested for 24 hours to insure proper operation
- Using water, stack can be filled and plugged from same position
- Made in the USA

MADE IN THE **USA**

PART NO.	PIPE SIZE	MFG PART NO.	CTN/MSTR
T30002	1-1/4" - 2"	WATP 2	1/6
T30034	3 - 4"	WATP 3-4	1/10
T30046	4 - 6"	WATP 4-6	1/1
T30068	5" - 8"	WATP 6-8	1/1
T30102	10" - 12"	WATP 10-12	1/1

Two Stage Long Test Plug



- Two stage deflation allows access pipe to remain sealed while water clears drain line

PART NO.	PIPE SIZE	MFG PART NO.	CTN/MSTR
T30203	2" - 3"	DDO203	1/1
T30304	3" - 4"	DDO304	1/1

Inflatable Tee Plug



- Body is high quality natural rubber
- Top is made from high impact ABS plastic
- Threads directly into test tee
- Threads into both cast iron and plastic pipe

PART NO.	DESCRIPTION	CTN/MSTR
T33200	2" inflatable tee plug	6/36
T33300	3" inflatable tee plug	1/6
T33400	4" inflatable tee plug	1/6

Drain King®



D18501



D18186



D18034



D18750



D18340

- Insert in drain line opening and turn water on
- Automatically seals drain and powerful water pulses loosen and clear drain
- Brass on each end

PART NO.	PIPE SIZE	DK NO.	CTN/MSTR
D18501	1" - 2"	D501	1/12
D18186	1-1/2" - 3"	D186	12/144
D18034	3" - 4"	H34	1/6
D18750	3" - 6"	D750	1/6
D18850	6" - 10"	D850	1/1
D18340	1-1/2" - 3" with 10" hose and faucet adapter	PE60	1/12
D18060	Drain adapter	PE60	1/12

Plumbjet



D18400



D18401

- Attaches to garden hose
- All natural
- Environmentally safe

PART NO.	PIPE SIZE	DK NO.	CTN/MSTR
D18400	1" - 2"	D501	10/60
D18401	1-1/2" - 3"	D186	10/60

Extension Hose



- For pneumatic test plug
- Can be used in tandem

PART NO.	DESCRIPTION	CTN/MSTR
T45002	2' extension hose	1/6
T45003	3' extension hose	1/6

Force Cup Plunger



Red Rubber



Black Rubber

- Highest quality rubber
- Supplied with handle

PART NO.	DESCRIPTION	CTN/MSTR
D18001	5 1/2" diameter (red rubber)	1/48
D18002	6" professional style (black rubber)	1/24

Professional Force Cup Display



Display

- Highest quality rubber
- Supplied with handle
- Attractive point of purchase display
- Display box contains 30 rubber plungers
- CARTON QUANTITIES ONLY

PART NO.	DESCRIPTION	CTN/MSTR
D18000	Rubber plungers and display box	30/30

Toilet Plunger

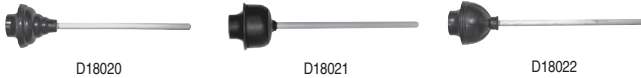

- Professional quality
- Yellow hardwood handles with black tailpiece

PART NO.	DESCRIPTION	CTN/MSTR
D18020	Thronemaster® professional stepped plunger	1/4
D18021	Professional plumber's plunger	1/12
D18022	HYDRO-TRUST heavy duty deluxe plunger	1/24

Qwik Tee



PART NO.	DESCRIPTION	CTN/MSTR
T07150	1-1/2" x 1-1/2" x 1-1/2" tee	1/50
T07200	2" x 2" x 2" tee	1/20
T07300	3" x 3" x 3" tee	1/20
T07400	4" x 4" x 4" tee	1/6

Qwik Elbow



- Flexible

PART NO.	DESCRIPTION	CTN/MSTR
E10150	1-1/2" x 1-1/2" elbow	1/50
E10200	2" x 2" elbow	1/20
E10300	3" x 3" elbow	1/20
E10400	4" x 4" elbow	1/6

Flexible PVC Saddle Fitting

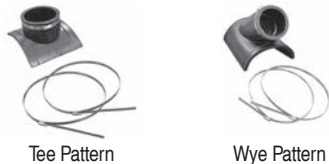

- Provided with stainless steel clamp on inlet
- Includes stainless steel clamps on saddle to fit up to 12" clay pipe
- Extension clamps may be used for larger pipe sizes

Tee Pattern		
PART NO.	DESCRIPTION	CTN/MSTR
S26001	6" plastic-12" clay saddle x 4" Sch.40 CI or SDR35 inlet	1/1
S26002	6" plastic - 12" clay saddle x 6" Sch.40 CI or SDR35 inlet	1/1
Wye Pattern		
PART NO.	DESCRIPTION	CTN/MSTR
S27001	6" plastic - 12" clay saddle x 4" Sch. 40 cast iron or SDR35 inlet	1/1
S27002	6" plastic - 12" clay saddle x 6" Sch. 40 cast iron or SDR35 inlet	1/1
Replacement Clamp		
PART NO.	DESCRIPTION	CTN/MSTR
S26100	4"-12" gear clamp	1/100

Items marked with the Jones Stephens logo are "You Need It... We Got It" Items.

Flexible Trap Drain Connector



PART NO.	DESCRIPTION	CTN/MSTR
T06001	Connects 1-1/4" - 1 1/2" tubular to 1-1/4" - 1-1/2" tubular	1/180
T06002	Connects 1-1/4" DWV or 1-1/2" CTS to 1-1/4" - 1-1/2" tubular	1/100
T06003	Connects 1-1/2" DWV or CTS to 1-1/4" - 1-1/2" tubular	1/100
T06004	Connects 2" DWV to 1-1/4" - 1-1/2" tubular	1/100

Flexible Transition Coupling



- Flexible PVC
- For use on PVC, DWV and CI pipe
- Stainless steel clamps and housing
- UPC listed



PART NO.	DESCRIPTION	CTN/MSTR
T06025	1-1/4" PL + CI to PL + CI	1/300
T06050	1-1/2" PL + CI to PL + CI	1/150
T06024	1-1/2" x 1-1/4" PL + CI to PL + CI	1/100
T06200	2" PL + CI to PL + CI	1/105
T06250	2" x 1-1/2" PL + CI to PL + CI	1/105
T06300	3" PL + CI to PL + CI	1/60
T06320	3" x 2" PL + CI to PL + CI	1/80
T06400	4" PL + CI to PL + CI	1/36
T06430	4" x 3" PL + CI to PL + CI	1/44
T06600	6" PL + CI to PL + CI	1/12
T06640	6" x 4" PL + CI to PL + CI	1/15
T06800	8" PL + CI to PL + CI	1/6

Bore O-Ring



PART NO.	DESCRIPTION	CTN/MSTR
B12640	6" bore x 4" plastic or cast iron	1/60

Bushing for Qwik Tees and Qwik Elbows



PART NO.	DESCRIPTION	CTN/MSTR
B12210	2" x 1-1/2" bushing	1/24
B12320	3" x 2" bushing	1/24
B12430	4" x 3" bushing	1/24

Dishwasher Hose

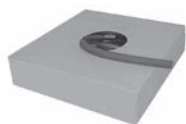

- New softer formulation
- Resists deformation during storage
- Single spiral reinforcement
- Connects dishwasher pump to air gap inlet or dishwasher tailpiece
- Resists kinking
- Marked per foot
- 14°F to 180°F
- IAPMO/UPC listed; meets ANSI, AHAM-DWI specifications



PART NO.	SIZE	BURST PRESSURE	WORKING PRESSURE	CTN/MSTR
D10626	5/8" ID x 50'	200 PSI	90 PSI	1/1
D10876	7/8" ID x 50'	100 PSI	70 PSI	1/1

Dishwasher Drain Connector



- 410 Stainless steel clamps
- Includes two worm gear clamps

PART NO.	DESCRIPTION	CTN/MSTR
D10001	Universal connector	50/200

Icemaker Boxes with Valves



- Includes two fixed nails for installation
- Blue handle valves
- UPC listed
- IAPMO listed



PART NO.	DESCRIPTION	CTN/MSTR
B05910LF	with MIP/SWT connection	1/10
B05911LF	with Flowguard all CPVC icemaker connection	1/10
B05913LF	with 1/2" PEX connection	1/12
B05914LF	with 1/2" crimp style PEX connection	1/12
B05925LF	with MIP/SWT connection and WHA	1/10
B05926LF	with CPVC connection and WHA	1/10
B05931LF	with 1/2" PEX connection and WHA	1/12
B05932LF	with 1/2" crimp style PEX connection and WHA	1/12

Replacement Frame

PART NO.	DESCRIPTION	CTN/MSTR
B05928	Replacement frame for icemaker box	1/1

Hose Grip Clothes Washer Connector



- Fits 1-1/2" or 2" standpipe
- Fits 1" - 1-7/16" drain hose
- Securely holds drain hose in standpipe

PART NO.	DESCRIPTION	CTN/MSTR
D08001	Drain hose connector	1/100

Flexible Drain Trap



- J-bend

PART NO.	DESCRIPTION	CTN/MSTR
J01001	1-1/4" or 1-1/2" tubular trap j-bend	1/20

Center Outlet Washing Machine Boxes



- All valves are quarter turn
- Easy to remove test plug
- Can be adapted to side outlet if needed
- IAPMO listed



Without Water Hammer Arrester

PART NO.	DESCRIPTION	CTN/MSTR
B05940	1/2" MIP/SWEAT	1/6
B05941	1/2" CPVC	1/6
B05942	1/2" PEX	1/6
B05943	3/8" PEX	1/6
B05944	1/2" crimp style PEX	1/6

With Water Hammer Arrester

PART NO.	DESCRIPTION	CTN/MSTR
B05946	1/2" MIP/SWEAT	1/6
B05947	1/2" CPVC	1/6
B05948	1/2" PEX	1/6
B05949	3/8" PEX	1/6
B05950	1/2" crimp style PEX	1/6

Replacement Frame

PART NO.	DESCRIPTION	CTN/MSTR
B05927	Replacement frame for washing machine box	1/1

Right Outlet Washing Machine Boxes



- All valves are quarter turn
- Easy to remove test plug
- IAPMO listed



Without Water Hammer Arrester

PART NO.	DESCRIPTION	CTN/MSTR
B05740	1/2" MIP/SWEAT	1/6
B05741	1/2" CPVC	1/6
B05742	1/2" PEX	1/6
B05743	3/8" PEX	1/6
B05744	1/2" crimp style PEX	1/6
B05751	Single Lever, 1/2" MIP/SWT	1/6
B05752	Single Lever, 1/2" CPVC	1/6
B05753	Single Lever, 1/2" PEX	1/6
B05754	Single Lever, 3/8" PEX	1/6
B05755	Single Lever, 1/2" crimp style PEX	1/6

With Water Hammer Arrester

PART NO.	DESCRIPTION	CTN/MSTR
B05746	1/2" MIP/SWEAT	1/6
B05747	1/2" CPVC	1/6
B05748	1/2" PEX	1/6
B05749	3/8" PEX	1/6
B05750	1/2" crimp style PEX	1/6
B05756	Single Lever, 1/2" MIP/SWT	1/6
B05757	Single Lever, 1/2" CPVC	1/6
B05758	Single Lever, 1/2" PEX	1/6
B05759	Single Lever, 3/8" PEX	1/6
B05760	Single Lever, 1/2" crimp style PEX	1/6

Replacement Frame

PART NO.	DESCRIPTION	CTN/MSTR
B05927	Replacement frame for washing machine box	1/1

Items marked with the Jones Stephens logo are "You Need It... We Got It" Items.

Left Outlet Washing Machine Boxes



- All valves are quarter turn
- Easy to remove test plug
- IAPMO listed



Without Water Hammer Arrester

PART NO.	DESCRIPTION	CTN/MSTR
B05840	1/2" MIP/SWEAT	1/6
B05841	1/2" CPVC	1/6
B05842	1/2" PEX	1/6
B05843	3/8" PEX	1/6
B05844	1/2" crimp style PEX	1/6
B05851	Single Lever, 1/2" MIP/SWT	1/6
B05852	Single Lever, 1/2" CPVC	1/6
B05853	Single Lever, 1/2" PEX	1/6
B05854	Single Lever, 3/8" PEX	1/6
B05855	Single Lever, 1/2" crimp style PEX	1/6

With Water Hammer Arrester

PART NO.	DESCRIPTION	CTN/MSTR
B05845	1/2" MIP/SWEAT	1/6
B05847	1/2" CPVC	1/6
B05848	1/2" PEX	1/6
B05849	3/8" PEX	1/6
B05850	1/2" crimp style PEX	1/6
B05856	Single Lever, 1/2" MIP/SWT	1/6
B05857	Single Lever, 1/2" CPVC	1/6
B05858	Single Lever, 1/2" PEX	1/6
B05859	Single Lever, 3/8" PEX	1/6
B05860	Single Lever, 1/2" crimp Style PEX	1/6

Replacement Frame

PART NO.	DESCRIPTION	CTN/MSTR
B05927	Replacement frame for washing machine box	1/1

Washing Machine Hose



Straight Female



With 90° Elbow

- 3/8" ID rubber for hot or cold use
- Standard female hose threads
- Bursting pressure 800 lbs. per sq. inch
- Bagged with washers

PART NO.	DESCRIPTION	CTN/MSTR
J04104	4' with 90° elbow	1/12
J04105	5' with 90° elbow	1/12
J04106	6' with 90° elbow	1/12
J04004	4' straight female	1/12
J04005	5' straight female	1/12
J04006	6' straight female	1/12

Washing Machine Hose



- Industrial quality
- 1/2" ID EPDM rubber for hot and cold use
- Polyester yarn reinforcement
- 3/4" female hose ends
- Temp. rating -40°F to +190°F
- 200 PSI working pressure
- Bagged with washers

PART NO.	DESCRIPTION	CTN/MSTR
J04204	4' washing machine hose	1/12
J04205	5' washing machine hose	1/12
J04206	6' washing machine hose	1/12

Mixer Hose



- High pressure hose; 12" arms
- Individually bagged

PART NO.	DESCRIPTION	CTN/MSTR
J04012	Mixer hose	1/25

Steam Dryer Wye



- 3-way male garden hose wye for steam dryer hook-up
- Allows a washing machine water supply to be easily split for supplying both the washing machine and a dryer with a steam function
- Can be used along with a female X female washing machine hose anywhere a hose bib or sill cock must be split into two
- Chrome plated die cast zinc suitable for use both outdoors and indoors

PART NO.	DESCRIPTION	CTN/MSTR
G20200	3/4" MHT x 3/4" MHT x 3/4" MHT wye	20/200

Fit-All Drain Hose for Washing Machine



- 3 size step down 3/4", 7/8" and 1" for drain lines
- Individually bagged

PART NO.	DESCRIPTION	CTN/MSTR
J04016	5' fit-all drain hose	1/12

Washing Machine Pan



- 2-1/2" deep heavy gauge plastic pan
- White
- 1" adapter
- CARTON QUANTITIES ONLY

PART NO.	DESCRIPTION	CTN/MSTR
J04250	27" x 29" with side mount drain	1/5

Dryer Vent Hood



- PVC hood
- Weather proof 12" aluminum extension
- Pre-punched mounting holes
- CARTON QUANTITIES ONLY

PART NO.	DESCRIPTION	CTN/MSTR
D04012	4" dryer vent hood	1/12

Aluminum Vent Hood



- For clothes dryers or exhaust fans
- Complete with damper and flange plate

PART NO.	DESCRIPTION	CTN/MSTR
D04023	3" aluminum vent hood	1/12
D04024	4" aluminum vent hood	1/12

Louvered Dryer Vent Hood



- Includes hood, aluminum pipe and collar

PART NO.	DESCRIPTION	CTN/MSTR
D04025	4" white hood assembly	1/12
D04026	4" brown hood assembly	1/12

Complete Dryer Vent Kit

C



- Kit includes hose, vent and 2 plastic clamps
- PVC hood
- Weather proof 12" aluminum extension
- Pre-punched mounting holes
- 12" aluminum extension, pre-punched mounting holes

PART NO.	DESCRIPTION	CTN/MSTR
D04005	4" x 5' vent kit	1/10
D04008	4" x 8' vent kit	1/10
D04009	4" x 8' flex aluminum duct with louvered hood and two metal clamps	1/6
D04010	4" clamp only	1/10

Metal Clamp for Dryer Vent



- Heavy duty all metal design
- Excellent for use with metal ducting

PART NO.	DESCRIPTION	CTN/MSTR
D04015	3" metal clamp	10/50
D04016	4" metal clamp	10/50
D04017	5" metal clamp	10/50
D04018	6" metal clamp	10/50

Aluminum Elbow and Pipe



- All aluminum

PART NO.	DESCRIPTION	CTN/MSTR
D04013	3" x 90° swivel elbow	1/12
D04014	3" x 24" aluminum pipe	1/25
D04027	4" x 90° swivel elbow	1/12
D04028	4" x 24" aluminum pipe	1/25

Flexible Duct Connector Kit



- Connects flexible ducting
- Extends exhaust collar of clothes dryer

PART NO.	DESCRIPTION	CTN/MSTR
D04019	4" duct connector kit	1/6

Increaser/Reducer



- Connects 3" to 4" ducting or 4" ducting to 3" exhaust collar

PART NO.	DESCRIPTION	CTN/MSTR
D04021	3"-4" plastic increaser/reducer	1/6
D04022	4"-3" aluminum reducer	1/6

Indoor Dryer Vent Kit



- Use on electric clothes dryers when outside venting is not possible
- Recirculates warm, moist air
- Specially designed lint reservoir

PART NO.	DESCRIPTION	CTN/MSTR
D04036	Indoor dryer vent kit	1/6

Flexible Aluminum Ducting



- Ideal for exhausting clothes dryers
- Bendable to any configuration
- No fire or UL ratings

PART NO.	DESCRIPTION	CTN/MSTR
D04031	3" x 8' aluminum ducting	1/14
D04032	4" x 8' aluminum ducting	1/9
D04033	5" x 8' aluminum ducting	1/6
D04034	6" x 8' aluminum ducting	1/3
D04053	3" x 25' aluminum ducting	1/10
D04054	4" x 25' aluminum ducting	1/6

Proflex Aluminum Foil Ducting



- Flexible, fire resistant
- Will not support combustion
- Wire reinforced

PART NO.	DESCRIPTION	CTN/MSTR
D04058	4" x 5' Proflex aluminum foil ducting	1/12
D04059	4" x 8' Proflex aluminum foil ducting	1/12
D04060	4" x 50' Proflex aluminum foil ducting	1/1

Flexible Aluminum Foil Ducting



- Ideal for exhausting clothes dryers and bathroom fans
- Will not support combustion
- No fire or UL ratings

PART NO.	DESCRIPTION	CTN/MSTR
D04056	4" x 25' aluminum foil ducting	1/1
D04057	4" x 8' aluminum foil ducting	1/12

Dryer Vent Hose



- Wire-reinforced vinyl

PART NO.	DESCRIPTION	CTN/MSTR
D04020	4" x 20' (boxed)	1/5
D04051	4" x 5' (bagged)	1/12

Dryer Vent Kit with Louvered Hood



- Includes vinyl hose, aluminum pipe, collar, clamps and louvered hood

PART NO.	DESCRIPTION	CTN/MSTR
D04001	4" x 5' with white hood	1/10
D04002	4" x 5' with brown hood	1/10
D04003	4" x 8' with white hood	1/10
D04004	4" x 8' with brown hood	1/10

Items marked with the Jones Stephens logo are "You Need It... We Got It" Items.

Bathroom Fan Vent Kit



- Contains the following parts for 3" and 4" wall type exhaust fans: 4" x 5' flexible vinyl ducting, clamps, 4" louvered vent, 3"-4" foam increaser

PART NO.	DESCRIPTION	CTN/MSTR
D04035	Bathroom fan vent kit	1/10
D04050	4" x 50' vinyl hose only (boxed)	1/1
D04062	3" x 50' vinyl hose only (boxed)	1/1

Domestic Pipe Wrap Tape



- Both sides have adhesive
- CARTON QUANTITIES ONLY

PART NO.	COLOR	SIZE	THICKNESS	CTN/MSTR
T16002	Yellow	2" x 100'	12 mil.	24/24
T16004	Yellow	4" x 100'	12 mil.	12/12
T17002	Black	2" x 100'	12 mil.	24/24
T17004	Black	4" x 100'	12 mil.	12/12

Imported Pipe Wrap Tape



- Black tape with PVC backing
- UPC listed
- CARTON QUANTITIES ONLY



PART NO.	SIZE	THICKNESS	CTN/MSTR
T17101	1" x 100'	10 mil.	48/48
T17102	2" x 100'	10 mil.	24/24
T17104	4" x 100'	10 mil.	12/12
T18201	1" x 100'	20 mil.	48/48
T18202	2" x 100'	20 mil.	24/24

Primer for Pipe Wrap Tape



- Maximizes tape performance
- Final step in preparing steel surfaces for taping
- Can more than double adhesion of corrosion tapes to cleaned steel
- CARTON QUANTITIES ONLY
- MOTOR FREIGHT ONLY / FLAMMABLE

PART NO.	DESCRIPTION	CTN/MSTR
T16100	Quart	12/12

Electrical Tape



- Black vinyl
- Individually wrapped
- UL listed
- CARTON QUANTITIES ONLY



PART NO.	DESCRIPTION	CTN/MSTR
T20030	3/4" x 60' electrical tape	10/250

Duct Tape



- Premium grade, waterproof non-elastic reinforced cloth
- Pressure sensitive; vapor and flame resistant
- CARTON QUANTITIES ONLY

PART NO.	DESCRIPTION	THICKNESS	CTN/MSTR
T20020	2" x 60 yds (gray)	8.5 mil.	24/24
T20023	2" x 60 yds (black)	10 mil.	24/24

PTFE Thread Seal Tape



- Thickness 3 mil. plus
- Temperature range is 500°F to +650°F
- Withstands pressure up to 5000 PSI

PART NO.	DESCRIPTION	CTN/MSTR
T19122	1/2" x 260" thread seal tape	100/500
T19125	1/2" x 520" thread seal tape	100/500
T19342	3/4" x 260" thread seal tape	100/500
T19345	3/4" x 520" thread seal tape	100/500

Thread Seal Tape Jar Display



- Withstands pressure up to 5000 PSI
- Temperatures to +650°F
- Thickness 3 mil. plus

PART NO.	DESCRIPTION	CTN/MSTR
CJ1002	1/2" x 260" Teflon™ tape	1/1

PTFE Yellow Gas Line Thread Seal Tape



- 0035 mil.
- Temperature range is -450°F to +500°F
- Withstands pressure up to 5000 PSI
- Meets U.S. government military specification MIL-T27730A
- UL listed



PART NO.	DESCRIPTION	CTN/MSTR
T19222	1/2" x 260" thread seal tape	100/500

Box Sealing Tape



PART NO.	DESCRIPTION	CTN/MSTR
T20040	2" x 55 yds	1/36
T20041	2" x 110 yds	1/36
T20050	Dispenser only	1/24

Stretch Wrap



- Use instead of tape to bind packages or parts
- Protects products from dirt and moisture
- Can be used on palletized shipments or small orders
- Great for wrapping lengths of pipe
- CARTON QUANTITIES ONLY

PART NO.	DESCRIPTION	GAUGE	CTN/MSTR
S51120	3" x 700'	120	18/18
S51080	3" x 1000'	80	18/18

C

Stretch Wrap Film and Dispenser



- Secures packages to pallets
- Reduces lost packages
- Retards moisture
- Lowers handling costs
- Wrapping is priced per carton - no broken cartons

PART NO.	DESCRIPTION	CTN/MSTR
S51001	80 gauge wrap 18" x 1500' (4 rolls)	1/1
S51002	Hand dispenser only	1/1

Pipe Sleeving



- Made of polyethylene material
- Underground sleeving protects against lime reaction in concrete
- Allows expansion and contraction of pipe, minimizing stress
- Individually boxed; color-coded (red for hot, blue for cold)
- IAPMO listed



PART NO.	PIPE SIZE	THICKNESS	COLOR	LENGTH	CTN/MSTR
S22001	1/2"-1"	6 mil	Red	200'	1/20
S22002	1/2"-1"	6 mil	Blue	200'	1/20
S22003	1/2"-1"	10 mil	Red	100'	1/20
S22004	1/2"-1"	10 mil	Blue	100'	1/20
S22005	1/2"-1"	25 mil	Red	100'	1/20
S22006	1/2"-1"	25 mil	Blue	100'	1/20

Water Resistant Sand Cloth



- Dispenser box
- Water resistant aluminum oxide
- 120 grit abrasive cloth for cleaning pipe and fittings

PART NO.	DESCRIPTION	CTN/MSTR
C25000	1-1/2" x 2 yds	1/50
C25001	1-1/2" x 5 yds	1/50
C25002	1-1/2" x 10 yds	1/50
C25003	1-1/2" x 25 yds	1/25

Open Mesh

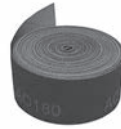

- Dispenser box
- 100% waterproof
- Polyester on both sides
- 180 grit with large holes for aggressive sanding
- Can be exposed to water and solvents indefinitely without breakdown

PART NO.	DESCRIPTION	CTN/MSTR
C25010	1-1/2" x 5 yds	1/50
C25011	1-1/2" x 10 yds	1/50

Flexible Open Mesh



- Dispenser box
- 100% waterproof
- Polyester on both sides
- 180 grit
- Smaller holes for finer sanding

PART NO.	DESCRIPTION	CTN/MSTR
C25012	1-1/2" x 5 yds	1/50
C25013	1-1/2" x 10 yds	1/50

Waterproof Aluminum Oxide



- Dispenser box
- 100% waterproof
- Wet cut
- 120 grit

PART NO.	DESCRIPTION	CTN/MSTR
C25020	1-1/2" x 5 yds	1/50
C25021	1-1/2" x 10 yds	1/50
C25022	1-1/2" x 25 yds	1/25

Rubber Pipe Insulation

CLOSED CELL FLEXIBLE ELASTOMERIC FOAM INSULATION

*Excludes Titan(TM) Insulation Tubes and Rubber Insulation Rolls.
See our website for specifications and certifications on these products.



DESCRIPTION

Rubber pipe insulation is an NBR/PVC based closed cell, flexible elastomeric foam insulation. It is environmentally friendly as it is free of CFCs, HFCs, HCFCs, PBDEs, formaldehyde and fibers. An EPA-registered antimicrobial agent is incorporated into the product providing additional protection against mold, fungal and bacterial growth. It is UL GREENGUARD® Gold Certified for low VOC emissions. The product's key physical properties are approved by Factory Mutual.

APPLICATION

Rubber pipe insulation is recommended for applications with service temperatures ranging from -297°F (-182°C) to +220°F (+104°C). For applications below -40°F (-40°C), contact us for support. The product is used to retard heat gain and prevent condensation or frost formation on below-ambient applications, including refrigerant, cold water plumbing, chilled water, and industrial process lines, among others. It can be used with heat tracing tapes. It also retards heat loss from medium hot systems, including hot water plumbing, liquid heating, dual temperature, and solar thermal piping, among others.

OUTDOOR APPLICATION

Rubber pipe insulation is made from a UVresistant elastomeric blend. For severe UV exposure (rooftop applications) or for optimum performance, protective coating or approved jacketing is recommended.

UNDERGROUND APPLICATIONS

Rubber pipe insulation is acceptable for use in buried applications using the same installation principles as above ground applications. For lines above the water table, use a clean fill such as sand (3"-5" layer) to protect the insulation before backfilling. For optimum performance, the lines should be encased in a conduit to protect them from problems associated with ground water intrusion and compaction. If a conduit is not used, the insulation thickness should be increased by one thickness size to compensate for compaction.

INSTALLATIONS

Rubber pipe insulation is flexible (even at low temperatures), durable (nonfracturing and skin is resistant to tearing from handling and environment), safe to handle (non-dusting and non-abrasive), and lightweight for an efficient installation. It is recommended that insulation is installed on non-operational systems with clean, dry surfaces in ambient conditions between 40°F and 100°F. Properly sized insulation tubing can be slid over piping (tubing should be pushed, not pulled) or, when applied to existing lines, can be slit lengthwise (using a sharp, non-serated knife) and fitted into place. All seams, butt joints, termination points and open ends should be sealed with an approved contact adhesive, making sure both surfaces to be joined are coated. Longitudinal seams should face downward and vapor stops should be installed as needed. Fittings (elbows, tees, p-traps) can be field fabricated from insulation tubes. ASTM C1710, Installation Guide for Flexible Closed Cell Foams should be used as comprehensive installation guides.

RESISTANCE TO MOISTURE VAPOR FLOW

The expanded closed cell structure and unique formulation inherently resists moisture vapor intrusion and is considered a Class 1 vapor retarder per ASHRAE. For most indoor applications, rubber pipe insulation needs no additional protection. Additional vapor barrier protection may be necessary when installed on cold surfaces that are exposed to continuous high humidity.

FLAME AND SMOKE RATING

Rubber pipe insulation in wall thicknesses of 2" (50 mm) and below has a flame spread rating of 25 or less and a smoke development rating of 50 or less as tested to ASTM E84, "Surface Burning Characteristics of Building Materials". It is acceptable for duct/plenum applications, meeting the requirements of NFPA 90A/B. Numerical flammability ratings alone may not

SPECIFICATION COMPLIANCE

- ASTM C534 Type 1, Grade 1
- ASTM D1056-00-2B1
- New York City MEA 186-86-M Vol. V
- USDA Compliant
- CFIA Compliant
- RoHS Compliant
- UL 94-5V Flammability Classification (#E300774)
- ASTM E84 25/50-rated (to 2") - tested to UL 723, NFPA 255 and CAN/ULC S102-03
- FMVSS 302
- FAR 25.853
- FMRC Approval Guide: Chapter 14 Pipe Insulation
- NFPA No. 101 Class A Rating
- NFPA 90A, 90B
- MIL-P-15280, Form T
- Meets requirements of California ECB Title 24
- UL GREENGUARD® Gold Certified
- Meets energy code requirements of ASHRAE 90.1 and 189.1



RUBBER PIPE INSULATION TECHNICAL DATA

Physical properties	Rubber Pipe Insulation	Test methods
Thermal Conductivity (K) BTU - in/hr - Ft ² - °F (W/mK)	90°F (32°C) Mean Temp 0.258 (0.0372) 75°F (24°C) Mean Temp 0.245 (0.0353) 32°F (0°C) Mean Temp 0.235 (0.0339)	ASTM C 177
Density	3-6 lb/ft ³	ASTM D 1667
Operating Temperature Range	-297°F* (-183°C) to +220°F (+104°C)	ASTM C534
Water Vapor Permeability (Dry Cup)	<0.01 perm-in	ASTM E96
Water Absorption (Volume Change)	0%	ASTM C209
Flame Spread / Smoke Development (up to 2" wall)	<25/50	ASTM E84
Dimensional Stability	<7% Linear Shrinkage	ASTM C534
Hot Surface Performance (250°F for 96 hours)	No Cracking or Delamination	ASTM C411
Ozone Resistance	Pass	ASTM D1171
Odor Emissions	No Objectionable Odor	ASTM C1304
Chemical/Solvent/Oil/Grease Resistance	Good	Compatibility Data Available on Request
Flexibility	Excellent Pass: Cold Crack Test at -40°F (-40°C)	ASTM C534 ASTM D1056
Mildew Growth Resistance/Air Erosion	Pass	UL 181, ASTM G21
Corrosion Risk	pH neutral: 6.6±0.04	DIN 1988
Leachable Chlorides	<0.05% water-soluble chloride ions	DIN 1988
UV / Weather Resistance ¹	Pass	QUV Chamber Test
Sound Transmission Class (1")	13	ASTM E90

*For applications below -40°F (-40°C), contact us for technical support.
¹ Outdoor applications should be protected with an approved coating.

RUBBER PIPE INSULATION THICKNESS RECOMMENDATIONS - TO PREVENT CONDENSATION

SERVICE TEMPERATURE	50°F (10°C)			35°F (2°C)			0°F (-18°C)			-20°F (-29°C)			
	Pipe Size	Mild	Normal	Severe	Mild	Normal	Severe	Mild	Normal	Severe	Mild	Normal	Severe
3/8" ID to 1-1/8" ID	3/8"	3/8"	3/4"	3/8"	1/2"	3/4"	1/2"	3/4"	1-1/2"	1/2"	1"	1-1/2"	1-1/2"
1-3/8" ID to 3" IPS	3/8"	3/8"	3/4"	3/8"	3/4"	1"	1/2"	1"	1-1/2"	3/4"	1-1/2"	1-1/2"	1-1/2"
4" IPS to 8" IPS	1/2"	1/2"	3/4"	1/2"	3/4"	1"	3/4"	1"	2"	3/4"	1-1/2"	2"	2"

Thickness listed for the specified ranges will prevent condensation on indoor piping under the defined design conditions. Normal: 85°F and 70% R.H. Mild: Most air conditioned spaces and arid climates: 80°F and 50% R.H. Severe: Areas where excessive moisture is introduced or in poorly ventilated areas where the temperature may be depressed below the ambient: 90°F and 80% R.H.

RUBBER PIPE INSULATION PIPE "R" VALUES PER SQUARE FOOT (ALL SIZES ARE NOMINAL)

Nominal insulation I.D.	3/8" WALL	1/2" WALL	3/4" WALL	1" WALL	1-1/2" WALL	2" WALL
3/8"	2.7	3.6	5.6	8.5	14.6	20.4
1/2"	2.5	3.4	5.4	7.9	13.5	18.9
5/8"	2.5	3.3	5.4	7.5	12.8	17.8
3/4"	2.3	3.1	5.4	7.5	12.4	16.8
7/8"	2.3	3.2	5.4	7.2	11.6	16.1
1-1/8"	2.2	3.1	5.5	7.1	10.8	15.8
1-3/8"	2.2	3.2	5.3	7.3	10.2	14.9
1-5/8"	2.4	3.1	5.1	7.1	9.8	14.6
1-1/2" IPS	2.0	2.6	4.4	6.2	9.9	13.8
2-1/8"	2.3	3.0	4.9	6.6	9.2	13.6
2" IPS	2.3	2.9	4.8	6.5	9.0	13.3
2-1/2" IPS	2.3	3.0	4.6	6.3	8.6	12.6
2-5/8"	2.3	3.1	4.7	6.4	8.8	12.9
3-1/8"	2.3	3.0	4.6	6.2	8.5	12.4
3" IPS	2.3	3.2	4.6	6.1	8.3	12.2
3-5/8"	2.3	3.2	4.6	6.1	8.3	12.1
4-1/8"	2.3	3.1	4.6	6.0	8.1	11.7
4" IPS	2.2	3.2	4.6	5.5	8.0	11.6
5" IPS	-	3.0	4.5	5.7	7.7	11.1
6" IPS	-	3.0	4.4	5.6	7.5	10.9
8" IPS	-	2.9	4.2	5.3	7.2	-

Seamless Rubber Pipe Insulation



- Closed cell flexible elastomeric foam insulation tubes
- Non-slit for slide-on applications
- For use on HVAC/R, commercial, and industrial process piping and equipment
- High resistance to moisture vapor intrusion; low thermal conductivity
- For most indoor applications, no additional jacketing is required.
- UL GREENGUARD® Gold Certified as a low VOC material
- CARTON QUANTITIES ONLY



Specifications:

Temp Range: -297°F (-183°C) to +220°F (+104°C)
 Flame/Smoke: ASTM E84 25/50-rated (to 2")
 Water Vapor Permeability: <0.01 perm-in
 Density: 3-6 lb/cubic ft
 Mold growth: None
 Ozone Resistance: Good

3/8" Wall Thickness

PART NO.	INSULATION NOMINAL ID	CTS (NOM. ID PLUMBING)	CTS (OD HVAC/R)	IPS NOMINAL	FT/BOX
I60025	1/4"	1/8"	1/4"	--	630'
I60038	3/8"	1/4"	3/8"	1/8"	612'
I60050	1/2"	3/8"	1/2"	1/4"	432'
I60058	5/8"	1/2"	5/8"	3/8"	378'
I60075	3/4"	5/8"	3/4"	--	342'
I60078	7/8"	3/4"	7/8"	1/2"	288'
I60118	1-1/8"	1"	1-1/8"	3/4"	216'
I60138	1-3/8"	1-1/4"	1-3/8"	1"	168'
I60158	1-5/8"	1-1/2"	1-5/8"	1-1/4"	150'
I60200	2"	--	--	1-1/2"	120'
I60218	2-1/8"	2"	2-1/8"	--	96'
I60250	2-3/8"	--	--	2"	84'
I60258	2-5/8"	2-1/2"	2-5/8"	--	72'
I60300	2-7/8"	--	--	2-1/2"	60'
I60318	3-1/8"	3"	3-1/8"	--	60'
I60350	3-1/2"	--	--	3"	48'

1/2" Wall Thickness

PART NO.	INSULATION NOMINAL ID	CTS (NOM. ID PLUMBING)	CTS (OD HVAC/R)	IPS NOMINAL	FT/BOX
I61025	1/4"	1/8"	1/4"	--	510'
I61038	3/8"	1/4"	3/8"	1/8"	456'
I61050	1/2"	3/8"	1/2"	1/4"	360'
I61058	5/8"	1/2"	5/8"	3/8"	324'
I61075	3/4"	5/8"	3/4"	--	270'
I61078	7/8"	3/4"	7/8"	1/2"	228'
I61118	1-1/8"	1"	1-1/8"	3/4"	156'
I61138	1-3/8"	1-1/4"	1-3/8"	1"	120'
I61158	1-5/8"	1-1/2"	1-5/8"	1-1/4"	114'
I61200	2"	--	--	1-1/2"	114'
I61218	2-1/8"	2"	2-1/8"	--	102'
I61250	2-3/8"	--	--	2"	66'
I61258	2-5/8"	2-1/2"	2-5/8"	--	60'
I61300	2-7/8"	--	--	2-1/2"	48'
I61318	3-1/8"	3"	3-1/8"	--	48'
I61350	3-1/2"	--	--	3"	36'
I61358	3-5/8"	3-1/2"	3-5/8"	--	36'
I61418	4-1/8"	4"	4-1/8"	3-1/2"	24'
I61450	4-1/2"	--	--	4"	24'

3/4" Wall Thickness

PART NO.	INSULATION NOMINAL ID	CTS (NOM. ID PLUMBING)	CTS (OD HVAC/R)	IPS NOMINAL	FT/BOX
I62025	1/4"	1/8"	1/4"	--	240'
I62038	3/8"	1/4"	3/8"	1/8"	228'
I62050	1/2"	3/8"	1/2"	1/4"	228'
I62058	5/8"	1/2"	5/8"	3/8"	180'
I62075	3/4"	5/8"	3/4"	--	144'
I62078	7/8"	3/4"	7/8"	1/2"	126'
I62118	1-1/8"	1"	1-1/8"	3/4"	90'
I62138	1-3/8"	1-1/4"	1-3/8"	1"	78'
I62158	1-5/8"	1-1/2"	1-5/8"	1-1/4"	72'
I62200	2"	--	--	1-1/2"	66'
I62218	2-1/8"	2"	2-1/8"	--	60'
I62250	2-3/8"	--	--	2"	48'
I62258	2-5/8"	2-1/2"	2-5/8"	--	42'
I62300	2-7/8"	--	--	2-1/2"	36'
I62318	3-1/8"	3"	3-1/8"	--	36'
I62350	3-1/2"	--	--	3"	30'
I62358	3-5/8"	3-1/2"	3-5/8"	--	30'
I62418	4-1/8"	4"	4-1/8"	3-1/2"	24'
I62450	4-1/2"	--	--	4"	24'

1" Wall Thickness

PART NO.	INSULATION NOMINAL ID	CTS (NOM. ID PLUMBING)	CTS (OD HVAC/R)	IPS NOMINAL	FT/BOX
I63025	1/4"	1/8"	1/4"	--	120'
I63038	3/8"	1/4"	3/8"	1/8"	120'
I63050	1/2"	3/8"	1/2"	1/4"	114'
I63058	5/8"	1/2"	5/8"	3/8"	108'
I63075	3/4"	5/8"	3/4"	--	108'
I63078	7/8"	3/4"	7/8"	1/2"	90'
I63118	1-1/8"	1"	1-1/8"	3/4"	66'
I63138	1-3/8"	1-1/4"	1-3/8"	1"	60'
I63158	1-5/8"	1-1/2"	1-5/8"	1-1/4"	54'
I63200	2"	--	--	1-1/2"	42'
I63218	2-1/8"	2"	2-1/8"	--	42'
I63250	2-3/8"	--	--	2"	36'
I63258	2-5/8"	2-1/2"	2-5/8"	--	36'
I63300	2-7/8"	--	--	2-1/2"	36'
I63318	3-1/8"	3"	3-1/8"	--	30'
I63350	3-1/2"	--	--	3"	30'
I63358	3-5/8"	3-1/2"	3-5/8"	--	30'
I63418	4-1/8"	4"	4-1/8"	3-1/2"	18'

1-1/2" Wall Thickness

PART NO.	INSULATION NOMINAL ID	CTS (NOM. ID PLUMBING)	CTS (OD HVAC/R)	IPS NOMINAL	FT/BOX
I64050	1/2"	3/8"	1/2"	1/4"	48'
I64058	5/8"	1/2"	5/8"	3/8"	48'
I64075	3/4"	5/8"	3/4"	--	48'
I64078	7/8"	3/4"	7/8"	1/2"	48'
I64118	1-1/8"	1"	1-1/8"	3/4"	36'
I64138	1-3/8"	1-1/4"	1-3/8"	1"	36'
I64158	1-5/8"	1-1/2"	1-5/8"	1-1/4"	36'

Double Stick Rubber Pipe Insulation

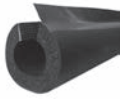

- Closed cell flexible elastomeric foam insulation tubes
- Self-Seal (Pre-Slit / Pre-Glued / DoubleSeal closure system) for retrofit applications
- For use on HVAC/R, commercial, and industrial process piping and equipment
- High resistance to moisture vapor intrusion; low thermal conductivity
- For most indoor applications, no additional jacketing is required.
- UL GREENGUARD® Gold Certified as a low VOC material
- CARTON QUANTITIES ONLY

3/8" Wall Thickness

PART NO.	INSULATION NOMINAL ID	CTS (NOM. ID PLUMBING)	CTS (OD HVAC/R)	IPS NOMINAL	FT/BOX
I80038	3/8"	1/4"	3/8"	1/8"	570'
I80058	5/8"	1/2"	5/8"	3/8"	348'
I80034	3/4"	5/8"	3/4"	--	318'
I80078	7/8"	3/4"	7/8"	1/2"	288'
I80118	1-1/8"	1"	1-1/8"	3/4"	216'
I80138	1-3/8"	1-1/4"	1-3/8"	1"	150'
I80150	2"	--	--	1-1/2"	120'
I80158	1-5/8"	1-1/2"	1-5/8"	1-1/4"	132'
I80218	2-1/8"	2"	2-1/8"	--	78'
I80200	2-3/8"	--	--	2"	78'

1/2" Wall Thickness

PART NO.	INSULATION NOMINAL ID	CTS (NOM. ID PLUMBING)	CTS (OD HVAC/R)	IPS NOMINAL	FT/BOX
I81038	3/8"	1/4"	3/8"	1/8"	420'
I81050	1/2"	3/8"	1/2"	1/4"	312'
I81058	5/8"	1/2"	5/8"	3/8"	312'
I81034	3/4"	5/8"	3/4"	--	270'
I81078	7/8"	3/4"	7/8"	1/2"	216'
I81118	1-1/8"	1"	1-1/8"	3/4"	150'
I81138	1-3/8"	1-1/4"	1-3/8"	1"	120'
I81150	2"	--	--	1-1/2"	108'
I81158	1-5/8"	1-1/2"	1-5/8"	1-1/4"	108'
I81218	2-1/8"	2"	2-1/8"	--	102'
I81200	2-3/8"	--	--	2"	60'
I81258	2-5/8"	2-1/2"	2-5/8"	--	60'
I81250	2-7/8"	--	--	2-1/2"	48'
I81318	3-1/8"	3"	3-1/8"	--	48'
I81300	3-1/2"	--	--	3"	36'
I81358	3-5/8"	3-1/2"	3-5/8"	--	36'
I81418	4-1/8"	4"	4-1/8"	3-1/2"	24'
I81400	4-1/2"	--	--	4"	24'

Specifications:

Temp Range: -297°F (-183°C) to +220°F (+104°C)
 Flame/Smoke: ASTM E84 25/50-rated (to 2")
 Water Vapor Permeability: <0.01 perm-in
 Density: 3-6 lb/cubic ft
 Mold growth: None
 Ozone Resistance: Good



3/4" Wall Thickness

PART NO.	INSULATION NOMINAL ID	CTS (NOM. ID PLUMBING)	CTS (OD HVAC/R)	IPS NOMINAL	FT/BOX
I82038	3/8"	1/4"	3/8"	1/8"	228'
I82050	1/2"	3/8"	1/2"	1/4"	192'
I82058	5/8"	1/2"	5/8"	3/8"	180'
I82034	3/4"	5/8"	3/4"	--	120'
I82078	7/8"	3/4"	7/8"	1/2"	126'
I82118	1-1/8"	1"	1-1/8"	3/4"	90'
I82100	1-3/8"	1-1/4"	1-3/8"	1"	78'
I82158	1-5/8"	1-1/2"	1-5/8"	1-1/4"	72'
I82150	2"	--	--	1-1/2"	66'
I82218	2-1/8"	2"	2-1/8"	--	60'
I82200	2-3/8"	--	--	2"	48'
I82258	2-5/8"	2-1/2"	2-5/8"	--	42'
I82250	2-7/8"	--	--	2-1/2"	36'
I82318	3-1/8"	3"	3-1/8"	--	36'
I82358	3-5/8"	3-1/2"	3-5/8"	--	30'
I82418	4-1/8"	4"	4-1/8"	3-1/2"	24'
I82400	4-1/2"	--	--	4"	24'

1" Wall Thickness

PART NO.	INSULATION NOMINAL ID	CTS (NOM. ID PLUMBING)	CTS (OD HVAC/R)	IPS NOMINAL	FT/BOX
I83058	5/8"	1/2"	5/8"	3/8"	108'
I83034	3/4"	5/8"	3/4"	--	78'
I83078	7/8"	3/4"	7/8"	1/2"	78'
I83118	1-1/8"	1"	1-1/8"	3/4"	66'
I83138	1-3/8"	1-1/4"	1-3/8"	1"	60'
I83158	1-5/8"	1-1/2"	1-5/8"	1-1/4"	42'
I83150	2"	--	--	1-1/2"	42'
I83218	2-1/8"	2"	2-1/8"	--	42'
I83200	2-3/8"	--	--	2"	36'
I83250	2-7/8"	--	--	2-1/2"	36'
I83358	3-5/8"	3-1/2"	3-5/8"	--	30'
I83418	4-1/8"	4"	4-1/8"	3-1/2"	18'

Titan™ Seamless UV Resistant Rubber Pipe Insulation



- Closed cell elastomeric foam NBR/PVC tube with flexible polymeric jacketing material.
- Non-slit for slide-on applications
- For use on HVAC/R, commercial, and industrial process piping and equipment
- Ideal for outdoor applications: UV resistant, tear resistant, weather resistant
- 1-Step Install: No field applied protective coating or additional jacketing required
- High resistance to moisture vapor intrusion; low thermal conductivity
- Patent Pending
- CARTON QUANTITIES ONLY

MADE IN THE
USA

Specifications:

Temp Range: -70°F* (-57°C) to +220°F (+104°C)
 Flame/Smoke: ASTM E84 25/50-rated (to 1")
 Water Vapor Permeability: <0.01 perm-in
 Density: 3-6 lb/cubic ft
 Mold growth: None
 Ozone Resistance: Good

1/2" Wall Thickness					
PART NO.	INSULATION NOMINAL ID	CTS (NOM. ID PLUMBING)	CTS (OD HVAC/R)	IPS NOMINAL	FT/BOX
I91025	1/4"	--	1/4"	--	510'
I91038	3/8"	1/4"	3/8"	1/8"	456'
I91050	1/2"	3/8"	1/2"	1/4"	360'
I91058	5/8"	1/2"	5/8"	3/8"	324'
I91075	3/4"	5/8"	3/4"	--	270'
I91078	7/8"	3/4"	7/8"	1/2"	228'
I91118	1-1/8"	1"	1-1/8"	3/4"	156'
I91138	1-3/8"	1-1/4"	1-3/8"	1"	120'

3/4" Wall Thickness					
PART NO.	INSULATION NOMINAL ID	CTS (NOM. ID PLUMBING)	CTS (OD HVAC/R)	IPS NOMINAL	FT/BOX
I92050	1/2"	3/8"	1/2"	1/4"	228'
I92058	5/8"	1/2"	5/8"	3/8"	180'
I92075	3/4"	5/8"	3/4"	--	144'
I92078	7/8"	3/4"	7/8"	1/2"	126'
I92118	1-1/8"	1"	1-1/8"	3/4"	90'
I92138	1-3/8"	1-1/4"	1-3/8"	1"	78'
I92158	1-5/8"	1-1/2"	1-5/8"	1-1/4"	72'

C

Rubber Insulation Roll



- Closed cell flexible elastomeric foam insulation rolls
- For use on HVAC/R and industrial process ductwork, vessels, equipment and large ID piping (>8" IPS)
- High resistance to moisture vapor intrusion; low thermal conductivity
- For most indoor applications, no additional jacketing is required.
- Available as S2S (skin-two-side)
- UL GREENGUARD® Gold Certified as a low VOC material
- CARTON QUANTITIES ONLY



Specifications:

Temp Range: -297°F to 220°F (-182°C to 104°C)
 Flame/Smoke: ASTM E84 25/50-rated (to 2")
 Water Vapor Permeability: <0.01 perm-in
 Density: 3-6 lb/cubic ft
 Mold growth: None
 Ozone Resistance: Good

1/2" Wall Thickness		
PART NO.	DESCRIPTION	SQ FT/ BOX
IR1470	1/2" thick x 4' x 70' roll	280'
IR5415	2" thick x 4' x 15' roll	60'
I91138	1-3/8"	120'

Poly Pipe Insulation

CLOSED CELL FLEXIBLE FOAM INSULATION

UNDERGROUND APPLICATIONS

Poly pipe insulation is acceptable for use in buried applications when installed above the water table. Below the water table, lines must be encased in a conduit to protect them from problems associated with ground water intrusion and compaction.

INSTALLATIONS

Poly pipe insulation is flexible (even at low temperatures), durable (non-fracturing and skin is resistant to tearing from handling and environment), safe to handle (non-dusting and non-abrasive) and lightweight for an efficient installation. It is recommended that insulation be installed on nonoperational systems with clean, dry surfaces in ambient conditions between 40°F and 110°F. Properly sized tubing can be slid over piping and copper fittings or can be applied to existing lines using the seam-seal product. All butt joints, termination points, and open ends should be sealed with an approved contact depending on the requirements of the application, making sure both surfaces to be joined are coated. Longitudinal seams should face downward and vapor stops should be installed as needed. Fittings (elbows, tees, and p-traps) can be field-fabricated from insulation tubes and sheet. ASTM C1710, Installation Guide for Flexible Closed Cell Foams should be used as comprehensive installation guides.

RESISTANCE TO MOISTURE VAPOR FLOW

The closed cell structure and unique formulation inherently resists moisture vapor intrusion. For most indoor applications, poly pipe insulation needs no additional protection. Additional vapor barrier protection may be necessary when installed on cold systems located in high humidity environments.

FLAME AND SMOKE RATING

Poly pipe insulation in wall thicknesses of 1" (25mm) and below has a flame spread rating of 25 or less and a smoke development rating of 50 or less when tested per ASTM E84, "Surface Burning Characteristics of Building Materials". Numerical flammability ratings alone may not define the performance of products under actual fire conditions. They are provided only for use in the selection of products to meet specified limits.

SPECIFICATION COMPLIANCE

- ASTM C 1427 Type I Pipe, Type II Sheet (Specification for Extruded Preformed Flexible Cellular Polyolefin Thermal Insulation in Sheet and Tubular Form.)
- ASTM E84 25/50 rated (to 1") – tested according to UL 723. NFPA 255 NFPA 90A/B – Acceptable for plenum applications
- UL 94 HF-1 Flammability Classification (#E300774)
- Greenguard Gold Certified
- Contains no halogens
- Fiber Free
- Non-dusting

C



DESCRIPTION

Poly pipe insulation is a polyethylene based closed cell, flexible foam insulation meeting the requirements of ASTM C 1427. It is environmentally-friendly as it is free of CFCs, HFCs, HCFCs, PBDEs, formaldehyde and fibers. Poly pipe insulation contains no halogens. Poly pipe insulation has excellent thermal, physical, and chemical resistance properties as exhibited by its low thermal conductivity and low water absorption and water vapor permeability values.

APPLICATION

Poly pipe insulation is recommended for applications with service temperatures ranging from -200°F (-129°C) to +200°F (93°C). The product is used to retard heat gain or loss and prevent condensation on below-ambient applications including cold water plumbing, chilled water, and industrial process lines, among others. It also can be used to prolong the time to freezing and can be used with heat tracing tapes. It also retards heat loss from medium hot systems, including hot water plumbing. Poly pipe insulation is used in both residential and commercial applications.

OUTDOOR APPLICATION

Poly pipe insulation is designed for indoor or outdoor use. For UV exposure (rooftop applications) Poly pipe insulation must be protected with an approved coating or jacketed.

C

POLY PIPE INSULATION TECHNICAL DATA				
Physical properties	POLY PIPE INSULATION	Test methods	Required	Pass/Fail
Nominal Density, pcf	1.5 +/- 0.5	ASTM D 1622		
Specification		ASTM C 1427, Type I, Type II		
*Upper Use Limit, °F (°C)	200 (93)	ASTM C 411	200 (93)	Pass
Lower Use Limit, °F (°C)	-200 (-129)		-150 (-101)	Pass
Thermal Conductivity, Btu-in./hr-ft² °F (W/(m-K))		ASTM C 177 OR C 518		
75°F (24°C) Mean Temp	.27 (.039)		<0.35 (.050)	Pass
120°F (49°C) Mean Temp	.295 (.042)		<0.37 (.053)	Pass
Water Vapor Permeability	<0.05	ASTM E 96	0.05 max	Pass
Water Absorption Max %	<0.20	ASTM C 209	% by volume (0.20 max)	Pass
Linear Shrinkage at Max Use Temp (200°F)	-1.2%	ASTM C 1427	% change (2.0 max)	Pass
** Flame/Smoke Rating (max)* Up to and including 1" Thickness	25/50	ASTM E 84	25/50	Pass
Microbial Resistance	Excellent	ASTM G 21	No Growth	Pass
Fungi Resistance	Excellent	UL 181	No Growth	Pass
Odor Emission	None	ASTM C 1304	None	Pass
Corrosion Resistance (Steel, Copper, AL)	None	ASTM C 665	None	Pass
Ozone Resistance (50 mPa)	No Cracks	ASTM D 1171	No Cracks	Pass

* Meets the requirements of NFPA 90A/90B when tested at 250°F (125°C)
** Numerical flammability ratings alone may not define the performance of products under actual fire conditions. They are provided only for the use in the selection of products

POLY PIPE INSULATION THICKNESS RECOMMENDATIONS - TO PREVENT CONDENSATION												
SERVICE TEMPERATURE	50°F (10°C)			35°F (2°C)			0°F (-18°C)			-20°F (-29°C)		
Pipe Size	Mild	Normal	Severe	Mild	Normal	Severe	Mild	Normal	Severe	Mild	Normal	Severe
3/8" ID to 1-1/8" ID	3/8"	3/8"	3/4"	3/8"	1/2"	3/4"	1/2"	3/4"	-	1/2"	1"	-
1-3/8" ID to 4-1/2" ID	3/8"	3/8"	3/4"	3/8"	3/4"	1"	1/2"	1"	-	3/4"	-	-

Thickness listed for the specified ranges will prevent condensation on indoor piping under the defined design conditions. Normal 85°F and 70% R.H. Mild: Most air conditioned spaces and arid climates: 80°F and 50% R.H. Severe: Areas where excessive moisture is introduced or in poorly ventilated areas where the temperature may be depressed below the ambient: 90°F and 80% R.H.

RANGE

Wall Thickness (nominal) 3/8", 1/2", 3/4", and 1" - (10, 13, 19 and 25 mm)
 Inside Diameter, Tubular Form 3/8" - 4-1/2" ID - (10 mm ID to 114 mm ID)
 Length of Sections, Tubular Form 6' (1.83m)

POLY PIPE INSULATION "R" VALUES							
Nominal insulation I.D.	Copper tube size (nom. I.D. plumbing)	Copper tube size (O.D. HVAC/R)	IPS nominal	3/8"	1/2"	3/4"	1"
3/8"	1/4"	3/8"	1/8"	2.6	3.5	5.5	8.4
1/2"	3/8"	1/2"	1/4"	2.5	3.3	5.2	7.9
5/8"	1/2"	5/8"	3/8"	2.9	3.2	5.3	7.4
3/4"	5/8"	3/4"	1/2"	2.3	3.0	5.3	7.3
7/8"	3/4"	7/8"	-	2.2	3.1	5.3	7.0
1"	-	-	3/4"	2.2	3.1	5.2	7.2
1-1/8"	1"	1-1/8"	-	2.2	3.0	5.4	6.9
1-1/4"	1-1/8"	1-1/4"	-	2.2	3.2	5.3	6.8
1-3/8"	1-1/4"	1-3/8"	1"	2.1	3.1	5.1	7.2
1-5/8"	1-1/2"	1-5/8"	1-1/4"	2.4	3.0	5.0	6.9
2"	-	-	1-1/2"	2.3	2.9	4.8	6.6
2-1/8"	2"	2-1/8"	-	2.3	2.9	4.8	6.5
2-3/8"	-	-	2"	2.3	2.9	4.7	6.4
2-5/8"	2-1/2"	2-5/8"	-	2.2	3.0	4.6	6.2
2-7/8"	-	-	2-1/2"	2.2	3.0	4.5	6.1
3-1/8"	3"	3-1/8"	-	2.2	3.0	4.5	6.1
3-1/2"	-	-	3"	2.3	3.0	4.5	6.0
3-5/8"	3-1/2"	3-5/8"	-	2.3	3.1	4.5	6.0
4-1/8"	4"	4-1/8"	-	2.2	3.1	4.5	5.8
4-1/2"	-	-	4"	2.3	3.1	4.6	5.9

Semi-Slit Pipe Insulation



- Polyethylene-based closed cell, flexible foam insulation
- Semi-slit for retrofit applications
- For use on hot or cold plumbing lines
- For outdoor use, paint with a high quality exterior acrylic latex paint
- High resistance to moisture vapor intrusion; low thermal conductivity
- CARTON QUANTITIES ONLY

MADE IN THE USA

Specifications:

Temp Range: -200°F (-129°C) to +200°F (93°C)
 Flame/Smoke: ASTM E84 25/50-rated (to 1")
 Water Vapor Permeability: <0.05 perm-in
 Density: 1.5 +/- 0.5 lbs/cubic foot
 Mold growth: None
 Ozone Resistance: Good

3/8" Wall Thickness

PART NO.	INSULATION NOMINAL ID	R VALUES	CTS (NOM. ID PLUMBING)	IPS NOMINAL	FT/BOX
I50058	5/8"	2.9	1/2"	3/8"	396'
I50075	3/4"	2.3	5/8"	-	300'
I50078	7/8"	2.2	3/4"	1/2"	276'
I50118	1-1/8"	2.2	1"	3/4"	222'
I50138	1-3/8"	2.1	1-1/4"	1"	180'
I50158	1-5/8"	2.4	1-1/2"	1-1/4"	138'
I50178	2"	2.3	-	1-1/2"	126'
I50218	2-1/8"	2.3	2"	-	96'
I50258	2-5/8"	2.2	2-1/2"	-	72'

1/2" Wall Thickness

PART NO.	INSULATION NOMINAL ID	R VALUES	CTS (NOM. ID PLUMBING)	IPS NOMINAL	FT/BOX
I51058	5/8"	3.2	1/2"	3/8"	330'
I51078	7/8"	3.1	3/4"	1/2"	240'
I51118	1-1/8"	3.0	1"	3/4"	186'
I51138	1-3/8"	3.1	1-1/4"	1"	150'
I51158	1-5/8"	3.0	1-1/2"	1-1/4"	120'
I51178	2"	2.9	-	1-1/2"	102'
I51218	2-1/8"	2.9	2"	-	84'
I51238	2-3/8"	2.9	-	2"	72'
I51258	2-5/8"	3.0	2-1/2"	-	60'

3/4" Wall Thickness

PART NO.	INSULATION NOMINAL ID	R VALUES	CTS (NOM. ID PLUMBING)	IPS NOMINAL	FT/BOX
I54050	1/2"	5.2	3/8"	1/4"	210'
I54058	5/8"	5.3	1/2"	3/8"	180'
I54075	3/4"	5.3	5/8"	1/2"	162'
I54078	7/8"	5.3	3/4"	-	150'
I54118	1-1/8"	5.4	1"	-	120'
I54138	1-3/8"	5.1	1-1/4"	1"	96'
I54158	1-5/8"	5.0	1-1/2"	1-1/4"	84'
I54178	2"	4.8	-	1-1/2"	66'
I54218	2-1/8"	4.8	2"	-	54'
I54258	2-5/8"	4.6	2-1/2"	-	48'

1" Wall Thickness

PART NO.	INSULATION NOMINAL ID	R VALUES	CTS (NOM. ID PLUMBING)	IPS NOMINAL	FT/BOX
I55058	5/8"	7.4	1/2"	3/8"	120'
I55075	3/4"	7.3	5/8"	1/2"	120'
I55078	7/8"	7.0	3/4"	-	96'
I55118	1-1/8"	6.9	1"	-	84'
I55158	1-5/8"	6.9	1-1/2"	1-1/4"	60'
I55178	2"	6.6	-	1-1/2"	54'
I55218	2-1/8"	6.5	2"	-	54'

Self-Sealing Pipe Insulation



- Polyethylene-based closed cell, flexible foam insulation
- Two strips of self-adhesive seal easily at any length
- For use on hot or cold plumbing lines
- For outdoor use, paint with a high quality exterior acrylic latex paint
- High resistance to moisture vapor intrusion; low thermal conductivity
- CARTON QUANTITIES ONLY

MADE IN THE USA

Specifications:

Temp Range: -200°F (-129°C) to +200°F (93°C)
 Flame/Smoke: ASTM E84 25/50-rated (to 1")
 Water Vapor Permeability: <0.05 perm-in
 Density: 1.5 +/- 0.5 lbs/cubic foot
 Mold growth: None
 Ozone Resistance: Good

3/8" Wall Thickness

PART NO.	INSULATION NOMINAL ID	R VALUES	CTS (NOM. ID PLUMBING)	IPS NOMINAL	FT/BOX
I52058	5/8"	2.9	1/2"	3/8"	396'
I52034	3/4"	2.3	5/8"	-	300'
I52078	7/8"	2.2	3/4"	1/2"	276'
I52118	1-1/8"	2.2	1"	3/4"	222'
I52138	1-3/8"	2.1	1-1/4"	1"	180'
I52158	1-5/8"	2.4	1-1/2"	1-1/4"	138'
I52178	2"	2.3	-	1-1/2"	126'
I52218	2-1/8"	2.3	2"	-	96'
I52238	2-3/8"	2.3	-	2"	84'
I52258	2-5/8"	2.2	2-1/2"	-	72'
I52318	3-1/8"	2.2	3"	-	54'
I52358	3-5/8"	2.3	3-1/2"	-	42'

1/2" Wall Thickness

PART NO.	INSULATION NOMINAL ID	R VALUES	CTS (NOM. ID PLUMBING)	IPS NOMINAL	FT/BOX
I53038	3/8"	3.5	1/4"	-	414'
I53050	1/2"	3.3	3/8"	1/4"	336'
I53058	5/8"	3.2	1/2"	3/8"	300'
I53075	3/4"	3.0	3/4"	1/2"	264'
I53078	7/8"	3.1	3/4"	1/2"	240'
I53118	1-1/8"	3.0	1"	3/4"	186'
I53138	1-3/8"	3.1	1-1/4"	1"	150'
I53158	1-5/8"	3.0	1-1/2"	1-1/4"	120'
I53178	2"	2.9	-	1-1/2"	102'
I53218	2-1/8"	2.9	2"	-	84'
I53238	2-3/8"	2.9	-	2"	72'
I53258	2-5/8"	3.0	2-1/2"	-	60'
I53318	3-1/8"	3.0	3"	-	48'
I53312	3-1/2"	3.0	-	3"	36'
I53358	3-5/8"	3.1	3-1/2"	-	36'
I53418	4-1/8"	3.1	4"	-	30'
I53412	4-1/2"	3.1	-	4"	24'

3/4" Wall Thickness

PART NO.	INSULATION NOMINAL ID	R VALUES	CTS (NOM. ID PLUMBING)	IPS NOMINAL	FT/BOX
I56058	5/8"	5.3	1/2"	3/8"	180'
I56075	3/4"	5.3	5/8"	1/2"	162'
I56078	7/8"	5.3	3/4"	1/2"	150'
I56118	1-1/8"	5.4	1"	3/4"	120'
I56138	1-3/8"	5.1	1-1/4"	1"	96'
I56158	1-5/8"	5.0	1-1/2"	1-1/4"	84'
I56218	2-1/8"	4.8	2"	-	54'

1" Wall Thickness

PART NO.	INSULATION NOMINAL ID	R VALUES	CTS (NOM. ID PLUMBING)	IPS NOMINAL	FT/BOX
I57058	5/8"	7.4	1/2"	3/8"	120'
I57115	3/4"	7.3	5/8"	-	120'
I57078	7/8"	7.0	3/4"	1/2"	96'
I57118	1-1/8"	6.9	1"	-	84'
I57138	1-3/8"	7.2	1-1/4"	1"	72'
I57158	1-5/8"	6.9	1-1/2"	1-1/4"	60'
I57178	2"	6.6	-	1-1/2"	54'
I57218	2-1/8"	6.5	2"	-	54'
I57238	2-3/8"	6.4	-	2"	42'
I57258	2-5/8"	6.2	2-1/2"	-	36'

Poly Pipe Insulation Tees and Elbows



- Polyethylene-based closed cell, flexible foam insulation in factory-made fitting form
- For use on plumbing pipe bends, intersections and curvatures for hot or cold pipe
- Two strips of self-adhesive to seal easily
- CARTON QUANTITIES ONLY

MADE IN THE USA

Specifications:
 Temp Range: -200°F (-129°C) to +200°F (93°C)
 Flame/Smoke: ASTM E84 25/50-rated (to 1")
 Water Vapor Permeability: <0.05 perm-in
 Density: 1.5 +/- 0.5 lbs/cubic foot
 Mold growth: None
 Ozone Resistance: Good

PART NO.	DESCRIPTION	WALL THICKNESS	CTN/MSTR
I59050	1/2" tee	3/8"	1/16
I59075	3/4" tee	3/8"	1/12
I59100	1" tee	3/8"	1/12
I59125	1-1/4" tee	3/8"	1/8
I59150	1/2" elbow	3/8"	1/32
I59175	3/4" elbow	3/8"	1/20
I59200	1" elbow	3/8"	1/16
I59225	1-1/4" elbow	3/8"	1/12

Insulation Contact Adhesive



- Air-drying, solvent-based adhesives for joining seams and joints.
- Brush top can
- Fast tack drying time: 2-4 minutes
- Slow tack drying time: 5-10 minutes minimum
- MOTOR FREIGHT ONLY/FLAMMABLE
- CARTON QUANTITIES ONLY

PART NO.	DESCRIPTION	CTN/MSTR
IA1050	1/2 pint Fast tack, Amber	48/48
IA1100	1 pint Fast tack, Amber	24/24
IA2050	1/2 pint Slow tack, Blue	48/48
IA2100	1 pint Slow tack, Blue	24/24

Insulation Protective Coating



ur-based coating that provides UV protection on closed cell rg and sheet insulation. sts UV for 2-3 years

PART NO.	DESCRIPTION	CTN/MSTR
IPC004	1 gallon, White	1/4

Insulation Tape



erior pressure sensitive adhesive il for short runs of pipes or valves

PART NO.	DESCRIPTION	CTN/MSTR
INT001	1/8" x 2" x 30' Cork tape, Black	1/12
INT002	1/8" x 2" x 30' Foam tape, Black	1/12

Flanged Dielectric Union



- Temperature range: 180°F at 200 PSI
- Maximum temperature 200°F
- Lead free

PART NO.	FIP x COPPER SWEAT	CTN/MSTR
D06250	2-1/2" x 2-1/2"	1/4
D06300	3" x 3"	1/4
D06400	4" x 4"	1/2

Items marked with the Jones Stephens logo are "You Need It... We Got It" Items.

Thermal Expansion Tank



- Designed for the protection of potable hot water systems
- Install between the backflow preventer and the water heater
- Six year warranty

SPECIFICATIONS:

Factory pre-charge: 35psi
 System connection: 304 Stainless Steel
 Diaphragm: Butyl Rubber
 Liner Material: Food Grade Polypropylene
 Max. Operating Temperature: 200°F
 Max. Operating Pressure: 150psi

PART NO.	DESCRIPTION	CTN. QTY.	PALLET QTY.
R15202	2 gallon tank	1	150
R15204	4-1/2 gallon tank	1	80

Water Heater Grounding Kit



- Kit includes 2 bare bronze clamps
- Fits 1/2" to 1" pipe
- 6 gauge copper wire

PART NO.	DESCRIPTION	CTN/MSTR
J36500	Kit with 12" copper wire	1/6
J36501	Kit with 24" copper wire	1/6

Dielectric Union



Female x Sweat



Male x Sweat

- Zinc plated forged steel
- Prevents electrolysis or galvanic action when connecting dissimilar metals
- Residential or commercial use
- Solder ends conform to ANSI B16.19
- EPDM washer, ABS fiber sleeve
- Threads conform to ANSI B2.1
- Pressure rated at 250 PSI at 180°F
- Lead Free

PART NO.	FIP x COPPER SWEAT	OD	CTN/MSTR
D06050	1/2" x 1/2"	5/8"	24/144
D06075	3/4" x 3/4"	7/8"	24/96
D06100	1" x 1"	1-1/8"	12/96
D06125	1-1/4" x 1-1/4"	1-3/8"	6/48
D06150	1-1/2" x 1-1/2"	1-5/8"	6/48
D06200	2" x 2"	2-1/8"	6/18

PART NO.	FIP x COPPER SWEAT	OD	CTN/MSTR
D06350	3/4" x 1/2"	5/8"	24/96

PART NO.	MIP x COPPER SWEAT	OD	CTN/MSTR
D06005	1/2" x 1/2"	7/8"	24/96
D06750	3/4" x 3/4"	7/8"	24/96

PART NO.	MIP x COPPER SWEAT	OD	CTN/MSTR
D06755	3/4" x 1/2"	5/8"	24/72

Universal Copper Thermocouple



- All copper with brass fittings
- Adaptable to 5 different pilot valves
- Kit includes 2 clips and nuts
- Individually carded

PART NO.	DESCRIPTION	CTN/MSTR
J36118	18" copper thermocouple	10/100
J36124	24" copper thermocouple	10/100
J36130	30" copper thermocouple	1/10
J36136	36" copper thermocouple	1/10
J36148	48" copper thermocouple	1/10

Gasket and Insert for Dielectric Union



Insert



Gasket

- For water
- 200°F temperature rating
- CARTON QUANTITIES ONLY

PART NO.	DESCRIPTION	CTN/MSTR
D06800	1/2" insert	25/600
D06801	3/4" insert	25/600
D06802	1" insert	25/400
D06803	1-1/4" insert	25/400
D06804	1-1/2" insert	25/200
D06805	2" insert	25/100
D06850	1/2" gasket	10/1000
D06875	3/4" gasket (EPDM rubber)	10/1000
D06900	1" gasket	10/1000
D06901	1-1/4" gasket	10/1000
D06902	1-1/2" gasket	10/1000
D06903	2" gasket	10/1000

Dielectric Nipple



- Electroplated steel casing with non-corrosion thermoplastic lining • 180° maximum temperature
- Prevents corrosion, lime and scale buildup
- Adds years of life to any water system
- For use on water heaters, dishwashers, water filtration systems

PART NO.	SIZE	CTN/MSTR
D06753	3/4" MIP x 3" length	50/100
D06450	1/2" MIP x 3" length	50/100
D06500	1" MIP x 3" length	25/50
D06510	1" MIP x 4" length	25/50
D06525	1-1/4" MIP x 4" length	25/50
D06550	1-1/2" MIP x 4" length	5/25
D06600	2" MIP x 4" length	5/25
D06650	2-1/2" MIP x 6" length	5/10
D06700	3" MIP x 6" length	5/10

Braided Stainless Steel Water Heater Connector

- UPC listed
- Lead Free



PART NO.	FIP x LENGTH	CTN/MSTR
S04350	3/4" x 12"	10/40
S04351	3/4" x 18"	10/40
S04352	3/4" x 24"	10/40



PART NO.	FIP x COMP x LENGTH	CTN/MSTR
S04353	3/4" x 3/4" x 12"	10/40
S04354	3/4" x 3/4" x 18"	10/40
S04355	3/4" x 3/4" x 24"	10/40



PART NO.	FIP x MIP x LENGTH	CTN/MSTR
S04356	3/4" x 3/4" x 12"	10/40
S04357	3/4" x 3/4" x 18"	10/40
S04358	3/4" x 3/4" x 24"	10/40



PART NO.	MIP x COMP x LENGTH	CTN/MSTR
S04359	3/4" x 3/4" x 12"	10/40
S04360	3/4" x 3/4" x 18"	10/50

Corrugated Water Heater Connector

- Corrugated for easy flex on water heaters and softeners
- Includes rubber washers



Copper



PART NO.	FPT x LENGTH	CTN/MSTR
J34712	3/4" x 12"	1/50
J34715	3/4" x 15"	1/50
J34718	3/4" x 18"	1/50
J34724	3/4" x 24"	1/50



PART NO.	FIP x SWT x LENGTH	CTN/MSTR
J35712	3/4" x 3/4" x 12"	25/50
J35715	3/4" x 3/4" x 15"	25/50
J35718	3/4" x 3/4" x 18"	25/50
J35724	3/4" x 3/4" x 24"	25/50

Stainless Steel



PART NO.	MIP x FIP x LENGTH	CTN/MSTR
J38712	3/4" x 3/4" x 12"	25/50
J38715	3/4" x 3/4" x 15"	25/50
J38718	3/4" x 3/4" x 18"	25/50
J38724	3/4" x 3/4" x 24"	25/50



PART NO.	FIP x FIP x LENGTH	CTN/MSTR
J39712	3/4" x 3/4" x 12"	25/50
J39715	3/4" x 3/4" x 15"	25/50
J39718	3/4" x 3/4" x 18"	25/50
J39724	3/4" x 3/4" x 24"	25/50

Plumbite® Push On Water Heater Connector



- Heat-free method for joining copper, CPVC, PEX or PE-RT tubing
- Ideal for piping systems service and repair
- No soldering, glue, heat or external tools required to join the pipe
- Secure connection and seal with stainless steel gripper ring and EPDM o-ring
- Maximum temperature is 180°F and maximum pressure is 200 PSI
- Can be disassembled and re-used using the disassembly tool (sold separately)
- Standards/Certifications: NSF/ANSI 61, NSF/ANSI 372, NSF/ANSI 14, ASSE 1061, UPC, cUPC and IAPMO
- Lead free



PART NO.	PF x FIP x LENGTH	CTN/MSTR
C76605LF	1/2" x 3/4" x 12"	10/40
C76606LF	1/2" x 3/4" x 15"	10/40
C76612LF	3/4" x 3/4" x 12"	10/40
C76613LF	3/4" x 3/4" x 15"	10/40
C77478LF	3/4" x 3/4" x 18"	10/40
C77479LF	3/4" x 3/4" x 24"	10/40
C76616LF	1/2" valve x 3/4" x 18"	10/40
C77477LF	3/4" valve x 3/4" x 18"	10/40

Items marked with the Jones Stephens logo are "You Need It... We Got It" Items.

Water Heater Stand



- 16 gauge galvanized steel
- Heavy duty
- Corrosion resistant
- Top 21.5" x 21.5"
- Rated up to 650 pounds
- For water heaters up to 52 gallons
- Includes mounting clips for securing to wall/floor
- Quick assembly
- Meets UPC and IPC requirements

PART NO.	DESCRIPTION	CTN/MSTR
J36400	21-1/2" square x 16" high water heater stand	1/1



- 18 gauge galvanized steel
- Corrosion resistant
- Top 18" x 18"
- Rated up to 2,000 pounds
- For water heaters up to 29 gallons
- Quick assembly
- Meets UPC and IPC requirements

PART NO.	DESCRIPTION	CTN/MSTR
J36200	18" square x 17" high water heater stand	1/4



- 1 in. sq. tubular steel
- Heavy duty
- Corrosion resistant
- Rated up to 2200 pounds
- For water heaters up to 100 gallons
- No assembly required

PART NO.	DESCRIPTION	CTN/MSTR
J36300	25-1/4" x 19" high water heater stand	1/1
J36250	28-3/8" x 18-3/8" high water heater stand	1/1

Water Heater Safety Pan



- High impact plastic
- 1" pan adapter (J34800) included
- 2-1/2" depth
- Southern Building Code and natural gas approved
- CARTON QUANTITIES ONLY

PART NO.	BOTTOM ID	TOP ID	CTN/MSTR
J36018	19"	20-1/2"	1/10
J36022	22"	22-1/2"	1/10
J36024	24"	25-1/2"	1/10
J36026	26"	27-1/2"	1/10
J36030	30"	31-1/2"	1/5

Galvanized Hot Water Heater Pan



- 24 gauge
- Flared sides
- 1" pan adapter (J34800) included

PART NO.	DESCRIPTION	CTN/MSTR
J37022	22" x 22" x 4" water heater pan	1/1
J37024	24" x 24" x 4" water heater pan	1/1
J37026	26" x 26" x 4" water heater pan	1/1
J37028	28" x 28" x 4" water heater pan	1/1
J37030	30" x 30" x 4" water heater pan	1/1

Water Heater Pan

CORNERS FOLDED FOR STRENGTH



Seamless Galvanized Corner



- Seamless galvanized water heater pans are folded not welded
- 1" pan adapter (J34800) included
- One piece stamped aluminum .032 mil (20 gauge)
- Aluminum pans comply with SBCCI, sec. 1213.7

PART NO.	DESCRIPTION	CTN/MSTR
J38020	20" round water heater pan (aluminum)	1/6
J38022	22" round water heater pan (aluminum)	1/6
J38024	24" round water heater pan (aluminum)	1/6
J38026	26" round water heater pan (aluminum)	1/6
J38030	30" round water heater pan (aluminum)	1/5

Water Heater Pan Adapter



- 1" PVC
- Washer and locknut
- Fits all Jones Stephens pans

PART NO.	DESCRIPTION	CTN/MSTR
J34800	1" Adapter	1/25

Run-Off Tube



- For water heaters
- Electroplated fittings
- 230°F temperature rating
- Hand tighten to T and P valve
- Meets AMSE A112.4.1
- UL listed
- J34970 is sold in CARTON QUANTITIES ONLY



PART NO.	DESCRIPTION	CTN/MSTR
J34975	3/4" NPT x 60" side mount	1/100
J34980	3/4" NPT top mount	1/25
J34970	3/4" NPT x 60" side mount	12/12

Gas Testing Equipment



- Large 4" face
- Class 1A gauge
- 5 lb. gas test gauge/15 lb. gas test gauge
- 1/10 # increments
- Inches of mercury scale
- External set hand
- Bellows design
- 1/4 NPT connection
- Gauge meets all requirements of the City of Houston code Word 94-108, Section 1204.3.2, revised January 18, 2001
- Individually boxed
- ALL SALES FINAL; NO WARRANTY; NO RETURN

PART NO.	DESCRIPTION	CTN/MSTR
G60055	15 lb. gas test gauge only	1/20
G60005	5 lb. gas test gauge only	1/20

Liquid Filled Pressure Gauge



- Polished 304 stainless steel case with vent plug
- 2-1/2" face (glass)
- +/- 1.5% accuracy
- Glycerin filled for use where vibration or pressure pulsation occur
- -50 to 150°F operating temperature
- 1/4" NPT bottom connection
- Individually boxed

PART NO.	DESCRIPTION	CTN/MSTR
J40553	0-30 PSI	1/50
J40554	0-60 PSI	1/50
J40555	0-100 PSI	1/50
J40556	0-200 PSI	1/50
J40557	0-300 PSI	1/50

Pressure Gauge



- Steel case
- Shatterproof face
- 1/4" MIP brass lower connection
- Applicable with air, water, oil and gas - anything which does not attack brass
- Not for use on oxygen service
- Class 2.5-2% accuracy
- Individually boxed

PART NO.	FACE SIZE	PRESSURE RATING	CTN/MSTR
G60015	2"	15 PSI	1/100
G60030	2"	30 PSI	1/100
G60060	2"	60 PSI	1/100
G60100	2"	100 PSI	1/100
G60160	2"	160 PSI	1/100
G60200	2"	200 PSI	1/100
G60300	2"	300 PSI	1/100
G61015	2-1/2"	15 PSI	1/100
G61030	2-1/2"	30 PSI	1/60
G61060	2-1/2"	60 PSI	1/100
G61100	2-1/2"	100 PSI	1/100
G61160	2-1/2"	160 PSI	1/100
G61200	2-1/2"	200 PSI	1/100
G61300	2-1/2"	300 PSI	1/100
G62030	3-1/2"	30 PSI	1/50
G62060	3-1/2"	60 PSI	1/50
G62100	3-1/2"	100 PSI	1/50
G62200	3-1/2"	200 PSI	1/50
G62300	3-1/2"	300 PSI	1/50

Pigtail Syphon



- Steel construction
- For use with gauges on steam line
- 1/4" MPT x 1/4" MPT

PART NO.	DESCRIPTION	CTN/MSTR
G60000	Straight	20/200
G60001	90° Angle	10/200

Water Test Gauge



- Steel case with 2-1/2" shatterproof face
- 3/4" female brass hose connection
- Individually boxed

PART NO.	DESCRIPTION	CTN/MSTR
J66300	300 PSI	1/50
J66301	300 PSI with indicator arm	1/50
J66302	160 PSI with indicator arm	1/50

Silcock/Water or Gas Test Gauge Assembly



- Steel case with 2" shatterproof face
- Brass air valve
- Adapts to 3/4" male garden hose or 3/4" MIP
- Comes with garden hose adapter
- Individually boxed

PART NO.	DESCRIPTION	CTN/MSTR
G64101	200 PSI	1/50

5 Pound Gas Test Gauge



- 1/4" NPT
- 2-1/2" diaphragm
- 1/10 # increments
- For building code inspection
- Individually boxed

PART NO.	DESCRIPTION	CTN/MSTR
G61005	5 lb. gas test gauge	1/100

Gas Test Gauge



- 2" steel case gauge on 15 lb.
- 5 lb. is marked in 1/10 lb. increments
- 15 lbs. is marked in 1/10 lb. increments
- Plated body with 3/4" FIP inlet
- 2 1/2" diaphragm on 5 lb.
- Adapts to 3/4" MPT
- Brass air valve
- Individually boxed

PART NO.	DESCRIPTION	CTN/MSTR
G64015	15 lb. gas test gauge assembly	1/50
G64005	5 lb. gas test gauge assembly	1/50

Test Gauge Assembly



- Bell type
- Individually boxed

PART NO.	DESCRIPTION	CTN/MSTR
G66015	15# x 3/4" FIP	1/50
G66030	30# x 3/4" FIP	1/50
G66060	60# x 3/4" FIP	1/50
G66100	100# x 3/4" FIP	1/24
G67015	15# x 1" FIP	1/50
G67030	30# x 1" FIP	1/50
G67060	60# x 1" FIP	1/50
G67100	100# x 1" FIP	1/100
G66000	3/4" Bell body (less air valve)	1/100
G66002	3/4" Bell body (with air valve)	1/100
G67000	1" Bell body (less air valve)	1/59
G67002	1" Bell body (with air valve)	1/80

Items marked with the Jones Stephens logo are "You Need It... We Got It" Items.

Gas Test Gauge Assembly



- 4" face and pressure snubber
- Regulates air to an even flow
- Over pressurization will void the warranty
- Protects the diaphragm from compressed air damage
- Class 1A gauge
- Individually boxed

PART NO.	DESCRIPTION	CTN/MSTR
G64155	5 lb. test gauge assembly	1/20
G65155	15 lb. test gauge assembly	1/20

Gas Test Gauge Assembly



- Steel case with 2" shatterproof face
- Adapts to 3/4" MPT
- Plated body with 3/4" FIP inlet
- Brass air valve
- Individually boxed

PART NO.	DESCRIPTION	CTN/MSTR
G64030	30 PSI	1/50
G64060	60 PSI	1/50
G64100	100 PSI	1/50
G64160	160 PSI	1/50
G64200	200 PSI	1/50
G64333	300 PSI	1/50
G64000	1/4" air valve and cap	50/500
G64001	Gas test body only	1/100
G64002	1/8" air valve and cap	500/1000
G64020	Gas test body and air valve assembly	1/100

Tridicator



- 0-55 PSI
- 70°F to 250°F temperature range
- Back mount

PART NO.	DESCRIPTION	CTN/MSTR
J40550	2 1/2" face angle 2 1/4" stem (1/4" NPT)	1/50
J40551	2 1/2" face angle 2 1/2" stem (1/4" NPT)	1/50
J40558	2 1/2" face angle 1" stem (1/4" NPT)	1/50
J40560	3 1/2" face angle 2 3/4" stem (1/2" NPT)	1/50

Dual Scale Boiler Gauge



- 0-75 PSI
- 1/4" MIP connection
- -60-320° F, 20-160° C
- Center back mount
- 3-1/2" face

PART NO.	DESCRIPTION	CTN/MSTR
J40575	Dual scale boiler gauge	1/100

Vacuum Gauge



- 1/4" brass lower connection
- -30 to 0 inch Hg
- Black steel case with bronze internals
- 2" face

PART NO.	DESCRIPTION	CTN/MSTR
G63001	Vacuum gauge	1/100

Items marked with the Jones Stephens logo are "You Need It... We Got It" Items.

Pressure Snubber



- Bronze body and core
- Use on lines with noticeable pressure changes/oscillations
- 1000 PSI maximum

PART NO.	DESCRIPTION	CTN/MSTR
G64300	1/4" NPT for air or gas	1/500
G64301	1/4" NPT for oil, steam or water	1/200

Needle Valve for Pressure Gauge



- Brass body, seat, stem and handle
- 1/4" NPT
- 300°F maximum temperature
- Female x female
- Teflon packing
- 2000 PSI

PART NO.	DESCRIPTION	CTN/MSTR
G64004	1/4" needle valve	1/125

Hot Water/Refrigerant Line Thermometer

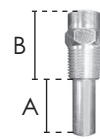

- Straight or angle pattern
- Steel or brass well included
- 40°-280°F x 5°F (5-120°C x 2°C)
- 1/2" NPT; 1" stem

PART NO.	DESCRIPTION	DIM (A)	DIM (B)	CTN/MSTR
J40500	Straight pattern with steel well	1"	1/2" NPT	1/50
J40501	Straight pattern with brass well	1"	1/2" NPT	1/50
J40502	Angle pattern with steel well	1"	1/2" NPT	1/50
J40503	Angle pattern with brass well	1"	1/2" NPT	1/50

Dial Thermometer



- 2-1/2" face
- 5° increments
- Dual scale: 40°-240°/0°-120°C
- Brass wells/removable thermometers
- Thermometers are not supplied with wells

SWT Connection

MIP Connection

PART NO.	DESCRIPTION	CTN/MSTR
J40702	3/4" SWT connection	1/50
J40703	1/2" MIP connection	1/100
J40704	3/4" SWT well	1/100
J40705	1/2" MIP well	1/100

Pocket Test Thermometer



- 2% accuracy for hot and cold
- Pocket clip on sheath; 5" stem

PART NO.	DESCRIPTION	CTN/MSTR
J40700	Cold thermometer (-40° to 160°F)	1/80
J40701	Hot thermometer (0° to 220°F)	1/80

Weksler Industrial Multi-Angle Thermometer

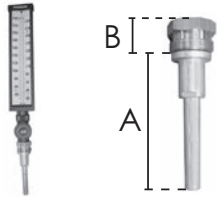

- Must have well - no well provided; order wells separately
- 9" scale, red-reading mercury tubes
- Molded cyclocac case with glass window
- Adjustable to any angle
- Accurate to +/- one scale division

PART NO.	DESCRIPTION	DIM (A)	DIM (B)	CTN/MSTR
J40505	Hot water 30°-240°F	3-1/2" stem	1" NPSM	1/50
J40506	Cold water 0°-120°F	3-1/2" stem	1" NPSM	1/25
J40510	Standard brass well	2-1/2" stem	3/4" NPT	1/50
J40511	Extended well	1-3/4" stem	3/4" NPT	1/50

Bi-Metal Dial Thermometer

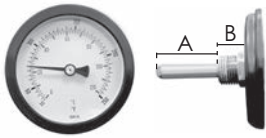

- For commercial or home heating systems
- 1/2" NPT
- 20°-240°F temperature range
- 3" dial in steel case
- Angle has back connection; straight has bottom connection

PART NO.	DESCRIPTION	DIM (A)	DIM (B)	CTN/MSTR
J40561	Angle outlet with brass well	2-3/8" stem	1/2" NPT	1/50
J40562	Straight outlet with brass well	2-3/8" stem	1/2" NPT	1/50



- Solid brass construction
- 1-1/2" stem
- 1/2" MPT x 1/4" FPT threads

PART NO.	DESCRIPTION	CTN/MSTR
J40563	Brass well for J40562	1/200

Natural Polyethylene Tubing



- Non-toxic, 100% virgin material
- 100' coil in dispenser box
- FDA grade
- -40°F to +135°F
- Low density

PART NO.	OD	ID	PSI	WALL	FT/BOX	CTN/MSTR
T25250	1/4"	.170"	120	.040	100'	1/1
T25312	5/16"	.187"	150	.040	100'	1/1
T25375	3/8"	.250"	125	.062	100'	1/1
T25500	1/2"	.375"	95	.062	100'	1/1
T25625	5/8"	.500"	75	.500	100'	1/1

Clear Vinyl Tubing



- 75 duro clear
- 100' coil in dispenser box
- -5°F to +125°F
- Self-dispensing cartons
- FDA grade

PART NO.	OD	ID	WALL	WPPSI	FT/BOX	CTN/MSTR
T26124	3/16"	1/8"	1/32"	50	100'	1/1
T26125	1/4"	1/8"	1/16"	80	100'	1/1
T26186	1/4"	3/16"	1/32"	40	100'	1/1
T26187	5/16"	3/16"	1/16"	60	100'	1/1
T26250	3/8"	1/4"	1/16"	55	100'	1/1
T26252	1/2"	1/4"	1/8"	90	100'	1/1
T26312	7/16"	5/16"	1/16"	50	100'	1/1
T26313	1/2"	5/16"	3/32"	60	100'	1/1
T26375	1/2"	3/8"	1/16"	45	100'	1/1
T26376	9/16"	3/8"	3/32"	55	100'	1/1
T26377	5/8"	3/8"	1/8"	65	100'	1/1
T26498	5/8"	1/2"	1/16"	30	100'	1/1
T26500	3/4"	1/2"	1/8"	45	100'	1/1
T26626	3/4"	5/8"	1/16"	30	100'	1/1
T26625	7/8"	5/8"	1/8"	40	100'	1/1
T26750	1"	3/4"	1/8"	35	100'	1/1
T26875	1 1/8"	7/8"	1/8"	30	50'	1/1
T26000	1 1/4"	1"	1/8"	28	50'	1/1

Soft Aluminum Tubing



- 50' coils
- Alloy 3003-0, ASTM B-483

PART NO.	OD	WALL	CTN/MSTR
T27125	1/8"	.025	1/10
T27188	3/16"	.028	1/10
T27250	1/4"	.032	1/10
T27313	5/16"	.035	1/10
T27375	3/8"	.035	1/10
T27438	7/16"	.035	1/10
T27500	1/2"	.035	1/10
T27625	5/8"	.035	1/10

Items marked with the Jones Stephens logo are "You Need It...We Got It" Items.

Self-Nailing Stud Guards

- Protects piping and wiring from nails
- CARTON QUANTITIES ONLY

MADE IN THE
USA



PART NO.	SIZE	GAUGE	CTN/MSTR
S16003	1-1/2" x 3"	16	100/100
S16015	1-1/2" x 4"	16	100/100
S16005	1-1/2" x 5"	16	100/100
S33005	1-1/2" x 6"	16	100/100
S16009	1-1/2" x 9"	16	100/100
S16012	1-1/2" x 12"	16	100/100
S16018	1-1/2" x 18"	16	50/50
S16024	1-1/2" x 24"	16	25/25
S33036	2" x 5"	16	100/100
S33035	3" x 5"	16	100/100
S16008	5" x 8"	16	50/50
S33002	1-1/2" x 3"	18	100/100
S33006	1-1/2" x 5"	18	100/100
S33001	1-1/2" x 6"	18	100/100
S33038	3" x 5"	18	100/100
S16007	1-1/2" x 5"	20	100/100
S16014	1-1/2" x 8"	20	100/100
S20009	1-1/2" x 9"	20	100/100
S20012	1-1/2" x 12"	20	100/100
S33011	1-1/2" x 3"	22	100/100
S33010	1-1/2" x 6"	22	100/100



PART NO.	SIZE	GAUGE	CTN/MSTR
S33037	4" x 5"	16	100/100
S16010	5" x 8"	16	25/25



PART NO.	SIZE	GAUGE	CTN/MSTR
S33039	3" x 5" offset	16	100/100
S16001	3" x 5" offset	18	25/25
S16002	5" x 6" offset	16	50/50



PART NO.	SIZE	GAUGE	CTN/MSTR
S33007	1-1/2" x 6"	16	100/100
S33016	3-1/2" x 6"	16	25/25
S16004	1-1/2" x 6"	18	100/100
S33004	1-1/2" x 6"	20	100/100



PART NO.	SIZE	GAUGE	CTN/MSTR
S16011	5" x 8"	16	25/25
S180032	1-1/2" x 3"	18	200/200



PART NO.	SIZE	GAUGE	CTN/MSTR
S33013	5" x 8"	16	25/25

Not Self-Nailing Stud Guards

- Protects piping and wiring from nails
- CARTON QUANTITIES ONLY

MADE IN THE
USA



PART NO.	SIZE	GAUGE	CTN/MSTR
S16006	1-1/2" x 6"	16	100/100
S16016	1-1/2" x 6"	18	100/100



PART NO.	SIZE	GAUGE	CTN/MSTR
F12001	3-1/2" x 6"	16	25/25



PART NO.	SIZE	GAUGE	CTN/MSTR
S33012	3-1/2" x 6"	16	100/100
S33318	3-1/2" x 18"	16	25/25



PART NO.	SIZE	GAUGE	CTN/MSTR
S16017	3-1/2" x 6"	16	25/25



PART NO.	SIZE	GAUGE	CTN/MSTR
S33003	5" x 8"	16	50/50



PART NO.	SIZE	GAUGE	CTN/MSTR
S163566	3-1/2" x 6"	16	25/25



PART NO.	SIZE	GAUGE	CTN/MSTR
F12004	3" x 18"	16	50/50



PART NO.	SIZE	GAUGE	CTN/MSTR
F12003	3-1/2" x 18"	16	25/25



PART NO.	SIZE	GAUGE	CTN/MSTR
F12002	5" x 18"	16	15/15



PART NO.	SIZE	GAUGE	CTN/MSTR
S33518	5" x 18"	16	15/15

C

F.H.A. Straps

• CARTON QUANTITIES ONLY

MADE IN THE
USA



• Four holes

PART NO.	SIZE	GAUGE	CTN/MSTR
F165181	5" x 18"	16	15/15



• Two holes

PART NO.	SIZE	GAUGE	CTN/MSTR
F180032	1-1/2" x 3"	18	200/200



• Six holes

PART NO.	SIZE	GAUGE	CTN/MSTR
F160123	1-1/2" x 12"	16	50/50
F160183	1-1/2" x 18"	16	50/50
F160243	1-1/2" x 24"	16	50/50
F160363	3" x 6"	16	50/50
F160393	3" x 9"	16	50/50
F160063	1-1/2" x 6"	16	50/50
F160093	1-1/2" x 9"	16	50/50



• Eight offset holes

PART NO.	SIZE	GAUGE	CTN/MSTR
F12009	1-1/2" x 9"	12	50/50
F12012	1-1/2" x 12"	12	50/50
F12018	1-1/2" x 18"	12	50/50
F12024	1-1/2" x 24"	12	50/50
F14012	1-1/2" x 12"	14	50/50
F16012	1-1/2" x 12"	16	50/50
F160184	1-1/2" x 18"	16	50/50
F160094	1-1/2" x 9"	16	50/50
F18009	1-1/2" x 9"	18	100/100
F18012	1-1/2" x 12"	18	100/100
F18018	1-1/2" x 18"	18	100/100
F18024	1-1/2" x 24"	18	100/100



• Twelve offset holes

PART NO.	SIZE	GAUGE	CTN/MSTR
F160126	1-1/2" x 12"	16	50/50
F16016	1-1/2" x 16"	16	50/50
F160186	1-1/2" x 18"	16	50/50
F160246	1-1/2" x 24"	16	50/50
F163186	3" x 18"	16	50/50
F163246	3" x 24"	16	50/50
F165186	5" x 18"	16	15/15



• Twelve holes

PART NO.	SIZE	GAUGE	CTN/MSTR
F18309	3" x 9"	18	50/50
F18312	3" x 12"	18	50/50
F18318	3" x 18"	18	50/50
F18324	3" x 24"	18	50/50

Stud Shoes

MADE IN THE
USA



- 4 nail holes on each side
- Pipe opening accommodates 2" IPS or smaller pipe
- Stud/Joist reinforcement when drilling or notching for pipe runs
- CARTON QUANTITIES ONLY

PART NO.	DESCRIPTION	GAUGE	CTN/MSTR
S33021	Single stud shoe	18	50/50
S33022	Double stud shoe	18	25/25
S33023	Triple stud shoe	18	10/10
S33024	Single stud shoe	16	50/50
S33025	Double stud shoe	16	25/25
S33026	Triple stud shoe	16	10/10

Copper Stub Out Elbow



- Connects to ASTM F1960 (Cold Expansion Style) PEX
- Closed end for pressure testing
- cUPC approved for use in USA and Canada
- ANSI/NSF 61 & ANSI/NSF 372 approved for drinking water



PART NO.	DESCRIPTION	CTN/MSTR
S71000	1/2" Cold Expansion PEX (F1960), 13" x 8"	1/50
S71001	1/2" Cold Expansion PEX (F1960), 4" x 8"	1/50
S71002	3/4" Cold Expansion PEX (F1960), 6" x 8"	1/25
S71003	1" Cold Expansion PEX (F1960), 6" x 12"	1/25



- Connects to ASTM 1870 (Crimp Style) PEX
- Closed end for pressure testing
- cUPC approved for use in USA and Canada
- ANSI/NSF 61 & ANSI/NSF 372 approved for drinking water



PART NO.	DESCRIPTION	CTN/MSTR
S72000	1/2" Crimp PEX (F1807), 3-1/2" x 6"	1/50
S72001	1/2" Crimp PEX (F1807), 3-1/4" x 8"	1/50
S72002	1/2" Crimp PEX (F1807), 3-1/2" x 12"	1/50
S72003	1/2" Crimp PEX (F1807), 13" x 8"	1/25
S72004	3/4" Crimp PEX (F1807), 4-1/2" x 8"	1/50
S72005	3/4" Crimp PEX (F1807), 4-1/2" x 12"	1/50
S72006	3/4" Crimp PEX (F1807), 13" x 6"	1/25
S72007	1" Crimp PEX (F1807), 6" x 8"	1/25
S72008	1" Crimp PEX (F1807), 6" x 12"	1/25



- Connects to CPVC tubing (Solvent Weld)
- Closed end for pressure testing
- cUPC approved for use in USA and Canada
- ANSI/NSF 61 & ANSI/NSF 372 approved for drinking water



PART NO.	DESCRIPTION	CTN/MSTR
S73000	1/2" CPVC, 3-1/2" x 12"	1/50
S73001	1/2" CPVC, 8" x 7"	1/50
S73002	3/4" CPVC, 6" x 8"	1/50
S73003	3/4" CPVC, 6" x 12"	1/25
S73004	1" CPVC, 11" x 10"	1/25

Copper Stub Out Elbow with Mounting Flange



- Connects to ASTM F1960 (Cold Expansion Style) PEX
- Closed end for pressure testing
- Flange for nailing to a stud
- cUPC approved for use in USA and Canada
- ANSI/NSF 61 & ANSI/NSF 372 approved for drinking water



PART NO.	DESCRIPTION	CTN/MSTR
S71004	1/2" Cold Expansion PEX (F1960) Double, 7" x 8"	1/25
S71005	1/2" Cold Expansion PEX (F1960), 4" x 8"	1/25
S71006	3/4" Cold Expansion PEX (F1960), 6" x 8"	1/25
S71007	1" Cold Expansion PEX (F1960), 6" x 12"	1/25



- Connects to ASTM 1870 (Crimp Style) PEX
- Closed end for pressure testing
- Flange for nailing to a stud
- cUPC approved for use in USA and Canada
- ANSI/NSF 61 & ANSI/NSF 372 approved for drinking water



PART NO.	DESCRIPTION	CTN/MSTR
S72009	1/2" Crimp PEX (F1807), 4" x 12"	1/50
S72010	1/2" Crimp PEX (F1807), 3-1/2" x 6"	1/50
S72011	1/2" Crimp PEX (F1807), 3-1/2" x 8"	1/50
S72012	3/4" Crimp PEX (F1807), 4-1/2" x 8"	1/50
S72013	1" Crimp PEX (F1807), 6" x 8"	1/25



- Connects to CPVC tubing (Solvent Weld)
- Closed end for pressure testing
- Flange for nailing to a stud
- cUPC approved for use in USA and Canada
- ANSI/NSF 61 & ANSI/NSF 372 approved for drinking water



PART NO.	DESCRIPTION	CTN/MSTR
S73005	1/2" CPVC Socket, 3-1/2" x 8"	1/25
S73006	1" CPVC Socket, 11" x 10"	1/25

Copper Stub Out Tub/Shower Valve Connector



- Connects to ASTM F1960 (Cold Expansion Style) PEX
- cUPC approved for use in USA and Canada
- ANSI/NSF 61 & ANSI/NSF 372 approved for drinking water



PART NO.	DESCRIPTION	CTN/MSTR
S71011	1/2" Cold Expansion PEX (F1960) x 1/2" Male Sweat Connection, 6"	1/50
S71012	1/2" Cold Expansion PEX (F1960) x 1/2" Male Swivel Pipe Thread Connection, 7"	1/50
S71013	1/2" Cold Expansion PEX (F1960) x 1/2" Female Swivel Pipe Thread Connection, 6"	1/50



- Connects to ASTM 1870 (Crimp Style) PEX
- cUPC approved for use in USA and Canada
- ANSI/NSF 61 & ANSI/NSF 372 approved for drinking water



PART NO.	DESCRIPTION	CTN/MSTR
S72020	1/2" Crimp PEX (F1807) x 1/2" Male Sweat Connection, 4"	1/50
S72021	1/2" Crimp PEX (F1807) x 1/2" Male Sweat Connection, 6"	1/50
S72022	1/2" Crimp PEX (F1807) x 1/2" Male Sweat Connection, 8"	1/50



- Connects to CPVC tubing (Solvent Weld)
- Closed end for pressure testing
- cUPC approved for use in USA and Canada
- ANSI/NSF 61 & ANSI/NSF 372 approved for drinking water



PART NO.	DESCRIPTION	CTN/MSTR
S73007	1/2" CPVC Socket x 1/2" Male Sweat Elbow, 6" x 2-1/4"	1/50
S73008	1/2" CPVC Socket x 1/2" Male Sweat Elbow, 8" x 2-1/4"	1/50

Copper Stub Out Straight



- Connects to ASTM F1960 (Cold Expansion Style) PEX
- Closed end for pressure testing
- cUPC approved for use in USA and Canada
- ANSI/NSF 61 & ANSI/NSF 372 approved for drinking water



PART NO.	DESCRIPTION	CTN/MSTR
S71008	1/2" Cold Expansion PEX (F1960) Closed End, 8" long	1/50
S71009	1/2" Cold Expansion PEX (F1960) Closed End, 15" long	1/50



- Connects to ASTM 1870 (Crimp Style) PEX
- cUPC approved for use in USA and Canada
- ANSI/NSF 61 & ANSI/NSF 372 approved for drinking water



PART NO.	DESCRIPTION	CTN/MSTR
S72014	1/2" Crimp PEX (F1807), Closed End, 8" Long	1/50
S72015	1/2" Crimp PEX (F1807), Closed End, 12" Long	1/50
S72016	3/4" Crimp PEX (F1807), Closed End, 12" Long	1/50
S72018	1/2" Crimp PEX (F1807), Open End, 8" Long	1/50
S72019	1/2" Crimp PEX (F1807), Open End, 12" Long	1/50

Copper Stub Out Straight with Mounting Flange



- Connects to ASTM F1960 (Cold Expansion Style) PEX
- Closed end for pressure testing
- Flange for nailing to a stud
- cUPC approved for use in USA and Canada
- ANSI/NSF 61 & ANSI/NSF 372 approved for drinking water



PART NO.	DESCRIPTION	CTN/MSTR
S71010	1/2" Crimp PEX (F1807), Closed End, 12" Long	1/50

C



- Connects to ASTM 1870 (Crimp Style) PEX
- Closed end for pressure testing
- Flange for nailing to a stud
- cUPC approved for use in USA and Canada
- ANSI/NSF 61 & ANSI/NSF 372 approved for drinking water



PART NO.	DESCRIPTION	CTN/MSTR
S72017	1/2" Crimp PEX (F1807), Closed End, 12" Long	1/50

Hanger Straps

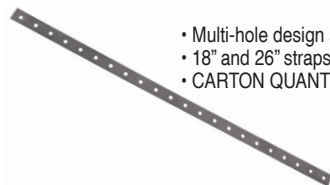

- Multi-hole design allows for versatility
- 18" and 26" straps accommodate most common jobs
- CARTON QUANTITIES ONLY



PART NO.	SIZE	GAUGE	CTN/MSTR
S33041	5/8" x 18"	14	100/100
S33040	5/8" x 26"	14	100/100

Flat Copper Plated Bracket



- For use on sinks, lavatories or other fixtures
- Use for 1/2" copper pipe
- CARTON QUANTITIES ONLY



PART NO.	SIZE	HR #	CTN/MSTR
B00003	1/2" x 20"	101-18	50/50
B00021	1/2" x 26"	101-26	50/50

Flat Copper Plated Bracket



- For use on water heater connections
- Use for 3/4" and 1" copper pipe
- CARTON QUANTITIES ONLY



PART NO.	SIZE	HR #	CTN/MSTR
B00004	3/4" - 1" x 20"	102-18	50/50

Flat Copper Plated Bracket



- For use on 1/2", 3/4" or 1" copper pipe
- CARTON QUANTITIES ONLY



PART NO.	SIZE	HR #	CTN/MSTR
B00005	1/2" - 1" x 20"	107-18	50/50

Flat Copper Plated Bracket



- Copper-Bonded™ steel
- For support of 1/2" and 3/4" pipes on 4" or 8" centers
- Positions copper water supplies for sinks, water closets, and other fixtures
- 25 lb. load rating
- CARTON QUANTITIES ONLY



PART NO.	SIZE	HR #	CTN/MSTR
B00025	1/2" - 3/4" x 20"	150-20	50/50

Copper Plated Carrier Bracket



- Secures 1" stub out at 11-1/2" above the rim
- CARTON QUANTITIES ONLY



PART NO.	DESCRIPTION	HR #	CTN/MSTR
B00022	Carrier bracket	114-C	6/6

Pipe Bracket



- 150 lb. load capacity
- Can attach to stud or directly to wall
- CARTON QUANTITIES ONLY



PART NO.	DESCRIPTION	HR #	CTN/MSTR
B00024	Pipe bracket	V2	25/25

Extruded Hole Copper Plated Bracket



- For use on 1/2", 3/4" or 1" copper pipe
- Extruded holes
- CARTON QUANTITIES ONLY



PART NO.	SIZE	HR #	CTN/MSTR
B00006	1/2" - 1" x 20"	108-20	50/50
B00019	1/2" - 1" x 26"	108-26	50/50

Extruded Notches Copper Plated Bracket



- For use on 1/2", 3/4" or 1" copper pipe
- Extruded holes
- CARTON QUANTITIES ONLY



PART NO.	SIZE	HR #	CTN/MSTR
B00007	1/2" - 3/4" x 20"	140	50/50

Galvanized Bracket



- For use on sinks, lavatories and toilets on 16" center spuds
- For use with 1/2" and 3/4" CPVC; 1/2", 3/4" and 1" copper or PEX
- 1-3/8" keyed holes, 20" long
- Use with B00016, B00017, B00018 and B00013
- CARTON QUANTITIES ONLY

MADE IN THE **USA**

PART NO.	SIZE	HR #	CTN/MSTR
B00001	1/2" - 1" x 20"	103-18	50/50

Galvanized Lockright Pipe Bracket for CPVC



- For use on sinks or lavatories using CPVC
- 20 gauge galvanized steel with 1" holes on 2" centers
- Use with B00014
- CARTON QUANTITIES ONLY

MADE IN THE **USA**

PART NO.	SIZE	HR #	CTN/MSTR
B00008	1/2" - 3/4" x 20"	601-20	50/50

Galvanized Lockright Bracket



- CARTON QUANTITIES ONLY

MADE IN THE **USA**

PART NO.	SIZE	HR #	CTN/MSTR
B00020	1/2" - 3/4" x 26"	601-26	50/50

Copper Plated Bracket for Water Closet



- For use on 1/2" copper pipe
- For use with water closets or hose bibbs
- CARTON QUANTITIES ONLY

MADE IN THE **USA**



PART NO.	SIZE	HR #	CTN/MSTR
B00002	1/2"	109-N-6	50/50

Galvanized L Bracket for PEX



- For use with PEX on overhead and side runs
- Use with B00013, B00016, B00017 and B00018 inserts
- CARTON QUANTITIES ONLY

MADE IN THE **USA**

PART NO.	SIZE	HR #	CTN/MSTR
B00009	1-3/8"	709L	50/50

Turnout Bend Support for PEX



- PEX turnout bend support for potable water installations
- CARTON QUANTITIES ONLY

MADE IN THE **USA**

PART NO.	SIZE	HR #	CTN/MSTR
B00013	3/8" - 1/2"	704	25/100

Insert for CPVC



- Fire retardant plastic
- CARTON QUANTITIES ONLY

MADE IN THE **USA**

PART NO.	DESCRIPTION	HR #	CTN/MSTR
B00014	1/2" insert	604	100/100

Metal Stud Insulator



- Fire retardant plastic
- Use for copper pipe
- CARTON QUANTITIES ONLY

MADE IN THE **USA**

PART NO.	DESCRIPTION	HR #	CTN/MSTR
B00016	1/2" insulator	404-R	100/100
B00017	3/4" insulator	405-R	100/100
B00018	1" insulator	406-R	100/100

Drive J-Hook



- Copper clad
- CARTON QUANTITIES ONLY

MADE IN THE **USA**

PART NO.	DESCRIPTION	CTN/MSTR
H23050	1/2" x 3/4" CTS drive j-hook	100/100

Plastic Coated Pipe Hook



- Steel pipe hook with plastic insulation
- Coated black
- CARTON QUANTITIES ONLY

MADE IN THE **USA**

PART NO.	DESCRIPTION	CTN/MSTR
H12054	1/2" x 4" plastic coated pipe hook	50/1000
H12056	1/2" x 6" plastic coated pipe hook	50/1000
H12074	3/4" x 4" plastic coated pipe hook	50/1000
H12076	3/4" x 6" plastic coated pipe hook	50/1000
H12106	1" x 6" plastic coated pipe hook	50/1000

"Copper Boy" Pipe Hook



- CARTON QUANTITIES ONLY

MADE IN THE **USA**

PART NO.	DESCRIPTION	CTN/MSTR
H10052	1/2" x 2-1/2" copper clad pipe hook	50/2200
H10072	3/4" x 2-1/2" copper clad pipe hook	50/500

Pipe Hook



Plain Steel



Copper Clad

- 10 gauge
- CARTON QUANTITIES ONLY

MADE IN THE USA

PART NO.	SIZE	MATERIAL	CTN/MSTR
H10054	1/2" x 4"	Plain Steel	50/500
H10056	1/2" x 6"	Plain Steel	50/500
H10058	1/2" x 8"	Plain Steel	50/500
H10074	3/4" x 4"	Plain Steel	50/500
H10076	3/4" x 6"	Plain Steel	50/500
H10078	3/4" x 8"	Plain Steel	50/500
H10080	3/4" x 10"	Plain Steel	50/500
H10106	1" x 6"	Plain Steel	50/500
H10108	1" x 8"	Plain Steel	50/500
H10110	1" x 10"	Plain Steel	50/500
H10126	1-1/4" x 6"	Plain Steel	50/500
H10128	1-1/4" x 8"	Plain Steel	50/500
H10156	1-1/2" x 6"	Plain Steel	50/500
H10158	1-1/2" x 8"	Plain Steel	50/500
H10208	2" x 8"	Plain Steel	50/500
H11054	1/2" x 4"	Copper Clad	50/500
H11056	1/2" x 6"	Copper Clad	50/500
H11058	1/2" x 8"	Copper Clad	50/500
H11074	3/4" x 4"	Copper Clad	50/500
H11076	3/4" x 6"	Copper Clad	50/500
H11078	3/4" x 8"	Copper Clad	50/500
H11080	3/4" x 10"	Copper Clad	50/500
H11106	1" x 6"	Copper Clad	50/500
H11108	1" x 8"	Copper Clad	50/500
H11126	1-1/4" x 6"	Copper Clad	50/500
H11156	1-1/2" x 6"	Copper Clad	50/500
H11208	2" x 8"	Copper Clad	50/500
H11210	2" x 10"	Copper Clad	50/500

Galvanized Pipe Hanger for Schedule 40 Pipe



- Alternating screw and nail holes
- Load rating 250# max
- CARTON QUANTITIES ONLY

MADE IN THE USA

PART NO.	DESCRIPTION	CTN/MSTR
H30001	1-1/2" galvanized pipe hanger	50/50
H30002	2" galvanized pipe hanger	50/50
H30003	3" galvanized pipe hanger	50/50
H30004	4" galvanized pipe hanger	50/50

Vinyl Coated Pipe Hanger for Schedule 40 Pipe



- Alternating screw and nail holes
- Load rating 250# max
- CARTON QUANTITIES ONLY

PART NO.	DESCRIPTION	CTN/MSTR
H30011	1-1/2" vinyl coated pipe hanger	100/100
H30022	2" vinyl coated pipe hanger	50/50
H30033	3" vinyl coated pipe hanger	50/50
H30044	4" vinyl coated pipe hanger	50/50

Vinyl Coated Pipe Hanger for DWV Pipe



- Alternating screw and nail holes
- Provides maximum support
- Vinyl coating dampens noise and vibration
- Cuts installation time
- CARTON QUANTITIES ONLY

PART NO.	DESCRIPTION	CTN/MSTR
H30005	1-1/2" (3/4" wide) vinyl coated pipe hanger	50/50
H30006	2" (3/4" wide) vinyl coated pipe hanger	50/50
H30007	3" (3/4" wide) vinyl coated pipe hanger	50/50
H30008	4" (3/4" wide) vinyl coated pipe hanger	50/50
H30012	1-1/2" (1" wide) vinyl coated pipe hanger	50/50
H30013	2" (1" wide) vinyl coated pipe hanger	50/50
H30014	3" (1" wide) vinyl coated pipe hanger	50/50
H30015	4" (1" wide) vinyl coated pipe hanger	50/50

Pipe Straps



H13038

H18050

MADE IN THE USA

- CARTON QUANTITIES ONLY

PART NO.	SIZE	MATERIAL	# HOLES	CTN/MSTR
H18050	1/2" IPS	Galvanized	1	100/100
H18075	3/4" IPS	Galvanized	1	100/100
H13038	3/8" IPS	Galvanized	2	200/200
H13050	1/2" IPS	Galvanized	2	150/150
H13075	3/4" IPS	Galvanized	2	50/50
H13100	1" IPS	Galvanized	2	50/50
H13125	1-1/4" IPS	Galvanized	2	50/50
H13150	1-1/2" IPS	Galvanized	2	25/25
H13200	2" IPS	Galvanized	2	25/25
H13250	2-1/2" IPS	Galvanized	2	25/25
H13300	3" IPS	Galvanized	2	10/10
H13302	3-1/2" IPS	Galvanized	2	15/15
H13400	4" IPS	Galvanized	2	10/10
H130500	6" IPS	Galvanized	2	20/20
H15048	1/4" CTS	Copper Clad	2	500/500
H15049	3/8" CTS	Copper Clad	2	500/500
H15050	1/2" CTS	Copper Clad	2	100/100
H15075	3/4" CTS	Copper Clad	2	100/100
H15100	1" CTS	Copper Clad	2	100/100
H15125	1-1/4" CTS	Copper Clad	2	100/100
H15150	1-1/2" CTS	Copper Clad	2	100/100
H15200	2" CTS	Copper Clad	2	100/100
H16038	3/8" CTS	Solid Copper	2	100/100
H16050	1/2" CTS	Solid Copper	2	100/100
H16075	3/4" CTS	Solid Copper	2	100/100
H16100	1" CTS	Solid Copper	2	100/100
H13501	1-1/2" IPS	Vinyl Coated	2	50/50
H13502	2" IPS	Vinyl Coated	2	50/50
H13503	3" IPS	Vinyl Coated	2	25/25
H13504	4" IPS	Vinyl Coated	2	25/25

Plastic Hanger Tape



- Flexible, non-conductive polypropylene
- .050 thick
- 1/8" diameter holes every 3/4"
- 125 lb. ultimate load ASTM A-370-77 (Not H21200)
- Can be cut with scissors or utility knife
- Uses: pipe hanger, duct hanger and tubing utility strapping

MADE IN THE
USA

PART NO.	SIZE	CTN/MSTR
H21010	3/4" x 10'	1/200
H21025	3/4" x 25'	1/50
H21050	3/4" x 50'	1/20
H21100	3/4" x 100'	1/30
H21101	3/4" x 100' (dispenser box)	1/25
H21200	2" x 100'	1/5

Perforated Hanger Iron



- Alternating holes (bolt and nail)
- CARTON QUANTITIES ONLY

MADE IN THE
USA

PART NO.	SIZE	MATERIAL	GAUGE	CTN/MSTR
H20001	3/4" x 10'	Galvanized	20 (heavy)	50/50
H20002	3/4" x 10'	Galvanized	24 (medium)	50/50
H20003	3/4" x 10'	Galvanized	28 (light)	50/50
H20005	3/4" x 50'	Galvanized	20 (heavy)	10/10
H20006	3/4" x 50'	Galvanized	24 (medium)	10/10
H20007	3/4" x 50'	Galvanized	28 (light)	10/10
H20010	3/4" x 100'	Galvanized	20 (heavy)	5/5
H20011	3/4" x 100'	Galvanized	24 (medium)	10/10
H20012	3/4" x 100'	Galvanized	28 (light)	10/10
H20100	3/4" x 10'	Copper Clad	22 (heavy)	50/50
H20150	3/4" x 50'	Copper Clad	22 (heavy)	10/10
H20101	3/4" x 10'	Copper	24 (medium)	100/100

Earthquake Strap



- Holes are spread 1" apart on center
- CARTON QUANTITIES ONLY

PART NO.	SIZE	GAUGE	CTN/MSTR
H20500	2" x 10'	22	1/10

Tie Wire



- Annealed and rolled to assure easily workable
- Ideal for securing rebar in place before pouring concrete
- CARTON QUANTITIES ONLY

MADE IN THE
USA

PART NO.	SIZE	GAUGE	CTN/MSTR
S33200	400'	16	20/20

Items marked with the Jones Stephens logo are "You Need It... We Got It" Items.

Copper Clad Nails



- CARTON QUANTITIES ONLY

MADE IN THE
USA

PART NO.	SIZE	MATERIAL	CTN/MSTR
H15001	1-1/4"	Copper Clad	200/2000

Copper Coated J-Nails



- CARTON QUANTITIES ONLY

MADE IN THE
USA

PART NO.	SIZE	MATERIAL	CTN/MSTR
H22050	1/2"	Copper Clad	100/1300
H22075	3/4"	Copper Clad	100/1300

J-Hook for CTS Water System



- Fabricated of durable ABS plastic
- Nail holes on all four sides - nails are included!
- No heat distortion even at 250°
- Eliminates corrosion and electrolysis on copper pipe
- FULL BAG QUANTITIES ONLY

Baby J-Hooks

PART NO.	DESCRIPTION	BAG/CTN QTY
J01050	1/2" CTS x 4" length	25/300
J01075	3/4" CTS x 4" length	25/300
J01100	1" CTS x 4" length	25/200

Long Baby J-Hooks

PART NO.	DESCRIPTION	BAG/CTN QTY
J01057	1/2" CTS x 7-1/2" length	25/200
J01077	3/4" CTS x 7-1/2" length	25/200

J-Hook for Drain Pipe System



- Fabricated of durable ABS plastic
- Nails included
- Reduces installation time
- Glueable with universal cement
- Designed for PVC and ABS pipe
- Calibrated for 1/8" fall per foot - no more measuring & adjusting for fall
- UPC listed
- FULL BAG QUANTITIES ONLY



PART NO.	DESCRIPTION	BAG/CTN QTY
J01150	1-1/2" DWV x 7" length	25/300
J01200	2" DWV x 7" length	25/300
J01300	3" DWV x 7" length	25/300
J01400	4" DWV x 7" length	25/300

Full Clamp



- Plastic clamp with preloaded nail for copper, CPVC, polybutylene tubing
- CARTON QUANTITIES ONLY

PART NO.	TUBING SIZE	CTN/MSTR
H25050	1/2"	100/4000
H25075	3/4"	50/2000
H25100	1"	25/1025

Half Clamp



- Plastic clamp with preloaded nail for copper, CPVC, polybutylene tubing
- CARTON QUANTITIES ONLY

PART NO.	TUBING SIZE	CTN/MSTR
H24038	3/8"	100/7500
H24050	1/2"	50/1000
H24075	3/4"	50/1000
H24100	1"	50/2000

Insulating/Suspension Clamp

C



- Plastic insulating and suspension clamp in one
- Eliminates noise from tubing expansion and contraction
- For copper, CPVC and polybutylene tubing
- CARTON QUANTITIES ONLY

PART NO.	TUBING SIZE	CTN/MSTR
H26050	1/2"	50/1000
H26075	3/4"	50/1000
H26100	1"	50/600
H26125	1 1/4"	50/500
H26150	1 1/2"	25/500
H26200	2"	25/350

Pipe Insulator



- Plastic insulator eliminates noise from expansion and contraction
- For copper, CPVC and polybutylene tubing
- Drill hole size 1 3/8"
- UPC listed
- CARTON QUANTITIES ONLY



PART NO.	TUBING SIZE	CTN/MSTR
H27050	1/2"	25/1000
H27075	3/4"	25/1000
H27100	1"	25/1000

2-Hole Pipe Clamp



- Plastic clamp eliminates noise from tubing expansion and contraction
- Supports copper, CPVC and polybutylene tubing
- CARTON QUANTITIES ONLY

PART NO.	TUBING SIZE	CTN/MSTR
H28050	1/2"	100/1000
H28075	3/4"	100/1000
H28100	1"	50/500
H28125	1 1/4"	50/750
H28150	1 1/2"	25/500
H28200	2"	25/250

F.H.A. Tub Hanger



- 12 gauge galvanized steel
- Adjustable on stud
- CARTON QUANTITIES ONLY

PART NO.	DESCRIPTION	CTN/MSTR
T12001	Tub Hanger	100/100

Metal Stud Pipe Insulator



- CARTON QUANTITIES ONLY

PART NO.	DESCRIPTION	CTN/MSTR
H29000	3/8", 1/2", 3/4"	50/500
H29010	1"	50/500

Mason's Nylon Twine



- Twisted yellow twine
- Approximately 165 lb. break strength

PART NO.	DESCRIPTION	CTN/MSTR
T60001	#18 x 225' nylon twine	24/192
T60000	#18 x 1100' nylon twine	12/72

Candle Wick Packing



- Medium packing in 2 ounce balls

PART NO.	DESCRIPTION	CTN/MSTR
T60003	Candle wick packing	12/396

Graphite Packing



- Non-asbestos material in resealable spools
- Up to 150°F

PART NO.	DESCRIPTION	CTN/MSTR
T60005	1/8" diameter x 12' spool	12/120
T60006	1/4" diameter x 8' spool	12/120

Oakum



- The original Oakum with benonite-expands over 10 times when wet
- Baled in coils or cut length for easy use
- No tar in brown oakum
- CARTON QUANTITIES ONLY (except 1 lb. bags)

PART NO.	DESCRIPTION	INNER PACK	CTN/MSTR
O15001	Brown random cut	10 - 5 lb. bags	10/10
O15002	White 3/8" cord	6 - 10 lb. coils	6/10
O15003	White 3/8" cord (27" cut length)	10 - 5 lb. bags	10/10
O15006	Brown random cut	1 lb. bags	1/20
O15007	White 3/8" cord (27" cut length)	1 lb. bags	1/20

Items marked with the Jones Stephens logo are "You Need It... We Got It" Items.

Lead Wool



- Five pound box

PART NO.	DESCRIPTION	CTN/MSTR
L40001	5 lbs. lead wool	1/10

Lead Ingot



L42002

L42052

PART NO.	DESCRIPTION	CTN/MSTR
L40002	25 lbs. (Handle with four 5 lb. plugs)	1/1
L42052	5 lbs.	1/1

Lead Melting Pot



- Wire handle
- 3" depth

PART NO.	DESCRIPTION	CTN/MSTR
L42006	6" pot	1/1
L42008	8" pot	1/1

Lead Pouring Ladle



- Wrought steel

PART NO.	DESCRIPTION	CTN/MSTR
L42102	3" ladle	1/100
L42103	3-1/2" ladle	1/50
L42104	4" ladle	1/50

Drum Trap Cover



- Flanged, plated die cast
- Cover supplied with gasket

PART NO.	DESCRIPTION	CTN/MSTR
D02001	Cover and gasket	25/100
D02002	Gasket only	25/100
P55300	Rough brass cover	1/60

Trap Covers



C98001

C98002

- Stainless steel

PART NO.	DESCRIPTION	CTN/MSTR
C98001	5-3/4" flat SS trap cover	150/300
C98002	5-3/4" raised SS trap cover	50/200

Wet-R-Dri Roofing Cement



- All-weather plastic
- Chemically fortified to bond to water-covered, damp or dry surfaces
- Great for emergency repairs under wet conditions
- CARTON QUANTITIES ONLY

PART NO.	DESCRIPTION	CTN/MSTR
C09000	5 gallon can	1/1
C09001	1 gallon can	6/6
C09002	10.5 ounce cartridge	12/12

Foundation and Roof Coating



- Non-fibered liquid damp-proof seal
- All weather plastic
- Chemically fortified to bond to water covered, damp or dry surfaces
- Great for emergency repairs under wet conditions

PART NO.	DESCRIPTION	CTN/MSTR
C09003	1 gallon can	6/6

Sewage Ejector/Sump Pump Check Valve



- Couplings are sized for IPS ID hose
- Combination unit for 1-1/2" and 1-1/4" IPS, 1-1/2" copper

PART NO.	DESCRIPTION	CTN/MSTR
C29150	1-1/2" slip x 1-1/2" slip	1/50
C29200	2" slip x 2" slip	1/50
C29126	1-1/4" slip x 1-1/2" slip	1/50

Flexible Discharge Hose



- Ideal for sump pumps, centrifugal pumps, and submersible pumps
- Kits include 24' hose, threaded adapter and steel clamp

PART NO.	DESCRIPTION	CTN/MSTR
C29123	1-1/2" flex discharge hose kit	1/5
C29124	1-1/4" flex discharge hose kit	1/5

Roofite® Hi-Heat Silicone Flashing



- Silicone range is designed for high temperature applications up to 390°F
- Ideal for corrugated metal roofs
- Can be used on flat roofs
- Pipe diameter markings
- For plumbing, heating, air conditioning, electrical or exhaust vents
- Pleated cone adjusts to any pitch up to 45° F
- Ozone and UV resistant

PART NO.	DESCRIPTION	CTN/MSTR
R16100	0" - 2-3/4"	1/25
R16101	2" - 6-1/8"	1/20
R16107	6" - 10-1/32"	1/10
R16108	9-1/2" - 14-3/4"	1/10

Roofite® Roof Flashing



- Made of EPDM with flexible aluminum base
- -30°F to +250°F
- Ideal for corrugated metal roofs
- Can be used on flat roofs
- Pipe diameter markings
- For plumbing, heating, air conditioning, electrical or exhaust vents
- Pleated cone adjusts to any pitch
- Ozone and UV resistant

PART NO.	DESCRIPTION	CTN/MSTR
R15109	0" - 1-1/4"	1/20
R15100	0" - 2-3/4" pipe	1/20
R15101	2" - 6-1/8" pipe	1/20
R15107	6" - 10-1/32" pipe	1/10
R15108	9-1/2" - 14-3/4" pipe	1/10

C

Galvanized Roof Flashing



- Double seal neoprene collar
- UPC listed, BOCA ad SBCCI approved



PART NO.	DESCRIPTION	FLANGE	CTN/MSTR
R40150	1-1/4" and 1-1/2"	8-3/4" x 12-1/2"	1/12
R40200	2"	8-3/4" x 12-1/2"	1/12
R40300	3"	10-3/4" x 14-1/2"	1/12
R40400	4"	12" x 16"	1/12

Aluminum Roof Flashing



- Double seal neoprene collar



PART NO.	DESCRIPTION	FLANGE	CTN/MSTR
R45150	1-1/4" and 1-1/2"	8-3/4" x 12-1/2"	1/12
R45200	2"	8-3/4" x 12-1/2"	1/12
R45300	3"	10-3/4" x 14-1/2"	1/12
R45400	4"	12" x 16"	1/12

All Neoprene Roof Flashing



- Double seal neoprene collar



PART NO.	DESCRIPTION	FLANGE	CTN/MSTR
R50150	1-1/4" and 1-1/2"	9" x 11-3/8"	1/20
R50200	2"	9" x 11-3/8"	1/20
R50300	3"	10" x 13-1/4"	1/20
R50400	4"	12" x 14-3/4"	1/20

Neo-poly Roof Flashing



- Poly vinyl base
- Neoprene collar



PART NO.	DESCRIPTION	FLANGE	CTN/MSTR
R57150	1-1/4" and 1-1/2"	9-1/4" x 13"	1/12
R57200	2"	9-1/4" x 13"	1/12
R57300	3"	11-1/8" x 15"	1/12
R57400	4"	12" x 15-1/2"	1/12

Lead Roof Flashing



- Southeastern Code
- 2-1/2 pounds
- Multi-pitch from flat to 7/12"
- CARTON QUANTITIES ONLY



PART NO.	DESCRIPTION	FLANGE	CTN/MSTR
R70150	1-1/2"	8-1/2" x 10-1/2"	12/12
R70200	2"	8-1/2" x 10-1/2"	12/12
R70300	3"	10-1/2" x 11-1/2"	6/6
R70400	4"	10-1/2" x 11-1/4"	6/6

Instant Sealant



- Flame resistant
- Fills holes and cracks
- Deadens sound
- Insulates against air conditioning and heat loss
- Prevents passage of dirt, water and insects
- Both 12 and 24 oz. cans spray in any position
- UPS GROUND AND MOTOR FREIGHT ONLY
- CARTON QUANTITIES ONLY



PART NO.	DESCRIPTION	CTN/MSTR
S30012	12 oz. cans	12/12
S30024	24 oz. cans	12/12

Hose and Hose Bracket for Service Sink



- Heavy duty 300 cloth-reinforced 5/8" rubber hose (2-1/2" long)
- 3/4" brass hose coupling at one end
- 5" x 3" stainless steel bracket with rubber grip

PART NO.	DESCRIPTION	CTN/MSTR
M05001	Hose with bracket	1/1
M05005	Bracket only	1/100

Mop Hanger for Service Sink



- 24" x 3" stainless steel hanger with three rubber tool grips
- Anchors included

PART NO.	DESCRIPTION	CTN/MSTR
M05003	Mop hanger	1/5

Items marked with the Jones Stephens logo are "You Need It...We Got It" Items.

Stove Bolt with Nut



- Zinc plated
- CARTON QUANTITIES ONLY

PART NO.	SIZE	CTN/MSTR
F33009	3/16" x 3/4"	100/100
F33010	1/4" x 3/4"	100/100
F33011	1/4" x 1"	100/100
F33012	1/4" x 1-1/4"	100/100
F33013	1/4" x 1-1/2"	100/100
F33014	1/4" x 2"	100/100

Flat Phillips Head Brass Wood Screw



- Solid brass construction
- CARTON QUANTITIES ONLY

PART NO.	SIZE	CTN/MSTR
F33300	#12 x 1-1/4"	100/100
F33301	#12 x 1-1/2"	100/100
F33302	#12 x 2"	100/100
F33303	#14 x 1-1/4"	100/100

Phillips Head Wood Screw



- Zinc plated
- CARTON QUANTITIES ONLY

PART NO.	SIZE	CTN/MSTR
F33030	#10 x 1-1/2"	100/100
F33031	#12 x 1"	100/100
F33032	#12 x 1-1/4"	100/100
F33033	#12 x 1-1/2"	100/100
F33034	#12 x 2"	100/100
F33035	#12 x 2-1/2"	100/100
F33036	#12 x 3"	100/100
F33037	#14 x 1-1/4"	100/100
F33038	#14 x 1-1/2"	100/100
F33039	#14 x 2"	100/100
F33040	#14 x 2-1/2"	100/100
F33041	#14 x 3"	100/100

Hex Head Lag Screw



- CARTON QUANTITIES ONLY

PART NO.	SIZE	CTN/MSTR
F33140	3/8" x 1"	100/100
F33141	3/8" x 1-1/2"	100/100
F33142	3/8" x 2"	100/100
F33143	3/8" x 2-1/2"	50/50
F33144	3/8" x 3"	50/50

E-Z Anchor/Self-Drilling Wall Board



- Die cast zinc
- Installs with #2 Phillips screwdriver
- CARTON QUANTITIES ONLY

PART NO.	DESCRIPTION	CTN/MSTR
A33010	E-Z Anchor with 1-1/4" screws	10/10

Toggle Bolt



- Zinc plated
- Spring loaded wing
- CARTON QUANTITIES ONLY

PART NO.	DESCRIPTION	CTN/MSTR
F33060	3/16" x 4" toggle bolt	50/50
F33061	1/4" x 3" toggle bolt only	50/50
F33062	1/4" x 4" toggle bolt only	50/50
F33063	1/4" x 6" toggle bolt only	50/50
F33064	3/8" x 4" toggle bolt only	50/50
F33065	3/8" x 6" toggle bolt only	50/50
F33066	3/16" toggle wing only	100/100
F33067	1/4" toggle wing only	100/100
F33068	3/8" toggle wing only	100/100
F33069	1/2" toggle wing only	100/100

Hex Head Tapping Screw



- Zinc plated
- CARTON QUANTITIES ONLY

PART NO.	SIZE	CTN/MSTR
F33101	#7 x 1/2"	100/100
F33102	#7 x 1/2"	1000/1000
F33103	#8 x 1/2"	100/100
F33104	#8 x 1/2"	1000/1000
F33105	#8 x 3/4"	100/100
F33106	#8 x 3/4"	1000/1000
F33107	#8 x 1"	100/100
F33108	#8 x 1"	500/500
F33109	#8 x 1-1/2"	50/50
F33110	#8 x 1-1/2"	500/500
F33111	#8 x 2"	50/50
F33112	#8 x 2"	250/250
F33113	#10 x 3/4"	100/100
F33114	#10 x 3/4"	1000/1000
F33115	#10 x 1"	100/100
F33116	#10 x 1"	500/500

Drill Point Tech Screw



- CARTON QUANTITIES ONLY

PART NO.	SIZE	CTN/MSTR
F33120	#8 x 1/2"	100/100
F33121	#8 x 1/2"	500/500
F33122	#8 x 3/4"	100/100
F33123	#8 x 3/4"	500/500
F33124	#10 x 3/4"	100/100
F33125	#10 x 3/4"	500/500
F33126	#10 x 1"	100/100
F33127	#10 x 1"	500/500
F33128	#10 x 1-1/2"	100/100
F33129	#12 x 3/4"	100/100
F33130	#12 x 1"	100/100
F33131	#12 x 1-1/2"	100/100
F33132	#12 x 2"	100/100

Hex Nut



- Zinc plated
- CARTON QUANTITIES ONLY

PART NO.	SIZE	CTN/MSTR
F33080	1/4" - 20	100/100
F33081	5/16" - 18	100/100
F33082	3/8" - 16	100/100
F33083	1/2" - 13	50/50

Anchor Bolt Kit

C



- Includes anchors, hex head screws and drill bit

PART NO.	SIZE	PIECES	DRILL BIT	CTN/MSTR
A33001	#8 x 1"	100	3/16"	1/50
A33002	#10 x 1-1/4"	100	1/4"	1/36
A33005	#14 x 1-1/2"	50	5/16"	1/36

Hollow Wall Anchor Kit



- 100 pieces
- 4 sizes and styles
- Anchors, screws and toggle bolts
- Reclosable, reusable, divided plastic container

PART NO.	DESCRIPTION	CTN/MSTR
A33006	100 piece hollow wall anchor kit	12/72

Fender Washer



- Zinc plated
- CARTON QUANTITIES ONLY

PART NO.	SIZE	OD	CTN/MSTR
F33098	1/4"	1-1/2"	100/100
F33096	3/8"	1-1/2"	100/100
F33097	1/2"	2"	100/100

Flat Washer



- Zinc plated
- CARTON QUANTITIES ONLY

PART NO.	SIZE	OD	CTN/MSTR
F33094	3/8"	1"	100/100
F33095	1/2"	1-3/8"	100/100

Carrier Nuts and Washer Set



- 4 aluminum nuts and plastic washers
- 5/8 - 11 threads
- Much lower cost than specification companies

PART NO.	DESCRIPTION	CTN/MSTR
C56100	Carrier nuts and washer set (4-pack)	1/100

Items marked with the Jones Stephens logo are "You Need It... We Got It" Items.

Universal Beam Clamp



- 3/8" UNC bolt thread
- Steel set screw

PART NO.	SIZE	ROD SIZE	MAX LOAD	CTN/MSTR
H60375	3/8"	3/8"	500 lbs.	1/25
H60050	1/2"	1/2"	800 lbs.	1/25
H60625	5/8"	5/8"	1130 lbs.	1/25

Copper Pipe Hanger - Bell & Milford Types



Bell Type



Milford Type

- Copper clad

PART NO.	DESCRIPTION	CTN/MSTR
H83050	1/2" bell type	25/500
H83075	3/4" bell type	25/500
H83100	1" bell type	25/500
H84050	1/2" x 6" milford type	1/25
H84075	3/4" x 6" milford type	1/25
H84100	1" x 6" milford type	1/25
H85050	1/2" x 12" milford type	1/25
H85075	3/4" x 12" milford type	1/25

Conduit Hanger



- Packed with bolts and nuts

Zinc Plated

PART NO.	CODE NO.	RIGID	THIN WALL	CTN/MSTR
H14050	0	1/2"-3/8"	1/2"	1/100
H14075	1	3/4"	3/4"	1/50
H14100	2	1"	1"	1/50
H14125	3	1-1/4"	-	1/50
H14150	4	1-1/2"	1-1/2"	1/25
H14200	5	2"	2"	1/25
H14250	6	2-1/2"	-	1/10
H14300	7	3"	-	1/10
H14400	9	4"	-	1/10

Copper Plated

PART NO.	CODE NO.	RIGID	THIN WALL	CTN/MSTR
H17050	0	1/2"-3/8"	1/2"	1/100
H17075	1	3/4"	3/4"	1/100
H17100	2	1"	1"	1/50
H17125	3	1-1/4"	-	1/50
H17150	4	1-1/2"	1-1/2"	1/25
H17200	5	2"	2"	1/25
H17250	6	2-1/2"	-	1/25
H17300	7	3"	-	1/25
H17350	8	3-1/2"	-	1/25
H17400	9	4"	-	1/25

Swivel Ring



• Supplied with nuts

Zinc Plated

PART NO.	SIZE	ROD SIZE	CTN/MSTR
H65050	1/2"	3/8"	1/25
H65075	3/4"	3/8"	1/25
H65100	1"	3/8"	1/25
H65125	1-1/4"	3/8"	1/25
H65150	1-1/2"	3/8"	1/25
H65200	2"	1/2"	1/20
H65250	2-1/2"	1/2"	1/20
H65300	3"	1/2"	1/10
H65400	4"	1/2"	1/10
H65500	5"	1/2"	1/5
H65600	6"	1/2"	1/5

Copper Plated

PART NO.	SIZE	ROD SIZE	CTN/MSTR
H66050	1/2"	3/8"	1/25
H66075	3/4"	3/8"	1/25
H66100	1"	3/8"	1/25
H66125	1-1/4"	3/8"	1/25
H66150	1-1/2"	3/8"	1/25
H66200	2"	3/8"	1/20
H66250	2-1/2"	3/8"	1/20
H66300	3"	3/8"	1/10
H66400	4"	3/8"	1/10

Zinc Plated Clevis Hanger



Standard - 401# Steel

PART NO.	SIZE	ROD SIZE	CTN/MSTR
H68050	1/2"	3/8"	1/25
H68075	3/4"	3/8"	1/25
H68100	1"	3/8"	1/25
H68125	1-1/4"	3/8"	1/25
H68150	1-1/2"	3/8"	1/25
H68200	2"	3/8"	1/20
H68250	2-1/2"	1/2"	1/20
H68300	3"	1/2"	1/10
H68350	3-1/2"	1/2"	1/10
H68400	4"	5/8"	1/10
H68500	5"	5/8"	1/5
H68600	6"	3/4"	1/5
H68800	8"	7/8"	1/5

Light Duty - 400# Steel

PART NO.	SIZE	ROD SIZE	CTN/MSTR
H69050	1/2"	3/8"	1/25
H69075	3/4"	3/8"	1/25
H69100	1"	3/8"	1/25
H69150	1-1/2"	3/8"	1/25
H69200	2"	3/8"	1/20
H69250	2-1/2"	1/2"	1/20
H69300	3"	1/2"	1/10
H69400	4"	5/8"	1/10

Riser Clamp



• For Schedule 40 iron pipe only - Not for soil pipe

PART NO.	SIZE	OVERALL WIDTH	CTN/MSTR
H70050	1/2"	9-3/8"	1/25
H70075	3/4"	9-3/8"	1/25
H70100	1"	9-3/8"	1/25
H70125	1-1/4"	10"	1/25
H70150	1-1/2"	10-3/8"	1/25
H70200	2"	10-7/8"	1/25
H70250	2-1/2"	11-1/4"	1/25
H70300	3"	11-3/4"	1/10
H70350	3-1/2"	13-1/4"	1/10
H70400	4"	13-1/2"	1/10

Hinged Split Ring



Zinc Plated for Iron Pipe

PART NO.	SIZE	ROD SIZE	CTN/MSTR
H72375	3/8"	3/8"	1/25
H72050	1/2"	3/8"	1/25
H72075	3/4"	3/8"	1/25
H72100	1"	3/8"	1/25
H72125	1-1/4"	3/8"	1/25
H72150	1-1/2"	3/8"	1/25
H72200	2"	3/8"	1/20
H72250	2-1/2"	1/2"	1/20
H72300	3"	1/2"	1/10
H72400	4"	1/2"	1/10

Copper Plated for Copper Tube

PART NO.	SIZE	ROD SIZE	CTN/MSTR
H73375	3/8"	3/8"	1/25
H73050	1/2"	3/8"	1/25
H73075	3/4"	3/8"	1/25
H73100	1"	3/8"	1/25
H73125	1-1/4"	3/8"	1/25
H73150	1-1/2"	3/8"	1/25
H73200	2"	3/8"	1/10

Ceiling Flange

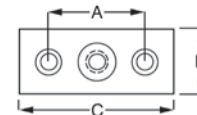

DIMENSIONS		
A	B	C
2"	1-3/8"	2-3/4"

PART NO.	SIZE	CTN/MSTR
H80375	3/8" plain finish (black)	1/25
H80050	1/2" plain finish (black)	1/25
H81375	3/8" zinc finish (galvanized)	1/25
H81050	1/2" zinc finish (galvanized)	1/25
H82375	3/8" copper finish	1/25
H82050	1/2" copper finish	1/25

Threaded Steel Rod



- Priced per rod
- CARTON QUANTITIES ONLY

PART NO.	DESCRIPTION	CTN/MSTR
T38006	3/8" x 6' plain finish (black)	1/25
T38010	3/8" x 10' plain finish (black)	1/25
T12006	1/2" x 6' plain finish (black)	1/12
T12010	1/2" x 10' plain finish (black)	1/12
T38106	3/8" x 6' zinc finish (galvanized)	1/25
T38110	3/8" x 10' zinc finish (galvanized)	1/25
T12106	1/2" x 6' zinc finish (galvanized)	1/12
T12110	1/2" x 10' zinc finish (galvanized)	1/12

Drop-In Concrete Anchor



- Priced per rod
- CARTON QUANTITIES ONLY

PART NO.	DESCRIPTION	CTN/MSTR
T38038	3/8" drop-in anchor	100/900
T12050	1/2" drop-in anchor	50/500

Rod Coupling Nut



- Hex, zinc plated, carbon steel

PART NO.	DESCRIPTION	CTN/MSTR
R60001	1/4" x 7/8" rod coupling nut	50/1000
R60002	3/8" x 1-3/4" rod coupling nut	50/1000
R60003	1/2" x 1-3/4" rod coupling nut	50/1000
R60004	5/8" x 2-1/8" rod coupling nut	50/200

Water Meter Box Keys and Covers



M07001



M07002



M25900



M25900 bottom view

PART NO.	DESCRIPTION	CTN/MSTR
M07001	Meter box key	1/100
M07002	Combination key and wrench	1/50
M25900	Penta head meter box and roadway box wrench	1/100

Water Meter Coupling Complete



- Heavy cast brass
- Complete with gasket
- Lead Free

PART NO.	SIZE	NPSM	LENGTH	NPT	CTN/MSTR
M20058	1/2"	3/4"	2-3/8"	1/2"	1/100
M20075	3/4"	1"	2-1/2"	3/4"	25/100
M20100	1"	1-1/4"	2-5/8"	1"	25/100

Gasket Only for Water Meter Couplings



- 3/32" thick
- CARTON QUANTITIES ONLY

PART NO.	DESCRIPTION	CTN/MSTR
M20581	5/8" gasket for coupling	25/25
M20751	3/4" gasket for coupling	25/25
M20101	1" gasket for coupling	25/25

10" Economy Plastic Water Meter Box

MADE IN THE USA

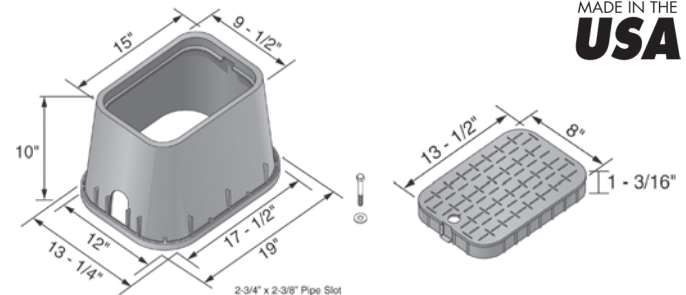

- Snap-in green lid
- 96 per pallet
- Drop in reader cover

PART NO.	DESCRIPTION	CTN/MSTR
M06001	10" rectangular box and green lid	1/96
M06002	10" green snap-in lid only	1/360

Note: All items shown are for non-vehicular applications. Concrete and asphalt installations are not recommended for plastic parts.

Items marked with the Jones Stephens logo are "You Need It... We Got It" Items.

12" Plastic Water Meter Box

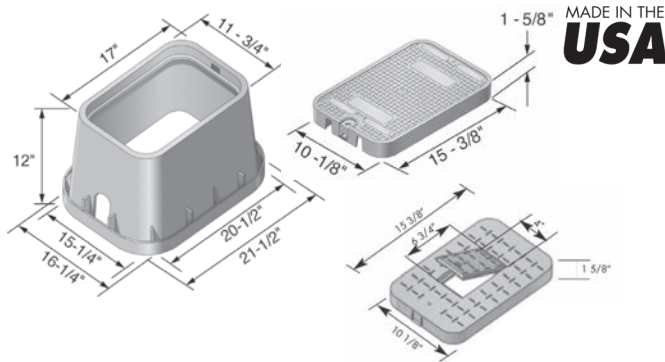

MADE IN THE
USA

PART NO.	DESCRIPTION	CTN/MSTR
M12001	12" box and solid green lid	1/72
M12002	12" box and black reader lid	1/72
M12022	12" box and black lid marked "sewer"	1/72
M12003	6" extension	1/42
M12005	12" solid green lid only	1/216
M12006	12" black reader lid only	1/216
M12009	12" box and solid black lid	1/72

Note: All items shown are for non-vehicular applications. Concrete and asphalt installations are not recommended for plastic parts.

12" Plastic Water Meter Box with Solid Cast Iron Lid

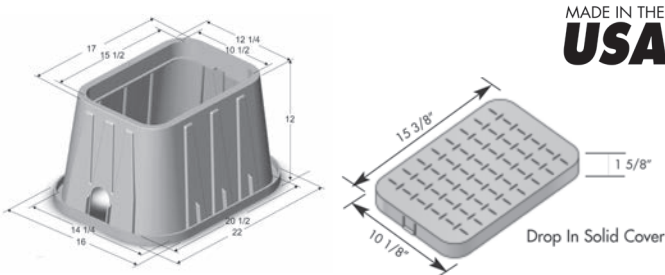

MADE IN THE
USA

• Drop in solid lid

PART NO.	DESCRIPTION	CTN/MSTR
M12100	12" box with black solid cast iron lid	1/72
M12085	Black cast iron lid only	1/230

Note: All items shown are for non-vehicular applications. Concrete and asphalt installations are not recommended for plastic parts.

Items marked with the Jones Stephens logo are "You Need It...We Got It" Items.

12" Plastic Standard Water Meter Box with Plastic Lid and Cast Iron Reader

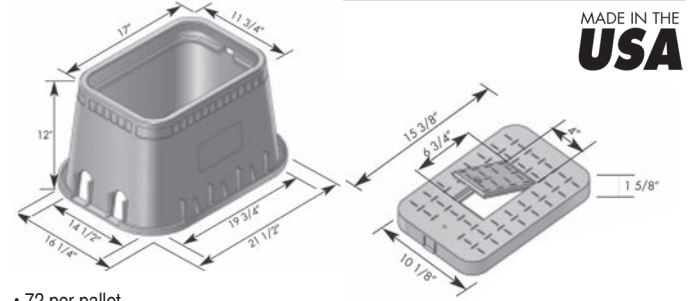

MADE IN THE
USA

• 72 per pallet
• Drop in reader lid

PART NO.	DESCRIPTION	CTN/MSTR
M12004	12" box with plastic lid & black cast iron reader	1/72

Note: All items shown are for non-vehicular applications. Concrete and asphalt installations are not recommended for plastic parts.

12" Plastic Irrigation Box

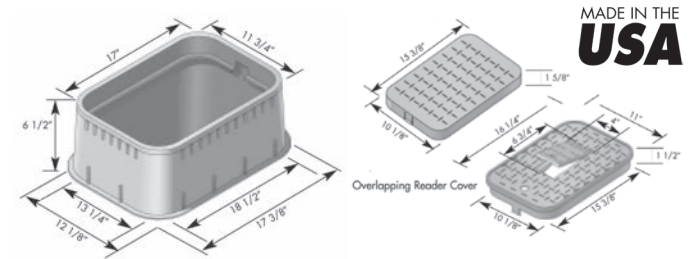

MADE IN THE
USA

• 6 1/2" deep
• Drop in solid lid or overlapping reader lid available

PART NO.	DESCRIPTION	CTN/MSTR
M12007	12" box with green lid	1/1
M12005	12" solid green lid only	1/1
M12006	12" black reader lid only	1/1

Note: All items shown are for non-vehicular applications. Concrete and asphalt installations are not recommended for plastic parts.

15" Jumbo Water Meter Box

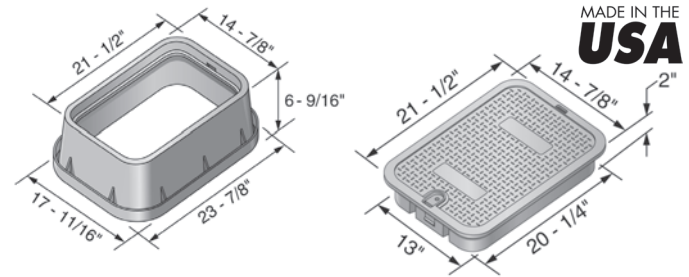

MADE IN THE
USA

PART NO.	DESCRIPTION	CTN/MSTR
M15001	15" box and green solid lid	1/48
M15009	6" extension for M15001	1/36
M15002	15" box and black reader lid	1/48
M15005	15" black reader lid only	1/96

Note: All items shown are for non-vehicular applications. Concrete and asphalt installations are not recommended for plastic parts.

C

6" Residential Valve Box

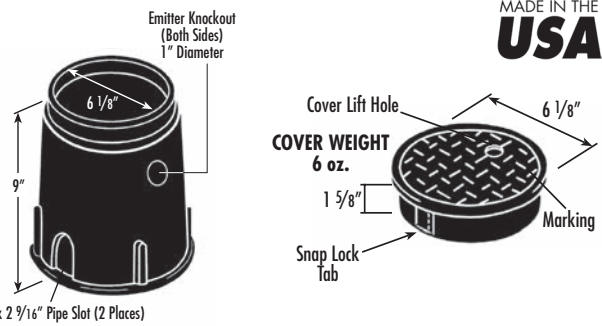

MADE IN THE
USA

- 9" deep
- Snap-in green lid
- Overlapping cover keeps dirt or grass from between body and lid
- Valve box can be extended with any 6" plastic or iron pipe

PART NO.	DESCRIPTION	CTN/MSTR
M06006	6" valve box with green lid	1/36
M06007	6" green snap-in lid only	1/10

Note: All items shown are for non-vehicular applications. Concrete and asphalt installations are not recommended for plastic parts.

Plastic Tub Box



MADE IN THE
USA

PART NO.	SIZE	CTN/MSTR
T40001	13"L x 13"W x 7"D	1/100
T40002	12"L x 8-1/8"W x 6-1/2"D	1/150

Cardboard Tub Box



MADE IN THE
USA

PART NO.	SIZE	CTN/MSTR
T40003	12"L x 8"W x 8-1/2"D wax coated	1/10
T40004	14-1/2"L x 11-5/16"W x 6"D wax coated	1/10
T40005	15"L x 12"W x 9"D non-coated	1/10
T40007	12"L x 12"W x 9"D non-coated	1/10
T40008	12"L x 12"W x 12"D non-coated	1/10

10" Round Valve Box

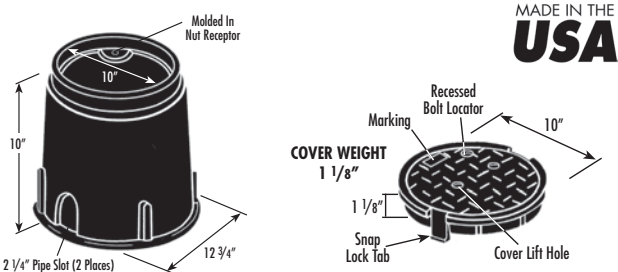

MADE IN THE
USA

- Snap-in green lid
- Overlapping cover keeps dirt or grass from between body and lid
- 96 per pallet

PART NO.	DESCRIPTION	CTN/MSTR
M06010	10" round body and snap-in green lid	1/96

Note: All items shown are for non-vehicular applications. Concrete and asphalt installations are not recommended for plastic parts.

Shipping Boxes



- 32 ECT board test
- Kraft (brown)
- 200 pound burst strength
- BUNDLE QUANTITIES ONLY

MADE IN THE
USA

PART NO.	SIZE	CTN/MSTR
BOX011	11-1/8"L x 11-1/8"W x 9-1/8"D	1/20
BOX008	8"L x 8"W x 8"D	1/20
BOX006	6"L x 6"W x 8"D	1/20

Bin Boxes



MADE IN THE
USA

PART NO.	SIZE	CTN/MSTR
BIN004	4-1/4"W x 12-1/2"L x 6-1/2"H	1/20
BIN005	5-1/2"W x 12"L x 6"H	1/20
BIN008	9"W x 12-1/2"L x 8"H	1/20
BIN012	12-3/4"W x 12-1/2"L x 9-1/4"H	1/20

FITTINGS & VALVES

Brass Compression Fittings	133-134
Chrome Plated Compression Fittings	134
45° Flare Tube Fittings	135-136
Space Heater & Gas Range Fittings	137
Yellow Brass Pipe Fittings	138-139
PEX Fittings	140-141
Push On Fittings	142-145
Red Brass Pipe Fittings	146-147
Bronze Pipe Fittings	148-149
Chrome Plated Pipe Nipples & Fittings	150
Brass Garden Hose Fittings	151-152
Brass Hose Barbs	153
Nylon Fittings.....	154-155
Poly Insert Fittings.....	156
Red Brass Insert Fittings.....	157
Galvanized Insert Fittings.....	158
Brass Needle Valves	159
Shut-Off Valves	160
Drain Cocks/Air Cocks.....	161
Ball Valves	162-164
Radiator Accessories	164
Hose Bibbs	165
Gear Clamps	165-166
Flange Connection Gaskets & Kits	167-168
Rubber Sheet/Gasket Material	168
Water Hammer Arresters	169-170



Compression Cap

Style 61C



PART NO.	TUBE SIZE	CTN/MSTR
C74001LF	1/4"	500/1000
C74002LF	3/8"	500/1000
C74147LF	1/2"	1/1
C74155LF	5/8"	1/1

Compression Sleeve

Style 60

• CARTON QUANTITIES ONLY



PART NO.	TUBE SIZE	CTN/MSTR
C74003	1/8"	10/2000
C74004	3/16"	10/2000
C74005	1/4"	10/2000
C74006	5/16"	10/2000
C74007	3/8"	5/2000
C74008	1/2"	5/2000
C74009	5/8"	5/2000
C74010	3/4"	5/1000
C74011	7/8"	3/1005

Compression Nut



PART NO.	TUBE SIZE	CTN/MSTR
C74012	1/8"	10/1000
C74013	3/16"	10/1000
C74014	1/4"	10/2000
C74015	5/16"	10/1000
C74016	3/8"	5/2000
C74152	7/16"	1/25
C74017	1/2"	5/1000
C74018	5/8"	5/1000
C74019	3/4"	5/400
C74020	7/8"	3/300

Delrin Compression Sleeve

Style 60P

• CARTON QUANTITIES ONLY



PART NO.	TUBE SIZE	CTN/MSTR
C74096	1/4"	100/100
C74097	3/8"	100/100
C74098	1/2"	100/100
C74099	5/8"	50/50

Compression Insert

Style 63P

• Lead Free
• CARTON QUANTITIES ONLY



PART NO.	TUBE SIZE	CTN/MSTR
C74100LF	1/4"	100/2000
C74101LF	3/8"	100/2000
C74102LF	1/2"	10/2000
C74103LF	5/8"	10/2000

Compression Union

Style 62

• Lead Free



PART NO.	TUBE SIZE	CTN/MSTR
C74021LF	1/8"	10/300
C74022LF	3/16"	10/300
C74023LF	1/4"	10/500
C74025LF	3/8"	5/500
C74026LF	1/2"	100/400
C74027LF	5/8"	5/250
C74029LF	7/8"	3/102
C74030LF	3/8" x 1/4"	10/300
C74031LF	1/2" x 3/8"	5/300
C74032LF	5/8" x 3/8"	5/300
C74033LF	5/8" x 1/2"	5/300

Compression Tee

Style 64

• Lead Free



PART NO.	TUBE SIZE	CTN/MSTR
C74034LF	1/4"	10/300
C74036LF	3/8"	5/300
C74037LF	3/8" x 3/8" x 1/4"	10/300
C74038LF	1/2"	50/200
C74039LF	5/8"	5/200

Compression x FIP Branch Tee

Style 78

• Lead Free



PART NO.	TUBE x FIP	CTN/MSTR
C74091LF	3/8" x 1/8"	1/1

Compression x Sweat Adapter

Style 666

• Lead Free



PART NO.	TUBE x OD	CTN/MSTR
C74093LF	3/8" x 5/8" (1/2" swt)	5/200

Compression x FIP Connector

Style 66

• Lead Free



PART NO.	TUBE x FIP	CTN/MSTR
C74045LF	1/4" x 1/8"	10/200
C74046LF	1/4" x 1/4"	10/200
C74113LF	1/4" x 3/8"	10/200
C74114LF	1/4" x 1/2"	10/200
C74048LF	3/8" x 1/8"	200/800
C74049LF	3/8" x 1/4"	10/200
C74050LF	3/8" x 3/8"	5/200
C74051LF	3/8" x 1/2"	5/200
C74052LF	1/2" x 3/8"	100/400
C74053LF	1/2" x 1/2"	100/400
C74054LF	5/8" x 1/2"	5/200
C74118LF	5/8" x 3/4"	3/201
C74055LF	7/8" x 3/4"	3/201

Compression x MIP Connector

Style 68

• Lead Free



PART NO.	TUBE x MIP	CTN/MSTR
C74121LF	1/8" x 1/8"	10/200
C74058LF	1/4" x 1/8"	10/200
C74059LF	1/4" x 1/4"	250/1000
C74060LF	1/4" x 3/8"	10/200
C74123LF	1/4" x 1/2"	10/200
C74063LF	3/8" x 1/8"	10/200
C74064LF	3/8" x 1/4"	10/200
C74065LF	3/8" x 3/8"	5/200
C74066LF	3/8" x 1/2"	5/200
C74067LF	3/8" x 3/4"	3/201
C74068LF	1/2" x 1/4"	5/200
C74069LF	1/2" x 3/8"	5/200
C74070LF	1/2" x 1/2"	5/200
C74146LF	5/8" x 3/8"	5/200
C74071LF	5/8" x 1/2"	5/200
C74072LF	5/8" x 3/4"	3/201
C74149LF	7/8" x 1/2"	3/120
C74073LF	7/8" x 3/4"	3/201

Compression Elbow

Style 65

• Lead Free



PART NO.	TUBE SIZE	CTN/MSTR
C74040LF	1/4"	10/300
C74041LF	3/8"	5/300
C74042LF	1/2"	5/200
C74043LF	5/8"	5/200
C74044LF	5/8" x 3/8"	100/200
C74112LF	7/8"	50/100

Compression x FIP Elbow

Style 70

• Lead Free



PART NO.	TUBE x FIP	CTN/MSTR
C74078LF	3/8" x 1/2"	5/200
C74131LF	1/2" x 3/8"	5/200

Compression x MIP Elbow

Style 69

• Lead Free



PART NO.	TUBE x MIP	CTN/MSTR
C74081LF	1/4" x 1/8"	10/200
C74082LF	1/4" x 1/4"	10/200
C74135LF	1/4" x 3/8"	10/200
C74136LF	1/4" x 1/2"	10/200
C74085LF	3/8" x 1/4"	10/200
C74086LF	3/8" x 3/8"	5/200
C74087LF	3/8" x 1/2"	5/200
C74088LF	1/2" x 3/8"	5/200
C74089LF	1/2" x 1/2"	125/250
C74090LF	5/8" x 1/2"	100/200

Pilot Line Breakaway Nut

• Lead Free



PART NO.	DESCRIPTION	CTN/MSTR
C74158LF	1/4" OD	10/200

Chrome Plated Compression Nut

• Lead Free



PART NO.	SIZE	CTN/MSTR
C74095	1/2"	50/400

Chrome Plated Compression Union

• Lead Free



PART NO.	TUBE SIZE	CTN/MSTR
N62006LF	3/8"	250/500
N62086LF	1/2" x 3/8"	100/400
N62106LF	5/8" x 3/8"	50/200

Chrome Plated Compression Elbow

• Lead Free



PART NO.	TUBE SIZE	CTN/MSTR
N65106LF	5/8" x 3/8"	50/200

Chrome Plated Compression x FIP Connector

• Lead Free



PART NO.	TUBE x FIP	CTN/MSTR
N66066LF	3/8" x 3/8"	200/800
N66068LF	3/8" x 1/2"	100/400
N66088LF	1/2" x 1/2"	125/250

Chrome Plated Compression x MIP Connector

• Lead Free



PART NO.	TUBE x MIP	CTN/MSTR
N68066LF	3/8" x 3/8"	125/500
N68068LF	3/8" x 1/2"	100/400
N68088LF	1/2" x 1/2"	100/400

Chrome Plated Compression x Sweat Adapter

• Lead Free



PART NO.	TUBE x OD	CTN/MSTR
N66610LF	3/8" x 5/8" (1/2" swt)	100/200

Chrome Plated Compression x FIP Elbow

• Lead Free



PART NO.	TUBE x FIP	CTN/MSTR
N70066LF	3/8" x 3/8"	100/400
N70068LF	3/8" x 1/2"	100/400
N70086LF	1/2" x 3/8"	100/400

Chrome Plated Compression x MIP Elbow

• Lead Free



PART NO.	TUBE x MIP	CTN/MSTR
N69066LF	3/8" x 3/8"	100/400
N69068LF	3/8" x 1/2"	100/400

3' Chrome Plated Brass Cover Tubes



• Plain ends
(no threads)
• 20 gauge

PART NO.	DESCRIPTION	CTN/MSTR
T73125	1-1/4" OD x 3' tube	1/25
T73138	1-3/8" OD x 3' tube	1/25
T73150	1-1/2" OD x 3' tube	1/25
T73175	1-3/4" OD x 3' tube	1/25
T73200	2" OD x 3' tube	1/20

Short Flare Nut

Style 41S



PART NO.	TUBE SIZE	CTN/MSTR
F40001	3/16"	10/3000
F40002	1/4"	10/2000
F40003	5/16"	5/1000
F40004	3/8"	5/850
F40005	1/2"	5/750
F40006	5/8"	5/450
F40007	3/4"	3/201
F40126	7/8"	3/99

Flare Tee

Style 44



PART NO.	TUBE SIZE	CTN/MSTR
F40033	1/4"	10/500
F40034	5/16"	5/500
F40035	3/8"	5/400
F40036	1/2"	5/250
F40037	5/8"	5/100
F40038	3/8"x 3/8"x 1/4"	5/300
F40039	1/2"x 1/2"x 3/8"	5/150
F40120	5/8"x 5/8"x 1/2"	5/150

Long Flare Nut

Style 141L



PART NO.	TUBE SIZE	CTN/MSTR
F40008	3/8"	5/750
F40131	1/4"	10/1000
F40132	1/2"	5/400
F40133	5/8"	5/300

Flare x MIP Branch Tee

Style 45



PART NO.	TUBE x MIP	CTN/MSTR
F40040	3/8"x 1/4"	5/400
F40041	3/8"x 3/8"	5/400

Short Forged Flare Nut

Style 141S



PART NO.	TUBE SIZE	CTN/MSTR
F40009	1/4"	10/1500
F40010	3/8"	5/800
F40011	1/2"	5/600
F40012	5/8"	5/400
F40013	3/8"x 1/4"	5/800
F40014	1/2"x 3/8"	5/450
F40119	5/8"x 1/2"	5/300

Female Flare Swivel

Style 70



PART NO.	TUBE SIZE	CTN/MSTR
F40125	1/4"	10/400
F40095	3/8"	10/350
F40096	1/2"	5/200
F40097	5/8"	5/150

Flare Plug

Style 39



PART NO.	TUBE SIZE	CTN/MSTR
F40015	1/4"	10/1200
F40016	3/8"	5/600
F40017	1/2"	5/500
F40018	5/8"	5/250

Flare Union

Style 42



PART NO.	TUBE SIZE	CTN/MSTR
F40023	1/4"	10/800
F40024	5/16"	5/700
F40025	3/8"	5/400
F40026	1/2"	5/350
F40027	5/8"	5/300
F40100	3/4"	5/200
F40127	7/8"	3/100
F40028	3/8"x 1/4"	5/400
F40029	1/2"x 1/4"	5/500
F40030	1/2"x 3/8"	5/500
F40031	5/8"x 3/8"	5/300
F40032	5/8"x 1/2"	5/300

Flare Cap

Style 40



PART NO.	TUBE SIZE	CTN/MSTR
F40019	1/4"	10/1000
F40098	5/16"	5/500
F40020	3/8"	5/1500
F40021	1/2"	5/600
F40022	5/8"	5/600

Flare x MIP Half Union

Style 48



PART NO.	TUBE x MIP	CTN/MSTR
F40063	1/4" x 1/8"	10/200
F40064	1/4" x 1/4"	10/1500
F40107	1/4" x 3/8"	5/600
F40108	1/4" x 1/2"	5/600
F40065	5/16" x 1/8"	5/800
F40066	5/16" x 1/4"	5/700
F40067	3/8" x 1/8"	5/600
F40068	3/8" x 1/4"	5/700
F40069	3/8" x 3/8"	5/600
F40070	3/8" x 1/2"	5/450
F40071	3/8" x 3/4"	3/250
F40072	1/2" x 1/4"	5/300
F40073	1/2" x 3/8"	3/201
F40074	1/2" x 1/2"	5/350
F40075	1/2" x 3/4"	3/201
F40109	5/8" x 3/8"	5/300
F40076	5/8" x 1/2"	5/300
F40077	5/8" x 3/4"	3/201
F40110	3/4" x 1/2"	3/200
F40112	3/4" x 3/4"	3/201
F40122	7/8" x 3/4"	3/99

Flare Elbow

Style 55



PART NO.	TUBE SIZE	CTN/MSTR
F40078	1/4"	10/1000
F40079	3/8"	10/500
F40080	1/2"	10/550
F40081	5/8"	5/150

Flare x FIP Elbow

Style 50



PART NO.	TUBE x FIP	CTN/MSTR
F40104	1/4" x 1/4"	10/700
F40105	1/4" x 3/8"	5/700
F40056	3/8" x 1/4"	5/600
F40057	3/8" x 3/8"	5/650
F40058	3/8" x 1/2"	5/200
F40059	1/2" x 3/8"	5/400
F40060	1/2" x 1/2"	5/300
F40061	5/8" x 1/2"	5/250
F40106	5/8" x 3/4"	3/201
F40135	1/2" x 3/4"	3/201

Flare x FIP Coupling

Style 46



PART NO.	TUBE x FIP	CTN/MSTR
F40042	1/4" x 1/8"	10/1500
F40043	1/4" x 1/4"	10/1000
F40117	1/4" x 3/8"	5/700
F40118	1/4" x 1/2"	5/500
F40044	5/16" x 1/8"	5/1000
F40045	5/16" x 1/4"	5/1000
F40047	3/8" x 1/4"	5/800
F40048	3/8" x 3/8"	5/500
F40049	3/8" x 1/2"	5/500
F40050	3/8" x 3/4"	3/300
F40051	1/2" x 1/4"	5/500
F40052	1/2" x 3/8"	5/500
F40053	1/2" x 1/2"	5/400
F40054	1/2" x 3/4"	3/300
F40055	5/8" x 1/2"	5/300
F40101	5/8" x 3/4"	3/250
F40102	3/4" x 1/2"	3/99
F40103	3/4" x 3/4"	3/99
F40121	7/8" x 3/4"	3/99

Flare x MIP Elbow

Style 49



PART NO.	TUBE x MIP	CTN/MSTR
F40082	1/4" x 1/8"	10/800
F40083	1/4" x 1/4"	10/1000
F40113	1/4" x 3/8"	5/600
F40084	5/16" x 1/8"	5/800
F40085	5/16" x 1/4"	5/800
F40086	3/8" x 1/8"	5/650
F40087	3/8" x 1/4"	5/650
F40088	3/8" x 3/8"	5/600
F40089	3/8" x 1/2"	5/400
F40091	1/2" x 3/8"	5/400
F40114	1/2" x 1/4"	5/400
F40092	1/2" x 1/2"	5/300
F40093	1/2" x 3/4"	3/150
F40128	5/8" x 3/8"	5/200
F40094	5/8" x 1/2"	5/200
F40115	5/8" x 3/4"	5/150
F40111	3/4" x 1/2"	3/120
F40116	3/4" x 3/4"	3/99

D

Space Heater Fittings

Cap



• 9/16"-24 Fine threaded flare

PART NO.	OD	CTN/MSTR
F41003	3/8"	10/750

Union



• 9/16"-24 Fine threaded flare

PART NO.	OD	CTN/MSTR
F41008	3/8"	5/325

Female Coupling



• 9/16"-24 Fine threaded flare

PART NO.	OD x FIP	CTN/MSTR
F41004	3/8" x 3/8"	1/1
F41005	3/8" x 1/2"	1/1

Male Half Union



• 9/16"-24 Fine threaded flare

PART NO.	OD x MIP	CTN/MSTR
F41006	3/8" x 3/8"	1/1
F41007	3/8" x 1/2"	1/1

Tee



• 9/16"-24 Fine threaded flare

PART NO.	OD	CTN/MSTR
F41009	3/8"	10/500

Male Elbow



• 9/16"-24 Fine threaded flare

PART NO.	OD x MIP	CTN/MSTR
F41012	3/8" x 3/8"	10/100
F41013	3/8" x 1/2"	10/100

Gas Range Fittings

Flare x Male



PART NO.	OD x MIP	CTN/MSTR
F481012	5/8" (15/16-16) x 3/4"	1/1

Flare x Female



PART NO.	OD x FIP	CTN/MSTR
F46108	5/8" (15/16-16) x 1/2"	1/1

Flare Cap & Nut



PART NO.	SIZE	CTN/MSTR
F401516 (cap)	15/16"	1/1
F411516 (nut)	15/16"	1/1



D

Yellow Brass 90° Elbow



PART NO.	IPT	CTN/MSTR
P20002	1/8"	1/1
P20004	1/4"	1/1
P20006	3/8"	1/1
P20008	1/2"	1/1

Yellow Brass 90° Male Elbow



PART NO.	IPT	CTN/MSTR
P13986	1/2"	1/1

D

Yellow Brass 90° Street Elbow



PART NO.	IPT	CTN/MSTR
P16002	1/8"	1/1
P16004	1/4"	1/1
P16006	3/8"	1/1
P16008	1/2"	1/1

Yellow Brass 45° Elbow



PART NO.	IPT	CTN/MSTR
P10452	1/8"	1/1
P10454	1/4"	1/1

Yellow Brass 45° Street Elbow



PART NO.	IPT	CTN/MSTR
P12402	1/8"	1/1
P12404	1/4"	1/1
P12408	1/2"	1/1

Yellow Brass Tee



PART NO.	IPT	CTN/MSTR
P10012	1/8"	1/1
P10014	1/4"	1/1
P10016	3/8"	1/1
P10018	1/2"	1/1

Yellow Brass Bell Reducer



PART NO.	IPT	CTN/MSTR
P19062	3/8" x 1/8"	1/1
P19082	1/2" x 1/8"	1/1
P19084	1/2" x 1/4"	1/1
P19086	1/2" x 3/8"	1/1
P19128	3/4" x 1/2"	1/1

Yellow Brass Coupling



PART NO.	IPT	CTN/MSTR
P10032	1/8"	1/1
P10034	1/4"	1/1
P10036	3/8"	1/1
P10038	1/2"	1/1
P10312	3/4"	1/1

Yellow Brass Cap



PART NO.	IPT	CTN/MSTR
P10082	1/8"	1/1
P10084	1/4"	1/1
P10086	3/8"	1/1
P10088	1/2"	1/1
P10812	3/4"	1/1

Yellow Brass Square Head Plug



PART NO.	IPT	CTN/MSTR
P10092	1/8"	1/1
P10094	1/4"	1/1
P10096	3/8"	1/1
P10098	1/2"	1/1
P10912	3/4"	1/1

Yellow Brass HEX Head Plug



PART NO.	IPT	CTN/MSTR
P12102	1/8"	1/1
P12104	1/4"	1/1
P12106	3/8"	1/1
P12108	1/2"	1/1
P12112	3/4"	1/1

Yellow Brass Countersunk Plug



PART NO.	IPT	CTN/MSTR
P20092	1/8"	1/1
P20094	1/4"	1/1
P20096	3/8"	1/1
P20098	1/2"	1/1

Yellow Brass Lock Nut



PART NO.	IPT	CTN/MSTR
P11102	1/8"	1/1
P11104	1/4"	1/1
P11106	3/8"	1/1
P11108	1/2"	1/1

Yellow Brass HEX Bushing



PART NO.	IPT	CTN/MSTR
P11042	1/4" x 1/8"	1/1
P11062	3/8" x 1/8"	1/1
P11064	3/8" x 1/4"	1/1
P11082	1/2" x 1/8"	1/1
P11084	1/2" x 1/4"	1/1
P11086	1/2" x 3/8"	1/1
P11122	3/4" x 1/8"	1/1
P11124	3/4" x 1/4"	1/1
P11126	3/4" x 3/8"	1/1
P11128	3/4" x 1/2"	1/1

Yellow Brass Face Bushing



PART NO.	IPT	CTN/MSTR
P11986	1/2" x 3/8"	1/1
P11928	3/4" x 1/2"	1/1

Yellow Brass Close Nipple



PART NO.	IPT	CTN/MSTR
P11202	1/8"	1/1
P11204	1/4"	1/1
P11206	3/8"	1/1
P11208	1/2"	1/1

Yellow Brass Long Nipple



PART NO.	IPT	CTN/MSTR
P13224	1/8" x 1-1/2"	1/1
P13232	1/8" x 2"	1/1
P13424	1/4" x 1-1/2"	1/1
P13432	1/4" x 2"	1/1
P13624	3/8" x 1-1/2"	1/1
P13632	3/8" x 2"	1/1

Yellow Brass HEX Nipple



PART NO.	IPT	CTN/MSTR
P12202	1/8"	1/1
P12204	1/4"	1/1
P12206	3/8"	1/1
P12208	1/2"	1/1
P12212	3/4"	1/1
P12342	1/4" x 1/8"	1/1
P12362	3/8" x 1/8"	1/1
P12364	3/8" x 1/4"	1/1
P12386	1/2" x 3/8"	1/1
P12328	3/4" x 1/2"	1/1

Brass PEX Coupling



• Lead Free

PART NO.	SIZE	CTN/MSTR
C76001LF	1/2"	100/1000
C76002LF	3/4"	50/500
C76003LF	1"	50/300
C76004LF	3/4" x 1/2"	50/500
C76005LF	1" x 3/4"	25/250

Brass PEX 90° Elbow



• Lead Free

PART NO.	SIZE	CTN/MSTR
C76008LF	1/2"	100/500
C76009LF	3/4"	50/250
C76010LF	1"	25/100

Brass PEX x MIP 90° Elbow



• Lead Free

PART NO.	SIZE	CTN/MSTR
C76013LF	1/2" x 1/2"	25/100

Brass PEX Equal Tee



• Lead Free

PART NO.	SIZE	CTN/MSTR
C76014LF	1/2"	50/500
C76015LF	3/4"	50/250
C76016LF	1"	25/100

Brass PEX Tee



• Lead Free

PART NO.	SIZE	CTN/MSTR
C76017LF	1/2" x 1/2" x 3/4"	50/250
C76018LF	3/4" x 1/2" x 1/2"	50/250
C76019LF	3/4" x 1/2" x 3/4"	25/250
C76020LF	3/4" x 3/4" x 1/2"	25/250
C76021LF	1" x 3/4" x 3/4"	25/100
C76022LF	1" x 1" x 1/2"	25/100
C76023LF	1" x 1" x 3/4"	25/100

Brass PEX x Female Sweat Adapter



• Lead Free

PART NO.	PEX x FSW	CTN/MSTR
C76027LF	1/2" x 1/2"	100/500
C76028LF	3/4" x 3/4"	50/250
C76029LF	1/2" x 3/4"	25/250
C76030LF	1" x 1"	25/200

Brass PEX x Male Adapter



• Lead Free

PART NO.	PEX x MIP	CTN/MSTR
C76034LF	1/2" x 1/2"	25/400
C76035LF	1/2" x 3/4"	25/200
C76036LF	3/4" x 3/4"	50/250
C76037LF	1" x 1"	50/250
C76038LF	1" x 3/4"	25/100

Brass PEX x FIP Female Adapter



• Lead Free

PART NO.	PEX x FIP	CTN/MSTR
C76041LF	1/2" x 1/2"	50/250
C76042LF	1/2" x 3/4"	50/200
C76043LF	3/4" x 3/4"	25/200
C76044LF	1" x 1"	25/250

Brass PEX x Male Sweat Adapter



• Lead Free

PART NO.	PEX x MALE	CTN/MSTR
C76047LF	3/8" x 1/2"	50/500
C76048LF	1/2" x 1/2"	50/500
C76049LF	1/2" x 3/4"	25/100
C76050LF	3/4" x 3/4"	50/250
C76051LF	1" x 1"	25/100

Brass PEX x FIP 90° Elbow with Swivel Plastic Nut



• Lead Free

PART NO.	PEX x FIP	CTN/MSTR
C76060LF	1/2" x 1/2"	50/200

Brass PEX Ball Valve



• Lead Free

PART NO.	PEX x PEX	CTN/MSTR
B63050LF	1/2"	10/100
B63075LF	3/4"	10/100
B63100LF	1"	6/48

Brass PEX Plug



• Lead Free

PART NO.	PEX x FIP	CTN/MSTR
C76065LF	1/2"	100/1000
C76066LF	3/4"	100/500
C76067LF	1"	25/250

Brass PEX Crimp Ring



PART NO.	PEX x FIP	CTN/MSTR
C76070	3/8"	100/2000
C76071	1/2"	100/2000
C76072	3/4"	100/1000
C76073	1"	100/1000

Brass PEX x FIP Drop Ear 90° Elbow



• Lead Free

PART NO.	PEX x FIP	EARS	CTN/MSTR
C76080LF	1/2" x 1/2"	2	25/200
C76081LF	3/4" x 1/2"	2	25/200
C76079LF	1/2" x 1/2"	3	25/200

Oetiker PEX Stainless Steel Clamp



- The original patented PEX assembly clamp designed by ASTM F 2098
- Ingenious stepless design provides uniform compression for a 360° watertight seal
- Available for 3/8", 1/2", 3/4" and 1" ASTM F 876/877 pex tubing sizes
- Specified for use with ASTM F 1807 and F 2159 insert fittings

TECHNICAL DATA

APPLICATION:
PLUMBING & HYDRONIC
HEATING
HOT AND COLD WATER

MAXIMUM OPERATING
TEMPERATURE: 180°F

MAXIMUM OPERATING
PRESSURE (PSI): 100

MATERIAL: STAINLESS
STEEL UNS S304000

PART NO.	SIZE	CTN/MSTR
C76074	3/8"	100/2000
C76075	1/2"	100/2000
C76076	3/4"	50/2000
C76077	1"	50/1000

Black Plastic PEX Elbow



- Listed by Warnock Hersey
- Meets ASTM F2159, F877 and CSA B1375
- Will not rust or corrode
- Unaffected by household cleaners and chemicals
- Smooth interior for better water flow
- Resists scale build-up
- Lead free

WHITE PEX	BLACK PEX	SIZE	CTN/MSTR
C76702	C76751	1/2"	50/500
C76703	C76752	3/4"	50/350
C76720	C76753	1"	50/150

Plastic PEX Equal Tee



- Listed by Warnock Hersey
- Meets ASTM F2159, F877 and CSA B1375
- Will not rust or corrode
- Unaffected by household cleaners and chemicals
- Smooth interior for better water flow
- Resists scale build-up
- Lead free

WHITE PEX	BLACK PEX	SIZE	CTN/MSTR
C76700	C76762	1/2"	50/400
C76701	C76763	3/4"	50/200
—	C76773	1"	50/200

Black Plastic PEX Reducing Tee



- Listed by Warnock Hersey
- Meets ASTM F2159, F877 and CSA B1375
- Will not rust or corrode
- Unaffected by household cleaners and chemicals
- Smooth interior for better water flow
- Resists scale build-up
- Lead free

WHITE PEX	BLACK PEX	SIZE	CTN/MSTR
C76709	C76764	1/2" x 1/2" x 3/4"	25/300
C76710	C76765	3/4" x 1/2" x 1/2"	25/300
C76711	C76766	3/4" x 1/2" x 3/4"	25/300
C76712	C76767	3/4" x 3/4" x 1/2"	25/300
—	C76774	3/4" x 3/4" x 1"	25/300
—	C76772	1" x 3/4" x 3/4"	25/300
—	C76776	1" x 3/4" x 1"	25/300
—	C76770	1" x 1" x 1/2"	25/300
—	C76775	1" x 1" x 3/4"	25/300

Black Plastic PEX Coupling



- Listed by Warnock Hersey
- Meets ASTM F2159, F877 and CSA B1375
- Will not rust or corrode
- Unaffected by household cleaners and chemicals
- Smooth interior for better water flow
- Resists scale build-up
- Lead free

WHITE PEX	BLACK PEX	SIZE	CTN/MSTR
C76704	C76754	1/2"	50/1000
C76705	C76755	3/4"	50/600
C76706	C76756	3/4" x 1/2"	50/600
C76722	C76757	1"	50/200
C76723	C76758	1" x 3/4"	50/300

Black Plastic PEX Adapter



- Listed by Warnock Hersey
- Meets ASTM F2159, F877 and CSA B1375
- Will not rust or corrode
- Unaffected by household cleaners and chemicals
- Smooth interior for better water flow
- Resists scale build-up
- Lead free

WHITE PEX	BLACK PEX	PEX x MPT	CTN/MSTR
C76707	C76759	1/2" x 1/2"	25/500
C76708	C76760	3/4" x 3/4"	25/300
C76727	C76761	1" x 1"	25/150

Black Plastic PEX Plug



- Listed by Warnock Hersey
- Meets ASTM F2159, F877 and CSA B1375
- Will not rust or corrode
- Unaffected by household cleaners and chemicals
- Smooth interior for better water flow
- Resists scale build-up
- Lead free

WHITE PEX	BLACK PEX	SIZE	CTN/MSTR
C76740	C76768	1/2"	100/2000
C76741	C76769	3/4"	100/1000
—	C76771	1"	100/1000

PlumBite® Push On Fittings

- Joins copper, CPVC, PE-RT or PEX tubing
- No soldering, glue, heat or external tools required
- Max. Temp 180°F
- Max. Pressure 200 PSI
- Generous warranty
- NSF/ANSI 61, NSF 372, NSF 14, ASSE 1061, UPC and cUPC, and IAPMO Certified
- Lead free



Coupling (Bulk)		
PART NO.	SIZE	CTN/MSTR
C76500LF	1/2"	5/100
C76501LF	3/4"	5/100

Coupling (Bagged)		
PART NO.	SIZE	CTN/MSTR
C77400LF	1/2"	6/60
C77401LF	3/4"	6/24
C77402LF	1"	4/24
C77403LF	1-1/4"	10/40
C77404LF	1-1/2"	3/18
C77405LF	2"	2/12



Reducer Coupling (Bulk)		
PART NO.	SIZE	CTN/MSTR
C76502LF	3/4" x 1/2"	15/60

Reducer Coupling (Bagged)		
PART NO.	SIZE	CTN/MSTR
C77406LF	3/4" x 1/2"	6/24
C77407LF	1" x 3/4"	4/24
C77408LF	1/2" x 3/8"	4/24
C77409LF	1-1/4" x 1"	10/50
C77410LF	1/2" x 1/4"	4/24



Transition Coupling (Bagged)		
PART NO.	SIZE	CTN/MSTR
C77411LF	3/4" Polybutylene	4/24
C77412LF	3/4" PVC	4/24



Repair Coupling (Bulk)		
PART NO.	SIZE	CTN/MSTR
C76530LF	1/2"	5/70
C76531LF	3/4"	5/70
C76532LF	1"	5/40

Repair Coupling with Removal Tool (Bagged)		
PART NO.	SIZE	CTN/MSTR
C77470LF	1/2"	3/24
C77471LF	3/4"	3/24
C77472LF	1"	4/24



Adapter C x F (Bulk)		
PART NO.	SIZE	CTN/MSTR
C76503LF	1/2" x 1/2" FPT	10/100
C76504LF	3/4" x 3/4" FPT	20/60
C76553LF	1"x1" FPT	5/100

Adapter C x F (Bagged)		
PART NO.	SIZE	CTN/MSTR
C77413LF	1/2" x 1/2" FPT	6/60
C77514LF	3/4" x 3/4" FPT	4/24
C77416LF	1"x1" FPT	4/24



Adapter (Bulk)		
PART NO.	SIZE	CTN/MSTR
C76505LF	1/2" x 1/2" MPT	10/200
C76506LF	3/4" x 3/4" MPT	5/100

Adapter (Bagged)		
PART NO.	SIZE	CTN/MSTR
C77417LF	1/2" x 1/2" MPT	6/60
C77418LF	3/4" x 3/4" MPT	6/24
C77419LF	1" x 1" MPT	4/24



Male Adapter (Bagged)		
PART NO.	SIZE	CTN/MSTR
C77420LF	1/2" x 3/4" MPT	4/24
C77421LF	3/8" x 1/2" MPT	4/24



Female Adapter (Bagged)		
PART NO.	SIZE	CTN/MSTR
C77422LF	1/2" x 3/4" FPT	4/24
C77423LF	3/8" x 1/2" FPT	4/24



90° Elbow (Bulk)		
PART NO.	SIZE	CTN/MSTR
C76507LF	1/2"	10/150
C76508LF	3/4"	5/80

90° Elbow (Bagged)		
PART NO.	SIZE	CTN/MSTR
C77425LF	1/2"	6/60
C77426LF	3/4"	4/24
C77427LF	1"	4/24
C77428LF	1-1/4"	5/25
C77429LF	1-1/2"	5/20
C77430LF	2"	3/12



Elbow C x F (Bagged)		
PART NO.	SIZE	CTN/MSTR
C77431LF	1/2" x 1/2" FPT	4/24



Elbow C x M (Bagged)		
PART NO.	SIZE	CTN/MSTR
C77432LF	1/2" x 1/2" MPT	4/24



Drop Ear 90° Elbow F x F (Bagged)		
PART NO.	SIZE	CTN/MSTR
C77434LF	1/2"	6/24



Drop Ear 90° Elbow C x F (Bulk)		
PART NO.	SIZE	CTN/MSTR
C76509LF	1/2"	10/100

D

We Got It -



Tee (Bulk)		
PART NO.	SIZE	CTN/MSTR
C76510LF	1/2"	10/100
C76512LF	3/4" x 3/4" x 1/2"	5/50
C76513LF	3/4" x 1/2" x 3/4"	5/50
C76514LF	3/4" x 1/2" x 1/2"	5/50
C76511LF	3/4"	10/100

Tee (Bagged)		
PART NO.	SIZE	CTN/MSTR
C77440LF	1/2"	6/24
C77444LF	3/4" x 3/4" x 1/2"	4/24
C77447LF	3/4" x 1/2" x 3/4"	4/24
C77443LF	3/4" x 1/2" x 1/2"	4/24
C77441LF	3/4"	4/24
C77442LF	1"	3/24
C77445LF	3/4" x 3/4" x 1/4"	10/60
C77446LF	3/4" x 3/4" x 1"	3/24



Cap (Bulk)		
PART NO.	SIZE	CTN/MSTR
C76515LF	1/2"	10/200
C76516LF	3/4"	5/150

Cap (Bagged)		
PART NO.	SIZE	CTN/MSTR
C77450LF	1/2"	6/60
C77451LF	3/4"	4/24
C77452LF	1"	4/24
C77453LF	1-1/4"	10/60
C77454LF	1-1/2"	10/40
C77455LF	2"	5/25



Ball Valve (Bulk)		
PART NO.	SIZE	CTN/MSTR
C76561LF	1/2"	10/60
C76562LF	3/4"	10/40

Ball Valve (Bagged)		
PART NO.	SIZE	CTN/MSTR
C77460LF	1/2"	10/100
C77461LF	3/4"	10/100
C77462LF	1"	5/50
C77463LF	1-1/4"	10/100
C77464LF	1-1/2"	10/100
C77465LF	2"	5/50



Check Valve (Bagged)		
PART NO.	SIZE	CTN/MSTR
C77466LF	1/2"	20/120
C77467LF	3/4"	10/60



Thermostatic Mixing Valve (Bagged)		
PART NO.	SIZE	CTN/MSTR
C77468LF	1/2"	1/24
C77469LF	3/4"	1/24



Supply Stop (Bulk)		
PART NO.	SIZE	CTN/MSTR
C76570LF	Straight 1/2" x 3/8"OD	1/120
C76571LF	Angle 1/2" x 3/8"OD	1/120

Supply Stop (Bagged)		
PART NO.	SIZE	CTN/MSTR
C77475LF	Straight 1/2" x 3/8"OD Comp	6/48
C77476LF	Straight 1/2" x 1/4"OD Comp	4/48
C77473LF	Angle 1/2" x 3/8"OD Comp	6/48
C77474LF	Angle 1/2" x 1/4"OD Comp	4/48



Water Heater Connector		
PART NO.	PF x FIP x LENGTH	CTN/MSTR
C76605LF	1/2" x 3/4" FIP x 12"	10/80
C76606LF	1/2" x 3/4" FIP x 15"	10/80
C76607LF	1/2" x 3/4" FIP x 18"	10/80
C76608LF	1/2" x 3/4" FIP x 24"	10/80
C76612LF	3/4" x 3/4" FIP x 12"	10/80
C76613LF	3/4" x 3/4" FIP x 15"	10/80
C77478LF	3/4" x 3/4" FIP x 18"	6/36
C76614LF	3/4" x 3/4" FIP x 18"	10/80
C77479LF	3/4" x 3/4" FIP x 24"	8/48
C76615LF	3/4" x 3/4" FIP x 24"	10/80
C76616LF	1/2" valve x 3/4" FIP x 18"	1/10
C76617LF	3/4" valve x 3/4" FIP x 18"	1/10



Water Heater Connector with Ball Valve		
• Lead Free		
PART NO.	SIZE	CTN/MSTR
C77477LF	3/4" x 3/4" FIP x 18"	5/30



Removal Tool Kit (Bagged)		
• Lead Free		
PART NO.	SIZE	CTN/MSTR
C77488LF	1/4" Through 1"	6/24



Removal Tool (Bulk)		
PART NO.	SIZE	CTN QTY
C76520	1/2"	1/500
C76521	3/4"	5/250
C76522	1"	5/200

Removal Tool (Bagged)		
PART NO.	SIZE	CTN QTY
C77482LF	1/2"	100/600
C77483LF	3/4"	60/360
C77480LF	1/4"	100/600
C77481LF	3/8"	100/600
C77484LF	1"	40/240



Large Removal Tool		
PART NO.	SIZE	CTN/MSTR
C77485LF	1-1/4"	10/100
C77486LF	1-1/2"	20/60
C77487LF	2"	5/100

Twist To Lock Plastic Fittings

- Reduced installation time
- Ideal for service and repair
- "O-ring" design for leak-free seals
- Working temps and pressure:
180PSI@68°F, 100PSI@150°F, 45PSI@180°F

INSTRUCTIONS FOR USE

To Connect: Squarely cut tubing or pipe to desired length, removing all burrs. Push fitting onto the end of tube or pipe. Fitting will grip before it seals. Ensure that tubing or pipe is pushed into the fitting until the end is fully seated into the internal tube stop.



To Lock Fitting: Twist the screw cap until colored line is no longer visible.

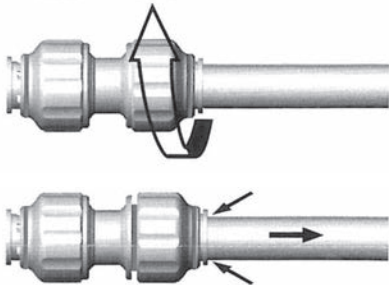

Plastic inserts are required for plastic pipe connections in heating installations. It is recommended to use pipe inserts for plastic pipe connections in standard residential plumbing (hot and cold water) installations.

Drop Ear Elbow CTS



PART NO.	SIZE	CTN/MSTR
C76800	1/2"	3/144

Enlarger Connector CTS STACK x CTS



PART NO.	SIZE	CTN/MSTR
C76801	3/4" x 1"	3/120

Female Adapter CTS x FIP



PART NO.	SIZE	CTN/MSTR
C76802	1/2" x 1/2"	3/321
C76803	1/2" x 3/4"	3/480
C76804	3/4" x 3/4"	3/216
C76805	1" x 1"	3/36

Female Garden Hose Adapter CTS x FGH



PART NO.	SIZE	CTN/MSTR
C76806	1/2" x 3/4"	3/168

Male Adapter CTS x MIP



PART NO.	SIZE	CTN/MSTR
C76807	1/2" x 1/2"	3/330
C76808	1/2" x 3/4"	3/282
C76809	3/4" x 3/4"	3/192

Male Elbow CTS x MIP



PART NO.	SIZE	CTN/MSTR
C76810	1/2" x 1/2"	3/168

Reducing Connector CTS x CTS Stem



PART NO.	SIZE	CTN/MSTR
C76811	1/2" x 3/4"	3/300

Swivel Elbow Union CTS x FIP



PART NO.	SIZE	CTN/MSTR
C76812	1/2" x 1/2"	3/160

Swivel Union Connector CTS x BC



PART NO.	SIZE	CTN/MSTR
C76813	1/2" x BC	3/300

Tube End Stop CTS



PART NO.	SIZE	CTN/MSTR
C76814	1/2"	3/336
C76815	3/4"	3/640
C76816	1"	3/135

Tube Elbow Union CTS x CTS Stem



PART NO.	SIZE	CTN/MSTR
C76817	1/2" x 1/2"	3/345
C76818	3/4" x 3/4"	3/180

Elbow Union CTS x CTS



PART NO.	SIZE	CTN/MSTR
C76819	1/2"	3/480
C76820	3/4"	3/60
C76821	1"	3/138

Tube Tee Union Connector CTS x CTS x CTS Stem



PART NO.	SIZE	CTN/MSTR
C76822	1/2" x 1/2" x 1/2"	3/180

Stack Tube Tee Union CTS



PART NO.	SIZE	CTN/MSTR
C76823	1/2"	3/195
C76824	3/4"	3/102

Union Connector CTS x CTS



PART NO.	SIZE	CTN/MSTR
C76825	3/8"	3/351
C76826	1/2" x 5/8"	3/528
C76827	1/2"	3/480
C76828	3/4" x 1/2"	3/330
C76829	3/4"	3/288
C76830	1" x 3/4"	3/180
C76831	1"	3/165

Tee Union CTS x CTS x CTS



PART NO.	SIZE	CTN/MSTR
C76832	1/2"	3/150
C76833	3/4" x 3/4" x 1/2"	3/180
C76834	3/4"	3/90
C76835	1"	3/78
C76836	1" x 3/4" x 3/4"	3/81
C76837	3/4" x 1/2" x 1/2"	3/180

Hand Valve Union Connector CTS x CTS



PART NO.	SIZE	CTN/MSTR
C76838	1/2"	3/210
C76839	3/4"	3/120

Plastic Push On Fittings

- Quick and easy installation
- Very durable and fatigue resistant
- Manufactured from safe, non-toxic materials meeting the requirements of the US FDA, WRAS, ANSI/NSF-51, 61 and SK Zert
- All connections can be assembled and disassembled repeatedly



1. Cut the part of the tube to be inserted into the fitting to plane the end.

2. Make sure to use a clean tube without any foreign material or cracks.



3. When inserting the tube, remove any obstructions before fully inserting the tube. Make sure the tube is fully inserted.

4. Inserting the tube into the fitting only takes moderate force. The tube or fitting should not be scratched or damaged in the process, as this is the main cause for water leaks later on.



5. To make sure that the fitting is properly connected to the tube, pull it once. After pulling, insert a spanner under the collet and push the tube into the fitting once more for a complete insertion.



6. When no play is desired for the fitting and tube, use our company's LC to eliminate the play of the fitting.



7. Make sure to completely eliminate pressure before disassembling the fitting.

8. When disassembling the tube, push the clip in direction to the main assembly and then pull the tube out for easy disassembling.

9. Fittings and tubes can be reused.

Straight Needle Valve Tube OD x MIP



PART NO.	SIZE	CTN/MSTR
C76840	1/4" x 1/4"	400/1600
C76841	3/8" x 3/8"	100/400

Straight Needle Valve Tube OD



PART NO.	SIZE	CTN/MSTR
C76842	1/4"	100/400
C76843	3/8"	150/600

Angle Valve Tube OD x FIP



PART NO.	SIZE	CTN/MSTR
C76844	1/4" x 1/4"	300/1200
C76845	3/8" x 3/8"	100/400

Straight Valve Tube OD x MIP



PART NO.	SIZE	CTN/MSTR
C76846	1/4" x 1/4"	50/600
C76847	3/8" x 3/8"	100/400

Straight Valve Tube OD x Tube OD



PART NO.	SIZE	CTN/MSTR
C76848	1/4"	150/600
C76849	3/8"	100/400

End Cap Tube OD



PART NO.	SIZE	CTN/MSTR
C76850	1/4"	500/3600
C76851	3/8"	600/2400
C76852	1/2"	400/1600

Plug Tube OD



PART NO.	SIZE	CTN/MSTR
C76853	1/4"	600/2400
C76854	3/8"	1000/4000
C76855	1/2"	500/2000

Union & Reducing Union Tube OD x Tube OD



PART NO.	SIZE	CTN/MSTR
C76856	1/4"	700/2800
C76857	3/8" x 1/4"	250/1000
C76858	3/8" x 3/8"	250/1000
C76859	1/2" x 3/8"	200/800

Bulkhead Union Tube OD x Tube OD



PART NO.	SIZE	CTN/MSTR
C76860	1/4" x 1/4"	200/800
C76861	3/8" x 3/8"	200/800
C76862	1/2" x 3/8"	100/400

Tee & Reducing Tee Tube OD x Tube OD x Tube OD



PART NO.	SIZE	CTN/MSTR
C76863	1/4"	400/1600
C76864	3/8" x 3/8" x 1/4"	200/800
C76865	3/8"	150/600
C76866	1/2" x 1/2" x 3/8"	100/400
C76867	1/2"	100/400

Elbow Tube OD x Tube OD



PART NO.	SIZE	CTN/MSTR
C76868	1/4"	700/2800
C76869	3/8"	300/1200
C76870	1/2"	150/600

Coupling Tube OD x FIP



PART NO.	SIZE	CTN/MSTR
C76871	1/4" x 1/8"	400/1600
C76872	1/4" x 1/4"	600/2400
C76873	3/8" x 1/4"	300/1200

Kitchen Faucet Adapter Tee FIP x MIP x Tube OD



PART NO.	SIZE	CTN/MSTR
C76874	1/2" x 1/2" x 1/4"	100/400
C76875	1/2" x 1/2" x 3/8"	100/400

Connector Tube OD x MIP



PART NO.	SIZE	CTN/MSTR
C76876	1/4" x 1/8"	800/3200
C76877	1/4" x 1/4"	800/3200
C76878	1/4" x 3/8"	600/2400
C76879	3/8" x 1/4"	400/1600
C76880	3/8" x 3/8"	400/1600
C76881	3/8" x 1/2"	200/800
C76882	1/2" x 3/8"	300/1200
C76883	1/2" x 1/2"	200/800

Elbow Tube OD x MIP



PART NO.	SIZE	CTN/MSTR
C76884	1/4" x 1/8"	800/3200
C76885	1/4" x 1/4"	600/2400
C76886	1/4" x 3/8"	500/2000
C76887	3/8" x 1/4"	800/3200
C76888	3/8" x 3/8"	300/1200

Elbow Adapter Tube OD x Tube OD Stem



PART NO.	SIZE	CTN/MSTR
C76889	1/4" x 1/4"	500/2000
C76890	3/8" x 3/8"	200/800

Connector Tube OD Stem x Tube ID



PART NO.	SIZE	CTN/MSTR
C76891	3/8" x 3/8"	800/3200
C76892	3/8" x 1/2"	200/800
C76893	1/2" x 1/2"	400/1600

Red Brass Pipe Nipples



- Meets ASTM B687
- Lead free

PART NO.	IPT	CTN/MSTR
N20000	1/8" x close	200/800
N20001	1/8" x 1-1/2"	200/800
N20002	1/8" x 2"	200/800
N20003	1/8" x 2-1/2"	200/800
N20004	1/8" x 3"	200/800
N20005	1/8" x 3-1/2"	100/400
N20006	1/8" x 4"	100/400
N20007	1/8" x 4-1/2"	100/400
N20008	1/8" x 5"	100/400
N20009	1/8" x 5-1/2"	100/400
N20010	1/8" x 6"	100/400
N20012	1/8" x 7"	1/400
N20014	1/8" x 8"	1/400
N21000	1/4" x close	150/600
N21001	1/4" x 1-1/2"	100/800
N21002	1/4" x 2"	100/800
N21003	1/4" x 2-1/2"	100/800
N21004	1/4" x 3"	50/400
N21005	1/4" x 3-1/2"	50/400
N21006	1/4" x 4"	50/200
N21007	1/4" x 4-1/2"	50/200
N21008	1/4" x 5"	40/320
N21009	1/4" x 5-1/2"	40/320
N21010	1/4" x 6"	40/320
N21014	1/4" x 8"	1/150
N21022	1/4" x 12"	1/100
N22000	3/8" x close	100/400
N22001	3/8" x 1-1/2"	100/400
N22002	3/8" x 2"	80/320
N22003	3/8" x 2-1/2"	80/320
N22004	3/8" x 3"	50/200
N22005	3/8" x 3-1/2"	40/320
N22006	3/8" x 4"	40/320
N22007	3/8" x 4-1/2"	35/280
N22008	3/8" x 5"	30/120
N22009	3/8" x 5-1/2"	30/120
N22010	3/8" x 6"	30/120
N22014	3/8" x 8"	1/160
N22018	3/8" x 10"	1/120
N22022	3/8" x 12"	1/110
N23000	1/2" x close	75/600
N23001	1/2" x 1-1/2"	60/480
N23002	1/2" x 2"	50/200
N23003	1/2" x 2-1/2"	35/280
N23004	1/2" x 3"	35/280
N23005	1/2" x 3-1/2"	25/100
N23006	1/2" x 4"	25/100
N23007	1/2" x 4-1/2"	25/100
N23008	1/2" x 5"	25/100

Red Brass Pipe Nipples cont...

PART NO.	IPT	CTN/MSTR
N23009	1/2" x 5-1/2"	25/100
N23010	1/2" x 6"	25/100
N23012	1/2" x 7"	1/100
N23014	1/2" x 8"	1/100
N23016	1/2" x 9"	1/100
N23018	1/2" x 10"	1/100
N23020	1/2" x 11"	1/100
N23022	1/2" x 12"	1/100
N24000	3/4" x close	40/320
N24001	3/4" x 1-1/2"	30/240
N24002	3/4" x 2"	30/240
N24003	3/4" x 2-1/2"	25/200
N24004	3/4" x 3"	25/100
N24005	3/4" x 3-1/2"	35/140
N24006	3/4" x 4"	35/140
N24007	3/4" x 4-1/2"	30/120
N24008	3/4" x 5"	30/120
N24009	3/4" x 5-1/2"	25/100
N24010	3/4" x 6"	25/100
N24012	3/4" x 7"	1/65
N24014	3/4" x 8"	1/65
N24016	3/4" x 9"	1/45
N24018	3/4" x 10"	1/45
N24022	3/4" x 12"	1/45
N25000	1" x close	25/200
N25002	1" x 2"	25/200
N25003	1" x 2-1/2"	40/160
N25004	1" x 3"	40/160
N25005	1" x 3-1/2"	25/100
N25006	1" x 4"	25/100
N25007	1" x 4-1/2"	25/100
N25008	1" x 5"	20/80
N25009	1" x 5-1/2"	10/40
N25010	1" x 6"	10/40
N25012	1" x 7"	1/40
N25014	1" x 8"	1/40
N25016	1" x 9"	1/30
N25018	1" x 10"	1/30
N25022	1" x 12"	1/30
N27000	1-1/4" x close	25/100
N27002	1-1/4" x 2"	25/100
N27003	1-1/4" x 2-1/2"	10/80
N27004	1-1/4" x 3"	10/80
N27005	1-1/4" x 3-1/2"	1/40
N27006	1-1/4" x 4"	10/40
N27007	1-1/4" x 4-1/2"	10/40
N27008	1-1/4" x 5"	10/40
N27009	1-1/4" x 5-1/2"	10/40
N27010	1-1/4" x 6"	10/40
N27014	1-1/4" x 8"	1/25
N27016	1-1/4" x 9"	1/20

Red Brass Pipe Nipples cont...



PART NO.	IPT	CTN/MSTR
N27018	1-1/4" x 10"	1/20
N27022	1-1/4" x 12"	1/20
N28000	1-1/2" x close	25/100
N28002	1-1/2" x 2"	20/80
N28003	1-1/2" x 2-1/2"	15/60
N28004	1-1/2" x 3"	15/60
N28005	1-1/2" x 3-1/2"	15/60
N28006	1-1/2" x 4"	15/60
N28007	1-1/2" x 4-1/2"	15/60
N28008	1-1/2" x 5"	10/40
N28009	1-1/2" x 5-1/2"	10/40
N28010	1-1/2" x 6"	10/40
N28014	1-1/2" x 8"	1/20
N28016	1-1/2" x 9"	1/15
N28018	1-1/2" x 10"	1/15
N28022	1-1/2" x 12"	1/15
N29000	2" x close	15/60
N29003	2" x 2-1/2"	10/40
N29004	2" x 3"	10/40
N29005	2" x 3-1/2"	10/40
N29006	2" x 4"	10/40
N29007	2" x 4-1/2"	10/40
N29008	2" x 5"	1/25
N29009	2" x 5-1/2"	1/25
N29010	2" x 6"	1/25
N29012	2" x 7"	1/10
N29014	2" x 8"	1/10
N29016	2" x 9"	1/10
N29018	2" x 10"	1/10
N29020	2" x 11"	1/10
N29022	2" x 12"	1/10
N30000	2-1/2" x close	1/40
N30004	2-1/2" x 3"	1/40
N30005	2-1/2" x 3-1/2"	1/20
N30006	2-1/2" x 4"	1/20
N30007	2-1/2" x 4-1/2"	1/20
N30008	2-1/2" x 5"	1/20
N30010	2-1/2" x 6"	1/20
N31000	3" x close	1/20
N31004	3" x 3"	1/20
N31005	3" x 3-1/2"	1/10
N31006	3" x 4"	1/10
N31008	3" x 5"	1/10
N31010	3" x 6"	1/10

D

Bronze 90° Elbow



• Lead Free

PART NO.	SIZE	CTN/MSTR
B74001LF	1/8"	150/600
B74002LF	1/4"	100/400
B74003LF	3/8"	75/300
B74004LF	1/2"	50/200
B74005LF	3/4"	25/100
B74006LF	1"	1/80
B74007LF	1-1/4"	1/50
B74008LF	1-1/2"	1/35
B74009LF	2"	1/20
B74343LF	3/4" x 1/2"	30/120
B74344LF	1" x 1/2"	25/100
B74345LF	1" x 3/4"	25/100
B74347LF	1-1/2" x 1-1/4"	1/40

SPECIFICATIONS:
ANSI B16.15
ANSI B2.1 (PIPE THREADS)
FED WW-P-460
FED WW-U-516
150 PSI @400°F WSP
225 PSI WOG@ -20°F / 150°F

D

Bronze 90° Street Elbow



• Lead Free

PART NO.	SIZE	CTN/MSTR
B74021LF	1/8"	200/800
B74022LF	1/4"	100/400
B74023LF	3/8"	60/240
B74024LF	1/2"	50/200
B74025LF	3/4"	25/100
B74026LF	1"	1/50
B74027LF	1-1/4"	1/40
B74028LF	1-1/2"	1/35
B74029LF	2"	1/20

Bronze 45° Elbow



• Lead Free

PART NO.	SIZE	CTN/MSTR
B74042LF	1/4"	120/480
B74044LF	1/2"	50/200
B74045LF	3/4"	25/100
B74046LF	1"	1/90

Bronze 45° Street Elbow



• Lead Free

PART NO.	SIZE	CTN/MSTR
B74066LF	1"	1/80
B74067LF	1-1/4"	1/50

Bronze Union



• Lead Free

PART NO.	SIZE	CTN/MSTR
B74262LF	1/4"	60/240
B74263LF	3/8"	30/120
B74264LF	1/2"	25/100
B74265LF	3/4"	20/80
B74266LF	1"	1/50
B74267LF	1-1/4"	1/35
B74268LF	1-1/2"	1/25
B74269LF	2"	1/18

Bronze Tee



• Lead Free

PART NO.	SIZE	CTN/MSTR
B74081LF	1/8"	120/480
B74082LF	1/4"	75/300
B74083LF	3/8"	50/200
B74084LF	1/2"	25/100
B74085LF	3/4"	1/85
B74086LF	1"	1/35
B74087LF	1-1/4"	1/35
B74088LF	1-1/2"	1/24
B74089LF	2"	1/15
B74090LF	2-1/2"	1/8
B74354LF	1/2" x 3/8"	35/140
B74396LF	3/4" x 3/8"	25/100
B74358LF	3/4" x 1/2" x 3/4"	1/100
B74359LF	3/4" x 1/2"	25/100
B74365LF	1" x 3/4"	1/70
B74369LF	1-1/4" x 3/4"	1/35
B74367LF	1-1/2" x 1-1/4"	1/25
B74368LF	2" x 1-1/2"	1/15

Bronze Cap



• Lead Free

PART NO.	SIZE	CTN/MSTR
B74181LF	1/8"	1/1200
B74182LF	1/4"	200/800
B74183LF	3/8"	150/600
B74184LF	1/2"	100/400
B74185LF	3/4"	50/200
B74186LF	1"	40/160
B74187LF	1-1/4"	1/100
B74188LF	1-1/2"	1/100
B74189LF	2"	1/70

Bronze Locknut



PART NO.	SIZE	CTN/MSTR
B74380LF	1/2"	150/600
B74381	3/4"	90/360
B74382	1"	60/240
B74384	1-1/2"	30/120

Bronze Coupling/Reducer



• Lead Free

PART NO.	SIZE	CTN/MSTR
B74121LF	1/8"	200/800
B74122LF	1/4"	150/600
B74123LF	3/8"	100/400
B74124LF	1/2"	50/200
B74125LF	3/4"	5/100
B74126LF	1"	1/100
B74127LF	1-1/4"	1/175
B74128LF	1-1/2"	1/50
B74129LF	2"	1/30
B74132LF	4"	1/6
B74140LF	1/4" x 1/8"	150/600
B74142LF	3/8" x 1/4"	90/360
B74144LF	1/2" x 1/4"	75/300
B74145LF	1/2" x 3/8"	70/280
B74148LF	3/4" x 1/2"	45/180
B74150LF	1" x 3/4"	25/100
B74152LF	1-1/4" x 3/4"	1/90
B74153LF	1-1/4" x 1"	1/80
B74154LF	1-1/2" x 1/2"	1/75
B74155LF	1-1/2" x 3/4"	1/80
B74156LF	1-1/2" x 1"	1/65
B74157LF	1-1/2" x 1-1/4"	1/60
B74160LF	2" x 1-1/4"	1/40
B74161LF	2" x 1-1/2"	1/35

Bronze Extension Piece



• Lead Free

PART NO.	SIZE	CTN/MSTR
B74370LF	3/4"	40/160

Bronze Cored Square Head Plug



• Lead Free

PART NO.	SIZE	CTN/MSTR
B74284LF	1/2"	150/600
B74285LF	3/4"	100/400
B74286LF	1"	50/200
B74287LF	1-1/4"	35/140
B74288LF	1-1/2"	30/120
B74289LF	2"	1/75

Bronze Solid Square Head Plug



• Lead Free

PART NO.	SIZE	CTN/MSTR
B74301LF	1/8"	300/1200
B74302LF	1/4"	1/690
B74303LF	3/8"	1/310
B74304LF	1/2"	100/400
B74305LF	3/4"	50/200
B74306LF	1"	35/140

Bronze Countersunk Plug

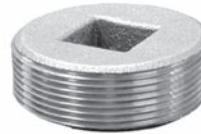

• Lead Free

PART NO.	SIZE	CTN/MSTR
B74331LF	3"	1/32

Bronze Cross



• Lead Free

PART NO.	SIZE	CTN/MSTR
B74104LF	1/2"	25/100
B74105LF	3/4"	1/60
B74107LF	1-1/4"	1/24
B74108LF	1-1/2"	1/22

Bronze HEX Bushing



• Lead Free

PART NO.	SIZE	CTN/MSTR
B74200LF	1/4" x 1/8"	300/1200
B74201LF	3/8" x 1/8"	250/1000
B74202LF	3/8" x 1/4"	125/500
B74203LF	1/2" x 1/8"	150/600
B74204LF	1/2" x 1/4"	150/600
B74205LF	1/2" x 3/8"	1/1000
B74206LF	3/4" x 1/8"	75/300
B74207LF	3/4" x 1/4"	80/320
B74208LF	3/4" x 3/8"	85/340
B74209LF	3/4" x 1/2"	90/360
B74210LF	1" x 1/4"	50/200
B74212LF	1" x 1/2"	50/200
B74213LF	1" x 3/4"	50/200
B74216LF	1-1/4" x 1/2"	1/120
B74217LF	1-1/4" x 3/4"	1/120
B74218LF	1-1/4" x 1"	1/120
B74220LF	1-1/2" x 3/8"	1/120
B74222LF	1-1/2" x 3/4"	1/85
B74223LF	1-1/2" x 1"	1/115
B74224LF	1-1/2" x 1-1/4"	1/120
B74228LF	2" x 3/4"	1/60
B74229LF	2" x 1"	1/60
B74230LF	2" x 1-1/4"	1/65
B74231LF	2" x 1-1/2"	1/65
B74232LF	2-1/2" x 2"	1/40
B74235LF	4" x 3"	1/12

Chrome Plated Nipples/Pipe Lengths



• Lead Free

PART NO.	SIZE	CTN/MSTR
N15100	3/8" x close	50/400
N15150	3/8" x 1-1/2"	25/400
N15200	3/8" x 2"	50/400
N15250	3/8" x 2-1/2"	50/300
N15300	3/8" x 3"	50/300
N15350	3/8" x 3-1/2"	50/200
N15400	3/8" x 4"	25/100
N15450	3/8" x 4-1/2"	50/200
N15500	3/8" x 5"	50/200
N15550	3/8" x 5-1/2"	25/100
N15600	3/8" x 6"	25/100
N15900	3/8" x 12"	25/50
N16100	1/2" x close	50/400
N16150	1/2" x 1-1/2"	50/400
N16200	1/2" x 2"	50/400
N16250	1/2" x 2-1/2"	75/300
N16300	1/2" x 3"	25/200
N16350	1/2" x 3-1/2"	50/200
N16400	1/2" x 4"	25/100
N16450	1/2" x 4-1/2"	25/100
N16500	1/2" x 5"	25/100
N16550	1/2" x 5-1/2"	25/100
N16600	1/2" x 6"	25/100
N16900	1/2" x 12"	25/50
N16918	1/2" x 18"	1/10
N16924	1/2" x 24"	1/10
N16936	1/2" x 36"	1/10
N17100	3/4" x close	50/100
N17150	3/4" x 1-1/2"	50/200
N17300	3/4" x 3"	1/30
N17400	3/4" x 4"	25/100
N17600	3/4" x 6"	25/100
N18100	1" x close	20/200
N18200	1" x 2"	20/200
N18250	1" x 2-1/2"	25/100
N18300	1" x 3"	25/100
N18400	1" x 4"	25/100
N18500	1" x 5"	25/50
N18600	1" x 6"	25/50

Chrome Plated 45° Elbow



• Lead Free

PART NO.	SIZE	CTN/MSTR
B50011LF	3/8"	25/100
B50012LF	1/2"	50/200

Chrome Plated 90° Elbow



• Lead Free

PART NO.	SIZE	CTN/MSTR
B50001LF	3/8"	25/100
B50002LF	1/2"	50/200
B50003LF	3/4"	25/100
B50004LF	1"	25/100

Chrome Plated 90° Street Elbow



• Lead Free

PART NO.	SIZE	CTN/MSTR
B50094LF	1/2"	25/100
B50098LF	3/4"	25/100
B50103LF	1"	1/50

Chrome Plated Tee



• Lead Free

PART NO.	SIZE	CTN/MSTR
B50031LF	3/8"	50/200
B50032LF	1/2"	50/100
B50033LF	3/4"	1/85

Chrome Plated Coupling



• Lead Free

PART NO.	SIZE	CTN/MSTR
B50041LF	3/8"	25/400
B50042LF	1/2"	50/200
B50043LF	3/4"	25/100
B50044LF	1"	25/100

Chrome Plated Reducer



• Lead Free

PART NO.	SIZE	CTN/MSTR
B50051LF	1/2"x 3/8"	70/280
B50052LF	3/4"x 1/2"	45/180

Chrome Plated Bushing



• Lead Free

PART NO.	SIZE	CTN/MSTR
B50072LF	1/2"x 3/8"	50/200
B50073LF	3/4"x 1/2"	90/360

Chrome Plated Union



• Lead Free

PART NO.	SIZE	CTN/MSTR
B50092LF	1/2"	25/100
B50097LF	3/4"	20/80
B50100LF	1"	25/100

Chrome Plated Plug



• Lead Free

PART NO.	SIZE	CTN/MSTR
B50096LF	1/2"	100/400
B50099LF	3/4"	25/100

Chrome Plated Cap



• Lead Free

PART NO.	SIZE	CTN/MSTR
B50081LF	3/8"	150/600
B50082LF	1/2"	100/400
B50083LF	3/4"	50/200

D

Male Hose To Male Pipe



PART NO.	MHT x MPT	CTN/MSTR
G20002	3/4" x 1/2"	20/200
G20003	3/4" x 3/4" (1/2" FIP tap)	20/200
G20004	3/4" x 1/2" (1/2" SWT)	50/200

Male Hose To Male Pipe - Lead Free



PART NO.	MHT x MPT	CTN/MSTR
G20102	3/4" x 1/2"	1/40
G20103	3/4" x 3/4" (1/2" FIP tap)	50/200

Male Hose To Male Hose



PART NO.	MHT x MHT	CTN/MSTR
G20008	3/4" x 3/4" (1/2" FIP tap)	20/200

Male Hose To Male Hose - Lead Free

• Lead Free



PART NO.	MHT x MHT	CTN/MSTR
G20108	3/4" x 3/4" (1/2" FIP tap)	1/40

Male Hose To Female Pipe



PART NO.	MHT x FPT	CTN/MSTR
G20010	3/4" x 1/2"	100/500
G20011	3/4" x 3/4"	20/200

Male Hose To Female Pipe - Lead Free

• Lead Free



PART NO.	MHT x FPT	CTN/MSTR
G20110	3/4" x 1/2"	1/40
G20111	3/4" x 3/4"	1/40

Female Hose To Male Pipe



PART NO.	FHT x MPT	CTN/MSTR
G20005	3/4" x 1/2" (1/2" SWT)	10/300
G20015	3/4" x 1/2"	50/250
G20016	3/4" x 3/4"	50/250
G20017	3/4" x 3/4" (1/2" FIP tap)	10/300

Female Hose To Male Pipe - Lead Free

• Lead Free



PART NO.	FHT x MPT	CTN/MSTR
G20115	3/4" x 1/2"	50/200
G20116	3/4" x 3/4"	1/40

Female Hose To Female Pipe



PART NO.	FHT x FPT	CTN/MSTR
G20020	3/4" x 1/2"	50/200
G20021	3/4" x 3/4"	50/200

Female Hose To Female Pipe - Lead Free

• Lead Free



PART NO.	FHT x FPT	CTN/MSTR
G20120	3/4" x 1/2"	1/40
G20121	3/4" x 3/4"	1/40

Female Hose To Female Hose Swivel



PART NO.	FHT x FHT	CTN/MSTR
G20030	3/4" x 3/4"	20/200

Female Hose To Female Hose Swivel - Lead Free

• Lead Free



PART NO.	FHT x FHT	CTN/MSTR
G20130	3/4" x 3/4"	1/40

Female Hose To Female Pipe Swivel



PART NO.	FHT x FPT	CTN/MSTR
G20031	3/4" x 1/2"	20/200
G20032	3/4" x 3/4"	125/250

Female Hose To Female Pipe Swivel - Lead Free



• Lead Free

PART NO.	FHT x FPT	CTN/MSTR
G20131	3/4" x 1/2"	1/40
G20132	3/4" x 3/4"	1/40

Hose Barb To Female Hose Swivel



• Lead Free

PART NO.	HB x FHT	CTN/MSTR
G20035	3/8" x 3/4"	10/400
G20036	1/2" x 3/4"	20/245
G20037	5/8" x 3/4"	10/400
G20038	3/4" x 3/4"	10/400

Hose Barb To Female Hose Swivel - Lead Free



• Lead Free

PART NO.	HB x FHT	CTN/MSTR
G20136	1/2" x 3/4"	50/200
G20137	5/8" x 3/4"	50/200
G20138	3/4" x 3/4"	50/200

Hose Barb To Male Hose



PART NO.	HB x MHT	CTN/MSTR
G20040	3/8" x 3/4"	10/300
G20041	1/2" x 3/4"	50/200
G20042	5/8" x 3/4"	1/200
G20043	3/4" x 3/4"	50/200

Hose Barb To Male Hose - Lead Free



• Lead Free

PART NO.	HB x MHT	CTN/MSTR
G20141	1/2" x 3/4"	50/200
G20142	5/8" x 3/4"	50/200
G20143	3/4" x 3/4"	50/200

Male Pipe To Female Hose Swivel



PART NO.	MPT x FHT	CTN/MSTR
G20045	1/4" x 3/4"	10/300
G20047	1/2" x 3/4"	50/200

Hose WYE



PART NO.	DESCRIPTION	CTN/MSTR
G20050	3/4" x 3/4"	20/200

Hose WYE - Lead Free



• Lead Free

PART NO.	DESCRIPTION	CTN/MSTR
G20150	3/4" x 3/4"	1/100

Garden Hose Shut Off



• Buna-N seals

PART NO.	DESCRIPTION	CTN/MSTR
G20051	Dual shut off/ green ABS	16/192
G20053	Brass hose with shut off "wye"	15/60
G20054	CP die cast with shut off "wye"	20/100

Garden Hose Cap



PART NO.	FHT	CTN/MSTR
G20055	3/4"	100/600
G20056	3/4" with chain	10/600

Garden Hose Cap - Lead Free



• Lead Free

PART NO.	FHT	CTN/MSTR
G20155	3/4" with washer	1/500

Garden Hose Washer



PART NO.	SIZE	CTN/MSTR
G20057	3/4" vinyl	1/5000
G20057R	3/4" red rubber	1/2500

Garden Hose Filter Washer



PART NO.	SIZE	CTN/MSTR
G20060	3/4"	10/1000

Evaporation Cooler Drain



PART NO.	MHT x FPT	CTN/MSTR
G20006	3/4" x 1/2"	25/200

Hose Barb To Male Pipe

• Barb refers to hose I.D.



PART NO.	BARB x MPT	CTN/MSTR
G25022	1/8" x 1/8"	10/100
G25032	3/16" x 1/8"	10/100
G25034	3/16" x 1/4"	10/100
G25042	1/4" x 1/8"	10/100
G25044	1/4" x 1/4"	10/100
G25046	1/4" x 3/8"	10/100
G25048	1/4" x 1/2"	10/100
G25052	5/16" x 1/8"	10/100
G25054	5/16" x 1/4"	10/100
G25056	5/16" x 3/8"	10/100
G25062	3/8" x 1/8"	10/100
G25064	3/8" x 1/4"	10/100
G25066	3/8" x 3/8"	10/100
G25068	3/8" x 1/2"	10/100
G25612	3/8" x 3/4"	10/100
G25084	1/2" x 1/4"	10/100
G25086	1/2" x 3/8"	10/100
G25088	1/2" x 1/2"	10/100
G25812	1/2" x 3/4"	10/100
G25106	5/8" x 3/8"	10/100
G25108	5/8" x 1/2"	10/100
G25101	5/8" x 3/4"	10/100
G25128	3/4" x 1/2"	10/100
G25121	3/4" x 3/4"	10/100
G25161	1" x 3/4"	10/100
G25169	1" x 1"	10/100

Hose Barb To Female Pipe

• Barb refers to hose I.D.



PART NO.	BARB x FPT	CTN/MSTR
G26022	1/8" x 1/8"	10/100
G26032	3/16" x 1/8"	10/100
G26034	3/16" x 1/4"	10/100
G26042	1/4" x 1/8"	10/100
G26044	1/4" x 1/4"	10/100
G26046	1/4" x 3/8"	10/100
G26052	5/16" x 1/8"	10/100
G26054	5/16" x 1/4"	10/100
G26056	5/16" x 3/8"	10/100
G26062	3/8" x 1/8"	10/100
G26064	3/8" x 1/4"	10/100
G26066	3/8" x 3/8"	10/100
G26068	3/8" x 1/2"	10/100
G26084	1/2" x 1/4"	10/100
G26086	1/2" x 3/8"	10/100
G26088	1/2" x 1/2"	10/100
G26121	3/4" x 3/4"	10/100
G26161	1" x 3/4"	10/100

Barb To Barb Hose Splicer

• Barb refers to hose I.D.



PART NO.	BARB	CTN/MSTR
G29003	3/16"	10/100
G29004	1/4"	10/100
G29005	5/16"	10/100
G29006	3/8"	10/100
G29008	1/2"	10/100
G29010	5/8"	10/100

Hose Barb To Male Pipe Elbow

• Barb refers to hose I.D.



PART NO.	BARB x MPT	CTN/MSTR
G27042	1/4" x 1/8"	10/100
G27044	1/4" x 1/4"	10/100
G27054	5/16" x 1/4"	10/100
G27062	3/8" x 1/8"	10/100
G27064	3/8" x 1/4"	10/100
G27066	3/8" x 3/8"	10/100
G27068	3/8" x 1/2"	10/100
G27084	1/2" x 1/4"	10/100
G27086	1/2" x 3/8"	10/100
G27088	1/2" x 1/2"	10/100
G27106	5/8" x 3/8"	10/100
G27108	5/8" x 1/2"	10/100

Hose Barb To Female Ball End Swivel

• Barb refers to hose I.D.



PART NO.	BARB x NPSM	CTN/MSTR
G28044	1/4" x 1/4"	10/100
G28066	3/8" x 3/8"	10/100
G28088	1/2" x 1/2"	10/100

Hose Barb Tee

• Barb refers to hose I.D.



PART NO.	BARB x BARB X BARB	CTN/MSTR
G24004	1/4"	10/100
G24006	3/8"	10/100

Nylon Hose Barb Spicer

• Barb refers to hose I.D.



PART NO.	BARB x BARB	CTN/MSTR
N10001	1/8" x 1/8"	10/100
N10002	1/4" x 1/4"	10/100
N10003	5/16" x 5/16"	10/100
N10004	3/8" x 3/8"	10/100
N10005	1/2" x 1/2"	10/100
N10006	5/8" x 5/8"	10/100
N10007	3/4" x 3/4"	10/100
N10008	1" x 1"	5/50

Nylon Hose Barb Adapter

• Barb refers to hose I.D.



PART NO.	MPT x BARB	CTN/MSTR
N14001	1/4" x 1/4"	10/100
N14002	1/4" x 3/8"	10/100
N14003	3/8" x 1/4"	10/100
N14004	3/8" x 3/8"	10/100
N14005	3/8" x 1/2"	10/100
N14006	1/2" x 1/4"	10/100
N14007	1/2" x 3/8"	10/100
N14008	1/2" x 1/2"	10/100
N14009	1/2" x 5/8"	10/100
N14010	1/2" x 3/4"	10/100
N14011	3/4" x 3/8"	10/100
N14012	3/4" x 1/2"	10/100
N14013	3/4" x 5/8"	10/100
N14014	3/4" x 3/4"	10/100
N14015	3/4" x 1"	5/50
N14016	1" x 1/2"	5/50
N14017	1" x 5/8"	5/50
N14018	1" x 3/4"	5/50
N14019	1" x 1"	5/50

Nylon Hose Barb Tee

• Barb refers to hose I.D.

D



PART NO.	BARB x BARB	CTN/MSTR
N11001	1/8" x 1/8" x 1/8"	10/100
N11002	1/4" x 1/4" x 1/4"	10/100
N11003	3/8" x 3/8" x 3/8"	10/100
N11004	1/2" x 1/2" x 3/8"	10/100
N11005	1/2" x 1/2" x 1/2"	10/100
N11006	5/8" x 5/8" x 5/8"	10/100
N11007	3/4" x 3/4" x 3/4"	10/100
N11008	1" x 1" x 1"	5/50

Nylon Hose Barb Elbow

• Barb refers to hose I.D.



PART NO.	BARB x BARB	CTN/MSTR
N12001	1/4" x 1/4"	10/100
N12002	3/8" x 3/8"	10/100
N12003	1/2" x 1/2"	10/100
N12004	5/8" x 5/8"	10/100
N12005	3/4" x 3/4"	10/100
N12006	1" x 1"	5/50

Nylon Male Garden Hose To Female Pipe



PART NO.	MHT x FPT	CTN/MSTR
N18001	3/4" x 1/2"	10/100
N18002	3/4" x 3/4"	10/100

Nylon Garden Hose Cap



PART NO.	FHT	CTN/MSTR
N06001	3/4"	10/100

Nylon Male Garden Hose To Male Pipe



PART NO.	MHT x MPT	CTN/MSTR
N09001	3/4" x 1/2"	10/100
N09002	3/4" x 3/4"	10/100

Nylon Female Hose Barb Adapter

• Barb refers to hose I.D.



PART NO.	BARB x FPT	CTN/MSTR
N15001	1/2" x 1/2"	10/100

Nylon Female Garden Hose To Female Pipe



PART NO.	FHT x FPT	CTN/MSTR
N07001	3/4" x 1/2"	10/100

Nylon Male Insert Adapter



- For flexible polyethylene plastic pipe
- NSF listed



PART NO.	SIZE	CTN/MSTR
I11001	1/2"	10/100
I11002	3/4"	10/100
I11003	1"	10/100
I11004	1-1/4"	10/100
I11005	1-1/2"	10/100
I11006	2"	10/100

Nylon Insert Combination Elbow



- For flexible polyethylene plastic pipe
- NSF listed



PART NO.	SIZE	CTN/MSTR
I11025	1/2"	10/100
I11026	3/4"	10/100
I11027	1"	10/100
I11028	1-1/4"	10/100

Nylon Insert Coupling



- For flexible polyethylene plastic pipe
- NSF listed



PART NO.	SIZE	CTN/MSTR
I11007	1/2"	10/100
I11008	3/4"	10/100
I11009	1"	10/100
I11010	1-1/4"	10/100
I11011	1-1/2"	10/100
I11012	2"	10/100

Nylon Insert Elbow



- For flexible polyethylene plastic pipe
- NSF listed



PART NO.	SIZE	CTN/MSTR
I11013	1/2"	10/100
I11014	3/4"	10/100
I11015	1"	10/100
I11016	1-1/4"	10/100
I11017	1-1/2"	10/100
I11018	2"	5/50

Nylon Insert Tee



- For flexible polyethylene plastic pipe
- NSF listed



PART NO.	SIZE	CTN/MSTR
I11019	1/2"	10/100
I11020	3/4"	10/100
I11021	1"	10/100
I11022	1-1/4"	10/100
I11023	1-1/2"	10/100
I11024	2"	5/50

D

Poly Male Insert Adapter



- For flexible polyethylene plastic pipe
- NSF listed



PART NO.	SIZE	CTN/MSTR
I10001	1/2"	10/100
I10002	3/4"	10/250
I10003	1"	10/160
I10004	1-1/4"	10/80
I10005	1-1/2"	5/60
I10006	2"	5/40

Poly Insert Elbow



- For flexible polyethylene plastic pipe
- NSF listed



PART NO.	SIZE	CTN/MSTR
I10023	1/2"	10/300
I10024	3/4"	10/180
I10025	1"	10/100
I10026	1-1/4"	5/60
I10027	1-1/2"	5/40
I10028	2"	5/25

Poly Female Insert Adapter



- For flexible polyethylene plastic pipe
- NSF listed



PART NO.	SIZE	CTN/MSTR
I10007	1/2"	10/400
I10008	3/4"	10/250
I10009	1"	10/160
I10010	1-1/4"	10/80

Poly Insert Tee



- For flexible polyethylene plastic pipe
- NSF listed



PART NO.	SIZE	CTN/MSTR
I10029	1/2"	10/180
I10030	3/4"	10/100
I10031	1"	10/60
I10032	1-1/4"	5/40
I10033	1-1/2"	5/30
I10034	2"	5/15

Poly Insert Coupling



- For flexible polyethylene plastic pipe
- NSF listed



PART NO.	SIZE	CTN/MSTR
I10011	1/2"	10/400
I10012	3/4"	10/250
I10013	1"	10/160
I10014	1-1/4"	10/80
I10015	1-1/2"	5/60
I10016	2"	5/40

Poly Insert x MIP Combination Elbow



- For flexible polyethylene plastic pipe
- NSF listed



PART NO.	SIZE	CTN/MSTR
I10035	1/2"	10/300
I10036	3/4"	10/200
I10037	1"	10/100
I10038	1-1/4"	5/50
I10039	1-1/2"	5/50

Poly Reducing Insert Coupling



- For flexible polyethylene plastic pipe
- NSF listed



PART NO.	SIZE	CTN/MSTR
I10017	3/4" x 1/2"	10/300
I10018	1" x 1/2"	10/220
I10019	1" x 3/4"	10/220
I10020	1-1/4" x 1"	10/100
I10021	1-1/2" x 1-1/4"	5/15
I10022	2" x 1-1/2"	5/15

Poly Insert Reducing Tee



- For flexible polyethylene plastic pipe
- NSF listed



PART NO.	SIZE	CTN/MSTR
I10043	3/4" x 3/4" x 1/2"	1/1
I10044	3/4" x 1/2" x 1/2"	1/1
I10045	1" x 1" x 1/2"	1/1
I10046	1" x 1" x 3/4"	1/1
I10047	1" x 3/4" x 3/4"	1/1
I10048	1-1/2" x 1-1/2" x 1"	1/1
I10049	2" x 2" x 1"	1/1

Poly Male Insert Reducer



- For flexible polyethylene plastic pipe
- NSF listed



PART NO.	SIZE	CTN/MSTR
I10040	3/4" x 1/2"	10/300
I10041	1" x 3/4"	10/220
I10042	1-1/4" x 1"	10/100

Red Brass Male Insert Adapter



- For flexible polyethylene plastic pipe
- Lead free

PART NO.	SIZE	CTN/MSTR
I13001LF	1/2"	10/200
I13002LF	3/4"	10/200
I13003LF	1"	10/100
I13004LF	1 1/4"	10/100
I13005LF	1 1/2"	10/60
I13006LF	2"	5/40

Red Brass Male Insert Reducer



- For flexible polyethylene plastic pipe
- Lead free

PART NO.	INSERT x MPT	CTN/MSTR
I13007LF	1" x 3/4"	1/100

Red Brass Female Insert Adapter



- For flexible polyethylene plastic pipe
- Lead free

PART NO.	SIZE	CTN/MSTR
I13010LF	3/4"	10/100
I13011LF	1"	1/200
I13012LF	1-1/4"	1/100
I13013LF	1-1/2"	1/100

Red Brass Insert x MIP 90° Elbow



- For flexible polyethylene plastic pipe
- Lead free

PART NO.	INSERT	MIP	CTN/MSTR
I13031LF	3/4"	3/4"	1/100
I13032LF	1"	3/4"	1/100
I13033LF	1"	1"	10/100

Red Brass Insert x Sweat Adapter



- For flexible polyethylene plastic pipe
- Lead free

PART NO.	INSERT	SWEAT	CTN/MSTR
I13036LF	3/4"	3/4"	10/100
I13037LF	1"	1"	10/200

Red Brass Insert Coupling



- For flexible polyethylene plastic pipe
- Lead free

PART NO.	SIZE	CTN/MSTR
I13016LF	3/4"	1/100
I13017LF	1"	1/100
I13018LF	1 1/4"	1/100
I13019LF	1 1/2"	1/100
I13020LF	2"	10/100

Red Brass Insert Tee



- For flexible polyethylene plastic pipe
- Lead free

PART NO.	SIZE	CTN/MSTR
I13021LF	3/4"	1/100
I13022LF	1"	1/100
I13023LF	1 1/4"	10/50

Red Brass Insert Elbow



- For flexible polyethylene plastic pipe
- Lead free

PART NO.	SIZE	CTN/MSTR
I13024LF	3/4"	1/100
I13025LF	1"	1/100
I13026LF	1 1/4"	1/50

Red Brass Insert Male Rope Adapter



- For flexible polyethylene plastic pipe
- Lead free

PART NO.	SIZE	CTN/MSTR
I13027LF	1"	1/100
I13029LF	1"x 1 1/4"	1/100

Brass PEX to PB (Polybutylene) Adapter



- Lead free

PART NO.	SIZE	CTN/MSTR
C76100LF	1/2"	25/500
C76101LF	3/4"	25/300

Steel Male Insert Adapter



- For flexible polyethylene plastic pipe

PART NO.	SIZE	CTN/MSTR
I12001	1/2"	50/300
I12002	3/4"	25/200
I12003	1"	25/100
I12004	1-1/4"	12/96
I12005	1-1/2"	6/84
I12006	2"	5/40

INSERT FITTINGS VS HOSE BARBS?

Insert Fittings only fit polyethylene plastic pipe (water service pipe).

Hose Barbs are designed to fit the inside diameter of various rubber hose sizes.

Both types of fittings are normally secured with hose gear clamps.

D

Steel Female Insert Adapter



- For flexible polyethylene plastic pipe

PART NO.	SIZE	CTN/MSTR
I12007	1/2"	25/200
I12008	3/4"	25/150
I12009	1"	15/150
I12010	1-1/4"	12/96
I12011	1-1/2"	10/60
I12012	2"	4/20

Steel Insert Coupling



- For flexible polyethylene plastic pipe

PART NO.	SIZE	CTN/MSTR
I12013	1/2"	50/300
I12014	3/4"	25/200
I12015	1"	25/200
I12016	1-1/4"	12/96
I12017	1-1/2"	6/84
I12018	2"	5/40

Brass Angle Compression Needle Valve



PART NO.	COMP x MIP	CTN/MSTR
N10442LF	1/4" x 1/8"	20/400
N10444LF	1/4" x 1/4"	20/400

Brass Straight Compression Needle Valve



PART NO.	COMP x COMP	CTN/MSTR
N10544LF	1/4" x 1/4"	20/400
N10566LF	3/8" x 3/8"	20/400

Brass Straight Compression Needle Valve



PART NO.	COMP x MIP	CTN/MSTR
N10664LF	3/8" x 1/4"	20/400

Brass Pipe Needle Valve



PART NO.	FIP x FIP	CTN/MSTR
N10944LF	1/4" x 1/4"	20/200

Brass Saddle Clamp



- Fits up to 3/4" iron pipe
- Fits up to 1" hard copper
- Unassembled

PART NO.	FPT	CTN/MSTR
N01038	1/8"	10/200

Brass Saddle Clamp With Self Piercing Valve



- Fits up to 3/4" iron pipe
- Fits up to 1" hard copper
- Unassembled

PART NO.	OD	CTN/MSTR
N01039	1/4"	10/200

Self Piercing Valve



- 1/4" OD compression outlet
- Fits 3/8" to 1.315" OD tube
- Lead free

PART NO.	TUBE SIZE	CTN/MSTR
S92001	1/4"	50/100

Icemaker/Humidifier Kit



- 1/4" tubing
- Self piercing valve
- Brass fittings
- Lead free

PART NO.	TUBE SIZE	CTN/MSTR
S92025	1/4" x 25' poly tubing	1/10
S92030	1/4" x 25' copper tubing	1/10
S92031	1/4" x 15' copper tubing	1/10

D

Gas Shut-Off Valve

- Rated at 2 PSIG
- Cast bronze plug style

MADE IN THE
USA



Lever Handle

PART NO.	SIZE	CTN/MSTR
G17025	1/4"	1/25
G17037	3/8"	1/25
G17050	1/2"	1/50
G17075	3/4"	1/50
G17100	1"	1/25
G17125	1-1/4"	1/10
G17150	1-1/2"	1/10
G17200	2"	1/5



Square Head

PART NO.	SIZE	CTN/MSTR
G18025	1/4"	1/25
G18037	3/8"	1/25
G18050	1/2" AGA	1/50
G18075	3/4" AGA	1/50
G18100	1"	1/25
G18125	1-1/4"	1/10
G18150	1-1/2"	1/10
G18200	2"	1/5



Flat/Tee Head

PART NO.	SIZE	CTN/MSTR
G19025	1/4"	1/25
G19037	3/8"	1/25
G19050	1/2" AGA	1/50
G19075	3/4" AGA	1/50
G19100	1"	1/25
G19125	1-1/4"	1/10
G19150	1-1/2"	1/10
G19200	2"	1/5

Flare x Flare



• 30 PSI

PART NO.	SIZE	CTN/MSTR
N01014	3/8"	1/10

Female Pipe x Female Pipe



• 30 PSI

PART NO.	SIZE	CTN/MSTR
N01010	1/8"	1/10
N01011	1/4"	1/10

Female Pipe x Male Pipe



• 30 PSI

PART NO.	SIZE	CTN/MSTR
N01027	1/8"	1/10
N01028	1/4"	1/10
N01029	3/8"	1/10

D

Drain Cock Tee Handle with Bibb



• Hose x Male IPT

PART NO.	SIZE	CTN/MSTR
N01032	1/4"	1/500

Drain Cock External Seat



PART NO.	SIZE	CTN/MSTR
N01033	1/8"	1/1000
N01034	1/4"	1/1000

Drain Cock



PART NO.	SIZE	CTN/MSTR
N01001	1/8"	1/500
N01002	1/4"	1/500

Satin Brass Air Cock Female x Male Lever Handle HEX Shoulder



• Spring bottoms

PART NO.	SIZE	CTN/MSTR
A11011	1/8" x 1/8"	1/100
A11001	1/4" x 1/4"	100/200

Satin Brass Air Cock Male x Spigot Tee Handle HEX Shoulder



• Spring bottoms

PART NO.	SIZE	CTN/MSTR
A11002	1/4" x spigot	100/200

Satin Brass Air Cock Female x Male Tee Handle HEX Shoulder



• Spring bottoms

PART NO.	SIZE	CTN/MSTR
A11003	1/4" x 1/4"	1/200

Satin Brass Air Cock Female x Female Lever Handle Round Shoulder



• Spring bottoms

PART NO.	SIZE	CTN/MSTR
A11004	1/4" x 1/4"	1/100

Satin Brass Air Cock Female x Female Tee Handle HEX Shoulder



• Spring bottoms

PART NO.	SIZE	CTN/MSTR
A11005	1/4" x 1/4"	1/200

Satin Brass Air Cock Female x Female Tee Handle Round Shoulder



• Spring bottoms

PART NO.	SIZE	CTN/MSTR
A11016	1/8" x 1/8"	1/50
A11006	1/4" x 1/4"	100/200

Satin Brass Air Cock Female x Female Lever Handle HEX Shoulder



• Spring bottoms

PART NO.	SIZE	CTN/MSTR
A11017	1/8" x 1/8"	1/100
A11007	1/4" x 1/4"	1/100

Satin Brass Air Cock Female x Male Tee Handle Round Shoulder



• Spring bottoms

PART NO.	SIZE	CTN/MSTR
A11008	1/4" x 1/4"	100/200

Gas Ball Valve

- Forged brass body
- 3/8" x 3/4" one piece body
- 1"-2" two-piece body with plated steel handle
- Chrome plated brass ball
- Temperatures up to 175°F
- Threaded ends comply with ANSI B2.1
- CSA- certified for use with natural, manufactured, mixed, liquefied petroleum and LP gas/air mixtures up to 2 PSIG
- UL listed 757x (1/2" and 3/4")
- Made in Italy



Lever Handle, Female x Female



PART NO.	SIZE	CTN/MSTR
B64375	3/8" FIP	10/100
B64050	1/2" FIP	10/100
B64075	3/4" FIP	10/100
B64100	1" FIP	6/36
B64125	1-1/4" FIP	4/24
B64150	1-1/2" FIP	4/16
B64200	2" FIP	2/10

Tee Handle, Female x Female



PART NO.	SIZE	CTN/MSTR
B65375	3/8" FIP	10/100
B65050	3/8" FIP	10/100
B65075	3/4" FIP	10/100
B65100	1" FIP	6/36

Square Head, Female x Female



PART NO.	SIZE	CTN/MSTR
B66375	3/8" FIP	10/100
B66050	1/2" FIP	10/100
B66075	3/4" FIP	10/100

Two-Piece Gas Ball Valve

- Forged brass body
- Two-piece body
- Lever handle
- Chrome plated brass ball
- Temperatures up to 125° F
- CSA- certified for use with natural, manufactured, mixed liquefied petroleum and L.P gas/air mixtures up to 2 PSIG
- Made in Italy



PART NO.	SIZE	CTN/MSTR
B64450	1/2"	10/50
B64475	3/4"	10/50

Texas Pattern Gas Ball Valve

- Forged brass body
- One piece body construction
- Lever handle
- Female IPS x hose end x 1/8" MIP
- CSA- certified for use with natural, manufactured, mixed liquefied petroleum and L.P gas/air mixtures up to 2 PSIG
- Made in Italy



PART NO.	SIZE	CTN/MSTR
B69121	1/2" FIP x 1/8" MIP	10/100

Lever Handle Gas Ball Valve

- Forged brass body
- One piece body construction
- 3/4" Chrome plated forged brass ball
- Temperatures up to 175°F
- Threaded ends comply with ANSI B2.1
- CSA- certified for use with natural, manufactured, mixed, liquefied petroleum and LP gas/air mixtures up to 2 PSIG
- Made in Italy



Flare x Female



PART NO.	SIZE	CTN/MSTR
B67375	3/8" flare x 1/2" FIP	10/100
B67050	1/2" flare x 1/2" FIP	10/100
B67937	15/16" flare x 1/2" FIP	10/100
B67975	15/16" flare x 3/4" FIP	10/100

Flare x Male



PART NO.	SIZE	CTN/MSTR
B68001	1/2" flare x 1/2" MIP	10/100

Flare x Flare



PART NO.	SIZE	CTN/MSTR
B68375	3/8" flare x 3/8" flare	10/100
B68050	1/2" flare x 1/2" flare	10/100
B68058	5/8" flare x 5/8" flare	10/100

Gas Heater Valve

- Forged brass body
- One piece body construction
- Chrome plated forged brass ball
- Temperatures up to 175°F
- 9/16" - 24 Fine Thread Flare (for 3/8" tube)
- CSA certified for use with natural, manufactured, liquefied petroleum and LP gas/air mixtures up to 2 PSIG
- Made in Italy



PART NO.	SIZE	CTN/MSTR
B69050	9/16"-24 x 1/2" FIP	10/100

Brass Gas Ball Valve

- Forged brass body
- Two piece body construction
- Chrome plated brass ball
- Double O-ring packing
- PTFE Seats
- 1/4 turn aluminum handle
- 1/2 PSI for indoor appliance connections

- per ANSI Z21.15/CGA 9.1
- Blowout-proof stem
- 5 PSI for indoor shutoff per CGA 91-002 & ASME B16.44
- CSA listed



Female x Female

PART NO.	SIZE	CTN/MSTR
B67100	1/2" FIP x 1/2" FIP	1/160
B67101	3/4" FIP x 3/4" FIP	1/100



Flare x Female

PART NO.	SIZE	CTN/MSTR
B67102	3/8" FL x 1/2" FIP	1/160
B67103	1/2" FL x 1/2" FIP	1/160

Flare x Male

PART NO.	SIZE	CTN/MSTR
B67104	1/2" FL x 1/2" MIP	1/160

Flare

PART NO.	SIZE	CTN/MSTR
B67105	3/8" FL x 3/8" FL	1/160
B67106	1/2" FL x 1/2" FL	1/160

Brass Ball Valve

- Full-port design
- Forged brass body up to 4"
- Chrome plated brass ball
- Adjustable packing nut
- Non-sticking teflon seats
- 1/4 turn zinc plated steel handle

- 600 PSI, WOG (water, oil, gas)
- Working steam pressure: 150 PSI
- Blowout-proof stem
- Teflon packing for safety against leakage
- UPC listed
- Lead free



Threaded

PART NO.	SIZE	CTN/MSTR
B67200	3/8"	20/100
B67201	1/2"	50/100
B67202	3/4"	30/60
B67203	1"	20/40
B67204	1-1/4"	12/24
B67205	1-1/2"	9/18
B67206	2"	6/12



Sweat

PART NO.	SIZE	CTN/MSTR
B67208	1/2"	50/100
B67209	3/4"	30/60
B67210	1"	20/40
B67211	1-1/4"	12/24
B67212	1-1/2"	9/18
B67213	2"	6/12

Brass Ball and Waste Valve

- Full-port with waste design
- Forged brass body
- Chrome plated brass ball
- Adjustable packing nut
- Non-sticking teflon seats
- 1/4 turn zinc plated steel handle
- 600 PSI, WOG (water, oil, gas)

- Working steam pressure: 150 PSI
- Blowout-proof stem
- Teflon packing for safety against leakage
- NSF61 certified
- UPC listed
- Lead free



Sweat

PART NO.	SIZE	CTN/MSTR
B67214	1/2"	10/60
B67215	3/4"	10/60
B67216	1"	5/40



Threaded

PART NO.	SIZE	CTN/MSTR
B67217	1/2"	10/60
B67218	3/4"	10/60
B67219	1"	5/40

Brass Stop Valve

- Cast brass body
- Cast iron handle
- 125 PSI WOG to 100° F

- Maximum temperature 180°F
- Lead free



Threaded

PART NO.	SIZE	CTN/MSTR
B67312	1/2"	6/48
B67313	3/4"	6/48



Stop & Waste Valve Threaded

PART NO.	SIZE	CTN/MSTR
B67315	3/4"	10/100



Sweat

PART NO.	SIZE	CTN/MSTR
B67316	1/2"	6/48
B67317	3/4"	10/100

Brass Broiler Drain Valve

- Forged brass body
- Copper or threads to hose
- Cast iron handle
- Non-sticking teflon seats

- 125 PSI WOG to 100°F
- Maximum temperature 180°F
- UPC listed



Male

PART NO.	SIZE	CTN/MSTR
B67320	1/2" MIP x 3/4" MHT	10/100
B67321	3/4" MIP x 3/4" MHT	10/100

- Forged brass body
- Threads to hose
- Cast iron handle

- 125 PSI WOG to 100°F
- Maximum temperature 180°F



Female

PART NO.	SIZE	CTN/MSTR
B67322	1/2" FIP x 3/4" MHT	10/100
B67323	3/4" FIP x 3/4" MHT	10/100

PVC Ball Valve Solvent Ends

- One piece body construction
- Standard port
- EPDM seats and o-rings
- Working pressure 150 PSI at 73°F
- Quarter turn operation
- Not for compressed air
- Ideal for swimming pools, irrigation and water supply uses
- Solvent ends comply with ASTM D 2466
- Threaded ends comply with ANSI B2.1
- For cold water lines
- Large flow opening



PART NO.	SIZE	CTN/MSTR
B90050	1/2"	1/162
B90075	3/4"	1/80
B90100	1"	1/84
B90125	1-1/4"	1/50
B90150	1-1/2"	1/50
B90200	2"	1/24
B90250	2-1/2"	1/15
B90300	3"	1/2
B90400	4"	1/1

D

PVC Ball Valve with Threaded Ends

- One-piece body construction
- Standard port
- EPDM seats and o-rings
- Working pressure 150 PSI at 73°F
- Quarter turn operation
- Not for compressed air
- Ideal for swimming pools, irrigation and water supply uses
- Solvent ends comply with ASTM D 2466
- Threaded ends comply with ANSI B2.1
- For cold water lines
- Large flow opening



PART NO.	SIZE	CTN/MSTR
B91050	1/2"	1/162
B91075	3/4"	25/100
B91100	1"	1/84
B91125	1-1/4"	1/60
B91150	1-1/2"	1/40
B91200	2"	6/24
B91250	2-1/2"	1/16
B91300	3"	1/10
B91400	4"	1/1

CPVC Ball Valve

- Standard port
- For use on CPVC tubing size (OD)
- Teflon seats
- EPDM o-rings
- One piece body construction
- Large flow opening
- For hot or cold water lines up to 100 PSI at temperature up to 180°F
- Solvent ends comply with ASTM D2846
- Quarter turn operation
- NSF 61 listed



PART NO.	SIZE	CTN/MSTR
B92050	1/2" (5/8" OD)	10/100
B92075	3/4" (7/8" OD)	10/100

Single Union PVC Swimming Pool Valve



- Teflon seats
- 150 PSI working pressure
- EPDM o-rings seal on union end
- Suitable for swimming pools, spas and plumbing
- Full port
- Solvent ends

PART NO.	SIZE	CTN/MSTR
B95150	1-1/2"	8/32
B95200	2"	5/20

Radiator Coin Key Air Valve and Key



- 1/8" threads
- 125 PSI
- CARTON QUANTITIES ONLY

PART NO.	DESCRIPTION	CTN/MSTR
R20001	Vent valve with key	50/500
R20002	Key only	100/5000
R20003	Valve only	100/1000

Bronze Steam Radiator Angle Valve



PART NO.	SIZE	CTN/MSTR
R20005	1/2"	10/60

Radiator Angle Air Valve



PART NO.	SIZE	CTN/MSTR
R20150	1/8"	12/144
R20151	1/8" adjustable	12/144

Dual Check Backflow Preventer



- Female by female
- Forged brass body
- 150 psi
- Acetyl-resin check modules
- Stainless steel spring
- 180° F maximum temperature
- Lead free

PART NO.	SIZE	CTN/MSTR
B59001LF	3/4"	1/100
B59002LF	1"	1/25

Inline PVC Check Valve



- Stainless steel spring
- EPDM seats
- Maintenance-free operation
- .5 PSI required to open unit
- 200 PSI static pressure rating at 77°F
- Use anywhere to stop backflow and siphoning
- Suitable for swimming pools, hot tubs, spas and solar installations

Solvent Ends		
PART NO.	SIZE	CTN/MSTR
C30050	1/2"	30/120
C30075	3/4"	30/120
C30100	1"	16/64
C30125	1-1/4"	12/48
C30150	1-1/2"	8/32
C30200	2"	4/16

Threaded Ends		
PART NO.	SIZE	CTN/MSTR
C31050	1/2"	30/120
C31075	3/4"	30/120
C31100	1"	16/64
C31125	1-1/4"	12/48
C31150	1-1/2"	8/32
C31200	2"	4/16

Items marked with the Jones Stephens logo are "You Need It... We Got It" Items.

Forged Brass Hose Bibb



- Hard chrome ball
- Quarter-turn operation
- Teflon seats
- T-handle

PART NO.	SIZE	CTN/MSTR
B60950	1/2"	10/100
B60975	3/4"	10/100

Cast Brass Hose Bibb



- Lead Free

PART NO.	MIP x MALE HOSE	CTN/MSTR
B59050	1/2" x 3/4"	10/100
B59075	3/4" x 3/4"	10/100
B59100	1" x 1"	6/36

Economy Hose Bibb Vacuum Breaker



- Brass
- 3/4" hose thread
- Vandal-proof breakoff screw
- ASSE 1011

PART NO.	DESCRIPTION	CTN/MSTR
G04004	Economy	20/200
G04003LF	Economy - Lead Free	20/200

Hose Faucet Anchor



- Long lasting solution for loose exterior faucets
- Works with any wall material (brick, concrete, vinyl siding or stucco)
- For repair or new home applications
- Fits all exterior or faucet water lines
- Corrosion free

PART NO.	DESCRIPTION	CTN/MSTR
B59000	Hose faucet anchor	1/100

Replacement Clamp For Flexible Coupling



- Made in USA
- CARTON QUANTITIES ONLY

MADE IN THE
USA

PART NO.	SIZE	CTN/MSTR
G15002	2"	10/200
G15003	3"	10/100
G15004	4"	10/100
G15006	6"	1/100
G15008	8"	1/50

Micro Size Gear Clamp



- 5/16" band
- Made in USA
- CARTON QUANTITIES ONLY

MADE IN THE
USA

Part Stainless

PART NO.	TRADE SIZE	SIZE	CTN/MSTR
G08004	4	1/4" - 5/8"	10/1000
G08006	6	5/16" - 7/8"	10/1000
G08008	8	3/8" - 1"	10/500
G08012	12	1/2" - 1-1/4"	10/500
G08016	16	1/2" - 1-1/2"	10/500
G08020	20	3/4" - 1-3/4"	10/500
G08024	24	1" - 2"	10/500

All Stainless

PART NO.	TRADE SIZE	SIZE	CTN/MSTR
G09004	4	1/4" - 5/8"	10/1000
G09006	6	5/16" - 7/8"	10/1000
G09008	8	1/2" - 1"	10/500
G09012	12	1/2" - 1-1/4"	10/500
G09016	16	1/2" - 1-1/2"	10/500
G09020	20	3/4" - 1-3/4"	10/500
G09024	24	1" - 2"	10/500

Full Size Gear Clamp



- 1/2" band
- Made in USA
- CARTON QUANTITIES ONLY

MADE IN THE
USA

Part Stainless

PART NO.	TRADE SIZE	SIZE	CTN/MSTR
G10006	6	3/8" - 7/8"	10/200
G10008	8	7/16" - 1"	10/200
G10010	10	1/2" - 1-1/16"	10/500
G10012	12	1/2" - 1-1/4"	10/500
G10016	16	3/4" - 1-1/2"	10/500
G10020	20	3/4" - 1-3/4"	10/500
G10024	24	1" - 2"	10/500
G10032	32	1-1/2" - 2-1/2"	10/500
G10036	36	7/8" - 2-3/4"	10/500
G10040	40	1-1/8" - 3"	10/200
G10052	52	1-7/8" - 3-3/4"	10/100
G10072	72	3-1/8" - 5"	10/100
G10080	80	3-5/8" - 5-1/2"	10/100
G10104	104	5" - 7"	10/100

All Stainless

PART NO.	TRADE SIZE	SIZE	CTN/MSTR
G11006	6	3/8" - 7/8"	10/200
G11008	8	7/16" - 1"	10/200
G11010	10	1/2" - 1-1/16"	10/500
G11012	12	1/2" - 1-1/4"	10/500
G11016 	16	11/16" - 1-1/2"	10/500
G11020	20	3/4" - 1-3/4"	10/500
G11024	24	1" - 2"	10/500
G11028	28	1-5/16" - 2-1/4"	10/500
G11032	32	1-9/16" - 2-1/2"	10/500
G11036	36	1-3/4" - 2-3/4"	10/500
G11040	40	1-1/8" - 3"	10/200
G11044	44	2-1/4" - 3 1/4"	10/200
G11048	48	1-5/8" - 3-1/2"	10/200
G11052	52	1-7/8" - 3-3/4"	10/200
G11056	56	2-1/8" - 4"	10/100
G11064	64	2-1/2" - 4-1/2"	10/100
G11072	72	3" - 5"	10/100
G11080	80	3-1/2" - 5-1/2"	10/100
G11088	88	4" - 6"	10/100
G11096	96	4-3/4" - 6-1/2"	10/100
G11104	104	5" - 7"	10/100

"68" Series Stainless Steel Gear Clamp



- 9/16" band
- All stainless, 300 grade construction
- Ideal for well drilling and applications requiring marine grade stainless clamps
- Made in USA
- CARTON QUANTITIES ONLY

MADE IN THE
USA

PART NO.	TRADE SIZE	SIZE	CTN/MSTR
G14006	6	3/8" - 7/8"	10/200
G14008	8	7/16" - 1"	10/200
G14010	10	1/2" - 1-1/16"	10/500
G14012	12	1/2" - 1-1/4"	10/500
G14016	16	11/16" - 1-1/2"	10/500
G14020	20	3/4" - 1-3/4"	10/500
G14024	24	1" - 2"	10/500
G14028	28	1-1/4" - 2-1/4"	10/500
G14032	32	1-1/2" - 2-1/2"	10/500
G14036	36	1-3/4" - 2-3/4"	10/200
G14040	40	1-1/8" - 3"	10/200
G14044	44	2-1/4" - 3-1/4"	10/200
G14048	48	1-5/8" - 3-1/2"	10/200
G14052	52	1-7/8" - 3-3/4"	10/100
G14056	56	2-1/8" - 4"	10/100
G14064	64	2-1/2" - 4-1/2"	10/100
G14072	72	3" - 5"	10/100
G14080	80	3-1/2" - 5-1/2"	10/100
G14088	88	4" - 6"	10/100
G14096	96	4-1/2" - 6-1/2"	10/100
G14104	104	5" - 7"	10/100

Stainless Steel Gear Clamp



- 1/2" band
- All stainless
- Hanging bag
- CARTON QUANTITIES ONLY

PART NO.	TRADE SIZE	SIZE	CTN/MSTR
G16006	6	3/8" - 7/8"	200/2000
G16008	8	7/16" - 1"	100/1000
G16010	10	1/2" - 1-1/16"	100/1000
G16012	12	1/2" - 1-1/4"	100/1000
G16016	16	5/8" - 1-1/2"	100/1000
G16020	20	3/4" - 1-3/4"	100/1000
G16024	24	1" - 2"	100/1000
G16028	28	1-3/8" - 2-1/4"	100/1000
G16032	32	1-5/8" - 2-1/2"	100/1000
G16036	36	1-7/8" - 2-3/4"	100/1000
G16040	40	2" - 3"	100/500
G16044	44	2-1/4" - 3-1/4"	100/500
G16048	48	2-5/8" - 3-1/2"	100/500
G16052	52	2-7/8" - 3-3/4"	100/500
G16056	56	3" - 4"	100/500
G16064	64	2-1/2" - 4-1/2"	100/500
G16072	72	3" - 5"	100/500
G16080	80	3-1/2" - 5-1/2"	50/250
G16088	88	4" - 6"	50/250
G16096	96	4-1/2" - 6-1/2"	50/250
G16104	104	5" - 7"	50/250

 Items marked with the Jones Stephens logo are "You Need It... We Got It" Items.

Asbestos-Free Full Face Gasket



- Meets ASTM F152, F36A and F146
- 1/16" thick
- Temperature rating of 750°F
- Manufactured of Garlock 4401

PART NO.	SIZE	LBS.	CTN/MSTR
G54075	3/4"	150	1/1
G54001	1"	150	1/1
G54013	1-1/4"	150	1/1
G54015	1-1/2"	150	1/1
G54002	2"	150	1/1
G54025	2-1/2"	150	1/1
G54003	3"	150	1/1
G54035	3-1/2"	150	1/1
G54004	4"	150	1/1
G54005	5"	150	1/1
G54006	6"	150	1/1
G54008	8"	150	1/1
G54010	10"	150	1/1
G54012	12"	150	1/1

Asbestos-Free Ring Gasket



- Meets ASTM F152, F36A and F146
- 1/16" thick
- Temperature rating of 750°F
- Manufactured of Garlock 4401

PART NO.	SIZE	LBS.	CTN/MSTR
G53050	1/2"	150	1/1
G53075	3/4"	150	1/1
G53001	1"	150	1/1
G53013	1-1/4"	150	1/1
G53015	1-1/2"	150	1/1
G53002	2"	150	1/1
G53025	2-1/2"	150	1/1
G53003	3"	150	1/1
G53035	3-1/2"	150	1/1
G53004	4"	150	1/1
G53005	5"	150	1/1
G53006	6"	150	1/1
G53008	8"	150	1/1
G53010	10"	150	1/1
G53012	12"	150	1/1

Red Rubber Full Face Gasket



- Meets ASTM D1330
- 1/16" thick
- Temperature rating of 350° F

PART NO.	SIZE	LBS.	CTN/MSTR
G51050	1/2"	150	1/1
G51075	3/4"	150	1/1
G51001	1"	150	1/1
G51013	1-1/4"	150	1/1
G51015	1-1/2"	150	1/1
G51002	2"	150	1/1
G51025	2-1/2"	150	1/1
G51003	3"	150	1/1
G51035	3-1/2"	150	1/1
G51004	4"	150	1/1
G51005	5"	150	1/1
G51006	6"	150	1/1
G51008	8"	150	1/1
G51010	10"	150	1/1
G51012	12"	150	1/1

Red Rubber Ring Gasket



- Meets ASTM D1330
- 1/16" thick
- Temperature rating of 350° F

PART NO.	SIZE	LBS.	CTN/MSTR
G52075	3/4"	150	1/1
G52001	1"	150	1/1
G52013	1-1/4"	150	1/1
G52015	1-1/2"	150	1/1
G52002	2"	150	1/1
G52025	2-1/2"	150	1/1
G52003	3"	150	1/1
G52035	3-1/2"	150	1/1
G52004	4"	150	1/1
G52005	5"	150	1/1
G52006	6"	150	1/1
G52008	8"	150	1/1
G52010	10"	150	1/1
G52012	12"	150	1/1

Asbestos-Free Full Face Gasket Kit



- Meets ASTM F152, F36A and F146
- Gaskets are 1/16" thick
- ASTM A307 hex bolts and heavy hex nuts
- Constructed of Garlock 4401

PART NO.	SIZE	BOLT SIZE	BOLTS/KIT	CTN/MSTR
G54115	1-1/2"	1/2" x 2-1/4"	4	1/1
G54102	2"	5/8" x 2-3/4"	4	1/1
G54125	2-1/2"	5/8" x 3"	4	1/1
G54103	3"	5/8" x 3"	4	1/1
G54104	4"	5/8" x 3"	8	1/1
G54105	5"	3/4" x 3-1/4"	8	1/1
G54106	6"	3/4" x 3-1/4"	8	1/1
G54108	8"	3/4" x 3-1/2"	8	1/1
G54110	10"	7/8" x 3-3/4"	12	1/1
G54112	12"	7/8" x 4"	12	1/1

Asbestos-Free Ring Gasket Kit



- Meets ASTM F152, F36A and F146
- Gaskets are 1/16" thick
- ASTM A307 hex bolts and heavy hex nuts
- Constructed of Garlock 4401

PART NO.	SIZE	BOLT SIZE	BOLTS/KIT	CTN/MSTR
G53101	1"	1/2" x 2"	4	1/1
G53113	1-1/4"	1/2" x 2-1/4"	4	1/1
G53115	1-1/2"	1/2" x 2-1/4"	4	1/1
G53102	2"	5/8" x 2-3/4"	4	1/1
G53125	2-1/2"	5/8" x 3"	4	1/1
G53103	3"	5/8" x 3"	4	1/1
G53104	4"	5/8" x 3"	8	1/1
G53105	5"	3/4" x 3-1/4"	8	1/1
G53106	6"	3/4" x 3-1/4"	8	1/1
G53108	8"	3/4" x 3-1/2"	8	1/1
G53110	10"	7/8" x 3-3/4"	12	1/1

Red Rubber Full Face Gasket Kit



- Meets ASTM D1330
- Gaskets are 1/16" thick
- ASTM A307 hex bolts and heavy hex nuts

PART NO.	SIZE	BOLT SIZE	BOLTS/KIT	CTN/MSTR
G51101	1"	1/8" x 2-3/8"	4	1/1
G51102	2"	5/8" x 2-3/4"	4	1/1
G51125	2-1/2"	5/8" x 3"	4	1/1
G51103	3"	5/8" x 3"	4	1/1
G51135	3-1/2"	5/8" x 3"	8	1/1
G51104	4"	5/8" x 3"	8	1/1
G51105	5"	3/4" x 3-1/4"	8	1/1
G51106	6"	3/4" x 3-1/4"	8	1/1
G51108	8"	3/4" x 3-1/2"	8	1/1
G51110	10"	7/8" x 3-3/4"	12	1/1
G51112	12"	7/8" x 4"	12	1/1

D

Red Rubber Ring Gasket Kit



- Meets ASTM D1330
- Gaskets are 1/16" thick
- ASTM A307 hex bolts and heavy hex nuts

PART NO.	SIZE	BOLT SIZE	BOLTS/KIT	CTN/MSTR
G52115	1-1/2"	1/2" x 2-1/4"	4	1/1
G52102	2"	5/8" x 2-3/4"	4	1/1
G52125	2-1/2"	5/8" x 3"	4	1/1
G52103	3"	5/8" x 3"	4	1/1
G52104	4"	5/8" x 3"	8	1/1
G52105	5"	3/4" x 3-1/4"	8	1/1
G52106	6"	3/4" x 3-1/4"	8	1/1
G52108	8"	3/4" x 3-1/2"	8	1/1
G52110	10"	7/8" x 3-3/4"	12	1/1

Insulation Kit with Poly Sleeves



- Use with flange connection kits
- To form dielectric connection use fiber washers

PART NO.	SIZE	#SLEEVES	#WASHERS	CTN/MSTR
G55150	1-1/2"	4	8	1/1
G55200	2"	4	8	1/1
G55250	2-1/2"	4	8	1/1
G55300	3"	4	8	1/1
G55350	4"	8	16	1/1
G55400	5"	8	16	1/1
G55450	6"	8	16	1/1
G55500	8"	8	16	1/1
G55550	10"	12	24	1/1
G55600	12"	12	24	1/1

Asbestos-Free Ring Gasket Kit with Insulation Kit



- Meets ASTM F152, F36A and F146
- Gaskets are 1/16" thick
- Temperature rating of 750°F
- Manufactured of Garlock 4401
- To form dielectric connection use fiber washers

PART NO.	SIZE	BOLT SIZE	BOLTS/KIT	CTN/MSTR
G53203	3"	5/8" x 3"	4	1/1
G53204	4"	5/8" x 3"	8	1/1
G53206	6"	3/4" x 3-1/4"	8	1/1
G53215	1-1/2"	1/2" x 2-1/4"	4	1/1
G53225	2-1/2"	5/8" x 3"	4	1/1

Asbestos-Free Full Face Gasket Kit with Insulation Kit



- Meets ASTM F152, F36A and F146
- Gaskets are 1/16" thick
- Temperature rating of 750°F
- Manufactured of Garlock 4401
- To form dielectric connection use fiber washers

PART NO.	SIZE	BOLT SIZE	BOLTS/KIT	CTN/MSTR
G54215	1-1/2"	1/2" x 2-1/4"	4	1/1
G54202	2"	5/8" x 2-3/4"	4	1/1
G54225	2-1/2"	5/8" x 3"	4	1/1
G54203	3"	5/8" x 3"	4	1/1
G54204	4"	5/8" x 3"	8	1/1
G54205	5"	3/4" x 3-1/4"	8	1/1
G54206	6"	3/4" x 3-1/4"	8	1/1
G54208	8"	3/4" x 3-1/2"	8	1/1
G54210	10"	7/8" x 3-3/4"	12	1/1
G54212	12"	7/8" x 4"	12	1/1

Red Rubber Sheet Packing/Gasket Material



- Priced per roll (approximately 100 pounds)
- FULL ROLLS ONLY

PART NO.	SIZE	CTN/MSTR
G55016	1/16" x 36" x 60'	1/1
G55018	1/8" x 36" x 30'	1/1
G55014	1/4" x 36" x 15'	1/1

Red Rubber Sheet Packing/Gasket Material



- Single 3' x 5' sheet

PART NO.	MATERIAL	THICKNESS	CTN/MSTR
G55116	Red Rubber (1 sheet)	1/16"	1/1
G55118	Red Rubber (1 sheet)	1/8"	1/1

Gasket and Washer Materials



- Make your own gaskets and washers
- 6" x 6" square in hanging display bag

PART NO.	MATERIAL	THICKNESS	CTN/MSTR
G55001	Red Rubber (1 sheet)	1/16"	1/1
G55002	Black Fiber (1 sheet)	1/32"	1/1
G55003	Cork/Rubber (1 sheet)	1/16"	1/1
G55004	Combo (1 sheet of each)	—	1/1

Circulator Flange Gasket Pair



- SOLD IN PAIRS ONLY

PART NO.	DESCRIPTION	CTN/MSTR
G55005	Circulator flange gasket	1/1

Water Hammer Arresters

- Maximum working temperature: 250°F
- Maximum working pressure: 300 PSI
- Poly bagged
- UPC listed
- Lead free



FIXTURE	TYPE OF SUPPLY CONTROL	PUBLIC			PRIVATE		
		TOTAL	C.W.	H.W.	TOTAL	C.W.	H.W.
Water Closet	Flush Valve	10	10	--	6	6	--
Water Closet	Flush Tank	5	5	--	3	3	--
Pedestal Urinal	Flush Valve	10	10	--	--	--	--
Stall or Wall Unit	Flush Valve	5	5	--	--	--	--
Stall or Wall Unit	Flush Tank	3	3	--	--	--	1
Lavatory	Faucet	2	1-1/2	1-1/2	1	1	1-1/2
Bath tub	Faucet	4	2	3	2	1-1/2	1-1/2
Shower Head	Mixing Valve	4	2	3	2	1	2
Bathroom Group	Flush Valve Closet	--	--	--	8	8	3
Bathroom Group	Flush Tank Closet	--	--	--	6	6	3
Separate Shower	Mixing Valve	--	--	--	2	1	2
Service Sink	Faucet	3	3	3	--	--	--
Laundry Tubs (3)	Faucet	--	--	--	3	3	3
Combination Fixture	Faucet	--	--	--	3	3	3

Now apply the total fixture units to Table B to obtain your PDI size value.

PDI SIZE ARRESTER:	AA	A	B	C	D	E	F
FIXTURE UNITS:	1-5	1-11	12-32	33-60	61-113	114-154	155-330
THREAD SIZE:	1/2	1/2	3/4	3/4	1	1	1
CATALOG NUMBER:	ALL A97 SERIES						

MIP AA



PART NO.	SIZE	CTN/MSTR
A97001	1/2"	1/1

MSWT AA



PART NO.	SIZE	CTN/MSTR
A97002	1/2"	1/1

CPVC AA



PART NO.	SIZE	CTN/MSTR
A97004	1/2"	1/1

PEX TEE AA



PART NO.	SIZE	CTN/MSTR
A97007	1/2"	1/1

OD TEE AA



PART NO.	SIZE	CTN/MSTR
A97009	3/8"	1/1

MHT x FHS AA



PART NO.	SIZE	CTN/MSTR
A97011	3/4"	1/1

M x FAA



PART NO.	SIZE	CTN/MSTR
A97012	1/4"	1/1

M x FAA



PART NO.	SIZE	CTN/MSTR
A97013	3/8"	1/1



M x FAA



PART NO.	SIZE	CTN/MSTR
A97014	5/8"	1/1

D

COMMERCIAL & RESIDENTIAL PLASTICS

Closet Flanges and Accessories	174-178	
Residential Drains	179-182	
LevelBest Drainage and Cleanout System.....	183-184	
Commercial Drains.....	185-210	
Commercial Pipe/Hub Fit Adapter Drains.....	185-191	
8-1/2" Pan Commercial Drains.....	192-198	
8-1/2" Commercial Slab Drains.....	199-205	
10" Pan Heavy Duty Commercial Drains	206-210	
Commercial Drain Bases.....	211-212	
Commercial Spuds and Strainers.....	213-216	
General Purpose/Utility Drains.....	217-221	
Inside Pipe Fit Drains and Cleanouts	222	
Residential and Light Commercial Cleanouts.....	223-225	
Commerical Cleanouts.....	226-229	
Cleanout Spuds.....	230-231	
Floor Sinks and Accessories	232-233	
Backwater Valves and Accessories.....	234-235	
Roof Drains.....	236	

E

*Published December 2019

Plastic components are proudly made in the United States.
Final assembly is completed in our Operational Center
of Excellence in Moody, Alabama.

JONES STEPHENS RESIDENTIAL SHOWER DRAINS

The very definition of versatility.

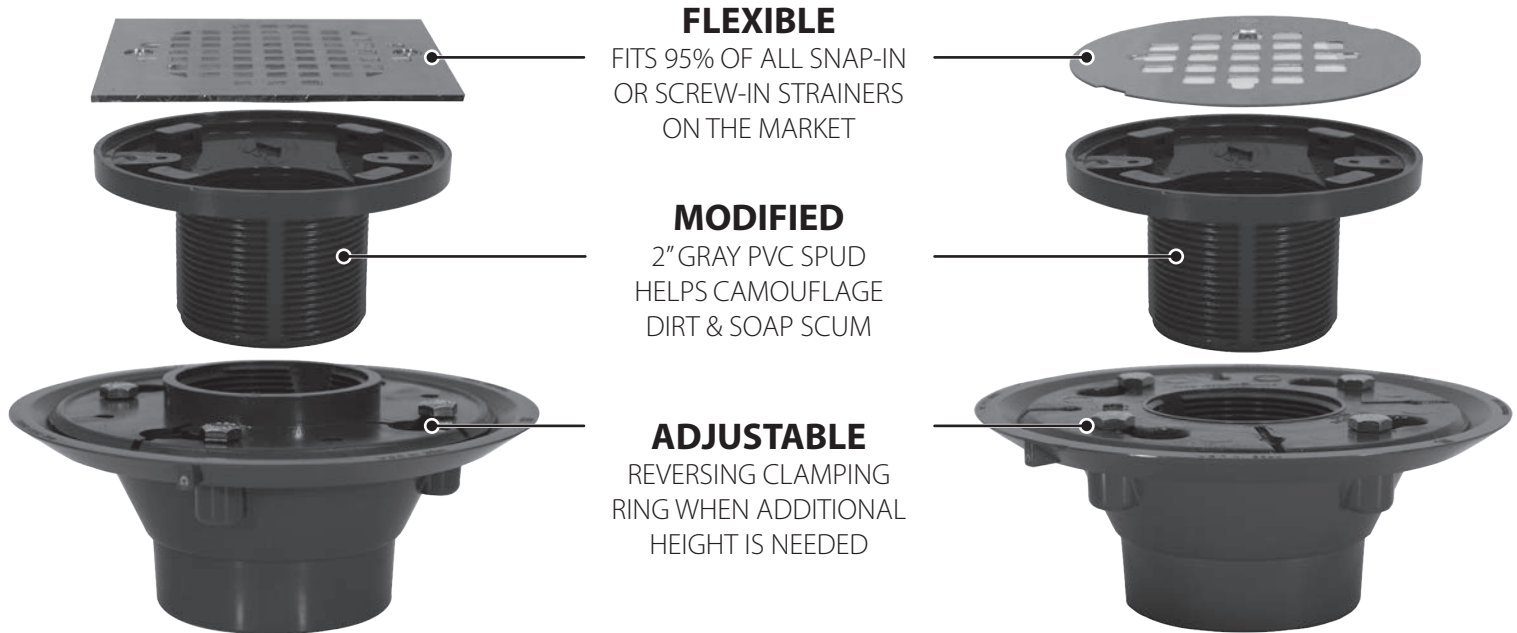

FLEXIBLE

FITS 95% OF ALL SNAP-IN
OR SCREW-IN STRAINERS
ON THE MARKET

MODIFIED

2" GRAY PVC SPUD
HELPS CAMOUFLAGE
DIRT & SOAP SCUM

ADJUSTABLE

REVERSING CLAMPING
RING WHEN ADDITIONAL
HEIGHT IS NEEDED

ADAPTABLE

ENDLESS OPTIONS FOR ALL TYPES OF APPLICATIONS

D50001 The ultimate drain solution.



STYLE

Choose from cast or stamped, round or square, screw-in or snap-in.*



C60809



C6087BN

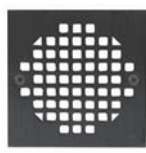

C6083WB



D40005



C60888



D41101



D50805



C60806
C60818

TYPE

Choose from metal or plastic spud with strainer.*



D50980



D60981

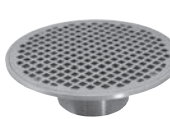

D60989



D60942

FINISH

Choose from several finishes to complete the look.

Chrome Plated, Brushed Nickel, Oil Rubbed Bronze,
Old World Bronze, Pearl Nickel, Polished Brass (PVD),
Polished Stainless

*All models have additional finishes available. See Section E in JS Catalog.



We Got It -

JONES STEPHENS LEVELBEST ADJUSTABLE DRAINS



LevelBest drains allow for adjustment to floor level *after* the concrete is poured.

- **LevelBest** has industry standard IPS threads that are compatible with most adapters and drain bodies.
- **LevelBest** is compatible with most plastic and brass spuds used in the industry.
- **LevelBest** includes a spacer ring that can be used with brass spuds.
- **LevelBest** is compatible with PVC, ABS or CAST IRON drains and cleanouts.
- **LevelBest** can be used with tile rings.



REMOVABLE DOME CAP
REMOVE WITH PLIERS OR WATER METER KEY AFTER THE CONCRETE IS POURED

SPACER
INCLUDED FOR BRASS SPUDS

ADJUSTABLE
ALLOWS STRAINER ADJUSTMENT TO FLOOR LEVEL AFTER THE CONCRETE IS POURED

HOW IT WORKS

1

Set drain with LevelBest rough-in adapter at concrete pour level. The height can be adjusted by tightening or loosening the adapter.

3

After concrete pour is complete, remove the temporary cap with pliers or water meter key as shown on the label. The cap eliminates the need for duct tape or other protective coating on the cover or strainer. The strainer spuds or the cleanout spuds are installed after the pour.

2

The concrete should be poured so that it is level to the top of the LevelBest adapter. The cap of the LevelBest allows the slab to be finished easily without using a hand trowel.

4

Install the spud and strainer and adjust to meet the floor covering. The adjustment of the spud eliminates the need to break and repair the floor when the concrete is poured too high. Use grout or silicone to seal.

Plumbfit Closet Flange

3" Fits Inside 3" Schedule 40 DWV Pipe
3" x 4" Fits Flush with Floor



- Long shank
- 6 screw holes
- Extra-thick flange with short slots for extra strength
- For 3" units cut pipe 1/8" below floor and remove concrete so unit will fit flush
- 3" has 4 closet bolt slots



PVC		
PART NO.	DESCRIPTION	CTN/MSTR
C51300	3" less knockout	1/20
C50300	3" with knockout	1/20
C51340	3" x 4" less knockout	1/20
C50340	3" x 4" with knockout	1/20

ABS		
PART NO.	DESCRIPTION	CTN/MSTR
C51301	3" less knockout	1/20
C50301	3" with knockout	1/20
C51341	3" x 4" less knockout	1/20
C50341	3" x 4" with knockout	1/20

Plumbfit Closet Flange

Fits Over 4" Schedule 40 DWV Pipe



- Long shank
- 6 screw holes
- Extra thick flange with short slots for extra strength



PVC		
PART NO.	DESCRIPTION	CTN/MSTR
C51400	4" less knockout	1/20
C50400	4" with knockout	1/20

ABS		
PART NO.	DESCRIPTION	CTN/MSTR
C51401	4" less knockout	1/20

Plumbfit Closet Flange with Metal Ring

3" x 4" Fits Over 3" or Inside 4" Schedule 40 DWV Pipe
4" Fits Over 4" Schedule 40 DWV Pipe



- Adjustable metal ring
- 6 screw holes
- 2 radial slots for closet bolts



PVC		
PART NO.	DESCRIPTION	CTN/MSTR
C53340	3" x 4" less knockout	1/20
C52340	3" x 4" with knockout	1/20
C53400	4" less knockout	1/20
C52400	4" with knockout	1/20

ABS		
PART NO.	DESCRIPTION	CTN/MSTR
C53341	3" x 4" less knockout	1/20
C52341	3" x 4" with knockout	1/20
C53401	4" less knockout	1/20
C52401	4" with knockout	1/20

Plumbfit Closet Flange with Stainless Steel Ring

3" Fits Inside 3" Schedule 40 DWV Pipe
3" x 4" Fits Over 3" or Inside 4" Schedule 40 DWV Pipe
4" Fits Over 4" Schedule 40 DWV Pipe



- Exclusive 400 grade stainless with plumb fit bodies
- Radial slots for closet bolts; 6 screw holes
- For Schedule 40 DWV pipe
- C57034, C57134, and C57140 are UPC listed



PVC		
PART NO.	DESCRIPTION	CTN/MSTR
C57234	3" less knockout; 4" long shank	1/20
C57236	3" less knockout; 6" long shank	1/20
C57134	3" x 4" less knockout	1/20
C57034	3" x 4" with knockout	1/20
C57334	3" x 4" less knockout; 6" long shank	1/20
C57040	4" with knockout	1/20
C57140	4" less knockout	1/20

ABS		
PART NO.	DESCRIPTION	CTN/MSTR
C58234	3" less knockout; 4" long shank	1/20
C58236	3" less knockout; 6" long shank	1/20
C58134	3" x 4" less knockout	1/20
C58034	3" x 4" with knockout	1/20
C58334	3" x 4" less knockout; 6" long shank	1/20
C58040	4" with knockout	1/20
C58140	4" less knockout	1/20

Closet Flange with Knockout

Fits Over 3" or Inside 4" Schedule 40 DWV Pipe



- Easy to remove knockout comes out in one piece
- 6 screw holes
- 2 radial slots for closet bolts
- Fits flush with floor
- Boxed
- UPC listed



PVC		
PART NO.	DESCRIPTION	CTN/MSTR
C50345	3" x 4" with knockout	1/25

ABS		
PART NO.	DESCRIPTION	CTN/MSTR
C50346	3" x 4" with knockout	1/25

Closet Flange with Metal Ring and Knockout

Fits Over 3" or Inside 4" Schedule 40 DWV Pipe



- Easy to remove knockout comes out in one piece
- 6 screw holes
- 2 radial slots for closet bolts
- Fits flush with floor
- Boxed
- UPC listed



PVC		
PART NO.	DESCRIPTION	CTN/MSTR
C52345	3" x 4" with knockout	1/25

ABS		
PART NO.	DESCRIPTION	CTN/MSTR
C52346	3" x 4" with knockout	1/25

Items marked with the Jones Stephens logo are "You Need It... We Got It" Items.

Closet Flange with Stainless Steel Ring and Knockout

Fits Over 3" or Inside 4" Schedule 40 DWV Pipe



- Easy to remove knockout comes out in one piece
- 6 screw holes
- 2 radial slots for closet bolts
- Fits flush with floor
- Boxed
- UPC listed



PVC		
PART NO.	DESCRIPTION	CTN/MSTR
C57045	3" x 4" with knockout	1/25
ABS		
PART NO.	DESCRIPTION	CTN/MSTR
C58045	3" x 4" with knockout	1/25

Spigot Fit Closet Flange



- Extra-thick flange with short slots for extra strength
- 6 screw holes
- Flush fit

MADE IN THE **USA**

PVC		
PART NO.	DESCRIPTION	CTN/MSTR
C51350	3" less knockout	1/20
C51450	4" less knockout	1/20
ABS		
PART NO.	DESCRIPTION	CTN/MSTR
C51351	3" less knockout	1/20
C51451	4" less knockout	1/20

Plumbfit Closet Flange with Adjustable Ring

Fits Over 3" and Inside 4" Schedule 40 DWV Pipe



- 6" long shank
- Can be cut to desired length
- Swivel rings

MADE IN THE **USA**

PVC		
PART NO.	DESCRIPTION	CTN/MSTR
C53600	3" x 4" with metal ring	1/10
C53700	3" x 4" with plastic ring	1/10
ABS		
PART NO.	DESCRIPTION	CTN/MSTR
C53601	3" x 4" with metal ring	1/10
C53701	3" x 4" with plastic ring	1/10

3" Closet Flange with Adjustable Ring

Fits Inside 3" Schedule 40 DWV

MADE IN THE **USA**



- Adjustable swivel rings
- Flush fit

PVC			
PART NO.	DESCRIPTION	BARREL SIZE	CTN/MSTR
C50302	3" with metal ring	4"	1/10
C50306	3" with plastic ring	4"	1/10
C50304	3" with metal ring	6"	1/10
C50308	3" with plastic ring	6"	1/10
ABS			
PART NO.	DESCRIPTION	BARREL SIZE	CTN/MSTR
C50303	3" with metal ring	4"	1/10
C50307	3" with plastic ring	4"	1/10
C50305	3" with metal ring	6"	1/10
C50309	3" with plastic ring	6"	1/10

Plastic Two Finger Flange



- Fits flush
- Patent #: 5,937,450
- Will fit oblong horns
- Pushes easily into 3" or 4" cast iron or Schedule 40 DWV pipe
- ASTM C-564 rubber gasket

MADE IN THE **USA**

White Plastic		
PART NO.	DESCRIPTION	CTN/MSTR
C4733P	3" x 3" less knockout	1/6
C4743P	4" x 3" less knockout	1/6
ABS		
PART NO.	DESCRIPTION	CTN/MSTR
C4733A	3" x 3" less knockout	1/6
C4743A	4" x 3" less knockout	1/6

Closet Flange with 3-1/2" Extended Threads



MADE IN THE **USA**

PVC		
PART NO.	DESCRIPTION	CTN/MSTR
C54150	with 3-1/2" extended threads	1/20

Items marked with the Jones Stephens logo are "You Need It... We Got It" Items.

Plumbfit Closet Flange with Plastic Swivel Ring

3" x 4" Fits Over 3" or Inside 4" Schedule 40 DWV Pipe
4" Fits Over Schedule 40 DWV Pipe



- Plastic ring will not deteriorate
- 360° rotation
- 2 radial slots and 2 grooved slots for closet bolts
- 6 screw holes for securing to floor



PVC		
PART NO.	DESCRIPTION	CTN/MSTR
C53342	3" x 4" less knockout	1/20
C54402	3" x 4" offset less knockout	1/20
C52342	3" x 4" with knockout	1/6
C52402	4" with knockout	1/10
C53402	4" less knockout	1/10

ABS		
PART NO.	DESCRIPTION	CTN/MSTR
C53343	3" x 4" less knockout	1/20
C54403	3" x 4" offset less knockout	1/20
C52343	3" x 4" with knockout	1/20
C52403	4" with knockout	1/10
C53403	4" less knockout	1/10

45° Closet Flange

Fits Over 3" DWV with a 4" Sweep

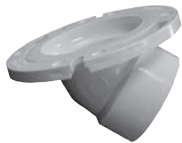

- CSA certified
- With plastic swivel ring
- More versatile than an offset closet flange
- Provides unlimited offset when used in conjunction with a socket x socket 45° elbow

PVC		
PART NO.	DESCRIPTION	CTN/MSTR
C55043	3" x 4" with plastic ring	1/20

ABS		
PART NO.	DESCRIPTION	CTN/MSTR
C55143	3" x 4" with plastic ring	1/20

Offset Plumbfit Closet Flange with Stainless Steel Ring

Fits Over 3" or Inside 4" Schedule 40 DWV Pipe



- Exclusive 400 grade stainless with plumbfit bodies
- Radial slots for closet bolts; 6 screw holes
- 2" offset



PVC		
PART NO.	DESCRIPTION	CTN/MSTR
C57434	3" x 4" offset less knockout	1/20

ABS		
PART NO.	DESCRIPTION	CTN/MSTR
C58434	3" x 4" offset less knockout	1/20

Offset Closet Flange

Fits Over 3" or Inside 4" Schedule 40 DWV Pipe



- 2" offset
- 4 closet bolt slots and 2 mounting screw holes



PVC		
PART NO.	DESCRIPTION	CTN/MSTR
C54340	3" x 4" offset less knockout	1/20

ABS		
PART NO.	DESCRIPTION	CTN/MSTR
C54341	3" x 4" offset less knockout	1/20

Offset Closet Flange with Metal Ring

Fits Over 3" or Inside 4" Schedule 40 DWV Pipe



- 2" offset
- Adjustable metal ring
- 2 radial slots for closet bolts



PVC		
PART NO.	DESCRIPTION	CTN/MSTR
C54400	3" x 4" offset less knockout	1/20

ABS		
PART NO.	DESCRIPTION	CTN/MSTR
C54401	3" x 4" offset less knockout	1/20

4-Way Offset Closet Flange

Fits Over 3" or Inside 4" Schedule 40 DWV Pipe



- 2" offset
- 1-13/16" barrel depth



PVC		
PART NO.	DESCRIPTION	CTN/MSTR
C54342	3" x 4" offset less knockout	1/20

ABS		
PART NO.	DESCRIPTION	CTN/MSTR
C54343	3" x 4" offset less knockout	1/20

3" Over Schedule 30 Pipe Closet Flange



PVC		
PART NO.	DESCRIPTION	CTN/MSTR
C51150	3" less knockout	1/20
C52150	3" with knockout	1/20

Adjustable Urinal Flange Kit

Spigot Fits Inside Hub of Fitting
Socket Fits Over 2" Schedule 40 DWV Pipe

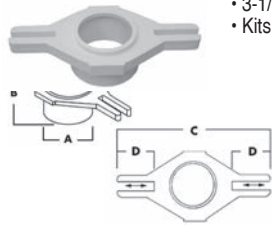

- 3-1/4" - 7" flange mounting centers
- Kits include bolts, nuts, washers and gasket

PVC		
PART NO.	DESCRIPTION	CTN/MSTR
F10001	2" spigot outlet	1/20
F10002	2" socket/hub outlet	1/20

ABS		
PART NO.	DESCRIPTION	CTN/MSTR
F11001	2" spigot outlet	1/20
F11002	2" socket/hub outlet	1/20

Radial Fit Urinal Flange Kit



- Permits parallel alignment using radial slots
- Adjusts to 4" to 6" centers
- Socket and spigot connections
- Kit includes bolts, nuts, washers and gasket

PVC		
PART NO.	DESCRIPTION	CTN/MSTR
F10003	2" with socket connection	1/1
F10004	2" with spigot connection	1/1

ABS		
PART NO.	DESCRIPTION	CTN/MSTR
F11003	2" with socket connection	1/1
F11004	2" with spigot connection	1/1

Closet Flange Extender



- Stackable to desired height
- For raising floor height when adding ceramic tile or hardwood

MADE IN THE
USA

PVC		
PART NO.	DESCRIPTION	CTN/MSTR
C88001	1/2" thick	1/20
C88501	1/4" thick	1/20

Waxless Gasket



- Reusable
- Seals closet flange without using wax

MADE IN THE
USA

PART NO.	DESCRIPTION	CTN/MSTR
C88002	Waxless gasket	1/1

Ⓢ Items marked with the Jones Stephens logo are "You Need It...We Got It" Items.

Closet Flange Ring



- Fits over 3" or 4" PVC
- Converts 3" and 4" PVC pipe into a toilet ready application

MADE IN THE
USA

PVC		
PART NO.	DESCRIPTION	CTN/MSTR
C51302	3" ring	1/10
C51402	4" ring	1/10

ABS		
PART NO.	DESCRIPTION	CTN/MSTR
C51303	3" ring	1/10
C51403	4" ring	1/10

Closet Flange Repair Ring



- Securely attaches to concrete or wood sub-floor
- Replaces most closet rings
- Corrosion resistant
- Mounting ears offset by 1/8" to allow closet bolts to be installed

PART NO.	DESCRIPTION	CTN/MSTR
C85000	Closet flange repair ring	20/80

Closet Flange Spacer Kit



- Reusable toilet seal gasket
- For repair or correction of problems resulting from installation errors or remodeling projects
- Complete kit includes: 2 gaskets, 1/2" spacer, 1/4" x 3-1/2" closet bolt kit, 2 plastic shims

MADE IN THE
USA

PART NO.	DESCRIPTION	CTN/MSTR
C88600	Spacer kit	1/10

Complete Closet Flange Extension Kit with Gaskets



- Useful when overlaying, replacing or tiling bathroom floors
- Two 3-1/2" closet bolts with washers and nuts
- Anchors toilet bolts when closet ring is broken
- No caulking required
- Has built-in gaskets
- One 1/4" flange & one 1/2" flange

MADE IN THE
USA

PART NO.	DESCRIPTION	CTN/MSTR
C88500	Complete kit	1/10
C88502	Kit less bolts	1/10

Complete Closet Flange Extension Kit with Caulk



MADE IN THE
USA

- Three 1/4" extenders for easy adjustment
- Two 3-1/2" closet bolts with washers and nuts
- Adhesive caulk and all hardware included

PART NO.	DESCRIPTION	CTN/MSTR
C88500C	Complete kit	1/10

Closet Flange Extension Kit



MADE IN THE
USA

- No mastic necessary between pieces as with stackable units
- Heavy solid plastic construction
- Two 3-1/2" closet bolts with washers and nuts
- Packaged in display header bag
- One 1/2" flange

PART NO.	DESCRIPTION	CTN/MSTR
C88050	1/2" extension kit	1/10

Gapper Flange



- Used to repair broken closet flanges
- Individually carded for easy display or bulk

PART NO.	DESCRIPTION	CTN/MSTR
C87100	Repair flange	24/240

Flexible and Rigid Super Shims



MADE IN THE
USA

- Stackable
- Rigid, can be driven
- Flexible, can be trimmed
- 10 per bag
- Priced per bag

PART NO.	DESCRIPTION	CTN/MSTR
S55950	1-1/8" x 1-15/16" x 1/4" flexible	10/400
S55951	1-1/8" x 1-15/16" x 1/4" rigid	10/400

Flexible Super Shims



MADE IN THE
USA

- 200 Flexible super shims packaged in a convenient refillable "candy bowl" counter display
- Priced per display

PART NO.	DESCRIPTION	CTN/MSTR
S55952	200 Flexible super shims	200/200

Rigid Super Shims

MADE IN THE
USA



- 200 Rigid super shims packaged in a convenient refillable "candy bowl" counter display
- Priced per display

PART NO.	DESCRIPTION	CTN/MSTR
S55953	200 Rigid super shims	200/200

Closet Wedge Shims

MADE IN THE
USA

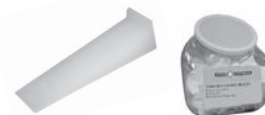

- Stackable
- 3/8" width x 1-3/8" length x 5/16" height
- Easily trimmed to desired height
- 100 per bag
- Priced per bag or display

PART NO.	DESCRIPTION	CTN/MSTR
S55902	100 shims poly bagged	100/100
S55903	1000 shims counter display	1000/1000

PVC and ABS Residential Shower/Floor Drains

Pages 179-182

SIZES: 2", 2"x 3"



For use in
residential applications.

2" x 3" Shower/Floor Drain

Fits Over 2" or Inside 3" Schedule 40 DWV Pipe

ASSEMBLED IN
USA



- Low profile for first and second floor installations
- Beveled edge allows for recessed installation
- Reversible clamping ring for additional 1/2" height adjustment
- Brass inserts ensure secure clamping of membrane
- Dual weeps holes
- Recessed sump area for added drainage
- D50001 UPC Listed

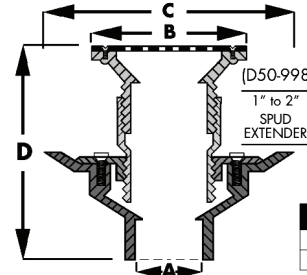

- Use **D50998** Spud Extension (listed below) when additional height is needed

	A	B	C	D
Over 2" pipe		4-1/4"	6-1/2"	3-1/4" - 4-3/8"
Inside 3" pipe		4-1/4"	6-1/2"	3-1/4" - 4-3/8"

PVC

PART NO.	STRAINER	REPL. STRAINER	CTN/MSTR
D50001	4" SS	C60809	1/20
D50002	4" PB	C60810	1/20
D50132	4" PB cast	C60807	1/20
D50133	4" PB cast w/ring	C60807/C60824	1/20
D50130	4" NB cast	C60808	1/20
D50131	4" NB cast w/ring	C60808/C60825	1/20
D50011	4" CP cast	C60806	1/20
D50010	4" CP cast w/ring	C60806/C60818	1/20
D50134	4" CP cast square	C60812	1/20
D50135	4" PB cast square	C60813	1/20

PVC with Primer Tap

PART NO.	STRAINER	REPL. STRAINER	CTN/MSTR
D50120	PT and 4" SS	C60809	1/1
D50121	PT and 4" PB	C60810	1/1
D50122	PT and 4" PB cast	C60807	1/1
D50123	PT and 4" CP cast	C60806	1/1
D50124	PT and 4" CP cast	C60808	1/1

ABS

PART NO.	STRAINER	REPL. STRAINER	CTN/MSTR
D50301	4" SS	C60809	1/20
D50302	4" PB	C60810	1/20
D50332	4" PB cast	C60807	1/20
D50333	4" PB cast w/ring	C60807/C60824	1/20
D50330	4" NB cast	C60808	1/20
D50331	4" NB cast w/ring	C60808/C60825	1/20
D50311	4" CP cast	C60806	1/20
D50310	4" CP cast w/ring	C60806/C60818	1/20
D50334	4" CP cast square	C60812	1/20
D50335	4" PB cast square	C60813	1/20

Items marked with the Jones Stephens logo are "You Need It... We Got It" Items.

2" x 3" Shower/Floor Drain with Test Plug

Fits Over 2" or Inside 3" Schedule 40 DWV Pipe

ASSEMBLED IN
USA



- New! Gray spud to camouflage dirt and soap scum
- New! Ability to use a snap-in or screw-in strainer
- Low profile for first and second floor installations
- Beveled edge allows for recessed installation
- Reversible clamping ring for additional 1/2" height adjustment
- Brass inserts ensure secure clamping of membrane
- Dual weeps holes
- Recessed sump area for added drainage
- Use D50998 tailpiece extension when additional height is needed
- Complies with new construction drain test requirements
- Covers both the wet test from the shower, as well as pressure test from above floors
- Before testing, the spud should be threaded down to its lowest point making contact with the plug
- Plug should make complete contact with drain opening
- Remove test plug with pliers and discard

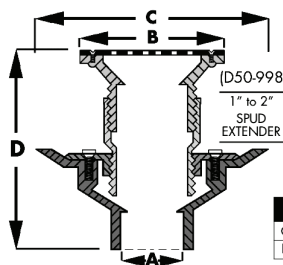

• Use **D50998** Spud Extension (listed below) when additional height is needed

	A	B	C	D
Over 2" pipe	4-1/4"	6-1/2"	3-1/4" - 4-3/8"	
Inside 3" pipe	4-1/4"	6-1/2"	3-1/4" - 4-3/8"	

PVC

PART NO.	STRAINER	REPL. STRAINER	CTN/MSTR
D50001TP	4" SS	C60809	1/20
D50002TP	4" PB	C60810	1/20
D50132TP	4" PB cast	C60807	1/20
D50133TP	4" PB cast w/ring	C60807/C60824	1/20
D50130TP	4" NB cast	C60808	1/20
D50131TP	4" NB cast w/ring	C60808/C60825	1/20
D50011TP	4" CP cast	C60806	1/20
D50010TP	4" CP cast w/ring	C60806/C60818	1/20
D50134TP	4" CP cast square	C60812	1/20
D50135TP	4" PB cast square	C60813	1/20
D50141TP	4" NB square	-	1/20
D5088BNTTP	4" BN square	-	1/1
D5088RBTP	4" RB square	-	1/1
D5088WBTP	4" WB square	-	1/1
D50888TP	4" SS square	-	1/1
D5001BNTP	4" BN round	-	1/1
D5001RBTP	4" RB round	-	1/1
D5001WBTP	4" WB round	-	1/1

ABS

PART NO.	STRAINER	REPL. STRAINER	CTN/MSTR
D50301TP	4" SS	C60809	1/20
D50302TP	4" PB	C60810	1/20
D50332TP	4" PB cast	C60807	1/20
D50333TP	4" PB cast w/ring	C60807/C60824	1/20
D50330TP	24" NB cast	C60808	1/20
D50331TP	4" NB cast w/ring	C60808/C60825	1/20
D50311TP	4" CP cast	C60806	1/20
D50310TP	4" CP cast w/ring	C60806/C60818	1/20
D50334TP	4" CP cast square	C60812	1/20
D50335TP	4" PB cast square	C60813	1/20

Tailpiece Extension



- Use when additional height is needed
- Compensates for thick shower bases

ASSEMBLED IN
USA

PART NO.	DESCRIPTION	CTN/MSTR
D50998	1" - 2" tailpiece extension	1/1

Brass Drain Extension



- 2" MIP x 2" FIP for 2" drain spuds
- Use when additional height is required to overcome inconsistent concrete pours
- Height extension from 1-1/2" to 3-1/2"
- Solid brass construction

PART NO.	DESCRIPTION	CTN/MSTR
D60978	Brass drain extension	1/1

2" x 3" Shower/Floor Drain with Brass Tailpiece

Fits Over 2" or Inside 3" Schedule 40 DWV Pipe

ASSEMBLED IN
USA

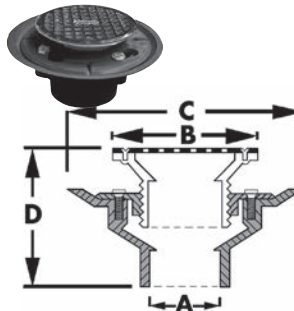

- Low profile for first and second floor installations
- Beveled edge allows for recessed installation
- Reversible clamping ring for additional 1/2" height adjustment
- Brass inserts ensure secure clamping of membrane
- Dual weeps holes
- Recessed sump area for added drainage

	A	B	C	D
Over 2" pipe	4-1/4"	6-1/2"	3-1/4" - 4-3/8"	
Inside 3" pipe	4-1/4"	6-1/2"	3-1/4" - 4-3/8"	

PVC

PART NO.	STRAINER	REPL. STRAINER	CTN/MSTR
D50101	4" SS round	D60780	1/20
D50111	4" CP round	D60781	1/20
D50102	4" PB round	D60782	1/20
D50800	6" CP round	-	1/20
D50802	6" PB round	-	1/20
D50161	4" CP square	C60812	1/20
D50152	4" PB square	C60813	1/20
D5001BN	4" BN round	-	1/1
D5001RB	4" RB round	-	1/1
D5001WB	4" WB round	-	1/1
D5001NP	4" NP round	-	1/1

ABS

PART NO.	STRAINER	REPL. STRAINER	CTN/MSTR
D50401	4" SS round	D60780	1/20
D50411	4" CP round	D60781	1/20
D50402	4" PB round	D60782	1/20
D50830	6" CP round	-	1/20
D50832	6" PB round	-	1/20
D50162	4" CP square	C60812	1/20
D50153	4" PB square	C60813	1/20

2" x 3" Shower/Floor Drain with Square Strainer

Fits Over 2" or Inside 3" Schedule 40 DWV Pipe

ASSEMBLED IN
USA



- Low profile for first and second floor installations
- Beveled edge allows for recessed installation
- Reversible clamping ring for additional 1/2" height adjustment
- Brass inserts ensure secure clamping of membrane
- Dual weeps holes
- Recessed sump area for added drainage

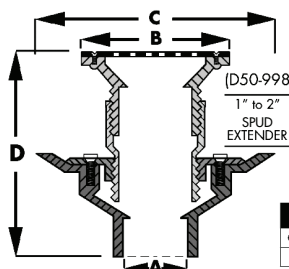

• Use **D50998** Spud Extension (listed below) when additional height is needed

	A	B	C	D
Over 2" pipe	4-1/4"	6-1/2"	3-1/4" - 4-3/8"	
Inside 3" pipe	4-1/4"	6-1/2"	3-1/4" - 4-3/8"	

PVC

PART NO.	STRAINER	CTN/MSTR
D50141	4" NB square	1/20

2" x 3" Shower/Floor Drain with 2" Spud and 4" Square Snap-in Strainer



- No screws
- Four prong installation
- Plastic spud

PART NO.	STRAINER	CTN/MSTR
D5088BN	4" BN square	1/1
D5088RB	4" RB square	1/1
D5088WB	4" WB square	1/1
D50888	4" SS square	1/1

2" x 3" "Perfect Low Profile" Shower/Floor Drain

Fits Over 2" or Inside 3" PVC Schedule 40 DWV Pipe

ASSEMBLED IN **USA**

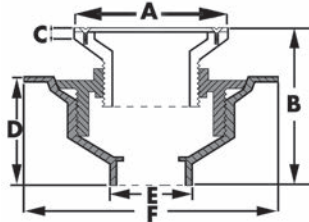

- 3" total height; perfect for multiple stories
- Reversible clamping ring, stainless steel strainer

A	B	C	D	E	F
4-1/4"	MIN: 3" - MAX: 4-1/4"	3/8"	2"	ID: 2-3/8" OD: 3-1/16"	6-5/8"

PVC

PART NO.	STRAINER	CTN/MSTR
D50PLP	4" SS round	1/20
D50PL1	4-1/4" SS square	1/20
D50125	PT and 4" SS round	1/1
D50126	PT and 4" NB round cast	1/1

2" Shower/Floor Drain with Brass Tailpiece

Fits Over 2" Schedule 40 DWV Pipe

ASSEMBLED IN **USA**

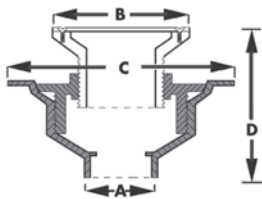

- Coverall top
- Brass tailpiece
- Screw-down clamping ring has weep holes for secondary drainage

A	B	C	D
Over 2" pipe	4-1/8" or 6"	7"	3-5/8" - 5-1/4"

PVC

PART NO.	STRAINER	CTN/MSTR
D50710	4" SS round	1/10
D50712	4" PB round	1/10
D50711	4" CP round	1/10
D50721	6" PB round	1/10
D50720	6" CP round	1/10

ABS

PART NO.	STRAINER	CTN/MSTR
D50713	4" SS round	1/10
D50715	4" PB round	1/10
D50714	4" CP round	1/10
D50723	6" PB round	1/10
D50722	6" CP round	1/10

Items marked with the Jones Stephens logo are "You Need It... We Got It" Items.

2" x 3" Shower/Floor Drain with Brass Tailpiece and Test Plug

Fits Over 2" or Inside 3" Schedule 40 DWV Pipe

ASSEMBLED IN **USA**



- Low profile for first and second floor installations
- Beveled edge allows for recessed installation
- Reversible clamping ring for additional 1/2" height adjustment
- Brass inserts ensure secure clamping of membrane
- Dual weeps holes
- Recessed sump area for added drainage

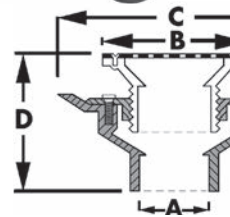

A	B	C	D
Over 2" pipe	4-1/4"	6-1/2"	3-1/4" - 4-3/8"
Inside 3" pipe	4-1/4"	6-1/2"	3-1/4" - 4-3/8"

PVC

PART NO.	STRAINER	REPL. STRAINER	CTN/MSTR
D50101TP	4" SS round	D60780	1/20
D50111TP	4" CP round	D60781	1/20
D50102TP	4" PB round	D60782	1/20
D50800TP	6" CP round	-	1/20
D50802TP	6" PB round	-	1/20
D50161TP	4" CP square	C60812	1/20
D50152TP	4" PB square	C60813	1/20
D50942TP	4-1/4" CP square	-	1/1
D5094BNTP	4-1/4" BN square	-	1/1
D5094RBTP	4-1/4" RB square	-	1/1
D5094WBTP	4-1/4" WB square	-	1/1

ABS

PART NO.	STRAINER	REPL. STRAINER	CTN/MSTR
D50401TP	4" SS round	D60780	1/20
D50411TP	4" CP round	D60781	1/20
D50402TP	4" PB round	D60782	1/20
D50830TP	6" CP round	-	1/20
D50832TP	6" PB round	-	1/20
D50162TP	4" CP square	C60812	1/20
D50153TP	4" PB square	C60813	1/20

2" Shower/Floor Drain with Plastic Tailpiece

Fits Over 2" Schedule 40 DWV Pipe

ASSEMBLED IN **USA**

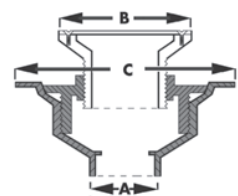

- Coverall top
- Plastic tailpiece
- Screw-down clamping ring has weep holes for secondary drainage

A	B	C	D
Over 2" pipe	4-1/8" or 6"	7"	3-5/8" - 5-1/4"

PVC

PART NO.	STRAINER	CTN/MSTR
D50700	4" SS round	1/10
D50702	4" PB round	1/10
D50708	4" PB round cast	1/10
D50709	4" PB round with ring	1/10
D50701	4" CP round	1/10
D50706	4" NB round	1/10
D50707	4" NB round with ring	1/10

ABS

PART NO.	STRAINER	CTN/MSTR
D50703	4" SS round	1/10
D50705	4" PB round	1/10
D50726	4" PB round cast	1/10
D50727	4" PB round with ring	1/10
D50704	4" CP round	1/10
D50724	4" NB round	1/10
D50725	4" NB round with ring	1/10

2" No Caulk Shower/Floor Drain

Pushes Over 2" DWV Pipe

ASSEMBLED IN
USA

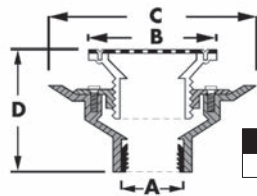

- Coverall top
- Tongue-and-grooved beveled clamping ring
- Brass inserts
- Supplied with gasket

A	B	C	D
2" no caulk	4-1/4"	6-1/2"	3-1/2" - 4-3/4"

PVC - PLASTIC TAILPIECE

PART NO.	STRAINER	CTN/MSTR
D50500	4" SS round	1/10
D50510	4" CP round	1/10

PVC - BRASS TAILPIECE

PART NO.	STRAINER	CTN/MSTR
D50501	4" SS round	1/10
D50502	4" PB round	1/10
D50511	4" CP round	1/10

2" No Caulk Shower Stall Drain

Fits Over 2" Schedule 40 DWV Pipe

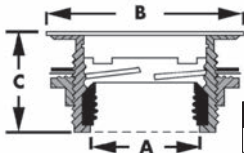

- Coverall top
- Snap-in strainer
- Wrench included
- For 2" CTS order gasket separately
- D40140, D40101, D40401, D40010 and D40151 are UPC Listed

A	B	C
2"	4-1/4"	2"

Plastic Body

PART NO.	STRAINER	CTN/MSTR
D40101	4" SS round	1/20
D40151	4" White plastic round	1/20
D40201	4" PB round	1/25
D40401	4" White epoxy coated SS round	1/10

Brass Body

PART NO.	STRAINER	CTN/MSTR
D40140	4" SS round	1/20
D40240	4" PB round	1/36
D40440	4" White epoxy coated SS round	1/10

Snap-In Replacement Strainers

PART NO.	DESCRIPTION	CTN/MSTR
D40005	SS round strainer for solvent outlet drains	1/1
D40003	PB round replacement strainer	1/50
D40004	White epoxy coated SS replacement strainer	1/50
D40006	Replacement wrench key	1/1
D40007	2" Schedule 40 DWV gasket	1/1
D40008	2" CTS replacement gasket	1/1
D40009	White plastic round replacement strainer	1/1
D40010	SN replacement strainer	1/20

2" Drop-In Shower Stall Drain

Fits Over 2" Schedule 40 DWV Pipe

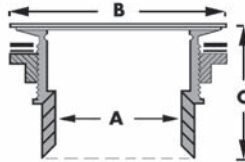

- Drain body drops through shower base
- Locknut tightens from underside
- Snap-in strainer
- D40010 is UPC listed

A	B	C
2"	4-1/4"	2-5/8"

PVC

PART NO.	DESCRIPTION	STRAINER	CTN/MSTR
D41007	Solvent outlet	4" SS	1/25
D41009	Solvent outlet	4" PB	1/20
D41008	No-caulk/solvent outlet	4" SS	1/20

ABS

PART NO.	DESCRIPTION	STRAINER	CTN/MSTR
D41307	Solvent outlet	4" SS	1/25
D41105	Solvent outlet	4" PB	1/20

Snap-In Replacement Strainers

PART NO.	DESCRIPTION	CTN/MSTR
D40005	SS for solvent outlet drains	1/10
D41103	SS for no caulk/solvent drains	1/10
D41104	PB Snap-in for D41008	1/10
D40010	SN	1/10
D40003	PB	1/10

2" Shower Stall Drain with Receptor Base

Fits Over 2" Schedule 40 DWV Pipe

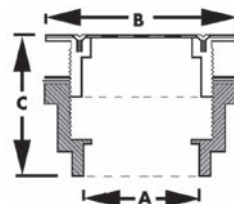

- Allows for secondary drainage
- Accepts knockout test cap for testing
- 3" OD threads

A	B	C
2"	4-1/4"	2"

PVC

PART NO.	STRAINER	CTN/MSTR
D41001	4" SS round	1/25
D41002	4" PB round	1/20
D41003	4" AB round	1/20
D41004	4" SN round	1/20

ABS

PART NO.	STRAINER	CTN/MSTR
D41301	4" SS round	1/20
D41302	4" PB round	1/20
D41303	4" AB round	1/20

PVC - 2" Offset

PART NO.	STRAINER	CTN/MSTR
D41600	4" SS round	1/25

ABS - 2" Offset

PART NO.	STRAINER	CTN/MSTR
D41601	4" SS round	1/25

Replacement Strainers with Screws

PART NO.	DESCRIPTION	CTN/MSTR
D41101	SS round replacement strainer with screws	50/250
D41102	PB round replacement strainer with screws	50/250
D41107	SN round replacement strainer with screws	50/250

Items marked with the Jones Stephens logo are "You Need It... We Got It" Items.

PVC LevelBest Drainage and Cleanout System

Pages 183-184

SIZES: 2" x 3", 3", 3" x 4", 4"



For use in applications where adjustments after the concrete pour are required.

Adapter

Allows adjustment to floor level after concrete is poured!

MADE IN THE
USA



- PVC, ABS or Cast Iron drains compatible
- Industry standard iron pipe size threads compatible with most adapter and drain bodies
- Compatible with most plastic and brass spuds used in the industry
- Includes the spacer ring that can be used with brass spuds
- Can be used with tile rings

PART NO.	DESCRIPTION	CTN/MSTR
D50448	3-1/2" x 3" x 6"	1/1
D50449	4" x 3-1/2" x 6"	1/1
D50450	4" x 3-1/2" x 5"	1/1
D50451	3-1/2" x 3" x 5"	1/1
D50452	Replacement cap	1/1
D50453	Replacement ring	1/1
D50454	Leveling shim for 5" strainer	1/1

3" x 4" PVC Base with 3-1/2" Adapter

Allows adjustment to floor level after concrete is poured!

MADE IN THE
USA



- PVC, ABS or Cast Iron drains compatible
- Industry standard iron pipe size threads compatible with most adapter and drain bodies
- Includes the spacer ring that can be used with brass spuds
- Can be used with tile rings
- Primer tapped with 1/2" IPS plug

PART NO.	DESCRIPTION	CTN/MSTR
D50440	3" x 4" PVC base with 3-1/2" LevelBest adapter	1/1

Adapter with Spud and Strainer

Allows adjustment to floor level after concrete is poured!

MADE IN THE
USA



- PVC, ABS or Cast Iron drains compatible
- Industry standard iron pipe size threads compatible with most adapter and drain bodies
- Includes the spacer ring that can be used with brass spuds
- Can be used with tile rings

PART NO.	SIZE	SPUD	STRAINER	CTN/MSTR
D50522	3-1/2"	3" Plastic	5" NB round	1/1
D50523	3-1/2"	3" Metal	5" NB round	1/1
D50520	4"	3-1/2" Plastic	5" NB round	1/1
D50521	4"	3-1/2" Metal	5" NB round	1/1
D50524	3-1/2"	3-1/2" Plastic	6" NB round	1/1
D50526	4"	3-1/2" Plastic	6" NB round	1/1

Adapter with Spud and Cleanout

Allows adjustment to floor level after concrete is poured!

MADE IN THE
USA



- PVC, ABS or Cast Iron drains compatible
- Industry standard iron pipe size threads compatible with most adapter and drain bodies
- Includes the spacer ring that can be used with brass spuds
- Can be used with tile rings

PART NO.	PIPE SIZE	SPUD	COVER	CTN/MSTR
D50525	3-1/2"	3" Plastic	6" NB round	1/1

Complete Pipe Fit Drain System

Allows adjustment to floor level after concrete is poured!

MADE IN THE
USA



- Includes the spacer ring that can be used with brass spuds
- Can be used with tile rings
- Primer tapped with 1/2" IPS plug

PART NO.	PIPE SIZE	SPUD	STRAINER	CTN/MSTR
D50460	3" x 4"	3" Plastic	5" NB round	1/1
D50461	3" x 4"	3" Metal	5" NB round	1/1
D50473	3" x 4"	3" Plastic	6" NB round	1/1
D50486	3" x 4"	3-1/2" Plastic	5" NB round	1/1
D50469	3" x 4"	3" Plastic	6" NB square	1/1
D50472	4"	3-1/2" Plastic	6" NB round	1/1
D50470	4"	3-1/2" Plastic	5" NB round	1/1
D50471	4"	3-1/2" Metal	5" NB round	1/1
D50465	4"	3" Metal	5" NB round	1/1
D50464	4"	3" Plastic	5" NB round	1/1
D50474	4"	3" Plastic	6" NB round	1/1

Complete Pipe Fit Cleanout System

Allows adjustment to floor level after concrete is poured!

MADE IN THE
USA



- Includes the spacer ring that can be used with brass spuds
- Can be used with tile rings

PART NO.	PIPE SIZE	SPUD	COVER	CTN/MSTR
C59242	3" x 4"	3" Plastic	5" NB round	1/1
C59252	3" x 4"	3-1/2" Plastic	5" NB round	1/1
D50481	3" x 4"	3" Plastic	6" NB round	1/1
C59244	4"	3" Plastic	5" NB round	1/1
C59245	4"	3" Metal	5" NB round	1/1
C59250	4"	3-1/2" Plastic	5" NB round	1/1
C59251	4"	3-1/2" Metal	5" NB round	1/1
D50482	4"	3" Plastic	6" NB round	1/1
D50480	4"	3-1/2" Plastic	6" NB round	1/1

Complete Hub Fit Drain System

Allows adjustment to floor level after concrete is poured!

MADE IN THE
USA



- Includes the spacer ring that can be used with brass spuds
- Can be used with tile rings

PART NO.	PIPE SIZE	SPUD	STRAINER	CTN/MSTR
D50462	4"	3" Plastic	5" NB round	1/1
D50463	4"	3" Metal	5" NB round	1/1

Complete Hub Fit Cleanout System

Allows adjustment to floor level after concrete is poured!

MADE IN THE
USA



- Includes the spacer ring that can be used with brass spuds
- Can be used with tile rings

PART NO.	PIPE SIZE	SPUD	COVER	CTN/MSTR
C59240	4"	3" Plastic	5" NB round	1/1
C59241	4"	3" Metal	5" NB round	1/1

Complete Heavy Duty Drain System

Allows adjustment to floor level after concrete is poured!

MADE IN THE
USA



- Includes the spacer ring that can be used with brass spuds
- Can be used with tile rings
- Completely adjustable; reversible clamping ring gains additional 1" height
- 8-1/2" Pan primer tapped with 1/2" plug
- Extra weep holes

PART NO.	PIPE SIZE	SPUD	STRAINER	CTN/MSTR
D49640	4"	3" Plastic	5" NB round	1/1
D49641	4"	3" Metal	5" NB round	1/1
D49646	4"	3-1/2" Plastic	5" NB round	1/1
D49647	4"	3-1/2" Metal	5" NB round	1/1
D49644	2" x 3"	3" Plastic	5" NB round	1/1
D49645	2" x 3"	3" Metal	5" NB round	1/1
D49650	2" x 3"	3-1/2" Plastic	5" NB round	1/1
D49651	2" x 3"	3-1/2" Metal	5" NB round	1/1
D49642	3" x 4"	3" Plastic	5" NB round	1/1
D49643	3" x 4"	3" Metal	5" NB round	1/1
D49648	3" x 4"	3-1/2" Plastic	5" NB round	1/1
D49649	3" x 4"	3-1/2" Metal	5" NB round	1/1
D50477	3"	3-1/2" Plastic	6" NB round	1/1
D50479	4"	3-1/2" Plastic	6" NB round	1/1

Complete Heavy Duty Slab Drain System

Allows adjustment to floor level after concrete is poured!

MADE IN THE
USA



- Includes the spacer ring that can be used with brass spuds
- Can be used with tile rings
- 8-1/2" Pan for applications where no clamping ring is required
- Primer tapped with 1/2" plug

PART NO.	PIPE SIZE	SPUD	STRAINER	CTN/MSTR
D49656	2" x 3"	3" Plastic	5" NB round	1/1
D49657	2" x 3"	3" Metal	5" NB round	1/1
D49662	2" x 3"	3-1/2" Plastic	5" NB round	1/1
D49663	2" x 3"	3-1/2" Metal	5" NB round	1/1
D49654	3" x 4"	3" Plastic	5" NB round	1/1
D49655	3" x 4"	3" Metal	5" NB round	1/1
D49660	3" x 4"	3-1/2" Plastic	5" NB round	1/1
D49661	3" x 4"	3-1/2" Metal	5" NB round	1/1
D49652	4"	3" Plastic	5" NB round	1/1
D49653	4"	3" Metal	5" NB round	1/1
D49658	4"	3-1/2" Plastic	5" NB round	1/1
D49659	4"	3-1/2" Metal	5" NB round	1/1

Items marked with the Jones Stephens logo are "You Need It... We Got It" Items.

PVC and ABS Commercial Pipe/Hub Fit Adapter Drains

Pages 185-191

SIZES: 2", 3", 3"x 4", 4"



For use in applications where a membrane is not required.

3"x 4" Pipe Fit Base with 3-1/2" Plastic Spud

Fits Over 3" or Inside 4" Schedule 40 DWV Pipe

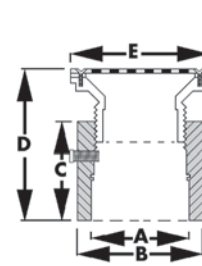

- Strainers available in SS, PB, NB and CP
- SS strainers are 1/16" thick
- PB, NB and CP strainers are 3/16" thick
- Primer tapped, includes 1/2" plug
- Adjustable (see dimension D)

STRAINER	A	B	C	D	E
5" round	Over 3" pipe	Inside 4" pipe	4-1/2"	5-1/16" - 7-1/8"	5-3/16"
5" round with ring	Over 3" pipe	Inside 4" pipe	4-1/2"	5-13/16" - 7-1/4"	5-1/2"
6" round	Over 3" pipe	Inside 4" pipe	4-1/2"	5-3/4" - 7-1/4"	6-1/8"
6" round with ring	Over 3" pipe	Inside 4" pipe	4-1/2"	6-1/16" - 7-5/16"	6-1/2"
6" square	Over 3" pipe	Inside 4" pipe	4-1/2"	5-3/4" - 7-1/8"	6"
7" square	Over 3" pipe	Inside 4" pipe	4-1/2"	5-15/16" - 7-3/8"	7"

PVC

PART NO.	STRAINER	CTN/MSTR
D53428	5" SS round	1/1
D53429	5" PB round	1/1
D53430	5" PB round with ring	1/1
D53431	5" NB round	1/1
D53432	5" NB round with ring	1/1
D53433	5" CP round	1/1
D53434	5" CP round with ring	1/1
D53020	6" SS round	1/1
D53022	6" PB round	1/1
D53074	6" PB round with ring	1/1
D53072	6" NB round	1/1
D53076	6" NB round with ring	1/1
D53021	6" CP round	1/1
D53284	6" CP round with ring	1/1
D59900	5" NB round with 6" square top	1/1

ABS

PART NO.	STRAINER	CTN/MSTR
D53435	5" SS round	1/1
D53436	5" PB round	1/1
D53437	5" PB round with ring	1/1
D53438	5" NB round	1/1
D53439	5" NB round with ring	1/1
D53440	5" CP round	1/1
D53441	5" CP round with ring	1/1
D53023	6" SS round	1/1
D53025	6" PB round	1/1
D53075	6" PB round with ring	1/1
D53073	6" NB round	1/1
D53077	6" NB round with ring	1/1
D53024	6" CP round	1/1
D53285	6" CP round with ring	1/1
D53249	5" NB round with 7" square top	1/1

3"x 4" Pipe Fit Base with 3-1/2" Metal Spud

Fits Over 3" or Inside 4" Schedule 40 DWV Pipe

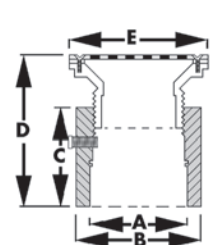

ASSEMBLED IN
USA
NSF CM

- Strainers are available in PB, NB and CP
- Strainers are 3/16" thick
- Primer tapped, includes 1/2" plug
- Adjustable (see dimension D)

STRAINER	A	B	C	D	E
5" round	Over 3" pipe	Inside 4" pipe	4-1/2"	4-7/8" - 6-1/16"	5"
6" round	Over 3" pipe	Inside 4" pipe	4-1/2"	5-5/16" - 6-11/16"	6"
8" round	Over 3" pipe	Inside 4" pipe	4-1/2"	5-3/8" - 6-7/8"	8"
9" round	Over 3" pipe	Inside 4" pipe	4-1/2"	5-3/8" - 6-7/8"	9"
5" or 6" square top	Over 3" pipe	Inside 4" pipe	4-1/2"	5-3/4" - 7-1/8"	5" or 6"

PVC

PART NO.	STRAINER	CTN/MSTR
D53027	5" PB round	1/1
D53124	5" NB round	1/1
D53026	5" CP round	1/1
D53029	6" PB round	1/1
D53125	6" NB round	1/1
D53028	6" CP round	1/1
D53031	8" PB round	1/1
D53138	8" NB round	1/1
D53142	9" PB round	1/1
D53140	9" NB round	1/1
D53078	5" PB square	1/1
D53082	5" NB square	1/1
D53080	6" PB square	1/1
D53084	6" NB square	1/1

ABS

PART NO.	STRAINER	CTN/MSTR
D53033	5" PB round	1/1
D53126	5" NB round	1/1
D53032	5" CP round	1/1
D53035	6" PB round	1/1
D53127	6" NB round	1/1
D53034	6" CP round	1/1
D53037	8" PB round	1/1
D53139	8" NB round	1/1
D53143	9" PB round	1/1
D53141	9" NB round	1/1
D53079	5" PB square	1/1
D53083	5" NB square	1/1
D53081	6" PB square	1/1
D53085	6" NB square	1/1

2" Over Pipe Fit Base with 2" Plastic Spud

Fits Over 2" Schedule 40 DWV Pipe

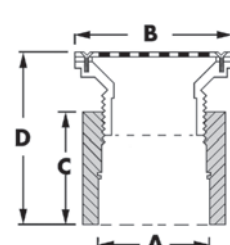

ASSEMBLED IN
USA

- Strainers are available in SS, PB, NB and CP
- Stainless steel strainers are 1/16" thick
- PB, NB and CP strainers are 3/16" thick
- Adjustable (see dimension D)

STRAINER	A	B	C	D
4" round	Over 2" pipe	4-1/4"	1-3/4"	3-3/8" - 3-13/16"
4" round with ring	Over 2" pipe	4-1/4"	1-3/4"	3-1/2" - 3-7/8"
4" square	Over 2" pipe	4-1/4"	1-3/4"	3-3/16" - 3-11/16"

PVC

PART NO.	STRAINER	CTN/MSTR
D53190	4" SS round	1/1
D53194	4" PB round stamped	1/1
D53196	4" PB round cast	1/1
D53200	4" PB round with ring	1/1
D53198	4" NB round	1/1
D53202	4" NB round with ring	1/1
D53325	4" NB round with ring and 1/2" PT	1/1
D53192	4" CP round	1/1
D53290	4" CP round with ring	1/1
D53298	4" PB square	1/1
D53296	4" CP square	1/1

ABS

PART NO.	STRAINER	CTN/MSTR
D53191	4" SS round	1/1
D53195	4" PB round stamped	1/1
D53197	4" PB round cast	1/1
D53201	4" PB round with ring	1/1
D53199	4" NB round	1/1
D53203	4" NB round with ring	1/1
D53193	4" CP round	1/1
D53291	4" CP round with ring	1/1
D53299	4" PB square	1/1
D53297	4" CP square	1/1

2" Over Pipe Fit Base with 2" Metal Spud

Fits Over 2" Schedule 40 DWV Pipe

ASSEMBLED IN
USA

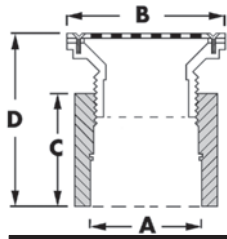

- Strainers are available in SS, PB and CP
- Stainless steel strainers are 1/16" thick
- PB and CP strainers are 3/16" thick
- Adjustable (see dimension D)

STRAINER	A	B	C	D
4" round	Over 2" pipe	4-1/4"	1-3/4"	3-1/8" - 3-5/8"
6" round	Over 2" pipe	6"	1-3/4"	3-1/8" - 3-5/8"

PVC

PART NO.	STRAINER	CTN/MSTR
D53204	4" SS round	1/1
D53208	4" PB round	1/1
D53206	4" CP round	1/1
D53218	6" PB round	1/1
D53216	6" CP round	1/1

ABS

PART NO.	STRAINER	CTN/MSTR
D53205	4" SS round	1/1
D53209	4" PB round	1/1
D53207	4" CP round	1/1
D53219	6" PB round	1/1
D53217	6" CP round	1/1

3" Over Pipe Fit Base with 3" Plastic Spud

Fits Over 3" Schedule 40 DWV Pipe

ASSEMBLED IN
USA

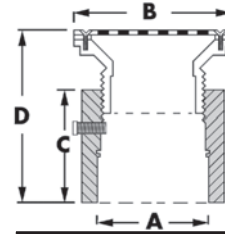

- Strainers are available in SS, PB, NB and CP
- Stainless steel strainers are 1/16" thick
- PB, NB and CP strainers are 3/16" thick
- Primer tapped, includes 1/2" plug
- Adjustable (see dimension D)

STRAINER	A	B	C	D
6" round	Over 3" pipe	6-1/8"	3-7/8"	4-13/16" - 5-3/4"
6" round with ring	Over 3" pipe	6-1/2"	3-7/8"	4-15/16" - 5-13/16"
7" square	Over 3" pipe	7"	3-7/8"	4-13/16" - 6-1/8"

PVC

PART NO.	STRAINER	CTN/MSTR
D53100	6" SS round	1/1
D53104	6" PB round	1/1
D53108	6" PB round with ring	1/1
D53106	6" NB round	1/1
D53110	6" NB round with ring	1/1
D53102	6" CP round	1/1
D53288	6" CP round with ring	1/1
D53260	5" NB round with 7" square top	1/1

ABS

PART NO.	STRAINER	CTN/MSTR
D53101	6" SS round	1/1
D53105	6" PB round	1/1
D53109	6" PB round with ring	1/1
D53107	6" NB round	1/1
D53111	6" NB round with ring	1/1
D53103	6" CP round	1/1
D53289	6" CP round with ring	1/1
D53261	5" NB round with 7" square top	1/1

3" Over Pipe Fit Base with 3" Metal Spud

Fits Over 3" Schedule 40 DWV Pipe

ASSEMBLED IN
USA

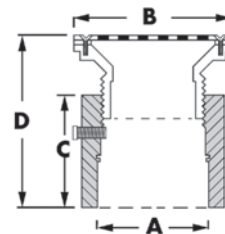

- Strainers are available in PB and NB
- Strainers are 3/16" thick
- Primer tapped, includes 1/2" plug
- Adjustable (see dimension D)

STRAINER	A	B	C	D
5" round	Over 3" pipe	5"	3-7/8"	4-15/16" - 5-3/4"

PVC

PART NO.	STRAINER	CTN/MSTR
D53312	5" PB round	1/1
D53306	5" NB round	1/1

ABS

PART NO.	STRAINER	CTN/MSTR
D53313	5" PB round	1/1
D53307	5" NB round	1/1

4" Over Pipe Fit Base with 3-1/2" Plastic Spud

Fits Over 4" Schedule 40 DWV Pipe

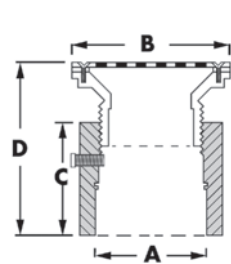

ASSEMBLED IN
USA
NSF[®] M[®] C[®]

- Strainers are available in SS, PB, NB and CP
- Stainless steel strainers are 1/16" thick
- PB, NB and CP strainers are 3/16" thick
- Primer tapped, includes 1/2" plug
- Adjustable (see dimension D)

STRAINER	A	B	C	D
5" round	Over 4" pipe	5-3/16"	4-3/4"	6" - 7-3/8"
5" round with ring	Over 4" pipe	5-1/2"	4-3/4"	6-1/8" - 7-1/2"
6" round	Over 4" pipe	6-1/8"	4-3/4"	6" - 7-1/2"
6" round with ring	Over 4" pipe	6-1/2"	4-3/4"	6-1/4" - 7-5/8"
7" square	Over 4" pipe	7"	4-3/4"	5-1/2" - 6-7/8"

PVC

PART NO.	STRAINER	CTN/MSTR
D53414	5" SS round	1/1
D53415	5" PB round	1/1
D53416	5" PB round with ring	1/1
D53417	5" NB round	1/1
D53418	5" NB round with ring	1/1
D53419	5" CP round	1/1
D53420	5" CP round with ring	1/1
D53040	6" SS round	1/1
D53088	6" PB round with ring	1/1
D53086	6" NB round	1/1
D53090	6" NB round with ring	1/1
D53041	6" CP round	1/1
D53282	6" CP round with ring	1/1
D53252	5" NB round with 7" square top	1/1

ABS

PART NO.	STRAINER	CTN/MSTR
D53421	5" SS round	1/1
D53422	5" PB round	1/1
D53423	5" PB round with ring	1/1
D53424	5" NB round	1/1
D53425	5" NB round with ring	1/1
D53426	5" CP round	1/1
D53427	5" CP round with ring	1/1
D53043	6" SS round	1/1
D53045	6" PB round	1/1
D53089	6" PB round with ring	1/1
D53087	6" NB round	1/1
D53091	6" NB round with ring	1/1
D53044	6" CP round	1/1
D53283	6" CP round with ring	1/1
D53253	5" NB round with 7" square top	1/1

4" Over Pipe Fit Base with 3-1/2" Metal Spud

Fits Over 4" Schedule 40 DWV Pipe

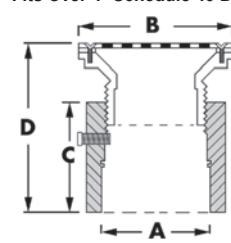

ASSEMBLED IN
USA
NSF[®] M[®] C[®]

- Strainers are available in PB, NB and CP
- Strainers are 3/16" thick
- Primer tapped, includes 1/2" plug
- Adjustable (see dimension D)

STRAINER	A	B	C	D
5" round	Over 4" pipe	5-3/16"	4-3/4"	5-1/8" - 6-3/8"
6" round	Over 4" pipe	6-3/16"	4-3/4"	5-5/16" - 6-5/8"
8" round	Over 4" pipe	8"	4-3/4"	5-1/2" - 7"
9" round	Over 4" pipe	9"	4-3/4"	5-1/2" - 7-1/8"
5" or 6" square	Over 4" pipe	5" or 6"	4-3/4"	5-5/16" - 6-5/8"

PVC

PART NO.	STRAINER	CTN/MSTR
D53047	5" PB round	1/1
D53128	5" NB round	1/1
D53046	5" CP round	1/1
D53049	6" PB round	1/1
D53129	6" NB round	1/1
D53048	6" CP round	1/1
D53051	8" PB round	1/1
D53132	8" NB round	1/1
D53136	9" PB round	1/1
D53134	9" NB round	1/1
D53092	5" PB square	1/1
D53096	5" NB square	1/1
D53094	6" PB square	1/1
D53098	6" NB square	1/1

ABS

PART NO.	STRAINER	CTN/MSTR
D53053	5" PB round	1/1
D53130	5" NB round	1/1
D53052	5" CP round	1/1
D53055	6" PB round	1/1
D53131	6" NB round	1/1
D53054	6" CP round	1/1
D53057	8" PB round	1/1
D53133	8" NB round	1/1
D53137	9" PB round	1/1
D53135	9" NB round	1/1
D53093	5" PB square	1/1
D53097	5" NB square	1/1
D53095	6" PB square	1/1
D53099	6" NB square	1/1

4" Over Pipe Fit Base with 4" Plastic Spud

Fits Over 4" Schedule 40 DWV Pipe

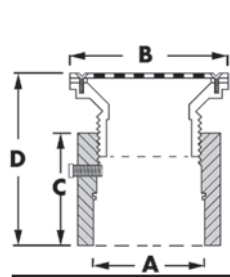

ASSEMBLED IN
USA



- Strainers are available in SS, PB, NB and CP
- Stainless steel strainers are 1/16" thick
- PB, NB and CP strainers are 3/16" thick
- Primer tapped, includes 1/2" plug
- Adjustable (see dimension D)

STRAINER	A	B	C	D
6" round	Over 4" pipe	6-1/8"	4-3/4"	6" - 7-3/16"
6" round with ring	Over 4" pipe	6-1/2"	4-3/4"	6-1/8" - 7-5/16"
7" square	Over 4" pipe	7"	4-3/4"	6-1/16" - 7-3/8"

PVC

PART NO.	STRAINER	CTN/MSTR
D53262	6" SS round	1/4
D53263	6" PB round	1/4
D53264	6" PB round with ring	1/4
D53265	6" NB round	1/4
D53266	6" NB round with ring	1/4
D53269	6" CP round	1/4
D53286	6" CP round with ring	1/4
D53268	5" NB round with 7" square top	1/1

ABS

PART NO.	STRAINER	CTN/MSTR
D53272	6" SS round	1/4
D53273	6" PB round	1/4
D53274	6" PB round with ring	1/4
D53275	6" NB round	1/4
D53276	6" NB round with ring	1/4
D53279	6" CP round	1/4
D53287	6" CP round with ring	1/4
D53278	5" NB round with 7" square top	1/1

4" Over Pipe Fit Base with 4" Metal Spud

Fits Over 4" Schedule 40 DWV Pipe

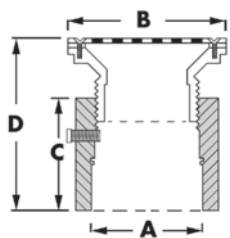

ASSEMBLED IN
USA



- Strainers are available in PB and NB
- Strainers are 3/16" thick
- Primer tapped, includes 1/2" plug
- Adjustable (see dimension D)

STRAINER	A	B	C	D
5" round	Over 4" pipe	5"	4-3/4"	6-1/16" - 7-3/8"

PVC

PART NO.	STRAINER	CTN/MSTR
D53308	5" PB round	1/4
D53304	5" NB round	1/4

ABS

PART NO.	STRAINER	CTN/MSTR
D53309	5" PB round	1/4
D53305	5" NB round	1/4

3" Inside Pipe Fit Base with 2" Plastic Spud

Fits Inside 3" Schedule 40 DWV Pipe

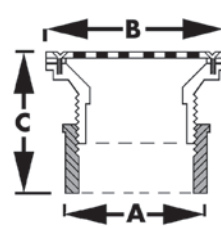

ASSEMBLED IN
USA

- Strainers are available in SS, PB, NB and CP
- Stainless steel strainers are 1/16" thick
- PB, NB and CP strainers are 3/16" thick
- Adjustable (see dimension C)

STRAINER	A	B	C
4" round	Inside 3" pipe	4-1/4"	2-5/8" - 3-7/8"
4" round with ring	Inside 3" pipe	4-1/2"	2-11/16" - 4"
4" square	Inside 3" pipe	4-1/4"	2-1/2" - 3-13/16"

PVC

PART NO.	STRAINER	CTN/MSTR
D53150	4" SS round	1/1
D53154	4" PB round stamped	1/1
D53156	4" PB round cast	1/1
D53160	4" PB round with ring	1/1
D53158	4" NB round	1/1
D53162	4" NB round with ring	1/1
D53152	4" CP round	1/1
D53294	4" CP round with ring	1/1
D53300	4" CP square	1/1
D53302	4" PB square	1/1

ABS

PART NO.	STRAINER	CTN/MSTR
D53151	4" SS round	1/1
D53155	4" PB round stamped	1/1
D53157	4" PB round cast	1/1
D53161	4" PB round with ring	1/1
D53159	4" NB round	1/1
D53163	4" NB round with ring	1/1
D53153	4" CP round	1/1
D53295	4" CP round with ring	1/1
D53301	4" CP square	1/1
D53303	4" PB square	1/1

3" Inside Pipe Fit Base with 2" Metal Spud

Fits Inside 3" Schedule 40 DWV Pipe

MADE IN THE USA

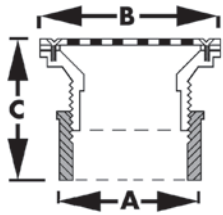

- Strainers are available in SS, PB and CP
- Stainless steel strainers are 1/16" thick
- PB and CP strainers are 3/16" thick
- Adjustable (see dimension C)

STRAINER	A	B	C
4" or 6" round	Inside 3" pipe	4-1/4" or 6"	2-7/16" - 3-3/4"

PVC

PART NO.	STRAINER	CTN/MSTR
D53180	4" SS round	1/1
D53184	4" PB round	1/1
D53182	4" CP round	1/1
D53188	6" PB round	1/1
D53186	6" CP round	1/1

ABS

PART NO.	STRAINER	CTN/MSTR
D53181	4" SS round	1/1
D53185	4" PB round	1/1
D53183	4" CP round	1/1
D53189	6" PB round	1/1
D53187	6" CP round	1/1

4" Inside Pipe Fit Base with 3" Metal Spud

Fits Inside 4" Schedule 40 DWV Pipe

ASSEMBLED IN USA

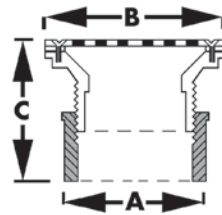

- Strainers are available in PB and NB
- Strainers are 3/16" thick
- Adjustable (see dimension C)

STRAINER	A	B	C
5" round	Inside 4" pipe	5"	2-5/8" - 3-1/2"

PVC

PART NO.	STRAINER	CTN/MSTR
D53314	5" PB round	1/1
D53310	5" NB round	1/1

ABS

PART NO.	STRAINER	CTN/MSTR
D53315	5" PB round	1/1
D53311	5" NB round	1/1

4" Inside Pipe Fit Base with 3" Plastic Spud

Fits Inside 4" Schedule 40 DWV Pipe

ASSEMBLED IN USA

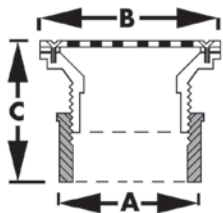

- Strainers are available in SS, PB, NB and CP
- Stainless steel strainers are 1/16" thick
- PB, NB and CP strainers are 3/16" thick
- Adjustable (see dimension C)

STRAINER	A	B	C
6" round	Inside 4" pipe	6-1/8"	3-13/16" - 4-5/8"
6" round with ring	Inside 4" pipe	6-1/2"	4" - 4-13/16"

PVC

PART NO.	STRAINER	CTN/MSTR
D53230	6" SS round	1/1
D53232	6" PB round	1/1
D53238	6" PB round with ring	1/1
D53234	6" NB round	1/1
D53240	6" NB round with ring	1/1
D53236	6" CP round	1/1
D53292	6" CP round with ring	1/1

ABS

PART NO.	STRAINER	CTN/MSTR
D53231	6" SS round	1/1
D53233	6" PB round	1/1
D53239	6" PB round with ring	1/1
D53235	6" NB round	1/1
D53241	6" NB round with ring	1/1
D53237	6" CP round	1/1
D53293	6" CP round with ring	1/1

4" Hub Fit Base with 3-1/2" Plastic Spud

Fits Inside 4" Schedule 40 DWV Pipe

ASSEMBLED IN
USA

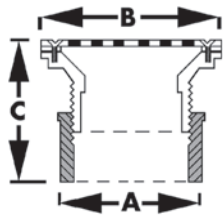

- Strainers are available in SS, PB, NB and CP
- Stainless steel strainers are 1/16" thick
- PB, NB and CP strainers are 3/16" thick
- Adjustable (see dimension C)

STRAINER	A	B	C
5" round	4" hub fit	5-3/16"	3" - 4-1/2"
5" round with ring	4" hub fit	5-1/2"	3-1/8" - 4-5/8"
6" round	4" hub fit	6-1/8"	3-1/16" - 4-11/16"
6" round with ring	4" hub fit	6-1/2"	3-1/4" - 4-3/4"

PVC

PART NO.	STRAINER	CTN/MSTR
D53400	5" SS round	1/1
D53401	5" PB round	1/1
D53402	5" PB round with ring	1/1
D53403	5" NB round	1/1
D53404	5" NB round with ring	1/1
D53405	5" CP round	1/1
D53406	5" CP round with ring	1/1
D53017	6" SS round	1/1
D53001	6" PB round	1/1
D53060	6" PB round with ring	1/1
D53058	6" NB round	1/1
D53062	6" NB round with ring	1/1
D53003	6" CP round	1/1
D53280	6" CP round with ring	1/1

ABS

PART NO.	STRAINER	CTN/MSTR
D53407	5" SS round	1/1
D53408	5" PB round	1/1
D53409	5" PB round with ring	1/1
D53410	5" NB round	1/1
D53411	5" NB round with ring	1/1
D53412	5" CP round	1/1
D53413	5" CP round with ring	1/1
D53018	6" SS round	1/1
D53002	6" PB round	1/1
D53061	6" PB round with ring	1/1
D53059	6" NB round	1/1
D53063	6" NB round with ring	1/1
D53004	6" CP round	1/1
D53281	6" CP round with ring	1/1

4" Hub Fit Base with 3-1/2" Metal Spud

Fits Inside 4" Schedule 40 DWV Pipe

ASSEMBLED IN
USA

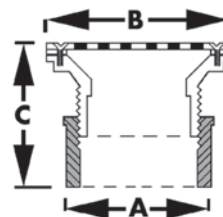

- Strainers are available in PB, NB and CP
- Strainers are 3/16" thick
- Adjustable (see dimension C)

STRAINER	A	B	C
5" round	5" hub fit	5-3/16"	2-3/8" - 3-5/8"
6" round	6" hub fit	6-3/16"	2-5/8" - 4"
5" or 6" square	4" hub fit	5" or 6"	2-3/4" - 4-3/16"

PVC

PART NO.	STRAINER	CTN/MSTR
D53005	5" PB round	1/1
D53120	5" NB round	1/1
D53011	5" CP round	1/1
D53006	6" PB round	1/1
D53121	6" NB round	1/1
D53012	6" CP round	1/1
D53064	5" PB square	1/4
D53068	5" NB square	1/4
D53066	6" PB square	1/4
D53070	6" NB square	1/4

ABS

PART NO.	STRAINER	CTN/MSTR
D53008	5" PB round	1/1
D53122	5" NB round	1/1
D53014	5" CP round	1/1
D53009	6" PB round	1/1
D53123	6" NB round	1/1
D53015	6" CP round	1/1
D53065	5" PB square	1/4
D53069	5" NB square	1/4
D53067	6" PB square	1/4
D53071	6" NB square	1/4

PVC and ABS 8-1/2" Pan Commercial Drains

Pages 192-198

SIZES: 2" x 3", 3" x 4", 4"



For use in applications where a membrane is required.

2" x 3" Drain Base with 3" Plastic Spud

Fits Over 2" and Inside 3" Schedule 40 DWV Pipe

ASSEMBLED IN
USA

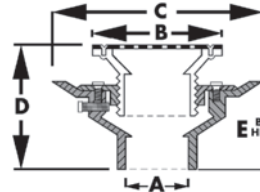

- Completely adjustable; reversible clamping ring gains additional 1" height (Dimension D)
- Strainers are available in SS, PB, NB and CP
- Stainless steel strainers are 1/16" thick
- PB, NB and CP strainers are 3/16" thick
- 8-1/2" pan primer tapped with 1/2" plug
- Gray PVC or Black ABS
- Extra weep holes

STRAINER	A	B	C	D	E
6" round stainless steel	Over 2" Inside 3"	6-1/8"	8-9/16"	5-1/16" - 6-3/16"	3-3/4"
6" round	Over 2" Inside 3"	6-1/8"	8-9/16"	5-1/8" - 6-3/8"	3-3/4"
6" with ring	Over 2" Inside 3"	6-7/16"	8-9/16"	5-5/16" - 6-3/16"	3-3/4"

PVC

PART NO.	STRAINER	CTN/MSTR
D49001	6" SS round	1/1
D49003	6" PB round	1/1
D49005	6" PB round with ring	1/1
D49007	6" NB round	1/1
D49009	6" NB round with ring	1/1
D49011	6" CP round	1/1
D49013	6" CP round with ring	1/1

ABS

PART NO.	STRAINER	CTN/MSTR
D49002	6" SS round	1/1
D49004	6" PB round	1/1
D49006	6" PB round with ring	1/1
D49008	6" NB round	1/1
D49010	6" NB round with ring	1/1
D49012	6" CP round	1/1
D49014	6" CP round with ring	1/1

2" x 3" Drain Base with 3" Metal Spud

Fits Over 2" and Inside 3" Schedule 40 DWV Pipe

ASSEMBLED IN
USA

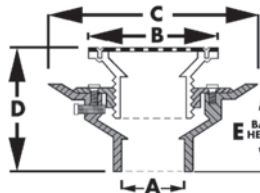

- Completely adjustable; reversible clamping ring gains additional 1" height (Dimension D)
- Strainers are available in PB and NB
- Strainers are 3/16" thick
- 8-1/2" pan primer tapped with 1/2" plug
- Gray PVC or Black ABS
- Extra weep holes

STRAINER	A	B	C	D	E
5" round	Over 2" Inside 3"	5-3/16"	8-9/16"	4-3/16" - 5-3/8"	3-3/4"

PVC

PART NO.	STRAINER	CTN/MSTR
D49019	5" PB round	1/1
D49021	5" NB round	1/1

ABS

PART NO.	STRAINER	CTN/MSTR
D49020	5" PB round	1/1
D49022	5" NB round	1/1

2" x 3" Drain Base with 3-1/2" Plastic Spud

Fits Over 2" and Inside 3" Schedule 40 DWV Pipe

ASSEMBLED IN
USA

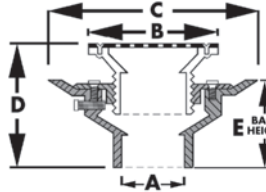

- Completely adjustable; reversible clamping ring gains additional 1" height (Dimension D)
- Strainers are available in SS, PB, NB and CP
- Stainless steel strainers are 1/16" thick
- PB, NB and CP strainers are 3/16" thick
- 8-1/2" pan primer tapped with 1/2" plug
- Gray PVC or Black ABS
- Extra weep holes

STRAINER	A	B	C	D	E
5" round stainless steel	Over 2" Inside 3"	5-1/4"	8-9/16"	4-5/8" - 6-1/8"	3-3/4"
5" round	Over 2" Inside 3"	5-1/4"	8-9/16"	4-11/16" - 6-1/4"	3-3/4"
5" round with ring	Over 2" Inside 3"	5-9/16"	8-9/16"	4-3/4" - 6-5/16"	3-3/4"
6" round stainless steel	Over 2" Inside 3"	6-1/4"	8-9/16"	4-13/16" - 6-1/4"	3-3/4"
6" round	Over 2" Inside 3"	6-1/4"	8-9/16"	4-15/16" - 6-5/16"	3-3/4"
6" round with ring	Over 2" Inside 3"	6-9/16"	8-9/16"	5-1/16" - 6-1/2"	3-3/4"

PVC

PART NO.	STRAINER	CTN/MSTR
D49023	5" SS round	1/1
D49025	5" PB round	1/1
D49027	5" PB round with ring	1/1
D49029	5" NB round	1/1
D49031	5" NB round with ring	1/1
D49033	5" CP round	1/1
D49035	5" CP round with ring	1/1
D49037	6" SS round	1/1
D49039	6" PB round	1/1
D49041	6" PB round with ring	1/1
D49043	6" NB round	1/1
D49045	6" NB round with ring	1/1
D49047	6" CP round	1/1
D49049	6" CP round with ring	1/1

ABS

PART NO.	STRAINER	CTN/MSTR
D49024	5" SS round	1/1
D49026	5" PB round	1/1
D49028	5" PB round with ring	1/1
D49030	5" NB round	1/1
D49032	5" NB round with ring	1/1
D49034	5" CP round	1/1
D49036	5" CP round with ring	1/1
D49038	6" SS round	1/1
D49040	6" PB round	1/1
D49042	6" PB round with ring	1/1
D49044	6" NB round	1/1
D49046	6" NB round with ring	1/1
D49048	6" CP round	1/1
D49050	6" CP round with ring	1/1

2" x 3" Drain Base with 3-1/2" Metal Spud

Fits Over 2" and Inside 3" Schedule 40 DWV Pipe

ASSEMBLED IN
USA

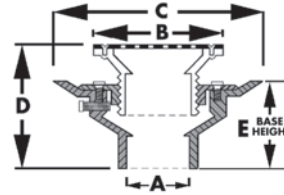

- Completely adjustable; reversible clamping ring gains additional 1" height (Dimension D)
- Strainers are available in PB, NB and CP
- Strainers are 3/16" thick
- 8-1/2" pan primer tapped with 1/2" plug
- Gray PVC or Black ABS
- Extra weep holes

STRAINER	A	B	C	D	E
4" round	Over 2" Inside 3"	4-1/8"	8-9/16"	4-1/8" - 5-1/4"	3-3/4"
5" round	Over 2" Inside 3"	5-3/16"	8-9/16"	4-1/8" - 5-5/16"	3-3/4"
6" round	Over 2" Inside 3"	6-3/16"	8-9/16"	4-5/16" - 5-3/4"	3-3/4"

PVC

PART NO.	STRAINER	CTN/MSTR
D49051	4" PB round	1/1
D49053	4" NB round	1/1
D49055	5" PB round	1/1
D49057	5" NB round	1/1
D49059	5" CP round	1/1
D49061	6" PB round	1/1
D49063	6" NB round	1/1
D49065	6" CP round	1/1

ABS

PART NO.	STRAINER	CTN/MSTR
D49052	4" PB round	1/1
D49054	4" NB round	1/1
D49056	5" PB round	1/1
D49058	5" NB round	1/1
D49060	5" CP round	1/1
D49062	6" PB round	1/1
D49064	6" NB round	1/1
D49066	6" CP round	1/1

2" x 3" Drain Base with 4" Plastic Spud

Fits Over 2" and Inside 3" Schedule 40 DWV Pipe

ASSEMBLED IN
USA

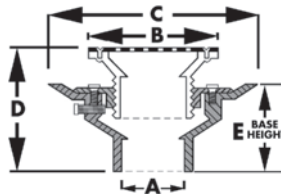

- Completely adjustable; reversible clamping ring gains additional 1" height (Dimension D)
- Strainers are available in SS, PB, NB and CP
- Stainless steel strainers are 1/16" thick
- PB, NB and CP strainers are 3/16" thick
- 8-1/2" pan primer tapped with 1/2" plug
- Gray PVC or Black ABS
- Extra weep holes

STRAINER	A	B	C	D	E
6" round stainless steel	Over 2" Inside 3"	6-3/16"	8-9/16"	5" - 6-3/16"	3-3/4"
6" round	Over 2" Inside 3"	6-3/16"	8-9/16"	5-1/16" - 6-1/4"	3-3/4"

PVC

PART NO.	STRAINER	CTN/MSTR
D49077	6" SS round	1/1
D49079	6" PB round	1/1
D49081	6" PB round with ring	1/1
D49083	6" NB round	1/1
D49085	6" NB round with ring	1/1
D49087	6" CP round	1/1
D49089	6" CP round with ring	1/1

ABS

PART NO.	STRAINER	CTN/MSTR
D49078	6" SS round	1/1
D49080	6" PB round	1/1
D49082	6" PB round with ring	1/1
D49084	6" NB round	1/1
D49086	6" NB round with ring	1/1
D49088	6" CP round	1/1
D49090	6" CP round with ring	1/1

3" x 4" Drain Base with 3" Plastic Spud

Fits Over 3" and Inside 4" Schedule 40 DWV Pipe

ASSEMBLED IN
USA

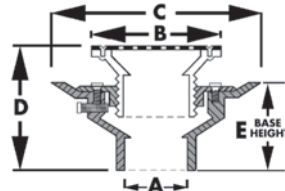

- Completely adjustable; reversible clamping ring gains additional 1" height (Dimension D)
- Strainers are available in SS, PB, NB and CP
- Stainless steel strainers are 1/16" thick
- PB, NB and CP strainers are 3/16" thick
- 8-1/2" pan primer tapped with 1/2" plug
- Gray PVC or Black ABS
- Extra weep holes

STRAINER	A	B	C	D	E
6" round stainless steel	Over 3" Inside 4"	6-1/8"	8-9/16"	5-1/16" - 6-3/16"	5-3/16"
6" round	Over 3" Inside 4"	6-1/8"	8-9/16"	5-1/8" - 6-3/8"	5-3/16"
6" round with ring	Over 3" Inside 4"	6-7/16"	8-9/16"	5-5/16" - 6-1/2"	5-3/16"

PVC

PART NO.	STRAINER	CTN/MSTR
D49101	6" SS round	1/1
D49103	6" PB round	1/1
D49105	6" PB round with ring	1/1
D49107	6" NB round	1/1
D49109	6" NB round with ring	1/1
D49111	6" CP round	1/1
D49113	6" CP round with ring	1/1

ABS

PART NO.	STRAINER	CTN/MSTR
D49102	6" SS round	1/1
D49104	6" PB round	1/1
D49106	6" PB round with ring	1/1
D49108	6" NB round	1/1
D49110	6" NB round with ring	1/1
D49112	6" CP round	1/1
D49114	6" CP round with ring	1/1

2" x 3" Drain Base with 4" Metal Spud

Fits Over 2" and Inside 3" Schedule 40 DWV Pipe

MADE IN THE
USA

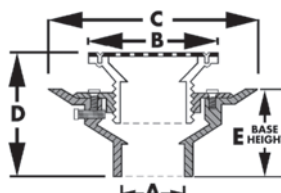

- Completely adjustable; reversible clamping ring gains additional 1" height (Dimension D)
- Strainers are available in PB and NB
- Strainers are 3/16" thick
- 8-1/2" pan primer tapped with 1/2" plug
- Gray PVC or Black ABS
- Extra weep holes

STRAINER	A	B	C	D	E
5" round	Over 2" Inside 3"	5-3/16"	8-9/16"	4-1/8" - 5-3/16"	3-3/4"

PVC

PART NO.	STRAINER	CTN/MSTR
D49095	5" PB round	1/1
D49097	5" NB round	1/1

ABS

PART NO.	STRAINER	CTN/MSTR
D49096	5" PB round	1/1
D49098	5" NB round	1/1

3" x 4" Drain Base with 3" Metal Spud

Fits Over 3" and Inside 4" Schedule 40 DWV Pipe

ASSEMBLED IN
USA

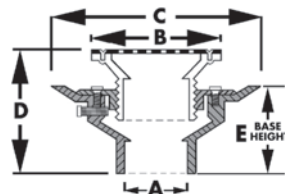

- Completely adjustable; reversible clamping ring gains additional 1" height (Dimension D)
- Strainers are available in PB and NB
- Strainers are 3/16" thick
- 8-1/2" pan primer tapped with 1/2" plug
- Gray PVC or Black ABS
- Extra weep holes

STRAINER	A	B	C	D	E
5" round	Over 3" Inside 4"	5-3/16"	8-9/16"	4-3/16" - 5-3/8"	5-3/16"

PVC

PART NO.	STRAINER	CTN/MSTR
D49119	5" PB round	1/1
D49121	5" NB round	1/1

ABS

PART NO.	STRAINER	CTN/MSTR
D49120	5" PB round	1/1
D49122	5" NB round	1/1

3" x 4" Drain Base with 3-1/2" Plastic Spud

Fits Over 3" and Inside 4" Schedule 40 DWV Pipe

ASSEMBLED IN
USA

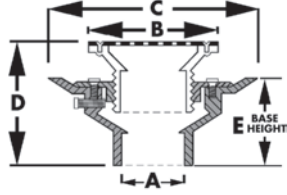

- Completely adjustable; reversible clamping ring gains additional 1" height (Dimension D)
- Strainers are available in SS, PB, NB and CP
- Stainless steel strainers are 1/16" thick
- PB, NB and CP strainers are 3/16" thick
- 8-1/2" pan primer tapped with 1/2" plug
- Gray PVC or Black ABS
- Extra weep holes

STRAINER	A	B	C	D	E
5" round stainless steel	Over 3" Inside 4"	5-1/4"	8-9/16"	4-5/8" - 6-1/8"	5-1/4"
5" round	Over 3" Inside 4"	5-1/4"	8-9/16"	4-11/16" - 6-1/4"	5-1/4"
5" round with ring	Over 3" Inside 4"	5-9/16"	8-9/16"	4-3/4" - 6-5/16"	5-1/4"
6" round stainless steel	Over 3" Inside 4"	6-1/4"	8-9/16"	4-13/16" - 6-1/4"	5-1/4"
6" round	Over 3" Inside 4"	6-1/4"	8-9/16"	4-15/16" - 6-5/16"	5-1/4"
6" round with ring	Over 3" Inside 4"	6-9/16"	8-9/16"	5-1/16" - 6-1/2"	5-1/4"

PVC

PART NO.	STRAINER	CTN/MSTR
D49123	5" SS round	1/1
D49125	5" PB round	1/1
D49127	5" PB round with ring	1/1
D49129	5" NB round	1/1
D49131	5" NB round with ring	1/1
D49133	5" CP round	1/1
D49135	5" CP round with ring	1/1
D49137	6" SS round	1/1
D49139	6" PB round	1/1
D49141	6" PB round with ring	1/1
D49143	6" NB round	1/1
D49145	6" NB round with ring	1/1
D49147	6" CP round	1/1
D49149	6" CP round with ring	1/1

ABS

PART NO.	STRAINER	CTN/MSTR
D49124	5" SS round	1/1
D49126	5" PB round	1/1
D49128	5" PB round with ring	1/1
D49130	5" NB round	1/1
D49132	5" NB round with ring	1/1
D49134	5" CP round	1/1
D49136	5" CP round with ring	1/1
D49138	6" SS round	1/1
D49140	6" PB round	1/1
D49142	6" PB round with ring	1/1
D49144	6" NB round	1/1
D49146	6" NB round with ring	1/1
D49148	6" CP round	1/1
D49150	6" CP round with ring	1/1

3" x 4" Drain Base with 3-1/2" Metal Spud

Fits Over 3" and Inside 4" Schedule 40 DWV Pipe

ASSEMBLED IN
USA

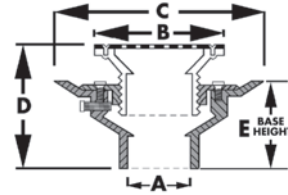

- Completely adjustable; reversible clamping ring gains additional 1" height (Dimension D)
- Strainers are available in PB, NB and CP
- Strainers are 3/16" thick
- 8-1/2" pan primer tapped with 1/2" plug
- Gray PVC or Black ABS
- Extra weep holes

STRAINER	A	B	C	D	E
4" round	Over 3" Inside 4"	4-1/8"	8-9/16"	4-1/8" - 5-1/4"	5-1/4"
5" round	Over 3" Inside 4"	5-3/16"	8-9/16"	4-1/8" - 5-5/16"	5-1/4"
6" round	Over 3" Inside 4"	6-3/16"	8-9/16"	4-5/16" - 5-3/4"	5-1/4"

PVC

PART NO.	STRAINER	CTN/MSTR
D49151	4" PB round	1/1
D49153	4" NB round	1/1
D49155	5" PB round	1/1
D49157	5" NB round	1/1
D49159	5" CP round	1/1
D49161	6" PB round	1/1
D49163	6" NB round	1/1
D49165	6" CP round	1/1

ABS

PART NO.	STRAINER	CTN/MSTR
D49152	4" PB round	1/1
D49154	4" NB round	1/1
D49156	5" PB round	1/1
D49158	5" NB round	1/1
D49160	5" CP round	1/1
D49162	6" PB round	1/1
D49164	6" NB round	1/1
D49166	6" CP round	1/1

3" x 4" Drain Base with 4" Plastic Spud

Fits Over 3" and Inside 4" Schedule 40 DWV Pipe

ASSEMBLED IN
USA

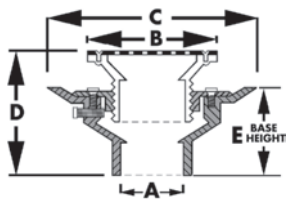

- Completely adjustable; reversible clamping ring gains additional 1" height (Dimension D)
- Strainers are available in SS, PB, NB and CP
- Stainless steel strainers are 1/16" thick
- PB, NB and CP strainers are 3/16" thick
- 8-1/2" pan primer tapped with 1/2" plug
- Gray PVC or Black ABS
- Extra weep holes

STRAINER	A	B	C	D	E
6" round stainless steel	Over 3" Inside 4"	6-3/16"	8-9/16"	5-1/16" - 6-3/16"	5-1/4"
6" round	Over 3" Inside 4"	6-3/16"	8-9/16"	5-1/8" - 6-3/8"	5-1/4"
6" round with ring	Over 3" Inside 4"	6-7/16"	8-9/16"	5-5/16" - 6-1/2"	5-1/4"

PVC

PART NO.	STRAINER	CTN/MSTR
D49177	6" SS round	1/1
D49179	6" PB round	1/1
D49181	6" PB round with ring	1/1
D49183	6" NB round	1/1
D49185	6" NB round with ring	1/1
D49187	6" CP round	1/1
D49189	6" CP round with ring	1/1

ABS

PART NO.	STRAINER	CTN/MSTR
D49178	6" SS round	1/1
D49180	6" PB round	1/1
D49182	6" PB round with ring	1/1
D49184	6" NB round	1/1
D49186	6" NB round with ring	1/1
D49188	6" CP round	1/1
D49190	6" CP round with ring	1/1

3" x 4" Drain Base with 4" Metal Spud

Fits Over 3" and Inside 4" Schedule 40 DWV Pipe

ASSEMBLED IN
USA

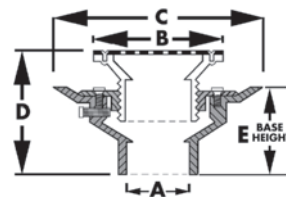

- Completely adjustable; reversible clamping ring gains additional 1" height (Dimension D)
- Strainers are available in PB and NB
- Strainers are 3/16" thick
- 8-1/2" pan primer tapped with 1/2" plug
- Gray PVC or Black ABS
- Extra weep holes

STRAINER	A	B	C	D	E
5" round	Over 3" Inside 4"	5-3/16"	8-9/16"	4-3/16" - 5-3/8"	5-1/4"

PVC

PART NO.	STRAINER	CTN/MSTR
D49195	5" PB round	1/1
D49197	5" NB round	1/1

ABS

PART NO.	STRAINER	CTN/MSTR
D49196	5" PB round	1/1
D49198	5" NB round	1/1

4" Drain Base with 3" Plastic Spud

Fits Over 4" Schedule 40 DWV Pipe

ASSEMBLED IN
USA

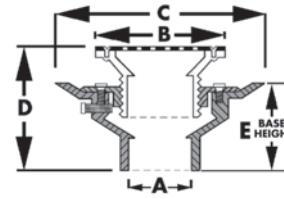

- Completely adjustable; reversible clamping ring gains additional 1" height (Dimension D)
- Strainers are available in SS, PB, NB and CP
- Stainless steel strainers are 1/16" thick
- PB, NB and CP strainers are 3/16" thick
- 8-1/2" pan primer tapped with 1/2" plug
- Gray PVC or Black ABS
- Extra weep holes

STRAINER	A	B	C	D	E
6" round stainless steel	Over 4"	6-1/8"	8-9/16"	5-9/16" - 6-11/16"	4-1/4"
6" round	Over 4"	6-1/8"	8-9/16"	5-5/8" - 6-7/8"	4-1/4"
6" round with ring	Over 4"	6-7/16"	8-9/16"	5-13/16" - 7"	4-1/4"

PVC

PART NO.	STRAINER	CTN/MSTR
D49201	6" SS round	1/1
D49203	6" PB round	1/1
D49205	6" PB round with ring	1/1
D49207	6" NB round	1/1
D49209	6" NB round with ring	1/1
D49211	6" CP round	1/1
D49213	6" CP round with ring	1/1

ABS

PART NO.	STRAINER	CTN/MSTR
D49202	6" SS round	1/1
D49204	6" PB round	1/1
D49206	6" PB round with ring	1/1
D49208	6" NB round	1/1
D49210	6" NB round with ring	1/1
D49212	6" CP round	1/1
D49214	6" CP round with ring	1/1

4" Drain Base with 3" Metal Spud

Fits Over 4" Schedule 40 DWV Pipe

ASSEMBLED IN
USA

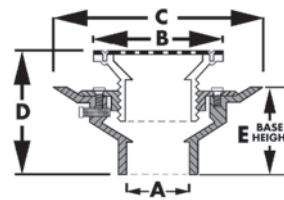

- Completely adjustable; reversible clamping ring gains additional 1" height (Dimension D)
- Strainers are available in PB and NB
- Strainers are 3/16" thick
- 8-1/2" pan primer tapped with 1/2" plug
- Gray PVC or Black ABS
- Extra weep holes

STRAINER	A	B	C	D	E
5" round	Over 4"	5-3/16"	8-9/16"	4-11/16" - 5-7/8"	4-1/4"

PVC

PART NO.	STRAINER	CTN/MSTR
D49219	5" PB round	1/1
D49221	5" NB round	1/1

ABS

PART NO.	STRAINER	CTN/MSTR
D49220	5" PB round	1/1
D49222	5" NB round	1/1

4" Drain Base with 3-1/2" Plastic Spud

Fits Over 4" Schedule 40 DWV Pipe



ASSEMBLED IN
USA

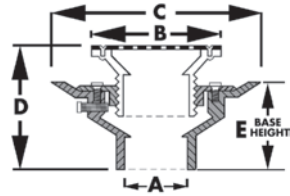

- Completely adjustable; reversible clamping ring gains additional 1" height (Dimension D)
- Strainers are available in SS, PB, NB and CP
- Stainless steel strainers are 1/16" thick
- PB, NB and CP strainers are 3/16" thick
- 8-1/2" pan primer tapped with 1/2" plug
- Gray PVC or Black ABS
- Extra weep holes

STRAINER	A	B	C	D	E
5" round stainless steel	Over 4"	5-1/4"	8-9/16"	5-1/8" — 6-5/8"	4-1/4"
5" round	Over 4"	5-1/4"	8-9/16"	5-3/16" — 6-3/4"	4-1/4"
5" round with ring	Over 4"	5-9/16"	8-9/16"	5-1/4" — 6-13/16"	4-1/4"
6" round stainless steel	Over 4"	6-1/4"	8-9/16"	5-5/16" — 6-3/4"	4-1/4"
6" round	Over 4"	6-1/4"	8-9/16"	5-7/16" — 6-13/16"	4-1/4"
6" round with ring	Over 4"	6-9/16"	8-9/16"	5-9/16" — 7"	4-1/4"

PVC

PART NO.	STRAINER	CTN/MSTR
D49223	5" SS round	1/1
D49225	5" PB round	1/1
D49227	5" PB round with ring	1/1
D49229	5" NB round	1/1
D49231	5" NB round with ring	1/1
D49233	5" CP round	1/1
D49235	5" CP round with ring	1/1
D49237	6" SS round	1/1
D49239	6" PB round	1/1
D49241	6" PB round with ring	1/1
D49243	6" NB round	1/1
D49245	6" NB round with ring	1/1
D49247	6" CP round	1/1
D49249	6" CP round with ring	1/1

ABS

PART NO.	STRAINER	CTN/MSTR
D49224	5" SS round	1/1
D49226	5" PB round	1/1
D49228	5" PB round with ring	1/1
D49230	5" NB round	1/1
D49232	5" NB round with ring	1/1
D49234	5" CP round	1/1
D49236	5" CP round with ring	1/1
D49238	6" SS round	1/1
D49240	6" PB round	1/1
D49242	6" PB round with ring	1/1
D49244	6" NB round	1/1
D49246	6" NB round with ring	1/1
D49248	6" CP round	1/1
D49250	6" CP round with ring	1/1

4" Drain Base with 3-1/2" Metal Spud

Fits Over 4" Schedule 40 DWV Pipe



ASSEMBLED IN
USA

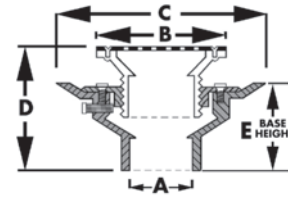

- Completely adjustable; reversible clamping ring gains additional 1" height (Dimension D)
- Strainers are available in PB, NB and CP
- Strainers are 3/16" thick
- 8-1/2" pan primer tapped with 1/2" plug
- Gray PVC or Black ABS
- Extra weep holes

STRAINER	A	B	C	D	E
4" round	Over 4"	4-1/8"	8-9/16"	4-5/8" — 5-3/4"	4-1/4"
5" round	Over 4"	5-3/16"	8-9/16"	4-5/8" — 5-13/16"	4-1/4"
6" round	Over 4"	6-3/16"	8-9/16"	4-13/16" — 6-1/4"	4-1/4"

PVC

PART NO.	STRAINER	CTN/MSTR
D49251	4" PB round	1/1
D49253	4" NB round	1/1
D49255	5" PB round	1/1
D49257	5" NB round	1/1
D49259	5" CP round	1/1
D49261	6" PB round	1/1
D49263	6" NB round	1/1
D49265	6" CP round	1/1

ABS

PART NO.	STRAINER	CTN/MSTR
D49252	4" PB round	1/1
D49254	4" NB round	1/1
D49256	5" PB round	1/1
D49258	5" NB round	1/1
D49260	5" CP round	1/1
D49262	6" PB round	1/1
D49264	6" NB round	1/1
D49266	6" CP round	1/1

4" Drain Base with 4" Plastic Spud

Fits Over 4" Schedule 40 DWV Pipe

ASSEMBLED IN
USA

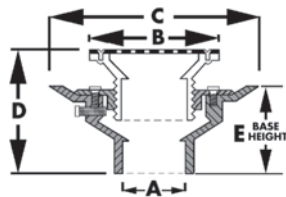

- Completely adjustable; reversible clamping ring gains additional 1" height (Dimension D)
- Strainers are available in SS, PB, NB and CP
- Stainless steel strainers are 1/16" thick
- PB, NB and CP strainers are 3/16" thick
- 8-1/2" pan primer tapped with 1/2" plug
- Gray PVC or Black ABS
- Extra weep holes

STRAINER	A	B	C	D	E
6" round stainless steel	Over 4"	6-3/16"	8-9/16"	5-1/2" — 6-11/16"	4-1/4"
6" round	Over 4"	6-3/16"	8-9/16"	5-9/16" — 6-3/4"	4-1/4"
6" round with ring	Over 4"	6-7/16"	8-9/16"	5-3/4" — 7"	4-1/4"

PVC

PART NO.	STRAINER	CTN/MSTR
D49277	6" SS round	1/1
D49279	6" PB round	1/1
D49281	6" PB round with ring	1/1
D49283	6" NB round	1/1
D49285	6" NB round with ring	1/1
D49287	6" CP round	1/1
D49289	6" CP round with ring	1/1

ABS

PART NO.	STRAINER	CTN/MSTR
D49278	6" SS round	1/1
D49280	6" PB round	1/1
D49282	6" PB round with ring	1/1
D49284	6" NB round	1/1
D49286	6" NB round with ring	1/1
D49288	6" CP round	1/1
D49290	6" CP round with ring	1/1

4" Drain Base with 4" Metal Spud

Fits Over 4" Schedule 40 DWV Pipe

ASSEMBLED IN
USA

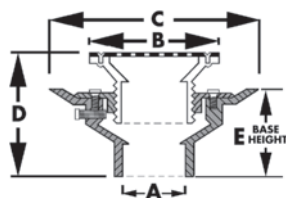

- Completely adjustable; reversible clamping ring gains additional 1" height (Dimension D)
- Strainers are available in PB and NB
- Strainers are 3/16" thick
- 8-1/2" pan primer tapped with 1/2" plug
- Gray PVC or Black ABS
- Extra weep holes

STRAINER	A	B	C	D	E
5" round	Over 4"	5-3/16"	8-9/16"	4-5/8" — 5-11/16"	4-1/4"

PVC

PART NO.	STRAINER	CTN/MSTR
D49295	5" PB round	1/1
D49297	5" NB round	1/1

ABS

PART NO.	STRAINER	CTN/MSTR
D49296	5" PB round	1/1
D49298	5" NB round	1/1

PVC and ABS 8-1/2" Pan Commercial Slab Drains

Pages 199-205

SIZES: 2" x 3", 3" x 4", 4"



For use in applications where a membrane is not required.

2" x 3" Slab Drain Base with 3" Plastic Spud

Fits Over 2" and Inside 3" Schedule 40 DWV Pipe

ASSEMBLED IN
USA

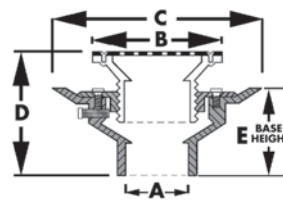

- Completely adjustable (See Dimension D)
- 8-1/2" pan for applications where no clamping ring is required
- Strainers are available in SS, PB, NB and CP
- Stainless steel strainers are 1/16" thick
- PB, NB and CP strainers are 3/16" thick
- Spud threads directly into base
- Primer tapped with 1/2" plug
- Gray PVC or Black ABS

STRAINER	A	B	C	D	E
6" round stainless steel	Over 2" Inside 3"	6-1/8"	8-9/16"	4-15/16" — 5-7/8"	3-3/4"
6" round	Over 2" Inside 3"	6-1/8"	8-9/16"	5" — 6"	3-3/4"
6" round with ring	Over 2" Inside 3"	6-7/16"	8-9/16"	5-1/8" — 6-1/8"	3-3/4"

PVC

PART NO.	STRAINER	CTN/MSTR
D49301	6" SS round	1/1
D49303	6" PB round	1/1
D49305	6" PB round with ring	1/1
D49307	6" NB round	1/1
D49309	6" NB round with ring	1/1
D49311	6" CP round	1/1
D49313	6" CP round with ring	1/1

ABS

PART NO.	STRAINER	CTN/MSTR
D49302	6" SS round	1/1
D49304	6" PB round	1/1
D49306	6" PB round with ring	1/1
D49308	6" NB round	1/1
D49310	6" NB round with ring	1/1
D49312	6" CP round	1/1
D49314	6" CP round with ring	1/1

2" x 3" Slab Drain Base with 3" Metal Spud

Fits Over 2" and Inside 3" Schedule 40 DWV Pipe

ASSEMBLED IN
USA

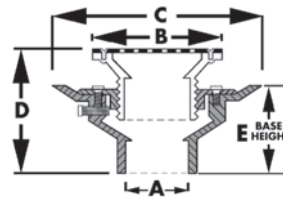
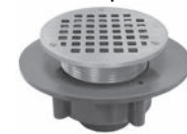

- Completely adjustable (See Dimension D)
- 8-1/2" pan for applications where no clamping ring is required
- Strainers are available in PB and NB
- Strainers are 3/16" thick
- Spud threads directly into base
- Primer tapped with 1/2" plug
- Gray PVC or Black ABS

STRAINER	A	B	C	D	E
5" round	Over 2" Inside 3"	5-3/16"	8-9/16"	3-15/16" — 4-15/16"	3-3/4"

PVC

PART NO.	STRAINER	CTN/MSTR
D49319	5" PB round	1/1
D49321	5" NB round	1/1

ABS

PART NO.	STRAINER	CTN/MSTR
D49320	5" PB round	1/1
D49322	5" NB round	1/1

2"x 3" Slab Drain Base with 3-1/2" Plastic Spud

Fits Over 2" and Inside 3" Schedule 40 DWV Pipe

ASSEMBLED IN
USA

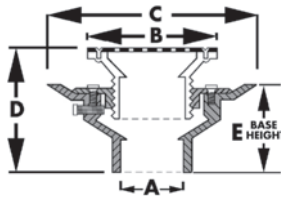

- Completely adjustable (See Dimension D)
- 8-1/2" pan for applications where no clamping ring is required
- Strainers are available in SS, PB, NB and CP
- Stainless steel strainers are 1/16" thick
- PB, NB and CP strainers are 3/16" thick
- Spud threads directly into base
- Primer tapped with 1/2" plug
- Gray PVC or Black ABS

STRAINER	A	B	C	D	E
5" round stainless steel	Over 2" Inside 3"	5-1/4"	8-9/16"	4-3/4" - 6-1/16"	3-3/4"
5" round	Over 2" Inside 3"	5-1/4"	8-9/16"	5" - 5-15/16"	3-3/4"
5" round with ring	Over 2" Inside 3"	5-9/16"	8-9/16"	5-1/8" - 6-1/8"	3-3/4"
6" round stainless steel	Over 2" Inside 3"	6-1/4"	8-9/16"	5" - 6-1/16"	3-3/4"
6" round	Over 2" Inside 3"	6-1/4"	8-9/16"	5-1/8" - 6"	3-3/4"
6" round with ring	Over 2" Inside 3"	6-9/16"	8-9/16"	5-1/4" - 6-1/4"	3-3/4"

PVC

PART NO.	STRAINER	CTN/MSTR
D49323	5" SS round	1/1
D49325	5" PB round	1/1
D49327	5" PB round with ring	1/1
D49329	5" NB round	1/1
D49331	5" NB round with ring	1/1
D49333	5" CP round	1/1
D49335	5" CP round with ring	1/1
D49337	6" SS round	1/1
D49339	6" PB round	1/1
D49341	6" PB round with ring	1/1
D49343	6" NB round	1/1
D49345	6" NB round with ring	1/1
D49349	6" CP round with ring	1/1

ABS

PART NO.	STRAINER	CTN/MSTR
D49324	5" SS round	1/1
D49326	5" PB round	1/1
D49328	5" PB round with ring	1/1
D49330	5" NB round	1/1
D49332	5" NB round with ring	1/1
D49334	5" CP round	1/1
D49336	5" CP round with ring	1/1
D49338	6" SS round	1/1
D49340	6" PB round	1/1
D49342	6" PB round with ring	1/1
D49344	6" NB round	1/1
D49346	6" NB round with ring	1/1
D49348	6" CP round	1/1
D49350	6" CP round with ring	1/1

2"x 3" Slab Drain Base with 3-1/2" Metal Spud

Fits Over 2" and Inside 3" Schedule 40 DWV Pipe

ASSEMBLED IN
USA

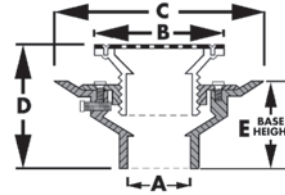

- Completely adjustable (See Dimension D)
- 8-1/2" pan for applications where no clamping ring is required
- Strainers are available in PB, NB and CP
- Strainers are 3/16" thick
- Spud threads directly into base
- Primer tapped with 1/2" plug
- Gray PVC or Black ABS

STRAINER	A	B	C	D	E
4" round	Over 2" Inside 3"	4-1/8"	8-9/16"	4 7/8" - 4-15/16"	3-3/4"
5" round	Over 2" Inside 3"	5-3/16"	8-9/16"	4" - 5"	3-3/4"
6" round	Over 2" Inside 3"	6-3/16"	8-9/16"	4-7/16" - 5-1/2"	3-3/4"

PVC

PART NO.	STRAINER	CTN/MSTR
D49351	4" PB round	1/1
D49353	4" NB round	1/1
D49355	5" PB round	1/1
D49357	5" NB round	1/1
D49359	5" CP round	1/1
D49361	6" PB round	1/1
D49363	6" NB round	1/1
D49365	6" CP round	1/1

ABS

PART NO.	STRAINER	CTN/MSTR
D49352	4" PB round	1/1
D49354	4" NB round	1/1
D49356	5" PB round	1/1
D49358	5" NB round	1/1
D49360	5" CP round	1/1
D49362	6" PB round	1/1
D49364	6" NB round	1/1
D49366	6" CP round	1/1

2"x 3" Slab Drain Base with 4" Plastic Spud

Fits Over 2" and Inside 3" Schedule 40 DWV Pipe

ASSEMBLED IN
USA

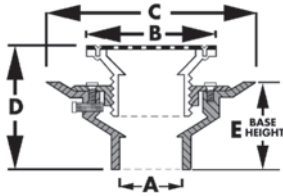

- Completely adjustable (See Dimension D)
- 8-1/2" pan for applications where no clamping ring is required
- Strainers are available in SS, PB, NB and CP
- Stainless steel strainers are 1/16" thick
- PB, NB and CP strainers are 3/16" thick
- Spud threads directly into base
- Primer tapped with 1/2" plug
- Gray PVC or Black ABS

STRAINER	A	B	C	D	E
6" round stainless steel	Over 2" Inside 3"	6-3/16"	8-9/16"	5" - 5-15/16"	3-3/4"
6" round	Over 2" Inside 3"	6-3/16"	8-9/16"	5" - 6"	3-3/4"
6" round with ring	Over 2" Inside 3"	6-7/16"	8-9/16"	5-3/16" - 6-3/16"	3-3/4"

PVC

PART NO.	STRAINER	CTN/MSTR
D49377	6" SS round	1/1
D49379	6" PB round	1/1
D49381	6" PB round with ring	1/1
D49383	6" NB round	1/1
D49385	6" NB round with ring	1/1
D49387	6" CP round	1/1
D49389	6" CP round with ring	1/1

ABS

PART NO.	STRAINER	CTN/MSTR
D49378	6" SS round	1/1
D49380	6" PB round	1/1
D49382	6" PB round with ring	1/1
D49384	6" NB round	1/1
D49386	6" NB round with ring	1/1
D49388	6" CP round	1/1
D49390	6" CP round with ring	1/1

2"x 3" Slab Drain Base with 4" Metal Spud

Fits Over 2" and Inside 3" Schedule 40 DWV Pipe

ASSEMBLED IN
USA

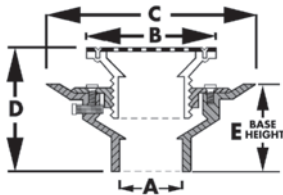

- Completely adjustable (See Dimension D)
- 8-1/2" pan for applications where no clamping ring is required
- Strainers are available in PB and NB
- Strainers are 3/16" thick
- Spud threads directly into base
- Primer tapped with 1/2" plug
- Gray PVC or Black ABS

STRAINER	A	B	C	D	E
5" round	Over 2" Inside 3"	5-3/16"	8-9/16"	3-7/8" - 4-7/8"	3-3/4"

PVC

PART NO.	STRAINER	CTN/MSTR
D49395	5" PB round	1/1
D49397	5" NB round	1/1

ABS

PART NO.	STRAINER	CTN/MSTR
D49396	5" PB round	1/1
D49398	5" NB round	1/1

3"x 4" Slab Drain Base with 3" Plastic Spud

Fits Over 3" and Inside 4" Schedule 40 DWV Pipe

ASSEMBLED IN
USA

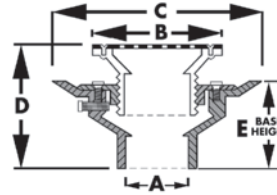

- Completely adjustable (See Dimension D)
- 8-1/2" pan for applications where no clamping ring is required
- Strainers are available in SS, PB, NB and CP
- Stainless steel strainers are 1/16" thick
- PB, NB and CP strainers are 3/16" thick
- Spud threads directly into base
- Primer tapped with 1/2" plug
- Gray PVC or Black ABS

STRAINER	A	B	C	D	E
6" round stainless steel	Over 3" Inside 4"	6-1/8"	8-9/16"	5-1/16" - 6-1/16"	3-3/4"
6" round	Over 3" Inside 4"	6-1/8"	8-9/16"	5-1/8" - 6-3/16"	3-3/4"
6" round with ring	Over 3" Inside 4"	6-7/16"	8-9/16"	5-5/16" - 6-3/8"	3-3/4"

PVC

PART NO.	STRAINER	CTN/MSTR
D49401	6" SS round	1/1
D49403	6" PB round	1/1
D49405	6" PB round with ring	1/1
D49407	6" NB round	1/1
D49411	6" CP round	1/1
D49413	6" CP round with ring	1/1

ABS

PART NO.	STRAINER	CTN/MSTR
D49402	6" SS round	1/1
D49404	6" PB round	1/1
D49406	6" PB round with ring	1/1
D49408	6" NB round	1/1
D49410	6" NB round with ring	1/1
D49412	6" CP round	1/1
D49414	6" CP round with ring	1/1

3"x 4" Slab Drain Base with 3" Metal Spud

Fits Over 3" and Inside 4" Schedule 40 DWV Pipe

ASSEMBLED IN
USA

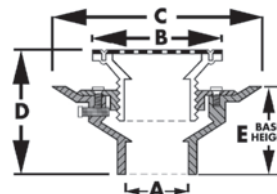

- Completely adjustable (See Dimension D)
- 8-1/2" pan for applications where no clamping ring is required
- Strainers are available in PB and NB
- Strainers are 3/16" thick
- Spud threads directly into base
- Primer tapped with 1/2" plug
- Gray PVC or Black ABS

STRAINER	A	B	C	D	E
5" round	Over 3" Inside 4"	5-3/16"	8-9/16"	4-1/8" - 5-1/8"	3-3/4"

PVC

PART NO.	STRAINER	CTN/MSTR
D49419	5" PB round	1/1
D49421	5" NB round	1/1

ABS

PART NO.	STRAINER	CTN/MSTR
D49420	5" PB round	1/1
D49422	5" NB round	1/1

3"x 4" Slab Drain Base with 3-1/2" Plastic Spud

Fits Over 3" and Inside 4" Schedule 40 DWV Pipe

ASSEMBLED IN
USA

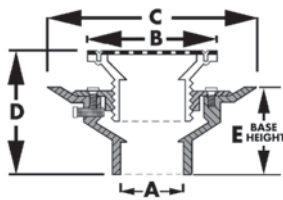

- Completely adjustable (See Dimension D)
- 8-1/2" pan for applications where no clamping ring is required
- Strainers are available in SS, PB, NB and CP
- Stainless steel strainers are 1/16" thick
- PB, NB and CP strainers are 3/16" thick
- Spud threads directly into base
- Primer tapped with 1/2" plug
- Gray PVC or Black ABS

STRAINER	A	B	C	D	E
5" round stainless steel	Over 3" Inside 4"	5-1/4"	8-9/16"	5" - 6-1/8"	3-3/4"
5" round	Over 3" Inside 4"	5-1/4"	8-9/16"	5-3/16" - 6-3/16"	3-3/4"
5" round with ring	Over 3" Inside 4"	5-9/16"	8-9/16"	5-3/8" - 6-5/16"	3-3/4"
6" round stainless steel	Over 3" Inside 4"	6-1/4"	8-9/16"	5-1/16" - 6-1/16"	3-3/4"
6" round	Over 3" Inside 4"	6-1/4"	8-9/16"	5-3/16" - 6-3/16"	3-3/4"
6" round with ring	Over 3" Inside 4"	6-9/16"	8-9/16"	5-5/16" - 6-3/8"	3-3/4"

E

PVC

PART NO.	STRAINER	CTN/MSTR
D49423	5" SS round	1/1
D49425	5" PB round	1/1
D49427	5" PB round with ring	1/1
D49429	5" NB round	1/1
D49431	5" NB round with ring	1/1
D49433	5" CP round	1/1
D49435	5" CP round with ring	1/1
D49437	6" SS round	1/1
D49439	6" PB round	1/1
D49441	6" PB round with ring	1/1
D49443	6" NB round	1/1
D49445	6" NB round with ring	1/1
D49447	6" CP round	1/1
D49449	6" CP round with ring	1/1

ABS

PART NO.	STRAINER	CTN/MSTR
D49424	5" SS round	1/1
D49426	5" PB round	1/1
D49428	5" PB round with ring	1/1
D49430	5" NB round	1/1
D49432	5" NB round with ring	1/1
D49434	5" CP round	1/1
D49436	5" CP round with ring	1/1
D49438	6" SS round	1/1
D49440	6" PB round	1/1
D49442	6" PB round with ring	1/1
D49444	6" NB round	1/1
D49446	6" NB round with ring	1/1
D49448	6" CP round	1/1
D49450	6" CP round with ring	1/1

3"x 4" Slab Drain Base with 3-1/2" Metal Spud

Fits Over 3" and Inside 4" Schedule 40 DWV Pipe

ASSEMBLED IN
USA

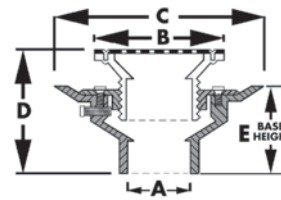

- Completely adjustable (See Dimension D)
- 8-1/2" pan for applications where no clamping ring is required
- Strainers are available in PB, NB and CP
- Strainers are 3/16" thick
- Spud threads directly into base
- Primer tapped with 1/2" plug
- Gray PVC or Black ABS

STRAINER	A	B	C	D	E
4" round	Over 3" Inside 4"	4-1/8"	8-9/16"	4-1/8" - 5-1/16"	3-15/16"
5" round	Over 3" Inside 4"	5-3/16"	8-9/16"	4-1/8" - 5-1/4"	3-15/16"
6" round	Over 3" Inside 4"	6-3/16"	8-9/16"	4-9/16" - 5-7/16"	3-15/16"
8" round	Over 3" Inside 4"	8-1/8"	8-9/16"	5-1/16" - 6"	3-15/16"
9" round	Over 3" Inside 4"	9"	8-9/16"	5" - 6-1/8"	3-15/16"

PVC

PART NO.	STRAINER	CTN/MSTR
D49451	4" PB round	1/1
D49453	4" NB round	1/1
D49455	5" PB round	1/1
D49457	5" NB round	1/1
D49459	5" CP round	1/1
D49461	6" PB round	1/1
D49463	6" NB round	1/1
D49465	6" CP round	1/1
D49467	8" PB round	1/1
D49469	8" NB round	1/1
D49473	9" PB round	1/1
D49475	9" NB round	1/1

ABS

PART NO.	STRAINER	CTN/MSTR
D49452	4" PB round	1/1
D49454	4" NB round	1/1
D49456	5" PB round	1/1
D49458	5" NB round	1/1
D49460	5" CP round	1/1
D49462	6" PB round	1/1
D49464	6" NB round	1/1
D49466	6" CP round	1/1
D49468	8" PB round	1/1
D49470	8" NB round	1/1
D49474	9" PB round	1/1
D49476	9" NB round	1/1

3"x 4" Slab Drain Base with 4" Plastic Spud

Fits Over 3" and Inside 4" Schedule 40 DWV Pipe

ASSEMBLED IN
USA

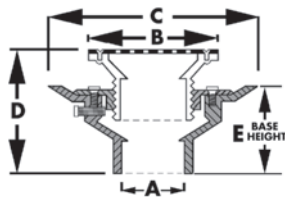

- Completely adjustable (See Dimension D)
- 8-1/2" pan for applications where no clamping ring is required
- Strainers are available in SS, PB, NB and CP
- Stainless steel strainers are 1/16" thick
- PB, NB and CP strainers are 3/16" thick
- Spud threads directly into base
- Primer tapped with 1/2" plug
- Gray PVC or Black ABS

STRAINER	A	B	C	D	E
6" round stainless steel	Over 3" Inside 4"	6-3/16"	8-9/16"	5-1/16" - 6-1/8"	3-15/16"
6" round	Over 3" Inside 4"	6-3/16"	8-9/16"	5-1/4" - 6-3/16"	3-15/16"
6" round with ring	Over 3" Inside 4"	6-7/16"	8-9/16"	5-3/8" - 6-5/16"	3-15/16"

PVC

PART NO.	STRAINER	CTN/MSTR
D49477	6" SS round	1/1
D49479	6" PB round	1/1
D49481	6" PB round with ring	1/1
D49483	6" NB round	1/1
D49485	6" NB round with ring	1/1
D49487	6" CP round	1/1
D49489	6" CP round with ring	1/1

ABS

PART NO.	STRAINER	CTN/MSTR
D49478	6" SS round	1/1
D49480	6" PB round	1/1
D49482	6" PB round with ring	1/1
D49484	6" NB round	1/1
D49486	6" NB round with ring	1/1
D49488	6" CP round	1/1
D49490	6" CP round with ring	1/1

3"x 4" Slab Drain Base with 4" Metal Spud

Fits Over 3" and Inside 4" Schedule 40 DWV Pipe

ASSEMBLED IN
USA

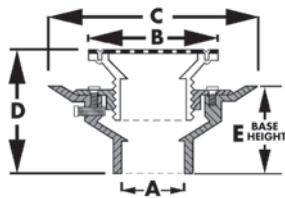

- Completely adjustable (See Dimension D)
- 8-1/2" pan for applications where no clamping ring is required
- Strainers are available in PB and NB
- Strainers are 3/16" thick
- Spud threads directly into base
- Primer tapped with 1/2" plug
- Gray PVC or Black ABS

STRAINER	A	B	C	D	E
5" round	Over 3" Inside 4"	5-3/16"	8-9/16"	4" - 5-1/8"	3-15/16"

PVC

PART NO.	STRAINER	CTN/MSTR
D49495	5" PB round	1/1
D49497	5" NB round	1/1

ABS

PART NO.	STRAINER	CTN/MSTR
D49496	5" PB round	1/1
D49498	5" NB round	1/1

4" Slab Drain Base with 3" Plastic Spud

Fits Over 4" Schedule 40 DWV Pipe

ASSEMBLED IN
USA

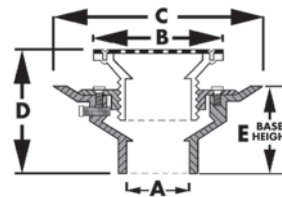

- Completely adjustable (See Dimension D)
- 8-1/2" pan for applications where no clamping ring is required
- Strainers are available in SS, PB, NB and CP
- Stainless steel strainers are 1/16" thick
- PB, NB and CP strainers are 3/16" thick
- Spud threads directly into base
- Primer tapped with 1/2" plug
- Gray PVC or Black ABS

STRAINER	A	B	C	D	E
6" round stainless steel	Over 4"	6-1/8"	8-9/16"	5-5/16" - 6-3/8"	4-3/16"
6" round	Over 4"	6-1/8"	8-9/16"	5-3/8" - 6-5/16"	4-3/16"
6" round with ring	Over 4"	6-7/16"	8-9/16"	5-1/8" - 6-9/16"	4-3/16"

PVC

PART NO.	STRAINER	CTN/MSTR
D49501	6" SS round	1/1
D49503	6" PB round	1/1
D49505	6" PB round with ring	1/1
D49507	6" NB round	1/1
D49509	6" NB round with ring	1/1
D49511	6" CP round	1/1
D49513	6" CP round with ring	1/1

ABS

PART NO.	STRAINER	CTN/MSTR
D49502	6" SS round	1/1
D49504	6" PB round	1/1
D49506	6" PB round with ring	1/1
D49508	6" NB round	1/1
D49510	6" NB round with ring	1/1
D49512	6" CP round	1/1
D49514	6" CP round with ring	1/1

4" Slab Drain Base with 3" Metal Spud

Fits Over 4" Schedule 40 DWV Pipe

ASSEMBLED IN
USA

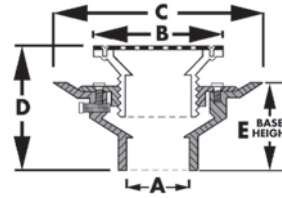

- Completely adjustable (See Dimension D)
- 8-1/2" pan for applications where no clamping ring is required
- Strainers are available in PB and NB
- Strainers are 3/16" thick
- Spud threads directly into base
- Primer tapped with 1/2" plug
- Gray PVC or Black ABS

STRAINER	A	B	C	D	E
5" round	Over 4"	5-3/16"	8-9/16"	4-5/16" - 5-3/8"	4-3/16"

PVC

PART NO.	STRAINER	CTN/MSTR
D49519	5" PB round	1/1
D49521	5" NB round	1/1

ABS

PART NO.	STRAINER	CTN/MSTR
D49520	5" PB round	1/1
D49522	5" NB round	1/1

4" Slab Drain Base with 3-1/2" Plastic Spud

Fits Over 4" Schedule 40 DWV Pipe

ASSEMBLED IN
USA

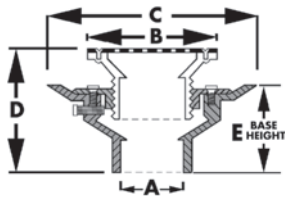

- Completely adjustable (See Dimension D)
- 8-1/2" pan for applications where no clamping ring is required
- Strainers are available in SS, PB, NB and CP
- Stainless steel strainers are 1/16" thick
- PB, NB and CP strainers are 3/16" thick
- Spud threads directly into base
- Primer tapped with 1/2" plug
- Gray PVC or Black ABS

STRAINER	A	B	C	D	E
5" round stainless steel	Over 4"	5-1/4"	8-9/16"	5-1/4" - 6-7/16"	4-3/16"
5" round	Over 4"	5-1/4"	8-9/16"	5-3/8" - 6-7/16"	4-3/16"
5" round with ring	Over 4"	5-9/16"	8-9/16"	5-9/16" - 6-5/8"	4-3/16"
6" round stainless steel	Over 4"	6-1/4"	8-9/16"	5-3/8" - 6-7/16"	4-3/16"
6" round	Over 4"	6-1/4"	8-9/16"	5-7/16" - 6-7/16"	4-3/16"
6" round with ring	Over 4"	6-9/16"	8-9/16"	5-1/2" - 6-5/8"	4-3/16"

PVC

PART NO.	STRAINER	CTN/MSTR
D49523	5" SS round	1/1
D49525	5" PB round	1/1
D49527	5" PB round with ring	1/1
D49529	5" NB round	1/1
D49531	5" NB round with ring	1/1
D49533	5" CP round	1/1
D49535	5" CP round with ring	1/1
D49537	6" SS round	1/1
D49539	6" PB round	1/1
D49541	6" PB round with ring	1/1
D49543	6" NB round	1/1
D49545	6" NB round with ring	1/1
D49547	6" CP round	1/1
D49549	6" CP round with ring	1/1

ABS

PART NO.	STRAINER	CTN/MSTR
D49524	5" SS round	1/1
D49526	5" PB round	1/1
D49528	5" PB round with ring	1/1
D49530	5" NB round	1/1
D49532	5" NB round with ring	1/1
D49534	5" CP round	1/1
D49536	5" CP round with ring	1/1
D49538	6" SS round	1/1
D49540	6" PB round	1/1
D49542	6" PB round with ring	1/1
D49544	6" NB round	1/1
D49546	6" NB round with ring	1/1
D49548	6" CP round	1/1
D49550	6" CP round with ring	1/1

4" Slab Drain Base with 3-1/2" Metal Spud

Fits Over 4" Schedule 40 DWV Pipe

ASSEMBLED IN
USA

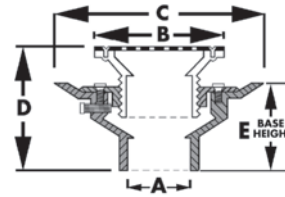

- Completely adjustable (See Dimension D)
- 8-1/2" pan for applications where no clamping ring is required
- Strainers are available in PB, NB and CP
- Strainers are 3/16" thick
- Spud threads directly into base
- Primer tapped with 1/2" plug
- Gray PVC or Black ABS

STRAINER	A	B	C	D	E
4" round	Over 4"	4-1/8"	8-9/16"	4-7/16" - 5-7/16"	4-3/16"
5" round	Over 4"	5-3/16"	8-9/16"	4-5/16" - 5-7/16"	4-3/16"
6" round	Over 4"	6-3/16"	8-9/16"	4-13/16" - 5-13/16"	4-3/16"

PVC

PART NO.	STRAINER	CTN/MSTR
D49551	4" PB round	1/1
D49553	4" NB round	1/1
D49555	5" PB round	1/1
D49557	5" NB round	1/1
D49559	5" CP round	1/1
D49561	6" PB round	1/1
D49563	6" NB round	1/1
D49565	6" CP round	1/1

ABS

PART NO.	STRAINER	CTN/MSTR
D49552	4" PB round	1/1
D49554	4" NB round	1/1
D49556	5" PB round	1/1
D49558	5" NB round	1/1
D49560	5" CP round	1/1
D49562	6" PB round	1/1
D49564	6" NB round	1/1
D49566	6" CP round	1/1

4" Slab Drain Base with 4" Plastic Spud

Fits Over 4" Schedule 40 DWV Pipe



ASSEMBLED IN
USA

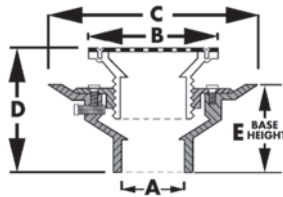

- Completely adjustable (See Dimension D)
- 8-1/2" pan for applications where no clamping ring is required
- Strainers are available in SS, PB, NB and CP
- Stainless steel strainers are 1/16" thick
- PB, NB and CP strainers are 3/16" thick
- Spud threads directly into base
- Primer tapped with 1/2" plug
- Gray PVC or Black ABS

STRAINER	A	B	C	D	E
6" round stainless steel	Over 4"	6-3/16"	8-9/16"	5-3/8" - 6-3/8"	4-3/16"
6" round	Over 4"	6-3/16"	8-9/16"	5-7/16" - 6-7/16"	4-3/16"
6" round with ring	Over 4"	6-7/16"	8-9/16"	5-5/8" - 6-9/16"	4-3/16"

PVC

PART NO.	STRAINER	CTN/MSTR
D49577	6" SS round	1/1
D49579	6" PB round	1/1
D49581	6" PB round with ring	1/1
D49583	6" NB round	1/1
D49585	6" NB round with ring	1/1
D49587	6" CP round	1/1
D49589	6" CP round with ring	1/1

ABS

PART NO.	STRAINER	CTN/MSTR
D49578	6" SS round	1/1
D49580	6" PB round	1/1
D49582	6" PB round with ring	1/1
D49584	6" NB round	1/1
D49586	6" NB round with ring	1/1
D49588	6" CP round	1/1
D49590	6" CP round with ring	1/1

4" Slab Drain Base with 4" Metal Spud

Fits Over 4" Schedule 40 DWV Pipe



ASSEMBLED IN
USA

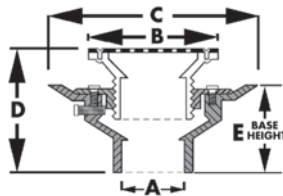

- Completely adjustable (See Dimension D)
- 8-1/2" pan for applications where no clamping ring is required
- Strainers are available in PB and NB
- Strainers are 3/16" thick
- Spud threads directly into base
- Primer tapped with 1/2" plug
- Gray PVC or Black ABS

STRAINER	A	B	C	D	E
5" round	Over 4"	5-3/16"	8-9/16"	4-1/4" - 5-5/16"	4-3/16"

PVC

PART NO.	STRAINER	CTN/MSTR
D49595	5" PB round	1/1
D49597	5" NB round	1/1

ABS

PART NO.	STRAINER	CTN/MSTR
D49596	5" PB round	1/1
D49598	5" NB round	1/1



PVC and ABS 10" Pan Commercial Drains

Pages 206-210

SIZES: 2", 3", 4"



For use in applications where a membrane is required.

2" Heavy Duty Drain Base with 3-1/2" Plastic Spud

Fits Over 2" Schedule 40 DWV Pipe

ASSEMBLED IN
USA

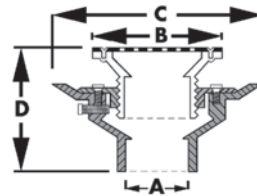

- 10" Pan
- Strainers are available in SS, PB, NB and CP
- Stainless steel strainers are 1/16" thick
- PB, NB and CP strainers are 3/16" thick
- Primer tapped with 1/2" plug
- Adjustable (see dimension D)

STRAINER	A	B	C	D
5" round	Over 2"	5-3/16"	11"	4-3/8" - 6"
5" round with ring	Over 2"	5-1/2"	11"	4-1/2" - 6-1/8"
6" round	Over 2"	6-1/8"	11"	4-7/16" - 6-1/16"
6" round with ring	Over 2"	6-1/2"	11"	4-1/2" - 6-1/4"

PVC

PART NO.	STRAINER	CTN/MSTR
D53442	5" SS round	1/1
D53443	5" PB round	1/1
D53444	5" PB round with ring	1/1
D53445	5" NB round	1/1
D53446	5" NB round with ring	1/1
D53447	5" CP round	1/1
D53448	5" CP round with ring	1/1
D50037	6" SS round	1/1
D50044	6" PB round	1/1
D50050	6" PB round with ring	1/1
D50047	6" NB round	1/1
D50053	6" NB round with ring	1/1
D50278	6" CP round with ring	1/1

ABS

PART NO.	STRAINER	CTN/MSTR
D53449	5" SS round	1/1
D53450	5" PB round	1/1
D53451	5" PB round with ring	1/1
D53452	5" NB round	1/1
D53453	5" NB round with ring	1/1
D53454	5" CP round	1/1
D53455	5" CP round with ring	1/1
D51037	6" SS round	1/1
D51044	6" PB round	1/1
D51050	6" PB round with ring	1/1
D51047	6" NB round	1/1
D51053	6" NB round with ring	1/1
D51040	6" CP round	1/1
D51278	6" CP round with ring	1/1

2" Heavy Duty Drain Base with 3-1/2" Metal Spud

Fits Over 2" Schedule 40 DWV Pipe

ASSEMBLED IN
USA

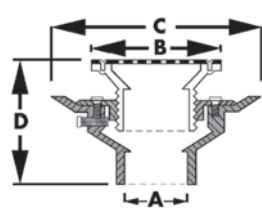

- 10" Pan
- Strainers are available in PB, NB and CP
- PB, NB and CP strainers are 3/16" thick
- Primer tapped with 1/2" plug
- Adjustable (see dimension D)

STRAINER	A	B	C	D
5" or 6" round	Over 2"	5" or 6"	11"	4-1/4" - 5-5/8"
5" or 6" square	Over 2"	5" or 6"	11"	4-1/4" - 5-5/8"

PVC

PART NO.	STRAINER	CTN/MSTR
D50027	5" PB round	1/1
D50060	5" NB round	1/1
D50022	5" CP round	1/1
D50028	6" PB round	1/1
D50063	6" NB round	1/1
D50023	6" CP round	1/1
D50066	5" PB square	1/1
D50072	5" NB square	1/1
D50069	6" PB square	1/1
D50075	6" NB square	1/1

ABS

PART NO.	STRAINER	CTN/MSTR
D51027	5" PB round	1/1
D51060	5" NB round	1/1
D51022	5" CP round	1/1
D51028	6" PB round	1/1
D51063	6" NB round	1/1
D51023	6" CP round	1/1
D51066	5" PB square	1/1
D51072	5" NB square	1/1
D51069	6" PB square	1/1
D51075	6" NB square	1/1

2" Heavy Duty Drain Base with 4" Plastic Spud

Fits Over 2" Schedule 40 DWV Pipe

ASSEMBLED IN
USA

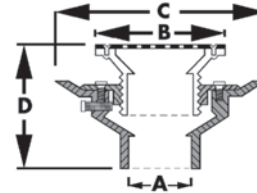

- 10" Pan
- Strainers are available in SS, PB, NB and CP
- Stainless steel strainers are 1/16" thick
- PB, NB and CP strainers are 3/16" thick
- Primer tapped with 1/2" plug
- Adjustable (see dimension D)

STRAINER	A	B	C	D
6" round	Over 2"	6-1/8"	11"	4-7/16" - 6-1/16"
6" round with ring	Over 2"	6-1/2"	11"	4-1/2" - 6-1/4"

PVC

PART NO.	STRAINER	CTN/MSTR
D50340	6" SS round	1/1
D50341	6" PB round	1/1
D50342	6" PB round with ring	1/1
D50343	6" NB round	1/1
D50345	6" CP round	1/1
D50346	6" CP round with ring	1/1

ABS

PART NO.	STRAINER	CTN/MSTR
D51340	6" SS round	1/1
D51341	6" PB round	1/1
D51342	6" PB round with ring	1/1
D51343	6" NB round	1/1
D51344	6" NB round with ring	1/1
D51345	6" CP round	1/1
D51346	6" CP round with ring	1/1

2" Heavy Duty Drain Base with 4" Metal Spud

Fits Over 2" Schedule 40 DWV Pipe

ASSEMBLED IN
USA

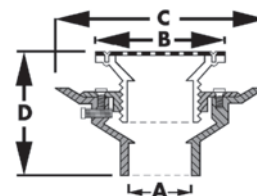

- 10" Pan
- Strainers are available in PB and NB
- Strainers are 3/16" thick
- Primer tapped with 1/2" plug
- Adjustable (see dimension D)

STRAINER	A	B	C	D
5" round	Over 2"	5"	11"	4-1/4" - 5-5/8"

PVC

PART NO.	STRAINER	CTN/MSTR
D50349	5" NB round	1/1
D50350	5" PB round	1/1

ABS

PART NO.	STRAINER	CTN/MSTR
D51349	5" NB round	1/1
D51350	5" PB round	1/1

3" Heavy Duty Drain Base with 3-1/2" Plastic Spud

Fits Over 3" Schedule 40 DWV Pipe



ASSEMBLED IN
USA

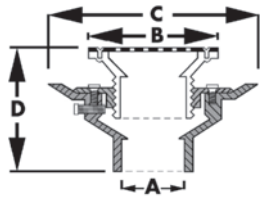

- 10" Pan
- Strainers are available in SS, PB, NB and CP
- Stainless steel strainers are 1/16" thick
- PB, NB and CP strainers are 3/16" thick
- Primer tapped with 1/2" plug
- Adjustable (see dimension D)

STRAINER	A	B	C	D
5" round	Over 3"	5-3/16"	11"	4-3/8" - 6"
5" round with ring	Over 3"	5-1/2"	11"	4-1/2" - 6-1/8"
6" round	Over 3"	6-1/8"	11"	4-11/16" - 6-7/16"
6" round with ring	Over 3"	6-1/2"	11"	4-3/4" - 6-1/2"

PVC

PART NO.	STRAINER	CTN/MSTR
D53457	5" PB round	1/1
D53458	5" PB round with ring	1/1
D53459	5" NB round	1/1
D53460	5" NB round with ring	1/1
D53461	5" CP round	1/1
D53462	5" CP round with ring	1/1
D50038	6" SS round	1/1
D50045	6" PB round	1/1
D50051	6" PB round with ring	1/1
D50048	6" NB round	1/1
D50054	6" NB round with ring	1/1
D50041	6" CP round	1/1
D50279	6" CP round with ring	1/1

ABS

PART NO.	STRAINER	CTN/MSTR
D53463	5" SS round	1/1
D53464	5" PB round	1/1
D53465	5" PB round with ring	1/1
D53466	5" NB round	1/1
D53467	5" NB round with ring	1/1
D53468	5" CP round	1/1
D53469	5" CP round with ring	1/1
D51038	6" SS round	1/1
D51045	6" PB round	1/1
D51051	6" PB round with ring	1/1
D51048	6" NB round	1/1
D51054	6" NB round with ring	1/1
D51041	6" CP round	1/1
D51279	6" CP round with ring	1/1

3" Heavy Duty Drain Base with 3-1/2" Metal Spud

Fits Over 3" Schedule 40 DWV Pipe



ASSEMBLED IN
USA

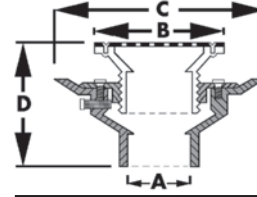

- 10" Pan
- Strainers are available in PB, NB and CP
- Strainers are 3/16" thick
- Primer tapped with 1/2" plug
- Adjustable (see dimension D)

STRAINER	A	B	C	D
5", 6", 8" or 9" round	Over 3"	5", 6", 8" or 9"	11"	5" - 6-1/2"
5" or 6" square	Over 3"	5" or 6"	11"	5" - 6-1/2"

PVC

PART NO.	STRAINER	CTN/MSTR
D50012	5" PB round	1/1
D50061	5" NB round	1/1
D50013	6" PB round	1/1
D50064	6" NB round	1/1
D50005	6" CP round	1/1
D50014	8" PB round	1/1
D53144	8" NB round	1/1
D53148	9" PB round	1/1
D53146	9" NB round	1/1
D50067	5" PB square	1/1
D50073	5" NB square	1/1
D50070	6" PB square	1/1
D50076	6" NB square	1/1

ABS

PART NO.	STRAINER	CTN/MSTR
D51012	5" PB round	1/1
D51061	5" NB round	1/1
D51004	5" CP round	1/1
D51013	6" PB round	1/1
D51064	6" NB round	1/1
D51005	6" CP round	1/1
D51014	8" PB round	1/1
D53145	8" NB round	1/1
D53149	9" PB round	1/1
D53147	9" NB round	1/1
D51067	5" PB square	1/1
D51073	5" NB square	1/1
D51070	6" PB square	1/1
D51076	6" NB square	1/1

Items marked with the Jones Stephens logo are "You Need It... We Got It" Items.

3" Heavy Duty Drain Base with 4" Plastic Spud

Fits Over 3" Schedule 40 DWV Pipe

ASSEMBLED IN **USA**

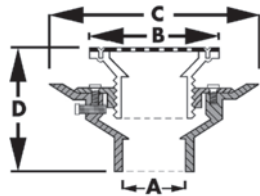

- 10" Pan
- Strainers are available in SS, PB, NB and CP
- Stainless steel strainers are 1/16" thick
- PB, NB and CP strainers are 3/16" thick
- Primer tapped with 1/2" plug
- Adjustable (see dimension D)

STRAINER	A	B	C	D
6" round	Over 3"	6-1/8"	4-5/8" - 6"	4-11/16" - 6-7/16"
6" round with ring	Over 3"	6-1/2"	4-5/8" - 6"	4-3/4" - 6-1/2"

PVC

PART NO.	STRAINER	CTN/MSTR
D50351	6" SS round	1/1
D50352	6" PB round	1/1
D50353	6" PB round with ring	1/1
D50354	6" NB round	1/1

ABS

PART NO.	STRAINER	CTN/MSTR
D51351	6" SS round	1/1
D51352	6" PB round	1/1
D51353	6" PB round with ring	1/1
D51354	6" NB round	1/1
D51355	6" NB round with ring	1/1
D51356	6" CP round	1/1
D51357	6" CP round with ring	1/1

3" Heavy Duty Drain Base with 4" Metal Spud

Fits Over 3" Schedule 40 DWV Pipe

ASSEMBLED IN **USA**

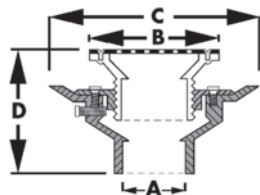

- 10" Pan
- Strainers are available in PB and NB
- Strainers are 3/16" thick
- Primer tapped with 1/2" plug
- Adjustable (see dimension D)

STRAINER	A	B	C	D
5" round	Over 3"	5"	4-5/8" - 6"	5" - 6-1/2"

PVC

PART NO.	STRAINER	CTN/MSTR
D50361	5" PB round	1/1
D50360	5" NB round	1/1

ABS

PART NO.	STRAINER	CTN/MSTR
D51361	5" PB round	1/1
D51360	5" NB round	1/1

4" Heavy Duty Drain Base with 3-1/2" Plastic Spud

Fits Over 4" Schedule 40 DWV Pipe

ASSEMBLED IN **USA**

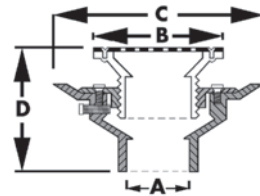

- 10" Pan
- Strainers are available in SS, PB, NB and CP
- Stainless steel strainers are 1/16" thick
- PB, NB and CP strainers are 3/16" thick
- Primer tapped with 1/2" plug
- Adjustable (see dimension D)

STRAINER	A	B	C	D
5" round	Over 4"	5-3/16"	11"	4-3/8" - 6"
5" round with ring	Over 4"	5-1/2"	11"	4-1/2" - 6-1/8"
6" round	Over 4"	6-1/8"	11"	5-1/16" - 6-13/16"
6" round with ring	Over 4"	6-1/2"	11"	5-1/4" - 6-15/16"

PVC

PART NO.	STRAINER	CTN/MSTR
D53470	5" SS round	1/1
D53471	5" PB round	1/1
D53472	5" PB round with ring	1/1
D53473	5" NB round	1/1
D53474	5" NB round with ring	1/1
D53475	5" CP round	1/1
D53476	5" CP round with ring	1/1
D50039	6" SS round	1/1
D50046	6" PB round	1/1
D50052	6" PB round with ring	1/1
D50049	6" NB round	1/1
D50280	6" CP round with ring	1/1

ABS

PART NO.	STRAINER	CTN/MSTR
D53477	5" SS round	1/1
D53478	5" PB round	1/1
D53479	5" PB round with ring	1/1
D53480	5" NB round	1/1
D53481	5" NB round with ring	1/1
D53482	5" CP round	1/1
D53483	5" CP round with ring	1/1
D51039	6" SS round	1/1
D51046	6" PB round	1/1
D51052	6" PB round with ring	1/1
D51049	6" NB round	1/1
D51055	6" NB round with ring	1/1
D51042	6" CP round	1/1
D51280	6" CP round with ring	1/1

4" Heavy Duty Drain Base with 3-1/2" Metal Spud

Fits Over 4" Schedule 40 DWV Pipe

ASSEMBLED IN
USA

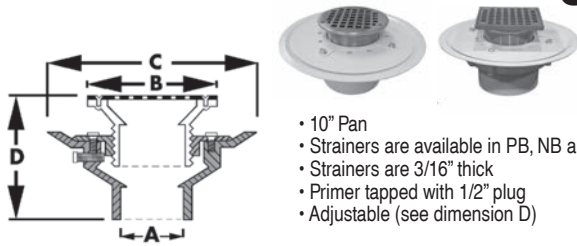

- 10" Pan
- Strainers are available in PB, NB and CP
- Strainers are 3/16" thick
- Primer tapped with 1/2" plug
- Adjustable (see dimension D)

STRAINER	A	B	C	D
5" or 6" round	Over 4"	5" or 6"	11"	4-5/8" - 5-7/8"
5" or 6" square	Over 4"	5" or 6"	11"	4-5/8" - 5-7/8"

PVC

PART NO.	STRAINER	CTN/MSTR
D50062	5" NB round	1/1
D50015	5" PB round	1/1
D50065	6" NB round	1/1
D50016	6" PB round	1/1
D50008	6" CP round	1/1
D50068	5" PB square	1/1
D50074	5" NB square	1/1
D50071	6" PB square	1/1
D50077	6" NB square	1/1

ABS

PART NO.	STRAINER	CTN/MSTR
D51062	5" NB round	1/1
D51015	5" PB round	1/1
D51007	5" CP round	1/1
D51065	6" NB round	1/1
D51016	6" PB round	1/1
D51008	6" CP round	1/1
D51068	5" PB square	1/1
D51074	5" NB square	1/1
D51071	6" PB square	1/1
D51077	6" NB square	1/1

4" Heavy Duty Drain Base with 4" Plastic Spud

Fits Over 4" Schedule 40 DWV Pipe

ASSEMBLED IN
USA

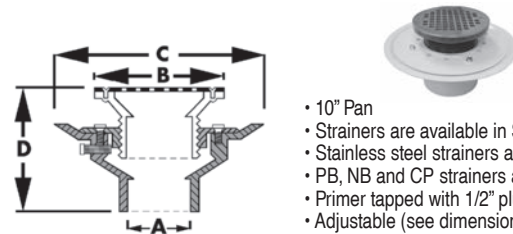

- 10" Pan
- Strainers are available in SS, PB, NB and CP
- Stainless steel strainers are 1/16" thick
- PB, NB and CP strainers are 3/16" thick
- Primer tapped with 1/2" plug
- Adjustable (see dimension D)

STRAINER	A	B	C	D
6" round	Over 4"	6-1/8"	11"	5-1/16" - 6-13/16"
6" round with ring	Over 4"	6-1/2"	11"	5-1/4" - 6-15/16"

PVC

PART NO.	STRAINER	CTN/MSTR
D50362	6" SS round	1/1
D50363	6" PB round	1/1
D50364	6" PB round with ring	1/1
D50365	6" NB round	1/1
D50366	6" NB round with ring	1/1
D50367	6" CP round	1/1
D50368	6" CP round with ring	1/1

ABS

PART NO.	STRAINER	CTN/MSTR
D51362	6" SS round	1/1
D51363	6" PB round	1/1
D51364	6" PB round with ring	1/1
D51365	6" NB round	1/1
D51366	6" NB round with ring	1/1
D51367	6" CP round	1/1
D51368	6" CP round with ring	1/1

4" Heavy Duty Drain Base with 4" Metal Spud

Fits Over 4" Schedule 40 DWV Pipe

ASSEMBLED IN
USA

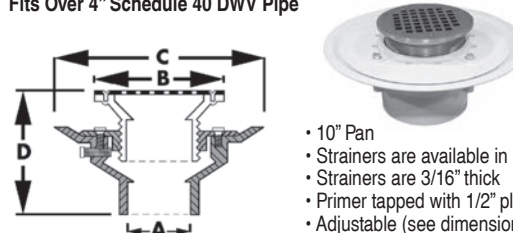

- 10" Pan
- Strainers are available in PB and NB
- Strainers are 3/16" thick
- Primer tapped with 1/2" plug
- Adjustable (see dimension D)

STRAINER	A	B	C	D
5" round	Over 4"	5"	11"	4-5/8" - 5-7/8"

PVC

PART NO.	STRAINER	CTN/MSTR
D50372	5" PB round	1/1
D50371	5" NB round	1/1

ABS

PART NO.	STRAINER	CTN/MSTR
D51372	5" PB round	1/1
D51371	5" NB round	1/1

PVC and ABS Commercial Drain Components

Pages 211-216

**SIZES: 2", 2" x 3", 3", 3-1/2",
3" x 4", 4"**

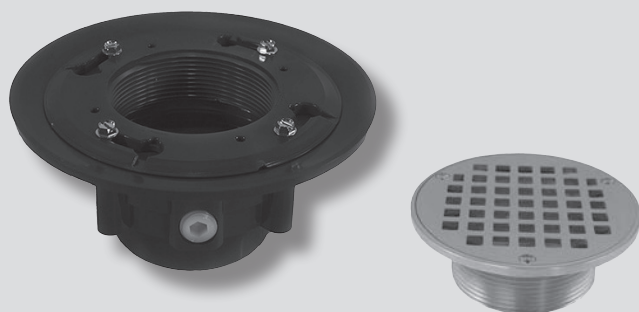

For use in
commercial applications.

Pipe Fit Base

2" Fits Over 2" Schedule 40 DWV Pipe
3" Fits Over 3" Schedule 40 DWV Pipe
3" x 4" Fits Over 3" or Inside 4" Schedule 40 DWV Pipe
4" Fits Over 4" Schedule 40 DWV Pipe



PVC

PART NO.	PIPE SIZE	SPUD	CTN/MSTR
D52120	2" with PT	2"	1/20
D52012	2"	2"	1/20
D52450	3" x 4" with PT	3"	1/10
D52400	3" x 4"	3-1/2"	1/10
D52451	3" x 4" with PT	3-1/2"	1/10
D52005	4"	3-1/2"	1/10
D52452	4" with PT	3-1/2"	1/10
D52014	4"	4"	1/10
D52453	4" with PT	4"	1/10

ABS

PART NO.	PIPE SIZE	SPUD SIZE	CTN/MSTR
D52112	2"	2"	1/20
D52016	3"	3"	1/10
D52460	3" x 4" with PT	3"	1/10
D52500	3" x 4"	3-1/2"	1/10
D52461	3" x 4" with PT	3-1/2"	1/10
D52105	4"	3-1/2"	1/10
D52462	4" with PT	3-1/2"	1/10
D52017	4"	4"	1/10
D52463	4" with PT	4"	1/10

Inside Pipe Fit Base

3" Fits Over 3" Schedule 40 DWV Pipe
4" Fits Over 4" Schedule 40 DWV Pipe



PVC

PART NO.	PIPE SIZE	SPUD	CTN/MSTR
D52023	3"	2"	1/1
D52004	4"	3"	1/1

ABS

PART NO.	PIPE SIZE	SPUD	CTN/MSTR
D52123	3"	2"	1/1
D52104	4"	3"	1/1

Hub Fit Base

Fits Inside 4" Hub Schedule 40 DWV Pipe



PVC			
PART NO.	PIPE SIZE	SPUD	CTN/MSTR
D52003	4"	3-1/2"	1/1

ABS			
PART NO.	PIPE SIZE	SPUD	CTN/MSTR
D52103	4"	3-1/2"	1/1

Slab Drain Base

2" x 3" Fits Over 2" or Inside 3" Schedule 40 DWV Pipe
 3" x 4" Fits Over 3" or Inside 4" Schedule 40 DWV Pipe
 4" Fits Over 4" Schedule 40 DWV Pipe



- Completely adjustable
- 8-1/2" Pan for applications where no clamping ring is required
- Spud threads directly into base
- Primer tapped with 1/2" plug
- Gray PVC or Black ABS

PVC			
PART NO.	PIPE SIZE	SPUD	CTN/MSTR
D49850	2" x 3"	3"	1/1
D49851	2" x 3"	3-1/2"	1/1
D49852	2" x 3"	4"	1/1
D49853	3" x 4"	3"	1/1
D49854	3" x 4"	3-1/2"	1/1
D49855	3" x 4"	4"	1/1
D49856	4"	3"	1/1
D49857	4"	3-1/2"	1/1
D49858	4"	4"	1/1

Heavy Duty Base with Clamping Ring

2" x 3" Fits Over 2" or Inside 3" Schedule 40 DWV Pipe
 3" x 4" Fits Over 3" or Inside 4" Schedule 40 DWV Pipe
 4" Fits Over 4" Schedule 40 DWV Pipe



- Completely adjustable; reversible clamping ring gains additional 1" height
- 8-1/2" Pan
- Extra weep holes
- Primer tapped with 1/2" plug
- Gray PVC or Black ABS

PVC			
PART NO.	PIPE SIZE	SPUD	CTN/MSTR
D49800	2" x 3"	3"	1/1
D49801	2" x 3"	3-1/2"	1/1
D49802	2" x 3"	4"	1/1
D49803	3" x 4"	3"	1/1
D49804	3" x 4"	3-1/2"	1/1
D49805	3" x 4"	4"	1/1
D49806	4"	3"	1/1
D49807	4"	3-1/2"	1/1
D49808	4"	4"	1/1

ABS			
PART NO.	PIPE SIZE	SPUD	CTN/MSTR
D49810	2" x 3"	3"	1/1
D49811	2" x 3"	3-1/2"	1/1
D49812	2" x 3"	4"	1/1
D49813	3" x 4"	3"	1/1
D49814	3" x 4"	3-1/2"	1/1
D49815	3" x 4"	4"	1/1
D49816	4"	3"	1/1
D49817	4"	3-1/2"	1/1
D49818	4"	4"	1/1

ABS			
PART NO.	PIPE SIZE	SPUD	CTN/MSTR
D49860	2" x 3"	3"	1/1
D49861	2" x 3"	3-1/2"	1/1
D49862	2" x 3"	4"	1/1
D49863	3" x 4"	3"	1/1
D49864	3" x 4"	3-1/2"	1/1
D49865	3" x 4"	4"	1/1
D49866	4"	3"	1/1
D49867	4"	3-1/2"	1/1
D49868	4"	4"	1/1

Heavy Duty Base

2" Fits Over 2" Schedule 40 DWV Pipe
 3" Fits Over 3" Schedule 40 DWV Pipe
 4" Fits Over 4" Schedule 40 DWV Pipe
 6" Fits Over 6" Schedule 40 DWV Pipe



- 10" Pan
- Primer tapped with 1/2" plug
- Adjustable

PVC			
PART NO.	PIPE SIZE	SPUD	CTN/MSTR
D52202	2"	3-1/2"	1/1
D52205	2"	4"	1/1
D52203	3"	3-1/2"	1/1
D52204	4"	3-1/2"	1/1
D52207	4"	4"	1/1
D52216	6"	3-1/2"	1/1
D52217	6"	4"	1/1

ABS			
PART NO.	PIPE SIZE	SPUD	CTN/MSTR
D52302	2"	3-1/2"	1/1
D52305	2"	4"	1/1
D52303	3"	3-1/2"	1/1
D52306	3"	4"	1/1
D52304	4"	3-1/2"	1/1
D52307	4"	4"	1/1
D52316	6"	3-1/2"	1/1
D52317	6"	4"	1/1

2" Plastic Spud with Round Strainer



PVC			
PART NO.	IPS	STRAINER	CTN/MSTR
D50980	2"	4" SS	1/1
D50987	2"	4" CP	1/1
D50988	2"	4" CP with ring	1/1
D50985	2"	4" NB	1/1
D50986	2"	4" NB with ring	1/1
D50983	2"	4" PB cast	1/1
D50982	2"	4" PB stamped	1/1
D50984	2"	4" PB with ring	1/1

ABS			
PART NO.	IPS	STRAINER	CTN/MSTR
D57980	2"	4" SS	1/1
D57987	2"	4" CP	1/1
D57988	2"	4" CP with ring	1/1
D57985	2"	4" NB	1/1
D57986	2"	4" NB with ring	1/1
D57983	2"	4" PB cast	1/1
D57982	2"	4" PB stamped	1/1
D57984	2"	4" PB with ring	1/1

3" Plastic Spud with Round Strainer



PVC			
PART NO.	IPS	STRAINER	CTN/MSTR
D56105	3"	6" SS	1/1
D56205	3"	6" CP	1/1
D56210	3"	6" CP with ring	1/1
D56405	3"	6" NB	1/1
D56404	3"	6" NB with ring	1/1
D56305	3"	6" PB	1/1
D56304	3"	6" PB with ring	1/1

ABS			
PART NO.	IPS	STRAINER	CTN/MSTR
D57105	3"	6" SS	1/1
D57205	3"	6" CP	1/1
D57210	3"	6" CP with ring	1/1
D57405	3"	6" NB	1/1
D57404	3"	6" NB with ring	1/1
D57305	3"	6" PB	1/1
D57304	3"	6" PB with ring	1/1

2" Metal Spud with Round Strainer



PART NO.	IPS	STRAINER	CTN/MSTR
D60980	2"	4" SS	1/50
D60981	2"	4" CP	1/50
D60982	2"	4" PB	1/50
D60970	2"	6" CP	1/30
D60975	2"	6" PB	1/30

3" Metal Spud with Round Strainer



PART NO.	IPS	STRAINER	CTN/MSTR
D60955	3"	5" NB	1/30
D60956	3"	5" PB	1/30
D60945	3"	8" NB	1/12

2" Plastic Spud with Square Strainer



PVC			
PART NO.	IPS	STRAINER	CTN/MSTR
D50989	2"	4" CP	1/1
D50990	2"	4" PB	1/1

ABS			
PART NO.	IPS	STRAINER	CTN/MSTR
D57989	2"	4" CP	1/1
D57990	2"	4" PB	1/1

3" Plastic Spud with 7" Square Top and Round Strainer



PVC			
PART NO.	IPS	STRAINER	CTN/MSTR
D56501	3"	5" NB	1/1

ABS			
PART NO.	IPS	STRAINER	CTN/MSTR
D57501	3"	5" NB	1/1

3-1/2" Plastic Spud with Round Strainer



PVC			
PART NO.	IPS	STRAINER	CTN/MSTR
D56211	3-1/2"	5" SS	1/1
D56216	3-1/2"	5" CP	1/1
D56217	3-1/2"	5" CP with ring	1/1
D56214	3-1/2"	5" NB	1/1
D56215	3-1/2"	5" NB with ring	1/1
D56212	3-1/2"	5" PB	1/1
D56213	3-1/2"	5" PB with ring	1/1
D56106	3-1/2"	6" SS	1/1
D56206	3-1/2"	6" CP	1/1
D56209	3-1/2"	6" CP with ring	1/1
D56406	3-1/2"	6" NB	1/1
D56407	3-1/2"	6" NB with ring	1/1
D56306	3-1/2"	6" PB	1/1
D56307	3-1/2"	6" PB with ring	1/1

ABS			
PART NO.	IPS	STRAINER	CTN/MSTR
D57211	3-1/2"	5" SS	1/1
D57216	3-1/2"	5" CP	1/1
D57217	3-1/2"	5" CP with ring	1/1
D57214	3-1/2"	5" NB	1/1
D57215	3-1/2"	5" NB with ring	1/1
D57212	3-1/2"	5" PB	1/1
D57213	3-1/2"	5" PB with ring	1/1
D57106	3-1/2"	6" SS	1/1
D57206	3-1/2"	6" CP	1/1
D57209	3-1/2"	6" CP with ring	1/1
D57406	3-1/2"	6" NB	1/1
D57407	3-1/2"	6" NB with ring	1/1
D57306	3-1/2"	6" PB	1/1
D57307	3-1/2"	6" PB with ring	1/1

3-1/2" Metal Spud with Round Strainer



PART NO.	IPS	STRAINER	CTN/MSTR
D60986	3-1/2"	4" NB	1/40
D60987	3-1/2"	4" PB	1/40
D60990	3-1/2"	5" CP	1/40
D60996	3-1/2"	5" NB	1/40
D60991	3-1/2"	5" PB	1/40
D60992	3-1/2"	6" CP	1/20
D60997	3-1/2"	6" NB	1/20
D60993	3-1/2"	6" PB	1/20
D60998	3-1/2"	8" NB	1/12
D60995	3-1/2"	8" PB	1/10
D60989	3-1/2"	9" PB	1/12

3-1/2" Metal Spud with Square Strainer



PART NO.	IPS	STRAINER	CTN/MSTR
D60954	3-1/2"	5" CP	1/20
D60962	3-1/2"	5" NB	1/20
D60960	3-1/2"	5" PB	1/20
D60963	3-1/2"	6" NB	1/12
D60961	3-1/2"	6" PB	1/12

3-1/2" Plastic Spud with 7" Square Top and Round Strainer

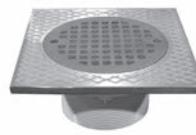

PVC			
PART NO.	IPS	STRAINER	CTN/MSTR
D56503	3-1/2"	5" NB	1/1

4" Plastic Spud with Round Strainer



PVC			
PART NO.	IPS	STRAINER	CTN/MSTR
D56107	4"	6" SS	1/1
D56207	4"	6" CP	1/1
D56208	4"	6" CP with ring	1/1
D56408	4"	6" NB	1/1
D56409	4"	6" NB with ring	1/1
D56308	4"	6" PB	1/1
D56309	4"	6" PB with ring	1/1

ABS			
PART NO.	IPS	STRAINER	CTN/MSTR
D57107	4"	6" SS	1/1
D57207	4"	6" CP	1/1
D57208	4"	6" CP with ring	1/1
D57408	4"	6" NB	1/1
D57409	4"	6" NB with ring	1/1
D57308	4"	6" PB	1/1
D57309	4"	6" PB with ring	1/1

4" Metal Spud with Round Strainer



PART NO.	IPS	STRAINER	CTN/MSTR
D60958	4"	5" NB	1/30
D60959	4"	5" PB	1/30

4" Plastic Spud with 7" Square Top and Round Strainer



ASSEMBLED IN
USA



PVC

PART NO.	IPS	STRAINER	CTN/MSTR
D56505	4"	5" NB	1/1

ABS

PART NO.	IPS	STRAINER	CTN/MSTR
D57505	4"	5" NB	1/1

Replacement Strainer for Metal Spud



- Round
- Includes screws

PART NO.	FINISH	SIZE	CTN/MSTR
D60780	Stainless Steel	4" stamped	100/400
D60781	Chrome Plated	4"	1/200
D60782	Polished Brass	4"	1/200
D60967	Polished Brass	4"	1/100
D60966	Nickel Bronze	4"	1/50
D60790	Chrome Plated	5"	1/150
D60791	Polished Brass	5"	1/50
D60968	Nickel Bronze	5"	1/50
D60792	Chrome Plated	6"	1/50
D60793	Polished Brass	6"	1/50
D60969	Nickel Bronze	6"	1/50
D60795	Polished Brass	8"	1/30

Strainers/Coveralls



- 4" Fits 4-1/4" diameter drain and cleanout spuds, D50 (2" x 3") series shower drains and 2" x 3" General Purpose Drains
- 5" Fits 5" diameter drain and cleanout spuds and 3" x 4" General Purpose Drains
- 6" Fits 6-1/8" diameter drain and cleanout spuds and 4" General Purpose Drains
- Includes screws

PART NO.	SIZE	DESCRIPTION	CTN/MSTR
C60809	4"	SS coverall	100/400
D54008	4"	SS fits inside plastic ring	100/400
C60806	4"	CP cast coverall	1/100
C60808	4"	NB cast coverall	1/100
C60807	4"	PB cast coverall	1/100
C60810	4"	PB PVD finish coverall	1/400
C60814	4"	SN coverall	100/400
D54010	4"	PB fits inside plastic ring	1/100
C60811	5"	SS coverall	50/200
D54108	5"	SS fits inside plastic ring	60/240
C60803	5"	CP cast coverall	1/50
C60805	5"	NB cast coverall	1/50
C60804	5"	PB cast coverall	1/50
D59100	6"	SS coverall	1/125
C60800	6"	CP cast coverall	1/50
C60802	6"	NB cast coverall	1/50
C60801	6"	PB cast coverall	1/50

PART NO.	SIZE	DESCRIPTION	CTN/MSTR
C60888	4"	SS stamped square snap-in coverall	1/100
C60812	4"	CP cast square coverall	1/100
C60813	4"	PB cast square coverall	1/100
C60810	4"	PB PVD finish coverall	1/400

Rings



- 4" Fits 4-1/4" diameter drain and cleanout spuds, D50 (2" x 3") series shower drains and 2" x 3" General Purpose Drains
- 5" Fits 5" diameter drain and cleanout spuds and 3" x 4" General Purpose Drains
- 6" Fits 6-1/8" diameter drain and cleanout spuds and 4" General Purpose Drains

PART NO.	SIZE	DESCRIPTION	CTN/MSTR
C60818	4"	CP ring	1/200
C60825	4"	NB ring	1/200
C60824	4"	PB ring	1/200
C60819	5"	CP ring	1/100
C60823	5"	NB ring	1/100
C60822	5"	PB ring	1/100
C60817	6"	CP ring	1/80
C60821	6"	NB ring	1/80
C60820	6"	PB ring	1/80

Spud Extension



- 2-1/2" - 4" extension for a 3-1/2" drain / cleanout spud
- Use on cast iron or PVC drain bodies when additional height is needed to offset inconsistent concrete pours

PART NO.	SIZE	DESCRIPTION	CTN/MSTR
D60979	3-1/2"	Spud extension	1/12

Funnels



- Supplied with screws
- Vandal-proof installation
- Fits virtually any floor/shower drain
- Funnel tapped for 10-24 screws which are supplied with washers

PART NO.	SIZE	DESCRIPTION	CTN/MSTR
F65400	4"	Funnel	1/1
F65600	6"	Funnel	1/1

E Got To Have It!
The Green Drain Waterless Trap Seal

- Prevents the spread of different dangerous bacteria that can cause potential heal hazards
- Eliminates the need to frequently pour primer and fresh water down the drain
- Saves a significant amount of time, water, costs and energy

- Requires no caulk or expensive installation tool
- Easy to install and easy to remove - no pliers needed
- Durable - will not break during installation or removal
- Seals tight - no leaking!

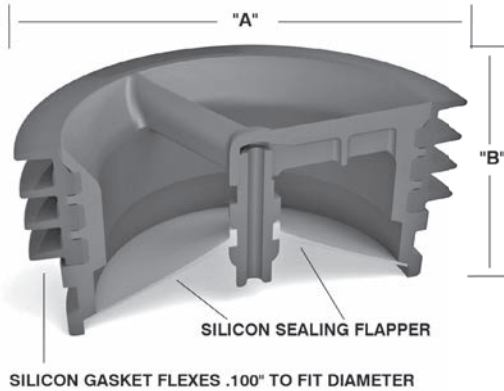

MODEL NUMBER	"A" (PIPE SIZE)	"B" (HEIGHT)
P24001	2" (51)	2" (51)
P24002	3" (76)	2" (51)
P24003	3 1/2" (89)	2" (51)
P24004	4" (102)	2" (51)

PART NO.	DESCRIPTION	CTN/MSTR
P24001	2" waterless trap seal	1/96
P24002	3" waterless trap seal	1/96
P24003	3-1/2" waterless trap seal	1/96
P24004	4" waterless trap seal	1/96

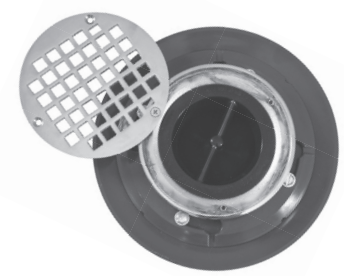

Items marked with the Jones Stephens logo are "You Need It... We Got It" Items.

PVC and ABS General Purpose/Utility Drains

Pages 217-221

SIZES: 2", 2" x 3", 3", 3" x 4", 4"



For use in residential and commercial applications.

2" x 3" General Purpose Drain

Fits Over 2" or Inside 3" Schedule 40 DWV Pipe

ASSEMBLED IN
USA
NSF

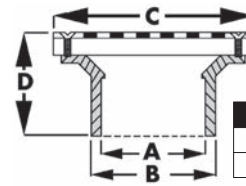

- Coverall top
- Brass inserts

	A	B	C	D
Less rings: Over 2" pipe		Inside 3" pipe	4-1/4"	1-1/2"
With rings: Over 2" pipe		Inside 3" pipe	4-1/2"	2-1/4"

PVC

PART NO.	STRAINER	CTN/MSTR
D54001	4" SS round	1/20
D54013	4" NB round	1/20
D54014	4" NB round with ring	1/20
D54002	4" CP round	1/20
D54022	4" CP round with ring	1/20
D54015	4" PB round stamped (PVD)	1/20
D54011	4" PB round cast	1/20
D54012	4" PB round cast with ring	1/20

ABS

PART NO.	STRAINER	CTN/MSTR
D54301	4" SS round	1/20
D54313	4" NB round	1/20
D54314	4" NB round with ring	1/20
D54302	4" CP round	1/20
D54319	4" CP round with ring	1/20
D54315	4" PB round stamped (PVD)	1/20
D54311	4" PB round cast	1/20
D54312	4" PB round cast with ring	1/20

2" x 3" General Purpose Drain with Long Body

Fits Over 2" or Inside 3" Schedule 40 DWV Pipe

ASSEMBLED IN
USA

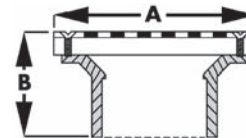

- Coverall top
- Brass inserts

PART NO.	A	B
D54001L	4-1/4"	2"
D54002L	4-1/4"	2-1/8"
D54013L	4-1/4"	2-1/8"
D54014L	4-1/2"	2-1/4"

PVC

PART NO.	DESCRIPTION	CTN/MSTR
D54001L	4" SS round	1/20
D54002L	4" CP brass round	1/20
D54013L	4" NB round	1/20
D54014L	4" NB round with ring	1/20

General Purpose Drain with Cast Iron Strainer

2" x 3" Fits Over 2" or Inside 3" Schedule 40 DWV Pipe
 3" x 4" Fits Over 3" or Inside 4" Schedule 40 DWV Pipe
 4" Fits Over 4" Schedule 40 DWV Pipe

ASSEMBLED IN
USA

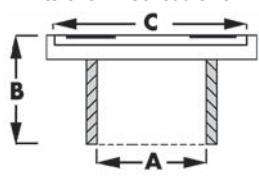

• Cast iron strainer for heavy trucking traffic areas

SIZE	A	B	C
2" x 3"	2-3/8" ID 3" OD	2-1/8"	4-3/4" ID 5-1/8" OD
3" x 4"	3-5/8" ID 4" OD	3-1/8"	4-5/8" ID 5-1/8" OD
4"	4-5/8" ID 5-1/16" OD	3-3/8"	5-3/8" ID 5-3/4" OD

PVC

PART NO.	SIZE	STRAINER	CTN/MSTR
D54016	2" x 3"	CI with ring	1/1
D54126	3" x 4"	CI with ring	1/1
D54136	4"	CI with ring	1/1

ABS

PART NO.	SIZE	STRAINER	CTN/MSTR
D54316	2" x 3"	CI with ring	1/1
D54326	3" x 4"	CI with ring	1/1
D54336	4"	CI with ring	1/1

3" x 4" General Purpose Drain

Fits Over 3" or Inside 4" DWV Pipe

ASSEMBLED IN
USA
NSF

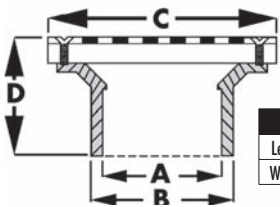

• Coverall top
• Brass inserts

A	B	C	D
Less rings: 3" socket	Inside 4" pipe	5-3/16"	2-3/8"
With rings: 3" socket	Inside 4" pipe	5-1/2"	2-11/16"

PVC

PART NO.	STRAINER	CTN/MSTR
D54100	5" SS round	1/10
D54113	5" NB round	1/10
D54114	5" NB round with ring	1/10
D54101	5" CP round	1/10
D54107	5" CP round with ring	1/10
D54111	5" PB round	1/10
D54112	5" PB round with ring	1/10

ABS

PART NO.	STRAINER	CTN/MSTR
D54400	5" SS round	1/10
D54323	5" NB round	1/10
D54324	5" NB round with ring	1/10
D54401	5" CP round	1/10
D54307	5" CP round with ring	1/10
D54321	5" PB round	1/10
D54322	5" PB round with ring	1/10

4" General Purpose Drain

Fits Over 4" Schedule 40 DWV Pipe

ASSEMBLED IN
USA

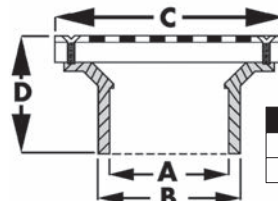

• Coverall top
• Brass Inserts

A	B	C	D
Less rings: Over 4" pipe	5"	6-3/16"	2-5/8"
With rings: Over 4" pipe	5"	6-7/16"	2-3/4"

PVC

PART NO.	STRAINER	CTN/MSTR
D54104	6" SS round	1/10
D54130	6" NB round	1/10
D54132	6" NB round with ring	1/10
D54102	6" CP round	1/10
D54137	6" CP round with ring	1/10
D54105	6" PB round	1/10
D54131	6" PB round with ring	1/10
D54134	7" NB square	1/5

ABS

PART NO.	STRAINER	CTN/MSTR
D54304	6" SS round	1/10
D54330	6" NB round	1/10
D54332	6" NB round with ring	1/10
D54305	6" CP round	1/10
D54337	6" CP round with ring	1/10
D54306	6" PB round	1/10
D54331	6" PB round with ring	1/10
D54334	7" NB square	1/5

8-1/2" Pan Heavy Duty Traffic Floor Drain

ASSEMBLED IN
USA



• Floor sink, area drain, garbage drain, yard drain
 • Full plastic 7-1/4" grate; 8-1/2" pan
 • Sediment bucket option

PVC

PART NO.	DESCRIPTION	CTN/MSTR
D49820	2" x 3" drain	1/1
D49821	3" x 4" drain	1/1
D49822	4" drain	1/1
D49826	2" x 3" drain (with sediment bucket)	1/1
D49827	3" x 4" drain (with sediment bucket)	1/1
D49828	4" drain (with sediment bucket)	1/1

ABS

PART NO.	DESCRIPTION	CTN/MSTR
D49823	2" x 3" drain	1/1
D49824	3" x 4" drain	1/1
D49825	4" drain	1/1
D49829	2" x 3" drain (with sediment bucket)	1/1
D49830	3" x 4" drain (with sediment bucket)	1/1
D49831	4" drain (with sediment bucket)	1/1

Sediment Bucket Only

PART NO.	DESCRIPTION	CTN/MSTR
D49924	Sediment bucket	1/1

Heavy Duty Traffic Floor Drain

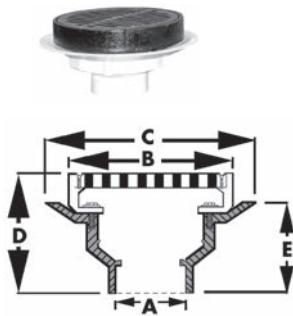

- Floor sink, area drain, garbage drain, yard drain
- 8-1/2" diameter grate
- Brass inserts
- Available with cast iron or plastic grate and ring
- Includes 1/2" primer tap



	A	B	C	D	E
Over 2" pipe	9"	11"	4-11/16"	3-5/16"	
Over 3" pipe	9"	11"	4-11/16"	3-5/16"	
Over 4" pipe	9"	11"	5-1/16"	3-5/16"	

PVC - Full Cast Iron Grate and Ring

PART NO.	DESCRIPTION	CTN/MSTR
D50092	2" drain	1/1
D50093	3" drain	1/1
D50094	4" drain	1/1
D50089	2" drain with CI sediment bucket	1/1
D50090	3" drain with CI sediment bucket	1/1
D50091	4" drain with CI sediment bucket	1/1

ABS - Full Cast Iron Grate and Ring

PART NO.	DESCRIPTION	CTN/MSTR
D50392	2" drain	1/1
D50393	3" drain	1/1
D50394	4" drain	1/1
D50389	2" drain with CI sediment bucket	1/1
D50390	3" drain with CI sediment bucket	1/1
D50391	4" drain with CI sediment bucket	1/1

PVC - Full Plastic Grate and Ring

PART NO.	DESCRIPTION	CTN/MSTR
D50177	2" drain	1/1
D50179	3" drain	1/1
D50181	4" drain	1/1
D50178	2" drain with plastic debris bucket	1/1
D50180	3" drain with plastic debris bucket	1/1
D50182	4" drain with plastic debris bucket	1/1
D50682	6" drain with plastic debris bucket	1/1

ABS - Full Plastic Grate and Ring

PART NO.	DESCRIPTION	CTN/MSTR
D50377	2" drain	1/1
D50379	3" drain	1/1
D50381	4" drain	1/1
D50378	2" drain with plastic debris bucket	1/1
D50380	3" drain with plastic debris bucket	1/1
D50382	4" drain with plastic debris bucket	1/1
D50683	6" drain with plastic debris bucket	1/1

PVC - Three-Quarter Plastic Grate and Ring

PART NO.	DESCRIPTION	CTN/MSTR
D50183	2" drain	1/1
D50184	3" drain	1/1
D50185	4" drain	1/1

ABS - Three-Quarter Plastic Grate and Ring

PART NO.	DESCRIPTION	CTN/MSTR
D50383	2" drain	1/1
D50384	3" drain	1/1
D50385	4" drain	1/1

PVC - Half Plastic Grate and Ring

PART NO.	DESCRIPTION	CTN/MSTR
D50186	2" drain	1/1
D50187	3" drain	1/1
D50188	4" drain	1/1

ABS - Half Plastic Grate and Ring

PART NO.	DESCRIPTION	CTN/MSTR
D50386	2" drain	1/1
D50387	3" drain	1/1
D50388	4" drain	1/1

PVC - Replacement Parts

PART NO.	DESCRIPTION	CTN/MSTR
D50904	Full plastic grate	1/1
D50906	Three-quarter plastic grate	1/1
D50908	Half plastic grate	1/1
D50910	Plastic debris bucket	1/1
D50095	CI sediment bucket	1/1

ABS - Replacement Parts

PART NO.	DESCRIPTION	CTN/MSTR
D50905	Full plastic grate	1/1
D50907	Three-quarter plastic grate	1/1
D50909	Half plastic grate	1/1
D50911	Plastic debris bucket	1/1

All Plastic Snap-In Drain

Fits Into Schedule 40 DWV Pipe

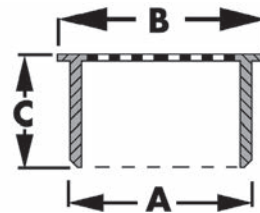

	A	B	C
Inside 2"		2-3/8"	1"
Inside 3"		3-1/2"	1-3/4"
Inside 4"		4-1/2"	2"

PVC

PART NO.	DESCRIPTION	CTN/MSTR
D42002	2" snap-in drain	1/20
D42003	3" snap-in drain	1/20
D42004	4" snap-in drain	1/20

ABS

PART NO.	DESCRIPTION	CTN/MSTR
D42022	2" snap-in drain	1/20
D42023	3" snap-in drain	1/20
D42024	4" snap-in drain	1/20

Snap-In Drain with Stainless Steel Strainer

Fits Into Schedule 40 DWV Pipe

ASSEMBLED IN
USA

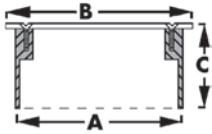

A	B	C
Inside 3" pipe	3-1/2"	2"
Inside 4" pipe	4-1/2"	2"

PVC

PART NO.	DESCRIPTION	CTN/MSTR
D54003	3" snap-in drain	1/20
D54004	4" snap-in drain	1/20

ABS

PART NO.	DESCRIPTION	CTN/MSTR
D54005	3" snap-in drain	1/20
D54006	4" snap-in drain	1/20

Snap-In Strainer

Fits Inside Pipe



• Stainless steel

PART NO.	DESCRIPTION	CTN/MSTR
D59001	3-1/8" strainer fits inside 2" pipe	10/200
D59002	4-1/8" strainer fits inside 3" pipe	10/200
D59003	5-1/8" strainer fits inside 4" pipe	10/100

Socket Ring

ASSEMBLED IN
USA

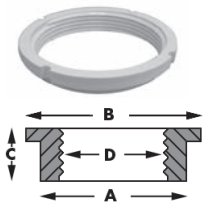

• Solvent welds into Schedule 40 hub to make threaded connection

A	B	C	D
2"	2-3/4"	1/2"	2" FIP
3"	4-1/16"	5/8"	3" FIP
4"	5-1/16"	5/8"	4" FIP

PVC

PART NO.	DESCRIPTION	CTN/MSTR
P48002	2" socket ring	1/20
P48003	3" socket ring	1/20
P48004	4" socket ring	1/20

ABS

PART NO.	DESCRIPTION	CTN/MSTR
P48102	2" socket ring	1/20
P48103	3" socket ring	1/20
P48104	4" socket ring	1/20

Utility Drain

ASSEMBLED IN
USA

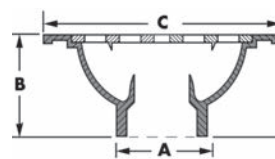

• Snap-in lid
• Use 2" coupling to connect 6" x 6" to 2" pipe

A	B	C	D
1-1/2" x 2"	2-3/8"	6"	4-9/16"
3" x 4"	3-7/16"	9"	7-11/16"
4"	4-9/16"	9"	7-11/16"
4" w/out stop	4-9/16"	9"	7-11/16"

PVC

PART NO.	DESCRIPTION	CTN/MSTR
D40020	6" x 6" with pipe stop; 1-1/2" hub; 2" spigot	1/20
D40021	9" x 9" with pipe stop; 3" hub; 4" spigot	1/10
D40023	9" x 9" with pipe stop; 4" hub	1/10
D42019	9" x 9" with 4" hub	1/10

ABS

PART NO.	DESCRIPTION	CTN/MSTR
D42029	9" x 9" with 4" hub	1/10

Bell Trap

ASSEMBLED IN
USA

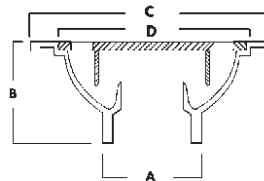

• Snap-in lid
• Molded bell in lid
• Use 2" coupling to convert 6" x 6" x 1-1/2" to 2" outlet

A	B	C	D
1-1/2" x 2"	2-3/8"	6"	4-9/16"
3" x 4"	4"	9"	7-3/4"
4"	4-1/2"	9"	7-3/4"

PVC

PART NO.	DESCRIPTION	CTN/MSTR
D42006	6" x 6" with 1-1/2" x 2" outlet	1/20
D42009	9" x 9" with 3" x 4" outlet	1/10
D42010	9" x 9" with 4" hub fit outlet	1/10

ABS

PART NO.	DESCRIPTION	CTN/MSTR
D42011	6" x 6" with 1-1/2" x 2" outlet	1/20
D42012	9" x 9" with 3" x 4" outlet	1/10
D42013	9" x 9" with 4" hub fit outlet	1/10

PVC Accessories

PART NO.	DESCRIPTION	CTN/MSTR
D42007	Lid for the D42006	1/1
D42008	Lid for the D42009 and D42010	1/1

ABS Accessories

PART NO.	DESCRIPTION	CTN/MSTR
D42014	Lid for the D42011	1/1
D42015	Lid for the D42012 and D42013	1/1

Heavy Duty PVC Bell Trap with Hinged Lid

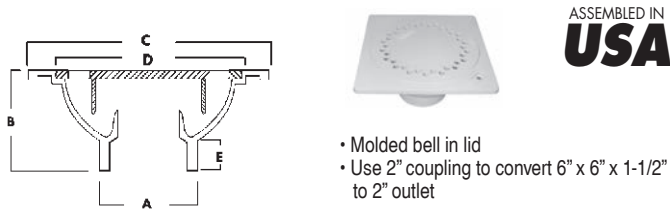

- Molded bell in lid
- Use 2" coupling to convert 6" x 6" x 1-1/2" to 2" outlet

A	B	C	D	E
1-1/2" x 2"	2-1/2"	6"	4-1/2"	3/4"
3" x 4"	4-3/8"	9"	7-3/4"	3/4"
4"	4-1/2"	9"	7-3/4"	3/4"

PVC

PART NO.	DESCRIPTION	CTN/MSTR
D42006H	6" x 6" with 1-1/2" x 2" outlet	1/20
D42009H	9" x 9" with 3" x 4" outlet	1/10
D42010H	9" x 9" with 4" outlet	1/10

Accessories

PART NO.	DESCRIPTION	CTN/MSTR
D42007H	Lid for the D42006H	1/1
D42008H	Lid for the D42009H and D42010H	1/1

Floor Drain with Trap

2" Solvent Weld Outlet

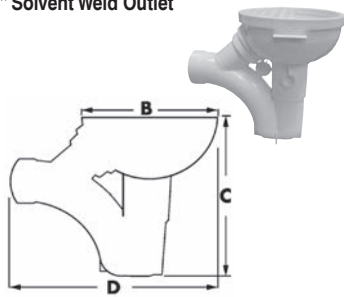

- Full 2" flow
- One-piece construction (not welded together)
- For concrete floors on or below grade
- Deep 3-1/4" sump bowl
- Dual primer bosses
- Strainer is 1/2" thick
- 2" concealed cleanout
- Stands upright for easy rough-in, also has rough-in tabs
- Threaded for backwater device

PIPE SIZE	B	C	D
2" IPS	7-5/8"	10-7/8"	11-3/4"

PVC

PART NO.	DESCRIPTION	CTN/MSTR
D50200	2" with full plastic grate	1/12
D50208	2" with 7-1/2" NB strainer	1/12

ABS

PART NO.	DESCRIPTION	CTN/MSTR
D50600	2" with full plastic grate	1/12

PVC - Accessories

PART NO.	DESCRIPTION	CTN/MSTR
D50202	Full grate strainer	1/1
D50204	Half grate strainer	1/1

ABS - Accessories

PART NO.	DESCRIPTION	CTN/MSTR
D50205	Full grate strainer	1/1
D50206	Three-quarter grate strainer	1/1
D50207	Half grate strainer	1/1

Other Accessories

PART NO.	DESCRIPTION	CTN/MSTR
D50213	NB strainer	1/1
B06001	Plastic backwater device	1/1
B70499	Replacement ball	1/1

4-Way Area Drain

Fits 2" or 3" Pipe

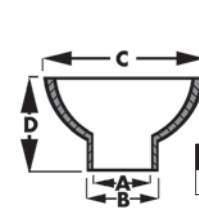

- Use with or without a p-trap

A	B	C	D
Over 2" pipe	Inside 3" pipe	7-1/4"	3-3/4"

PVC

PART NO.	DESCRIPTION	CTN/MSTR
D50201	2" x 3" area drain	1/15
D50220	2" x 3" area drain without stop	1/15
B06010	Replacement strainer for D50201	1/1

ABS

PART NO.	DESCRIPTION	CTN/MSTR
D50601	2" x 3" area drain	1/15
D50221	2" x 3" area drain without stop	1/15
B06100	Replacement strainer for D50601	1/1

Area Drain

2" x 3" Fits Over 2" or Inside 3" Schedule 40 DWV Pipe
3" x 4" Fits Over 3" or Inside 4" Schedule 40 DWV Pipe

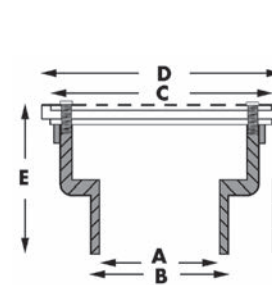

- 5" strainer can be installed as snap-in or screwed in

SIZE	A	B	C	D	E
2" x 3"	2"	3"	5"	6-3/16"	2-3/8"
3" x 4"	3"	4"	5"	6-3/16"	2-3/8"

PVC

PART NO.	DESCRIPTION	CTN/MSTR
D40600	2" x 3" area drain	1/12
D40601	3" x 4" area drain	1/12
D40602	PVC replacement strainer	1/1

ABS

PART NO.	DESCRIPTION	CTN/MSTR
D40700	2" x 3" area drain	1/12
D40701	3" x 4" area drain	1/12

PVC Inside Pipe Fit Drains and Cleanouts

Page 222

SIZES: 3", 4"



For use in applications where adjustments after the concrete pour are required.

Items marked with the Jones Stephens logo are "You Need It... We Got It" Items.

Inside Pipe Fit Drain

ASSEMBLED IN
USA



• Strainer is the same diameter as the pipe to provide full coverage every time!

PART NO.	BASE	STRAINER	CTN/MSTR
D60131	3" PVC	3-1/2" CP round	1/1
D60130	3" PVC	3-1/2" NB round	1/1
D60141	4" PVC	4-1/2" CP round	1/1
D60140	4" PVC	4-1/2" NB round	1/1

Inside Pipe Fit Cleanout

ASSEMBLED IN
USA



• Cover is the same diameter as the pipe to provide full coverage every time!

PART NO.	BASE	COVER	CTN/MSTR
C60172	3" PVC	3-1/2" NB round	1/1
C60170	4" PVC	4-1/2" NB round	1/1
C60171	4" PVC	4-1/2" Cast Iron round	1/1

HOW IT WORKS!

Concrete Floor Application



The concrete should be poured so that the pipe stack is above the finished surface.



After concrete is complete, use an EZ Stroke pipe saw to cut flush with concrete. Then, use a socket saver or inside pipe cutter to trim pipe 3/8" below concrete surface.

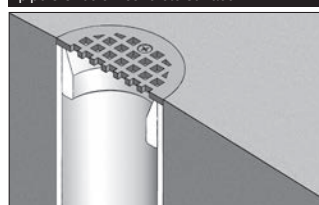

The inside pipe fit drain/cleanout can easily be glued into the pipe creating a level surface once the strainer is installed. No chisel or tape needed!

Tile Floor Application



The concrete should be poured so that the pipe stack is above the finished surface.



After concrete is complete, use an EZ Stroke pipe saw to cut flush with concrete. The inside pipe fit drain/cleanout can easily be glued into the pipe.



Lay tile to the edge of the cover or strainer. No chisel or tape needed!

PVC and ABS Residential and Light Commercial Cleanouts

Pages 223-225

SIZES: 1-1/2", 2", 2-1/2", 2"x 3", 3", 3-1/2", 3"x 4", 4"



For use in residential and light commercial applications.

Internal Pipe Cleanout

Solvent Welds Into Schedule 40 DWV Pipe

ASSEMBLED IN
USA

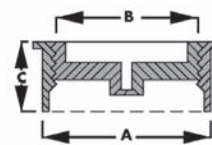

- Allows pipe to be cut flush with floor or wall
- Countersunk plug included

	A	B	C
Inside 2"		1-1/2"	1"
Inside 3"		2-1/2"	1-1/8"
Inside 4"		3-1/2"	1-1/4"

PVC

PART NO.	PIPE SIZE	PLUG SIZE	OD	CTN/MSTR
C60106	2"	1-1/2" IPS	1-7/8"	1/100
C60007	3"	2-1/2" IPS	2-13/16"	1/10
C60008	4"	3-1/2" IPS	4"	1/50
C60116	2"	1-1/2" with insert	—	1/10
C60117	3"	2-1/2" with insert	—	1/10
C60118	4"	3-1/2" with insert	—	1/10

ABS

PART NO.	PIPE SIZE	PLUG SIZE	OD	CTN/MSTR
C60107	2"	1-1/2" IPS	1-7/8"	1/100
C60011	3"	2-1/2" IPS	2-13/16"	1/10
C60012	4"	3-1/2" IPS	4"	1/10

Heavy Duty Internal Pipe Cleanout

Solvent Welds Into Schedule 40 DWV Pipe

ASSEMBLED IN
USA

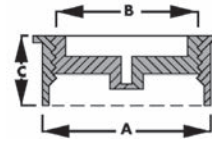

- Allows pipe to be cut flush with floor or wall
- Countersunk plug included

	A	B	C
Inside 3"		2-1/4"	1-7/8"
Inside 4"		3-1/2"	2"

PVC

PART NO.	SIZE	PLUG SIZE	CTN/MSTR
C60207	3"	2" IPS	1/10
C60108	4"	3" IPS	1/10

ABS

PART NO.	SIZE	PLUG SIZE	CTN/MSTR
C60211	3"	2" IPS	1/10
C60112	4"	3" IPS	1/10

Hub/Fitting Cleanout

Fits Inside 4" Schedule 40 DWV Fittings

ASSEMBLED IN
USA

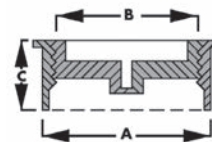

- 3-1/2" IPS countersunk plug
- Solvent welds into 4" fitting hubs

	A	B	C
	4-1/2"	3-7/8"	2-3/16"

PVC

PART NO.	DESCRIPTION	CTN/MSTR
C60009	4" hub/fitting cleanout	1/10

ABS

PART NO.	DESCRIPTION	CTN/MSTR
C60010	4" hub/fitting cleanout	1/10

Fit-Flush Cleanout

2" x 3" Fits Over 2" or Inside 3" Schedule 40 DWV Pipe
 3" x 4" Fits Over 3" or Inside 4" Schedule 40 DWV Pipe

ASSEMBLED IN
USA

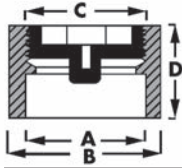

- Built-in stop
- Fits flush everytime

A	B	C	D
Over 2"	Inside 3"	2"	2"
Over 3"	Inside 4"	3"	2-1/2"

PVC

PART NO.	SIZE	PLUG SIZE	OD	CTN/MSTR
C61023	2" x 3"	2" IPS	2-3/8"	1/1
C61034	3" x 4"	3" IPS	3-1/2"	1/1
C61223	2" x 3"	2" IPS brass	2-3/8"	1/1
C61234	3" x 4"	3" IPS brass	3-1/2"	1/1
C61432	2" x 3"	2" with insert	2-3/8"	1/1
C61434	3" x 4"	3" with insert	3-1/2"	1/1

ABS

PART NO.	SIZE	PLUG SIZE	OD	CTN/MSTR
C61123	2" x 3"	2" IPS	2-3/8"	1/1
C61134	3" x 4"	3" IPS	3-1/2"	1/1

Drainable Cleanout Test Plug

ASSEMBLED IN
USA

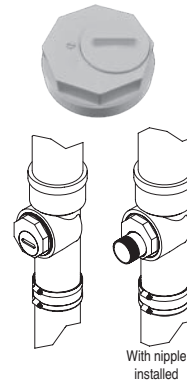

- PVC
- 4" IPS thread size; 2" thread size for drain plug and spout
- Threads into any plastic or cast iron cleanout, or test tee that accepts 4" threads
- Add nipple to create drainage spout
- Easy installation; can be installed horizontal or vertical
- Drain the line without coming in contact with waste!
- Reduce distance between technician and blockage - shorter sewer rods!
- Search for another access is not needed!

PART NO.	DESCRIPTION	CTN/MSTR
P48400	4" drainable cleanout test plug	1/72

4" PVC Hub Fit Cleanout with 3-1/2" Countersunk Brass Plug

ASSEMBLED IN
USA



- Fits flush
- Fits inside 4" hub or Schedule 40 DWV fitting

PART NO.	DESCRIPTION	CTN/MSTR
C61009	4" PVC hub fit cleanout	1/10

Countersunk Cleanout Plug with Insert

ASSEMBLED IN
USA



- White plastic
- With threaded brass insert for cleanout covers

PART NO.	DESCRIPTION	CTN/MSTR
P49915	1-1/2" countersunk cleanout plug	1/100
P49920	2" countersunk cleanout plug	1/100
P49925	2-1/2" countersunk cleanout plug	1/25
P49930	3" countersunk cleanout plug	1/25
P49935	3-1/2" countersunk cleanout plug	1/25
P49940	4" countersunk cleanout plug	1/25

General Purpose Cleanout

3" x 4" Fits Over 3" or Inside 4" Schedule 40 DWV Pipe
 4" Fits Over 4" Schedule 40 DWV Pipe

ASSEMBLED IN
USA

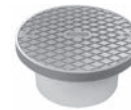
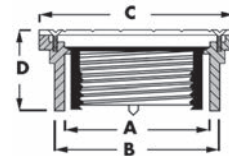

- Supplied with a combination test plug installed

A	B	C	D
Over 3"	Inside 4"	5-3/16"	2-1/2"
Over 4"	—	6-1/8"	2-1/2"

PVC

PART NO.	DESCRIPTION	CTN/MSTR
C60162	3" x 4" with NB cover	1/5
C60165	3" x 4" with NB cover & ring	1/5
C60160	3" x 4" with PB cover	1/5
C60164	3" x 4" with PB cover & ring	1/5
C60142	4" with NB cover	1/5
C60146	4" with NB cover & ring	1/5
C60140	4" with PB cover	1/5
C60144	4" with PB cover & ring	1/5

ABS

PART NO.	DESCRIPTION	CTN/MSTR
C60163	3" x 4" with NB cover	1/5
C60167	3" x 4" with NB cover & ring	1/5
C60161	3" x 4" with PB cover	1/5
C60166	3" x 4" with PB cover & ring	1/5
C60143	4" with NB cover	1/5
C60147	4" with NB cover & ring	1/5
C60141	4" with PB cover	1/5
C60145	4" with PB cover & ring	1/5

Raised Head Cleanout Plug

ASSEMBLED IN
USA



- White plastic

PART NO.	DESCRIPTION	CTN/MSTR
P49250	2-1/2" raised head cleanout plug	1/25
P49350	3-1/2" raised head cleanout plug	1/25

Countersunk Cleanout Plug

ASSEMBLED IN
USA



- White plastic

PART NO.	DESCRIPTION	CTN/MSTR
P49015	1-1/2" countersunk cleanout plug	1/100
P49002	2" countersunk cleanout plug	1/100
P49025	2-1/2" countersunk cleanout plug	1/25
P49003	3" countersunk cleanout plug	1/25
P49035	3-1/2" countersunk cleanout plug	1/25
P49004	4" countersunk cleanout plug	1/25

General Purpose Access Fitting

3" x 4" Fits Over 3" or Inside 4" Schedule 40 DWV Pipe
4" Fits Over 4" Schedule 40 DWV Pipe

ASSEMBLED IN
USA

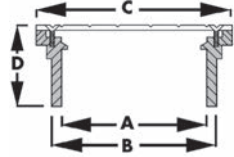

• For use with internal pipe cleanout, order separately

A	B	C	D
Over 3"	Inside 4"	5-3/16"	2-1/2"
Over 4"	—	6-1/8"	2-1/2"

PVC

PART NO.	DESCRIPTION	CTN/MSTR
C60062	3" x 4" with NB cover	1/5
C60065	3" x 4" with NB cover & ring	1/5
C60060	3" x 4" with PB cover	1/5
C60064	3" x 4" with PB cover & ring	1/5
C60042	4" with NB cover	1/5
C60046	4" with NB cover & ring	1/5
C60040	4" with PB cover	1/5
C60044	4" with PB cover & ring	1/5

ABS

PART NO.	DESCRIPTION	CTN/MSTR
C60063	3" x 4" with NB cover	1/5
C60067	3" x 4" with NB cover & ring	1/5
C60061	3" x 4" with PB cover	1/5
C60066	3" x 4" with PB cover & ring	1/5
C60043	4" with NB cover	1/5
C60047	4" with NB cover & ring	1/5
C60041	4" with PB cover	1/5
C60045	4" with PB cover & ring	1/5

Snap-in Access Fitting

ASSEMBLED IN
USA

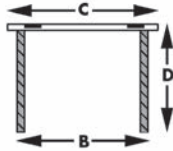

A	B	C	D
3"	3-1/16"	3-1/2"	2"
4"	4"	4-1/2"	2"

PVC

PART NO.	DESCRIPTION	CTN/MSTR
C60013	3" with SS strainer	1/20
C60014	4" with SS strainer	1/20

Sewer Relief Plug

ASSEMBLED IN
USA



- High-density construction
- Eliminates costly damages caused by sewer back-up
- Spring-loaded to close automatically to eliminate sewer gas
- Made of ABS

PART NO.	DESCRIPTION	CTN/MSTR
S25150	1-1/2" sewer relief plug	1/50
S25200	2" sewer relief plug	1/50
S25250	2-1/2" sewer relief plug	1/100
S25300	3" sewer relief plug	1/100
S25350	3-1/2" sewer relief plug	1/100
S25400	4" sewer relief plug	1/100

Test Tee with Plug

ASSEMBLED IN
USA



- Easy pop top test
- PVC plug included
- Test up to 3 floors

PART NO.	DESCRIPTION	CTN/MSTR
C67450	2" test tee	1/10
C67451	3" test tee	1/12

PVC Internal Cleanout with SS Cover



PART NO.	DESCRIPTION	CTN/MSTR
C60015	3" with 5" SS external wall cover	1/1
C60016	4" with 6" SS external wall cover	1/1

Saddle Tees and Kits

ASSEMBLED IN
USA



- Use bushing to reduce 2" unit to 1-1/2"
- Kits include V-bolts, nuts and washers
- Conversion kit also contains gasket mat for use with cast iron pipe
- Solvent branch

PART NO.	DESCRIPTION	CTN/MSTR
S26014	3" x 2" Saddle tee only	1/20
S26015	4" x 2" Saddle tee only	1/10
S26016	4" x 3" Saddle tee only	1/10
S26017	4" x 4" Saddle tee only	1/10
S26004	3" x 2" Saddle tee kit less gasket	1/20
S26005	4" x 2" Saddle tee kit less gasket	1/10
S26006	4" x 3" Saddle tee kit less gasket	1/10
S26007	4" x 4" Saddle tee kit less gasket	1/10
S26009	3" x 2" Saddle tee conversion kit with gasket	1/20
S26010	4" x 2" Saddle tee conversion kit with gasket	1/10
S26011	4" x 3" Saddle tee conversion kit with gasket	1/10
S26012	4" x 4" Saddle tee conversion kit with gasket	1/10
S26008	6" x 7" x 1/4" closed cell foam gasket	1/20

PVC and ABS Adjustable Commercial Cleanouts

Pages 226-229

SIZES: 2" x 3", 3", 3" x 4", 4"



For use in applications where height adjustments are necessary.

4" Hub Fit Base with 3-1/2" Plastic Spud

Fits Inside 4" Schedule 40 DWV Pipe

ASSEMBLED IN

USA

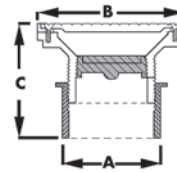

- Supplied with 3" IPS (3-1/2" OD) countersunk plug
- Covers available in PB and NB
- Covers are 3/16" thick
- Adjustable (see dimension C)

COVER	A	B	C
5" round	4" Hub fit	5-3/16"	3-1/8" - 4-5/8"
5" round with ring	4" Hub fit	5-1/2"	3-5/16" - 4-13/16"
6" round	4" Hub fit	6-1/8"	3-1/8" - 4-5/8"
6" round with ring	4" Hub fit	6-1/2"	3-5/16" - 4-13/16"
7" square	4" Hub fit	7"	3-3/8" - 4-15/16"

PVC

PART NO.	COVER	CTN/MSTR
C59200	5" PB round	1/1
C59201	5" PB round with ring	1/1
C59202	5" NB round	1/1
C59203	5" NB round with ring	1/1
C59001	6" PB round	1/1
C59005	6" PB round with ring	1/1
C59003	6" NB round	1/1
C59007	6" NB round with ring	1/1
C59050	7" PB square	1/1
C59052	7" NB square	1/1

ABS

PART NO.	COVER	CTN/MSTR
C59204	5" PB round	1/1
C59205	5" PB round with ring	1/1
C59206	5" NB round	1/1
C59207	5" NB round with ring	1/1
C59002	6" PB round	1/1
C59006	6" PB round with ring	1/1
C59004	6" NB round	1/1
C59008	6" NB round with ring	1/1
C59051	7" PB square	1/1
C59053	7" NB square	1/1

4" Hub Fit Base with 3-1/2" Metal Spud

Fits Inside 4" Schedule 40 DWV Pipe

ASSEMBLED IN

USA

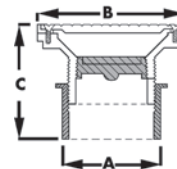

- Supplied with 3" IPS (3-1/2" OD) countersunk plug
- Covers available in PB and NB
- Covers are 3/16" thick
- Adjustable (see dimension C)

COVER	A	B	C
5" round	4" Hub fit	5-3/16"	3-1/4" - 4-1/4"

PVC

PART NO.	COVER	CTN/MSTR
C59060	5" PB round	1/1
C59062	5" NB round	1/1

ABS

PART NO.	COVER	CTN/MSTR
C59061	5" PB round	1/1
C59063	5" NB round	1/1

3" x 4" Pipe Fit Base with 3-1/2" Plastic Spud

Fits Over 3" or Inside 4" Schedule 40 DWV Pipe

ASSEMBLED IN
USA

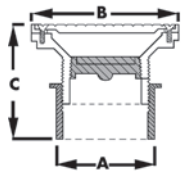

- Supplied with 3" IPS (3-1/2" OD) countersunk plug
- Covers available in PB and NB
- Covers are 3/16" thick
- Primer tapped with 1/2" plug
- Adjustable (see dimension C)

COVER	A	B	C
5" round	Over 3" Pipe Inside 4" Pipe	5-3/16"	3-1/8" - 4-5/8"
5" round with ring	Over 3" Pipe Inside 4" Pipe	5-1/2"	3-5/16" - 4-13/16"
6" round	Over 3" Pipe Inside 4" Pipe	6-1/8"	3-1/8" - 4-5/8"
6" round with ring	Over 3" Pipe Inside 4" Pipe	6-1/2"	3-5/16" - 4-13/16"
7" square	Over 3" Pipe Inside 4" Pipe	7"	5-15/16" - 7-1/2"

PVC

PART NO.	COVER	CTN/MSTR
C59216	5" PB round	1/1
C59217	5" PB round with ring	1/1
C59218	5" NB round	1/1
C59219	5" NB round with ring	1/1
C59010	6" PB round	1/1
C59014	6" PB round with ring	1/1
C59012	6" NB round	1/1
C59016	6" NB round with ring	1/1
C59054	7" PB square	1/1
C59056	7" NB square	1/1

ABS

PART NO.	COVER	CTN/MSTR
C59220	5" PB round	1/1
C59221	5" PB round with ring	1/1
C59222	5" NB round	1/1
C59223	5" NB round with ring	1/1
C59011	6" PB round	1/1
C59015	6" PB round with ring	1/1
C59013	6" NB round	1/1
C59017	6" NB round with ring	1/1
C59055	7" PB square	1/1
C59057	7" NB square	1/1

3" x 4" Pipe Fit Base with 3-1/2" Metal Spud

Fits Over 3" or Inside 4" Schedule 40 DWV Pipe

ASSEMBLED IN
USA

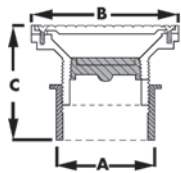

- Supplied with 3" IPS (3-1/2" OD) countersunk plug
- Covers available in PB and NB
- Covers are 3/16" thick
- Primer tapped with 1/2" plug
- Adjustable (see dimension C)

COVER	A	B	C
5" round	Over 3" Pipe Inside 4" Pipe	5-3/16"	5-3/4" - 7"

PVC

PART NO.	COVER	CTN/MSTR
C59068	5" PB round	1/1
C59070	5" NB round	1/1

ABS

PART NO.	COVER	CTN/MSTR
C59069	5" PB round	1/1
C59071	5" NB round	1/1

4" Over Pipe Fit Base with 3-1/2" Plastic Spud

Fits Over 4" Schedule 40 DWV Pipe

ASSEMBLED IN
USA

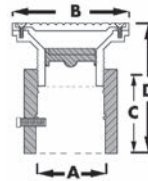

- Supplied with 3" IPS (3-1/2" OD) countersunk plug
- Covers available in PB and NB
- Covers are 3/16" thick
- Primer tapped with 1/2" plug
- Adjustable (see dimension D)

COVER	A	B	C	D
5" round	Over 4" Pipe	5-3/16"	4-1/4"	5-15/16" - 7-1/2"
5" round with ring	Over 4" Pipe	5-1/2"	4-1/4"	6-1/16" - 7-5/8"
6" round	Over 4" Pipe	6-1/8"	4-1/4"	5-15/16" - 7-1/2"
6" round with ring	Over 4" Pipe	6-1/2"	4-1/4"	6-1/16" - 7-5/8"
7" square	Over 4" Pipe	7"	4-1/4"	6-1/8" - 7-11/16"

PVC

PART NO.	COVER	CTN/MSTR
C59208	5" PB round	1/1
C59209	5" PB round with ring	1/1
C59210	5" NB round	1/1
C59211	5" NB round with ring	1/1
C60001	6" PB round	1/1
C60022	6" PB round with ring	1/1
C60020	6" NB round	1/1
C60024	6" NB round with ring	1/1
C60050	7" PB square	1/1
C60052	7" NB square	1/1

ABS

PART NO.	COVER	CTN/MSTR
C59212	5" PB round	1/1
C59213	5" PB round with ring	1/1
C59214	5" NB round	1/1
C59215	5" NB round with ring	1/1
C60003	6" PB round	1/1
C60023	6" PB round with ring	1/1
C60021	6" NB round	1/1
C60025	6" NB round with ring	1/1
C60051	7" PB square	1/1
C60053	7" NB square	1/1

4" Over Pipe Fit Base with 3-1/2" Metal Spud

Fits Over 4" Schedule 40 DWV Pipe

ASSEMBLED IN
USA

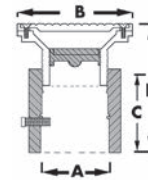

- Supplied with 3" IPS (3-1/2" OD) countersunk plug
- Covers available in PB and NB
- Covers are 3/16" thick
- Primer tapped with 1/2" plug
- Adjustable (see dimension D)

COVER	A	B	C	D
5" round	Over 4" Pipe	5"	4-1/4"	6" - 7-1/16"

PVC

PART NO.	COVER	CTN/MSTR
C59064	5" PB round	1/1
C59066	5" NB round	1/1

ABS

PART NO.	COVER	CTN/MSTR
C59065	5" PB round	1/1
C59067	5" NB round	1/1

4" Over Pipe Fit Base with 4" Plastic Spud

Fits Over 4" Schedule 40 DWV Pipe



- Supplied with 3" IPS (3-1/2" OD) countersunk plug
- Covers available in PB and NB
- Covers are 3/16" thick
- Primer tapped with 1/2" plug
- Adjustable (see dimension D)

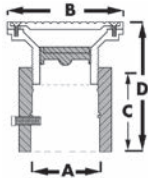

COVER	A	B	C	D
6" round	Over 4" Pipe	6"	4-3/4"	6-1/16" - 7-3/16"
6" round with ring	Over 4" Pipe	6-1/8"	4-3/4"	6-1/8" - 7-1/4"
7" square	Over 4" Pipe	7"	4-3/4"	6-3/16" - 7-3/8"

PVC

PART NO.	COVER	CTN/MSTR
C60070	6" PB round	1/1
C60071	6" PB round with ring	1/1
C60072	6" NB round	1/1
C60073	6" NB round with ring	1/1
C60075	7" NB square	1/1

ABS

PART NO.	COVER	CTN/MSTR
C60076	6" PB round	1/1
C60077	6" PB round with ring	1/1
C60078	6" NB round	1/1
C60079	6" NB round with ring	1/1
C60080	7" PB square	1/1
C60081	7" NB square	1/1

4" Over Pipe Fit Base with 4" Metal Spud

Fits Over 4" Schedule 40 DWV Pipe



- 5" Supplied with 3" IPS (3-1/2" OD) countersunk plug
- 6" Supplied with 4" IPS plug
- Covers available in PB and NB
- Covers are 3/16" thick
- Primer tapped with 1/2" plug
- Adjustable (see dimension D)

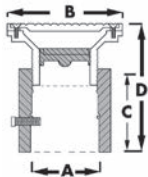

COVER	A	B	C	D
5" round	Over 4" Pipe	5"	4-3/4"	5" - 6"
6" round	Over 4" Pipe	6"	4-3/4"	5" - 6"

PVC

PART NO.	COVER	CTN/MSTR
C60082	5" NB round	1/1
C60092	5" PB round	1/1
C60094	6" NB round	1/1
C60096	6" PB round	1/1

ABS

PART NO.	COVER	CTN/MSTR
C60083	5" NB round	1/1
C60095	6" NB round	1/1
C60097	6" PB round	1/1

3" Over Pipe Fit Base with 3" Plastic Spud

Fits Over 3" Schedule 40 DWV Pipe



- Supplied with 2-1/2" IPS (3" OD) countersunk plug
- Covers available in PB and NB
- Covers are 3/16" thick
- Adjustable (see dimension D)

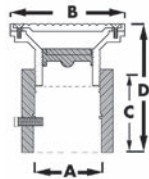

COVER	A	B	C	D
6" round	Over 3" Pipe	6-1/8"	4-1/2"	5-7/8" - 7-1/8"
6" round with ring	Over 3" Pipe	6-1/2"	4-1/2"	6" - 7-3/16"
7" square	Over 3" Pipe	7"	4-1/2"	6" - 7-3/16"

PVC

PART NO.	COVER	CTN/MSTR
C60026	6" PB round	1/1
C60030	6" PB round with ring	1/1
C60028	6" NB round	1/1
C60032	6" NB round with ring	1/1
C60054	7" PB square	1/1
C60056	7" NB square	1/1

ABS

PART NO.	COVER	CTN/MSTR
C60027	6" PB round	1/1
C60031	6" PB round with ring	1/1
C60029	6" NB round	1/1
C60033	6" NB round with ring	1/1
C60055	7" PB square	1/1
C60057	7" NB square	1/1

3" Over Pipe Fit Base with 3" Metal Spud

Fits Over 3" Schedule 40 DWV Pipe



- Supplied with 2-1/2" IPS (3" OD) countersunk plug
- Covers available in PB, NB and CP
- Covers are 3/16" thick
- Adjustable (see dimension D)

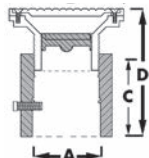

COVER	A	B	C	D
5" round	Over 3" Pipe	5-3/16"	4-1/2"	5" - 6"

PVC

PART NO.	COVER	CTN/MSTR
C60086	5" PB round	1/1
C60084	5" NB round	1/1
C60088	5" CP round	1/1

ABS

PART NO.	COVER	CTN/MSTR
C60087	5" PB round	1/1
C60085	5" NB round	1/1
C60089	5" CP round	1/1

4" Inside Pipe Fit Base with 3" Plastic Spud

Fits Inside 4" Schedule 40 DWV Pipe

ASSEMBLED IN
USA

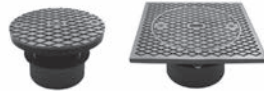
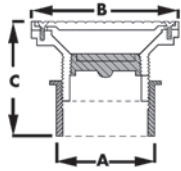

- Supplied with 3" IPS (3-1/2" OD) countersunk plug
- Covers available in PB and NB
- Covers are 3/16" thick
- Adjustable (see dimension C)

COVER	A	B	C
6" round	Inside 4" Pipe	6-1/8"	3-7/8" - 4-5/8"
6" round with ring	Inside 4" Pipe	6-1/2"	4" - 4-3/4"
7" square	Inside 4" Pipe	7"	4" - 4-7/8"

PVC

PART NO.	COVER	CTN/MSTR
C59020	6" PB round	1/1
C59024	6" PB round with ring	1/1
C59022	6" NB round	1/1
C59026	6" NB round with ring	1/1
C59028	7" PB square	1/1
C59030	7" NB square	1/1

ABS

PART NO.	COVER	CTN/MSTR
C59021	6" PB round	1/1
C59025	6" PB round with ring	1/1
C59023	6" NB round	1/1
C59027	6" NB round with ring	1/1
C59029	7" PB square	1/1
C59031	7" NB square	1/1

4" Inside Pipe Fit Base with 3" Metal Spud

Fits Inside 4" Schedule 40 DWV Pipe

ASSEMBLED IN
USA

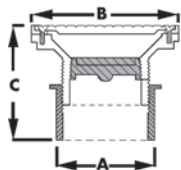

- Supplied with 3" IPS (3-1/2" OD) countersunk plug
- Covers available in PB, NB and CP
- Covers are 3/16" thick
- Adjustable (see dimension C)

COVER	A	B	C
5" round	Inside 4" Pipe	5"	2-7/16" - 3-1/2"

PVC

PART NO.	COVER	CTN/MSTR
C59090	5" NB round	1/1
C59092	5" PB round	1/1
C59094	5" CP round	1/1

ABS

PART NO.	COVER	CTN/MSTR
C59091	5" NB round	1/1
C59093	5" PB round	1/1
C59095	5" CP round	1/1

2" x 3" Cleanout with 2" Plastic Spud

Fits Over 2" or Inside 3" Schedule 40 DWV Pipe

ASSEMBLED IN
USA

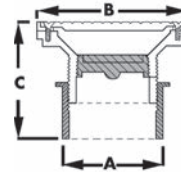

- Supplied with 2" t-cone test plug installed
- Covers available in PB and NB
- Covers are 3/16" thick
- Adjustable (see dimension C)

COVER	A	B	C
4" round	2"	4-1/4"	3-3/8" - 3-13/16"
4" round with ring	2"	4-1/2"	3-1/2" - 3-7/8"

PVC

PART NO.	COVER	CTN/MSTR
C59096	4" PB round	1/1
C59097	4" PB round with ring	1/1
C59098	4" NB round	1/1
C59099	4" NB round with ring	1/1

ABS

PART NO.	COVER	CTN/MSTR
C59100	4" PB round	1/1
C59101	4" PB round with ring	1/1
C59102	4" NB round	1/1
C59103	4" NB round with ring	1/1

E

PVC and ABS Commercial Cleanout Components

Pages 230-231

SIZES: 2", 3", 3-1/2", 4"

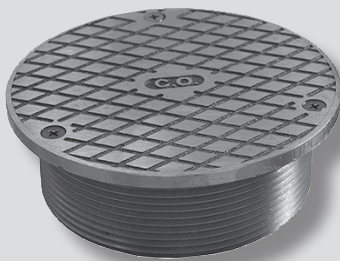

For use in
commercial applications.

2" Plastic Spud with Round Cover



• Supplied with 2" IPS / 2-1/2" OD
countersunk t-cone test plug



PVC

PART NO.	IPS	COVER	CTN/MSTR
D59920	2"	4" PB	1/1
D59921	2"	4" PB with ring	1/1
D59922	2"	4" NB	1/1
D59923	2"	4" NB with ring	1/1

ABS

PART NO.	IPS	COVER	CTN/MSTR
D59924	2"	4" PB	1/1
D59925	2"	4" PB with ring	1/1
D59926	2"	4" NB	1/1
D59927	2"	4" NB with ring	1/1

3" Plastic Spud with Round Cover



• Supplied with 2-1/2" IPS / 3" OD
countersunk plug



PVC

PART NO.	IPS	COVER	CTN/MSTR
D59904	3"	6" PB	1/1
D59908	3"	6" PB with ring	1/1
D59905	3"	6" NB	1/1
D59909	3"	6" NB with ring	1/1

ABS

PART NO.	IPS	COVER	CTN/MSTR
D57904	3"	6" PB	1/1
D57908	3"	6" PB with ring	1/1
D57905	3"	6" NB	1/1
D57909	3"	6" NB with ring	1/1

3" Metal Spud with Round Cover



• Supplied with 2-1/2" IPS / 3" OD
countersunk plug



PART NO.	IPS	COVER	CTN/MSTR
C37801	3"	5" PB	1/20
C37803	3"	5" NB	1/20

3" Plastic Spud with Square Cover

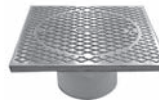

• Supplied with 2-1/2" IPS / 3" OD
countersunk plug



PVC

PART NO.	IPS	COVER	CTN/MSTR
D59912	3"	7" PB	1/1
D59913	3"	7" NB	1/1

ABS

PART NO.	IPS	COVER	CTN/MSTR
D57912	3"	7" PB	1/1
D57913	3"	7" NB	1/1

3-1/2" Plastic Spud with Round Cover



• Supplied with 3" IPS countersunk plug



PVC			
PART NO.	IPS	COVER	CTN/MSTR
D59943	3-1/2"	5" PB	1/1
D59944	3-1/2"	5" PB with ring	1/1
D59945	3-1/2"	5" NB	1/1
D59946	3-1/2"	5" NB with ring	1/1
D59901	3-1/2"	6" PB	1/1
D59906	3-1/2"	6" PB with ring	1/1
D59902	3-1/2"	6" NB	1/1
D59907	3-1/2"	6" NB with ring	1/1

ABS			
PART NO.	IPS	COVER	CTN/MSTR
D59947	3-1/2"	5" PB	1/1
D59948	3-1/2"	5" PB with ring	1/1
D59949	3-1/2"	5" NB	1/1
D59950	3-1/2"	5" NB with ring	1/1
D57901	3-1/2"	6" PB	1/1
D57906	3-1/2"	6" PB with ring	1/1
D57902	3-1/2"	6" NB	1/1
D57907	3-1/2"	6" NB with ring	1/1

3-1/2" Metal Spud with Round Cover



• Supplied with 3-1/2" IPS countersunk plug



PART NO.	IPS	COVER	CTN/MSTR
C37811	3-1/2"	5" PB	1/18
C37810	3-1/2"	5" NB	1/18

3-1/2" Plastic Spud with Square Cover

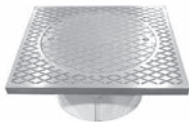

• Supplied with 3" IPS countersunk plug



PVC			
PART NO.	IPS	COVER	CTN/MSTR
D59910	3-1/2"	7" PB	1/1
D59911	3-1/2"	7" NB	1/1

ABS			
PART NO.	IPS	COVER	CTN/MSTR
D57910	3-1/2"	7" PB	1/1
D57911	3-1/2"	7" NB	1/1

4" Plastic Spud with Round Cover



• Supplied with 3" IPS countersunk plug



PVC			
PART NO.	IPS	COVER	CTN/MSTR
D59914	4"	6" PB	1/1
D59915	4"	6" PB with ring	1/1
D59916	4"	6" NB	1/1
D59917	4"	6" NB with ring	1/1

ABS			
PART NO.	IPS	COVER	CTN/MSTR
D57914	4"	6" PB	1/1
D57915	4"	6" PB with ring	1/1
D57916	4"	6" NB	1/1
D57917	4"	6" NB with ring	1/1

4" Metal Spud with Round Cover



• 5" Cover supplied with 3-1/2" IPS countersunk plug
• 6" Cover supplied with 4" IPS countersunk plug



PART NO.	IPS	COVER	CTN/MSTR
C37806	4"	5" PB	1/20
C37805	4"	5" NB	1/20
C37808	4"	6" PB	1/8
C37807	4"	6" NB	1/8

4" Plastic Spud with Square Cover

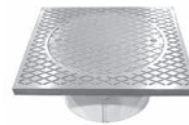

• Supplied with 3" IPS countersunk plug



PVC			
PART NO.	IPS	COVER	CTN/MSTR
D59918	4"	7" PB	1/1
D59919	4"	7" NB	1/1

ABS			
PART NO.	IPS	COVER	CTN/MSTR
D57918	4"	7" PB	1/1
D57919	4"	7" NB	1/1

Covers

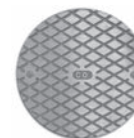

- 4" Fits 4-1/4" diameter drain and cleanout spuds, D50 (2" x 3") series shower drains and 2" x 3" General Purpose Drains
- 5" Fits 5" diameter drain and cleanout spuds and 3" x 4" General Purpose Drains
- 6" Fits 6-1/8" diameter drain and cleanout spuds and 4" General Purpose Drains
- Includes screws

PART NO.	SIZE	DESCRIPTION	CTN/MSTR
C60504	4"	NB cast	1/50
C60505	4"	PB cast	1/50
C60503	5"	NB cast	1/50
C60502	5"	PB cast	1/50
C60501	6"	NB cast	1/30
C60500	6"	PB cast	1/30

Round Slop Sink

Fits Over 3" or Inside 4" Pipe

ASSEMBLED IN
USA

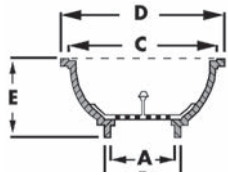

- 4-7/8" OD scoop strainer with stem for easy removal
- 12" diameter

A	B	C	D	E
3"	4"	11"	12"	6-3/8"

PART NO.	DESCRIPTION	CTN/MSTR
S55001	3" x 4" PVC sink and strainer	1/1
S55002	Replacement strainer	1/1

Floor Sink

To Be Used with Coupling or Hub Kit

ASSEMBLED IN
USA

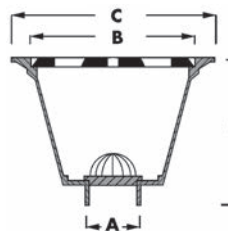

- 3/4" thick top grate in three styles
- 12" x 12" top flange

A	B	C	D
Inside 2" fitting	9-3/16"	12"	8"
Inside 3" fitting	9-3/16"	12"	8"
Inside 4" fitting	9-3/16"	12"	8"

PVC

PART NO.	DESCRIPTION	CTN/MSTR
S59002	2" sink only	1/1
S59003	3" sink only	1/1
S59004	4" sink only	1/1

ABS

PART NO.	DESCRIPTION	CTN/MSTR
S59302	2" sink only	1/1
S59303	3" sink only	1/1
S59304	4" sink only	1/1

Complete PVC Floor Sink Kit

ASSEMBLED IN
USA



- Includes sink, top grate and bottom strainer
- To be used with coupling or hub kit



PART NO.	DESCRIPTION	CTN/MSTR
S49042	2" - 1/2 top grate - dome bottom grate	1/1
S49052	2" - 3/4 top grate - dome bottom grate	1/1
S49062	2" - full top grate - dome bottom grate	1/1
S49072	2" - 1/2 top grate - flat bottom grate	1/1
S49082	2" - 3/4 top grate - flat bottom grate	1/1
S49092	2" - full top grate - flat bottom grate	1/1
S49043	3" - 1/2 top grate - dome bottom grate	1/1
S49053	3" - 3/4 top grate - dome bottom grate	1/1
S49063	3" - full top grate - dome bottom grate	1/1
S49073	3" - 1/2 top grate - flat bottom grate	1/1
S49083	3" - 3/4 top grate - flat bottom grate	1/1
S49093	3" - full top grate - flat bottom grate	1/1
S49044	4" - 1/2 top grate - dome bottom grate	1/1
S49054	4" - 3/4 top grate - dome bottom grate	1/1
S49064	4" - full top grate - dome bottom grate	1/1
S49074	4" - 1/2 top grate - flat bottom grate	1/1
S49084	4" - 3/4 top grate - flat bottom grate	1/1
S49094	4" - full top grate - flat bottom grate	1/1

Pipe Fit Floor Sink

2" x 3" Fits Over 2" or Inside 3" Schedule 40 DWV Pipe
3" x 4" Fits Over 3" or Inside 4" Schedule 40 DWV Pipe
4" Fits Over 4" Schedule 40 DWV Pipe

ASSEMBLED IN
USA

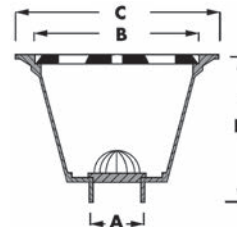

- 3/4" thick top grate in three styles
- 12" x 12" top flange
- Temp up to 180°

A	B	C	D
Over 2" Inside 3"	9-3/16"	12"	8"
Over 3" Inside 4"	9-3/16"	12"	8"
Over 4"	9-3/16"	12"	8"

PVC

PART NO.	DESCRIPTION	CTN/MSTR
S59102	2" x 3" sink only	1/1
S59103	3" x 4" sink only	1/1
S59104	4" sink only	1/1

ABS

PART NO.	DESCRIPTION	CTN/MSTR
S59402	2" x 3" sink only	1/1
S59403	3" x 4" sink only	1/1

Complete PVC Floor Sink Kit-Pipe Fit



- Includes sink, top grate and bottom strainer

ASSEMBLED IN

USA



PART NO.	DESCRIPTION	CTN/MSTR
S59042	2"x 3" - 1/2 top grate - dome bottom grate	1/1
S59052	2"x 3" - 3/4 top grate - dome bottom grate	1/1
S59062	2"x 3" - full top grate - dome bottom grate	1/1
S59072	2"x 3" - 1/2 top grate - flat bottom grate	1/1
S59082	2"x 3" - 3/4 top grate - flat bottom grate	1/1
S59092	2"x 3" - full top grate - flat bottom grate	1/1
S59043	3"x 4" - 1/2 top grate - dome bottom grate	1/1
S59053	3"x 4" - 3/4 top grate - dome bottom grate	1/1
S59063	3"x 4" - full top grate - dome bottom grate	1/1
S59073	3"x 4" - 1/2 top grate - flat bottom grate	1/1
S59083	3"x 4" - 3/4 top grate - flat bottom grate	1/1
S59093	3"x 4" - full top grate - flat bottom grate	1/1
S59044	4" - 1/2 top grate - dome bottom grate	1/1
S59054	4" - 3/4 top grate - dome bottom grate	1/1
S59064	4" - full top grate - dome bottom grate	1/1
S59074	4" - 1/2 top grate - flat bottom grate	1/1
S59084	4" - 3/4 top grate - flat bottom grate	1/1
S59094	4" - full top grate - flat bottom grate	1/1

Full Top Grate for Floor Sink



- Accessories for all S49 and S59 series floor sinks

ASSEMBLED IN

USA



PVC		
PART NO.	DESCRIPTION	CTN/MSTR
S59010	Full top grate	1/10

ABS		
PART NO.	DESCRIPTION	CTN/MSTR
S59310	Full top grate	1/10

Three-Quarters Top Grate for Floor Sink



- Accessories for all S49 and S59 series floor sinks

ASSEMBLED IN

USA



PVC		
PART NO.	DESCRIPTION	CTN/MSTR
S59011	3/4 top grate	1/10

ABS		
PART NO.	DESCRIPTION	CTN/MSTR
S59311	3/4 top grate	1/10

Half Top Grate for Floor Sink



- Accessories for all S49 and S59 series floor sinks

ASSEMBLED IN

USA



PVC		
PART NO.	DESCRIPTION	CTN/MSTR
S59012	1/2 top grate	1/10

ABS		
PART NO.	DESCRIPTION	CTN/MSTR
S59312	1/2 top grate	1/10

Aluminum Dome Strainer for Floor Sink



- Accessories for all S49 and S59 series floor sinks

PART NO.	DESCRIPTION	CTN/MSTR
S60002	2" aluminum dome bottom strainer	1/10
S60003	3" aluminum dome bottom strainer	1/10
S60004	4" aluminum dome bottom strainer	1/10

Flat Aluminum Bottom Strainer for Floor Sink



- Accessories for all S49 and S59 series floor sinks

PART NO.	DESCRIPTION	CTN/MSTR
S60005	Flat aluminum bottom strainer	1/10

Backwater Valve

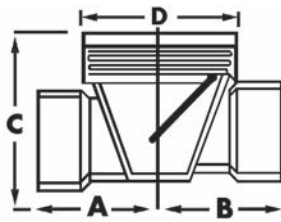

ASSEMBLED IN
USA
UPC NSF

- Sockets are Schedule 40 DWV
- Reduces backflow in drainage system
- Threaded access cover for easy inspection
- Magnetic strip for underground detection
- Flapper and cover have elastomeric gasket to ensure watertight seal
- Stepped construction encourages flow (minimum 1/4" per foot fall)
- The 1-1/2", 2" and 6" have UPC, SBCCI and CSA listings
- The 3" and 4" are NSF and UPC listed

A	B	C	D
1/2"	2-3/16"	2"	4"
2"	2-7/16"	3-7/8"	4"
3"	3-7/8"	5-1/2"	6"
4"	5-3/8"	6-3/4"	8"
6"	7-3/4"	9-1/4"	10-3/4"

PVC

PART NO.	DESCRIPTION	CTN/MSTR
B04150	1-1/2" backwater valve	1/1
B04200	2" backwater valve	1/1
B04300	3" backwater valve	1/1
B04400	4" backwater valve	1/1
B04600	6" backwater valve	1/1

ABS

PART NO.	DESCRIPTION	CTN/MSTR
B05150	1-1/2" backwater valve	1/1
B05200	2" backwater valve	1/1
B05300	3" backwater valve	1/1
B05400	4" backwater valve	1/1
B05600	6" backwater valve	1/1



- Extension kit includes 16" sleeve, lid and adapter
- Sockets are Schedule 40 DWV
- Reduces backflow in drainage system
- Threaded access cover for easy inspection
- Magnetic strip for underground detection
- Flapper and cover have elastomeric gasket to ensure watertight seal
- Stepped construction encourages flow (minimum 1/4" per foot fall)
- The 1-1/2", 2" and 6" have UPC, SBCCI and CSA listings
- The 3" and 4" are NSF and UPC listed

ASSEMBLED IN
USA
UPC NSF

PVC

PART NO.	DESCRIPTION	CTN/MSTR
B04150K	1-1/2" with extension kit & CI lid	1/1
B04200K	2" with extension kit & CI lid	1/1
B04300K	3" with extension kit & CI lid	1/1
B04400K	4" with extension kit & CI lid	1/1
B04151K	1-1/2" with extension kit & plastic lid	1/1
B04201K	2" with extension kit & plastic lid	1/1
B04301K	3" with extension kit & plastic lid	1/1
B04401K	4" with extension kit & plastic lid	1/1

ABS

PART NO.	DESCRIPTION	CTN/MSTR
B05150K	1-1/2" with extension kit & CI lid	1/1
B05200K	2" with extension kit & CI lid	1/1
B05300K	3" with extension kit & CI lid	1/1
B05400K	4" with extension kit & CI lid	1/1

Flapper with Gasket for Backwater Valve



PART NO.	DESCRIPTION	CTN/MSTR
B04201	Fits 1-1/2" & 2" backwater valve	1/1
B04301	Fits 3" backwater valve	1/1
B04401	Fits 4" backwater valve	1/1

Extension Kit



- Kit includes lid, 16" sleeve, and adapter

ASSEMBLED IN
USA

PART NO.	DESCRIPTION	CTN/MSTR
B04303	3" complete kit with CI lid	1/1
B04403	4" complete kit with CI lid	1/1
B04304	3" complete kit with plastic lid	1/1
B04404	4" complete kit with plastic lid	1/1
BWV200	Ring adapter for 1-1/2" and 2"	1/1
BWV300	Ring adapter for 3"	1/1
BWV400	Ring adapter for 4"	1/1
B04006	6" CI lid for 3" (fits 6" pipe)	1/1
B04008	8" CI lid for 4" (fits 8" pipe)	1/1

Cover for PVC and ABS Pipe



- Covers 6" or 8" PVC and ABS pipe

PART NO.	DESCRIPTION	CTN/MSTR
B04007	6" cast iron lid marked "water" (fits 6" pipe)	1/1
B04006	6" cast iron lid marked "sewer" (fits 6" pipe)	1/1
B04008	8" cast iron lid "sewer" (fits 8" pipe)	1/1

Condensate Trap



- Manufactured of Schedule 40 DWV pipe
- One-piece design

PART NO.	DESCRIPTION	CTN/MSTR
P15050	1/2" p-trap	1/100
P15075	3/4" p-trap	1/100
P15175	3/4" mini p-trap	1/250
R15050	1/2" running trap	1/100
R15075	3/4" running trap	1/100

Items marked with the Jones Stephens logo are "You Need It... We Got It" Items.

Mushroom Vent Cap

Fits 3" or 4" Vent Stacks

ASSEMBLED IN
USA



- Gray PVC construction
- Includes three installation screws

PART NO.	DESCRIPTION	CTN/MSTR
M05034	3" x 4" mushroom vent cap	1/20

Flat Top Vent Cap

ASSEMBLED IN
USA



- White PVC construction
- Fits 3" and 4" vent stacks
- Includes 2 set screws for securing cap

PART NO.	DESCRIPTION	CTN/MSTR
M05134	Flat top vent cap	1/20

PVC Coupling

ASSEMBLED IN
USA



- Connects 4" Schedule 40 DWV pipe to 4" SDR

PART NO.	DESCRIPTION	CTN/MSTR
C67440	4" DWV x 4" SDR coupling	1/10

PVC Multi-Use Coupling

ASSEMBLED IN
USA



- Use to reduce or increase variety of sizes of Schedule 40 pipe

PART NO.	DESCRIPTION	CTN/MSTR
C67230	2" x 3" coupling	1/1
C67340	3" x 4" coupling	1/1

Spigot Adapter

ASSEMBLED IN
USA



PART NO.	DESCRIPTION	CTN/MSTR
C67445	4" DWV x 4" SDR spigot	1/1

Plastic Over-Fitting Repair Fitting

ASSEMBLED IN
USA



- More efficient and less costly way to handle many common PVC re-piping problems
- Available in 1-1/2", 2", 3" and 4" PVC
- Compatible with all fittings
- Raised lettering on hub actually helps seal chemical bond
- Glues over the hub of a fitting on one end and is a 1-1/2" or 2" hub on the other end

PVC

PART NO.	DESCRIPTION	CTN/MSTR
P22100	1-1/2" repair fitting	1/1
P22200	2" repair fitting	1/1
P22300	3" repair fitting	1/1

ABS

PART NO.	DESCRIPTION	CTN/MSTR
P22101	1-1/2" repair fitting	1/1
P22201	2" repair fitting	1/1

Roof Drain with Cast Iron Dome

Fits over Schedule 40 DWV Pipe

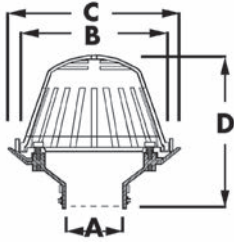

- Brass inserts in underside for underdeck clamps
- Dome has 50 square inches of free area

	A	B	C	D
Over 2" pipe		8-1/4"	11"	9"
Over 3" pipe		8-1/4"	11"	9"
Over 4" pipe		8-1/4"	11"	9"
Over 6" pipe		8-1/4"	11"	8"

PVC

PART NO.	DESCRIPTION	CTN/MSTR
R18001	2" cast iron dome	1/1
R18005	3" cast iron dome	1/1
R18006	4" cast iron dome	1/1
R18026	6" cast iron dome	1/1

E

ABS

PART NO.	DESCRIPTION	CTN/MSTR
R18009	2" cast iron dome	1/1
R18007	3" cast iron dome	1/1
R18008	4" cast iron dome	1/1

Accessories for Roof Drains



PART NO.	DESCRIPTION	CTN/MSTR
R18011	2", 3" & 4" underdeck clamp	1/1
R18028	6" underdeck clamp	1/10
R18012	16" plastic receiving pan	1/1
R18019	Plastic roof dome	1/1
R18020	Cast iron roof dome	1/1

Roof Drain with Plastic Dome

Fits over Schedule 40 DWV Pipe

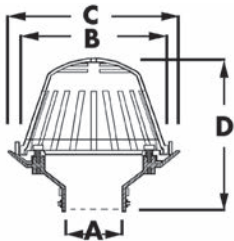

- Brass inserts in underside for underdeck clamps
- Dome has 50 square inches of free area

	A	B	C	D
Over 2" pipe		8-1/4"	11"	8"
Over 3" pipe		8-1/4"	11"	8"
Over 4" pipe		8-1/4"	11"	8"
Over 6" pipe		8-1/4"	11"	8"

PVC

PART NO.	DESCRIPTION	CTN/MSTR
R18013	2" plastic dome	1/1
R18014	3" plastic dome	1/1
R18015	4" plastic dome	1/1
R18027	6" plastic dome	1/1

ABS

PART NO.	DESCRIPTION	CTN/MSTR
R18016	2" plastic dome	1/1
R18017	3" plastic dome	1/1
R18018	4" plastic dome	1/1

CAST IRON

Closet Flanges and Accessories 239-240

Residential Shower/Floor Drains 241-243

Assembled Cast Iron Drains 244-248

Drain Bodies 249

Spuds and Strainers 250-251

General Purpose Drains..... 252-253

Assembled Cleanouts..... 254-257

Cleanout Bodies and Spuds..... 258-259

Cleanout Plugs 260-261

Cleanout Cover Plates..... 262

Bell Traps..... 263

Floor and Cesspool Drains/Grates 264

Service Sinks and Accessories 265

Roof Drains..... 266

Bar Grates/Sewer Strainers and Boxes 267

Vent Boxes/Caps/Backwater Valves 268

Test Tees and Closet Bends 269

Gas Burners/Log Lighter Valves/Accessories 270-271

F

*Published December 2019

Cast Iron Two Finger Flange



- Patent #: 5,937,450
- Flush fit
- Redesigned to fit oblong horns
- Made of cast iron
- Pushes easily into cast iron or Schedule 40 DWV pipe
- No tear out or caulking required
- ASTM C-564 rubber gasket
- 3" x 2", 4" x 2" and 4" x 3": for areas with the bend close to the flange
- 3" x 4", 4" x 4" and 4" x 6": for areas without the bend close to the flange or broken pipe



PART NO.	DESCRIPTION	CTN/MSTR
C47320	3" x 2" CI two finger flange	1/8
C47340	3" x 4" CI two finger flange	1/4
C47420	4" x 2" CI two finger flange	1/8
C47430	4" x 3" CI two finger flange	1/4
C47440	4" x 4" CI two finger flange	1/4
C47460	4" x 6" CI two finger flange	1/2

Inside Caulk Closet Flange



- Notched and slotted
- Inside caulk connection



Service Weight

PART NO.	DESCRIPTION	CTN/MSTR
C41410	4" x 1" inside caulk	1/10
C41411	4" x 1-1/2" inside caulk	1/10
C41420	4" x 2" inside caulk	1/8
C41421	4" x 2-1/2" inside caulk	1/8
C41430	4" x 3" inside caulk	1/6
C41440	4" x 4" inside caulk	1/4
C41460	4" x 6" inside caulk	1/2

Extra Heavy - 5" I.D. - NO BEAD

PART NO.	DESCRIPTION	CTN/MSTR
C42421	4" x 2-1/2" inside caulk	1/8
C42440	4" x 4" inside caulk	1/4
C42460	4" x 6" inside caulk	1/2

Inside Caulk Reducing Closet Flange



- Notched and slotted
- Inside caulk connection



PART NO.	DESCRIPTION	CTN/MSTR
C45433	4" inlet x 3" outlet x 3" depth	1/6

No Caulk Closet Flange with Test Cap



- Slotted
- Stainless bolts and washers

PART NO.	DESCRIPTION	CTN/MSTR
C40425	4" x 2" no caulk	1/8

Code Blue No Caulk Closet Flange



- Four stainless bolts and washers
- Neoprene gasket meets ASTM C564
- Ideal for both repair and new construction
- Easy to install- reduces installation time by 80%
- Push over cast iron or plastic pipe, anchor to floor and tighten bolts
- C40420, C40430, and C40440 are UPC listed



PART NO.	DESCRIPTION	CTN/MSTR
C40320	3" pipe x 2" depth	1/8
C40420	4" pipe x 2" depth	1/8
C40430	4" pipe x 3" depth	1/4
C40440	4" pipe x 4" depth	1/4

F

Code Blue No Caulk Closet Flange with Test Cap



- Cut out neoprene test cap
- Stainless steel bolts



PART NO.	DESCRIPTION	CTN/MSTR
C40500	4" x 2" no caulk	1/8
C40503	3" x 3" no caulk	1/8

No Hub Closet Flange



- Notched and slotted
- C46331 and C46451 are UPC listed



PART NO.	DESCRIPTION	CTN/MSTR
C46331	3" x 3-1/2" no hub	1/6
C46431	4" x 3-1/2" no hub	1/6
C46351	3" x 5-1/2" no hub	1/6
C46451	4" x 5-1/2" no hub	1/6

2" Offset Closet Flange



• IAPMO listed



PART NO.	DESCRIPTION	CTN/MSTR
C43440	4" x 4" x 2" inside caulk	1/4
C43441	4" x 4" x 2" no hub	1/4

Code Blue 1" Offset Closet Flange



• 5/16" bolt slots
• IAPMO listed



PART NO.	DESCRIPTION	CTN/MSTR
C40640	4" no caulk	1/4

F

Four Way Offset Closet Flange



• 1-1/2" offset
• Internal clip allows 360° offset capability

PART NO.	DESCRIPTION	CTN/MSTR
C44420	4 "x 2" inside caulk	1/8
C44440	4" x 4" inside caulk	1/4

Brass Closet Flange



PART NO.	DESCRIPTION	CTN/MSTR
C49440	14 oz.	1/50
C49441	Deep seal 1-1/8"	1/50
C49442	16 oz.	1/50

Brass Four Way Offset Closet Flange



• Clip allows four way 1-1/2" offset
• For use with lead bends

PART NO.	DESCRIPTION	CTN/MSTR
C49421	4" x 2" 4-way offset closet flange	1/40

Closet Flange Repair Ring



• Securely attaches to concrete or wood sub-floor
• Replaces most closet rings
• Corrosion resistant
• Mounting ears offset by 1/8" to allow closet bolts to be installed

PART NO.	DESCRIPTION	CTN/MSTR
C85000	Closet flange repair ring	20/80

Moss Bay Repair Flange



• For corroded and rusted toilet flanges
• Installs in minutes
• Galvanized

PART NO.	DESCRIPTION	CTN/MSTR
C85500	Moss bay repair flange	1/50

Gapper Flange



• Used to repair broken closet flanges
• Individually carded

PART NO.	DESCRIPTION	CTN/MSTR
C87100	Repair flange	24/240

Flange Support for Wood Floors



• Supports flange if floor has rotted or if rough-in hole is too large
• Easy to install- complete kit includes screws
• Made of steel
• Individually carded

PART NO.	DESCRIPTION	CTN/MSTR
C01001	Fits 3", 4", or 3"x4" plastic flange	1/50
C01002	Fits 3" or 4" cast iron flange	1/50

Items marked with the Jones Stephens logo are "You Need It... We Got It" Items.

Cast Iron Residential Shower/Floor Drains

Pages 241-243

SIZES: 1-1/2", 2"



For use in residential applications.

1-1/2" or 2" Code Blue EZ Test Shower Drain



- Includes cover plate and stainless steel screws
- Nipple not included
- D64012 and D64302 are UPC approved

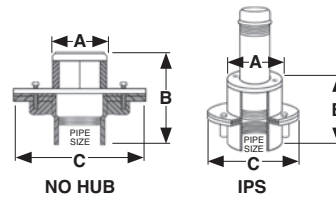

PIPE SIZE	A	B	C
1-1/2"	3-1/2"	4-1/4"	6"
2"	3-1/2"	4-1/4"	7"

PART NO.	SIZE	BASE	STRAINER	CTN/MSTR
D64150	1-1/2" IPS	6"	SS	1/4
D64202	2" IPS	6"	SS	1/4
D64012	2" IPS	7"	SS	1/4
D64302	2" no hub	6"	SS	1/4

2" Code Blue Shower Drain



- Includes cover plate and stainless steel screws
- No caulk includes built-in test plug
- D64002 and D64022 are UPC approved

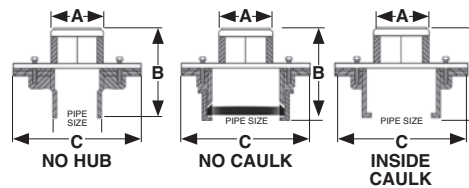

PIPE SIZE	A	B	C
2"	3-1/2"	4-1/4"	6"
2"	3-1/2"	4-1/4"	7"

PART NO.	SIZE	BASE	STRAINER	CTN/MSTR
D64502	2" no caulk	6"	SS	1/4
D64002	2" no caulk	7"	SS	1/4
D64022	2" no hub	7"	SS	1/4

2" Code Blue Roman Tub Drain



- 6" and 7" pans
- Non-adjustable

PART NO.	SIZE	BASE	FINISH	CTN/MSTR
D64800	2" IPS	7"	CP (PVD)	1/1
D64801	2" no caulk	7"	CP (PVD)	1/1
D64802	2" IPS	6"	CP (PVD)	1/1
D64803	2" no caulk	6"	CP (PVD)	1/1
D64804	2" IPS	7"	PB (PVD)	1/1
D64805	2" no caulk	7"	PB (PVD)	1/1
D64806	2" IPS	6"	PB (PVD)	1/1
D64807	2" no caulk	6"	PB (PVD)	1/1
D64808	2" IPS	7"	SN (PVD)	1/1
D64809	2" no caulk	7"	SN (PVD)	1/1
D64810	2" IPS	6"	SN (PVD)	1/1
D64811	2" no caulk	6"	SN (PVD)	1/1

Items marked with the Jones Stephens logo are "You Need It...We Got It" Items.

Code Blue Replacement Strainer



- Roman tub drains
- Fits non-adjustable Code Blue drains

PART NO.	DESCRIPTION	CTN/MSTR
D40000	CP strainer	1/50
D40001	PB (PVD) strainer	1/50
D40002	SN (PVD) strainer	1/50

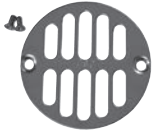

- Regular strainer
- Fits non-adjustable Code Blue drains
- Will not fit D64010 or D64011
- Includes screws

PART NO.	DESCRIPTION	CTN/MSTR
D64000	2" SS	1/50
D64401	2" SS crown	1/400
D64001	2" PB (PVD)	1/100
D6400BN	2" Brushed Nickel	1/250
D6400RB	2" Oil Rubbed Bronze	1/250
D6400WB	2" Old World Bronze	1/250

F

2" Code Blue Non-Adjustable Drain



- With ABS base and cast iron top

PART NO.	TOP	BASE	CTN/MSTR
D64010	Cast Iron	ABS base	1/8
D64011 (with test cap)	Cast Iron	ABS base	1/8

2" Shower/Floor Drain



- Brass spud
- 6-1/2" pan
- Tongue and groove cast iron bolt down clamping ring
- Weep holes on both top and bottom for secondary drainage
- Inside caulk unit can be used with gasket to make unit no-caulk

PART NO.	SIZE	STRAINER	CTN/MSTR
D60100	2" inside caulk	4" SS round	1/8
D60102	2" FIP	4" SS round	1/8
D60103	2" no hub	4" SS round	1/8
D60201	2" inside caulk	4" CP cast round	1/8
D60202	2" inside caulk	4" PB cast round	1/8
D60203	2" FIP	4" CP cast round	1/8
D60204	2" FIP	4" PB cast round	1/8
D60205	2" no hub	4" CP cast round	1/8
D60206	2" no hub	4" PB cast round	1/8
D60211	2" inside caulk	6" CP cast round	1/1
D60212	2" inside caulk	6" PB cast round	1/1
D60207	2" FIP	6" CP cast round	1/1
D60208	2" FIP	6" PB cast round	1/1
D60209	2" no hub	6" CP cast round	1/1
D60210	2" no hub	6" PB cast round	1/1
D60400	2" inside caulk	4" CP cast square	1/1
D60410	2" inside caulk	4" PB cast square	1/1
D60402	2" FIP	4" CP cast square	1/1
D60412	2" FIP	4" PB cast square	1/1
D60403	2" no hub	4" CP cast square	1/1
D60413	2" no hub	4" PB cast square	1/1
D60499	2" inside caulk push on	4" CP cast square	1/1
D60498	2" inside caulk push on	4" PB cast square	1/1
D60101	2" gasket for inside caulk unit	—	1/1

Items marked with the Jones Stephens logo are "You Need It... We Got It" Items.

2" Shower Drain with Brass Spud and Brass Threaded Clamping Ring



- Brass spud
- 6-1/2" pan
- Designed for lead pan showers
- Weep holes in clamping ring

PART NO.	SIZE	STRAINER	CTN/MSTR
D61101	2" IPS	4" SS round	1/4
D61102	2" no hub	4" SS round	1/4
D61103	2" inside caulk	4" SS round	1/4
D61201	2" IPS	4" CP cast brass round	1/4
D61202	2" no hub	4" CP cast brass round	1/4
D61203	2" inside caulk	4" CP cast brass round	1/4
D61301	2" IPS	6" PB cast brass round	1/4
D61302	2" no hub	6" PB cast brass round	1/4
D61303	2" inside caulk	6" PB cast brass round	1/4
D61850	Brass screw-down clamping ring	—	1/1

2" Shower Drain Base with Clamping Ring and Bolts



- 6-1/2" pan; 2-1/2" height
- Tongue and groove cast iron bolt down clamping ring
- Weep holes on both top and bottom for secondary drainage
- Inside caulk unit can be used with gasket to make unit no caulk
- For 2" IPS threaded tailpieces

PART NO.	SIZE	HEIGHT	CTN/MSTR
D60900	2" inside caulk	2-1/2"	1/1
D60901	2" FIP	2-1/2"	1/1
D60902	2" no hub	2-1/2"	1/1

2" Shower Drain Base with Brass Threaded Clamping Ring



- 6-3/8" pan; 3-1/4" height
- Designed for lead pan showers
- Weep holes in clamping ring
- For 2" IPS threaded tailpieces

PART NO.	SIZE	HEIGHT	CTN/MSTR
D61800	2" FIP	3-1/4"	1/1

F

Cast Iron Commercial Drains

Pages 244-248

F

SIZES: 2", 3", 4"



For use in commercial applications.

2" Code Blue No Caulk (Mechanical Joint) Floor Drain



- 1/2" Primer tapped with brass plug
- Supplied with stainless steel bolts
- D66500, D66501, D66502, D66503, d66504, D66505, D66509, D66510, D66511, and D66512 are UPC listed

PART NO.	PAN	STRAINER	HEIGHT	CTN/MSTR
D65661	7"	4" NB round	4" - 4-13/16"	1/1
D65662	7"	4" PB round	4" - 4-13/16"	1/1
D66681	9"	4" NB round	4" - 4-13/16"	1/1
D66682	9"	4" PB round	4" - 4-13/16"	1/1
D65500	7"	5" NB round	4" - 5"	1/1
D65501	7"	5" PB round	4" - 5"	1/1
D65502	7"	5" CP round	4" - 5"	1/1
D66500	9"	5" NB round	4" - 5"	1/1
D66501	9"	5" PB round	4" - 5"	1/1
D66502	9"	5" CP round	4" - 5"	1/1
D65503	7"	6" NB round	4-1/4" - 5-1/4"	1/1
D65504	7"	6" PB round	4-1/4" - 5-1/4"	1/1
D65505	7"	6" CP round	4-1/4" - 5-1/4"	1/1
D66503	9"	6" NB round	4-1/4" - 5-1/4"	1/1
D66504	9"	6" PB round	4-1/4" - 5-1/4"	1/1
D66505	9"	6" CP round	4-1/4" - 5-1/4"	1/1
D65509	7"	5" NB square	4-1/4" - 5-1/4"	1/1
D65511	7"	5" PB square	4-1/4" - 5-1/4"	1/1
D66509	9"	5" NB square	4-1/4" - 5-1/4"	1/1
D66511	9"	5" PB square	4-1/4" - 5-1/4"	1/1
D65510	7"	6" NB square	4-1/4" - 5-1/4"	1/1
D65512	7"	6" PB square	4-1/4" - 5-1/4"	1/1
D66510	9"	6" NB square	4-1/4" - 5-1/4"	1/1
D66512	9"	6" PB square	4-1/4" - 5-1/4"	1/1

2" Code Blue (Mechanical Joint) No Caulk Slab Drain



- 1/2" Primer tapped with brass plug
- No clamping ring

PART NO.	PAN	STRAINER	HEIGHT	CTN/MSTR
D67001	7"	4" NB round	3-3/4" - 4-3/4"	1/1
D67002	7"	4" PB round	3-3/4" - 4-3/4"	1/1
D67003	7"	5" NB round	3-3/4" - 4-7/8"	1/1
D67004	7"	5" PB round	4" - 5-3/8"	1/1
D67005	7"	5" CP round	3-1/2" - 4-7/8"	1/1
D67006	7"	6" NB round	3-3/4" - 5-1/8"	1/1
D67007	7"	6" PB round	3-3/4" - 5-1/8"	1/1
D67008	7"	6" CP round	4" - 5-1/2"	1/1

2" Code Blue No Hub Floor Drain

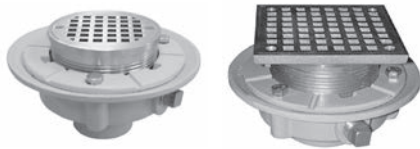

- 1/2" Primer tapped with brass plug
- Supplied with stainless steel bolts
- D66675, D66676, D65655, and D65656 are not UPC listed

3 1/2" IPS Spud with 4", 5" or 6" Round Strainer

PART NO.	PAN	STRAINER	HEIGHT	CTN/MSTR
D66675	9"	4" NB round	3-3/4" - 4-5/8"	1/1
D66676	9"	4" PB round	3-3/4" - 4-5/8"	1/1
D65655	7"	4" NB round	3-3/4" - 4-7/16"	1/1
D65656	7"	4" PB round	3-3/4" - 4-7/16"	1/1
D65560	7"	5" NB round	2-7/8" - 4-1/2"	1/1
D65561	7"	5" PB round	2-7/8" - 4-1/2"	1/1
D65562	7"	5" CP round	2-7/8" - 4-1/2"	1/1
D66560	9"	5" NB round	3-1/2" - 5-1/8"	1/1
D66561	9"	5" PB round	3-1/2" - 5-1/8"	1/1
D66562	9"	5" CP round	3-1/2" - 5-1/8"	1/1
D65563	7"	6" NB round	4" - 5-1/4"	1/1
D65564	7"	6" PB round	4" - 5-1/4"	1/1
D65565	7"	6" CP round	4" - 5-1/4"	1/1
D66563	9"	6" NB round	3-5/8" - 5-5/8"	1/1
D66564	9"	6" PB round	3-5/8" - 5-5/8"	1/1
D66565	9"	6" CP round	3-5/8" - 5-5/8"	1/1
D65569	7"	5" NB square	3-1/4" - 5-1/4"	1/1
D65571	7"	5" PB square	3-1/4" - 5-1/4"	1/1
D66569	9"	5" NB square	3-7/8" - 5-7/8"	1/1
D66571	9"	5" PB square	3-7/8" - 5-7/8"	1/1
D65570	7"	6" NB square	4" - 5-1/4"	1/1
D65572	7"	6" PB square	4" - 5-1/4"	1/1
D66570	9"	6" NB square	4-1/8" - 6-3/8"	1/1
D66572	9"	6" PB square	4-1/8" - 6-3/8"	1/1

2" Code Blue No Hub Slab Drain



- 1/2" Primer tapped with brass plug
- No clamping ring

PART NO.	PAN	STRAINER	HEIGHT	CTN/MSTR
D67016	7"	4" NB round	3-5/8" - 4-3/4"	1/1
D67017	7"	4" PB round	3-5/8" - 4-3/4"	1/1
D67018	7"	5" NB round	3-1/2" - 4-7/8"	1/1
D67019	7"	5" PB round	4" - 5-3/8"	1/1
D67020	7"	5" CP round	3-1/2" - 4-7/8"	1/1
D67021	7"	6" NB round	3-7/8" - 5"	1/1
D67022	7"	6" PB round	3-3/4" - 5"	1/1
D67023	7"	6" CP round	4" - 5-3/8"	1/1
D67027	7"	5" NB square	3-3/4" - 5-1/8"	1/1
D67028	7"	5" PB square	3-3/4" - 5-1/8"	1/1
D67029	7"	6" NB square	4" - 5-3/16"	1/1
D67030	7"	6" PB square	4" - 5-3/16"	1/1

2" Code Blue IPS Floor Drain



- 1/2" Primer tapped with brass plug
- Supplied with stainless steel bolts
- D66687, D66688, and D65665 are not UPC listed

PART NO.	PAN	STRAINER	HEIGHT	CTN/MSTR
D66687	9"	4" NB round	3-1/4" - 4"	1/1
D66688	9"	4" PB round	3-1/4" - 4"	1/1
D65665	7"	4" NB round	3-3/16" - 4-3/16"	1/1
D65620	7"	5" NB round	2-7/8" - 4-1/2"	1/1
D65621	7"	5" PB round	2-7/8" - 4-1/2"	1/1
D65622	7"	5" CP round	2-7/8" - 4-1/2"	1/1
D66620	9"	5" NB round	3-1/2" - 5-1/8"	1/1
D66621	9"	5" PB round	3-1/2" - 5-1/8"	1/1
D66622	9"	5" CP round	3-1/2" - 5-1/8"	1/1
D65623	7"	6" NB round	3-1/2" - 4-1/2"	1/1
D65624	7"	6" PB round	3-1/2" - 4-1/2"	1/1
D65625	7"	6" CP round	3-1/2" - 4-1/2"	1/1
D66623	9"	6" NB round	3-5/8" - 5-5/8"	1/1
D66624	9"	6" PB round	3-5/8" - 5-5/8"	1/1
D66625	9"	6" CP round	3-5/8" - 5-5/8"	1/1

2" Code Blue Push-On Floor Drain



- 1/2" Primer tapped with brass plug
- With clamping ring
- Supplied with V96002 gasket for 2" cast iron pipe

PART NO.	PAN	STRAINER	HEIGHT	CTN/MSTR
D66700	9"	4" NB round	4-5/8" - 5-1/2"	1/1
D66701	9"	4" PB round	4-5/8" - 5-1/2"	1/1
D66702	9"	5" NB round	4-5/8" - 5-1/2"	1/1
D66703	9"	5" PB round	5-3/16" - 6-1/8"	1/1
D66704	9"	5" CP round	4-3/4" - 5-1/2"	1/1
D66705	9"	6" NB round	4-7/8" - 5-3/4"	1/1
D66706	9"	6" PB round	4-7/8" - 5-3/4"	1/1
D66707	9"	6" CP round	5-1/4" - 6-1/4"	1/1

2" Bronze Shower Drain



- Heavy bronze body
- Suitable for residential and commercial installation
- 4-1/2" strainers in stainless steel or PVD polished brass
- Solid bronze strainer spuds in standard (1-1/2") or long pattern (2-1/2") length

2" IPS Drain

PART NO.	SPUD	STRAINER	CTN/MSTR
D68510	Standard	4-1/2" SS round	1/1
D68511	Standard	4-1/2" PB (PVD) round	1/1
D68512	Long pattern	4-1/2" SS round	1/1
D68513	Long pattern	4-1/2" PB (PVD) round	1/1

2" Sweat Drain

PART NO.	SPUD	STRAINER	CTN/MSTR
D68710	Standard	4-1/2" SS round	1/1
D68711	Standard	4-1/2" PB (PVD) round	1/1
D68712	Long pattern	4-1/2" SS round	1/1
D68713	Long pattern	4-1/2" PB (PVD) round	1/1

Replacement Strainers

PART NO.	DESCRIPTION	CTN/MSTR
D68507	4 1/2" SS strainer with screws	100/400
D68508	4 1/2" (PVD) PB strainer with screws	100/400

3" Heavy Duty No Hub Floor/Shower Drain



- Cast metal strainer and spud
- Cast iron body

PART NO.	PAN	STRAINER	HEIGHT	CTN/MSTR
D80200	10"	5" CP round	4-1/2"- 6-1/2"	1/1
D80201	10"	5" PB round	4-1/2"- 6-1/2"	1/1
D80212	10"	5" NB round	4-1/2"- 6-1/2"	1/1
D80202	10"	6" CP round	4-1/2"- 6-1/2"	1/1
D80203	10"	6" PB round	4-1/2"- 6-1/2"	1/1
D80213	10"	6" NB round	4-1/2"- 6-1/2"	1/1
D80214	10"	5" PB square	4-1/2"- 6-1/2"	1/1
D80216	10"	5" NB square	4-1/2"- 6-1/2"	1/1
D80215	10"	6" PB square	4-1/2"- 6-1/2"	1/1
D80217	10"	6" NB square	4-1/2"- 6-1/2"	1/1

3" Heavy Duty Inside Caulk Floor/Shower Drain



- Cast metal strainer and spud
- Cast iron body

PART NO.	PAN	STRAINER	HEIGHT	CTN/MSTR
D80100	10"	5" CP round	4-1/2"- 6-1/2"	1/1
D80101	10"	5" PB round	4-1/2"- 6-1/2"	1/1
D80112	10"	5" NB round	4-1/2"- 6-1/2"	1/1
D80102	10"	6" CP round	4-3/4"- 6-3/4"	1/1
D80103	10"	6" PB round	4-3/4"- 6-3/4"	1/1
D80113	10"	6" NB round	4-3/4"- 6-3/4"	1/1

3" Code Blue No Caulk (Mechanical Joint) Floor Drain



- 1/2" Primer tapped with brass plug
- Supplied with stainless steel bolts
- D66683, D66684, D65663, and D65664 are not UPC listed

PART NO.	PAN	STRAINER	HEIGHT	CTN/MSTR
D66683	9"	4" NB round	4"- 4-3/4"	1/1
D66684	9"	4" PB round	4"- 4-3/4"	1/1
D65663	7"	4" NB round	4"- 4-13/16"	1/1
D65664	7"	4" PB round	4"- 4-13/16"	1/1
D65520	7"	5" NB round	2-7/8"- 4-1/2"	1/1
D65521	7"	5" PB round	2-7/8"- 4-1/2"	1/1
D65522	7"	5" CP round	2-7/8"- 4-1/2"	1/1
D66520	9"	5" NB round	3-1/2"- 5-1/8"	1/1
D66521	9"	5" PB round	3-1/2"- 5-1/8"	1/1
D66522	9"	5" CP round	3-1/2"- 5-1/8"	1/1
D65523	7"	6" NB round	3"- 5"	1/1
D65524	7"	6" PB round	3"- 5"	1/1
D65525	7"	6" CP round	3"- 5"	1/1
D66523	9"	6" NB round	3-5/8"- 5-5/8"	1/1
D66524	9"	6" PB round	3-5/8"- 5-5/8"	1/1
D66525	9"	6" CP round	3-5/8"- 5-5/8"	1/1

3" Code Blue No Hub Slab Drain



- 1/2" Primer tapped with brass plug
- No clamping ring

PART NO.	PAN	STRAINER	HEIGHT	CTN/MSTR
D67031	7"	4" NB round	3-1/2"- 4-3/4"	1/1
D67032	7"	4" PB round	3-1/2"- 4-3/4"	1/1
D67033	7"	5" NB round	3-1/2"- 4-13/16"	1/1
D67034	7"	5" PB round	4"- 5-5/16"	1/1
D67035	7"	5" CP round	3-1/2"- 4-13/16"	1/1
D67036	7"	6" NB round	3-3/4"- 5"	1/1
D67037	7"	6" PB round	3-3/4"- 5"	1/1
D67038	7"	6" CP round	4"- 5-3/8"	1/1
D67039	7"	8" NB round	4-1/8"- 5-5/8"	1/1
D67040	7"	8" PB round	4-1/8"- 5-5/8"	1/1
D67042	7"	9" NB round	4-1/4"- 5-5/8"	1/1
D67043	7"	9" PB round	4-1/4"- 5-5/8"	1/1
D67044	7"	5" NB square	3-3/4"- 5-1/16"	1/1
D67045	7"	5" PB square	3-7/8"- 5-1/16"	1/1
D67046	7"	6" NB square	4"- 5-1/4"	1/1
D67047	7"	6" PB square	4"- 5-1/4"	1/1

3" Code Blue No Hub Floor Drain



- 1/2" Primer tapped with brass plug
- Supplied with stainless steel bolts
- D65657, D65658, D66677, and D66678 are not UPC listed



PART NO.	PAN	STRAINER	HEIGHT	CTN/MSTR
D65657	7"	4" NB round	3-3/4"- 4-7/16"	1/1
D65658	7"	4" PB round	3-3/4"- 4-7/16"	1/1
D66677	9"	4" NB round	3-3/4"- 4-5/8"	1/1
D66678	9"	4" PB round	3-3/4"- 4-5/8"	1/1
D65580	7"	5" NB round	2-7/8"- 4-1/2"	1/1
D65581	7"	5" PB round	2-7/8"- 4-1/2"	1/1
D65582	7"	5" CP round	2-7/8"- 4-1/2"	1/1
D66580	9"	5" NB round	3-1/2"- 5-1/8"	1/1
D66581	9"	5" PB round	3-1/2"- 5-1/8"	1/1
D66582	9"	5" CP round	3-1/2"- 5-1/8"	1/1
D65583	7"	6" NB round	3"- 5"	1/1
D65584	7"	6" PB round	3"- 5"	1/1
D65585	7"	6" CP round	3"- 5"	1/1
D66583	9"	6" NB round	3-5/8"- 5-5/8"	1/1
D66584	9"	6" PB round	3-5/8"- 5-5/8"	1/1
D66585	9"	6" CP round	3-5/8"- 5-5/8"	1/1

Items marked with the Jones Stephens logo are "You Need It...We Got It" Items.

3" Code Blue IPS Floor Drain



- 1/2" Primer tapped with brass plug
- Supplied with stainless steel bolts
- D66689, D66690, D65667, and D65668 are not UPC listed



PART NO.	PAN	STRAINER	HEIGHT	CTN/MSTR
D66689	9"	4" NB round	3-1/4" x 4"	1/1
D66690	9"	4" PB round	3-1/4" x 4"	1/1
D65667	7"	4" NB round	3-3/16"- 4-13/16"	1/1
D65668	7"	4" PB round	3-3/16"- 4-13/16"	1/1
D65640	7"	5" NB round	2-7/8"- 4-1/2"	1/1
D65641	7"	5" PB round	2-7/8"- 4-1/2"	1/1
D65642	7"	5" CP round	2-7/8"- 4-1/2"	1/1
D66640	9"	5" NB round	3-1/2"- 5-1/8"	1/1
D66641	9"	5" PB round	3-1/2"- 5-1/8"	1/1
D66642	9"	5" CP round	3-1/2"- 5-1/8"	1/1
D65643	7"	6" NB round	3"- 5"	1/1
D65644	7"	6" PB round	3"- 5"	1/1
D65645	7"	6" CP round	3"- 5"	1/1
D66643	9"	6" NB round	3-5/8"- 5-5/8"	1/1
D66644	9"	6" PB round	3-5/8"- 5-5/8"	1/1
D66645	9"	6" CP round	3-5/8"- 5-5/8"	1/1

4" Heavy Duty No Hub Floor/Shower Drain



- Cast metal strainer and tailpiece
- Cast iron body

PART NO.	PAN	STRAINER	HEIGHT	CTN/MSTR
D80206	10"	5" CP round	4-1/2"- 6-1/2"	1/1
D80207	10"	5" PB round	4-1/2"- 6-1/2"	1/1
D80218	10"	5" NB round	4-1/2"- 6-1/2"	1/1
D80209	10"	6" PB round	4-3/4"- 6-3/4"	1/1
D80219	10"	6" NB round	4-3/4"- 6-3/4"	1/1
D80211	10"	8" PB round	5"- 7"	1/1
D80220	10"	5" PB square	4-1/2"- 6-1/2"	1/1
D80222	10"	5" NB square	4-1/2"- 6-1/2"	1/1
D80221	10"	6" PB square	4-3/4"- 6-3/4"	1/1
D80223	10"	6" NB square	4-3/4"- 6-3/4"	1/1

4" Heavy Duty Inside Caulk Floor/Shower Drain



- Cast metal strainer and tailpiece
- Cast iron body

PART NO.	PAN	STRAINER	HEIGHT	CTN/MSTR
D80106	10"	5" CP round	4-1/2"- 6-1/2"	1/1
D80107	10"	5" PB round	4-1/2"- 6-1/2"	1/1
D80118	10"	5" NB round	4-1/2"- 6-1/2"	1/1
D80108	10"	6" CP round	4-3/4"- 6-3/4"	1/1
D80109	10"	6" PB round	4-3/4"- 6-3/4"	1/1
D80119	10"	6" NB round	4-3/4"- 6-3/4"	1/1

4" Code Blue No Caulk (Mechanical Joint) Floor Drain



- 1/2" Primer tapped with brass plug
- Supplied with stainless steel bolts
- D66685 and D66686 are not UPC listed



PART NO.	PAN	STRAINER	HEIGHT	CTN/MSTR
D66685	9"	4" NB round	4" - 4-7/8"	1/1
D66686	9"	4" PB round	4" - 4-7/8"	1/1
D66540	9"	5" NB round	3-1/2" - 5-1/8"	1/1
D66541	9"	5" PB round	3-1/2" - 5-1/8"	1/1
D66542	9"	5" CP round	3-1/2" - 5-1/8"	1/1
D66543	9"	6" NB round	3-5/8" - 5-5/8"	1/1
D66544	9"	6" PB round	3-5/8" - 5-5/8"	1/1
D66545	9"	6" CP round	3-5/8" - 5-5/8"	1/1

4" Code Blue No Hub Slab Drain



- 1/2" Primer tapped with brass plug
- No clamping ring

PART NO.	PAN	STRAINER	HEIGHT	CTN/MSTR
D67048	7"	4" NB round	3-5/8" - 4-7/8"	1/1
D67049	7"	4" PB round	3-5/8" - 4-7/8"	1/1
D67050	7"	5" NB round	3-5/8" - 4-7/8"	1/1
D67051	7"	5" PB round	4" - 5-3/8"	1/1
D67052	7"	5" CP round	3-1/2" - 4-7/8"	1/1
D67053	7"	6" NB round	3-7/8" - 5-1/16"	1/1
D67054	7"	6" PB round	3-3/4" - 5-1/16"	1/1
D67055	7"	6" CP round	4" - 5-1/2"	1/1

4" Code Blue IPS Floor Drain



- 1/2" Primer tapped with brass plug
- Supplied with stainless steel bolts
- D66691 and D66692 are not UPC listed



PART NO.	PAN	STRAINER	HEIGHT	CTN/MSTR
D66691	9"	4" NB round	3-1/4" - 4"	1/1
D66692	9"	4" PB round	3-1/4" - 4"	1/1
D66660	9"	5" NB round	3-1/2" - 5 1/8"	1/1
D66661	9"	5" PB round	3-1/2" - 5-1/8"	1/1
D66662	9"	5" CP round	3-1/2" - 5-1/8"	1/1
D66663	9"	6" NB round	3-5/8" - 5-5/8"	1/1
D66664	9"	6" PB round	3-5/8" - 5-5/8"	1/1
D66665	9"	6" CP round	3-5/8" - 5-5/8"	1/1

4" Code Blue Push-On Floor Drain



- 1/2" Primer tapped with brass plug
- With clamping ring
- Supplied with V96004 gasket for 4" cast iron pipe

PART NO.	PAN	STRAINER	HEIGHT	CTN/MSTR
D66732	9"	4" NB round	4-3/4" - 5-1/2"	1/1
D66733	9"	4" PB round	4-3/4" - 5-1/2"	1/1
D66734	9"	5" NB round	4-3/4" - 5-5/8"	1/1
D66735	9"	5" PB round	5-1/4" - 6-3/16"	1/1
D66736	9"	5" CP round	4-3/4" - 5-5/8"	1/1
D66737	9"	6" NB round	5" - 6-1/8"	1/1
D66738	9"	6" PB round	5" - 6-1/8"	1/1
D66739	9"	6" CP round	5-3/8" - 6-3/8"	1/1

4" Code Blue No Hub Floor Drain



- 1/2" Primer tapped with brass plug
- Supplied with stainless steel bolts
- D66679, D66680, and D65659 are not UPC listed



PART NO.	PAN	STRAINER	HEIGHT	CTN/MSTR
D66679	9"	4" NB round	3-3/8" - 4-5/8"	1/1
D66680	9"	4" PB round	3-3/8" - 4-5/8"	1/1
D65659	7"	4" NB round	3-3/4" - 4-7/16"	1/1
D65660	7"	4" PB round	3-3/4" - 4-7/16"	1/1
D65600	7"	5" NB round	3-1/2" - 4-3/4"	1/1
D65601	7"	5" PB round	3-1/2" - 4-3/4"	1/1
D65602	7"	5" CP round	3-1/2" - 4-3/4"	1/1
D66600	9"	5" NB round	3-1/2" - 4-3/4"	1/1
D66601	9"	5" PB round	3-1/2" - 4-3/4"	1/1
D66602	9"	5" CP round	3-1/2" - 4-3/4"	1/1
D65603	7"	6" NB round	3-3/4" - 5"	1/1
D65604	7"	6" PB round	3-3/4" - 5"	1/1
D65605	7"	6" CP round	3-3/4" - 5"	1/1
D66603	9"	6" NB round	3-3/4" - 5"	1/1
D66604	9"	6" PB round	3-3/4" - 5"	1/1
D66605	9"	6" CP round	3-3/4" - 5"	1/1

Cast Iron Commercial Drain Components

Pages 249-251

SIZES: 2", 3", 3-1/2", 4"



For use in
commercial applications.

Heavy Duty Drain Base



- 1/2" Primer tapped with brass plug
- For use with heavy duty floor drains
- For 3-1/2" IPS threaded tailpieces

PART NO.	SIZE	PAN	HEIGHT	CTN/MSTR
D80097	3" no hub	10-1/2"	3-1/2"	1/1
D80099	3" inside caulk	10-1/2"	3-1/2"	1/1
D80090	3" no hub; 1/2 PT	10-1/2"	3-1/2"	1/1
D80096	4" no hub	10-1/2"	3-1/2"	1/1
D80098	4" inside caulk	10-1/2"	3-1/2"	1/1
D80091	4" no hub; 1/2 PT	10-1/2"	3-1/2"	1/1

Code Blue No Caulk (Mechanical Joint) Drain Base



- Tapped for 3-1/2" spud
- 1/2" Primer tapped with brass plug
- Supplied with stainless steel bolts
- Test plug included
- D65002 is not UPC listed



PART NO.	SIZE	PAN	SPUD	HEIGHT	CTN/MSTR
D65002	2"	7"	3-1/2"	2-1/2"	1/1
D66002	2"	9"	3-1/2"	3-1/8"	1/1
D65003	3"	7"	3-1/2"	2-1/2"	1/1
D66003	3"	9"	3-1/2"	3-1/8"	1/1
D66004	4"	9"	3-1/2"	3-1/8"	1/1

F

Code Blue No Hub Drain Base



- Tapped for 3-1/2" spud
- 1/2" Primer tapped with brass plug
- Supplied with stainless steel bolts
- UPC listed



PART NO.	SIZE	PAN	SPUD	HEIGHT	CTN/MSTR
D65102	2"	7"	3-1/2"	2-1/2"	1/1
D66102	2"	9"	3-1/2"	3-1/8"	1/1
D65103	3"	7"	3-1/2"	2-1/2"	1/1
D66103	3"	9"	3-1/2"	3-1/4"	1/1
D65104	4"	7"	3-1/2"	2-1/2"	1/1
D66104	4"	9"	3-1/2"	3-1/8"	1/1

Code Blue IPS Drain Base



- Tapped for 3-1/2" spud
- 1/2" Primer tapped with brass plug
- Supplied with stainless steel bolts
- UPC listed



PART NO.	SIZE	PAN	SPUD	HEIGHT	CTN/MSTR
D65202	2" IPS	7"	3-1/2"	2-1/2"	1/1
D66202	2" IPS	9"	3-1/2"	3-1/8"	1/1
D65203	3" IPS	7"	3-1/2"	2-1/2"	1/1
D66203	3" IPS	9"	3-1/2"	3-1/8"	1/1
D66204	4" IPS	9"	3-1/2"	3-1/8"	1/1

Code Blue No Caulk (Mechanical Joint) Slab Drain Base



- 1/2" primer tap with brass plug
- Less clamping ring
- Tapped for 3-1/2" spud

PART NO.	SIZE	PAN	SPUD	HEIGHT	CTN/MSTR
D67201	2"	7"	3-1/2"	3-3/8"	1/1

Code Blue No Hub Slab Drain Base



- 1/2" primer tap with brass plug
- Less clamping ring
- Tapped for 3-1/2" spud

PART NO.	SIZE	PAN	SPUD	HEIGHT	CTN/MSTR
D67200	2"	7"	3-1/2"	3-3/8"	1/1
D67300	3"	7"	3-1/2"	3-3/8"	1/1
D67400	4"	7"	3-1/2"	3-3/8"	1/1

Code Blue Push-On Drain Base

F



- 1/2" primer tapped with brass plug
- Tapped for 3-1/2" spud
- Supplied with stainless steel bolts
- For PVC connections, you must replace with extra heavy Dual Tite gaskets

PART NO.	SIZE	PAN	SPUD	HEIGHT	CTN/MSTR
D66200	2"	9"	3-1/2"	3-3/4"	1/1
D66400	4"	9"	3-1/2"	3-3/4"	1/1

No Hub Base



- Use with CI strainers or covers for heavy trucking traffic
- Use with PB, NB, SS or CP strainers or covers for heavy pedestrian traffic

NOTE: 3" No hub will receive a 2" multi-tite gasket and therefore becomes a 2" push-on body. 4" No hub will receive a 3" multi-tite gasket.

PART NO.	NO HUB BASE x SPUD	HEIGHT	CTN/MSTR
D63300	3"x 3" IPS	4-1/4"	1/1
D63349	3"x 3-1/2" IPS	4-1/4"	1/1
D63350	4"X 3-1/2" IPS	4-1/4"	1/1
D63400	4"x 4" IPS	4-1/4"	1/1

Gasket Connection Base



- Supplied with Multi-Tite gasket
- Use with CI strainers or covers for heavy trucking traffic
- Use with PB, NB, SS or CP strainers or covers for heavy pedestrian traffic

PART NO.	S.V. BASE x SPUD	HEIGHT	CTN/MSTR
D62300	3"x 3" IPS	5-1/4"	1/1
D62349	3"x 3-1/2"IPS	5-1/4"	1/1
D62350	4"x 3-1/2" IPS	5-1/2"	1/1
D62400	4"x 4" IPS	5-1/2"	1/1

3-1/2" Spud Extension



- 2-1/2"-4" extension for a 3-1/2 drain/cleanout spud
- Use on cast iron or PVC drain bodies when additional height is needed to offset inconsistent concrete pours

PART NO.	DESCRIPTION	CTN/MSTR
D60979	3-1/2" spud extension	1/1

Cast Iron Spud with Round Strainer for Heavy Duty Drain Base



- For use with heavy duty floor drains

2-1/2" IPS Threaded Throat for Testing with Round Strainer

PART NO.	SPUD	STRAINER	CTN/MSTR
D62130	3" IPS	4-9/16" CI round	1/1
D62131	3" IPS	5" NB round with ring	1/1
D62132	3" IPS	5" PB round with ring	1/1

3" IPS Threaded Throat for Testing with Round Strainer

PART NO.	SPUD	STRAINER	CTN/MSTR
D62135	3-1/2" IPS	5-1/2" CI round	1/1
D62136	3-1/2" IPS	6" NB round with ring	1/1
D62137	3-1/2" IPS	6" PB round with ring	1/1

3-1/2" IPS Threaded Throat for Testing with Round Strainer

PART NO.	SPUD	STRAINER	CTN/MSTR
D62140	4" IPS	5-1/2" CI round	1/1
D62141	4" IPS	6" NB round with ring	1/1
D62142	4" IPS	6" PB round with ring	1/1

Plastic Spud with Square Top and Round Strainer for Heavy Duty Drain Base



- For use with heavy duty floor drains
- 5" round cover with 7" square top

PART NO.	IPS	STRAINER	CTN/MSTR
D56501	3"	5" NB round with square top	1/1
D56503	3-1/2"	5" NB round with square top	1/1
D56505	4"	5" NB round with square top	1/1

3-1/2" Metal Spud with Round Strainer



• For use with floor drains

PART NO.	IPS	STRAINER	CTN/MSTR
D60986	3-1/2"	4" NB round	1/40
D60987	3-1/2"	4" PB round	1/40
Replacement Strainer			
PART NO.	DESCRIPTION	CTN/MSTR	
D60966	Replacement strainer for D60986	1/50	
D60967	Replacement strainer for D60987	1/100	

3-1/2" Metal Spud with Square Strainer



• For use with floor drains



PART NO.	IPS	STRAINER	SCREWS	CTN/MSTR
D60954	3-1/2"	5" CP square	4 (3-7/8")	1/20
D60960	3-1/2"	5" PB square	4 (3-7/8")	1/20
D60962	3-1/2"	5" NB square	4 (3-7/8")	1/20
D60961	3-1/2"	6" PB square	4 (4-7/8")	1/12
D60963	3-1/2"	6" NB square	4 (4-7/8")	1/12

Metal Spud with Round Strainer



• For use with shower/ floor drains
 • D60990, D60991, D60996, D60997, D60992, D60993, D60995, D60998, D60989, and D60999 are UPC listed



PART NO.	IPS	STRAINER	SCREWS	CTN/MSTR
D60980	2"	4" SS stamped	2 (3-3/8")	1/50
D60981	2"	4" Chrome cast	2 (3-3/8")	1/50
D60982	2"	4" PB cast	2 (3-3/8")	1/50
D60970	2"	6" CP	2 (5")	1/30
D60975	2"	6" PB	2 (5")	1/30
D60955	2"	5" NB	3 (3-7/8")	1/30
D60956	3"	5" PB	3 (3-7/8")	1/30
D60986	3-1/2"	4" NB	2 (3-1/4")	1/40
D60987	3-1/2"	4" PB	2 (3-1/4")	1/40
D60990	3-1/2"	5" CP	3 (3-7/8")	1/40
D60991	3-1/2"	5" PB	3 (3-7/8")	1/40
D60996	3-1/2"	5" NB	3 (3-7/8")	1/30
D60997	3-1/2"	6" NB	3 (4-3/4")	1/20
D60992	3-1/2"	6" CP	2 (5")	1/20
D60993	3-1/2"	6" PB	2 (5")	1/20
D60995	3-1/2"	8" PB	4 (6-3/4")	1/10
D60998	3-1/2"	8" NB	4 (6-3/4")	1/12
D60989	3-1/2"	9" PB	4 (7-5/8")	1/12
D60999	3-1/2"	9" NB	4 (7-5/8")	1/12
D60958	4"	5" NB	3 (3-7/8")	1/30
D60959	4"	5" PB	3 (3-7/8")	1/30

Items marked with the Jones Stephens logo are "You Need It...We Got It" Items.

Funnel



• Vandal-proof installation
 • Fits virtually any floor/shower drain
 • Funnel tapped for 10-24 screws which are supplied with washers

PART NO.	DESCRIPTION	CTN/MSTR
F65400	4" funnel	1/1
F65600	6" funnel	1/18

The Green Drain Waterless Trap Seal



• Requires NO caulk or expensive installation tool
 • Easy to install and easy to remove - NO pliers needed
 • Durable - will not break during installation or removal
 • Seals tight - NO leaking

PART NO.	DESCRIPTION	CTN/MSTR
P24001	2" waterless trap seal	1/96
P24002	3" waterless trap seal	1/96
P24003	3-1/2" waterless trap seal	1/96
P24004	4" waterless trap seal	1/96

F

Cast Iron General Purpose/Utility Drains

Pages 252-253

F

SIZES: 1-1/2", 2", 3", 4"



For use in residential and commercial applications.

Area Drain



- Full waterway
- Lip secures strainer

DRAIN SPECS

SIZE	TOP WIDTH	OVERALL HEIGHT
2"	4-7/8"	3-1/4"
3"	6-3/16"	3-1/4"
4"	7-3/16"	3-1/4"

STRAINER SPECS

SIZE	A	B
2"	4-1/4"	4-1/4"
3"	5-3/8"	5-5/8"
4"	6-11/16"	6-11/16"

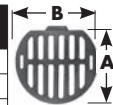

PART NO.	DESCRIPTION	CTN/MSTR
D76002	2" inside caulk drain	1/8
D77002	2" no hub drain	1/8
D76012	2" inside caulk CP area drain with strainer	1/8
D76092	2" strainer only	1/1
D76003	3" inside caulk drain	1/4
D77003	3" no hub drain	1/4
D76013	3" inside caulk CP area drain with strainer	1/4
D76093	3" strainer only	1/1
D76004	4" inside caulk drain	1/4
D77004	4" no hub drain	1/4
D76014	4" inside caulk CP area drain with strainer	1/4
D76094	4" strainer only	1/1

Cast Iron Gasket Connection Drain



- Supplied with Multi-Tite gasket
- Lube gasket and push over S.V. or N.H. cast iron pipe
- NB and PB covers are for heavy pedestrian traffic areas
- CI covers are for heavy duty traffic

PART NO.	SIZE	STRAINER	CTN/MSTR
D62950	3"	5" NB round with ring	1/1
D62951	3"	5" PB round with ring	1/1
D62952	3"	4" CI round	1/1
D62960	4"	6" NB round with ring	1/1
D62961	4"	6" PB round with ring	1/1
D62962	4"	5" CI round	1/1

Kentucky Drain



- Inside caulk

PART NO.	DESCRIPTION	CTN/MSTR
C73003	3" inside caulk drain	1/4
C73093	3" strainer only	1/1
C73192	3" drain with 2" hole in strainer	1/4
C73004	4" inside caulk drain	1/4
C73094	4" strainer only	1/1

St. Louis Drain



- Heavy duty loose set strainer
- Inside caulk

PART NO.	DESCRIPTION	CTN/MSTR
C72003	3" inside caulk	1/4
C72093	6-1/4" OD round strainer	1/1

Inside Caulk Shower Stall Drain



- Designed for prefab shower stalls
- Snap in stainless steel strainer
- Fits 2" Schedule 40 and cast iron pipe
- Can be adapted to no caulk with gasket
- 4-1/4" OD strainer

PART NO.	DESCRIPTION	STRAINER	CTN/MSTR
D40102	2" inside caulk	4" SS round	1/36
D40202	2" inside caulk	4" PB round	1/20
D60101	Gasket to make unit no caulk	—	1/1

IPS Shower Stall Drain



- Designed for prefab shower stalls
- Snap in stainless steel strainer
- 4-1/4" O.D. strainer

PART NO.	SIZE	STRAINER	CTN/MSTR
D40104	1-1/2"	4" SS round	1/36
D40204	1-1/2"	4" PB round	1/20
D40103	2"	4" SS round	1/36
D40203	2"	4" PB round	1/20

FIP Shower Stall Drain



- Cast brass body
- Stainless steel strainer

PART NO.	SIZE	BODY	STRAINER	CTN/MSTR
D40200	2"	Cast brass	SS round	1/100

Brass Inside Caulk Floor Drain



- For use where pan liner is not required
- Brass body

PART NO.	DESCRIPTION	BODY	STRAINER	CTN/MSTR
D76601	2" inside caulk	Brass	SS round	1/50

Urinal Drain



- Brass body with stainless steel strainer

PART NO.	DESCRIPTION	CTN/MSTR
D45002	2" IPS brass body	1/40

Urinal Drain Flange Kit



- Brass
- Kit includes all necessary hardware
- Center-to-center for bolt holes is 4-1/4"

PART NO.	SIZE	CTN/MSTR
F10005	2" IPS x 4-1/4"	1/50

Combination Drain Trap



- Bolt-down clamping collar
- Weep holes and grooves in clamping flange

PART NO.	SIZE	STRAINER	CTN/MSTR
J60060	2" IPS	4" SS round	1/1
J60061	2" IPS	4" CP brass round	1/1
J60062	2" IPS	4" PB round	1/1

Floor Drain with Trap



- Throat of drain is threaded for backwater device D70500

Concealed Cleanout

PART NO.	DESCRIPTION	CTN/MSTR
D70001	2" drain	1/1
D70011	2" drain with backwater device	1/1
D70098	6-3/8" cast iron strainer	1/1

Exposed Cleanout

D70020	2" drain with backwater device	1/1
D70022	2" drain with 1/2" PT	1/1
D71103	3" drain - backwater device not compatible	1/1
D70021	2" drain with backwater device	1/1

Des Moines Pattern Floor Drain



- Bolt down lid
- Integral trap

PART NO.	DESCRIPTION	CTN/MSTR
D71003	3" with trap	1/1
D71004	Strainer for Des Moines (screws not included)	1/1

Backwater Device



- Sleeve type
- Ball included

PART NO.	DESCRIPTION	CTN/MSTR
D70500	2" MIP brass body	1/50
B06001	2" MIP plastic body	1/50
B70499	2" plastic ball	1/1300

Cast Iron Commercial Cleanouts

Pages 254-257

F

SIZES: 2", 3", 4", 6"



For use in applications
where height adjustments
are necessary.

Push-On Cleanout



- Meets ASTM A74-98 and ASME A112.36.2M-91
- Cut pipe to desired level, lube gasket and push-on pipe, tap with lead hammer to seat, then install plug
- Schedule 40 unit fits plastic and extra heavy cast iron pipe

Less Gasket

PART NO.	PIPE SIZE	PLUG	HEIGHT	CTN/MSTR
C36003	3" SV	2-1/2" raised head	3"	1/8
C36013	3" SV	2-1/2" countersunk	3"	1/8
C36004	4" SV	3-1/2" raised head	3"	1/8
C36014	4" SV	3-1/2" countersunk	3"	1/8
C36024	4" Sch.40	3-1/2" raised head	3"	1/8
C36034	4" Sch.40	3-1/2" countersunk	3"	1/8
C36006	6" SV	4" raised head	2-3/4"	1/4
C36016	6" SV	4" countersunk	2-3/4"	1/4

With Gasket

PART NO.	PIPE SIZE	PLUG	HEIGHT	CTN/MSTR
C36104	4" SV	3-1/2" raised head	3-1/4"	1/8
C36114	4" SV	3-1/2" countersunk	3-1/4"	1/8
C36124	4" Sch.40	3-1/2" raised head	3-1/4"	1/8
C36134	4" Sch.40	3-1/2" countersunk	3-1/4"	1/8
C36106	6" SV	4" raised head	3"	1/4
C36116	6" SV	4" countersunk	3"	1/4

No Hub Cleanout with Plug



Southern Code Plug

PART NO.	PIPE SIZE	PLUG	HEIGHT	CTN/MSTR
C38402	2"	1-1/2" raised head	2-1/8"	1/10
C39402	2"	1-1/2" countersunk	2-1/8"	1/10
C38403	3"	2-1/2" raised head	2-1/8"	1/10
C39403	3"	2-1/2" countersunk	2-1/8"	1/10
C38404	4"	3-1/2" raised head	2-1/8"	1/10
C39404	4"	3-1/2" countersunk	2-1/8"	1/10

Heavy Plug

PART NO.	PIPE SIZE	PLUG	HEIGHT	CTN/MSTR
C38502	2"	1-1/2" raised head	2-1/8"	1/10
C38503	3"	2-1/2" raised head	2-1/8"	1/10
C39503	3"	2-1/2" countersunk	2-1/8"	1/10
C38504	4"	3-1/2" raised head	2-1/8"	1/10
C39504	4"	3-1/2" countersunk	2-1/8"	1/10

New Orleans Code Plug

PART NO.	PIPE SIZE	PLUG	HEIGHT	CTN/MSTR
C40102	2"	1-1/2" plug	2-1/4"	1/10
C40103	3"	2-1/2" plug	2-1/4"	1/10
C40104	4"	3-1/2" plug	2-1/4"	1/10

Plain End Cleanout Short Pattern



- Fits flush with hub
- With Southern code plug

PART NO.	PIPE SIZE	PLUG	HEIGHT	CTN/MSTR
C38102	2"	1-1/2" raised head	2-7/8"	1/10
C39102	2"	1-1/2" countersunk	2-7/8"	1/10
C38103	3"	2-1/2" raised head	3-5/8"	1/10
C39103	3"	2-1/2" countersunk	3-5/8"	1/10
C38104	4"	3" raised head	3"	1/10
C39104	4"	3" countersunk	3"	1/10
C38114	4"	3-1/2" raised head	3"	1/10
C39114	4"	3-1/2" countersunk	3"	1/10

Plain End Cleanout Long Pattern



- For use with service weight (caulk into hub) or no-hub (use coupling)

With Southern Code Plug

PART NO.	PIPE SIZE	PLUG	HEIGHT	CTN/MSTR
C38002	2"	1-1/2" raised head (low sq.)	3-1/4"	1/12
C39002	2"	1-1/2" countersunk	3-1/4"	1/12
C38003	3"	2-1/2" raised head (low sq.)	4"	1/12
C39003	3"	2-1/2" countersunk	4"	1/12
C38004	4"	3" raised head (low sq.)	4"	1/8
C39004	4"	3" countersunk	4"	1/8
C38014	4"	3-1/2" raised head (low sq.)	4"	1/8
C39014	4"	3-1/2" countersunk	4"	1/8
C38005	5"	4" raised head (low sq.)	3-1/2"	1/4
C39005	5"	4" countersunk	3-1/2"	1/4
C38006	6"	5" raised head (low sq.)	4"	1/2
C39006	6"	5" countersunk	4"	1/2

With Heavy Pattern Plug

PART NO.	PIPE SIZE	PLUG	HEIGHT	CTN/MSTR
C38202	2"	1-1/2" raised head (hex)	3-1/4"	1/12
C38203	3"	2-1/2" raised head (hex)	4"	1/12
C39203	3"	2-1/2" countersunk	4"	1/12
C38204	4"	3" raised head (hex)	4"	1/8
C39204	4"	3" countersunk	4"	1/8
C38214	4"	3-1/2" raised head (hex)	4"	1/8
C39214	4"	3-1/2" countersunk	4"	1/8
C38205	5"	4" raised head (hex)	3-1/2"	1/4
C39205	5"	4" countersunk	3-1/2"	1/4
C38206	6"	5" raised head (hex)	4"	1/2
C39206	6"	5" countersunk	4"	1/2

Cleanout Ferrule with New Orleans Code Plug



- Service weight

PART NO.	PIPE SIZE	PLUG	HEIGHT	CTN/MSTR
C40002	2" SV	1-1/2"	3"	1/12
C40003	3" SV	2-1/2"	4"	1/12
C40004	4" SV	3 1/2"	4"	1/8
C40006	6" SV	5"	4"	1/2

Plumb Lock Adjustable Cleanout



- Supplied with Multi-Tite gasket
- Similar to Zurn Neo-Loc line

3" Spud with 3" Gasket Connection

PART NO.	PIPE SIZE	COVER	BODY HEIGHT	ADJ. HEIGHT	CTN/MSTR
D62330	3"	5" CI round	5-1/4"	5-7/8" - 7"	1/1
D62333	3"	5" NB round	5-1/4"	5-7/8" - 7"	1/1
D62334	3"	5" PB round	5-1/4"	5-7/8" - 7"	1/1
D62335	3"	5" CP round	5-1/4"	5-7/8" - 7"	1/1

4" Spud with 4" Gasket Connection

PART NO.	PIPE SIZE	COVER	BODY HEIGHT	ADJ. HEIGHT	CTN/MSTR
D62433	4"	5" NB round	5-1/2"	6-1/8" - 7-1/4"	1/1
D62434	4"	5" PB round	5-1/2"	6-1/8" - 7-1/4"	1/1
D62443	4"	5" NB round w/4" plug	5-1/2"	6-1/8" - 7-1/4"	1/1
D62444	4"	5" PB round w/4" plug	5-1/2"	6-1/8" - 7-1/4"	1/1

4" Spud with 6" Gasket Connection

PART NO.	PIPE SIZE	COVER	BODY HEIGHT	ADJ. HEIGHT	CTN/MSTR
D62601	6"	5" NB round	3-1/4"	3-5/8" - 4-3/4"	1/1
D62602	6"	5" PB round	3-1/4"	3-5/8" - 4-3/4"	1/1

No Hub Adjustable Cleanout



- CI cover is for forklift or heavy trucking traffic
- NB and PB covers are for heavy pedestrian traffic

3" Spud					
PART NO.	PIPE SIZE	COVER	BODY HEIGHT	ADJ. HEIGHT	CTN/MSTR
D63330	3"	5" CI round	4-1/4"	4-7/8" - 6"	1/1
D63333	3"	5" NB round	4-1/4"	4-7/8" - 6"	1/1
D63334	3"	5" PB round	4-1/4"	4-7/8" - 6"	1/1
D63335	3"	5" CP round	4-1/4"	4-7/8"-6"	1/1

4" Spud					
PART NO.	PIPE SIZE	COVER	BODY HEIGHT	ADJ. HEIGHT	CTN/MSTR
D63433	4"	5" NB round	4-1/4"	4-7/8"- 6"	1/1
D63434	4"	5" PB round	4-1/4"	4-7/8"- 6"	1/1

Adjustable Plain End Cleanout

F



- CI cover is for forklift or heavy trucking traffic
- NB and PB covers are for heavy pedestrian traffic
- Cleanout body with brass plug
- Can also be caulked into hub

PART NO.	PIPE SIZE	COVER	ADJ. HEIGHT	CTN/MSTR
C33021	2"	5-1/4" CI round with center screw	3-1/8"- 4-1/4"	1/1
C33022	2"	5-1/2" NB round with ring	3"- 4-3/4"	1/1
C33023	2"	5-1/2" PB round with ring	3"- 4-3/4"	1/1
C33031	3"	5-1/4" CI round with center screw	4"- 5-3/4"	1/1
C33032	3"	5-1/2" NB round with ring	4-1/4"- 6"	1/1
C33033	3"	5-1/2" PB round with ring	4-1/4"- 6"	1/1
C33044	4"	6-3/16" CI with center screw	5-1/8"- 6-1/8"	1/1
C33045	4"	6-1/2" NB round with ring	5-3/8"- 6-3/8"	1/1
C33046	4"	6-1/2" PB round with ring	5-3/8"- 6-3/8"	1/1

Adjustable Push-On Cleanout for Cast Iron Pipe



- Supplied with gasket for cast iron pipe
- CI cover is for forklift or heavy trucking traffic
- NB and PB covers are for heavy pedestrian traffic
- Cleanout body with brass plug

PART NO.	PIPE SIZE	COVER	ADJ. HEIGHT	CTN/MSTR
C33121	3"	5-1/4" CI round with center screw	3-7/8"- 4-3/4"	1/1
C33122	3"	5-1/2" NB round with ring	4-1/8"- 5"	1/1
C33123	3"	5-1/2" PB round with ring	4-1/8"- 5"	1/1
C33144	4"	6-3/16" CI round with center screw	4-7/8"- 5-3/4"	1/1
C33145	4"	6-1/2" NB round with ring	5"- 6"	1/1
C33146	4"	6-1/2" PB round with ring	5"- 6"	1/1

Adjustable Cleanout for Plastic Pipe



- CI cover is for forklift or heavy trucking traffic
- NB and PB covers are for heavy pedestrian traffic
- Cleanout body with plastic plug

PART NO.	HEIGHT ADJUSTMENT
C33221	2-7/8" - 3-7/8"
C33222	3-1/8" - 4-1/8"
C33223	3-1/8" - 4-1/8"
C33231	4" - 5"
C33232	4-1/4" - 5-1/4"
C33233	4-1/4" - 5-1/4"
C33244	5-1/8" - 6-1/4"
C33245	5-3/8" - 6-1/2"
C33246	5-3/8" - 6-1/2"

PART NO.	HEIGHT ADJUSTMENT
C33321	2-7/8" - 3-7/8"
C33322	3-1/8" - 4-1/8"
C33323	3-1/8" - 4-1/8"
C33331	4" - 5"
C33332	4-1/4" - 5-1/4"
C33333	4-1/4" - 5-1/4"
C33344	5-1/8" - 6-1/4"
C33345	5-3/8" - 6-1/2"
C33346	5-3/8" - 6-1/2"

PVC			
PART NO.	SIZE	COVER	CTN/MSTR
C33221	2"	5-1/4" CI round with center screw	1/1
C33222	2"	5-1/2" NB round with ring	1/1
C33223	2"	5-1/2" PB round with ring	1/1
C33231	3"	5-1/4" CI round with center screw	1/1
C33232	3"	5-1/2" NB round with ring	1/1
C33233	3"	5-1/2" PB round with ring	1/1
C33244	4"	6-3/16" CI round with center screw	1/1
C33245	4"	6-1/2" NB round with ring	1/1
C33246	4"	6-1/2" PB round with ring	1/1

ABS			
PART NO.	SIZE	COVER	CTN/MSTR
C33321	2"	5-1/4" CI round with center screw	1/1
C33322	2"	5-1/2" NB round with ring	1/1
C33323	2"	5-1/2" PB round with ring	1/1
C33331	3"	5-1/4" CI round with center screw	1/1
C33332	3"	5-1/2" NB round with ring	1/1
C33333	3"	5-1/2" PB round with ring	1/1
C33344	4"	6-3/16" CI round with center screw	1/1
C33345	4"	6-1/2" NB round with ring	1/1
C33346	4"	6-1/2" PB round with ring	1/1

Adjustable Cleanout for Plastic Pipe Hub



- CI cover is for forklift or heavy trucking traffic
- NB and PB covers are for heavy pedestrian traffic
- Cleanout body with plastic plug

PART NO.	HEIGHT ADJUSTMENT
C33444	3" - 4-1/2"
C33445	3-1/4" - 4-3/4"
C33446	3-1/4" - 4-3/4"

PART NO.	HEIGHT ADJUSTMENT
C33544	3" - 4-1/2"
C33545	3-1/4" - 4-3/4"
C33546	3-1/4" - 4-3/4"

PVC			
PART NO.	SIZE	COVER	CTN/MSTR
C33444	4"	6-3/16" CI round with center screw	1/1
C33445	4"	6-3/16" NB round with ring	1/1
C33446	4"	6-3/16" PB round with ring	1/1

ABS			
PART NO.	SIZE	COVER	CTN/MSTR
C33544	4"	6-3/16" CI round with center screw	1/1
C33545	4"	6-3/16" NB round with ring	1/1
C33546	4"	6-3/16" PB round with ring	1/1

Adjustable Access Cover



- CI cover is for forklift or heavy trucking traffic
- NB and PB covers are for heavy pedestrian traffic
- Designed to fit over 2", 3" and 4" plastic adapter, cast iron cleanout, ferrules and various drainage piping (2" x 3" fits 2" and 3" bodies)
- 3 set screws allow for vertical adjustment

PART NO.	PIPE SIZE	COVER	HEIGHT	INSIDE C.O.	CTN/MSTR
C33001	2" & 3"	5-1/4" CI round with center screw	2-1/8"	4-9/16"	1/1
C33002	2" & 3"	5-1/2" NB round with ring	2-1/8"	4-9/16"	1/1
C33003	2" & 3"	5-1/2" PB round with ring	2-1/8"	4-9/16"	1/1
C33004	4"	6-3/16" CI round with center screw	2-5/8"	5-5/16"	1/1
C33005	4"	6-1/2" NB round with ring	2-5/8"	5-5/16"	1/1
C33006	4"	6-1/2" PB round with ring	2-5/8"	5-5/16"	1/1

Heavy Duty Adjustable Access Cover



- Scoriated cover
- Fits any 6" pipe
- CI top is for forklift or heavy trucking traffic for up to 2000 lbs.
- 3 bolts secure the cleanout while curing concrete

PART NO.	PIPE SIZE	DESCRIPTION	HEIGHT	CTN/MSTR
C33088	6"	CI cleanout	3"	1/1

Heavy Duty Cleanout



- Scoriated cover
- Fits any 6" pipe
- 3 bolts secure the cleanout while curing concrete

PART NO.	PIPE SIZE	DESCRIPTION	HEIGHT	INSIDE C.O.	CTN/MSTR
D76005	6"	CI cleanout	5-3/8"	6-3/4"	1/1

Items marked with the Jones Stephens logo are "You Need It... We Got It" Items.

Cast Iron Commercial Cleanout Components

Pages 258-259

F

SIZES: 2", 3", 3-1/2", 4", 5", 6"

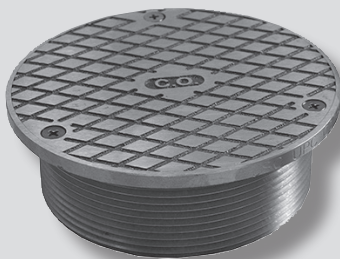

For use in
commercial applications.

No Hub Cleanout Body



PART NO.	PIPE SIZE	TAP SIZE	HEIGHT	CTN/MSTR
C37102	2" Body	1-1/2"	2-1/8"	1/10
C37103	3" Body	2-1/2"	2-1/8"	1/10
C37104	4" Body	3-1/2"	2-1/8"	1/10

Plain End Cast Iron Cleanout Short Pattern



- Short pattern less plug
- Fits flush with hub

PART NO.	PIPE SIZE	TAP SIZE	HEIGHT	CTN/MSTR
C37302	2"	1-1/2"	2-3/4"	1/12
C37303	3"	2-1/2"	3-1/2"	1/12
C37304	4"	3"	3"	1/8
C37314	4"	3-1/2"	3"	1/8

Plain End Cast Iron Cleanout Long Pattern



- Long pattern less plug
- Meets ASTM A-74

PART NO.	PIPE SIZE	TAP SIZE	HEIGHT	CTN/MSTR
C37002	2"	1-1/2"	2-3/4"	1/12
C37003	3"	2-1/2"	4"	1/12
C37004	4"	3"	4"	1/8
C37014	4"	3-1/2"	4"	1/8
C37005	5"	4"	3-1/2"	1/4
C37006	6"	5"	4"	1/2

No Hub Base



- Use with CI strainers or covers for heavy trucking traffic
- Use with PB, NB, SS or CP strainers or covers for heavy pedestrian traffic

PART NO.	PIPE SIZE	TAP SIZE	HEIGHT	CTN/MSTR
D63300	3"	3" IPS	4-1/4"	1/1
D63349	3"	3-1/2 IPS	4-1/4"	1/1
D63350	4"	3-1/2 IPS	4-1/4"	1/1
D63400	4"	4" IPS	4-1/4"	1/1

Gasket Connection Base



- Use with CI strainers or covers for heavy trucking traffic
- Use with PB, NB or CP strainers or covers for heavy pedestrian traffic
- Supplied with multi-tite gasket

PART NO.	PIPE SIZE	TAP SIZE	HEIGHT	CTN/MSTR
D62300	3"	3" IPS	5"	1/1
D62349	3"	3-1/2" IPS	5-1/4"	1/1
D62350	4"	3-1/2" IPS	5-1/4"	1/1
D62400	4"	4" IPS	5-1/4"	1/1

Cast Iron Spud with Cover for Heavy Duty Cleanout



- For use with heavy duty cleanouts

2-1/2" IPS Brass Plug with Round Cover

PART NO.	SIZE	COVER	CTN/MSTR
D62230	3"	5" CI round	1/1
D62231	3"	5" NB round with ring	1/1
D62232	3"	5" PB round with ring	1/1

3" IPS Brass Plug with Round Cover

PART NO.	SIZE	COVER	CTN/MSTR
D62235	3-1/2"	5" CI round	1/1
D62236	3-1/2"	6" NB round with ring	1/1
D62237	3-1/2"	6" PB round with ring	1/1

3-1/2" IPS Brass Plug with Round Cover

PART NO.	SIZE	COVER	CTN/MSTR
D62240	4"	5" CI round	1/1
D62241	4"	6" NB round with ring	1/1
D62242	4"	6" PB round with ring	1/1

Plastic Spud with Cover and Square Top for Heavy Duty Cleanout

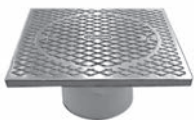

- For use with heavy duty cleanouts
- Round cover with 7" square top

2-1/2" IPS Brass Plug with Square Top

PART NO.	SIZE	COVER	CTN/MSTR
D59912	3"	7" PB square	1/1
D59913	3"	7" NB square	1/1

3" IPS Brass Plug with Square Top

PART NO.	SIZE	COVER	CTN/MSTR
D59910	3-1/2"	7" PB square	1/1
D59911	3-1/2"	7" NB square	1/1

3-1/2" IPS Brass Plug with Square Top

PART NO.	SIZE	COVER	CTN/MSTR
D59918	4"	7" PB square	1/1
D59919	4"	7" NB square	1/1

Plastic Spud with Round Cover for Heavy Duty Cleanout



- For use with heavy duty cleanouts
- NSF listed



2-1/2" IPS Plastic Plug with Round Cover

PART NO.	SIZE	COVER	CTN/MSTR
D59904	3"	6" PB round	1/1
D59908	3"	6" PB round with ring	1/1
D59905	3"	6" NB round	1/1
D59909	3"	6" NB round with ring	1/1
D59940	3"	6" CI round with ring	1/1

3" IPS Plastic Plug with Round Cover

PART NO.	SIZE	COVER	CTN/MSTR
D59943	3-1/2"	5" PB round	1/1
D59944	3-1/2"	5" PB round with ring	1/1
D59945	3-1/2"	5" NB round	1/1
D59946	3-1/2"	5" NB round with ring	1/1
D59901	3-1/2"	6" PB round	1/1
D59906	3-1/2"	6" PB round with ring	1/1
D59902	3-1/2"	6" NB round	1/1
D59907	3-1/2"	6" NB round with ring	1/1
D59941	3-1/2"	6" CI round with ring	1/1
D59914	4"	6" PB round	1/1
D59915	4"	6" PB round with ring	1/1
D59916	4"	6" NB round	1/1
D59917	4"	6" NB round with ring	1/1
D59942	4"	6" CI round with ring	1/1

Metal Spud with Round Cover for Heavy Duty Cleanout



- For use with heavy duty cleanouts

2-1/2" IPS Brass Plug with Round Cover

PART NO.	SIZE	COVER	SCREWS	CENTER X CENTER	CTN/MSTR
C37803	3"	5" NB round	3	3-7/8"	1/20
C37801	3"	5" PB round	3	3-7/8"	1/20

3-1/2" IPS Brass Plug with Round Cover

PART NO.	SIZE	COVER	SCREWS	CENTER X CENTER	CTN/MSTR
C37810	3-1/2"	5" NB round	3	3-7/8"	1/18
C37811	3-1/2"	5" PB round	3	3-7/8"	1/18
C37805	4"	5" NB round	3	3-7/8"	1/20
C37806	4"	5" PB round	3	3-7/8"	1/20

4" IPS Brass Countersunk Plug with Round Cover

PART NO.	SIZE	COVER	SCREWS	CENTER X CENTER	CTN/MSTR
C37807	4"	6" NB round	2	4-7/8"	1/8
C37808	4"	6" PB round	2	4-7/8"	1/8

New Orleans Code Brass Plug



• Raised head

PART NO.	DESCRIPTION	O.D.	CTN/MSTR
P55150	1-1/2" plug	1-13/16"	1/200
P55250	2-1/2" plug	2-3/4"	1/100
P55300	3" plug	3-3/8"	1/60
P55350	3-1/2" plug	4"	1/80
P55500	5" plug	5-1/2"	1/30

Lead Fit-All Plug



• Raised head
• Cast iron cored
• Sizes are true measurement, not iron pipe size

PART NO.	DESCRIPTION	CTN/MSTR
P56200	2" fit-all plug	24/48
P56250	2-1/2" fit-all plug	24/48
P56300	3" fit-all plug	12/24
P56350	3-1/2" fit-all plug	12/24
P56400	4" fit-all plug	12/24
P56450	4-1/2" fit-all plug	12/12
P56500	5" fit-all plug	12/12
P56550	5-1/2" fit-all plug	12/12
P56600	6" fit-all plug	12/12

Southern Code Brass Plug



PART NO.	DESCRIPTION	O.D.	CTN/MSTR
P50100	1" raised head	1-9/32"	1/200
P50125	1- 1/4" raised head	1-5/8"	1/250
P50150	1-1/2" raised head	1-7/8"	1/200
P51150	1-1/2" countersunk	1-7/8"	1/200
P50200	2" raised head	2-3/8"	1/200
P51200	2" countersunk	2-3/8"	1/200
P50250	2-1/2" raised head	2-7/8"	1/200
P51250	2-1/2" countersunk	2-7/8"	1/200
P50300	3" raised head	3-3/8"	1/120
P51300	3" countersunk	3-3/8"	1/120
P50350	3-1/2" raised head	3-7/8"	1/90
P51350	3-1/2" countersunk	3-7/8"	1/120
P50400	4" raised head	4-1/2"	1/90
P51400	4" countersunk	4-1/2"	1/90
P50500	5" raised head	5-1/2"	1/50
P51500	5" countersunk	5-1/2"	1/50
P50600	6" raised head	6-1/2"	1/30
P51600	6" countersunk	6-1/2"	1/30
P50800	8" raised head	8-1/2"	1/15
P51800	8" countersunk	8-1/2"	1/15
P50999	10" raised head	10-5/8"	1/10

Heavy Pattern Brass Plug



PART NO.	DESCRIPTION	O.D.	CTN/MSTR
P52150	1-1/2" raised head	1-3/4"	1/100
P52200	2" raised head	2-3/8"	1/100
P53200	2" countersunk	2-3/8"	1/200
P52250	2-1/2" raised head	2-3/4"	1/60
P53250	2-1/2" countersunk	2-3/4"	1/100
P52300	3" raised head	3-1/2"	1/60
P53300	3" countersunk	3-1/2"	1/120
P52350	3-1/2" raised head	3-7/8"	1/60
P53350	3-1/2" countersunk	3-7/8"	1/80
P52400	4" raised head	4-3/8"	1/40
P53400	4" countersunk	4-3/8"	1/60
P52500	5" raised head	5-1/2"	1/30
P53500	5" countersunk	5-1/2"	1/40

Items marked with the Jones Stephens logo are "You Need It... We Got It" Items.

Code Pattern Plug



• Meets ASTM A74-98

PART NO.	DESCRIPTION	CTN/MSTR
P59300	3" raised head	1/50
P59333	3" countersunk	1/50
P59350	3-1/2" raised head	1/50
P59355	3-1/2" countersunk	1/50
P59400	4" raised head	1/50
P59444	4" countersunk	1/50

Slotted Brass Plug with 1/4" Tap



• Includes a blind hole for mounting a cover plate to conform with local codes

PART NO.	DESCRIPTION	CTN/MSTR
P58150	1-1/2" slotted	1/150
P58200	2" slotted	1/100
P58250	2-1/2" slotted	1/80
P58300	3" slotted	1/60
P58350	3-1/2" slotted	1/40
P58400	4" slotted	1/30

Brass Plug For Extension Cover

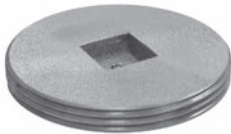

• Countersunk plug tapped 1/4-20
• Includes a blind hole for mounting a cover plate to conform with local codes

PART NO.	DESCRIPTION	O.D.	CTN/MSTR
P54150	1-1/2" countersunk	1-7/8"	1/200
P54200	2" countersunk	2-3/8"	1/200
P54250	2-1/2" countersunk	2-7/8"	1/150
P54300	3" countersunk	3-3/8"	1/100
P54350	3-1/2" countersunk	3-7/8"	1/100
P54400	4" countersunk	4-1/2"	1/80
P54500	5" countersunk	5-1/2"	1/40
P54600	6" countersunk	6-1/2"	1/30
P54800	8" countersunk	8-1/2"	1/12

Extension Cover Set

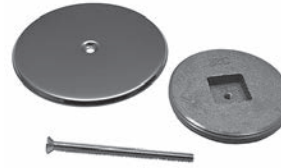

• Set includes stainless steel extension cover, brass countersunk or slotted plug and 1/4-20 x 4" flat head machine screws
• Includes a blind hole for mounting a cover plate to conform with local codes

Wall Cover (24 gauge)

PART NO.	PLUG	COVER	CTN/MSTR
C92150	1-1/2" countersunk	3"	1/10
C92151	1-1/2" slotted	3"	1/10
C92200	2" countersunk	4"	1/10
C92202	2" slotted	4"	1/10
C92250	2-1/2" countersunk	5"	1/10
C92252	2-1/2" slotted	5"	1/10
C92300	3" countersunk	5"	1/10
C92301	3" countersunk	6"	1/10
C92303	3" slotted	6"	1/10
C92350	3-1/2" countersunk	6"	1/10
C92351	3-1/2" countersunk	7"	1/10
C92353	3-1/2" slotted	7"	1/10
C92400	4" countersunk	7"	1/10
C92404	4" slotted	7"	1/10
C92500	5" countersunk	8"	1/10
C92600	6" countersunk	8"	1/5
C92601	6" countersunk	10"	1/5
C92800	8" countersunk	10"	1/5

Floor Cover (16 gauge)

PART NO.	PLUG	COVER	CTN/MSTR
C93150	1-1/2" countersunk	3"	1/10
C93200	2" countersunk	4"	1/10
C93250	2-1/2" countersunk	5"	1/10
C93300	3" countersunk	5"	1/10
C93301	3" countersunk	6"	1/10
C93350	3-1/2" countersunk	6"	1/10
C93351	3-1/2" countersunk	7"	1/10
C93400	4" countersunk	7"	1/10
C93500	5" countersunk	8"	1/10

Stainless Steel Cleanout/Extension Cover



- Beveled edge
- 1500°F fire rating

Wall Mount (24 gauge)

PART NO.	SIZE	CTN/MSTR
C90300	3"	50/500
C90400	4"	25/200
C90500	5"	25/200
C90600 	6"	25/100
C90700	7"	25/100
C90800	8"	25/100
C90999	10"	25/50

Floor Mount (16 gauge)

PART NO.	SIZE	CTN/MSTR
C91300	3"	25/200
C91400	4"	25/200
C91500	5"	25/200
C91600	6"	25/100
C91700	7"	25/100
C91800	8"	25/50
C91999	10"	25/50

Wall Mount With 4" Bolt (24 gauge)

PART NO.	SIZE	CTN QTY
C90013	3"	25/200
C90014	4"	25/200
C90015	5"	25/200
C90016	6"	25/100
C90017	7"	25/100
C90018	8"	25/100
C90019	10"	25/50

Floor Mount With 4" Bolt (16 gauge)

PART NO.	SIZE	CTN QTY
C91013	3"	25/150
C91014	4"	25/150
C91015	5"	25/100
C91016	6"	25/75
C91017	7"	25/50
C91018	8"	25/50
C91019	10"	10/30

Bolts for Cleanout/Extension Covers



- Flat slotted head plated machine screw

PART NO.	SIZE	CTN/MSTR
C90002	1/4" - 20 x 2-1/2"	100/1000
C90004	1/4" - 20 x 4"	100/1500
C90006	1/4" - 20 x 6"	100/1200

High Impact Plastic Cleanout Cover Plate



- Polished chrome or white matte finish
- Individually bagged with # 14 wood screw included

Flat Design

PART NO.	SIZE	CTN/MSTR
C94004	4-1/4" chrome finish	25/200
C94005	5-1/4" chrome finish	25/200
C94007	7-1/4" chrome finish	25/200
C94009	9-1/4" chrome finish	25/100
C95004	4-1/4" white finish	25/200
C95005	5-1/4" white finish	25/200
C95007	7-1/4" white finish	25/200
C95009	9-1/4" white finish	25/100

Bell Design

PART NO.	SIZE	CTN/MSTR
C96004	4-1/4" chrome finish	25/200
C96005	5-1/4" chrome finish	25/200
C96007	7-1/4" chrome finish	25/200
C96009	9-1/4" chrome finish	25/100
C97004	4-1/4" white finish	25/200
C97005 	5-1/4" white finish	25/200
C97007	7-1/4" white finish	25/200
C97009	9-1/4" white finish	25/100

Trap Cover



- Stainless steel

PART NO.	DESCRIPTION	CTN/MSTR
C98001	5-3/4" flat SS trap cover	150/300
C98002	5-3/4" raised SS trap cover	50/200

Stainless Steel Dome Cover Plate



- 1-1/2" depth
- 1500°F fire rating
- High grade stainless steel
- Individually bagged with #14 wood screw and 1/4" x 2-1/2" machine screw

PART NO.	DESCRIPTION	CTN/MSTR
C98014	4" SS dome cover plate	60/240
C98016	6" SS dome cover plate	50/150
C98018	8" SS dome cover plate	50/100

 Items marked with the Jones Stephens logo are "You Need It... We Got It" Items.

Inside Caulk Bell Trap



- Hinged lid
- Bell attached

PIPE SIZE	BODY	STRAINER	OUTLET HEIGHT	OVERALL HEIGHT
2"	6" x 6"	4-7/8"	1-3/4"	4-1/8"
3"	9" x 9"	6-3/4"	1-7/8"	4-7/8"
4"	12" x 12"	9-3/4"	1-3/4"	4-7/8"

PART NO.	DESCRIPTION	CTN/MSTR
D76202	6" x 6" x 4"	1/1
D76203	9" x 9" x 4"	1/1
D76204	12" x 12" x 4"	1/1

Strainers less Hinge

PART NO.	DESCRIPTION	CTN/MSTR
D76205L	4-7/8" strainer for 6" x 6"	1/20
D76207L	6-3/4" strainer for 9" x 9"	1/20

Cast Iron Bell with Nut and Bolt

PART NO.	SIZE	CTN/MSTR
D76256	Bell for 6" x 6"	1/20
D76259	Bell for 9" x 9"	1/20

No Hub Bell Trap



- Spigot outlet
- Hinged lid
- Bell attached

PIPE SIZE	BODY	STRAINER	OUTLET HEIGHT	OVERALL HEIGHT
2"	6" x 6"	4-7/8"	1-1/4"	3-1/4"
3"	9" x 9"	6-3/4"	1-1/2"	4-1/4"
4"	12" x 12"	9-3/4"	1-1/2"	4-7/8"

PART NO.	DESCRIPTION	CTN/MSTR
D76302	6" x 6" x 2"	1/1
D76303	9" x 9" x 3"	1/1
D76304	12" x 12" x 4"	1/1

Strainers less Hinge

PART NO.	DESCRIPTION	CTN/MSTR
D76205L	4-7/8" strainer for 6" x 6"	1/20
D76207L	6-3/4" strainer for 9" x 9"	1/20
D76209L	9-3/4" strainer for 12" x 12"	1/10

Cast Iron Bell with Nut and Bolt

PART NO.	DESCRIPTION	CTN/MSTR
D76256	Bell for 6" x 6"	1/20
D76259	Bell for 9" x 9"	1/20
D76252	Bell for 12" x 12"	1/10

Spigot Outlet Bell Trap



- Loose lid
- Bell cast on

PIPE SIZE	BODY	STRAINER	OUTLET HEIGHT	OVERALL HEIGHT
2"	6" x 6"	4-7/8"	1-3/8"	3-1/2"
3"	9" x 9"	6-3/4"	1-1/2"	4-1/2"
4"	12" x 12"	9-3/4"	1-1/2"	4-7/8"

PART NO.	DESCRIPTION	CTN/MSTR
D76402	6" x 6" x 2"	1/1
D76403	9" x 9" x 3"	1/1
D76404	12" x 12" x 4"	1/1

Replacement Strainer with Cast-In Bell

PART NO.	DESCRIPTION	CTN/MSTR
D76412	4-7/8" cast-in bell for 6" x 6"	1/20
D76413	6-3/4" cast-in bell for 9" x 9"	1/20
D76414	9-3/4" cast-in bell for 12" x 12"	1/10

Pittsburgh Bell Trap



- Deep body
- 4" inside caulk

PIPE SIZE	BODY	STRAINER	OVERALL HEIGHT
4"	9" x 9"	6-3/4"	4-1/2"

PART NO.	DESCRIPTION	CTN/MSTR
B60994	9" x 9" x 4" inside caulk less bell	1/1

Strainer Only (Loose Lid)

PART NO.	DESCRIPTION	CTN/MSTR
B60099	6-3/4" ID strainer for 9" x 9"	1/1

Heavy Duty Floor Drain



- 8-1/2" heavy duty cast iron grate
- Cast iron sediment bucket

No Hub less Sediment Bucket

PART NO.	SIZE	PAN	GRATE	HEIGHT	CTN/MSTR
D79703	3"	10-1/2"	9" CI	5 1/4"	1/1
D79704	4"	10-1/2"	9" CI	5 1/4"	1/1

No Hub with Sediment Bucket

PART NO.	SIZE	PAN	GRATE	HEIGHT	CTN/MSTR
D79705	3"	10-1/2"	9" CI	5 1/4"	1/1
D79706	4"	10-1/2"	9" CI	5 1/4"	1/1

Inside Caulk less Sediment Bucket

PART NO.	SIZE	PAN	GRATE	HEIGHT	CTN/MSTR
D79805	3"	10-1/2"	9" CI	5 1/4"	1/1
D79806	4"	10-1/2"	9" CI	5 1/4"	1/1

Inside Caulk with Sediment Bucket

PART NO.	SIZE	PAN	GRATE	HEIGHT	CTN/MSTR
D79803	3"	10-1/2"	9" CI	5 1/4"	1/1
D79804	4"	10-1/2"	9" CI	5 1/4"	1/1

Sediment Bucket

PART NO.	DESCRIPTION	CTN/MSTR
D50095	CI sediment bucket	1/1

Code Blue No Caulk (Mechanical Joint) Cesspool Drain



- Supplied with stainless steel bolts
- Includes test plug
- UPC listed



PART NO.	SIZE	STRAINER	HEIGHT	CTN/MSTR
D76702	2"	6" CI	4 1/16"	1/1
D76703	3"	7" CI	4 1/16"	1/1
D76704	4"	8" CI	4 1/16"	1/1



- 3/4" Thick

PART NO.	DESCRIPTION	CTN/MSTR
D76705	Grate for D76702	1/1
D76707	Grate for D76704	1/1

Caulk Cesspool with Recessed Grate



PART NO.	DESCRIPTION	CTN/MSTR
D76504	12" x 12" x 4"	1/1
D76519	Grate only	1/1

Rainleader Cesspool



- For areas requiring downspout, rainleader and cesspool drain
- Grate secured by screw
- 12-3/4" diameter pan fits over outlet

PART NO.	DESCRIPTION	CTN/MSTR
J60030	4" hub inlet x 4" spigot outlet	1/1

Square Cesspool Grate



PART NO.	DESCRIPTION	CTN/MSTR
D59156	6" x 6" square grate	1/10
D59158	8" x 8" square grate	1/5
D59160	10" x 10" square grate	1/2
D59162	12" x 12" square grate	1/2

Round Slop Sink, Hydrant Cesspool



- 2" IPS outlet
- Removable Strainer

PART NO.	DESCRIPTION	CTN/MSTR
S55100	2" IPS ink painted	1/1
S55101	2" IPS galvanized cast iron	1/1

Square Hydrant Cesspool



- Grate included
- Spigot outlet

PART NO.	DESCRIPTION	CTN/MSTR
S57034	11" x 11" x 4"	1/1
S57035	Grate only	1/1

Porcelain Coated Floor Sink



- 12"x 12" white porcelain coated cast iron
- No hub and inside caulk
- Aluminum dome bottom strainer included

PART NO.	DESCRIPTION	CTN/MSTR
S55104	4" inside caulk 6" deep	1/1
S55004	4" inside caulk 8" deep	1/1
S55112	2" no hub 6" deep	1/1
S55113	3" no hub 6" deep	1/1
S55114	4" no hub 6" deep	1/1

Top Grates Only To Fit Floor Sinks



PART NO.	DESCRIPTION	CTN/MSTR
S55010	Full top grate	1/1
S55075	Three-quarter top grate	1/1
S55050	Half top grate	1/1

Aluminum Bottom Dome for Cast Iron Sink



- Fits all sizes porcelain coated cast iron sinks

BOTTOM OD	HEIGHT
5-3/8"	2-1/4"

PART NO.	DESCRIPTION	CTN/MSTR
S55115	Aluminum bottom dome- Fit All	1/1
S60002	2" aluminum bottom dome	1/10
S60003	3" aluminum bottom dome	1/10
S60004	4" aluminum bottom dome	1/10

Plumlock Porcelain Coated Floor Sink



- 12"x 12" white porcelain coated cast iron
- Aluminum dome strainer included
- Push-On Connection; gasket supplied

PART NO.	DESCRIPTION	CTN/MSTR
S55122	2" Plumlock floor sink- 6" deep	1/1
S55123	3" Plumlock floor sink- 6" deep	1/1
S55124	4" Plumlock floor sink- 6" deep	1/1

Plumlock Gasket for Cast Iron or Schedule 40 Pipe Connectors



- Fits 12" x 12" white porcelain coated cast iron Plumlock Sinks

PART NO.	DESCRIPTION	CTN/MSTR
S55192	2" Plumlock gasket	1/1
S55193	3" Plumlock gasket	1/1
S55194	4" Plumlock gasket	1/1

Service Sink Faucet



- Chrome plated
- Integral stops
- Integrated vacuum breaker
- Complete with all mounting hardware
- Meets ASSE 1001
- Front hook to hang bucket

PART NO.	DESCRIPTION	CTN/MSTR
S55349	Service sink faucet with lever handles	1/8
S55350	Service sink faucet w/cross handles	1/6
S55352	Lever handle stem repair kit for S55349	1/100
S55353	Integral stop repair kit for S55349	1/100
S55354	Vacuum breaker repair kit (S55349 or S55350)	1/100

Trap Standard



- Cast iron body with white coating
- Chrome plated brass strainer
- Fits American Standard*, Kohler*, Eljer* and Crane* cast iron service sinks

PART NO.	DESCRIPTION	CTN/MSTR
T00002	2" IPS	1/1
T00003	3" IPS	1/1
T00005	Base plate for trap standard	1/1
T00006	1-1/2" N.O. plug with gasket	1/1
T00009	Strainer and stud for trap standard	1/1

* The manufacturers' names are used only to describe whose products the products will fit.

Mop Service Basin

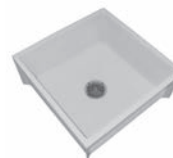

- One-piece molded construction; 24" x 24" x 10"
- Crushed stone with polyester resin
- Supplied with 3" gasketed connection and stainless steel strainer

PART NO.	DESCRIPTION	CTN/MSTR
S55240	Mop service basin	1/1

Hose and Bracket for Service Sink



- Heavy duty 300# cloth-reinforced hose
- 5" x 3" stainless steel bracket with rubber grip
- 3/4" brass hose coupling at one end

PART NO.	DESCRIPTION	CTN/MSTR
M05001	Hose with bracket	1/1

Mop Hanger for Service Sink



- 24" x 3" stainless steel hanger with three rubber tool grips
- Anchors included

PART NO.	DESCRIPTION	CTN/MSTR
M05003	Mop hanger	1/25

Roof Drain with Cast Iron Dome



- 10" diameter pan
- Dome has 50 sq. Inches of drain area
- Cast iron dome

PART NO.	SIZE	PAN	DOMES	HEIGHT	CTN/MSTR
R19003	3" inside caulk	10"	5-1/2"	8"	1/1
R19005	3" no hub	10"	5-1/2"	8"	1/1
R19004	4" inside caulk	10"	5-1/2"	8"	1/1
R19006	4" no hub	10"	5-1/2"	8"	1/1
R18020	Cast iron roof dome		5-1/2"		1/1

Code Blue No Hub Roof Drain with Square Pan



- 8 1/2" square pan
- Cast iron dome and drain
- Supplied with stainless steel bolts
- UPC listed



PART NO.	SIZE	PAN	HEIGHT	CTN/MSTR
R19202	2" no hub	8-1/2"	9-1/2"	1/1
R19203	3" no hub	8-1/2"	9-3/4"	1/1
R19204	4" no hub	8-1/2"	9-3/4"	1/1
R19206	6" no hub	8-1/2"	9-3/4"	1/1

Code Blue No Caulk (Mechanical Joint) Roof Drain with Square Pan

F



- 8 1/2" square pan for 2" and 3" outlet
- 15" pan for 4" outlet
- Cast iron dome and drain
- Supplied with stainless steel bolts
- UPC listed



PART NO.	SIZE	PAN	HEIGHT	CTN/MSTR
R19102	2" no caulk	8-1/2"	9-1/2"	1/1
R19103	3" no caulk	8-1/2"	9-1/2"	1/1
R19104	4" no caulk	8-1/2"	9-1/2"	1/1

Code Blue No Hub Dual Roof Drain

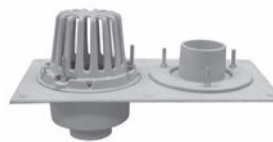

- Supplied with stainless steel bolts
- Overflow
- R19302, R19303, and R19304 are UPC listed

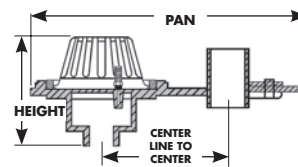

PIPE SIZE	CENTER TO CENTER	PAN	OVERALL HEIGHT	
			SINGLE	DOUBLE
2"	8-1/2"	19"	8"	8-1/2"
3"	8-1/2"	19"	9-1/2"	10"
4"	8-1/2"	19"	10"	10-1/2"

Single Dome

PART NO.	SIZE	PAN	CTN/MSTR
R19302	2" no hub dual drain	19"	1/1
R19303	3" no hub dual drain	19"	1/1
R19304	4" no hub dual drain	19"	1/1

Double Dome

PART NO.	SIZE	PAN	CTN/MSTR
R19307	2" no hub dual dome drain	19"	1/1
R19305	3" no hub dual dome drain	19"	1/1
R19306	4" no hub dual dome drain	19"	1/1

Replacement Parts

PART NO.	SIZE	CTN/MSTR
R19099	Roof drain dome	1/1
R19100	Clamping ring	1/1

Code Blue No Hub Side Outlet Roof Drain with Square Pan



PART NO.	SIZE	PAN	HEIGHT	CTN/MSTR
R19402	2"	8-1/2"	9-1/2"	1/1
R19403	3"	8-1/2"	9-1/2"	1/1
R19404	4"	8-1/2"	9-1/2"	1/1

Bar Grate



• For hub openings in soil pipe

PART NO.	DESCRIPTION	DIAMETER	CTN/MSTR
D59102	2" (less legs)	2-3/4"	1/10
D59103	3" (less legs)	3-1/2"	1/10
D59104	4" (less legs)	4-7/8"	1/10
D59106	6" (less legs)	6-7/8"	1/10
D59114	4" (with legs)	4-7/8"	1/10

Perforated Sewer Strainer with Legs



• For hub openings in clay sewer pipe

PART NO.	DESCRIPTION	DIAMETER	CTN/MSTR
D59124	4" sewer strainer	5-1/2"	1/10
D59126	6" sewer strainer	7-3/8"	1/5
D59128	8" sewer strainer	10-1/8"	1/5
D59130	10" sewer strainer	12-1/4"	1/2
D59132	12" sewer strainer	14-1/4"	1/2

Sewer Box



• Sewer lid is marked "sewer"
• Water lid is marked "water"
• Plain lid is unmarked

PART NO.	DESCRIPTION	CTN/MSTR
S36006	8" water lid and ring	1/1
S36007	8" sewer lid	1/1
S36008	8" sewer lid and ring	1/1
S36091	8" plain lid and ring	1/1
S36011	10" water lid and ring	1/1
S36009	10" sewer lid only	1/1
S36010	10" sewer lid and ring	1/1
S36096	10" plain lid and ring	1/1

Ohio Style Grate



• Cast iron grate

PART NO.	DESCRIPTION	CTN/MSTR
J60006	6" Ohio style grate	1/1

Water Access Box



• Lockable lid

PART NO.	DESCRIPTION	CTN/MSTR
J60026	6" x 6" x 2" water access box	1/6

Perforated Vent Box

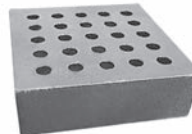

PART NO.	DESCRIPTION	CTN/MSTR
J60027	6" x 6" x 2" perforated vent box	1/6

Philadelphia Style Vent Box



• Strainer secured by overlapping lug and screw
• Integral cast baffles

PART NO.	DESCRIPTION	CTN/MSTR
J60004	4" inside caulk	1/1
J60094	Replacement strainer	1/1

Fresh Air Inlet/Floor Drain



PART NO.	DESCRIPTION	CTN/MSTR
J60007	3" spigot	1/15
J60008	4" spigot	1/15

Vent Cap



• Cast iron cap for 3" or 4" pipe

PART NO.	DESCRIPTION	CTN/MSTR
J60005	3" - 4" vent cap	1/10

Lockable Vent Cap



- Cast iron grate fits inside spigot end of pipe
- Secured with adjustable screw and clamp

PART NO.	DESCRIPTION	CTN/MSTR
J60010	4" cast iron vent cap	1/10

Brass Deck Plug



- Inside caulk
- Polished brass ring
- Cast brass body
- Skid-resistant scoriated lid

PART NO.	DESCRIPTION	CTN/MSTR
D28003	3" deck plug	1/20
D28004	4" deck plug	1/12

F Blind Plugs



No Hub		
PART NO.	DESCRIPTION	CTN/MSTR
D59202	2" blind plug	1/10
D59203	3" blind plug	1/10
D59204	4" blind plug	1/8

Service Weight		
PART NO.	DESCRIPTION	CTN/MSTR
D59302	2" blind plug	1/10
D59304	4" blind plug	1/4

Reading Style Vent



- 4" Inside caulk

PART NO.	DESCRIPTION	CTN/MSTR
J60011	Reading vent	1/1

Reading Style Cleanout



- 4" Inside caulk

PART NO.	DESCRIPTION	CTN/MSTR
J60012	Reading cleanout	1/1

Cast Iron Backwater Valves



- Reduces backflow in drainage system
- All neoprene gaskets
- 300 series stainless bolts and washers
- Repairable in service
- Revolutionary design- that works!
- B01002 is not UPC listed

Service Weight				
PART NO.	SIZE	LENGTH	HUB	CTN/MSTR
B01013	3"	10-3/4"	5-1/8"	1/1
B01014	4"	11-3/4"	6-1/2"	1/1
B01016	6"	12-3/4"	7-1/4"	1/1

No Hub				
PART NO.	SIZE	LENGTH	HUB	CTN/MSTR
B01002	2"	10-3/4"	—	1/1
B01003	3"	11-3/4"	—	1/1
B01004	4"	12-3/4"	—	1/1
B01006	6"	14-1/2"	—	1/1

Replacement Flappers		
PART NO.	DESCRIPTION	CTN/MSTR
B01017	2" bolt-in flapper and ring	1/1
B01018	3" bolt-in flapper and ring	1/1
B01019	4" bolt-in flapper and ring	1/1
B01020	6" bolt-in flapper and ring	1/1

Items marked with the Jones Stephens logo are "You Need It... We Got It" Items.

Test Tee



- Available with or without plug
- Plug is Southern Code

Service Weight Tee

PART NO.	DESCRIPTION	LENGTH	PLUG	CTN/MSTR
T55002	2"x 2" less plug	10-3/8"	2"	1/1
T55012	2"x 2" with plug	10-3/8"	2"	1/1
T55003	3"x 3" less plug	12-1/2"	3"	1/1
T55013	3"x 3" with plug	12-1/2"	3"	1/1
T55004	4"x 4" less plug	13-7/8"	4"	1/1
T55014	4"x 4" with plug	13-7/8"	4"	1/1

No Hub Tee

PART NO.	DESCRIPTION	LENGTH	PLUG	CTN/MSTR
T56002	2"x 2" less plug	6-3/8"	2"	1/1
T56012	2"x 2" with plug	6-3/8"	2"	1/1
T56003	3"x 3" less plug	7-3/4"	3"	1/1
T56013	3"x 3" with plug	7-3/4"	3"	1/1
T56004	4"x 4" less plug	8-7/8"	4"	1/1
T56014	4"x 4" with plug	8-7/8"	4"	1/1

Test Tee with Heavy Plug



Service Weight Tee

PART NO.	DESCRIPTION	LENGTH	PLUG	CTN/MSTR
T55022	2"x 2" with plug	10-3/8"	2"	1/1
T55033	3"x 3" with plug	12-1/2"	3"	1/1
T55044	4"x 4" with plug	13-7/8"	4"	1/1

No Hub Tee

PART NO.	DESCRIPTION	LENGTH	PLUG	CTN/MSTR
T56022	2"x 2" with plug	6-3/8"	2"	1/1
T56033	3"x 3" with plug	7-3/4"	3"	1/1
T56044	4"x 4" with plug	8-7/8"	4"	1/1

Cast Iron Single Vent Running Trap



PART NO.	DESCRIPTION	CTN/MSTR
T64540	5"x 4" single vent running trap	1/1
T63106	6"x 4" single vent running trap	1/1

Tapped Saddle Tee



- U-bolt included

PART NO.	DESCRIPTION	CTN/MSTR
T21001	3"x 1 1/2"	1/1
T21002	3"x 2"	1/1
T21004	4"x 2"	1/1
S26008	6" x 7" (1/4" thick) closed cell foam gasket	1/1

Repair Plate



- U-bolt included

PART NO.	DESCRIPTION	CTN/MSTR
T21062	2" plate with u-bolt	1/1
T21063	3" plate with u-bolt	1/1
T21064	4" plate with u-bolt	1/1

F

“T” Burner Bar



- 12-1/4" long by 1-3/8" high, tapped 1/2" IPS in ends and bottom
- Supplied with two 1/2" plugs and close nipple orifice

PART NO.	DESCRIPTION	LENGTH	HEIGHT	CTN/MSTR
L75080	Natural Gas	12-1/4"	1-3/8"	1/10
L75180	LPG	12-1/4"	1-3/8"	1/10

Two Leg Burner



- Dimensions 14" long x 1-3/4" high x 2-1/4" wide
- Tapped 1/2" IPS on both ends and one leg
- Comes with two 1/2" IPS plugs and close nipple orifice
- Ledge over burner holes prevents clogging

PART NO.	DESCRIPTION	LENGTH	HEIGHT	CTN/MSTR
L75081	Natural Gas	14"	1-3/4"	1/10
L75181	LPG	14"	1-3/4"	1/10

Round Burner



- 1-3/4" high x 4 1/2" wide, tapped 1/2" IPS in bottom and sides
- Supplied with close nipple orifice and 1/2" plug

PART NO.	DESCRIPTION	WIDTH	HEIGHT	CTN/MSTR
L75086	Natural Gas	4-1/2"	1-3/4"	1/10
L75186	LPG	4-1/2"	1-3/4"	1/10

Rectangular Burner



- Dimensions 8-3/4" long x 1-1/2" high x 1-3/4" wide with 1/2" IPS inlet
- Supplied with close nipple orifice and removable lid
- Low profile

PART NO.	DESCRIPTION	LENGTH	HEIGHT	CTN/MSTR
L75085	Natural Gas	8-3/4"	1-1/2"	1/10
L75185	LPG	8-3/4"	1-1/2"	1/10

Log Lighter Burner Bar



- Air mixing chamber
- Straight: 17" pipe plus 3" mixing chamber
- T-Pattern: Two 7" pipes plus 3" mixing chamber

PART NO.	DESCRIPTION	CTN/MSTR
L75091	Straight for natural gas	1/10
L75092	Straight for LPG	1/10
L75095	T-pattern for natural gas	1/10
L75096	T-pattern for LPG	1/10

Log Lighter Valves

- CSA design certified
- Zinc escutcheon
- 1/4" Key included
- Individually tested (pressure test in open and closed position after installation)
- BTU rating: angle 188,000, straight 120,000
- To extend escutcheon use 1/2" pipe coupling and 1/2" pipe nipple

Standard Valve (7 turns open/close)



PART NO.	DESCRIPTION	CTN/MSTR
L75001	Chrome plated angle	1/36
L75002	Polished brass angle	1/36
L75006	Chrome plated straight	1/36
L75007	Polished brass straight	1/36

Ball Valve (1/4" turn)



PART NO.	DESCRIPTION	CTN/MSTR
L75040	Chrome plated angle	1/36
L75041	Polished brass angle	1/36
L75042	Chrome plated straight	1/36
L75043	Polished brass straight	1/36

Escutcheons Only

PART NO.	DESCRIPTION	CTN/MSTR
L75908	Chrome plated	1/36
L75909	Polished brass	1/36

Items marked with the Jones Stephens logo are "You Need It...We Got It" Items.

2-Way Combo Log Lighter Valve



- Straight or angle pattern
- 5/16" key and brass plug for extra outlet included

PART NO.	FINISH	CTN/MSTR
L75009	Chrome plated	1/10
L75010	Polished brass	1/10

Log Lighter Valve with T-Burner



- Solid brass escutcheon, 1/4" key and close nipple orifice included
- Individually tested (pressure test open and closed after installation)
- Angle: 188,000 BTU/Straight: 120,000 BTU

PART NO.	DESCRIPTION	CTN/MSTR
L75406	Chrome plated angle natural gas	1/1
L75407	Polished brass angle natural gas	1/1
L75408	Chrome plated straight natural gas	1/1
L75409	Polished brass straight natural gas	1/1
L75400	Chrome plated angle LPG	1/1
L75401	Polished brass angle LPG	1/1
L75402	Chrome plated straight LPG	1/1
L75403	Polished brass straight LPG	1/1

Log Lighter Keys and Accessories



- 1/4" and 5/16" drives on keys
- Brass

PART NO.	SIZE	MATERIAL	CTN/MSTR
L75019	1/4"x 3"	Brass	1/200
L75020	5/16"x 3"	Brass	1/200
L75021	1/4"x 6"	Brass	1/240
L75023	5/16"x 6"	Brass	1/240
L75022	1/4"x 12"	Brass	1/100
L75024	5/16"x 12"	Brass	1/100



- Die cast zinc

PART NO.	SIZE	MATERIAL	CTN/MSTR
L75017	1/4"x 3"	Die cast zinc	1/250
L75018	5/16"x 3"	Die cast zinc	1/250

Close Nipple Orifices



PART NO.	DESCRIPTION	CTN/MSTR
L75015	7/64" Orifice for natural gas	1/100
L75016	5/64" Orifice for LP gas	1/100

TOOLS..... 275-303

G

JONES STEPHENS E-Z STROKE SAWS

NEW!

Metal Cutting Blade



- Bi-metal blade cuts metals (iron, copper, brass, aluminum, and other metals)
- Cuts on the pull stroke unlike standard metal cutting saws
- Use to cut off closet bolts, copper tubing, brass tubular, iron pipe and much more
- Replaceable blade
- Orange handle accepts all Jones Stephens E-Z Stroke blades

- Cuts plastic pipe and wood
- For smooth, fast, accurate cutting
- Tri-edge teeth are borazon wheel ground
- Pull-stroke cutting action
- Flexible blade allows flush cutting without marring adjacent surface
- Replaceable blade
- Orange handle accepts all Jones Stephens E-Z Stroke blades

PART NO.	DESCRIPTION	CTN/MSTR
S49030	8" E-Z Stroke metal cutting saw	10/100
S49031	8" Replacement blade	50/250

PART NO.	DESCRIPTION	CTN/MSTR
S49005	8" E-Z Stroke pipe saw	10/100
S49006	8" Replacement blade	50/250
S49008	12" E-Z Stroke pipe saw	10/100
S49007	12" Replacement blade	50/250



S49030

Cuts iron, copper, brass, aluminum, and other metals

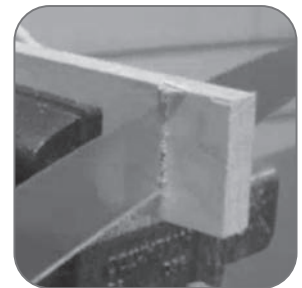

S49005 & S49008

Cuts plastic pipe and wood

Tub and Shower Valve Wrench Set



- Plated steel
- Complete set with handle includes: 21/32" x 27/32", 29/32" x 31/32", 1-1/32" x 1-3/32", 1-11/32" x 1-7/16", 1-5/32" x 1-9/32"

PART NO.	DESCRIPTION	CTN/MSTR
J40002	Valve wrench set (boxed)	1/20
J40000	21/32" x 27/32" wrench only (carded)	20/100
J40001	1-1/32" x 1-3/32" wrench only (carded)	20/100
J40006	29/32" x 31/32" wrench only (carded)	50/100
J40008	1-11/32" x 1-7/16" wrench only (carded)	1/100

Garbage Disposal Wrench



- 1/2" steel
- 10" long

PART NO.	DESCRIPTION	CTN/MSTR
J40025	Disposal wrench	25/50

4-Way Key



- Plated steel
- For valve, faucet and sillcock sizes 1/4", 9/32", 5/16" and 11/32"
- Carded

PART NO.	DESCRIPTION	CTN/MSTR
J40005	4-way key	25/100

No Hub Torque Wrench



- For 5/16"
- Automatic release at 60 in.lb.
- Built-in reversing lever
- Ratchets one way
- Chrome vanadium socket
- Carded

PART NO.	DESCRIPTION	CTN/MSTR
T60060	No hub torque wrench	20/80

Mega Torque Wrench



- Slide down locking reversing feature
- Heavy duty construction with chrome vanadium sockets

PART NO.	DESCRIPTION	CTN/MSTR
T60065	60 lb. with 5/16" socket	15/60
T60080	80 lb. with 3/8" socket	15/60
T60081	80 lb. with 5/16" socket	15/60
T60066	5/16" Socket kit	15/60

Element Wrench



- Zinc plated steel
- 1-1/2" ID - 1-3/4" OD
- For removing heater elements

PART NO.	DESCRIPTION	CTN/MSTR
J36100	Regular unit wrench	25/100
J36101	Heavy duty wrench	25/50

Sillcock Key



- Die cast
- 5/16" and 1/4"

PART NO.	DESCRIPTION	CTN/MSTR
J40003	1/4" Sillcock key	1/400
J40004	5/16" Sillcock key	1/400

14 Piece Folding Hex Key Wrench Set



- Chrome plated steel case
- Fourteen fractional U.S. sizes
- Carded

PART NO.	DESCRIPTION	CTN/MSTR
J40015	Hex key wrench set	12/72

Basin Wrench



B11010



B11012



B11011



B11013

- Spring-hinged jaw
- Telescoping body allows for easier use in hard-to-reach areas
- Swivel head operates from either right or left side
- Use on hard-to-reach basin nuts, ballcocks and flush valves
- B11013 is carded

PART NO.	DESCRIPTION	JAW	CTN/MSTR
B11010	10"-17" telescoping	1-1/4"	10/30
B11011	11-3/8" long non-telescoping	1-1/4"	20/40
B11012	9-1/2" - 16-1/2" telescoping	2"	15/30
B11013	Spring hinged replacement jaw for B11011	-	20/100

Radiator Spud Wrench



- Plated malleable iron
- For use as spud key and wrench

PART NO.	DESCRIPTION	CTN/MSTR
J40030	Radiator spud wrench	10/20

Items marked with the Jones Stephens logo are "You Need It... We Got It" Items.

4-Way P.O. Plug Wrench



- For installing or removing basket strainers, tub drains and P.O. plugs

PART NO.	DESCRIPTION	CTN/MSTR
J40026	4-way P.O. plug wrench	20/60

4-Way Plug Wrench



- For installing or removing countersunk plugs

PART NO.	DESCRIPTION	CTN/MSTR
J40040	4-way plug wrench	1/20

4-Way Countersunk Plug Wrench



- For installing or removing countersunk plugs

PART NO.	DESCRIPTION	CTN/MSTR
J40041	4-way countersunk plug wrench	5/15

G 6-Way Countersunk Plug Wrench



- 4 head sizes for square plugs
- 2 head sizes for slotted plugs
- Extra-strong iron construction

PART NO.	DESCRIPTION	CTN/MSTR
J40042	6-way wrench	1/20

Faucet Seat Repair Kit



- Reversible cone
- 4 sizes of cutters
- Hardened steel cutters smooth worn seats
- Saves repair costs; stops faucet drips
- Kit includes faucet washers and bibb screw
- Carded

PART NO.	DESCRIPTION	CTN/MSTR
J40007	Faucet seat repair kit	12/120

Faucet Seat Wrench



- Tapered for use on all sizes and types of seats

PART NO.	DESCRIPTION	CTN/MSTR
S62001	Straight tapered wrench	50/200
S62002	Angle tapered wrench	10/60
S62003	Straight stepped wrench	50/200
S62004	Angle stepped wrench	10/60

Seat Wrench for Recessed Seats



- Works in hard-to-reach recessed seats

PART NO.	DESCRIPTION	CTN/MSTR
S62005	Seat wrench for recessed seats	50/100

Dual Kwik Tite Wrench



- Install stops easily
- Tightens 3/8" supply nuts
- Carded

PART NO.	DESCRIPTION	CTN/MSTR
J40490	Dual kwik tite wrench	10/60

Lavatory Nut Removal Tool



- Lightweight, high strength plastic
- For 7/8" metal or plastic hex nuts
- Extra long to reach mounting nuts on faucets, sprayers, and ballcocks
- Bagged with header card

PART NO.	DESCRIPTION	CTN/MSTR
J40035	Lavatory nut removal tool	10/50

Universal Drain Wrench



- 6" long
- Die cast aluminum
- Installs and removes tub drains and closet spuds
- Prevents damage to decorative finishes
- Use crescent wrench or screwdriver to turn tool
- Carded

PART NO.	DESCRIPTION	CTN/MSTR
J45010	Universal drain wrench	12/48

Angle Compression Stop Wrench



- Fits 3/8" compression or 1/2" male IPS outlet threads on angle stops
- Protects finishes
- Carded

PART NO.	DESCRIPTION	CTN/MSTR
J40491	Angle compression stop wrench	10/60

Extract-a-Drain Tub Drain Removal Tool



- Removes old or rusty drains - even drains with missing crossbars!
- Fits both 1-3/8" and 1-1/2" tub drains
- Jaws expand to firmly grip the inside of the drain
- Prevents damage to your tub's finish
- A wrench is the only other tool that you'll need to complete this job

PART NO.	DESCRIPTION	CTN/MSTR
J40018	Extract-a-drain tool	1/50

Compression Sleeve Puller

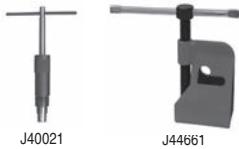

- Removes leaking compression sleeves without damaging walls
- Unique armless design - screws directly into compression nut for fast removal
- For 5/8" compression nuts
- Made in the USA (J40021)
- Carded

MADE IN THE USA

PART NO.	DESCRIPTION	CTN/MSTR
J40021	Compression sleeve puller	1/35
J44661	Compression sleeve puller - 1/2" OD	10/40

Compression Sleeve Puller Adapter



- Converts any standard faucet handle puller to remove compression sleeves

PART NO.	DESCRIPTION	CTN/MSTR
J40013	Adapter	50/100

E-ZEE Pull Deluxe Faucet Handle Puller



- 4" bracket width
- Pulls all size handles
- Forged steel with case - hardened pin

PART NO.	DESCRIPTION	CTN/MSTR
J40012	E-ZEE pull deluxe faucet handle puller	25/50

Faucet Handle Puller

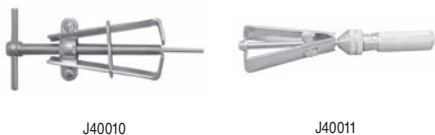

- Plated steel
- Removes faucet and valve handles
- J40010 is carded

PART NO.	DESCRIPTION	CTN/MSTR
J40010	Standard unit (carded)	25/50
J40011	Heavy duty impact unit	15/30

Quick Drain Wrench



- Installs no caulk shower drains quickly
- Provides tongue to seal drain

PART NO.	DESCRIPTION	CTN/MSTR
J40235	Quick drain wrench	10/60

Sink Drain Wrench



- Fits kitchen, bath and laundry tub basket strainers, p-traps, wing nuts and tub drains
- Made in the USA

MADE IN THE USA

PART NO.	DESCRIPTION	CTN/MSTR
J40023	Sink drain wrench	1/24

Moen Stem and Cartridge Wrench



- Removes Moen stems and cartridges
- Works on plastic and brass faucet and shower valves
- Carded

PART NO.	DESCRIPTION	CTN/MSTR
J45015	Stem and cartridge wrench	12/72

Adjustable Strainer and Spud Wrench



- Chrome plated
- Fits closet spuds, basket strainers, lock nuts and slip nuts
- Adjustment 7/8" to 3-1/8"

PART NO.	DESCRIPTION	CTN/MSTR
J40022	Strainer & spud wrench	20/40

Spud Wrench



- For strainer, lock and slip nuts
- 1" - 3" capacity
- Heat treated forging

PART NO.	DESCRIPTION	CTN/MSTR
J40305	Spud wrench	20/40

Spud Wrench with Hinged Arm



- Hinged arm allows use on any size

PART NO.	DESCRIPTION	CTN/MSTR
J40306	Spud wrench with hinged arm	30/60

Spanner/Strainer Wrench



- Plated malleable iron
- Used for basket strainer jam nuts

PART NO.	DESCRIPTION	CTN/MSTR
J40024	Spanner/strainer wrench	25/50

Strainer Wrench



- Plated steel
- For use on basket strainers and tub drains with cross bars
- Long handle for leverage

PART NO.	DESCRIPTION	CTN/MSTR
J40028	Strainer wrench	20/60

Plumb Easy Sink Strainer Wrench



- Fits most basket strainers
- Installs and removes basket strainers with ease

PART NO.	DESCRIPTION	CTN/MSTR
J40128	Plumb Easy sink strainer wrench	4/32

Do All Plumbers Wrench



- Longer, more comfortable handle allows greater leverage for tightening or loosening locknuts
- Fits most standard size basket strainers including: Opella, Duo, Twist Lock and PB Duo. Use on any strainer which uses a standard 3-3/8" locknut
- Fits most shower stall drains
- Fits the following drain styles:
 - 2" Plastic No Caulk for plastic pipe
 - 2" Brass No Caulk for plastic pipe
 - 2" Receptor Base for plastic pipe
 - 2" Drop In style for plastic pipe
- Carded

PART NO.	DESCRIPTION	CTN/MSTR
J40019	Do All plumbers wrench	10/40

Heavy Duty Pipe Wrench



- Manufactured to U.S. Specification GGG-W651 Type II Class A
- Upper and lower jaws forged and tempered
- Nodular cast iron handle



PART NO.	LENGTH	CAPACITY	ROTHENBERGER	CTN/MSTR
J40065	8"	1"	7.0150	1/6
J40066	10"	1-1/2"	7.0151	1/6
J40067	12"	2"	7.0152	1/6
J40068	14"	2"	7.0153	1/4
J40069	18"	2-1/2"	7.0154	1/2
J40070	24"	3"	7.0155	1/4
J40105	36"	5"	7.0156	1/4

Aluminum Pipe Wrench



- Manufactured to U.S. Specification GGG-W651 Type I Class B
- Forged and tempered handle, bottom jaw and nut
- Alloy handle



PART NO.	LENGTH	CAPACITY	ROTHENBERGER	CTN/MSTR
J40071	10"	1-1/2"	7.0159	1/4
J40072	14"	2"	7.0160	1/6
J40073	18"	2-1/2"	7.0161	1/6
J40074	24"	3"	7.0162	1/6
J40106	36"	5"	7.0163	1/4

Adjustable Wrench



- Manufactured to Federal Specification GGG-W-631-B Type I Class I
- Drop forged
- Chrome plated



PART NO.	LENGTH	CAPACITY	CHANNELLOCK	CTN/MSTR
J40075	6"	13/16"	806W	1/5
J40076	8"	15/16"	808W	1/5
J40077	10"	1-3/16"	810W	1/5
J40078	12"	1-3/8"	812W	1/5
J40079	15"	1-3/8"	815	1/1

Curb Box Wrench



- For pentagon curb boxes
- Thin wall socket fits most boxes

PART NO.	DESCRIPTION	CTN/MSTR
M25900	Curb box wrench	1/100

Box Wrench



- For B and MC tanks

PART NO.	DESCRIPTION	CTN/MSTR
J40230	Box wrench	1/1

Bibb Seat Tool Set



- Set includes:
 - 3/8" x 7/16" ratcheting box wrench
 - Small hex/large hex tapered bibb seat tool
 - Small square/large square tapered bibb seat tool
 - Small square/large square straight bibb seat tool
 - Sleeved pouch

PART NO.	DESCRIPTION	CTN/MSTR
J40308	Bibb seat tool set	20/40

Strap Wrench



- For chrome fittings and nipples

PART NO.	DESCRIPTION	CTN/MSTR
J40307	7" strap wrench	25/50
J40311	11" strap wrench	12/24

Twist-Off Strap Wrench



- Grips when wet
- Will not scratch
- High density polyethylene handle
- Heavy duty rubber strap
- Carded

PART NO.	DESCRIPTION	CTN/MSTR
J40325	Twist-off strap wrench	15/60

Hydrostatic Pressure Pump



- Maximum pressure 700 PSI
- 1/2" NPT hose connection
- Three gallon tank capacity



PART NO.	DESCRIPTION	ROTHENBERGER	CTN/MSTR
J40223	Complete pressure pump unit	6.1004	1/1
J40224	0 - 700 PSI gauge	6.1313	1/1
J40225	Piston	6.1300	1/1

RP 30 Hydrostatic Test Pump



- For quick pressure testing and/or air tight testing
- Ideal for use in small spaces
- Steel reinforced test hose
- Test up to 440 lbs
- 500 PSI
- No false reading from any bulging of the hose!



PART NO.	DESCRIPTION	ROTHENBERGER	CTN/MSTR
J40123	Hydrostatic test pump	RP 30	1/1

High Pressure Hose with Fitting



- For hydrostatic pressure pump

PART NO.	DESCRIPTION	CTN/MSTR
J40198	High pressure hose with fitting	1/1

Air Pump



- Large diameter
- Heavy metal construction
- Pressure gauge included

PART NO.	DESCRIPTION	CTN/MSTR
P10001	Heavy duty air pump	1/10

Economy Air Pump



- Pressurizes inflatable test plugs

PART NO.	DESCRIPTION	CTN/MSTR
P10002	Economy air pump	1/12

Water Pump



- Excellent for draining water meter boxes
- High impact PVC; non-sparking; lightweight
- No priming necessary- removes 35 ounce/stroke
- Remove foot valve to clean

PART NO.	DESCRIPTION	CTN/MSTR
P13600	36" pump with 72" discharge hose	1/1

Insulated Hose Nozzle



- Heavy duty with threaded end
- Soft comfort grip
- Carded

PART NO.	DESCRIPTION	CTN/MSTR
G04030	Insulated hose nozzle	12/72

Contractor Grade Rubber Hose



- Contractor grade
- Reinforced rubber
- Heavy duty brass coupling

PART NO.	DESCRIPTION	CTN/MSTR
G04026	3/4" x 50' contractor grade rubber	1/2

Commercial Premium Rubber Hose



PART NO.	DESCRIPTION	CTN/MSTR
G04005	5/8" x 25' commercial premium rubber	1/1
G04006	5/8" x 50' commercial premium rubber	1/1

Garden Hose



- G04001:
- 500 PSI burst strength
 - Kink-free construction
 - Heavy-duty solid brass nickel plated coupling
 - Built-in spring at faucet end to prevent hose damage
 - Nylon reinforced

- G04002 and G04000:
- 300 PSI burst strength
 - Solid brass couplings
 - Reinforced green nylon construction

PART NO.	DESCRIPTION	CTN/MSTR
G04001	5/8" x 60' (500 PSI) garden	1/6
G04002	5/8" x 50' (300 PSI) garden	1/6
G04000	5/8" x 75' (300 PSI) garden	1/6

4-N-1 Copper Tube Fitting Brush



- Includes four long lasting high carbon steel brushes for 1-1/2" and 3/4" copper tube and fittings

PART NO.	DESCRIPTION	CTN/MSTR
B10004	Copper tube and fitting brush	1/10

Female Copper Tube Brush



- For cleaning copper tubing
- CARTON QUANTITIES ONLY

PART NO.	DESCRIPTION	CTN/MSTR
B29625	CTS OD 5/8" copper tube brush	6/6
B29875	CTS OD 7/8" copper tube brush	6/6
B29999	CTS OD 1-1/8" copper tube brush	6/6

Copper Fitting Brush

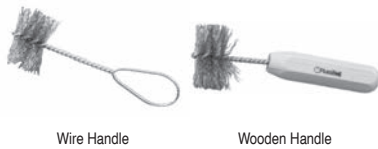

- Carbon steel
- CARTON QUANTITIES ONLY

Wire Handle

Wooden Handle

Wire Handle

PART NO.	ID	OD	CTN/MSTR
B28025	1/4"	3/8"	12/72
B28375	3/8"	1/2"	12/72
B28050	1/2"	5/8"	12/72
B28051	1/2"	5/8"	100/100
B28075	3/4"	7/8"	12/72
B28076	3/4"	7/8"	100/100
B28100	1"	1-1/8"	12/72
B28125	1-1/4"	1-3/8"	6/36
B28150	1-1/2"	1-5/8"	12/72
B28200	2"	2-1/8"	6/36

Wooden Handle

PART NO.	ID	OD	CTN/MSTR
B29025	1/4"	3/8"	12/72
B29375	3/8"	1/2"	12/72
B29050	1/2"	5/8"	12/72
B29051	1/2"	5/8"	100/100
B29075	3/4"	7/8"	12/72
B29076	3/4"	7/8"	100/100
B29100	1"	1-1/8"	12/72
B29125	1-1/4"	1-3/8"	6/36
B29150	1-1/2"	1-5/8"	6/36
B29200	2"	2-1/8"	6/36

Socket Savers



- Removes Schedule 40 plastic pipe from a hub
- Cuts ABS or PVC DWV pipe below slab
- Fits 1/2" variable speed power drill
- Carded

PART NO.	DESCRIPTION	CTN/MSTR
J44050	1/2" Socket Saver	36/144
J44075	3/4" Socket Saver	30/120
J44100	1" Socket Saver	24/96
J44150	1-1/2" Socket Saver	24/96
J44200	2" Socket Saver	12/72
J44300	3" Socket Saver	12/48
J44400	4" Socket Saver	20/40

Inside Pipe Cutter



- Cuts 2" and larger plastic pipe
- Fits electric drill

PART NO.	DESCRIPTION	CTN/MSTR
P70023	3" shaft with 2 blades	1/50
P70029	(3) Replacement blades	1/10

EZY Grind Pipe Cutter



- Fast and easy way to cut plastic pipe at or below floor level
- Cuts plastic DWV and HDPE pipe from the interior of the pipe
- Made from tool steel
- Suitable for portable power drills
- 1/4" hex shank, fits all drill chucks
- Guided cutting motion
- Pre-set depth of cut
- Replaceable diamond blade
- Carded

PART NO.	DESCRIPTION	CTN/MSTR
J40650	EZY Grind plastic pipe cutter for 4" - 6" pipe	1/1
J40652	Replacement blade for EZY Grind 4" - 6" plastic pipe cutter J40650 (2 pk)	1/1
J40651	EZY Grind plastic pipe cutter for 1-1/2" - 3" pipe	1/1
J40653	Replacement blade for EZY Grind 1-1/2" - 3" plastic pipe cutter J40651 (2 pk)	1/1

E-Z Shear Inside Pipe Cutter



- Cuts PVC and ABS pipe
- High speed steel blade with zinc-plated shaft

PART NO.	DESCRIPTION	CTN/MSTR
J40830	E-Z shear inside pipe cutter	24/192
J40831	(2) E-Z shear replacement blades	1/100

PVC Pipe Cutter



- High carbon steel blades
- Repair kits includes all screws and springs needed to repair cutter
- Aluminum alloy handles
- Ratchet action
- P70001 is carded

PART NO.	DESCRIPTION	CTN/MSTR
P70001	1" pipe cutter	10/50
P70005	Replacement blade	50/300
P70015	1" repair kit	1/100

Heavy Duty PVC Pipe Cutter



- High carbon steel blades
- Repair kit includes all screws and springs needed to repair cutter
- Aluminum alloy handles
- P70010 and P70002 are boxed

PART NO.	DESCRIPTION	CTN/MSTR
P70010	1" heavy duty pipe cutter	1/60
P70011	1" heavy duty replacement blade	1/100
P70012	1" repair kit	1/100
P70002	2" pipe cutter	1/20
P70006	2" replacement blade	1/100
P70016	2" repair kit	1/100

PVC One-Handed Pipe Cutter



- Easy one-handed ratchet cutting action
- Spring loaded blade
- Heat treated hardened steel blade for straighter cuts - longer life
- Cuts up to 2" pipe (2-1/2" OD)
- P70035 is carded

PART NO.	DESCRIPTION	CTN/MSTR
P70035	2" PVC one-handed pipe cutter	6/24
P70036	Replacement blade	25/50

Items marked with the Jones Stephens logo are "You Need It... We Got It" Items.

Professional PVC Pipe Cutter



- Rustproof
- Capacity to 1-1/4" diameter PVC
- The blade is non-electro nickel plated which ensures a sharper blade
- Locking hook can be used to deburr pipe
- P70018 and P70019 are carded

PART NO.	DESCRIPTION	CTN/MSTR
P70018	1-1/4" PVC pipe cutter	5/30
P70019	Replacement blade	10/100
P70020	Repair kit (spring and screws)	10/100

Vinyl Tubing Cutter



- Plastic body
- Cuts up to 1" vinyl tubing

PART NO.	DESCRIPTION	CTN/MSTR
P70030	Vinyl tube cutter	12/72
P70031	Replacement blade	50/500

Telescopic Tubing Cutter



- Extra wheel in handle
- Grooved roller
- 1/4"- 1-1/4" cutter
- Built-in deburring tool

PART NO.	DESCRIPTION	CTN/MSTR
P70050	Telescopic tubing cutter	10/100
P70055	Replacement cutter wheel	1/100
P70056	(2) Replacement cutter wheels	50/500

Telescoping Tubing Cutter



- Enclosed feed mechanism
- Grooved rollers for close-to-flare cuts
- Anodized body for corrosion resistance
- Allows cut with shorter arc
- Fold-away reamer
- Spare cutter wheel stored in body



PART NO.	DESCRIPTION	ROTHENBERGER	CTN/MSTR
J40240	1/8" - 1-1/8" O.D. capacity	70010	1/1
J40241	1/4" - 1-5/8" O.D. capacity	70011	1/1
J40242	Replacement cutter wheel	70007	1/1
J40243	Cutter wheel pin	51250	1/1
J40244	Cutter wheel pin retaining ring	51240	1/1

Enclosed Feed Tube Cutter



Retractable
Deburring
Blade

- Extra cutter in knob
- Heavy duty one piece slide
- Polished rollers for easy rotation
- Cuts: copper, brass, aluminum tubing, thin-wall conduit
- P70056 is carded

PART NO.	DESCRIPTION	CTN/MSTR
P70064	1/8" x 1-3/16"	10/60
P70056	(2) Replacement cutter wheels	50/500

Quick Release Tubing Cutter



- Spring-loaded for quick size adjustment
- Spring cutter wheel in handle
- P70069 is carded

PART NO.	DESCRIPTION	CTN/MSTR
P70065	1/4" - 2" O.D. Capacity tubing cutter	6/48
P70069	(2) Replacement cutter wheels	50/500

Quick Release Tubing Cutter



- Spring-loaded ratchet allows for quick size adjustment and release
- Spare cutter wheel in handle



PART NO.	DESCRIPTION	ROTHENBERGER	CTN/MSTR
J40217	1/4" - 2 5/8" heavy duty cutter	70030	1/1
J40218	Repl. cutter wheel for metal	70005	1/1
J40219	Repl. cutter wheel for plastic	70028	1/1
J40228	Cutter wheel screw	70006	1/10

Economy Tube Cutter



- Screw-feed
- Zinc plated

PART NO.	DESCRIPTION	CTN/MSTR
P70066	1/8" - 1-1/8"	10/60
P70067	(2) Replacement blades (slide blister)	50/500

Ratcheting Handle Copper Tube Cutter



- Cuts multiple sizes of copper, aluminum tubing, and thin-wall conduit
- Long handle for more leverage

PART NO.	DESCRIPTION	CTN/MSTR
J40262	1/4"-3/4" Ratcheting handle copper tube cutter	6/48

Mini Tubing Cutter



- Good for all soft metal tubing



PART NO.	DESCRIPTION	ROTHENBERGER	CTN/MSTR
J40213	5/8" capacity tubing cutter	70001	1/24
J40215	Replacement cutter wheel	70003	1/1
J40228	Cutter wheel screw	70006	6/48

Items marked with the Jones Stephens logo are "You Need It...We Got It" Items.

Mini Tubing Cutter



- Good for all soft metal tubing
- P70052 is carded

PART NO.	DESCRIPTION	CTN/MSTR
P70051	Mini tubing cutter - 1/8"-5/8"	20/200
P70052	Mini tubing cutter-1/8"-7/8" (uses P70056 repl. blade)	1/100
P70053	Mini tubing cutter- 1/8" - 1-1/8"	1/80
P70060	(2) Replacement blades (bulk)	25/250
P70067	(2) Replacement blades (slide blister)	50/500

Copper Tube Cutter



- Self-clamping and self-aligning
- Easy to use in close quarters
- Cuts copper and PVC quickly and easily
- J40260 and J40261 are carded

PART NO.	DESCRIPTION	CTN/MSTR
J40260	1/2" Copper tube cutter	10/100
J40261	3/4" Copper tube cutter	10/60
J40263	(2) Replacement blades for J40260 and J40261	50/500

Plastic Saw



- Die cast aluminum handle
- Quickly cuts PVC, ABS, wood, sheetrock, etc.
- Large comfortable grip
- Flame hardened blade
- Blade has 10 teeth/inch

PART NO.	DESCRIPTION	CTN/MSTR
S49001	18" Saw	1/6
S49002	Replacement blade	50/100
S49010	Handle only	20/100

Drywall Saw



- High quality carbon steel blade
- Great for sheetrock, wallboard, gypsum, plywood, wood and plastic pipe
- 6" 8 TPI aggressive tooth design ensures super sharp, fast and easy cut
- Comfortable grip with thumb stop for greater leverage

PART NO.	DESCRIPTION	CTN/MSTR
S49012	Drywall saw	1/10
S49013	Replacement blade	1/300

Cable Saw



- For cutting PVC pipe
- For tight spots offering little clearance
- Fits easily into tool box and pocket
- Faster and easier than hacksaws in close quarters
- Individually bagged with header card

PART NO.	DESCRIPTION	CTN/MSTR
S49136	36" cable saw display - 36 pieces	1/1
S49148	48" cable saw display - 24 pieces	1/1
S49036	36" cable saw	1/36
S49048	48" cable saw	1/24

T-Handle Cable Saw



- For cutting PVC pipe
- Strong and comfortable t-handles
- Great for use in tight spots
- Long-lasting stainless steel cutting cable
- Polybagged with header card

PART NO.	DESCRIPTION	CTN/MSTR
S49236	36" cable saw	1/100

Close Quarters Hacksaw



- Nickel plated steel frame
- Cuts wood, plastic, brass, aluminum and steel

PART NO.	DESCRIPTION	CTN/MSTR
S50060	6" close quarters hacksaw	1/50
S50061	(5) Replacement blades for S50060	5/800
S50062	6" adjustable hacksaw	12/144
S50063	(5) Replacement blades for S50062	5/1000

Hacksaw



- Heavy square tubing and die cast construction
- Stores extra blades
- Blade tensioning adjustment
- Cuts flush with surface

PART NO.	DESCRIPTION	CTN/MSTR
S49003	Hacksaw with blade	6/36

Got To Have It!

E-Z Stroke Pipe Saw

- Orange handle
- For smooth, fast, accurate cutting
- Tri-edge teeth are borazon wheel ground
- Pull-stroke cutting action
- Cuts plastic pipe and wood
- Replaceable blade

PART NO.	DESCRIPTION	CTN/MSTR
S49005	8" E-Z stroke pipe saw	10/100
S49006	8" Replacement blade	50/250
S49008	12" E-Z stroke pipe saw	10/100
S49007	12" Replacement blade	50/200



S49005



S49006



S49008



- Bi-metal blade cuts metals (iron, copper, brass, aluminum, and other metals)
- Cuts on the pull stroke unlike standard metal cutting saws
- Use to cut off closet bolts, copper tubing, brass tubular, iron pipe and much more
- Replaceable blade
- Orange handle accepts all Jones Stephens E-Z Stroke blades

PART NO.	DESCRIPTION	CTN/MSTR
S49030	8" E-Z stroke metal cutting saw	10/100
S49031	8" Replacement blade	50/250

Items marked with the Jones Stephens logo are "You Need It... We Got It" Items.

Snap Knife



- 8 point snap-off blade
- Counter display box has 30 pcs.
- 10 per tube, priced each
- CARTON QUANTITIES ONLY

PART NO.	DESCRIPTION	CTN/MSTR
K50001	Snap knives display box	30/300
K50002	8 point snap knife	40/480
K50003	8 point replacement blade	10/200

Deluxe Autolock Snap Knife



- Blade automatically locks into position
- Contoured shape for a more comfortable grip

PART NO.	DESCRIPTION	CTN/MSTR
K50005	Deluxe autolock snap knife	20/200

Utility Knife



- Heavy duty construction
- Supplied with extra blade
- Coated case

PART NO.	DESCRIPTION	CTN/MSTR
K50041	Utility knife	12/120
K50042	(5) Replacement blades	100/1000

Fiberglass Handle Shovel



- STINGER SERIES - Fiberglass handle is 40% stronger than Federal Strength Test for long handle wood tools.
- Large steel collar adds maximum strength to handle/socket connection.
- Forward - turned step for secure foot placement

PART NO.	DESCRIPTION	AMES #	CTN/MSTR
S49412	Long handle square point	SFGLS	1/6
S49416	D-Handle 16" drain spade	SFGD16	1/6
S49413	Long handle 16" drain spade	SFGDSL	1/6

Long Handle Round Point Fiberglass Shovel



- Long fiberglass handle
- Round point

PART NO.	DESCRIPTION	CTN/MSTR
S49400	Long handle round point	1/12

Premium Grade Wood Handle Shovel

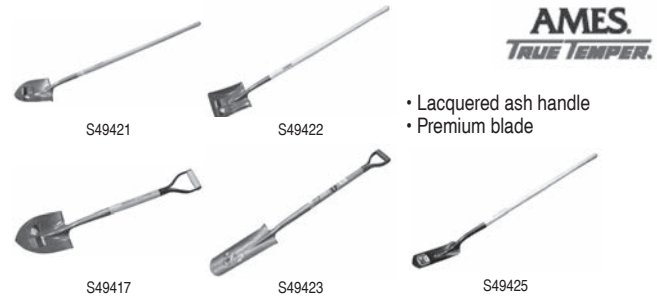

- Lacquered ash handle
- Premium blade

PART NO.	DESCRIPTION	AMES #	CTN/MSTR
S49421	Long handle round point	BMTLR	1/6
S49422	Long handle square point	BMTLS	1/6
S49417	D-Handle round point	BMTDR	1/6
S49423	D-Handle 16" drain spade	15-738	1/6
S49425	LH trenching shovel 4" blade	15-566	1/6
S49427	LH trenching shovel 5" blade	15-567	1/6

Economy Grade Wood Handle Shovel



- Wood handle
- Standard steel blade

PART NO.	DESCRIPTION	AMES #	CTN/MSTR
S49431	Long handle round point	15-047	1/6
S49432	Long handle square point	15-049	1/6

Economy Grade Wood Handle Shovel



- Wood handle
- Standard steel blade

PART NO.	DESCRIPTION	CTN/MSTR
S49401	Long handle round point	1/6
S49402	Long handle square point	1/6

Specialty Shovel



- KODIAK CUB - smaller design for easier use in tight spaces
- 16 gauge tempered steel blade
- Forward turned step
- 27" overall length



PART NO.	DESCRIPTION	AMES #	CTN/MSTR
S49429	Compact utility shovel	15-663	1/6

44" Telescopic Snow Brush



- Great for trucks and SUV's!
- Combination snow brush, scraper, and squeegee
- Extra thick bristles
- Aluminum handle

PART NO.	DESCRIPTION	CTN/MSTR
S80201	44" telescopic snow brush	1/24

Short Nose Caulking Tool



• For finishing lead joint

PART NO.	DESCRIPTION	CTN/MSTR
J41008	5/8" wide x 7-1/2" long	1/24

Inside Caulking Tool



• For finishing lead joint

PART NO.	DESCRIPTION	CTN/MSTR
J41009	5/8" wide x 7" long	1/24

Outside Caulking Tool



• For finishing lead joint

PART NO.	DESCRIPTION	CTN/MSTR
J41010	5/8" wide x 7" long	1/24

Broad Curve Nose Caulking Tool



• Used for packing Oakum tight
• For first pass on lead

PART NO.	DESCRIPTION	CTN/MSTR
J41011	5/8" wide x 8" x 1-1/2"	1/24

17 Pound Digging/Tamping Bar



• For digging holes, cutting roots or tamping

PART NO.	DESCRIPTION	CTN/MSTR
S49500	1" x 69" post hole digger	1/1

Slim Bar 360 Nail Puller



• 14" long
• Hang tab included

PART NO.	DESCRIPTION	CTN/MSTR
J40400	Slim bar 360 nail puller	6/36

Utility Pry Bar



• Length: 13.75" +/-1.14"
• Width: 3.75"
• Height: 2.63"



PART NO.	DESCRIPTION	CTN/MSTR
S49489	13" utility pry bar	1/5

Manhole Cover Lifter



• 25" long



PART NO.	DESCRIPTION	CTN/MSTR
S49490	Manhole cover lifter	1/10

Gooseneck Wrecking Bar



• Painted and polished
• Claw on end removes nails

PART NO.	DESCRIPTION	CTN/MSTR
S49501	30" wrecking bar	1/10

Striking Tools



• Hickory handles
• Long life - high quality
• Made in the USA

MADE IN THE
USA

PART NO.	DESCRIPTION	CTN/MSTR
J40144	3 lb. engineers hammer	1/2
J40142	6 lb. sledgehammer	1/3
J40143	8 lb. sledgehammer	1/3

Pick Mattock



• Hardwood handle
• 5 pound head



PART NO.	DESCRIPTION	CTN/MSTR
J40141	5 lb. pick mattock with handle	1/4

Probing Rod



• Weather resistant fiberglass
• Eliminates danger of shock
• Tip is not replaceable

PART NO.	DESCRIPTION	CTN/MSTR
P27048	4' probing rod	1/5

Steel Probing Rod



• Stainless steel tips
• Cushion vinyl handle
• Welded steel construction

PART NO.	DESCRIPTION	CTN/MSTR
P27004	4' steel probing rod	1/5
P27005	5' steel probing rod	1/5
P27001	Stainless steel tip	1/5

Steel Probing Rod with Ball Point



- Steel shaft
- Vinyl handle for comfort
- Carbon steel ballpoint will not puncture soft pipe
- Tip is not replaceable

Ballpoint Tip

PART NO.	DESCRIPTION	CTN/MSTR
P27003	3' metal probing rod	1/1
P27040	4' metal probing rod	1/1

Water Meter Key



- Rebar shaft and handle for greater strength
- Vinyl covered handle comfort

PART NO.	DESCRIPTION	CTN/MSTR
M25127	1/2" x 27" meter key	1/5
M25136	1/2" x 36" meter key	1/5
M25148	1/2" x 48" meter key	1/5
M25527	5/8" x 27" meter key	1/5
M25536	5/8" x 36" meter key	1/5
M25560	5/8" x 60" meter key	1/5
M25736	3/4" x 36" meter key	1/5
M25760	3/4" x 60" meter key	1/5
M25784	3/4" x 84" meter key	1/5

Combo Water Meter Key



- Rebar shaft and handle for greater strength
- Vinyl covered handle comfort
- Combo lid key and meter key

PART NO.	DESCRIPTION	CTN/MSTR
M25130	1/2" x 30" meter key	1/5

Gate Valve Key



PART NO.	DESCRIPTION	CTN/MSTR
M25100	30" gate valve key	1/5

Copper Sizing Tool



- For type "M" copper tubing
- Impact type to reround tube

PART NO.	DESCRIPTION	CTN/MSTR
J40750	1/2" Copper sizing tool	10/60
J40775	3/4" Copper sizing tool	10/40
J40800	1" Copper sizing tool	10/30

Copper Swedge Tool



J40375 J40369

- Use J40375 on 1/4", 5/16", 3/8", 1/2", and 5/8" copper tube
- Use J40369 on 5/8", 7/8", and 1 1/8" copper tube
- Heat-treated carbon steel
- Can also be used on soft copper, aluminum or any other thin-walled tubing

PART NO.	DESCRIPTION	CTN/MSTR
J40375	copper swedge tool	25/100
J40369	copper swedge tool (up to 1 1/8")	12/24

Polybutylene Crimping Tools



- Single crimp and combo tools
- Accurate and easy to use
- Unit can be calibrated in the field
- Made in the USA

MADE IN THE
USA

PART NO.	DESCRIPTION	CTN/MSTR
J42002	1/2" regular crimping tool	1/10
J42003	3/4" regular crimping tool	1/10
J42004	1/2" - 3/4" combo crimping tool	1/10

Note: These tools cannot be returned for repair.

PEX Crimp Ring Go/No-Go Gauge



- Confirms correct crimp
- 4 popular sizes: 3/8", 1/2", 5/8" and 3/4"
- Heavy steel

PART NO.	DESCRIPTION	CTN/MSTR
J40955	PEX crimp sizing tool	1/1

PEX Multi-Jaw Crimp and Removal Set for F1807 Standard Crimp Rings



- PEX Multi-head copper crimp tool with 3/8", 1/2" and 3/4" jaws included
- PEX copper ring removal tool for 1/2", 3/4" and 1"
- Multi-size go/no-go gauge for crimp confirmation
- All required jaw and adjustment/calibration tools included
- Convenient storage case

PART NO.	DESCRIPTION	CTN/MSTR
J40950	PEX crimp set with 3/8", 1/2", 3/4" heads	1/1

PEX Copper Crimp Ring Tool for F1807 Standard Crimp Rings



- Sized to crimp PEX fittings
- Go/no-go gauge for crimp confirmation
- Adjustment wrench included
- Comfort rubber grip handles
- Heavy steel construction

PART NO.	DESCRIPTION	CTN/MSTR
J40951	3/8" PEX crimp tool	1/1
J40952	1/2" PEX crimp tool	1/1
J40953	3/4" PEX crimp tool	1/1
J40954	1" PEX crimp tool	1/1

Items marked with the Jones Stephens logo are "You Need It... We Got It" Items.

PEX One-Hand Ratchet Cinch Tool for F2098 Standard Cinch Clamp



- Suitable for 3/8", 1/2", 5/8", 3/4" and 1" stainless steel cinch clamps
- Indicator on the tool allows for easy visual confirmation of complete cinch
- Quick ratchet release
- All required adjustment/calibration tools included
- Steel body
- Comfort rubber grip handles

PART NO.	DESCRIPTION	CTN/MSTR
J40965	PEX SS clamp tool	1/1

PEX Clamp Tool for F2098 Standard Cinch Clamp



- Suitable for 3/8", 1/2", 5/8", 3/4" and 1" stainless steel cinch clamps
- Ratcheting and self-releasing ensures complete cinch
- Factory adjusted
- Comfort vinyl coated handles

PART NO.	DESCRIPTION	CTN/MSTR
J40966	PEX SS clamp tool	1/1

Oetiker® 3-Handle Ratcheting Crimp Tool for F2098 Standard Cinch Clamp



- Suitable for 3/8", 1/2", 5/8", 3/4" and 1" stainless steel cinch clamps
- Tool will not release until clamp is properly closed
- Robust fastener with assist lever
- Single handed installation possible
- Made in the USA

MADE IN THE USA

PART NO.	DESCRIPTION	CTN/MSTR
J40967	3-handle crimp tool	1/1

Flaring Tool



- Makes smooth flare
- For O.D. sizes 3/16", 1/4", 5/16", 3/8", 1/2" and 5/8"

PART NO.	DESCRIPTION	CTN/MSTR
J40080	Bar flaring tool	6/24

Swing Release Flaring Tool



- 3/16" - 5/8" O.D.
- 45° single flare

PART NO.	DESCRIPTION	CTN/MSTR
J40220	45° flaring tool	1/12

Deburring Tool



- Easily removes burrs inside and outside of copper and plastic
- Handle stores spare blades

PART NO.	DESCRIPTION	CTN/MSTR
J40221	Deburring tool with blade	40/180
J40222	Replacement blade	1/1

Nipple Extractor Set



- Heat treated and cad plated
- Removes nipples

PART NO.	DESCRIPTION	CTN/MSTR
J40054	Nipple extractor set - 3/8", 1/2", 3/4"	20/40
J40055	Nipple extractor set - 3/8", 1/2", 3/4", 1"	1/1

Internal Pipe Nipple Extractor



- Heat treated and cad plated
- Removes nipples

PART NO.	DESCRIPTION	CTN/MSTR
J40050	3/8" nipple extractor	100/200
J40051	1/2" nipple extractor	20/120
J40052	3/4" nipple extractor	50/100
J40053	1" nipple extractor	25/50

Nipple and Screw Extractor



- Left hand spiral
- Removes nipples, bolts, and screws without thread damage

PART NO.	PIPE SIZE	DRILL SIZE	BOLT SIZE	CTN/MSTR
J41103	1/8"	1/4"	9/32" - 3/8"	1/1
J41104	1/4"	19/64"	3/8" - 5/8"	1/1
J41105	3/8"	13/32"	5/8" - 7/8"	1/1
J41106	1/2"	17/32"	7/8" - 1-1/8"	1/1
J41107	3/4"	13/16"	1-1/8" - 1-3/8"	1/1
J41108	1"	1-1/16"	1-3/8" - 2"	1/1

Carbide Tipped Masonry Drill Bit



PART NO.	REGULAR LENGTHS	SHANK SIZE	CTN/MSTR
S41349	5/32" x 4"	3/16"	1/1
S41351	3/16" x 4"	3/16"	1/1
S41350	1/4" x 4"	1/4"	1/1
S41352	5/16" x 4"	1/4"	1/1
S41353	3/8" x 6"	1/4"	1/1
S41355	1/2" x 6"	3/8"	1/1
S41356	9/16" x 6"	1/2"	1/1
S41357	5/8" x 6"	1/2"	1/1

Dual Auger Wood Drill Bit



- Screw point
- Up to 1" for use in 3/8" or 1/2" power drill; 1" and up for use in 1/2"

PART NO.	DESCRIPTION	CTN/MSTR
B21625	5/8" x 6" dual auger wood bit	1/1
B21075	3/4" x 6" dual auger wood bit	1/1
B21087	7/8" x 6" dual auger wood bit	1/1
B21100	1" x 6" dual auger wood bit	1/1
B21112	1-1/8" x 6" dual auger wood bit	1/1
B21125	1-1/4" x 6" dual auger wood bit	1/1
B21150	1-1/2" x 6" dual auger wood bit	1/1

We Got It -

Flat "Paddle" Wood Drill Bit



- Round shank
- Includes hole for fishing wire back through stud

PART NO.	DESCRIPTION	CTN/MSTR
B24375	3/8" flat paddle wood bit	1/1
B24050	1/2" flat paddle wood bit	1/1
B24056	9/16" flat paddle wood bit	1/1
B24063	5/8" flat paddle wood bit	1/1
B24075	3/4" flat paddle wood bit	1/1
B24081	13/16" flat paddle wood bit	1/1
B24088	7/8" flat paddle wood bit	1/1
B24100	1" flat paddle wood bit	1/1
B24113	1-1/8" flat paddle wood bit	1/1
B24125	1-1/4" flat paddle wood bit	1/1
B24150	1-1/2" flat paddle wood bit	1/1

Straight Shank Drill Bit



- High speed steel
- Jobber's length

PART NO.	DESCRIPTION	CTN/MSTR
B20062	1/16" drill	1/1
B20078	5/64" drill	1/1
B20094	3/32" drill	1/1
B20109	7/64" drill	1/1
B20125	1/8" drill	1/1
B20141	9/64" drill	1/1
B20156	5/32" drill	1/1
B20172	11/64" drill	1/1
B20188	3/16" drill	1/1
B20203	13/64" drill	1/1
B20219	7/32" drill	1/1
B20234	15/64" drill	1/1
B20250	1/4" drill	1/1
B20266	17/64" drill	1/1
B20281	9/32" drill	1/1
B20297	19/64" drill	1/1
B20313	5/16" drill	1/1
B20328	21/64" drill (1/8" pipe tap)	1/1
B20344	11/32" drill	1/1
B20359	23/64" drill	1/1
B20375	3/8" drill	1/1
B20391	25/64" drill	1/1
B20406	13/32" drill	1/1
B20422	27/64" drill	1/1
B20438	7/16" drill (1/4" pipe tap)	1/1
B20453	29/64" drill	1/1
B20469	15/32" drill	1/1
B20484	31/64" drill	1/1
B20500	1/2" drill	1/1

Pipe Tap



- NPT
- High carbon steel

PART NO.	DESCRIPTION	CTN/MSTR
T41001	1/8" NPT pipe tap	1/1
T41002	1/4" NPT pipe tap	1/1
T41003	3/8" NPT pipe tap	1/1
T41004	1/2" NPT pipe tap	1/1
T41005	3/4" NPT pipe tap	1/1
T41006	1" NPT pipe tap	1/1
T41009	1-1/4" NPT pipe tap	1/1
T41007	1-1/2" NPT pipe tap	1/1
T41008	2" NPT pipe tap	1/1

PlumbRule Measuring Tape

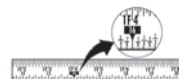

- 1" locking blade with push button lock
- Offset fractions for easy reading
- Auto recoil; belt clip and wrist strap
- Red stud markings and joist markings

PART NO.	DESCRIPTION	CTN/MSTR
J40101	1" x 25' tape	6/48

Neon Precision Measuring Tape



- Sure grip case

PART NO.	DESCRIPTION	CTN/MSTR
J40086	1" x 25' neon orange tape	6/48
J40087	1" x 25' neon yellow tape	6/48

Long Measuring Tape



- Hook blade
- Pop-open handle

Starrett

PART NO.	DESCRIPTION	CTN/MSTR
J40088	3/8" x 50' tape	6/36
J40089	3/8" x 100' tape	6/24

Locking Measuring Tape



- Chrome plated case
- Power return
- Double riveted tang
- Cushion stop
- Positive lock
- Yellow tape
- Carded

PART NO.	DESCRIPTION	CTN/MSTR
J40046	1" x 25' tape	6/48
J40045	3/4" x 16' tape	12/144

Brass Plumb Bob



- Solid brass
- Removable tip

PART NO.	DESCRIPTION	CTN/MSTR
J42008	8 oz. brass plumb bob	10/80
J42012	12 oz. brass plumb bob	1/50

Soap Stone and Holder



- ROUND- Pen size lightweight aluminum holder with built-in chuck
- FLAT- Stainless steel spring tension with locknut
- J40062 and J40063 sold in CARTON QUANTITIES ONLY

PART NO.	DESCRIPTION	CTN/MSTR
J40060	Round soap stone holder	1/6
J40061	Flat soap stone holder	1/6
J40062	Round soap stone	144/box
J40063	Flat soap stone	144/box

Flint Striker



- Round file style
- Renewable flint
- Flint priced per pack of 5 renewals

PART NO.	DESCRIPTION	CTN/MSTR
J40048	Striker	25/200
J40049	(5) Flint renewals	50/200

Three Flint Friction Lighter



- Flint priced per pack of 4 renewals
- CARTON QUANTITIES ONLY

PART NO.	DESCRIPTION	CTN/MSTR
J40047	Three flint friction lighter	6/48
J40044	Flint renewal unit (4/card)	1/1

Self Igniting Hand Torch for MAPP or Propane



- Heavy duty
- For MAPP or propane
- Use with either Propane or MAPP Gas
- Cyclone flame pattern for concentrated high heat
- Piezo Igniter for instant flame
- Adjustable knob for variable flame patterns
- Safety lock feature to prevent accidental ignition
- Ignition lock for continuous use
- Cast body for durability, strength and long life
- Ergonomic handle design
- Stainless steel nozzle with brass tip

PART NO.	DESCRIPTION	CTN/MSTR
J40432	Self igniting hand torch for MAPP or propane	4/24
J40529	Hand torch with swivel tip and self-igniter	1/20
J40329	Replacement tip for J40529	1/1
J40629	Hand torch with swivel tip	1/20
J40429	Replacement tip for J40629	1/1
J40229	Pencil flame torch	1/1

MAPP and Propane Cylinders



- Temperatures for burning: Propane 2300°, MAPP 3300°
- LTL TRANSPORTATION ONLY
- NO UPS/FED EX
- CARTON QUANTITIES ONLY

PART NO.	DESCRIPTION	CTN/MSTR
J40601	14.1 oz. Propane	12/12
J40600	14.1 oz. MAPP	12/12

Solder Shield Protective Blanket

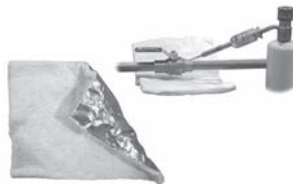

- For use when combustible material is present during soldering
- 9" x 12" protection area
- Protects up to 2300°F for five minutes
- Smoke and odor free non-asbestos material
- Lends a clean, professional appearance to your work
- Durable woven ceramic holds up well in multiple uses

PART NO.	DESCRIPTION	CTN/MSTR
J40812	9" x 12" solder shield	1/1

Flux Paste



- Meets ASTM B813
- Water flushable for faster rinsing from pipe lines
- Super detergent action cleans as it solders
- Non-acid, non-toxic, lead free
- Contains no zinc chloride
- Use with all lead-free and common soft solders
- For use on copper, brass, galvanized iron, lead, zinc, tin, silver, nickel, mild steel, terne plate, and malleable iron
- Meets Mil. Spec. Mil-F-4995 Type II



PART NO.	DESCRIPTION	CTN/MSTR
S95102	4 oz. Flux paste	1/48
S95106	4 oz. Flux paste with brush in cap	1/48
S95103	1 lb. Flux paste	1/24

Phos-Copper Brazing Rod



- 92.9% copper/ 7.1% phos
- Tensile strength 91,000 PSI
- Self-fluxing
- Liquid 1460°F, solid 1310°F
- Working temp 1350°-1500°F
- 1 pound plastic tubes

PART NO.	DESCRIPTION	CTN/MSTR
J41021	1 lb. tube brazing rod	1/10

2% Silver Solder



- 91% copper/ 7% phos/ 2% silver
- Liquid 1450°F, solid 1190°F
- Meets AWS A5.8QQB-650 B Cup-6
- 1 pound plastic tubes

PART NO.	DESCRIPTION	CTN/MSTR
J41022	1 lb. tube 2% silver solder	1/10

5% Silver Solder



- 89% copper/ 6% phos/ 5% silver
- Meets AWS A5.8-81-BCup3 Fed QQB650B
- Liquid 1475°F, solid 1190°F
- Working temperature 1300°-1550°F
- 1 pound plastic tubes

PART NO.	DESCRIPTION	CTN/MSTR
J41023	1 lb. 5% silver solder	1/10

15% Silver Solder



- 80% copper/ 5% phos/ 15% silver
- Meets AWS A5.8-81-BC7P3 Fed QQB650B
- Liquid 1495°F, solid 1190°F
- Working temperature 1300°-1500°F
- 1 pound plastic tubes

PART NO.	DESCRIPTION	CTN/MSTR
J41024	1 lb. tube 15% silver solder	1/10

Freeze Fix Pipe Jacket

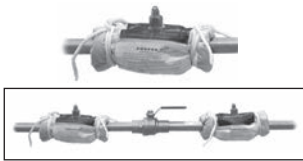

- Fast, easy way to freeze pipe up to 4"
- Saves time and money on pipe repairs
- Repairs can be made without draining the water out of the line

Quick Way to Freeze Pipes for Easy Repair!

PART NO.	DESCRIPTION	L x W	CTN/MSTR
J40801	3/8" - 3/4" jacket	8" x 4-1/2"	1/1
J40802	3/4" - 1-1/2" jacket	10-1/2" x 7"	1/1
J40803	1-1/2" - 3" jacket	14" x 8-1/2"	1/1
J40804	3" - 4" jacket	16" x 11"	1/1
J40805	8' hose and connectors for CO2 kit	-	1/1
J40806	Tee connector for CO2 freeze kit	-	1/1
J40807	Freeze fix carry bag	-	1/1
J40808	CO2 empty cylinder (20 lb. size)	-	1/1

Files



- Durable plastic handles
- Top quality alloy steel

PART NO.	DESCRIPTION	CTN/MSTR
J41201	8" mil bastard file with handle	1/4
J41202	10" mil bastard file with handle	1/4
J41205	12" half round file	1/4
J41206	14" half round file	1/4

Slip Jaw Pliers



- Plated finish
- Plastic grips
- Yellow handle

PART NO.	DESCRIPTION	CTN/MSTR
P60001	2-1/8" capacity / 10" long	1/5

Water Pump Pliers



- Drop forged vanadium steel; black epoxy powder coated
- Cushion grip
- Self-locking on pipe



PART NO.	LENGTH	CAPACITY	ROTHENBERGER	CTN/MSTR
J40210	7"	1"	7.0521	1/6
J40211	10"	1-1/4"	7.0522	1/6
J40212	12"	1-1/2"	7.0523	1/6

Griplock Tongue and Groove Water Pump Pliers



- Comfort grips



PART NO.	LENGTH	NO. ADJ.	CAPACITY	CHANNEL LOCK NO.	CTN/MSTR
J40410	10"	5	1-1/4"	GL10	1/5
J40411	12"	6	2-1/4"	GL12	1/5

"No Pinch" Pipe Wrench Pliers



- 10" comfort cushion grips
- Unique handle design prevents pinched fingers
- 1-3/4" jaw capacity
- Drop forged; plated finish

PART NO.	DESCRIPTION	CTN/MSTR
P60002	10" Pipe wrench pliers	4/40

Smooth Jaw Pliers



- 2-1/8" jaw opening
- Smooth jaws for non-marring surfaces (chrome, polished brass)
- Cushioned vinyl grips

PART NO.	DESCRIPTION	CTN/MSTR
P60003	10" Smooth jaw pliers	10/50

Tongue and Groove Pliers



- Right angle teeth
- Undercut tongue and groove- won't slip
- Comfort grips

PART NO.	LENGTH	NO. ADJ.	CAPACITY	CHANNEL LOCK NO.	CTN/MSTR
J40401	6-1/2"	5	7/8"	426	1/5
J40402	9-1/2"	5	1-1/2"	420	1/5
J40403	10"	7	2"	430	1/5
J40404	12"	7	2-1/4"	440	1/5
J40405	16"	8	4-1/4"	460	1/2

Curved Jaw Tongue and Groove Pliers



- Curved jaw for use on round stock and tubing
- Right angle teeth

PART NO.	LENGTH	NO. ADJ.	CAPACITY	CHANNEL LOCK NO.	CTN/MSTR
J40407	9-1/2"	5	1-1/2"	422	1/5
J40408	12"	7	2-1/4"	442	1/5

Smooth Jaw Tongue and Groove Pliers



- Smooth jaws for non-marring surfaces (PVC, chromes, etc.)
- Undercut tongue and groove- won't slip
- Comfort grips

PART NO.	LENGTH	NO. ADJ.	CAPACITY	CHANNEL LOCK NO.	CTN/MSTR
J40406	10"	7	2"	415	1/5

4 in 1 Screwdriver



- Alloy tool steel bits
- Ground and polished
- Heat treated for maximum strength
- High impact handle
- Floating ball bearing for tight fit

S41001 - 12 pk Display

PART NO.	DESCRIPTION	CTN/MSTR
S41001	Phillips and slotted display	1/12
S41002	Slotted bit for 4 in 1 or 6 in 1	1/1
S41003	Phillips bit for 4 in 1	1/1

6 in 1 Screwdriver



- Shaft ends are 1/4" and 15/16" hex size for use as nut drivers
- Each bit has two sizes

S41006 - 12 pk Display

PART NO.	DESCRIPTION	CTN/MSTR
S41006	6 in 1 screwdriver display	1/12
S41002	Slotted bit for 4 in 1 or 6 in 1	1/1
S41007	Phillips bit for 6 in 1	1/1

Magnetic Power Nut Setters



- 1/4" hex shaft

PART NO.	DESCRIPTION	CTN/MSTR
S41300	1-3/4" long 1/4" head size	1/1
S41301	1-3/4" long 5/16" head size	1/1
S41302	2-9/16" long 1/4" head size	1/1
S41303	2-9/16" long 5/16" head size	1/1

Nut Driver



- Steel driver
- Plastic handle

PART NO.	DESCRIPTION	CTN/MSTR
S06014	3/16" nut driver	1/10
S06015	1/4" nut driver	1/10
S06016	5/16" nut driver	1/10
S06017	3/8" nut driver	1/10
S06018	7/16" nut driver	1/10
S06019	1/2" nut driver	1/10

Bit Holder



- For insert type bits
- Magnetic

PART NO.	DESCRIPTION	CTN/MSTR
S41307	1/4" drive x 3" long	1/1

Phillips Bit



PART NO.	DESCRIPTION	CTN/MSTR
S41306	#2 point 1/4" hex 1" insert type	1/1
S41308	# 2 point 1/4" hex 11 5/16" long insert type	1/1

100% Silicone Tub and Tile Sealant



- Ideal for tubs, sinks, toilets, showers and resetting loose tiles
- Warranted to last as long as the fixture
- Contains potent mildewcide
- Application temperature range -10°F to 100°F
- Service temperature range -60°F to 400°F
- J40197 and J40199 are carded
- CARTON QUANTITIES ONLY



PART NO.	DESCRIPTION	CTN/MSTR
J40199	2.8 oz. tube caulk, clear	12/12
J40197	2.8 oz. tube caulk, white	12/12
J40200	10.2 oz. tube caulk, clear	12/12
J40201	10.2 oz. tube caulk, white	12/12

100% Silicone Caulk



- Flexible, easy to use
- 50 year life
- Will not stain or bleed
- Seal, bond or insulate
- CARTON QUANTITIES ONLY

PART NO.	DESCRIPTION	CTN/MSTR
J40208	10.1 oz. tube caulk, clear	12/12
J40288	10.1 oz. tube caulk, white	12/12

25-Year Siliconized Acrylic Caulk



- Cleans up with water
- Paintable
- Will not stain or bleed
- Application temperature range 40°F to 90°F
- Service temperature range 0°F to 200°F
- CARTON QUANTITIES ONLY



PART NO.	DESCRIPTION	CTN/MSTR
J40202	10.1 oz. tube caulk, white	12/12

Acrylic Tub and Tile Caulk



- Long-lasting watertight seal around tubs, showers, and sinks
- Cleans up with water
- Odorless, mildew resistant
- Paintable
- Application temperature range 40°F to 90°F
- Service temperature range 0°F to 200°F
- CARTON QUANTITIES ONLY



PART NO.	DESCRIPTION	CTN/MSTR
J40203	5.5 oz. tube caulk, biscuit	12/12
J40204	10.1 oz. tube caulk, white	12/12
J40206	5.5 oz. tube caulk, white	12/12

Latex Caulk



- General purpose
- Dries quickly
- Will not stain or bleed
- Paintable
- CARTON QUANTITIES ONLY



PART NO.	DESCRIPTION	CTN/MSTR
J40207	10.1 oz. tube caulk, white	12/12

Items marked with the Jones Stephens logo are "You Need It... We Got It" Items.

Hi-Temp 100% Red Silicone Caulk



- 100% silicone
- USDA approved, UL listed, meets NSF 51
- Temperature from 65°F to 650°F
- CARTON QUANTITIES ONLY



PART NO.	DESCRIPTION	CTN/MSTR
J40285	Hi-temp 100% silicone caulk	12/12

Caulking Gun



- 9" barrel
- Drop-in half barrel type
- Painted steel

PART NO.	DESCRIPTION	CTN/MSTR
C35090	Caulking gun, red	1/10

Professional Caulking Gun



- Parallel hex rod frame
- Seal puncture tool
- Thumb release
- E-Z thrust mechanism
- Spout cutter
- Ladder hook

PART NO.	DESCRIPTION	CTN/MSTR
C35091	Parallel hex rod caulking gun, yellow	1/12

Firestop 814+ Intumescent Firestopping Sealant



- Colored red for ease of inspection
- Fulfills residential and commercial firestopping code requirements
- Meets ASTM-E814/UL 1479 test standards
- Resumes integrity for 1 & 2 hour fire rated assemblies

PART NO.	DESCRIPTION	CTN/MSTR
J40286	10.3 oz. tube	1/12

Fire Seal-136 Firestopping Caulk



- Resumes integrity of fireblocks 1 & 2 family construction
- Meets ASTM-E136 test standards
- Fulfills all residential fireblocking code requirements

PART NO.	DESCRIPTION	CTN/MSTR
J40287	10.3 oz. tube	1/12

Handicap



- No tools required - manual installation allows for no time wasted applying and removing thread tape after each use
- Reusable - long lasting
- Caps and 1/2" male thread for testing

PART NO.	DESCRIPTION	CTN/MSTR
H54100	1/2" FIP Handicap	1/1000

Lumber Crayon



- Fade-proof, waterproof and smear-proof
- Will work on wet or dry wood, metal and concrete
- 4 1/2" long by 1/2" diameter
- CARTON QUANTITIES ONLY

PART NO.	DESCRIPTION	CTN/MSTR
J40350	Black lumber crayon	12/144
J40351	Yellow lumber crayon	12/144
J40352	Red lumber crayon	12/144
J40353	Blue lumber crayon	12/144

Marking Products



- High-performance industrial marking products
- Permanent paint
- Quick drying



PART NO.	DESCRIPTION	CTN/MSTR
J40330	Red Dura-Ink® 15 marker	12/72
J40331	Black Dura-Ink® 15 marker	12/72
J40332	Black Dura-Ink® 25 marker	12/48
J40333	Red Dura-Ink® 55 marker	12/48
J40334	Black Dura-Ink® 55 marker	12/48
J40335	Black Dura-Ink® 200 marker	12/24
J40336	White paint marker	12/48
J40337	Yellow paint marker	12/48
J40338	Red paint marker	12/48
J40339	Black paint marker	12/48
J40340	Blue paint marker	12/48
J40341	Paint marker display yellow, white, and black	1/1

G

Got To Have It!

Handi-Plug Combination Test Plug and Stub-Out

- Combination test plug and stub-out for drop eared elbow
- No tools required - manual installation allows for no time wasted applying and removing thread tape after each use! Cost-effective, too!
- No thread seal required
- Reusable - long lasting
- Smooth at thread end for easy plastering
- Time and labor savings

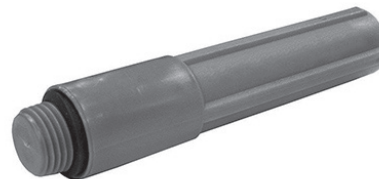

PART NO.	DESCRIPTION	CTN/MSTR
H54050	1/2" MIP Handi-Plug	1/25
H54051	Handi-Plug counter display	1/1

Items marked with the Jones Stephens logo are "You Need It...We Got It" Items.

Rustoleum® Industrial Choice® Construction Marking Paint



- Product Application: construction, excavation, surveying, landscaping, and other commercial operations
- Best resistance to early fading and chalking; dries fast
- Excellent visibility on concrete, pavement, dirt, gravel, grass & more
- Easy to apply – no messy tip adjustments, non-clogging, locking spray tip won't pop off
- 17 oz.
- 40-90°F application temperature range
- Less than 5 minutes dry time at 70-80°F
- MIR compliant
- GROUND TRANSPORTATION ONLY
- CARTON QUANTITIES ONLY



PART NO.	DESCRIPTION	CTN/MSTR
J40380	White marking paint	12/12
J40381	Hi visibility yellow marking paint	12/12
J40382	Safety red marking paint	12/12
J40383	Caution blue marking paint	12/12
J40384	Fluorescent green marking paint	12/12
J40385	Fluorescent orange marking paint	12/12
J40387	Fluorescent pink marking paint	12/12

Paint Spotter Hand-Help Wand



- For quick, easy one-hand application of marking point
- Non-adjustable

PART NO.	DESCRIPTION	CTN/MSTR
J40386	Paint spotter	1/1

Acid Brush



- Tin handle
- CARTON QUANTITIES ONLY

PART NO.	DESCRIPTION	CTN/MSTR
B29700	3/8" x 6" acid brush	144/1728
B29701	1/2" x 6" acid brush	144/1428
B29702	9/16" x 6" acid brush	144/1008
B29699	1/4" x 3" acid brush	144/1428

Paint and Dope Brush



- Natural bristles
- Ideal for use with pipe cleaners, thread cutting oil, paint, pipe dope
- CARTON QUANTITIES ONLY

PART NO.	DESCRIPTION	CTN/MSTR
B29801	1" paint and dope brush	36/36
B29802	2" paint and dope brush	24/432

Chip Brush



- Pure 100% natural white color bristle
- Epoxy set bristles for lasting durability
- Can be used with all paints, glue, and stains
- Interior/exterior
- Smooth natural wood handles

PART NO.	DESCRIPTION	CTN/MSTR
B29805	1-1/2" chip brush	36/864
B29806	2" chip brush	36/864

Long Handle Wire Brush with Scraper



- Long bent handle
- 3x19 rows
- For removing rust and corrosion from metals, roughing-up wood and brushing loose stucco surfaces
- Oil tempered carbon steel wire tynes
- Smooth sanded hardwood block

PART NO.	DESCRIPTION	CTN/MSTR
B29901	Long handle wire brush with scraper	12/144

Wire Brush



- For cleaning rough surfaces
- Stiff steel wire bristle
- Polished hardwood handle
- CARTON QUANTITIES ONLY

PART NO.	DESCRIPTION	CTN/MSTR
B29900	1" wire brush	12/72

5 in 1 Painters Tool



- Solid plastic handle
- Mirror finish tempered high carbon steel blade
- Precision ground
- Full tang
- Professional grade

PART NO.	DESCRIPTION	CTN/MSTR
K50011	5 in 1 painters tool	10/100

Putty Knife



PART NO.	DESCRIPTION	CTN/MSTR
K50015	1-1/4" putty knife	12/144
K50016	3" putty knife	12/144
K50018	4" putty knife	10/50

Clip Point Putty Knife



- Solid plastic handle
- Mirror finish tempered high carbon steel blade
- Precision ground
- Full tang
- Professional grade

PART NO.	DESCRIPTION	CTN/MSTR
K50012	Clip point putty knife	10/100

Spray Weld



- Cleaner, primer & cement all-in-one!
- No Mess – No Waste
- Spray at any angle
- Goes twice as far as brush and can method
- Work in a wider range of temperatures

PART NO.	DESCRIPTION	CTN/MSTR
S30800	11 oz. with purple primer	12/12
S30801	4.5 oz. with purple primer	12/12
S30802	11 oz. with clear primer	12/12
S30803	4.5 oz. with clear primer	12/12

2 oz. Pipe Joint Compound



- Smooth, grit-free, gray colored
- Will not crack or crumble
- Disassembly months or years later is easy
- Contains no lead and is safe for all water systems
- CARTON QUANTITIES ONLY

PART NO.	DESCRIPTION	CTN/MSTR
3188	2 oz. pipe joint compound	1/6

Whitlam “Blue Magic” Pipe Joint Compound



- Slow set
- Meets FED spec TT-S-1732
- Use on plastic and metal threads
- NSF listed
- ORM-D
- GROUND TRANSPORTATION ONLY
- CARTON QUANTITIES ONLY



PART NO.	DESCRIPTION	CTN/MSTR
S95710	1/2 pint brush top can joint compound	24/24
S95711	1 pint brush top can joint compound	12/12
S96014	1/4 pint joint compound	24/24
S96016	1 quart pipe joint compound	12/12

Whitlam Seal Unyte



- Hard set
- Dark gray
- Semi-paste
- Use on all metal threaded connections and flanges

PART NO.	DESCRIPTION	CTN/MSTR
S95012	1/2 pint Whitlam seal unyte	24/24
S95014	1/4 pint Whitlam seal unyte	24/24
S96012	1 pint Whitlam seal unyte	12/12
S95016	1 quart Whitlam seal unyte	12/12

Whitlam “Select Unyte” Teflon Pipe Joint Compound



- NSF listed
- Soft set, white virgin teflon (PTFE)
- Use on plastic and metal threads
- For use on air, steam, petroleum, water, gas and chemical lines
- ORM-D
- GROUND TRANSPORTATION ONLY
- CARTON QUANTITIES ONLY



PART NO.	DESCRIPTION	CTN/MSTR
S95712	1/2 pint brush top can joint compound	24/24
S95713	1 pint brush top can joint compound	12/12

Items marked with the Jones Stephens logo are “You Need It... We Got It” Items.

Slic-tite® Heavy Duty Thread Sealing Compound



- Working pressures: to 10,000 PSI (liquids), 3,000 (gases)
- Temp: -50°F to +500°F
- Use for threaded connections on steel, aluminum, brass, PVC, CPVC & ABS



PART NO.	DESCRIPTION	CTN/MSTR
S95011	8 fl. oz. Slic-tite® HD thread sealing compound	1/24
S95010	Pint Slic-tite® HD thread sealing compound	1/24

Cool Gel®



- Protects surfaces and components from heat damage such as piping, drywall, and shower valves
- Used for any soldering or brazing job
- Safe, non-toxic, and harmless to the skin
- Will evaporate in 24-48 hrs. eliminating cleanup
- Unique gelling formula sticks to any surface without dripping or running off



PART NO.	DESCRIPTION	CTN/MSTR
S95100	1 qt. Cool Gel®	1/12
S95101	1 pt. Cool Gel®	1/24

Liquid Lightning Pro Drain Opener



- Organic digester; biodegradable
- Dissolves grease, hair, sanitary napkins, sludge, soap and paper
- Environmentally safe
- Each bottle is enclosed in a plastic bag
- ORM-D (S95701/S95793) GROUND TRANSPORTATION ONLY
- HAZMAT (S95794/S95795) LIGHT TRUCK LOAD ONLY
- CARTON QUANTITIES ONLY

G

PART NO.	DESCRIPTION	CTN/MSTR
S95701	1 pint drain opener	12/12
S95793	1 quart drain opener	12/12
S95794	1/2 gallon drain opener (HAZMAT)	6/6
S95795	1 gallon drain opener (HAZMAT)	4/4

Drain King® Mini Snake



- Unclogs sinks, showers, bath drains & urinals
- Safe, easy to use
- No chemicals
- Carded

PART NO.	DESCRIPTION	CTN/MSTR
D18190	Mini snake	36/144

Cloth Inserted Plunger Disc



- Cloth inserted rubber

PART NO.	DESCRIPTION	CTN/MSTR
D18052	3” cloth inserted plunger disc	5/30
D18051	4” cloth inserted plunger disc	5/30
D18050	Plunger disc holder	30/300

Visu-Glow Leak Detector



- Fluorescent gas leak detector



PART NO.	DESCRIPTION	CTN/MSTR
S95200	8 oz. Visu-Glow leak detector	1/24

Plumber's Faucet and Valve Grease



- Lubricates faucet stems, threads, o-rings, packing, gaskets
- Resists high temperatures
- Counter display
- CARTON QUANTITIES ONLY

PART NO.	DESCRIPTION	CTN/MSTR
S95709	2.0 fl.oz. tins in counter display	12/12

Plumber's Putty



- Use on sinks, strainers, faucets and other fixtures wherever a non-drying watertight seal is needed
- DO NOT USE ON MARBLE OR PLASTIC
- Meets Federal Specification TT-P-1536
- CARTON QUANTITIES ONLY

PART NO.	DESCRIPTION	CTN/MSTR
P40014	14 oz. putty	24/24
P40080	5 lb. putty	6/6

Plumber's Epoxy Putty



- Seal leaks in sink traps, water tanks, pipe joints, drain leaks and radiators
- Stop leaks in pools and drain lines
- Repair cracked porcelain wall tiles, floor tiles and fixtures
- CARTON QUANTITIES ONLY

PART NO.	DESCRIPTION	CTN/MSTR
P40004	4 oz. Epoxy putty tubes in counter display	12/12

Plumber's Goop Adhesive



- 3.7 oz. tube, carded
- Watertight bond for use on PVC, tile or porcelain
- ORM-D
- GROUND TRANSPORTATION ONLY
- CARTON QUANTITIES ONLY

PART NO.	DESCRIPTION	CTN/MSTR
J45100	3.7 oz. tube plumber's goop adhesive	12/12

2CanCaddy™



- Grab and go handle
- Special velcro strap to keep cans organized and secure
- Works well with all size cans up to 32 oz.
- Made of extremely durable polymer
- Easily cleans, stain resistant and virtually indestructible
- Perfect for plumbers, electricians, painters & more
- Blister carded

PART NO.	DESCRIPTION	CTN/MSTR
S95015	2CanCaddy™	1/12

Steel Nipple Caddy Tray



- Steel construction
- Baked epoxy finish
- Push away handles
- Nipple storage range (close-6")

PART NO.	SIZE	DIMENSIONS	CAPACITY	CTN/MSTR
N70050	1/2"	10-1/2" x 7" x 6-1/2"	77 pieces	1/8
N70075	3/4"	12-1/2" x 7" x 6-1/2"	66 pieces	1/8
N70016	1"	14-1/8" x 7-3/4" x 6-1/2"	50 pieces	1/6
N70020	1-1/4"	18" x 8" x 6-1/2"	40 pieces	1/8
N70024	1-1/2"	19-1/2" x 6-1/2" x 6-1/2"	30 pieces	1/8
N70032	2"	23-7/8" x 8-1/2" x 6-1/2"	27 pieces	1/4

1/2" & 3/4" Combo Nipple Caddy



- Holds 39 1/2" x close-6"
- Holds 33 3/4" x close-6"
- Steel construction with baked epoxy finish
- Fold over handle

PART NO.	DESCRIPTION	DIMENSIONS	CTN/MSTR
N70575	Combo Caddy	12 1/8" x 7" x 6 1/2"	1/8

Fitting Tote Tray



- Excellent for copper and PVC fittings
- Steel construction with baked epoxy finish
- Inside compartments measure 4-7/8" x 4-7/8" x 3-7/8"
- 8 compartments
- Fold over handle

PART NO.	DESCRIPTION	DIMENSIONS	CTN/MSTR
N70500	Fitting Caddy	20" x 10-1/2" x 5"	1/4

Utility Tote Tray



- Lightweight, durable, high impact plastic

PART NO.	DESCRIPTION	DIMENSIONS	CTN/MSTR
T60100	Tote tray	10" x 15" x 5"	1/12

Plastic Nipple Caddy



- High impact plastic
- Strong and lightweight
- Will not rust or corrode
- Nipple storage range (close-6")

PART NO.	SIZE	DIMENSIONS	CAPACITY	CTN/MSTR
N70150	1/2"	11" x 7-1/2" x 6-1/2"	77 pieces	1/4
N70175	3/4"	13-1/4" x 7-7/8" x 6-1/2"	66 pieces	1/4
N70200	1"	14-3/4" x 8-1/8" x 6-1/2"	50 pieces	1/4
N70250	1-1/2"	21" x 7" x 6-1/2"	30 pieces	1/2
N70300	2"	23-1/4" x 8-1/2" x 6-1/2"	27 pieces	1/2

Items marked with the Jones Stephens logo are "You Need It... We Got It" Items.

Tool Totes



- High density polyethylene construction resistant to acids, chemicals, oils and glues
- Removable dividers
- Reinforced metal handle
- Made in the USA

MADE IN THE USA

PART NO.	DESCRIPTION	CTN/MSTR
T60121	12" x 24" x 6" deep tray with 4 dividers	1/5
T60122	9" x 15" x 5" deep tray with 4 dividers	1/10
T60123	9" x 15" x 3" deep tray with 4 dividers	1/10
T60124	12-1/2" x 18" x 4-1/2" deep tray	1/5
T60125	Extra divider for T60121	1/4
T60126	Extra divider for T60122	1/4
T60127	Extra divider for T60123	1/4

Bucket Caddies



- 5 gallon high-impact red plastic bucket holds 4 combinations of trays- 3 large; 6 small; 1 large with 4 small; and 2 large with 2 small
- All trays have 4 sections; use tray subdividers to increase small tray capacity up to 8 sections
- Tool apron fits 5 and 3 1/2" gallon buckets; apron straps on or can be permanently secured (hardware included)
- Made in the USA

MADE IN THE USA

PART NO.	DESCRIPTION	CTN/MSTR
T60101	5 gallon bucket with 6 small trays	1/8
T60102	5 gallon bucket with 1 large tray & 4 small trays	1/8
T60103	Large trays (4-1/2" deep)	1/3
T60104	Small trays (2-1/2" deep)	1/6
T60105	Lid for 5 gallon bucket	1/1
T60106	5 gallon bucket only	1/1
T60107	Subdividers for small trays (4 pack)	1/1
T60108	20-pocket tool apron	1/1
T60110	5 gallon bucket with 2 large and 2 small trays	1/1
T60111	5 gallon bucket with 3 large trays	1/1

5 Gallon Bucket with Lid and JS Logo



- 5 gallon high-impact plastic bucket
- Blue bucket with white Jones Stephens logo
- White lid
- Made in the USA

MADE IN THE USA

PART NO.	DESCRIPTION	CTN/MSTR
T60112	5 gallon bucket with lid and JS logo	1/1

Brute® Gray Utility Container, Less Lid



- All-plastic, professional-grade construction will not rust, chip, or peel and resists dents
- Strong, snap-on lids provide secure, stable stacking
- Certified to NSF-Standard #2 and Standard #21



PART NO.	DESCRIPTION	CTN/MSTR
G80001	55 gallon	1/3

Dolly for Brute® Utility Containers



- Fits 32, 44, and 55 gallon BRUTE® Containers
- Swivel casters offer better mobility through work areas
- Heavy-duty 3" casters
- Attach waste containers with easy twist-on/twist-off action

PART NO.	DESCRIPTION	CTN/MSTR
G80007	Fits 32, 44, and 55 gallon	1/2

Lipped Utility Cart with 2 Shelves



- Durable structural foam construction won't leak, rust, chip, dent, or peel
- Deep pocket shelves keep contents in place
- TPR casters absorb shock and provide floor surface protection and quiet operation
- Heavy duty models have variable grip-height handle

PART NO.	DESCRIPTION	CTN/MSTR
G80012	24" x 36" (500 lb. capacity)	1/1

Anti-Vibration Synthetic Leather Gloves



- Neoprene knuckle protection
- Flexible 4-way stretch
- Sure Grip™ reinforced thumb saddle
- Gel-padded Sure Grip™ patch palm
- Machine-washable Parity™
- Header card
- CARTON QUANTITIES ONLY

PART NO.	DESCRIPTION	CTN/MSTR
G50211	Pair synthetic leather gloves	12/12

Nitrile Gloves



- 3/4 coating offers more protection
- Micro foam nitril offers great grip
- Coating draws oil and water aside to allow for enhanced grip
- Good abrasion resistance
- Silicone free and antibacterial
- Header card
- CARTON QUANTITIES ONLY

PART NO.	DESCRIPTION	CTN/MSTR
G50215	Pair nitrile gloves	12/12

Polyester Nitrile Dipped Palm Gloves



- 100% polyester
- Large/X-large
- Pair
- Knit wrist to keep out dirt
- Header card

PART NO.	DESCRIPTION	CTN/MSTR
G50225	Polyester nitrile dipped palm gloves	12/144

Blue Nitrile Gloves



- Powdered
- Priced per box
- 100 per box (50 pair)
- Thickness: 3 mil.

PART NO.	DESCRIPTION	CTN/MSTR
G50230	Blue nitrile gloves - size large/XL	1/10
G50231	Blue nitrile gloves - size medium/large	1/10

All Purpose Latex Palm/Mesh Back Gloves



- Durable
- Excellent in wet conditions
- Protects hands during rugged jobs
- Header card
- CARTON QUANTITIES ONLY

PART NO.	DESCRIPTION	CTN/MSTR
G50202	Latex palm/mesh back gloves	12/240

Disposable Blue Latex Gloves



- 14 mil
- Priced per box
- 50 per box
- Powder free
- Examination grade
- Large

PART NO.	DESCRIPTION	CTN/MSTR
G50212	Disposable blue latex gloves	1/10

Industrial Rubber Gloves



- Extra heavy
- Large
- Pair
- Rolled cuffs
- CARTON QUANTITIES ONLY

PART NO.	DESCRIPTION	CTN/MSTR
G50220	18" rough hands, 25 mil	10/60

G Brown Jersey Gloves



- 100% brown cotton
- One size fits all
- Knit wrist
- 8 ounce
- Priced per pair
- Header card
- CARTON QUANTITIES ONLY

PART NO.	DESCRIPTION	CTN/MSTR
G50200 	Brown cotton jersey glove	12/300
G50210	Brown cotton jersey glove (display- 216 pairs)	1/1

Economy Brown Jersey Gloves



- 65% cotton / 35% polyester
- Large
- Close fitting knit wrist
- Straight thumb
- Full size
- Priced per pair
- Header card
- CARTON QUANTITIES ONLY

PART NO.	DESCRIPTION	CTN/MSTR
G50300	Economy brown cotton jersey glove	12/144

White Cotton Gloves with Grippers



- Durable cotton canvas
- No-slip grip on palm
- One size fits all
- Knit wrist
- Priced per pair
- Header card
- CARTON QUANTITIES ONLY

PART NO.	DESCRIPTION	CTN/MSTR
G50205	White cotton gloves with rubber dots	12/240
G50206	White cotton gloves with rubber palms	12/240

Leather Palm Work Gloves



- Split leather palm, thumb, fingers and knuckles
- Cotton back and liner
- Safety cuff
- Priced per pair
- Header card
- CARTON QUANTITIES ONLY

PART NO.	DESCRIPTION	CTN/MSTR
G50204	Leather palm low safety cuff	12/120
G50214	Leather palm low safety cuff	96 pair

Drivers' Style Leather Gloves



- Durable and long lasting - conforms to your hand with time
- Grain leather glove
- Elastic cuff
- Priced per pair
- Header card
- CARTON QUANTITIES ONLY

PART NO.	DESCRIPTION	CTN/MSTR
G50208	Drivers' style leather	12/120
G50218	Drivers' style leather (display - 48 pair)	1/1

Vinyl Gloves



- 5 mil.
- One size fits all
- Lightly powdered
- 100 reversible gloves (50 pair)

PART NO.	DESCRIPTION	CTN/MSTR
G50250	100 vinyl gloves	1/10

Disposable Vinyl Gloves



- One size fits all
- Rolled cuff
- Lightly powdered for easy on and off
- Ready to hang or place on shelf

PART NO.	DESCRIPTION	CTN/MSTR
G50251	20 pack disposable gloves	1/20

Protective Shoe Covers



- Fits easily over work shoes and boots
- Elastic top allows fit up to size 12
- Keeps dirt and grime outside
- Carton holds 200 pieces (100 pair)
- SOLD BY FULL CARTON OR 10 PAIR PACK

PART NO.	DESCRIPTION	CTN/MSTR
B05010	Protective shoe covers (100 pair)	1/10
B05011	Protective shoe covers (10 pair)	1/15

Shubee Shoe Covers



- Dark blue
- Fits easily over work shoes and boots
- Elastic top allows fit up to size 12
- Keeps dirt and grime outside
- Carton holds 150 pair

PART NO.	DESCRIPTION	CTN/MSTR
B05015	Shubee shoe covers	1/1

 Items marked with the Jones Stephens logo are "You Need It... We Got It" Items.

Disposable Coverall



- Tear and puncture resistant
- Use when comfort and coolness is a priority
- CARTON QUANTITIES ONLY

PART NO.	DESCRIPTION	CTN/MSTR
B05020	Large disposable coverall	5/25
B05021	X-large disposable coverall	5/25

Dust Mask



- 50 per box
- Disposable
- Non-toxic

PART NO.	DESCRIPTION	CTN/MSTR
G30021	Dust mask	1/20

Orange Safety Vest



- Non-ANSI
- High visibility orange
- 100% polyester

PART NO.	DESCRIPTION	CTN/MSTR
B05090	Orange safety vest	1/20

Safety Hat



- Fits sizes 6 1/2- 8
- Meets ANSI z89.1 requirement
- Short peak design creates greater upward visibility
- Comfortable 4-point suspension with terry cloth sweatbands
- Low nape strap and rain trough features
- Universal slots to accommodate hearing, welding and face shield accessories

PART NO.	DESCRIPTION	CTN/MSTR
H40001	Yellow with 4-point pin lock suspension	1/12
H40002	White with 4-point pin lock suspension	1/12
H40003	Yellow with 4-point ratchet suspension	1/12
H40004	White with 4-point ratchet suspension	1/12

Knee Pads



- Lightweight and water-resistant
- Comfortable while kneeling, standing or walking
- Won't pinch or bind behind knee
- Soft, breathable inner lining for coolness and comfort
- Velcro closures on straps

PART NO.	DESCRIPTION	CTN/MSTR
K01120	Heavy duty foam economy	1/1
K012000	Heavy duty knee cap	1/1

Ready Fit Corded Ear Plugs



- Display box included
- CARTON QUANTITIES ONLY

PART NO.	DESCRIPTION	CTN/MSTR
E85000	Ready fit corded ear plugs	200 pair/1

Items marked with the Jones Stephens logo are "You Need It... We Got It" Items.

Nemesis® Safety Glasses



Display



- Soft-touch temples
- Light weight construction
- Single-lens wrap-around protection
- 99.9% UV resistant
- Meets ANSI Z87.1 + standards

PART NO.	DESCRIPTION	CTN/MSTR
G30011	Nemesis® clear glasses	12/12
G30012	Nemesis® smoke mirror glasses	12/12
G30013	Nemesis® blue mirror glasses	12/12
G30014	Nemesis® camo/bronze glasses	12/12
G30000	Display includes: 12 pair smoke mirror, 6 pair blue mirror, 6 pair clear, free display	1/1

Hellraiser Safety Glasses



Clear



Smoke



Blue Mirror

PART NO.	DESCRIPTION	CTN/MSTR
G30015	Hellraiser clear safety glasses	12/12
G30016	Hellraiser smoke safety glasses	12/12
G30017	Hellraiser blue mirror safety glasses	12/12

Visio Safety Glasses



- One-piece frame
- Adjustable temples
- Sleek, lightweight and comfortable
- Meets ANSI z87.1

PART NO.	DESCRIPTION	CTN/MSTR
G30003	Visio clear safety glasses	12/12
G30004	Visio blue mirror safety glasses	12/12
G30005	Visio silver indoor/outdoor glasses	12/12

Clear Safety Goggles



- Direct ventilation
- Economical protection

PART NO.	DESCRIPTION	CTN/MSTR
G30001	Clear safety glasses	1/200

Caution Tape



- Black print on safety yellow
- 3 mil thickness
- Non-stick

PART NO.	DESCRIPTION	CTN/MSTR
J43300	3" x 300' caution tape	1/16
J43310	3" x 1000' caution tape	1/8

50 Pound UV Black Cable Tie



- Black UV rated for outdoor use
- UL Listed



PART NO.	DESCRIPTION	CTN/MSTR
J40116	7" long cable ties	100 per bag/10,000
J40117	11" long cable ties	50 per bag/5,000

Nylon Cable Ties



Natural Color



Black

- Standard size
- Nylon
- CARTON QUANTITIES ONLY

PART NO.	DESCRIPTION	CTN/MSTR
J40107	7" long (1/16" - 1-3/4") natural	100/6600
J40111	11" regular (1/16" - 3") natural	100/18700
J40115	15" (5/16") black	100/2300

Heat and UV Stabilized Nylon Cable Ties



- Heat & UV stabilized nylon-66
- Priced per bag of 100

PART NO.	DESCRIPTION	CTN/MSTR
J40437	14" 50lb. natural cable ties	12/72
J40447	14" 50lb. black cable ties	12/72

Duct Straps



- HVAC application
- Natural nylon
- Up to 10" diameter
- CARTON QUANTITIES ONLY

PART NO.	DESCRIPTION	CTN/MSTR
J40134	34" duct straps	10 per bag/500

Poly Pro Rope



PART NO.	DESCRIPTION	CTN/MSTR
T60007	3/8" x 50' poly pro rope	1/25

Heavy Duty Utility Strap



- Plated S-hooks
- Meets or exceeds ASTM standards
- Weather and wear resistant
- Made in the USA
- CARTON QUANTITIES ONLY

 MADE IN THE
USA

PART NO.	DESCRIPTION	CTN/MSTR
S20015	15" heavy duty utility strap	25/25
S20021	21" heavy duty utility strap	25/25
S20031	31" heavy duty utility strap	25/25
S20041	41" heavy duty utility strap	25/25

Ratchet Tie Down Strap



- 1" wide/400 lb. working load limit
- Comfort grip handles
- Weather and corrosion resistant
- PVC coated hooks that will not scratch
- Cut and abrasion resistant webbing

PART NO.	DESCRIPTION	CTN/MSTR
S20300	1" x 16' ratchet tie down strap	1/4

Camouflage Strap with Hooks



- 1" wide/300 lb. working load limit
- 2 hooks included with each strap
- Pack of 4 ratchet straps
- Package can hang

PART NO.	DESCRIPTION	CTN/MSTR
S20301	1" x 9' camo strap with hooks (4/pack)	1/6

Ratchet Strap with Step Release J-Hooks



- 2" wide/ 3,333 lb. working load limit
- Step by step release action
- Gradually releases tension with double J-hook
- Flex grip handle

PART NO.	DESCRIPTION	CTN/MSTR
S20302	2" x 27' ratchet strap	1/8

Cam Straps



- 1" wide / 750# test nylon straps
- All colored straps and threads are UV resistant
- Straps are secured by a heavy duty zinc plated metal cam buckle, which will not slip even in wet conditions
- Header card

PART NO.	DESCRIPTION	CTN/MSTR
S20100	1" x 2' black single pack	24/144
S20101	1" x 4' red single pack	24/144
S20102	1" x 6' yellow single pack	24/144
S20103	1" x 8' green single pack	24/144
S20104	1" x 10' blue single pack	24/144
S20105	1" x 12' purple single pack	24/144
S20106	1" x 20' black single pack	24/72
S20200	1" x 2' black twin pack	1/1
S20201	1" x 4' red twin pack	1/1
S20202	1" x 6' yellow twin pack	1/1
S20203	1" x 8' green twin pack	1/1
S20204	1" x 10' blue twin pack	1/1

Items marked with the Jones Stephens logo are "You Need It...We Got It" Items.

3-N-1 Tubing Bender



- For 1/4", 5/16" or 3/8" tubing

PART NO.	DESCRIPTION	CTN/MSTR
T50001	3-N-1 tubing bender	10/20

Spring Tubing Bender



- Spring prevents collapse of the wall at bending point
- Allows fast free-form bending of soft copper and aluminum tube

PART NO.	DESCRIPTION	CTN/MSTR
J41030	3/8" spring tubing bender	1/200
J41031	1/2" spring tubing bender	1/100
J41032	5/8" spring tubing bender	1/100

WD-40® Lubricant



- Cleans
- Protects against rust and corrosion
- Lubricates
- Penetrates stuck metal parts
- Displaces moisture
- Low VOC
- ORM-D
- GROUND TRANSPORTATION ONLY
- CARTON QUANTITIES ONLY

PART NO.	DESCRIPTION	CTN/MSTR
S95800	8 oz. can lubricant low VOC	12/12

Gas Line Marking Labels



- Yellow self adhesive stickers
- Clearly identifies gas lines from other utility and water lines
- 100 labels per roll

PART NO.	DESCRIPTION	CTN/MSTR
J40481	2 PSI gas line stickers	1/100
J40482	Gas line stickers	1/100

E-Z Light



- Extendable for lighting flames from a distance
- Safe and convenient for torch, fireplace, or any hard-to-reach area

PART NO.	DESCRIPTION	CTN/MSTR
J40450	E-Z light	1/12

E-Z Reach



- Extendable, magnetized arm for easy retrieval of small metal parts
- Great for shop or job site

PART NO.	DESCRIPTION	CTN/MSTR
J40451	E-Z reach	24/240

24" Grab-It Tool



- Makes hard-to-reach areas accessible using retractable fingers

PART NO.	DESCRIPTION	CTN/MSTR
J40020	24" Grab-it tool	1/50

Steel Wool



- Packaged 16 pads per bag, 12 bags per carton
- Priced per bag

PART NO.	DESCRIPTION	CTN/MSTR
B29300	Size 00 steel wool	1/6
B29310	Size 0 steel wool	1/6

Copper Cleaning Pad

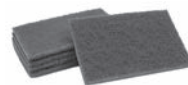

- Reusable
- Use wet or dry - will not clog
- Nylon impregnated fine maroon
- Good general cleaner for removing rust, corrosion, etc.
- Deoxidizes and cleans copper tube and fittings for soldering
- CARTON QUANTITIES ONLY

PART NO.	DESCRIPTION	CTN/MSTR
B29400	4" x 6-1/4" x 1/4" cleaning pad	10/710

Lead Joint Runner



- Includes clamp
- Allows pouring lead joints on horizontal pipe or upside down hubs

PART NO.	DESCRIPTION	CTN/MSTR
L42011	#1 - 2" - 4" pipe size	1/10
L42012	#2 - 4" - 6" pipe size	1/10
L42013	#3 - 6" - 10" pipe size	1/5
L42014	#4 - 10" - 14" pipe size	1/1
L42015	#5 - 16" - 20" pipe size	1/1
L42016	#6 - 20" - 24" pipe size	1/1
L42017	#7 - 24" - 30" pipe size	1/1
L42018	#8 - 30" - 36" pipe size	1/1
L42019	#9 - 36" - 42" pipe size	1/1
L42023	#10 - up to 48" pipe size	1/1

7-1/2" Torpedo Level



- Manufactured to rigid requirements
- Professional quality
- Aluminum construction
- Magnetic sides



PART NO.	DESCRIPTION	CTN/MSTR
J40100	7-1/2" torpedo level	1/10

Plastic Magnetic Level



- Has front vial viewer
- Saves time and money
- Eliminates neck and back strain
- Internal aluminum frame for accuracy and strength
- Magnetic
- Integrated Euroslot hanging hole

PART NO.	DESCRIPTION	CTN/MSTR
J42101	10" plastic magnetic level	1/6

Top Grade Gradient Level



- Set accurate slopes of 1 and 2 percent
- Includes conversion of pitch and slope
- Accuracy: 0.5mm/ M-0.029" on all vials
- Length: 60cm/24"
- U.S. patent 6,209,211

PART NO.	DESCRIPTION	CTN/MSTR
J42200	24" length gradient level	1/6

Rayovac® Floating Lantern and Battery



F20003



F20004



F20005

- 6-volt F20004 battery included
- Heavy duty battery priced each

PART NO.	DESCRIPTION	CTN/MSTR
F20003	Floating lantern with battery	1/6
F20004	6 volt spring top - battery only	1/12
F20005	6 volt screw top - battery only	1/4

Rayovac Industrial Flashlight



- Yellow flashlights with ring hangers
- Carded
- Batteries included

PART NO.	DESCRIPTION	CTN/MSTR
F20001	2 cell D size flashlight	1/6

Rayovac® Workhorse™ 6V Krypton Swivel Stand Lantern



- Hands-free 45° Swivel
- Comfort grip handle
- Spare bulb holder
- Water resistant
- Includes 6V Rayovac® battery
- Lumens: 75

PART NO.	DESCRIPTION	CTN/MSTR
F20018	6-Volt swivel stand lantern	1/6

Sportsman LED Head-Lite



- New technology unique 3-way hands-free L.E.D. system
- Close range use super white L.E.D., "Night vision" 2 super red L.E.D., Long range beam- krypton bulb
- Batteries last 20 times longer with L.E.D. bulbs than normal bulbs
- Rubber spot-flood reflector, head rotates 180° compact design, comfort-grip band
- Weatherproof, heavy duty construction
- Lumens: 22
- Carded

PART NO.	DESCRIPTION	CTN/MSTR
F20019	Sportsman LED head-lite	1/4

3 Watt LED Flashlight



- Aluminum body
- Large easy grip
- 3 light options: high, low and safety flash
- Uses 3 AAA batteries (not included)
- Blister

PART NO.	DESCRIPTION	CTN/MSTR
F20053	3 watt LED flashlight	6/48

5 Watt LED Flashlight



- Aluminum body
- Includes charger
- 3 light options: high, low and safety flash
- Rechargeable lithium ion battery (included)
- Blister

PART NO.	DESCRIPTION	CTN/MSTR
F20055	5 watt LED flashlight with charger	6/48

Orange Trouble Light



- Industrial quality
- 25 ft. 16/3 SJT cord
- 3-prong side outlets
- Metal cage

PART NO.	DESCRIPTION	CTN/MSTR
E25021	Orange trouble light with metal cage	1/12

Orange Extension Cord



- Safety orange color
- Heavy duty
- Outdoor/grounded
- ETL Listed

PART NO.	DESCRIPTION	CTN/MSTR
E25000	16/3 SJT 15 ft. extension cord	6/24
E25001	16/3 SJT 25 ft. extension cord	6/24
E25002	16/3 SJT 50 ft. extension cord	6/12
E25004	16/3 SJT 100 ft. extension cord	1/6
E25005	12/3 SJT 25 ft. extension cord	1/8
E25006	12/3 SJT 50 ft. extension cord	1/6
E25007	12/3 SJT 100 ft. extension cord	1/4
E25040	14/3 SJT 25 ft. extension cord	1/12
E25041	14/3 SJT 50 ft. extension cord	1/8
E25042	14/3 SJT 100 ft. extension cord	1/4

Round Extension Cord Power Block



- 14/3 SJT
- 15 AMP
- 125 V
- ETL Listed

PART NO.	DESCRIPTION	CTN/MSTR
E25010	3 ft. round extension cord block	12/48

Rayovac® Industrial Batteries



- Priced per battery
- PACK QUANTITIES ONLY

PART NO.	DESCRIPTION	CTN/MSTR
F20006	Heavy duty C batteries	6/72
F20007	Heavy duty D batteries	6/72
F20012	AAA alkaline batteries	8/96
F20008	AA alkaline batteries	8/96
F20009	9 volt alkaline batteries	6/72
F20010	C alkaline batteries	6/72
F20011	D alkaline batteries	6/72

Energizer® Alkaline Batteries



- Priced per pack
- Carded
- PACK QUANTITIES ONLY

PART NO.	DESCRIPTION	CTN/MSTR
F20020	AAA alkaline batteries - 2 pack	1/48
F20021	AAA alkaline batteries - 4 pack	1/48
F20022	AA alkaline batteries - 2 pack	1/48
F20023	AA alkaline batteries - 4 pack	1/48
F20024	C alkaline batteries - 2 pack	1/48
F20025	D alkaline batteries - 2 pack	1/12
F20026	9 volt alkaline battery	1/48

Cutting Oil



- Medium brown color

PART NO.	DESCRIPTION	CTN/MSTR
J45005	Premium all-purpose oil (gallon)	1/6

Poly Sheeting



- Clear
- 4 mil super tough plastic
- Hundreds of uses
- Made in the USA

MADE IN THE
USA

PART NO.	DESCRIPTION	CTN/MSTR
S08100	8' x 100' poly sheeting	1/1
S10100	10' x 100' poly sheeting	1/1

Garbage Disposal Cord



- 16/3 gauge wire
- 13 Amps, 125V, 1625W

PART NO.	DESCRIPTION	CTN/MSTR
E25015	3' straight disposal cord	1/50
E25016	6' straight disposal cord	1/50
E25017	3' angle disposal cord	1/50
E25018	6' angle disposal cord	1/50

Garbage Disposal Wiring Kit



- Complete with 3 wire nuts and connector coupling
- 16/3 gauge wire
- 13 Amps, 125V, 1625W
- Polybagged

PART NO.	DESCRIPTION	CTN/MSTR
E25115	Kit for 3' cord with straight plug	1/1
E25116	Kit for 6' cord with straight plug	1/1
E25117	Kit for 3' cord with angle plug	1/1
E25118	Kit for 6' cord with angle plug	1/1

Screw-On Wire Connector



- Clamshell packaging

PART NO.	DESCRIPTION	CTN/MSTR
E25125	Gray wire connector	1/100
E25126	Blue wire connector	1/100
E25127	Orange wire connector	1/100
E25128	Yellow wire connector	1/45
E25129	Red wire connector	1/45

8" Industrial Utility Blower



- High velocity, high-volume output
- Multi-purpose:
 - Cools & ventilates large areas
 - Exhaust fumes and odors
 - Dries wet areas
- All metal construction
- Rolled steel opening
- Auto reset thermal protection
- Durable carry handle
- Rubber feet for stability
- Grounded cord set meets OSHA requirements
- Dimensions: 8.875" L x 12" W x 11.25" H

PART NO.	DESCRIPTION	CTN/MSTR
H90123	8" industrial utility blower	1/1

Leak Alert Water Detector



- Loud alarm sounds with direct water contact
- Floats and signals for up to 72 hours
- Fully automatic operation - no wiring required
- Low battery indicator for optimum safety and performance

PART NO.	DESCRIPTION	CTN/MSTR
L95400	Leak alert water detector	1/12

Angle Broom with 1" Diameter Handle



- Cut and shaped for easy sweeping
- Long-lasting, stain-resistant polypropylene bristles
- Permanent fusion-set bristles won't pull out

PART NO.	DESCRIPTION	CTN/MSTR
G80023	Angle broom with 1" diameter handle	1/6

Cotton Terry Cloth Towels



- 100% cotton
- 14" x 17"
- Waxes, dries and polishes
- Super soft

PART NO.	DESCRIPTION	CTN/MSTR
B05026	Terry cloth towels, 8 pack	1/12

Trash Bags



- 2'8" x 4'2"
- 20 bags per box
- 42 gallon
- 3 mil

PART NO.	DESCRIPTION	CTN/MSTR
G02042	42 gallon trash bags	1/6

Drum Liners



- 37.5" x 48" x 10"
- 20 bags per box
- 55 gallon
- 2 mil

PART NO.	DESCRIPTION	CTN/MSTR
G02050	55 gallon drum liners	1/6

Wypall® Teri® Towels



- Strong and durable, wet or dry
- 125 reusable sheets per box - equivalent to 18 lbs. of rags
- Reinforced HYDROKNIT® provides extra scrubbing power
- CASE QUANTITIES ONLY



PART NO.	DESCRIPTION	CTN/MSTR
B05003	9-3/4" x 16-3/4" x 125 sheets	1/10

Box of Rags



- Colored cotton sweatshirt material
- 100% recycled
- Pull out dispensing
- Multi-colored

PART NO.	DESCRIPTION	CTN/MSTR
B05001	4 lb. box of rags	1/1

Cotton Plumbers Handy Towels



- 100% cotton heavy duty shop towels are washable, reusable & nonabrasive
- Ideal for cleaning hands, wiping spills, removing grime from tools & parts
- 12 towels per bag

PART NO.	DESCRIPTION	CTN/MSTR
B05004	Plumbers handy towels	12/12

Plastic Drop Cloth



- Medium duty 1 mil plastic
- Convenient pleat fold pack design
- Protects furniture, appliances and carpets

PART NO.	DESCRIPTION	CTN/MSTR
D50000	9' x 12' plastic drop cloth	1/48

Cotton Canvas Drop Cloth



- 8 oz.
- Absorbs and traps spills
- Washable and reusable

PART NO.	DESCRIPTION	CTN/MSTR
G02010	6' x 9' cotton canvas drop cloth	1/6
G02011	9' x 12' cotton canvas drop cloth	1/4

Reinforced Plastic Blue Tarp



- Metal gromets
- Heavy duty plastic
- Blue color

PART NO.	DESCRIPTION	CTN/MSTR
B05101	10' x 20' plastic blue tarp	1/8

Urinal Screen and Refills



- 4 oz. scented deodorant block
- Cherry scent
- S95251 is priced each and sold in CARTON QUANTITIES ONLY

PART NO.	DESCRIPTION	CTN/MSTR
S95250	Urinal screen	12/72
S95251	4 oz. cherry scent refills for urinal screen, 12 piece	12/72

Commercial Sponge



- Commercial grade cellulose sponges - made to last!
- Deeply textured top makes cleanup easier
- Made in the USA

MADE IN THE USA

DIMENSIONS	
S50001	6-3/4" x 4-3/8" x 3/4"
S50002	8" x 4-1/2" x 3/4"

PART NO.	DESCRIPTION	CTN/MSTR
S50001	Medium cellulose sponge	1/24
S50002	Large cellulose sponge	1/24

Spray Bottle



- Economical to use for leak testing when filled with soapy water
- Clear bottle with various color tints based on availability

PART NO.	DESCRIPTION	CTN/MSTR
B25001	16 oz. clear spray bottle	1/60

Heavy Duty Big Wipes



- 80 count tub, 8 tubs per case; priced each
- Wipe size is 8" x 12"
- Lint free
- Removes paint, glue, oil, sealants, grease and grime
- Dermatologically tested, plus vitamin E and aloe vera added
- Dual sided, scrubs and cleans
- CARTON QUANTITIES ONLY

PART NO.	DESCRIPTION	CTN/MSTR
B05050	80 count tub	8/8
B05051	Single pack - priced each (bag of 100)	1/100

Wypall® Waterless Hand Wipes



- 10 x 12 pre-moistened towels; 50 count
- Lower price per tub
- Conveniently sized tub
- All of the towels can be used before they dry out
- CARTON QUANTITIES ONLY

PART NO.	DESCRIPTION	CTN/MSTR
B05007	50-count dispenser tub	8/8
B05008	Wypall display (32 tubs)	1/1



- Full-sized pre-moistened hand towels- smooth for wiping on one side, tough for scrubbing on the other
- Natural d'limonene cleaning agent tough on grease, grime, ink & paint
- CASE QUANTITIES ONLY

PART NO.	DESCRIPTION	CTN/MSTR
B05002	12" x 12" x 75 sheets	6/6



- L40 Wipes in pop up box
- 9.8" x 16.4" sheets, 100 count white sheets
- For use with THE GRABBER Dispenser #09352

PART NO.	DESCRIPTION	CTN/MSTR
B05012	9.8" x 16.4" x 100 sheets	1/9

Laminated Padlock with Keys



- Includes 2 keys
- Laminated
- Hardened steel shackle
- Shackle height is 1"
- Precision engineered double locking
- Brass pin cylinder - 5 PIN
- Protective bumper
- Clamshell pack

PART NO.	DESCRIPTION	CTN/MSTR
L26003	1-3/4" standard shackle padlock with keys	12/72

WordLock® Loop and Lock™ with MatchKey



- 8 ft.
- Ultimate utility cable lock
- Heavy duty flexible steel cable
- Integrated lock head means no padlocks to lose
- Ideal for securing ladders and other tools
- Key color matches cable color
- Word on key matches word on lock
- Unique key shape
- Carded

PART NO.	DESCRIPTION	CTN/MSTR
L26005	8 ft. black Loop and Lock with matchkey	4/16

4 Dial Combination Padlock



- Heavy duty, solid brass
- Resettable
- Hardened shackle
- Shackle height is 1"
- Clamshell pack

PART NO.	DESCRIPTION	CTN/MSTR
L26015	4 dial combination padlock	6/48

GASKETS AND COUPLINGS

Gaskets	307
Couplings	308
Import Couplings.....	309



Multi-Tite Gasket



SERVICE WEIGHT



EXTRA HEAVY

MADE IN THE
USA

- Multi rings on outside make this gasket the easiest to install
- Meets ASTM Standard C564

Service Weight

PART NO.	SIZE	CTN/MSTR
V95002	2"	1/150
V95003	3"	1/75
V95004	4"	1/60
V95005	5"	1/30
V95006	6"	1/30
V95008	8"	1/20
V95010	10"	1/10
V95012	12"	1/10
V95015	15"	1/5

Extra Heavy

PART NO.	SIZE	CTN/MSTR
V94004	4"	1/60

Dual Tite Gasket



SERVICE WEIGHT



EXTRA HEAVY

MADE IN THE
USA

- Meets ASTM Standard C564

Service Weight

PART NO.	SIZE	CTN/MSTR
V96002	2"	1/150
V96003	3"	1/75
V96004	4"	1/60
V96005	5"	1/30
V96006	6"	1/30
V96008	8"	1/20
V96010	10"	1/10
V96012	12"	1/10
V96015	15"	1/5

Extra Heavy

PART NO.	SIZE	CTN/MSTR
V97002	2"	1/150
V97003	3"	1/75
V97004	4"	1/60
V97005	5"	1/30
V97006	6"	1/30
V97008	8"	1/20
V97010	10"	1/10
V97012	12"	1/10
V97015	15"	1/5

Dual Tite Buna N "Nitrile" Gasket



MADE IN THE
USA

PART NO.	SIZE	CTN/MSTR
V98002	2"	1/150
V98003	3"	1/75
V98004	4"	1/60
V98005	5"	1/30
V98006	6"	1/30
V98008	8"	1/20
V98010	10"	1/10
V98012	12"	1/10
V98015	15"	1/5

Pipe Lubricant



MADE IN THE
USA

- L95202 - ORM-D. Ships UPS Ground and Motor Freight ONLY
- CARTON QUANTITIES ONLY

PART NO.	DESCRIPTION	CTN/MSTR
L95200	Quart lubricant	12/12
L95201	Gallon lubricant	4/4
L95202	Quart adhesive lube	12/12

H&I

No Hub Coupling



- Manufactured in accordance with CISPI Standard 310
- Gasket sleeve conforms to ASTM C564
- Screw is ASI 305 stainless steel

MADE IN THE USA

PART NO.	SIZE	CTN/MSTR
U95001	1-1/2"	1/100
U95002	2"	1/100
U95003	3"	1/100
U95004	4"	1/100
U95005	5"	1/20
U95006	6"	1/20
U95008	8"	1/10
U95010	10"	1/10
U95012	12"	1/12
U95015	15"	1/6
U95211	2" x 1-1/2"	1/100
U95320	3" x 2"	1/100
U95430	4" x 3"	1/60

No Hub Torque Wrench



- Automatic release at 60 in.lb.
- Ratchets one way
- Built-in reversing lever
- Chrome vanadium socket

PART NO.	DESCRIPTION	CTN/MSTR
T60060	No hub torque wrench	20/80

Mega Torque Wrench

H&I



- Heavy duty construction with chrome vanadium 5/16" or 3/8" sockets
- Socket kit includes screw and washer
- Slide down locking reversing feature

PART NO.	DESCRIPTION	CTN/MSTR
T60065	60 lb. - 5/16"	15/60
T60080	80 lb. - 3/8"	15/60
T60081	80 lb. - 5/16"	15/60
T60066	5/16" socket kit	15/60

Medium Duty No Hub Coupling



- Manufactured in accordance with CISPI Standard 310
- 9/16" stainless steel bands
- Stainless steel housing and shield
- 5/16" stainless steel screws
- 80 inch/lb. installation torque
- UPC listed

MADE IN THE USA

PART NO.	SIZE	CTN/MSTR
U97001	1-1/2"	1/60
U97002	2"	1/75
U97003	3"	1/48
U97004	4"	1/48
U97005	5"	1/15
U97006	6"	1/15
U97008	8"	1/15
U97010	10"	1/12

Heavy Duty No Hub Coupling



- Manufactured in accordance with CISPI Standard 310
- 9/16" stainless steel bands
- Stainless steel housing and shield
- 3/8" stainless steel screws
- 80 inch/lb. installation torque
- UPC listed

MADE IN THE USA

PART NO.	SIZE	CTN/MSTR
HDNHC1	1-1/2"	1/60
HDNHC2	2"	1/75
HDNHC3	3"	1/48
HDNHC4	4"	1/48
HDNHC5	5"	1/15
HDNHC6	6"	1/15
HDNHC8	8"	1/15
HDNHC10	10"	1/12

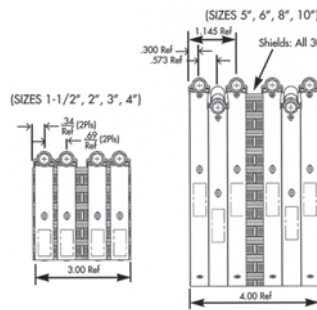

DESCRIPTION: Couplings consist of gasket and shield assemblies, the shield assemblies have four or six clamps depending on size. The clamps are fastened with eyelets to the bi-directional corrugated shield.

MATERIALS: Steels used in couplings are stainless steels. Shields, bands and housings are AISI 304. Screws and eyelets are ASI 305. Gaskets are neoprene rubber.

SPECIFICATIONS: Couplings conform to CISPI 310. Factory Mutual EN 1618. Couplings comply with ASTM C564, ASTM 1277, IAPMO file #3198, Commonwealth of Massachusetts CMR-248 and City of New York MEA 253-98-E. Gaskets are made from an elastomeric compound that meets the requirements of ASTM C564.

COUPLING SIZE	INSTALLATION TORQUE	CLAMPS FOR COUPLING
1-1/2"	80	4
2"	80	4
3"	80	4
4"	80	4
5"	80	6
6"	80	6
8"	80	6
10"	80	6



Larger Hex Head Screw: The new 3/8" hex head screw is designed to apply the full load of 80in/lbs. of insulation torque to the band/shield assembly.

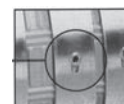

Floating Eyelet Design: "Floating eyelets" fasten the clamps to the shield, allowing the clamp band and shield to move independently. This freedom prevents the shield from crimping during tightening, which can lead to leakage later on.

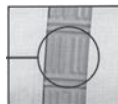

Patented Bi-directional Shield Design: Our unique shield design employs bi-directional corrugations for maximum transfer of pressure from the clamps the gasket. This patented shield design adjusts to differences in the circumference and outside diameters for the pipes being joined. This eliminates gasket wrinkling and thereby eliminates leak paths. These parallel and transverse patterns on the gasket and pipe work to avoid pullout failures and provides a positive, reliable seal.



Mechanical Interlocking Clamp Design: IDEAL clamps feature a one-piece screw housing that mechanically interlocks the housing to the band. This one-piece housing design eliminates leak paths that can occur in staked or welded clamps.

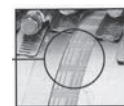

Green Shield: The distinctive green shield quickly identifies the newly re-engineered IDEAL Heavy-Duty Couplings.



Specially Beaded Gaskets: The heavy-duty coupling utilizes a specially beaded gasket that mates with the shield and clamping forces for superior sealing pressure and holding power. IDEAL gaskets comply with ASTM C564.

Import No Hub Coupling



- Manufactured in accordance with CISPI Standard 310
- All stainless construction
- UPC listed



PART NO.	SIZE	CTN/MSTR
U99001	1-1/2"	1/100
U99002	2"	1/100
U99003	3"	1/100
U99004	4"	1/100
U99005	5"	1/40
U99006	6"	1/30
U99008	8"	1/15
U99010	10"	1/12
U99211	2" x 1-1/2"	1/100
U99320	3" x 2"	1/100

Import Heavy Duty No Hub Coupling



- Manufactured in accordance with CISPI Standard 310
- 9/16" stainless steel bands
- Stainless steel housing and shield
- 3/8" stainless steel screws
- 80 inch/lb. installation torque
- UPC listed



PART NO.	DESCRIPTION	CTN/MSTR
U99220	2"	1/75
U99330	3"	1/48
U99440	4"	1/48
U99550	5"	1/15
U99660	6"	1/15
U99880	8"	1/15
U99110	10"	1/10



SECTION T - TUBULAR

Chrome Plated	313-318
Rough Brass.....	319
PVC Plastic	320-322
ABS Plastic	323-325
Bath Wastes.....	326
Lav Drains & Pop Ups.....	327
Slip Joint Nuts.....	328
Connectors	329
Basket Strainers.....	330-331
Escutcheons	332

T

Chrome Plated Brass P-Trap



- Zinc nuts
- Shallow escutcheon
- Less cleanout
- UPC listed



PART NO.	SIZE	GAUGE	CTN/MSTR
P38001	1-1/4"	22	1/30
P38002	1-1/4"	20	1/30
P38003	1-1/4"	17	1/30
P38004	1-1/2"	22	1/30
P38005	1-1/2"	20	1/30
P38006	1-1/2"	17	1/30

Chrome Plated Brass P-Trap



- Brass nuts
- Shallow escutcheon
- Less cleanout
- UPC listed



PART NO.	SIZE	GAUGE	CTN/MSTR
P38091	1-1/4"	22	1/30
P38007	1-1/4"	20	1/30
P38138	1-1/4" x 1-1/2"	17	1/30
P38092	1-1/4"	17	1/30
P38093	1-1/2"	22	1/30
P38008	1-1/2"	20	1/30
P38094	1-1/2"	17	1/30

Chrome Plated Brass P-Trap



- Brass nuts
- Box escutcheon
- Less cleanout
- UPC listed



PART NO.	SIZE	GAUGE	CTN/MSTR
P38003B	1-1/4"	17	1/30
P38005B	1-1/2"	20	1/30
P38006B	1-1/2"	17	1/30

Chrome Plated Brass P-Trap



- Heavy zinc nuts
- Bell escutcheon
- With cleanout
- UPC listed



PART NO.	SIZE	GAUGE	CTN/MSTR
P38002B	1-1/4"	20	1/30

Chrome Plated Brass P-Trap



- Zinc nuts
- Shallow escutcheon
- With cleanout
- UPC listed



PART NO.	SIZE	GAUGE	CTN/MSTR
P38009	1-1/4"	20	1/30
P38009B (box esc.)	1-1/4"	20	1/30
P38011	1-1/2"	20	1/30

Chrome Plated Brass P-Trap



- Brass nuts
- Shallow escutcheon
- With cleanout
- UPC listed



PART NO.	SIZE	GAUGE	CTN/MSTR
P38010	1-1/4"	17	1/30
P38012	1-1/2"	17	1/30

Chrome Plated Brass P-Trap



- Brass nuts
- Box escutcheon
- With cleanout
- UPC listed



PART NO.	SIZE	GAUGE	CTN/MSTR
P38010B	1-1/4"	17	1/30
P38012B	1-1/2"	17	1/30

Chrome Plated Brass P-Trap



- Brass nuts
- Semi-cast commercial
- Shallow escutcheon
- With cleanout
- UPC listed



PART NO.	SIZE	GAUGE	CTN/MSTR
J37124	1-1/4"	17	1/30
J37150	1-1/2"	17	1/30

Chrome Plated Brass P-Trap



- Brass nuts
- Bell escutcheon
- Less cleanout
- UPC listed



PART NO.	SIZE	GAUGE	CTN/MSTR
P38150	1-1/4"	17	1/30

Chrome Plated Boston Style P-Trap



- Brass nuts
- Box escutcheon
- With cleanout
- UPC listed

PART NO.	SIZE	GAUGE	CTN/MSTR
P38142	1-1/4" x 1-1/2"	17	1/30

Chrome Plated Brass S-Trap



- Zinc nuts
- Shallow escutcheon
- Less cleanout
- UPC listed

PART NO.	SIZE	GAUGE	CTN/MSTR
P38013	1-1/4"	22	1/15
P38014	1-1/2"	22	1/15

Chrome Plated Milwaukee Style Trap



- Brass nuts
- 10" Arm
- Cast elbow
- With cleanout
- UPC listed

PART NO.	SIZE	GAUGE	CTN/MSTR
P38129	1-1/2"	17	1/30

Chrome Plated Brass S-Trap



- Brass nuts
- Box escutcheon
- Less cleanout
- UPC listed

PART NO.	SIZE	GAUGE	CTN/MSTR
P38095	1-1/4"	20	1/15
P38096	1-1/2"	20	1/15
P38137	1-1/4"	17	1/15
P38097	1-1/2"	17	1/50

Chrome Plated Sink Trap with Sweat Connection



- Brass nuts
- Box escutcheon
- With cleanout
- UPC listed

PART NO.	SIZE	GAUGE	CTN/MSTR
P38140	1-1/2"	17	1/30

Chrome Plated Brass J-Bend



- Heavy zinc nuts
- Slip joint
- Less cleanout
- UPC listed

PART NO.	SIZE	GAUGE	CTN/MSTR
P38015	1-1/4"	22	1/36
P38016	1-1/4"	20	1/36
P38017	1-1/4"	17	1/36
P38018	1-1/2"	22	1/36
P38019	1-1/2"	20	1/36
P38020	1-1/2"	17	1/36

T

Chrome Plated Sink Trap with PVC Adapter



- Brass nuts
- PVC adapter
- Box escutcheon
- With cleanout
- UPC listed

PART NO.	SIZE	GAUGE	CTN/MSTR
P38130	1-1/2"	17	1/20

Chrome Plated Sink Trap with ABS Adapter



- Brass nuts
- ABS adapter
- Box escutcheon
- With cleanout
- UPC listed

PART NO.	SIZE	GAUGE	CTN/MSTR
P38141	1-1/2"	17	1/20



- Captured brass nuts
- Washer joint
- Less cleanout
- UPC listed

PART NO.	SIZE	GAUGE	CTN/MSTR
P38107	1-1/4"	22	1/60
P38108	1-1/4"	20	1/60
P38109	1-1/4"	17	1/60
P38110	1-1/2"	22	1/60
P38111	1-1/2"	20	1/60
P38112	1-1/2"	17	1/60

Chrome Plated Brass J-Bend



- Brass nuts
- Slip joint
- With cleanout
- UPC listed

PART NO.	SIZE	GAUGE	CTN/MSTR
P38021	1-1/4"	17	1/36
P38022	1-1/2"	17	1/36



- Heavy zinc nuts
- Slip joint
- With cleanout
- UPC listed

PART NO.	SIZE	GAUGE	CTN/MSTR
P38113	1-1/4"	20	1/60
P38114	1-1/2"	20	1/60

Chrome Plated Brass L.A. Pattern Sink Trap



- P38099 and P38100 with cast brass elbows
- Brass nuts
- Less cleanout
- UPC listed

PART NO.	SIZE	GAUGE	CTN/MSTR
P38098	1-1/2"	22	1/50
P38099	1-1/2"	20	1/50
P38100	1-1/2"	17	1/50

Chrome Plated Brass Repair Trap



- Brass nuts
- Less cleanout
- UPC listed

PART NO.	SIZE	GAUGE	CTN/MSTR
P38105	1-1/4"	17	1/60
P38106	1-1/2"	17	1/60



- Heavy zinc nuts
- Less cleanout
- UPC listed

PART NO.	SIZE	GAUGE	CTN/MSTR
P38101	1-1/4"	22	1/60
P38102	1-1/4"	20	1/60
P38103	1-1/2"	22	1/60
P38104	1-1/2"	20	1/60

Chrome Plated Brass Slip Joint End Outlet Tee



- Zinc nuts
- 4" Tailpiece
- No baffle
- UPC listed

PART NO.	SIZE	GAUGE	CTN/MSTR
P38023	1-1/2"	22	1/50
P38024	1-1/2"	20	1/50

Chrome Plated Brass Direct Connection End Outlet Waste



- Zinc nuts
- 4" Tailpiece
- No baffle
- UPC listed

PART NO.	SIZE	GAUGE	CTN/MSTR
P38025	1-1/2" x 16"	22	1/20
P38026	1-1/2" x 16"	20	1/20

Chrome Plated Brass Slip Joint End Outlet Waste



- Zinc nuts
- 4" Tailpiece
- No baffle
- UPC listed

PART NO.	SIZE	GAUGE	CTN/MSTR
P38027	1-1/2" x 16"	22	1/20
P38028	1-1/2" x 16"	20	1/20

Chrome Plated Brass Slip Joint Center Outlet Tee



- Zinc nuts
- 4" Tailpiece
- No baffle
- UPC listed

PART NO.	SIZE	GAUGE	CTN/MSTR
P38029	1-1/2"	20	12/120

Chrome Plated Brass Slip Joint Center Outlet Waste



- Zinc nuts
- 4" Tailpiece
- No baffle
- UPC listed

PART NO.	SIZE	GAUGE	CTN/MSTR
P38030	1-1/2" x 16"	22	1/20
P38031	1-1/2" x 16"	20	1/20

Chrome Plated Brass Direct Connection Center Outlet Waste



- Zinc nuts
- 4" Tailpiece
- No baffle
- UPC listed

PART NO.	SIZE	GAUGE	CTN/MSTR
P38032	1-1/2" x 16"	22	1/20
P38033	1-1/2" x 16"	20	10/100

Chrome Plated Brass Slip Joint Waste Arm



- Zinc nut
- Bagged
- UPC listed

PART NO.	SIZE	GAUGE	CTN/MSTR
P38034	1-1/4" x 6"	22	10/100
P38035	1-1/4" x 8"	22	10/50
P38036	1-1/4" x 12"	22	10/50
P38037	1-1/4" x 16"	22	10/50
P38038	1-1/2" x 8"	22	10/100
P38039	1-1/2" x 12"	22	10/50
P38040	1-1/2" x 16"	22	10/50
P38238	1-1/2" x 7"	17	10/50

Chrome Plated Brass Direct Connection Waste Arm



- Bagged
- UPC listed

PART NO.	SIZE	GAUGE	CTN/MSTR
P38045	1-1/2" x 7"	22	10/100
P38117	1-1/2" x 15"	22	10/100
P38217	1-1/2" x 15"	17	1/25

Chrome Plated Brass Wall Bend



- Bagged
- UPC listed

PART NO.	SIZE	GAUGE	CTN/MSTR
P38041	1-1/4" x 7"	22	10/100
P38042	1-1/4" x 7"	20	10/100
P38115	1-1/4" x 7-1/2"	17	10/100
P38043	1-1/2" x 7-1/2"	22	10/100
P38044	1-1/2" x 7-1/2"	20	10/100
P38116	1-1/2" x 7-1/2"	17	10/100

Chrome Plated Brass Slip Joint Double Offset



- Zinc nuts
- Bagged
- UPC listed

PART NO.	SIZE	GAUGE	CTN/MSTR
P38046	1-1/4" x 12"	22	10/100
P38047	1-1/2" x 12"	22	10/50

Chrome Plated Brass Sink Tailpiece



- Bagged
- UPC listed

PART NO.	SIZE	GAUGE	CTN/MSTR
P38048	1-1/4" x 6"	22	10/100
P38049	1-1/4" x 8"	22	10/100
P38050	1-1/4" x 12"	22	10/100
P38051	1-1/4" x 6"	17	10/100
P38052	1-1/4" x 8"	17	10/100
P38053	1-1/4" x 12"	17	10/50
P38054	1-1/2" x 4"	22	10/100
P38055	1-1/2" x 6"	22	10/100
P38056	1-1/2" x 8"	22	10/100
P38057	1-1/2" x 12"	22	10/50
P38058	1-1/2" x 6"	17	10/100
P38059	1-1/2" x 8"	17	10/100
P38060	1-1/2" x 12"	17	10/50

Chrome Plated Brass Double Flange Tailpiece



- Bagged
- UPC listed

PART NO.	SIZE	GAUGE	CTN/MSTR
P38061	1-1/2" x 16"	22	10/50

T

Chrome Plated Brass Double Slip Joint Extension Tube



- Zinc nuts
- Bagged
- UPC listed



PART NO.	SIZE	GAUGE	CTN/MSTR
P38062	1-1/2" x 16"	22	10/50
P38162	1-1/4" x 16"	22	10/50

Chrome Plated Brass Slip Joint Extension Tube



- Zinc nut
- Bagged
- UPC listed



PART NO.	SIZE	GAUGE	CTN/MSTR
P38065	1-1/4" x 6"	22	10/100
P38066	1-1/4" x 8"	22	10/100
P38067	1-1/4" x 12"	22	10/50
P38121	1-1/4" x 6"	20	10/100
P38122	1-1/4" x 8"	20	10/100
P38068	1-1/4" x 12"	20	10/50
P38118	1-1/4" x 6"	17	10/100
P38119	1-1/4" x 8"	17	10/100
P38120	1-1/4" x 12"	17	10/50
P38069	1-1/2" x 6"	22	10/100
P38070	1-1/2" x 8"	22	10/100
P38071	1-1/2" x 12"	22	25/50
P38123	1-1/2" x 6"	20	10/100
P38124	1-1/2" x 8"	20	10/100
P38125	1-1/2" x 12"	20	10/50
P38126	1-1/2" x 6"	17	10/100
P38127	1-1/2" x 8"	17	10/100
P38128	1-1/2" x 12"	17	10/50

Chrome Plated Brass Solder Extension Tube



- UPC listed



PART NO.	SIZE	GAUGE	CTN/MSTR
P38072	1-1/4" x 6"	22	10/100
P38073	1-1/4" x 8"	22	10/100
P38074	1-1/4" x 12"	22	10/100
P38131	1-1/4" x 6"	20	10/100
P38132	1-1/4" x 8"	20	10/100
P38133	1-1/4" x 12"	20	10/100
P38075	1-1/2" x 6"	22	10/100
P38076	1-1/2" x 8"	22	10/100
P38077	1-1/2" x 12"	22	10/100
P38134	1-1/2" x 6"	20	10/100
P38135	1-1/2" x 8"	20	10/100
P38136	1-1/2" x 12"	20	10/100

Chrome Plated Brass Threaded Extension Tube



- Bagged
- Threaded on both ends
- UPC listed



PART NO.	SIZE	GAUGE	CTN/MSTR
P38078	1-1/4" x 6"	20	10/100
P38079	1-1/4" x 8"	20	10/100
P38080	1-1/4" x 12"	20	10/50
P38081	1-1/2" x 6"	20	10/100
P38082	1-1/2" x 8"	20	10/100
P38083	1-1/2" x 12"	20	10/50
P38084	1-1/4" x 6"	17	10/100
P38085	1-1/4" x 8"	17	10/100
P38086	1-1/4" x 12"	17	10/50
P38087	1-1/2" x 6"	17	10/100
P38088	1-1/2" x 8"	17	10/50
P38089	1-1/2" x 12"	17	10/50

Chrome Plated Brass Direct Connect Dishwasher Tailpiece



- Zinc nut
- Bagged
- UPC listed

PART NO.	SIZE	GAUGE	CTN/MSTR
P38063	1-1/2" x 6" with 3/4" branch	22	10/100
P38064	1-1/2" x 8" with 3/4" branch	22	10/50
P38163	1-1/2" x 6" with 1/2" branch	22	5/30
P38148	1-1/2" x 8" with 1/2" branch	22	10/100

Chrome Plated Threaded Connection Dishwasher Tailpiece



- UPC listed

PART NO.	SIZE	GAUGE	CTN/MSTR
P38166	1-1/2" x 6" with 1/2" branch	22	1/50

Chrome Plated Slip Joint Dishwasher Tailpiece



- Zinc nut
- Bagged
- UPC listed

PART NO.	SIZE	GAUGE	CTN/MSTR
P38164	1-1/2" x 8" with 3/4" branch	22	10/50
P38143	1-1/2" x 8" with 1/2" branch	22	10/50

Chrome Plated Closet Flush Elbow

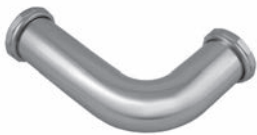

- Includes rubber slip joint washers
- Zinc nuts
- Bagged
- UPC listed

PART NO.	SIZE	GAUGE	CTN/MSTR
P38257	2" x 5" x 7"	20	1/25

Chrome Plated Disposer Kit



- Zinc nuts
- UPC listed

PART NO.	SIZE	GAUGE	CTN/MSTR
P38165	1-1/2" x 13"	17	1/20

Chrome Plated Slip Joint Tee



- Zinc nuts
- Chrome plated satin finish cast brass

PART NO.	SIZE	CTN/MSTR
C74105	1-1/2" x 1-1/2" x 1-1/2"	10/60

Chrome Plated Brass Double Slip Fittings



- 22 gauge

PART NO.	DESCRIPTION	CTN/MSTR
T74001	1-1/4" coupling	10/100
T74002	1-1/2" coupling	10/100
T74003	1-1/4" 90° elbow	10/100
T74004	1-1/2" 90° elbow	10/100
T74005	1-1/4" 45° elbow	10/100
T74006	1-1/2" 45° elbow	10/100

T

Rough Brass P-Trap



- Brass nuts
- Deep flange
- Less cleanout
- UPC listed



PART NO.	SIZE	GAUGE	CTN/MSTR
P38406	1-1/2"	17	1/30

Rough Brass Double Threaded Extension Tube



- UPC listed



PART NO.	SIZE	GAUGE	CTN/MSTR
P38486	1-1/4" x 12"	17	10/100
P38489	1-1/2" x 12"	17	10/100

Rough Brass Direct Connection Waste Arm



- UPC listed



PART NO.	SIZE	GAUGE	CTN/MSTR
P38444	1-1/2" x 7"	17	1/100
P38447	1-1/2" x 15"	17	1/50

Rough Brass Flanged Tailpiece



- UPC listed



PART NO.	SIZE	GAUGE	CTN/MSTR
P38454	1-1/2" x 4"	17	10/50
P38458	1-1/2" x 6"	17	10/100
P38459	1-1/2" x 8"	17	10/100
P38460	1-1/2" x 12"	17	10/50

Rough Brass Slip Joint Tailpiece with 1/2" Sweat Branch



- Brass nut
- UPC listed



PART NO.	SIZE	GAUGE	CTN/MSTR
P38443	1-1/2" x 8"	17	1/50

Rough Brass Slip Joint Extension Tube



- Brass nut
- UPC listed



PART NO.	SIZE	GAUGE	CTN/MSTR
P38420	1-1/4" x 12"	17	10/50
P38428	1-1/2" x 12"	17	10/50

T

PVC P-Trap



• UPC listed



PART NO.	SIZE	CTN/MSTR
P37001	1-1/4"	25/100
P37002	1-1/2"	10/50

PVC P-Trap with Solvent Weld Marvel Adapter



• Master trap
• UPC listed



PART NO.	SIZE	CTN/MSTR
P37003	1-1/2" slip joint	25/50
P37100	1-1/2" slip joint with clear poly washers	25/50
P37032	1-1/2" solvent weld	10/100

PVC Slip Joint Center Outlet Waste



• Baffle tee
• UPC listed



PART NO.	SIZE	CTN/MSTR
P37004	1-1/2"	10/40

PVC Direct Connection Center Outlet Waste



• Baffle tee
• UPC listed



PART NO.	SIZE	CTN/MSTR
P37005	1-1/2"	10/40

PVC Center Outlet Tee



• Baffle
• Tailpiece included
• May be used as slipjoint or direct connect
• UPC listed



PART NO.	SIZE	CTN/MSTR
P37006	1-1/2"	25/100

PVC Slip Joint End Outlet Waste



• Baffle
• UPC listed



PART NO.	SIZE	CTN/MSTR
P37007	1-1/2" x 16"	10/40
P37034	1-1/2" x 16" Adjustable arm	10/40

PVC Slip Joint End Outlet Waste



• 1/2" branch
• Adjustable arm
• With dishwasher tailpiece
• UPC listed



PART NO.	SIZE	CTN/MSTR
P37042	1-1/2"	10/40

PVC Direct Connection End Outlet Waste



• Baffle
• UPC listed



PART NO.	SIZE	CTN/MSTR
P37008	1-1/2"	10/50
P37036	1-1/2" Adjustable arm	10/50

PVC Slip Joint End Outlet Tee Only with Baffle



• Baffle
• UPC listed



PART NO.	SIZE	CTN/MSTR
P37009	1-1/2"	25/100

T

PVC Slip Joint S-Trap



• UPC listed



PART NO.	SIZE	CTN/MSTR
P37010	1-1/4"	15/60
P37011	1-1/2"	15/60

PVC Slip Joint Dishwasher Tailpiece



• UPC listed



PART NO.	SIZE	CTN/MSTR
P37012	1-1/2" x 8" with 1/2" branch	1/25
P37030	1-1/2" x 8" with 3/4" branch	5/25

PVC Direct Connection Dishwasher Tailpiece



• May be used as slip joint or direct connect
• UPC listed



PART NO.	SIZE	CTN/MSTR
P37013	1-1/2" x 8" with 1/2" branch	5/25
P37031	1-1/2" x 8" with 3/4" branch	5/25

PVC Universal End Outlet Waste with Dishwasher Connection



• 1-1/2" tubular; 16" maximum adjustment
• Baffle tee
• May be used as slip joint or direct connect
• UPC listed



PART NO.	SIZE	CTN/MSTR
P37040	1/2" branch	10/60
P37041	3/4" branch	10/60

PVC Slip Joint Repair Trap



• UPC listed



PART NO.	SIZE	CTN/MSTR
P37014	1-1/2"	1/80

PVC Slip Joint J-Bend



• UPC listed



PART NO.	SIZE	CTN/MSTR
P37015	1-1/2"	10/60

PVC Slip Joint Waste Arm



• UPC listed



PART NO.	SIZE	CTN/MSTR
P37016	1-1/2" x 16"	25/100

PVC Direct Connection Waste Arm



• UPC listed



PART NO.	SIZE	CTN/MSTR
P37017	1-1/2" x 16"	10/100

PVC Slip Joint Extension Tube



• UPC listed



PART NO.	SIZE	CTN/MSTR
P37018	1-1/2" x 16"	25/50
P37118	1-1/4" x 16"	10/100

PVC Double Flange Extension



• UPC listed



PART NO.	SIZE	CTN/MSTR
P37019	1-1/2" x 16"	25/100

PVC Slip Joint Extension Tube



• UPC listed



PART NO.	SIZE	CTN/MSTR
P37020	1-1/4" x 6"	25/100
P37021	1-1/2" x 8"	25/100
P37022	1-1/2" x 12"	25/100

PVC Solvent Extension Tube



• UPC listed



PART NO.	SIZE	CTN/MSTR
P37023	1-1/4" x 8"	25/100
P37024	1-1/2" x 6"	25/100
P37025	1-1/2" x 12"	25/100

PVC Flanged Tailpiece



• UPC listed



PART NO.	SIZE	CTN/MSTR
P37026	1-1/2" x 6"	25/200
P37027	1-1/2" x 8"	25/200
P37028	1-1/2" x 12"	25/200
P37029	1-1/2" x 16"	25/100

PVC Direct Connection Disposer Kit with 13" Arm



- Poly washers and wing nuts
- Disposer washer
- Baffle tee
- 6" Tailpiece
- UPC listed



PART NO.	SIZE	CTN/MSTR
P37033	1-1/2" x 16"	10/50

PVC Direct Connection Disposer Kit with Adjustable Arm

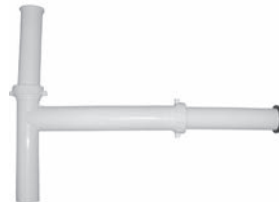

- Arm adjusts up to 16"
- Poly washers and wing nuts
- Disposer washer
- Baffle tee
- 6" tailpiece

PART NO.	SIZE	CTN/MSTR
P37035	1-1/2" Adjustable arm	10/40

PVC Slip Joint Double Offset Tailpiece



- Slip joint on both ends
- UPC listed



PART NO.	SIZE	CTN/MSTR
P37150	1/2"	1/40

PVC Slip Joint Tee



- With 1-1/4" washer

PART NO.	SIZE	CTN/MSTR
P37400	1-1/2"	120

PVC Double Slip Fittings



PART NO.	DESCRIPTION	SIZE	CTN/MSTR
P37200	Coupling	1-1/2"	10/100
P37445	45° Elbow	1-1/2"	1/100
P37490	90° Elbow	1-1/2"	1/100

T

Chrome Plated PVC P-Trap



- Complete with nuts and washers
- Box escutcheon
- P36103 includes reducing washer

PART NO.	SIZE	CTN/MSTR
P36102	1-1/4"	1/50
P36103	1-1/2"	1/50

ABS P-Trap



- UPC listed



PART NO.	SIZE	CTN/MSTR
P39001	1-1/4"	10/100
P39002	1-1/2"	10/50

ABS P-Trap with Adapter



- Master trap
- UPC listed



PART NO.	SIZE	CTN/MSTR
P39003	1-1/2" slip joint	1/50
P39032	1-1/2" solvent weld	10/50

ABS Slip-Joint Center Outlet Waste



- UPC listed



PART NO.	SIZE	CTN/MSTR
P39004	1-1/2"	10/40

ABS Direct Connection Center Outlet Waste



- Tailpiece included
- May be used as slip joint or direct connect
- UPC listed



PART NO.	SIZE	CTN/MSTR
P39005	1-1/2"	10/40

ABS Slip-Joint Center Outlet Tee



- UPC listed



PART NO.	SIZE	CTN/MSTR
P39006	1-1/2"	10/100

ABS Slip-Joint End Outlet Waste



- Baffle
- UPC listed



PART NO.	SIZE	CTN/MSTR
P39007	1-1/2" x 16"	20/40
P39034	1-1/2" x 16" adjustable	10/40

ABS Direct Connection End Outlet Waste



- Baffle
- UPC listed



PART NO.	SIZE	CTN/MSTR
P39008	1-1/2"	20/40

ABS Slip Joint End Outlet Tee



- UPC listed



PART NO.	SIZE	CTN/MSTR
P39009	1-1/2"	25/100

ABS S-Trap



- UPC listed



PART NO.	SIZE	CTN/MSTR
P39010	1-1/4"	15/60
P39011	1-1/2"	15/60

ABS Slip Joint Dishwasher Tailpiece



• UPC listed



PART NO.	SIZE	CTN/MSTR
P39012	1-1/2" x 8" with 1/2" branch	5/25
P39030	1-1/2" x 8" with 3/4" branch	5/25

ABS Direct Connection Dishwasher Tailpiece



• UPC listed



PART NO.	SIZE	CTN/MSTR
P39013	1-1/2" x 8" with 1/2" branch	5/25
P39031	1-1/2" x 8" with 3/4" branch	5/25

ABS Slip Joint Repair Trap



• UPC listed



PART NO.	SIZE	CTN/MSTR
P39014	1-1/2"	20/80

ABS Slip Joint J-Bend



• UPC listed



PART NO.	SIZE	CTN/MSTR
P39015	1-1/2"	20/80

ABS Slip Joint Waste Arm



• UPC listed



PART NO.	SIZE	CTN/MSTR
P39016	1-1/2" x 16"	25/100

ABS Direct Connection Waste Arm



• UPC listed



PART NO.	SIZE	CTN/MSTR
P39017	1-1/2" x 16"	25/100

ABS Slip Joint Extension Tube



• UPC listed



PART NO.	SIZE	CTN/MSTR
P39018	1-1/2" x 16"	10/50

ABS Double Flange Extension



• UPC listed



PART NO.	SIZE	CTN/MSTR
P39019	1-1/2" x 16"	25/100

ABS Slip Joint Extension Tube



• UPC listed



PART NO.	SIZE	CTN/MSTR
P39020	1-1/4" x 6"	10/100
P39021	1-1/2" x 8"	10/100
P39022	1-1/2" x 12"	25/100

1-1/2" ABS Direct Connection Disposer Kit



- Poly washer and wing nuts
- Disposer washer
- 6" Tailpiece
- UPC listed



PART NO.	SIZE	CTN/MSTR
P39033	1-1/2" x 16"	10/50

T

ABS Direct Connection Disposer Kit with Adjustable Arm



- Arm adjusts up to 16"
- Poly washers and wing nuts
- Disposer washer
- Baffle tee
- 6" Tailpiece
- UPC listed

PART NO.	SIZE	CTN/MSTR
P39035	1-1/2" Adjustable arm	1/40

ABS Universal End Outlet Waste with Dishwasher Connection



- 1-1/2" tubular; 16" maximum adjustment
- Baffle tee
- May be used as slip joint or direct connect
- UPC listed

PART NO.	SIZE	CTN/MSTR
P39040	1/2" branch	10/40
P39041	3/4" branch	10/40

ABS Solvent Extension Tube



- UPC listed

PART NO.	SIZE	CTN/MSTR
P39023	1-1/4" x 8"	25/100
P39024	1-1/2" x 6"	25/100
P39025	1-1/2" x 12"	25/100

ABS Flanged Tailpiece



- UPC listed

PART NO.	SIZE	CTN/MSTR
P39026	1-1/2" x 6"	25/200
P39027	1-1/2" x 8"	25/200
P39028	1-1/2" x 12"	25/200
P39029	1-1/2" x 16"	25/100

Chrome Plated ABS P-Trap



- Slip joint connection
- Box escutcheon
- UPC listed

PART NO.	SIZE	CTN/MSTR
P36104	1-1/4"	10/50
P36105	1-1/2"	10/50

T

PVC and ABS Tubular Bath Waste Kits



- Heavy walled PVC and ABS tubular
- 2-hole faceplates with wrap-around gaskets and tapped holes
- 1-1/2" IPS threaded drain shoe
- Overflow elbow designed to accommodate B07202 test kit
- Wing nuts and poly washers
- Boxed
- UPC listed

1-1/2" Lift and Turn Bath Waste Tubular Kit



PART NO.	FINISH	MATERIAL	CTN/MSTR
P37500	CP	PVC	1/20
P39500	CP	ABS	1/20
P37502	SN (PVD)	PVC	1/20
P39502	SN (PVD)	ABS	1/20

1-1/2" Brass Friction Lift Bath Waste Tubular Kit



PART NO.	FINISH	MATERIAL	CTN/MSTR
P37503	CP	PVC	1/20
P39503	CP	ABS	1/20
P37505	SN (PVD)	PVC	1/20
P39505	SN (PVD)	ABS	1/20

1-1/2" Brass Toe Touch Bath Waste Tubular Kit



PART NO.	FINISH	MATERIAL	CTN/MSTR
P37506	CP	PVC	1/20
P39506	CP	ABS	1/20
P37508	SN (PVD)	PVC	1/20
P39508	SN (PVD)	ABS	1/20

1-1/2" Trip Lever Bath Waste Tubular Kit



PART NO.	FINISH	MATERIAL	CTN/MSTR
P37509	CP	PVC	1/20
P39509	CP	ABS	1/20
P37511	SN (PVD)	PVC	1/20
P39511	SN (PVD)	ABS	1/20

PVC and ABS Tubular Cable Drive Bath Waste Half Kits



- 1-1/2" IPS threaded drain shoe
- UPC listed

1-1/2" - 27" Cable Drive



PART NO.	FINISH	MATERIAL	CTN/MSTR
P37512	CP	PVC	1/20
P39512	CP	ABS	1/20
P37514	SN (PVD)	PVC	1/20
P39514	SN (PVD)	ABS	1/20

1-1/2" - 35" Cable Drive

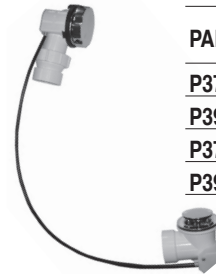

PART NO.	FINISH	MATERIAL	CTN/MSTR
P37515	CP	PVC	1/20
P39515	CP	ABS	1/20
P37517	SN (PVD)	PVC	1/20
P39517	SN (PVD)	ABS	1/20

1-1/2" - 45" Cable Drive



PART NO.	FINISH	MATERIAL	CTN/MSTR
P37518	CP	PVC	1/20
P39518	CP	ABS	1/20
P37520	SN (PVD)	PVC	1/20

T

Commercial Lav Grid Drain



- Polished chrome plated brass
- Mack washer and brass locknut
- 17 Gauge 1-1/4" tailpiece; 6" long

PART NO.	DESCRIPTION	CTN/MSTR
D70100	Commercial lav drain	1/50

Handicap Style Lav Grid Drain



- Polished chrome plated brass
- Twin 90° construction
- Mack washer and brass locknut
- 17 gauge 1-1/4" tailpiece; cast brass elbows
- With overflow
- UPC listed



PART NO.	DESCRIPTION	CTN/MSTR
D70101	Handicap style lav grid drain	1/25

Commercial Handicap Style Lav Grid Drain with Elbow



- Polished chrome plated brass; cast brass elbow
- 1-1/4" female thread
- Complete with gaskets and brass locknut

PART NO.	DESCRIPTION	CTN/MSTR
D70102	Handicap style lav grid drain with elbow	1/48

Chrome Plated Brass Pop-Up Assembly



- All metal construction
- Tool free locknut and ballrod nut
- With overflow holes
- 17 gauge
- Boxed

PART NO.	DESCRIPTION	CTN/MSTR
P35001	CP pop-up assembly	1/50

Polished Brass Pop-Up Assembly

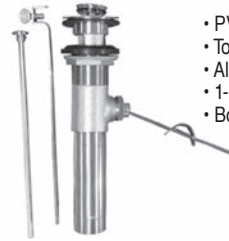

- PVD durable finish
- Tool free locknut and ballrod nut
- All metal construction
- 1-1/4" Tubular
- Boxed

PART NO.	DESCRIPTION	CTN/MSTR
P35002	PB (PVD) pop-up assembly	1/50

ABS Lav Pop-Up Assembly



- Carded

PART NO.	DESCRIPTION	CTN/MSTR
P35004	Grey plastic	1/30

Chrome Plated ABS Lav Pop-Up Assembly

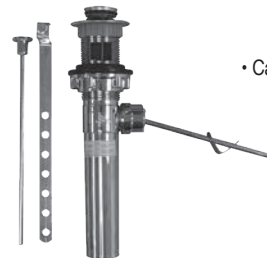

- Carded

PART NO.	DESCRIPTION	CTN/MSTR
P35005	Chrome plated plastic	1/30

Chrome Plated Brass Pop-Up Assembly

Brass P.O. Plug Lav Drain



- With chain and stopper

PART NO.	DESCRIPTION	CTN/MSTR
D70103	P.O. plug drain	1/50

Items marked with the Jones Stephens logo are "You Need It... We Got It" Items.

Chrome Plated Trap Primer Tailpiece



- 17 Gauge tubular chrome plated steel
- Sturdy one-piece construction eliminates leaks and crossthreading

PART NO.	SIZE	CTN/MSTR
T74010	1-1/4" x 8" threaded top	1/50
T74011	1-1/2" x 8" direct connection	1/50

Plastic Slip Joint Nut



- White
- CARTON QUANTITIES ONLY

PART NO.	SIZE	CTN/MSTR
T83150	1-1/2" with wings	100/1200
T85125	1-1/4" x 1-1/4"	100/1200
T85150	1-1/2" x 1-1/2"	100/1200

Plastic Slip Nut



- Replace fractured or stripped slip nuts without tubular disassembly
- Supplied with washer

PART NO.	SIZE	CTN/MSTR
T82125	1-1/4" Split nut	100/400
T82150	1-1/2" Split nut	100/400

Chrome Plated Die Cast Zinc Slip Joint Nut



- Chrome plated
- CARTON QUANTITIES ONLY

PART NO.	IPS x SLIP TUBE	CTN/MSTR
T77125	1-1/4" x 1-1/4"	25/500
T77138	1-1/2" x 1-3/8"	25/800
T77150	1-1/2" x 1-1/2"	25/300
T77151	1-1/2" x 1-1/4"	25/300
T77152	2" x 1-1/2"	25/300
T77200	2" x 2"	25/200

Chrome Plated Brass Slip Joint Nut



- Chrome plated
- CARTON QUANTITIES ONLY

PART NO.	IPS x SLIP TUBE	CTN/MSTR
T78125	1-1/4" x 1-1/4"	200/400
T78150	1-1/2" x 1-1/2"	200/400
T78151	1-1/2" x 1-1/4"	200/400
T78152	2" x 1-1/2"	125/250
T78200	2" x 2"	25/250

Rough Brass Slip Joint Nut



- Heavy cast brass
- CARTON QUANTITIES ONLY

PART NO.	IPS x SLIP TUBE	CTN/MSTR
T84125	1-1/4" x 1-1/4"	25/300
T84150	1-1/2" x 1-1/2"	25/300
T84151	1-1/2" x 1-1/4"	25/300
T84200	2" x 2"	25/300

Chrome Plated Die Cast Slip Joint Nut and Washer



- Chrome plated nut packed with square cut rubber washer
- CARTON QUANTITIES ONLY

PART NO.	SIZE	CTN/MSTR
T77014	1-1/4" x 1-1/4"	25/500
T77012	1-1/2" x 1-1/2"	25/500
T77013	1-1/2" x 1-1/4"	25/500
T77020	2" x 2"	25/500

Chrome Plated Brass Slip Joint Nut and Washer



- Chrome plated nut packed with square cut rubber washer
- CARTON QUANTITIES ONLY

PART NO.	SIZE	CTN/MSTR
T78014	1-1/4" x 1-1/4"	25/400
T78012	1-1/2" x 1-1/2"	200/400
T78013	1-1/2" x 1-1/4"	200/400
T78020	2" x 2"	25/400

Square Cut Rubber Slip Joint Washer



• CARTON QUANTITIES ONLY

PART NO.	NUT x TUBE	CTN/MSTR
T79125	1-1/4" x 1-1/4"	100/5600
T79150	1-1/2" x 1-1/2"	100/5600
T79151	1-1/2" x 1-1/4"	100/5600
T79200	2" x 2"	100/2400
T79201	2" x 1-1/2"	100/2400
T79152	1-1/2" x 1-1/4" cloth inserted	100/1000

Poly Beveled Slip Joint Washer



• CARTON QUANTITIES ONLY

PART NO.	NUT x TUBE	CTN/MSTR
T80125	1-1/4" x 1-1/4"	100/5000
T80150	1-1/2" x 1-1/2"	100/5000
T80200	2" x 2"	100/5000

TPR Blue Beveled Slip Joint Washer



• CARTON QUANTITIES ONLY

PART NO.	NUT x TUBE	CTN/MSTR
T80135	1-1/4" x 1-1/4"	100/5000
T80160	1-1/2" x 1-1/2"	100/5000
T80151	1-1/2" x 1-1/4"	100/5000

Flanged Tailpiece Washer



• CARTON QUANTITIES ONLY

PART NO.	NUT x TUBE	CTN/MSTR
T81150	1-1/2" x 1-1/2" (poly)	100/5000
T79152	1-1/2" x 1-1/4" cloth inserted (rubber)	100/5000

Marvel Ring



• Use on closet/urinal stub out adapter

PART NO.	FSWT x MIP	CTN/MSTR
B55004	1-1/4" SJ x 1-1/4" SWT	1/1000
B55005	1-1/2" SJ x 1-1/2" SWT	1/500
B55006	2" SJ x 2" SWT	1/500
B55007	1-1/2" SJ x 1-1/4" SWT	1/500

PVC Marvel Adapter



• Thread x Hub

PART NO.	SIZE	CTN/MSTR
P37000	1-1/2" PVC	1/100
P39000	1-1/2" ABS	1/100

Tray Plug



- Stainless steel body with die cast locknut
- Fits 1-1/2" bar sink
- Complete with washers and stopper

PART NO.	DESCRIPTION	CTN/MSTR
B02051	Tray plug	1/100

FIP x SLIP Waste Connector



- Brass body ferrule and nut; OD is copper tubular dimension
- MIP units are combination female sweat
- With stop

PART NO.	FIP x OD	CTN/MSTR
T75125	1-1/4" x 1-1/4"	12/72
T75150	1-1/2" x 1-1/2"	12/72
T75151	1-1/2" x 1-1/4"	12/72

MIP x SLIP Waste Connector



- Brass body ferrule and nut; OD is copper tubular dimension
- MIP units are combination female sweat
- With stop

PART NO.	MIP x OD	CTN/MSTR
T76125	1-1/4" x 1-1/4"	12/72
T76150	1-1/2" x 1-1/2"	12/72
T76151	1-1/2" x 1-1/4"	12/72

Flexible Trap Drain Connector



PART NO.	DESCRIPTION	CTN/MSTR
T06001	Connects 1-1/4"- 1-1/2" tubular to 1-1/4"- 1-1/2" tubular	1/180
T06002	Connects 1" DWV or 1-1/2" CTS to 1-1/4"- 1-1/2" tubular	1/100
T06003	Connects 1-1/2" DWV or CTS to 1-1/4"- 1-1/2" tubular	1/100
T06004	Connects 2" DWV to 1-1/4"- 1-1/2" tubular	1/100

Duo Basket Strainer



- 4-1/2" diameter to fit 3-1/2" drilling
- All stainless steel with zinc locknut
- Basket with rolled edge
- UPC listed



PART NO.	DESCRIPTION	CTN/MSTR
S14001	SS duo basket strainer	1/50

Snap Lock Basket Strainer



- 4-1/2" diameter to fit 3-1/2" drilling
- All stainless steel with zinc locknut
- Ball bearing basket with rolled edge (less tailpiece)
- UPC listed



PART NO.	DESCRIPTION	CTN/MSTR
S14005	Snap lock basket strainer	1/50

Flat Top Grid Strainer



- 4-1/2" diameter to fit 3-1/2" drilling
- All stainless steel with zinc locknut (less tailpiece)
- UPC listed



PART NO.	DESCRIPTION	CTN/MSTR
S14002	Flat top grid strainer	1/24

Shallow Cup Duo Basket Strainer



- 4-1/2" diameter to fit 3-1/2" drilling
- All stainless steel with zinc locknut
- Basket with rolled edge (less tailpiece)
- UPC listed



PART NO.	DESCRIPTION	CTN/MSTR
S14006	Shallow cup duo strainer	1/50

Twist & Lock Basket Strainer



- 4-1/2" diameter to fit 3-1/2" drilling
- Screw-in basket (less tailpiece)
- UPC listed



PART NO.	DESCRIPTION	CTN/MSTR
S14003	Twist & lock basket strainer	1/50
S14103	Replacement basket	10/200

Stainless Steel Duo Basket Strainer



- Stainless steel body and basket
- Neoprene stopper
- Spring style snap-in basket
- UPC listed



PART NO.	DESCRIPTION	CTN/MSTR
S14606	SS duo basket strainer	1/50

T Stainless Steel Duo Post Style Basket Strainer



- Stainless steel body and basket
- Polished inner cup
- Compare to JB250SS
- CP zinc post and slip nut
- Heavy duty rubber gasket and zinc locknut
- UPC listed



PART NO.	DESCRIPTION	CTN/MSTR
S14251	SS Duo post style basket strainer	1/50

Chrome Plated Brass Duo Basket Strainer



- Beveled stopper w/o-ring seal
- Brass slip joint nut and lock nut
- Compare to Kohler K8801

PART NO.	DESCRIPTION	CTN/MSTR
S14007	CP brass duo basket strainer	1/25

Deep Cup Basket Strainer



- 4-1/2" diameter to fit 3-1/2" drilling
- All stainless steel with zinc locknut
- Basket with rolled edge (less tailpiece)
- UPC listed



PART NO.	DESCRIPTION	CTN/MSTR
S14004	Deep cup basket strainer	1/50

Chrome Plated Brass Duo Basket Strainer



- Chrome plated brass body with stainless steel basket
- Heavy duty construction
- Neoprene stopper
- UPC listed



PART NO.	DESCRIPTION	CTN/MSTR
S14250	CP brass duo basket strainer	1/50

Quick Fit Stainless Steel Basket Strainer



- Minimizes installation time
- Triangle frame mounts to underside
- Fits virtually all sinks
- Durable stainless construction with brass nut
- For replacement basket use B03015
- UPC listed



PART NO.	DESCRIPTION	CTN/MSTR
S14008	SS basket strainer	1/50

Economy Replacement Basket Strainer



- ABS post
- Stainless steel basket

PART NO.	DESCRIPTION	CTN/MSTR
B03015	Replacement basket strainer	10/200

Stainless Steel Deep Cup Basket Strainer



- Stainless steel body and basket
- Neoprene stopper
- Spring style snap-in basket
- UPC listed



PART NO.	DESCRIPTION	CTN/MSTR
S14014	SS cup basket strainer	1/50

Fit-All Basket Strainer



- Stainless steel

PART NO.	DESCRIPTION	CTN/MSTR
B03010	Fit-all basket strainer	20/200

Junior Duo Basket Strainer



- Stainless steel body and basket with die cast locknut; 1-1/2" threads
- Complete with washers
- Fits 1-3/4" bar sink

PART NO.	DESCRIPTION	CTN/MSTR
B02050	Junior duo basket strainer	1/100
B02049	Replacement basket	100/500

Snap N Lock Stainless Steel Basket Strainer



- Brass slip joint and lock nuts

PART NO.	DESCRIPTION	CTN/MSTR
S14010	Snap N Lock stainless steel basket strainer	1/50

Flat Duplex Strainer



- Stainless steel body and strainer with die cast locknut
- Complete with washers
- Fits 1-3/4" bar sink

PART NO.	DESCRIPTION	CTN/MSTR
B02052	Flat duplex strainer	1/100

Deep Junior Duo Basket Strainer



- For 2" and 2-1/2" deep outlets and bar sinks

PART NO.	DESCRIPTION	CTN/MSTR
B02102	2" Deep basket strainer	1/100
B02103	Replacement basket	1/250

T

Low Pattern Tubular Sure Grip Escutcheon



- Chrome plated steel
- CARTON QUANTITIES ONLY

PART NO.	SIZE	FLANGE OD	CTN/MSTR
E03125	1-1/4" Tubular	2-7/8"	25/1200
E03150	1-1/2" Tubular	2-7/8"	25/1200
E03200	2" Tubular	3-1/2"	25/400

Box Pattern Tubular Sure Grip Escutcheon



- Chrome plated steel
- CARTON QUANTITIES ONLY

PART NO.	SIZE	FLANGE OD	CTN/MSTR
E04125	1-1/4" Tubular	3"	5/300
E04150	1-1/2" Tubular	3"	5/300
E04200	2" Tubular	3"	5/300

PVC DWV FITTINGS..... 335-341

**PVC
DWV**

Coupling

H x H



- Used to join straight lengths of pipe

PART NO.	SIZE	CTN/MSTR
PFC114	1-1/4"	1/100
PFC115	1-1/2"	1/100
PFC120	2"	1/100
PFC130	3"	1/60
PFC140	4"	1/25
PFC160	6"	1/15

Repair Coupling

H x H



- Furnished without center stop so that stationary lengths of pipe can be spliced together

PART NO.	SIZE	CTN/MSTR
PFC116	1-1/2"	1/25
PFC122	2"	1/25
PFC133	3"	1/10
PFC144	4"	1/5

Reducer Coupling

H x H



- Used to reduce or increase pipe sizes

PART NO.	SIZE	CTN/MSTR
PFC121	2" x 1-1/2"	1/25
PFC131	3" x 1-1/2"	1/25
PFC132	3" x 2"	1/20
PFC142	4" x 2"	1/10
PFC143	4" x 3"	1/20

Flush Bushing

Spg x H



- Inserts into fitting hub to reduce to smaller pipe sizes

PART NO.	SIZE	CTN/MSTR
PFB211	1-1/2" x 1-1/4"	1/50
PFB221	2" x 1-1/2"	1/100
PFB231	3" x 1-1/2"	1/20
PFB232	3" x 2"	1/30
PFB242	4" x 2"	1/30
PFB243	4" x 3"	1/30
PFB264	6" x 4"	1/10

Male Adapter

H x MPT



- Adapts to standard female pipe threads
- Teflon thread tape is recommended for threaded joints

PART NO.	SIZE	CTN/MSTR
PMA414	1-1/4"	1/50
PMA415	1-1/2"	1/50
PMA420	2"	1/50
PMA430	3"	1/25
PMA440	4"	1/25

Female Adapter

H x FPT



- Adapts to standard male pipe threads
- Teflon thread tape is recommended for threaded joints

PART NO.	SIZE	CTN/MSTR
PFA314	1-1/4"	1/100
PFA315	1-1/2"	1/100
PFA311	1-1/2" x 1-1/4"	1/100
PFA320	2"	1/100
PFA330	3"	1/30
PFA340	4"	1/10
PFA360	6"	1/10

Fitting C.O. Adapter with Plug

Spg x FPT



- Solvent welds into fitting hub to provide access to piping
- Teflon thread tape is recommended for threaded joints

PART NO.	SIZE	CTN/MSTR
PFA615	1-1/2"	1/50
PFA620	2"	1/50
PFA630	3"	1/25
PFA640	4"	1/10

45° Street Elbow

Spg x H



- Used to change direction from a fitting hub to a pipe
- Sometimes called a "Street 1/8 bend"

PART NO.	SIZE	CTN/MSTR
PSL715S	1-1/2" short turn	1/100
PSL716S	1-1/2" long turn	1/100
PSL720	2"	1/50
PSL730	3"	1/20
PSL740	4"	1/10
PSL760	6"	1/3

PVC DWV

60° Elbow

H x H



- Used to change direction in piping
- Sometimes called a "OK bend"

PART NO.	SIZE	CTN/MSTR
PFL915	1-1/2"	1/40
PFL930	3"	1/20

90° Vent Elbow

H x H



- Used to change direction in the "dry" portion of vent piping where water flow is not a consideration

PART NO.	SIZE	CTN/MSTR
PFL715	1-1/2"	1/20
PFL720	2"	1/30
PFL730	3"	1/10

90° Elbow

H x H



- Used to change direction in piping
- Sometimes called a "1/4 bend"

PART NO.	SIZE	CTN/MSTR
PFL814	1-1/4"	1/100
PFL815	1-1/2"	1/100
PFL820	2"	1/50
PFL830	3"	1/25
PFL840	4"	1/10
PFL860	6"	1/5
PFL821	2" x 1-1/2"	1/20
PFL834	4" x 3"	1/20

90° Elbow with Side Inlet

H x H x Spg/H



- Used to connect a branch line or vent at a change of direction in a larger vertical or horizontal pipe
- The inlet is constructed to accept a 2" fitting over its outside diameter or a 1-1/2" pipe into its inside diameter

PART NO.	SIZE	CTN/MSTR
PFL131	3" x 2" Spg or 1-1/2" Hub	1/20

90° Street Elbow

Spg x H



- Used to change direction in piping
- Sometimes called a "street 1/4 bend"

PART NO.	SIZE	CTN/MSTR
PSL916	1-1/2"	1/100
PSL926	2"	1/50
PSL936	3"	1/20
PSL946	4"	1/10

90° Long Sweep Elbow

H x H



- Used to change direction in piping
- Sometimes called a "long turn 1/4 bend"

PART NO.	SIZE	CTN/MSTR
PFL815L	1-1/2"	1/50
PFL820L	2"	1/25
PFL830L	3"	1/10
PFL840L	4"	1/5

90° Lowwheel Inlet Elbow

H x H x Spg/H or H x H x H



- Used to connect a branch line or vent at a change of direction in a larger vertical or horizontal pipe
- The inlet is constructed to accept a 2" fitting over its outside diameter or a 1-1/2" pipe into its inside diameter

PART NO.	SIZE	CTN/MSTR
PFL031	3" x 2" Spg or 1-1/2" Hub	1/25
PFL032	3" x 2" Hub	1/25

Fitting C.O. Adapter

Spg x FPT



- Solvent welds into fitting hub and adapts to male threaded plug
- This fitting is a component part of "Fitting Cleanout with Threaded Plug"

PART NO.	SIZE	CTN/MSTR
PFA614	1-1/2"	1/50
PFA619	2"	1/50
PFA629	3"	1/25
PFA639	4"	1/10
PFA659	6"	1/10

PVC
DWV

Cap

Hub



- Used for permanently or temporarily capping pipe

PART NO.	SIZE	CTN/MSTR
PHC151	1-1/2"	1/10
PHC152	2"	1/5
PHC153	3"	1/10
PHC154	4"	1/5

22-1/2° Elbow

H x H



- Used to change direction in piping
- Sometimes called a "1/16 bend"

PART NO.	SIZE	CTN/MSTR
PFL515	1-1/2"	1/50
PFL520	2"	1/25
PFL530	3"	1/20
PFL540	4"	1/15
PFL560	6"	1/3

22-1/2° Street Elbow

H x Spg



- Used to change direction in piping
- Sometimes called a "Street 1/16 bend"

PART NO.	SIZE	CTN/MSTR
PSL815	1-1/2"	1/50
PSL820	2"	1/25
PSL830	3"	1/20
PSL840	4"	1/10

45° Elbow

H x H



- Used to change direction in piping
- Sometimes called a "1/8 bend"

PART NO.	SIZE	CTN/MSTR
PFL614	1-1/4"	1/100
PFL615	1-1/2"	1/100
PFL620	2"	1/50
PFL630	3"	1/20
PFL640	4"	1/10
PFL660	6"	1/3
PFL615S	1-1/2" short turn	1/100
PFL620S	2" short turn	1/100

Double 90° Elbow

H x H x H



- Ideal for "back to back" sink or lavatory installations

PART NO.	SIZE	CTN/MSTR
PDL716	1-1/2"	1/20
PDL736	3"	1/10
PDL722	2" x 1-1/2" x 1-1/2"	1/25

Wye

H x H x H



- Used when connecting a branch line into a horizontal drain pipe
- Also used in conjunction with a "twist-lok" plug to provide a cleanout in a drain pipe

PART NO.	SIZE	CTN/MSTR
PFY015	1-1/2"	1/50
PFY020	2"	1/25
PFY030	3"	1/25
PFY040	4"	1/5
PFY060	6"	1/4
PFY021	2" x 1-1/2"	1/25
PFY023	2" x 1-1/2" x 1-1/2"	1/25
PFY031	3" x 1-1/2"	1/15
PFY032	3" x 2"	1/25
PFY041	4" x 4" x 1-1/2"	1/10
PFY042	4" x 2"	1/10
PFY043	4" x 3"	1/10
PFY064	6" x 4"	1/5

**PVC
DWV**

Double Wye

H x H x H x H



- Used to bring two branch lines into a horizontal drain pipe

PART NO.	SIZE	CTN/MSTR
PDY415	1-1/2"	1/40
PDY420	2"	1/20
PDY430	3"	1/15
PDY440	4"	1/5
PDY442	4" x 4" x 2" x 2"	1/5
PDY443	4" x 4" x 3" x 3"	1/5

Double Fixture Tee

H x H x H x H



PART NO.	SIZE	CTN/MSTR
PDT621	2" x 1-1/2" x 1-1/2" x 1-1/2"	1/20

Vent Tee

H x H x H



- Used primarily in seepage bed piping grids in conjunction with perforated pipe
- Used where flow characteristics are not a primary consideration

PART NO.	SIZE	CTN/MSTR
PVT415	1-1/2"	1/10
PVT420	2"	1/10
PVT430	3"	1/10
PVT440	4"	1/10

Long Turn Tee Wye

H x H x H



- Used in some plumbing code areas to connect a branch line into a vertical drain pipe instead of a conventional tee fitting
- Also used to connect horizontal branch pipe approaching a horizontal drain pipe on the perpendicular

PART NO.	SIZE	CTN/MSTR
PFY515L	1-1/2"	1/20
PFY520L	2"	1/10
PFY530L	3"	1/10
PFY540L	4"	1/5
PFY521	2" x 1-1/2"	1/20
PFY531	3" x 1-1/2"	1/10
PFY532	3" x 2"	1/10
PFY542	4" x 2"	1/10
PFY543	4" x 3"	1/5

Cleanout Test Tee

H x H x FPT



- Used in conjunction with a threaded plug to provide a cleanout opening
- Teflon thread tape is recommended for threaded joints

PART NO.	SIZE	CTN/MSTR
PCT416	1-1/2"	1/20
PCT421	2"	1/20
PCT431	3"	1/10
PCT441	4"	1/10

Cleanout Test Tee with Cleanout Plug

H x H x FPT



- Used at the base of a vertical drain pipe to provide a cleanout opening flush with the finished wall

PART NO.	SIZE	CTN/MSTR
PCT315	1-1/2"	1/10
PCT320	2"	1/10
PCT330	3"	1/10
PCT340	4"	1/5

Sanitary Tee

H x H x H



- Used when connecting a branch line into a vertical drain pipe

PART NO.	SIZE	CTN/MSTR
PST114	1-1/4"	1/25
PST115	1-1/2"	1/100
PST120	2"	1/35
PST130	3"	1/30
PST140	4"	1/5
PST160	6"	1/6
PST121	2" x 1-1/2"	1/50
PST122	2" x 1-1/2" x 2"	1/25
PST123	2" x 1-1/2" x 1-1/2"	1/25
PST131	3" x 1-1/2"	1/20
PST132	3" x 2"	1/10
PST141	4" x 1-1/2"	1/10
PST142	4" x 2"	1/10
PST143	4" x 3"	1/10
PST164	6" x 4"	1/6

PVC
DWV

Sanitary Tee Street

Spg x H x H



PART NO.	SIZE	CTN/MSTR
PSS140	4"	1/10

Sanitary Tee with Right Side Inlet

H x H x H x H



• Provides for the connection of 2" vent or branch waste piping to a vertical pipe

PART NO.	SIZE	CTN/MSTR
PST232	3" x 3" x 3" x 2"	1/10

Sanitary Tee with Left Side Inlet

H x H x H x H



• Provides for the connection of 2" vent or branch waste piping to a vertical pipe

PART NO.	SIZE	CTN/MSTR
PSL132	3" x 3" x 3" x 2"	1/10

Sanitary Tee with Right and Left Side Inlet

H x H x Spg/H x Spg/H



Sanitary Tee with Right and Left Side Inlet

- Provides for the connection of 1-1/2" or 2" vent or branch waste piping to a vertical pipe as well as receiving the discharge of a water closet
- The inlets are constructed to accept a 2" fitting hub over their outside diameter or a 1-1/2" pipe into their inside diameter

PART NO.	SIZE	CTN/MSTR
PSL031	3" x 3" x 3" x 1-1/2" / 2" x 1-1/2" / 2"	1/10

Sanitary Tee with Right and Left Side Inlet

- Provides for the connection of 2" vent or branch waste piping to a vertical pipe as well as receive the discharge of a water closet

PART NO.	SIZE	CTN/MSTR
PSL042	4" x 4" x 4" x 2" x 2"	1/5

Double Sanitary Tee

H x H x H x H



- Used to bring two branch lines into a vertical drain pipe

PART NO.	SIZE	CTN/MSTR
PDT515	1-1/2"	1/25
PDT520	2"	1/20
PDT530	3"	1/20
PDT540	4"	1/4
PDT521	2" x 2" x 1-1/2" x 1-1/2"	1/15
PDT531	3" x 3" x 1-1/2" x 1-1/2"	1/20
PDT532	3" x 3" x 2" x 2"	1/10
PDT542	4" x 4" x 2" x 2"	1/5
PDT543	4" x 4" x 3" x 3"	1/5

Two-Way Cleanout Tee

H x H x H



- Used with a vertical pipe stack, this fitting provides for above ground level access to piping

PART NO.	SIZE	CTN/MSTR
PTC633	3"	1/10
PTC644	4"	1/5

P-Trap LA Pattern with Union

SJ x H



- Used to prevent the passage of sewer gas from the plumbing system into house through the plumbing fixture drain, when local code doesn't permit the use of slip coupled traps

PART NO.	SIZE	CTN/MSTR
PPT715	1-1/2"	1/20

P-Trap with Union

H x H



- Used to prevent the passage of sewer gas from the plumbing system into house through the plumbing fixture drain

PART NO.	SIZE	CTN/MSTR
PPT315	1-1/2"	1/20
PPT320	2"	1/25

PVC DWV

P-Trap with Solvent Weld Joint

H x H



- Used to prevent the passage of sewer gas from the plumbing system into house through the plumbing fixture drain

PART NO.	SIZE	CTN/MSTR
PPT515	1-1/2"	1/25
PPT520	2"	1/20
PPT530	3"	1/10
PPT540	4"	1/4

P-Trap with Cleanout and Solvent Weld Joint

H x H



- Used to prevent the passage of sewer gas from the plumbing system into house through the plumbing fixture drain

PART NO.	SIZE	CTN/MSTR
PPT415	1-1/2"	1/10
PPT420	2"	1/10

P-Trap U-Bend

H x H



- Bottom part of trap furnished without cleanout

PART NO.	SIZE	CTN/MSTR
PPT015	1-1/2"	1/20
PPT020	2"	1/20
PPT030	3"	1/15
PPT040	4"	1/10

PVC DWV

P-Trap Elbow

Spg x H Short Sweep



- Used to change direction in the "dry" portion of vent piping where water flow is not a consideration

PART NO.	SIZE	CTN/MSTR
PPT915S	1-1/2"	1/100
PPT920S	2"	1/20

Swivel Drum Trap

H x H



- PVC version of the old style bathtub "drum trap"
- Largely replaced today by the conventional 1-1/2" P-trap

PART NO.	SIZE	CTN/MSTR
PDT715	3" x 6" x 1-1/2"	1/15

Female Trap Adapter with Self Sealing Nut

H x SJT



- Utilized to adapt PVC pipe to tubular traps at wall or floor
- Utilizes special washer which seals to either 1-1/2" or 1-1/4" tubular products, reducing the number of SKU's needed in inventory
- Solvent welds over a 1-1/2" DWV pipe
- Sometimes referred to as a "marvel"

PART NO.	SIZE	CTN/MSTR
PTA215	1-1/2"	1/100
PTA221	1-1/2" x 1-1/2" or 1-1/4"	1/100

Male Trap Adapter less Washer and Nuts

Spg x MPT



- Adapts fitting hub to standard female pipe threads
- Teflon thread tape is recommended for threaded joints

PART NO.	SIZE	CTN/MSTR
PTA415	1-1/2" (less washer)	1/100
PTA420	2" (less washer)	1/100

Male Trap Adapter with Washer and Nuts

Spg x SJT



- Adapts PVC fitting hub to tubular traps in a wall or floor
- Utilizes special washer which seals to either 1-1/2" or 1-1/4" tubular products, reducing the number of SKU's needed in inventory
- Solvent welds into a 1-1/2" DWV fitting hub
- Sometimes called a "marvel"

PART NO.	SIZE	CTN/MSTR
PTA315	1-1/2" (with washer)	1/50
PTA311	1-1/2" x 1-1/2" or 1-1/4" (with washer)	1/75

Reducing Closet Bend

Spg x H



- Used to change direction in piping and size of pipe directly into fitting hub
- Usually a closet flange directly under a toilet
- Works well in tight space applications on second floors

PART NO.	SIZE	CTN/MSTR
PCB934	4" x 3"	1/20

Expansion Joint

H x H



- To provide for expansion in straight vertical pipe runs exceeding 35 feet in length

PART NO.	SIZE	CTN/MSTR
PEJ530	3"	1/10
PEJ540	4"	1/10

Cast Iron No Hub Adapter

Spg x H



- Adapts no hub elastomer coupling to DWV spigot
- Provides a proper method of adapting from no-hub cast iron pipe utilizing the standard no-hub clamp ring

PART NO.	SIZE	CTN/MSTR
PNH120	2"	1/100
PNH130	3"	1/20
PNH140	4"	1/10

Cast Iron Hub Adapter

Spg x H



- Adapts cast iron hub to DWV Spigot
- Can be joined to cast iron with Genova plastic lead or hot molten lead

PART NO.	SIZE	CTN/MSTR
PHA520	2"	1/25
PHA521	2" x 1-1/2"	1/20
PHA530	3"	1/20
PHA540	4"	1/10
PHA543	4" x 3"	1/20

Cast Iron Spigot Adapter

H x H



- Adapts cast iron spigot to DWV spigot
- Adapts Sch. 40 pipe to 4" cast iron spigot

PART NO.	SIZE	CTN/MSTR
PSA740	4"	1/10

Adapter Coupling

Sewer H x DWV H



- Adapts sewer and drain spigot to DWV spigot

PART NO.	SIZE	CTN/MSTR
PAC543	4" x 3"	1/20

Adapter Bushing

DWV Spg x Sewer H



- Adapts DWV hub to sewer and drain spigot

PART NO.	SIZE	CTN/MSTR
PAB75340	4"	1/25

Adapter Bushing

Sewer Spg x DWV H



- Adapts sewer and drain hub to DWV spigot

PART NO.	SIZE	CTN/MSTR
PAB243	4" x 3"	1/20

**PVC
DWV**

BLACK & GALVANIZED MALLEABLES & PIPE NIPPLES

Black and Galvanized Malleable Fittings..... 345-349
Black and Galvanized Pipe Nipples..... 350-351
Black and Galvanized Readycut Pipe..... 352
Black and Galvanized Merchant Couplings..... 352

BG

HEX Bushing

M x F, Concentric



- CSA approved
- UL listed
- FM approved
- NSF 61-4 and AB1953
- Meets ASTM A197, ASME B16.3, and ASTM A153



BLACK PART NO.	GALV. PART NO.	SIZE	CTN/MSTR
B144-0007	G144-0007	1/4" x 1/8"	120/1,440
B144-0032	G144-0032	3/8" x 1/4"	75/900
B144-0033	G144-0033	3/8" x 1/8"	75/900
B144-0058	G144-0058	1/2" x 3/8"	100/1,200
B144-0059	G144-0059	1/2" x 1/4"	100/1,200
B144-0060	G144-0060	1/2" x 1/8"	100/1,200
B144-0107	G144-0107	3/4" x 1/2"	50/600
B144-0108	G144-0108	3/4" x 3/8"	50/600
B144-0109	G144-0109	3/4" x 1/4"	50/600
B144-0110	G144-0110	3/4" x 1/8"	50/600
B144-0159	G144-0159	1" x 3/4"	50/400
B144-0160	G144-0160	1" x 1/2"	50/400
B144-0161	G144-0161	1" x 3/8"	50/400
B144-0162	G144-0162	1" x 1/4"	50/400
B144-0222	G144-0222	1-1/4" x 1"	30/240
B144-0223	G144-0223	1-1/4" x 3/4"	30/240
B144-0224	G144-0224	1-1/4" x 1/2"	30/240
B144-0225	G144-0225	1-1/4" x 3/8"	30/240
B144-0226	G144-0226	1-1/4" x 1/4"	30/240
B144-0303	G144-0303	1-1/2" x 1-1/4"	25/150
B144-0304	G144-0304	1-1/2" x 1"	25/150
B144-0305	G144-0305	1-1/2" x 3/4"	25/150
B144-0306	G144-0306	1-1/2" x 1/2"	25/150
B144-0307	G144-0307	1-1/2" x 3/8"	25/150
B144-0308	G144-0308	1-1/2" x 1/4"	25/150
B144-0398	G144-0398	2" x 1-1/2"	20/120
B144-0399	G144-0399	2" x 1-1/4"	20/120
B144-0400	G144-0400	2" x 1"	20/120
B144-0401	G144-0401	2" x 3/4"	20/120
B144-0402	G144-0402	2" x 1/2"	20/120
B144-0403	—	2" x 3/8"	20/120
B144-0531	G144-0531	2-1/2" x 2"	15/60
B144-0532	G144-0532	2-1/2" x 1-1/2"	15/60
B144-0533	G144-0533	2-1/2" x 1-1/4"	15/60
B144-0534	G144-0534	2-1/2" x 1"	15/60
B144-0535	G144-0535	2-1/2" x 3/4"	15/60
B144-0536	—	2-1/2" x 1/2"	15/60
B144-0662	G144-0662	3" x 2-1/2"	12/48
B144-0663	G144-0663	3" x 2"	12/48
B144-0664	G144-0664	3" x 1-1/2"	12/48
B144-0665	G144-0665	3" x 1-1/4"	12/48
B144-0666	G144-0666	3" x 1"	12/48
B144-0667	—	3" x 3/4"	12/48
B144-0790	G144-0790	3-1/2" x 3"	8/32
B144-0870	G144-0870	4" x 3"	5/20
B144-0871	G144-0871	4" x 2-1/2"	5/20
B144-0872	G144-0872	4" x 2"	5/20
B144-0873	G144-0873	4" x 1-1/2"	5/20
B144-0875	—	4" x 1"	5/20
B144-1109	G144-1109	6" x 4"	4/8
B144-1111	—	6" x 3"	4/8

Cap



- CSA approved
- UL listed
- FM approved
- NSF 61-4 and AB1953
- Meets ASTM A197, ASME B16.3, and ASTM A153



BLACK PART NO.	GALV. PART NO.	SIZE	CTN/MSTR
B155-0001	G155-0001	1/8"	120/1,440
B155-0002	G155-0002	1/4"	80/960
B155-0025	G155-0025	3/8"	60/720
B155-0050	G155-0050	1/2"	75/600
B155-0100	G155-0100	3/4"	40/320
B155-0150	G155-0150	1"	35/200
B155-0215	G155-0215	1-1/4"	25/160
B155-0295	G155-0295	1-1/2"	25/108
B155-0390	G155-0390	2"	18/72
B155-0520	G155-0520	2-1/2"	14/56
B155-0650	G155-0650	3"	12/36
B155-0860	G155-0860	4"	7/21
B155-0975	G155-0975	5"	8/16
B155-1100	G155-1100	6"	4/8

Extension Piece

M x F



- CSA approved
- UL listed
- FM approved
- NSF 61-4 and AB1953
- Meets ASTM A197, ASME B16.3, and ASTM A153



BLACK PART NO.	GALV. PART NO.	SIZE	CTN/MSTR
B335-0050	G335-0050	1/2"	75/600
B335-0100	G335-0100	3/4"	40/320
B335-0150	G335-0150	1"	30/180
B335-0215	G335-0215	1-1/4"	30/120
B335-0390	—	2"	15/60

Coupling, Banded

F x F



- CSA approved
- UL listed
- FM approved
- NSF 61-4 and AB1953
- Meets ASTM A197, ASME B16.3, and ASTM A153



BLACK PART NO.	GALV. PART NO.	SIZE	CTN/MSTR
B165-0001	G165-0001	1/8"	70/840
B165-0002	G165-0002	1/4"	40/480
B165-0025	G165-0025	3/8"	50/600
B165-0050	G165-0050	1/2"	60/480
B165-0100	G165-0100	3/4"	50/300
B165-0150	G165-0150	1"	25/150
B165-0215	G165-0215	1-1/4"	32/128
B165-0295	G165-0295	1-1/2"	18/72
B165-0390	G165-0390	2"	12/48
B165-0520	G165-0520	2-1/2"	4/32
B165-0650	G165-0650	3"	12/24
B165-0860	G165-0860	4"	3/12
B165-1100	G165-1100	6"	3/6

BG

Reducing Coupling, Banded

F x F, Concentric



- CSA approved
- UL listed
- FM approved
- NSF 61-4 and AB1953
- Meets ASTM A197, ASME B16.3, and ASTM A153



BLACK PART NO.	GALV. PART NO.	SIZE	CTN/MSTR
B165-0007	G165-0007	1/4" x 1/8"	50/600
B165-0032	G165-0032	3/8" x 1/4"	30/360
B165-0033	G165-0033	3/8" x 1/8"	35/420
B165-0058	G165-0058	1/2" x 3/8"	40/480
B165-0059	G165-0059	1/2" x 1/4"	50/600
B165-0060	G165-0060	1/2" x 1/8"	50/600
B165-0107	G165-0107	3/4" x 1/2"	60/360
B165-0108	G165-0108	3/4" x 3/8"	30/360
B165-0109	G165-0109	3/4" x 1/4"	30/360
B165-0110	—	3/4" x 1/8"	35/420
B165-0159	G165-0159	1" x 3/4"	25/200
B165-0160	G165-0160	1" x 1/2"	40/240
B165-0161	G165-0161	1" x 3/8"	40/240
B165-0162	G165-0162	1" x 1/4"	45/270
B165-0222	G165-0222	1-1/4" x 1"	20/120
B165-0223	G165-0223	1-1/4" x 3/4"	25/150
B165-0224	G165-0224	1-1/4" x 1/2"	25/150
B165-0303	G165-0303	1-1/2" x 1-1/4"	24/96
B165-0304	G165-0304	1-1/2" x 1"	25/100
B165-0305	G165-0305	1-1/2" x 3/4"	30/120
B165-0306	G165-0306	1-1/2" x 1/2"	20/120
B165-0307	G165-0307	1-1/2" x 3/8"	30/120
B165-0398	G165-0398	2" x 1-1/2"	12/72
B165-0399	G165-0399	2" x 1-1/4"	14/72
B165-0400	G165-0400	2" x 1"	14/84
B165-0401	G165-0401	2" x 3/4"	14/84
B165-0402	G165-0402	2" x 1/2"	14/84
B165-0531	G165-0531	2-1/2" x 2"	10/40
B165-0532	G165-0532	2-1/2" x 1-1/2"	10/40
B165-0533	G165-0533	2-1/2" x 1-1/4"	10/40
B165-0534	G165-0534	2-1/2" x 1"	10/40
B165-0535	—	2-1/2" x 3/4"	10/40
B165-0662	G165-0662	3" x 2-1/2"	12/24
B165-0663	G165-0663	3" x 2"	8/32
B165-0664	G165-0664	3" x 1-1/2"	8/32
B165-0665	G165-0665	3" x 1-1/4"	8/32
B165-0666	G165-0666	3" x 1"	8/32
B165-0870	G165-0870	4" x 3"	6/12
B165-0871	G165-0871	4" x 2-1/2"	6/18
B165-0872	G165-0872	4" x 2"	6/12
B165-0873	—	4" x 1-1/2"	6/18
—	G165-1109	6" x 4"	4/8

90° Reducing Elbow, Banded

F x F



- CSA approved
- UL listed
- FM approved
- NSF 61-4 and AB1953
- Meets ASTM A197, ASME B16.3, and ASTM A153



BLACK PART NO.	GALV. PART NO.	SIZE	CTN/MSTR
B235-0007	—	1/4" x 1/8"	1/480
B235-0032	—	3/8" x 1/4"	60/720
B235-0058	G235-0058	1/2" x 3/8"	50/400
B235-0059	G235-0059	1/2" x 1/4"	40/480
B235-0060	—	1/2" x 1/8"	40/480
B235-0107	G235-0107	3/4" x 1/2"	40/240
B235-0108	G235-0108	3/4" x 3/8"	50/300
B235-0159	G235-0159	1" x 3/4"	25/150
B235-0160	G235-0160	1" x 1/2"	30/180
B235-0222	G235-0222	1-1/4" x 1"	20/80
B235-0223	G235-0223	1-1/4" x 3/4"	30/120
B235-0224	G235-0224	1-1/4" x 1/2"	35/140
B235-0303	G235-0303	1-1/2" x 1-1/4"	15/60
B235-0304	G235-0304	1-1/2" x 1"	20/80
B235-0305	G235-0305	1-1/2" x 3/4"	15/90
B235-0306	G235-0306	1-1/2" x 1/2"	25/100
B235-0398	G235-0398	2" x 1-1/2"	10/40
B235-0399	G235-0399	2" x 1-1/4"	10/40
B235-0400	G235-0400	2" x 1"	14/56
B235-0401	G235-0401	2" x 3/4"	15/60
B235-0402	—	2" x 1/2"	15/60
B235-0531	—	2-1/2" x 2"	12/24
B235-0532	G235-0532	2-1/2" x 1-1/2"	6/24
B235-0533	G235-0533	2-1/2" x 1-1/4"	6/40
B235-0662	G235-0662	3" x 2-1/2"	4/16
B235-0663	G235-0663	3" x 2"	6/18

90° Elbow, Banded

F x F



- CSA approved
- UL listed
- FM approved
- NSF 61-4 and AB1953
- Meets ASTM A197, ASME B16.3, and ASTM A153



BLACK PART NO.	GALV. PART NO.	SIZE	CTN/MSTR
B235-0001	G235-0001	1/8"	50/600
B235-0002	G235-0002	1/4"	35/420
B235-0025	G235-0025	3/8"	45/540
B235-0050	G235-0050	1/2"	50/400
B235-0100	G235-0100	3/4"	35/210
B235-0150	G235-0150	1"	20/120
B235-0215	G235-0215	1-1/4"	20/80
B235-0295	G235-0295	1-1/2"	20/60
B235-0390	G235-0390	2"	8/32
B235-0520	G235-0520	2-1/2"	8/18
B235-0650	G235-0650	3"	7/14
B235-0860	G235-0860	4"	2/6
B235-0975	—	5"	2/4
B235-1100	G235-1100	6"	1/2

BG

90° Street Elbow, Banded

M x F



- CSA approved
- UL listed
- FM approved
- NSF 61-4 and AB1953
- Meets ASTM A197, ASME B16.3, and ASTM A153



BLACK PART NO.	GALV. PART NO.	SIZE	CTN/MSTR
B254-0001	G254-0001	1/8"	60/720
B254-0002	G254-0002	1/4"	35/420
B254-0025	G254-0025	3/8"	40/480
B254-0050	G254-0050	1/2"	60/360
B254-0100	G254-0100	3/4"	35/210
B254-0150	G254-0150	1"	30/120
B254-0215	G254-0215	1-1/4"	25/75
B254-0295	G254-0295	1-1/2"	18/54
B254-0390	G254-0390	2"	10/30
B254-0520	G254-0520	2-1/2"	9/18
B254-0650	G254-0650	3"	1/14
B254-0860	G254-0860	4"	1/6

45° Elbow, Banded

F x F



- CSA approved
- UL listed
- FM approved
- NSF 61-4 and AB1953
- Meets ASTM A197, ASME B16.3, and ASTM A153



BLACK PART NO.	GALV. PART NO.	SIZE	CTN/MSTR
B290-0001	G290-0001	1/8"	50/600
B290-0002	G290-0002	1/4"	30/360
B290-0025	G290-0025	3/8"	50/600
B290-0050	G290-0050	1/2"	50/400
B290-0100	G290-0100	3/4"	40/240
B290-0150	G290-0150	1"	20/120
B290-0215	G290-0215	1-1/4"	20/80
B290-0295	G290-0295	1-1/2"	15/60
B290-0390	G290-0390	2"	12/36
B290-0520	G290-0520	2-1/2"	1/27
B290-0650	G290-0650	3"	1/20
B290-0860	G290-0860	4"	1/6

45° Street Elbow, Banded

M x F



- CSA approved
- UL listed
- FM approved
- NSF 61-4 and AB1953
- Meets ASTM A197, ASME B16.3, and ASTM A153



BLACK PART NO.	GALV. PART NO.	SIZE	CTN/MSTR
B295-0001	—	1/8"	70/840
B295-0002	G295-0002	1/4"	40/480
B295-0025	—	3/8"	50/600
B295-0050	G295-0050	1/2"	75/450
B295-0100	G295-0100	3/4"	40/240
B295-0150	G295-0150	1"	25/150
B295-0215	G295-0215	1-1/4"	20/80
B295-0295	G295-0295	1-1/2"	20/60
B295-0390	G295-0390	2"	12/36
B295-0520	—	2-1/2"	1/24
B295-0650	G295-0650	3"	1/18
B295-0860	—	4"	1/7

Cross, Banded

F x F x F x F



- CSA approved
- UL listed
- FM approved
- NSF 61-4 and AB1953
- Meets ASTM A197, ASME B16.3, and ASTM A153



BLACK PART NO.	GALV. PART NO.	SIZE	CTN/MSTR
B195-0002	G195-0002	1/4"	80/480
B195-0025	G195-0025	3/8"	50/300
B195-0050	G195-0050	1/2"	45/180
B195-0100	G195-0100	3/4"	30/120
B195-0150	G195-0150	1"	20/60
B195-0215	G195-0215	1-1/4"	20/40
B195-0295	G195-0295	1-1/2"	18/36
—	G195-0390	2"	10/20

Floor Flange



- CSA approved
- UL listed
- FM approved
- NSF 61-4 and AB1953
- Meets ASTM A197, ASME B16.3, and ASTM A153



BLACK PART NO.	GALV. PART NO.	SIZE	CTN/MSTR
B355-0025	G355-0025	3/8"	25/150
B355-0050	G355-0050	1/2"	25/100
B355-0100	G355-0100	3/4"	20/80
B355-0150	G355-0150	1"	20/60
B355-0215	G355-0215	1-1/4"	15/60
B355-0295	G355-0295	1-1/2"	12/48
B355-0390	G355-0390	2"	8/32

Locknut/Backnut



- CSA approved
- UL listed
- FM approved
- NSF 61-4 and AB1953
- Meets ASTM A197, ASME B16.3, and ASTM A153



BLACK PART NO.	GALV. PART NO.	SIZE	CTN/MSTR
—	G375-0002	1/4"	125/1500
—	G375-0050	1/2"	100/1200
—	G375-0150	1"	60/480
—	G375-0215	1-1/4"	60/360
—	G375-0295	1-1/2"	45/270
—	G375-0390	2"	25/150

BG

Street Tee, Banded

F x M x F



- CSA approved
- UL listed
- FM approved
- NSF 61-4 and AB1953
- Meets ASTM A197, ASME B16.3, and ASTM A153



BLACK PART NO.	GALV. PART NO.	SIZE	CTN/MSTR
B486-0050	—	1/2"	40/240
B486-0100	G486-0100	3/4"	25/150
B486-0150	G486-0150	1"	20/80

Tee, Banded

F x F x F



- CSA approved
- UL listed
- FM approved
- NSF 61-4 and AB1953
- Meets ASTM A197, ASME B16.3, and ASTM A153



BLACK PART NO.	GALV. PART NO.	SIZE	CTN/MSTR
B460-0001	G460-0001	1/8"	80/960
B460-0002	G460-0002	1/4"	50/600
B460-0025	G460-0025	3/8"	45/360
B460-0050	G460-0050	1/2"	40/240
B460-0100	G460-0100	3/4"	35/140
B460-0150	G460-0150	1"	20/80
B460-0215	G460-0215	1-1/4"	14/56
B460-0295	G460-0295	1-1/2"	15/45
B460-0390	G460-0390	2"	10/30
B460-0520	G460-0520	2-1/2"	8/16
B460-0650	G460-0650	3"	6/12
B460-0860	G460-0860	4"	2/6
B460-1100	—	6"	2/2

Reducing Tee, Banded

F x F x F



- CSA approved
- UL listed
- FM approved
- NSF 61-4 and AB1953
- Meets ASTM A197, ASME B16.3, and ASTM A153



BLACK PART NO.	GALV. PART NO.	SIZE	CTN/MSTR
B460-0032	—	3/8" x 1/4"	60/300
B460-0056	—	1/2" x 1"	40/160
B460-0057	G460-0057	1/2" x 3/4"	30/180
B460-0058	G460-0058	1/2" x 3/8"	45/270
B460-0059	G460-0059	1/2" x 1/4"	50/300
B460-0106	G460-0106	3/4" x 1"	20/120
B460-0107	G460-0107	3/4" x 1/2"	45/180
B460-0108	G460-0108	3/4" x 3/8"	45/180
B460-0109	G460-0109	3/4" x 1/4"	50/200
B460-0116	G460-0116	3/4" x 1/2" x 1"	35/140
B460-0117	G460-0117	3/4" x 1/2" x 3/4"	40/160
B460-0118	G460-0118	3/4" x 1/2" x 1/2"	30/180
—	G460-0157	1" x 1-1/2"	15/60
B460-0158	—	1" x 1-1/4"	15/60
B460-0159	G460-0159	1" x 3/4"	25/100
B460-0160	G460-0160	1" x 1/2"	30/120
B460-0162	G460-0162	1" x 1/4"	25/150
B460-0169	G460-0169	1" x 3/4" x 1"	15/90
B460-0170	G460-0170	1" x 3/4" x 3/4"	25/100
B460-0171	G460-0171	1" x 3/4" x 1/2"	25/120
B460-0180	G460-0180	1" x 1/2" x 1"	15/90
B460-0181	G460-0181	1" x 1/2" x 3/4"	30/120
B460-0182	G460-0182	1" x 1/2" x 1/2"	20/120
—	G460-0215	1-1/4" x 2"	14/56
B460-0221	G460-0221	1-1/4" x 1-1/2"	14/56
B460-0222	G460-0222	1-1/4" x 1"	16/64
B460-0223	G460-0223	1-1/4" x 3/4"	18/72
B460-0224	G460-0224	1-1/4" x 1/2"	20/80
B460-0234	G460-0234	1-1/4" x 1" x 1-1/4"	15/60
B460-0235	G460-0235	1-1/4" x 1" x 1"	18/72
B460-0236	G460-0236	1-1/4" x 1" x 3/4"	18/72
B460-0237	G460-0237	1-1/4" x 1" x 1/2"	18/72

Reducing Tee, Banded (cont.)

BLACK PART NO.	GALV. PART NO.	SIZE	CTN/MSTR
B460-0245	G460-0245	1-1/4" x 3/4" x 1-1/4"	15/60
B460-0246	G460-0246	1-1/4" x 3/4" x 1"	20/80
B460-0247	G460-0247	1-1/4" x 3/4" x 3/4"	20/80
B460-0248	—	1-1/4" x 3/4" x 1/2"	25/100
B460-0256	—	1-1/4" x 1/2" x 1-1/4"	15/60
B460-0257	—	1-1/4" x 1/2" x 1"	20/80
B460-0258	G460-0258	1-1/4" x 1/2" x 3/4"	25/50
B460-0259	—	1-1/4" x 1/2" x 1/2"	25/50
B460-0302	—	1-1/2" x 2"	15/45
B460-0303	G460-0303	1-1/2" x 1-1/4"	15/45
B460-0304	G460-0304	1-1/2" x 1"	13/52
B460-0305	G460-0305	1-1/2" x 3/4"	10/60
B460-0306	G460-0306	1-1/2" x 1/2"	18/72
B460-0315	G460-0315	1-1/2" x 1-1/4" x 1-1/2"	10/40
B460-0316	G460-0316	1-1/2" x 1-1/4" x 1-1/4"	12/48
B460-0317	G460-0317	1-1/2" x 1-1/4" x 1"	14/56
B460-0318	G460-0318	1-1/2" x 1-1/4" x 3/4"	16/64
B460-0319	G460-0319	1-1/2" x 1-1/4" x 1/2"	16/64
B460-0328	G460-0328	1-1/2" x 1" x 1-1/2"	14/56
B460-0329	—	1-1/2" x 1" x 1-1/4"	14/56
B460-0330	G460-0330	1-1/2" x 1" x 1"	15/60
B460-0331	—	1-1/2" x 1" x 3/4"	15/60
B460-0339	—	1-1/2" x 3/4" x 1-1/2"	12/48
B460-0340	G460-0340	1-1/2" x 3/4" x 1-1/4"	15/60
B460-0342	—	1-1/2" x 3/4" x 3/4"	15/60
B460-0350	G460-0350	1-1/2" x 1/2" x 1-1/2"	12/48
B460-0398	G460-0398	2" x 1-1/2"	16/32
B460-0399	G460-0399	2" x 1-1/4"	8/32
B460-0400	G460-0400	2" x 1"	12/36
B460-0401	G460-0401	2" x 3/4"	10/40
B460-0402	G460-0402	2" x 1/2"	10/40
B460-0413	—	2" x 1-1/2" x 2"	10/30
B460-0414	G460-0414	2" x 1-1/2" x 1-1/2"	8/32
B460-0415	G460-0415	2" x 1-1/2" x 1-1/4"	8/32
B460-0416	G460-0416	2" x 1-1/2" x 1"	10/40
B460-0417	—	2" x 1-1/2" x 3/4"	10/40
B460-0429	G460-0429	2" x 1-1/4" x 2"	13/26
B460-0430	G460-0430	2" x 1-1/4" x 1-1/2"	8/32
B460-0431	G460-0431	2" x 1-1/4" x 1-1/4"	12/36
B460-0444	G460-0444	2" x 1" x 2"	8/32
B460-0447	G460-0447	2" x 1" x 1"	12/48
B460-0457	—	2" x 3/4" x 2"	8/32
B460-0470	G460-0470	2" x 1/2" x 2"	8/32
B460-0531	G460-0531	2-1/2" x 2"	4/16
B460-0532	G460-0532	2-1/2" x 1-1/2"	5/15
B460-0533	—	2-1/2" x 1-1/4"	10/20
B460-0534	G460-0534	2-1/2" x 1"	12/24
B460-0535	—	2-1/2" x 3/4"	12/24
B460-0536	G460-0536	2-1/2" x 1/2"	12/24
B460-0662	G460-0662	3" x 2-1/2"	6/12
B460-0663	G460-0663	3" x 2"	4/12
B460-0664	—	3" x 1-1/2"	4/12
B460-0665	G460-0665	3" x 1-1/4"	4/12
B460-0666	G460-0666	3" x 1"	5/15
B460-0667	—	3" x 3/4"	6/18
B460-0668	—	3" x 1/2"	6/18
B460-0870	G460-0870	4" x 3"	2/6
B460-0871	—	4" x 2-1/2"	2/6
B460-0872	G460-0872	4" x 2"	2/8
B460-0873	—	4" x 1-1/2"	2/8

Square Head Plug

M



- Cored
- CSA approved
- UL listed
- FM approved
- NSF 61-4 and AB1953
- Meets ASTM A197, ASME B16.3, and ASTM A153



BLACK PART NO.	GALV. PART NO.	SIZE	CTN/MSTR
B396-0001	G396-0001	1/8"	300/3600
B396-0002	G396-0002	1/4"	150/1800
B396-0025	G396-0025	3/8"	100/1200
B396-0050	G396-0050	1/2"	50/600
B396-0100	G396-0100	3/4"	30/360
B396-0150	G396-0150	1"	20/240
B396-0215	G396-0215	1-1/4"	40/240
B396-0295	G396-0295	1-1/2"	30/180
B396-0390	G396-0390	2"	20/120
B396-0520	G396-0520	2-1/2"	8/64
B396-0650	G396-0650	3"	8/48
B396-0860	G396-0860	4"	8/16
B396-1100	—	6"	5/10

Union



- Brass to iron seat
- CSA approved
- UL listed
- FM approved
- NSF 61-4 and AB1953
- Meets ASTM A197, ASME B16.3, and ASTM A153



BLACK PART NO.	GALV. PART NO.	SIZE	CTN/MSTR
B657-0001	G657-0001	1/8"	30/360
B657-0002	G657-0002	1/4"	20/240
B657-0025	G657-0025	3/8"	20/240
B657-0050	G657-0050	1/2"	50/200
B657-0100	G657-0100	3/4"	35/140
B657-0150	G657-0150	1"	20/80
B657-0215	G657-0215	1-1/4"	15/60
B657-0295	G657-0295	1-1/2"	10/40
B657-0390	G657-0390	2"	6/24
B657-0520	G657-0520	2-1/2"	4/16
B657-0650	G657-0650	3"	7/14
B657-0860	G657-0860	4"	7/7

Pipe Nipples



BLACK PART NO.	GALV. PART NO.	SIZE	CTN/MSTR
30100	50100	1/8" x Close	25/400
30110	50110	1/8" x 10"	25/200
—	50111	1/8" x 11"	25/200
30112	50112	1/8" x 12"	25/200
30115	50115	1/8" x 1-1/2"	25/400
30120	50120	1/8" x 2"	25/400
30125	50125	1/8" x 2-1/2"	25/400
30130	50130	1/8" x 3"	25/400
30135	50135	1/8" x 3-1/2"	25/400
30140	50140	1/8" x 4"	25/400
30145	50145	1/8" x 4-1/2"	25/400
30150	50150	1/8" x 5"	25/400
30155	50155	1/8" x 5-1/2"	25/400
30160	50160	1/8" x 6"	25/400
30170	50170	1/8" x 7"	25/200
30180	50180	1/8" x 8"	25/200
—	50190	1/8" x 9"	25/200
30200	50200	1/4" x Close	25/400
30210	50210	1/4" x 10"	25/200
30211	50211	1/4" x 11"	25/200
30212	50212	1/4" x 12"	25/200
30215	50215	1/4" x 1-1/2"	25/400
30220	50220	1/4" x 2"	25/400
30225	50225	1/4" x 2-1/2"	25/400
30230	50230	1/4" x 3"	25/400
30235	50235	1/4" x 3-1/2"	25/400
30240	50240	1/4" x 4"	25/400
30245	50245	1/4" x 4-1/2"	25/400
30250	50250	1/4" x 5"	25/400
30255	50255	1/4" x 5-1/2"	25/400
30260	50260	1/4" x 6"	25/400
30270	50270	1/4" x 7"	25/200
30280	50280	1/4" x 8"	25/200
30290	50290	1/4" x 9"	25/200
30300	50300	3/8" x Close	25/400
30310	50310	3/8" x 10"	25/100
30311	—	3/8" x 11"	25/100
30312	50312	3/8" x 12"	25/100
30315	50315	3/8" x 1-1/2"	25/400
30320	50320	3/8" x 2"	25/400
30325	50325	3/8" x 2-1/2"	25/400
30330	50330	3/8" x 3"	25/400
30335	50335	3/8" x 3-1/2"	25/400
30340	50340	3/8" x 4"	25/400
30345	50345	3/8" x 4-1/2"	25/400
30350	50350	3/8" x 5"	25/300
30355	50355	3/8" x 5-1/2"	25/300
30360	50360	3/8" x 6"	25/300
30370	50370	3/8" x 7"	25/150
30380	50380	3/8" x 8"	25/150
30500	50500	1/2" x Close	25/400
30510	50510	1/2" x 10"	25/100
30511	50511	1/2" x 11"	25/100
30512	50512	1/2" x 12"	25/100
30515	50515	1/2" x 1-1/2"	25/400
30520	50520	1/2" x 2"	25/400
30525	50525	1/2" x 2-1/2"	25/300
30530	50530	1/2" x 3"	25/300
30535	50535	1/2" x 3-1/2"	25/300
30540	50540	1/2" x 4"	25/200
30545	50545	1/2" x 4-1/2"	25/200
30550	50550	1/2" x 5"	25/200
30555	50555	1/2" x 5-1/2"	25/200
30560	50560	1/2" x 6"	25/200
30570	50570	1/2" x 7"	25/100
30575	—	1/2" x 7-1/2"	25/100

BG

Pipe Nipples (cont.)

BLACK PART NO.	GALV. PART NO.	SIZE	CTN/MSTR
30580	50580	1/2" x 8"	25/100
30590	50590	1/2" x 9"	25/100
30700	50700	3/4" x Close	25/400
30710	50710	3/4" x 10"	25/50
30711	50711	3/4" x 11"	25/50
30712	50712	3/4" x 12"	25/50
30715	50715	3/4" x 1-1/2"	25/400
30720	50720	3/4" x 2"	25/300
30725	50725	3/4" x 2-1/2"	25/300
30730	50730	3/4" x 3"	25/200
30735	50735	3/4" x 3-1/2"	25/200
30740	50740	3/4" x 4"	25/150
30745	50745	3/4" x 4-1/2"	25/150
30750	50750	3/4" x 5"	25/100
30755	50755	3/4" x 5-1/2"	25/100
30760	50760	3/4" x 6"	25/100
30765	—	3/4" x 6-1/2"	25/75
30770	50770	3/4" x 7"	25/75
30775	50775	3/4" x 7-1/2"	25/75
30780	50780	3/4" x 8"	25/75
30790	50790	3/4" x 9"	25/50
31000	51000	1" x Close	25/200
31010	51010	1" x 10"	25/50
31011	51011	1" x 11"	25/50
31012	51012	1" x 12"	25/50
31014	51014	1" x 14"	5/25
31020	51020	1" x 2"	25/200
31025	51025	1" x 2-1/2"	25/150
31030	51030	1" x 3"	25/150
31035	51035	1" x 3-1/2"	25/100
31040	51040	1" x 4"	25/100
31045	51045	1" x 4-1/2"	25/100
31050	51050	1" x 5"	25/75
31055	51055	1" x 5-1/2"	25/75
31060	51060	1" x 6"	25/50
31065	—	1" x 6-1/2"	25/50
31070	51070	1" x 7"	25/50
31075	—	1" x 7-1/2"	25/50
31080	51080	1" x 8"	25/50
31090	51090	1" x 9"	25/50
31200	51200	1-1/4" x Close	25/100
31210	51210	1-1/4" x 10"	20/40
31211	51211	1-1/4" x 11"	20/40
31212	51212	1-1/4" x 12"	10/30
31213	—	1-1/4" x 13"	3/30
31214	—	1-1/4" x 14"	3/30
31220	51220	1-1/4" x 2"	25/100
31225	51225	1-1/4" x 2-1/2"	25/100
31230	51230	1-1/4" x 3"	25/100
31235	51235	1-1/4" x 3-1/2"	25/50
31240	51240	1-1/4" x 4"	25/50
31245	51245	1-1/4" x 4-1/2"	25/50
31250	51250	1-1/4" x 5"	25/50
31255	51255	1-1/4" x 5-1/2"	25/50
31260	51260	1-1/4" x 6"	25/50
31270	51270	1-1/4" x 7"	25/50
31280	51280	1-1/4" x 8"	25/50
31285	—	1-1/4" x 8-1/2"	25/30
31290	51290	1-1/4" x 9"	25/50
31500	51500	1-1/2" x Close	25/100
31510	51510	1-1/2" x 10"	15/30
31511	51511	1-1/2" x 11"	15/30
31512	51512	1-1/2" x 12"	15/30
31514	—	1-1/2" x 14"	3/6
31520	51520	1-1/2" x 2"	25/100
31525	51525	1-1/2" x 2-1/2"	25/50
31530	51530	1-1/2" x 3"	25/50
31535	51535	1-1/2" x 3-1/2"	25/50
31540	51540	1-1/2" x 4"	25/50
31545	51545	1-1/2" x 4-1/2"	25/50
31550	51550	1-1/2" x 5"	25/50
31555	51555	1-1/2" x 5-1/2"	25/50
31560	51560	1-1/2" x 6"	25/50

Pipe Nipples (cont.)

BLACK PART NO.	GALV. PART NO.	SIZE	CTN/MSTR
31570	51570	1-1/2" x 7"	20/40
31580	51580	1-1/2" x 8"	20/40
31590	51590	1-1/2" x 9"	10/20
32000	52000	2" x Close	25/50
32010	52010	2" x 10"	15/30
32011	52011	2" x 11"	15/30
32012	52012	2" x 12"	15/30
32013	—	2" x 13"	3/6
32025	52025	2" x 2-1/2"	25/50
32030	52030	2" x 3"	25/50
32035	52035	2" x 3-1/2"	25/50
32040	52040	2" x 4"	25/50
32045	52045	2" x 4-1/2"	25/50
32050	52050	2" x 5"	25/50
32055	52055	2" x 5-1/2"	25/50
32060	52060	2" x 6"	25/50
32065	—	2" x 6-1/2"	20/20
32070	52070	2" x 7"	20/20
32075	—	2" x 7-1/2"	20/20
32080	52080	2" x 8"	20/20
32090	52090	2" x 9"	20/20
32500	52500	2-1/2" x Close	20/40
32510	52510	2-1/2" x 10"	10/10
32511	52511	2-1/2" x 11"	10/10
32512	52512	2-1/2" x 12"	10/10
32530	52530	2-1/2" x 3"	20/40
32535	52535	2-1/2" x 3-1/2"	30/30
32540	52540	2-1/2" x 4"	30/30
32545	52545	2-1/2" x 4-1/2"	30/30
32550	52550	2-1/2" x 5"	20/20
32555	52555	2-1/2" x 5-1/2"	20/20
32560	52560	2-1/2" x 6"	20/20
32570	52570	2-1/2" x 7"	20/20
32580	52580	2-1/2" x 8"	10/10
32590	52590	2-1/2" x 9"	10/10
33000	53000	3" x Close	30/30
33010	53010	3" x 10"	5/5
33011	53011	3" x 11"	5/5
33012	53012	3" x 12"	5/5
33030	53030	3" x 3"	20/20
33035	53035	3" x 3-1/2"	15/15
33040	53040	3" x 4"	15/15
33045	53045	3" x 4-1/2"	15/15
33050	53050	3" x 5"	15/15
33055	53055	3" x 5-1/2"	15/15
33060	53060	3" x 6"	10/10
33070	53070	3" x 7"	7/7
33080	53080	3" x 8"	7/7
33090	—	3" x 9"	7/7
33500	—	3-1/2" x Close	20/20
33540	—	3-1/2" x 4"	10/10
33550	53550	3-1/2" x 5"	8/8
34000	54000	4" x Close	20/20
34010	54010	4" x 10"	4/4
34011	54011	4" x 11"	4/4
34012	54012	4" x 12"	4/4
34035	54035	4" x 3-1/2"	10/10
34040	54040	4" x 4"	10/10
34045	54045	4" x 4-1/2"	8/8
34050	54050	4" x 5"	8/8
34055	54055	4" x 5-1/2"	8/8
34060	54060	4" x 6"	8/8
34070	54070	4" x 7"	4/4
34080	54080	4" x 8"	4/4
34090	54090	4" x 9"	4/4
35045	—	5" x 4-1/2"	1/5
35050	—	5" x 5"	1/4
35055	—	5" x 5-1/2"	1/5
35060	—	5" x 6"	1/4
35070	—	5" x 7"	1/4
35080	—	5" x 8"	1/4
36000	56000	6" x Close	1/4

Pipe Nipples (cont.)

BLACK PART NO.	GALV. PART NO.	SIZE	CTN/MSTR
36010	56010	6" x 10"	1/3
36011	56011	6" x 11"	1/3
36012	56012	6" x 12"	3/3
36045	56045	6" x 4-1/2"	1/2
—	56050	6" x 5"	1/5
—	56055	6" x 5-1/2"	1/2
36060	56060	6" x 6"	1/2
36070	56070	6" x 7"	1/4
36080	56080	6" x 8"	1/4
36090	56090	6" x 9"	1/4
31210TOE	—	1-1/4" x 10"	20/40
31212TOE	—	1-1/4" x 12"	10/30

Installation Kit

Kit includes:

Size	Close	1-1/2"	2"	2-1/2"	3"	3-1/2"	4"	4-1/2"	5"	5-1/2"	6"
1/2"	1	1	1	1	1	1	1	1	1	1	1
3/4"	1	1	1	1	1	1	1	1	1	1	1
1"	1		1	1	1	1	1	1	1	1	1
1-1/4"	1		1	1	1	1	1	1	1	1	1
1-1/2"	1		1	1	1	1	1	1	1	1	1
2"	1			1	1	1	1	1	1	1	1

BLACK PART NO.	GALV. PART NO.	SIZE	CTN/MSTR
BI05	GI05	1/2"	1/1
BI07	GI07	3/4"	1/1
BI10	GI10	1"	1/1
BI12	GI12	1-1/4"	1/1
BI15	GI15	1-1/2"	1/1
BI20	—	2"	1/1

C-Assortment

Assortment includes:

Size	Close	1-1/4"	1-1/2"	2"	2-1/2"	3"	3-1/2"	4"	4-1/2"	5"	5-1/2"	6"
1/2"	4		3	3	3	2	2	2	1	2	1	2
3/4"	6			4	3	2	2	2	1	2	1	2
1"	5			5	3	2	2	2	1	2	1	2
1-1/4"	6			4	3	2	2	2	1	2	1	2
1-1/2"	5	1		5	3	2	2	2	1	2	1	2

BLACK PART NO.	GALV. PART NO.	SIZE	CTN/MSTR
CB05	CG05	1/2"	1/1
CB07	CG07	3/4"	1/1
CB10	CG10	1"	1/1
CB12	—	1-1/4"	1/1
CB15	—	1-1/2"	1/1

A-Assortment

Assortment includes:

Size	Close	1-1/2"	2"	2-1/2"	3"	3-1/2"	4"	4-1/2"	5"	5-1/2"	6"
1/2"	20	10	15	10	10	5	10	5	5	5	5
3/4"	25		20	10	10	5	10	5	5	5	5
1"	15		12	5	12	3	12	3	5	3	5

BLACK PART NO.	GALV. PART NO.	SIZE	CTN/MSTR
AB05	AG05	1/2"	1/1
AB07	AG07	3/4"	1/1
—	AG10	1"	1/1

6-Pack Assortment

Assortment includes:

Size	Close	1-1/2"	2"	2-1/2"	3"	3-1/2"	4"	4-1/2"	5"	5-1/2"	6"
1/2"	6	6	6	6	6	6	6	6	6	6	6
3/4"	6	6	6	6	6	6	6	6	6	6	6
1"	6		6	6	6	6	6	6	6	6	6

BLACK PART NO.	GALV. PART NO.	SIZE	CTN/MSTR
605B	605G	1/2"	1/1
607B	607G	3/4"	1/1
610B	610G	1"	1/1

BG

Readycut Pipe



BLACK PART NO.	GALV. PART NO.	SIZE	CTN/MSTR
300B0218	301G0218	1/4"x18"	5/10
300B0224	301G0224	1/4"x24"	5/10
300B0230	301G0230	1/4"x30"	5/10
300B0236	301G0236	1/4"x36"	5/10
300B0248	301G0248	1/4"x48"	5/10
300B0260	301G0260	1/4"x60"	5/10
300B0272	—	1/4"x72"	5/10
300B0318	301G0318	3/8"x18"	5/10
300B0324	301G0324	3/8"x24"	5/10
300B0330	—	3/8"x30"	5/10
300B0336	301G0336	3/8"x36"	5/10
300B0348	301G0348	3/8"x48"	5/10
300B0360	301G0360	3/8"x60"	5/10
300B0372	—	3/8"x72"	5/10
300B0518	301G0518	1/2"x18"	5/10
300B0524	301G0524	1/2"x24"	5/10
300B0530	301G0530	1/2"x30"	5/10
300B0536	301G0536	1/2"x36"	5/10
300B0542	301G0542	1/2"x42"	5/10
300B0548	301G0548	1/2"x48"	5/10
300B0560	301G0560	1/2"x60"	5/10
300B0572	301G0572	1/2"x72"	5/10
300B0718	301G0718	3/4"x18"	5/10
300B0724	301G0724	3/4"x24"	5/10
300B0730	301G0730	3/4"x30"	5/10
300B0736	301G0736	3/4"x36"	5/10
300B0742	301G0742	3/4"x42"	5/10
300B0748	301G0748	3/4"x48"	5/10
300B0754	301G0754	3/4"x54"	5/10
300B0760	301G0760	3/4"x60"	5/10
300B0772	301G0772	3/4"x72"	5/10
300B1018	301G1018	1"x18"	5/10
300B1024	301G1024	1"x24"	5/10
300B1030	301G1030	1"x30"	5/10
300B1036	301G1036	1"x36"	5/10
—	301G1042	1"x42"	5/10
300B1048	301G1048	1"x48"	5/10
300B1060	301G1060	1"x60"	3/6
300B1066	—	1"x66"	3/6
300B1072	301G1072	1"x72"	3/6
300B1218	301G1218	1-1/4"x18"	3/6
—	301G1220	1-1/4"x20"	3/6
300B1224	301G1224	1-1/4"x24"	3/6
300B1230	301G1230	1-1/4"x30"	3/6
300B1236	301G1236	1-1/4"x36"	3/6
—	301G1242	1-1/4"x42"	3/6
300B1248	301G1248	1-1/4"x48"	3/6
300B1260	301G1260	1-1/4"x60"	3/6
300B1272	—	1-1/4"x72"	3/6
300B1518	301G1518	1-1/2"x18"	3/6
300B1524	301G1524	1-1/2"x24"	3/6
300B1530	301G1530	1-1/2"x30"	3/6
300B1536	301G1536	1-1/2"x36"	3/6

Readycut Pipe (cont.)

BLACK PART NO.	GALV. PART NO.	SIZE	CTN/MSTR
300B1548	301G1548	1-1/2"x48"	3/6
300B1560	301G1560	1-1/2"x60"	3/6
300B1572	—	1-1/2"x72"	3/6
300B2018	301G2018	2"x18"	3/6
300B2024	301G2024	2"x24"	3/6
300B2030	301G2030	2"x30"	3/6
300B2036	301G2036	2"x36"	3/6
300B2042	—	2"x42"	3/6
300B2048	301G2048	2"x48"	3/6
300B2060	301G2060	2"x60"	3/6
300B2072	—	2"x72"	3/6
32518	—	2-1/2"x18"	3/6
32520	—	2-1/2"x20"	3/6
—	52524	2-1/2"x24"	3/6
300B2530	—	2-1/2"x30"	3/6
33018	301G3018	3"x18"	2/4
300B3024	301G3024	3"x24"	2/4
300B3036	—	3"x36"	2/4
300B4018	301G4018	4"x18"	2/2
34024	54024	4"x24"	2/2
—	301G4048	4"x48"	2/2
300B4060	—	4"x60"	2/2

Standard Merchant Coupling



BLACK PART NO.	GALV. PART NO.	SIZE	CTN/MSTR
M301	M101	1/8"	100/600
M302	M102	1/4"	100/500
M303	M103	3/8"	100/300
M305	M105	1/2"	100/250
M307	M107	3/4"	50/150
M310	M110	1"	30/100
M312	M112	1-1/4"	25/70
M315	M115	1-1/2"	25/60
M320	M120	2"	20/40
M325	M125	2-1/2"	10/20
M330	M130	3"	10/10
M340	M140	4"	10/5

Standard Merchant Half Coupling



BLACK PART NO.	GALV. PART NO.	SIZE	CTN/MSTR
H305	—	1/2"	1/500
H307	—	3/4"	1/300
H310	—	1"	1/200
H320	—	2"	1/80

BG

COPPER FITTINGS

Stub Outs	355-356
Wrot/ACR Solder Fittings	357-363
Press Fittings	364-366
Forged Brass/Cast Pressure Fittings	367-368
Wrot DWV Solder Fittings.....	369
Cast DWV Solder Fittings.....	370-371
Cast Brass Flanges	371

Copper Stub Out Elbow



- Connects to ASTM F1960 (Cold Expansion Style) PEX
- Closed end for pressure testing
- cUPC approved for use in USA and Canada
- ANSI/NSF 61 & ANSI/NSF 372 approved for drinking water



PART NO.	DESCRIPTION	CTN/MSTR
S71000	1/2" Cold Expansion PEX (F1960), 13" x 8"	1/50
S71001	1/2" Cold Expansion PEX (F1960), 4" x 8"	1/50
S71002	3/4" Cold Expansion PEX (F1960), 6" x 8"	1/25
S71003	1" Cold Expansion PEX (F1960), 6" x 12"	1/25



- Connects to ASTM 1870 (Crimp Style) PEX
- Closed end for pressure testing
- cUPC approved for use in USA and Canada
- ANSI/NSF 61 & ANSI/NSF 372 approved for drinking water



PART NO.	DESCRIPTION	CTN/MSTR
S72000	1/2" Crimp PEX (F1807), 3-1/2" x 6"	1/50
S72001	1/2" Crimp PEX (F1807), 3-1/4" x 8"	1/50
S72002	1/2" Crimp PEX (F1807), 3-1/2" x 12"	1/50
S72003	1/2" Crimp PEX (F1807), 13" x 8"	1/25
S72004	3/4" Crimp PEX (F1807), 4-1/2" x 8"	1/50
S72005	3/4" Crimp PEX (F1807), 4-1/2" x 12"	1/50
S72006	3/4" Crimp PEX (F1807), 13" x 6"	1/25
S72007	1" Crimp PEX (F1807), 6" x 8"	1/25
S72008	1" Crimp PEX (F1807), 6" x 12"	1/25



- Connects to CPVC tubing (Solvent Weld)
- Closed end for pressure testing
- cUPC approved for use in USA and Canada
- ANSI/NSF 61 & ANSI/NSF 372 approved for drinking water



PART NO.	DESCRIPTION	CTN/MSTR
S73000	1/2" CPVC, 3-1/2" x 12"	1/50
S73001	1/2" CPVC, 8" x 7"	1/50
S73002	3/4" CPVC, 6" x 8"	1/50
S73003	3/4" CPVC, 6" x 12"	1/25
S73004	1" CPVC, 11" x 10"	1/25

Copper Stub Out Elbow with Mounting Flange



- Connects to ASTM F1960 (Cold Expansion Style) PEX
- Closed end for pressure testing
- Flange for nailing to a stud
- cUPC approved for use in USA and Canada
- ANSI/NSF 61 & ANSI/NSF 372 approved for drinking water



PART NO.	DESCRIPTION	CTN/MSTR
S71004	1/2" Cold Expansion PEX (F1960) Double, 7" x 8"	1/25
S71005	1/2" Cold Expansion PEX (F1960), 4" x 8"	1/25
S71006	3/4" Cold Expansion PEX (F1960), 6" x 8"	1/25
S71007	1" Cold Expansion PEX (F1960), 6" x 12"	1/25



- Connects to ASTM 1870 (Crimp Style) PEX
- Closed end for pressure testing
- Flange for nailing to a stud
- cUPC approved for use in USA and Canada
- ANSI/NSF 61 & ANSI/NSF 372 approved for drinking water



PART NO.	DESCRIPTION	CTN/MSTR
S72009	1/2" Crimp PEX (F1807), 4" x 12"	1/50
S72010	1/2" Crimp PEX (F1807), 3-1/2" x 6"	1/50
S72011	1/2" Crimp PEX (F1807), 3-1/2" x 8"	1/50
S72012	3/4" Crimp PEX (F1807), 4-1/2" x 8"	1/50
S72013	1" Crimp PEX (F1807), 6" x 8"	1/25



- Connects to CPVC tubing (Solvent Weld)
- Closed end for pressure testing
- Flange for nailing to a stud
- cUPC approved for use in USA and Canada
- ANSI/NSF 61 & ANSI/NSF 372 approved for drinking water



PART NO.	DESCRIPTION	CTN/MSTR
S73005	1/2" CPVC Socket, 3-1/2" x 8"	1/25
S73006	1" CPVC Socket, 11" x 10"	1/25

Copper Stub Out Tub/Shower Valve Connector



- Connects to ASTM F1960 (Cold Expansion Style) PEX
- cUPC approved for use in USA and Canada
- ANSI/NSF 61 & ANSI/NSF 372 approved for drinking water



PART NO.	DESCRIPTION	CTN/MSTR
S71011	1/2" Cold Expansion PEX (F1960) x 1/2" Male Sweat Connection, 6"	1/50
S71012	1/2" Cold Expansion PEX (F1960) x 1/2" Male Swivel Pipe Thread Connection, 7"	1/50
S71013	1/2" Cold Expansion PEX (F1960) x 1/2" Female Swivel Pipe Thread Connection, 6"	1/50



- Connects to ASTM 1870 (Crimp Style) PEX
- cUPC approved for use in USA and Canada
- ANSI/NSF 61 & ANSI/NSF 372 approved for drinking water



PART NO.	DESCRIPTION	CTN/MSTR
S72020	1/2" Crimp PEX (F1807) x 1/2" Male Sweat Connection, 4"	1/50
S72021	1/2" Crimp PEX (F1807) x 1/2" Male Sweat Connection, 6"	1/50
S72022	1/2" Crimp PEX (F1807) x 1/2" Male Sweat Connection, 8"	1/50



- Connects to CPVC tubing (Solvent Weld)
- Closed end for pressure testing
- cUPC approved for use in USA and Canada
- ANSI/NSF 61 & ANSI/NSF 372 approved for drinking water



PART NO.	DESCRIPTION	CTN/MSTR
S73007	1/2" CPVC Socket x 1/2" Male Sweat Elbow, 6" x 2-1/4"	1/50
S73008	1/2" CPVC Socket x 1/2" Male Sweat Elbow, 8" x 2-1/4"	1/50

Copper Stub Out Straight



- Connects to ASTM F1960 (Cold Expansion Style) PEX
- Closed end for pressure testing
- cUPC approved for use in USA and Canada
- ANSI/NSF 61 & ANSI/NSF 372 approved for drinking water



PART NO.	DESCRIPTION	CTN/MSTR
S71008	1/2" Cold Expansion PEX (F1960) Closed End, 8" long	1/50
S71009	1/2" Cold Expansion PEX (F1960) Closed End, 15" long	1/50



- Connects to ASTM 1870 (Crimp Style) PEX
- cUPC approved for use in USA and Canada
- ANSI/NSF 61 & ANSI/NSF 372 approved for drinking water



PART NO.	DESCRIPTION	CTN/MSTR
S72014	1/2" Crimp PEX (F1807), Closed End, 8" Long	1/50
S72015	1/2" Crimp PEX (F1807), Closed End, 12" Long	1/50
S72016	3/4" Crimp PEX (F1807), Closed End, 12" Long	1/50
S72018	1/2" Crimp PEX (F1807), Open End, 8" Long	1/50
S72019	1/2" Crimp PEX (F1807), Open End, 12" Long	1/50

Copper Stub Out Straight with Mounting Flange



- Connects to ASTM F1960 (Cold Expansion Style) PEX
- Closed end for pressure testing
- Flange for nailing to a stud
- cUPC approved for use in USA and Canada
- ANSI/NSF 61 & ANSI/NSF 372 approved for drinking water



PART NO.	DESCRIPTION	CTN/MSTR
S71010	1/2" Crimp PEX (F1807), Closed End, 12" Long	1/50



- Connects to ASTM 1870 (Crimp Style) PEX
- Closed end for pressure testing
- Flange for nailing to a stud
- cUPC approved for use in USA and Canada
- ANSI/NSF 61 & ANSI/NSF 372 approved for drinking water



PART NO.	DESCRIPTION	CTN/MSTR
S72017	1/2" Crimp PEX (F1807), Closed End, 12" Long	1/50

Wrot Male Adapter

C x M



PART NO.	ALT NO.	SIZE	CTN/MSTR
C75311	K151010001	1/8"	25/3000
C75312	K151010002	1/4"	25/1600
C75313	K151010025	3/8"	25/1000
C75314	K151010050	1/2"	25/600
C75315	K151010100	3/4"	25/250
C75316	K151010150	1"	10/150
C75317	K151010215	1-1/4"	110/110
C75318	K151010295	1-1/2"	65/65
C75319	K151010390	2"	38/38
C75320	K151010520	2-1/2"	48/48
C75321	K151010650	3"	36/36
C75322	K151010860	4"	12/12
C75323	K151010024	1/8" x 1/4"	25/2000
C75324	K151010007	1/4" x 1/8"	25/2000
C75325	K151010006	1/4" x 3/8"	25/750
C75326	K151010005	1/4" x 1/2"	25/600
C75327	K151010032	3/8" x 1/4"	25/750
C75328	K151010031	3/8" x 1/2"	25/500
C75329	K151010059	1/2" x 1/4"	25/1000
C75330	K151010058	1/2" x 3/8"	25/800
C75331	K151010057	1/2" x 3/4"	25/250
C75332	K151010056	1/2" x 1"	10/150
C75334	K151010092	5/8" x 3/4"	25/250
C75335	K151010107	3/4" x 1/2"	25/250
C75336	K151010106	3/4" x 1"	10/150
C75337	K151010160	1" x 1/2"	10/180
C75338	K151010159	1" x 3/4"	10/150
C75339	K151010158	1" x 1-1/4"	85/85
C75340	K151010157	1" x 1-1/2"	65/65
C75341	K151010223	1-1/4" x 3/4"	130/130
C75342	K151010222	1-1/4" x 1"	120/120
C75343	K151010221	1-1/4" x 1-1/2"	90/90
C75345	K151010304	1-1/2" x 1"	120/120
C75346	K151010303	1-1/2" x 1-1/4"	60/60
C75347	K151010302	1-1/2" x 2"	50/50
C75348	K151010399	2" x 1-1/4"	48/48
C75349	K151010398	2" x 1-1/2"	48/48
C75350	K151010531	2-1/2" x 2"	36/36

Wrot Fitting Male Adapter

Ftg x M



PART NO.	ALT NO.	SIZE	CTN/MSTR
C75352	K151140025	3/8"	25/800
C75353	K151140050	1/2"	25/500
C75354	K151140057	1/2" x 3/4"	25/250
C75355	K151140100	3/4"	25/250
C75356	K151140150	1"	10/130
C75357	K151140215	1-1/4"	80/80
C75358	K151140295	1-1/2"	50/50
C75359	K151140390	2"	38/38

Wrot Female Adapter

C x F



PART NO.	ALT NO.	SIZE	CTN/MSTR
C75111	K151050001	1/8"	25/1500
C75112	K151050002	1/4"	25/1000
C75113	K151050025	3/8"	25/800
C75114	K151050050	1/2"	25/450
C75115	K151050100	3/4"	25/200
C75116	K151050150	1"	10/140
C75117	K151050215	1-1/4"	80/80
C75118	K151050295	1-1/2"	60/60
C75119	K151050390	2"	36/36
C75120	K151050520	2-1/2"	48/48
C75121	K151050650	3"	30/30
C75122	K151050024	1/8" x 1/4"	25/1000
C75123	K151050006	1/4" x 3/8"	25/900
C75124	K151050032	3/8" x 1/4"	25/750
C75125	K151050031	3/8" x 1/2"	25/500
C75126	K151050060	1/2" x 1/8"	25/500
C75127	K151050059	1/2" x 1/4"	25/500
C75128	K151050058	1/2" x 3/8"	25/800
C75129	K151050057	1/2" x 3/4"	25/300
C75130	K151050056	1/2" x 1"	10/160
C75131	K151050093	5/8" x 1/2"	25/300
C75132	K151050092	5/8" x 3/4"	25/250
C75133	K151050107	3/4" x 1/2"	25/300
C75134	K151050106	3/4" x 1"	10/140
C75135	K151050160	1" x 1/2"	10/150
C75136	K151050159	1" x 3/4"	10/150
C75137	K151050158	1" x 1-1/4"	85/85
C75138	K151050223	1-1/4" x 3/4"	120/120
C75139	K151050222	1-1/4" x 1"	120/120
C75140	K151050221	1-1/4" x 1-1/2"	65/65
C75141	K151050303	1-1/2" x 1-1/4"	70/70
C75142	K151050302	1-1/2" x 2"	60/60
C75494	K151050398	2" x 1-1/2"	40/40

Wrot Fitting Female Adapter

Ftg x F



PART NO.	ALT NO.	SIZE	CTN/MSTR
C75392	K151150002	1/4"	25/1500
C75394	K151150050	1/2"	25/500
C75395	K151150100	3/4"	25/250
C75396	K151150150	1"	10/140
C75397	K151150215	1-1/4"	85/85
C75398	K151150295	1-1/2"	80/80
C75399	K151150390	2"	40/40
C75400	K151150058	1/2" x 3/8"	25/700
C75401	K151150057	1/2" x 3/4"	25/300

Wrot Flush Bushing

Ftg x F



PART NO.	ALT NO.	SIZE	CTN/MSTR
C75375	K151420060	1/2" x 1/8"	25/1500

Wrot Coupling (Socket) with Rolled Tube Stop

C x C



PART NO.	ALT NO.	SIZE	CTN/MSTR
C75000	K151650001	1/8"	25/3000
C75001	K151650002	1/4"	25/2000
C75566	K151650015	5/16" OD	25/3000
C75002	K151650025	3/8"	25/1200
C75003	K151650050	1/2"	25/800
C75004	K151650090	5/8"	25/400
C75005	K151650100	3/4"	25/300
C75006	K151650150	1"	10/150
C75007	K151650215	1-1/4"	100/100
C75008	K151650295	1-1/2"	60/60
C75009	K151650390	2"	40/40
C75010	K151650520	2-1/2"	50/50
C75011	K151650650	3"	30/30
C75012	K151650780	3-1/2"	18/18
C75013	K151650860	4"	20/20
C75477	K151651100	6"	3/3
C75478	K151651225	8"	1/1

Wrot Coupling (Socket) with Dimple Tube Stop

C x C



PART NO.	ALT NO.	SIZE	CTN/MSTR
C75550	K151700001	1/8"	25/3000
C75551	K151700002	1/4"	25/2000
C75553	K151700025	3/8"	25/1200
C75554	K151700050	1/2"	25/800
C75555	K151700090	5/8"	25/400
C75556	K151700100	3/4"	25/300
C75557	K151700150	1"	10/150
C75558	K151700215	1-1/4"	100/100
C75559	K151700295	1-1/2"	60/60
C75580	K151700390	2"	40/40
C75581	K151700520	2-1/2"	50/50
C75582	K151700650	3"	30/30
C75583	K151700780	3-1/2"	25/25
C75564	K151700860	4"	12/12
C75565	K151700975	5"	6/6
C75586	K151701100	6"	3/3

Wrot Coupling (Socket) less Tube Stop

C x C



PART NO.	ALT NO.	SIZE	CTN/MSTR
C75412	K151720001	1/8"	25/3000
C75413	K151720002	1/4"	25/2000
C75414	K151720025	3/8"	25/1200
C75415	K151720050	1/2"	25/800
C75519	K151720090	5/8"	25/400
C75416	K151720100	3/4"	25/300
C75417	K151720150	1"	10/150
C75418	K151720215	1-1/4"	100/100
C75419	K151720295	1-1/2"	60/60
C75420	K151720390	2"	40/40
C75421	K151720520	2-1/2"	50/50
C75422	K151720650	3"	30/30
C75423	K151720860	4"	12/12
C75424	K151720975	5"	6/6

Wrot Reducing Coupling

C x C



PART NO.	ALT NO.	SIZE	CTN/MSTR
C75069	K151650007	1/4" x 1/8"	25/2000
C75516	K151650008	1/4" OD x 3/16" OD	25/2000
C75070	K151650033	3/8" x 1/8"	25/800
C75071	K151650032	3/8" x 1/4"	25/800
C75073	K151650059	1/2" x 1/4"	25/800
C75074	K151650058	1/2" x 3/8"	25/800
C75075	K151650095	5/8" x 1/4"	25/500
C75076	K151650094	5/8" x 3/8"	25/500
C75077	K151650093	5/8" x 1/2"	25/500
C75078	K151650109	3/4" x 1/4"	25/400
C75079	K151650108	3/4" x 3/8"	25/400
C75080	K151650107	3/4" x 1/2"	25/350
C75081	K151650149	3/4" x 5/8"	25/350
C75517	K151650161	1" x 3/8"	10/200
C75082	K151650160	1" x 1/2"	10/200
C75083	K151651498	1" x 5/8"	10/180
C75084	K151650159	1" x 3/4"	10/160
C75085	K151650224	1-1/4" x 1/2"	100/100
C75086	K151650223	1-1/4" x 3/4"	100/100
C75087	K151650222	1-1/4" x 1"	100/100
C75088	K151650306	1-1/2" x 1/2"	100/100
C75089	K151650305	1-1/2" x 3/4"	100/100
C75090	K151650304	1-1/2" x 1"	100/100
C75091	K151650303	1-1/2" x 1-1/4"	100/100
C75092	K151650402	2" x 1/2"	50/50
C75093	K151650401	2" x 3/4"	50/50
C75094	K151650400	2" x 1"	50/50
C75095	K151650399	2" x 1-1/4"	50/50
C75096	K151650398	2" x 1-1/2"	50/50
C75097	K151650534	2-1/2" x 1"	30/30
C75098	K151650533	2-1/2" x 1-1/4"	30/30
C75099	K151650532	2-1/2" x 1-1/2"	30/30
C75100	K151650531	2-1/2" x 2"	30/30
C75101	K151650664	3" x 1-1/2"	20/20
C75102	K151650663	3" x 2"	20/20
C75103	K151650662	3" x 2-1/2"	15/15
C75104	K151650874	4" x 1-1/4"	20/20
C75105	K151650873	4" x 1-1/2"	20/20
C75106	K151650872	4" x 2"	18/18
C75107	K151650871	4" x 2-1/2"	18/18
C75108	K151650870	4" x 3"	18/18
C75109	K151651111	6" x 3"	4/4
C75110	K151651109	6" x 4"	4/4

Wrot Crossover Coupling

C x C



PART NO.	ALT NO.	SIZE	CTN/MSTR
C75548	K151670050	1/2"	180/180

Wrot Cap



PART NO.	ALT NO.	SIZE	CTN/MSTR
C75055	K151540001	1/8"	25/3300
C75056	K151540002	1/4"	25/3000
C75057	K151540025	3/8"	25/2500
C75058	K151540050	1/2"	25/1400
C75059	K151540090	5/8"	25/850
C75060	K151540100	3/4"	25/500
C75061	K151540150	1"	10/300
C75062	K151540215	1-1/4"	200/200
C75063	K151540295	1-1/2"	140/140
C75064	K151540390	2"	60/60
C75065	K151540520	2-1/2"	30/30
C75066	K151540650	3"	20/20
C75067	K151540860	4"	25/25
C75068	K151541100	6"	5/5

Wrot 90° Short Turn Elbow

C x C



PART NO.	ALT NO.	SIZE	CTN/MSTR
C75014	K152350001	1/8"	25/3000
C75015	K152350002	1/4"	25/1200
C75016	K152350025	3/8"	25/1000
C75030	K152350032	3/8" x 1/4"	25/800
C75017	K152350050	1/2"	25/500
C75031	K152350059	1/2" x 1/4"	25/500
C75018	K152350090	5/8"	25/300
C75019	K152350100	3/4"	25/200
C75033	K152350107	3/4" x 1/2"	25/200
C75020	K152350150	1"	10/100
C75034	K152350160	1" x 1/2"	10/80
C75035	K152350159	1" x 3/4"	10/80
C75021	K152350215	1-1/4"	80/80
C75522	K152350223	1-1/4" x 3/4"	50/50
C75036	K152350222	1-1/4" x 1"	50/50
C75022	K152350295	1-1/2"	35/35
C75037	K152350303	1-1/2" x 1-1/4"	35/35
C75023	K152350390	2"	17/17
C75038	K152350398	2" x 1-1/2"	17/17
C75024	K152350520	2-1/2"	20/20
C75025	K152350650	3"	13/13
C75523	K152350780	3-1/2"	7/7
C75026	K152350860	4"	6/6
C75027	K152350975	5"	2/2
C75028	K152351100	6"	1/1
C75029	K152351225	8"	1/1

Wrot 90° Long Turn Elbow

C x C



PART NO.	ALT NO.	SIZE	CTN/MSTR
C75481	K152420001	1/8"	25/2000
C75482	K152420002	1/4"	25/1200
C75540	K152420015	5/16" OD	25/1600
C75483	K152420025	3/8"	25/750
C75484	K152420050	1/2"	25/350
C75485	K152420090	5/8"	25/200
C75486	K152420100	3/4"	10/120
C75487	K152420150	1"	10/60
C75488	K152420215	1-1/4"	35/35
C75489	K152420295	1-1/2"	25/25
C75490	K152420390	2"	12/12
C75491	K152420520	2-1/2"	16/16
C75492	K152420650	3"	8/8
C75544	K152420860	4"	4/4

Wrot 90° Short Turn Street Elbow

Ftg x C



PART NO.	ALT NO.	SIZE	CTN/MSTR
C75377	K152540002	1/4"	25/1200
C75378	K152540025	3/8"	25/1000
C75379	K152540050	1/2"	25/500
C75380	K152540090	5/8"	25/300
C75381	K152540100	3/4"	25/200
C75382	K152540150	1"	10/100
C75383	K152540215	1-1/4"	50/50
C75384	K152540295	1-1/2"	35/35
C75385	K152540390	2"	17/17
C75386	K152540520	2-1/2"	20/20
C75387	K152540650	3"	13/13
C75388	K152540860	4"	25/1200

Wrot 90° Short Turn Street Elbow

Ftg x Ftg



PART NO.	ALT NO.	SIZE	CTN/MSTR
C75535	K152670050	1/2"	25/500
C75536	K152670100	3/4"	25/250

CF

Wrot 90° Long Turn Street Elbow

Ftg x C



PART NO.	ALT NO.	SIZE	CTN/MSTR
C75403	K152720002	1/4"	25/1200
C75404	K152720025	3/8"	25/750
C75405	K152720050	1/2"	25/350
C75406	K152720090	5/8"	25/200
C75407	K152720100	3/4"	10/120
C75408	K152720150	1"	10/60
C75409	K152720215	1-1/4"	35/35
C75410	K152720295	1-1/2"	25/25
C75411	K152720390	2"	12/12
C75479	K152720520	2-1/2"	16/16
C75546	K152720860	4"	6/6

Wrot 45° Elbow

C x C



PART NO.	ALT NO.	SIZE	CTN/MSTR
C75039	K152900001	1/8"	25/2000
C75040	K152900002	1/4"	25/2000
C75041	K152900025	3/8"	25/800
C75042	K152900050	1/2"	25/500
C75043	K152900090	5/8"	25/300
C75044	K152900100	3/4"	25/200
C75045	K152900150	1"	10/100
C75046	K152900215	1-1/4"	60/60
C75047	K152900295	1-1/2"	40/40
C75048	K152900390	2"	18/18
C75049	K152900520	2-1/2"	20/20
C75050	K152900650	3"	15/15
C75051	K152900860	4"	6/6
C75052	K152900975	5"	4/4
C75053	K152901100	6"	2/2

Wrot 45° Street Elbow

Ftg x C



CF

PART NO.	ALT NO.	SIZE	CTN/MSTR
C75463	K152950002	1/4"	25/2000
C75464	K152950025	3/8"	25/800
C75465	K152950050	1/2"	25/500
C75466	K152950090	5/8"	25/300
C75467	K152950100	3/4"	25/200
C75468	K152950150	1"	10/100
C75469	K152950215	1-1/4"	60/60
C75470	K152950295	1-1/2"	40/40
C75471	K152950390	2"	18/18
C75472	K152950520	2-1/2"	20/20
C75473	K152950650	3"	15/15
C75474	K152950860	4"	6/6

Wrot Fitting Plug



PART NO.	ALT NO.	SIZE	CTN/MSTR
C75525	K153960050	1/2"	25/1400
C75527	K153960150	1"	10/300

Wrot Suction Line P-Trap

C x C



PART NO.	ALT NO.	SIZE	CTN/MSTR
K155330050	—	1/2"	5/60
K155330090	—	5/8"	5/60
K155330100	—	3/4"	40/40
K155330150	—	1"	3/15
K155330215	—	1-1/4"	2/10
K155330295	—	1-1/2"	2/6
K155330390	—	2"	1/4

Wrot Flush Bushing

Ftg x C



PART NO.	ALT NO.	SIZE	CTN/MSTR
C75360	K151400007	1/4" x 1/8"	25/3300
C75361	K151400032	3/8" x 1/4"	25/2500
C75363	K151400058	1/2" x 3/8"	25/1500
C75362	K151400059	1/2" x 1/4"	25/1500
C75568	K151400108	3/4" x 3/8"	25/700
C75366	K151400107	3/4" x 1/2"	25/700
C75367	K151400149	3/4" x 5/8"	25/500
C75368	K151400160	1" x 1/2"	10/320
C75370	K151400159	1" x 3/4"	10/300
C75371	K151400223	1-1/4" x 3/4"	200/200
C75372	K151400222	1-1/4" x 1"	200/200
C75373	K151400303	1-1/2" x 1-1/4"	140/140
C75374	K151400398	2" x 1-1/2"	60/60

Wrot Fitting Reducer

Ftg x C



PART NO.	ALT NO.	SIZE	CTN/MSTR
C75425	K154100007	1/4" x 1/8"	25/3300
C75427	K154100032	3/8" x 1/4"	25/1200
C75428	K154100059	1/2" x 1/4"	25/1000
C75429	K154100058	1/2" x 3/8"	25/1000
C75430	K154100094	5/8" x 3/8"	25/500
C75431	K154100093	5/8" x 1/2"	25/500
C75432	K154100109	3/4" x 1/4"	25/400
C75433	K154100108	3/4" x 3/8"	25/400
C75434	K154100107	3/4" x 1/2"	25/400
C75435	K154100149	3/4" x 5/8"	25/400
C75437	K154100160	1" x 1/2"	10/200
C75438	K154101498	1" x 5/8"	10/200
C75439	K154100159	1" x 3/4"	10/160
C75440	K154100224	1-1/4" x 1/2"	100/100
C75441	K154100223	1-1/4" x 3/4"	100/100
C75442	K154100222	1-1/4" x 1"	100/100
C75443	K154100306	1-1/2" x 1/2"	100/100
C75444	K154100305	1-1/2" x 3/4"	100/100
C75445	K154100304	1-1/2" x 1"	100/100
C75446	K154100303	1-1/2" x 1-1/4"	100/100
C75447	K154100402	2" x 1/2"	50/50
C75448	K154100401	2" x 3/4"	50/50
C75449	K154100400	2" x 1"	50/50
C75450	K154100399	2" x 1-1/4"	50/50
C75451	K154100398	2" x 1-1/2"	50/50
C75452	K154100534	2-1/2" x 1"	30/30
C75453	K154100533	2-1/2" x 1-1/4"	30/30
C75454	K154100532	2-1/2" x 1-1/2"	30/30
C75455	K154100531	2-1/2" x 2"	30/30
C75456	K154100665	3" x 1-1/4"	20/20
C75457	K154100664	3" x 1-1/2"	20/20
C75458	K154100663	3" x 2"	20/20
C75459	K154100662	3" x 2-1/2"	15/15
C75460	K154100872	4" x 2"	18/18
C75461	K154100871	4" x 2-1/2"	18/18
C75462	K154100870	4" x 3"	18/18
C75562	K154100869	4" x 3-1/2"	15/15
C75563	K154100983	5" x 4"	12/12

Wrot Union

C x C



PART NO.	ALT NO.	SIZE	CTN/MSTR
C75502	K156570050	1/2"	25/200
C75503	K156570100	3/4"	25/100
C75504	K156570150	1"	10/70
C75505	K126570215	1-1/4"	50/50
C75506	K126570295	1-1/2"	30/30
C75507	K126570390	2"	18/18
C75508	K126570520	2-1/2"	8/8
C75509	K126570650	3"	6/6

Wrot U-Type Strap



PART NO.	ALT NO.	SIZE	CTN/MSTR
K159470001	—	1/8"	25/2000
K159470002	—	1/4"	25/1500
K159470025	—	3/8"	25/1300
K159470050	—	1/2"	25/1000
K159470090	—	5/8"	25/500
K159470100	—	3/4"	25/600
K159470150	—	1"	10/350
K159470215	—	1-1/4"	1/350
K159470295	—	1-1/2"	300/300
K159470390	—	2"	300/300

Wrot Tee

C x C x C



PART NO.	ALT NO.	SIZE	CTN/MSTR
C75143	K154600001	1/8"	25/2000
C75144	K154600002	1/4"	25/1300
C75162	K154600007	1/4" x 1/4" x 1/8"	25/1300
C75163	K154600006	1/4" x 1/4" x 3/8"	25/1300
C75160	K154600013	1/4" x 1/8" x 1/8"	25/1500
C75161	K154600012	1/4" x 1/8" x 1/4"	25/1300
C75145	K154600025	3/8"	25/600
C75166	K154600041	3/8" x 1/4" x 1/4"	25/500
C75167	K154600033	3/8" x 3/8" x 1/8"	25/600
C75168	K154600032	3/8" x 3/8" x 1/4"	25/600
C75169	K154600031	3/8" x 3/8" x 1/2"	25/350
C75146	K154600050	1/2"	50/500
C75170	K154600075	1/2" x 1/4" x 1/2"	25/400
C75171	K154600068	1/2" x 3/8" x 1/4"	25/400
C75173	K154600066	1/2" x 3/8" x 1/2"	25/350
C75174	K154600060	1/2" x 1/2" x 1/8"	25/400
C75175	K154600059	1/2" x 1/2" x 1/4"	25/400
C75176	K154600058	1/2" x 1/2" x 3/8"	25/400
C75177	K154600057	1/2" x 1/2" x 3/4"	10/180
C75178	K154600056	1/2" x 1/2" x 1"	10/70
C75147	K154600090	5/8"	25/200
C75571	K154600095	5/8" x 5/8" x 1/4"	25/200
C75181	K154600092	5/8" x 5/8" x 3/4"	25/200
C75148	K154600100	3/4"	20/160
C75572	K154600127	3/4" x 3/8" x 1/2"	10/170
C75182	K154600118	3/4" x 1/2" x 1/2"	10/180
C75183	K154600117	3/4" x 1/2" x 3/4"	10/120
C75184	K154600109	3/4" x 3/4" x 1/4"	10/170
C75185	K154600108	3/4" x 3/4" x 3/8"	10/170
C75186	K154600107	3/4" x 3/4" x 1/2"	10/170
C75188	K154600106	3/4" x 3/4" x 1"	10/80
C75149	K154600150	1"	10/60
C75195	K154600161	1" x 1" x 3/8"	10/100
C75196	K154600160	1" x 1" x 1/2"	10/100
C75198	K154600159	1" x 1" x 3/4"	10/60
C75199	K154600158	1" x 1" x 1-1/4"	35/35
C75200	K154600157	1" x 1" x 1-1/2"	25/25
C75192	K154600171	1" x 3/4" x 1/2"	10/60
C75193	K154600170	1" x 3/4" x 3/4"	10/60
C75194	K154600169	1" x 3/4" x 1"	10/60
C75189	K154600182	1" x 1/2" x 1/2"	10/100
C75190	K154600181	1" x 1/2" x 3/4"	10/80
C75191	K154600180	1" x 1/2" x 1"	10/60
C75197	K154601498	1" x 1" x 5/8"	10/70
C75150	K154600215	1-1/4"	35/35
C75202	K154600256	1-1/4" x 1/2" x 1-1/4"	35/35
C75203	K154600248	1-1/4" x 3/4" x 1/2"	50/50
C75204	K154600247	1-1/4" x 3/4" x 3/4"	50/50
C75205	K154600246	1-1/4" x 3/4" x 1"	45/45
C75206	K154600245	1-1/4" x 3/4" x 1-1/4"	35/35

Wrot Tee (cont.)

PART NO.	ALT NO.	SIZE	CTN/MSTR
C75207	K154600237	1-1/4" x 1" x 1/2"	60/60
C75208	K154600236	1-1/4" x 1" x 3/4"	50/50
C75209	K154600235	1-1/4" x 1" x 1"	50/50
C75210	K154600234	1-1/4" x 1" x 1-1/4"	30/30
C75211	K154600224	1-1/4" x 1-1/4" x 1/2"	50/50
C75212	K154600223	1-1/4" x 1-1/4" x 3/4"	50/50
C75213	K154600222	1-1/4" x 1-1/4" x 1"	40/40
C75214	K154600221	1-1/4" x 1-1/4" x 1-1/2"	20/20
C75215	K154600220	1-1/4" x 1-1/4" x 2"	10/10
C75151	K154600295	1-1/2"	20/20
C75233	K154600306	1-1/2" x 1-1/2" x 1/2"	40/40
C75234	K154600305	1-1/2" x 1-1/2" x 3/4"	35/35
C75235	K154600304	1-1/2" x 1-1/2" x 1"	35/35
C75236	K154600303	1-1/2" x 1-1/2" x 1-1/4"	25/25
C75237	K154600302	1-1/2" x 1-1/2" x 2"	10/10
C75228	K154600319	1-1/2" x 1-1/4" x 1/2"	10/40
C75229	K154600318	1-1/2" x 1-1/4" x 3/4"	40/40
C75230	K154600317	1-1/2" x 1-1/4" x 1"	30/30
C75231	K154600316	1-1/2" x 1-1/4" x 1-1/4"	30/30
C75232	K154600315	1-1/2" x 1-1/4" x 1-1/2"	20/20
C75223	K154600332	1-1/2" x 1" x 1/2"	40/40
C75225	K154600331	1-1/2" x 1" x 3/4"	40/40
C75224	K154600330	1-1/2" x 1" x 1"	35/35
C75226	K154600329	1-1/2" x 1" x 1-1/4"	30/30
C75227	K154600328	1-1/2" x 1" x 1-1/2"	20/20
C75218	K154600343	1-1/2" x 3/4" x 1/2"	40/40
C75219	K154600342	1-1/2" x 3/4" x 3/4"	30/30
C75220	K154600341	1-1/2" x 3/4" x 1"	40/40
C75221	K154600340	1-1/2" x 3/4" x 1-1/4"	30/30
C75222	K154600339	1-1/2" x 3/4" x 1-1/2"	20/20
C75216	K154600352	1-1/2" x 1/2" x 1"	40/40
C75217	K154600350	1-1/2" x 1/2" x 1-1/2"	20/20
C75152	K154600390	2"	10/10
C75254	K154600402	2" x 2" x 1/2"	20/20
C75255	K154600401	2" x 2" x 3/4"	20/20
C75256	K154600400	2" x 2" x 1"	18/18
C75257	K154600399	2" x 2" x 1-1/4"	15/15
C75258	K154600398	2" x 2" x 1-1/2"	10/10
C75259	K154600397	2" x 2" x 2-1/2"	15/15
C75248	K154600418	2" x 1-1/2" x 1/2"	20/20
C75249	K154600417	2" x 1-1/2" x 3/4"	20/20
C75250	K154600416	2" x 1-1/2" x 1"	20/20
C75251	K154600415	2" x 1-1/2" x 1-1/4"	10/10
C75252	K154600414	2" x 1-1/2" x 1-1/2"	15/15
C75253	K154600413	2" x 1-1/2" x 2"	10/10
C75243	K154600433	2" x 1-1/4" x 3/4"	20/20
C75244	K154600432	2" x 1-1/4" x 1"	20/20
C75245	K154600431	2" x 1-1/4" x 1-1/4"	15/15
C75246	K154600430	2" x 1-1/4" x 1-1/2"	15/15
C75247	K154600429	2" x 1-1/4" x 2"	10/10
C75240	K154600447	2" x 1" x 1"	20/20
C75242	K154600444	2" x 1" x 2"	15/15
C75238	K154600470	2" x 1/2" x 2"	15/15
C75239	K154600457	2" x 3/4" x 2"	10/10
C75153	K154600520	2-1/2"	15/15
C75260	K154600608	2-1/2" x 3/4" x 2-1/2"	15/15

CF

Wrot Tee (cont.)

PART NO.	ALT NO.	SIZE	CTN/MSTR
C75261	K154600595	2-1/2" x 1" x 2-1/2"	15/15
C75262	K154600583	2-1/2" x 1-1/4" x 1-1/4"	20/20
C75263	K154600580	2-1/2" x 1-1/4" x 2-1/2"	15/15
C75573	K154600566	2-1/2" x 1-1/2" x 1-1/2"	10/10
C75574	K154600565	2-1/2" x 1-1/2" x 2"	15/15
C75264	K154600564	2-1/2" x 1-1/2" x 2-1/2"	15/15
C75265	K154600554	2-1/2" x 2" x 1/2"	20/20
C75266	K154600553	2-1/2" x 2" x 3/4"	20/20
C75267	K154600552	2-1/2" x 2" x 1"	20/20
C75268	K154600551	2-1/2" x 2" x 1-1/4"	20/20
C75269	K154600550	2-1/2" x 2" x 1-1/2"	20/20
C75270	K154600549	2-1/2" x 2" x 2"	15/15
C75271	K154600548	2-1/2" x 2" x 2-1/2"	15/15
C75272	K154600536	2-1/2" x 2-1/2" x 1/2"	25/25
C75273	K154600535	2-1/2" x 2-1/2" x 3/4"	25/25
C75274	K154600534	2-1/2" x 2-1/2" x 1"	25/25
C75275	K154600533	2-1/2" x 2-1/2" x 1-1/4"	20/20
C75276	K154600532	2-1/2" x 2-1/2" x 1-1/2"	20/20
C75277	K154600531	2-1/2" x 2-1/2" x 2"	15/15
C75154	K154600650	3"	10/10
C75281	K154600708	3" x 1-1/2" x 3"	8/8
C75282	K154600696	3" x 2" x 1-1/2"	10/10
C75283	K154600695	3" x 2" x 2"	15/15
C75285	K154600694	3" x 2" x 2-1/2"	10/10
C75286	K154600693	3" x 2" x 3"	10/10
C75576	K154600682	3" x 2-1/2" x 1"	25/25
C75288	K154600680	3" x 2-1/2" x 1-1/2"	15/15
C75289	K154600679	3" x 2-1/2" x 2"	15/15
C75290	K154600678	3" x 2-1/2" x 2-1/2"	10/10
C75291	K154600677	3" x 2-1/2" x 3"	10/10
C75292	K154600668	3" x 3" x 1/2"	10/10
C75293	K154600667	3" x 3" x 3/4"	20/20
C75294	K154600666	3" x 3" x 1"	20/20
C75295	K154600665	3" x 3" x 1-1/4"	15/15
C75296	K154600664	3" x 3" x 1-1/2"	15/15
C75297	K154600663	3" x 3" x 2"	13/13
C75298	K154600662	3" x 3" x 2-1/2"	10/10
C75155	K154600860	4"	5/5
C75299	K154600914	4" x 2" x 4"	4/4
C75300	K154600896	4" x 3" x 2-1/2"	5/5
C75301	K154600895	4" x 3" x 3"	5/5
C75302	K154600893	4" x 3" x 4"	5/5
C75303	K154600877	4" x 4" x 1/2"	5/5
C75304	K154600876	4" x 4" x 3/4"	8/8
C75305	K154600875	4" x 4" x 1"	8/8
C75306	K154600874	4" x 4" x 1-1/4"	8/8
C75307	K154600873	4" x 4" x 1-1/2"	8/8
C75308	K154600872	4" x 4" x 2"	6/6
C75309	K154600871	4" x 4" x 2-1/2"	5/5
C75310	K154600870	4" x 4" x 3"	5/5
C75156	K154600975	5"	2/2
C75157	K154601100	6"	1/1
C75577	K154601113	6" x 6" x 2"	2/2
C75578	K154601111	6" x 6" x 3"	2/2
C75579	K154601109	6" x 6" x 4"	2/2
C75158	K154601225	8"	1/1

CF

Copper Press Coupling (Socket) with Rolled Tube Stop

P x P



PART NO.	SIZE	CTN/MSTR
C77001	1/2" x 1/2"	10/550
C77002	3/4" x 3/4"	10/260
C77003	1" x 1"	5/170
C77004	1-1/4" x 1-1/4"	1/80
C77005	1-1/2" x 1-1/2"	1/50
C77006	2" x 2"	1/35
C77007	2-1/2" x 2-1/2"	1/32
C77008	3" x 3"	1/18
C77009	4" x 4"	1/12

Copper Press Coupling (Socket) Less Stop

P x P



PART NO.	SIZE	CTN/MSTR
C77010	1/2" x 1/2"	10/450
C77011	3/4" x 3/4"	10/260
C77012	1" x 1"	5/170
C77013	1-1/4" x 1-1/4"	1/80
C77014	1-1/2" x 1-1/2"	1/50
C77015	2" x 2"	1/35
C77016	2-1/2" x 2-1/2"	1/32
C77017	3" x 3"	1/18
C77018	4" x 4"	1/12

Copper Press Reducer

P x P



PART NO.	SIZE	CTN/MSTR
C77019	3/4" x 1/2"	10/300
C77020	1" x 3/4"	10/200
C77021	1-1/4" x 1"	1/80
C77022	1-1/2" x 1-1/4"	1/60
C77023	2" x 1-1/2"	1/40

Copper Press 45° Elbow

P x P



PART NO.	SIZE	CTN/MSTR
C77044	1/2" x 1/2"	10/400
C77045	3/4" x 3/4"	10/200
C77046	1" x 1"	5/140
C77047	1-1/4" x 1-1/4"	1/70
C77048	1-1/2" x 1-1/2"	1/40
C77049	2" x 2"	1/25
C77050	2-1/2" x 2-1/2"	1/16
C77051	3" x 3"	1/12
C77052	4" x 4"	1/6

Copper Press 45° Street Elbow

P x Ftg



PART NO.	SIZE	CTN/MSTR
C77053	1/2" x 1/2"	10/450
C77054	3/4" x 3/4"	10/260
C77055	1" x 1"	5/140
C77056	1-1/4" x 1-1/4"	1/70
C77057	1-1/2" x 1-1/2"	1/40
C77058	2" x 2"	1/25
C77059	2-1/2" x 2-1/2"	1/18
C77060	3" x 3"	1/12
C77061	4" x 4"	1/6

Copper Press 90° Elbow

P x P



PART NO.	SIZE	CTN/MSTR
C77062	1/2" x 1/2"	10/350
C77063	3/4" x 3/4"	10/180
C77064	1" x 1"	5/100
C77065	1-1/4" x 1-1/4"	1/55
C77066	1-1/2" x 1-1/2"	1/35
C77067	2" x 2"	1/18
C77068	2-1/2" x 2-1/2"	1/12
C77069	3" x 3"	1/9
C77070	4" x 4"	1/4

CF

Copper Press 90° Street Elbow

P x Ftg



PART NO.	SIZE	CTN/MSTR
C77071	1/2" x 1/2"	10/400
C77072	3/4" x 3/4"	10/200
C77073	1" x 1"	5/100
C77074	1-1/4" x 1-1/4"	1/55
C77075	1-1/2" x 1-1/2"	1/35
C77076	2" x 2"	1/20
C77077	2-1/2" x 2-1/2"	1/14
C77078	3" x 3"	1/9
C77079	4" x 4"	1/4

Copper Press Cap

P



PART NO.	SIZE	CTN/MSTR
C77218	1/2"	10/450
C77219	3/4"	10/450
C77220	1"	5/250
C77221	1-1/4"	1/100
C77222	1-1/2"	1/80
C77223	2"	1/55
C77224	2-1/2"	1/40
C77225	3"	1/36
C77226	4"	1/24

Copper Press Female Adapter

P x FPT



PART NO.	SIZE	CTN/MSTR
C77149	1/2" x 1/2"	10/300
C77173	3/4" x 1/2"	10/180
C77150	3/4" x 3/4"	10/150
C77151	1" x 1"	10/180
C77152	1-1/4" x 1-1/4"	1/80
C77153	1-1/2" x 1-1/2"	1/55
C77154	2" x 2"	1/40
C77155	1/2" x 3/4"	10/180
C77159	1" x 3/4"	10/200
C77162	1-1/4" x 1"	1/100

Copper Press Female Fitting Adapter

FTG x FPT



PART NO.	SIZE	CTN/MSTR
C77165	1/2" x 1/2"	5/250
C77166	3/4" x 3/4"	5/150
C77167	1" x 1"	1/110
C77168	1-1/4" x 1-1/4"	1/80
C77169	1-1/2" x 1-1/2"	1/55
C77170	2" x 2"	1/40

Copper Press Male Adapter

P x MPT



PART NO.	SIZE	CTN/MSTR
C77174	1/2" x 1/2"	10/300
C77175	3/4" x 3/4"	10/160
C77176	1" x 1"	10/160
C77177	1-1/4" x 1-1/4"	1/100
C77178	1-1/2" x 1-1/2"	1/50
C77179	2" x 2"	1/35
C77180	2-1/2" x 2-1/2"	1/28
C77181	3" x 3"	1/18
C77182	4" x 4"	1/12
C77183	1/2" x 3/4"	10/180
C77185	3/4" x 1/2"	10/180
C77186	1" x 1-1/4"	10/100
C77187	1" x 3/4"	10/180
C77188	1-1/4" x 1-1/2"	1/55
C77189	1-1/4" x 1"	1/95
C77190	1-1/2" x 1-1/4"	1/55

Copper Press Male Fitting Adapter

FTG x MPT



PART NO.	SIZE	CTN/MSTR
C77191	1/2" x 1/2"	5/250
C77199	3/4" x 1/2"	5/180
C77192	3/4" x 3/4"	5/160
C77193	1" x 1"	5/200
C77194	1-1/4" x 1-1/4"	1/80
C77195	1-1/2" x 1-1/2"	1/60
C77196	2" x 2"	1/40

CF

Copper Press Fitting Reducer

P x Ftg



PART NO.	SIZE	CTN/MSTR
C77131	3/4" x 1/2"	10/400
C77132	1" x 1/2"	10/300
C77133	1" x 3/4"	10/240
C77134	1-1/4" x 1"	5/150
C77135	1-1/4" x 3/4"	5/170
C77136	1-1/2" x 1-1/4"	1/70
C77137	1-1/2" x 1"	1/70
C77138	2" x 1-1/2"	1/40
C77139	2" x 1-1/4"	1/50
C77140	2" x 1"	1/50
C77141	2-1/2" x 2"	1/35
C77142	3" x 2-1/2"	1/24
C77143	3" x 2"	1/24
C77144	4" x 3"	1/10
C77145	4" x 2-1/2"	1/10
C77146	4" x 2"	1/12

Copper Press Tee

P x P x P



PART NO.	SIZE	CTN/MSTR
C77080	1/2" x 1/2" x 1/2"	10/200
C77081	3/4" x 3/4" x 3/4"	10/120
C77082	1" x 1" x 1"	5/70
C77083	1-1/4" x 1-1/4" x 1-1/4"	1/45
C77084	1-1/2" x 1-1/2" x 1-1/2"	1/25
C77085	2" x 2" x 2"	1/15
C77086	2-1/2" x 2-1/2" x 2-1/2"	1/10
C77087	3" x 3" x 3"	1/7
C77088	4" x 4" x 4"	1/4
C77091	3/4" x 1/2" x 3/4"	5/120
C77092	3/4" x 3/4" x 1/2"	10/140
C77093	3/4" x 1/2" x 1/2"	10/150
C77094	1" x 3/4" x 1"	5/70
C77095	1" x 1/2" x 1"	5/80
C77096	1" x 1" x 3/4"	5/80
C77097	1" x 3/4" x 3/4"	5/100
C77098	1" x 1" x 1/2"	5/100
C77099	1" x 3/4" x 1/2"	5/100
C77100	1-1/4" x 1-1/4" x 1"	1/50
C77101	1-1/4" x 1" x 1"	1/50
C77102	1-1/4" x 1-1/4" x 3/4"	1/55
C77103	1-1/4" x 1" x 3/4"	1/45
C77104	1-1/4" x 1-1/4" x 1/2"	1/60
C77105	1-1/2" x 1-1/2" x 1-1/4"	1/30
C77106	1-1/2" x 1-1/4" x 1-1/4"	1/30
C77107	1-1/2" x 1-1/2" x 1"	1/35
C77108	1-1/2" x 1-1/2" x 3/4"	1/35
C77109	2" x 2" x 1-1/4"	1/20
C77110	2" x 2" x 1-1/2"	1/16
C77113	2-1/2" x 2-1/2" x 2"	1/12
C77114	3" x 3" x 2-1/2"	1/7
C77115	3" x 3" x 2"	1/10
C77116	4" x 4" x 3"	1/4
C77117	4" x 4" x 2-1/2"	1/4
C77118	4" x 4" x 2"	1/6

Brass Male Adapter

C x M



PART NO.	SIZE	CTN/MSTR
K101010050	1/2"	50/200
K101010100	3/4"	25/150
K101010295	1-1/2" cast	10/50
K101010390	2" cast	5/50

Brass Female Adapter

C x F



PART NO.	SIZE	CTN/MSTR
K101050100	3/4"	25/150

Brass Drain Coupling with Cap

C x C



PART NO.	SIZE	CTN/MSTR
K101750100	3/4" cast	25/200

Brass 90° Flanged Sink Elbow

C x F



PART NO.	SIZE	CTN/MSTR
K102600050	1/2"	25/100

Brass 90° Drop Elbow

C x F



PART NO.	SIZE	CTN/MSTR
K102590050	1/2"	25/200
K102590058	1/2" x 3/8"	25/200

Brass 90° Elbow

C x M



PART NO.	SIZE	CTN/MSTR
K102550050	1/2"	50/200
K102550058	1/2" x 3/8"	50/250
K102550100	3/4"	25/150
K102550150	1"	10/80

C x F



PART NO.	SIZE	CTN/MSTR
K102570050	1/2"	50/250
K102570058	1/2" x 3/8"	25/250
K102570100	3/4"	25/100
K102570107	3/4" x 1/2"	25/200
K102570150	1"	10/50

Brass Drop Tee

C x C x C



PART NO.	SIZE	CTN/MSTR
K104670050	1/2"	25/250

C x C x F



PART NO.	SIZE	CTN/MSTR
K104820050	1/2"	25/150

CF

Brass Tee

C x C x F



PART NO.	SIZE	CTN/MSTR
K104800050	1/2"	25/200
K104800057	1/2" x 1/2" x 3/4"	25/200
K104800058	1/2" x 1/2" x 3/8"	25/200
K104800100	3/4"	10/100
K104800107	3/4" x 3/4" x 1/2"	25/100
K104800159	1" x 1" x 3/4"	10/80
K104800160	1" x 1" x 1/2"	10/100
K104800222	1-1/4" x 1-1/4" x 1" cast	1/25
K104800223	1-1/4" x 1-1/4" x 3/4"	10/50
K104800224	1-1/4" x 1-1/4" x 1/2"	10/50

C x F x C



PART NO.	SIZE	CTN/MSTR
K104920050	1/2"	25/300
K104920100	3/4"	10/100

F x F x C



PART NO.	SIZE	CTN/MSTR
K104980118	3/4" x 1/2" x 1/2"	10/100

Brass Baseboard Tee

C x F x C

CF



PART NO.	SIZE	CTN/MSTR
K104920143	3/4" x 1/8" x 3/4"	25/100

Brass Union

C x M



PART NO.	SIZE	CTN/MSTR
K126610050	1/2"	25/200
K126610100	3/4"	10/100
K126610150	1"	10/50
K126610215	1-1/4"	5/30
K126610295	1-1/2"	1/50
K126610390	2"	1/25

C x F



PART NO.	SIZE	CTN/MSTR
K126650050	1/2"	25/200
K126650100	3/4"	25/100
K126650150	1"	10/100
K126650215	1-1/4"	5/40
K126650295	1-1/2"	1/50

Wrot DWV Male Adapter

C x M



PART NO.	SIZE	CTN/MSTR
161010295	1-1/2"	10/100
161010390	2"	5/100

Wrot DWV Female Adapter

C x F



PART NO.	SIZE	CTN/MSTR
161050215	1-1/4"	150/150
161050295	1-1/2"	10/100
161050390	2"	10/100

Wrot DWV Test Cap



PART NO.	SIZE	CTN/MSTR
161570050	1/2"	1/1
161570100	3/4"	1/1
161570150	1"	400/400
161570215	1-1/4"	50/600
161570295	1-1/2"	50/600
161570390	2"	50/100
161570650	3"	25/200

Wrot DWV Tee

C x C x C



PART NO.	SIZE	CTN/MSTR
164600390	2"	16/16
164600398	2" x 1-1/2"	5/50

Wrot DWV Coupling with Stop

C x C



PART NO.	SIZE	CTN/MSTR
161650215	1-1/4"	25/250
161650295	1-1/2"	130/130
161650303	1-1/2" x 1-1/4"	25/300
161650390	2"	250/250
161650398	2" x 1-1/2"	10/100
161650399	2" x 1-1/4"	10/100
161650650	3"	80/80
161650663	3" x 2"	5/100

Wrot DWV Coupling less Stop

C x C



PART NO.	SIZE	CTN/MSTR
161720215	1-1/4"	25/200
161720295	1-1/2"	25/200
161720390	2"	100/100
161720650	3"	1/1

Wrot DWV 90° Elbow

C x C



PART NO.	SIZE	CTN/MSTR
162350215	1-1/4"	80/80
162350295	1-1/2"	40/40
162350390	2"	20/20

Wrot DWV 90° Long Turn Elbow

C x C



PART NO.	SIZE	CTN/MSTR
162420295	1-1/2"	1/1

Wrot DWV 90° Street Elbow

Ftg x C



PART NO.	SIZE	CTN/MSTR
162540215	1-1/4"	200/200
162540295	1-1/2"	50/50
162540390	2"	50/50

Wrot DWV 45° Elbow

C x C



PART NO.	SIZE	CTN/MSTR
162900215	1-1/4"	120/120
162900295	1-1/2"	60/60
162900390	2"	30/30
162900650	3"	2/2

Wrot DWV 45° Street Elbow

Ftg x C



PART NO.	SIZE	CTN/MSTR
162950215	1-1/4"	120/120
162950295	1-1/2"	60/60
162950390	2"	30/30

Wrot DWV Fitting Reducer

Ftg x C



PART NO.	SIZE	CTN/MSTR
164100303	1-1/2" x 1-1/4"	25/250
164100398	2" x 1-1/2"	10/100
164100399	2" x 1-1/4"	1/1
164100663	3" x 2"	1/50
164100664	3" x 1-1/2"	5/50

CF

Cast DWV Male Adapter

C x M



PART NO.	SIZE	CTN/MSTR
K201010215	1-1/4"	10/300
K201010295	1-1/2"	10/100
K201010390	2"	60/60
K201010650	3"	1/20

Cast DWV Female Adapter

C x F



PART NO.	SIZE	CTN/MSTR
K201050295	1-1/2"	10/150
K201050650	3"	1/25

Cast DWV Soil Pipe Adapter

C x Spg



PART NO.	SIZE	CTN/MSTR
K201100390	2"	50/50

Cast DWV Fitting Cleanout

Ftg x Cleanout with Plug



PART NO.	SIZE	CTN/MSTR
K201610215	1-1/4"	120/120
K201610295	1-1/2"	1/100
K201610390	2"	60/60

Cast DWV Flush Fitting Cleanout

Ftg x Cleanout with Plug



PART NO.	SIZE	CTN/MSTR
K201620215	1-1/4"	25/25
K201620650	3"	25/25

Cast DWV 90° Elbow

C x C



PART NO.	SIZE	CTN/MSTR
K202350398	2" x 1-1/2"	25/25
K202350650	3"	10/10

Cast DWV 22-1/2° Elbow

C x C



PART NO.	SIZE	CTN/MSTR
K203100295	1-1/2"	1/1

Cast DWV Tee

C x C x C



PART NO.	SIZE	CTN/MSTR
K204600215	1-1/4"	50/50
K204600295	1-1/2"	60/60
K204600390	2"	25/25
K204600398	2" x 1-1/2"	40/40
K204600414	2" x 1-1/2" x 1-1/2"	50/50

Cast DWV Test Tee

C x C x Cleanout with Plug



PART NO.	SIZE	CTN/MSTR
K204850295	1-1/2"	1/50
K204850390	2"	1/25

Cast DWV Double Tee

C x C x C x C



PART NO.	SIZE	CTN/MSTR
K204650295	1-1/2"	25/25
K204650390	2"	1/25
K204650398	2" x 1-1/2"	1/1

CF

Cast DWV Wye

C x C x C



PART NO.	SIZE	CTN/MSTR
K208400215	1-1/4"	1/1
K208400295	1-1/2"	1/50
K208400303	1-1/2" x 1-1/4"	1/1
K208400390	2"	1/25
K208400398	2" x 1-1/2"	1/50
K208400413	2" x 1-1/2" x 2"	1/50
K208400664	3" x 3" x 1-1/2"	1/1

Cast DWV Double Wye

C x C x C x C



PART NO.	SIZE	CTN/MSTR
K208450295	1-1/2"	1/50
K208450650	3"	1/10

Cast DWV P-Trap

C x C



PART NO.	SIZE	CTN/MSTR
K245500295	1-1/2"	1/1
K245500390	2"	1/20

C x SJ



PART NO.	SIZE	CTN/MSTR
K245540295	1-1/2"	1/25

Cast DWV P-Trap with Cleanout

C x C x Cleanout with Plug



PART NO.	SIZE	CTN/MSTR
K245510295	1-1/2"	20/20
K245510390	2"	1/25

125# Cast Brass Companion Flange with A.S.M.E. Drilling

Copper Sweat



PART NO.	SIZE	CTN/MSTR
K113420215	1-1/4"	45/45
K113420520	2-1/2"	12/12
K113420650	3"	6/6
K113420860	4"	6/6

150# Cast Brass Companion Flange with A.S.M.E. Drilling

Copper Sweat



PART NO.	SIZE	CTN/MSTR
K113450650	3"	6/6
K113450860	4"	3/3

- IAPMO & NSF-61 CERTIFICATIONS
- MEETS STRICT ANSI SPECS
- MATERIAL SPECIFICATIONS TO ASTM B88
- CARTON QUANTITIES ONLY

NOMINAL PLUMBING TO REFRIGERATION HVAC

NOMINAL (I.D.) PLUMBING SIZE	REFRIGERATION (O.D.) HVAC SIZE
1/8"	1/4"
1/4"	3/8"
3/8"	1/2"
5/8"	3/4"
3/4"	7/8"
1"	1-1/8"
1-1/4"	1-3/8"
1-1/2"	1-5/8"
2"	2-1/8"
2-1/2"	2-5/8"
3"	3-1/8"
4"	4-1/8"

CF

TOILET SEATS

Wood Seats 375-377

Plastic Seats 378-382

Soft Seats 382

Acrylic Seats..... 383

Replacement Hardware 383

TS

*Published December 2019

TOP SELLING JONES STEPHENS TOILET SEATS

GOOD • BETTER • BEST

REFERENCE CHART

PART CODE (R/E)	FEATURES	CATEGORY	IMAGES			
RESIDENTIAL WOOD SEATS						
U003WD00 / U004WD00	Adjustable Hinge	GOOD		GOOD	BETTER	BEST
C013WD00 / C014WD00	Adjustable Hinge	BETTER				
C023WD00 / C024WD00	Adjustable Hinge, QuickClean®	BEST				
RESIDENTIAL PLASTIC SEATS						
C101000 / C101100	Adjustable Hinge	GOOD		GOOD	BETTER	BEST
C803200 / C803300	Adjustable Hinge	BETTER				
C160600 / C220000	Adjustable Hinge, QuickClean®	BEST				
SLOW-CLOSE RESIDENTIAL PLASTIC SEATS						
C1106S00 / C1107S00	Adjustable Hinge, Slow-Close	GOOD		GOOD	BETTER	BEST
C1606S00 / C2200S00	Adjustable Hinge, QuickClean®, Slow-Close	BETTER				
(Elongated Only) C8019S00	Adjustable Hinge, QuickClean®, Slow-Close	BEST				
COMMERCIAL PLASTIC SEATS (ELONGATED ONLY)						
C106C00	Check Hinge	BETTER		BETTER	BEST	
C106SSC00	Self-Sustaining Check Hinge	BETTER				
C108C00	Check Hinge	BEST				
C108SSC00	Self-Sustaining Check Hinge	BEST				

All Jones Stephens toilet seats listed have four color-matched bumpers.



Premium Molded Wood

- Durable molded wood
 - Stainless steel pintel on C023 and C024 seats
 - Adjustable
 - QuickKlean® adjustable hinges on specified models
 - Multi-coat high gloss enamel paint
 - Beveled lid
 - Four color-matched bumpers
 - Color-matched hinges
 - Stainless steel screws
- Non-skid rubberized pads
 - Corrosion resistant mounting hardware

IDEAL FOR:

- Manufactured Housing
- Residential
- Apartments
- Condos

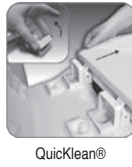

NOTE: Existing standard hinges will change to QuickKlean® upon depletion of existing inventory.

With Color-Matched QuickKlean® Hinges - Closed Front with Cover

ROUND	ELONGATED	SEAT / HINGE COLOR
C023WD00	C024WD00	White / White
C023WD01	C024WD01	Bone / Bone
C023WD02	C024WD02	Biscuit / Biscuit
C023WD04	C024WD04	Cotton White / Cotton White

See inside back cover for available seat and hinge color swatches.



For Vortens® Toilets - Closed Front with Cover

ROUND	ELONGATED	SEAT / HINGE COLOR
—	U300V00	White / White

See inside back cover for available seat and hinge color swatches.

* The manufacturer's names are used only to describe which toilets the seats will fit. The seats are not manufactured by those companies.

Deluxe Molded Wood

- Durable molded wood
- Adjustable
- Slow-Close feature on specified models
- Multi-coat high gloss enamel paint
- Beveled lid
- Four color-matched bumpers
- Color-matched hinges
- Stainless steel screws
- Non-skid rubberized pads
- Corrosion resistant mounting hardware

IDEAL FOR:

- Manufactured Housing
- Offices
- Residential
- Apartments
- Condos
- Restaurants
- Dormitories



With Plastic Color-Matched Hinges - Closed Front with Cover

ROUND	ELONGATED	SEAT / HINGE COLOR
C013WD00	C014WD00	White / White
C013WD01	C014WD01	Bone / Bone
C013WD02	C014WD02	Biscuit / Biscuit
C3B4R220	C014WD20	Venetian Pink / Venetian Pink
C3B4R230	C014WD30	Fawn Beige / Fawn Beige
C3B4R240	C014WD40	Dresden Blue / Dresden Blue
C3B4R245	C014WD45	Regency Blue / Regency Blue
C3B4R250	C014WD50	Citron Yellow / Citron Yellow
C3B4R253	—	Harvest Gold / Harvest Gold
C3B4R290	C014WD90	Black / Black

See inside back cover for available seat and hinge color swatches.



NOTE: Existing bar hinges will change to single post hinges upon depletion of existing inventory.

With Decorative Metal Hinges - Closed Front with Cover

ROUND	ELONGATED	SEAT / HINGE COLOR
C013WD00CH	C014WD00CH	White / Chrome
—	C014WD00BN	White / Brushed Nickel
C3B4R201BN	—	Bone / Brushed Nickel
C3B4R290CH	C3B4E290CH	Black / Chrome

See inside back cover for available seat and hinge color swatches.



Slow-Close with Plastic Color-Matched Hinges - Closed Front with Cover

ROUND	ELONGATED	SEAT / HINGE COLOR
C013WDS00	C014WDS00	White / White

See inside back cover for available seat and hinge color swatches.

Items marked with the Jones Stephens logo are "You Need It... We Got It" Items.

TS

Deluxe Molded Wood (cont.)

- Durable molded wood
- Adjustable
- Slow-Close feature on specified models
- Multi-coat high gloss enamel paint
- Beveled lid
- Four color-matched bumpers
- Color-matched hinges
- Stainless steel screws
- Non-skid rubberized pads
- Corrosion resistant mounting hardware

IDEAL FOR:

- Manufactured Housing
- Offices
- Residential
- Apartments
- Condos
- Restaurants
- Dormitories



Hinge Color Matched to Seat

With Plastic Color-Matched Hinges - Open Front with Cover

ROUND	ELONGATED	SEAT / HINGE COLOR
C013WDO00	C014WDO00	White / White

See inside back cover for available seat and hinge color swatches.

Standard Molded Wood

- Durable molded wood
- Multi-coat high gloss enamel paint
- Color-matched hinges and bumpers
- Stainless steel screws
- Corrosion resistant mounting hardware

IDEAL FOR:

- Manufactured Housing
- Residential
- Apartments
- Condos



Hinge Color Matched to Seat

With Plastic Color-Matched Hinges - Closed Front with Cover

ROUND	ELONGATED	SEAT / HINGE COLOR
C001WD00	C002WD00	White / White
C001WD01	C002WD01	Bone / Bone

See inside back cover for available seat and hinge color swatches.

Utility Molded Wood

- Durable molded wood
- Adjustable
- Multi-coat high gloss enamel paint
- Color-matched hinges and bumpers
- Stainless steel screws
- Non-skid rubberized pads
- Corrosion resistant mounting hardware

IDEAL FOR:

- Manufactured Housing
- Residential
- Apartments
- Condos



Decorative Metal Hinges

NOTE: Existing bar hinges will change to single post hinges upon depletion of existing inventory.

Sculpted with Decorative Metal Hinges - Closed Front with Cover

ROUND	ELONGATED	SEAT / HINGE COLOR
C3B4R400CH	—	White Bead Board / Chrome

See inside back cover for available seat and hinge color swatches.



Hinge Color Matched to Seat

With Plastic Color-Matched Hinges - Closed Front with Cover

ROUND	ELONGATED	SEAT / HINGE COLOR
U003WD00	U004WD00	White / White

See inside back cover for available seat and hinge color swatches.

TS

Square Front for Eljer® New Emblem™ Toilets with Plastic Color-Matched Hinges - Closed Square Front with Cover

ROUND	ELONGATED	SEAT / HINGE COLOR
C049WD00	C050WD00	White / White

See inside back cover for available seat and hinge color swatches.

* The manufacturer's names are used only to describe which toilets the seats will fit. The seats are not manufactured by those companies.

Decorative Piano Finish, Solid Oak

- Solid oak construction
- Sealed with 1 mil of high gloss polyurethane
- PVD hinge
- Four color-matched bumpers
- Corrosion resistant mounting hardware

IDEAL FOR:

- Manufactured Housing
- Residential
- Apartments
- Condos



Decorative Metal Hinges

NOTE: Existing bar hinges will change to single post hinges upon depletion of existing inventory.

With Decorative Metal Hinges - Closed Front with Cover

ROUND	ELONGATED	SEAT / HINGE COLOR
C2B1R16CH	C2B1E16CH	Mahogany Finish / Chrome
C2B1R16BR	C2B1E16BR	Mahogany Finish / Brass
C2B1R16BN	C2B1E16BN	Mahogany Finish / Brushed Nickel
C2B1R17CH	C2B1E17CH	Natural Oak / Chrome
C2B1R17BR	C2B1E17BR	Natural Oak / Brass
C2B1R17BN	C2B1E17BN	Natural Oak / Brushed Nickel
C2B1R18CH	C2B1E18CH	Dark Brown Finish / Chrome
C2B1R18BN	C2B1E18BN	Dark Brown Finish / Brushed Nickel
C2B1R19CH	C2B1E19CH	Walnut Finish / Chrome
C2B1R19BN	C2B1E19BN	Walnut Finish / Brushed Nickel

See inside back cover for available seat and hinge color swatches.

Decorative Natural Finish, Solid Oak

- Slow-Close feature on specified models
- Sealed with polyurethane
- Four color-matched bumpers
- Corrosion resistant mounting hardware

IDEAL FOR:

- Manufactured Housing
- Residential
- Apartments
- Condos



Decorative Metal Hinges

NOTE: Existing bar hinges will change to single post hinges upon depletion of existing inventory.

With Decorative Metal Hinges - Closed Front with Cover

ROUND	ELONGATED	SEAT / HINGE COLOR
C3B2R117CH	—	Light Oak Finish / Chrome
C3B2R117BR	C3B2E117BR	Light Oak Finish / Brass
C3B2R117BN	C3B2E117BN	Light Oak Finish / Brushed Nickel
C3B2R118CH	C3B2E118CH	Dark Brown Finish / Chrome
—	C3B2E118BN	Dark Brown Finish / Brushed Nickel
—	C3B2E115BN	Cherry Finish / Brushed Nickel

See inside back cover for available seat and hinge color swatches.

Decorative Piano Finish, Solid Bamboo

- Sealed with 1 mil of high gloss polyurethane
- Four color-matched bumpers
- Corrosion resistant mounting hardware

IDEAL FOR:

- Manufactured Housing
- Residential
- Apartments
- Condos



Decorative Metal Hinges

NOTE: Existing bar hinges will change to single post hinges upon depletion of existing inventory.

With Decorative Metal Hinges - Closed Front with Cover

ROUND	ELONGATED	SEAT / HINGE COLOR
C3B2R220BN	C3B2E220BN	Natural Bamboo / Brushed Nickel

See inside back cover for available seat and hinge color swatches.



Decorative Metal Hinges



Slow-Close

Slow-Close with Decorative Metal Hinges - Closed Front with Cover

ROUND	ELONGATED	SEAT / HINGE COLOR
C2B1RS19CH	C2B1ES19CH	Natural Black Walnut / Chrome

See inside back cover for available seat and hinge color swatches.

Premium Residential Plastic

- Injection molded durable polypropylene plastic with UV protection
- QuickKlean® adjustable hinges on specified models
- Slow-Close feature on specified models
- Beveled lid
- Four molded-in color-matched bumpers
- Color-matched hinges
- Non-skid rubberized pads
- Corrosion resistant mounting hardware

IDEAL FOR:

- Manufactured Housing
- Residential
- Apartments
- Condos
- Schools
- Offices
- Hotels
- Restaurants
- Dormitories



NOTE: Existing standard hinges will change to QuickKlean® upon depletion of existing inventory.

Slow-Close with Color-Matched QuickKlean® Hinges - Closed Front with Cover

ROUND	ELONGATED	SEAT / HINGE COLOR
C1606S00	C2200S00	White / White
C1606S01	C2200S01	Bone / Bone
C1606S02	C2200S02	Biscuit / Biscuit
—	C2200S04	Cotton White / Cotton White
—	C2200S90	Black / Black

See inside back cover for available seat and hinge color swatches.



NOTE: Existing standard hinges will change to QuickKlean® upon depletion of existing inventory.

With Color-Matched QuickKlean® Hinges - Closed Front with Cover

ROUND	ELONGATED	SEAT / HINGE COLOR
C160600	C220000	White / White

See inside back cover for available seat and hinge color swatches.



NOTE: Existing standard hinges will change to QuickKlean® upon depletion of existing inventory.

Slow-Close with Color-Matched QuickKlean® Hinges - Closed Front with Cover

ROUND	ELONGATED	SEAT / HINGE COLOR
C3B3RSL00	C3B3ESL00	White / White

See inside back cover for available seat and hinge color swatches.

TS

* The manufacturer's names are used only to describe which toilets the seats will fit. The seats are not manufactured by those companies.

Items marked with the Jones Stephens logo are "You Need It... We Got It" Items.

Deluxe Residential Plastic

- Injection molded durable polypropylene plastic with UV protection
- QuickKlean® adjustable hinges on specified models
- Slow-Close feature on specified models
- Adjustable
- Four molded-in bumpers
- Color-matched hinges and bumpers
- Non-skid rubberized pads
- Corrosion resistant mounting hardware

IDEAL FOR:

- Manufactured Housing
- Residential
- Apartments
- Condos
- Offices
- Portable Toilets



With Color-Matched Hinges - Closed Front with Cover

ROUND	ELONGATED	SEAT / HINGE COLOR
C104100	C104200	White / White

See inside back cover for available seat and hinge color swatches.



NOTE: Existing standard hinges will change to QuickKlean® upon depletion of existing inventory.

Slow-Close with Color-Matched QuickKlean® Hinges - Closed Front with Cover

ROUND	ELONGATED	SEAT / HINGE COLOR
C1210S00	C1211S00	White / White
—	C1211S02	Biscuit / Biscuit

See inside back cover for available seat and hinge color swatches.



Square Front for Eljer®* New Emblem™ Toilets with Color-Matched Hinges - Closed Square Front with Cover

ROUND	ELONGATED	SEAT / HINGE COLOR
—	C105000	White / White

See inside back cover for available seat and hinge color swatches.



Slow-Close Square Front for Eljer®* New Emblem™ Toilets with Color-Matched Hinges - Closed Square Front with Cover

ROUND	ELONGATED	SEAT / HINGE COLOR
—	C1050S00	White / White
—	C1050S01	Bone / Bone

See inside back cover for available seat and hinge color swatches.

Standard Residential Plastic

- Injection molded durable polypropylene plastic with UV protection
- QuickKlean® adjustable hinges on specified models
- Slow-Close feature on specified models
- Adjustable
- Four molded-in color-matched bumpers
- Color-matched hinges
- Non-skid rubberized pads
- Corrosion resistant mounting hardware

IDEAL FOR:

- Manufactured Housing
- Residential
- Apartments
- Condos
- Schools
- Offices
- Hotels
- Restaurants
- Dormitories
- Portable Toilets



Hinge Color Matched to Seat

With Color-Matched Hinges - Closed Front with Cover

ROUND	ELONGATED	SEAT / HINGE COLOR
C803200	C803300	White / White
C803201	—	Bone / Bone

See inside back cover for available seat and hinge color swatches.



Hinge Color Matched to Seat



Slow-Close

Slow-Close with Color-Matched Hinges - Closed Front with Cover

ROUND	ELONGATED	SEAT / HINGE COLOR
C1106S00	C1107S00	White / White

See inside back cover for available seat and hinge color swatches.

Builder Grade Residential Plastic

- Injection molded durable polypropylene plastic with UV protection
- Adjustable
- Four molded-in color-matched bumpers
- Color-matched hinges
- Non-skid rubberized pads
- Corrosion resistant mounting hardware
- Truck packs available on specified models (Box of 10 individually shrink wrapped seats separated by cardboard slats)

IDEAL FOR:

- Manufactured Housing
- Residential
- Apartments
- Condos
- Offices
- Portable Toilets



Hinge Color Matched to Seat

With Color-Matched Hinges - Closed Front with Cover

ROUND	ELONGATED	SEAT / HINGE COLOR
C101000	C101100	White / White
C101001	C101101	Bone / Bone
C101002	C101102	Biscuit / Biscuit

Truck Pack

ROUND	ELONGATED	SEAT / HINGE COLOR
C1010TK00	C1011TK00	White / White

See inside back cover for available seat and hinge color swatches.

Items marked with the Jones Stephens logo are "You Need It... We Got It" Items.

Utility Grade Residential Plastic

- Injection molded durable polypropylene plastic with UV protection
- Adjustable
- Four molded-in color-matched bumpers
- Color-matched hinges
- Corrosion resistant mounting hardware
- Truck packs available on specified models (Box of 10 individually shrink wrapped seats separated by cardboard slats)

IDEAL FOR:

- Manufactured Housing
- Apartments
- Condos
- Portable Toilets



Hinge Color Matched to Seat

With Color-Matched Hinges - Closed Front with Cover

ROUND	ELONGATED	SEAT / HINGE COLOR
U100500	U100600	White / White
—	U100800	White / White

Truck Pack

ROUND	ELONGATED	SEAT / HINGE COLOR
—	U1008TK00	White / White

See inside back cover for available seat and hinge color swatches.

Extra Heavy Duty Commercial Plastic

- Injection molded durable polypropylene plastic with UV protection
- External color-matched check hinge
- Four molded-in color-matched bumpers
- Extra heavy duty weight and posture curve design
- Ergonomic design
- 304 grade stainless steel hinge post and hardware
- Anti-skid rubberized bushings
- Concealed hinges

IDEAL FOR:

- Service Stations
- Public Restrooms
- Hospitals
- Hotels
- Assisted Living
- Offices
- Correctional Institutes
- Park Facilities
- Schools
- Stadiums
- Airports



Hinge Color Matched to Seat

With Color-Matched Check Hinge - Open Front less Cover

ROUND	ELONGATED	SEAT / HINGE COLOR
—	C110C00	White / White

See inside back cover for available seat and hinge color swatches.

TS

Heavy Duty Commercial Plastic

- Injection molded durable polypropylene plastic with UV protection
- External color-matched check hinge
- Four molded-in color-matched bumpers
- Heavy duty weight
- 304 grade stainless steel hinge post and hardware
- Anti-skid rubberized bushings
- Concealed hinges
- Self-sustaining feature available on specified models

IDEAL FOR:

- Service Stations
- Public Restrooms
- Hospitals
- Hotels
- Assisted Living
- Offices
- Correctional Institutes
- Park Facilities
- Schools
- Stadiums
- Airports



Deluxe Heavy Duty Commercial Plastic

- Injection molded durable polypropylene plastic with UV protection
- QuicKlean® adjustable hinges
- Slow-Close feature on specified models
- Adjustable
- Four molded-in color-matched bumpers
- Color-matched hinges
- Corrosion resistant mounting hardware
- Stainless steel pintels
- Anti-skid rubberized pads
- Stainless steel posts

IDEAL FOR:

- Public Restrooms
- Offices
- Airports
- Manufactured Housing
- Portable Toilets
- Residential
- Condos
- Apartments



NOTE: Existing standard hinges will change to QuicKlean® upon depletion of existing inventory.

With Color-Matched Check Hinge - Open Front less Cover

ROUND	ELONGATED	SEAT / HINGE COLOR
—	C108C00	White / White

With Color-Matched Self-Sustaining Check Hinge - Open Front less Cover

ROUND	ELONGATED	SEAT / HINGE COLOR
—	C108SSC00	White / White

With Color-Matched Self-Sustaining Check Hinge - Open Front less Cover

ROUND	ELONGATED	SEAT / HINGE COLOR
—	C108SSCAM00	White / White

See inside back cover for available seat and hinge color swatches.

Slow-Close with Color-Matched Hinges - Closed Front with Cover

ROUND	ELONGATED	SEAT / HINGE COLOR
—	C8019S00	White / White

See inside back cover for available seat and hinge color swatches.

Got To Have It!

Deluxe Commercial Plastic Slow-Close with Chrome Plated Check Hinge - Open Front less Cover

- Injection molded durable polypropylene plastic with UV protection
- Slow-Close damper system minimizes risk of cracked toilet bowls from slamming seats
- Hinge functions as both a standard check and self-sustaining check model
- Chrome finish metal hinge for ease of cleaning and hygienic requirements
- Hinges are completely hidden under the seat to minimize risk of pinching
- No pinching of fingers – Safer for children in schools, nurseries, and daycares
- 304 stainless steel non-corrosive hardware
- Perfect for Health Care/Assisted Living/Hospitality environments
- Anti-skid rubberized bushing/washer prevents movement and loosening of seat



ROUND	ELONGATED	SEAT / HINGE COLOR
—	C106CEZ00	White / Chrome

See inside back cover for available seat and hinge color swatches.

TS

Deluxe Commercial Plastic

- Injection molded durable polypropylene plastic with UV protection
- External color-matched check hinge
- Four molded-in color-matched bumpers
- 304 grade stainless steel hinge post and hardware
- Anti-skid rubberized bushings
- Concealed hinges
- Self-sustaining
- Fire retardant on specified models

IDEAL FOR:

- Service Stations
- Public Restrooms
- Hospitals
- Hotels
- Assisted Living
- Offices
- Correctional Institutes
- Park Facilities
- Schools
- Stadiums
- Airports



With Color-Matched Check Hinge - Open Front less Cover

ROUND	ELONGATED	SEAT / HINGE COLOR
C105C00	C106C00	White / White
—	C106C90	Black / Black

With Color-Matched Self-Sustaining Check Hinge - Open Front less Cover

ROUND	ELONGATED	SEAT / HINGE COLOR
C105SSC00	C106SSC00	White / White
—	C106SSC01	Bone / Bone
—	C106SSC90	Black / Black

With Color-Matched Self-Sustaining Check Hinge - Open Front less Cover

ROUND	ELONGATED	SEAT / HINGE COLOR
—	C106SSCAM00	White / White
—	C106SSCAM90	Black / Black

Fire Retardant with Color-Matched Self-Sustaining Check Hinge - Open Front less Cover

ROUND	ELONGATED	SEAT / HINGE COLOR
—	C106SSCAMFR0	White / White

See inside back cover for available seat and hinge color swatches.

Standard Commercial Plastic

- Injection molded durable polypropylene plastic with UV protection
- External color-matched check hinge
- Four molded-in color-matched bumpers
- Anti-skid rubberized bushings
- Concealed hinges

IDEAL FOR:

- Portable Toilets
- Hospitals
- Assisted Living



With Color-Matched Check Hinge, Plastic and Stainless Steel Hardware - Open Front less Cover

ROUND	ELONGATED	SEAT / HINGE COLOR
—	C106CHPM00	White / White

See inside back cover for available seat and hinge color swatches.

Items marked with the Jones Stephens logo are "You Need It...We Got It" Items.

Commercial Baby Bowl Plastic

- Injection molded durable polypropylene plastic with UV protection
- External color-matched check hinge
- Four molded-in color-matched bumpers
- 304 grade stainless steel hinge post and hardware
- Anti-skid rubberized bushings
- Concealed hinges
- Self-sustaining

IDEAL FOR:

- Schools
- Public Family Restrooms



With Color-Matched Self-Sustaining Check Hinge - Open Front less Cover

ROUND	ELONGATED	SEAT / HINGE COLOR
C100BBSSCAM0	—	White / White

See inside back cover for available seat and hinge color swatches.

Premium Commercial/Institutional Plastic

- Injection molded durable polypropylene plastic with UV protection
- Slow-Close feature on specified models
- Adjustable
- Four molded-in color-matched bumpers
- Color-matched hinges
- Corrosion resistant mounting hardware
- Anti-skid rubberized pads
- Fire retardant on specified models
- Stainless steel posts

IDEAL FOR:

- Public Restrooms
- Schools
- Hospitals
- Airports
- Hotels
- Restaurants
- Offices
- Dormitories



With Color-Matched Hinges and Stainless Steel Hinge Posts - Closed Front with Cover

ROUND	ELONGATED	SEAT / HINGE COLOR
C1606HPSS00	C2200HPSS00	White / White

Fire Retardant with Color-Matched Hinges and Stainless Steel Hinge Posts - Closed Front with Cover

ROUND	ELONGATED	SEAT / HINGE COLOR
—	C2200HPSSAMF	White / White

See inside back cover for available seat and hinge color swatches.



Slow-Close with Color-Matched Hinges - Open Front with Cover

ROUND	ELONGATED	SEAT / HINGE COLOR
C1606OS00	C2200OS00	White / White

TS

Premium Heavy Duty Commercial Plastic

- Injection molded durable polypropylene plastic with UV protection
- Slow-Close feature on specified models
- QuickKlean® adjustable hinges on specified models
- Adjustable
- Four molded-in color-matched bumpers
- Color-matched hinges
- Corrosion resistant mounting hardware
- Stainless steel pintels
- Anti-skid rubberized pads
- Stainless steel posts

IDEAL FOR:

- Public Restrooms
- Offices
- Airports
- Manufactured Housing
- Portable Toilets
- Residential
- Condos
- Apartments



Hinge Color Matched to Seat

With Color-Matched Hinges - Closed Front with Cover

ROUND	ELONGATED	SEAT / HINGE COLOR
C801800	—	White / White

See inside back cover for available seat and hinge color swatches.

Light Duty Commercial Plastic

- Injection molded durable polypropylene plastic with UV protection
- Adjustable
- Four molded-in color-matched bumpers
- Color-matched hinges
- Corrosion resistant mounting hardware
- Extra large pintels
- Anti-skid rubberized pads

IDEAL FOR:

- Public Restrooms
- Portable Toilets
- Hotels
- Offices
- Schools
- Airports
- Restaurants
- Dormitories



Hinge Color Matched to Seat

With Color-Matched Hinges - Open Front with Cover

ROUND	ELONGATED	SEAT / HINGE COLOR
—	C8033000	White / White

Standard and Deluxe Soft Seats

- Standard is constructed using high density vinyl
- Deluxe is constructed using heavy duty embossed vinyl
- UV paint color protection
- QuickKlean® adjustable hinges on specified models
- Color-matched hinges
- Four color-matched bumpers

- Adjustable
- Non-skid rubberized pads
- Corrosion resistant mounting hardware

IDEAL FOR:

- Manufactured Housing
- Apartments
- Condos
- Residential



Hinge Color Matched to Seat



QuickKlean®

NOTE: Existing standard hinges will change to QuickKlean® upon depletion of existing inventory.

Deluxe with Solid Wood Core and Color-Matched QuickKlean® Hinges - Closed Front with Cover

ROUND	ELONGATED	SEAT / HINGE COLOR
C3B5R200	C3B5E200	White / White
C3B5R201	C3B5E201	Bone / Bone
C3B5R260	—	Forest Green / Forest Green

See inside back cover for available seat and hinge color swatches.



Decorative Metal Hinges

NOTE: Existing bar hinges will change to single post hinges upon depletion of existing inventory.

Deluxe with Solid Wood Core and Decorative Metal Hinge-Closed Front with Cover

ROUND	ELONGATED	SEAT / HINGE COLOR
C3B5R200CH	C3B5E200CH	White / Chrome

See inside back cover for available seat and hinge color swatches.

Designer Acrylic

- Clear acrylic
- Life-like embedded objects
- Corrosion resistant mounting hardware
- Four clear bumpers

IDEAL FOR:

- Manufactured Housing
- Apartments
- Condos
- Residential



Decorative Metal Hinges

NOTE: Existing bar hinges will change to single post hinges upon depletion of existing inventory.

Aquarium with Decorative Metal Hinges - Closed Front with Cover

ROUND	ELONGATED	SEAT / HINGE COLOR
C2B6R9AQCH	—	Aquarium / Chrome

See inside back cover for available seat and hinge color swatches.



Decorative Metal Hinges

NOTE: Existing bar hinges will change to single post hinges upon depletion of existing inventory.

Seahorse with Decorative Metal Hinges - Closed Front with Cover

ROUND	ELONGATED	SEAT / HINGE COLOR
C2B6R9SHCH	—	Seahorse / Chrome

See inside back cover for available seat and hinge color swatches.

Replacement Hardware



C200HPSS



C200HEX

Hinge Post Hardware

PART NO.	DESCRIPTION	MATERIAL
C200HPSS	For all top mounts except C001WD, C002WD, C1005	Stainless Steel
C200HEX	Hinge post hardware for all top mounts except C001WD, C002WD, C1005	White Plastic



C306CHPSS00



C406SSCHPSS00

Hinge Post Hardware

PART NO.	DESCRIPTION	MATERIAL
C306CHPSS00	Hinge pack for check hinge toilet seat (white only)	304 Stainless
C406SSCHPSS00	Hinge pack for self-sustaining check hinge toilet seat (white only)	304 Stainless

2CanCaddy™	294	Trap	67
3' Chrome Plated Brass Cover Tubes	134	Twist To Lock	144
3-N-1		Wrot DWV	369
Tubing Bender	299	Wrot Female, Copper	357
4-Way		Wrot Male, Copper	357
Countersunk Plug Wrench	276	Adhesive, Plumber's Goop	294
Key	275	Aerator	
P.O. Plug Wrench	276	Chicago Style Faucet	72
6-Way Countersunk Plug Wrench	276	Counter Display	72
8-1/2" Pan Commercial Drains	192	Non-Slotted .5 GPM	72
45° Flare Tube Fittings		Non-Slotted Full Flow	72
Female Flare Swivel	135	Non-Slotted Reduced Flow	72
Flare Cap	135	Six Pack Tubes For Counter Display	72
Flare Elbow	136	Slotted 2.2 GPM Flow	72
Flare Plug	135	Slotted Full Flow	72
Flare Tee	135	Slotted Reduced Flow	72
Flare Union	135	Snap Fitting	73
Flare x FIP Coupling	136	Spring-Flo	73
Flare x MIP Branch Tee	135	Swivel Spray	73
Flare x MIP Half Union	136	Vandal-Proof	73
Long Flare Nut	135	Air Cock	161
Short Flare Nut	135	Air Gap	
Short Forged Flare Nut	135	Chrome Plated ABS	65
A		Cover	5, 65
Access Fittings	225	Decorative	5
Snap-in Access Fittings	225	Dishwasher Kit	65
Access Panel		Spacer	65
Plastic	91	Air Pump	
Snap-Ease	91	Economy	279
Spring Loaded	91	Air Valve	164
Acid Brushes	292	Air Vent, Plumb Aire	65
Acrylic Tub And Tile Caulk	290	Aluminum Bar for Waste and Overflow	62
Actuator Unit		Anchor	
for American Standard	46	Drop-In Concrete	128
Adapter Bushing	341	Anchor Bolt Kit	126
Adapter		Angle Compression Stop Wrench	276
Black Plastic PEX	141	Angle Stop	22-24
Brass Compression	133	Angle Valve	
Brass Hose Barb	153	Plastic Push On	145
Brass PEX	140	Aqualine Replacement Handles	74
Cast DWV	370	Aqua Seal Washer	44
Cast Iron Spigot, PVC DWV	341	Area Drain	221
Faucet	73	Assembly	64
Faucet To Garden Hose	73	ABS Pop-Up	64
Female Adapter	335	Brass Pop-up	64
Female, PVC DWV	335	Brass Pop-up, Replacement Parts	64
Fitting C.O. Adapter, w/Plug	335	Chrome Plated ABS Pop-Up	64
Forged Brass/Cast Pressure	367	Delta Style Spray	69
Garden Hose, Twist To Lock	144	Lift & Lock Pop-Up	64
Hub Adapter for Cast Iron, PVC DWV	341	B	
Insert, Galvanized	158	Backflow Preventer	164
Insert Male Rope, Red Brass	157	Backflow Preventer/Sewer Stopper	77
Insert, Nylon	155	Backnut	
Insert, Poly	156	Black Malleable	347
Insert, Red Brass	157	Backwater Valve	
Male Adapter	335	Flat Top Vent Cap	235
Male, PVC DWV	335	Mushroom Vent Cap	235
No Hub Adapter	341	Plastic Over-Fitting Repair Fitting	235
No Hub for Cast Iron, PVC DWV	341	PVC Coupling	235
Nylon	154	Spigot Adapter	235
PlumbBite	142	Cast Iron	268
Press Fitting, Female	365	Extension Kit	234
Press Fitting, Male	365	Flapper with Gasket	234
Soil Pipe	370	Ballcock	
Spigot Adapter	341	And Flush Valve Repair Parts for Mansfield	46
Sweat Male	68	Coupling Nut And Locknut	66

Mansfield Style 45
 Mansfield Style, With Float Rod 45
 Repair Parts for American Standard 46
 Repair Parts For American Standard 46
 Repair Parts for Amerline/Hoov-R-Line 46
 Repair Parts for Coast 46
 Repair Parts For Coast 46
 Repair Parts for Fluidmaster 46
 Repair Parts For Fluidmaster 46
 Repair Parts For Hoover/Amerline 46
 Repair Parts for Kohler 46
 Repair Parts For Kohler 46
 Repair Parts for Mansfield 46

Ball Valve
 Brass Broiler Drain Valve 163
 Brass PEX 140
 CPVC 164
 Gas 162
 Gas Heater 162
 Gas, Texas Pattern 162
 PlumBite 143
 PVC 164

Bar
 Digging/Tamping 284
 Gooseneck Wrecking 284
 Utility Pry 284

Bar Faucet 33

Bar Plug, Brass 71

Bar Tap Faucet 4, 69

Basin
 And Tub Stopper 58
 Cock Locknut 66
 Crumb Cups 72
 Faucet 81
 Self-Closing and Shower Valve 82
 Nut 66

Basket Strainer
 ABS Body And Post 71
 ASAP, Chrome Plated 70
 Chrome Plated Brass Duo 71, 330
 Decorative 3
 Deep Cup 70, 330
 Deep Junior Duo 4, 71, 331
 Duo 70, 330
 Flat Duplex 331
 Flat Top Grid 70, 330
 Junior Duo 71, 331
 Locknuts And Washers 66
 Quick Fit Stainless Steel 70, 331
 Replacement Strainer 70, 331
 Shallow Cup Duo 70, 330
 Snap Lock 70, 330
 Snap N Lock Stainless Steel 331
 Stainless Steel 71
 Stainless Steel Deep Cup 71, 331
 Stainless Steel Duo 71, 330
 Stainless Steel Duo Post Style 330
 Twist And Lock 70
 Twist & Lock 330

Bath Accessories 34-35

Bathcock
 for Clawfoot Tub 55
 Repair Kit 55

Bath Drain 12-13, 57, 58-59
 Adapter Bushing 57

Bathroom Fan Vent Kit 99

Bathroom Faucet 30-31

Bath Supplies, Offset 55

Bathtub Protector 57

Bathtub Protectors 57

Bath Waste
 ABS Tubular 326
 and Overflow Test Kit 62
 Cable Drive, ABS Tubular 326
 Cable Drive, PVC Tubular 326
 Conversion Kit 62
 PVC Tubular 326
 Rough-In, Schedule 40 62
 Rough-In, Schedule 40 With Test Kit 62
 Schedule 40 Kit 60, 61
 Trim Kit 62

Batteries 301

Bell Reducer 138

Bell Trap
 Inside Caulk, Cast Iron 263
 No Hub, Cast Iron 263
 Pittsburgh, Cast Iron 263
 Spigot Outlet, Cast Iron 263

Bibb Seat Tool Set 278

Bit
 Holders 290
 Phillips 290

Blower, Industrial Utility 301

Boiler Gauge
 Dual Scale 113

Bolt
 Stove Bolt with Nut 125
 Toggle Bolt 125

Bore O-Ring 95

Boxes
 Bin 130
 Cardboard Tub 130
 Plastic Tub 130
 Shipping 130

Box Wrench 278

Bracket
 Carrier 118
 Extruded Hole Copper Plated 118
 Extruded Notches Copper Plated 118
 Flat Copper Plated 118
 Galvanized 119
 Galvanized L 119
 Galvanized Lockright 119
 Galvanized Lockright Pipe-CPVC 119
 Pipe 118
 Water Closet-Copper Clad 119

Brass Float Rod 45

Brass Lift Wire Guide 44

Brass Needle Valves 159

Brass Nipples 21

Brass Overflow Tube 45

Brass Plumb Bob 288

Brass P.O. Plug Drain 64

Brass Saddle Clamp 159

Brazing Rod 288

Bronze Locknuts 148

Bronze Pipe Fittings
 Bushing 149
 Cap 148
 Coupling/ Reducer 149
 Cross 149
 Elbow 148

Extension Piece	149	Shipping Boxes	130
Locknut	148	Tub Box	130
Plug	149	Carrier Bracket	118
Tee	148	Carrier Nuts and Washer Set	126
Union	148	Cast Iron Commercial Drain Components	249
Brush		Caulk	
4-N-1 Copper Tube Fitting	279	100% Silicone	290
Acid	292	Acrylic Tub And Tile	290
Chip	292	Fire Seal-136 Firestopping	291
Copper Fitting	280	Gun	291
Female Copper Tube	279	Hi-Temp Red Silicone	291
Long Handle Wire with Scraper	292	Latex	290
Wire	292	Siliconized Acrylic	290
Brute® Containers	295	Caulking Tools	
Bubbler		Broad Curve Nose	284
Drinking Fountain82	Gun	291
Drinking Fountain With Face Guard82	Gun, Professional	291
Retrofit Kit82	Inside	284
Bucket Caddies	295	Outside	284
Bushing		Short Nose	284
Adapter, For Bath Drain57	Caution Tape	297
Brass Trap55	Ceiling Flange	127
Bronze	149	Ceiling Plates, Floor and76
Chrome Plated	150	Flexible76
HEX, Black Malleable345	Center Outlet Tee	
HEX, Yellow Brass139	Chrome Plated Brass315
Twin Elbow And Face55	PVC320
Wrot Flush, Copper	357,360	Center Outlet Waste	
Yellow Brass139	ABS323
Bushing for Qwik Tees and Qwik Elbows95	Chrome Plated Brass316
Buttons		PVC320
Faucet Index74	Check Valves	164
Single Handle Replacement74	Chip Brush	292
C		Chrome Elbow	134
Cable Drive Full Kit17	Chrome Plated Brass	
Cable Ties	298	End Outlet Tee315
Caddies		Chrome Plated Compression Fittings	
1/2" & 3/4" Combo Nipple	294	3' Chrome Plated Brass Cover Tubes	134
2CanCaddy	294	Connector	134
Bucket	295	Elbow	134
Fitting Tote Tray	294	Pilot Line Breakaway Nut	134
Plastic Nipple	294	Sweat Adapter	134
Steel Nipple Tray	294	Union	134
Tool Totes	295	Chrome Plated Nipples & Pipe Lengths	150
Utility Tote Tray	294	Chrome Plated Pipe Fittings	
Camouflage Strap With Hooks	298	Bushing	150
Cam Strap	298	Cap	150
Canvas Drop Cloth	302	Coupling	150
Cap		Elbow	150
45° Flare Tube Fitting	135	Plug	150
Black Malleable345	Reducer	150
Brass Compression133	Tee	150
Bronze	148	Union	150
Chrome Plated	150	Chrome Plated Sink Trap with ABS Adapter	314
Garden Hose, Nylon	154	Chrome Union	134
Plastic Push On	145	Clamp	
PlumBite	143	2-Hole Pipe	122
Press Fitting365	Full	121
PVC DWV337	Half	122
Space Heater Fitting	137	Insulating/Suspension	122
Test369	Oetiker, PEX	141
Test, Wrot DWV369	Stainless Steel Repair Clamp91
Wrot, Copper359	Universal Beam Clamp	126
Yellow Brass	138	Cleanout	
Cardboard Box		Cast DWV370
Bin Boxes	130	Test Tee, PVC DWV338

Two-Way Tee, PVC DWV 339

Cleanout And Relief Valve

Sewer 77

Cleanout Bodies 258

Cleanout Covers 262

Cleanout Plugs

Countersunk Cleanout Plugs 224

Drainable Cleanout Test Plug 224

Raised Head Cleanout Plugs 224

Cleanouts

Commercial

Access Cover Adjustable, Cast Iron 257

Adjustable, Cast Iron 256

Cleanout Ferrule, Cast Iron 255

Components

Gasket Connection Base, Cast Iron 259

Metal Spud with Round Cover 230, 231, 259

No Hub Base, Cast Iron 258

No Hub Cleanout Body, Cast Iron 258

Plain End Cleanout, Cast Iron 258

Plastic Spud with Cover and Square Top 259

Plastic Spud with Round Cover 230, 231, 259

Plastic Spud with Square Cover 230, 231

Spud with Cover, Cast Iron 259

Replacement Covers 231

Heavy Duty, Cast Iron 257

Hub Fit Base 226

Inside Pipe Fit 229

No Hub Adjustable, Cast Iron 256

No Hub, Cast Iron 254

Over Pipe Fit 227

Pipe Fit 227

Plain End Adjustable, Cast Iron 256

Plain End, Cast Iron 255

Plumb Lock Adjustable, Cast Iron 255

Push-On Adjustable, Cast Iron 256

Push-On, Cast Iron 254

Countersunk Plug with Insert 224

Cover 262

Dome Cover Plate 262

Fit-Flush 224

Fit-Flush Cleanout 224

General Purpose 224

General Purpose Access Fitting 225

General Purpose Cleanouts 224

Heavy Duty 223

Heavy Duty Internal Pipe Cleanout 223

Hub Fit 224

Hub Fit Cleanout with Countersunk Brass Plug 224

Hub/Fitting 223

Hub/Fitting Cleanouts 223

Inside Pipe Fit 222

Internal Cleanout w/SS Cover 225

Internal Pipe 223

Internal Pipe Cleanout 223

Internal with SS Cover 225

Plug

Code Pattern 261

New Orleans Code 260

Extension Cover Set 261

for Extension Cover 261

Heavy Pattern 260

Lead Fit-All 260

Slotted 261

Southern Code 260

Sewer Relief Plug 225

Snap-in Access Fitting 225

Test Tee with Plug 225

Trap Cover 262

Cleanout Spuds 259

Cleanout Tee 339

Close Nipple 139

Closet Bend 340

PVC DWV 340

Closet Bolts

Bulk Packed 48

Cap 49

Component Parts 49

Custom Packed 48

Display Bucket 47

Elite Packs 49

Enduro 47

Snap-Off 49

with Tinnerman Nuts 47

Closet Flange

4-Way Offset 176

Brass 240

Brass Four Way Offset 240

Code Blue 239, 240

Extender 177

Extension Kit 177

Flange Support for Wood Floors 240

Gapper Flange 240

Gapper Repair Flange 178

Inside Caulk 239

No Caulk 239

No Hub 239

Offset 176, 240

Over Schedule 30 Pipe 176

Plumbfit 176

Repair Flange 240

Repair Ring 177, 240

Ring 177

Two Finger Flange 239

Urinal Flange 177

Closet Flange Extender 177

Closet Flange Extension Kit 178

Closet Flange Repair Ring 240

Closet Flush Elbow 318

Chrome Plated Brass 318

Closet Screws 50

Closet Spud 43

Friction Ring 44

Washer 43

Closet Supply 23-24

Closet Wedge Shims 47, 178

Flexible and Rigid Super Shims 47

Cloth Inserted Plunger Disc 293

Coast Ballcock Repair Parts 46

Combination Lock 303

Commercial 64

Grid Drain Without Overflow Holes 64

Handicap Drain With Elbow 64

Lav Drain 64

Commercial Cleanouts, Adjustable 226

Commercial Cleanouts, Residential and Light 223

Commercial Drain Base 211-212

Heavy Duty Bases 212

Heavy Duty Bases with Clamping Ring 212

Hub Fit Bases 212

Inside Pipe Fit Base 211

Pipe Fit Base 211

Slab Drain Bases	212	Forged Brass/Cast Pressure	367
Commercial Pipe/Hub Fit Adapter Drains	185	Heavy Duty No Hub	308
Commercial Sponges	302	Import Heavy Duty No Hub	309
Companion Flanges, Cast Brass		Import No Hub	309
125# w/A.S.M.E. Drilling	371	Insert, Galvanized	158
150# w/A.S.M.E. Drilling	371	Insert, Nylon	155
Compression Branch Tee	133	Insert, Poly	156
Compression Cap	133	Insert, Red Brass	157
Compression Connector	133	Medium Duty No Hub	308
Compression Coupling		Merchant, Black Malleable	352
Bronze91	No Hub	308
CPVC92	Plastic Push On	145
Malleable Iron91	PlumBite	142
PVC91	Press Fitting	364
Compression Elbow	134	PVC DWV	335
Compression Nuts	133	PVC Expansion92
Compression Sleeve	133	Reducing, Banded Black Malleable	346
Compression Sleeve Puller	277	Wrot DWV	369
Adapter	277	Wrot Reducing, Copper	358
Compression Tee	133	Yellow Brass	138
PVC92	Cover69
Compression Union	133	Repair Plates, Stainless Steel77
Compression x Sweat Adapter	133	Coverall, Disposable	297
Condensate Trap	234	Coveralls, Replacement	215
Conduit Hangers	126	Cover Plates8, 77
Connector		Cover, Toilet Tank47
Brass Compression	133, 134	Cover Tubes	
Flexible Trap Drain95, 329	Brass Compression	134
Gas83	Crimping Tools	
Hose Grip Clothes Washer96	Polybutylene	285
Plastic Push On	145	Crimp Ring	
Screw-On Wire	301	Brass PEX	141
Twist To Lock	144	Cross	149
Waste	67, 329	Banded, Black Malleable	347
Contoured Shower Rod52	Bronze	149
Contractor's Choice29-35	Cross, Banded	347
Conversion Kit - 2 hole	10-11	Cross Handle Self Closing Valve81
Conversion Kit - One hole10	Crumb Cups, Sink and Basin72
Conversion Kits62	Curb Box Wrench	278
Bath Waste62	Curved Jaw Tongue & Groove Pliers	289
With Cross Bar62	Cutting Oil	301
Cool Gel®	293	D	
Copper	280	Deburring Tool	286
4-N-1 Tube Fitting Brush	279	Delrin Compression Sleeve	133
Cleaning Pads	299	Delta74
Female Tube Brush	279	Faucet Index Buttons74
Fitting Brush	280	Replacement Handles74
Sizing Tool	285	Dielectric Union	109
Swedge Tool	285	Flanged	109
Copper Pipe Hangers - Bell & Milford Types	126	Gasket and Insert	110
Copper Refill Tube44	Digging/Tamping Bar	284
Copper Sizing Tool	285	Dishwasher Connection	
Copper Stub Out	116-118	PVC	321
Corded Square Head Plug	149	Dishwasher Kit65
Coupling		Dishwasher Repair96
45° Flare Tube	136	Dishwasher Drain Connector96
Banded, Black Malleable	345	Dishwasher Hose96
Black Plastic PEX	141	Dishwasher Tailpiece	324
Brass PEX	140	ABS	324
Bronze	149	Chrome Plated Brass	318
Chrome Plated	150	PVC	321
Compression91	Dispenser, Soap and Lotion69
CPVC Compression92	Disposable	296
Crossover	358	Coverall	297
Drain, with Cap	367, 368	Vinyl Gloves	296
Flexible Transition95	Disposal Assembly3

Disposer Kit 318, 324
 ABS 324
 Chrome Plated 318
 PVC 322
Disposer Kit w/13" Arm 322
Disposer Kit w/Adjustable Arm 322, 325
Disposer Kit with Adjustable Arm
 PVC 322
Diverter Spout 9-10
 7" Chrome Plated 55
 Add-A-Shower 54
 Chrome Plated 55, 56
 Chrome Plated Slip-On, With Polished Brass Knob 55
 Extension 56
 Slip-On 55
Do All Plumbers Wrench 278
Double Flange Extension 324
 ABS 324
 PVC 322
Double Flange Tailpiece
 Chrome Plated Brass 316
Double Offset 316
 Chrome Plated Brass 316
Double Offset Tailpiece
 PVC 322
Double Slip Fittings 67, 318, 322
 PVC 322
Drainable Cleanout Test Plug 224
Drain Bodies 250
Drain Cleaner, Floweasy 293
Drain Cock 161
Drain King 94
Drain Opener
 Drain King Mini Snake 293
 Liquid Lightning Pro 293
Drains
 4-Way Area Drain 221
 Bell Trap 220
 Bell Trap with Hinged Lid 221
 Brass Inside Caulk Floor 253
 Bronze Shower 246
 Cast Iron Commercial Drains 244
 Caulk Cesspool with Recessed Grate, Cast Iron 264
Commercial
 Components 211
 Coveralls 215
 Funnels 216
 Green Drain Waterless Trap Seal 216
 Heavy Duty Base 212
 Heavy Duty Base with Clamping Ring 212
 Hub Fit Base 212
 Inside Pipe Fit Base 211
 Metal Spud with Round Strainer 213, 214, 215
 Metal Spud with Square Strainer 214
 Pipe Fit Base 211
 Plastic Spud with 7" Square Top and Round Strainer 213, 214, 215
 Plastic Spud with Round Strainer 213, 214
 Plastic Spud with Square Strainer 213
 Replacement Strainer for Metal Spud 215
 Rings 215
 Slab Drain Base 212
 Spud Extension 216
 Strainers 215
 Inside Pipe Fit 189, 190
 Over Pipe Fit 186, 187, 188
 Pipe Fit 185, 186

Slab Drain with 8-1/2" Pan 199, 200, 201, 202, 203, 204, 205
 with 8-1/2" Pan 192, 193, 194, 195, 196, 197, 198
 with 10" Pan 206, 207, 208, 209, 210
Components
 Gasket Connection Base, Cast Iron 250
 Heavy Duty Drain Base, Cast Iron 249
 IPS Drain Base, Code Blue 249
 Metal Spud with Round Strainer 251
 Metal Spud with Square Strainer 251
 No Caulk Mechanical Joint Drain Base, Code Blue 249
 No Caulk Mechanical Joint Slab Drain Base, Code Blue 250
 No Hub Base, Cast Iron 250
 No Hub Drain Base, Code Blue 249
 No Hub Slab Drain Base 250
 Plastic Spud with Square Strainer 250
 Push-On Drain Base, Code Blue 250
 Spud Extension, Cast Iron 250
 Spud with Round Strainer, Cast Iron 250
 Floor Drain with Trap 221
General Purpose
 Area Drain 221
 Area Drain, Cast Iron 252
 Backwater Device 253
 Combination Drain Trap 253
 Des Moines Pattern Floor Drain 253
 Floor Drain with Trap 253
 Gasket Connection Drain, Cast Iron 252
 Heavy Duty Traffic Floor Drain 218, 219
 Kentucky Drain, Cast Iron 252
 Plastic Snap-In 219
 Snap-In 220
 Snap-In Strainer 220
 Socket Ring 220
 St. Louis Drain, Cast Iron 253
 Urinal Drain Flange Kit 253
 with Long Body 217
 Inside Caulk Floor/Shower, Heavy Duty 246, 247
 Inside Pipe Fit 222
 IPS Floor, Code Blue 247, 248
 IPS Floor Drain, Code Blue 245
 No Caulk Floor Drain, Code Blue 244
 No Caulk Mechanical Joint Cesspool, Code Blue 264
 No Caulk Mechanical Joint Floor, Code Blue 246, 248
 No Caulk Slab Mechanical Joint, Code Blue 244
 No Hub Floor, Code Blue 247, 248
 No Hub Floor Drain, Code Blue 245
 No Hub Floor/Shower, Heavy Duty 246, 247
 No Hub Slab, Code Blue 247, 248
 No Hub Slab Drain, Code Blue 245
 Non-Adjustable, Code Blue 242
 Push-On Floor, Code Blue 245, 248
 Rainleader Cesspool, Cast Iron 264
 Replacement Strainer, Code Blue 242
 Roman Tub, Code Blue 241
 Roman Tub Replacement Strainer, Code Blue 242
 Roof Drain, Code Blue 266
 Roof Drains, Accessories for 236
 Roof Drain with Cast Iron Dome 236, 266
 Roof Drain with Plastic Dome 236
 Round Slop Sink, Hydrant Cesspool, Cast Iron 264
 Shower 242, 243
 FIP 253
 Inside Caulk 253
 IPS 253
 Square Cesspool Grate, Cast Iron 264
 Square Hydrant Cesspool, Cast Iron 264

Utility	220	Insert, Red Brass	157
Drain, Three Prong Protector	72	Nylon	154
Dresser Coupling	91, 92	PlumBite	142
Drill Bits	286	Press Fitting	364
Carbide Tipped Masonry	286	P-Trap, PVC DWV	340
Dual Auger Wood	286	PVC DWV	335
Flat "Paddle" Wood	287	Qwik	95
Straight Shank	287	Reducing, Banded Black Malleable	346
Drinking Fountain		Twist To Lock	144
Bubbler and Cartridge	82	Union, Twist To Lock	144
Bubbler With Face Guard	82	Wrot, Copper	359
Cross Handle Self Closing Valve	81	Wrot DWV	369
Retrofit Bubbler Kit	82	Yellow Brass	138
Self-Closing	82	Eljer Replacement Handles	74
Drop Cloth	302	Ells	
Drop Cord Light	300	22 1/2°	366, 370
Drop Ear	68	45°	360, 369
Elbow	68	Street	360, 369
Drop-In Concrete Anchor	128	90°	364, 367, 369, 370
Dryer Repair		Flanged Sink	367
Aluminum Ducting		Hi-Ear	367
Flexible Aluminum	98	Long Turn	369
Flexible Aluminum Foil	98	Short Turn Street	359
Proflex Aluminum Foil	98	Street	369
Aluminum Elbow and Pipe	98	Enclosed Feed Tube Cutter	281
Flexible Duct Connector Kit	98	End Outlet Tee	
Increaser/Decreaser	98	ABS	323
Vent		End Outlet Tee Only	315, 323
Aluminum Hood	97	End Outlet Waste	315, 323
Complete Dryer Vent Kit	98	ABS	323
Dryer Vent Hood	97	Chrome Plated Brass	315
Dryer Vent Hose	98	PVC	320
Dryer Vent Kit w/Louvered Hood	98	Engineers Hammer	284
Indoor Dryer Vent Kit	98	Escutcheon	332
Louvered Dryer Vent Hood	98	Escutcheons	
Metal Clamp for Dryer Vent	98	Plastic Shallow Flange	76
Dual Flush Toilet Kit	46	Poly Bagged	75
Ducting		Sure Grip	75
Flexible Aluminum	98	Expansion Coupling	92
Proflex Aluminum Foil	98	PVC	92
Duct Straps	298	PVC Expansion Coupling	92
Duo Basket Strainer	3	Expansion Joint	341
Junior	3	Expansion Tank	109
Duracell® Alkaline Batteries	301	Extension Cord	300
Dust Masks	297	Extension Cord Power Block	300
E		Extension Hose	94
Ear Plugs, Ready Fit Corded	297	Extension Piece	149, 345
Earthquake Strap	121	Black Malleable	345
Elbow	335, 336, 337	Bronze	149
45° Flare Tube	136	Extension Tube	6, 317, 319, 322, 324
Banded, Black Malleable	347	ABS	324, 325
Black Plastic PEX	141	Chrome Plated Brass	317
Brass Compression	134	PVC	321, 322
Brass Hose Barb	153	Rough Brass	319
Brass PEX	140	Extract-a-Drain Tub Drain Removal Tool	276
Bronze	148	E-Z	299
Cast DWV	364, 370	Light	299
Chrome Plated	150	Reach	299
Double, PVC DWV	337	E-Z Anchor/Self-Drilling Wall Board	125
Drop Ear	68	E-Z Shear Inside Pipe Cutter	280
Drop Ear, Brass PEX	141	F	
Flanged Sink, Forged Brass/Cast Pressure	367	Face Bushing	55, 139
Forged Brass/Cast Pressure	367	Face Plate Gasket	57
Hi-Ear, Forged Brass/Cast Pressure	367	Fan	
Insert, Nylon	155	Industrial Utility Blower	301
Insert, Poly	156	Faucet	29-33, 69, 276

Adapters73
 Bar Tap69
 Basin81
 Self-Closing and Shower Valve82
Bathroom
 Two Handle74, 75
 Ceramic Cartridge75
 Index Buttons74
 Laundry Tray81
 Long Reach Bar Tap69
 Replacement Handle73-75
 Seat Repair Kit276
 Seat Wrench276
 Seat Wrench For Recessed Seats276
 Service Sink82
 Stem and Seats75
 Wall Mount Sink81
Faucet And Valve Grease, Plumber's294
Faucet Handle Pullers277
 E-ZEE Pull Deluxe277
Faucet Hole Cover4, 5, 69
Faucet Seat68
Faucet Seat Kit68
Faucet To Garden Hose Adapters73
Female Copper Tube Brush279
Female Coupling
 Space Heater Fitting137
Female Flare Swivel135
F.H.A. Strap116
F.H.A. Tub Hanger122
Files289
Fill Valve
 Integral Float45
 Korky45
Fire Seal-136 Firestopping Caulk291
Firestop 814+ Intumescent Firestopping Sealant291
Fit-All58
 Basket Strainer70
 Kitchen Hose And Spray69
 Replacement Handles73
 Stopper58
Fitting Cleanout370
Fitting Cleanout, Flush370
Fitting Plug360
Fitting Reducer369
Fittings, Double Slip67, 318
Flange
 Cast Brass371
Flange Connection Gasket167
Flanged Tailpiece319, 322, 325
 PVC322
 Rough Brass319
Flanges52
 Jumbo Shower Bar52
 Shower Arm53
 Shower Rod52
Flange Support240
Flapper42, 43
 2 Way, with Separate Trunion42
 Carded Blue Vinyl42
 Jumbo ToTo Style42
 Korky42
Flare Elbow136
Flare Tees135
Flare Union135
Flare x FIP Coupling136

Flare x MIP Branch Tee135
Flare x MIP Half Union136
Flaring Tools286
 Swing Release286
Flashlights
 Rayovac Industrial300
Flat Duplex Strainer71
Flat Top Vent Cap235
Flexible Discharge Hose123
Flexible Drain Trap96
Flexible Floor And Ceiling Plates21
Flexible PVC Saddle Fitting95
Flexible Transition Coupling95
Flexible Trap Drain Connector95, 329
Flint Striker288
 Three Flint Friction Lighter288
Flip-It58
Flip-It Conversion Kit11
Flip-It Tub Stopper13
Float Ball42
Float Rod45
Floor & Ceiling Plates
 Flexible Plastic76
 Heavy 21 Gauge76
 Light 24 Gauge76
Floor Drain179, 180, 181, 221
 with Trap221
Floor Drains244-248
Floor Flange347
 Black Malleable347
Floor Sink
 Aluminum Bottom Dome For Cast Iron Sink265
 Plumlock Porcelain265
 Porcelain Coated265
Floor Sinks
Aluminum Dome Strainers
 for Floor Sinks233
 Complete PVC Floor Sink Kits232
 Complete PVC Floor Sink Kits-Pipe Fit233
Flat Aluminum Bottom Strainer
 for Floor Sinks233
 Full Top Grate for Floor Sinks233
 Half Top Grate for Floor Sinks233
 Round Slop Sink232
 Three-Quarters Top Grate for Floor Sinks233
Flow Restrictor54
Flush Bushing335
 PVC DWV335
Flush Fitting Cleanout370
Flush Valve
 Douglas45
 Dual Flush Kit46
 for American Standard46
 Mansfield #21045
 Pipe Support65
 Repair Parts for Mansfield46
 Shank Washer44
Flux Paste288
Foundation and Roof Coating123
Freeze Fix Pipe Jackets289
Friction Ring
 Brass67
 Closet Spud44
Full Clamp121
Funnels251
Funnels, for Shower/Floor Drains216

G	
Galvanized Insert Fittings	158
Insert Adapter	158
Insert Coupling	158
Gapper Flange	178, 240
Garbage Disposal	71, 301
Cords	301
Splash Guard	72
Stopper	71
Wiring Kits	301
Wrench	275
Garbage Disposal Wiring Kit	301
Garden Hose Fittings	
Adpater	151
Cap	152
Evaporation Cooler Drain	152
Filter Washer	152
Hose Barb	152
Shut Off	152
Swivel	152
Washer	152
WYE	152
Garden Hoses	279
Gas Ball Valve	162, 163
Gas Burners	
2-Way Combo Log Lighter Valve	271
Log Lighter Burner Bar	270
Log Lighter Keys and Accessories	271
Log Lighter Valves	270
Log Lighter Valve with T-Burner	271
Rectangular Burner	270
Round Burner	270
“T” Burner Bar	270
Two Leg Burner	270
Gas Connectors	
Black Coated	87
1/2" OD	87
3/8" OD	87
Coated	83
1/2" OD with Fittings	86
3/8" OD with Fittings	83
5/8" OD with Fittings	85
Uncoated	83
3/8" OD with Fittings	83
5/8" OD with Fittings	84
Gas Heater Valves	162
Gasket	
Asbestos- Free Full Face Gasket	167
Asbestos- Free Ring Gasket	167
Circulator Flange Gasket Pair	168
Dual Tite	307
Dual Tite Buna N “Nitrile”	307
Face Plate	57
Materials	168
Multi-Tite	307
Radiant Seal Sponge Rubber Closet Gasket	51
Red Rubber Full Face Gasket	167
Red Rubber Ring Gasket	167
Shoe	57
Sponge Closet	44
Tank to Bowl	51
Wax	51
Gasket Kits	167
Gasket Material	168
Gas Line Marking Labels	299
Gas Range Fittings	137
Gas Shut-Off Valve	160
Gate Valve Key	285
Gear Clamps	
“68” Series Stainless	166
Full Size	166
Micro Size	165
Replacement Clamp For Flexible Coupling	165
Stainless Steel	166
General Purpose Drain	217–218
General Purpose/Utility Drains	217
Glasses, Safety	297
Hellraiser	297
Nemesis	297
Visio	297
Gloves	
All Purpose Latex Palm/Mesh Back	296
Anti-Vibration Synthetic Leather	295
Blue Nitrile	295
Brown Jersey	296
Disposable Blue Latex	296
Drivers’ Style Leather	296
Economy Brown Jersey	296
Industrial Rubber	296
Leather Palm Work	296
Nitrile	295
Polyester Nitrile Dipped Palm	295
Vinyl	296
Vinyl Disposable	296
White Cotton with Grippers	296
Goggles, Clear Safety	297
Gooseneck Bar Faucet	33
Grab Bar	
Fastening System	63
With Concealed Snap-On Flange	63
With Exposed Flange	63
Grab-It Tool	299
Gradient Level	300
Gradient Level, Top Grade	300
Green Drain Waterless Trap Seal	216
Grid Drain	
Commercial Lav	64, 327
Handicap Style Lav	64, 327
Grid Strainer	330
Griplock Tongue & Groove Water Pump Pliers	289
H	
Hacksaw	282
Close Quarters	282
Hair Strainer	71
Half Clamp	122
Handicap	291
Handi-Plug	291
Hand Torch	288
Hand Wipes	303
Handy Foam	124
Hangers	70
Adjustable Lavatory	70
Lavatory	70
Mop, for Service Sink	82
Sink	70
Hanger Strap	118
Hats, Safety	297
Head Light	300
Head-Lite, Sportsman L.E.D.	300
Heavy Duty Commercial Drain	196–210
Hexagon Bushings	345
HEX Brushing	149

Brass	44	Combo	294
Brass Guide	44	Plastic	294
Lift Wire Guide	44	Steel Tray	294
Liquid Lightning Pro	293	Nipple Extractor	286
Lock	303	Nipple Extractors	286
Locknut	66	And Screw Extractors	286
Ballcock Coupling Nut And	66	Internal Pipe	286
Basin Cock	66	Sets	286
Basket Strainer, And Washers	66	No Hub Torque Wrench	308
Black Malleable	347	Non-Adjustable Drain	242
Bronze	148	“No Pinch” Pipe Wrench Pliers	289
Lock Nut	139	Nut	
Locknut/Backnut	347	45° Flare Tube Fitting	135
Long Flare Nut	135	Basin	66
Long Nipple	139	Brass Compression	133
Long Sweep Elbow	336	Carrier Nuts and Washer Set	126
Loop and Lock	303	Chrome Plated Brass Slip Joint	66
Lotion And Soap Dispenser	4	Chrome Plated Die Cast Zinc Slip Joint	328
Lubricant	299	Die Cast Zinc Slip Joint	66
Cutting Oil	301	Hex Nut	126
Lubricant, WD-40®	299	Lavatory Supply	66
Lugs, Sink	69	Lock, Yellow Brass	139
M		Plastic Slip Joint	66, 328
Magnetic	290	Rod Coupling	128
Plastic Level	299	Rough Brass Slip Joint	66, 328
Power Nut Setters	290	Setters	290
Torpedo Level	299	Split	66
Manhole Cover Lifter	284	Stove Bolt with Nut	125
Mansfield Style	45	Nut Driver	290
Ballcock	45	Nut Setters, Magnetic Power	290
Ballcock and Flush Valve Repair Parts	46	Nylon Fittings	
Ballcock With Float Rod	45	Adapter	154
MAPP Cylinders	288	Elbow	154
Markers	291	Garden Hose Cap	154
Marking Labels, Gas Line	299	Hose Barb Adapter	154
Marking Paint	292	Insert Adapter	155
Marking Paint, Industrial Choice Precision-Line Inverted	292	Insert Combination Elbow	155
Marvel Adapter	68, 329	Insert Coupling	155
Marvel Ring	329	Insert Elbow	155
Marvel Rings	329	Insert Tee	155
Marvel Rings, Sweat Male Adapter	68	Splicer	154
Mega Torque Wrench	308	Tee	154
Merchant Couplings	352	Nylon Garden Hose Fittings	154
Metal Stud Insulator	119	Nylon Hose Barb Fittings	154
Metal Stud Pipe Insulator	122	Nylon Insert Adapters	155
Meter Key	285	O	
Milwaukee Style Trap	314	Oakum	122
Mixer Hose	97	Oetiker PEX Stainless Steel Clamp	141
Mixet Replacement Handles	74	Offset Bath Supplies	7, 55
Moen	74	Offset Tank to Bowl Bolts	50
Replacement Handles	74	Oil	301
Single Handle Replacement Buttons	74	Oil, Cutting	301
Mop Hanger for Service Sink	124	One-Hole Schedule 40 Half Kit	14–15, 60–61, 61–62
Moss Bay Repair Flange	240	O-Ring	
Mushroom Vent Cap	235	Bore	95
N		Kit And Pick	68
Nail Puller	284	Outlet Tee	
Nails	121	PVC	320
Copper Clad Nail	121	Overflow Plate	57
Copper Coated J-Nails	121	Overflow Plates	57
Needle Valve for Pressure Gauge	113	Overflow Plates - One hole	11
Nipple		Overflow Tube	45
Chrome Plated	150	Over Pipe Fit Commercial Drain	188–192
Red Brass	146	P	
Yellow Brass	139	Packing	
Nipple Caddy		Candle Wick	122

Graphite 122

Padlock 303

Pads 297

 Copper Cleaning 299

 Knee 297

Paint 292

 5 in 1 Painters Tool 292

 Marking, Industrial Choice Precision-Line Inverted 292

 Spotter Hand-Help Wand 292

Paint Holder 292

Pantry Faucet 69

Peerless 74

 Faucet Index Buttons 74

 Replacement Handles 74

“Perfect Low Profile” Shower Drain 181

Perforated Hanger Iron 121

PEX Fittings

 Adapter 140, 141,

 Ball Valve 140

 Coupling 141,

 Crimp Ring 141

 Elbow 140, 141

 Plug 141,

 Tee 141,

Phillips Bits 290

Pick 284

 Mattock 284

Pigtail Syphon 112

Pilot Line Breakaway Nut 134

Pipe

 Lubricant 307

 Readycut, Black Malleable 352

Pipe Bracket 118–119

 Carrier 118

 Extruded Hole Copper Plated 118

 Extruded Notches Copper Plated 118

 Flat Copper Plated 118

 For Water Closet-Copper Clad 119

 Galvanized 119

 Galvanized L 119

 Galvanized Lockright 119

 Galvanized Lockright-CPVC 119

Pipe Cutters 280

 Heavy Duty PVC 280

 Inside 280

 Professional PVC 281

 PVC 280

 PVC One-Handed 280

Pipe Fit Adapter Drains 185

Pipe Fit Commercial Drain 185–186

Pipe Hanger 120

 Conduit Hanger 126

 Copper - Bell & Milford Types 126

 Schedule 40 120

Pipe Hook 119–120

 “Copper Boy” 119

 Plastic Coated 119

Pipe Insulation

 Insulation Protective Coating 109

 Insulation Tape 109

 Poly

 Rubber

 Tees and Elbows 109

 Double Stick Rubber Pipe Insulation 104

 Seamless Rubber Pipe Insulation 103

Pipe Insulator 122

Metal Stud 122

Pipe Jacket 289

Pipe Jackets, Freeze Fix 289

Pipe Joint Compound 293

 Whitlam “Blue Magic” 293

 Whitlam “Select Unyte” Teflon 293

Pipe Lubricant 307

Pipe Nipple Black 350, 351, 352

Pipe Nipple Extractor 286

Pipe Nipples

 Black Malleable 350

 Chrome Plated 150

 Red Brass 146

Pipe Sleeveing 100

Pipe Strap 120

Pipe Support, Flush Valve 65

Pipe Taps 287

Pipe Wrap Tape 99

Pipe Wrench 278

 Aluminum 278

 Heavy Duty 278

Plastic Access Panel 91

Plastic Drop Cloth 302

Plastic Flow Restrictor 54

Plastic Hanger Tape 121

Plastic Magnetic Level 299

Plastic Push On Fittings 145

Pliers 289

 Curved Jaw Tongue & Groove 289

 Pipe Wrench, “No Pinch” 289

 Slip Jaw 289

 Smooth Jaw 289

 Smooth Jaw Tongue & Groove 289

 Tongue & Groove 289

 Water Pump 289

 Water Pump, Griplock Tongue & Groove 289

Plug 71, 150

 45° Flare Tube Fitting 135

 Black Plastic PEX 141

 Brass Bar 71

 Brass PEX 140

 Bronze 149

 Chrome Plated 150

 Fitting C.O. Adapter with Plug 335

 Plastic Push On 145

 Square Head, Black Malleable 349

 Tray 71, 329

 Wrot, Copper 360

 Yellow Brass 138

Plug Drain

 Brass P.O. 64

Plug, Fitting 360

Plumb Aire Air Vent 65

Plumb Bob 288

Plumb Bob, Brass 288

Plumber’s 294

 Cotton Handy Towels 302

 Epoxy Putty 294

 Faucet And Valve Grease 294

 Goop Adhesive 294

 Putty 294

Plumbing Connectors 78

 Braided Nylon 79

 Flexible Stainless Steel 78, 79

PlumbBite Push On Fittings 142

Plumbjet 94

Plumb Kit	57	Elbow	340
Plunger		LA Pattern with Union	339
Force Cup	94	Milwaukee Style	314
Professional Force Cup Display	94	P-Trap w/Adapter	323
Plunge Right	63	PVC	320
Poly Fittings		PVC, Chrome Plated	323
Combination Elbow	156	PVC DWV	339
Insert Adapter	156	PVC with Solvent Weld Marvel	320
Insert Coupling	156	Rough Brass	319
Insert Elbow	156	Rough Brass P-Trap	319
Insert Reducer	156	Suction Line	360
Insert Tee	156	U-Bend	340
Poly Insert Fittings	156	with ABS Adapter	314
Poly Pipe Insulation	106–109	With Cleanout	371
Poly Sheeting	301	with PVC Adapter	314
P.O. Plug Lav Drain	327	with Solvent Weld Joint	340
Pop-Up Assembly		with Sweat Connection	314
ABS	64, 327	with Union	339
Brass	64	Wrot Suction Line, Copper	360
Chrome Plated ABS	64, 327	Pumps	278
Chrome Plated Brass	327	Air	279
Polished Brass	327	Economy Air	279
Replacement Parts	64	Hydrostatic Pressure	278
Pop-Up Drain		RP 30 Hydrostatic Test	278
Lav Lift and Lock	64	Water	279
Press Fittings	364–366	Push On Fittings	
Pressure Gauges	112, 113	Plastic	
Gas	112	Angle Valve	145
Gas Test Assembly	113	Cap	145
Gas Test Gauge	112	Connector	145
Gas Test Gauge Assembly	113	Coupling	145
Gas Testing Equipment	111	Elbow	145
Liquid Filled	112	Needle Valve	145
Needle Valve	113	Plug	145
Pressure Gauge	112	Straight Valve	145
Sillcock/Water or Gas Test Gauge Assembly	112	Tee	145
Test Gauge Assembly	112	Union	145
Tridicator	113	PlumbBite	
Vacuum Gauge	113	Adapter	142
Water Test Gauge	112	Ball Valve	143
Pressure Snubber	113	Cap	143
Priana	29–34	Coupling	142
Primer for Pipe Wrap Tape	99	Elbow	142
Propane Cylinders	288	Removal Tool	143
Protective Blanket	288	Supply Stop	143
Protector, Three Prong Drain	72	Tee	143
Provent	65	Twist To Lock	
PTFE Thread Seal Tape	99	Connector	144
P-Trap		Coupling	144
ABS	323	Elbow	144
ABS, Chrome Plated	325	Tube End Stop	144
ABS Plastic	323	Union	144
Boston Style	314	Putty	
Brass Tubular	6	Plumber's	294
Cast DWV	371	Plumber's Epoxy	294
Chrome Plated	314	Putty Knife	292
Chrome Plated ABS	323, 325	PVC Shower Pan Liner Cement	53
Chrome Plated Boston Style	314	Q	
Chrome Plated Brass	313	Qwik Elbow	95
Chrome Plated Milwaukee Style	314	Qwik Tee	95
Chrome Plated PVC	65	R	
Chrome Plated Sink Trap with PVC Adapter	314	Radiant Seal Sponge Rubber Closet Gasket	51
Chrome Plated Sink Trap with Sweat		Radiator Accessories	164
Connection	314	Radiator Angle Air Valve	164
Commercial	65	Radiator Angle Valve	164
Commercial, with Cleanout	65	Radiator Coin Key Air Valve And Key	164

Radiator Spud Wrench	275	Mixet	74
Rags	302	Moen	74
Rags, Box of	302	Peerless	74
Ratchet Strap	298	Sears	74
Tie Down	298	Stanadyne	74
With Step Release J-Hooks	298	Valley	74
Rayovac		Replacement Strainer for Metal Spud	215
Batteries	301	Replacement Strainers	20, 242, 246
Heavy Duty Industrial	301	For Roman Tub Drains	20, 242
Floating Lantern & Battery	300	Regular Strainers	20, 242
Industrial Flashlights	300	Restrictor	53
Readycut Pipe		Rings, for Drain and Cleanout Spuds	215
Black Malleable	352	Rinse-Quik Hose and Spray	69
Readycut Pipe Black	352	Riser Clamp	127
Ready Fit Corded Ear Plugs	297	Robe Hook	34-35
Red Brass Insert Fittings	157	Rod	284
Insert Adapter	157	Probing	284
Insert Coupling	157	Steel Probing	284
Insert Elbow	157	Steel Probing, with Ball Point	285
Insert Male Rope Adapter	157	Rod Coupling Nut	128
Insert Reducer	157	Roman Tub Drains	241
Insert Tee	157	Roof Drains	236
Insert x MIP 90° Elbow	157	Accessories for Roof Drains	236
Insert x Sweat Adapters	157	Roof Drains w/Cast Iron Dome	236
Red Brass Pipe Nipples	146	Roof Drains w/Plastic Dome	236
Red Rubber Sheet Packing/Gasket Material	168	Roof Flashing	
Reducer	150	All Neoprene	124
Bell, Yellow Brass	138	Aluminum	124
Bronze	149	Galvanized	124
Chrome Plated	150	Lead	124
Insert, Poly	156	Neo-poly	124
Insert, Red Brass	157	Roofite	124
Press Fitting, Copper	366	Roofite Hi-Heat Silicone	123
Wrot DWV	369	Rosettes	65
Wrot Fitting, Copper	361	Rough Brass Tubular	319
Reducer Coupling	335	Rough-In Kit	62
PVC DWV	335	Rubber Hose	279
Reducing Coupling, Banded	346	Rubbermaid® Commercial Products	295-296
Reducing Tee, Banded	348	Rubber Pipe Insulation	101-105
Refill Tube	44	Rubber Sheet	168
Relief Valve, Cleanout And		Running Trap	269
Sewer	77	Run-Off Tube	111
Removal Tool	276	S	
Extract-a-Drain Tub Drain	276	Saddle Tees and Kits	225
Lavatory Nut	276	Saddle Tee, Tapped	269
PlumBite	143	Safety	
Repair Clamp		Disposable Coverall	297
Stainless Steel	91	Dust Mask	297
Repair Coupling	335	Glasses	297
PVC DWV	335	Hellraiser	297
Repair Cover Plates	77	Nemesis	297
Repair Fitting	235	Visio	297
Repair Flange	240	Goggles	297
Repair Plate	269	Goggles, Clear	297
Repair Plug	92	Hat	297
Repair Trap	324	Knee Pads	297
ABS	324	Leak Alert Water Detector	301
Chrome Plated Brass	315	Protective Shoe Covers	296
PVC	321	Ready Fit Corded Ear Plugs	297
Replacement Basket Strainer	3	Shubee Shoe Covers	296
Replacement Clamp For Flexible Couplings	165	Sand Cloth	100
Replacement Handles	73	Flexible Open Mesh	100
Aqualine	74	Open Mesh	100
Delta	74	Waterproof Aluminum Oxide	100
Eljer	74	Water Resistant	100
Fit-All	73	Sanitary Tee	338

Sanitray Tee	339	Shower, Add-A-	54
Satin Brass Air Cock	161	Accessories	54
Saws		Code Pattern	54
Cable	282	Complete Unit	54
Close Quarters Hacksaw	282	Diverter Spout & Riser	54
Drywall	282	D-Style	54
PlumBest Plastic	282	Less Oval Shower Rod	54
T-Handle Cable	282	Shower and Floor Drains	242
Screw and Nipple Extractors	286	Shower Arm	7-8
Screwdrivers	290	And Kits	53
4 in 1	290	Flange	53
6 in 1	290	Heavy Adjustable	53
Screw-On Wire Connector	301	Plastic	53
Screws		with Flange and Set Screw	53
Anchor Bolt Kit	126	Shower Arm Flange	8
Drill Point Tech Screw	125	Shower Curtain Pin	53
E-Z Anchor/Self-Drilling Wall Board	125		53
Flat Phillips Head Brass Wood Screw	125	Shower Curtain Rod	8
Hex Head Lag Screw	125	Shower Diverter Valve	7, 55
Hex Head Tapping Screw	125		55
Hollow Wall Anchor Kit	126	Shower Drain	18-19, 179, 180, 181, 182
Phillips Head Wood Screw	125	Shower Drains	241, 243, 246
Screws, Solid Brass Bibb Assortment Kit	68	Shower Elbow, Brass For Fiberglass Shower Stall	55
Sealant		Shower/Floor Drain	179-180, 180-181
100% Silicone Tub and Tile	290	Shower Head	
Firestop 814+ Intumescent Firestopping	291	Adjustable Massage	53
Instant	124	Adjustable Plastic	53
Silicone Tub And Tile	290	Brass	52
Sears Replacement Handles	74	Brass Aerating Water Saver	52
Seat Disc	41	Deluxe	52
Seat Disc and Tank Ball		Die Cast	52
for American Standard	42	Octagonal	53
Service Sink		Plastic	52
Faucet	265	Vandal Proof	53
Hose and Bracket	265	Shower Pan Liner	53
Mop Hanger	265		53
Mop Service Basin	265	Shower Pan Liner Cement	53
Trap Standard	265	Shower Pan Liner Cement, PVC	53
Service Sink Faucet	82	Shower Rod	
Service Sink Repair		Adjustable Aluminum	52
Hose and Hose Bracket	124	Aluminum	52
Mop Hanger	124	Aluminum, with Holders	52
Sewage Ejector/Sump Pump Check Valve	123	Contoured	52
Sewer Popper	76	Shower Rod Flange	7, 52
Sewer Relief Plugs	225	Shower Stall Drain	182
Sewer Relief Valve and Cleanout	77	Shower Utility	55
Sewer Stopper/Backflow Preventer	77	Shower Valve	82
Sheeting, Poly	301	Shut-Off Valve, Gas	160
Sheet Packing	168	Shut-Off Valves	160
Shims		Silicone	290
Closet Wedge	178	Caulk	290
Closet Wedge Shims	47	Tub And Tile Sealant	290
Flexible	178	Siliconized Acrylic Caulk	290
Rigid	178	Sillcock Key	275
Shoe Covers	296	Sink	69
Protective	296	Basin Faucet	81
Shubee	296	Connection Washer	66
Shoe Gasket	57	Crumb Cups	72
Short Flare Nut	135	Hangers	70
Shovel	283	Kitchen Stopper	71
Shovels	283	Laundry Tray Faucet	81
Economy	283	Lugs	69
Fiberglass Handle	283	Self-Closing Basin Faucet	82
Long Handle Round Point Fiberglass	283	Service	82
Premium Grade Wood Handle	283	Hose & Hose Bracket	82
Specialty	283	Mop Hanger	82

Single Sink Bibb	81	Telescoping Tub	56
Undermount Installation Kit	69	Tub	56
Wall Mount Faucet	81	Spray	69
Sink Tailpiece		Delta Style Assembly	69
Chrome Plated Brass	316	Kitchen (Fit All)	69
Sink Trap	314	Rinse-Quik	69
L.A. Pattern	315	Spray Assembly	69
L.A. Pattern Sink Trap	315	Spray Bottle	303
Sink Trap w/ABS Adapter	314	Spray Paint	292
Sink Trap w/Sweat Connection	314	Spray Weld	293
Slab Drain	244, 245, 247, 248	Spring Tubing Bender	299
Sledgehammer	284	Spud	277
Sleeve		Adjustable, Strainer and	277
Brass Compression	133	Wrench	277
Slip Jaw Pliers	289	Wrench With Hinged Arm	277
Slip Joint	66	Spud and Strainer	17-19
Cone, Washer	67	Spud Extension, for Drains and Cleanouts	216
Nut	66	Spuds	250-251
Nut And Washer	67	Square Head Plug	138, 349
Rough Brass, Nut	66	Stanadyne	74
Tee	68	Replacement Handles	74
Washer	67	Single Handle Replacement Buttons	74
Slip Joint Nut	328	Standard Two-Hole Schedule 40 Half Kit	15-16
Slip Joint Nut & Washer	328	Standard Waste and Overflow	
Slip Joint Tee		1-Hole Full Kit	57
PVC	322	1-Hole Half Kit	57
Slip Nut	328	2-Hole Half Kit	57
Slip-On Plastic Cap	93	Steel Wool	299
Smooth Jaw Pliers		Stopper	58
Tongue & Groove	289	Basin And Tub	58
Snake		Fit-All	58
Drain King Mini Snake	293	Flip-It Tub	58
Snap-Ease Access Panel	91	Garbage Disposal	71
Snap-in Drain	219-220	Kitchen Sink	71
Snap-in Strainers	19	Pop-Up Basin	58
Snow Brush	283	Stove Bolt with Nut	125
Soap And Lotion Dispenser, Chrome Plated	69	Straight Needle Valve	
Soap Stones And Holders	288	Plastic Push On	145
Socket Ring	220	Straight Stop	22-24
Socket Savers	280	Strainer	70, 277
Solder	288	ABS Body And Post Basket	71
Phos-Copper Brazing Rod	288	Adjustable, and Spud	277
Shield Protective Blanket	288	Beehive Urinal, Cast Brass	71
Silver	288	Chrome Plated Brass Duo Basket	71
Solder Extension Tube		Deep Cup Basket	70
Chrome Plated Brass	317	Deep Junior Duo Basket	4, 71
Solid Square Head Plug	149	Duo Basket	70
Solvent Extension Tube	325	Duo, CP Brass	70
PVC	322	Economy Replacement Basket	70
Space Heater Fittings	137	Fit-All Basket	70
Spacer		Flat Duplex	71
Air Gap	65	Flat Top Grid	70
Closet Bend	51	Flexible Hair	71
Foam	51	Junior Duo Basket	71
Styrofoam Closet Flange	51	Plumb Easy Sink Wrench	277
Spanner/Strainer Wrench	277	Quick Fit Stainless Steel Basket	70
Specialty Faucet	33	Shallow Cup Duo Basket	70
Splash Guard, Garbage Disposal	72	Stainless Steel Deep Cup Basket	71
Splicer		Stainless Steel Duo Basket	71
Nylon	154	Twist And Lock Basket	70
Split Nut	66	Wrench	277
Sponge	302	Strainers, Replacement	215
Sponge Closet Gaskets	44	Strap	
Sponges, Commercial	302	U-Type, Copper	361
Sportsman L.E.D. Head-Lite	300	S-Trap	323
Spouts		ABS	323

Chrome Plated Brass	314	Offset Bolts	50
PVC	321	Offset Tank to Bowl Bolts	50
Straps	298	Set	50
Cam	298	Tri-Bolt Tank to Bowl Bolt Set	50
Camouflage, with Hooks	298	Tri-Tank to Bowl Bolt Kit for American Standard	50
Duct	298	Tank to Bowl Bolt Kit	50
Heavy Duty Utility	298	For American Standard	50
Ratchet Tie Down	298	For Mansfield	50
Ratchet, with Step Release J-Hooks	298	Tri-Bolt Tank	50
S-Traps	314	Tri-Tank, American Standard	50
Strap Wrench	278	Tank Trip Lever	24, 25, 40, 41
Street Tee, Banded	347	Eljer Touch Flush Assembly	41
Stretch Wrap		Fit-All	40
Film and Dispenser	100	for American Standard	25, 40
Striking Tools	284	for Crane	40
Stub Out	116–118, 355–356	for Eljer	25, 40
Stud Shoe	116	for Kohler	25, 41
Super Shims	178	for Mansfield	41
Supply and Stop Kit	23	for ToTo	24, 41
Closet	23	for Universal Rundle/Sears	41
Lavatory	23	for Western Pottery	41
Supply Stop		Ultrafit	24, 41
Easy Connect Tee	80	Universal	25
Multi-Turn	22, 80	Tape	
PlumBite	143	Box Sealing	99
Quarter Turn	22, 81	Duct	99
Repair Stop Valve	80	Electrical	99
Supply Tubes	23	Gas Line Marking Labels	299
Closet	24	Insulation	109
Flexible Basin	80	Pipe Wrap	
Flexible with Rubber Nose	80	Domestic Pipe Wrap Tape	99
Lavatory	24	Imported Pipe Wrap Tape	99
PEX	80	Primer for Pipe Wrap Tape	99
PEX With Ferrule	80	Thread Seal	
Sure Grip Escutcheon	332	PTFE Thread Seal Tape	99
Sweat Male Adapter	68	PTFE Yellow Gas Line Thread Seal Tape	99
Sweat Male Adapter/Marvel Rings	68	Thread Seal Tape Jar Display	99
Swimming Pool Valves	164	Tape, Caution	297
Swivel		Tape Measure	287
45° Flare Tube Fitting	135	Locking	287
Swivel Drum Trap	340	Long	287
Swivel Ring	127	Neon Precision	287
T		PlumbRule	287
Tailpiece	316	T-Cone Cleanout Repair Plugs	92
ABS	325	Tee	
Brass Direct Connect Dishwasher		45° Flare Tube Fitting	135
Tailpiece	318	Banded	348
Brass Double Flange Tailpiece	316	Banded, Black Malleable	348
Brass Sink Tailpiece	316	Baseboard	368
Slip Joint Tailpiece	318	Black Plastic PEX	141
Slip Joint Tailpiece w/1/2" Sweat Branch	319	Brass Compression	133
Threaded Connection Dishwasher		Brass Hose Barb	153
Tailpiece	318	Brass PEX	140
Trap Primer	64	Bronze	148
Trap Primer Tailpiece	328	Bronze Compression	92
Tailpiece Extension	180	Cast DWV	370
Tamping Bar	284	Chrome Plated	150
Tamping/Digging Bar	284	Double	370
Tank Ball	41	Double, Cast DWV	370
Tank to Bowl		Double Sanitary, PVC DWV	339
Bolt Kit for American Standard	50	Drop	367
Bolt Kit for Gerber	50	Forged Brass/Cast Pressure	367
Bolt Kit for Mansfield	50	Insert, Nylon	155
Bolt Set	50	Insert, Poly	156
Components	51	Insert, Red Brass	157
Gasket	51	Nylon	154

Plastic Push On 145
 PlumBite 143
 Press Fitting 366
 PVC Compression 92
 PVC DWV 338
 Qwik 95
 Reducing, Banded Black Malleable 348
 Sanitary, PVC DWV 338
 Slip Joint 68
 Space Heater Fitting 137
 Street, Banded Black Malleable 347
 Test 370
 Tubular, Chrome Plated 318
 Wrot, Copper 362, 363
 Wrot DWV 369
 Yellow Brass 138

Tee Plug 94
 Inflatable 94

Test Cap 93
 Flexible PVC 93
 Knockout 93
 PVC Dual Fit 93
 PVC Test Cap 93
 Slip-On Plastic 93
 Techno Test Plug 93
 Wrot DWV 369

Test Gauge
 5 Pound Gas 112
 Assembly 112
 Gas 112
 Gas Test Gauge Assembly 113
 Gas Testing Equipment 111
 Liquid Filled Pressure Gauge 112
 Pressure Gauge 112
 Sillcock/Water or Gas Test Gauge Assembly 112
 Tridicator 113
 Water 112

Test Plug 92
 Cast Iron 93
 Combination 92
 Economy 92
 "Plum-Tite" Mechanical 92
 Pneumatic 93
 Pneumatic-Hydraulic 94
 T-Cone 92
 Two Stage Long 94

Test Tee
 Cast DWV 370

Test Tee, Cast Iron 269

Test Tee with Plug 225, 269

Test Tee w/Plug 225

Texas Pattern Gas Ball Valve 162

The Green Drain Waterless Trap Seal 216

Thermometer
 Bi-Metal Dial 114
 Dial 113
 Hot Water/Refrigerant Line 113
 Pocket Test 113
 Weksler Industrial Multi-Angle 114

Threaded Extension Tube
 Chrome Plated Brass 317

Threaded Steel Rod 128

Thread Sealing Compound, Slic-tite® Heavy Duty 293

Thread Seal Tape
 PTFE 99
 PTFE Yellow Gas Line 99

Tissue Roller 65

Toggle Bolt 125

Toilet Paper Holder 34-35

Toilet Seat
 Builder Grade Residential Plastic 379
 Commercial Baby Bowl Plastic 381
 Decorative Natural Finish, Solid Oak 377
 Decorative Piano Finish, Solid Bamboo 377
 Decorative Piano Finish, Solid Oak 377
 Deluxe Commercial Plastic 381
 Deluxe Molded Wood 375, 376
 Deluxe Residential Plastic 378
 Designer Acrylic 383
 Extra Heavy Duty Commercial Plastic 379
 Heavy Duty Commercial Plastic 380
 Light Duty Commercial Plastic 382
 Premium Commercial/Institutional Plastic 381
 Premium Heavy Duty Commercial Plastic 382
 Premium Molded Wood 375
 Premium Residential Plastic 378
 Replacement Hardware 383
 Standard and Deluxe Soft Seats 382
 Standard Commercial Plastic 381
 Standard Molded Wood 376
 Standard Residential Plastic 379
 Utility Grade Residential Plastic 379
 Utility Molded Wood 376

Tongue & Groove Pliers 289

Top Grade Gradient Level 300

Top Hat Washer 44

Torpedo Level 299

Torque Wrench 308

Totes 294
 2CanCaddy 294
 Bucket Caddies 295
 Combo Nipple Caddy 294
 Fitting Tote Tray 294
 Fitting Tray 294
 Plastic Nipple Caddy 294
 Steel Nipple Caddy Tray 294
 Tool 295
 Utility Tote Tray 294
 Utility Tray 294

Towel Bar 34-35

Towel Ring 34-35

Towels 302
 Cotton Plumbers Handy 302
 Wypall Teri 302

Traffic Floor Drain 218-219

Transition Coupling, Flexible 95

Trap Adapter 340

Trap Adapters 67

Trap Bushing 55

Trap Cover 123
 Drum 123

Trap Primer Tailpiece 64, 328

Trash Bags 302

Tray Plug 71, 329

Tridicator 113

Trip Lever
 Trim 62
 with Spring 57

Trouble Light 300

Tub And Shower Valve Wrench Set 275

Tub Drain
 Roman 58

Tube End Stop		
Twist To Lock	144	
Tubing		
Clear Vinyl	114	
Natural Polyethylene	114	
Soft Aluminum	114	
Tubing Benders	299	
3-N-1	299	
Spring	299	
Tubing Cutter	281	
Copper	282	
Economy	281	
Mini	281	
Quick Release	281	
Ratcheting Handle Copper	281	
Telescoping	281	
Vinyl	281	
Tub/Shower Faucet	31-33	
Tub/Shower Valves, Rough-In	33	
Tub Spout		
Chrome Plated	56	
Solid Brass	56	
Telescoping	56	
TubSpouts	9-10	
Tubular Bath Waste Full Kit	16	
Turnout Bend Support for PEX	119	
Twine	122	
Mason's Nylon	122	
Twin Elbow Bushing	55	
Twist-Off Strap Tool	278	
Twist To Lock Plastic Fittings	144	
U		
U-Bend		
PVC DWV	340	
Union	148, 150, 368	
45° Flare Tube	136	
45° Flare Tube Fitting	135	
Black Malleable	349	
Brass Compression	133	
Bronze	148	
Chrome Plated	150	
Copper	361	
Forged Brass/Cast Pressure	368	
Plastic Push On	145	
Space Heater Fitting	137	
Stack Tube Tee, Twist To Lock	144	
Twist To Lock	144	
Union, Brass to Iron Seat	349	
Universal Beam Clamp	126	
Universal Copper Thermocouple	109	
Universal Drain Wrench	276	
Universal End Outlet Waste with Dishwasher Connection		
ABS	325	
Urinal		
Strainer, Cast Brass Beehive	71	
Urinal Flange	177	
Urinal Flange Kits	177	
Urinal Screen	302	
Urinal Spud	43	
Urinal Strainer	71	
Utility Drain	220	
Utility Pry Bar	284	
Utility Shower	55	
Utility Strap	298	
V		
Vacuum Gauge	113	
Valley	74	
Replacement Handles	74	
Valve		
Plastic Push On	145	
Valve Grease	294	
Valve Key	285	
Valve Seal		
Korky	45	
Korky for Champion 4	45	
Vent Cap	235	
Vent Elbow	336	
Vinyl Gloves	296	
Disposable	296	
Volos	29-34	
W		
Wall Bend	316	
Chrome Plated Brass	316	
Washer	329	
Aqua Seal	44	
Assorted Kit	68	
Basket Strainer	66	
Beveled Ballcock Shank	44	
Beveled Bibb	44	
Beveled Slip Joint Washer	329	
Carrier Nuts and Washer Set	126	
Cone Slip Joint	67	
Fender	126	
Flanged Poly Tailpiece	67, 329	
Flanged Poly Tailpiece Washer	329	
Flat	126	
Flat Bibb	44	
Materials	168	
Poly Beveled Slip Joint	329	
Rubber Slip Joint Washer	329	
Sink Connection	66	
Slip Joint	67	
Square Cut Rubber Slip Joint	329	
Top Hat	44	
Washing Machine Repair		
Boxes		
with Hammer Arrester	96	
Hoses		
Fit-All Drain	97	
Mixer	97	
Washing Machine	97	
Pan	97	
Waste And Overflow	62	
Aluminum Bar	62	
Test Kits	62	
Waste Arm	316, 319, 324	
ABS	324	
Chrome Plated Brass	316	
PVC	321	
Rough Brass	319	
Waste Connector	67, 329	
Waste w/Dishwasher Connection	325	
Water Detector	301	
Water Detector, Leak Alert	301	
Water Hammer Arresters	169	
Water Heater Repair		
Connector		
Braided Stainless Steel	110	
Corrugated Copper	110	
Corrugated Stainless Steel	110	
Dielectric Nipple	110	
Dielectric Union	109	

Gasket and Insert for Dielectric Union 110
 Pan 111
 Adapter 111
 Galvanized 111
 Safety 111
 Water Heater 111
 Run-Off Tube 111
 Thermal Expansion Tank 109
 Universal Copper Thermocouple 109
Waterless Trap Seal 216
Water Meter Keys 285
 Combo 285
 Gate Valve Key 285
Water Meter Repair
 Gasket Only for Water Meter Couplings 128
 Irrigation Box 129
 Round Valve Box 130
 Water Meter Box 128
 Water Meter Box Keys and Covers 128
 Water Meter Coupling Complete 128
Water Pump 279
 Pliers 289
Water Supply Tubes 23
Water Tank 109
Water Volume Control 53
Water Volume Restrictor 53
Wax Gaskets 51
Waxless Gasket 177
WD-40® Lubricant 299
Wet-R-Dri Roofing Cement 123
Whitlam 293
 "Blue Magic" Pipe Joint Compound 293
 Seal Unyte 293
 "Select Unyte" Teflon Pipe Joint Compound 293
Wire Brush 292
Wire Connectors, Screw-On 301
Wood Bits 286
 Dual Auger 286
 Flat "Paddle" 287
Wool, Steel 299
Wrecking Bar 284
Wrench
 4-Way Countersunk Plug 276
 4-Way P.O. Plug 276
 6-Way Countersunk Plug 276
 Adjustable 278
 Adjustable Strainer And Spud 277
 Aluminum Pipe 278
 Angle Compression Stop 276
 Box 278
 Curb Box 278
 Do All Plumbers 278
 Dual Kwik Tie 276
 Element 275
 Faucet Seat 276
 Garbage Disposal 275
 Heavy Duty Pipe 278
 Mega Torque 275
 Moen Stem And Cartridge 277
 No Hub Torque 275
 Plumb Easy Sink Strainer 277
 Quick Drain 277
 Radiator Spud 275
 Seat, for Recessed Seats 276
 Set 275
 14 Piece Folding Hex Key Wrench 275

Tub And Shower Valve Wrench 275
 Sink Drain 277
 Spanner/Strainer 277
 Spud 277
 Spud With Hinged Arm 277
 Strainer 277
 Strap 278
 Universal Drain 276
Wye 337, 338, 371
 Cast DWV 371
 Double 371
 Double, Cast DWV 371
 PVC DWV 337
Wypall 303
 Teri Towels 302
 Waterless Hand Wipes 303
Y
Yellow Brass Pipe Fittings
 Bell Reducer 138
 Bushing 139
 Coupling 138
 Elbow 138
 Lock Nut 139
 Nipple 139
 Plug 138, 139
 Tee 138
Z
Zinc Plated Clevis Hanger 127
Zip Ties 298

PART NO.	PG #	PART NO.	PG #	PART NO.	PG #	PART NO.	PG #
3188	293	30750	350	32075	351	50150	350
30100	350	30755	350	32080	351	50155	350
30110	350	30760	350	32090	351	50160	350
30112	350	30765	350	32500	351	50170	350
30115	350	30770	350	32510	351	50180	350
30120	350	30775	350	32511	351	50190	350
30125	350	30780	350	32512	351	50200	350
30130	350	30790	350	32518	352	50210	350
30135	350	31000	350	32520	352	50211	350
30140	350	31010	350	32530	351	50212	350
30145	350	31011	350	32535	351	50215	350
30150	350	31012	350	32540	351	50220	350
30155	350	31014	350	32545	351	50225	350
30160	350	31020	350	32550	351	50230	350
30170	350	31025	350	32555	351	50235	350
30180	350	31030	350	32560	351	50240	350
30200	350	31035	350	32570	351	50245	350
30210	350	31040	350	32580	351	50250	350
30211	350	31045	350	32590	351	50255	350
30212	350	31050	350	33000	351	50260	350
30215	350	31055	350	33010	351	50270	350
30220	350	31060	350	33011	351	50280	350
30225	350	31065	350	33012	351	50290	350
30230	350	31070	350	33018	352	50300	350
30235	350	31075	350	33030	351	50310	350
30240	350	31080	350	33035	351	50312	350
30245	350	31090	350	33040	351	50315	350
30250	350	31200	350	33045	351	50320	350
30255	350	31210	350	33050	351	50325	350
30260	350	31211	350	33055	351	50330	350
30270	350	31212	350	33060	351	50335	350
30280	350	31213	350	33070	351	50340	350
30290	350	31214	350	33080	351	50345	350
30300	350	31220	350	33090	351	50350	350
30310	350	31225	350	33500	351	50355	350
30311	350	31230	350	33540	351	50360	350
30312	350	31235	350	33550	351	50370	350
30315	350	31240	350	34000	351	50380	350
30320	350	31245	350	34010	351	50500	350
30325	350	31250	350	34011	351	50510	350
30330	350	31255	350	34012	351	50511	350
30335	350	31260	350	34024	352	50512	350
30340	350	31270	350	34035	351	50515	350
30345	350	31280	350	34040	351	50520	350
30350	350	31285	350	34045	351	50525	350
30355	350	31290	350	34050	351	50530	350
30360	350	31500	350	34055	351	50535	350
30370	350	31510	350	34060	351	50540	350
30380	350	31511	350	34070	351	50545	350
30500	350	31512	350	34080	351	50550	350
30510	350	31514	350	34090	351	50555	350
30511	350	31520	350	35045	351	50560	350
30512	350	31525	350	35050	351	50570	350
30515	350	31530	350	35055	351	50580	350
30520	350	31535	350	35060	351	50590	350
30525	350	31540	350	35070	351	50700	350
30530	350	31545	350	35080	351	50710	350
30535	350	31550	350	36000	351	50711	350
30540	350	31555	350	36010	351	50712	350
30545	350	31560	350	36011	351	50715	350
30550	350	31570	351	36012	351	50720	350
30555	350	31580	351	36045	351	50725	350
30560	350	31590	351	36060	351	50730	350
30570	350	32000	351	36070	351	50735	350
30575	350	32010	351	36080	351	50740	350
30580	350	32011	351	36090	351	50745	350
30590	350	32012	351	36214	35	50750	350
30700	350	32013	351	50100	350	50755	350
30710	350	32025	351	50110	350	50760	350
30711	350	32030	351	50111	350	50770	350
30712	350	32035	351	50112	350	50775	350
30715	350	32040	351	50115	350	50780	350
30720	350	32045	351	50120	350	50790	350
30725	350	32050	351	50125	350	51000	350
30730	350	32055	351	50130	350	51010	350
30735	350	32060	351	50135	350	51011	350
30740	350	32065	351	50140	350	51012	350
30745	350	32070	351	50145	350	51014	350

PART NO.	PG #	PART NO.	PG #	PART NO.	PG #	PART NO.	PG #
51020	350	53030	351	1550601	31	161650390	369
51025	350	53035	351	1558001	30	161650398	369
51030	350	53040	351	1558002	30	161650399	369
51035	350	53045	351	1558010	29	161650650	369
51040	350	53050	351	1558030	29	161650663	369
51045	350	53055	351	1558031	29	161720215	369
51050	350	53060	351	1559000	30	161720295	369
51055	350	53070	351	1559001	30	161720390	369
51060	350	53080	351	1559002	30	161720650	369
51070	350	53550	351	1559010	31	162350215	369
51080	350	54000	351	1559011	31	162350295	369
51090	350	54010	351	1559012	31	162350390	369
51200	350	54011	351	1559020	29	162420295	369
51210	350	54012	351	1559023	29	162540215	369
51211	350	54024	352	1559030	30	162540295	369
51212	350	54035	351	1559031	30	162540390	369
51220	350	54040	351	1559032	30	162900215	369
51225	350	54045	351	1559040	31	162900295	369
51230	350	54050	351	1559041	31	162900390	369
51235	350	54055	351	1559042	31	162900650	369
51240	350	54060	351	1559050	30	162950215	369
51245	350	54070	351	1559051	30	162950295	369
51250	350	54080	351	1559052	30	162950390	369
51255	350	54090	351	1559060	29	164100303	369
51260	350	56000	351	1559063	29	164100398	369
51270	350	56010	351	1559070	29	164100399	369
51280	350	56011	351	1559073	29	164100663	369
51290	350	56012	351	1559080	32	164100664	369
51500	350	56045	351	1559081	32	164600390	369
51510	350	56050	351	1559082	32	164600398	369
51511	350	56055	351	1559090	32	164600399	369
51512	350	56060	351	1559091	32	164100663	369
51520	350	56070	351	1559092	32	164100664	369
51525	350	56080	351	1559230	30	164600390	369
51530	350	56090	351	1559231	30	164600398	369
51535	350	62062	35	1559240	30	300B0218	352
51540	350	62070	35	1559241	30	300B0224	352
51545	350	97170	35	1559250	30	300B0230	352
51550	350	97180	35	1559251	30	300B0236	352
51555	350	97187	35	1559260	29	300B0248	352
51560	350	97896	35	1559263	29	300B0260	352
51570	351	97897	35	1559270	29	300B0272	352
51580	351	97900	34	1559273	29	300B0318	352
51590	351	97901	34	1559280	31	300B0324	352
52000	351	97910	34	1559281	31	300B0330	352
52010	351	97911	34	1559290	31	300B0336	352
52011	351	97920	34	1559291	31	300B0348	352
52012	351	97921	34	1559900	33	300B0360	352
52025	351	97930	34	1559901	33	300B0372	352
52030	351	97931	34	1559902	33	300B0518	352
52035	351	97940	34	1822025	33	300B0524	352
52040	351	97941	34	1822026	33	300B0536	352
52045	351	97950	34	1828010	33	300B0542	352
52050	351	97951	34	1836015	33	300B0548	352
52055	351	97952	34	1836050	33	300B0560	352
52060	351	97960	34, 35	1850022	33	300B0572	352
52070	351	97961	34, 35	1854010	33	300B0718	352
52080	351	97962	34, 35	1854015	32	300B0724	352
52090	351	97970	34	1854030	32	300B0730	352
52500	351	97971	34	1854035	33	300B0736	352
52510	351	97972	34	1855050	32	300B0742	352
52511	351	97980	34	1855051	32	300B0748	352
52512	351	97981	34	1855055	32	300B0754	352
52524	352	97982	34	161010295	369	300B0760	352
52530	351	97990	34	161010390	369	300B0772	352
52535	351	97991	34	161050215	369	300B1018	352
52540	351	97992	34	161050295	369	300B1024	352
52545	351	660001	74	161050390	369	300B1030	352
52550	351	660011	74	161570050	369	300B1036	352
52555	351	660041	74	161570100	369	300B1048	352
52560	351	660042	74	161570150	369	300B1060	352
52570	351	660071	74	161570215	369	300B1066	352
52580	351	660081	74	161570295	369	300B1072	352
52590	351	660143	74	161570390	369	300B1218	352
53000	351	1550110	30	161570650	369	300B1224	352
53010	351	1550203	31	161650215	369	300B1230	352
53011	351	1550223	75	161650295	369	300B1236	352
53012	351	1550301	31	161650303	369	300B1248	352
						300B1260	352
						300B1272	352
						300B1518	352
						300B1524	352

PART NO.	PG #	PART NO.	PG #	PART NO.	PG #	PART NO.	PG #
300B1530	352	31210TOE	351	A11008	161	B02407	3
300B1536	352	31212TOE	351	A11011	161	B02408	3
300B1548	352	605B	351	A11016	161	B0240BN	3
300B1560	352	605G	351	A11017	161	B0240BS	3
300B1572	352	607B	351	A33001	126	B0240PN	3
300B2018	352	607G	351	A33002	126	B0240PS	3
300B2024	352	610B	351	A33005	126	B0240RB	3
300B2030	352	610G	351	A33006	126	B0240WB	3
300B2036	352	A01001	72	A33010	125	B0250BN	3
300B2042	352	A01002	72	A97001	169	B0250RB	3
300B2048	352	A01003	72	A97002	169	B0250WB	3
300B2060	352	A01004	72	A97004	169	B03001	3
300B2072	352	A01005	72	A97007	169	B03001B	3
300B2530	352	A01006	72	A97009	169	B03003	3
300B3024	352	A01007	72	A97011	169	B03003B	3
300B3036	352	A01008	72	A97012	169	B03004	3
300B4018	352	A01011	72	A97013	169	B03004B	3
300B4060	352	A01012	72	A97014	169	B03005	3
301G0218	352	A01013	72	AB05	351	B03005B	3
301G0224	352	A01014	73	AB07	351	B03010	70, 331
301G0230	352	A01015	72	AG05	351	B03015	70, 331
301G0236	352	A01016	72	AG07	351	B03050	3
301G0248	352	A01017	72	AG10	351	B03400	3
301G0260	352	A01018	72	B00001	119	B03401	3
301G0318	352	A01019	21	B00002	119	B03405	3
301G0324	352	A01020	72	B00003	118	B03406	3
301G0336	352	A01021	72	B00004	118	B03407	3
301G0348	352	A01022	72	B00005	118	B03408	3
301G0360	352	A01023	72	B00006	118	B0350BN	3
301G0518	352	A01024	73	B00007	118	B0350RB	3
301G0524	352	A01026	73	B00008	119	B0350WB	3
301G0530	352	A01027	73	B00009	119	B04006	234
301G0536	352	A01029	73	B00013	119	B04007	234
301G0542	352	A01030	73	B00014	119	B04008	234
301G0548	352	A01031	73	B00016	119	B04150	234
301G0560	352	A01032	73	B00017	119	B04150K	234
301G0572	352	A01033	73	B00018	119	B04151K	234
301G0718	352	A01034	73	B00019	118	B04200	234
301G0724	352	A01035	73	B00020	119	B04200K	234
301G0730	352	A01036	73	B00021	118	B04201	234
301G0736	352	A01037	72	B00022	118	B04201K	234
301G0742	352	A01040	73	B00024	118	B04300	234
301G0748	352	A01041	73	B00025	118	B04300K	234
301G0754	352	A01050	72	B01002	268	B04301	234
301G0760	352	A01051	72	B01003	268	B04301K	234
301G0772	352	A01060	72	B01004	268	B04303	234
301G1018	352	A01061	72	B01006	268	B04304	234
301G1024	352	A01062	72	B01013	268	B04400	234
301G1030	352	A01900	73	B01014	268	B04400K	234
301G1036	352	A01901	73	B01016	268	B04401	234
301G1042	352	A04006	91	B01017	268	B04401K	234
301G1048	352	A04012	91	B01018	268	B04403	234
301G1060	352	A05008	91	B01019	268	B04404	234
301G1072	352	A05014	91	B01020	268	B04600	234
301G1218	352	A05027	91	B02001	3	B05001	302
301G1220	352	A06008	91	B02003	3	B05002	303
301G1224	352	A06014	91	B02004	3	B05003	302
301G1230	352	A10001	65	B02005	3	B05004	302
301G1236	352	A10001	5	B02008	3	B05007	303
301G1242	352	A10002	5	B02049	71, 331	B05008	303
301G1248	352	A10004	5	B02050	3, 331	B05010	296
301G1260	352	A10010	5	B02050	71	B05011	296
301G1518	352	A10011	5	B02051	71, 329	B05012	303
301G1524	352	A10015	5, 65	B02052	71, 331	B05015	296
301G1530	352	A10017	5	B02060	71	B05020	297
301G1536	352	A10018	5	B02100	3	B05021	297
301G1548	352	A10019	5	B02101	4	B05026	302
301G1560	352	A10100	65	B02102	4, 71, 331	B05050	303
301G2018	352	A10150	65	B02103	4, 71, 331	B05051	303
301G2024	352	A10200	65	B02301	3	B05090	297
301G2030	352	A10901	65	B02303	3	B05101	302
301G2036	352	A11001	161	B02304	3	B05150	234
301G2048	352	A11002	161	B02305	3	B05150K	234
301G2060	352	A11003	161	B02400	3	B05200	234
301G3018	352	A11004	161	B02401	3	B05200K	234
301G3024	352	A11005	161	B02404	3	B05300	234
301G4018	352	A11006	161	B02405	3	B05300K	234
301G4048	352	A11007	161	B02406	3	B05400	234

PART NO.	PG #	PART NO.	PG #	PART NO.	PG #	PART NO.	PG #
B05400K	234	B07015	14, 61	B0711PW	15	B07170	62
B05600	234	B07016	14, 61	B0711RB	15	B07171	62
B05740	96	B07017	61	B0711WB	15	B07172	62
B05741	96	B07020	60	B07120	60	B07173	62
B05742	96	B07021	60	B07121	60	B0717AB	15
B05743	96	B07022	60	B07122	60	B0717AL	15
B05744	96	B07023	60	B07123	60	B0717AN	15
B05746	96	B07024	60	B07124	60	B0717BI	15
B05747	96	B07025	60	B07125	60	B0717BL	15
B05748	96	B07027	60	B07126	60	B0717BN	15
B05749	96	B07030	14, 61	B07127	60	B0717BS	15
B05750	96	B07031	14, 61	B07130	15, 61	B0717PN	15
B05751	96	B07032	14, 61	B07131	15, 61	B0717PS	15
B05752	96	B07033	14, 61	B07132	16, 61	B0717PW	15
B05753	96	B07034	14, 61	B07133	16, 61	B0717RB	15
B05754	96	B07035	14, 61	B07134	15, 61	B0717WB	15
B05755	96	B07036	14, 61	B07135	15, 61	B0718AB	16
B05756	96	B07037	14, 61	B07136	16, 61	B0718AL	16
B05757	96	B07038	60	B07137	16, 61	B0718AN	16
B05758	96	B07039	60	B07138	60	B0718BI	16
B05759	96	B07040	60	B07139	60	B0718BL	16
B05760	96	B07041	60	B0713AB	15	B0718BN	16
B05840	97	B07042	60	B0713AL	15	B0718BS	16
B05841	97	B07043	60	B0713AN	15	B0718PN	16
B05842	97	B07044	60	B0713BI	15	B0718PS	16
B05843	97	B07045	60	B0713BL	15	B0718PW	16
B05844	97	B07046	60	B0713BN	15	B0718RB	16
B05845	97	B07047	60	B0713BS	15	B0718WB	16
B05847	97	B07048	60	B0713PN	15	B07200	62
B05848	97	B07049	60	B0713PS	15	B07201	62
B05849	97	B07050	61	B0713PW	15	B07202	62
B05850	97	B07051	61	B0713RB	15	B07203	62
B05851	97	B07052	14, 61	B0713WB	15	B07210	62
B05852	97	B07053	14, 61	B07140	60	B07219	57
B05853	97	B07054	14, 61	B07141	60	B07220T	57
B05854	97	B07055	14, 61	B07142	60	B07221T	57
B05855	97	B07056	61	B07143	60	B07374	62
B05856	97	B07057	61	B07144	60	B07375	62
B05857	97	B07058	14, 61	B07146	60	B07376	62
B05858	97	B07059	14, 61	B07147	60	B07377	62
B05859	97	B07060	14, 61	B07148	60	B07470	62
B05860	97	B07061	14, 61	B07149	60	B07472	62
B05910LF	96	B07070	62	B07150	61	B07476	62
B05911LF	96	B07071	62	B07151	61	B07477	62
B05913LF	96	B07072	62	B07152	16, 61	B0750BN	14
B05914LF	96	B07073	62	B07153	16, 61	B0750RB	14
B05925LF	96	B07074	62	B07154	16, 61	B0750WB	14
B05926LF	96	B07075	62	B07155	16, 61	B0751BN	14
B05927	96, 97	B07076	62	B07156	61	B0751RB	14
B05928	96	B07077	62	B07157	61	B0751WB	14
B05931LF	96	B07101	60	B07158	15, 61	B0752BN	14
B05932LF	96	B07102	60	B07159	15, 61	B0752RB	14
B05940	96	B07103	60	B0715AB	16	B0752WB	14
B05941	96	B07104	60	B0715AL	16	B0753BN	14
B05942	96	B07105	60	B0715AN	16	B0753RB	14
B05943	96	B07106	60	B0715BI	16	B0753WB	14
B05944	96	B07107	60	B0715BL	16	B0754BN	14
B05946	96	B07108	60	B0715BN	16	B0754RB	14
B05947	96	B07110	15	B0715BS	16	B0755BN	14
B05948	96	B07110	61	B0715PN	16	B0755NP	14
B05949	96	B07111	15, 61	B0715PS	16	B0755RB	14
B05950	96	B07111S	57	B0715PW	16	B0755WB	14
B06001	221, 253	B07112	15, 61	B0715RB	16	B08071	62
B06010	221	B07113	15, 61	B0715WB	16	B0811AB	15
B06100	221	B07114	15, 61	B07160	15, 61	B0811AL	15
B07001	60	B07114S	57	B07161	15, 61	B0811AN	15
B07002	60	B07115	15, 61	B0716AB	15	B0811BI	15
B07003	60	B07116	15, 61	B0716AL	15	B0811BL	15
B07004	60	B07117	15, 61	B0716AN	15	B0811BN	15
B07005	60	B0711AB	15	B0716BI	15	B0811BS	15
B07006	60	B0711AL	15	B0716BL	15	B0811PN	15
B07007	60	B0711AN	15	B0716BN	15	B0811PS	15
B07008	60	B0711BI	15	B0716BS	15	B0811PW	15
B07010	14, 61	B0711BL	15	B0716PN	15	B0811RB	15
B07011	14, 61	B0711BN	15	B0716PS	15	B0811WB	15
B07012	14, 61	B0711BS	15	B0716PW	15	B0813AB	15
B07013	14, 61	B0711PN	15	B0716RB	15	B0813AL	15
B07014	14, 61	B0711PS	15	B0716WB	15	B0813AN	15

PART NO.	PG#	PART NO.	PG#	PART NO.	PG#	PART NO.	PG#
B0813BL	15	B10104	66	B1550025	345	B20172	287
B0813BN	15	B10105	66	B1550050	345	B20188	287
B0813PN	15	B10110	65	B1550100	345	B20203	287
B0813PS	15	B10111	65	B1550150	345	B20219	287
B0813PW	15	B10195	65	B1550215	345	B20234	287
B0813RB	15	B10200	69	B1550295	345	B20250	287
B0813WB	15	B10201	69	B1550390	345	B20266	287
B0815AB	16	B10202	69	B1550520	345	B20281	287
B0815AL	16	B1020AB	4	B1550650	345	B20297	287
B0815AN	16	B1020AL	4	B1550860	345	B20313	287
B0815BI	16	B1020AN	4	B1550975	345	B20328	287
B0815BL	16	B1020BI	4	B1551100	345	B20344	287
B0815BN	16	B1020BL	4	B1650001	345	B20359	287
B0815PN	16	B1020BN	4	B1650002	345	B20375	287
B0815PS	16	B1020PN	4	B1650007	346	B20391	287
B0815PW	16	B1020PS	4	B1650025	345	B20406	287
B0815RB	16	B1020PW	4	B1650032	346	B20422	287
B0815WB	16	B1020RB	4	B1650033	346	B20438	287
B0816AB	15	B1020WB	4	B1650050	345	B20453	287
B0816AL	15	B11010	275	B1650058	346	B20469	287
B0816AN	15	B11011	275	B1650059	346	B20484	287
B0816BI	15	B11012	275	B1650060	346	B20500	287
B0816BL	15	B11013	275	B1650100	345	B21075	286
B0816BN	15	B12210	95	B1650107	346	B21087	286
B0816BS	15	B12320	95	B1650108	346	B21100	286
B0816PN	15	B12430	95	B1650109	346	B21112	286
B0816PS	15	B12640	95	B1650110	346	B21125	286
B0816PW	15	B1440007	345	B1650150	345	B21150	286
B0816RB	15	B1440032	345	B1650159	346	B21625	286
B0816WB	15	B1440033	345	B1650160	346	B2350001	346
B0817AB	15	B1440058	345	B1650161	346	B2350002	346
B0817AL	15	B1440059	345	B1650162	346	B2350007	346
B0817BI	15	B1440060	345	B1650215	345	B2350025	346
B0817BL	15	B1440107	345	B1650222	346	B2350032	346
B0817BN	15	B1440108	345	B1650223	346	B2350050	346
B0817BS	15, 61	B1440109	345	B1650224	346	B2350058	346
B0817PN	15	B1440110	345	B1650295	345	B2350059	346
B0817PS	15	B1440159	345	B1650303	346	B2350060	346
B0817PW	15	B1440160	345	B1650304	346	B2350100	346
B0817RB	15	B1440161	345	B1650305	346	B2350107	346
B0817WB	15	B1440162	345	B1650306	346	B2350108	346
B0818AB	16	B1440222	345	B1650307	346	B2350150	346
B0818AL	16	B1440223	345	B1650390	345	B2350159	346
B0818AN	16	B1440224	345	B1650398	346	B2350160	346
B0818BI	16	B1440225	345	B1650399	346	B2350215	346
B0818BL	16	B1440226	345	B1650400	346	B2350222	346
B0818BN	16	B1440303	345	B1650401	346	B2350223	346
B0818PN	16	B1440304	345	B1650402	346	B2350224	346
B0818PS	16	B1440305	345	B1650520	345	B2350295	346
B0818PW	16	B1440306	345	B1650531	346	B2350303	346
B0818RB	16	B1440307	345	B1650532	346	B2350304	346
B0818WB	16	B1440308	345	B1650533	346	B2350305	346
B0850BN	14	B1440398	345	B1650534	346	B2350306	346
B0850RB	14	B1440399	345	B1650535	346	B2350390	346
B0850WB	14	B1440400	345	B1650650	345	B2350398	346
B0851BN	14	B1440401	345	B1650662	346	B2350399	346
B0851RB	14	B1440402	345	B1650663	346	B2350400	346
B0851WB	14	B1440403	345	B1650664	346	B2350401	346
B0852BN	14	B1440531	345	B1650665	346	B2350402	346
B0852RB	14	B1440532	345	B1650666	346	B2350520	346
B0852WB	14	B1440533	345	B1650860	345	B2350531	346
B0853BN	14	B1440534	345	B1650870	346	B2350532	346
B0853RB	14	B1440535	345	B1650871	346	B2350533	346
B0853WB	14	B1440536	345	B1650872	346	B2350650	346
B0854BN	14	B1440662	345	B1650873	346	B2350662	346
B0854RB	14	B1440663	345	B1651100	345	B2350663	346
B0855BN	14	B1440664	345	B1950002	347	B2350860	346
B0855RB	14	B1440665	345	B1950025	347	B2350975	346
B0855WB	14	B1440666	345	B1950050	347	B2351100	346
B10004	279	B1440667	345	B1950100	347	B24050	287
B10080	66	B1440790	345	B1950150	347	B24056	287
B10081	66	B1440870	345	B1950215	347	B24063	287
B10090	66	B1440871	345	B1950295	347	B24075	287
B10091	66	B1440872	345	B20062	287	B24081	287
B10092	66	B1440873	345	B20078	287	B24088	287
B10093	66	B1440875	345	B20094	287	B24100	287
B10094	66	B1441109	345	B20109	287	B24113	287
B10100	66	B1441111	345	B20125	287	B24125	287
B10102	66	B1550001	345	B20141	287	B24150	287

PART NO.	PQ#	PART NO.	PQ#	PART NO.	PQ#	PART NO.	PQ#
B25001	303	B3550100	347	B4600162	348	B4600873	348
B2540001	347	B3550150	347	B4600169	348	B4601100	348
B2540002	347	B3550215	347	B4600170	348	B4860050	347
B2540025	347	B3550295	347	B4600171	348	B4860100	347
B2540050	347	B3550390	347	B4600180	348	B4860150	347
B2540100	347	B3960001	349	B4600181	348	B49001	55
B2540150	347	B3960002	349	B4600182	348	B49002	55
B2540215	347	B3960025	349	B4600215	348	B49010	55
B2540295	347	B3960050	349	B4600221	348	B49011	55
B2540390	347	B3960100	349	B4600222	348	B49012	55
B2540520	347	B3960150	349	B4600223	348	B49013	55
B2540650	347	B3960215	349	B4600224	348	B49020	7, 55
B2540860	347	B3960295	349	B4600234	348	B49021	7, 55
B28025	280	B3960390	349	B4600235	348	B49022	7, 55
B28050	280	B3960520	349	B4600236	348	B50001LF	150
B28051	280	B3960650	349	B4600237	348	B50002LF	150
B28075	280	B3960860	349	B4600245	348	B50003LF	150
B28076	280	B3961100	349	B4600246	348	B50004LF	150
B28100	280	B40000	68	B4600247	348	B50011LF	150
B28125	280	B40001	68	B4600248	348	B50012LF	150
B28150	280	B40002	68	B4600256	348	B50031LF	150
B28200	280	B40003	68	B4600257	348	B50032LF	150
B28375	280	B40004	68	B4600258	348	B50033LF	150
B2900001	347	B40005	68	B4600259	348	B50041LF	150
B2900002	347	B40006	68	B4600295	348	B50042LF	150
B2900025	347	B40007	68	B4600302	348	B50043LF	150
B2900050	347	B40008	68	B4600303	348	B50044LF	150
B2900100	347	B40009	68	B4600304	348	B50051LF	150
B2900150	347	B40010	68	B4600305	348	B50052LF	150
B2900215	347	B40011	68	B4600306	348	B50072LF	150
B2900295	347	B40012	68	B4600315	348	B50073LF	150
B2900390	347	B40013	68	B4600316	348	B50081LF	150
B2900520	347	B40014	68	B4600317	348	B50082LF	150
B2900650	347	B40015	68	B4600318	348	B50083LF	150
B2900860	347	B40017	68	B4600319	348	B50092LF	150
B29025	280	B40018	68	B4600328	348	B50094LF	150
B29050	280	B40019	68	B4600329	348	B50096LF	150
B29051	280	B40020	68	B4600330	348	B50097LF	150
B29075	280	B40021	68	B4600331	348	B50098LF	150
B29076	280	B40023	68	B4600339	348	B50099LF	150
B29100	280	B40024	68	B4600340	348	B50100LF	150
B29125	280	B40025	68	B4600342	348	B50103LF	150
B29150	280	B40026	68	B4600350	348	B51003	10
B29200	280	B40027	68	B4600390	348	B51004	10
B29300	299	B40028	68	B4600398	348	B51005	10, 62
B29310	299	B40030	68	B4600399	348	B51006	62
B29375	280	B40032	68	B4600400	348	B51007	10, 62
B29400	299	B40033	68	B4600401	348	B51008	62
B2950001	347	B40034	68	B4600402	348	B51009	62
B2950002	347	B40035	68	B4600413	348	B51010	10, 62
B2950025	347	B40036	68	B4600414	348	B51011	62
B2950050	347	B45010	4, 69	B4600415	348	B51014	11, 62
B2950100	347	B45014	69	B4600416	348	B51015	11, 62
B2950150	347	B45200	82	B4600417	348	B51019	10, 62
B2950215	347	B45215	82	B4600429	348	B51020	10, 62
B2950295	347	B45216	82	B4600430	348	B5112AP	11
B2950390	347	B45217	82	B4600431	348	B5112BB	11
B2950520	347	B45218	82	B4600444	348	B5112BI	11
B2950650	347	B45220	82	B4600447	348	B5112BN	11
B2950860	347	B4600001	348	B4600457	348	B5112BS	11
B29625	279	B4600002	348	B4600470	348	B5112PW	11
B29699	292	B4600025	348	B4600520	348	B5112RB	11
B29700	292	B4600032	348	B4600531	348	B5112WB	11
B29701	292	B4600050	348	B4600532	348	B5114AP	11
B29702	292	B4600056	348	B4600533	348	B5114BB	11
B29801	292	B4600057	348	B4600534	348	B5114BN	11
B29802	292	B4600058	348	B4600535	348	B5114PB	11
B29805	292	B4600059	348	B4600536	348	B5114PN	11
B29806	292	B4600100	348	B4600650	348	B5114PS	11
B29875	279	B4600106	348	B4600662	348	B5114RB	11
B29900	292	B4600107	348	B4600663	348	B5114WB	11
B29901	292	B4600108	348	B4600664	348	B5155AB	10
B29999	279	B4600109	348	B4600665	348	B5155AL	10
B3350050	345	B4600116	348	B4600666	348	B5155AN	10
B3350100	345	B4600117	348	B4600667	348	B5155AP	10
B3350150	345	B4600118	348	B4600668	348	B5155BB	10
B3350215	345	B4600150	348	B4600860	348	B5155BI	10
B3350390	345	B4600158	348	B4600870	348	B5155BL	10
B3550025	347	B4600159	348	B4600871	348	B5155BN	10

PART NO.	PG #	PART NO.	PG #	PART NO.	PG #	PART NO.	PG #
B5155BNB	10	B6570520	349	B74026LF	148	B74229LF	149
B5155BS	10	B6570650	349	B74027LF	148	B74230LF	149
B5155PS	10	B6570860	349	B74028LF	148	B74231LF	149
B5155PW	10	B66050	162	B74029LF	148	B74232LF	149
B5155RB	10	B66075	162	B74042LF	148	B74235LF	149
B5155WB	10	B66375	162	B74044LF	148	B74262LF	148
B5155WBB	10	B67050	162	B74045LF	148	B74263LF	148
B5156AP	10	B67100	163	B74046LF	148	B74264LF	148
B5156BB	10	B67101	163	B74066LF	148	B74265LF	148
B5156BN	10	B67102	163	B74067LF	148	B74266LF	148
B5156PS	10	B67103	163	B74081LF	148	B74267LF	148
B5156RB	10	B67104	163	B74082LF	148	B74268LF	148
B5156WB	10	B67105	163	B74083LF	148	B74269LF	148
B5160AP	10	B67106	163	B74084LF	148	B74284LF	149
B5160BB	10	B67200	163	B74085LF	148	B74285LF	149
B5160BN	10	B67201	163	B74086LF	148	B74286LF	149
B5160BS	10	B67202	163	B74087LF	148	B74287LF	149
B5160PN	10	B67203	163	B74088LF	148	B74288LF	149
B5160PS	10	B67204	163	B74089LF	148	B74289LF	149
B5160RB	10	B67205	163	B74090LF	148	B74301LF	149
B5160WB	10	B67206	163	B74104LF	149	B74302LF	149
B5161AP	10	B67208	163	B74105LF	149	B74303LF	149
B5161BB	10	B67209	163	B74107LF	149	B74304LF	149
B5161BN	10	B67210	163	B74108LF	149	B74305LF	149
B5161PS	10	B67211	163	B74121LF	149	B74306LF	149
B5161RB	10	B67212	163	B74122LF	149	B74331LF	149
B5161WB	10	B67213	163	B74123LF	149	B74343LF	148
B55001	68	B67214	163	B74124LF	149	B74344LF	148
B55002	68	B67215	163	B74125LF	149	B74345LF	148
B55003	68	B67216	163	B74126LF	149	B74347LF	148
B55004	68, 329	B67217	163	B74127LF	149	B74354LF	148
B55005	68, 329	B67218	163	B74128LF	149	B74358LF	148
B55006	68, 329	B67219	163	B74129LF	149	B74359LF	148
B55007	68, 329	B67312	163	B74132LF	149	B74365LF	148
B55008	68	B67313	163	B74140LF	149	B74367LF	148
B55009	68	B67315	163	B74142LF	149	B74368LF	148
B55050	68	B67316	163	B74144LF	149	B74369LF	148
B55100LF	68	B67317	163	B74145LF	149	B74370LF	149
B55101LF	68	B67320	163	B74148LF	149	B74380LF	148
B55103LF	68	B67321	163	B74150LF	149	B74381	148
B55150	55	B67322	163	B74152LF	149	B74382	148
B59000	165	B67323	163	B74153LF	149	B74384	148
B59001LF	164	B67375	162	B74154LF	149	B74396LF	148
B59002LF	164	B67937	162	B74155LF	149	B90050	164
B59050	165	B67975	162	B74156LF	149	B90075	164
B59075	165	B68001	162	B74157LF	149	B90100	164
B59100	165	B68050	162	B74160LF	149	B90125	164
B60001	54	B68058	162	B74161LF	149	B90150	164
B60002	54	B68375	162	B74181LF	148	B90200	164
B60099	263	B69050	162	B74182LF	148	B90250	164
B60950	165	B69121	162	B74183LF	148	B90300	164
B60975	165	B70001	4	B74184LF	148	B90400	164
B60994	263	B70003	4	B74185LF	148	B91050	164
B63050LF	140	B70004	4	B74186LF	148	B91075	164
B63075LF	140	B70006	4	B74187LF	148	B91100	164
B63100LF	140	B70007	4	B74188LF	148	B91125	164
B64050	162	B70008	4	B74189LF	148	B91150	164
B64075	162	B70009	4	B74200LF	149	B91200	164
B64100	162	B70030	4	B74201LF	149	B91250	164
B64125	162	B70031	4	B74202LF	149	B91300	164
B64150	162	B70032	4	B74203LF	149	B91400	164
B64200	162	B70033	4	B74204LF	149	B92050	164
B64375	162	B70045	4	B74205LF	149	B92075	164
B64450	162	B70499	221, 253	B74206LF	149	B95150	164
B64475	162	B74001LF	148	B74207LF	149	B95200	164
B65050	162	B74002LF	148	B74208LF	149	BI05	351
B65075	162	B74003LF	148	B74209LF	149	BI07	351
B65100	162	B74004LF	148	B74210LF	149	BI10	351
B65375	162	B74005LF	148	B74212LF	149	BI12	351
B6570001	349	B74006LF	148	B74213LF	149	BI15	351
B6570002	349	B74007LF	148	B74216LF	149	BI20	351
B6570025	349	B74008LF	148	B74217LF	149	BIN004	130
B6570050	349	B74009LF	148	B74218LF	149	BIN005	130
B6570100	349	B74021LF	148	B74220LF	149	BIN008	130
B6570150	349	B74022LF	148	B74222LF	149	BIN012	130
B6570215	349	B74023LF	148	B74223LF	149	BOX	3
B6570295	349	B74024LF	148	B74224LF	149	BOX006	130
B6570390	349	B74025LF	148	B74228LF	149	BOX008	130

PART NO.	PG #	PART NO.	PG #	PART NO.	PG #	PART NO.	PG #
BOX011	130	C02045	49	C02993	49	C05049	44
BWV200	234	C02046	49	C02994	49	C05051	44
BWV300	234	C02050	47	C02995	49	C05052	45
BWV400	234	C02075	50	C02996	49	C05053	45
C001WD00	376	C02100	49	C02997	49	C05054	45
C001WD01	376	C02103	49	C02998	49	C05056	44
C002WD00	376	C02104	49	C02999	49	C05057	44
C002WD01	376	C02105	49	C03200	50	C05070	45
C01001	240	C02106	49	C03201	50	C05071	45
C01002	240	C02200	50	C03202	50	C05080	66
C013WD00	375	C02201	50	C03203	50	C05081	66
C013WD00CH	375	C02202	50	C03210	50	C05082	66
C013WD01	375	C02203	50	C03211	50	C05085	45
C013WD02	375	C02210	50	C03212	50	C05086	45
C013WDO00	376	C02211	50	C03213	50	C050WD00	376
C013WDS00	375	C02300	50	C03240	50	C05200	45
C014WD00	375	C02301	50	C03250	50	C06001	5
C014WD00BN	375	C02302	50	C03251	50	C06002	5
C014WD00CH	375	C02303	50	C03252	50	C06004	5
C014WD01	375	C02310	50	C03253	50	C06006	5
C014WD02	375	C02311	50	C03260	50	C06007	5
C014WD20	375	C023WD00	375	C03265	50	C06008	5
C014WD30	375	C023WD01	375	C03270	50	C06011	5
C014WD40	375	C023WD02	375	C03271	50	C06013	5
C014WD45	375	C023WD04	375	C03272	50	C06014	5
C014WD50	375	C02401	47	C03280	50	C06016	5
C014WD90	375	C02402	47	C03300	51	C06018	5
C014WDO00	376	C02403	47	C03301	51	C06020	5
C014WDS00	375	C02404	47	C03302	51	C06021	5
C02000	48	C02405	47	C03303	51	C06024	5
C02000B	48	C02421	47	C03304	51	C09000	123
C02001	48	C02422	47	C03305	51	C09001	123
C02001B	48	C02423	47	C03306	51	C09002	123
C02002	48	C02424	47	C03800	51	C09003	123
C02002B	48	C024WD00	375	C03801	51	C100BBSSCAM0	381
C02003	48	C024WD01	375	C03803	51	C101000	379
C02003B	48	C024WD02	375	C03804	51	C101001	379
C02004	48	C024WD04	375	C03805	51	C101002	379
C02004B	48	C02800	49	C03807	51	C1010TK00	379
C02005	48	C02801	49	C03810	51	C101100	379
C02005B	48	C02802	49	C04000	42	C101101	379
C02010	48	C02803	49	C04001	42	C101102	379
C02010B	48	C02804	49	C04002	42	C1011TK00	379
C02011	48	C02805	49	C04004	42	C104100	378
C02011B	48	C02806	49	C04005	42	C104200	378
C02012	48	C02807	49	C04006	42	C105000	378
C02012B	48	C02808	49	C04007	42	C1050S00	378
C02013	48	C02809	49	C04008	42	C1050S01	378
C02014	48	C02810	49	C04010	42	C105C00	381
C02014B	48	C02811	49	C04011	42	C105SSC00	381
C02015	48	C02812	49	C04013	43	C106C00	381
C02015B	48	C02813	49	C04014	42	C106C90	381
C02020	48	C02814	49	C04015	43	C106CE200	380
C02020B	48	C02815	49	C04016	42	C106CHPM00	381
C02021	48	C02820	49	C04017	43	C106SSC00	381
C02021B	48	C02821	49	C04019	41	C106SSC01	381
C02022	48	C02822	49	C04020	41	C106SSC90	381
C02022B	48	C02823	49	C04021	41	C106SSCAM00	381
C02023	48	C02824	49	C04024	42	C106SSCAM90	381
C02023B	48	C02825	49	C04025	42	C106SSCAMFRO	381
C02024	48	C02830	49	C04027	43	C108C00	380
C02024B	48	C02832	49	C04028	42	C108SSC00	380
C02025	48	C02850	49	C04029	42	C108SSCAM00	380
C02025B	48	C02851	49	C04030	41	C11050	91
C02029	48	C02852	49, 51	C04031	41	C1106S00	379
C02029B	48	C02853	49	C04032	43	C11075	91
C02030	48	C02860	49	C04033	43	C1107S00	379
C02030B	48	C02861	49	C04034	43	C110C00	379
C02031	48	C02862	49	C04038	43	C11100	91
C02031B	48	C02863	49	C04039	43	C11125	91
C02032	48	C02864	49	C049WD00	376	C11150	91
C02032B	48	C02865	49	C05040	42	C11200	91
C02033	48	C02900	49	C05041	42	C11250	91
C02033B	48	C02901	49	C05042	45	C11300	91
C02034	48	C02987	49	C05045	44	C11400	91
C02034B	48	C02989	49	C05046	44	C12050	91
C02040	49	C02990	47	C05047	44	C12075	91
C02041	49	C02992	49	C05048	44	C12100	91

PART NO.	PG #	PART NO.	PG #	PART NO.	PG #	PART NO.	PG #
C1210S00	378	C27201	43	C33145	256	C38206	255
C1211S00	378	C27202	43	C33146	256	C38214	255
C1211S02	378	C27301	43	C33221	256	C384	73
C12125	91	C27302	43	C33222	256	C38402	254
C12150	91	C27303	43	C33223	256	C38403	254
C12200	91	C27304	43	C33231	256	C38404	254
C12250	91	C27305	43	C33232	256	C38502	254
C12300	91	C27308	43	C33233	256	C38503	254
C12400	91	C27309	43	C33244	256	C38504	254
C12600	91	C27310	43	C33245	256	C39002	255
C13050	92	C27321	44	C33246	256	C39003	255
C13075	92	C27322	44	C33321	256	C39004	255
C14205	91	C27323	44	C33322	256	C39005	255
C14206	91	C27324	44	C33323	256	C39006	255
C14207	91	C27325	44	C33331	256	C39014	255
C15300	91	C27328	44	C33332	256	C39102	255
C15301	91	C29123	123	C33333	256	C39103	255
C15302	91	C29124	123	C33344	256	C39104	255
C15303	91	C29126	123	C33345	256	C39114	255
C15304	91	C29150	123	C33346	256	C39203	255
C15305	91	C29200	123	C33444	256	C39204	255
C15306	91	C2B1E16BN	377	C33445	256	C39205	255
C15307	91	C2B1E16BR	377	C33446	256	C39206	255
C160600	378	C2B1E16CH	377	C33544	256	C39214	255
C1606HPSS00	381	C2B1E17BN	377	C33545	256	C39402	254
C1606OS00	381	C2B1E17BR	377	C33546	256	C39403	254
C1606S00	378	C2B1E17CH	377	C35090	291	C39404	254
C1606S01	378	C2B1E18BN	377	C35091	291	C39503	254
C1606S02	378	C2B1E18CH	377	C36003	254	C39504	254
C17050	92	C2B1E19BN	377	C36004	254	C3B2E115BN	377
C17075	92	C2B1E19CH	377	C36006	254	C3B2E117BN	377
C17100	92	C2B1ES19CH	377	C36013	254	C3B2E117BR	377
C17125	92	C2B1R16BN	377	C36014	254	C3B2E118BN	377
C17150	92	C2B1R16BR	377	C36016	254	C3B2E118CH	377
C17200	92	C2B1R16CH	377	C36024	254	C3B2E220BN	377
C1740CH	75	C2B1R17BN	377	C36034	254	C3B2R117BN	377
C1742C	75	C2B1R17BR	377	C36104	254	C3B2R117BR	377
C1742H	75	C2B1R17CH	377	C36106	254	C3B2R117CH	377
C1744D	75	C2B1R18BN	377	C36114	254	C3B2R118CH	377
C1754CH	75	C2B1R18CH	377	C36116	254	C3B2R220BN	377
C1756C	75	C2B1R19BN	377	C36124	254	C3B3ESL00	378
C1756H	75	C2B1R19CH	377	C36134	254	C3B3RSL00	378
C1757CH	75	C2B1RS19CH	377	C37002	258	C3B4E290CH	375
C1759D	75	C2B6R9AQCH	383	C37003	258	C3B4R201BN	375
C1807A	75	C2B6R9SHCH	383	C37004	258	C3B4R220	375
C1809A	75	C30050	164	C37005	258	C3B4R230	375
C19050	92	C30075	164	C37006	258	C3B4R240	375
C19051	92	C30100	164	C37014	258	C3B4R245	375
C19075	92	C30125	164	C37102	258	C3B4R250	375
C200HEX	383	C30150	164	C37103	258	C3B4R253	375
C200HPSS	383	C30200	164	C37104	258	C3B4R290	375
C2200000	378	C306CHPSS00	383	C37302	258	C3B4R290CH	375
C2200HPSS00	381	C31050	164	C37303	258	C3B4R400CH	376
C2200HPSSAMF	381	C31075	164	C37304	258	C3B5E200	382
C2200OS00	381	C31100	164	C37314	258	C3B5E200CH	382
C2200S00	378	C31125	164	C37801	230, 259	C3B5E201	382
C2200S01	378	C31150	164	C37803	230, 259	C3B5R200	382
C2200S02	378	C31200	164	C37805	231, 259	C3B5R200CH	382
C2200S04	378	C33001	257	C37806	231, 259	C3B5R201	382
C2200S90	378	C33002	257	C37807	231, 259	C3B5R260	382
C25000	100	C33003	257	C37808	231, 259	C40002	255
C25001	100	C33004	257	C37810	231, 259	C40003	255
C25002	100	C33005	257	C37811	231, 259	C40004	255
C25003	100	C33006	257	C38002	255	C40006	255
C25010	100	C33021	256	C38003	255	C40102	254
C25011	100	C33022	256	C38004	255	C40103	254
C25012	100	C33023	256	C38005	255	C40104	254
C25013	100	C33031	256	C38006	255	C40320	239
C25020	100	C33032	256	C38014	255	C40420	239
C25021	100	C33033	256	C38102	255	C40425	239
C25022	100	C33044	256	C38103	255	C40430	239
C27125	43	C33045	256	C38104	255	C40440	239
C27126	43	C33046	256	C38114	255	C40500	239
C27127	43	C33088	257	C382	73	C40503	239
C27134	43	C33121	256	C38202	255	C406	73
C27150	43	C33122	256	C38203	255	C40640	240
C27150A	43	C33123	256	C38204	255	C406A	73
C27200	43	C33144	256	C38205	255	C406SSCHPSS00	383

PART NO.	PG #	PART NO.	PG #	PART NO.	PG #	PART NO.	PG #
C41410	239	C53400	174	C59064	227	C60032	228
C41411	239	C53401	174	C59065	227	C60033	228
C41420	239	C53402	176	C59066	227	C60040	225
C41421	239	C53403	176	C59067	227	C60041	225
C41430	239	C53600	175	C59068	227	C60042	225
C41440	239	C53601	175	C59069	227	C60043	225
C41460	239	C53700	175	C59070	227	C60044	225
C42421	239	C53701	175	C59071	227	C60045	225
C42440	239	C54150	175	C59090	229	C60046	225
C42460	239	C54340	176	C59091	229	C60047	225
C43440	240	C54341	176	C59092	229	C60050	227
C43441	240	C54342	176	C59093	229	C60051	227
C44420	240	C54343	176	C59094	229	C60052	227
C44440	240	C54400	176	C59095	229	C60053	227
C45433	239	C54401	176	C59096	229	C60054	228
C46331	239	C54402	176	C59097	229	C60055	228
C46351	239	C54403	176	C59098	229	C60056	228
C46431	239	C55043	176	C59099	229	C60057	228
C46451	239	C55143	176	C59100	229	C60060	225
C47320	239	C56100	126	C59101	229	C60061	225
C4733A	175	C57034	174	C59102	229	C60062	225
C4733P	175	C57040	174	C59103	229	C60063	225
C47340	239	C57045	175	C59200	226	C60064	225
C47420	239	C57134	174	C59201	226	C60065	225
C47430	239	C57140	174	C59202	226	C60066	225
C4743A	175	C57234	174	C59203	226	C60067	225
C4743P	175	C57236	174	C59204	226	C60070	228
C47440	239	C57334	174	C59205	226	C60071	228
C47460	239	C57434	176	C59206	226	C60072	228
C49421	240	C58034	174	C59207	226	C60073	228
C49440	240	C58040	174	C59208	227	C60075	228
C49441	240	C58045	175	C59209	227	C60076	228
C49442	240	C58134	174	C59210	227	C60077	228
C50300	174	C58140	174	C59211	227	C60078	228
C50301	174	C58234	174	C59212	227	C60079	228
C50302	175	C58236	174	C59213	227	C60080	228
C50303	175	C58334	174	C59214	227	C60081	228
C50304	175	C58434	176	C59215	227	C60082	228
C50305	175	C59001	226	C59216	227	C60083	228
C50306	175	C59002	226	C59217	227	C60084	228
C50307	175	C59003	226	C59218	227	C60085	228
C50308	175	C59004	226	C59219	227	C60086	228
C50309	175	C59005	226	C59220	227	C60087	228
C50340	174	C59006	226	C59221	227	C60088	228
C50341	174	C59007	226	C59222	227	C60089	228
C50345	174	C59008	226	C59223	227	C60092	228
C50346	174	C59010	227	C59240	184	C60094	228
C50400	174	C59011	227	C59241	184	C60095	228
C51150	176	C59012	227	C59242	184	C60096	228
C51300	174	C59013	227	C59244	184	C60097	228
C51301	174	C59014	227	C59245	184	C60106	223
C51302	177	C59015	227	C59250	184	C60107	223
C51303	177	C59016	227	C59251	184	C60108	223
C51340	174	C59017	227	C59252	184	C60112	223
C51341	174	C59020	229	C60001	227	C60116	223
C51350	175	C59021	229	C60003	227	C60117	223
C51351	175	C59022	229	C60007	223	C60118	223
C51400	174	C59023	229	C60008	223	C60140	224
C51401	174	C59024	229	C60009	223	C60141	224
C51402	177	C59025	229	C60010	223	C60142	224
C51403	177	C59026	229	C60011	223	C60143	224
C51450	175	C59027	229	C60012	223	C60144	224
C51451	175	C59028	229	C60013	225	C60145	224
C52150	176	C59029	229	C60014	225	C60146	224
C52340	174	C59030	229	C60015	225	C60147	224
C52341	174	C59031	229	C60016	225	C60160	224
C52342	176	C59050	226	C60020	227	C60161	224
C52343	176	C59051	226	C60021	227	C60162	224
C52345	174	C59052	226	C60022	227	C60163	224
C52346	174	C59053	226	C60023	227	C60164	224
C52400	174	C59054	227	C60024	227	C60165	224
C52401	174	C59055	227	C60025	227	C60166	224
C52402	176	C59056	227	C60026	228	C60167	224
C52403	176	C59057	227	C60027	228	C60170	222
C53340	174	C59060	226	C60028	228	C60171	222
C53341	174	C59061	226	C60029	228	C60172	222
C53342	176	C59062	226	C60030	228	C60207	223
C53343	176	C59063	226	C60031	228	C60211	223

PART NO.	PG #	PART NO.	PG #	PART NO.	PG #	PART NO.	PG #
C60500	231	C74003	133	C74099	133	C75057	359
C60501	231	C74004	133	C74100LF	133	C75058	359
C60502	231	C74005	133	C74101LF	133	C75059	359
C60503	231	C74006	133	C74102LF	133	C75060	359
C60504	231	C74007	133	C74103LF	133	C75061	359
C60505	231	C74008	133	C74105	68, 318	C75062	359
C60800	215	C74009	133	C74112LF	134	C75063	359
C60801	215	C74010	133	C74113LF	133	C75064	359
C60802	215	C74011	133	C74114LF	133	C75065	359
C60803	20, 215	C74012	133	C74118LF	133	C75066	359
C60804	20, 215	C74013	133	C74121LF	134	C75067	359
C60805	215	C74014	133	C74123LF	134	C75068	359
C60806	19, 215	C74015	133	C74131LF	134	C75069	358
C60807	19, 215	C74016	133	C74135LF	134	C75070	358
C60808	215	C74017	133	C74136LF	134	C75071	358
C60809	215	C74018	133	C74146LF	134	C75073	358
C60810	19, 215	C74019	133	C74147LF	133	C75074	358
C60811	215	C74020	133	C74149LF	134	C75075	358
C60812	215	C74021LF	133	C74152	133	C75076	358
C60813	19, 215	C74022LF	133	C74155LF	133	C75077	358
C60814	19, 215	C74023LF	133	C74158LF	134	C75078	358
C60817	215	C74025LF	133	C74250LF	80	C75079	358
C60818	215	C74026LF	133	C74251LF	80	C75080	358
C60819	215	C74027LF	133	C75000	358	C75081	358
C60820	215	C74029LF	133	C75001	358	C75082	358
C60821	215	C74030LF	133	C75002	358	C75083	358
C60822	215	C74031LF	133	C75003	358	C75084	358
C60823	215	C74032LF	133	C75004	358	C75085	358
C60824	215	C74033LF	133	C75005	358	C75086	358
C60825	215	C74034LF	133	C75006	358	C75087	358
C6083BN	19	C74036LF	133	C75007	358	C75088	358
C6083RB	19	C74037LF	133	C75008	358	C75089	358
C6083WB	19	C74038LF	133	C75009	358	C75090	358
C6084BN	20	C74039LF	133	C75010	358	C75091	358
C6084RB	20	C74040LF	134	C75011	358	C75092	358
C6084WB	20	C74041LF	134	C75012	358	C75093	358
C6087BN	19	C74042LF	134	C75013	358	C75094	358
C6087RB	19	C74043LF	134	C75014	359	C75095	358
C6087WB	19	C74044LF	134	C75015	359	C75096	358
C60888	19, 215	C74045LF	133	C75016	359	C75097	358
C6088BN	19	C74046LF	133	C75017	359	C75098	358
C6088RB	19	C74048LF	133	C75018	359	C75099	358
C6088WB	19	C74049LF	133	C75019	359	C75100	358
C6089AB	19	C74050LF	133	C75020	359	C75101	358
C6089AL	19	C74051LF	133	C75021	359	C75102	358
C6089AN	19	C74052LF	133	C75022	359	C75103	358
C6089BI	19	C74053LF	133	C75023	359	C75104	358
C6089BL	19	C74054LF	133	C75024	359	C75105	358
C6089BN	19	C74055LF	133	C75025	359	C75106	358
C6089PN	19	C74058LF	134	C75026	359	C75107	358
C6089PS	19	C74059LF	134	C75027	359	C75108	358
C6089PW	19	C74060LF	134	C75028	359	C75109	358
C6089RB	19	C74063LF	134	C75029	359	C75110	358
C6089WB	19	C74064LF	134	C75030	359	C75111	357
C61009	224	C74065LF	134	C75031	359	C75112	357
C61023	224	C74066LF	134	C75033	359	C75113	357
C61034	224	C74067LF	134	C75034	359	C75114	357
C61123	224	C74068LF	134	C75035	359	C75115	357
C61134	224	C74069LF	134	C75036	359	C75116	357
C61223	224	C74070LF	134	C75037	359	C75117	357
C61234	224	C74071LF	134	C75038	359	C75118	357
C61432	224	C74072LF	134	C75039	360	C75119	357
C61434	224	C74073LF	134	C75040	360	C75120	357
C67230	235	C74078LF	134	C75041	360	C75121	357
C67340	235	C74081LF	134	C75042	360	C75122	357
C67440	235	C74082LF	134	C75043	360	C75123	357
C67445	235	C74085LF	134	C75044	360	C75124	357
C67450	225	C74086LF	134	C75045	360	C75125	357
C67451	225	C74087LF	134	C75046	360	C75126	357
C72003	253	C74088LF	134	C75047	360	C75127	357
C72093	253	C74089LF	134	C75048	360	C75128	357
C73003	252	C74090LF	134	C75049	360	C75129	357
C73004	252	C74091LF	133	C75050	360	C75130	357
C73093	252	C74093LF	133	C75051	360	C75131	357
C73094	252	C74095	134	C75052	360	C75132	357
C73192	252	C74096	133	C75053	360	C75133	357
C74001LF	133	C74097	133	C75055	359	C75134	357
C74002LF	133	C74098	133	C75056	359	C75135	357

PART NO.	PG #	PART NO.	PG #	PART NO.	PG #	PART NO.	PG #
C75136	357	C75222	362	C75306	363	C75395	357
C75137	357	C75223	362	C75307	363	C75396	357
C75138	357	C75224	362	C75308	363	C75397	357
C75139	357	C75225	362	C75309	363	C75398	357
C75140	357	C75226	362	C75310	363	C75399	357
C75141	357	C75227	362	C75311	357	C75400	357
C75142	357	C75228	362	C75312	357	C75401	357
C75143	362	C75229	362	C75313	357	C75403	360
C75144	362	C75230	362	C75314	357	C75404	360
C75145	362	C75231	362	C75315	357	C75405	360
C75146	362	C75232	362	C75316	357	C75406	360
C75147	362	C75233	362	C75317	357	C75407	360
C75148	362	C75234	362	C75318	357	C75408	360
C75149	362	C75235	362	C75319	357	C75409	360
C75150	362	C75236	362	C75320	357	C75410	360
C75151	362	C75237	362	C75321	357	C75411	360
C75152	362	C75238	362	C75322	357	C75412	358
C75153	362	C75239	362	C75323	357	C75413	358
C75154	363	C75240	362	C75324	357	C75414	358
C75155	363	C75242	362	C75325	357	C75415	358
C75156	363	C75243	362	C75326	357	C75416	358
C75157	363	C75244	362	C75327	357	C75417	358
C75158	363	C75245	362	C75328	357	C75418	358
C75160	362	C75246	362	C75329	357	C75419	358
C75161	362	C75247	362	C75330	357	C75420	358
C75162	362	C75248	362	C75331	357	C75421	358
C75163	362	C75249	362	C75332	357	C75422	358
C75166	362	C75250	362	C75333	357	C75423	358
C75167	362	C75251	362	C75334	357	C75424	358
C75168	362	C75252	362	C75335	357	C75425	361
C75169	362	C75253	362	C75336	357	C75427	361
C75170	362	C75254	362	C75337	357	C75428	361
C75171	362	C75255	362	C75338	357	C75428	361
C75173	362	C75256	362	C75339	357	C75429	361
C75174	362	C75257	362	C75340	357	C75430	361
C75175	362	C75258	362	C75341	357	C75431	361
C75176	362	C75259	362	C75342	357	C75432	361
C75177	362	C75260	362	C75343	357	C75433	361
C75178	362	C75261	363	C75344	357	C75434	361
C75181	362	C75262	363	C75345	357	C75434	361
C75182	362	C75263	363	C75346	357	C75435	361
C75183	362	C75264	363	C75347	357	C75437	361
C75184	362	C75265	363	C75348	357	C75438	361
C75185	362	C75266	363	C75349	357	C75439	361
C75186	362	C75267	363	C75350	357	C75440	361
C75188	362	C75268	363	C75352	357	C75441	361
C75189	362	C75269	363	C75353	357	C75442	361
C75190	362	C75270	363	C75354	357	C75443	361
C75191	362	C75271	363	C75355	357	C75444	361
C75192	362	C75272	363	C75356	357	C75445	361
C75193	362	C75273	363	C75357	357	C75446	361
C75194	362	C75274	363	C75358	357	C75447	361
C75195	362	C75275	363	C75359	357	C75448	361
C75196	362	C75276	363	C75360	360	C75449	361
C75197	362	C75277	363	C75361	360	C75450	361
C75198	362	C75281	363	C75362	360	C75451	361
C75199	362	C75282	363	C75363	360	C75452	361
C75200	362	C75283	363	C75366	360	C75453	361
C75202	362	C75285	363	C75367	360	C75454	361
C75203	362	C75286	363	C75368	360	C75455	361
C75204	362	C75288	363	C75370	360	C75456	361
C75205	362	C75289	363	C75371	360	C75457	361
C75206	362	C75290	363	C75372	360	C75458	361
C75207	362	C75291	363	C75373	360	C75459	361
C75208	362	C75292	363	C75374	360	C75460	361
C75209	362	C75293	363	C75375	357	C75461	361
C75210	362	C75294	363	C75377	359	C75462	361
C75211	362	C75295	363	C75378	359	C75463	360
C75212	362	C75296	363	C75379	359	C75464	360
C75213	362	C75297	363	C75380	359	C75465	360
C75214	362	C75298	363	C75381	359	C75466	360
C75215	362	C75299	363	C75382	359	C75467	360
C75216	362	C75300	363	C75383	359	C75468	360
C75217	362	C75301	363	C75384	359	C75469	360
C75218	362	C75302	363	C75385	359	C75470	360
C75219	362	C75303	363	C75386	359	C75471	360
C75220	362	C75304	363	C75387	359	C75472	360
C75221	362	C75305	363	C75388	359	C75473	360
				C75392	357	C75474	360
				C75394	357	C75477	358

PART NO.	PG #	PART NO.	PG #	PART NO.	PG #	PART NO.	PG #
C75478	358	C76019LF	140	C76700	141	C76833	144
C75479	360	C76020LF	140	C76701	141	C76834	144
C75481	359	C76021LF	140	C76702	141	C76835	144
C75482	359	C76022LF	140	C76703	141	C76836	144
C75483	359	C76023LF	140	C76704	141	C76837	144
C75484	359	C76027LF	140	C76705	141	C76838	144
C75485	359	C76028LF	140	C76706	141	C76839	144
C75486	359	C76029LF	140	C76707	141	C76840	145
C75487	359	C76030LF	140	C76708	141	C76841	145
C75488	359	C76034LF	140	C76709	141	C76842	145
C75489	359	C76035LF	140	C76710	141	C76843	145
C75490	359	C76036LF	140	C76711	141	C76844	145
C75491	359	C76037LF	140	C76712	141	C76845	145
C75492	359	C76038LF	140	C76720	141	C76846	145
C75494	357	C76041LF	140	C76722	141	C76847	145
C75502	361	C76042LF	140	C76723	141	C76848	145
C75503	361	C76043LF	140	C76727	141	C76849	145
C75504	361	C76044LF	140	C76740	141	C76850	145
C75505	361	C76047LF	140	C76741	141	C76851	145
C75506	361	C76048LF	140	C76751	141	C76852	145
C75507	361	C76049LF	140	C76752	141	C76853	145
C75508	361	C76050LF	140	C76753	141	C76854	145
C75509	361	C76051LF	140	C76754	141	C76855	145
C75516	358	C76060LF	140	C76755	141	C76856	145
C75517	358	C76065LF	140	C76756	141	C76857	145
C75519	358	C76066LF	140	C76757	141	C76858	145
C75522	359	C76067LF	140	C76758	141	C76859	145
C75523	359	C76070	141	C76759	141	C76860	145
C75525	360	C76071	141	C76760	141	C76861	145
C75527	360	C76072	141	C76761	141	C76862	145
C75535	359	C76073	141	C76762	141	C76863	145
C75536	359	C76074	141	C76763	141	C76864	145
C75540	359	C76075	141	C76764	141	C76865	145
C75544	359	C76076	141	C76765	141	C76866	145
C75546	360	C76077	141	C76766	141	C76867	145
C75548	358	C76079LF	141	C76767	141	C76868	145
C75550	358	C76080LF	141	C76768	141	C76869	145
C75551	358	C76081LF	141	C76769	141	C76870	145
C75553	358	C76100LF	157	C76770	141	C76871	145
C75554	358	C76101LF	157	C76771	141	C76872	145
C75555	358	C76500LF	142	C76772	141	C76873	145
C75556	358	C76501LF	142	C76773	141	C76874	145
C75557	358	C76502LF	142	C76774	141	C76875	145
C75558	358	C76503LF	142	C76775	141	C76876	145
C75559	358	C76504LF	142	C76776	141	C76877	145
C75562	361	C76505LF	142	C76800	144	C76878	145
C75563	361	C76506LF	142	C76801	144	C76879	145
C75564	358	C76507LF	142	C76802	144	C76880	145
C75565	358	C76508LF	142	C76803	144	C76881	145
C75566	358	C76509LF	142	C76804	144	C76882	145
C75568	360	C76510LF	143	C76805	144	C76883	145
C75571	362	C76511LF	143	C76806	144	C76884	145
C75572	362	C76512LF	143	C76807	144	C76885	145
C75573	363	C76513LF	143	C76808	144	C76886	145
C75574	363	C76514LF	143	C76809	144	C76887	145
C75576	363	C76515LF	143	C76810	144	C76888	145
C75577	363	C76516LF	143	C76811	144	C76889	145
C75578	363	C76520	143	C76812	144	C76890	145
C75579	363	C76521	143	C76813	144	C76891	145
C75580	358	C76522	143	C76814	144	C76892	145
C75581	358	C76530LF	142	C76815	144	C76893	145
C75582	358	C76531LF	142	C76816	144	C77001	364
C75583	358	C76532LF	142	C76817	144	C77002	364
C75586	358	C76553LF	142	C76818	144	C77003	364
C76001LF	140	C76561LF	143	C76819	144	C77004	364
C76002LF	140	C76562LF	143	C76820	144	C77005	364
C76003LF	140	C76570LF	81, 143	C76821	144	C77006	364
C76004LF	140	C76571LF	81, 143	C76822	144	C77007	364
C76005LF	140	C76605LF	110, 143	C76823	144	C77008	364
C76008LF	140	C76606LF	110, 143	C76824	144	C77009	364
C76009LF	140	C76607LF	143	C76825	144	C77010	364
C76010LF	140	C76608LF	143	C76826	144	C77011	364
C76013LF	140	C76612LF	110, 143	C76827	144	C77012	364
C76014LF	140	C76613LF	110, 143	C76828	144	C77013	364
C76015LF	140	C76614LF	143	C76829	144	C77014	364
C76016LF	140	C76615LF	143	C76830	144	C77015	364
C76017LF	140	C76616LF	110, 143	C76831	144	C77016	364
C76018LF	140	C76617LF	143	C76832	144	C77017	364

PART NO.	PG #	PART NO.	PG #	PART NO.	PG #	PART NO.	PG #
C77018	364	C77132	366	C77417LF	142	C90004	262
C77019	364	C77133	366	C77418LF	142	C90006	262
C77020	364	C77134	366	C77419LF	142	C90013	262
C77021	364	C77135	366	C77420LF	142	C90014	262
C77022	364	C77136	366	C77421LF	142	C90015	262
C77023	364	C77137	366	C77422LF	142	C90016	262
C77044	364	C77138	366	C77423LF	142	C90017	262
C77045	364	C77139	366	C77425LF	142	C90018	262
C77046	364	C77140	366	C77426LF	142	C90019	262
C77047	364	C77141	366	C77427LF	142	C90300	262
C77048	364	C77142	366	C77428LF	142	C90400	262
C77049	364	C77143	366	C77429LF	142	C90500	262
C77050	364	C77144	366	C77430LF	142	C90600	262
C77051	364	C77145	366	C77431LF	142	C90700	262
C77052	364	C77146	366	C77432LF	142	C90800	262
C77053	364	C77149	365	C77434LF	142	C90999	262
C77054	364	C77150	365	C77440LF	143	C91013	262
C77055	364	C77151	365	C77441LF	143	C91014	262
C77056	364	C77152	365	C77442LF	143	C91015	262
C77057	364	C77153	365	C77443LF	143	C91016	262
C77058	364	C77154	365	C77444LF	143	C91017	262
C77059	364	C77155	365	C77445LF	143	C91018	262
C77060	364	C77159	365	C77446LF	143	C91019	262
C77061	364	C77162	365	C77447LF	143	C91300	262
C77062	364	C77165	365	C77450LF	143	C91400	262
C77063	364	C77166	365	C77451LF	143	C91500	262
C77064	364	C77167	365	C77452LF	143	C91600	262
C77065	364	C77168	365	C77453LF	143	C91700	262
C77066	364	C77169	365	C77454LF	143	C91800	262
C77067	364	C77170	365	C77455LF	143	C91999	262
C77068	364	C77173	365	C77460LF	143	C92150	261
C77069	364	C77174	365	C77461LF	143	C92151	261
C77070	364	C77175	365	C77462LF	143	C92200	261
C77071	365	C77176	365	C77463LF	143	C92202	261
C77072	365	C77177	365	C77464LF	143	C92250	261
C77073	365	C77178	365	C77465LF	143	C92252	261
C77074	365	C77179	365	C77466LF	143	C92300	261
C77075	365	C77180	365	C77467LF	143	C92301	261
C77076	365	C77181	365	C77468LF	143	C92303	261
C77077	365	C77182	365	C77469LF	143	C92350	261
C77078	365	C77183	365	C77470LF	142	C92351	261
C77079	365	C77185	365	C77471LF	142	C92353	261
C77080	366	C77186	365	C77472LF	142	C92400	261
C77081	366	C77187	365	C77473LF	143	C92404	261
C77082	366	C77188	365	C77474LF	143	C92500	261
C77083	366	C77189	365	C77475LF	143	C92600	261
C77084	366	C77190	365	C77476LF	143	C92601	261
C77085	366	C77191	365	C77477LF	110, 143	C92800	261
C77086	366	C77192	365	C77478LF	110, 143	C93150	261
C77087	366	C77193	365	C77479LF	110, 143	C93200	261
C77088	366	C77194	365	C77480LF	143	C93250	261
C77091	366	C77195	365	C77481LF	143	C93300	261
C77092	366	C77196	365	C77482LF	143	C93301	261
C77093	366	C77199	365	C77483LF	143	C93350	261
C77094	366	C77218	365	C77484LF	143	C93351	261
C77095	366	C77219	365	C77485LF	143	C93400	261
C77096	366	C77220	365	C77486LF	143	C93500	261
C77097	366	C77221	365	C77487LF	143	C94004	262
C77098	366	C77222	365	C77488LF	143	C94005	262
C77099	366	C77223	365	C77514LF	142	C94007	262
C77100	366	C77224	365	C801800	382	C94009	262
C77101	366	C77225	365	C8019S00	380	C95004	262
C77102	366	C77226	365	C803200	379	C95005	262
C77103	366	C77400LF	142	C803201	379	C95007	262
C77104	366	C77401LF	142	C803300	379	C95009	262
C77105	366	C77402LF	142	C8033000	382	C96004	262
C77106	366	C77403LF	142	C85000	177, 240	C96005	262
C77107	366	C77404LF	142	C85500	240	C96007	262
C77108	366	C77405LF	142	C87100	178, 240	C96009	262
C77109	366	C77406LF	142	C88001	177	C97004	262
C77110	366	C77407LF	142	C88002	177	C97005	262
C77113	366	C77408LF	142	C88050	178	C97007	262
C77114	366	C77409LF	142	C88500	177	C97009	262
C77115	366	C77410LF	142	C88500C	178	C98001	123, 262
C77116	366	C77411LF	142	C88501	177	C98002	123, 262
C77117	366	C77412LF	142	C88502	177	C98014	262
C77118	366	C77413LF	142	C88600	177	C98016	262
C77131	366	C77416LF	142	C90002	262	C98018	262

PART NO.	PG #	PART NO.	PG #	PART NO.	PG #	PART NO.	PG #
CB05	351	D03016	9	D10001	96	D4110BN	20
CB07	351	D03020	9	D10626	96	D4110PN	20
CB10	351	D04001	98	D10876	96	D4110RB	20
CB12	351	D04002	98	D18000	94	D4110WB	20
CB15	351	D04003	98	D18001	94	D41301	182
CB2001	47	D04004	98	D18002	94	D41302	182
CB2002	47	D04005	98	D18020	95	D41303	182
CB2003	47	D04008	98	D18021	95	D41307	182
CB2004	47	D04009	98	D18022	95	D41600	182
CB2005	47	D04010	98	D18034	94	D41601	182
CB2011	47	D04012	97	D18050	293	D42002	219
CB2012	47	D04013	98	D18051	293	D42003	219
CB2013	47	D04014	98	D18052	293	D42004	219
CB2014	47	D04015	98	D18060	94	D42006	220
CB2015	47	D04016	98	D18062	72	D42006H	221
CB2021	47	D04017	98	D18063	72	D42007	220
CB2022	47	D04018	98	D18186	94	D42007H	221
CB2023	47	D04019	98	D18190	293	D42008	220
CB2024	47	D04020	98	D18340	94	D42008H	221
CB2025	47	D04021	98	D18400	94	D42009	220
CB2030	47	D04022	98	D18401	94	D42009H	221
CB2031	47	D04023	97	D18501	94	D42010	220
CB2032	47	D04024	97	D18750	94	D42010H	221
CB2033	47	D04025	98	D18850	94	D42011	220
CB2034	47	D04026	98	D28003	268	D42012	220
CB2040	49	D04027	98	D28004	268	D42013	220
CB2041	49	D04028	98	D40000	58, 242	D42014	220
CB2045	49	D04031	98	D40001	58, 242	D42015	220
CB2046	49	D04032	98	D40002	58, 242	D42019	220
CG05	351	D04033	98	D40003	19, 182	D42022	219
CG07	351	D04034	98	D40004	19, 182	D42023	219
CG10	351	D04035	99	D40005	19, 182	D42024	219
CJ1002	99	D04036	98	D40006	182	D42029	220
CJ1003	47	D04050	99	D40007	182	D45000	71
D01001	56	D04051	98	D40008	182	D45001	71
D01002	56	D04053	98	D40009	182	D45002	253
D01003	56	D04054	98	D40010	19, 182	D49001	192
D01004	56	D04056	98	D40020	220	D49002	192
D01005	56	D04057	98	D40021	220	D49003	192
D01008	56	D04058	98	D40023	220	D49004	192
D01009	56	D04059	98	D4005BN	19	D49005	192
D01010	9, 56	D04060	98	D4005RB	19	D49006	192
D01011	9, 56	D04062	99	D4005WB	19	D49007	192
D01015	9, 56	D06005	109	D40101	182	D49008	192
D01016	8, 56	D06050	109	D40102	253	D49009	192
D01017	8, 56	D06075	109	D40103	253	D49010	192
D01018	8, 56	D06100	109	D40104	253	D49011	192
D01020	8, 56	D06125	109	D4010BN	19	D49012	192
D01021	8, 56	D06150	109	D4010RB	19	D49013	192
D01022	56	D06200	109	D4010WB	19	D49014	192
D01023	56	D06250	109	D40140	182	D49019	192
D01024	9, 55	D06300	109	D40151	182	D49020	192
D01025	9, 55	D06350	109	D40200	253	D49021	192
D01026	9, 56	D06400	109	D40201	182	D49022	192
D01027	9, 56	D06450	110	D40202	253	D49023	193
D01028	56	D06500	110	D40203	253	D49024	193
D01029	56	D06510	110	D40204	253	D49025	193
D01030	9, 56	D06525	110	D40240	182	D49026	193
D01031	9, 56	D06550	110	D40401	182	D49027	193
D01032	9, 55	D06600	110	D40440	182	D49028	193
D01040	55	D06650	110	D40600	221	D49029	193
D01041	55	D06700	110	D40601	221	D49030	193
D01042	55	D06750	109	D40602	221	D49031	193
D0104BN	10	D06753	110	D40700	221	D49032	193
D0104RB	10	D06755	109	D40701	221	D49033	193
D0104WB	10	D06800	110	D41001	182	D49034	193
D01050	10	D06801	110	D41002	182	D49035	193
D01050BN	10	D06802	110	D41003	182	D49036	193
D01050RB	10	D06803	110	D41004	182	D49037	193
D01050WB	10	D06804	110	D41007	182	D49038	193
D02001	123	D06805	110	D41008	182	D49039	193
D02002	66, 123	D06850	110	D41009	182	D49040	193
D03001	9	D06875	110	D41101	20, 182	D49041	193
D03002	9	D06900	110	D41102	20, 182	D49042	193
D03004	9	D06901	110	D41103	182	D49043	193
D03010	9	D06902	110	D41104	182	D49044	193
D03011	9	D06903	110	D41105	182	D49045	193
D03015	9	D08001	96	D41107	20, 182	D49046	193

PART NO.	PG #	PART NO.	PG #	PART NO.	PG #	PART NO.	PG #
D49047	193	D49142	195	D49240	197	D49338	200
D49048	193	D49143	195	D49241	197	D49339	200
D49049	193	D49144	195	D49242	197	D49340	200
D49050	193	D49145	195	D49243	197	D49341	200
D49051	193	D49146	195	D49244	197	D49342	200
D49052	193	D49147	195	D49245	197	D49343	200
D49053	193	D49148	195	D49246	197	D49344	200
D49054	193	D49149	195	D49247	197	D49345	200
D49055	18, 193	D49150	195	D49248	197	D49346	200
D49056	193	D49151	195	D49249	197	D49348	200
D49057	18, 193	D49152	195	D49250	197	D49349	200
D49058	193	D49153	195	D49251	197	D49350	200
D49059	18, 193	D49154	195	D49252	197	D49351	200
D49060	193	D49155	18, 195	D49253	197	D49352	200
D49061	193	D49156	195	D49254	197	D49353	200
D49062	193	D49157	18, 195	D49255	197	D49354	200
D49063	193	D49158	195	D49256	197	D49355	200
D49064	193	D49159	18, 195	D49257	197	D49356	200
D49065	193	D49160	195	D49258	197	D49357	200
D49066	193	D49161	195	D49259	197	D49358	200
D49077	194	D49162	195	D49260	197	D49359	200
D49078	194	D49163	195	D49261	197	D49360	200
D49079	194	D49164	195	D49262	197	D49361	200
D49080	194	D49165	195	D49263	197	D49362	200
D49081	194	D49166	195	D49264	197	D49363	200
D49082	194	D49177	196	D49265	197	D49364	200
D49083	194	D49178	196	D49266	197	D49365	200
D49084	194	D49179	196	D49277	198	D49366	200
D49085	194	D49180	196	D49278	198	D49377	201
D49086	194	D49181	196	D49279	198	D49378	201
D49087	194	D49182	196	D49280	198	D49379	201
D49088	194	D49183	196	D49281	198	D49380	201
D49089	194	D49184	196	D49282	198	D49381	201
D49090	194	D49185	196	D49283	198	D49382	201
D49095	194	D49186	196	D49284	198	D49383	201
D49096	194	D49187	196	D49285	198	D49384	201
D49097	194	D49188	196	D49286	198	D49385	201
D49098	194	D49189	196	D49287	198	D49386	201
D49101	194	D49190	196	D49288	198	D49387	201
D49102	194	D49195	196	D49289	198	D49388	201
D49103	194	D49196	196	D49290	198	D49389	201
D49104	194	D49197	196	D49295	198	D49390	201
D49105	194	D49198	196	D49296	198	D49395	201
D49106	194	D49201	196	D49297	198	D49396	201
D49107	194	D49202	196	D49298	198	D49397	201
D49108	194	D49203	196	D49301	199	D49398	201
D49109	194	D49204	196	D49302	199	D49401	201
D49110	194	D49205	196	D49303	199	D49402	201
D49111	194	D49206	196	D49304	199	D49403	201
D49112	194	D49207	196	D49305	199	D49404	201
D49113	194	D49208	196	D49306	199	D49405	201
D49114	194	D49209	196	D49307	199	D49406	201
D49119	194	D49210	196	D49308	199	D49407	201
D49120	194	D49211	196	D49309	199	D49408	201
D49121	194	D49212	196	D49310	199	D49410	201
D49122	194	D49213	196	D49311	199	D49411	201
D49123	195	D49214	196	D49312	199	D49412	201
D49124	195	D49219	196	D49313	199	D49413	201
D49125	195	D49220	196	D49314	199	D49414	201
D49126	195	D49221	196	D49319	199	D49419	201
D49127	195	D49222	196	D49320	199	D49420	201
D49128	195	D49223	197	D49321	199	D49421	201
D49129	195	D49224	197	D49322	199	D49422	201
D4912BN	18	D49225	197	D49323	200	D49423	202
D4912RB	18	D49226	197	D49324	200	D49424	202
D4912WB	18	D49227	197	D49325	200	D49425	202
D49130	195	D49228	197	D49326	200	D49426	202
D49131	195	D49229	197	D49327	200	D49427	202
D49132	195	D49230	197	D49328	200	D49428	202
D49133	195	D49231	197	D49329	200	D49429	202
D49134	195	D49232	197	D49330	200	D49430	202
D49135	195	D49233	197	D49331	200	D49431	202
D49136	195	D49234	197	D49332	200	D49432	202
D49137	195	D49235	197	D49333	200	D49433	202
D49138	195	D49236	197	D49334	200	D49434	202
D49139	195	D49237	197	D49335	200	D49435	202
D49140	195	D49238	197	D49336	200	D49436	202
D49141	195	D49239	197	D49337	200	D49437	202

PART NO.	PG #	PART NO.	PG #	PART NO.	PG #	PART NO.	PG #
D49438	202	D49528	204	D49661	184	D5001BNTP	180
D49439	202	D49529	204	D49662	184	D5001NP	180
D49440	202	D49530	204	D49663	184	D5001RB	18, 180
D49441	202	D49531	204	D49800	212	D5001RBTP	180
D49442	202	D49532	204	D49801	212	D5001WB	18, 180
D49443	202	D49533	204	D49802	212	D5001WBTP	180
D49444	202	D49534	204	D49803	212	D50022	207
D49445	202	D49535	204	D49804	212	D50023	207
D49446	202	D49536	204	D49805	212	D50027	207
D49447	202	D49537	204	D49806	212	D50028	207
D49448	202	D49538	204	D49807	212	D50037	206
D49449	202	D49539	204	D49808	212	D50038	208
D49450	202	D49540	204	D49810	212	D50039	209
D49451	202	D49541	204	D49811	212	D50041	208
D49452	202	D49542	204	D49812	212	D50044	206
D49453	202	D49543	204	D49813	212	D50045	208
D49454	202	D49544	204	D49814	212	D50046	209
D49455	202	D49545	204	D49815	212	D50047	206
D49456	202	D49546	204	D49816	212	D50048	208
D49457	202	D49547	204	D49817	212	D50049	209
D49458	202	D49548	204	D49818	212	D50050	206
D49459	202	D49549	204	D49820	218	D50051	208
D49460	202	D49550	204	D49821	218	D50052	209
D49461	202	D49551	204	D49822	218	D50053	206
D49462	202	D49552	204	D49823	218	D50054	208
D49463	202	D49553	204	D49824	218	D50060	207
D49464	202	D49554	204	D49825	218	D50061	208
D49465	202	D49555	204	D49826	218	D50062	210
D49466	202	D49556	204	D49827	218	D50063	207
D49467	202	D49557	204	D49828	218	D50064	208
D49468	202	D49558	204	D49829	218	D50065	210
D49469	202	D49559	204	D49830	218	D50066	207
D49470	202	D49560	204	D49831	218	D50067	208
D49473	202	D49561	204	D4984BN	19	D50068	210
D49474	202	D49562	204	D4984RB	19	D50069	207
D49475	202	D49563	204	D4984WB	19	D50070	208
D49476	202	D49564	204	D49850	212	D50071	210
D49477	203	D49565	204	D49851	212	D50072	207
D49478	203	D49566	204	D49852	212	D50073	208
D49479	203	D49577	205	D49853	212	D50074	210
D49480	203	D49578	205	D49854	212	D50075	207
D49481	203	D49579	205	D49855	212	D50076	208
D49482	203	D49580	205	D49856	212	D50077	210
D49483	203	D49581	205	D49857	212	D50089	219
D49484	203	D49582	205	D49858	212	D50090	219
D49485	203	D49583	205	D49860	212	D50091	219
D49486	203	D49584	205	D49861	212	D50092	219
D49487	203	D49585	205	D49862	212	D50093	219
D49488	203	D49586	205	D49863	212	D50094	219
D49489	203	D49587	205	D49864	212	D50095	219, 264
D49490	203	D49588	205	D49865	212	D50101	180
D49495	203	D49589	205	D49866	212	D50101TP	181
D49496	203	D49590	205	D49867	212	D50102	180
D49497	203	D49595	205	D49868	212	D50102TP	181
D49498	203	D49596	205	D4991BN	18	D50111	18, 180
D49501	203	D49597	205	D4991RB	18	D50111TP	181
D49502	203	D49598	205	D4991WB	18	D50120	179
D49503	203	D49640	184	D49924	218	D50121	179
D49504	203	D49641	184	D4996BN	18	D50122	179
D49505	203	D49642	184	D4996RB	18	D50123	179
D49506	203	D49643	184	D4996WB	18	D50124	179
D49507	203	D49644	184	D50000	302	D50125	181
D49508	203	D49645	184	D50001	179	D50126	181
D49509	203	D49646	184	D50001TP	180	D50130	179
D49510	203	D49647	184	D50002	179	D50130TP	180
D49511	203	D49648	184	D50002TP	180	D50131	179
D49512	203	D49649	184	D50005	208	D50131TP	180
D49513	203	D49650	184	D50008	210	D50132	179
D49514	203	D49651	184	D50010	179	D50132TP	180
D49519	203	D49652	184	D50010TP	180	D50133	179
D49520	203	D49653	184	D50011	179	D50133TP	180
D49521	203	D49654	184	D50011TP	180	D50134	179
D49522	203	D49655	184	D50012	208	D50134TP	180
D49523	204	D49656	184	D50013	208	D50135	179
D49524	204	D49657	184	D50014	208	D50135TP	180
D49525	204	D49658	184	D50015	210	D50141	180
D49526	204	D49659	184	D50016	210	D50141TP	180
D49527	204	D49660	184	D5001BN	18, 180	D50152	180

PART NO.	PG #	PART NO.	PG #	PART NO.	PG #	PART NO.	PG #
D50152TP	181	D50379	219	D50714	181	D51044	206
D50153	180	D50380	219	D50715	181	D51045	208
D50153TP	181	D50381	219	D50720	181	D51046	209
D50161	180	D50382	219	D50721	181	D51047	206
D50161TP	181	D50383	219	D50722	181	D51048	208
D50162	180	D50384	219	D50723	181	D51049	209
D50162TP	181	D50385	219	D50724	181	D51050	206
D50177	219	D50386	219	D50725	181	D51051	208
D50178	219	D50387	219	D50726	181	D51052	209
D50179	219	D50388	219	D50727	181	D51053	206
D50180	219	D50389	219	D50800	180	D51054	208
D50181	219	D50390	219	D50800TP	181	D51055	209
D50182	219	D50391	219	D50802	180	D51060	207
D50183	219	D50392	219	D50802TP	181	D51061	208
D50184	219	D50393	219	D50830	180	D51062	210
D50185	219	D50394	219	D50830TP	181	D51063	207
D50186	219	D50401	180	D50832	180	D51064	208
D50187	219	D50401TP	181	D50832TP	181	D51065	210
D50188	219	D50402	180	D5087BN	18	D51066	207
D50200	221	D50402TP	181	D5087RB	18	D51067	208
D50201	221	D50411	180	D5087WB	18	D51068	210
D50202	221	D50411TP	181	D50887	18	D51069	207
D50204	221	D50440	183	D50888	18, 181	D51070	208
D50205	221	D50448	183	D50888TP	180	D51071	210
D50206	221	D50449	183	D5088BN	18, 181	D51072	207
D50207	221	D50450	183	D5088BNT	180	D51073	208
D50208	221	D50451	183	D5088RB	18, 181	D51074	210
D50213	221	D50452	183	D5088RBTP	180	D51075	207
D50220	221	D50453	183	D5088WB	18, 181	D51076	208
D50221	221	D50454	183	D5088WBTP	180	D51077	210
D50278	206	D50460	184	D50904	219	D51278	206
D50279	208	D50461	184	D50905	219	D51279	208
D50280	209	D50462	184	D50906	219	D51280	209
D50301	179	D50463	184	D50907	219	D51340	207
D50301TP	180	D50464	184	D50908	219	D51341	207
D50302	179	D50465	184	D50909	219	D51342	207
D50302TP	180	D50469	184	D50910	219	D51343	207
D50310	179	D50470	184	D50911	219	D51344	207
D50310TP	180	D50471	184	D50942	18	D51345	207
D50311	179	D50472	184	D50942TP	181	D51346	207
D50311TP	180	D50473	184	D5094BN	18	D51349	207
D50330	179	D50474	184	D5094BNT	181	D51350	207
D50330TP	180	D50477	184	D5094RB	18	D51351	209
D50331	179	D50479	184	D5094RBTP	181	D51352	209
D50331TP	180	D50480	184	D5094WB	18	D51353	209
D50332	179	D50481	184	D5094WBTP	181	D51354	209
D50332TP	180	D50482	184	D50980	213	D51355	209
D50333	179	D50486	184	D50982	213	D51356	209
D50333TP	180	D50500	182	D50983	213	D51357	209
D50334	179	D50501	182	D50984	213	D51360	209
D50334TP	180	D50502	182	D50985	213	D51361	209
D50335	179	D50510	182	D50986	213	D51362	210
D50335TP	180	D50511	182	D50987	213	D51363	210
D50340	207	D50520	183	D50988	213	D51364	210
D50341	207	D50521	183	D50989	213	D51365	210
D50342	207	D50522	183	D50990	213	D51366	210
D50343	207	D50523	183	D50998	180	D51367	210
D50345	207	D50524	183	D50PL1	181	D51368	210
D50346	207	D50525	183	D50PLP	181	D51371	210
D50349	207	D50526	183	D51004	208	D51372	210
D50350	207	D50600	221	D51005	208	D52003	212
D50351	209	D50601	221	D51007	210	D52004	211
D50352	209	D50682	219	D51008	210	D52005	211
D50353	209	D50683	219	D51012	208	D52012	211
D50354	209	D50700	181	D51013	208	D52014	211
D50360	209	D50701	181	D51014	208	D52016	211
D50361	209	D50702	181	D51015	210	D52017	211
D50362	210	D50703	181	D51016	210	D52023	211
D50363	210	D50704	181	D51022	207	D52103	212
D50364	210	D50705	181	D51023	207	D52104	211
D50365	210	D50706	181	D51027	207	D52105	211
D50366	210	D50707	181	D51028	207	D52112	211
D50367	210	D50708	181	D51037	206	D52120	211
D50368	210	D50709	181	D51038	208	D52123	211
D50371	210	D50710	181	D51039	209	D52202	212
D50372	210	D50711	181	D51040	206	D52203	212
D50377	219	D50712	181	D51041	208	D52204	212
D50378	219	D50713	181	D51042	209	D52205	212

PART NO.	PG #	PART NO.	PG #	PART NO.	PG #	PART NO.	PG #
D52207	212	D53070	191	D53156	189	D53285	185
D52216	212	D53071	191	D53157	189	D53286	189
D52217	212	D53072	185	D53158	189	D53287	189
D52302	212	D53073	185	D53159	189	D53288	187
D52303	212	D53074	185	D53160	189	D53289	187
D52304	212	D53075	185	D53161	189	D53290	186
D52305	212	D53076	185	D53162	189	D53291	186
D52306	212	D53077	185	D53163	189	D53292	190
D52307	212	D53078	186	D53180	190	D53293	190
D52316	212	D53079	186	D53181	190	D53294	189
D52317	212	D53080	186	D53182	190	D53295	189
D52400	211	D53081	186	D53183	190	D53296	186
D52450	211	D53082	186	D53184	190	D53297	186
D52451	211	D53083	186	D53185	190	D53298	186
D52452	211	D53084	186	D53186	190	D53299	186
D52453	211	D53085	186	D53187	190	D53300	189
D52460	211	D53086	188	D53188	190	D53301	189
D52461	211	D53087	188	D53189	190	D53302	189
D52462	211	D53088	188	D53190	186	D53303	189
D52463	211	D53089	188	D53191	186	D53304	189
D52500	211	D53090	188	D53192	186	D53305	189
D53001	191	D53091	188	D53193	186	D53306	187
D53002	191	D53092	188	D53194	186	D53307	187
D53003	191	D53093	188	D53195	186	D53308	189
D53004	191	D53094	188	D53196	186	D53309	189
D53005	191	D53095	188	D53197	186	D53310	190
D53006	191	D53096	188	D53198	186	D53311	190
D53008	191	D53097	188	D53199	186	D53312	187
D53009	191	D53098	188	D53200	186	D53313	187
D53011	191	D53099	188	D53201	186	D53314	190
D53012	191	D53100	187	D53202	186	D53315	190
D53014	191	D53101	187	D53203	186	D53325	186
D53015	191	D53102	187	D53204	187	D53400	191
D53017	191	D53103	187	D53205	187	D53401	191
D53018	191	D53104	187	D53206	187	D53402	191
D53020	185	D53105	187	D53207	187	D53403	191
D53021	185	D53106	187	D53208	187	D53404	191
D53022	185	D53107	187	D53209	187	D53405	191
D53023	185	D53108	187	D53216	187	D53406	191
D53024	185	D53109	187	D53217	187	D53407	191
D53025	185	D53110	187	D53218	187	D53408	191
D53026	186	D53111	187	D53219	187	D53409	191
D53027	186	D53120	191	D53230	190	D53410	191
D53028	186	D53121	191	D53231	190	D53411	191
D53029	186	D53122	191	D53232	190	D53412	191
D53031	186	D53123	191	D53233	190	D53413	191
D53032	186	D53124	186	D53234	190	D53414	188
D53033	186	D53125	186	D53235	190	D53415	188
D53034	186	D53126	186	D53236	190	D53416	188
D53035	186	D53127	186	D53237	190	D53417	188
D53037	186	D53128	188	D53238	190	D53418	188
D53040	188	D53129	188	D53239	190	D53419	188
D53041	188	D53130	188	D53240	190	D53420	188
D53043	188	D53131	188	D53241	190	D53421	188
D53044	188	D53132	188	D53249	185	D53422	188
D53045	188	D53133	188	D53252	188	D53423	188
D53046	188	D53134	188	D53253	188	D53424	188
D53047	188	D53135	188	D53260	187	D53425	188
D53048	188	D53136	188	D53261	187	D53426	188
D53049	188	D53137	188	D53262	189	D53427	188
D53051	188	D53138	186	D53263	189	D53428	185
D53052	188	D53139	186	D53264	189	D53429	185
D53053	188	D53140	186	D53265	189	D53430	185
D53054	188	D53141	186	D53266	189	D53431	185
D53055	188	D53142	186	D53268	189	D53432	185
D53057	188	D53143	186	D53269	189	D53433	185
D53058	191	D53144	208	D53272	189	D53434	185
D53059	191	D53145	208	D53273	189	D53435	185
D53060	191	D53146	208	D53274	189	D53436	185
D53061	191	D53147	208	D53275	189	D53437	185
D53062	191	D53148	208	D53276	189	D53438	185
D53063	191	D53149	208	D53278	189	D53439	185
D53064	191	D53150	189	D53279	189	D53440	185
D53065	191	D53151	189	D53280	191	D53441	185
D53066	191	D53152	189	D53281	191	D53442	206
D53067	191	D53153	189	D53282	188	D53443	206
D53068	191	D53154	189	D53283	188	D53444	206
D53069	191	D53155	189	D53284	185	D53445	206

PART NO.	PG #	PART NO.	PG #	PART NO.	PG #	PART NO.	PG #
D53446	206	D54306	218	D57407	214	D59923	230
D53447	206	D54307	218	D57408	214	D59924	230
D53448	206	D54311	217	D57409	214	D59925	230
D53449	206	D54312	217	D57501	213	D59926	230
D53450	206	D54313	217	D57505	215	D59927	230
D53451	206	D54314	217	D57901	231	D59940	259
D53452	206	D54315	217	D57902	231	D59941	259
D53453	206	D54316	218	D57904	230	D59942	259
D53454	206	D54319	217	D57905	230	D59943	231, 259
D53455	206	D54321	218	D57906	231	D59944	231, 259
D53457	208	D54322	218	D57907	231	D59945	231, 259
D53458	208	D54323	218	D57908	230	D59946	231, 259
D53459	208	D54324	218	D57909	230	D59947	231
D53460	208	D54326	218	D57910	231	D59948	231
D53461	208	D54330	218	D57911	231	D59949	231
D53462	208	D54331	218	D57912	230	D59950	231
D53463	208	D54332	218	D57913	230	D60100	242
D53464	208	D54334	218	D57914	231	D60101	242, 253
D53465	208	D54336	218	D57915	231	D60102	242
D53466	208	D54337	218	D57916	231	D60103	242
D53467	208	D54400	218	D57917	231	D60130	222
D53468	208	D54401	218	D57918	231	D60131	222
D53469	208	D56105	213	D57919	231	D60140	222
D53470	209	D56106	214	D57980	213	D60141	222
D53471	209	D56107	214	D57982	213	D60201	242
D53472	209	D56205	213	D57983	213	D60202	242
D53473	209	D56206	214	D57984	213	D60203	242
D53474	209	D56207	214	D57985	213	D60204	242
D53475	209	D56208	214	D57986	213	D60205	242
D53476	209	D56209	214	D57987	213	D60206	242
D53477	209	D56210	213	D57988	213	D60207	242
D53478	209	D56211	20, 214	D57989	213	D60208	242
D53479	209	D56212	20, 214	D57990	213	D60209	242
D53480	209	D56213	214	D59001	220	D60210	242
D53481	209	D56214	20, 214	D59002	220	D60211	242
D53482	209	D56215	214	D59003	220	D60212	242
D53483	209	D56216	20, 214	D59100	215	D60400	242
D54001	217	D56217	214	D59102	267	D60402	242
D54001L	217	D56304	213	D59103	267	D60403	242
D54002	217	D56305	213	D59104	267	D60410	242
D54002L	217	D56306	214	D59106	267	D60412	242
D54003	220	D56307	214	D59114	267	D60413	242
D54004	220	D56308	214	D59124	267	D60498	242
D54005	220	D56309	214	D59126	267	D60499	242
D54006	220	D56404	213	D59128	267	D60780	215
D54008	215	D56405	213	D59130	267	D60781	215
D54010	20, 215	D56406	214	D59132	267	D60782	215
D54011	217	D56407	214	D59156	264	D60790	215
D54012	217	D56408	214	D59158	264	D60791	215
D54013	217	D56409	214	D59160	264	D60792	215
D54013L	217	D56501	213, 250	D59162	264	D60793	215
D54014	217	D56503	214, 250	D59202	268	D60795	215
D54014L	217	D56505	215, 250	D59203	268	D6084BN	20
D54015	217	D57105	213	D59204	268	D6084RB	20
D54016	218	D57106	214	D59302	268	D6084WB	20
D54022	217	D57107	214	D59304	268	D60900	243
D54100	218	D57205	213	D59900	185	D60901	243
D54101	218	D57206	214	D59901	231, 259	D60902	243
D54102	218	D57207	214	D59902	231, 259	D6091BN	20
D54104	218	D57208	214	D59904	230, 259	D6091RB	20
D54105	218	D57209	214	D59905	230, 259	D6091WB	20
D54107	218	D57210	213	D59906	231, 259	D60942	18
D54108	215	D57211	214	D59907	231, 259	D60945	213
D54111	218	D57212	214	D59908	230, 259	D6094BN	18
D54112	218	D57213	214	D59909	230, 259	D6094PB	18
D54113	218	D57214	214	D59910	231, 259	D6094RB	18
D54114	218	D57215	214	D59911	231, 259	D6094WB	18
D54126	218	D57216	214	D59912	230, 259	D60954	17, 214, 251
D54130	218	D57217	214	D59913	230, 259	D60955	213, 251
D54131	218	D57304	213	D59914	231, 259	D60956	213, 251
D54132	218	D57305	213	D59915	231, 259	D60958	215, 251
D54134	218	D57306	214	D59916	231, 259	D60959	215, 251
D54136	218	D57307	214	D59917	231, 259	D60960	17, 214, 251
D54137	218	D57308	214	D59918	231, 259	D60961	214, 251
D54301	217	D57309	214	D59919	231, 259	D60962	17, 214, 251
D54302	217	D57404	213	D59920	230	D60963	214, 251
D54304	218	D57405	213	D59921	230	D60966	215, 251
D54305	218	D57406	214	D59922	230	D60967	215, 251

PART NO.	PG #	PART NO.	PG #	PART NO.	PG #	PART NO.	PG #
D60968	215	D63333	256	D65604	248	D66602	248
D60969	215	D63334	256	D65605	248	D66603	248
D6096BN	17	D63335	256	D65620	245	D66604	248
D6096RB	17	D63349	250, 258	D65621	245	D66605	248
D6096WB	17	D63350	250, 258	D65622	245	D66620	245
D60970	213, 251	D63400	250, 258	D65623	245	D66621	245
D60975	213, 251	D63433	256	D65624	245	D66622	245
D60978	180	D63434	256	D65625	245	D66623	245
D60979	216, 250	D64000	20, 242	D65640	247	D66624	245
D60980	17, 213, 251	D64001	20, 242	D65641	247	D66625	245
D60981	17, 213, 251	D64002	241	D65642	247	D66640	247
D60982	17, 213, 251	D6400BN	20, 242	D65643	247	D66641	247
D60986	214, 251	D6400RB	20, 242	D65644	247	D66642	247
D60987	214, 251	D6400WB	20, 242	D65645	247	D66643	247
D60989	214, 251	D64010	242	D65655	245	D66644	247
D6098BN	17	D64011	242	D65656	245	D66645	247
D6098RB	17	D64012	241	D65657	247	D66660	248
D6098WB	17	D64022	241	D65658	247	D66661	248
D60990	20, 214, 251	D64150	241	D65659	248	D66662	248
D60991	20, 214, 251	D64202	241	D65660	248	D66663	248
D60992	214, 251	D64302	241	D65661	244	D66664	248
D60993	214, 251	D64401	20, 242	D65662	244	D66665	248
D60995	214, 251	D64502	241	D65663	246	D66675	245
D60996	20, 214, 251	D64800	241	D65664	246	D66676	245
D60997	214, 251	D64801	241	D65665	245	D66677	247
D60998	214, 251	D64802	241	D65667	247	D66678	247
D60999	251	D64803	241	D65668	247	D66679	248
D61101	243	D64804	241	D66002	249	D66680	248
D61102	243	D64805	241	D66003	249	D66681	244
D61103	243	D64806	241	D66004	249	D66682	244
D61201	243	D64807	241	D66102	249	D66683	246
D61202	243	D64808	241	D66103	249	D66684	246
D61203	243	D64809	241	D66104	249	D66685	248
D61301	243	D64810	241	D66200	250	D66686	248
D61302	243	D64811	241	D66202	249	D66687	245
D61303	243	D65002	249	D66203	249	D66688	245
D61800	243	D65003	249	D66204	249	D66689	247
D61850	243	D65102	249	D66400	250	D66690	247
D62130	250	D65103	249	D66500	244	D66691	248
D62131	250	D65104	249	D66501	244	D66692	248
D62132	250	D65202	249	D66502	244	D66700	245
D62135	250	D65203	249	D66503	244	D66701	245
D62136	250	D65500	244	D66504	244	D66702	245
D62137	250	D65501	244	D66505	244	D66703	245
D62140	250	D65502	244	D66509	244	D66704	245
D62141	250	D65503	244	D66510	244	D66705	245
D62142	250	D65504	244	D66511	244	D66706	245
D62230	259	D65505	244	D66512	244	D66707	245
D62231	259	D65509	244	D66520	246	D66732	248
D62232	259	D65510	244	D66521	246	D66733	248
D62235	259	D65511	244	D66522	246	D66734	248
D62236	259	D65512	244	D66523	246	D66735	248
D62237	259	D65520	246	D66524	246	D66736	248
D62240	259	D65521	246	D66525	246	D66737	248
D62241	259	D65522	246	D66540	248	D66738	248
D62242	259	D65523	246	D66541	248	D66739	248
D62300	250, 259	D65524	246	D66542	248	D67001	244
D62330	255	D65525	246	D66543	248	D67002	244
D62333	255	D65560	245	D66544	248	D67003	244
D62334	255	D65561	245	D66545	248	D67004	244
D62335	255	D65562	245	D66560	245	D67005	244
D62349	250, 259	D65563	245	D66561	245	D67006	244
D62350	250, 259	D65564	245	D66562	245	D67007	244
D62400	250, 259	D65565	245	D66563	245	D67008	244
D62433	255	D65569	245	D66564	245	D67016	245
D62434	255	D65570	245	D66565	245	D67017	245
D62443	255	D65571	245	D66569	245	D67018	245
D62444	255	D65572	245	D66570	245	D67019	245
D62601	255	D65580	247	D66571	245	D67020	245
D62602	255	D65581	247	D66572	245	D67021	245
D62950	252	D65582	247	D66580	247	D67022	245
D62951	252	D65583	247	D66581	247	D67023	245
D62952	252	D65584	247	D66582	247	D67027	245
D62960	252	D65585	247	D66583	247	D67028	245
D62961	252	D65600	248	D66584	247	D67029	245
D62962	252	D65601	248	D66585	247	D67030	245
D63300	250, 258	D65602	248	D66600	248	D67031	247
D63330	256	D65603	248	D66601	248	D67032	247

PART NO.	PG #	PART NO.	PG #	PART NO.	PG #	PART NO.	PG #
D67033	247	D76205L	263	E01075	75	E16075	76
D67034	247	D76207L	263	E01100	75	E16150	76
D67035	247	D76209L	263	E01125	75	E16151	76
D67036	247	D76252	263	E01150	75	E16200	76
D67037	247	D76256	263	E01375	75	E16375	76
D67038	247	D76259	263	E02050	75	E25000	300
D67039	247	D76302	263	E0205BN	21	E25001	300
D67040	247	D76303	263	E0205RB	21	E25002	300
D67042	247	D76304	263	E0205WB	21	E25004	300
D67043	247	D76402	263	E02075	75	E25005	300
D67044	247	D76403	263	E02100	75	E25006	300
D67045	247	D76404	263	E02125	75	E25007	300
D67046	247	D76412	263	E02150	75	E25010	300
D67047	247	D76413	263	E02152	75	E25015	301
D67048	248	D76414	263	E02200	75	E25016	301
D67049	248	D76504	264	E02375	75	E25017	301
D67050	248	D76519	264	E03125	75, 332	E25018	301
D67051	248	D76601	253	E03150	75, 332	E25021	300
D67052	248	D76702	264	E03200	75, 332	E25040	300
D67053	248	D76703	264	E03225	76	E25041	300
D67054	248	D76704	264	E03250	76	E25042	300
D67055	248	D76705	264	E04125	75, 332	E25115	301
D67200	250	D76707	264	E0412BN	21	E25116	301
D67201	250	D77002	252	E0412RB	21	E25117	301
D67300	250	D77003	252	E0412WB	21	E25118	301
D67400	250	D77004	252	E04150	75, 332	E25125	301
D68507	246	D79703	264	E0415BN	21	E25126	301
D68508	246	D79704	264	E0415RB	21	E25127	301
D68510	246	D79705	264	E0415WB	21	E25128	301
D68511	246	D79706	264	E04200	75, 332	E25129	301
D68512	246	D79803	264	E05125	75	E80050	20
D68513	246	D79804	264	E05150	75	E80075	20
D68710	246	D79805	264	E06050	75	E81050	20
D68711	246	D79806	264	E0605BN	21	E81375	20
D68712	246	D80090	249	E0605PB	21	E82125	20
D68713	246	D80091	249	E0605RB	21	E82150	20
D70001	253	D80096	249	E0605WB	21	E85000	297
D70011	253	D80097	249	E06075	75	F01050	76
D70020	253	D80098	249	E06100	75	F01075	76
D70021	253	D80099	249	E06125	75	F01100	76
D70022	253	D80100	246	E06150	75	F01125	76
D70098	253	D80101	246	E06375	75	F01150	76
D70100	327	D80102	246	E07025	75	F01375	76
D70100	64	D80103	246	E07050	75	F02050	76
D70101	64, 327	D80106	247	E0705BN	21	F02075	76
D70102	64, 327	D80107	247	E0705PB	21	F02100	76
D70103	64, 327	D80108	247	E0705RB	21	F02125	76
D70104	64	D80109	247	E0705WB	21	F02150	76
D70105	6, 64	D80112	246	E07375	75	F02200	76
D7010BN	6	D80113	246	E08125	75	F02375	76
D7010PB	6	D80118	247	E0812BN	21	F03050	76
D7010RB	6	D80119	247	E0812PB	21	F03075	76
D7010WB	6	D80200	246	E0812RB	21	F03100	76
D70205	6	D80201	246	E0812WB	21	F03125	76
D7020BN	6	D80202	246	E08138	75	F03150	76
D7020RB	6	D80203	246	E08150	75	F03200	76
D7020WB	6	D80206	247	E0815BN	21	F03250	76
D70210	6	D80207	247	E0815PB	21	F03300	76
D7021BN	6	D80209	247	E0815RB	21	F03375	76
D7021RB	6	D80211	247	E0815WB	21	F04050	76
D7021WB	6	D80212	246	E09050	92	F04075	76
D70500	253	D80213	246	E09075	92	F04100	76
D71003	253	D80214	246	E09100	92	F04125	76
D71004	253	D80215	246	E09125	92	F04150	76
D71103	253	D80216	246	E09150	92	F04200	76
D76002	252	D80217	246	E09200	92	F04250	76
D76003	252	D80218	247	E09250	92	F04300	76
D76004	252	D80219	247	E09300	92	F04350	76
D76005	257	D80220	247	E09400	92	F04375	76
D76012	252	D80221	247	E10150	95	F04400	76
D76013	252	D80222	247	E10200	95	F04500	76
D76014	252	D80223	247	E10300	95	F04600	76
D76092	252	E01049	75	E10400	95	F04800	76
D76093	252	E01050	75	E15050	76	F04999	76
D76094	252	E0105BN	21	E15052	76	F05001	3
D76202	263	E0105RB	21	E15075	76	F06050	76
D76203	263	E0105WB	21	E15375	76	F06075	76
D76204	263	E01074	75	E16050	76	F06099	76

PART NO.	PG #	PART NO.	PG #	PART NO.	PG #	PART NO.	PG #
F06100	76	F20003	300	F33124	125	F40055	136
F06124	76	F20004	300	F33125	125	F40056	136
F06125	76	F20005	300	F33126	125	F40057	136
F06150	76	F20006	301	F33127	125	F40058	136
F06200	76	F20007	301	F33128	125	F40059	136
F06201	76	F20008	301	F33129	125	F40060	136
F06250	76	F20009	301	F33130	125	F40061	136
F06251	76	F20010	301	F33131	125	F40063	136
F06300	76	F20011	301	F33132	125	F40064	136
F06301	76	F20012	301	F33140	125	F40065	136
F06351	76	F20018	300	F33141	125	F40066	136
F06375	76	F20019	300	F33142	125	F40067	136
F06400	76	F20020	301	F33143	125	F40068	136
F06401	76	F20021	301	F33144	125	F40069	136
F06500	76	F20022	301	F33300	125	F40070	136
F06600	76	F20023	301	F33301	125	F40071	136
F06800	76	F20024	301	F33302	125	F40072	136
F07050	76	F20025	301	F33303	125	F40073	136
F07075	76	F20026	301	F39001	81	F40074	136
F07099	76	F20053	300	F39002	81	F40075	136
F07100	76	F20055	300	F39004	81	F40076	136
F07124	76	F33009	125	F39005	81	F40077	136
F07125	76	F33010	125	F39010	82	F40078	136
F07150	76	F33011	125	F39700	65	F40079	136
F07200	76	F33012	125	F39800	65	F40080	136
F07201	76	F33013	125	F40001	135	F40081	136
F07300	76	F33014	125	F40002	135	F40082	136
F07375	76	F33030	125	F40003	135	F40083	136
F08050	21	F33031	125	F40004	135	F40084	136
F08124	21	F33032	125	F40005	135	F40085	136
F08150	21	F33033	125	F40006	135	F40086	136
F08375	21	F33034	125	F40007	135	F40087	136
F10001	177	F33035	125	F40008	135	F40088	136
F10002	177	F33036	125	F40009	135	F40089	136
F10003	177	F33037	125	F40010	135	F40091	136
F10004	177	F33038	125	F40011	135	F40092	136
F10005	253	F33039	125	F40012	135	F40093	136
F11001	177	F33040	125	F40013	135	F40094	136
F11002	177	F33041	125	F40014	135	F40095	135
F11003	177	F33060	125	F40015	135	F40096	135
F11004	177	F33061	125	F40016	135	F40097	135
F12001	115	F33062	125	F40017	135	F40098	135
F12002	115	F33063	125	F40018	135	F40100	135
F12003	115	F33064	125	F40019	135	F40101	136
F12004	115	F33065	125	F40020	135	F40102	136
F12009	116	F33066	125	F40021	135	F40103	136
F12012	116	F33067	125	F40022	135	F40104	136
F12018	116	F33068	125	F40023	135	F40105	136
F12024	116	F33069	125	F40024	135	F40106	136
F14012	116	F33080	126	F40025	135	F40107	136
F160063	116	F33081	126	F40026	135	F40108	136
F160093	116	F33082	126	F40027	135	F40109	136
F160094	116	F33083	126	F40028	135	F40110	136
F16012	116	F33094	126	F40029	135	F40111	136
F160123	116	F33095	126	F40030	135	F40112	136
F160126	116	F33096	126	F40031	135	F40113	136
F16016	116	F33097	126	F40032	135	F40114	136
F160183	116	F33098	126	F40033	135	F40115	136
F160184	116	F33101	125	F40034	135	F40116	136
F160186	116	F33102	125	F40035	135	F40117	136
F160243	116	F33103	125	F40036	135	F40118	136
F160246	116	F33104	125	F40037	135	F40119	135
F160363	116	F33105	125	F40038	135	F40120	135
F160393	116	F33106	125	F40039	135	F40121	136
F163186	116	F33107	125	F40040	135	F40122	136
F163246	116	F33108	125	F40041	135	F40125	135
F165181	116	F33109	125	F40042	136	F40126	135
F165186	116	F33110	125	F40043	136	F40127	135
F180032	116	F33111	125	F40044	136	F40128	136
F18009	116	F33112	125	F40045	136	F40131	135
F18012	116	F33113	125	F40047	136	F40132	135
F18018	116	F33114	125	F40048	136	F40133	135
F18024	116	F33115	125	F40049	136	F40135	136
F18309	116	F33116	125	F40050	136	F401516	137
F18312	116	F33120	125	F40051	136	F41003	137
F18318	116	F33121	125	F40052	136	F41004	137
F18324	116	F33122	125	F40053	136	F41005	137
F20001	300	F33123	125	F40054	136	F41006	137

PART NO.	PG #	PART NO.	PG #	PART NO.	PG #	PART NO.	PG #
F41007	137	G12036	63	G13634	44	G1550100	345
F41008	137	G12042	63	G13638	44	G1550150	345
F41009	137	G12048	63	G14006	166	G1550215	345
F41012	137	G12112	63	G14008	166	G1550295	345
F41013	137	G12116	63	G14010	166	G1550390	345
F411516	137	G12118	63	G14012	166	G1550520	345
F46108	137	G12124	63	G14016	166	G1550650	345
F481012	137	G12130	63	G14020	166	G1550860	345
F65400	216, 251	G12132	63	G14024	166	G1550975	345
F65600	216, 251	G12136	63	G14028	166	G1551100	345
G02010	302	G12142	63	G14032	166	G16006	166
G02011	302	G12148	63	G14036	166	G16008	166
G02042	302	G12212	63	G14040	166	G16010	166
G02050	302	G12216	63	G14044	166	G16012	166
G04000	279	G12218	63	G14048	166	G16016	166
G04001	279	G12224	63	G14052	166	G16020	166
G04002	279	G12230	63	G14056	166	G16024	166
G04003LF	165	G12232	63	G14064	166	G16028	166
G04004	165	G12236	63	G14072	166	G16032	166
G04005	279	G12242	63	G14080	166	G16036	166
G04006	279	G12248	63	G14088	166	G16040	166
G04026	279	G12312	63	G14096	166	G16044	166
G04030	279	G12316	63	G14104	166	G16048	166
G08004	165	G12318	63	G1440007	345	G16052	166
G08006	165	G12324	63	G1440032	345	G16056	166
G08008	165	G12330	63	G1440033	345	G16064	166
G08012	165	G12332	63	G1440058	345	G16072	166
G08016	165	G12336	63	G1440059	345	G16080	166
G08020	165	G12342	63	G1440060	345	G16088	166
G08024	165	G12348	63	G1440107	345	G16096	166
G09004	165	G12999	63	G1440108	345	G16104	166
G09006	165	G13001	51	G1440109	345	G1650001	345
G09008	165	G13002	51	G1440110	345	G1650002	345
G09012	165	G13003	51	G1440159	345	G1650007	346
G09016	165	G13004	51	G1440160	345	G1650025	345
G09020	165	G13005	51	G1440161	345	G1650032	346
G09024	165	G13006	51	G1440162	345	G1650033	346
G10006	166	G13012	63	G1440222	345	G1650050	345
G10008	166	G13016	63	G1440223	345	G1650058	346
G10010	166	G13018	63	G1440224	345	G1650059	346
G10012	166	G13024	63	G1440225	345	G1650060	346
G10016	166	G13030	63	G1440226	345	G1650100	345
G10020	166	G13032	63	G1440303	345	G1650107	346
G10024	166	G13036	63	G1440304	345	G1650108	346
G10032	166	G13042	63	G1440305	345	G1650109	346
G10036	166	G13048	63	G1440306	345	G1650150	345
G10040	166	G13112	63	G1440307	345	G1650159	346
G10052	166	G13116	63	G1440308	345	G1650160	346
G10072	166	G13118	63	G1440398	345	G1650161	346
G10080	166	G13124	63	G1440399	345	G1650162	346
G10104	166	G13130	63	G1440400	345	G1650215	345
G11006	166	G13132	63	G1440401	345	G1650222	346
G11008	166	G13136	63	G1440402	345	G1650223	346
G11010	166	G13142	63	G1440531	345	G1650224	346
G11012	166	G13148	63	G1440532	345	G1650295	345
G11016	166	G13212	63	G1440533	345	G1650303	346
G11020	166	G13216	63	G1440534	345	G1650304	346
G11024	166	G13218	63	G1440535	345	G1650305	346
G11028	166	G13224	63	G1440662	345	G1650306	346
G11032	166	G13230	63	G1440663	345	G1650307	346
G11036	166	G13232	63	G1440664	345	G1650390	345
G11040	166	G13236	63	G1440665	345	G1650398	346
G11044	166	G13242	63	G1440666	345	G1650399	346
G11048	166	G13248	63	G1440790	345	G1650400	346
G11052	166	G13312	63	G1440870	345	G1650401	346
G11056	166	G13316	63	G1440871	345	G1650402	346
G11064	166	G13318	63	G1440872	345	G1650520	345
G11072	166	G13324	63	G1440873	345	G1650531	346
G11080	166	G13330	63	G1441109	345	G1650532	346
G11088	166	G13332	63	G15002	165	G1650533	346
G11096	166	G13336	63	G15003	165	G1650534	346
G11104	166	G13342	63	G15004	165	G1650650	345
G12012	63	G13348	63	G15006	165	G1650662	346
G12016	63	G13500	44	G15008	165	G1650663	346
G12018	63	G13516	44	G1550001	345	G1650664	346
G12024	63	G13534	44	G1550002	345	G1650665	346
G12030	63	G13601	44	G1550025	345	G1650666	346
G12032	63	G13616	44	G1550050	345	G1650860	345

PART NO.	PG #	PART NO.	PG #	PART NO.	PG #	PART NO.	PG #
G1650870	346	G20115	151	G2540025	347	G30013	297
G1650871	346	G20116	151	G2540050	347	G30014	297
G1650872	346	G20120	151	G2540100	347	G30015	297
G1651100	345	G20121	151	G2540150	347	G30016	297
G1651109	346	G20130	151	G2540215	347	G30017	297
G17025	160	G20131	152	G2540295	347	G30021	297
G17037	160	G20132	152	G2540390	347	G3350050	345
G17050	160	G20136	152	G2540520	347	G3350100	345
G17075	160	G20137	152	G2540650	347	G3350150	345
G17100	160	G20138	152	G2540860	347	G3350215	345
G17125	160	G20141	152	G25612	153	G3550025	347
G17150	160	G20142	152	G25812	153	G3550050	347
G17200	160	G20143	152	G26022	153	G3550100	347
G18025	160	G20150	152	G26032	153	G3550150	347
G18037	160	G20155	152	G26034	153	G3550215	347
G18050	160	G20200	97	G26042	153	G3550295	347
G18075	160	G2350001	346	G26044	153	G3550390	347
G18100	160	G2350002	346	G26046	153	G3750002	347
G18125	160	G2350025	346	G26052	153	G3750050	347
G18150	160	G2350050	346	G26054	153	G3750150	347
G18200	160	G2350058	346	G26056	153	G3750215	347
G19025	160	G2350059	346	G26062	153	G3750295	347
G19037	160	G2350100	346	G26064	153	G3750390	347
G19050	160	G2350107	346	G26066	153	G3960001	349
G19075	160	G2350108	346	G26068	153	G3960002	349
G19100	160	G2350150	346	G26084	153	G3960025	349
G19125	160	G2350159	346	G26086	153	G3960050	349
G19150	160	G2350160	346	G26088	153	G3960100	349
G19200	160	G2350215	346	G26121	153	G3960150	349
G1950002	347	G2350222	346	G26161	153	G3960215	349
G1950025	347	G2350223	346	G27042	153	G3960295	349
G1950050	347	G2350224	346	G27044	153	G3960390	349
G1950100	347	G2350295	346	G27054	153	G3960520	349
G1950150	347	G2350303	346	G27062	153	G3960650	349
G1950215	347	G2350304	346	G27064	153	G3960860	349
G1950295	347	G2350305	346	G27066	153	G4600001	348
G1950390	347	G2350306	346	G27068	153	G4600002	348
G20002	151	G2350390	346	G27084	153	G4600025	348
G20003	151	G2350398	346	G27086	153	G4600050	348
G20004	151	G2350399	346	G27088	153	G4600057	348
G20005	151	G2350400	346	G27106	153	G4600058	348
G20006	152	G2350401	346	G27108	153	G4600059	348
G20008	151	G2350520	346	G28044	153	G4600100	348
G20010	151	G2350532	346	G28066	153	G4600106	348
G20011	151	G2350533	346	G28088	153	G4600107	348
G20015	151	G2350650	346	G2900001	347	G4600108	348
G20016	151	G2350662	346	G2900002	347	G4600109	348
G20017	151	G2350663	346	G2900025	347	G4600116	348
G20020	151	G2350860	346	G2900050	347	G4600117	348
G20021	151	G2351100	346	G2900100	347	G4600118	348
G20030	151	G24004	153	G2900150	347	G4600150	348
G20031	151	G24006	153	G2900215	347	G4600157	348
G20032	151	G25022	153	G2900295	347	G4600159	348
G20035	152	G25032	153	G29003	153	G4600160	348
G20036	152	G25034	153	G2900390	347	G4600162	348
G20037	152	G25042	153	G29004	153	G4600169	348
G20038	152	G25044	153	G29005	153	G4600170	348
G20040	152	G25046	153	G2900520	347	G4600171	348
G20041	152	G25048	153	G29006	153	G4600180	348
G20042	152	G25052	153	G2900650	347	G4600181	348
G20043	152	G25054	153	G29008	153	G4600182	348
G20045	152	G25056	153	G2900860	347	G4600215	348
G20047	152	G25062	153	G29010	153	G4600221	348
G20050	152	G25064	153	G2950002	347	G4600222	348
G20051	152	G25066	153	G2950050	347	G4600223	348
G20053	152	G25068	153	G2950100	347	G4600224	348
G20054	152	G25084	153	G2950150	347	G4600234	348
G20055	152	G25086	153	G2950215	347	G4600235	348
G20056	152	G25088	153	G2950295	347	G4600236	348
G20057	152	G25101	153	G2950390	347	G4600237	348
G20057R	152	G25106	153	G2950650	347	G4600245	348
G20060	152	G25108	153	G30000	297	G4600246	348
G20086LF	79	G25121	153	G30001	297	G4600247	348
G20102	151	G25128	153	G30003	297	G4600258	348
G20103	151	G25161	153	G30004	297	G4600295	348
G20108	151	G25169	153	G30005	297	G4600303	348
G20110	151	G2540001	347	G30011	297	G4600304	348
G20111	151	G2540002	347	G30012	297	G4600305	348

PART NO.	PG #	PART NO.	PG #	PART NO.	PG #	PART NO.	PG #
G4600306	348	G51105	168	G54105	167	G64333	113
G4600315	348	G51106	168	G54106	167	G65155	113
G4600316	348	G51108	168	G54108	167	G6570001	349
G4600317	348	G51110	168	G54110	167	G6570002	349
G4600318	348	G51112	168	G54112	167	G6570025	349
G4600319	348	G51125	168	G54115	167	G6570050	349
G4600328	348	G51135	168	G54125	167	G6570100	349
G4600330	348	G52001	167	G54202	168	G6570150	349
G4600340	348	G52002	167	G54203	168	G6570215	349
G4600350	348	G52003	167	G54204	168	G6570295	349
G4600390	348	G52004	167	G54205	168	G6570390	349
G4600398	348	G52005	167	G54206	168	G6570520	349
G4600399	348	G52006	167	G54208	168	G6570650	349
G4600400	348	G52008	167	G54210	168	G6570860	349
G4600401	348	G52010	167	G54212	168	G66000	112
G4600402	348	G52012	167	G54215	168	G66002	112
G4600414	348	G52013	167	G54225	168	G66015	112
G4600415	348	G52015	167	G55001	168	G66030	112
G4600416	348	G52025	167	G55002	168	G66060	112
G4600429	348	G52035	167	G55003	168	G66100	112
G4600430	348	G52075	167	G55004	168	G67000	112
G4600431	348	G52102	168	G55005	168	G67002	112
G4600444	348	G52103	168	G55014	168	G67015	112
G4600447	348	G52104	168	G55016	168	G67030	112
G4600470	348	G52105	168	G55018	168	G67060	112
G4600520	348	G52106	168	G55116	168	G67100	112
G4600531	348	G52108	168	G55118	168	G70000	83
G4600532	348	G52110	168	G55150	168	G70001	83
G4600534	348	G52115	168	G55200	168	G70002	83
G4600536	348	G52125	168	G55250	168	G70003	83
G4600650	348	G53001	167	G55300	168	G70004	83
G4600662	348	G53002	167	G55350	168	G70005	83
G4600663	348	G53003	167	G55400	168	G70006	83
G4600665	348	G53004	167	G55450	168	G70007	83
G4600666	348	G53005	167	G55500	168	G70008	83
G4600860	348	G53006	167	G55550	168	G70009	83
G4600870	348	G53008	167	G55600	168	G70010	83
G4600872	348	G53010	167	G60000	112	G70011	83
G4860100	347	G53012	167	G60001	112	G70012	83
G4860150	347	G53013	167	G60005	111	G70013	83
G50200	296	G53015	167	G60015	112	G70014	83
G50202	296	G53025	167	G60030	112	G70015	83
G50204	296	G53035	167	G60055	111	G70016	83
G50205	296	G53050	167	G60060	112	G70017	83
G50206	296	G53075	167	G60100	112	G70018	83
G50208	296	G53101	167	G60160	112	G70019	83
G50210	296	G53102	167	G60200	112	G70020	83
G50211	295	G53103	167	G60300	112	G70021	83
G50212	296	G53104	167	G61005	112	G70022	83
G50214	296	G53105	167	G61015	112	G70023	83
G50215	295	G53106	167	G61030	112	G70024	83
G50218	296	G53108	167	G61060	112	G70025	83
G50220	296	G53110	167	G61100	112	G70026	83
G50225	295	G53113	167	G61160	112	G70027	83
G50230	295	G53115	167	G61200	112	G70028	83
G50231	295	G53125	167	G61300	112	G70029	83
G50250	296	G53203	168	G62030	112	G70030	83
G50251	296	G53204	168	G62060	112	G70031	83
G50300	296	G53206	168	G62100	112	G70032	83
G51001	167	G53215	168	G62200	112	G70033	83
G51002	167	G53225	168	G62300	112	G70034	83
G51003	167	G54001	167	G63001	113	G70035	83
G51004	167	G54002	167	G64000	113	G70036	83
G51005	167	G54003	167	G64001	113	G70037	83
G51006	167	G54004	167	G64002	113	G70038	83
G51008	167	G54005	167	G64004	113	G70039	83
G51010	167	G54006	167	G64005	112	G70040	83
G51012	167	G54008	167	G64015	112	G70041	83
G51013	167	G54010	167	G64020	113	G70042	83
G51015	167	G54012	167	G64030	113	G70043	83
G51025	167	G54013	167	G64060	113	G70044	83
G51035	167	G54015	167	G64100	113	G70045	83
G51050	167	G54025	167	G64101	112	G70046	83
G51075	167	G54035	167	G64155	113	G70047	83
G51101	168	G54075	167	G64160	113	G70048	83
G51102	168	G54102	167	G64200	113	G70049	83
G51103	168	G54103	167	G64300	113	G70050	83
G51104	168	G54104	167	G64301	113	G70051	83

PART NO.	PG #	PART NO.	PG #	PART NO.	PG #	PART NO.	PG #
G70052	83	G71018	84	G71120	85	G72122	86
G70053	83	G71019	84	G71121	85	G72123	86
G70054	83	G71020	84	G71122	85	G72124	86
G70055	83	G71021	84	G71123	85	G72126	86
G70100	83	G71022	84	G71124	85	G72127	86
G70101	83	G71023	84	G71125	85	G72128	86
G70102	83	G71024	84	G71126	85	G72129	86
G70103	83	G71025	84	G71127	85	G72130	86
G70104	83	G71026	84	G71128	85	G72131	86
G70105	83	G71027	84	G71129	85	G72132	86
G70106	83	G71028	84	G71130	85	G72133	86
G70107	83	G71029	84	G71131	85	G72134	86
G70108	83	G71031	84	G71132	85	G72135	86
G70109	83	G71032	84	G71133	85	G72136	86
G70110	83	G71033	84	G71134	85	G72137	86
G70111	83	G71034	84	G71135	85	G72140	86
G70112	83	G71035	84	G71136	85	G72141	86
G70113	83	G71036	84	G71137	85	G72142	86
G70114	83	G71037	84	G71138	85	G72143	86
G70115	83	G71038	84	G71139	85	G72144	86
G70116	83	G71039	84	G71140	85	G72146	87
G70117	83	G71040	84	G71141	85	G72147	87
G70118	83	G71041	84	G71142	85	G72148	87
G70119	83	G71042	84	G71143	86	G72149	87
G70120	83	G71043	84	G71144	86	G72150	87
G70121	83	G71044	84	G71145	86	G72151	87
G70122	83	G71045	84	G71146	86	G72152	87
G70123	84	G71046	85	G71147	86	G72153	87
G70124	84	G71047	85	G71148	86	G72154	87
G70125	84	G71048	85	G71149	86	G72155	87
G70126	84	G71049	85	G71150	86	G73101	87
G70127	84	G71050	85	G71151	86	G73108	87
G70128	84	G71051	85	G71152	86	G73115	87
G70129	84	G71052	85	G71153	86	G73122	87
G70130	84	G71053	85	G71154	86	G73129	87
G70131	84	G71054	85	G71155	86	G74103	87
G70132	84	G71055	85	G71156	86	G74105	87
G70133	84	G71056	85	G71157	86	G74111	87
G70134	84	G71057	85	G71158	86	G74113	87
G70135	84	G71058	85	G71159	86	G74119	87
G70136	84	G71059	85	G71160	86	G74121	87
G70137	84	G71060	85	G71161	86	G74127	87
G70138	84	G71061	85	G71162	86	G74129	87
G70139	84	G71062	85	G71167	86	G74135	87
G70140	84	G71063	85	G71168	86	G74137	87
G70141	84	G71064	85	G71169	86	G76001	87
G70142	84	G71066	85	G71170	86	G76002	87
G70143	84	G71067	85	G71172	86	G76003	87
G70144	84	G71068	85	G71173	86	G76005	87
G70145	84	G71069	85	G71174	86	G76013	87
G70146	84	G71070	85	G71176	86	G76015	87
G70147	84	G71071	85	G71177	86	G76023	87
G70148	84	G71072	85	G71179	86	G76025	87
G70149	84	G71074	85	G71401	87	G76041	87
G70150	84	G71075	85	G71402	87	G76042	87
G70151	84	G71076	85	G71403	87	G76043	87
G70152	84	G71077	85	G71404	87	G76045	87
G70153	84	G71078	85	G72100	86	G76051	87
G70154	84	G71079	85	G72101	86	G76052	87
G70155	84	G71100	85	G72102	86	G76053	87
G71000	84	G71102	85	G72103	86	G76062	87
G71001	84	G71103	85	G72104	86	G76072	87
G71002	84	G71104	85	G72105	86	G76073	87
G71003	84	G71105	85	G72107	86	G80001	295
G71004	84	G71106	85	G72108	86	G80007	295
G71005	84	G71107	85	G72109	86	G80012	295
G71006	84	G71108	85	G72110	86	G80023	302
G71007	84	G71109	85	G72111	86	GI05	351
G71008	84	G71110	85	G72112	86	GI07	351
G71009	84	G71111	85	G72113	86	GI10	351
G71010	84	G71112	85	G72114	86	GI12	351
G71011	84	G71113	85	G72115	86	GI15	351
G71012	84	G71114	85	G72116	86	H10052	119
G71013	84	G71115	85	G72117	86	H10054	120
G71014	84	G71116	85	G72118	86	H10056	120
G71015	84	G71117	85	G72119	86	H10058	120
G71016	84	G71118	85	G72120	86	H10072	119
G71017	84	G71119	85	G72121	86	H10074	120

PART NO.	PG #	PART NO.	PG #	PART NO.	PG #	PART NO.	PG #
H10076	120	H18075	120	H54014	74	H72400	127
H10078	120	H20001	121	H54015	74	H73050	127
H10080	120	H20002	121	H54017	74	H73075	127
H10106	120	H20003	121	H54018	74	H73100	127
H10108	120	H20005	121	H54025	74	H73125	127
H10110	120	H20006	121	H54026	74	H73150	127
H10126	120	H20007	121	H54027	74	H73200	127
H10128	120	H20010	121	H54028	74	H73375	127
H10156	120	H20011	121	H54029	74	H80050	127
H10158	120	H20012	121	H54030	74	H80375	127
H10208	120	H20100	121	H54040	74	H81050	127
H11054	120	H20101	121	H54041	74	H81375	127
H11056	120	H20150	121	H54060	74	H82050	127
H11058	120	H20500	121	H54061	74	H82375	127
H11074	120	H21010	121	H54100	291	H83050	126
H11076	120	H21025	121	H60050	126	H83075	126
H11078	120	H21050	121	H60375	126	H83100	126
H11080	120	H21100	121	H60625	126	H84050	126
H11106	120	H21101	121	H65050	127	H84075	126
H11108	120	H21200	121	H65075	127	H84100	126
H11126	120	H22050	121	H65100	127	H85050	126
H11156	120	H22075	121	H65125	127	H85075	126
H11208	120	H23050	119	H65150	127	H90123	301
H11210	120	H24038	122	H65200	127	HDNHC1	308
H12054	119	H24050	122	H65250	127	HDNHC10	308
H12056	119	H24075	122	H65300	127	HDNHC2	308
H12074	119	H24100	122	H65400	127	HDNHC3	308
H12076	119	H25050	121	H65500	127	HDNHC4	308
H12106	119	H25075	121	H65600	127	HDNHC5	308
H13038	120	H25100	121	H66050	127	HDNHC6	308
H13050	120	H26050	122	H66075	127	HDNHC8	308
H130500	120	H26075	122	H66100	127	I10001	156
H13075	120	H26100	122	H66125	127	I10002	156
H13100	120	H26125	122	H66150	127	I10003	156
H13125	120	H26150	122	H66200	127	I10004	156
H13150	120	H26200	122	H66250	127	I10005	156
H13200	120	H27050	122	H66300	127	I10006	156
H13250	120	H27075	122	H66400	127	I10007	156
H13300	120	H27100	122	H68050	127	I10008	156
H13302	120	H28050	122	H68075	127	I10009	156
H13400	120	H28075	122	H68100	127	I10010	156
H13501	120	H28100	122	H68125	127	I10011	156
H13502	120	H28125	122	H68150	127	I10012	156
H13503	120	H28150	122	H68200	127	I10013	156
H13504	120	H28200	122	H68250	127	I10014	156
H14050	126	H29000	122	H68300	127	I10015	156
H14075	126	H29010	122	H68350	127	I10016	156
H14100	126	H30001	120	H68400	127	I10017	156
H14125	126	H30002	120	H68500	127	I10018	156
H14150	126	H30003	120	H68600	127	I10019	156
H14200	126	H30004	120	H68800	127	I10020	156
H14250	126	H30005	120	H69050	127	I10021	156
H14300	126	H30006	120	H69075	127	I10022	156
H14400	126	H30007	120	H69100	127	I10023	156
H15001	121	H30008	120	H69150	127	I10024	156
H15048	120	H30011	120	H69200	127	I10025	156
H15049	120	H30012	120	H69250	127	I10026	156
H15050	120	H30013	120	H69300	127	I10027	156
H15075	120	H30014	120	H69400	127	I10028	156
H15100	120	H30015	120	H70050	127	I10029	156
H15125	120	H30022	120	H70075	127	I10030	156
H15150	120	H30033	120	H70100	127	I10031	156
H15200	120	H30044	120	H70125	127	I10032	156
H16038	120	H305	352	H70150	127	I10033	156
H16050	120	H307	352	H70200	127	I10034	156
H16075	120	H310	352	H70250	127	I10035	156
H16100	120	H320	352	H70300	127	I10036	156
H17050	126	H40001	297	H70350	127	I10037	156
H17075	126	H40002	297	H70400	127	I10038	156
H17100	126	H40003	297	H72050	127	I10039	156
H17125	126	H40004	297	H72075	127	I10040	156
H17150	126	H54001	73	H72100	127	I10041	156
H17200	126	H54002	73	H72125	127	I10042	156
H17250	126	H54003	73	H72150	127	I10043	156
H17300	126	H54010	74	H72200	127	I10044	156
H17350	126	H54011	74	H72250	127	I10045	156
H17400	126	H54012	74	H72300	127	I10046	156
H18050	120	H54013	74	H72375	127	I10047	156

PART NO.	PG #	PART NO.	PG #	PART NO.	PG #	PART NO.	PG #
I10048	156	I50075	108	I57238	108	I63318	103
I10049	156	I50078	108	I57258	108	I63350	103
I11001	155	I50118	108	I59050	109	I63358	103
I11002	155	I50138	108	I59075	109	I63418	103
I11003	155	I50158	108	I59100	109	I64050	103
I11004	155	I50178	108	I59125	109	I64058	103
I11005	155	I50218	108	I59150	109	I64075	103
I11006	155	I50258	108	I59175	109	I64078	103
I11007	155	I51058	108	I59200	109	I64118	103
I11008	155	I51078	108	I59225	109	I64138	103
I11009	155	I51118	108	I60025	103	I64158	103
I11010	155	I51138	108	I60038	103	I80034	104
I11011	155	I51158	108	I60050	103	I80038	104
I11012	155	I51178	108	I60058	103	I80058	104
I11013	155	I51218	108	I60075	103	I80078	104
I11014	155	I51238	108	I60078	103	I80118	104
I11015	155	I51258	108	I60118	103	I80138	104
I11016	155	I52034	108	I60138	103	I80150	104
I11017	155	I52058	108	I60158	103	I80158	104
I11018	155	I52078	108	I60200	103	I80200	104
I11019	155	I52118	108	I60218	103	I80218	104
I11020	155	I52138	108	I60250	103	I81034	104
I11021	155	I52158	108	I60258	103	I81038	104
I11022	155	I52178	108	I60300	103	I81050	104
I11023	155	I52218	108	I60318	103	I81058	104
I11024	155	I52238	108	I60350	103	I81078	104
I11025	155	I52258	108	I61025	103	I81118	104
I11026	155	I52318	108	I61038	103	I81138	104
I11027	155	I52358	108	I61050	103	I81150	104
I11028	155	I53038	108	I61058	103	I81158	104
I12001	158	I53050	108	I61075	103	I81200	104
I12002	158	I53058	108	I61078	103	I81218	104
I12003	158	I53075	108	I61118	103	I81250	104
I12004	158	I53078	108	I61138	103	I81258	104
I12005	158	I53118	108	I61158	103	I81300	104
I12006	158	I53138	108	I61200	103	I81318	104
I12007	158	I53158	108	I61218	103	I81358	104
I12008	158	I53178	108	I61250	103	I81400	104
I12009	158	I53218	108	I61258	103	I81418	104
I12010	158	I53238	108	I61300	103	I82034	104
I12011	158	I53258	108	I61318	103	I82038	104
I12012	158	I53312	108	I61350	103	I82050	104
I12013	158	I53318	108	I61358	103	I82058	104
I12014	158	I53358	108	I61418	103	I82078	104
I12015	158	I53412	108	I61450	103	I82100	104
I12016	158	I53418	108	I62025	103	I82118	104
I12017	158	I54050	108	I62038	103	I82150	104
I12018	158	I54058	108	I62050	103	I82158	104
I13001LF	157	I54075	108	I62058	103	I82200	104
I13002LF	157	I54078	108	I62075	103	I82218	104
I13003LF	157	I54118	108	I62078	103	I82250	104
I13004LF	157	I54138	108	I62118	103	I82258	104
I13005LF	157	I54158	108	I62138	103	I82318	104
I13006LF	157	I54178	108	I62158	103	I82358	104
I13007LF	157	I54218	108	I62200	103	I82400	104
I13010LF	157	I54258	108	I62218	103	I82418	104
I13011LF	157	I55058	108	I62250	103	I83034	104
I13012LF	157	I55075	108	I62258	103	I83058	104
I13013LF	157	I55078	108	I62300	103	I83078	104
I13016LF	157	I55118	108	I62318	103	I83118	104
I13017LF	157	I55158	108	I62350	103	I83138	104
I13018LF	157	I55178	108	I62358	103	I83150	104
I13019LF	157	I55218	108	I62418	103	I83158	104
I13020LF	157	I56058	108	I62450	103	I83200	104
I13021LF	157	I56075	108	I63025	103	I83218	104
I13022LF	157	I56078	108	I63038	103	I83250	104
I13023LF	157	I56118	108	I63050	103	I83358	104
I13024LF	157	I56138	108	I63058	103	I83418	104
I13025LF	157	I56158	108	I63075	103	I91025	105
I13026LF	157	I56218	108	I63078	103	I91038	105
I13027LF	157	I57058	108	I63118	103	I91050	105
I13029LF	157	I57078	108	I63138	103	I91058	105
I13031LF	157	I57115	108	I63158	103	I91075	105
I13032LF	157	I57118	108	I63200	103	I91078	105
I13033LF	157	I57138	108	I63218	103	I91118	105
I13036LF	157	I57158	108	I63250	103	I91138	105
I13037LF	157	I57178	108	I63258	103	I92050	105
I50058	108	I57218	108	I63300	103	I92058	105

PART NO.	PG #	PART NO.	PG #	PART NO.	PG #	PART NO.	PG #
I92075	105	J38712	110	J40106	278	J40351	291
I92078	105	J38715	110	J40107	298	J40352	291
I92118	105	J38718	110	J40111	298	J40353	291
I92138	105	J38724	110	J40115	298	J40369	285
I92158	105	J39712	110	J40116	298	J40375	285
IA1050	109	J39715	110	J40117	298	J40380	292
IA1100	109	J39718	110	J40123	278	J40381	292
IA2050	109	J39724	110	J40128	277	J40382	292
IA2100	109	J40000	275	J40134	298	J40383	292
INT001	109	J40001	275	J40141	284	J40384	292
INT002	109	J40002	275	J40142	284	J40385	292
IPC004	109	J40003	275	J40143	284	J40386	292
IR1470	105	J40004	275	J40144	284	J40387	292
IR5415	105	J40005	275	J40150	68	J40400	284
J01001	96	J40006	275	J40151	68	J40401	289
J01050	121	J40007	276	J40153	68	J40402	289
J01057	121	J40008	275	J40197	290	J40403	289
J01075	121	J40010	277	J40198	279	J40404	289
J01077	121	J40011	277	J40199	290	J40405	289
J01100	121	J40012	277	J40200	290	J40406	289
J01150	121	J40013	277	J40201	290	J40407	289
J01200	121	J40015	275	J40202	290	J40408	289
J01300	121	J40016	63	J40203	290	J40410	289
J01400	121	J40017	63	J40204	290	J40411	289
J04004	97	J40018	276	J40206	290	J40429	288
J04005	97	J40019	278	J40207	290	J40432	288
J04006	97	J40020	299	J40208	290	J40437	298
J04012	97	J40021	277	J40210	289	J40447	298
J04016	97	J40022	277	J40211	289	J40450	299
J04104	97	J40023	277	J40212	289	J40451	299
J04105	97	J40024	277	J40213	281	J40481	299
J04106	97	J40025	275	J40215	281	J40482	299
J04204	97	J40026	276	J40217	281	J40490	276
J04205	97	J40028	277	J40218	281	J40491	276
J04206	97	J40030	275	J40219	281	J40500	113
J04250	97	J40035	276	J40220	286	J40501	113
J34712	110	J40040	276	J40221	286	J40502	113
J34715	110	J40041	276	J40222	286	J40503	113
J34718	110	J40042	276	J40223	278	J40505	114
J34724	110	J40044	288	J40224	278	J40506	114
J34800	111	J40045	287	J40225	278	J40510	114
J34970	111	J40046	287	J40228	281	J40511	114
J34975	111	J40047	288	J40229	288	J40529	288
J34980	111	J40048	288	J40230	278	J40550	113
J35712	110	J40049	288	J40235	277	J40551	113
J35715	110	J40050	286	J40240	281	J40553	112
J35718	110	J40051	286	J40241	281	J40554	112
J35724	110	J40052	286	J40242	281	J40555	112
J36018	111	J40053	286	J40243	281	J40556	112
J36022	111	J40054	286	J40244	281	J40557	112
J36024	111	J40055	286	J40260	282	J40558	113
J36026	111	J40060	288	J40261	282	J40560	113
J36030	111	J40061	288	J40262	281	J40561	114
J36100	275	J40062	288	J40263	282	J40562	114
J36101	275	J40063	288	J40285	291	J40563	114
J36118	109	J40065	278	J40286	291	J40575	113
J36124	109	J40066	278	J40287	291	J40600	288
J36130	109	J40067	278	J40288	290	J40601	288
J36136	109	J40068	278	J40305	277	J40629	288
J36148	109	J40069	278	J40306	277	J40650	280
J36200	111	J40070	278	J40307	278	J40651	280
J36250	111	J40071	278	J40308	278	J40652	280
J36300	111	J40072	278	J40311	278	J40653	280
J36400	111	J40073	278	J40325	278	J40700	113
J36500	109	J40074	278	J40329	288	J40701	113
J36501	109	J40075	278	J40330	291	J40702	113
J37022	111	J40076	278	J40331	291	J40703	113
J37024	111	J40077	278	J40332	291	J40704	113
J37026	111	J40078	278	J40333	291	J40705	113
J37028	111	J40079	278	J40334	291	J40750	285
J37030	111	J40080	286	J40335	291	J40775	285
J37124	65, 313	J40086	287	J40336	291	J40800	285
J37150	65, 313	J40087	287	J40337	291	J40801	289
J38020	111	J40088	287	J40338	291	J40802	289
J38022	111	J40089	287	J40339	291	J40803	289
J38024	111	J40100	299	J40340	291	J40804	289
J38026	111	J40101	287	J40341	291	J40805	289
J38030	111	J40105	278	J40350	291	J40806	289

PART NO.	PG #	PART NO.	PG #	PART NO.	PG #	PART NO.	PG #
J40807	289	K101010295	367	K151010221	357	K151540001	359
J40808	289	K101010390	367	K151010222	357	K151540002	359
J40812	288	K101050100	367	K151010223	357	K151540025	359
J40830	280	K101750100	367	K151010295	357	K151540050	359
J40831	280	K102550050	367	K151010302	357	K151540090	359
J40950	285	K102550058	367	K151010303	357	K151540100	359
J40951	285	K102550100	367	K151010304	357	K151540150	359
J40952	285	K102550150	367	K151010390	357	K151540215	359
J40953	285	K102570050	367	K151010398	357	K151540295	359
J40954	285	K102570058	367	K151010399	357	K151540390	359
J40955	285	K102570100	367	K151010520	357	K151540520	359
J40965	286	K102570107	367	K151010531	357	K151540650	359
J40966	286	K102570150	367	K151010650	357	K151540860	359
J40967	286	K102590050	367	K151010860	357	K151541100	359
J41008	284	K102590058	367	K151050001	357	K151650001	358
J41009	284	K102600050	367	K151050002	357	K151650002	358
J41010	284	K104670050	367	K151050006	357	K151650007	358
J41011	284	K104800050	368	K151050024	357	K151650008	358
J41021	288	K104800057	368	K151050025	357	K151650015	358
J41022	288	K104800058	368	K151050031	357	K151650025	358
J41023	288	K104800100	368	K151050032	357	K151650032	358
J41024	288	K104800107	368	K151050050	357	K151650033	358
J41030	299	K104800159	368	K151050056	357	K151650050	358
J41031	299	K104800160	368	K151050057	357	K151650058	358
J41032	299	K104800222	368	K151050058	357	K151650059	358
J41103	286	K104800223	368	K151050059	357	K151650090	358
J41104	286	K104800224	368	K151050060	357	K151650093	358
J41105	286	K104820050	367	K151050092	357	K151650094	358
J41106	286	K104920050	368	K151050093	357	K151650095	358
J41107	286	K104920100	368	K151050100	357	K151650100	358
J41108	286	K104920143	368	K151050106	357	K151650107	358
J41201	289	K104980118	368	K151050107	357	K151650108	358
J41202	289	K113420215	371	K151050150	357	K151650109	358
J41205	289	K113420520	371	K151050158	357	K151650149	358
J41206	289	K113420650	371	K151050159	357	K151650150	358
J42002	285	K113420860	371	K151050160	357	K151650159	358
J42003	285	K113450650	371	K151050215	357	K151650160	358
J42004	285	K113450860	371	K151050221	357	K151650161	358
J42008	288	K126570215	361	K151050222	357	K151650215	358
J42012	288	K126570295	361	K151050223	357	K151650222	358
J42101	299	K126570390	361	K151050295	357	K151650223	358
J42200	300	K126570520	361	K151050302	357	K151650224	358
J43300	297	K126570650	361	K151050303	357	K151650295	358
J43310	297	K126610050	368	K151050390	357	K151650303	358
J44050	280	K126610100	368	K151050398	357	K151650304	358
J44075	280	K126610150	368	K151050520	357	K151650305	358
J44100	280	K126610215	368	K151050650	357	K151650306	358
J44150	280	K126610295	368	K151140025	357	K151650390	358
J44200	280	K126610390	368	K151140050	357	K151650398	358
J44300	280	K126650050	368	K151140057	357	K151650399	358
J44400	280	K126650100	368	K151140100	357	K151650400	358
J44661	277	K126650150	368	K151140150	357	K151650401	358
J45005	301	K126650215	368	K151140215	357	K151650402	358
J45010	276	K126650295	368	K151140295	357	K151650520	358
J45015	277	K151010001	357	K151140390	357	K151650531	358
J45100	294	K151010002	357	K151150002	357	K151650532	358
J60004	267	K151010005	357	K151150050	357	K151650533	358
J60005	267	K151010006	357	K151150057	357	K151650534	358
J60006	267	K151010007	357	K151150058	357	K151650650	358
J60007	267	K151010024	357	K151150100	357	K151650662	358
J60008	267	K151010025	357	K151150150	357	K151650663	358
J60010	268	K151010031	357	K151150215	357	K151650664	358
J60011	268	K151010032	357	K151150295	357	K151650780	358
J60012	268	K151010050	357	K151150390	357	K151650860	358
J60026	267	K151010056	357	K151400007	360	K151650870	358
J60027	267	K151010057	357	K151400032	360	K151650871	358
J60030	264	K151010058	357	K151400058	360	K151650872	358
J60060	253	K151010059	357	K151400059	360	K151650873	358
J60061	253	K151010092	357	K151400107	360	K151650874	358
J60062	253	K151010100	357	K151400108	360	K151651100	358
J60094	267	K151010106	357	K151400149	360	K151651109	358
J66300	112	K151010107	357	K151400159	360	K151651111	358
J66301	112	K151010150	357	K151400160	360	K151651225	358
J66302	112	K151010157	357	K151400222	360	K151651498	358
K01120	297	K151010158	357	K151400223	360	K151670050	358
K012000	297	K151010159	357	K151400303	360	K151700001	358
K101010050	367	K151010160	357	K151400398	360	K151700002	358
K101010100	367	K151010215	357	K151420060	357	K151700025	358

PART NO.	PG #	PART NO.	PG #	PART NO.	PG #	PART NO.	PG #
K151700050	358	K152540860	359	K154100872	361	K154600340	362
K151700090	358	K152670050	359	K154100983	361	K154600341	362
K151700100	358	K152670100	359	K154101498	361	K154600342	362
K151700150	358	K152720002	360	K154600001	362	K154600343	362
K151700215	358	K152720025	360	K154600002	362	K154600350	362
K151700295	358	K152720050	360	K154600006	362	K154600352	362
K151700390	358	K152720090	360	K154600007	362	K154600390	362
K151700520	358	K152720100	360	K154600012	362	K154600397	362
K151700650	358	K152720150	360	K154600013	362	K154600398	362
K151700780	358	K152720215	360	K154600025	362	K154600399	362
K151700860	358	K152720295	360	K154600031	362	K154600400	362
K151700975	358	K152720390	360	K154600032	362	K154600401	362
K151701100	358	K152720520	360	K154600033	362	K154600402	362
K151720001	358	K152720860	360	K154600041	362	K154600413	362
K151720002	358	K152900001	360	K154600050	362	K154600414	362
K151720025	358	K152900002	360	K154600056	362	K154600415	362
K151720050	358	K152900025	360	K154600057	362	K154600416	362
K151720090	358	K152900050	360	K154600058	362	K154600417	362
K151720100	358	K152900090	360	K154600059	362	K154600418	362
K151720150	358	K152900100	360	K154600060	362	K154600429	362
K151720215	358	K152900150	360	K154600066	362	K154600430	362
K151720295	358	K152900215	360	K154600068	362	K154600431	362
K151720390	358	K152900295	360	K154600075	362	K154600432	362
K151720520	358	K152900390	360	K154600090	362	K154600433	362
K151720650	358	K152900520	360	K154600092	362	K154600444	362
K151720860	358	K152900650	360	K154600095	362	K154600447	362
K151720975	358	K152900860	360	K154600100	362	K154600457	362
K152350001	359	K152900975	360	K154600106	362	K154600470	362
K152350002	359	K152901100	360	K154600107	362	K154600520	362
K152350025	359	K152950002	360	K154600108	362	K154600531	363
K152350032	359	K152950025	360	K154600109	362	K154600532	363
K152350050	359	K152950050	360	K154600117	362	K154600533	363
K152350059	359	K152950090	360	K154600118	362	K154600534	363
K152350090	359	K152950100	360	K154600127	362	K154600535	363
K152350100	359	K152950150	360	K154600150	362	K154600536	363
K152350107	359	K152950215	360	K154600157	362	K154600548	363
K152350150	359	K152950295	360	K154600158	362	K154600549	363
K152350159	359	K152950390	360	K154600159	362	K154600550	363
K152350160	359	K152950520	360	K154600160	362	K154600551	363
K152350215	359	K152950650	360	K154600161	362	K154600552	363
K152350222	359	K152950860	360	K154600169	362	K154600553	363
K152350223	359	K153960050	360	K154600170	362	K154600554	363
K152350295	359	K153960150	360	K154600171	362	K154600564	363
K152350303	359	K154100007	361	K154600180	362	K154600565	363
K152350390	359	K154100032	361	K154600181	362	K154600566	363
K152350398	359	K154100058	361	K154600182	362	K154600580	363
K152350520	359	K154100059	361	K154600215	362	K154600583	363
K152350650	359	K154100093	361	K154600220	362	K154600595	363
K152350780	359	K154100094	361	K154600221	362	K154600608	362
K152350860	359	K154100107	361	K154600222	362	K154600650	363
K152350975	359	K154100108	361	K154600223	362	K154600662	363
K152351100	359	K154100109	361	K154600224	362	K154600663	363
K152351225	359	K154100149	361	K154600234	362	K154600664	363
K152420001	359	K154100159	361	K154600235	362	K154600665	363
K152420002	359	K154100160	361	K154600236	362	K154600666	363
K152420015	359	K154100222	361	K154600237	362	K154600667	363
K152420025	359	K154100223	361	K154600245	362	K154600668	363
K152420050	359	K154100224	361	K154600246	362	K154600677	363
K152420090	359	K154100303	361	K154600247	362	K154600678	363
K152420100	359	K154100304	361	K154600248	362	K154600679	363
K152420150	359	K154100305	361	K154600256	362	K154600680	363
K152420215	359	K154100306	361	K154600295	362	K154600682	363
K152420295	359	K154100398	361	K154600302	362	K154600693	363
K152420390	359	K154100399	361	K154600303	362	K154600694	363
K152420520	359	K154100400	361	K154600304	362	K154600695	363
K152420650	359	K154100401	361	K154600305	362	K154600696	363
K152420860	359	K154100402	361	K154600306	362	K154600708	363
K152540002	359	K154100531	361	K154600315	362	K154600860	363
K152540025	359	K154100532	361	K154600316	362	K154600870	363
K152540050	359	K154100533	361	K154600317	362	K154600871	363
K152540090	359	K154100534	361	K154600318	362	K154600872	363
K152540100	359	K154100662	361	K154600319	362	K154600873	363
K152540150	359	K154100663	361	K154600328	362	K154600874	363
K152540215	359	K154100664	361	K154600329	362	K154600875	363
K152540295	359	K154100665	361	K154600330	362	K154600876	363
K152540390	359	K154100869	361	K154600331	362	K154600877	363
K152540520	359	K154100870	361	K154600332	362	K154600893	363
K152540650	359	K154100871	361	K154600339	362	K154600895	363

PART NO.	PG #	PART NO.	PG #	PART NO.	PG #	PART NO.	PG #
K154600896	363	K50042	283	L75081	270	M25736	285
K154600914	363	K52001	69	L75085	270	M25760	285
K154600975	363	K52002	69	L75086	270	M25784	285
K154601100	363	K52003	69	L75091	270	M25900	128, 278
K154601109	363	K52004	69	L75092	270	M301	352
K154601111	363	K52005	69	L75095	270	M302	352
K154601113	363	K52010	4, 69	L75096	270	M303	352
K154601225	363	K52011	4	L75180	270	M305	352
K154601498	362	K52013	4	L75181	270	M307	352
K155330050	360	K52014	4	L75185	270	M310	352
K155330090	360	K52016	4	L75186	270	M312	352
K155330100	360	K52017	4	L75400	271	M315	352
K155330150	360	K53001	69	L75401	271	M320	352
K155330215	360	K53002	69	L75402	271	M325	352
K155330295	360	K53003	69	L75403	271	M330	352
K155330390	360	K53004	69	L75406	271	M340	352
K156570050	361	K53005	69	L75407	271	N01001	161
K156570100	361	K53006	69	L75408	271	N01002	161
K156570150	361	K53007	69	L75409	271	N01010	160
K159470001	361	K53008	69	L75908	270	N01011	160
K159470002	361	K53055	69	L75909	270	N01014	160
K159470025	361	K53056	69	L95200	307	N01027	160
K159470050	361	K53057	69	L95201	307	N01028	160
K159470090	361	K53058	69	L95202	307	N01029	160
K159470100	361	K53060	69	L95400	301	N01032	161
K159470150	361	K53077	69	M05001	82, 124, 265	N01033	161
K159470215	361	K55006	69	M05003	82, 124, 265	N01034	161
K159470295	361	K55007	69	M05005	82, 124	N01038	159
K159470390	361	L26003	303	M05034	235	N01039	159
K201010215	370	L26005	303	M05134	235	N06001	154
K201010295	370	L26015	303	M06001	128	N07001	154
K201010390	370	L40001	123	M06002	128	N09001	154
K201010650	370	L40002	123	M06006	130	N09002	154
K201050295	370	L42006	123	M06007	130	N10001	154
K201050650	370	L42008	123	M06010	130	N10002	154
K201100390	370	L42011	299	M07001	128	N10003	154
K201610215	370	L42012	299	M07002	128	N10004	154
K201610295	370	L42013	299	M101	352	N10005	154
K201610390	370	L42014	299	M102	352	N10006	154
K201620215	370	L42015	299	M103	352	N10007	154
K201620650	370	L42016	299	M105	352	N10008	154
K202350398	370	L42017	299	M107	352	N10442LF	159
K202350650	370	L42018	299	M110	352	N10444LF	159
K203100295	370	L42019	299	M112	352	N10544LF	159
K204600215	370	L42023	299	M115	352	N10566LF	159
K204600295	370	L42052	123	M120	352	N10664LF	159
K204600390	370	L42102	123	M12001	129	N10944LF	159
K204600398	370	L42103	123	M12002	129	N11001	154
K204600414	370	L42104	123	M12003	129	N11002	154
K204650295	370	L47001	81	M12004	129	N11003	154
K204650390	370	L47004	81	M12005	129	N11004	154
K204650398	370	L56020	70	M12006	129	N11005	154
K204850295	370	L56023	70	M12007	129	N11006	154
K204850390	370	L56024	70	M12009	129	N11007	154
K208400215	371	L56026	70	M12022	129	N11008	154
K208400295	371	L56027	70	M12085	129	N12001	154
K208400303	371	L65001	69	M12100	129	N12002	154
K208400390	371	L75001	270	M125	352	N12003	154
K208400398	371	L75002	270	M130	352	N12004	154
K208400413	371	L75006	270	M140	352	N12005	154
K208400664	371	L75007	270	M15001	129	N12006	154
K208450295	371	L75009	271	M15002	129	N14001	154
K208450650	371	L75010	271	M15005	129	N14002	154
K245500295	371	L75015	271	M15009	129	N14003	154
K245500390	371	L75016	271	M20058	128	N14004	154
K245510295	371	L75017	271	M20075	128	N14005	154
K245510390	371	L75018	271	M20100	128	N14006	154
K245540295	371	L75019	271	M20101	128	N14007	154
K50001	283	L75020	271	M20581	128	N14008	154
K50002	283	L75021	271	M20751	128	N14009	154
K50003	283	L75022	271	M25100	285	N14010	154
K50005	283	L75023	271	M25127	285	N14011	154
K50011	292	L75024	271	M25130	285	N14012	154
K50012	292	L75040	270	M25136	285	N14013	154
K50015	292	L75041	270	M25148	285	N14014	154
K50016	292	L75042	270	M25527	285	N14015	154
K50018	292	L75043	270	M25536	285	N14016	154
K50041	283	L75080	270	M25560	285	N14017	154

PART NO.	PG #	PART NO.	PG #	PART NO.	PG #	PART NO.	PG #
N14018	154	N22006	146	N27010	146	O15003	122
N14019	154	N22007	146	N27014	146	O15006	122
N15001	154	N22008	146	N27016	146	O15007	122
N15100	150	N22009	146	N27018	147	O25199	68
N15150	150	N22010	146	N27022	147	O25200	68
N15200	150	N22014	146	N28000	147	O25202	44
N15250	150	N22018	146	N28002	147	O25203	44
N15300	150	N22022	146	N28003	147	O25204	44
N15350	150	N2206BN	21	N28004	147	O25205	44
N15400	150	N2206RB	21	N28005	147	O25206	44
N15450	150	N2206WB	21	N28006	147	O25207	44
N15500	150	N2210BN	21	N28007	147	O25208	44
N15550	150	N2210PB	21	N28008	147	O25209	44
N15600	150	N2210RB	21	N28009	147	O25210	44
N15900	150	N23000	146	N28010	147	O25302	44
N16100	150	N23001	146	N28014	147	O25303	44
N16150	150	N23002	146	N28016	147	O25304	44
N16200	150	N23003	146	N28018	147	O25305	44
N16250	150	N23004	146	N28022	147	O25306	44
N16300	150	N23005	146	N29000	147	O25307	44
N16350	150	N23006	146	N29003	147	O25308	44
N16400	150	N23007	146	N29004	147	O25309	44
N16450	150	N23008	146	N29005	147	O25310	44
N16500	150	N23009	146	N29006	147	ORA225	68
N16550	150	N23010	146	N29007	147	P10001	279
N16600	150	N23012	146	N29008	147	P10002	279
N16900	150	N23014	146	N29009	147	P10012	138
N16918	150	N23016	146	N29010	147	P10014	138
N16924	150	N23018	146	N29012	147	P10016	138
N16936	150	N23020	146	N29014	147	P10018	138
N17050	21	N23022	146	N29016	147	P10032	138
N17100	150	N2306BN	21	N29018	147	P10034	138
N17150	150	N2306RB	21	N29020	147	P10036	138
N17300	150	N2306WB	21	N29022	147	P10038	138
N17375	21	N2310BN	21	N30000	147	P10082	138
N17400	150	N2310PB	21	N30004	147	P10084	138
N17600	150	N2310RB	21	N30005	147	P10086	138
N18001	154	N2310WB	21	N30006	147	P10088	138
N18002	154	N24000	146	N30007	147	P10092	138
N18100	150	N24001	146	N30008	147	P10094	138
N18200	150	N24002	146	N30010	147	P10096	138
N18250	150	N24003	146	N31000	147	P10098	138
N18300	150	N24004	146	N31004	147	P10312	138
N18400	150	N24005	146	N31005	147	P10452	138
N18500	150	N24006	146	N31006	147	P10454	138
N18600	150	N24007	146	N31008	147	P10812	138
N20000	146	N24008	146	N31010	147	P10912	138
N20001	146	N24009	146	N62006LF	134	P11042	139
N20002	146	N24010	146	N62086LF	134	P11062	139
N20003	146	N24012	146	N62106LF	134	P11064	139
N20004	146	N24014	146	N65106LF	134	P11082	139
N20005	146	N24016	146	N66066LF	134	P11084	139
N20006	146	N24018	146	N66068LF	134	P11086	139
N20007	146	N24022	146	N66088LF	134	P11102	139
N20008	146	N25000	146	N66610LF	134	P11104	139
N20009	146	N25002	146	N68066LF	134	P11106	139
N20010	146	N25003	146	N68068LF	134	P11108	139
N20012	146	N25004	146	N68088LF	134	P11122	139
N20014	146	N25005	146	N69066LF	134	P11124	139
N21000	146	N25006	146	N69068LF	134	P11126	139
N21001	146	N25007	146	N70016	294	P11128	139
N21002	146	N25008	146	N70020	294	P11202	139
N21003	146	N25009	146	N70024	294	P11204	139
N21004	146	N25010	146	N70032	294	P11206	139
N21005	146	N25012	146	N70050	294	P11208	139
N21006	146	N25014	146	N70066LF	134	P11928	139
N21007	146	N25016	146	N70068LF	134	P11986	139
N21008	146	N25018	146	N70075	294	P12102	138
N21009	146	N25022	146	N70086LF	134	P12104	138
N21010	146	N27000	146	N70150	294	P12106	138
N21014	146	N27002	146	N70175	294	P12108	138
N21022	146	N27003	146	N70200	294	P12112	138
N22000	146	N27004	146	N70250	294	P12202	139
N22001	146	N27005	146	N70300	294	P12204	139
N22002	146	N27006	146	N70500	294	P12206	139
N22003	146	N27007	146	N70575	294	P12208	139
N22004	146	N27008	146	O15001	122	P12212	139
N22005	146	N27009	146	O15002	122	P12328	139

PART NO.	PG #	PART NO.	PG #	PART NO.	PG #	PART NO.	PG #
P12342	139	P3504RB	6	P3562PN	13	P37012	321
P12362	139	P3504WB	6	P3562PS	13	P37013	321
P12364	139	P35050	12, 13	P3562PW	13	P37014	321
P12386	139	P35051	12	P3562RB	13	P37015	321
P12402	138	P35052	12	P3562WB	13	P37016	321
P12404	138	P35055	12	P3563AB	13	P37017	321
P12408	138	P35056	12, 58	P3563AL	13	P37018	321
P13224	139	P35057	58	P3563AN	13	P37019	322
P13232	139	P35058	12	P3563BI	13	P37020	322
P13424	139	P35060	12, 58	P3563BL	13	P37021	322
P13432	139	P35061	12, 58	P3563BN	13	P37022	322
P13600	279	P35062	12, 13, 58	P3563BS	13	P37023	322
P13624	139	P35063	12, 58	P3563PN	13	P37024	322
P13632	139	P35064	13, 58	P3563PS	13	P37025	322
P13986	138	P35065	12	P3563PW	13	P37026	322
P15050	234	P35066	13, 58	P3563RB	13	P37027	322
P15075	234	P35067	13, 58	P3563WB	13	P37028	322
P15175	234	P35068	12, 13	P3565AB	12	P37029	322
P16002	138	P35070	13, 58	P3565AL	12	P37030	321
P16004	138	P35071	13	P3565AN	12	P37031	321
P16006	138	P35072	12	P3565BI	12	P37032	320
P16008	138	P35073	12	P3565BL	12	P37033	322
P19062	138	P35077	58	P3565BN	12	P37034	320
P19082	138	P35125	58	P3565BS	12	P37035	322
P19084	138	P35150	58	P3565PN	12	P37036	320
P19086	138	P35158	58	P3565PS	12	P37040	321
P19128	138	P35159	71	P3565PW	12	P37041	321
P20002	138	P35160	58	P3565RB	12	P37042	320
P20004	138	P35161	58	P3565WB	12	P37100	320
P20006	138	P35162	71	P3566AB	11	P37118	321
P20008	138	P35163	72	P3566AL	11	P37150	322
P20092	139	P35165	72	P3566AN	11	P37200	322
P20094	139	P35166	72	P3566BI	11	P37400	322
P20096	139	P35167	72	P3566BL	11	P37445	322
P20098	139	P35170	11, 58	P3566BN	11	P37490	322
P21100	65	P35171	11	P3566BS	11	P37500	16, 326
P21101	65	P35172	11	P3566PN	11	P37502	16, 326
P21102	65	P35175	58	P3566PS	11	P37503	16, 326
P21103	65	P35180	71	P3566PW	11	P37505	16, 326
P21104	65	P35260	58	P3566RB	11	P37506	17, 326
P21107	65	P3560AB	13	P3566WB	11	P37508	17, 326
P21150	65	P3560AL	13	P35900	64	P37509	17, 326
P22100	235	P3560AN	13	P35901	64	P3750AB	16
P22101	235	P3560BI	13	P35902	64	P3750AL	16
P22200	235	P3560BL	13	P35904	64	P3750AN	16
P22201	235	P3560BN	13	P35905	64	P3750BI	16
P22300	235	P3560BS	13	P35906	64	P3750BL	16
P24001	216, 251	P3560PN	13	P35907	64	P3750BN	16
P24002	216, 251	P3560PS	13	P35908	64	P3750BS	16
P24003	216	P3560PW	13	P35909	64	P3750PN	16
P24003	251	P3560RB	13	P35910	64	P3750PS	16
P24004	216, 251	P3560WB	13	P35911	64	P3750PW	16
P27001	284	P35610	12, 13	P35912	64	P3750RB	16
P27003	285	P35611	12, 13	P35913	64	P3750WB	16
P27004	284	P35612	12	P35920	6	P37511	17, 326
P27005	284	P35613	12	P35921	6	P37512	326
P27040	285	P35614	12	P35922	6	P37514	326
P27048	284	P35615	12	P36002	58	P37515	326
P3450BN	6	P35616	11	P36003	58	P37517	326
P3450CP	6	P3561AB	13	P36004	58	P37518	326
P3450RB	6	P3561AL	13	P36102	65, 323	P3751AB	16
P35000	64	P3561AN	13	P36103	65, 323	P3751AL	16
P35001	6, 327	P3561BI	13	P36104	325	P3751AN	16
P35002	6, 327	P3561BL	13	P36105	325	P3751BI	16
P35003	6, 64	P3561BN	13	P36125	6	P3751BL	16
P35004	64, 327	P3561BS	13	P36150	6	P3751BN	16
P35005	64, 327	P3561PN	13	P37000	329	P3751BS	16
P3500BN	6	P3561PS	13	P37001	320	P3751PN	16
P3500PB	6	P3561PW	13	P37002	320	P3751PS	16
P3500RB	6	P3561RB	13	P37003	320	P3751PW	16
P3500WB	6	P3561WB	13	P37004	320	P3751RB	16
P35033	6	P3562AB	13	P37005	320	P3751WB	16
P3503BN	6	P3562AL	13	P37006	320	P37520	326
P3503RB	6	P3562AN	13	P37007	320	P3752AB	17
P3503WB	6	P3562BI	13	P37008	320	P3752AL	17
P35041	64	P3562BL	13	P37009	320	P3752AN	17
P35044	6	P3562BN	13	P37010	321	P3752BI	17
P3504BN	6	P3562BS	13	P37011	321	P3752BL	17

PART NO.	PG #	PART NO.	PG #	PART NO.	PG #	PART NO.	PG #
P3752BN	17	P38048	316	P38127	317	P39034	323
P3752PN	17	P38049	316	P38128	317	P39035	325
P3752PS	17	P38050	316	P38129	314	P39040	325
P3752PW	17	P38051	316	P38130	314	P39041	325
P3752RB	17	P38052	316	P38131	317	P39500	16, 326
P3752WB	17	P38053	316	P38132	317	P39502	16, 326
P37550	17	P38054	316	P38133	317	P39503	16, 326
P3755BN	17	P38055	316	P38134	317	P39505	16, 326
P3755PB	17	P38056	316	P38135	317	P39506	17, 326
P3755RB	17	P38057	316	P38136	317	P39508	17, 326
P3755WB	17	P38058	316	P38137	314	P39509	17, 326
P3755WH	17	P38059	316	P38138	313	P3950AB	16
P3761AB	17	P38060	316	P38140	314	P3950AL	16
P3761AL	17	P38061	316	P38141	314	P3950AN	16
P3761AN	17	P38062	317	P38142	314	P3950BI	16
P3761BI	17	P38063	318	P38143	318	P3950BL	16
P3761BL	17	P38064	318	P38148	318	P3950BN	16
P3761BN	17	P38065	317	P38150	313	P3950BS	16
P3761BS	17	P38066	317	P38162	317	P3950PN	16
P3761PN	17	P38067	317	P38163	318	P3950PS	16
P3761PS	17	P38068	317	P38164	318	P3950PW	16
P3761PW	17	P38069	317	P38165	318	P3950RB	16
P3761RB	17	P38070	317	P38166	318	P3950WB	16
P3761WB	17	P38071	317	P3819BN	6	P39511	17, 326
P38001	313	P38072	317	P3819RB	6	P39512	326
P38002	313	P38073	317	P38217	316	P39514	326
P38002B	313	P38074	317	P38238	316	P39515	326
P38003	313	P38075	317	P38257	318	P39517	326
P38003B	313	P38076	317	P38406	319	P39518	326
P38004	313	P38077	317	P38420	319	P3951AB	16
P38005	313	P38078	317	P38428	319	P3951AL	16
P38005B	313	P38079	317	P38443	319	P3951AN	16
P38006	313	P38080	317	P38444	319	P3951BI	16
P38006B	313	P38081	317	P38447	319	P3951BL	16
P38007	313	P38082	317	P38454	319	P3951BN	16
P38008	313	P38083	317	P38458	319	P3951BS	16
P38009	313	P38084	317	P38459	319	P3951PN	16
P38009B	313	P38085	317	P38460	319	P3951PS	16
P38010	313	P38086	317	P38486	319	P3951PW	16
P38010B	313	P38087	317	P38489	319	P3951RB	16
P38011	313	P38088	317	P3892BN	6	P3951WB	16
P38012	313	P38089	317	P3892PB	6	P3952AB	17
P38012B	313	P38091	313	P3892RB	6	P3952AL	17
P38013	314	P38092	313	P3892WB	6	P3952AN	17
P38014	314	P38093	313	P39000	329	P3952BI	17
P38015	314	P38094	313	P39001	323	P3952BL	17
P38016	314	P38095	314	P39002	323	P3952BN	17
P38017	314	P38096	314	P39003	323	P3952PN	17
P38018	314	P38097	314	P39004	323	P3952PS	17
P38019	314	P38098	315	P39005	323	P3952PW	17
P38020	314	P38099	315	P39006	323	P3952RB	17
P38021	315	P38100	315	P39007	323	P3952WB	17
P38022	315	P38101	315	P39008	323	P3961AB	17
P38023	315	P38102	315	P39009	323	P3961AL	17
P38024	315	P38103	315	P39010	323	P3961AN	17
P38025	315	P38104	315	P39011	323	P3961BI	17
P38026	315	P38105	315	P39012	324	P3961BL	17
P38027	315	P38106	315	P39013	324	P3961BN	17
P38028	315	P38107	314	P39014	324	P3961PN	17
P38029	315	P38108	314	P39015	324	P3961PS	17
P38030	316	P38109	314	P39016	324	P3961PW	17
P38031	316	P38110	314	P39017	324	P3961RB	17
P38032	316	P38111	314	P39018	324	P3961WB	17
P38033	316	P38112	314	P39019	324	P40004	294
P38034	316	P38113	315	P39020	324	P40014	294
P38035	316	P38114	315	P39021	324	P40080	294
P38036	316	P38115	316	P39022	324	P48002	220
P38037	316	P38116	316	P39023	325	P48003	220
P38038	316	P38117	316	P39024	325	P48004	220
P38039	316	P38118	317	P39025	325	P48102	220
P38040	316	P38119	317	P39026	325	P48103	220
P38041	316	P38120	317	P39027	325	P48104	220
P38042	316	P38121	317	P39028	325	P48400	224
P38043	316	P38122	317	P39029	325	P49002	224
P38044	316	P38123	317	P39030	324	P49003	224
P38045	316	P38124	317	P39031	324	P49004	224
P38046	316	P38125	317	P39032	323	P49015	224
P38047	316	P38126	317	P39033	324	P49025	224

PART NO.	PG #	PART NO.	PG #	PART NO.	PG #	PART NO.	PG #
P49035	224	P60001	289	PFA629	336	PFY532	338
P49250	224	P60002	289	PFA630	335	PFY540L	338
P49350	224	P60003	289	PFA639	336	PFY542	338
P49915	224	P70001	280	PFA640	335	PFY543	338
P49920	224	P70002	280	PFA659	336	PHA520	341
P49925	224	P70005	280	PFB211	335	PHA521	341
P49930	224	P70006	280	PFB221	335	PHA530	341
P49935	224	P70010	280	PFB231	335	PHA540	341
P49940	224	P70011	280	PFB232	335	PHA543	341
P50100	260	P70012	280	PFB242	335	PHC151	337
P50125	260	P70015	280	PFB243	335	PHC152	337
P50150	260	P70016	280	PFB264	335	PHC153	337
P50200	260	P70018	281	PFC114	335	PHC154	337
P50250	260	P70019	281	PFC115	335	PMA414	335
P50300	260	P70020	281	PFC116	335	PMA415	335
P50350	260	P70023	280	PFC120	335	PMA420	335
P50400	260	P70029	280	PFC121	335	PMA430	335
P50500	260	P70030	281	PFC122	335	PMA440	335
P50600	260	P70031	281	PFC130	335	PNH120	341
P50800	260	P70035	280	PFC131	335	PNH130	341
P50999	260	P70036	280	PFC132	335	PNH140	341
P51150	260	P70050	281	PFC133	335	PPT015	340
P51200	260	P70051	282	PFC140	335	PPT020	340
P51250	260	P70052	282	PFC142	335	PPT030	340
P51300	260	P70053	282	PFC143	335	PPT040	340
P51350	260	P70055	281	PFC144	335	PPT315	339
P51400	260	P70056	281	PFC160	335	PPT320	339
P51500	260	P70060	282	PFL031	336	PPT415	340
P51600	260	P70064	281	PFL032	336	PPT420	340
P51800	260	P70065	281	PFL131	336	PPT515	340
P52150	260	P70066	281	PFL515	337	PPT520	340
P52200	260	P70067	281, 282	PFL520	337	PPT530	340
P52250	260	P70069	281	PFL530	337	PPT540	340
P52300	260	PAB243	341	PFL540	337	PPT715	339
P52350	260	PAB75340	341	PFL560	337	PPT915S	340
P52400	260	PAC543	341	PFL614	337	PPT920S	340
P52500	260	PCB934	340	PFL615	337	PSA740	341
P53200	260	PCT315	338	PFL615S	337	PSL031	339
P53250	260	PCT320	338	PFL620	337	PSL042	339
P53300	260	PCT330	338	PFL620S	337	PSL132	339
P53350	260	PCT340	338	PFL630	337	PSL715S	335
P53400	260	PCT416	338	PFL640	337	PSL716S	335
P53500	260	PCT421	338	PFL660	337	PSL720	335
P54150	261	PCT431	338	PFL715	336	PSL730	335
P54200	261	PCT441	338	PFL720	336	PSL740	335
P54250	261	PDL716	337	PFL730	336	PSL760	335
P54300	261	PDL722	337	PFL814	336	PSL815	337
P54350	261	PDL736	337	PFL815	336	PSL820	337
P54400	261	PDT515	339	PFL815L	336	PSL830	337
P54500	261	PDT520	339	PFL820	336	PSL840	337
P54600	261	PDT521	339	PFL820L	336	PSL916	336
P54800	261	PDT530	339	PFL821	336	PSL926	336
P55150	260	PDT531	339	PFL830	336	PSL936	336
P55250	260	PDT532	339	PFL830L	336	PSL946	336
P55300	123, 260	PDT540	339	PFL834	336	PSS140	339
P55350	260	PDT542	339	PFL840	336	PST114	338
P55500	260	PDT543	339	PFL840L	336	PST115	338
P56200	260	PDT621	338	PFL860	336	PST120	338
P56250	260	PDT715	340	PFL915	336	PST121	338
P56300	260	PDY415	338	PFL930	336	PST122	338
P56350	260	PDY420	338	PFY015	337	PST123	338
P56400	260	PDY430	338	PFY020	337	PST130	338
P56450	260	PDY440	338	PFY021	337	PST131	338
P56500	260	PDY442	338	PFY023	337	PST132	338
P56550	260	PDY443	338	PFY030	337	PST140	338
P56600	260	PEJ530	341	PFY031	337	PST141	338
P58150	261	PEJ540	341	PFY032	337	PST142	338
P58200	261	PFA311	335	PFY040	337	PST143	338
P58250	261	PFA314	335	PFY041	337	PST160	338
P58300	261	PFA315	335	PFY042	337	PST164	338
P58350	261	PFA320	335	PFY043	337	PST232	339
P58400	261	PFA330	335	PFY060	337	PTA215	340
P59300	261	PFA340	335	PFY064	337	PTA221	340
P59333	261	PFA360	335	PFY515L	338	PTA311	340
P59350	261	PFA614	336	PFY520L	338	PTA315	340
P59355	261	PFA615	335	PFY521	338	PTA415	340
P59400	261	PFA619	336	PFY530L	338	PTA420	340
P59444	261	PFA620	335	PFY531	338	PTC633	339

PART NO.	PG #	PART NO.	PG #	PART NO.	PG #	PART NO.	PG #
PTC644	339	R40300	124	S01155	7	S04104	80
PVT415	338	R40400	124	S01156	7	S04105	80
PVT420	338	R45150	124	S01157	7	S04106	80
PVT430	338	R45200	124	S01158	8	S04107	80
PVT440	338	R45300	124	S0130BN	8	S04108	80
R15050	234	R45400	124	S0130RB	8	S04121	80
R15075	234	R50150	124	S0130WB	8	S04123	80
R15100	124	R50200	124	S0132BN	8	S04124	80
R15101	124	R50300	124	S0132RB	8	S04125	80
R15107	124	R50400	124	S0132WB	8	S04127	80
R15108	124	R57150	124	S0151BN	7	S04128	80
R15109	124	R57200	124	S0151RB	7	S04200	78
R15202	109	R57300	124	S0151WB	7	S04201	78
R15204	109	R57400	124	S0152BN	7	S04202	78
R16100	123	R60001	128	S0152RB	7	S04203	78
R16101	123	R60002	128	S0152WB	7	S04204	78
R16107	123	R60003	128	S0153BN	7	S04205	78
R16108	123	R60004	128	S0153RB	7	S04206	78
R18001	236	R60050	91	S0153WB	7	S04207	78
R18005	236	R60075	91	S0155BN	7	S04208	78
R18006	236	R60100	91	S0155RB	7	S04209	78
R18007	236	R60125	91	S0155WB	7	S04210	78
R18008	236	R60150	91	S0156BN	7	S04211	78
R18009	236	R60200	91	S0156RB	7	S04212	78
R18011	236	R60250	91	S0156WB	7	S04213	78
R18012	236	R60300	91	S0157BN	7	S04214	78
R18013	236	R60375	91	S0157RB	7	S04215	78
R18014	236	R60400	91	S0157WB	7	S04216	78
R18015	236	R60600	91	S0158BN	8	S04217	78
R18016	236	R70150	124	S0158RB	8	S04218	78
R18017	236	R70200	124	S0158WB	8	S04219	78
R18018	236	R70300	124	S02015	52	S04220	78
R18019	236	R70400	124	S02016	52	S04221	78
R18020	236, 266	S01001	52	S02055	52	S04222	78
R18026	236	S01002	52	S02056	52	S04223	78
R18027	236	S01003	52	S02057	52	S04224	78
R18028	236	S01004	52	S02058	52	S04225	78
R19003	266	S01005	52	S02059	52	S04226	78
R19004	266	S01008	52	S02066	52	S04227	78
R19005	266	S01009	52	S02069	52	S04228	78
R19006	266	S01010	52	S02070	52	S04229	78
R19099	266	S01013	52	S02071	52	S04230	78
R19100	266	S01014	52	S02072	52	S04231	78
R19102	266	S01015	53	S02073	52	S04232	78
R19103	266	S01016	53	S02074	52	S04233	79
R19104	266	S01020	53	S02100	53	S04234	79
R19202	266	S01025	53	S02150	52	S04235	79
R19203	266	S01030	8, 53	S02151	52	S04236	79
R19204	266	S01032	8, 53	S02152	52	S04237	79
R19206	266	S01035	7, 53	S02190	52	S04238	79
R19302	266	S01036	8	S02193	52	S04239	78
R19303	266	S01037	8	S02197	8, 52	S04240	78
R19304	266	S01038	7, 53	S02198	8, 52	S04241	78
R19305	266	S01039	53	S02290	52	S04242	78
R19306	266	S01040	53	S02293	52	S04243	78
R19307	266	S01041	53	S02300	52	S04244	78
R19402	266	S01042	53	S03030	8	S04245	78
R19403	266	S01044	53	S03032	8	S04246	78
R19404	266	S01045	53	S03040	8	S04247	78
R20001	164	S01049	53	S03152	7	S04248	78
R20002	164	S01050	55	S03220	57	S04249	78
R20003	164	S01051	7	S03222	57	S04250	78
R20005	164	S01052	7	S04020	24, 80	S04255	78
R20150	164	S01053	7	S04021	80	S04260	79
R20151	164	S01055	7	S04022	24, 80	S04261	78
R30050	91	S01056	7	S04023	80	S04267	79
R30075	91	S01057	7	S04024	80	S04268	79
R30100	91	S01058	8	S04025	80	S04269	79
R30125	91	S01060	53	S04026	80	S04270	79
R30150	91	S01061	53	S04027	24, 80	S04275	79
R30200	91	S01070	7, 55	S04028	80	S04276	79
R30250	91	S01071	7	S04029	24, 80	S04280	78
R30300	91	S01072	7	S04030	80	S04285	78
R30375	91	S01073	7	S04031	80	S04288	78
R30400	91	S01080	54	S04032	80	S04350	110
R30600	91	S01151	7	S04101	80	S04351	110
R40150	124	S01152	7	S04102	80	S04352	110
R40200	124	S01153	7	S04103	80	S04353	110

PART NO.	PG #	PART NO.	PG #	PART NO.	PG #	PART NO.	PG #
S04354	110	S10301	80	S10411	80	S20200	298
S04355	110	S10302	80	S10412	80	S20201	298
S04356	110	S10303	80	S10414	81	S20202	298
S04357	110	S10310	81	S10416	81	S20203	298
S04358	110	S10311	81	S10417	81	S20204	298
S04359	110	S10312	81	S10418	81	S20300	298
S04360	110	S10313	81	S10419	80	S20301	298
S04400	79	S10314	81	S10420	80	S20302	298
S04401	79	S10315	81	S10421	80	S22001	100
S04402	79	S10316	80	S10422	80	S22002	100
S04403	79	S10317	81	S10423	81	S22003	100
S04404	79	S10318	80	S10424	81	S22004	100
S04405	79	S10319	80	S1135BN	23	S22005	100
S04406	79	S10320	80	S1135RB	23	S22006	100
S04407	79	S10321	80	S1136BN	23	S25150	225
S04408	79	S10323	80	S1136RB	23	S25200	225
S04409	79	S10324	80	S1137BN	23	S25250	225
S04410	79	S10325	80	S1137RB	23	S25300	225
S04411	79	S10326	80	S1138BN	23	S25350	225
S04412	79	S10327	81	S1138RB	23	S25400	225
S04413	79	S10328	81	S12005	51	S26001	95
S04414	79	S10330	81	S13130	51	S26002	95
S04415	79	S10331	81	S13140	51	S26004	225
S04416	79	S10332	81	S13240	51	S26005	225
S04417	79	S10333	81	S14001	70, 330	S26006	225
S04418	79	S10334	81	S14002	70, 330	S26007	225
S04419	79	S10335	80	S14003	330	S26008	225, 269
S04420	79	S10336	81	S14003	70	S26009	225
S04421	79	S10337	80	S14004	70, 330	S26010	225
S04422	79	S10338	80	S14005	70, 330	S26011	225
S04423	79	S10339	81	S14006	70, 330	S26012	225
S04424	79	S10340	81	S14007	3, 70, 330	S26014	225
S04430	79	S10341	81	S14008	70, 331	S26015	225
S04440	79	S1034BN	23	S14009	70	S26016	225
S04450	79	S1034RB	23	S14010	70, 331	S26017	225
S04455	79	S10351	23	S14011	70	S26100	95
S05100	82	S10355	80	S14014	71, 331	S27001	95
S05101	82	S1035AP	23	S14030	71	S27002	95
S05102	82	S1035BB	23	S1407BN	3	S30012	124
S05105	81	S1035BN	23	S1407RB	3	S30024	124
S06014	290	S1035PS	23	S1407WB	3	S30800	293
S06015	290	S1035RB	23	S14103	70, 331	S30801	293
S06016	290	S1035WB	23	S14250	71, 331	S30802	293
S06017	290	S10361	23	S14251	71, 331	S30803	293
S06018	290	S1036AP	23	S14606	71, 331	S33001	115
S06019	290	S1036BN	23	S16001	115	S33002	115
S08003	81	S1036RB	23	S16002	115	S33003	115
S08008	81	S1036WB	23	S16003	115	S33004	115
S08012	81	S10371	23	S16004	115	S33005	115
S08020	4, 69	S1037AP	23	S16005	115	S33006	115
S08030	81	S1037BB	23	S16006	115	S33007	115
S08031	81	S1037BN	23	S16007	115	S33010	115
S08032	81	S1037CP	23	S16008	115	S33011	115
S08100	301	S1037PS	23	S16009	115	S33012	115
S10020	4	S1037RB	23	S16010	115	S33013	115
S10021	4	S1037WB	23	S16011	115	S33016	115
S10022	4	S10381	23	S16012	115	S33021	116
S10023	4	S1038AP	23	S16014	115	S33022	116
S10024	4	S1038BB	23	S16015	115	S33023	116
S10025	4	S1038BN	23	S16016	115	S33024	116
S10068	54	S1038CP	23	S16017	115	S33025	116
S10069	54	S1038PS	23	S16018	115	S33026	116
S10070	54	S1038RB	23	S16024	115	S33035	115
S10071	54	S1038WB	23	S163566	115	S33036	115
S10072	54	S1039BN	23	S180032	115	S33037	115
S10073	54	S1039CP	23	S20009	115	S33038	115
S10074	54	S1039RB	23	S20012	115	S33039	115
S10075	54	S10400	81	S20015	298	S33040	118
S10076	54	S10401	81	S20021	298	S33041	118
S10077	54	S10402	81	S20031	298	S33200	121
S10078	54	S10403	81	S20041	298	S33318	115
S10079	55	S10404	81	S20100	298	S33518	115
S10080	54	S10405	81	S20101	298	S36006	267
S10081	54	S10406	81	S20102	298	S36007	267
S10082	54	S10407	81	S20103	298	S36008	267
S10083	54	S10408	80	S20104	298	S36009	267
S10100	301	S10409	81	S20105	298	S36010	267
S10300	80	S10410	80	S20106	298	S36011	267

PART NO.	PG #	PART NO.	PG #	PART NO.	PG #	PART NO.	PG #
S36091	267	S4405WB	24	S55194	265	S71008	117,356
S36096	267	S45001	3	S55240	265	S71009	117,356
S41001	290	S49001	282	S55349	82,265	S71010	118,356
S41002	290	S49002	282	S55350	82,265	S71011	117,356
S41003	290	S49003	282	S55352	82,265	S71012	117,356
S41006	290	S49010	282	S55353	82,265	S71013	117,356
S41007	290	S49012	282	S55354	82,265	S72000	116,355
S41300	290	S49013	282	S55902	47,178	S72001	116,355
S41301	290	S49036	282	S55903	47,178	S72002	116,355
S41302	290	S49042	232	S55950	47,178	S72003	116,355
S41303	290	S49043	232	S55951	47,178	S72004	116,355
S41306	290	S49044	232	S55952	47,178	S72005	116,355
S41307	290	S49048	282	S55953	47,178	S72006	116,355
S41308	290	S49052	232	S57034	264	S72007	116,355
S41349	286	S49053	232	S57035	264	S72008	116,355
S41350	286	S49054	232	S58050	69	S72009	117,355
S41351	286	S49062	232	S58051	69	S72010	117,355
S41352	286	S49063	232	S58052	69	S72011	117,355
S41353	286	S49064	232	S58053	69	S72012	117,355
S41355	286	S49072	232	S58101	69	S72013	117,355
S41356	286	S49073	232	S59002	232	S72014	117,356
S41357	286	S49074	232	S59003	232	S72015	117,356
S42021	22	S49082	232	S59004	232	S72016	117,356
S4202BN	22	S49083	232	S59010	233	S72017	118,356
S4202PB	22	S49084	232	S59011	233	S72018	117,356
S4202RB	22	S49092	232	S59012	233	S72019	117,356
S4202WB	22	S49093	232	S59042	233	S72020	117,356
S42031	22	S49094	232	S59043	233	S72021	117,356
S4203BN	22	S49136	282	S59044	233	S72022	117,356
S4203PB	22	S49148	282	S59052	233	S73000	116,355
S4203RB	22	S49236	282	S59053	233	S73001	116,355
S4203WB	22	S49400	283	S59054	233	S73002	116,355
S4211BN	22	S49401	283	S59062	233	S73003	116,355
S4211RB	22	S49402	283	S59063	233	S73004	116,355
S4211WB	22	S49412	283	S59064	233	S73005	117,355
S4212BN	22	S49413	283	S59072	233	S73006	117,355
S4212RB	22	S49416	283	S59073	233	S73007	117,356
S4212WB	22	S49417	283	S59074	233	S73008	117,356
S4213BN	22	S49421	283	S59082	233	S80201	283
S4213RB	22	S49422	283	S59083	233	S92001	159
S4213WB	22	S49423	283	S59084	233	S92025	159
S42220	22	S49425	283	S59092	233	S92030	159
S4222BN	22	S49427	283	S59093	233	S92031	159
S4222RB	22	S49429	283	S59094	233	S95010	293
S4222WB	22	S49431	283	S59102	232	S95011	293
S43021	22	S49432	283	S59103	232	S95012	293
S4302BN	22	S49489	284	S59104	232	S95014	293
S4302PB	22	S49490	284	S59302	232	S95015	294
S4302RB	22	S49500	284	S59303	232	S95016	293
S4302WB	22	S49501	284	S59304	232	S95100	293
S43031	22	S50001	302	S59310	233	S95101	293
S4303BN	22	S50002	302	S59311	233	S95102	288
S4303PB	22	S50060	282	S59312	233	S95103	288
S4303RB	22	S50061	282	S59402	232	S95106	288
S4303WB	22	S50062	282	S59403	232	S95200	294
S4311BN	22	S50063	282	S60002	233,265	S95250	302
S4311RB	22	S51001	100	S60003	233,265	S95251	302
S4311WB	22	S51002	100	S60004	233,265	S95701	293
S4312BN	22	S51080	100	S60005	233	S95709	294
S4312RB	22	S51120	100	S62001	276	S95710	293
S4312WB	22	S55001	232	S62002	276	S95711	293
S4314BN	22	S55002	232	S62003	276	S95712	293
S4314RB	22	S55004	265	S62004	276	S95713	293
S4314WB	22	S55010	265	S62005	276	S95793	293
S44002	23	S55050	265	S62100	77	S95794	293
S44003	23	S55075	265	S62101	77	S95795	293
S44005	23	S55100	264	S62304	77	S95800	299
S4401BN	24	S55101	264	S63200	77	S96012	293
S4401RB	24	S55104	265	S63300	77	S96014	293
S4401WB	24	S55112	265	S63400	77	S96016	293
S4402BN	24	S55113	265	S71000	116,355	S99100	53
S4402RB	24	S55114	265	S71001	116,355	S994050	53
S4402WB	24	S55115	265	S71002	116,355	S995040	53
S4403BN	24	S55122	265	S71003	116,355	S996050	53
S4403RB	24	S55123	265	S71004	117,355	S996080	53
S4403WB	24	S55124	265	S71005	117,355	T00002	265
S4405BN	24	S55192	265	S71006	117,355	T00003	265
S4405RB	24	S55193	265	S71007	117,355	T00005	265

PART NO.	PG #	PART NO.	PG #	PART NO.	PG #	PART NO.	PG #
T00006	265	T018RB	24	T08021	12	T30046	94
T00009	265	T018WB	24	T08113	11	T30068	94
T01000	25	T02005	47	T0812BN	11	T30102	94
T01001	40	T02020	46	T0812RB	11	T30203	94
T01002	40	T02021	46	T0812WB	11	T30304	94
T01003	24	T02022	46	T0813BN	12	T31000	92
T01004	24	T02023	46	T0813PW	12	T31001	92
T01005	40	T02024	46	T0813RB	12	T31002	92
T01006	24	T02025	42	T0813WB	12	T31003	92
T01007	24	T02026	46	T10014	57	T31004	92
T01008	24	T02027	46	T10016	57	T31006	92
T0100BN	25	T02028	44	T10216	57	T32001	93
T0100PB	25	T02035	46	T12001	122	T32002	93
T0100RB	25	T02036	46	T12006	128	T32003	93
T0100WB	25	T02037	46	T12010	128	T32004	93
T01010	41	T02038	46	T12050	128	T32006	93
T01012	41	T02039	46	T12106	128	T32008	93
T01015	25	T02050	46	T12110	128	T32011	93
T01016	41	T02051	46	T16002	99	T32022	93
T01017	25	T02052	46	T16004	99	T32033	93
T01020	40	T02053	46	T16100	99	T32044	93
T01021	25	T02062	46	T17002	99	T33001	93
T0102BN	25	T02064	46	T17004	99	T33002	93
T0102RB	25	T02065	46	T17101	99	T33003	93
T0102WB	25	T02066	45	T17102	99	T33004	93
T01030	40	T02067	46	T17104	99	T33152	93
T01031	25	T02070	45	T18201	99	T33200	94
T01032	25	T02075	45	T18202	99	T33300	94
T01033	25	T03008	45	T19122	99	T33304	93
T01034	40	T04001	24	T19125	99	T33400	94
T01035	24	T05002	11, 57	T19222	99	T34001	92
T01036	24	T05003	11, 57	T19342	99	T34002	92
T01037	24	T05010	57	T19345	99	T34003	92
T01040	41	T05011	12, 57	T20020	99	T34004	92
T01042	40	T05012	11, 57	T20023	99	T34006	92
T01043	25	T05013	12, 57	T20030	99	T34008	92
T01044	25	T05021	12, 57	T20040	99	T34012	92
T01045	25	T05023	57, 58	T20041	99	T34013	92
T01048	40	T05024	12, 57, 58	T20050	99	T34014	92
T01049	25	T05025	57	T21001	269	T34150	92
T01050	40	T05026	57	T21002	269	T34200	92
T01051	25	T05029	57	T21004	269	T34300	92
T01052	25	T0521AB	12	T21062	269	T34350	92
T01053	25	T0521AL	12	T21063	269	T34400	92
T0105BN	25	T0521AN	12	T21064	269	T35001	93
T0105RB	25	T0521BI	12	T25250	114	T35002	93
T0105WB	25	T0521BL	12	T25312	114	T35003	93
T01060	40	T0521BN	12	T25375	114	T35004	93
T01061	24	T0521BS	12	T25500	114	T35201	93
T01062	40	T0521PN	12	T25625	114	T35202	93
T01064	40	T0521PS	12	T26000	114	T35203	93
T01065	25	T0521PW	12	T26124	114	T35204	93
T01066	41	T0521RB	12	T26125	114	T35206	93
T01068	40	T0521WB	12	T26186	114	T36150	93
T01070	40	T06001	95, 329	T26187	114	T36200	93
T01071	24	T06002	95, 329	T26250	114	T36300	93
T01072	41	T06003	95, 329	T26252	114	T36400	93
T01073	24	T06004	95, 329	T26312	114	T36600	93
T01074	40	T06024	95	T26313	114	T37001	92
T01075	24	T06025	95	T26375	114	T37002	92
T01080	41	T06050	95	T26376	114	T37003	92
T01081	41	T06200	95	T26377	114	T37004	92
T0108BN	25	T06250	95	T26498	114	T37006	92
T0108RB	25	T06300	95	T26500	114	T37008	92
T0108WB	25	T06320	95	T26625	114	T38006	128
T01099	40	T06400	95	T26626	114	T38010	128
T01100	24, 41	T06430	95	T26750	114	T38038	128
T01101	24	T06600	95	T26875	114	T38106	128
T01102	24	T06640	95	T27125	114	T38110	128
T01103	24	T06800	95	T27188	114	T39002	93
T01181	25	T07150	95	T27250	114	T39003	93
T01200	40	T07200	95	T27313	114	T39004	93
T01201	40	T07300	95	T27375	114	T39006	93
T01330	25	T07400	95	T27438	114	T39008	93
T0133BN	25	T08003	11	T27500	114	T39010	93
T0133RB	25	T08004	11	T27625	114	T39012	93
T0133WB	25	T08012	11	T30002	94	T40001	130
T018BN	24	T08013	11	T30034	94	T40002	130

PART NO.	PG #	PART NO.	PG #	PART NO.	PG #	PART NO.	PG #
T40003	130	T73001	8, 77	T85051	67	V97002	307
T40004	130	T73002	8, 77	T85052	67	V97003	307
T40005	130	T73003	8, 77	T85053	67	V97004	307
T40007	130	T73004	8, 77	T85054	67	V97005	307
T40008	130	T73125	134	T85055	67	V97006	307
T41001	287	T73138	134	T85056	44	V97008	307
T41002	287	T73150	134	T85057	44	V97010	307
T41003	287	T73175	134	T85125	66, 328	V97012	307
T41004	287	T73200	134	T85150	66, 328	V97015	307
T41005	287	T73300	22	T86050	67	V98002	307
T41006	287	T7330BN	22	T86052	67	V98003	307
T41007	287	T7330PB	22	T86053	67	V98004	307
T41008	287	T7330RB	22	T86054	67	V98005	307
T41009	287	T7330WB	22	T86055	67	V98006	307
T45002	94	T73815	8, 77	U003WD00	376	V98008	307
T45003	94	T73816	8, 77	U004WD00	376	V98010	307
T45010	93	T73817	8, 77	U100500	379	V98012	307
T45012	93	T73818	8, 77	U100600	379	V98015	307
T45151	94	T74001	67, 318	U100800	379		
T45201	94	T74002	67, 318	U1008TK00	379		
T45301	94	T74003	67, 318	U300V00	375		
T45401	94	T74004	67, 318	U95001	308		
T45600	93	T74005	67, 318	U95002	308		
T45800	93	T74006	67, 318	U95003	308		
T46200	93	T74010	64, 328	U95004	308		
T46300	93	T74011	64, 328	U95005	308		
T46400	93	T75000	67	U95006	308		
T50001	299	T75001	67	U95008	308		
T55002	269	T75125	67, 329	U95010	308		
T55003	269	T75150	67, 329	U95012	308		
T55004	269	T75151	67, 329	U95015	308		
T55012	269	T75250	67	U95211	308		
T55013	269	T76125	67, 329	U95320	308		
T55014	269	T76150	329	U95430	308		
T55022	269	T76150	67	U97001	308		
T55033	269	T76151	67, 329	U97002	308		
T55044	269	T76250	67	U97003	308		
T56002	269	T77012	67, 328	U97004	308		
T56003	269	T77013	67, 328	U97005	308		
T56004	269	T77014	67, 328	U97006	308		
T56012	269	T77020	67, 328	U97008	308		
T56013	269	T77125	66, 328	U97010	308		
T56014	269	T77138	66, 328	U99001	309		
T56022	269	T77150	66, 328	U99002	309		
T56033	269	T77151	66, 328	U99003	309		
T56044	269	T77152	66, 328	U99004	309		
T60000	122	T77200	66, 328	U99005	309		
T60001	122	T78012	67, 328	U99006	309		
T60003	122	T78013	67, 328	U99008	309		
T60005	122	T78014	67, 328	U99010	309		
T60006	122	T78020	67, 328	U99110	309		
T60007	298	T78125	66, 328	U99211	309		
T60060	275, 308	T78150	66, 328	U99220	309		
T60065	275, 308	T78151	66, 328	U99320	309		
T60066	275, 308	T78152	66, 328	U99330	309		
T60080	275, 308	T78200	66, 328	U99440	309		
T60081	275, 308	T79000	66	U99550	309		
T60100	294	T79125	67, 329	U99660	309		
T60101	295	T79150	67, 329	U99880	309		
T60102	295	T79151	67, 329	V94004	307		
T60103	295	T79152	67, 329	V95002	307		
T60104	295	T79200	67, 329	V95003	307		
T60105	295	T79201	67, 329	V95004	307		
T60106	295	T80125	67, 329	V95005	307		
T60107	295	T80135	67, 329	V95006	307		
T60108	295	T80150	67, 329	V95008	307		
T60110	295	T80151	67, 329	V95010	307		
T60111	295	T80160	67, 329	V95012	307		
T60112	295	T80200	67, 329	V95015	307		
T60121	295	T81150	67, 329	V96002	307		
T60122	295	T82125	66, 328	V96003	307		
T60123	295	T82150	66, 328	V96004	307		
T60124	295	T83150	66, 328	V96005	307		
T60125	295	T84125	66, 328	V96006	307		
T60126	295	T84150	66, 328	V96008	307		
T60127	295	T84151	66, 328	V96010	307		
T63106	269	T84200	66, 328	V96012	307		
T64540	269	T85050	67	V96015	307		