



**WITHOUT YOU  
THERE IS NO US.**

**Effective March 26, 2025**

**Fittings | Fabrications  
Repair | Connection | Branching  
All Common Types & Sizes of Pipe**





# JCM GENERAL PRODUCT DIRECTORY

Effective March 26, 2025

## UNIVERSAL CLAMP COUPLINGS/REPAIR FITTINGS

101 Universal Clamp Coupling - Standard Range .....	6-7
102 Universal Clamp Coupling - Extended Range .....	8-9
103 - 174 Tapped Outlet Clamps .....	18
108 Universal Clamp Coupling For Sewer Pipe .....	3
131 All Stainless Universal Clamp Coupling - Std Range .....	10-11
132 All Stainless Universal Clamp Coupling - Exd Range .....	12-13
133 - 163 All Stainless Tapped Outlet Clamps .....	18
161 All Stainless Steel Fabricated Lug Clamp .....	14-15
162 All Stainless Steel Fabricated Lug Clamp - Extended Range .....	16
168 All Stainless Fabricated Lug Lightweight Clamp .....	17
171 UCC Removeable Lug - Standard Range .....	6-7
172 UCC Removeable Lug - Extended Range .....	8-9
105 - 135 Collar Leak Clamp .....	19
106 Bell Joint Leak Clamp for PVC Pipe .....	20
143 Bell Joint Leak Clamp - Cast Iron, Ductile Iron, C-900/905 .....	20
110 Patch Clamp .....	22
111 Full Repair Clamps .....	23
112 Heavy Duty Patch Clamp - Single Band .....	24
113 Heavy Duty Patch Clamp - Multi-Band .....	24
114 Mechanical Joint Repair Sleeve .....	28-30
116 Repair Sleeve for Concrete Steel Cylinder Pipe .....	31
118 Fabricated Repair Sleeve .....	32-33
136 Heavy Duty All Stainless Steel Repair Sleeve .....	34
159 Abandoned Corporation Cap Sleeve .....	25-27

## COUPLINGS - FLANGED COUPLING ADAPTERS

201 Steel Coupling - IPS PVC & Stl Pipe O.D. - CI, DI O.D .....	38-39
202 Long Steel Coupling .....	40
203 Steel Transition Coupling .....	41
204 Steel Reducing Coupling .....	41
210 Ductile Iron Coupling - CI, DI, C900, HDPE & A/C .....	42
211 Ductile Iron Coupling - IPS PVC, Steel, HDPE .....	42
212 Ductile Iron Transition Coupling .....	43
214 Pipe End Cap Coupling .....	44
215 Long Ductile Iron Coupling .....	45
219 Restrained Ductile Iron Coupling .....	44
220 Galvanized Compression Coupling Series .....	47
225 Insulating Adapter Gasket .....	47
230 Stiffener Insert for High Density Polyethylene Pipe .....	51
241 - 242 Optimum Range Coupling .....	48
250 Mechanical Joint Coupling .....	Call JCM
262 Fabricated Stainless Steel Coupling .....	49-50
301 Flanged Coupling Adapter .....	52-53
303 Steel Fabricated FCA - Special .....	54
304 Steel Fabricated Reducing FCA .....	55
306 Fabricated FCA .....	56
307 Fabricated Reducing FCA .....	57
309 Dismantling Joint .....	58
362 Fabricated Stainless Steel FCA .....	59

## SERVICE SADDLES

401 Single Strap Service Saddle .....	62
402 Double Strap Service Saddle .....	64
403 Wide Body Service Saddle - SS Strap .....	62
404 Service Saddle with Double SS Straps .....	64
405 Coated Wide Body Service Saddle - SS Strap .....	63
406 Coated Service Saddle with Double SS Straps .....	65
407 Coated Single Strap SS - electro-galvanized strap .....	63
408 Coated Double Strap SS - electro-galvanized straps .....	65
425 Service Saddle for Concrete Steel Cylinder Pipe .....	66
502 Stainless Steel Service Saddle .....	68-69

## TAPPING SLEEVES

411 Fabricated Tapping Sleeve - Plain End Outlet .....	73
412 Fabricated Tapping Sleeve - Flanged Outlet .....	78-79
413 Fabricated Tapping Cross .....	73
414 Fabricated Mechanical Joint Tapping Sleeve .....	91
415 Fabricated Tapping Sleeve - Concrete Steel Cylinder Pipe .....	92
416 Weld-On Tapping Sleeve - Outlet Only .....	93
417 Weld-On Tapping Sleeve .....	93
418 Fabricated Threaded Outlet Tapping Sleeve .....	70
419 Fabricated Tapping Sleeve - Mechanical Joint Outlet .....	82
422 Fabricated Tapping Sleeve for PVC Pipe .....	80-81
429 Fabricated Tapping Sleeve for PVC/MJ Outlet .....	83
432 All Stainless Steel Tapping Sleeve .....	84-85
438 All Stainless Steel Threaded Outlet Tapping Sleeve .....	71
439 Stainless Steel Tapping Slv - Mechanical Joint Outlet .....	86-87
440 Line Stop Fittings .....	94-101
452 All Stainless Steel Tapping Sleeve Outlet Seal Gasket .....	88-89
459 Stainless Steel Tap Slv - Mechanical Joint Outlet .....	90
462 Stainless Steel Tapping Sleeve - Carbon Steel Flange .....	84-85
464 Stainless Steel Tapping Sleeve - Carbon Steel Flange .....	88-89
465 Stainless Steel Tapping Sleeve - Carbon MJ Outlet .....	90
469 Stainless Steel Tapping Sleeve - Carbon MJ Outlet .....	86-87
400 Series Tapping Sleeves for HDPE Pipe .....	102-103

## RESTRAINERS

600 Sur-Grip Restrainers .....	105-106
607 - 617 Weld On Restrainers .....	107
630 - 631 Asbestos Cement Restrainers .....	104
650 HDPE Mechanical Wall Anchor .....	108

## PIPE FABRICATIONS, TOOLS & ACCESSORIES

800 Fabricated Tee, Spools & Wall Fittings .....	112
801 Expansion Joint - Single End .....	110-111
802 Expansion Joint - Double End .....	110-111
910 Deep Well Socket Set .....	113
920 Pipe Outside Diameter Tape .....	113

## ENGINEERED FITTINGS

114 Mechanical Joint Repair Sleeve .....	28-30
116 Repair Sleeve for Concrete Steel Cylinder Pipe .....	31
118 Fabricated Repair Sleeve .....	32-33
136 Heavy Duty All Stainless Steel Repair Sleeve .....	34
414 Fabricated Mechanical Joint Tapping Sleeve .....	91
415 Fabricated Tapping Sleeve - Concrete Steel Cylinder Pipe .....	92
800 Fabricated Tee, Spools & Wall Fittings .....	112
801 Expansion Joint - Single End .....	110-111
802 Expansion Joint - Double End .....	110-111
Engineered Fittings Data Sheet .....	115
HDPE Fittings Information .....	116-120
Large Diameter Repair Information .....	120-121
Galvanic Chart .....	122
Stainless Steel Information .....	123-124
Pipe O.D. Chart .....	125
Industry Cross Reference Chart .....	126-127

Other publications available from JCM  
JCM Engineered Fittings Manual  
JCM Fittings and Fabrications for HDPE Manual  
JCM Industrial Fittings Manual



## JCM Selection Guide to Repair Fittings





PRODUCT	NUMBER & TYPE	APPLICATION, SIZES AND INFORMATION
 	<p>101 Universal Clamp Coupling Standard Range</p> <p>108 Sewer Clamp</p> <p>102 Universal Clamp Coupling Extended Range</p> <p>121 Gas Repair Clamp</p>	<p>Most popular and economical clamp provides a full circumferential seal and wide range. Sizes 1-1/2" - 12".</p> <p>This multi-band clamp provides a full circumferential seal and offers extended range, heavy duty design and extra safety factor in larger sizes. Sizes 4" - 60".</p> <p>This popular and economical clamp provides a full circumferential seal permanently repairing cast iron and steel gas service lines. Sizes 2" - 12".</p>
	<p>103 Tapped Universal Clamp Coupling - Standard Range</p> <p>104 Tapped Universal Clamp Coupling - Extended Range</p> <p>123 Gas Service Clamp</p>	<p>Repair clamps with tapped outlets are recommended for replacement of pulled out corporation stops and in applications where pipe reinforcement is necessary. Taps 3/4" - 2".</p>
 	<p>131 All Stainless Steel Univ. Clamp Coupling Std. Range</p> <p>132 All Stainless Steel Univ. Clamp Coupling Extd. Range</p> <p>151 All Stainless Gas Repair Clamp</p>	<p>All stainless version of the popular single band clamp provides a full circumferential seal and wide range. Sizes 1-1/2" - 12".</p> <p>This all stainless multi-band clamp provides a full circumferential seal and offers extended range, heavy duty design and extra safety factor in larger sizes. Sizes 4" - 60".</p> <p>All Stainless Steel construction provides extra corrosion resistance for permanent repair of cast iron and steel gas service lines.</p>
	<p>133 All Stainless Tapped Univ. Clamp Cplg. Standard Range</p> <p>134 All Stainless Tapped U.C.C. Extended Range</p> <p>153 All Stainless Gas Service Clamp</p>	<p>All stainless repair clamps with tapped outlets are recommended for replacement of pulled out corporation stops and in applications where pipe reinforcement is necessary. Taps 3/4" - 2".</p>
	<p>105 Collar Leak Clamp</p> <p>135 All Stainless Collar Leak Clamp</p>	<p>This specialty clamp provides a quick, simple means of repairing solvent weld PVC pipe joints. Pressure pipe sizes 2" - 8". Plastic Irrigation Pipe sizes 4" - 15".</p>
	<p>159 Cap Sleeve for Abandoned Corporation Services</p>	<p>Offers quick and efficient installation over the abandoned corporation stop, permanently sealing the service area. This cap ensures a long term, watertight seal for the discarded corporation service and prevents any potential infiltration to the system.</p>

## JCM Selection Guide to Repair Fittings

PRODUCT	NUMBER & TYPE	APPLICATION, SIZES AND INFORMATION
	<p>161 All SS Fabricated Lug Clamp Standard Range</p> <p>162 All SS Fab Lug Extd Range</p> <p>163 Tapped All Stainless Steel Fabricated Lug Clamp</p> <p>168 All SS Fab Lug Lightweight Clamp</p> <p>169 All SS Fab Lug Lightweight Clamp Extd Range</p>	<p>All stainless steel fabricated repair clamp provides full circumferential seal and wide range. All stainless construction is suitable for hot, acidic or corrosive environments. Sizes 2" - 12".</p> <p>168 and 169 All stainless steel fabricated lug Lightweight Clamp for Sewer and Slip Lining applications.</p>
	<p>171 Universal Clamp Coupling Removeable Lug Standard Range</p> <p>172 Universal Clamp Coupling Removeable Lug Extended Range</p>	<p>Universal Clamp Coupling with unique feature of <b>removeable</b> lug. Lug slides off to accommodate installations in rockbound soils, narrow piping galleries and other limited space installation applications. Sizes 1-1/2" - 12"</p> <p>Multi-band clamp provide full circumferential seal and the <b>removeable</b> lug feature. Heavy duty design and extra safety factor in large sizes. Sizes 4" - 60"</p>
	<p>106 Bell Joint Leak Clamp for IPS PVC</p>	<p>A bell joint repair clamp specifically for rubber joint IPS size plastic pipe. Clamp also fits solvent weld joints and many standard steel pipe threaded couplings. Sizes 4" - 8".</p>
	<p>143 Bell Joint Leak Clamps for Ductile Iron, Cast Iron, C-900 PVC Pipe and customized for other types of pipe</p>	<p>Bell joint clamps for leaking caulk and rubber joints on cast iron, ductile iron and C-900/905 PVC Pipe. Sizes 4" - 12" are cast ductile fittings, 14" and larger are fabricated.</p> <p>Sizes 14" and larger are fabricated steel which can accommodate application specific requirements including space limitations, oversized bells, out of round pipe, etc.</p>
	<p>108 Universal Clamp Coupling for Sewer Pipe</p> <p>138 All Stainless Steel Univ. Clamp Cplg. for Sewer Pipe</p>	<p>A full circumferential clamp coupling to join and repair various types of sewer pipe, single and multi-band versions. Sizes 4" - 48".</p> <p>All stainless full circumferential clamp coupling to join and repair sewer pipe, single and multi-band versions. Sizes 4" - 48".</p>
	<p>110 Patch Clamp</p> <p>111 Full-Repair Clamp</p>	<p>Fast, economical repair clamps to permanently repair pinholes, punctures or splits in steel pipe. Sizes 1/2" - 24".</p> <p>Fully gasketed repair clamp. Especially recommended for repairs to heavily damaged pipe and pipe with reduced diameter due to corrosion. Steel Sizes 1/2" - 2".</p>
	<p>112 Heavy Duty Patch Clamp Single Band</p> <p>113 Heavy Duty Patch Clamp Multi-Band</p>	<p>Heavy duty single band patch clamp for repairing pinholes, punctures or splits. Sizes 1-1/2" - 12".</p> <p>Heavy duty multi-band clamp offers increased performance and range in repairing pinholes, punctures and splits. Sizes 10" and larger.</p>

## JCM Engineered Repair Fitting Selection Guide

JCM provides fittings for repairs to all types and sizes of pipe. Selection of the proper fitting is a determining factor to the success of the repair and returning the pipeline to its original service capacity. This chart is an introduction to the Engineered Repair Fittings JCM fabricates and the types of applications for which they would be considered. For specific product application recommendations, contact the JCM Sales Team.

PRODUCT	TYPE OF PIPE	APPLICATION, SIZES AND INFORMATION
 <p style="text-align: center;">JCM 114 MJ Repair Sleeve</p>	Cast Iron Ductile Iron Asbestos Cement Steel PVC HDPE	<b>114 Split Repair Sleeve</b> repairs cracks, splits, longitudinal and circumferential breaks. Especially useful for repairs to critical lines that cannot be shutdown. Product is custom fabricated to accommodate all types and sizes of pipe. Pipe Sizes 6" and larger.
	Cast Iron Ductile Iron Asbestos Cement Steel PVC HDPE	<b>114 Bell Joint Repair Sleeve</b> repairs cracked cast iron bells, split or leaking couplings, leaking joints. Repair fitting "houses" the leaking connection and provides permanent water tight joint. Product is fabricated to specific application dimensions, ensuring custom fit over damaged area. Pipe Sizes 6" and larger.
 <p style="text-align: center;">JCM 116 Repair Sleeve for Concrete Steel Cylinder Pipe and Large Diameter Pipe</p>	C301/SP-5/PCCP C301/SP-12/ECCP C303/SP-3/RCCP	Repairs holes, punctures, construction damage, and corroded areas on PCCP. Repairs directly on the steel cylinder preventing further corrosion damage to pipeline. Requires minimal excavation of pipeline. Pipe Sizes 14" and larger.
	Cast Iron Ductile Iron Steel Other large diameter rigid pipe	Repairs holes, punctures, construction damage and corrosion areas on large diameter pipe. Concentration of gasket compression around damage area allows for high working pressure capability. Pipe Sizes 14" and larger
 <p style="text-align: center;">JCM 136 Heavy Duty Stainless Steel Repair Sleeve</p>	Cast Iron Ductile Iron Steel Asbestos Cement PVC	Repairs holes, punctures, splits, cracks, breaks and other serious damage to pipelines. The fully gasketed stainless shell provides a complete seal on the full circumference of the pipe. Heavy duty tapping sleeve lug system provides for higher bolt torque capabilities. Pipe Sizes 6" and larger.
 <p style="text-align: center;">JCM 118 Large Diameter and Non-Standard Contour Pipe Repair Sleeve</p>	Cast Iron Ductile Iron Steel Asbestos Cement PVC HDPE	Repairs holes, punctures, construction damage and corrosion areas on large diameter pipe. Accommodates application parameters such as limited space, non-standard pipe diameters, uneven pipe surfaces, out of round pipe high working pressure systems. Pipe Sizes 3" and larger.

## JCM Universal Clamp Couplings Selection

Industry standard repair clamps require bolt torque ranges between 60 - 85 ft. lbs. of torque. Some manufacturers advise not to exceed 75 ft. lbs. of torque due to excessive lug deformation. Difficult installations involving pipe offset or deflection often require more torque to assure proper clamp conformation to the pipe and high gasket compression. Larger pipe sizes and pipelines with higher working pressures also require greater torque capability. JCM Universal Clamp Couplings have bolt torque capability in excess of 100 ft. lbs. on 5/8" bolts and 150 ft. lbs. on 3/4" bolts. These elevated torque value capabilities allow JCM Universal Clamp Couplings to go beyond the "standard installation".

As an added PLUS, JCM Universal Clamp Couplings come standard with a thicker gasket in all but the smallest sizes. This heavy 1/4" thick gasket was introduced to the industry to provide for better performance on heavily damaged and pitted pipe. However, it had been available in only 10" and 12" clamp sizes. In JCM clamps this heavier gasket is standard in all sizes 3" and larger. Combined with the **greater bolt torque capability**, the heavy gasket feature means more clamp capability under extreme conditions.

### Width Selection - 101, 102, 171, 172 Universal Clamp Couplings

JCM Universal Clamp Couplings are available in a great many widths. Because these clamps utilize a heavier gasket and bolting arrangement than most comparable clamps, when you use JCM Universal Clamp Couplings significant savings are possible. The following general recommendations are offered to assist you in taking advantage of the design benefits of these clamps. Specific circumstance may require widths other than these general recommendations.

**6" Width:** Best and most economical width to repair most beam breaks and to connect pipe in sizes 4" and smaller. Short length with thicker gasket gives outstanding deflection capability. Recommend 2" of gasket on both sides of the break.

**7-1/2" Width:** Best for Asbestos Cement coupling replacements, beam breaks and connection of pipe in sizes 6" and larger.

**12" Width:** Best for longer breaks, repairs on working pressure above 150 PSI and for larger sizes of pipe.

**15, 18, 24, 30" and longer widths:** Best for long splits and heavily damaged pipe. For best performance the separation between pipe ends should be no more than 1/4". If the space is larger, or a large hole is being repaired, use a sheet of stainless steel over the hole under the gasket or a spacer to fill gap between pipe ends.

### JCM Multi-Segment Clamps for Extended Width Clamps

JCM clamps with widths greater than 48" are often provided as multi-segmented clamps which install in an overlapping band/gasket design. The gasket in the first section extends out from the band. The next section clamp has the gasket offset in the clamp, the second band butts up to the first band and covers the extended gasket and the additional sections continue with the offset assembly. The last band segment has a gasket flush with the stainless band, providing the last segment of the clamp. This overlapping band design allows for nearly unlimited clamp widths, ensures safe, damage free transport on common carriers and hot shot service, eases installation for a small number of crew members and provides for direct tightening of bolt sections over the gasket.

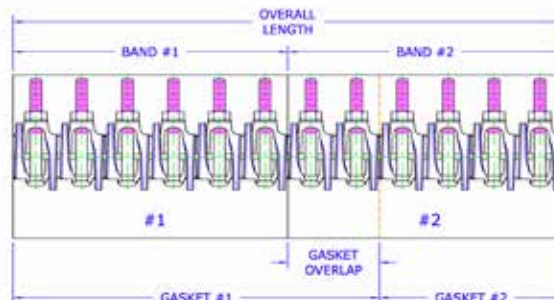

## JCM Universal Clamp Couplings - Single Band

JCM Universal Clamp Couplings provide a full circumferential seal and wide range for the permanent repair or reconnection of asbestos-cement, cast iron, ductile iron, PVC, HDPE and other types of pipe.

### JCM 101 Series Universal Clamp Couplings

**Balanced, Low Profile Ductile Iron lugs (ASTM A536)** with mutually supporting sliding fingers provide distortion free tightening over a wide range. Ductile Iron lugs offer corrosion resistance and an efficient method of transfer of energy from the fastener attachment directly to compression of the gasket.

**Corrosion Resistant Type 304 Stainless Steel Band** conforms to pipe irregularities, maintains sealing pressure over the entire gasket area. Design criteria requires gauge thickness to increase with clamp size. This is just one of the design points which enables JCM Universal Clamp Couplings to withstand the internal forces involved with large pipe repair.

**Positive Attachment** of stainless band to lugs is a structurally sound fabrication design element which accommodates the greater torque capabilities ensuring permanent repairs on high pressure applications.

**Gridded Gasket** with long tapered ends and recessed bridge plate assures even gasket pressure through out the range - without wrinkling or crimping. **Diamond gridded, 1/4" thick gasket** (JCM standard on nominal sizes 4" and larger) adapt to pitted or uneven pipe surfaces to completely seal damaged areas. Standard gasket is compounded for use with water, salt solutions, mild acids, bases and sewage. Other gasket compounds for exotic line contents are available.

**Larger Bolts** for greater torque ratings are provided on 10" nominal size clamps and larger. The 3/4" bolts have bolt torque capability in excess of 100 ft. lbs. These higher torque value capabilities allow JCM Universal Clamp Couplings to go beyond the "standard installation."

### JCM 170 Series Universal Clamp Coupling with Removeable Lug System

**Features an Easy to Remove Lug** - simply slide the open ear lug section off the stainless band receiver pleat, install the clamp around the pipe and slide the lug back into place. A simple transfer of bolt torque energy from the bolt to the stainless steel band locks the lug into place and prevents band pull out.

**Full Line of Diameters and Widths** - JCM 170 Series is available in the exact sizes and ranges as the JCM Models 101, 102, 103 and 104 have the same great availability. Single band, multi-band and tapped outlets are readily available.

**JCM 170 Series with Removeable Lug Overcomes common installation problems such as:**

**Cramped Underground Utility Applications  
Rockbound Soil Conditions  
Restricted, Narrow Space Piping Galleries  
Limited Excavation Applications**

Corrosion resistant, high strength low alloy bolts and nuts (AWWA C-111, ANSI A21.11.) are standard. Optional 18-8 Type 304 Stainless Steel available. Drop-in bolts means no loose parts.

Meets ANSI/AWWA C230 Stainless-Steel Full-Encirclement Repair and Service Connection Clamps.

Low profile Ductile Iron lugs (ASTM A536) with mutually supporting sliding fingers provide distortion free tightening over wide range.

Model 101 Positive attachment of band to lugs eliminates mechanical weaknesses and band pull-out.



Type 304 Stainless Steel band conforms to pipe irregularities maintaining sealing pressure for entire gasket.

Gridded gasket with long tapered ends and recessed bridge plate assures even gasket pressure throughout range - without wrinkling or crimping. Compounded for use with water, salt solutions, mild acids and bases.



Image Reflects 6" Clamp Width

Meets ANSI/AWWA C230 Stainless-Steel Full-Encirclement Repair and Service Connection Clamps as applicable.  
JCM 100 Series Universal Clamp Couplings are ANSI/NSF Standard 61, Annex G and ANSI/NSF 372 Certified.



# JCM 101 Universal Clamp Couplings

# JCM 171 Universal Clamp Couplings

Meets ANSI/AWWA C230 Stainless-Steel Full-Encirclement Repair and Service Connection Clamps as applicable.  
 JCM 100 Series Universal Clamp Couplings are ANSI/NSF Standard 61, Annex G and ANSI/NSF 372 Certified.



## SINGLE BAND CLAMPS

NOM PIPE SIZE (IN)	CLAMP O.D. RANGE (IN)	101 ATTACHED LUG	171 REMOVEABLE LUG	Clamp Width - Approximate Weight						
				6"	7"	12"	15"	18"	24"	30"
				Lbs.#	Lbs.#	Lbs.#	Lbs.#	Lbs.#	Lbs.#	Lbs.#
1-1/2	1.88 - 2.15		0190	•		•				
				7#		14#				
2 - 2-1/2	2.35 - 2.63 2.70 - 3.13		0238 0275	•	•	•	•			
				8#	9#	15#	19#			
3	3.46 - 3.70 3.73 - 4.13		0350 0400	•	•	•	•			
				8#	10#	16#	20#			
4	4.45 - 4.75 4.74 - 5.14 4.95 - 5.35 5.22 - 5.62		0450 0480 0500 0525	•	•	•	•	•	•	•
				9#	11#	18#	22#	27#	36#	44#
6	5.95 - 6.35 6.56 - 6.96 6.85 - 7.25 7.05 - 7.45 7.45 - 7.85		0600 0663 0690 0710 0745	•	•	•	•	•	•	•
				10#	12#	19#	24#	29#	38#	48#
8	7.95 - 8.35 8.54 - 8.94 8.99 - 9.39 9.27 - 9.67 9.90 - 10.30		0800 0863 0905 0940 1000	•	•	•	•	•	•	•
				11#	13#	21#	27#	32#	42#	53#
10*	10.60 - 11.00 11.04 - 11.44 11.34 - 11.74 11.75 - 12.15 12.00 - 12.40		1075 1110 1140 1175 1200		•	•	•	•	•	•
					19#	36#	39#	52#	70#	78#
12*	12.60 - 13.02 13.10 - 13.50 13.40 - 13.80 13.70 - 14.10 14.00 - 14.40		1275 1320 1340 1370 1400		•	•	•	•	•	•
					20#	37#	40#	52#	74#	82#
<b>Number of Bolts</b>				<b>2</b>	<b>2</b>	<b>4</b>	<b>4</b>	<b>6</b>	<b>8</b>	<b>10</b>

Note: Clamps do not prevent lateral movement of pipe. Applications in which the pipe may move out of the clamp, proper anchorage of the pipe must be provided.

**\*7" and 15" widths use 5/8" bolts**

### HOW TO ORDER

1. Determine O.D. of pipe. Select proper clamp O.D. range and width.
2. Determine Model Number. Model 101 for standard clamp, 171 for Removeable lug system.
3. Specify clamp number.

Example: To fit Cast Iron pipe, 6.90 O.D. with 6" width, order: 101-0690-6 or 171-0690-6  
 For tapped/threaded outlet clamps, see JCM Tapped Clamps

### Available Options Upon Request Models 101-171-102-172

- Pipe sizes and ranges not listed
- Stainless Steel Bolts
- Conductive Buttons
- Specialty Gaskets
- Tapped Outlets
- Other Sizes and Ranges

# JCM 102 Extended Range Universal Clamp Couplings

## JCM 172 Extended Range UCC with Removeable Lug

### JCM Extended Range Universal Clamp Coupling - Double/Multi-Band

JCM 102 and 172 Extended Range Universal Clamp Couplings are designed especially for systems with both asbestos-cement and cast iron pipe, or with oversized pipe. This extended range, multi-band clamp provides a full circumferential seal and extra wide range. Only 6 clamps are needed to fit all cast-iron and asbestos-cement pressure pipe in sizes 4" through 12". Extra range and safety factor make this clamp particularly suited for pipe sizes 10" and larger.

JCM 102 and 172 Extended Range/Multi-Band clamps are designed to accommodate the working characteristics of large diameter pipe. In repair applications to large diameter pipe, there are several factors to consider to maintain pipe integrity and return to 100% service capacity. Factors critical to the application include: size and type of pipe, severity of damage, working pressure or service requirements, location or repair and time factor. JCM 102 UCC design criteria accommodate these factors by providing the following strength features...

**Heavy Duty Lug** - provides the safety factor and solid platform to support the increased bolt torque levels required to compress the gasket and seal the damaged area.

**Large Bolts** - supply bolting power and greater torque ability to fully compress the full circumferential gasket.

**Thick Stainless Steel Band** - increases pressure holding capability and provides even, consistent compression over the gasket area.

**JCM 172 provides an easy to remove lug that accommodates cramped underground utility applications, rockbound soil conditions, restricted, narrow space piping galleries and limited excavation applications.**

**JCM Extended Range  
Universal Clamp Couplings  
with  
Heavy Duty Lug System  
Thicker Gauge Stainless Steel Band**



Image Reflects 12" Clamp Width

### MATERIAL SPECIFICATIONS - JCM Universal Clamp Couplings - Models 101, 102, 171, 172

**Band:** 18-8 Type 304 Certifiable Prime Stainless Steel

**Lugs:** Ductile Iron ASTM A536, 60-40-18

**Bolts:** Corrosion resistant low alloy per ASTM A242, ANSI A21.11, AWWA C-111. National coarse rolled thread and heavy hex nut.

Optional Stainless Steel 18-8 Type 304 or 316 available.

Optional Electro Coated low alloy bolts/nuts available.

**Gasket:** Virgin Styrene-Butadiene Rubber (SBR) - Compounded for use with water, salt solutions, mild acids and bases. Per ASTM D-2000 M4AA 607. Standard temperature range from -40° to 150° F (-40° to 65° C) constant, maximum intermittent 180°F (82°C). For applications on high temperatures or chemical pipelines, contact JCM Industries Technical Services.

**Coating:** Corrosion resistant shop coat paint primer.

**Pressure Rating:** Pressure holding capabilities vary according to application.

For specific pressure ratings, contact JCM Industries Technical Services.

Meets ANSI/AWWA C230 Stainless-Steel Full-Encirclement Repair and Service Connection Clamps as applicable.  
JCM 100 Series Universal Clamp Couplings are ANSI/NSF Standard 61, Annex G and ANSI/NSF 372 Certified.



# JCM 102 Extended Range Universal Clamp Couplings

## JCM 172 Removeable Lug Extended Range UCC

Meets ANSI/AWWA C230 Stainless-Steel Full-Encirclement Repair and Service Connection Clamps as applicable.  
 JCM 100 Series Universal Clamp Couplings are ANSI/NSF Standard 61, Annex G and ANSI/NSF 372 Certified.



### DOUBLE BAND CLAMPS

NOM PIPE SIZE (IN)	CLAMP O.D. RANGE (IN)	102 ATTACHED LUG	172 REMOVEABLE LUG	Clamp Width - Approximate Weight						
				6"	7"	12"	15"	18"	24"	30"
				Lbs.#	Lbs.#	Lbs.#	Lbs.#	Lbs.#	Lbs.#	Lbs.#
4	4.44 - 5.24 4.74 - 5.57	0450 0480		•	•	•	•	•	•	•
				16#	20#	32#	40#	48#	64#	80#
6	6.62 - 7.42 6.84 - 7.64	0663 0690		•	•	•	•	•	•	•
				16#	20#	32#	40#	48#	64#	80#
8	8.62 - 9.42 8.99 - 9.79	0863 0905		•	•	•	•	•	•	•
				17#	21#	34#	43#	51#	68#	85#
10	10.72 - 11.72 11.04 - 12.24	1075 1110				•		•	•	•
						53#		80#	106#	132#
12	12.72 - 13.92 13.14 - 14.34 13.65 - 14.65	1275 1320 1365				•		•	•	•
						55#		80#	106#	132#
14	15.20 - 16.20	1530				•		•	•	•
						58#		87#	106#	145#
14 - 16	16.00 - 17.00 17.20 - 18.20	1600 1740				•		•	•	•
						59#		89#	108#	148#
16 - 18	18.40 - 19.40	1846				•		•	•	•
						62#		95#	124#	158#
18 - 20	19.40 - 20.40 20.40 - 21.40	1950 2050				•		•	•	•
						63#		95#	126#	158#
20 - 22	21.40 - 22.40 22.50 - 23.60	2160 2260				•		•	•	•
						67#		100#	134#	168#
<b>Number of Bolts</b>				<b>4</b>	<b>4</b>	<b>8</b>	<b>8</b>	<b>12</b>	<b>16</b>	<b>20</b>

### MULTI-BAND CLAMPS

24	23.80 - 25.00 25.50 - 26.70 27.90 - 29.10	2400 2580 2800				•		•	•	•
						93#		140#	186#	233#
24 - 30	29.80 - 31.00 31.70 - 32.90	3000 3200				•		•	•	•
						98#		147#	196#	245#
36	37.85 - 39.20	3830				•		•	•	•
						117#		175#	234#	292#

Larger sizes, greater widths and custom ranges available upon request, contact JCM Sales Team.

Note: Clamps do not prevent lateral movement of pipe. Applications in which the pipe may move out of the clamp, proper anchorage of the pipe must be provided.

### HOW TO ORDER

1. Determine O.D. of pipe. Select proper clamp O.D. range and width.
2. Determine Model Number. Model 102 for standard clamp, 172 for Removeable lug system.
3. Specify clamp number.

Example: To fit Cast Iron pipe, 6.90 O.D. with 12" width, order: 102-0690-12or 172-0690-12

For tapped/threaded outlet clamps, see JCM Tapped Clamps

### Available Options Upon Request Models 101-171-102-172

- Pipe sizes and ranges not listed
- Stainless Steel Bolts
- Conductive Buttons
- Specialty Gaskets
- Tapped Outlets
- Other Sizes and Ranges

# JCM 131 All Stainless Steel Universal Clamp Coupling - Single Band

JCM All Stainless Universal Clamp Couplings work on the mechanical sealing principle providing a stronger, more structurally positive fastener system that is capable of obtaining maximum gasket compression. JCM All Stainless Steel Universal Clamp Couplings with heavy, cast stainless steel lugs provide the means of making the clamp conform to the pipe and provide maximum performance. Advanced design features include:

**Low Profile Cast Stainless Steel Lugs** - with mutually supporting sliding fingers provide distortion free tightening over a wide range. Cast Stainless Steel Lugs offer corrosion resistance for hot and acidic environments.

**Positive Attachment** - of the stainless band to lugs eliminates band pull out and mechanical weakness at this critical point. Allow greater torque capabilities to ensure permanent repairs on high pressure applications

**Larger Bolts** - are provided on 10" clamps and larger the 3/4" bolts have bolt torque capability in excess of 100 ft. lbs allowing the JCM 131 to go beyond the "standard installation."

## JCM Series 130 Stainless Steel Universal Clamp Couplings Nominal sizes 1-1/2" - 8" have 5/8" bolts Nominal sizes 10" and larger 3/4" bolts

Balanced, low profile CF-8 Cast Stainless Steel Lugs with mutually supporting sliding fingers provide distortion free tightening over a wide range. Stainless Steel lugs offer corrosion resistance and the most efficient method of transfer of energy from the fastener attachment directly to compression of the gasket.

Corrosion resistant stainless steel band conforms to pipe irregularities, maintaining sealing pressure over the entire gasket area. Design criteria requires gauge thickness increase with clamp size. This is just one of the design points which enables JCM Universal Clamp Couplings to withstand the internal forces involved with large pipe repair.

Positive attachment of stainless band to lugs eliminates band pull out and mechanical weakness at this critical point. This structurally sound fabrication design element also allows the high torque capabilities to ensure permanent repair on high pressure applications.



Image Reflects 6" Clamp Width

Gridded gasket with long tapered ends and recessed bridge plate assures even gasket pressure throughout the range - without wrinkling or crimping. Diamond Gridded Gasket 1/4" Thick (JCM standard on nominal sizes 3" and larger) adapts to pitted or uneven pipe surfaces to completely seal damaged areas.

Meets ANSI/AWWA C230 Stainless-Steel Full-Encirclement Repair and Service Connection Clamps as applicable. JCM 100 Series Universal Clamp Couplings are ANSI/NSF Standard 61, Annex G and ANSI/NSF 372 Certified.



# JCM 131 All Stainless Steel Universal Clamp Couplings



JCM 131 All Stainless Steel Clamp Coupling with larger bolts and heavier lug - especially for piping systems that are exposed to hot soils or corrosive environments. JCM All Stainless Clamps provide the corrosion resistance of stainless to this means of repairing and connecting pipe.

NOM PIPE SIZE (IN)	CLAMP O.D. RANGE (IN)	131 STAINLESS STEEL UNIVERSAL CLAMP CLAMP NUMBER	Clamp Width - Approximate Weight						
			6"	7"	12"	15"	18"	24"	30"
			Lbs.#	Lbs.#	Lbs.#	Lbs.#	Lbs.#	Lbs.#	Lbs.#
1-1/2	1.88 - 2.15	0190	.		.				
			5#		10#				
2 - 2-1/2	2.35 - 2.63 2.70 - 3.13	0238 0275	.	.	.	.			
			5#	6#	10#	12#			
3	3.46 - 3.70 3.73 - 4.13	0350 0400	.	.	.	.			
			6#	7#	11#	13#			
4	4.45 - 4.75 4.74 - 5.14 4.95 - 5.35 5.22 - 5.62	0450 0480 0500 0525	.	.	.	.	.	.	.
			6#	7#	12#	14#	18#	24#	28#
6	5.95 - 6.35 6.56 - 6.96 6.85 - 7.25 7.05 - 7.45 7.45 - 7.85	0600 0663 0690 0710 0745	.	.	.	.	.	.	.
			7#	8#	13#	16#	21#	26#	31#
8	7.95 - 8.35 8.54 - 8.94 8.99 - 9.39 9.27 - 9.67 9.90 - 10.30	0800 0863 0905 0940 1000	.	.	.	.	.	.	.
			8#	9#	15#	19#	24#	30#	38#
8 - 10*	10.60 - 11.00 11.04 - 11.44 11.34 - 11.74 11.75 - 12.15 12.00 - 12.40	1075 1110 1140 1175 1200		.	.	.	.	.	.
				15#	26#	31#	39#	42#	60#
12*	12.60 - 13.02 13.10 - 13.50 13.40 - 13.80 13.70 - 14.10 14.00 - 14.40	1275 1320 1340 1370 1400		.	.	.	.	.	.
				17#	28#	34#	42#	56#	68#
Number of Bolts			2	2	4	4	6	8	10

Note: Clamps do not prevent lateral movement of pipe. Applications in which the pipe may move out of the clamp, proper anchorage of the pipe must be provided.

**\*7" & 15" widths use 5/8" bolts**

Meets ANSI/AWWA C230 Stainless-Steel Full-Encirclement Repair and Service Connection Clamps as applicable. JCM 100 Series Universal Clamp Couplings are ANSI/NSF Standard 61, Annex G and ANSI/NSF 372 Certified.

## HOW TO ORDER

1. Determine O.D. of pipe. Select proper clamp O.D. range and width.
2. Determine Model Number. Model 131 for standard clamp.
3. Specify clamp number.

Example: To fit Cast Iron pipe, 6.90 O.D. with 6" width, order: 131-0690-6

## Available Options Upon Request Models 131-132

- Pipe sizes and ranges not listed
- Conductive Buttons
- Specialty Gaskets
- Tapped Outlets
- Other Sizes and Ranges

## JCM 132 Extended Range All Stainless Universal Clamp Coupling - Double/Multi-Band

JCM 132 Extended Range All Stainless Steel Universal Clamp Couplings are designed especially for systems with both asbestos-cement and cast iron pipe, or with oversized pipe. This extended range, multi-band clamp provides a full circumferential seal and extra wide range. Only 6 clamps are needed to fit all cast-iron and asbestos-cement pressure pipe in sizes 4" through 12". Extra range and safety factor make this clamp particularly suited for pipe sizes 10" and larger. All stainless steel construction makes the 132 All Stainless Steel Clamps corrosion resistant and ideal for use in corrosive environments.

JCM 132 All Stainless Extended Range/Multi-Band clamps are designed to accommodate the working characteristics of large diameter pipe, especially in hot or acidic soils. In the repair applications to large diameter pipe, there are several factors to be considered to maintain pipe integrity and return to 100% service capacity. Factors which are critical to the application include: size and type of pipe, severity of damage, working pressure or service requirements, location or repair and time factor. JCM 132 All Stainless UCC Design criteria accommodate these factors by providing the following strength features...

**Heavy Duty Lug** - and positive fastener attachment provides the safety factor and solid platform to support the increased bolt torque levels required to compress the gasket and seal the damaged area.

**Large Bolts** - supply bolting power and high torque ability to fully compress the full circumferential gasket.

**Thick Stainless Steel Band** - increases pressure holding capability and provides even, consistent compression over the gasket area.

### JCM Series 130 Stainless Steel Universal Clamp Couplings Nominal sizes 1-1/2" - 8" have 5/8" bolts Nominal sizes 10" and larger 3/4" bolts



Image Reflects 12" Clamp Width

#### JCM All Stainless Steel Universal Clamp Couplings - Models 131, 132, 133, 134

**Band:** 18-8 Type 304 Certifiable Prime Stainless Steel

**Lugs:** CF8 Cast Stainless Steel (equivalent to 304 Stainless Steel). Optional 316 material available.

**Bolts:** Stainless Steel 18-8 Type 304 or 316 available.

**Gasket:** Virgin Styrene-Butadiene Rubber (SBR) - Compounded for use with water, salt solutions, mild acids and bases. Per ASTM D-2000 M4AA 607. Standard temperature range from -40° to 150° F (-40° to 65° C) constant, maximum intermittent 180° F (82° C). For applications on high temperatures or chemical pipelines, contact JCM Industries Technical Services.

**Pressure Rating:** Pressure holding capabilities vary according to application.  
For specific pressure ratings, contact JCM Industries Technical Services.

Meets ANSI/AWWA C230 Stainless-Steel Full-Encirclement Repair and Service Connection Clamps as applicable.  
JCM 100 Series Universal Clamp Couplings are ANSI/NSF Standard 61, Annex G and ANSI/NSF 372 Certified.



# JCM 132 All Stainless Steel Extended Range Universal Clamp Couplings



## DOUBLE BAND CLAMPS

NOM PIPE SIZE (IN)	CLAMP O.D. RANGE (IN)	132 STAINLESS STEEL EXTENDED RANGE CLAMP NUMBER	Clamp Width - Approximate Weight						
			6"	7"	12"	15"	18"	24"	30"
			Lbs.#	Lbs.#	Lbs.#	Lbs.#	Lbs.#	Lbs.#	Lbs.#
4	4.44 - 5.24 4.74 - 5.57	0450 0480	•	•	•	•	•	•	•
			9#	11#	16#	20#	25#	32#	44#
6	6.62 - 7.42 6.84 - 7.64	0663 0690	•	•	•	•	•	•	•
			10#	12#	19#	26#	30#	38#	55#
8	8.62 - 9.42 8.99 - 9.79	0863 0905	•	•	•	•	•	•	•
			11#	13#	20#	29#	33#	40#	55#
10	10.72 - 11.72 11.04 - 12.24	1075 1110			•		•	•	•
					32#		48#	64#	80#
12	12.72 - 13.92 13.14 - 14.34 13.65 - 14.65	1275 1320 1365			•		•	•	•
					34#		51#	68#	85#
14	15.20 - 16.20	1530			•		•	•	•
					36#		54#	72#	89#
14 - 16	16.00 - 17.00 17.20 - 18.20	1600 1740			•		•	•	•
					37#		56#	74#	92#
16 - 18	18.40 - 19.40	1846			•		•	•	•
					39#		59#	78#	97#
18 - 20	19.40 - 20.40 20.40 - 21.40	1950 2050			•		•	•	•
					41#		62#	82#	103#
20 - 22	21.40 - 22.40 22.50 - 23.60	2160 2260			•		•	•	•
					45#		67#	90#	111#
<b>Number of Bolts</b>			<b>4</b>	<b>4</b>	<b>8</b>	<b>8</b>	<b>12</b>	<b>16</b>	<b>20</b>

## MULTI-BAND CLAMPS

24	23.80 - 25.00 25.50 - 26.70 27.90 - 29.10	2400 2580 2800			•		•	•	•
					59#		88#	108#	146#
24 - 30	29.80 - 31.00 31.70 - 32.90	3000 3200			•		•	•	•
					64#		95#	128#	158#
36	37.85 - 39.20	3830			•		•	•	•
					82#		123#	164#	205#

Larger sizes, greater widths and custom ranges available upon request, contact JCM Sales Team.

Note: Clamps do not prevent lateral movement of pipe. Applications in which the pipe may move out of the clamp, proper anchorage of the pipe must be provided.

### HOW TO ORDER

1. Determine O.D. of pipe. Select proper clamp O.D. range and width.
2. Determine Model Number. Model 132 for standard clamp.
3. Specify clamp number.

Example: To fit Cast Iron pipe, 6.90 O.D. with 12" width, order: 132-0690-12

### Available Options Upon Request Models 131-132

- Pipe sizes and ranges not listed
- Conductive Buttons
- Specialty Gaskets
- Tapped Outlets
- Other Sizes and Ranges

## JCM 161 Fabricated Lug All Stainless Steel Clamps

The JCM 161 Fabricated Lug All Stainless Steel Clamp offers an economical solution to problems such as breaks, splits, cracks, holes in all types of pipe. Available in standard sizes for cast iron, ductile iron, IPS PVC, C900 PVC, steel, asbestos cement and others. The 161 is a stainless steel clamp that offers all the benefits of stainless: corrosion resistance, lightweight, flexible yet

strong. The JCM 161 is especially recommended for hot soil conditions and corrosive environments.

The full circumferential gasket provides a complete repair while the molded in stainless steel bridge plate provides the full stainless steel barrier to aggressive elements.

### MATERIAL SPECIFICATIONS - JCM 161, 162, 163, 168 FABRICATED LUG ALL STAINLESS STEEL CLAMP COUPLINGS

<b>Bolting Assembly:</b>	18-8 Type 304 Stainless Steel
<b>Band:</b>	18-8 Type 304 Stainless Steel
<b>Bolts And Nuts:</b>	18-8 Type 304 Stainless Steel
<b>Gasket:</b>	Virgin Styrene-Butadiene Rubber (SBR) - Compounded for use with water, salt solutions, mild acids and bases. Per ASTM D-2000 M4AA 607. Temperature range from -40° to 150°F (-40° to 65°C) constant, maximum intermittent 180°F (82°C). For applications on high temperatures or chemical pipelines, contact JCM Industries Technical Services.

#### Strong Stainless Steel Studs

-permanently attached to eliminate loose parts and nuts are treated to speed installation and prevent seizing.

**Thick Gridded Gasket** - long tapered ends and recessed bridge plate assure even gasket pressure throughout range -without wrinkling or crimping. Compounded for use with water, salt solutions, mild acids and bases.

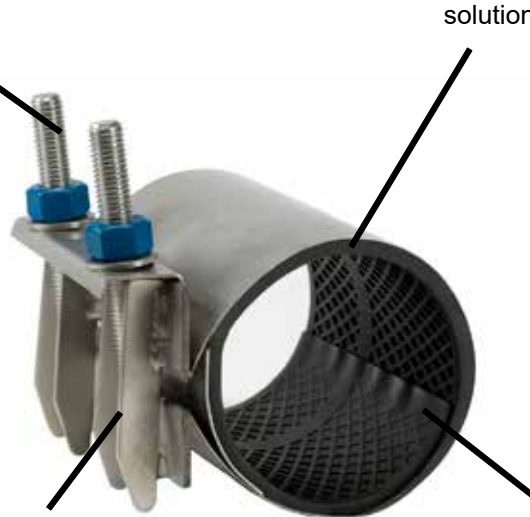

Image Reflects 7" Clamp Width

**Positive Attachment of Band to Lugs** - strong TIG welds eliminate mechanical weaknesses and prevents band separation. Thick stainless lifter bar plate prevents distortion or warping during tightening.

**Type 304 Stainless Steel Band** - conforms to pipe irregularities, maintaining sealing pressure over the entire gasket.

Meets ANSI/AWWA C230 Stainless-Steel Full-Encirclement Repair and Service Connection Clamps as applicable. JCM 100 Series Universal Clamp Couplings are ANSI/NSF Standard 61, Annex G and ANSI/NSF 372 Certified.





# JCM 161 Fabricated Lug Stainless Steel Universal Clamps

The JCM 161 Fabricated Lug All Stainless Steel Clamp offers an economical solution to problems such as breaks, splits, cracks, holes in all types of pipe. Available in standard sizes, the 161 is a stainless steel clamp that offers all the benefits of stainless: corrosion resistance, lightweight, flexible yet strong.



Image Reflects 7" Clamp Width

NOM PIPE SIZE (IN)	CLAMP O.D. RANGE (IN)	161 STAINLESS STEEL CLAMP CLAMP NUMBER	Clamp Width - <i>Approximate Weight</i>					
			7"	12"	15"	18"	24"	30"
			Lbs.#	Lbs.#	Lbs.#	Lbs.#	Lbs.#	Lbs.#
2 - 2-1/2	2.35 - 2.63 2.70 - 3.13	0238 0275	•	•	•			
			5#	8#	10#			
3	3.46 - 3.70 3.73 - 4.13	0350 0400	•	•	•			
			6#	9#	11#			
4	4.45 - 4.75 4.74 - 5.14 4.95 - 5.35 5.22 - 5.62	0450 0480 0500 0525	•	•	•	•	•	•
			7#	10#	12#	17#	20#	24#
			•	•	•	•	•	•
			•	•	•	•	•	•
6	5.95 - 6.35 6.56 - 6.96 6.85 - 7.25 7.05 - 7.45 7.45 - 7.85	0600 0663 0690 0710 0745	•	•	•	•	•	•
			9#	13#	17#	20#	26#	34#
			•	•	•	•	•	•
			•	•	•	•	•	•
8	7.95 - 8.35 8.54 - 8.94 8.99 - 9.39 9.27 - 9.67 9.90 - 10.30	0800 0863 0905 0940 1000	•	•	•	•	•	•
			11#	16#	21#	25#	32#	44#
			•	•	•	•	•	•
			•	•	•	•	•	•
10	10.60 - 11.00 11.04 - 11.44 11.34 - 11.74 11.75 - 12.15 12.00 - 12.40	1075 1110 1140 1175 1200	•	•	•	•	•	•
			15#	18#	24#	30#	36#	50#
			•	•	•	•	•	•
			•	•	•	•	•	•
12	12.60 - 13.02 13.10 - 13.50 13.40 - 13.80 13.70 - 14.10 14.00 - 14.40	1275 1320 1340 1370 1400	•	•	•	•	•	•
			17#	20#	27#	34#	40#	56#
			•	•	•	•	•	•
			•	•	•	•	•	•
<b>Number of Bolts</b>			<b>2</b>	<b>3</b>	<b>4</b>	<b>4</b>	<b>6</b>	<b>8</b>

Clamp width should be equal to or greater than the pipe diameter for higher working pressures.

Not recommended for use for joining plain end pressure pipe.

Other ranges and widths available upon request.

Note: Clamps do not prevent lateral movement of pipe. Applications in which the pipe may move out of the clamp, proper anchorage of the pipe must be provided.

## HOW TO ORDER

1. Determine O.D. of pipe. Select proper clamp O.D. range and width.
2. Determine Model Number. Model 161 for standard clamp.
3. Specify clamp number.

Example: To fit Cast Iron pipe, 6.90 O.D. with 6" width, order: 161-0690-6

## Available Options Upon Request Models 161-162

- Pipe sizes and ranges not listed
- Conductive Buttons
- Specialty Gaskets
- Tapped Outlets
- Other Sizes and Ranges



# JCM 162 Fabricated Lug All Stainless Steel Extended Range Clamps

JCM 162 All Stainless Steel Extended Range Clamps - for piping systems that are exposed to hot soils or corrosive environments. Provides extra corrosion resistance of stainless steel to this means of repair and connecting pipe.



Image Reflects 12" Clamp Width

## DOUBLE BAND CLAMPS

NOM PIPE SIZE (IN)	CLAMP O.D. RANGE (IN)	162 STAINLESS STEEL EXTENDED RANGE CLAMP NUMBER	Clamp Width - Approximate Weight					
			7"	12"	15"	18"	24"	30"
			Lbs.#	Lbs.#	Lbs.#	Lbs.#	Lbs.#	Lbs.#
4	4.44 - 5.24 4.74 - 5.57	0450 0480	•	•	•	•	•	•
			9#	13#	16#	25#	27#	34#
6	6.62 - 7.42 6.84 - 7.64	0663 0690	•	•	•	•	•	•
			11#	14#	19#	28#	30#	40#
8	8.62 - 9.42 8.99 - 9.79	0863 0905	•	•	•	•	•	•
			13#	19#	23#	36#	41#	45#
10	10.72 - 11.72 11.04 - 12.24	1075 1110	•	•	•	•	•	•
				28#	32#	43#	56#	64#
12	12.72 - 13.92 13.14 - 14.34 13.65 - 14.65	1275 1320 1365	•	•	•	•	•	•
				30#	40#	52#	60#	80#
14	15.20 - 16.20	1530	•	•	•	•	•	•
				34#	43#	55#	79#	86#
14 - 16	16.00 - 17.00 17.20 - 18.20	1600 1740	•	•	•	•	•	•
				36#	46#	59#	87#	92#
16 - 18	18.40 - 19.40	1846	•	•	•	•	•	•
				38#	49#	61#	90#	96#
18 - 20	19.40 - 20.40 20.40 - 21.40	1950 2050	•	•	•	•	•	•
				43#	52#	63#	94#	101#
20 - 22	21.40 - 22.40 22.50 - 23.60	2160 2260	•	•	•	•	•	•
				47#	59#	67#	99#	106#
Number of Bolts			4	6	8	8	12	16

Clamp width should be equal to or greater than the pipe diameter for higher working pressures.

Not recommended for use for joining plain end pressure pipe.

Other ranges and widths available upon request.

Note: Clamps do not prevent lateral movement of pipe. Applications in which the pipe may move out of the clamp, proper anchorage of the pipe must be provided.

### HOW TO ORDER

1. Determine O.D. of pipe. Select proper clamp O.D. range and width.
2. Determine Model Number. Model 162 for standard clamp.
3. Specify clamp number.

Example: To fit Cast Iron pipe, 6.90 O.D. with 6" width, order: 162-0690-6

### Available Options Upon Request

#### Models 161-162

- Pipe sizes and ranges not listed
- Conductive Buttons
- Specialty Gaskets
- Tapped Outlets
- Other Sizes and Ranges

# JCM 168 Fabricated Lug Lightweight Stainless Steel Clamps

The JCM 168 Fabricated Lug All Stainless Steel Lightweight Clamp offers an economical solution for applications on low pressure systems. Typical applications include joining plain end pipe in slip lining applications, gravity and low pressure pipelines. For pressure applications, see JCM 161 Fabricated Lug Stainless Steel Clamp.



Image Reflects 7" Clamp Width

NOM PIPE SIZE (IN)	CLAMP O.D. RANGE (IN)	168 STAINLESS STEEL CLAMP CLAMP NUMBER	Clamp Width - Approximate Weight					
			7"	12"	15"	18"	24"	30"
			Lbs.#	Lbs.#	Lbs.#	Lbs.#	Lbs.#	Lbs.#
4	4.00 - 4.40 4.45 - 4.75 4.74 - 5.14	0420 0450 0480	•	•	•	•	•	•
			7#	10#	12#	17#	20#	24#
6	6.00 - 6.40 6.56 - 6.96 6.85 - 7.25	0630 0663 0690	•	•	•	•	•	•
			9#	13#	17#	20#	26#	34#
8	8.20 - 8.60 8.54 - 8.94 8.99 - 9.39	0840 0863 0905	•	•	•	•	•	•
			11#	16#	21#	25#	32#	44#
10	10.30 - 10.70 10.60 - 11.00 11.04 - 11.44	1050 1075 1110	•	•	•	•	•	•
			15#	18#	24#	30#	36#	50#
12	12.30 - 12.70 12.60 - 13.02 13.10 - 13.50	1250 1275 1320	•	•	•	•	•	•
			17#	20#	27#	34#	40#	56#
<b>Number of Bolts</b>			<b>2</b>	<b>3</b>	<b>4</b>	<b>4</b>	<b>6</b>	<b>8</b>

Not recommended for use for joining plain end pressure pipe.

Other ranges and widths available upon request.

Conductive Buttons for electrical thawing available for all models upon request.

Note: Clamps do not prevent lateral movement of pipe. Applications in which the pipe may move out of the clamp, proper anchorage of the pipe must be provided.

## HOW TO ORDER

1. Determine O.D. of pipe. Select proper clamp O.D. range and width.
2. Determine Model Number. Model 168 for standard clamp.
3. Specify clamp number.

Example: To fit Cast Iron pipe, 6.90 O.D. with 12" width, order: 168-0690-12

Available in double band, JCM Model 169. Contact JCM Inside Sales Team.



# JCM Tapped Outlet Repair Clamps - 103, 104, 173, 174, 133, 134, 123, 153, 163, 164

Models of JCM Universal Clamp Couplings are available with tapped outlets for repair of direct tap pull outs and broken or split pipe requiring a service outlet.

## HOW TO ORDER

1. Select standard model, size and width clamp to fit pipe.
2. Change model number to corresponding Tapped Outlet Clamp Model Number.
3. Select size and type of tapped outlet from outlet guide below. Note minimum widths and range/sizes.
4. Add Outlet Tap Code to clamp number. Add-On outlet price to standard clamp list price.

### Ordering Example:

For model 101 clamp to fit 6" Cast Iron Pipe with 12" width, with 2" IP outlet, order:

103-0690-12 x 14IP

Standard Clamp Model	Tapped Outlet Clamp Model
101 Universal Clamp Coupling - Standard Range	103 Tapped Universal Clamp Coupling - Standard Range
102 Universal Clamp Coupling - Extended Range	104 Tapped Universal Clamp Coupling - Extended Range
131 All Stainless Steel UCC - Std Range	133 Tapped All Stainless Steel UCC - Std Range
132 All Stainless Steel UCC - Extd Range	134 Tapped All Stainless Steel UCC - Extd Range
121 Gas Repair Clamp	123 Tapped Gas Service Clamp
151 Gas Repair Clamp	153 Tapped All Stainless Steel Gas Service Clamp
161 All Stainless Steel Fabricated Lug Clamp	163 <sup>^</sup> All Stainless Steel Tapped Fabricated Lug Clamp
162 All Stainless Steel Fabricated Lug Clamp - Ext Range	164 <sup>^</sup> All Stainless Steel Tapped Fabricated Lug Clamp - Ext Range
171 UCC - Standard Range - Removeable Lug	173 Tapped UCC - Standard Range - Removeable Lug
172 UCC - Extended Range - Removeable Lug	174 Tapped UCC - Standard Range - Removeable Lug

CLAMP RANGE/SIZE (IN)	MINIMUM CLAMP LENGTH (IN)	TYPE OF THREAD	TAP SIZE	ADD OUTLET TAP CODE	
				IP TAP ORDER CODE	CC TAP ORDER CODE
**2.38 - 4.80	6*	IP or CC	3/4"	06	07
			1"	08	09
**2.38 - 14.00	7-1/2*	IP or CC	3/4"	06	07
			1"	08	09
4.50 - 14.00	12	IP or CC	1-1/4"	10	11
4.50 - 14.00	12	IP or CC	1-1/2"	12	13
4.50 - 14.00	12	IP	2"	14	N/A
4.50 - 14.00	12	CC	2"	N/A	15

\*Taps larger than 1" not available in these widths

\*\*Smallest clamp tapped 2.38

<sup>^</sup>Model 163 Nominal Sizes 2" thru 8" only. For larger sizes see 164.

<sup>^</sup>Model 164 Nominal Sizes 10" and larger available 12" width minimum.

All Tapped Clamps are Non-Returnable Items. Confirm sizes before ordering.



JCM  
103  
123  
173



JCM  
133  
153



JCM  
163



Images Reflect 7" Clamp Width

# JCM 105 Collar Leak Clamps

## JCM 135 All Stainless Steel Collar Leak Clamps

For Quick, Permanent repairs of solvent weld PVC pipe joints.



JCM 105/135 Collar Leak Clamps provide a simple, quick solution to troublesome leaks in PVC solvent weld pipe systems - without having to cut out fittings or modifying your system. These heavy duty clamps have many features which assure a successful repair, even under the most adverse conditions.

### HOW TO ORDER

1. Determine O.D. of pipe. Select proper clamp O.D. range and band width.
2. Specify clamp number. Model 105 for standard clamp
3. For all stainless clamp, change model number to 135.

EXAMPLE:  
For 3" Class 160 PVC pipe, order: 105-0350-6.  
For All Stainless Clamp, order: 135-0350-6.



NOM PIPE SIZE (IN)	PIPE O.D. SIZE (IN)	TYPE OF SOLVENT WELD PIPE JOINT	Clamp Width	105 CLAMP NUMBER	APPR WT EACH (LBS)	135 ALL STAINLESS CLAMP NUMBER	APPR WT EACH (LBS)
2	2.38	BELL END CLASS 160, 200 SCH 40 COUPLING AND BELL END	6	105-0238-6	7.3	135-0238-6	5.3
			7	105-0238-7	9.3	135-0238-7	6
2-1/2	2.88	BELL END CLASS 160, 200 SCH 40 COUPLING AND BELL END	6	105-0288-6	7.7	135-0288-6	5.7
			7	105-0288-7	9.9	135-0288-7	6
3	3.50	BELL END CLASS 160, 200 SCH 40 COUPLING AND BELL END	6	105-0350-6	8.0	135-0350-6	6
			7	105-0350-7	10	135-0350-7	7
4	4.50	BELL END CLASS 160, 200 SCH 40 COUPLING AND BELL END	6	105-0450-6	9.1	135-0450-6	6
			7	105-0450-7	11	135-0450-7	7
5	5.56	BELL END CLASS 160, 200 SCH 40 COUPLING AND BELL END	6	105-0556-6	9.4	135-0556-6	6.5
			7	105-0556-7	11	135-0556-7	7
6	6.63	BELL END CLASS 160, 200 SCH 40 COUPLING AND BELL END	6	105-0663-6	10	135-0663-6	7.5
			7	105-0663-7	12	135-0663-7	8.5
8	8.63	BELL END CLASS 160, 200 SCH 40 COUPLING AND BELL END	6	105-0863-6	11	135-0863-6	8.7
			7	105-0863-7	13	135-0863-7	9.5

Other widths available upon request

### 105 COLLAR LEAK CLAMPS FOR PLASTIC IRRIGATION PIPE

NOM PIPE SIZE (IN)	PIPE O.D. SIZE (IN)	CLAMP WIDTH (IN)	FOR PIPE WALL THICKNESS	CLAMP NUMBER	APPR WT EA (LBS)
4	4.125	6	.125	105-0413-6	9.1
6	6.140	6	.150	105-0614-6	9.8
8	8.160	6	.199	105-0816-6	10.7
10	10.200	6	.249	105-1020-6	14.1
12	12.240	6	.290	105-1224-6	14.9
15	15.300	6	.375	105-1530-6	18.0

Other widths available upon request

Collar Leak Clamps are installed with half the clamp over the collar and half on the pipe spigot. The clamp is standard with an additional layer of 1/4" gasket, half the width of the clamp that "steps" down to accommodate the smaller pipe O.D. which butts up against the solvent weld pipe collar at the joint to seal the leak.

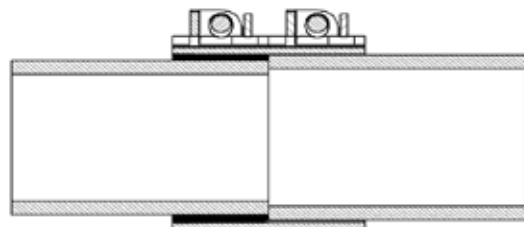

## JCM 106 Bell Joint Leak Clamp

For quick repair or water tight joint assurance for rubber joint PVC pipe, solvent weld pipe or coupled pipe specify JCM 106 Bell Joint Leak Clamps. These clamps are engineered to provide a simple, dependable repair or assured joint. In addition, the JCM 106 eliminates possible notching of PVC pipe and offers maximum versatility and corrosion resistance.

### For Repair of:

- PVC Rubber Joint Bells - Std. Steel Sizes (SDR 26, SDR 21)
- PVC Solvent Weld Joints and Couplings
- Std. Steel Threaded Couplings



### 106 Bell Joint Leak Clamp

NOM PIPE SIZE (IN)	PIPE O.D. (IN)	MAXIMUM BELL O.D. (IN)	MAXIMUM LIP O.D. (IN)	OVERALL LENGTH*	MAX. STD. CPLG. LENGTH	CLAMP NUMBER	APPR WT EACH (LBS)
4	4.50	6.13	5.43	11-1/2	7	106-0450	12
6	6.63	8.25	7.56	11-1/2	7	106-0663	17
8	8.63	10.88	9.56	11-1/2	7	106-0863	21

\*Dimension will change with use of studs.



## JCM 143 Bell Joint Leak Clamps

### Pipe Sizes 4" - 12" Cast Iron Pipe, Ductile Iron Pipe, C-900 PVC

- **Strong** - Split, interlocking rings provide maximum gasket compression. Heavy duty ductile iron components for the life of the pipeline.
- **Eliminates Extra Parts and Time Loss** - Comes complete to repair cast iron, ductile iron and C-900 PVC in its nominal size without any special order bolts, gaskets or other parts. Simple transfer from shelf to job site to pipe joint without confusion.
- **Simple, Fast Installation** - Split, interlocking rings and pre-cut gasket eliminates field cutting.
- **Install Under Pressure** - Repair leaking joint or install as a leak preventative on older pipe joints that have been excavated or disturbed during other pipeline maintenance (a low-cost, long-term insurance policy).



JCM 143 - 4" - 12"

### Pipe Sizes 14" and Larger for Ductile Iron/Cast Iron Pipe

Fabricated Bell Joint Leak Clamps with split, bolt-on designed provides a positive seal for large diameter Ductile Iron and Cast Iron leaking bells.

### 143 Bell Joint Leak Clamp - 4" - 36"

NOMINAL PIPE SIZE (IN)	CLAMP O.D. RANGE	CLAMP NUMBER	APPR WT EACH (LBS)
4	4.80 - 5.00	143-0480	18
6	6.90 - 7.10	143-0690	27
8	9.05 - 9.30	143-0905	33
10	11.10 - 11.40	143-1110	43
12	13.20 - 13.50	143-1320	48
14	15.30	143-1530	125
16	17.40	143-1740	150
18	19.50	143-1950	175
20	21.60	143-2160	200
24	25.80	143-2580	325
30	32.00	143-3200	400
36	38.30	143-3830	600

JCM 143 Bell Joint Leak Clamp 14" and Larger - fabricated steel.

Sizes 14" and larger based on working ranges of industry standard pipe tolerances +/- To ensure exact fit when ordering provide specific bell/spigot outside diameters.

Larger Sizes & Ranges Available, Contact JCM Sales Team.



JCM 143 - 14" - 36"



# Custom Designed JCM 143 Bell Joint Leak Clamps

## Leaking lead joint valves in 100 year old sewage pipe system

48" Pipe (Cast Pipe and Lock-Bar/Riveted Steel Pipe)

Pipe O.D.s 51.27/48.94

Bell O.D.s 60.27/50.93/50.77

PSI 150 and less

Line Content: Sewage

Issue – old lead joint valves without mechanical joint packing system. In these applications the pipe was inserted into the valve and packing was installed - without a traditional “mechanical joint pusher” mechanism. The “shoulder” of the old valves featured strengthening support gussets that prevented a traditional bell joint leak clamp from being installed on the valve side of the joint area. Custom fabrications were needed to “push” the gasket packing & hold a gasket seal up against the lead joint material to seal the leaks.



Above, JCM provided a fabricated bell joint leak clamp with a specifically designed “backing” ring to be installed on the pipe side of the gasket pusher ring (rather than opposite over the joint). The special backing ring was installed up against existing flanged joints which provided secure leverage for the backing ring. This enabled the pusher ring to provide compression to the gasket installed at the valve flange face. Tightening the bolts provided a “pushing” action rather than a pulling action.

In the application above, the pipe did not have flange joints at this site to leverage the backing ring against. So a method of anchoring the ring on the pipe was required.

JCM engineered a fabricated “backing” ring to be installed on the pipe side of the gasket pusher ring. The custom backing ring featured 68 restraining set pins that were tightened into the surface of the steel pipe. These set pins anchored the backing ring and provided the immobile force for the pusher ring to leveraged against.

For more information on these and other applications, contact JCM Industries.

# JCM 110 Patch Clamps

JCM Patch Clamps are designed with a partial gasket for fast, economical repairs for pinholes, punctures, splits or corrosion areas on steel and PVC pipelines. Partial gasket creates a "patch area" applied directly over the damage. Stainless steel band conforms to the pipe circumference with bolt torque applied directly to spot gasket sealing. Larger sizes available see JCM 112 and 113 Heavy Duty Patch Clamp.



NOMINAL PIPE SIZE (IN)	PIPE O.D. (IN)	CLAMP NUMBER E-GALV. BOLT	WIDTH (IN)	SS BOLT Add (SS)	ALL STAINLESS Add (AS)	WT EA LBS.	CTN. QTY.
1/2	.84	110-0084	3	SS	AS	.6	20
			6	SS	AS	1.2	10
3/4	1.05	110-0105	3	SS	AS	.6	16
			6	SS	AS	1.2	8
1	1.32	110-0132	3	SS	AS	.6	16
			6	SS	AS	1.4	8
1-1/4	1.66	110-0166	3	SS	AS	.7	12
			6	SS	AS	1.4	6
1-1/2	1.90	110-0190	3	SS	AS	1.1	12
			6	SS	AS	2.2	6
2	2.38	110-0238	3	SS	AS	1.1	8
			6	SS	AS	2.3	4
			9	SS	AS	3.4	2
			12	SS	AS	4.5	2
2-1/2	2.88	110-0288	3	SS	AS	1.2	8
			6	SS	AS	2.4	4
			9	SS	AS	3.6	2
			12	SS	AS	4.8	2
3	3.50	110-0350	3	SS	AS	1.6	8
			6	SS	AS	3.2	4
			9	SS	AS	4.8	2
			12	SS	AS	6.4	2
4	4.50	110-0450	3	SS	AS	1.6	8
			6	SS	AS	3.2	4
			9	SS	AS	4.8	2
			12	SS	AS	6.4	2
5	5.56	110-0556	3	SS	AS	1.7	8
			6	SS	AS	3.4	4
			9	SS	AS	5.1	-
			12	SS	AS	6.8	-
6	6.63	110-0663	3	SS	AS	1.9	8
			6	SS	AS	3.8	4
			9	SS	AS	5.7	-
			12	SS	AS	7.6	-
8	8.63	110-0863	3	SS	AS	2.2	8
			6	SS	AS	4.4	4
			9	SS	AS	6.6	-
			12	SS	AS	8.8	-
<b>DOUBLE BAND CLAMPS FOR STEEL PIPE SIZES</b>							
10	10.75	110-1075	3	SS	AS	3.4	-
			6	SS	AS	6.8	-
			9	SS	AS	10.2	-
			12	SS	AS	13.6	-
12	12.75	110-1275	3	SS	AS	3.7	-
			6	SS	AS	7.4	-
			9	SS	AS	13.1	-
			12	SS	AS	14.8	-
<b>COPPER TUBE SIZES</b>							
1/2	.63	110-0063	3	SS	AS	.6	20
			6	SS	AS	1.2	10
3/4	.88	110-0084	3	SS	AS	.6	20
			6	SS	AS	1.2	10
1	1.13	110-0105	3	SS	AS	.6	16
			6	SS	AS	1.2	8
1-1/4	1.38	110-0132	3	SS	AS	.6	16
			6	SS	AS	1.4	8
1-1/2	1.63	110-0166	3	SS	AS	.7	12
			6	SS	AS	1.4	6
2	2.13	110-0213	3	SS	AS	1.1	8
			6	SS	AS	2.3	4

### How To Order

1. Determine clamp size, material options and width required.
2. Order by clamp number.

Model 110 for standard clamp

For Stainless Steel Bolt(s)

add **(SS)** to clamp number.

For ALL Stainless Steel Clamp

add **(AS)** to clamp number.

Example: All Stainless Steel Clamp for 4" IPS PVC with 4.50 O.D. 3" width, order:

110-0450-3AS.





## JCM 111 Full-Repair Clamps

JCM 111 Full-Repair clamps are a fast economical means of permanently repairing steel pipe with extensive corrosion, splits, punctures or pin holes. These clamps have a heavy, full circumferential Buna-N gasket with a hardened recessed armor. This provides extra sealing capability for heavily damaged pipe and pipe with reduced diameter due to corrosion. Available in all stainless steel.



### 111 FULL- REPAIR CLAMPS

#### Steel Pipe Sizes - IPS Copper Tube Sizes - CTS

NOMINAL PIPE SIZE (IN)	PIPE O. D. (IN)	TYPE OF PIPE	WIDTH (IN)	CLAMP NUMBER E-GALV. BOLT	STAINLESS BOLT Add (SS)	ALL STAINLESS Add (AS)	WT EA (LBS)	CTN. QTY.
1/2	0.84	IPS	3	111-0084-3	SS	AS	.7	20
			6	111-0084-6	SS	AS	1.4	10
3/4	1.05	IPS	3	111-0105-3	SS	AS	.7	16
			6	111-0105-6	SS	AS	1.4	8
	0.88	CTS	3	111-0088-3	SS	AS	.7	16
			6	111-0088-6	SS	AS	1.4	8
1	1.32	IPS	3	111-0132-3	SS	AS	.8	16
			6	111-0132-6	SS	AS	1.5	8
	1.13	CTS	3	111-0113-3	SS	AS	.8	16
			6	111-0113-6	SS	AS	1.5	8
1-1/4	1.66	IPS	3	111-0166-3	SS	AS	.9	12
			6	111-0166-6	SS	AS	1.8	6
1-1/2	1.63	CTS	3	111-0166-3	SS	AS	.9	12
			6	111-0166-6	SS	AS	1.8	6
	1.90	IPS	3	111-0190-3	SS	AS	1.3	12
			6	111-0190-6	SS	AS	2.6	6
2	2.38	IPS	3	111-0238-3	SS	AS	1.3	8
			6	111-0238-6	SS	AS	2.7	4

#### HOW TO ORDER

- Determine clamp size, material options and width required.
- Order by clamp number.

For **Stainless Steel Bolt(s)** add **(SS)** to clamp number.

For **ALL Stainless Steel Clamp** add **(AS)** to clamp number.

Example: All Stainless Steel Clamp for 2" IPS PVC with 2.38 O.D. 3" with, order 111-0238-3AS

#### MATERIAL SPECIFICATIONS JCM 110 PATCH CLAMPS and JCM 111 FULL-REPAIR CLAMPS

##### JCM 110 PATCH CLAMP

**Lug:** Ductile Iron ASTM A-536. Optional CF8  
Stainless Steel available.

**Gasket:** Rubber gasket, suitable for gas.

**Band:** 18-8 Type 304 Stainless Steel

**Hardware:** Electro-galvanized steel. Optional Stainless Steel available

##### JCM 111 FULL-REPAIR CLAMP

**Lug:** Ductile Iron ASTM A-536. Optional CF8  
Stainless Steel available.

**Gasket:** Buna-N

**Band:** 18-8 Type 304 Stainless Steel

**Hardware:** Electro-galvanized steel. Optional Stainless Steel available



# JCM 112 Heavy Duty Patch Clamps

## JCM 113 Multi-band Patch Clamps

Heavy Duty Patch Clamps provide fast, permanent repair of pin holes, punctures or splits in steel and other types of pipe where a beam break is not involved. The clamps are readily available for all sizes of pipe 1-1/2" and larger.



### 112 & 113 MATERIAL SPECIFICATIONS

**Lug:** Ductile Iron ASTM A536. Options: 304 or 316 Stainless Steel

**Band:** 18-8 Type 304 Stainless Steel. Option: 316 Stainless Steel

**Gasket:** Gridded gasket is compounded for use with water, salt solutions, mild acids and bases. Optional Buna-N gasket available.

**Bolts/Nuts:** Corrosion resistant, high strength low alloy per ASTM A242(AWWA C-111, ANSI A21.11). Optional Stainless Steel, 18-8 Type 304 available or 316

### HOW TO ORDER

1. Determine O.D. of pipe.
2. Select proper clamp O.D. range and width.
3. Determine Model Number. Model 112 for standard clamp, 113 for large diameter clamp.
4. Specify clamp number.

Example: To fit steel pipe, 6.63 O.D. with 6" width, order: 112-0663-6

### 112 Heavy Duty Patch Clamps

NOM PIPE SIZE (IN)	CLAMP O.D. RANGE (IN)	CLAMP NUMBER	WIDTH (IN)	WT EA (LBS)
1-1/2	1.90 - 2.00	112-0190- 6	6	6
		112-0190-12	12	12
2	2.38 - 2.50	112-0238- 6	6	6
		112-0238-12	12	12
2-1/2	2.88 - 3.00	112-0288- 6	6	6
		112-0288-12	12	12
3	3.50 - 3.88	112-0350- 6	6	6
		112-0350-12	12	13
3-1/2	4.00 - 4.35	112-0400- 6	6	7
		112-0400-12	12	14
4	4.50 - 4.85	112-0450- 6	6	8
		112-0450-12	12	15
5	5.56 - 6.00	112-0556- 6	6	8
		112-0556-12	12	15
6	6.63 - 6.90	112-0663- 6	6	8
		112-0663-12	12	16
8	8.63 - 9.05	112-0863- 6	6	8
		112-0863-12	12	17
10	10.00 - 10.30	112-1000- 6	6	9
		112-1000-12	12	18
10	10.75 - 11.10	112-1075- 6	6	9
		112-1075-12	12	18
12	12.00 - 12.30	112-1200- 6	6	9
		112-1200-12	12	18
12	12.75 - 13.05	112-1275- 6	6	10
		112-1275-12	12	20

### 113 Multi-band Patch Clamps

NOM PIPE SIZE (IN)	CLAMP O.D. RANGE (IN)	CLAMP NUMBER	WIDTH (IN)	WT EA (LBS)
10	10.00 - 10.75	113-1000- 6	6	17
		113-1000-12	12	34
12	12.00 - 12.75	113-1200- 6	6	19.
		113-1200-12	12	38
14	14.00 - 14.75	113-1400- 6	6	20
		113-1400-12	12	40
16	16.00 - 16.75	113-1600- 6	6	23
		113-1600-12	12	46
18	18.00 - 18.75	113-1800- 6	6	24
		113-1800-12	12	49
20	20.00 - 20.75	113-2000- 6	6	26
		113-2000-12	12	52
22	22.00 - 22.75	113-2200- 6	6	27
		113-2200-12	12	54
24	24.00 - 24.75	113-2400- 6	6	28
		113-2400-12	12	56
30	30.00 - 30.75	113-3000- 6	6	29
		113-3000-12	12	58
36	36.00 - 36.75	113-3600- 6	6	31
		113-3600-12	12	62

**LARGER OR CUSTOM SIZES AVAILABLE UPON REQUEST.**

**FOR COMPLETE BREAKS USE JCM UNIVERSAL CLAMP COUPLINGS MODELS 101, 102**



# JCM 159 CAP SLEEVE FOR ABANDONED CORPORATION SERVICES

JCM Model 159 Cap Sleeve for Abandoned Corporation Services offers quick and efficient installation over the abandoned corporation stop, permanently sealing the service area. This cap ensures a long term, watertight seal for the discarded corporation service and prevents any potential infiltration to the system.

JCM Cap Sleeve ranges can be modified to accommodate unique or exotic pipe diameters.

Sleeves are rated for 250 PSI working pressure. Higher working pressures available, contact JCM Engineered and Technical Sales Team.

## How To Order:

Confirm dimensions of corporation stop to ensure the proper cap size and height. Fittings are non-returnable.

1. Determine O.D. of Pipe
2. Select proper sleeve range or provide O.D. to JCM
3. Select proper cap size/cap height to accommodate corporation stop.
4. Specify catalog number and Type # of sleeve.

Example: Sleeve with full circumferential gasket, for Ductile Iron Pipe with 9.05 O.D., order:

For standard gasket: 159-0905x3 T1  
For EPDM gasket add: 159-0905x3 T1 EPDM



Standard fittings seal over 3/4" through 2" direct service connections. Other sizes available upon request.

## JCM 159 Cap Sleeve Configuration Options:

- **Type 1 (T1)** All Stainless Steel 18-8 Type 304 with Full Circumferential Gasket  
Optional Material: Stainless Steel 18-8 Type 316
- **Type 2 (T2)** Carbon Steel, corrosion resistant shopcoat primer  
w/High Strength, Low Alloy Bolts ASTM 242/ANSI 21.11/AWWA C111  
Optional Bolts: stainless steel 18-8 Type 304 or electro coated alloy (Powercron 590-534)  
Optional Finish: fusion applied epoxy coating per ANSI/AWWA C213
- **Type 3 (T3)** All Stainless Steel 18-8 Type 304 with Outlet Seal Gasket (Type 3 or T3)  
Optional Material: Stainless Steel 18-8 Type 316



**Gasket: Type 1** - Full circumferential Virgin Styrene-Butadiene Rubber (SBR) - Compounded for use with water, salt solutions, mild acids and bases. Per ASTM D-2000 M4AA 607. Standard temperature range from -40° to 150°F (-40° to 65°C) constant, maximum intermittent 180°F (82°C). Optional Gasket: EPDM

**Type 2 & Type 3** - Nitrile Butadiene Rubber (NBR, Buna-N) per ASTM D2000. Molded virgin rubber with a pressure activated hydromechanical design. Gasket temperature range -40°F to 212°F (-40°C - 100°C). Gasket suitable for water, salt solutions, mild acids, bases and sewage. Optional Gasket: EPDM

For applications on high temperatures or chemical pipelines, contact JCM Industries Engineered & Technical Sales Team



JCM 159 Type 1  
Full Circumferential Gasket



JCM 159 Type 2 & 3  
Outlet Seal Gasket

All JCM 159 Sleeves are furnished with 3/4" test port to ensure watertight seal after installation.



## JCM 159 Cap Sleeve for Abandoned Corporation Services

### Type 1 All Stainless Steel (304) with Full Circumferential Gasket

NOM SIZE (IN)	PIPE O.D. RANGE (IN)	SLEEVE NUMBER	CAP SIZE (IN)	CAP HEIGHT (IN)	SLEEVE WIDTH (IN)	APPR WT (LBS)
4	4.74 - 5.00	159-0480x3 T1	3.25 ID	5.00	15	35
6	6.83 - 7.16	159-0690x3 T1	3.25 ID	5.00	15	42
	7.05 - 7.40	159-0720x3 T1	3.25 ID	5.00	15	42
8	8.98 - 9.37	159-0905x3 T1	3.25 ID	5.00	15	45
	9.27 - 9.69	159-0940x3 T1	3.25 ID	5.00	15	45
10	11.00 - 11.40	159-1110x3 T1	3.25 ID	5.00	15	46
	11.36 - 11.80	159-1140x3 T1	3.25 ID	5.00	15	46
12	13.10 - 13.50	159-1320x3 T1	3.25 ID	5.00	15	47
	13.70 - 14.09	159-1392x3 T1	3.25 ID	5.00	15	47
	14.08 - 14.40	159-1420x3 T1	3.25 ID	5.00	15	47
6	6.83 - 7.16	159-0690x6 T1	6.36 ID	8.00	15	49
	7.05 - 7.40	159-0720x6 T1	6.36 ID	8.00	15	49
8	8.98 - 9.37	159-0905x6 T1	6.36 ID	8.00	15	54
	9.27 - 9.69	159-0940x6 T1	6.36 ID	8.00	15	54
10	11.00 - 11.40	159-1110x6 T1	6.36 ID	8.00	15	60
	11.36 - 11.80	159-1140x6 T1	6.36 ID	8.00	15	60
12	13.10 - 13.50	159-1320x6 T1	6.36 ID	8.00	15	64
	13.70 - 14.09	159-1392x6 T1	6.36 ID	8.00	15	64
	14.08 - 14.40	159-1420x6 T1	6.36 ID	8.00	15	64

### Type 2 Carbon Steel with Outlet Seal Gasket

NOM SIZE (IN)	PIPE O.D. RANGE (IN)	SLEEVE NUMBER	CAP SIZE (IN)	CAP HEIGHT (IN)	SLEEVE WIDTH (IN)	APPR WT (LBS)
4	4.80	159-0480x3 T2	3.07 ID	5.00	9	30
6	6.83 - 7.16	159-0690x3 T2	3.07 ID	5.00	12	50
	7.05 - 7.40	159-0720x3 T2	3.07 ID	5.00	12	50
8	8.98 - 9.37	159-0905x3 T2	3.07 ID	5.00	12	83
	9.27 - 9.69	159-0940x3 T2	3.07 ID	5.00	12	83
10	11.03 - 11.47	159-1110x3 T2	3.07 ID	5.00	12	90
	11.36 - 11.80	159-1140x3 T2	3.07 ID	5.00	12	90
12	13.13 - 13.60	159-1320x3 T2	3.07 ID	5.00	12	98
	13.60 - 14.09	159-1392x3 T2	3.07 ID	5.00	12	98
	14.08 - 14.56	159-1420x3 T2	3.07 ID	5.00	12	98
6	6.83 - 7.16	159-0690x6 T2	6.13 ID	8.00	12	82
	7.05 - 7.40	159-0720x6 T2	6.13 ID	8.00	12	82
8	8.98 - 9.37	159-0905x6 T2	6.13 ID	8.00	12	88
	9.27 - 9.69	159-0940x6 T2	6.13 ID	8.00	12	88
10	11.03 - 11.47	159-1110x6 T2	6.13 ID	8.00	12	96
	11.36 - 11.80	159-1140x6 T2	6.13 ID	8.00	12	96
12	13.13 - 13.60	159-1320x6 T2	6.13 ID	8.00	12	120
	13.60 - 14.09	159-1392x6 T2	6.13 ID	8.00	12	120
	14.08 - 14.56	159-1420x6 T2	6.13 ID	8.00	12	120

Dimensions shown in inches. Sleeves furnished standard with 3/4" test port on cap.  
Type 2 Fitting furnished shopcoat/alloy bolts. Other options available upon request.

## JCM 159 Cap Sleeve for Abandoned Corporation Services Type 3 All Stainless Steel (304) with Outlet Seal Gasket

NOM SIZE (IN)	PIPE O.D. RANGE (IN)	SLEEVE NUMBER	CAP SIZE (IN)	CAP HEIGHT (IN)	SLEEVE WIDTH (IN)	APPR WT (LBS)
4	4.80	159-0480x3 T3	3.25 ID	5.00	9	32
6	6.83 - 7.16	159-0690x3 T3	3.25 ID	5.00	9	74
	7.05 - 7.40	159-0720x3 T3	3.25 ID	5.00	9	74
8	8.98 - 9.37	159-0905x3 T3	3.25 ID	5.00	9	83
	9.27 - 9.69	159-0940x3 T3	3.25 ID	5.00	9	83
10	11.03 - 11.47	159-1110x3 T3	3.25 ID	5.00	9	90
	11.36 - 11.80	159-1140x3 T3	3.25 ID	5.00	9	90
12	13.13 - 13.60	159-1320x3 T3	3.25 ID	5.00	9	98
	13.60 - 14.09	159-1392x3 T3	3.25 ID	5.00	9	98
	14.08 - 14.56	159-1420x3 T3	3.25 ID	5.00	9	98
6	6.83 - 7.16	159-0690x6 T3	6.36 ID	8.00	12	82
	7.05 - 7.40	159-0720x6 T3	6.36 ID	8.00	12	82
8	8.98 - 9.37	159-0905x6 T3	6.36 ID	8.00	12	88
	9.27 - 9.69	159-0940x6 T3	6.36 ID	8.00	12	88
10	11.03 - 11.47	159-1110x6 T3	6.36 ID	8.00	12	96
	11.36 - 11.80	159-1140x6 T3	6.36 ID	8.00	12	96
12	13.13 - 13.60	159-1320x6 T3	6.36 ID	8.00	12	104
	13.60 - 14.09	159-1392x6 T3	6.36 ID	8.00	12	104
	14.08 - 14.56	159-1420x6 T3	6.36 ID	8.00	12	104

Dimensions shown in inches. Sleeves furnished standard with 3/4 test port on cap.

JCM 159 Type 2 & Type 3 Outlet Seal Gaskets are set in a machined retaining groove that traps the gasket both internally and externally, lowering the profile of the sleeve on the pipe and eliminates gasket displacement.



## JCM 114 Fabricated Mechanical Joint Repair Sleeve

For the repair of cast iron bells, split or leaking coupling and weld joints, flanged pipe joints or straight runs of pipe without costly shutdown or disruption to critical service.

**No Shutdown or Interruption of Critical Service** - by implementing a split fabricated mechanical joint design, the JCM 114 prevents costly down time and service disruption.

**True Mechanical Joint Design** - heavy fabricated steel body and pusher gland construction prevents the warpage and distortion experienced by repair sleeves using the split steel coupling designs.

**Custom Built For Specific Application** - this versatile mechanical joint fitting is built to meet the specific requirements of special applications. Eliminates lost time due to field or factory modifications.

**Strong and Lightweight** - the 114 sleeves are ideal for installations where strength, weight and continued service are critical. The reduced weight of high strength steel aids in installation and handling as well as minimizing weight load on the pipe.

**Available in Three Styles** - the 114 MJ Split Repair Sleeve for use on straight runs of pipe and the 114 MJ Bell Repair Sleeve which is fabricated to accommodate the specific dimensions of the bell, collar or coupling to be repaired. The JCM 114 MJ Repair Sleeve can also be fabricated to accommodate two different O.D.'s of pipe.

**Optional Materials** - the 114 is available in carbon steel with special coatings and fasteners, or is available fabricated of 304 stainless steel or 316 stainless steel.

**Sizes & Configurations** - the 114 is available for pipe sizes 4" and larger. Custom design and product submittal for unique or problematic applications provided by JCM Engineering Group.

Typical Application: Repair pipe in service - Temporary or permanent

- Cracked/Broken Pipe Joints (Bell/Spigot, Couplings, Fusion, etc.)
- Splits
- Holes
- Failed MJ Joints, Fittings or Flanges

Suitable for Cast Iron, Ductile Iron, Asbestos Cement, Steel, HDPE and others

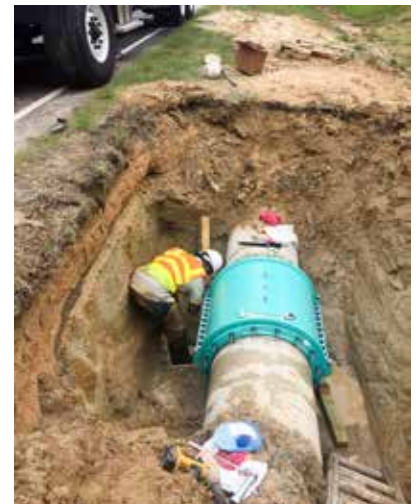

JCM 114 Mechanical Joint Bell Repair Sleeve installed over problematic leaking Asbestos Cement Coupling

## JCM 114 Mechanical Joint Repair Sleeve - Material Specifications

- Body:** A36, A516 Grade 70 Steel or equal  
Optional 304 or 316 Stainless Steel
- Glands:** ASTM A36 Steel, Ductile Iron or equal. Optional 304 or 316 Stainless Steel.
- Bolts:** Corrosion resistant, high strength low alloy ASTM A242, A193 B5, B7
- Gasket:** Optional A193 B8 304 stainless steel or 316 stainless steel  
Nitrile - Compounded for use with water, salt solutions, mild acids and bases.  
Heavy coat of corrosion resistant shop coat primer.
- Finish:** Optional Fusion Epoxy Coating available  
NSF/ANSI Standard 61, Annex G, NSF/ANSI Standard 372 Certified

### HOW TO SPECIFY:

For specific product submittal, the following information must be furnished:

#### JCM 114 Mechanical Joint Split Repair Sleeve

The following information must be furnished.

- Type of Pipe
- Pipe Outside Diameter
- Length Requirements
- Line Content and Temperature
- Line Pressure
- Finish or Coating Requirements

#### JCM 114 Mechanical Joint Bell Repair Sleeve

The following information must be furnished.

- Type of Pipe
- Spigot or Pipe Outside Diameter
- Largest Bell, Coupling, Flange Dimension Length Requirements
- Line Content and Temperature
- Line Pressure
- Finish or Coating Requirements

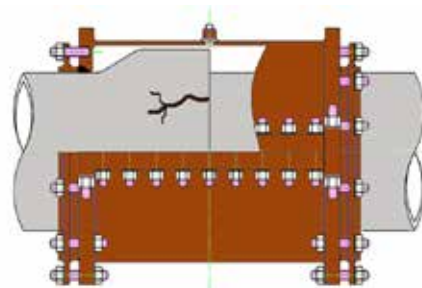
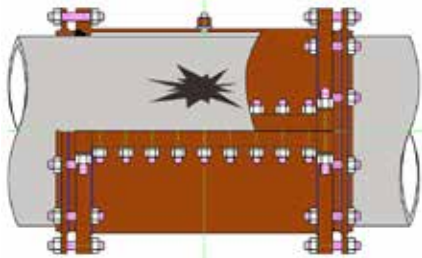

Available in sizes 4" and larger



Available in 304 or 316 Stainless Steel

# Custom Designed JCM 114 Mechanical Joint Bell Repair Sleeve Solves Leak Issue

## JCM 114-3830-57BR ESS (Mitered)

36" (38.30 OD Pipe) Ductile Iron Pipe  
Treatment Plant Effluent Pipeline  
For Repair of 11° MJ Elbow Fitting

Fabricated of Carbon Steel  
Fusion Bonded Epoxy Coating  
304 Stainless Steel Hardware

Accommodates 49" OD MJ Ends  
57" & 67.38" body length  
3,000 lbs.



Clockwise from above:

Fabrication of 114 by qualified welder in JCM production facility.

114 Installed on test fixture custom built to the site location pipeline dimensions to ensure proper angle and fit. Pressure tested.

Fitting installation at job site.

Undisclosed pipe joint tolerances in the field, contractor modification to existing joint hardware allowed installation to continue.



For more information on this  
and other applications, contact  
JCM Industries



## JCM 116 Repair Sleeve for Concrete Steel Cylinder Pipe

The JCM 116 Repair Sleeve for Concrete Steel Cylinder Pipe provides a quick easy means of repairing and reinforcing damaged concrete steel cylinder pipe of all sizes. This repair sleeve permits repairs to be made on any side of the pipe - without requiring complete stripping of the concrete. The standard repair gasket seals around a 12" damaged area. Larger repair sizes are available. This sleeve is especially recommended for larger sizes of pipe and where the concrete and pipe require reinforcement.

**Minimal Pipe Excavation** - JCM 116 Repair Sleeve requires limited pipe exposure around the damaged area. Full section joint exposure is eliminated.

**Wide Supportive Body** - reinforces pipe which is weakened due to structural interruption. The body's grout seal assembly provides a system for replacement of the critical corrosion retarding concrete encasement. By restoring the concrete casing, the steel cylinder is protected from corrosive elements.

**Eliminates Excessive Concrete Coating Removal** - concrete removal is limited to the damaged area only, preventing further pipe structural damage.

**Epoxy Coated Repair Plate** - the internal repair plate is fusion epoxy coated to provide a quality repair protected against corrosion in the pipe interior.

**Eliminates Welding On Thin Cylinders** - JCM 116 directly repairs the damaged cylinder making a watertight seal, preventing the line contents from infiltrating the concrete-steel interface.

**Availability** - The JCM 116 Repair Sleeve for Concrete Steel Cylinder Pipe is available from JCM on both an emergency and a contingency basis. Timely delivery and installation prevents extensive pipe damage, content loss and environmental violations.



### HOW TO ORDER

For pricing and engineering, the following information must be furnished:

- Type of pipe (manufacturer and class if known)
- Diameter of damaged area
- Outside Diameter of Concrete and Cylinder
- Line Content and Pressure
- Any special requirements or options

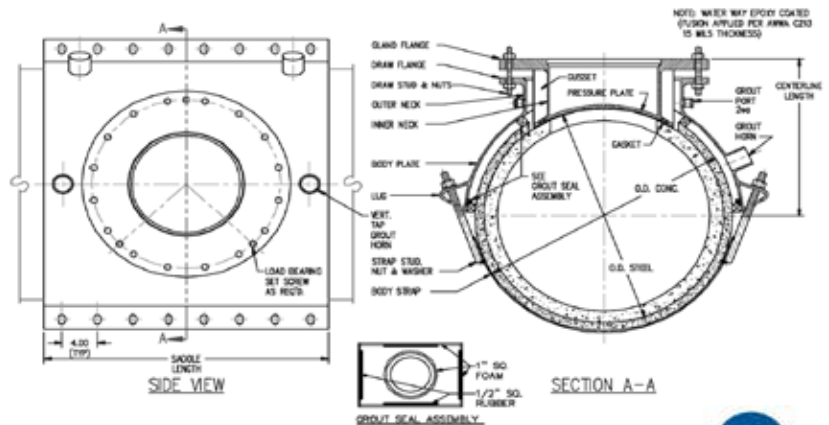

### JCM 116 Repair Sleeve for Large Diameter Pipe

The JCM 116 Repair Sleeve design is also recommended for repairs on large diameter pipe including cast iron, ductile iron, steel, and other types of large diameter rigid pipe. The direct concentration of bolting pressure to the repair gland area enables the 116 to repair the damaged area while maintaining the pipeline's pressure capability.

JCM 116 Repair Sleeves for Concrete Steel Cylinder Pipe are Priced on Application. For quotation, contact the JCM Engineered and Technical Sales Team.

# JCM 118 Fabricated Repair Sleeve

The JCM 118 Repair Sleeve is designed to provide immediate repair for pipe with large damaged areas, irregular pressure surges, high working pressure service and other unique application parameters. Engineered specifically for the internal pressure forces involved with large holes, gouges and large diameter pipe and its working characteristics, the JCM 118 is available in pipe sizes up through 120" and larger with several design options for the specific application.

## Features built into the design of the JCM 118 include:

**Reinforcement of the Pipe Wall** - strong, yet lightweight steel (pressure vessel quality) directly reinforces the pipe wall on the circumference of the pipe.

**Heavy Duty Design** - large fitting components, spacious bolt holes and heavy hardware combine to make installations in less than ideal environments easy and fast. The JCM 118 especially lends itself for easier underwater and low visibility installation applications.

**Maximum Gasket Sealing** - heavy duty materials provides high levels of bolt torque transferred directly to gasket sealing compression. Higher bolt torques maintain greater working pressures.

**Minimal Pipe Excavation** - the JCM 118 sleeve requires limited pipe exposure around the damaged area. Full section joint exposure of underground pipelines is eliminated.

**Low Profile Stance** - the hydro-mechanical lip gasket is trapped both internally and externally in a recessed groove that provides a low profile stance on the pipe eliminating the chance of gasket displacement or "blow-out" in high pressure applications.

**Availability** - The JCM 118 Repair Sleeve is available from JCM on both an emergency and a contingency basis. Timely delivery and installation prevents extensive pipe damage, content loss and environmental violations.

Typical Application: Repair pipe in service - Temporary or permanent

- Splits
- Holes
- Punctures
- Gouges

Suitable for Cast Iron, Ductile Iron, Asbestos Cement, Steel, HDPE and others

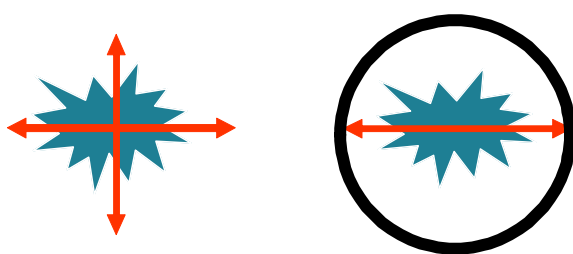

Simple and fast repair. The damaged area falls within the "Inside Diameter (I.D.) of the gasket" trapping (encompassing) the hole within the gasket area. Repair Sleeve gasket loads faster and provides greater gasket compression on the pipe.



Suitable for these types of damage:



Available with or without threaded outlet. Carbon steel, 304 stainless steel or 316 stainless steel.

# JCM 118 Fabricated Repair Sleeves

118 Fitting furnished standard no outlet.  
For outlet, see below

NOM PIPE SIZE (IN)	SLEEVE OD RANGE (IN)	SLEEVE NUMBER	MAXIMUM REPAIR AREA (IN)	MINIMUM SLEEVE WIDTH (IN)
3	3.50	118-0350 x 00	3	9
	3.96	118-0396 x 00	3	9
4	4.50	118-0450 x 00	4	9
	4.80	118-0480 x 00	4	9
6	6.63	118-0663 x 00	6	12
	6.83 - 7.16	118-0690 x 00	6	12
	7.05 - 7.40	118-0720 x 00	6	12
	7.40 - 7.73	118-0745 x 00	6	12
8	8.63	118-0863 x 00	8	16
	8.98 - 9.37	118-0905 x 00	8	16
	9.27 - 9.69	118-0940 x 00	8	16
	9.83 - 10.25	118-1000 x 00	8	16
10	10.64 - 10.86	118-1075 x 00	10	20
	11.03 - 11.47	118-1110 x 00	10	20
	11.36 - 11.80	118-1140 x 00	10	20
	11.76 - 12.24	118-1200 x 00	10	20
12	12.62 - 12.88	118-1275 x 00	12	24
	13.13 - 13.60	118-1320 x 00	12	24
	13.60 - 14.09	118-1392 x 00	12	24
	14.08 - 14.56	118-1420 x 00	12	24
14	14.59 - 15.08	118-1475 x 00	12	24
	15.23 - 15.80	118-1530 x 00	12	24
	15.73 - 16.22	118-1600 x 00	12	24
	16.30 - 16.73	118-1650 x 00	12	24
16	16.74 - 17.26	118-1684 x 00	12	24
	17.33 - 17.87	118-1740 x 00	12	24
	17.88 - 18.43	118-1800 x 00	12	24
	18.62 - 19.19	118-1875 x 00	12	24
18	18.87 - 19.45	118-1920 x 00	12	24
	19.41 - 20.01	118-1950 x 00	12	24
	20.00 - 20.60	118-2000 x 00	12	24
	20.29 - 20.94	118-2050 x 00	12	24
	20.93 - 21.57	118-2130 x 00	12	24
20	21.51 - 22.15	118-2160 x 00	12	24
	22.16 - 22.81	118-2254 x 00	12	24
	22.78 - 23.45	118-2294 x 00	12	24
	23.46 - 24.16	118-2400 x 00	12	24
	24.15 - 24.85	118-2450 x 00	12	24
24	24.82 - 25.52	118-2502 x 00	12	24
	25.71 - 26.41	118-2580 x 00	12	24
	26.55 - 27.25	118-2715 x 00	12	24
	27.26 - 27.96	118-2746 x 00	12	24
	28.14 - 28.84	118-2834 x 00	12	24
30	29.78 - 30.48	118-3000 x 00	12	24
	30.48 - 31.18	118-3075 x 00	12	24
	31.52 - 32.22	118-3200 x 00	12	24
Custom Sizes Available Contact JCM Industries			Other Repair Sizes Available	Other Widths Available

For Optional Outlet Replace (x) 00 with order code below	
Outlet Size	Order Code IP
3/4	6
1	8
1-1/4	10
1-1/2	12
2	14
2-1/2	16
3	17
4	18

### Options Available:

Epoxy Coating  
Fabricated of Stainless Steel  
(304 or 316)  
Stainless Steel Hardware  
Electro Coated Hardware

Available as Weld On  
Reinforcement Sleeve

Special fabrication options include:  
Laying Length  
Pipe Range  
Gasket - Coating - Hardware  
Body Material  
Damaged area accommodation



# JCM 136 Heavy Duty Stainless Repair Clamp Coupling

The JCM 136 Heavy Duty Stainless Steel Repair Clamp incorporates the corrosion resistance of stainless steel, the full circumferential gasketing of a Universal Clamp Coupling and the triangular bolting configuration of the 432 Stainless Steel Tapping Sleeve to provide a repair clamp with high working pressure capabilities.

**All Stainless Steel Construction** - provides superior corrosion resistance in harsh or acidic environments. The JCM 136 is available fabricated of 304 or 316 stainless steel (Model 6136).

**Heavy Duty Stainless Material** - the JCM 136 has a minimum standard material of 14 gauge certifiable prime material. This strong, yet flexible stainless shell conforms to uneven or unusual pipe surfaces and provides complete compression of the gasket on the pipe wall.

**Tapping Sleeve Bolting System** - with a triangular lug design, allows for pass-through, replaceable bolts. This lug configuration eliminates alignment problems and allows tightening from either side of the pipe.

**Full Circumferential Gasket** - provides a water tight seal on the full circumference of the pipe. The gridded 1/4" thick gasket is of a durometer hardness that allows the rubber to conform to and fill the pits and voids of uneven pipe surfaces.

The JCM 136 Heavy Duty Stainless Repair Clamp is available for all types and sizes of pipe. Options for this fitting includes: threaded outlet, 304 Stainless Steel, 316 Stainless Steel, SBR, EPDM or Buna-N Gaskets, 304 Stainless Hardware, 316 Stainless Hardware. Call the JCM Inside Sales Team for product recommendations.

The JCM 136 Heavy Duty Stainless Repair Clamp larger than 16" nominal pipe size may include multiple bands. Contact JCM for information.

Typical Application: Repair pipe in service - Temporary or permanent

- Breaks
- Cracks
- Splits
- Holes
- Corroded Areas
- Gouges

Suitable for Cast Iron, Ductile Iron, Asbestos Cement, Steel, HDPE and others







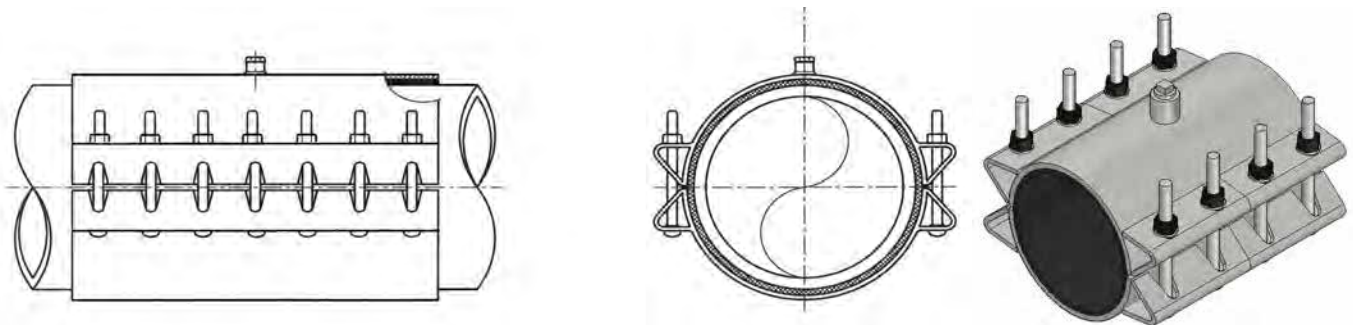

## HOW TO ORDER - For price and engineering, furnish the following information

Type of Pipe	Type of Damage
Pipe Outside Diameter	Dimension of Damaged Area
Line Content	Space Limitations
Line Working Pressure	Optional Material Requirements







## JCM Selection Guide to Couplings

PRODUCT	NUMBER & TYPE	APPLICATION, SIZES AND INFORMATION
	201 Steel Coupling	Steel coupling for joining steel, galvanized, PVC and other pipe with standard steel dimensions. 1/2" - 24". Available for cast iron and other pipe in sizes 14" and larger.
	202 Long Sleeve Steel Coupling	Provides longer length for long space between pipe ends. Especially good for repairing PVC pipe. Sizes 2" - 12". Larger sizes available on request.
	203 Steel Transition Coupling	For connection of oversize to standard size pipe within the same nominal pipe size. Special ranges available.
	204 Steel Reducing Coupling	For connection of any combination of two sizes or types of pipe either to increase or decrease sizes.
	210 Ductile Iron Coupling	The standard wide range coupling for joining Cast Iron, Ductile Iron, A/C, C900 PVC and other types of pipe. Sizes 2" - 24"
	211 Ductile Iron Coupling	Sized for steel and IPS PVC this ductile iron coupling offers more deflection capability and corrosion resistance than steel couplings. Sizes 2"- 24"
	212 Ductile Iron Transition Coupling	Utilizes special transition gaskets in standard ductile iron couplings to join pipe of the same nominal size but different outside diameters. Sizes 2-1/4" - 24"
	214 Pipe End Cap Coupling	Provides a simple means of capping all types of plain end pipe. Also used for line testing, air release and reducing line for service extensions. Sizes 3" - 12" Larger sizes on request.
	215 Long Ductile Iron Couplings	Extra long coupling provides a wide range, accommodates wide gaps between pipe ends, reduces inventory and fits both cast iron and A/C Class 150 pipe in the popular 4", 6" and 8" sizes. Utilizes the JCM original transition gasket system.
	219 Restrained Ductile Iron Coupling	Simplifies piping installations requiring couplings and tie rods or other types of restraint. Provides an easy joint makeup with restraint in a minimum amount of space. Sizes 4" - 12"
	241 Optimum Range Coupling - Standard Length	Optimum range coupling accommodates all types of pipe within the same nominal size. No change of gasket, end rings or bolts. Can be installed without complete disassembly. Sizes 3" - 16"
	242 Optimum Range Coupling - Long Length	

## JCM Selection Guide to Stainless Steel Couplings & FCAs

PRODUCT	NUMBER & TYPE	APPLICATION, SIZES AND INFORMATION
	<p>262 Fabricated Stainless Steel Coupling</p>	<p>JCM Model 262 Fabricated Stainless Steel Coupling - Coated, carbon steel end rings and 304 stainless steel middle ring join together to provide corrosion resistance to both exterior and interior elements. For more corrosion resistances see the JCM 4262 or the Model 6262 All 316 Stainless Steel Coupling. Sizes 3" through 24". Uses JCM Transition Gasket System.</p>
	<p>362 Fabricated Stainless Steel FCA</p>	<p>The 362 Fabricated Stainless Steel Coupling - Coated, carbon steel end rings and 304 Stainless Steel middle ring and flange join together to provide corrosion resistance to both exterior and interior elements. 3" through 24". Uses JCM Transition Gasket System.</p>
	<p>4262 All 304 Stainless Steel Coupling</p> <p>6262 All 316 Stainless Steel Coupling</p>	<p>JCM Model 4262 All 304 Stainless Steel Coupling - Stainless steel end rings and 304 stainless steel middle ring join together to provide corrosion resistance to both exterior and interior elements.</p> <p>Model 6262 All 316 Stainless Steel Coupling - offers exceptional corrosion resistance. Uses JCM Transition Gasket System.</p>
	<p>4362 All 304 Stainless Steel FCA</p> <p>6262 All 316 Stainless Steel FCA</p>	<p>The 4362 All 304 Stainless Steel Flanged Coupling Adapter - Stainless steel flange, end rings and 3 middle ring and flange join together to provide corrosion resistance to both exterior and interior elements. 3" through 24". Uses JCM Transition Gasket System.</p> <p>Model 6262 All 316 Stainless Steel Flanged Coupling Adapter.</p>

## JCM Selection Guide to Flanged Coupling Adapters

PRODUCT	NUMBER & TYPE	APPLICATION, SIZES AND INFORMATION
	301 Flanged Coupling Adapter	This most popular and versatile cast FCA provides a quick means of joining plain end pipe for flanged fittings, valves and equipment. Short laying length does not require exact alignment of pipe and preparation. Can be used with butterfly and wafer valves. Restraint option available. Sizes 4" through 12"
	303 Fabricated Flanged Coupling Adapter	Quick means of joining plain end pipe to flanged fittings of same nominal size. Most popular sizes - 14" and larger. Also available in sizes 2" - 12"
	304 Fabricated Reducing Flanged Coupling Adapter	Provides a quick means of increasing or reducing pipe sizes at a flanged connection. Sizes 2" and larger.
	306 Fabricated Flanged Coupling Adapter	A very versatile FCA which combines the ductile iron coupling system to a flanged outlet. Excellent for cutting in equipment or where more take up capability is needed. Available for 10" and 12" Asbestos Cement pipe. Sizes 3" - 12". Larger sizes upon request.
	307 Fabricated Reducing Flanged Coupling Adapter	Similar to the JCM 306 FCA this adapter is available with reducing or larger flanges. Excellent for installing reduced sizes of meters and equipment in lines. For pipe sizes 3" - 12" with larger or smaller flanges. Larger sizes upon request.
	309 Fabricated Dismantling Joint	Simplify installations and replacement of flanged fittings in retrofitting applications. Provides the solution for adding, repairing or replacing flanged fittings within a flanged pipe system. Adjustable, slip joint design accommodates either wide gaps or close quarter installations and eliminates the need for precise measurements between flange connections.  Available in sizes 2" and larger, for ductile iron or flanged steel pipe systems.

## JCM 201 Steel Couplings for Steel Pipe Sizes

JCM 201 Steel Couplings provide an easy means of joining plain end pipe. These couplings are especially applicable for use on steel, galvanized, PVC and other pipe with standard steel dimensions.



### 201 STEEL COUPLINGS FOR STEEL PIPE SIZES

NOM PIPE SIZE (IN)	PIPE O.D. RANGE (IN)	SLEEVE LENGTH & THICKNESS	NO. OF BOLTS	CATALOG NUMBER	CARTON QUANTITY	APPR WT EACH (LBS)
1/2	.84	.157 x 3-1/2	2	201-008401	12	1
3/4	1.05	.157 x 5	2	201-010501	12	2
1	1.32	.157 x 5	2	201-013201	12	3-1/2
1-1/4	1.66	.138 x 5	2	201-016601	6	4
1-1/2	1.90	.157 x 5	2	201-019001	6	4-1/2
2	2.38	.157 x 5	2	201-023800	6	5
2	2.38	.157 x 5	3	201-023801	1	7
2-1/2	2.88	.197 x 5	3	201-028801	1	8
3	3.50	.157 x 5	4	201-035001	1	10
3	3.50	.157 x 7	4	201-035002	1	12
4	4.50	.157 x 5	4	201-045001	1	12
4	4.50	.157 x 7	4	201-045002	1	15
5	5.56	.25 x 7	4	201-055602	1	16
6	6.63	.25 x 5	6	201-066301	1	18
6	6.63	.25 x 7	6	201-066302	1	22
8	8.63	.25 x 5	6	201-086301	1	20
8	8.63	.25 x 7	6	201-086302	1	26
10	10.75	.25 x 5	8	201-107501	1	32
10	10.75	.31 x 7	8	201-107507	1	46
12	12.75	.25 x 5	8	201-127501	1	51
12	12.75	.31 x 7	8	201-127507	1	62
14	14.00	.38 x 7	8	201-140007	1	89
16	16.00	.38 x 7	10	201-160007	1	95
18	18.00	.38x 7	10	201-180007	1	102
20	20.00	.38 x 7	12	201-200007	1	115
22	22.00	.38 x 7	14	201-220007	1	126
24	24.00	.38 x 7	14	201-240007	1	132
28	28.00	.38 x 7	15	201-280007	1	140
30	30.00	.38 x 7	16	201-300007	1	158
36	36.00	.50 x 10	18	201-360009	1	250
42	42.00	.50 x 10	20	201-420009	1	315
48	48.00	.50 x 10	22	201-480009	1	375

Note: Applications in which pipe may move out of the coupling, proper anchorage of the pipe must be provided.

JCM 201 Steel Coupling furnished standard with SBR gasket. Options: Buna-N, EPDM  
 Meets or exceeds ANSI/AWWA C219 Standard for Bolted Sleeve-Type Couplings for Plain End Pipe.  
 Couplings rated for 250PSI working pressure.





# JCM 201 Steel Couplings for Cast Iron Pipe Sizes - 14" and Larger

## 201 STEEL COUPLINGS FOR CAST IRON PIPE SIZES

NOM PIPE SIZE (IN)	PIPE O.D. RANGE (IN)	SLEEVE LENGTH & THICKNESS	NO. OF BOLTS	CATALOG NUMBER	APPR WT EA (LBS)
14	15.30	.38 X 7	8	201-153007	85
14	15.65	.38 X 7	8	201-156507	85
14	16.75	.38 X 7	10	201-167507	89
16	17.40	.38 X 7	10	201-174007	90
16	17.80	.38 X 7	10	201-178007	90
16	18.88	.38 X 7	10	201-188807	95
18	19.50	.38 X 7	12	201-195007	113
18	19.92	.38 X 7	12	201-199207	115
20	21.60	.38 X 7	12	201-216007	126
20	22.06	.38 X 7	14	201-220607	126
24	25.80	.38 X 7	15	201-258007	141
24	26.32	.38 X 7	15	201-263207	147
30	31.74	.38 X 7	16	201-317407	200
30	32.00	.50 X 10	16	201-320009	210
36	37.96	.50 X 10	18	201-379609	273
36	38.30	.50 X 10	18	201-383009	278
42	44.20	.50 X 10	20	201-442009	338
42	44.50	.50 X 10	20	201-445009	338
48	50.50	.50 X 10	22	201-505009	375
48	50.80	.50 X 10	22	201-508009	375

Other Sizes Available Upon Request

\*For ductile iron sizes 2" through 12" See JCM 210 Ductile Iron Couplings

Note: Applications in which pipe may move out of the coupling, proper anchorage of the pipe must be provided.

### Sizes 1/2" through 3/4"

**Middle Ring:** ASTM A36  
**Followers:** Ductile Iron ASTM A536  
**Bolts:** ASTM A242 low alloy with yellow dichromate seal. Optional 18-8 Type 304 Stainless Steel.

### Sizes 2-1/2" through 12"

**Middle Ring:** ASTM A36  
**Followers:** ASTM A36 or Ductile Iron ASTM A536  
**Bolts:** Corrosion resistant high strength low alloy per AWWA C111, ANSI 21.11. Optional 18-8 Type 304 or 316 Stainless Steel.

### Sizes 14" and larger

**Middle Ring:** ASTM A36  
**Followers:** ASTM A36  
**Bolts:** Corrosion resistant high strength low alloy per AWWA C111, ANSI 21.11. Optional 18-8 Type 304 or 316 Stainless Steel.  
**Finish:** Heavy coat of corrosion resistant shop coat primer. Optional Fusion Epoxy Coating available (AWWA C213).

**Gaskets:** Sizes 1/2" & 3/4" Nitrile Butadiene Rubber (NBR, Buna-N)  
 Sizes 1" - 12" Styrene Butadiene Rubber (SBR) Options: Buna N, EPDM  
 Gaskets per ASTM D2000. Molded virgin rubber. Gasket temperature range -40°F to 212°F (-40°C - 100°C)  
 Recommended for water, salt solutions, mild acids, bases and sewage. Other line content with appropriate gasket material.

**Finish:** 1/2" through 12" cathodic electrocoat epoxy, applied electrostatically to a minimum thickness of 12 µm to provide a uniform protective finish across all surfaces, recesses and edges. Metal surfaces shall be cleaned, conditioned, coated and rinsed to provide a durable, safe coating without voids, gaps or exposed areas. ANSI/NSF 61 Certified.

JCM Industries 201 Steel Couplings meet or exceed the ANSI/AWWA C219 Standard as applicable

## JCM 202 Long Steel Couplings for Steel Pipe Sizes



### 202 LONG STEEL COUPLINGS - STEEL PIPE SIZES

NOM PIPE SIZE (IN)	PIPE O.D. RANGE (IN)	SLEEVE LENGTH & THICKNESS	NO. OF BOLTS	CATALOG NUMBER	APPR WT EA (LBS)
2	2.375	.154 X 12	3	202-023811	15
2-1/2	2.875	.203 X 12	3	202-028811	20
3	3.500	.203 X 12	4	202-035011	23
4	4.500	.203 X 12	4	202-045011	28
6	6.625	.25 X 16	6	202-066311	51
8	8.625	.25 X 16	6	202-086311	54
10	10.750	.25 X 16	8	202-107511	81
12	12.750	.25 X 16	8	202-127511	119

Other sizes available upon request

Note: Applications in which pipe may move out of the coupling, correct anchorage of the pipe must be provided.

### JCM STEEL COUPLINGS OFFER THESE ADVANTAGES

- No beveling, costly threading, exact pipe alignment or fitting is required.
- Quick, simple to install, using only a wrench.
- Gaskets absorb vibration and pipe movement - permits curves to be laid with straight pieces of pipe.
- Simple, rugged and serviceable, JCM couplings are available for most sizes of steel, PVC or cast iron pipe sizes.



## JCM 203 Steel Transition Couplings



The JCM 203 Steel Transition Coupling provides a simple means of joining plain end pipe of the same nominal size but different outside diameter dimensions. The couplings are especially useful in joining old cast iron pipe to ductile iron pipe. Listed are the most common sizes. Other sizes are available upon request. Also see JCM 212 Ductile Iron Couplings.

### 203 STEEL TRANSITION COUPLINGS

NOM PIPE SIZE (IN)	FROM O.D. RANGE (IN)	TRANSITION TO O.D. RANGE (IN)	SLEEVE LENGTH (IN)	MIDDLE RING THICKNESS (IN)	CATALOG NUMBER	APPR WT EA (LBS)
14	15.65	15.30	7	.38	203-1565-1530	104
16	17.80	17.40	7	.38	203-1780-1740	117
18	19.92	19.50	7	.38	203-1992-1950	131
20	22.06	21.60	7	.38	203-2206-2160	148
24	26.32	25.80	7	.38	203-2632-2580	175

OTHER SIZES AVAILABLE UPON REQUEST

NOTE: Applications in which pipe may move out of the coupling, correct anchorage of the pipe must be provided.

## JCM 204 Steel Reducing Couplings

The JCM 204 Steel Reducing Coupling is the simplest means of connecting any combination of two sizes or types of pipe. There is practically no limit to the pipe sizes that can be connected - either to reduce or increase in size. One common use is joining large steel pipe to ductile iron or C-900 PVC pipe. Listed are the most common sizes.

### 204 STEEL REDUCING COUPLINGS

NOM PIPE SIZE (IN)	FROM O.D. RANGE (IN)	REDUCE TO O.D. RANGE (IN)	CATALOG NUMBER	APPR WT EACH (LBS)
14	15.30	14.00	204-1530-1400	170
	15.65	14.00	204-1565-1400	170
16	17.40	16.00	204-1740-1600	195
	17.80	16.00	204-1780-1600	195
	18.88	17.40	204-1888-1740	205
18	19.50	18.00	204-1950-1800	215
	19.92	18.00	204-1992-1800	215
20	21.60	20.00	204-2160-2000	245
	22.06	20.00	204-2206-2000	245
24	25.80	24.00	204-2580-2400	290
	26.32	24.00	204-2632-2400	290

OTHER SIZES AVAILABLE UPON REQUEST

NOTE: Applications in which pipe may move out of the coupling, correct anchorage of the pipe must be provided.



# JCM 210 Ductile Iron Couplings

## JCM 211 Ductile Iron Couplings

JCM Ductile Iron Couplings employ the mechanical compression joint principle to join two pieces of plain end pipe. This stress receiving flexible joint eliminates precise cutting and fitting in the field while providing for deflection, limited expansion-contraction, pipe settlement and a quick easy means of disassembling the system for maintenance.



### 210 DUCTILE IRON COUPLINGS - DUCTILE IRON, CAST IRON, C900 PVC, HDPE, A/C 150

NOM PIPE SIZE (IN)	PIPE O.D. RANGE (IN)	CATALOG NUMBER	FITS TYPE AND CLASS OF PIPE	NO. OF BOLTS	SLEEVE LENGTH (IN)	APPR WT EACH (LBS)
2	2.34 - 2.63	210-0250	STEEL, PVC, CI	2	5	8
2-1/4, 2-1/2	2.62 - 2.92	210-0288	CI, STEEL, PVC	2	5	9
3	3.80 - 4.17	210-0396	CI, DI, A/C 150	3	6	15
4	4.80 - 5.10	210-0480	CI, DI, A/C 150, C-900PVC, DI HDPE	4	6	20
6	6.90 - 7.20	210-0690	CI, DI, A/C 150, C-900 PVC, DI HDPE	5	6	24
8	9.05 - 9.40	210-0905	CI, DI, A/C 150, C-900 PVC, DI HDPE	6	6	36
10	11.10 - 11.40	210-1110	CI, DI, C-900 PVC, DI HDPE	7	6	46
12	13.20 - 13.50	210-1320	CI, DI, C-900 PVC, DI HDPE	8	6	62
14	15.30 - 15.70	210-1530	CI, DI, C-905 PVC, DI HDPE	9	7	100
16	17.40 - 17.80	210-1740	CI, DI, C-905 PVC, DI HDPE	10	7	132
18	19.10 - 19.70	210-1950	CI, DI, C-905 PVC, DI HDPE	12	7	140
20	21.35 - 21.75	210-2160	CI, DI, C-905 PVC, DI HDPE	12	7	150
24	25.70 - 26.00	210-2580	CI, DI, C-905 PVC, DI HDPE	14	10	285

Note: Applications in which pipe may move out of the coupling, proper anchorage of the pipe must be provided.

JCM Ductile Iron Bolted Couplings meet or exceed the ANSI/AWWA C219 Standard as applicable.

### 211 DUCTILE IRON COUPLINGS - IPS PVC, IPS HDPE, STEEL PIPE

NOM PIPE SIZE (IN)	PIPE O.D. RANGE (IN)	CATALOG NUMBER	FITS SIZES OF PIPE STEEL	NO. OF BOLTS	SLEEVE LENGTH (IN)	APPR WT EA (LBS)
2	2.38	210-0250	STANDARD IPS & SCHEDULE PIPE	2	5	8
2-1/2	2.88	210-0288	STANDARD IPS & SCHEDULE PIPE	2	5	9
3	3.50	211-0350	STANDARD IPS & SCHEDULE PIPE	3	6	15
4	4.50	211-0450	STD. IPS PVC, SCHEDULE PIPE, IPS HDPE	4	6	20
6	6.63	211-0663	STD. IPS PVC, SCHEDULE PIPE, IPS HDPE	5	6	25
8	8.63	211-0863	STD. IPS PVC, SCHEDULE PIPE, IPS HDPE	6	6	38
10	10.75	211-1075	STD. IPS PVC, SCHEDULE PIPE, IPS HDPE	7	6	46
12	12.75	211-1275	STD. IPS PVC, SCHEDULE PIPE, IPS HDPE	8	6	64
16	16.00	211-1600	STD. IPS PVC, SCHEDULE PIPE, IPS HDPE	10	7	132
18	18.00	211-1800	STD. IPS PVC, SCHEDULE PIPE, IPS HDPE	12	7	140
20	20.00	211-2000	STD. IPS PVC, SCHEDULE PIPE, IPS HDPE	12	7	150
24	24.00	211-2400	STD. IPS PVC, SCHEDULE PIPE, IPS HDPE	13	7	165

Note: Applications in which pipe may move out of the coupling, proper anchorage of the pipe must be provided.

JCM Ductile Iron Bolted Couplings meet or exceed the ANSI/AWWA C219 Standard as applicable.



## JCM 212 Ductile Iron Transition Couplings

JCM Transition Ductile Iron Couplings employ the mechanical compression joint principle to join two pieces of plain end pipe. JCM 212 Transition Couplings provide connections between the same nominal pipe sizes to different outside diameter ranges. A simple change of gasket accommodates the variations in pipe outside diameters.



### 212 DUCTILE IRON TRANSITION COUPLINGS

NOM PIPE SIZE (IN)	FROM O.D. RANGE (IN)	TRANSITION TO O.D. RANGE (IN)	CATALOG NUMBER	NO. OF BOLTS	SLEEVE LENGTH (IN)	APPR WT EACH (LBS)
2, 2-1/2	2.62 - 2.92	2.38 - 2.50	212-0288-0238	2	5	9
3	3.80 - 4.17	3.50	212-0396-0350	3	6	15
4	4.50	4.00	212-0450-0400	4	6	20
4	4.50	4.22	212-0450-0422	4	6	20
4	4.80 - 5.10	4.00	212-0480-0400	4	6	20
4	4.80 - 5.10	4.22	212-0480-0422	4	6	20
4	4.80 - 5.10	4.50	212-0480-0450	4	6	20
6	6.63	6.00	212-0663-0600	5	6	26
6	6.63	6.30	212-0663-0630	5	6	26
6	6.90 - 7.20	6.00	212-0690-0600	5	6	26
6	6.90 - 7.20	6.30	212-0690-0630	5	6	26
6	6.90 - 7.20	6.63	212-0690-0663	5	6	26
8	8.63	8.00	212-0863-0800	6	6	38
8	8.63	8.40	212-0863-0840	6	6	38
8	9.05 - 9.40	8.00	212-0905-0800	6	6	38
8	9.05 - 9.40	8.40	212-0905-0840	6	6	38
8	9.05 - 9.40	8.63	212-0905-0863	6	6	38
10	10.75	10.50	212-1075-1050	7	6	46
10	11.10 - 11.40	10.50	212-1110-1050	7	6	46
10	11.10 - 11.40	10.75	212-1110-1075	7	6	46
12	12.75	12.50	212-1275-1250	8	6	64
12	13.20 - 13.50	12.50	212-1320-1250	8	6	64
12	13.20 - 13.50	12.75	212-1320-1275	8	6	64
24	26.10 - 26.32	25.70 - 26.00	212-2635-2580	14	10	285

Note: Applications in which pipe may move out of the coupling, proper anchorage of the pipe must be provided. JCM Ductile Iron Bolted Couplings meet or exceed the ANSI/AWWA C219 Standard as applicable.



## JCM 214 Pipe End Cap Couplings

The JCM 214 Pipe End Cap Coupling is a quick, simple means of capping plain end pipe in either permanent or temporary installations. Furnished standard with a threaded outlet, this fitting is often used as a test cap, air release or as a means of reduction for a smaller line extension. The optional restrained coupling end eliminates the need for required thrust blocks.



### 214 PIPE END CAP COUPLINGS (WITH 2" IPS OUTLET)

NOM PIPE SIZE (IN)	PIPE O.D. RANGE (IN)	CATALOG NUMBER	FITS TYPES & CLASSES OF PIPE	NO. OF BOLTS	SLEEVE LENGTH (IN)	APPR WT EACH (LBS)
3	3.50	214-0350	STEEL, PVC	3	6	19
3	3.80 - 4.17	214-0396	CI, DI, A/C 150	3	6	19
4	4.50	214-0450	STEEL, PVC	4	6	25
4	4.80 - 5.10	214-0480	CI, DI, A/C 150, C-900 PVC	4	6	25
6	6.63	214-0663	STEEL, PVC	5	6	32
6	6.90 - 7.20	214-0690	CI, DI, A/C 150, C-900 PVC	5	6	32
8	8.63	214-0863	STEEL, PVC	6	6	51
8	9.05 - 9.40	214-0905	CI, DI, A/C 150, C-900 PVC	6	6	49
10	10.75	214-1075	STEEL, PVC	7	6	64
10	11.10 - 11.40	214-1110	CI, DI, A/C 150, C-900 PVC	7	6	64
12	12.75	214-1275	STEEL, PVC	8	6	88
12	13.20 - 13.50	214-1320	CI, DI, A/C 150, C-900 PVC	8	6	86

\*Pipe sizes 3.50 & 3.96 have 1-1/2" IPS outlet.

Larger Sizes Available Upon Request

Requires thrust blocks or restraint. Restrained ends available sizes 4" -12". Add (R) to end of catalog number to indicate restrained ends.

Restraining Set Pins Not for use A/C pipe, HDPE or PVC pipe. Contact JCM for optional fittings

Note: Applications in which pipe may move out of the coupling, correct anchorage of the pipe must be provided.

## JCM 219 Restrained Ductile Iron Couplings

JCM 219 Restrained Ductile Iron Coupling simplifies piping installations requiring tie rods or other types of thrust restraint. The Ductile Iron Coupling eliminates the need for exact pipe fit, alignment and end preparation. The integral restraining set screws provide restraint equal to restrained M.J. glands and eliminate the need for cumbersome tie rods or harness assemblies.



### 219 RESTRAINED DUCTILE IRON COUPLINGS

NOM PIPE SIZE (IN)	PIPE O.D. RANGE (IN)	CATALOG NUMBER	NO. OF BOLTS	NO. OF SET SCREWS EA END	APPR WT EACH (LBS)
3	3.80 - 4.17	219-0396	4	4	19
4	4.80 - 5.10	219-0480	4	4	22
6	6.90 - 7.20	219-0690	8	8	38
8	9.05 - 9.40	219-0905	8	8	46
10	11.10 -11.40	219-1110	12	12	67
12	13.20 -13.50	219-1320	12	12	81

Larger Sizes Available Upon Request

Requires thrust blocks or restraint. Restrained ends available sizes 4" -12". Add (R) to end of catalog number to indicate restrained ends.

Restraining Set Pins Not for use A/C pipe, HDPE or PVC pipe. Contact JCM for optional fittings

Note: Applications in which pipe may move out of the coupling, correct anchorage of the pipe must be provided.



## JCM 215 Long Ductile Iron Couplings



JCM Introduces the 215 Long Ductile Iron Coupling. This extra-long coupling provides a wide range, accommodates wide gaps between pipe ends, reduces inventory and fits both cast iron and A/C Class 150 pipe in the popular 4", 6" & 8" sizes. The JCM 215 utilizes the same JCM original transition gasket system. One coupling replaces two or more standard couplings. Unique transition gaskets change standard couplings into transition couplings, eliminating the need to stock transition couplings or color-coded end rings, gaskets and loose parts.

### 215 LONG DUCTILE IRON COUPLINGS

NOM PIPE SIZE (IN)	PIPE O.D. RANGE (IN)	CATALOG NUMBER	FITS TYPE AND CLASS OF PIPE	NO. OF BOLTS	COUPLING LENGTH (IN)	APPR WT EACH (LBS)
2	2.34 - 2.63	215-0250	STEEL, PVC, CI	2	10	16
2-1/2	2.62 - 2.92	215-0288	CI, STEEL, PVC	2	10	18
3	3.50	215-0350	STANDARD IPS & SCHEDULE PIPE	3	12	30
3	3.80 - 4.17	215-0396	CI, DI, A/C 150	3	12	30
4	4.50	215-0450	STANDARD IPS & SCHEDULE PIPE	4	12	35
4	4.80 - 5.10	215-0480	CI, DI, A/C 150, C-900PVC	4	12	35
6	6.63	215-0663	STANDARD IPS & SCHEDULE PIPE	5	12	42
6	6.90 - 7.20	215-0690	CI, DI, A/C 150, C-900 PVC	5	12	42
8	8.63	215-0863	STANDARD IPS & SCHEDULE PIPE	6	12	65
8	9.05 - 9.40	215-0905	CI, DI, A/C 150, C-900 PVC	6	12	65
10	10.75	215-1075	STANDARD IPS & SCHEDULE PIPE	7	12	79
10	11.10 - 11.40	215-1110	CI, DI, C-900 PVC	7	12	79
12	12.75	215-1275	STANDARD IPS & SCHEDULE PIPE	8	12	111
12	13.20 - 13.50	215-1320	CI, DI, C-900 PVC	8	12	111

Note: Applications in which pipe may move out of the coupling, correct anchorage of the pipe must be provided.

### MATERIAL SPECIFICATIONS - JCM MODELS 210, 211, 212, 214, 215, 219 DUCTILE IRON COUPLINGS

**Sleeve & Flanges:** Ductile Iron ASTM A536

**Gaskets:** Styrene-Butadiene Rubber (SBR) has good physical properties. Compounded for use with water, salt solutions, mild acids and bases; has excellent abrasion resistance. Per ASTM D2000 Standard, temperature range from -40° to 150°F (-40° to 65°C) constant, maximum intermittent 180°F (82°C). For applications on high temperatures or chemical pipelines, contact JCM Industries Technical Services. Not recommended for use on oil, ozone or weather resistant applications.

**Bolts:** Corrosion resistant, high strength low alloy bolts per ASTM A242 (AWWA C111, ANSI 21.11) and nuts per A563 or equal. Optional Stainless Steel 18-8 Type 304.

**Finish:** Heavy coating of corrosion resistant metal primer. Optional fusion applied epoxy coating.

**214 End Cap:** A36 Steel or equal. Fabricated with ASTM A105 threaded outlet. Optional solid cap available.

**Restraint Set Pins:** AISI Type 1022 Carbon Steel



## JCM Transition Gaskets

**COUPLINGS 210, 211, 212, 214, 215, 216, 262, 4262, 6262**  
**FLANGED ADAPTERS 301, 306, 307, 362, 4362, 6362**

The uniquely simple JCM Wide Range Coupling and Flanged Coupling Adapter system utilizes self-centering, extra wide transition gaskets eliminating the need for stocking special transition couplings or color coded flanges and gaskets. Stock JCM Ductile Iron Coupling and JCM Flanged Coupling Adapters and change only gaskets to make a transition between A/C, Cast Iron, Ductile Iron, Steel and PVC pipe. Use the same size gasket on both ends to make a straight coupling. Gaskets are NSF/ANSI Standard 61, Annex G & NSF/ANSI 372 Certified.

### GASKETS FOR STANDARD SIZED COUPLINGS

Nom. Pipe Size (IN)	Fits Coupling Sleeve	Pipe OD Range (IN)	Gasket OD Range	Catalog Number
2	288	2.62 - 2.92 2.38 - 2.50	CI, 2-1/2" PVC, STEEL 2" PVC, STEEL, CI	G212-0288 G212-0288-0238*
3	396	3.80 - 4.17 3.50	CI, DI, A/C 150, C-900 PVC IPS PVC, STEEL	G212-0396 G212-0396-0350*
4	480	4.74 - 5.10 4.50 4.22 4.00	CI, DI, A/C 150, C-900 PVC IPS PVC, STEEL, HDPE SDR 35 STEEL TUBING	G212-0480 G212-0480-0450 G212-0480-0422 G212-0480-0400
6	690	6.84 - 7.26 6.63 6.30 6.00	CI, DI, A/C 150, C-900 PVC IPS PVC, STEEL, HDPE SDR 35 STEEL TUBING	G212-0690 G212-0690-0663 G212-0690-0630 G212-0690-0600
8	905	8.99 - 9.42 8.63 8.40 8.00	CI, DI, A/C 150, C-900 PVC IPS PVC, STEEL, HDPE SDR 35 STEEL TUBING	G212-0905 G212-0905-0863 G212-0905-0840 G212-0905-0800
10	1110	11.04 - 11.40 10.75 10.50	CI, DI, C-900 PVC IPS PVC, STEEL, HDPE SDR 35	G212-1110 G212-1110-1075 G212-1110-1050
12	1320	13.14 - 13.50 12.75 12.50	CI, DI, C-900 PVC IPS PVC, STEEL, HDPE SDR 35	G212-1320 G212-1320-1275 G212-1320-1250

\*This size gasket does not have extended lip.

### GASKETS FOR OVERSIZED COUPLINGS

Nom. Pipe Size (IN)	Fits Coupling Sleeve	Pipe OD Range (IN)	Gasket OD Range	Catalog Number
4	535	5.06 - 5.40 4.80 - 5.10 4.50	A/C CI, DI, C-900 PVC IPS PVC, STEEL, HDPE	G212-0535 G212-0535-0480 G212-0535-0450
6	740	7.17 - 7.55 6.90 - 7.10 6.63	A/C CI, DI, C-900 PVC IPS PVC, STEEL, HDPE	G212-0740 G212-0740-0690 G212-0740-0663
8	960	9.32 - 9.75 9.05 - 9.30 8.63	A/C CI, DI, C-900 PVC IPS PVC, STEEL, HDPE	G212-0967 G212-0967-0905 G212-0967-0863
10	1200	11.60 - 12.05 11.10 - 11.30 10.75	A/C CI, DI, C-900 PVC IPS PVC, STEEL, HDPE	G212-1200 G212-1200-1110 G212-1200-1075
12	1420	13.92 - 14.40 13.20 - 13.50 12.75	A/C CI, DI, C-900 PVC IPS PVC, STEEL, HDPE	G212-1420 G212-1420-1320 G212-1420-1275



## JCM 220 Galvanized Compression Fittings



### 220 GALVANIZED COMPRESSION COUPLINGS

JCM FITTINGS	NOM PIPE SIZE (IN)	PIPE O.D. (IN)	CATALOG NUMBER	OVERALL LENGTH (IN)	CTN. QTY.	CTN. WT	APPR WT EACH (LBS)
 220 Compression Coupling	1/2	.840	220-0084-L	4-1/8	12	11	.80
	3/4	1.050	220-0105-L	4-1/4	12	14	1.08
	1	1.315	220-0132-L	4-1/2	12	19	1.42
	1-1/4	1.660	220-0166-L	4-3/4	12	23	1.92
	1-1/2	1.900	220-0190-L	5	12	28	2.33
	2	2.375	220-0238-L	5-1/4	12	40	3.38

## JCM 225 Insulating Adapter Gaskets

For adapting iron pipe size fittings to copper tube size. Also for insulation between dissimilar metals to prevent galvanic corrosion.

### 225 INSULATING ADAPTER GASKETS

NOMINAL PIPE SIZES	CATALOG NUMBER
1/2 IP X 1/2 CT	225-0084-0063
3/4 IP X 3/4 CT	225-0105-0080
1 IP X 1 CT	225-0132-0113
1-1/4 IP X 1-1/4 CT	225-0166-0138
1-1/2 IP X 1-1/2 CT	225-0190-0163
2 IP X 2 CT	225-0238-0213



# JCM 241 Standard Length Optimum Range Ductile Iron Couplings

## JCM 242 Long Length Optimum Range Ductile Iron Couplings



**Full Range capability** - for pipe sizes 3" through 16"

**242 Long length middle ring** - allows for deeper pipe insertion and accommodates wide gaps between pipe ends

Rated for 250 PSI working pressure

**Reduces inventory** - one coupling fits SDR35, IPS PVC, C-900 PVC, Ductile Iron, Steel, Cast Iron and A/C Pipe classes 100, 150 and 200

**Non-compromising design** - with maximum number of bolts for uniform tightening provides the engineered test and field proven service and reliability of the JCM Ductile Iron Coupling family.

### 241 & 242 OPTIMUM RANGE COUPLING

NOM PIPE SIZE (IN)	PIPE O.D. RANGE (IN)	CATALOG NUMBER	SLEEVE LENGTH (IN)	NO. OF BOLTS	APPR WT EA (LBS)
3	3.45 - 4.20	241-0420	6	3	22
		242-0420	10	3	26
4	4.22 - 5.60	241-0550	6	4	30
		242-0550	10	4	35
6	6.28 - 7.60	241-0760	6	5	39
		242-0760	10	5	46
8	8.40 - 9.75	241-0960	6	6	47
		242-0960	10	6	55
10	10.50 - 12.12	241-1200	6	8	62
		242-1200	10	8	71
12	12.50 - 14.38	241-1430	6	8	71
		242-1430	10	8	84
14	15.05 - 16.93	242-1690	10	10	115
16	17.32 - 19.20	242-1920	10	11	118

### MATERIAL SPECIFICATIONS - JCM MODELS 241 & 242 OPTIMUM RANGE DUCTILE IRON COUPLINGS

**Sleeve & Flanges:** Ductile Iron ASTM A536

**Gaskets:** Styrene-Butadiene Rubber (SBR) has good physical properties. Compounded for use with water, salt solutions, mild acids and bases; has excellent abrasion resistance. Per ASTM D2000 Standard, temperature range from -40° to 150°F (-40° to 65°C) constant, maximum intermittent 180°F (82°C). For applications on high temperatures or chemical pipelines, contact JCM Industries Technical Services. Not recommended for use on oil, ozone or weather resistant applications.

**Bolts:** Corrosion resistant, high strength low alloy bolts and nuts per ASTM A242 (AWWA C111, ANSI 21.11) per A563 or equal. Optional Stainless Steel 18-8 Type 304.

**Finish:** Heavy coating of corrosion resistant metal primer. Optional fusion applied epoxy coating per ANSI/AWWA C213.



## JCM 262 Fabricated Stainless Steel Coupling

The JCM 262 Fabricated Stainless Steel Coupling provides an economical solution to joining two plain end pieces of pipe. Constructed of Carbon Steel End Rings with resilient Fusion Plastic Coating, a 304 Stainless Steel middle ring and alloy hardware, electro coated with Powercron 590-534, the JCM 262 is prepared for the harshest of elements, corrosive line content - or both!

**American Iron and Steel Compliance - for AIS Compliant Couplings, contact JCM Industries for price and availability.**



NOM PIPE SIZE (IN)	FROM O.D. RANGE (IN)	TO O.D. RANGE (IN)	CATALOG NUMBER	NO. OF BOLTS	EFFECTIVE LENGTH (IN)	OVERALL LENGTH (IN)	BOLT SIZE LENGTH (IN)	APPR WT EACH (LBS)
3	3.50	3.50	262-0350	3	5.63	7.5	5/8 X 9	12
3	3.80 - 4.17	3.50	262-0396-0350	3	5.63	7.5	5/8 X 9	12
3	3.80 - 4.17	3.80 - 4.17	262-0396	3	5.63	7.5	5/8 X 9	12
4	4.50	4.50	262-0450	4	5.63	7.5	5/8 X 9	18
4	4.50	4.00	262-0450-0400	4	5.63	7.5	5/8 X 9	18
4	4.50	4.22	262-0450-0422	4	5.63	7.5	5/8 X 9	18
4	4.80 - 5.10	4.80 - 5.10	262-0480	4	5.63	7.5	5/8 X 9	18
4	4.80 - 5.10	4.00	262-0480-0400	4	5.63	7.5	5/8 X 9	18
4	4.80 - 5.10	4.22	262-0480-0422	4	5.63	7.5	5/8 X 9	18
4	4.80 - 5.10	4.50	262-0480-0450	4	5.63	7.5	5/8 X 9	18
6	6.63	6.63	262-0663	5	5.63	7.5	5/8 X 9	21
6	6.63	6.00	262-0663-0600	5	5.63	7.5	5/8 X 9	21
6	6.63	6.30	262-0663-0630	5	5.63	7.5	5/8 X 9	21
6	6.90 - 7.20	6.90 - 7.20	262-0690	5	5.63	7.5	5/8 X 9	21
6	6.90 - 7.20	6.00	262-0690-0600	5	5.63	7.5	5/8 X 9	21
6	6.90 - 7.20	6.30	262-0690-0630	5	5.63	7.5	5/8 X 9	21
6	6.90 - 7.20	6.63	262-0690-0663	5	5.63	7.5	5/8 X 9	21
8	8.63	8.63	262-0863	6	5.63	7.5	5/8 X 9	28
8	8.63	8.00	262-0863-0800	6	5.63	7.5	5/8 X 9	28
8	8.63	8.40	262-0863-0840	6	5.63	7.5	5/8 X 9	28
8	9.05 - 9.40	9.05 - 9.40	262-0905	6	5.63	7.5	5/8 X 9	28
8	9.05 - 9.40	8.00	262-0905-0800	6	5.63	7.5	5/8 X 9	28
8	9.05 - 9.40	8.40	262-0905-0840	6	5.63	7.5	5/8 X 9	28
8	9.05 - 9.40	8.63	262-0905-0863	6	5.63	7.5	5/8 X 9	28
10	10.75	10.75	262-1075	7	5.63	7.5	5/8 X 9	37
10	10.75	10.50	262-1075-1050	7	5.63	7.5	5/8 X 9	37
10	11.10 - 11.40	11.10 - 11.40	262-1110	7	5.63	7.5	5/8 X 9	37
10	11.10 - 11.40	10.50	262-1110-1050	7	5.63	7.5	5/8 X 9	37
10	11.10 - 11.40	10.75	262-1110-1075	7	5.63	7.5	5/8 X 9	37
12	12.75	12.75	262-1275	8	5.63	7.5	5/8 X 9	44
12	12.75	12.50	262-1275-1250	8	5.63	7.5	5/8 X 9	44
12	13.20 - 13.50	13.20 - 13.50	262-1320	8	5.63	7.5	5/8 X 9	44
12	13.20 - 13.50	12.50	262-1320-1250	8	5.63	7.5	5/8 X 9	44
12	13.20 - 13.50	12.75	262-1320-1275	8	5.63	7.5	5/8 X 9	44

Note: Applications in which pipe may move out of the coupling, proper anchorage of the pipe must be provided. Custom sizes & lengths available upon request. Contact JCM Industries.



Purchase orders for the JCM Industries 262 type coupling signify an agreement between the manufacturer and customer that both parties agree to the JCM test procedure for meeting ANSI/AWWA C219 Standard for Bolted, Sleeve-Type Couplings for Plain-End Pipe. All couplings are pneumatically tested to a minimum of 25 PSI. Additional testing for certification purposes available upon request with additional charge.

## JCM 262 OVERSIZED FABRICATED STAINLESS STEEL COUPLING



The JCM 262 Oversized Fabricated Stainless Steel Coupling provides an economical solution for joining old cast iron, larger classes of asbestos cement and other types of oversized pipe. The JCM 262 Coupling uses the popular and economical JCM G212 Transition Gasket System. Making transitions of the same nominal pipe size easy with just the change of gasket.

The JCM 262 Oversized Coupling is constructed of same corrosion resistant materials - Carbon Steel End Rings with resilient Fusion Plastic Coating, a 304 Stainless Steel middle ring and alloy hardware, electro coated with Powercron 590-534, the JCM 262 is prepared for the harshest of elements, corrosive line content - or both!

**Available American Iron and Steel Compliance - for AIS Compliant Couplings, contact JCM Industries for price and availability.**

NOM PIPE SIZE (IN)	FROM O.D. RANGE (IN)	TO O.D. RANGE (IN)	CATALOG NUMBER	NO. OF BOLTS	EFFECTIVE LENGTH (IN)	OVERALL LENGTH (IN)	BOLT SIZE LENGTH (IN)	APPR WT EACH (LBS)
4	5.10 - 5.40	5.10 - 5.40	262-0535	4	5.63	7.5	5/8 X 9	18
4	5.10 - 5.40	4.50	262-0535-0450	4	5.63	7.5	5/8 X 9	18
4	5.10 - 5.40	4.80	262-0535-0480	4	5.63	7.5	5/8 X 9	18
6	7.20 - 7.55	7.20 - 7.55	262-0740	5	5.63	7.5	5/8 X 9	21
6	7.20 - 7.55	6.63	262-0740-0663	5	5.63	7.5	5/8 X 9	21
6	7.20 - 7.55	6.90	262-0740-0690	5	5.63	7.5	5/8 X 9	21
8	9.40 - 9.75	9.40 - 9.75	262-0960	6	5.63	7.5	5/8 X 9	28
8	9.40 - 9.75	8.63	262-0960-0863	6	5.63	7.5	5/8 X 9	28
8	9.40 - 9.75	9.05	262-0960-0905	6	5.63	7.5	5/8 X 9	28
10	11.60 - 12.05	11.60 - 12.05	262-1200	7	5.63	7.5	5/8 X 9	37
10	11.60 - 12.05	10.75	262-1200-1075	7	5.63	7.5	5/8 X 9	37
10	11.60 - 12.05	11.10	262-1200-1110	7	5.63	7.5	5/8 X 9	37
12	13.92 - 14.40	13.92 - 14.40	262-1420	8	5.63	7.5	5/8 X 9	44
12	13.92 - 14.40	12.75	262-1420-1275	8	5.63	7.5	5/8 X 9	44
12	13.92 - 14.40	13.20	262-1420-1320	8	5.63	7.5	5/8 X 9	44

Note: Applications in which pipe may move out of the coupling, proper anchorage of the pipe must be provided. Custom sizes & lengths available upon request. Contact JCM Industries, Inc.

### JCM 262 Fabricated Stainless Steel Couplings Material Specifications

- Followers:** Steel per ASTM A36, ASTM A516 GR70 or equal.  
Optional Followers: Ductile Iron, per ASTM A536
- Middle Ring:** 304 Stainless Steel ASTM A240
- Follower Coating:** Fusion bonded high density blue plastic, 12 mils minimum thickness, with a dielectric strength of over 12,000 volts. Water absorption less than .20% (less than nylon) prevents undercutting and blistering.
- Gasket:** Styrene-Butadiene Rubber (SBR) has good physical properties. Compounded for use with water, salt solutions, mild acids and bases; has excellent abrasion resistance. Per ASTM D-2000. Standard temperature range from -40° to 150°F (-40° to 65°C) constant, maximum intermittent 180°F (82°C). For applications on high temperatures or chemical pipelines, contact JCM Industries Technical Services. The material is not recommended for use on oil, ozone or weather resistant applications. Available Options: EPDM
- Hardware:** Electro Coated Hardware, Powercron 590-534 black cationic electrocoat, 5/8" Corrosion resistant, high strength low alloy oval neck track head bolts per ASTM A242/ANSI 21.11/AWWA C111 and heavy hex nuts per A563 or equal. Optional Hardware: Stainless Steel 18-8 Type 304 or 316
- Working Pressure:** Fittings are rated for 150 PSI working pressure when installed per manufacturer's instructions. Inspection of pipe integrity is the responsibility of the end user. For higher working pressure applications, contact JCM Industries.
- Options:** **For ALL 304 Stainless Steel Coupling, use model number 4262**  
**For ALL 316 Stainless Steel Coupling, use model number 6262**  
**For EPDM Gasket, insert an "M" at the end of the catalog number**



Purchase orders for the JCM Industries, Inc 262 type coupling signify an agreement between the manufacturer and customer that both parties agree to the JCM test procedure for meeting ANSI/AWWA C219 Standard for Bolted, Sleeve-Type Couplings for Plain-End Pipe. All couplings are pneumatically tested to a minimum of 25 PSI. Additional testing for certification purposes available upon request with additional charge.

**JCM 230 STAINLESS STEEL STIFFENERS FOR HDPE PIPE (6" width)**  
**JCM 231 LONG STAINLESS STEEL STIFFENERS FOR HDPE PIPE (12" width)**

JCM Industries recommends fusion as the primary method to join plain end HDPE. Often, however, logistics of the job site, weather, site conditions and accessibility can eliminate the fusion process as an option and mechanical, bolted fittings are selected. When mechanical fittings are selected as the means to join plain end pipe, JCM recommends that internal stiffeners be used. The expansion/contraction of HDPE pipe requires that the sealing system maintain a seal throughout all cycles which the system will experience in its life. Proper gasket capture, pipe support and reinforcement are critical factors for long term reliability.



**JCM Stainless Stiffeners offer:**

- Corrosion Resistance
- Rigid Reinforcement of Pipe Wall for Pipe Connections
- Accurate Pipe I.D. Sizing maintains proper Outside Diameter
- 1/8" Tapered Insert End provides easy installation
- Flared End or Tab Stop secures Stiffener to End of Pipe
- Positive Reinforcement without interference

JCM Stainless Steel Stiffeners perform two functions when installed. First, the stiffener brings the pipe "into round" so that fabricated/cast mechanical bolt-on product will fit correctly as designed on the full circumference of the pipe.

Secondly, it provides support to the pipe wall and prevents movement away from the pressure when gasketed bolted fittings are tightened. HDPE has a high coefficient of thermal expansion and contraction along with a low modulus of elasticity. This sensitivity to pressure and temperature causes HDPE to expand and contract more than traditional water and sewer piping materials.

The potential pipe expansion or contraction must be considered when assembling bolt-on fittings. HDPE will relax ("creep") at lower stress levels than other piping materials. The use of stiffeners in the interior of the pipe can prevent these types of issues. Along with the stiffeners, the use of restraint products suitable for HDPE should be factored into the application.



**JCM 230 Stiffeners 6" in width**  
**JCM 231 Stiffeners 12" in width**  
**JCM 230/231 Stiffeners are available in**  
**304 or 316 stainless steel**

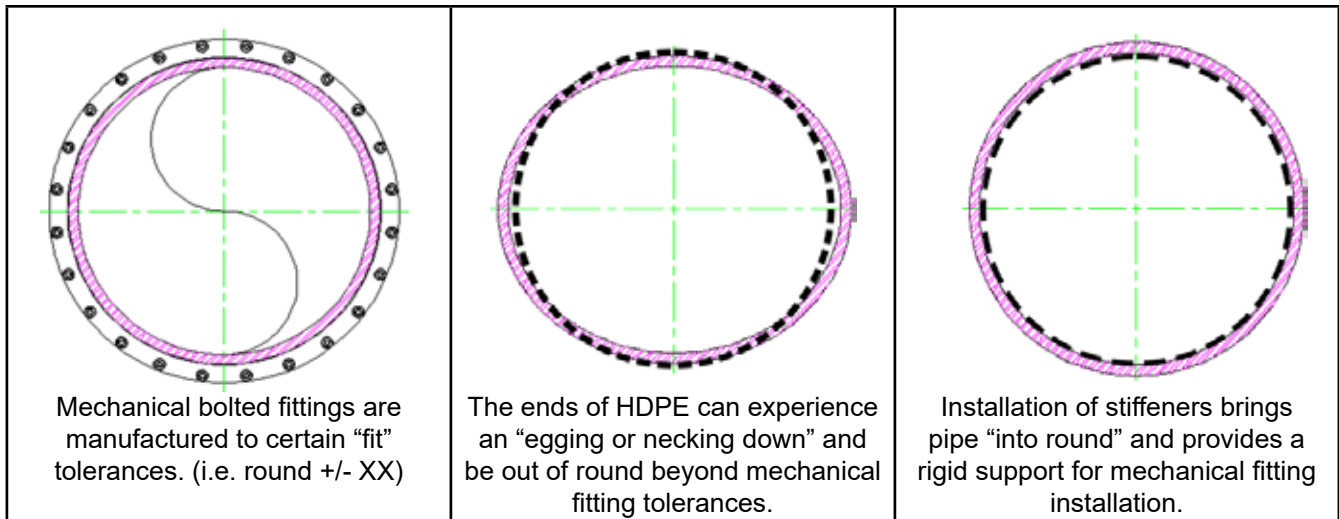

# JCM 301 Flanged Coupling Adapters

**The Quick, Simple, Economical way to join flanged fittings, valves and meters to plain end pipe.**

The JCM 301 Flanged Coupling Adapter combines a flange with a ductile iron flexible coupling to provide a compact adapter fitting to connect plain end pipe to flanged fittings, meters, valves and equipment. The JCM 301 can be used to make on-site flanged spools and, when used with the optional set screws, eliminates the need for extra tie rods or harnessing assemblies on flanged equipment.

Ductile Iron body and flange and corrosion resistant high strength alloy bolts provide high strength and corrosion resistance to installations.

Laying length provides extra margin of safety for field cutting of pipe, yet is short enough for close quarter installations.

Full bolting to compression flange provides proper gasket compression. Many adapters use half the number of the standard flange.

Special flange gasket provides extra sealing capability on new and old flanged fittings and equipment. The wide molded gasket has a special lip which increases its sealing pressure with increases in line pressure.

Optional retainer set screws anchor the adapter on steel, cast iron and ductile iron pipe eliminating the need for tie rods, thrust blocks and additional joint restraint. Retainer set screws are not exposed to the line contents and do not require drilling of pipe.

Special flange design provides extra versatility which makes it an excellent means for installing wafer type valves, fittings and equipment.

Special wide range gaskets, which are interchangeable with JCM Ductile Iron Couplings, provide extra field versatility necessary on installations involving deflection, oversize pipe, out-of-round and uneven pipe ends.



## JCM 301 Flanged Coupling Adapter Dimensions

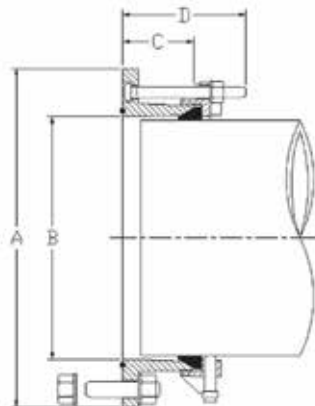

Nominal Size	A	B	C	D
3	8-1/8	4-1/4	3	5-1/2
4	9-1/8	5-1/4	3	5-1/2
6	11-1/8	7-5/16	3-1/2	5-1/2
8	13-1/2	9-9/16	3-1/2	5-1/2
10	16-1/4	11-9/16	4	7
12	19	13-5/8	4	7

# JCM 301 Flanged Coupling Adapters



## 301 Standard Flanged Coupling Adapter

### 301 Standard Flexible Flanged Coupling Adapter

The JCM 301 FCA provides a quick simple means of joining flanged fittings to plain end pipe. The 301 will absorb vibration, accommodate pipe deflection and expansion, provide for easy equipment removal and re-installation, and eliminate the need for exact measurements.



## 301 Restrained Flanged Coupling Adapter

Applications especially advantageous for using JCM FCA's

- Valve insertions
- Equipment connections and offset adjustment
- Converting flanged fittings to mechanical joint or push on type
- Dampening vibration
- Providing for field fitting of flanged spool pieces

### 301 FLANGED COUPLING ADAPTERS

NOM PIPE SIZE (IN)	PIPE O.D. RANGE (IN)	CATALOG NUMBER	QTY OPTIONAL SET SCREWS	APPR WT EACH (LBS)
3	3.50	301-0350	4	17
	3.80 - 4.17	301-0396	4	17
4	4.00	301-0400	N/A	22
	4.50	301-0450	4	22
	4.80 - 5.10	301-0480	4	22
6	6.00	301-0600	N/A	37
	6.63	301-0663	8	37
	6.90 - 7.20	301-0690	8	37
8	8.00	301-0800	N/A	44
	8.63	301-0863	8	44
	9.05 - 9.40	301-0905	8	44
10	10.75	301-1075	12	67
	11.10 - 11.40	301-1110	12	67
12	12.75	301-1275	12	94
	13.20 - 13.50	301-1320	12	94

\*Set Screws are not for use on Asbestos Cement, HDPE or PVC pipe.

Add (R) to end of Catalog Number to indicate optional set screws.

Note: Applications in which pipe may move out of the coupling, proper anchorage of the pipe must be provided.

### MATERIAL SPECIFICATIONS - JCM 301 FLANGED COUPLING ADAPTER

**Sleeve & Flange:** Ductile Iron ASTM A536

**Gaskets:** Styrene-Butadiene Rubber (SBR) has good physical properties. Compounded for use with water, salt solutions, mild acids and bases; has excellent abrasion resistance. Per ASTM D2000 Standard, temperature range from -40° to 150°F (-40° to 65°C) constant, maximum intermittent 180°F (82°C). For applications on high temperatures or chemical pipelines, contact JCM Industries Technical Services. Not recommended for use on oil, ozone or weather resistant applications.

**Bolts:** Corrosion resistant, high strength low alloy bolts and nuts ASTM A242 (AWWA C111, ANSI 21.11) per A563 or equal. Optional Stainless Steel 18-8 Type 304.

**Finish:** Heavy coating of corrosion resistant metal primer. Optional fusion applied epoxy coating.

**Restraint Set Pins:** AISI Type 1022 Carbon Steel

JCM Industries flanged adapters meet or exceed the ANSI/AWWA C219 Standard as applicable.



# JCM 303 Fabricated Flanged Coupling Adapters

The JCM 303 Fabricated Flanged Coupling Adapter provides a simple means of joining plain end pipe to flanged fittings, valves and equipment. Fabricated of carbon steel, these fittings are readily available in large or small sizes with a standard ANSI/AWWA Class D flange. Special or heavier flanges are available on request.



Flange: Standard 125# Class D - other flanges available upon request.

## HOW TO ORDER

1. Determine pipe O.D. and flange size & type to be joined.
2. Order catalog Number indicating O.D. and flange size selected.

EXAMPLE: For 17.40 O.D. ductile iron pipe to be joined to 16" Class D flange, order: 303-1740 x16

## 303 FLANGED COUPLING ADAPTERS

NOM PIPE SIZE (IN)	PIPE O.D. RANGE (IN)	NOMINAL FLANGE SIZE	CATALOG NUMBER	APPR WT EACH (LBS)
3	3.50	3	303-0350 X 3	19
3	3.96	3	303-0396 X 3	20
4	4.50	4	303-0450 X 4	25
4	4.80 - 5.00	4	303-0480 X 4	26
5	5.56	5	303-0556 X 5	32
6	6.63	6	303-0663 X 6	38
6	6.90 - 7.10	6	303-0690 X 6	40
8	8.63	8	303-0863 X 8	50
8	9.05 - 9.30	8	303-0905 X 8	52
10	10.75	10	303-1075 X 10	58
10	11.10 - 11.40	10	303-1110 X 10	61
12	12.75	12	303-1275 X 12	78
12	13.20 - 13.50	12	303-1320 X 12	84
14	14.00	14	303-1400 X 14	90
14	15.30	14	303-1530 X 14	110
14	15.65	14	303-1565 X 14	110
16	16.00	16	303-1600 X 16	113
16	17.40	16	303-1740 X 16	130
16	17.80	16	303-1780 X 16	137
18	18.00	18	303-1800 X 18	137
18	19.50	18	303-1950 X 18	144
18	19.92	18	303-1992 X 18	144
20	20.00	20	303-2000 X 20	158
20	21.60	20	303-2160 X 20	162
20	22.06	20	303-2206 X 20	162
24	24.00	24	303-2400 X 24	192
24	25.80	24	303-2580 X 24	220
24	26.32	24	303-2632 X 24	220
30	32.00	30	303-3200 X 30	442
36	38.30	36	303-3830 X 36	602
42	44.50	42	303-4450 X 42	771
48	50.80	48	303-5080 X 48	885

NOTE: Applications in which pipe may move out of the coupling, correct anchorage of the pipe must be provided. Epoxy coating and stainless steel bolts are available as an extra. Other sizes available upon request.





# JCM 304 Fabricated Reducing Flanged Coupling Adapters

The JCM 304 Reducing Flanged Coupling Adapter is similar in construction to the JCM 303 FCA but has a reducer or increaser combination of coupling and flange.

FLANGES: Standard 125 Class D, other flanges available.



## HOW TO ORDER

1. Determine pipe O.D. and flange size & type to be joined.
2. Order catalog Number indicating O.D. and flange size selected.

EXAMPLE: For 17.40 O.D. ductile iron pipe to be joined to 14" Class D flange, order: 304-1740 x14

## 304 FABRICATED REDUCING FLANGED COUPLING ADAPTERS

NOM PIPE SIZE (IN)	PIPE O.D. RANGE (IN)	CATALOG NUMBER	(X) ADD FLANGE SIZE
4	4.50	304-0450	X
4	4.80 - 5.00	304-0480	X
5	5.56	304-0556	X
6	6.63	304-0663	X
6	6.90 - 7.10	304-0690	X
8	8.63	304-0863	X
8	9.05 - 9.30	304-0905	X
10	10.75	304-1075	X
10	11.10 - 11.40	304-1110	X
12	12.75	304-1275	X
12	13.20 - 13.50	304-1320	X
14	14.00	304-1400	X
14	15.30	304-1530	X
14	15.65	304-1565	X
16	16.00	304-1600	X
16	17.40	304-1740	X
16	17.80	304-1780	X
18	18.00	304-1800	X
18	19.50	304-1950	X
18	19.92	304-1992	X
20	20.00	304-2000	X
20	21.60	304-2160	X
20	22.06	304-2206	X
24	24.00	304-2400	X
24	25.80	304-2580	X
24	26.32	304-2632	X

STANDARD AVAILABLE FLANGE SIZES
2
3
4
6
8
10
12
14
16
18
20
24



NOTE: Applications in which pipe may move out of the coupling, correct anchorage of the pipe must be provided.

Epoxy coating and stainless steel bolts are available as an extra.

Other sizes available upon request.

# JCM 306 Fabricated Flanged Coupling Adapters

The JCM 306 Fabricated Flanged Coupling Adapter combines the versatile JCM Ductile Iron Coupling system with a fabricated flanged end to provide a fitting which allows for pipe misalignment, less critical pipe end preparation and ease of equipment installation and removal. The 306 FCAs are easily adapted from one type of pipe to another with the simple JCM Transition Gasket system. These FCAs simplify installations on larger A/C pipe and are available in the hard to find 10" and 12" sizes.



## MATERIAL SPECIFICATIONS - JCM 306 & 307 FLANGED COUPLING ADAPTERS

**Sleeve:** Ductile Iron ASTM A536

**Flange & Neck:** Fabricated ASTM A285 Grade C Steel or equal with AWWA C207 Class D Flange, with ANSI 150lb. drilling.

**Gaskets:** Styrene-Butadiene Rubber (SBR) has good physical properties. Compounded for use with water, salt solutions, mild acids and bases; has excellent abrasion resistance. Per ASTM D2000 Standard, temperature range from -40° to 150°F (-40° to 65°C) constant, maximum intermittent 180°F (82°C). For applications on high temperatures or chemical pipelines, contact JCM Industries Technical Services. Not recommended for use on oil, ozone or weather resistant applications.

**Bolts:** Corrosion resistant, high strength low alloy bolts and nuts ASTM A242 (AWWA C111, ANSI 21.11) per A563 or equal. Optional Stainless Steel 18-8 Type 304.

**Finish:** Heavy coating of corrosion resistant metal primer. Optional fusion applied epoxy coating.

JCM Industries flanged adapters meet or exceed the ANSI/AWWA C219 Standard as applicable.

## 306 FLANGED COUPLING ADAPTERS

NOM PIPE SIZE (IN)	COUPLING O.D. RANGE (IN)	NOM FLANGE SIZE	CATALOG NUMBER	OVERALL LENGTH (IN)	APPR WT EACH (LBS)
3	3.50 3.80 - 4.17	3 3	306-0350 X 3	12	32
			306-0396 X 3	12	32
4	4.50 4.80 - 5.10	4 4	306-0450 X 4	12	42
			306-0480 X 4	12	42
6	6.63 6.90 - 7.20	6 6	306-0663 X 6	12	59
			306-0690 X 6	12	59
8	8.63 9.05 - 9.40	8 8	306-0863 X 8	12	86
			306-0905 X 8	12	86
10	10.75 11.10 - 11.40	10 10	306-1075 X 10	12	115
			306-1110 X 10	12	115
12	12.75 13.20 - 13.50	12 12	306-1275 X 12	12	163
			306-1320 X 12	12	163

NOTE: Applications in which pipe may move out of the coupling, proper anchorage of the pipe must be provided. Integral retainer set screws are available as an extra. Add (R) to end of catalog number. Price on application.

NOTE: Restraining set screws are not for use on Asbestos Cement, HDPE or PVC pipe.

Epoxy coating and stainless steel bolts available as an extra.

Larger sizes available upon request.



## JCM 307 Fabricated Reducing Flanged Coupling Adapters

The JCM 307 Reducing Fabricated Flanged Coupling Adapter combines the versatile JCM Ductile Iron Coupling system with an increaser or reducer fabricated flanged end to provide a fitting which allows for pipe misalignment, less critical pipe end preparation and ease of equipment installation and removal. The 307 FCAs are easily adapted from one type of pipe to another with the simple JCM Transition Gasket system. These FCAs simplify installations on larger A/C pipe and are available in the hard to find 10" and 12" sizes.



### 307 FLANGED REDUCING COUPLING ADAPTERS

NOM PIPE SIZE (IN)	COUPLING O.D. RANGE (IN)	CATALOG NUMBER	(X) ADD REQUIRED FLANGE SIZE	OVERALL LENGTH (IN)
3	3.50	307-0350	X	12
	3.80 - 4.17	307-0396	X	12
4	4.50	307-0450	X	12
	4.80 - 5.10	307-0480	X	12
6	6.63	307-0663	X	12
	6.90 - 7.20	307-0690	X	12
8	8.63	307-0863	X	12
	9.05 - 9.40	307-0905	X	12
10	10.75	307-1075	X	12
	11.10 - 11.40	307-1110	X	12
12	12.75	307-1275	X	12
	13.20 - 13.50	307-1320	X	12

NOTE: Applications in which pipe may move out of the coupling, proper anchorage of the pipe must be provided.

Integral retainer set screws are available as an extra. Add (R) to end of catalog number.

NOTE: Restraining set screws are not for use on Asbestos Cement, HDPE or PVC pipe.

Epoxy coating and stainless steel bolts available.

Larger sizes available upon request



## JCM 309 Dismantling Joints

Dismantling joints simplify installations and replacement of flanged fittings in retrofitting applications. JCM 309 Dismantling Joints provide the solution for adding, repairing or replacing flanged fittings within a flanged pipe system. Adjustable, slip joint design accommodates either wide gaps or close quarter installations and eliminates the need for precise measurements between flange connections. Available in sizes 2" (50mm) and larger, for ductile iron or flanged steel pipe systems.

### MATERIAL SPECIFICATIONS - JCM 309 Dismantling Joint

- Flanged Adapter Body:** ASTM A36 or Ductile Iron ASTM A536
- Follower Flange:** AISI C1012, ASME SA36, or Ductile Iron ASTM A536
- Flange Extension:** Schedule 40 Steel Pipe
- Bolts:** Corrosion resistant, high strength low alloy ASTM A242, A193 B5, B7, Optional A193 B8 304 stainless steel or 316 stainless steel.
- Finish:** Heavy coat of corrosion resistant metal primer. Optional Fusion Applied Epoxy per ANSI/AWWA C213 available. Other coatings available.
- Gasket:** Nitrile - Specially compounded new rubber polymer for superior shelf life and resistance to permanent set per ASTM Recommended for water, salt solutions, mild acids, bases.
- Standard Flange:** ASME/ANSI B16.1 Class 125 Compatible Steel Ring Flange

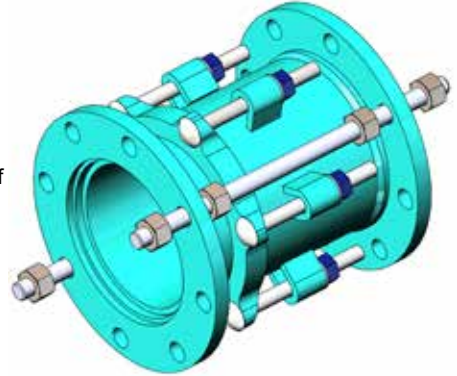

### Optional Flanges Available Upon Request:

ASME/ANSI B16.5 Class 150, 300  
Weld Neck, Blind, Slip-on, Reducing, Threaded,  
Socket Weld, Lap Joint, Angle Face, Van Stone  
Concentric and Eccentric Flanges

NOM PIPE SIZE* (IN)	CATALOG NUMBER	FLANGE AWWA CLASS D	NOMINAL (MID RANGE) (IN)	OPEN MAX (IN)	CLOSED MIN (IN)	BOLTS		RESTRAINT RODS/ STRAPS			APPROX WT EA (LBS)
						QTY	SIZE	QTY	SIZE	LENGTH	
3	309-3	3	11.00	12.00	10.00	4	5/8 x 6-1/2	2	5/8	16	34
4	309-4	4	11.00	12.00	10.00	4	5/8 x 6-1/2	2	5/8	16	47
6	309-6	6	11.50	12.50	10.50	6	5/8 x 6-1/2	2	3/4	18	65
8	309-8	8	11.50	13.00	10.50	6	5/8 x 6-1/2	2	3/4	18	102
10	309-10	10	12.00	13.00	11.00	8	5/8 x 6-1/2	2	7/8	18	125
12	309-12	12	12.00	13.00	11.00	8	5/8 x 6-1/2	2	7/8	18	150
14	309-14	14	13.00	14.50	11.50	8	5/8 x 6-1/2	4	1	24	175
16	309-16	16	13.00	14.50	11.50	10	5/8 x 6-1/2	4	1	24	212
18	309-18	18	13.50	15.00	12.00	10	5/8 x 6-1/2	6	1-1/8	24	250
20	309-20	20	13.50	15.00	12.00	12	5/8 x 6-1/2	6	1-1/8	24	380
24	309-24	24	14.75	16.50	13.00	14	5/8 x 6-1/2	6	1-1/4	26	425
30	309-30	30	14.75	16.50	13.00	16	5/8 x 6-1/2	6	1-1/4	24	590

\*2 inch available, contact JCM Industries for information  
 Sizes 14" and larger incorporate a strap restraint configuration. Other sizes available upon request.  
 Other flanges available upon request.  
 309 Dismantling Joints are priced on application. Contact JCM Sales Team.  
 Dismantling joints do not provide for lateral pipe movement.  
 309 Dismantling Joints rated for 150PSI. Higher pressure ratings available, contact JCM Industries.



## JCM 362 Fabricated Stainless Steel Flanged Coupling Adapter



The JCM 362 Fabricated Stainless Steel Flanged Adapter provides an economical solution to join a plain end piece of pipe to a flanged fitting. Constructed of Carbon Steel End Ring with resilient Fusion Plastic Coating, a 304 Stainless Steel middle ring, flange and hardware. The JCM 362 is prepared for the harshest of elements or corrosive line content - or both!

**For American Iron and Steel (AIS) Compliance, contact JCM Sales Team for price and availability. Adapter uses the popular and economical JCM G212 Transition Gasket System. Making transitions of the same nominal pipe size easy with just the change of gasket.**

NOM PIPE SIZE (IN)	FROM OD RANGE (IN)	TO FLANGE (IN)	CATALOG NUMBER	NO OF BOLTS	EFFECTIVE LENGTH (IN)	BOLT SIZE (IN)	APPR WT EA (LBS)
4	4.50	4	362-0450	4	5.63	5/8	20
4	4.80 - 5.10	4	362-0480	4	5.63	5/8	20
6	6.63	6	362-0663	5	5.63	5/8	26
6	6.90 - 7.20	6	362-0690	5	5.63	5/8	26
8	8.63	8	362-0863	6	5.63	5/8	36
8	9.05 - 9.40	8	362-0905	6	5.63	5/8	36
10	10.75	10	362-1075	7	5.63	5/8	47
10	11.10 - 11.40	10	362-1110	7	5.63	5/8	47
12	12.75	12	362-1275	8	5.63	5/8	56
12	13.20 - 13.50	12	362-1320	8	5.63	5/8	56

## JCM 362 Oversized Fabricated Stainless Steel Flanged Adapters

The JCM 362 Oversized Fabricated Stainless Steel Flanged Adapters provides an economical solution for joining old cast iron, larger classes of asbestos cement and other types of oversized pipe to flanged fittings. The 362 Oversized Fabricated Stainless Steel Flanged Adapter uses the popular and economical JCM G212 Transition Gasket System. Making transitions of the same nominal pipe size easy with just the change of gasket. **For American Iron and Steel (AIS) Compliance, contact JCM Sales Team for price and availability.**

NOM PIPE SIZE (IN)	FROM OD RANGE (IN)	TO FLANGE (IN)	CATALOG NUMBER	NO OF BOLTS	EFFECTIVE LENGTH (IN)	BOLT SIZE (IN)	APPR WT EA (LBS)
4	5.10 - 5.40	4	362-0535	4	5.63	5/8	20
6	7.20 - 7.55	6	362-0740	5	5.63	5/8	26
8	9.40 - 9.75	8	362-0960	6	5.63	5/8	36
10	11.60 - 12.05	10	362-1200	7	5.63	5/8	47
12	13.92 - 14.40	12	362-1420	8	5.63	5/8	56

Purchase orders for the JCM Industries, Inc 362 type FCA coupling signify an agreement between the manufacturer and customer that both parties agree to the JCM test procedure for meeting ANSI/AWWA C219 Standard for Bolted, Sleeve-Type Couplings for Plain-End Pipe. All couplings are pneumatically tested to a minimum of 25 PSI. Additional testing for certification purposes available upon request with additional charge.



**JCM 4362 All 304 Stainless Steel FCA**

**JCM 6362 All 316 Stainless Steel FCA**

**For All 304 Stainless Steel FCA - order Catalog Number Model 4362**

**For All 316 Stainless Steel FCA - order Catalog Number Model 6362**



## JCM Service Saddle Selection Guide

PRODUCT	NUMBER & TYPE	APPLICATION, SIZES AND INFORMATION
	402 Double Strap Service Saddle	Large outlet heavy duty double strap saddle. Sizes 2" - 24" with outlet sizes 1/2" - 2-1/2".
	408 Coated Double Strap Service Saddle	Coated saddle with electro-galvanized straps. Sizes 2" - 24" with outlet sizes 1/2" - 2-1/2".
	401 Single Strap Service Saddle	Single strap saddle with wrap around design utilizes single electro-galvanized strap. Sizes 2" - 12" with outlet sizes 1/2" - 2-1/2".
	407 Coated Single Strap Service Saddle	Coated saddle with electro-galvanized strap. Sizes 2" - 12" with outlet sizes 1/2" - 2-1/2".
	403 Wide Body Service Saddle	Single strap saddle with stainless steel band especially recommended for pipe requiring extra reinforcement. Sizes 2" - 12" with outlet sizes 1/2" - 2-1/2".
	405 Coated Wide Body Service Saddle	Single strap saddle, stainless steel band and fusion plastic coating for hot and corrosive soils. Sizes 2" - 12" with outlet sizes 1/2" - 2-1/2".
	404 Service Saddle with Double Stainless Steel Straps	Heavy duty saddle with two wide stainless steel straps for extra pipe support and corrosion resistance. Sizes 2" - 24" with outlet sizes 1/2" - 2-1/2".
	406 Coated Service Saddle with Double Stainless Steel Straps	Heavy duty saddle with two wide stainless steel straps and fusion plastic coating for hot and corrosive soils. Sizes 2" - 24" with outlet sizes 1/2" - 2-1/2".
	418 Threaded Outlet Tap Sleeve	For taps and connections on larger pipe, thin wall pipe and pipe requiring extra reinforcement. Sizes 4" - 60" with outlet sizes 1/2" - 4".
	438 All Stainless Threaded Outlet Tap Slv	All stainless steel construction, especially recommended for aggressive or corrosive environments. Sizes 4" - 60" with outlet sizes 1/2" - 4"
	425 Service Saddle for Concrete Steel Cylinder Pipe	For 3/4" - 2" taps and connections in 16" - 48" concrete steel cylinder pipe. Available for standard and embedded cylinder pipe.
	502 Stainless Steel Service Saddle	Stainless Steel Service Saddle of heavy duty construction and balanced bolt design for pipe support, bolt torque and gasket compression. Recommended for PS PVC, C-900 PVC, Ductile Iron, Cast Iron, Steel and other types of pipe. Not recommended for High Density Polyethylene Pipe (HDPE).

## JCM Service Saddles

JCM Service Saddles provide a quick, dependable means of tapping pipe for branch connections of 1/2" through 2-1/2". Use of economical JCM Service Saddles eliminate problems common to direct taps, such as leaking threads or split pipe, and reinforces the critical connection.

JCM Service Saddles are designed for maximum safety and performance. The wrap around design, wide skirt and wide straps support and reinforce the pipe while providing excellent stability to the saddle. The heavy duty design of these saddles provides strength and mass for long term service.

High pressure performance is assured by the broad,

pressure activated gasket. Permanently set in a retaining cavity, the contoured gasket produces a positive initial seal which increases with increase in line pressure.

The JCM 402, 404, 406, 408 saddles, with their wide bodies and large sealed outlet areas, provide an excellent means of repairing holes, pin holes and leaking 3/4" and 1" direct taps.

### DESIGNED FOR SAFETY AND PERFORMANCE

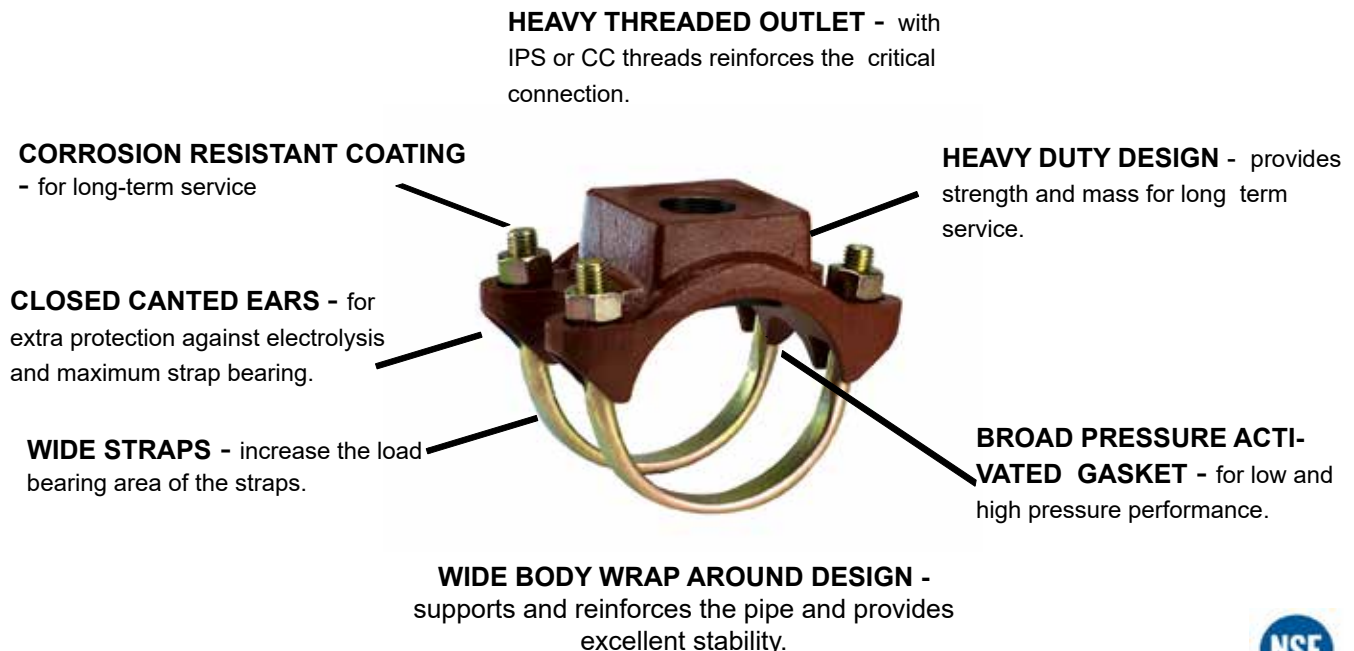

### MATERIAL SPECIFICATIONS - JCM SERVICE SADDLES

**Body:** Ductile Iron ASTM A536

**Straps:** **Models 401, 402, 407, 408** - Electro Galvanized Steel  
**Models 403, 404, 405, 406** - Bands, Bolts, Nuts and Washers are 18-8 Type 304 Stainless Steel.

**Gasket:** Nitrile Butadiene Rubber (NBR, Buna-N) per ASTM D2000. Molded virgin rubber with a pressure activated hydromechanical design. Gasket is bonded into a cavity for internal and external retention. Gasket temperature range -40°F to 212°F (-40°C - 100°C) Gasket suitable for water, salt solutions, mild acids, bases, and sewage. Optional EPDM gasket available.

**Finish:** **Models 401, 402, 403, 404** - Standard Shop Coat Primer: Heavy coat of corrosion resistant metal primer.

**Models 405, 406, 407, 408** - Fusion Plastic Coating: fusion bonded, high density blue plastic coating, 12 mils minimum thickness with a dielectric strength of over 12,000 volts.

# JCM 401 Single Strap Service Saddle with Electro Galvanized Strap

## JCM 403 Wide Body Service Saddle with Stainless Steel Strap

The **JCM 401 Single Strap Service Saddle** is designed for maximum safety, performance and economy. The wrap around design, broad, pressure activated gasket and corrosion electro galvanized steel strap provide for ease of installation, high pressure performance and a long service life.

The **JCM 403 Wide Body Service Saddle** utilizes an extra wide stainless steel strap with the broad, wrap around single strap saddle body to provide extra support and stability as well as to eliminate point loading. The 403 is especially recommended for PVC, thin wall pipe and pipe sensitive to point loading.

NOM PIPE SIZE (IN)	PIPE O.D. RANGE (IN)	APPR WT EACH (LBS)	CTN. QTY.	JCM 401 SERVICE SADDLE	JCM 403 SERVICE SADDLE
				CATALOG NUMBER X TAP CODE	CATALOG NUMBER X TAP CODE
2	2.35 - 2.63	2.5	12	*401-0238 X --	*403-0238 X --
2-1/2	2.70 - 3.13	3.0	12	*401-0288 X --	*403-0288 X --
3	3.25 - 3.50	3.0	12	*401-0350 X --	*403-0350 X --
3 - 4	3.80 - 4.13	3.0	12	N/A	*403-0413 X --
4	4.25 - 4.50	4.5	10	401-0450 X --	403-0450 X --
4	4.50 - 4.80	4.5	10	401-0480 X --	403-0480 X --
4	4.74 - 5.45	4.5	10	*401-0545 X --	*403-0545 X --
6	6.50 - 6.63	4.5	10	401-0663 X --	403-0663 X --
6	6.63 - 6.90	4.5	10	401-0690 X --	403-0690 X --
6	6.84 - 7.60	4.5	10	401-0745 X --	403-0745 X --
8	8.50 - 8.63	5.0	10	401-0863 X --	403-0863 X --
8	8.63 - 9.05	5.0	10	401-0905 X --	403-0905 X --
8	8.99 - 9.79	5.0	10	401-0963 X --	403-0963 X --
10	10.60 - 10.75	5.5	6	401-1075 X --	403-1075 X --
10	10.75 - 11.10	5.5	6	401-1110 X --	403-1110 X --
10	11.10 - 11.40	5.5	6	401-1140 X --	403-1140 X --
10	11.00 - 12.25	5.5	6	401-1225 X --	403-1225 X --
12	12.60 - 12.75	6.0	6	401-1275 X --	403-1275 X --
12	12.75 - 13.20	6.0	6	401-1320 X --	403-1320 X --
12	12.75 - 13.50	6.0	6	401-1350 X --	403-1350 X --
12	13.10 - 14.38	6.0	4	401-1426 X --	403-1426 X --

\*Not available in 1-1/4, 1-1/2, 2, 2-1/2 Outlets

### HOW TO ORDER

1. Determine O.D. of pipe, outlet type and thread type
2. Select proper model saddle, O.D. range, and tap order code
3. Refer to saddle listing to determine order number.
4. Add tap code after base catalog number.

Example: To fit Cast Iron pipe, 6.98 O.D. with 1"IP thread, order: 401-0745X08IP

For stainless steel strap, order 403-0745X08IP

OUTLET SIZES	TAP CODES IP	TAP CODES CC
1/2"	04	-
3/4"	06	07
1"	08	09
1-1/4"	10	11
1-1/2"	12	13
2"	14	15
2-1/2"	16	-

JCM 401



JCM 403



JCM 401/403 Strap Service Saddles with outlets 1-1/4" - 2-1/2"





# JCM 402 Double Strap Service Saddle

## JCM 404 Service Saddle with Double Stainless Steel Straps

The JCM 402 and 404 utilize the heavy duty double strap saddle body with corrosion resistant shop coat primer. The 402 is furnished with two electro galvanized straps sizes 2" -12", on sizes 15.20 and larger, the 402 incorporates two fabricated, wide electro galvanized steel straps. The 404 is furnished with two wide stainless steel straps.



NOM PIPE SIZE (IN)	PIPE O.D. RANGE (IN)	WT EA (LBS)	CTN. QTY.	JCM 402 SERVICE SADDLE	JCM 404 SERVICE SADDLE
				BASE CATALOG NUMBER X ADD TAP CODE	BASE CATALOG NUMBER X ADD TAP CODE
2	2.35 - 2.63	4	6	*402-0238 X --	*404-0238 X --
2-1/2	2.70 - 3.13	5	6	*402-0288 X --	*404-0288 X --
3	3.25 - 3.50	7	6	**402-0350 X --	**404-0350 X --
3 - 4	3.80 - 4.13	7	6	**402-0413 X --	**404-0413 X --
4	4.25 - 4.50	10	4	402-0450 X --	404-0450 X --
4	4.50 - 4.80	10	4	402-0480 X --	404-0480 X --
4	4.74 - 5.45	10	4	402-0545 X --	404-0545 X --
5	5.50 - 5.56	10	4	N/A	404-0556 X --
6	6.50 - 6.63	10	4	402-0663 X --	404-0663 X --
6	6.63 - 6.90	10	4	402-0690 X --	404-0690 X --
6	6.84 - 7.60	10	4	402-0745 X --	404-0745 X --
8	8.50 - 8.63	12	4	402-0863 X --	404-0863 X --
8	8.63 - 9.05	13	4	402-0905 X --	404-0905 X --
8	8.99 - 9.79	13	4	402-0963 X --	404-0963 X --
10	10.60 - 10.75	14	3	402-1075 X --	404-1075 X --
10	10.75 - 11.10	14	3	402-1110 X --	404-1110 X --
10	11.10 - 11.40	14	3	402-1140 X --	404-1140 X --
10	11.00 - 12.25	14	3	402-1225 X --	404-1225 X --
12	12.75 - 13.20	16	3	402-1320 X --	404-1320 X --
12	12.75 - 13.50	16	3	402-1350 X --	404-1350 X --
12	13.10 - 14.38	16	2	402-1426 X --	404-1426 X --
12 - 14	14.00 - 15.20	15	1	402-1520 X --	404-1520 X --
14	C-905 15.30	15	1	402-1530 X --	404-1530 X --
14 - 16	15.20 - 16.60	15	1	402-1660 X --	404-1660 X --
16	C-905 17.40	16	1	402-1740 X --	404-1740 X --
16 - 18	17.30 - 18.88	16	1	402-1888 X --	404-1888 X --
18	C-905 19.50	18	1	402-1950 X --	404-1950 X --
18 - 20	19.00 - 20.50	18	1	402-2050 X --	404-2050 X --
18 - 20	20.50 - 21.50	18	1	402-2125 X --	404-2125 X --
20	C-905 21.60	20	1	402-2160 X --	404-2160 X --
20	21.35 - 22.60	20	1	402-2260 X --	404-2260 X --
20	22.50 - 23.70	20	1	402-2370 X --	404-2370 X --
24	23.75 - 25.25	20	1	402-2525 X --	404-2525 X --
24	C-905 25.80	20	1	402-2580 X --	404-2580 X --
24	25.50 - 26.50	20	1	402-2650 X --	404-2650 X --

OUTLET SIZES	TAP CODES IP	TAP CODES CC
1/2"	04	-
3/4"	06	07
1"	08	09
1-1/4"	10	11
1-1/2"	12	13
2"	14	15
2-1/2"	16	-

\*Outlets Not available in 1-1/4", 1-1/2", 2" or 2-1/2"

\*\*Outlets Not available in 2" CC or 2-1/2" IP

### HOW TO ORDER

1. Determine O.D. of pipe, outlet type and thread type
2. Select proper model saddle, O.D. range, and tap order cod
3. Refer to saddle listing to determine order number.
4. Add tap code after base catalog number.

Example: To fit Cast Iron pipe, 6.98 O.D. with 1"IP thread, order: 402-0745X08IP  
For stainless steel straps, order 404-0745X08IP

# JCM 405 Single Strap Service Saddle with Stainless Steel Strap JCM 407 Wide Body Service Saddle with Electro Galvanized Strap

The **JCM 405 Coated Wide Body Service Saddle with Stainless Steel Strap** is designed for maximum safety and performance in tapping all types of pipe in hot and corrosive soils. Extra corrosion resistance is built into this saddle with the heavy resilient plastic coating which is fusion applied to the saddle body.

The **JCM 407 Coated Wide Body Service Saddle** utilizes an electro galvanized steel strap with the broad, wrap around single strap saddle body. The 407 features the extra corrosion resistance is built into this saddle with the heavy resilient plastic coating which is fusion applied to the saddle body.

NOM PIPE SIZE (IN)	PIPE O.D. RANGE (IN)	APPR WT EACH (LBS)	CTN. QTY.	JCM 405 SERVICE SADDLE	JCM 407 SERVICE SADDLE
				CATALOG NUMBER X TAP CODE	CATALOG NUMBER X TAP CODE
2	2.35 - 2.63	2.5	12	*405-0238 X --	*407-0238 X --
2-1/2	2.70 - 3.13	3.0	12	*405-0288 X --	*407-0288 X --
3	3.25 - 3.50	3.0	12	*405-0350 X --	*407-0350 X --
3 - 4	3.80 - 4.13	3.0	12	*405-0413 X --	N/A
4	4.25 - 4.50	4.5	10	405-0450 X --	*407-0450 X --
4	4.50 - 4.80	4.5	10	405-0480 X --	407-0480 X --
4	4.74 - 5.45	4.5	10	*405-0545 X --	*407-0545 X --
6	6.50 - 6.63	4.5	10	405-0663 X --	407-0663 X --
6	6.63 - 6.90	4.5	10	405-0690 X --	407-0690 X --
6	6.84 - 7.60	4.5	10	405-0745 X --	407-0745 X --
8	8.50 - 8.63	5.0	10	405-0863 X --	407-0863 X --
8	8.63 - 9.05	5.0	10	405-0905 X --	407-0905 X --
8	8.99 - 9.79	5.0	10	405-0963 X --	407-0963 X --
10	10.60 - 10.75	5.5	6	405-1075 X --	407-1075 X --
10	10.75 - 11.10	5.5	6	405-1110 X --	407-1110 X --
10	11.10 - 11.40	5.5	6	405-1140 X --	407-1140 X --
10	11.00 - 12.25	5.5	6	405-1225 X --	407-1225 X --
12	12.60 - 12.75	6.0	6	405-1275 X --	407-1275 X --
12	12.75 - 13.20	6.0	6	405-1320 X --	407-1320 X --
12	12.75 - 13.50	6.0	6	405-1350 X --	407-1350 X --
12	13.10 - 14.38	6.0	4	405-1426 X --	407-1426 X --

\*Not available in 1-1/4, 1-1/2, 2, 2-1/2 Outlets

## HOW TO ORDER

1. Determine O.D. of pipe, outlet type and thread type
2. Select proper model saddle, O.D. range, and tap order cod
3. Refer to saddle listing to determine order number.
4. Add tap code after base catalog number.

Example: To fit Cast Iron pipe, 6.98 O.D. with 1"IP thread, order: 405-0745X08IP

For electro galvanized strap, order 407-0745X08IP

OUTLET SIZES	TAP CODES IP	TAP CODES CC
1/2"	04	-
3/4"	06	07
1"	08	09
1-1/4"	10	11
1-1/2"	12	13
2"	14	15
2-1/2"	16	-

JCM 405



JCM 407



JCM 405/407 Strap Service Saddles with outlet sizes 1-1/4" - 2-1/2"



## JCM 406 Coated Saddle - Double Stainless Steel Straps

## JCM 408 Coated Saddle - Electro Galvanized Straps

The JCM 406 and 408 utilize the heavy duty double strap saddle body with a fusion applied, heavy resilient plastic coating. The JCM 406 is furnished with two stainless steel straps. The model 408 is furnished with two electro galvanized steel straps.



NOM PIPE SIZE (IN)	PIPE O.D. RANGE (IN)	WT EA LBS.	CTN. QTY.	JCM 406 SERVICE SADDLE	JCM 408 SERVICE SADDLE
				BASE CATALOG NUMBER X ADD TAP CODE	BASE CATALOG NUMBER X ADD TAP CODE
2	2.35 - 2.63	4	6	*406-0238 X --	*408-0238 X --
2-1/2	2.70 - 3.13	5	6	*406-0288 X --	*408-0288 X --
3	3.25 - 3.50	7	6	**406-0350 X --	**408-0350 X --
3 - 4	3.80 - 4.13	7	6	**406-0413 X --	**408-0413 X --
4	4.25 - 4.50	10	4	406-0450 X --	408-0450 X --
4	4.50 - 4.80	10	4	406-0480 X --	408-0480 X --
4	4.74 - 5.45	10	4	406-0545 X --	408-0545 X --
5	5.50 - 5.56	10	4	406-0556 X --	N/A
6	6.50 - 6.63	10	4	406-0663 X --	408-0663 X --
6	6.63 - 6.90	10	4	406-0690 X --	408-0690 X --
6	6.84 - 7.60	10	4	406-0745 X --	408-0745 X --
8	8.50 - 8.63	12	4	406-0863 X --	408-0863 X --
8	8.63 - 9.05	13	4	406-0905 X --	408-0905 X --
8	8.99 - 9.79	13	4	406-0963 X --	408-0963 X --
10	10.60 - 10.75	14	3	406-1075 X --	408-1075 X --
10	10.75 - 11.10	14	3	406-1110 X --	408-1110 X --
10	11.10 - 11.40	14	3	406-1140 X --	408-1140 X --
10	11.00 - 12.25	14	3	406-1225 X --	408-1225 X --
12	12.75 - 13.20	16	3	406-1320 X --	408-1320 X --
12	12.75 - 13.50	16	3	406-1350 X --	408-1350 X --
12	13.10 - 14.38	16	2	406-1426 X --	408-1426 X --
12 - 14	14.00 - 15.20	15	1	406-1520 X --	408-1520 X --
14	C-905 15.30	15	1	406-1530 X --	408-1530 X --
14 - 16	15.20 - 16.60	15	1	406-1660 X --	408-1660 X --
16	C-905 17.40	16	1	406-1740 X --	408-1740 X --
16 - 18	17.30 - 18.88	16	1	406-1888 X --	408-1888 X --
18	C-905 19.50	18	1	406-1950 X --	408-1950 X --
18 - 20	19.00 - 20.50	18	1	406-2050 X --	408-2050 X --
18 - 20	20.50 - 21.50	18	1	406-2125 X --	408-2125 X --
20	C-905 21.60	20	1	406-2160 X --	408-2160 X --
20	21.35 - 22.60	20	1	406-2260 X --	408-2260 X --
20	22.50 - 23.70	20	1	406-2370 X --	408-2370 X --
24	23.75 - 25.25	20	1	406-2525 X --	408-2525 X --
24	C-905 25.80	20	1	406-2580 X --	408-2580 X --
24	25.50 - 26.50	20	1	406-2650 X --	408-2650 X --

OUTLET SIZES	TAP CODES IP	TAP CODES CC
1/2"	04	-
3/4"	06	07
1"	08	09
1-1/4"	10	11
1-1/2"	12	13
2"	14	15
2-1/2"	16	-

\*Outlets Not available in 1-1/4", 1-1/2", 2" or 2-1/2"  
\*\*Outlets Not available in 2" CC or 2-1/2" IP

### HOW TO ORDER

1. Determine O.D. of pipe, outlet type and thread type
2. Select proper model saddle, O.D. range, and tap order cod
3. Refer to saddle listing to determine order number.
4. Add tap code after base catalog number.

Example: To fit Cast Iron pipe, 6.98 O.D. with 1"IP thread, order: 406-0745X08IP  
For electro galvanized strap, order 408-0745X08IP

# JCM 425 Service Saddle for Concrete Steel Cylinder Pipe

## Service Saddle for 3/4" through 2" Taps and Connections on Concrete Steel Cylinder Pipe, Reinforced Concrete Pipe, Large Diameter Cast Iron and Ductile Iron.

The JCM 425 Service Saddle is specifically designed for making safe, dependable taps into Concrete Steel Cylinder Pipe and Concrete Coated Steel Pipe. The threaded outlet, available in sizes 3/4" through 2" IP or CC, provides critical reinforcement to branch connections for service lines. These saddles can also be used to install air and vacuum valves, pitot tubes, injection lines and other equipment.

The following are important features and benefits this saddle offers:

**Provides critical reinforcement** of pipe prior to removal of the prestress wire from the outlet area. This is a required feature to maintain pipe integrity on larger taps and many small taps. The separate bolt-in outlet makes possible this essential installation step.

The **adjustable outlet** accommodates variation in concrete coating from no coating to a thickness of 1-1/8". Special outlets are available for embedded cylinder pipe and thicker coatings of concrete.

**High and low pressure performance are assured** by a broad, pressure-activated gasket. Permanently set in a retaining cavity, the contoured gasket produces a positive initial seal which increases with increases in line pressure.



For coating thickness of 1-1/8" or less.



For coating thickness of over 1-1/8".  
Outlet for Embedded Cylinder Pipe.

### 425 SERVICE SADDLE FOR CONCRETE STEEL CYLINDER PIPE

NOM PIPE SIZE (IN)	CONCRETE O.D. RANGE (IN)	STEEL CYLINDER O.D.* RANGE (IN)	CATALOG NUMBER X TAP CODE	APPROX. WT EA (LBS)
16	19.25 - 20.15	17.25 - 20.15	425-2015 X --	50
18	21.75 - 22.75	19.50 - 22.75	425-2275 X --	50
20	23.64 - 24.65	21.70 - 24.65	425-2465 X --	50
24	27.62 - 29.15	25.75 - 29.15	425-2915 X --	50
30	33.88 - 35.75	31.88 - 35.75	425-3575 X --	60
36	39.75 - 41.00	37.75 - 41.00	425-4100 X --	70
36	41.50 - 43.00	40.50 - 43.00	425-4300 X --	70
42	45.75 - 47.25	43.75 - 47.25	425-4725 X --	85
42	48.00 - 49.50	46.00 - 49.50	425-4950 X --	85
48	51.50 - 53.00	49.50 - 53.00	425-5300 X --	100
48	55.38 - 56.50	53.40 - 56.50	425-5650 X --	100

OUTLET TAP CODES		
OUTLET SIZE	IP THREAD	CC THREAD
3/4"	06	07
1"	08	09
1-1/4"	10	11
1-1/2"	12	13
2"	14	15



\*Longer outlet bolts are required for making taps on pipe with less than 1/4" coating

### MATERIAL SPECIFICATIONS - JCM 425 SERVICE SADDLE FOR CONCRETE STEEL CYLINDER PIPE

- Body, Outlet, Washers:** Ductile Iron ASTM A536
- Outlet Bolts:** Corrosion resistant, high strength, low alloy (AWWA C111, ANSI 21.11)
- Straps:** Steel per ASTM A36. Optional Stainless Steel 18-8 Type 304.
- Gasket:** Buna-N compounded for use with water, salt solutions, mild acids, bases, gas.
- Coating:** Heavy coating of corrosion resistant shop coat primer. Optional Fusion Epoxy Coating available.

### Grout Diapers for Service Saddles

These diapers make the recommended grouting of the service saddle a very quick procedure. Diapers are 11" wide with two 5/8" straps and are constructed of one layer of Typar backed by a 6 mil ply of polyethylene film. Order by pipe size.

GROUT DIAPERS	CATALOG
SADDLE SIZE	NUMBER
16" - 24"	89106
30" - 36"	89107
42" - 48"	89108

## Selection and Application of Service Saddles

JCM Industries provides guidance and recommendations for ideal applications for our products. Many JCM products have certain design features that are more suitable for specific types of pipe and their working characteristics. In the waterworks industry product selection and use, many times, is mandated by local specifications, competitive pricing, delivery times and, ultimately, the end user's preference. JCM's application recommendations are based on product design benefits, pipe working characteristics, general installation parameters and more than 50 years experience in the waterworks industry.

Service saddles are an alternative to direct tapping pipe and cut-in tees. Saddles available in the current market are furnished in ductile iron, malleable iron, bronze, brass and stainless steel with a variety of designs and styles. Some designs focus specifically on certain types of pipe and its characteristics while other designs offer a broader scope of application. Following are the JCM Industries fittings' design concepts and recommendations.



To start the JCM Service Saddle Models share a specific feature – a broad, hydromechanical-lip gasket of an acceptable durometer captured in a recessed groove around the outlet. The key working feature of a service saddle is the gasket which provides the watertight seal around the outlet area.

### ***What is a Hydromechanical Lip?***

Commonly used gaskets in the pipe fitting industry include an “O-Ring” design - simply put - this is a generic gasket that has limited capabilities in certain applications. By definition, an O-Ring is a gasket consisting of a round ring of rubber or plastic; used to seal a joint against high pressure. They are found in all types of applications ranging from blenders to SCUBA equipment; auto parts to space shuttle construction. These gaskets are usually installed on smooth or machined surfaces. Our reference will be restricted to the water works industry.

Depending on their size, standard “O-Ring” gaskets have inadequate material for pipe to gasket contact, provide little (if any) ability to store energy and in some designs cause a high profile stance of the fitting on the pipe - allowing for gasket “displacement” or blow out. JCM incorporates a broad, hydromechanical lip in the molded gasket design. This “lip” is a feathered edge that tapers into the waterway area of the branching fitting and furnishes a smooth, wide intersection at gasket to pipe contact location.



### ***Here's how it works.***

The fitting is installed on the pipe per installation instructions. The broad cross section and hydromechanical lip of the gasket will seal against the surface of the pipe creating a large footprint of gasket around the outlet area. As the pipe is tapped, line content (let's assume water) will fill the outlet area. As the cavity of the outlet fills with water, it (the water) will create a pressure on the inside diameter of the gasket, putting pressure on the feathered edge, compressing it against the pipe. This is the mechanical theory of “increases sealing pressure with increasing line pressure” the more pressure created in the outlet cavity, the greater the pressure on the hydromechanical lip against the pipe surface. This also works well inhibiting surges, hammers and vacuums.

JCM incorporates this gasket design with the internal groove in the metal pipe fitting which:

- Traps the gasket internally/externally to prevent gasket displacement or blow out.
- Lowers the profile of the fitting on the pipe to trap the gasket in the groove, thus preventing gasket displacement and increasing high pressure holding capability.
- Prevents the gasket from being torn from its seat during installation (provided all installation instructions are followed).

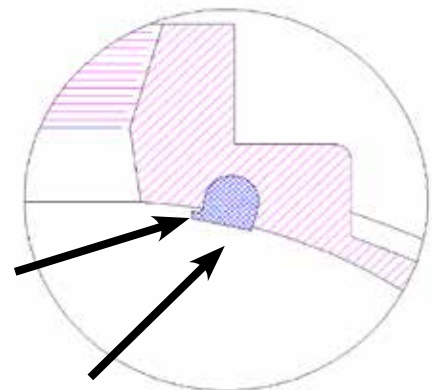

## JCM Model 502 Stainless Steel Service Saddle

The JCM 502 Stainless Steel Service Saddle is engineered with the pipe in mind. Heavy duty construction with balanced bolt design provides the pipe support, bolt torque and gasket compression necessary for a successful, long term saddle installation.

Recommended for IPS PVC, C-900 PVC, Ductile Iron, Cast Iron, Steel and other types of pipe. Not recommended for High Density Polyethylene Pipe (HDPE).

Durable bolting unit comprised of fabricated, interlocking finger lugs, 5/8" stainless steel studs, structurally designed lift bar and welded plates join together to provide torque values to efficiently compress the gasket without damage to the pipe wall.

Nuts furnished with anti-seize coating to prevent galling of hardware during installation.

Heavyweight threaded stainless steel outlet is available with IP/NPT or CC threads. Meets ANSI/AWWA C800

JCM 502 Service Saddle pressure rating:  
200 PSI Working Pressure  
225 PSI Test Pressure

Standard 8" width through all sizes provides maximum pipe support.

Environmentally friendly passivation of the 304 Stainless Steel fabrication ensures a return to the stainless steel's natural corrosion resistant state to last the life of the pipeline. Per ASTM A380.

Full circumferential stainless steel band provides utmost corrosion resistance and support to the pipe wall both at the tap location and the backside of the pipe wall. Per ASTM A240.

Raised outlet gasket with molded channels for maximum watertight contact between fitting and pipe wall.

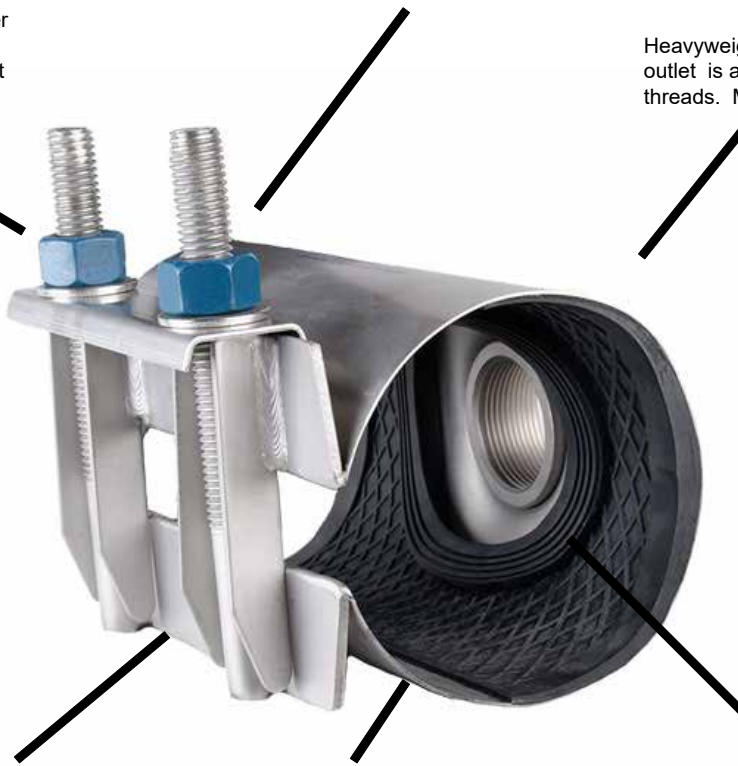

**JCM 502 Stainless Steel Service Saddles**  
**All 304 Stainless Steel Construction**



NOMINAL PIPE SIZE (IN)	PIPE O.D. RANGE (IN)	SADDLE NUMBER X OUTLET ORDER CODE	SADDLE WIDTH (IN)	AVAILABLE OUTLETS 3/4" & 1"	AVAILABLE OUTLETS 1-1/4" - 2"	APPROX. WEIGHT (LBS)
2	2.38	502-0238 x --	8	•	N/A	2.0
2-1/2	2.63 - 2.88	502-0288 x --	8	•	N/A	2.5
3	3.13 - 3.50	502-0350 x --	8	•	N/A	3.0
3 - 4	3.80 - 4.13	502-0413 x --	8	•	N/A	3.5
4	4.50 - 4.80 4.80 - 5.20	502-0480 x -- 502-0500 x --	8 8	• •	• •	4.3
6	6.63 - 6.90 6.90 - 7.30	502-0690 x -- 502-0710 x --	8 8	• •	• •	6.0
8	8.63 - 9.05 9.05 - 9.45	502-0905 x -- 502-0940 x --	8 8	• •	• •	8.5
10	10.75 - 11.10 11.70 - 12.10	502-1110 x -- 502-1175 x --	8 8	• •	• •	10.0
12	12.75 - 13.20 14.00 - 14.40	502-1320 x -- 502-1400 x --	8 8	• •	• •	13.0

\*502-048x15CC (2" CC) Not available

Available sizes listed only.

502 Service Saddles are made to order and are non-returnable items.

OUTLET SIZE	IP ORDER CODE	CC ORDER CODE
3/4"	06	07
1"	08	09
1-1/4"	10	11
1-1/2"	12	13
2"	14	15

502 SADDLE NUMBER	OUTLET SIZES AVAILABLE	IP/CC
502-0238 thru 502-0413	3/4 - 1	IP/CC
502-0480 thru 502-1320	3/4" thru 2"	IP/CC

**2" CC Threaded Saddles are Non-Returnable Items**

**MATERIAL SPECIFICATIONS - JCM 502 STAINLESS STEEL SERVICE SADDLE**

- Band:** 18-8 Type 304 Stainless Steel. Per ASTM A240
- Outlet:** 18-8 Type 304 Stainless Steel Threaded Half Coupling. Meets ANSI/AWWA C800 as applicable.
- Bolting Assembly:** 18-8 Type 304 Stainless Steel. Per ASTM A240
- Lifter Bar:** 18-8 Type 304 Stainless Steel. Per ASTM A240
- Fasteners:** 18-8 Type 304 Stainless Steel.
- Gasket:** EPDM - excellent resistance to aging factors including ozone, oxygen, elevated temperatures and fluctuations in weather. Recommended for service in hot water, steam and dry heat. Most popular application on chloramine. Suitable for other popular chemicals - ketones, alcohols, phosphate ester hydraulic fluids, glycols, dilute acids and alkalis. Maximum temperature 300°F wet. Not suitable for petroleum.

**Pressure Rating:** 200 PSI Working Pressure, 225 PSI Test Pressure

Recommended For:

IPS PVC, C-900 PVC, Ductile Iron, Cast Iron, Steel and other types of pipe.

Not recommended for High Density Polyethylene Pipe (HDPE).

Environmentally friendly passivation of the 304 Stainless Steel fabrication ensures a return to the stainless steel's natural corrosion resistant state to last the life of the pipeline. Per ASTM A380.

Not available in 316 Stainless Steel.

# JCM 418 Threaded Outlet Tapping Sleeve

For taps and connections on larger pipe, thin wall pipe and pipe requiring extra reinforcement.



The JCM 418 Fabricated Threaded Outlet Tapping Sleeve is especially recommended for service connections, air relief valve connections, taps on larger A/C, Cast Iron, Ductile Iron, PVC and Reinforced Concrete Pipe. The heavy gasket section and full sleeve support of this fitting offer much more stability, pipe reinforcement and strength than a strapped saddle, yet they are competitively priced. Readily available for pipe 4" and larger requiring IPS outlets of 3/4" through 4", these sleeves are furnished with shop coat and alloy bolts. Epoxy coating and stainless steel bolts are available at an additional charge.

## HOW TO ORDER

1. Determine O.D. of pipe, outlet type and thread type
2. Select proper model sleeve, O.D. range, and tap order code
3. Refer to sleeve listing to determine order number.
4. Add tap code after base catalog number.

Example: To fit Cast Iron pipe, 6.90 O.D. with 1"IP thread, order: 418-0690X08IP

For epoxy coating, add (E), for stainless steel hardware, add (SS): 418-0690X08IPESS

## 418 Fabricated Threaded Outlet Tapping Sleeve

NOM PIPE SIZE (IN)	SLEEVE O.D. RANGE (IN)	CATALOG NUMBER X OUTLET SIZE	APPR WT EACH (LBS)
2	*2.38	418-0238 X --	12
	*2.50	418-0250 X --	12
3	3.50	418-0350 X --	18
	3.96	418-0396 X --	18
4	4.50	418-0450 X --	21
	4.80	418-0480 X --	21
6	6.63	418-0663 X --	23
	6.90	418-0690 X --	23
8	8.63	418-0863 X --	31
	9.05	418-0905 X --	33
10	10.75	418-1075 X --	38
	11.10	418-1110 X --	40
12	12.75	418-1275 X --	48
	13.20	418-1320 X --	51
14	14.59 - 15.08	418-1475 X --	54
	15.23 - 15.80	418-1530 X --	57
	16.30 - 16.73	418-1650 X --	60
16	17.33 - 17.87	418-1740 X --	64
	18.62 - 19.19	418-1875 X --	68
18	19.41 - 20.01	418-1950 X --	72
	20.93 - 21.57	418-2130 X --	77
20	21.51 - 22.15	418-2160 X --	80
	23.46 - 24.16	418-2400 X --	87
24	25.71 - 26.41	418-2580 X --	95
	28.14 - 28.84	418-2834 X --	104
30	31.62 - 32.22	418-3200 X --	115
36	38.10 - 38.75	418-3830 X --	139
42	44.10 - 44.70	418-4450 X --	160
48	50.40 - 51.00	418-5080 X --	183
54	56.60 - 57.25	418-5710 X --	205

OUTLET SIZE	IP ORDER CODE	CC ORDER CODE
3/4"	06	07
1"	08	09
1-1/4"	10	11
1-1/2"	12	13
2"	14	15
3"	17	N/A
4"	18	N/A

OTHER SIZES AVAILABLE UPON REQUEST.

\*2" Steel & Cast Iron Pipe Only

Available Options for JCM 418:

- Epoxy Coated
- Stainless Steel Hardware
- Male Threaded Outlet





# JCM 438 All 304 Stainless Steel Threaded Outlet Tapping Sleeve

For taps and connections on larger pipe, thin wall pipe and pipe requiring extra reinforcement in corrosive or aggressive conditions.

The JCM 438 All Stainless Steel Threaded Outlet Tapping Sleeve is especially recommended for aggressive or acidic conditions. The heavy gasket section and full sleeve support of this fitting offer much more stability, pipe reinforcement and strength than a strapped saddle, yet they are competitively priced. Readily available for pipe 4" and larger requiring IPS outlets of 3/4" through 4".



## HOW TO ORDER

1. Determine O.D. of pipe, outlet type and thread type
2. Select proper model sleeve, O.D. range, and tap order code
3. Refer to sleeve listing to determine order number.
4. Add tap code after base catalog number.

Example: To fit Cast Iron pipe, 6.90 O.D. with 1"IP thread, order: 438-0690X08IP

For all 316 stainless steel sleeve, order: 6438-0690X08IP

## 438 All Stainless Steel Threaded Outlet Tapping Sleeve

NOM PIPE SIZE (IN)	SLEEVE O.D. RANGE (IN)	CATALOG NUMBER X OUTLET SIZE	APPR WT EACH (LBS)
3	3.50	438-0350 X --	19
	3.96	438-0396 X --	19
4	4.50	438-0450 X --	21
	4.80	438-0480 X --	21
6	6.63	438-0663 X --	23
	6.90	438-0690 X --	23
8	8.63	438-0863 X --	31
	9.05	438-0905 X --	33
10	10.75	438-1075 X --	38
	11.10	438-1110 X --	40
12	12.75	438-1275 X --	48
	13.20	438-1320 X --	51
14	14.59 - 15.08	438-1475 X --	54
	15.23 - 15.80	438-1530 X --	57
	16.30 - 16.73	438-1650 X --	60
16	17.33 - 17.87	438-1740 X --	64
	18.62 - 19.19	438-1875 X --	68
18	19.41 - 20.01	438-1950 X --	72
	20.93 - 21.57	438-2130 X --	77
20	21.51 - 22.15	438-2160 X --	80
	23.46 - 24.16	438-2400 X --	87
24	25.71 - 26.41	438-2580 X --	95
	28.14 - 28.84	438-2834 X --	104
30	31.62 - 32.22	438-3200 X --	115
36	38.10 - 38.75	438-3830 X --	139
42	44.10 - 44.70	438-4450 X --	160
48	50.40 - 51.00	438-5080 X --	183
54	56.60 - 57.25	438-5710 X --	205

OTHER SIZES AVAILABLE UPON REQUEST.

Available Options for JCM 438:

- JCM Model 6438 All 316 Stainless Steel Tapping Sleeve
- EPDM Gasket
- Male Threaded Outlet

OUTLET SIZE	IP ORDER CODE	CC ORDER CODE
3/4"	06	07
1"	08	09
1-1/4"	10	11
1-1/2"	12	13
2"	14	15
3"	17	N/A
4"	18	N/A



# JCM TAPPING SLEEVES

## MORE SELECTION, BENEFITS, OPTIONS

Specifying the right tapping sleeve for the condition of the job is the best way to assure a successful tap. JCM Tapping Sleeves are readily available in a wide variety of types and options to meet your exact conditions. High strength to weight ratio, built-in range and large gasket cross sections are just some of the design features that make JCM Tapping Sleeve highly desirable on critical installations.



JCM's expanded tapping sleeve selections and versatility assist our customers in selecting the correct JCM Model Tapping Sleeve for the job. Below is a chart that defines each tapping sleeve offering, its body material, design and gasket style along with the outlet material and style.

For specialty, engineered tapping sleeves, refer to the JCM Industries Engineered Fittings Specification Manual. This manual includes: mechanical joint tapping sleeves, concrete steel cylinder pipe tapping sleeves, large diameter and unique contour sleeves along with numerous options and designs.



### JCM Tapping Sleeve Selection Chart

JCM Model Number	Body Material	Gasket Style	Outlet Material	Outlet Style
418	Carbon Steel	Outlet Seal	Carbon Steel	Threaded Outlet
438	304 Stainless Steel	Outlet Seal	304 Stainless Steel	Threaded Outlet
412	Carbon Steel	Outlet Seal	Carbon Steel	Flanged
419	Carbon Steel	Outlet Seal	Carbon Steel	Mechanical Joint
422	Carbon Steel	Outlet Seal	Carbon Steel	Flanged
429	Carbon Steel	Outlet Seal	Carbon Steel	Mechanical Joint
432	304 Stainless Steel	Full Circumferential	304 Stainless Steel	Flanged
439	304 Stainless Steel	Full Circumferential	304 Stainless Steel	Mechanical Joint
462	304 Stainless Steel	Full Circumferential	Carbon Steel	Flanged
469	304 Stainless Steel	Full Circumferential	Carbon Steel	Mechanical Joint
452	304 Stainless Steel	Outlet Seal	304 Stainless Steel	Flanged
459	304 Stainless Steel	Outlet Seal	304 Stainless Steel	Mechanical Joint
464	304 Stainless Steel	Outlet Seal	Carbon Steel	Flanged
465	304 Stainless Steel	Outlet Seal	Carbon Steel	Mechanical Joint
6432	316 Stainless Steel	Full Circumferential	316 Stainless Steel	316 Flanged
6439	316 Stainless Steel	Full Circumferential	316 Stainless Steel	316 Mechanical Joint
6438	316 Stainless Steel	Outlet Seal	316 Stainless Steel	316 Threaded Outlet
6452	316 Stainless Steel	Outlet Seal	316 Stainless Steel	316 Flanged
6459	316 Stainless Steel	Outlet Seal	316 Stainless Steel	316 Mechanical Joint

## JCM Carbon Steel Fabricated Tapping Sleeve Selection Guide



PRODUCT	NUMBER & TYPE	APPLICATION, SIZES AND INFORMATION
	<p>411 Plain Outlet Sleeve</p>	<p>Most economical sleeve for dry taps and connections to be made without a valve. Also excellent as a base sleeve for special sleeves. Available with reducing and size on size outlets for all types of pipe, 6" and larger.</p>
	<p>412 Flanged Outlet Tapping Sleeve</p> <p>422 Flanged Outlet Tapping Sleeve for PVC &amp; Steel Pipe</p> <p>413 Flanged Outlet Tapping Cross</p>	<p>The standard sleeve for quick, economical taps on all types of pipe, standard or high pressure service. Most available of all types in standard or special sizes. Available with reducing and size on size outlets, pipe sizes 6" and larger. Special outlets readily available.</p> <p>Specially designed tapping sleeve for the exact O.D. of steel pipe, IPS PVC and C-900. Sizes 4" -12".</p> <p>Quick economical cross for all types of pipe 8" and larger. Outlets must be minimum of three nominal sizes smaller than run. Made similar to the 412, the sleeve length is extended to provide more pipe support.</p>
	<p>414 Mechanical Joint Tapping Sleeve &amp; Cross</p>	<p>The sleeve with side and end gaskets to provide extra margin of safety on lines which are subject to problems of beam loads. Available with size on size and reducing outlets. Competitive with cast sleeves in larger and special sizes. Excellent availability.</p>
	<p>415 Concrete Steel Cylinder Tapping Sleeve</p>	<p>Designed to tap all types and brands of concrete steel cylinder pipe. Sleeve reinforces pipe prior to cutting of pipe reinforcing rod. Extra heavy retained gasket and easily installed gland provide a locked in, positive seal. Available with reducing outlets in pipe sizes 16" and larger.</p>
	<p>416 Weld On Outlets</p> <p>417 Weld on Tapping Sleeve</p>	<p>Outlets, partial sleeves and complete sleeves for pipe sizes 6" and larger with size on size and reducing outlets. These outlets are designed for steel pipe with wall thickness of 1/4" and greater.</p> <p>Split weld on sleeve designed to reinforce pipe to be tapped. Standard sleeve thickness 1/4".</p>

## JCM Carbon Steel Fabricated Tapping Sleeve Selection Guide

PRODUCT	NUMBER & TYPE	APPLICATION, SIZES AND INFORMATION
	<p>418 Threaded Outlet Tapping Sleeve</p>	<p>For taps and connections in larger sizes of pipe (service connections, taps for air relief valves). Heavy gasket section and full sleeve offer better performance than strapped saddle, yet competitively priced. Available with IPS outlets, pipe sizes 4" and larger, outlets 3/4" - 4", in standard shopcoat alloy bolts or epoxy coated/stainless steel bolts.</p>
	<p>419 Fabricated Carbon Steel Tapping Sleeve with Mechanical Joint Outlet</p> <p>429 Fabricated Carbon Steel Tap Sleeve with MJ Outlet for IPS PVC, C-900 PVC and Steel Pipe sizes</p>	<p>Fabricated Carbon Steel Tapping Sleeve with TRUE Mechanical Joint Outlet. Durable construction, and alignment set pins provides a competitive option for using MJ valves in lieu of tapping valves. Available in shopcoat or epoxy, standard or stainless steel hardware. Sizes 4" and larger up through 12" outlets. JCM 429 is provided standard epoxy coated.</p> <p>JCM Mechanical Joint Outlets meet AWWA C-111/ANSI 21.11 Standard Dimensions</p>
	<p>440 Line Stop Fitting</p>	<p>Largest selection of options in the industry. Available in all JCM sleeve body/material combinations with options of threaded plug or push pin plug.</p> <p>Designed for use on 150 PSI piping systems, the heavier materials and extra bolting power built into these sleeves eliminate flexing and provides extra sealing capability necessary for long term performance. The heavy all stainless construction and full circumferential sealing gasket means these non-compromising sleeves will be trouble free and become a permanent part of the piping system just as the mechanical joint fittings already in use.</p> <p>Carbon Steel Stainless Steel Combination Stainless/Carbon</p>



**JCM Tapping Sleeves meet or exceed the ANSI/AWWA C223 and the MSS-SP 124 Standards as applicable.**

## JCM Stainless Steel (304) Tapping Sleeve Selection Guide

PRODUCT	NUMBER & TYPE	APPLICATION, SIZES AND INFORMATION
	438 All 304 Stainless Steel Threaded Outlet Tapping Sleeve	All stainless steel construction for taps and connections of larger sizes of pipe in corrosive, acidic environments. The 438 is available construction of either 304 or 316 Stainless Steel. Heavy gasket section and full sleeve offer better performance than strapped saddle, yet competitively priced. Available with IPS outlets, pipe sizes 4" and larger, outlets 3/4" - 4"
	432 All Stainless Steel Tapping Sleeve  462 Stainless Steel Tapping Sleeve with <b>Carbon Steel                      Flange</b>	The sleeve for taps requiring full circumferential seal with high safety factor. Strong stainless construction with independent bolting for higher bolt torque capabilities. Sizes 4" - 24".
	452 All Stainless Steel Tapping Sleeve with Outlet Seal Gasket  464 Stainless Steel Tapping Sleeve with Outlet Seal Gasket <b>Carbon Steel                      Flange</b>	Stainless steel tapping sleeve for large diameter pipe and high pressure applications. Stainless construction provides superior corrosion resistance for long term service. Sizes 6" and larger.

**JCM Tapping Sleeves meet or exceed the ANSI/AWWA C223 and the MSS-SP 124 Standards as applicable.**





## JCM Stainless Steel (304) Tapping Sleeve Selection Guide

PRODUCT	NUMBER & TYPE	APPLICATION, SIZES AND INFORMATION
	<p>439 All 304 Stainless Steel Sleeve with Mechanical Joint Outlet</p> <p>469 Stainless Steel Sleeve with <b>Carbon Steel Mechanical Joint Outlet</b></p>	<p><b>True mechanical joint</b> outlet tapping sleeve reduces application costs and inventory by utilizing MJ gate valve in lieu of tapping valve. All stainless steel construction provides corrosion resistance. Unique load bearing set pins transfer load and prevents movement or misalignment during or after the tap. Available in full circumferential gasket style or outlet seal gasket style. Sizes: Outlets 4" - 12", pipe sizes 4" and larger.</p> <p><b>JCM Mechanical Joint Outlets meet AWWA C111/ANSI 21.11 Standard Dimensions</b></p>
	<p>459 All 304 Stainless Steel Sleeve with Mechanical Joint Outlet</p> <p>465 Stainless Steel Sleeve with Outlet Seal Gasket and <b>Carbon Steel Mechanical Joint Outlet</b></p>	

JCM Tapping Sleeves meet or exceed the ANSI/AWWA C223 and the MSS-SP 124 Standards as applicable.

## JCM Stainless Steel (316) Tapping Sleeve Selection Guide

Tapping Sleeves featured are available constructed of ALL 316 Stainless Steel material. Four digit model numbers reflect JCM standard tapping sleeve design style and outlet configuration. Fittings are available in same O.D. ranges and outlet sizes as their corresponding model numbers indicate. These fittings are priced on application. Contact JCM Inside Sales Team for information.

PRODUCT	NUMBER & TYPE	APPLICATION, SIZES AND INFORMATION
	<p>6438 All 316 Stainless Steel Threaded Outlet Tapping Sleeve</p>	<p>All 316 stainless steel construction for taps and connections of larger sizes of pipe in corrosive, saltwater and extreme acidic environments. Heavy gasket section and full sleeve offer better performance than strapped saddle. Available with IPS outlets, pipe sizes 4" and larger, outlets 3/4" - 4"</p>
	<p>6432 All 316 Stainless Steel Tapping Sleeve</p>	<p>The sleeve for taps requiring full circumferential seal with high safety factor. Strong stainless steel construction with independent bolting for higher bolt torque capabilities. Sizes 4" and larger.</p>
	<p>6452 All 316 Stainless Steel Tapping Sleeve with Outlet Seal Gasket</p>	<p>Stainless steel tapping sleeve for large diameter pipe and high pressure applications. Stainless construction provides superior corrosion resistance for long term service. Sizes 6" and larger.</p>
	<p>6439 All 316 Stainless Steel Sleeve with Mechanical Joint Outlet</p> <p>6459 All 316 Stainless Steel Sleeve with Mechanical Joint Outlet</p>	<p><b>True mechanical joint outlet</b> tapping sleeve reduces application costs and inventory by utilizing MJ gate valve in lieu of tapping valve. All stainless steel construction provides corrosion resistance. Unique load bearing set pins transfer load and prevents movement or misalignment during or after the tap. Available in full circumferential gasket style or outlet seal gasket style. Sizes: Outlets 4" - 12", pipe sizes 4" and larger.</p> <p><b>JCM Mechanical Joint Outlets meet AWWA C111/ANSI 21.11 Standard Dimensions</b></p>

JCM Tapping Sleeves meet or exceed the ANSI/AWWA C223 and the MSS-SP 124 Standards as applicable.

# JCM 412 Fabricated Carbon Steel Tapping Sleeves

Built-in benefits make these heavy fabricated steel sleeves increasingly popular for making larger taps on all types of pipe. By placing the design emphasis on eliminating problems inherent with older pipe and field installations, JCM 412 Tapping Sleeves have taken the complexity out of tapping larger pipe.

**Built in range** assures proper fit on more than one class of pipe - reducing inventory requirements and the chance of not having the right size sleeve.

**Ease of assembly** eliminates extra equipment, time and specially trained personnel.

**Ready availability** means taps can be made without long delays - even taps on special sizes of pipe - or services requiring high pressure flanges.

**Direct reinforcement of the pipe** by the sleeve eliminates flexing or deflection of pipe opposite the tap. Less weight than heavy cast iron sleeves reduces the load on the pipe.

Most important, **JCM 412 Tapping Sleeves assure a safe dependable tap**. A large gasket cross section provides a positive initial seal which increases with increases in line pressure.

Alignment recess for aligning sleeve and tapping valve.

Corrosion resistant, high strength low alloy bolts and nuts. Optional Stainless Steel.

Test Plug 3/4" NPT (stainless steel in the Epoxy Coated tapping sleeve).

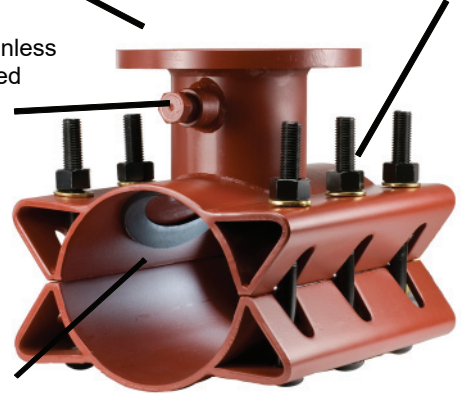

Broad cross section gasket set in retaining cavity.

Heavy steel sleeve - built-in range reinforces pipe - eliminates deflection possibility.

**Body:** ASTM A36, A516 GR 70 or equal.

**Flange:** Per ANSI/AWWA C207 Class D, ANSI 150lb Drilling, recessed for tapping valve per MSS-SP60. Optional flanges available upon request.

**Bolts:** Sleeve sizes 7.45 and smaller: 5/8", sleeve 9.05 and larger: 3/4" Electro coated Powercron 590-534, high strength low alloy oval neck track head bolts per ASTM A242 and nuts per ASTM A563 or equal. Optional stainless steel Type 304 or Type 316.

**Gasket:** Nitrile Butadiene Rubber (NBR, Buna-N) per ASTM D2000. Molded virgin rubber with a pressure activated hydromechanical design. Gasket is bonded into a cavity for internal and external retention. Gasket temperature range -40°F to 212°F (-40°C - 100°C) Gasket suitable for water, salt solutions, mild acids, bases, and sewage. Optional gasket materials available.

**Finish:** Heavy coat of corrosion resistant shop coat primer. Optional fusion applied epoxy coating, minimum 12 mils thickness per ANSI/AWWA Standard C213 Fusion Bonded Epoxy Coatings and Linings for Steel Water Pipe and Fittings. ANSI/NSF Standard 61, (61-G), ANSI/NSF 372 Certified.

**Service**

**Rating:** 2" through 12" Outlets: 175PSI. Higher service rating available for specific applications and sizes, contact JCM Industries.

## 412 TAPPING SLEEVE DIMENSIONS

Flange Size*	A	B	C	D	E	F
3	12	5	4-1/32	3-1/2	6	3/4
4	12	5	5-1/32	4-1/2	6	3/4
6	12	5	7-1/32	6-1/2	6	3/4
8	16	5-1/8	9-1/32	8-1/8	8	3/4
10	20	5-1/2	11-1/16	10-1/4	10	3/4
12	24	5-3/4	13-1/16	12-1/4	12	3/4

For outlets 14" and larger the manufacturer of the tapping valve must be specified to assure proper alignment recess dimension.  
 Size on size tapping sleeve requires 1/2" undersized cutter to assure proper cutter clearance and complete severance of the coupon.  
 On nominal pipe size 07.45 and smaller dimension D is 6-1/8".  
 On nominal pipe sizes 07.45 and smaller dimensions: E = 8, F = 5/8"

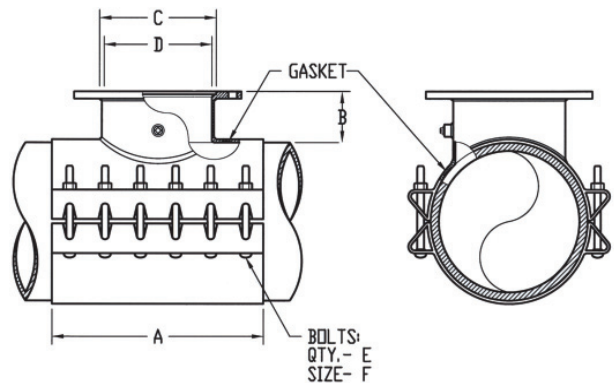



## JCM 412 Fabricated Carbon Steel Tapping Sleeves

NOM PIPE SIZE (IN)	SLEEVE O.D. RANGE (IN)	CATALOG NUMBER	OUTLET SIZES	APPR WT EACH (LBS)
6**	6.63 (SEE 422)	412-0690	X 3	74
	6.83 - 7.16	412-0720	X 4	76
	7.05 - 7.40	412-0745	X 6	82
	7.40 - 7.73			
8	8.63 (SEE 422)	412-0905	X 3	83
	8.98 - 9.37	412-0940	X 4	85
	9.27 - 9.69		X 6	88
			X 8	118
10	9.83 - 10.25*	412-1000*	X 3	90
	10.64 - 10.86	412-1075	X 4	92
	11.03 - 11.47	412-1110	X 6	96
	11.36 - 11.80	412-1140	X 8	125
	11.76 - 12.24	412-1200	X 10	168
12	12.62 - 12.88	412-1275	X 3	98
	13.13 - 13.60	412-1320	X 4	100
	13.60 - 14.09	412-1392	X 6	104
	14.08 - 14.56	412-1420	X 8	140
			X 10	176
			X 12	216
14	14.59 - 15.08	412-1475	X 3	113
	15.23 - 15.80	412-1530	X 4	115
	15.73 - 16.22	412-1600	X 6	116
	16.30 - 16.73	412-1650	X 8	150
			X 10	190
			X 12	220
16	16.74 - 17.26	412-1684	X 3	113
	17.33 - 17.87	412-1740	X 4	115
	17.88 - 18.43	412-1800	X 6	120
	18.62 - 19.19	412-1875	X 8	162
			X 10	210
			X 12	230
18	18.87 - 19.45	412-1920	X 3	120
	19.41 - 20.01	412-1950	X 4	122
	20.00 - 20.60	412-2000	X 6	126
	20.29 - 20.94	412-2050	X 8	180
	20.93 - 21.57	412-2130	X 10	240
			X 12	245
20	21.51 - 22.15	412-2160	X 3	131
	22.16 - 22.81	412-2254	X 4	133
	22.78 - 23.45	412-2294	X 6	140
	23.46 - 24.16	412-2400	X 8	185
	24.15 - 24.85	412-2450	X 10	245
	24.82 - 25.52	412-2502	X 12	255
24	25.71 - 26.41	412-2580	X 3	143
	26.55 - 27.25	412-2715	X 4	143
	27.26 - 27.96	412-2746	X 6	160
	28.14 - 28.84	412-2834	X 8	215
			X 10	280
			X 12	312
30	29.78 - 30.48	412-3000	X 3	163
	30.48 - 31.18	412-3075	X 4	165
	31.52 - 32.22	412-3200	X 6	175
			X 8	226
			X 10	295
			X 12	310

Larger outlets and pipe sizes 72" and larger available upon request.

\*These sizes not available with size on size outlets.

\*\*These sizes incorporate (8) - 5/8 bolts.

For size on size outlets a 1/2" undersized shell cutter is required.

**Larger Sizes: For outlets 14" and larger**, the tapping valve to be used must be specified to assure proper alignment recess dimension.

JCM 412 Tapping Sleeves furnished with test plugs unless otherwise specified.



# JCM 422 Carbon Steel Tapping Sleeves for PVC & Steel Pipe Sizes

Built-in benefits make JCM 422 Tapping Sleeves the ideal selection for tapping and branching IPS sized PVC, Steel, High Density Polyethylene Pipe and C-900 PVC. Sleeves are designed to reinforce the pipe and assure simple, safe installation - even under the most adverse field conditions. The extra wide reinforcement and exact fit of these sleeves provide reinforcement which strengthens the PVC pipe and prevents pipe stress at the branch. Not recommended for cast iron, ductile iron or asbestos cement pipe (see JCM 412 Tapping Sleeve).

## Built-in Corrosion Resistance

JCM 422 Tapping Sleeves are furnished standard Fusion Epoxy Coated with Electro-Coated bolts.

## Heavy Gasket Best for PVC Pipe

JCM 422 Tapping Sleeves utilize a broad, heavy gasket with hydro-mechanical lip to assure a positive seal on PVC pipe with its normal expansion-contraction characteristics.

## Extra Wide for Support and Stability

JCM Sleeves are designed extra wide for reinforcement to the main, to spread the load over a wider area and to provide stability during the tapping process.

## Stronger - yet lighter than Cast Sleeves

Extra strength provides an extra margin of safety against damage to the sleeve in handling and installation, or due to concentrated stress. Reduced weight speeds installation and reduces the load placed on the pipe.

## Ease Of Assembly Assures Proper Installation

Simplicity of design permits JCM Tapping Sleeves to be installed with minimum of crew, equipment, time and experience.

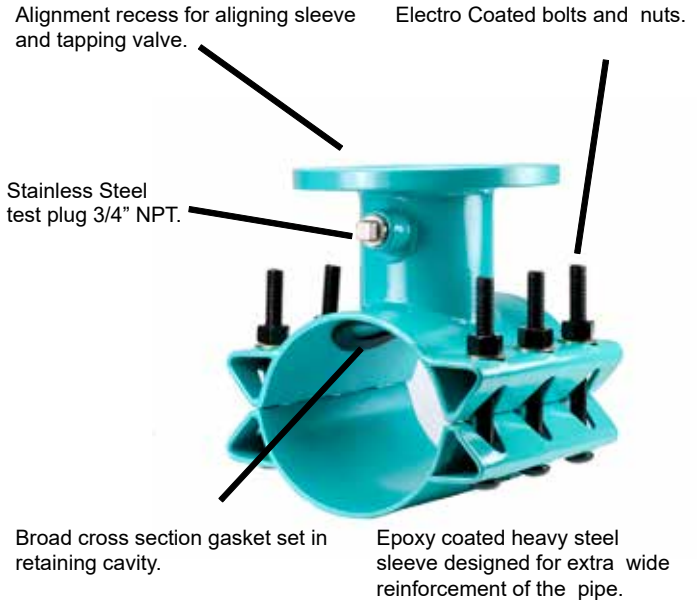

## MATERIAL SPECIFICATIONS - JCM 422 TAPPING SLEEVE

**Body:** ASTM A36, A516 GR 70 or equal.

**Flange:** Per ANSI/AWWA C207 Class D, ANSI 150lb Drilling, recessed for tapping valve per MSS-SP60. Optional flanges available upon request.

**Bolts:** Electro coated Powercron 590-534, high strength low alloy oval neck track head bolts per ASTM A242 and nuts per ASTM A563 or equal. Optional stainless steel Type 304 or Type 316.

**Gasket:** Nitrile Butadiene Rubber (NBR, Buna-N) per ASTM D2000. Molded virgin rubber with a pressure activated hydromechanical design. Gasket is bonded into a cavity for internal and external retention. Gasket temperature range -40°F to 212°F (-40°C -100°C) Gasket suitable for water, salt solutions, mild acids, bases, and sewage. Optional gasket materials available.

**Finish:** Fusion applied epoxy coating, minimum 12 mils thickness per ANSI/AWWA Standard C213 Fusion Bonded Epoxy Coatings and Linings for Steel Water Pipe and Fittings. ANSI/NSF 61, Annex G, ANSI/NSF 372 Certified.

**Service Rating:** 2" through 12" Outlets: 175PSI. Higher service rating available for specific applications and sizes, contact JCM Industries.

FLANGE SIZE	A	B	C	D	E	F
3	9*	5	4-1/32	3-1/2	6	5/8
4	9*	5	5-1/32	4	6	5/8
6	12	5	7-1/32	6-1/8	8	5/8
8	15	5-1/8	9-1/32	8-1/8	10	5/8
10	21	5-1/2	11-1/16	10-1/4	14	5/8
12	24	5-3/4	13-1/16	12-1/4	16	5/8

NOTE: 422 Sleeves requires a standard 1/2" oversized cutter be used.  
\*10" & 12" Nominal pipe sizes - dimension A is 12"

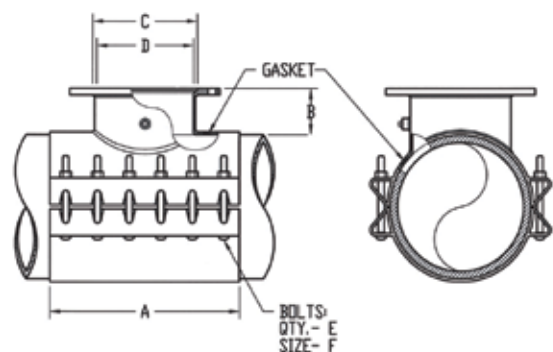

## JCM 422 Carbon Steel Tapping Sleeves for PVC & Steel Pipe

TYPE AND CLASS OF PIPE	NOM PIPE SIZE (IN)	O.D. RANGE (IN)	CATALOG NUMBER	OUTLET SIZES	APPR WT EACH (LBS)	
<b>PVC PIPE</b> IPS SIZED SDR 26, 21 SCH. 40 CLASS 200, CLASS 160	2*	2.38 2.50	422-0238 422-0250	x 2	12	
	3	3.50	422-0350	x 3	18	
	4	4.50	422-0450	x 3 x 4	29 31	
<b>STEEL PIPE</b> IPS SIZES, SCHEDULE PIPE	5	5.56	422-0556	x 3 x 4	32 33	
	<b>HDPE IPS</b> <b>*2" Steel and Cast Iron Only</b>	6	6.63	422-0663	x 3 x 4 x 6	33 35 44
8		8.63	422-0863	x 3 x 4 x 6 x 8	36 38 49 64	
10		10.75	422-1075	x 3 x 4 x 6 x 8 x 10	90 92 96 125 168	
12		12.75	422-1275	x 3 x 4 x 6 x 8 x 10 x 12	98 100 104 140 176 216	
<b>C900 PVC</b> AWWA/C900 All Classes		3	3.96	422-0396	x 3	20
		4	4.80	422-0480	x 3 x 4	33 35
	<b>HDPE DIPS</b>  Not recommended for Ductile Iron Cast Iron Asbestos Cement	6	6.90	422-0690	x 3 x 4 x 6	38 40 60
		8	9.05	422-0905	x 3 x 4 x 6 x 8	43 45 56 71
		10	11.10	422-1110	x 3 x 4 x 6 x 8 x 10	90 92 96 125 168
		12	13.20	422-1320	x 3 x 4 x 6 x 8 x 10 x 12	98 100 104 140 176 216

422 Tapping Sleeves are furnished with test plugs; standard fusion epoxy coated with Electro coated low alloy bolts; require that a 1/2" undersized cutter be used

### HOW TO ORDER - JCM TAPPING SLEEVES

1. Determine O.D. of pipe.
  2. Select proper sleeve O.D. range and outlet size.
  3. Specify catalog number and outlet size. JCM 422 is standard Epoxy Coated. Add (SS) for Stainless Hardware.
- Example: For PVC pipe with 8.63 O.D. with 6" outlet, order: 422-0863 x 6. For stainless steel hardware, add (SS).



# JCM 419 Fabricated Carbon Steel Tapping Sleeves Mechanical Joint Outlet

JCM Mechanical Joint Outlets meet AWWA C-111/ANSI 21.11 Standard Dimensions

NOM PIPE SIZE (IN)	SLEEVE O.D. RANGE (IN)	CATALOG NUMBER	OUTLET SIZES	APPR WT EACH (LBS)
6	6.63 (SEE 429)	419-0690	X 3	73
	6.83 - 7.16	419-0720	X 4	76
	7.05 - 7.40	419-0745	X 6	82
8	8.63 (SEE 429)	419-0905	X 3	83
	8.98 - 9.37	419-0940	X 4	85
	9.27 - 9.69		X 6	88
			X 8	118
10	9.83 - 10.25*	419-1000*	X 3	90
	10.64 - 10.86	419-1075	X 4	92
	11.03 - 11.47	419-1110	X 6	96
	11.36 - 11.80	419-1140	X 8	125
	11.76 - 12.24	419-1200	X 10	168
12	12.62 - 12.88	419-1275	X 3	97
	13.13 - 13.60	419-1320	X 4	100
	13.60 - 14.09	419-1392	X 6	104
	14.08 - 14.56	419-1420	X 8	140
			X 10	176
			X 12	216
14	14.59 - 15.08	419-1475	X 3	110
	15.23 - 15.80	419-1530	X 4	115
	15.73 - 16.22	419-1600	X 6	116
	16.30 - 16.73	419-1650	X 8	150
			X 10	190
		X 12	220	
16	16.74 - 17.26	419-1684	X 3	110
	17.33 - 17.87	419-1740	X 4	115
	17.88 - 18.43	419-1800	X 6	120
	18.62 - 19.19	419-1875	X 8	162
			X 10	210
			X 12	230
18	18.87 - 19.45	419-1920	X 3	120
	19.41 - 20.01	419-1950	X 4	122
	20.00 - 20.60	419-2000	X 6	126
	20.29 - 20.94	419-2050	X 8	180
	20.93 - 21.57	419-2130	X 10	240
			X 12	245
20	21.51 - 22.15	419-2160	X 3	130
	22.16 - 22.81	419-2254	X 4	133
	22.78 - 23.45	419-2294	X 6	140
	23.46 - 24.16	419-2400	X 8	185
	24.15 - 24.85	419-2450	X 10	245
	24.82 - 25.52	419-2502	X 12	255
24	25.71 - 26.41	419-2580	X 3	140
	26.55 - 27.25	419-2715	X 4	143
	27.26 - 27.96	419-2746	X 6	160
	28.14 - 28.84	419-2834	X 8	215
			X 10	280
		X 12	312	
30	29.78 - 30.48	419-3000	X 3	160
	30.48 - 31.18	419-3075	X 4	165
	31.52 - 32.22	419-3200	X 6	175
			X 8	226
			X 10	295
		X 12	310	

\*These sizes not available with size on size outlets. Larger outlets and pipe sizes 72" and larger available upon request.

For size on size outlets a 1/2" undersized shell cutter is required.

JCM 419 are furnished with test plugs unless otherwise specified.

## JCM 419 FABRICATED TAPPING SLEEVE - MECHANICAL JOINT OUTLET

OUTLET	A	B	C	D	E
3	12	5	3.32	6	3/4
4	12	5-1/8	4.26	6	3/4
6	12	5-1/4	6.36	6	3/4
8	16	5-3/8	8.33	8	3/4
10	20	5-3/8	10.42	10	3/4
12	24	5-3/8	12.39	12	3/4

On nominal pipe sizes 07.45 and smaller dimensions: D = 8, E = 5/8"

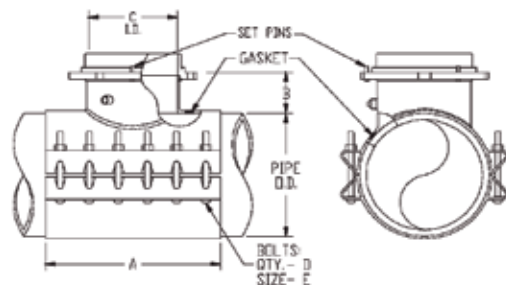

# JCM 429 Fabricated Carbon Steel Tapping Sleeve Mechanical Joint Outlet

JCM Mechanical Joint Outlets meet AWWA C-111/ANSI 21.11 Standard Dimensions

TYPE AND CLASS OF PIPE	NOM PIPE SIZE (IN)	O.D. RANGE (IN)	CATALOG NUMBER	OUTLET SIZES	APPR WT EACH (LBS)
<b>PVC PIPE</b> IPS SIZED SDR 26, 21 SCH. 40 CLASS 200, CLASS 160	4	4.50	429-0450	x 3 x 4	29 31
	5	5.56	429-0556	x 3 x 4	31 33
<b>STEEL PIPE</b> IPS SIZES, SCHEDULE PIPE	6	6.63	429-0663	x 3 x 4 x 6	32 35 44
	8	8.63	429-0863	x 3 x 4 x 6 x 8	35 38 49 64
x 3 x 4 x 6 x 8 x 10				89 92 96 125 168	
<b>HDPE IPS</b>	10	10.75	429-1075	x 3 x 4 x 6 x 8 x 10	96 100 104 140 176 216
	12	12.75	429-1275	x 3 x 4 x 6 x 8 x 10 x 12	96 100 104 140 176 216
<b>C900 PVC</b> AWWA/C900 All Classes	4	4.80	429-0480	x 3 x 4	29 31
	6	6.90	429-0690	x 3 x 4 x 6	32 35 44
<b>HDPE DIPS</b>  Not recommended for Ductile Iron Cast Iron Asbestos Cement	8	9.05	429-0905	x 3 x 4 x 6 x 8	35 38 49 64
	10	11.10	429-1110	x 3 x 4 x 6 x 8 x 10	89 92 96 125 168
	12	13.20	429-1320	x 3 x 4 x 6 x 8 x 10 x 12	96 100 104 140 176 216

429 Tapping Sleeves are furnished with test plugs; standard fusion epoxy coated with Electro coated low alloy bolts; require that a 1/2" under-sized cutter be used. Dimensional submittal drawings available upon request.



JCM 419 Fabricated Carbon Steel Tapping Sleeve with MJ Outlet



JCM 429 Fabricated Carbon Steel Tapping Sleeve with MJ Outlet for PVC, Steel, HDPE & C900 Pipe



# JCM 432 All Stainless Steel Tapping Sleeve

## JCM 462 Stainless Steel Tapping Sleeve with Carbon Steel Flange

**EXTRA BOLTING POWER...**The true tapping sleeve design of this sleeve incorporates replaceable, self-aligning bolts, which facilitate conversion of high bolt torques to high gasket pressure, can be torqued to 125 ft. lbs. This increases gasket sealing pressure and pressure holding capability.

**FULL CIRCUMFERENTIAL SEAL...**The extra bolting power assures the gasket will seal the full circumference of the pipe. This provides insurance against beam breaks in size on size taps. Molded in recessed bridge plate assures even gasket pressure throughout the range of the sleeve.

**STRONGER YET LIGHTER THAN CAST SLEEVES...**Extra strength eliminates possible cracking of the sleeve or flange. Reduced weight speeds installation and reduces the load placed on the pipe.

**EXTRA WIDE FOR SUPPORT AND STABILITY...**Extra width and heavier neck and body material provide extra reinforcement of the outlet and extra stability during the tapping process.



JCM 432 - All stainless construction provides extra corrosion resistance. The stainless steel flange, outlet and body join as one unit of similar metals for highest structural strength and corrosion resistance.

JCM 462 - Stainless steel body/neck construction joins with a strong, economical carbon steel flange. Coated steel flange is to AWWA C207, Class D standard with recess for tapping alignment.

### MATERIAL SPECIFICATIONS - JCM 432 and 462 TAPPING SLEEVES:

**Body:** Stainless Steel 18-8 Type 304

**Bolts:** Stainless Steel Type 304

**Branch Outlet:** Schedule 10 Stainless Steel Pipe

**Gasket:** Full circumferential virgin Styrene-Butadiene Rubber (SBR) gasket compounded for use with water, salt solutions, mild acids, bases and sewage. Per ASTM D2000 M4AA 607. Standard temperature range from -40° to 150°F (-40° to 65°C) constant, maximum intermittent 180°F (82°C). For higher temperatures or chemical compounds, contact JCM Industries. Optional: EPDM available.

**432 Flange:** 304 Stainless Steel per ANSI/AWWA Standard C228, ANSI 150lb. Drilling, recessed for tapping valve per MSS-SP60.

**462 Flange:** Carbon Steel per ANSI/AWWA C207 Class D, ANSI 150lb. Drilling, recessed for tapping valve per MSS-SP60. Coated for corrosion resistance.

### JCM 432 & 462 STAINLESS STEEL TAPPING SLEEVE DIMENSIONS

FLANGE SIZE	A	B	C	D	E	F
2	15	4	3-1/32	2.16	10	5/8
3	15	5	4-1/32	3.26	10	5/8
4	15	5	5-1/32	4.26	10	5/8
6	15	5	7-1/32	6.35	10	5/8
8	21	5-1/8	9-1/32	8.32	14	5/8
10	27	5-1/2	11-1/16	10.42	18	5/8
12	30	5-3/4	13-1/16	12.39	20	5/8

Revised 11/15/2021

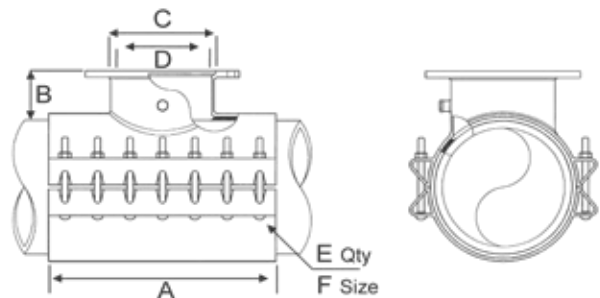

### HOW TO ORDER - JCM TAPPING SLEEVES

1. Determine O.D. of pipe.
  2. Select proper sleeve O.D. range and outlet size.
  3. Specify catalog number and outlet size. JCM 432 furnished with stainless steel flange. JCM 462 furnished with coated carbon steel flange.
- Example: For PVC pipe with 8.63 O.D. with 6" outlet, order: 432-0863X6. For carbon flange, order: 462-0863X6



**Stainless Steel Tapping Sleeve - Full Circumferential Gasket - Flanged Outlet**  
**JCM 432 Stainless Steel Flanged Outlet**  
**JCM 462 Carbon Steel Flanged Outlet**

NOM PIPE SIZE (IN)	SLEEVE O.D. RANGE (IN)	MODEL 432 STAINLESS STEEL FLANGE CATALOG NUMBER	MODEL 462 CARBON STEEL FLANGE CATALOG NUMBER	OUTLET SIZES	WIDTH OF SLEEVE	NUMBER OF BOLTS	APPR WT EA (LBS)
4	4.40 - 4.60	432-0450	462-0450	X 2	15	10	38
	4.50 - 4.80	432-0465	462-0465	X 3	15	10	40
	4.74 - 5.00	432-0480	462-0480	X 4	15	10	42
	5.10 - 5.30	432-0520	462-0520				
6	6.56 - 6.90++	432-0663	462-0663	X 2	15	10	42
	6.83 - 7.16	432-0690	462-0690	X 3	15	10	42
	7.05 - 7.40	432-0720	462-0720	X 4	15	10	47
	7.40 - 7.73	432-0745	462-0745	X 6	15	10	49
8	8.54 - 8.74	432-0863	462-0863	X 2	15	10	45
	8.60 - 9.05++	432-0900	462-0900	X 3	15	10	45
	8.98 - 9.37	432-0905	462-0905	X 4	15	10	51
	9.27 - 9.69	432-0940	462-0940	X 6	15	10	54
				X 8	21	14	78
10	9.83 - 10.25	432-1000+	462-1000+	X 2	15	10	46
	10.64 - 10.86	432-1075+	462-1075+	X 3	15	10	46
	10.75 - 11.15++	432-1110+	462-1110+	X 4	15	10	55
	11.00 - 11.40	432-1140	462-1140	X 6	15	10	60
	11.36 - 11.80	432-1200	462-1200	X 8	21	14	72
	11.76 - 12.24			X 10	27	18	132
12	12.62 - 12.88	432-1275	462-1275	X 2	15	10	47
	12.75 - 13.20++	432-1300*	462-1300*	X 3	15	10	47
	13.10 - 13.50	432-1320	462-1320	X 4	15	10	60
	13.70 - 14.09	432-1392	462-1392	X 6	15	10	64
	14.08 - 14.40	432-1420	462-1420	X 8	21	14	90
				X 10	27	18	138
14	15.20 - 15.60	432-1530	462-1530	X 12	30	20	161
	15.80 - 16.20	432-1600	462-1600	X 2	15	10	74
	16.38 - 16.78	432-1650	462-1650	X 3	15	10	74
				X 4	15	10	80
				X 6	15	10	85
				X 8	21	14	114
16	17.40 - 17.80	432-1740	462-1740	X 10	27	18	150
	17.75 - 18.15	432-1800	462-1800	X 12	30	20	171
	18.58 - 18.98	432-1875	462-1875	X 2	15	10	78
				X 3	15	10	78
				X 4	15	10	78
				X 6	15	10	90
18	19.30 - 19.70	432-1950	462-1950	X 8	21	14	126
	19.80 - 20.20	432-1990	462-1990	X 10	27	18	163
	21.20 - 21.40	432-2130	462-2130	X 12	30	20	175
				X 3	15	10	80
20	21.40 - 21.80	432-2160	462-2160	X 4	15	10	80
	21.90 - 22.30	432-2206	462-2206	X 6	15	10	90
	22.30 - 22.70	432-2250	462-2250	X 8	21	14	130
				X 3	15	10	85
24	23.45 - 23.85	432-2360	462-2360	X 4	15	10	85
	25.60 - 26.00	432-2580	462-2580	X 6	15	10	92
	26.20 - 26.60	432-2632	462-2632	X 8	21	14	136
				X 3	15	10	105

+NOTE: This size not available with a size on size outlet.

++NOTE: Recommended for IPS PVC, STEEL, C-900 PVC, Ductile Iron Pipe Diameters.

++Not recommended for Pit Cast Iron Pipe. For oversized or Pit Cast Iron Pipe, see next larger range.

\*Not available with 10" & 12" Outlets

For larger sizes and outlets, see JCM 452 All Stainless Steel Tapping Sleeve or JCM 412 Fabricated Tapping Sleeve  
Tapping sleeves with outlets 3" and smaller are non-returnable items.



# JCM Stainless Steel Tapping Sleeves with Mechanical Joint Outlet

**Available,  
JCM Mechanical Joint Outlet  
Tapping Sleeves**

**Great JCM Quality,  
Great JCM Delivery  
Reduce Application Costs  
Reduce Valve Inventory  
Available Immediately  
Provide Load Bearing Set Pins**



**True Mechanical Joint Outlet** - one cast piece creates a strong, corrosion resistant unit. No glued or attached parts to separate or cause misalignment. JCM Mechanical Joint Outlets meet AWWA C111/ANSI 21.11 Standard Dimensions.

**Durable** - JCM Mechanical Joint Outlet Tapping Sleeves are fabricated of quality materials for long term service.

**Load Bearing Set Pins** - JCM Tapping Sleeves with MJ Outlet connections come furnished with load bearing set pins on the MJ outlet gland. After valve installation, the set pins are tightened against the face of the MJ valve flange, transferring any load and preventing movement or misalignment during or after the tap.

**Strong pipe outlet** - heavy duty neck outlet provides stability and a full size cutter bore. Standard lengths accommodate industry common tapping machine travel.

**Consistent Inside Diameter Outlet** - through the MJ flange outlet and through the pipe neck outlet. No modifications, changes or alterations that can interfere with cutter travel.

**Quality Workmanship** - JCM Tapping Sleeves with Mechanical Joint Outlets are manufactured of certifiable materials and are fabricated to the JCM standard quality recognized in the industry.

## **JCM MJ OUTLET TAPPING SLEEVES AVAILABLE IN THE FOLLOWING CONFIGURATIONS ALL**

**304 Stainless Steel (Models 439, 459)**

**All 316 Stainless Steel (Models 6439, 6459)**

**Stainless Body/Neck with Carbon Steel Outlet (Models 469, 465)**

**All Fabricated Carbon Steel (Models 419, 429)**

JCM Tapping Sleeves meet or exceed the ANSI/AWWA C223 and the MSS-SP 124 Standards as applicable.





**Stainless Steel Tapping Sleeve - Full Circumferential Gasket - Mechanical Joint Outlet**  
**JCM 439 Stainless Steel Mechanical Joint Outlet**  
**JCM 469 Carbon Steel Mechanical Joint Outlet**  
**JCM Mechanical Joint Outlets meet AWWA C-111/ANSI 21.11 Standard Dimensions**

**FULL CIRCUMFERENTIAL SEAL • EXTRA WIDTH • EXTRA BOLTING POWER**

NOM PIPE SIZE (IN)	SLEEVE O.D. RANGE (IN)	MODEL 439 STAINLESS STEEL MJ OUTLET	MODEL 469 CARBON STEEL MJ OUTLET	OUTLET SIZES	WIDTH OF SLEEVE	NUMBER OF BOLTS	APPR WT EACH (LBS)
4	4.40 - 4.60	439-0450	469-0450				
	4.50 - 4.80	439-0465	469-0465	X 3^	15	10	38
	4.74 - 5.00	439-0480	469-0480	X 4	15	10	40
	5.10 - 5.30	439-0520	469-0520				
6	6.56 - 6.90++	439-0663	469-0663	X 3^	15	10	45
	6.83 - 7.16	439-0690	469-0690	X 4	15	10	47
	7.05 - 7.40	439-0720	469-0720	X 6	15	10	49
	7.40 - 7.73	439-0745	439-0745				
8	8.54 - 8.74	439-0863	469-0863	X 3^	15	10	50
	8.60 - 9.05++	439-0900	469-0900	X 4	15	10	51
	8.98 - 9.37	439-0905	469-0905	X 6	15	10	54
	9.27 - 9.69	439-0940	469-0940	X 8	21	14	78
10	9.83 - 10.25	439-1000+	469-1000	X 3^	15	10	52
	10.64 - 10.86	439-1075+	469-1075	X 4	15	10	55
	10.75 - 11.15++	439-1110+	469-1110	X 6	15	10	60
	11.00 - 11.40	439-1140	469-1140	X 8	21	14	82
	11.36 - 11.80	439-1200	469-1200	X 10	27	18	125
	11.76 - 12.24						
12	12.62 - 12.88	439-1275	469-1275	X 3^	15	10	58
	12.75 - 13.20++	439-1300*	469-1300*	X 4	15	10	60
	13.10 - 13.50	439-1320	469-1320	X 6	15	10	64
	13.70 - 14.09	439-1392	469-1392	X 8	21	14	90
	14.08 - 14.40	439-1420	469-1420	X 10	27	18	138
				X 12	30	20	161
14	15.20 - 15.60	439-1530	469-1530	X 3^	15	10	68
	15.80 - 16.20	439-1600	469-1600	X 4	15	10	70
	16.38 - 16.78	439-1650	469-1650	X 6	15	10	85
				X 8	21	14	114
				X 10	27	18	150
				X 12	30	20	171
16	17.40 - 17.80	439-1740	469-1740	X 3^	15	10	76
	17.75 - 18.15	439-1800	469-1800	X 4	15	10	78
	18.58 - 18.98	439-1875	469-1875	X 6	15	10	90
				X 8	21	14	126
				X 10	27	18	163
				X 12	30	20	175
18	19.30 - 19.70	439-1950	469-1950	X 3^	15	10	80
	19.80 - 20.20	439-1990	469-1990	X 4	15	10	80
	21.20 - 21.40	439-2130	469-2130	X 6	15	10	90
				X 8	21	14	130
20	21.40 - 21.80	439-2160	469-2160	X 3^	15	10	85
	21.90 - 22.30	439-2206	469-2206	X 4	15	10	85
	22.30 - 22.70	439-2250	469-2250	X 6	15	10	92
				X 8	21	14	136
24	23.45 - 23.85	439-2360	469-2360	X 3^	15	10	105
	25.60 - 26.00	439-2580	469-2580	X 4	15	10	105
	26.20 - 26.60	439-2632	469-2632	X 6	15	10	125
				X 8	21	14	150

^3" Outlet available in stainless steel only (Model 439)

+NOTE: This size not available with a size on size outlet.

++NOTE: Recommended for IPS PVC, STEEL, C-900 PVC, Ductile Iron Pipe Diameters.

+++NOTE: Not recommended for Pit Cast Iron Pipe. For oversized or Pit Cast Iron Pipe, see next larger range.

\*Not available with 10" & 12" Outlets

For larger sizes and outlets, see JCM 452 Tapping Sleeve or JCM 412 Tapping Sleeve

Tapping sleeves with outlets 3" and smaller are non-returnable items.



# JCM Stainless Steel Tapping Sleeves with Outlet Seal Gasket

**Available Flanged or Mechanical Joint Outlet - Stainless Steel or Carbon Steel**

**Rugged and Heavy Duty Stainless Tapping Sleeves Offer Extra Benefits.**

## **Heavy Duty Design...**

Heavier construction and thicker metal provide extra reinforcement of the pipe and outlet. The extra bolting power and body thickness eliminate problems inherent with light weight sleeves. Reduced weight aids in installation and handling as well as reducing load on the pipe.

## **High Pressure Capability - High Safety Factor...**

The broad, heavy hydromechanical gasket provides for high working pressure applications. They are also ideal for critical problem prone taps such as pump and lift stations, large diameter mains and large outlets.

## **Large Sizes - High Pressure...**

The premier sleeve for larger sizes of ductile iron, PVC, PE and steel pipe, these sleeves are capable of working pressure of 1.5 times the valves commonly used with these types of pipe. Higher pressure sleeves are available on request.

## **Extra Wide for Support and Stability...**

Extra width and heavier neck and body material provide extra reinforcement of the outlet and extra stability during the tapping process.

## **Affordable...**

These stainless sleeves are surprisingly affordable in all sizes. Larger sleeves are priced less than ductile iron mechanical joint sleeves which offer less corrosion resistance and pressure capability.



**JCM 452 - 464 Stainless Tapping Sleeve  
Flanged Outlet**



**JCM 459 - 465 Stainless Tapping Sleeve  
Mechanical Joint Outlet**

## **MATERIAL SPECIFICATIONS - JCM 452, 464, 459, 465 Stainless Tapping Sleeves**

**Body:** Stainless Steel, 18-8 Type 304. Optional 316 Stainless Steel

**Bolts:** Stainless Steel, 18-8 Type 304. Optional 316 Stainless Steel

**Branch Outlet:** 304 Heavy Stainless Steel Pipe. Optional 316 Stainless Steel

**Gasket:** Nitrile Butadiene Rubber (NBR, Buna-N) per ASTM D2000. Molded virgin rubber with a pressure activated hydromechanical design. Gasket is bonded into a cavity for internal and external retention. Gasket temperature range -40°F to 212°F (-40°C - 100°C) Gasket suitable for water, salt solutions, mild acids, bases, and sewage. Optional gasket materials available.

**452 Flange:** 304 Stainless Steel or equivalent, per ANSI/AWWA C228 Class SD, 150lb. Drilling indexed for MSS-SP60 to accept tapping valve and have the equivalent O. D. and drilling as Class 125 Cast-Iron Flanges (ANSI/ASME B16.1) and Class 150 Steel-Ring Flanges (ANSI/ASME B16.5). Other flanges available upon request.

**464 Flange:** AWWA C207 Class D, ANSI 150lb. Drilling, recessed for tapping valve MSS-SP60.

**459 Outlet:** CF8 Cast Stainless Steel - equivalent to 18-8 Type 304 Stainless Steel meets AWWA C-111/ANSI 21.11 Standard Dimensions. Optional 316 Stainless Steel.

**465 Outlet:** Carbon Steel meets AWWA C-111/ANSI 21.11 Standard Dimensions

**Service Rating:** 2" - 12" Outlets: 175PSI, per ANSI/AWWA C228. For higher service ratings, contact JCM Technical Services.

JCM Industries Tapping Sleeves meet or exceed the ANSI/AWWA C223 and the MSS-SP 124 Standards as applicable. Dimensional submittal drawings available upon request.

# Stainless Steel Tapping Sleeves - Outlet Seal Gasket - Flanged Outlet

## JCM 452 Stainless Steel Flanged Outlet

## JCM 464 Carbon Steel Flanged Outlet

NOM PIPE SIZE (IN)	SLEEVE O.D. RANGE (IN)	MODEL 452 STAINLESS STEEL FLANGE	MODEL 464 CARBON STEEL FLANGE	OUTLET SIZES	APPROX. WT EA (LBS)
4	4.50	452-0450	464-0450	X 3	32
	4.80	452-0480	464-0480	X 4	32
6**	6.63	452-0663	464-0663	X 3	74
	6.83 - 7.16	452-0690	464-0690	X 4	76
	7.05 - 7.40	452-0720	464-0720	X 6	82
	7.40 - 7.73	452-0745	464-0745		
8	8.63	452-0863	464-0863	X 3	83
	8.98 - 9.37	452-0905	464-0905	X 4	85
	9.27 - 9.69	452-0940	464-0940	X 6	88
				X 8	118
10	9.83 - 10.25*	452-1000*	464-1000*	X 3	90
	10.64 - 10.86	452-1075	464-1075	X 4	92
	11.03 - 11.47	452-1110	464-1110	X 6	96
	11.36 - 11.80	452-1140	464-1140	X 8	125
	11.76 - 12.24	452-1200	464-1200	X 10	168
12	12.62 - 12.88	452-1275	464-1275	X 3	98
	13.13 - 13.60	452-1320	464-1320	X 4	100
	13.60 - 14.09	452-1392	464-1392	X 6	104
	14.08 - 14.56	452-1392	464-1392	X 8	140
		452-1420	464-1420	X 10	176
			X 12	216	
14	14.59 - 15.08	452-1475	464-1475	X 3	113
	15.23 - 15.80	452-1530	464-1530	X 4	115
	15.73 - 16.22	452-1600	464-1600	X 6	116
	16.30 - 16.73	452-1600	464-1600	X 8	150
		452-1650	464-1650	X 10	190
			X 12	220	
16	16.74 - 17.26	452-1684	464-1684	X 3	113
	17.33 - 17.87	452-1740	464-1740	X 4	115
	17.88 - 18.43	452-1800	464-1800	X 6	120
	18.62 - 19.19	452-1800	464-1800	X 8	162
		452-1875	464-1875	X 10	210
			X 12	230	
18	18.87 - 19.45	452-1920	464-1920	X 3	120
	19.41 - 20.01	452-1950	464-1950	X 4	122
	20.00 - 20.60	452-2000	464-2000	X 6	126
	20.29 - 20.94	452-2050	464-2050	X 8	180
	20.93 - 21.57	452-2050	464-2050	X 10	240
		452-2130	464-2130	X 12	245
20	21.51 - 22.15	452-2160	464-2160	X 3	131
	22.16 - 22.81	452-2254	464-2254	X 4	133
	22.78 - 23.45	452-2294	464-2294	X 6	140
	23.46 - 24.16	452-2400	464-2400	X 8	185
	24.15 - 24.85	452-2450	464-2450	X 10	245
	24.82 - 25.52	452-2502	464-2502	X 12	255
24	25.71 - 26.41	452-2580	464-2580	X 3	143
	26.55 - 27.25	452-2715	464-2715	X 4	143
	27.26 - 27.96	452-2746	464-2746	X 6	160
	28.14 - 28.84	452-2746	464-2746	X 8	215
		452-2834	464-2834	X 10	280
			X 12	312	
30	29.78 - 30.48	452-3000	464-3000	X 3	163
	30.48 - 31.18	452-3075	464-3075	X 4	165
	31.52 - 32.22	452-3075	464-3075	X 6	175
		452-3200	464-3200	X 8	226
			X 10	295	
			X 12	310	

\*These sizes not available with size on size outlets.

\*\*Sizes incorporate (8) 5/8" bolts.

JCM 452/464 Tapping Sleeves furnished with test plugs unless otherwise specified.

For size on size outlets a 1/2" undersized shell cutter is required.

Larger outlets and pipe sizes 72" and larger available upon request.

For outlets 14" and larger, the tapping valve to be used must be specified to assure proper alignment recess dimension

Tapping Sleeves with outlets 3" and smaller non-returnable items.



# Stainless Steel Tapping Sleeves - Outlet Seal Gasket - Mechanical Joint Outlet

## JCM 459 Stainless Steel Mechanical Joint Outlet

## JCM 465 Carbon Steel Mechanical Joint Outlet

JCM Mechanical Joint Outlets meet AWWA C111/ANSI 21.11 Standard Dimensions

NOM PIPE SIZE (IN)	SLEEVE O.D. RANGE (IN)	MODEL 459 STAINLESS STEEL MJ OUTLET	MODEL 465 CARBON STEEL MJ OUTLET	OUTLET SIZES	APPR WT EA (LBS)
4	4.50	459-0450	465-0450	X 3 <sup>A</sup>	32
	4.80	459-0480	465-0480	X 4	35
6**	6.63	459-0663	465-0663	X 3 <sup>A</sup>	74
	6.83 - 7.16	459-0690	465-0690	X 4	76
	7.05 - 7.40	459-0720	465-0720	X 6	82
	7.40 - 7.73	459-0745	465-0745		
8	8.63	459-0863	465-0863	X 3 <sup>A</sup>	82
	8.98 - 9.37	459-0905	465-0905	X 4	85
	9.27 - 9.69	459-0940	465-0940	X 6	88
				X 8	118
10	9.83 - 10.25*	459-1000*	465-1000*	X 3 <sup>A</sup>	89
	10.64 - 10.86	459-1075	465-1075	X 4	92
	11.03 - 11.47	459-1110	465-1110	X 6	96
	11.36 - 11.80	459-1140	465-1140	X 8	125
	11.76 - 12.24	459-1200	465-1200	X 10	168
12	12.62 - 12.88	459-1275	465-1275	X 3 <sup>A</sup>	95
	13.13 - 13.60	459-1320	465-1320	X 4	100
	13.60 - 14.09	459-1392	465-1392	X 6	104
	14.08 - 14.56	459-1420	465-1420	X 8	140
				X 10	176
			X 12	216	
14	14.59 - 15.08	459-1475	465-1475	X 3 <sup>A</sup>	102
	15.23 - 15.80	459-1530	465-1530	X 4	115
	15.73 - 16.22	459-1600	465-1600	X 6	116
	16.30 - 16.73	459-1650	465-1650	X 8	150
				X 10	190
			X 12	220	
16	16.74 - 17.26	459-1684	465-1684	X 3 <sup>A</sup>	102
	17.33 - 17.87	459-1740	465-1740	X 4	115
	17.88 - 18.43	459-1800	465-1800	X 6	120
	18.62 - 19.19	459-1875	465-1875	X 8	162
				X 10	210
			X 12	230	
18	18.87 - 19.45	459-1920	465-1920	X 3 <sup>A</sup>	115
	19.41 - 20.01	459-1950	465-1950	X 4	122
	20.00 - 20.60	459-2000	465-2000	X 6	126
	20.29 - 20.94	459-2050	465-2050	X 8	180
	20.93 - 21.57	459-2130	465-2130	X 10	240
				X 12	245
20	21.51 - 22.15	459-2160	465-2160	X 3 <sup>A</sup>	125
	22.16 - 22.81	459-2254	465-2254	X 4	133
	22.78 - 23.45	459-2294	465-2294	X 6	140
	23.46 - 24.16	459-2400	465-2400	X 8	185
	24.15 - 24.85	459-2450	465-2450	X 10	245
	24.82 - 25.52	459-2502	465-2502	X 12	255
24	25.71 - 26.41	459-2580	465-2580	X 3 <sup>A</sup>	138
	26.55 - 27.25	459-2715	465-2715	X 4	143
	27.26 - 27.96	459-2746	465-2746	X 6	160
	28.14 - 28.84	459-2834	465-2834	X 8	215
				X 10	280
			X 12	312	
30	29.78 - 30.48	459-3000	465-3000	X 3 <sup>A</sup>	159
	30.48 - 31.18	459-3075	465-3075	X 4	165
	31.52 - 32.22	459-3200	465-3200	X 6	175
				X 8	226
			X 10	295	
			X 12	310	

<sup>A</sup>3" OUTLET IN STAINLESS STEEL ONLY (JCM MODEL 459). Tapping sleeves with outlets 3" and smaller are non-returnable items.

\*Range not available with size on size outlet.

\*\*Sizes incorporate (8) - 5/8" bolts.

JCM 459/465 Tapping Sleeves furnished with test plugs unless otherwise specified.

For size on size outlets a 1/2" undersized shell cutter is required.

Outlet sizes 14" & 16" available in Stainless Steel.

Larger outlets and pipe sizes 72" and larger available upon request.

Tapping Sleeves with outlets 3" and smaller non-returnable items.



## JCM 414 Fabricated Mechanical Joint Tapping Sleeve

The JCM 414 Fabricated Mechanical Joint Tapping Sleeve is recommended for taps on pipe that will not accommodate a direct outlet seal tapping sleeve. The 414 utilizes a true mechanical joint sleeve design that completely encompasses the tap area, eliminating any potential leaks due to pipe cracks or breaks. Side gaskets are internally and externally trapped in a recessed groove machined into the bolting lug bars that completely compress the gaskets creating the watertight seal on the sides of the sleeve. The end gaskets are compressed into the sleeve housing with mechanical joint end glands, providing the water tight seal on the ends of the sleeve and completing the full encapsulation of the tap area.

This tapping sleeve combines the high strength and versatility of fabricated steel with the traditional side and end gasketed mechanical joint design. These sleeves are ideal for potential problem installations where strength, weight and beam load considerations are critical.

**High Strength Steel** - eliminates stress cracked casting or flange possibility.

**True Mechanical Joint Design** - industrial grade, fabricated steel body and heavyweight pusher glands prevent the warpage and distortion experienced by tapping sleeves using the split steel coupling design. JCM 414 meets design criteria in AWWA C110/111, ANSI 21.10/21.11 for tolerances, dimensions and configuration of the time proven mechanical joint seal.

**Side And End Gaskets** - provide complete seal around the pipe.

**Fabricated Sleeves** - provide more strength with significantly reduced weight than a cast sleeve. The lighter sleeve reduces the load on the pipe and aids in installation and handling.

**Accommodates Non-Standard Pipe Characteristics** - oversize, undersize or irregularities in the pipe O.D. can be accommodated within the fitting increasing performance and safety factor. The JCM 414 is available in larger sizes, non-standard sizes and with many special options (special flanges, special laying lengths, etc.)

**Improved Availability** - fabricated sleeves with non-standard sizes have a delivery schedule of three to five weeks, significantly less than a cast sleeve's six to nine months.

Available fabricated of carbon steel, all 304 stainless steel and all 316 stainless steel. Optional gaskets available.

### HOW TO ORDER - For price and engineering, furnish the following information

Type of Pipe	Irregular or non-standard pipe characteristics
Pipe Outside Diameter	Space Limitations
Outlet Size	Outlet Flange Drilling
Line Content	Optional Material Requirements
Line Working Pressure	

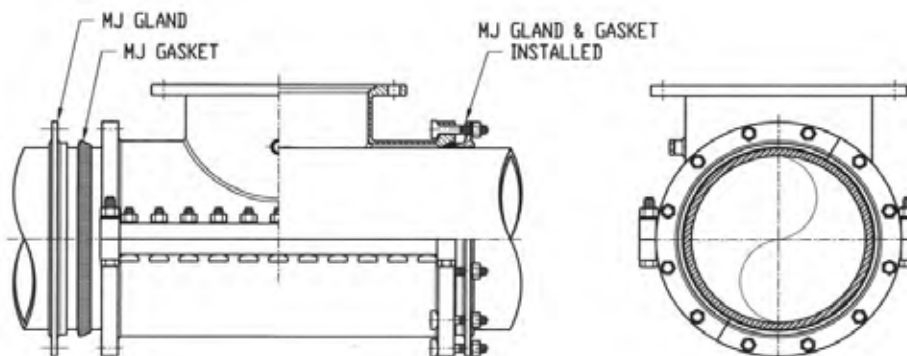

## JCM 415 Tapping Sleeve for Concrete Steel Cylinder Pipe

The JCM 415 Tapping Sleeve for Concrete Steel Cylinder Pipe is the standard in the industry for fast safe taps on Concrete Pressure Pipe. Designed to meet the AWWA M-9 Manual, the JCM 415 is the leading sleeve preferred by PCCP tapping contractors. These fabricated tapping sleeves are designed to reinforce the pipe and provide for easy installation with maximum safety factor. There are many unique features as well as options available on these sleeves. Unique to these sleeves are the following:

**Separate Body and Tapping Gland (outlet)** - by separating the outlet gland from the sleeve body the sleeve reinforces the pipe prior to removal of the critical prestress wire from the outlet area.

**Broad Cross Section Gasket** - the 7/8" wide gasket with a hydromechanical lip provides a broad sealing surface which produces an initial seal that increases with increases in line pressure. The broad, flat gasket is very advantageous for sealing on beveled cylinder welds.

**Gusseted Pressure Plate** - the gusseted pressure plate eliminates problems caused by flexing of the cylinder or tapping sleeve pressure plate. This grooved plate is contoured to fit the cylinder and retains the broad profile gasket to provide an extra margin of safety at this critical point.

**Combination Gland/Draw Flange** - the combination gland/draw flange on 4" - 12" outlet sizes facilitates tapping with a 25" travel tapping machine. Larger outlets utilize separate flanges for each function to make bolt take-up on large flanges more accessible.

**Load Bearing Set Screws** - the JCM 415 Tapping Sleeve is furnished with load bearing set screws on the gland flange that are tightened after the gland is installed. These set screws tighten against the sleeve draw flange, transferring any load on the outlet away from the steel cylinder and onto the sleeve.

**Grout Seal Assembly** - Type I 415 Tapping Sleeve, the standard sleeve, is furnished with straps and a grout seal assembly under the sleeve. These two design features facilitate fitting oversize, undersize and out-of-round pipe by providing the means to pour cement grout into a cavity to make a perfect sleeve fit. This feature is in accordance with AWWA M-9 Manual as recommended by the manufacturers of concrete pressure pipe. Epoxy coated sleeves and sleeves with a solid back sit directly on the pipe, precluding the use of the grout seal assembly.

**Epoxy Coated Waterway** - the tapping sleeve's waterway is fusion applied epoxy coated to provide a quality connection protected against corrosion in the critical waterway

### HOW TO ORDER

For pricing and engineering, the following information must be furnished:

Type of pipe (manufacturer and class if known)

Type of sleeve

Outside diameter of pipe and cylinder O.D.

Line content and pressure

Outlet size

Any special requirements or options.

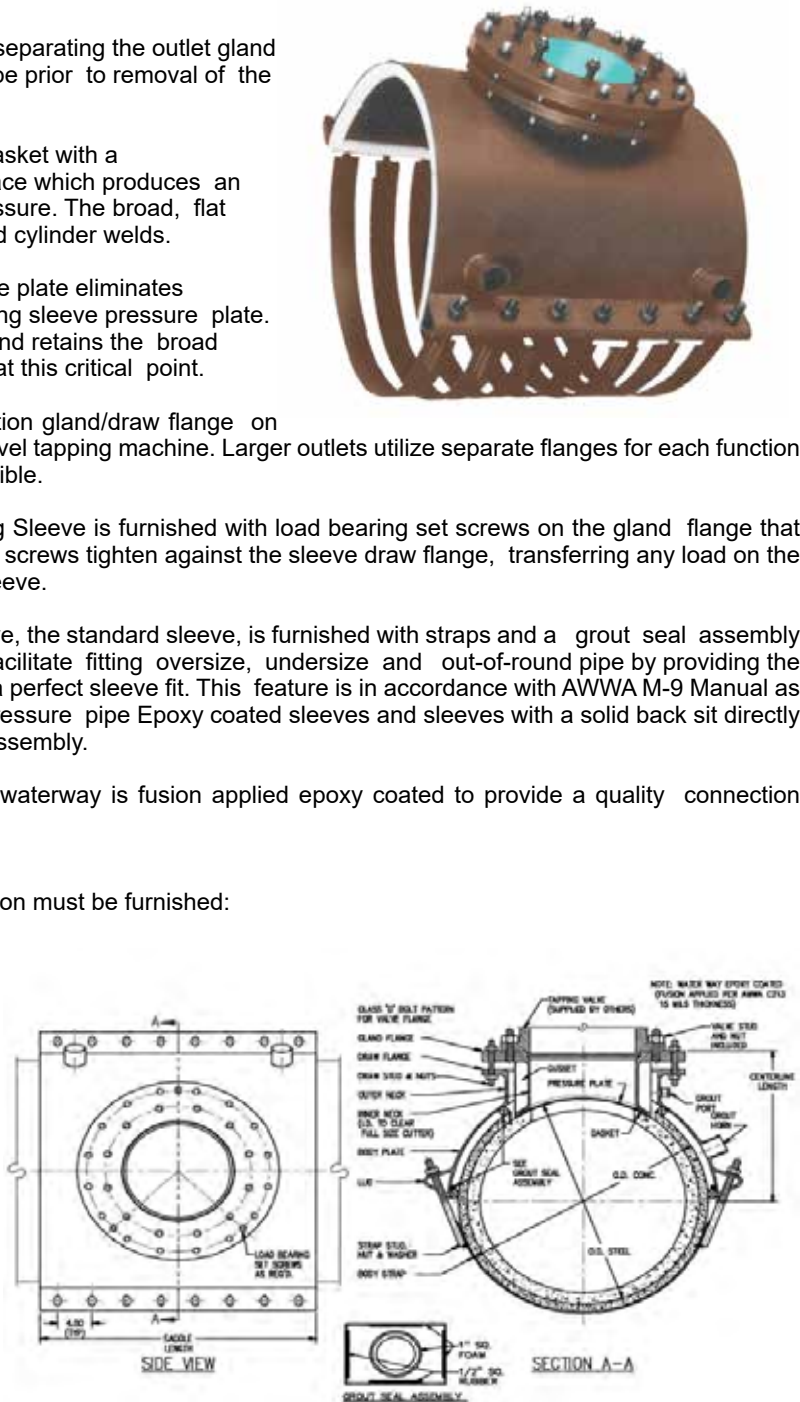

Tapping Sleeves for Concrete Steel Cylinder Pipe shall be in accordance with AWWA Manual M-9. They shall also meet AWWA C301 and C303 Standards pertaining to design, manufacturing quality tests and welders qualifications. Manufacturers shall have manufactured this type of tapping sleeve for a minimum of ten (10) years.

**FOR SLEEVES FOR REINFORCED CONCRETE PIPE ASK FOR JCM 412 TAPPING SLEEVES FOR REINFORCED CONCRETE PIPE.**

## JCM Weld On Tapping Outlets

### Weld-on outlets & connections are dependable and economical with JCM Weld On Fittings

Outlets, partial sleeves and complete sleeves are readily available for steel pipe 6" and larger with size on size and reducing outlets. Outlets and partial sleeves are also available for tank and bulkhead use. Various configurations of this design are available. Featured below are the most popular.



**416 Type 1\*:  
Weld On Outlet**



**416 Type 2HW:  
Split Tee  
Three Piece Weld On Saddle**



**416 Type 3:  
Flanged Nozzle  
Weld On Outlet**



**416 Type 4\*:  
Hat Flange Weld On  
Outlet**



**417 Type 1:  
Split Tee  
Weld On Tapping Sleeve**

#### MATERIAL SPECIFICATIONS

**Body:** Carbon steel per ASTM A36, A516 GR70 or equal.  
Optional 304 or 316 Stainless Steel.

**Flange:** AWWA C207 Class D, ANSI 150 lb. Drilling, recessed for tapping valve  
MSS-SP60. Other Flanges Available Upon Request.

**Finish:** Heavy coat of corrosion resistant shop coat primer.  
Optional Fusion Epoxy Coating available.  
ANSI/NSF Standard 61, Annex G and ANSI/NSF 372 Certified.

Other configurations available  
upon request.

#### How To Order:

1. Determine nominal pipe O.D. and outlet size.
2. Determine sleeve type required.
3. Determine special coatings required.
4. Specify sleeve "type", pipe O.D. and outlet size.

Example: For Steel Pipe with 8.63 O.D. with 6" flanged outlet, full sleeve style, order:  
417-0863x6 Type 1

\*Not available M11 Compliant



# JCM 440 Line Stop Sleeves

## 440 Type Material Specifications

### All 440 Line Stop Fitting Types include:

- Line Stop Plug:** Ductile Iron per ASTM A536
- Plug O-Ring:** Nitrile (NBR, Buna-N) Rubber - Gasket temperature range -40° to 180°F (-40°C to 82°C).
- Blind Flange:** 150#, ASTM A36 Carbon Steel, Epoxy Coated
- Blind Flange Gasket:** Styrene-Butadiene Rubber (SBR) - Compounded for use with water, salt solutions, mild acids and bases. Standard temperature range from -40° to 150°F (-40° to 65°C) constant, maximum intermittent 180°F (82°C).
- Push Plug/Pin Hardware:** SAE Grade 8

### 440 Type 1 Threaded Plug/440 Type 11 Push Plug/Pin

- Body:** Stainless Steel, 18-8 Type 304
- Flange:** ASME/ANSI 150 lb. Drilling, B16.1 Class 125 Compatible, Type 304 Stainless Steel, recess for tapping valve MSS-SP60
- Bolts:** Stainless Steel 18-8 Type 304
- Gasket:** Full circumferential Virgin Styrene-Butadiene Rubber (SBR) - Compounded for use with water, salt solutions, mild acids and bases. Per ASTM D-2000 M4AA 607. Standard temperature range from -40° to 150°F (-40° to 65°C) constant, maximum intermittent 180°F (82°C).

### 440 Type 2 Threaded Plug/440 Type 12 Push Plug/Pin

- Body:** ASTM A36 Carbon Steel or equal
- Flange:** ASME/ANSI 150 lb. Drilling, B16.1 Class 125 Compatible, Carbon Steel, recess for tapping valve MSS-SP60
- Bolts:** ASTM A242 corrosion resistant high strength, low alloy (per ANSI 21.11/AWWA C-111). Optional Stainless Steel 18-8 Type 304 or 316 available.
- Finish:** Heavy coat of corrosion resistant shop coat primer. Optional fusion applied Epoxy Coating per ANSI/ AWWA C213 Standard.
- Gasket:** Nitrile Butadiene Rubber (NBR, Buna-N) per ASTM D2000. Molded virgin rubber with a pressure activated hydromechanical design. Gasket is bonded into a cavity for internal and external retention. Gasket temperature range -40° to 180°F (-40° - 82°C). Gasket suitable for water, salt solutions, mild acids, bases, and sewage.

### 440 Type 3 Threaded Plug/440 Type 13 Push Plug/Pin

- Body:** Stainless Steel, 18-8 Type 304
- Flange:** ASME/ANSI 150 lb. Drilling, B16.1 Class 125 Compatible, Type 304 Stainless Steel, recess for tapping valve MSS-SP60
- Bolts:** Stainless Steel 18-8 Type 304
- Gasket:** Nitrile Butadiene Rubber (NBR, Buna-N) per ASTM D2000. Molded virgin rubber with a pressure activated hydromechanical design. Gasket is bonded into a cavity for internal and external retention. Gasket temperature range -40° to 180°F (-40° - 82°C). Gasket suitable for water, salt solutions, mild acids, bases, and sewage.

### 440 Type 4 Threaded Plug/440 Type 14 Push Plug/Pin

- Body:** Stainless Steel, 18-8 Type 304
- Flange:** ASME/ANSI 150 lb. Drilling, B16.1 Class 125 Compatible, Type 304 Stainless Steel, recess for tapping valve MSS-SP60, fusion epoxy coated for corrosion resistance.
- Bolts:** Stainless Steel, 18-8 Type 304
- Gasket:** Full circumferential Virgin Styrene-Butadiene Rubber (SBR) - Compounded for use with water, salt solutions, mild acids and bases. Per ASTM D-2000 M4AA 607. Standard temperature range from -40° to 150°F (-40° to 65°C) constant, maximum intermittent 180°F (82°C).

### 440 Type 5 Threaded Plug/440 Type 15 Push Plug/Pin

- Body:** Stainless Steel, 18-8 Type 304
- Flange:** ASME/ANSI 150 lb. Drilling, B16.1 Class 125 Compatible, Type 304 Stainless Steel, recess for tapping valve MSS-SP60, fusion epoxy coated for corrosion resistance.
- Bolts:** Stainless Steel, 18-8 Type 304
- Gasket:** Nitrile Butadiene Rubber (NBR, Buna-N) per ASTM D2000. Molded virgin rubber with a pressure activated hydro mechanical design. Gasket is bonded into a cavity for internal and external retention. Gasket temperature range -40° to 180°F (-40° - 82°C). Gasket suitable for water, salt solutions, mild acids, bases, and sewage.





## JCM Line Stop Fittings with Full Circumferential Gasket



The 440 Line Stop Sleeve Family offers the sleeve you need for the application. As the **NUMBER ONE** choice of contractors, JCM continues to meet the challenge of field application requirements with product design, material selection and delivery expectations.

JCM 440 Line Stop Family continues to grow with advanced designs, material combinations and numerous options to fit your application.

JCM's patented Line Stop Sleeves adapt to popular line stop machines and can be rated up to 250 PSI.

JCM Line Stop Sleeves with Full Circumferential Gasket are designed for applications in which the pipe is susceptible to breaking during or after the tapping/line stop procedure. JCM 440 Line Stops with Full Circumferential Gasket are offered in two fabricated material combinations: All Stainless Steel or Stainless Steel with Carbon Steel Outlet.

Both sleeves are offered with either the "threaded plug" design or the "push plug" design.

440 Line Stop Sleeve	Outlet Material Options for Stainless Steel Sleeve - Full Circumferential Gasket
	<p>JCM 440 Type 1 - All Stainless Steel with Full Circumferential Gasket - Threaded Plug                      JCM 440 Type 11 - All Stainless Steel with Full Circumferential Gasket - Push Plug/Pin</p> <p><b>Outlet Material:</b>                      ASME/ANSI 150 lb. Drilling, B16.1 Class 125 Compatible, Type 304 Stainless Steel, recess for tapping valve MSS-SP60</p>
	<p>JCM 440 Type 4 - Stainless Steel Carbon Steel Outlet Full Circumferential Gasket - Threaded Plug                      JCM 440 Type 14 - Stainless Steel Carbon Steel Outlet Full Circumferential Gasket - Push Plug/Pin</p> <p><b>Outlet Material:</b>                      ASME/ANSI 150 lb. Drilling, B16.1 Class 125 Compatible, Carbon Steel, recess for tapping valve MSS-SP60, fusion applied epoxy coating.</p>

### How To Order

1. Determine O.D. of pipe
2. Select proper catalog number
3. Select proper outlet size
4. Select proper outlet plug type code (threaded or push/pin)
5. Add outlet Type Code (T1 - Threaded or T11 - Push Plug/Pin Style)

Example: For Ductile Iron with 6.90 O.D. with 6" threaded plug, order: 440-0690x 6 T1

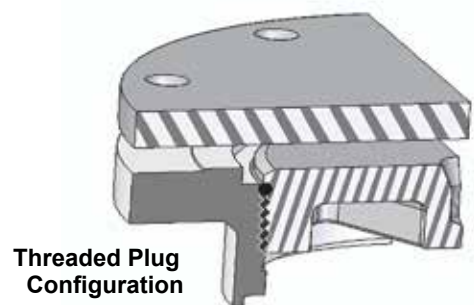
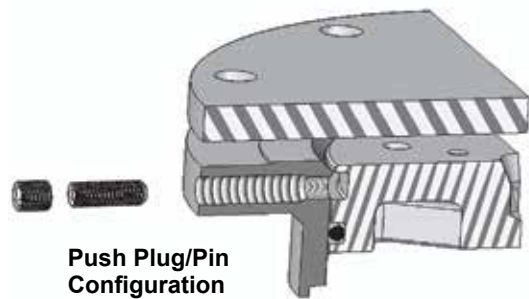



**JCM 440 Type 1 Line Stop with Full Circumferential Gasket - Threaded Plug**  
**JCM 440 Type 11 Line Stop with Full Circumferential Gasket - Push Plug/Pin**  
**All Stainless Steel Construction - Full Circumferential Gasket**

Recommended for: cast iron, ductile iron, asbestos cement, PVC and other types of pipe susceptible to breakage.

NOMINAL PIPE SIZE (IN)	SLEEVE O.D. RANGE (IN)	CATALOG NUMBER X OUTLET SIZE X PLUG CODE	OUTLET SIZE	THREADED PLUG TYPE CODE	PUSH PLUG/PIN TYPE CODE	APPR WT EA (LBS)
4	4.40 - 4.60	440-0450	x 4	T1	T11	56
	4.50 - 4.80	440-0465		T1	T11	
	4.74 - 5.00	440-0480		T1	T11	
	5.10 - 5.30	440-0520		T1	T11	
6	6.56 - 6.76	440-0663	x 4	T1	T11	63 81
	6.84 - 7.10	440-0690		T1	T11	
	7.05 - 7.25	440-0720	x 6	T1	T11	
	7.40 - 7.65	440-0745		T1	T11	
8	8.54 - 8.74	440-0863	x 6	T1	T11	86 132
	8.60 - 9.05	440-0900		T1	T11	
	8.98 - 9.30	440-0905	x 8	T1	T11	
	9.27 - 9.50	440-0940		T1	T11	
10	9.83 - 10.25	440-1000	x 8 x10	T1	T11	126 192
	10.64 - 10.86	440-1075		T1	T11	
	11.03 - 11.40	440-1110		T1	T11	
	11.36 - 11.80	440-1140		T1	T11	
	11.85 - 12.15	440-1200		T1	T11	
12	12.62 - 12.85	440-1275	x 8 x 12	T1	T11	144 269
	12.75 - 13.20	440-1300		T1	T11	
	13.12 - 13.50	440-1320		T1	T11	
	13.70 - 14.09	440-1392		T1	T11	
	14.10 - 14.35	440-1420		T1	T11	



**JCM 440 Type 4 Line Stop Full Circumferential Gasket - Threaded Plug**  
**JCM 440 Type 14 Line Stop Full Circumferential Gasket - Push Plug/Pin**  
**Stainless Steel Body - Carbon Steel Outlet - Full Circumferential Gasket**

Recommended for: cast iron, ductile iron, asbestos cement, PVC and other types of pipe susceptible to breakage.

NOMINAL PIPE SIZE (IN)	SLEEVE O.D. RANGE (IN)	CATALOG NUMBER X OUTLET SIZE X PLUG CODE	OUTLET SIZE	THREADED PLUG TYPE CODE	PUSH PLUG/PIN TYPE CODE	APPR WT EA (LBS)
4	4.40 - 4.60	440-0450	x 4	T4	T14	56
	4.50 - 4.80	440-0465		T4	T14	
	4.74 - 5.00	440-0480		T4	T14	
	5.10 - 5.30	440-0520		T4	T14	
6	6.56 - 6.76	440-0663	x 4	T4	T14	63 81
	6.84 - 7.10	440-0690		T4	T14	
	7.05 - 7.25	440-0720	x 6	T4	T14	
	7.40 - 7.65	440-0745		T4	T14	
8	8.54 - 8.74	440-0863	x 6	T4	T14	86 132
	8.60 - 9.05	440-0900		T4	T14	
	8.98 - 9.30	440-0905	x 8	T4	T14	
	9.27 - 9.50	440-0940		T4	T14	
10	9.83 - 10.25	440-1000	x 8 x 10	T4	T14	126 192
	10.64 - 10.86	440-1075		T4	T14	
	11.03 - 11.40	440-1110		T4	T14	
	11.36 - 11.80	440-1140		T4	T14	
	11.85 - 12.15	440-1200		T4	T14	
12	12.62 - 12.85	440-1275	x 8 x 12	T4	T14	144 269
	12.75 - 13.20	440-1300		T4	T14	
	13.12 - 13.50	440-1320		T4	T14	
	13.70 - 14.09	440-1392		T4	T14	
	14.10 - 14.35	440-1420		T4	T14	

Other sleeve ranges and outlet sizes available upon request.

## JCM Line Stop Fittings with Outlet Seal Gasket

The JCM 440 Line Stop Fitting with Outlet Seal Gasket are fabricated for types of pipe that are not susceptible to breaking and for large diameter pipelines. JCM offers the broadest selection of material combination in the industry and can meet the exacting standards of your application. Fabrication materials include: carbon steel, carbon/stainless and all stainless steel. JCM patented Line Stop Sleeves adapt to popular line stop machines and can be rated up to 250 PSI. Other designs available: weld-on outlets and sleeves, mechanical joint sleeves, specialty configurations. All combinations are available with "threaded plug" design or "push plug" design.

440 Line Stop Sleeve	Outlet Gasket Sleeve Description
	<p><b>JCM 440 Type 2 - Carbon Steel Construction - Outlet Seal Gasket - Threaded Plug</b>  <b>JCM 440 Type 12 - Carbon Steel Construction - Outlet Seal Gasket - Push Plug/pin</b>                      Pipe Sizes: 4" - 20" and larger                      Optional epoxy coating per ANSI/AWWA Standard C213                      Optional Hardware 304 or 316 stainless                      Optional gasket materials.                      Recommended for: cast iron, ductile iron, C-900/C905 PVC, HDPE, steel</p>
	<p><b>JCM 440 Type 3 - All Stainless Steel Construction - Outlet Seal Gasket - Threaded Plug</b>  <b>JCM 440 Type 13 - All Stainless Steel Construction - Outlet Seal Gasket - Push Plug Pin</b>                      Pipe Sizes: 4" - 20" and larger                      Optional gasket materials                      Recommended for: cast iron, ductile iron, C-900/C905 PVC, HDPE, steel</p>
	<p><b>JCM 440 Type 5 - Stainless Steel Body - Carbon Steel Outlet - Outlet Seal Gasket - Threaded Plug</b>  <b>JCM 440 Type 15 - Stainless Steel Body - Carbon Steel Outlet - Outlet Seal Gasket - Push Plug Pin</b>                      Pipe Sizes: 4" - 20" and larger                      Optional gasket materials                      Recommended for: cast iron, ductile iron, C-900/C905 PVC, HDPE, steel</p>

**How To Order:**

1. Determine O.D. of pipe
  2. Select proper catalog number
  3. Select proper outlet size
  4. Select proper outlet plug type code (threaded or push/pin)
  5. Add Outlet Type Code (T2 or T12)
- Example: For Ductile Iron with 6.90 O.D. with 6" threaded plug, order: 440-0690 x 6 T2  
 Other sleeve size and outlet size combinations available upon request.

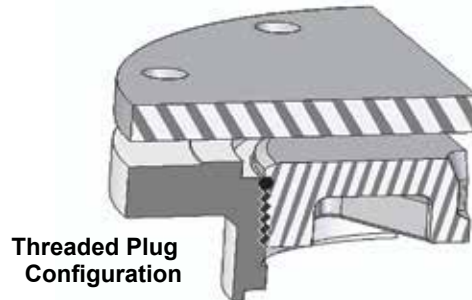
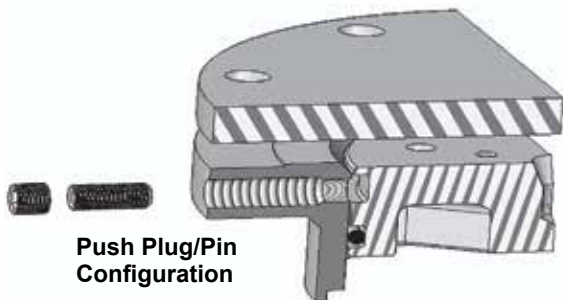

**JCM 440 Type 2 - Carbon Steel - Outlet Seal Gasket - Threaded Plug**

**JCM 440 Type 12 - Carbon Steel - Outlet Seal Gasket - Push Plug/Pin**

Furnished standard shopcoat with alloy hardware

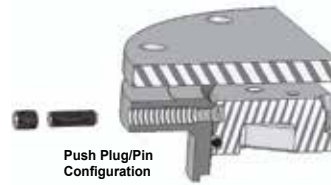
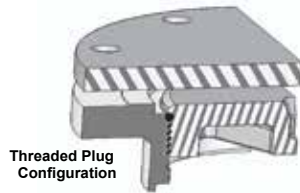

**440 Type 2 - Carbon Steel - Outlet Seal Gasket - Threaded Plug**

**440 Type 12 - Carbon Steel - Outlet Seal Gasket - Push Plug/Pin**

NOMINAL PIPE SIZE (IN)	SLEEVE O.D. RANGE (IN)	CATALOG NUMBER X OUTLET SIZE X PLUG CODE	OUTLET SIZE	THREADED PLUG TYPE CODE	PUSH PLUG/PIN TYPE CODE	APPR WT EA (LBS)
4	4.50	440-0450	x 4	T2	T12	48
	4.80	440-0480		T2	T12	
	5.20	440-0520		T2	T12	
	5.56	440-0556		T2	T12	
6	6.63	440-0663	x 4	T2	T12	92 114
	6.84 - 7.10	440-0690		T2	T12	
	7.05 - 7.25	440-0720	x 6	T2	T12	
	7.40 - 7.65	440-0745		T2	T12	
8	8.63	440-0863	x 6	T2	T12	120 172
	8.98 - 9.30	440-0905		T2	T12	
	9.27 - 9.50	440-0940	x 8	T2	T12	
	9.83 - 10.25	440-1000		T2	T12	
10	10.64 - 10.86	440-1075	x 8	T2	T12	179 267
	11.03 - 11.40	440-1110		T2	T12	
	11.36 - 11.80	440-1140	x 10	T2	T12	
	11.85 - 12.15	440-1200		T2	T12	
12	12.62 - 12.85	440-1275	x 8	T2	T12	194 324
	13.12 - 13.50	440-1320		T2	T12	
	13.70 - 14.09	440-1392	x 12	T2	T12	
	14.10 - 14.35	440-1420		T2	T12	
14	14.59 - 15.08	440-1475	x 12	T2	T12	328
	15.23 - 15.80	440-1530		T2	T12	
	15.73 - 16.22	440-1600		T2	T12	
	16.30 - 16.73	440-1650		T2	T12	
16	16.74 - 17.26	440-1684	x 12	T2	T12	338
	17.33 - 17.87	440-1740		T2	T12	
	17.88 - 18.43	440-1800		T2	T12	
	18.62 - 19.19	440-1875		T2	T12	
18	18.87 - 19.45	440-1920	x 12	T2	T12	353
	19.41 - 20.01	440-1950		T2	T12	
	20.00 - 20.60	440-2000		T2	T12	
	20.29 - 20.94	440-2050		T2	T12	
	20.93 - 21.57	440-2130		T2	T12	
20	21.51 - 22.15	440-2160	x 12	T2	T12	363
	22.16 - 22.81	440-2254		T2	T12	
	22.78 - 23.45	440-2294		T2	T12	
	23.46 - 24.16	440-2400		T2	T12	
	24.15 - 24.85	440-2450		T2	T12	
	24.82 - 25.52	440-2502		T2	T12	

Other sleeve ranges and outlet sizes available upon request.

**JCM 440 Type 3 - All Stainless Steel - Outlet Seal Gasket - Threaded Plug**  
**JCM 440 Type 13 - All Stainless Steel - Outlet Seal Gasket - Push Plug/Pin**

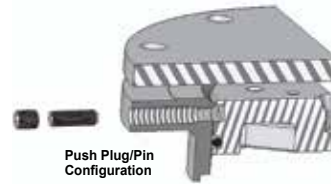
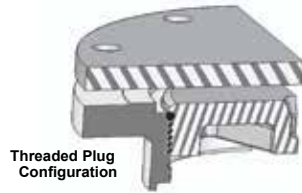

**440 Type 3 - All Stainless Steel - Outlet Seal Gasket - Threaded Plug**  
**440 Type 13 - All Stainless Steel - Outlet Seal Gasket - Push Plug/Pin**

NOMINAL PIPE SIZE (IN)	SLEEVE O.D. RANGE (IN)	CATALOG NUMBER X OUTLET SIZE X PLUG CODE	OUTLET SIZE	THREADED PLUG TYPE CODE	PUSH PLUG/PIN TYPE CODE	APPR WT EA (LBS)
4	4.50	440-0450	x 4	T3	T13	48
	4.80	440-0480		T3	T13	
	5.20	440-0520		T3	T13	
	5.56	440-0556		T3	T13	
6	6.63	440-0663	x 4	T3	T13	92 114
	6.84 - 7.10	440-0690		T3	T13	
	7.05 - 7.25	440-0720	x 6	T3	T13	
	7.40 - 7.65	440-0745		T3	T13	
8	8.63	440-0863	x 6	T3	T13	120 172
	8.98 - 9.30	440-0905		T3	T13	
	9.27 - 9.50	440-0940	x 8	T3	T13	
	9.83 - 10.25	440-1000		T3	T13	
10	10.64 - 10.86	440-1075	x 8	T3	T13	179 267
	11.03 - 11.40	440-1110		T3	T13	
	11.36 - 11.80	440-1140	x 10	T3	T13	
	11.85 - 12.15	440-1200		T3	T13	
12	12.62 - 12.85	440-1275	x 8	T3	T13	194 324
	13.12 - 13.50	440-1320		T3	T13	
	13.70 - 14.09	440-1392	x 12	T3	T13	
	14.10 - 14.35	440-1420		T3	T13	
14	14.59 - 15.08	440-1475	x 12	T3	T13	328
	15.23 - 15.80	440-1530		T3	T13	
	15.73 - 16.22	440-1600		T3	T13	
	16.30 - 16.73	440-1650		T3	T13	
16	16.74 - 17.26	440-1684	x 12	T3	T13	338
	17.33 - 17.87	440-1740		T3	T13	
	17.88 - 18.43	440-1800		T3	T13	
	18.62 - 19.19	440-1875		T3	T13	
18	18.87 - 19.45	440-1920	x 12	T3	T13	353
	19.41 - 20.01	440-1950		T3	T13	
	20.00 - 20.60	440-2000		T3	T13	
	20.29 - 20.94	440-2050		T3	T13	
	20.93 - 21.57	440-2130		T3	T13	
20	21.51 - 22.15	440-2160	x 12	T3	T13	363
	22.16 - 22.81	440-2254		T3	T13	
	22.78 - 23.45	440-2294		T3	T13	
	23.46 - 24.16	440-2400		T3	T13	
	24.15 - 24.85	440-2450		T3	T13	
	24.82 - 25.52	440-2502		T3	T13	

Other sleeve ranges and outlet sizes available upon request.

**JCM 440 Type 5 - Stainless Body - Carbon Steel Outlet - Outlet Seal Gasket - Threaded Plug**  
**JCM 440 Type 15 - Stainless Body - Carbon Steel Outlet - Outlet Seal Gasket - Push Plug/Pin**

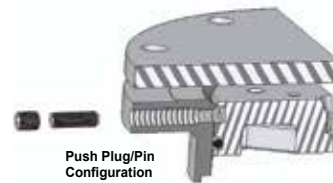
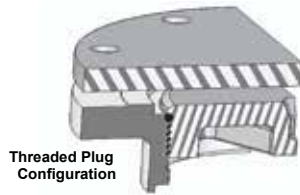

**440 Type 5 - Stainless Body - Carbon Steel Outlet - Outlet Seal Gasket - Threaded Plug**  
**440 Type 15 - Stainless Body - Carbon Steel Outlet - Outlet Seal Gasket - Push Plug/Pin**

NOMINAL PIPE SIZE (IN)	SLEEVE O.D. RANGE (IN)	CATALOG NUMBER X OUTLET SIZE X PLUG CODE	OUTLET SIZE	THREADED PLUG TYPE CODE	PUSH PLUG/PIN TYPE CODE	APPR WEIGHT (LBS)
4	4.50	440-0450	x 4	T5	T15	48
	4.80	440-0480		T5	T15	
	5.20	440-0520		T5	T15	
	5.56	440-0556		T5	T15	
6	6.63	440-0663	x 4	T5	T15	92
	6.84 - 7.10	440-0690	x 6	T5	T15	
	7.05 - 7.25	440-0720		T5	T15	
	7.40 - 7.65	440-0745		T5	T15	
8	8.63	440-0863	x 6 x 8	T5	T15	120 172
	8.98 - 9.30	440-0905		T5	T15	
	9.27 - 9.50	440-0940		T5	T15	
	9.83 - 10.25	440-1000		T5	T15	
10	10.64 - 10.86	440-1075	x 8 x 10	T5	T15	179 267
	11.03 - 11.40	440-1110		T5	T15	
	11.36 - 11.80	440-1140		T5	T15	
	11.85 - 12.15	440-1200		T5	T15	
12	12.62 - 12.85	440-1275	x 8 x 12	T5	T15	194 324
	13.12 - 13.50	440-1320		T5	T15	
	13.70 - 14.09	440-1392		T5	T15	
	14.10 - 14.35	440-1420		T5	T15	
14	14.59 - 15.08	440-1475	x 12	T5	T15	328
	15.23 - 15.80	440-1530		T5	T15	
	15.73 - 16.22	440-1600		T5	T15	
	16.30 - 16.73	440-1650		T5	T15	
16	16.74 - 17.26	440-1684	x 12	T5	T15	338
	17.33 - 17.87	440-1740		T5	T15	
	17.88 - 18.43	440-1800		T5	T15	
	18.62 - 19.19	440-1875		T5	T15	
18	18.87 - 19.45	440-1920	x 12	T5	T15	353
	19.41 - 20.01	440-1950		T5	T15	
	20.00 - 20.60	440-2000		T5	T15	
	20.29 - 20.94	440-2050		T5	T15	
	20.93 - 21.57	440-2130		T5	T15	
20	21.51 - 22.15	440-2160	x 12	T5	T15	363
	22.16 - 22.81	440-2254		T5	T15	
	22.78 - 23.45	440-2294		T5	T15	
	23.46 - 24.16	440-2400		T5	T15	
	24.15 - 24.85	440-2450		T5	T15	
	24.82 - 25.52	440-2502		T5	T15	

Other sleeve ranges and outlet sizes available upon request.

# JCM Fabricated Weld On Line Stop Outlets

Carbon Steel and All Stainless Steel (304 & 316) Construction Available

Outlets, partial sleeves and full sleeves readily available for steel pipe 4" and larger. Size on size and reducing outlets to accommodate folding head or bag stop machinery available. Outlets and partial sleeves available for tank and bulkhead use.

- JCM 440 Type 6 - Full Body- Threaded Plug
- JCM 440 Type 16 - Full Body - Push Plug/Pin
- JCM 440 Type 7 - Outlet Only - Threaded Plug
- JCM 440 Type 17 - Outlet Only - Push Plug/Pin

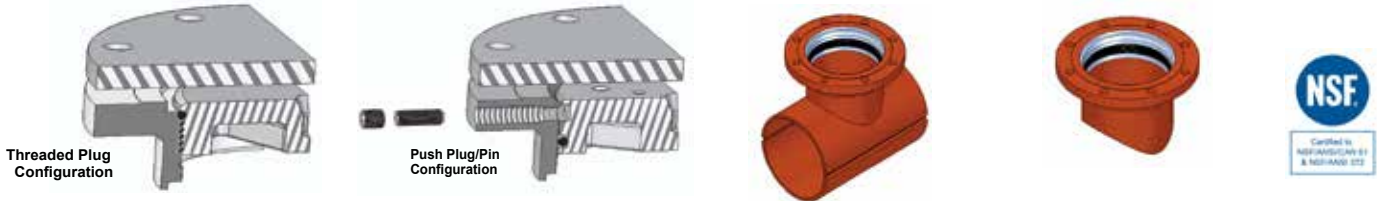

NOMINAL PIPE SIZE (IN)	CATALOG NUMBER	OUTLET SIZES	SLEEVE STYLE THREADED PLUG TYPE CODE	SLEEVE STYLE PUSH PLUG/PIN TYPE CODE	SLEEVE STYLE THREADED PLUG TYPE CODE	SLEEVE STYLE PUSH PLUG/PIN TYPE CODE
4	440-0450	x 4	T6	T16	T7	T17
6	440-0663	x 4 x 6	T6 T6	T16 T16	T7 T7	T17 T17
8	440-0863	x 6 x 8	T6 T6	T16 T16	T7 T7	T17 T17
10	440-1075	x 8 x 10	T6 T6	T16 T16	T7 T7	T17 T17
12	440-1275	x 8 x 12	T6 T6	T16 T16	T7 T7	T17 T17
14	440-1400	x 12	T6	T16	T7	T17
16	440-1600	x 12	T6	T16	T7	T17
18	440-1800	x 12	T6	T16	T7	T17
20	440-2000	x 12	T6	T16	T7	T17

## How To Order:

1. Determine O.D. of pipe
2. Select proper catalog number
3. Select proper outlet size
4. Select proper sleeve style and outlet plug type code (threaded or push/pin)
5. Add Outlet Type Code (T6 or T16)

Example: For Steel Pipe with 6.63 O.D., full sleeve style, with threaded plug, order: 440-0663 T6

**JCM 440 Weld On Line Stop Fittings are standard no test plugs. For optional test plug, contact JCM. Fittings are fabricated to exact O.D. of pipe.**

**Larger sizes available.**

**Other designs offered; contact JCM Industries.**



## JCM Fabricated Tapping Sleeves for High Density Polyethylene Pipe

JCM Products for tapping PE pipe have been tested and evaluated for their suitability and design capability. In each case JCM products have performed satisfactorily in respect to their design application.

High Density Polyethylene Pipe (HDPE) has several unique characteristics which must be taken into consideration. HDPE has a high coefficient of thermal expansion and a low modulus of elasticity. This sensitivity to pressure and temperature causes HDPE to expand and contract more than traditional water and sewer piping materials. HDPE will also relax ("creep") at lower stress levels than other piping materials.

In consideration of the unique characteristics, JCM provides fabricated tapping fittings that are sized specifically with applicable ranges for HDPE. These sleeves are featured on the following pages.

### JCM Outlet Seal Threaded Outlet Tapping Sleeves for HDPE Pipe Model Numbers 418, 438

Ranges and Part Numbers provided specifically for High Density Polyethylene Pipe.

NOM PIPE SIZE (IN)	SLEEVE O.D. RANGE (IN)	SLEEVE NUMBER X ANY OUTLET	OUTLET SIZE	ORDER CODE IP		
14	13.60 - 14.09	1392	3/4"	06		
	14.99 - 15.49	1520				
16	15.68 - 16.18	1590				
	17.05 - 17.55	1730				
18	17.64 - 18.14	1790				
	19.11 - 19.61	1940				
20	19.60 - 20.10	1990			1"	
	21.17 - 21.67	2150				
21	20.60 - 21.10	2090			1-1/4"	10
	21.60 - 22.10	2190				
24	23.46 - 24.16	2400			1-1/2"	12
	25.30 - 25.80	2570				
27	26.50 - 27.00	2690			2"	14
	27.50 - 28.00	2790				
30	29.50 - 30.00	2990			2-1/2"	16
	31.50 - 32.00	3190				
36	35.50 - 36.00	3590			3"	17
	37.80 - 38.30	3820				
42	41.50 - 42.00	4190	4"	18		
	44.00 - 44.50	4440				
48	47.50 - 48.00	4790				
	50.30 - 50.80	5070				
54	53.50 - 54.00	5390				
	57.06 - 57.56	5746				
60	59.50 - 60.00	5990				
	61.11 - 61.61	6151				



For detailed application information for products on HDPE, see JCM Manual: "Fittings and Fabrications for HDPE Pipe"

**How to Order:**

1. Determine outside diameter of HDPE Pipe (IPS, DI), provide SDR#.
2. Select sleeve material (carbon, stainless) and proper size outlet.
3. Select model number (418, 438). For full product description see JCM Catalog.
4. Select proper sleeve O.D. Range and sleeve number.
5. Specify Model Number-Sleeve Number x Outlet Size

Example: For 24" HDPE SDR 17 IPS O.D. pipe, with 2" threaded outlet, carbon steel, order: 418-2400 x 14IP

Example: For 24" HDPE SDR 17 IPS O.D. Pipe, with 2" threaded outlet, All Stainless Steel, order: 438-2400 x 14IP

Note: 2" CC Threaded Saddles are Non-Returnable Items

**For sizes not listed, contact JCM Inside Sales Team.**





# JCM Fabricated Tapping Sleeves for HDPE

## Model Numbers 412, 419, 452, 464, 459, 465

Ranges and Part Numbers provided specifically for High Density Polyethylene Pipe

For sizes not listed, contact JCM Inside Sales Team at 800-527-8482 or 903-832-2581.

NOM PIPE SIZE (IN)	SLEEVE O.D. RANGE (IN)	SLEEVE NUMBER X ANY OUTLET	OUTLET SIZES AVAILABLE
14	13.60 - 14.09	1392	2" and Larger Outlets Available Contact JCM Industries
	14.99 - 15.49	1520	
16	15.68 - 16.18	1590	
	17.05 - 17.55	1730	
18	17.64 - 18.14	1790	
	19.11 - 19.61	1940	
20	19.60 - 20.10	1990	
	21.17 - 21.67	2150	
21	20.60 - 21.10	2090	
22	21.60 - 22.10	2190	
24	23.46 - 24.16	2400	
	25.30 - 25.80	2570	
27	26.50 - 27.00	2690	
28	27.50 - 28.00	2790	
30	29.50 - 30.00	2990	
	31.50 - 32.00	3190	
36	35.50 - 36.00	3590	
	37.80 - 38.30	3820	
42	41.50 - 42.00	4190	
	44.00 - 44.50	4440	
48	47.50 - 48.00	4790	
	50.30 - 50.80	5070	
54	53.50 - 54.00	5390	
	57.06 - 57.56	5746	
60	59.50 - 60.00	5990	
	61.11 - 61.61	6151	



For detailed application information for products on HDPE, see JCM Manual: "Fittings and Fabrications for HDPE Pipe"

2" Mechanical Joint Outlets Not Available

JCM Flanged and Mechanical Joint Outlet Tapping Sleeves furnished with test plugs unless otherwise specified.



### How to Order:

1. Determine outside diameter of HDPE Pipe (IPS, DI), provide SDR#.
2. Select sleeve material (carbon, stainless) and proper size outlet.
3. Select model number (412, 419, 452, 464, 459, 465). For full product description see JCM Model Number
4. Select proper sleeve O.D. Range and sleeve number.
5. Specify Model Number-Sleeve Number x Outlet Size

Example: For 24" HDPE SDR 17 IPS O.D. pipe, with 6" flanged outlet, carbon steel, order: 412-2400 x 6

Example: For 24" HDPE SDR 17 IPS O.D. Pipe, with 6" MJ outlet, All Stainless Steel, order: 459-2400 x 6



### JCM 630 Restrainers for Asbestos Cement Pipe

JCM 630 Restrainers have been developed to fill the need to anchor 4 - 16 inch Asbestos Cement pipe. The wide supportive stance around the pipe combined with the split design make these restrainers ideal for retrofitting installations. Necessary excavation of Asbestos Cement Pipe will release the compacted backfill around joint areas exposing the joints to shifting or movement. This disturbance can lead to displaced and leaking gaskets. Hydrants, dead ends, ground subsidence and unstable soils often require restraint other than concrete thrust blocking.

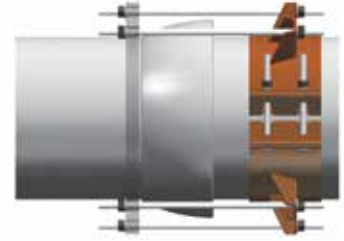

### JCM 630 Fitting Restrainer for Asbestos Cement Pipe

Restrainer for use with fittings, hydrants, flanged coupling adapters, meter and mechanical joints. All thread rods (16" long) nuts and washers are included.

NOM PIPE SIZE (IN)	PIPE RANGE O.D. (IN)	FITTING WIDTH (IN)	TIE RODS		CATALOG NUMBER	APPR WT EA (LBS)
			NUMBER	SIZE		
4	4.80 - 5.10	9	2	3/4 x 16	630-0500	43
6	7.05 - 7.40	8	2	3/4 x 16	630-0720	50
8	9.27 - 9.60	8	2	3/4 x 16	630-0940	70
10	11.76 - 12.24	8	4	3/4 x 16	630-1200	82
12	14.08 - 14.56	8	4	3/4 x 16	630-1420	110
14	16.30 - 16.73	12	6	3/4 x 16	630-1650	1225
16	18.62 - 19.19	12	6	3/4 x 16	630-1875	175

Rated for 150PSI



### JCM 631 Coupling Restrainer for Asbestos Cement Pipe

Restrainer for use over A/C coupling, MJ couplings and mechanical couplings. Tie rods (36" long), nuts and washers are included with restraint

NOM PIPE SIZE (IN)	PIPE RANGE O.D. (IN)	FITTING WIDTH (IN)	TIE RODS		CATALOG NUMBER	APPR WT EA (LBS)
			NUMBER	SIZE		
4	4.80 - 5.10	9	2	3/4 x 36	631-0500	68
6	7.05 - 7.40	8	2	3/4 x 36	631-0720	73
8	9.27 - 9.60	8	2	3/4 x 36	631-0940	130
10	11.76 - 12.24	8	4	3/4 x 36	631-1200	160
12	14.08 - 14.56	8	4	3/4 x 36	631-1420	182
14	16.30 - 16.73	12	6	3/4 x 36	631-1650	195
16	18.62 - 19.19	12	6	3/4 x 36	631-1875	315

Rated for 150PSI

For optional Epoxy Coating add (E) to end of Catalog Number.

For optional Epoxy Coating and Stainless Steel bolts add (ESS) to end of Catalog Number.

#### Material Specifications

Restrainer Body: Pressure Vessel Quality Steel ASTM A285 Grade C or equal.

Bolts and Nuts: Corrosion resistant high strength, low alloy AWWA C-111, ANSI 21.11.

Optional stainless steel, 18-8 Type 304.

Finish: Standard Shop Coat - heavy coating of corrosion inhibiting metal primer.

Optional Fusion applied Epoxy Coating ANSI/AWWA C213.

## JCM 610 Sur-Grip Fitting Restrainer

Anchors IPS, C-900 PVC Pipe, HDPE & Ductile Iron Pipe to mechanical joint and fittings provided with anchor lugs.

NOM PIPE SIZE (IN)	PIPE OD RANGE (IN)	CATALOG NUMBER	SERRATED RING BODY WIDTH	T-HEAD BOLTS		APPR WT EA (LBS)
				BOLT SIZE	QTY	
6	6.63	610-0663	2-1/2"	3/4 X 9-1/2	2	15
6	6.90	610-0690	2-1/2"	3/4 X 9-1/2	2	15
8	8.63	610-0863	2-3/4"	3/4 X 9-1/2	2	22
8	9.05	610-0905	2-3/4"	3/4 X 9-1/2	2	22
10	11.10	610-1110	Contact JCM for Information			
12	13.20	610-1320	2-3/4"	3/4 X 9-1/2	4	41



## JCM 620 Sur-Grip Bell Joint Restrainer

Anchors IPS PVC, C-900 PVC Pipe and Ductile Iron Pipe over the bell, flexible couplings and other low profile joints

NOM PIPE SIZE (IN)	PIPE OD RANGE (IN)	CATALOG NUMBER	SERRATED RING BODY WIDTH	COMPRESSION FOLLOWER RING WIDTH	FOLLOWER RING QTY	BOLTS		APPR WT EA (LBS)
						BOLT SIZE	QTY	
6	6.63	620-0663	2-1/2"	1-1/2"	2	3/4 X 12	2	21
6	6.90	620-0690	2-1/2"	1-1/2"	2	3/4 X 12	2	21
8	8.63	620-0863	2-3/4"	1-3/4"	2	3/4 X 14	2	32
8	9.05	620-0905	2-3/4"	1-3/4"	2	3/4 X 14	2	32
10	11.10	620-1110	Contact JCM for Information					
12	13.20	620-1320	2-3/4"	1-3/4"	2	3/4 X 18-1/2	4	63



## JCM 621 Sur-Grip Restrainer

Anchors IPS PVC, C-900 PVC Pipe and Ductile Iron Pipe over flexible couplings and other low profile joints. Provides serrated restraint on both sides of joint.

NOM PIPE SIZE (IN)	PIPE OD RANGE (IN)	CATALOG NUMBER	SERRATED RING BODY		COMPRESSION FOLLOWER RING		BOLTS		APPR WT EA (LBS)
			WIDTH	QTY	WIDTH	QTY	SIZE	QTY	
6	6.63	621-0663	2-1/2"	2	1-1/2"	2	3/4 X 12	2	24
6	6.90	621-0690	2-1/2"	2	1-1/2"	2	3/4 X 12	2	24
8	8.63	621-0863	2-3/4"	2	1-3/4"	2	3/4 X 14	2	38
8	9.05	621-0905	2-3/4"	2	1-3/4"	2	3/4 X 14	2	38
10	11.10	621-1110	Contact JCM for Information						
12	13.20	621-1320	2-3/4"	2	1-3/4"	2	3/4 X 18-1/2	4	72

JCM 610/620 Sur-Grip Restrainers - rated for 235 PSI on DR-18 PVC Pipe, and equal to the pipe rating on other classes. JCM 610 and 620 Sur-Grip Restrainers are rated for 350 PSI on Ductile Iron Pipe with a 2:1 safety factor.

## JCM 610 Sur-Grip Restrainer - 14" - 30" for use with C900 PVC Pipe, HDPE

Anchors pipe to mechanical joint and other type of fittings provided with anchor lugs.

NOM PIPE SIZE (IN)	PIPE OD RANGE (IN)	CATALOG NUMBER	BODY WIDTH (IN)	RESTRAINING RODS		BOLTS		APPR WT EA (LBS)
				SIZE	QTY	SIZE	QTY	
14	15.30	610-1530	5	3/4 X 14	6	1 X 9	4	60
16	17.40	610-1740	5	3/4 X 14	6	1 X 9	4	63
18	19.50	610-1950	5	3/4 X 14	8	1 X 9	4	73
20	21.60	610-2160	7	3/4 X 16	8	1 X 9	6	120
24	25.80	610-2580	7	3/4 X 16	12	1 X 9	6	175
30	32.00	610-3200	10	1 X 18	14	1 X 9	8	330



## JCM 611 Sur-Grip PVC Fitting Restrainer - 14" - 30" for use with C900 PVC Fittings and Pipe

Anchors Long Bell PVC Gasketed Fittings to C-905 PVC Pipe. JCM 611 PVC Fitting Restrainers

NOM PIPE SIZE (IN)	BASE CATALOG NUMBER	PROVIDE OD OF PVC FITTING
14	611-1530	XXXX
16	611-1740	XXXX
18	611-1950	XXXX
20	611-2160	XXXX
24	611-2580	XXXX
30	611-3200	XXXX



## JCM 621 Sur-Grip Bell/Joint Restrainer - 14" - 30" for use with C900 PVC Pipe, HDPE

Anchors over the bell-spigot & fused joint connection, the JCM 621 prevents joint separation on pressure pipe.

NOM PIPE SIZE (IN)	PIPE OD RANGE (IN)	CATALOG NUMBER	BODY WIDTH (IN)	RESTRAINING RODS		BOLTS		APPR WT EA (LBS)
				SIZE	QTY	BOLT SIZE	QTY	
14	15.30	621-1530	5	3/4 X 26	6	1 X 9	8	113
16	17.40	621-1740	5	3/4 X 26	6	1 X 9	8	120
18	19.50	621-1950	5	3/4 X 26	8	1 X 9	8	137
20	21.60	621-2160	7	3/4 X 32	8	1 X 9	12	230
24	25.80	621-2580	7	3/4 X 32	12	1 X 9	12	280
30	32.00	621-3200	10	1 X 36	14	1 X 9	16	660

JCM 610, 611 and 621 Sur-Grip Restrainers sizes 14" - 30" are available for HDPE IPS Diameters. For quotation, contact JCM Inside Sales Team. JCM 610, 611 and 621 Sur-Grip Restrainers sizes 14" - 30" are not for use on ductile iron, cast iron, asbestos cement, steel or any other rigid types of pipe. For application recommendations, contact JCM Inside Sales Team.

## JCM 607 Fabricated Weld On Restrainer/Joint Anchor Loops

The JCM 607 Fabricated Weld On Restrainer/Joint Anchor Loops are designed to provide permanent restraint for fittings installed on carbon and stainless steel pipelines. The JCM 607 Fabricated Weld On Restrainer/Joint Anchor Loops are available fabricated of carbon steel, 304 or 316 stainless steel and can be custom designed to the specific application.

The JCM 607 consists of an appropriate number of anchor loops (dependent upon pipe size) that are permanently field welded directly to the pipeline. JCM 607's can be installed to provide restraint directly to the fitting (when anchor loops on the fitting are present) or with restraining tie rods that extend across the fitting to the opposite side pipe restraint product (JCM or third party restrainer). Quantity and size of anchor loops tie rods are determined by nominal pipe size, opposite restraint product or by customer provided information. Tie rods provided by JCM is optional.

Standard working pressure allowable: 150PSI, for higher working pressures contact JCM Industries Engineered/ Technical Sales.

For quotation or ordering, the following information is required:

- Type of Pipe
- Nominal Size of Pipe
- Outside Diameter of Pipe
- Dimensions of fitting to restrain or restrain over
- Material of construction
- Pressure rating requirements
- Number & Size of restraining tie rods
- Mating Third Party Restrainer - manufacturer or bolting pattern/size
- Any special coatings, materials or customer required modifications

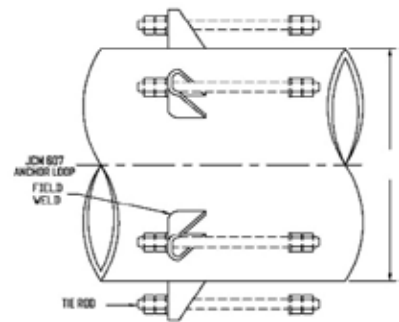

## JCM 617 Fabricated Weld On Restrainer/Joint Anchor Assembly

The JCM 617 Fabricated Weld On Restrainer Assembly is designed to provide permanent restraint for fittings installed in carbon and stainless steel pipelines. The JCM 617 Weld On Restrainers are available fabricated of carbon steel, 304 or 316 stainless steel and can be custom designed to the specific application.

The JCM 617 consists of an appropriate number of bolting lugs/loops (dependent upon size) that are welded to (2) rolled half rings that are permanently welded to the pipeline. JCM 617's can be installed to provide restraint directly to the fitting (when anchor loops are present) or with restraining tie rods that extend across the fitting to the opposite side pipe restraint product (JCM or third party restrainer). Quantity and size of tie rods are determined by nominal pipe size, opposite restraint product or by customer provided information. Tie rods provided by JCM is optional.

Standard working pressure allowable: 150PSI, for higher working pressures contact JCM Industries Engineered/ Technical Sales.

For quotation or ordering, the following information is required:

- Type of Pipe
- Nominal Size of Pipe
- Outside Diameter of Pipe
- Dimensions of fitting to restrain or restrain over
- Material of construction
- Pressure rating requirements
- Number & Size of restraining tie rods
- Mating Third Party Restrainer - manufacturer or bolting pattern/size
- Any special coatings, materials or customer required modifications

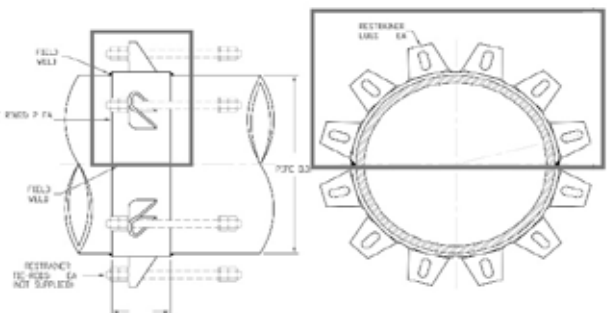

# JCM 650 HDPE Mechanical Wall Anchor Restraint

Bi-Directional Lateral Restraint of HDPE Pipe

BIDIRECTIONAL RESTRAINT - Two-way serration system to counteract lateral pipe movement from either direction. Serrated Restraint - prevents both push/pull-back and radial slipping of the pipe. Serrations are designed to bite into the exterior pipe wall without damaging the pipe.



Nom Size (IN)	Pipe O.D. Size (A)	Body Plate Thickness (B)	Body Width (C)	Qty & Ring Thickness (D)	Number of Bolts (E)	Size of Bolts (E)
12	12.75	3/8	16	4-5/16	8	3/4
12	13.20	3/8	16	4-5/16	8	3/4
14	14.00	3/8	10	4-5/16	8	1
14	15.30	3/8	10	4-5/16	8	1
16	16.00	3/8	10	6-5/16	8	1
16	17.40	3/8	10	6-5/16	8	1
18	18.00	3/8	10	6-5/16	8	1
18	19.50	3/8	10	6-5/16	8	1
20	20.00	3/8	14	8-5/16	8	1
20	21.60	1/2	14	8-3/8	12	1
20	22.00	1/2	14	8-3/8	12	1
24	24.00	1/2	14	10-3/8	12	1
24	24.80	1/2	14	10-3/8	12	1
24	25.80	1/2	14	10-3/8	12	1
26	26.00	1/2	14	10-3/8	12	1
27	27.00	1/2	14	12-3/8	12	1
30	30.00	1/2	20	12-3/8	16	1
30	32.00	1/2	20	12-3/8	16	1
36	36.00	1/2	20	14-3/8	16	1
36	38.30	1/2	20	16-3/8	16	1

## OPTIONS

### Carbon Steel

Shopcoat  
Epoxy

### Stainless Steel

304 or 316

### Hardware Options

Alloy

304 Stainless

316 Stainless Epoxy

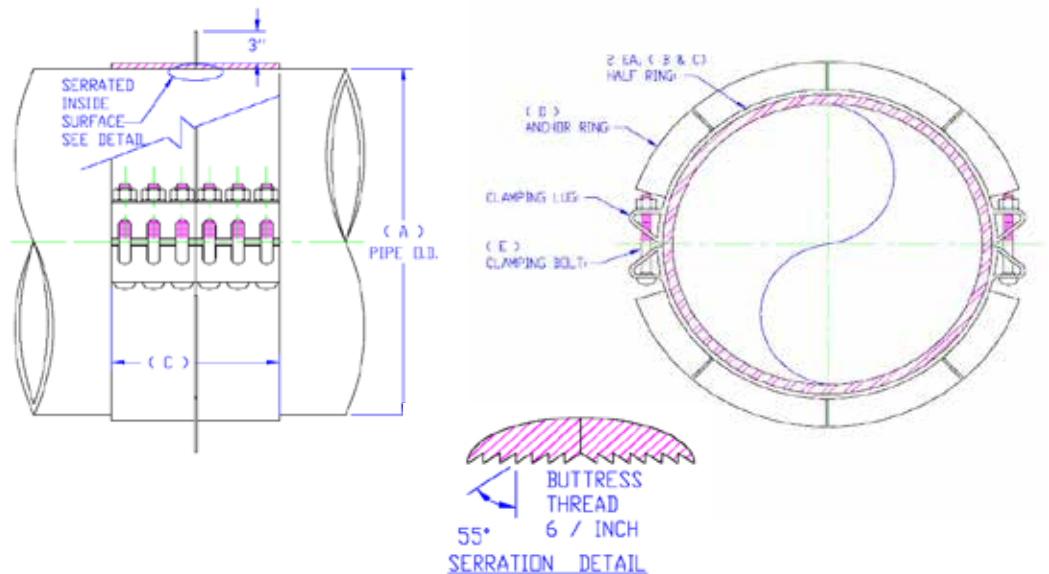

# JCM Transition Coupling and Restrainers Changes the Complex to Simple

Emergency Services

## Fabricated Couplings to Repair Asbestos Cement Pipe Damaged Joint

16" Asbestos Water Main

150 PSI Working Pressure

Pipeline furnishes water supply to the third largest natural gas processing plant in the United States.

Plant shutdown loss is approximately \$200,000 per day.

Major supply line from the wells to the facility and approximately 4-1/2 miles long.

Pipeline buried about 20' below ground level.

Damaged Asbestos Cement (A/C) Pipeline - images show the pipeline had shifted and pulled out from the original A/C Pipe coupling. This severe movement most likely unseated the gasket inside the coupling causing the joint to fail. The pipeline is 16" Asbestos Cement with a 19.10" Outside Diameter and Inside Diameter of 16.00" (no longer available). To match up the Inside Diameters, a section of 18" HDPE pipe with an Outside Diameter of 18.00" and an Inside Diameter of 15.59" was selected.



The A/C coupling was removed along with a section of A/C pipe. The JCM 204 Reducing Coupling (customer built length) was installed on the A/C pipe and the substitution HDPE pipe was installed on the other side.



To reinforce the connection and ensure the pipe did not pull out from the coupling under pressure, fabricated restraint systems were provided for both the HDPE Side (JCM 610) and the Asbestos Cement Side (JCM 630).

JCM Industries provided these fittings with expedited service - with 24 hour window from submitting the order to our production facility to delivery of fittings on the job site.



For more information on this and other applications, contact JCM Industries.

## JCM Fabricated Expansion Joints

JCM Expansion Joints permit up to 10" of concentrated pipe movement that provides for normal expansion/contraction of pipelines subject to variations of both environmental and line content temperatures. JCM Expansion Joints are manufactured using a telescoping design that consists of a fabricated steel body, or housing, that accommodates an inserted internal "slip pipe" that moves in and out of the body. This free movement absorbs the linear, or axial, movement of the section of pipe. The fabricated steel body houses a "packing" area of alternating rings of lubricated flax and rubber that provides the water tight seal during the cycling of the joint. JCM Expansion Joints offer several design options including end connections, coatings, limit rods, stainless steel fabrication and others. JCM Expansion Joints are manufactured for each specific application allowing for the incorporation of special options or engineered features required for the installation.

**Heavy Duty Construction** - The heavy duty, durable exterior body provides the protective shell for the slip pipe and packing system. For corrosive or acidic environments, the expansion joint may be epoxy coated or fabricated of stainless steel.

**Externally Guided Slip Pipe** - The corrosion resistant slip pipe furnishes a hard, surface that reduces friction between the slip pipe and packing material. For corrosive environments or line contents, slip pipe is available fabricated of stainless steel.

**Adjustable Packing Gland** - Alternating rings of lubricated flax and rubber are packed tightly into the packing area of the body by the adjustable packing gland. This packing gland maintains a consistent compression of the flax/rubber rings to ensure a tight, leak proof seal between the slip pipe and body.

**Lubricated Packing** - The rings of lubricated flax provide the "lubrication" to the slip pipe ensuring a smooth expanding/contracting movement while the square rubber rings secure the water tight seal. This packing area is easily accessible, without disruption of service, should repacking be required.



### HOW TO ORDER

For pricing and engineering, the following information must be furnished:

- Type of pipe
- Outside diameter of pipe
- Type of End Connections
- Line Contents
- Minimum and maximum temperatures
- Maximum working pressure
- Material and Coating specifications

**JCM 802 Double End Expansion Joints** are designed for special applications such as middle of line use where expansion joint body can be anchored. This fitting permits up to 10" total pipe movement, 5" on each end, with properly anchored body.





## JCM Fabricated Expansion Joints

JCM Expansion Joints are available as Model 801 Single End design or Model 802 Double End Expansion Joint and are available with the following options:

- (1) Weld-On Ends without Limit Rods
  - (2) Weld-On Ends with Limit Rods
  - (3) Flanged Ends without Limit Rods
  - (4) Flanged Ends with Limit Rods
  - (5) Mechanical Joint Ends without Limit Rods
  - (6) Mechanical Joint Ends with Limit Rods
- Other end connections available  
Increased or decreased amounts of pipe movement capability

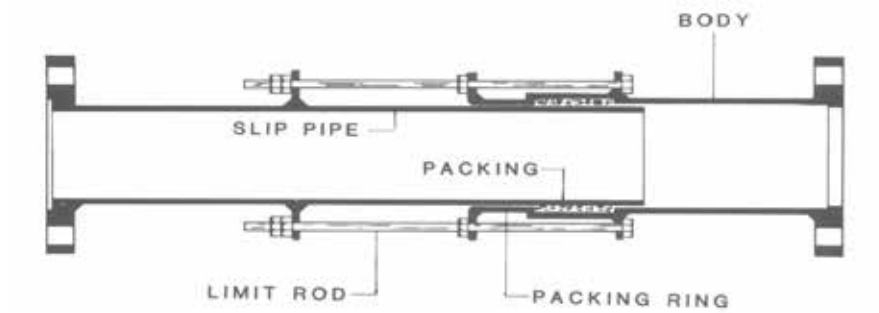

**JCM 801 Single End Expansion Joint**

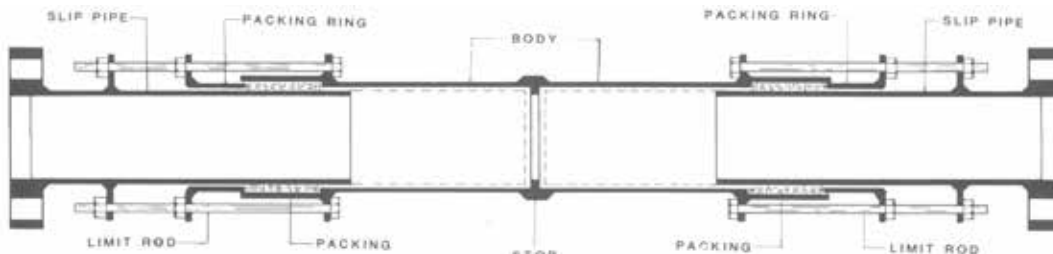







**JCM 802 Double End Expansion Joint**

### JCM Expansion Joint - Typical Specifications

Expansion Joints shall be of the externally guided, slip joint type, permitting up to 10" of concentrated pipe movement. The packing gland shall have alternate rings of lubricated flax and rubber specially compounded for use with water, salt solutions, mild acids, bases, natural gas and sewage. The body of the expansion joint shall have a shop coat primer. The slip pipe shall be stainless steel. Expansion Joints shall be JCM 801 or approved equal.

## JCM Fabricated Spools and Bypass Tees

 <p>820</p>  <p>822</p>  <p>823</p>	<p><b>820 Fabricated Plain End Tee</b>  <b>822 Fabricated Flanged x Plain End Tee</b>  <b>823 Bypass Tee (Flg x Flg x Flg)</b>            Sizes 3" and Larger, Available size on size and reducing</p> <p>Custom fabricated tees for cutting in services, replacing existing piping and for installing bypasses. The ability to meet exact length requirements, epoxy coated for extra corrosion resistance and quick shipment make these tee's real problem solvers.</p> <p><b>How To Order</b></p> <ol style="list-style-type: none"> <li>1. Determine Nominal Pipe and Flange Size</li> <li>2. Determine Outlet Tee/ Flange Size</li> <li>3. Determine Exact Laying Length Requirements</li> </ol> <p>Example: Flange x Flange Bypass Tee            6" Nominal Run with 4" Flanged Outlet, 10" in Length            Part Number: 823-6 x 6 x 4 x 10</p>
 <p>831</p>  <p>832</p>	<p><b>831 Flange x Flange Spool with Test Outlets</b>  <b>832 Flange x Flange Spool without Test Outlets</b>            Sizes 3" and Larger, Available size on size and reducing</p> <p>Ideal for installing new meters and equipment where the laying length of the new equipment is shorter than the equipment being replaced. These flanged spools can make up the difference and add test outlets if necessary. Custom fabrication allows exact length requirements to be met.</p> <p><b>How To Order</b></p> <ol style="list-style-type: none"> <li>1. Determine Nominal Pipe and Flange Size</li> <li>2. Determine Size and Quantity of Test Outlets (for 831)</li> <li>3. Determine Exact Laying Length Requirements - minimum length available:              Size on Size: 3" nominal size - 5-3/4", 4" - 12" nominal size - 6-3/4"</li> </ol> <p>Example: 6" Nominal run with two (2) 1-3/4" Test Outlets, 10" in Length            831 Part Number: 831-6 x 6 x 1-3/4 x 10 with two (2) Test Outlets            832 Part Number: 832-6 x 6 x 10</p>
 <p>833</p>  <p>834</p>	<p><b>833 Flange x Plain End Spool with Test Outlets</b>  <b>834 Flange x Plain End Spool without Test Outlets</b>            Sizes 3" and Larger, Available size on size and reducing</p> <p>Ideal for use on installations requiring field fit up. Plain end accommodates a flexible coupling for easy adjustment.</p> <p><b>How To Order</b></p> <ol style="list-style-type: none"> <li>1. Determine Nominal Pipe and Flange Size</li> <li>2. Determine Size and Quantity of Test Outlets (for 833)</li> <li>3. Determine Exact Laying Length Requirements -minimum length available:              Size on Size: 3" nominal size - 8-3/4", 4" - 12" nominal size - 9-3/4"</li> </ol> <p>Example: 6" Nominal run with two (2) 1-3/4" Test Outlets, 10" in Length            833 Part Number: 833-6 x 6 x 1-3/4 x 10 with two (2) Test Outlets            834 Part Number: 834-6 x 6 x 10</p>



**JCM 910 Extra Deep Socket Set**

Four piece deep socket set includes the popular 1/2" drive sockets sizes 15/16", 1-1/16", 1-1/8", 1-1/4" with a plastic storage case to protect and store sockets when not in use



**JCM 920 Pipe O.D. Tape - 8' Length**

This popular tape has a 8' blade which has standard inches on the reverse from the diameter in 100ths. This reversed blade allows a quick and accurate measurement of the diameter or circumference of the pipe.



CATALOG NUMBER	DESCRIPTION
910	Extra Deep Socket Set
920	8' Pipe Diameter Tape

## JCM PRODUCTS FOR POLYETHYLENE PIPE

JCM Industries manufactures a number of products which have proven to be very applicable to HDPE Pipe. Due to the unique characteristics of polyethylene pipe, special attention should be applied to the repair, connection and tapping procedures performed in systems using this type of pipe. Products especially applicable to HDPE pipe include:

### COUPLINGS AND REPAIR CLAMPS

101 - 102 Universal Clamp Couplings  
131 - 132 All Stainless Steel Universal Clamp Couplings  
201 Steel Couplings  
210 Series Ductile Iron Couplings  
230/231 Series HDPE Stainless Steel Stiffeners

### TAPPING SLEEVES AND SADDLES

404 - 406 Service Saddle with Double Stainless Steel Straps (3/4" thru 2-1/2" outlets, 2" - 24" sizes)  
412 - 422 - 452 Tapping Sleeves (4" size and larger)  
418 - 438 Threaded Outlet Tapping Sleeve (1/2" - 4" Outlets)



JCM 230 Stiffener

Success in these products is largely due to the design criteria that took the working characteristics of HDPE Pipe into consideration. Design characteristics inherent to JCM clamps, couplings, tapping sleeves, saddles and other products area as follows:

**GASKETS** - Tapping sleeve and service saddle gaskets should have wide cross section with enough volume to store compression energy. Gaskets should be of a hardness which will flex with pipe pressure fluctuations. Outlet seals should have a mechanical sealing lip that utilizes line pressure to increase seal. Outlet gaskets should be externally and internally confined.

**TAPPING SLEEVE OR CLAMP BODY** - Tapping sleeve or clamp coupling body should conform to the HDPE pipe and support it and the branch (in cases of outlets). Width of sleeve should be such that it spreads the load to prevent point loading or deformation of the pipe.

**BOLTING** - Bolting should be self-aligning and heavy enough to properly load the gasket and assure an adequate safety factor.

**For specific applications or questions regarding product recommendations or availability, please call the JCM Inside Sales Team.**

## PRODUCTS FOR POLYETHYLENE PIPE

For additional information product information, see JCM Manual "Fittings and Fabrications for HDPE Pipe"



JCM 101 Universal Clamp Coupling



JCM 404 Service Saddle



JCM 412 Tapping Sleeve

**JCM recommends Model 230/231 pipe stiffeners be used for joining, or connecting to, High Density Polyethylene Pipe.**

## **Fittings and Fabrications for High Density Polyethylene Pipe General Application Information**

JCM Products for repairing, connecting and tapping Polyethylene pipe have been tested and evaluated for their suitability and design capability. In each case JCM products have performed satisfactorily in respect to their design application. Test criteria range from short-term for special applications to long-term 1000 hour evaluations with the most common applications. Temperature and pressure cycles are also incorporated to fully address the pipe characteristics and full range of occurrences. Special monitoring equipment is utilized to produce accurate test data and for historical reference.

High Density Polyethylene Pipe (HDPE) has several unique characteristics which are taken into consideration in the following guidelines. The disregard of these guidelines and/or the installation instructions supplied with each fitting may cause unsatisfactory results and void the expressed product warranty.

HDPE Pipe considered for use must be manufactured to the recommendations set forth in the ANSI/AWWA Standard C906 and complies with criteria in reference to size.

HDPE has a high coefficient of thermal expansion and contraction along with a low modulus of elasticity. This sensitivity to pressure and temperature causes HDPE to expand and contract more than traditional water and sewer piping materials. The potential pipe expansion or contraction must be considered when assembling bolt on fittings.

HDPE will relax ("creep") at lower stress levels than other piping materials. Due to these special characteristics, the following parameters should be adhered to when utilizing JCM products for HDPE (ANSI/AWWA C901, C906).

- HDPE and bolt-on fitting connections are vulnerable to forces experienced with expansion/contraction of the pipe and require special consideration. Restraint must be considered when joining plain end pipe to ensure against pipe pull out. HDPE is manufactured with a smooth pipe wall surface resulting in a low coefficient of friction that can enable fittings to slide, shift, move, rotate and/or travel on the pipe after installation. JCM products are limited in the tolerance of axial movement of the pipe.
- JCM products for HDPE are designed for underground pressurized fluid service and are pressure rated to match the pipe SDR pressure rating or with a maximum service rating of 150 PSI (Temperature 35° -75°F/Maximum test pressure limited to rated pipe pressure or fitting, whichever is lower). For above ground applications, contact JCM Industries Technical Services.
- Pipe stiffeners must be used when joining, or connecting to, HDPE. Pipe systems must be engineered to prevent movement causing fittings to slide or rotate on the pipe. Cutting HDPE can cause the pipe to ovate or "neck" down and become egg shaped. This pipe movement can interfere with the assembly of bolt on fittings.

Thirty years of successful performance has been one of the most stringent proving grounds for JCM products and their application with Polyethylene Pipe. Generally speaking, most common potable water pressure applications utilize HDPE SDR 17 through 11. For applications on thinner wall pipe, special applications, higher pressure ratings and product usage recommendations, please contact JCM.

Note: JCM recommends fusion joints as a primary method of connection. When correctly implemented, fused joints are self-restraining and leak proof. In some instances conditions are not conducive to properly fuse the joint per manufacturers' recommendations. Mechanical fittings to join or repair HDPE are a secondary and limiting choice. The information included on this page is provided to address the known factors when repairing, joining or tapping HDPE with mechanical fittings.

Effective 01/02/18

## Applications of JCM Products on High Density Polyethylene Pipe Frequently Asked Questions

### ***Why does JCM not use Spring Washers?***

“A Belleville washer, also known as a cupped spring washer, is a type of non-flat washer with a slight conical shape which gives the washer a spring characteristic.” These washers are used both singularly and in multiple “stacks” for maintaining uniform tension load on a bolt. Basically, these metal curved disks are manufactured to a predetermined tension level that will accommodate thermal or pressure expansion and contractions. There are numerous formulas and design criteria to determine the material, size, curve, number and method of installation of these washers in various industries (industrial piping, automotive, electrical, construction, etc.), more data than space allows for here. A simple search on the internet provides a wealth of information on these items. **How they relate to installation on underground (buried) fittings is what JCM will address here.**

The theory behind the spring washer is that when installed, the “spring” in the washer will provide the uniform load on the fitting’s bolting assembly should the pipe expand/contract – so as HDPE pipe shrinks and expands on the circumference, the spring washers will flex and absorb the expansion/contraction. That theory is applicable in above ground, vault or gallery piping installations in which the assembly has freedom of movement. It is JCM’s opinion that when installed on a fitting that is buried underground, the ability of the washers to move or “flex” with the fitting is eliminated due to the site backfill bedding material. The spring washers perform no significant function in that environment. The space, voids and gaps around the assembly are filled with dirt, clay, mud, gravel and other soil matter that compacts around the fitting resulting in a solid, compressed environment (similar to concrete). The factors of compaction, debris between washers, rocks between fitting halves and various other backfill material fragments will encase the assembly in earthen “material” and prevent any chance of movement, no matter how slight.



JCM Industries has worked closely with HDPE manufacturers and contractors to engineer fittings that are specifically designed to accommodate the unique characteristics of HDPE – the thermal expansion and contraction is one of the major features of the pipe. The design criteria that makes JCM fittings extremely successful on HDPE is the gasket and the machined groove. JCM implements a unique gasket design in all of our products that are especially recommended for use on HDPE pipe. This thick cross section of gasket, of a specific profile, is where the pipe expansion/contraction finds accommodation. The special gasket is compressed during installation of the fitting with specified bolt torque. As the bolts are tightened, the bolt torque is directly transferred through the bolting system and into the gasket, compressing and storing “flexing” the appropriate amount of energy between the pipe and fitting. The ability to accommodate the expansion/contraction is housed in the gasket itself, thus eliminating the need to try transferring the expansion/contraction energy through the exterior of the fitting by washers.

Therefore, based on this mechanical philosophy, JCM does not furnish spring washers – the energy stored in the gasket which is in direct contact with the pipe wall is a more effective and efficient application.

Compression of the gasket and a true “bolt torque” reading at the completion of the fitting installation is critical. As HDPE goes through the varying changes of the thermal dynamics, the secure seal of the gasket on the pipe is the key to the watertight connection.

## Applications of JCM Products on High Density Polyethylene Pipe Frequently Asked Questions (Continued)

### ***Are ALL JCM products suitable for HDPE?***

No. JCM recommends particular products to be installed in applications on HDPE because of certain distinctive design features that make them most suitable for HDPE characteristics. HDPE's high coefficient of thermal expansion/contraction and the low modulus of elasticity present two important working traits to consider when selecting bolt on pipe fittings. Generally, products that provide a broad footprint on the pipe wall with extensive gasket to pipe contact and a wide cross section gasket with enough volume to store compression energy are most desirable for HDPE. The gasket should be of hardness (durometer) which will flex with pipe pressure fluctuations. Outlet seals should have a mechanical sealing lip that utilizes line pressure to increase the seal. Outlet gaskets, such as on tapping sleeves and service saddles, should be externally and internally confined in a groove. Fittings should be sized and formed to fit the HDPE pipe outside diameter to ensure the sleeve or body conforms to the HDPE pipe and prevents undue stress. A wide stance design provides pipe wall support and spreads prevent point loading or deformation of the pipe.

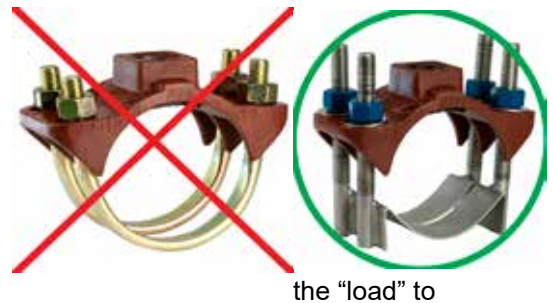

### ***Why do bolt on pipe fitting manufacturers insist on the use of “stiffeners” in a connection application?***

Under pressure, HDPE will move or “creep” (cold flow of material) away from the point of pressure, a trait that works against the typical bolted coupling design. As pressure is applied by the tightening of the bolts, HDPE will relax and move away from the pressure, preventing the bolt torque from fully compressing the gasket and complete a water tight, long term installation. The use of an internal pipe stiffener will block the “creep” or movement and provide a stable base for the bolt torque energy.

Another associated issue is commonly known as “toe-in.” This is when a plain end of HDPE will “neck down” or ovate after cutting. If left uncorrected, the ovation (egging, necking down) of the pipe will hinder the bolt on fitting gasket from making proper 360° contact and in some cases prevent the fitting from being installed. The internal stainless steel stiffener used in the pipe ends will provide a durable support for the bolted fitting and the bolt torque to fully compress the gasket for a watertight, long term seal.

### ***Are restraint devices or anchorage systems really necessary when using bolt-on clamps or couplings with HDPE?***



Yes, they are really necessary. Without incorporating a physics lesson, simply put, the HDPE pipe surface is smooth and without texture (unlike asbestos cement or cast iron pipe), thus the surface produces a “low coefficient of friction.” The coefficient of friction is the relative amount of force required to make two surface materials slide past each other. A low number reflects low resistance and smooth action (i.e. lubricated bearings, Teflon finishes, etc.). So with the lower coefficient of friction, the HDPE can more easily slide in various soils and out of bolt-on fittings if the pipe is not restrained to prevent axial (linear) movement that causes pipe movement, pull out from the bolted fitting can occur. HDPE fused joints are “self-restraining” and according to HDPE manufacturers, do not require external restraint methods – as long as the fusion procedure was done correctly. Refer to the PPI (Plastic Pipe

Institute). PPI provides a complete Handbook of PE Pipe that specifically addresses designing and installing PE piping systems and methods of restraint.

### ***How much of a consideration is thermal expansion and contraction?***

HDPE has a high thermal coefficient of expansion/contraction. When subjected to a temperature change, unrestrained, above and below grade, polyethylene pipe will experience expansion and contraction. As a rule of thumb, a change of 1” per 100’ of pipe per 10°F change in temperature. This is especially important in installations in which the HDPE is laid along the trench site. Forces encountered due to thermal expansion and contraction can be significant. Properly designed systems that account for the potential expansion/contraction will be required.

## Tapping High Density Polyethylene Pipe

An important factor for consideration is the SDR (Standard Dimension Ratio) of the pipe to be tapped. HDPE pipe with an SDR number greater than 17 (SDR 19, 21, 26, 32.5) have a lesser wall thickness and can be subject to flexing. This limits the type and size of branch that can be provided.

Conversely, other factors must be considered with increased wall thickness. Calculations should be completed prior to the branching procedure that include the wall thickness of the pipe, travel distance of the tapping machine and the size of the tapping machine cutter. In some instances a size on size branch with a full opening may not be possible due to the wall thickness and the inability of the cutter to make a clean cut through the “shoulder” of the pipe wall. This can be overcome by reducing the size of the cutter (reducing the size of the cut opening in the pipe). JCM provides various sleeve types and designs that provide an array of options that can overcome critical size-on-size requirements.

These factors should be included with the standard branching considerations such as size of pipe, size of branch outlet, working/test pressure requirements, line content and any environmental factors such as hot or acidic soils.

### JCM Gasket Performance is Unique on HDPE

JCM gasket design was conceived based on the working characteristics of HDPE and the distinctive fluctuations that transform the pipe through thermal dynamics. Within the JCM Tapping Sleeves and Service Saddles, the gasket durometer (hardness of the gasket material) formulation is pliable enough to accommodate compression and storage of energy with thermal changes in pipe diameter, yet hard enough to withstand high working pressures – the working features of the gasket durometer, the broad, hydromechanical lip design and the confinement in a recessed groove around the outlet join together to provide a secure, active watertight seal at the pipe/gasket interface.

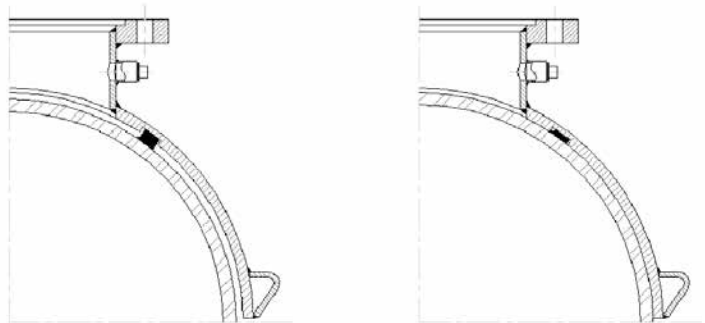

The drawing right demonstrates the system of the gasket storing and releasing energy as the pipe contracts and expands.

JCM Universal Clamp Couplings share the same gasket compression “stored energy” theory. This working energy is the reason JCM does not use “spring washers” to store energy. (Once backfilled and buried, the ability of the spring washer to perform as designed can be limited.) JCM uses a 1/4”, or thicker in some cases, gasket for Universal Clamp Coupling (thickest in the industry). This thick gasket stores the energy as the pipe diameter increases and releases the energy back as the diameter decreases. The image right reflects the compression and release of the stored energy along the body of the clamp.

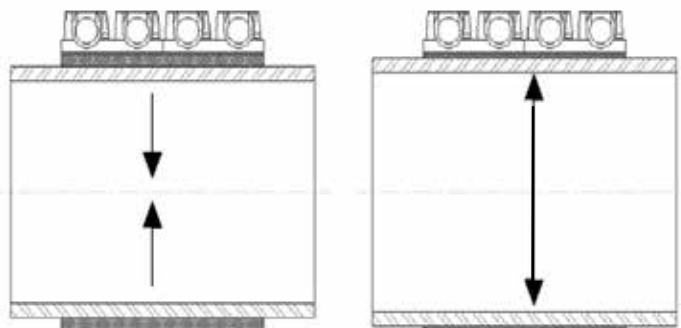

As pipe contracts, gasket expands and releases stored energy.

As pipe expands, gasket compresses and stores energy.



## Custom Engineered Fittings Repair - Connection - Branching

Services for custom designed, specialty and emergency fabrication of fittings for the Repair, Connection or Tapping of pipelines is an everyday occurrence at JCM. To best serve the end user, the application information included in the data sheet below is critical to ensure the fastest response for quotation and product delivery. Once the application parameters are determined, generic product information can be provided with material specifications for submittal to agencies.

### Engineered Fitting Data Submittal Sheet

Contact Name: \_\_\_\_\_

Contact Email/Phone Number: \_\_\_\_\_

Type of Application	Repair	Connection	Branching
Type of Pipe			
O.D. of Pipe			
SDR/Wall Thickness (if applicable)			
Max. Working Pressure			
Max. Test Pressure			
Line Content			
Line Content Temp. Max.			
Material of Construction	Carbon Steel	Stainless Steel	304 or 316
Carbon Construction Coating	Shop Coat Primer	Fusion Epoxy Coat	Other
Carbon Construction Hardware	Alloy	Stainless Steel	304 or 316
Considerable Space Limitations			

JCM Industries custom fabricates fittings for all types of unique applications. Fittings ranging from as small as 3" up through tank and bulkhead applications. Additional Information to include for:

#### Repair

Type of Repair - break, split, leaking joint, pinhole, etc.

Size of Repair - width, length, approximate gap between pipe ends, type/size of leaking joint, joint configuration

#### Connection

O.D.s of both pipes to be joined

Flange type and size for flanged coupling adapters

Restraint requirements

#### Tapping/Branching

Size of outlet

Type of outlet - flanged, threaded, mechanical joint, beveled for welding, line stop

Submit information:

Phone: 800-527-8482 or 903-832-2581

Fax: 800-874-9524 or 903-838-6260

E-mail: [sales@jcmindustries.com](mailto:sales@jcmindustries.com)

## Repairs to Large Diameter Pipe General Application Information

As the leading manufacturer of large diameter repair, connection and branching fittings, JCM is often asked the same questions on a regular basis. The following FAQ and responses are to assist you in understanding the dynamics of selecting and installing bolt-on fittings for large diameter pipe. For information specific to your proposed application, contact JCM Industries Engineered and Technical Sales Team at 1-800-527-8482 or 903-832-2581.

### What is considered “large diameter” pipe?

The answer depends on several factors – often the owner’s perspective. For some developed urban utilities, 16” nominal pipe may be considered large diameter; for rural systems, the largest pipe may be 12”. “Large diameter” is really defined by the person who is responsible for the reliability of service for the pipeline. For these frequently asked questions, we define “large diameter pipe” as nominal size 36” and larger. This benchmark pipe size is being used because industry manufacturers of cast iron fittings and fabricated fittings furnish products up through 30” each and every day without difficulty. Larger pipe – starting at 36” nominal size begins to take on other characteristics that must be contemplated during engineering and producing quality fittings for maximum performance. Large diameter pipe has similar issues as smaller pipe (corrosion, splits, cracks, manmade damage, etc.) – with greater force involved. When making a repair or tapping into large diameter pipe, bolt on fittings require strength, robust weight and potential force resistance engineered into the design to withstand increased forces working with large diameter pipe.

For example – a bolt-on, fabricated tapping sleeve installed on a pipeline experiences a great deal of internal force at the branch/outlet location. The chart below illustrates the amount of internal pressure that a tapping sleeve experiences on a pipeline operating at 100 PSI.

Outlet Size	Force at Outlet at 100PSI
6	2,827 lbs.
8	5,027 lbs.
10	7,854 lbs.
12	11,310 lbs.
14	15,394 lbs.
16	20,106 lbs.
24	45,239 lbs.

The internal force at the outlet area can cause the sleeve to “lift” away from the pipe and interrupt the gasket/pipe surface contact creating the opportunity for the gasket to be ripped from its seat or to completely blow out.

With the application dynamics of size and working pressure, the fitting design criteria includes thickness of materials (pressure vessel quality, structural grade material), bolt sizes/strength, body width on the pipe, machining contours and other critical points. Factoring in working formulas for pressure containment such as Barlow’s formula, engineers calculate the acceptable balance of fitting design verses application requirements. The external strength containing the line content must be greater than the internal force. This difference is the safety factor of the application.

These design concepts are considered for all types of large diameter fittings including repair clamps, bolted couplings, tapping sleeves and other fittings to be installed.

### What about repairing damaged large pipe?

In repair applications to large diameter pipe, there are several factors to consider to maintain pipe integrity and return it to 100% service capacity. These factors, which are critical to the application, include: size and type of pipe, severity of damage, working pressure or service requirements, location of repair and time factor.

*(Continued)*

## Repairs to Large Diameter Pipe General Application Information

Line pressure forces encountered in repair applications will determine the success or failure of a repair fitting. The forces of large pipe reduce the working capability and safety factor of large full circle gasket repair clamps. Performance of these fittings is determined by the relationship of bolting power to gasket area, fastener attachment, bolt efficiency and thickness of metal. Therefore, a repair clamp may not be the proper repair fitting for certain applications. JCM offers various repair fittings which are suitable for repairs to large pipe operating at higher working pressures. To understand the forces involved in the application, see the comparison values listed below relating size of pipe to the internal forces involved.

Nominal Pipe Size (IN)	Outside Diameter (IN)	Circumferential Area of 1/4" Beam Break (SQ IN)	Hoop Stress on Clamp at 100 PSI Operating Pressure
12	13.20	10.37	12,336
16	17.40	13.67	16,262
20	21.60	16.96	20,187
24	25.80	20.26	24,112
30	32.00	25.13	29,907
36	38.30	30.08	35,794
42	44.50	34.95	41,589
48	50.80	39.90	47,477

On repair clamps the mechanical seal is made by tightening bolts to create a greater force on the gasket (PSI) than is in the pipeline. Safety factor is that amount of sealing capability the clamp has above the operating pressure of the pipeline. Clamps are limited in performance by the relationship of bolting power to gasket area.

Another example of an application that arises often is for a "repair clamp" to repair a significant hole or gouge in the pipe. Addressing this type of damage on large diameter pipe – again – the forces involved in the inside of the pipe have a direct influence on the type of repair fitting that is recommended. The following drawing demonstrates the engineering formula to calculate the force being shoved against the repair clamp.

JCM clamps have been designed to limit traditional clamp weaknesses, thereby giving a higher working capability and safety factor. Even so, they do have a limited capability. Most often we suggest other types of repair fittings for consideration. Fabricated, heavy duty repair sleeves are designed to overcome the forces involved with large diameter pipe and its characteristics.

Dealing with large diameter pipe presents greater challenges than smaller pipe sizes. JCM engineers keep all the factors as the priority when engineering a fitting that will accomplish the required task and return the pipeline to 100% working capacity. Larger fittings involve bigger components; for example, in comparison to the standard fittings available in the industry, JCM's usually offers wider bodies for substantial reinforcement of the pipe, thicker body material for strength/safety factor and stouter bolting lug sections. JCM bolt sizes and quantities change as fitting sizes increase – especially in our repair clamps – at 10" pipe size, we upgrade from a 5/8" bolt and lug mass to 3/4" bolts and a much beefier lug design (in both cast ductile lugs and cast stainless steel lugs) – along with a thicker stainless steel gauge material. These increases have a direct impact on long term performance of the fitting – and the cost of the fitting. Compared to competitive products in the industry – fittings often consist of the same size bolts and lugs through all nominal size offerings – increasing the quantity of bolts rather than the size/torque capability of the bolts.

This data is for general reference only and does not represent expected performance. Each application for repair clamps – small or large diameter – is dependent upon many factors combined. Type of pipe, size and type of damage, fluctuating pressures and others are included in the combination. Taking these factors into consideration along with the size of the pipe will determine the repair fitting best suited for the application.

## Galvanic Series of Metals

A galvanic series has been drawn up for metals and alloys in seawater, which shows their relative nobility. The series is based on corrosion potential measurements in seawater only. The relative position of the materials can change in other environments.

In general, the further apart the materials are in this series, the higher the risk of galvanic corrosion. However, the series does not provide any information on the rate of galvanic corrosion and thus serves as basic qualitative guide only.

### Most Cathodic or Resistant To Corrosion (Most Noble)

Platinum  
Gold  
Graphite  
Titanium  
Silver  
Chlorimet 3  
Hastelloy C  
18-8 Stainless Steel (Passive)  
Chromium steel >11% Cr (passive)  
Nickel (passive)  
Silver Solder  
Monel  
Bronzes  
Copper  
Brasses  
Inconel (active)  
Nickel (active)  
Tin  
Lead  
Lead-Tin Solders  
18-8 Stainless Steel (Active)  
Ni-Resist  
Chromium Steel >11% Cr (active)  
Ductile Cast Iron  
Grey Cast Iron  
Steel or Iron  
2024 Aluminum  
Cadmium  
Commercially Pure Aluminium  
Zinc  
Magnesium Alloys  
Magnesium

### Most Anodic or Easy To Corrode (Least Noble)

Information presented is for reference use only. For specific criteria, manufacturer should be contacted.

## **JCM Industries and All 316/316L Stainless Steel Fittings and Fabrications**

JCM offers our most popular items available in All 316/316L stainless steel. JCM provides 316/316L stainless steel options in all our fabricated (constructed/welded) fittings and also includes many common production items with a 316 stainless steel option.

### **Selection of Stainless Steel**

Stainless steel, especially the austenitic 300 series grades, has become a waterworks industry standard with decades of proven corrosion resistant performance in underground, underwater, above ground applications and in treatment and process piping systems. Ranking well above both ductile iron and carbon steel on the galvanic chart for corrosion resistance, stainless steel provides the strength, weldability and heat resistance for pipe fitting fabrication and applications.

Commonly, water and wastewater fittings incorporate the 304/304L material in various sheet, plate, pipe and cast components. The 304/304L grade stainless steel provides corrosion resistance, weldability, machinability and strength at an economical cost. It is the stainless steel most popular for industrial and consumer applications.

The same design of fittings are frequently offered in the higher grade 316/316L stainless steel. While these two grades of stainless have an identical appearance, the 316/316L stainless steel has an addition of molybdenum for improved resistance to chlorides. Nickel and chromium contents are adjusted appropriately to maintain the austenitic characteristics.

### **Why All 316 Stainless Steel?**

For the underground piping industry, field replacement of corroded cast iron or mild steel fittings installed years before has provided the water and wastewater industry a glimpse into the future of the life expectancy of underground fittings in a variety of soil types and surrounding environments. Replacement of fittings due to corrosive attack caused by levels of oxygen, carbon dioxide, slightly acidic water, stagnant slow moving waters, and unusual levels of other elements reveal that a more resistant material is often needed to fulfill or extend the systems life expectancy.

There are many solutions to battle these environmental attacks including fusion applied epoxy coatings and encasement in polywrap & concrete. Another simple solution is to install 316/316L stainless steel fittings that will resist the destructive elements naturally.

What distinguishes Type 316/316L from Type 304/304L is the addition of 2 to 3% molybdenum. The molybdenum increases the corrosion resistance of the chromium-nickel alloy to withstand attack by many industrial chemicals, solvents and even in the presence of chlorides (such sea water and de-icing salts). Strong, yet lightweight, 316/316L Stainless Steel has an industry wide proven track record in underground, industrial and process piping applications, environmental conditions including extreme temperatures.

### **Does JCM Use 316 or 316L?**

JCM's design and fabrication process, along with the performance expectations of the fitting, determines the types and grades of material and components that are incorporated according to their fabrication suitability.

The 316 and 316L Stainless Steel are similar in corrosion resistance when installed in harsh applications (both environment and line content).

The 316L stainless steel is often used in heavy-gauge welded products because of the lower carbon content which improves weldability. The 316L materials reduces the threat of corrosion in the heat-affected zone in oxidizing environments.

Another form of 316 stainless steel used by JCM is the CF8M (equal to 316 stainless). Cast stainless steel lugs are incorporated into the all 316 stainless steel Universal Clamp Couplings (6130 Series). These castings will provide the expected service life of other wrought 316 material.

## Stainless Steel Gauges and Pipe Dimensions

<b>Stainless Steel – Gauges, Sizes and Dimensions</b>	
<b>Gauge</b>	<b>Thickness (IN)</b>
24 ga.	.024"
22 ga.	.029"
20 ga.	.036"
18 ga.	.048"
17 ga.	.056"
16 ga.	.059"
14 ga.	.075"
12 ga.	.105"
10 ga.	.135"

<b>Stainless Steel Pipe - Sizes and Dimensions</b>					
<b>Nominal Size</b>	<b>Outside Dimension</b>	<b>Schedule 10 Pipe</b>		<b>Schedule 5 Pipe</b>	
		<b>Inside Dimension</b>	<b>Wall Thickness</b>	<b>Inside Dimension</b>	<b>Wall Thickness</b>
2	2.375	2.157	.109	2.245	.065
3	3.500	3.260	.120	3.334	.083
4	4.500	4.260	.120	4.334	.083
6	6.625	6.357	.134	6.407	.109
8	8.625	8.329	.148	8.407	.109
10	10.750	10.420	.165	10.482	.134
12	12.750	12.390	.180	12.420	.165

# JCM Pipe OD Chart

IMPORTANT: This Pipe O.D. Guide is furnished for your convenience and is based on the latest pipe standards and information supplied by pipe manufacturers. Due to occasional changes and variances in outside diameters, the pipe O.D. should always be verified before ordering fittings.

## SMALL DIAMETER PIPE SIZES

NOMINAL PIPE SIZE (INCHES)	1/2	3/4	1	1-1/4	1-1/2	2	2-1/2
COPPER TUBING	.63	.88	1.13	1.38	1.63	2.13	2.63
STEEL & PLASTIC PIPE	.84	1.05	1.32	1.66	1.90	2.38	2.88

## STANDARD PRESSURE PIPE SIZES

NOMINAL PIPE SIZE (INCHES)	3	4	5	6	8	10	12	14	15	16	18	20	24	30
COPPER TUBING	3.13	4.13	5.13	6.13										
STEEL & PLASTIC PIPE (SDR 26,21 & SCHEDULE)	3.50	4.50	5.56	6.63	8.63	10.75	12.75	14.00		16.00	18.00	20.00	24.00	30.00
PLASTIC IRRIGATION PIPE (PIP)		4.13		6.14	8.16	10.20	12.24		15.30		18.70	22.05	24.80	
PLASTIC SEWER PIPE (SDR 35)		4.22		6.28	8.40	10.50	12.50		15.30		18.70		24.80	
PLASTIC (PVC) AWWA C-900/C-905/C-909		4.80		6.90	9.05	11.10	13.20	15.30		17.40	19.50	21.60	25.80	
POLYETHYLENE PIPE (IPS SIZE)	3.50	4.50		6.63	8.63	10.75	12.75	14.00		16.00	18.00	20.00	24.00	30.00
POLYETHYLENE PIPE (DIP SIZE)		4.80		6.90	9.05	11.10	13.20	15.30		17.40	19.50	21.60	25.80	32.00

CAST IRON	DUCTILE IRON PIPE	3.96	4.80		6.90	9.05	11.10	13.20	15.30		17.40	19.50	21.60	25.80	32.00
	CLASS 100 - 250 AWWA	3.96	4.80		6.90	9.05	11.10	13.20	15.30		17.40	19.50	21.60	25.80	32.00
	CLASS A AWWA PIT CAST	3.80	4.80		6.90	9.05	11.10	13.20	15.30		17.40	19.50	21.60	25.80	31.74
	CLASS B AWWA PIT CAST	3.96	5.00		7.10	9.05	11.10	13.20	15.30		17.40	19.50	21.60	25.80	32.00
	CLASS C - D AWWA PIT CAST	3.96	5.00		7.10	9.30	11.40	13.50	15.65		17.80	19.92	22.06	26.32	

ABESTOS CEMENT PIPE	Class 100	MACHINED END	3.74	4.64		6.91	9.11	11.24*	13.44*	15.07		17.15	19.90	22.12	26.48	33.12		
		FLINTITE ROUGH BARREL	3.94	4.90		7.13	9.33	11.30	13.42	15.45		17.60						
		FLUID-TITE ROUGH BARREL	3.93	5.05		7.16	9.32	11.46	13.70	15.36		17.50	20.44	22.50	27.17			
		PERMAFLEX ROUGH BARREL		4.84		7.15	9.35	11.47	13.74	15.55		17.55	20.50	22.70	27.15			
		RING-TITE ROUGH BARREL	3.95	4.92		7.19	9.39	11.47	13.74	15.51		17.65	20.44	22.68	27.12	33.80		
		MIN. STD. ROUGH BARREL		4.79		7.05	9.22	11.25	13.37	15.36		17.50						
		MAX. STD. ROUGH BARREL		5.26		7.40	9.57	11.77	14.04	15.80		17.94						
	Class 150	MACHINED END	3.84	4.81		6.91	9.11	11.66	13.92	16.22		18.46	20.94	23.28	27.96	35.00		
		FLINTITE ROUGH BARREL	4.40	5.06		7.13	9.33	11.88	14.14	16.48		18.72						
		FLUID-TITE ROUGH BARREL	4.03	5.14		7.12	9.32	11.85	14.11	16.41		18.65	21.20	23.54	28.22			
		PERMAFLEX ROUGH BARREL		5.00		7.20	9.40	11.92	14.20	16.50		18.75	21.30	23.64	28.32			
		RING-TITE ROUGH BARREL	4.13	5.07		7.17	9.37	11.92	14.18	16.48		18.72	21.30	23.64	28.32	35.42		
		MIN. STD. ROUGH BARREL		4.97		7.07	9.27	11.82	14.08	16.38		18.62						
		MAX. STD. ROUGH BARREL		5.32		7.37	9.62	12.12	14.38	16.73		18.97						
	Class 200	MACHINED END	3.84	4.81		6.91	9.11	11.66	13.92	16.22		18.46	22.18	24.66	29.62	37.06		
		FLINTITE ROUGH BARREL	4.17	5.32		7.26	9.44	11.88	14.14	16.53		18.84						
		FLUID-TITE ROUGH BARREL	4.18	5.32		7.36	9.46	11.88	14.11	16.44		18.74						
		PERMAFLEX ROUGH BARREL		5.32		7.25	9.50	11.95	14.20	16.55		18.90	22.54	25.02	29.98			
		RING-TITE ROUGH BARREL	4.17	5.33		7.32	9.50	11.92	14.18	16.59		18.90	22.54	25.02	29.98	37.48		
		MIN. STD. ROUGH BARREL		5.22		7.26	9.39	11.77	14.03	16.44		18.74						
		MAX. STD. ROUGH BARREL		5.57		7.60	9.79	12.12	14.38	16.88		19.19						
	NOMINAL PIPE SIZE (INCHES)		3	4	5	6	8	10	12	14	15	16	18	20	24	30		

\* Flintite ME is 10.89 for 10" and 12.99 for 12" sizes.

## JCM Industries - Product Cross Reference & Comparison Chart

	JCM Product Description	JCM	Smith-Blair	Dresser	Ford	Romac	PowerSeal	Cascade	Robar	Mueller
<b>REPAIR FITTINGS</b>	101 UCC - Standard Range	101	226	360	F1	CL1	3121	CDR1	5518	500
	102 UCC - Extended Range	102	227, 228	361	F2, F3	CL2, CL3	3122	CDR2 -3	5528, 5538	510
	103 Tapped UCC - Std. Range	103	238	360	F1	CL1	3131	CDRT		501-509
	104 Tapped UCC - Ext. Range	104	239	361	F2, F3	CL2, CL3	3132	CDR2T		511, 519
	131 All Stainless Steel UCC - Std. Range	131	256	364	FLS1	*SS1				
	132 All Stainless Steel UCC - Ext. Range	132	257	360	FLS2	*SS2, *SS3				
	133 Tapped All Stainless UCC - Std. Rng.	133	264		FLS1	*SS1				
	134 Tapped All Stainless UCC - Ext. Rng.	134	265		FLS2	*SS2, *SS3				
	136 Heavy Duty Stainless Repair Clamp	136	267				3122AS-HP			3122AS
	161 All SS Fabricated Clamp	161	261	8364	FS1	SS1	3121AS	CR1	5616	540
	162 All SS Fabricated Clamp - Ext. Rng.	162	262		FS2	SS2	3122AS	CR2	5626	550
	163 Tapped All SS Fabricated Clamp	163	264		FS1					
	164 Tapped All SS Fabricated Clamp - Ext Rng	164	265		FS2					
	168 - 169 SS Fabricated Lightweight Clamp	168					LSS1, LSS2	3121ASLW	CSS1, CSS2	
	105 PVC Collar Leak UCC	105	229		FCC	CLC	3141	CCLC		773
	135 All Stainless Steel PVC Collar Leak Clamp	135	269		FCC	CLC	3143AS			
	106 Bell Joint - IPS PVC	106			FBC	517				
	108 UCC Sewer Pipe	108	221	4, 41			LSS1	3541		
	110 Patch Clamp	110	245, 248	118	FSLC	SC	3151A, 3151AS		5696SC	213
	111 Full-Repair Clamp	111	244		FLSC-R	SCC	3152	CFC		230
	112 Heavy Duty Patch Clamp	112					3151HD			220
	113 Heavy Duty Patch Clamp	113	246	77, 79						
	114 Mechanical Joint Repair Sleeve	114				MJSC/MJBE				
	116 Repair Slv for CSCP	116								
	143 Bell Joint Clamp - DI, CI, C-900 PVC	143	274	60, 160	FBC	416, 516	3231, 3232		5508	
<b>COUPLINGS - FLANGED ADAPTERS</b>	201 Steel Coupling	201	411 Reg	38, 138	FC3-7	400	3538		1808	
	202 Long Steel Coupling	202	411 Long	40	FLC	-	3540			
	203 Steel Transition Coupling	203	413	62 TII	FC5	TC400				
	204 Steel Reducing Coupling	204	415	62 TII	FC6	RC400	3562R		1848	
	210 Ductile Iron Coupling	210	441		FC1	501		CR CER	1408*	
	211 Ductile Iron Cplg - Stl, IPS PVC	211			FC1	501				
	212 Ductile Iron Transition Cplg	212	433		FC2	501	3501		1408*	
	214 Pipe End Cap Coupling	214	481, 482	31	FEC	EC501	3501EC			
	215 Long Ductile Iron Couplings	215	442		FC1-L12	501	3501LB			
	219 Restrained Ductile Cplg	219								
	220 Compression Coupling	220	525	65		702	3504		1200	
	225 Insulating Adapter Gasket	225		3065						
	230 HDPE Pipe Stiener	230	Maxi-Grip		INSERT	206	3530	CPS	9626	
	241 Standard - Optimum Coupling	241	461		FC2W	XR501	3506		Vantage	
	242 Long - Optimum Coupling	242	462		FC2W-L12	XR501			Vantage	
	250 Mechanical Joint Coupling	250			MJC					
	4262 All 304 Stainless Steel Coupling	4262		38**						
	6262 All 316 Stainless Steel Coupling	6262		38**						
	301 Cast Flanged Coupling Adapter	301	912	127	FFCA	FCA501	3521	CRFAER	7404	
	303 Fabricated Flg Cplg Adapter	303	913	128	FCA	FC400	3528		7808	
304 Reducing Fabricated FCA	304	914	128	FCA	FC400					
306 Fabricated FCA	306	913								
307 Reducing Fabricated FCA	307	914				3506R				
309 Fabricated Dismantling Joint	309	971	131	FDJ	DJ400-05	3563		Dismantling Jt	Dismantling Jt	

\*Items of similar materials, designs vary. Confirm with manufacturer.

\*\*Custom Order Materials

JCM Industries Comparison Chart is compiled from information available at time of printing. Product comparisons are provided for reference purposes only. Design and material criteria should be confirmed prior to specification or purchase.



## JCM Industries - Product Cross Reference & Comparison Chart

	JCM Product Description	JCM	Smith-Blair	Dresser	Ford	Romac	PowerSeal	Cascade	Robar	Mueller
<b>SERVICE SADDLES</b>	401 Single Strap Service Saddle	401	311	291	F101	101U				DR1A
	402 Double Strap Service Saddle	402	313	291	F202	202U			2408	DR2A
	403 Wide Body Service Saddle - SS Strap	403	315	194		101S				DR1S
	404 Service Saddle - Double SS Straps	404	317		FS202	202S			2406	DR2S
	405 Ctd Wide Service Saddle - SS Strap	405	315		FC101	101N	3415	CNS1		
	406 Ctd Service Saddle - Dbl SS Straps	406	317		FCD202	202N	3417DI	CNS2	2506	
	407 Ctd ServSdl - Electro Galv Strap	407	311		F101	101NU	3411DI	CDS1		
	408 Ctd Serv Sdl - Dbl Elctro Galv Straps	408	313		F202	202NU	3413DI	CDS2	2508	
	502 Stainless Steel Service Saddle	502	372		FS313	306	3412AS		2616	
	<b>TAPPING SLEEVES</b>	411 Fab Tapping Sleeve - Plain End Outlet	411							
412 Fab Tapping Sleeve - Flanged Outlet		412	622	610	FTS, FTSC	FTS420	3460	CFT	6808, 6908	H306
419 Fab Tap Slv - Mechanical Joint Outlet		419	622MJ		MJ		3460MJCS			H306MJ
422 Fab Tapping Sleeve for PVC/Stl/HDPE		422		615		FTS419		CFTLP		*H612
429 Fab Tap Slv - PVC/Stl/HDPE - MJ Outlet		429								
414 Fab Mechanical Joint Tapping Sleeve		414	*623/624		MJTS	*FTS425				*H615
415 Tap Slv for CSCP		415	625		FRCTS(C)	FTS435			6898, 6996	
416 Fab Weld-On Tapping Outlet - Partial		416	626		FWS	FTS445	3428	CFT-WO		
417 Fab Weld-On Tapping Sleeve		417	627				3428			
418 Fab Threaded Outlet Tap Slv		418	366			FTS420T		CFTTO		
425 Service Saddle for CSCP		425	362				3465CS		2996	
432 All Stainless Steel Tapping Sleeve		432	665	630	FTSS	SSTIII	3490AS	CSTEX	6606BB	H304
438 All SS Threaded Outlet Tap Slv		438				STS420T			6606BBMJ	
439 All SS Tap Slv - MJ Outlet		439	665MJ		FTSS-MJ	SST-MJ	3490MJAS			H304MJ
440 Line Stop Fitting		440	680	640		*SST-X				
452 All SS Tap Slv - Outlet Seal Gasket		452			FTSAS	STS420	3460AS	CFTSS		*H300
462 All SS Tap Slv - Carbon Steel Flange		462	664	630	FTSS	SSTIII	3490CS		6606BBCSF	H304
464 SS Tap Slv - Outlet Gskt - Carbon Flg		464			FTSAS					
465 SS Tap Slv - Outlet Seal Gskt - Carbon MJ		465	664MJ							
469 SS Tap Slv - Full Gskt- Carbon MJ		469			FTSAS	SST-III-MJ	3490MJCS			
459 All SS Tapping Sleeve - MJ Outlet	459			FTSAS		3460ASMJ				
<b>SPC</b>	801 Expansion Joint - Single End	801	611	63	FEJ 1	EJ400	3563		8808, S1	
	802 Expansion Joint - Double End	802	612	63	FEJ 2	EJ400	3563		8808, S2	

\*Items of similar materials, designs vary. Confirm with manufacturer.

\*\*Custom Order Materials

JCM Industries Comparison Chart is compiled from information available at time of printing. Product comparisons are provided for reference purposes only. Design and material criteria should be confirmed prior to specification or purchase.





# WITHOUT YOU THERE IS NO US.



JCM Industries is a leading manufacturer of pipe fittings and fabrications for the repair, connection and branching of all types of pipe. The company has built the business on the assurance: Fittings Delivered When YOU Need Them.

At JCM we know service interruptions to water & wastewater systems greatly impact a community including fire protection, hospitals, healthcare centers, schools, retail & service businesses, factories, and residential consumers. It is our mission to ensure we provide the right fittings at the right time.

We believe that “The Customer is The Boss” and our focus is to ensure that YOU - our Boss has what is needed in a timely fashion.

JCM offers a wide variety of product designs, features, materials, and special modifications for both standard and non-standard piping applications. We invite you to contact our Customer Service & Sales Team



Scan the QR code to  
check us out on our website.

# JCM INDUSTRIES

**800.527.8482 | 903.832.2581 | [jcmindustries.com](http://jcmindustries.com)**

Orders, Questions, Quote Requests: Email: [sales@jcmindustries.com](mailto:sales@jcmindustries.com)