

Engineered
Solutions

Product
Catalog



HoldRite™

Product Catalog





Table of Contents

Welcome to our complete range of products and solutions.

About RWC and HoldRite	4	Firestopping Sleeves and Accessories	
Job Site Efficiency	8	Cast-in-Place Sleeves	64
Pipe Supports		Cast-in-Place Large Diameter Sleeves	66
Brackets	12	Tub Boxes	66
In-Wall PEX Supports	17	Cast-in-Place Sleeves	67
In-Slab PEX Supports	19	Cast-in-Place Electrical Sleeves	68
Liners and Pads	21	Cast-in-Place Sleeve Accessories	69
Inserts	22	Wraps, Collars, Pads	71
Clamps	24	Firestop Sealants	72
Insulation Couplings	31	Firestop Sealant Accessories	73
Hangers	33	Water Heater Accessories	
Appliance and Fixture Boxes		Sheds	78
Fixture Outlet Boxes	38	Stands & Platforms	78
Washing Machine Outlet Boxes	39	Restraints	80
DWV Testing System		Index	82
Test Wedges	44		
Tees	44		
Assembled Tees	45		
Accessories	47		
#117 Series No-Hub Fitting Restraints			
No-Hub Fitting Restraints	52		

One family of brands, one solution.

RWC is a global leader and manufacturer of plumbing solutions and water control systems for residential and commercial applications. The RWC portfolio includes industry-leading brands: SharkBite™ push-to-connect plumbing solutions; HoldRite™ engineered plumbing and mechanical solutions; Cash Acme™ control valves; John Guest™ fittings and fluid dispense products and Eastman™ and EZ-Flo™ appliance connectors, supply lines, stop valves and gas connectors.



Pipe, Fittings and Valves

PEX-a, PEX-b, crimp, expansion and push-to-connect fittings and valves for residential and commercial applications.



Engineered Solutions

Secondary pipe supports, acoustic noise and vibration plumbing solutions, firestop systems, DWV testing solutions and water heater accessories.



Water Control Valves

Pressure regulating valves, thermostatic mixing valves and temperature & pressure relief valves for safeguarding water systems.



Specialist Industry Solutions

Fluid dispense and push-to-connect solutions for specialist industries and OEMs.



Appliance Installation and Repair

Premium quality appliance and plumbing connectors, pans, outlet boxes, expansion tanks and more.



Kitchen and Bath Accessories

Toilet and faucet repair, bath accessories, faucets, sinks, tubing and drain parts.



A Valued Member of the RWC Family of Brands

RWC's family of innovative brands are designed to make our customer's lives easier by working seamlessly with each other and providing consistent quality across the jobsite. For decades, HoldRite has been in the field helping contractors improve efficiency and overcome challenges with new innovations.

We own our manufacturing process from concept to delivery and strive each day to ensure the quality of our products. HoldRite products have been designed and manufactured in the USA since 1982.

HoldRite has created a national footprint with strategically placed locations across the United States. With allied resources in Georgia, Alabama, Nevada and California, HoldRite is able to distribute patent-protected products to consumers in North America.

Developing engineered solutions that save time on the job site since 1982.

In 1982, Master Plumber George Hubbard designed a pipe support solution (the HoldRite 101-18) to replace the time-consuming and labor-intensive method of cutting blocks of wood for every job. Hubbard's invention revolutionized plumbing in North America by ushering in the plumbing methodology of secondary pipe support.

Today, HoldRite is an industry leader in products and services including secondary pipe supports, acoustic noise and vibration plumbing solutions, sleeving and firestop systems, equipment support, water heater accessories, and drain waste and vent (DWV) solutions.

Understanding your perspective has always been in our DNA. Even though we've evolved into an international company and recognized industry-leading brand, we know our value comes from providing superior products and services for building projects— without increasing costs.

Thank you for giving us the opportunity to pioneer new products and transform the plumbing industry together.

holdrite.com





Innovative
Solutions
**That Transform
Job Sites**

Makeshift

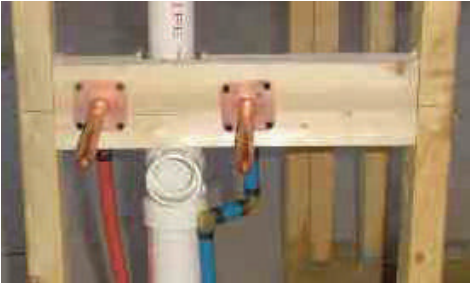

Sink/Lavatory



Engineered Solutions



Water Heater Support



No-Hub Fitting Restraint



Shower Head

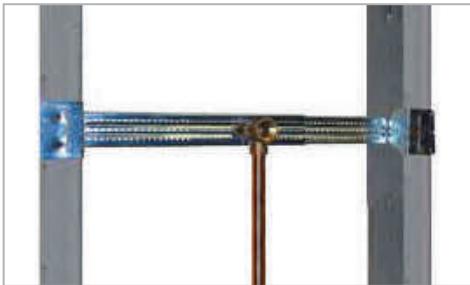



Pipe Supports

HoldRite manufactures a large range of pipe supports for several applications and pipe types, including in-wall, in-slab and overhead supports. These engineered solutions are the safer, more reliable alternative to field-devised supports and help contractors maximize productivity with quicker installations and versatile designs. HoldRite also offers noise and vibration isolation solutions, which integrate with pipe supports for a professional installation with superior protection against plumbing noise and vibration disturbance.

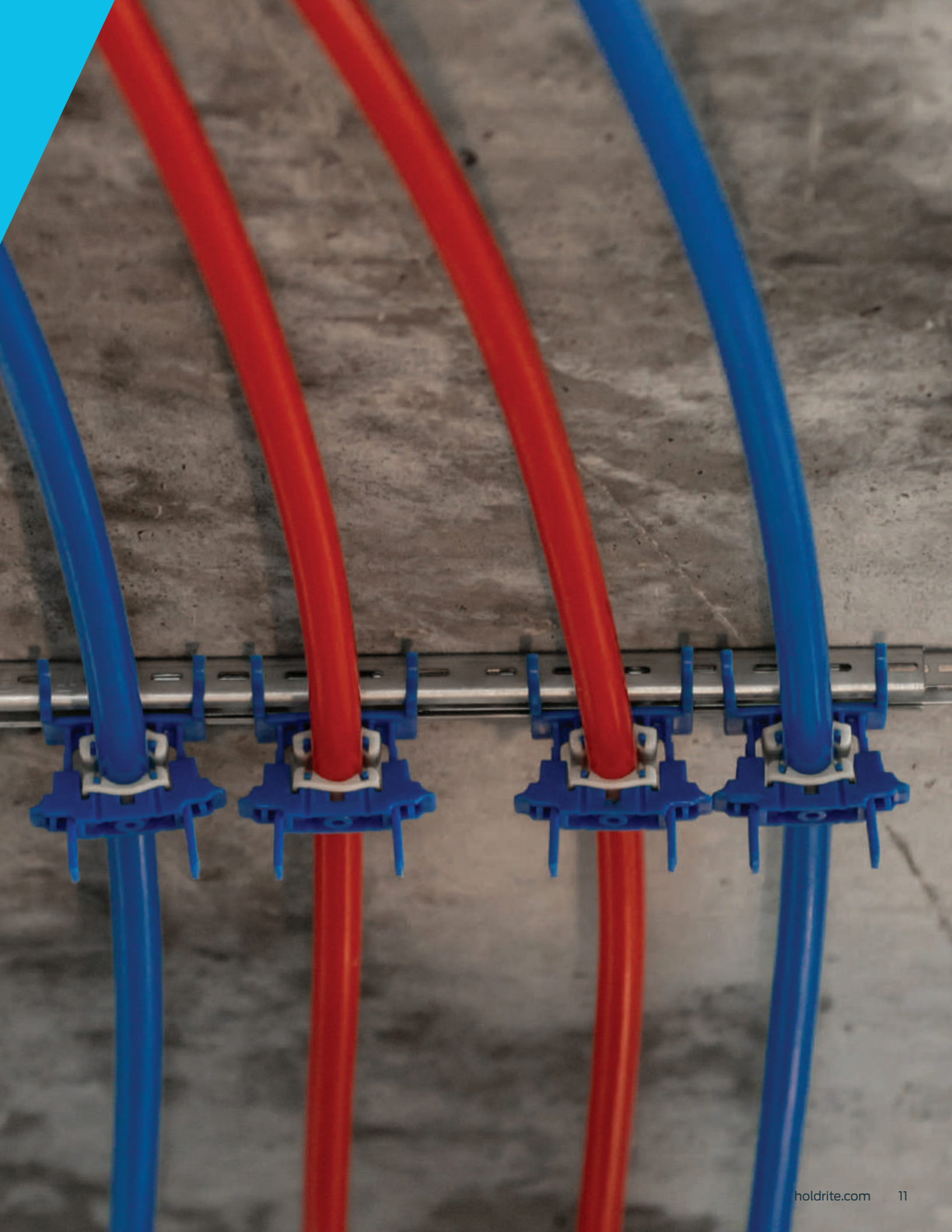

Brackets

100 Series Copper-Bonded Flat Bracket

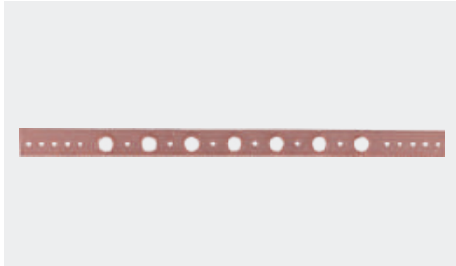

- 5/8 in. holes on 2 in. centers
- Ideal for lavatory/sink or water closet

Part number	Size	Pipe size	Box qty
100-18	20 in.	1/2 in. CTS	
101-18	20 in.	1/2 in. CTS	50
101-26	26 in.	1/2 in. CTS	50
101-18-R	20 in.	1/2 in. CTS	25
101-26-R	26 in.	1/2 in., 3/4 in. CTS	25

102 Series Copper-Bonded Flat Bracket



- Ideal for water heater and relief line applications

Part number	Size	Pipe size	Box qty
102-18	20 in.	3/4 in., 1 in. CTS	50
102-26	26 in.	3/4 in., 1 in. CTS	50

107 Series Copper-Bonded Flat Bracket

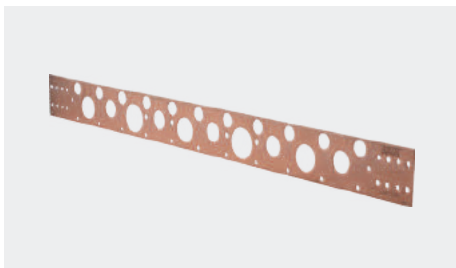

- Ideal for lavatory, toilet and water heater

Part number	Size	Pipe size	Box qty
107-26	26 in.	1/2 in., 3/4 in., 1 in., 1-1/4 in. CTS	50
107-18	20 in.	1/2 in., 3/4 in., 1 in. CTS	50

108 Series Copper-Bonded Flat Bracket

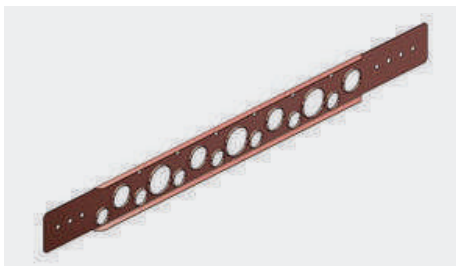

- Ideal for lavatory, toilet and water heater
- Rolled edges for extra strength and extruded holes for additional soldering surface

Part number	Size	Pipe size	Box qty
108-20	20 in.	1/2 in., 3/4 in., 1 in. CTS	50
108-26	26 in.	1/2 in., 3/4 in., 1 in. CTS	50

109 Series Copper-Bonded Bracket for Nail Plate and Toilet

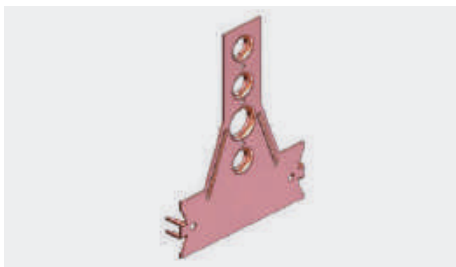

- Supports 1/2" stub-outs at various heights from 2-1/4" – 6" or a 3/4" stub-out at 3-1/2" height
- Ideal for water closet applications and also functions as a nail plate

Part number	Size	Pipe size	Box qty
109-N-6	6-1/2 in.	1/2 in., 3/4 in. CTS	50

Brackets

109 Series Copper-Bonded L Bracket for Toilet



- Has 5/8 in. holes for 1/2 in. copper tubing at 2-3/4 in., 4-1/2 in., 6 in., 7 in., 8 in. and 9 in.
- Most holes are extruded for additional strength
- Ideal for water closet applications

Part number	Size	Pipe size	Box qty
109-A-9	9-1/2 in.	1/2 in. CTS	50

Copper-Bonded Notched Flat Bracket

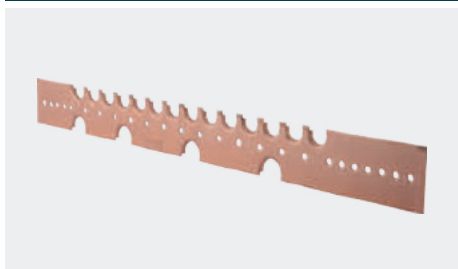

- Ideal for lavatory, water closet and water heater applications
- Extruded notches for 1/2 in. tubing on 1 in. centers and 3/4 in. tubing on 4 in. centers
- Ideal for tubing that is capped prior to soldering onto bracket

Part number	Size	Pipe size	Box qty
140	20 in.	1/2 in., 3/4 in. CTS	50

150 Series Copper-Bonded Flat Bracket



- 5/8 in. and 7/8 in. holes on 4 in. centers
- Ideal for multiple applications such as lavatory, water closet and water heater

Part number	Size	Pipe size	Box qty
150-20	20 in.	1/2 in., 3/4 in. CTS	50
150-26	26 in.	1/2 in., 3/4 in. CTS	50

Copper-Bonded Carrier Bracket for Toilet

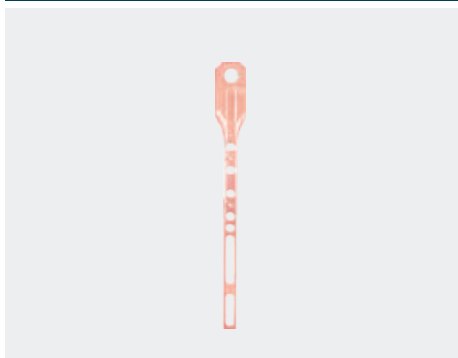

- 1 in. flush valve support for four-bolt wall hung toilet carriers
- Copper-bonded, heavy gauge steel bracket solution that mounts directly to four-bolt toilet carriers and positions flush valves at a height of 11 1/2" above the toilet
- Allows for rough-in prior to erecting studs

Part number	Size	Pipe size	Box qty
114-C	23-1/4 in. x 2-1/2 in.	1 in. CTS	6
114-C-EXT	27 in. x 1 in.	1 in. CTS	6
114-CO	23-1/4 in. x 2-1/2 in.	1 in. CTS	6
114-COH	23-1/4 in. x 2-1/2 in.	1 in. CTS	6
114-CR	23-1/4 in. x 2-1/2 in.	1 in. CTS	6

Brackets

Copper-Bonded Pipe-on-Pipe Bracket Kits



- Copper-bonded, heavy gauge steel bracket that mounts directly to waste/vent pipe prior to erecting studs
- Self-locking stainless steel band and self-adhesive isolating felt included
- Easy prefabrication at the shop or on the job site

Part number	Size	Pipe size	Box qty
110-S-12	9-1/2 in. x 2-1/2 in.	1/2 in. CTS	50
111-S	9-1/2 in. x 1-1/2 in.	1/2 in., 3/4 in. CTS	50
118-T-6	9-1/8 in. x 1-3/4 in. x 1-1/2 in.	1/2 in., 3/4 in. CTS	50
118-T-8	9-1/8 in. x 1-3/4 in. x 1-1/2 in.	1/2 in., 3/4 in. CTS	50
V-2	4-1/2 in. x 4-1/2 in.	1/2 in. - 3 in. CTS	25

Galvanized Pipe-on-Pipe Bracket Kit



- Galvanized steel bracket mounts directly to the waste/vent pipe prior to studs being erected
- Supports 1/2 in. to 2 in. tubing and comes with self-locking stainless steel band, metal straps, screws and self-adhesive isolating felt strip
- Easy pre-fabrication at the shop or on the job site
- Multiple horizontal/vertical mounting applications

Part number	Size	Pipe size	Box qty
115	7-1/2 in. x 2 in.	1/2 in. - 2 in. CTS	25
115-C	7-1/2 in. x 1/2 in.	1/2 in. - 2 in. CTS	25

Copper Single-Hole Flat Bracket

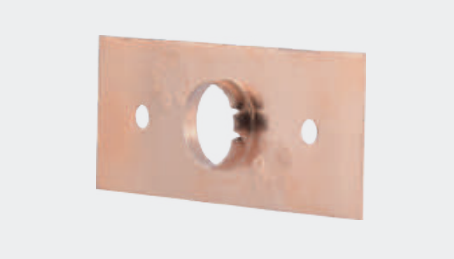

- Ideal for copper tubing penetrating through the floor
- Single 5/8 in. extruded hole

Part number	Size	Pipe size	Box qty
101-F	3 in. x 1-1/4 in.	1/2 in. CTS	50

Stout Bracket® Galvanized Telescoping Brackets



- Multi-purpose galvanized steel bracket supports various application solutions
- Ideal for lavatory, shower, toilet, vertical, horizontal and much more
- Numerous clamps and fittings integrate onto multiple sides of the stout bracket for superior strength and versatility

Part number	Size	Pipe size	Box qty
SB1	10 in. - 18 in.	Various	50
SB1S*	10 in. - 18 in.	Various	50
SB2	13 in. - 25 in.	Various	50
SB2S*	13 in. - 25 in.	Various	50

*Comes with screws

Brackets

Stout Bracket® Galvanized Telescoping Brackets & Clamps Kit



- Multi-purpose galvanized steel bracket supports various application solutions
- Ideal for lavatory, shower, toilet, vertical, horizontal and much more
- Numerous clamps and fittings integrate onto multiple sides of the Stout Bracket for superior strength and versatility
- Acoustic noise reduction data available

Part number	Size	Pipe size	Box qty
SBI-2502	10 in. - 18 in.	Up to 1 in. CTS	25
SB2-2502	13 in. - 25 in.	Up to 1 in. CTS	25

Stout Bracket® Galvanized Wide Telescoping Bracket



- Telescoping galvanized steel design supports CPVC, copper and PEX tubing
- Supports both 2-eared and 3-eared 90s
- Ideal for shower head, tub spout, vertical mid-span and much more
- cUL and UL Listed

Part number	Size	Pipe size	Box qty
SB3	10-1/4 in. - 17-1/2 in.	Various	50
SB4	14-1/2 in. - 25-1/2 in.	Various	50

LockRite™ Galvanized Bracket for Nail Plate and Toilet



- Ideal for toilet or hose bibb stub-outs and functions as a nail plate
- Use in conjunction with #604 and #605 glueable inserts
- 16-gage galvanized steel bracket supports various height rough-ins from 2-1/4 in. - 6 in.

Part number	Size	Pipe size	Box qty
609-N-6	6-3/4 in. x 5 in.	1/2 in., 3/4 in. CTS	50

LockRite™ Galvanized Flat Bracket for CPVC



- Galvanized steel bracket for CPVC tubing support
- Ideal for fixture stub-out supports at sinks, lavatories and toilets
- Accepts 1/2 in. or 3/4 in. glueable inserts (#604 or #605)

Part number	Size	Pipe size	Box qty
601-20	20 in.	1/2 in., 3/4 in. CTS	50
601-26	26 in.	1/2 in., 3/4 in. CTS	50

Brackets

Solid Copper Clip for Hyco Bar



- Ideal for lavatory/sink, water closet, water heater and others
- Solid copper clip for support of tubing

Part number	Size	Pipe size	Box qty
130	2-1/4 in. x 2 in.	1/2 in. CTS	100
131	2-1/4 in. x 2-3/8 in.	3/4 in. CTS	100
132	2-1/4 in. x 2-5/8 in.	1 in. CTS	100

EZ-Strut™ Galvanized Telescoping Trapeze Bracket



- Ideal for multiple pipe run applications including medical gas, natural gas, copper, CPVC and PEX
- Works best with HoldRite #250 and #280 clamps
- Attaches to standard 3/8 in. all-thread rod with load rating up to 1,000 pounds
- cUL and UL Listed

Part number	Size	Pipe size	Box qty
EZ-1	12 in. - 21 in.	Various	25
EZ-2	23 in. - 40 in.	Various	25

Rapid System™ Galvanized Stout Bracket



- Use with #251 clamp; attachment requires no tools or hardware
- Low-cost pipe support solution
- UPC and UL Listed

Part number	Size	Pipe size	Box qty
170	18 in. x 5/8 in. Galvanized Steel Bracket with 2 Screws	Various	50
170-251	18 in. x 5/8 in. Galvanized Steel Bracket and Clamps Bulk Kit	Up to 1 in. CTS	50 Brackets, 100 clamps
170-26	26 in. x 5/8 in. Galvanized Steel Bracket	Various	50
170-C	18 in. x 5/8 in. Copper-bonded Steel Bracket	Various	50

HYCO Bars



- Made from Durable 14ga gal steel
- Pre-drilled holes allow for easy screw installation
- Comes in 2 fixed lengths, but can be cut to size

Part number	Description	Box qty
HYCO18	HYCO Bar - 18 in.	50
HYCO26	HYCO Bar - 26 in.	50

In-Wall PEX Supports

ProGuard® Pre-Assembled Turn-Out Kit for Toilets and Sinks



- Pre-assembled kit for toilets (1/2 in. CTS)
- Compatible with PEX, copper or CPVC
- Ideal for PEX-to-copper transition
- 1 bracket and (1 or 2 clamps) #731 stub-out support

Part number	Pipe size	Box qty
SB3-7311	1/2 in. CTS	25
SB4-7311	1/2 in. CTS	25
SB3-7312	1/2 in. CTS	25
SB4-7312	1/2 in. CTS	25

ProGuard® Pre-Assembled Kit for Water Heater



- Pre-assembled kit for water heaters (3/4 in. CTS)
- Compatible with PEX, copper or CPVC
- Flame Rated: UL 94 V-0
- 1 bracket and (2) #732 stub-out supports

Part number	Pipe size	Box qty
SB3-7322	3/4 in. CTS	25
SB4-7322	3/4 in. CTS	25

ProGuard® Pre-Assembled PEX Turn-Out Kit for Toilets and Sinks



- Pre-assembled PEX-only stub-out kit for lavatories or sinks
- Prevents unwanted extreme turning radius that may cause PEX to kink
- Eliminates in-wall fittings and concealed joints
- Fire Rated: UL 94 V-0
- 1 bracket and (1 or 2 turn outs) #734 turn-out supports

Part number	Pipe size	Box qty
SB3-7341	1/2 in. CTS	25
SB4-7341	1/2 in. CTS	25
SB3-7342	1/2 in. CTS	25
SB4-7342	1/2 in. CTS	25

PEXRite® Galvanized Stub Bracket with Keyed Holes



- Ideal for toilets and hose bibbs
- Galvanized steel brackets with 1-3/8 in. keyed holes
- Allows for 360-degree orientation when used with #701, #702 or #704

Part number	Size	Pipe size	Box qty
709	7-1/2 in. x 2 in.	3/8 in. - 1 in. CTS	50
709-EXT	9 in. x 2-1/8 in. x 2 in.	3/8 in. - 1 in. CTS	50
709-L	4-1/4 in. x 3-1/4 in. x 2 in.	3/8 in. - 1 in. CTS	50

In-Wall PEX Supports

PEXRite® Galvanized Flat Bracket with Keyed Holes

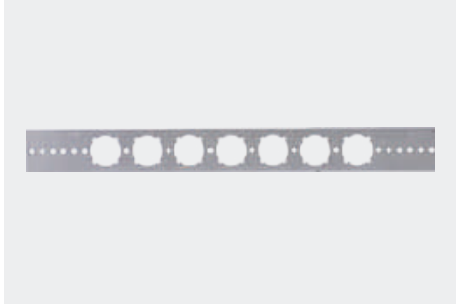

- Galvanized steel bracket with 1–3/8 in. keyed holes on 2 in. centers
- Versatile bracket ideal for sink, lavatory and toilet plumbing solutions
- Integrates with PEXRite #701, #702 or #704 with patented connection and other HoldRite inserts

Part number	Size	Pipe size	Box qty
103-18	20 in.	1/2 in., 3/4 in., 1 in. CTS	50
103-26	26 in.	1/2 in., 3/4 in., 1 in. CTS	50

PEXRite® Galvanized Pipe-on-Pipe Bracket with Keyed Holes



- Galvanized steel bracket with 1–3/8 in. keyed holes on 2 in. centers
- Versatile bracket ideal for sink, lavatory and toilet plumbing solutions
- Integrates with PEXRite #701, #702 or #704 with patented connection and other HoldRite inserts

Part number	Size	Pipe size	Box qty
110-R	2–1/8 in. x 1–1/8 in.	1/2 in., 3/4 in., 1 in. CTS	50

PEXRite® Galvanized Single Hole Bracket



- Attaches to framing or directly to HoldRite Stout Bracket™
- Galvanized steel bracket with 1–3/8 in. keyed hole
- Allows for 360-degree orientation when used with #701, #702 or #704 inserts
- Ideal for lavatory or toilet support

Part number	Size	Pipe size	Box qty
721	2–3/4 in. x 3–3/8 in.	3/8 in. - 1 in. CTS	50

PEXRite® Turn-Out PEX Support



- PEX turnout integrates with #103, #110-R, and #709 series brackets
- Can be installed directly to stud
- Reduces in-wall fittings and concealed joints
- Provide 360-degree turning radius
- Torch-free environment at stub-out location
- Compatible with all PEX tubing manufacturers

Part number	Size	Pipe size	Box qty
704	3–1/4 in. x 5–1/2 in.	3/8 in. - 1/2 in. CTS	100

In-Wall PEX Supports

PEXRite® Flat Base Turn-Out PEX Support



- Turn-out support of 3/8 in. and 1/2 in. CTS PEX tubing
- Ideal for lavatory/sink and toilet stub-out and overhead 90-degree turn
- Mount to block of wood or other flat surface
- Unique design allows for side-entry of tubing

Part number	Size	Pipe size	Box qty
705	5-1/3 in. x 4-1/8 in. x 2-1/2 in.	3/8 in. - 1/2 in. CTS	50

90° Bend Support



- Rigid plastic bend support
- Provides rigid 90-degree bend for PEX tubing
- Compatible with all PEX tubing manufacturers

Part number	Size	Pipe size	Box qty
710	5-1/16 in. x 2-1/2 in. x 1 in.	1/2 in.	50
711	13-3/8 in. x 4-1/2 in. x 7-7/8 in.	3/4 in.	50

ProGuard™ Bend Support for PEX



- Prevents unwanted extreme turning radius that may cause PEX to kink
- Eliminates in wall fittings and concealed joints
- Flame Rated: UL 94 V-0
- Compatible with all manufacturers' 1/2 in. CTS PEX tubing

Part number	Pipe size	Box qty
734	1/2 in. CTS	50

In-Slab PEX Supports

703 Series In-Slab Stub-Up Support for PEX and Conduit



- Available in single and double pipe runs for multiple slab depths
- Multi-run versatility for manifolds with interlocking feet
- IAPMO PS 42-2013
- Material: Reinforced Polypropylene
- Fluid Temperature range: 32°F thru 200°F
- Temperature range: -10 °F to 120°F

Part number	Size	Pipe size	Box qty
703-SC	8.25 in. x 4 in. x 7.40 in.	1/2 in. PEX Tubing	20
703-DC	8.25 in. x 4 in. x 7.40 in.	1/2 in. PEX Tubing	20
703-SEC	8.25 in. x 4 in. x 7.40 in.	1/2 in. PEX Tubing	20
703-DEC	8.25 in. x 4 in. x 7.40 in.	1/2 in. PEX Tubing	20

In-Slab PEX Supports

703 Series Sleeve Extension



- In-slab support extension for slab depths greater than 10 in.

Part number	Size	Pipe size	Box qty
703-EXT	4 in. x 4 in. x 3.5 in.	1/2 in. PEX Tubing	20

703 Series PEX Retainer Ring



- Secures PEX within recessed cavity
- Prevents movement of the PEX prior to the slab pour

Part number	Pipe size	Box qty
703-RET	1/2 in. PEX Tubing	25

703 Series PEX Protector Bullet



- Protects the end of the PEX from damage and debris
- Eases installation when inserting PEX through the 703 body

Part number	Pipe size	Box qty
703-RBUL	1/2 in. PEX Tubing	25
703-BBUL	1/2 in. PEX Tubing	25

PEXRite® Pop-Up In-Slab Support



- Manifold capability with interlocking feet
- Compatible with PEX, soft copper and flexible conduit
- Unique design allows for side-entry of tubing
- Mounts to form decking or slab-on-grade with rebar

Part number	Size	Pipe size	Box qty
706	5-1/3 in. x 5 in. x 2-1/2 in.	3/8 in. - 1/2 in. CTS	50
707	8-1/2 in. x 8-5/8 in. x 1-1/4 in.	3/8 in. CTS - 7/8 in. OD	25
707-E	8-1/2 in. x 8-5/8 in. x 1-1/4 in.	3/8 in. CTS - 7/8 in. OD	25
708	10-1/2 in. x 11-1/8 in. x 2-1/2 in.	3/8 in. CTS - 1-1/8 in. OD	15
708-E	10-1/2 in. x 11-1/6 in. x 3-1/4 in.	3/8 in. CTS - 2-1/2 in. IPS	15

Liners & Pads

Silencer™ Acoustic Liner



- Lab-tested rubber isolation liner
- Ideal for sound-rated and isolation applications for copper, PEX, CPVC, PVC, iron pipe, ABS and cast iron
- Attaches to loop hangers and HoldRite™ Stout Bracket
- Acoustic noise reduction data available

Part number	Width	Box qty
270	3/4 in.	50 ft. Roll
271	2 in.	25 ft. Roll

Silencer™ Acoustic Felt Liner



- Isolating felt is used for eliminating dissimilar metal contact and provides minimal sound and vibration isolation

Part number	Size	Box qty
272-2	2 in. x 1/4 in. x 25 ft.	25 ft. Roll
Felt-100	2-1/4 in. x 1/8 in. x 100 ft.	100 ft. Roll

Silencer™ Neoprene Waffle Pad



- Lab-tested Neoprene vibration isolation waffle pad
- Ideal for riser clamps or equipment isolation
- Minimizes noise and vibration transfer at piping stacks and risers
- Acoustic noise reduction data available

Part number	Size	Box qty
274	2 in. x 2 in. x 3/4 in.	180 (sold in sheets of 36)
275	2 in. x 2 in. x 7/8 in. (includes bearing plate)	100
275-T	2 in. x 2 in. x 7/8 in. (includes bearing plate with tabs)	100

Silencer™ Riser Pad



- Ideal for riser clamps or equipment support
- Minimizes noise and vibration transfer at piping stacks and risers
- Acoustic noise reduction data available

Part number	Size	Box qty
276	2 in. x 2 in. x 1/4 in.	50
278	2 in. x 2 in. x 1/4 in. (includes bearing plate)	50

Inserts

Tube Isolator Insert



- Ideal for pipe support with HoldRite® #103 series, #121 series, #700 series and #110-R brackets
- Provides a tight grip to tubing
- Compatible with PEX, copper and CPVC tubing
- Often used at fixture stub-out locations

Part number	Pipe size	Box qty
104	1/2 in. CTS	100
105	3/4 in. CTS	100
106	1 in. CTS	100

Plastic Through-Stud Tube Isolator Insert



- Ideal for copper, PEX and CPVC tubing
- Positioning and dissimilar metal isolation for copper, CPVC and PEX tubing
- Isolate tubing from wood framing
- Uses 1-3/8 in. hole

Part number	Pipe size	Box qty
161	1/2 in. CTS	50
162	3/4 in. CTS	50
163	1 in. CTS	25

Silencer™ Through-Stud Acoustic Tube Isolator Insert / Suspension Clamp



- Ideal for sound-rated and isolation applications
- Through-stud insert/suspension clamp, dual purpose design
- Compatible with copper, PEX and CPVC tubing
- Integrates directly with Stout Bracket or EZ-Strut bracket
- Lab tested
- Acoustic noise reduction data available

Part number	Pipe size	Box qty
261	1/2 in. CTS	50
262	3/4 in. CTS	50
263	1 in. CTS	50
264	1-1/4 in. CTS	50

Flame-Rated Tube Isolator Insert



- Through-stud and bracket isolator
- Integrates with most HoldRite™ galvanized brackets
- Ideal for metal studs with PEX, copper and CPVC tubing
- Fits in 1-3/8 in. or 1-11/32 in. holes
- Meets UL 94 V-2 standards

Part number	Pipe size	Box qty
404-R	1/2 in. CTS	100
405-R	3/4 in. CTS	100
406-R	1 in. CTS	100

Inserts

Flame-Rated Gray Tube Isolator Insert



- Positioning and dissimilar metal isolation for copper, CPVC and PEX tubing
- Meets UL 94 HB requirements

Part number	Pipe size	Box qty
424	1/2 in. CTS	50
425	3/4 in. CTS	50
426	1 in. CTS	50

Flame-Rated Cold Line Tube Isolator Insert



- Integrates with HoldRite #121 and #125 series brackets
- Positioning and dissimilar metal isolation for copper, CPVC and PEX tubing
- Meets UL 94 V-2 requirements
- Off-center hole design allows for cross-over without fittings
- Blue color to signify cold water piping

Part number	Pipe size	Box qty
424-RB	1/2 in. CTS	50
425-RB	3/4 in. CTS	50
426-RB	1 in. CTS	50

Flame-Rated Hot Line Tube Isolator Insert



- Integrates with HoldRite #121 and #125 series brackets
- Positioning and dissimilar metal isolation for copper, CPVC and PEX tubing
- Meets UL 94 V-2 requirements
- Off-center hole design allows for cross-over without fittings
- Red color to signify hot water piping

Part number	Pipe size	Box qty
424-RR	1/2 in. CTS	50
425-RR	3/4 in. CTS	50
426-RR	1 in. CTS	50

Flame Fighter™ Plenum-Rated Tube Isolator Insert



- Ideal for metal through-stud applications and integrates with HoldRite™ #121 and #125 series brackets
- Positioning and dissimilar metal isolation for copper, CPVC and PEX tubing
- Meets ASTM E84 25/50 and UL 94 V-0 requirements (Plenum-rated)

Part number	Pipe size	Box qty
424-S	1/2 in. CTS	25
425-S	3/4 in. CTS	25
426-S	1 in. CTS	25

Inserts

LockRite™ Glueable Insert for CPVC



- Glueable 1/2 in. CTS insert for support of CPVC tubing
- Ideal for lavatory, sink and toilet stub-out support
- Inserts lock into LockRite brackets and create a strong support with use of CPVC cement

Part number	Pipe size	Box qty
604	1/2 in. CTS	100
605	3/4 in. CTS	100

Clamps

Full S-Nail Clamp

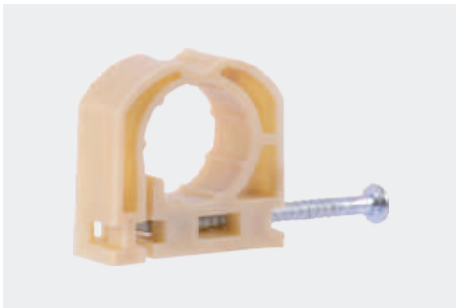

- Vertical or horizontal support
- Ideal for copper, PEX and CPVC tubing
- Durable plastic construction
- Helps to minimize noise transfer and isolates against dissimilar metal contact

Part number	Pipe size	Box qty
181	1/2 in. CTS	100
182	3/4 in. CTS	100
183	1 in. CTS	50

Half S-Nail Clamp



- Vertical or horizontal support
- Ideal for copper, PEX and CPVC tubing
- Durable plastic construction
- Helps to minimize noise transfer and isolates against dissimilar metal contact

Part number	Pipe size	Box qty
191	1/2 in. CTS	100
192	3/4 in. CTS	100
193	1 in. CTS	50

Quick-Closing Pro Clamp



- Ideal for securing copper, PEX and CPVC tubing to Stout Bracket or #170 bracket
- Nylon clamps attach with a single fastener
- Flame-rated per UL 94 V-2 standards

Part number	Pipe size	Box qty
201	1/2 in. CTS	50
202	3/4 in. CTS	50

Clamps

Half-Moon Snap Clamp



- Fire-retardant PVC clamp
- Meets UL 94 V-0 requirements
- CPVC tubing glues directly to clamp
- Mounts to Stout Brackets, #170 brackets or framing members

Part number	Pipe size	Box qty
211	1/2 in. CTS	100
212	3/4 in. CTS	100

Suspension Clamp



- Suspension clamp
- Ideal for copper, PEX and CPVC tubing
- Mounts directly on Stout Bracket or other surfaces

Part number	Pipe size	Box qty
221	1/2 in. CTS	100
222	3/4 in. CTS	100
223	1 in. CTS	50
224	1-1/4 in. CTS	25
225	1-1/2 in. CTS	25
226	2 in. CTS	25
227	1-1/2 in. IPS	25
228	2 in. IPS	25

Plenum-Rated Suspension Clamp



- Ideal for CPVC, copper and PEX tubing
- Meets ASTM E84 25/50 and UL 94 V-0 requirements (Plenum-rated)

Part number	Pipe size	Box qty
221-S	1/2 in. CTS	100
222-S	3/4 in. CTS	100

Standard Clamp



- Ideal for copper, PEX and CPVC tubing
- Mounts directly on HoldRite™ Stout Bracket or other surfaces

Part number	Pipe size	Box qty
231	1/2 in. CTS	100
232	3/4 in. CTS	100
233	1 in. CTS	50
234	1-1/4 in. CTS	25
235	1-1/2 in. CTS	25
236	2 in. CTS	25
237	1-1/2 in. IPS	25
238	2 in. IPS	25

Clamps

Plenum-Rated Standard Clamp



- Ideal for copper, PEX and CPVC tubing
- Mounts directly on HoldRite™ Stout Bracket or other surfaces
- Meets ASTM E84 25/50 and UL 94 V-0 requirements (Plenum-rated)

Part number	Pipe size	Box qty
231-S	1/2 in. CTS	100
232-S	3/4 in. CTS	100

Variable Closure Isolation Clamp

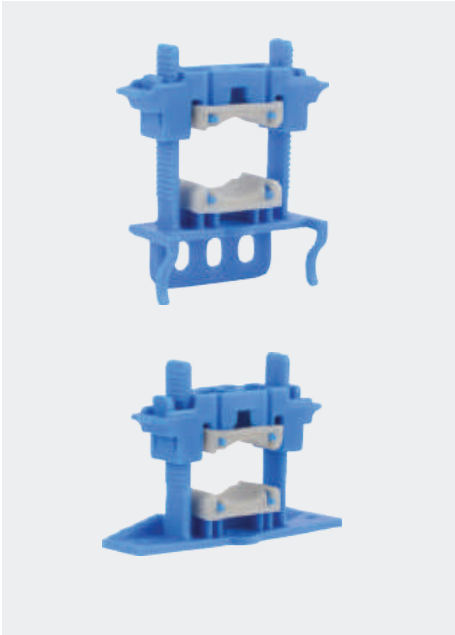

- Lab-tested, sound-rated and isolation solution
- Compatible with copper, PEX, CPVC, iron pipe and other system materials
- Variable closure clamp mounts directly to HoldRite Stout Bracket™ SB1S/SB2S and EZ-STRUT™ Bracket
- Supports up to 2" pipe sizes, with load ratings up to 300 pounds
- Framework meets UL 94 V-2 flame rating
- Includes isolation pads to minimize noise and vibration
- Acoustic noise reduction data available

Part number	Pipe size	Box qty
250	Up to 1 in. CTS	50
280	1 in. - 2 in. CTS/IPS	50

- Lab-tested, sound-rated and isolation solution
- Compatible with copper, PEX, CPVC, iron pipe and other system materials
- Flat base, variable closure clamp mounts directly to HoldRite Stout Bracket™ #SB3 and #SB4 brackets, wood, metal or other flat surfaces
- Supports up to 2" pipe sizes, with load ratings up to 300 pounds
- Framework meets UL 94 V-2 flame rating
- Includes isolation pads to minimize noise and vibration
- Acoustic noise reduction data available

Part number	Pipe size	Box qty
255	Up to 1 in. CTS	50
285	1 in. - 2 in. CTS/IPS	50

Plenum-Rated Variable Closure Clamp



- Compatible with copper, PEX, CPVC, iron pipe and other system materials
- Load rating of up to 300 pounds
- Meets ASTM E84 25/50 rating and UL 94 V-0 requirements (Plenum-rated)

Part number	Pipe size	Box qty
250-S	Up to 1 in. CTS	50
255-S	Up to 1 in. CTS	50
280-S	1 in. - 2 in. CTS/IPS	50
285-S	1 in. - 2 in. CTS/IPS	50

Rapid System™ Variable Closure Clamp



- Variable size tubing clamp
- Mounts directly to #170 bracket
- No tools required to install clamp in seconds

Part number	Pipe size	Box qty
251	Up to 1 in. CTS	50

Variable Closure Strut Clamp



- Variable size strut clamp
- Ideal for securing copper, PEX, CPVC and gas tubing directly to strut/channel
- Fire retardant framework meets requirements UL 94 V-2 rating
- Does not include isolation pads

Part number	Pipe size	Box qty
257	Up to 1 in. CTS	50
287	1 in. - 2 in. CTS	50

Variable Closure Isolation Strut Clamp with Pad



- Variable size strut clamp
- Ideal for securing copper, PEX, CPVC and gas tubing directly to strut/channel
- Fire retardant framework meets requirements UL 94 V-2 rating
- Acoustic noise reduction data available

Part number	Pipe size	Box qty
257-P	Up to 1 in. CTS	50
287-P	1 in. - 2 in. CTS	50

Plenum-Rated Variable Closure Strut Clamp

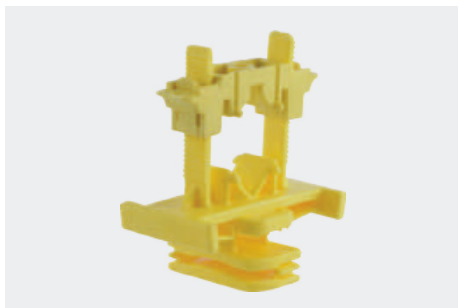

- Variable size strut clamp
- Ideal for securing copper, PEX, CPVC and gas tubing directly to strut/channel
- Meets ASTM E84 25/50 rating and UL 94 V-0 requirements (Plenum-rated)
- Does not include isolation pads

Part number	Pipe size	Box qty
257-S	Up to 1 in. CTS	50
287-S	1 in. - 2 in. CTS	50

Clamps

Silencer™ Acoustic Shower Head Clamp



- Shower head/tub spout acoustical anchor point, lab tested
- Ideal for minimizing noise transfer to the building
- Mounts directly to the HoldRite™ Stout Bracket
- Acoustic noise reduction data available

Part number	Size	Box qty
265	2-1/4 in. x 1-5/8 in. x 1-1/8 in.	50

Silencer™ Noise and Vibration Isolation Standard Clamp



- Compatible with copper, PEX, CPVC, cast iron and other pipe materials
- Framework meets UL 94 V-2 flame rating
- IAPMO UPC/IPC Listed
- Acoustic noise reduction data available

Part number	Box qty
266	50
267	50
268	50
269	50

PEXRite® Stub-Out Clamp



- Secure fit prevents forward and backward movement
- Compatible with PEX, copper and CPVC

Part number	Pipe size	Box qty
701	1/2 in. CTS	50
702	3/4 in. CTS	50

ProGuard™ Stub-Out Clamp



- Stub-out clamps integrate with model #SB3 and #SB4
- Flame-rated: UL 94 V-0
- Compatible with PEX, CPVC and copper tubing

Part number	Pipe size	Box qty
731	1/2 in. CTS	50
732	3/4 in. CTS	50

PEXRite® Galvanized Bracket and Tube Clamp Kit

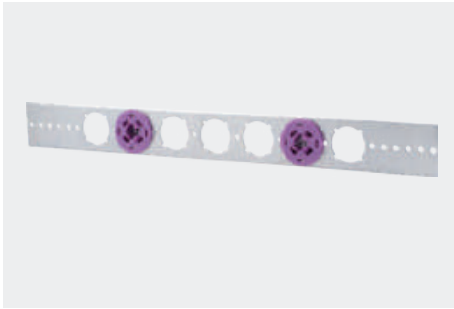

- 20 in. or 26 in. galvanized bracket and 1/2 in. #701 stub-out clamps
- Ideal for lavatory/sink and toilet stub-outs

Part number	Size	Pipe size	Box qty
103-18-701	20 in. Bracket	1/2 in. CTS	50 Brackets/100 Clamps
103-26-701	26 in. Bracket	1/2 in. CTS	50 Brackets/100 Clamps

100 Series 316 Stainless Steel Strut Mount Cushion Clamp



- Permits various size lines to be mixed to suit installation
- Ideal for overhead pipe on a trapeze

Part number	Pipe size	Box qty
HR100025-4-655	1/4 in. OD	25
HR100037-4-655	3/8 in. OD	25
HR100050-4-655	1/2 in. OD	25
HR100062-4-655	5/8 in. OD	25
HR100075-4-655	3/4 in. OD	25
HR100087-4-655	7/8 in. OD	25
HR100100-4-655	1 in. OD	25
HR100112-4-655	1-1/8 in. OD	20
HR100137-4-655	1-3/8 in. OD	20
HR100162-4-655	1-5/8 in. OD	20
HR100212-4-655	2-1/8 in. OD	10
HR100262-4-655	2-5/8 in. OD	5
HR100312-4-655	3-1/8 in. OD	5
HR100412-4-655	4-1/8 in. OD	5

100 Series 304 Stainless Steel Strut Mount Cushion Clamp



- Permits various size lines to be mixed to suit installation
- Ideal for overhead pipe on a trapeze

Part number	Pipe size	Box qty
HR100025-4-555	1/4 in. OD	25
HR100037-4-555	3/8 in. OD	25
HR100050-4-555	1/2 in. OD	25
HR100062-4-555	5/8 in. OD	25
HR100075-4-555	3/4 in. OD	25
HR100087-4-555	7/8 in. OD	25
HR100100-4-555	1 in. OD	25
HR100112-4-555	1-1/8 in. OD	20
HR100137-4-555	1-3/8 in. OD	20
HR100162-4-555	1-5/8 in. OD	20
HR100212-4-555	2-1/8 in. OD	10
HR100262-4-555	2-5/8 in. OD	5
HR100312-4-555	3-1/8 in. OD	5
HR100412-4-555	4-1/8 in. OD	5
HR100612-4-555	6-1/8 in. OD	1

Clamps

100 Series Mild Steel Strut Mount Cushion Clamp



- Yellow trivalent (non-hex) plated mild steel
- Ideal for overhead pipe on a trapeze
- Permits various size lines to be mixed to suit installation

Part number	Pipe size	Box qty
HR100025	1/4 in. OD	25
HR100037	3/8 in. OD	25
HR100050	1/2 in. OD	25
HR100062	5/8 in. OD	25
HR100075	3/4 in. OD	25
HR100087	7/8 in. OD	25
HR100100	1 in. OD	25
HR100112	1-1/8 in. OD	20
HR100137	1-3/8 in. OD	20
HR100162	1-5/8 in. OD	20
HR100212	2-1/8 in. OD	10
HR100262	2-5/8 in. OD	5
HR100312	3-1/8 in. OD	5
HR100412	4-1/8 in. OD	5
HR100612	6-1/8 in. OD	1

200 Series Mild Steel Strut Mount Cushion Clamp



- Yellow trivalent (non-hex) plated mild steel
- Ideal for overhead pipe on a trapeze
- Permits various size lines to be mixed to suit installation

Part number	Pipe size	Box qty
HR200050	1/2 in. Nominal Pipe	25
HR200075	3/4 in. Nominal Pipe	20
HR200100	1 in. Nominal Pipe	20
HR200125	1-1/4 in. Nominal Pipe	20
HR200150	1-1/2 in. Nominal Pipe	20
HR200200	2 in. Nominal Pipe	10
HR200300	3 in. Nominal Pipe	5
HR200400	4 in. Nominal Pipe	5
HR200600	6 in. Nominal Pipe	1

200 Series 304 Stainless Steel Strut Mount Cushion Clamp



- 304 Stainless steel
- Ideal for overhead pipe on a trapeze
- Permits various size lines to be mixed to suit installation

Part number	Pipe size	Box qty
HR200050-4-555	1/2 in. Nominal Pipe	25
HR200075-4-555	3/4 in. Nominal Pipe	20
HR200100-4-555	1 in. Nominal Pipe	20
HR200125-4-555	1-1/4 in. Nominal Pipe	20
HR200150-4-555	1-1/2 in. Nominal Pipe	20
HR200200-4-555	2 in. Nominal Pipe	10
HR200300-4-555	3 in. Nominal Pipe	5
HR200400-4-555	4 in. Nominal Pipe	5
HR200600-4-555	6 in. Nominal Pipe	1

Clamps

200 Series 316 Stainless Steel Strut Mount Cushion Clamp



- Permits various size lines to be mixed to suit installation
- Ideal for overhead pipe on a trapeze

Part number	Pipe size	Box qty
HR200050-4-655	1/2 in. Nominal Pipe	25
HR200075-4-655	3/4 in. Nominal Pipe	20
HR200100-4-655	1 in. Nominal Pipe	20
HR200125-4-655	1-1/4 in. Nominal Pipe	20
HR200150-4-655	1-1/2 in. Nominal Pipe	10
HR200200-4-655	2 in. Nominal Pipe	10
HR200300-4-655	3 in. Nominal Pipe	5
HR200400-4-655	4 in. Nominal Pipe	5
HR200600-4-655	6 in. Nominal Pipe	1

Copper-bonded 2-Hole Pipe Strap



- Suitable for use in both residential and commercial applications.
- Vertical or horizontal support of copper tubing

Part number	Pipe size	Box qty
CPS050	1/2 in. CTS	100
CPS075	3/4 in. CTS	100
CPS100	1 in. CTS	100

Insulation Couplings

Clevis Hanger Insulation Coupling

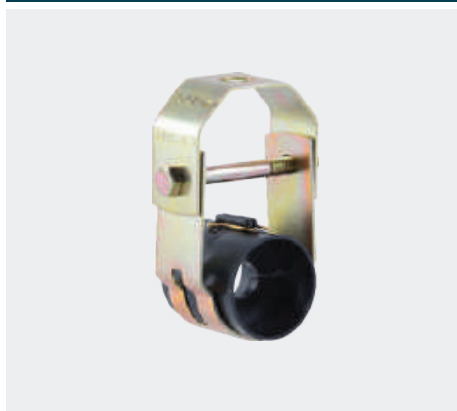

- Mounts directly to suspended hanger rod
- Ideal for overhead insulated pipe
- Meets the 25/50 flame spread/smoke developed index

Part number	Pipe O.D.	Insulation Thickness	Box qty
HR704062	5/8 in. O.D.	1/2 in.	10
HR704087	7/8 in. O.D.	1/2 in.	10
HR704112	1-1/8 in. O.D.	1/2 in.	10
HR704137	1-3/8 in. O.D.	1/2 in.	10
HR704162	1-5/8 in. O.D.	1/2 in.	10
HR704212	2-1/8 in. O.D.	1/2 in.	10
HR704262	2-5/8 in. O.D.	1/2 in.	10
HR704312	3-1/8 in. O.D.	1/2 in.	10
HR704412	4-1/8 in. O.D.	1/2 in.	10
HR708062	5/8 in. O.D.	1 in.	10
HR708087	7/8 in. O.D.	1 in.	10
HR708112	1-1/8 in. O.D.	1 in.	10
HR708137	1-3/8 in. O.D.	1 in.	10
HR708162	1-5/8 in. O.D.	1 in.	10
HR708212	2-1/8 in. O.D.	1 in.	5
HR708262	2-5/8 in. O.D.	1 in.	5
HR708312	3-1/8 in. O.D.	1 in.	5

Insulation Couplings

Plastic Strut Mount Insulation Coupling



- Mounts directly to strut
- Meets the 25/50 flame spread/smoke developed index
- Ideal for overhead insulated pipe on trapeze

Part number	Pipe O.D.	Insulation Thickness	Box qty
HR824062	5/8 in. O.D.	1/2 in.	20
HR824087	7/8 in. O.D.	1/2 in.	20
HR824112	1-1/8 in. O.D.	1/2 in.	20
HR824137	1-3/8 in. O.D.	1/2 in.	20
HR824162	1-5/8 in. O.D.	1/2 in.	20
HR824212	2-1/8 in. O.D.	1/2 in.	10
HR828087	7/8 in. O.D.	1 in.	10
HR828112	1-1/8 in. O.D.	1 in.	10
HR828137	1-3/8 in. O.D.	1 in.	10
HR828162	1-5/8 in. O.D.	1 in.	10
HR828212	2-1/8 in. O.D.	1 in.	10
HR828262	2-5/8 in. O.D.	1 in.	10

Steel Strut Mount Insulation Coupling



- Mounts directly to strut
- Meets the 25/50 flame spread/smoke developed index
- Ideal for overhead insulated pipe on trapeze

Part number	Pipe O.D.	Insulation Thickness	Box qty
HR724062	5/8 in. O.D.	1/2 in.	20
HR724087	7/8 in. O.D.	1/2 in.	20
HR724112	1-1/8 in. O.D.	1/2 in.	20
HR724137	1-3/8 in. O.D.	1/2 in.	20
HR724162	1-5/8 in. O.D.	1/2 in.	20
HR724212	2-1/8 in. O.D.	1/2 in.	10
HR724262	2-5/8 in. O.D.	1/2 in.	10
HR724312	3-1/8 in. O.D.	1/2 in.	10
HR724412	4-1/8 in. O.D.	1/2 in.	10
HR726062	5/8 in. O.D.	3/4 in.	10
HR726087	7/8 in. O.D.	3/4 in.	10
HR726112	1-1/8 in. O.D.	3/4 in.	10
HR726137	1-3/8 in. O.D.	3/4 in.	10
HR726162	1-5/8 in. O.D.	3/4 in.	10
HR726212	2-1/8 in. O.D.	3/4 in.	10
HR726262	2-5/8 in. O.D.	3/4 in.	10
HR726312	3-1/8 in. O.D.	3/4 in.	10
HR726362	3-5/8 in. O.D.	3/4 in.	10
HR726412	4-1/8 in. O.D.	3/4 in.	10
HR728062	5/8" O.D.	1 in.	10
HR728087	7/8 in. O.D.	1 in.	10
HR728112	1-1/8 in. O.D.	1 in.	10
HR728137	1-3/8 in. O.D.	1 in.	10
HR728162	1-5/8 in. O.D.	1 in.	10
HR728212	2-1/8 in. O.D.	1 in.	10
HR728262	2-5/8 in. O.D.	1 in.	10
HR728312	3-1/8 in. O.D.	1 in.	10
HR728412	4-1/8 in. O.D.	1 in.	10

Hangers

Bell Hanger

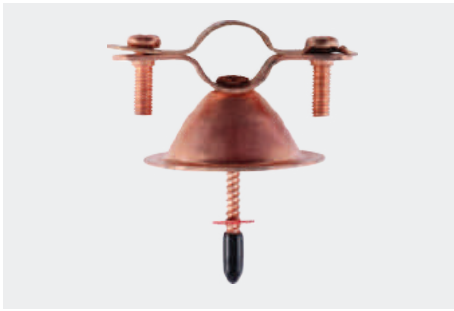

- Vertical or horizontal support of copper tubing
- Provides a 13/16" standoff from mounting location

Part number	Pipe size	Box qty
CBH050	1/2 in. CTS	25
CBH075	3/4 in. CTS	25
CBH100	1 in. CTS	25

Plastic J-Hook Pipe Hanger



- Vertical or horizontal support of copper tubing
- Provides a 13/16" standoff from mounting location

Part number	Pipe size	Box qty
P-JHOOK050CTS	1/2 in. CTS	50
P-JHOOK075CTS	3/4 in. CTS	50
P-JHOOK100CTS	1 in. CTS	50
P-JHOOK125CTS	1-1/4 in. CTS	50

DWV J-Hook Pipe Hanger



- Supports DWV piping systems to joists and rafters
- Ideal for supporting DWV pipe

Part number	Pipe size	Box qty
P-JHOOK150DWV	1-1/2 in. IPS	50
P-JHOOK200DWV	2 in. IPS	50
P-JHOOK300DWV	3 in. IPS	50
P-JHOOK400DWV	4 in. IPS	25

Galvanized Pipe Hanger

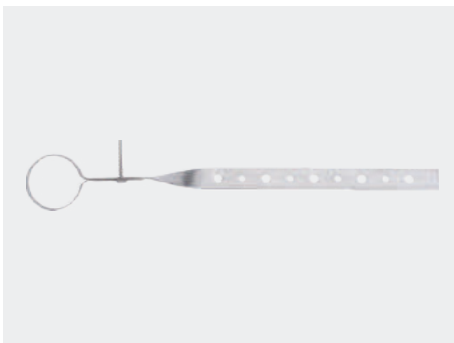

- Ideal for supporting DWV pipe from overhead
- Numerous nail holes allow you to achieve the right length for your installation
- Strap keeps pipes securely in place
- Supports DWV piping systems to joists and rafters

Part number	Pipe size	Box qty
GPH150	1-1/2 in. IPS	20
GPH200	2 in. IPS	20
GPH300	3 in. IPS	20
GPH400	4 in. IPS	20

Hangers

Silencer™ Acoustic J-Hanger



- Adjustable J-hanger
- Ideal for noise and vibration isolation and dissimilar metal isolation
- Framed with rubber liner
- Conforms with MSS SP-58 and SP-69

Part number	Size	Box qty
320	1/2 in. CTS	50
321	3/4 in. IPS, 1/2 in. CTS	50
322	1 in. IPS, 3/4 in. CTS	50
323	1-1/4 in. IPS, 1 in. CTS	50
324	1-1/2 in. IPS, 1-1/4 in. CTS	50
325	2 in. IPS, 1-1/2 in. CTS	50
326	2-1/2 in. IPS, 2 in. CTS	50
327	3 in. IPS, 2-1/2 in. CTS	25
328	3 in. IPS	25
330	4 in. CTS, 4 in. IPS	25

Silencer™ Acoustic Loop Hanger



- Adjustable loop hanger
- Ideal for noise and vibration isolation and dissimilar metal isolation
- Loop hanger with 3/8 in. swivel nut and rubber liner
- Conforms with Federal Specification WW-H-171, MSS SP-58 and SP-69

Part number	Size	Box qty
300	1/2 in. CTS	100
301	1/2 in. IPS, 3/4 in. CTS	100
302	3/4 in. IPS, 1 in. CTS	100
303	1 in. IPS, 1-1/4 in. CTS	100
304	1-1/4 in. - 1-1/2 in. IPS, 1-1/2 in. CTS	100
306	1-1/4 in. - 2 in. IPS, 2 in. CTS	100
307	2-1/2 in. IPS/CTS	50
308	3 in. IPS/CTS	50
310	4 in. IPS/CTS	25

Galvanized Cast-in-Place Hanger



- Galvanized steel bracket with 2 in. center line height from structure
- Cast-in-place concrete hanger for horizontal support
- Compatible with HoldRite #400 series and #261/262 inserts
- Meets MSS-SP-58 load requirements (150 pound load rating)

Part number	Size	Pipe size	Box qty
125-D	9-5/8 in. x 5 in.	1/2 in., 3/4 in., 1 in. CTS	50

121 Series Galvanized 90° Hanger - Single Hole



- Provides various distanced center line height from structure
- Can be cast into concrete slab, then bent into position
- Compatible with HoldRite #400 Series and #261/#262 inserts
- Single hole design
- Attaches directly to a flat surface or suspend from 3/8 in. all-thread rod providing any desired height.

Part number	Size	Pipe size	Box qty
121-R	2 in. x 1-3/4 in. x 1-1/2 in.	1/2 in., 3/4 in., 1 in. CTS	25
121-RLS	4-1/2 in. x 2-5/8 in. x 1 in.	1/2 in., 3/4 in., 1 in. CTS	50
121-W	3 in. x 1-3/4 in. x 3/4 in.	1/2 in., 3/4 in., 1 in. CTS	25

121 Series Galvanized 90° Hanger - Double Hole

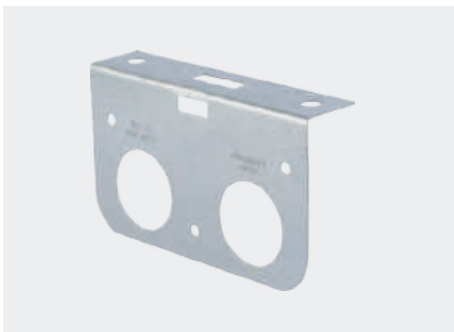

- Provides various distanced center line height from structure
- Can be cast into concrete slab, then bent into position
- Compatible with HoldRite #400 Series and #261/#262 inserts
- Double hole design
- Attaches directly to a flat surface or suspend from 3/8 in. all-thread rod providing any desired height.

Part number	Size	Pipe size	Box qty
121-D	5 in. x 3 in. x 1 in.	1/2 in., 3/4 in., 1 in. CTS	25
121-DLS	5 in. x 4-1/2 in. x 1 in.	1/2 in., 3/4 in., 1 in. CTS	25
121-DS	5 in. x 2-1/4 in. x 1-3/4 in.	1/2 in., 3/4 in., 1 in. CTS	25
121-L	5 in. x 2-1/2 in. x 2 in.	1/2 in., 3/4 in., 1 in. CTS	25

121 Series Galvanized 90° Hanger - Triple Hole



- Provides various distanced center line height from structure
- Can be cast into concrete slab, then bent into position
- Compatible with HoldRite #400 Series and #261/#262 inserts
- Triple hole design
- Attaches directly to a flat surface or suspend from 3/8 in. all-thread rod providing any desired height.

Part number	Size	Pipe size	Box qty
121-O	4-1/2 in. x 4 in. x 1-1/2 in.	1/2 in., 3/4 in., 1 in. CTS	25



Appliance and Fixture Boxes

HoldRite appliance and fixture boxes are designed with versatility, made from durable ABS material, and allow for easy installations, while providing high-end aesthetics and a professional appearance. Available for connection types on PEX, copper and CPVC pipe in both fire rated and non-fire rated versions.



Fixture Outlet Boxes

Non Fire-Rated

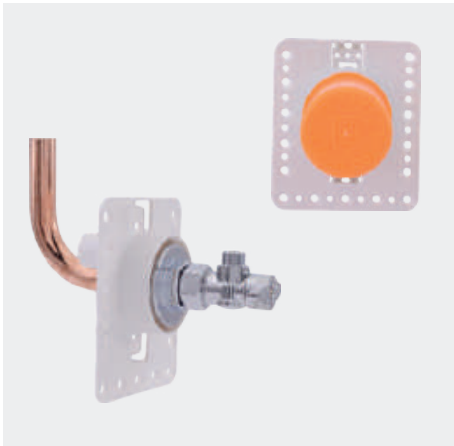

- Attaches to SB1, SB2, SB3, SB4 brackets, 170 and 170-26 brackets, hyco bars or directly to studs
- Tail pieces have near 360° movement for installation in any orientation
- Copper, CPVC and PEX end connections
- Chrome lock nut to match valve and allows for “Z” axis movement to handle multiple drywall layer options and or cabinet wall installations

Part number	Description
HR-F-C-1	Non Fire-Rated Fixture Outlet Box - CPVC 3/8 in. outlet
HR-F-C-0	Non Fire-Rated Fixture Outlet Box - CPVC 1/4 in. outlet
HR-F-M-1	Non Fire-Rated Fixture Outlet Box - Copper 3/8 in. outlet
HR-F-M-0	Non Fire-Rated Fixture Outlet Box - Copper 1/4 in. outlet
HR-F-P-1	Non Fire-Rated Fixture Outlet Box - PEX 3/8 in. outlet
HR-F-P-0	Non Fire-Rated Fixture Outlet Box - PEX 1/4 in. outlet

Fire-Rated



- Attaches to SB1, SB2, SB3, SB4 brackets, 170 and 170-26 brackets, hyco bars or directly to studs
- Tail pieces have near 360° movement for installation in any orientation
- Copper, CPVC and PEX end connections
- Chrome lock nut to match valve and allows for “Z” axis movement to handle multiple drywall layer options and/or cabinet wall installations

Part number	Description
HR-FR-C-1	Fire-Rated - CPVC 3/8 in. outlet
HR-FR-C-0	Fire-Rated - CPVC 1/4 in. outlet
HR-FR-M-1	Fire-Rated - Copper 3/8 in. outlet
HR-FR-M-0	Fire-Rated - Copper 1/4 in. outlet
HR-FR-P-1	Fire-Rated - PEX 3/8 in. outlet
HR-FR-P-0	Fire-Rated - PEX 1/4 in. outlet

Accessories



- White or chrome trim plate options (also have extended trim plate options & “goof” ring options) that thread into place, no need for adhesives or fasteners
- Support leg sockets for additional support options where needed
- Valve extension for applications where multiple layers of drywall are used and installs falls within a cabinet wall

Part number	Description
HR-F-WH	White Trim Cover
HR-F-CH	Chrome Trim Cover
HR-F-WHE	White Trim Cover - Extended
HR-F-CHE	Chrome Trim Cover - Extended
HR-F-WHL	White Trim Cover - Large Hole
HR-F-CHL	Chrome Trim Cover - Large Hole
HR-F-SL	Support Leg
HR-F-VE	Valve Extension
HR-F-RV-0	Replacement Valve 1/4 in.
HR-F-RV-1	Replacement Valve 3/8 in.
HR-F-PC	Protective Cover

Washing Machine Outlet Boxes

Non Fire-Rated No Arrestors



- Attaches to 170 and 170-26 brackets (only in top position), hycu or directly to studs
- Copper, CPVC and PEX end connections
- Valves are in locked position but can be installed upright or inverted position
- Drain knockout on both sides of box

Part number	Description
HR-W-P	Washing machine outlet box non fire-rated PEX
HR-W-C	Washing machine outlet box non fire-rated CPVC
HR-W-M	Washing machine outlet box non fire-rated copper

Non-Fire Rated with Arrestors



- Attaches to 170 and 170-26 brackets (only in top position), hycu or directly to studs
- Copper, CPVC and PEX end connections
- Valves are in locked position but can be installed upright or inverted position
- Drain knockout on both sides of box

Part number	Description
HR-WA-P	Washing machine outlet box non fire-rated PEX w/ arrestors
HR-WA-C	Washing machine outlet box non fire-rated CPVC w/ arrestors
HR-WA-M	Washing machine outlet box non fire-rated copper w/ arrestors

Fire-Rated No Arrestors



- Attaches to 170 and 170-26 brackets (only in top position), hycu or directly to studs
- Copper, CPVC and PEX end connections
- Valves are in locked position but can be installed upright or inverted position
- Drain knockout on both sides of box

Part number	Description
HR-WR-P	Washing machine outlet box fire-rated PEX
HR-WR-C	Washing machine outlet box fire-rated CPVC
HR-WR-M	Washing machine outlet box fire-rated copper

Fire-Rated with Arrestors



- Attaches to 170 and 170-26 brackets (only in top position), hycu or directly to studs
- Copper, CPVC and PEX end connections
- Valves are in locked position but can be installed upright or inverted position
- Drain knockout on both sides of box

Part number	Description
HR-WRA-P	Washing machine outlet box fire-rated PEX w/ arrestors
HR-WRA-C	Washing machine outlet box fire-rated CPVC w/ arrestors
HR-WRA-M	Washing machine outlet box fire-rated copper w/ arrestors

Washing Machine Outlet Boxes

Face Plate



- White paintable trim cover – snaps into place, no adhesives or fasteners needed (will fit 1 or 2 layers of 1/2 in. or 5/8 in. sheetrock)

Part number	Description
HR-W-FP	Face plate, non fire-rated

Funnel Attachment



- Use when utilizing condensate/T&P to provide water wall effect to avoid splashing within the box

Part number	Description
HR-W-FN	Funnel attachment

Low Lead Replacement Valves 1/2" x 3/4" Hose



- Valves can be installed upright or inverted position
- Arrestor or no arrestor options

Part number	Description
HR-WZ-RH	Replacement valves - right hand, no arrestor
HR-WZ-A-RH	Replacement valves - right hand, arrestors
HR-WZ-LH	Replacement valves - left hand, no arrestor
HR-WZ-A-LH	Replacement valves - left hand, arrestors

Drain Box



- Drain in multiple configurations: center, left or right
- Box floor to slope to 2 in. in drain with front edge of box with a lip on the front to contain drips, splashing water etc.

Part number	Description
HR-W-OB	Drain box only

Washing Machine Outlet Boxes

Drain Box Only, Fire-Rated



- Drain in multiple configurations: center, left or right
- Box floor to slope to 2 in. in drain with front edge of box with a lip on the front to contain drips, splashing water etc.

Part number	Description
HR-WR-OB	Drain box only, fire-rated





TestRite DWV Testing Solutions

TestRite DWV products are the safer, drier and quicker DWV testing method. Complete the job up to five times faster than plumbing test balls or inflatable test devices while preventing water spillage and property damage. The system is lab-tested and IAPMO (UPC/cUPC/IPC) listed and is rated up to 50 feet of head pressure, 22 psi and five floors.

Test Tee	Complies with ASTM Standard
PVC	D2665
ABS	D2661
NO-HUB	A888

Pipe Material Systems



PVC

ABS

NO-HUB
CAST IRON*

**TestRite® No-Hub Cast Iron Test Tee is black PVC material for use in markets permitting hybrid systems.*



HOLDRITE®
MADE IN USA

↑
PRESSURE
SIDE

WARNING
May Be Under Test
While Press

Test Wedges

TestRite® Test Wedge with Valve



- Compatible with TestRite PVC, ABS and cast iron no-hub test/cleanout tees
- Included 3/4 in. male hose threads on the valve stem allow installer to fill and drain at the test port
- For use with TestRite test/cleanout tee only

Part number	Size	Box qty	Case qty
TRW2V	2 in.	1	10
TRW3V	3 in.	1	10
TRW4V	4 in.	1	10
TRW6V	6 in.	1	5

TestRite® Test Wedge Seal Replacement Kit



- Three seals per kit (enough for one Test wedge refurbishment)

Part number	Size	Bag qty
TRR2	2 in.	1 Kit
TRR3	3 in.	1 Kit
TRR4	4 in.	1 Kit
TRR6	6 in.	1 Kit

Tees

TestRite® PVC DWV Test/Cleanout Tee



- PVC Test/Cleanout Tee only

Part number	Size	Box qty
TRPVC2	2 in.	10
TRPVC3	3 in.	10
TRPVC4	4 in.	10
TRPVC6	6 in.	6

Assembled Tees

TestRite® PVC DWV Test/Cleanout Tee with Plug



- PVC test/cleanout tee, spanner ring and cleanout plug

Part number	Size	Box qty
TRPVC2A	2 in.	10
TRPVC3A	3 in.	10
TRPVC4A	4 in.	10
TRPVC6A	6 in.	6

TestRite® PVC DWV Test/Cleanout Tee with Brass Insert Plug



- PVC test/cleanout tee, spanner ring and cleanout plug
- 1/4" x 20" female brass thread tap for cleanout cover screw

Part number	Size	Box qty
TRPVC2A-B	2 in.	10
TRPVC3A-B	3 in.	10
TRPVC4A-B	4 in.	10
TRPVC6A-B	6 in.	6

TestRite® ABS DWV Test/Cleanout Tee



- ABS test/cleanout tee only

Part number	Size	Box qty
TRABS2	2 in.	10
TRABS3	3 in.	10
TRABS4	4 in.	10

TestRite® ABS DWV Test/Cleanout Tee with Plug



- ABS test/cleanout tee, spanner ring and cleanout plug

Part number	Size	Box qty
TRABS2A	2 in.	10
TRABS3A	3 in.	10
TRABS4A	4 in.	10

Assembled Tees

TestRite® ABS DWV Test/Cleanout Tee with Brass Insert Plug



- ABS test/cleanout tee, spanner ring and cleanout plug
- 1/4 in. x 20 in. female brass thread tap for cleanout cover screw

Part number	Size	Box qty
TRABS2A-B	2 in.	10
TRABS3A-B	3 in.	10
TRABS4A-B	4 in.	10

TestRite® No-Hub DWV Test/Cleanout Tee



- Black PVC test/cleanout tee for no-hub cast iron piping systems
- Designed for markets that allow combined plastic and cast iron piping (hybrid systems)

Part number	Size	Box qty
TRPVCNH2	2 in.	10
TRPVCNH3	3 in.	10
TRPVCNH4	4 in.	10
TRPVCNH6	6 in.	6

TestRite® No-Hub DWV Test/Cleanout Tee with Plug



- Black pvc test/cleanout tee, black spanner ring and cleanout plug for no-hub cast iron piping systems
- Designed for markets that allow combined plastic and cast iron piping (hybrid systems)

Part number	Size	Box qty
TRPVCNH2A	2 in.	10
TRPVCNH3A	3 in.	10
TRPVCNH4A	4 in.	10
TRPVCNH6A	6 in.	6

TestRite® No-Hub DWV Test/Cleanout Tee with Brass Insert Plug



- Black pvc test/cleanout tee, black spanner ring and cleanout plug for no-hub cast iron piping systems
- Designed for markets that allow combined plastic and cast iron piping (hybrid systems)
- 1/4 in. x 20 in. female brass thread tap for cleanout cover screw

Part number	Size	Box qty
TRPVCNH2A-B	2 in.	10
TRPVCNH3A-B	3 in.	10
TRPVCNH4A-B	4 in.	10
TRPVCNH6A-B	6 in.	6

Accessories

TestRite® PVC Spanner Ring



- Spanner ring for PVC test/cleanout tee

Part number	Size	Box qty
TRSPVC2	2 in.	10
TRSPVC3	3 in.	10
TRSPVC4	4 in.	10
TRSPVC6	6 in.	6

TestRite® ABS Spanner Ring



- Spanner Ring for ABS test/cleanout tee

Part number	Size	Box qty
TRSABS2	2 in.	10
TRSABS3	3 in.	10
TRSABS4	4 in.	10

TestRite® No-Hub Cast Iron Spanner Ring



- Black spanner ring for no-hub cast iron piping systems
- Designed for markets that allow combined plastic and cast iron piping (hybrid systems)

Part number	Size	Box qty
TRSPVCNH2	2 in.	10
TRSPVCNH3	3 in.	10
TRSPVCNH4	4 in.	10
TRSPVCNH6	6 in.	6

TestRite® Cleanout Plug

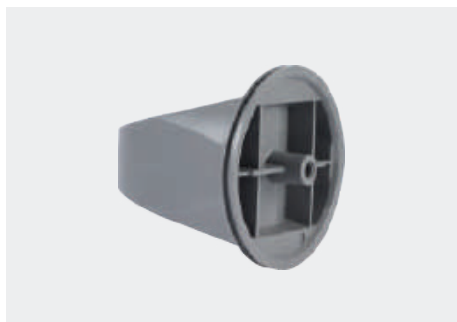

- Compatible with TestRite PVC, ABS and cast iron no-hub test/cleanout tees
- Ready to accept cleanout cover screw
- For use with TestRite test/cleanout tee only

Part number	Size	Box qty
TRC2	2 in.	10
TRC3	3 in.	10
TRC4	4 in.	10
TRC6	6 in.	6

Accessories

TestRite® Cleanout Plug with Brass Insert



- Compatible with TestRite PVC, ABS and cast iron no-hub test/cleanout tees
- Ready to accept cleanout cover screw
- For use with TestRite test/cleanout tee only
- 1/4 in. x 20 in. female brass thread tap for cleanout cover screw

Part number	Size	Box qty
TRC2-B	2 in.	10
TRC3-B	3 in.	10
TRC4-B	4 in.	10
TRC6-B	6 in.	6

TestRite® Tools



- Nickel-plated steel
- Ideal for new construction

Part number	Size	Box qty
TRT2-3	2 in. - 3 in.	1
TRT4-6	4 in. - 6 in.	1
TRTSR	2 in. - 6 in.	1





#117 Series No-Hub Fitting Restraints

Restrain hubless cast iron soil pipe without on-site cutting, bending, measuring or modifications. With over 160 configurations and sizes up to 15 in., HoldRite #117 series no-hub fitting restraints provide the ideal professional solution for no-hub DWV joints in potential high-thrust force situations.

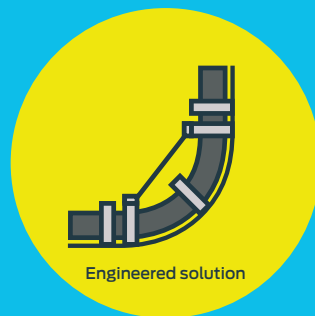
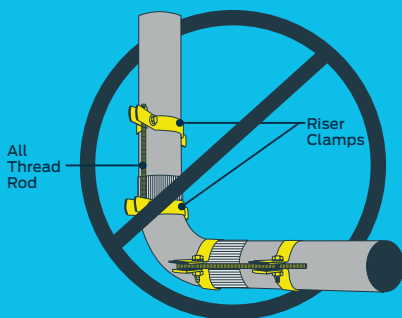



No-Hub Fitting Restraints

Made to order

#117-K Series - 1/4 Bends and Short Sweep 1/4 Bend Restraints



- 1/4 bends and short sweep 1/4 bend restraint kits (2 in. - 8 in.)

- Includes two galvanized straps and five stainless steel band clamps

Part number	For pipe size(s)	Box qty
117-3K	2 in. - 3 in.	6
117-4K	4 in.	6
117-5K	5 in.	6
117-6K	6 in.	6
117-8K	8 in.	6

#117-K Series - Short Sweep 1/4 Bend Restraints



- Short sweep 1/4 bend restraint kits (10 in. - 15 in.)

- Includes two galvanized straps and black iron pipe clamps

Part number	For pipe size(s)	Box qty
117-10K	10 in.	2
117-12K	12 in.	1
117-15K	15 in.	1

#117-K-G Series - Short Sweep 1/4 Bend Restraints



- Short sweep 1/4 bend restraint kits (10 in. - 15 in.)

- Includes all galvanized steel components

Part number	For pipe size(s)	Box qty
117-10K-G	10 in.	2
117-12K-G	12 in.	1
117-15K-G	15 in.	1

#117-LS Series - Long Sweep 1/4 Bend Restraints



- Long sweep 1/4 bend restraint kits (2 in. - 6 in.)

- Includes two galvanized steel straps and five stainless steel band clamps

Part number	For pipe size(s)	Box qty
117-3LS	2 in. - 3 in.	1
117-4LS	4 in.	1
117-6LS	6 in.	1

No-Hub Fitting Restraints

Made to order

#117-LL Series - Double 1/8 Bend Restraints



- Double 45° 1/8 bend restraint kits
- Includes two galvanized straps and six stainless steel band clamps

Part number	For pipe size(s)	Box qty
117-3LL	2 in. - 3 in.	1
117-4LL	4 in.	1
117-6LL	6 in.	1
117-8LL	8 in.	1

#117-L Series - 1/16, 1/8 and 1/6 Bend Restraints



- 1/16, 1/8 and 1/6 bend restraint kits (2 in. - 8 in.)
- Includes two galvanized steel straps and five stainless steel band clamps

Part number	For pipe size(s)	Box qty
117-3L	2 in. - 3 in.	6
117-4L	4 in.	6
117-5L	5 in.	6
117-6L	6 in.	6
117-8L	8 in.	6

#117-L Series - 1/8 Bend Restraints



- 1/8 bend restraint kits (10 in. - 15 in.)
- Includes two black iron clamps with T-bolts and two galvanized steel straps

Part number	For pipe size(s)	Box qty
117-10L	10 in.	2
117-12L	12 in.	1
117-15L	15 in.	1

#117-L-G Series - 1/8 Bend Restraints



- 1/8 bend restraint kits (10 in. - 15 in.)
- Includes all galvanized steel components

Part number	For pipe size(s)	Box qty
117-10L-G	10 in.	1
117-12L-G	12 in.	1
117-15L-G	15 in.	1

No-Hub Fitting Restraints

Made to order

#117-CE Series - Combo-End-of-Line Position Restraints



- End-of-line, combination Wye and 1/8 bend fitting with blind plug restraint kits
- Include three galvanized steel straps with six stainless steel band clamps for kits up to 4 in.
- Kits for combos with 5 in. or larger barrels include four galvanized steel straps and eight stainless steel band clamps

Part number	For pipe size(s)	Box qty
117-3CE	2 in. - 3 in.	1
117-4CE	4 in.	1
117-4x3CE	4 in. x 3 in. (or 4 in. x 2 in.)	1
117-5CE	5 in.	1
117-5x4CE	5 in. x 4 in.	1
117-6CE	6 in.	1
117-6x5CE	6 in. x 5 in.	1
117-6x4CE	6 in. x 4 in.	1
117-6x3CE	6 in. x 3 in. (or 6 in. x 2 in.)	1
117-8CE	8 in.	1
117-8x6CE	8 in. x 6 in.	1
117-8x5CE	8 in. x 5 in.	1
117-8x4CE	8 in. x 4 in.	1

#117-CM Series - Combo-Mid-Stream Position Restraints



- Combination Wye and 1/8 bend fitting restraint kits
- Includes three galvanized steel straps with six stainless steel band clamps for 3 in. and 4 in.
- Kits for fittings with 5 in. or larger barrels include four galvanized steel straps and 8 stainless steel straps

Part number	For pipe size(s)	Box qty
117-3CM	2 in. - 3 in.	1
117-4CM	4 in.	1
117-5CM	5 in.	1
117-5x4CM	5 in. x 4 in.	1
117-6CM	6 in.	1
117-6x5CM	6 in. x 5 in.	1
117-6x4CM	6 in. x 4 in.	1
117-6x3CM	6 in. x 3 in. (or 6 in. x 2 in.)	1
117-8CM	8 in.	1
117-8x6CM	8 in. x 6 in.	1
117-8x5CM	8 in. x 5 in.	1
117-8x4CM	8 in. x 4 in.	1

No-Hub Fitting Restraints

Made to order

#117-W Series - Wye Branch and Sanitary Tee Restraints



- Wye/santee fitting restraint kit
- Includes two galvanized steel straps with four stainless steel band clamps for 2 in. - 4 in.
- Kits for 5 in. - 8 in. branches include four galvanized steel straps and eight stainless steel straps

Part number	For pipe size(s)	Box qty
117-3W	2 in. - 3 in.	1
117-4W	4 in.	1
117-5W	5 in.	1
117-5x4W	5 in. x 4 in.	1
117-6W	6 in.	1
117-6x5W	6 in. x 5 in.	1
117-6x4W	6 in. x 4 in.	1
117-6x3W	6 in. x 3 in. (or 6 in. x 2 in.)	1
117-8W	8 in.	1
117-8x6W	8 in. x 6 in.	1
117-8x5W	8 in. x 5 in.	1
117-8x4W	8 in. x 4 in.	1

#117-W Series - Wye Restraints



- 10 in. - 15 in. Wye kits with 4 in. - 8 in. branches have two black iron clamps with T-bolts and two galvanized straps with band clamps
- Kits with 10 in. - 15 in. branches have three black iron clamps and five galvanized straps with T-bolts

Part number	For pipe size(s)	Box qty
117-10W	10 in.	1
117-10x4W	10 in. x 4 in.	1
117-10x6W	10 in. x 6 in.	1
117-10x8W	10 in. x 8 in.	1
117-12W	12 in.	1
117-15W	15 in.	1

#117-W Series - Wye Restraints



- 10 in. - 15 in. Wye kits with 4 in. - 8 in. branches have two galvanized clamps with T-bolts and two galvanized straps with band clamps
- Kits with 10 in. - 15 in. branches have three galvanized clamps and five galvanized straps with T-bolts

Part number	For pipe size(s)	Box qty
117-10W-G	10 in.	1
117-10x4W-G	10 in. x 4 in.	1
117-10x6W-G	10 in. x 6 in.	1
117-10x8W-G	10 in. x 8 in.	1
117-12W-G	12 in.	1
117-15W-G	15 in.	1

No-Hub Fitting Restraints

Made to order

#117-WR Series - Wyes with Reducers



- 12 in. and 15 in. Wye kits with 4 in. - 8 in. short reducers include two black iron pipe clamps, two galvanized straps with T-bolts and two galvanized straps with stainless steel band clamps
- Kits with 10 in. or 12 in. reducers include three black iron pipe clamps, four galvanized straps with T-bolts and one galvanized steel strap

Part number	For pipe size(s)	Box qty
117-12x4WR	12 in. x 4 in.	1
117-12x6WR	12 in. x 6 in.	1
117-12x8WR	12 in. x 8 in.	1
117-12x10WR	12 in. x 10 in.	1
117-15x4WR	15 in. x 4 in.	1
117-15x6WR	15 in. x 6 in.	1
117-15x8WR	15 in. x 8 in.	1
117-15x10WR	15 in. x 10 in.	1
117-15x12WR	15 in. x 12 in.	1

#117-WR-G Series - Wyes with Reducers



- 12 in. and 15 in. Wye kits with 4 in. - 8" short reducers include two galvanized pipe clamps, two galvanized straps with T-bolts and two galvanized straps with stainless steel band clamps
- Kits with 10 in. or 12 in. reducers include three galvanized pipe clamps, four galvanized straps with T-bolts and one galvanized steel strap

Part number	For pipe size(s)	Box qty
117-12x4WR-G	12 in. x 4 in.	1
117-12x6WR-G	12 in. x 6 in.	1
117-12x8WR-G	12 in. x 8 in.	1
117-12x10WR-G	12 in. x 10 in.	1
117-15x4WR-G	15 in. x 4 in.	1
117-15x6WR-G	15 in. x 6 in.	1
117-15x8WR-G	15 in. x 8 in.	1
117-15x10WR-G	15 in. x 10 in.	1
117-15x12WR-G	15 in. x 12 in.	1

#117-BP Series - Blind Plug Restraints

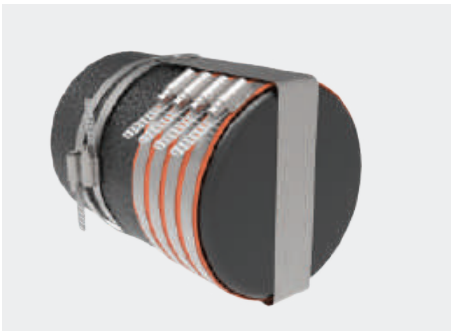

- Blind plug restraint kits include one galvanized steel strap with two stainless steel band clamps for sizes 2 in. - 8 in.

Part number	For pipe size(s)	Box qty
117-3BP	2 in. - 3 in.	1
117-4BP	4 in.	1
117-5BP	5 in.	1
117-6BP	6 in.	1
117-8BP	8 in.	1

No-Hub Fitting Restraints

Made to order

#117-BP Series - Blind Plug Restraints



- Blind plug 10" - 15" Restraint kits include one black iron pipe clamp and one galvanized steel strap with T-bolts

Part number	For pipe size(s)	Box qty
117-10BP	10"	1
117-12BP	12"	1
117-15BP	15"	1

#117-BP-G Series - Blind Plug Restraints



- Blind Plug 10" - 15" Restraint Kits include one galvanized pipe clamp and one galvanized steel strap with T-bolts

Part number	For pipe size(s)	Box qty
117-10BP-G	10"	1
117-12BP-G	12"	1
117-15BP-G	15"	1

#117-R Series - Short Reducer Restraints



- Short Reducer Fitting Restraint Kits include two galvanized steel straps with four stainless steel straps for 2 in. - 8 in. sizes

Part number	For pipe size(s)	Box qty
117-4x2R	4 in. x 2 in.	1
117-4x3R	4 in. x 3 in.	1
117-5x2R	5 in. x 2 in.	1
117-5x3R	5 in. x 3 in.	1
117-5x4R	5 in. x 4 in.	1
117-6x2R	6" x 2"	1
117-6x3R	6" x 3"	1
117-6x4R	6" x 4"	1
117-6x5R	6" x 5"	1
117-8x2R	8" x 2"	1
117-8x3R	8" x 3"	1
117-8x4R	8" x 4"	1
117-8x5R	8" x 5"	1
117-8x6R	8" x 6"	1

No-Hub Fitting Restraints

Made to order

#117-R Series - Short Reducer Restraints



- Short reducers with 10 in. - 15 in. x 2 in. - 8 in. sizes include one black iron pipe clamp and two galvanized straps with two stainless steel band clamps

- Short reducers with 12 in. - 15 in. x 10 in. - 12 in. reducing sizes include two black iron pipe clamps and two heavy galvanized straps with T-bolts

Part number	For pipe size(s)	Box qty
117-10x4R	10 in. x 4 in.	1
117-10x6R	10 in. x 6 in.	1
117-10x8R	10 in. x 8 in.	1
117-12x4R	12 in. x 4 in.	1
117-12x6R	12 in. x 6 in.	1
117-12x8R	12 in. x 8 in.	1
117-12x10R	12 in. x 10 in.	1
117-15x4R	15 in. x 4 in.	1
117-15x6R	15 in. x 6 in.	1
117-15x8R	15 in. x 8 in.	1
117-15x10R	15 in. x 10 in.	1
117-15x12R	15 in. x 12 in.	1

#117-R-G - Short Reducers



- Short reducers with 10 in. - 15 in. x 2 in. - 8 in. sizes include one galvanized pipe clamp and two galvanized straps with two stainless steel band clamps

- Short reducers with 12 in. - 15 in. x 10 in. - 12 in. reducing sizes include two galvanized pipe clamps and two heavy galvanized straps with T-bolts. ("-G" includes all galvanized steel components.)

Part number	For pipe size(s)	Box qty
117-10x4R-G	10 in. x 4 in.	1
117-10x6R-G	10 in. x 6 in.	1
117-10x8R-G	10 in. x 8 in.	1
117-12x4R-G	12 in. x 4 in.	1
117-12x6R-G	12 in. x 6 in.	1
117-12x8R-G	12 in. x 8 in.	1
117-12x10R-G	12 in. x 10 in.	1
117-15x4R-G	15 in. x 4 in.	1
117-15x6R-G	15 in. x 6 in.	1
117-15x8R-G	15 in. x 8 in.	1
117-15x10R-G	15 in. x 10 in.	1
117-15x12R-G	15 in. x 12 in.	1

No-Hub Fitting Restraints

Made to order

#117-S Series - End-to-End (Coupling) Restraints



- End-to-end restraint kits for 2 in. - 8 in. coupling restraints

- Includes two galvanized straps and four stainless steel band clamps

Part number	For pipe size(s)	Box qty
117-3S	2 in. - 3 in.	6
117-4S	4 in.	6
117-5S	5 in.	6
117-6S	6 in.	6
117-8S	8 in.	6

#117-S Series - End-to-End (Coupling) Restraints



- End-to-end restraint kits for 10 in. - 15 in. coupling restraints

- Includes two black iron pipe clamps and two galvanized steel straps with T-bolts

Part number	For pipe size(s)	Box qty
117-10S	10 in.	2
117-12S	12 in.	1
117-15S	15 in.	1

#117-S-G Series - End-to-End (Coupling) Restraints



- End-to-end restraint kits for 10 in. - 15 in. coupling restraints include two galvanized pipe clamps and two galvanized steel straps with T-bolts

Part number	For pipe size(s)	Box qty
117-10S-G	10 in.	2
117-12S-G	12 in.	1
117-15S-G	15 in.	1

#117-T Series - Test Tee Restraints



- Test tee/cleanout tee restraint kits

- Includes two galvanized straps and four stainless steel band clamps

Part number	For pipe size(s)	Box qty
117-3T	2 in. - 3 in.	1
117-4T	4 in.	1
117-5T	5 in.	1
117-6T	6 in.	1
117-8T	8 in.	1

No-Hub Fitting Restraints

Made to order

#117-T Series - Test-Tee Restraints



- Kit includes two black iron pipe clamps and 2 galvanized straps with T-bolts

Part number	For pipe size(s)	Box qty
117-10T	10 in.	1

#117-T-G Series - Test-Tee Restraints



- Kit includes two galvanized pipe clamps and two galvanized straps with T-bolts

Part number	For pipe size(s)	Box qty
117-10T-G	10 in.	1





Firestopping Sleeves and Accessories

From initial construction to firestop system maintenance, find what you need for the job in HoldRite's extensive suite of firestop solutions. UL Listed for fire, water and smoke, HydroFlame products provide a water seal while also acting as a barrier to guard against the spread of fire, smoke and gases.

For intumescent firestopping systems, choose from an array of options to best meet your needs: cast-in-place sleeves, sealants, wraps, collars or putty pads. For added watertight requirements, you can also get water dam and water module accessories that are compatible with our firestop sleeves.





Hydra-Flame
Firestop Sleeve
Model #HFP-P5
Telescoping 7 1/2" - 11 3/4"
Pipe Type: Plastic/Metal

Pipe Size	Min:	Max:
MINIMUM PIPE DIMENSION	4"	5"

Instructions to Installer

Cast-In-Place Sleeves

HydroFlame™ Pro Cast-In-Place Telescoping Firestop Sleeve



- Telescoping design adjusts from 7-1/2 in. to 11-3/4 in., in 1/4 in. increments
- For insulated and non-insulated pipes
- Cut to as short as 2-1/2 in.
- Includes locator whiskers to locate buried sleeves and to identify pipe type
- Safety caps meet OSHA hole cover requirements
- UL Listed firestop devices (2 or 3 hour F-ratings)
- Meets and/or exceeds building code requirements
- Built-in fire, smoke, gas and water protection
- UL W-Rated seal, watertight for most penetrants, refer to UL System data for specific sizing requirements
- Extensions available for slabs over 11-3/4 in.
- UL 50 Pa Ratings

Part number	Penetrating Pipe type	Size	Box qty
HFP-P1	Plastic and Metal	1/2 in. - 1 in.	10
HFP-P2	Plastic and Metal	1-1/4 in. - 2 in.	10
HFP-P3	Plastic and Metal	2 in. - 3 in.	10
HFP-P4	Plastic and Metal	3 in. - 4 in.	10
HFP-P5	Plastic and Metal	4 in. - 5 in.	2
HFP-P6	Plastic and Metal	5 in. - 6 in.	2
HFP-M1	Metal	1/2 in. - 1 in.	10
HFP-M2	Metal	1-1/4 in. - 2 in.	10
HFP-M3	Metal	2 in. - 3 in.	10
HFP-M4	Metal	3 in. - 4 in.	10
HFP-M5	Metal	4 in. - 5 in.	2
HFP-M6	Metal	5 in. - 6 in.	2

HydroFlame™ Pro Cast-In-Place Hollow Telescoping Sleeve



- Telescoping design adjusts from 7-1/2 in. to 11-3/4 in., in 1/4 in. increments
- UL Listed sleeves when installed per UL Systems
- Sleeve only; Firestopping provided by others (no intumescent material included), can achieve 2 or 3-hour F-Ratings
- Cut to as short as 4-1/2 in.
- For insulated and non-insulated pipes
- Includes locator whiskers, to locate buried sleeves and to identify pipe type
- Safety caps meet OSHA hole cover requirements
- Accepts HoldRite HydroFlame Pro series corrugated metal deck plate for corrugated deck forms
- Extensions available for slabs over 11-3/4 in.

Part number	Penetrating Pipe type	Size	Box qty
HFP-H2	Plastic and Metal	1/4 in. - 1-1/4 in.	10
HFP-H3	Plastic and Metal	1 in. - 2 in.	10
HFP-H4	Plastic and Metal	1-1/4 in. - 3 in.	10
HFP-H5	Metal	2-1/2 in. - 4 in.	10
HFP-H6	Metal	3 in. - 5 in.	2
HFP-H7	Metal	4 in. - 6 in.	2

Cast-In-Place Sleeves

HydroFlame™ Pro Cast-In-Place Firestop Sleeve with Adjustable Cap



- 7-1/4 in. to 8 in. tall with adjustable cap. Can be cut to as short as 3-1/2 in.
- For insulated and non-insulated pipes
- Includes locator whiskers to locate buried sleeves and to identify Pipe type
- Safety caps meet OSHA hole cover requirements
- UL Listed firestop devices (2 or 3 hour F-ratings)
- Meets and/or exceeds building code requirements
- Built-in fire, smoke, gas and water protection
- UL W-Rated seal, watertight for most penetrants, refer to UL System data for specific sizing requirements
- UL 50 Pa Ratings

Part number	Penetrating Pipe type	Size	Box qty
HFP-P1B	Plastic and Metal	1/2 in. - 1 in.	10
HFP-P2B	Plastic and Metal	1- 1/4 in. - 2 in.	10
HFP-P3B	Plastic and Metal	2 in. - 3 in.	10
HFP-P4B	Plastic and Metal	3 in. - 4 in.	10
HFP-P5B	Plastic and Metal	4 in. - 5 in.	2
HFP-P6B	Plastic and Metal	5 in. - 6 in.	2
HFP-M1B	Metal	1/2 in. - 1 in.	10
HFP-M2B	Metal	1- 1/4 in. - 2 in.	10
HFP-M3B	Metal	2 in. - 3 in.	10
HFP-M4B	Metal	3 in. - 4 in.	10
HFP-M5B	Metal	4 in. - 5 in.	2
HFP-M6B	Metal	5 in. - 6 in.	2

HydroFlame™ Pro Cast-In-Place Hollow Sleeve with Adjustable Cap



- 7-1/4 in. to 8 in. tall with adjustable cap. Can be cut to as short as 3-1/2 in.
- UL Listed sleeves, when installed per UL Systems
- Sleeve only; Firestopping provided by others (no intumescent material included), can achieve 2 or 3-hour F-Ratings
- For insulated and non-insulated pipes
- Includes locator whiskers to locate buried sleeves and to identify Pipe type
- Safety caps meet OSHA hole cover requirements
- Accepts HoldRite HydroFlame Pro series corrugated metal deck plate for corrugated deck forms
- Extensions available for slabs over 11-3/4 in.

Part number	Penetrating Pipe type	Size	Box qty
HFP-H2B	Plastic and Metal	1/4 in. - 1- 1/4 in.	10
HFP-H3B	Plastic and Metal	1 in. - 2 in.	10
HFP-H4B	Plastic and Metal	1- 1/4 in. - 3 in.	10
HFP-H5B	Metal	2- 1/2 in. - 4 in.	10
HFP-H6B	Metal	3 in. - 5 in.	2
HFP-H7B	Metal	4 in. - 6 in.	2

Cast-In-Place Large Diameter Sleeves

HydroFlame™ Large Diameter Firestop Sleeve

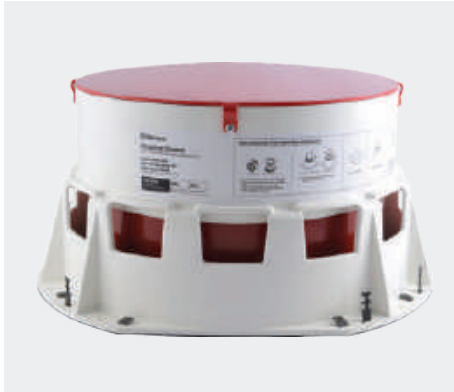

- Device comes standard at 8 in. tall
- Provides 3-hour fire rating for slabs 6 in. or thicker
- Includes OSHA-compliant hole cover plate/safety cap
- W rating is achievable with all our firestop sealants (HF100, and HF200 intumescent sealants)
- L ratings available

Part number	Size	Penetrating Pipe type	Size	Box qty
HF-P8	8"	Plastic, Metal or Insulated Metallic	6 in. - 8 in.	1
HF-P10	10"	Plastic, Metal or Insulated Metallic	8 in. - 10 in.	1
HF-P12	12"	Plastic, Metal or Insulated Metallic	10 in. - 12 in.	1
HF-M8	8"	Metal or Insulated Metallic	6 in. - 8 in.	1
HF-M10	10"	Metal or Insulated Metallic	8 in. - 10 in.	1
HF-M12	12"	Metal or Insulated Metallic	10 in. - 12 in.	1

HydroFlame™ Large Diameter Hollow Sleeve



- Device comes standard at 8 in. tall
- Includes OSHA-compliant hole cover plate/safety cap
- W rating is achievable with all our firestop sealants (HF100, and HF200 intumescent sealants)
- L ratings available

Part number	Size	Penetrating Pipe type	Size	Box qty
HF-H10	10 in.	Metal or Insulated Metallic	6 in. CTS - 8 in. IPS	1
HF-H12	12 in.	Metal or Insulated Metallic	8 in. CTS - 10 in. IPS	1
HF-H14	14 in.	Metal or Insulated Metallic	10 in. CTS - 12 in. IPS	1

Tub Boxes

HydroFlame™ Pro Tub Box



- UL Listed firestop device for bathtub drains
- Up to 3-hour fire rating (F-Rating)
- Accepts 1-1/2 in. PVC, ABS, cast iron and brass drain pipes; Thin wall tub box SKUs come with appropriate rubber seal plug
- Provides a UL listed W rating for watertight slab protection for all drain pipe types. Rubber seal plug included for thin wall drain applications
- Tested to ASTM E814, UL 1479 and CAN/ULC S115 Testing Standards

Part number	Slab height	Penetrating Pipe type	Size	Box qty
HFPTB-TW-0200	10-1/2 in.	1-1/2 in. Thin Wall drain, 2 in. HFP-P2B Sleeve Diameter	1-1/2 in. OD	5
HFPTB-NP-0200	10-1/2 in.	1-1/2 in. Nominal Pipe size Drain, 2 in. HFP-P2B Sleeve Diameter	1-1/2 in. IPS	5
HFPTB-1.5NP		Plastic and Metal	1-1/2 in. IPS	10
HFPLTB-NP-0200-8	8 in.	1-1/2 in. Nominal Pipe size Drain, 2 in. Sleeve Diameter	1-1/2 in. IPS	4
HFPLTB-TW-0200-8	8 in.	1-1/2 in. Thin Wall Drain, 2 in. Sleeve Diameter	1-1/2 in. OD	4
HFPLTB-NP-0300-8	8 in.	1-1/2 in. Nominal Pipe size Drain, 3 in. Sleeve Diameter	1-1/2 in. IPS	4
HFPLTB-TW-0300-8	8 in.	1-1/2 in. Thin Wall Drain, 3 in. Sleeve Diameter	1-1/2 in. OD	4
HFPLTB-NP-0200-9	9 in.	1-1/2 in. Nominal Pipe size Drain, 3 in. Sleeve Diameter	1-1/2 in. IPS	4
HFPLTB-TW-0200-9	9 in.	1-1/2 in. Thin Wall Drain, 2 in. Sleeve Diameter	1-1/2 in. OD	4
HFPLTB-NP-0300-9	9 in.	1-1/2 in. Nominal Pipe size Drain, 3 in. Sleeve Diameter	1-1/2 in. IPS	4
HFPLTB-TW-0300-9	9 in.	1-1/2 in. Thin Wall Drain, 3 in. Sleeve Diameter	1-1/2 in. OD	4
HFPLTB-NP-0200-10	10 in.	1-1/2 in. Nominal Pipe size Drain, 2 in. Sleeve Diameter	1-1/2 in. IPS	3
HFPLTB-TW-0200-10	10 in.	1-1/2 in. Thin Wall Drain, 2 in. Sleeve Diameter	1-1/2 in. OD	3
HFPLTB-NP-0300-10	10 in.	1-1/2 in. Nominal Pipe size Drain, 3 in. Sleeve Diameter	1-1/2 in. IPS	3
HFPLTB-TW-0300-10	10 in.	1-1/2 in. Thin Wall Drain, 3 in. Sleeve Diameter	1-1/2 in. OD	3

Cast-in-Place Sleeves

HydroFlame™ Pro Shower Drain Sleeve



- UL Listed firestop device – 3-hour F-Rating
- For 2 in. shower/floor drains
- Adjustable height sleeve – up to 14-3/4 in. slab height
- Cast iron drain is not included

Part number	Penetrating Pipe type	Size	Box qty
HFP-SH2-DRN	Plastic	2 in.	6
HFP-SH3-DRN	Plastic	2 in. - 3 in.	6

Drain not included.

HydroFlame™ Pro Cast-Iron Drain Sleeve



- UL Listed firestop device
- For Neo-Loc style drain outlets
- Cast iron drain is not included

Part number	Penetrating Pipe type	Size	Box qty
HFP-2CI-DRN	Hubless Cast Iron	2 in.	10
HFP-23CI-DRN	Hubless Cast Iron	2 in. - 3 in.	10
HFP-34CI-DRN	Hubless Cast Iron	2 in. - 3 in.	10
HFP-6CI-DRN	Hubless Cast Iron	6 in.	2

Drain not included.

HydroFlame™ Pro Cable & Line-Set Sleeve



- UL Listed firestop device – 2-3 hour F-Rating

Part number	Penetrating Pipe type	Pipe & cable size	Box qty
HFP-CSM2	Cables	45% fill max	10
HFP-CSM3	Cables	45% fill max	10
HFP-CSM2B	Cables	45% fill max	10
HFP-CSM3B	Cables	45% fill max	10
HFP-LSP3	Line-sets and multiple pipes	Various, including insulation	10
HFP-LSP3B	Line-sets and multiple pipes	Various, including insulation	10

HydroFlame™ Pro Closet Flange Sleeve



- UL Listed firestop device – 3-hour F-Rating
- Mid-body seal provides watertight penetration. Refer to UL System data for specific sizing requirements
- Adjustable height sleeve up to 12 in.
- Models for 3 in. or 4 in. toilet flanges

Part number	Penetrating Pipe type	Pipe & cable size	Box qty
HFP-CF3PL	Plastic	3 in.	10
HFP-CF4PL	Plastic	3 in. - 4 in.	10
HFP-CF3NH	Hubless- Cast Iron	3 in.	10
HFP-CF4NH	Hubless- Cast Iron	3 in. - 4 in.	10

Flange not included.

Cast-In-Place Electrical Sleeves

HoldRite™ HydroFlame Pro Series Telescoping Electrical Firestop Sleeves



- Ideal for flat concrete form decks and corrugated metal decks
- Available for 1/2 in. to 6 in. penetrants – conduit, cables, cable bundles, etc.
- Built-in fire, smoke/gas and water protection
- Telescoping design adjusts from 7-1/2 in. to 11-3/4 in. in 1/4 in. increments (extensions available)
- Safety caps meet OSHA hole cover requirements
- Allows for contraction, expansion, movement and off-center pipes
- Can be field cut as low as 2-1/2 in. tall

Model#	Penetrating Conduit or Cable Bundle	Nominal Penetrant Size	Box Qty
HFP-G1	Plastic, metal and cable bundles	1/2 in. - 1 in.	10
HFP-G2	Plastic, metal and cable bundles	1-1/4 in. - 2 in.	10
HFP-G3	Plastic, metal and cable bundles	2 in. - 3 in.	10
HFP-G4	Plastic, metal and cable bundles	3 in. - 4 in.	10
HFP-G5	Plastic, metal and cable bundles	4 in. - 5 in.	2
HFP-G6	Plastic, metal and cable bundles	5 in. - 6 in.	2

HoldRite™ HydroFlame Pro Series Electrical Firestop Sleeves with Adjustable Cap



- Ideal for flat concrete form decks and corrugated metal decks
- Available for 1/2 in. to 6 in. penetrants – conduit, cables, cable bundles, etc.
- Built-in fire, smoke/gas and water protection
- Safety cap adjusts from 7-1/4 in. to 8 in. in 1/4 in. increments
- Safety caps meet OSHA hole cover requirements
- Allows for contraction, expansion, movement and off-center pipes
- Can be field cut as low as 3-1/2 in. tall

Model#	Penetrating Conduit or Cable Bundle	Nominal Penetrant Size	Box Qty
HFP-G1B	Plastic, metal and cable bundles	1/2 in. - 1 in.	10
HFP-G2B	Plastic, metal and cable bundles	1-1/4 in. - 2 in.	10
HFP-G3B	Plastic, metal and cable bundles	2 in. - 3 in.	10
HFP-G4B	Plastic, metal and cable bundles	3 in. - 4 in.	10
HFP-G5B	Plastic, metal and cable bundles	4 in. - 5 in.	2
HFP-G6B	Plastic, metal and cable bundles	5 in. - 6 in.	2

Cast-In-Place Sleeve Accessories

Sleeve Extension with Safety Cap



- Extends the height of all HoldRite HydroFlame Pro Series sleeve sizes by as much as 4–3/4 in. in 1/4 in. increments
- Ideal for use on concrete pours over 11–3/4 in.
- No coupling needed for connection to sleeves
- Connects to safety caps, water dams, water modules and underside of sleeves

Part number	Fits Firestop Sleeves	Fits Hollow Sleeves	Size	Box qty
HFPE1	#1 Firestop Sleeves	#2 Hollow Sleeves	1/4 in. - 1-1/4 in.	5
HFPE2	#2 Firestop Sleeves	#3 Hollow Sleeves	1 in. - 2 in.	10
HFPE3	#3 Firestop Sleeves	#4 Hollow Sleeves	1-1/4 in. - 3 in.	10
HFPE4	#4 Firestop Sleeves	#5 Hollow Sleeves	2-1/2 in. - 4 in.	10
HFPE5	#5 Firestop Sleeves	#6 Hollow Sleeves	3 in. - 5 in.	2
HFPE6	#6 Firestop Sleeves	#7 Hollow Sleeves	4 in. - 6 in.	2

HydroFlame™ Pro Firestop Sleeve Extension



- Extends the height of HoldRite HydroFlame Pro Series sleeves by as much as 4–3/4 in - 1/4 in. increments
- No coupling needed for connection to sleeves
- Ideal for use on concrete pours over 11–3/4 in.
- Available for all HoldRite HydroFlame Pro Series sleeve sizes
- Connects to safety caps, water dams, water modules and underside of sleeves

Part number	Fits Firestop Sleeves	Fits Hollow Sleeves	Size	Box qty
HFPE1	#1 Firestop Sleeves	#2 Hollow Sleeves	1/4 - 1-1/4 in. NPS	
HFPE2	#2 Firestop Sleeves, Tub Box	#3 Hollow Sleeves	1 - 2 in. NPS	
HFPE3	#3 Firestop Sleeves	#4 Hollow Sleeves	1-1/4 - 3 in. NPS	
HFPE4	#4 Firestop Sleeves	#5 Hollow Sleeves	2-1/2 - 4 in. NPS	
HFPE5	#5 Firestop Sleeves	#6 Hollow Sleeves	4-5 in. NPS	
HFPE6	#6 Firestop Sleeves	#7 Hollow Sleeves	5-6 in. NPS	

HydroFlame™ Firestop Large Diameter Sleeve Extension



- Provides height extensions in 1" increments
- Two extensions can be combined to form a water dam
- Includes built in Riser Clamp Bearing Plate

Part number	Fits Firestop Sleeves	Fits Hollow Sleeves	Description	Box qty
HFEXT81	#8 Firestop Sleeve	#10 Hollow Sleeve	1 in. high extension to be used on HF-M8 or HF-P8 device.	
HFEXT101	#10 Firestop Sleeve	#12 Firestop Sleeve	1 in. high extension to be used on HF-M10 or HF-P10 device.	
HFEXT121	#12 Firestop Sleeve	#14 Hollow Sleeve	1 in. high extension to be used on HF-M12 or HF-P12 device.	

HydroFlame™ Pro Safety Cap Tool



- For removal of HydroFlame Pro series safety caps
- Works with all sizes of Pro series safety caps

Part number	Safety Cap Compatibility Size	Box qty
HFPT	1 in. - 6 in.	1

Cast-In-Place Sleeve Accessories

HydroFlame™ Pro Water Module



- Prevents debris from falling into annular space around piping
- Adds 1/2 in. to the overall height of HydroFlame Pro series sleeves
- UL W-Rated seal, watertight for most penetrants. Refer to UL System data for specific sizing requirements

Part number	Fits Firestop Sleeve	Fits hollow sleeve	Size	Box qty
HFPWM1	#1	#2	1/2 in. - 1 in.	5
HFPWM2	#2	#3	1-1/4 in. - 2 in.	5
HFPWM3	#3	#4	2 in. - 3 in.	5
HFPWM4	#4	#5	3 in. - 4 in.	5
HFPWM6	#6	#7	5 in. - 6 in.	5

HydroFlame™ Pro Water Dam



- Adds 2 in. of overall height of HydroFlame Pro series sleeves
- Load-rated for riser clamp support
- Impedes water when used with cast-in-place sleeves
- Screws onto HoldRite HydroFlame Pro series telescoping sleeves or water modules

Part number	Fits Firestop Sleeve	Fits hollow sleeve	Size	Box qty
HFPWD1	#1	#2	1/4 in. - 1-1/4 in.	5
HFPWD2	#2	#3	1 in. - 2 in.	5
HFPWD3	#3	#4	1-1/4 in. - 3 in.	5
HFPWD4	#4	#5	2-1/2 in. - 4 in.	5
HFPWD5	#5	#6	4 in. - 5 in.	5
HFPWD6	#6	#7	4 in. - 6 in.	5

HydroFlame™ Pro Aerator Adapter



- Provides a recess in the underside of the concrete floor for fitting access
- For use in concrete floors as thin as 5 - 1/2 in.

Part number	Fits Firestop Sleeve	Fits hollow sleeve	Size	Height	Box qty	Prox. footprint
HFPA2	#2	#3	1/4 in. - 2 in.	2-5/8 in.	10	4 in. x 6-1/8 in.
HFPA3	#3	#4	1-1/4 in. - 3 in.	2-5/8 in.	10	6 in. x 6-7/9 in.
HFPA4	#4	#5	2-1/2 in. - 4 in.	4 in.	10	6 in. x 8-3/4 in.
HFPA5	#5	#6	4 in. - 5 in.	4 in.	2	8 in. x 9 in.
HFPA6	#6	#7	4 in. - 6 in.	3-1/2 in.	5	10 in. x 10 in.

HydroFlame™ Pro Corrugated Metal Deck Plate

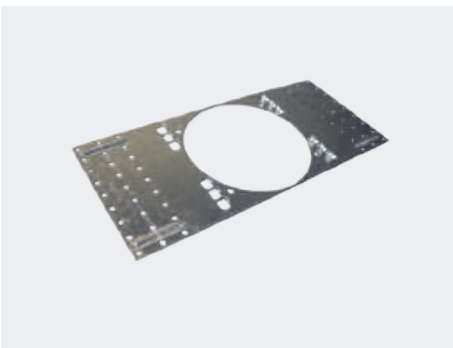

- Assembles directly to HoldRite HydroFlame Pro Series Firestop Sleeves
- Telescoping design adjusts from 7-1/2 in. to 11-3/4 in., in 1/4 in. increments

Part number	Penetrating Pipe type	Used with	Size	Box qty
HFPCD1	Plastic and Metal	HFP-P/M1, HFP-P/M1B, HFP-H2, HFP-H2B	1/4 in. - 1-1/4 in.	10
HFPCD2	Plastic and Metal	HFP-P/M2, HFP-P/M2B, HFP-H3, HFP-H3B	1 in. - 2 in.	10
HFPCD3	Plastic and Metal	HFP-P/M3, HFP-P/M3B, HFP-H4, HFP-H4B	1-1/4 in. - 3 in.	10
HFPCD4	Plastic and Metal	HFP-P/M4, HFP-P/M4B, HFP-H5, HFP-H5B	2-1/2 in. - 4 in.	10
HFPCD5	Plastic and Metal	HFP-P/M5, HFP-P/M5B, HFP-H6, HFP-H6B	3 in. - 5 in.	10
HFPCD6	Metal	HFP-P/M6, HFP-P/M6B, HFP-H7, HFP-H7B	4 in. - 6 in.	10
HFPCD6-DC	Plastic and Metal	HFP-P/M6, HFP-P/M6B, HFP-H7, HFP-H7B	4 in. - 6 in.	2

Wraps, Collars, Pads

HydroFlame™ Firestop Pipe Collar



- FBC™ system compatible
- Approved for PVC, CPVC, FRPP, ABS and PVC/ABS foam core insulations and more
- Clean Air Gold certified
- UL Listed Firestop Systems
- Tested to ASTM E814, UL 1479 and CAN/ULC S115 testing standards

Part number	Size	Box qty
HF-PC-0150	1-1/2 in.	12
HF-PC-0200	2 in.	12
HF-PC-0300	3 in.	6
HF-PC-0400	4 in.	6
HF-PC-0600	6 in.	2

HydroFlame™ Firestop Putty Pad



- DOT classification is not regulated
- Clean Air Gold certified
- UL Listing CLIV Report

Part number	Size	Box qty
HF-PP-1	7 in. x 7 in. x 1/8 in.	20
HF-PP-2	9 in. x 9 in. x 1/8 in.	20

HydroFlame™ Wrap Strip



- Systems up to 12 in. (PVC)
- FBC™ system compatible
- Clean Air Gold certified
- UL Listed firestop systems
- Tested to ASTM E814, UL 1479, and CAN/ULC S115 testing standards

Part number	Roll Size	Box qty
HF-WS14-0100	1 in. x 12 in.	6
HF-WS14-0200-36	2 in. x 36 ft.	2
HF-CC-0100	1 in. x 50 ft.	1
HF-CC-0200	2 in. x 50 ft.	1

Firestop Sealants

HydroFlame™ 50 Smoke & Acoustic Sealant



- Meets LEED criteria
- Low VOC content
- FBC™ system compatible
- Clean Air Gold certified
- High STC rating 69
- ASTM G-21 Mold Resistant

Part number	Size	Box qty
HF50-20S	20.2 oz. Sausage	12

HydroFlame™ 100 Water Based Firestop Sealant



- Low VOC
- High STC Rating 65
- FBC™ system compatible
- G21 testing for obstruction of mold growth
- Clean Air Gold certified
- UL Listed Firestop Systems
- Tested to ASTM E814, UL 1479, and CAN/ULC S115 testing standards

Part number	Size	Box qty
HF100-10C	10.3 oz. Cartridge	12
HF100-20S	20.2 oz. Sausage	12
HF100-30C	30 oz. Cartridge	12
HF100-5B	5 Gallon Bucket	36 per pallet

HydroFlame™ 200 Water Based Intumescent Firestop Sealant



- Low VOC
- STC Rating 66
- FBC™ system compatible
- G21 testing for obstruction of mold growth
- Clean Air Gold certified
- UL Listed Firestop Systems
- Tested to ASTM E814, UL 1479, and CAN/ULC S115 testing standards

Part number	Size	Box qty
HF200-10C	10.3 oz. Cartridge	12
HF200-20S	20.2 oz. Sausage	12
HF200-30C	30 oz. Cartridge	12
HF200-5B	5 Gallon Bucket	36 per pallet

Firestop Sealant Accessories

HydroFlame™ Caulk Gun



- Designed for standard viscosity materials
- Convenient rotating swivel barrel

Part number	Size	Box qty
HF-CG-20SP	20 oz.	1
HF-CG-20SE	20 oz.	1
HF-CG-32B	32 oz.	1

HydroFlame™ Follow Plate

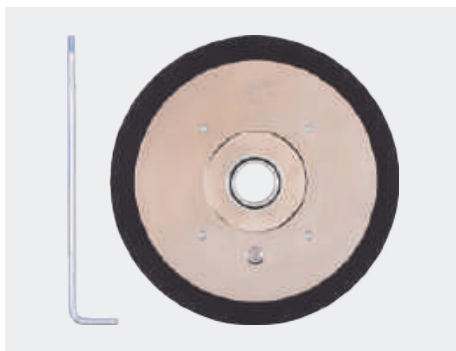

- For 2" diameter barrel bulk gun
- 5 gal. diameter- 11.5" with 1" neoprene seal

Part number	Size	Box qty
HF-FP-5	5 Gallon	1

HydroFlame™ Replacement Tip



- Easily replace caulking tips

Part number	Size	Box qty
HF-CG-T20	20 oz.	1
HF-CG-T32	32 oz.	1

Cast-in-Place Firestop Sleeve Product Configuration

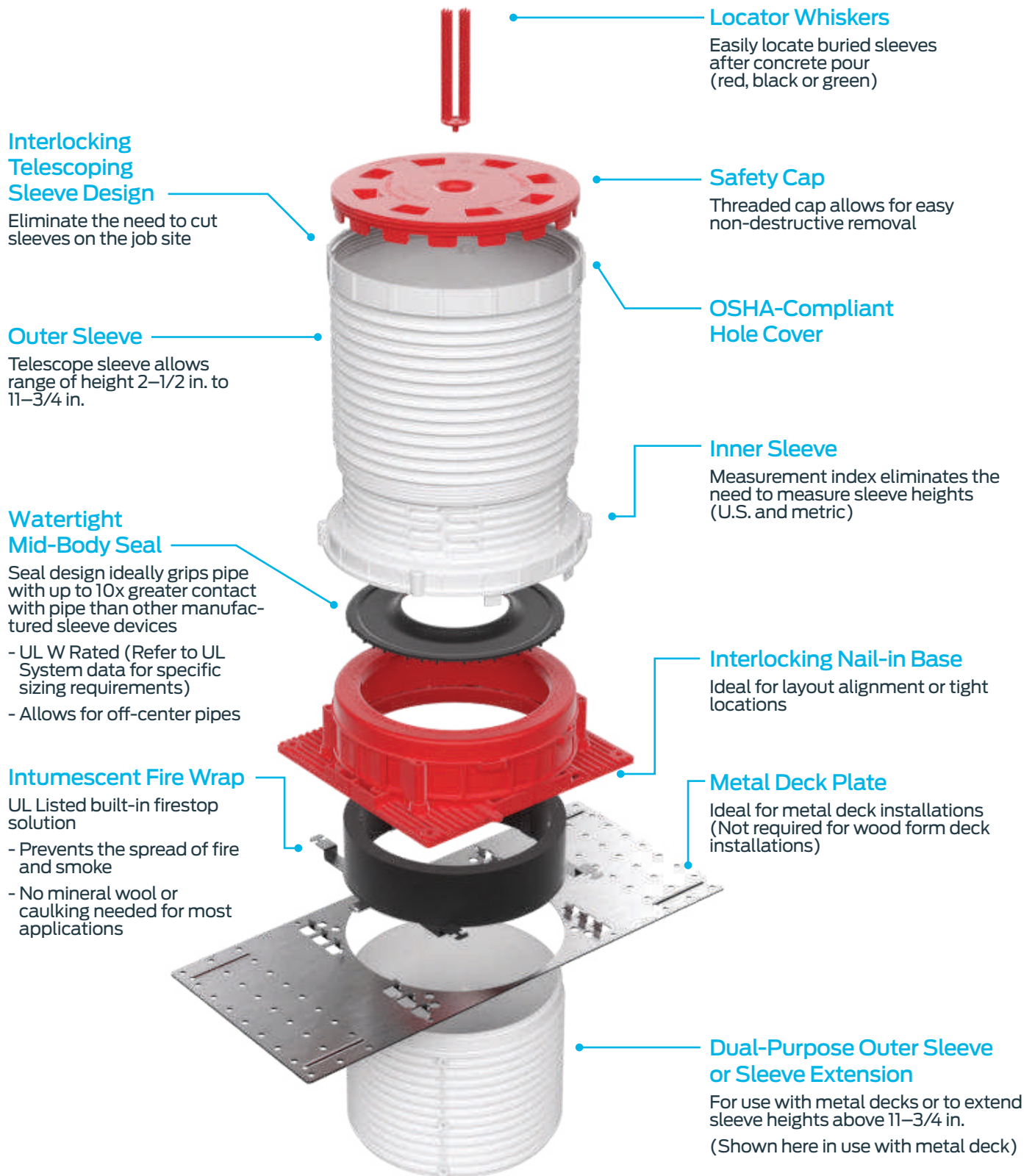

No assembly required

HoldRite HydroFlame Pro Series

Firestop Sleeve Advantages vs. Commonly Observed Cast-in-Place Devices

Features and Benefits	HoldRite™ HydroFlame™ Pro Series	Commonly Observed Cast-in-Place Sleeves
Adjustable height sleeves	✓	✗
Fast install	✓	✗
UL W-Rated watertight mid-body seal (Refer to UL System data for specific sizing requirements)	✓	✗
Locator whiskers to locate sleeves after pour	✓	✗
Safety caps are easy to remove without demolition	✓	✗
Aerator adapter available in 2", 3", 4", 5" and 6" varieties	✓	✗
Available exclusively through wholesale distribution	✓	✗
Most stable metal deck kit and requires just one accessory	✓	✗
UL fire rated for 1/2"-6" pipes and conduits without any accessories	✓	✗
Hollow sleeve versions available if caulking is preferred	✓	✗
Made in the USA	✓	✗
Most stable sleeve height extensions on the market	✓	✗
Excellent shower & floor drain, tub box and toilet sleeve kits	✓	✗
Height markings and straight lines aid in cutting sleeves short	✓	✗





Water Heater Accessories

Give water heaters the stability and long-lasting support they need. HoldRite Quick Stand water heater stands replace untested and unproven manual installations with innovative solutions designed for safety and durability. Instead of spending valuable time on the job cobbling together a water heater stand or platform, save on labor costs with solutions that are quick to install.





WARNING!

UL
DANGER

Sheds

Quick Shed™ Water Heater Enclosure



- Water heater enclosures are constructed of galvanized steel
- Provide protection for water heaters and similar equipment installed in outdoor locations
- Anchor points at the rear of the enclosure allow for optional attachment to the adjacent building structure

Part number	Size	Box qty
QS-E24	24 in. X 74 in. X 24 in.	1
QS-E26	26 in. X 74 in. X 26 in.	1
QS-E30	30 in. X 74 in. X 30 in.	1
QS-E24-B	24 in. X 74 in. X 24 in.	1
QS-E26-B	26 in. X 74 in. X 26 in.	1
QS-E30-B	30 in. X 74 in. X 30 in.	1
QS-E36-B	36 in. X 84 in. X 36 in.	1

Quick Shed™ Water Heater Enclosure Vent Cap



- Allows air circulation
- Prevents excess heat accumulation
- Keeps most rain and weather out
- Ideal for electric water heaters

Part number	Box qty
QS-EVC	1

Stands & Platforms

Quick Stand™ Water Heater Floor Stand



- Galvanized construction

Part number	Size	Weight capacity	Box qty
40-S-22-A	21-1/2 in. square	Up to 52 Gal/ 650 lbs	1
40-S-24-A	24 in. square	Up to 100 Gal/1200 lbs	1
40-S-30-U	30 in. square	Up to 120 Gal/1350 lbs	1
40-S-22-U	22 in. square	Up to 52 Gal/650 lbs	1
40-S-34-U	34 in. square	Up to 2000 lbs	1
40-S-24-U	24 in. square	Up to 100 Gal/1200 lbs	1

Stands & Platforms

Quick Stand™ Ceiling Mounted Water Heater Platform



- Ceiling-mounted equipment platform
- Accepts four 3/8 in. or 1/2 in. threaded hanger rods

* Models that ship with cross braces

Part number	Size	Drain fitting included	Weight capacity	Box qty
30-SWHP-M	24 in. X 24 in. X 4 in.	1-1/4 in. welded galvanized steel	Up to 20 Gal/300 lbs	1
40-SWHP*	21-1/4 in. X 21-1/4 in. X 2-1/2 in.	1 in. PVC (MIP/socket)	Up to 20 Gal/375 lbs	1
40-SWHP-A	21-1/4 in. X 21-1/4 in. X 2-1/2 in.	1 in. PVC (MIP/socket)	Up to 20 Gal/375 lbs	1
40-SWHP-M	21-1/4 in. X 21-1/4 in. X 2-1/2 in.	1-1/4 in. welded galvanized steel (MIP)	Up to 20 Gal/375 lbs	1
40-SWHP-C*	21-1/4 in. X 21-1/4 in. X 2-1/2 in.	1 in. CPVC	Up to 20 Gal/375 lbs	1
40-SWHP-A-C	21-1/4 in. X 21-1/4 in. X 2-1/2 in.	1 in. CPVC	Up to 20 Gal/375 lbs	1
50-SWHP-C*	26-1/2 in. X 26-1/2 in. X 2-1/2 in.	1 in. CPVC	Up to 50 Gal/600 lbs	1
50-SWHP-A-C	26-1/2 in. X 26-1/2 in. X 2-1/2 in.	1 in. CPVC	Up to 50 Gal/600 lbs	1
50-SWHP*	26-1/2 in. X 26-1/2 in. X 2-1/2 in.	1 in. PVC (MIP/socket)	Up to 50 Gal/600 lbs	1
50-SWHP-A	26-1/2 in. X 26-1/2 in. X 2-1/2 in.	1 in. PVC (MIP/socket)	Up to 50 Gal/600 lbs	1
50-SWHP-M	26-1/2 in. X 26-1/2 in. X 2-1/2 in.	1 in. welded galvanized steel	Up to 50 Gal/600 lbs	1
60-SWHP-M	28-1/2 in. X 28-1/2 in. X 3"	1-1/4 in. welded galvanized steel (MIP)	Up to 50 Gal/750 lbs	1
60-SWHP-A	28-1/2 in. X 28-1/2 in. X 3"	1-1/4 in. PVC (MIP/socket)	Up to 50 Gal/750 lbs	1
60-SWHP*	28-1/2 in. X 28-1/2 in. X 3"	1-1/4 in. PVC (MIP/socket)	Up to 50 Gal/750 lbs	1

Kit Part number

40-CB	40 series platform cross brace kit for adding or replacing cross braces
50-CB	50 series platform cross brace kit for adding or replacing cross braces
60-CB	60 series platform cross brace kit for adding or replacing cross braces

Quick Stand™ Wall Mounted Water Heater Platform



- Wall-mounted equipment platform
- Includes hanger rods and hardware
- Pre-assembled and watertight
- Can adapt to concrete or framed walls

Part number	Size	Drain fitting included	Weight capacity	Box qty
30-SWHP-WM	24 in. X 24 in. X 4 in.	1-1/4 in. galvanized welded steel	Up to 20 Gal/300 lbs	1
40-SWHP-W	21-1/4 in. X 21-1/4 in. X 2-1/2 in.	1 in. PVC (MIP/socket)	Up to 20 Gal/375 lbs	1
40-SWHP-WM	21-1/4 in. X 21-1/4 in. X 2-1/2 in.	1 in. galvanized welded steel	Up to 20 Gal/375 lbs	1
40-SWHP-W-C	21-1/4 in. X 21-1/4 in. X 2-1/2 in.	1 in. CPVC	Up to 20 Gal/375 lbs	1
50-SWHP-W	26-1/2 in. X 26-1/2 in. X 2-1/2 in.	1 in. PVC (MIP/socket)	Up to 50 Gal/600 lbs	1
50-SWHP-WM	26-1/2 in. X 26-1/2 in. X 2-1/2 in.	1 in. galvanized welded steel	Up to 50 Gal/600 lbs	1
50-SWHP-W-C	26-1/2 in. X 26-1/2 in. X 2-1/2 in.	1 in. CPVC	Up to 50 Gal/600 lbs	1
60-SWHP-WM	28-1/2 in. X 28-1/2 in. X 3 in.	1-1/4 in. galvanized welded steel	Up to 50 Gal/750 lbs	1
60-SWHP-W	28-1/2 in. X 28-1/2 in. X 3 in.	1-1/4 in. PVC (MIP/socket)	Up to 50 Gal/750 lbs	1

Kit Part number

Kit Part number	Kit Includes
40-WMK	40 series Hardware Kit for converting ceiling mount platforms to wall mount C-Brackets (2), 45° Brackets (4) & Threaded Rod (2)
50-WMK	50 series Hardware Kit for converting ceiling mount platforms to wall mount C-Brackets (2), 45° Brackets (4) & Threaded Rod (2)
60-WMK	60 series Hardware Kit for converting ceiling mount platforms to wall mount C-Brackets (2), 45° Brackets (4) & Threaded Rod (2)

Restraints

QuickStrap Expansion Tank Mounting Bracket

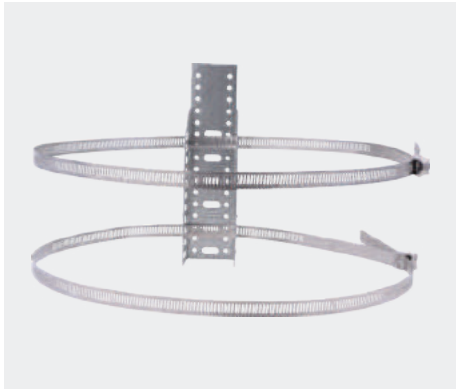

- Secures expansion tank to wall and takes weight load off pipes
- Galvanized and stainless steel construction

Part number	Size	Box qty
QS-U-C	Up to 5 gal./up to 13 in diameter (a contractor pack product)	15

QuickStrap Water Heater Restraint



- The most tested and recognized water heater seismic restraint
- Galvanized water heater strap in box

Part number	Size	Box qty
QS-120	Up to 120 Gal	12
QS-50	Up to 80 Gal	15
QS-50-P	Up to 80 Gal	15
QS-50-D	Up to 80 Gal	15
QS-50-S	Up to 80 Gal	15

Quick Belt Water Heater Restraint



- Water heater seismic restraint kit
- Soft-belt style water heater strap
- Includes hardware

Part number	Size	Box qty
QB-50-F	Up to 80 Gal	20

Galvanized Steel Water Heater Restraint



- Rated up to 80 gallons
- Self drilling lag bolts
- Patented adjustable restraint secures at the front-center of tank

Part number	Box qty
HR-80-180	15
HR-80-360	15



Index

Part Number	Page	Part Number	Page	Part Number	Page	Part Number	Page	Part Number	Page	Part Number	Page
101-18	12	117-12x6R	58	117-5x4CM	54	170-C	16	308	34	703-RET	20
101-18-R	12	117-12x6R-G	58	117-5x4R	57	181	24	310	34	703-SC	19
101-26	12	117-12x6WR	56	117-5x4W	55	182	24	320	34	703-SEC	19
101-26-R	12	117-12x6WR-G	56	117-6BP	56	183	24	321	34	704	18
101-F	14	117-12x8R	58	117-6CE	54	191	24	322	34	705	19
102-18	12	117-12x8R-G	58	117-6CM	54	192	24	323	34	706	20
102-26	12	117-12x8WR	56	117-6K	52	193	24	324	34	707	20
103-18	18	117-12x8WR-G	56	117-6L	53	201	24	325	34	707-E	20
103-18-701	29	117-15BP	57	117-6LL	53	202	24	326	34	708	20
103-26	18	117-15BP-G	57	117-6LS	52	211	25	327	34	708-E	20
103-26-701	29	117-15K	52	117-6S	59	212	25	328	34	709	17
104	22	117-15K-G	52	117-6T	59	221	25	330	34	709-EXT	17
105	22	117-15L	53	117-6W	55	221-S	25	40-CB	79	709-L	17
106	22	117-15L-G	53	117-6x2R	57	222	25	40-S-22-A	78	710	19
107-18	12	117-15S	59	117-6x3CE	54	222-S	25	40-S-22-U	78	711	19
107-26	12	117-15S-G	59	117-6x3CM	54	223	25	40-S-24-A	78	721	18
108-20	12	117-15W	55	117-6x3R	57	224	25	40-S-24-U	78	731	28
108-26	12	117-15W-G	55	117-6x3W	55	225	25	40-S-30-U	78	732	28
109-A-9	13	117-15x10R	58	117-6x4CE	54	226	25	40-S-34-U	78	734	19
109-N-6	12	117-15x10R-G	58	117-6x4CM	54	227	25	40-SWHP	79	CBH050	33
110-R	18	117-15x10WR	56	117-6x4R	57	228	25	40-SWHP-A	79	CBH075	33
110-S-12	14	117-15x10WR-G	56	117-6x4W	55	231	25	40-SWHP-A-C	79	CBH100	33
111-S	14	117-15x12R	58	117-6x5CE	54	231-S	26	40-SWHP-C	79	CPS050	31
114-C	13	117-15x12R-G	58	117-6x5CM	54	232	25	40-SWHP-M	79	CPS075	31
114-C-EXT	13	117-15x12WR	56	117-6x5R	57	232-S	26	40-SWHP-W	79	CPS100	31
114-CO	13	117-15x12WR-G	56	117-6x5W	55	233	25	40-SWHP-W-C	79	EZ-1	16
114-COH	13	117-15x4R	58	117-8BP	56	234	25	40-SWHP-WM	79	EZ-2	16
114-CR	13	117-15x4R-G	58	117-8CE	54	235	25	40-WMK	79	Felt-100	21
115	14	117-15x4WR	56	117-8CM	54	236	25	404-R	22	GPH150	33
115-C	14	117-15x4WR-G	56	117-8K	52	237	25	405-R	22	GPH200	33
117-10BP	57	117-15x6R	58	117-8L	53	238	25	406-R	22	GPH300	33
117-10BP-G	57	117-15x6R-G	58	117-8LL	53	250	26	424	23	GPH400	33
117-10K	52	117-15x6WR	56	117-8S	59	250-S	26	424-RB	23	HF-CC-0100	71
117-10K-G	52	117-15x6WR-G	56	117-8T	59	251	27	424-RR	23	HF-CC-0200	71
117-10L	53	117-15x8R	58	117-8W	55	255	26	424-S	23	HF-CG-20SE	73
117-10L-G	53	117-15x8R-G	58	117-8x2R	57	255-S	26	425	23	HF-CG-20SP	73
117-10S	59	117-15x8WR	56	117-8x3R	57	257	27	425-RB	23	HF-CG-32B	73
117-10S-G	59	117-15x8WR-G	56	117-8x4CE	54	257-P	27	425-RR	23	HF-CG-T20	73
117-10T	60	117-3BP	56	117-8x4CM	54	257-S	27	425-S	23	HF-CG-T32	73
117-10T-G	60	117-3CE	54	117-8x4R	57	261	22	426	23	HF-FP-5	73
117-10W	55	117-3CM	54	117-8x4W	55	262	22	426-RB	23	HF-H10	66
117-10W-G	55	117-3K	52	117-8x5CE	54	263	22	426-RR	23	HF-H12	66
117-10x4R	58	117-3L	53	117-8x5CM	54	264	22	426-S	23	HF-H14	66
117-10x4R-G	58	117-3LL	53	117-8x5R	57	265	28	50-CB	79	HF-M10	66
117-10x4W	55	117-3LS	52	117-8x5W	55	266	28	50-SWHP	79	HF-M12	66
117-10x4W-G	55	117-3S	59	117-8x6CE	54	267	28	50-SWHP-A	79	HF-M8	66
117-10x6R	58	117-3T	59	117-8x6CM	54	268	28	50-SWHP-A-C	79	HF-P10	66
117-10x6R-G	58	117-3W	55	117-8x6R	57	269	28	50-SWHP-C	79	HF-P12	66
117-10x6W	55	117-4BP	56	117-8x6W	55	270	21	50-SWHP-M	79	HF-P8	66
117-10x6W-G	55	117-4CE	54	118-T-6	14	271	21	50-SWHP-W	79	HF-PC-0150	71
117-10x8R	58	117-4CM	54	118-T-8	14	272-2	21	50-SWHP-W-C	79	HF-PC-0200	71
117-10x8R-G	58	117-4K	52	121-D	35	274	21	50-SWHP-WM	79	HF-PC-0300	71
117-10x8W	55	117-4L	53	121-DLS	35	275	21	50-WMK	79	HF-PC-0400	71
117-10x8W-G	55	117-4LL	53	121-DS	35	275-T	21	60-CB	79	HF-PC-0600	71
117-12BP	57	117-4LS	52	121-L	35	276	21	60-SWHP	79	HF-PP-1	71
117-12BP-G	57	117-4S	59	121-O	35	278	21	60-SWHP-A	79	HF-PP-2	71
117-12K	52	117-4T	59	121-R	35	280	26	60-SWHP-M	79	HF-WS14-0100	71
117-12K-G	52	117-4W	55	121-RLS	35	280-S	26	60-SWHP-W	79	HF-WS14-0200-36	71
117-12L	53	117-4x2R	57	121-W	35	285	26	60-SWHP-WM	79	HFI00-10C	72
117-12L-G	53	117-4x3CE	54	125-D	34	285-S	26	60-WMK	79	HFI00-20S	72
117-12S	59	117-4x3R	57	130	16	287	27	601-20	15	HFI00-30C	72
117-12S-G	59	117-5BP	56	131	16	287-P	27	601-26	15	HFI00-5B	72
117-12W	55	117-5CE	54	132	16	287-S	27	604	24	HF200-10C	72
117-12W-G	55	117-5CM	54	140	13	30-SWHP-M	79	605	24	HF200-20S	72
117-12x10R	58	117-5K	52	150-20	13	30-SWHP-WM	79	609-N-6	15	HF200-30C	72
117-12x10R-G	58	117-5L	53	150-26	13	300	34	701	28	HF200-5B	72
117-12x10WR	56	117-5S	59	161	22	301	34	702	28	HF50-20S	72
117-12x10WR-G	56	117-5T	59	162	22	302	34	703-BBUL	20	HFEXT101	69
117-12x4R	58	117-5W	55	163	22	303	34	703-DC	19	HFEXT121	69
117-12x4R-G	58	117-5x2R	57	170	16	304	34	703-DEC	19	HFEXT81	69
117-12x4WR	56	117-5x3R	57	170-251	16	306	34	703-EXT	20	HFP-23CI-DRN	67
117-12x4WR-G	56	117-5x4CE	54	170-26	16	307	34	703-RBUL	20	HFP-2CI-DRN	67

Part Number	Page	Part Number	Page	Part Number	Page	Part Number	Page	Part Number	Page	Part Number	Page
HFP-34CI-DRN	67	HFPCD6	70	HR-WA-C	39	HR200150-4-655	31	P-JHOOK050CTS	33	TRPVCNH2A-B	46
HFP-6CI-DRN	67	HFPCD6-DC	70	HR-WA-M	39	HR200200	30	P-JHOOK075CTS	33	TRPVCNH3	46
HFP-CF3NH	67	HFPE1	69	HR-WA-P	39	HR200200-4-555	30	P-JHOOK100CTS	33	TRPVCNH3A	46
HFP-CF3PL	67	HFPE2	69	HR-WR-C	39	HR200200-4-655	31	P-JHOOK125CTS	33	TRPVCNH3A-B	46
HFP-CF4NH	67	HFPE3	69	HR-WR-M	39	HR200300	30	P-JHOOK150DWV	33	TRPVCNH4	46
HFP-CF4PL	67	HFPE4	69	HR-WR-OB	41	HR200300-4-555	30	P-JHOOK200DWV	33	TRPVCNH4A	46
HFP-CSM2	67	HFPE5	69	HR-WR-P	39	HR200300-4-655	31	P-JHOOK300DWV	33	TRPVCNH4A-B	46
HFP-CSM2B	67	HFPE6	69	HR-WRA-C	39	HR200400	30	P-JHOOK400DWV	33	TRPVCNH6	46
HFP-CSM3	67	HFPE5C1	69	HR-WRA-M	39	HR200400-4-555	30	QB-50-F	80	TRPVCNH6A	46
HFP-CSM3B	67	HFPE5C2	69	HR-WRA-P	39	HR200400-4-655	31	QS-120	80	TRPVCNH6A-B	46
HFP-G1	68	HFPE5C3	69	HR-WZ-A-LH	40	HR200600	30	QS-50	80	TRR2	44
HFP-G1B	68	HFPE5C4	69	HR-WZ-A-RH	40	HR200600-4-555	30	QS-50-D	80	TRR3	44
HFP-G2	68	HFPE5C5	69	HR-WZ-LH	40	HR200600-4-655	31	QS-50-P	80	TRR4	44
HFP-G2B	68	HFPE5C6	69	HR-WZ-RH	40	HR704062	31	QS-50-S	80	TRR6	44
HFP-G3	68	HFPLTB-NP-0200-10	66	HR100025	30	HR704087	31	QS-E24	78	TRSABS2	47
HFP-G3B	68	HFPLTB-NP-0200-8	66	HR100025-4-555	29	HR704112	31	QS-E24-B	78	TRSABS3	47
HFP-G4	68	HFPLTB-NP-0200-9	66	HR100025-4-655	29	HR704137	31	QS-E26	78	TRSABS4	47
HFP-G4B	68	HFPLTB-NP-0300-10	66	HR100037	30	HR704162	31	QS-E26-B	78	TRSPVC2	47
HFP-G5	68	HFPLTB-NP-0300-8	66	HR100037-4-555	29	HR704212	31	QS-E30	78	TRSPVC3	47
HFP-G5B	68	HFPLTB-NP-0300-9	66	HR100037-4-655	29	HR704262	31	QS-E30-B	78	TRSPVC4	47
HFP-G6	68	HFPLTB-TW-0200-10	66	HR100050	30	HR704312	31	QS-E36-B	78	TRSPVC6	47
HFP-G6B	68	HFPLTB-TW-0200-8	66	HR100050-4-555	29	HR704412	31	QS-EVC	78	TRSPVCNH2	47
HFP-H2	64	HFPLTB-TW-0200-9	66	HR100050-4-655	29	HR708062	31	QS-U-C	80	TRSPVCNH3	47
HFP-H2B	65	HFPLTB-TW-0300-10	66	HR100062	30	HR708087	31	SBI	14	TRSPVCNH4	47
HFP-H3	64	HFPLTB-TW-0300-8	66	HR100062-4-555	29	HR708112	31	SBI-2502	15	TRSPVCNH6	47
HFP-H3B	65	HFPLTB-TW-0300-9	66	HR100062-4-655	29	HR708137	31	SB1S	14	TRT2-3	48
HFP-H4	64	HFPT	69	HR100075	30	HR708162	31	SB2	14	TRT4-6	48
HFP-H4B	65	HFPTB-1.5NP	66	HR100075-4-555	29	HR708212	31	SB2-2502	15	TRTSR	48
HFP-H5	64	HFPTB-NP-0200	66	HR100075-4-655	29	HR708262	31	SB2S	14	TRW2V	44
HFP-H5B	65	HFPTB-TW-0200	66	HR100087	30	HR708312	31	SB3	15	TRW3V	44
HFP-H6	64	HFPWD1	70	HR100087-4-555	29	HR724062	32	SB3-7311	17	TRW4V	44
HFP-H6B	65	HFPWD2	70	HR100087-4-655	29	HR724087	32	SB3-7312	17	TRW6V	44
HFP-H7	64	HFPWD3	70	HR100100	30	HR724112	32	SB3-7322	17	V-2	14
HFP-H7B	65	HFPWD4	70	HR100100-4-555	29	HR724137	32	SB3-7341	17		
HFP-LSP3	67	HFPWD5	70	HR100100-4-655	29	HR724162	32	SB3-7342	17		
HFP-LSP3B	67	HFPWD6	70	HR100112	30	HR724212	32	SB4	15		
HFP-M1	64	HFPWM1	70	HR100112-4-555	29	HR724262	32	SB4-7311	17		
HFP-M1B	65	HFPWM2	70	HR100112-4-655	29	HR724312	32	SB4-7312	17		
HFP-M2	64	HFPWM3	70	HR100137	30	HR724412	32	SB4-7322	17		
HFP-M2B	65	HFPWM4	70	HR100137-4-555	29	HR726062	32	SB4-7341	17		
HFP-M3	64	HFPWM6	70	HR100137-4-655	29	HR726087	32	SB4-7342	17		
HFP-M3B	65	HR-80-180	80	HR100162	30	HR726112	32	TRABS2	45		
HFP-M4	64	HR-80-360	80	HR100162-4-555	29	HR726137	32	TRABS2A	45		
HFP-M4B	65	HR-F-C-0	38	HR100162-4-655	29	HR726162	32	TRABS2A-B	46		
HFP-M5	64	HR-F-C-1	38	HR100212	30	HR726212	32	TRABS3	45		
HFP-M5B	65	HR-F-CH	38	HR100212-4-555	29	HR726262	32	TRABS3A	45		
HFP-M6	64	HR-F-CHE	38	HR100212-4-655	29	HR726312	32	TRABS3A-B	46		
HFP-M6B	65	HR-F-CHL	38	HR100262	30	HR726362	32	TRABS4	45		
HFP-P1	64	HR-F-M-0	38	HR100262-4-555	29	HR726412	32	TRABS4A	45		
HFP-P1B	65	HR-F-M-1	38	HR100262-4-655	29	HR728062	32	TRABS4A-B	46		
HFP-P2	64	HR-F-P-0	38	HR100312	30	HR728087	32	TRC2	47		
HFP-P2B	65	HR-F-P-1	38	HR100312-4-555	29	HR728112	32	TRC2-B	48		
HFP-P3	64	HR-F-PC	38	HR100312-4-655	29	HR728137	32	TRC3	47		
HFP-P3B	65	HR-F-RV-0	38	HR100412	30	HR728162	32	TRC3-B	48		
HFP-P4	64	HR-F-RV-1	38	HR100412-4-555	29	HR728212	32	TRC4	47		
HFP-P4B	65	HR-F-SL	38	HR100412-4-655	29	HR728262	32	TRC4-B	48		
HFP-P5	64	HR-F-VE	38	HR100612	30	HR728312	32	TRC6	47		
HFP-P5B	65	HR-F-WH	38	HR100612-4-555	29	HR728412	32	TRC6-B	48		
HFP-P6	64	HR-F-WHE	38	HR200050	30	HR824062	32	TRPVC2	44		
HFP-P6B	65	HR-F-WHL	38	HR200050-4-555	30	HR824087	32	TRPVC2A	45		
HFP-SH2-DRN	67	HR-FR-C-0	38	HR200050-4-655	31	HR824112	32	TRPVC2A-B	45		
HFP-SH3-DRN	67	HR-FR-C-1	38	HR200075	30	HR824137	32	TRPVC3	44		
HFPA2	70	HR-FR-M-0	38	HR200075-4-555	30	HR824162	32	TRPVC3A	45		
HFPA3	70	HR-FR-M-1	38	HR200075-4-655	31	HR824212	32	TRPVC3A-B	45		
HFPA4	70	HR-FR-P-0	38	HR200100	30	HR828087	32	TRPVC4	44		
HFPA5	70	HR-FR-P-1	38	HR200100-4-555	30	HR828112	32	TRPVC4A	45		
HFPA6	70	HR-W-C	39	HR200100-4-655	31	HR828137	32	TRPVC4A-B	45		
HFPCD1	70	HR-W-FN	40	HR200125	30	HR828162	32	TRPVC6	44		
HFPCD2	70	HR-W-FP	40	HR200125-4-555	30	HR828212	32	TRPVC6A	45		
HFPCD3	70	HR-W-M	39	HR200125-4-655	31	HR828262	32	TRPVC6A-B	45		
HFPCD4	70	HR-W-OB	40	HR200150	30	HYCO18	16	TRPVCNH2	46		
HFPCD5	70	HR-W-P	39	HR200150-4-555	30	HYCO26	16	TRPVCNH2A	46		



holdrite.com

Manufactured and distributed by Reliance Worldwide Corporation

Certifications

The most up to date certifications can be found at holdrite.com.

Warranty

The most up to date warranty can be found at holdrite.com.

2023.10

