

PRICE LIST

MULTIPLIER (x)

STEEL MECHANICAL FITTING / STEEL SERVICE / PA MECHANICAL FITTING **MULTIPLIER (UGCF):**

CON-STAB FITTING **MULTIPLIER (UGSF):**

CON-STAB CHAMFER / LYCOFIT TOOLS & ACCESORIES **MULTIPLIER (LCT2):**

STEEL TRANSITION FITTING **MULTIPLIER (UGTF):**

LYCOFIT FITTING **MULTIPLIER (LCF):**

FUSION FITTING **MULTIPLIER (FUSI):**



GAS FITTINGS

— **WIDE PRODUCT** —
OFFERING AVAILABLE

PRICE SHEET: H01.GF.0422
EFFECTIVE: **04.18.2022**



TABLE OF CONTENTS

STEEL MECHANICAL FITTINGS

GF+ PAGE 1

STEEL MECHANICAL FITTINGS EPOXY COATED COMPRESSION COUPLINGS
 STEEL MECHANICAL FITTINGS EPOXY COATED COMPRESSION MALE ADAPTERS
 STEEL MECHANICAL FITTINGS EPOXY COATED COMPRESSION TEES

STEEL MECHANICAL FITTINGS



PAGE 2

CHICAGO STEEL SERVICE FITTINGS with INTEGRAL STIFFENER MALE ADAPTERS
 CHICAGO STEEL SERVICE FITTINGS with INTEGRAL STIFFENER COUPLING

CONTINENTAL PA MECHANICAL FITTINGS



PAGE 3

PA COMPRESSION COUPLINGS

CON-STAB FITTINGS



PAGES 4 - 8

CON-STAB ID SEAL® - FULL COUPLINGS PAGE 4
 CON-STAB ID SEAL® - REDUCING COUPLINGS PAGE 5
 CON-STAB ID SEAL® - CAP-N-GO COUPLINGS PAGE 5
 CON-STAB ID SEAL® - 3-WAY TEES PAGE 6
 CON-STAB ID SEAL® - 90° ELBOWS PAGE 6
 CON-STAB ID SEAL® - STEEL TRANSITION FITTINGS (CON-STAB x STEEL) PAGE 7
 CON-STAB ID SEAL® - STEEL TRANSITION FITTINGS (CON-STAB x STEEL - LONG PIECE OF PIPE) PAGE 7
 CON-STAB ID SEAL® - STEEL TRANSITION FITTINGS (CON-STAB x STEEL - SHORT PIECE OF PIPE) PAGE 7
 CON-STAB ID CHAMPFER TOOLS WITH GAUGE PAGE 8
 CON-STAB DOUBLE ENDED ID CHAMPFER TOOLS PAGE 8

STEEL TO PE TRANSITION FITTINGS

GF+ PAGE 9

TRANSITION FITTING THREADED END (NPT x IPS) PAGE 9
 TRANSITION FITTING WELDED END (NPT x IPS) PAGE 9

LYCOFIT® FITTINGS



PAGES 10 - 13

LYCOFIT® COUPLINGS PAGE 10
 LYCOFIT® REDUCING COUPLINGS PAGE 10
 LYCOFIT® 3-WAY TEES PAGE 11
 LYCOFIT® 3-WAY REDUCING TEES PAGE 11
 LYCOFIT® CAPS PAGE 12
 LYCOFIT® THREAD-ON TRANSITION FITTINGS PAGE 12
 LYCOFIT® TOOLS & ACCESSORIES PAGE 13

SOCKET FUSION FITTINGS

GF+ PAGES 14 - 16

SOCKET FUSION COUPLINGS (CTS & IPS) PAGE 14
 SOCKET FUSION REDUCERS PAGE 14 & 15
 SOCKET FUSION 90° ELBOWS PAGE 15
 SOCKET FUSION TEES PAGE 16
 SOCKET FUSION CAPS PAGE 16

BUTT FUSION FITTINGS

GF+ PAGES 17 - 19

BUTT FUSION REDUCERS PAGE 17
 BUTT FUSION 45° ELBOWS PAGE 17
 BUTT FUSION 90° ELBOWS PAGE 18
 BUTT FUSION TEES PAGE 18
 BUTT FUSION CAPS PAGE 19

ELECTROFUSION FITTINGS

GF+ PAGE 19

STEEL MECHANICAL FITTINGS

- Epoxy Coated Grey
- Includes Carbon Steel Stiffener
- Meets ASTM D2513



GEORG FISCHER CENTRAL PLASTICS

STEEL MECHANICAL FITTING MULTIPLIER (UGCF):



MODEL #	DESCRIPTION (SIZE)	SDR	MASTER CARTON QTY.	LIST PRICE
STEEL MECHANICAL FITTINGS EPOXY COATED COMPRESSION COUPLINGS				
360000703	3/4" COATED STEEL COMP CPLG IPS	SDR 11	16	\$ 109.85
360000704	1" COATED STEEL COMP CPLG IPS	SDR 11	15	\$ 131.90
360000705	1-1/4" COATED STEEL COMP CPLG IPS	SDR 10	10	\$ 146.95
360000706	1-1/2" COATED STEEL COMP CPLG IPS	SDR 11	6	\$ 235.75
360000707	2" COATED STEEL COMP CPLG IPS	SDR 11	3	\$ 300.05

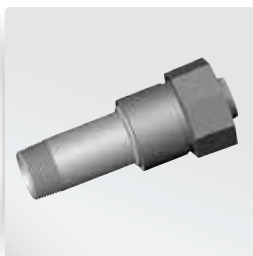

MODEL #	DESCRIPTION (SIZE)	SDR	MASTER CARTON QTY.	LIST PRICE
STEEL MECHANICAL FITTINGS EPOXY COATED COMPRESSION MALE ADAPTERS				
360000708	1/2" COATED STEEL COMP MALE ADAPTER IPS	SDR 9.3	35	\$ 70.45
360011406	3/4" COATED STEEL COMP MALE ADAPTER IPS	SDR 11	30	\$ 71.50
360011407	1" COATED STEEL COMP MALE ADAPTER CTS	.099 WALL	-	\$ 90.40
360011408	1" COATED STEEL COMP MALE ADAPTER IPS	SDR 11	25	\$ 80.90
360011410	1-1/4" COATED STEEL COMP MALE ADAPTER IPS	SDR 10	15	\$ 98.55
360000709	1-1/2" COATED STEEL COMP MALE ADAPTER IPS	SDR 11	10	\$ 186.50
360000710	2" COATED STEEL COMP MALE ADAPTER IPS	SDR 11	6	\$ 184.85



MODEL #	DESCRIPTION (SIZE)	SDR	MASTER CARTON QTY.	LIST PRICE
STEEL MECHANICAL FITTINGS EPOXY COATED COMPRESSION TEES				
360000715	3/4" COATED STEEL COMP TEE IPS	SDR 11	10	\$ 245.90
360000713	1" COATED STEEL COMP TEE IPS	SDR 11	10	\$ 280.90
360000712	1-1/4" COATED STEEL COMP TEE IPS	SDR 10	6	\$ 287.90
360000711	1-1/2" COATED STEEL COMP TEE IPS	SDR 11	4	\$ 419.80
360000714	2" COATED STEEL COMP TEE IPS	SDR 11	2	\$ 567.70



STEEL MECHANICAL FITTINGS

- Bar Stock Steel Construction
- Integral Steel Stiffener
- For underground use, uncoated fittings must be protected by tape/wrap as defined by local code



STEEL SERVICE FITTING MULTIPLIER (UGCF):



MODEL #	DESCRIPTION (SIZE)	SDR	MASTER CARTON QTY.	LIST PRICE
CHICAGO STEEL SERVICE FITTINGS WITH INTEGRAL STIFFENER				
M597C11S090	1/2" IPS STEEL 597 SERIES MALE ADAPTER *	SDR 9.3	25	\$ 68.65
M597C1S090	1/2" CTS STEEL 597 SERIES MALE ADAPTER *	.090 WALL	25	\$ 31.65
M597C32S095	3/4" MIP STEEL 597 SERIES MALE ADAPTER	SDR 11	25	\$ 73.85
M597C53S119	1" MIP STEEL 597 SERIES MALE ADAPTER	SDR 11	15	\$ 83.60
M597C74S151	1-1/4" MIP STEEL 597 SERIES MALE ADAPTER *	SDR 11	10	\$ 107.75
M597C74S166	1-1/4" MIP STEEL 597 SERIES MALE ADAPTER *	SDR 10	10	\$ 107.75
M597C82S173	1-1/2" MIP STEEL 597 SERIES MALE ADAPTER *	SDR 11	10	\$ 158.00
M597C96S216	2" MIP STEEL 597 SERIES MALE ADAPTER *	SDR 11	6	\$ 177.15
M750C10	1/2" CTS STEEL 750 SERIES COUPLING *	.090 WALL	25	\$ 63.30
M750C13	1/2" IPS STEEL 750 SERIES COUPLING *	SDR 9.3	25	\$ 120.70
M750C17	3/4" IPS STEEL 750 SERIES COUPLING *	SDR 11	20	\$ 113.50
M750C21	1" IPS STEEL 750 SERIES COUPLING *	SDR 11	14	\$ 136.30
M750C27	1-1/4" IPS STEEL 750 STEEL COUPLING *	SDR 11	9	\$ 242.95
M750C27-166	1-1/4" IPS STEEL 750 STEEL COUPLING *	SDR 10	9	\$ 243.60
M750C31	1-1/2" IPS STEEL 750 STEEL COUPLING *	SDR 11	5	\$ 243.60
M750C38	2" IPS STEEL 750 SERIES COUPLING *	SDR 11	4	\$ 310.05



* ORDER AS NEEDED -- LONGER LEAD TIMES THAN NORMAL

CONTINENTAL PA MECHANICAL FITTINGS

PA MECHANICAL FITTING MULTIPLIER (UGCF):



MODEL #	DESCRIPTION (SIZE)	SDR	MASTER CARTON QTY.	LIST PRICE
PA COMPRESSION COUPLINGS				
CI565752100400	1/2" CTS PA COMPRESSION COUPLING *	.090 WALL	1	\$ 90.55
CI565752101300	3/4" IPS PA COMPRESSION COUPLING	SDR 11	1	\$ 88.50
CI565752101400	1" IPS PA COMPRESSION COUPLING	SDR 11	1	\$ 153.10
CI565752101500	1-1/4" IPS PA COMPRESSION COUPLING *	SDR 10 / .166 WALL	1	\$ 309.80

* **ORDER AS NEEDED** -- LONGER LEAD TIMES THAN NORMAL

PA COMPRESSION COUPLING INNER DIAGRAM

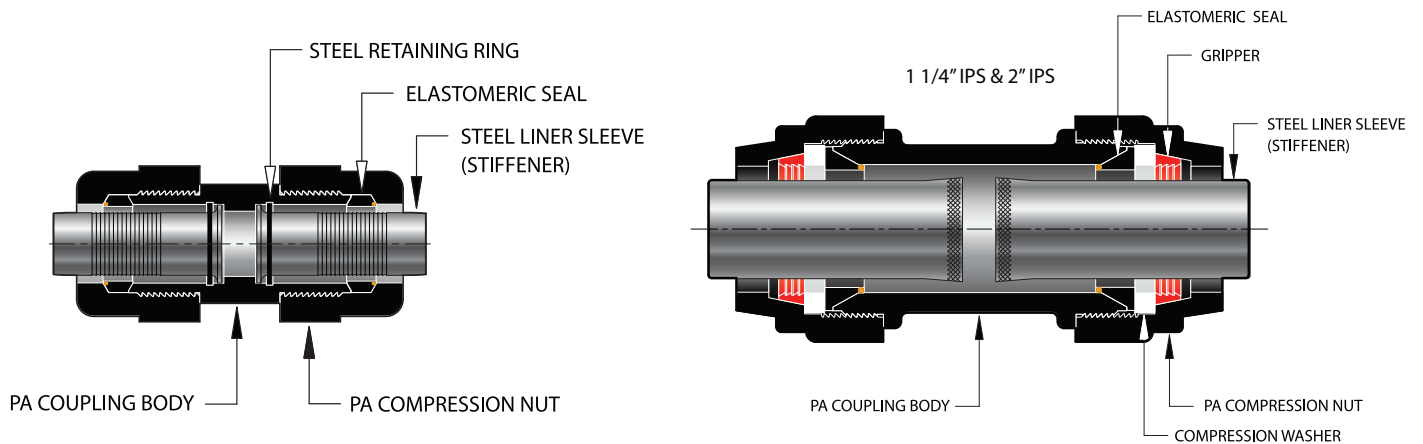

CON-STAB FITTINGS

- CON-STAB ID SEAL® fittings provide a cost-effective joining method
- No additional assembly equipment required for installation (just chamfer pipe and push)
- Pressure rating that meets or exceeds the maximum design pressure of the piping system
- Meets or exceeds all D.O.T., ASTM and NFPA 58 Requirements
- Uni-body design eliminating all external parts
- Listed with IAPMO/UPC and CSA



CON-STAB FITTING MULTIPLIER (UGSF):



MODEL #	DESCRIPTION (SIZE)	SDR	MASTER CARTON QTY.	LIST PRICE
CON-STAB ID SEAL® - FULL COUPLINGS				
CI325952100400	1/2" CTS CON-STAB COUPLING	.090 WALL	1	\$ 43.25
CI325952101200	1/2" IPS CON-STAB COUPLING	SDR 9.3	1	\$ 94.95
CI325952100600	3/4" CTS CON-STAB COUPLING	.090 WALL	1	\$ 178.00
CI325952100800	1" CTS CON-STAB COUPLING	.090 / .101 WALL	1	\$ 80.65
CI325952101300	3/4" IPS CON-STAB COUPLING	SDR 11	1	\$ 74.55
CI325952101400	1" IPS CON-STAB COUPLING	SDR 11	1	\$ 110.80
CI325952101500	1-1/4" IPS CON-STAB COUPLING	SDR 10 / .166 WALL	1	\$ 223.05
CI3259521015AA	1-1/4" IPS CON-STAB COUPLING	SDR 11	1	\$ 276.30
CI325952101600	1-1/2" IPS CON-STAB COUPLING	SDR 11	1	\$ 281.45
CI325952101700	2" IPS CON-STAB COUPLING	SDR 11	1	\$ 323.45

Con-Stab®'s patented "ID-Seal" is formed on the *INSIDE* of the pipe -- where the surface is the smoothest. Therefore **you must chamfer the INSIDE of your pipe with a Continental® Chamfer tool.**

COUPLING INNER DIAGRAM

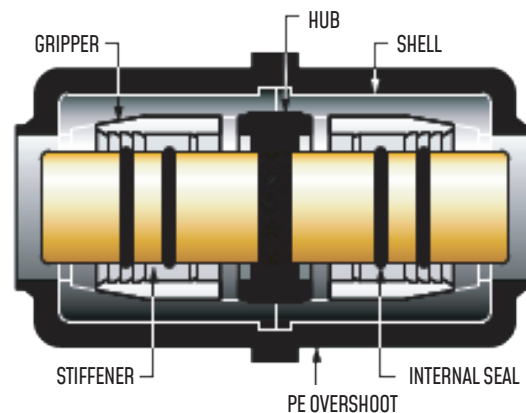

CON-STAB FITTINGS

CON-STAB FITTING MULTIPLIER (UGSF):



MODEL #	DESCRIPTION (SIZE)	SDR	MASTER CARTON QTY.	LIST PRICE
CON-STAB ID SEAL® - REDUCING COUPLINGS				
CI325954130400	3/4" IPS X 1/2" CTS CON-STAB COUPLING	SDR 11 x .090 WALL	1	\$ 188.05
CI325954131200	3/4" IPS X 1/2" IPS CON-STAB COUPLING	SDR 11 x SDR 9.3	1	\$ 185.35
CI325954140400	1" IPS X 1/2" CTS CON-STAB COUPLING	SDR 11 x .090 WALL	1	\$ 234.65
CI325954141300	1" IPS X 3/4" IPS CON-STAB COUPLING	SDR 11 x SDR 11	1	\$ 209.95
CI325954151400	1-1/4" IPS X 1" IPS CON-STAB COUPLING	SDR 10/.166 WALL x SDR 11	1	\$ 359.35
CI3259541514A0	1-1/4" IPS X 1" IPS CON-STAB COUPLING	SDR 11/.151 WALL x SDR 11	1	\$ 238.25
CI325954161400	1-1/2" IPS X 1" IPS CON-STAB COUPLING	SDR 11 x SDR 11	1	\$ 349.65
CI336954161500	1-1/2" IPS X 1-1/4" IPS CON-STAB COUPLING	SDR 11 x SDR 10/.166 WALL	1	\$ 438.80
CI325954171400	2" IPS X 1" IPS CON-STAB COUPLING	SDR 11 x SDR 11	1	\$ 366.05
CI325954171600	2" IPS X 1-1/2" IPS CON-STAB COUPLING	SDR 11 x SDR 11	1	\$ 460.05

Con-Stab®'s patented "ID-Seal" is formed on the *INSIDE* of the pipe -- where the surface is the smoothest. Therefore **you must chamfer the INSIDE of your pipe with a Continental® Chamfer tool.**



MODEL #	DESCRIPTION (SIZE)	SDR	MASTER CARTON QTY.	LIST PRICE
CON-STAB ID SEAL® - CAP-N-GO COUPLINGS				
CI325957101300	3/4" IPS CON-STAB CAP-N-GO COUPLING	SDR 11 / .095 WALL	1	\$ 163.40
CI325957101400	1" IPS CON-STAB CAP-N-GO COUPLING *	SDR 11 / .119 WALL	1	\$ 119.30
CI325957101500	1-1/4" IPS CON-STAB CAP-N-GO COUPLING *	SDR 10 / .166 WALL	1	\$ 352.95

* **ORDER AS NEEDED** -- LONGER LEAD TIMES THAN NORMAL

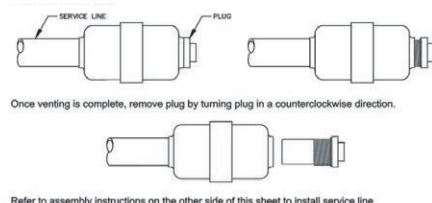

SEE LAST PAGE OF PRICE SHEET FOR **PRODUCT OPERATING INSTRUCTIONS** OR **CLICK HERE TO JUMP TO PAGE.**

CON-STAB FITTINGS

CON-STAB FITTING MULTIPLIER (UGSF):



MODEL #	DESCRIPTION (SIZE)	SDR	MASTER CARTON QTY.	LIST PRICE
CON-STAB ID SEAL® - 3 WAY TEES				
CI325950100400	1/2" CTS CON-STAB 3-WAY TEE	.090 WALL	1	\$ 148.80
CI325950101200	1/2" IPS CON-STAB 3-WAY TEE *	SDR 9.3	1	\$ 185.00
CI325950101300	3/4" IPS CON-STAB 3-WAY TEE	SDR 11	1	\$ 201.75
CI325950101400	1" IPS CON-STAB 3-WAY TEE	SDR 11	1	\$ 225.20
CI336950101500	1-1/4" IPS CON-STAB 3-WAY TEE	SDR 10 / .166 WALL	1	\$ 452.45
CI325950101600	1-1/2" IPS CON-STAB 3-WAY TEE	SDR 11	1	\$ 730.85
CI325950101700	2" IPS CON-STAB 3-WAY TEE	SDR 11	1	\$ 660.90

* **ORDER AS NEEDED** -- LONGER LEAD TIMES THAN NORMAL

Con-Stab®'s patented "ID-Seal" is formed on the **INSIDE** of the pipe -- where the surface is the smoothest. Therefore **you must chamfer the INSIDE** of your pipe with a **Continental® Chamfer tool**.



MODEL #	DESCRIPTION (SIZE)	SDR	MASTER CARTON QTY.	LIST PRICE
CON-STAB ID SEAL® - 90° ELBOWS				
CI325951100400	1/2" CTS CON-STAB 90° ELBOW	.090 WALL	1	\$ 66.95
CI325951101300	3/4" IPS CON-STAB 90° ELBOW	SDR 11	1	\$ 87.65
CI325951101400	1" IPS CON-STAB 90° ELBOW	SDR 11	1	\$ 98.60
CI336951101500	1-1/4" IPS CON-STAB 90° ELBOW	SDR 10 / .166 WALL	1	\$ 340.80
CI325951101600	1-1/2" IPS CON-STAB 90° ELBOW *	SDR 11	1	\$ 493.55
CI325951101700	2" IPS CON-STAB 90° ELBOW	SDR 11	1	\$ 427.20

* **ORDER AS NEEDED** -- LONGER LEAD TIMES THAN NORMAL

CON-STAB FITTINGS

CON-STAB FITTING MULTIPLIER (UGSF):



MODEL #	DESCRIPTION (SIZE)	SDR	MASTER CARTON QTY.	LIST PRICE
STEEL TRANSITION FITTINGS (CON-STAB x STEEL)				
CI043200091200	1/2" CTS x 1/2" MIP CON-STAB TRANSITION FITTING	.090 WALL	1	\$ 206.20
CI043200151200	1/2" CTS x 1/2" FIP CON-STAB TRANSITION FITTING	.090 WALL	1	\$ 206.20



MODEL #	DESCRIPTION (SIZE)	SDR	MASTER CARTON QTY.	LIST PRICE
STEEL TRANSITION FITTINGS (CON-STAB x STEEL - LONG PIECE OF PE PIPE)				
CI133200091300	3/4" IPS x 3/4" MIP CON-STAB TRANSITION FITTING	SDR 11	1	\$ 288.45
CI133200151300	3/4" IPS x 3/4" FIP CON-STAB TRANSITION FITTING	SDR 11	1	\$ 219.10



MODEL #	DESCRIPTION (SIZE)	SDR	MASTER CARTON QTY.	LIST PRICE
STEEL TRANSITION FITTINGS (CON-STAB x STEEL - SHORT PIECE OF PE PIPE)				
CI464600190425	1/2" CTS X 1/2" MIP CON-STAB TRANSITION FITTING *	.090 WALL	1	\$ 131.45
CI464600191325	3/4" IPS X 3/4" MIP CON-STAB TRANSITION FITTING	SDR 11	1	\$ 133.90
CI464600191425	1" IPS x 1" MIP CON-STAB TRANSITION FITTING *	SDR 11	1	\$ 176.50
CI464600191525	1-1/4" IPS X 1-1/4" MIP CON-STAB TRANSITION FITTING *	SDR 10 / .166	1	\$ 298.20
CI464600191625	1-1/2" IPS X 1-1/2" MIP CON-STAB TRANSITION FITTING *	SDR 11	1	\$ 419.90
CI464600191725	2" IPS X 2" MIP CON-STAB TRANSITION FITTING *	SDR 11	1	\$ 438.15

* ORDER AS NEEDED -- LONGER LEAD TIMES THAN NORMAL



CON-STAB CHAMFER TOOLS

CON-STAB CHAMFER TOOL MULTIPLIER (LCT2):

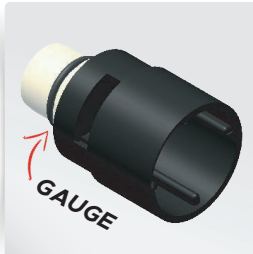

MODEL #	DESCRIPTION (SIZE)	SDR	MASTER CARTON QTY.	LIST PRICE
ID CHAMFER TOOLS WITH GAUGE				
CI000033658004	1/2" CTS CHAMFER TOOL w. GAUGE	.090 WALL	1	\$ 104.95
CI000033658012	1/2" IPS CHAMFER TOOL w. GAUGE	SDR 9.3	1	\$ 104.95
CI000033658008	1" CTS CHAMFER TOOL w. GAUGE	.090 / .101 WALL	1	\$ 104.95
CI000033658013	3/4" IPS CHAMFER TOOL w. GAUGE	SDR 11	1	\$ 104.95
CI000033658014	1" IPS CHAMFER TOOL w. GAUGE	SDR 11	1	\$ 104.95
CI000033658015	1-1/4" IPS CHAMFER TOOL w. GAUGE	SDR 10 / .166 WALL	1	\$ 104.95
CI000033658010	1-1/4" IPS CHAMFER TOOL w. GAUGE	SDR 11 / .151 WALL	1	\$ 104.95
CI000033658016	1-1/2" IPS CHAMFER TOOL w. GAUGE	SDR 11	1	\$ 104.95
CI000033658017	2" IPS CHAMFER TOOL w. GAUGE	SDR 11	1	\$ 104.95



MODEL #	DESCRIPTION (SIZE)	SDR	MASTER CARTON QTY.	LIST PRICE
DOUBLE ENDED ID CHAMFER TOOLS				
CI000033548100	3/4" IPS X 1/2" CTS DOUBLE ENDED CHAMFER TOOL	SDR 11 x .090 WALL	1	\$ 104.95
CI000033551600	1" IPS X 3/4" IPS DOUBLE ENDED CHAMFER TOOL	SDR 11	1	\$ 104.95

STEEL TO PE TRANSITION FITTINGS

- Epoxy Coated Grey
- Includes Carbon Steel Stiffener
- Meets ASTM D2513



GEORG FISCHER CENTRAL PLASTICS

STEEL TO PE TRANSITION FITTING MULTIPLIER (UGTF):



MODEL #	DESCRIPTION (SIZE)	SDR	MASTER CARTON QTY.	LIST PRICE
TRANSITION FITTING THREADED END (NPT x IPS)				
360002546	3/4" TRANSITION FITTING MPT x IPS	SDR 11	36	\$ 63.45
360002555	1" TRANSITION FITTING MPT x IPS	SDR 11	25	\$ 77.10
360002559	1-1/4" TRANSITION FITTING MPT x IPS	SDR 10	16	\$ 90.45
360002563	1-1/2" TRANSITION FITTING MPT x IPS	SDR 11	8	\$ 112.70
360002565	2" TRANSITION FITTING MPT x IPS	SDR 11	15	\$ 137.55
360002571	3" TRANSITION FITTING MPT x IPS	SDR 11	-	\$ 367.20
360002573	4" TRANSITION FITTING MPT x IPS	SDR 11	-	\$ 404.30



TRANSITION FITTING WELDED END (NPT x IPS)				
360003851	1" TRANSITION FITTING MPT x WELD END	SDR 11	1	\$ 90.85
360002872	2" TRANSITION FITTING MPT x WELD END	SDR 11	1	\$ 127.50
360003855	3" TRANSITION FITTING MPT x WELD END	SDR 11.5	1	\$ 282.50
360002627	4" TRANSITION FITTING MPT x WELD END	SDR 11.5	1	\$ 449.00
360003863	8" TRANSITION FITTING MPT x WELD END	SDR 11.5	1	\$ 3,835.65





LYCOFIT® FITTINGS

- For Polyethylene Pipe Natural Gas & LP Gas Services
- Meets or exceeds all D.O.T. and ASTM Requirements
- Listed with IAPMO/UPC and CSA (Where Applicable)
- Extensive Testing of the Lycofit Has Proven that they exceed the Life Expectancy, Tensile Pull, Burst Pressure and Elevated Temperature Stress Rupture Points of the PE Pipe itself.

ITEMS BELOW STOCKED IN HOUSTON ONLY

LYCOFIT MULTIPLIER (LCF):

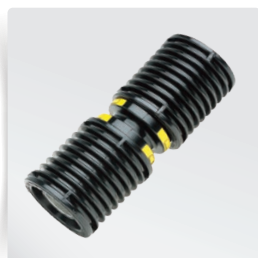

MODEL #	DESCRIPTION (SIZE)	SDR	MASTER CARTON QTY.	LIST PRICE
LYCOFIT® COUPLINGS				
LC010BDER	1/2" CTS COUPLING	.090 WALL	25	\$ 31.00
LC050WDER	1/2" IPS COUPLING	SDR 9.3	25	\$ 51.85
LC060YDER	3/4" IPS COUPLING	SDR 11	25	\$ 60.80
LC070YDER	1" IPS COUPLING	SDR 11	25	\$ 69.95
LC080XDESR	1-1/4" IPS COUPLING	SDR 10 / 11	10	\$ 148.95
LC090YDESR	1-1/2" IPS COUPLING	SDR 11	5	\$ 185.90
LC200YDESR	2" IPS COUPLING	SDR 11	5	\$ 243.10



MODEL #	DESCRIPTION (SIZE)	SDR	MASTER CARTON QTY.	LIST PRICE
LYCOFIT® REDUCING COUPLINGS				
LC060Y010BRR	3/4" IPS x 1/2" CTS REDUCING COUPLING	SDR 11 x .090 WALL	3	\$ 87.00
LC060Y050WRR	3/4" x 1/2" IPS REDUCING COUPLING	SDR 11 x SDR 9.3	3	\$ 102.50
LC070Y060YRR	1" x 3/4" IPS REDUCING COUPLING	SDR 11 x SDR 11	3	\$ 165.65
LC080X050WRR	1-1/4" x 1/2" IPS REDUCING COUPLING	SDR 11 x SDR 11	3	\$ 229.65
LC080X070YRR	1-1/4" x 1" IPS REDUCING COUPLING	SDR 11 x SDR 11	3	\$ 169.75
LC090Y060YRR	1-1/2" x 3/4" IPS REDUCING COUPLING *	SDR 11 x SDR 11	3	\$ 401.45
LC090Y070YRR	1-1/2" x 1" IPS REDUCING COUPLING *	SDR 11 x SDR 11	3	\$ 366.80
LC200Y010BRR	2" IPS x 1/2" CTS REDUCING COUPLING	SDR 11 x .090 WALL	3	\$ 387.35
LC200Y060YRR	2" x 3/4" IPS REDUCING COUPLING	SDR 11 x SDR 11	5	\$ 393.20
LC200Y090YRR	2" x 1-1/2" IPS REDUCING COUPLING *	SDR 11 x SDR 11	3	\$ 407.65





LYCOFIT® FITTINGS

- For Polyethylene Pipe Natural Gas & LP Gas Services
- Meets or exceeds all D.O.T. and ASTM Requirements
- Listed with IAPMO/UPC and CSA (Where Applicable)
- Extensive Testing of the Lycofit Has Proven that they exceed the Life Expectancy, Tensile Pull, Burst Pressure and Elevated Temperature Stress Rupture Points of the PE Pipe itself.

ITEMS BELOW STOCKED IN HOUSTON ONLY

LYCOFIT MULTIPLIER (LCF):



MODEL #	DESCRIPTION (SIZE)	SDR	MASTER CARTON QTY.	LIST PRICE
LYCOFIT® 3-WAY TEES				
LC010B3TR	1/2" CTS TEE	.090 WALL	25	\$ 150.95
LC050W3TR	1/2" IPS TEE	SDR 9.3	25	\$ 173.25
LC060Y3TR	3/4" IPS TEE	SDR 11	25	\$ 163.25
LC070Y3TR	1" IPS TEE	SDR 11	25	\$ 190.65
LC080X3TR	1-1/4" IPS TEE	SDR 10 / .166 WALL	10	\$ 357.45
LC090Y3TR	1-1/2" IPS TEE	SDR 11	5	\$ 414.65
LC200Y3TR	2" IPS TEE *	SDR 11	5	\$ 434.90

* **ORDER AS NEEDED** -- LONGER LEAD TIMES THAN NORMAL



MODEL #	DESCRIPTION (SIZE)	SDR	MASTER CARTON QTY.	LIST PRICE
LYCOFIT® 3-WAY REDUCING TEES				
LC070Y060Y060YR	1" x 3/4" x 3/4" IPS REDUCING TEE	SDR 11	3	\$ 591.40
LC070Y070Y060YR	1" x 1" x 3/4" IPS REDUCING TEE	SDR 11	3	\$ 321.70
LC090Y090Y060YR	1-1/2" x 1-1/2" x 3/4" IPS REDUCING TEE	SDR 11	3	\$ 743.75



LYCOFIT® FITTINGS

- For Polyethylene Pipe Natural Gas & LP Gas Services
- Meets or exceeds all D.O.T. and ASTM Requirements
- Listed with IAPMO/UPC and CSA (Where Applicable)
- Extensive Testing of the Lycofit Has Proven that they exceed the Life Expectancy, Tensile Pull, Burst Pressure and Elevated Temperature Stress Rupture Points of the PE Pipe itself.

ITEMS BELOW STOCKED IN HOUSTON ONLY

LYCOFIT MULTIPLIER (LCF):



MODEL #	DESCRIPTION (SIZE)	SDR	MASTER CARTON QTY.	LIST PRICE
LYCOFIT® CAPS				
LC010BECR	1/2" CTS CAP *	.090 WALL	25	\$ 41.70
LC050WECR	1/2" IPS CAP *	SDR 9.3	25	\$ 66.75
LC060YECR	3/4" IPS CAP	SDR 11	25	\$ 67.95
LC070YECR	1" IPS CAP	SDR 11	25	\$ 70.45
LC080XECR	1-1/4" IPS CAP *	SDR 10 / 11	10	\$ 125.10
LC090YECR	1-1/2" IPS CAP *	SDR 11	5	\$ 152.55
LC200YECR	2" IPS CAP *	SDR 11	5	\$ 235.95

* ORDER AS NEEDED -- LONGER LEAD TIMES THAN NORMAL



MODEL #	DESCRIPTION (SIZE)	SDR	MASTER CARTON QTY.	LIST PRICE
LYCOFIT® THREAD-ON TRANSITION FITTINGS				
LC050S010BSPB	1/2" MIP x 1/2" CTS PE TRANSITION FITTING	.090 WALL	25	\$ 69.70
LC060S010BSPB	3/4" MIP x 1/2" CTS PE TRANSITION FITTING	.090 WALL	25	\$ 73.90
LC060S060YSPB	3/4" MIP x 3/4" IPS THRD TRANSITION FITTING	SDR 11	25	\$ 78.65
LC070S070YSPB	1" MIP x 1" IPS THRD TRANSITION FITTING	SDR 11	25	\$ 120.35
LC080S080XSPB	1-1/4" MIP x 1-1/4" IPS THRD TRANSITION FITTING *	SDR 10 / 11	10	\$ 170.40
LC090S090YSPB	1-1/2" MIP x 1-1/2" IPS THRD TRANSITION FITTING *	SDR 11	10	\$ 195.90
LC200S200YSPB	2" MIP x 2" IPS THRD TRANSITION FITTING	SDR 11	10	\$ 212.10

* ORDER AS NEEDED -- LONGER LEAD TIMES THAN NORMAL





LYCOFIT® TOOLS & ACCESSORIES

- For Polyethylene Pipe Natural Gas & LP Gas Services
- Meets or exceeds all D.O.T. and ASTM Requirements
- Listed with IAPMO/UPC and CSA (Where Applicable)
- Extensive Testing of the Lycofit Has Proven that they exceed the Life Expectancy, Tensile Pull, Burst Pressure and Elevated Temperature Stress Rupture Points of the PE Pipe itself.

ITEMS BELOW STOCKED IN HOUSTON ONLY

LYCOFIT MULTIPLIER (LCT2):



MODEL #	DESCRIPTION (SIZE)	MASTER CARTON QTY.	LIST PRICE
LYCOFIT® TOOLS & ACCESSORIES			
QRP100	1/2" CTS THROUGH 1" IPS SINGLE RATCHET PRESS	1	\$ 592.15

NOTE: The QRP100 tools requires one (1) long handled, 1/2" drive ratchet wrench to operate.

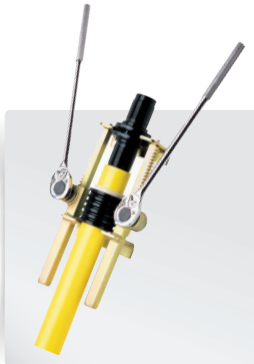

MODEL #	DESCRIPTION (SIZE)	MASTER CARTON QTY.	LIST PRICE
LYCOFIT® TOOLS & ACCESSORIES			
QRP200	1/2" CTS THROUGH 2" IPS DUAL RATCHET PRESS	1	\$1,675.20

NOTE: The QRP200 tools requires two (2) 1/2" drive ratchet wrenches to operate

TOOL MODEL	LYCOFIT® Coupling / Fittings Chart									
	CTS [Copper Tube Size]				IPS [Iron Pipe Size]					
	1/2	3/4	1	1-1/4	1/2	3/4	1	1-1/4	1-1/2	2
QRP100	Yes	Yes	Yes		Yes	Yes	Yes			
QRP200	Yes*	Yes*	Yes*	Yes*	Yes*	Yes*	Yes*	Yes*	Yes*	Yes*

YES = Installs the coupling / fitting size when using the appropriate tool adapter plates.*

The Products listed on this page only represent the most commonly used sizes and configurations. Please contact a HydraPro Representative or a HydraPro Customer Service Representative for additional sizes, customized configurations and available options.

SOCKET FUSION FITTINGS

- Molded PE2406/PE2708 virgin yellow medium density ASTM D3350 resin
- Meets ASTM D2513 and ASTM2683.
- Compatible for heat fusion with any pipe or fitting manufactured out of similar resin
- CSA and IAPMO approved

FUSION FITTING **MULTIPLIER (FUSI):**



MODEL #	DESCRIPTION (SIZE)	SDR	MASTER CARTON QTY.	LIST PRICE
SOCKET FUSION COUPLING (CTS)				
360002130	1/2" x 1/2" FUSION COUPLING (CTS)	-	100	\$ 3.95
SOCKET FUSION COUPLING (IPS)				
360002132	1/2" x 1/2" FUSION COUPLING (IPS)	-	100	\$ 3.90
360002134	3/4" x 3/4" FUSION COUPLING (IPS)	-	100	\$ 4.55
360002138	1" x 1" FUSION COUPLING (IPS)	-	100	\$ 6.50
360002140	1-1/4" x 1-1/4" FUSION COUPLING (IPS)	-	100	\$ 6.15
360002142	1-1/2" x 1-1/2" FUSION COUPLING (IPS)	-	100	\$ 9.70
360002144	2" x 2" FUSION COUPLING (IPS)	-	100	\$ 12.90
360002146	3" x 3" FUSION COUPLING (IPS)	-	10	\$ 35.20
360002148	4" x 4" FUSION COUPLING (IPS)	-	10	\$ 67.75
SOCKET FUSION REDUCER				
360002155	3/4" x 1/2" FUSION REDUCER	-	100	\$ 7.75
360002163	1" x 1/2" FUSION REDUCER	-	100	\$ 15.25
360002165	1" x 3/4" FUSION REDUCER	-	100	\$ 11.60
360002169	1-1/4" x 1/2" FUSION REDUCER	-	100	\$ 22.60
360003545	1-1/4" x 3/4" FUSION REDUCER	-	100	\$ 17.75
360002173	1-1/4" x 1" FUSION REDUCER	-	100	\$ 18.10
360002174	1-1/2" x 3/4" FUSION REDUCER	-	100	\$ 30.05
360002176	1-1/2" x 1" FUSION REDUCER	-	100	\$ 30.05
360002178	1-1/2" x 1-1/4" FUSION REDUCER	-	10	\$ 30.05
360002181	2" x 1" FUSION REDUCER	-	10	\$ 14.25



WE STOCK A WIDE VARIETY OF FUSION TOOLS.

CLICK IMAGE TO BE DIRECTED TO OUR FUSION TOOLS PRICE SHEET.

[CLICK HERE](#) 



SOCKET FUSION FITTINGS

- Molded PE2406/PE2708 virgin yellow medium density ASTM D3350 resin
- Meets ASTM D2513 and ASTM2683.
- Compatible for heat fusion with any pipe or fitting manufactured out of similar resin
- CSA and IAPMO approved

FUSION FITTING **MULTIPLIER (FUSI)**:



MODEL #	DESCRIPTION (SIZE)	SDR	MASTER CARTON QTY.	LIST PRICE
SOCKET FUSION REDUCERS (CONTINUED)				
360002183	2" x 1-1/4" FUSION REDUCER	-	100	\$ 14.25
360003405	2" x 1-1/2" FUSION REDUCER	-	100	\$ 21.65
360002187	3" x 2" FUSION REDUCER	-	100	\$ 61.35
360002189	4" x 2" FUSION REDUCER	-	100	\$ 61.35



MODEL #	DESCRIPTION (SIZE)	SDR	MASTER CARTON QTY.	LIST PRICE
SOCKET FUSION 90° ELBOW				
360002094	1/2" x 1/2" 90° FUSION ELBOW	-	100	\$ 8.45
360002096	3/4" x 3/4" 90° FUSION ELBOW	-	100	\$ 8.45
360002100	1" x 1" 90° FUSION ELBOW	-	50	\$ 7.45
360002102	1-1/4" x 1-1/4" 90° FUSION ELBOW	-	100	\$ 11.35
360002104	1-1/2" x 1-1/2" 90° FUSION ELBOW	-	70	\$ 22.90
360002106	2" x 2" 90° FUSION ELBOW	-	50	\$ 24.20
360002108	3" x 3" 90° FUSION ELBOW	-	8	\$ 71.00
360002110	4" x 4" 90° FUSION ELBOW	-	8	\$ 148.45

SOCKET FUSION FITTINGS

- Molded PE2406/PE2708 virgin yellow medium density ASTM D3350 resin
- Meets ASTM D2513 and ASTM2683.
- Compatible for heat fusion with any pipe or fitting manufactured out of similar resin
- CSA and IAPMO approved

FUSION FITTING MULTIPLIER (FUSI):



MODEL #	DESCRIPTION (SIZE)	SDR	MASTER CARTON QTY.	LIST PRICE
SOCKET FUSION TEES				
360002196	1/2" x 1/2" x 1/2" FUSION TEE	-	100	\$ 7.45
360002199	3/4" x 3/4" x 3/4" FUSION TEE	-	100	\$ 7.10
360002204	1" x 1" x 3/4" FUSION TEE	-	100	\$ 9.20
360002206	1" x 1" x 1" FUSION TEE	-	100	\$ 13.60
360002208	1-1/4" x 1-1/4" x 1-1/4" FUSION TEE	-	100	\$ 13.60
360002211	1-1/2" x 1-1/2" x 1-1/2" FUSION TEE	-	40	\$ 26.50
360002213	2" x 2" x 2" FUSION TEE	-	30	\$ 25.30
360002216	3" x 3" x 3" FUSION TEE	-	8	\$ 84.90
360002235	4" x 4" x 4" FUSION TEE	-	-	\$ 200.65



MODEL #	DESCRIPTION (SIZE)	SDR	MASTER CARTON QTY.	LIST PRICE
SOCKET FUSION CAPS				
360002114	1/2" FUSION CAP	-	100	\$ 5.20
360002116	3/4" FUSION CAP	-	100	\$ 4.90
360002117	1" FUSION CAP (CTS)	-	100	\$ 8.45
360002119	1" FUSION CAP (IPS)	-	100	\$ 7.25
360002121	1-1/4" FUSION CAP	-	100	\$ 7.10
360002123	1-1/2" FUSION CAP	-	100	\$ 11.35
360002125	2" FUSION CAP	-	100	\$ 12.90
360002127	3" FUSION CAP	-	10	\$ 34.55
360002128	4" FUSION CAP	-	10	\$ 55.50

BUTT FUSION FITTINGS

- Molded PE2406/PE2708 virgin yellow medium density ASTM D3350 resin
- Meets ASTM D2513 and ASTM D3261
- Compatible for heat fusion with any pipe or fitting manufactured out of similar resin
- CSA and IAPMO approved



GEORG FISCHER CENTRAL PLASTICS

FUSION FITTING MULTIPLIER (FUSI):



MODEL #	DESCRIPTION (SIZE)	SDR	MASTER CARTON QTY.	LIST PRICE
BUTT FUSION REDUCERS				
360000383	1" x 3/4" FUSION REDUCER	SDR 11	100	\$ 20.00
360000390	1-1/4" x 1" FUSION REDUCER	SDR 11	100	\$ 19.00
360000398	1-1/2" x 3/4" FUSION REDUCER	SDR 11	100	\$ 33.35
360000394	1-1/2" x 1" FUSION REDUCER	SDR 11	100	\$ 12.50
360000396	1-1/2" x 1-1/4" FUSION REDUCER	SDR 11	100	\$ 26.05
360000419	2" x 1-1/4" FUSION REDUCER	SDR 11	100	\$ 38.90
360000423	2" x 1-1/2" FUSION REDUCER	SDR 11	50	\$ 28.80
360003460	2" x 1" FUSION REDUCER	SDR 11	100	\$ 21.25
360002880	3" x 2" FUSION REDUCER	SDR 11	10	\$ 52.20
360000433	4" x 2" FUSION REDUCER	SDR 11	10	\$ 39.00
360019983	4" x 3" FUSION REDUCER	SDR 11	10	\$ 42.50



MODEL #	DESCRIPTION (SIZE)	SDR	MASTER CARTON QTY.	LIST PRICE
BUTT FUSION 45° ELBOWS				
360000188	3" 45° FUSION ELBOW	SDR 11	10	\$ 46.45
360000195	4" 45° FUSION ELBOW	SDR 11	10	\$ 63.05

WE STOCK A WIDE VARIETY OF FUSION TOOLS.

CLICK IMAGE TO BE DIRECTED TO OUR FUSION TOOLS PRICE SHEET.

[CLICK HERE](#)



BUTT FUSION FITTINGS

- Molded PE2406/PE2708 virgin yellow medium density ASTM D3350 resin
- Meets ASTM D2513 and ASTM D3261
- Compatible for heat fusion with any pipe or fitting manufactured out of similar resin
- CSA and IAPMO approved



GEORG FISCHER CENTRAL PLASTICS

FUSION FITTING MULTIPLIER (FUSI):



MODEL #	DESCRIPTION (SIZE)	SDR	MASTER CARTON QTY.	LIST PRICE
BUTT FUSION 90° ELBOWS				
360000229	3/4" 90° FUSION ELBOW	SDR 11	100	\$ 14.95
360000235	1" 90° FUSION ELBOW	SDR 11	100	\$ 16.35
360000240	1-1/4" 90° FUSION ELBOW	SDR 11	100	\$ 18.15
360000242	1-1/2" 90° FUSION ELBOW	SDR 11	10	\$ 15.60
360000267	2" 90° FUSION ELBOW	SDR 11	10	\$ 19.65
360000270	3" 90° FUSION ELBOW	SDR 11	10	\$ 46.10
360029255	4" 90° FUSION ELBOW	SDR 11	10	\$ 61.15
360000286	6" 90° FUSION ELBOW	SDR 11	2	\$ 139.30



MODEL #	DESCRIPTION (SIZE)	SDR	MASTER CARTON QTY.	LIST PRICE
BUTT FUSION TEES				
360000478	3/4" FUSION TEE	SDR 11	50	\$ 13.25
360000483	1" FUSION TEE	SDR 11	100	\$ 19.70
360000485	1-1/4" FUSION TEE	SDR 11	50	\$ 21.75
360000488	1-1/2" FUSION TEE	SDR 11	40	\$ 34.90
360000515	2" FUSION TEE	SDR 11	10	\$ 17.65
360000520	3" FUSION TEE	SDR 11	10	\$ 54.55
360029209	4" FUSION TEE	SDR 11	8	\$ 73.20
360000539	6" FUSION TEE	SDR 11	1	\$ 186.35

WE STOCK A WIDE VARIETY OF FUSION TOOLS.

[CLICK HERE](#) 

CLICK IMAGE TO BE DIRECTED TO OUR FUSION TOOLS PRICE SHEET.



BUTT FUSION FITTINGS

- Molded PE2406/PE2708 virgin yellow medium density ASTM D3350 resin
- Meets ASTM D2513 and ASTM D3261
- Compatible for heat fusion with any pipe or fitting manufactured out of similar resin
- CSA and IAPMO approved

FUSION FITTING **MULTIPLIER (FUSI)**:



MODEL #	DESCRIPTION (SIZE)	SDR	MASTER CARTON QTY.	LIST PRICE
BUTT FUSION CAPS				
360000315	3/4" FUSION CAP	SDR 11	100	\$ 7.70
360000319	1" FUSION CAP	SDR 11	100	\$ 14.60
360000320	1-1/4" FUSION CAP	SDR 11	50	\$ 16.65
360000323	1-1/2" FUSION CAP	SDR 11	50	\$ 10.30
360000335	2" FUSION CAP	SDR 11	40	\$ 11.55
360003406	3" FUSION CAP	SDR 11	10	\$ 23.45
360000344	4" FUSION CAP	SDR 11	10	\$ 41.00

WE STOCK A WIDE VARIETY OF FUSION TOOLS.

[CLICK HERE](#)

CLICK IMAGE TO BE DIRECTED TO OUR FUSION TOOLS PRICE SHEET.



ELECTROFUSION FITTINGS

- Molded PE2406/PE2708 virgin yellow medium density ASTM D3350 resin
- Meets ASTM F-1055
- Compatible for heat fusion with any pipe manufactured out of similar resin
- CSA and IAPMO approved

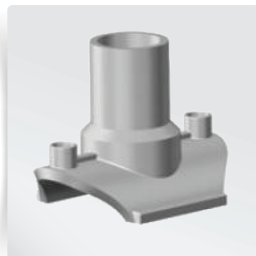

MODEL #	DESCRIPTION (SIZE)	SDR	MASTER CARTON QTY.	LIST PRICE
ELECTROFUSION SADDLES				
360001278	2" X 1" IPS SDR11 BR .80	SDR 11	40	\$ 104.50
360001340	4" X 1" IPS SDR11 PE2406	SDR 11	30	\$ 111.15
360001376	6" X 1" IPS SDR11 PE2406	SDR 11	20	\$ 137.70

CAP-N-GO OPERATION INSTRUCTIONS

OPERATING INSTRUCTIONS FOR **PURGING** A SERVICE LINE WITH CAP-N-GO FITTINGS

- 1 Clean all dirt and debris from fitting.
- 2 Unthread plug counterclockwise until venting occurs (approx. 3 to 5 complete turns). When venting is detected, remove all metallic tools from area. (Note: To detect if venting has occurred, listen for escaping gas.)
- 3 Once purging operation has been completed, turn plug clockwise until plug is in contact with body of fitting, as shown below.

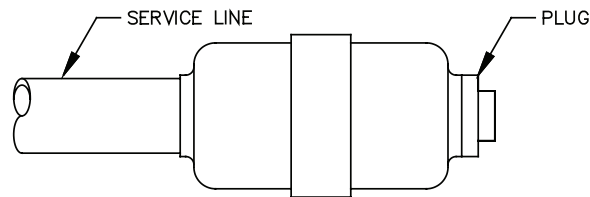

OPERATING INSTRUCTIONS FOR **CONTINUING SERVICE** WITH CAP-N-GO FITTINGS

Clean all dirt and debris from fitting.

Unthread plug counterclockwise until venting occurs (approx. 3 to 5 complete turns). When venting is detected, remove all metallic tools from area. (Note: To detect if venting has occurred, listen for escaping gas.)

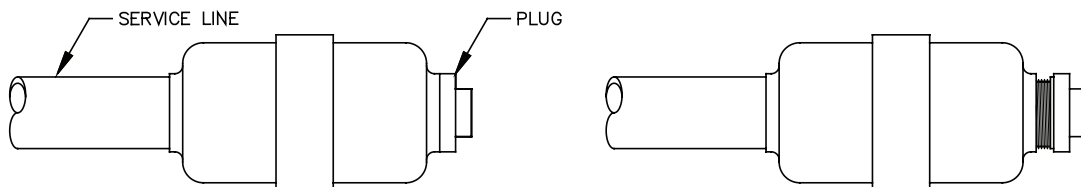

Once venting is complete, remove plug by turning plug in a counterclockwise direction.

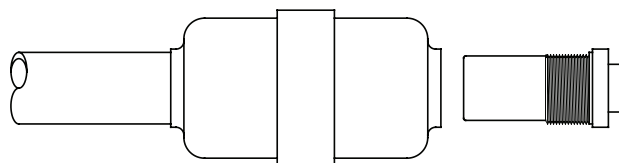

Refer to assembly instructions on the other side of this sheet to install service line.