

*HIGH-EFFICIENCY
R-32 SPLIT SYSTEM AIR CONDITIONER
UP TO 16.5 SEER2
1½ To 5 TONS*



Contents

Nomenclature..... 2
 Product Specifications..... 3
 Expanded Cooling Data 4
 Performance Data 18
 Dimensions 19
 Wiring Diagrams 20
 Accessories 22

R32

Standard Features

- High-Efficiency Scroll Compressor
- Factory-installed filter drier
- Fully charged for 15' of tubing length
- 5mm diameter copper tube/ enhanced aluminum fin coil
- Factory-installed filter drier
- Sweat connection service valves with easy access to gauge ports
- Enclosed contactor
- High-pressure switch
- Ground lug connection
- Capacitors with extended life
- AHRI Certified
- ETL Listed

Cabinet Features

- Removable grille-style top design compliant with UL 60335-2-40
- Venturi for increased velocity of airflow
- Attractive Architectural Gray powder-paint finish with 500-hour salt-spray approval
- Wire fan discharge grille
- Steel louver coil guard
- Top and side maintenance access
- Single-panel access to controls with space provided for field-installed accessories
- When properly anchored, meets the 2023 Florida Building Code unit integrity requirements for hurricane-type winds (Anchor bracket kits available).









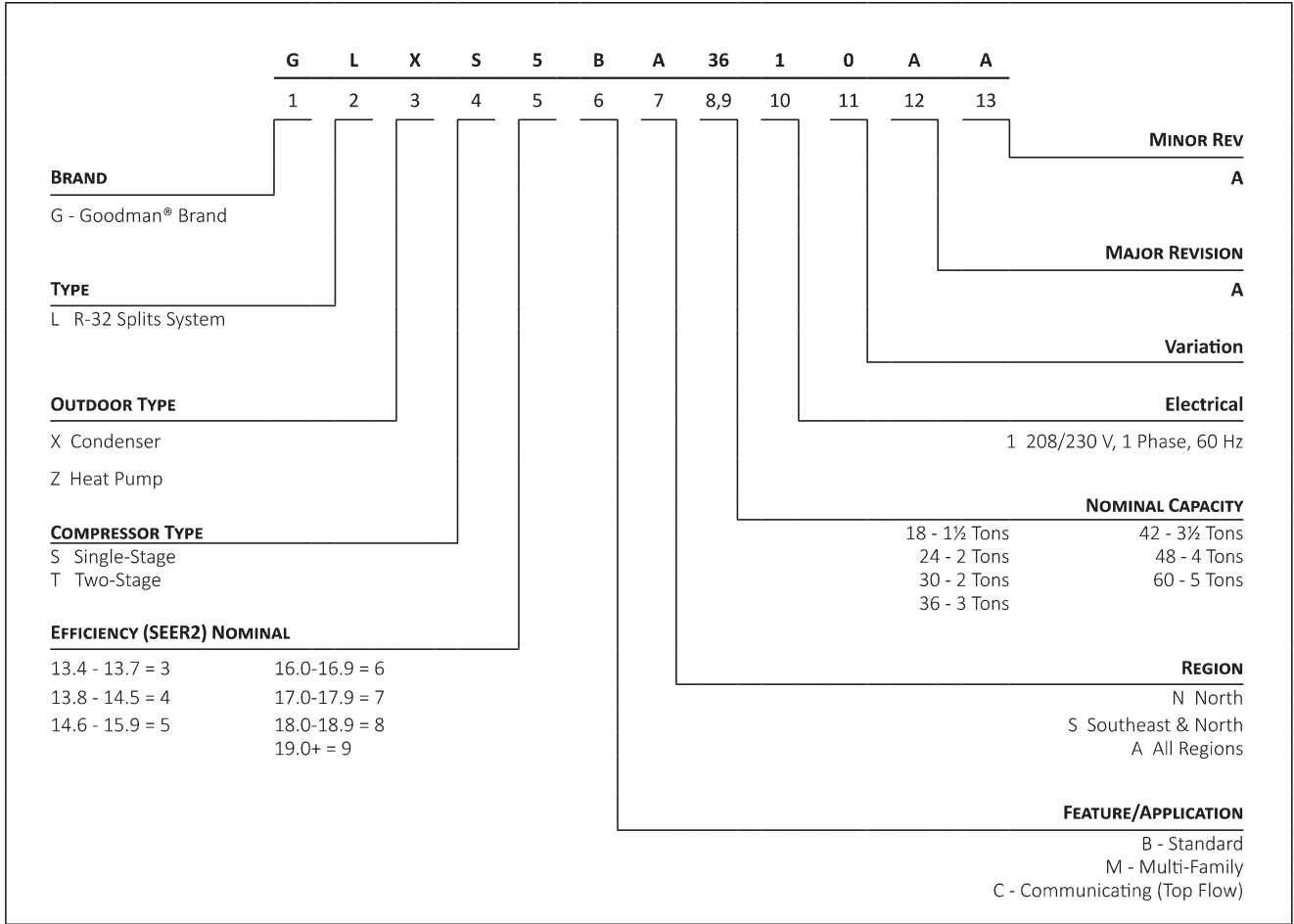

Proper sizing and installation of equipment is critical to achieving optimal performance. Split system air conditioners and heat pumps must be matched with appropriate coil components to meet ENERGY STAR® criteria. Ask your contractor for details or visit www.energystar.gov.



* Complete warranty details available from your local dealer or at www.goodmanmfg.com. To receive the 10-Year Parts Limited Warranty, online registration must be completed within 60 days of installation. Online registration is not required in California or Québec. The duration of warranty coverage in Texas and Florida differs in some cases.

NOMENCLATURE



	GLXS5B A1810A*	GLXS5B A2410A*	GLXS5B A3010A*	GLXS5B A3610A*	GLXS5B A4210A*	GLXS5B A4810A*	GLXS5B A6010A*
CAPACITIES							
Nominal Cooling (BTU/h)	18,000	24,000	30,000	36,000	42,000	48,000	60,000
Decibels (dBA)	73.0	69.0	73.0	71.0	74.0	75.0	76.0
COMPRESSOR							
RLA	8.3	10.2	11.5	13.4	14.4	19.4	27.1
LRA	44.3	59.3	66.3	83.3	112.2	127.7	178
Stage	Single	Single	Single	Single	Single	Single	Two
Type	Scroll	Scroll	Scroll	Scroll	Scroll	Scroll	Scroll
CONDENSER FAN MOTOR							
Motor Type	PSC	PSC	PSC	PSC	PSC	PSC	ECM
Horsepower	1/8	1/6	1/6	1/6	1/4	1/4	1/3
FLA	0.70	0.95	0.95	0.95	1.30	1.30	2.60
REFRIGERATION SYSTEM							
Refrigerant Line Size ¹							
Liquid Line Size ("O.D.)	3/8"	3/8"	3/8"	3/8"	3/8"	3/8"	3/8"
Suction Line Size ("O.D.)	3/4"	3/4"	3/4"	7/8"	1 1/8"	1 1/8"	1 1/8"
Refrigerant Connection Size							
Liquid Valve Size ("O.D.)	3/8"	3/8"	3/8"	3/8"	3/8"	3/8"	3/8"
Suction Valve Size ("O.D.) ²	3/4"	3/4"	3/4"	7/8"	7/8"	7/8"	7/8"
Valve Type	Sweat	Sweat	Sweat	Sweat	Sweat	Sweat	Sweat
Refrigerant Charge ³	54	65	87	88	141	138	167
ELECTRICAL DATA							
Voltage-Phase	208/230-1	208/230-1	208/230-1	208/230-1	208/230-1	208/230-1	208/230-1
Minimum Circuit Ampacity ⁴	11.1	13.8	15.4	17.8	19.3	25.5	36.4
Max. Overcurrent Protection ⁵	15	20	25	30	30	40	60
Min / Max Volts	197/253	197/253	197/253	197/253	197/253	197/253	197/253
Electrical Conduit Size	1/2" or 3/4"	1/2" or 3/4"	1/2" or 3/4"	1/2" or 3/4"	1/2" or 3/4"	1/2" or 3/4"	1/2" or 3/4"
EQUIPMENT WEIGHT (LBS)	116	149	192	191	250	249	287
SHIP WEIGHT (LBS)	134	167	214	213	272	271	309
ENERGY STAR® CERTIFIED							

¹ Line sizes denoted for 25' line sets, tested and rated in accordance with ARI Standard 210/240. For other line set lengths or sizes, refer to the Installation Instructions and/or the Long Line Set Applications guide.

² Any suction line adapter will need to be supplied by the field.

³ Unit is factory charged with refrigerant for 15' of 3/8" liquid line. System charge must be adjusted per the Final Charge Adjustment procedure found in the Installation Instructions.

⁴ Wire size should be determined in accordance with National Electrical Codes; extensive wire runs will require larger wire sizes

⁵ Must use time-delay fuses or HACR-type circuit breakers of the same size as noted.

NOTES

- Always check the S&R plate for electrical data on the unit being installed.

ENERGY STAR NOTES

- Proper sizing and installation of equipment is critical to achieving optimal performance. Split system air conditioners and heat pumps must be matched with appropriate coil components to meet ENERGY STAR criteria.
- Ask your contractor for details or visit www.energystar.gov. The www.energystar.gov website provides up-to-date system combinations certified to meet ENERGY STAR requirements.

EXPANDED COOLING DATA — GLXS5BA1810A*+CAPTA2422*3A*

IDB		OUTDOOR AMBIENT TEMPERATURE																																			
		65						75						85						95						105						115					
		59	63	67	71	59	63	67	71	59	63	67	71	59	63	67	71	59	63	67	71	59	63	67	71	59	63	67	71	59	63	67	71				
AIREFLOW		18.1	18.4	18.9	-	18.0	18.2	18.8	-	17.5	17.8	18.3	-	16.7	17.0	17.5	-	15.7	16.0	16.5	-	14.8	15.1	15.6	-	15.7	16.0	16.5	-	14.8	15.1	15.6	-				
MBh		0.62	0.55	0.42	-	0.63	0.56	0.43	-	0.65	0.58	0.45	-	0.67	0.60	0.47	-	0.69	0.62	0.49	-	1.00	0.67	0.54	-	0.69	0.62	0.49	-	1.00	0.67	0.54	-				
S/T		21	19	15	-	21	19	15	-	21	19	15	-	21	19	15	-	20	18	14	-	22	20	16	-	20	18	14	-	22	20	16	-				
ΔT		1.12	1.11	1.11	-	1.24	1.24	1.23	-	1.37	1.37	1.37	-	1.52	1.52	1.52	-	1.68	1.68	1.68	-	1.87	1.87	1.87	-	1.68	1.68	1.68	-	1.87	1.87	1.87	-				
kW		4.0	4.0	4.0	-	4.6	4.6	4.6	-	5.2	5.2	5.2	-	5.9	5.9	5.9	-	6.6	6.6	6.6	-	7.5	7.5	7.5	-	6.6	6.6	6.6	-	7.5	7.5	7.5	-				
Amps		18.5	18.7	19.3	-	18.3	18.6	19.1	-	17.8	18.1	18.6	-	17.0	17.3	17.8	-	16.1	16.3	16.8	-	15.2	15.4	15.9	-	16.1	16.3	16.8	-	15.2	15.4	15.9	-				
MBh		0.66	0.58	0.46	-	0.66	0.59	0.46	-	0.69	0.61	0.49	-	0.70	0.63	0.51	-	0.72	0.65	0.53	-	1.00	0.70	0.57	-	0.72	0.65	0.53	-	1.00	0.70	0.57	-				
S/T		19	17	14	-	19	17	14	-	20	18	14	-	19	17	14	-	19	17	13	-	20	18	15	-	19	17	13	-	20	18	15	-				
ΔT		1.12	1.12	1.12	-	1.24	1.24	1.24	-	1.38	1.38	1.37	-	1.52	1.52	1.52	-	1.69	1.69	1.69	-	1.88	1.88	1.88	-	1.69	1.69	1.69	-	1.88	1.88	1.88	-				
kW		4.1	4.1	4.1	-	4.6	4.6	4.6	-	5.2	5.2	5.2	-	5.9	5.9	5.9	-	6.7	6.7	6.7	-	7.5	7.5	7.5	-	6.7	6.7	6.7	-	7.5	7.5	7.5	-				
Amps		18.9	19.1	19.7	-	18.7	19.0	19.5	-	18.2	18.5	19.0	-	17.4	17.7	18.2	-	16.5	16.7	17.2	-	15.6	15.8	16.3	-	16.5	16.7	17.2	-	15.6	15.8	16.3	-				
MBh		0.66	0.59	0.47	-	0.67	0.60	0.47	-	0.69	0.62	0.49	-	0.71	0.64	0.51	-	1.00	0.66	0.53	-	1.00	0.71	0.58	-	1.00	0.66	0.53	-	1.00	0.71	0.58	-				
S/T		18	16	13	-	18	16	13	-	19	17	13	-	18	16	13	-	18	16	12	-	19	17	14	-	18	16	12	-	19	17	14	-				
ΔT		1.13	1.13	1.12	-	1.25	1.25	1.24	-	1.38	1.38	1.38	-	1.53	1.53	1.53	-	1.69	1.69	1.69	-	1.89	1.88	1.88	-	1.69	1.69	1.69	-	1.89	1.88	1.88	-				
kW		4.1	4.1	4.1	-	4.6	4.6	4.6	-	5.3	5.3	5.3	-	5.9	5.9	5.9	-	6.7	6.7	6.7	-	7.6	7.6	7.6	-	6.7	6.7	6.7	-	7.6	7.6	7.6	-				
Amps		18.2	18.4	18.9	19.8	18.0	18.2	18.8	19.6	17.5	17.8	18.3	19.1	16.7	17.0	17.5	18.3	15.7	16.0	16.5	17.3	14.8	15.1	15.6	16.4	15.7	16.0	16.5	17.3	14.8	15.1	15.6	16.4				
MBh		0.74	0.67	0.54	0.4	0.75	0.68	0.55	0.4	0.77	0.70	0.57	0.4	1.00	0.72	0.59	0.5	1.00	0.74	0.61	0.5	1.00	0.79	0.66	0.5	1.00	0.74	0.61	0.5	1.00	0.79	0.66	0.5				
S/T		25	23	19	15	25	23	19	15	25	23	20	16	25	23	19	15	25	23	19	15	26	24	20	16	25	23	19	15	26	24	20	16				
ΔT		1.11	1.11	1.11	1.1	1.24	1.23	1.23	1.2	1.37	1.37	1.37	1.4	1.52	1.51	1.5	1.53	1.68	1.68	1.68	1.7	1.87	1.87	1.87	1.9	1.68	1.68	1.68	1.7	1.87	1.87	1.87	1.9				
kW		4.0	4.0	4.0	4.1	4.6	4.6	4.6	4.6	5.2	5.2	5.2	5.2	5.9	5.9	5.9	5.9	6.6	6.6	6.6	6.7	7.5	7.5	7.5	7.5	6.6	6.6	6.6	6.7	7.5	7.5	7.5	7.5				
Amps		18.5	18.7	19.3	20.1	18.3	18.6	19.1	19.9	17.9	18.1	18.6	19.5	17.0	17.3	17.8	18.7	16.1	16.3	16.9	17.7	15.2	15.4	16.0	16.8	16.1	16.3	16.9	17.7	15.2	15.4	16.0	16.8				
MBh		0.78	0.71	0.58	0.4	0.78	0.71	0.58	0.5	0.81	0.73	0.61	0.5	1.00	0.75	0.63	0.5	1.00	0.77	0.65	0.5	1.00	0.82	0.69	0.6	1.00	0.77	0.65	0.5	1.00	0.82	0.69	0.6				
S/T		24	22	18	14	24	22	18	14	24	22	18	14	24	22	18	14	24	22	18	14	25	23	19	15	24	22	18	14	25	23	19	15				
ΔT		1.12	1.12	1.12	1.13	1.24	1.24	1.24	1.25	1.38	1.38	1.37	1.38	1.52	1.52	1.52	1.53	1.69	1.69	1.69	1.69	1.88	1.88	1.88	1.89	1.69	1.69	1.69	1.69	1.88	1.88	1.88	1.89				
kW		4.1	4.1	4.1	4.1	4.6	4.6	4.6	4.6	5.2	5.2	5.2	5.3	5.9	5.9	5.9	5.9	6.7	6.7	6.7	6.7	7.5	7.5	7.5	7.6	6.7	6.7	6.7	6.7	7.5	7.5	7.5	7.6				
Amps		18.9	19.1	19.7	20.5	18.7	19.0	19.5	20.3	18.3	18.5	19.0	19.9	17.4	17.7	18.2	19.1	16.5	16.7	17.3	18.1	15.6	15.8	16.4	17.2	16.5	16.7	17.3	18.1	15.6	15.8	16.4	17.2				
MBh		0.78	0.71	0.59	0.5	0.79	0.72	0.59	0.5	0.81	0.74	0.62	0.5	1.00	0.76	0.63	0.5	1.00	0.78	0.65	0.5	1.00	0.83	0.70	0.6	1.00	0.78	0.65	0.5	1.00	0.83	0.70	0.6				
S/T		23	21	17	13	23	21	17	13	23	21	17	13	23	21	17	13	23	21	17	13	24	22	18	14	23	21	17	13	24	22	18	14				
ΔT		1.13	1.12	1.12	1.1	1.25	1.25	1.24	1.3	1.38	1.38	1.38	1.4	1.53	1.53	1.53	1.5	1.69	1.69	1.69	1.7	1.88	1.88	1.88	1.9	1.69	1.69	1.69	1.7	1.88	1.88	1.88	1.9				
kW		4.1	4.1	4.1	4.1	4.6	4.6	4.6	4.7	5.3	5.3	5.3	5.3	5.9	5.9	5.9	6.0	6.7	6.7	6.7	6.7	7.6	7.6	7.6	7.6	6.7	6.7	6.7	6.7	7.6	7.6	7.6	7.6				
Amps		18.9	19.1	19.7	20.5	18.7	19.0	19.5	20.3	18.3	18.5	19.0	19.9	17.4	17.7	18.2	19.1	16.5	16.7	17.3	18.1	15.6	15.8	16.4	17.2	16.5	16.7	17.3	18.1	15.6	15.8	16.4	17.2				

kW = Total system power
Amps = outdoor unit amps (comp.+fan)

Shaded area reflects ACCA (TVA) conditions

IDB: Entering Indoor Dry Bulb Temperature
High and low pressures are measured at the liquid and suction service valves.

EXPANDED COOLING DATA — GLXS5BA1810A*+CAPTA2422*3A* (CONT.)

IDB		OUTDOOR AMBIENT TEMPERATURE																							
		65				75				85				95				105				115			
		59	63	67	71	59	63	67	71	59	63	67	71	59	63	67	71	59	63	67	71	59	63	67	71
		ENTERING INDOOR WET BULB TEMPERATURE																							
		ENTERING INDOOR DRY BULB TEMPERATURE																							
		Amps = outdoor unit amps (comp.+fan)																							
80	MBh	18.2	18.5	19.0	19.8	18.1	18.3	18.9	19.7	17.6	17.9	18.4	19.2	16.8	17.1	17.6	18.4	15.8	16.1	16.6	17.4	14.9	15.2	15.7	16.5
	S/T	0.86	0.79	0.66	0.5	1.00	0.79	0.67	0.5	1.00	0.82	0.69	0.6	1.00	0.84	0.71	0.6	1.00	0.86	0.73	0.6	1.00	1.00	0.78	0.6
	ΔT	30	28	24	20	29	27	24	20	30	28	24	20	29	27	24	20	29	27	23	19	30	28	25	21
	kW	1.11	1.11	1.11	1.1	1.24	1.24	1.23	1.2	1.37	1.37	1.37	1.4	1.52	1.52	1.52	1.5	1.68	1.68	1.68	1.7	1.87	1.87	1.87	1.9
	Amps	4.0	4.0	4.0	4.1	4.6	4.6	4.6	4.6	5.2	5.2	5.2	5.2	5.9	5.9	5.9	5.9	6.6	6.6	6.6	6.7	7.5	7.5	7.5	7.5
600	MBh	18.6	18.8	19.4	20.2	18.4	18.7	19.2	20.0	17.9	18.2	18.7	19.5	17.1	17.4	17.9	18.7	16.2	16.4	16.9	17.8	15.3	15.5	16.0	16.9
	S/T	0.89	0.82	0.70	0.6	1.00	0.83	0.70	0.6	1.00	0.85	0.72	0.6	1.00	0.87	0.74	0.6	1.00	0.89	0.76	0.6	1.00	1.00	0.81	0.7
	ΔT	28	26	23	19	28	26	23	19	29	27	23	19	28	26	23	19	28	26	22	18	29	27	24	20
	kW	1.12	1.12	1.12	1.13	1.24	1.24	1.24	1.25	1.38	1.38	1.37	1.38	1.52	1.52	1.52	1.53	1.69	1.69	1.68	1.69	1.88	1.88	1.88	1.89
	Amps	4.1	4.1	4.1	4.1	4.6	4.6	4.6	4.7	5.2	5.2	5.2	5.3	5.9	5.9	5.9	5.9	6.7	6.7	6.7	6.7	7.5	7.5	7.5	7.6
675	MBh	19.0	19.2	19.8	20.6	18.8	19.1	19.6	20.4	18.3	18.6	19.1	20.0	17.5	17.8	18.3	19.1	16.6	16.8	17.3	18.2	15.7	15.9	16.4	17.3
	S/T	0.90	0.83	0.70	0.6	1.00	0.84	0.71	0.6	1.00	0.86	0.73	0.6	1.00	0.88	0.75	0.6	1.00	0.90	0.77	0.6	1.00	1.00	0.82	0.7
	ΔT	27	25	22	18	27	25	22	18	28	26	22	18	27	25	21	18	27	25	21	17	28	26	22	19
	kW	1.13	1.13	1.12	1.1	1.25	1.25	1.24	1.3	1.38	1.38	1.38	1.4	1.53	1.53	1.53	1.5	1.69	1.69	1.69	1.7	1.89	1.88	1.88	1.9
	Amps	4.1	4.1	4.1	4.1	4.6	4.6	4.6	4.7	5.3	5.3	5.3	5.3	5.9	5.9	5.9	6.0	6.7	6.7	6.7	6.7	7.6	7.6	7.6	7.6
85	MBh	18.5	18.8	19.3	20.2	18.4	18.6	19.2	20.0	17.9	18.2	18.7	19.5	17.1	17.4	17.9	18.7	16.1	16.4	16.9	17.7	15.2	15.5	16.0	16.8
	S/T	1.00	0.88	0.76	0.6	1.00	0.89	0.76	0.6	1.00	0.91	0.79	0.7	1.00	1.00	0.80	0.7	1.00	1.00	0.82	0.7	1.00	1.00	0.87	0.7
	ΔT	34	31	28	24	33	31	28	24	34	32	28	24	33	31	28	24	33	31	27	23	34	32	29	25
	kW	1.12	1.12	1.11	1.1	1.24	1.24	1.24	1.2	1.37	1.37	1.37	1.4	1.52	1.52	1.52	1.5	1.68	1.68	1.68	1.7	1.88	1.88	1.87	1.9
	Amps	4.1	4.0	4.0	4.1	4.6	4.6	4.6	4.6	5.2	5.2	5.2	5.3	5.9	5.9	5.9	5.9	6.6	6.6	6.6	6.7	7.5	7.5	7.5	7.6
600	MBh	18.9	19.1	19.7	20.5	18.7	19.0	19.5	20.3	18.2	18.5	19.0	19.9	17.4	17.7	18.2	19.0	16.5	16.7	17.2	18.1	15.6	15.8	16.3	17.2
	S/T	1.00	0.92	0.79	0.7	1.00	0.92	0.80	0.7	1.00	0.95	0.82	0.7	1.00	1.00	0.84	0.7	1.00	1.00	0.86	0.7	1.00	1.00	0.91	0.8
	ΔT	32	30	27	23	32	30	26	23	33	31	27	23	32	30	26	23	32	30	26	22	33	31	27	24
	kW	1.12	1.12	1.12	1.13	1.24	1.24	1.24	1.25	1.38	1.38	1.38	1.39	1.53	1.53	1.52	1.53	1.69	1.69	1.69	1.70	1.88	1.88	1.88	1.89
	Amps	4.1	4.1	4.1	4.1	4.6	4.6	4.6	4.7	5.3	5.3	5.2	5.3	5.9	5.9	5.9	6.0	6.7	6.7	6.7	6.7	7.6	7.6	7.6	7.6
675	MBh	19.3	19.5	20.1	20.9	19.1	19.4	19.9	20.7	18.6	18.9	19.4	20.3	17.8	18.1	18.6	19.4	16.9	17.1	17.6	18.5	16.0	16.2	16.8	17.6
	S/T	1.00	0.92	0.80	0.7	1.00	0.93	0.80	0.7	1.00	1.00	0.83	0.7	1.00	1.00	0.84	0.7	1.00	1.00	0.87	0.7	1.00	1.00	0.91	0.8
	ΔT	31	29	26	22	31	29	25	22	32	30	26	22	31	29	25	22	31	29	25	21	32	30	26	23
	kW	1.13	1.13	1.13	1.1	1.25	1.25	1.25	1.3	1.39	1.38	1.38	1.4	1.53	1.53	1.53	1.5	1.70	1.69	1.69	1.7	1.89	1.89	1.88	1.9
	Amps	4.1	4.1	4.1	4.1	4.7	4.7	4.7	4.7	5.3	5.3	5.3	5.3	5.9	5.9	5.9	6.0	6.7	6.7	6.7	6.7	7.6	7.6	7.6	7.6

IDB: Entering Indoor Dry Bulb Temperature
 High and low pressures are measured at the liquid and suction service valves.
 Shaded area reflects AHRI conditions
 kW = Total system power
 Amps = outdoor unit amps (comp.+fan)

EXPANDED COOLING DATA — GLXS5BA2410A*+CAPTA2422*3A*

IDB		OUTDOOR AMBIENT TEMPERATURE																								
		65				75				85				95				105				115				
		59	63	67	71	59	63	67	71	59	63	67	71	59	63	67	71	59	63	67	71	59	63	67	71	
AIREFLOW		59	63	67	71	59	63	67	71	59	63	67	71	59	63	67	71	59	63	67	71	59	63	67	71	
		24.3	24.7	25.4	-	24.1	24.4	25.2	-	23.5	23.8	24.5	-	22.4	22.7	23.5	-	21.1	21.4	22.1	-	21.1	21.4	22.1	-	
		0.63	0.56	0.43	-	0.63	0.56	0.43	-	0.66	0.59	0.46	-	1.00	0.60	0.48	-	1.00	0.62	0.50	-	1.00	0.62	0.50	-	
700		ΔT	21	19	15	-	21	19	15	-	21	19	15	-	21	19	15	-	20	18	15	-	22	20	16	-
		kW	1.49	1.49	1.48	-	1.65	1.65	1.65	-	1.84	1.84	1.83	-	2.04	2.03	2.03	-	2.26	2.26	2.25	-	2.52	2.52	2.52	-
		Amps	5.4	5.4	5.4	-	6.2	6.1	6.1	-	7.0	7.0	7.0	-	7.9	7.9	7.9	-	8.9	8.9	8.9	-	10.1	10.1	10.1	-
		MBh	24.8	25.1	25.8	-	24.5	24.9	25.6	-	23.9	24.3	25.0	-	22.8	23.2	23.9	-	21.5	21.9	22.6	-	20.3	20.7	21.4	-
		S/T	0.66	0.59	0.46	-	0.67	0.60	0.47	-	0.69	0.62	0.49	-	1.00	0.64	0.51	-	1.00	0.66	0.53	-	1.00	0.71	0.58	-
800		ΔT	20	17	14	-	19	17	14	-	20	18	14	-	19	17	14	-	19	17	13	-	20	18	15	-
		kW	1.50	1.49	1.49	-	1.66	1.66	1.66	-	1.85	1.84	1.84	-	2.04	2.04	2.04	-	2.27	2.27	2.26	-	2.53	2.53	2.52	-
		Amps	5.4	5.4	5.4	-	6.2	6.2	6.2	-	7.0	7.0	7.0	-	7.9	7.9	7.9	-	9.0	9.0	8.9	-	10.2	10.2	10.1	-
		MBh	25.3	25.6	26.4	-	25.1	25.4	26.1	-	24.5	24.8	25.5	-	23.4	23.7	24.4	-	22.1	22.4	23.1	-	20.9	21.2	21.9	-
		S/T	0.67	0.60	0.47	-	0.68	0.60	0.48	-	1.00	0.63	0.50	-	1.00	0.65	0.52	-	1.00	0.67	0.54	-	1.00	1.00	0.59	-
900		ΔT	18	16	13	-	18	16	13	-	19	17	13	-	18	16	13	-	18	16	12	-	19	17	14	-
		kW	1.50	1.50	1.50	-	1.67	1.67	1.66	-	1.85	1.85	1.85	-	2.05	2.05	2.05	-	2.27	2.27	2.27	-	2.54	2.53	2.53	-
		Amps	5.5	5.5	5.4	-	6.2	6.2	6.2	-	7.1	7.1	7.0	-	8.0	8.0	8.0	-	9.0	9.0	9.0	-	10.2	10.2	10.2	-

		24.3	24.7	25.4	26.5	24.1	24.5	25.2	26.3	23.5	23.8	24.6	25.6	22.4	22.8	23.5	24.6	21.1	21.4	22.2	23.3	19.9	20.2	21.0	22.0	
		0.75	0.68	0.55	0.4	0.76	0.68	0.56	0.4	1.00	0.71	0.58	0.4	1.00	0.73	0.60	0.5	1.00	0.75	0.62	0.5	1.00	1.00	1.00	0.67	
700		ΔT	25	23	19	15	25	23	19	15	25	23	20	16	25	23	19	15	25	23	19	15	26	24	20	16
		kW	1.49	1.49	1.48	1.5	1.65	1.65	1.65	1.7	1.84	1.83	1.83	1.8	2.04	2.03	2.03	2.0	2.26	2.26	2.25	2.3	2.52	2.52	2.51	2.5
		Amps	5.4	5.4	5.4	5.4	6.1	6.1	6.1	6.2	7.0	7.0	7.0	7.0	7.9	7.9	7.9	7.9	8.9	8.9	8.9	9.0	10.1	10.1	10.1	10.2
		MBh	24.8	25.1	25.8	26.9	24.6	24.9	25.6	26.7	23.9	24.3	25.0	26.1	22.9	23.2	23.9	25.0	21.5	21.9	22.6	23.7	20.3	20.7	21.4	22.5
		S/T	0.78	0.71	0.58	0.4	1.00	0.72	0.59	0.5	1.00	0.74	0.61	0.5	1.00	0.76	0.63	0.5	1.00	0.78	0.65	0.5	1.00	1.00	1.00	0.6
75		ΔT	24	22	18	14	24	22	18	14	24	22	18	14	24	22	18	14	24	22	18	14	25	23	19	15
		kW	1.50	1.49	1.49	1.50	1.66	1.66	1.66	1.67	1.84	1.84	1.84	1.85	2.04	2.04	2.04	2.05	2.27	2.26	2.26	2.27	2.53	2.53	2.52	2.54
		Amps	5.4	5.4	5.4	5.5	6.2	6.2	6.2	6.2	7.0	7.0	7.0	7.1	7.9	7.9	7.9	8.0	9.0	9.0	8.9	9.0	10.2	10.1	10.1	10.2
		MBh	25.3	25.7	26.4	27.5	25.1	25.4	26.2	27.3	24.5	24.8	25.5	26.6	23.4	23.7	24.5	25.6	22.1	22.4	23.1	24.2	20.9	21.2	21.9	23.0
		S/T	0.79	0.72	0.59	0.5	1.00	0.73	0.60	0.5	1.00	0.75	0.62	0.5	1.00	0.77	0.64	0.5	1.00	1.00	0.66	0.5	1.00	1.00	1.00	0.6
900		ΔT	23	21	17	13	23	21	17	13	23	21	17	13	23	21	17	13	23	21	17	13	24	22	18	14
		kW	1.50	1.50	1.50	1.5	1.67	1.67	1.66	1.7	1.85	1.85	1.85	1.9	2.05	2.05	2.05	2.1	2.27	2.27	2.27	2.3	2.53	2.53	2.53	2.5
		Amps	5.5	5.5	5.4	5.5	6.2	6.2	6.2	6.3	7.1	7.1	7.0	7.1	8.0	8.0	8.0	8.0	9.0	9.0	9.0	9.0	10.2	10.2	10.2	10.2

IDB: Entering Indoor Dry Bulb Temperature
 High and low pressures are measured at the liquid and suction service valves.
 Shaded area reflects ACCA (TVA) conditions
 kW = Total system power
 Amps = outdoor unit amps (comp.+fan)

EXPANDED COOLING DATA — GLXS5BA2410A*+CAPTA2422*3A* (CONT.)

IDB		OUTDOOR AMBIENT TEMPERATURE																								
		65				75				85				95				105				115				
		59	63	67	71	59	63	67	71	59	63	67	71	59	63	67	71	59	63	67	71	59	63	67	71	
700		MBh	24.5	24.8	25.5	26.6	24.2	24.6	25.3	26.4	23.6	24.0	24.7	25.8	22.5	22.9	23.6	24.7	21.2	21.6	22.3	23.4	20.0	20.4	21.1	22.2
		S/T	1.00	0.80	0.67	0.5	1.00	0.80	0.67	0.5	1.00	0.83	0.70	0.6	1.00	1.00	0.72	0.6	1.00	1.00	0.74	0.6	1.00	1.00	0.79	0.7
		ΔT	30	28	24	20	30	28	24	20	30	28	24	20	30	28	24	20	29	27	23	20	31	29	25	21
		kW	1.49	1.49	1.48	1.5	1.65	1.65	1.65	1.7	1.84	1.84	1.83	1.8	2.04	2.03	2.03	2.0	2.26	2.26	2.25	2.3	2.52	2.52	2.52	2.5
		Amps	5.4	5.4	5.4	5.4	6.2	6.1	6.1	6.2	7.0	7.0	7.0	7.0	7.9	7.9	7.9	7.9	8.9	8.9	8.9	9.0	10.1	10.1	10.1	10.2
80		MBh	24.9	25.2	26.0	27.1	24.7	25.0	25.7	26.8	24.1	24.4	25.1	26.2	23.0	23.3	24.0	25.1	21.7	22.0	22.7	23.8	20.5	20.8	21.5	22.6
		S/T	1.00	0.83	0.70	0.6	1.00	0.84	0.71	0.6	1.00	0.86	0.73	0.6	1.00	1.00	0.75	0.6	1.00	1.00	0.77	0.6	1.00	1.00	0.82	0.7
		ΔT	28	26	23	19	28	26	23	19	29	27	23	19	28	26	23	19	28	26	22	18	29	27	24	20
		kW	1.50	1.49	1.49	1.50	1.66	1.66	1.66	1.67	1.85	1.84	1.84	1.85	2.04	2.04	2.04	2.05	2.27	2.27	2.26	2.28	2.53	2.53	2.52	2.54
		Amps	5.4	5.4	5.4	5.5	6.2	6.2	6.2	6.2	7.0	7.0	7.0	7.1	7.9	7.9	7.9	8.0	9.0	9.0	8.9	9.0	10.2	10.1	10.1	10.2
900		MBh	25.4	25.8	26.5	27.6	25.2	25.6	26.3	27.4	24.6	24.9	25.7	26.8	23.5	23.9	24.6	25.7	22.2	22.5	23.3	24.4	21.0	21.3	22.1	23.2
		S/T	1.00	0.84	0.71	0.6	1.00	0.84	0.72	0.6	1.00	1.00	0.74	0.6	1.00	1.00	0.76	0.6	1.00	1.00	0.78	0.6	1.00	1.00	1.00	0.7
		ΔT	27	25	22	18	27	25	22	18	28	26	22	18	27	25	22	18	27	25	21	17	28	26	23	19
		kW	1.50	1.50	1.50	1.5	1.67	1.67	1.66	1.7	1.85	1.85	1.85	1.9	2.05	2.05	2.05	2.1	2.27	2.27	2.27	2.3	2.53	2.53	2.53	2.5
		Amps	5.5	5.5	5.4	5.5	6.2	6.2	6.2	6.3	7.1	7.1	7.0	7.1	8.0	8.0	8.0	8.0	9.0	9.0	9.0	9.0	10.2	10.2	10.2	10.2
700		MBh	24.9	25.2	25.9	27.0	24.7	25.0	25.7	26.8	24.0	24.4	25.1	26.2	22.9	23.3	24.0	25.1	21.6	22.0	22.7	23.8	20.4	20.8	21.5	22.6
		S/T	1.00	0.89	0.76	0.6	1.00	1.00	0.77	0.6	1.00	1.00	0.79	0.7	1.00	1.00	0.81	0.7	1.00	1.00	0.83	0.7	1.00	1.00	1.00	0.7
		ΔT	34	32	28	24	34	32	28	24	34	32	28	24	34	31	28	24	33	31	27	24	35	32	29	25
		kW	1.49	1.49	1.49	1.5	1.66	1.65	1.65	1.7	1.84	1.84	1.84	1.8	2.04	2.04	2.04	2.06	2.26	2.26	2.26	2.3	2.52	2.52	2.52	2.5
		Amps	5.4	5.4	5.4	5.4	6.2	6.2	6.1	6.2	7.0	7.0	7.0	7.0	7.9	7.9	7.9	8.0	8.9	8.9	8.9	9.0	10.1	10.1	10.1	10.2
85		MBh	25.3	25.6	26.4	27.5	25.1	25.4	26.1	27.2	24.5	24.8	25.5	26.6	23.4	23.7	24.4	25.5	22.1	22.4	23.1	24.2	20.9	21.2	21.9	23.0
		S/T	1.00	0.93	0.80	0.7	1.00	1.00	0.80	0.7	1.00	1.00	0.83	0.7	1.00	1.00	0.85	0.7	1.00	1.00	1.00	0.7	1.00	1.00	1.00	0.8
		ΔT	32	30	27	23	32	30	27	23	33	31	27	23	32	30	27	23	32	30	26	22	33	31	28	24
		kW	1.50	1.50	1.50	1.51	1.66	1.66	1.66	1.67	1.85	1.85	1.84	1.86	2.05	2.05	2.04	2.06	2.27	2.27	2.27	2.28	2.53	2.53	2.53	2.54
		Amps	5.4	5.4	5.4	5.5	6.2	6.2	6.2	6.2	7.0	7.0	7.0	7.1	8.0	7.9	7.9	8.0	9.0	9.0	9.0	9.0	10.2	10.2	10.2	10.2
900		MBh	25.8	26.2	26.9	28.0	25.6	26.0	26.7	27.8	25.0	25.3	26.1	27.2	23.9	24.3	25.0	26.1	22.6	22.9	23.7	24.8	21.4	21.7	22.5	23.6
		S/T	1.00	0.93	0.81	0.7	1.00	1.00	0.81	0.7	1.00	1.00	0.83	0.7	1.00	1.00	0.85	0.7	1.00	1.00	1.00	0.7	1.00	1.00	1.00	0.8
		ΔT	31	29	26	22	31	29	26	22	32	30	26	22	31	29	26	22	31	29	25	21	32	30	27	23
		kW	1.51	1.50	1.50	1.5	1.67	1.67	1.67	1.7	1.86	1.85	1.85	1.9	2.05	2.05	2.05	2.1	2.28	2.28	2.27	2.3	2.54	2.54	2.53	2.5
		Amps	5.5	5.5	5.5	5.5	6.2	6.2	6.2	6.3	7.1	7.1	7.1	7.1	8.0	8.0	8.0	8.0	9.0	9.0	9.0	9.0	10.2	10.2	10.2	10.2

IDB: Entering Indoor Dry Bulb Temperature
 High and low pressures are measured at the liquid and suction service valves.
 Shaded area reflects AHRI conditions
 kW = Total system power
 Amps = outdoor unit amps (comp.+fan)

EXPANDED COOLING DATA — GLXS5BA3010A*+CAPTA3026*3A*

IDB		OUTDOOR AMBIENT TEMPERATURE																																																																																																																												
		65						75						85						95						105						115																																																																																														
		59	63	67	71	59	63	67	71	59	63	67	71	59	63	67	71	59	63	67	71	59	63	67	71	59	63	67	71																																																																																																	
900		MBh	29.5	29.9	30.8	-	29.2	29.6	30.5	-	28.5	28.9	29.7	-	27.2	27.6	28.4	-	25.6	26.0	26.8	-	24.1	24.5	25.4	-	S/T	0.64	0.57	0.44	-	0.65	0.57	0.44	-	0.67	0.60	0.47	-	0.69	0.62	0.49	-	0.71	0.64	0.51	-	0.76	0.69	0.56	-	ΔT	20	18	14	-	20	18	14	-	20	18	15	-	20	18	14	-	20	18	14	-	21	19	15	-	kW	1.81	1.81	1.81	-	2.01	2.01	2.01	-	2.23	2.23	2.22	-	2.47	2.47	2.46	-	2.73	2.73	2.73	-	3.04	3.04	3.04	-	Amps	6.5	6.5	6.5	-	7.4	7.4	7.4	-	8.4	8.4	8.4	-	9.5	9.5	9.5	-	10.7	10.7	10.7	-	12.1	12.1	12.1	-
1000		MBh	29.9	30.3	31.2	-	29.6	30.0	30.9	-	28.9	29.3	30.1	-	27.6	28.0	28.8	-	26.0	26.4	27.2	-	24.5	24.9	25.8	-	S/T	0.67	0.60	0.47	-	0.68	0.60	0.47	-	0.70	0.63	0.50	-	0.72	0.65	0.52	-	0.74	0.67	0.54	-	1.00	0.72	0.59	-	ΔT	19	17	13	-	19	17	13	-	19	17	14	-	19	17	13	-	19	17	13	-	20	18	14	-	kW	1.82	1.82	1.82	-	2.02	2.02	2.01	-	2.24	2.24	2.23	-	2.48	2.47	2.47	-	2.74	2.74	2.74	-	3.05	3.05	3.05	-	Amps	6.5	6.5	6.5	-	7.4	7.4	7.4	-	8.4	8.4	8.4	-	9.5	9.5	9.5	-	10.7	10.7	10.7	-	12.2	12.1	12.1	-
1125		MBh	30.5	30.9	31.8	-	30.2	30.6	31.5	-	29.5	29.9	30.7	-	28.2	28.6	29.4	-	26.6	27.0	27.8	-	25.1	25.5	26.4	-	S/T	0.68	0.61	0.48	-	0.69	0.62	0.49	-	0.71	0.64	0.51	-	0.73	0.66	0.53	-	0.75	0.68	0.55	-	1.00	0.73	0.60	-	ΔT	18	16	12	-	18	16	12	-	18	16	13	-	18	16	12	-	18	16	12	-	19	17	13	-	kW	1.83	1.83	1.82	-	2.03	2.02	2.02	-	2.25	2.24	2.24	-	2.48	2.48	2.48	-	2.75	2.75	2.74	-	3.06	3.06	3.06	-	Amps	6.6	6.5	6.5	-	7.5	7.4	7.4	-	8.5	8.5	8.4	-	9.5	9.5	9.5	-	10.8	10.8	10.7	-	12.2	12.2	12.2	-

IDB		OUTDOOR AMBIENT TEMPERATURE																																																																																																																													
		65						75						85						95						105						115																																																																																															
		59	63	67	71	59	63	67	71	59	63	67	71	59	63	67	71	59	63	67	71	59	63	67	71	59	63	67	71																																																																																																		
900		MBh	29.5	29.9	30.8	32.1	29.2	29.6	30.5	31.8	28.5	28.9	29.8	31.1	27.2	27.6	28.4	29.8	25.6	26.0	26.9	28.2	24.1	24.5	25.4	26.7	S/T	0.76	0.69	0.56	0.4	0.77	0.70	0.57	0.4	0.79	0.72	0.59	0.5	0.81	0.74	0.61	0.5	1.00	0.76	0.63	0.5	1.00	0.81	0.68	0.5	ΔT	24	22	19	15	24	22	19	15	24	23	19	15	24	24	22	19	15	24	22	18	15	25	23	20	16	kW	1.81	1.81	1.81	1.8	2.01	2.01	2.00	2.0	2.23	2.23	2.22	2.2	2.47	2.46	2.46	2.5	2.73	2.73	2.73	2.7	3.04	3.04	3.04	3.1	Amps	6.5	6.5	6.5	6.5	7.4	7.4	7.4	7.4	8.4	8.4	8.4	8.4	9.5	9.5	9.4	9.5	10.7	10.7	10.7	10.7	12.1	12.1	12.1	12.2
1000		MBh	29.9	30.3	31.2	32.5	29.6	30.1	30.9	32.2	28.9	29.3	30.2	31.5	27.6	28.0	28.9	30.2	26.0	26.4	27.3	28.6	24.5	24.9	25.8	27.1	S/T	0.79	0.72	0.59	0.5	0.80	0.73	0.60	0.5	0.82	0.75	0.62	0.5	0.84	0.77	0.64	0.5	1.00	0.79	0.66	0.5	1.00	0.84	0.71	0.6	ΔT	23	21	18	14	23	21	18	14	24	22	18	14	23	21	18	14	23	21	17	14	24	22	19	15	kW	1.82	1.82	1.81	1.83	2.02	2.01	2.01	2.03	2.24	2.23	2.23	2.25	2.47	2.47	2.47	2.48	2.74	2.74	2.73	2.75	3.05	3.05	3.05	3.06	Amps	6.5	6.5	6.5	6.6	7.4	7.4	7.4	7.5	8.4	8.4	8.4	8.5	9.5	9.5	9.5	9.6	10.7	10.7	10.7	10.8	12.1	12.1	12.1	12.2	
1125		MBh	30.5	30.9	31.8	33.1	30.2	30.7	31.5	32.9	29.5	29.9	30.8	32.1	28.2	28.6	29.5	30.8	26.6	27.0	27.9	29.2	25.1	25.5	26.4	27.7	S/T	0.81	0.73	0.60	0.5	0.81	0.74	0.61	0.5	0.84	0.76	0.63	0.5	1.00	0.78	0.65	0.5	1.00	0.80	0.67	0.5	1.00	0.85	0.72	0.6	ΔT	22	20	17	13	22	20	17	13	23	21	17	13	22	20	17	13	22	20	16	13	23	21	18	14	kW	1.83	1.83	1.82	1.8	2.02	2.02	2.02	2.0	2.24	2.24	2.24	2.3	2.48	2.48	2.48	2.5	2.75	2.75	2.74	2.8	3.06	3.06	3.05	3.1	Amps	6.6	6.5	6.5	6.6	7.5	7.4	7.4	7.5	8.5	8.4	8.4	8.5	9.5	9.5	9.5	9.6	10.8	10.8	10.7	10.8	12.2	12.2	12.2	12.2	

IDB: Entering Indoor Dry Bulb Temperature
 High and low pressures are measured at the liquid and suction service valves.
 Shaded area reflects ACCA (TVA) conditions
 kW = Total system power
 Amps = outdoor unit amps (comp.+fan)

EXPANDED COOLING DATA — GLXS5BA3010A*+CAPTA3026*3A* (CONT.)

IDB		OUTDOOR AMBIENT TEMPERATURE																							
		65				75				85				95				105				115			
		59	63	67	71	59	63	67	71	59	63	67	71	59	63	67	71	59	63	67	71	59	63	67	71
80	AIRFLOW	59	63	67	71	59	63	67	71	59	63	67	71	59	63	67	71	59	63	67	71	59	63	67	71
	MBh	29.6	30.1	30.9	32.3	29.4	29.8	30.7	32.0	28.6	29.0	29.9	31.2	27.3	27.7	28.6	29.9	25.7	26.1	27.0	28.3	24.3	24.7	25.5	26.9
	S/T	0.89	0.81	0.68	0.5	0.89	0.82	0.69	0.6	1.00	0.84	0.71	0.6	1.00	0.86	0.73	0.6	1.00	0.88	0.75	0.6	1.00	0.93	0.80	0.7
	ΔT	29	27	23	19	29	27	23	19	29	27	23	19	28	27	23	19	28	26	23	19	29	28	24	20
	kW	1.81	1.81	1.81	1.8	2.01	2.01	2.00	2.0	2.23	2.23	2.22	2.2	2.47	2.47	2.46	2.5	2.73	2.73	2.73	2.7	3.04	3.04	3.04	3.1
Amps	6.5	6.5	6.5	6.5	7.4	7.4	7.4	7.4	8.4	8.4	8.4	8.4	9.5	9.5	9.5	9.5	10.7	10.7	10.7	10.7	12.1	12.1	12.1	12.2	
900	MBh	30.1	30.5	31.3	32.7	29.8	30.2	31.1	32.4	29.0	29.4	30.3	31.6	27.7	28.1	29.0	30.3	26.1	26.5	27.4	28.7	24.7	25.1	25.9	27.3
	S/T	0.92	0.84	0.71	0.6	0.92	0.85	0.72	0.6	1.00	0.87	0.74	0.6	1.00	0.89	0.76	0.6	1.00	0.91	0.78	0.6	1.00	0.96	0.83	0.7
	ΔT	28	26	22	18	28	26	22	18	28	26	22	19	28	26	22	18	27	25	22	18	29	27	23	19
	kW	1.82	1.82	1.82	1.83	2.02	2.02	2.01	2.03	2.24	2.24	2.23	2.25	2.47	2.47	2.47	2.48	2.74	2.74	2.74	2.75	3.05	3.05	3.05	3.06
	Amps	6.5	6.5	6.5	6.6	7.4	7.4	7.4	7.5	8.4	8.4	8.4	8.5	9.5	9.5	9.5	9.6	10.7	10.7	10.7	10.8	12.2	12.2	12.2	12.2
1125	MBh	30.7	31.1	31.9	33.3	30.4	30.8	31.7	33.0	29.6	30.0	30.9	32.2	28.3	28.7	29.6	30.9	26.7	27.1	28.0	29.3	25.3	25.7	26.6	27.9
	S/T	0.93	0.86	0.72	0.6	1.00	0.86	0.73	0.6	1.00	0.89	0.75	0.6	1.00	0.90	0.77	0.6	1.00	0.93	0.79	0.7	1.00	1.00	0.84	0.7
	ΔT	27	25	21	17	27	25	21	17	27	25	21	18	27	25	21	17	26	24	21	17	28	26	22	18
	kW	1.83	1.83	1.82	1.8	2.03	2.02	2.02	2.0	2.25	2.24	2.24	2.3	2.48	2.48	2.48	2.5	2.75	2.75	2.74	2.8	3.06	3.06	3.06	3.1
	Amps	6.6	6.5	6.5	6.6	7.5	7.4	7.4	7.5	8.5	8.5	8.4	8.5	9.5	9.5	9.5	9.6	10.8	10.8	10.7	10.8	12.2	12.2	12.2	12.2
85	MBh	30.1	30.5	31.4	32.7	29.9	30.3	31.2	32.5	29.1	29.5	30.4	31.7	27.8	28.2	29.1	30.4	26.2	26.6	27.5	28.8	24.8	25.2	26.0	27.4
	S/T	1.00	0.91	0.78	0.6	1.00	0.92	0.78	0.6	1.00	0.94	0.81	0.7	1.00	0.96	0.83	0.7	1.00	1.00	0.85	0.7	1.00	1.00	0.90	0.8
	ΔT	32	30	27	23	32	30	27	23	33	31	27	23	32	30	27	23	32	30	26	23	33	31	28	24
	kW	1.82	1.82	1.81	1.8	2.01	2.01	2.01	2.0	2.23	2.23	2.23	2.2	2.47	2.47	2.47	2.5	2.74	2.73	2.73	2.7	3.05	3.05	3.04	3.1
	Amps	6.5	6.5	6.5	6.5	7.4	7.4	7.4	7.4	8.4	8.4	8.4	8.5	9.5	9.5	9.5	9.5	10.7	10.7	10.7	10.8	12.1	12.1	12.1	12.2
1000	MBh	30.5	31.0	31.8	33.1	30.3	30.7	31.6	32.9	29.5	29.9	30.8	32.1	28.2	28.6	29.5	30.8	26.6	27.0	27.9	29.2	25.2	25.6	26.4	27.8
	S/T	1.00	0.94	0.81	0.7	1.00	0.95	0.81	0.7	1.00	0.97	0.84	0.7	1.00	1.00	0.86	0.7	1.00	1.00	0.88	0.7	1.00	1.00	0.93	0.8
	ΔT	32	30	26	22	31	30	26	22	32	30	26	22	31	29	26	22	31	29	26	22	32	30	27	23
	kW	1.82	1.82	1.82	1.83	2.02	2.02	2.02	2.03	2.24	2.24	2.24	2.25	2.48	2.48	2.47	2.49	2.74	2.74	2.74	2.75	3.06	3.05	3.05	3.07
	Amps	6.5	6.5	6.5	6.6	7.4	7.4	7.4	7.5	8.4	8.4	8.4	8.5	9.5	9.5	9.5	9.6	10.7	10.7	10.7	10.8	12.2	12.2	12.2	12.2
1125	MBh	31.1	31.6	32.4	33.8	30.9	31.3	32.2	33.5	30.1	30.5	31.4	32.7	28.8	29.2	30.1	31.4	27.2	27.6	28.5	29.8	25.8	26.2	27.0	28.4
	S/T	1.00	0.95	0.82	0.7	1.00	0.96	0.83	0.7	1.00	0.98	0.85	0.7	1.00	1.00	0.87	0.7	1.00	1.00	0.89	0.8	1.00	1.00	0.94	0.8
	ΔT	31	29	25	21	30	29	25	21	31	29	25	21	30	29	25	21	30	28	25	21	31	29	26	22
	kW	1.83	1.83	1.83	1.8	2.03	2.03	2.02	2.0	2.25	2.25	2.24	2.3	2.49	2.49	2.48	2.5	2.75	2.75	2.75	2.8	3.06	3.06	3.06	3.1
	Amps	6.6	6.6	6.5	6.6	7.5	7.5	7.5	7.5	8.5	8.5	8.5	8.5	9.6	9.6	9.5	9.6	10.8	10.8	10.8	10.8	12.2	12.2	12.2	12.3

IDB: Entering Indoor Dry Bulb Temperature
 High and low pressures are measured at the liquid and suction service valves.
 Shaded area reflects AHRI conditions
 kW = Total system power
 Amps = outdoor unit amps (comp.+fan)

EXPANDED COOLING DATA — GLXS5BA3610A*+CAPTA3626*3A* (CONT.)

IDB		OUTDOOR AMBIENT TEMPERATURE																											
		65				75				85				95				105				115							
		59	63	67	71	59	63	67	71	59	63	67	71	59	63	67	71	59	63	67	71	59	63	67	71				
		ENTERING INDOOR WET BULB TEMPERATURE																											
		AIRFLOW																											
1050	MBh	35.5	36.0	37.0	38.6	35.1	35.6	36.7	38.3	34.2	34.7	35.8	37.4	34.2	33.1	34.2	35.8	30.7	31.2	32.3	33.9	30.7	31.2	32.3	33.9	28.9	29.4	30.5	32.1
	S/T	1.00	0.79	0.66	0.5	1.00	0.80	0.66	0.5	1.00	0.82	0.69	0.5	1.00	1.00	0.71	0.6	1.00	1.00	0.73	0.6	1.00	1.00	0.73	0.6	1.00	1.00	0.78	0.6
	ΔT	29	27	23	20	29	27	23	20	29	27	24	20	29	27	23	20	28	27	23	19	30	29	23	19	30	28	24	20
	kW	2.18	2.18	2.18	2.2	2.42	2.42	2.41	2.4	2.69	2.68	2.68	2.7	2.97	2.97	2.97	3.0	3.30	3.29	3.29	3.3	3.30	3.29	3.29	3.3	3.67	3.67	3.67	3.7
	Amps	7.6	7.6	7.6	7.7	8.7	8.7	8.7	8.7	9.9	9.9	9.9	10.0	11.2	11.2	11.2	11.3	12.7	12.7	12.7	12.7	12.7	12.7	12.7	12.7	14.4	14.4	14.4	14.5
80	MBh	35.9	36.4	37.4	39.0	35.6	36.0	37.1	38.7	34.6	35.1	36.2	37.8	33.1	33.5	34.6	36.2	31.1	31.6	32.7	34.3	31.1	31.6	32.7	34.3	29.4	29.9	30.9	32.5
	S/T	1.00	0.84	0.71	0.6	1.00	0.85	0.71	0.6	1.00	0.88	0.74	0.6	1.00	1.00	0.76	0.6	1.00	1.00	0.78	0.6	1.00	1.00	0.78	0.6	1.00	1.00	0.83	0.7
	ΔT	28	26	22	19	28	26	22	19	28	26	23	19	28	26	22	19	27	26	22	18	29	27	22	18	29	27	23	19
	kW	2.19	2.19	2.19	2.21	2.43	2.43	2.43	2.44	2.70	2.70	2.69	2.71	2.98	2.98	2.98	3.00	3.31	3.30	3.30	3.32	3.31	3.30	3.30	3.32	3.68	3.68	3.68	3.70
	Amps	7.6	7.6	7.6	7.7	8.7	8.7	8.7	8.8	10.0	9.9	9.9	10.0	11.3	11.3	11.2	11.3	12.7	12.7	12.7	12.8	12.7	12.7	12.7	12.8	14.5	14.5	14.5	14.5
1350	MBh	36.5	37.0	38.1	39.7	36.2	36.7	37.7	39.4	35.3	35.8	36.8	38.4	33.7	34.2	35.2	36.9	31.8	32.3	33.3	34.9	31.8	32.3	33.3	34.9	30.0	30.5	31.6	33.2
	S/T	1.00	0.88	0.75	0.6	1.00	0.89	0.75	0.6	1.00	1.00	0.78	0.6	1.00	1.00	0.80	0.7	1.00	1.00	0.82	0.7	1.00	1.00	0.82	0.7	1.00	1.00	1.00	0.7
	ΔT	27	25	21	18	27	25	21	17	27	25	21	18	27	25	21	17	26	24	21	17	26	24	21	17	27	26	22	18
	kW	2.21	2.20	2.20	2.2	2.44	2.44	2.44	2.5	2.71	2.71	2.70	2.7	3.00	2.99	2.99	3.0	3.32	3.32	3.31	3.3	3.32	3.32	3.31	3.3	3.69	3.69	3.69	3.7
	Amps	7.7	7.7	7.7	7.8	8.8	8.8	8.8	8.8	10.0	10.0	10.0	10.1	11.3	11.3	11.3	11.4	12.8	12.8	12.8	12.8	12.8	12.8	12.8	12.8	14.5	14.5	14.5	14.6
1050	MBh	36.0	36.5	37.6	39.2	35.7	36.2	37.3	38.9	34.8	35.3	36.4	38.0	33.2	33.7	34.8	36.4	31.3	31.8	32.8	34.5	31.3	31.8	32.8	34.5	29.5	30.0	31.1	32.7
	S/T	1.00	0.89	0.76	0.6	1.00	1.00	0.76	0.6	1.00	1.00	0.79	0.6	1.00	1.00	0.81	0.7	1.00	1.00	1.00	0.7	1.00	1.00	1.00	0.7	1.00	1.00	1.00	0.7
	ΔT	32	31	27	23	32	31	27	23	33	31	27	24	32	30	27	23	32	30	27	23	32	30	27	23	33	31	28	24
	kW	2.19	2.19	2.18	2.2	2.43	2.42	2.42	2.4	2.69	2.69	2.69	2.7	2.98	2.98	2.97	3.0	3.30	3.30	3.29	3.3	3.30	3.30	3.29	3.3	3.68	3.67	3.67	3.7
	Amps	7.6	7.6	7.6	7.7	8.7	8.7	8.7	8.8	9.9	9.9	9.9	10.0	11.2	11.2	11.2	11.3	12.7	12.7	12.7	12.8	12.7	12.7	12.7	12.8	14.4	14.4	14.4	14.5
85	MBh	36.5	37.0	38.0	39.6	36.1	36.6	37.7	39.3	35.2	35.7	36.8	38.4	33.6	34.1	35.2	36.8	31.7	32.2	33.3	34.9	31.7	32.2	33.3	34.9	29.9	30.4	31.5	33.1
	S/T	1.00	0.95	0.81	0.7	1.00	1.00	0.82	0.7	1.00	1.00	0.84	0.7	1.00	1.00	0.86	0.7	1.00	1.00	1.00	0.7	1.00	1.00	1.00	0.7	1.00	1.00	1.00	0.8
	ΔT	31	30	26	22	31	30	26	22	32	30	26	23	31	29	26	22	31	29	26	22	31	29	26	22	32	30	27	23
	kW	2.20	2.20	2.19	2.21	2.44	2.43	2.43	2.45	2.70	2.70	2.70	2.71	2.99	2.99	2.98	3.00	3.31	3.31	3.30	3.32	3.31	3.31	3.30	3.32	3.69	3.69	3.68	3.70
	Amps	7.7	7.7	7.6	7.7	8.8	8.7	8.7	8.8	10.0	10.0	9.9	10.0	11.3	11.3	11.3	11.3	12.8	12.8	12.7	12.8	12.8	12.8	12.7	12.8	14.5	14.5	14.5	14.5
1350	MBh	37.1	37.6	38.7	40.3	36.8	37.3	38.3	39.9	35.9	36.4	37.4	39.0	34.3	34.8	35.8	37.4	32.4	32.9	33.9	35.5	32.4	32.9	33.9	35.5	30.6	31.1	32.1	33.8
	S/T	1.00	0.98	0.85	0.7	1.00	1.00	0.85	0.7	1.00	1.00	0.88	0.7	1.00	1.00	0.90	0.8	1.00	1.00	1.00	0.8	1.00	1.00	1.00	0.8	1.00	1.00	1.00	0.8
	ΔT	30	28	25	21	30	28	25	21	31	29	25	21	30	28	25	21	30	28	25	21	31	29	26	22	31	29	26	22
	kW	2.21	2.21	2.20	2.2	2.45	2.45	2.44	2.5	2.71	2.71	2.71	2.7	3.00	3.00	3.00	3.0	3.32	3.32	3.32	3.3	3.32	3.32	3.32	3.3	3.70	3.70	3.69	3.7
	Amps	7.7	7.7	7.7	7.8	8.8	8.8	8.8	8.9	10.0	10.0	10.0	10.1	11.3	11.3	11.3	11.4	12.8	12.8	12.8	12.9	12.8	12.8	12.8	12.9	14.5	14.5	14.5	14.6

IDB: Entering Indoor Dry Bulb Temperature
 High and low pressures are measured at the liquid and suction service valves.
 Shaded area reflects AHRI conditions
 kW = Total system power
 Amps = outdoor unit amps (comp.+fan)

EXPANDED COOLING DATA — GLXS5BA4210A*+CAPTA4230*3A*

IDB		OUTDOOR AMBIENT TEMPERATURE																								
		65				75				85				95				105				115				
		59	63	67	71	59	63	67	71	59	63	67	71	59	63	67	71	59	63	67	71	59	63	67	71	
AIREFLOW		MBh	40.7	41.3	42.5	-	40.3	40.9	42.1	-	39.3	39.8	41.1	-	37.4	38.0	39.2	-	35.2	35.8	37.0	-	33.2	33.7	35.0	-
		S/T	0.61	0.53	0.40	-	0.61	0.54	0.40	-	0.64	0.56	0.43	-	1.00	0.58	0.45	-	1.00	0.60	0.47	-	1.00	0.66	0.52	-
1225		ΔT	21	19	15	-	21	19	15	-	21	19	15	-	20	19	15	-	20	18	15	-	21	20	16	-
		kW	2.53	2.53	2.52	-	2.80	2.80	2.79	-	3.11	3.10	3.10	-	3.44	3.43	3.43	-	3.81	3.80	3.80	-	4.24	4.24	4.23	-
		Amps	8.7	8.7	8.7	-	10.0	10.0	10.0	-	11.4	11.4	11.4	-	12.9	12.9	12.9	-	14.6	14.6	14.6	-	16.6	16.6	16.5	-
70		MBh	41.2	41.8	43.0	-	40.9	41.4	42.7	-	39.8	40.4	41.6	-	38.0	38.5	39.8	-	35.7	36.3	37.5	-	33.7	34.3	35.5	-
		S/T	0.67	0.59	0.46	-	0.67	0.60	0.46	-	0.70	0.62	0.49	-	1.00	0.64	0.51	-	1.00	0.66	0.53	-	1.00	0.72	0.58	-
		ΔT	19	18	14	-	19	17	14	-	20	18	14	-	19	17	14	-	19	17	14	-	20	18	15	-
		kW	2.54	2.54	2.54	-	2.82	2.81	2.81	-	3.12	3.12	3.11	-	3.45	3.45	3.44	-	3.82	3.82	3.81	-	4.25	4.25	4.24	-
		Amps	8.8	8.8	8.8	-	10.1	10.1	10.0	-	11.5	11.4	11.4	-	13.0	13.0	12.9	-	14.7	14.6	14.6	-	16.6	16.6	16.6	-
1575		MBh	41.9	42.4	43.7	-	41.5	42.1	43.3	-	40.4	41.0	42.2	-	38.6	39.2	40.4	-	36.4	37.0	38.2	-	34.3	34.9	36.1	-
		S/T	0.70	0.63	0.49	-	0.71	0.63	0.50	-	0.73	0.66	0.52	-	1.00	0.68	0.54	-	1.00	0.70	0.56	-	1.00	0.75	0.61	-
		ΔT	18	17	13	-	18	16	13	-	19	17	13	-	18	16	13	-	18	16	13	-	19	17	14	-
		kW	2.55	2.55	2.55	-	2.83	2.83	2.82	-	3.13	3.13	3.13	-	3.46	3.46	3.46	-	3.83	3.83	3.82	-	4.26	4.26	4.26	-
		Amps	8.9	8.9	8.8	-	10.1	10.1	10.1	-	11.5	11.5	11.5	-	13.0	13.0	13.0	-	14.7	14.7	14.7	-	16.7	16.7	16.7	-

1225		MBh	40.7	41.3	42.5	44.4	40.4	40.9	42.1	44.0	39.3	39.9	41.1	42.9	37.5	38.0	39.3	41.1	35.2	35.8	37.0	38.9	33.2	33.8	35.0	36.8
		S/T	0.74	0.66	0.52	0.4	0.74	0.67	0.53	0.4	1.00	0.69	0.56	0.4	1.00	0.71	0.58	0.4	1.00	0.73	0.60	0.5	1.00	1.00	0.65	0.5
		ΔT	25	23	19	16	25	23	19	16	25	23	20	16	25	23	19	16	24	23	19	15	26	24	20	16
		kW	2.53	2.52	2.52	2.5	2.80	2.80	2.79	2.8	3.10	3.10	3.10	3.1	3.43	3.43	3.43	3.4	3.80	3.80	3.80	3.8	4.24	4.23	4.23	4.2
		Amps	8.7	8.7	8.7	8.8	10.0	10.0	10.0	10.1	11.4	11.4	11.4	11.4	12.9	12.9	12.9	13.0	14.6	14.6	14.6	14.6	16.6	16.6	16.5	16.6
75		MBh	41.3	41.8	43.0	44.9	40.9	41.5	42.7	44.5	39.8	40.4	41.6	43.5	38.0	38.6	39.8	41.6	35.8	36.3	37.6	39.4	33.7	34.3	35.5	37.4
		S/T	0.80	0.72	0.58	0.4	1.00	0.73	0.59	0.4	1.00	0.75	0.62	0.5	1.00	0.77	0.64	0.5	1.00	0.79	0.66	0.5	1.00	1.00	0.71	0.6
		ΔT	24	22	18	14	24	22	18	14	24	22	18	15	24	22	18	14	23	21	18	14	24	23	19	15
		kW	2.54	2.54	2.53	2.55	2.81	2.81	2.81	2.83	3.12	3.12	3.11	3.13	3.45	3.45	3.44	3.46	3.82	3.82	3.81	3.83	4.25	4.25	4.24	4.26
		Amps	8.8	8.8	8.8	8.9	10.1	10.0	10.0	10.1	11.5	11.4	11.4	11.5	13.0	13.0	12.9	13.0	14.6	14.6	14.6	14.7	16.6	16.6	16.6	16.7
1575		MBh	41.9	42.5	43.7	45.5	41.5	42.1	43.3	45.2	40.5	41.0	42.3	44.1	38.6	39.2	40.4	42.3	36.4	37.0	38.2	40.1	34.4	34.9	36.2	38.0
		S/T	0.83	0.75	0.62	0.5	1.00	0.76	0.62	0.5	1.00	0.79	0.65	0.5	1.00	0.81	0.67	0.5	1.00	1.00	0.69	0.5	1.00	1.00	0.74	0.6
		ΔT	23	21	17	13	23	21	17	13	23	21	17	14	23	21	17	13	22	20	17	13	23	22	18	14
		kW	2.55	2.55	2.55	2.6	2.83	2.82	2.82	2.8	3.13	3.13	3.12	3.1	3.46	3.46	3.45	3.5	3.83	3.83	3.82	3.8	4.26	4.26	4.26	4.3
		Amps	8.9	8.8	8.8	8.9	10.1	10.1	10.1	10.2	11.5	11.5	11.5	11.6	13.0	13.0	13.0	13.1	14.7	14.7	14.7	14.8	16.7	16.7	16.7	16.7

IDB: Entering Indoor Dry Bulb Temperature
 High and low pressures are measured at the liquid and suction service valves.
 Shaded area reflects ACCA (TVA) conditions
 kW = Total system power
 Amps = outdoor unit amps (comp.+fan)

IDB		OUTDOOR AMBIENT TEMPERATURE																							
		65				75				85				95				105				115			
		59	63	67	71	59	63	67	71	59	63	67	71	59	63	67	71	59	63	67	71	59	63	67	71
		ENTERING INDOOR WET BULB TEMPERATURE																							
		ENTERING INDOOR DRY BULB TEMPERATURE																							
		Amps																							
80	MBh	40.9	41.5	42.7	44.6	40.6	41.1	42.4	44.2	39.5	40.1	41.3	43.2	37.7	38.2	39.5	41.3	35.4	36.0	37.2	39.1	33.4	34.0	35.2	37.0
	S/T	1.00	0.79	0.65	0.5	1.00	0.79	0.66	0.5	1.00	0.82	0.68	0.5	1.00	1.00	0.70	0.6	1.00	1.00	0.72	0.6	1.00	1.00	0.77	0.6
	ΔT	29	27	23	20	29	27	23	20	29	27	24	20	29	27	23	20	29	27	23	19	30	28	24	21
	kW	2.53	2.53	2.52	2.5	2.80	2.80	2.79	2.8	3.11	3.10	3.10	3.1	3.44	3.43	3.43	3.5	3.80	3.80	3.80	3.8	4.24	4.24	4.23	4.3
	Amps	8.7	8.7	8.7	8.8	10.0	10.0	10.0	10.1	11.4	11.4	11.4	11.5	12.9	12.9	12.9	13.0	14.6	14.6	14.6	14.7	16.6	16.6	16.5	16.6
1225	MBh	41.5	42.0	43.3	45.1	41.1	41.7	42.9	44.7	40.0	40.6	41.8	43.7	38.2	38.8	40.0	41.9	36.0	36.5	37.8	39.6	33.9	34.5	35.7	37.6
	S/T	1.00	0.85	0.71	0.6	1.00	0.85	0.72	0.6	1.00	0.88	0.74	0.6	1.00	1.00	0.76	0.6	1.00	1.00	0.78	0.6	1.00	1.00	0.83	0.7
	ΔT	28	26	22	19	28	26	22	19	28	26	23	19	28	26	22	19	27	26	22	18	29	27	23	20
	kW	2.54	2.54	2.54	2.56	2.82	2.81	2.81	2.83	3.12	3.12	3.11	3.13	3.45	3.45	3.44	3.46	3.82	3.82	3.81	3.83	4.25	4.25	4.24	4.27
	Amps	8.8	8.8	8.8	8.9	10.1	10.1	10.0	10.1	11.5	11.4	11.4	11.5	13.0	13.0	12.9	13.0	14.7	14.6	14.6	14.7	16.6	16.6	16.6	16.7
1575	MBh	42.1	42.7	43.9	45.8	41.7	42.3	43.5	45.4	40.7	41.3	42.5	44.3	38.9	39.4	40.6	42.5	36.6	37.2	38.4	40.3	34.6	35.2	36.4	38.2
	S/T	1.00	0.88	0.74	0.6	1.00	0.89	0.75	0.6	1.00	0.91	0.78	0.6	1.00	1.00	0.80	0.7	1.00	1.00	0.82	0.7	1.00	1.00	0.87	0.7
	ΔT	27	25	21	18	27	25	21	18	27	25	22	18	27	25	21	18	27	25	21	17	28	26	22	19
	kW	2.55	2.55	2.55	2.6	2.83	2.83	2.82	2.8	3.13	3.13	3.13	3.1	3.46	3.46	3.46	3.5	3.83	3.83	3.82	3.8	4.26	4.26	4.26	4.3
	Amps	8.9	8.9	8.8	8.9	10.1	10.1	10.1	10.2	11.5	11.5	11.5	11.6	13.0	13.0	13.0	13.1	14.7	14.7	14.7	14.8	16.7	16.7	16.7	16.8
85	MBh	41.6	42.2	43.4	45.3	41.3	41.8	43.0	44.9	40.2	40.8	42.0	43.8	38.4	38.9	40.2	42.0	36.1	36.7	37.9	39.8	34.1	34.7	35.9	37.7
	S/T	1.00	0.89	0.75	0.6	1.00	1.00	0.76	0.6	1.00	1.00	0.78	0.6	1.00	1.00	0.80	0.7	1.00	1.00	0.82	0.7	1.00	1.00	1.00	0.7
	ΔT	33	31	27	24	33	31	27	23	33	31	27	24	33	31	27	23	32	30	27	23	34	32	28	24
	kW	2.53	2.53	2.53	2.5	2.81	2.80	2.80	2.8	3.11	3.11	3.10	3.1	3.44	3.44	3.43	3.5	3.81	3.81	3.80	3.8	4.24	4.24	4.24	4.3
	Amps	8.8	8.8	8.7	8.8	10.0	10.0	10.0	10.1	11.4	11.4	11.4	11.5	12.9	12.9	12.9	13.0	14.6	14.6	14.6	14.7	16.6	16.6	16.6	16.7
1225	MBh	42.2	42.7	43.9	45.8	41.8	42.4	43.6	45.4	40.7	41.3	42.5	44.4	38.9	39.5	40.7	42.5	36.7	37.2	38.5	40.3	34.6	35.2	36.4	38.3
	S/T	1.00	0.95	0.81	0.7	1.00	1.00	0.82	0.7	1.00	1.00	0.84	0.7	1.00	1.00	0.86	0.7	1.00	1.00	0.88	0.7	1.00	1.00	1.00	0.8
	ΔT	32	30	26	22	31	30	26	22	32	30	26	23	31	30	26	22	31	29	26	22	32	30	27	23
	kW	2.55	2.55	2.54	2.56	2.82	2.82	2.81	2.83	3.13	3.12	3.12	3.14	3.46	3.45	3.45	3.47	3.82	3.82	3.82	3.84	4.26	4.25	4.25	4.27
	Amps	8.8	8.8	8.8	8.9	10.1	10.1	10.1	10.1	11.5	11.5	11.4	11.5	13.0	13.0	13.0	13.1	14.7	14.7	14.6	14.7	16.7	16.6	16.6	16.7
1575	MBh	42.8	43.4	44.6	46.4	42.4	43.0	44.2	46.1	41.4	41.9	43.2	45.0	39.5	40.1	41.3	43.2	37.3	37.9	39.1	41.0	35.3	35.8	37.1	38.9
	S/T	1.00	0.98	0.85	0.7	1.00	1.00	0.85	0.7	1.00	1.00	0.88	0.7	1.00	1.00	0.90	0.8	1.00	1.00	0.92	0.8	1.00	1.00	1.00	0.8
	ΔT	31	29	25	21	31	29	25	21	31	29	25	22	30	29	25	21	30	28	25	21	31	30	26	22
	kW	2.56	2.56	2.55	2.6	2.83	2.83	2.83	2.8	3.14	3.14	3.13	3.2	3.47	3.47	3.46	3.5	3.84	3.83	3.83	3.9	4.27	4.27	4.26	4.3
	Amps	8.9	8.9	8.9	9.0	10.1	10.1	10.1	10.2	11.5	11.5	11.5	11.6	13.0	13.0	13.0	13.1	14.7	14.7	14.7	14.8	16.7	16.7	16.7	16.8

kW = Total system power
Amps = outdoor unit amps (comp.+fan)

Shaded area reflects AHRI conditions

IDB: Entering Indoor Dry Bulb Temperature
High and low pressures are measured at the liquid and suction service valves.

EXPANDED COOLING DATA — GLXS5BA4810A*+CAPTA6030*3A*

IDB		OUTDOOR AMBIENT TEMPERATURE																																																																																																																												
		65						75						85						95						105						115																																																																																														
		59	63	67	71	59	63	67	71	59	63	67	71	59	63	67	71	59	63	67	71	59	63	67	71	59	63	67	71																																																																																																	
1450		MBh	46.9	47.6	48.9	-	46.5	47.1	48.5	-	45.3	45.9	47.3	-	43.2	43.9	45.2	-	40.7	41.3	42.7	-	38.3	39.0	40.4	-	S/T	0.63	0.56	0.43	-	0.63	0.56	0.43	-	0.66	0.59	0.46	-	0.68	0.60	0.48	-	1.00	0.62	0.50	-	1.00	0.67	0.55	-	ΔT	19	17	14	-	19	17	14	-	19	17	14	-	19	17	14	-	19	17	13	-	20	18	15	-	kW	2.86	2.86	2.85	-	3.18	3.18	3.17	-	3.54	3.54	3.53	-	3.93	3.92	3.92	-	4.36	4.36	4.35	-	4.87	4.86	4.86	-	Amps	10.2	10.2	10.1	-	11.6	11.6	11.6	-	13.3	13.3	13.2	-	15.0	15.0	15.0	-	17.0	17.0	17.0	-	19.3	19.3	19.3	-
1600		MBh	47.5	48.1	49.5	-	47.1	47.7	49.1	-	45.9	46.5	47.9	-	43.8	44.4	45.8	-	41.2	41.9	43.3	-	38.9	39.6	41.0	-	S/T	0.66	0.58	0.46	-	0.66	0.59	0.46	-	0.69	0.61	0.49	-	0.70	0.63	0.50	-	1.00	0.65	0.53	-	1.00	0.70	0.57	-	ΔT	18	16	13	-	18	16	13	-	18	17	13	-	18	16	13	-	18	16	13	-	19	17	14	-	kW	2.87	2.87	2.87	-	3.19	3.19	3.19	-	3.55	3.55	3.54	-	3.94	3.94	3.93	-	4.37	4.37	4.36	-	4.88	4.87	4.87	-	Amps	10.2	10.2	10.2	-	11.7	11.7	11.7	-	13.3	13.3	13.3	-	15.1	15.1	15.1	-	17.1	17.1	17.0	-	19.4	19.4	19.4	-
1800		MBh	48.4	49.1	50.5	-	48.0	48.7	50.1	-	46.8	47.5	48.9	-	44.7	45.4	46.8	-	42.2	42.9	44.2	-	39.9	40.5	41.9	-	S/T	0.67	0.60	0.47	-	0.68	0.60	0.48	-	0.70	0.63	0.50	-	1.00	0.65	0.52	-	1.00	0.67	0.54	-	1.00	0.72	0.59	-	ΔT	17	15	12	-	17	15	12	-	18	16	12	-	17	15	12	-	17	15	12	-	18	16	13	-	kW	2.89	2.88	2.88	-	3.21	3.20	3.20	-	3.56	3.56	3.56	-	3.95	3.95	3.94	-	4.38	4.38	4.38	-	4.89	4.89	4.88	-	Amps	10.3	10.3	10.3	-	11.8	11.7	11.7	-	13.4	13.4	13.4	-	15.2	15.1	15.1	-	17.1	17.1	17.1	-	19.5	19.4	19.4	-

IDB		OUTDOOR AMBIENT TEMPERATURE																																																																																																																													
		65						75						85						95						105						115																																																																																															
		59	63	67	71	59	63	67	71	59	63	67	71	59	63	67	71	59	63	67	71	59	63	67	71	59	63	67	71																																																																																																		
1450		MBh	46.9	47.6	49.0	51.1	46.5	47.2	48.5	50.7	45.3	46.0	47.3	49.5	43.2	43.9	45.3	47.4	40.7	41.3	42.7	44.8	38.4	39.0	40.4	42.5	S/T	0.75	0.68	0.55	0.4	0.76	0.68	0.56	0.4	1.00	0.71	0.58	0.4	1.00	0.70	0.60	0.5	1.00	0.75	0.62	0.5	1.00	0.80	0.67	0.5	ΔT	23	21	18	14	23	21	18	14	23	22	18	14	23	23	21	18	14	23	21	17	14	24	22	19	15	kW	2.86	2.86	2.85	2.9	3.18	3.18	3.17	3.2	3.54	3.53	3.53	3.6	3.92	3.92	3.92	3.9	4.36	4.35	4.35	4.4	4.86	4.86	4.86	4.9	Amps	10.2	10.2	10.1	10.2	11.6	11.6	11.6	11.7	13.3	13.3	13.2	13.3	15.0	15.0	15.0	15.1	17.0	17.0	17.0	17.1	19.3	19.3	19.3	19.4
1600		MBh	47.5	48.2	49.6	51.7	47.1	47.8	49.1	51.3	45.9	46.6	47.9	50.0	43.8	44.5	45.9	48.0	41.3	41.9	43.3	45.4	39.0	39.6	41.0	43.1	S/T	0.78	0.71	0.58	0.4	0.78	0.71	0.58	0.4	1.00	0.74	0.61	0.5	1.00	0.75	0.63	0.5	1.00	0.77	0.65	0.5	1.00	1.00	0.70	0.6	ΔT	22	21	17	13	22	20	17	13	23	21	17	14	22	20	17	13	22	20	17	13	23	21	18	14	kW	2.87	2.87	2.86	2.89	3.19	3.19	3.18	3.21	3.55	3.55	3.54	3.57	3.94	3.93	3.93	3.95	4.37	4.37	4.36	4.38	4.88	4.87	4.87	4.89	Amps	10.2	10.2	10.2	10.3	11.7	11.7	11.6	11.8	13.3	13.3	13.3	13.4	15.1	15.1	15.1	15.2	17.1	17.1	17.0	17.1	19.4	19.4	19.4	19.5	
1800		MBh	48.5	49.1	50.5	52.6	48.1	48.7	50.1	52.2	46.8	47.5	48.9	51.0	44.8	45.4	46.8	48.9	42.2	42.9	44.3	46.4	39.9	40.6	41.9	44.1	S/T	0.79	0.72	0.59	0.5	0.80	0.73	0.60	0.5	1.00	0.75	0.62	0.5	1.00	0.77	0.64	0.5	1.00	0.79	0.66	0.5	1.00	1.00	0.71	0.6	ΔT	21	20	16	12	21	20	16	12	22	20	16	13	21	19	16	12	21	19	16	12	22	20	17	13	kW	2.88	2.88	2.88	2.9	3.21	3.20	3.20	3.2	3.56	3.56	3.55	3.6	3.95	3.95	3.94	4.0	4.38	4.38	4.37	4.4	4.89	4.89	4.88	4.9	Amps	10.3	10.3	10.2	10.4	11.7	11.7	11.7	11.8	13.4	13.4	13.3	13.5	15.2	15.1	15.1	15.2	17.1	17.1	17.1	17.2	19.5	19.4	19.4	19.5	

IDB: Entering Indoor Dry Bulb Temperature
 High and low pressures are measured at the liquid and suction service valves.
 Shaded area reflects ACCA (TVA) conditions
 kW = Total system power
 Amps = outdoor unit amps (comp.+fan)

EXPANDED COOLING DATA — GLXS5BA4810A*+CAPTA6030*3A* (CONT.)

		OUTDOOR AMBIENT TEMPERATURE																									
		65				75				85				95				105				115					
		IDB	AIRFLOW	59	63	67	71	59	63	67	71	59	63	67	71	59	63	67	71	59	63	67	71	59	63	67	71
80	MBh	47.2	47.8	49.2	51.3	46.8	47.4	48.8	50.9	45.5	46.2	47.6	49.7	43.5	44.1	45.5	47.6	40.9	41.6	43.0	45.1	38.6	39.3	40.6	42.8	42.8	
	S/T	0.87	0.80	0.67	0.5	1.00	0.80	0.67	0.5	1.00	0.83	0.70	0.6	1.00	0.84	0.72	0.6	1.00	1.00	1.00	0.74	0.6	1.00	1.00	1.00	0.79	0.7
	ΔT	27	25	22	18	27	25	22	18	28	26	22	19	27	25	22	18	27	25	22	18	28	26	26	23	19	
	kW	2.86	2.86	2.85	2.9	3.18	3.18	3.17	3.2	3.54	3.54	3.53	3.6	3.93	3.92	3.92	3.9	4.36	4.36	4.35	4.4	4.87	4.86	4.86	4.86	4.9	
	Amps	10.2	10.2	10.1	10.2	11.6	11.6	11.6	11.7	13.3	13.3	13.2	13.3	15.0	15.0	15.0	15.1	17.0	17.0	17.0	17.1	19.3	19.3	19.3	19.3	19.4	
	MBh	47.8	48.4	49.8	51.9	47.3	48.0	49.4	51.5	46.1	46.8	48.2	50.3	44.1	44.7	46.1	48.2	41.5	42.2	43.6	45.7	39.2	39.8	41.2	43.3	43.3	
	S/T	1.00	0.82	0.70	0.6	1.00	0.83	0.70	0.6	1.00	0.85	0.73	0.6	1.00	0.87	0.74	0.6	1.00	1.00	0.77	0.6	1.00	1.00	1.00	0.81	0.7	
	ΔT	27	25	21	18	26	25	21	17	27	25	21	18	26	25	21	17	26	24	21	17	27	25	22	18		
	kW	2.87	2.87	2.86	2.89	3.19	3.19	3.19	3.21	3.55	3.55	3.54	3.57	3.94	3.93	3.93	3.95	4.37	4.37	4.36	4.39	4.88	4.87	4.87	4.87	4.89	
	Amps	10.2	10.2	10.2	10.3	11.7	11.7	11.7	11.8	13.3	13.3	13.3	13.4	15.1	15.1	15.1	15.2	17.1	17.1	17.1	17.1	19.4	19.4	19.4	19.4	19.5	
	MBh	48.7	49.4	50.7	52.9	48.3	48.9	50.3	52.4	47.1	47.7	49.1	51.2	45.0	45.7	47.0	49.2	42.5	43.1	44.5	46.6	40.1	40.8	42.2	44.3	44.3	
	S/T	1.00	0.84	0.71	0.6	1.00	0.84	0.72	0.6	1.00	0.87	0.74	0.6	1.00	1.00	0.76	0.6	1.00	1.00	0.78	0.6	1.00	1.00	1.00	0.83	0.7	
ΔT	26	24	20	17	26	24	20	17	26	24	20	17	25	24	20	17	25	23	20	16	26	25	21	17			
kW	2.89	2.88	2.88	2.9	3.21	3.20	3.20	3.2	3.56	3.56	3.56	3.6	3.95	3.95	3.94	4.0	4.38	4.38	4.38	4.4	4.89	4.89	4.88	4.88	4.9		
Amps	10.3	10.3	10.2	10.4	11.8	11.7	11.7	11.8	13.4	13.4	13.4	13.5	15.2	15.1	15.1	15.2	17.1	17.1	17.1	17.2	19.5	19.4	19.4	19.4	19.5		
85	MBh	47.9	48.6	50.0	52.1	47.5	48.2	49.6	51.7	46.3	47.0	48.4	50.5	44.2	44.9	46.3	48.4	41.7	42.4	43.7	45.9	39.4	40.0	41.4	43.5	43.5	
	S/T	1.00	0.89	0.76	0.6	1.00	0.90	0.77	0.6	1.00	1.00	0.79	0.7	1.00	1.00	0.81	0.7	1.00	1.00	0.83	0.7	1.00	1.00	1.00	0.7		
	ΔT	31	29	26	22	31	29	26	22	31	29	26	22	31	29	26	22	31	29	25	22	32	30	26	23		
	kW	2.87	2.86	2.86	2.9	3.19	3.18	3.18	3.2	3.55	3.54	3.54	3.6	3.93	3.93	3.92	3.9	4.36	4.36	4.36	4.4	4.87	4.87	4.86	4.86	4.9	
	Amps	10.2	10.2	10.2	10.3	11.7	11.7	11.6	11.7	13.3	13.3	13.3	13.4	15.1	15.1	15.0	15.1	17.0	17.0	17.0	17.1	19.4	19.4	19.4	19.3	19.4	
	MBh	48.5	49.2	50.6	52.7	48.1	48.8	50.2	52.3	46.9	47.6	49.0	51.1	44.8	45.5	46.9	49.0	42.3	42.9	44.3	46.4	40.0	40.6	42.0	44.1	44.1	
	S/T	1.00	0.92	0.79	0.7	1.00	0.93	0.80	0.7	1.00	1.00	0.82	0.7	1.00	1.00	0.84	0.7	1.00	1.00	0.86	0.7	1.00	1.00	1.00	0.8		
	ΔT	30	28	25	21	30	28	25	21	30	29	25	21	30	28	25	21	30	28	25	21	31	29	26	22		
	kW	2.88	2.88	2.87	2.90	3.20	3.20	3.19	3.22	3.56	3.55	3.55	3.57	3.94	3.94	3.94	3.96	4.38	4.37	4.37	4.39	4.88	4.88	4.88	4.88	4.90	
	Amps	10.3	10.2	10.2	10.3	11.7	11.7	11.7	11.8	13.4	13.3	13.3	13.4	15.1	15.1	15.1	15.2	17.1	17.1	17.1	17.2	19.4	19.4	19.4	19.4	19.5	
	MBh	49.5	50.1	51.5	53.6	49.1	49.7	51.1	53.2	47.9	48.5	49.9	52.0	45.8	46.4	47.8	49.9	43.2	43.9	45.3	47.4	40.9	41.6	43.0	45.1	45.1	
	S/T	1.00	0.93	0.81	0.7	1.00	1.00	0.81	0.7	1.00	1.00	0.84	0.7	1.00	1.00	0.85	0.7	1.00	1.00	0.88	0.7	1.00	1.00	1.00	0.8		
ΔT	29	27	24	20	29	27	24	20	29	28	24	20	29	27	24	20	29	27	24	20	30	28	25	21			
kW	2.89	2.89	2.88	2.9	3.21	3.21	3.20	3.2	3.57	3.57	3.56	3.6	3.96	3.95	3.95	4.0	4.39	4.39	4.38	4.4	4.90	4.89	4.89	4.89	4.9		
Amps	10.3	10.3	10.3	10.4	11.8	11.8	11.7	11.9	13.4	13.4	13.4	13.5	15.2	15.2	15.2	15.3	17.2	17.2	17.1	17.2	19.5	19.5	19.4	19.4	19.6		

IDB: Entering Indoor Dry Bulb Temperature
 High and low pressures are measured at the liquid and suction service valves.
 Shaded area reflects AHRI conditions
 kW = Total system power
 Amps = outdoor unit amps (comp.+fan)

EXPANDED COOLING DATA — GLXS5BA6010A*+CAPTA6030*3A*

IDB		OUTDOOR AMBIENT TEMPERATURE																								
		65				75				85				95				105				115				
		59	63	67	71	59	63	67	71	59	63	67	71	59	63	67	71	59	63	67	71	59	63	67	71	
1485		MBh	58.8	59.6	61.3	-	58.2	59.1	60.8	-	56.7	57.5	59.3	-	54.1	54.9	56.7	-	50.9	51.7	53.5	-	48.0	48.8	50.6	-
		S/T	0.59	0.52	0.40	-	0.59	0.53	0.41	-	0.62	0.55	0.43	-	0.63	0.57	0.45	-	0.65	0.59	0.47	-	1.00	0.63	0.51	-
		ΔT	22	20	16	-	22	20	16	-	23	20	16	-	22	20	16	-	22	20	16	-	23	21	17	-
		kW	3.52	3.52	3.51	-	3.94	3.94	3.93	-	4.41	4.41	4.40	-	4.92	4.92	4.91	-	5.49	5.48	5.48	-	6.15	6.15	6.14	-
		Amps	13.1	13.1	13.1	-	15.0	15.0	15.0	-	17.2	17.2	17.1	-	19.5	19.5	19.4	-	22.1	22.1	22.0	-	25.1	25.1	25.1	-
70		MBh	61.8	62.6	64.3	-	61.2	62.1	63.8	-	59.7	60.5	62.3	-	57.1	57.9	59.7	-	53.9	54.8	56.5	-	51.0	51.9	53.6	-
		S/T	0.62	0.56	0.44	-	0.63	0.56	0.44	-	0.65	0.58	0.46	-	0.67	0.60	0.48	-	1.00	0.62	0.50	-	1.00	0.67	0.55	-
		ΔT	20	17	13	-	19	17	13	-	20	18	14	-	19	17	13	-	19	17	13	-	21	18	14	-
		kW	3.57	3.57	3.56	-	3.99	3.99	3.98	-	4.46	4.46	4.45	-	4.97	4.96	4.96	-	5.53	5.53	5.52	-	6.20	6.19	6.19	-
		Amps	13.3	13.3	13.3	-	15.2	15.2	15.2	-	17.4	17.4	17.3	-	19.7	19.7	19.7	-	22.3	22.3	22.3	-	25.3	25.3	25.3	-
2250		MBh	63.8	64.7	66.4	-	63.3	64.1	65.9	-	61.8	62.6	64.4	-	59.2	60.0	61.7	-	56.0	56.8	58.6	-	53.1	53.9	55.7	-
		S/T	0.59	0.52	0.40	-	0.60	0.53	0.41	-	0.62	0.55	0.43	-	1.00	0.57	0.45	-	1.00	0.59	0.47	-	1.00	0.63	0.51	-
		ΔT	18	16	12	-	18	16	12	-	19	16	12	-	18	16	12	-	18	16	12	-	19	17	13	-
		kW	3.59	3.59	3.58	-	4.01	4.01	4.00	-	4.48	4.48	4.47	-	4.99	4.98	4.98	-	5.55	5.55	5.54	-	6.22	6.21	6.21	-
		Amps	13.4	13.4	13.4	-	15.3	15.3	15.3	-	17.5	17.5	17.4	-	19.8	19.8	19.7	-	22.4	22.4	22.3	-	25.4	25.4	25.4	-

IDB		OUTDOOR AMBIENT TEMPERATURE																								
		65				75				85				95				105				115				
		59	63	67	71	59	63	67	71	59	63	67	71	59	63	67	71	59	63	67	71	59	63	67	71	
1485		MBh	58.8	59.6	61.3	64.0	58.3	59.1	60.8	63.5	56.8	57.6	59.3	62.0	54.1	55.0	56.7	59.3	51.0	51.8	53.5	56.2	48.1	48.9	50.6	53.3
		S/T	0.70	0.64	0.52	0.4	0.71	0.64	0.52	0.4	0.73	0.66	0.54	0.4	1.00	0.68	0.56	0.4	1.00	0.70	0.58	0.5	1.00	0.75	0.63	0.5
		ΔT	27	25	21	17	27	25	21	17	27	25	21	17	27	25	21	17	27	25	21	16	28	26	22	18
		kW	3.52	3.52	3.51	3.5	3.94	3.94	3.93	4.0	4.41	4.41	4.40	4.4	4.92	4.91	4.91	4.9	5.48	5.48	5.47	5.5	6.15	6.15	6.14	6.2
		Amps	13.1	13.1	13.0	13.2	15.0	15.0	15.0	15.1	17.2	17.1	17.1	17.3	19.5	19.5	19.4	19.6	22.1	22.1	22.0	22.2	25.1	25.1	25.1	25.2
75		MBh	61.8	62.6	64.3	67.0	61.3	62.1	63.8	66.5	59.8	60.6	62.3	65.0	57.2	58.0	59.7	62.4	54.0	54.8	56.5	59.2	51.1	51.9	53.6	56.3
		S/T	0.74	0.67	0.55	0.4	0.74	0.68	0.56	0.4	1.00	0.70	0.58	0.5	1.00	0.72	0.60	0.5	1.00	0.74	0.62	0.5	1.00	0.78	0.66	0.5
		ΔT	24	22	18	14	24	22	18	14	25	22	18	14	24	22	18	14	24	22	18	13	25	23	19	15
		kW	3.57	3.56	3.56	3.59	3.99	3.98	3.98	4.01	4.46	4.45	4.45	4.48	4.96	4.96	4.95	4.99	5.53	5.53	5.52	5.55	6.20	6.19	6.19	6.22
		Amps	13.3	13.3	13.3	13.4	15.2	15.2	15.2	15.3	17.4	17.4	17.3	17.5	19.7	19.7	19.6	19.8	22.3	22.3	22.2	22.4	25.3	25.3	25.3	25.4
2250		MBh	63.9	64.7	66.4	69.1	63.3	64.2	65.9	68.5	61.8	62.7	64.4	67.0	59.2	60.0	61.8	64.4	56.0	56.9	58.6	61.2	53.1	54.0	55.7	58.3
		S/T	0.70	0.64	0.52	0.4	0.71	0.64	0.52	0.4	1.00	0.66	0.54	0.4	1.00	0.68	0.56	0.4	1.00	0.70	0.58	0.5	1.00	1.00	0.63	0.5
		ΔT	23	21	17	13	23	21	17	13	23	21	17	13	23	21	17	13	23	21	17	12	24	22	18	14
		kW	3.59	3.58	3.58	3.6	4.01	4.00	4.00	4.0	4.48	4.47	4.47	4.5	4.98	4.98	4.97	5.0	5.55	5.55	5.54	5.6	6.21	6.21	6.20	6.2
		Amps	13.4	13.4	13.3	13.5	15.3	15.3	15.3	15.4	17.5	17.4	17.4	17.6	19.8	19.8	19.7	19.9	22.4	22.4	22.3	22.5	25.4	25.4	25.4	25.5

IDB: Entering Indoor Dry Bulb Temperature
 High and low pressures are measured at the liquid and suction service valves.
 Shaded area reflects ACCA (TVA) conditions
 kW = Total system power
 Amps = outdoor unit amps (comp.+fan)

EXPANDED COOLING DATA — GLXS5BA6010A*+CAPTA6030*3A* (CONT.)

IDB		OUTDOOR AMBIENT TEMPERATURE																							
		65				75				85				95				105				115			
		59	63	67	71	59	63	67	71	59	63	67	71	59	63	67	71	59	63	67	71	59	63	67	71
		ENTERING INDOOR WET BULB TEMPERATURE																							
		ENTERING INDOOR DRY BULB TEMPERATURE																							
80	MBh	59.1	59.9	61.6	64.3	58.6	59.4	61.1	63.8	57.1	57.9	59.6	62.3	54.4	55.3	57.0	59.6	51.3	52.1	53.8	56.5	48.4	49.2	50.9	53.6
	S/T	0.81	0.75	0.63	0.5	1.00	0.75	0.63	0.5	1.00	0.77	0.65	0.5	1.00	0.79	0.67	0.5	1.00	0.81	0.69	0.6	1.00	1.00	0.74	0.6
	ΔT	32	30	26	21	32	30	26	21	32	30	26	22	32	30	26	21	32	29	25	21	33	31	27	22
	kW	3.52	3.52	3.51	3.5	3.94	3.94	3.93	4.0	4.41	4.41	4.40	4.4	4.92	4.92	4.91	4.9	5.49	5.48	5.48	5.5	6.15	6.15	6.14	6.2
	Amps	13.1	13.1	13.1	13.2	15.0	15.0	15.0	15.1	17.2	17.2	17.1	17.3	19.5	19.5	19.4	19.6	22.1	22.1	22.0	22.2	25.1	25.1	25.1	25.2
1485	MBh	62.1	62.9	64.6	67.3	61.6	62.4	64.1	66.8	60.1	60.9	62.6	65.3	57.5	58.3	60.0	62.7	54.3	55.1	56.8	59.5	51.4	52.2	53.9	56.6
	S/T	0.85	0.78	0.66	0.5	1.00	0.79	0.67	0.5	1.00	0.81	0.69	0.6	1.00	0.83	0.71	0.6	1.00	1.00	0.73	0.6	1.00	1.00	0.77	0.6
	ΔT	29	27	23	19	29	27	23	19	29	27	23	19	29	27	23	19	29	27	23	18	30	28	24	20
	kW	3.57	3.57	3.56	3.59	3.99	3.99	3.98	4.01	4.46	4.46	4.45	4.48	4.97	4.96	4.96	4.99	5.53	5.53	5.52	5.55	6.20	6.19	6.19	6.22
	Amps	13.3	13.3	13.3	13.4	15.2	15.2	15.2	15.3	17.4	17.4	17.3	17.5	19.7	19.7	19.7	19.8	22.3	22.3	22.2	22.4	25.3	25.3	25.3	25.4
2000	MBh	64.2	65.0	66.7	69.4	63.6	64.5	66.2	68.8	62.1	63.0	64.7	67.3	59.5	60.3	62.1	64.7	56.3	57.2	58.9	61.5	53.4	54.3	56.0	58.6
	S/T	1.00	0.75	0.63	0.5	1.00	0.75	0.63	0.5	1.00	0.78	0.66	0.5	1.00	0.79	0.67	0.5	1.00	1.00	0.69	0.6	1.00	1.00	0.74	0.6
	ΔT	28	26	22	17	28	26	22	17	28	26	22	18	28	26	22	17	28	25	21	17	29	27	23	18
	kW	3.59	3.59	3.58	3.6	4.01	4.01	4.00	4.0	4.48	4.47	4.47	4.5	4.99	4.98	4.97	5.0	5.55	5.55	5.54	5.6	6.22	6.21	6.21	6.2
	Amps	13.4	13.4	13.4	13.5	15.3	15.3	15.3	15.4	17.5	17.5	17.4	17.6	19.8	19.8	19.7	19.9	22.4	22.4	22.3	22.5	25.4	25.4	25.4	25.5
2250	MBh	60.1	60.9	62.6	65.3	59.5	60.4	62.1	64.7	58.0	58.8	60.6	63.2	55.4	56.2	58.0	60.6	52.2	53.1	54.8	57.4	49.3	50.2	51.9	54.5
	S/T	1.00	0.84	0.72	0.6	1.00	0.84	0.72	0.6	1.00	0.86	0.74	0.6	1.00	1.00	0.76	0.6	1.00	1.00	0.78	0.7	1.00	1.00	0.83	0.7
	ΔT	36	34	30	26	36	34	30	26	37	34	30	26	36	34	30	26	36	34	30	25	37	35	31	27
	kW	3.53	3.53	3.52	3.6	3.95	3.95	3.94	4.0	4.42	4.42	4.41	4.4	4.93	4.92	4.92	4.9	5.49	5.49	5.48	5.5	6.16	6.16	6.15	6.2
	Amps	13.1	13.1	13.1	13.2	15.1	15.0	15.0	15.2	17.2	17.2	17.2	17.3	19.5	19.5	19.5	19.6	22.1	22.1	22.1	22.2	25.2	25.2	25.1	25.3
85	MBh	63.1	63.9	65.6	68.3	62.6	63.4	65.1	67.8	61.0	61.9	63.6	66.2	58.4	59.3	61.0	63.6	55.3	56.1	57.8	60.4	52.3	53.2	54.9	57.5
	S/T	1.00	0.87	0.75	0.6	1.00	0.88	0.76	0.6	1.00	1.00	0.78	0.7	1.00	1.00	0.80	0.7	1.00	1.00	0.82	0.7	1.00	1.00	0.86	0.7
	ΔT	33	31	27	23	33	31	27	23	34	32	27	23	33	31	27	23	33	31	27	23	34	32	28	24
	kW	3.58	3.58	3.57	3.60	4.00	3.99	3.99	4.02	4.47	4.46	4.46	4.49	4.97	4.97	4.96	5.00	5.54	5.54	5.53	5.56	6.21	6.20	6.20	6.23
	Amps	13.4	13.3	13.3	13.5	15.3	15.3	15.2	15.4	17.4	17.4	17.4	17.5	19.7	19.7	19.7	19.8	22.3	22.3	22.3	22.4	25.4	25.4	25.3	25.5
2000	MBh	65.1	66.0	67.7	70.3	64.6	65.4	67.2	69.8	63.1	63.9	65.7	68.3	60.5	61.3	63.1	65.7	57.3	58.1	59.9	62.5	54.4	55.2	57.0	59.6
	S/T	1.00	0.84	0.72	0.6	1.00	1.00	0.72	0.6	1.00	1.00	0.74	0.6	1.00	1.00	0.76	0.6	1.00	1.00	0.78	0.7	1.00	1.00	1.00	0.7
	ΔT	32	30	26	22	32	30	26	22	33	30	26	22	32	30	26	22	32	30	26	21	33	31	27	23
	kW	3.60	3.59	3.59	3.6	4.02	4.01	4.01	4.0	4.49	4.48	4.48	4.5	4.99	4.99	4.98	5.0	5.56	5.56	5.55	5.6	6.23	6.22	6.21	6.2
	Amps	13.4	13.4	13.4	13.5	15.4	15.3	15.3	15.5	17.5	17.5	17.5	17.6	19.8	19.8	19.8	19.9	22.4	22.4	22.4	22.5	25.5	25.4	25.4	25.6

kW = Total system power
Amps = outdoor unit amps (comp.+fan)

Shaded area reflects AHRI conditions

IDB: Entering Indoor Dry Bulb Temperature
High and low pressures are measured at the liquid and suction service valves.

PERFORMANCE DATA

GLXS5BA1810A*+CAPTA1818*3A*				
CONDITIONS: 80 °F IBD, 67 °F IWB @ 525 CFM				
OUTDOOR TEM. ° F.	TOTAL BTU/H	SENSIBLE BTU/H	LATENT BTU/H	TOTAL WATTS
75	18,870	12,590	6,280	1,230
80	18,635	12,650	5,985	1,300
85	18,400	12,710	5,690	1,370
90	18,000	12,590	5,410	1,445
95	17,600	12,470	5,130	1,520
100	17,110	12,295	4,815	1,600
105	16,620	12,120	4,500	1,680
110	16,170	12,170	4,000	1,775
115	15,720	12,220	3,500	1,870
TVA CONDITIONS @ 95° OD DB, 75° ID DB 63° ID WB				
95°	16,970	12,190	4,780	1,520

GLXS5BA2410A*+CAPTA2422*3A*				
CONDITIONS: 80 °F IBD, 67 °F IWB @ 700 CFM				
OUTDOOR TEM. ° F.	TOTAL BTU/H	SENSIBLE BTU/H	LATENT BTU/H	TOTAL WATTS
75	25,310	17,050	8,260	1,650
80	24,995	17,130	7,865	1,740
85	24,680	17,210	7,470	1,830
90	24,140	17,050	7,090	1,930
95	23,600	16,890	6,710	2,030
100	22,940	16,650	6,290	2,140
105	22,280	16,410	5,870	2,250
110	21,680	16,480	5,200	2,385
115	21,080	16,550	4,530	2,520
TVA CONDITIONS @ 95° OD DB, 75° ID DB 63° ID WB				
95°	22,760	16,510	6,250	2,030

GLXS5BA3010A*+CAPTA3026*3A*				
CONDITIONS: 80 °F IBD, 67 °F IWB @ 900 CFM				
OUTDOOR TEM. ° F.	TOTAL BTU/H	SENSIBLE BTU/H	LATENT BTU/H	TOTAL WATTS
75	30,670	21,080	9,590	2,000
80	30,290	21,180	9,110	2,110
85	29,910	21,280	8,630	2,220
90	29,255	21,085	8,170	2,340
95	28,600	20,890	7,710	2,460
100	27,800	20,590	7,210	2,595
105	27,000	20,290	6,710	2,730
110	26,270	20,375	5,895	2,885
115	25,540	20,460	5,080	3,040
TVA CONDITIONS @ 95° OD DB, 75° ID DB 63° ID WB				
95°	27,580	20,410	7,170	2,460

GLXS5BA3610A*+CAPTA3626*3A*				
CONDITIONS: 80 °F IBD, 67 °F IWB @ 1180 CFM				
OUTDOOR TEM. ° F.	TOTAL BTU/H	SENSIBLE BTU/H	LATENT BTU/H	TOTAL WATTS
75	37,100	26,520	10,580	2,430
80	36,640	26,645	9,995	2,560
85	36,180	26,770	9,410	2,690
90	35,390	26,520	8,870	2,835
95	34,600	26,270	8,330	2,980
100	33,635	25,895	7,740	3,140
105	32,670	25,520	7,150	3,300
110	31,785	25,630	6,155	3,490
115	30,900	25,740	5,160	3,680
TVA CONDITIONS @ 95° OD DB, 75° ID DB 63° ID WB				
95°	33,370	25,670	7,700	2,980

GLXS5BA4210A*+CAPTA4230*3A*				
CONDITIONS: 80 °F IBD, 67 °F IWB @ 1400 CFM				
OUTDOOR TEM. ° F.	TOTAL BTU/H	SENSIBLE BTU/H	LATENT BTU/H	TOTAL WATTS
75	42,890	30,740	12,150	2,810
80	42,360	30,885	11,475	2,960
85	41,830	31,030	10,800	3,110
90	40,915	30,740	10,175	3,275
95	40,000	30,450	9,550	3,440
100	38,885	30,020	8,865	3,625
105	37,770	29,590	8,180	3,810
110	36,750	29,710	7,040	4,025
115	35,730	29,830	5,900	4,240
TVA CONDITIONS @ 95° OD DB, 75° ID DB 63° ID WB				
95°	38,570	29,760	8,810	3,450

GLXS5BA4810A*+CAPTA6030*3A*				
CONDITIONS: 80 °F IBD, 67 °F IWB @ 1450 CFM				
OUTDOOR TEM. ° F.	TOTAL BTU/H	SENSIBLE BTU/H	LATENT BTU/H	TOTAL WATTS
75	48,790	32,900	15,890	3,170
80	48,185	33,055	15,130	3,350
85	47,580	33,210	14,370	3,530
90	46,540	32,900	13,640	3,725
95	45,500	32,590	12,910	3,920
100	44,230	32,125	12,105	4,135
105	42,960	31,660	11,300	4,350
110	41,800	31,795	10,005	4,605
115	40,640	31,930	8,710	4,860
TVA CONDITIONS @ 95° OD DB, 75° ID DB 63° ID WB				
95°	43,880	31,850	12,030	3,920

GLXS5BA6010A*+CAPTA6030*3A*				
CONDITIONS: 80 °F IBD, 67 °F IWB @ 1485 CFM				
OUTDOOR TEM. ° F.	TOTAL BTU/H	SENSIBLE BTU/H	LATENT BTU/H	TOTAL WATTS
75	61,120	38,650	22,470	3,930
80	60,360	38,830	21,530	4,165
85	59,600	39,010	20,590	4,400
90	58,300	38,650	19,650	4,655
95	57,000	38,290	18,710	4,910
100	55,410	37,745	17,665	5,195
105	53,820	37,200	16,620	5,480
110	52,365	37,355	15,010	5,810
115	50,910	37,510	13,400	6,140
TVA Conditions @ 95° OD DB, 75° ID DB 63° ID WB				
95°	54,970	37,420	17,550	4,910

MODEL	DIMENSIONS		
	W"	D"	H"
GLXS5BA1810A*	26	26	27
GLXS5BA2410A*	29	29	32
GLXS5BA3010A*	35½	35½	39½
GLXS5BA3610A*	35½	35½	39½
GLXS5BA4210A*	35½	35½	36½
GLXS5BA4810A*	35½	35½	36½
GLXS5BA6010A*	35½	35½	41½

*Note: All the Dimensions (W, D, H) are for reference only.

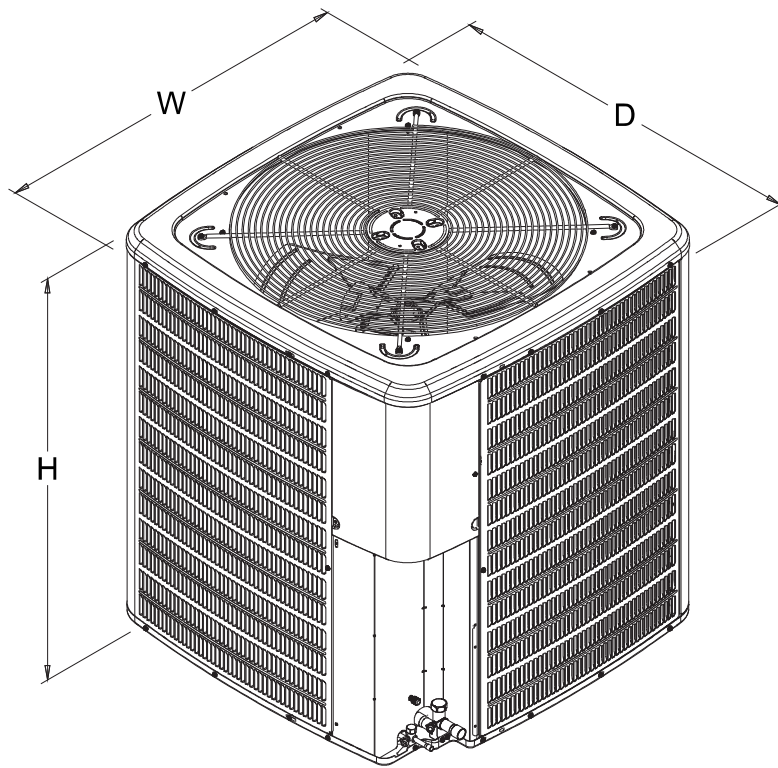

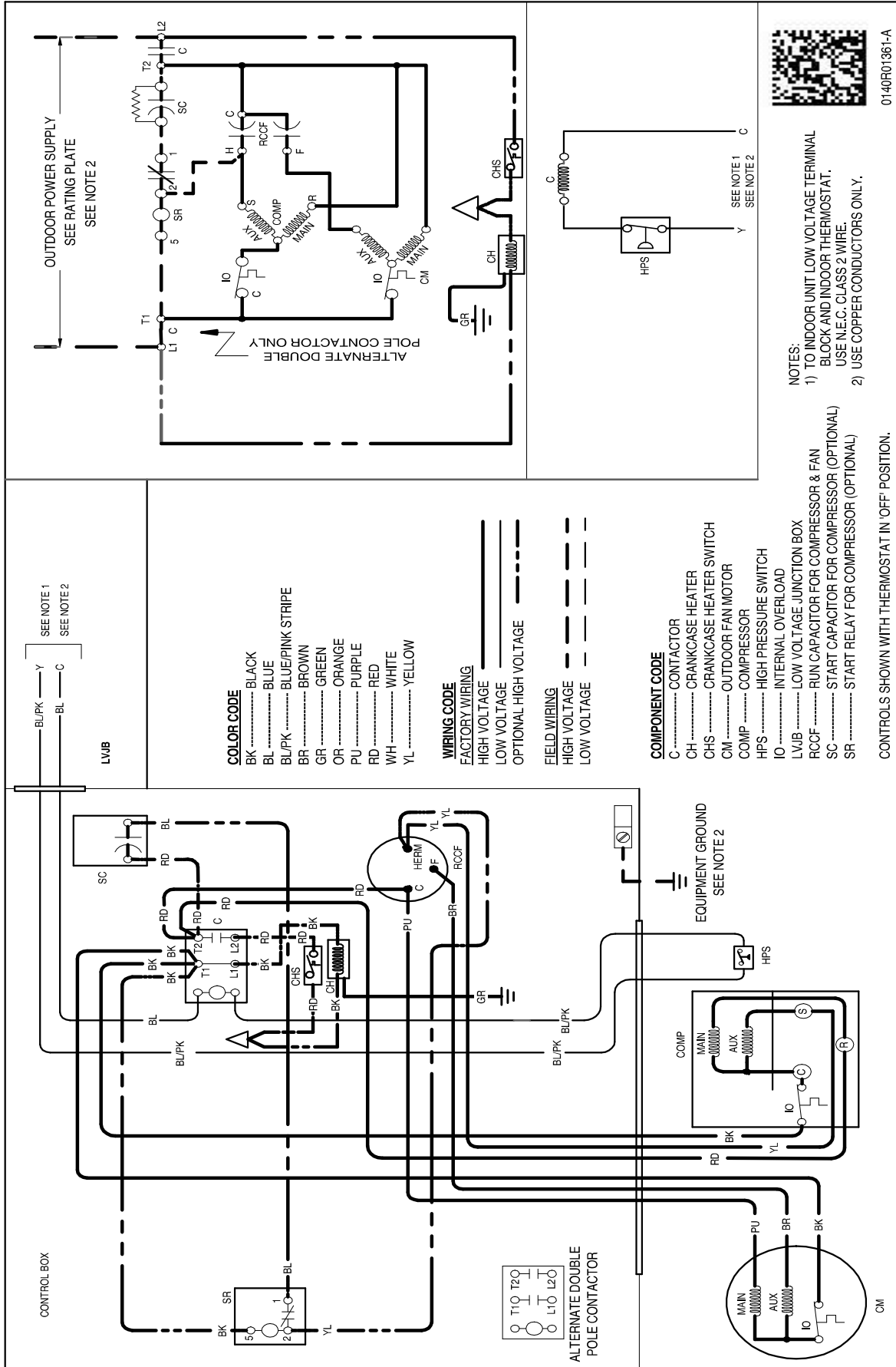

WARNING

High Voltage: Disconnect all power before servicing or installing this unit. Multiple power sources may be present. Failure to do so may cause property damage, personal injury, or death.

Wiring is subject to change. Always refer to the wiring diagram or the unit for the most up-to-date wiring.

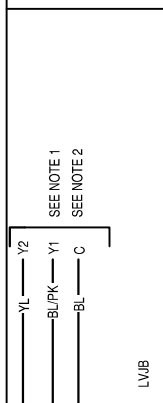
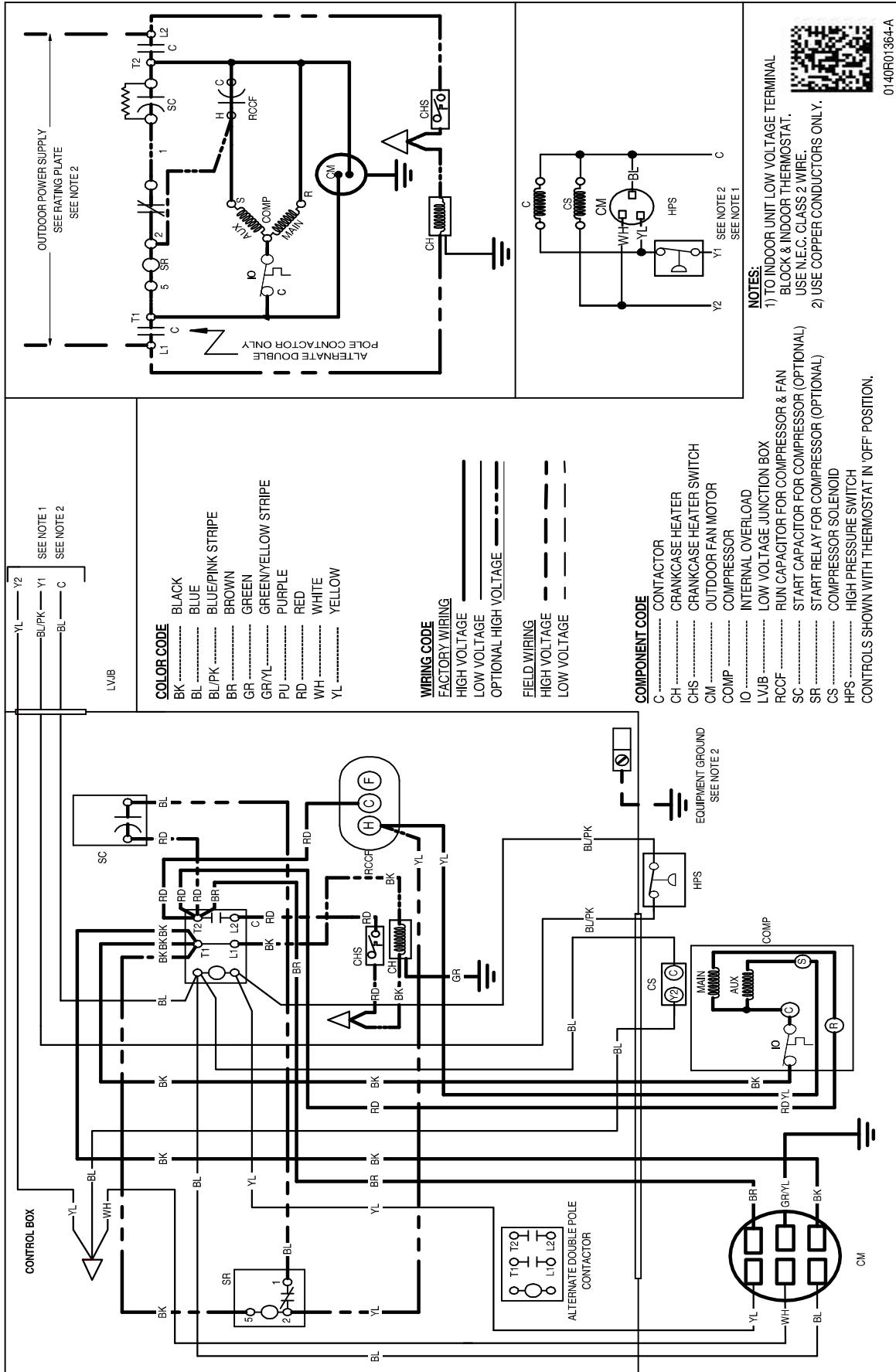

COLOR CODE

BK	BLACK
BL	BLUE
BL/PK	BLUE/PINK STRIPE
BR	BROWN
GR	GREEN
GR/YL	GREEN/YELLOW STRIPE
PU	PURPLE
RD	RED
WH	WHITE
YL	YELLOW

WIRING CODE

FACTORY WIRING

=====	HIGH VOLTAGE
-----	LOW VOLTAGE
-----	OPTIONAL HIGH VOLTAGE

FIELD WIRING

-----	HIGH VOLTAGE
-----	LOW VOLTAGE

COMPONENT CODE

C	CONTACTOR
CH	CRANKCASE HEATER
CHS	CRANKCASE HEATER SWITCH
CM	OUTDOOR FAN MOTOR
COMP	COMPRESSOR
IO	INTERNAL OVERLOAD
LVJB	LOW VOLTAGE JUNCTION BOX
RCCF	RUN CAPACITOR FOR COMPRESSOR & FAN
SC	START CAPACITOR FOR COMPRESSOR (OPTIONAL)
SR	START RELAY FOR COMPRESSOR (OPTIONAL)
CS	COMPRESSOR SOLENOID
HPS	HIGH PRESSURE SWITCH

CONTROLS SHOWN WITH THERMOSTAT IN 'OFF' POSITION.

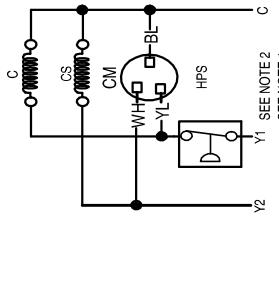
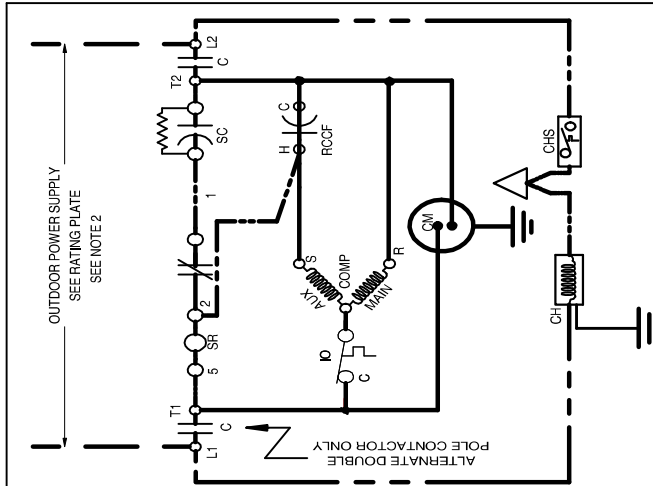

NOTES:

- TO INDOOR UNIT LOW VOLTAGE TERMINAL BLOCK & INDOOR THERMOSTAT. USE N.E.C. CLASS 2 WIRE.
- USE COPPER CONDUCTORS ONLY.



0140R01364-A

WARNING

High Voltage: Disconnect all power before servicing or installing this unit. Multiple power sources may be present. Failure to do so may cause property damage, personal injury, or death.

ACCESSORIES

MODEL	DESCRIPTION	GLXS5B A1810A*	GLXS5B A2410A*	GLXS5B A3010A*	GLXS5B A3610A*	GLXS5B A4210A*	GLXS5B A4810A*	GLXS5B A6010A*
016R00128	Neutral Circular Cap	X	X	X	X	X	X	
ABK-20	Anchor Bracket Kit ^	X	X	X	X	X	X	X
ASC01A	Anti-Short Cycle Kit	X	X	X	X	X	X	X
CSR-U-1	Hard-start Kit	X	X	X	X			
CSR-U-2	Hard-start Kit				X	X	X	X
CSR-U-3	Hard-start Kit						X	X
Factory Installed Crank Case Heater						X	X	X
0163R00006	Crank Case Heater	X	X	X	X			
0130M00106	CCH Temp Switch	X	X	X	X			
FSK01A ¹	Freeze Protection Kit	X	X	X	X	X	X	X
LSK02A ²	Liquid Line Solenoid Kit	X	X	X	X	X	X	X
LAKT01	Low-Ambient Kit	X	X	X	X	X	X	
0130R000005	Low-Pressure Switch Kit	X	X	X	X	X	X	X

[^] Contains 20 brackets; four brackets needed to anchor unit to pad

¹ Installed on indoor coil

² Condensing units and heat pumps with reciprocating or rotary compressors require the use of start-assist components when used in conjunction with an indoor coil using a non-bleed thermal expansion valve refrigerant metering device or liquid line solenoid kit. The TXV should always be sized based on the tonnage of the outdoor unit.

All AHRI system ratings are accessible in the System Configurator tool via PartnerLink.

