



FLUSHMATE® INTELLI-Flush™

AUTOMATIC FLUSHING SYSTEM

Installation Instructions MODEL # K-100

Flushmate®
30075 Research Drive,
New Hudson, MI 48165
Phone: (248) 446-5300
800-533-3450
www.flushmate.com

COMPONENTS

Tools Required: Philips and slotted screwdriver, pliers and ruler.

- A) Flush Module
- B) Battery Pack
- C) Battery Holder
- D) Override Button
- E) Cover Key
- F) T-Wrench/Depth Gauge/ Sensor Tool
- G) Screws & Anchors (2)
- H) C-cell Alkaline Batteries (4)
- I) AA-cell Alkaline Batteries (4)
- J) On-Wall Sensor
- K) Adapter 504
- L) Adapter 501-B
- M) Mounting Screws (8)

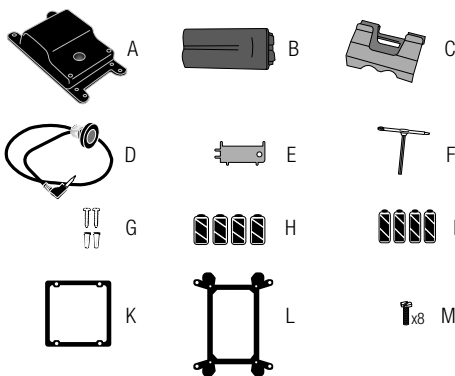

The Sensor and Flush Module contained within this kit have been programmed to work together and should not be switched with similar components from other kits.

Not designed for use with center push-button tanks.

STEP #1

- Remove retainer clips, (image 1), flush rod, (image 2), and handle, (image 3). (Note: reverse threads on handle.)

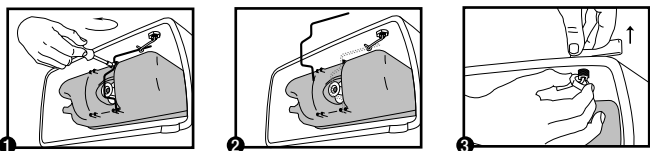

STEP #2

- Install Override Button (D), (image 4). Identify appropriate Adapter (L or M) if needed, (image 5).

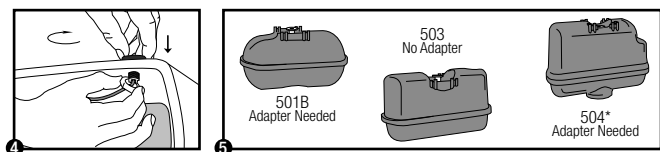

*Does not support Mancosa, Vitromex, St. Thomas and Gerber 1-pc 21-012 fixtures.

- Place Flush Module (A) in position over Actuator (image 6). (Actuator is the centered white disk with Philip screw in center.) If using Adapter, (image 7) note the positioning of the Flush Module (A) wire, (image 6 & 7).
- Insert T-wrench/Depth Gauge/Sensor tool (F) in hole of Flush Module (A), (image 8). Adjust Actuator by loosening set screw and turning Actuator to proper height according to depth gauge, so that yellow ring on depth gauge aligns with top of Flush Module (A), (image 9). Tighten set screw on Actuator.
- Attach the Flush Module (A) with (4) screws, (image 10). For the 501-B Adapter (M), (8) screws are required.

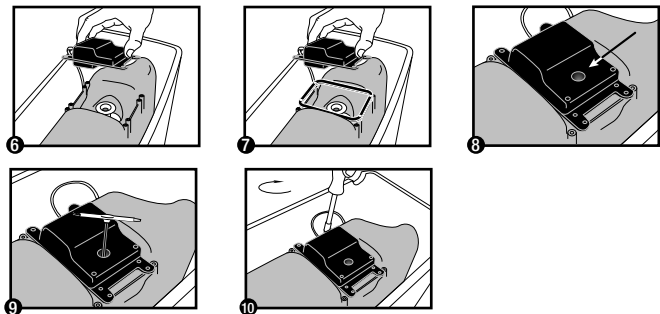

STEP #3

- Plug Override Button (D) wire into Flush Module (A), (image 11)
- Remove cover on Battery Pack (B), (image 12). Install batteries, (image 13), noting the battery polarity (+/-) printed on pack. Reinstall cover on Battery Pack (B), (image 14). Place Battery Pack (B) in Battery Holder (C), (image 15). Hang Battery Holder (C) on top edge of china tank and connect the Flush Module (A) wire into the Battery Pack (B). Slide rubber boot over connection, (image 16). (Using the Battery Holder (C) is optional. If there is ample space, you can place it anywhere in the tank as long as the wire is not being stretched.)

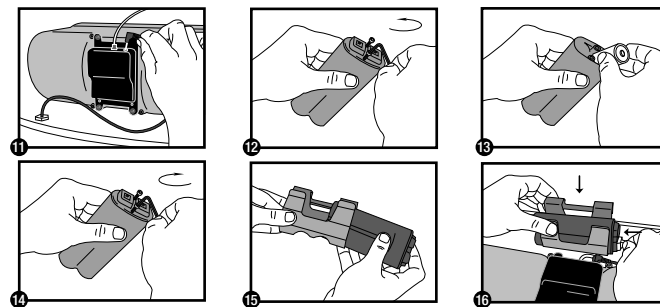

STEP #4 On-Wall Sensor Mounting

- Center sensor eye 2-1/2" above the seat in up position, (image 17). Attach to wall using adhesive strip and/or screws & anchors (G). Note the orientation of the sensor, (image 17). **WARNING:** Adhesive strip can only be applied once; once installed it is difficult to remove.
- Remove cover using key, (image 18) and install (4) AA batteries. Reattach sensor cover. To adjust sensor range see Step #5.

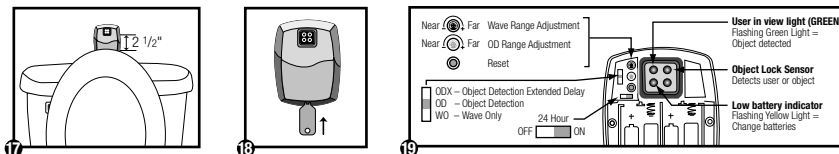

STEP #5 Adjusting AutoFlush Range

OD – Object Detection Range Adjustment – (factory setting is 32") ODX – Object Detection Extended Delay Range adjustment – (factory setting is 32")

- Remove the cover of the sensor assembly with the sensor cover key (E).
- Remove the rubber seal located on the left side of the sensor lens.
- Press sensor range reset button shown above (image 19).
NOTE: The green light will flash continuously when it has an object in view during the seven minute reset period. This allows you to select the correct range.
- Hold a white piece of paper in front of the sensor. Slowly back the paper away until the green light stops, to determine if the sensor range needs to be adjusted Near or Far (max range = 48").
- Use the sensor adjustment tool to turn Object Detection (OD) Adjustment Screw as needed until the light flashes with the piece of paper held at the proper range.
- Ensure Object Lock Sensor is not detecting unwanted objects by stepping out of the sensor path making sure that the green light is not flashing. If sensor locks onto an unwanted object, unit will not flush properly.
- Replace sensor cover.
- After the 7-minute reset period, the green light will flash 3 times when a user is in view (after the 3 second delay in OD mode or 5 second delay in ODX mode).

WO – Wave Only Range Adjustment – (factory setting is 2")

- Remove the cover of the sensor assembly with the sensor cover key (E).
- Remove the rubber seal located on the left side of the sensor lens.
- Press sensor range reset button shown above (image 19).
- Place your hand at the required wave activation distance (max range = 6")
- Hold a white piece of paper in front of the sensor. Slowly back the paper away until the green light stops. Determine if the sensor range needs to be adjusted Near or Far.
- Ensure Wave Only Sensor is not detecting unwanted objects by moving your hand out of the sensor path and making sure the green light does not turn on. If sensor locks onto an unwanted object, unit will not flush properly. Shorten, activation distance.
- Replace sensor cover.
- After the 7-minute reset period, the green light will turn on when your hand is in view.

STEP #6 Test Sensor Range/Adjustment

Sensor is factory set. Green light on sensor will flash 3 times at the start of every use. Should the sensor need adjusting:

- Remove the cover using Cover Key (E), (image 18). For On-Wall sensor, remove rubber cover concealing the reset button and range adjuster screw.
- Depress the sensor range reset button, (image 19). During the 7 minute start up sequence the green light flashes constantly when a user is in view.
- Using the Sensor Tool (F), turn the sensor range adjustment screw, (image 19) counter-clock wise, shortening the sensor range, until the green light stops flashing while you are standing at the front rim of the bowl. Slowly turn the sensor range adjustment screw clock-wise until the green light flashes while standing at the front of the bowl.
- Reinstall rubber cover for On-Wall sensor and re-attach the cover.

Modes of Operation

The INTELLI-Flush™ comes with 4 modes of operation:

- Switchable automatic flush time delay setting (5 or 7 second). Object Detection (OD) and Object Detection with Extended Delay (ODX). Toilet will flush 5 seconds after patron leaves sensing zone (32" factory setting). For immediate flush, patron can wave hand in front of sensor (factory setting).
- Hand wave actuation (WO). Toilet will flush only when patron waves hand in front of sensor.
- Override. Override button replaces flush handle and flushes on demand every time it is depressed.
- 24-hour auto-flush feature (switchable ON/OFF). Factory setting-OFF, the sensor can be set to automatically flush the toilet every 24 hours from the last flush. Recommended for commercial installation. To activate, push the 24-hour switch to ON position.

TROUBLESHOOTING

PROBLEM	CAUSE	SOLUTION TO PROBLEM
Green light flashes 3 times when there are no users.	Front of Object Lock Sensor is covered or Object Lock Sensor is set too far out, registering unwanted object.	Remove item covering sensor or adjust Sensor Object Lock activation distance. (See image 19 - Adjust Sensor Range)
Yellow light flashes.	Batteries need replacing.	Replace batteries. Use Only Alkaline Batteries.

OBJECT LOCK SENSOR - Detects user or object.

BATTERY LIGHT - Yellow light flashes indicating it is time to replace the batteries.

USER-IN-VIEW LIGHT - Green light flashes 3 times, after 5 second delay, when a user is in view. The green light flashes constantly when a user is in view during the 7 minute start up sequence.

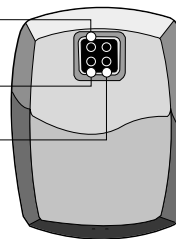

This device complies with Part 15 of the FCC Rules. Operation is subject to the following two conditions:
(1) this device may not cause harmful interference; and (2) this device must accept any interference received, including interference that may cause undesired operation.
FCC ID: RNW0009919150

Battery pack is equipped with a red light.

- During normal operation the red light should flash three times. If not, check the batteries in the sensor and if needed re-synchronize the sensor. (Separate instructions)
- A constant flashing red light indicates low voltage and the batteries should be replaced.

Date Installed: _____

Serial No.: _____

Please keep tools accessible for future use. For additional information visit: <http://www.flushmate.com>.

ATTENTION OWNER: THESE ARE THE TERMS OF YOUR LIMITED WARRANTY

Sloan Flushmate® (the "Company") warrants the INTELLI-Flush™ Automatic Flushing System (the "unit") to be free of defects in material and workmanship for a period of one (1) year from the date of purchase and the Company promises to provide a replacement for any part of this product that proves, upon our inspection and within one year from date of purchase, to be defective in material or workmanship. All labor and transportation costs or charges incidental to warranty service are to be borne by the purchaser-user. This limited warranty does not cover the life of the batteries and is subject to the following:

Specific Conditions to Limited Warranty

- A Warranty Registration card has been fully completed and mailed by the purchaser (the "user") to the Company within thirty (30) days of the date of purchase. Product may also be registered online at www.flushmate.com or by calling 800-533-3460.
- The unit has been subject to proper installation, operation and maintenance as outlined in the installation instructions that were supplied with the unit. Note carefully that this warranty is voided if the unit is installed on anything other than 501-B, 503, 504, or later Series Flushmate® systems.
- Service and repairs may only be performed by authorized representatives of the Company or by others upon specific approval by the Company. Unauthorized repairs or alterations shall specifically void the warranty.

- USE OF PETROLEUM-BASED LUBRICANTS OR CORROSIVE CLEANING PRODUCTS CONTAINING CHLORINE, SUCH AS HOUSEHOLD BLEACH, DROP-IN BLOCKS OR TABLETS, OR DISINFECTANTS THAT ARE APPLIED INSIDE THE CHINA HOLDING TANK WILL VOID YOUR INTELLI-Flush™ WARRANTY.
- PROOF OF PURCHASE IS REQUIRED.

Exclusions

IN NO EVENT SHALL THE COMPANY BE LIABLE FOR INCIDENTAL OR CONSEQUENTIAL DAMAGES, FOR DAMAGES RESULTING FROM IMPROPER INSTALLATION, OR FOR DAMAGES CAUSED BY NEGLIGENCE, ABUSE OR ALTERATION. ALL IMPLIED WARRANTIES, INCLUDING ANY IMPLIED WARRANTY OF MERCHANTABILITY OR FITNESS FOR ANY PARTICULAR PURPOSE ARE LIMITED TO A PERIOD OF ONE (1) YEAR FROM DATE OF PURCHASE.

Some states do not allow limitations on the duration of an implied warranty and some states do not allow exclusions or limitations regarding incidental or consequential damages so the above limitations may not apply to you. This warranty gives you specific legal rights and you may have other rights which vary from state to state. No person is authorized to change, add to, or create any warranty or obligation other than that set forth herein. To obtain warranty service, contact Consumer Services toll free (USA, CANADA, and MEXICO) 800-533-3460 or write to us at:

Flushmate® A Division of Sloan Valve Company, ISO 17025 Certified, 30075 Research Drive, New Hudson, MI 48165 U.S.A., 800-533-3460, 248-446-5300, www.flushmate.com