



Global Pipe Manufacturer

EASYFLEX®

PRODUCT CATALOG





OUR COMMITMENT ***OVER 30 YEARS OF MANUFACTURING***

Easyflex, Inc. is a leading manufacturer and distributor of corrugated stainless steel tubing products. Our specialization over the years of flexible corrugated stainless steel products has made job completion easier and faster which is also cost-effective for all end users. Combining the strength of stainless steel with flexibility of corrugation are the top reasons why its popularity has increased in recent years with its customers around the world. Our product line is an excellent choice for new construction or renovation projects.

Easyflex's warehouse is located in Denton, TX which also acts as our on-site distribution center where we fully stock and ship products to our customers. For decades, Easyflex has been producing superior products and serving more than 50 countries throughout the world. Innovation, detail orientation, quality control, and determination are core values that have delivered superior results. Our company philosophy is the backbone and the engine that has made us where we are today. We emphasize in manufacturing high quality products and understand the importance of affordability to our customers. Easyflex believes in producing top notch products for our first class customers and find ways to save them money.

Flexible lines are rapidly replacing rigid pipes in new construction because of its flexibility and cost saving installation. They are widely used to retrofit in tenant improvement projects. The greatest advantage of using flexline in place of rigid piping is incredible time saving benefits in installation. Rather cutting the tube to exact length and making 90 degree connections every time you need a bend, flexlines offer the ease of simply bending the tubing—without any extra connections—for a hassle-free installation of one seamless line.

Our ultimate goal is to connect the world with Easyflex products and to demonstrate a safer, simpler, and easier way to get the job done.

Why

Should You Choose Easyflex?

It's Easy.

Imagine installing an entire gas or water line system with just one connection at each end! No more mid-line connections, cuts, angles, and bulky fittings, just one clean line that gives you the freedom to make bends by hand wherever and whenever you need them.

It's Fast.

It is perhaps the greatest advantage of using Easyflex flexible CSST. By eliminating all the countless steps of measuring and cutting to account for those rigid 90 degree angles, you save valuable time on installation.

It's Durable.

Stainless steel 304 is strong, corrosion-resistant, and withstands natural wear and tear better over time than rigid piping alternatives. When it comes to the longevity of the material, there's no comparison to stainless steel.

It's Flexible.

Annular corrugations of the tubing create flexibility by working with the strength of stainless steel.

It's Lightweight.

Tubing, ranging from 50 ft. in length to 150 ft., is efficiently coiled into a single roll that you can easily carry over your shoulder. You only need one trip from your car to the job site.

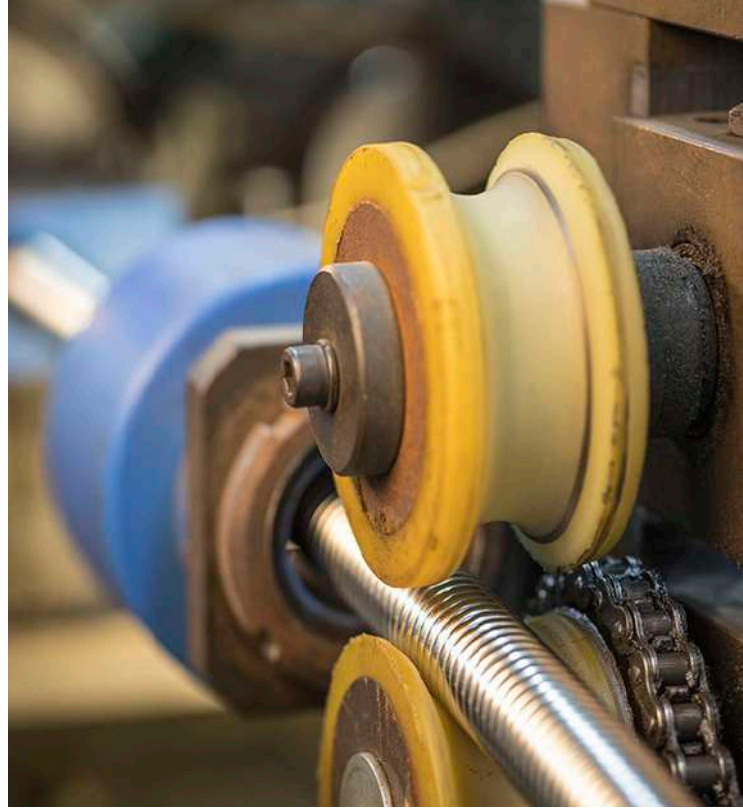

ORDERING INFORMATION

Our Locations



Central Office

1500 N. Western Blvd. Suite #280
Denton, TX 76207

West Coast Office

2700 N. Main St. Suite #800
Santa Ana, CA 92705

 **Toll Free** (888) 577-8999

Tel: (714) 897-2200

Email: info@easyflexusa.com

Fax: (714) 892-2221

Submit Order: order@easyflexusa.com

SALES REPRESENTATION

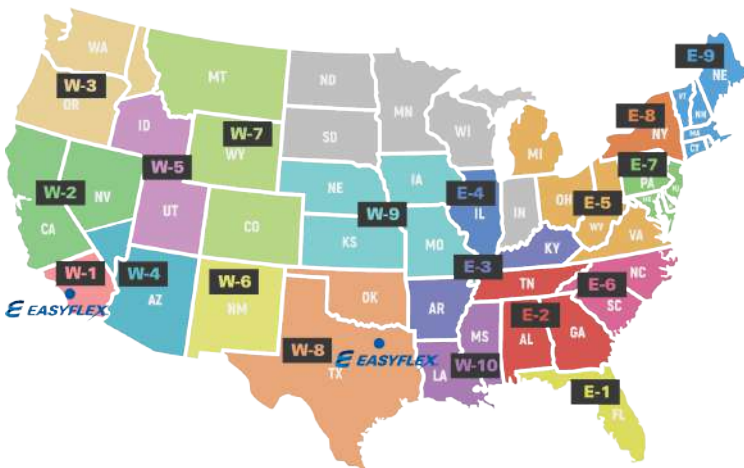

- | | |
|---|--|
| W-1 S. CA
O' Connor Sales, Inc. | E-1 FL
Maco Southeast, llc |
| W-2 CA / NV
Elmco + Associates | E-2 AL / GA / TN
Odum Sales |
| W-3 WA / OR
Norpac, Inc. | E-3 KY / AR
Kemper Sales & Associates |
| W-4 AZ
DW Sales Reps | E-4 IL
HOK Sales |
| W-5 UT / ID
G & S Sales, Inc. | E-5 MI / OH / WV / VA
Moxie Market Sales, Inc. |
| W-6 NM
Pinnacle Marketing, Inc. | E-6 SC / NC
Richardson Sales Inc. |
| W-7 CO / WY / MT
Dalcart & Associates, Inc. | E-7 PA / MD / DE / NJ
East Coast Marketing |
| W-8 TX / OK
Tipton Company | E-8 NY
Rothenberg Associates |
| W-9 KS / MO / NE / IA
Prism Sales, Inc. | E-9 NE
KSM Enterprise |
| W-10 LA / MS
Superior Products Inc.
BBWC | |

CONTENTS



05 **Gastop** *Gas Connectors*
EFV • Gas Connectors • Gas Fittings • Gas Valves

Gas
Connectors



57 *Commercial Gas Connectors*
Food Service Gas Connectors • Countertop Gas Connectors • Stationary Gas Connectors

Commercial
Gas
Connectors



71 **vectorFLEX** *Gas Line System*
VectorFlex™ Gas CSST Tubing • Accessories • Manifold

Gas
Line System



85 **QuickFLARE**™ *Gas CSST Fittings*
QuickFlare™ Brass Fittings • Full Port Ball Valves

Gas
CSST Fittings



91 **vectorFLOW** *Water Line System*
VectorFlow™ Water CSST Tubing • Accessories • Manifold

Water
Line System



99 **QuickSNAP**™ *Water CSST Fittings*
QuickSnap™ Lead-Free Brass Fittings/Brass Fittings • Full Port Ball Valves

Water
CSST Fittings



107 **Safeflow** *Braided Water Connectors*
Braided Water Connectors • Safeflow Braided Water Connectors

Braided
Water
Connectors



121 *Supply Stop Valves*
1/4-Turn Ball Valves

Supply stop
Valve



127 *Water Heater Connectors*
Water Heater Connectors • Copper Water Heater Connectors

Water
Heater
Connectors



137 **SOFT-TURN** *Isolation Valves*
Isolation Valve Kit • Lead-Free Isolation Valve Kit

Isolation
Valves



147 **TANK ONE** *Thermal Expansion Tanks*

Thermal
Expansion
Tanks



151 *No-Hub Couplings*

No-Hub
Couplings

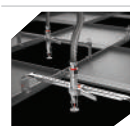

157 *Flexible Sprinkler Drops*

Flexible
Sprinkler
Drops

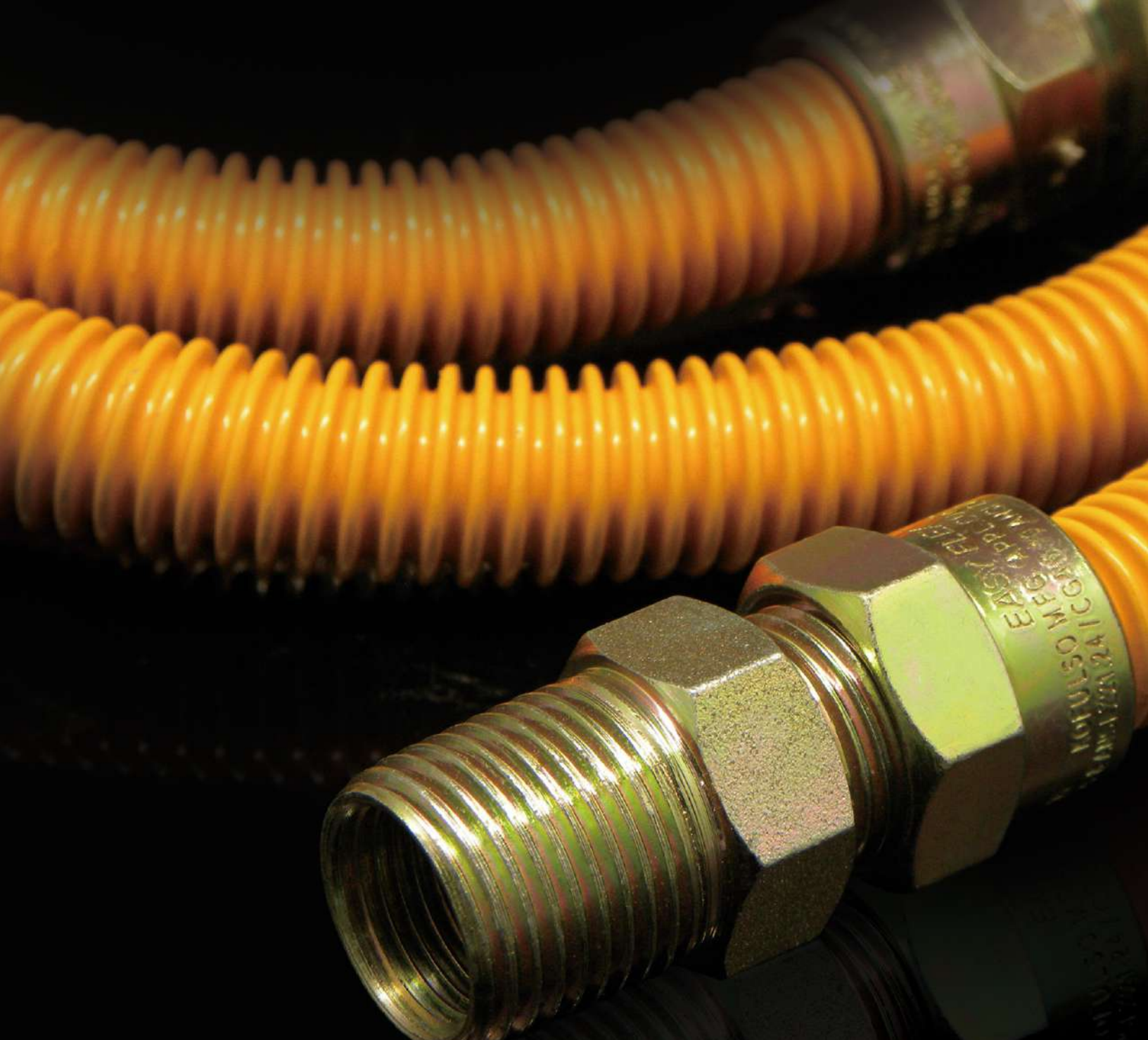

Stainless Steel Flexible Gas Connectors

Complete selection of flexible connectors for gas appliance applications.

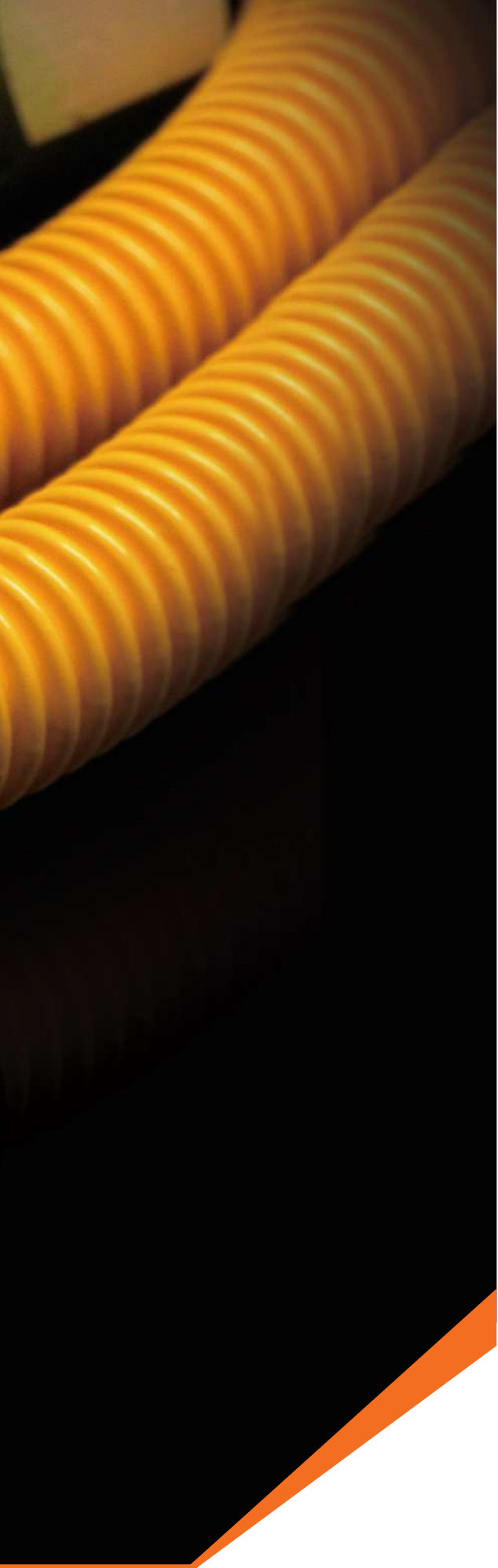

Stainless Steel Flexible Gas Connectors

Applications

Dryers / Boilers / Fireplace / Space Heaters /
Manufactured Homes / Tankless Water Heaters /
Rooftop Units / Ranges / Ovens / BBQ Grills / Furnaces

Benefits

- Flexible to Reduce Labor Costs
- Interchangeable Fittings for Any Application
- Corrosion & Scaling Resistant
- Withstand 15 Applications of 90° Twists

Certifications & Approvals

- ANSI Z 21.24 / CSA 6.10 Gas Appliances
- ANSI Z 21.75 / CSA 6.27 Outdoor Gas Appliances & Manufactured Homes
- Commonwealth of Massachusetts Board of State Examiners
- City of New York-MEA #376-92-M



Materials

Tubing	Stainless Steel 304(ASTM A240)
Coating	Epoxy
Fitting	Zinc-Plated Steel S45C

Pressure-Temperature

Rated Operating Temperature	-40°F to 150°F (-40°C to 65°C)
Rated Pressure	0.5 psi

Gas Connectors

Commercial Gas Connectors

Gas Line System

Gas CSST Fittings

Water Line System

Water CSST Fittings

Braided Water Connectors

Supply stop Valve

Water Heater Connectors

Isolation Valves

Thermal Expansion Tanks

No-Hub Couplings

Flexible Sprinkler Drops

Stainless Steel Flexible **Gas Connectors**

Product Testing

Strength Test	Withstands an internal hydrostatic pressure of 250 psi (17MPa) without bursting or leaking.
Bending Test	Withstands 30 bends without leaking in depths of 2 inches or less of water.
Torsion Test	Withstands 15 applications of 90° twists.
Durability at High Temperature Test	Withstands up to 800°F.
Strength of Fittings	Does not leak within a tightened torque of 1,040 inch-pounds.

CERTIFICATIONS, APPROVALS, LISTINGS and COMPLIANCE

United States | CSA USA Standards Association

- ANSI Z 21.24 Connectors for Gas Appliances
- ANSI Z 21.75 Connectors for Outdoor Appliances and Manufactured Homes

Canada | CSA Canadian Standards Association

- CSA 6.10 Connectors for Gas Appliances
- CSA 6.27 Connectors for Outdoor Appliances and Manufactured
- Meets the requirements of CSA B149.1 National Gas and Propane Installation Code



Connector Minimum Flow Capacity

Straight Length Capacity (BTU/Hr., 0.64 Sp Gr., 1,000 BTU per cubic ft. at 0.5 inch W.C. pressure drop)

Series	Nominal OD	Nominal ID	12"	18"	24"	30"	36"	48"	60"	72"
014	3/8"	1/4"	48,000	43,800	40,000	36,400	33,400	28,300	24,900	23,100
038	1/2"	3/8"	102,000	93,100	85,000	77,100	71,100	60,500	53,200	49,100
012	5/8"	1/2"	180,000	164,200	150,000	136,000	125,000	106,000	93,200	86,000
034	1"	3/4"	290,900	290,900	290,900	270,500	255,900	215,000	197,400	173,900

The above flow capacities are the minimum performance requirement per ANSI Z21.24 CSA 6.10 & ANSI Z21.75-CSA 6.27. Easyflex Gas Connectors exceed these minimum flow capacity requirements.

Stainless Steel Flexible **Gas Connectors**



Certificate of Compliance

Certificate: 1992377 Master Contract: 238420
Project: 1992377 Date Issued: 2008/02/19
Issued to: Kofulso Co., Ltd.
377-8 Gungok-Dong, Seo-Gu
Inchon City,
South Korea

The products listed below are eligible to bear the CSA Mark shown with adjacent indicators 'C' and 'US'



Issued by: Russell Dworzniak

Authorized by: Trevor Perera, Manager of Certification Services

Trevor Perera

PRODUCTS

- CLASS 3303 86** - CONNECTORS (GAS) - Gas Appliances and - Manufactured Homes-Certified to US Standards
- CLASS 3303 06** - CONNECTORS (GAS) - Outdoor Gas Appliances - and Manufactured Homes
- CLASS 3303 85** - CONNECTORS (GAS) - For Moveable Appliances-Certified to U.S. Standards
- CLASS 3303 05** - CONNECTORS (GAS) - For Moveable Appliances
- CLASS 3303 81** - CONNECTORS (GAS) - Connectors For Gas Appliances-Certified to U.S. Standards
- CLASS 3303 01** - CONNECTORS (GAS) - Connectors For Gas Appliances

The 'C' and 'US' indicators adjacent to the CSA Mark signify that the product has been evaluated to the applicable CSA and ANSI/UL Standards, for use in Canada and the U.S., respectively. This 'US' indicator includes products eligible to bear the 'NRTL' indicator. NRTL, i.e. National Recognized Testing Laboratory, is a designation granted by the U.S. Occupational Safety and Health Administration (OSHA) to laboratories which have been recognized to perform certification to U.S. Standards.

Gas Connectors

Commercial Gas Connectors

Gas Line System

Gas CSST Fittings

Water Line System

Water CSST Fittings

Braided Water Connectors

Supply Stop Valve

Water Heater Connectors

Isolation Valves

Thermal Expansion Tanks

No-Hub Couplings

Flexible Sprinkler Drops

Stainless Steel Flexible Gas Connectors

Combining flexibility, durability, and functionality, Easyflex gas appliance connectors are CSA design certified and 100% leak tested for the quality and security you demand. Available in safe-guard epoxy coating in yellow, black, or uncoated stainless steel with the largest variety of fittings, we have the gas connectors that will meet your needs.



Easyflex Stainless Steel Gas Appliance Connectors

Easyflex gas connectors offer a full spectrum of products to fit your needs—whatever they may be. Corrosion resistant stainless steel 304 tubing and zinc-plated steel fittings are made with quality materials you can trust.



Easyflex Yellow Coated Gas Appliance Connectors

Easyflex Yellow Coated gas connectors offer the same wide variety of products with safe-guard yellow epoxy coating for added durability. It provides extra protection from corrosion, chemical stains from common household products, and during plumbing repairs. Corrosion resistant stainless steel 304 tubing and zinc-plated steel fittings are made with quality materials you can trust.



Easyflex Black Coated Gas Appliance Connectors

For gas hearth installations, Easyflex Black Coated gas connectors with safe-guard black epoxy coating are durable and corrosion resistant. Safe-guard protects better against common wear and tear, including chemical stains from common household products and during plumbing repairs.

With the additional benefit of the discreet black coating for minimal visibility, gas connectors are the ideal product for fireplaces, BBQ grills, and radiant heaters. Corrosion resistant stainless steel 304 tubing and zinc-plated steel fittings are made with quality materials you can trust.



Stainless Steel Flexible **Gas** Connectors

Parts Numbering System

EFGC - 012 - SS - 1010 - 12

TUBE ID | COATING | FITTINGS | LENGTH

TUBE ID

Part#	Size (ID)	Thread
014	1/4" ID (3/8" OD)	5/8"-18
038	3/8" ID (1/2" OD)	3/4"-16
012	1/2" ID (5/8" OD)	15/16"-16
034	3/4" ID (1" OD)	1-1/8"-16

COATING

Part#	
SS	Uncoated Stainless Steel 304
YE	Yellow Epoxy Coated Stainless Steel 304
BE	Black Epoxy Coated Stainless Steel 304

ADAPTERS/ VALVES

Part#	Size (ID)
10	1/2" MIP (Tapped 3/8" FIP)
11	1/2" FIP
12	3/8" MIP (Tapped 1/4" FIP)
13	3/8" FIP
14	3/4" MIP (Tapped 1/2" FIP)
15	3/4" FIP
16	1" MIP (Tapped 3/4" FIP)
17	1" FIP
31	1/2" FIP Ball Valve
33	3/4" FIP Ball Valve
41	1/2" FIP Angle Valve
43	3/4" FIP Angle Valve

LENGTH

Part#
12"
18"
24"
30"
36"
48"
60"
72"

Gas Connectors

Commercial Gas Connectors

Gas Line System

Gas CSST Fittings

Water Line System

Water CSST Fittings

Braided Water Connectors

Supply stop Valve

Water Heater Connectors

Isolation Valves

Thermal Expansion Tanks

No-Hub Couplings

Flexible Sprinkler Drops

Stainless Steel Flexible Gas Connectors

014-SS Series Connector with Fittings

- Tube : Stainless Steel
- Fitting : Zinc-Plated Steel S45C
- 5/8-18 Thread
- 3/8" OD (1/4" ID)

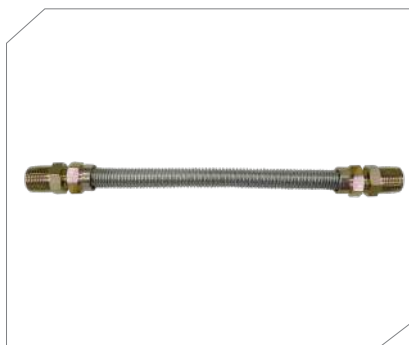

ID	Part #	Description	U/M	Price	Qty/ Box
1/4" (3/8"OD)	EFGC-014-SS-1010-12	1/2" MIP x 1/2" MIP, 12"	EA		25
1/4" (3/8"OD)	EFGC-014-SS-1010-18	1/2" MIP x 1/2" MIP, 18"	EA		25
1/4" (3/8"OD)	EFGC-014-SS-1010-24	1/2" MIP x 1/2" MIP, 24"	EA		25
1/4" (3/8"OD)	EFGC-014-SS-1010-30	1/2" MIP x 1/2" MIP, 30"	EA		25
1/4" (3/8"OD)	EFGC-014-SS-1010-36	1/2" MIP x 1/2" MIP, 36"	EA		25
1/4" (3/8"OD)	EFGC-014-SS-1010-48	1/2" MIP x 1/2" MIP, 48"	EA		25
1/4" (3/8"OD)	EFGC-014-SS-1010-60	1/2" MIP x 1/2" MIP, 60"	EA		12
1/4" (3/8"OD)	EFGC-014-SS-1010-72	1/2" MIP x 1/2" MIP, 72"	EA		12

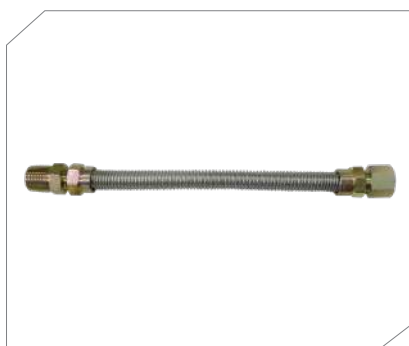

ID	Part #	Description	U/M	Price	Qty/ Box
1/4" (3/8"OD)	EFGC-014-SS-1011-12	1/2" MIP x 1/2" FIP, 12"	EA		25
1/4" (3/8"OD)	EFGC-014-SS-1011-18	1/2" MIP x 1/2" FIP, 18"	EA		25
1/4" (3/8"OD)	EFGC-014-SS-1011-24	1/2" MIP x 1/2" FIP, 24"	EA		25
1/4" (3/8"OD)	EFGC-014-SS-1011-30	1/2" MIP x 1/2" FIP, 30"	EA		25
1/4" (3/8"OD)	EFGC-014-SS-1011-36	1/2" MIP x 1/2" FIP, 36"	EA		25
1/4" (3/8"OD)	EFGC-014-SS-1011-48	1/2" MIP x 1/2" FIP, 48"	EA		25
1/4" (3/8"OD)	EFGC-014-SS-1011-60	1/2" MIP x 1/2" FIP, 60"	EA		12
1/4" (3/8"OD)	EFGC-014-SS-1011-72	1/2" MIP x 1/2" FIP, 72"	EA		12

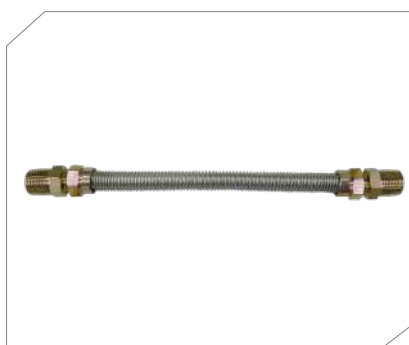

ID	Part #	Description	U/M	Price	Qty/ Box
1/4" (3/8"OD)	EFGC-014-SS-1012-12	1/2" MIP x 3/8" MIP, 12"	EA		25
1/4" (3/8"OD)	EFGC-014-SS-1012-18	1/2" MIP x 3/8" MIP, 18"	EA		25
1/4" (3/8"OD)	EFGC-014-SS-1012-24	1/2" MIP x 3/8" MIP, 24"	EA		25
1/4" (3/8"OD)	EFGC-014-SS-1012-30	1/2" MIP x 3/8" MIP, 30"	EA		25
1/4" (3/8"OD)	EFGC-014-SS-1012-36	1/2" MIP x 3/8" MIP, 36"	EA		25
1/4" (3/8"OD)	EFGC-014-SS-1012-48	1/2" MIP x 3/8" MIP, 48"	EA		25
1/4" (3/8"OD)	EFGC-014-SS-1012-60	1/2" MIP x 3/8" MIP, 60"	EA		12
1/4" (3/8"OD)	EFGC-014-SS-1012-72	1/2" MIP x 3/8" MIP, 72"	EA		12

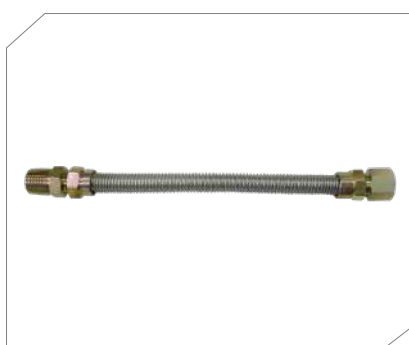

ID	Part #	Description	U/M	Price	Qty/ Box
1/4" (3/8"OD)	EFGC-014-SS-1013-12	1/2" MIP x 3/8" FIP, 12"	EA		25
1/4" (3/8"OD)	EFGC-014-SS-1013-18	1/2" MIP x 3/8" FIP, 18"	EA		25
1/4" (3/8"OD)	EFGC-014-SS-1013-24	1/2" MIP x 3/8" FIP, 24"	EA		25
1/4" (3/8"OD)	EFGC-014-SS-1013-30	1/2" MIP x 3/8" FIP, 30"	EA		25
1/4" (3/8"OD)	EFGC-014-SS-1013-36	1/2" MIP x 3/8" FIP, 36"	EA		25
1/4" (3/8"OD)	EFGC-014-SS-1013-48	1/2" MIP x 3/8" FIP, 48"	EA		25
1/4" (3/8"OD)	EFGC-014-SS-1013-60	1/2" MIP x 3/8" FIP, 60"	EA		12
1/4" (3/8"OD)	EFGC-014-SS-1013-72	1/2" MIP x 3/8" FIP, 72"	EA		12

Stainless Steel Flexible Gas Connectors

014-SS Series Connector with Fittings

- Tube : Stainless Steel
- Fitting : Zinc-Plated Steel S45C
- 5/8-18 Thread
- 3/8" OD (1/4" ID)



ID	Part #	Description	U/M	Price	Qty/ Box
1/4" (3/8"OD)	EFGC-014-SS-1213-12	3/8" MIP x 3/8" FIP, 12"	EA		25
1/4" (3/8"OD)	EFGC-014-SS-1213-18	3/8" MIP x 3/8" FIP, 18"	EA		25
1/4" (3/8"OD)	EFGC-014-SS-1213-24	3/8" MIP x 3/8" FIP, 24"	EA		25
1/4" (3/8"OD)	EFGC-014-SS-1213-30	3/8" MIP x 3/8" FIP, 30"	EA		25
1/4" (3/8"OD)	EFGC-014-SS-1213-36	3/8" MIP x 3/8" FIP, 36"	EA		25
1/4" (3/8"OD)	EFGC-014-SS-1213-48	3/8" MIP x 3/8" FIP, 48"	EA		25
1/4" (3/8"OD)	EFGC-014-SS-1213-60	3/8" MIP x 3/8" FIP, 60"	EA		12
1/4" (3/8"OD)	EFGC-014-SS-1213-72	3/8" MIP x 3/8" FIP, 72"	EA		12



014-SS Series Connector with Ball Valve

- Tube : Stainless Steel
- Fitting : Zinc-Plated Steel S45C
- 5/8-18 Thread
- 3/8" OD (1/4" ID)



ID	Part #	Description	U/M	Price	Qty/ Box
1/4" (3/8"OD)	EFGC-014-SS-1031-12	1/2" MIP x 1/2" B.Valve, 12"	EA		25
1/4" (3/8"OD)	EFGC-014-SS-1031-18	1/2" MIP x 1/2" B.Valve, 18"	EA		25
1/4" (3/8"OD)	EFGC-014-SS-1031-24	1/2" MIP x 1/2" B.Valve, 24"	EA		25
1/4" (3/8"OD)	EFGC-014-SS-1031-30	1/2" MIP x 1/2" B.Valve, 30"	EA		25
1/4" (3/8"OD)	EFGC-014-SS-1031-36	1/2" MIP x 1/2" B.Valve, 36"	EA		25
1/4" (3/8"OD)	EFGC-014-SS-1031-48	1/2" MIP x 1/2" B.Valve, 48"	EA		25
1/4" (3/8"OD)	EFGC-014-SS-1031-60	1/2" MIP x 1/2" B.Valve, 60"	EA		12
1/4" (3/8"OD)	EFGC-014-SS-1031-72	1/2" MIP x 1/2" B.Valve, 72"	EA		12

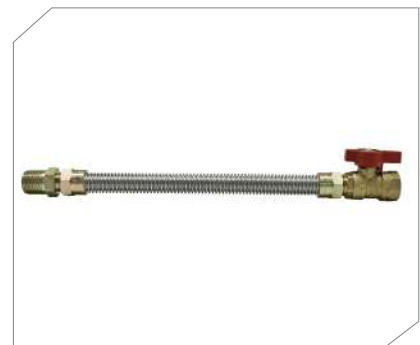

Gas Connectors

Commercial Gas Connectors

Gas Line System

Gas CSST Fittings

Water Line System

Water CSST Fittings

Braided Water Connectors

Supply stop Valve

Water Heater Connectors

Isolation Valves

Thermal Expansion Tanks

No-Hub Couplings

Flexible Sprinkler Drops

Stainless Steel Flexible Gas Connectors

014-YE Series Connector with Fittings

- Tube : Stainless Steel
- Coating : Yellow Epoxy
- Fitting : Zinc-Plated Steel S45C
- 5/8-18 Thread
- 3/8" OD (1/4" ID)

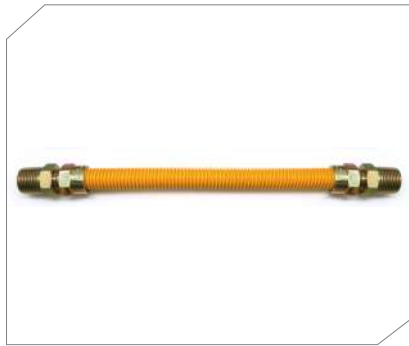

ID	Part #	Description	U/M	Price	Qty/ Box
1/4" (3/8"OD)	EFGC-014-YE-1010-12	1/2" MIP x 1/2" MIP, 12"	EA		25
1/4" (3/8"OD)	EFGC-014-YE-1010-18	1/2" MIP x 1/2" MIP, 18"	EA		25
1/4" (3/8"OD)	EFGC-014-YE-1010-24	1/2" MIP x 1/2" MIP, 24"	EA		25
1/4" (3/8"OD)	EFGC-014-YE-1010-30	1/2" MIP x 1/2" MIP, 30"	EA		25
1/4" (3/8"OD)	EFGC-014-YE-1010-36	1/2" MIP x 1/2" MIP, 36"	EA		25
1/4" (3/8"OD)	EFGC-014-YE-1010-48	1/2" MIP x 1/2" MIP, 48"	EA		25
1/4" (3/8"OD)	EFGC-014-YE-1010-60	1/2" MIP x 1/2" MIP, 60"	EA		12
1/4" (3/8"OD)	EFGC-014-YE-1010-72	1/2" MIP x 1/2" MIP, 72"	EA		12



ID	Part #	Description	U/M	Price	Qty/ Box
1/4" (3/8"OD)	EFGC-014-YE-1011-12	1/2" MIP x 1/2" FIP, 12"	EA		25
1/4" (3/8"OD)	EFGC-014-YE-1011-18	1/2" MIP x 1/2" FIP, 18"	EA		25
1/4" (3/8"OD)	EFGC-014-YE-1011-24	1/2" MIP x 1/2" FIP, 24"	EA		25
1/4" (3/8"OD)	EFGC-014-YE-1011-30	1/2" MIP x 1/2" FIP, 30"	EA		25
1/4" (3/8"OD)	EFGC-014-YE-1011-36	1/2" MIP x 1/2" FIP, 36"	EA		25
1/4" (3/8"OD)	EFGC-014-YE-1011-48	1/2" MIP x 1/2" FIP, 48"	EA		25
1/4" (3/8"OD)	EFGC-014-YE-1011-60	1/2" MIP x 1/2" FIP, 60"	EA		12
1/4" (3/8"OD)	EFGC-014-YE-1011-72	1/2" MIP x 1/2" FIP, 72"	EA		12

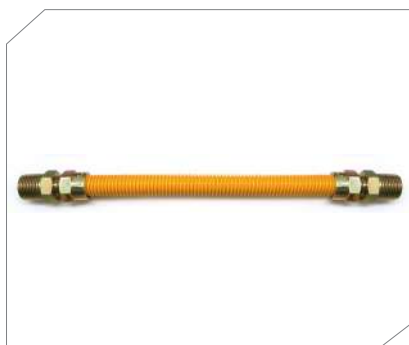

ID	Part #	Description	U/M	Price	Qty/ Box
1/4" (3/8"OD)	EFGC-014-YE-1012-12	1/2" MIP x 3/8" MIP, 12"	EA		25
1/4" (3/8"OD)	EFGC-014-YE-1012-18	1/2" MIP x 3/8" MIP, 18"	EA		25
1/4" (3/8"OD)	EFGC-014-YE-1012-24	1/2" MIP x 3/8" MIP, 24"	EA		25
1/4" (3/8"OD)	EFGC-014-YE-1012-30	1/2" MIP x 3/8" MIP, 30"	EA		25
1/4" (3/8"OD)	EFGC-014-YE-1012-36	1/2" MIP x 3/8" MIP, 36"	EA		25
1/4" (3/8"OD)	EFGC-014-YE-1012-48	1/2" MIP x 3/8" MIP, 48"	EA		25
1/4" (3/8"OD)	EFGC-014-YE-1012-60	1/2" MIP x 3/8" MIP, 60"	EA		12
1/4" (3/8"OD)	EFGC-014-YE-1012-72	1/2" MIP x 3/8" MIP, 72"	EA		12



ID	Part #	Description	U/M	Price	Qty/ Box
1/4" (3/8"OD)	EFGC-014-YE-1013-12	1/2" MIP x 3/8" FIP, 12"	EA		25
1/4" (3/8"OD)	EFGC-014-YE-1013-18	1/2" MIP x 3/8" FIP, 18"	EA		25
1/4" (3/8"OD)	EFGC-014-YE-1013-24	1/2" MIP x 3/8" FIP, 24"	EA		25
1/4" (3/8"OD)	EFGC-014-YE-1013-30	1/2" MIP x 3/8" FIP, 30"	EA		25
1/4" (3/8"OD)	EFGC-014-YE-1013-36	1/2" MIP x 3/8" FIP, 36"	EA		25
1/4" (3/8"OD)	EFGC-014-YE-1013-48	1/2" MIP x 3/8" FIP, 48"	EA		25
1/4" (3/8"OD)	EFGC-014-YE-1013-60	1/2" MIP x 3/8" FIP, 60"	EA		12
1/4" (3/8"OD)	EFGC-014-YE-1013-72	1/2" MIP x 3/8" FIP, 72"	EA		12

Stainless Steel Flexible Gas Connectors

014-YE Series Connector with Fittings

- Tube : Stainless Steel
- Coating : Yellow Epoxy
- Fitting : Zinc-Plated Steel S45C
- 5/8-18 Thread
- 3/8" OD (1/4" ID)



ID	Part #	Description	U/M	Price	Qty/ Box
1/4" (3/8"OD)	EFGC-014-YE-1213-12	3/8" MIP x 3/8" FIP, 12"	EA		25
1/4" (3/8"OD)	EFGC-014-YE-1213-18	3/8" MIP x 3/8" FIP, 18"	EA		25
1/4" (3/8"OD)	EFGC-014-YE-1213-24	3/8" MIP x 3/8" FIP, 24"	EA		25
1/4" (3/8"OD)	EFGC-014-YE-1213-30	3/8" MIP x 3/8" FIP, 30"	EA		25
1/4" (3/8"OD)	EFGC-014-YE-1213-36	3/8" MIP x 3/8" FIP, 36"	EA		25
1/4" (3/8"OD)	EFGC-014-YE-1213-48	3/8" MIP x 3/8" FIP, 48"	EA		25
1/4" (3/8"OD)	EFGC-014-YE-1213-60	3/8" MIP x 3/8" FIP, 60"	EA		12
1/4" (3/8"OD)	EFGC-014-YE-1213-72	3/8" MIP x 3/8" FIP, 72"	EA		12



014-YE Series Connector with Ball Valve

- Tube : Stainless Steel
- Coating : Yellow Epoxy
- Fitting : Zinc-Plated Steel S45C, Brass Ball Valve
- 5/8-18 Thread
- 3/8" OD (1/4" ID)



ID	Part #	Description	U/M	Price	Qty/ Box
1/4" (3/8"OD)	EFGC-014-YE-1031-12	1/2" MIP x 1/2" B.Valve, 12"	EA		25
1/4" (3/8"OD)	EFGC-014-YE-1031-18	1/2" MIP x 1/2" B.Valve, 18"	EA		25
1/4" (3/8"OD)	EFGC-014-YE-1031-24	1/2" MIP x 1/2" B.Valve, 24"	EA		25
1/4" (3/8"OD)	EFGC-014-YE-1031-30	1/2" MIP x 1/2" B.Valve, 30"	EA		25
1/4" (3/8"OD)	EFGC-014-YE-1031-36	1/2" MIP x 1/2" B.Valve, 36"	EA		25
1/4" (3/8"OD)	EFGC-014-YE-1031-48	1/2" MIP x 1/2" B.Valve, 48"	EA		25
1/4" (3/8"OD)	EFGC-014-YE-1031-60	1/2" MIP x 1/2" B.Valve, 60"	EA		12
1/4" (3/8"OD)	EFGC-014-YE-1031-72	1/2" MIP x 1/2" B.Valve, 72"	EA		12

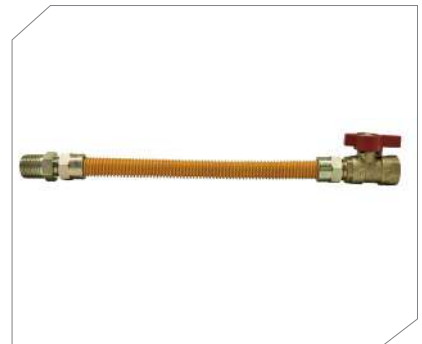

Gas Connectors

Commercial Gas Connectors

Gas Line System

Gas CSST Fittings

Water Line System

Water CSST Fittings

Braided Water Connectors

Supply stop Valve

Water Heater Connectors

Isolation Valves

Thermal Expansion Tanks

No-Hub Couplings

Flexible Sprinkler Drops

Stainless Steel Flexible Gas Connectors

014-BE Series Connector with Fittings

- Tube : Stainless Steel
- Coating : Black Epoxy
- Fitting : Zinc-Plated Steel S45C
- 5/8-18 Thread
- 3/8" OD (1/4" ID)

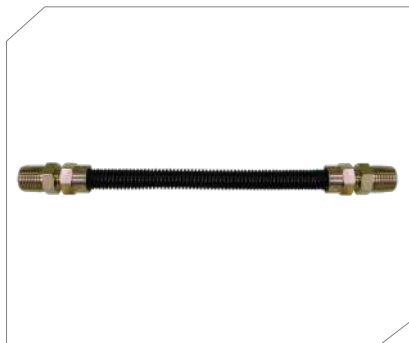

ID	Part #	Description	U/M	Price	Qty/ Box
1/4" (3/8"OD)	EFGC-014-BE-1010-12	1/2" MIP x 1/2" MIP, 12"	EA		25
1/4" (3/8"OD)	EFGC-014-BE-1010-18	1/2" MIP x 1/2" MIP, 18"	EA		25
1/4" (3/8"OD)	EFGC-014-BE-1010-24	1/2" MIP x 1/2" MIP, 24"	EA		25
1/4" (3/8"OD)	EFGC-014-BE-1010-30	1/2" MIP x 1/2" MIP, 30"	EA		25
1/4" (3/8"OD)	EFGC-014-BE-1010-36	1/2" MIP x 1/2" MIP, 36"	EA		25
1/4" (3/8"OD)	EFGC-014-BE-1010-48	1/2" MIP x 1/2" MIP, 48"	EA		25
1/4" (3/8"OD)	EFGC-014-BE-1010-60	1/2" MIP x 1/2" MIP, 60"	EA		12
1/4" (3/8"OD)	EFGC-014-BE-1010-72	1/2" MIP x 1/2" MIP, 72"	EA		12

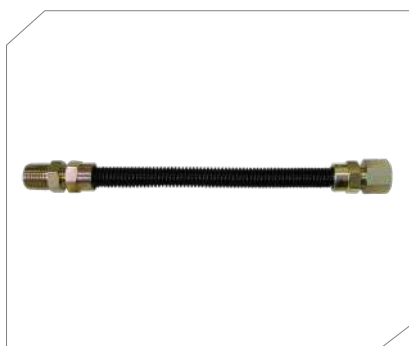

ID	Part #	Description	U/M	Price	Qty/ Box
1/4" (3/8"OD)	EFGC-014-BE-1011-12	1/2" MIP x 1/2" FIP, 12"	EA		25
1/4" (3/8"OD)	EFGC-014-BE-1011-18	1/2" MIP x 1/2" FIP, 18"	EA		25
1/4" (3/8"OD)	EFGC-014-BE-1011-24	1/2" MIP x 1/2" FIP, 24"	EA		25
1/4" (3/8"OD)	EFGC-014-BE-1011-30	1/2" MIP x 1/2" FIP, 30"	EA		25
1/4" (3/8"OD)	EFGC-014-BE-1011-36	1/2" MIP x 1/2" FIP, 36"	EA		25
1/4" (3/8"OD)	EFGC-014-BE-1011-48	1/2" MIP x 1/2" FIP, 48"	EA		25
1/4" (3/8"OD)	EFGC-014-BE-1011-60	1/2" MIP x 1/2" FIP, 60"	EA		12
1/4" (3/8"OD)	EFGC-014-BE-1011-72	1/2" MIP x 1/2" FIP, 72"	EA		12

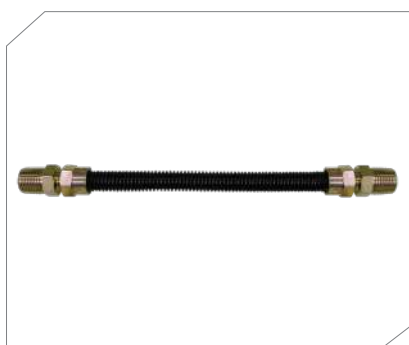

ID	Part #	Description	U/M	Price	Qty/ Box
1/4" (3/8"OD)	EFGC-014-BE-1012-12	1/2" MIP x 3/8" MIP, 12"	EA		25
1/4" (3/8"OD)	EFGC-014-BE-1012-18	1/2" MIP x 3/8" MIP, 18"	EA		25
1/4" (3/8"OD)	EFGC-014-BE-1012-24	1/2" MIP x 3/8" MIP, 24"	EA		25
1/4" (3/8"OD)	EFGC-014-BE-1012-30	1/2" MIP x 3/8" MIP, 30"	EA		25
1/4" (3/8"OD)	EFGC-014-BE-1012-36	1/2" MIP x 3/8" MIP, 36"	EA		25
1/4" (3/8"OD)	EFGC-014-BE-1012-48	1/2" MIP x 3/8" MIP, 48"	EA		25
1/4" (3/8"OD)	EFGC-014-BE-1012-60	1/2" MIP x 3/8" MIP, 60"	EA		12
1/4" (3/8"OD)	EFGC-014-BE-1012-72	1/2" MIP x 3/8" MIP, 72"	EA		12

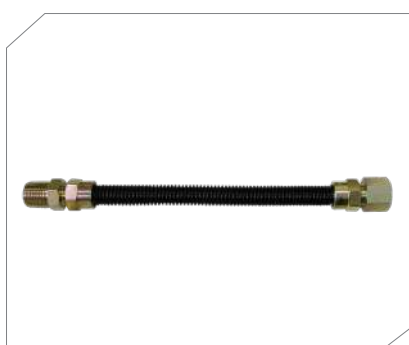

ID	Part #	Description	U/M	Price	Qty/ Box
1/4" (3/8"OD)	EFGC-014-BE-1013-12	1/2" MIP x 3/8" FIP, 12"	EA		25
1/4" (3/8"OD)	EFGC-014-BE-1013-18	1/2" MIP x 3/8" FIP, 18"	EA		25
1/4" (3/8"OD)	EFGC-014-BE-1013-24	1/2" MIP x 3/8" FIP, 24"	EA		25
1/4" (3/8"OD)	EFGC-014-BE-1013-30	1/2" MIP x 3/8" FIP, 30"	EA		25
1/4" (3/8"OD)	EFGC-014-BE-1013-36	1/2" MIP x 3/8" FIP, 36"	EA		25
1/4" (3/8"OD)	EFGC-014-BE-1013-48	1/2" MIP x 3/8" FIP, 48"	EA		25
1/4" (3/8"OD)	EFGC-014-BE-1013-60	1/2" MIP x 3/8" FIP, 60"	EA		12
1/4" (3/8"OD)	EFGC-014-BE-1013-72	1/2" MIP x 3/8" FIP, 72"	EA		12

Stainless Steel Flexible Gas Connectors

014-BE Series Connector with Fittings

- Tube : Stainless Steel
- Coating : Black Epoxy
- Fitting : Zinc-Plated Steel S45C
- 5/8-18 Thread
- 3/8" OD (1/4" ID)



ID	Part #	Description	U/M	Price	Qty/ Box
1/4" (3/8"OD)	EFGC-014-BE-1213-12	3/8" MIP x 3/8" FIP, 12"	EA		25
1/4" (3/8"OD)	EFGC-014-BE-1213-18	3/8" MIP x 3/8" FIP, 18"	EA		25
1/4" (3/8"OD)	EFGC-014-BE-1213-24	3/8" MIP x 3/8" FIP, 24"	EA		25
1/4" (3/8"OD)	EFGC-014-BE-1213-30	3/8" MIP x 3/8" FIP, 30"	EA		25
1/4" (3/8"OD)	EFGC-014-BE-1213-36	3/8" MIP x 3/8" FIP, 36"	EA		25
1/4" (3/8"OD)	EFGC-014-BE-1213-48	3/8" MIP x 3/8" FIP, 48"	EA		25
1/4" (3/8"OD)	EFGC-014-BE-1213-60	3/8" MIP x 3/8" FIP, 60"	EA		12
1/4" (3/8"OD)	EFGC-014-BE-1213-72	3/8" MIP x 3/8" FIP, 72"	EA		12

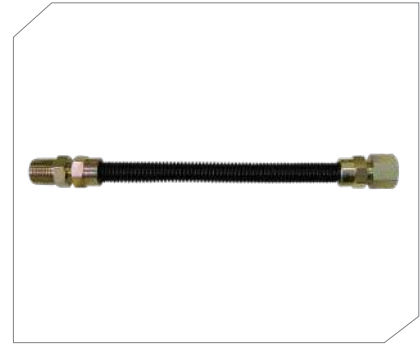

014-BE Series Connector with Ball Valve

- Tube : Stainless Steel
- Coating : Black Epoxy
- Fitting : Zinc-Plated Steel S45C, Brass Ball Valve
- 5/8-18 Thread
- 3/8" OD (1/4" ID)



ID	Part #	Description	U/M	Price	Qty/ Box
1/4" (3/8"OD)	EFGC-014-BE-1031-12	1/2" MIP x 1/2" B.Valve, 12"	EA		25
1/4" (3/8"OD)	EFGC-014-BE-1031-18	1/2" MIP x 1/2" B.Valve, 18"	EA		25
1/4" (3/8"OD)	EFGC-014-BE-1031-24	1/2" MIP x 1/2" B.Valve, 24"	EA		25
1/4" (3/8"OD)	EFGC-014-BE-1031-30	1/2" MIP x 1/2" B.Valve, 30"	EA		25
1/4" (3/8"OD)	EFGC-014-BE-1031-36	1/2" MIP x 1/2" B.Valve, 36"	EA		25
1/4" (3/8"OD)	EFGC-014-BE-1031-48	1/2" MIP x 1/2" B.Valve, 48"	EA		25
1/4" (3/8"OD)	EFGC-014-BE-1031-60	1/2" MIP x 1/2" B.Valve, 60"	EA		12
1/4" (3/8"OD)	EFGC-014-BE-1031-72	1/2" MIP x 1/2" B.Valve, 72"	EA		12



Gas Connectors

Commercial Gas Connectors

Gas Line System

Gas CSST Fittings

Water Line System

Water CSST Fittings

Braided Water Connectors

Supply stop Valve

Water Heater Connectors

Isolation Valves

Thermal Expansion Tanks

No-Hub Couplings

Flexible Sprinkler Drops

Stainless Steel Flexible Gas Connectors

038-SS Series Connector with Fittings

- Tube : Stainless Steel
- Fitting : Zinc-Plated Steel S45C
- 3/4-16 Thread
- 1/2" OD (3/8" ID)

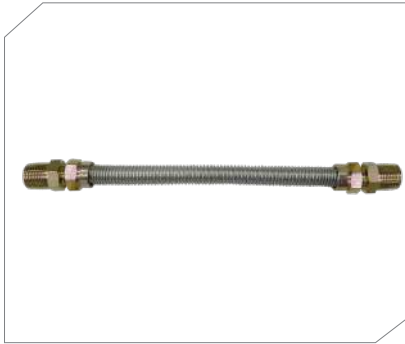

ID	Part #	Description	U/M	Price	Qty/ Box
3/8" (1/2"OD)	EFGC-038-SS-1010-12	1/2" MIP x 1/2" MIP, 12"	EA		25
3/8" (1/2"OD)	EFGC-038-SS-1010-18	1/2" MIP x 1/2" MIP, 18"	EA		25
3/8" (1/2"OD)	EFGC-038-SS-1010-24	1/2" MIP x 1/2" MIP, 24"	EA		25
3/8" (1/2"OD)	EFGC-038-SS-1010-30	1/2" MIP x 1/2" MIP, 30"	EA		25
3/8" (1/2"OD)	EFGC-038-SS-1010-36	1/2" MIP x 1/2" MIP, 36"	EA		25
3/8" (1/2"OD)	EFGC-038-SS-1010-48	1/2" MIP x 1/2" MIP, 48"	EA		25
3/8" (1/2"OD)	EFGC-038-SS-1010-60	1/2" MIP x 1/2" MIP, 60"	EA		12
3/8" (1/2"OD)	EFGC-038-SS-1010-72	1/2" MIP x 1/2" MIP, 72"	EA		12

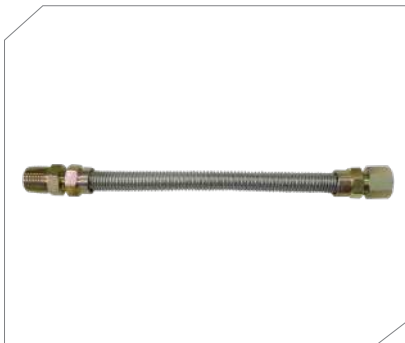

ID	Part #	Description	U/M	Price	Qty/ Box
3/8" (1/2"OD)	EFGC-038-SS-1011-12	1/2" MIP x 1/2" FIP, 12"	EA		25
3/8" (1/2"OD)	EFGC-038-SS-1011-18	1/2" MIP x 1/2" FIP, 18"	EA		25
3/8" (1/2"OD)	EFGC-038-SS-1011-24	1/2" MIP x 1/2" FIP, 24"	EA		25
3/8" (1/2"OD)	EFGC-038-SS-1011-30	1/2" MIP x 1/2" FIP, 30"	EA		25
3/8" (1/2"OD)	EFGC-038-SS-1011-36	1/2" MIP x 1/2" FIP, 36"	EA		25
3/8" (1/2"OD)	EFGC-038-SS-1011-48	1/2" MIP x 1/2" FIP, 48"	EA		25
3/8" (1/2"OD)	EFGC-038-SS-1011-60	1/2" MIP x 1/2" FIP, 60"	EA		12
3/8" (1/2"OD)	EFGC-038-SS-1011-72	1/2" MIP x 1/2" FIP, 72"	EA		12



ID	Part #	Description	U/M	Price	Qty/ Box
3/8" (1/2"OD)	EFGC-038-SS-1111-12	1/2" FIP x 1/2" FIP, 12"	EA		25
3/8" (1/2"OD)	EFGC-038-SS-1111-18	1/2" FIP x 1/2" FIP, 18"	EA		25
3/8" (1/2"OD)	EFGC-038-SS-1111-24	1/2" FIP x 1/2" FIP, 24"	EA		25
3/8" (1/2"OD)	EFGC-038-SS-1111-30	1/2" FIP x 1/2" FIP, 30"	EA		25
3/8" (1/2"OD)	EFGC-038-SS-1111-36	1/2" FIP x 1/2" FIP, 36"	EA		25
3/8" (1/2"OD)	EFGC-038-SS-1111-48	1/2" FIP x 1/2" FIP, 48"	EA		25
3/8" (1/2"OD)	EFGC-038-SS-1111-60	1/2" FIP x 1/2" FIP, 60"	EA		12
3/8" (1/2"OD)	EFGC-038-SS-1111-72	1/2" FIP x 1/2" FIP, 72"	EA		12

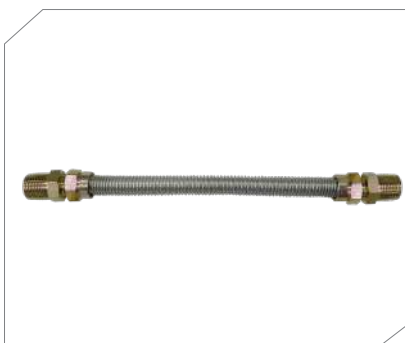

ID	Part #	Description	U/M	Price	Qty/ Box
3/8" (1/2"OD)	EFGC-038-SS-1012-12	1/2" MIP x 3/8" MIP, 12"	EA		25
3/8" (1/2"OD)	EFGC-038-SS-1012-18	1/2" MIP x 3/8" MIP, 18"	EA		25
3/8" (1/2"OD)	EFGC-038-SS-1012-24	1/2" MIP x 3/8" MIP, 24"	EA		25
3/8" (1/2"OD)	EFGC-038-SS-1012-30	1/2" MIP x 3/8" MIP, 30"	EA		25
3/8" (1/2"OD)	EFGC-038-SS-1012-36	1/2" MIP x 3/8" MIP, 36"	EA		25
3/8" (1/2"OD)	EFGC-038-SS-1012-48	1/2" MIP x 3/8" MIP, 48"	EA		25
3/8" (1/2"OD)	EFGC-038-SS-1012-60	1/2" MIP x 3/8" MIP, 60"	EA		12
3/8" (1/2"OD)	EFGC-038-SS-1012-72	1/2" MIP x 3/8" MIP, 72"	EA		12

Stainless Steel Flexible Gas Connectors

038-SS Series Connector with Fittings

- Tube : Stainless Steel
- Fitting : Zinc-Plated Steel S45C
- 3/4-16 Thread
- 1/2" OD (3/8" ID)



ID	Part #	Description	U/M	Price	Qty/ Box
3/8" (1/2"OD)	EFGC-038-SS-1013-12	1/2" MIP x 3/8" FIP, 12"	EA		25
3/8" (1/2"OD)	EFGC-038-SS-1013-18	1/2" MIP x 3/8" FIP, 18"	EA		25
3/8" (1/2"OD)	EFGC-038-SS-1013-24	1/2" MIP x 3/8" FIP, 24"	EA		25
3/8" (1/2"OD)	EFGC-038-SS-1013-30	1/2" MIP x 3/8" FIP, 30"	EA		25
3/8" (1/2"OD)	EFGC-038-SS-1013-36	1/2" MIP x 3/8" FIP, 36"	EA		25
3/8" (1/2"OD)	EFGC-038-SS-1013-48	1/2" MIP x 3/8" FIP, 48"	EA		25
3/8" (1/2"OD)	EFGC-038-SS-1013-60	1/2" MIP x 3/8" FIP, 60"	EA		12
3/8" (1/2"OD)	EFGC-038-SS-1013-72	1/2" MIP x 3/8" FIP, 72"	EA		12



ID	Part #	Description	U/M	Price	Qty/ Box
3/8" (1/2"OD)	EFGC-038-SS-1213-12	3/8" MIP x 3/8" FIP, 12"	EA		25
3/8" (1/2"OD)	EFGC-038-SS-1213-18	3/8" MIP x 3/8" FIP, 18"	EA		25
3/8" (1/2"OD)	EFGC-038-SS-1213-24	3/8" MIP x 3/8" FIP, 24"	EA		25
3/8" (1/2"OD)	EFGC-038-SS-1213-30	3/8" MIP x 3/8" FIP, 30"	EA		25
3/8" (1/2"OD)	EFGC-038-SS-1213-36	3/8" MIP x 3/8" FIP, 36"	EA		25
3/8" (1/2"OD)	EFGC-038-SS-1213-48	3/8" MIP x 3/8" FIP, 48"	EA		25
3/8" (1/2"OD)	EFGC-038-SS-1213-60	3/8" MIP x 3/8" FIP, 60"	EA		12
3/8" (1/2"OD)	EFGC-038-SS-1213-72	3/8" MIP x 3/8" FIP, 72"	EA		12

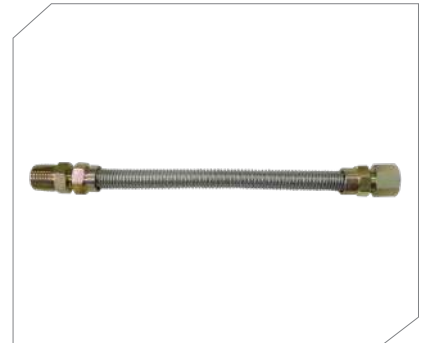

038-SS Series Connector with Ball Valve

- Tube : Stainless Steel
- Fitting : Zinc-Plated Steel S45C
- 3/4-16 Thread
- 1/2" OD (3/8" ID)



ID	Part #	Description	U/M	Price	Qty/ Box
3/8" (1/2"OD)	EFGC-038-SS-1031-12	1/2" MIP x 1/2" B.Valve, 12"	EA		25
3/8" (1/2"OD)	EFGC-038-SS-1031-18	1/2" MIP x 1/2" B.Valve, 18"	EA		25
3/8" (1/2"OD)	EFGC-038-SS-1031-24	1/2" MIP x 1/2" B.Valve, 24"	EA		25
3/8" (1/2"OD)	EFGC-038-SS-1031-30	1/2" MIP x 1/2" B.Valve, 30"	EA		25
3/8" (1/2"OD)	EFGC-038-SS-1031-36	1/2" MIP x 1/2" B.Valve, 36"	EA		25
3/8" (1/2"OD)	EFGC-038-SS-1031-48	1/2" MIP x 1/2" B.Valve, 48"	EA		25
3/8" (1/2"OD)	EFGC-038-SS-1031-60	1/2" MIP x 1/2" B.Valve, 60"	EA		12
3/8" (1/2"OD)	EFGC-038-SS-1031-72	1/2" MIP x 1/2" B.Valve, 72"	EA		12

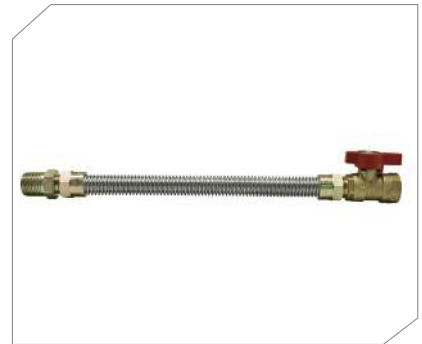

Gas Connectors

Commercial Gas Connectors

Gas Line System

Gas CSST Fittings

Water Line System

Water CSST Fittings

Braided Water Connectors

Supply stop Valve

Water Heater Connectors

Isolation Valves

Thermal Expansion Tanks

No-Hub Couplings

Flexible Sprinkler Drops

Stainless Steel Flexible Gas Connectors

038-YE Series Connector with Fittings

- Tube : Stainless Steel
- Coating : Yellow Epoxy
- Fitting : Zinc-Plated Steel S45C
- 3/4-16 Thread
- 1/2" OD (3/8" ID)



ID	Part #	Description	U/M	Price	Qty/ Box
3/8" (1/2"OD)	EFGC-038-YE-1010-12	1/2" MIP x 1/2" MIP, 12"	EA		25
3/8" (1/2"OD)	EFGC-038-YE-1010-18	1/2" MIP x 1/2" MIP, 18"	EA		25
3/8" (1/2"OD)	EFGC-038-YE-1010-24	1/2" MIP x 1/2" MIP, 24"	EA		25
3/8" (1/2"OD)	EFGC-038-YE-1010-30	1/2" MIP x 1/2" MIP, 30"	EA		25
3/8" (1/2"OD)	EFGC-038-YE-1010-36	1/2" MIP x 1/2" MIP, 36"	EA		25
3/8" (1/2"OD)	EFGC-038-YE-1010-48	1/2" MIP x 1/2" MIP, 48"	EA		25
3/8" (1/2"OD)	EFGC-038-YE-1010-60	1/2" MIP x 1/2" MIP, 60"	EA		12
3/8" (1/2"OD)	EFGC-038-YE-1010-72	1/2" MIP x 1/2" MIP, 72"	EA		12

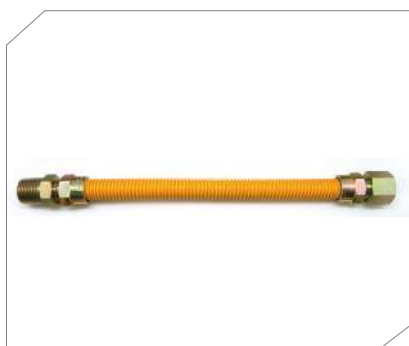

ID	Part #	Description	U/M	Price	Qty/ Box
3/8" (1/2"OD)	EFGC-038-YE-1011-12	1/2" MIP x 1/2" FIP, 12"	EA		25
3/8" (1/2"OD)	EFGC-038-YE-1011-18	1/2" MIP x 1/2" FIP, 18"	EA		25
3/8" (1/2"OD)	EFGC-038-YE-1011-24	1/2" MIP x 1/2" FIP, 24"	EA		25
3/8" (1/2"OD)	EFGC-038-YE-1011-30	1/2" MIP x 1/2" FIP, 30"	EA		25
3/8" (1/2"OD)	EFGC-038-YE-1011-36	1/2" MIP x 1/2" FIP, 36"	EA		25
3/8" (1/2"OD)	EFGC-038-YE-1011-48	1/2" MIP x 1/2" FIP, 48"	EA		25
3/8" (1/2"OD)	EFGC-038-YE-1011-60	1/2" MIP x 1/2" FIP, 60"	EA		12
3/8" (1/2"OD)	EFGC-038-YE-1011-72	1/2" MIP x 1/2" FIP, 72"	EA		12



ID	Part #	Description	U/M	Price	Qty/ Box
3/8" (1/2"OD)	EFGC-038-YE-1111-12	1/2" FIP x 1/2" FIP, 12"	EA		25
3/8" (1/2"OD)	EFGC-038-YE-1111-18	1/2" FIP x 1/2" FIP, 18"	EA		25
3/8" (1/2"OD)	EFGC-038-YE-1111-24	1/2" FIP x 1/2" FIP, 24"	EA		25
3/8" (1/2"OD)	EFGC-038-YE-1111-30	1/2" FIP x 1/2" FIP, 30"	EA		25
3/8" (1/2"OD)	EFGC-038-YE-1111-36	1/2" FIP x 1/2" FIP, 36"	EA		25
3/8" (1/2"OD)	EFGC-038-YE-1111-48	1/2" FIP x 1/2" FIP, 48"	EA		25
3/8" (1/2"OD)	EFGC-038-YE-1111-60	1/2" FIP x 1/2" FIP, 60"	EA		12
3/8" (1/2"OD)	EFGC-038-YE-1111-72	1/2" FIP x 1/2" FIP, 72"	EA		12

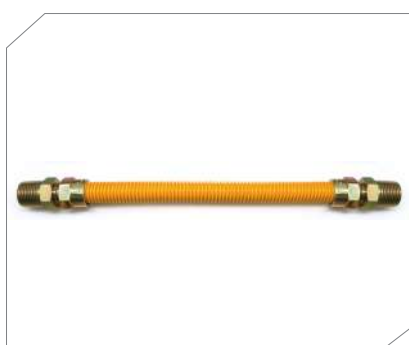

ID	Part #	Description	U/M	Price	Qty/ Box
3/8" (1/2"OD)	EFGC-038-YE-1012-12	1/2" MIP x 3/8" MIP, 12"	EA		25
3/8" (1/2"OD)	EFGC-038-YE-1012-18	1/2" MIP x 3/8" MIP, 18"	EA		25
3/8" (1/2"OD)	EFGC-038-YE-1012-24	1/2" MIP x 3/8" MIP, 24"	EA		25
3/8" (1/2"OD)	EFGC-038-YE-1012-30	1/2" MIP x 3/8" MIP, 30"	EA		25
3/8" (1/2"OD)	EFGC-038-YE-1012-36	1/2" MIP x 3/8" MIP, 36"	EA		25
3/8" (1/2"OD)	EFGC-038-YE-1012-48	1/2" MIP x 3/8" MIP, 48"	EA		25
3/8" (1/2"OD)	EFGC-038-YE-1012-60	1/2" MIP x 3/8" MIP, 60"	EA		12
3/8" (1/2"OD)	EFGC-038-YE-1012-72	1/2" MIP x 3/8" MIP, 72"	EA		12

Stainless Steel Flexible Gas Connectors

038-YE Series Connector with Fittings

- Tube : Stainless Steel
- Coating : Yellow Epoxy
- Fitting : Zinc-Plated Steel S45C
- 3/4-16 Thread
- 1/2" OD (3/8" ID)



ID	Part #	Description	U/M	Price	Qty/ Box
3/8" (1/2"OD)	EFGC-038-YE-1013-12	1/2" MIP x 3/8" FIP, 12"	EA		25
3/8" (1/2"OD)	EFGC-038-YE-1013-18	1/2" MIP x 3/8" FIP, 18"	EA		25
3/8" (1/2"OD)	EFGC-038-YE-1013-24	1/2" MIP x 3/8" FIP, 24"	EA		25
3/8" (1/2"OD)	EFGC-038-YE-1013-30	1/2" MIP x 3/8" FIP, 30"	EA		25
3/8" (1/2"OD)	EFGC-038-YE-1013-36	1/2" MIP x 3/8" FIP, 36"	EA		25
3/8" (1/2"OD)	EFGC-038-YE-1013-48	1/2" MIP x 3/8" FIP, 48"	EA		25
3/8" (1/2"OD)	EFGC-038-YE-1013-60	1/2" MIP x 3/8" FIP, 60"	EA		12
3/8" (1/2"OD)	EFGC-038-YE-1013-72	1/2" MIP x 3/8" FIP, 72"	EA		12

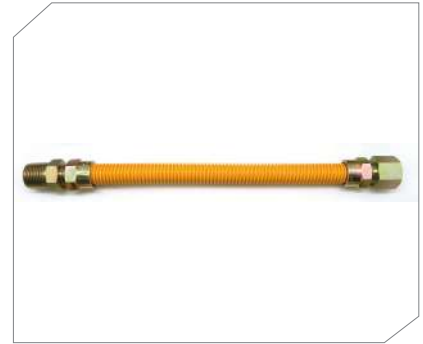

ID	Part #	Description	U/M	Price	Qty/ Box
3/8" (1/2"OD)	EFGC-038-YE-1213-12	3/8" MIP x 3/8" FIP, 12"	EA		25
3/8" (1/2"OD)	EFGC-038-YE-1213-18	3/8" MIP x 3/8" FIP, 18"	EA		25
3/8" (1/2"OD)	EFGC-038-YE-1213-24	3/8" MIP x 3/8" FIP, 24"	EA		25
3/8" (1/2"OD)	EFGC-038-YE-1213-30	3/8" MIP x 3/8" FIP, 30"	EA		25
3/8" (1/2"OD)	EFGC-038-YE-1213-36	3/8" MIP x 3/8" FIP, 36"	EA		25
3/8" (1/2"OD)	EFGC-038-YE-1213-48	3/8" MIP x 3/8" FIP, 48"	EA		25
3/8" (1/2"OD)	EFGC-038-YE-1213-60	3/8" MIP x 3/8" FIP, 60"	EA		12
3/8" (1/2"OD)	EFGC-038-YE-1213-72	3/8" MIP x 3/8" FIP, 72"	EA		12

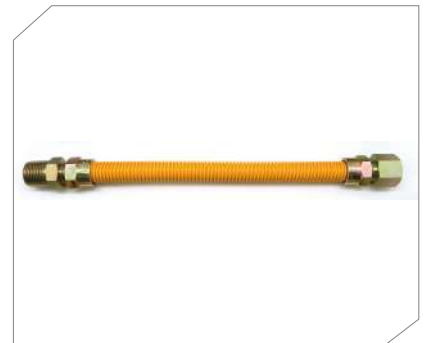

038-YE Series Connector with Ball Valve

- Tube : Stainless Steel
- Coating : Yellow Epoxy
- Fitting : Zinc-Plated Steel S45C
- 3/4-16 Thread
- 1/2" OD (3/8" ID)



ID	Part #	Description	U/M	Price	Qty/ Box
3/8" (1/2"OD)	EFGC-038-YE-1031-12	1/2" MIP x 1/2" B.Valve, 12"	EA		25
3/8" (1/2"OD)	EFGC-038-YE-1031-18	1/2" MIP x 1/2" B.Valve, 18"	EA		25
3/8" (1/2"OD)	EFGC-038-YE-1031-24	1/2" MIP x 1/2" B.Valve, 24"	EA		25
3/8" (1/2"OD)	EFGC-038-YE-1031-30	1/2" MIP x 1/2" B.Valve, 30"	EA		25
3/8" (1/2"OD)	EFGC-038-YE-1031-36	1/2" MIP x 1/2" B.Valve, 36"	EA		25
3/8" (1/2"OD)	EFGC-038-YE-1031-48	1/2" MIP x 1/2" B.Valve, 48"	EA		25
3/8" (1/2"OD)	EFGC-038-YE-1031-60	1/2" MIP x 1/2" B.Valve, 60"	EA		12
3/8" (1/2"OD)	EFGC-038-YE-1031-72	1/2" MIP x 1/2" B.Valve, 72"	EA		12

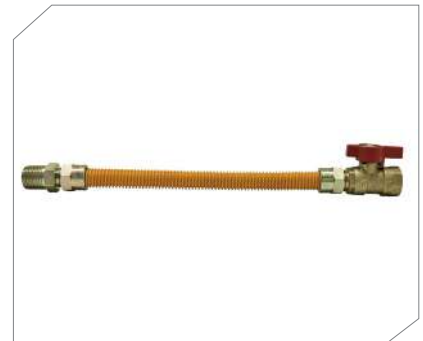

Gas Connectors

Commercial Gas Connectors

Gas Line System

Gas CSST Fittings

Water Line System

Water CSST Fittings

Braided Water Connectors

Supply stop Valve

Water Heater Connectors

Isolation Valves

Thermal Expansion Tanks

No-Hub Couplings

Flexible Sprinkler Drops

Stainless Steel Flexible Gas Connectors

038-BE Series Connector with Fittings

- Tube : Stainless Steel
- Coating : Black Epoxy
- Fitting : Zinc-Plated Steel S45C
- 3/4-16 Thread
- 1/2" OD (3/8" ID)



ID	Part #	Description	U/M	Price	Qty/ Box
3/8" (1/2"OD)	EFGC-038-BE-1010-12	1/2" MIP x 1/2" MIP, 12"	EA		25
3/8" (1/2"OD)	EFGC-038-BE-1010-18	1/2" MIP x 1/2" MIP, 18"	EA		25
3/8" (1/2"OD)	EFGC-038-BE-1010-24	1/2" MIP x 1/2" MIP, 24"	EA		25
3/8" (1/2"OD)	EFGC-038-BE-1010-30	1/2" MIP x 1/2" MIP, 30"	EA		25
3/8" (1/2"OD)	EFGC-038-BE-1010-36	1/2" MIP x 1/2" MIP, 36"	EA		25
3/8" (1/2"OD)	EFGC-038-BE-1010-48	1/2" MIP x 1/2" MIP, 48"	EA		25
3/8" (1/2"OD)	EFGC-038-BE-1010-60	1/2" MIP x 1/2" MIP, 60"	EA		12
3/8" (1/2"OD)	EFGC-038-BE-1010-72	1/2" MIP x 1/2" MIP, 72"	EA		12

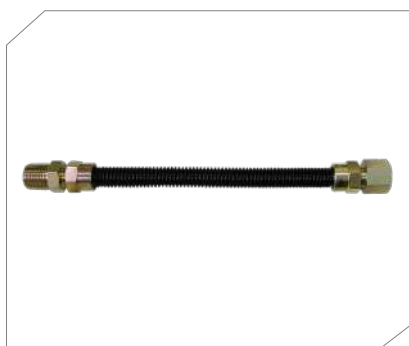

ID	Part #	Description	U/M	Price	Qty/ Box
3/8" (1/2"OD)	EFGC-038-BE-1011-12	1/2" MIP x 1/2" FIP, 12"	EA		25
3/8" (1/2"OD)	EFGC-038-BE-1011-18	1/2" MIP x 1/2" FIP, 18"	EA		25
3/8" (1/2"OD)	EFGC-038-BE-1011-24	1/2" MIP x 1/2" FIP, 24"	EA		25
3/8" (1/2"OD)	EFGC-038-BE-1011-30	1/2" MIP x 1/2" FIP, 30"	EA		25
3/8" (1/2"OD)	EFGC-038-BE-1011-36	1/2" MIP x 1/2" FIP, 36"	EA		25
3/8" (1/2"OD)	EFGC-038-BE-1011-48	1/2" MIP x 1/2" FIP, 48"	EA		25
3/8" (1/2"OD)	EFGC-038-BE-1011-60	1/2" MIP x 1/2" FIP, 60"	EA		12
3/8" (1/2"OD)	EFGC-038-BE-1011-72	1/2" MIP x 1/2" FIP, 72"	EA		12



ID	Part #	Description	U/M	Price	Qty/ Box
3/8" (1/2"OD)	EFGC-038-BE-1111-12	1/2" FIP x 1/2" FIP, 12"	EA		25
3/8" (1/2"OD)	EFGC-038-BE-1111-18	1/2" FIP x 1/2" FIP, 18"	EA		25
3/8" (1/2"OD)	EFGC-038-BE-1111-24	1/2" FIP x 1/2" FIP, 24"	EA		25
3/8" (1/2"OD)	EFGC-038-BE-1111-30	1/2" FIP x 1/2" FIP, 30"	EA		25
3/8" (1/2"OD)	EFGC-038-BE-1111-36	1/2" FIP x 1/2" FIP, 36"	EA		25
3/8" (1/2"OD)	EFGC-038-BE-1111-48	1/2" FIP x 1/2" FIP, 48"	EA		25
3/8" (1/2"OD)	EFGC-038-BE-1111-60	1/2" FIP x 1/2" FIP, 60"	EA		12
3/8" (1/2"OD)	EFGC-038-BE-1111-72	1/2" FIP x 1/2" FIP, 72"	EA		12

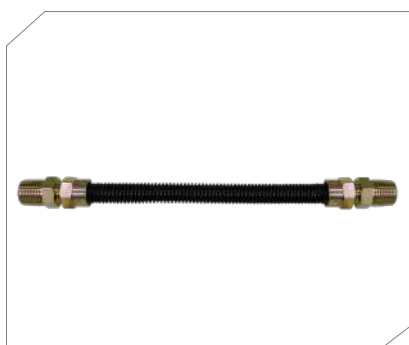

ID	Part #	Description	U/M	Price	Qty/ Box
3/8" (1/2"OD)	EFGC-038-BE-1012-12	1/2" MIP x 3/8" MIP, 12"	EA		25
3/8" (1/2"OD)	EFGC-038-BE-1012-18	1/2" MIP x 3/8" MIP, 18"	EA		25
3/8" (1/2"OD)	EFGC-038-BE-1012-24	1/2" MIP x 3/8" MIP, 24"	EA		25
3/8" (1/2"OD)	EFGC-038-BE-1012-30	1/2" MIP x 3/8" MIP, 30"	EA		25
3/8" (1/2"OD)	EFGC-038-BE-1012-36	1/2" MIP x 3/8" MIP, 36"	EA		25
3/8" (1/2"OD)	EFGC-038-BE-1012-48	1/2" MIP x 3/8" MIP, 48"	EA		25
3/8" (1/2"OD)	EFGC-038-BE-1012-60	1/2" MIP x 3/8" MIP, 60"	EA		12
3/8" (1/2"OD)	EFGC-038-BE-1012-72	1/2" MIP x 3/8" MIP, 72"	EA		12

Stainless Steel Flexible Gas Connectors

038-BE Series Connector with Fittings

- Tube : Stainless Steel
- Coating : Black Epoxy
- Fitting : Zinc-Plated Steel S45C
- 3/4-16 Thread
- 1/2" OD (3/8" ID)



ID	Part #	Description	U/M	Price	Qty/ Box
3/8" (1/2"OD)	EFGC-038-BE-1013-12	1/2" MIP x 3/8" FIP, 12"	EA		25
3/8" (1/2"OD)	EFGC-038-BE-1013-18	1/2" MIP x 3/8" FIP, 18"	EA		25
3/8" (1/2"OD)	EFGC-038-BE-1013-24	1/2" MIP x 3/8" FIP, 24"	EA		25
3/8" (1/2"OD)	EFGC-038-BE-1013-30	1/2" MIP x 3/8" FIP, 30"	EA		25
3/8" (1/2"OD)	EFGC-038-BE-1013-36	1/2" MIP x 3/8" FIP, 36"	EA		25
3/8" (1/2"OD)	EFGC-038-BE-1013-48	1/2" MIP x 3/8" FIP, 48"	EA		25
3/8" (1/2"OD)	EFGC-038-BE-1013-60	1/2" MIP x 3/8" FIP, 60"	EA		12
3/8" (1/2"OD)	EFGC-038-BE-1013-72	1/2" MIP x 3/8" FIP, 72"	EA		12



ID	Part #	Description	U/M	Price	Qty/ Box
3/8" (1/2"OD)	EFGC-038-BE-1213-12	3/8" MIP x 3/8" FIP, 12"	EA		25
3/8" (1/2"OD)	EFGC-038-BE-1213-18	3/8" MIP x 3/8" FIP, 18"	EA		25
3/8" (1/2"OD)	EFGC-038-BE-1213-24	3/8" MIP x 3/8" FIP, 24"	EA		25
3/8" (1/2"OD)	EFGC-038-BE-1213-30	3/8" MIP x 3/8" FIP, 30"	EA		25
3/8" (1/2"OD)	EFGC-038-BE-1213-36	3/8" MIP x 3/8" FIP, 36"	EA		25
3/8" (1/2"OD)	EFGC-038-BE-1213-48	3/8" MIP x 3/8" FIP, 48"	EA		25
3/8" (1/2"OD)	EFGC-038-BE-1213-60	3/8" MIP x 3/8" FIP, 60"	EA		12
3/8" (1/2"OD)	EFGC-038-BE-1213-72	3/8" MIP x 3/8" FIP, 72"	EA		12



038-BE Series Connector with Ball Valve

- Tube : Stainless Steel
- Coating : Black Epoxy
- Fitting : Zinc-Plated Steel S45C
- 3/4-16 Thread
- 1/2" OD (3/8" ID)



ID	Part #	Description	U/M	Price	Qty/ Box
3/8" (1/2"OD)	EFGC-038-BE-1031-12	1/2" MIP x 1/2" B.Valve, 12"	EA		25
3/8" (1/2"OD)	EFGC-038-BE-1031-18	1/2" MIP x 1/2" B.Valve, 18"	EA		25
3/8" (1/2"OD)	EFGC-038-BE-1031-24	1/2" MIP x 1/2" B.Valve, 24"	EA		25
3/8" (1/2"OD)	EFGC-038-BE-1031-30	1/2" MIP x 1/2" B.Valve, 30"	EA		25
3/8" (1/2"OD)	EFGC-038-BE-1031-36	1/2" MIP x 1/2" B.Valve, 36"	EA		25
3/8" (1/2"OD)	EFGC-038-BE-1031-48	1/2" MIP x 1/2" B.Valve, 48"	EA		25
3/8" (1/2"OD)	EFGC-038-BE-1031-60	1/2" MIP x 1/2" B.Valve, 60"	EA		12
3/8" (1/2"OD)	EFGC-038-BE-1031-72	1/2" MIP x 1/2" B.Valve, 72"	EA		12

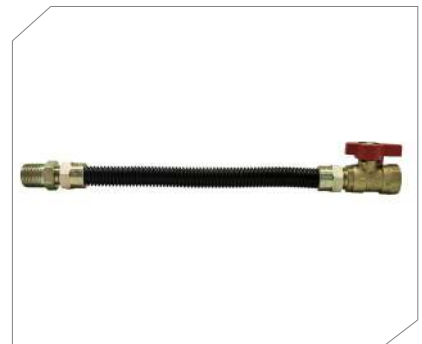

- Gas Connectors
- Commercial Gas Connectors
- Gas Line System
- Gas CSST Fittings
- Water Line System
- Water CSST Fittings
- Braided Water Connectors
- Supply stop Valve
- Water Heater Connectors
- Isolation Valves
- Thermal Expansion Tanks
- No-Hub Couplings
- Flexible Sprinkler Drops

Stainless Steel Flexible Gas Connectors

012-SS Series Connector with Fittings

- Tube : Stainless Steel
- Fitting : Zinc-Plated Steel S45C
- 15/16-16 Thread
- 5/8" OD (1/2" ID)

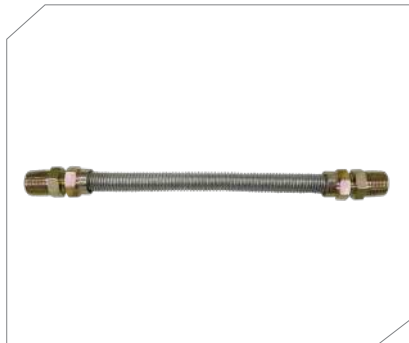

ID	Part #	Description	U/M	Price	Qty/ Box
1/2" (5/8"OD)	EFGC-012-SS-1010-12	1/2" MIP x 1/2" MIP, 12"	EA		25
1/2" (5/8"OD)	EFGC-012-SS-1010-18	1/2" MIP x 1/2" MIP, 18"	EA		25
1/2" (5/8"OD)	EFGC-012-SS-1010-24	1/2" MIP x 1/2" MIP, 24"	EA		25
1/2" (5/8"OD)	EFGC-012-SS-1010-30	1/2" MIP x 1/2" MIP, 30"	EA		25
1/2" (5/8"OD)	EFGC-012-SS-1010-36	1/2" MIP x 1/2" MIP, 36"	EA		25
1/2" (5/8"OD)	EFGC-012-SS-1010-48	1/2" MIP x 1/2" MIP, 48"	EA		25
1/2" (5/8"OD)	EFGC-012-SS-1010-60	1/2" MIP x 1/2" MIP, 60"	EA		12
1/2" (5/8"OD)	EFGC-012-SS-1010-72	1/2" MIP x 1/2" MIP, 72"	EA		12

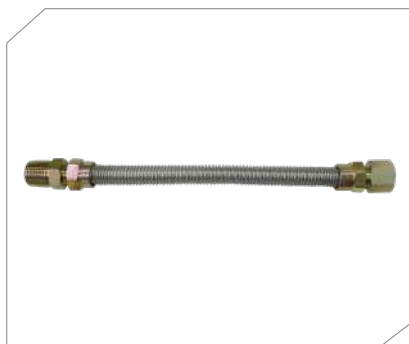

ID	Part #	Description	U/M	Price	Qty/ Box
1/2" (5/8"OD)	EFGC-012-SS-1011-12	1/2" MIP x 1/2" FIP, 12"	EA		25
1/2" (5/8"OD)	EFGC-012-SS-1011-18	1/2" MIP x 1/2" FIP, 18"	EA		25
1/2" (5/8"OD)	EFGC-012-SS-1011-24	1/2" MIP x 1/2" FIP, 24"	EA		25
1/2" (5/8"OD)	EFGC-012-SS-1011-30	1/2" MIP x 1/2" FIP, 30"	EA		25
1/2" (5/8"OD)	EFGC-012-SS-1011-36	1/2" MIP x 1/2" FIP, 36"	EA		25
1/2" (5/8"OD)	EFGC-012-SS-1011-48	1/2" MIP x 1/2" FIP, 48"	EA		25
1/2" (5/8"OD)	EFGC-012-SS-1011-60	1/2" MIP x 1/2" FIP, 60"	EA		12
1/2" (5/8"OD)	EFGC-012-SS-1011-72	1/2" MIP x 1/2" FIP, 72"	EA		12



ID	Part #	Description	U/M	Price	Qty/ Box
1/2" (5/8"OD)	EFGC-012-SS-1111-12	1/2" FIP x 1/2" FIP, 12"	EA		25
1/2" (5/8"OD)	EFGC-012-SS-1111-18	1/2" FIP x 1/2" FIP, 18"	EA		25
1/2" (5/8"OD)	EFGC-012-SS-1111-24	1/2" FIP x 1/2" FIP, 24"	EA		25
1/2" (5/8"OD)	EFGC-012-SS-1111-30	1/2" FIP x 1/2" FIP, 30"	EA		25
1/2" (5/8"OD)	EFGC-012-SS-1111-36	1/2" FIP x 1/2" FIP, 36"	EA		25
1/2" (5/8"OD)	EFGC-012-SS-1111-48	1/2" FIP x 1/2" FIP, 48"	EA		25
1/2" (5/8"OD)	EFGC-012-SS-1111-60	1/2" FIP x 1/2" FIP, 60"	EA		12
1/2" (5/8"OD)	EFGC-012-SS-1111-72	1/2" FIP x 1/2" FIP, 72"	EA		12

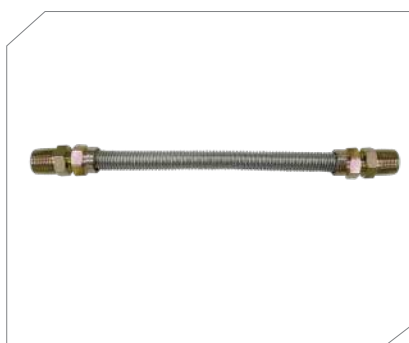

ID	Part #	Description	U/M	Price	Qty/ Box
1/2" (5/8"OD)	EFGC-012-SS-1014-12	1/2" MIP x 3/4" MIP, 12"	EA		25
1/2" (5/8"OD)	EFGC-012-SS-1014-18	1/2" MIP x 3/4" MIP, 18"	EA		25
1/2" (5/8"OD)	EFGC-012-SS-1014-24	1/2" MIP x 3/4" MIP, 24"	EA		25
1/2" (5/8"OD)	EFGC-012-SS-1014-30	1/2" MIP x 3/4" MIP, 30"	EA		25
1/2" (5/8"OD)	EFGC-012-SS-1014-36	1/2" MIP x 3/4" MIP, 36"	EA		25
1/2" (5/8"OD)	EFGC-012-SS-1014-48	1/2" MIP x 3/4" MIP, 48"	EA		25
1/2" (5/8"OD)	EFGC-012-SS-1014-60	1/2" MIP x 3/4" MIP, 60"	EA		12
1/2" (5/8"OD)	EFGC-012-SS-1014-72	1/2" MIP x 3/4" MIP, 72"	EA		12

Stainless Steel Flexible Gas Connectors

012-SS Series Connector with Fittings

- Tube : Stainless Steel
- Fitting : Zinc-Plated Steel S45C
- 15/16-16 Thread
- 5/8" OD (1/2" ID)



ID	Part #	Description	U/M	Price	Qty/ Box
1/2" (5/8"OD)	EFGC-012-SS-1015-12	1/2" MIP x 3/4" FIP, 12"	EA		25
1/2" (5/8"OD)	EFGC-012-SS-1015-18	1/2" MIP x 3/4" FIP, 18"	EA		25
1/2" (5/8"OD)	EFGC-012-SS-1015-24	1/2" MIP x 3/4" FIP, 24"	EA		25
1/2" (5/8"OD)	EFGC-012-SS-1015-30	1/2" MIP x 3/4" FIP, 30"	EA		25
1/2" (5/8"OD)	EFGC-012-SS-1015-36	1/2" MIP x 3/4" FIP, 36"	EA		25
1/2" (5/8"OD)	EFGC-012-SS-1015-48	1/2" MIP x 3/4" FIP, 48"	EA		25
1/2" (5/8"OD)	EFGC-012-SS-1015-60	1/2" MIP x 3/4" FIP, 60"	EA		12
1/2" (5/8"OD)	EFGC-012-SS-1015-72	1/2" MIP x 3/4" FIP, 72"	EA		12

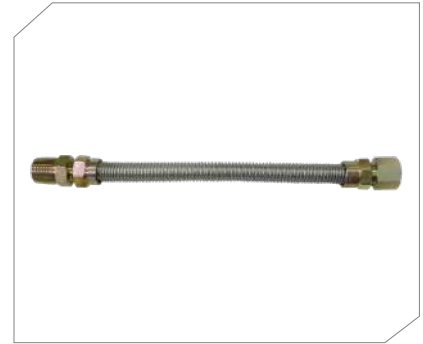

ID	Part #	Description	U/M	Price	Qty/ Box
1/2" (5/8"OD)	EFGC-012-SS-1414-12	3/4" MIP x 3/4" MIP, 12"	EA		25
1/2" (5/8"OD)	EFGC-012-SS-1414-18	3/4" MIP x 3/4" MIP, 18"	EA		25
1/2" (5/8"OD)	EFGC-012-SS-1414-24	3/4" MIP x 3/4" MIP, 24"	EA		25
1/2" (5/8"OD)	EFGC-012-SS-1414-30	3/4" MIP x 3/4" MIP, 30"	EA		25
1/2" (5/8"OD)	EFGC-012-SS-1414-36	3/4" MIP x 3/4" MIP, 36"	EA		25
1/2" (5/8"OD)	EFGC-012-SS-1414-48	3/4" MIP x 3/4" MIP, 48"	EA		25
1/2" (5/8"OD)	EFGC-012-SS-1414-60	3/4" MIP x 3/4" MIP, 60"	EA		12
1/2" (5/8"OD)	EFGC-012-SS-1414-72	3/4" MIP x 3/4" MIP, 72"	EA		12



ID	Part #	Description	U/M	Price	Qty/ Box
1/2" (5/8"OD)	EFGC-012-SS-1415-12	3/4" MIP x 3/4" FIP, 12"	EA		25
1/2" (5/8"OD)	EFGC-012-SS-1415-18	3/4" MIP x 3/4" FIP, 18"	EA		25
1/2" (5/8"OD)	EFGC-012-SS-1415-24	3/4" MIP x 3/4" FIP, 24"	EA		25
1/2" (5/8"OD)	EFGC-012-SS-1415-30	3/4" MIP x 3/4" FIP, 30"	EA		25
1/2" (5/8"OD)	EFGC-012-SS-1415-36	3/4" MIP x 3/4" FIP, 36"	EA		25
1/2" (5/8"OD)	EFGC-012-SS-1415-48	3/4" MIP x 3/4" FIP, 48"	EA		25
1/2" (5/8"OD)	EFGC-012-SS-1415-60	3/4" MIP x 3/4" FIP, 60"	EA		12
1/2" (5/8"OD)	EFGC-012-SS-1415-72	3/4" MIP x 3/4" FIP, 72"	EA		12



ID	Part #	Description	U/M	Price	Qty/ Box
1/2" (5/8"OD)	EFGC-012-SS-1515-12	3/4" FIP x 3/4" FIP, 12"	EA		25
1/2" (5/8"OD)	EFGC-012-SS-1515-18	3/4" FIP x 3/4" FIP, 18"	EA		25
1/2" (5/8"OD)	EFGC-012-SS-1515-24	3/4" FIP x 3/4" FIP, 24"	EA		25
1/2" (5/8"OD)	EFGC-012-SS-1515-30	3/4" FIP x 3/4" FIP, 30"	EA		25
1/2" (5/8"OD)	EFGC-012-SS-1515-36	3/4" FIP x 3/4" FIP, 36"	EA		25
1/2" (5/8"OD)	EFGC-012-SS-1515-48	3/4" FIP x 3/4" FIP, 48"	EA		25
1/2" (5/8"OD)	EFGC-012-SS-1515-60	3/4" FIP x 3/4" FIP, 60"	EA		12
1/2" (5/8"OD)	EFGC-012-SS-1515-72	3/4" FIP x 3/4" FIP, 72"	EA		12



Gas Connectors

Commercial Gas Connectors

Gas Line System

Gas CSST Fittings

Water Line System

Water CSST Fittings

Braided Water Connectors

Supply stop Valve

Water Heater Connectors

Isolation Valves

Thermal Expansion Tanks

No-Hub Couplings

Flexible Sprinkler Drops

Stainless Steel Flexible Gas Connectors

012-SS Series Connector with Ball Valve

- Tube : Stainless Steel
- Fitting : Zinc-Plated Steel S45C, Brass Ball Valve
- 15/16-16 Thread
- 5/8" OD (1/2" ID)

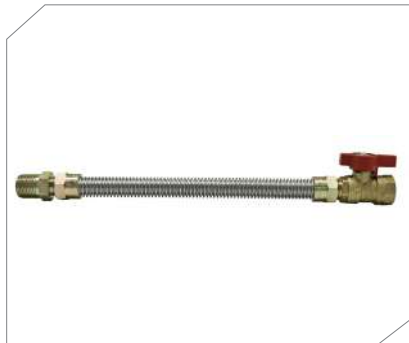

ID	Part #	Description	U/M	Price	Qty/ Box
1/2" (5/8"OD)	EFGC-012-SS-1031-12	1/2" MIP x 1/2" B.Valve, 12"	EA		25
1/2" (5/8"OD)	EFGC-012-SS-1031-18	1/2" MIP x 1/2" B.Valve, 18"	EA		25
1/2" (5/8"OD)	EFGC-012-SS-1031-24	1/2" MIP x 1/2" B.Valve, 24"	EA		25
1/2" (5/8"OD)	EFGC-012-SS-1031-30	1/2" MIP x 1/2" B.Valve, 30"	EA		25
1/2" (5/8"OD)	EFGC-012-SS-1031-36	1/2" MIP x 1/2" B.Valve, 36"	EA		25
1/2" (5/8"OD)	EFGC-012-SS-1031-48	1/2" MIP x 1/2" B.Valve, 48"	EA		25
1/2" (5/8"OD)	EFGC-012-SS-1031-60	1/2" MIP x 1/2" B.Valve, 60"	EA		12
1/2" (5/8"OD)	EFGC-012-SS-1031-72	1/2" MIP x 1/2" B.Valve, 72"	EA		12

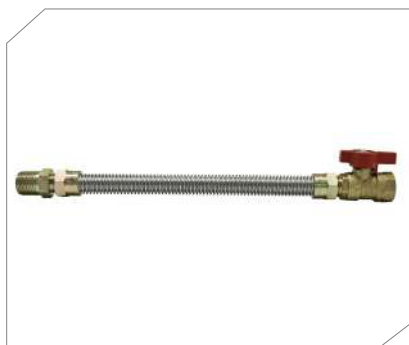

ID	Part #	Description	U/M	Price	Qty/ Box
1/2" (5/8"OD)	EFGC-012-SS-1033-12	1/2" MIP x 3/4" B.Valve, 12"	EA		25
1/2" (5/8"OD)	EFGC-012-SS-1033-18	1/2" MIP x 3/4" B.Valve, 18"	EA		25
1/2" (5/8"OD)	EFGC-012-SS-1033-24	1/2" MIP x 3/4" B.Valve, 24"	EA		25
1/2" (5/8"OD)	EFGC-012-SS-1033-30	1/2" MIP x 3/4" B.Valve, 30"	EA		25
1/2" (5/8"OD)	EFGC-012-SS-1033-36	1/2" MIP x 3/4" B.Valve, 36"	EA		25
1/2" (5/8"OD)	EFGC-012-SS-1033-48	1/2" MIP x 3/4" B.Valve, 48"	EA		25
1/2" (5/8"OD)	EFGC-012-SS-1033-60	1/2" MIP x 3/4" B.Valve, 60"	EA		12
1/2" (5/8"OD)	EFGC-012-SS-1033-72	1/2" MIP x 3/4" B.Valve, 72"	EA		12

012-SS Series Connector with Angle Valve

- Tube : Stainless Steel
- Fitting : Zinc-Plated Steel S45C, Brass Angle Valve
- 15/16-16 Thread
- 5/8" OD (1/2" ID)

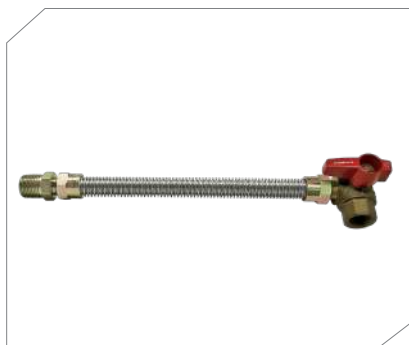

ID	Part #	Description	U/M	Price	Qty/ Box
1/2" (5/8"OD)	EFGC-012-SS-1043-12	1/2" MIP x 3/4" A.Valve, 12"	EA		25
1/2" (5/8"OD)	EFGC-012-SS-1043-18	1/2" MIP x 3/4" A.Valve, 18"	EA		25
1/2" (5/8"OD)	EFGC-012-SS-1043-24	1/2" MIP x 3/4" A.Valve, 24"	EA		25
1/2" (5/8"OD)	EFGC-012-SS-1043-30	1/2" MIP x 3/4" A.Valve, 30"	EA		25
1/2" (5/8"OD)	EFGC-012-SS-1043-36	1/2" MIP x 3/4" A.Valve, 36"	EA		25
1/2" (5/8"OD)	EFGC-012-SS-1043-48	1/2" MIP x 3/4" A.Valve, 48"	EA		25
1/2" (5/8"OD)	EFGC-012-SS-1043-60	1/2" MIP x 3/4" A.Valve, 60"	EA		12
1/2" (5/8"OD)	EFGC-012-SS-1043-72	1/2" MIP x 3/4" A.Valve, 72"	EA		12

Stainless Steel Flexible Gas Connectors

012-YE Series Connector with Fittings

- Tube : Stainless Steel
- Coating : Yellow Epoxy
- Fitting : Zinc-Plated Steel S45C
- 15/16-16 Thread
- 5/8" OD (1/2" ID)



ID	Part #	Description	U/M	Price	Qty/ Box
1/2" (5/8"OD)	EFGC-012-YE-1010-12	1/2" MIP x 1/2" MIP, 12"	EA		25
1/2" (5/8"OD)	EFGC-012-YE-1010-18	1/2" MIP x 1/2" MIP, 18"	EA		25
1/2" (5/8"OD)	EFGC-012-YE-1010-24	1/2" MIP x 1/2" MIP, 24"	EA		25
1/2" (5/8"OD)	EFGC-012-YE-1010-30	1/2" MIP x 1/2" MIP, 30"	EA		25
1/2" (5/8"OD)	EFGC-012-YE-1010-36	1/2" MIP x 1/2" MIP, 36"	EA		25
1/2" (5/8"OD)	EFGC-012-YE-1010-48	1/2" MIP x 1/2" MIP, 48"	EA		25
1/2" (5/8"OD)	EFGC-012-YE-1010-60	1/2" MIP x 1/2" MIP, 60"	EA		12
1/2" (5/8"OD)	EFGC-012-YE-1010-72	1/2" MIP x 1/2" MIP, 72"	EA		12



ID	Part #	Description	U/M	Price	Qty/ Box
1/2" (5/8"OD)	EFGC-012-YE-1011-12	1/2" MIP x 1/2" FIP, 12"	EA		25
1/2" (5/8"OD)	EFGC-012-YE-1011-18	1/2" MIP x 1/2" FIP, 18"	EA		25
1/2" (5/8"OD)	EFGC-012-YE-1011-24	1/2" MIP x 1/2" FIP, 24"	EA		25
1/2" (5/8"OD)	EFGC-012-YE-1011-30	1/2" MIP x 1/2" FIP, 30"	EA		25
1/2" (5/8"OD)	EFGC-012-YE-1011-36	1/2" MIP x 1/2" FIP, 36"	EA		25
1/2" (5/8"OD)	EFGC-012-YE-1011-48	1/2" MIP x 1/2" FIP, 48"	EA		25
1/2" (5/8"OD)	EFGC-012-YE-1011-60	1/2" MIP x 1/2" FIP, 60"	EA		12
1/2" (5/8"OD)	EFGC-012-YE-1011-72	1/2" MIP x 1/2" FIP, 72"	EA		12



ID	Part #	Description	U/M	Price	Qty/ Box
1/2" (5/8"OD)	EFGC-012-YE-1111-12	1/2" FIP x 1/2" FIP, 12"	EA		25
1/2" (5/8"OD)	EFGC-012-YE-1111-18	1/2" FIP x 1/2" FIP, 18"	EA		25
1/2" (5/8"OD)	EFGC-012-YE-1111-24	1/2" FIP x 1/2" FIP, 24"	EA		25
1/2" (5/8"OD)	EFGC-012-YE-1111-30	1/2" FIP x 1/2" FIP, 30"	EA		25
1/2" (5/8"OD)	EFGC-012-YE-1111-36	1/2" FIP x 1/2" FIP, 36"	EA		25
1/2" (5/8"OD)	EFGC-012-YE-1111-48	1/2" FIP x 1/2" FIP, 48"	EA		25
1/2" (5/8"OD)	EFGC-012-YE-1111-60	1/2" FIP x 1/2" FIP, 60"	EA		12
1/2" (5/8"OD)	EFGC-012-YE-1111-72	1/2" FIP x 1/2" FIP, 72"	EA		12



ID	Part #	Description	U/M	Price	Qty/ Box
1/2" (5/8"OD)	EFGC-012-YE-1014-12	1/2" MIP x 3/4" MIP, 12"	EA		25
1/2" (5/8"OD)	EFGC-012-YE-1014-18	1/2" MIP x 3/4" MIP, 18"	EA		25
1/2" (5/8"OD)	EFGC-012-YE-1014-24	1/2" MIP x 3/4" MIP, 24"	EA		25
1/2" (5/8"OD)	EFGC-012-YE-1014-30	1/2" MIP x 3/4" MIP, 30"	EA		25
1/2" (5/8"OD)	EFGC-012-YE-1014-36	1/2" MIP x 3/4" MIP, 36"	EA		25
1/2" (5/8"OD)	EFGC-012-YE-1014-48	1/2" MIP x 3/4" MIP, 48"	EA		25
1/2" (5/8"OD)	EFGC-012-YE-1014-60	1/2" MIP x 3/4" MIP, 60"	EA		12
1/2" (5/8"OD)	EFGC-012-YE-1014-72	1/2" MIP x 3/4" MIP, 72"	EA		12



Gas Connectors

Commercial Gas Connectors

Gas Line System

Gas CSST Fittings

Water Line System

Water CSST Fittings

Braided Water Connectors

Supply stop Valve

Water Heater Connectors

Isolation Valves

Thermal Expansion Tanks

No-Hub Couplings

Flexible Sprinkler Drops

Stainless Steel Flexible Gas Connectors

012-YE Series Connector with Fittings

- Tube : Stainless Steel
- Coating : Yellow Epoxy
- Fitting : Zinc-Plated Steel S45C
- 15/16-16 Thread
- 5/8" OD (1/2" ID)

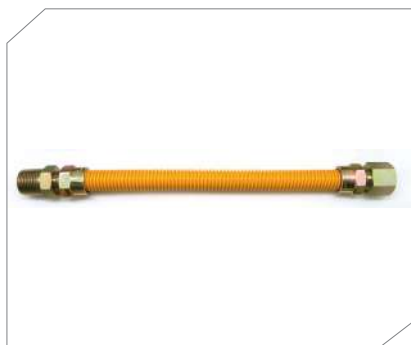

ID	Part #	Description	U/M	Price	Qty/ Box
1/2" (5/8"OD)	EFGC-012-YE-1015-12	1/2" MIP x 3/4" FIP, 12"	EA		25
1/2" (5/8"OD)	EFGC-012-YE-1015-18	1/2" MIP x 3/4" FIP, 18"	EA		25
1/2" (5/8"OD)	EFGC-012-YE-1015-24	1/2" MIP x 3/4" FIP, 24"	EA		25
1/2" (5/8"OD)	EFGC-012-YE-1015-30	1/2" MIP x 3/4" FIP, 30"	EA		25
1/2" (5/8"OD)	EFGC-012-YE-1015-36	1/2" MIP x 3/4" FIP, 36"	EA		25
1/2" (5/8"OD)	EFGC-012-YE-1015-48	1/2" MIP x 3/4" FIP, 48"	EA		25
1/2" (5/8"OD)	EFGC-012-YE-1015-60	1/2" MIP x 3/4" FIP, 60"	EA		12
1/2" (5/8"OD)	EFGC-012-YE-1015-72	1/2" MIP x 3/4" FIP, 72"	EA		12

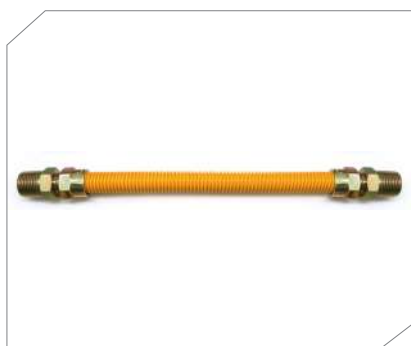

ID	Part #	Description	U/M	Price	Qty/ Box
1/2" (5/8"OD)	EFGC-012-YE-1414-12	3/4" MIP x 3/4" MIP, 12"	EA		25
1/2" (5/8"OD)	EFGC-012-YE-1414-18	3/4" MIP x 3/4" MIP, 18"	EA		25
1/2" (5/8"OD)	EFGC-012-YE-1414-24	3/4" MIP x 3/4" MIP, 24"	EA		25
1/2" (5/8"OD)	EFGC-012-YE-1414-30	3/4" MIP x 3/4" MIP, 30"	EA		25
1/2" (5/8"OD)	EFGC-012-YE-1414-36	3/4" MIP x 3/4" MIP, 36"	EA		25
1/2" (5/8"OD)	EFGC-012-YE-1414-48	3/4" MIP x 3/4" MIP, 48"	EA		25
1/2" (5/8"OD)	EFGC-012-YE-1414-60	3/4" MIP x 3/4" MIP, 60"	EA		12
1/2" (5/8"OD)	EFGC-012-YE-1414-72	3/4" MIP x 3/4" MIP, 72"	EA		12

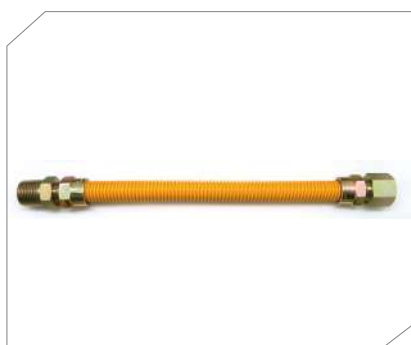

ID	Part #	Description	U/M	Price	Qty/ Box
1/2" (5/8"OD)	EFGC-012-YE-1415-12	3/4" MIP x 3/4" FIP, 12"	EA		25
1/2" (5/8"OD)	EFGC-012-YE-1415-18	3/4" MIP x 3/4" FIP, 18"	EA		25
1/2" (5/8"OD)	EFGC-012-YE-1415-24	3/4" MIP x 3/4" FIP, 24"	EA		25
1/2" (5/8"OD)	EFGC-012-YE-1415-30	3/4" MIP x 3/4" FIP, 30"	EA		25
1/2" (5/8"OD)	EFGC-012-YE-1415-36	3/4" MIP x 3/4" FIP, 36"	EA		25
1/2" (5/8"OD)	EFGC-012-YE-1415-48	3/4" MIP x 3/4" FIP, 48"	EA		25
1/2" (5/8"OD)	EFGC-012-YE-1415-60	3/4" MIP x 3/4" FIP, 60"	EA		12
1/2" (5/8"OD)	EFGC-012-YE-1415-72	3/4" MIP x 3/4" FIP, 72"	EA		12

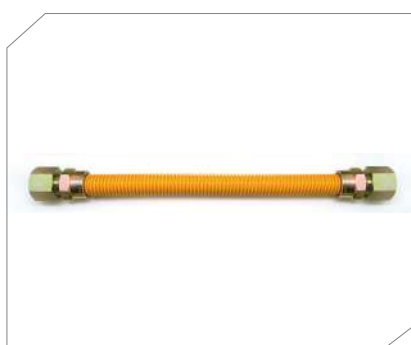

ID	Part #	Description	U/M	Price	Qty/ Box
1/2" (5/8"OD)	EFGC-012-YE-1515-12	3/4" FIP x 3/4" FIP, 12"	EA		25
1/2" (5/8"OD)	EFGC-012-YE-1515-18	3/4" FIP x 3/4" FIP, 18"	EA		25
1/2" (5/8"OD)	EFGC-012-YE-1515-24	3/4" FIP x 3/4" FIP, 24"	EA		25
1/2" (5/8"OD)	EFGC-012-YE-1515-30	3/4" FIP x 3/4" FIP, 30"	EA		25
1/2" (5/8"OD)	EFGC-012-YE-1515-36	3/4" FIP x 3/4" FIP, 36"	EA		25
1/2" (5/8"OD)	EFGC-012-YE-1515-48	3/4" FIP x 3/4" FIP, 48"	EA		25
1/2" (5/8"OD)	EFGC-012-YE-1515-60	3/4" FIP x 3/4" FIP, 60"	EA		12
1/2" (5/8"OD)	EFGC-012-YE-1515-72	3/4" FIP x 3/4" FIP, 72"	EA		12

Stainless Steel Flexible Gas Connectors

012-YE Series Connector with Ball Valve

- Tube : Stainless Steel
- Coating : Yellow Epoxy
- Fitting : Zinc-Plated Steel S45C, Brass Ball Valve
- 15/16-16 Thread
- 5/8" OD (1/2" ID)



ID	Part #	Description	U/M	Price	Qty/ Box
1/2" (5/8"OD)	EFGC-012-YE-1031-12	1/2" MIP x 1/2" B.Valve, 12"	EA		25
1/2" (5/8"OD)	EFGC-012-YE-1031-18	1/2" MIP x 1/2" B.Valve, 18"	EA		25
1/2" (5/8"OD)	EFGC-012-YE-1031-24	1/2" MIP x 1/2" B.Valve, 24"	EA		25
1/2" (5/8"OD)	EFGC-012-YE-1031-30	1/2" MIP x 1/2" B.Valve, 30"	EA		25
1/2" (5/8"OD)	EFGC-012-YE-1031-36	1/2" MIP x 1/2" B.Valve, 36"	EA		25
1/2" (5/8"OD)	EFGC-012-YE-1031-48	1/2" MIP x 1/2" B.Valve, 48"	EA		25
1/2" (5/8"OD)	EFGC-012-YE-1031-60	1/2" MIP x 1/2" B.Valve, 60"	EA		12
1/2" (5/8"OD)	EFGC-012-YE-1031-72	1/2" MIP x 1/2" B.Valve, 72"	EA		12



ID	Part #	Description	U/M	Price	Qty/ Box
1/2" (5/8"OD)	EFGC-012-YE-1033-12	1/2" MIP x 3/4" B.Valve, 12"	EA		25
1/2" (5/8"OD)	EFGC-012-YE-1033-18	1/2" MIP x 3/4" B.Valve, 18"	EA		25
1/2" (5/8"OD)	EFGC-012-YE-1033-24	1/2" MIP x 3/4" B.Valve, 24"	EA		25
1/2" (5/8"OD)	EFGC-012-YE-1033-30	1/2" MIP x 3/4" B.Valve, 30"	EA		25
1/2" (5/8"OD)	EFGC-012-YE-1033-36	1/2" MIP x 3/4" B.Valve, 36"	EA		25
1/2" (5/8"OD)	EFGC-012-YE-1033-48	1/2" MIP x 3/4" B.Valve, 48"	EA		25
1/2" (5/8"OD)	EFGC-012-YE-1033-60	1/2" MIP x 3/4" B.Valve, 60"	EA		12
1/2" (5/8"OD)	EFGC-012-YE-1033-72	1/2" MIP x 3/4" B.Valve, 72"	EA		12



012-YE Series Connector with Angle Valve

- Tube : Stainless Steel
- Coating : Yellow Epoxy
- Fitting : Zinc-Plated Steel S45C, Brass Angle Valve
- 15/16-16 Thread
- 5/8" OD (1/2" ID)



ID	Part #	Description	U/M	Price	Qty/ Box
1/2" (5/8"OD)	EFGC-012-YE-1043-12	1/2" MIP x 3/4" A.Valve, 12"	EA		25
1/2" (5/8"OD)	EFGC-012-YE-1043-18	1/2" MIP x 3/4" A.Valve, 18"	EA		25
1/2" (5/8"OD)	EFGC-012-YE-1043-24	1/2" MIP x 3/4" A.Valve, 24"	EA		25
1/2" (5/8"OD)	EFGC-012-YE-1043-30	1/2" MIP x 3/4" A.Valve, 30"	EA		25
1/2" (5/8"OD)	EFGC-012-YE-1043-36	1/2" MIP x 3/4" A.Valve, 36"	EA		25
1/2" (5/8"OD)	EFGC-012-YE-1043-48	1/2" MIP x 3/4" A.Valve, 48"	EA		25
1/2" (5/8"OD)	EFGC-012-YE-1043-60	1/2" MIP x 3/4" A.Valve, 60"	EA		12
1/2" (5/8"OD)	EFGC-012-YE-1043-72	1/2" MIP x 3/4" A.Valve, 72"	EA		12



Gas Connectors

Commercial Gas Connectors

Gas Line System

Gas CSST Fittings

Water Line System

Water CSST Fittings

Braided Water Connectors

Supply stop Valve

Water Heater Connectors

Isolation Valves

Thermal Expansion Tanks

No-Hub Couplings

Flexible Sprinkler Drops

Stainless Steel Flexible Gas Connectors

034-SS Series Connector with Fittings

- Tube : Stainless Steel
- Fitting : Zinc-Plated Steel S45C
- 1-1/8-16 Thread
- 1" OD (3/4" ID)



ID	Part #	Description	U/M	Price	Qty/ Box
3/4" (1"OD)	EFGC-034-SS-1414-12	3/4" MIP x 3/4" MIP, 12"	EA		25
3/4" (1"OD)	EFGC-034-SS-1414-18	3/4" MIP x 3/4" MIP, 18"	EA		25
3/4" (1"OD)	EFGC-034-SS-1414-24	3/4" MIP x 3/4" MIP, 24"	EA		25
3/4" (1"OD)	EFGC-034-SS-1414-30	3/4" MIP x 3/4" MIP, 30"	EA		25
3/4" (1"OD)	EFGC-034-SS-1414-36	3/4" MIP x 3/4" MIP, 36"	EA		25
3/4" (1"OD)	EFGC-034-SS-1414-48	3/4" MIP x 3/4" MIP, 48"	EA		25
3/4" (1"OD)	EFGC-034-SS-1414-60	3/4" MIP x 3/4" MIP, 60"	EA		12
3/4" (1"OD)	EFGC-034-SS-1414-72	3/4" MIP x 3/4" MIP, 72"	EA		12

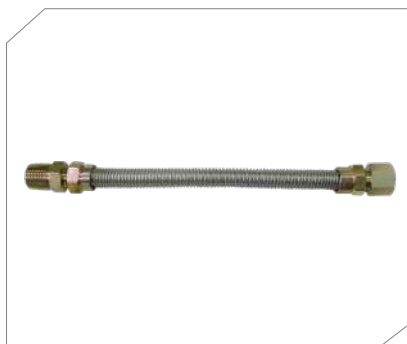

ID	Part #	Description	U/M	Price	Qty/ Box
3/4" (1"OD)	EFGC-034-SS-1415-12	3/4" MIP x 3/4" FIP, 12"	EA		25
3/4" (1"OD)	EFGC-034-SS-1415-18	3/4" MIP x 3/4" FIP, 18"	EA		25
3/4" (1"OD)	EFGC-034-SS-1415-24	3/4" MIP x 3/4" FIP, 24"	EA		25
3/4" (1"OD)	EFGC-034-SS-1415-30	3/4" MIP x 3/4" FIP, 30"	EA		25
3/4" (1"OD)	EFGC-034-SS-1415-36	3/4" MIP x 3/4" FIP, 36"	EA		25
3/4" (1"OD)	EFGC-034-SS-1415-48	3/4" MIP x 3/4" FIP, 48"	EA		25
3/4" (1"OD)	EFGC-034-SS-1415-60	3/4" MIP x 3/4" FIP, 60"	EA		12
3/4" (1"OD)	EFGC-034-SS-1415-72	3/4" MIP x 3/4" FIP, 72"	EA		12

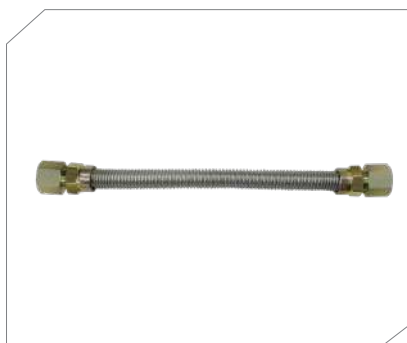

ID	Part #	Description	U/M	Price	Qty/ Box
3/4" (1"OD)	EFGC-034-SS-1515-12	3/4" FIP x 3/4" FIP, 12"	EA		25
3/4" (1"OD)	EFGC-034-SS-1515-18	3/4" FIP x 3/4" FIP, 18"	EA		25
3/4" (1"OD)	EFGC-034-SS-1515-24	3/4" FIP x 3/4" FIP, 24"	EA		25
3/4" (1"OD)	EFGC-034-SS-1515-30	3/4" FIP x 3/4" FIP, 30"	EA		25
3/4" (1"OD)	EFGC-034-SS-1515-36	3/4" FIP x 3/4" FIP, 36"	EA		25
3/4" (1"OD)	EFGC-034-SS-1515-48	3/4" FIP x 3/4" FIP, 48"	EA		25
3/4" (1"OD)	EFGC-034-SS-1515-60	3/4" FIP x 3/4" FIP, 60"	EA		12
3/4" (1"OD)	EFGC-034-SS-1515-72	3/4" FIP x 3/4" FIP, 72"	EA		12

Stainless Steel Flexible Gas Connectors

034-YE Series Connector with Fittings

- Tube : Stainless Steel
- Coating : Yellow Epoxy
- Fitting : Zinc-Plated Steel S45C
- 1-1/8-16 Thread
- 1" OD (3/4" ID)



ID	Part #	Description	U/M	Price	Qty/ Box
3/4" (1"OD)	EFGC-034-YE-1414-12	3/4" MIP x 3/4" MIP, 12"	EA		25
3/4" (1"OD)	EFGC-034-YE-1414-18	3/4" MIP x 3/4" MIP, 18"	EA		25
3/4" (1"OD)	EFGC-034-YE-1414-24	3/4" MIP x 3/4" MIP, 24"	EA		25
3/4" (1"OD)	EFGC-034-YE-1414-30	3/4" MIP x 3/4" MIP, 30"	EA		25
3/4" (1"OD)	EFGC-034-YE-1414-36	3/4" MIP x 3/4" MIP, 36"	EA		25
3/4" (1"OD)	EFGC-034-YE-1414-48	3/4" MIP x 3/4" MIP, 48"	EA		25
3/4" (1"OD)	EFGC-034-YE-1414-60	3/4" MIP x 3/4" MIP, 60"	EA		12
3/4" (1"OD)	EFGC-034-YE-1414-72	3/4" MIP x 3/4" MIP, 72"	EA		12



ID	Part #	Description	U/M	Price	Qty/ Box
3/4" (1"OD)	EFGC-034-YE-1415-12	3/4" MIP x 3/4" FIP, 12"	EA		25
3/4" (1"OD)	EFGC-034-YE-1415-18	3/4" MIP x 3/4" FIP, 18"	EA		25
3/4" (1"OD)	EFGC-034-YE-1415-24	3/4" MIP x 3/4" FIP, 24"	EA		25
3/4" (1"OD)	EFGC-034-YE-1415-30	3/4" MIP x 3/4" FIP, 30"	EA		25
3/4" (1"OD)	EFGC-034-YE-1415-36	3/4" MIP x 3/4" FIP, 36"	EA		25
3/4" (1"OD)	EFGC-034-YE-1415-48	3/4" MIP x 3/4" FIP, 48"	EA		25
3/4" (1"OD)	EFGC-034-YE-1415-60	3/4" MIP x 3/4" FIP, 60"	EA		12
3/4" (1"OD)	EFGC-034-YE-1415-72	3/4" MIP x 3/4" FIP, 72"	EA		12

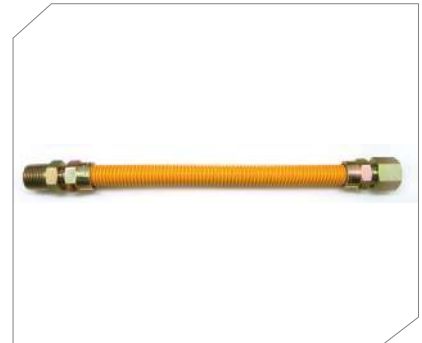

ID	Part #	Description	U/M	Price	Qty/ Box
3/4" (1"OD)	EFGC-034-YE-1515-12	3/4" FIP x 3/4" FIP, 12"	EA		25
3/4" (1"OD)	EFGC-034-YE-1515-18	3/4" FIP x 3/4" FIP, 18"	EA		25
3/4" (1"OD)	EFGC-034-YE-1515-24	3/4" FIP x 3/4" FIP, 24"	EA		25
3/4" (1"OD)	EFGC-034-YE-1515-30	3/4" FIP x 3/4" FIP, 30"	EA		25
3/4" (1"OD)	EFGC-034-YE-1515-36	3/4" FIP x 3/4" FIP, 36"	EA		25
3/4" (1"OD)	EFGC-034-YE-1515-48	3/4" FIP x 3/4" FIP, 48"	EA		25
3/4" (1"OD)	EFGC-034-YE-1515-60	3/4" FIP x 3/4" FIP, 60"	EA		12
3/4" (1"OD)	EFGC-034-YE-1515-72	3/4" FIP x 3/4" FIP, 72"	EA		12



Gas Connectors

Commercial Gas Connectors

Gas Line System

Gas CSST Fittings

Water Line System

Water CSST Fittings

Braided Water Connectors

Supply stop Valve

Water Heater Connectors

Isolation Valves

Thermal Expansion Tanks

No-Hub Couplings

Flexible Sprinkler Drops

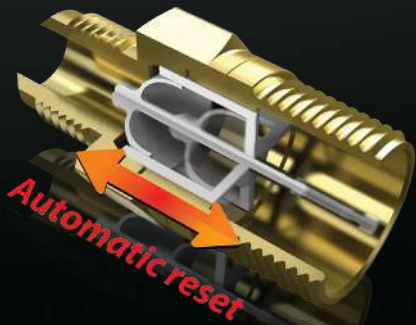

NEW Automatic Safety Valve for Gas Appliance

Automatic Excess Flow Shut-off Connectors

In the case of a gas line rupture or a disconnect from the appliance, Easyflex's EFV detects the increase of gas flow and immediately shuts-off the supply of gas. Gas flow is controlled only at the appliance where the problem exists. The valve will remain activated until the gas line is properly repaired.

- Automatic Activation
- Simple Reset
- Battery Not Required
- 100% Performance Tested

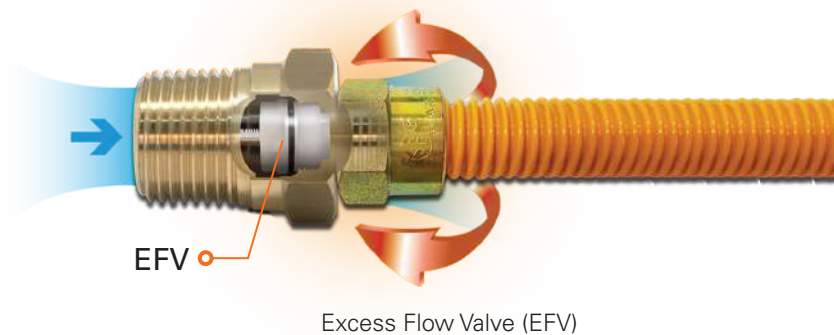

Stainless Steel Flexible Gas Connectors



Product Testing

Strength Test	Withstands an internal hydrostatic pressure of 250 psi (17MPa) without bursting or leaking
Bending Test	Withstands 30 bends without leaking in depths less than 2 inches of water
Torsion Test	Withstands 15 applications of 90° twists
Durability at High Temperature Test	Withstands temperatures of up to 800°F
Strength of Fittings	Does not leak within a tightened torque of 1,040 inch-pounds

Certifications, Approvals, Listings and Compliance

United States | CSA USA Standards Association

- ANSI Z 21.24 Connectors for Gas Appliances
- ANSI Z 21.75 Connectors for Outdoor Appliances and Manufactured Homes
- ANSI Z 21.93 Excess Flow Valves for Natural and LP Gas with Pressures of Up to 5 psig

Canada | CSA Canadian Standards Association

- CSA 6.10 Connectors for Gas Appliances
- CSA 6.27 Connectors for Outdoor Appliances and Manufactured
- Meets the requirements of CSA B149.1 National Gas and Propane Installation Code
- CSA 6.30 Excess Flow Valves for Natural and LP Gas with Pressures of Up to 5 psig



Sizing and Model Selection

Model No.	Connection		Rated Trip Flow Rate(kBtu/hr)			Maximum Flow Capacity(kBtu/hr)			
	Flow Direction	Inlet	Outlet	Horizontal	Vertical Up	Vertical Down	Horizontal	Vertical Up	Vertical Down
G014-10A		1/2" MIP	3/8" OD Flare	107 @ 0.94	113 @ 0.99	103 @ 0.90	84 @ 0.50	83 @ 0.50	84 @ 0.50
G014-12A		3/8" MIP	3/8" OD Flare						
G014-11A		1/2" FIP	3/8" OD Flare						
G014-13A		3/8" FIP	3/8" OD Flare						
G038-10A		1/2" MIP	1/2" OD Flare	166 @ 0.87	149 @ 1.29	139 @ 0.63	133 @ 0.50	97 @ 0.50	123 @ 0.50
G038-12A		3/8" MIP	1/2" OD Flare						
G038-11A		1/2" FIP	1/2" OD Flare						
G038-13A		3/8" FIP	1/2" OD Flare						
G012-10A		1/2" MIP	5/8" OD Flare	202 @ 1.39	214 @ 1.24	178 @ 0.97	121 @ 0.50	105 @ 0.50	133 @ 0.50
G012-14A		3/4" MIP	5/8" OD Flare						
G012-11A		1/2" FIP	5/8" OD Flare						
G012-15A		3/4" FIP	5/8" OD Flare						

- Rated Trip Flow and Max Flow Capacity values are kBtu/max. "w.c PD (natural gas.0.64 s.g., 1000 BTU/cu.ft.)
- A minimum of 5" w.c inlet pressure is required with a maximum inlet pressure of 14" w.c. (1/2 psig)
- Operating temperature range. -20°F ~ 150°F (-29°C ~ 66°C)
- EFV type: EFVNB
- Installation orientation: Multi-position (horizontal, vertical up, vertical down)

Gas Connectors
 Commercial Gas Connectors
 Gas Line System
 Gas CSST Fittings
 Water Line System
 Water CSST Fittings
 Braided Water Connectors
 Supply stop Valve
 Water Heater Connectors
 Isolation Valves
 Thermal Expansion Tanks
 No-Hub Couplings
 Flexible Sprinkler Drops



Certificate of Compliance

Certificate: 70056507 (238420) **Master Contract:** 238420
Project: 70081678 **Date Issued:** 2016-08-09
Issued to: Kofulso Co., Ltd.
 377-8 Gungok-Dong, Seo-Gu
 Incheon City,
 SOUTH KOREA
 Attention: Steven Cho

The products listed below are eligible to bear the CSA Mark shown with adjacent indicators 'C' and 'US' for Canada and US or with adjacent indicator 'US' for US only or without either indicator for Canada only.



Issued by: *James Sekerak*
 James Sekerak

PRODUCTS

CLASS - C337187 - VALVES (GAS)-Excess Flow-Certified to U.S. Standards
 CLASS - C337107 - VALVES (GAS)-Excess Flow

For details related to rating, size, configuration, etc. reference should be made to the CSA Certification Record or the descriptive report.

For Use With Natural and Propane Gas
For use with Natural and Liquefied Petroleum Gases

Trade Name: GASTOP

<u>Model</u>	<u>Pressure Rating</u>	<u>Inlet</u>	<u>Outlet</u>
G012-10V	1/2 psig	1/2" MIP	5/8" OD (15/16"-16 UNF-2A) flare
G012-11V	1/2 psig	1/2" FIP	5/8" OD (15/16"-16 UNF-2A) flare
G012-14V	1/2 psig	3/4" MIP	5/8" OD (15/16"-16 UNF-2A) flare
G012-15V	1/2 psig	3/4" FIP	5/8" OD (15/16"-16 UNF-2A) flare
G014-10V	1/2 psig	1/2" MIP	3/8" OD (5/8"-18 UNF-2A) flare
G014-11V	1/2 psig	1/2" FIP	3/8" OD (5/8"-18 UNF-2A) flare

Stainless Steel Flexible Gas Connectors



Parts Numbering System

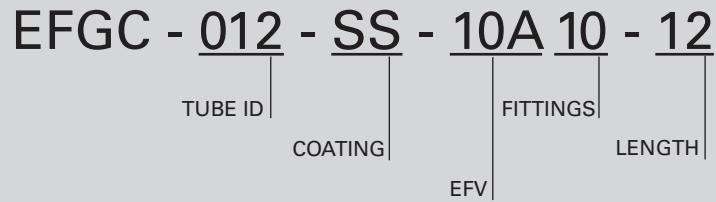

TUBE ID

Part#	Size (ID)	Thread
014	1/4" ID (3/8" OD)	5/8"-18
038	3/8" ID (1/2" OD)	3/4"-16
012	1/2" ID (5/8" OD)	15/16"-16
034	3/4" ID (1" OD)	1-1/8"-16

COATING

Part#	Description
SS	Uncoated Stainless Steel 304
YE	Yellow Epoxy Coated Stainless Steel 304
BE	Black Epoxy Coated Stainless Steel 304

ADAPTERS/ VALVES

Part#	Size (ID)
10A	1/2" MIP EFV
11A	1/2" FIP EFV
12A	3/8" MIP EFV
13A	3/8" FIP EFV
14A	3/4" MIP EFV

LENGTH

Part#	Size (ID)	Part#
10	1/2" MIP	12"
11	1/2" FIP	18"
12	3/8" MIP	24"
13	3/8" FIP	30"
14	3/4" MIP	36"
		48"
		60"
		72"

- Gas Connectors
- Commercial Gas Connectors
- Gas Line System
- Gas CSST Fittings
- Water Line System
- Water CSST Fittings
- Braided Water Connectors
- Supply stop Valve
- Water Heater Connectors
- Isolation Valves
- Thermal Expansion Tanks
- No-Hub Couplings
- Flexible Sprinkler Drops

Stainless Steel Flexible Gas Connectors



014-SS Series Connector with Fittings / EFV

- Tube : Stainless Steel
- Fitting : Zinc-Plated Steel S45C
- 5/8-18 Thread
- 3/8" OD (1/4" ID)

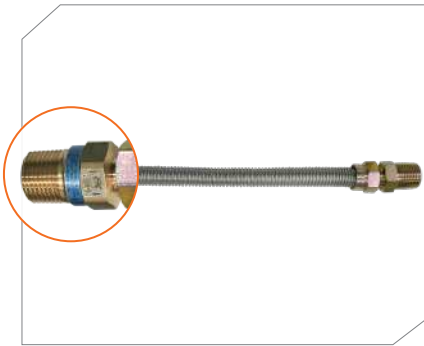

ID	Part #	Description	U/M	Price	Qty/ Box
1/4" (3/8"OD)	EFGC-014-SS-10A10-12	1/2" M.EFV x 1/2" MIP, 12"	EA		25
1/4" (3/8"OD)	EFGC-014-SS-10A10-18	1/2" M.EFV x 1/2" MIP, 18"	EA		25
1/4" (3/8"OD)	EFGC-014-SS-10A10-24	1/2" M.EFV x 1/2" MIP, 24"	EA		25
1/4" (3/8"OD)	EFGC-014-SS-10A10-30	1/2" M.EFV x 1/2" MIP, 30"	EA		25
1/4" (3/8"OD)	EFGC-014-SS-10A10-36	1/2" M.EFV x 1/2" MIP, 36"	EA		25
1/4" (3/8"OD)	EFGC-014-SS-10A10-48	1/2" M.EFV x 1/2" MIP, 48"	EA		25
1/4" (3/8"OD)	EFGC-014-SS-10A10-60	1/2" M.EFV x 1/2" MIP, 60"	EA		12
1/4" (3/8"OD)	EFGC-014-SS-10A10-72	1/2" M.EFV x 1/2" MIP, 72"	EA		12

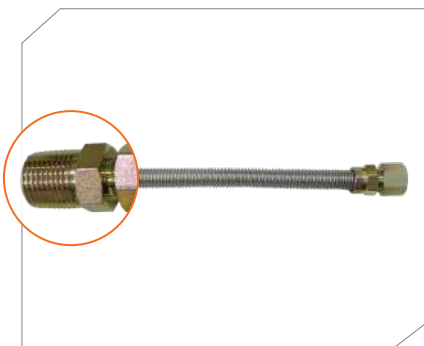

ID	Part #	Description	U/M	Price	Qty/ Box
1/4" (3/8"OD)	EFGC-014-SS-10A11-12	1/2" M.EFV x 1/2" FIP, 12"	EA		25
1/4" (3/8"OD)	EFGC-014-SS-10A11-18	1/2" M.EFV x 1/2" FIP, 18"	EA		25
1/4" (3/8"OD)	EFGC-014-SS-10A11-24	1/2" M.EFV x 1/2" FIP, 24"	EA		25
1/4" (3/8"OD)	EFGC-014-SS-10A11-30	1/2" M.EFV x 1/2" FIP, 30"	EA		25
1/4" (3/8"OD)	EFGC-014-SS-10A11-36	1/2" M.EFV x 1/2" FIP, 36"	EA		25
1/4" (3/8"OD)	EFGC-014-SS-10A11-48	1/2" M.EFV x 1/2" FIP, 48"	EA		25
1/4" (3/8"OD)	EFGC-014-SS-10A11-60	1/2" M.EFV x 1/2" FIP, 60"	EA		12
1/4" (3/8"OD)	EFGC-014-SS-10A11-72	1/2" M.EFV x 1/2" FIP, 72"	EA		12

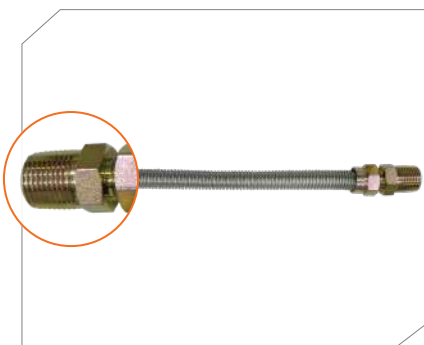

ID	Part #	Description	U/M	Price	Qty/ Box
1/4" (3/8"OD)	EFGC-014-SS-10A12-12	1/2" M.EFV x 3/8" MIP, 12"	EA		25
1/4" (3/8"OD)	EFGC-014-SS-10A12-18	1/2" M.EFV x 3/8" MIP, 18"	EA		25
1/4" (3/8"OD)	EFGC-014-SS-10A12-24	1/2" M.EFV x 3/8" MIP, 24"	EA		25
1/4" (3/8"OD)	EFGC-014-SS-10A12-30	1/2" M.EFV x 3/8" MIP, 30"	EA		25
1/4" (3/8"OD)	EFGC-014-SS-10A12-36	1/2" M.EFV x 3/8" MIP, 36"	EA		25
1/4" (3/8"OD)	EFGC-014-SS-10A12-48	1/2" M.EFV x 3/8" MIP, 48"	EA		25
1/4" (3/8"OD)	EFGC-014-SS-10A12-60	1/2" M.EFV x 3/8" MIP, 60"	EA		12
1/4" (3/8"OD)	EFGC-014-SS-10A12-72	1/2" M.EFV x 3/8" MIP, 72"	EA		12

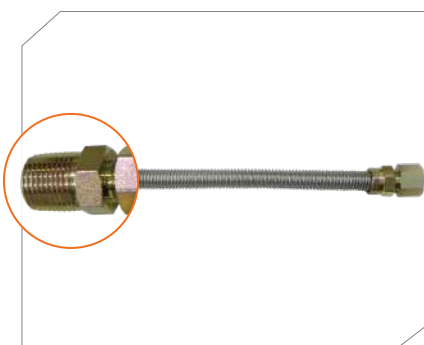

ID	Part #	Description	U/M	Price	Qty/ Box
1/4" (3/8"OD)	EFGC-014-SS-10A13-12	1/2" M.EFV x 3/8" FIP, 12"	EA		25
1/4" (3/8"OD)	EFGC-014-SS-10A13-18	1/2" M.EFV x 3/8" FIP, 18"	EA		25
1/4" (3/8"OD)	EFGC-014-SS-10A13-24	1/2" M.EFV x 3/8" FIP, 24"	EA		25
1/4" (3/8"OD)	EFGC-014-SS-10A13-30	1/2" M.EFV x 3/8" FIP, 30"	EA		25
1/4" (3/8"OD)	EFGC-014-SS-10A13-36	1/2" M.EFV x 3/8" FIP, 36"	EA		25
1/4" (3/8"OD)	EFGC-014-SS-10A13-48	1/2" M.EFV x 3/8" FIP, 48"	EA		25
1/4" (3/8"OD)	EFGC-014-SS-10A13-60	1/2" M.EFV x 3/8" FIP, 60"	EA		12
1/4" (3/8"OD)	EFGC-014-SS-10A13-72	1/2" M.EFV x 3/8" FIP, 72"	EA		12

Stainless Steel Flexible Gas Connectors



014-SS Series Connector with Fittings / EFV

- Tube : Stainless Steel
- Fitting : Zinc-Plated Steel S45C
- 5/8-18 Thread
- 3/8" OD (1/4" ID)



ID	Part #	Description	U/M	Price	Qty/ Box
1/4" (3/8"OD)	EFGC-014-SS-12A13-12	3/8" M.EFV x 3/8" FIP, 12"	EA		25
1/4" (3/8"OD)	EFGC-014-SS-12A13-18	3/8" M.EFV x 3/8" FIP, 18"	EA		25
1/4" (3/8"OD)	EFGC-014-SS-12A13-24	3/8" M.EFV x 3/8" FIP, 24"	EA		25
1/4" (3/8"OD)	EFGC-014-SS-12A13-30	3/8" M.EFV x 3/8" FIP, 30"	EA		25
1/4" (3/8"OD)	EFGC-014-SS-12A13-36	3/8" M.EFV x 3/8" FIP, 36"	EA		25
1/4" (3/8"OD)	EFGC-014-SS-12A13-48	3/8" M.EFV x 3/8" FIP, 48"	EA		25
1/4" (3/8"OD)	EFGC-014-SS-12A13-60	3/8" M.EFV x 3/8" FIP, 60"	EA		12
1/4" (3/8"OD)	EFGC-014-SS-12A13-72	3/8" M.EFV x 3/8" FIP, 72"	EA		12

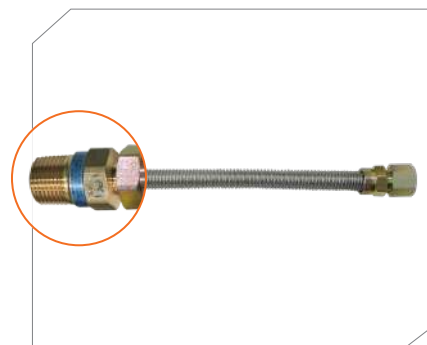

- Gas Connectors
- Commercial Gas Connectors
- Gas Line System
- Gas CSST Fittings
- Water Line System
- Water CSST Fittings
- Braided Water Connectors
- Supply stop Valve
- Water Heater Connectors
- Isolation Valves
- Thermal Expansion Tanks
- No-Hub Couplings
- Flexible Sprinkler Drops

Stainless Steel Flexible Gas Connectors



014-YE Series Connector with Fittings / EFV

- Tube : Stainless Steel
- Coating : Yellow Epoxy
- Fitting : Zinc-Plated Steel S45C
- 5/8-18 Thread
- 3/8" OD (1/4" ID)

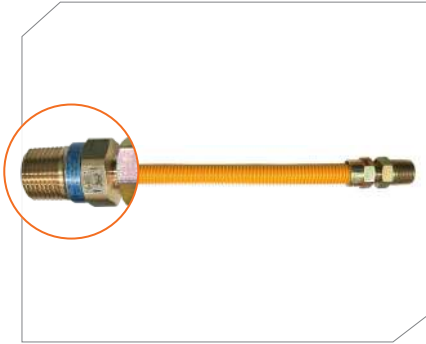

ID	Part #	Description	U/M	Price	Qty/ Box
1/4" (3/8"OD)	EFGC-014-YE-10A10-12	1/2" M.EFV x 1/2" MIP, 12"	EA		25
1/4" (3/8"OD)	EFGC-014-YE-10A10-18	1/2" M.EFV x 1/2" MIP, 18"	EA		25
1/4" (3/8"OD)	EFGC-014-YE-10A10-24	1/2" M.EFV x 1/2" MIP, 24"	EA		25
1/4" (3/8"OD)	EFGC-014-YE-10A10-30	1/2" M.EFV x 1/2" MIP, 30"	EA		25
1/4" (3/8"OD)	EFGC-014-YE-10A10-36	1/2" M.EFV x 1/2" MIP, 36"	EA		25
1/4" (3/8"OD)	EFGC-014-YE-10A10-48	1/2" M.EFV x 1/2" MIP, 48"	EA		25
1/4" (3/8"OD)	EFGC-014-YE-10A10-60	1/2" M.EFV x 1/2" MIP, 60"	EA		12
1/4" (3/8"OD)	EFGC-014-YE-10A10-72	1/2" M.EFV x 1/2" MIP, 72"	EA		12

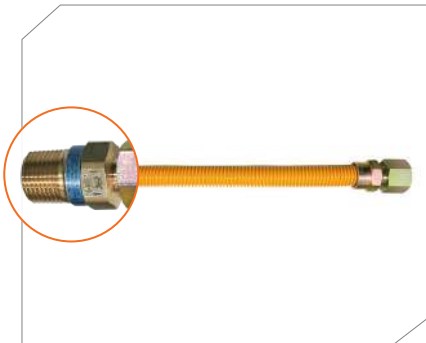

ID	Part #	Description	U/M	Price	Qty/ Box
1/4" (3/8"OD)	EFGC-014-YE-10A11-12	1/2" M.EFV x 1/2" FIP, 12"	EA		25
1/4" (3/8"OD)	EFGC-014-YE-10A11-18	1/2" M.EFV x 1/2" FIP, 18"	EA		25
1/4" (3/8"OD)	EFGC-014-YE-10A11-24	1/2" M.EFV x 1/2" FIP, 24"	EA		25
1/4" (3/8"OD)	EFGC-014-YE-10A11-30	1/2" M.EFV x 1/2" FIP, 30"	EA		25
1/4" (3/8"OD)	EFGC-014-YE-10A11-36	1/2" M.EFV x 1/2" FIP, 36"	EA		25
1/4" (3/8"OD)	EFGC-014-YE-10A11-48	1/2" M.EFV x 1/2" FIP, 48"	EA		25
1/4" (3/8"OD)	EFGC-014-YE-10A11-60	1/2" M.EFV x 1/2" FIP, 60"	EA		12
1/4" (3/8"OD)	EFGC-014-YE-10A11-72	1/2" M.EFV x 1/2" FIP, 72"	EA		12

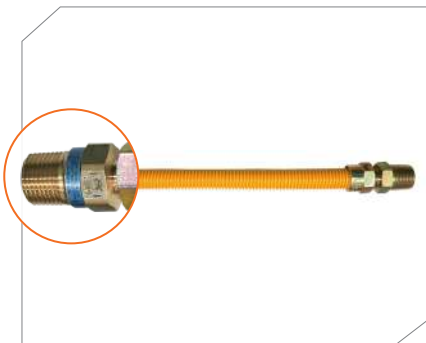

ID	Part #	Description	U/M	Price	Qty/ Box
1/4" (3/8"OD)	EFGC-014-YE-10A12-12	1/2" M.EFV x 3/8" MIP, 12"	EA		25
1/4" (3/8"OD)	EFGC-014-YE-10A12-18	1/2" M.EFV x 3/8" MIP, 18"	EA		25
1/4" (3/8"OD)	EFGC-014-YE-10A12-24	1/2" M.EFV x 3/8" MIP, 24"	EA		25
1/4" (3/8"OD)	EFGC-014-YE-10A12-30	1/2" M.EFV x 3/8" MIP, 30"	EA		25
1/4" (3/8"OD)	EFGC-014-YE-10A12-36	1/2" M.EFV x 3/8" MIP, 36"	EA		25
1/4" (3/8"OD)	EFGC-014-YE-10A12-48	1/2" M.EFV x 3/8" MIP, 48"	EA		25
1/4" (3/8"OD)	EFGC-014-YE-10A12-60	1/2" M.EFV x 3/8" MIP, 60"	EA		12
1/4" (3/8"OD)	EFGC-014-YE-10A12-72	1/2" M.EFV x 3/8" MIP, 72"	EA		12

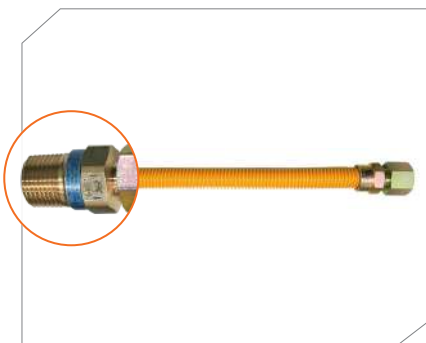

ID	Part #	Description	U/M	Price	Qty/ Box
1/4" (3/8"OD)	EFGC-014-YE-10A13-12	1/2" M.EFV x 3/8" FIP, 12"	EA		25
1/4" (3/8"OD)	EFGC-014-YE-10A13-18	1/2" M.EFV x 3/8" FIP, 18"	EA		25
1/4" (3/8"OD)	EFGC-014-YE-10A13-24	1/2" M.EFV x 3/8" FIP, 24"	EA		25
1/4" (3/8"OD)	EFGC-014-YE-10A13-30	1/2" M.EFV x 3/8" FIP, 30"	EA		25
1/4" (3/8"OD)	EFGC-014-YE-10A13-36	1/2" M.EFV x 3/8" FIP, 36"	EA		25
1/4" (3/8"OD)	EFGC-014-YE-10A13-48	1/2" M.EFV x 3/8" FIP, 48"	EA		25
1/4" (3/8"OD)	EFGC-014-YE-10A13-60	1/2" M.EFV x 3/8" FIP, 60"	EA		12
1/4" (3/8"OD)	EFGC-014-YE-10A13-72	1/2" M.EFV x 3/8" FIP, 72"	EA		12

Stainless Steel Flexible Gas Connectors



014-YE Series Connector with Fittings / EFV

- Tube : Stainless Steel
- Coating : Yellow Epoxy
- Fitting : Zinc-Plated Steel S45C
- 5/8-18 Thread
- 3/8" OD (1/4" ID)



ID	Part #	Description	U/M	Price	Qty/ Box
1/4" (3/8"OD)	EFGC-014-SS-12A13-12	3/8" M.EFV x 3/8" FIP, 12"	EA		25
1/4" (3/8"OD)	EFGC-014-SS-12A13-18	3/8" M.EFV x 3/8" FIP, 18"	EA		25
1/4" (3/8"OD)	EFGC-014-SS-12A13-24	3/8" M.EFV x 3/8" FIP, 24"	EA		25
1/4" (3/8"OD)	EFGC-014-SS-12A13-30	3/8" M.EFV x 3/8" FIP, 30"	EA		25
1/4" (3/8"OD)	EFGC-014-SS-12A13-36	3/8" M.EFV x 3/8" FIP, 36"	EA		25
1/4" (3/8"OD)	EFGC-014-SS-12A13-48	3/8" M.EFV x 3/8" FIP, 48"	EA		25
1/4" (3/8"OD)	EFGC-014-SS-12A13-60	3/8" M.EFV x 3/8" FIP, 60"	EA		12
1/4" (3/8"OD)	EFGC-014-SS-12A13-72	3/8" M.EFV x 3/8" FIP, 72"	EA		12

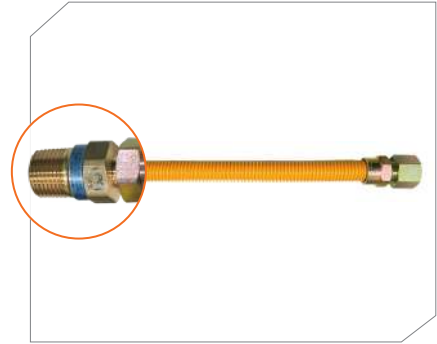

Gas Connectors

Commercial Gas Connectors

Gas Line System

Gas CSST Fittings

Water Line System

Water CSST Fittings

Braided Water Connectors

Supply stop Valve

Water Heater Connectors

Isolation Valves

Thermal Expansion Tanks

No-Hub Couplings

Flexible Sprinkler Drops

Stainless Steel Flexible Gas Connectors



014-BE Series Connector with Fittings / EFV



- Tube : Stainless Steel
- Coating : Black Epoxy
- Fitting : Zinc-Plated Steel S45C
- 5/8-18 Thread
- 3/8" OD (1/4" ID)

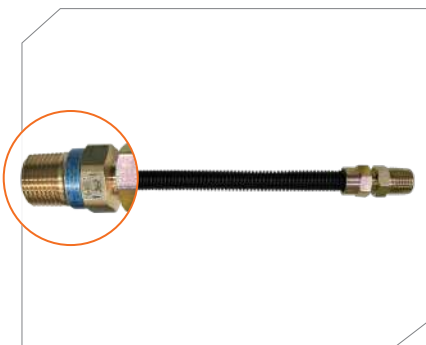

ID	Part #	Description	U/M	Price	Qty/ Box
1/4" (3/8"OD)	EFGC-014-BE-10A10-12	1/2" M.EFV x 1/2" MIP, 12"	EA		25
1/4" (3/8"OD)	EFGC-014-BE-10A10-18	1/2" M.EFV x 1/2" MIP, 18"	EA		25
1/4" (3/8"OD)	EFGC-014-BE-10A10-24	1/2" M.EFV x 1/2" MIP, 24"	EA		25
1/4" (3/8"OD)	EFGC-014-BE-10A10-30	1/2" M.EFV x 1/2" MIP, 30"	EA		25
1/4" (3/8"OD)	EFGC-014-BE-10A10-36	1/2" M.EFV x 1/2" MIP, 36"	EA		25
1/4" (3/8"OD)	EFGC-014-BE-10A10-48	1/2" M.EFV x 1/2" MIP, 48"	EA		25
1/4" (3/8"OD)	EFGC-014-BE-10A10-60	1/2" M.EFV x 1/2" MIP, 60"	EA		12
1/4" (3/8"OD)	EFGC-014-BE-10A10-72	1/2" M.EFV x 1/2" MIP, 72"	EA		12

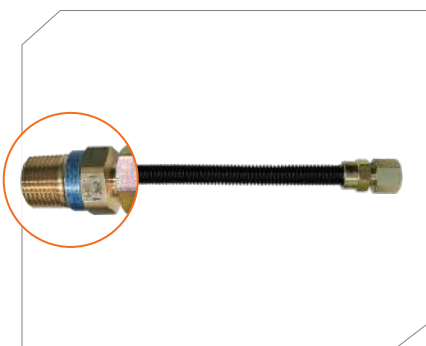

ID	Part #	Description	U/M	Price	Qty/ Box
1/4" (3/8"OD)	EFGC-014-BE-10A11-12	1/2" M.EFV x 1/2" FIP, 12"	EA		25
1/4" (3/8"OD)	EFGC-014-BE-10A11-18	1/2" M.EFV x 1/2" FIP, 18"	EA		25
1/4" (3/8"OD)	EFGC-014-BE-10A11-24	1/2" M.EFV x 1/2" FIP, 24"	EA		25
1/4" (3/8"OD)	EFGC-014-BE-10A11-30	1/2" M.EFV x 1/2" FIP, 30"	EA		25
1/4" (3/8"OD)	EFGC-014-BE-10A11-36	1/2" M.EFV x 1/2" FIP, 36"	EA		25
1/4" (3/8"OD)	EFGC-014-BE-10A11-48	1/2" M.EFV x 1/2" FIP, 48"	EA		25
1/4" (3/8"OD)	EFGC-014-BE-10A11-60	1/2" M.EFV x 1/2" FIP, 60"	EA		12
1/4" (3/8"OD)	EFGC-014-BE-10A11-72	1/2" M.EFV x 1/2" FIP, 72"	EA		12

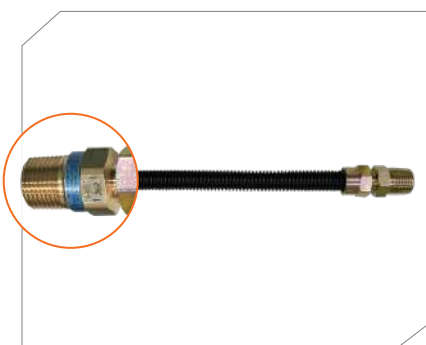

ID	Part #	Description	U/M	Price	Qty/ Box
1/4" (3/8"OD)	EFGC-014-BE-10A12-12	1/2" M.EFV x 3/8" MIP, 12"	EA		25
1/4" (3/8"OD)	EFGC-014-BE-10A12-18	1/2" M.EFV x 3/8" MIP, 18"	EA		25
1/4" (3/8"OD)	EFGC-014-BE-10A12-24	1/2" M.EFV x 3/8" MIP, 24"	EA		25
1/4" (3/8"OD)	EFGC-014-BE-10A12-30	1/2" M.EFV x 3/8" MIP, 30"	EA		25
1/4" (3/8"OD)	EFGC-014-BE-10A12-36	1/2" M.EFV x 3/8" MIP, 36"	EA		25
1/4" (3/8"OD)	EFGC-014-BE-10A12-48	1/2" M.EFV x 3/8" MIP, 48"	EA		25
1/4" (3/8"OD)	EFGC-014-BE-10A12-60	1/2" M.EFV x 3/8" MIP, 60"	EA		12
1/4" (3/8"OD)	EFGC-014-BE-10A12-72	1/2" M.EFV x 3/8" MIP, 72"	EA		12

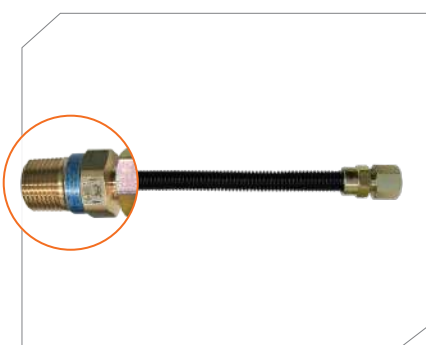

ID	Part #	Description	U/M	Price	Qty/ Box
1/4" (3/8"OD)	EFGC-014-BE-10A13-12	1/2" M.EFV x 3/8" FIP, 12"	EA		25
1/4" (3/8"OD)	EFGC-014-BE-10A13-18	1/2" M.EFV x 3/8" FIP, 18"	EA		25
1/4" (3/8"OD)	EFGC-014-BE-10A13-24	1/2" M.EFV x 3/8" FIP, 24"	EA		25
1/4" (3/8"OD)	EFGC-014-BE-10A13-30	1/2" M.EFV x 3/8" FIP, 30"	EA		25
1/4" (3/8"OD)	EFGC-014-BE-10A13-36	1/2" M.EFV x 3/8" FIP, 36"	EA		25
1/4" (3/8"OD)	EFGC-014-BE-10A13-48	1/2" M.EFV x 3/8" FIP, 48"	EA		25
1/4" (3/8"OD)	EFGC-014-BE-10A13-60	1/2" M.EFV x 3/8" FIP, 60"	EA		12
1/4" (3/8"OD)	EFGC-014-BE-10A13-72	1/2" M.EFV x 3/8" FIP, 72"	EA		12

Stainless Steel Flexible Gas Connectors



014-BE Series Connector with Fittings / EFV

- Tube : Stainless Steel
- Coating : Black Epoxy
- Fitting : Zinc-Plated Steel S45C
- 5/8-18 Thread
- 3/8" OD (1/4" ID)



ID	Part #	Description	U/M	Price	Qty/ Box
1/4" (3/8"OD)	EFGC-014-BE-12A13-12	3/8" M.EFV x 3/8" FIP, 12"	EA		25
1/4" (3/8"OD)	EFGC-014-BE-12A13-18	3/8" M.EFV x 3/8" FIP, 18"	EA		25
1/4" (3/8"OD)	EFGC-014-BE-12A13-24	3/8" M.EFV x 3/8" FIP, 24"	EA		25
1/4" (3/8"OD)	EFGC-014-BE-12A13-30	3/8" M.EFV x 3/8" FIP, 30"	EA		25
1/4" (3/8"OD)	EFGC-014-BE-12A13-36	3/8" M.EFV x 3/8" FIP, 36"	EA		25
1/4" (3/8"OD)	EFGC-014-BE-12A13-48	3/8" M.EFV x 3/8" FIP, 48"	EA		25
1/4" (3/8"OD)	EFGC-014-BE-12A13-60	3/8" M.EFV x 3/8" FIP, 60"	EA		12
1/4" (3/8"OD)	EFGC-014-BE-12A13-72	3/8" M.EFV x 3/8" FIP, 72"	EA		12

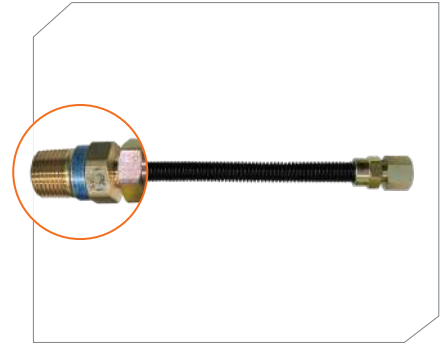

Gas Connectors

Commercial Gas Connectors

Gas Line System

Gas CSST Fittings

Water Line System

Water CSST Fittings

Braided Water Connectors

Supply stop Valve

Water Heater Connectors

Isolation Valves

Thermal Expansion Tanks

No-Hub Couplings

Flexible Sprinkler Drops

Stainless Steel Flexible Gas Connectors



038-SS Series Connector with Fittings / EFV

- Tube : Stainless Steel
- Fitting : Zinc-Plated Steel S45C
- 3/4-16 Thread
- 1/2" OD (3/8" ID)

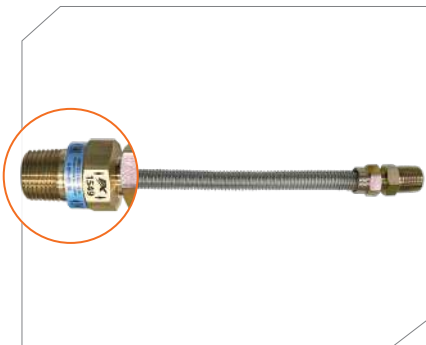

ID	Part #	Description	U/M	Price	Qty/ Box
3/8" (1/2"OD)	EFGC-038-SS-10A10-12	1/2" M.EFV x 1/2" MIP, 12"	EA		25
3/8" (1/2"OD)	EFGC-038-SS-10A10-18	1/2" M.EFV x 1/2" MIP, 18"	EA		25
3/8" (1/2"OD)	EFGC-038-SS-10A10-24	1/2" M.EFV x 1/2" MIP, 24"	EA		25
3/8" (1/2"OD)	EFGC-038-SS-10A10-30	1/2" M.EFV x 1/2" MIP, 30"	EA		25
3/8" (1/2"OD)	EFGC-038-SS-10A10-36	1/2" M.EFV x 1/2" MIP, 36"	EA		25
3/8" (1/2"OD)	EFGC-038-SS-10A10-48	1/2" M.EFV x 1/2" MIP, 48"	EA		25
3/8" (1/2"OD)	EFGC-038-SS-10A10-60	1/2" M.EFV x 1/2" MIP, 60"	EA		12
3/8" (1/2"OD)	EFGC-038-SS-10A10-72	1/2" M.EFV x 1/2" MIP, 72"	EA		12

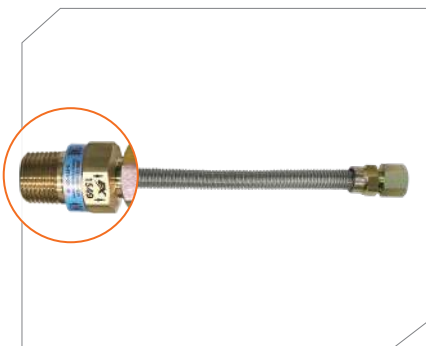

ID	Part #	Description	U/M	Price	Qty/ Box
3/8" (1/2"OD)	EFGC-038-SS-10A11-12	1/2" M.EFV x 1/2" FIP, 12"	EA		25
3/8" (1/2"OD)	EFGC-038-SS-10A11-18	1/2" M.EFV x 1/2" FIP, 18"	EA		25
3/8" (1/2"OD)	EFGC-038-SS-10A11-24	1/2" M.EFV x 1/2" FIP, 24"	EA		25
3/8" (1/2"OD)	EFGC-038-SS-10A11-30	1/2" M.EFV x 1/2" FIP, 30"	EA		25
3/8" (1/2"OD)	EFGC-038-SS-10A11-36	1/2" M.EFV x 1/2" FIP, 36"	EA		25
3/8" (1/2"OD)	EFGC-038-SS-10A11-48	1/2" M.EFV x 1/2" FIP, 48"	EA		25
3/8" (1/2"OD)	EFGC-038-SS-10A11-60	1/2" M.EFV x 1/2" FIP, 60"	EA		12
3/8" (1/2"OD)	EFGC-038-SS-10A11-72	1/2" M.EFV x 1/2" FIP, 72"	EA		12

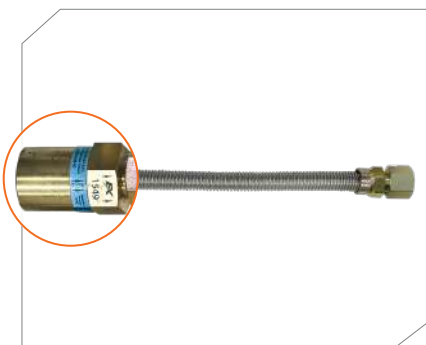

ID	Part #	Description	U/M	Price	Qty/ Box
3/8" (1/2"OD)	EFGC-038-SS-11A11-12	1/2" FEFV x 1/2" FIP, 12"	EA		25
3/8" (1/2"OD)	EFGC-038-SS-11A11-18	1/2" FEFV x 1/2" FIP, 18"	EA		25
3/8" (1/2"OD)	EFGC-038-SS-11A11-24	1/2" FEFV x 1/2" FIP, 24"	EA		25
3/8" (1/2"OD)	EFGC-038-SS-11A11-30	1/2" FEFV x 1/2" FIP, 30"	EA		25
3/8" (1/2"OD)	EFGC-038-SS-11A11-36	1/2" FEFV x 1/2" FIP, 36"	EA		25
3/8" (1/2"OD)	EFGC-038-SS-11A11-48	1/2" FEFV x 1/2" FIP, 48"	EA		25
3/8" (1/2"OD)	EFGC-038-SS-11A11-60	1/2" FEFV x 1/2" FIP, 60"	EA		12
3/8" (1/2"OD)	EFGC-038-SS-11A11-72	1/2" FEFV x 1/2" FIP, 72"	EA		12

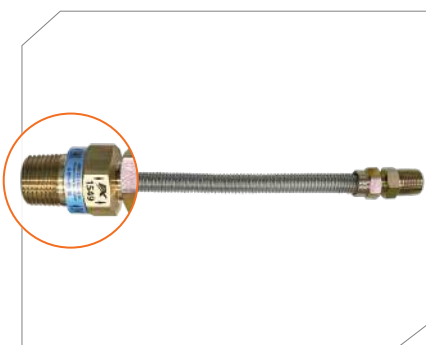

ID	Part #	Description	U/M	Price	Qty/ Box
3/8" (1/2"OD)	EFGC-038-SS-10A12-12	1/2" M.EFV x 3/8" MIP, 12"	EA		25
3/8" (1/2"OD)	EFGC-038-SS-10A12-18	1/2" M.EFV x 3/8" MIP, 18"	EA		25
3/8" (1/2"OD)	EFGC-038-SS-10A12-24	1/2" M.EFV x 3/8" MIP, 24"	EA		25
3/8" (1/2"OD)	EFGC-038-SS-10A12-30	1/2" M.EFV x 3/8" MIP, 30"	EA		25
3/8" (1/2"OD)	EFGC-038-SS-10A12-36	1/2" M.EFV x 3/8" MIP, 36"	EA		25
3/8" (1/2"OD)	EFGC-038-SS-10A12-48	1/2" M.EFV x 3/8" MIP, 48"	EA		25
3/8" (1/2"OD)	EFGC-038-SS-10A12-60	1/2" M.EFV x 3/8" MIP, 60"	EA		12
3/8" (1/2"OD)	EFGC-038-SS-10A12-72	1/2" M.EFV x 3/8" MIP, 72"	EA		12

Stainless Steel Flexible Gas Connectors



038-SS Series Connector with Fittings / EFV

- Tube : Stainless Steel
- Fitting : Zinc-Plated Steel S45C
- 3/4-16 Thread
- 1/2" OD (3/8" ID)



ID	Part #	Description	U/M	Price	Qty/ Box
3/8" (1/2"OD)	EFGC-038-SS-10A13-12	1/2" M.EFV x 3/8" FIP, 12"	EA		25
3/8" (1/2"OD)	EFGC-038-SS-10A13-18	1/2" M.EFV x 3/8" FIP, 18"	EA		25
3/8" (1/2"OD)	EFGC-038-SS-10A13-24	1/2" M.EFV x 3/8" FIP, 24"	EA		25
3/8" (1/2"OD)	EFGC-038-SS-10A13-30	1/2" M.EFV x 3/8" FIP, 30"	EA		25
3/8" (1/2"OD)	EFGC-038-SS-10A13-36	1/2" M.EFV x 3/8" FIP, 36"	EA		25
3/8" (1/2"OD)	EFGC-038-SS-10A13-48	1/2" M.EFV x 3/8" FIP, 48"	EA		25
3/8" (1/2"OD)	EFGC-038-SS-10A13-60	1/2" M.EFV x 3/8" FIP, 60"	EA		12
3/8" (1/2"OD)	EFGC-038-SS-10A13-72	1/2" M.EFV x 3/8" FIP, 72"	EA		12

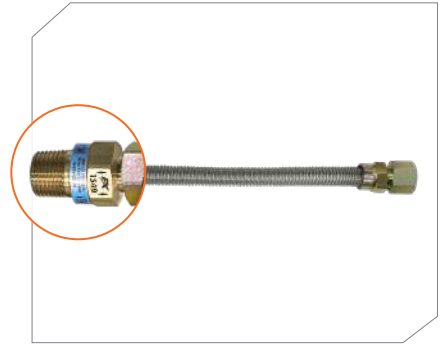

ID	Part #	Description	U/M	Price	Qty/ Box
3/8" (1/2"OD)	EFGC-038-SS-12A13-12	3/8" M.EFV x 3/8" FIP, 12"	EA		25
3/8" (1/2"OD)	EFGC-038-SS-12A13-18	3/8" M.EFV x 3/8" FIP, 18"	EA		25
3/8" (1/2"OD)	EFGC-038-SS-12A13-24	3/8" M.EFV x 3/8" FIP, 24"	EA		25
3/8" (1/2"OD)	EFGC-038-SS-12A13-30	3/8" M.EFV x 3/8" FIP, 30"	EA		25
3/8" (1/2"OD)	EFGC-038-SS-12A13-36	3/8" M.EFV x 3/8" FIP, 36"	EA		25
3/8" (1/2"OD)	EFGC-038-SS-12A13-48	3/8" M.EFV x 3/8" FIP, 48"	EA		25
3/8" (1/2"OD)	EFGC-038-SS-12A13-60	3/8" M.EFV x 3/8" FIP, 60"	EA		12
3/8" (1/2"OD)	EFGC-038-SS-12A13-72	3/8" M.EFV x 3/8" FIP, 72"	EA		12

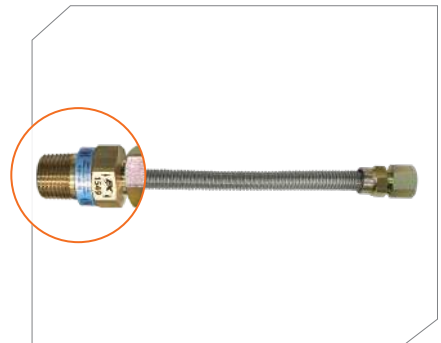

Gas Connectors

Commercial Gas Connectors

Gas Line System

Gas CSST Fittings

Water Line System

Water CSST Fittings

Braided Water Connectors

Supply stop Valve

Water Heater Connectors

Isolation Valves

Thermal Expansion Tanks

No-Hub Couplings

Flexible Sprinkler Drops

Stainless Steel Flexible Gas Connectors



038-YE Series Connector with Fittings / EFV



- Tube : Stainless Steel
- Coating : Yellow Epoxy
- Fitting : Zinc-Plated Steel S45C
- 3/4-16 Thread
- 1/2" OD (3/8" ID)

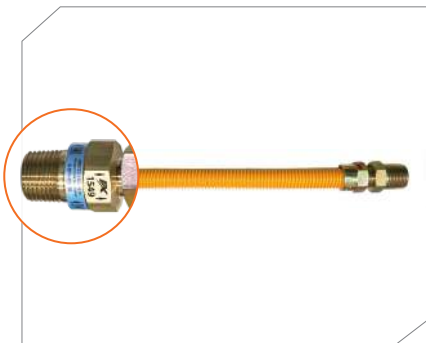

ID	Part #	Description	U/M	Price	Qty/ Box
3/8" (1/2"OD)	EFGC-038-YE-10A10-12	1/2" M.EFV x 1/2" MIP, 12"	EA		25
3/8" (1/2"OD)	EFGC-038-YE-10A10-18	1/2" M.EFV x 1/2" MIP, 18"	EA		25
3/8" (1/2"OD)	EFGC-038-YE-10A10-24	1/2" M.EFV x 1/2" MIP, 24"	EA		25
3/8" (1/2"OD)	EFGC-038-YE-10A10-30	1/2" M.EFV x 1/2" MIP, 30"	EA		25
3/8" (1/2"OD)	EFGC-038-YE-10A10-36	1/2" M.EFV x 1/2" MIP, 36"	EA		25
3/8" (1/2"OD)	EFGC-038-YE-10A10-48	1/2" M.EFV x 1/2" MIP, 48"	EA		25
3/8" (1/2"OD)	EFGC-038-YE-10A10-60	1/2" M.EFV x 1/2" MIP, 60"	EA		12
3/8" (1/2"OD)	EFGC-038-YE-10A10-72	1/2" M.EFV x 1/2" MIP, 72"	EA		12

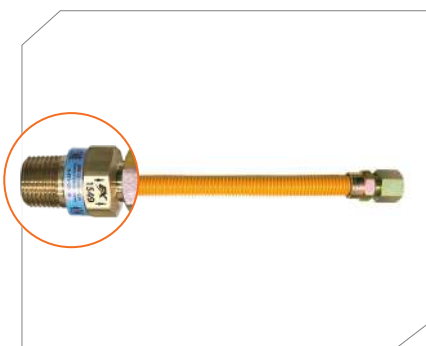

ID	Part #	Description	U/M	Price	Qty/ Box
3/8" (1/2"OD)	EFGC-038-YE-10A11-12	1/2" M.EFV x 1/2" FIP, 12"	EA		25
3/8" (1/2"OD)	EFGC-038-YE-10A11-18	1/2" M.EFV x 1/2" FIP, 18"	EA		25
3/8" (1/2"OD)	EFGC-038-YE-10A11-24	1/2" M.EFV x 1/2" FIP, 24"	EA		25
3/8" (1/2"OD)	EFGC-038-YE-10A11-30	1/2" M.EFV x 1/2" FIP, 30"	EA		25
3/8" (1/2"OD)	EFGC-038-YE-10A11-36	1/2" M.EFV x 1/2" FIP, 36"	EA		25
3/8" (1/2"OD)	EFGC-038-YE-10A11-48	1/2" M.EFV x 1/2" FIP, 48"	EA		25
3/8" (1/2"OD)	EFGC-038-YE-10A11-60	1/2" M.EFV x 1/2" FIP, 60"	EA		12
3/8" (1/2"OD)	EFGC-038-YE-10A11-72	1/2" M.EFV x 1/2" FIP, 72"	EA		12

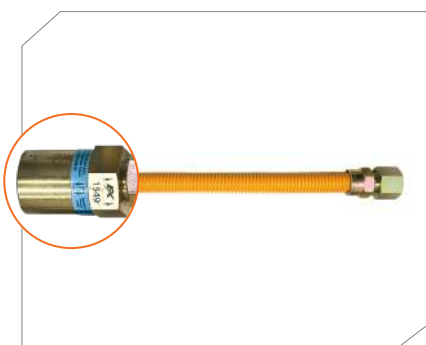

ID	Part #	Description	U/M	Price	Qty/ Box
3/8" (1/2"OD)	EFGC-038-YE-11A11-12	1/2" FEFV x 1/2" FIP, 12"	EA		25
3/8" (1/2"OD)	EFGC-038-YE-11A11-18	1/2" FEFV x 1/2" FIP, 18"	EA		25
3/8" (1/2"OD)	EFGC-038-YE-11A11-24	1/2" FEFV x 1/2" FIP, 24"	EA		25
3/8" (1/2"OD)	EFGC-038-YE-11A11-30	1/2" FEFV x 1/2" FIP, 30"	EA		25
3/8" (1/2"OD)	EFGC-038-YE-11A11-36	1/2" FEFV x 1/2" FIP, 36"	EA		25
3/8" (1/2"OD)	EFGC-038-YE-11A11-48	1/2" FEFV x 1/2" FIP, 48"	EA		25
3/8" (1/2"OD)	EFGC-038-YE-11A11-60	1/2" FEFV x 1/2" FIP, 60"	EA		12
3/8" (1/2"OD)	EFGC-038-YE-11A11-72	1/2" FEFV x 1/2" FIP, 72"	EA		12

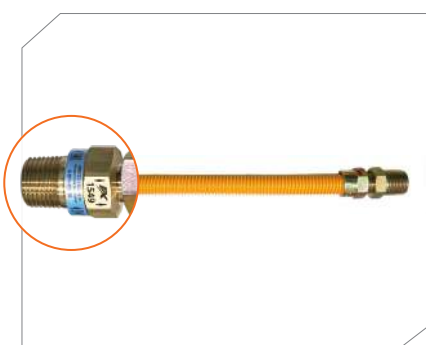

ID	Part #	Description	U/M	Price	Qty/ Box
3/8" (1/2"OD)	EFGC-038-YE-10A12-12	1/2" M.EFV x 3/8" MIP, 12"	EA		25
3/8" (1/2"OD)	EFGC-038-YE-10A12-18	1/2" M.EFV x 3/8" MIP, 18"	EA		25
3/8" (1/2"OD)	EFGC-038-YE-10A12-24	1/2" M.EFV x 3/8" MIP, 24"	EA		25
3/8" (1/2"OD)	EFGC-038-YE-10A12-30	1/2" M.EFV x 3/8" MIP, 30"	EA		25
3/8" (1/2"OD)	EFGC-038-YE-10A12-36	1/2" M.EFV x 3/8" MIP, 36"	EA		25
3/8" (1/2"OD)	EFGC-038-YE-10A12-48	1/2" M.EFV x 3/8" MIP, 48"	EA		25
3/8" (1/2"OD)	EFGC-038-YE-10A12-60	1/2" M.EFV x 3/8" MIP, 60"	EA		12
3/8" (1/2"OD)	EFGC-038-YE-10A12-72	1/2" M.EFV x 3/8" MIP, 72"	EA		12

Stainless Steel Flexible Gas Connectors



038-YE Series Connector with Fittings / EFV

- Tube : Stainless Steel
- Coating : Yellow Epoxy
- Fitting : Zinc-Plated Steel S45C
- 3/4-16 Thread
- 1/2" OD (3/8" ID)



ID	Part #	Description	U/M	Price	Qty/ Box
3/8" (1/2"OD)	EFGC-038-YE-10A13-12	1/2" M.EFV x 3/8" FIP, 12"	EA		25
3/8" (1/2"OD)	EFGC-038-YE-10A13-18	1/2" M.EFV x 3/8" FIP, 18"	EA		25
3/8" (1/2"OD)	EFGC-038-YE-10A13-24	1/2" M.EFV x 3/8" FIP, 24"	EA		25
3/8" (1/2"OD)	EFGC-038-YE-10A13-30	1/2" M.EFV x 3/8" FIP, 30"	EA		25
3/8" (1/2"OD)	EFGC-038-YE-10A13-36	1/2" M.EFV x 3/8" FIP, 36"	EA		25
3/8" (1/2"OD)	EFGC-038-YE-10A13-48	1/2" M.EFV x 3/8" FIP, 48"	EA		25
3/8" (1/2"OD)	EFGC-038-YE-10A13-60	1/2" M.EFV x 3/8" FIP, 60"	EA		12
3/8" (1/2"OD)	EFGC-038-YE-10A13-72	1/2" M.EFV x 3/8" FIP, 72"	EA		12

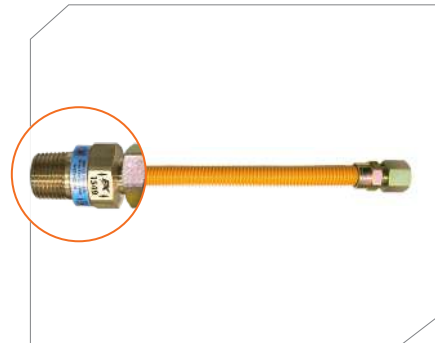

ID	Part #	Description	U/M	Price	Qty/ Box
3/8" (1/2"OD)	EFGC-038-YE-12A13-12	3/8" M.EFV x 3/8" FIP, 12"	EA		25
3/8" (1/2"OD)	EFGC-038-YE-12A13-18	3/8" M.EFV x 3/8" FIP, 18"	EA		25
3/8" (1/2"OD)	EFGC-038-YE-12A13-24	3/8" M.EFV x 3/8" FIP, 24"	EA		25
3/8" (1/2"OD)	EFGC-038-YE-12A13-30	3/8" M.EFV x 3/8" FIP, 30"	EA		25
3/8" (1/2"OD)	EFGC-038-YE-12A13-36	3/8" M.EFV x 3/8" FIP, 36"	EA		25
3/8" (1/2"OD)	EFGC-038-YE-12A13-48	3/8" M.EFV x 3/8" FIP, 48"	EA		25
3/8" (1/2"OD)	EFGC-038-YE-12A13-60	3/8" M.EFV x 3/8" FIP, 60"	EA		12
3/8" (1/2"OD)	EFGC-038-YE-12A13-72	3/8" M.EFV x 3/8" FIP, 72"	EA		12

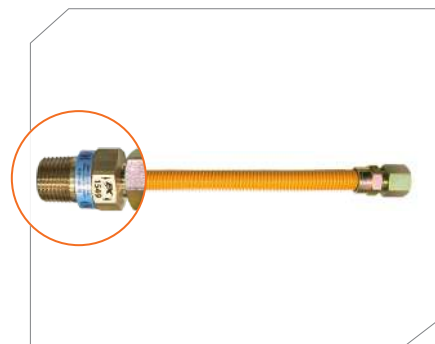

Gas Connectors

Commercial Gas Connectors

Gas Line System

Gas CSST Fittings

Water Line System

Water CSST Fittings

Braided Water Connectors

Supply stop Valve

Water Heater Connectors

Isolation Valves

Thermal Expansion Tanks

No-Hub Couplings

Flexible Sprinkler Drops

Stainless Steel Flexible Gas Connectors



038-BE Series Connector with Fittings / EFV

- Tube : Stainless Steel
- Coating : Black Epoxy
- Fitting : Zinc-Plated Steel S45C
- 3/4-16 Thread
- 1/2" OD (3/8" ID)

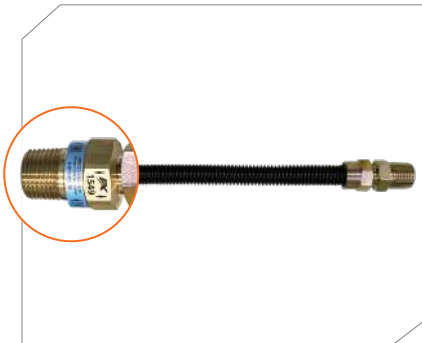

ID	Part #	Description	U/M	Price	Qty/ Box
3/8" (1/2"OD)	EFGC-038-BE-10A10-12	1/2" M.EFV x 1/2" MIP, 12"	EA		25
3/8" (1/2"OD)	EFGC-038-BE-10A10-18	1/2" M.EFV x 1/2" MIP, 18"	EA		25
3/8" (1/2"OD)	EFGC-038-BE-10A10-24	1/2" M.EFV x 1/2" MIP, 24"	EA		25
3/8" (1/2"OD)	EFGC-038-BE-10A10-30	1/2" M.EFV x 1/2" MIP, 30"	EA		25
3/8" (1/2"OD)	EFGC-038-BE-10A10-36	1/2" M.EFV x 1/2" MIP, 36"	EA		25
3/8" (1/2"OD)	EFGC-038-BE-10A10-48	1/2" M.EFV x 1/2" MIP, 48"	EA		25
3/8" (1/2"OD)	EFGC-038-BE-10A10-60	1/2" M.EFV x 1/2" MIP, 60"	EA		12
3/8" (1/2"OD)	EFGC-038-BE-10A10-72	1/2" M.EFV x 1/2" MIP, 72"	EA		12

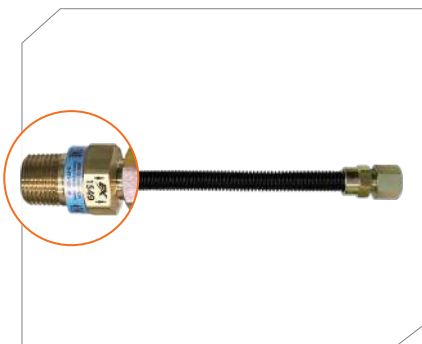

ID	Part #	Description	U/M	Price	Qty/ Box
3/8" (1/2"OD)	EFGC-038-BE-10A11-12	1/2" M.EFV x 1/2" FIP, 12"	EA		25
3/8" (1/2"OD)	EFGC-038-BE-10A11-18	1/2" M.EFV x 1/2" FIP, 18"	EA		25
3/8" (1/2"OD)	EFGC-038-BE-10A11-24	1/2" M.EFV x 1/2" FIP, 24"	EA		25
3/8" (1/2"OD)	EFGC-038-BE-10A11-30	1/2" M.EFV x 1/2" FIP, 30"	EA		25
3/8" (1/2"OD)	EFGC-038-BE-10A11-36	1/2" M.EFV x 1/2" FIP, 36"	EA		25
3/8" (1/2"OD)	EFGC-038-BE-10A11-48	1/2" M.EFV x 1/2" FIP, 48"	EA		25
3/8" (1/2"OD)	EFGC-038-BE-10A11-60	1/2" M.EFV x 1/2" FIP, 60"	EA		12
3/8" (1/2"OD)	EFGC-038-BE-10A11-72	1/2" M.EFV x 1/2" FIP, 72"	EA		12

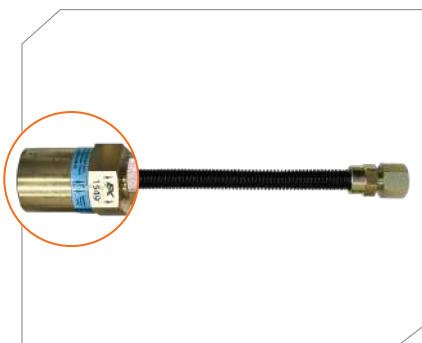

ID	Part #	Description	U/M	Price	Qty/ Box
3/8" (1/2"OD)	EFGC-038-BE-11A11-12	1/2" FEFV x 1/2" FIP, 12"	EA		25
3/8" (1/2"OD)	EFGC-038-BE-11A11-18	1/2" FEFV x 1/2" FIP, 18"	EA		25
3/8" (1/2"OD)	EFGC-038-BE-11A11-24	1/2" FEFV x 1/2" FIP, 24"	EA		25
3/8" (1/2"OD)	EFGC-038-BE-11A11-30	1/2" FEFV x 1/2" FIP, 30"	EA		25
3/8" (1/2"OD)	EFGC-038-BE-11A11-36	1/2" FEFV x 1/2" FIP, 36"	EA		25
3/8" (1/2"OD)	EFGC-038-BE-11A11-48	1/2" FEFV x 1/2" FIP, 48"	EA		25
3/8" (1/2"OD)	EFGC-038-BE-11A11-60	1/2" FEFV x 1/2" FIP, 60"	EA		12
3/8" (1/2"OD)	EFGC-038-BE-11A11-72	1/2" FEFV x 1/2" FIP, 72"	EA		12

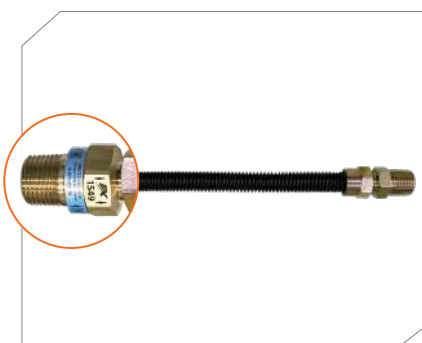

ID	Part #	Description	U/M	Price	Qty/ Box
3/8" (1/2"OD)	EFGC-038-BE-10A12-12	1/2" M.EFV x 3/8" MIP, 12"	EA		25
3/8" (1/2"OD)	EFGC-038-BE-10A12-18	1/2" M.EFV x 3/8" MIP, 18"	EA		25
3/8" (1/2"OD)	EFGC-038-BE-10A12-24	1/2" M.EFV x 3/8" MIP, 24"	EA		25
3/8" (1/2"OD)	EFGC-038-BE-10A12-30	1/2" M.EFV x 3/8" MIP, 30"	EA		25
3/8" (1/2"OD)	EFGC-038-BE-10A12-36	1/2" M.EFV x 3/8" MIP, 36"	EA		25
3/8" (1/2"OD)	EFGC-038-BE-10A12-48	1/2" M.EFV x 3/8" MIP, 48"	EA		25
3/8" (1/2"OD)	EFGC-038-BE-10A12-60	1/2" M.EFV x 3/8" MIP, 60"	EA		12
3/8" (1/2"OD)	EFGC-038-BE-10A12-72	1/2" M.EFV x 3/8" MIP, 72"	EA		12

Stainless Steel Flexible Gas Connectors



038-BE Series Connector with Fittings / EFV

- Tube : Stainless Steel
- Coating : Black Epoxy
- Fitting : Zinc-Plated Steel S45C
- 3/4-16 Thread
- 1/2" OD (3/8" ID)



ID	Part #	Description	U/M	Price	Qty/ Box
3/8" (1/2"OD)	EFGC-038-BE-10A13-12	1/2" M.EFV x 3/8" FIP, 12"	EA		25
3/8" (1/2"OD)	EFGC-038-BE-10A13-18	1/2" M.EFV x 3/8" FIP, 18"	EA		25
3/8" (1/2"OD)	EFGC-038-BE-10A13-24	1/2" M.EFV x 3/8" FIP, 24"	EA		25
3/8" (1/2"OD)	EFGC-038-BE-10A13-30	1/2" M.EFV x 3/8" FIP, 30"	EA		25
3/8" (1/2"OD)	EFGC-038-BE-10A13-36	1/2" M.EFV x 3/8" FIP, 36"	EA		25
3/8" (1/2"OD)	EFGC-038-BE-10A13-48	1/2" M.EFV x 3/8" FIP, 48"	EA		25
3/8" (1/2"OD)	EFGC-038-BE-10A13-60	1/2" M.EFV x 3/8" FIP, 60"	EA		12
3/8" (1/2"OD)	EFGC-038-BE-10A13-72	1/2" M.EFV x 3/8" FIP, 72"	EA		12

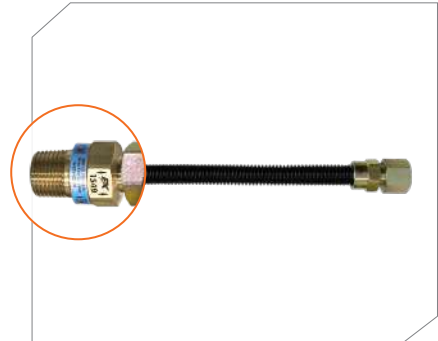

ID	Part #	Description	U/M	Price	Qty/ Box
3/8" (1/2"OD)	EFGC-038-BE-12A13-12	3/8" M.EFV x 3/8" FIP, 12"	EA		25
3/8" (1/2"OD)	EFGC-038-BE-12A13-18	3/8" M.EFV x 3/8" FIP, 18"	EA		25
3/8" (1/2"OD)	EFGC-038-BE-12A13-24	3/8" M.EFV x 3/8" FIP, 24"	EA		25
3/8" (1/2"OD)	EFGC-038-BE-12A13-30	3/8" M.EFV x 3/8" FIP, 30"	EA		25
3/8" (1/2"OD)	EFGC-038-BE-12A13-36	3/8" M.EFV x 3/8" FIP, 36"	EA		25
3/8" (1/2"OD)	EFGC-038-BE-12A13-48	3/8" M.EFV x 3/8" FIP, 48"	EA		25
3/8" (1/2"OD)	EFGC-038-BE-12A13-60	3/8" M.EFV x 3/8" FIP, 60"	EA		12
3/8" (1/2"OD)	EFGC-038-BE-12A13-72	3/8" M.EFV x 3/8" FIP, 72"	EA		12

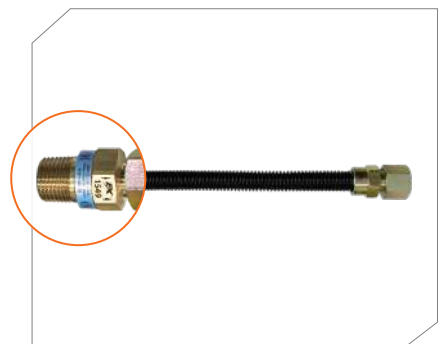

Gas Connectors

Commercial Gas Connectors

Gas Line System

Gas CSST Fittings

Water Line System

Water CSST Fittings

Braided Water Connectors

Supply stop Valve

Water Heater Connectors

Isolation Valves

Thermal Expansion Tanks

No-Hub Couplings

Flexible Sprinkler Drops

Stainless Steel Flexible Gas Connectors



012-SS Series Connector with Fittings / EFV



- Tube : Stainless Steel
- Fitting : Zinc-Plated Steel S45C
- 15/16-16 Thread
- 5/8" OD (1/2" ID)

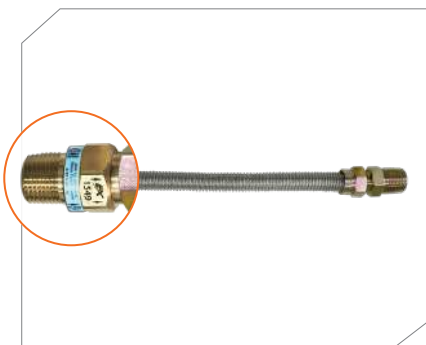

ID	Part #	Description	U/M	Price	Qty/ Box
1/2" (5/8"OD)	EFGC-012-SS-10A10-12	1/2" M.EFV x 1/2" MIP, 12"	EA		25
1/2" (5/8"OD)	EFGC-012-SS-10A10-18	1/2" M.EFV x 1/2" MIP, 18"	EA		25
1/2" (5/8"OD)	EFGC-012-SS-10A10-24	1/2" M.EFV x 1/2" MIP, 24"	EA		25
1/2" (5/8"OD)	EFGC-012-SS-10A10-30	1/2" M.EFV x 1/2" MIP, 30"	EA		25
1/2" (5/8"OD)	EFGC-012-SS-10A10-36	1/2" M.EFV x 1/2" MIP, 36"	EA		25
1/2" (5/8"OD)	EFGC-012-SS-10A10-48	1/2" M.EFV x 1/2" MIP, 48"	EA		25
1/2" (5/8"OD)	EFGC-012-SS-10A10-60	1/2" M.EFV x 1/2" MIP, 60"	EA		12
1/2" (5/8"OD)	EFGC-012-SS-10A10-72	1/2" M.EFV x 1/2" MIP, 72"	EA		12

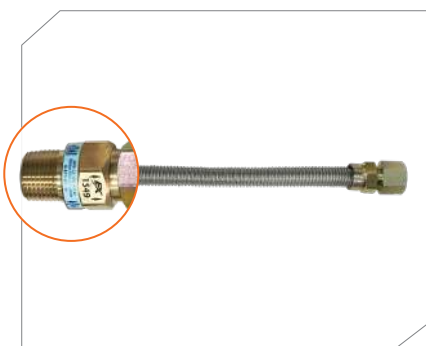

ID	Part #	Description	U/M	Price	Qty/ Box
1/2" (5/8"OD)	EFGC-012-SS-10A11-12	1/2" M.EFV x 1/2" FIP, 12"	EA		25
1/2" (5/8"OD)	EFGC-012-SS-10A11-18	1/2" M.EFV x 1/2" FIP, 18"	EA		25
1/2" (5/8"OD)	EFGC-012-SS-10A11-24	1/2" M.EFV x 1/2" FIP, 24"	EA		25
1/2" (5/8"OD)	EFGC-012-SS-10A11-30	1/2" M.EFV x 1/2" FIP, 30"	EA		25
1/2" (5/8"OD)	EFGC-012-SS-10A11-36	1/2" M.EFV x 1/2" FIP, 36"	EA		25
1/2" (5/8"OD)	EFGC-012-SS-10A11-48	1/2" M.EFV x 1/2" FIP, 48"	EA		25
1/2" (5/8"OD)	EFGC-012-SS-10A11-60	1/2" M.EFV x 1/2" FIP, 60"	EA		12
1/2" (5/8"OD)	EFGC-012-SS-10A11-72	1/2" M.EFV x 1/2" FIP, 72"	EA		12

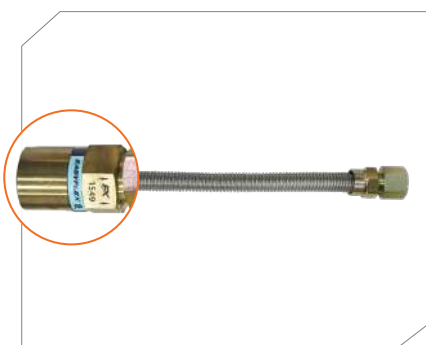

ID	Part #	Description	U/M	Price	Qty/ Box
1/2" (5/8"OD)	EFGC-012-SS-11A11-12	1/2" FEFV x 1/2" FIP, 12"	EA		25
1/2" (5/8"OD)	EFGC-012-SS-11A11-18	1/2" FEFV x 1/2" FIP, 18"	EA		25
1/2" (5/8"OD)	EFGC-012-SS-11A11-24	1/2" FEFV x 1/2" FIP, 24"	EA		25
1/2" (5/8"OD)	EFGC-012-SS-11A11-30	1/2" FEFV x 1/2" FIP, 30"	EA		25
1/2" (5/8"OD)	EFGC-012-SS-11A11-36	1/2" FEFV x 1/2" FIP, 36"	EA		25
1/2" (5/8"OD)	EFGC-012-SS-11A11-48	1/2" FEFV x 1/2" FIP, 48"	EA		25
1/2" (5/8"OD)	EFGC-012-SS-11A11-60	1/2" FEFV x 1/2" FIP, 60"	EA		12
1/2" (5/8"OD)	EFGC-012-SS-11A11-72	1/2" FEFV x 1/2" FIP, 72"	EA		12

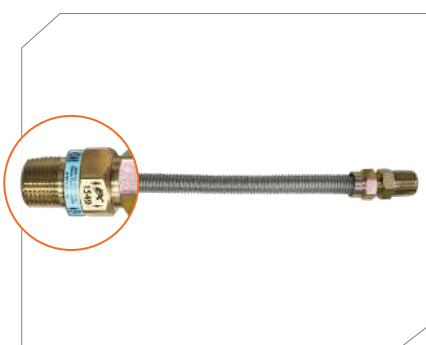

ID	Part #	Description	U/M	Price	Qty/ Box
1/2" (5/8"OD)	EFGC-012-SS-10A14-12	1/2" M.EFV x 3/4" MIP, 12"	EA		25
1/2" (5/8"OD)	EFGC-012-SS-10A14-18	1/2" M.EFV x 3/4" MIP, 18"	EA		25
1/2" (5/8"OD)	EFGC-012-SS-10A14-24	1/2" M.EFV x 3/4" MIP, 24"	EA		25
1/2" (5/8"OD)	EFGC-012-SS-10A14-30	1/2" M.EFV x 3/4" MIP, 30"	EA		25
1/2" (5/8"OD)	EFGC-012-SS-10A14-36	1/2" M.EFV x 3/4" MIP, 36"	EA		25
1/2" (5/8"OD)	EFGC-012-SS-10A14-48	1/2" M.EFV x 3/4" MIP, 48"	EA		25
1/2" (5/8"OD)	EFGC-012-SS-10A14-60	1/2" M.EFV x 3/4" MIP, 60"	EA		12
1/2" (5/8"OD)	EFGC-012-SS-10A14-72	1/2" M.EFV x 3/4" MIP, 72"	EA		12

Stainless Steel Flexible Gas Connectors



012-SS Series Connector with Fittings / EFV

- Tube : Stainless Steel
- Fitting : Zinc-Plated Steel S45C
- 15/16-16 Thread
- 5/8" OD (1/2" ID)



ID	Part #	Description	U/M	Price	Qty/ Box
1/2" (5/8"OD)	EFGC-012-SS-10A15-12	1/2" M.EFV x 3/4" FIP, 12"	EA		25
1/2" (5/8"OD)	EFGC-012-SS-10A15-18	1/2" M.EFV x 3/4" FIP, 18"	EA		25
1/2" (5/8"OD)	EFGC-012-SS-10A15-24	1/2" M.EFV x 3/4" FIP, 24"	EA		25
1/2" (5/8"OD)	EFGC-012-SS-10A15-30	1/2" M.EFV x 3/4" FIP, 30"	EA		25
1/2" (5/8"OD)	EFGC-012-SS-10A15-36	1/2" M.EFV x 3/4" FIP, 36"	EA		25
1/2" (5/8"OD)	EFGC-012-SS-10A15-48	1/2" M.EFV x 3/4" FIP, 48"	EA		25
1/2" (5/8"OD)	EFGC-012-SS-10A15-60	1/2" M.EFV x 3/4" FIP, 60"	EA		12
1/2" (5/8"OD)	EFGC-012-SS-10A15-72	1/2" M.EFV x 3/4" FIP, 72"	EA		12

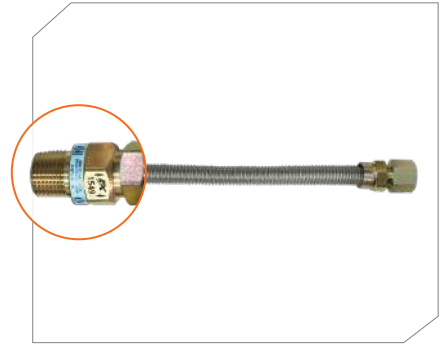

ID	Part #	Description	U/M	Price	Qty/ Box
1/2" (5/8"OD)	EFGC-012-SS-14A14-12	3/4" M.EFV x 3/4" MIP, 12"	EA		25
1/2" (5/8"OD)	EFGC-012-SS-14A14-18	3/4" M.EFV x 3/4" MIP, 18"	EA		25
1/2" (5/8"OD)	EFGC-012-SS-14A14-24	3/4" M.EFV x 3/4" MIP, 24"	EA		25
1/2" (5/8"OD)	EFGC-012-SS-14A14-30	3/4" M.EFV x 3/4" MIP, 30"	EA		25
1/2" (5/8"OD)	EFGC-012-SS-14A14-36	3/4" M.EFV x 3/4" MIP, 36"	EA		25
1/2" (5/8"OD)	EFGC-012-SS-14A14-48	3/4" M.EFV x 3/4" MIP, 48"	EA		25
1/2" (5/8"OD)	EFGC-012-SS-14A14-60	3/4" M.EFV x 3/4" MIP, 60"	EA		12
1/2" (5/8"OD)	EFGC-012-SS-14A14-72	3/4" M.EFV x 3/4" MIP, 72"	EA		12

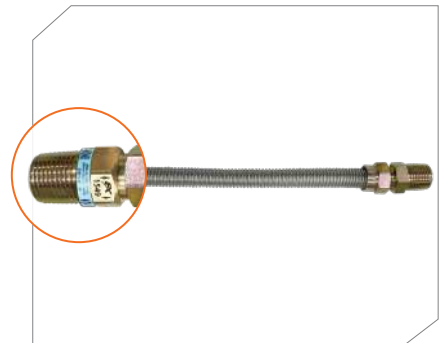

ID	Part #	Description	U/M	Price	Qty/ Box
1/2" (5/8"OD)	EFGC-012-SS-14A15-12	3/4" M.EFV x 3/4" FIP, 12"	EA		25
1/2" (5/8"OD)	EFGC-012-SS-14A15-18	3/4" M.EFV x 3/4" FIP, 18"	EA		25
1/2" (5/8"OD)	EFGC-012-SS-14A15-24	3/4" M.EFV x 3/4" FIP, 24"	EA		25
1/2" (5/8"OD)	EFGC-012-SS-14A15-30	3/4" M.EFV x 3/4" FIP, 30"	EA		25
1/2" (5/8"OD)	EFGC-012-SS-14A15-36	3/4" M.EFV x 3/4" FIP, 36"	EA		25
1/2" (5/8"OD)	EFGC-012-SS-14A15-48	3/4" M.EFV x 3/4" FIP, 48"	EA		25
1/2" (5/8"OD)	EFGC-012-SS-14A15-60	3/4" M.EFV x 3/4" FIP, 60"	EA		12
1/2" (5/8"OD)	EFGC-012-SS-14A15-72	3/4" M.EFV x 3/4" FIP, 72"	EA		12

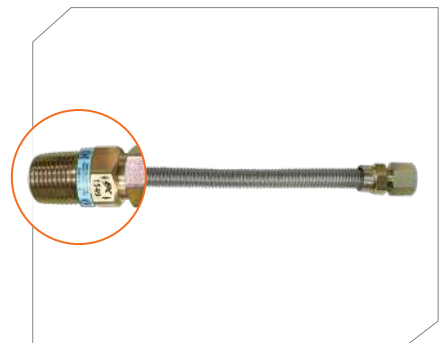

Gas Connectors

Commercial Gas Connectors

Gas Line System

Gas CSST Fittings

Water Line System

Water CSST Fittings

Braided Water Connectors

Supply stop Valve

Water Heater Connectors

Isolation Valves

Thermal Expansion Tanks

No-Hub Couplings

Flexible Sprinkler Drops

Stainless Steel Flexible Gas Connectors



012-YE Series Connector with Fittings / EFV



- Tube : Stainless Steel
- Coating : Yellow Epoxy
- Fitting : Zinc-Plated Steel S45C
- 15/16-16 Thread
- 5/8" OD (1/2" ID)

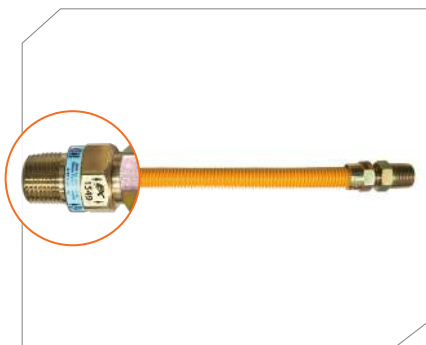

ID	Part #	Description	U/M	Price	Qty/ Box
1/2" (5/8"OD)	EFGC-012-YE-10A10-12	1/2" M.EFV x 1/2" MIP, 12"	EA		25
1/2" (5/8"OD)	EFGC-012-YE-10A10-18	1/2" M.EFV x 1/2" MIP, 18"	EA		25
1/2" (5/8"OD)	EFGC-012-YE-10A10-24	1/2" M.EFV x 1/2" MIP, 24"	EA		25
1/2" (5/8"OD)	EFGC-012-YE-10A10-30	1/2" M.EFV x 1/2" MIP, 30"	EA		25
1/2" (5/8"OD)	EFGC-012-YE-10A10-36	1/2" M.EFV x 1/2" MIP, 36"	EA		25
1/2" (5/8"OD)	EFGC-012-YE-10A10-48	1/2" M.EFV x 1/2" MIP, 48"	EA		25
1/2" (5/8"OD)	EFGC-012-YE-10A10-60	1/2" M.EFV x 1/2" MIP, 60"	EA		12
1/2" (5/8"OD)	EFGC-012-YE-10A10-72	1/2" M.EFV x 1/2" MIP, 72"	EA		12

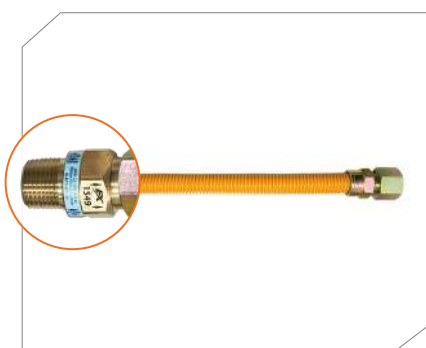

ID	Part #	Description	U/M	Price	Qty/ Box
1/2" (5/8"OD)	EFGC-012-YE-10A11-12	1/2" M.EFV x 1/2" FIP, 12"	EA		25
1/2" (5/8"OD)	EFGC-012-YE-10A11-18	1/2" M.EFV x 1/2" FIP, 18"	EA		25
1/2" (5/8"OD)	EFGC-012-YE-10A11-24	1/2" M.EFV x 1/2" FIP, 24"	EA		25
1/2" (5/8"OD)	EFGC-012-YE-10A11-30	1/2" M.EFV x 1/2" FIP, 30"	EA		25
1/2" (5/8"OD)	EFGC-012-YE-10A11-36	1/2" M.EFV x 1/2" FIP, 36"	EA		25
1/2" (5/8"OD)	EFGC-012-YE-10A11-48	1/2" M.EFV x 1/2" FIP, 48"	EA		25
1/2" (5/8"OD)	EFGC-012-YE-10A11-60	1/2" M.EFV x 1/2" FIP, 60"	EA		12
1/2" (5/8"OD)	EFGC-012-YE-10A11-72	1/2" M.EFV x 1/2" FIP, 72"	EA		12

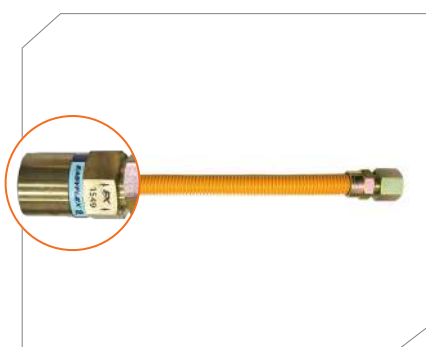

ID	Part #	Description	U/M	Price	Qty/ Box
1/2" (5/8"OD)	EFGC-012-YE-11A11-12	1/2" FEFV x 1/2" FIP, 12"	EA		25
1/2" (5/8"OD)	EFGC-012-YE-11A11-18	1/2" FEFV x 1/2" FIP, 18"	EA		25
1/2" (5/8"OD)	EFGC-012-YE-11A11-24	1/2" FEFV x 1/2" FIP, 24"	EA		25
1/2" (5/8"OD)	EFGC-012-YE-11A11-30	1/2" FEFV x 1/2" FIP, 30"	EA		25
1/2" (5/8"OD)	EFGC-012-YE-11A11-36	1/2" FEFV x 1/2" FIP, 36"	EA		25
1/2" (5/8"OD)	EFGC-012-YE-11A11-48	1/2" FEFV x 1/2" FIP, 48"	EA		25
1/2" (5/8"OD)	EFGC-012-YE-11A11-60	1/2" FEFV x 1/2" FIP, 60"	EA		12
1/2" (5/8"OD)	EFGC-012-YE-11A11-72	1/2" FEFV x 1/2" FIP, 72"	EA		12

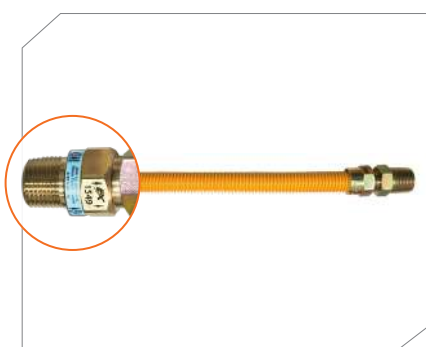

ID	Part #	Description	U/M	Price	Qty/ Box
1/2" (5/8"OD)	EFGC-012-YE-10A14-12	1/2" M.EFV x 3/4" MIP, 12"	EA		25
1/2" (5/8"OD)	EFGC-012-YE-10A14-18	1/2" M.EFV x 3/4" MIP, 18"	EA		25
1/2" (5/8"OD)	EFGC-012-YE-10A14-24	1/2" M.EFV x 3/4" MIP, 24"	EA		25
1/2" (5/8"OD)	EFGC-012-YE-10A14-30	1/2" M.EFV x 3/4" MIP, 30"	EA		25
1/2" (5/8"OD)	EFGC-012-YE-10A14-36	1/2" M.EFV x 3/4" MIP, 36"	EA		25
1/2" (5/8"OD)	EFGC-012-YE-10A14-48	1/2" M.EFV x 3/4" MIP, 48"	EA		25
1/2" (5/8"OD)	EFGC-012-YE-10A14-60	1/2" M.EFV x 3/4" MIP, 60"	EA		12
1/2" (5/8"OD)	EFGC-012-YE-10A14-72	1/2" M.EFV x 3/4" MIP, 72"	EA		12

Stainless Steel Flexible Gas Connectors



012-YE Series Connector with Fittings / EFV

- Tube : Stainless Steel
- Coating : Yellow Epoxy
- Fitting : Zinc-Plated Steel S45C
- 15/16-16 Thread
- 5/8" OD (1/2" ID)



ID	Part #	Description	U/M	Price	Qty/ Box
1/2" (5/8"OD)	EFGC-012-YE-10A15-12	1/2" M.EFV x 3/4" FIP, 12"	EA		25
1/2" (5/8"OD)	EFGC-012-YE-10A15-18	1/2" M.EFV x 3/4" FIP, 18"	EA		25
1/2" (5/8"OD)	EFGC-012-YE-10A15-24	1/2" M.EFV x 3/4" FIP, 24"	EA		25
1/2" (5/8"OD)	EFGC-012-YE-10A15-30	1/2" M.EFV x 3/4" FIP, 30"	EA		25
1/2" (5/8"OD)	EFGC-012-YE-10A15-36	1/2" M.EFV x 3/4" FIP, 36"	EA		25
1/2" (5/8"OD)	EFGC-012-YE-10A15-48	1/2" M.EFV x 3/4" FIP, 48"	EA		25
1/2" (5/8"OD)	EFGC-012-YE-10A15-60	1/2" M.EFV x 3/4" FIP, 60"	EA		12
1/2" (5/8"OD)	EFGC-012-YE-10A15-72	1/2" M.EFV x 3/4" FIP, 72"	EA		12

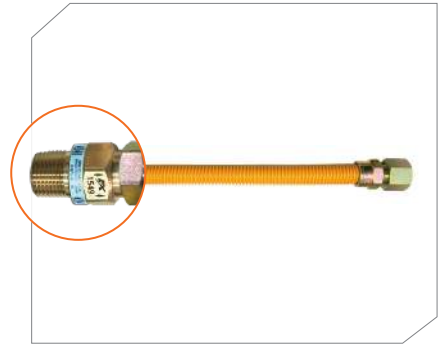

ID	Part #	Description	U/M	Price	Qty/ Box
1/2" (5/8"OD)	EFGC-012-YE-14A14-12	3/4" M.EFV x 3/4" MIP, 12"	EA		25
1/2" (5/8"OD)	EFGC-012-YE-14A14-18	3/4" M.EFV x 3/4" MIP, 18"	EA		25
1/2" (5/8"OD)	EFGC-012-YE-14A14-24	3/4" M.EFV x 3/4" MIP, 24"	EA		25
1/2" (5/8"OD)	EFGC-012-YE-14A14-30	3/4" M.EFV x 3/4" MIP, 30"	EA		25
1/2" (5/8"OD)	EFGC-012-YE-14A14-36	3/4" M.EFV x 3/4" MIP, 36"	EA		25
1/2" (5/8"OD)	EFGC-012-YE-14A14-48	3/4" M.EFV x 3/4" MIP, 48"	EA		25
1/2" (5/8"OD)	EFGC-012-YE-14A14-60	3/4" M.EFV x 3/4" MIP, 60"	EA		12
1/2" (5/8"OD)	EFGC-012-YE-14A14-72	3/4" M.EFV x 3/4" MIP, 72"	EA		12

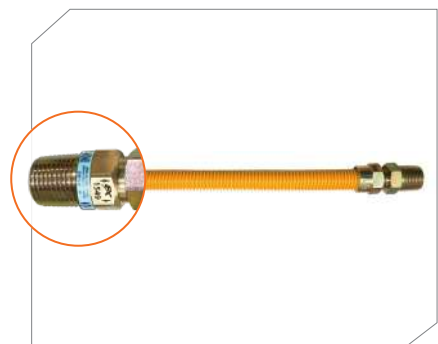

ID	Part #	Description	U/M	Price	Qty/ Box
1/2" (5/8"OD)	EFGC-012-YE-14A15-12	3/4" M.EFV x 3/4" FIP, 12"	EA		25
1/2" (5/8"OD)	EFGC-012-YE-14A15-18	3/4" M.EFV x 3/4" FIP, 18"	EA		25
1/2" (5/8"OD)	EFGC-012-YE-14A15-24	3/4" M.EFV x 3/4" FIP, 24"	EA		25
1/2" (5/8"OD)	EFGC-012-YE-14A15-30	3/4" M.EFV x 3/4" FIP, 30"	EA		25
1/2" (5/8"OD)	EFGC-012-YE-14A15-36	3/4" M.EFV x 3/4" FIP, 36"	EA		25
1/2" (5/8"OD)	EFGC-012-YE-14A15-48	3/4" M.EFV x 3/4" FIP, 48"	EA		25
1/2" (5/8"OD)	EFGC-012-YE-14A15-60	3/4" M.EFV x 3/4" FIP, 60"	EA		12
1/2" (5/8"OD)	EFGC-012-YE-14A15-72	3/4" M.EFV x 3/4" FIP, 72"	EA		12

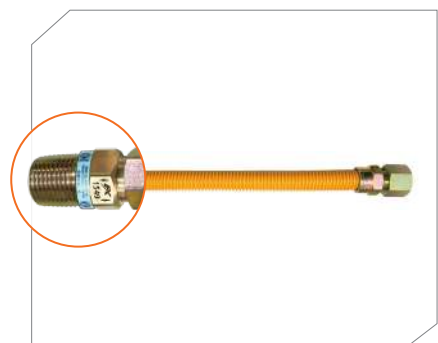

Gas Connectors

Commercial Gas Connectors

Gas Line System

Gas CSST Fittings

Water Line System

Water CSST Fittings

Braided Water Connectors

Supply stop Valve

Water Heater Connectors

Isolation Valves

Thermal Expansion Tanks

No-Hub Couplings

Flexible Sprinkler Drops

Gas Fittings

3/8" OD Flare Gas Fittings | Flare Adapter

- Zinc-Plated Steel S45C
- 5/8-18 Thread
- 3/8" OD (1/4" ID)



ID	Part #	Description	U/M	Price	Qty/Box
1/4" (3/8" OD)	G014-10	3/8" OD Flare x 1/2" MIP	EA		
1/4" (3/8" OD)	G014-12	3/8" OD Flare x 3/8" MIP	EA		

ID	Part #	Description	U/M	Price	Qty/Box
1/4" (3/8" OD)	G014-11	3/8" OD Flare x 1/2" FIP	EA		
1/4" (3/8" OD)	G014-13	3/8" OD Flare x 3/8" FIP	EA		

1/2" OD Flare Gas Fittings | Flare Adapter

- Zinc-Plated Steel S45C
- 3/4-16 Thread
- 1/2" OD (3/8" ID)

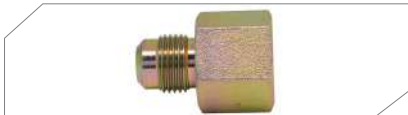

ID	Part #	Description	U/M	Price	Qty/Box
3/8" (1/2" OD)	G038-10	1/2" OD Flare x 1/2" MIP	EA		
3/8" (1/2" OD)	G038-12	1/2" OD Flare x 3/8" MIP	EA		

ID	Part #	Description	U/M	Price	Qty/Box
3/8" (1/2" OD)	G038-11	1/2" OD Flare x 1/2" FIP	EA		
3/8" (1/2" OD)	G038-13	1/2" OD Flare x 3/8" FIP	EA		

5/8" OD Flare Gas Fittings | Flare Adapter

- Zinc-Plated Steel S45C
- 15/16-16 Thread
- 5/8" OD (1/2" ID)

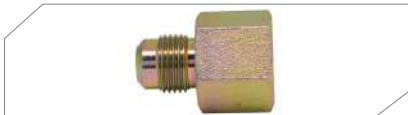

ID	Part #	Description	U/M	Price	Qty/Box
1/2" (5/8" OD)	G012-10	5/8" OD Flare x 1/2" MIP	EA		
1/2" (5/8" OD)	G012-14	5/8" OD Flare x 3/4" MIP	EA		

Gas Fittings

1" OD Flare Gas Fittings | Flare Adapter

- Zinc-Plated Steel S45C
- 1-1/8-16 Thread
- 1" OD (3/4" ID)

ID	Part #	Description	U/M	Price	Qty/Box
3/4" (1" OD)	G034-14	5/8" OD Flare x 3/4" MIP	EA		
3/4" (1" OD)	G034-16	5/8" OD Flare x 1" MIP	EA		

ID	Part #	Description	U/M	Price	Qty/Box
3/4" (1" OD)	G034-15	5/8" OD Flare x 3/4" FIP	EA		
3/4" (1" OD)	G034-17	5/8" OD Flare x 1" FIP	EA		



- Gas Connectors
- Commercial Gas Connectors
- Gas Line System
- Gas CSST Fittings
- Water Line System
- Water CSST Fittings
- Braided Water Connectors
- Supply stop Valve
- Water Heater Connectors
- Isolation Valves
- Thermal Expansion Tanks
- No-Hub Couplings
- Flexible Sprinkler Drops

Gas Fittings

3/8" OD Flare EFV Gas Fittings | Flare Excess Flow Valve



- Zinc-Plated Steel S45C
- 1-1/8-16 Thread
- 3/8" OD (1/4" ID)

ID	Part #	Description	U/M	Price	Qty/Box
1/4" (3/8" OD)	G014-10A	3/8" OD Flare x 1/2" M.EFV	EA		
1/4" (3/8" OD)	G014-12A	3/8" OD Flare x 3/8" M.EFV	EA		

ID	Part #	Description	U/M	Price	Qty/Box
1/4" (3/8" OD)	G014-11A	3/8" OD Flare x 1/2" FEFV	EA		
1/4" (3/8" OD)	G014-13A	3/8" OD Flare x 3/8" FEFV	EA		



1/2" OD Flare EFV Gas Fittings | Flare Excess Flow Valve

- Zinc-Plated Steel S45C
- 1-1/8-16 Thread
- 1/2" OD (3/8" ID)

ID	Part #	Description	U/M	Price	Qty/Box
3/8" (1/2" OD)	G038-10A	1/2" OD Flare x 1/2" M.EFV	EA		
3/8" (1/2" OD)	G038-12A	1/2" OD Flare x 3/8" M.EFV	EA		

ID	Part #	Description	U/M	Price	Qty/Box
3/8" (1/2" OD)	G038-11A	1/2" OD Flare x 1/2" FEFV	EA		
3/8" (1/2" OD))	G038-13A	1/2" OD Flare x 3/8" FEFV	EA		



5/8" OD Flare Gas Fittings | Flare Excess Flow Valve

- Zinc-Plated Steel S45C
- 1-1/8-16 Thread
- 5/8" OD (1/2" ID)

ID	Part #	Description	U/M	Price	Qty/Box
1/2" (5/8" OD)	G012-10A	5/8" OD Flare x 1/2" M.EFV	EA		
1/2" (5/8" OD)	G012-14A	5/8" OD Flare x 3/4" M.EFV	EA		

ID	Part #	Description	U/M	Price	Qty/Box
1/2" (5/8" OD)	G012-11A	5/8" OD Flare x 1/2" FEFV	EA		
1/2" (5/8" OD)	G012-15A	5/8" OD Flare x 3/4" FEFV	EA		



Gas Valves

Straight Ball Valves | FIP x FIP

- Lever Handle
- For use with liquified petroleum, LP gas and air mixtures up to 175 PSI
- Brass Body
- FIP x FIP



ID	Part #	Description	U/M	Price	Qty/Box
1/2" (5/8" OD)	GV-012-RD	1/2" FIP x 1/2" FIP, Red Handle	EA		
3/4" (1" OD)	GV-034-RD	3/4" FIP x 3/4" FIP, Red Handle	EA		
1" (1 1/4" OD)	GV-100-RD	1" FIP x 1" FIP, Red Handle	EA		
ID	Part #	Description	U/M	Price	Qty/Box
1/2" (5/8" OD)	GV-012-YE	1/2" FIP x 1/2" FIP, Yellow Handle	EA		
3/4" (1" OD)	GV-034-YE	3/4" FIP x 3/4" FIP, Yellow Handle	EA		
1" (1 1/4" OD)	GV-100-YE	1" FIP x 1" FIP, Yellow Handle	EA		

Gas Ball Valves | Flare x FIP

- Zinc-Plated Steel S45C
- Lever Handle
- For use with liquefied petroleum, LP gas and air mixtures up to 175 PSI



ID	Part #	Description	U/M	Price	Qty/Box
1/4" (3/8" OD)	G014-31	3/8" OD Flare x 1/2" FIP	EA		
3/8" (1/2" OD)	G038-31	1/2" OD Flare x 1/2" FIP	EA		
1/2" (5/8" OD)	G012-31	5/8" OD Flare (15/16-16Thread) x 1/2" FIP	EA		
1/2" (5/8" OD)	G012-33	5/8" OD Flare (15/16-16Thread) x 3/4" FIP	EA		

Gas Angle Valves | Flare x FIP

- Brass Body
- Lever Handle
- For use with liquified petroleum, LP gas and air mixtures up to 175 PSI



ID	Part #	Description	U/M	Price	Qty/Box
1/2" (5/8" OD)	G012-43	5/8" OD Flare (15/16-16Thread) x 3/4" FIP Angle	EA		

Easy to Use Handle

- Handles are ergonomically designed for smooth turns.
- Quarter-turn handle design allows for easy on/off operation.
- The forged brass body eliminates the possibility of leaks typically associated with cast products.
- All valves are 100% leak tested.

Gas Connectors

Commercial Gas Connectors

Gas Line System

Gas CSST Fittings

Water Line System

Water CSST Fittings

Braided Water Connectors

Supply stop Valve

Water Heater Connectors

Isolation Valves

Thermal Expansion Tanks

No-Hub Couplings

Flexible Sprinkler Drops



Commercial Food Service Gas Connectors

Braided Stainless Steel for durability, PVC coated for sanitation,
and 360° rotational fittings for free movement.



Commercial Food Service Gas Connectors

Applications

- Movable Caster-Mounted Gas Appliances
- Stationary Gas Appliances
- Stationary Countertop Gas Appliances

Benefits

- Braided Stainless Steel Construction
- PVC Coated
- 360° Rotational Ends

Certifications & Approvals

- ANSI Z21.69 / CSA 6.16 Connectors for Movable Gas Appliances
- A restraining device is required for all movable gas equipment.



Materials

Tubing	Stainless Steel 304 (ASTM A240)
Braid	Stainless Steel 304 (ASTM A240)
Coating	Yellow or Black PVC
Fitting	Zinc-Plated Steel S45C

Pressure-Temperature

Rated Operating Temperature	-40°F to 150°F (-40°C to 65°C)
Rated Pressure	0.5 psi

Gas Connectors

Commercial Gas Connectors

Gas Line System

Gas CSST Fittings

Water Line System

Water CSST Fittings

Braided Water Connectors

Supply stop Valve

Water Heater Connectors

Isolation Valves

Thermal Expansion Tanks

No-Hub Couplings

Flexible Sprinkler Drops

Commercial Food Service Gas Connectors

Commercial Food Service Gas Connector Installation Guide

Please read the following instructions carefully. Failure to read, comply, and follow these instructions may result in severe injury or death.

CAUTIONS AND WARNINGS

- The installation **MUST BE** compliant with the National Fuel Gas Code (ANSI Z223.1) and local gas installation codes.
- Installation and testing **MUST BE** performed by qualified personnel. Make sure that the gas supply and all the appliance gas valves are shut-off before connecting to the gas supply.
- Gas outlet must be in the same room as the appliance and the connector must not be concealed within or run through any wall, floor, or partition. Gas connections shall not be in contact with surfaces of temperatures in excess of 110°C (230°F), sharp edges or wiring.
- The final assembly must be tested for leaks after installation. Open flame or any sources of ignition must not be used for the testing. Leak test solutions may cause corrosion and **WATER RINSE AFTER TESTING**. To check leakage on the gas supply piping system, see National Fuel Gas Code Z223.1, NFPA 54 or CSA B149.1, Natural Gas and Propane Gas Installation Code. If odor of gas is detected, turn off the gas to the appliance and have a qualified professional fix the source of the leak.
- **STRONG CLEANING SOLUTIONS OR CHEMICAL SUBSTANCES MUST NOT COME IN CONTACT WITH THE CONNECTOR.** These may include acids, solvents, fluxes with zinc chloride, or other chlorinated chemicals. In case of contact, rinse down the connector with water and dry thoroughly.
- An accessible manual shut-off valve must be installed at the outlet of the gas supply piping system upstream of the connector.
- Contact with foreign objects, wiring or substances be avoided.
- Avoid movement after installation on fixed appliances.
- Bending or flexing of connectors on moveable appliances (e.g. those factory equipped with casters) should be limited to pulling and pushing the appliance in or out for cleaning or maintenance.
- Connectors are for use only on piping systems having fuel gas pressure not in excess of 1/2 psi (3.5 kPa). Flexible connections are suitable for use with 1st, 2nd and 3rd family gases only on piping systems operating at a pressure not exceeding 50 mbar.
- **DO NOT REUSE ON ANOTHER APPLIANCE OR AT ANOTHER LOCATION.** In addition to the main gas supply shut-off valve, an approved accessible manual gas shut-off valve **MUST BE** installed upstream of the gas connector (within 6 feet of the equipment it serves). Each piece of equipment must have its own shut-off valve.
- **DO NOT USE** the quick-disconnect coupling as the primary gas Shut-off.
- The quick disconnect **MUST BE INSTALLED** so that the gas enters the coupling half and exits the nipple half. You must follow the flow direction arrows that are permanently marked on the coupling.
- **NEVER INSERT** screwdrivers, probes, etc. into the quick disconnect coupling. The valve seat can be damaged or forced off center.
- The connector shall not be kinked, twisted, or torqued when installed.
- Make sure that all fittings are tightened properly. When installing an Easyflex® connector, two 14 inch adjustable wrenches (minimum size) are recommended as installation tools.
- Adequate means must be provided to limit the movement of castered appliances. A restraining device is **REQUIRED** for all types of moveable gas appliances.
- When installing an equipment line-up with dual fed front manifold gas inlets, **DO NOT** use a quick-disconnect coupling.
- Appliance **MUST BE** disconnected prior to maximum movement. **DO NOT OVEREXTEND** the gas connector assembly.

Commercial Food Service **Gas Connectors**

Movable Appliance Gas Connectors

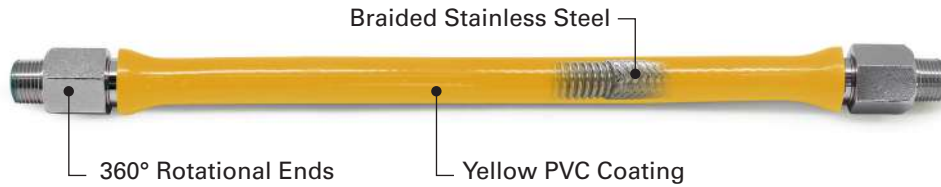

Specifications

- CSST Tubing : Stainless Steel 304 (ASTM A 240)
- Fittings : Zinc-Plated Steel S45C
- Braid : Stainless Steel 304 (ASTM A 240)
- Coating : Non-Flammable Yellow PVC
- Max. Operating Pressure : 0.5 psi
- For Indoor Use Only

Certifications & Approvals

ANSI Z 21.69 / CSA 6.16 Connectors for Movable Gas Appliances.
A restraining device is required for all movable gas equipment.



Connector Minimum Flow Capacity

Straight Length Capacity (BTU/Hr., 0.64 SpGr., 1,000 BTU per cubic ft. at 0.5" W.C. pressure drop)

Series	ID	OD	12"	18"	24"	30"	36"	48"	60"	72"
012	1/2"	5/8"	180,000	164,200	150,000	136,000	125,000	106,000	93,200	86,000
034	3/4"	1"	-	-	290,900	270,500	255,900	215,900	197,400	173,900
100	1"	1 1/4"	-	-	581,800	545,200	515,900	442,700	398,900	347,300

The above flow capacities are the minimum performance requirement.
Easyflex Gas Connectors exceed these minimum flow capacity requirements.

Commercial Food Service Gas Connectors

012-BJ Series Connector with Rotational Fittings

- Food Service Gas Connector
- Tube : Braided Stainless Steel Construction (ASTM A 240)
- Yellow PVC Coating
- Fittings : Zinc-Plated Steel S45C
- 360° Rotational Ends
- 5/8" OD (1/2" ID)

ID	Part #	Description	U/M	Price	Qty/ Box
1/2" (5/8"OD)	EFGC-012-BJ-1010-24	1/2" MIP x 1/2" MIP,	24"	EA	20
1/2" (5/8"OD)	EFGC-012-BJ-1010-36	1/2" MIP x 1/2" MIP,	36"	EA	20
1/2" (5/8"OD)	EFGC-012-BJ-1010-48	1/2" MIP x 1/2" MIP,	48"	EA	20
1/2" (5/8"OD)	EFGC-012-BJ-1010-60	1/2" MIP x 1/2" MIP,	60"	EA	20



034-BJ Series Connector with Rotational Fittings

- Food Service Gas Connector
- Tube : Braided Stainless Steel Construction (ASTM A 240)
- Yellow PVC Coating
- Fittings : Zinc-Plated Steel S45C
- 360° Rotational Ends
- 1" OD (3/4" ID)

ID	Part #	Description	U/M	Price	Qty/ Box
3/4" (1"OD)	EFGC-034-BJ-1414-24	3/4" MIP x 3/4" MIP,	24"	EA	20
3/4" (1"OD)	EFGC-034-BJ-1414-36	3/4" MIP x 3/4" MIP,	36"	EA	20
3/4" (1"OD)	EFGC-034-BJ-1414-48	3/4" MIP x 3/4" MIP,	48"	EA	20
3/4" (1"OD)	EFGC-034-BJ-1414-60	3/4" MIP x 3/4" MIP,	60"	EA	20
3/4" (1"OD)	EFGC-034-BJ-1414-72	3/4" MIP x 3/4" MIP,	72"	EA	20



100-BJ Series Connector with Rotational Fittings

- Food Service Gas Connector
- Tube : Braided Stainless Steel Construction (ASTM A 240)
- Yellow PVC Coating
- Fittings : Zinc-Plated Steel S45C
- 360° Rotational Ends
- 1-1/4" OD (1" ID)

ID	Part #	Description	U/M	Price	Qty/ Box
1" (1-1/4"OD)	EFGC-100-BJ-1616-24	1" MIP x 1" MIP,	24"	EA	20
1" (1-1/4"OD)	EFGC-100-BJ-1616-36	1" MIP x 1" MIP,	36"	EA	20
1" (1-1/4"OD)	EFGC-100-BJ-1616-48	1" MIP x 1" MIP,	48"	EA	20
1" (1-1/4"OD)	EFGC-100-BJ-1616-60	1" MIP x 1" MIP,	60"	EA	20



Gas Connectors

Commercial Gas Connectors

Gas Line System

Gas CSST Fittings

Water Line System

Water CSST Fittings

Braided Water Connectors

Supply stop Valve

Water Heater Connectors

Isolation Valves

Thermal Expansion Tanks

No-Hub Couplings

Flexible Sprinkler Drops

Commercial Food Service **Gas Connectors**

Countertop Appliance Gas Connectors



Specifications

- CSST Tubing : Stainless Steel 304 (ASTM A 240)
- Fittings : Zinc-Plated Steel S45C
- Braid : Stainless Steel 304 (ASTM A 240)
- Coating : Yellow PVC

Certifications & Approvals

ANSI Z 21.24 / CSA 6.10
ANSI Z 21.75 / CSA 6.27



Connector Minimum Flow Capacity

Straight Length Capacity (BTU/Hr., 0.64 SpGr., 1,000 BTU per cubic ft. at 0.5" W.C. pressure drop)

Series	ID	OD	12"	18"	24"	30"	36"	48"	60"	72"
014	1/4"	3/8"	48,000	43,800	40,000	36,400	33,400	28,300	24,900	23,100
038	3/8"	1/2"	102,000	93,100	85,000	77,100	71,100	60,500	53,200	49,100
012	1/2"	5/8"	180,000	164,200	150,000	136,000	125,000	106,000	93,200	86,000
034	3/4"	1"	290,900	290,900	290,900	270,500	255,900	215,000	197,400	173,900

The above flow capacities are the minimum performance requirement per ANSI Z 21.24/ CSA 6.10 and ANSI Z 21.75/ CSA 6.27

Easyflex Gas Connectors exceed these minimum flow capacity requirements.

Commercial Food Service **Gas Connectors**

012-BJC Series Connector with Fittings

- Tube : Braided Stainless Steel Construction
- Yellow PVC Coating
- Fitting : Zinc-Plated Steel S45C
- 15/16-16 Thread
- 5/8" OD (1/2" ID)



ID	Part #	Description	U/M	Price	Qty/ Box
1/2"(5/8"OD)	EFGC-012-BJC-1010-24	1/2" MIP x 1/2" MIP, 24"	EA		20
1/2"(5/8"OD)	EFGC-012-BJC-1010-36	1/2" MIP x 1/2" MIP, 36"	EA		20

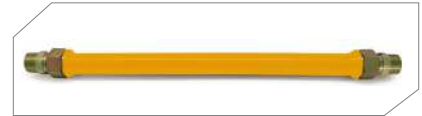

ID	Part #	Description	U/M	Price	Qty/ Box
1/2"(5/8"OD)	EFGC-012-BJC-1011-24	1/2" MIP x 1/2" FIP, 24"	EA		20
1/2"(5/8"OD)	EFGC-012-BJC-1011-36	1/2" MIP x 1/2" FIP, 36"	EA		20

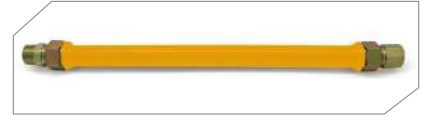

- Gas Connectors
- Commercial Gas Connectors**
- Gas Line System
- Gas CSST Fittings
- Water Line System
- Water CSST Fittings
- Braided Water Connectors
- Supply stop Valve
- Water Heater Connectors
- Isolation Valves
- Thermal Expansion Tanks
- No-Hub Couplings
- Flexible Sprinkler Drops

Commercial Food Service **Gas Connectors**

Stationary Appliance Gas Connectors

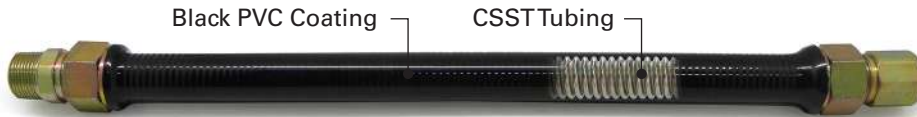

Specifications

- CSST Tubing : Stainless Steel 304 (ASTM A 240)
- Fittings : Zinc-Plated Steel S45C
- Coating : Black PVC

Certifications & Approvals

ANSI Z 21.24 / CSA 6.10
ANSI Z 21.75 / CSA 6.27



Connector Minimum Flow Capacity

Straight Length Capacity (BTU/Hr., 0.64 SpGr., 1,000 BTU per cubic ft. at 0.5" W.C. pressure drop)

Series	ID	OD	12"	18"	24"	30"	36"	48"	60"	72"
014	1/4"	3/8"	48,000	43,800	40,000	36,400	33,400	28,300	24,900	23,100
038	3/8"	1/2"	102,000	93,100	85,000	77,100	71,100	60,500	53,200	49,100
012	1/2"	5/8"	180,000	164,200	150,000	136,000	125,000	106,000	93,200	86,000
034	3/4"	1"	290,900	290,900	290,900	270,500	255,900	215,900	197,400	173,900

The above flow capacities are the minimum performance requirement per ANSI Z 21.24/ CSA 6.10 and ANSI Z 21.75/ CSA 6.27

Easyflex Gas Connectors exceed these minimum flow capacity requirements.

Commercial Food Service Gas Connectors

012-BES Series Connector with Fittings

- Tube : Stainless Steel
- Black PVC Coating
- Fitting : Zinc-Plated Steel S45C
- 15/16-16 Thread
- 5/8" OD (1/2" ID)



ID	Part #	Description	U/M	Price	Qty/ Box
1/2" (5/8"OD)	EFGC-012-BES-1010-24	1/2" MIP x 1/2" MIP, 24"	EA		20
1/2" (5/8"OD)	EFGC-012-BES-1010-36	1/2" MIP x 1/2" MIP, 36"	EA		20
1/2" (5/8"OD)	EFGC-012-BES-1010-48	1/2" MIP x 1/2" MIP, 48"	EA		20
1/2" (5/8"OD)	EFGC-012-BES-1010-60	1/2" MIP x 1/2" MIP, 60"	EA		20
1/2" (5/8"OD)	EFGC-012-BES-1010-72	1/2" MIP x 1/2" MIP, 72"	EA		20



ID	Part #	Description	U/M	Price	Qty/ Box
1/2" (5/8"OD)	EFGC-012-BES-1011-24	1/2" MIP x 1/2" FIP, 24"	EA		20
1/2" (5/8"OD)	EFGC-012-BES-1011-36	1/2" MIP x 1/2" FIP, 36"	EA		20
1/2" (5/8"OD)	EFGC-012-BES-1011-48	1/2" MIP x 1/2" FIP, 48"	EA		20
1/2" (5/8"OD)	EFGC-012-BES-1011-60	1/2" MIP x 1/2" FIP, 60"	EA		20
1/2" (5/8"OD)	EFGC-012-BES-1011-72	1/2" MIP x 1/2" FIP, 72"	EA		20



034-BES Series Connector with Fittings

- Tube : Stainless Steel
- Black PVC Coating
- Fitting : Zinc-Plated Steel S45C
- 1-1/8-16 Thread
- 1" OD (3/4" ID)



ID	Part #	Description	U/M	Price	Qty/ Box
3/4" (1"OD)	EFGC-034-BES-1414-24	3/4" MIP x 3/4" MIP, 24"	EA		20
3/4" (1"OD)	EFGC-034-BES-1414-36	3/4" MIP x 3/4" MIP, 36"	EA		20
3/4" (1"OD)	EFGC-034-BES-1414-48	3/4" MIP x 3/4" MIP, 48"	EA		20
3/4" (1"OD)	EFGC-034-BES-1414-60	3/4" MIP x 3/4" MIP, 60"	EA		20
3/4" (1"OD)	EFGC-034-BES-1414-72	3/4" MIP x 3/4" MIP, 72"	EA		20



ID	Part #	Description	U/M	Price	Qty/ Box
3/4" (1"OD)	EFGC-034-BES-1415-24	3/4" MIP x 3/4" FIP, 24"	EA		20
3/4" (1"OD)	EFGC-034-BES-1415-36	3/4" MIP x 3/4" FIP, 36"	EA		20
3/4" (1"OD)	EFGC-034-BES-1415-48	3/4" MIP x 3/4" FIP, 48"	EA		20
3/4" (1"OD)	EFGC-034-BES-1415-60	3/4" MIP x 3/4" FIP, 60"	EA		20
3/4" (1"OD)	EFGC-034-BES-1415-72	3/4" MIP x 3/4" FIP, 72"	EA		20



Gas Connectors

Commercial Gas Connectors

Gas Line System

Gas CSST Fittings

Water Line System

Water CSST Fittings

Braided Water Connectors

Supply stop Valve

Water Heater Connectors

Isolation Valves

Thermal Expansion Tanks

No-Hub Couplings

Flexible Sprinkler Drops

Commercial Food Service **Gas Connector Kits**

BJ Kit 1	QD (1)	Quick Disconnect	
	EL (2)	Elbow	
	RC (1)	Restraining Cable	
	V (1)	Full Port Valve	
BJ Kit 2	QD (1)	Quick Disconnect	
	EL (1)	Elbow	
	SW (1)	Swivel	
	RC (1)	Restraining Cable	
	V (1)	Full Port Valve	
BJ Kit 3	QD (1)	Quick Disconnect	
	SW (2)	Swivel	
	RC (1)	Restraining Cable	
	V (1)	Full Port Valve	

Commercial Food Service BJ Series Connector | Kit 1

- Food Service BJ Gas Connector (1) / QD(1) / EL(2) / RC(1) / V(1)
- Fittings : Zinc-Plated Steel S45C
- Yellow PVC Coating
- 360° Rotational Ends



ID	Part #	Description	U/M	Price	Qty/ Box
1/2" (5/8"OD)	EFGC-FS-012-K1-24	BJ Kit 1, 24"	EA		1
1/2" (5/8"OD)	EFGC-FS-012-K1-36	BJ Kit 1, 36"	EA		1
1/2" (5/8"OD)	EFGC-FS-012-K1-48	BJ Kit 1, 48"	EA		1
1/2" (5/8"OD)	EFGC-FS-012-K1-60	BJ Kit 1, 60"	EA		1

ID	Part #	Description	U/M	Price	Qty/ Box
3/4" (1"OD)	EFGC-FS-034-K1-24	BJ Kit 1, 24"	EA		1
3/4" (1"OD)	EFGC-FS-034-K1-36	BJ Kit 1, 36"	EA		1
3/4" (1"OD)	EFGC-FS-034-K1-48	BJ Kit 1, 48"	EA		1
3/4" (1"OD)	EFGC-FS-034-K1-60	BJ Kit 1, 60"	EA		1

ID	Part #	Description	U/M	Price	Qty/ Box
1" (1-1/4"OD)	EFGC-FS-100-K1-24	BJ Kit 1, 24"	EA		1
1" (1-1/4"OD)	EFGC-FS-100-K1-36	BJ Kit 1, 36"	EA		1
1" (1-1/4"OD)	EFGC-FS-100-K1-48	BJ Kit 1, 48"	EA		1
1" (1-1/4"OD)	EFGC-FS-100-K1-60	BJ Kit 1, 60"	EA		1

Commercial Food Service Gas Connector Kits

Commercial Food Service BJ Series Connector | Kit 2

- Food Service BJ Gas Connector(1) / QD(1) / EL(1) / SW(1) / RC(1) / V(1)
- Fittings : Zinc-Plated Steel S45C
- Yellow PVC Coating
- 360° Rotational Ends



ID	Part #	Description	U/M	Price	Qty/ Box
3/4" (1"OD)	EFGC-FS-034-K2-24	BJ Kit 2, 24"	EA		1
3/4" (1"OD)	EFGC-FS-034-K2-36	BJ Kit 2, 36"	EA		1
3/4" (1"OD)	EFGC-FS-034-K2-48	BJ Kit 2, 48"	EA		1
3/4" (1"OD)	EFGC-FS-034-K2-60	BJ Kit 2, 60"	EA		1

ID	Part #	Description	U/M	Price	Qty/ Box
1" (1-1/4"OD)	EFGC-FS-100-K2-24	BJ Kit 2, 24"	EA		1
1" (1-1/4"OD)	EFGC-FS-100-K2-36	BJ Kit 2, 36"	EA		1
1" (1-1/4"OD)	EFGC-FS-100-K2-48	BJ Kit 2, 48"	EA		1
1" (1-1/4"OD)	EFGC-FS-100-K2-60	BJ Kit 2, 60"	EA		1



Commercial Food Service BJ Series Connector | Kit 3

- Food Service BJ Gas Connector(1) / QD(1) / SW(2) / RC(1) / V(1)
- Fittings : Zinc-Plated Steel S45C
- Yellow PVC Coating
- 360° Rotational Ends



ID	Part #	Description	U/M	Price	Qty/ Box
3/4" (1"OD)	EFGC-FS-034-K3-24	BJ Kit 3, 24"	EA		1
3/4" (1"OD)	EFGC-FS-034-K3-36	BJ Kit 3, 36"	EA		1
3/4" (1"OD)	EFGC-FS-034-K3-48	BJ Kit 3, 48"	EA		1
3/4" (1"OD)	EFGC-FS-034-K3-60	BJ Kit 3, 60"	EA		1

ID	Part #	Description	U/M	Price	Qty/ Box
1" (1-1/4"OD)	EFGC-FS-100-K3-24	BJ Kit 3, 24"	EA		1
1" (1-1/4"OD)	EFGC-FS-100-K3-36	BJ Kit 3, 36"	EA		1
1" (1-1/4"OD)	EFGC-FS-100-K3-48	BJ Kit 3, 48"	EA		1
1" (1-1/4"OD)	EFGC-FS-100-K3-60	BJ Kit 3, 60"	EA		1



**Customizable Kits are available.
Contact your local sales rep or Easyflex for more information!**

Gas Connectors

Commercial Gas Connectors

Gas Line System

Gas CSST Fittings

Water Line System

Water CSST Fittings

Braided Water Connectors

Supply stop Valve

Water Heater Connectors



Isolation Valves

Thermal Expansion Tanks

No-Hub Couplings

Flexible Sprinkler Drops

Commercial Food Service **Gas Connector Kits**

BJC Kit 1	EL (2)	Elbow	
	V (1)	Full Port Valve	
BES Kit 1	EL (2)	Elbow	
	V (1)	Full Port Valve	

Countertop Gas Appliance Connector | **Kit 1**

- BJC Gas Connector (1) / EL(2) / V(1)
- Fittings : Zinc-Plated Steel S45C
- Yellow PVC Coating



ID	Part #	Description	U/M	Price	Qty/ Box
1/2" (3/4"OD)	EFGC-CC-012-K1-24	BJC Kit 1, 24"	EA		1
1/2" (3/4"OD)	EFGC-CC-012-K1-36	BJC Kit 1, 36"	EA		1

Stationary Gas Appliance Connector | **Kit 1**

- BES Gas Connector (1) / EL(2) / V(1)
- Fittings : Zinc-Plated Steel S45C
- Black PVC Coating



ID	Part #	Description	U/M	Price	Qty/ Box
1/2" (3/4"OD)	EFGC-CS-012-K1-24	BES Kit 1, 24"	EA		1
1/2" (3/4"OD)	EFGC-CS-012-K1-36	BES Kit 1, 36"	EA		1
1/2" (3/4"OD)	EFGC-CS-012-K1-48	BES Kit 1, 48"	EA		1

ID	Part #	Description	U/M	Price	Qty/ Box
3/4" (1"OD)	EFGC-CS-034-K1-24	BES Kit 1, 24"	EA		1
3/4" (1"OD)	EFGC-CS-034-K1-36	BES Kit 1, 36"	EA		1
3/4" (1"OD)	EFGC-CS-034-K1-48	BES Kit 1, 48"	EA		1
3/4" (1"OD)	EFGC-CS-034-K1-60	BES Kit 1, 60"	EA		1

Commercial Food Service Gas Connector - Parts

Full Port Ball Valve

- Lever Handle
- Brass

Part #	Description	U/M	Price	Qty/ Box
FV-012	1/2" FIP x 1/2" FIP, Full Port Ball Valve	EA		
FV-034	3/4" FIP x 3/4" FIP, Full Port Ball Valve	EA		
FV-100	1" FIP x 1" FIP, Full Port Ball Valve	EA		



90° Elbow

- Black Iron

Part #	Description	U/M	Price	Qty/ Box
EFG-L-012	1/2" FIP, 90° Elbow	EA		
EFG-L-034	3/4" FIP, 90° Elbow	EA		
EFG-L-100	1" FIP, 90° Elbow	EA		



Quick Disconnect

- Brass

Part #	Description	U/M	Price	Qty/ Box
FS-QD-012	1/2" Quick Disconnect	EA		
FS-QD-034	3/4" Quick Disconnect	EA		
FS-QD-100	1" Quick Disconnect	EA		



Swivel Fitting

- Carbon Steel

Part #	Description	U/M	Price	Qty/ Box
FS-SW-034	3/4" Swivel Fitting	EA		
FS-SW-100	1" Swivel Fitting	EA		



Restraining Cable

- Restraining Cable (1), Mounting Parts

Part #	Description	U/M	Price	Qty/ Box
FS-RC-24	Restraining Cable, 24"	EA		
FS-RC-36	Restraining Cable, 36"	EA		
FS-RC-48	Restraining Cable, 48"	EA		
FS-RC-60	Restraining Cable, 60"	EA		



Gas
Connectors

Commercial
Gas
Connectors

Gas
Line System

Gas
CSST Fittings

Water
Line System

Water
CSST Fittings

Braided
Water
Connectors

Supply stop
Valve

Water
Heater
Connectors

Isolation
Valves

Thermal
Expansion
Tanks

No-Hub
Couplings

Flexible
Sprinkler
Drops

vectorFLEX™

vectorflex.com

1000°F  No Leakage

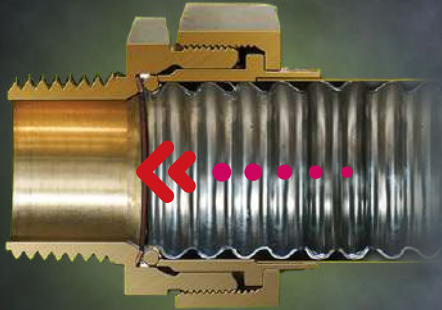

- Easy Installation
- Quick Connect
- Safety Use



Corrugated Stainless Steel Tubing Gas Line System

Flexible CSST piping system for natural and propane gas applications that's engineered and manufactured to address the inherent problems associated with rigid pipe systems.



VectorFlex

Corrugated Stainless Steel Tubing Gas Line System

VectorFlex Corrugated Stainless Steel Tubing (CSST) is a flexible, durable, lightweight, corrosion - resistant gas pipe.



Patented QuickFlare™ fittings provide the easiest and fastest installation of gas piping for natural gas or propane gas appliances.

The easy 3-step installation (Cut–Push–Tighten) will save you time and money. Installers do NOT need to open and re-assemble the fitting. These precalibrated semi push-fit fittings are ready to be installed without any special tools or equipment.

Applications

- Gas Range
- Gas Fireplace
- Gas Water Heater
- Gas Dryer
- Gas Furnace
- Gas Grill
- Gas Distribution System (Residential & Commercial)

Certifications & Approvals

- ANSI LC-1 / CSA 6.26 Fuel Gas Piping Systems Using Corrugated Stainless Steel Tubing



- Commercial Gas Connectors
- Gas Line System
- Gas CSST Fittings
- Water Line System
- Water CSST Fittings
- Braided Water Connectors
- Supply stop Valve
- Water Heater Connectors
- Isolation Valves
- Thermal Expansion Tanks
- No-Hub Couplings
- Flexible Sprinkler Drops

VectorFlex

Corrugated Stainless Steel Tubing Gas Line System

Technical Specifications

CSST Material	Stainless Steel 304 (ASTM A 240)
Coating (Optional)	Polyethylene (ASTM D 335)
Types	Yellow PE, Black PE
Sizes	3/8", 1/2", 3/4", 1", 1-1/4", 1-1/2", 2"
Lengths	50 ft ~ 500 ft
Operating Pressure	25 Psig
Max No. of re-assemblies per fitting	3

Size	3/8"	1/2"	3/4"	1"	1-1/4"	1-1/2"	2"
Min Bend Radius	3"			5"			
Min Tightening Torque [ft-lbs]	110	130	160	190	210	230	260

Installation Instructions

1. Cut

Determine the proper length of the tubing needed and cut to desired length. Cut a straight section that has not been bent.



A clean cut must be applied.
A rough cut can perforate the silicone ring and cause leakage.



2. Mark and Strip Jacket

Mark the appropriate length of tubing (5 corrugations from the end). Using a utility knife, and strip PE jacket.



3. Install Fitting

Connect threaded end of the fitting to the appliance. Use pipe thread sealant on the threaded end of fitting only.



DO NOT use PTFE tape or sealant between body and nut connection.



4. Install QuickFlare Fitting and Remove Safety Clip

Insert the tubing into the fitting until the marked line is aligned with the end of the fitting. Proper installation will make a click sound. After inserting tubing to the fitting and before wrench tightening, remove the safety clip.



Remove Safety Clip

5. Confirm Proper Installation

After installation of fitting, hand-tighten the nut. To ensure proper installation, try to pull the tubing out of the fitting. If the tubing can be pulled out of the fitting, the installation should be done again.

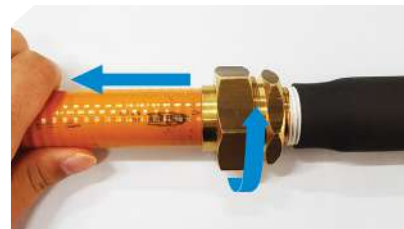

Confirm Proper Installation

6. Wrench Tightening

Hold the fitting body using one wrench and turn the nut using the second a wrench. Do not vice or squeeze the fitting body under any circumstances.



Wrench Tightening

VectorFlex

Corrugated Stainless Steel Tubing Gas Line System

Product Testing

Leak Test	Shall not leak externally in excess of 20cm ³ /hr(1.22 in ³ /hr) of air
Pressure Test	Withstand a hydrostatic pressure of 250 psi (1.72 Mpa) without bursting or visible loss of fluid
Bending Test	Withstands 12 bends without leaking with minimum bend radius
Torsion Test	Withstands 6 applications of 90° twists
Axial strength test	Withstands a tensile load of 800 lb/in ² (0.14 kN/mm) of nominal tubing diameter without leaking or becoming detached
Crushing strength test	Withstands a crushing force of 1000 lb (4.45 kN) without a decrease in flow capacity of more than 50 percent
Impact test	Withstands an impact of 30 ft-lb (40.7 J) without leaking
Strength of fittings test	Shall not crack, break or leak with tightening torque of 1040 in-lb (117.5 Nm)
Elevated temperature	Withstands temperatures of up to 1000°F (538°C) for one hour without leaking
Corrosive resistance	Withstands exposure to corrosive environments without leaking
Electrical resistance	Will not exceed electrical resistance limited by ANSI LC1 / CSA 6.26 standard

Certifications, Approvals, Listing and Compliance

United States | CSA USA Standards Association

ANSI LC1 Fuel Gas Piping Systems Using Corrugated Stainless Steel Tubing

Canada | CSA Canadian Standards Association

CSA 6.26 Fuel Gas Piping Systems Using Corrugated Stainless Steel Tubing

Gas Connectors

Commercial Gas Connectors

Gas Line System

Gas CSST Fittings

Water Line System

Water CSST Fittings

Braided Water Connectors

Supply stop Valve

Water Heater Connectors

Isolation Valves

Thermal Expansion Tanks

No-Hub Couplings

Flexible Sprinkler Drops

VectorFlex

Corrugated Stainless Steel Tubing Gas Line System



Certificate of Compliance

Certificate: 2556790 (238420)

Master Contract: 238420

Project: 70041880

Date Issued: 2016-04-28

Issued to: **Kofulso Co., Ltd.**
377-8 Gungok-Dong, Seo-Gu
Inchon City,
SOUTH KOREA
Attention: Hun Kim

The products listed below are eligible to bear the CSA Mark shown with adjacent indicators 'C' and 'US' for Canada and US or with adjacent indicator 'US' for US only or without either indicator for Canada only.



Issued by: *John Kristoff-Kichka*
John Kristoff-Kichka

PRODUCTS

CLASS - C333504 - SYSTEMS (GAS)-Fuel Piping

CLASS - C333584 - SYSTEMS (GAS)-Fuel Piping-Certified to U.S. Standards

Model Number	Size
Rated Pressure 25 psi	
GL-038-YPE, NGL-038-CGYCT	3/8
GL-012-YPE, NGL-012-CGYCT	1/2
GL-034-YPE, NGL-034-CGYCT	3/4
GL-100-YPE, NGL-100-CGYCT	1
GL-114-YPE, NGL-114-CGYCT	1 1/4
GL-112-YPE, NGL-112-CGYCT	1 1/2
GL-200-YPE, NGL-200-CGYCT	2

APPLICABLE REQUIREMENTS

ANSI L1-2014•CSA 6.26-2014, Fuel Gas Piping systems Using Corrugated Stainless Steel Tubing

VectorFlex

Corrugated Stainless Steel Tubing Gas Line System

VectorFlex Gas CSST | Yellow PE Jacket

- Tubing : Stainless Steel 304
- Coating : Yellow Polyethylene(PE)
- Coating Thickness: 0.02"
- Max. Operating Temperature : 212° F
- Max. Operating Pressure : 25psig



ID	Part #	Description	U/M	Price	Qty/ Box
3/8"	NGL-038-YW-050	3/8" ID, Yellow PE Jacket, 50 ft	Box		
3/8"	NGL-038-YW-100	3/8" ID, Yellow PE Jacket, 100 ft	Roll		
3/8"	NGL-038-YW-250	3/8" ID, Yellow PE Jacket, 250 ft	Roll		
1/2"	NGL-012-YW-050	1/2" ID, Yellow PE Jacket, 50 ft	Box		
1/2"	NGL-012-YW-100	1/2" ID, Yellow PE Jacket, 100 ft	Roll		
1/2"	NGL-012-YW-250	1/2" ID, Yellow PE Jacket, 250 ft	Roll		
3/4"	NGL-034-YW-050	3/8" ID, Yellow PE Jacket, 50 ft	Box		
3/4"	NGL-034-YW-100	3/4" ID, Yellow PE Jacket, 100 ft	Roll		
3/4"	NGL-034-YW-250	3/4" ID, Yellow PE Jacket, 250 ft	Roll		
1"	NGL-100-YW-050	1" ID, Yellow PE Jacket, 50 ft	Box		
1"	NGL-100-YW-100	1" ID, Yellow PE Jacket, 100 ft	Roll		
1"	NGL-100-YW-250	1" ID, Yellow PE Jacket, 250 ft	Roll		
1-1/4"	NGL-114-YW-150	1-1/4" ID, Yellow PE Jacket, 150 ft	Roll		
1-1/2"	NGL-112-YW-150	1-1/2" ID, Yellow PE Jacket, 150 ft	Roll		
2"	NGL-200-YW-150	2" ID, Yellow PE Jacket, 150 ft	Roll		



VectorFlex Gas CSST | Black PE Jacket

- Tubing : Stainless Steel 304
- Coating : Black Polyethylene(PE)
- Coating Thickness: 0.02"
- Max. Operating Temperature : 212° F
- Max. Operating Pressure : 25psig



ID	Part #	Description	U/M	Price	Qty/ Box
3/8"	NGL-038-BK-050	3/8" ID, Black PE Jacket, 50 ft	Box		
3/8"	NGL-038-BK-100	3/8" ID, Black PE Jacket, 100 ft	Roll		
3/8"	NGL-038-BK-250	3/8" ID, Black PE Jacket, 250 ft	Roll		
1/2"	NGL-012-BK-050	1/2" ID, Black PE Jacket, 50 ft	Box		
1/2"	NGL-012-BK-100	1/2" ID, Black PE Jacket, 100 ft	Roll		
1/2"	NGL-012-BK-250	1/2" ID, Black PE Jacket, 250 ft	Roll		
3/4"	NGL-034-BK-050	3/8" ID, Black PE Jacket, 50 ft	Box		
3/4"	NGL-034-BK-100	3/4" ID, Black PE Jacket, 100 ft	Roll		
3/4"	NGL-034-BK-250	3/4" ID, Black PE Jacket, 250 ft	Roll		
1"	NGL-100-BK-050	1" ID, Black PE Jacket, 50 ft	Box		
1"	NGL-100-BK-100	1" ID, Black PE Jacket, 100 ft	Roll		
1"	NGL-100-BK-250	1" ID, Black PE Jacket, 250 ft	Roll		
1-1/4"	NGL-114-BK-150	1-1/4" ID, Black PE Jacket, 150 ft	Roll		
1-1/2"	NGL-112-BK-150	1-1/2" ID, Black PE Jacket, 150 ft	Roll		
2"	NGL-200-BK-150	2" ID, Black PE Jacket, 150 ft	Roll		



- Gas Connectors
- Commercial Gas Connectors
- Gas Line System
- Gas CSST Fittings
- Water Line System
- Water CSST Fittings
- Braided Water Connectors
- Supply stop Valve
- Water Heater Connectors
- Isolation Valves
- Thermal Expansion Tanks
- No-Hub Couplings
- Flexible Sprinkler Drops

VectorFlex

Corrugated Stainless Steel Tubing Gas Line System

Flange

- Material: Stainless Steel 304
- Nut: Brass B124 C37700 (C3771)
- Connection: Threaded



Part #	Description	U/M	Price	Qty/ Box
NGLF-038-CGFG	3/8" Flange Fitting, 3/8" Nut	EA		
NGLF-012-CGFG	1/2" Flange Fitting, 1/2" Nut	EA		
NGLF-034-CGFG	3/4" Flange Fitting, 3/4" Nut	EA		
NGLF-100-CGFG	1" Flange Fitting, 1" Nut	EA		
NGLF-114-CGFG	1 1/4" Flange Fitting, 1 1/4" Nut	EA		
NGLF-112-CGFG	1 1/2" Flange Fitting, 1 1/2" Nut	EA		
NGLF-200-CGFG	2" Flange Fitting, 2" Nut	EA		

Manifold

- Material: Stainless Steel 304
- Connection: Threaded



Part #	Description	U/M	Price	Qty/ Box
NGLF-MFD-01	In 1/2"F, Out 1/2"F, Socket(3ea) 1/2"F, Manifold	EA		
NGLF-MFD-02	In 1/2"F, Out 1/2"F, Socket(4ea) 1/2"F, Manifold	EA		
NGLF-MFD-03	In 3/4"F, Out 1/2"F, Socket(4ea) 1/2"F, Manifold	EA		
NGLF-MFD-04	In 3/4"F, Out 1/2"F, Socket(5ea) 1/2"-3/4"F, Manifold	EA		
NGLF-MFD-05	In 3/4"F, Out 3/4"F, Socket(4ea) 1/2"F, Manifold	EA		
NGLF-MFD-06	In 3/4"F, Out 3/4"F, Socket(5ea) 1/2"F, Manifold	EA		
NGLF-MFD-07	In 1"F, Out 3/4"F, Socket(5ea) 1/2"-3/4"F, Manifold	EA		
NGLF-MFD-08	In 1"F, Out 1"F, Socket(4ea) 1/2"F, Manifold	EA		
NGLF-MFD-09	In 1 1/4"F, Out 1"F, Socket(5ea) 1/2"F, Manifold	EA		
NGLF-MFD-10	In 1 1/4"F, Out 1 1/4"F, Socket(4ea) 1/2"F, Manifold	EA		
NGLF-MFD-11	In 1"F, Out 1 1/4"F, Socket(4ea) 3/4"F, Manifold	EA		
NGLF-MFD-12	In 1"F, Out 1"F, Socket(4ea) 3/4"F, Manifold	EA		
NGLF-MFD-13	In 1 1/4"F, Out 1"F, Socket(4ea) 3/4"F, Manifold	EA		
NGLF-MFD-14	In 1 1/2"F, Out 1 1/2"F, Socket(5ea) 3/4"F, Manifold	EA		
NGLF-MFD-15	In 2"F, Out 1 1/2"F, Socket(4ea) 1"F, Manifold	EA		
NGLF-MFD-16	In 2"F, Out 1 1/2"F, Socket(6ea) 1"F, Manifold	EA		
NGLF-MFD-17	In 2"F, Out 1 1/2"F, Socket(4ea) 1"F, Manifold	EA		
NGLF-MFD-18	In 2"F, Out 2"F, Socket(6ea) 1"F, Manifold	EA		

VectorFlex

Corrugated Stainless Steel Tubing Gas Line System

Appliance Stub Out

- Material: Stainless Steel 304
- Connection: Threaded

Part #	Description	U/M	Price	Qty/ Box
NGLF-012-APSO-012S	1/2" Appliance Stub Out Short	EA		
NGLF-012-APSO-012L	1/2" Appliance Stub Out Long	EA		
NGLF-012-APSO-034S	1/2" Appliance Stub Out Short	EA		
NGLF-012-APSO-034L	1/2" Appliance Stub Out Long	EA		
NGLF-034-APSO-034S	3/4" Appliance Stub Out Short	EA		
NGLF-034-APSO-034L	3/4" Appliance Stub Out Long	EA		



Straight Stub Out

- Material: Stainless Steel 304
- Connection: Threaded

Part #	Description	U/M	Price	Qty/ Box
NGLF-012-SSO-06	1/2" Straight Stub Out 6" Length	EA		
NGLF-012-SSO-12	1/2" Straight Stub Out 12" Length	EA		
NGLF-034-SSO-06	3/4" Straight Stub Out 6" Length	EA		
NGLF-034-SSO-12	3/4" Straight Stub Out 12" Length	EA		
NGLF-100-SSO-06	1" Straight Stub Out 6" Length	EA		
NGLF-100-SSO-12	1" Straight Stub Out 12" Length	EA		
NGLF-114-SSO-06	1 1/4" Straight Stub Out 6" Length	EA		
NGLF-114-SSO-12	1 1/4" Straight Stub Out 12" Length	EA		
NGLF-112-SSO-06	1 1/2" Straight Stub Out 6" Length	EA		
NGLF-112-SSO-12	1 1/2" Straight Stub Out 12" Length	EA		
NGLF-200-SSO-06	2" Straight Stub Out 6" Length	EA		
NGLF-200-SSO-12	2" Straight Stub Out 12" Length	EA		



Termination Fitting

- Material: Stainless Steel 304
- Connection: Threaded

Part #	Description	U/M	Price	Qty/ Box
NGLF-038-TM	3/8" Termination Fitting	EA		
NGLF-012-TM	1/2" Termination Fitting	EA		
NGLF-034-TM	3/4" Termination Fitting	EA		
NGLF-100-TM	1" Termination Fitting	EA		
NGLF-114-TM	1 1/4" Termination Fitting	EA		
NGLF-112-TM	1 1/2" Termination Fitting	EA		
NGLF-200-TM	2" Termination Fitting	EA		

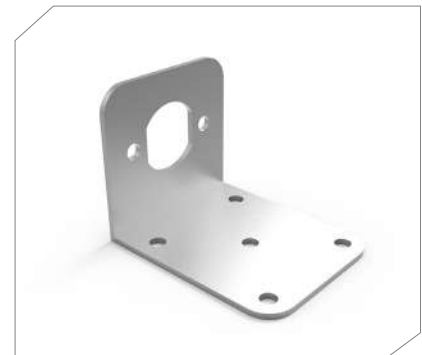

Gas Connectors

Commercial Gas Connectors

Gas Line System

Gas CSST Fittings

Water Line System

Water CSST Fittings

Braided Water Connectors

Supply Valve

Water Heater Connectors

Isolation Valves

Thermal Expansion Tanks

No-Hub Couplings

Flexible Sprinkler Drops

VectorFlex

Corrugated Stainless Steel Tubing Gas Line System

Multi Outlet Stub Out

- Material: Stainless Steel 304
- Connection: Threaded



Part #	Description	U/M	Price	Qty/ Box
NGLF-MULSOO	3/4" x 1/2" x 3/4" Multi Stub Out	EA		

Angle Stub Out

- Material: Stainless Steel 304
- Connection: Threaded

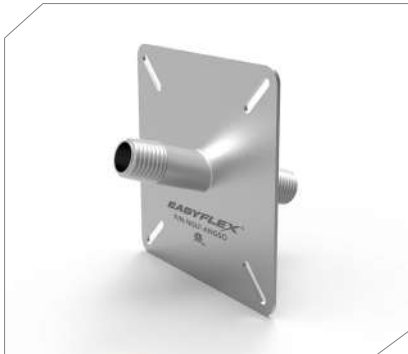

Part #	Description	U/M	Price	Qty/ Box
NGLF-ANGSO	1/2" x 4.5" x 72.5° Angle Stub Out	EA		

Deck Stub Out

- Material: Stainless Steel 304
- Connection: Threaded



Part #	Description	U/M	Price	Qty/ Box
NGLF-DSO-012	1/2" Male, 3", Deck Stub Out	EA		

VectorFlex

Corrugated Stainless Steel Tubing Gas Line System

Half Striker Plate

- Material: Stainless Steel 304
- Connection: Threaded

Part #	Description	U/M	Price	Qty/ Box
NGLF-STKP-37	3" x 7" Half Striker Plate	EA		



Half Striker Plate - Double

- Material: Stainless Steel 304
- Connection: Threaded

Part #	Description	U/M	Price	Qty/ Box
NGLF-STKP-384	3" x 8.4" Half Striker Plate-Double	EA		



Quarter Striker Plate

- Material: Stainless Steel 304
- Connection: Threaded

Part #	Description	U/M	Price	Qty/ Box
NGLF-STKP-32	3" x 2" Quarter Striker Plate	EA		

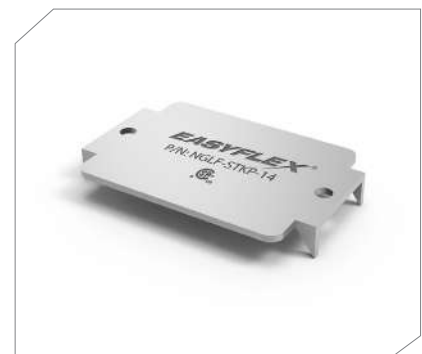

Gas Connectors

Commercial Gas Connectors

Gas Line System

Gas CSST Fittings

Water Line System

Water CSST Fittings

Braided Water Connectors

Supply stop Valve

Water Heater Connectors

Isolation Valves

Thermal Expansion Tanks

No-Hub Couplings

Flexible Sprinkler Drops

VectorFlex

Corrugated Stainless Steel Tubing Gas Line System

Three Quarter Striker Plate

- Material: Stainless Steel 304
- Connection: Threaded



Part #	Description	U/M	Price	Qty/ Box
NGLF-STKP-38	3" x 8" Three Quarter Striker Plate	EA		

Extra Large Striker Plate

- Material: Stainless Steel 304
- Connection: Threaded



Part #	Description	U/M	Price	Qty/ Box
NGLF-STKP-EX	6" x 17" Extra Large Striker Plate	EA		

Full Striker Plate

- Material: Stainless Steel 304
- Connection: Threaded



Part #	Description	U/M	Price	Qty/ Box
NGLF-STKP-312	3" x 12" Full Striker Plate	EA		

VectorFlex

Corrugated Stainless Steel Tubing Gas Line System

Full Drop Striker Plate

- Material: Stainless Steel 304
- Connection: Threaded

Part #	Description	U/M	Price	Qty/ Box
NGLF-STKP-BC	1/2" x 3/4" Full Drop Striker Plate	EA		
NGLF-STKP-ED	1" x 1-1/4" Full Drop Striker Plate	EA		



Bonding Clamp

- Material: Brass B124 C37700 (C3771)
- Connection: Threaded

Part #	Description	U/M	Price	Qty/ Box
NGLF-BC-S	3/8", 1/2", 3/4"	EA		
NGLF-BC-L	1", 1-1/4", 1-1/2", 2"	EA		



Gas Connectors

Commercial Gas Connectors

Gas Line System

Gas CSST Fittings

Water Line System

Water CSST Fittings

Braided Water Connectors

Supply stop Valve

Water Heater Connectors

Isolation Valves

Thermal Expansion Tanks

No-Hub Couplings

Flexible Sprinkler Drops

VectorFlex™ and VectorFlow™ - Tools



Tube Cutter

- Reamer included for deburring the tube
- Easy-to-replace blade

Part #	Description	U/M	Price	Qty/ Box
EF-Cutter-32	CSST Cutter, up to 5-32mm(1-1/4")	EA		10
EF-Cutter-50	CSST Cutter, up to 6-50mm(2")	EA		10
EF-Cutter-70	CSST Cutter, up to 7-70mm(2-3/4")	EA		10



Tube Jacket Striper

- Gas CSST
- Water CSST (PE Coated)

Part #	Description	U/M	Price	Qty/ Box
EF-JT-Striper	Tube Jacket Striper, 3/8" to 2"	EA		10



Plastic Pipe Cutter

- PB
- PEX
- CPVC

Part #	Description	U/M	Price	Qty/ Box
EW-PP-Cutter	Plastic Pipe Cutter, up to 1"	EA		20

VectorFlex™ and VectorFlow™ - Tools

Tube Mounting Saddle

- Material: Stainless Steel 304
- 2 ears

Part #	Description	U/M	Price	Qty/ Bag
EFW-WB-038	3/8" CSST Mounting Bracket	EA		50
EFW-WB-012	1/2" CSST Mounting Bracket	EA		50
EFW-WB-034	3/4" CSST Mounting Bracket	EA		50
EFW-WB-100	1" CSST Mounting Bracket	EA		50
EFW-WB-114	1-1/4" CSST Mounting Bracket	EA		50
EFW-WB-112	1-1/2" CSST Mounting Bracket	EA		50
EFW-WB-200	2" CSST Mounting Bracket	EA		50



PTFE Thread Seal Tape

- WH (0.77g/cm³) / YE (1.38g/cm³)
- 012 / 034

Part #	Description	U/M	Price	Qty/ Bag
EF-TP-WH-012-520	1/2" x 520" x 0.0035", White	EA		100
EF-TP-YE-012-520	1/2" x 520" x 0.0035", Yellow	EA		100
EF-TP-WH-034-520	3/4" x 520" x 0.0035", White	EA		100
EF-TP-YE-034-520	3/4" x 520" x 0.0035", Yellow	EA		100



- Gas Connectors
- Commercial Gas Connectors
- Gas Line System
- Gas CSST Fittings
- Water Line System
- Water CSST Fittings
- Braided Water Connectors
- Supply stop Valve
- Water Heater Connectors
- Isolation Valves
- Thermal Expansion Tanks
- No-Hub Couplings
- Flexible Sprinkler Drops

QuickFLARE[™]
vectorflex.com



Gas Brass Fittings

Patented and ready-to-install from the factory, QuickFlare fittings eliminate all the hassles of threading, welding, or gluing connections. Simply **CUT**, **PUSH**, and **TIGHTEN**. It's that easy!

FLARE™
QuickFLARE™
VectorFlex™
EASYFLEX™



QuickFlare™ Brass Fittings for VectorFlex™ Gas CSST



« Easy Installation « Certified
 « Quick Connect « No Rubber Parts

Benefits

- Patented 3-Step Installation (CUT, PUSH, TIGHTEN)
- Reduced Labor Costs
- Resistant to Scaling & Corrosion
- No Special Tools Required
- Factory Ready-To-Install
- Variety of Applications

Applications

- Gas Range
- Gas Fireplace
- Gas Water Heaters
- Gas Dryer
- Gas Furnace
- Gas Grill
- Gas Distribution (Residential & Commercial)

Certifications & Approvals

- ANSI LC-1 / CSA 6.26 Fuel Gas Piping Systems Using Corrugated Stainless Steel Tubing



Materials

Body	Brass UNS C 37700 (ASTM DS-561)
Bushing	Brass UNS C 37700 (ASTM DS-561)
Nut	Brass UNS C 37700 (ASTM DS-561)
Comp. Ring	Brass UNS C 36400 (ASTM B16)
Comp. Washer	Brass UNS C 36400 (ASTM B16)
Safety Clip	Stainless Steel 304

Technical Specifications

Sizes	3/8", 1/2", 3/4", 1", 1-1/4", 1-1/2", 2"
Rated Working Pressure	25 psi

Gas Connectors

Commercial Gas Connectors

Gas Line System

Gas CSST Fittings

Water Line System

Water CSST Fittings

Braided Water Connectors

Supply stop Valve

Water Heater Connectors

Isolation Valves

Thermal Expansion Tanks

No-Hub Couplings

Flexible Sprinkler Drops

QuickFlare CSST Gas Line System Fittings

Straight Male

- Brass B124 C37700 (C3771)
- Bushing-Brass B124 C37700 (C3771)
- Compression Ring-B124 C360400(C3604)

- Compression Washer-C1220 T-H C360400(C3604)
- Safety Clip-ASTM 1010



Part #	Description	U/M	Price	Qty/ Box
NGLF-038-ST	3/8" MIP, Straight Brass Adapter	EA		
NGLF-038-ST-012	1/2" MIP, Straight Brass Adapter	EA		
NGLF-012-ST	1/2" MIP, Straight Brass Adapter	EA		
NGLF-012-ST-038	3/8" MIP, Straight Brass Adapter	EA		
NGLF-034-ST	3/4" MIP, Straight Brass Adapter	EA		
NGLF-034-ST-012	1/2" MIP, Straight Brass Adapter	EA		
NGLF-100-ST	1" MIP, Straight Brass Adapter	EA		
NGLF-100-ST-034	3/4" MIP, Straight Brass Adapter	EA		
NGLF-114-ST	1 1/4" MIP, Straight Brass Adapter	EA		
NGLF-112-ST	1 1/2" MIP, Straight Brass Adapter	EA		
NGLF-200-ST	2" MIP, Straight Brass Adapter	EA		

Straight Female

- Brass B124 C37700 (C3771)
- Bushing-Brass B124 C37700 (C3771)
- Compression Ring-B124 C360400(C3604)

- Compression Washer-C1220 T-H C360400(C3604)
- Safety Clip-ASTM 1010



Part #	Description	U/M	Price	Qty/ Box
NGLF-038-SF	3/8" FIP, Straight Brass Adapter	EA		
NGLF-038-SF-012	1/2" FIP, Straight Brass Adapter	EA		
NGLF-012-SF	1/2" FIP, Straight Brass Adapter	EA		
NGLF-012-SF-038	3/8" FIP, Straight Brass Adapter	EA		
NGLF-034-SF	3/4" FIP, Straight Brass Adapter	EA		
NGLF-034-SF-012	1/2" FIP, Straight Brass Adapter	EA		
NGLF-100-SF	1" FIP, Straight Brass Adapter	EA		
NGLF-100-SF-034	3/4" FIP, Straight Brass Adapter	EA		
NGLF-114-SF	1 1/4" FIP, Straight Brass Adapter	EA		
NGLF-112-SF	1 1/2" FIP, Straight Brass Adapter	EA		
NGLF-200-SF	2" FIP, Straight Brass Adapter	EA		

Coupling / Union

- Brass B124 C37700 (C3771)
- Bushing-Brass B124 C37700 (C3771)
- Compression Ring-B124 C360400(C3604)

- Compression Washer-C1220 T-H C360400(C3604)
- Safety Clip-ASTM 1010



Part #	Description	U/M	Price	Qty/ Box
NGLF-038-CP	3/8" Coupling, Straight Brass Adapter	EA		
NGLF-012-CP	1/2" Coupling, Straight Brass Adapter	EA		
NGLF-034-CP	3/4" Coupling, Straight Brass Adapter	EA		
NGLF-100-CP	1" Coupling, Straight Brass Adapter	EA		
NGLF-114-CP	1 1/4" Coupling, Straight Brass Adapter	EA		
NGLF-112-CP	1 1/2" Coupling, Straight Brass Adapter	EA		
NGLF-200-CP	2" Coupling, Straight Brass Adapter	EA		

QuickFlare CSST Gas Line System Fittings

Tee

- Brass B124 C37700 (C3771)
- Bushing-Brass B124 C37700 (C3771)
- Compression Ring-B124 C360400(C3604)
- Compression Washer-C1220 T-H C360400(C3604)
- Safety Clip-ASTM 1010



Part #	Description	U/M	Price	Qty/ Box
NGLF-038-T	3/8" Tee	EA		
NGLF-012-T	1/2" Tee	EA		
NGLF-034-T	3/4" Tee	EA		
NGLF-100-T	1" Tee	EA		
NGLF-114-T	1 1/4" Tee	EA		
NGLF-112-T	1 1/2" Tee	EA		
NGLF-200-T	2" Tee	EA		



Female Tee

- Brass B124 C37700 (C3771)
- Bushing-Brass B124 C37700 (C3771)
- Compression Ring-B124 C360400(C3604)
- Compression Washer-C1220 T-H C360400(C3604)
- Safety Clip-ASTM 1010



Part #	Description	U/M	Price	Qty/ Box
NGLF-012-FT	1/2" Female Tee	EA		
NGLF-034-FT	3/4" Female Tee	EA		
NGLF-100-FT	1" Female Tee	EA		
NGLF-114-FT	1 1/4" Female Tee	EA		
NGLF-112-FT	1 1/2" Female Tee	EA		
NGLF-200-FT	2" Female Tee	EA		



Reducing Female Tee

- Brass B124 C37700 (C3771)
- Bushing-Brass B124 C37700 (C3771)
- Compression Ring-B124 C360400(C3604)
- Compression Washer-C1220 T-H C360400(C3604)
- Safety Clip-ASTM 1010



Part #	Description	U/M	Price	Qty/ Box
NGLF-012-RFT-038	3/8" Reducing Female Tee	EA		
NGLF-034-RFT-012	1/2" Reducing Female Tee	EA		
NGLF-100-RFT-034	3/4" Reducing Female Tee	EA		



- Gas Connectors
- Commercial Gas Connectors
- Gas Line System
- Gas CSST Fittings
- Water Line System
- Water CSST Fittings
- Braided Water Connectors
- Supply stop Valve
- Water Heater Connectors
- Isolation Valves
- Thermal Expansion Tanks
- No-Hub Couplings
- Flexible Sprinkler Drops

QuickFlare CSST Gas Line System Fittings

Reducing Run and Tee

- Brass B124 C37700 (C3771)
- Bushing-Brass B124 C37700 (C3771)
- Compression Ring-B124 C360400(C3604)
- Compression Washer-C1220 T-H C360400(C3604)
- Safety Clip-ASTM 1010



Part #	Description	U/M	Price	Qty/ Box
NGLF-012-RT-038	1/2" x 3/8"(T), Reducing Run & Tee	EA		
NGLF-034-RT-012038	3/4" x 1/2" x 3/8"(T), Reducing Run & Tee	EA		
NGLF-034-RT-012	3/4" x 1/2"(T), Reducing Run & Tee	EA		
NGLF-100-RT-034012	1" x 3/4" x 1/2"(T), Reducing Run & Tee	EA		
NGLF-100-RT-034	1" x 3/4"(T), Reducing Run & Tee	EA		
NGLF-114-RT-100012	1 1/4" x 1" x 1/2"(T), Reducing Run & Tee	EA		
NGLF-114-RT-100034	1 1/4" x 1" x 3/4"(T), Reducing Run & Tee	EA		
NGLF-114-RT-100	1 1/4" x 1"(T), Reducing Run & Tee	EA		
NGLF-112-RT-114012	1 1/2" x 1 1/4" x 1/2"(T), Reducing Run & Tee	EA		
NGLF-112-RT-114034	1 1/2" x 1 1/4" x 3/4"(T), Reducing Run & Tee	EA		
NGLF-112-RT-114100	1 1/2" x 1 1/4" x 1"(T), Reducing Run & Tee	EA		
NGLF-112-RT-114	1 1/2" x 1 1/4"(T), Reducing Run & Tee	EA		
NGLF-200-RT-112012	2" x 1 1/2" x 1/2"(T), Reducing Run & Tee	EA		
NGLF-200-RT-112034	2" x 1 1/2" x 3/4"(T), Reducing Run & Tee	EA		
NGLF-200-RT-112100	2" x 1 1/2" x 1"(T), Reducing Run & Tee	EA		
NGLF-200-RT-112114	2" x 1 1/2" x 1 1/4"(T), Reducing Run & Tee	EA		
NGLF-200-RT-112	2" x 1 1/2"(T), Reducing Run & Tee	EA		

Bushing

- Brass B124 C37700 (C3771)



Part #	Description	U/M	Price	Qty/ Box
NGLF-038-CGB	3/8" Bushing	EA		
NGLF-012-CGB	1/2" Bushing	EA		
NGLF-034-CGB	3/4" Bushing	EA		
NGLF-100-CGB	1" Bushing	EA		
NGLF-114-CGB	1 1/4" Bushing	EA		
NGLF-112-CGB	1 1/2" Bushing	EA		
NGLF-200-CGB	2" Bushing	EA		

QuickFlare

CSST Gas Line System Fittings

Nut

- Brass B124 C37700 (C3771)

Part #	Description	U/M	Price	Qty/ Box
NGLF-038-CGN	3/8" Nut	EA		
NGLF-012-CGN	1/2" Nut	EA		
NGLF-034-CGN	3/4" Nut	EA		
NGLF-100-CGN	1" Nut	EA		
NGLF-114-CGN	1 1/4" Nut	EA		
NGLF-112-CGN	1 1/2" Nut	EA		
NGLF-200-CGN	2" Nut	EA		



Compression Ring

- B124 C360400(C3604)

Part #	Description	U/M	Price	Qty/ Box
NGLF-038-CGCR	3/8" Compression Ring	EA		
NGLF-012-CGCR	1/2" Compression Ring	EA		
NGLF-034-CGCR	3/4" Compression Ring	EA		
NGLF-100-CGCR	1" Compression Ring	EA		
NGLF-114-CGCR	1 1/4" Compression Ring	EA		
NGLF-112-CGCR	1 1/2" Compression Ring	EA		
NGLF-200-CGCR	2" Compression Ring	EA		



Compression Washer

- C1220 TH C360400(C3604)

Part #	Description	U/M	Price	Qty/ Box
NGLF-038-CGCW	3/8" Compression Washer	EA		
NGLF-012-CGCW	1/2" Compression Washer	EA		
NGLF-034-CGCW	3/4" Compression Washer	EA		
NGLF-100-CGCW	1" Compression Washer	EA		
NGLF-114-CGCW	1 1/4" Compression Washer	EA		
NGLF-112-CGCW	1 1/2" Compression Washer	EA		
NGLF-200-CGCW	2" Compression Washer	EA		



High Temperature O Ring

- NE-Z150(Silicone Rubber)

Part #	Description	U/M	Price	Qty/ Box
NGLF-038-CGHTO	3/8" High Temperature O Ring	EA		
NGLF-012-CGHTO	1/2" High Temperature O Ring	EA		
NGLF-034-CGHTO	3/4" High Temperature O Ring	EA		
NGLF-100-CGHTO	1" High Temperature O Ring	EA		
NGLF-114-CGHTO	1 1/4" High Temperature O Ring	EA		
NGLF-112-CGHTO	1 1/2" High Temperature O Ring	EA		
NGLF-200-CGHTO	2" High Temperature O Ring	EA		



Gas Connectors

Commercial Gas Connectors

Gas Line System

Gas CSST Fittings

Water Line System

Water CSST Fittings

Braided Water Connectors

Supply Valve

Water Heater Connectors

Isolation Valves

Thermal Expansion Tanks

No-Hub Couplings

Flexible Sprinkler Drops



vectorFLOWTM

Corrugated Stainless Steel Tubing Water Line System

Flexible water distribution piping system for plumbing applications. The simplest and fastest solution for re-piping, renovations and new constructions.

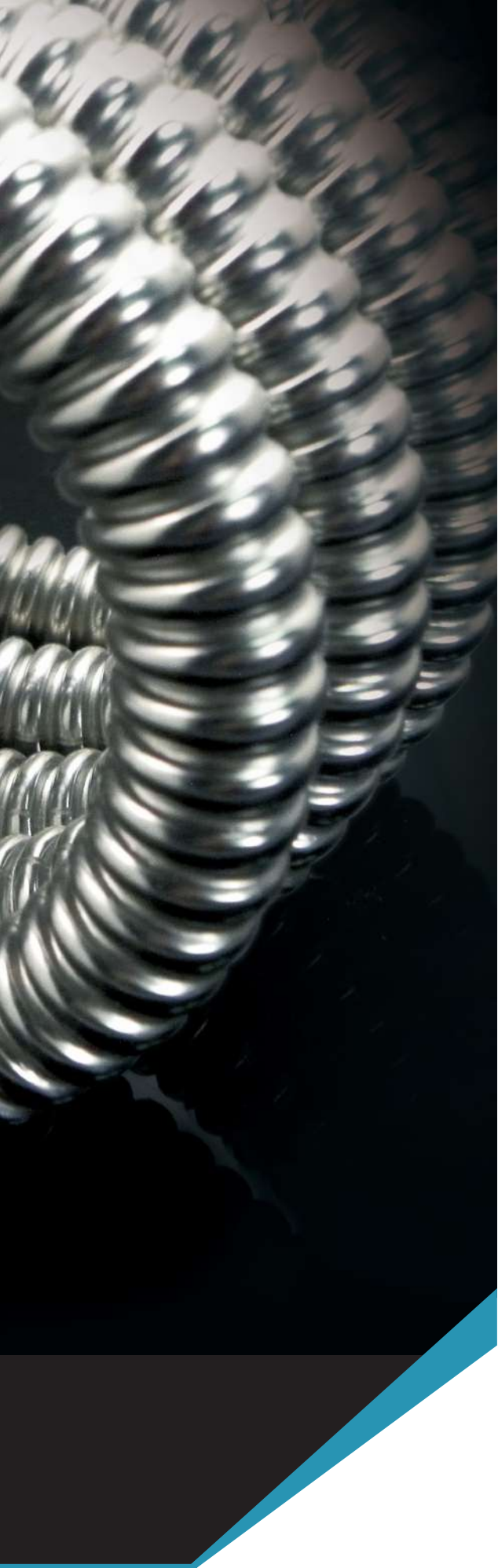

VectorFlow™

Corrugated Stainless Steel Tubing

Water Line System

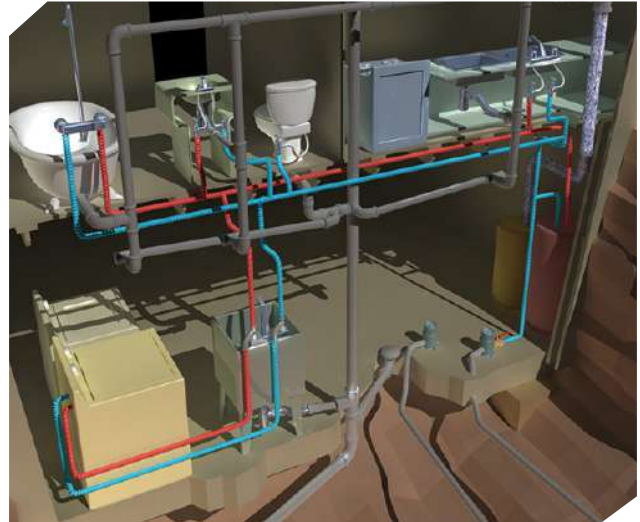

This system consists of flexible, durable, lightweight, corrosion-resistant corrugated stainless steel tubing and is perfect for general plumbing, water distribution systems, water heating systems, tankless water heaters, heat exchangers, and fan coil units.

Applications

- General Plumbing
- Water Distribution Systems
- Tankless Water Heaters
- Heat Exchangers
- Fan Coil Units

Benefits

- Reduced Labor Costs
- Resistance to Scaling & Corrosion
- No Special Tools Required
- Minimal Fittings
- Environmentally Safe

Certifications & Approvals

- CSA
- UPC / NSF 61 Compliant for safe drinking water
- NSF 372 Compliant : Lead-Free



Gas Connectors

Commercial Gas Connectors

Gas Line System

Gas CSST Fittings

Water Line System

Water CSST Fittings

Braided Water Connectors

Supply stop Valve

Water Heater Connectors

Isolation Valves

Thermal Expansion Tanks

No-Hub Couplings

Flexible Sprinkler Drops

VectorFlow

Corrugated Stainless Steel Tubing Water Line System

Technical Specifications

CSST Material	Stainless Steel 304 (ASTM A 240)			
Coating (Optional)	Polyethylene (ASTM D 335)			
Types	Uncoated, Blue PE, Red PE			
Sizes	1/2"	3/4"	1"	1-1/4"
Inner Dia.	0.55 in	0.83 in	1.03 in	1.26 in
CSST Thickness	0.010"		0.012"	
PE Coating Thickness	0.02"			
Available Lengths	50, 100, 150 ft / Roll Custom lengths are available			
Burst Pressure	588 psi with fittings attached			
Rated Pressure	147 psi at 212° F			
Maximum Working Pressure	1/2"	220 psi		
	3/4"	176 psi		
	1"	147 psi		
	1-1/4"	110 psi		

Minimum Bend Radius	Size	Recommended
	1/2"	3 inches
	3/4"	3 inches
	1"	3 inches
	1-1/4"	5 inches
	1-1/2"	6 inches
	2"	8 inches

Friction Loss Data

GPM	Nominal Size (ID)					
	1/2"	3/4"	1"	1-1/4"	1-1/2"	2"
1	0.032	0.004	0.002	0.001	0.000	0.000
2	0.114	0.015	0.005	0.002	0.001	0.000
3	0.241	0.032	0.012	0.004	0.001	0.000
4	0.41	0.055	0.020	0.008	0.002	0.001
5	0.619	0.083	0.030	0.011	0.003	0.001
6	0.867	0.117	0.042	0.016	0.004	0.001
7	1.153	0.155	0.055	0.021	0.005	0.002
8	1.476	0.199	0.071	0.027	0.007	0.002
9		0.247	0.088	0.034	0.009	0.002
10		0.301	0.107	0.041	0.010	0.003
15		0.637	0.226	0.087	0.022	0.006
20		1.084	0.386	0.147	0.038	0.011
25		1.638	0.583	0.223	0.057	0.016
30			0.816	0.312	0.080	0.023
35			1.086	0.415	0.106	0.030
40				0.531	0.136	0.039
45				0.660	0.169	0.048
50					0.206	0.059
60					0.288	0.082
70					0.383	0.110
80						0.140
90						0.175
100						0.212
110						0.253
120						0.297

1. Table is based on the *Hazen-Williams formula.
2. Fluid velocities in excess of 5 - 8 ft/sec are not recommended.
3. Friction loss values shown are for the flow rates that do not exceed a velocity of 8 ft/sec.

$$P = \frac{4.52Q^{1.85}}{C^{1.85} D^{1.85}}$$

Where :

P= friction loss, psi per linear foot

Q= flow, gpm

D= average, ID, in inches

C= 70, friction constant

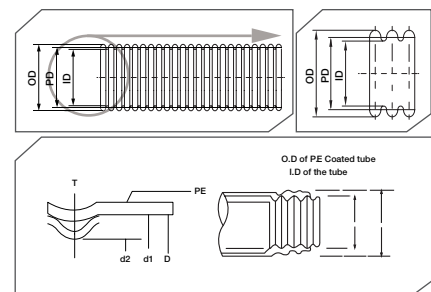

VectorFlow

Corrugated Stainless Steel Tubing Water Line System

Installation Instructions

1. Cut

Determine the proper length of the tubing needed and cut to desired length. Cut a straight section that has not been bent.

⚠ A clean cut must be applied.
A rough cut can perforate the silicone ring and cause leakage.

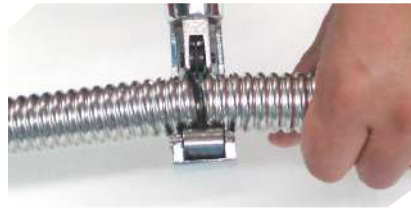

Cut

2. Connect

Remove nut and make sure all internal components are in place. Replace nut and insert tube completely into fitting until it seats on internal wall. (about 4~5 corrugations into the fitting)

⚠ DO NOT use PTFE tape or sealant between body and nut connection.



Connect

3. Tighten

Tighten the nut and body using appropriate torque (see table below). If done properly, resistance should increase greatly or nut will not turn after 1.5 turns.

Tube size (ID)	1/2"	3/4"	1"	1-1/4"
Torque(ft-lbs)	40~44	44~48	72~76	120~140



Tighten

Standards & Listings

NSF/ANSI 61	Drinking Water System Components - Health Effects
NSF/ANSI 372	Lead Content Compliance
ASTM A240	Chromium and Chromium-Nickel Stainless Steel Plate, Sheet and Strip for Pressure Vessels and for General Applications
ASTM D3350	Polyethylene Injection and Extrusion Material
ASTM DS-561	Metals and alloys in the Unified Numbering System
ASME B1.20.1	Pipe Threads, General Purpose (Inch)
IAPMO IGC-233	Corrugated Stainless Steel Hot- and Cold- Water Distribution Systems

Product Testing

Hydrostatic Test	Internal hydrostatic pressure increased to 220 ± 7 psi (1516 ± 48 kPa) or 1.5 times the rated pressure, whichever is greater, at the temperature of 68° ± 5° F (20° ± 3° C) for a period of 5 minutes.
Hydrostatic Burst Test	Internal hydrostatic pressure increased to 588 ± 7 psi (4051 ± 48 kPa) or 4 times that rated pressure, whichever is greater, at the temperature of 68° ± 5° F (20° ± 3° C) for a period of 5 minutes.
Bending Test	Bending motion being applied uniformly at the rate of 5-6 cycles per minute.
Hydraulic Shock Test	Subjected to a hydraulic shock for 2,000 cycles at 68° F ± 5° F. The Hydraulic shock shall consist of a sudden increase in pressure from 50 psi (345 kPa) to 284 psi (1967 kPa) lasting 1 second.
Vibration Test	Filled with water. The amplitude of vibration was 0.2 inches and the frequency was 25 Hz for 3 hours.
Flattening Test	Pressed to 2/3 D height of the outer diameter until the tube is flat. No signs of cracks or leakage shall be found.
Impact Test	An impact force of 9.76 to 15.19 lbf-ft was applied to various fitting sizes by using a hammer.
Toxicity Test	Conforms to NSF/ANSI 61 & 372

Gas Connectors

Commercial Gas Connectors

Gas Line System

Gas CSST Fittings

Water Line System

Water CSST Fittings

Braided Water Connectors

Supply stop Valve

Water Heater Connectors

Isolation Valves

Thermal Expansion Tanks

No-Hub Couplings

Flexible Sprinkler Drops



Certificate of Compliance

Certificate: 2492723

Master Contract: 254883

Project: 2492723

Date Issued: April 5, 2012

Issued to: EasyFlex Inc.
1371 Santa Fe Dr.
Tustin, CA 92780
US
Attention: Hun Kim

The products listed below are eligible to bear the CSA Mark shown



Elaine Mantelos
Issued by: Elaine Mantelos

PRODUCTS

CLASS 6861 04 - PIPES AND RELATED PRODUCTS - NSF/ANSI 61 SECTION 4 -
Certified to NSF/ANSI 61

Materials Only (Hot 82°C)

Non-Insulated Corrugated Stainless Steel Tubing:

½" CSST: EW-012-050; EW-012-100; EW-012-150

¾" CSST: EW-034-050; EW-034-100; EW-034-150

1" CSST: EW-010-050; EW-010-100; EW-010-150

1 ½" CSST: EW-114-050; EW-114-100; EW-114-150

CSST with PE Jacket (Blue or Red):

1/2" CSST: EW-012-050BL/RD; EW-012-100BL/RD; EW-012-150BL/RD

¾" CSST: EW-034-050BL/RD; EW-034-100BL/RD; EW-034-150BL/RD

1" CSST: EW-010-050BL/RD; EW-010-100BL/RD; EW-010-150BL/RD

VectorFlow

Corrugated Stainless Steel Tubing Water Line System

VectorFlow CSST

- Tubing : Stainless Steel 304
- Max. Operating Temperature : 212° F
- Max. Operating Pressure : 147psi



ID	Part #	Description	U/M	Price	Qty/ Box
1/2"	EW-012-050	1/2" ID, 50 ft	Roll		
1/2"	EW-012-100	1/2" ID, 100 ft	Roll		
1/2"	EW-012-150	1/2" ID, 150 ft	Roll		
ID	Part #	Description	U/M	Price	Qty/ Box
3/4"	EW-034-050	3/4" ID, 50 ft	Roll		
3/4"	EW-034-100	3/4" ID, 100 ft	Roll		
3/4"	EW-034-150	3/4" ID, 150 ft	Roll		
ID	Part #	Description	U/M	Price	Qty/ Box
1"	EW-100-050	1" ID, 50 ft	Roll		
1"	EW-100-100	1" ID, 100 ft	Roll		
1"	EW-100-150	1" ID, 150 ft	Roll		
ID	Part #	Description	U/M	Price	Qty/ Box
1-1/4"	EW-114-050	1-1/4" ID, 50 ft	Roll		
1-1/4"	EW-114-100	1-1/4" ID, 100 ft	Roll		
1-1/4"	EW-114-150	1-1/4" ID, 150 ft	Roll		



VectorFlow CSST | Blue PE Jacket

- Tubing : Stainless Steel 304
- Coating : Blue Polyethylene(PE)
- Coating Thickness: 0.02"
- Max. Operating Temperature : 212° F
- Max. Operating Pressure : 147psi



ID	Part #	Description	U/M	Price	Qty/ Box
1/2"	EW-012-050 BL	1/2" ID, W/ Blue PE Jacket	50 ft	Roll	
1/2"	EW-012-100 BL	1/2" ID, W/ Blue PE Jacket	100 ft	Roll	
1/2"	EW-012-150 BL	1/2" ID, W/ Blue PE Jacket	150 ft	Roll	
ID	Part #	Description	U/M	Price	Qty/ Box
3/4"	EW-034-050 BL	3/4" ID, W/ Blue PE Jacket	50 ft	Roll	
3/4"	EW-034-100 BL	3/4" ID, W/ Blue PE Jacket	100 ft	Roll	
3/4"	EW-034-150 BL	3/4" ID, W/ Blue PE Jacket	150 ft	Roll	
ID	Part #	Description	U/M	Price	Qty/ Box
1"	EW-100-050 BL	1" ID, W/ Blue PE Jacket	50 ft	Roll	
1"	EW-100-100 BL	1" ID, W/ Blue PE Jacket	100 ft	Roll	
1"	EW-100-150 BL	1" ID, W/ Blue PE Jacket	150 ft	Roll	
ID	Part #	Description	U/M	Price	Qty/ Box
1-1/4"	EW-114-050 BL	1-1/4" ID, W/ Blue PE Jacket	50 ft	Roll	
1-1/4"	EW-114-100 BL	1-1/4" ID, W/ Blue PE Jacket	100 ft	Roll	
1-1/4"	EW-114-150 BL	1-1/4" ID, W/ Blue PE Jacket	150 ft	Roll	



- Gas Connectors
- Commercial Gas Connectors
- Gas Line System
- Gas CSST Fittings
- Water Line System
- Water CSST Fittings
- Braided Water Connectors
- Supply stop Valve
- Water Heater Connectors
- Isolation Valves
- Thermal Expansion Tanks
- No-Hub Couplings
- Flexible Sprinkler Drops

VectorFlow

Corrugated Stainless Steel Tubing Water Line System

VectorFlow CSST | Red PE Jacket

- Tubing : Stainless Steel 304
- Coating : Red Polyethylene (PE)
- Coating Thickness: 0.02"
- Max. Operating Temperature : 212° F
- Max. Operating Pressure : 147psi



ID	Part #	Description	U/M	Price	Qty/ Box
1/2"	EW-012-050 RD	1/2" ID, W/ Red PE Jacket	50 ft	Roll	
1/2"	EW-012-100 RD	1/2" ID, W/ Red PE Jacket	100 ft	Roll	
1/2"	EW-012-150 RD	1/2" ID, W/ Red PE Jacket	150 ft	Roll	
ID	Part #	Description	U/M	Price	Qty/ Box
3/4"	EW-034-050 RD	3/4" ID, W/ Red PE Jacket	50 ft	Roll	
3/4"	EW-034-100 RD	3/4" ID, W/ Red PE Jacket	100 ft	Roll	
3/4"	EW-034-150 RD	3/4" ID, W/ Red PE Jacket	150 ft	Roll	
ID	Part #	Description	U/M	Price	Qty/ Box
1"	EW-100-050 RD	1" ID, W/ Red PE Jacket	50 ft	Roll	
1"	EW-100-100 RD	1" ID, W/ Red PE Jacket	100 ft	Roll	
1"	EW-100-150 RD	1" ID, W/ Red PE Jacket	150 ft	Roll	
ID	Part #	Description	U/M	Price	Qty/ Box
1-1/4"	EW-114-050 RD	1-1/4" ID, W/ Red PE Jacket	50 ft	Roll	
1-1/4"	EW-114-100 RD	1-1/4" ID, W/ Red PE Jacket	100 ft	Roll	
1-1/4"	EW-114-150 RD	1-1/4" ID, W/ Red PE Jacket	150 ft	Roll	

VectorFlow

Corrugated Stainless Steel Tubing Water Line System

VectorFlow CSST | Manifolds

034 Manifold

- Material: Stainless Steel 304
- Connection: Threaded

Part #	Description	U/M	Price	Qty/ Box
EW-MFD-034-01	Manifold, 1/2" (3) Ports, 3/4"F x 3/4"F	EA		15
EW-MFD-034-02	Manifold, 1/2" (4) Ports, 3/4"F x 3/4"F	EA		15



100 Manifold

- Material: Stainless Steel 304
- Connection: Threaded

Part #	Description	U/M	Price	Qty/ Box
EW-MFD-100-01	Manifold, 1/2" (3) Ports, 1"F x 1"F	EA		10
EW-MFD-100-02	Manifold, 1/2" (4) Ports, 1"F x 1"F	EA		10
EW-MFD-100-03	Manifold, 3/4" (3) Ports, 1"F x 1"F	EA		10
EW-MFD-100-04	Manifold, 3/4" (4) Ports, 1"F x 1"F	EA		10



Gas
Connectors

Commercial
Gas
Connectors

Gas
Line System

Gas
CSST Fittings

Water
Line System

Water
CSST Fittings

Braided
Water
Connectors

Supply stop
Valve

Water
Heater
Connectors

Isolation
Valves

Thermal
Expansion
Tanks

No-Hub
Couplings

Flexible
Sprinkler
Drops

QuickSNAP™



QuickSnap™ Brass Fittings

Semi push-fit fittings for the VectorFlow Water CSST that eliminate all the hassles of threading, welding, or gluing connections. Simply push the tube into the fitting and tighten. It's that easy.



QuickSnap™ Brass Fittings for VectorFlex™ Water CSST

Applications

- Water Distribution Systems
- Boilers
- Water Heaters
- Solar Thermal Systems
- Tankless Water Heaters

Benefits

- Semi Push-Fit Design
- Reduced Labor Costs
- Resistant to Scaling & Corrosion
- No Special Tools Required
- Versatility of Application

Certifications & Approvals

- IAPMO/ UPC Certified
- NSF 61 Compliant
- NSF 372 Compliant : Lead-Free



Materials

Body/ Nut	Brass UNS C 37700 (ASTM DS-561)
Lead-Free Body/ Nut	Brass UNS C 46500 (ASTM B171)
Sealing Ring	Silicone
Isolation Ring	Nylon 66

Technical Specifications

Sizes	1/2", 3/4", 1", 1-1/4", 1-1/2", 2"
Rated Working Pressure	147 psi

- Gas Connectors
- Commercial Gas Connectors
- Gas Line System
- Gas CSST Fittings
- Water Line System
- Water CSST Fittings
- Braided Water Connectors
- Supply stop Valve
- Water Heater Connectors
- Isolation Valves
- Thermal Expansion Tanks
- No-Hub Couplings
- Flexible Sprinkler Drops

Lead-Free QuickSnap Brass Fittings



Lead-Free Straight Male

- Brass UNS C 46500 (ASTM B171)
- Sealing Ring-Silicone
- Isolation Ring-Nylon 66



Part #	Description	U/M	Price	Qty/ Box
EFW-012-ST	1/2" MIP, Lead-Free Straight	EA		
EFW-034-ST	3/4" MIP, Lead-Free Straight	EA		
EFW-100-ST	1" MIP, Lead-Free Straight	EA		
EFW-114-ST	1-1/4" MIP, Lead-Free Straight	EA		



Lead-Free Straight Female

- Brass UNS C 46500 (ASTM B171)
- Sealing Ring-Silicone
- Isolation Ring-Nylon 66



Part #	Description	U/M	Price	Qty/ Box
EFW-012-SF	1/2" FIP, Lead-Free Straight	EA		
EFW-034-SF	3/4" FIP, Lead-Free Straight	EA		
EFW-100-SF	1" FIP, Lead-Free Straight	EA		
EFW-114-SF	1-1/4" FIP, Lead-Free Straight	EA		



Lead-Free Copper Sweat Adapter

- Brass UNS C 46500 (ASTM B171)
- Sealing Ring-Silicone
- Isolation Ring-Nylon 66



Part #	Description	U/M	Price	Qty/ Box
EFW-012-SW	1/2", Lead-Free Sweat Adapter	EA		
EFW-034-SW	3/4", Lead-Free Sweat Adapter	EA		
EFW-100-SW	1", Lead-Free Sweat Adapter	EA		
EFW-114-SW	1-1/4", Lead-Free Sweat Adapter	EA		

QuickSnap Brass Fittings

Straight Male

- Brass UNS C37700 (ASTM DS-561)
- Sealing Ring-Silicone
- Isolation Ring-Nylon 66



Part #	Description	U/M	Price	Qty/ Box
EFS-012-ST	1/2" MIP, Straight Brass Adapter	EA		
EFS-034-ST	3/4" MIP, Straight Brass Adapter	EA		
EFS-100-ST	1" MIP, Straight Brass Adapter	EA		
EFS-114-ST	1-1/4" MIP, Straight Brass Adapter	EA		



Straight Female

- Brass UNS C37700 (ASTM DS-561)
- Sealing Ring-Silicone
- Isolation Ring-Nylon 66



Part #	Description	U/M	Price	Qty/ Box
EFS-012-SF	1/2" FIP, Straight Brass Adapter	EA		
EFS-034-SF	3/4" FIP, Straight Brass Adapter	EA		
EFS-100-SF	1" FIP, Straight Brass Adapter	EA		
EFS-114-SF	1-1/4" FIP, Straight Brass Adapter	EA		



Copper Sweat Adapter

- Brass UNS C37700 (ASTM DS-561)
- Sealing Ring-Silicone
- Isolation Ring-Nylon 66



Part #	Description	U/M	Price	Qty/ Box
EFS-012-SW	1/2" Sweat, Straight Brass Adapter	EA		
EFS-034-SW	3/4" Sweat, Straight Brass Adapter	EA		
EFS-100-SW	1" Sweat, Straight Brass Adapter	EA		
EFS-114-SW	1-1/4" Sweat, Straight Brass Adapter	EA		



COUPLING / UNION

- Brass UNS C37700 (ASTM DS-561)
- Sealing Ring-Silicone
- Isolation Ring-Nylon 66



Part #	Description	U/M	Price	Qty/ Box
EFS-012-CP	1/2" Coupling, Straight Brass Adapter	EA		
EFS-034-CP	3/4" Coupling, Straight Brass Adapter	EA		
EFS-100-CP	1" Coupling, Straight Brass Adapter	EA		
EFS-114-CP	1-1/4" Coupling, Straight Brass Adapter	EA		



- Gas Connectors
- Commercial Gas Connectors
- Gas Line System
- Gas CSST Fittings
- Water Line System
- Water CSST Fittings
- Braided Water Connectors
- Supply stop Valve
- Water Heater Connectors
- Isolation Valves
- Thermal Expansion Tanks
- No-Hub Couplings
- Flexible Sprinkler Drops

QuickSnap Brass Fittings



Push-Fit Coupling

- Body / Nut : Brass UNS C37700 (ASTM DS-561)
- Push-Fit Nut : Nylon 66
- Push-Fit Sealing Ring : EPDM
- Push-Fit Grab Ring : Stainless Steel 304



Part #	Description	U/M	Price	Qty/ Box
EFS-012-EC-CP	1/2" Push-Fit	EA		
EFS-034-EC-CP	3/4" Push-Fit	EA		
EFS-100-EC-CP	1" Push-Fit	EA		



Reducing Coupling

- Brass UNS C37700 (ASTM DS-561)
- Sealing Ring-Silicone
- Isolation Ring-Nylon 66



Part #	Description	U/M	Price	Qty/ Box
EFS-034-RCP-012	3/4" x 1/2" Reducing Coupling	EA		
EFS-100-RCP-012	1" x 1/2" Reducing Coupling	EA		
EFS-100-RCP-034	1" x 3/4" Reducing Coupling	EA		



Female Elbow

- Brass UNS C37700 (ASTM DS-561)
- Sealing Ring-Silicone
- Isolation Ring-Nylon 66



Part #	Description	U/M	Price	Qty/ Box
EFS-012-EL	1/2" 90° Female Elbow	EA		
EFS-034-EL	3/4" 90° Female Elbow	EA		
EFS-100-EL	1" 90° Female Elbow	EA		



Tee

- Brass UNS C37700 (ASTM DS-561)
- Sealing Ring-Silicone
- Isolation Ring-Nylon 66



Part #	Description	U/M	Price	Qty/ Box
EFS-012-T	1/2" Tee	EA		
EFS-034-T	3/4" Tee	EA		
EFS-100-T	1" Tee	EA		

QuickSnap Brass Fittings

Reducing Tee

- Brass UNS C37700 (ASTM DS-561)
- Sealing Ring-Silicone
- Isolation Ring-Nylon 66



Part #	Description	U/M	Price	Qty/ Box
EFS-034-RT-012	3/4" x 1/2" (T), Reducing Tee	EA		
EFS-100-RT-012	1" x 1/2" (T), Reducing Tee	EA		
EFS-100-RT-034	1" x 3/4" (T), Reducing Tee	EA		



Female Tee

- Brass UNS C37700 (ASTM DS-561)
- Sealing Ring-Silicone
- Isolation Ring-Nylon 66



Part #	Description	U/M	Price	Qty/ Box
EFS-012-FT	1/2" Female Tee	EA		
EFS-034-FT	3/4" Female Tee	EA		
EFS-100-FT	1" Female Tee	EA		



Reducing Female Tee

- Brass UNS C37700 (ASTM DS-561)
- Sealing Ring-Silicone
- Isolation Ring-Nylon 66



Part #	Description	U/M	Price	Qty/ Box
EFS-034-FRT-012	3/4" x 1/2" (T), Reducing Female Tee	EA		
EFS-100-FRT-012	1" x 1/2" (T), Reducing Female Tee	EA		
EFS-100-FRT-034	1" x 3/4" (T), Reducing Female Tee	EA		



- Gas Connectors
- Commercial Gas Connectors
- Gas Line System
- Gas CSST Fittings
- Water Line System
- Water CSST Fittings
- Braided Water Connectors
- Supply stop Valve
- Water Heater Connectors
- Isolation Valves
- Thermal Expansion Tanks
- No-Hub Couplings
- Flexible Sprinkler Drops

QuickSnap Brass Fittings - Parts



Isolation Ring

- Isolation Ring-Formulated Fiber Glass w/ Nylon 66
- Temperature Rating : 350° F
- Application : High Performance Solar Thermal System

Part #	Description	U/M	Price	Qty/ Bag
EFS-IR-012	1/2" High Temp. Isolation Ring	EA		100
EFS-IR-034	3/4" High Temp. Isolation Ring	EA		100
EFS-IR-100	1" High Temp. Isolation Ring	EA		100
EFS-IR-114	1-1/4" High Temp. Isolation Ring	EA		100



Isolation Ring

- Isolation Ring-Formulated Fiber Glass w/ Nylon 66
- Temperature Rating : 300° F
- Application : Solar Thermal System

Part #	Description	U/M	Price	Qty/ Bag
EFW-IR-012	1/2" Isolation Ring	EA		100
EFW-IR-034	3/4" Isolation Ring	EA		100
EFW-IR-100	1" Isolation Ring	EA		100
EFW-IR-114	1-1/4" Isolation Ring	EA		100

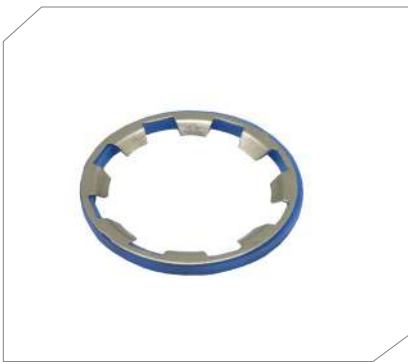

Isolation Ring

- Teeth Ring : Stainless Steel
- Spacer : Formulated Fiber Glass w/ Nylon
- Temperature Rating : 300° F

Part #	Description	U/M	Price	Qty/ Bag
EFM-IR-012	1/2" High Temp. Stainless Steel Isolation Ring	EA		100
EFM-IR-034	3/4" High Temp. Stainless Steel Isolation Ring	EA		100
EFM-IR-100	1" High Temp. Stainless Steel Isolation Ring	EA		100
EFM-IR-114	1-1/4" High Temp. Stainless Steel Isolation Ring	EA		100



Sealing Ring

- Sealing Ring-Silicone
- Temperature Rating : 250° F

Part #	Description	U/M	Price	Qty/ Bag
EFW-SR-012	1/2" Sealing Ring	EA		100
EFW-SR-034	3/4" Sealing Ring	EA		100
EFW-SR-100	1" Sealing Ring	EA		100
EFW-SR-114	1-1/4" Sealing Ring	EA		100

VectorFlow Full Port Ball Valves

Sealing Ring

- High Temperature Graded Silicone
- Application : High Temperature Solar Thermal System

Part #	Description	U/M	Price	Qty/ Box
EFS-SR-012	1/2" High Temp. Sealing Ring	EA		100
EFS-SR-034	3/4" High Temp. Sealing Ring	EA		100
EFS-SR-100	1" High Temp. Sealing Ring	EA		100
EFS-SR-114	1-1/4" High Temp. Sealing Ring	EA		100



Ball Valve | FIP x Flex

- 150 WSP
- 400 WOG
- Rubber Coated Steel Lever
- Ball Disc Packing : PTFE Seal

Part #	Description	U/M	Price	Qty/ Box
EFW-BVF-012	1/2" FIP	EA		
EFW-BVF-034	3/4" FIP	EA		
EFW-BVF-100	1" FIP	EA		



Ball Valve | MIP x Flex

- 150 WSP
- 400 WOG
- Rubber Coated Steel Lever
- Ball Disc Packing : PTFE Seal

Part #	Description	U/M	Price	Qty/ Box
EFW-BVM-012	1/2" MIP	EA		
EFW-BVM-034	3/4" MIP	EA		
EFW-BVM-100	1" MIP	EA		



Gas
Connectors

Commercial
Gas
Connectors

Gas
Line System

Gas
CSST Fittings

Water
Line System

Water
CSST Fittings

Braided
Water
Connectors

Supply stop
Valve

Water
Heater
Connectors

Isolation
Valves

Thermal
Expansion
Tanks

No-Hub
Couplings

Flexible
Sprinkler
Drops



Braided Stainless Steel Water Connectors

Burst-free, lead-free, and hassle-free water connectors for all plumbing applications.



Braided Stainless Steel Water Connectors

Applications

- Faucets
- Toilets
- Dishwashers
- Ice Makers
- Washing Machines

Benefits

- Reduced Labor Costs
- Burst-Free
- No Special Tools Required
- Variety of Connections
- Environmentally Safe

Certifications & Approvals

- cUPC / NSF 61 Compliant for safe drinking water
- NSF 372 Compliant : Lead-Free
- ASME A 112.18.6-2009 / CSA B 125.6-2009



Materials

Jacket	Braided Stainless Steel 304
Inner Hose	Reinforced PVC
Fittings	Chrome-Plated Brass

Technical Specifications

Rated Temperature	-40° F to 180° F (-40° C to 82° C)
Maximum Pressure	125 psi (8.6 bar)

- Gas Connectors
- Commercial Gas Connectors
- Gas Line System
- Gas CSST Fittings
- Water Line System
- Water CSST Fittings
- Braided Water Connectors**
- Supply stop Valve
- Water Heater Connectors
- Isolation Valves
- Thermal Expansion Tanks
- No-Hub Couplings
- Flexible Sprinkler Drops

Braided Stainless Steel Water Connectors

Easyflex braided water connectors can be used for commercial or residential applications. Easyflex offers a complete line of flexible water connectors that are built to last. Durable lead-free connectors are chosen by professional plumbers.

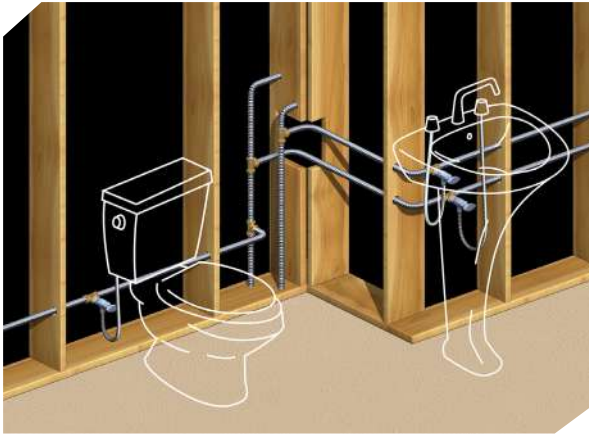

No Special Tools Required!

- Durable, flexible water connector features reinforced PVC inner hose, braided with stainless steel.
- Requires no cutting or soldering during installation.
- Chrome plated brass hex nuts for corrosion resistance
- Nut-to-hose connection with 12-sided pneumatic crimp
- EPDM gasket helps provide a water-tight connection.

Parts Numbering System

EF - FC - 38C12F - 12

APPLICATION | FITTINGS | LENGTH

APPLICATION

Part#	Size (ID)
FC	FAUCET CONNECTOR
TC	TOILET CONNECTOR
IC	ICE MAKER CONNECTOR
WM	WASHING MACHINE CONNECTOR
DC	DISHWASHER CONNECTOR

FITTINGS

Part#	Size (ID)
14C	1/4" COMPRESSION
38C	3/8" COMPRESSION
12C	1/2" COMPRESSION
12F	1/2" FIP
MBC	7/8" METAL BALLCOCK
BC	7/8" BALLCOCK
DT	DELTA TYPE
34HB	3/4" GARDEN HOSE THREAD
38L	3/8" ELBOW
HBL	3/4" GARDEN HOSE ELBOW

LENGTH

Standard Lengths
ALL IN INCHES EXCEPT ICE MAKER (FT)

Braided Stainless Steel Water Connectors

IAPMO RESEARCH AND TESTING, INC.

5001 East Philadelphia Street, Ontario, California 91761-2816 • (909) 472-4100 Fax (909) 472-4244 • www.iapmo.org



CERTIFICATE OF LISTING

IAPMO Research and Testing, Inc. is a product certification body which tests and inspects samples taken from the supplier's stock or from the market or a combination of both to verify compliance to the requirements of applicable codes and standards. This activity is coupled with periodic surveillance of the supplier's factory and warehouses as well as the assessment of the supplier's Quality Assurance System. This listing is subject to the conditions set forth in the characteristics below and is not to be construed as any recommendation, assurance or guarantee by IAPMO Research and Testing, Inc. of the product acceptance by Authorities Having Jurisdiction.

Effective Date: October 2013 -Rev. 10/28/2013- Void After: October 2014
 Product: Flexible Metallic Water Connectors File No. K-8333
 Issued To: Easyflex
 1371 Santa Fe Drive
 Tustin, CA 92780

Identification: All connectors shall have the manufacturer's name or trademark on nuts and fittings. An acceptable label shall be placed on tubing showing size, model, manufacturer's name or trademark and the cUPC® certification mark. SPECIAL NOTE ON LABEL: "For use with water in accessible locations only."

Characteristics: Corrugated flexible metallic water connectors can be field fabricated or prefabricated for use in accessible locations with other IAPMO listed fittings. Connectors are manufactured with end fittings and dielectric bushings, or seat or barbed ends to connect water devices to the water supply. To be installed in accordance with the manufacturer's instructions, and the requirements of the latest edition of the Uniform Plumbing Code.

Products listed on this certificate have been tested by an IAPMO R&T recognized laboratory. This recognition has been granted based upon the laboratory's compliance to the applicable requirements of ISO/IEC 17025.

Products are in compliance with the following code(s):
 Uniform Plumbing Code (UPC®)
 National Plumbing Code of Canada

David McHenry
 Chairman, Product Certification Committee

Russ Chaney
 CEO, The IAPMO Group



This listing period is based upon the last date of the month indicated on the Effective Date and Void After Date shown above. Any change in material, manufacturing process, marking or design without having first obtained the approval of the Product Certification Committee, or any evidence of non-compliance with applicable codes and standards or of inferior workmanship, may be deemed sufficient cause for revocation of this listing. Production of or reference to this form for advertising purposes may be made only by specific written permission of IAPMO Research and Testing, Inc. Any alteration of this certificate could be grounds for revocation of the listing.

- Gas Connectors
- Commercial Gas Connectors
- Gas Line System
- Gas CSST Fittings
- Water Line System
- Water CSST Fittings
- Braided Water Connectors**
- Supply stop Valve
- Water Heater Connectors
- Isolation Valves
- Thermal Expansion Tanks
- No-Hub Couplings
- Flexible Sprinkler Drops

Braided Stainless Steel Water Connectors



FAUCET Connector 1/2" FIP x 1/2" FIP

- Tube-PVC
- Jacket-Braided Stainless Steel 304
- Nut-Chrome Plated Brass
- Max. Working Temperature 180°F (82°C)
- Max. Working Pressure 125 psi (8.6bar)



Part #	Description	U/M	Price	Qty/ Box
EF-FC-12F12F-12	SS Braided Faucet Connector, 1/2"FIP x 1/2"FIP, 12"	EA		50
EF-FC-12F12F-16	SS Braided Faucet Connector, 1/2"FIP x 1/2"FIP, 16"	EA		50
EF-FC-12F12F-20	SS Braided Faucet Connector, 1/2"FIP x 1/2"FIP, 20"	EA		50
EF-FC-12F12F-24	SS Braided Faucet Connector, 1/2"FIP x 1/2"FIP, 24"	EA		50
EF-FC-12F12F-30	SS Braided Faucet Connector, 1/2"FIP x 1/2"FIP, 30"	EA		50



FAUCET Connector 1/2" Compression x 1/2" FIP

- Tube-PVC
- Jacket-Braided Stainless Steel 304
- Nut-Chrome Plated Brass
- Max. Working Temperature 180°F (82°C)
- Max. Working Pressure 125 psi (8.6bar)



Part #	Description	U/M	Price	Qty/ Box
EF-FC-12C12F-12	SS Braided Faucet Connector, 1/2"C x 1/2"FIP, 12"	EA		50
EF-FC-12C12F-16	SS Braided Faucet Connector, 1/2"C x 1/2"FIP, 16"	EA		50
EF-FC-12C12F-20	SS Braided Faucet Connector, 1/2"C x 1/2"FIP, 20"	EA		50



FAUCET Connector 3/8" Compression x 3/8" Compression

- Tube-PVC
- Jacket-Braided Stainless Steel 304
- Nut-Chrome Plated Brass
- Max. Working Temperature 180°F (82°C)
- Max. Working Pressure 125 psi (8.6bar)



Part #	Description	U/M	Price	Qty/ Box
EF-FC-38C38C-9	SS Braided Faucet Connector, 3/8"C x 3/8"C, 9"	EA		50
EF-FC-38C38C-12	SS Braided Faucet Connector, 3/8"C x 3/8"C, 12"	EA		50
EF-FC-38C38C-16	SS Braided Faucet Connector, 3/8"C x 3/8"C, 16"	EA		50
EF-FC-38C38C-20	SS Braided Faucet Connector, 3/8"C x 3/8"C, 20"	EA		50
EF-FC-38C38C-24	SS Braided Faucet Connector, 3/8"C x 3/8"C, 24"	EA		50
EF-FC-38C38C-30	SS Braided Faucet Connector, 3/8"C x 3/8"C, 30"	EA		50



FAUCET Connector 3/8" Compression x Delta Type

- Tube-PVC
- Jacket-Braided Stainless Steel 304
- Nut-Chrome Plated Brass
- Max. Working Temperature 180°F (82°C)
- Max. Working Pressure 125 psi (8.6bar)



Part #	Description	U/M	Price	Qty/ Box
EF-FC-38DT-12	SS Braided Faucet Connector, 3/8"C x Delta Type, 12"	EA		50
EF-FC-38DT-16	SS Braided Faucet Connector, 3/8"C x Delta Type, 16"	EA		50
EF-FC-38DT-20	SS Braided Faucet Connector, 3/8"C x Delta Type, 20"	EA		50

Braided Stainless Steel Water Connectors

FAUCET Connector 3/8" Compression x 1/2" FIP

- Tube-PVC
- Jacket-Braided Stainless Steel 304
- Nut-Chrome Plated Brass
- Max. Working Temperature 180°F (82°C)
- Max. Working Pressure 125 psi (8.6bar)



Part #	Description	U/M	Price	Qty/ Box
EF-FC-38C12F-9	SS Braided Faucet Connector, 3/8"C x 1/2"FIP, 9"	EA		50
EF-FC-38C12F-12	SS Braided Faucet Connector, 3/8"C x 1/2"FIP, 12"	EA		50
EF-FC-38C12F-16	SS Braided Faucet Connector, 3/8"C x 1/2"FIP, 16"	EA		50
EF-FC-38C12F-20	SS Braided Faucet Connector, 3/8"C x 1/2"FIP, 20"	EA		50
EF-FC-38C12F-24	SS Braided Faucet Connector, 3/8"C x 1/2"FIP, 24"	EA		50
EF-FC-38C12F-30	SS Braided Faucet Connector, 3/8"C x 1/2"FIP, 30"	EA		50
EF-FC-38C12F-36	SS Braided Faucet Connector, 3/8"C x 1/2"FIP, 36"	EA		50



ICE MAKER Connector 1/4" Compression x 1/4" Compression

- Tube-PVC
- Jacket-Braided Stainless Steel 304
- Nut-Chrome Plated Brass
- Max. Working Temperature 180°F (82°C)
- Max. Working Pressure 125 psi (8.6bar)



Part #	Description	U/M	Price	Qty/ Box
EF-IC-14C14C-5	SS Braided Ice Maker Connector, 1/4"C x 1/4" C, 5 ft	EA		50
EF-IC-14C14C-6	SS Braided Ice Maker Connector, 1/4"C x 1/4" C, 6 ft	EA		50
EF-IC-14C14C-10	SS Braided Ice Maker Connector, 1/4"C x 1/4" C, 10 ft	EA		25



WASHING MACHINE Connector 3/4" Hose Bibb

- Tube-PVC
- Jacket-Braided Stainless Steel 304
- Nut-Chrome Plated Brass
- Max. Working Temperature 180°F (82°C)
- Max. Working Pressure 125 psi (8.6bar)



Part #	Description	U/M	Price	Qty/ Box
EF-WM-34HB-48	SS Braided Washing Machine Connector, 3/4"HB, 48"	EA		25
EF-WM-34HB-60	SS Braided Washing Machine Connector, 3/4"HB, 60"	EA		25
EF-WM-34HB-72	SS Braided Washing Machine Connector, 3/4"HB, 72"	EA		25



Gas Connectors

Commercial Gas Connectors

Gas Line System

Gas CSST Fittings

Water Line System

Water CSST Fittings

Braided Water Connectors

Supply stop Valve

Water Heater Connectors

Isolation Valves

Thermal Expansion Tanks

No-Hub Couplings

Flexible Sprinkler Drops

Braided Stainless Steel Water Connectors



TOILET Connector 3/8" Compression x 7/8" Ballcock

- Tube-PVC
- Jacket-Braided Stainless Steel 304
- Nut-Chrome Plated Brass
- Max. Working Temperature 180°F (82°C)
- Max. Working Pressure 125 psi (8.6bar)



Part #	Description	U/M	Price	Qty/ Box
EF-TC-38CBC-9	SS Braided Toilet Connector, 3/8"C x 7/8"BC, 9"	EA		50
EF-TC-38CBC-12	SS Braided Toilet Connector, 3/8"C x 7/8"BC, 12"	EA		50
EF-TC-38CBC-16	SS Braided Toilet Connector, 3/8"C x 7/8"BC, 16"	EA		50
EF-TC-38CBC-20	SS Braided Toilet Connector, 3/8"C x 7/8"BC, 20"	EA		50



TOILET Connector 3/8" Compression x 7/8" Metal Ballcock

- Tube-PVC
- Jacket-Braided Stainless Steel 304
- Nut-Chrome Plated Brass
- Max. Working Temperature 180°F (82°C)
- Max. Working Pressure 125 psi (8.6bar)



Part #	Description	U/M	Price	Qty/ Box
EF-TC-38CMBC-9	SS Braided Toilet Connector, 3/8"C x 7/8" Metal BC, 9"	EA		50
EF-TC-38CMBC-12	SS Braided Toilet Connector, 3/8"C x 7/8" Metal BC, 12"	EA		50
EF-TC-38CMBC-16	SS Braided Toilet Connector, 3/8"C x 7/8" Metal BC, 16"	EA		50
EF-TC-38CMBC-20	SS Braided Toilet Connector, 3/8"C x 7/8" Metal BC, 20"	EA		50



TOILET Connector 1/2" FIP x 7/8" Ballcock

- Tube-PVC
- Jacket-Braided Stainless Steel 304
- Nut-Chrome Plated Brass
- Max. Working Temperature 180°F (82°C)
- Max. Working Pressure 125 psi (8.6bar)



Part #	Description	U/M	Price	Qty/ Box
EF-TC-12FBC-12	SS Braided Toilet Connector, 1/2"FIP x 7/8"BC, 12"	EA		50
EF-TC-12FBC-16	SS Braided Toilet Connector, 1/2"FIP x 7/8"BC, 16"	EA		50
EF-TC-12FBC-20	SS Braided Toilet Connector, 1/2"FIP x 7/8"BC, 20"	EA		50

Braided Stainless Steel Water Connectors

DISHWASHER Connector 3/8" Compression x 3/8" Compression

- Tube-PVC
- Jacket-Braided Stainless Steel 304
- Nut-Chrome Plated Brass
- Max. Working Temperature 180°F (82°C)
- Max. Working Pressure 125 psi (8.6bar)



Part #	Description	U/M	Price	Qty/ Box
EF-DC-38C38C-48	SS Braided Dishwasher Connector, 3/8"C x 3/8"C, 48"	EA		50
EF-DC-38C38C-60	SS Braided Dishwasher Connector, 3/8"C x 3/8"C, 60"	EA		50
EF-DC-38C38C-72	SS Braided Dishwasher Connector, 3/8"C x 3/8"C, 72"	EA		50



DISHWASHER Connector 3/8" Compression x 3/8" Elbow

- Tube-PVC
- Jacket-Braided Stainless Steel 304
- Nut-Chrome Plated Brass
- Max. Working Temperature 180°F (82°C)
- Max. Working Pressure 125 psi (8.6bar)



Part #	Description	U/M	Price	Qty/ Box
EF-DC-38C38L-48	SS Braided Dishwasher Connector, 3/8"C x 3/8"EL, 48"	EA		50
EF-DC-38C38L-60	SS Braided Dishwasher Connector, 3/8"C x 3/8"EL, 60"	EA		50
EF-DC-38C38L-72	SS Braided Dishwasher Connector, 3/8"C x 3/8"EL, 72"	EA		50
EF-DC-38C38L-96	SS Braided Dishwasher Connector, 3/8"C x 3/8"EL, 96"	EA		50



DISHWASHER Connector 1/2" Compression x 3/8" Elbow

- Tube-PVC
- Jacket-Braided Stainless Steel 304
- Nut-Chrome Plated Brass
- Max. Working Temperature 180°F (82°C)
- Max. Working Pressure 125 psi (8.6bar)



Part #	Description	U/M	Price	Qty/ Box
EF-DC-12C38L-60	SS Braided Dishwasher Connector, 1/2"C x 3/8"EL, 60"	EA		50



DISHWASHER Connector 3/8" Compression x 3/4" Hose Bibb Elbow

- Tube-PVC
- Jacket-Braided Stainless Steel 304
- Nut-Chrome Plated Brass
- Max. Working Temperature 180°F (82°C)
- Max. Working Pressure 125 psi (8.6bar)



Part #	Description	U/M	Price	Qty/ Box
EF-DC-38CHBL-48	SS Braided Dishwasher Connector, 3/8"C x 3/4" GH Elbow, 48"	EA		50
EF-DC-38CHBL-60	SS Braided Dishwasher Connector, 3/8"C x 3/4" GH Elbow, 60"	EA		50
EF-DC-38CHBL-72	SS Braided Dishwasher Connector, 3/8"C x 3/4" GH Elbow, 72"	EA		50



- Connectors Gas
- Commercial Connectors Gas
- Line System Gas
- Gas CSST Fittings
- Water Line System
- Water CSST Fittings
- Braided Water Connectors
- Supply stop Valve
- Water Heater Connectors
- Isolation Valves
- Thermal Expansion Tanks
- No-Hub Couplings
- Flexible Sprinkler Drops



Safeflow



Lead -free

NEW Braided Stainless Steel Safe-flow Water Connector

Prevents unexpected water damage from a burst of hose or excessive flow of water.

The Easyflex Safe-Flow EFV is our new supply line with a built-in excess flow valve that can be installed between angle stop and fixture. This unique valve automatically activates to prevent water damage caused by breakage, bursts or excessive water flow.

- Minimum Flow: 2.0 gpm
- Shut-off Flow: 2.5 - 3.5 gpm

- UPC / NSF 61 Compliant
- NSF 372 Compliant : Lead-Free
- ASME A 112.18.6-2009 / CSA B 125.6-2009

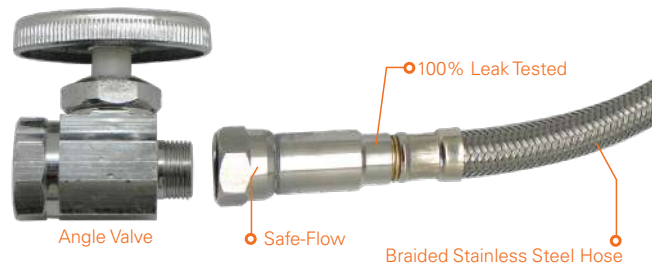

Resetting Safe-Flow

To reset Safe-Flow, check to see if the supply line is not damaged, then simply turn on the water supply valve.

Available Applications

Faucets /Toilets / Dishwashers / Washing Machines / Ice Makers

Braided Stainless Steel **Safe-flow** Water Connectors

Safeflow



TEST REPORT

5001 East Philadelphia Street
Ontario, California - USA 91761-2816
Ph: 909.472.4100 | Fax: 909.472.4243
<http://www.iapmortl.org>

Report Number: 885-13015
Report Issued: October 31, 2013
Client: Kofulso
377-8 Gum Gok-Dong Seo-Gu
Incheon City, South Korea 404-330
Source of Samples: The samples were shipped to IAPMO R&T Lab from Kofulso, and received in good condition on September 19, 2013.
Date of Testing: October 17, 2013 to October 30, 2013.
Sample Description: Flexible hoses with excess shut-off, refer to pages 2-3 for model numbers and descriptions.
Scope of Testing: The purpose of the testing was to determine whether the sample tested of the Flexible hoses with excess shut-off met the applicable requirements of CSA B125-5/Z600-2011, entitled, "Flexible water connectors with excess flow shut-off devices".
Conclusion: The samples, tested of the Flexible hoses with excess shut-off, models listed on pages 2-3, from Kofulso, **COMPLIED** with the applicable requirements of CSA B125-5/Z600-2011.
Pending: NSF61.

Project No.: 22347

Contact: Hun Kim

By our signatures below, we certify that all the testing and sample preparation for this report was performed under continuous, direct supervision of IAPMO R&T Lab, unless stated otherwise.

Tested By,

Reviewed by,

Vinh Nguyen, Test Technician

Sean Vuu, P.E. Manager, Specialty Projects

This report may not be copied, except in its entirety, without the written permission of IAPMO R&T Lab

Gas Connectors

Commercial Gas Connectors

Gas Line System

Gas CSST Fittings

Water Line System

Water CSST Fittings

Braided Water Connectors

Supply stop Valve

Water Heater Connectors

Isolation Valves

Thermal Expansion Tanks

No-Hub Couplings

Flexible Sprinkler Drops

Braided Stainless Steel *Safe-flow* Water Connectors



FAUCET Connector 1/2" FIP x 1/2" FIP

- Tube-PVC
- Jacket-Braided Stainless Steel 304
- Excess Flow Shut-off Valve
- Nut-Chrome Plated Brass
- Max. Working Temperature 180°F (82°C)
- Max. Working Pressure 125 psi (8.6bar)
- Minimum Flow: 2.0 gpm
- Shut-off Flow: 2.5- 3.5 gpm



Part #	Description	U/M	Price	Qty/ Box
EF-FC-12F12F-12V	1/2"FIP x 1/2"FIP, Excess Flow Shut-off Valve, 12"	EA		50
EF-FC-12F12F-16V	1/2"FIP x 1/2"FIP, Excess Flow Shut-off Valve, 16"	EA		50
EF-FC-12F12F-20V	1/2"FIP x 1/2"FIP, Excess Flow Shut-off Valve, 20"	EA		50



FAUCET Connector 1/2" Compression x 1/2" FIP

- Tube-PVC
- Jacket-Braided Stainless Steel 304
- Excess Flow Shut-off Valve
- Nut-Chrome Plated Brass
- Max. Working Temperature 180°F (82°C)
- Max. Working Pressure 125 psi (8.6bar)
- Minimum Flow: 2.0 gpm
- Shut-off Flow: 2.5- 3.5 gpm



Part #	Description	U/M	Price	Qty/ Box
EF-FC-12C12F-12V	1/2"C x 1/2"FIP, Excess Flow Shut-off Valve, 12"	EA		50
EF-FC-12C12F-16V	1/2"C x 1/2"FIP, Excess Flow Shut-off Valve, 16"	EA		50
EF-FC-12C12F-20V	1/2"C x 1/2"FIP, Excess Flow Shut-off Valve, 20"	EA		50



FAUCET Connector 3/8" Compression x 3/8" Compression

- Tube-PVC
- Jacket-Braided Stainless Steel 304
- Excess Flow Shut-off Valve
- Nut-Chrome Plated Brass
- Max. Working Temperature 180°F (82°C)
- Max. Working Pressure 125 psi (8.6bar)
- Minimum Flow: 2.0 gpm
- Shut-off Flow: 2.5- 3.5 gpm



Part #	Description	U/M	Price	Qty/ Box
EF-FC-38C38C-12V	3/8"C x 3/8"C, Excess Flow Shut-off Valve, 12"	EA		50
EF-FC-38C38C-16V	3/8"C x 3/8"C, Excess Flow Shut-off Valve, 16"	EA		50
EF-FC-38C38C-20V	3/8"C x 3/8"C, Excess Flow Shut-off Valve, 20"	EA		50
EF-FC-38C38C-24V	3/8"C x 3/8"C, Excess Flow Shut-off Valve, 24"	EA		50
EF-FC-38C38C-30V	3/8"C x 3/8"C, Excess Flow Shut-off Valve, 30"	EA		50



FAUCET Connector 3/8" Compression x Delta Type

- Tube-PVC
- Jacket-Braided Stainless Steel 304
- Excess Flow Shut-off Valve
- Nut-Chrome Plated Brass
- Max. Working Temperature 180°F (82°C)
- Max. Working Pressure 125 psi (8.6bar)
- Minimum Flow: 2.0 gpm
- Shut-off Flow: 2.5- 3.5 gpm



Part #	Description	U/M	Price	Qty/ Box
EF-FC-38DT-12V	3/8"C x Delta Type, Excess Flow Shut-off Valve, 12"	EA		50
EF-FC-38DT-16V	3/8"C x Delta Type, Excess Flow Shut-off Valve, 16"	EA		50
EF-FC-38DT-20V	3/8"C x Delta Type, Excess Flow Shut-off Valve, 20"	EA		50

Braided Stainless Steel **Safe-flow** Water Connectors

Safeflow

FAUCET Connector 3/8" Compression x 1/2" FIP

- Tube-PVC
- Jacket-Braided Stainless Steel 304
- Excess Flow Shut-off Valve
- Nut-Chrome Plated Brass
- Max. Working Temperature 180°F (82°C)
- Max. Working Pressure 125 psi (8.6bar)
- Minimum Flow: 2.0 gpm
- Shut-off Flow: 2.5- 3.5 gpm



Part #	Description	U/M	Price	Qty/ Box
EF-FC-38C12F-9V	3/8"C x 1/2"FIP, Excess Flow Shut-off Valve, 9"	EA		50
EF-FC-38C12F-12V	3/8"C x 1/2"FIP, Excess Flow Shut-off Valve, 12"	EA		50
EF-FC-38C12F-16V	3/8"C x 1/2"FIP, Excess Flow Shut-off Valve, 16"	EA		50
EF-FC-38C12F-20V	3/8"C x 1/2"FIP, Excess Flow Shut-off Valve, 20"	EA		50
EF-FC-38C12F-24V	3/8"C x 1/2"FIP, Excess Flow Shut-off Valve, 24"	EA		50
EF-FC-38C12F-30V	3/8"C x 1/2"FIP, Excess Flow Shut-off Valve, 30"	EA		50
EF-FC-38C12F-36V	3/8"C x 1/2"FIP, Excess Flow Shut-off Valve, 36"	EA		50



ICE MAKER Connector 1/4" Compression x 1/4" Compression

- Tube-PVC
- Jacket-Braided Stainless Steel 304
- Excess Flow Shut-off Valve
- Nut-Chrome Plated Brass
- Max. Working Temperature 180°F (82°C)
- Max. Working Pressure 125 psi (8.6bar)
- Minimum Flow: 2.0 gpm
- Shut-off Flow: 2.5- 3.5 gpm



Part #	Description	U/M	Price	Qty/ Box
EF-IC-14C14C-5V	1/4"C x 1/4" C, Excess Flow Shut-off Valve, 5 ft	EA		50
EF-IC-14C14C-6V	1/4"C x 1/4" C, Excess Flow Shut-off Valve, 6 ft	EA		50
EF-IC-14C14C-10V	1/4"C x 1/4" C, Excess Flow Shut-off Valve, 10 ft	EA		25



WASHING MACHINE Connector 3/4" Hose Bibb

- Tube-PVC
- Jacket-Braided Stainless Steel 304
- Excess Flow Shut-off Valve
- Nut-Chrome Plated Brass
- Max. Working Temperature 180°F (82°C)
- Max. Working Pressure 125 psi (8.6bar)
- Minimum Flow: 2.0 gpm
- Shut-off Flow: 2.5- 3.5 gpm



Part #	Description	U/M	Price	Qty/ Box
EF-WM-34HB-48V	3/4"HB, Excess Flow Shut-off Valve, 48"	EA		25
EF-WM-34HB-60V	3/4"HB, Excess Flow Shut-off Valve, 60"	EA		25
EF-WM-34HB-72V	3/4"HB, Excess Flow Shut-off Valve, 72"	EA		25



Gas Connectors
Commercial Gas Connectors
Gas Line System
Gas CSST Fittings
Water Line System
Water CSST Fittings
Braided Water Connectors
Supply stop Valve
Water Heater Connectors
Isolation Valves
Thermal Expansion Tanks
No-Hub Couplings
Flexible Sprinkler Drops

Braided Stainless Steel *Safe-flow* Water Connectors



TOILET Connector 3/8" Compression x 7/8" Ballcock

- Tube-PVC
- Jacket-Braided Stainless Steel 304
- Excess Flow Shut-off Valve
- Nut-Chrome Plated Brass
- Max. Working Temperature 180°F (82°C)
- Max. Working Pressure 125 psi (8.6bar)
- Minimum Flow: 2.0 gpm
- Shut-off Flow: 2.5- 3.5 gpm



Part #	Description	U/M	Price	Qty/ Box
EF-TC-38CBC-9V	3/8"C x 7/8"BC, Excess Flow Shut-off Valve, 9"	EA		50
EF-TC-38CBC-12V	3/8"C x 7/8"BC, Excess Flow Shut-off Valve, 12"	EA		50
EF-TC-38CBC-16V	3/8"C x 7/8"BC, Excess Flow Shut-off Valve, 16"	EA		50
EF-TC-38CBC-20V	3/8"C x 7/8"BC, Excess Flow Shut-off Valve, 20"	EA		50



TOILET Connector 3/8" Compression x 7/8" Metal Ballcock

- Tube-PVC
- Jacket-Braided Stainless Steel 304
- Excess Flow Shut-off Valve
- Nut-Chrome Plated Brass
- Max. Working Temperature 180°F (82°C)
- Max. Working Pressure 125 psi (8.6bar)
- Minimum Flow: 2.0 gpm
- Shut-off Flow: 2.5- 3.5 gpm



Part #	Description	U/M	Price	Qty/ Box
EF-TC-38CMBC-12V	3/8"C x 7/8" Metal BC, Excess Flow Shut-off Valve, 12"	EA		50
EF-TC-38CMBC-16V	3/8"C x 7/8" Metal BC, Excess Flow Shut-off Valve, 16"	EA		50
EF-TC-38CMBC-20V	3/8"C x 7/8" Metal BC, Excess Flow Shut-off Valve, 20"	EA		50



TOILET Connector 1/2" FIP x 7/8" Ballcock

- Tube-PVC
- Jacket-Braided Stainless Steel 304
- Excess Flow Shut-off Valve
- Nut-Chrome Plated Brass
- Max. Working Temperature 180°F (82°C)
- Max. Working Pressure 125 psi (8.6bar)
- Minimum Flow: 2.0 gpm
- Shut-off Flow: 2.5- 3.5 gpm



Part #	Description	U/M	Price	Qty/ Box
EF-TC-12FBC-12V	1/2"FIP x 7/8"BC, Excess Flow Shut-off Valve, 12"	EA		50
EF-TC-12FBC-16V	1/2"FIP x 7/8"BC, Excess Flow Shut-off Valve, 16"	EA		50
EF-TC-12FBC-20V	1/2"FIP x 7/8"BC, Excess Flow Shut-off Valve, 20"	EA		50

Braided Stainless Steel **Safe-flow** Water Connectors

Safeflow

DISHWASHER Connector 3/8" Compression x 3/8" Elbow

- Tube-PVC
- Jacket-Braided Stainless Steel 304
- Excess Flow Shut-off Valve
- Nut-Chrome Plated Brass
- Max. Working Temperature 180°F (82°C)
- Max. Working Pressure 125 psi (8.6bar)
- Minimum Flow: 2.0 gpm
- Shut-off Flow: 2.5- 3.5 gpm



Part #	Description	U/M	Price	Qty/ Box
EF-DC-38C38L-48V	3/8"C x 3/8"EL, Excess Flow Shut-off Valve, 48"	EA		50
EF-DC-38C38L-60V	3/8"C x 3/8"EL, Excess Flow Shut-off Valve, 60"	EA		50
EF-DC-38C38L-72V	3/8"C x 3/8"EL, Excess Flow Shut-off Valve, 72"	EA		50
EF-DC-38C38L-96V	3/8"C x 3/8"EL, Excess Flow Shut-off Valve, 96"	EA		50



DISHWASHER Connector 1/2" Compression x 3/8" Elbow

- Tube-PVC
- Jacket-Braided Stainless Steel 304
- Excess Flow Shut-off Valve
- Nut-Chrome Plated Brass
- Max. Working Temperature 180°F (82°C)
- Max. Working Pressure 125 psi (8.6bar)
- Minimum Flow: 2.0 gpm
- Shut-off Flow: 2.5- 3.5 gpm



Part #	Description	U/M	Price	Qty/ Box
EF-DC-12C38L-60V	1/2"C x 3/8"EL, Excess Flow Shut-off Valve, 60"	EA		50



DISHWASHER Connector 3/8" Compression x 3/4" Hose Bibb Elbow

- Tube-PVC
- Jacket-Braided Stainless Steel 304
- Excess Flow Shut-off Valve
- Nut-Chrome Plated Brass
- Max. Working Temperature 180°F (82°C)
- Max. Working Pressure 125 psi (8.6bar)
- Minimum Flow: 2.0 gpm
- Shut-off Flow: 2.5- 3.5 gpm



Part #	Description	U/M	Price	Qty/ Box
EF-DC-38CHBL-48V	3/8"C x 3/4" GH Elbow, Excess Flow Shut-off Valve, 48"	EA		50
EF-DC-38CHBL-60V	3/8"C x 3/4" GH Elbow, Excess Flow Shut-off Valve, 60"	EA		50
EF-DC-38CHBL-72V	3/8"C x 3/4" GH Elbow, Excess Flow Shut-off Valve, 72"	EA		50



Connectors
Gas

Connectors
Gas

Line System
Gas

Fittings
Gas

Line System
Water

Fittings
Water

Connectors
Water

Supply stop
Valve

Connectors
Water

Valves
Isolation

Tanks
Expansion

Couplings
No-Hub

Drops
Sprinkler



*Lead Free / Quarter Turn
Supply Stop Valve*

Lead Free / Quarter Turn Supply Stop Valve

Technical Reference

- Forged lead free brass body
- Chrome plated
- Pressure rating : 125 psi / 180°F
- Precision machined brass ball valve is specifically engineered and manufactured with PTFE seats to provide smooth operation without freeze-ups even after long periods of non-use.
- Two high-performance o-rings withstand high temperatures and corrosion from harsh water environments.
- 100% leak tested

Connection

- Compression
- CPVC
- FIP
- Sweat
- PEX

1/4 - Turn Ball Valve

The 1/4-Turn Ball Valve and stem are made of brass and built for longevity and frequent use. Sweat, compression, or crimp fittings provide a quick and reliable connection.



Specifications

Name	Material	Qty.
Compression Nut	Brass	1
Sleeve	Copper	1
Body	Lead Free Brass	1
Stem	Brass	1
O-ring	NBR	2
Handle	Zinc	1
Screw	Steel	1
Ball seat	PTFE	2
Ball	Lead Free Brass	1
Adapter	Lead Free Brass	1



Gas Connectors

Commercial Gas Connectors

Gas Line System

Gas CSST Fittings

Water Line System

Water CSST Fittings

Braided Water Connectors

Supply Stop Valve

Water Heater Connectors

Isolation Valves

Thermal Expansion Tanks

No-Hub Couplings

Flexible Sprinkler Drops

Supply Stop Valve

Compression × Compression- Angle

- Lead Free Brass Body
- Pressure Rating : 125 psi / 180 °F
- Finish : Chrome



Part #	Description	U/M	Price	Qty/Box
EFSV-AG-58C14C	5/8" OD × 1/4" OD Comp	EA		
EFSV-AG-58C38C	5/8" OD × 3/8" OD Comp	EA		
EFSV-AG-58C12C	5/8" OD × 1/2" OD Comp	EA		

Compression × Compression- Straight

- Lead Free Brass Body
- Pressure Rating : 125 psi / 180 °F
- Finish : Chrome



Part #	Description	U/M	Price	Qty/Box
EFSV-ST-38C38C	3/8" OD × 3/8" OD Comp	EA		
EFSV-ST-58C14C	5/8" OD × 1/4" OD Comp	EA		
EFSV-ST-58C38C	5/8" OD × 3/8" OD Comp	EA		
EFSV-ST-58C12C	5/8" OD × 1/2" OD Comp	EA		

FIP × Compression- Angle

- Lead Free Brass Body
- Pressure Rating : 125 psi / 180 °F
- Finish : Chrome



Part #	Description	U/M	Price	Qty/Box
EFSV-AG-38FT38C	3/8" FIP × 3/8" OD Comp	EA		
EFSV-AG-12FT14C	1/2" FIP × 1/4" OD Comp	EA		
EFSV-AG-12FT38C	1/2" FIP × 3/8" OD Comp	EA		
EFSV-AG-12FT12C	1/2" FIP × 1/2" OD Comp	EA		

FIP × Compression- Straight

- Lead Free Brass Body
- Pressure Rating : 125 psi / 180 °F
- Finish : Chrome



Part #	Description	U/M	Price	Qty/Box
EFSV-ST-38FT38C	3/8" FIP × 3/8" OD Comp	EA		
EFSV-ST-12FT38C	1/2" FIP × 3/8" OD Comp	EA		

Supply Stop Valve

- Lead Free Brass Body
- Pressure Rating : 125 psi / 180 °F
- Finish : Chrome

Part #	Description	U/M	Price	Qty/Box
EFSV-DU-58C38C14C	5/8" OD x 3/8" OD Comp x 1/4" OD Comp	EA		
EFSV-DU-58C38C38C	5/8" OD x 3/8" OD Comp x 3/8" OD Comp	EA		



Sweat x Compression- Angle

- Lead Free Brass Body
- Pressure Rating : 125 psi / 180 °F
- Finish : Chrome

Part #	Description	U/M	Price	Qty/Box
EFSV-AG-12SW14C	1/2" NOM SWEAT x 1/4" OD Comp	EA		
EFSV-AG-12SW38C	1/2" NOM SWEAT x 3/8" OD Comp	EA		



Sweat x Compression- Straight

- Lead Free Brass Body
- Pressure Rating : 125 psi / 180 °F
- Finish : Chrome

Part #	Description	U/M	Price	Qty/Box
EFSV-ST-12SW14C	1/2" NOM SWEAT x 1/4" OD Comp	EA		
EFSV-ST-12SW38C	1/2" NOM SWEAT x 3/8" OD Comp	EA		



- Gas Connectors
- Commercial Gas Connectors
- Gas Line System
- Gas CSST Fittings
- Water Line System
- Water CSST Fittings
- Braided Water Connectors
- Supply stop Valve
- Water Heater Connectors
- Isolation Valves
- Thermal Expansion Tanks
- No-Hub Couplings
- Flexible Sprinkler Drops

Supply Stop Valve

Crimp PEX Barb × Compression- **Angle**

- Lead Free Brass Body
- Pressure Rating : 125 psi / 180 °F
- Finish : Chrome



Part #	Description	U/M	Price	Qty/Box
EFSV-AG-12PX14C	1/2" NOM BARB × 1/4" OD Comp	EA		
EFSV-AG-12PX38C	1/2" NOM BARB × 3/8" OD Comp	EA		

Crimp PEX Barb × Compression- **Straight**

- Lead Free Brass Body
- Pressure Rating : 125 psi / 180 °F
- Finish : Chrome



Part #	Description	U/M	Price	Qty/Box
EFSV-ST-12PX38C	1/2" NOM BARB × 3/8" OD Comp	EA		

Crimp PEX Barb × Barb- **Angle**

- Lead Free Brass Body
- Pressure Rating : 125 psi / 180 °F
- Finish : Chrome



Part #	Description	U/M	Price	Qty/Box
EFSV-AG-12PX12PX	1/2" NOM BARB × 1/2" NOM BARB	EA		

Crimp PEX Barb × Barb- **Straight**

- Lead Free Brass Body
- Pressure Rating : 125 psi / 180 °F
- Finish : Chrome



Part #	Description	U/M	Price	Qty/Box
EFSV-ST-12PX12PX	1/2" NOM BARB × 1/2" NOM BARB	EA		

Supply Stop Valve

Compression × Slip Joint- **Angle**

- Lead Free Brass Body
- Pressure Rating : 125 psi / 180 °F
- Finish : Chrome

Part #	Description	U/M	Price	Qty/Box
EFSV-AG-12SJ	5/8" OD × 7/16" OD & 1/2" Slip-Joint	EA		



Compression × Slip Joint- **Straight**

- Lead Free Brass Body
- Pressure Rating : 125 psi / 180 °F
- Finish : Chrome

Part #	Description	U/M	Price	Qty/Box
EFSV-ST-12SJ	5/8" OD × 7/16" OD & 1/2" Slip-Joint	EA		



CPVC Solvent Weld × Compression- **Angle**

- Lead Free Brass Body
- Pressure Rating : 125 psi / 180 °F
- Finish : Chrome

Part #	Description	U/M	Price	Qty/Box
EFSV-AG-12CP14C	1/2" NOM CPVC × 1/4" OD Comp	EA		
EFSV-AG-12CP38C	1/2" NOM CPVC × 3/8" OD Comp	EA		



CPVC Solvent Weld × Compression- **Straight**

- Lead Free Brass Body
- Pressure Rating : 125 psi / 180 °F
- Finish : Chrome

Part #	Description	U/M	Price	Qty/Box
EFSV-ST-12CP14C	1/2" NOM CPVC × 1/4" OD Comp	EA		
EFSV-ST-12CP38C	1/2" NOM CPVC × 3/8" OD Comp	EA		



Gas
Connectors

Commercial
Gas
Connectors

Gas
Line System

Gas
CSST Fittings

Water
Line System

Water
CSST Fittings

Braided
Water
Connectors

Supply stop
Valve

Water
Heater
Connectors

Isolation
Valves

Thermal
Expansion
Tanks

No-Hub
Couplings

Flexible
Sprinkler
Drops

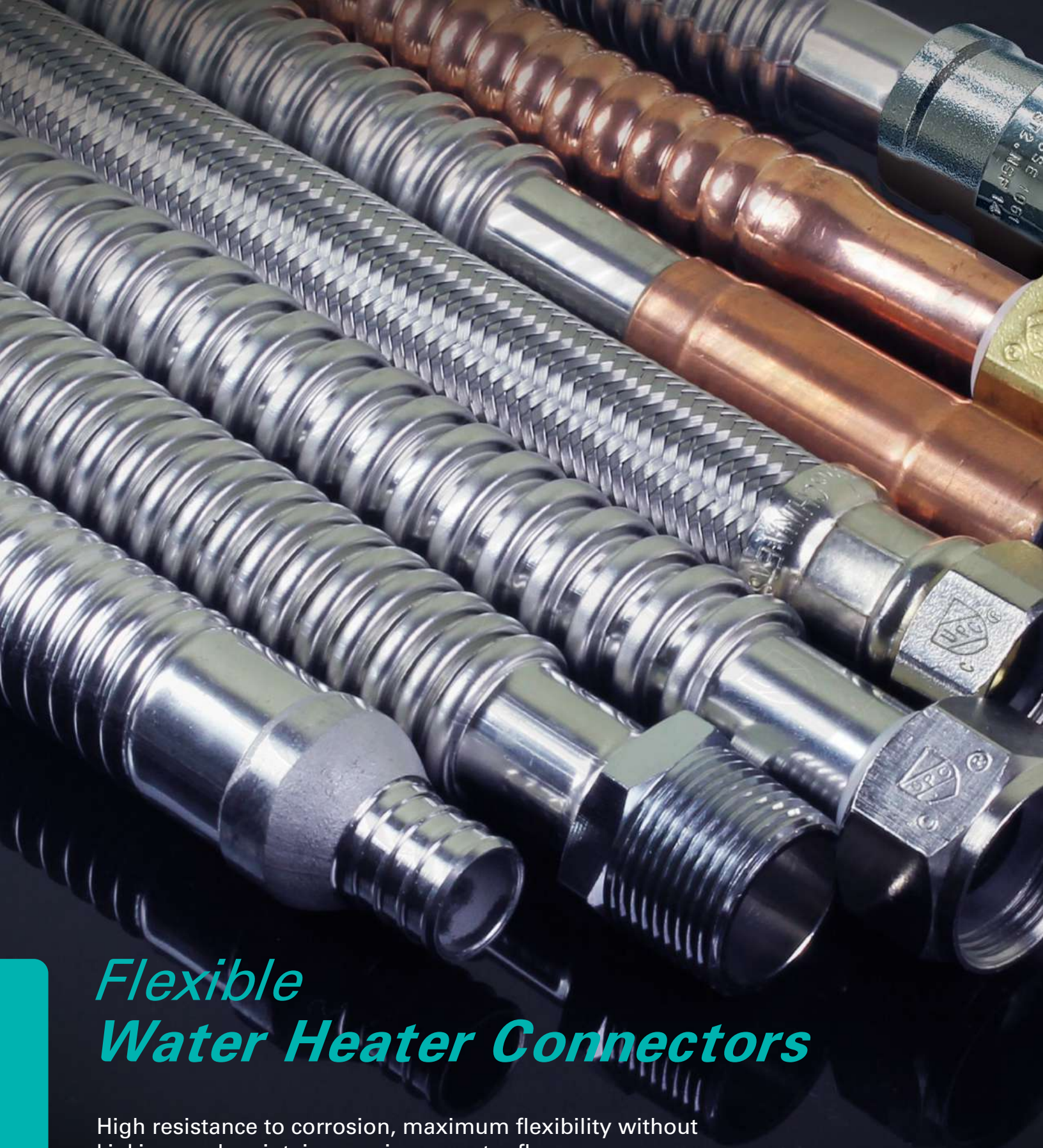

Flexible Water Heater Connectors

High resistance to corrosion, maximum flexibility without kinking, and maintains maximum water flow.



Flexible Stainless Steel Water Heater Connectors

Applications

- Boilers
- Water Softeners
- Water Heaters
- Tankless Water Heaters

Benefits

- 100% Leak Tested
- Reduced Labor Costs
- Corrosion & Scaling Resistant
- No Special Tools Required
- Minimal Use of Fittings
- Environmentally Safe

Certifications and Approvals

- IAPMO/ cUPC Certified
- ASME A112.18.6-2009/ CSA B125.6-2009
- NSF 61 Compliant
- NSF 372 Compliant : Lead-Free



Product Specifications

Tubing	Stainless Steel 304 (ASTM A 240)				
Tubing Thickness	0.01" and 0.012"				
Fittings	Chrome-Plated Brass 3771				
Gasket	High-Quality EPDM				
Lengths Available	12", 15", 18", 24", 36", 48"				
Sizes Available (ID)	3/4"	1"	1-1/4"	1-1/2"	2"
Thread Standard	ASME B1.20.1				

Technical Specifications

Working Pressure	Up to 125 psig
Intermittent Impulse Pressure	Up to 180 psig
Temperature Rating	-40° F to 180° F (-40° C to 82° C)
Min. Bend Radius	2.5" (Recommended)

Gas Connectors

Commercial Gas Connectors

Gas Line System

Gas CSST Fittings

Water Line System

Water CSST Fittings

Braided Water Connectors

Supply stop Valve

Water Heater Connectors

Isolation Valves

Thermal Expansion Tanks

No-Hub Couplings

Flexible Sprinkler Drops

Flexible Stainless Steel Water Heater Connectors

Strength and Flexibility

Easyflex water connectors are made from durable and highly corrosion resistant 304 stainless steel. The annular corrugations allow maximum flexibility while maintaining the durability and strength of stainless steel. Easyflex water connectors can be tightly bent and still maintain the inner diameter without any kinks.

Variety

Easyflex offers sizes from 3/4" to 2" with a variety of connections—threaded, sweat, and push-fit to meet all your needs.



Parts Numbering System

EFWC - 034 - SS - 1010 - 12

TUBE ID FITTINGS
TUBETYPE LENGTH

TUBE ID

Part#	Size (ID)
034	3/4"
034C	3/4"
100	1"
114	1-1/4"
112	1-1/2"
200	2"

TUBE TYPE

Part#	
SS	Stainless Steel
BR	Braided (Stainless Steel)
034C	Copper

FITTINGS

Part#	Size (ID)
10	3/4" FIP
11	3/4" MIP
12	1" FIP
13	1-1/4" FIP
14	1-1/2" FIP
15	2" FIP
50	3/4" Push-Fit
60	3/4" Sweat
70	3/4" PEX

LENGTH

Standard Lengths
12", 15", 18", 24", 36", 48"

Flexible Stainless Steel Water Heater Connectors

FIP/ MIP Fitting | 3/4" ID

- Tube-Stainless Steel 304 (ASTM A 240)
- Nut-Chrome-Plated Brass 3771

- Gasket-High Quality EPDM
- External Dielectric Sleeve

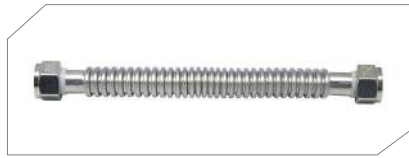

ID	Part #	Description	U/M	Price	Qty/ Box
3/4"	EFWC-034-SS-1010-12	3/4" FIP x 3/4" FIP, 12"	EA		25
3/4"	EFWC-034-SS-1010-15	3/4" FIP x 3/4" FIP, 15"	EA		25
3/4"	EFWC-034-SS-1010-18	3/4" FIP x 3/4" FIP, 18"	EA		25
3/4"	EFWC-034-SS-1010-24	3/4" FIP x 3/4" FIP, 24"	EA		25
3/4"	EFWC-034-SS-1010-36	3/4" FIP x 3/4" FIP, 36"	EA		25
3/4"	EFWC-034-SS-1010-48	3/4" FIP x 3/4" FIP, 48"	EA		25

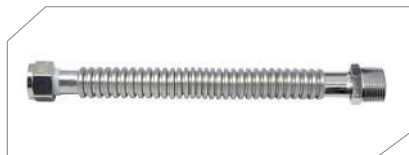

ID	Part #	Description	U/M	Price	Qty/ Box
3/4"	EFWC-034-SS-1011-15	3/4" FIP x 3/4" MIP, 15"	EA		25
3/4"	EFWC-034-SS-1011-18	3/4" FIP x 3/4" MIP, 18"	EA		25
3/4"	EFWC-034-SS-1011-24	3/4" FIP x 3/4" MIP, 24"	EA		25

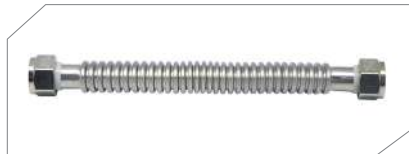

ID	Part #	Description	U/M	Price	Qty/ Box
3/4"	EFWC-034-SS-1012-18	3/4" FIP x 1" FIP, 18"	EA		25
3/4"	EFWC-034-SS-1012-24	3/4" FIP x 1" FIP, 24"	EA		25

Gas Connectors

Commercial Gas Connectors

Gas Line System

Gas CSST Fittings

Water Line System

Water CSST Fittings

Braided Water Connectors

Supply stop Valve

Water Heater Connectors

Isolation Valves

Thermal Expansion Tanks

No-Hub Couplings

Flexible Sprinkler Drops

Flexible Stainless Steel Water Heater Connectors

SWEAT Fitting | 3/4" ID

- Tube-Stainless Steel 304 (ASTM A 240)
- Nut-Chrome-Plated Brass 3771
- Gasket-High Quality EPDM
- External Dielectric Sleeve



ID	Part #	Description	U/M	Price	Qty/ Box
3/4"	EFWC-034-SS-1060-18	3/4" FIP x 3/4" Sweat, 18"	EA		25
3/4"	EFWC-034-SS-1060-24	3/4" FIP x 3/4" Sweat, 24"	EA		25



BRAIDED / FIP Fitting | 3/4" ID

- Tube-Reinforced PVC
- Jacket-Braided Stainless Steel 304 (ASTM A 240)
- Nut-Chrome-Plated Brass 3771
- Max. Working Temperature 180 °F (82°C)
- Max. Working Pressure 125 psi (8.6bar)



ID	Part #	Description	U/M	Price	Qty/ Box
3/4"	EFWC-034-BR-1010-18	3/4" FIP x FIP 3/4", 18"	EA		25
3/4"	EFWC-034-BR-1010-24	3/4" FIP x FIP 3/4", 24"	EA		25



FIP Fitting | 1" ID

- Tube-Stainless Steel 304 (ASTM A 240)
- Nut-Chrome-Plated Brass 3771
- Gasket-High Quality EPDM



ID	Part #	Description	U/M	Price	Qty/ Box
1"	EFWC-100-SS-1212-12	1" FIP x 1" FIP, 12"	EA		12
1"	EFWC-100-SS-1212-18	1" FIP x 1" FIP, 18"	EA		12
1"	EFWC-100-SS-1212-24	1" FIP x 1" FIP, 24"	EA		12



ID	Part #	Description	U/M	Price	Qty/ Box
1"	EFWC-100-SS-1213-12	1" FIP x 1-1/4" FIP, 12"	EA		12
1"	EFWC-100-SS-1213-15	1" FIP x 1-1/4" FIP, 15"	EA		12
1"	EFWC-100-SS-1213-18	1" FIP x 1-1/4" FIP, 18"	EA		12
1"	EFWC-100-SS-1213-24	1" FIP x 1-1/4" FIP, 24"	EA		12



Flexible Stainless Steel Water Heater Connectors

FIP Fitting | 1-1/4" ID

- Tube-Stainless Steel 304 (ASTM A 240)
- Nut-Chrome-Plated Brass 3771
- Gasket-High Quality EPDM



ID	Part #	Description	U/M	Price	Qty/ Box
1-1/4"	EFWC-114-SS-1313-18	1-1/4" FIP x 1-1/4" FIP, 18"	EA		12
1-1/4"	EFWC-114-SS-1313-24	1-1/4" FIP x 1-1/4" FIP, 24"	EA		12



FIP Fitting | 1-1/2" ID

- Tube-Stainless Steel 304 (ASTM A 240)
- Nut-Chrome-Plated Brass 3771
- Gasket-High Quality EPDM



ID	Part #	Description	U/M	Price	Qty/ Box
1-1/4"	EFWC-114-SS-1414-18	1-1/2" FIP x 1-1/4" FIP, 18"	EA		12
1-1/4"	EFWC-114-SS-1414-24	1-1/2" FIP x 1-1/4" FIP, 24"	EA		12



FIP Fitting | 2" ID

- Tube-Stainless Steel 304 (ASTM A 240)
- Nut-Chrome-Plated Brass 3771
- Gasket-High Quality EPDM



ID	Part #	Description	U/M	Price	Qty/ Box
2"	EFWC-200-SS-1515-18	2" FIP x 2" FIP, 18"	EA		9
2"	EFWC-200-SS-1515-24	2" FIP x 2" FIP, 24"	EA		9



- Gas Connectors
- Commercial Gas Connectors
- Gas Line System
- Gas CSST Fittings
- Water Line System
- Water CSST Fittings
- Braided Water Connectors
- Supply stop Valve
- Water Heater Connectors
- Isolation Valves
- Thermal Expansion Tanks
- No-Hub Couplings
- Flexible Sprinkler Drops

Flexible Stainless Steel Water Heater Connectors

FIP Fitting | 3/4" ID

- Tube-Stainless Steel 304 (ASTM A 240)
- Nut-Chrome-Plated Brass 3771
- Gasket-High Quality EPDM



ID	Part #	Description	U/M	Price	Qty/ Box
3/4"	EFWC-034-SS-1010-12N	3/4" FIP x 3/4" FIP, 12"	EA		25
3/4"	EFWC-034-SS-1010-15N	3/4" FIP x 3/4" FIP, 15"	EA		25
3/4"	EFWC-034-SS-1010-18N	3/4" FIP x 3/4" FIP, 18"	EA		25
3/4"	EFWC-034-SS-1010-24N	3/4" FIP x 3/4" FIP, 24"	EA		25
3/4"	EFWC-034-SS-1010-36N	3/4" FIP x 3/4" FIP, 36"	EA		25
3/4"	EFWC-034-SS-1010-48N	3/4" FIP x 3/4" FIP, 48"	EA		25



ID	Part #	Description	U/M	Price	Qty/ Box
3/4"	EFWC-034-SS-1012-18N	3/4" FIP x 1" FIP, 18"	EA		25
3/4"	EFWC-034-SS-1012-24N	3/4" FIP x 1" FIP, 24"	EA		25



MIP Fitting | 3/4" ID

- Tube-Stainless Steel 304 (ASTM A 240)
- Nut-Chrome-Plated Brass 3771
- Gasket-High Quality EPDM



ID	Part #	Description	U/M	Price	Qty/ Box
3/4"	EFWC-034-SS-1011-15N	3/4" FIP x 3/4" MIP, 15"	EA		25
3/4"	EFWC-034-SS-1011-18N	3/4" FIP x 3/4" MIP, 18"	EA		25
3/4"	EFWC-034-SS-1011-24N	3/4" FIP x 3/4" MIP, 24"	EA		25



PUSH-FIT Fitting | 3/4" ID

- Tube-Stainless Steel 304 (ASTM A 240)
- Nut-Chrome-Plated Brass 3771
- Gasket-High Quality EPDM



ID	Part #	Description	U/M	Price	Qty/ Box
3/4"	EFWC-034-SS-1050-15	3/4" FIP x 3/4" Push-Fit, 15"	EA		25
3/4"	EFWC-034-SS-1050-18	3/4" FIP x 3/4" Push-Fit, 18"	EA		25
3/4"	EFWC-034-SS-1050-24	3/4" FIP x 3/4" Push-Fit, 24"	EA		25

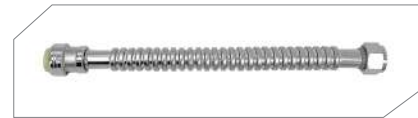

Flexible Stainless Steel Water Heater Connectors

SWEAT Fitting | 3/4" ID

- Tube-Stainless Steel 304 (ASTM A 240)
- Nut-Chrome-Plated Brass 3771
- Gasket-High Quality EPDM



ID	Part #	Description	U/M	Price	Qty/ Box
3/4"	EFWC-034-SS-1060-18	3/4" FIP x 3/4" Sweat, 18"	EA		25
3/4"	EFWC-034-SS-1060-24	3/4" FIP x 3/4" Sweat, 24"	EA		25



PEX Fitting | 3/4" ID

- Tube-Stainless Steel 304 (ASTM A 240)
- Nut-Chrome-Plated Brass 3771
- Gasket-High Quality EPDM



ID	Part #	Description	U/M	Price	Qty/ Box
3/4"	EFWC-034-SS-1070-18	3/4" FIP x 3/4" PEX, 18"	EA		25
3/4"	EFWC-034-SS-1070-24	3/4" FIP x 3/4" PEX, 24"	EA		25

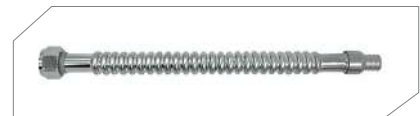

Cold Expansion Fitting | 3/4" ID

- Tube-Stainless Steel 304 (ASTM A 240)
- Nut-Chrome-Plated Brass 3771
- Gasket-High Quality EPDM



ID	Part #	Description	U/M	Price	Qty/ Box
3/4"	EFWC-034-SS-1080-18	3/4" FIP x 3/4" Cold Expansion 18"	EA		25
3/4"	EFWC-034-SS-1080-24	3/4" FIP x 3/4" Cold Expansion 24"	EA		25

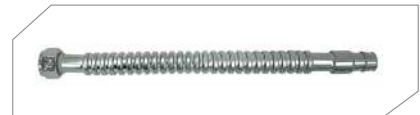

- Gas Connectors
- Commercial Gas Connectors
- Gas Line System
- Gas CSST Fittings
- Water Line System
- Water CSST Fittings
- Braided Water Connectors
- Supply stop Valve
- Water Heater Connectors
- Isolation Valves
- Thermal Expansion Tanks
- No-Hub Couplings
- Flexible Sprinkler Drops



Corrugated Copper Water Heater Connectors

Durable and Provides
Maximum Water Flow

Global Pipe Manufacturer

E EASYFLEX®

Corrugated Copper Water Heater Connectors



Applications

- Boilers
- Water Heaters
- Tankless Water Heaters

Benefits

- 100% Leak Tested
- Reduced Labor Costs
- Corrosion & Scaling Resistant
- No Special Tools Required
- Minimal Use of Fittings
- Environmentally Safe

Certifications & Approvals

- IAPMO/ UPC Certified
- ASME A 112.18.6-2009 / CSA B 125.6-2009
- NSF 61 Compliant
- NSF 372 Compliant : Lead-Free



Materials

Tubing	Copper
Fittings	Brass 3771
Gasket	High-Quality EPDM

Size

Lengths	12", 15", 18", 24"
Size	3/4" ID

Technical Specifications

Operating Pressure	Up to 125 psig
Intermittent Impulse Pressure	Up to 180 psig
Temperature	-40° F to 180° F (-40° C to 82° C)
Min. Bend Radius	8" (Recommended)

- Gas Connectors
- Commercial Gas Connectors
- Gas Line System
- Gas CSST Fittings
- Water Line System
- Water CSST Fittings
- Braided Water Connectors
- Supply Stop Valve
- Water Heater Connectors
- Isolation Valves
- Thermal Expansion Tanks
- No-Hub Couplings
- Flexible Sprinkler Drops

Corrugated Copper Water Heater Connectors

FIP Fittings

- Tube-Copper
- Nut-Brass 3771
- Gasket-High Quality EPDM
- External Dielectric Sleeve

ID	Part #	Description	U/M	Price	Qty/ Box
3/4"	EFWC-034C-1010-12	3/4" FIP x 3/4" FIP, Copper Flex, 12"	EA		25
3/4"	EFWC-034C-1010-15	3/4" FIP x 3/4" FIP, Copper Flex, 15"	EA		25
3/4"	EFWC-034C-1010-18	3/4" FIP x 3/4" FIP, Copper Flex, 18"	EA		25
3/4"	EFWC-034C-1010-24	3/4" FIP x 3/4" FIP, Copper Flex, 24"	EA		25



SWEAT Fittings

- Tube-Copper
- Nut-Brass 3771
- Gasket-High Quality EPDM
- External Dielectric Sleeve

ID	Part #	Description	U/M	Price	Qty/ Box
3/4"	EFWC-034C-1060-12	3/4" FIP x 3/4" Sweat, Copper Flex, 12"	EA		25
3/4"	EFWC-034C-1060-15	3/4" FIP x 3/4" Sweat, Copper Flex, 15"	EA		25
3/4"	EFWC-034C-1060-18	3/4" FIP x 3/4" Sweat, Copper Flex, 18"	EA		25
3/4"	EFWC-034C-1060-24	3/4" FIP x 3/4" Sweat, Copper Flex, 24"	EA		25



- Gas Connectors
- Commercial Gas Connectors
- Gas Line System
- Gas CSST Fittings
- Water Line System
- Water CSST Fittings
- Braided Water Connectors
- Supply stop Valve
- Water Heater Connectors
- Isolation Valves
- Thermal Expansion Tanks
- No-Hub Couplings
- Flexible Sprinkler Drops



Tankless Water Heater Isolation Valve Kits

Lead-Free Compact Isolation Valves for Tankless Water Heaters.
Drain, purge, and testing applications in one Kit.

Tankless Water Heater Isolation Valve Kits

Tankless Water Heater Isolation Valve Kit

- Cold Water Valve
- Hot Water Valve
- Pressure Relief Valve

Benefits

- Full Port
- 200K Rated
- 3/4" Female Threaded Connection or Sweat Connection
- Integrated Drain & Purge Port with Cap
- 600 WOG
- Brass (Lead-Free)
- PTFE Seats

Certifications

- NSF 372 Compliant : Lead-Free

Materials

Body	Brass UNS C 46500(ASTM B171)
Ball Valves	Chrome-Plated Brass
Ball Disc Packing	PTFE



Lead-Free

- Gas Connectors
- Commercial Gas Connectors
- Gas Line System
- Gas CSST Fittings
- Water Line System
- Water CSST Fittings
- Braided Water Connectors
- Supply stop Valve
- Water Heater Connectors
- Isolation Valves
- Thermal Expansion Tanks
- No-Hub Couplings
- Flexible Sprinkler Drops

Tankless Water Heater Isolation Valves



TEST REPORT

5001 East Philadelphia Street
Ontario, California – USA 91761-2816
Ph: 909.472.4100 | Fax: 909.472.4243
<http://www.iapmortl.org>

Report Number: 885-14018

Report Issued: February 14, 2014

Project No.: 22839

Client: Kofulso Co., Ltd.
377-8 Gum Gok-Dong Seo-Gu
Incheon City
404-330, South Korea

Source of Samples: The samples were shipped to IAPMO R&T Lab from Kofulso Co., Ltd. and received in good condition on October 16, 2013. Updated PMI received on February 13, 2014.

Date of Evaluation: January 25, 2014 and February 14, 2014

Product Description: Tankless Water Heater Isolation Valves

Model: EF-ISV-HC-LF

Note: The above model includes 1 set of model EF-ISV-H-LF (1ea) and EF-ISV-C-LF (1ea)

Scope of Evaluation: The purpose of the evaluation/testing was to determine whether the samples evaluated tested met the requirement of NSF/ANSI 372-2011, entitled "Drinking Water System Components-Lead Content".

Conclusion: **The samples evaluated/tested of model EF-ISV-HC-LF, Tankless Water Heater Isolation Valves from Kofulso Co., Ltd. met the requirements of NSF/ANSI 372-2011.**

By our signatures below we certify that all evaluation, testing and sample preparation for this report was performed under continuous, direct supervision of IAPMO R&T Lab, unless otherwise stated.

Tested By,

Reviewed By,

Frank Lopez, Test Technician

Michael N. Briggs, Manager, Analytical Lab

Page 1 of 3

This report may not be copied, except in its entirety, without the written permission of IAPMO R&T Lab

Tankless Water Heater Isolation Valves

Tankless Water Heater Isolation Valve Kits (FIP Threaded)

Lead-Free

- Hot & Cold Valve
- Pressure Relief Valve (Optional)
- NSF 372 Compliant: Lead-Free
- 3/4" Size (FIP Threaded)
- Brass UNS C46500 (ASTM B171)
- 600 WOG

Part #	Description	U/M	Price	Qty/ Box
EFLF-ISV-HC	Lead-Free Tankless Water Heater Service Valves, Hot & Cold Valve	EA		16
EFLF-ISV-HCTP	Lead-Free Tankless Water Heater Service Valves, Hot & Cold Valve w/ Pressure Relief Valve	EA		16



Tankless Water Heater Isolation Valve Kits (Sweat)

Lead-Free

- Hot & Cold Valve
- Pressure Relief Valve (Optional)
- NSF 372 Compliant: Lead-Free
- 3/4" Size (Sweat)
- Brass UNS C46500 (ASTM B171)
- 600 WOG

Part #	Description	U/M	Price	Qty/ Box
EFLF-ISV-SW-HC	Lead-Free Tankless Water Heater Service Valves, Hot & Cold Valve (Sweat Type)	EA		16
EFLF-ISV-SW-HCTP	Lead-Free Tankless Water Heater Service Valves, Hot & Cold Valve w/ Pressure Relief Valve (Sweat Type)	EA		16



Tankless Water Heater Isolation Valve Kits (Press)

Lead-Free

- Hot & Cold Valve
- NSF 372 Compliant: Lead-Free
- Pressure Relief Valve (Optional)
- 3/4" Size (Press)
- Brass UNS C46500 (ASTM B171)
- 600 WOG

Part #	Description	U/M	Price	Qty/ Box
EFLF-ISV-100-PHC	Lead-Free Tankless Water Heater Service Valves, Hot & Cold Valve (Press Type)	EA		16
EFLF-ISV-100-PHCTP	Lead-Free Tankless Water Heater Service Valves, Hot & Cold Valve w/ Pressure Relief Valve (Press Type)	EA		16

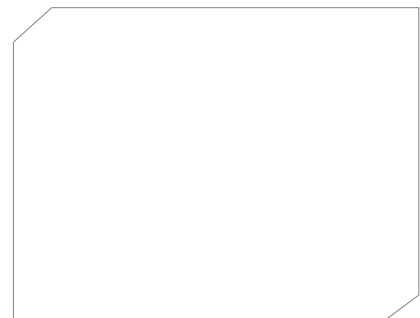

Gas Connectors

Commercial Gas Connectors

Gas Line System

Gas CSST Fittings

Water Line System

Water CSST Fittings

Braided Water Connectors

Supply Stop Valve

Water Heater Connectors

Isolation Valves

Thermal Expansion Tanks

No-Hub Couplings

Flexible Sprinkler Drops

SOFT-urn

HASSLE FREE BI-DIRECTIONAL TURN Tankless Water Heater Isolation Valve



Lead -Free

New Lead-Free compliant tankless water heater isolation valve featuring a smooth bi-directional turn knob for a drip tight seal.

- IPS connections
- Rated pressure : 125 psi
- Burst pressure : 500 psi
- Rated supply temperature : 160°F
- Maintains maximum water flow



Lead-Free Tankless Water Heater Isolation Valve Kits

Lead-Free Compact Isolation Valves for Tankless Water Heaters

New Lead-Free compliant tankless water heater isolation valve featuring a smooth bi-directional turn knob for easy maintenance.

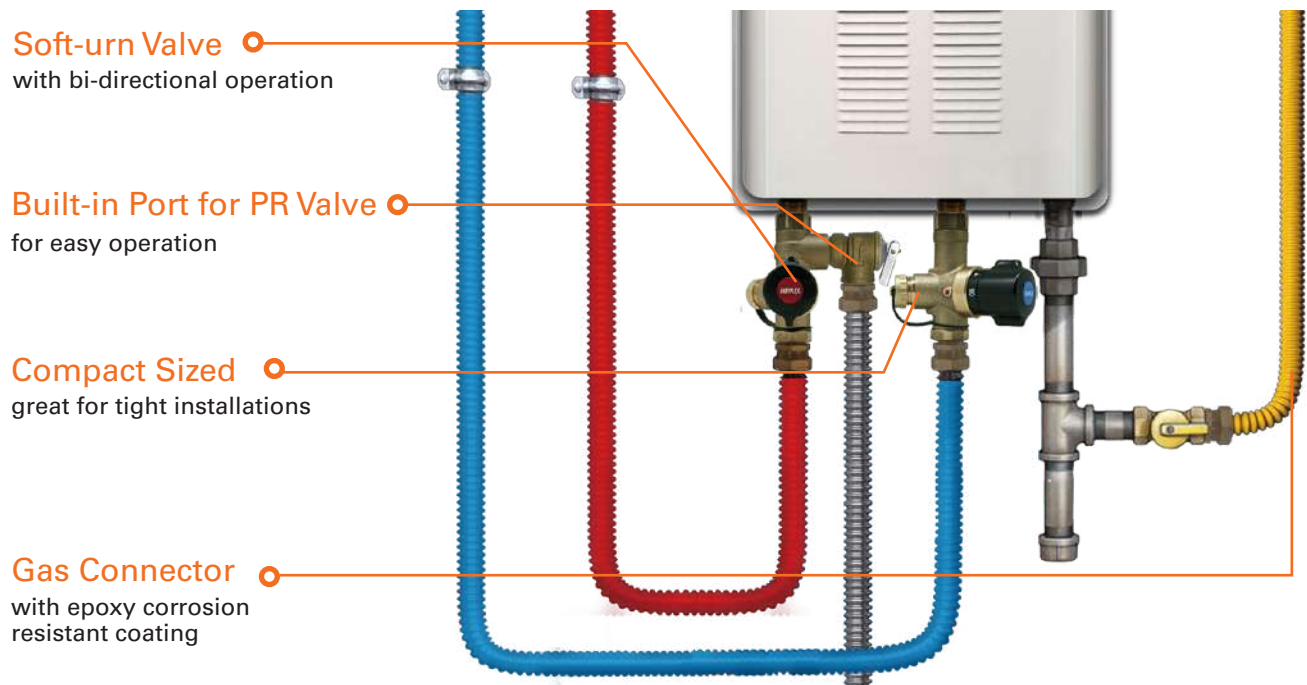

Installation

Easy two-step installation for your tankless water heater with unsurpassed safety, features and benefits. This is a complete inlet/outlet valve system that provides everything you need for a secure installation, including full port testing and flushing of the system with easy-to-install union connections.



- Gas Connectors
- Commercial Gas Connectors
- Gas Line System
- Gas CSST Fittings
- Water Line System
- Water CSST Fittings
- Braided Water Connectors
- Supply stop Valve
- Water Heater Connectors
- Isolation Valves
- Thermal Expansion Tanks
- No-Hub Couplings
- Flexible Sprinkler Drops

Lead-Free Tankless Water Heater Isolation Valves



TEST REPORT

5001 East Philadelphia Street
Ontario, California – USA 91761-2816
Ph: 909.472.4100 | Fax: 909.472.4243
<http://www.iapmortl.org>

Report Number: 885-14017 **Project No.:** 22830

Report Issued: February 11, 2014

Client: Kofulso
377-8 Gum Gok-Dong Seo-Gu
Incheon City, South Korea 404-330

Contact: Hun Kim

Source of Samples: The samples were sent by Kofulso, and received by IAPMO R&T Lab in good condition on January 08, 2014.

Date of Testing: January 16, 2014 through February 11, 2014

Sample Description: Isolation valves for Instantaneous Water Heaters.

Model number	Description
EF-ISV-H2	Tankless Water Heater Hot service valve
EF-ISV-C2	Tankless Water Heater Cold service valve

Scope of Testing: The purpose of the testing was to determine if the samples tested of the isolation valves met the applicable requirements of ASME A112.18.1-2012/CSA B125.1-12, entitled, "Plumbing Supply Fittings".

Conclusion: the samples tested of the isolation valves, models listed above, from Kofulso **COMPLIED** with the applicable requirements of ASME A112.18.1-2012/CSA B125.1-12.

Pending: NSF61/372

By our signatures below, we certify that all the testing and sample preparation for this report was performed under continuous, direct supervision of IAPMO R&T Lab, unless otherwise stated.

Tested by,

Reviewed by,

Vinh Nguyen, Test Technician

Sean Vuu, P.E., Manager, Specialty Projects

This report may not be copied, except in its entirety, without the written permission of IAPMO R&T Lab

Lead-Free Tankless Water Heater Isolation Valve Kits

Lead-Free Tankless Water Heater Isolation Valve Kit 1

- Hot & Cold Valve
- Complies to NSF 61 and 372
- 3/4" Size (FIP Threaded)
- Brass
- Rated pressure: 125 psi
- Burst pressure: 500 psi
- Rated supply temperature: 160° F



Part #	Description	U/M	Price	Qty/ Box
EF-ISV-3	Lead-Free Tankless Water Heater Service Valves, Hot & Cold Valve	EA		12



Lead-Free Tankless Water Heater Isolation Valve Kit 2

- Hot & Cold Valve
- Pressure Relief Valve
- Complies to NSF 61 and 372
- 3/4" Size (FIP Threaded)
- Brass
- Rated pressure: 125 psi
- Burst pressure: 500 psi
- Rated supply temperature: 160° F



Part #	Description	U/M	Price	Qty/ Box
EF-ISV-3PR	Lead-Free Tankless Water Heater Service Valves, Hot & Cold Valve w/ Pressure Relief Valve	EA		12



Lead-Free Tankless Water Heater Isolation Valve Kit 3 (Sweat)

- Hot & Cold Valve
- Complies to NSF 61 and 372
- 3/4" Size (Sweat Threaded)
- Brass
- Rated pressure: 125 psi
- Burst pressure: 500 psi
- Rated supply temperature: 160° F



Part #	Description	U/M	Price	Qty/ Box
EF-ISV-SW-3	Lead-Free Tankless Water Heater Service Valves, Hot & Cold Valve (Sweat Type)	EA		12



Lead-Free Tankless Water Heater Isolation Valve Kit 4 (Sweat)

- Hot & Cold Valve
- Pressure Relief Valve
- Complies to NSF 61 and 372
- 3/4" Size (Sweat Threaded)
- Brass
- Rated pressure: 125 psi
- Burst pressure: 500 psi
- Rated supply temperature: 160° F



Part #	Description	U/M	Price	Qty/ Box
EF-ISV-SW-3PR	Lead-Free Tankless Water Heater Service Valves, Hot & Cold Valve w/ Pressure Relief Valve (Sweat Type)	EA		12



Gas Connectors

Commercial Gas Connectors

Gas Line System

Gas CSST Fittings

Water Line System

Water CSST Fittings

Braided Water Connectors

Supply stop Valve

Water Heater Connectors

Isolation Valves

Thermal Expansion Tanks

No-Hub Couplings

Flexible Sprinkler Drops

CUSTOMIZE YOUR KIT



Tankless Water Heater Connection Kit

Tankless Water Heater Connection Kit



- Soft-urn & Ball valve type isolation valves
- PRV
- 3/4" WC (FIP×FIP/MIP×FIP)
- 3/4" & 1/2" GC (MIP×MIP/MIP×FIP)

Part #	Description	U/M	Price	Qty/ Box
EF-TWH-Kit-1	Isolation Valves / Water Connectors / Gas Connectors	EA		1

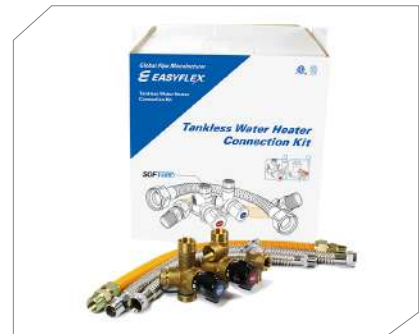

Tankless Water Heater Connection Kit

Contents

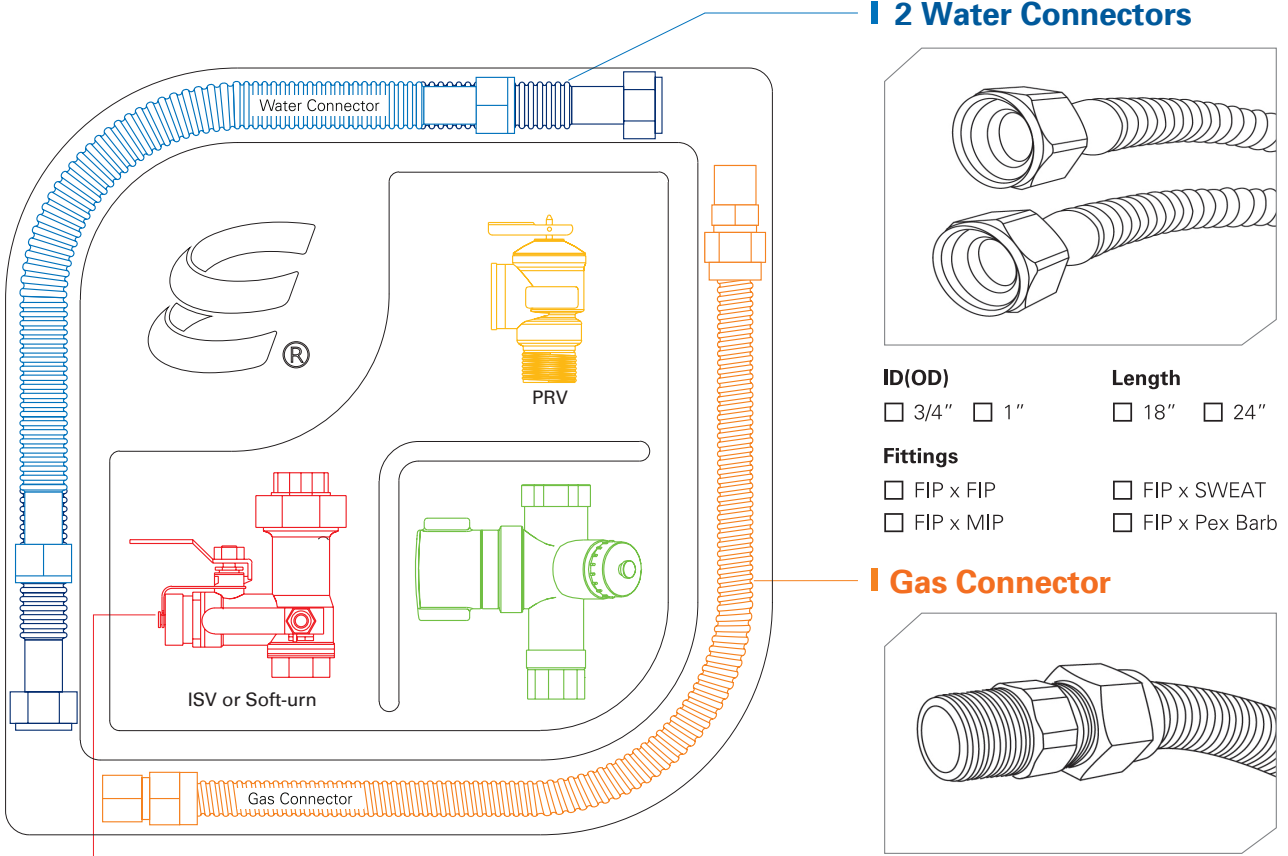

2 Water Connectors

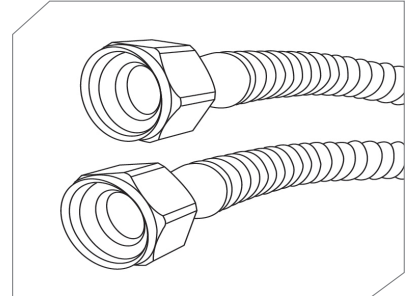

ID(OD)	<input type="checkbox"/> 3/4" <input type="checkbox"/> 1"	Length	<input type="checkbox"/> 18" <input type="checkbox"/> 24"
Fittings	<input type="checkbox"/> FIP x FIP <input type="checkbox"/> FIP x MIP	<input type="checkbox"/> FIP x SWEAT <input type="checkbox"/> FIP x Pex Barb	

1 Gas Connector

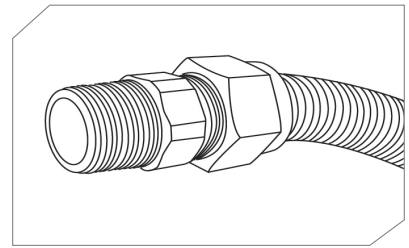

ID(OD)	<input type="checkbox"/> 1/2" (5/8" OD) <input type="checkbox"/> 3/4" (1" OD)	Type	<input type="checkbox"/> SS (Stainless steel) <input type="checkbox"/> YE (Yellow coated)
Length	<input type="checkbox"/> 18" <input type="checkbox"/> 24"	Fittings	<input type="checkbox"/> 3/4" MIP x 3/4" FIP <input type="checkbox"/> 1/2" MIP x 1/2" MIP <input type="checkbox"/> 1/2" MIP x 3/4" MIP <input type="checkbox"/> 1/2" MIP x 1/2" FIP <input type="checkbox"/> 3/4" MIP x 3/4" MIP

Isolation Valve

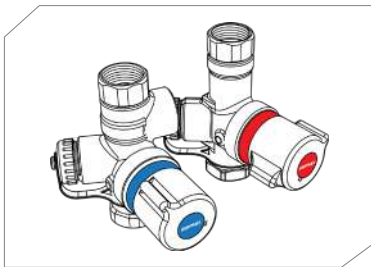

Soft-urn (Dial - knob type)

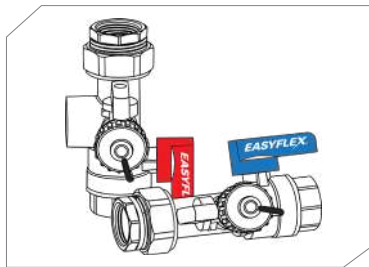

Isolation Valves (Ball valve type)

- Customizable Tankless Water Heater Connection Kits
- Traditional Ball Valves or Easyflex's Soft-urn Valves
- 2 Flexible Water Heater Connections - Your Choice of Size and Fittings
- 1 Flexible Gas Connector - Your Choice of Size and Fittings
- Everything You Need In One Neat Box

Gas Connectors
Commercial Gas Connectors
Gas Line System
Gas CSST Fittings
Water Line System
Water CSST Fittings
Braided Water Connectors
Supply Valve
Water Heater Connectors
Isolation Valves
Thermal Expansion Tanks
No-Hub Couplings
Flexible Sprinkler Drops



Thermal Expansion Tanks

Designed to protect potable water heater systems,
and helps maintain operational efficiency.



Thermal Expansion Tanks

Features

- Stainless Steel 3/4" MIP with Hex
- Butyl Rubber Diaphragm
- NSF 61 Compliant
- Factory pre-charged at 40 psig

Benefits

- Protects water heater, fixtures and appliances
- Prevents dangerous pressure build up
- Stainless steel connector
- Provides a reservoir for expanded water volume

Certifications

- cUPC



Materials

Shell	16 gauge cold rolled steel
Diaphragm	100% butyl rubber, lined with polypropylene
Connection	Stainless Steel

Pressure-Temperature

Connection Size	3/4" MIP
Tank Volume	2 Gallons / 4.5 Gallons
Factory Pre-Charge	40 psi
Max. Pressure	150 psi
Max. Temperature	200 °F

- Gas Connectors
- Commercial Gas Connectors
- Gas Line System
- Gas CSST Fittings
- Water Line System
- Water CSST Fittings
- Braided Water Connectors
- Supply stop Valve
- Water Heater Connectors
- Isolation Valves
- Thermal Expansion Tanks
- No-Hub Couplings
- Flexible Sprinkler Drops

Thermal Expansion Tanks



Thermal Expansion Tank (Water Heater Safety)

Built with a heavy duty butyl diaphragm system to absorb the expansion of water volume and helps prevent dangerous pressure build-up.

Stainless Steel

water connection to reduce corrosion

100% Pressure Tested

16 Gauge Solid Steel Shell

finished with the high quality urethane paint

Steel Clench Ring Regulates Movement

and prevents the diaphragm from rubbing against the tank wall



Easyflex Tankone water expansion tanks are designed to maintain safe pressures in a domestic water heating system that utilizes a backflow preventer or check valve. Tankone features a butyl rubber diaphragm and plastic liner to separate the system water from the tank's air charge. The system connection has a stainless steel nipple to prevent corrosion. High quality coating on the shell helps prevent external corrosion. Every Tankone tank is comprehensively tested and backed by an Easyflex 5 year limited warranty.

Materials

- Shell: 16 Gauge Cold Rolled Steel
- Finish: High Quality Coating Prevents Corrosion
- Diaphragm: 100% Butyl Rubber, Lined with Polypropylene
- Connection: Stainless Steel 3/4" MIP
- Air Charging Port: Brass Port with O-ring Seal

Thermal Expansion Tanks



Thermal Expansion Tank

- Shell: 16 Gauge Steel
- Stainless Steel Connection : 3/4" MIP
- Max. Pressure : 150 psi
- Max. Temperature : 200 °F



Part #	Description	U/M	Price	Qty/ Box
EF-TET-2	Thermal Expansion Tank, 2 Gallon	EA		1



Thermal Expansion Tank

- Shell: 16 Gauge Steel
- Stainless Steel Connection : 3/4" MIP
- Max. Pressure : 150 psi
- Max. Temperature : 200 °F



Part #	Description	U/M	Price	Qty/ Box
EF-TET-4	Thermal Expansion Tank, 4.5 Gallon	EA		1

- Gas Connectors
- Commercial Gas Connectors
- Gas Line System
- Gas CSST Fittings
- Water Line System
- Water CSST Fittings
- Braided Water Connectors
- Supply stop Valve
- Water Heater Connectors
- Isolation Valves
- Thermal Expansion Tanks**
- No-Hub Couplings
- Flexible Sprinkler Drops



No-Hub Couplings Cast Iron Soil Pipe Connections

Standard, Heavy Duty, and Reducing No-hub Couplings for all types of pipe connections.



No-Hub Couplings

Cast Iron Soil Pipe Connections

Applications

Provides a fast and easy fit for joining hubless cast iron soil pipes and fittings in drain waste and vent applications.

Benefits

- Soft Rubber Gaskets that Mold to the Pipes
- Water Tight Seal
- Low Expansion and Contraction
- Resistance to Vibrations

Certifications & Approvals

- UPC
- CSA
- NSF
- Conforms to CISPI 310, ASTM C1277 (Super Shield ASTM C1540)



Materials

Clamp	SS 301 AISI Stainless Steel (Super Shield SS 304)
Housing	SS 301 AISI Stainless Steel
Screw	5/16" Hex, SS 305 Stainless Steel (Super Shield SS 304)
Shield	Thickness: 0.007" SS 301 AISI Stainless Steel (Super Shield SS 304)
Gasket	Elastomeric compound conforming to ASTM C564

Technical Specifications

Installation Torque	60 in-lbs (Super Shield 80 in-lbs)
---------------------	------------------------------------

Gas Connectors

Commercial Gas Connectors

Gas Line System

Gas CSST Fittings

Water Line System

Water CSST Fittings

Braided Water Connectors

Supply stop Valve

Water Heater Connectors

Isolation Valves

Thermal Expansion Tanks

No-Hub Couplings

Flexible Sprinkler Drops

No-Hub Couplings **Cast Iron Soil Pipe Connections**

Submittal No-Hub Couplings

Easyflex No-Hub Couplings meet CISPI 310-2011 and ASTM C 1277-2012 standards. Couplings consist of a stainless steel shield, clamp assembly and a gasket manufactured from a properly vulcanized virgin compound in which the primary elastomer is polychloroprene conforming to ASTM C 564.



Coupling sizes range 1-1/2" through 10" diameters. The stainless steel shield and clamp assemblies are corrosion resistant.

Sleeve Test

Test	Physical Tests Min or Max Requirements	ASTM
Tensile Strength	1500 psi min.	D412
Elongation	250 min.	D412
Durometer	70 ± 5 @ 76° F ± 5° F	D2240
Accelerated aging	15% maximum tensile and 20% maximum elongation deterioration, 10 points maximum increase in hardness, all determinations after oven aging for 96 hours at 158°F	D573
Compression Set	25% maximum after 22 hours at 158° F	D395
Oil Immersion	80% maximum volume change after immersion in IRM 903 for 70 hours at 212° F	D471
Ozone Cracking	No visible cracking at 2 times magnification of the gasket after 100 hours exposure in 1.5ppm ozone concentration at 100°F. Testing and inspection to be on gasket which is loop mounted to give approximately 20% elongation of outer surface.	D1149
Tear Resistance	150 lbs. minimum per inch of thickness	D624
Water Absorption	20% maximum by weight after 7 days at 158° F	D471

	Size	Shield Width	No. of Camps	Torque (Inch Pounds)
Standard	1-1/2", 2", 3", 4"	2-1/8"	2	60
	5", 6"	3"	4	60
	8", 10"	4"	4	60
Standard NSF	1-1/2", 2", 3", 4"	-	2	60
	5", 6", 8", 10"	-	4	60
Heavy Duty	2", 3", 4"	3"	4	60
	5", 6", 8", 10"	4"	6	60
Super Shielded	1-1/2", 2", 3", 4"	-	4	80
	5", 6", 8", 10"	-	6	80
Reducing	2"×1-1/2", 3"×2", 4"×2", 4"×3"	2-1/8"	2	60

No-Hub Couplings *Cast Iron Soil Pipe Connections*



Descriptive and Test Report

MASTER CONTRACT: 219663

REPORT: 1467490

PROJECT: 2260094

- Edition 1:** September 09, 2003; Project 1467490 - Cleveland
Issued by Steve Tucky; Reviewed by Trevor Perera
- Edition 2:** September 23, 2008; Project 2078602 - Toronto
Issued by Ramiro Mata; Reviewed by Matthew Tomsic
- Edition 3:** February 9, 2010; Project 2260094 - Toronto
Issued by Kelly Yaremko; Reviewed by Gabriel Lippa

Contents: Certificate of Compliance - Page 1
Supplement to Certificate of Compliance – Page 1
Description and Tests – Pages 1 to 3
Figures – 1 to 18

PRODUCTS

CLASS 7021 01 – PIPE AND PIPE FITTINGS- Mechanical Joints (Non-Transitional Type)
CLASS 7021 02 – PIPE AND PIPE FITTINGS- Mechanical Coupling Mechanical joint (MJ) couplings, for use with plain-end cast iron soil pipe and pipe fittings

Same size pipe fittings; 1-1/2, 2, 3, 4, 5, 6, 8, 10 inch. (Corrugated Shield)
Reduced size pipe fittings; 2 x 1-1/2, 3 x 2, 4 x 3, 4 x 2 inch. (Corrugated Shield)

APPLICABLE REQUIREMENTS

CSA Standard CSA-B70-02 Cast Iron Soil Pipe, Fittings, and Means of Joining
CSA Standard CSA-B602-05 Mechanical Couplings for Drain, Waste, and Vent Pipe and Sewer Pipe

MARKINGS

The following permanent marking appears on the products in an acceptable manner.



Certification Marking: CSA Monogram.  on rubber gasket and shield.

The test report shall not be reproduced, except in full, without the approval of CSA International.

178 Rexdale Boulevard, Toronto, ON, Canada M9W 1R3
Telephone: 416.747.4000 1.800.463.6727 Fax: 416.747.4149 www.csa-international.org

Gas
Connectors

Commercial
Gas
Connectors

Gas
Line System

Gas
CSST Fittings

Water
Line System

Water
CSST Fittings

Braided
Water
Connectors

Supply stop
Valve

Water
Heater
Connectors

Isolation
Valves

Thermal
Expansion
Tanks

No-Hub
Couplings

Flexible
Sprinkler
Drops

No-Hub Couplings *Cast Iron Soil Pipe Connections*

No-Hub Coupling | Standard

- Clamp / Housing : SS 301 Stainless Steel
- Screw : SS 305 Stainless Steel



Part #	Description	U/M	Price	Qty/ Box
EF-NHC-112	1-1/2" No-Hub Coupling, 2 Bands	EA		100
EF-NHC-200	2" No-Hub Coupling, 2 Bands	EA		100
EF-NHC-300	3" No-Hub Coupling, 2 Bands	EA		100
EF-NHC-400	4" No-Hub Coupling, 2 Bands	EA		100
EF-NHC-500	5" No-Hub Coupling, 4 Bands	EA		30
EF-NHC-600	6" No-Hub Coupling, 4 Bands	EA		30
EF-NHC-800	8" No-Hub Coupling, 4 Bands	EA		15
EF-NHC-1000	10" No-Hub Coupling, 4 Bands	EA		12
EF-NHC-1200	12" No-Hub Coupling, 4 Bands	EA		8
EF-NHC-1500	15" No-Hub Coupling, 4 Bands	EA		4



No-Hub Coupling | Reducing

- Clamp / Housing : SS 301 Stainless Steel
- Screw : SS 305 Stainless Steel



Part #	Description	U/M	Price	Qty/ Box
EF-NHC-R2112	2"x1-1/2" Reducing No-Hub Coupling, 2 Bands	EA		100
EF-NHC-R3200	3"x2" Reducing No-Hub Coupling, 2 Bands	EA		100
EF-NHC-R4200	4"x3" Reducing No-Hub Coupling, 2 Bands	EA		100
EF-NHC-R4300	4"x3" Reducing No-Hub Coupling, 2 Bands	EA		100



No-Hub Coupling | Heavy Duty

- Clamp / Housing : SS 301 Stainless Steel
- Screw : SS 305 Stainless Steel
- Shield : 0.007" SS 301 Stainless Steel



Part #	Description	U/M	Price	Qty/ Box
EF-NHC-200HD	2" Heavy Duty No-Hub Coupling, 4 Bands	EA		75
EF-NHC-300HD	3" Heavy Duty No-Hub Coupling, 4 Bands	EA		48
EF-NHC-400HD	4" Heavy Duty No-Hub Coupling, 4 Bands	EA		48
EF-NHC-500HD	5" Heavy Duty No-Hub Coupling, 6 Bands	EA		15
EF-NHC-600HD	6" Heavy Duty No-Hub Coupling, 6 Bands	EA		15
EF-NHC-800HD	8" Heavy Duty No-Hub Coupling, 6 Bands	EA		15
EF-NHC-1000HD	10" Heavy Duty No-Hub Coupling, 6 Bands	EA		12



No-Hub Couplings *Cast Iron Soil Pipe Connections*

No-Hub Coupling | NSF

- Clamp/ Housing : SS 304 Stainless Steel
- Screw : SS 304 Stainless Steel
- Shield : 0.007" SS 301 Stainless Steel



Part #	Description	U/M	Price	Qty/ Box
EF-NHC-112N	1-1/2" No-Hub Coupling, 2 Bands, NSF	EA		100
EF-NHC-200N	2" No-Hub Coupling, 2 Bands, NSF	EA		100
EF-NHC-300N	3" No-Hub Coupling, 2 Bands, NSF	EA		100
EF-NHC-400N	4" No-Hub Coupling, 2 Bands, NSF	EA		100
EF-NHC-500N	5" No-Hub Coupling, 4 Bands, NSF	EA		30
EF-NHC-600N	6" No-Hub Coupling, 4 Bands, NSF	EA		30
EF-NHC-800N	8" No-Hub Coupling, 4 Bands, NSF	EA		15
EF-NHC-1000N	10" No-Hub Coupling, 4 Bands, NSF	EA		12



No-Hub Coupling | Super Shielded

- Clamp/ Housing : SS 304 Stainless Steel
- Screw : SS 304 Stainless Steel
- Shield : 0.007" SS 301 Stainless Steel



Part #	Description	U/M	Price	Qty/ Box
EF-NHC-112SS	1-1/2" No-Hub Coupling, 4 Bands, 3/8" HEX-Head	EA		75
EF-NHC-200SS	2" No-Hub Coupling, 4 Bands, 3/8" HEX-Head	EA		75
EF-NHC-300SS	3" No-Hub Coupling, 4 Bands, 3/8" HEX-Head	EA		48
EF-NHC-400SS	4" No-Hub Coupling, 4 Bands, 3/8" HEX-Head	EA		48
EF-NHC-500SS	5" No-Hub Coupling, 6 Bands, 3/8" HEX-Head	EA		15
EF-NHC-600SS	6" No-Hub Coupling, 6 Bands, 3/8" HEX-Head	EA		15
EF-NHC-800SS	8" No-Hub Coupling, 6 Bands, 3/8" HEX-Head	EA		15
EF-NHC-1000SS	10" No-Hub Coupling, 6 Bands, 3/8" HEX-Head	EA		10



- Gas Connectors
- Commercial Gas Connectors
- Gas Line System
- Gas CSST Fittings
- Water Line System
- Water CSST Fittings
- Braided Water Connectors
- Supply stop Valve
- Water Heater Connectors
- Isolation Valves
- Thermal Expansion Tanks
- No-Hub Couplings
- Flexible Sprinkler Drops

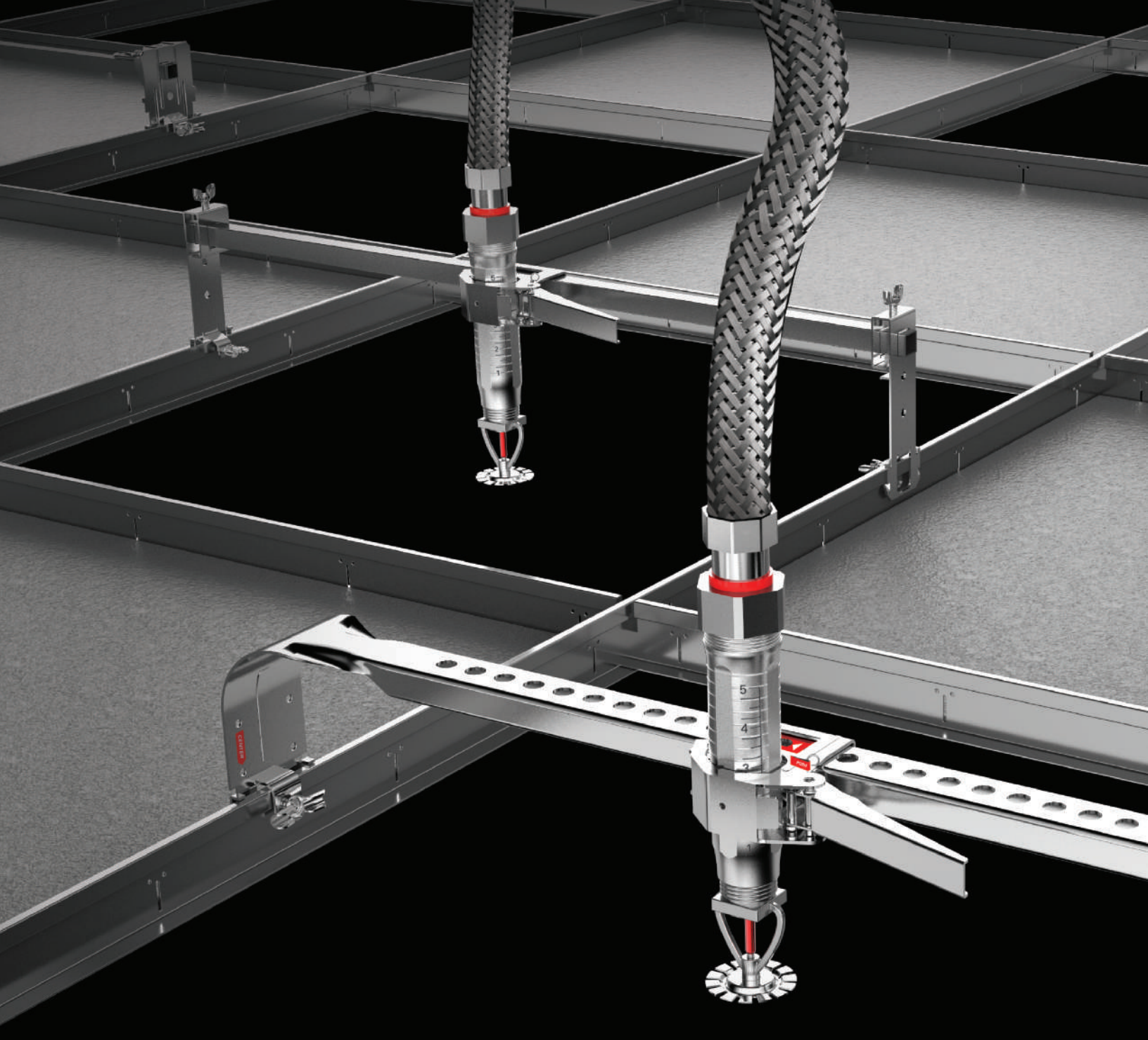

Commercial Flexible Fire Sprinkler Drops

The best solution for renovations and new construction.

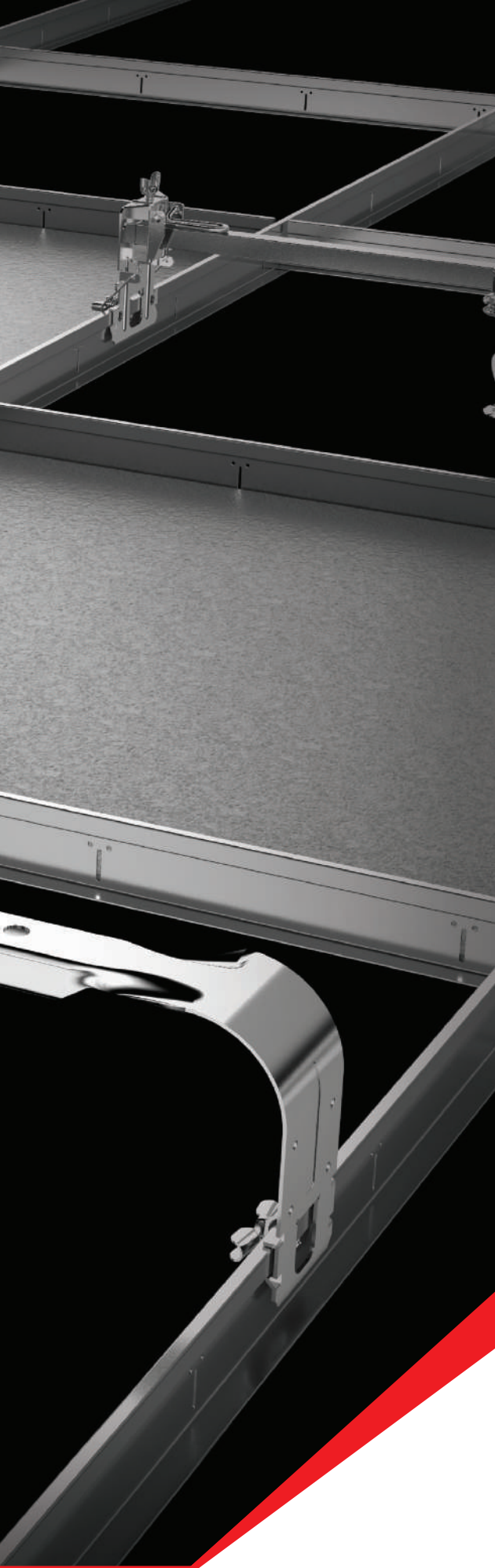

Commercial Flexible Fire Sprinkler Drops

Features & Materials

Lengths Available	Unbraided	28", 40", 48", 60", 72"
	Braided	24", 36", 48", 60", 72"
Outlet	1/2", 3/4"(Straight or 90° Elbow)	
Types	Unbraided	Braided
Hose Type	Stainless Steel 304	
Nut & Nipple	Zinc-Plated Steel	
Sealing Gasket / Isolation Ring	EPDM / NYLON	

Technical Data

Max. Temp.	225°F	
Operation Pressure	175 psi	
Connections	Inlet	1" NPT
	Outlet	1/2" or 3/4" NPT
Max. Bend Radius	Unbraided	4"(UL)
	Braided	4"(UL), 8"(FM)
K-Factors	1/2" Outlet	5.6
	3/4" Outlet	8.0

UNBRAIDED HOSE



BRAIDED HOSE



Certifications

- UL
- FM



Commercial Gas Connectors

Commercial Gas Connectors

Gas Line System

Gas CSST Fittings

Water Line System

Water CSST Fittings

Braided Water Connectors

Supply Stop Valve

Water Heater Connectors

Isolation Valves

Thermal Expansion Tanks

No-Hub Couplings

Flexible Sprinkler Drops

Commercial Flexible Fire Sprinkler Drops

Unbraided Flexible Hose

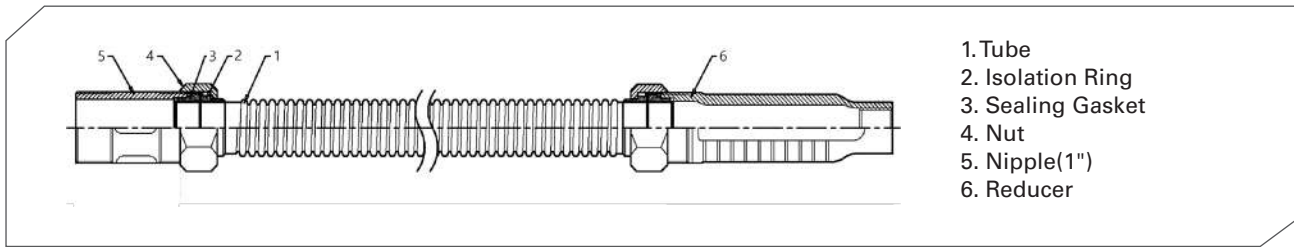

Specifications

Max. Temp.	150°F	
Max. Pressure.	203 psi	
Min. Bend Radius	4"	
K-Factors	1/2" Outlet	5.6
	3/4" Outlet	8.0

Size & Length

Outlet	1/2", 3/4"
Inlet	1" NPT
Length	28", 40", 48", 60", 72"

Friction Loss Data

EFU Series Unbraided Hose / TBSS



Lengths (in.)	Outlet Connection	Maximum Number of 90° Bends	Equivalent Length of 1in. Schedule 40 Pipe, ft.
28"	1/2"	2	27
	3/4"	2	28
40"	1/2"	3	37
	3/4"	3	41
48"	1/2"	3	49
	3/4"	3	47
60"	1/2"	3	63
	3/4"	3	64
72"	1/2"	4	78
	3/4"	4	80

* UL: 4" Minimum bend radius, where C=120

Unbraided

• Materials : Stainless Steel 304



Part #	Description	U/M	Price	Qty/ Box
EFU 228	1/2" FIP x 1" MIP	EA		20
EFU 328	3/4" FIP x 1" MIP	EA		20
EFU 240	1/2" FIP x 1" MIP	EA		20
EFU 340	3/4" FIP x 1" MIP	EA		20
EFU 248	1/2" FIP x 1" MIP	EA		10
EFU348	3/4" FIP x 1" MIP	EA		10
EFU 260	1/2" FIP x 1" MIP	EA		10
EFU 360	3/4" FIP x 1" MIP	EA		10
EFU 272	1/2" FIP x 1" MIP	EA		10
EFU 372	3/4" FIP x 1" MIP	EA		10

Commercial Flexible Fire Sprinkler Drops

Braided Flexible Hose

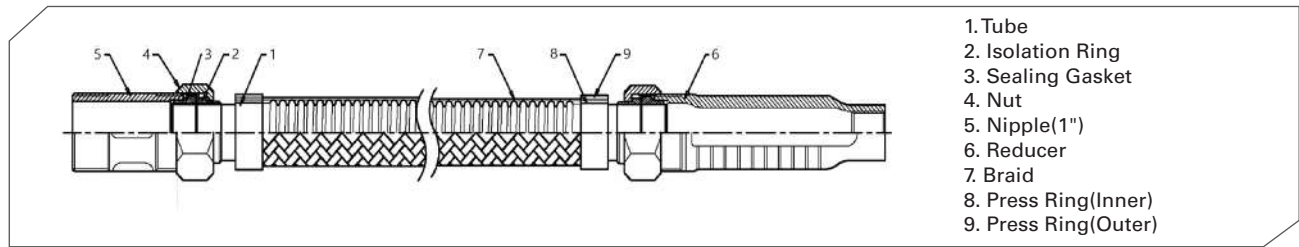

Specifications

Max.Temp.	225°F	
Max.Pressure.	175 psi	
Min. Bend Radius	4"	
K-Factors	1/2" Outlet	5.6
	3/4" Outlet	8.0

Size & Length

Outlet	1/2", 3/4"
Inlet	1" NPT
Length	24", 36", 48", 60", 72"

Friction Loss Data

EFB Series Braided Hose / TBS Bracket Systems



Lengths (in.)	Outlet Connection	Maximum Number of 90° Bends	Equivalent Length of 1in. Schedule 40 Pipe, ft.
24"	1/2"	1	18
	3/4"	1	18
36"	1/2"	2	31
	3/4"	2	34
48"	1/2"	3	48
	3/4"	3	51
60"	1/2"	4	60
	3/4"	4	65
72"	1/2"	4	71
	3/4"	4	72

* UL: 4" minimum bend radius, where C=120

Braided

• Materials : Stainless Steel 304



Part #	Description	U/M	Price	Qty/ Box
EFB 224	1/2" FIP x 1" MIP	EA		20
EFB 324	3/4" FIP x 1" MIP	EA		20
EFB 236	1/2" FIP x 1" MIP	EA		20
EFB 336	3/4" FIP x 1" MIP	EA		20
EFB 248	1/2" FIP x 1" MIP	EA		10
EFB 348	3/4" FIP x 1" MIP	EA		10
EFB 260	1/2" FIP x 1" MIP	EA		10
EFB 360	3/4" FIP x 1" MIP	EA		10
EFB 272	1/2" FIP x 1" MIP	EA		10
EFB 372	3/4" FIP x 1" MIP	EA		10



Gas Connectors
 Commercial Gas Connectors
 Gas Line System
 Gas CSST Fittings
 Water Line System
 Water CSST Fittings
 Braided Water Connectors
 Supply stop Valve
 Water Heater Connectors
 Isolation Valves
 Thermal Expansion Tanks
 No-Hub Couplings
 Flexible Sprinkler Drops

Commercial Flexible Fire Sprinkler Drops

Braided Flexible Hose

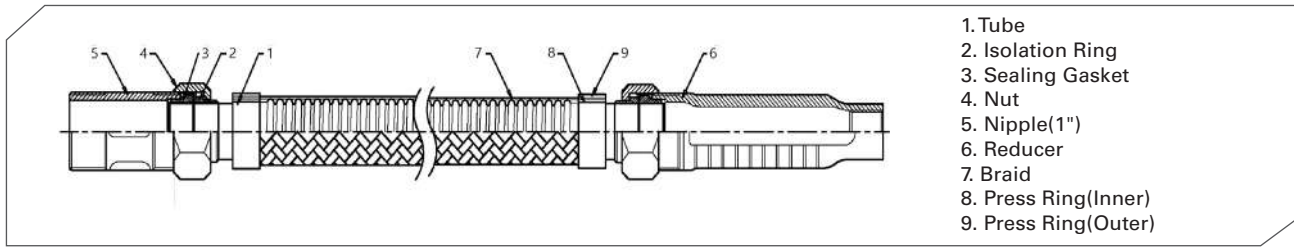

Specifications

Max.Temp.	225°F	
Max.Pressure.	175 psi	
Min. Bend Radius	8"	
K-Factors	1/2" Outlet	5.6
	3/4" Outlet	8.0

Size & Length

Outlet	1/2", 3/4"
Inlet	1" NPT
Length	24", 36", 48", 60", 72"

Friction Loss Data

EFB Series Braided Hose / OGSB,TBS Bracket Systems



Lengths (in.)	Outlet Connection	Maximum Number of 90° Bends	Equivalent Length of 1in. Schedule 40 Pipe, ft. (with straight outlet)	Equivalent Length of 1in. Schedule 40 Pipe, ft. (with 90° outlet)
24"	1/2"	1	27.0	28.4
	3/4"	1	18.6	19.7
36"	1/2"	2	37.4	38.8
	3/4"	2	30.4	30.9
48"	1/2"	3	54.9	57.1
	3/4"	3	48.3	50.4
60"	1/2"	4	72.5	75.4
	3/4"	4	66.2	69.9
72"	1/2"	4	90.5	90.9
	3/4"	4	83.0	84.5

FM : 8" minimum bend radius, where C=120

Braided

• Materials : Stainless Steel 304



Part #	Description	U/M	Price	Qty/ Box
EFB 224	1/2" FIP x 1" MIP	EA		20
EFB 324	3/4" FIP x 1" MIP	EA		20
EFB 236	1/2" FIP x 1" MIP	EA		20
EFB 336	3/4" FIP x 1" MIP	EA		20
EFB 248	1/2" FIP x 1" MIP	EA		10
EFB 348	3/4" FIP x 1" MIP	EA		10
EFB 260	1/2" FIP x 1" MIP	EA		10
EFB 360	3/4" FIP x 1" MIP	EA		10
EFB 272	1/2" FIP x 1" MIP	EA		10
EFB 372	3/4" FIP x 1" MIP	EA		10

Commercial Flexible Fire Sprinkler Drops

Braided Flexible Hose (High Performance)

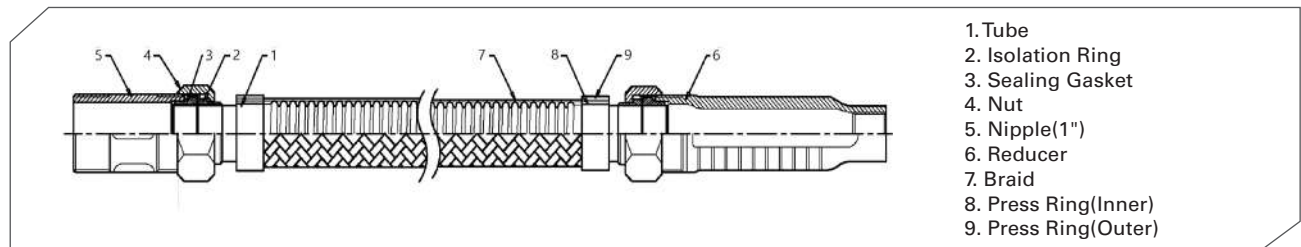

Specifications

Max.Temp.	225°F	
Max.Pressure.	175 psi	
Min. Bend Radius	8"	
K-Factors	1/2" Outlet	5.6
	3/4" Outlet	8.0 / 14.0

Size & Length

Outlet	1/2", 3/4"
Inlet	1" NPT
Length	24", 36", 48", 60", 72"

Friction Loss Data

EFB HP Series Braided Hose / OGSB, TBS Bracket Systems



Lengths (in)	Outlet Connection	K-Factor	Maximum Number of 90° Bends	Equivalent Length of 1in. Schedule 40 Pipe, ft.
24"	1/2"	5.6	1	17.8
	3/4"	8.0 / 14.0	1	8.3 / 8.3
36"	1/2"	5.6	2	23.0
	3/4"	8.0 / 14.0	2	13.9 / 13.7
48"	1/2"	5.6	3	30.2
	3/4"	8.0 / 14.0	3	21.7 / 21.6
60"	1/2"	5.6	4	37.4
	3/4"	8.0 / 14.0	4	29.5 / 29.5
72"	1/2"	5.6	4	43.3
	3/4"	8.0 / 14.0	4	34.5 / 33.2

FM : 8" minimum bend radius, where C=120

Braided

• Materials : Stainless Steel 304

Part #	Description	U/M	Price	Qty/ Box
EFB 224HP	1/2" FIP x 1" MIP	EA		20
EFB 324HP	3/4" FIP x 1" MIP	EA		20
EFB 236HP	1/2" FIP x 1" MIP	EA		20
EFB 336HP	3/4" FIP x 1" MIP	EA		20
EFB 248HP	1/2" FIP x 1" MIP	EA		10
EFB 348HP	3/4" FIP x 1" MIP	EA		10
EFB 260HP	1/2" FIP x 1" MIP	EA		10
EFB 360HP	3/4" FIP x 1" MIP	EA		10
EFB 272HP	1/2" FIP x 1" MIP	EA		10
EFB 372HP	3/4" FIP x 1" MIP	EA		10



Gas Connectors

Commercial Gas Connectors

Gas Line System

Gas CSST Fittings

Water Line System

Water CSST Fittings

Braided Water Connectors

Supply stop Valve

Water Heater Connectors

Isolation Valves

Thermal Expansion Tanks

No-Hub Couplings

Flexible Sprinkler Drops

Commercial Flexible Fire Sprinkler Drops

Braided Flexible Hose (Ultra Performance)

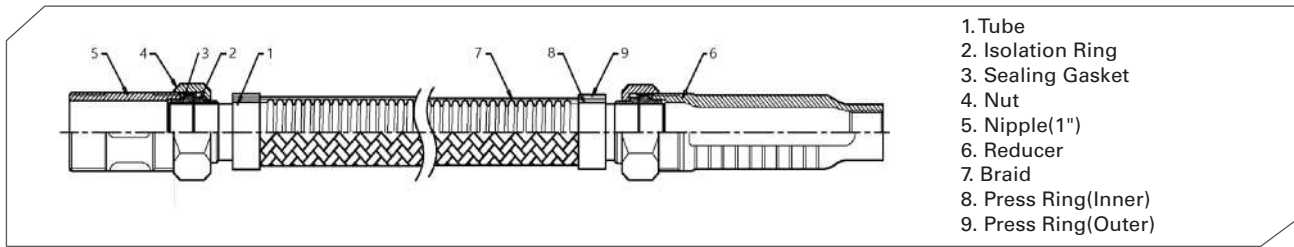

Specifications

Max.Temp.	225°F	
Max.Pressure.	225 psi	
Min. Bend Radius	6.5"	
K-Factors	1/2" Outlet	5.6 / 8.0
	3/4" Outlet	8.0 / 14.0

Size & Length

Outlet	1/2", 3/4"
Inlet	1" NPT or 1-1/4" Grooved
Length	24", 36", 48", 60", 72"

Friction Loss Data

EFB UP Series Braided Hose / OGSB,TBS Bracket Systems



Lengths (in)	Outlet Connection	K-Factor	Maximum Number of 90° Bends	Equivalent Length of 1in. Schedule 40 Pipe, ft.
24"	1/2"	5.6 / 8.0	1	2.1 / 3.6
	3/4"	8.0 / 14.0	1	3.6 / 3.8
36"	1/2"	5.6 / 8.0	2	4.5 / 5.1
	3/4"	8.0 / 14.0	2	6 / 6
48"	1/2"	5.6 / 8.0	3	6.9 / 6.6
	3/4"	8.0 / 14.0	3	8.4 / 8.3
60"	1/2"	5.6 / 8.0	4	9.4 / 8.7
	3/4"	8.0 / 14.0	4	10.9 / 10.6
72"	1/2"	5.6 / 8.0	4	11.9 / 9.7
	3/4"	8.0 / 14.0	4	13.4 / 12.9

FM : 6.5" minimum bend radius, where C=120

Braided

• Materials : Stainless Steel 304







Part #	Description	U/M	Price	Qty/ Box
EFB 224UP	1/2" FIP x 1" MIP	EA		20
EFB 324UP	3/4" FIP x 1" MIP	EA		20
EFB 236UP	1/2" FIP x 1" MIP	EA		20
EFB 336UP	3/4" FIP x 1" MIP	EA		20
EFB 248UP	1/2" FIP x 1" MIP	EA		10
EFB 348UP	3/4" FIP x 1" MIP	EA		10
EFB 260UP	1/2" FIP x 1" MIP	EA		10
EFB 360UP	3/4" FIP x 1" MIP	EA		10
EFB 272UP	1/2" FIP x 1" MIP	EA		10
EFB 372UP	3/4" FIP x 1" MIP	EA		10













Commercial Flexible Fire Sprinkler Drops

Parts for Unbraided and Braided Hoses (Standard, High Performance, Ultra Performance)

Reducer & Nipple

Image	Part #	Description	Image	Part #	Description
	RDL 12	Reducer 1/2" x 6"TXT (MXF)		RD 127 or 347	7" Reducer
	RDL 34	Reducer 3/4" x 6"TXT (MXF)		RD 128 or 348	8" Reducer
	LRDS 12 or 34	Elbow Reducer Short			NP 1
	LRDL 12 or 34	Elbow Reducer Long	SQ25		25" Stock Bar
				SQ50	50" Stock Bar

Center Bracket & End Bracket & One Piece Bracket

Image	Part #	Description	Image	Part #	Description
	SSB	Snap Clamp Center Bracket For Stock Bar		MSB	Metal Stud End Bracket
	OSSB	Open Gate Snap Center Bracket For Stock Bar		WSB	Wood Beam Stud End Bracket
	OSSBW	Open Gate Snap Side Wall Bracket For Stock Bar		OTBS-PA	Pre-assembled 24" or 48"
	OSSBJ	Open Gate Bracket With Mounting Threaded Rod		TBS-PA	Pre-assembled 24" or 48"
	TBS	Snap On T-Bar End Bracket (for recessed or concealed heads)		OGSB-02	Open Gate Snap System Bracket
	HCB	Hat Furring Channel End Bracket			
Image	Part #	Description	Image	Part #	Description
	GR	EPDM Gasket		PR	NYLON Isolation Ring

Gas Connectors

Commercial Gas Connectors

Gas Line System

Gas CSST Fittings

Water Line System

Water CSST Fittings

Braided Water Connectors

Supply Valve

Water Heater Connectors

Isolation Valves

Thermal Expansion Tanks

No-Hub Couplings

Flexible Sprinkler Drops



***Flexible Fire Sprinkler Drops for
Industrial Ducts & Cleanroom
Ceilings***



Flexible Fire Sprinkler Drops for Industrial Ducts / Cleanrooms

Applications

Industrial Ducts

Round or Square Metal Ducts

Cleanrooms

Specially Designed Ceilings

Materials

Tube & Nipples	Stainless Steel 304	
Flange	ABS (Duct)	Stainless Steel 304 (cleanroom)
O-ring	EPDM	No O Ring

Specifications

Max. Pressure	175 psig	
Max. Temperature.	225°F	
Min. Bend Radius	8"	
K-Factor	1/2" Outlet	5.6

Features

Size	1/2" Outlet, 1" Inlet	
Length	30", 47", 67"	
Type	Braided	

Certification

- FM



Ducts



Cleanroom Ceilings



Gas Connectors

Commercial Gas Connectors

Gas Line System

Gas CSST Fittings

Water Line System

Water CSST Fittings

Braided Water Connectors

Supply stop Valve

Water Heater Connectors

Isolation Valves

Thermal Expansion Tanks

No-Hub Couplings

Flexible Sprinkler Drops

Flexible Sprinkler Drops for *Industrial Ducts*

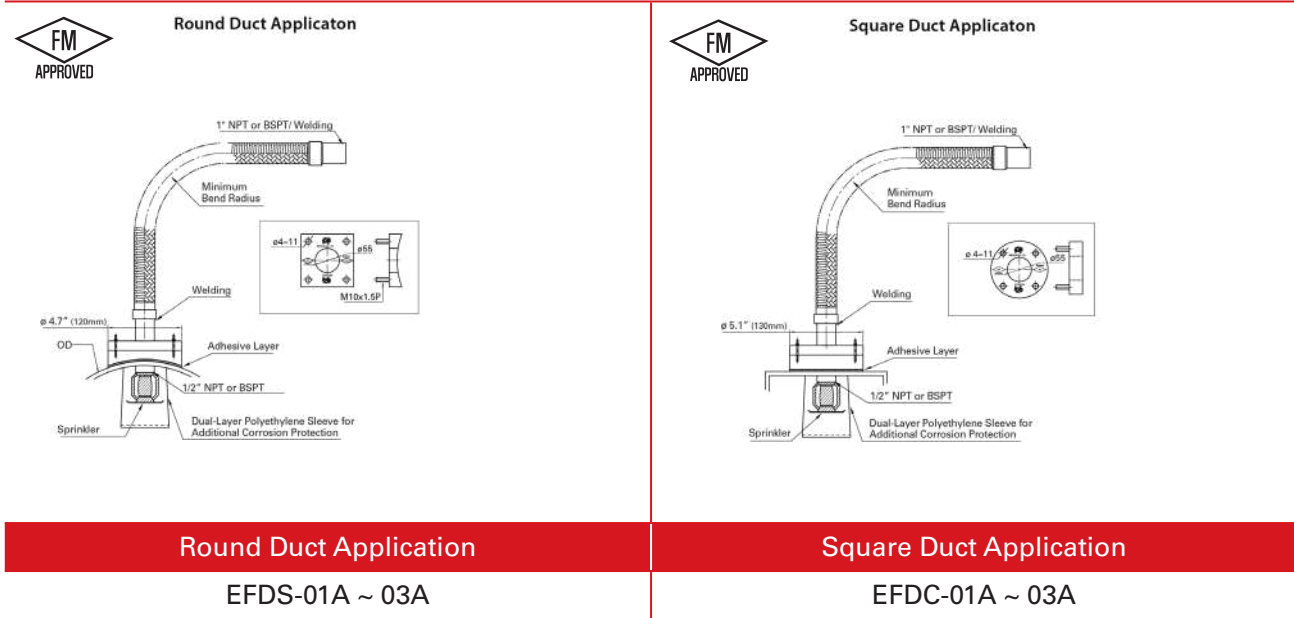

- Applicable for round and square ducts
- Pre-installed double layer polybag protects the life of the sprinkler head.

Model Numbers and Friction Loss Data

Model#	Length	Outlet	Max. # of 90° Bend	Equivalent Length of 1" Sch. 40 pipe in ft.
EFDC/ EFDS-01A	30"	1/2"	1	8.7
EFDC/ EFDS-02A	47"	1/2"	3	16.7
EFDC/ EFDS-03A	67"	1/2"	4	22.5

- Data on maximum number of bend(s) was provided as a test parameter by Easyflex and FM used maximum of 4 bends for their tests.

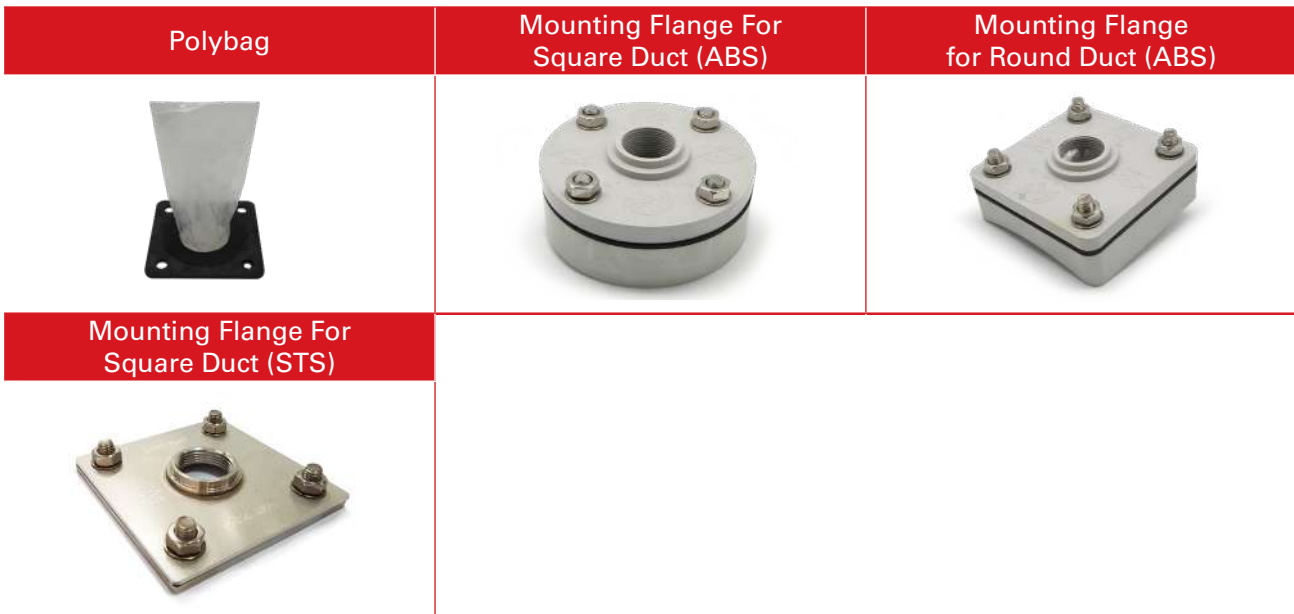

Flexible Sprinkler Drops for **Cleanrooms**

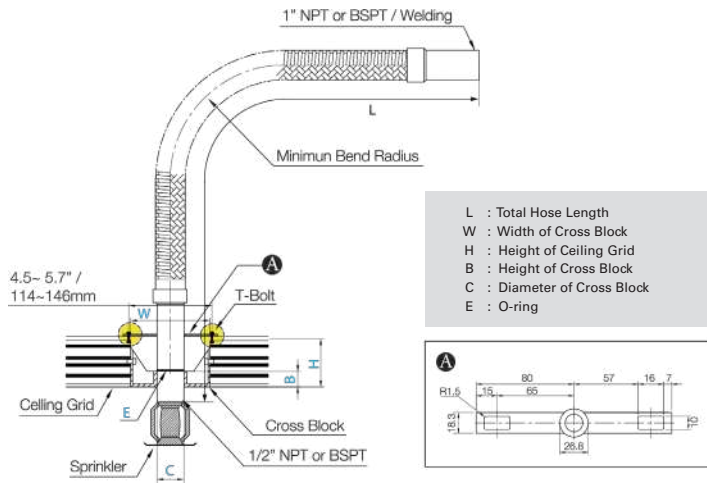

Sprinkler and escutcheon plate are not included

EFSPC-01A ~ 03A

Benefits

- Ready to install out of the box
- Accelerates cleanroom installation and certification
- Allows quick and easy relocations
- Dissipates any vibration even during seismic activities

Model Numbers and Friction Loss Data

Model#	Length	Outlet size	Max.# of 90° Bend	Equivalent Length of 1"Sch. 40 pipe in ft.
EFSPC-01A	30"	1/2"	1	1.6
EFSPC-02A	47"	1/2"	3	9.5
EFSPC-03A	67"	1/2"	4	13.6

- Data on Max. number of bend was provided as a test parameter by Easyflex and FM used a Max. of 4 bends for their test.

Gas Connectors
 Commercial Gas Connectors
 Gas Line System
 Gas CSST Fittings
 Water Line System
 Water CSST Fittings
 Braided Water Connectors
 Supply stop Valve
 Water Heater Connectors
 Isolation Valves
 Thermal Expansion Tanks
 No-Hub Couplings
Flexible Sprinkler Drops

TERMS AND CONDITIONS

ACCEPTANCE

Buyers expressly agree to terms and conditions when submitting a purchase order.

PAYMENT TERMS

Prices are F.O.B Easyflex distribution center and are subject to change at Easyflex's discretion. Our terms are 1% or 2% discount (as determined by product line) applied with payment within 10 days of receipt of goods and full payment of purchase price and other charges is due within thirty (30) days after invoice date*. Orders must be in box quantity, minimum of \$300. Broken boxes or orders below the minimum amount will incur a \$20 handling fee. If full payment is not received by the applicable due date, Buyer will incur a monthly late charge equal to 1.5% of all outstanding amounts in addition to other related collection or legal fees. Buyer shall be responsible for the payment of all taxes, duties, customs and other fees of any nature imposed to this transaction.

*Terms for qualified credit-approved buyers only.

CREDIT APPROVAL

All orders are subject to approval of Buyer's credit. If Buyer's credit is not approved by Easyflex prior to shipment of the Products, Easyflex may require different terms of payment from those specified in this document, including, but not limited to, requiring first three orders to be C.O.D. or full payment before shipment, requiring Buyer to pay Easyflex C.O.D or to return the products to Easyflex at Buyer's expense.

ORDERS

All orders are subject to acceptance by Easyflex and cannot be cancelled once accepted. No orders can be amended except with Easyflex written approval, and upon terms except Easyflex against any losses including loss of profit on additional costs resulting there from.

DELIVERY

Easyflex shall ship the Products to the location designated by Buyer via commercial carrier or private delivery at the date provide by Buyer in purchase order or earliest available shipment date, by most economical means. Easyflex will notify Buyer of changes or delays in shipping when information becomes available. Changes in the shipping schedule by Buyer may, at Easyflex's discretion, result in an increase in the freight costs.

WARRANTY

All Products sold by Easyflex are warranted to be free from defects in material and workmanship to the extent, in the manner and during the period provided in the applicable express warranty extended to Easyflex by the manufacture of such Products and to the extent Easyflex is able to enforce such manufacturer's warranty. Warranty varies dependent upon product line. Please see product line warranty information for specific information.

TERMS AND CONDITIONS

RETURNS AND CLAIMS

All claims for Products damaged and or lost during shipping must be made within seven (7) days after receipt to Easyflex or, if a common carrier is used, made to the common carrier within their specified claims period. Buyer will report to Easyflex exactly how the Products were damaged and request a Return Authorization Number to return the damaged Products to Easyflex. After Easyflex has inspected the damaged Products, Easyflex may replace the damaged Products at no cost to the Buyer, or issue a credit memo to the Buyer's account, or may disallow Buyer's claim, or may refer claim to the common carrier, if used. When the product is damaged in shipment, the Buyer is responsible for recovering any and all damages from the common carrier.

No returns will be accepted without our Return Authorization Number and there will be a 15% restocking fee. Buyer is responsible for all shipping and freight charges for returning products to Easyflex. In the first fifteen (15) days after a purchase, the Buyer may return the Products for full account credit and or exchange for products of the same price or greater. Buyer must tell Easyflex the specific reason(s) why they want to return the item. Easyflex may, at its discretion, not accept non-damaged Products for credit to the Buyer's account. All non-damaged Product(s) must be in resalable condition. After Easyflex confirms that the non-damaged Products are resalable, Easyflex will credit the Buyer's account.

NON-CONFORMING PRODUCTS

Buyer shall notify Easyflex within writing seven (7) days after delivery of any deficiencies or shortages; otherwise all such claims shall be deemed waived by Buyer. The use or resale by Buyer of any Products claimed to be non-conforming or deficient shall constitute acceptance of such items by Buyer. Buyer shall have no right to withhold payment of the purchase price or to adjust the amount of the purchase price because of such claims; the sole remedy shall be the replacement or repair by Easyflex, at Easyflex's option, of non-conforming or deficient items in accordance with the Disclaimer and Limited Warranty below.

CONFIDENTIALITY

Buyer and its directors, officers, employees and agents shall not disclose to any third party any information pertaining to the goods provided or services performed hereunder, or pertaining to Easyflex's business or operations which obtains or has access to in connection herewith, without the prior written consent of Easyflex.

NO WAIVER OF DEFAULTS

No failure by Easyflex to enforce at any time any of the terms or conditions of this agreement shall constitute a waiver thereof or in any way impair Easyflex's right at any time to avail itself of such remedies as it may have to enforce such terms or conditions. No waiver by Easyflex hereunder will be effective unless in writing and signed by Easyflex.

TERMS AND CONDITIONS

RETURNS AND CLAIMS

All claims for Products damaged and or lost during shipping must be made within seven (7) days after receipt to Easyflex or, if a common carrier is used, made to the common carrier within their specified claims period. Buyer will report to Easyflex exactly how the Products were damaged and request a Return Authorization Number to return the damaged Products to Easyflex. After Easyflex has inspected the damaged Products, Easyflex may replace the damaged Products at no cost to the Buyer, or issue a credit memo to the Buyer's account, or may disallow Buyer's claim, or may refer claim to the common carrier, if used. When the product is damaged in shipment, the Buyer is responsible for recovering any and all damages from the common carrier.

No returns will be accepted without our Return Authorization Number and there will be a 15% restocking fee. Buyer is responsible for all shipping and freight charges for returning products to Easyflex. In the first fifteen (15) days after a purchase, the Buyer may return the Products for full account credit and or exchange for products of the same price or greater. Buyer must tell Easyflex the specific reason(s) why they want to return the item. Easyflex may, at its discretion, not accept non-damaged Products for credit to the Buyer's account. All non-damaged Product(s) must be in resalable condition. After Easyflex confirms that the non-damaged Products are resalable, Easyflex will credit the Buyer's account.

NON-CONFORMING PRODUCTS

Buyer shall notify Easyflex within writing seven (7) days after delivery of any deficiencies or shortages; otherwise all such claims shall be deemed waived by Buyer. The use or resale by Buyer of any Products claimed to be non-conforming or deficient shall constitute acceptance of such items by Buyer. Buyer shall have no right to withhold payment of the purchase price or to adjust the amount of the purchase price because of such claims; the sole remedy shall be the replacement or repair by Easyflex, at Easyflex's option, of non-conforming or deficient items in accordance with the Disclaimer and Limited Warranty below.

CONFIDENTIALITY

Buyer and its directors, officers, employees and agents shall not disclose to any third party any information pertaining to the goods provided or services performed hereunder, or pertaining to Easyflex's business or operations which obtains or has access to in connection herewith, without the prior written consent of Easyflex.

NO WAIVER OF DEFAULTS

No failure by Easyflex to enforce at any time any of the terms or conditions of this agreement shall constitute a waiver thereof or in any way impair Easyflex's right at any time to avail itself of such remedies as it may have to enforce such terms or conditions. No waiver by Easyflex hereunder will be effective unless in writing and signed by Easyflex.

TERMS AND CONDITIONS

SEVERABILITY

Any provision of this agreement that is unenforceable in any jurisdiction shall be ineffective to the extent of such unenforceability (but shall be enforced to the maximum extent permissible) without invalidating the remaining provisions hereof.

GOVERNING LAW

This agreement shall be governed by the laws of the state from which the Easyflex corporate office resides (California), without giving effect to its principles of conflicts of law.

FORCE MAJEURE

Easyflex shall not be liable for any breach hereunder, including the failure to deliver or delays in delivery for causes beyond the control of Easyflex or Easyflex's suppliers or subcontractors, including, but not limited to, unavailability or excessive cost of material, strikes, labor slowdowns and stoppages, labor shortages, lockouts, fires, floods, earthquakes, storms, drought, adverse weather, riots, thefts, accidents, embargoes, war (whether or not declared) or other outbreaks of hostility, civil strike, acts of government, acts of God, acts of the public enemy, machinery breakdowns, delay or unavailability of carriers of suppliers, shortages of labor, and government acts or regulation, order or injunctions, or other reasons, whether similar or dissimilar to the forgoing (together a "Force Majeure Event"). In addition, in the event of a Force Majeure Event (i) the time for Easyflex's performance shall be reasonably extended (ii) Easyflex and Buyer shall take reasonable steps to adjust all affected dates in the agreement and (iii) an adjustment in the purchase price may be made for the resulting additional costs to Easyflex upon proof provided to Buyer.

LIMITED WARRANTY

Subject to the conditions and limitations in this Limited Warranty, Easyflex warrants to the real owner as installed by qualified installers, sold by Easyflex, under normal conditions of use, gas connectors, water connectors and components will be free from failure caused by manufacturing defects in material and workmanship for the lifetime of the original installation.

For VectorFlex CSST warranty, please visit vectorflex.com.

For VectorFlow CSST products, this limited warranty will be for (1) year from the original date of purchase.

For all gas connectors, this limited warranty will be for two (2) years from the original date of purchase.

For all water connectors, this limited warranty will be for one (1) year from the original date of purchase.

For all no hubs, this limited warranty will be for one (1) year from the original date of purchase.

Under this warranty, you only have a right to reimbursement if the failure or leak resulted from a manufacturing defect in the products covered by this warranty and occurred during the warranty period. You do not have a remedy or right of reimbursement under this warranty and this warranty does not apply if the failure or any resulting damage is caused by:

- Components other than those manufactured or sold by Easyflex
- Not designing, installing, inspecting or testing the connector in accordance with Easyflex's installation instructions at the time of the installation, applicable code requirements, and good plumbing/ piping/ fitting practices
- Improper handling and protection of the product prior to or during installation, inadequate freeze protection, exposure to pressures or temperatures in excess of the limitations on the tubing or fittings, or application of unauthorized solvents or chemicals
- Acts of nature such as earthquakes, fire, flood, or landslide
- Damage caused by lightning without proper grounding as per NFPA 780, NEC 2005 article 250.70 and clamps complying with UL 467 standards
- Exposure to abnormal environmental conditions relative to the norm for the installation site and outside manufacturer specified pressure and temperature range; including chemical and biological substance exposure
- Freezing during or after the installation or inadequate freeze protection
- Exposure to operating use and or conditions outside those specified by manufacturer

EASYFLEX SHALL NOT BE LIABLE FOR CONSEQUENTIAL ECONOMIC LOSS DAMAGES UNDER ANY LEGAL THEORY AND WHETHER ASSERTED BY DIRECT ACTION, FOR CONTRIBUTION OR INDEMNITY OR OTHERWISE. THE ABOVE LIMITED WARRANTY IS IN LIEU OF ALL OTHER WARRANTIES, EXPRESS OR IMPLIED, INCLUDING BUT NOT LIMITED TO, THE IMPLIED WARRANTIES OF MERCHANTABILITY AND FITNESS FOR A PARTICULAR PURPOSE.

Other than this limited warranty, Easyflex does not authorize any person or firm to create for it any other obligation or liability in connection with its products.

*Please request and read the full version of Easyflex Warranty explanation for more details.

PURCHASE ORDER



Date _____

Customer Acct. # _____

E-mail Address _____

Bill To _____

Ship To _____

Phone _____

FAX _____

P.O.#	Payment Terms	Freight Terms	Ship Via	Ship Date	Salesman/ Buyer
		PPD / COL			

Item #	Qty	Part #	Description	Unit Price	Total
1					
2					
3					
4					
5					
6					
7					
8					
9					
10					
11					
12					
13					
14					
15					

This order is only subject to approval by Easyflex. Any part or all is subject to cancellation or delay in delivery due to government regulation or contingencies beyond Easyflex's control. All prices subject to change without notice.



 **EASYFLEX**®