

# EXCEL<sup>®</sup>

BY JASON<sup>®</sup>

8328 MacArthur Drive • North Little Rock, AR 72118-2199  
501.771.4477 • Fax: 501.771.2333  
Customer Service: 800.255.5766  
EMail: tech@jasonhydrotherapy.com  
www.jasonhydrotherapy.com

## Excel<sup>™</sup> Series Specifications

### JAB3672

### Whirlpool & Soaking

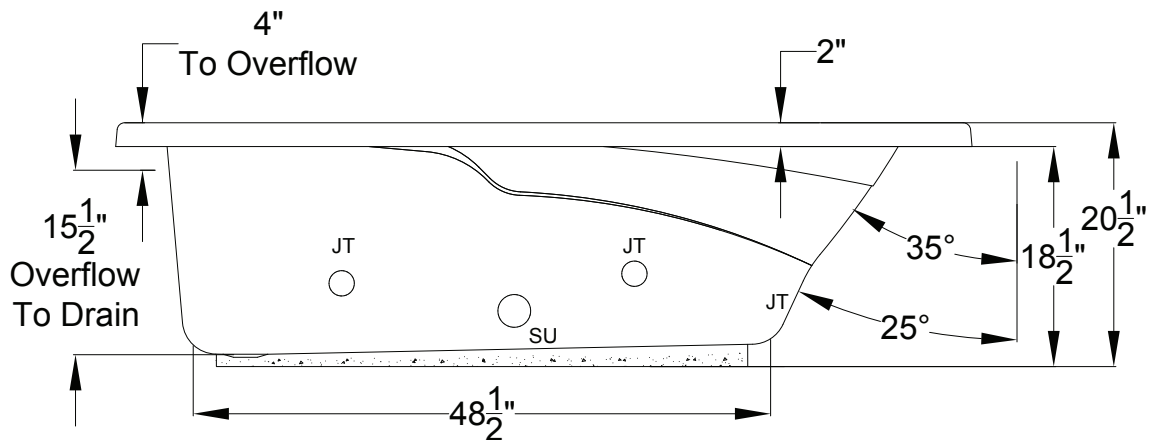
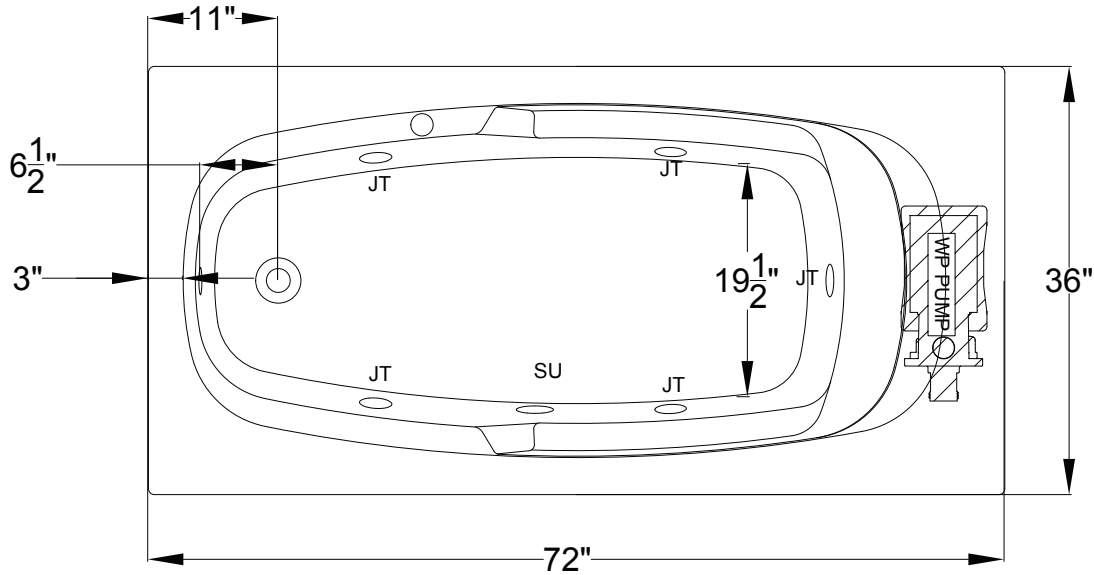

Patents received or pending.

Note: Dimensional Tolerances: ±1/4"

<b>Drop-in-Hole Size:</b>	34" x 70"
<b>Operating Capacity:</b>	45 Gal.
<b>Overflow Capacity:</b>	69 Gal.
<b>Floor Loading / sq.ft.:</b>	45.1/42.4 lbs.
<b>Carton Wt.:</b>	124/86 lbs.
<b>Cube:</b>	37.3 ft. <sup>3</sup>

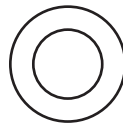

Includes a quiet, 120v, 1HP, 1-speed pump and an air switch on/off control. Requires (1) 20A, 120v GFCI protected circuit.

**Construction:** Reinforced Acrylic shell mounted on pre-leveled full support base.

*We provide products listed with Intertek ETL SEMKO (Edison Testing Laboratories) U.S. and Canadian and with International Association of Plumbing and Mechanical Officials (IAPMO). Consult factory with your listing requirements.*