



# MUSTEE

## List Price Catalog LPC-13

June 14, 2022



**Shower + Bath • Laundry Tubs + Sinks • Mop Basins + Washer Pans**

**PALLET ORDERING GUIDE.....3**

**SHIPPING CHARGES (USA) .....3**

**TOPAZ™ BATHTUB FREIGHT RESTRICTIONS .....3**

**CONDITIONS OF SALE .....4**

**WARRANTY .....4**

**QUICK REFERENCE NUMERICAL PRICE LIST.....5-6**

**DURASTALL® SHOWER STALLS .....7**

**UTILITY SINKS.....8-9**

**UTILATUB® & UTILATWIN® LAUNDRY TUBS .....9-11**

**UTILATUB® & UTILATWIN® COMBO LAUNDRY TUBS .....12-13**

**TOPAZ™ & DURAWALL® FIBERGLASS BATHTUB WALLS .....14-15**

**DURAWALL® DELUXE THERMOPLASTIC BATHTUB WALLS.....15**

**TOPAZ™ PREMIUM FIBERGLASS BATHTUBS .....16**

**DURABASE® SHOWER BASES.....17-18**

**EASY-ACCESS SHOWER FLOORS.....19-20**

**FIBERGLASS SHOWER WALLS.....21-23**

**DURAWALL® THERMOPLASTIC SHOWER WALLS.....23**

**CAREGIVER® SAFETY GRAB BARS .....24**

**CAREGIVER® FOLD-DOWN SHOWER SEATS .....25**

**STYLEMATE® SHOWER ENCLOSURES .....26**

**DURAPAN® WASHER & WATER HEATER PANS .....27**

**DURASTONE® MOP SERVICE BASINS.....28-29**

**SHOWER & BATH ENSEMBLES**

---

**DURAWALL® & VARISTONE™ SQUARE SHOWERS.....31**

**DURAWALL® & VARISTONE™ RECTANGULAR SHOWERS .....32-34**

**ADA EASY-ACCESS SHOWER ENSEMBLES .....35-37**

**DURAWALL® NEO-ANGLE SHOWERS .....38**

**TOPAZ™ PREMIUM FIBERGLASS BATHTUB ENSEMBLES .....39**

**VARISTONE™ & DURAWALL® BATHTUB ENSEMBLES .....40**

## PALLET ORDERING GUIDE

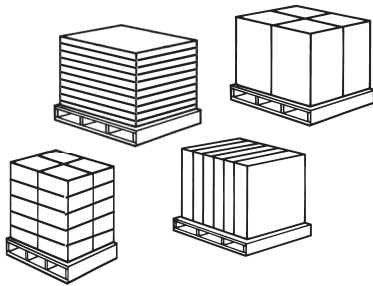

Mustee products can be ordered in pallet lots for easy handling. Review to determine how much product is shipped for a given pallet.

Pallet Packs: Order all like items.  
(Example 20 # 18F Laundry Tub is a pallet.)

### GENERAL RULES FOR PALLETS:

- All single laundry tubs are 20 per pallet.
- All shower floors are 10 per pallet.
- Bathtub and shower wall pallet quantity varies; contact Mustee.
- All bathtubs are 5 per pallet.
- Small mop basins are 24 per pallet.
- Large mop basins are 10 per pallet.

## SHIPPING CHARGES (USA)

**COMMON CARRIER:** FOB Factory, Collect. See Mustee Representative for prepaid requirements.

**UPS (United Parcel Service):** Shipping charges are determined by total weight of each package.

**PACKAGING CHARGE:** A packaging charge of \$6.00/shipment will be included for Parcel Post and UPS shipments.

## TOPAZ™ BATHTUB FREIGHT RESTRICTIONS

**Due to excessive freight rates, Mustee Topaz™ bathtubs can only be included on prepaid shipments as follows:**

1. Truckload / ½ Truckload
2. Delivery on Mustee truck

Contact our sales representatives or Mustee if you are not sure if the Topaz™ bathtub order qualifies for prepaid freight.

Bathtubs must be ordered in lots of 5 per pallet. Pallet must be either all right hand or all left hand model.

## CONDITIONS OF SALE

**TERMS:** Cash Discount 1% 10 days, NET 30 days, finance charge of 1½% per month applies thereafter.

**FREIGHT:** F.O.B. Factory Collect. A freight payment charge of \$25.00 will be applied to invoices when the customer requires collect shipments be changed to prepaid and charge. See Sales Representative for prepaid freight terms. Mustee reserves the right to pass along fuel surcharges for prepaid shipments.

**PRICES:** All products except accessories can be combined for price break. Subject to change without notice. Clerical errors subject to correction. All orders will be invoiced at prices in effect at time of shipment. Minimum billing \$50.00.

**UPS:** Designates UPS shippable product.

**PARCEL POST AND UPS:** A packaging charge of \$6.00/shipment will be included for parcel post and United Parcel shipments.

**WEIGHTS:** Weights shown in catalogs, price sheets, quotations or orders are approximate and are not guaranteed. They represent the average weight of products made from mold/die used when weights were compiled.

**SMALL ORDERS (1-5 PACKAGES):** Small orders of 1 to 5 packages require extra packaging to prevent concealed damages and will be billed at the single lot price no exception. If customer insist on different price then Mustee will not be liable for any concealed damage.

**DAMAGES AND SHORTAGES:** Manufacturer's responsibility ceases upon delivery of shipment to carrier. Any shortage must be reported directly to us within 24 hours after arrival to be considered. Any and all shortages or visible damage **MUST** be noted on freight bill and signed by driver. Do not refuse delivery.

**RETURNS:** No returns (except parts returned by parcel post or United Parcel Service) will be accepted without prior factory written authorization.

A 25% restocking charge, plus 8% freight out charges on original shipment will be assessed on all returns. Return must be shipped, freight prepaid unless specified.

**DEFECTIVE GOODS:** All goods claimed defective will be subject to inspection before replacement or credit.

**ACCEPTANCE:** All orders are subject to acceptance. We reserve the right to decline an order in whole or in part. Orders are accepted subject to strike, fire or other conditions beyond our control.

**NOTICE:** Our continuous commitment of product improvement may result in changes to product specifications without notice.

## WARRANTY

**ONE YEAR LIMITED CONSUMER WARRANTY:** We warrant to the original consumer user of the products of E.L. Mustee & Sons, Inc. for a period of one (1) year from the date of the sale to the consumer that our products will be free of defects in material and workmanship.

Our liability under this Warranty shall be to either repair or replace the product with an identical or reasonably equivalent product. In the alternative, we may refund, in full, the actual purchase price if the repair is not commercially reasonable or possible within a reasonable time and we are unable to supply a replacement product. We shall not be responsible for any labor, damages or installation costs.

This Warranty does not apply to our products which are not installed in accordance with our instructions and local building codes. This Warranty is not applicable if our product has been removed from the original installation or has been subject to accident, abuse or misuse.

After one year from the date of sale, we disclaim all implied warranties of merchantability and fitness for a particular purpose. The foregoing constitutes our entire obligation under this warranty and we make no other express or implied warranties. We further exclude from this warranty all consequential and incidental damages.

This Warranty gives you a specific legal right, and you may have other rights which vary from state to state.

A claim under this Warranty may be made through your distributor, dealer or contractor or by writing to our office. Claim must be accompanied by written proof of purchase and may be subject to inspection by our agent or representative—E. L. Mustee & Sons, Inc., 5431 West 164th Street, Brook Park, OH 44142-1586.



	Model No.	List Price	Page	
<b>DuraStall + DuraStall Accessories</b>	30	\$544.14	7	
	68	469.02	7	
	80	689.06	7	
	140	774.88	7	
	48.700	369.80	7	
	68.600	64.75	7	
	80.400P	77.63	7	
	82.400A	98.74	18	
	86.500	204.03	7	
	88.700	316.92	7	
	<b>Laundry/Utility Sinks</b>	10	170.86	8
		10K	145.29	8
10BN		188.15	8	
10BNK		159.72	8	
10C		165.68	8	
10CBT		182.52	8	
11		149.43	8	
11K		135.64	8	
11BN		165.08	8	
11BT		165.08	8	
20		100.33	8	
2218		300.66	9	
25		219.72	8	
25K		198.94	8	
25BT		244.12	8	
25PD		329.07	8	
25TW		329.07	8	
<b>Laundry/Utility Tubs</b>		12C	243.79	12
	12K	107.48	11	
	14	129.90	11	
	14CP	214.06	12	
	14K	102.42	11	
	14K-80	98.29	11	
	15F	185.74	10	
	15FK	160.49	10	
	15W	185.74	10	
	15WK	160.49	10	
	16	159.52	11	
	16K	119.31	11	
	17F	199.85	9	
	17FK	171.63	9	
	17W	199.85	9	
	17WK	171.63	9	
	18F	190.47	9	
	18FK	165.69	9	
18W	190.47	9		
18WK	165.69	9		

	Model No.	List Price	Page	
<b>Laundry/Utility Tubs (Continued)</b>	19F	\$185.74	10	
	19FK	160.49	10	
	19K-60	107.96	10	
	19W	185.74	10	
	19WK	160.49	10	
	19CF	280.05	12	
	19CFT	344.07	12	
	21F	138.79	10	
	22C	380.91	12	
	24C	380.91	12	
	26F	407.73	9	
	26W	407.73	9	
	27F	408.10	11	
	27W	408.10	11	
	28F	362.11	10	
	28CF	464.71	13	
	<b>Laundry/Utility Tub Accessories</b>	12.400F	40.73	13
		15.600	86.24	13
17.250W		63.10	13	
17.250WK		50.86	13	
18.200W		63.10	13	
18.200WK		50.86	13	
18.300F		63.10	13	
18.300FK		50.86	13	
19.204A		50.10	9	
20.600		6.93	13	
25.300		75.55	8	
28.600A		173.56	13	
93.600		131.19	13	
<b>Bathtub Walls</b>		53WHT	380.45	15
		56BN	487.06	15
		56WHT	466.95	15
		350BN	876.09	14
		350WHT	821.82	14
	557WHT	659.86	15	
	572TWHT	1,421.63	14	
	665WHT	NEW	14	
	670WHT	623.48	14	
	680BN	704.39	14	
	680BT	704.39	14	
	680WHT	669.21	14	
680WHTBB	922.74	14		
680-32WHT	726.68	14		
950	295.51	15		

	Model No.	List Price	Page	
<b>Bathtubs</b>	T6030L	\$444.17	16	
	T6030LBN	488.44	16	
	T6030LBT	488.44	16	
	T6030L-AFD	556.98	16	
	T6030R	444.17	16	
	T6030RBN	488.44	16	
	T6030RBT	488.44	16	
	T6030R-AFD	556.98	16	
	T6032L	524.05	16	
	T6032R	524.05	16	
	<b>Shower Floors</b>	3232BN	273.43	17
		3232M	248.81	17
		3248BN	378.94	17
		3248BT	378.94	17
		3248M	344.86	17
		3254M	454.10	17
		3260M	481.92	17
		3434DTM	349.92	18
3434M		462.85	17	
3442BN		380.81	17	
3442BT		380.81	17	
3442M		333.22	17	
3448BN		387.36	17	
3448BT		387.36	17	
3448M		352.50	17	
3454M		414.46	17	
3460M		438.27	17	
3636BN		335.08	17	
3636BT		335.08	17	
3636CBN		346.54	18	
3636CBT		346.54	18	
3636CM		312.70	18	
3636DTM		355.57	18	
3636M		290.29	17	
3642M	365.35	17		
3648M	378.54	17		
3660M	475.04	17		
3838CBN	432.40	18		
3838CBT	432.40	18		
3838CM	342.38	18		
4236M	347.53	17		
4242CBN	577.99	18		
4242CM	498.83	18		
4242M	382.05	17		
4248M	627.87	17		
4260M	694.03	17		
4848M	660.94	17		



	Model No.	List Price	Page
Easy Access Shower Floors	3060L	\$466.15	19
	3060LBN	489.09	19
	3060R	466.15	19
	3060RBN	489.09	19
	360L	753.92	19
	360R	753.92	19
	3739M	403.41	20
	3865	843.07	20
Shower Walls	237WHT	376.50	23
	247WHT	514.40	23
	260WHT	710.73	23
	265WHT	710.73	23
	572TWHT	1,421.63	21
	732WHT	814.44	22
	736CWHT	774.88	22
	736WHT	903.75	22
	738CWHT	842.81	23
	742CWHT	1,108.64	23
	748-32WHT	928.81	22
	748-34WHT	928.81	22
	760T-30WHT	1,244.15	21
	760T-34WHT	1,496.60	21
	760T-36WHT	1,382.02	21
	700.2W	501.55	22
	742.1W	607.12	23
	748.32W	427.26	22
	748.34W	427.26	22
	760T.1	471.51	21
	760T.2	464.37	21
	760T.6	308.28	21
	760T.10	560.72	21
	760T.12	446.11	21
Grab Bars	390.301	102.82	24
	390.302	135.46	24
	390.303	246.61	24
	390.304	229.93	24
	390.305	79.51	24
	390.306	106.24	24
	390.307	113.87	24
	390.308	208.43	24
	390.309	223.59	24
	390.310	208.43	24
	390.311	223.59	24
	390.312	206.54	24
	390.313	124.26	24
	390.314	174.47	24
	390.315	222.65	24
	390.323	158.68	24
390.324	180.87	24	

	Model No.	List Price	Page
Shower Seats	390.401	\$904.40	25
	390.402	904.40	25
	390.403	920.77	25
	390.404	920.77	25
	390.405	1,074.19	25
	390.406	1,122.20	25
	390.407	1,067.42	25
	390.408	1,115.92	25
	390.409	691.43	25
	390.410	780.05	25
	390.411	1,211.93	25
	390.412	1,244.06	25
	390.413	665.73	25
Shower Doors/Enclosures	32.705	577.84	26
	32.706	751.17	26
	36.403	577.84	26
	36.404	548.95	26
	36.750	924.54	26
	36.761	901.43	26
	36.762	1,097.87	26
	36.763	1,097.87	26
	38.750	953.42	26
	38.751	1,016.99	26
	38.752	1,271.23	26
	38.753	1,271.23	26
	42.751	1,155.68	26
	42.752	1,444.60	26
	42.753	1,444.60	26
	48.403	1,293.41	26
48.406	1,040.09	26	
48.407	1,040.09	26	
48.408	1,040.09	26	
60.403	1,097.87	26	
60.406	1,213.45	26	
60.407	1,213.45	26	
60.408	1,213.45	26	

	Model No.	List Price	Page	
Bath + Shower Accessories	32.401	\$17.53	18	
	32.404	17.53	18	
	32.405	17.53	18	
	42.320	17.53	7	
	42.321	17.53	19	
	42.322	17.53	18	
	42.326	36.46	18	
	42.327	36.46	18	
	42.330	17.53	19	
	360.100	351.68	19	
	360.210	76.49	19	
	300.600W	243.00	15	
	42.317A	31.27	18	
	42.400A	98.74	18	
	52.600W	127.64	15	
	572.300	63.87	21	
Drapery Washer + Water Heater Pans	60.300A	87.96	19	
	60.300ABN	87.96	19	
	60.320A	36.49	18	
	95	139.53	27	
	96	92.17	27	
	96K	76.11	27	
	98	174.68	27	
	99	180.87	27	
	Mop Basins + Accessories	63.401	35.26	29
		63.403	65.35	29
63.600A		247.39	29	
65.308		17.53	29	
65.309		17.53	29	
65.311		17.53	29	
65.403		35.26	29	
65.404		73.30	29	
65.600		103.97	29	
65.700		61.90	29	
67.2424	299.52	29		
67.2436	299.52	29		
63M	392.31	28		
65M	422.50	28		

**DURASTALL® SHOWER STALLS**

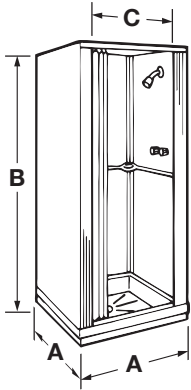

Model No.	Nom. Size	A	B	C	Base	UPC	Lbs.	Cu. Ft.	Ship Via	List Price
-----------	-----------	---	---	---	------	-----	------	---------	----------	------------

**80, 140 DURASTALL®** – Complete knock-down shower stall includes base, walls, curtain, shower valve, handrail and drain.

<b>80</b>	32"x32"	32 <sup>5</sup> / <sub>8</sub> "	75 <sup>3</sup> / <sub>8</sub> "	24"	Standard	6 71031 00314 0	55	7.0		<b>\$689.06</b>
<b>140</b>	36"x36"	36 <sup>5</sup> / <sub>8</sub> "	75 <sup>3</sup> / <sub>8</sub> "	28"	Standard	6 71031 00316 4	61	8.0		<b>774.88</b>

**30, 68 DURASTALL®** – Complete knock-down shower stall includes base, walls, curtain, shower valve, handrail and drain.

<b>30</b>	30"x30"	30 <sup>1</sup> / <sub>8</sub> "	73"	24"	Standard	6 71031 00059 0	38	6.3		<b>544.14</b>
<b>68</b>	32"x32"	32 <sup>5</sup> / <sub>8</sub> "	74 <sup>3</sup> / <sub>4</sub> "	24"	Standard	6 71031 00200 6	40	6.8		<b>469.02</b>

**ACCESSORIES**

Model No.	Description	Fits Models	UPC	Lbs.	Cu. Ft.	Ship Via	List Price
-----------	-------------	-------------	-----	------	---------	----------	------------

**GLASS SHOWER DOORS** – Obscure, Tempered Safety Glass with Aluminum Frame

<b>88.700</b>	24" opening	80	6 71031 00223 5	25	2.5		<b>316.92</b>
<b>48.700</b>	28" opening	140	6 71031 00170 2	26	2.9		<b>369.80</b>

**SHOWER VALVES**

<b>68.600</b>	Shower valve	68	6 71031 00201 3	0.7	—	UPS	<b>64.75</b>
<b>80.400P</b>	Shower valve	30, 80, 140	6 71031 00217 4	1.6	—	UPS	<b>77.63</b>

**DRAIN SEAL**

<b>42.320</b>	Drain seal — for 2" copper, use with drain #42.317A		6 71031 00309 6	—	—	UPS	<b>17.53</b>
---------------	---	--	-----------------	---	---	-----	--------------

**EXTENDED BASE KIT**

<b>86.500</b>		80, 140	6 71031 00521 2	23	2.1	UPS	<b>204.03</b>
	Fits models 80 and 140 purchased after 6-1-16						

**FIBERGLASS UTILITY SINKS**

Model No.	Colors	Quantity Packs	UPC	Lbs.	Cu. Ft.	Ship Via	List Price
-----------	--------	----------------	-----	------	---------	----------	------------

**MODEL 25 VECTOR™ MULTI-TASK SINK** – Self-rimming, includes drain for 1 1/2" P-Trap. Colorfast finish. Optional 25.300 utility rack.

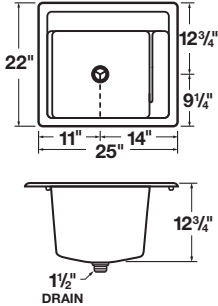

<b>25</b>	White		6 71031 00417 8	21	5.0		<b>\$219.72</b>
<b>25K</b>	White	4-Pack	—	72	9.4		<b>198.94</b>
<b>25BT</b>	Biscuit		6 71031 00418 5	21	5.0		<b>244.12</b>
<b>25PD</b>	Prairie Drift		6 71031 00427 7	21	5.0		<b>329.07</b>
<b>25TW</b>	Twilight		6 71031 00426 0	21	5.0		<b>329.07</b>
Inside Bowl – 15 1/2" x 22" x 12 3/4" Cut Out – 21" x 24"							

**ACCESSORIES**



**UTILITY RACK** – 21" x 14 1/2"

<b>25.300</b>	White		6 71031 00423 9	2.8	0.4	UPS	<b>75.55</b>
---------------	-------	--	-----------------	-----	-----	-----	--------------

**MODEL 10** – Self-rimming, includes drain for 1 1/2" P-Trap. Colorfast finish.

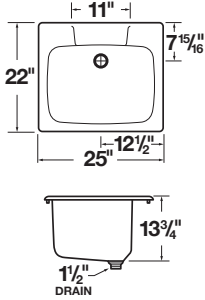

<b>10</b>	White		6 71031 00001 9	16	5.0		<b>170.86</b>
<b>10K</b>	White	4-Pack	—	64	10.0		<b>145.29</b>
<b>10BN</b>	Bone		6 71031 00006 4	16	5.0		<b>188.15</b>
<b>10BNK</b>	Bone	4-Pack	—	64	10.0		<b>159.72</b>
Inside Bowl – 15 1/4" x 21 3/8" x 13 1/4" Cut Out – 21" x 24"							

**MODEL 10C** – Self-rimming, 3 1/2" drain opening. Colorfast finish.

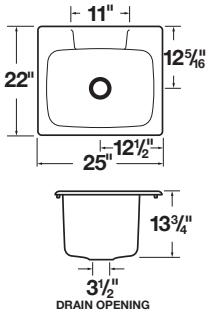

<b>10C</b>	White		6 71031 00300 3	17	5.0		<b>165.68</b>
<b>10CBT</b>	Biscuit		6 71031 00348 5	17	5.0		<b>182.52</b>
Inside Bowl – 15 3/4" x 21 3/8" x 13 1/4" Cut Out – 21" x 24"							

**MODEL 11** – Self-rimming, 3 1/2" drain opening. Colorfast finish.

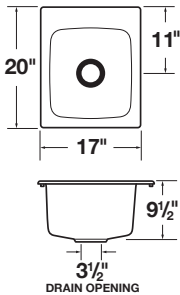

<b>11</b>	White		6 71031 00253 2	11	2.8	UPS	<b>149.43</b>
<b>11K</b>	White	6-Pack	—	50	5.3		<b>135.64</b>
<b>11BN</b>	Bone		6 71031 00254 9	11	2.8	UPS	<b>165.08</b>
<b>11BT</b>	Biscuit		6 71031 00349 2	11	2.8	UPS	<b>165.08</b>
Inside Bowl – 15" x 14" x 9 1/2" Cut Out – 18 1/2" x 15 1/2"							

**MODEL 20 BAR SINK** – Self-rimming, 3 1/2" drain opening. Colorfast finish.

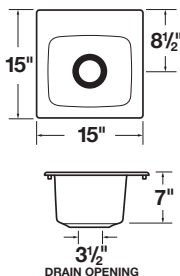

<b>20</b>	White		6 71031 00236 5	8	1.3	UPS	<b>100.33</b>
Inside Bowl – 10" x 12" x 7" Cut Out – 13 1/2" x 13 1/2"							

**FIBERGLASS UTILITY SINKS (Continued)**

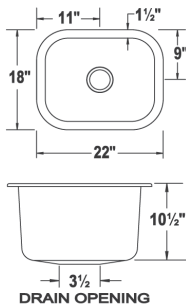

Model No.	Colors	Quantity Packs	UPC	Lbs.	Cu. Ft.	Ship Via	List Price
-----------	--------	----------------	-----	------	---------	----------	------------

**MODEL 2218 UNDERMOUNT OR TOP MOUNT SINK – 3 1/2" drain opening.**

<b>2218</b>	White		6 71031 00522 9	16	3.8	UPS	<b>\$300.66</b>
-------------	-------	--	-----------------	----	-----	-----	-----------------

Undermount Cut Out – 15" x 19", with round corners (See instructions.)  
 Drop In Cut Out – 15 1/2" x 19 1/2" (See instructions.)

See template included with sink for exact measurements.

**UTILATUB® & UTILATWIN® LAUNDRY TUBS**

**DURASTONE® LAUNDRY TUBS**

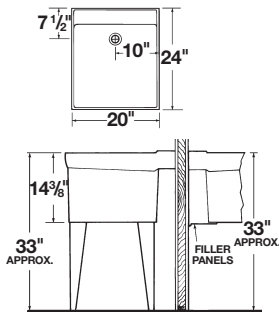

Model No.	Style / Mount	Quantity Packs	UPC	Lbs.	Cu. Ft.	Ship Via	List Price
-----------	---------------	----------------	-----	------	---------	----------	------------

**18F/W UTILATUB® – Floor or wall mount. Connects to standard 1 1/2" P-Trap.**

<b>18F</b>	Single / Floor		6 71031 00026 2	28	4.8		<b>190.47</b>
<b>18W</b>	Single / Wall		6 71031 00027 9	25	4.8		<b>190.47</b>
<b>18FK</b>	Single / Floor	4-Pack	—	105	8.7		<b>165.69</b>
<b>18WK</b>	Single / Wall	4-Pack	—	95	8.7		<b>165.69</b>

**ACCESSORIES**



**UTILATOP™ LAUNDRY TUB TOP COVER**

– Provides additional counter space, fits 18F, 18W, 19F and 19W.

<b>19.204A</b>	Single		6 71031 00380 5	3.2	0.3	UPS	<b>50.10</b>
----------------	--------	--	-----------------	-----	-----	-----	--------------

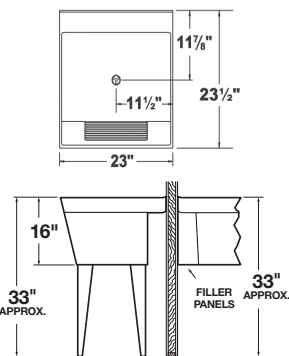

**17F/W UTILATUB® – With built-in scrub board and floor or wall mount hardware. Connects to standard 1 1/2" P-Trap.**

<b>17F</b>	Single / Floor		6 71031 00023 1	31	5.9		<b>199.85</b>
<b>17W</b>	Single / Wall		6 71031 00024 8	29	5.9		<b>199.85</b>
<b>17FK</b>	Single / Floor	4-Pack	—	116	10.8		<b>171.63</b>
<b>17WK</b>	Single / Wall	4-Pack	—	106	10.8		<b>171.63</b>

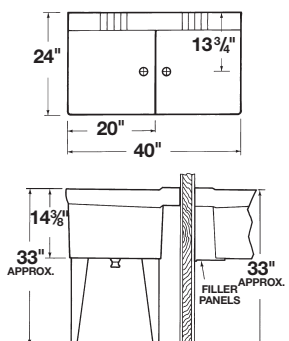

**26F/W UTILATWIN® – Floor or wall mount. Connects to standard 1 1/2" P-Trap.**

<b>26F</b>	Double / Floor		6 71031 00054 5	48	9.6		<b>407.73</b>
<b>26W</b>	Double / Wall		6 71031 00055 2	48	9.6		<b>407.73</b>

**THERMOPLASTIC LAUNDRY TUBS**

Model No.	Style / Mount	Quantity Packs	UPC	Lbs.	Cu. Ft.	Ship Via	List Price
-----------	---------------	----------------	-----	------	---------	----------	------------

**19F/W UTILATUB®** – Floor or wall mount. Connects to standard 1½" P-Trap.

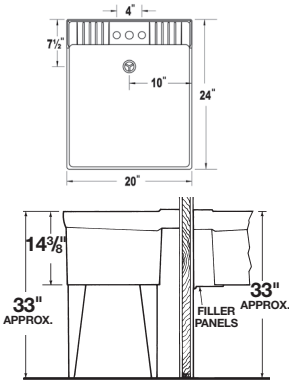

<b>19F</b>	Single / Floor		6 71031 00029 3	19	4.8	UPS	<b>\$185.74</b>
<b>19W</b>	Single / Wall		6 71031 00030 9	17	4.8	UPS	<b>185.74</b>
<b>19FK</b>	Single / Floor	4-Pack	—	70	8.7		<b>160.49</b>
<b>19WK</b>	Single / Wall	4-Pack	—	57	8.7		<b>160.49</b>
<b>19K-60</b>	Single	60-Skid	—	732	104.0		<b>107.96</b>
<b>18.300FK</b>	Fl. Hdw.	6-Pack	—	26	1.3		<b>50.86</b>
<b>18.200WK</b>	Wall Hdw.	6-Pack	—	14	1.3		<b>50.86</b>

**ACCESSORIES**



**UTILATOP™ LAUNDRY TUB TOP COVER**

– Provides additional counter space, fits 18F, 18W, 19F and 19W.

<b>19.204A</b>	Single		6 71031 00380 5	3.2	0.3	UPS	<b>50.10</b>
----------------	--------	--	-----------------	-----	-----	-----	--------------

**15F/W UTILATUB®** – With a built-in scrub board and floor or wall mount. Connects to standard 1½" P-Trap.

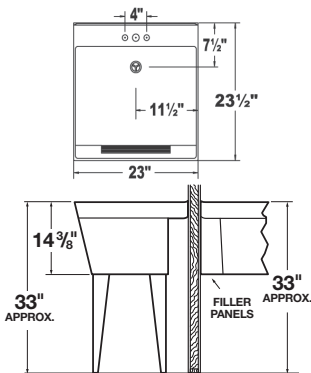

<b>15F</b>	Single / Floor		6 71031 00018 7	21	5.1	UPS	<b>185.74</b>
<b>15W</b>	Single / Wall		6 71031 00019 4	19	5.1	UPS	<b>185.74</b>
<b>15FK</b>	Single / Floor	4-Pack	—	60	8.3		<b>160.49</b>
<b>15WK</b>	Single / Wall	4-Pack	—	60	8.3		<b>160.49</b>

**21F LILTUB™ UTILATUB®**– Multi-purpose floor sink with narrow bowl for installation in almost any space. Connects to standard 1½" P-Trap.

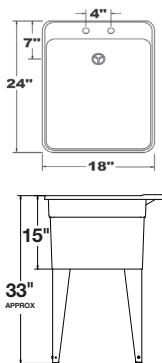

<b>21F</b>	Floor		6 71031 00502 1	42	4.1	UPS	<b>138.79</b>
------------	-------	--	-----------------	----	-----	-----	---------------

**28F UTILATUB®**– Large single bowl multi-purpose floor sink. Inside dimensions: 36½" wide x 17½" deep. Connects to standard 1½" P-Trap.

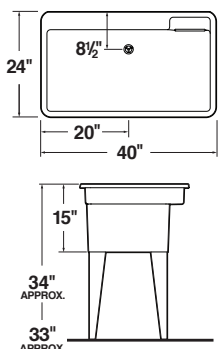

<b>28F</b>	Floor		6 71031 00499 4	23	9.6		<b>362.11</b>
------------	-------	--	-----------------	----	-----	--	---------------

**THERMOPLASTIC LAUNDRY TUBS**

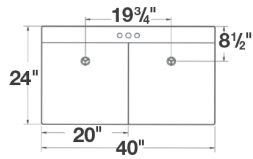

**27F/W UTILATWIN®** – Floor or wall mount. Connects to standard 1 1/2" P-Trap.

Model No.	Style / Mount	Quantity Packs	UPC	Lbs.	Cu. Ft.	Ship Via	List Price
<b>27F</b>	Double / Floor		6 71031 00057 6	40	9.6		<b>\$408.10</b>
<b>27W</b>	Double / Wall		6 71031 00058 3	40	9.6		<b>408.10</b>

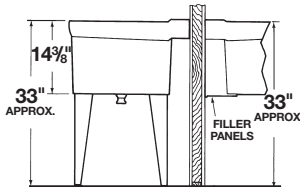

**CO-POLYPURE™ LAUNDRY TUBS**

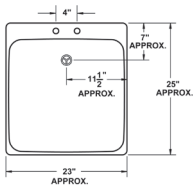

**14 UTILATUB®** – Floor mount. Connects to standard 1 1/2" P-Trap.

Model No.	Style / Mount	Quantity Packs	UPC	Lbs.	Cu. Ft.	Ship Via	List Price
<b>14</b>	Single		6 71031 00011 8	14	5.5	UPS	<b>129.90</b>
<b>14K</b>	Single	5-Pack	—	65	10.6		<b>102.42</b>
<b>14K-80</b>	Single	80-Skid	—	945	107.0		<b>98.29</b>

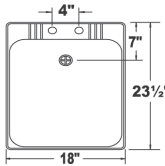
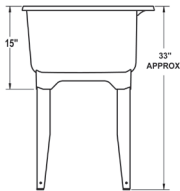

**12 UTILATUB®** – Floor mount. Extra-narrow 18" width. Connects to standard 1 1/2" P-Trap.

Model No.	Style / Mount	Quantity Packs	UPC	Lbs.	Cu. Ft.	Ship Via	List Price
<b>12K</b>	Single	4-Pack	—	42	7.3		<b>107.48</b>

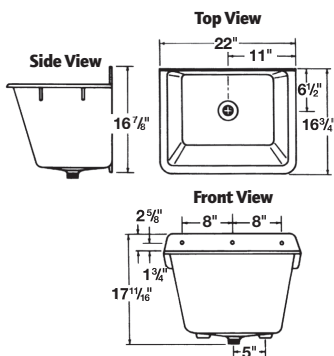
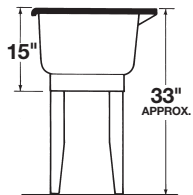

**16 SERVICE MOP SINK** – Wall mount. Connects to standard 1 1/2" P-Trap.

Model No.	Style / Mount	Quantity Packs	UPC	Lbs.	Cu. Ft.	Ship Via	List Price
<b>16</b>	Single		6 71031 00297 6	12	3.2	UPS	<b>159.52</b>
<b>16K</b>	Single	6-Pack	—	60	6.7		<b>119.31</b>

**UTILATUB® AND UTILATWIN® COMBO KITS**

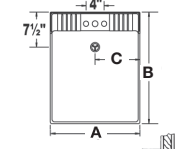
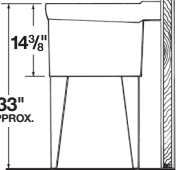
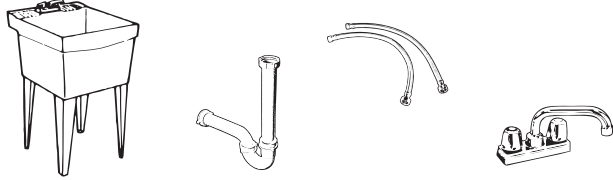
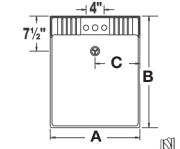
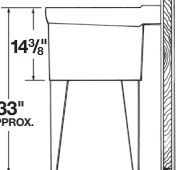
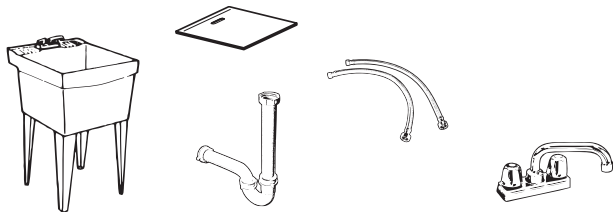
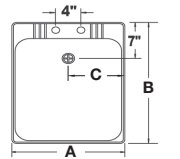
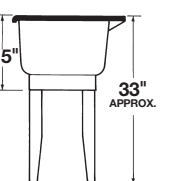
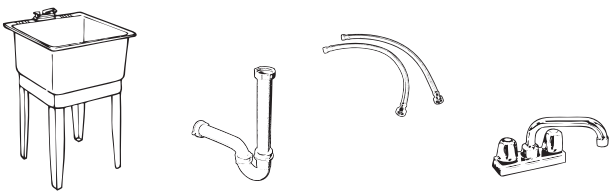
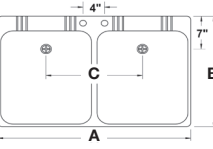
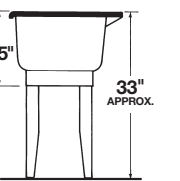
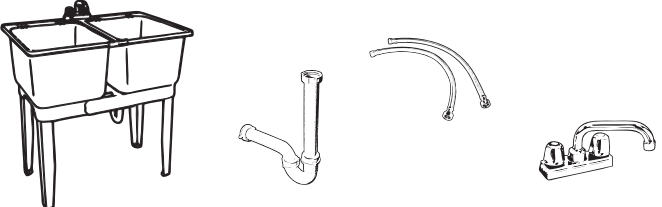
Model No.	Style	(A)	(B)	(C)	Height	UPC	Lbs.	Cu. Ft.	Ship Via	List Price
	<b>19CF UTILATUB® COMBO</b>									
	<b>19CF</b>	Single / Floor	20"	24"	10"	34"	6 71031 00346 1	26	4.8	UPS
	<b>KIT INCLUDES: LAUNDRY TUB, SWIVEL FAUCET, SUPPLY LINES, 1 1/2" P-TRAP, STOPPER AND TEFLON® TAPE</b>									
										
	<b>19CFT UTILATUB® COMBO WITH TOP COVER 19.204A</b>									
	<b>19CFT</b>	Single / Floor	20"	24"	10"	34"	6 71031 00424 6	26	4.8	UPS
	<b>KIT INCLUDES: TOP COVER, LAUNDRY TUB, SWIVEL FAUCET, SUPPLY LINES, 1 1/2" P-TRAP, STOPPER AND TEFLON® TAPE</b>									
										
	<b>12C/14CP UTILATUB® COMBO</b>									
	<b>12C</b>	Single / Floor	18"	23 1/2"	9"	34"	6 71031 00388 1	17	4.1	UPS
<b>14CP</b>	Single / Floor	23"	25"	11 1/2"	34"	6 71031 00347 8	19.5	5.5	UPS	<b>214.06</b>
	<b>KIT INCLUDES: LAUNDRY TUB, SWIVEL FAUCET, SUPPLY LINES, 1 1/2" P-TRAP, STOPPER AND TEFLON® TAPE</b>									
										
	<b>22C/24C UTILATWIN® COMBO</b>									
	<b>22C</b>	Double / Floor	36"	23 1/2"	18"	34"	6 71031 00389 8	25.5	5.5	
<b>24C</b>	Double / Floor	46"	25"	23"	34"	6 71031 00044 6	27.5	6.1		<b>380.91</b>
	<b>KIT INCLUDES: LAUNDRY TUB, SWIVEL FAUCET, SUPPLY LINES, 1 1/2" P-TRAP, STOPPERS AND TEFLON® TAPE</b>									
										

**UTILATUB® AND UTILATWIN® COMBO KITS (Continued)**

Model No.	Style	(A)	(B)	(C)	Height	UPC	Lbs.	Cu. Ft.	Ship Via	List Price
-----------	-------	-----	-----	-----	--------	-----	------	---------	----------	------------

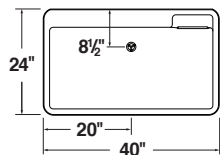

**28CF BIGTUB™ UTILATUB® COMBO**

<b>28CF</b>	Wide Single / Floor	40"	24"	20"	34"	6 71031 00489 5	40	9.6		<b>\$464.71</b>
-------------	---------------------	-----	-----	-----	-----	-----------------	----	-----	--	-----------------

**KIT INCLUDES: LAUNDRY TUB, SWIVEL FAUCET WITH PULL-OUT SPOUT, SUPPLY LINES, 1 1/2" P-TRAP, STOPPER AND TEFLON® TAPE**

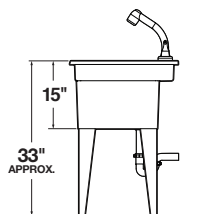
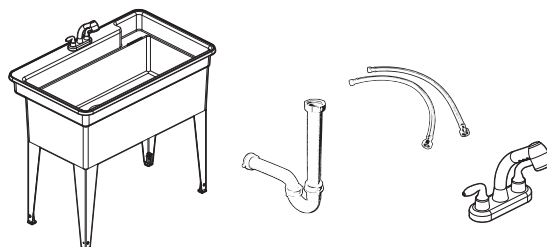

**ACCESSORIES**

Model No.	Description	Fits	UPC	Lbs.	Cu. Ft.	Ship Via	List Price
-----------	-------------	------	-----	------	---------	----------	------------



**FAUCET, FAUCET BLOCKS, TWIN WASTE & HANDIFLO®**

<b>93.600</b>	FAUCET – chrome plated 4" center set with brass body		6 71031 00232 7	2	—	UPS	<b>131.19</b>
<b>20.600</b>	FAUCET BLOCK – molded		6 71031 00031 6	0.2	—	UPS	<b>6.93</b>

**MOUNTING HARDWARE**

<b>12.400F</b>	FLOOR MOUNTING HARDWARE – for 14, 24, 12 & 22		6 71031 00490 1	5		UPS	<b>40.73</b>
<b>18.300F</b>	FLOOR MOUNTING HARDWARE – for 15F, 17F, 18F & 19F		6 71031 00014 9	5		UPS	<b>63.10</b>
<b>18.300FK</b>	FLOOR MOUNTING HARDWARE – 6-pk for 15F, 17F, 18F & 19F		—	26	1.3		<b>50.86</b>
<b>17.250W</b>	WALL MOUNTING HARDWARE – for 17W		6 71031 00021 7	2		UPS	<b>63.10</b>
<b>17.250WK</b>	WALL MOUNTING HARDWARE – 6-pk for 17W		—	X	X		<b>50.86</b>
<b>18.200W</b>	WALL MOUNTING HARDWARE – for 15W, 18W & 19W		6 71031 00013 2	2		UPS	<b>63.10</b>
<b>18.200WK</b>	WALL MOUNTING HARDWARE – 6-pk for 15W, 18W & 19W		—	14	1.3		<b>50.86</b>

**COMBO INSTALLATION KIT**

– Includes faucet, P-Trap, (2) supply lines and Teflon tape.

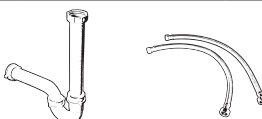

<b>28.600A</b>	PULL-OUT FAUCET – P-Trap, (2) supply lines & Teflon tape		6 71031 00498 7	3	0.2	UPS	<b>173.56</b>
<b>15.600</b>	FAUCET (PLASTIC) – P-Trap, (2) supply lines & Teflon tape		6 71031 00491 8	3	0.2	UPS	<b>86.24</b>

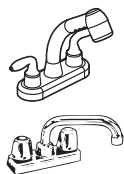

**PREMIUM FIBERGLASS BATHTUB WALLS**

	Model No.	Colors	UPC	Lbs.	Cu. Ft.	Ship Via	List Price
	<b>680-32 TOPAZ™</b>	– Fits Mustee’s Topaz™ bathtub T6032R/L and most other 32" x 60" bathtub. Fiberglass construction; mounts direct to stud; large molded-in shelf; smooth, semi-gloss finish.					
	<b>680-32WHT</b>	White	6 71031 00551 9	80	13.0		<b>\$726.68</b>
	<b>680 TOPAZ™</b>	– Fits Mustee’s Topaz™ bathtub T6030R/L and most other 30" x 60" bathtub. Fiberglass construction; mounts direct to stud.					
	<b>680WHT</b>	White	6 71031 00549 6	86	12.0		<b>669.21</b>
	<b>680BN</b>	Bone	6 71031 00557 1	86	12.0		<b>704.39</b>
<b>680BT</b>	Biscuit	6 71031 00558 8	86	12.0		<b>704.39</b>	
	<b>680WHTBB</b>	White	6 71031 00550 2	95.5	12.0		<b>922.74</b>
	<b>680WHTBB</b> – Fits Mustee’s Topaz™ bathtub T6030R/L and most other 30" x 60" bathtub. Model 680WHT with backer boards preinstalled at the factory for ADA applications. There are 6 backer boards placed to mount T-style grab bars. Order in pallet lots of 8.						
	<b>670 TOPAZ™</b>	– Fits Mustee’s Topaz™ bathtub T6030R/L and most other 30" x 60" bathtub. Molded fiberglass construction with distinctive 7" x 7" tile pattern. Mounts direct to stud. Semi-gloss finish.					
	<b>670WHT</b>	White	6 71031 00504 5	86	12.0		<b>623.48</b>
	<b>665 TOPAZ™</b>	– Fits Mustee’s Topaz™ bathtub T6030R/L and most other 30" x 60" bathtub. Fiberglass construction; mounts direct to stud; large molded-in shelf; smooth, semi-gloss finish.					
	<b>665WHT</b>	White	6 71031 00587 8	86	12.0		<b>SUMMER 2022</b>
<b>NEW</b>							
	<b>572T VARISTONE™</b>	– Fits Mustee’s Topaz™ bathtub and any standard bathtub up to 60" x 34". Tall 72" high. Fiberglass construction; embossed tile pattern; adhesive mounts; smooth, semi-gloss finish.					
	<b>572TWHT</b>	White	6 71031 00420 8	110	9.9		<b>1,421.63</b>
	<b>ACCESSORY VARISTONE™ SHELVES</b> – 7" high 572.300 – See pg. 21 for more details.						
	<b>350 DURAWALL®</b>	– Fits Mustee’s Topaz™ bathtub and any 30" x 60" bathtub. Fiberglass, adhesive mounts, smooth, semi-gloss finish. Large molded-in shelf.					
	<b>350WHT</b>	White	6 71031 00266 2	66	12.0		<b>821.82</b>
<b>350BN</b>	Bone	6 71031 00267 9	66	12.0		<b>876.09</b>	

**PREMIUM FIBERGLASS BATHTUB WALLS (Continued)**

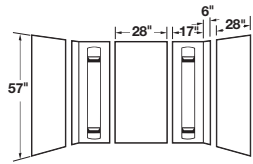

Model No.	Colors	UPC	Lbs.	Cu. Ft.	Ship Via	List Price
<b>557 DURAWALL®</b> – Fits Mustee’s Topaz™ bathtub and any 30" x 60" or 32" x 60" bathtubs. Fiberglass, adhesive mounts, smooth, semi-gloss finish. Four molded-in shelves.						
<b>557WHT</b>	White	6 71031 00336 2	46	6.0		<b>\$659.86</b>

**DURAWALL® DELUXE THERMOPLASTIC BATHTUB WALLS**

**THERMOPLASTIC BATHTUB WALLS**

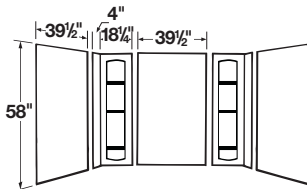

Model No.	Colors	UPC	Lbs.	Cu. Ft.	Ship Via	List Price
<b>56 DURAWALL®</b> – Fits Mustee Topaz™ bathtub or any whirlpool-sized bathtubs up to 42" x 72". Thermoplastic construction, adhesive mounts to drywall and like surfaces, six shelves.						
<b>56WHT</b>	White	6 71031 00288 4	28	6.8		<b>466.95</b>
<b>56BN</b>	Bone	6 71031 00289 1	28	5.0		<b>487.06</b>

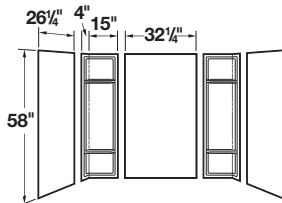

<b>53 DURAWALL®</b> – Fits Mustee’s Topaz™ bathtub or any 30" x 60" bathtub. Thermoplastic construction, adhesive mounts to drywall and like surfaces, four shelves.						
<b>53WHT</b>	White	6 71031 00428 4	26	5.0		<b>380.45</b>

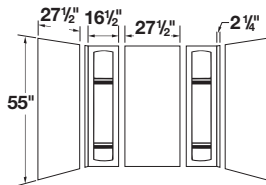

<b>950 DURAWALL®</b> – Fits Mustee’s Topaz™ bathtub or any 30" x 60" bathtub. Thermoplastic construction, adhesive mounts to drywall and like surfaces, four shelves.						
<b>950</b>	White	6 71031 00235 8	18	3.0		<b>295.51</b>

**ACCESSORIES**

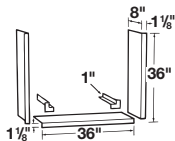

Part No.	Description	Material	UPC	Lbs.	Cu. Ft.	Ship Via	List Price
<b>300.600 DURATRIM™ FIBERGLASS WINDOW TRIM KIT</b>							
– Fit windows up to 36" wide by 8" sill depth.							
<b>300.600W</b>	White	Fiberglass	6 71031 00060 6	9	0.5	UPS	<b>243.00</b>

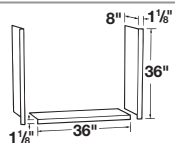

<b>52.600W DURATRIM™ THERMOPLASTIC WINDOW TRIM KIT</b>							
– Fit windows up to 36" wide by 8" sill depth.							
<b>52.600W</b>	White	Thermoplastic	6 71031 00185 6	3.1	0.5	UPS	<b>127.64</b>

**FIBERGLASS BATHTUBS**

See Topaz™ Bathtub Walls, page 14, for Tub/Shower combination.

Model No.	Colors	Bathtub Size	Drain	UPC	Lbs.	Cu. Ft.	Ship Via	List Price
<b>T6030 TOPAZ™ FIBERGLASS BATHTUBS</b> – Premium-molded fiberglass construction with structural underbody. Fits 30" x 60" alcove. Drain offset is 8 1/2" x 15". Features slip-resistant bottom surface; RH and LH drain positions; deep, color-fast surface finish.								
<b>T6030L</b>	White	30"x60"	Left Hand	6 71031 00411 6	55	21.0		<b>\$444.17</b>
<b>T6030LBN</b>	Bone	30"x60"	Left Hand	6 71031 00412 3	55	21.0		<b>488.44</b>
<b>T6030LBT</b>	Biscuit	30"x60"	Left Hand	6 71031 00431 4	55	21.0		<b>488.44</b>
<b>T6030R</b>	White	30"x60"	Right Hand	6 71031 00413 0	55	21.0		<b>444.17</b>
<b>T6030RBN</b>	Bone	30"x60"	Right Hand	6 71031 00414 7	55	21.0		<b>488.44</b>
<b>T6030RBT</b>	Biscuit	30"x60"	Right Hand	6 71031 00432 1	55	21.0		<b>488.44</b>

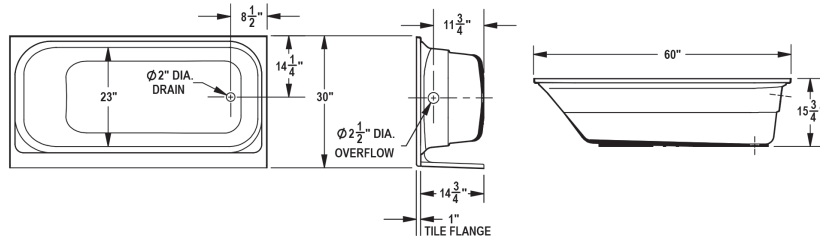

See Topaz™ Bathtub Walls, page 14, for Tub/Shower combination.

<b>T6030L-AFD &amp; T6030R-AFD TOPAZ™ ABOVE FLOOR DRAIN FIBERGLASS BATHTUBS</b> – Premium-molded fiberglass construction. Fits 30" x 60" alcove. Drain offset is 8 1/2" x 15". Raised bottom for above floor drain. Features slip-resistant bottom; RH and LH drain; color-fast finish.								
<b>T6030L-AFD</b>	White	30"x60"	Left Hand	6 71031 00581 6	66	24.4		<b>556.98</b>
<b>T6030R-AFD</b>	White	30"x60"	Right Hand	6 71031 00580 9	66	24.4		<b>556.98</b>

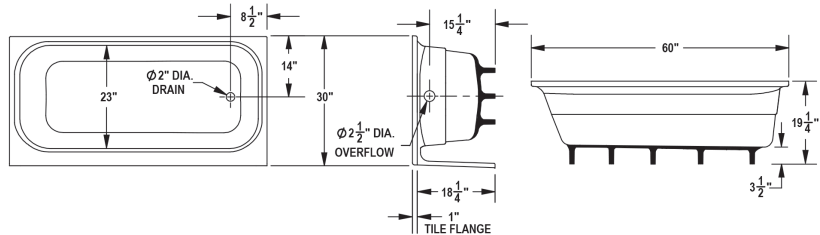

See Topaz™ Bathtub Walls, page 14, for Tub/Shower combination.

<b>T6032 TOPAZ™ FIBERGLASS BATHTUBS</b> – Premium-molded fiberglass construction with structural underbody. Fits 32" x 60" alcove. Drain offset is 8 1/2" x 15". Features slip-resistant bottom surface; RH and LH drain positions; deep, color-fast surface finish.								
<b>T6032L</b>	White	32"x60"	Left Hand	6 71031 00542 7	58	21.0		<b>524.05</b>
<b>T6032R</b>	White	32"x60"	Right Hand	6 71031 00543 4	58	21.0		<b>524.05</b>

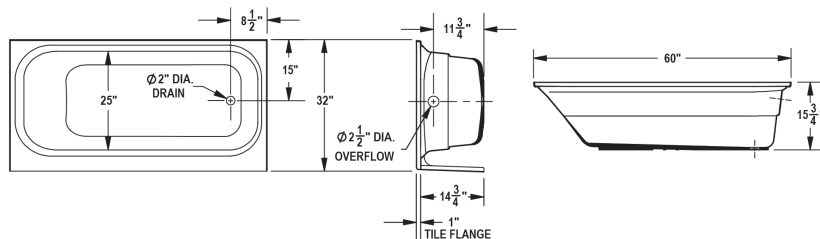

Mustee Fiberglass & Thermoplastic Bathtub Wall Surrounds – See pages 14 & 15.

**FIBERGLASS SHOWER BASES**

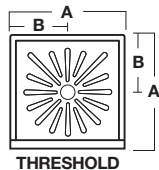

**DURABASE® SQUARE, SINGLE THRESHOLD** – Slip-resistant Starburst® floor design, connection to 2" DWV; integrally molded-in drain with seal and removable strainer.

Model No.	Colors	Size	A	B	C	D	UPC	Lbs.	Cu. Ft.	Ship Via	List Price
<b>3232M</b>	White	32"x32"	32"	16"	—	—	6 71031 00078 1	25	5.0		<b>\$248.81</b>
<b>3232BN</b>	Bone	32"x32"	32"	16"	—	—	6 71031 00075 0	25	5.0		<b>273.43</b>
<b>3434M</b>	White	34"x34"	34"	17"	—	—	6 71031 00101 6	47	5.5		<b>462.85</b>
<b>3636M</b>	White	36"x36"	36"	18"	—	—	6 71031 00148 1	34	6.3		<b>290.29</b>
<b>3636BN</b>	Bone	36"x36"	36"	18"	—	—	6 71031 00136 8	34	6.3		<b>335.08</b>
<b>3636BT</b>	Biscuit	36"x36"	36"	18"	—	—	6 71031 00350 8	34	6.3		<b>335.08</b>
<b>4242M</b>	White	42"x42"	42"	21"	—	—	6 71031 00334 8	48	8.0		<b>382.05</b>
<b>4848M</b>	White	48"x48"	48"	24"	—	—	6 71031 00523 6	52	13.4		<b>660.94</b>

**DURABASE® RECTANGULAR, SINGLE THRESHOLD** – Slip-resistant Starburst® floor design, connection to 2" DWV; integrally molded-in drain with seal and removable strainer.

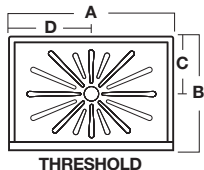

<b>3248M</b>	White	32"x48"	48"	32"	16"	24"	6 71031 00085 9	45	8.4		<b>344.86</b>
<b>3248BN</b>	Bone	32"x48"	48"	32"	16"	24"	6 71031 00083 5	45	8.4		<b>378.94</b>
<b>3248BT</b>	Biscuit	32"x48"	48"	32"	16"	24"	6 71031 00351 5	45	8.4		<b>378.94</b>
<b>3254M</b>	White	32"x54"	54"	32"	16"	27"	6 71031 00091 0	50	9.8		<b>454.10</b>
<b>3260M</b>	White	32"x60"	60"	32"	16"	30"	6 71031 00094 1	57	11.3		<b>481.92</b>
<b>3442M</b>	White	34"x42"	42"	34"	17"	21"	6 71031 00105 4	40	8.3		<b>333.22</b>
<b>3442BN</b>	Bone	34"x42"	42"	34"	17"	21"	6 71031 00103 0	40	5.6		<b>380.81</b>
<b>3442BT</b>	Biscuit	34"x42"	42"	34"	17"	21"	6 71031 00369 0	40	5.6		<b>380.81</b>
<b>3448M</b>	White	34"x48"	48"	34"	17"	24"	6 71031 00112 2	47	9.0		<b>352.50</b>
<b>3448BN</b>	Bone	34"x48"	48"	34"	17"	24"	6 71031 00108 5	45	9.0		<b>387.36</b>
<b>3448BT</b>	Biscuit	34"x48"	48"	34"	17"	24"	6 71031 00352 2	45	9.0		<b>387.36</b>
<b>3454M</b>	White	34"x54"	54"	34"	17"	27"	6 71031 00118 4	46	9.3		<b>414.46</b>
<b>3460M</b>	White	34"x60"	60"	34"	17"	30"	6 71031 00123 8	46	12.0		<b>438.27</b>
<b>3642M</b>	White	36"x42"	42"	36"	17"	21"	6 71031 00519 9	45	9.0		<b>365.35</b>
<b>3648M</b>	White	36"x48"	48"	36"	18"	24"	6 71031 00505 2	41	9.4		<b>378.54</b>
<b>3660M</b>	White	36"x60"	60"	36"	18"	24"	6 71031 00506 9	51	12.3		<b>475.04</b>
<b>4236M*</b>	White	42"x36"	36"	42"	21"	18"	6 71031 00344 7	47	9.0		<b>347.53</b>
* Threshold on 36" side											
<b>4248M</b>	White	42"x48"	48"	42"	21"	24"	6 71031 00548 9	53	11.5		<b>627.87</b>
<b>4260M</b>	White	42"x60"	60"	42"	21"	30"	6 71031 00525 0	67	14.0		<b>694.03</b>

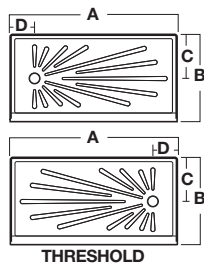

**DURABASE® (BATHTUB REPLACEMENT)** – Slip-resistant Starburst® floor design. Drain not included.

<b>3060L</b>	White	30"x60"	60"	30"	15"	30"	Left Hand	6 71031 00357 7	55	7.0		<b>466.15</b>
<b>3060LBN</b>	Bone	30"x60"	60"	30"	15"	30"	Left Hand	6 71031 00358 4	55	7.0		<b>489.09</b>
<b>3060R</b>	White	30"x60"	60"	30"	15"	30"	Right Hand	6 71031 00355 3	55	7.0		<b>466.15</b>
<b>3060RBN</b>	Bone	30"x60"	60"	30"	15"	30"	Right Hand	6 71031 00356 0	55	7.0		<b>489.09</b>

Optional Drains, Drain Seals and Strainers for DURABASE® Shower Floors – See pages 18 & 19.

**FIBERGLASS SHOWER BASES (Continued)**

Model No.	Colors	Size	A	B	C	D	UPC	Lbs.	Cu. Ft.	Ship Via	List Price
<b>DURABASE® NEO-ANGLE, CORNER THRESHOLD</b> – Fiberglass construction with slip-resistant Starburst® floor design, connection to 2" DWV; integrally molded-in drain with seal and removable strainer.											
<b>3636CM</b>	White	36"x36"	36"	12"	18"		6 71031 00140 5	34	7.3		<b>\$312.70</b>
<b>3636CBN</b>	Bone	36"x36"	36"	12"	18"		6 71031 00138 2	34	5.0		<b>346.54</b>
<b>3636CBT</b>	Biscuit	36"x36"	36"	12"	18"		6 71031 00377 5	34	5.0		<b>346.54</b>
<b>3838CM</b>	White	38"x38"	38"	12"	20"		6 71031 00160 3	36	6.7		<b>342.38</b>
<b>3838CBN</b>	Bone	38"x38"	38"	12"	20"		6 71031 00158 0	36	6.0		<b>432.40</b>
<b>3838CBT</b>	Biscuit	38"x38"	38"	12"	20"		6 71031 00378 2	33	6.0		<b>432.40</b>
<b>4242CM</b>	White	42"x42"	42"	12"	24"		6 71031 00318 8	48	8.0		<b>498.83</b>
<b>4242CBN</b>	Bone	42"x42"	42"	12"	24"		6 71031 00319 5	48	8.0		<b>577.99</b>

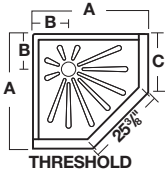

<b>DURABASE® CORNER, DOUBLE THRESHOLD</b> – Fiberglass construction with slip-resistant Starburst® floor design, connection to 2" DWV; integrally molded-in drain with seal and removable strainer.											
<b>3434DTM</b>	White	34"x34"	34"	17"			6 71031 00098 9	47	5.5		<b>349.92</b>
<b>3636DTM</b>	White	36"x36"	36"	18"			6 71031 00144 3	34	5.0		<b>355.57</b>

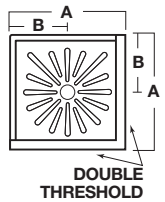

**ACCESSORIES**

Model No.	Description	UPC	Lbs.	Cu. Ft.	Ship Via	List Price
<b>DRAIN ASSEMBLY – 2"</b>						
<b>42.317A</b>	PVC drain with seal for 2" iron, PVC and ABS pipe, strainer	6 71031 00167 2	—	—	UPS	<b>31.27</b>
Optional Drain Seals – See page 19.						
<b>42.400A</b>	2" PVC for side outlet	6 71031 00488 8	—	—	UPS	<b>98.74</b>
<b>DRAIN ASSEMBLY – 1½"</b>						
<b>82.400A</b>	1½" PVC for side outlet	6 71031 00220 4	—	—	UPS	<b>98.74</b>
<b>DRAIN SEAL</b> – for "M" DURABASE® (molded drain)						
<b>32.401</b>	Use on 2" PVC, ABS or Iron pipe	6 71031 00306 5	—	—	UPS	<b>17.53</b>
<b>32.404</b>	Use on 2" copper	6 71031 00313 3	—	—	UPS	<b>17.53</b>
<b>32.405</b>	Use on 1½" PVC and ABS	6 71031 00397 3	—	—	UPS	<b>17.53</b>

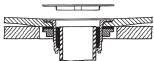

**STRAINER**

<b>42.322</b>	Plastic/white	6 71031 00533 5	—	—	UPS	<b>17.53</b>
<b>42.326</b>	Plastic/chrome plated	6 71031 00493 2	—	—	UPS	<b>36.46</b>
<b>42.327</b>	Plastic/gold plated	6 71031 00494 9	—	—	UPS	<b>36.46</b>



**60.320A GAPSEAL-PRO** – Flexible, adhesive-backed PVC strip seals the gap between drywall & like surfaces and the tile flange on shower floors or bathtubs.

<b>60.320A</b>		6 71031 00496 3	—	—	UPS	<b>36.49</b>
----------------	--	-----------------	---	---	-----	--------------

**EASY-ACCESS FIBERGLASS SHOWER FLOORS** 

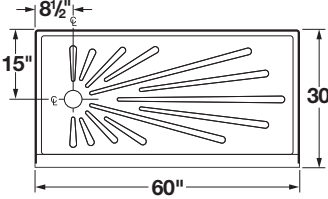
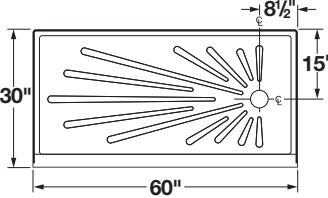
	Model No.	Colors	Size	UPC	Lbs.	Cu. Ft.	Ship Via	List Price
	<b>3060L/R DURABASE®</b> – Fits 30" x 60" alcove. Drain offset is 8½" x 15". Features slip-resistant Starburst® floor design; RH or LH drain position. Drain sold separately.							
	<b>3060L</b>	White	30"x60"	6 71031 00357 7	55	7.0		<b>\$466.15</b>
	<b>3060LBN</b>	Bone	30"x60"	6 71031 00358 4	55	7.0		<b>489.09</b>
	<b>3060R</b> White 30"x60" 6 71031 00355 3 55 7.0 <b>466.15</b>							
	<b>3060RBN</b>	Bone	30"x60"	6 71031 00356 0	55	7.0		<b>489.09</b>

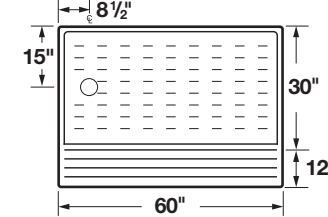
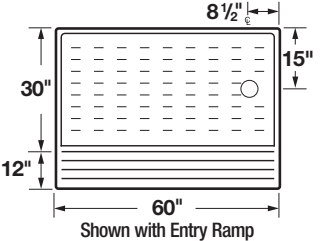
	Model No.	Colors	Size	UPC	Lbs.	Cu. Ft.	Ship Via	List Price
	<b>360L/R BARRIER-FREE SHOWER FLOOR</b> – Fits 30" x 60" alcove. Drain offset is 8½" x 15". Features slip-resistant floor; RH or LH drain position. Entry ramp and drain sold separately.							
	<b>360L</b>	White	30"x60"	6 71031 00273 0	50	5.6		<b>753.92</b>
 <p>Shown with Entry Ramp</p>	<b>360R</b> White 30"x60" 6 71031 00271 6 50 5.6 <b>753.92</b>							

**ACCESSORIES**

	Model No.	Colors	Size	UPC	Lbs.	Cu. Ft.	Ship Via	List Price
	<b>ENTRY RAMP</b>							
	<b>360.100</b>	White	12"x60"	6 71031 00275 4	25	0.7		<b>351.68</b>

	<b>CONTINUOUS WATER BARRIER KIT</b>							
	<b>360.210</b>	Continuous Water Barrier		6 71031 00479 6	0.5	—		<b>76.49</b>

	<b>SHOWER TUB™ DRAIN KIT</b> – ties into existing tub waste.							
	<b>60.300A</b>	White	3060R, 3060L, 360R, 360L	6 71031 00392 8	—	—	UPS	<b>87.96</b>
	<b>60.300ABN</b>	Bone	3060RBN, 3060LBN	6 71031 00393 5	—	—	UPS	<b>87.96</b>

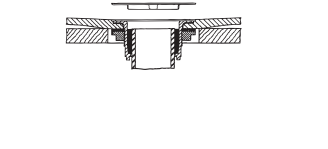
	Model No.	Colors	Size	UPC	Lbs.	Cu. Ft.	Ship Via	List Price
	<b>DRAIN ASSEMBLY – 2"</b>							
	<b>42.317A</b>		PVC drain with seal for 2" iron, PVC and ABS pipe, strainer	6 71031 00167 2	—	—	UPS	<b>31.27</b>
	<b>42.320</b>		Optional drain for 2" copper (DWV)	6 71031 00309 6	—	—	UPS	<b>17.53</b>
	<b>42.321</b>		Optional drain seal for 2" soil pipe (SW)	6 71031 00495 6	—	—	UPS	<b>17.53</b>
	<b>42.330</b>		Optional drain seal for 1½" pipe PVC	6 71031 00537 3	—	—	UPS	<b>17.53</b>

**EASY-ACCESS FIBERGLASS SHOWER FLOORS**  (Continued)

Model No.	Colors	Size	UPC	Lbs.	Cu. Ft.	Ship Via	List Price
-----------	--------	------	-----	------	---------	----------	------------

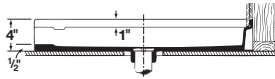
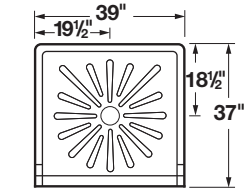

**3739 TRANSFER SHOWER FLOOR**  – Fits 39" x 37" alcove. Features slip-resistant Starburst® floor; center drain position; connection to 2" DWV; integrally molded-in drain with seal and removable strainer.

<b>3739M</b>	White	37"x39"	6 71031 00353 9	35	6.1		<b>\$403.41</b>
--------------	-------	---------	-----------------	----	-----	--	-----------------



**ACCESSORIES**

**CONTINUOUS WATER BARRIER KIT** (See below.)

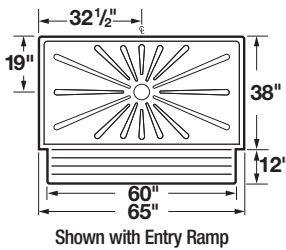

Shown with Entry Ramp

**3865 BARRIER-FREE SHOWER FLOOR**  – Fits 38" x 65" alcove. Features slip-resistant Starburst® floor. Entry ramp and drain sold separately.

<b>3865</b>	White	38"x65"	6 71031 00430 7	64	6.3		<b>843.07</b>
-------------	-------	---------	-----------------	----	-----	--	---------------



**ACCESSORIES**

**ENTRY RAMP**

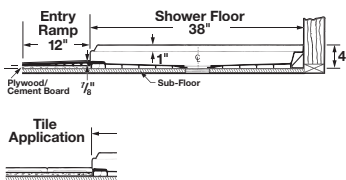

<b>360.100</b>	White	12"x60"	6 71031 00275 4	25	0.7		<b>351.68</b>
----------------	-------	---------	-----------------	----	-----	--	---------------

**CONTINUOUS WATER BARRIER KIT**

<b>360.210</b>	Continuous Water Barrier		6 71031 00479 6	0.5	—		<b>76.49</b>
----------------	--------------------------	--	-----------------	-----	---	--	--------------



Optional Drains, Drain Seals and Strainers – See pages 18 & 19.

**PREMIUM FIBERGLASS SHOWER WALLS**

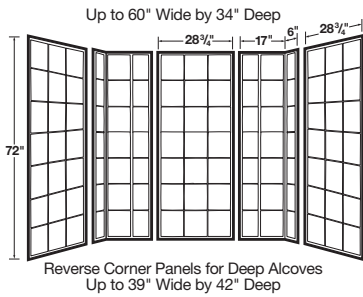

Model No.	Colors	Fits DURABASE®	UPC	Lbs.	Cu. Ft.	Ship Via	List Price
-----------	--------	----------------	-----	------	---------	----------	------------

**572T VARISTONE™ SHOWER WALL** – Tall 72" high with embossed tile pattern. Fits all DURABASE® Shower Floors and alcoves up to 60" wide by 34" deep or 39" wide by 42" deep. Fiberglass construction, adhesive mounts to drywall and like surfaces.

<b>572TWHT</b>	White	All Square & Rectangular sizes	6 71031 00420 8	110	9.9		<b>\$1,421.63</b>
----------------	-------	--------------------------------	-----------------	-----	-----	--	-------------------

(See bottom of page for Varistone™ shelves.)

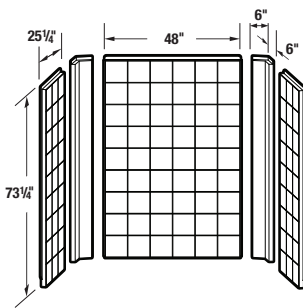

**760T-30WHT DURAWALL® SQUARE & RECTANGULAR** – Features embossed tile pattern or side and back panels. Fits Mustee's 3060/360 Shower Floors. Fiberglass construction, tongue-and-groove panels create watertight seal. Mounts direct-to-studs.

<b>760T-30WHT</b>	White	3060R, 3060L, 360R, 360L	—	95.5	15.8		<b>1,244.15</b>
-------------------	-------	--------------------------	---	------	------	--	-----------------

**Ships in three (3) cartons.**

<b>760T.1</b>	Back Panels	6 71031 00483 3	46	7.8		<b>471.51</b>
<b>760T.2</b>	Side Panels (2)	6 71031 00485 7	42	6.0		<b>464.37</b>
<b>760T.6</b>	Corners (2)	6 71031 00484 0	18	2.8		<b>308.28</b>

(See bottom of page for Varistone™ shelves.)

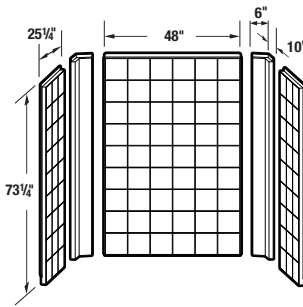

**760T-34WHT DURAWALL® SQUARE & RECTANGULAR** – Features embossed tile pattern or side and back panels. Fits Mustee's 3460M Shower Floor. Fiberglass construction, tongue-and-groove panels create watertight seal. Mounts direct-to-studs.

<b>760T-34WHT</b>	White	3460M	—	95.5	15.8		<b>1,496.60</b>
-------------------	-------	-------	---	------	------	--	-----------------

**Ships in three (3) cartons.**

<b>760T.1</b>	Back Panels	6 71031 00483 3	46	7.8		<b>471.51</b>
<b>760T.2</b>	Side Panels (2)	6 71031 00485 7	42	6.0		<b>464.37</b>
<b>760T.10</b>	Corners (2)	6 71031 00518 2	39	4.4		<b>560.72</b>

(See bottom of page for Varistone™ shelves.)

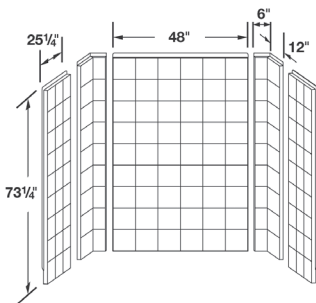

**760T-36WHT DURAWALL® SQUARE & RECTANGULAR** – Features embossed tile pattern or side and back panels. Fits Mustee's 3660M Shower Floor. Fiberglass construction, tongue-and-groove panels create watertight seal. Mounts direct-to-studs.

<b>760T-36WHT</b>	White	3660M	—	116	19.1		<b>1,382.02</b>
-------------------	-------	-------	---	-----	------	--	-----------------

**Ships in three (3) cartons.**

<b>760T.1</b>	Back Panels	6 71031 00483 3	46	7.8		<b>471.51</b>
<b>760T.2</b>	Side Panels (2)	6 71031 00485 7	42	6.0		<b>464.37</b>
<b>760T.12</b>	Corners (2)	6 71031 00556 4	28	5.3		<b>446.11</b>

(See bottom of page for Varistone™ shelves.)

**ACCESSORIES**

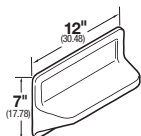

**572.300 VARISTONE™ SHELVES** – White 7" High

6 71031 00385 0	2.5	0.2	<b>63.87</b>
-----------------	-----	-----	--------------

**PREMIUM FIBERGLASS SHOWER WALLS (Continued)**

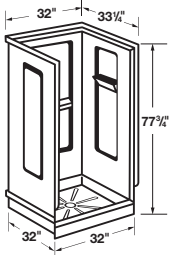
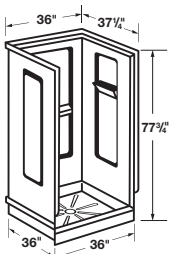
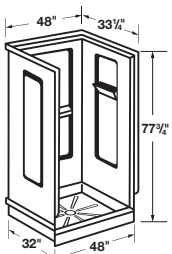
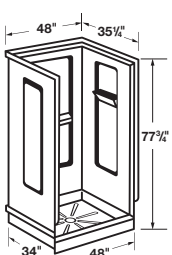
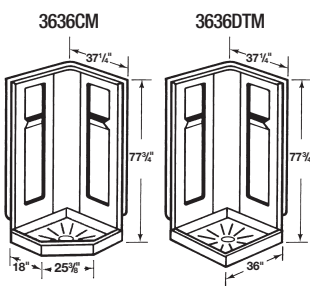
	Model No.	Colors	Fits DURABASE®	UPC	Lbs.	Cu. Ft.	Ship Via	List Price
 <p>Shown with Shower Floor</p>	<p><b>732 DURAWALL® SQUARE</b> – Fits Mustee’s DURABASE® 3232M. Mounts direct-to-studs; smooth, glossy finish; three shelves.</p>							
	<b>732WHT</b>	White	3232M	6 71031 00248 8	75	5.0		<b>\$814.44</b>
 <p>Shown with Shower Floor</p>	<p><b>736 DURAWALL® SQUARE</b> – Fits Mustee’s DURABASE® 3636M. Mounts direct-to-studs; smooth, glossy finish; three shelves.</p>							
	<b>736WHT</b>	White	3636M	6 71031 00209 9	78	11.7		<b>903.75</b>
 <p>Shown with Shower Floor</p>	<p><b>748-32 DURAWALL® SQUARE</b> – Fits Mustee’s DURABASE® 3248M. Mounts direct-to-studs; smooth, glossy finish; three shelves.</p>							
	<b>748-32WHT</b>	White	3248M	—	90	9.0		<b>928.81</b>
	<p><b>Ships in two (2) cartons.</b></p>							
	<b>700.2W</b>	Side Panels (2)		6 71031 00328 7	45	7.9		<b>501.55</b>
<b>748.32W</b>	Back Panels		6 71031 00341 6	45	9.1		<b>427.26</b>	
 <p>Shown with Shower Floor</p>	<p><b>748-34 DURAWALL® RECTANGULAR</b> – Fits Mustee’s DURABASE® 3448M. Mounts direct-to-studs; smooth, glossy finish; three shelves.</p>							
	<b>748-34WHT</b>	White	3448M	—	90	9.0		<b>928.81</b>
	<p><b>Ships in two (2) cartons.</b></p>							
	<b>700.2W</b>	Side Panels (2)		6 71031 00328 7	45	7.9		<b>501.55</b>
<b>748.34W</b>	Back Panels		6 71031 00343 0	45	9.1		<b>427.26</b>	
 <p>Shown with Shower Floor</p>	<p><b>736C DURAWALL® NEO-ANGLE/CORNER</b> – Fits Mustee’s DURABASE® 36” Neo-Angle or Double-Threshold floors. Mounts direct-to-studs; smooth, glossy finish; two shelves.</p>							
	<b>736CWHT</b>	White	—	6 71031 00207 5	58	9.5		<b>774.88</b>

**PREMIUM FIBERGLASS SHOWER WALLS (Continued)**

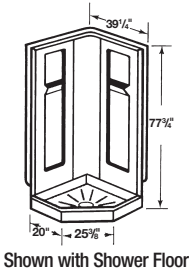

Shown with Shower Floor

Model No.	Colors	Fits DURABASE®	UPC	Lbs.	Cu. Ft.	Ship Via	List Price
<b>738C DURAWALL® NEO-ANGLE/CORNER</b>							
Fits Mustee's DURABASE® 3838CM. Fiberglass construction, tongue-and-groove panels create watertight seal. Mounts direct-to-studs; smooth, colorfast glossy finish; two molded-in shelves.							
<b>738CWHT</b>	White	3838CM	6 71031 00245 7	61	13.5		<b>\$842.81</b>

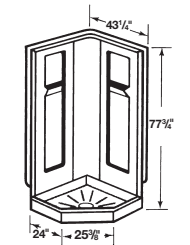

Shown with Shower Floor

<b>742C DURAWALL® NEO-ANGLE/CORNER</b>							
Fits Mustee's DURABASE® 4242CM. Fiberglass construction, tongue-and-groove panels create watertight seal. Mounts direct-to-studs; smooth, colorfast glossy finish; two molded-in shelves.							
<b>742CWHT</b>	White	4242CM	—	70	8.0		<b>1,108.64</b>
<b>Ships in two (2) cartons.</b>							
<b>700.2W</b>	Side Panels (2)		6 71031 00328 7	45	7.9		<b>501.55</b>
<b>742.1W</b>	Corner Panels		6 71031 00330 0	20	8.8		<b>607.12</b>

**DURAWALL® THERMOPLASTIC SHOWER WALLS**

**THERMOPLASTIC SHOWER WALLS**

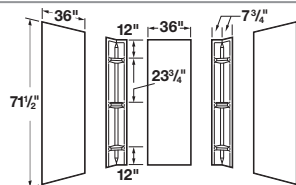

Model No.	Colors	UPC	Lbs.	Cu. Ft.	Ship Via	List Price
<b>247 DURAWALL® SQUARE &amp; RECTANGULAR</b>						
Fits alcoves up to 48" wide by 42" deep; thermoplastic construction; seamless corner panels to overlap trimmable side and back panels. Adhesive mounts to drywall and like surfaces; Smooth, colorfast glossy finish; six molded-in shelves						
<b>247WHT</b>	White	6 71031 00048 4	35	9.1		<b>514.40</b>

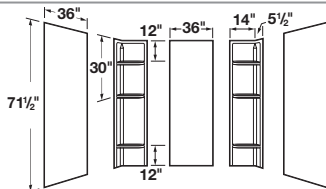

<b>260 DURAWALL® SQUARE &amp; RECTANGULAR</b>						
Fits alcoves up to 60" wide by 40" deep; thermoplastic construction. Seamless corner panels to overlap trimmable side and back panels. Adhesive mounts to drywall and like surfaces. Smooth, colorfast glossy finish; six molded-in shelves.						
<b>260WHT</b>	White	6 71031 00053 8	40	9.0		<b>710.73</b>

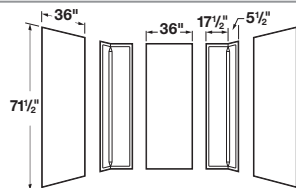

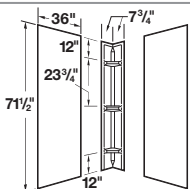

<b>265 DURAWALL® SQUARE &amp; RECTANGULAR</b>						
Fits alcoves up to 71" wide by 41 1/2" deep; thermoplastic construction. Seamless corner panels to overlap trimmable side and back panels. Adhesive mounts to drywall and like surfaces. Smooth, colorfast glossy finish.						
<b>265WHT</b>	White	6 71031 00478 9	43	9.0		<b>710.73</b>



<b>237 DURAWALL® NEO-ANGLE/CORNER</b>						
Fits corners up to 42" deep; thermoplastic construction. Seamless corner panels to overlap trimmable side panels; adhesive mounts to drywall and like surfaces. Smooth, colorfast glossy finish; three molded-in shelves						
<b>237WHT</b>	White	6 71031 00039 2	26	8.2		<b>376.50</b>

**GRAB BARS**

Part No.	Diameter	Size			UPC	Lbs.	Cu. Ft.	Ship Via	List Price
		A	B	C					
 <p><b>1 1/2" T STYLE</b> – Easy to mount flange! 3 Set Screws on post allow pre-mounting to the wall before attaching the bar.</p>									
<b>390.323</b>	1 1/2"	24"	—	—	6 71031 00554 0	2.1	0.2	UPS	<b>\$158.68</b>
<b>390.324</b>	1 1/2"	36"	—	—	6 71031 00555 7	2.8	0.27	UPS	<b>180.87</b>

 <p><b>1 1/2" DIA. STRAIGHT</b> – Features "Twist-Lock" concealed flange for tamper-proof mounting. 18 ga. Satin finish 304 stainless steel. Bar cannot separate from mounting flange.</p>									
<b>390.305</b>	1 1/2"	18"	—	—	6 71031 00452 9	2	0.2	UPS	<b>79.51</b>
<b>390.301</b>	1 1/2"	24"	—	—	6 71031 00359 1	3	0.2	UPS	<b>102.82</b>
<b>390.306</b>	1 1/2"	36"	—	—	6 71031 00434 5	2	0.3	UPS	<b>106.24</b>
<b>390.307</b>	1 1/2"	42"	—	—	6 71031 00435 2	3	0.3	UPS	<b>113.87</b>
<b>390.302</b>	1 1/2"	48"	—	—	6 71031 00360 7	5	1.5	UPS	<b>135.46</b>

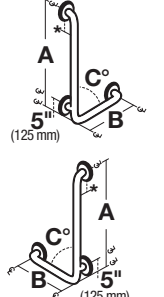
 <p><b>1 1/2" ANGLED</b> – Features "Twist-Lock" concealed flange for tamper-proof mounting. 18 ga. Satin finish 304 stainless steel. Bar cannot separate from mounting flange.</p>									
<b>390.308</b>	1 1/2" Left Hand	24"	16"	90°	6 71031 00436 9	2	1.2	UPS	<b>208.43</b>
<b>390.309</b>	1 1/2" Left Hand	32"	16"	90°	6 71031 00437 6	3	1.2	UPS	<b>223.59</b>
<b>390.310</b>	1 1/2" Right Hand	24"	16"	90°	6 71031 00438 3	2	1.2	UPS	<b>208.43</b>
<b>390.311</b>	1 1/2" Right Hand	32"	16"	90°	6 71031 00439 0	3	1.2	UPS	<b>223.59</b>

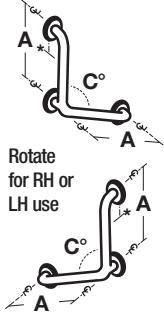
 <p>Rotate for RH or LH use</p>									
<b>390.312</b>	1 1/2"	30"	—	90°	6 71031 00440 6	3.5	1.7	UPS	<b>206.54</b>
<b>390.313</b>	1 1/2"	12"	—	120°	6 71031 00441 3	1.5	1.3	UPS	<b>124.26</b>
<b>390.314</b>	1 1/2"	16"	—	120°	6 71031 00442 0	2	1.3	UPS	<b>174.47</b>
<b>390.315</b>	1 1/2"	24"	—	120°	6 71031 00443 7	3	1.7	UPS	<b>222.65</b>

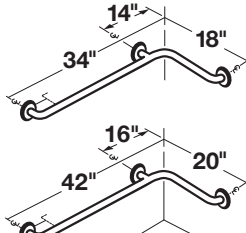
 <p><b>1 1/2" INSIDE CORNER STYLES</b> – Features "Twist-Lock" concealed flange for tamper-proof mounting. 18 ga. Satin finish 304 stainless steel. Bar cannot separate from mounting flange.</p>									
<b>390.304</b>	1 1/2" Inside Corner Style L	34"	18"	90°	6 71031 00362 1	5.5	2.4	UPS	<b>229.93</b>
<b>390.303</b>	1 1/2" Inside Corner Style L	42"	20"	90°	6 71031 00361 4	6.5	2.4	UPS	<b>246.61</b>

**FOLD-DOWN PADDED SEATS**

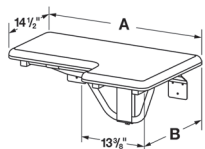
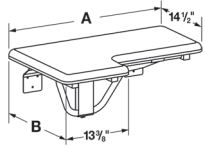
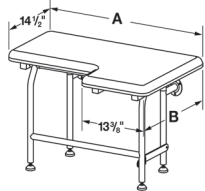
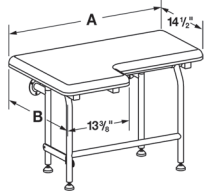
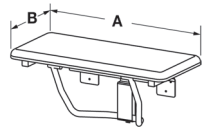
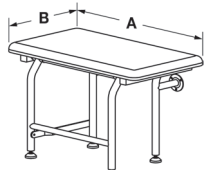
	Part No.	Description	Size		UPC	Lbs.	Cu. Ft.	Ship Via	List Price
			A	B					
		<b>LEFT-HAND RECTANGULAR SEAT, WALL MOUNT</b> – Stainless steel frame. White cushion filled with high density foam.							
	<b>390.402</b>	Left Hand Wall Mount	26"	21"	6 71031 00364 5	19	4.0	UPS	<b>\$904.40</b>
	<b>390.404</b>	Left Hand Wall Mount	32"	21"	6 71031 00366 9	20	4.0	UPS	<b>\$920.77</b>
		<b>RIGHT-HAND RECTANGULAR SEAT, WALL MOUNT</b> – Stainless steel frame. White cushion filled with high density foam.							
	<b>390.401</b>	Right Hand Wall Mount	26"	21"	6 71031 00363 8	19	4.0	UPS	<b>\$904.40</b>
	<b>390.403</b>	Right Hand Wall Mount	32"	21"	6 71031 00365 2	20	4.0	UPS	<b>\$920.77</b>
		<b>LEFT-HAND L-SHAPED SEAT, LEG SUPPORTED</b> – Stainless steel legs and frame. White cushion filled with high density foam.							
	<b>390.405</b>	Left Hand with Legs	26"	21"	6 71031 00444 4	16	2.6	UPS	<b>\$1,074.19</b>
	<b>390.406</b>	Left Hand with Legs	32"	21"	6 71031 00445 1	25	2.6	UPS	<b>\$1,122.20</b>
		<b>RIGHT-HAND L-SHAPED SEAT, LEG SUPPORTED</b> – Stainless steel legs and frame. White cushion filled with high density foam.							
	<b>390.407</b>	Right Hand with Legs	26"	21"	6 71031 00446 8	16	2.6	UPS	<b>\$1,067.42</b>
	<b>390.408</b>	Right Hand with Legs	32"	21"	6 71031 00447 5	25	2.6	UPS	<b>\$1,115.92</b>
		<b>RECTANGULAR SEAT, WALL MOUNT</b> – Stainless steel frame. White cushion filled with high density foam.							
	<b>390.409</b>	Rectangular Wall Mount	26"	14 1/2"	6 71031 00448 2	12	2.6	UPS	<b>\$691.43</b>
	<b>390.410</b>	Rectangular Wall Mount	32"	14 1/2"	6 71031 00449 9	14	2.6	UPS	<b>\$780.05</b>
	<b>390.413</b>	Rectangular Wall Mount	23"	14 1/2"	6 71031 00486 4	10	2.6	UPS	<b>\$665.73</b>
		<b>RECTANGULAR SEAT, LEG SUPPORTED</b> – Stainless steel legs and frame. White cushion filled with high density foam.							
	<b>390.411</b>	Rectangular with Legs	26"	14 1/2"	6 71031 00450 5	12	2.6	UPS	<b>\$1,211.93</b>
	<b>390.412</b>	Rectangular with Legs	32"	14 1/2"	6 71031 00451 2	14	2.6	UPS	<b>\$1,244.06</b>

**SHOWER ENCLOSURES**

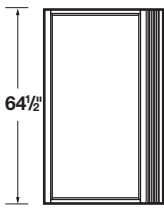
Model No.	Size/ Opening	Glass	Finish	UPC	Lbs.	Cu. Ft.	Ship Via	List Price
	<b>STYLEMATE® PIVOT DOORS</b> – Clear tempered safety glass; aluminum construction; LH or RH opening, adjustable; pull handle with magnetic catch.							
	<b>32.705</b>	Fits 29" to 31"	Clear	Bright Silver	6 71031 00462 8	28	3.1	<b>\$577.84</b>
<b>32.706</b>	Fits 29" to 31"	Clear	Black Bronze	6 71031 00463 5	29	3.1	<b>751.17</b>	
	<b>36.403</b>	Fits 34" to 35 1/2"	Clear	Bright Silver	6 71031 00464 2	33	4.8	<b>577.84</b>
	<b>36.404</b>	Fits 34" to 35 1/2"	Clear	Black Bronze	6 71031 00465 9	34	4.8	<b>548.95</b>

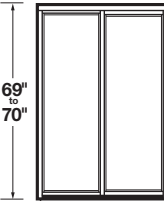
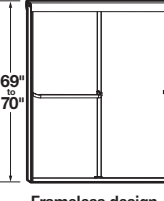
	<b>STYLEMATE® BY-PASS DOORS</b> – Framed or frameless styles; clear tempered safety glass; aluminum construction; adjustable.							
	FRAME							
	<b>48.403</b>	48"	Clear	Bright Silver	6 71031 00466 6	58	4.8	<b>1,293.41</b>
	FRAMELESS DESIGN							
	<b>48.406</b>	48"	Clear	Bright Silver	6 71031 00469 7	61	4.8	<b>1,040.09</b>
	<b>48.407</b>	48"	Clear	Brushed Nickel	6 71031 00470 3	61	4.8	<b>1,040.09</b>
	<b>48.408</b>	48"	Clear	Black Bronze	6 71031 00471 0	61	4.8	<b>1,040.09</b>
	FRAME							
	<b>60.403</b>	60"	Clear	Bright Silver	6 71031 00472 7	72	4.8	<b>1,097.87</b>
	FRAMELESS DESIGN							
	<b>60.406</b>	60"	Clear	Bright Silver	6 71031 00475 8	86	4.8	<b>1,213.45</b>
	<b>60.407</b>	60"	Clear	Brushed Nickel	6 71031 00476 5	86	4.8	<b>1,213.45</b>
	<b>60.408</b>	60"	Clear	Black Bronze	6 71031 00477 2	86	5.4	<b>1,213.45</b>

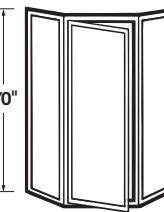
	<b>STYLEMATE® NEO-ANGLE DOORS</b> – LH or RH pivot door; clear or obscure tempered safety glass; adjustable; aluminum construction; pull handle with magnetic catch.							
	<b>36.750</b>	36" Neo	Obscure	Bright Silver	6 71031 00261 7	64	5.6	<b>924.54</b>
	<b>36.761</b>	36" Neo	Clear	Bright Silver	6 71031 00453 6	66	4.8	<b>901.43</b>
	<b>36.762</b>	36" Neo	Clear	Brushed Nickel	6 71031 00454 3	66	4.8	<b>1,097.87</b>
	<b>36.763</b>	36" Neo	Clear	Black Bronze	6 71031 00455 0	66	4.8	<b>1,097.87</b>
	<b>38.750</b>	38" Neo	Obscure	Bright Silver	6 71031 00269 3	68	5.6	<b>953.42</b>
	<b>38.751</b>	38" Neo	Clear	Bright Silver	6 71031 00456 7	68	4.8	<b>1,016.99</b>
	<b>38.752</b>	38" Neo	Clear	Brushed Nickel	6 71031 00457 4	68	4.8	<b>1,271.23</b>
	<b>38.753</b>	38" Neo	Clear	Black Bronze	6 71031 00458 1	68	4.8	<b>1,271.23</b>
	<b>42.751</b>	42" Neo	Clear	Bright Silver	6 71031 00459 8	71	4.8	<b>1,155.68</b>
	<b>42.752</b>	42" Neo	Clear	Brushed Nickel	6 71031 00460 4	71	4.8	<b>1,444.60</b>
	<b>42.753</b>	42" Neo	Clear	Black Bronze	6 71031 00461 1	71	4.8	<b>1,444.60</b>

**WASHER & WATER HEATER PANS**

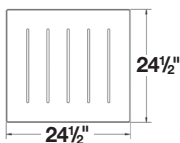

**95 DURAPAN®** – Great for condos, apartments, and high-rises. This high strength, impact-resistant molded pan features a 2¼" tall curb with a 1" 90 degree PVC elbow drain fitting for drainage. Measures (inside): 24" x 24" x 2".

Model No.	Size LxW*	Packing	Drain Location	UPC	Lbs.	Cu. Ft.	Ship Via	List Price
<b>95</b>	24½"x24½"		Side	6 71031 00524 3	5	2.1	UPS	<b>\$139.53</b>

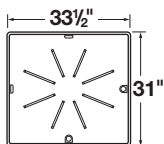

**96 DURAPAN®** – Prevent floor damage. Co-Polypure thermoplastic. Outlet fitting (included) can be installed on bottom or side to connect with 1" piping to drain. Measures (inside): 28" x 31½" x 2".

<b>96</b>	31"x33½"		Side or Bottom	6 71031 00381 2	7.5	1.5	UPS	<b>92.17</b>
<b>96K</b>	31"x33½"	6-Pack	Side or Bottom	—	40	3.1	UPS	<b>76.11</b>

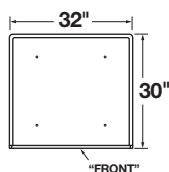

**98 DURAPAN®** – Prevent floor damage. High strength fiberglass. Outlet fitting (included) can be installed on bottom or side to connect with 1" piping to drain. **Removable front.** Measures (inside): 28" x 29" x 2".

<b>98</b>	30"x32"		Side	6 71031 00299 0	21	2.0	UPS	<b>174.68</b>
-----------	---------	--	------	-----------------	----	-----	-----	---------------

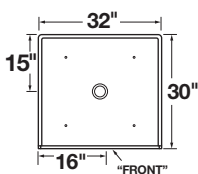

**99 DURAPAN®** – Prevent floor damage. High strength fiberglass. Center drain installs directly over 2" ABS, PVC (Sch. 40) or CI drain pipe. **Removable front.** Measures (inside): 28" x 29" x 2".

<b>99</b>	30"x32"		Center	6 71031 00281 5	21	2.0	UPS	<b>180.87</b>
-----------	---------	--	--------	-----------------	----	-----	-----	---------------

\* L=Length (front to back); W=Width (left to right)

**MOP SERVICE BASINS**

Model No.	Size	Drain	UPC	Lbs.	Cu. Ft.	Ship Via	List Price
-----------	------	-------	-----	------	---------	----------	------------

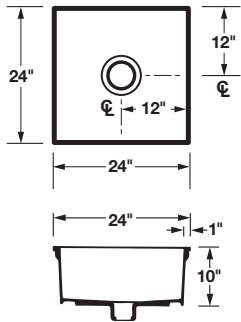

**63M MOP SERVICE BASIN** – DURASTONE® fiberglass construction for high impact resistance. Features extra-deep 10" side walls; integral molded-in drain with seal for 3" ABS, PVC (Sch. 80) or cast iron.

<b>63M</b>	24"x24"x10"	3"	6 71031 00189 4	32	4.2		<b>\$392.31</b>
------------	-------------	----	-----------------	----	-----	--	-----------------

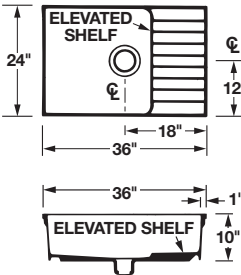

**65M MOP SERVICE BASIN** – DURASTONE® fiberglass construction for high impact resistance. Features molded-in elevated shelf; extra-deep 10" side walls; integral molded-in drain with seal for 3" ABS, PVC (Sch. 80) or cast iron.

<b>65M</b>	24"x36"x10"	3"	6 71031 00194 8	43	6.3		<b>\$422.50</b>
------------	-------------	----	-----------------	----	-----	--	-----------------

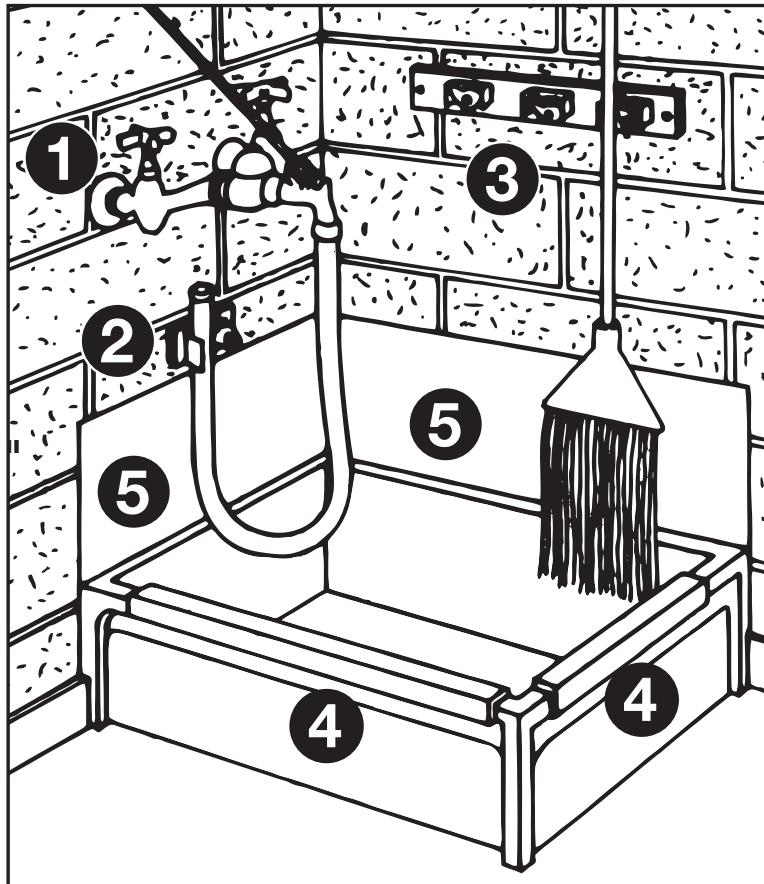

**MOP SERVICE BASIN ACCESSORIES**

ACCESSORIES	Model No.	Description	UPC	Ship Via	List Price
①	<b>MOP SERVICE FAUCET</b>				
	<b>63.600A</b>	Chrome plated brass body with vacuum breaker, 8" centers, reinforcing bracket, pail hook	6 71031 00277 8	UPS	<b>\$247.39</b>
②	<b>HOSE &amp; BRACKET</b>				
	<b>65.700</b>	32" long, 5/8" diameter, heavy-duty hose	6 71031 00196 2	UPS	<b>61.90</b>
③	<b>MOP HANGER</b>				
	<b>65.600</b>	Stainless steel, wall mounted, three spring-loaded mop handle holders	6 71031 00195 5	UPS	<b>103.97</b>
④	<b>BUMPER GUARD</b>				
	VINYL	63.401 20 3/4" long white PVC, fits models 63M and 65M	6 71031 00290 7	UPS	<b>35.26</b>
		65.403 32 3/4" long white PVC, fits model 65M	6 71031 00291 4	UPS	<b>35.26</b>
	STAINLESS STEEL	63.403 20 3/4" long stainless steel, fits model 63M and 65M	6 71031 00409 3	UPS	<b>65.35</b>
		65.404 32 3/4" long stainless steel, fits model 65M	6 71031 00410 3	UPS	<b>73.30</b>
⑤	<b>DURAGUARD™ WALL GUARD – Stainless Steel</b>				
	<b>67.2424</b>	Two panels and 1 bracket for 24"x24" corner	6 71031 00293 8	UPS	<b>299.52</b>
	<b>67.2436</b>	Two panels and 1 bracket for 24"x36" corner	6 71031 00294 5	UPS	<b>299.52</b>
	<b>DRAIN SEAL</b>				
	<b>65.308</b>	For 2" PVC, ABS and iron	6 71031 00303 4	UPS	<b>17.53</b>
	<b>65.309</b>	For 3" PVC, ABS and iron, included with mop basin	6 71031 00304 1	UPS	<b>17.53</b>
	<b>65.311</b>	For 3" soil pipe (no hub)	6 71031 00305 8	UPS	<b>17.53</b>

# SHOWER & BATH ENSEMBLES

**P**roduct guide to create your Mustee Shower or Bath Ensemble. All product options are arranged by size and include all product combinations to build your ensemble. Follow these easy steps.

### Step 1. Determine Alcove Size

Measure the alcove where your new shower or bath will be installed.

### Step 2. Find Right Combination

Refer to Table of Contents to locate the size of shower or bath ensemble.

### Step 3. Select Your Ensemble

Select the shower or bathtub combination that fits your installation and style.

### Step 3. Select Accessories

Available accessories for each ensemble are included on each page.

Sizing and configuration

The combinations of shower walls, enclosures and floors... or bathtub walls and bathtubs

E.L. Mustee & Sons, Inc. DURAWALL® VARISTONE™ RECTANGULAR SHOWERS						
30" x 60" RECTANGULAR SHOWER ENSEMBLES						
Model No.	Material / Color / Mount	UPC	Lbs.	Ship Via	List Price	
DURAWALL® & VARISTONE™ RECTANGULAR SHOWER WALLS						
572TWH	Varistone™ / White / Adhesive	6 71031 00420 8	110		\$1,421.63	
265WH	Thermoplastic / White / Adhesive	6 71031 00478 9	43		710.73	
260WH	Thermoplastic / White / Adhesive	6 71031 00053 8	40		710.73	
760T-30WH	Fiberglass / White / Direct to Stud	—	95.5		1,244.15	
STYLEMATE® BY-PASS DOORS						
FRAMED DESIGN						
60.403	Bright Silver / Clear Safety Glass	6 71031 00472 7	72		1,097.87	
FRAMELESS DESIGN						
60.406	Bright Silver / Clear Safety Glass	6 71031 00475 8	86		1,213.45	
60.407	Brushed Nickel / Clear Safety Glass	6 71031 00476 5	86		1,213.45	
60.408	Black Bronze / Clear Safety Glass	6 71031 00477 2	86		1,213.45	
DURABASE® RECTANGULAR SHOWER FLOORS						
SHOWERTUB®						
3060L	Fiberglass / White	6 71031 00357 7	55		466.15	
3060LBN	Fiberglass / Bone	6 71031 00358 4	55		489.09	
3060R	Fiberglass / White	6 71031 00355 3	55		466.15	
3060RBN	Fiberglass / Bone	6 71031 00356 0	55		489.09	
ACCESSORIES						
Part No. Description UPC Lbs. Ship Via List Price						
FOLD-DOWN SEATS – Stainless steel frame. White cushion filled with high density foam.						
390.413	Rectangular Wall Mount	6 71031 00486 4	10	UPS	665.73	
See additional Fold-Down Shower Seats that can be used with this ensemble on page 25.						
SHOWER TUB™ DRAIN KIT – ties into existing tub waste.						
60.300A	White – fits models: 3060R, 3060L, 360R, 360L	6 71031 00392 8	—	UPS	87.96	
60.300ABN	Bone – fits models: 3060RBN, 3060LBN	6 71031 00393 5	—	UPS	87.96	

Optional Drains, Drain Seals and Strainers – See pages 18 & 19.

## TABLE OF CONTENTS SHOWER & BATH ENSEMBLES

### SQUARE SHOWER ENSEMBLES

32" x 32" .....	31
36" x 36" .....	31
42" x 42" .....	31

### RECTANGULAR SHOWER ENSEMBLES

30" x 60" .....	32
32" x 48" & 34" x 48" .....	33
32" x 60", 34" x 60" & 36" x 60" ...	34
Various Sizes.....	34

### ADA EASY ACCESS SHOWER ENSEMBLES

30" x 60" .....	35
37" x 39" .....	36
38" x 65" .....	37

### NEO-ANGLE SHOWER ENSEMBLES

36" .....	38
38" .....	38
42" .....	38

### BATHTUB ENSEMBLES

30" x 60" Direct-to-Stud .....	39
32" x 60" Direct-to-Stud .....	39
Adhesive-Mount.....	40

**32" x 32" SQUARE SHOWER ENSEMBLES**

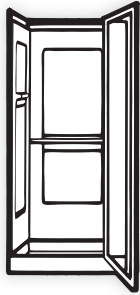

Model 732 shown

Model No.	Material / Color / Mount	UPC	Lbs.	Ship Via	List Price
<b>DURAWALL® &amp; VARISTONE™ SQUARE SHOWER WALLS</b>					
<b>247WHT</b>	Thermoplastic / White / Adhesive	6 71031 00048 4	35		<b>\$514.40</b>
<b>260WHT</b>	Thermoplastic / White / Adhesive	6 71031 00053 8	40		<b>710.73</b>
<b>265WHT</b>	Thermoplastic / White / Adhesive	6 71031 00478 9	43		<b>710.73</b>
<b>732WHT</b>	Fiberglass / White / Direct to Stud	6 71031 00248 8	75		<b>814.44</b>
<b>572TWHT</b>	Varistone™ / White / Adhesive	6 71031 00420 8	110		<b>1,421.63</b>



<b>STYLEMATE® PIVOT DOORS</b>					
<b>32.705</b>	Bright Silver / Clear Safety Glass	6 71031 00462 8	28		<b>577.84</b>
<b>32.706</b>	Black Bronze / Clear Safety Glass	6 71031 00463 5	29		<b>751.17</b>

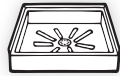

<b>DURABASE® SQUARE SHOWER FLOORS</b>					
<b>3232M</b>	Fiberglass / White	6 71031 00078 1	25		<b>248.81</b>
<b>3232BN</b>	Fiberglass / Bone	6 71031 00075 0	25		<b>273.43</b>

**36" x 36" SQUARE SHOWER ENSEMBLES**

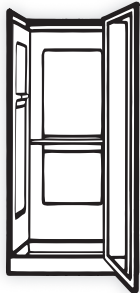

Model 736 shown

<b>DURAWALL® &amp; VARISTONE™ SQUARE SHOWER WALLS</b>					
<b>247WHT</b>	Thermoplastic / White / Adhesive	6 71031 00048 4	35		<b>\$514.40</b>
<b>260WHT</b>	Thermoplastic / White / Adhesive	6 71031 00053 8	40		<b>710.73</b>
<b>265WHT</b>	Thermoplastic / White / Adhesive	6 71031 00478 9	43		<b>710.73</b>
<b>736WHT</b>	Fiberglass / White / Direct to Stud	6 71031 00209 9	78		<b>903.75</b>
<b>572TWHT</b>	Varistone™ / White / Adhesive	6 71031 00420 8	110		<b>1,421.63</b>



<b>STYLEMATE® PIVOT DOORS</b>					
<b>36.403</b>	Bright Silver / Clear Safety Glass	6 71031 00464 2	33		<b>577.84</b>
<b>36.404</b>	Black Bronze / Clear Safety Glass	6 71031 00465 9	34		<b>548.95</b>



<b>DURABASE® SQUARE SHOWER FLOORS</b>					
<b>3636M</b>	Fiberglass / White	6 71031 00148 1	34		<b>290.29</b>
<b>3636BN</b>	Fiberglass / Bone	6 71031 00136 8	34		<b>335.08</b>

**42" x 42" SQUARE SHOWER ENSEMBLES**

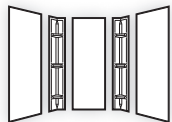
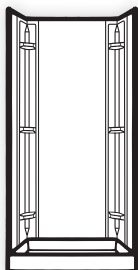

Model 247 shown

<b>DURAWALL® SQUARE SHOWER WALLS</b>					
<b>247WHT</b>	Thermoplastic / White / Adhesive	6 71031 00048 4	35		<b>514.40</b>

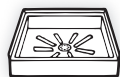

<b>DURABASE® SQUARE SHOWER FLOORS</b>					
<b>4242M</b>	Fiberglass / White	6 71031 00334 8	48		<b>382.05</b>

Model 247 shown

See the following pages for more Grab Bars, page 24 and Fold-Down Seats, page 25.

**30" x 60" RECTANGULAR SHOWER ENSEMBLES**

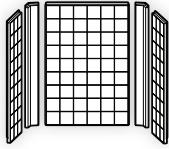
Model No.	Material / Color / Mount	UPC	Lbs.	Ship Via	List Price
<b>DURAWALL® &amp; VARISTONE™ RECTANGULAR SHOWER WALLS</b>					
	<b>572TWHT</b> Varistone™ / White / Adhesive	6 71031 00420 8	110		<b>\$1,421.63</b>
	<b>265WHT</b> Thermoplastic / White / Adhesive	6 71031 00478 9	43		<b>710.73</b>
	<b>260WHT</b> Thermoplastic / White / Adhesive	6 71031 00053 8	40		<b>710.73</b>
Model 760T-30 shown	<b>760T-30WHT</b> Fiberglass / White / Direct to Stud	—	95.5		<b>1,244.15</b>

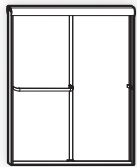
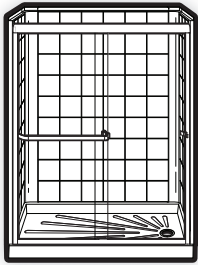

**STYLEMATE® BY-PASS DOORS**

FRAMED DESIGN

**60.403** Bright Silver / Clear Safety Glass 6 71031 00472 7 72 **1,097.87**

FRAMELESS DESIGN

**60.406** Bright Silver / Clear Safety Glass 6 71031 00475 8 86 **1,213.45**

**60.407** Brushed Nickel / Clear Safety Glass 6 71031 00476 5 86 **1,213.45**

**60.408** Black Bronze / Clear Safety Glass 6 71031 00477 2 86 **1,213.45**

**DURABASE® RECTANGULAR SHOWER FLOORS**

SHOWERTUB®



**3060L** Fiberglass / White 6 71031 00357 7 55 **466.15**

**3060LBN** Fiberglass / Bone 6 71031 00358 4 55 **489.09**



**3060R** Fiberglass / White 6 71031 00355 3 55 **466.15**

**3060RBN** Fiberglass / Bone 6 71031 00356 0 55 **489.09**

**ACCESSORIES**



**FOLD-DOWN SEATS** – Stainless steel frame. White cushion filled with high density foam.

**390.413** Rectangular Wall Mount 6 71031 00486 4 10 UPS **665.73**

See additional Fold-Down Shower Seats that can be used with this ensemble on page 25.

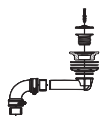



**SHOWER TUB™ DRAIN KIT** – ties into existing tub waste.

**60.300A** White – fits models: 3060R, 3060L, 360R, 360L 6 71031 00392 8 — UPS **87.96**

**60.300ABN** Bone – fits models: 3060RBN, 3060LBN 6 71031 00393 5 — UPS **87.96**

Optional Drains, Drain Seals and Strainers – See pages 18 & 19.

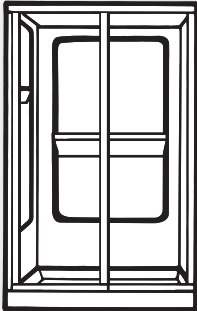
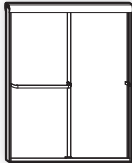
**32" x 48" & 34" x 48" RECTANGULAR SHOWER ENSEMBLES**

Model No.	Material / Color / Mount	UPC	Lbs.	Ship Via	List Price
<b>DURAWALL® &amp; VARISTONE™ RECTANGULAR SHOWER WALLS</b>					
	<b>247WHT</b> Thermoplastic / White / Adhesive	6 71031 00048 4	35		<b>\$514.40</b>
	<b>260WHT</b> Thermoplastic / White / Adhesive	6 71031 00053 8	40		<b>710.73</b>
	<b>265WHT</b> Thermoplastic / White / Adhesive	6 71031 00478 9	43		<b>710.73</b>
	<b>748-32WHT</b> Fiberglass / White / Direct to Stud (Fits 3248M only)	—	90		<b>928.81</b>
	<b>748-34WHT</b> Fiberglass / White / Direct to Stud (Fits 3448M only)	—	90		<b>928.81</b>
 Model 748-32 shown	<b>572TWHT</b> Varistone™ / White / Adhesive	6 71031 00420 8	110		<b>1,421.63</b>
<b>STYLEMATE® BY-PASS DOORS</b>					
	FRAMED DESIGN				
	<b>48.403</b> Bright Silver / Clear Safety Glass	6 71031 00466 6	58		<b>1,293.41</b>
	FRAMELESS DESIGN				
	<b>48.406</b> Bright Silver / Clear Safety Glass	6 71031 00469 7	61		<b>1,040.09</b>
	<b>48.407</b> Brushed Nickel / Clear Safety Glass	6 71031 00470 3	61		<b>1,040.09</b>
	<b>48.408</b> Black Bronze / Clear Safety Glass	6 71031 00471 0	61		<b>1,040.09</b>
<b>DURABASE® RECTANGULAR SHOWER FLOORS</b>					
	<b>3248M</b> Fiberglass / White	6 71031 00085 9	45		<b>344.86</b>
	<b>3248BN</b> Fiberglass / Bone	6 71031 00083 5	45		<b>378.94</b>
	<b>3448M</b> Fiberglass / White	6 71031 00112 2	47		<b>352.50</b>
	<b>3448BN</b> Fiberglass / Bone	6 71031 00108 5	45		<b>387.36</b>

**32" x 60", 34" x 60" & 36" x 60" RECTANGULAR SHOWERS – ADHESIVE MOUNT & DIRECT TO STUD**

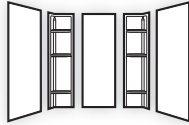
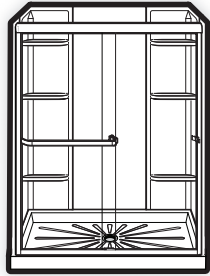

Model 260 shown

Model No.	Material / Color / Mount	UPC	Lbs.	Ship Via	List Price
<b>DURAWALL RECTANGULAR SHOWER WALLS</b>					
<b>572TWHT</b>	Varistone™ / White / Adhesive	6 71031 00420 8	110		<b>\$1,421.63</b>
<b>260WHT</b>	Thermoplastic / White / Adhesive	6 71031 00053 8	40		<b>710.73</b>
<b>265WHT</b>	Thermoplastic / White / Adhesive	6 71031 00478 9	43		<b>710.73</b>
<b>760T-34WHT</b>	Fiberglass / White / Direct to Stud (Fits 3460M only)	—	95.5		<b>1,496.60</b>
<b>760T-36WHT</b>	Fiberglass / White / Direct to Stud (Fits 3660M only)	—	116		<b>1,382.02</b>



<b>STYLEMATE® BY-PASS DOORS</b>					
FRAMED DESIGN					
<b>60.403</b>	Bright Silver / Clear Safety Glass	6 71031 00472 7	72		<b>1,097.87</b>
FRAMELESS DESIGN					
<b>60.406</b>	Bright Silver / Clear Safety Glass	6 71031 00475 8	86		<b>1,213.45</b>
<b>60.407</b>	Brushed Nickel / Clear Safety Glass	6 71031 00476 5	86		<b>1,213.45</b>
<b>60.408</b>	Black Bronze / Clear Safety Glass	6 71031 00477 2	86		<b>1,213.45</b>



<b>DURABASE® RECTANGULAR SHOWER FLOORS</b>					
<b>3260M</b>	Fiberglass / White	6 71031 00094 1	57		<b>481.92</b>
<b>3460M</b>	Fiberglass / White	6 71031 00123 8	46		<b>438.27</b>
<b>3660M</b>	Fiberglass / White	6 71031 00506 9	51		<b>475.04</b>

See the following pages for more Grab Bars, page 24 and Fold-Down Seats, page 25.

**VARIOUS SIZES RECTANGULAR SHOWER ENSEMBLES – ADHESIVE MOUNT**

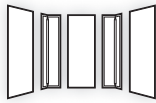

Model 265 shown

<b>DURAWALL RECTANGULAR SHOWER WALLS</b>					
<b>260WHT</b>	Thermoplastic / White / Adhesive	6 71031 00053 8	40		<b>710.73</b>
<b>265WHT</b>	Thermoplastic / White / Adhesive	6 71031 00478 9	43		<b>710.73</b>

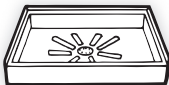

<b>DURABASE® RECTANGULAR SHOWER FLOORS</b>					
<b>3254M</b>	Fiberglass / White	6 71031 00091 0	50		<b>454.10</b>
<b>3260M</b>	Fiberglass / White	6 71031 00094 1	57		<b>481.92</b>
<b>3442M</b>	Fiberglass / White	6 71031 00105 4	40		<b>333.22</b>
<b>3454M</b>	Fiberglass / White	6 71031 00118 4	46		<b>414.46</b>
<b>3460M</b>	Fiberglass / White	6 71031 00123 8	46		<b>438.27</b>
<b>3642M</b>	Fiberglass / White	6 71031 00519 9	45		<b>365.35</b>
<b>3648M</b>	Fiberglass / White	6 71031 00505 2	41		<b>378.54</b>
<b>3660M</b>	Fiberglass / White	6 71031 00506 9	51		<b>475.04</b>
<b>4236M</b>	Fiberglass / White	6 71031 00344 7	47		<b>347.53</b>
<b>4248M</b>	Fiberglass / White	6 71031 00548 9	53		<b>627.87</b>

See the following pages for more Grab Bars, page 24 and Fold-Down Seats, page 25.

**30" x 60" BARRIER-FREE SHOWER ENSEMBLES**

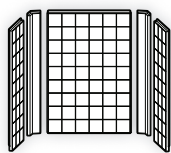
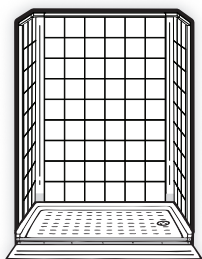

Model 760T-30 shown



Shown with optional ramp.

Model No.	Material / Color / Mount	UPC	Lbs.	Ship Via	List Price
<b>DURAWALL® &amp; VARISTONE™ RECTANGULAR SHOWER WALLS</b>					
<b>572TWHT</b>	Varistone™ / White / Adhesive	6 71031 00420 8	110		<b>\$1,421.63</b>
<b>260WHT</b>	Thermoplastic / White / Adhesive	6 71031 00053 8	40		<b>710.73</b>
<b>265WHT</b>	Thermoplastic / White / Adhesive	6 71031 00478 9	43		<b>710.73</b>
<b>760T-30WHT</b>	Fiberglass / White / Direct to Stud	—	95.5		<b>1,244.15</b>

**BARRIER-FREE SHOWER FLOORS**

<b>360L</b>	Fiberglass / White	6 71031 00273 0	50		<b>753.92</b>
<b>360R</b>	Fiberglass / White	6 71031 00271 6	50		<b>753.92</b>

**ACCESSORIES**

Part No.	Description	Dimensions LxW	UPC	Lbs.	Ship Via	List Price
----------	-------------	----------------	-----	------	----------	------------

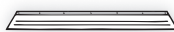

**ENTRY RAMP**

<b>360.100</b>	Fiberglass / White / 12"x60"		6 71031 00275 4	25		<b>351.68</b>
----------------	------------------------------	--	-----------------	----	--	---------------

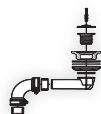

**DRAINS**

**SHOWER TUB™ DRAIN KIT**

<b>60.300A</b>	White/3060R, 3060L, 360R, 360L		6 71031 00392 8		UPS	<b>87.96</b>
<b>60.300ABN</b>	Bone/3060RBN, 3060LBN		6 71031 00393 5		UPS	<b>87.96</b>

Optional Drains, Drain Seals and Strainers – See pages 18 & 19.

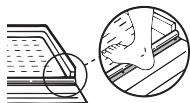

**CONTINUOUS WATER BARRIER KIT**

<b>360.210</b>	Continuous Water Barrier		6 71031 00479 6	0.5		<b>76.49</b>
----------------	--------------------------	--	-----------------	-----	--	--------------



**GRAB BAR**

<b>390.303</b>	Stainless Steel / 1½" Inside Corner Style L / 20"x 42"		6 71031 00361 4	6.5	UPS	<b>246.61</b>
----------------	--	--	-----------------	-----	-----	---------------



Model 390.401 shown

**FOLD-DOWN SEATS**

<b>390.402</b>	Left Hand Wall Mount	26" x 21"	6 71031 00364 5	19	UPS	<b>904.40</b>
<b>390.401</b>	Right Hand Wall Mount	26" x 21"	6 71031 00363 8	19	UPS	<b>904.40</b>
<b>390.405</b>	Left Hand with Legs	26" x 21"	6 71031 00444 4	16	UPS	<b>1,074.19</b>
<b>390.407</b>	Right Hand with Legs	26" x 21"	6 71031 00446 8	16	UPS	<b>1,067.42</b>
<b>390.409</b>	Rectangular Wall Mount	26" x 14½"	6 71031 00448 2	12	UPS	<b>691.43</b>

See the following pages for more Grab Bars, page 24 and Fold-Down Seats, page 25.

**37" x 39" TRANSFER-SHOWER ENSEMBLES**



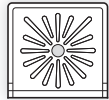

Model No.	Material / Color / Mount	UPC	Lbs.	Ship Via	List Price
<b>DURAWALL RECTANGULAR SHOWER WALLS</b>					
 Model 265 shown	<b>572TWHT</b> Varistone™ / White / Adhesive	6 71031 00420 8	110		<b>\$1,421.63</b>
	<b>247WHT</b> Thermoplastic / White / Adhesive	6 71031 00048 4	35		<b>514.40</b>
	<b>260WHT</b> Thermoplastic / White / Adhesive	6 71031 00053 8	40		<b>710.73</b>
	<b>265WHT</b> Thermoplastic / White / Adhesive	6 71031 00478 9	43		<b>710.73</b>



**CAREGIVER® TRANSFER SHOWER FLOORS**

<b>3739M</b>	Thermoplastic / White	6 71031 00353 9	35		<b>403.41</b>
--------------	-----------------------	-----------------	----	--	---------------

**ACCESSORIES**

Model No.	Material / Mount / Dimensions LxW / Angle	UPC	Lbs.	Ship Via	List Price
<b>CAREGIVER® SAFETY GRAB BARS – Stainless Steel, 1½", 18 Gauge</b>					
<b>T STYLE</b>					
 Model 390.324 shown	<b>390.323</b> 24"	6 71031 00554 0	2.1	UPS	<b>158.68</b>
	<b>390.324</b> 36"	6 71031 00555 7	2.8	UPS	<b>180.87</b>
<b>STRAIGHT</b>					
 Model 390.305 shown	<b>390.305</b> Stainless Steel / 18"	6 71031 00452 9	2	UPS	<b>79.51</b>
	<b>390.301</b> Stainless Steel / 24"	6 71031 00359 1	3	UPS	<b>102.82</b>
	<b>390.306</b> Stainless Steel / 36"	6 71031 00434 5	2	UPS	<b>106.24</b>
<b>ANGLED</b>					
 Model 390.308 shown	<b>390.308</b> Stainless Steel / Left Hand / 24" x 16" / 90°	6 71031 00436 9	2	UPS	<b>208.43</b>
	<b>390.309</b> Stainless Steel / Left Hand / 32" x 16" / 90°	6 71031 00437 6	3	UPS	<b>223.59</b>
	<b>390.310</b> Stainless Steel / Right Hand / 24" x 16" / 90°	6 71031 00438 3	2	UPS	<b>208.43</b>
	<b>390.311</b> Stainless Steel / Right Hand / 32" x 16" / 90°	6 71031 00439 0	3	UPS	<b>223.59</b>
<b>90°/120° ANGLED</b>					
 Model 390.313 shown	<b>390.312</b> Stainless Steel / 30" x 30" / 90°	6 71031 00440 6	3.5	UPS	<b>206.54</b>
	<b>390.313</b> Stainless Steel / 12" x 12" / 120°	6 71031 00441 3	1.5	UPS	<b>124.26</b>
	<b>390.314</b> Stainless Steel / 16" x 16" / 120°	6 71031 00442 0	2	UPS	<b>174.47</b>
	<b>390.315</b> Stainless Steel / 24" x 24" / 120°	6 71031 00443 7	3	UPS	<b>222.65</b>
<b>INSIDE-CORNER STYLE</b>					
	<b>390.304</b> Stainless Steel / Inside Corner Style L / 34" x 18" / 90°	6 71031 00362 1	5.5	UPS	<b>229.93</b>

See additional Safety Grab Bars that can be used with this ensemble on page 24.



Model 390.403 shown

**CAREGIVER® FOLD-DOWN SHOWER SEATS**

<b>390.404</b>	Left Hand Wall Mount / 32" x 21"	6 71031 00366 9	20	UPS	<b>920.77</b>
<b>390.403</b>	Right Hand Wall Mount / 32" x 21"	6 71031 00365 2	20	UPS	<b>920.77</b>
<b>390.406</b>	Left Hand with Legs / 32" x 21"	6 71031 00445 1	25	UPS	<b>1,122.20</b>
<b>390.408</b>	Right Hand with Legs / 32" x 21"	6 71031 00447 5	25	UPS	<b>1,115.92</b>
<b>390.410</b>	Rectangular Wall Mount / 32" x 14½"	6 71031 00449 9	14	UPS	<b>780.05</b>
<b>390.412</b>	Rectangular with Legs / 32" x 14½"	6 71031 00451 2	14	UPS	<b>1,244.06</b>

**38" x 65" ADA BARRIER-FREE SHOWER ENSEMBLE**

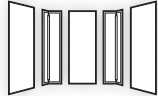
Model No.	Material / Color / Mount	UPC	Lbs.	Ship Via	List Price
					
<b>DURAWALL RECTANGULAR SHOWER WALLS</b>					
<b>265WHT</b>	Thermoplastic / White / Adhesive	6 71031 00478 9	43		<b>\$710.73</b>

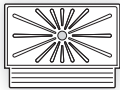
					
<b>CAREGIVER® BARRIER-FREE SHOWER FLOOR</b>					
<b>3865</b>	Fiberglass / White	6 71031 00430 7	64		<b>843.07</b>
ENTRY RAMP — Sold separately					
<b>360.100</b>	Fiberglass / White / 12"x60"	6 71031 00275 4	25		<b>351.68</b>

**ACCESSORIES**

Model No.	Material / Mount / Dimensions LxW / Angle	UPC	Lbs.	Ship Via	List Price
					
<b>DRAINS</b>					
SHOWER TUB™ DRAIN KIT					
<b>60.300A</b>	White/3060R, 3060L, 360R, 360L	6 71031 00392 8		UPS	<b>87.96</b>
<b>60.300ABN</b>	Bone/3060RBN, 3060LBN	6 71031 00393 5		UPS	<b>87.96</b>

Optional Drains, Drain Seals and Strainers – See pages 18 & 19.

					
Model 390.324 shown					
<b>CAREGIVER® SAFETY GRAB BARS</b> – Stainless Steel, 1½", 18 Gauge					
T STYLE					
<b>390.323</b>	24"	6 71031 00554 0	2.1	UPS	<b>158.68</b>
<b>390.324</b>	36"	6 71031 00555 7	2.8	UPS	<b>180.87</b>
STRAIGHT					
<b>390.305</b>	Stainless Steel / 18"	6 71031 00452 9	2	UPS	<b>79.51</b>
<b>390.301</b>	Stainless Steel / 24"	6 71031 00359 1	3	UPS	<b>102.82</b>
<b>390.306</b>	Stainless Steel / 36"	6 71031 00434 5	2	UPS	<b>106.24</b>
<b>390.307</b>	Stainless Steel / 42"	6 71031 00435 2	3	UPS	<b>113.87</b>
<b>390.302</b>	Stainless Steel / 48"	6 71031 00360 7	5	UPS	<b>135.46</b>
ANGLED					
<b>390.308</b>	Stainless Steel / Left Hand / 24" x 16" / 90°	6 71031 00436 9	2	UPS	<b>208.43</b>
<b>390.309</b>	Stainless Steel / Left Hand / 32" x 16" / 90°	6 71031 00437 6	3	UPS	<b>223.59</b>
<b>390.310</b>	Stainless Steel / Right Hand / 24" x 16" / 90°	6 71031 00438 3	2	UPS	<b>208.43</b>
<b>390.311</b>	Stainless Steel / Right Hand / 32" x 16" / 90°	6 71031 00439 0	3	UPS	<b>223.59</b>
90°/120° ANGLED					
<b>390.312</b>	Stainless Steel / 30" x 30" / 90°	6 71031 00440 6	3.5	UPS	<b>206.54</b>
<b>390.313</b>	Stainless Steel / 12" x 12" / 120°	6 71031 00441 3	1.5	UPS	<b>124.26</b>
<b>390.314</b>	Stainless Steel / 16" x 16" / 120°	6 71031 00442 0	2	UPS	<b>174.47</b>
<b>390.315</b>	Stainless Steel / 24" x 24" / 120°	6 71031 00443 7	3	UPS	<b>222.65</b>
INSIDE-CORNER STYLE					
<b>390.304</b>	Stainless Steel / Inside Corner Style L / 34" x 18" / 90°	6 71031 00362 1	5.5	UPS	<b>229.93</b>

See additional Safety Grab Bars that can be used with this ensemble on page 24.

					
Model 390.403 shown					
<b>CAREGIVER® FOLD-DOWN SHOWER SEATS</b>					
<b>390.404</b>	Left Hand Wall Mount / 32" x 21"	6 71031 00366 9	20	UPS	<b>920.77</b>
<b>390.403</b>	Right Hand Wall Mount / 32" x 21"	6 71031 00365 2	20	UPS	<b>920.77</b>
<b>390.406</b>	Left Hand with Legs / 32" x 21"	6 71031 00445 1	25	UPS	<b>1,122.20</b>
<b>390.408</b>	Right Hand with Legs / 32" x 21"	6 71031 00447 5	25	UPS	<b>1,115.92</b>
<b>390.410</b>	Rectangular Wall Mount / 32" x 14½"	6 71031 00449 9	14	UPS	<b>780.05</b>
<b>390.412</b>	Rectangular with Legs / 32" x 14½"	6 71031 00451 2	14	UPS	<b>1,244.06</b>

**36" NEO-ANGLE SHOWER ENSEMBLES**

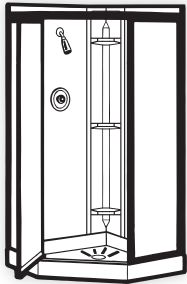

Model 736C shown

Model No.	Material / Color / Mount	UPC	Lbs.	Ship Via	List Price
<b>DURAWALL® NEO-ANGLE SHOWER WALLS</b>					
<b>237WHT</b>	Thermoplastic / White / Adhesive	6 71031 00039 2	26		<b>\$376.50</b>
<b>736CWHT</b>	Fiberglass / White / Direct to Stud	6 71031 00207 5	58		<b>774.88</b>



<b>STYLEMATE® NEO-ANGLE SHOWER ENCLOSURES</b>					
<b>36.750</b>	Bright Silver / Obscure Safety Glass	6 71031 00261 7	64		<b>924.54</b>
<b>36.761</b>	Bright Silver / Clear Safety Glass	6 71031 00453 6	66		<b>901.43</b>
<b>36.762</b>	Brushed Nickel / Clear Safety Glass	6 71031 00454 3	66		<b>1,097.87</b>
<b>36.763</b>	Black Bronze / Clear Safety Glass	6 71031 00455 0	66		<b>1,097.87</b>



<b>DURABASE® NEO-ANGLE SHOWER FLOORS</b>					
<b>3636CM</b>	Fiberglass / White	6 71031 00140 5	34		<b>312.70</b>
<b>3636CBN</b>	Fiberglass / Bone	6 71031 00138 2	34		<b>346.54</b>

**38" NEO-ANGLE SHOWER ENSEMBLES**

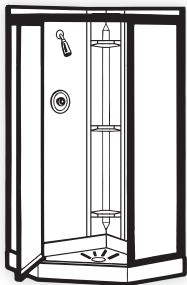

Model 738C shown

<b>DURAWALL® NEO-ANGLE SHOWER WALLS</b>					
<b>237WHT</b>	Thermoplastic / White / Adhesive	6 71031 00039 2	26		<b>376.50</b>
<b>738CWHT</b>	Fiberglass / White / Direct to Stud	6 71031 00245 7	61		<b>842.81</b>

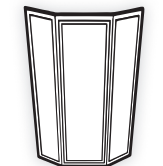

<b>STYLEMATE® NEO-ANGLE SHOWER ENCLOSURES</b>					
<b>38.750</b>	Bright Silver / Obscure Safety Glass	6 71031 00269 3	68		<b>953.42</b>
<b>38.751</b>	Bright Silver / Clear Safety Glass	6 71031 00456 7	68		<b>1,016.99</b>
<b>38.752</b>	Brushed Nickel / Clear Safety Glass	6 71031 00457 4	68		<b>1,271.23</b>
<b>38.753</b>	Black Bronze / Clear Safety Glass	6 71031 00458 1	68		<b>1,271.23</b>



<b>DURABASE® NEO-ANGLE SHOWER FLOORS</b>					
<b>3838CM</b>	Fiberglass / White	6 71031 00160 3	36		<b>342.38</b>

**42" NEO-ANGLE SHOWER ENSEMBLES**

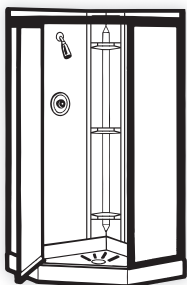

Model 742C shown

<b>DURAWALL® NEO-ANGLE SHOWER WALLS</b>					
<b>237WHT</b>	Thermoplastic / White / Adhesive	6 71031 00039 2	26		<b>376.50</b>
<b>742CWHT</b>	Fiberglass / White / Direct-to-Stud	—	70		<b>1,108.64</b>

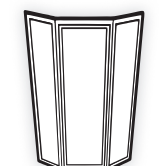

<b>STYLEMATE® NEO-ANGLE SHOWER ENCLOSURES</b>					
<b>42.751</b>	Bright Silver / Clear Safety Glass	6 71031 00459 8	71		<b>1,155.68</b>
<b>42.752</b>	Brushed Nickel / Clear Safety Glass	6 71031 00460 4	71		<b>1,444.60</b>
<b>42.753</b>	Black Bronze / Clear Safety Glass	6 71031 00461 1	71		<b>1,444.60</b>



<b>DURABASE® NEO-ANGLE SHOWER FLOORS</b>					
<b>4242CM</b>	Fiberglass / White	6 71031 00318 8	48		<b>498.83</b>

**30" x 60" FIBERGLASS FOUR-PIECE BATHTUB ENSEMBLES – DIRECT-TO-STUD**

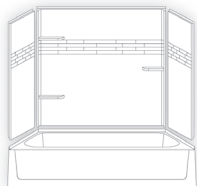
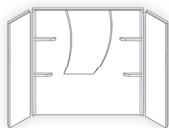
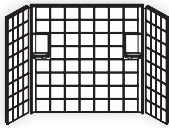
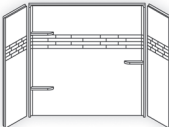
	Model No.	Material / Color / Mount	UPC	Lbs.	Ship Via	List Price
		<b>665 TOPAZ™</b> <b>665WHT</b> Fiberglass / White / Direct to Stud	6 71031 00587 8	86		<b>SUMMER 2022</b>
		<b>670 TOPAZ™</b> <b>670WHT</b> Fiberglass / White / Direct to Stud	6 71031 00504 5	86		<b>\$623.48</b>
		<b>680 TOPAZ™</b> <b>680WHT</b> Fiberglass / White / Direct to Stud <b>680BN</b> Fiberglass / Bone / Direct to Stud <b>680BT</b> Fiberglass / Biscuit / Direct to Stud	6 71031 00549 6 6 71031 00557 1 6 71031 00558 8	86 86 86		<b>669.21</b> <b>704.39</b> <b>704.39</b>

**680WHTBB TOPAZ™**

<b>680WHTBB</b>	Fiberglass / White / Direct to Stud	6 71031 00550 2	95.5	<b>922.74</b>
-----------------	-------------------------------------	-----------------	------	---------------

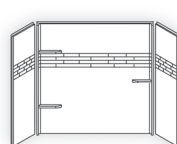

Front

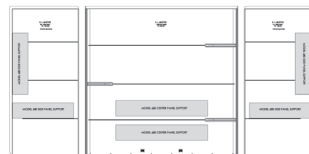

Back

Backer Board Placement

Topaz™ 680WHTBB with backer boards preinstalled at the factory for ADA applications.

**T3060 TOPAZ™ FIBERGLASS BATHTUBS**

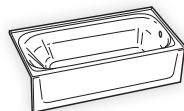

<b>T6030L</b>	Fiberglass / White / Left Hand	6 71031 00411 6	55	<b>444.17</b>
<b>T6030LBN</b>	Fiberglass / Bone / Left Hand	6 71031 00412 3	55	<b>488.44</b>
<b>T6030LBT</b>	Fiberglass / Biscuit / Left Hand	6 71031 00431 4	55	<b>488.44</b>
<b>T6030R</b>	Fiberglass / White / Right Hand	6 71031 00413 0	55	<b>444.17</b>
<b>T6030RBN</b>	Fiberglass / Bone / Right Hand	6 71031 00414 7	55	<b>488.44</b>
<b>T6030RBT</b>	Fiberglass / Biscuit / Right Hand	6 71031 00432 1	55	<b>488.44</b>
<b>T6030L-AFD</b>	Fiberglass / White / Left Hand	6 71031 00581 6	66	<b>556.98</b>
<b>T6030R-AFD</b>	Fiberglass / White / Right Hand	6 71031 00580 9	66	<b>556.98</b>

More information about Topaz™ Fiberglass Bathtubs on page 16.

**32" x 60" FIBERGLASS FOUR-PIECE BATHTUB ENSEMBLES – DIRECT-TO-STUD**

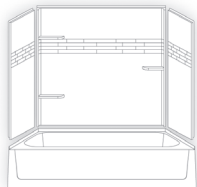
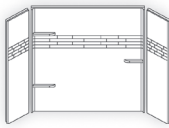
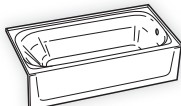
		<b>680-32WHT TOPAZ™</b> <b>680-32WHT</b> Fiberglass / White / Direct to Stud	6 71031 00551 9	80		<b>726.68</b>
		<b>T6032 TOPAZ™ FIBERGLASS BATHTUBS</b> <b>T6032L</b> Fiberglass / White / Direct to Stud <b>T6032R</b> Fiberglass / White / Direct to Stud	6 71031 00542 7 6 71031 00543 4	52 58		<b>524.05</b> <b>524.05</b>

**BATHTUB WALL & BATHTUB ENSEMBLES – ADHESIVE MOUNT WALLS**

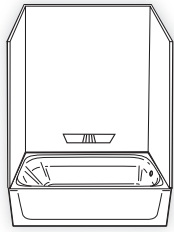

Model 350 shown

Model No.	Material / Color / Mount	UPC	Lbs.	Ship Via	List Price
<b>FIBERGLASS &amp; DURAWALL® BATHTUB WALLS</b>					
<b>572TWHT</b>	Varistone™ / White / Adhesive	6 71031 00420 8	110		<b>\$1,421.63</b>
<b>350WHT</b>	Fiberglass / White / Adhesive	6 71031 00266 2	66		<b>821.82</b>
<b>350BN</b>	Fiberglass / Bone / Adhesive	6 71031 00267 9	66		<b>876.09</b>
<b>557WHT</b>	Fiberglass / White / Adhesive (Also fits T6032L/R)	6 71031 00336 2	46		<b>659.86</b>

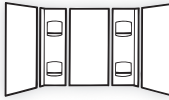
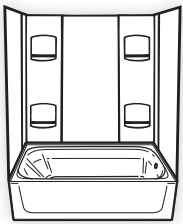

Model 952 shown

Model No.	Material / Color / Mount	UPC	Lbs.	Ship Via	List Price
<b>THERMOPLASTIC DURAWALL® BATHTUB WALLS</b>					
<b>56WHT</b>	Thermoplastic / White / Adhesive	6 71031 00288 4	28		<b>466.95</b>
<b>56BN</b>	Thermoplastic / Bone / Adhesive	6 71031 00289 1	28		<b>487.06</b>
<b>53WHT</b>	Thermoplastic / White / Adhesive	6 71031 00428 4	26		<b>380.45</b>
<b>950</b>	Thermoplastic / White / Adhesive	6 71031 00235 8	18		<b>295.51</b>

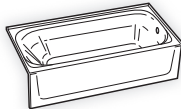

Model No.	Material / Color / Mount	UPC	Lbs.	Ship Via	List Price
<b>TOPAZ™ BATHTUBS</b>					
<b>T6030L</b>	Fiberglass / White / Left Hand	6 71031 00411 6	55		<b>444.17</b>
<b>T6030LBN</b>	Fiberglass / Bone / Left Hand	6 71031 00412 3	55		<b>488.44</b>
<b>T6030LBT</b>	Fiberglass / Biscuit / Left Hand	6 71031 00431 4	55		<b>488.44</b>
<b>T6030R</b>	Fiberglass / White / Right Hand	6 71031 00413 0	55		<b>444.17</b>
<b>T6030RBN</b>	Fiberglass / Bone / Right Hand	6 71031 00414 7	55		<b>488.44</b>
<b>T6030RBT</b>	Fiberglass / Biscuit / Right Hand	6 71031 00432 1	55		<b>488.44</b>
<b>T6030L-AFD</b>	Fiberglass / White / Left Hand	6 71031 00581 6	66		<b>556.98</b>
<b>T6030R-AFD</b>	Fiberglass / White / Right Hand	6 71031 00580 9	66		<b>556.98</b>

**ACCESSORIES**

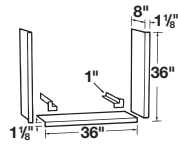

**DURATRIM™ FIBERGLASS WINDOW TRIM KIT**

– Fit windows up to 36" wide by 8" sill depth.

**300.600W**    White    Fiberglass    6 71031 00060 6    9    UPS    **\$243.00**

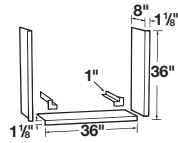

**DURATRIM™ THERMOPLASTIC WINDOW TRIM KIT**

– Fit windows up to 36" wide by 8" sill depth.

**52.600W**    Thermoplastic / White / Adhesive    6 71031 00185 6    3.1    UPS    **127.64**

Grab Bars – See page 24.

Mustee Fiberglass & Thermoplastic Bathtub Wall Surrounds – See pages 14 & 15.

More information about Topaz™ Fiberglass Bathtubs on page 16.





**Quality Products for  
Residential, Commercial, Healthcare & Institutional Applications**



**Residential – from new single-family and cluster homes to older homes and apartment bath renovations.**



**Healthcare – includes hospitals, health care facilities, adult communities, assisted living facilities, apartments and more.**



**Commercial – includes offices, industrial buildings, hotels and motels.**



**Institutional – includes schools, colleges, libraries, laboratories and more.**

Visit us on the web at: [\*\*www.mustee.com\*\*](http://www.mustee.com)



**E. L. Mustee & Sons, Inc.**

5431 West 164th St.  
Brook Park, OH 44142

Phone: 216-267-3100  
Fax: 216-267-9997

Email: [info@mustee.com](mailto:info@mustee.com)

**Code Compliance**

Code Compliance as indicated, most Mustee products are listed by:

International Association of Plumbing and Mechanical Officials (IAPMO®) – United States 

Warnock Hersey® – Canada   
Intertek

**To reorder, specify LPC-13**