



Farm, Ranch & Pet Products

- *Since 1941* -

2025 CATALOG



Helping backyard hobbyists,
homesteaders & hobby farmers



Farm & Ranch Products Since 1941



Dear Valued Customer,

As we introduce our 2025 catalog, I want to personally thank you for your ongoing loyalty and support to Miller Manufacturing. It is because of customers like you—farmers, ranchers, and hobbyists, hard-working individuals who understand the value of quality and resilience—that we’re inspired each day to produce dependable products that support your hobbies and livelihood.

At Miller, we believe that choosing American-made products is an investment in quality, efficiency, and reliability. By manufacturing the majority of our products locally, we are confident in our ability to deliver products that hold up under the rigorous demands of Hard Work Worth Doing.

Innovation is also at the heart of what we do. In 2024, we launched over 20 new products to help you work smarter and more efficiently, and we’re on track to bring you even more in 2025. We’ve also listened closely to your feedback, which led to the launch of our redesigned website this year. It’s now easier than ever to navigate product information, browse our catalog, and even order replacement parts with just a few clicks. Our new customer service chat box feature lets you connect with our dedicated team in real-time, offering how-to guidance and product support whenever you need it. Unlike purchasing from overseas vendors, you have direct access to Miller’s customer service team, ready to provide you with top-notch support.

We remain committed to being the brand you trust for years to come. Thank you for choosing Miller Manufacturing and **BUY AMERICAN!**

Sincerely,

Dan Ferrise
CEO, Miller Manufacturing



We take pride in hard work, care about the health and safety of animals, live a healthy and active lifestyle, and we like to grow and raise our own food.

WE BELIEVE IN THE **HARD WORK WORTH DOING**, WE CALL IT **THE MILLER WAY**.



Manufacturing and Distribution facility located in Glencoe, MN USA

Corporate Office
Eagan, MN USA



Little Giant® Poultry & Game Bird

Poultry & Game Bird	7-23
Duck Feeders & Waterers.....	8
Galvanized Feeders & Waterers.....	9-12
Plastic Feeders & Waterers.....	12-16
Poultry Cup.....	12
Feeding & Watering Display Kits.....	15
Automatic Waterer/Fount.....	17
Poultry Accessories.....	18
Ceramic Eggs.....	19
Egg Carton & Flats.....	19
Egg Baskets.....	19
Brooder Lamp & Bulbs.....	20
Beginner Poultry Kit.....	20
Nesting Boxes.....	21
Restraining Cone.....	21
Incubators & Accessories.....	22-23

Little Giant® Farm Products

Feeding & Watering Livestock.....24-42

Buckets	
Plastic Buckets.....	25-26
Wall Brackets.....	26, 36
Galvanized Pails.....	35
Stainless Steel Dairy Pails.....	29
Rubber Buckets & Pails.....	36-38

Tubs, Pans & Cans	
Plastic Tubs.....	27
Flex Tubs.....	30
Plastic Pans.....	32, 85
Galvanized Tubs.....	33-34
Galvanized Garbage Cans & Lids.....	34
Watering Can & Stainless Steel Pails.....	35
Rubber Pans & Tubs.....	37

Feeders & Waterers	
Plastic Feeders.....	31
Plastic Hook Over Feeders.....	29-31
Metal Feeders.....	35
Rubber Hook Over Feeder.....	36
Stock Tanks.....	38
Float Valves.....	39
Automatic Horse & Stock Waterers.....	40
Feed Scoops.....	41
Hog Feeders.....	42
Galvanized Feed Pan.....	42
Mineral & Salt Block Feeders.....	42
Auger Hoppers.....	42

Goat & Sheep Supplies.....28-29

Plastic Feeders.....	28-29
Plastic Bucket & Pails.....	28-29
Rubber Pan.....	28
Rubber Hookover Feeder.....	28
Metal Feeders.....	29
Stainless Steel Dairy Pail.....	29
Nursing Accessories.....	29

Nursing Supplies.....43-44

Baby Pig Waterers & Feeders.....	43
Nursing Pails.....	43
Nursing Bottles, Nipples & Accessories.....	44

Stall Supplies.....45-47

DuraFork Stable Cleaners.....	45
DuraFork Displays.....	46
Equine Care.....	47
Muck Cart.....	47
Totes & Tote Stools.....	46-47
Spray Bottles.....	47

Beekeeping Supplies.....48-55

Beginner Hive Kits.....	49
Woodenware.....	50-51
Protective Apparel.....	51
Accessories & Tools.....	51
Beekeeping Books.....	53
Feeders.....	53
Feeding & Treating.....	53
Honey Production.....	54-55
Winterizing.....	55

Flooring.....	56-57
Pre-Cut Rubber Utility Mats.....	56
VersaPad®.....	56
Trak-Safe Interlocking Mat.....	56
Rolled Rubber Mats.....	57
Flooring Displays.....	56-57

Pest Control.....58-59

Live Traps.....	58
Mouse & Rodent Traps.....	59

Fluid Management.....59

Funnels, Oil Pans & Utility Tub.....	59
--------------------------------------	----

Ranch Products

Hot-Shot®.....60-64

Electric Livestock Prods.....	61-63
Shafts & Rechargeable Prods.....	61-63
Power-Mite®.....	63
Sorting Poles & Paddles.....	64
Show Sticks.....	64

Springer Magrath®.....65-68

Livestock Prods, Prod Shafts, & Power Pak.....	66
Fluid Feeders.....	67
Bolus Gun.....	67
Cattle Pump System.....	68
Obstetrical Calf Straps.....	68
Transfer Needle.....	68
Orphan-No-More™.....	68

API® Heated Products

Livestock & Poultry.....69-74

Heated Buckets.....	70
Bucket De-Icers & Heaters.....	71
Tank De-Icers / Heaters.....	72-73
Heater Base.....	74
Heated Poultry Waterers.....	74
Heated Poultry Mat.....	74

Hoses & Electrical.....75

Heated Hoses & ClickShield® Cord Lock.....	75
--	----

Pet & Small Animal Care.....76-77

Heated Pet Beds.....	76
Heated Plastic Mats.....	76
Pet Bed Warmer.....	76
Heated Feeders & Waterers.....	77

Bird Bath & Pond.....78-80

Heated Bird Baths	
Deck Mount Bird Baths.....	78
Decorative Bird Baths.....	78
Bird Baths with Stands.....	79
Water Wigglers®.....	79
Bird Bath De-Icers.....	80

Pond Supplies	
De-Icers.....	80

Pet-Lodge® Pet Products

Pet Care.....81-94

Exercise Pens.....	82
Wire Pet Barrier.....	82
Wire Crates.....	83
Plastic Trays.....	83
Plastic Crates.....	84
Pet Beds.....	84
Feeders & Waterers.....	85-88
Pooper Scoopers.....	88

Small Animal Care.....89-94

Hutches & Homes.....	89-90
Tools & Accessories.....	91
Feeders & Waterers.....	92-94

Double-Tuf®.....95-97

Replacement Parts.....98-100

Item Number / UPC Listing.....101-106

Full Service Marketing Support.....107

NEW PRODUCTS

Farm & Ranch Products Since 1941



NEW!
EGGAPRON
Egg Collecting Apron
Page 18



NEW!
SKELTER
Egg Skelter
Page 18



NEW!
SKEWER
Chicken Treat Skewer
Page 18



NEW!
TB4
Chicken Treat Ball
Page 18



NEW!
PWBRUSH
Cleaning Brush for
Poultry Waterers
Page 18



NEW!
NESTPAD10
Fiber Nesting Pads
Page 18



NEW!
RNESTPAD6
Reusable Nesting Pads
Page 18



NEW!
P20FBGRAY6
Cool Gray 20 Qt Bucket
Page 25



NEW!
P20FBLAVENDER6
Lavender 20 Qt Bucket
Page 25



NEW!
DXDOMEWTR8
Deluxe Dome Waterer
(Available in 3 Sizes)
Page 14



NEW!
DXDOMEFDR50
Deluxe Dome Feeder
(Available in 3 Sizes)
Page 14



NEW!
P20FBLID
20 Qt Bucket Lid
Page 25



NEW!
PDF103DISPRED
Fork Head Display - Red
Page 46

NEW!
PDF103DISPGREEN
Fork Head Display - Green
Page 46

Farm & Ranch Products Since 1941

Understanding Item Listings

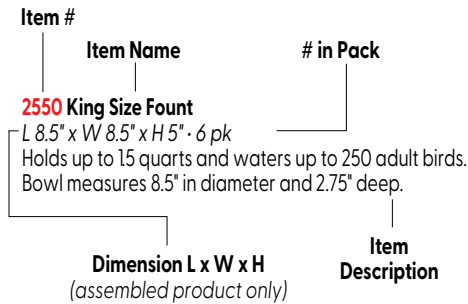

For more information on product carton dimensions and weights contact your Miller Manufacturing Sales Representative.

Unit Conversion Guide

Capacities of our products are approximate and may vary depending on use.

Length

- 22"es = 55.88 cm.
- 24"es = 60.96 cm.
- 32"es = 81.28 cm.
- 36"es = 91.44 cm.
- 42"es = 106.68 cm.
- 48"es = 121.92 cm.
- 52"es = 132.08 cm.
- 60"es = 152.4 cm.
- 72"es = 182.88 cm.

To calculate cubic feet:

$$L \times W \times H \div 1728$$

To convert inches to cm.:

Multiply the given inch value by 2.54 cm

Liquid Measure

- 8 Ozs = 1 Cup = 1/2 Pint = 0.24 liter
- 2 Pints = 1 Quart = 0.95 liter
- 2 Quarts = 1/2 Gallon = 1.89 liter
- 4 Quarts = 1 Gallon = 3.79 liter
- 8 Quarts = 2 Gallons = 7.57 liter
- 12 Quarts = 3 Gallons = 11.36 liter
- 16 Quarts = 4 Gallons = 15.14 liter
- 20 Quarts = 5 Gallons = 18.93 liter
- 26 Quarts = 6 1/2 Gallons = 24.61 liter
- 60 Quarts = 15 Gallons = 56.78 liter
- 70 Quarts = 17 1/2 Gallons = 0.95 liter

Dry Measure

- 2 Pints = 1 Quart = 1.14 liter
- 5 Pints = 2 1/2 Quarts = 2.84 liter
- 3 Quarts = 12 Cups = 3.41 liter
- 4 Quarts = 16 Cups = 4.55 liter
- 6 Quarts = 24 Cups = 6.82 liter

LEGEND

Available Color Swatches*:

- | | | | |
|---|---|--|--|
| ● BERRYBLUE | ● HOTPINK | ● PURPLE | ● BLACK |
| ● BLACK | ● LIMEGREEN/
APPLEGREEN | ● RED | ● GRAY |
| ● BLUE | ● NAVY | ● TEAL | ● LAVENDER |
| ● BURGUNDY | ● ORANGE | ○ WHITE | |
| ● GREEN | | ● YELLOW | |

*Colors subject to change due to availability

Easily Locate USA Products with these icons:



= Made in the USA



= Assembled in the USA



Our Efforts to be Eco-Friendly

We have made it a priority to consider the environment and natural resources in the manufacturing of our products and operation of our facilities, including:

- Use of recycled materials in many of our products
- Utilization of recycled plastic resin
- Utilization of recovered energy sources from our local landfill to power our manufacturing facility
- Investment in energy efficient lighting technologies allowing us to reduce our energy consumption
- Water-soluble machining oil used versus a hazardous waste oil
- Recycling of all manufacturing scrap materials
- This catalog has been printed on FSC certified paper with 10% PCW (post-consumer waste)

Questions?

We take pride in providing great customer service. Please let us know how we can assist you.

Corporate Office

2915 Commers Drive, Suite 100
Eagan, MN 55121 USA
Fax: (651) 982-5243

Manufacturing

1400 West 13th Street
Glencoe, MN 55336 USA

Distribution

1450 West 13th Street
Glencoe, MN 55336 USA

Customer Service

(800) 260-0888

Hours: M-F 7:00 AM - 5:00 PM CT

Main Phone (651) 982-5100

Main Fax (651) 982-5101

customerservice@miller-mfg.com

Live Chat

www.miller-mfg.com

Stay Connected With Us!



miller-mfg.com



www.linkedin.com/company/
miller-manufacturing



@MillerMfg



Youtube.com/millermfg1



@millermanufacturing



Miller Manufacturing



Poultry, Game Bird & Duck Products

Innovators in Poultry Supplies Since 1941

We are proud to offer a full line of products, with everything from feeders and waterers, to incubators and nesting supplies. And with many of our products produced here in the United States, we offer value and service that can't be beat.

Over 80 years in business has taught Little Giant® a thing or two about making quality, lasting products. Our products not only look good on the outside, they're built to last on the inside. Heavy-duty handles, reinforced tops, rolled edges for animal safety...these are all things we don't need to do, but we do them because we stand behind the quality of our product.

Learn more about our products and categories we offer, by locating them on the pages listed below:

Duck Feeders & Waterers.....	8
Galvanized Feeders	9
Galvanized Waterers.....	9-12
Plastic Poultry Waterers	12-15
Chick Starter & Poultry Kits.....	15, 20
Deluxe Hen Hydrators.....	16
Poultry Founts	17
Poultry Accessories.....	18-19
Brooder & Nesting Supplies.....	20-21
Incubators	22-23



Innovators in Poultry Supplies Since 1941

Duck Feeders & Waterers



DUCKFDR11

NEW! **DUCKFDR11 11 Pound Duck Feeder**
 15.25" x 15.25" x 11.875" · 6 pk
 Deep base accommodates large bills of ducks and other waterfowl. Adjustable feed level. Holds 11 lbs of feed.



DUCKWTR3

NEW! **DUCKWTR3 Duck Waterer 3 Gallon**
 17.5" x 14.25" x 11.5" · 6 pk
 Deep individual cups fit duck bills and discourage territorial behavior or playing. Removable filter cups for easy cleaning. Hold 3 gallons.



DOMEFDR45
 Holds up to 45 lbs. of feed.

DOMEFDR35
 Holds up to 35 lbs. of feed.

DOMEFDR60
 Holds up to 60 lbs. of feed.

Plastic Dome Feeders

Large-capacity feeders for your flock. Made out of durable plastic with UV protection. Top-fill design is easy to use. Three legs are easily assembled to the base and keep the feeder off the ground. Easy to clean. Works well for most poultry and some waterfowl.

ITEM	DESCRIPTION	SIZE	CASE PACK	BEST FOR UP TO...
DOMEFDR35	35 Pound Plastic Dome Feeder	L 22.75" x W 18.25" x H 18.25"	1 pk	55 Adult Birds
DOMEFDR45	45 Pound Plastic Dome Feeder	L 26.5" x W 18.25" x H 18.25"	1 pk	80 Adult Birds
DOMEFDR60	60 Pound Plastic Dome Feeder	L 30.75" x W 18.25" x H 18.25"	1 pk	100 Adult Birds

Plastic Waterer Jars & Bases

Jars are molded from durable, translucent polyethylene so the water level is always visible. Choose from threaded or lug design. Light weight, colorful designs, and very simple to use.



742

806
 Shown with 692 jar, sold separately.

692 1 Quart Screw-On Jar
 L 3.5" x W 3.5" x H 7.25" · 12 pk
 Best for up to 12 ducklings.

742 1 Quart Waterer Base fits 692
 L 6" x W 6" x H 1.5" · 12 pk
 Best for up to 12 ducklings.

Available in: ● ● ● ● ● ● ● ●
806 1 Quart Plastic Feeder Base fits 692
 L 6.375" x W 6.325" x H 2.5" · 12 pk
 Best for up to 15 ducklings. Constructed out of durable polypropylene. Base features 8 openings with ribs to minimize feed spillage. Removable cover. Available in: ● ● ● ● ● ● ● ●



TR20PLW

Plastic Ground Feeder

TR20PLW Plastic Poultry Trough Feeder with Wide Grid
 L 20" x W 4.7" x H 4.9" · 12 pk
 Made of durable plastic, this ground feeder features slanted feed-saver bars. Legs help boost the feeder a bit off the ground. Feed saver grid is widely spaced to accommodate up to 20 adult birds.

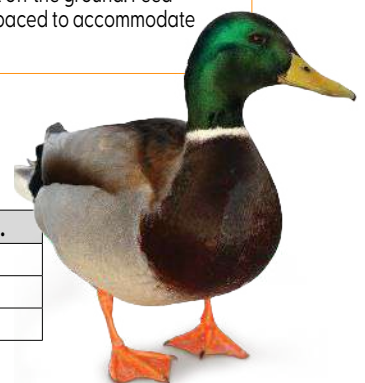

Galvanized Feeders

167543 Galvanized Hanging Corner Feeder

L 6.875" x W 3.375" x H 6.187" · 6 pk
Best for up to 3 adult birds. Works great for supplemental uses like feeding shells or grit. Space-saving corner design with built-in hooks for hanging in hutch or coop. Sturdy galvanized steel has rolled edges for safety.



167543
1 Pound

167451 1 Pint Galvanized Round Hanging Waterer

L 5.75" x W 4.25" x H 5.75" · 6 pk
Best for up to 3 adult birds. Built-in hooks allow this waterer to hang off the ground to reduce spillage and soiling of water. Gravity-feed design is easy to fill and clean. Sturdy galvanized steel has rolled edges for safety.



167451
1 Pint

167611 1 Gallon Galvanized Bucket Waterer

L 9.875" x W 7.5" x H 9.5" · 4 pk
Best for up to 5 adult birds. Unique design serves as a bucket for filling and carrying, then converts to a gravity-feed waterer. Sturdy galvanized steel has rolled edges for safety. Perfect for small poultry flocks.



167611
1 Gallon

**EASY
TO DISPLAY!
PACKAGING!**

Round Waterers

Perfect for chicks. Rounded, embossed edges help reduce chafing on head, neck and sheens.

9826 1 Quart Jar Waterer Base

L 5.5" x W 5.5" x H 1.125" · 12 pk
Best for up to 12 chicks.

MJ9826 Mason Jar Chick Waterer

L 5" x W 5" x H 7" · 6 pk
Best for up to 12 chicks. Gravity-fed chick waterer comes fully assembled and features a glass mason jar. Easy to fill and clean. It holds 1 quart of water. The base is made of heavy-duty galvanized steel with rounded, embossed edges to help reduce chafing on chick's head, neck and sheens.



MJ9826



MJ9810



9826
1 Quart



9810
1 Quart



9808

Round Feeders

Perfect for chicks. Rounded, embossed edges help reduce chafing on neck and head. Removable cover.

9808 6" Round Feeder

L 6" x W 6" x H 2" · 12 pk
Best for up to 15 chicks.

9810 1 Quart Round Jar Feeder Base

L 6" x W 6" x H 2.5" · 12 pk
Best for up to 15 chicks.

MJ9810 Mason Jar Chick Feeder

L 6.125" x W 6.125" x H 8.625" · 6 pk
Best for up to 15 chicks. Gravity-fed chick feeder comes fully assembled and features a glass mason jar. Easy to fill and clean. It holds 1 quart of feed. The base is made of heavy-duty galvanized steel. Base includes eight feeding holes.

9826 & 9810 can be paired with a glass mason jar or 692 plastic 1-quart jar found on pg 15. Sold separately.

Painted Galvanized Bucket Waterer

These buckets let you easily carry water to your backyard flock, then use the bucket itself as a poultry waterer! Unique design serves as a bucket for filling and carrying, then converts to a gravity-fed waterer. Attractively painted, sturdy galvanized steel has rolled edges for safety. Small size with built-in handle is perfect for small poultry flocks.

PGB1 1 Gallon Painted Galvanized Bucket Waterer

L 7.3" x W 7.3" x H 8.3" · 6 pk
Best for up to 5 adult birds.

PGB2 2 Gallon Painted Galvanized Bucket Waterer

L 8.7" x W 8.7" x H 9.6" · 4 pk
Best for up to 10 adult birds.



PGB1
1 Gallon

PGB2
2 Gallon

Innovators in Poultry Supplies Since 1941

Galvanized Double Wall Founts

These Little Giant® waterers are constructed of heavy-gauge galvanized steel and are available in four sizes. Edges are rolled for safety and feature arched inner handles for added strength. Copper spring and neoprene seal produce a positive water shut-off. Seams are constructed and tested to prevent leaks. Double wall founts also feature a locking pin.



! Locking pin holds cover securely in place.



9832
2 Gallon



9833
3 Gallon



9835
5 Gallon



DT9863
2 Gallon



9838
8 Gallon

ITEM	DESCRIPTION	SIZE	CASE PACK	BEST FOR UP TO...
9832	2 Gallon Double Wall Fount	L 12.25" x W 12.25" x H 10.75"	4 pk	100 Chicks or 65 Poult
9833	3 Gallon Double Wall Fount	L 12.25" x W 12.25" x H 15"	2 pk	150 Chicks or 75 Poult
9835	5 Gallon Double Wall Fount	L 15.25" x W 15.25" x H 15.25"	2 pk	75 Adult Hens or 100 Pullets
9838	8 Gallon Double Wall Fount	L 15.25" x W 15.25" x H 22"	2 pk	100 Adult Hens or 150 Pullets
DT9863	2 Gallon Poultry Fount	L 14.5" x W 14.5" x H 11.125"	6 pk	40 Adult Birds

Galvanized Hanging Feeders

Little Giant® hanging feeders are constructed of heavy-gauge galvanized steel with rolled edges for safety.

ITEM	DESCRIPTION	SIZE	CASE PACK	BEST FOR UP TO...
9112	12 Pound Feeder Tube with 12" Feeder Pan	L 12" x W 12" x H 10.125"	6 pk	25 Adult Birds or 100 Chicks
914043	30 Pound Feeder Tube with 14" Feeder Pan	L 14.25" x W 14.25" x H 14.25"	6 pk	50 Adult Birds
914273	40 Pound Feeder Tube with 17" Feeder Pan	L 17" x W 17" x H 20.25"	6 pk	75 Adult Birds
DT9864	17 Pound Poultry Feeder	L 14.5" x W 14.5" x H 12"	6 pk	35 Adult Birds



914273
40 lb. Feeder



914043
30 lb. Feeder



9112
12 lb. Feeder



DT9864
17 lb. Feeder

9144 Feeder Cover

L 11.5" x W 11.5" x H 2.25" • 1 pk
Prevents roosting, keeps feed dry and clean. For use with 12, 30, and 40 lb. feeders. Feeder must be suspended for cover to function as designed.



9144





Galvanized Feeders

171267 Galvanized High Capacity Poultry Feeder

L 11" x W 12" x H 22.625" · 1 pk
 Best for up to 15 adult birds. Made of heavy-gauge galvanized steel for durability. Feeder comes completely assembled for easy setup and immediate use. Ability to be mounted on wall or free stand on ground. Stores and dispenses up to 25 lbs of mash, pellet or crumble feed. Specially designed chute provides steady feed flow. Feed saver grid prevents bottom from overflowing and keeps birds from sweeping feed out of unit.

171267





Reel Top Ground Feeders

Curved feed-saving lip with snap-in reel. Made of heavy-gauge galvanized steel and features rolled edges for safety.



9818



ITEM	DESCRIPTION	SIZE	CASE PACK	BEST FOR UP TO...
9818	18" Reel Top Ground Feeder 	L 18.5" x W 4" x H 2.5"	12 pk	10 Adult Birds
9824	24" Reel Top Ground Feeder 	L 23.625" x W 4.25" x H 2.25"	12 pk	14 Adult Birds

Slide Top Ground Feeders

Individual holes minimize waste. Top slides off for easy access. Made of heavy-gauge galvanized steel and rolled edges.



9822



ITEM	DESCRIPTION	SIZE	CASE PACK	BEST FOR UP TO...
9814	12" Slide Top Feeder 	L 12.5" x W 3.875" x H 2.75"	12 pk	14 Adult Birds
9822	18" Slide Top Feeder 	L 18.5" x W 3.75" x H 2.5"	12 pk	20 Adult Birds
9830	24" Slide Top Feeder 	L 24.75" x W 4" x H 2.625"	12 pk	25 Adult Birds

Range Ground Feeders

Off-the-ground design for larger birds. Heavy-gauge galvanized steel and features rolled edges.



9836

ITEM	DESCRIPTION	SIZE	CASE PACK	BEST FOR UP TO...
9836	36" Range Feeder 	L 36.25" x W 6.5" x H 6.75"	6 pk	36 Adult Birds
9848	48" Range Feeder 	L 48.25" x W 6.5" x H 6.75"	6 pk	48 Adult Birds

Innovators in Poultry Supplies Since 1941

Galvanized Ground Feeders

TR20GALV Galvanized Trough Feeder with Narrow Grid

L 20" x W 5" x H 3.9" · 6 pk

Best for up to 20 adult birds. Made of sturdy galvanized steel, this ground feeder features slanted feed-saver bars that prevent roosting. Legs help boost the feeder off the ground.

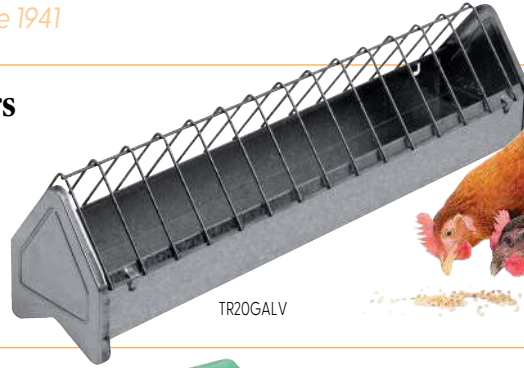

TR20GALV

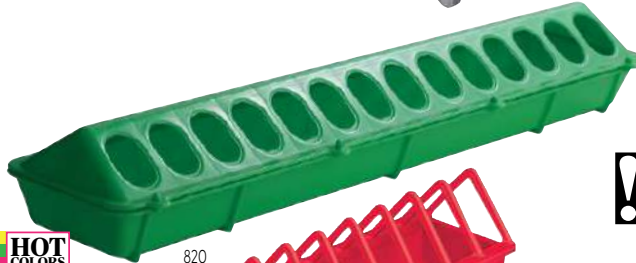

820

HOT COLORS Available!

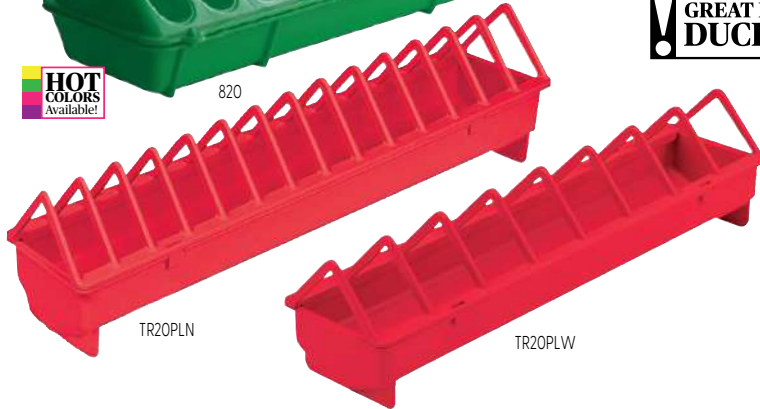

TR20PLN

TR20PLW

GREAT FOR DUCKS!

Plastic Ground Feeders

Snap-in hinge ensures long-lasting use.

820 20" Plastic Flip Top Feeder

L 20" x W 4.5" x H 3" · 12 pk

Best for up to 20 adult birds or 40 chicks.

Available in: ■ ■ ■ ■

TR20PLN Plastic Poultry Trough Feeder with Narrow Grid

L 20" x W 4.7" x H 4.9" · 12 pk

Best for up to 20 adult birds. Made of durable plastic, this ground feeder features slanted feed-saver bars that prevent roosting. Legs help boost the feeder off the ground.

TR20PLW Plastic Poultry Trough Feeder with Wide Grid

L 20" x W 4.7" x H 4.9" · 12 pk

Made of durable plastic, this ground feeder features slanted feed-saver bars that prevent roosting. Legs help boost the feeder a bit off the ground. Feed saver grid is widely spaced to accommodate up to 20 adult birds. Great for ducks!

Plastic Poultry Cups

CUP2 Poultry Drinking Cups, 2 Pack

L 7.25" x W 5.25" x H 2.125" · 6 pk

Best for up to 5 birds per cup. Use these handy cups to create your own low-maintenance poultry waterer!

Threaded, screw-in attachment fits into a 3/8" hole drilled into a PVC pipe or any plastic container. Made of durable plastic and features a small bar that birds peck to activate the flow of water. Can be installed either horizontally or vertically. 2 per package. Comes with free 6 piece clip-strip.



CUP2



EASY TO DISPLAY!



See page 91 & 92 for Plastic & Galvanized Cage Cups.

See page 74 for heated poultry products



7906
3 Gallon



HPW33
3 Gallon

Poultry Waterers

7906 3 Gallon Poultry Waterer

L 12" x W 12" x H 16" · 6 pk

Best for up to 60 adult birds.

Built-in handle for easy portability.

HPW33 Heated Poultry Fount 100 Watts, 120 Volts

L 13.62" x W 13.62" x H 16.75" · 4 pk

Best for up to 60 adult birds. Patented design provides your poultry with fresh water all winter long. Keeps water ice-free down to -5 degrees F in the winter, but can be used year round as well.

Thermostatically controlled with optimized heater pad design for maximum heating efficiency to ensure ice-free water. Sturdy galvanized steel handle. Rounded top of water jug helps prevent chickens from roosting. 3-gallon capacity. 4-foot cord. 60 Hz. cULus Listed. One year warranty.

Deep Base Poultry Waterers

These Deep Base Waterers are best for juvenile and adult birds. The handy design allows the base to remain on the jug while filling from bottom. Includes plastic stopper with o-ring on bottom to prevent leaks. Comes with carrying handle.

ITEM	DESCRIPTION	SIZE	CASE PACK	BEST FOR UP TO...
DBW1	1 Gallon Deep Base Poultry Waterer	L 8.375" x W 11.875" x H 11.875"	5 pk	5 Adult Birds
DBW2	2 Gallon Deep Base Poultry Waterer	L 13.25" x W 11.875" x H 11.875"	5 pk	10 Adult Birds
DBW3	3 Gallon Deep Base Poultry Waterer	L 18.125" x W 11.875" x H 11.875"	5 pk	20 Adult Birds

! Fits securely in base of Deep Feeders/ Waterers

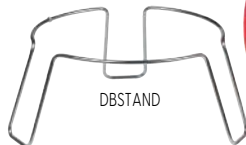

DBSTAND Metal Stand for Deep Base Waterers





L 4.5" x W 10" x H 10" - 5 pk

This stand works with our Little Giant® Deep Base Waterers to raise the waterer off the ground to keep dirt and debris out of the water.



Deluxe Plastic Poultry Feeders

Feed saver lips minimize spillage. These feeders feature adjustable feed levels. Anti-scratch vanes help prevent crowding and feed waste. Product designed to be used on ground or suspended.

ITEM	DESCRIPTION	SIZE	CASE PACK	BEST FOR UP TO...
DPHF3	Deluxe 3 Pound Poultry Feeder 	L 8.25" x W 8.25" x H 9"	6 pk	25 Chicks
DPHF11	Deluxe 11 Pound Poultry Feeder 	L 12.5" x W 12.5" x H 12"	3 pk	15 Adult Birds
DPHF22	Deluxe 22 Pound Poultry Feeder 	L 17.25" x W 17.25" x H 15"	2 pk	50 Adult Birds
PCSMLID	Lid for Hanging Feeder Small 	L 5.75" x W 5.75" x H 2.5"	1 pk	
PCLGLID	Lid for Hanging Feeder Large 	L 11.375" x W 11.375" x H 4.75"	1 pk	





DPHF22
with optional
PCLGLID



! Prevents roosting and helps keep feed dry!

Large Capacity Automatic Waterers

Top fill design. The vacuum-sealing cap creates an automatic water flow. Jar snaps onto base.

ITEM	DESCRIPTION	SIZE	CASE PACK	BEST FOR UP TO...
PPF3	3 Gallon Poultry Fount 	L 16" x W 16" x H 14.75"	2 pk	50 Adults or 75 Poults
PPF5	5 Gallon Poultry Fount 	L 16" x W 16" x H 19"	2 pk	75 Hens or 100 Pullets
PPF7	7 Gallon Poultry Fount 	L 16" x W 16" x H 24"	1 pk	80 Hens or 100 Pullets



! **Optimized cap design.** O-ring fits securely in a machined radial groove.

PPF310KIT

Replacement kit available. Contains 3 o-rings and 1 small cap. See page 99.



Innovators in Poultry Supplies Since 1941

Deluxe Dome Waterers

Each has a large lid for easy filling and cleaning. Internal float mechanism automatically controls water flow to accommodate large flocks of adult birds.

ITEM	DESCRIPTION	SIZE	CASE PACK	BEST FOR UP TO...
NEW! DXDOMEWTR8	8 Gallon Deluxe Dome Waterer	L 18" x W 18" x H 26"	4 pk	75 Adult Birds
NEW! DXDOMEWTR10	10 Gallon Deluxe Dome Waterer	L 18" x W 18" x H 30"	3 pk	100 Adult Birds
NEW! DXDOMEWTR13	13 Gallon Deluxe Dome Waterer	L 18" x W 18" x H 33"	3 pk	125 Adult Birds



Deluxe Dome Feeders

Large capacity design suitable for adult birds, including ducks! Large lid makes filling and cleaning easy. Feed saver ring minimizes spillage and prevents wasted food.

ITEM	DESCRIPTION	SIZE	CASE PACK	BEST FOR UP TO...
NEW! DXDOMEFDR50	50 Pound Deluxe Dome Feeder	L 18" x W 18" x H 26"	4 pk	85 Adult Birds
NEW! DXDOMEFDR65	65 Pound Deluxe Dome Feeder	L 18" x W 18" x H 30"	3 pk	120 Adult Birds
NEW! DXDOMEFDR80	80 Pound Deluxe Dome Feeder	L 18" x W 18" x H 33"	3 pk	185 Adult Birds

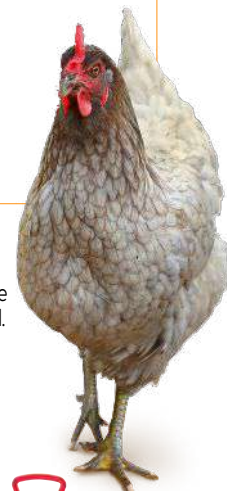

Plastic Dome Feeders

Large-capacity feeder for your flock. Made out of durable plastic with UV protection. Easy to fill, thanks to the top-fill design and lid. Fill from the top and screw the lid on tightly to protect feed from the elements. Three legs are easily assembled to the base and keep the feeder off the ground. Feed Saver Ring minimizes spillage to prevent wasted food and is easily removed for cleaning. Great for most poultry and waterfowl.

ITEM	DESCRIPTION	SIZE	CASE PACK	BEST FOR UP TO...
DOMEFDR35	35 Pound Plastic Dome Feeder	L 22.75" x W 18.25" x H 18.25"	1 pk	55 Adult Birds
DOMEFDR45	45 Pound Plastic Dome Feeder	L 26.5" x W 18.25" x H 18.25"	1 pk	80 Adult Birds
DOMEFDR60	60 Pound Plastic Dome Feeder	L 30.75" x W 18.25" x H 18.25"	1 pk	100 Adult Birds



Plastic Dome Waterers

Best suited for adult birds. Large-capacity waterer for your flock. Made out of durable plastic with UV protection. Top-fill design is easy to use. Valve in base controls water flow – close when filling, then open to allow water to fill the base. For best results, set waterer on level surface before filling. Works well for most poultry and some waterfowl.

ITEM	DESCRIPTION	SIZE	CASE PACK	BEST FOR UP TO...
DOMEWTR5	5 Gallon Plastic Dome Waterer	L 17.5" x W 18.25" x H 18.25"	1 pk	60 Adult Birds
DOMEWTR8	8 Gallon Plastic Dome Waterer	L 24.25" x W 18.25" x H 18.25"	1 pk	75 Adult Birds
DOMEWTR10	10 Gallon Plastic Dome Waterer	L 28.5" x W 18.25" x H 18.25"	1 pk	100 Adult Birds

Plastic Waterer Jars & Bases

Jars are molded from durable, translucent polyethylene so the water level is always visible. Choose from threaded or lug design. Light weight, colorful designs, and very simple to use.

666 1 Gallon Screw-On Jar

L 7" x W 7" x H 9.25" · 12 pk
Best for up to 25 chicks.

750 1 Gallon Screw-On Base fits 666

L 9" x W 9" x H 1.5" · 12 pk
Best for up to 5 adult birds or 25 chicks.
Available in: ● ● ● ●

7506 1 Gallon Poultry Fount Complete

L 9" x W 9" x H 10.25" · 6 pk
Best for up to 5 adult birds or 25 chicks.
Includes 666 and 750. With one UPC for easier scanning at the register.
Available in: ● ● ● ●

680 1 Gallon Nesting Jar - Lug Design

L 8" x W 8" x H 7.5" · 12 pk
Best for up to 25 chicks. The 680 nesting jar reduces storage space and shipping costs.

780 1 Gallon Nesting Base fits 680

L 11" x W 11" x H 1.75" · 12 pk
Best for up to 5 adult birds or 25 chicks.
Lug design. Available in: ● ● ● ●

692 1 Quart Screw-On Jar

L 3.5" x W 3.5" x H 7.25" · 12 pk
Best for up to 12 chicks.

732 1 Quart Waterer Quail Base fits 692

L 4" x W 4" x H 1.25" · 12 pk
Best for up to 15 quail chicks. Base features a narrow channel designed specifically for smaller birds.

742 1 Quart Screw-On Poultry Waterer Base

L 6" x W 6" x H 1.5" · 12 pk
Best for up to 12 chicks.
Available in: ● ● ● ● ● ●

806 1 Quart Plastic Feeder Base fits 692

L 6.375" x W 6.325" x H 2.5" · 12 pk
Best for up to 15 chicks. Constructed out of durable polypropylene. Base features 8 openings with ribs to minimize feed spillage. Removable cover.
Available in: ● ● ● ● ● ●



Some items now available in colorful case packs, ready for display on store shelves!



Chick Starter Kit

CKDISP Chick Starter Kit

L 20.38" x W 13.38" x H 54.63" · 1 pk
Ships fully loaded and ready to display.

Includes the following items:

- 742RED.....12 pcs.
- 742LIMEGREEN.....12 pcs.
- 742PURPLE.....6 pcs.
- 742YELLOW.....6 pcs.
- 806RED.....12 pcs.
- 806APPLEGREEN.....12 pcs.
- 806PURPLE.....6 pcs.
- 806YELLOW.....6 pcs.
- 692.....30 pcs.



CKDISP



PLTRYDISP

Poultry Kit

PLTRYDISP Poultry Kit

L 20.75" x W 23.75" x H 54" · 1 pk
Ships fully loaded and ready to display. Compact footprint fits just about anywhere.

Includes the following items:

- 680.....24 pcs.
- 780.....6 pcs.
- 780PURPLE.....6 pcs.
- 780LIMEGREEN.....6 pcs.
- 780YELLOW.....6 pcs.
- 820.....12 pcs.
- 820PURPLE.....12 pcs.
- 820LIMEGREEN.....12 pcs.
- 820YELLOW.....12 pcs.

Innovators in Poultry Supplies Since 1941

Deluxe Hen Hydrator

These gravity-fed Hen Hydrators provide access to clean water on demand. The translucent bucket was designed to provide UV protection to prevent algae growth and allow for easy viewing of the water level. Convenient twist locking lid is sloped to prevent roosting and makes cleaning easy. Ergonomic handle is designed for the unit to be hung easily and includes a free Little Giant® Bucket Handle Grip (Model #166713) for comfortable carrying with plenty of clearance between hand and bucket. Each of the 4 side-mounted drinking nipples accommodates up to 4 adult birds and allow for easy access.

DHH1 1 Gallon Deluxe Hen Hydrator

L 12.25" x W 13.75" x H 12.5" · 3 pk
Best for up to 10 adult birds.

DHH3 3 Gallon Deluxe Hen Hydrator

L 12.5" x W 20" x H 12.5" · 3 pk
Best for up to 18 adult birds.

HDHH3 API® 3 Gallon Heated Deluxe Hen Hydrator

L 12.5" x W 13.75" x H 12.5" · 3 pk
Best suited for up to 18 adult birds. Provides access to clean water on demand while keeping it ice-free up to -10F.



! Handle allows for easy hanging!



DHH1

! Help keep water clean and prevents disease.



HDHH3



EASY TO DISPLAY!



172035

188890



172035 4 Pack Vertically-Mounted Nipples

L 28.5" x W 4.75" x H 1.25" · 12 pk Clip Strip
Transform a standard bucket or PVC pipe into a poultry watering device. Nipples are easy to install and help keep water clean and prevent disease. Each nipple accommodates up to 4 juvenile or adult birds. Nipples should be mounted vertically.

188890 4 Pack Side-Mounted Nipples for Hen Hydrator

L 28.5" x W 4.75" x H 1.25" · 12 pk Clip Strip
Transform a standard bucket or PVC pipe into a poultry watering device. Nipples are easy to install and help keep water clean and prevent disease. Each nipple accommodates up to 4 birds. Nipples should be mounted on the sides horizontally. Recommended for adult birds only.

Automatic Poultry Waterer

166386 Automatic Poultry Waterer 

L 14" x W 12.75" x H 10.5" · 1 pk

Best for up to 15 adult birds. Includes a 30' hose (3/4" diameter) that attaches to a standard garden hose for a continuous flow of fresh water for your flock.

Automatic float controls the water level so there is no spilling or overflow. Oversized cover extends beyond the edge of the bowl to keep debris out of the water. Angled cover prevents roosting.

Designed for use with juvenile or adult birds (not intended for chicks).

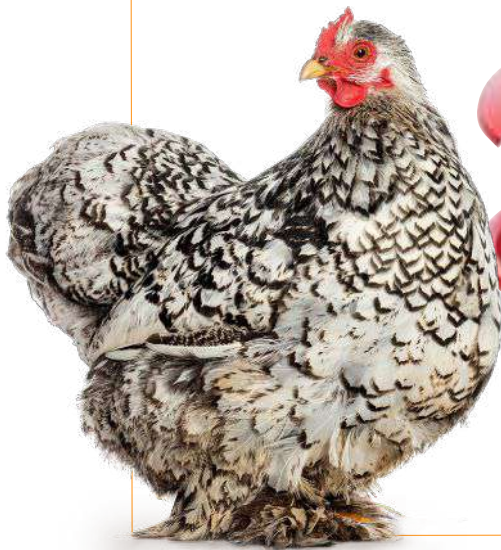

166386



Automatic Poultry & Game Bird Founts

Miller's original product dating back to our roots in 1941. The Little Giant® poultry founts have been used by poultry experts for years. These dependable waterers hook up to any standard 1/2" NPT pipe to provide a limitless supply of clean water. Safely operates between 20-50 psi.

2500 Game Bird Fount

L 6.5" x W 6.5" x H 5" · 6 pk

Best for up to 175 adult birds. Holds 2 pints of water. Bowl measures 6.5" in diameter and 2.5" deep.

2525 Baby Chick Fount

L 7.25" x W 7.25" x H 5" · 6 pk

Best for up to 200 chicks. This extra shallow bowl helps reduce the risk of baby birds drowning. Holds 1.5 pints of water. Bowl measures 7.25" in diameter and 1.25" deep.

2550 King Size Fount

L 8.5" x W 8.5" x H 5" · 6 pk

Best for up to 250 adult birds. Holds up to 1.5 quarts. Bowl measures 8.5" in diameter and 2.75" deep. Works well for larger birds, like turkeys, ducks or peafowl.

1018 Bowl Guard

L 6.75" x W 6.75" x H 1.75" · 1 pk

Accessory for the King Size (2550) and Game Bird (2500) Founts. Acts as an anti-roost device. Helps prevent debris from getting into water.



2500



2525



2550



1018

Replacement parts available. See page 99

See page 74 for heated poultry products



Innovators in Poultry Supplies Since 1941

Poultry Accessories



EGGAPRON

NEW! **EGGAPRON Egg Collecting Apron**
 L 9" x W 7" x H 15" · 6 pk
 This handy apron allows for hands-free collection of your backyard eggs. It has 15 individual pockets that are large enough to hold multiple eggs. Made of sturdy fabric that can hold the weight of the eggs. The apron size is 26" x 21" with a long tie. One size fits most.



SKELTER

NEW! **SKELTER Egg Skelter**
 L 14.375" x W 13.75" x H 14.625" · 4 pk
 Stores and displays farm fresh eggs at room temperature. Attractive spiral design allows for first in, first out egg collection and usage. Made of heavy duty stainless steel to support weight of eggs. Not recommended for store bought eggs. Holds up to 36 eggs.



SKEWER

NEW! **SKEWER Chicken Treat Skewer**
 L 10.5" x W 3" x H 1.375" · 6 pk
 Keep the coop clean and chickens happy and active with this stainless steel treat skewer. It fits a wide variety of fruits and vegetables such as apples, carrots and cob corn. A heavy-duty clip attached to a 9" chain and 4" skewer allows for easy hanging on cage or fence.

Great for avoiding bad habits with your flock due to boredom



TB4

NEW! **TB4 Chicken Treat Ball**
 L 12" x W 8.625" x H 8.5" · 12 pk
 This powder-coated metal ball keeps chickens busy and the coop clean. Perfect size for most fruits and vegetables such as lettuce, apples, carrots or others that chickens may enjoy. Small openings between wire to secure fruit and vegetable pieces inside. Strong 5.5" chain with hook for hanging. 4" diameter.



NESTPAD10

NEW! **NESTPAD10 Poultry Nesting Pads** 
 L 13.625" x W 13.625" x H 6.5" · 6 pk
 Poultry nesting pads provide a soft laying area for eggs that prevents breakage and keeps the coop clean. Designed to fit most nesting boxes, but can be cut for precise fit. Reduces moisture in nesting box to prevent bacteria growth. Elevates eggs for easier gathering. Each pad backed with brown craft paper. Pad size is 13" x 13". Package of 10.



RNESTPAD6

NEW! **RNESTPAD6 Reusable Poultry Nesting Pads**
 L 12.5" x W 12" x H 1.5" · 6 pk
 Reusable poultry nesting box pads provides a soft laying area for eggs that prevents breakage and keeps the coop clean. Simply rinse to clean and reuse. Pad size is 12" x 12". Pads are designed with holes to reduce moisture in nesting box, preventing bacteria growth. Package of 6 pads.

See page 21 for more nesting options

NEW! **PWBRUSH Poultry Waterer Cleaning Brush**
 L 24.625" x W 2.05" x H 7.375" · 6 pk
 L-shaped brush easily reaches inside of containers and enables thorough cleaning to protect against harmful bacteria. High quality polypropylene bristles are perfect for poultry feeders and waterers. Dishwasher safe. Overall length of brush is 24".



PWBRUSH



Egg Flats

EGGFLAT30 Egg Flat (12 per package) 

L 11.75" x W 11.75" x H 1.75" • 4 pk

These 5x6 Egg Flats hold up to 30 eggs, size small up to extra large. Great for selling or transporting your eggs, or for storing and organizing small parts.



EGGFLAT30



EGGCTNSLD

Egg Carton

EGGCTNSLD Egg Carton 

L 11.75" x W 4" x H 3.75" • 200 pk

High-quality, natural colored (gray) 100% reclaimed paper features simple, classic farm imagery. Includes the required FDA Safe Handling Instructions and Keep Refrigerated Warnings. No grade or size specified on carton, so carton can be used for a variety of egg sizes. Solid top. Comes in a pack of 200 cartons.

Ceramic Eggs

Simply place these ceramic eggs in a nesting box to encourage hens to lay eggs. They look and feel like the real thing – same color, size and weight! They also help discourage chickens from pecking or eating eggs.

CEGGBRN Ceramic Nest Eggs Brown (2 per pack) 

CEGGWHT Ceramic Nest Eggs White (2 per pack) 

L 4.25" x W 1.75" x H 7.25" • 6 pk



CEGGBRN

EASY TO DISPLAY PACKAGING!

CEGGWHT

Egg Baskets

Basket design allows for easy cooling, washing and quick drying of eggs. It is made of heavy-duty coated wire to help prevent corrosion and is securely welded at every joint.

EB8 Egg Basket Small

L 8.5" x W 8" x H 5.625" • 6 pk

Holds up to 3 dozen large eggs.

EB13 Egg Basket Large

L 13.375" x W 13" x H 6.875" • 6 pk

Holds up to 8 dozen large eggs.

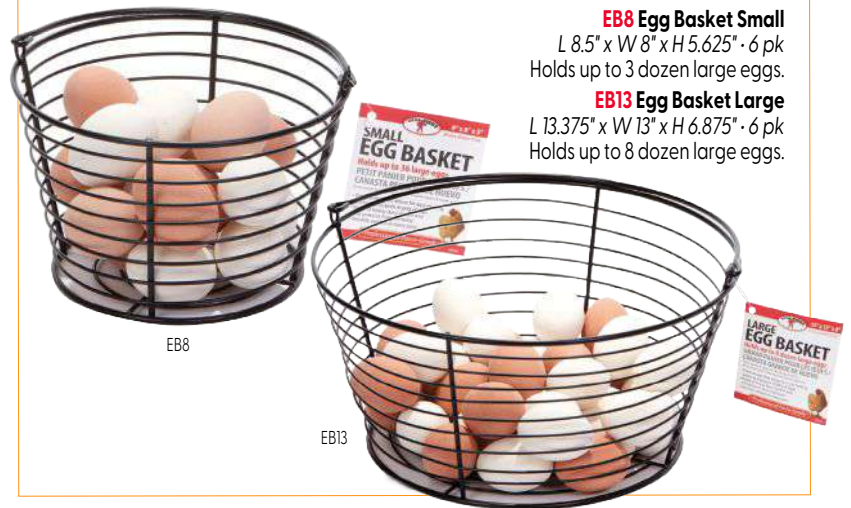

EB8

EB13



To learn about our full service marketing please see page 107.

Innovators in Poultry Supplies Since 1941

Brooder

BROODER Galvanized Chick Brooder Box

L 39.4" x W 18.7" x H 23.6" · 1 pk

A safe observatory for brooding chicks up to four or five weeks old. Sturdy metal arm holds a brooder lamp (sold separately) over one side of the brooder. Chicks can move between the section of the brooder with solid metal walls and the section with wire grid walls to warm up or cool down as needed. Wire mesh floor has openings 5/16" apart. Pine shavings, hay, or straw can be used for bedding, especially if the breed you have selected have smaller sheens for the floor spacing. Dropping pan slides in and out under the wire mesh floor for easy removal and cleaning. Easily assembled using a flathead screwdriver and the included hardware.



BROODER

Works great with other Little Giant® accessories. Sold separately.

Brooder Kit

172196 Chick Brooder Kit

L 32.5" x W 34" x H 34" · 1 pk

Best for up to 15 chicks. Kit comes with a washable and reusable plastic corrugated wall and stand which includes a hook for a Brooder Reflector Lamp to be hung. The lamp stand can be secured to the wall for added safety with the included cable ties. This stand is also adjustable allowing the height of the lamp to be modified as chicks grow. Enclosure measures approximately 3 feet in diameter and 16" tall when assembled.



QUICK & EASY Set-Up!

Circular design prevents corner crowding which can result in chick injury and/or suffocation

Brooder Lamp

170017 10.5" Brooder Reflector Lamp

L 10.5" x W 5.875" x H 13" · 4 pk

Best for up to 100 chicks. Heat-resistant ceramic socket and double wire bulb guard for safety. Features 6-foot electrical cord specially designed to prevent wires from coming loose and causing shock. The cord also features polarized male prongs and scratch-resistant clamp with ball joint for easy positioning. Corrosion-resistant aluminum shade has a built-in hanger. Uses 300W bulb maximum. cULus Listed.



170017



EASY TO DISPLAY PACKAGING



170024 Red Bulb



170031 Clear Bulb

Brooder Lamp Bulbs

Designed to provide enough heat for small flocks. 250 watt/120 volt bulb is great for brooding chickens and other poultry. Alloy bulb with non-stick base and 6,000-hour bulb life. Extra thick filaments are enclosed in a high quality bulb made with test tube glass. Additional filament support wires increase the durability and life of the bulb.

170024 Red Heat Lamp Bulb

L 5" x W 5" x H 6.5" · 12 pk

Best for up to 100 chicks. Red Bulb prevents pecking, injuries, and creates a calm environment.

170031 Clear Heat Lamp Bulb

L 5" x W 5" x H 6.5" · 12 pk

Best for up to 100 chicks.

Beginner Poultry Kit

NEW! LGBPKIT Little Giant® Beginner Poultry Kit

L 15.25" X W 10.5" X H 10" · 1 pk

This kit contains the Little Giant® items you need to get your chicks started! Includes a 250W red heat lamp bulb and 10.5" reflector lamp to provide safe heat for your chicks, plus a galvanized round feeder, two 1 quart plastic jars, a 1 quart plastic chick waterer base and 1 quart plastic chick feeder base. You'll also get our Guide to Backyard Poultry, which includes helpful tips, information and fun facts for your new flock. Bulb is 250 Watts/120 Volts, with a 6,000-hour life. Galvanized ground feeder and 1 quart plastic feeder base each have 8 feeding holes.



EASY TO DISPLAY PACKAGING

NEW!

LGBPKIT

Nesting Boxes

165525 Open Nesting Box

L 17" x W 11.625" x H 11.875" · 6 pk

Better than metal and wood nests, and costs less! Made of high-density, impact-resistant polyethylene that will not rust, rot, or corrode. Hen-friendly design features an open back and top to allow better ventilation and easier access to eggs inside coops. The front lip helps prevent loss of bedding and the slightly graded floor leads to a back drainage hole. Mounts securely on wall with slide-type screw holes or sits squarely on a shelf. Space-saving modular layout can be mounted vertically or side by side on 16" on-center studs.

163620 Single Nesting Box

L 16.5" x W 15.88" x H 19.75" · 6 pk

Made of high-density, impact-resistant polyethylene that is easy to keep clean and will not rust, rot or corrode. Mounts securely on wall with slide-type screw holes. Sloped roof prevents roosting.

- Mounts to 16" on-center studs
- Ventilation holes for fresh air
- Perch gives hens a place to land before entering nest

Hang three units vertically and fit within recommended guidelines - first unit should be mounted 24" off the ground to protect from predators. Top unit will be low enough from ceiling to prevent roosting.



! Can mount vertically or side by side.



PNB1 Deluxe Plastic Nesting Box

L 14.5" x W 16.5" x H 18" · 5 pk

Made of impact-resistant polyethylene which is easy to clean and will not rust, rot, or corrode. The bottom basket is closed to prevent loss of bedding or eggs, but it features a hinged cover which allows easy access to eggs. The sloped roof prevents roosting. Mounting hardware and instructions included.



! Hinged cover for easy access to eggs

COMPARE TO METAL AND WOOD UNITS:

- Stays warmer in winter months
- Reduces mite and bug infestations
- Easier to clean · More sanitary

Restraining Cones

Cones restrain birds during processing and make clean up easy. Made of heavy-gauge galvanized steel with hemmed edges for safety. The flat back design allows for easy mounting.

RC2 Restraining Cone Medium

L 10.5" x W 7.25" x H 16" · 6 pk

For use on large layers, broilers, roasters and young turkeys up to 10 lbs.

RC3 Restraining Cone Large

L 13.25" x W 9.25" x H 20.625" · 6 pk

For use on larger broilers and medium turkeys up to 18 lbs.



Nesting Pads



NEW! NESTPAD10 Poultry Nesting Pads

L 13.625" x W 13.625" x H 6.5" · 6 pk

Poultry nesting pads provide a soft laying area for eggs that prevents breakage and keeps the coop clean. Designed to fit most nesting boxes, but can be cut for precise fit. Reduces moisture in nesting box to prevent bacteria growth. Elevates eggs for easier gathering. Each pad backed with brown craft paper. Pad size is 13" x 13". Package of 10.



NEW! RNESTPAD6

Reusable Poultry Nesting Pads

L 12.5" x W 12" x H 1.5" · 6 pk

Reusable poultry nesting box pads provides a soft laying area for eggs that prevents breakage and keeps the coop clean. Simply rinse to clean and reuse. Pad size is 12" x 12". Pads are designed with holes to reduce moisture in nesting box, preventing bacteria growth. Package of 6 pads.

The Best Just Got Better!

In an effort to continually provide the highest quality products, we have made several changes to our Incubator line. We believe these updates will make our Incubators better than ever—easier to set up and use, with more accurate temperature and humidity readings, which will help contribute to better hatch rates.



Redesigned Controller

All information is now on one screen, eliminating the need to switch screens to set the temperature.

! Digital readout of temperature and humidity levels

Updated Styrofoam Top

Fewer openings and the addition of a gasket protect electronic components from humid air and condensation.



Patented Design

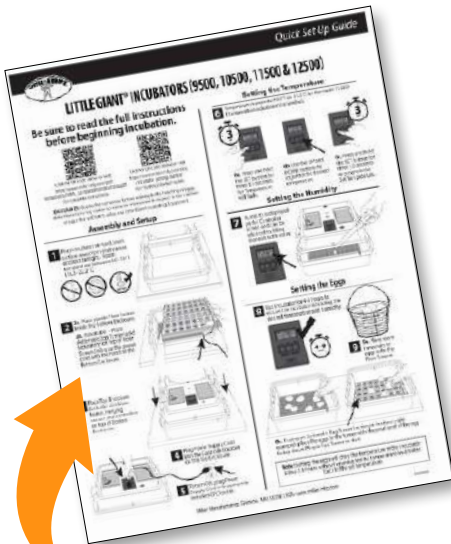

Quick Start Setup Guide

This one-page illustrated guide helps the user get their incubator going right away. QR codes link to complete instructions and a helpful video.

Improved Sensor

Keeps temperature steady and consistent during the hatch.

COMPARE TO COMPETITIVE UNITS:

- Plastic vs. metal heating element
- Includes digital hygrometer
- Assembled in the USA
- Dishwasher-safe plastic screen - easy to clean



Learn more about incubating with Little Giant®.

Digital Incubators

Durable styrofoam retains the warmth generated by a gentle and safe heating element controlled by a highly dependable, digital control board. The LCD display with LED light shows accurate temperature and humidity readings instantly. The self-regulating control board adjusts the temperature to suit varying environments. The built-in digital hygrometer and moisture channels help maintain humidity, a key factor in egg health during hatch. Patented design.



Little Giant® Incubators are not intended for professional or commercial use or for the incubation of exotic birds.

9500 Digital Still Air Incubator 
L 18" x W 18" x H 9" · 1pk

10500 Digital Circulated Air Incubator 
L 18" x W 18" x H 9" · 1pk
The 9500 with installed Circulated Air Fan Kit.

11500 Deluxe Incubator With Egg Turner 
L 18" x W 18" x H 9" · 1pk
The 10500 with installed Egg Turner included.

12500 UL Listed Digital Incubator 
L 18" x W 18" x H 9" · 1pk
UL Listed. Safe for use in schools. cULus listed.

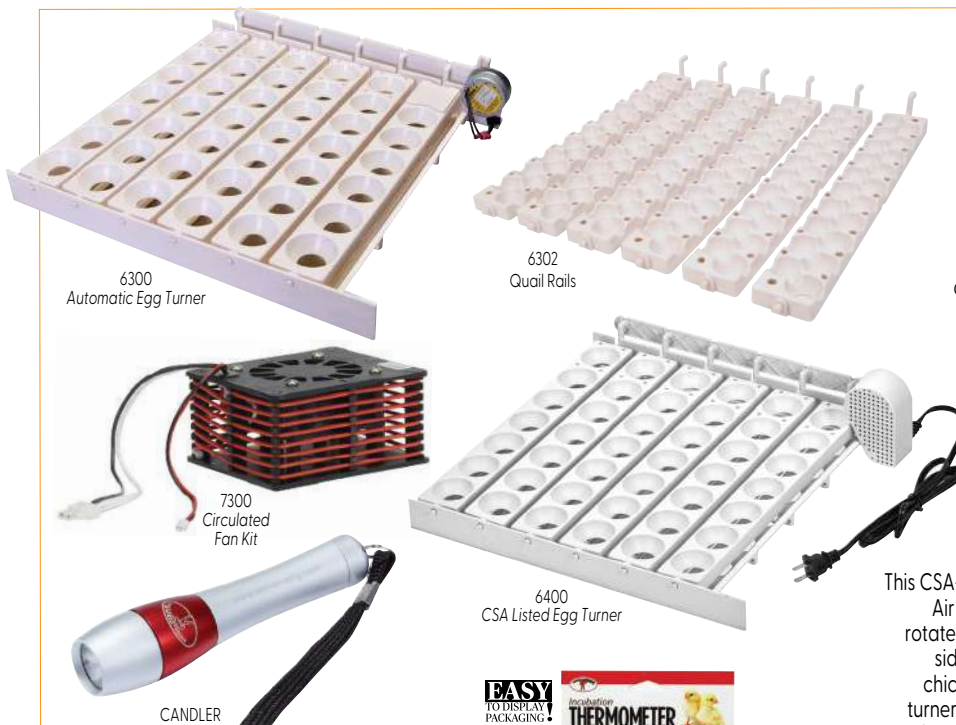

6300 Automatic Egg Turner

6302 Quail Rails

7300 Circulated Fan Kit

6400 CSA Listed Egg Turner

CANDLER

EASY TO DISPLAY! PACKAGING



6303 Thermometer Kit

Incubator Accessories

6300 Automatic Egg Turner

L 15.25" x W 15" x H 3" · 1pk

No assembly required. Easy to clean and operate. Turner is sold complete with 41 large egg cups (7 cups per rail).

6302 Quail Rails

L 15" x W 2" x H 4" · 1pk

Designed for quail and other small eggs. 120 egg capacity. Rails fit into 6300 and 6400 Egg Turners.

7300 Circulated Air Fan Kit

L 5.25" x W 4.875" x H 3.125" · 1pk

Transforms the Little Giant® Still Air Incubator into a Circulated-Air Incubator. Recommended for environments with frequent temperature fluctuations. Fan constantly circulates the air to maintain a proper temperature throughout the incubator, eliminating harmful hot and cold spots.

6400 CSA Listed Egg Turner

L 15.25" x W 15" x H 3" · 1pk

This CSA-listed Egg Turner fits any Little Giant® Circulated-Air or Still-Air Incubator. Electric motor automatically rotates the eggs to prevent the yolk from settling to one side and to exercise the embryo. Plastic cups hold 41 chicken eggs. (Turkey and duck eggs will not fit in this turner.) No assembly required. Dishwasher safe, easy to clean and operate. Quail rails for smaller eggs are sold separately.

6303 Thermometer Kit

L 4.25" x W 0.22" x H 4.5" · 1pk

Thermometer is filled with alcohol and kerosene, no mercury.

! Mylar backing keeps it on top of the eggs

CANDLER Egg Candler
L 3.6" x W 1.25" x H 7.5" · 6pk

Quickly and easily check the development of eggs. This battery-operated light features a bright, energy-efficient LED bulb that runs cooler than traditional bulbs. The convenient cord-free design fits easily in a pocket and features a wrist strap. Uses one AAA battery (included).



Farm & Ranch Products

Since 1941



Our Little Giant® brand provides hobby farmers and ranchers with high-quality, farm-tough products, designed for everyday use in caring for animals. Whether feeding and watering livestock and poultry, beekeeping or general stall maintenance, Little Giant® has the best selection of products to assist with animal care.

The Hot-Shot® brand is the industry standard of electric livestock prods that assist in the movement and transportation of livestock. Hot-Shot® leads the prod market with the world's largest selection and continues to provide innovative product solutions. **Our selection of Hot-Shot® products starts on page 61.**

Our Springer Magrath® brand is a leading brand of livestock prods, veterinary supplies and a diverse line of farm and ranch products. **Our selection of Springer Magrath® products starts on page 66.**















Learn more about our products and categories we offer, by locating them on the pages listed below:

Feeding & Watering Livestock.....	25-42
Goat & Sheep Supplies	28-29
Nursing Supplies.....	43-44
Stall Supplies.....	45-46
Beekeeping Supplies.....	48-55
Flooring.....	56-57
Pest Control.....	58-59
Fluid Management.....	59
Livestock Handling.....	60-66
Animal Health.....	65-68

Plastic Buckets

Plastic buckets have always been a favorite around the farm. The flat back fits more compactly against a wall or fence. These buckets really simplify feeding and watering on a daily basis. Buckets are made from polyethylene resin that is impact resistant, protects against warpage and helps prevent stress cracks.

ITEM	DESCRIPTION	SIZE	CASE PACK	COLORS AVAILABLE
P8	8 Quart Plastic Bucket 	L 11.5" x W 11.5" x H 8.5"	6 pk	
P8FB	8 Quart Flat Back Plastic Bucket 	L 11.5" x W 12" x H 9"	6 pk	
UB10	10 Quart Utility Bucket 	L 11.5" x W 11.5" x H 9.44"	12 pk	
P20FB	20 Quart Flat Back Plastic Bucket 	L 14.75" x W 14.75" x H 13"	6 pk	
P22FB	22 Quart Flat Back Plastic Bucket 	L 15" x W 15.5" x H 12.5"	12 pk	
P24FB	22 Quart Flat Back Plastic Bucket with Knob Bail Attachment 	L 14" x W 15.812" x H 12"	12 pk	



UB10
10 Quart



See page 70 for winter bucket solutions



P20FB
20 Quart



P22FB
22 Quart



HOT COLORS Available!

P8FB
8 Quart



P8
8 Quart



P20FBLID

NEW! P20FBLID 20 Quart Bucket Lid

L 14.5" x W 6.875" x H 14.813" - 6 pk
This durable polyethylene snap-on lid ensures the security of contents and is compatible with all Little Giant® 20 quart buckets. Comes packaged in a display carton and features a clip strip for convenient display options.



P24FB
22 Quart



Farm & Ranch Products Since 1941

Better Bucket®

Patented ergonomically-designed feeder is excellent for horses, cattle and other livestock. Angular design better accommodates animal's facial structure, allowing a more natural eating manner. Tapered sides funnel feed toward back of bucket which makes feed more accessible and reduces animal behavioral or straining concerns.

Flat back provides stability against a wall or fence. Fits on a flat wall with either a traditional wall bracket or snap hook. Durable, impact resistant, high-density polyethylene construction with smooth finished edges and heavy-duty handle.



BB20
20 Quart



BB10
10 Quart

! For best results bucket should be hung.

ITEM	DESCRIPTION	SIZE	CASE PACK	COLORS AVAILABLE
BB10	10 Quart Plastic Better Bucket®	L 17.5" x W 12.5" x H 11"	1 pk	
BB20	20 Quart Plastic Better Bucket®	L 21.75" x W 15.5" x H 13.5"	1 pk	

Wall Brackets

WB60 Metal Wall Bracket

L 1.185" x W 2.5" x H 7.75" · 1 pk
WB60 fits: P8FB, DF8FB, DF12FB, DF18FB, P20FB, DFW20, P22FB, P24FB, BB10 and BB20.

WB10 Plastic Wall Bracket

L 1.5" x W 3" x H 8.5" · 1 pk
WB10 fits: P20FB, P22FB, DF18FB, DFW20, BB10 and BB20.



WB60

WB10



166713

Handle Grip

166713 Plastic Handle Grip









L 6" x W 6" x H 0.38" · 12 pk Clip Strip
Ergonomic grips fit on standard v-handle buckets to reduce hand fatigue while still allowing bucket to be hung. Patented easy snap-on and snap-off design can be used with Little Giant® plastic and rubber v-handle buckets and most wall brackets. 3 per package.



EASY TO DISPLAY PACKAGING

12 pk
Clip Strip

Plastic Tubs

ITEM	DESCRIPTION	SIZE	CASE PACK	COLORS AVAILABLE
P800	8 Gallon Plastic Round Feeder 	L 18.5" x W 18.5" x H 13.5"	6 pk	
P65	6.5 Gallon All Purpose Tub 	L 18" x W 19" x H 8"	6 pk	
PSB70	70 Quart Muck Tub 	L 21.75" x W 25" x H 17.25"	6 pk	
PSB40	40 Quart Muck Tub 	L 19.5" x W 18" x H 14"	6 pk	



PSB70
70 Quart



PSB40
40 Quart



HOT
COLORS
Available!



P65
6.5 Gallon



Muck Cart
See page 47
for details



P800
8 Gallon



FS800
Shown with
P800. Sold
separately.



See page 70
for winter tub
solutions



FS800 Feed Saver Ring 

L 20" x W 20" x H 1.46" - 6 pk
Helps prevent waste by keeping feed from
spilling out of tub. Designed to fit our Little
Giant® P800 8-gallon plastic and HP750 6.5
gallon rubber feeders. Available in: ●



1-800-260-0888

GOAT & SHEEP SUPPLIES

Farm & Ranch Products Since 1941

Plastic Hook Over Feeders

The Hook Over is ideal for the field, pasture, trailer or stall. The durable, molded bracket easily hooks over any "2-by" board to instantly deliver a sturdy feeder or waterer. For more permanent installations simply install two screws in the holes provided.

HF52BLACK 52 Quart Hook Over Trough

L 47.38" x W 13.5" x H 9.56" · 1 pk

Volume for large feeding jobs. Strong hooks fit over most fencing. Available in: ●

HF9BLACK 9 Quart Hook Over Goat Trough

L 37.75" x W 8.44" x H 4.72" · 1 pk

Unique design helps reduce feed waste while promoting animal safety and improved health. Universal secure mounting on wire livestock panels or "2-by" board. Galvanized steel grid adds strength and keeps alpha animals from pushing others out while eating. Reinforced hooks provide extra support on ends of feeder. Available in: ●

MF6 6 Quart Plastic Mini-Feeder

L 9.75" x W 11" x H 5.5" · 6 pk

Available in: ● ● ● ● ● ●

HFP24D 24" Plastic Feeder with Divider and Brackets

L 24" x W 9.75" x H 7" · 3 pk

Available in: ● ● ● ● ● ●



HF52BLACK
52 Quart

HF9BLACK
9 Quart



MF6
6 Quart



HFP24D
16 Quart
Brackets adjust
from .25" to 2.25"

Rubber Pan

HP3 3 Gallon Rubber Feed Pan

L 17.5" x W 17.5" x H 4.5" · 6 pk

General purpose pans made of durable and pliable rubber.



HP3
3 Gallon



P20FB
20 Quart

Plastic Bucket

P20FB 20 Quart Flat Back Plastic Bucket

L 14.75" x W 14.75" x H 13" · 6 pk

Plastic buckets have always been a favorite around the farm. The flat back fits more compactly against a wall or fence. These buckets really simplify feeding and watering on a daily basis. Buckets are made from polyethylene resin that is impact resistant, protects against warpage and helps prevent stress cracks.

Available in: ● ● ● ● ● ● ● ● ● ● ● ●



Rubber Hook Over Feeder

DF18HF 18 Quart Rubber Hook Over Feeder

L 17" x W 16" x H 10" · 6 pk

Features molded bracket hooks that easily hook over any "2-by" board. Internal capacity marking shown in quarts and liters.



DF18HF
18 Quart

Metal Feeders

168779 Basic Goat & Sheep Feeder

L 44.5" x W 31.5" x H 45.13" · 1 pk
3" grid helps reduce nearly all forage and hay waste. Research studies show goats eat more easily out of a 4" trough. Ours is specifically designed with this in mind. It is important to keep grain, hay, and forage waste off the ground as goats are close grazers. By using this feeder there is less opportunity for ingestion of parasites. Loose hay and leaves fall into the bunk, not on the ground, for reduced waste and healthier livestock. Holds medium-size square bales. 18" from ground to trough. Accommodates up to 10 mature sheep or goats.



168793 Classic 2-in-1 Feeder

L 21.5" x W 13.06" x H 23.25" · 1 pk
Unique hook over feature allows universal mounting even on hurricane fencing. Keeps grain, hay and forage waste off the ground, reducing opportunity for ingestion of parasites. The compact design of this combination hay and grain feeder saves on space. Accommodates two flakes of hay.

Stainless Steel Dairy Pail

SS9P 9 Quart Stainless Steel Dairy Pail

L 12.88" x W 11.25" x H 9" · 1 pk
Rugged stainless steel is durable and easy to clean. Ideal for farm and ranch. Seamless and sanitary; rust and scratch resistant. Great for distributing feed and water. Heavy-gauge wire handle for easy carrying.



Calf, Lamb and Goat Pails

CPH 8 Quart Hook Over Feed Pail

L 12.5" x W 11.375" x H 8.5" · 6 pk
Bracket easily hooks over any "2-by" board to create a quick and sturdy feed pail anywhere. Available in: ● ● ●

CP8 8 Quart Plastic Calf Nursing Pail with Nipple Assembly

L 11.5" x W 11.5" x H 8.375" · 6 pk
Can be hung on fence with included hanging bracket. Available in: ●

CP8
8 Quart

CPH
8 Quart

Replacement parts available. See page 98

EASY TO DISPLAY PACKAGING!



92PK
3 Pack

92
12 Pack

Nipples and Nursing Accessories

92 Soda Bottle Lamb Nipple (12 per Box) w/ UPC

L 4.5" x W 2.75" x H 2" · 1 pk

92PK Soda Bottle Lamb Nipple (3 per Bag) w/ UPC

L 3.75" x W 1" x H 7" · 12 pk

Special rubber formula for long life and improved pliability.



FF11
4.5 Quarts Liquid/4 Quarts Dry



FF16
9 Quarts Liquid/7.75 Quarts Dry

Plastic Feeders

FF11 11" Fence Feeder with Snap Springs

L 11" x W 6.75" x H 6" · 6 pk

Can be mounted to wall instead of using provided clips. Capacity of 4.5 quarts liquid or 4 quarts dry. Available in: ● ●

FF16 16" Fence Feeder with Chain & Snap Springs

L 15.75" x W 8.25" x H 7" · 6 pk

Can be mounted to wall instead of using provided clips. Capacity of 9 quarts liquid or 7.75 quarts dry. Available in: ● ●

Farm & Ranch Products Since 1941



FT11
11 Gallon

FlexTubs

FT11 11 Gallon FlexTub Poly/Rubber

L 19.25" x W 17.5" x H 14.5" · 1 pk
Lightweight and flexible, though sturdy enough to handle heavy loads. Frost resistant and UV protected. Great for carrying tools, rubbish, compost, produce and more. Product is pliable enough to form lip into a pouring spout. Easy-grip handles. Available in:



Plastic Feeders

FF20 20 Quart Fence Feeder

L 14.25" x W 17.5" x H 10.75" · 6 pk

Complete with heavy gauge metal brackets for over-the-fence or on-the-wall installation. Available in:

FF11 11" Fence Feeder with Snap Springs

L 11" x W 6.75" x H 6" · 6 pk

Can be mounted to wall instead of using provided clips. Capacity of 4.5 quarts liquid or 4 quarts dry. Available in:

FF16 16" Fence Feeder with Chain & Snap Springs

L 15.75" x W 8.25" x H 7" · 6 pk

Can be mounted to wall instead of using provided clips. Capacity of 9 quarts liquid or 7.75 quarts dry. Available in:

MF35BLACK 3.5 Quart Mineral Feeder

L 13.25" x W 6" x H 5.375" · 12 pk

Two compartments for feed, minerals, vitamins, supplements or liquids. Capacity of 3.5 quarts liquid or 3 quarts dry. Available in:

PCF6 26 Quart Corner Feeder

L 25.5" x W 19.5" x H 9.75" · 6 pk

Available in:

PF25 9 Quart Foal Feeder

L 14" x W 13.75" x H 9" · 1 pk

Adjustable carbon steel bars. Available in:



FF20
20 Quart



FF11
4.5 Quarts Liquid/
4 Quarts Dry



FF16
9 Quarts Liquid/
7.75 Quarts Dry



PF25
9 Quart



MF35BLACK
3.5 Quarts Liquid/3 Quarts Dry



PCF6
26 Quart

Plastic Hook Over Feeders

The Hook Over is ideal for the field, pasture, trailer or stall. The durable, molded bracket easily hooks over any "2-by" board to instantly deliver a sturdy feeder or waterer. For more permanent installations simply install two screws in the holes provided.

HF52BLACK 52 Quart Hook Over Trough

L 47.38" x W 13.5" x H 9.56" · 1 pk

Volume for large feeding jobs. Strong hooks fit over most fencing. Available in: ●

HF9BLACK 9 Quart Hook Over Goat Trough

L 37.75" x W 8.44" x H 4.72" · 1 pk

Unique design helps reduce feed waste while promoting animal safety and improved health. Universal secure mounting on wire livestock panels or "2-by" board. Galvanized steel grid adds strength and keeps alpha animals from pushing others out while eating. Reinforced hooks provide extra support on ends of feeder. Available in: ●

MF6 6 Quart Plastic Mini-Feeder

L 9.75" x W 11" x H 5.5" · 6 pk

Available in: ● ● ● ● ● ●



MF6
6 Quart

HF12 12 Quart Fence Feeder

L 12.125" x W 13.875" x H 14.5" · 6 pk

Available in: ● ● ● ● ● ●

HF15 15 Quart Hook Over Feeder Economy Series

L 12" x W 13.25" x H 13.25" · 6 pk

Available in: ● ● ● ● ● ●



HF12
12 Quart



HF52BLACK
52 Quart

HF9BLACK
9 Quart



CPH
8 Quart



CPH 8 Quart Hook Over Feed Pail

L 12.5" x W 11.375" x H 8.5" · 6 pk
Molded bracket fits easily over any "2-by" board to create a sturdy feeder or waterer anywhere.

Available in: ● ● ● ●

HFP24D 24" Plastic Feeder with Divider and Brackets

L 24" x W 9.75" x H 7" · 3 pk

Available in: ● ● ● ● ● ●



HFP24D
16 Quart
Brackets adjust
from 25" to 2.25"



HF15
15 Quart

! Easily hooks over any "2-by" board!



Farm & Ranch Products Since 1941

Plastic Pans

ITEM	DESCRIPTION	SIZE	CASE PACK	COLORS AVAILABLE
P3	3 Gallon Plastic Utility Pan	L 17.25" x W 17.25" x H 4.5"	12 pk	● ● ●
P5	5 Quart Plastic Utility Pan	L 11.5" x W 11.5" x H 4"	6 pk	● ● ● ● ● ● ● ●
FPIOBLACK	10 Quart Feed Pan	L 18.5" x W 18.5" x H 5.25"	12 pk	●
NEW! FPH22	22 Quart Feed Pan with Handles	L 22.8" x W 19.2" x H 7.5"	6 pk	● ● ● ●
MPIOBLACK	10 Quart Mineral/Salt Pan	L 18.5" x W 18.5" x H 5.25"	12 pk	●
PBLP3	3 Gallon Plastic Pan	L 18.5" x W 18.5" x H 4.5"	12 pk	●



P3
3 Gallon



NEW!
FPH22
2 Quart



HOT COLORS Available!



P5
5 Quart



PBLP3
3 Gallon



MPIOBLACK
10 Quart



FPIOBLACK
10 Quart



Interior ribs lift and position salt block, allowing moisture to escape through drain holes



FP18
18 Quart

FP18 18 Quart Plastic Feed Pan

L 18.4" x W 20.5" x H 7.15" · 6 pk

Made of durable high-density polyethylene resin, this feed pan will stand up to tough farm use, indoors and out. Use a spare tire to anchor your feed pan. Available in: ● ● ● ● ●

Galvanized Pails and Tubs

Heavy-gauge galvanized construction to help prevent rust and corrosion.

ITEM	DESCRIPTION	SIZE	CASE PACK
GP1	1 Gallon Galvanized Pan	L 13" x W 13" x H 2.5"	6 pk
GP13	13 Quart Galvanized Utility Pan	L 16.75" x W 16.75" x H 3.75"	12 pk
GP3P	3 Pint Galvanized Pail	L 6.84" x W 6" x H 5.5"	1 pk
GP5	5 Quart Galvanized Dairy Pail	L 10.125" x W 10.625" x H 7.75"	1 pk
GP8	8 Quart Galvanized Dairy Pail	L 11.13" x W 10.25" x H 9.5"	1 pk
GP10	10 Quart Galvanized Dairy Pail	L 10.625" x W 10.75" x H 9.625"	1 pk
GP12	12 Quart Galvanized Dairy Pail	L 12.5" x W 11.5" x H 10.84"	1 pk
GP14	14 Quart Galvanized Dairy Pail	L 13" x W 11.75" x H 11.25"	1 pk
GWT425	4.25 Gallon Galvanized Round Tub	L 15" x W 13.13" x H 9"	1 pk
GBT8	8 Gallon Galvanized Bushel Tub	L 18.25" x W 17.5" x H 13.63"	1 pk
GWT1375	13.75 Gallon Galvanized Round Tub	L 22.75" x W 22" x H 13.5"	1 pk
GWT1675	16.75 Gallon Galvanized Round Tub	L 24.5" x W 23.25" x H 13.5"	1 pk



Galvanized Oval Tubs

Each features two strong wire handles.

ITEM	DESCRIPTION	SIZE	CASE PACK
GOT2	2 Gallon Galvanized Oval Tub	L 16" x W 9.5" x H 5.5"	1 pk
GOT4	4 Gallon Galvanized Oval Tub	L 19.5" x W 11.25" x H 6"	1 pk
GOT55	5.5 Gallon Galvanized Oval Tub	L 21.5" x W 13.75" x H 7"	1 pk
GOT75	7.5 Gallon Galvanized Oval Tub	L 24.1" x W 12.75" x H 7.3"	1 pk
GOT105	10.5 Gallon Galvanized Oval Tub	L 27.1" x W 15.25" x H 8.3"	1 pk
GOT16	16 Gallon Galvanized Oval Tub	L 31.5" x W 16.9" x H 10.12"	1 pk



Farm & Ranch Products Since 1941

Galvanized Round & Square Tubs

Each features two strong wire handles.

ITEM	DESCRIPTION	SIZE	CASE PACK
GWT105	10.5 Gallon Galvanized Round Tub	L 20.25" x W 20.125" x H 10.75"	1 pk
GWT15	15 Gallon Galvanized Round Tub	L 22" x W 22.125" x H 11.125"	1 pk
GST16	16 Gallon Galvanized Square Tub	L 20.25" x W 20.125" x H 11.375"	1 pk



GST16
16 Gallon



GWT105
10.5 Gallon

GWT15
15 Gallon



GGC20LID
20 Gallon

GGC31LID
31 Gallon

GGC20CAN
20 Gallon

! Cans and Lids sold separately!

GGC10LID
10 Gallon

GGC6LID
6 Gallon

GGC6CAN
6 Gallon

GGC10CAN
10 Gallon

GGC31CAN
31 Gallon

! Galvanized Trash Can Lids available in convenient display cut cases!



Galvanized Garbage Cans & Lids

Galvanized construction to help prevent rust and corrosion.

ITEM	DESCRIPTION	SIZE	CASE PACK
GGC6CAN	6 Gallon Garbage Can/Storage Bin	L 13" x W 11.75" x H 14.5"	1 pk
GGC6LID	6 Gallon Garbage Can/Storage Bin Lid	L 12" x W 12" x H 2"	6 pk
GGC10CAN	10 Gallon Garbage Can	L 15.5" x W 14.5" x H 17"	1 pk
GGC10LID	10 Gallon Garbage Can Lid	L 14.5" x W 14.5" x H 2.75"	6 pk
GGC20CAN	20 Gallon Garbage Can	L 17.75" x W 17.75" x H 22.625"	1 pk
GGC20LID	20 Gallon Garbage Can Lid	L 18.125" x W 18.125" x H 3"	6 pk
GGC31CAN	31 Gallon Garbage Can	L 21.75" x W 21.75" x H 27.5"	1 pk
GGC31LID	31 Gallon Garbage Can Lid	L 21" x W 21" x H 3.5"	6 pk



Stainless Steel Dairy Pails

Rugged stainless steel is durable and easy to clean. Ideal for farm and ranch. Seamless and sanitary; rust and scratch resistant. Great for distributing feed and water. Heavy-gauge wire handle for easy carrying.

ITEM	DESCRIPTION	SIZE	CASE PACK
SS9P	9 Quart Stainless Steel Dairy Pail	L 12.88" x W 11.25" x H 9"	1 pk
SS13P	13 Quart Stainless Steel Dairy Pail	L 14" x W 12.88" x H 10.5"	1 pk
SS16P	16 Quart Stainless Steel Dairy Pail	L 15.13" x W 13.88" x H 12.38"	1 pk
SS20P	20 Quart Stainless Steel Dairy Pail	L 16.75" x W 15.38" x H 11.5"	1 pk



GWC10
10 Quart

Galvanized Watering Can

GWC10 10 Quart Galvanized Watering Can

L 20.5" x W 9.63" x H 15.25" · 1 pk

Heavy-duty galvanized construction to help prevent rust and corrosion. Features a gentle flow head.

Metal Feeders

168779 Basic Goat & Sheep Feeder

L 44.5" x W 31.5" x H 45.13" · 1 pk

3" grid helps reduce nearly all forage and hay waste. Research studies show goats eat more easily out of a 4" trough. Ours is specifically designed with this in mind. It is important to keep grain, hay, and forage waste off the ground as goats are close grazers. By using this feeder there is less opportunity for ingestion of parasites. Loose hay and leaves fall into the bunk, not on the ground, for reduced waste and healthier livestock. Holds medium-size square bales. 18" from ground to trough. Accommodates up to 10 mature sheep or goats.



168793



168779

168793 Classic 2-in-1 Feeder

L 21.5" x W 13.06" x H 23.25" · 1 pk

Unique hook over feature allows universal mounting even on hurricane fencing. Keeps grain, hay and forage waste off the ground, reducing opportunity for ingestion of parasites. The compact design of this combination hay and grain feeder saves on space. Accommodates two flakes of hay.



168830

168830 Hay Grazer

L 28.13" x W 13.38" x H 27.88" · 1 pk

Provides a more natural, comfortable way for your horse to feed. Requires horse to eat in a slower, healthier manner; reduces boredom. Keeps hay off the ground, reducing waste and saving money. Mounts to a fence or wall at ground level. Less dust inhalation for horse. Stores hay in a cleaner, more compact way. Spring-loaded to mimic natural grazing.

Farm & Ranch Products Since 1941



Rubber Hook Over

DF18HF 18 Quart Rubber Hook Over Feeder

L 17" x W 16" x H 10" • 6 pk

Features molded bracket hooks that easily hook over any "2-by" board. Internal capacity marking shown in quarts and liters.



Rubber Flat Back Buckets

Little Giant® rubber buckets are tough, pliable, and weatherproof. Our design features a wider opening with convenient stacking lugs so the buckets are easier to stack and separate.

ITEM	DESCRIPTION	SIZE	CASE PACK
DF8FB	8 Quart Rubber Flat Back Bucket	L 11.5" x W 11.75" x H 9.75"	12 pk
DF12FB	12 Quart Rubber Flat Back Bucket	L 12.75" x W 13.25" x H 10.5"	12 pk
DF18FB	18 Quart Rubber Flat Back Bucket	L 15" x W 15.5" x H 12"	12 pk



Rubber Flat Back & Corner Buckets

Flat Back buckets have always been a favorite around the farm. The flat back fits more compactly against a wall or fence and makes hauling heavy loads of water or feed a lot easier.

DFC20 5 Gallon Rubber Corner Bucket

L 17" x W 16.75" x H 11" • 6 pk

DFW20 20 Quart Rubber Flat Back Bucket

L 15" x W 15" x H 12.5" • 12 pk

WB60 Metal Wall Bracket

L 1.185" x W 2.5" x H 7.75" • 1 pk



Rubber Pans & Tubs

General purpose pans and tubs. Made of durable and pliable rubber.

ITEM	DESCRIPTION	SIZE	CASE PACK
HP1	2 Quart Rubber Feed Pan	L 8.5" x W 8.5" x H 4"	6 pk
HP2	4 Quart Rubber Feed Pan	L 11" x W 11" x H 4"	6 pk
HP86	8 Quart Rubber Feed Pan	L 14.5" x W 14.5" x H 4.5"	6 pk
HP3	3 Gallon Rubber Feed Pan	L 17.5" x W 17.5" x H 4.5"	6 pk
HP650	6.5 Gallon Rubber All Purpose Tub	L 18" x W 18.25" x H 8"	6 pk
HP750	6.5 Gallon Rubber Feeder Tub with Eyelets	L 18.5" x W 19" x H 9"	6 pk
HP15	15 Gallon Rubber Heavy Duty Tub	L 26" x W 26" x H 9.75"	3 pk
DF3D	3 Gallon Rubber Pan with Handles	L 20.25" x W 17.38" x H 6.91"	1 pk
DF650D	6.5 Gallon Rubber Pan with Handles	L 21.09" x W 18.5" x H 9.84"	1 pk



HP750
6.5 Gallon



HP650
6.5 Gallon



HP2
4 Quart



HP1
2 Quart



! Use a spare tire to anchor your pan. HP3 shown (15" tire size)



HP3
3 Gallon



HP86
8 Quart



DF650D
6.5 Gallon



DF3D
3 Gallon



Farm & Ranch Products Since 1941

Rubber Round Pails

ITEM	DESCRIPTION	SIZE	CASE PACK
DF8	8 Quart Rubber Light Duty Pail	L 11" x W 11.5" x H 9"	12 pk
DF10	10 Quart Rubber All Purpose Pail	L 12" x W 12.75" x H 9.75"	12 pk
DF12	12 Quart Rubber Industrial Pail	L 12.5" x W 12.75" x H 10.5"	12 pk
DFP18	18 Quart Rubber Pail with Pouring Lip	L 15.5" x W 14.5" x H 12.5"	12 pk



DF8
8 Quart

DF10
10 Quart

DF12
12 Quart

DFP18
18 Quart

Poly Stock Tanks

Little Giant® Stock Tanks are built tough for superior performance and long-lasting durability. Stock Tanks have many versatile uses in the farm and ranch environment. Drain plug has a standard 3/4 inch fitting for attaching to a garden hose. Available in 5 sizes.

ITEM	DESCRIPTION	SIZE	CASE PACK
ST15	15 Gallon Stock Tank	L 29.75" x W 23" x H 8"	1 pk
ST40	40 Gallon Stock Tank	L 40.25" x W 28.75" x H 13.25"	1 pk
ST75	75 Gallon Stock Tank*	L 48" x W 34" x H 18"	1 pk
ST100	100 Gallon Stock Tank*	L 52.5" x W 37" x H 21"	1 pk
ST150	150 Gallon Stock Tank*	L 62" x W 43" x H 21.125"	1 pk

* STKIT Drain plug (STKIT) included on ST150, ST100, and ST75.

Molded
in handle



STKIT Stock Tank Drain Plug Kit

L 2.2" x W 2.2" x H 1.3" · 1 pk

Fits all Little Giant® Poly Stock Tanks and most other brands. For stock tanks that do not come with a drain plug, an electric drill with a step drill bit can be used to install this kit. Standard 3/4" fitting attaches to a garden hose. Durable ABS plastic for long wear.



ST150
150 Gallon

ST75
75 Gallon

ST100
100 Gallon

ST40
40 Gallon

ST15
15 Gallon

See page 71-73
for winter stock
tank solutions



Trough-O-Matic® Automatic Float Valves With Metal Housing

Little Giant® Trough-O-Matic® Float Valves automatically control the water level for most stock tanks, troughs, barrels or pans. Each features a 245 gallon-per-hour capacity, accepts standard 3/4" garden hose thread and operates between 20-50 psi.

TM830 Trough-O-Matic® Float Valve

L 3" x W 7.5" x H 3.5" · 6 pk
Durable cast aluminum housing with nylon orifice.

TM830T Trough-O-Matic® Float Valve

L 3" x W 7.5" x H 3.5" · 6 pk
Durable cast aluminum housing with nylon orifice. Includes expansion brackets to fit tank rims up to 2" thick and 4.325" wide.

TM830AS Anti-Siphon Trough-O-Matic® Float Valve

L 3" x W 7.5" x H 4.25" · 5 pk
Cast aluminum model that complies with basic back-siphoning regulations. Includes expansion brackets.



Valve close-up



TM830



TM830T



TM830AS



EASY TO DISPLAY PACKAGING!



Expansion Brackets

Trough-O-Matic® Automatic Float Valves With Plastic Housing

Little Giant® Trough-O-Matic® Float Valves automatically control the water level for most stock tanks, troughs, barrels or pans. Each features a 245 gallon-per-hour capacity, accepts standard 3/4" garden hose thread and operates between 20-50 psi.

TM825 Trough-O-Matic® Float Valve

L 3" x W 7.5" x H 3.5" · 6 pk
Popular rugged plastic housing molded from high-impact polystyrene for added strength and durability.

TM825T Trough-O-Matic® Float Valve

L 3" x W 7.5" x H 3.5" · 6 pk
Rugged plastic housing. Includes expansion brackets to fit tank rims up to 2" thick and 4.325" wide.

TM825AS Anti-Siphon Trough-O-Matic® Float Valve

L 3" x W 7.5" x H 4.25" · 5 pk
Popular plastic model that complies with basic back-siphoning regulations. Includes expansion brackets.



Expansion Brackets



TM825



TM825T



TM825AS



EASY TO DISPLAY PACKAGING!



Valve close-up

Farm & Ranch Products Since 1941

Automatic Plastic Horse & Stock Waterers

Includes metal brackets for over-the-fence or on-the-wall installation. Molded from impact-resistant polyethylene resin. Hooks up to 3/4" male garden hose. Operates between 20-50 psi.

FW16MTLBLACK Large Capacity DuraMate Automatic Waterer with Metal Cover

L 17.5" x W 14.25" x H 10.75" · 1pk

Includes metal float cover and 30" female hose attachment. 16-qt. capacity. Available in: ●

FW16 Large Capacity DuraMate Automatic Waterer with Plastic Cover

L 17.5" x W 14.25" x H 10.75" · 1pk

Includes 30" female hose attachment. 16-qt. capacity. Available in: ● ● ●

89PLWDP Plastic Automatic Stock Waterer with Drain Plug

L 17" x W 10.625" x H 5.75" · 1pk

Constructed from durable UV-resistant plastic and will not rust or corrode. Adjustable float control. Can be easily installed at any height using lag bolts or through bolts. Mounting plate included. Includes a drain plug for easier cleaning. Available in: ●



89PLWDP

FW16MTLBLACK
16 Quart



FW16
16 Quart



Float-controlled



Over-the-fence



On-the-wall

Automatic Metal Horse & Stock Waterers

These all-purpose waterers also work well for cattle, hogs, or other outdoor animals. Safely operates between 20-50 psi.

88SW Galvanized Automatic Waterer 2.375 Quarts

L 10" x W 10.75" x H 5.5" · 1pk

Constructed from heavy-gauge, prime draw quality steel. Can be easily installed at any height using lag bolts or U bolts. Will fit a 1/2" pipe with a left or right connection.

88ESW Black Epoxy-Coated Automatic Waterer 2.375 Quarts

L 10" x W 10.75" x H 5.5" · 1pk

Same as 88SW, yet features a non-toxic black-coated finish.

77 Push Paddle Automatic Waterer 1 Quart

L 10" x W 8.5" x H 5" · 1pk

Constructed of heavy-duty cast iron with a durable non-toxic black epoxy finish for rust and corrosion resistance, this waterer is designed for tough environments. Comes with two mounting brackets. Features stainless steel, heavy gauge push paddle with locking mechanism and non-siphoning water valve.



77
1 Quart



88ESW
2.375 Quarts



88SW
2.375 Quarts

Farm & Ranch Products Since 1941

Hog Feeders

Made of heavy-duty steel. Now 15% stronger! The top door flips open from the back for easy loading. Comes completely assembled.

HGFS Single Door Hog Feeder 50-lb. Capacity
L 19" x W 12.75" x H 29.5" · 1 pk

HGFD Double Door Hog Feeder 100-lb. Capacity
L 24.25" x W 19.75" x H 35.75" · 1 pk



Top door for easy loading



HGFD
100 Lb



HGFS
50 Lb

Now 15% Stronger!

Galvanized Feed Pan

This all-purpose utility pan is made of heavy-gauge galvanized steel. Rust-resistant properties make it ideal for outdoor use.

GP13 13 Quart Galvanized Feed Pan
L 16.25" x W 16.25" x H 3.75" · 12 pk

GP1 1 Gallon Galvanized Pan
L 13" x W 13" x H 2.5" · 6 pk



GP1
1 Gallon



GP13
13 Quart

For more Galvanized Pails, Tubs & Feeders see page 33-35

TAP2 Tap Adaptor

L 4.25" x W 4" x H 1" · 12 pk

Save time, worry, and work with this self-watering device. Attach to standard pipe fitting, turn on the faucet, and your animals will have a tongue-triggered fresh supply of water. Ideal for pigs, goats, sheep and other farm animals.

EASY TO INSTALL



TAP2

Mineral & Salt Block Feeders



SBI

Salt block not included.

SBI 4-lb. Salt Block Holder

L 3.125" x W 5" x H 5.625" · 6 pk
Vinyl-dipped for added protection and rust prevention. Holds most 4-lb. salt blocks. Available in: ●



SBPU

SBPU Universal Block Holder

L 12.63" x W 14.25" x H 9.69" · 1 pk
Unique design allows for feeding protein blocks, salt blocks, loose minerals and feed grain for goats, cattle and equine. Animals cannot gnaw on corners or knock block out of the holder, reducing waste and cost. Universal secure mounting on wire livestock panels or "2-by" board. Available in: ●



SBP3
1 Quart

SBP3 1 Quart Salt Block Feeder

L 9.31" x W 6.06" x H 5.56" · 1 pk
Feeder holds standard 4-lb. salt or mineral block. Raised ribs and drainage holes keep blocks dry. Contoured mounting plate has holes to allow for permanent mount. Available in: ●



MFIGREEN
1 Quart

MFIGREEN 1 Quart Mineral Feeder

L 9.19" x W 5.56" x H 5.5" · 1 pk
Simplifies measurement and consumption of multiple minerals. Divider for two types of granular minerals. Pre-drilled mounting holes for easy installation. Available in: ●

Auger Hoppers

Made of low density polyethylene material. Performs well under extreme temperatures and operating conditions. UV-resistant for long life with exposure to sun light. Durable canvas tension strap with metal buckle included.

DT00102 V Hopper - Standard Size Black
L 46.88" x W 38.5" x H 22.5" · 1 pk

DT00104 Large Round Hopper
L 52" x W 48.5" x H 18" · 1 pk

DT00103 Auger Hopper Replacement Strap · 1 pk
Heavy-duty black canvas tension strap with metal buckle.



DT00102



DT00104



DT00103

Baby Pig Waterers

This watering system has become an industry standard for watering piglets. Ready to use the day after farrowing. This reliable system includes polyethylene jug, durable polystyrene base, and galvanized mounting tray.

BPW4 1 Gallon Baby Pig Waterer 
L 6.75" x W 9.5" x H 13.125" · 6 pk



BPW4
1 Gallon





BPF2
7Lb

BPF3
9Lb

Baby Pig Feeders

These feeders are constructed out of heavy-gauge galvanized steel and troughs are removable for easy cleaning.

BPF2 2 Hole Feeder - 7-lb. Capacity 
L 8" x W 8.25" x H 12.5" · 8 pk

BPF3 3 Hole Feeder - 9-lb. Capacity 
L 12" x W 8" x H 12.5" · 6 pk

Calf, Lamb and Goat Pails

CP9 8 Quart Plastic Feed Pail with Metal Hanging Brackets 
L 12.5" x W 11.5" x H 7.75" · 5 pk
Great for calving operations.

Available in: ●

CPH 8 Quart Hook Over Feed Pail 
L 12.5" x W 11.375" x H 8.5" · 6 pk
Bracket easily hooks over any "2-by" board to create a quick and sturdy feed pail anywhere. Available in: ● ● ●

CP8 8 Quart Plastic Calf Nursing Pail with Nipple Assembly 
L 11.5" x W 11.5" x H 8.375" · 6 pk
Can be hung on fence with included hanging bracket. Available in: ●



CP9
8 Quart



CP8
8 Quart



CPH
8 Quart

Replacement parts available. See page 98



Farm & Ranch Products Since 1941

Calf, Lamb & Goat Nursing Bottles

Nursing bottles are made of strong and durable FDA-approved polyethylene. Nipples are made from a special rubber formula to prolong nipple life and improve pliability.



9812 2 Quart Nursing Bottle with Snap-On Nipple
 L 4.25" x W 4.25" x H 13.25" · 12 pk
 Features a high-quality snap-on nipple with vacuum air vent.

9312 2 Quart Nursing Bottle with Screw-On Cap
 L 4.25" x W 4.25" x H 13" · 12 pk
 Features a screw-on cap and nipple for easy attachment.

98CB 2 Quart Snap-On Nursing Bottle Only
 L 4.25" x W 4.25" x H 10" · 12 pk
 For use with Snap-on Calf Nipple (98CN).

93CB 2 Quart Screw-On Nursing Bottle Only
 L 4.25" x W 4.25" x H 10" · 12 pk
 For use with Screw-on Calf Nipple (93SCN).

9813 3 Quart Nursing Bottle with Snap-On Nipple
 L 4.1" x W 4.1" x H 17.187" · 12 pk
 Features a high quality snap-on nipple with air vent.

9313 3 Quart Nursing Bottle with Screw-On Nipple
 L 4.1" x W 4.1" x H 17" · 12 pk
 Features a screw-on cap and nipple for easy attachment.

9803CB 3 Quart Snap-On Nursing Bottle Only
 L 4.1" x W 4.1" x H 14" · 12 pk
 For use with Snap-On Calf Nipple (98CN).

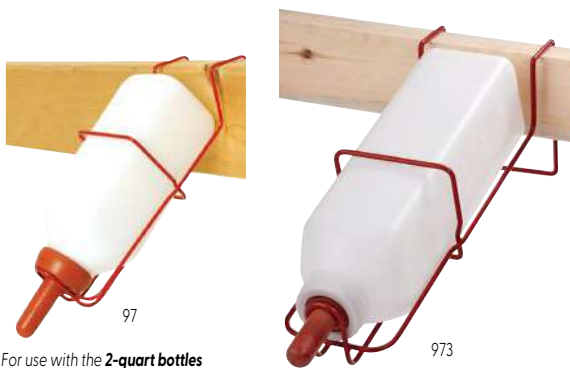

For use with the **2-quart bottles only**. Vinyl dipped for added protection and rust prevention. Bottle sold separately.

For use with the **3-quart bottles only**. Powder coated for added protection and rust prevention. Bottle sold separately.



EASY TO DISPLAY PACKAGING

92
12 Pack

Nipples and Nursing Accessories

Special rubber formula for long life and improved pliability. Calf nipples fit both 2 and 3 quart bottles.

98CN Snap-On Calf Nipple Bulk
 L 2.5" x W 2.5" x H 4" · 1 pk

98PK Snap-On Calf Nipple (2 per Bag) w/ UPC
 L 2.5" x W 7" x H 9" · 12 pk

93SCN Screw-On Calf Nipple Bulk
 L 2.25" x W 2.25" x H 3" · 1 pk

93PK Screw-On Nipple (1 per bag) w/ UPC
 L 6" x W 2.25" x H 8.25" · 12 pk

93SC Screw-On Cap Bulk
 L 2.5" x W 2.5" x H 0.625" · 1 pk

93SCPK Screw-On Cap w/ UPC
 L 2.5" x W 2.5" x H 0.75" · 12 pk

94LN Snap-On Lamb Nipple Bulk
 L 2.5" x W 2.5" x H 3.5" · 1 pk

94PK Snap-On Lamb Nipple (1 per bag) w/ UPC
 L 2.5" x W 6" x H 8.5" · 12 pk

92 Soda Bottle Lamb Nipple (12 per Box) w/ UPC
 L 4.5" x W 2.75" x H 2" · 1 pk

92PK Soda Bottle Lamb Nipple (3 per Bag) w/ UPC
 L 3.75" x W 1" x H 7" · 12 pk

97 Calf Bottle Holder
 L 13.5" x W 5" x H 6.5" · 6 pk
 Mounts on any "2-by" board. For use with the 2-quart bottles only.

973 3 Quart Calf Bottle Holder
 L 17.1" x W 7.3" x H 5.2" · 6 pk
 Mounts on any "2-by" board. For use with the 3-quart bottles only.



92PK
3 Pack



93SCN/93PK
1 Pack/12 Pack



93SC/93CPK
1 Pack/12 Pack



98CN/98PK
1 Pack/12 Pack

Farm & Ranch Products Since 1941

Fork Head Displays

These Fork Head Displays present Plastic DuraForks in your store simply and beautifully. Comes fully assembled and ready to go.

PDF103DISP Fork Head Display with Fork Heads
 L 16" x W 11.6" x H 13" · 1pk

Holds four DuraFork replacement fork heads. This display includes two Hot Pink and two Lime Green heads. Great for adding popular Hot Colors to your in-store selection, in a smaller case pack.

NEW! **PDF103DISPRED Fork Head Display Red**
 L 15.75" x W 11.5" x H 12.625" · 1pk

Holds four Red DuraFork replacement fork heads.

NEW! **PDF103DISPGREEN Fork Head Display Green**
 L 15.75" x W 11.5" x H 12.625" · 1pk

Holds four Green DuraFork replacement fork heads.

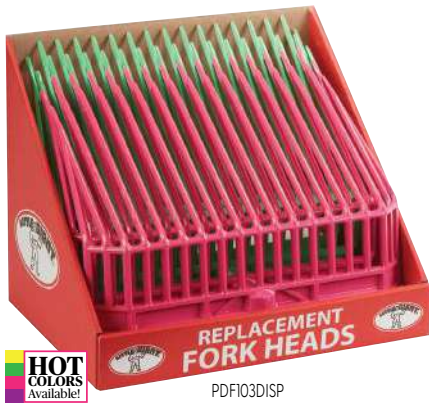
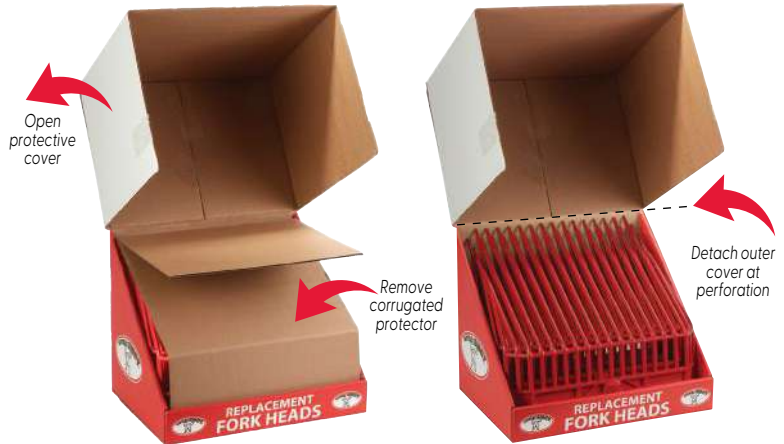

DuraTote Stool

DTSS DuraTote Stool
 L 20" x W 16.125" x H 14" · 2pk

Combination tote box and step stool. The step stool fits over a DuraTote which features a moveable handle. An internal tray fits onto the tote for extra storage. Ideal for any horse owner but can also be used for gardening, cleaning and painting. Available in: ● ● ● ●

! Stores up to 12" tall 32-oz. spray bottles and cans

AWARD WINNING Design!



! A padlock can be attached to protect contents.



Multi-Purpose Muck Cart

CA500 Muck Cart
 L 31.5" x W 28.5" x H 35.5" · 1pk
 Helps perform common chores around the farm. Durable construction can hold up to 350 lbs. It even folds for storage.



Retractable kickstand



Folds easily for storage.



CA500

PSB70 Muck Tub not included. See page 27 for details

Retaining ring collapses for easy unloading

Patented Design

Equine Care

Black powder-coated Sprayer Boom is designed for increased efficiency and to keep wash area neat and organized. Mounts on any wall or post, holding the hose up and away from feet. Gentle spray nozzle is animal friendly. Works great for equine and other animal wash stalls. Easy to install. 100 psi working pressure and 350 psi burst pressure.

169516 Sprayer Boom · 1pk

Extends out to 8' and swivels over 180 degrees.



169516



Professional Spray Bottles

PS32 Professional Spray Bottles 

L 4.375" x W 4.375" x H 10.5" · 12 pk

All-purpose 32 oz. spray bottle can be used to apply insecticides, disinfectants and most veterinary products with ease. Sprayer works with no o-ring to wear out. Great for use around the house.

Available in: ● ● ● ● ● ● ● ● ● ● ● ●



PS32



DuraTote Tote Boxes

DT6 Plastic DuraTote 

L 18" x W 13.75" x H 10" · 6 pk

Keep grooming supplies organized with the Little Giant® DuraTote. Extra-thick sidewalls and compartments make this tote the one that will last a long time! Compartments hold brushes, creams and sprays. Handle features holes to hold picks and tools. Ideal for storing household cleaning or automotive supplies.

Available in: ● ● ● ● ● ● ● ● ● ● ● ●



DT6



Modified handle for carrying tools (Brushes, bottles and tools not included)

HOT COLORS Available!





Beekeeping Supplies

A Simple Hobby with Sweet Rewards®

The Little Giant® beekeeping product line consists of top-quality products that are compatible with a wide range of existing products on the market. The Langstroth-design hive and accessories will work for the new hobbyist beekeeper or be compatible with existing products that experienced beekeepers are already working with in their orchards, farms, or gardens.

Our 10-frame unfinished pine hive has high-quality features not found on many of the other hives on the market, including: a screened bottom board and mite grid for pest management; metal frame rests for easier frame removal; and strong, interlocking box joints for a solid structure. **See pages 49-55 for our full line of beekeeping supplies.**



Learn more about our products and categories we offer, by locating them on the pages listed below:

Beginner Hive Kits.....	49
Woodenware.....	50-51
Protective Apparel.....	51
Accessories.....	52
How to Books	53
Honey Production.....	54-55
Winterizing Accessories.....	55

Beginner Hive Kits

Little Giant® woodenware products are the foundation for new and experienced beekeepers alike. Made from natural pine, Little Giant® hives, supers, and frames are designed to fit most standard 10-frame Langstroth hives to enable both beginner and established beekeepers to expand their beekeeping hobby. With specially designed features—such as a screened bottom board on the hive and wax-coated foundation installed in the frames—Little Giant® woodenware provides everything needed to raise healthy, thriving hives.



BEGHIVEKIT

BEGHIVEKIT Beginner Hive Kit

L 22" x W 18.5" x H 19.5" · 1pk

Looking to get into the rewarding hobby of beekeeping? Start here! This Little Giant® Beginner Hive Kit has all the basics to get you started. The Langstroth Hive comes pre-assembled for easy set up and use. The Beginner Beehive includes: telescoping outer cover, vented inner cover, 10-frame 9.5" deep hive body, 9.125" wooden frames with wax-coated black plastic foundation, solid bottom board and entrance reducer. You also get a smoker, smoker fuel, bee brush, hive tool and frame feeder. Bees and other supplies must be purchased separately.

EASY
TO DISPLAY!
PACKAGING!



HIVE10KIT

HIVE10KIT

10-Frame Deluxe Beginner Hive Kit

L 21.875" x W 18.25" x H 14" · 1pk

This kit contains everything a new beekeeper needs to get started with beekeeping in one box! Includes 10-frame Langstroth hive with frames and foundation, screened bottom board with mite grid, gloves, veil, smoker, smoker fuel, bee brush, hive tool, frame feeder and the book *Beekeeping for Dummies*. Bees must be purchased separately.

A Simple Hobby with Sweet Rewards®

Woodenware

Little Giant® woodenware products are the foundation for new and experienced beekeepers alike. Made from natural pine, Little Giant® hives, supers, and frames are designed to fit most standard 10-frame Langstroth hives to enable both beginner and established beekeepers to expand their beekeeping hobby. With specially designed features—such as a screened bottom board on the hive and wax-coated foundation installed in the frames—Little Giant® woodenware provides everything needed to raise healthy, thriving hives.



HIVE10

HIVE10 10-Frame Complete Hive

L 21.875" x W 18.25" x H 14" · 1 pk

Pre-assembled for easy set up and use. The Complete Beehive includes: telescoping outer cover with protective metal layer, vented inner cover, 10-frame 9.5" deep hive body, 9.125" wooden frames with wax-coated black plastic foundation, screened bottom board, mite grid and entrance reducer. Bees and other supplies must be purchased separately.



DEEPBOX10

MEDBOX10

DEEPBOX10 10-Frame Deep Hive Body

L 19.875" x W 16.25" x H 9.5" · 1 pk

Pre-assembled for easy set up and use. Includes ten wooden frames with pre-installed wax-coated black plastic foundation for easy viewing of hive activity. Made of natural pine, the Deep Hive Body can be used as either a Brood Box or Honey Super and is precision-milled for maximum strength. Ready to be added to your hive right out of the box!

MEDBOX10 10-Frame Medium Super

L 19.875" x W 16.25" x H 6.5" · 1 pk

Pre-assembled for easy set up and use. Includes ten wooden frames with pre-installed wax-coated yellow plastic foundation, preferable for honey harvesting. Made of natural pine, the Medium Super is precision-milled for maximum strength. Ready to be added to your hive right out of the box!



OUTERCOVER

OUTERCOVER Beehive Outer Cover

L 22" x W 18.625" x H 2.875" · 1 pk

Keep the elements out of your hive with this Little Giant® Outer Cover. Made from durable wood with a weather-resistant aluminum covering. This Outer Cover will fit securely on your 10-frame Langstroth hive. The cover can slide front to back (telescope) in order to provide more or less ventilation to the hive. Perfect for building your own hive, or as a replacement part for your Little Giant® hive. Can be painted or left natural.



INNERCOVER

INNERCOVER Beehive Inner Cover

L 20" x W 16.4375" x H 0.79" · 1 pk

This Little Giant® Inner Cover provides extra ventilation and fresh air to your hive, as well as an added layer of insulation and protection when placed under an outer cover. By adding this wooden vented Inner Cover to your 10-frame Langstroth hive, it prevents your Outer Cover from being propolized and stuck to the hive body. Made from 1/4" plywood with tongue-and-groove (on both cover and solidboard) framing. Fits on all Little Giant® 10-frame Hives. Can be used with our Little Giant® Bee Escape (sold separately) to easily remove bees from supers at honey-harvesting time.



SCREENBOARD

SCREENBOARD Beehive Screened Bottom Board

L 21.75" x W 16.25" x H 2.875" · 1 pk

The Screened Bottom Board is an important tool when it comes to pest management in beekeeping. Along with a mite grid (included), it allows you to passively control and monitor mite levels and accurately measure the number of mites present in the hive. Using this Little Giant® Screened Bottom Board can help you reduce mites, improve ventilation in your hive, and may increase brood production. This Screened Bottom Board is made of durable pine. Works with all Little Giant® 10-frame Hives.



SOLIDBOARD

SOLIDBOARD Beehive Solid Bottom Board

L 21.875" x W 16.3125" x H 1.88" · 1 pk

This Little Giant® Solid Bottom Board is made of one piece 3/4" exterior plywood with tongue-and-groove white pine rails. Can be used as an alternative to screened bottom boards in your hive. Makes a durable, stable base for your hive. Can be used with all Little Giant® 10-frame Hives.

Woodenware (Continued)

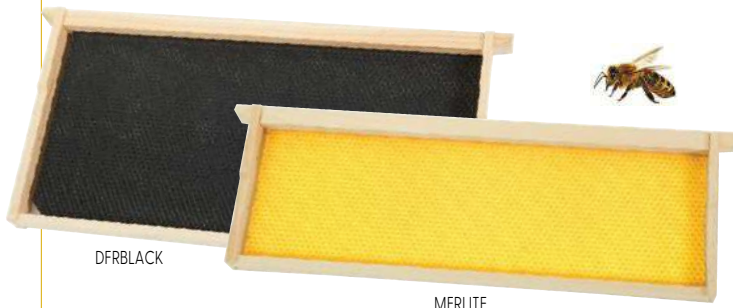

DFRBLACK

MFRLITE



FOUNDDEEP5

FOUNDMED5

DFRBLACK Deep Hive Frames (5 per box)

L 19.25" x W 9.5" x H 6.5" · 1 pk

Made of natural pine and comes with black wax-coated plastic foundation already installed for easy viewing of your hive's brood activity. Ready to be placed in your hive right out of the box!

MFRLITE Medium Hive Frames (5 per box)

L 19.25" x W 6.5" x H 6.5" · 1 pk

Made of natural pine and comes with yellow wax-coated plastic foundation already installed. The yellow of the foundation is preferable for honey harvesting. Ready to be placed in your hive right out of the box!

FOUNDDEEP5 Deep Foundation (5 per bag)

L 18" x W 10" x H 0.625" · 6 pk

Black plastic foundation coated with beeswax. Ready to install in deep (9.125") frames. More durable than wax foundation.

FOUNDMED5 Medium Foundation (5 per bag)

L 18" x W 6.5" x H 0.625" · 6 pk

Yellow plastic foundation coated with beeswax. Ready to install in medium (6.25") frames. More durable than wax foundation.

Protective Apparel



JKTM / JKTLG / JKTXL / JKT2XL

JKTM/JKTLG/JKTXL/JKT2XL Deluxe Beekeeping Jacket in 4 Sizes

L 12" x W 13" x H 3" · 3 pk

Made of 50/50 poly-cotton blend, this deluxe jacket comes with a self-supporting domed veil. The veil is attached with a heavy-duty, two-way cloth zipper that allows it to be easily removed. The collapsible veil does not need to be fully removed – it can also hang behind like a hood. The jacket features a hook-and-loop patch at the front of the neck opening which secures the veil/jacket connection for extra protection from stray bees.

This jacket is generously cut to allow freedom of movement and includes elastic wrist cuffs and waistband to keep bees out. It features four roomy front pockets that can hold smoker fuel or other items. On each sleeve there is an additional pocket which is the perfect size for a hive tool. A great alternative for someone who does not want to wear a full bee suit when inspecting hives. One jacket and veil per package.



HVEIL



GLVMD / GLVLG

GLVMD Gloves Goatskin - Medium

GLVLG Gloves Goatskin - Large

L 10.5" x W 6.75" x H 1.375" · 3 pk

Provides dexterity and protection when working with bees. The gloves are complete with elastic cuffs to keep bees out. The soft and pliable goatskin offers superior mobility and flexibility.



TYSUITMD / TYSUIT / TYSUITXL

TYSUITMD Beekeeping Tyvek® Coverall - Medium

TYSUIT Beekeeping Tyvek® Coverall - Large

TYSUITXL Beekeeping Tyvek® Coverall - Extra Large

L 13.5" x W 7.5" x H 1.375" · 3 pk

The full-front zipper closure will keep you protected while caring for your bees. Elastic closures at both the sleeves and ankles will keep you out of bees. This easy-to-wear suit is water-resistant and disposable.

HVEIL Beekeeping Veil with Hat

L 17" x W 20" x H 1" · 3 pk

Will keep you protected while inspecting and working with your hive. The hat and veil's one-piece construction makes this veil a quick grab-and-go option to get out to your hives without any fuss. The hat keeps the veil a proper distance away from your face to prevent bee stings, and there are no seams to inhibit your visibility. Elastic straps fit under arms to secure veil.

A Simple Hobby with Sweet Rewards®

Accessories & Tools



SM7

SM7 4" x 7" Smoker

L 8.5" x W 5.5" x H 11" · 3 pk

Will help to calm your bees when working on your hives. A surrounding wire grid protects you from the heat of the smoker, allowing you to safely smoke your hives throughout your inspection or harvest. A properly packed and lit smoker can last throughout the day.

SMFUEL Smoker Fuel

L 9.5" x W 6.75" x H 1.5" · 6 pk

This clean, untreated burlap is a favorite material of beekeepers as it produces a cool, white smoke and is easy to light.



SMFUEL



BKBR14

BKBR14 Beekeeping Brush

L 14" x W 3.5" x H 0.5" · 3 pk

Gently removes bees from the frames both during inspections of the hives and during removal of frames for honey extraction. The soft bristles of the brush are specially designed to remove the bees without harm.

ESCAPE Bee Escape, Porter Style (2 per bag)

L 5.25" x W 6.25" x H 0.75" · 6 pk

One-way valve that allows bees to leave but does not allow them back into the hive box. The Bee Escape inserts into the hole in the hive's inner cover to aid in clearing the super of bees so it will be ready for honey harvesting. Made of lightweight, durable plastic.



ESCAPE



FRGRIP Frame Grip

L 8.25" x W 7" x H 1.625" · 3 pk

Helps with handling beehive frames during inspections and honey harvesting. With its one-handed operation, this frame grip will easily lift and grip frames to pull them from the hive.



FRGRIP



QEPL

QEPL Queen Excluder Plastic

L 20" x W 16.5" x H 0.125" · 6 pk

Designed to fit a 10-frame Langstroth Hive. Prevents the queen from producing brood in the honey supers. Precisely measured holes allow the worker bees to move throughout the hive while preventing the queen from moving upward out of the brood box. Made of injection-molded plastic, the queen excluder is easy-to-clean and lies flat on the brood box.



HT10

HT10 Hive Tool

L 9.5" x W 1.75" x H 1.375" · 6 pk

A must-have for working with your hives. The Little Giant® Hive Tool is a versatile multi-tasker complete with a scraping edge, nail-pulling hole, and an angled end that is designed specifically to fit on a hive frame and help pry it loose.

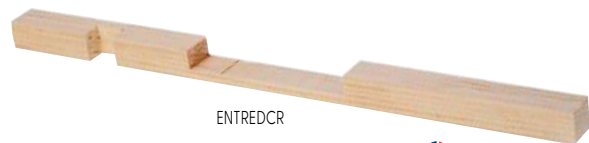

ENTREDCR

ENTREDCR Beehive Entrance Reducer

L 16.625" x W 3.625" x H 1.125" · 3 pk

This Little Giant® Entrance Reducer will help control ventilation and keep out pesky robbers! Designed to fit a 10-frame Langstroth hive, this reducer will work with either a solid or screened bottom board. Made of natural pine and cut with two notches to provide two different entrance sizes. Simply place the reducer beneath the bottom brood box to create the entrance size desired.

HIVEPLUG

Beehive Hole Plug (6 per bag)

L 5.25" x W 6.5" x H 0.5" · 6 pk

Many beekeepers in northern climates drill a hole in their hive bodies to aid in ventilation and provide an entrance when snow banks grow. This simple 1" plug will allow you to close or open the hole when the season dictates. Each plug fits a 1" diam. hole.



HIVEPLUG

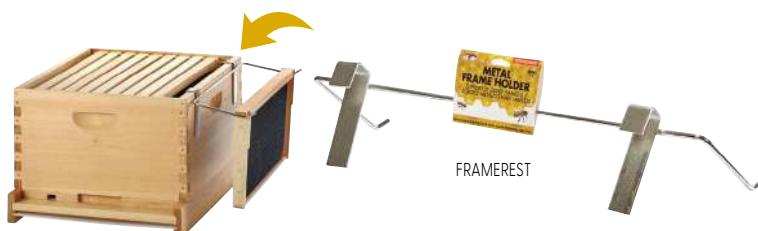

FRAMEREST

FRAMEREST Metal Frame Holder

L 20" x W 5.5" x H 7.875" · 3 pk

Gives you a helping hand when you're inspecting your hive. This handy Little Giant® Frame Rest provides a secure hold for your frame, keeping it out of your way and off the ground. Easily slides on and off the long side of your hive box and can be used from hive to hive.

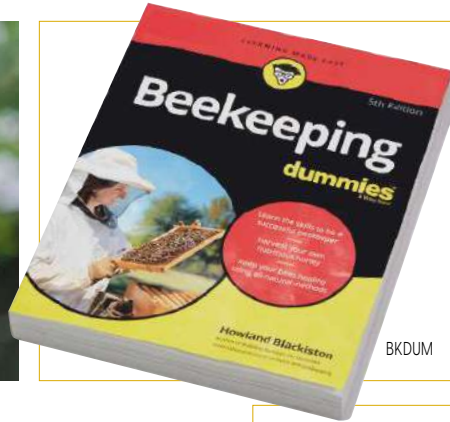

BKDUM

How-To Book

BKDUM *Beekeeping for Dummies*
L 9.25" x W 7.375" x H 0.875" · 6 pk 

The 5th Edition *Beekeeping for Dummies* by Howland Blackiston is a comprehensive training guide for all things beekeeping. The book will walk you through the tools of beekeeping, the steps necessary to build and maintain your own beehives, and the phases of honey production and extraction. Updates include information regarding the critical role nutrition plays in the health and productivity of bees.

Feeders

ENTFDR Entrance Feeder

L 6.5" x W 4" x H 7.375" · 3 pk

Easy-to-use plastic feeder that will fit directly into the front entrance of your hive. Designed to fit into the large opening of the entrance reducer on any Little Giant® 10-Frame Hive, the feeder allows space for the bees to come and go while nourishing them with a simple syrup when natural food sources are scarce. The base is made of high-impact plastic. The clear glass jar allows you to see the feed levels without disturbing the bees. Holds approximately 1 quart.

FRAMEFDR Frame Feeder

L 19" x W 9" x H 2.25" · 3 pk

Taking the place of one of the frames inside the brood box, the frame feeder holds 3 quarts of syrup. Inner ladders and grooved sides help the bees access the syrup while reducing the risk of drowning.

BKTFDR2 2 Gallon Bucket Feeder

L 10.5" x W 10.5" x H 7.5" · 3 pk

Easy-to-use design helps protect syrup from robbers to keep your bees fed when outside nectar sources are scarce. Fits atop the hole on your inner cover to allow bees access to the syrup through tiny holes in the lid.



ENTFDR

FRAMEFDR

BKTFDR2

Feeding & Treating

BEEFEED Bee Feeding Stimulant

L 7.125" x W 4.75" x H 6.5" · 6 pk

Feed your bees! This honeybee feeding stimulant is made up of lemongrass and spearmint essential oils. It helps promote healthy, vigorous hives. Use in late winter and early spring when nectar supply is low. Can also be added to your feeding mix to help build up packages, nucs and swarms. Can also be used in sugar water instead of smoke to calm bees, or sprayed on foundation to help encourage acceptance. Comes in an 8-oz. bottle.



BEEFEED



POLLENSUB Pollen Substitute Powder

L 12.37" x W 12.25" x H 15.5" · 18 pk

Bee-Pro® pollen substitute contains all the vitamins, minerals, lipids and antioxidants bees need to produce food for their larvae. This high-protein substitute can be used for building colonies in late winter or early spring, to prepare for pollination and to maintain or increase brood production prior to and after honey flow. Free of all contaminants and contains no natural pollen, as natural pollen may still contain pesticide residue and disease-carrying bacteria. Can be fed dry in a feeder box, or made into pollen patties. Comes in a 1-lb. canister.



POLLENSUB

PROSWEET1 Pro-Sweet Liquid Bee Feed

L 6.5" x W 6.5" x H 13" · 4 pk

Give your bees the best! This ready-to-use liquid bee feed has both binomial (bees treat these like nectar) and monomial (bees treat these like honey) sugars, so it stimulates the bees and helps them put on weight. No mixing necessary, and Pro-Sweet won't crystallize or ferment like sugar water. Feed any time. For oral honey bee use only, not for human consumption. Store tightly sealed in a cool dry place. Contains 1 gallon.



PROSWEET1

A Simple Hobby with Sweet Rewards®

Honey Production

Honey is this hobby's sweetest reward! Little Giant® honey extraction supplies take full frames of honey from hive to honey bear bottle. Designed with the hobbyist in mind, the following honey supplies focus on small batches of honey extraction and bottling for both friends and farmers' markets.

EXT2SS Stainless Steel 2-Frame Extractor

L 30.5" x W 16" x H 16" · 1 pk

This tangential extractor provides the simplicity of a hand-crank extractor and the superior quality of 18/10 stainless steel material. Can be used with either deep or medium frames. Adjustable leg height can easily accommodate a standard 5 gallon bucket. Includes honey gate and cover, some assembly required. Complete instructions included.



EXT2SS



Hand cranks



Fits deep or medium frames



BKT5

BKT5 5 Gallon Plastic Bucket

L 11.875" x W 11.875" x H 14.75" · 3 pk

Comes with a tightly fitting lid and honey gate. Place it under your extractor to collect honey. It can also be used to bring simple syrup to your hives and refill feeders early in the season. Made of HDPE food grade plastic.



HFORK

HFORK Uncapping Scratcher Fork

L 8.5" x W 3" x H 1" · 6 pk

Removes any caps leftover from an uncapping knife. Simple to use, the stainless steel points will fit right under the caps to pry them off and allow access to honey for extraction.



HSTRAINSS

HSTRAINSS Honey Strainer - Stainless Steel

L 9.5" x W 10" x H 4.125" · 1 pk

Uses a fine mesh to remove any leftover bits of wax and other particles before bottling. Designed to fit securely over a 5-gallon bucket. Place the strainer under the extractor before bottling.

HSTRAINIF Honey Filter

L 5" x W 6.5" x H 0.5" · 3 pk

Designed to be used with a 5-gallon bucket, this fabric strainer fits around the edge of the bucket to filter out pollen, wax and other impurities. The 400-micron washable fabric helps to create fine-filtered honey that has a beautiful appearance and longer shelf life (takes longer to crystallize). 1 filter per package. Use with or without HSTRAINSS.



HNYGATE

HNYGATE Honey Gate

L 5.25" x W 1.75" x H 5.5" · 6 pk

Made of high-quality plastic and can be used in a variety of different-sized buckets to best suit your needs. It fits through a 1.75" hole and comes with stainless steel hardware to keep it tightly sealed.



HSTRAINIF



HKNIFE

HKNIFE Electric Uncapping Knife

L 18.375" x W 2.75" x H 2.75" · 1 pk

Product is made out of stainless steel and natural pine. Heats up and quickly removes the wax from frames of capped honey. Preset at the appropriate temperature for removal of caps, the heated knife is ready to use within a minute.



COLDKNIFE

COLDKNIFE Cold Knife

L 17.375" x W 3.375" x H 5" · 6 pk

This Cold Knife is the fast and easy way to uncap your frames before honey extraction. No heat required due to sharp edges on blade. Blade can be heated with hot water if desired. The grooved wooden handle gives you a secure grip. Both edges of the knife are serrated for right or left-hand use.

LIDS INCLUDED on all!



HBEAR12



SKEP16



HJAR16



HJAR32

BPA FREE!

HBEAR12 12 Oz (340 g) Plastic Bear Bottle

L 7" x W 5" x H 7" · 12 pk

Made of BPA-free PETE plastic. Yellow flip-top lids with built-in freshness and safety seal are included. An area on bear's stomach will hold Little Giant® honey labels (sold separately).

SKEP16 16 Oz (1 lb.) Plastic Squeeze Jar

L 10" x W 4.5" x H 6" · 12 pk

Made of BPA-free PETE plastic. Space is provided on the bottle for Little Giant® honey labels (sold separately). Yellow flip-top lids with built-in freshness and safety seal are included.

*Honey weight is not equivalent to liquid volume.

HJAR16 16 Oz (1 lb.) Glass Jar

L 13.5" x W 7" x H 6" · 12 pk

This clear bottle in a traditional skep design helps show off your honey. There is room on both sides of the jar for a label. Airtight lids included in the 12-pack carton.

HJAR32 32 Oz (2 lb.) Glass Jar

L 16.5" x W 8.5" x H 7" · 12 pk

This clear bottle in a traditional skep design helps show off your honey. There is room on both sides of the jar for a label. Airtight lids included in the 12-pack carton.



HLABEL

HLABEL Labels for Honey Jars

L 8.5" x W 4.375" x H 0.125" · 12 pk

In order to sell honey and be compliant with federal regulations, each bottle or jar must have a label with the producer's name and the net weight of the honey. These self-adhesive labels make the process quick and easy to get your honey to market! Includes two sizes of labels for different sizes of bottles. 40 labels per package.

Winterizing Accessories

HOTBOX Hot Box® Winterizer

L 20.75" x W 16.25" x H 7.0" · 1 pk

The Hot Box® Hive Winterizer separates the warm air inside the hive from the cold outside air, reducing condensation. Insulation material in the center of the Hot Box® helps retain heat. The included moisture board draws liquid away from the bees and ventilation helps speed up evaporation to keep the bees dry. Includes bee escape holes which are the correct size for bees, but prevent small animals like mice from entering the hive. Made of natural pine. Fits any standard Langstroth 10-frame hive. Complete instructions included.



HOTBOX

Moisture board included!



Professional Grade Products

Pre-Cut Rubber Utility Mats

Little Giant® has all your flooring needs covered! Great for work or farm use. We carry a full line of Pre-Cut Rubber Utility Mats, Rolled Rubber Mats and VersaPad® options.



Free display with purchase of 5 pre-cut utility mats.

RM RACK 5 Slot Mat Rack

L 39" x W 22.75" x H 80" · 65 lbs. · 1pk

These space-saving racks feature colorful graphics to draw attention to the product and generate sales.



RM3660 Pre-Cut Utility Mat

L 60" x W 36" x H 0.25" · 22 lbs. · 1pk

RM4096 Pre-Cut Utility Mat

L 96" x W 40" x H 0.25" · 43.78 lbs. · 1pk

RM4872 Pre-Cut Utility Mat

L 72" x W 48" x H 0.25" · 38.6 lbs. · 1pk

RM4896 Pre-Cut Utility Mat

L 96" x W 48" x H 0.25" · 50.5 lbs. · 1pk

RM6096 Pre-Cut Utility Mat

L 96" x W 60" x H 0.25" · 65 lbs. · 1pk

RM60120 Pre-Cut Utility Mat

L 120" x W 60" x H 0.25" · 71 lbs. · 1pk

Applications

- Exercise areas
- Kennels
- Barns
- Horse stalls
- Trailers
- Garages
- ATV/truck beds
- Work benches
- Camping

Features

- Textured top for traction
- Grooved bottom for drainage
- Tailored sizes – minimal cutting
- Non-porous surface – will not harbor bacteria
- Made from recycled rubber and SBR

Benefits

- Will not shrink, curl or crumble
- Easy to clean
- Easy lifting and moving



RMIL3636 Trak-Safe Interlocking Mat

L 36" x W 36" x H 0.59" · 15.85 lbs. · 1pk

Applications

- Work areas
- Door entrances
- Wash down areas for bikes, ATV's, etc.

Features

- Interlocking edges
- Large open design
- Soft, yet durable
- Raised nubs on underside
- Made from recycled rubber and natural rubber

Benefits

- Can cover large areas without movement
- Exceptional drainage characteristics
- Allows water and debris to fall through
- Provides cushion under foot

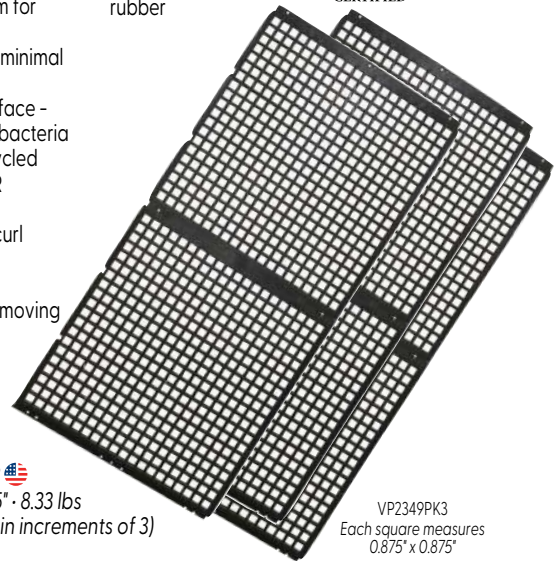

VP2349PK3 VersaPad®

L 24" x W 48.625" x H 0.5" · 8.33 lbs

· 1pk (must be ordered in increments of 3)

Applications

- Kennel flooring
- Greenhouse benching
- Paver installation
- Turf landscaping
- Slope protection

Features

- Interlocking edges
- Non-porous surface – will not harbor bacteria
- Moisture and waste dry fast
- Made from polypropylene

Benefits

- Surface allows for proper drainage and airflow for plants and animals
- Provides a great foundation under pavers while allowing for drainage
- Protects turf and soil from pedestrian foot traffic
- Holds 10-lbs. for every square foot

VP2349PK3
Each square measures
0.875' x 0.875'

Mat Specifications (for all Pre-cut Utility Mats)

Weight	7.32 kg/m ²
Hardness.....	65 Shore A Nominal
Density.....	1350 kg/m ³
Elongation.....	> = 180%
Shearing Strength.....	< 0.60 (N/mm3)
Temperature Stability	30 70
Compression Recovery	After 22 hours 75%
Tensile Strength.....	400 PSI
Critical Radiant Flux	0.11 watts/sq
Thermal Resistance.....	150 ppi



Rolled Rubber Mats

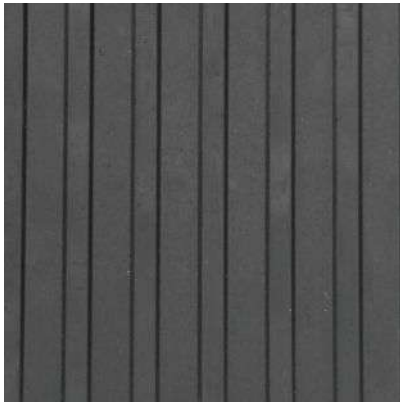

RMWR349 Wide Rib
L 49' x W 3.25' x H 0.15" · 164 lbs. · 1pk

Applications

- High traffic areas
- Door and walkways

Features

- Long lengths
- Non-porous
- Surface protection
- Made from recycled rubber and SBR

Benefits

- Avoids bacteria build-up
- Easy to clean
- Dries quickly
- Reduces chance of injury

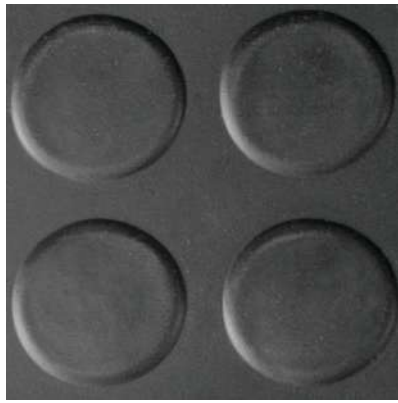

RMDOT349 Round Dot
L 49' x W 3.25' x H 0.15" · 189 lbs. · 1pk

Applications

- Hallways, corridors, etc.
- High traffic areas
- Behind retail counters

Features

- Long lengths
- Non-porous
- Surface protection
- Anti-slip
- Made from recycled rubber and SBR

Benefits

- Avoids bacteria build-up
- Easy to clean
- Dries quickly
- Reduces chance of injury

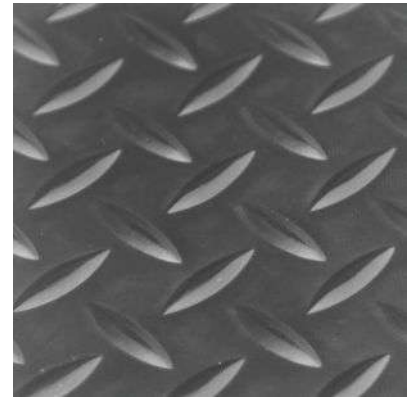

RMDIA380 Check Plate
L 80' x W 3.25' x H 0.125" · 211 lbs. · 1pk

RMDIA440 Check Plate

L 40' x W 4' x H 0.25" · 305 lbs. · 1pk

Applications

- Hallways, corridors, etc.
- High traffic areas
- Doors and walkways

Features

- Long lengths
- Non-porous
- Surface protection
- Anti-slip metal pattern
- Made from recycled rubber and SBR

Benefits

- Avoids bacteria build-up
- Easy to clean
- Dries quickly
- Reduces chance of injury



RM3DISP

Free display with purchase of 3 bulk rolls.



Utility knife and 2 x 4 board are not included.

RM3DISP 3 Roll Mat Dispenser with Metal Cutting Guide

L 60.25" x W 30.75" x H 59.25" · 1pk
95 lbs. · Bar length 60.25"

- Display allows you to cut to your desired size
- Easily cut a straight line using a utility knife to eliminate excess waste
- Display holds a maximum of 1,500 lbs.
- Utility knife and 2 x 4 board are not included



Mat Specifications (for all Rolled Rubber Mats)

Hardness.....	65 Shore A Nominal
Density.....	1500 kg/m ³
Elongation.....	> = 180%
Shearing Strength.....	< 0.60 (N/mm ³)
Temperature Stability.....	30 70
Compression Recovery.....	After 22 hours 75%
Tensile Strength.....	450 PSI
Critical Radiant Flux.....	0.11 watts/sq
Tear Resistance.....	150 ppi

Professional Grade Products

Single Door Live Traps

LT1 Single Door Live Trap
L 18" x W 6.75" x H 6.5" · 1pk
Ideal for mice, rats, weasels, red and flying squirrels, chipmunks and other similar sized animals.

LT2 Single Door Live Trap
L 24" x W 7.75" x H 7.5" · 1pk
Ideal for squirrels, chipmunks, rabbits, muskrats, mink and other similar sized animals.

LT3 Single Door Live Trap
L 24.25" x W 8.25" x H 10.125" · 1pk
Ideal for skunks, squirrels, rabbits and other similar sized animals.

LT4 Single Door Live Trap
L 32.125" x W 10.325" x H 12.75" · 1pk
Ideal for raccoons, porcupines, turtles, foxes and other similar sized animals.

LT5 Single Door Live Trap
L 42.25" x W 16.75" x H 16.75" · 1pk
Ideal for raccoons, foxes, cats, dogs and other similar sized animals.



EASY TO DISPLAY PACKAGING!



LT2



LT3

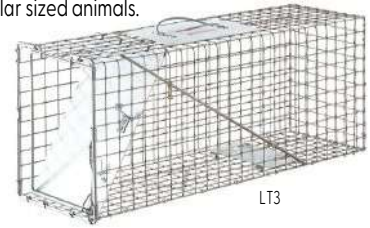

LT4



LT5

Double-Tuf.

!TWO TRAPS in One!

Live Trap Combo Pack

Features 2 live traps in one pack! See page 96 for details.



LT5



DDL4

EASY TO DISPLAY PACKAGING!



DDL2



DDL1

Double Door Live Traps

Two open entryways allow animals to enter with more confidence.

DDL1 Double Door Live Trap
L 18.75" x W 7" x H 6.5" · 1pk
Ideal for rats, weasels, red and flying squirrels, chipmunks and other similar sized animals.

DDL2 Double Door Live Trap
L 24" x W 7" x H 7" · 1pk
Ideal for squirrels, chipmunks, rabbits, muskrats, mink and other similar sized animals.

DDL4 Double Door Live Trap
L 36.5" x W 10.25" x H 12.75" · 1pk
Ideal for raccoons, woodchucks, skunks, opossums and other similar sized animals.



Professional Grade Products

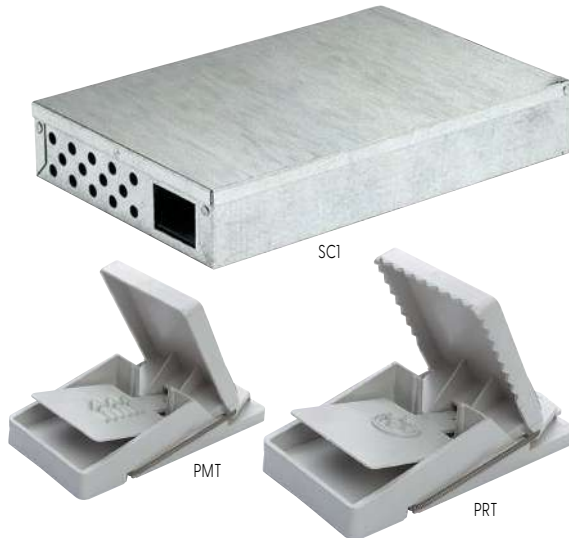



EASY
TO DISPLAY
PACKAGING



Mouse & Rodent Traps

Finally, there's an easier way to capture mice and rodents. The Better Mousetrap and The Better Rodent Trap have no complicated mechanical parts. Just press to set and squeeze to release. No-touch design makes these traps a snap to use. For mice, moles, shrews and other very small animals.

PRT The Better Rodent Trap 
L 7.5" x W 4" x H 3.5" · 6 pk

PMT The Better Mousetrap 
L 3.5" x W 2" x H 1.812" · 6 pk
2 per card

SCI Sure Catch Multiple Catch Mousetrap 
L 10.25" x W 2" x H 6.5" · 6 pk

FLUID MANAGEMENT SUPPLIES

Professional Grade Products

Fill-Fast Funnels

Little Giant® Fill-Fast Funnels are made of corrosion-proof polyethylene resin that can be used with practically any chemical and never rust. Initially designed for use in cold climates, these funnels hold up under tough environmental conditions.

100045 1 Pint Funnel with Screen

L 5" x W 4.75" x H 6" · 6 pk
The Fill-Fast Junior is a great seller in both urban and rural stores. Comes with a fine mesh brass screen.

100038 2 Quart Funnel with Screen

L 7.5" x W 7" x H 8.5" · 6 pk
The Fill-Fast All Purpose heavy-duty funnel sells itself...everywhere! Comes with a fine mesh brass screen.

100021 6 Quart Funnel with Screen

L 10.125" x W 9.125" x H 10.5" · 6 pk
The Fill-Fast Giant is designed to withstand rugged farm and industrial use. Comes with a fine mesh brass screen.

100069 1 Pint Funnel with Extension and Screen

L 5" x W 4.75" x H 19.25" · 6 pk
The Fill-Fast Fills-All is designed for automatic transmissions, but ideal for many hard to reach applications. Coarse brass screen allows flow of petroleum lubricants.



Our brass screens are heat sealed to provide a long, dependable life

100045
1 Pint

100038
2 Quart

100021
6 Quart

100069
1 Pint



Oil Pans

P3 3 Gallon Plastic Utility Pan

L 17.25" x W 17.25" x H 4.5" · 12 pk
Available in:   

GPI1 1 Gallon Galvanized Pan

L 13" x W 13" x H 2.5" · 6 pk

GPI3 13 Quart Galvanized Oil Pan

L 16.25" x W 16.25" x H 3.75" · 12 pk



GPI3
13 Quart

GPI1
1 Gallon

P3
3 Gallon



PT20BLACK
20 Gallon

PT20BLACK 20 Gallon Utility Tub

L 35.5" x W 24" x H 7.25" · 1 pk

This tough, impact-resistant rectangular tub is ideal for washing automotive parts, mixing concrete, or any application requiring a large, low-profile container. High-density polyethylene protects against warpage, stress cracks, and UV damage. Features a rounded lip for added durability.



Livestock Handling

Professional Grade Products



Hot-Shot® continues to be the industry standard and brand choice for electric livestock prods that assist in the movement and transportation of livestock.

Hot-Shot® electric livestock prods have been manufactured for over 85 years and continue to be proudly made in the USA. We offer a variety of options from Good, Better, Best guaranteed to suit your livestock needs.

We have improved The Green One® and The Red One® by modernizing their external designs and adding new performance enhancing features including a finger guard and increased water resistance. The internal motor and functionality are the same high quality as you have come to expect from Hot-Shot® prods, but with a fresh look. We are honoring the legacy of the Hot-Shot® brand with the innovation needed to continually improve our product.

The manufacturing process has been developed and refined over the past eight decades and is precise and complex.

Our stringent and time-tested quality systems are engineered into each and every prod. We carefully test 100% of our units using sophisticated electronic equipment before they are shipped.

All prods are tested for current and voltage draw, output voltage, output energy, pulse rate (frequency) and a calculated performance ratio based on these measurements to a standard range. Units that fall outside of the range are scrapped.

We run destructive testing on our Hot-Shot® prods to ensure they continue to meet our high performance requirements long after customers purchase them.

Learn more about our products we offer, by locating them on the pages listed below:

The Red One®.....	61
The Green One®.....	62
DuraProd®.....	62-63
Shafts.....	64
Sorting Paddles.....	64

GOOD

The Red One®

- Entry-level prod at an economical price
- Medium spark is most effective on clean, dry animals
- Modernized external design with added finger guard to prevent slipping
- Fully sealed solid state motor module certified to IP45 solid and water ingress standards
- No tools required; Easy to disassemble and clean
- All components easily replaced by user

Lowest voltage prod for small herds



BETTER

The Green One®

- Proven and preferred by commercial livestock haulers
- High output energy (strong spark) is effective on both clean, dry animals and those that are wet or have heavy hair or debris on them
- Modernized external design with added finger guard to prevent slipping
- Fully sealed solid state motor module certified to IP45 solid and water ingress standards
- No tools required; Easy to disassemble and clean
- All components easily replaced by user
- Good battery efficiency

Higher voltage than THE RED ONE® and meant for larger/commercial herds



BEST

HOT-SHOT DURAProd®

- Superior ergonomic design features oversized trigger, rubber grip and hand guard
- Sealed circuitry and patented design technology to reduce feedback shock
- Operates on only 4" C Alkaline batteries (instead of 6 like The Red/Green One®)
- Quick change battery packs – no tools required; rechargeable packs drop into charging station for convenience
- High output energy (strong spark) is effective on both clean, dry animals and those that are wet or have heavy hair or debris on them
- Fully sealed solid state motor

HOT-SHOT DURAProd® LIMITED DURATION

Same as the DuraProd® but...

- Delivers one-second of output with each press of the switch
- Conforms to the most stringent guidelines regarding the humane treatment of livestock.

Same voltage as THE GREEN ONE® with ergonomic handle for increased comfort





PORTABLE

POWER-MITE®

- Portable, light and compact
- Fits easily into a pocket
- Moisture-resistant on/off feedback shock
- Includes two 9-volt Alkaline batteries

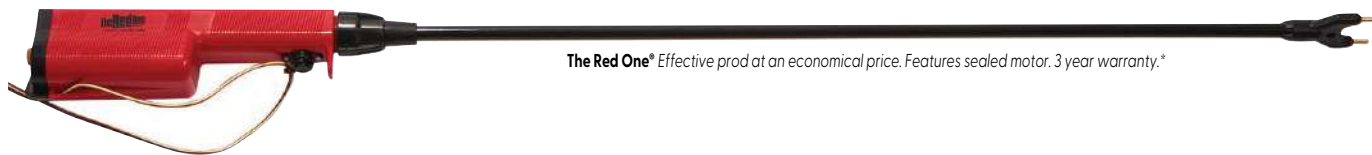

The Red One®



The Red One® Effective prod at an economical price. Features sealed motor. 3 year warranty.*

Battery Operated Prods

Available as complete units with Fiberglass or Flex Shaft. To create prods shorter than 32" or longer than 48", handle and shaft must be ordered separately.

ITEM	DESCRIPTION	SIZE	CASE PACK
SS236	The Red One® with RH36 Shaft	L 6.875" x W 2.875" x H 28.875"	6 pk
SS232	The Red One® with FX32 Shaft	L 6.875" x W 2.875" x H 24.625"	6 pk
SS242	The Red One® with FX42 Shaft	L 6.875" x W 2.875" x H 34.625"	6 pk
HU2SC	The Red One® Handle Unit Only in Clamshell	L 4.5" x W 3" x H 14"	6 pk

AVAILABLE WITHOUT PACKAGING

HU2S The Red One® Handle Unit Only
L 3" x W 2.5" x H 9" · 6 pk

REPLACEMENT PARTS

SS1 The Red One® Replacement Motor
L 3.75" x W 1.25" x H 6" · 1 pk

SS3 The Red One® Replacement Case without End Cover
L 3" x W 2.5" x H 10" · 1 pk

SS5 The Red One® Replacement Case with End Cover
L 3" x W 2.5" x H 10" · 1 pk

Available in clamshells!



The Red One®
Combo Packs



HU2SC

Note: All dimensions above are for product in retail packaging. No electric livestock prods or components may be exported or re-exported without prior U.S. government authorization.

Rechargeable Prods

HU2SRC The Red One® Rechargeable Handle Unit Only in Clamshell
L 4.5" x W 3" x H 14" · 6 pk
Includes the Rechargeable Battery Pack (RBP3).

HU2SRCHG The Red One® Rechargeable Handle with 12V Charger
L 12.75" x W 9.25" x H 2" · 6 pk
Includes the Rechargeable Battery Pack (RBP3) and 12 volt charger (R12).

The Red One® Most effective on clean, dry animals. Features sealed motor. 3 year warranty.*

AVAILABLE WITHOUT PACKAGING

HU2SR The Red One® Rechargeable Handle Unit Only
L 9.815" x W 2.75" x H 3.25" · 6 pk



HU2SR

RBP3 Rechargeable Battery Pack

L 5" x W 2.5" x H 3" · 1 pk
Closes securely with flip top. LED light lets you know it's charging. Charge it with our 12 volt auto charger, 120 volt wall charger or USB charger - all sold separately.

*Warranty is on electronics only. It does not include shaft, case breakage, any form of physical damage or damage due to normal wear and tear.



HU2SRC



HU2SRCHG

Available in clamshells!



R110



RUSBHSUS



R12



RBP3

Can be used on The Red One® and The Green One®

R12 12 Volt Auto Charger for RBP3
L 1.5" x W 1" x H 6.5" · 1 pk

R110 120 Volt Wall Outlet Charger for RBP3
L 1.5" x W 2.5" x H 4" · 1 pk

RUSBHSUS USB Charger
Hot-Shot® U.S. Plug
L 5" x W 7" x H 1.5" · 1 pk

USB Charger for Hot-Shot® brand rechargeable livestock prods. Includes power cord and wall charger unit. For use only with Hot-Shot® The Red One® and The Green One® livestock prods.

Farm & Ranch Products Since 1941

The Green One®



The Green One® provides unparalleled performance in all conditions, especially on wet animals. Proven and preferred by commercial livestock haulers. Features sealed motor. 3 year warranty.*

Battery Operated Prods

Available as complete units with Fiberglass or Flex Shaft. To create prods shorter than 32" or longer than 48", handle and shaft must be ordered separately.

ITEM	DESCRIPTION	SIZE	CASE PACK
HS236	The Green One® with RH36 Shaft	L 6.875" x W 2.875" x H 28.875"	6 pk
HS232	The Green One® with FX32 Shaft	L 6.875" x W 2.875" x H 24.625"	6 pk
HS242	The Green One® with FX42 Shaft	L 6.875" x W 2.875" x H 34.625"	6 pk
HU2HSC	The Green One® Handle Unit Only in Clamshell	L 4.5" x W 3" x H 14"	6 pk

AVAILABLE WITHOUT PACKAGING

HU2HS The Green One® Handle Unit Only
L 3" x W 2.5" x H 9" · 6 pk

REPLACEMENT PARTS

HS1 The Green One® Replacement Motor
L 3.75" x W 1.25" x H 6" · 1 pk

HS3 The Green One® Case without End cover
L 3" x W 2.5" x H 10" · 1 pk

HS5 The Green One® Case with End Cover
L 3" x W 2.5" x H 10" · 1 pk

! Available in clamshells!



Rechargeable Prods

All units include the Rechargeable Battery Pack (RBP3).

HSR236 The Green One® Rechargeable with RH36 Shaft
L 6.875" x W 2.875" x H 28.875" · 6 pk

HSR232 The Green One® Rechargeable with FX32 Shaft
L 6.875" x W 2.875" x H 24.625" · 6 pk

HU2HSRC The Green One® Rechargeable Handle Unit Only in Clamshell
L 4.5" x W 3" x H 14" · 6 pk

HU2HSRCHG The Green One® Rechargeable with USB Charger
L 12.75" x W 9.25" x H 2" · 6 pk



AVAILABLE WITHOUT PACKAGING
HU2HSR The Green One® Rechargeable Handle Unit Only
L 3" x W 2.5" x H 9" · 6 pk

Limited Duration DuraProd®

Features built in one-second technology that delivers one second of output with each press of the switch. Conforms to the most stringent guidelines regarding the humane treatment of livestock. The Limited Duration DuraProd® operates on 4 size "C" batteries and includes an LED light that indicates when the power is surging.

ITEM	DESCRIPTION	SIZE	CASE PACK
DXD32	Limited Duration with FX32 Shaft	L 25" x W 7" x H 3"	6 pk
HUDXD	Limited Duration Handle with Batteries	L 14" x W 4.5" x H 3"	6 pk
DXD1	Limited Duration Motor	L 14" x W 4.5" x H 3"	1 pk



*Warranty is on electronics only. It does not include shaft, case breakage, any form of physical damage or damage due to normal wear and tear.

Duraproduct



The DuraProd® is available in alkaline or rechargeable battery models. 3 year warranty.*

Battery Operated Prods

ITEM	DESCRIPTION	SIZE	CASE PACK
DX36	DuraProd® with RH36 Shaft	L 29" x W 7" x H 3"	6 pk
DX32	DuraProd® with FX32 Shaft	L 25" x W 7" x H 3"	6 pk
HUDX	DuraProd® Handle with Batteries	L 14" x W 4.5" x H 3"	6 pk
HUDXB	DuraProd® Handle with Batteries Bulk	L 11.25" x W 2.25" x H 3"	6 pk

Rechargeable Prods

ITEM	DESCRIPTION	SIZE	CASE PACK
DXR36	DuraProd® Rechargeable with RH36 Shaft	L 29" x W 7" x H 3"	6 pk
DXR32	DuraProd® Rechargeable with FX32 Shaft	L 25" x W 7" x H 3"	6 pk
HUDXR	DuraProd® Rechargeable Handle	L 14" x W 4.5" x H 3"	6 pk
HUDXRB	DuraProd® Rechargeable Handle Bulk	L 11.25" x W 2.25" x H 3"	6 pk
DX1	DuraProd® Motor	L 14" x W 4.5" x H 3"	1pk
DXABP	DuraProd® Alkaline Battery Pack	L 11.25" x W 5.625" x H 2.5"	1pk
DXRBP	DuraProd® Rechargeable Battery Pack	L 11.25" x W 5.625" x H 2.5"	1pk
DXRC1	DuraProd® Base with R110 Adaptor	L 5.625" x W 2.5" x H 11.25"	1pk
DXRKIT	DuraProd® Rechargeable Kit	L 10.375" x W 10.125" x H 3.25"	1pk

Note: All dimensions above are for product in retail packaging. *Warranty is on electronics only. It does not include shaft, case breakage, any form of physical damage or damage due to normal wear and tear. No electric livestock prods or components may be exported or re-exported without prior U.S. government authorization.



DXRC1



DXRBP



HUDXR



DXR32



DXRKIT

Includes: DXRBP, R12, R110 & Charger Base

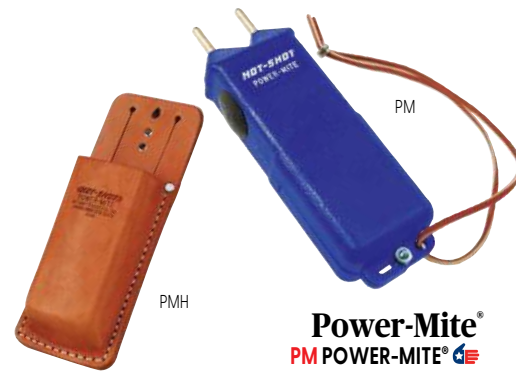

PMH

PM

Power-Mite®

PM POWER-MITE®

L 6.375" x W 2" x H 1.25" • 6 pk

Light and compact - fits easily into your pocket. Moisture-resistant on/off switch to reduce chance of feedback shock. Includes two 9V alkaline batteries.

PMH POWER-MITE® Leather Holster

L 1.75" x W 3.125" x H 8.5" • 1pk



ALKDP2

Batteries

ALKDP2 High Amp Alkaline Size C Batteries (6 batteries)

L 6.125" x W 1" x H 2" • 12 pk

6-pack high-energy, industrial strength alkaline batteries ideal for use in Hot-Shot® Stock Prods. Designed for long life and formulated to deliver high power.

Shaped By Experience

DuraProd® features include: sealed circuitry, patented design technology to reduce feedback shock, handle with rubber grip, oversized trigger, and hand guard. In addition, we test each DuraProd® using six proprietary measures to ensure reliability.



Rubber overmolded handle reduces fatigue



Snap on battery pack for fast battery changes



Built-in safety switch prevents accidental use



Specially designed shaft nut increases gripping surface and durability

Farm & Ranch Products Since 1941

Hot-Shot® Shafts

Hot-Shot® is the only brand of prods to offer two styles of shafts. Choose from the traditional rigid fiberglass (RH) or the durable flexible shaft (FX).

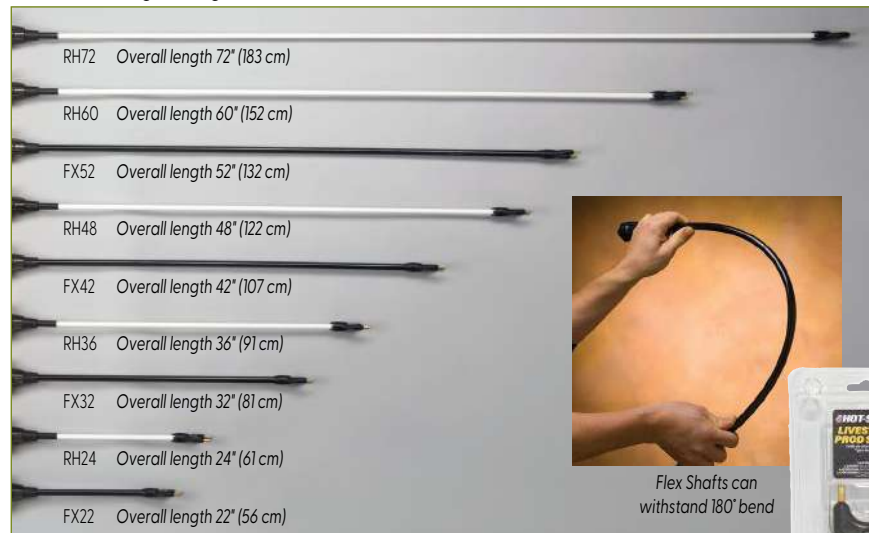

Lengths shown above are when attached to prod and include length of prod handle

Note: All dimensions above are for product in retail packaging. *Warranty is on electronics only. It does not include shaft, case breakage, any form of physical damage or damage due to normal wear and tear. No electric livestock prods or components may be exported or re-exported without prior U.S. government authorization.

! Some shafts available in clamshells!



Rigid Fiberglass Shafts

Available in 24", 36", 48", 60" and 72"

RH24 24" Rigid Fiberglass Shaft 🇺🇸

L 15.75" x W 1.75" x H 1.375" · 6 pk

RH36 36" Rigid Fiberglass Shaft 🇺🇸

L 27.75" x W 1.75" x H 1.375" · 6 pk

RH48 48" Rigid Fiberglass Shaft 🇺🇸

L 39.75" x W 1.75" x H 1.375" · 6 pk

RH48CL 48" Rigid Fiberglass Shaft in Clamshell 🇺🇸

L 30.75" x W 4" x H 1.5" · 6 pk

RH60 60" Rigid Fiberglass Shaft 🇺🇸

L 51.75" x W 1.75" x H 1.375" · 6 pk

RH72 72" Rigid Fiberglass Shaft 🇺🇸

L 63.75" x W 1.75" x H 1.375" · 6 pk

Flexible Shafts

Available in 22", 32", 42" and 52"

FX22 22" Flex Shaft 🇺🇸

L 13.5" x W 1.75" x H 1.375" · 6 pk

FX22C 22" Flex Shaft in Clamshell 🇺🇸

L 16.5" x W 4" x H 1.5" · 6 pk

FX32 32" Flex Shaft 🇺🇸

L 23.5" x W 1.75" x H 1.375" · 6 pk

FX42 42" Flex Shaft 🇺🇸

L 33.5" x W 1.75" x H 1.375" · 6 pk

FX52 52" Flex Shaft 🇺🇸

L 43.5" x W 1.75" x H 1.375" · 6 pk

Non Electric

Sorting Poles

For years, a common tool for sorting livestock of all types. Features a comfortable golf-style grip and vinyl covering for protection and easy cleaning. Available in 42", 48" and 54" lengths.

SPL42 42" Sorting Pole 🇺🇸

L 42" x W 1.125" x H 1.125" · 12 pk

SPL48 48" Sorting Pole 🇺🇸

L 48" x W 1.125" x H 1.125" · 12 pk

SPL54 54" Sorting Pole 🇺🇸

L 54" x W 1.125" x H 1.125" · 12 pk



Sorting Paddles

Animals respond to the sound of the BB's inside the paddle. Creates a visual barrier to guide livestock. Features a comfortable golf-style grip and vinyl covering for protection and easy cleaning. Available in 42" and 48" lengths. Available in: ■ ■ ■

PAD42 42" Paddle 🇺🇸

L 42" x W 6.25" x H 1.125" · 6 pk

PAD48 48" Paddle 🇺🇸

L 48" x W 6.25" x H 1.125" · 6 pk



SPL48

PAD48

All paddles feature dual rivet construction

Show Sticks

Great for use in showing cattle. Earns a quick response without hurting the animal. Features a durable aluminum hook and comfortable golf-style grip. The lightweight aluminum shaft locks at 38", 44" and 50" with push-button locking mechanism. Collapses to 29" for storage. Available in: ■ ■ ■

SHOB Black Sho-Stik

L 50" x W 1.125" x H 1.125" · 6 pk

SHOR Red Sho-Stik

L 50" x W 1.125" x H 1.125" · 6 pk

SHOS Silver Sho-Stik

L 50" x W 1.125" x H 1.125" · 6 pk



Features push-button locking mechanism



Golf-style grip for comfort



Springer Magrath®

Moving Livestock Effectively for Over 50 Years!

Springer Magrath® is a leading brand of livestock prods, veterinary supplies and a diverse line of farm and ranch products. Springer Magrath® products serve a variety of niches within the farm and agricultural markets.

Whether you're tending to a sprawling ranch or nurturing a small-scale farm, our collection of essential equipment ensures the well-being and efficient care of your animals.

As a market leader, Springer Magrath® has proven itself on the road and in the stockyards for over 50 years. Our farm and ranch products are distributed in the USA, Canada and over 30 countries around the world. Time tested and proven effective.

Learn more about our products and categories we offer, by locating them on the pages listed below:

Livestock Handling.....	66
Fluidfeeders.....	67
Animal Health.....	68



Farm & Ranch Products Since 1941

Livestock Prods

The Springer Magrath® Stock Prod is time-tested and proven on the road and in the stockyards for over 50 years. It's a leader for handling and moving livestock effectively and efficiently. The clog-free, no-ground tip rotates to any position. The durable, reliable solid-state electronics system transmits very low current to the animal yet delivers a strong, instantaneous sensation. Grooved finger guide allows finding the switch by feel, even with gloved hands; rubber switch insulator prevents feedback through the grip. Precious metal battery contacts won't corrode, and heavy coil spring assures firm battery contact. High-energy, longer lasting alkaline batteries included. Housed in a tough, structural-grade resin case for years of reliable service.



200PP
200PPWOB

200PP Power Pak - 4 Alkaline Batteries
L 10.75" x W 2" x H 4" · 6 pk

200PPWOB Power Pak - No Batteries
L 10.75" x W 2" x H 4" · 6 pk

BATT6PK Alkaline Size C Batteries

L 6" x W 2" x H 1" · 12 pk
6-pack high-energy, industrial strength alkaline batteries ideal for use in Springer Magrath® Stock Prods. Designed for long life and formulated to deliver high power.



BATT6PK

200PPC Power Pak In Clamshell

L 14" x W 5" x H 2" · 6 pk
Power Pak Handle Assembly for Springer Magrath® Stock Prod.

200PPRC Power Pak Rechargeable In Clamshell

L 14" x W 5" x H 2" · 6 pk
Power Pak Handle Assembly with Rechargeable Battery Stick for Springer Magrath® Stock Prod.

RUSBSPUS USB Charger Springer Magrath® U.S. Plug

L 5" x W 7" x H 1.5" · 1 pk
USB Charger for Springer Magrath® brand rechargeable Stock Prods. Includes power cord and wall charger unit. For use only with Springer Magrath® brand Stock Prods.



200PPC and 200PPRC



RUSBSPUS



PSTKR12C

PSTKR12C Springer Magrath® Rechargeable Battery Stick With 12V Charger

L 10" x W 6.5" x H 2" · 6 pk
Upgrade your Springer Magrath® Power Pak Handle from battery-powered to rechargeable using this Battery Stick. This battery stick is capable of 300-500 battery cycles, which is the equivalent of 1,000 alkaline batteries. Includes 12V Car Charger.

Livestock Prod Shafts

The clog-free, no-ground tip rotates to any position. Available in 9", 22", 34" and 44" lengths.

9SA 9" Shaft
L 14.5" x W 2" x H 1.5" · 6 pk

9SAC 9" Shaft in Clamshell
L 16.5" x W 4" x H 1.5" · 6 pk

22SA 22" Shaft
L 27.125" x W 2" x H 1.5" · 6 pk

22SAC 22" Shaft in Clamshell
L 29.5" x W 4" x H 1.5" · 6 pk

34SA 34" Shaft
L 39" x W 2" x H 1.5" · 6 pk

34SAC 34" Shaft in Clamshell
L 41.375" x W 4" x H 1.5" · 6 pk

44SA 44" Shaft
L 49" x W 2" x H 1.5" · 6 pk

44SAC 44" Shaft in Clamshell
L 51.375" x W 4" x H 1.5" · 6 pk



! Some shafts available in clamshells!



* Warranty is on electronics only. It does not include shaft, case breakage, any form of physical damage due to normal wear & tear. No electric livestock prod or components may be exported or re-exported without prior U.S. government authorization.

Fluidfeeders

Fluidfeeders provide a practical, easy-to-use tool for providing fluids and nourishment to calves that can't or won't nurse. The esophageal probe is the correct size for calves, and if used properly, the probe's size and shape do not allow it to be inserted into the trachea, reducing the danger of getting fluid into lungs and drowning the calf. The easy-to-handle 2-quart tube makes using the fluidfeeder a simple, one-person operation. When used properly, the rate of flow is slow enough to cause the calf to form saliva freely, which is necessary for proper digestion. Heavy-duty tube resists punctures and tears and remains flexible down to 0 degrees F (-18 degrees C). Bottle collapses without venting, and check valve keeps air out as liquid leaves the bottle. Bottle, tube, and probe are easy to clean.

No-Crimp Gravity Fluidfeeders

Gravity controls fluid flow.



50PLNSFF 2 Quart Fluidfeeder with Plastic Probe

L 30.25" x W 9.5" x H 4" • 6 pk

Durable plastic probe resists burrs that can cut the throat and cause infection.

101NA Nipple Attachment

L 4" x W 2.25" x H 2.25" • 1 pk

Fits on any Springer Magrath® Fluidfeeder to allow mouth feeding of fluids to young calves that are unable to nurse from a cow.



Bolus Gun

480NBG Bolus Gun

L 21.5" x W 2.25" x H 2.25" • 1 pk

The safe, easy way to administer medication to cattle of all sizes, eliminating coughing and spitting out. The Springer Magrath® Bolus Gun is made of industrial-quality aluminum. It holds up to rugged use and resists sharp edges that can cut and cause infections. Rounded leading edge allows easy insertion. Can administer up to five 1-lb boluses at one time.



480NBG

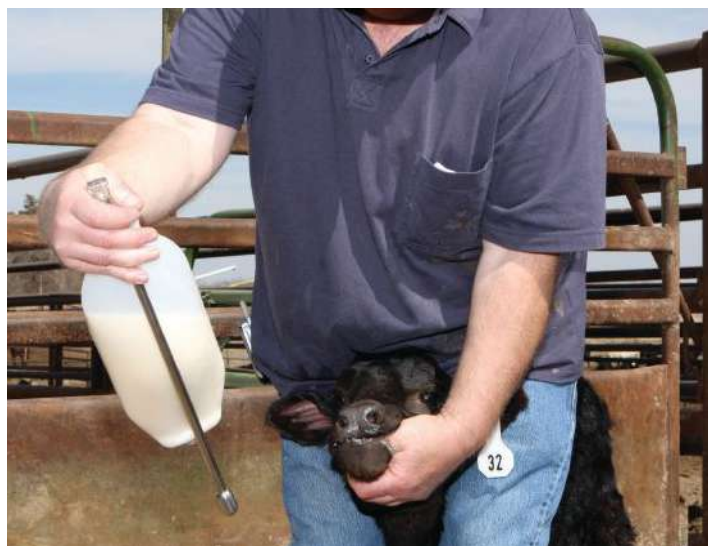

Crimp Valve Fluidfeeders

Design allows user easy control of fluid flow.



50SSFF 2 Quart Fluidfeeder with Stainless Steel Probe

L 32" x W 9.5" x H 4" • 6 pk

Durable hardened stainless-steel probe lasts for years.



50PLFF 2 Quart Fluidfeeder with Plastic Probe

L 31.5" x W 9.5" x H 4" • 6 pk

Durable plastic probe resists burrs that can cut the throat and cause infection.



50PLGLFF 1 Gallon Fluidfeeder with Plastic Probe

L 31" x W 6.25" x H 5.125" • 6 pk

Durable plastic probe resists burrs that can cut the throat and cause infection.



50SSGLFF 1 Gallon Fluidfeeder with Stainless Steel Probe

L 31" x W 6.25" x H 5.125" • 6 pk

Durable hardened stainless-steel probe lasts for years.

Professional Grade Products

Cattle Pump System

Includes everything needed to administer accurate dosage of both light and heavy-viscosity fluids to adult animals weighing 300 to over 900 lbs. A must for post-calving drenches and tonics, and for administering electrolytes, nutrient mixes, mineral oil, or medications. Effective for hydrating cattle for better response to antibiotics or vaccinations. Professional-quality system designed to be operated by one person with a pump that requires only seven strokes per gallon.

Features a flexible stainless-steel esophageal probe that utilizes the natural extended neck position of the bovine to bypass the trachea and deliver the probe into the stomach with a unique teardrop end for easy passage. Attached nose lead effectively holds the probe in place; built-in stop action reduces chances of regurgitation. System includes probe and attached nose lead, chrome-plated brass pump with hand grip, and 6' oil-resistant hose with screw-on brass fittings, all in a canvas carrying case.

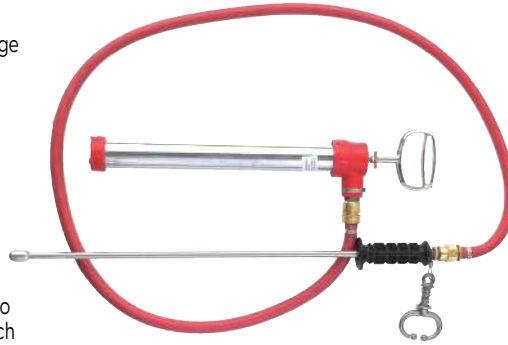

300CPS 300 Cattle Pump System
 L 36" x W 16" x H 3.5" · 1pk
 For cattle weighing 300 to 900 lbs.



500CPS 500 Cattle Pump System
 L 59.5" x W 16" x H 3.5" · 1pk
 For adult cattle weighing over 900 lbs.

Cattle Pump Probes

Esophageal probe made of flexible stainless-steel. Probe features unique teardrop end for easy insertion.

300CPSPR CPS 300 Probe
 L 36" x W 2.5" x H 3" · 1pk
 For cattle weighing 300 to 900 lbs.

500CPSPR CPS 500 Probe
 L 60" x W 2.5" x H 3" · 1pk
 For adult cattle weighing over 900 lbs.

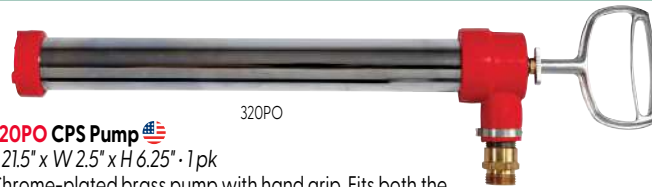
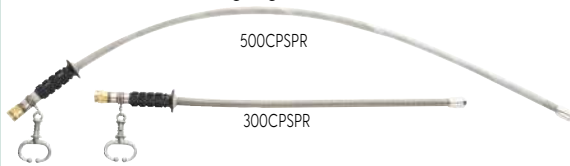

320PO CPS Pump
 L 21.5" x W 2.5" x H 6.25" · 1pk
 Chrome-plated brass pump with hand grip. Fits both the 300CPS and 500CPS Cattle Pump Systems.

Transfer Needle

The easy, sanitary solution for transferring fluids from one vial to another. A great tool for mixing components or rehydrating dried vaccines. 14-gauge stainless steel, double-pointed cannula is tapered on both ends with a flat metal thumb saddle that can be used even with gloves.



840MTN Transfer Needle
 L 3" x W 0.56" x H 0.31" · 1pk



Obstetrical Calf Straps

Obstetrical Straps are easier on both cow and calf than chains. The 1" width spreads pulling tension over a wider area of the calf's legs to help prevent bone fractures and soft-tissue injury. Made of soft yet sturdy, washable nylon webbing with stainless-steel D rings. Bright teal color that is easy to find. Can be used with or without a mechanical tension device. Available in three lengths.

10430S 30" Nylon OB Strap
 L 32.5" x W 1" x H 0.25" · 1pk

10460S 60" Nylon OB Strap
 L 62.5" x W 1" x H 0.25" · 1pk

10452CS 52" Nylon / Chain OB Strap
 L 52.5" x W 1" x H 0.5" · 1pk
 Includes 16" chain insert.

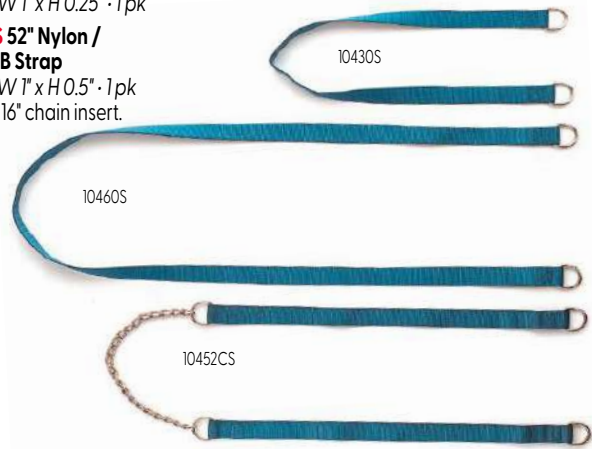

Orphan-No-More™

A simple, easy-to-use, and effective way to help assure calf and lamb adoption by natural or foster mothers. Orphan-No-More™ works by masking the odor of the calf or lamb with a more intense odor that is highly attractive to cows and ewes. Made of 95% natural animal protein products. Orphan-No-More™ has been field tested on both cattle and sheep, and has proven effective at cow-calf and ewe-lamb grafting. 9-oz jar contains enough powder for four to five calves or lambs.

106ONM 9 Oz Bottle Orphan-No-More™
 L 2.75" x W 2.75" x H 6" · 12 pk

106ONM





Heated Products

Professional Grade Products

API® has been a trusted name in heated products for over 75 years, offering a wide variety of solutions across the agricultural, pet, wild bird, and pond markets. Whether you're a hobbyist or simply looking to enhance the comfort of your animals, API® combines quality and highly efficient technology to provide the right products for all seasons.

Discover an extensive range designed to keep your feathered friends and beloved pets happy and hydrated year-round. Our API® Water Wigglers and heated bird baths ensure birds remain comfortable and nourished, while pond de-icers maintain a thriving aquatic ecosystem even in winter. For farm animals, our durable de-icers guarantee constant access to unfrozen water in ponds, buckets, and bird baths, ensuring their hydration and health during harsh conditions.

Additionally, our selection of heated pet products, including beds, mats, and thermal bowls, offers warmth and comfort for your furry companions, enhancing their well-being on chilly days and nights. With API's reliable solutions, you can create optimal conditions for both wildlife and domestic animals throughout the year.

Learn more about our products and categories we offer, by locating them on the pages listed below:

API® Livestock & Poultry.....	70-74
API® Hoses & Electrical.....	75
API® Pet Products.....	76-77
API® Bird Bath & Pond.....	78-80



Farm & Ranch Products Since 1941

Heated Buckets

API® Heated Buckets are constructed of high-quality, resilient plastic to withstand low temperatures without cracking. Thermostatic control with over-temperature protection ensures that it will keep water ice-free to low temperatures.

9HB Heated 9 Quart Bucket

50 Watts, 120 Volts 

L 11.25" x W 11.25" x H 9.375" · 6 pk

Perfect midsize bucket, especially suited for medium to large sized dogs or other similar sized animals. Includes 6-foot anti-chew cord. cULus Listed.



9HB
9 Quart

10FB Heated 10 Quart Flat Back Bucket

70 Watts, 120 Volts 

L 13.625" x W 12" x H 9.625" · 5 pk

Perfect for those who need a smaller flat back bucket. It hangs flush against the wall. Includes a patented sliding storage door on the bottom of the bucket to stow the 6-foot anti-chew cord during summer use. cULus Listed.



10FB
10 Quart

20FB Heated 20 Quart Flat Back Bucket

115 Watts, 120 Volts 

L 16.25" x W 14.25" x H 12.375" · 6 pk

The flat back design and over-sized metal handle allow this bucket to hang flush against a wall. Patented design features a bottom compartment to stow the 6-foot anti-chew cord during summer use. cULus Listed.



20FB
20 Quart

16HB Heated 16 Gallon Bucket

260 Watts, 120 Volts 

L 23.25" x W 21.5" x H 16.75" · 4 pk

Designed to accommodate multiple animals. Features strong and sturdy molded handles. Includes 6-foot anti-chew cord. cULus Listed.



16HB
16 Gallon





EASY TO DISPLAY PACKAGING

Patented Design



W250 Auto Waterer De-Icer 250 Watts, 120 Volts

L 4.75" x W 4.75" x H 1.125" · 6 pk

Equipped with aluminum feet, it is specially designed for use in automatic waterers/drinkers. Features a non-stick coating and is safe for use in plastic buckets or tanks. Recommended for up to 30 gallons of water. Includes 6-foot cord. cULus Listed.

W500 Auto Waterer De-Icer 500 Watts, 120 Volts

L 4.75" x W 4.75" x H 1.125" · 6 pk

Same as the W250 but 500 Watts, 120 Volts. Recommended for up to 70 gallons of water. Includes 6-foot cord. cULus Listed.

Bucket De-Icers

DT250 Bucket/Utility De-Icer 250 Watts, 120 Volts

L 4.75" x W 4.75" x H 1.125" · 6 pk

Uses multiple thermostats for optimized control. The low-profile, finned design provides a large surface area to run cooler while putting out the same amount of heat as conventional de-icers resulting in less mineral buildup and longer life. Can be used in plastic containers. Durable, coated-aluminum base. Recommended for up to 30 gallons of water. Includes 6-foot anti-chew cord. cULus Listed.

DT500 Bucket/Utility De-Icer 500 Watts, 120 Volts

L 4.75" x W 4.75" x H 1.125" · 6 pk

Same as the DT250 but 500 Watts, 120 Volts. Recommended for up to 70 gallons of water. Includes 6-foot anti-chew cord. cULus Listed.

DT250, DT500,
W250 & W500

Bucket Heaters

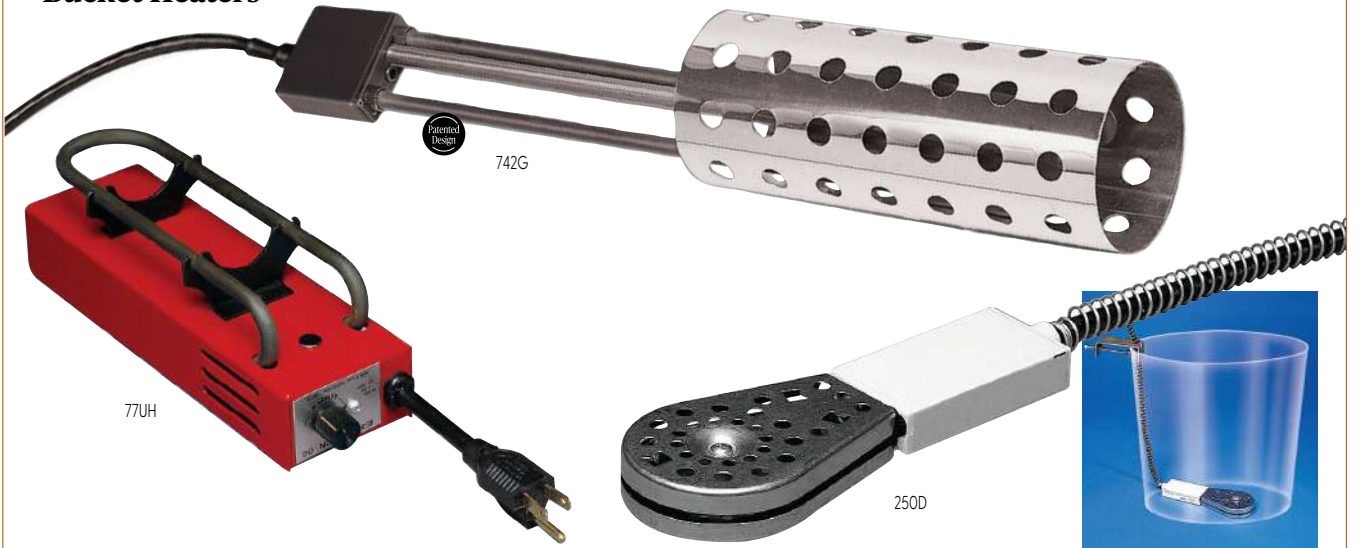

77UH Utility Heater 500 Watt, 120 Volts

L 9.875" x W 3.25" x H 3" · 6 pk

This utility heater is a versatile unit made of heavy-gauge steel with an attractive baked-on enamel finish. Though not immersible, this utility heater can be used under metal buckets, fountains, or inside various enclosures. With an adjustable and replaceable thermostat, the utility heater's compact design has a wide range of uses. Includes 12" cord.

742G Bucket Heater

1000 Watts, 120 Volts

L 17.5" x W 2.875" x H 2.875" · 6 pk

Designed to heat water as opposed to de-icing water. A stainless steel guard protects the durable heating element that will heat water past 150 degrees F towards boiling, depending on the bucket's volume and insulation. It comes with a 6-foot cord and is designed to rest easily inside a 5 gallon bucket. The heater is thermostatically controlled with over-temperature protection. For use in water only. Includes 6-foot cord. UL Listed. CSA Listed.

250D Pail & Bird Bath De-Icer 200 Watts, 120 Volts

L 7.75" x W 2.75" x H 0.875" · 6 pk

De-ices up to 15 gallons. Submersible de-icer features thermostatic control and a stainless steel guard for safety. An adjustable clamp is included to attach the unit to the container. Includes 6-foot anti-chew cord. cULus Listed. CSA Listed.

Farm & Ranch Products Since 1941

Tank De-Icers

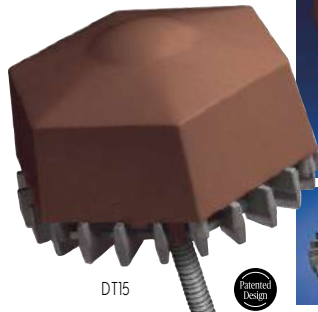

DT15



7521 & 7621

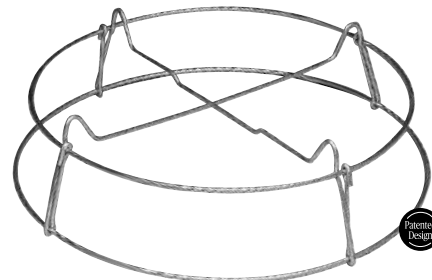

88R

DT15 3-in-1 De-Icer 1500 Watts, 120 Volts

L 7" x W 7" x H 4.375" · 6 pk

Easily converts to floating, sinking or drain-plug de-icer. To use as a sinking de-icer, simply remove the cover and float, turn the unit over to rest on its sturdy feet, or use the patented drain plug adapter to route the cord through the drain hole. Multiple, dedicated thermostats separately monitor water and heating element temperatures to provide efficient and safe operation. The sturdy, finned base spreads the heat to make the unit run cooler to the touch while still putting the maximum amount of heat into the water. Cooler operation and non-stick coating resists mineral buildup. Can safely operate in any plastic or metal tank without the use of a guard. Recommended for 100-300 gallons of water. 6-foot anti-rub cord. cULus Listed. Patented design.

521G Floating De-Icer with Galvanized Guard 1500 Watts, 120 Volts

L 14.25" x W 14.25" x H 6" · 6 pk

Thermostatic control coupled with thermal feedback protects the unit from overheating. Positioning the thermostat above the heating element ensures safety in low-water conditions. The float is completely enclosed in a rugged, plastic housing and will not sink over time. The galvanized guard is specially designed to protect rubber, plastic or structural-foam tanks. Recommended for 100-300 gallons of water. 6-foot anti-rub cord. cULus Listed.



521G

7621 Floating De-Icer 1000 Watts, 120 Volts

L 8.75" x W 8.75" x H 3.25" · 6 pk

Same as the 7521 but 1000 watts, 120 volts. Recommended for 70-100 gallons of water. 6-foot anti-rub cord. cULus Listed.

88R Galvanized De-Icer Guard

L 14.25" x W 14.25" x H 3.75" · 6 pk

May be used with floating, sinking or 2-in-1 de-icers. Guard is specially designed to protect rubber, plastic or structural-foam tanks.

15N Sinking De-Icer 1500 Watts, 120 Volts

L 14.25" x W 14.25" x H 6.25" · 6 pk

Operates at the bottom of the tank where it is less likely to be disturbed by livestock. Thermostatic control coupled with thermal feedback protects the unit from overheating. Positioning the thermostat above the heating element ensures safety in low-water conditions. Each unit comes complete with a galvanized wire guard for use in plastic tanks. Recommended for 100-300 gallons of water. 6-foot anti-rub cord. UL Listed. CSA Listed.

10N Sinking De-Icer 1000 Watts, 120 Volts

L 14.25" x W 14.25" x H 6.25" · 6 pk

Same as the 15N but 1000 Watts, 120 Volts. Recommended for 70-100 gallons of water. 6-foot anti-rub cord. UL Listed. CSA Listed.

DTS15 Sinking De-Icer 1500 Watts, 120 Volts

L 7" x W 7" x H 2.75" · 6 pk

This energy efficient sinking de-icer keeps your entire tank ice-free without overheating the water. Safe for animals, this de-icer includes a durable PTFE coating for easy cleaning. The large, finned base runs cooler than conventional de-icers, making it safe for plastic or metal tanks alike. Recommended for 100-300 gallons of water. 6-foot anti-rub cord. cULus Listed.



DTS15



See page 38 for compatible Little Giant® Stock Tanks



EASY TO DISPLAY PACKAGING



15N & 10N

Tank De-Icers (Continued)



15A 2-in-1 Sinking De-Icer 1500 Watts, 120 Volts

L 14.25" x W 14.25" x H 6.25" · 6 pk
Can be used as either a sinking or drain-plug de-icer. The power cord plug is specially designed to fit through a 1.125" drain hole, and a patented drain plug adapter seals around the cord to provide care-free routing. Operates at the bottom of the tank where it is less likely to be disturbed by livestock, protecting both equipment and animals. Thermostatic control coupled with thermal feedback protects the unit from overheating. Positioning the thermostat above the heating element ensures safety in low-water conditions. Recommended for 100-300 gallons of water. 6-foot anti-rub cord.

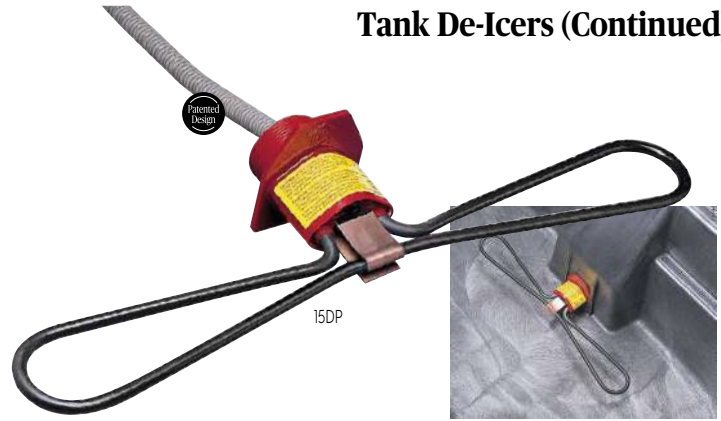

15DP Drain Plug De-Icer 1500 Watts, 120 Volts

L 18" x W 6.5" x H 3.25" · 6 pk

For Rubbermaid® tanks only. Mounts securely into the tank drain hole to keep the heating element away from livestock. Has a butterfly heating element and is designed to mount into the larger drain hole found on some Rubbermaid® tanks. Recommended for 100-300 gallons of water. 6-foot anti-rub cord. cULus Listed.



EASY
TO DISPLAY
PACKAGING

Tank Heaters

71502 Tankside Heater - 1500 Watts, 120 Volts

L 25" x W 20" x H 7" · 1pk

Clamps to the side of a metal stock tank. The tankside heater comes with an adjustable and replaceable thermostat that allows the user to set the water temperature. This unit takes the place of a de-icer by maintaining the water temperature near a set point. Not for use in plastic tanks. Includes 6-foot cord.



2002DP Universal Drain Plug De-Icer 1500 Watts, 120 Volts

L 12.5" x W 6" x H 3.25" · 6 pk
Mounts securely into the tank drain hole to keep the heating element away from livestock. Specially designed plug to fit through all drain holes 1.125" diameter or larger. Recommended for 100-300 gallons of water. 6-foot anti-rub cord. cULus Listed.

99DP Universal Drain Plug De-Icer 1500 Watts, 120 Volts

L 6.125" x W 13" x H 3.25" · 6 pk
Mounts securely into the tank drain hole to keep the heating element away from livestock. Includes a patented cord that detaches to pass through a drain hole 3/4" or larger. Recommended for 100-300 gallons of water. 6-foot anti-rub cord. cULus Listed.

EASY
TO DISPLAY
PACKAGING

! Riveted plastic cover protects the components located inside the base.

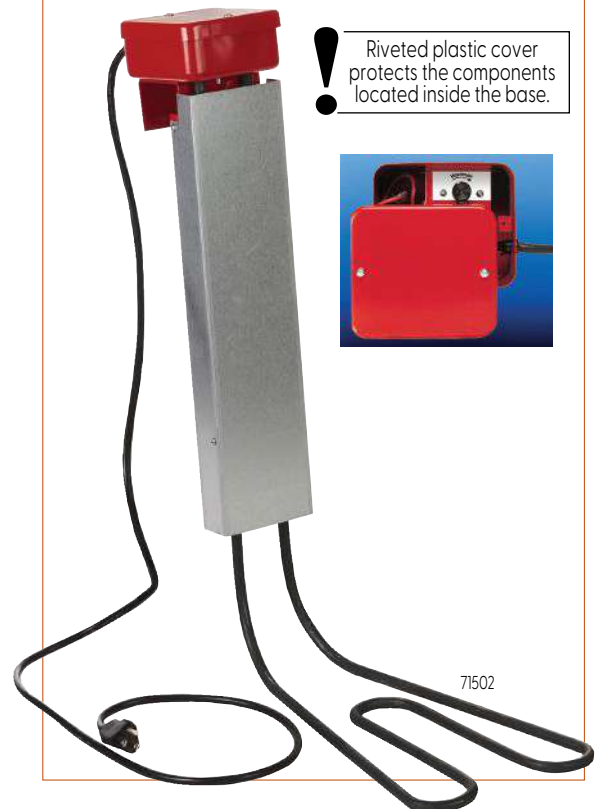

71502

Farm & Ranch Products Since 1941

Poultry Waterers

HPW33 3 Gallon Heated Poultry Fount

100 Watts, 120 Volts 

L 13.62" x W 13.62" x H 16.75" · 4 pk

Patented design provides your poultry with fresh water all winter long. Keeps water ice-free down to -5 degrees F in the winter, but can be used year round as well. Thermostatically controlled with optimized heater pad design for maximum heating efficiency to ensure ice-free water. Sturdy galvanized steel handle. Rounded top of water jug helps prevent chickens from roosting. 3-gallon capacity. 4-foot cord. 60 Hz. cULus Listed. One year warranty.



HPW33



HDHH3

HDHH3 API 3 Gallon Heated Deluxe Hen Hydrator

L 12.5" x W 12.5" x H 13.75" · 3 pk

Best suited for up to 16 adult birds. This easy to fill Deluxe Heated Hen Hydrator provides access to clean water on demand while keeping it ice-free up to -10 degrees F. The translucent bucket was designed to provide UV protection to prevent algae growth and allow for easy viewing of the water level. Convenient twist locking lid is sloped to prevent roosting and make cleaning easy. Thermostatically controlled cULus listed electrical components ensure safe operation. Ergonomic handle is designed for the unit to be hung easily and includes a free Little Giant® Bucket Handle Grip (Model #166713) for comfortable carrying with plenty of clearance between hand and bucket. Each of the 4 side-mounted drinking nipples accommodates up to 4 birds and allow for easy access. Holds up to 3 gallons. 65 Watts, 120 Volts. 6-foot cord. cULus listed. One year warranty.



! Cord wraps in bottoms for easy storage!



HB130 & HB140



Bottom fully enclosed with rubber pad

Electric Water Heater Base

Helps prevent water from freezing in temperatures as low as 10 degrees F. Designed for use with Little Giant® Double Wall Founts (Item Nos. 9832, 9833, 9835, and 9838, sold separately, see page 10) and other all-metal containers. The heating element is designed for safety and efficiency. The fully enclosed bottom adds another layer of protection. Intended for use outdoors in a dry, sheltered area. Made of heavy-duty, rust-resistant galvanized steel. Cord should be protected from animals and used with a Ground Fault Circuit Interrupter (GFCI) protected outlet. Unit will not draw electricity until temperature drops below freezing. Uses less than 1 amp per hour. 120V, 60 Hz, 110W, .92A.

HB130 Electric Water Heater Base - 110 Watts 
L 16.25" x W 16.25" x H 3.67" · 1 pk

HB140 Heater Base CSA Certified - 110 Watts 
L 16.25" x W 16.25" x H 3.67" · 1 pk

Heated Poultry Mat

HPM-S Heated Poultry Mat - 33 Watts, 120 Volts 

L 19" x W 13" x H 1" · 6 pk

Best for up to 5 adult birds or 20 chicks. Constructed of durable, weather-resistant plastic with welded seams for safety and longer life. Our mats are designed to be used for both adult birds and chicks. The low wattage and thermostat provides adequate heat without overheating the birds while also using less power. Our unique design allows air flow completely around the heating element to eliminate hot spots common with other plastic mats. 6-foot anti-chew cord. cULus Listed.



EASY TO DISPLAY!
PACKAGING!



HPM-S

Heated Hoses

This cold weather hose is excellent for tasks requiring running water in below-freezing temperatures. Featuring a highly efficient internal heating extrusion, API's heated hose maximizes heat retention. The heating element extends all the way to both ends, eliminating frozen connection points. It features a high-quality 5/8" hose with standard brass garden hose fittings and is thermostatically controlled for energy-efficient operation. It can be run continuously or simply plugged in when needed.

DH25 Deluxe Winterflo® Heated Hose
180 Watt, 120 Volts, 25 feet 
L 16" x W 16" x H 16" · 3 pk

DH50 Deluxe Winterflo® Heated Hose
360 Watt, 120 Volts, 50 feet 
L 15.25" x W 15.75" x H 23.5" · 3 pk



DH25



DH50



EASY TO DISPLAY PACKAGING

ClickShield® Cord Lock

The ClickShield® Cord Lock is the fast and inexpensive way to weatherproof any power cord, while also eliminating irritating and dangerous disconnects. The durable all-weather plastic shield has a unique ratchet mechanism; when you hear the 'click' you know it's securely locked. The internal gasket assures a water-resistant electrical connection. The ClickShield® is great for Christmas lights or other electrical holiday yard decor, power tools, or outdoor equipment of any kind. ClickShield® is the essential outdoor electrical accessory.

28CSG ClickShield® Cord Lock – Green 
L 4.625" x W 2.75" x H 2.125" · 12 pk

28CSK ClickShield® Cord Lock – Black 
L 4.625" x W 2.75" x H 2.125" · 12 pk

28CSO ClickShield® Cord Lock – Orange 
L 4.625" x W 2.75" x H 2.125" · 12 pk



28CSO



28CSK



28CSG

EASY TO DISPLAY PACKAGING



Farm & Ranch Products Since 1941

Heated Pet Beds

Made of durable faux suede with a fleece top. Our beds come with three separate foam layers that allow placement of the bed warmer for just the right amount of heat. Each bed is heated by included PBW Pet Bed Warmer. The warmer plugs into any standard 120 volt outlet but provides 24 volts to the heater for safety. 7.3 watts, 24 volts. 60 Hz. Includes 6' anti-chew cord. cULus Listed.

PBS Small Heated Pet Bed,

Assorted Colors 

L 23" x W 23" x H 2.5" • 6 pk

PBM Medium Heated Pet Bed,

Assorted Colors 

L 28" x W 28" x H 2.5" • 6 pk

PBL Large Heated Pet Bed,

Assorted Colors 

L 28" x W 43" x H 2.5" • 6 pk

PBR Round Heated Pet Bed

L 23" x W 23" x H 2.5" • 6 pk

6 PACK
Contains
assorted colors



PBR
Round



Small



Large



98P-M
Medium

Heated Plastic Mats

Approved for indoor or outdoor use. Constructed of durable, weather-resistant plastic with welded seams for safety and longer life. A machine washable, fleece-like cover is also included. Our unique, patented design allows air flow completely around the heating element to eliminate hot spots common with other plastic mats. Our mats are designed to be used in dog houses, garages, kennels, or anywhere your pet needs added warmth. Includes 6-foot anti-chew cord.

Each pet mat includes a washable, fleece-like cover.



98P-XS Extra Small Plastic Heated Pet Mat

25 Watts, 120 Volts

L 12" x W 9" x H 1" • 12 pk

Extra small size is great for rabbit cages.

98P-S Small Plastic Heated Pet Mat

33 Watts, 120 Volts 

L 19" x W 13" x H 1" • 6 pk

cULus listed.

98P-M Medium Plastic Heated Pet Mat

57 Watts, 120 Volts 

L 24" x W 17" x H 1" • 6 pk

cULus listed.

98P-L Large Plastic Heated Pet Mat

75 Watts, 120 Volts 

L 28.75" x W 22.875" x H 1" • 6 pk

cULus listed.



EASY
TO DISPLAY
PACKAGING



98P-XS
Extra Small

Pet Bed Warmer

PBW Pet Bed Warmer

7.3 Watts, 24 Volts 

L 15" x W 12" x H 0.375" • 6 pk

Provides gentle heat and can be used with any pet bed that measures at least 12" x 15". A transformer plugs into any standard 120 volt outlet and supplies a safe 24 volts to the heating element. Includes 6-foot anti-chew cord. cULus listed.

PBW



Fleece bed sold separately



Heated Pet Bowls

SB50 Heated 1.25 Gallon Stainless Pet Bowl 50 Watts, 120 Volts

L 15.375" x W 15.375" x H 4.5" • 6 pk
Stainless steel, tip-proof pet bowl holds 1.25 gallons and is thermostatically controlled. The heating element is detachable for summer storage and dishwasher-safe cleaning. Can be nested with the cord coiled and secured to the bottom for a neat shelf appearance. 6-foot anti-chew cord. cULus Listed.



SB50
1.25 Gallon



1B
1 Quart



1B Heated Plastic 1 Quart Pet Bowl 25 Watts, 120 Volts

L 9.75" x W 9.75" x H 4" • 6 pk
Thermostatically controlled for efficient operation and features a convenient non-tip design. 6-foot anti-chew cord.

HPB5 Heated Plastic 5-Quart Pet Bowl 50 Watts, 120 Volts

L 12.375" x W 12.375" x H 5.25" • 6 pk
Thermostatically controlled for efficient operation. Made from a special, resilient plastic that can flex slightly and prevent cracking in freezing temperatures. The non-tip design prevents spills and messes. 6-foot cord with anti-chew protector. cULus Listed. One year warranty.



HPB5
5 Quart



90
1 Quart



EASY
TO DISPLAY &
PACKAGING



90 Heated Stainless 1-Quart Pet Bowl With Cage Mount - 25 Watts, 120 Volts, 60 Hz

L 6.5" x W 7" x H 3.75" • 6 pk
Made of stainless steel for easy cleaning. Comes with a mounting ring for attachment to any cage. The bowl can also stand alone on a flat surface. 6-foot anti-chew cord. cULus Listed.



Farm & Ranch Products Since 1941

Bird Baths

API® offers a wide range of bird baths for our feathered friends in every season. API® bird baths will supply wild birds with fresh, open water throughout the winter while attracting them during the warm summer months, too!

Deck Mount Bird Baths



14B
Heated 14" Bird Bath



650
Heated 20" Bird Bath



14B Heated 14" Bird Bath with EZ-Tilt™
Deck & Pole Mount, 70 Watts, 120 Volts 
L 14" x W 14" x H 4" · 6 pk

Thermostatically controlled and tested to -20 degrees F. The unique patented EZ-Tilt™ Deck Mount is included and allows easy mounting to a wooden deck rail. 15-inch cord. CSA Listed.



650 Heated 20" Bird Bath with EZ-Tilt™
Deck Mount, 150 Watts, 120 Volts 
L 20" x W 20" x H 4" · 6 pk

Thermostatically controlled and tested to -20 degrees F. The unique patented EZ-Tilt™ Deck Mount is included and allows easy mounting to a wooden deck rail. 15-inch cord. CSA Listed.

Decorative Bird Baths



600
20" Bird Bath

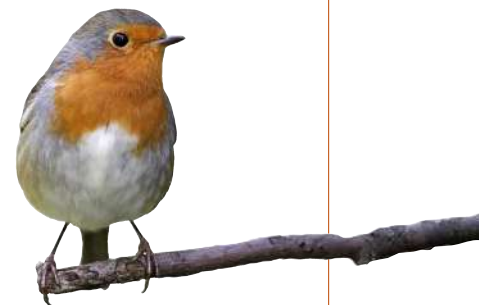

600 Heated 20" Bird Bath
150 Watts, 120 Volts, 60 Hz 

L 20" x W 20" x H 4" · 6 pk
Thermostatically controlled heated bird bath. Comes with hardware to mount to most posts, pedestals (stone, wood, or plastic) or deck railings. Includes 15-inch cord. CSA Listed.

Bird Baths with Stands



400
12" Bird Bath



970
20" Bird Bath

400 Heated 12" Bird Bath With Stand, 50 Watts, 120 Volts, 60 Hz

L 12" x W 12" x H 30" · 6 pk

Plastic, terra cotta-colored heated bird bath provides ice-free water all winter long. Thermostatically controlled and specifically designed to attract wild birds, a contoured rim fits the average bird's talon, a gradual slope encourages bathing, and a textured surface ensures a sure grip. The heating element containing all electrical parts simply snaps in place and may be removed during non-winter months so it can be used year-round. Includes 15-inch cord. CSA Listed.

970 Heated 20" Bird Bath With Stand, 150 Watts, 120 Volts, 60 Hz

L 20" x W 20" x H 30" · 6 pk

Thermostatically controlled and tested to -20 degrees F. Includes 15-inch cord and 30" metal stand. CSA Listed.

Water Wigglers®

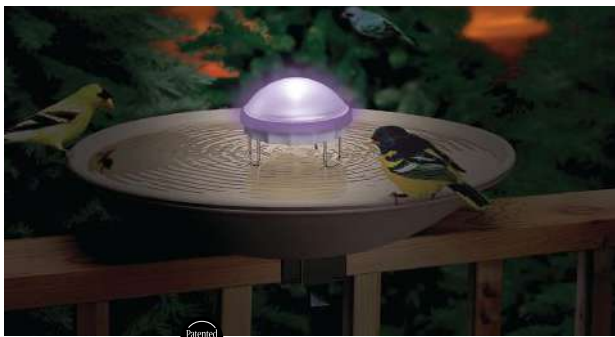

7WW



8WW

4WW Standard Water Wiggler®

L 5" x W 5" x H 5" · 6 pk

Features a unique agitator action that creates continuous ripples that help prevent the spread of West Nile Virus by eliminating stagnant water in bird baths. Easy to install - just place and go! The moving water created by the Water Wiggler® will help attract birds to your bath. There is no wiring and no plumbing. It operates on two D-cell batteries (not included). This Water Wiggler® is completely silent.

7WW Aurora Water Wiggler®

L 5.25" x W 5.25" x H 5.5" · 6 pk

Lights up at dusk and provides three hours of pleasing colors as the dome slowly shifts through the spectrum. A sensor on the underside of the Aurora Water Wiggler® turns the unit on at dusk. The lights will automatically shut off after three hours and come back on the following evening. It will continuously agitate the water to prevent mosquitoes from laying eggs even when the lights are off. Operates on two D cell batteries (not included). 8

8WW Solar Water Wiggler®

L 5.25" x W 5.25" x H 5.5" · 6 pk

Includes all of the great features of the Standard Water Wiggler® but it's powered by the sun. Just place it in your bird bath and it will operate unattended until you remove it. For best results, the Solar Water Wiggler® should be used in full sunlight. Rechargeable battery included.



8WW



4WW

Farm & Ranch Products Since 1941

Bird Bath De-Icers

Bird Bath de-icers are a great way to maintain a fresh, open water supply for wild birds with nearly any unheated bird bath. With low-profile designs, API® bird bath de-icers keep feathered friends hydrated using the same dependable heating technology expected from our products.

300 Bird Bath De-Icer - 200 Watts, 120 Volts, 60 Hz

L 7.75" x W 2.75" x H 0.875" · 6 pk

Features a built-in thermostat for temperature control and over-temperature protection to keep your bird bath ice-free all winter long. A stainless-steel guard shields wildlife from contacting the heating element. Can be used in pottery, plastic, or concrete bird baths. Recommended for up to 15 gallons of water. Includes 15-inch anti-rub cord. cULus Listed. CSA Listed.

BDT250 Bird Bath De-Icer With Aluminum Base

250 Watts, 120 Volts, 60 Hz

L 4.75" x W 4.75" x H 1.125" · 6 pk

Durable, non-stick coating, compact aluminum base in a low-profile design. Fins provide large surface area to make the unit run cooler while putting out the same amount of heat as conventional de-icers. Channels within the base promote water flow as the water is heated. Cooler running, non-stick coating, and flowing water all combine to reduce mineral buildup. Multiple thermostats allow efficient control while providing over-temperature protection. The BDT250 is safe to use in plastic bird baths and comes with a 10-foot anti-rub cord. Recommended for up to 15 gallons of water. cULus Listed.



300

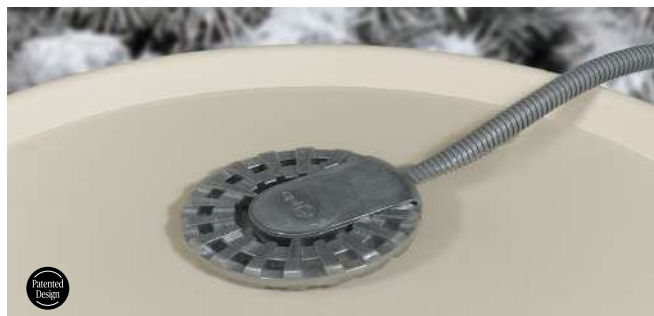

BDT250

Pond De-Icers

Maintaining open water during the winter in backyard ponds is critical to a healthy aquatic environment. API® heated pond products are designed to allow gases from decomposition to escape, allowing ponds to flourish.

P7521 Floating Pond De-Icer 1500 Watts, 120 Volts, 60 Hz

L 8.25" x W 8.25" x H 4" · 6 pk

Keeps a pond completely ice-free, providing fresh oxygen into your pond for healthy fish. Thermostatic control coupled with thermal feedback protects the unit from overheating, while positioning the thermostat above the heating element ensures safety in low-water conditions. The float is completely enclosed in a rugged, plastic housing and will not sink over time. Recommended for 100-300 gallons of water. Includes 15-foot anti-rub cord. cULus Listed.

P7621 Floating Pond De-Icer 1000 Watts, 120 Volts, 60 Hz

L 8.25" x W 8.25" x H 4" · 6 pk

Same as the P7521 but with 1000 watts, 120 volts. Recommended for 70-100 gallons of water. Includes 15-foot anti-rub cord. cULus Listed.



P7521 & P7621

P15N Sinking Pond De-Icer 1500 Watts, 120 Volts, 60 Hz

L 14.25" x W 14.25" x H 6.25" · 6 pk

Operates at the bottom of your pond where it is less likely to be disturbed by fish. Keeping your pond open allows fresh oxygen into your pond during all seasons, keeping your fish healthy. Thermostatic control coupled with thermal feedback protects the unit from overheating, while positioning the thermostat above the heating element ensures safety in low-water conditions. Each unit comes complete with a galvanized wire guard to protect rubber and plastic ponds. Recommended for 100-300 gallons of water. Includes 15-foot anti-rub cord. UL Listed. CSA Listed.



P15N

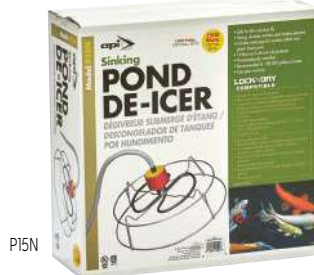

P15N



EASY
TO DISPLAY
PACKAGING

P7521



Small Animal & Pet Supplies

Quality Pet Products

In 2003, Miller Manufacturing introduced the Pet Lodge® brand of pet products. Since then, Pet Lodge® has expanded to over 140 top-quality feeding, watering, housing, bedding, and clean-up products, offering a comprehensive solution for farmers' and ranchers' favorite companions. We continually add reliable and safe products to meet the needs of our valued customers and their pets, ensuring top performance and safety.

Whether you're caring for dogs, cats, guinea pigs, or other small animals, Pet Lodge® provides the right solutions for pets of all sizes and types. From sturdy housing and comfortable bedding to convenient feeding and watering systems, our products are designed with your pets' well-being in mind, whether they're barking, purring, or hopping around the homestead.

Learn more about our products and categories we offer, by locating them on the pages listed below:

Carriers and Crates.....	82-84
Pet Beds.....	84
Feeders and Waterers.....	85-88
Small Homes and Hutches.....	89-90
Small Animal Feeder and Waterer	91-94

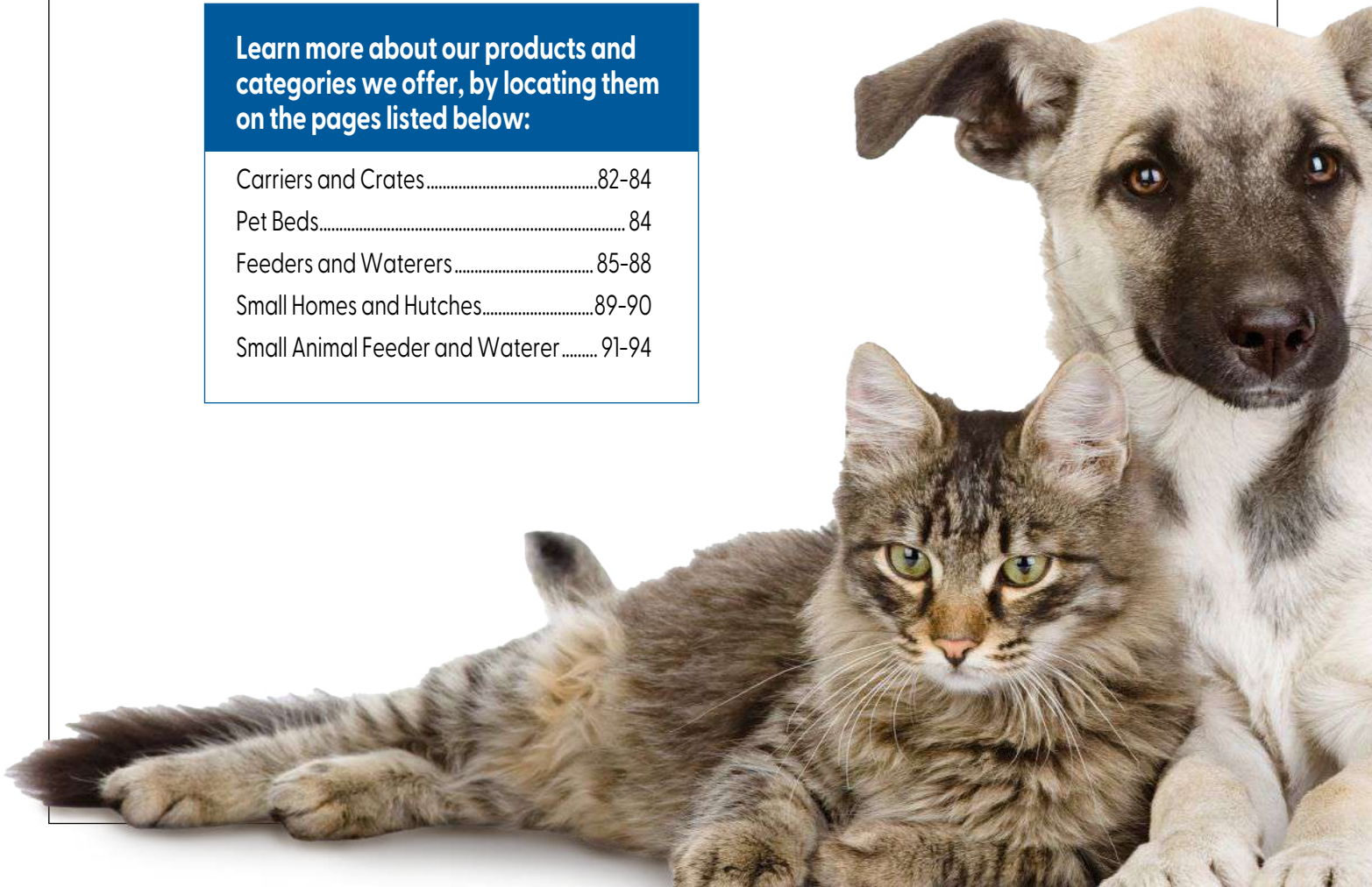

Quality Pet Products

Wire Pet Barrier

Helps keep pets safe in the rear of SUV's, minivans and other similar sized vehicles. The uniquely designed panels adjust vertically and horizontally offering a customized fit. Easy assembly with no tools required. Hardware and instructions included. Heavy-duty metal, black e-coated for corrosion resistance.

100434 Wire Pet Vehicle Barrier
L 40" x H 28.75" x W 2.25" · 1 pk

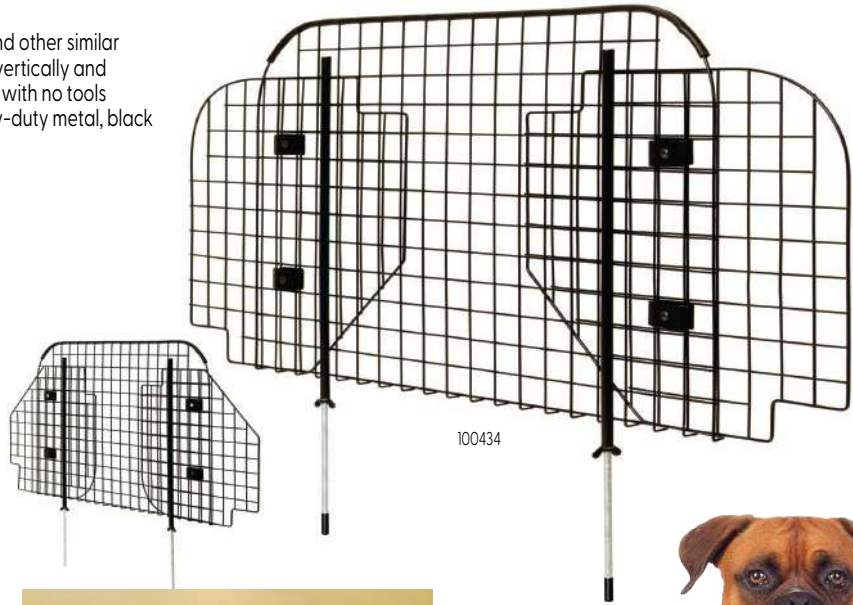

Customize It!
Side panels switch-out for a perfect custom fit!



Exercise Pens

Safely contains pets indoors and outdoors. Quickly folds flat for storage and transport. Attach two or more pens together for a larger play area. Available in five heights. Made out of heavy-duty metal, black e-coated for corrosion resistance.

ITEM	DESCRIPTION	SIZE	CASE PACK
100403	24" Exercise Pen	L 25.75" x W 24.75" x H 2.625"	1 pk
100441	30" Exercise Pen	L 31.5" x W 24.75" x H 2.625"	1 pk
100410	36" Exercise Pen	L 36.75" x W 30.5" x H 1.25"	1 pk
153218	42" Exercise Pen	L 45" x W 25" x H 3"	1 pk
100427	48" Exercise Pen	L 50.25" x W 25" x H 5"	1 pk

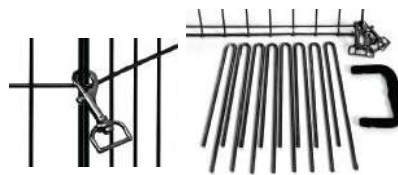

Includes 8 ground stakes, 4 easy-to-use bolt snaps and plastic carrying handle



Use for a variety of pets



Double Door Wire Pet Crates

Perfect for home, training and travel. This multi-functional pet crate is designed with your pet's safety in mind. Secure latches won't jiggle loose when in downward locked position. Rounded corners on all panels help ensure safety for owner and pet. Popular suitcase style crate sets up in seconds and folds down for storage. Includes removable easy-to-clean plastic tray and removable plastic carrying handle. Rubber feet at each corner. Available in 4 sizes. Black e-coated metal for corrosion resistance.

ITEM	DESCRIPTION	SIZE	CASE PACK
WCMED	Medium Wire Double Door Crate	L 31.25" x W 21.625" x H 3.625"	1pk
WCLRG	Large Wire Double Door Crate	L 36.75" x W 24.5" x H 3.75"	1pk
WCXLG	X-Large Wire Double Door Crate	L 43.5" x W 27.625" x H 3.625"	1pk
WCGNT	Giant Wire Double Door Crate	L 49.375" x W 30.625" x H 3.75"	1pk



Single Door Wire Pet Crate

ITEM	DESCRIPTION	SIZE	CASE PACK
WCXSM	Extra Small Wire Single Door Crate	L 20" x W 13.375" x H 3.75"	1pk
WCSML	Small Wire Single Door Crate	L 25.25" x W 18.625" x H 4"	1pk



EASY TO UNPACK!



Plastic Trays

ITEM	DESCRIPTION	SIZE	CASE PACK
179195	Extra Small Plastic Tray	L 18.5" x W 11.75" x H 1.25"	1pk
150552	Small Plastic Tray	L 23" x W 17.25" x H 1.25"	1pk
150569	Medium Plastic Tray	L 28.75" x W 20" x H 1.25"	1pk
150576	Large Plastic Tray	L 34.5" x W 23" x H 1.25"	1pk
150583	X-Large Plastic Tray	L 40.5" x W 26" x H 1.25"	1pk
150590	Giant Plastic Tray	L 46.5" x W 29" x H 1.25"	1pk



Quality Pet Products

Double Door Plastic Pet Crates

Twice as nice! The Pet Lodge® Double Door Portable Plastic Pet Crates include a second door for added flexibility in use and transport. They feature updated styling and colors and are designed to meet the requirements of the International Air Transport Association (IATA). The easy-to-assemble design includes durable wire doors. Vents are made of rugged polypropylene construction, which is strong enough to withstand the rigors of travel and regular use. They are available in 5 sizes.

ITEM	DESCRIPTION	SIZE	CASE PACK
157292	Small Double Door Plastic Crate	L 28" x W 20" x H 19"	3 pk
157308	Medium Double Door Plastic Crate	L 33" x W 22" x H 23"	3 pk
157315	Large Double Door Plastic Crate	L 37" x W 24" x H 26"	2 pk
157322	X-Large Double Door Plastic Crate	L 41" x W 27" x H 30"	2 pk
157339	Giant Double Door Plastic Crate	L 49" x W 32" x H 35"	1 pk



Fleece Pet Beds

Ideal for use in crates and houses. Your pet will enjoy relaxing on the soft cushioned poly and cotton base bed. Quickly rolls up for storage. Machine washable. Available in six sizes and two colors.

Extra Small Pet Bed

L 18.25" x W 11.5" x H 2.75" • 12 pk

179225 XS 19" Fleece Bed Cream

Small Pet Beds

L 22.5" x W 17.4" x H 1.22" • 12 pk

152235 SM 23" Fleece Bed Cream

160742 SM 23" Fleece Bed Chocolate

Medium Pet Beds

L 29" x W 21.25" x H 1.22" • 12 pk

152242 MED 29" Fleece Bed Cream

160759 MED 29" Fleece Bed Chocolate

Large Pet Beds

L 35" x W 22.5" x H 1.52" • 12 pk

152259 LG 35" Fleece Bed Cream

160766 LG 35" Fleece Bed Chocolate

X-Large Pet Beds

L 41" x W 25.5" x H 3" • 6 pk

152266 XL 41" Fleece Bed Cream

160773 XL 41" Fleece Bed Chocolate

Giant Pet Beds

L 47" x W 29.125" x H 3" • 6 pk

152273 GNT 47" Fleece Bed Cream

160780 GNT 47" Fleece Bed Chocolate



Chow Hound Dog Feeders

Chow Hound automatic dog feeders are manufactured from tough galvanized steel for durability. Specially angled chute provides a steady food flow on demand. The magnetized door stays shut until your dog nudges it open. Food stays fresh, dry and free from unwanted pests. Top opens for easy filling. Fully assembled.

ITEM	DESCRIPTION	SIZE	CASE PACK
CH12	12 Pound Chow Hound	L 8" x W 9" x H 19.25"	1 pk
CH25	25 Pound Chow Hound	L 11" x W 12" x H 22.625"	1 pk
CH50	50 Pound Chow Hound	L 12" x W 16.25" x H 28.25"	1 pk

EASY TO DISPLAY!
PACKAGING!



CH12
12 Pound

CH25
25 Pound

CH50
50 Pound



Feed Pans

ITEM	DESCRIPTION	SIZE	CASE PACK	COLORS AVAILABLE
P5	5 Quart Plastic Utility Pan	L 11.5" x W 11.5" x H 4"	6 pk	
FPI0BLACK	10 Quart Plastic Feed Pan	L 18.5" x W 18.5" x H 5.25"	12 pk	
HP1	2 Quart Rubber Feed Pan	L 8.5" x W 8.5" x H 4"	6 pk	
HP2	4 Quart Rubber Feed Pan	L 11" x W 11" x H 4"	6 pk	
HP86	8 Quart Rubber Feed Pan	L 14.5" x W 14.5" x H 4.5"	6 pk	



P5
5 Quart



HP2
4 Quart

HP86
8 Quart



HP1
2 Quart



FPI0BLACK
10 Quart

HOT COLORS Available!

Quality Pet Products

Crock Bowls

Crock-style dishes feature chew-resistant walls and rims. Dishwasher safe.

ITEM	DESCRIPTION	SIZE	CASE PACK
CR3GRANITE	20 Oz Medium Crock Bowl	L 5.75" x W 5.75" x H 2.25"	12 pk
CR4GRANITE	48 Oz Large Crock Bowl	L 7.79" x W 7.79" x H 2.7"	12 pk
CR5GRANITE	96 Oz Jumbo Crock Bowl	L 9.5" x W 9.5" x H 3.5"	12 pk



CR5GRANITE
96 Oz



CR3GRANITE
20 Oz



CR4GRANITE
48 Oz

Ever Full Dog Waterers

Ever Full is the automatic dog watering system that provides a continuous flow of the freshest water for your pet. Attach the 3/4" hose to your garden hose, turn on the tap, and the bowl fills to the perfect drinking level. The automatic float controls the water level so there's no spilling or overflow. Bowl is automatically replenished every time your dog drinks. Available in plastic or galvanized. Comes with hose and hose adapter.

PW5 5 Quart Plastic Ever Full Bowl

L 12" x W 11.5" x H 4.5" · 1pk
Available in blue.

EF3 3 Gallon Plastic Ever Full Bowl

L 17.25" x W 17" x H 4.5" · 1pk
Available in blue.

PW13 13 Quart Galvanized Steel Ever Full Bowl

L 17" x W 16.5" x H 3.625" · 1pk

TAP1 Tap Adapter

L 1.25" x W 1.25" x H 3.5" · 12pk
Save time, worry, and work with this stainless steel self-watering device. Attach to any outdoor spigot, turn on the faucet and your dog will have a tongue-triggered fresh supply of water.



EASY TO DISPLAY! PACKAGING!



PW13
13 Quart



PW5
5 Quart



EF3
3 Gallon



EASY TO DISPLAY! PACKAGING!

TAP1

Chow & Water Towers

Automatically dispenses a continuous supply of food or water into a sturdy plastic base.

Deluxe Towers

Features a solid one-piece base design. Easy-to-remove bottle makes refilling simple. Can be used both indoors and outdoors. Available in 3 sizes.

157759 3 Quart Water Tower Deluxe 
L 10.875" x W 6.125" x H 10.75" · 2 pk

157766 3 Pound Chow Tower Deluxe 
L 10.875" x W 6.125" x H 11" · 2 pk

157773 8 Quart Water Tower Deluxe 
L 14.5" x W 8.125" x H 14.5" · 2 pk

157780 8 Pound Chow Tower Deluxe 
L 14.5" x W 8.125" x H 14.75" · 2 pk

157797 16 Quart Water Tower Deluxe 
L 18.5" x W 10.125" x H 17.75" · 2 pk

157803 16 Pound Chow Tower Deluxe 
L 18.5" x W 10.125" x H 18" · 2 pk



157797
16 Quart

157803
16 Pounds



157766
3 Pounds



157759
3 Quart



157773
8 Quart

157780
8 Pounds



Quality Pet Products

Travel-Pal Waterer

Travel-Pal is the dog watering system that's rugged enough for outdoor use or travel, but attractive enough for indoor use. The translucent polyethylene jug allows you to monitor the water level. The molded handle makes it easy to carry.

TP3 3 Gallon Travel-Pal
L 13" x W 18.25" x H 14.75" · 2 pk

! Improved cap design. O-ring fits securely in a machined radial groove.



TP3
3 Gallon



EASY TO DISPLAY



KC20
20 Oz

Kennel Care

With the Kennel Crocks, dogs receive necessary nourishment while kennels stay clean! Off-the-floor design and secure attachments prevent spills. Ideal for pet carriers, holding pens, display cages and kennels. Quick-turn screw and bracket design locks crock in place. Available in granite color.

KC20 20 Oz Kennel Crock
L 6.5" x W 5" x H 3.75" · 12 pk

KC40 40 Oz Kennel Crock
L 7.5" x W 6" x H 4.875" · 12 pk

Kennel Crocks can easily be removed for cleaning. Dishwasher safe.

Easy Scoop Pooper Scoopers

Easy Scoops feature a lightweight polycarbonate basket that's tough, durable and built to last. Specially angled tines make scooping easy. Our telescoping model brings hi-tech engineering to the scooping business. The lightweight aluminum handle adjusts from 22" to 42" for efficient merchandising.

ES1 Standard Scoop with Hardwood Handle
L 5" x W 7.25" x H 42" · 6 pk

ES2 Premium Scoop with Telescoping Handle
L 5" x W 7.25" x H 22" min - 42" max · 6 pk



ES2
Adjusts
from 22"
to 42"

Travel Waterers

The WaterBoy® and ThirstyDog® make traveling with your dog a cinch.

TWB3 3 Quart WaterBoy® Travel Water Bowl
L 12" x W 8" x H 3" · 6 pk

Provides fresh water without spilling in your vehicle. It is great for use in RV's, SUV's, trucks, cars and boats. It allows you to take fresh water anywhere.



TWB3
3 Quart



TD20
20 Oz

TD20 20 Oz ThirstyDog® Pet Sport Bottle

L 7.5" x W 3.125" x H 3" · 6 pk
Flip down water bottle for dogs of all sizes. Simply unplug the bottle and the bowl fills - no squeezing required. Designed with wide mouth to allow the insertion of ice cubes for hot days. Comes with adjustable shoulder strap which can be carried on belt or wristband while walking or hiking.



Plastic Bottom Small Animal & Rabbit Homes

Deep plastic tray is ideal for in-home use by helping to contain bedding and litter. Easy to clean. Available in 3 sizes.

ITEM	DESCRIPTION	SIZE	CASE PACK
150934	24.5" Green Plastic Bottom Rabbit Cage	L 25.25" x W 14.375" x H 6.75"	1 pk
150941	31" Purple Plastic Bottom Rabbit Cage	L 30.75" x W 18.5" x H 6.75"	1 pk
150958	40" Blue Plastic Bottom Rabbit Cage	L 40.25" x W 19.5" x H 6.75"	1 pk



150934



150941

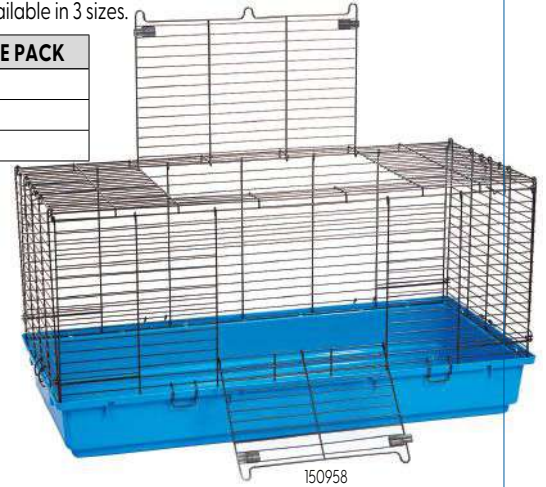

150958

Pop-Up Small Animal & Rabbit Homes

Features rounded corners and evenly spaced wire for hanging feeders and waterers. Black e-coated wire. Available in 3 sizes.

ITEM	DESCRIPTION	SIZE	CASE PACK
150903	25" Wire Pop-Up Rabbit Cage	L 5.45" x W 16" x H 4.5"	1 pk
150910	30" Wire Pop-Up Rabbit Cage	L 31.25" x W 17.25" x H 4.5"	1 pk
150927	37" Wire Pop-Up Rabbit Cage	L 37.5" x W 18" x H 4.5"	1 pk



150927



150910



150903



See page 91-92 for Cage Cups

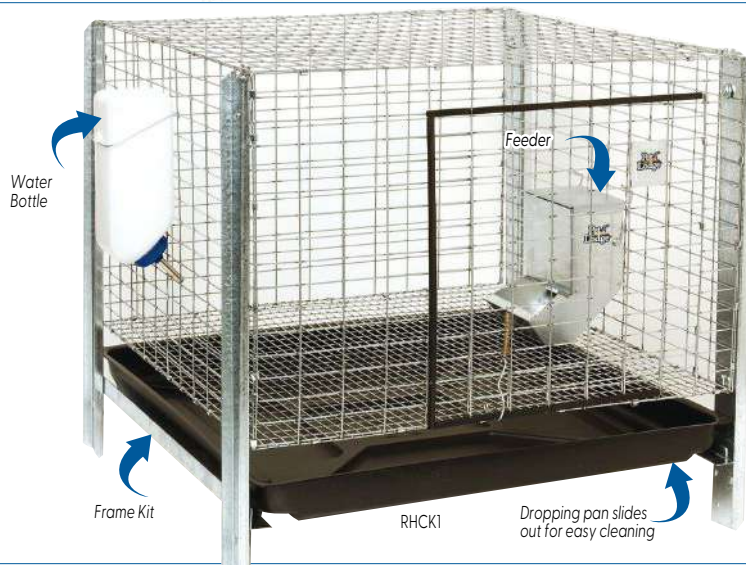

Rabbit Hutch Kit

RHCK1 Rabbit Hutch Complete Kit

L 25" x W 24.75" x H 5.75" • 1 pk

This easy-to-assemble kit includes everything needed for rabbit raising all-in-one package! Includes 24" x 24" x 16" hutch, plastic dropping pan, frame kit, 5" sifter feeder with lid, 32 oz. water bottle, cage clips and wire clip pliers



Quality Pet Products

Rabbit Hutches

Hutch Only Kits These easy-assembly hutches are constructed with rust-resistant, easy-to-clean galvanized wire mesh. Doors are surrounded by protective vinyl guards and feature spring tension door latches. Wire mesh bottom is 1" x 1/2" and sides are 2" x 1". Includes wire cage clips. Wire clip pliers are sold separately.

ITEM	DESCRIPTION	SIZE	CASE PACK
AH2424	24" x 24" Hutch	L 24.5" x W 24.375" x H 1.25"	1pk
AH3030	30" x 30" Hutch	L 30.625" x W 30.5" x H 1.25"	1pk
AH3036	30" x 36" Hutch	L 36.75" x W 30.5" x H 1.25"	1pk



AH2424



AH3036

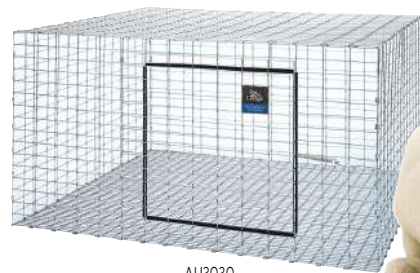

AH3030

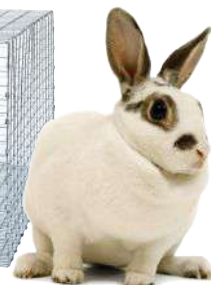

! Hutches can be stacked. See other accessories needed for stacking below.



Dropping Pans

Made from heavy-duty galvanized steel or plastic. Steel pans have riveted corners and hemmed edges. Pans pull out for easy cleaning. Fully assembled.

ADP2424 24" x 24" Galvanized Dropping Pan for AH2424
L 24" x W 24" x H 2.75" · 1pk

ADP3030 30" x 30" Galvanized Dropping Pan for AH3030
L 30" x W 30" x H 2.75" · 1pk

ADP3036 30" x 36" Galvanized Dropping Pan for AH3036
L 30" x W 36" x H 2.75" · 1pk

PDP2424 24" x 24" Plastic Dropping Pan
L 24" x W 24" x H 2" · 6pk
One-piece seamless construction makes cleaning a snap. This all-purpose pan can be used for rabbit hutches, pet homes, cat litter tray, feed tray, or oil drip pan.

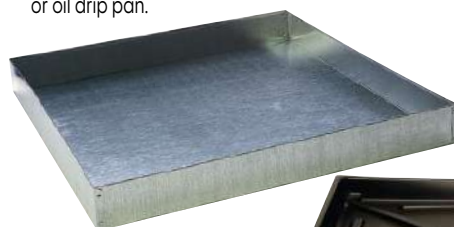

ADP2424



PDP2424



Urine Guard Kits

Galvanized guards help prevent urine from spraying out of the back and side of hutch. Attaches easily to wire mesh with pre-formed tabs.

AUG2424 For AH2424 Hutch
L 24.5" x W 4.5" x H 1.75" · 1pk

AUG3030 For AH3030 Hutch
L 30.5" x W 4.5" x H 1.75" · 1pk

AUG3036 For AH3036 Hutch
L 36.5" x W 4.5" x H 1.75" · 1pk



AUG2424



EASY TO DISPLAY PACKAGING



Frame Kits

Designed to suspend the hutch over the dropping pan for easier cleaning. Conserve space by stacking hutches four high when bolting frame kits together.

AHFK24 24" Frame Kit for AH2424
L 24.5" x W 2.5" x H 3" · 1pk

AHFK30 30" Frame Kit for AH3030, AH3036
L 30.5" x W 2.5" x H 3" · 1pk

Tools & Accessories

ACP2 Wire Clip Pliers

L 2" x W 0.5" x H 7.5" · 12 pk
Use to assemble hutches, pet homes and traps.

ACC1 1 Pound Bag Wire Cage Clips

L 6" x W 7" x H 8.5" · 12 pk
Use to assemble wire panels for rabbit hutches and pet homes. Great for other uses. One package assembles 3-4 average size units.

ANI Small Animal Nest

L 10" x W 18" x H 9.5" · 1 pk
Provides comfort and security for small animals. Nest is constructed from galvanized steel and includes removable wood floor.



ACC1



ACP2



ANI

EASY TO DISPLAY & PACKAGING!



Hay Rack

153171 Wire Hay Rack

L 8.25" x W 3.25" x H 7.5" · 12 pk
Keeps hay clean while eliminating food waste. Built-in mineral spool holder. Fits most wire cages.



153171



ACU7
1/2 Pint

ACU6
1 Pint



ACU5
1 Quart

See page 93 for SSW3 Salt Spool



Galvanized Cage Cups

Clips inside of cage for feeding & watering. Made of galvanized steel

ITEM	DESCRIPTION	SIZE	CASE PACK
ACU7	½ Pint Galvanized Cage Cup	L 4.56" x W 3.18" x H 1.56"	12 pk
ACU6	1 Pint Galvanized Cage Cup	L 6.12" x W 4.12" x H 1.93"	12 pk
ACU5	1 Quart Galvanized Cage Cup	L 8.75" x W 5.5" x H 2.25"	12 pk

Quality Pet Products

Plastic Cage Cups

Polyethylene cups feature built-in hooks to clip onto the side of any type of wire animal cage. Available in: ● ● ● ● ●

ITEM	DESCRIPTION	SIZE	CASE PACK
ACU1	1/2 Pint Plastic Cage Cup	L 5.29" x W 2.98" x H 1.78"	12 pk
ACU2	1 Pint Plastic Cage Cup	L 6.68" x W 3.65" x H 2.1"	12 pk
ACU4	1 Quart Plastic Cage Cup	L 8.9" x W 4.48" x H 2.4"	12 pk



ACU1
1/2 Pint



ACU4
1 Quart



ACU2
1 Pint



AF7ML
7" Size



AF7S
7" Size



AF7SL
7" Size

Small Animal Feeder with Metal Bottom & Lid

Independent wire hooks secure feeder to the hutch.

AF3ML 3" Feeder with Metal Bottom and Lid
L 5.5" x W 3.125" x H 7.125" - 12 pk

AF5ML 5" Feeder with Metal Bottom and Lid
L 5.5" x W 5.125" x H 7.125" - 12 pk

AF7ML 7" Feeder with Metal Bottom and Lid
L 5.5" x W 7.125" x H 7.125" - 12 pk



AF3ML
3" Size



AF5ML
5" Size

Small Animal Feeder with Sifter Bottom

Independent wire hooks secure feeder to the hutch.

AF3S 3" Feeder with Sifter Bottom
L 5.5" x W 3.125" x H 7.125" - 12 pk

AF5S 5" Feeder with Sifter Bottom
L 5.5" x W 5.125" x H 7.125" - 12 pk

AF7S 7" Feeder with Sifter Bottom
L 5.5" x W 7.125" x H 7.125" - 12 pk



AF3S
3" Size



AF5S
5" Size

Small Animal Feeder with Sifter Bottom & Lid

Independent wire hooks secure feeder to the hutch.

AF3SL 3" Feeder with Sifter Bottom and Lid
L 5.5" x W 3.125" x H 7.125" - 12 pk

AF5SL 5" Feeder with Sifter Bottom and Lid
L 5.5" x W 5.125" x H 7.125" - 12 pk

AF7SL 7" Feeder with Sifter Bottom and Lid
L 5.5" x W 7.125" x H 7.125" - 12 pk



AF3SL
3" Size





AF5SL
5" Size

Salt Spools

A tasty treat for rabbits and small animals. Provides trace minerals essential for good animal health.

SSH2 Salt Spool and Hanger 
L 3.5" x W 1" x H 7" · 12 pk

SSH1 Salt Spool Hanger 
L 1.5" x W 0.25" x H 2.75" · 1 pk

SSW3 Mineral Spool Bulk 
L 2" x W 2" x H 1" · 24 pk

SSWHITE Salt Spool Bulk 
L 2" x W 2" x H 1" · 24 pk

EASY TO DISPLAY PACKAGING



SSW3



SSWHITE



SSH1



Bulk Display Packaging

Quick-Lock Crocks

Attaches to horizontal or vertical wire. Quick-turn screw and bracket design locks crock in place. Crock can easily be removed for cleaning. Dishwasher safe. Available in granite color.

QLC10 10 Oz Quick-Lock Crock
L 6" x W 3.875" x H 3.75" · 12 pk

QLC20 20 Oz Quick-Lock Crock
L 6.5" x W 5" x H 3.75" · 12 pk



EASY TO DISPLAY PACKAGING



QLC20
20 Oz

Bottle Brush

BBRUSH Bottle Brush
L 18" x W 4" x H 1.5" · 12 pk

Two brushes in one! The larger brush has an extra long handle to clean all sizes of bottles. The smaller, tapered-head brush is great for cleaning thinner tubes, spouts and spigots. Also works well on critter tubes and modular cages.



BBRUSH

Oral Syringe

171601 Oral Syringe & Medicine Dropper 
L 4" x W 1" x H 8.25" · 12 pk

Includes 10 ml syringe and 3 ml dropper. For administering food and medicine to small animals.



171601

Bunny Bottle

BB64 64 Oz Bunny Bottle 
L 5.25" x W 5.5" x H 10" · 6 pk

Large capacity water bottle features extra-wide mouth for easy filling.



BB64
64 Oz

Flip Top Water Bottle

FTB32 32 Oz Flip Top Water Bottle 
L 4.75" x W 3.5" x H 11.75" · 12 pk

Hinged top flips up for easy cleaning and filling.



EASY TO DISPLAY PACKAGING

FTB32
32 Oz

Soda Bottle Converter

EFF1 Earth Friendly Fountain
L 1.25" x W 5.5" x H 7" · 36 pk

Converts most plastic soda pop bottles into a handy watering device for small animals. Simply screw in bottle and attach to cage with hanger.



EASY TO DISPLAY PACKAGING



EFF1

Earth Friendly Fountain

Quality Pet Products



Weather-Tuff Water Bottles

Weather-Tuff water bottles are constructed from strong, UV-resistant polyethylene. These bottles work great outdoors. Stainless steel ballpoint tube keeps water clean and cage dry.

AW8 8 Oz Weather-Tuff Water Bottle
 L 3" x W 2.25" x H 6.75" · 12 pk

AW16 16 Oz Weather-Tuff Water Bottle
 L 3.5" x W 2.75" x H 7.5" · 12 pk

AW32 32 Oz Weather-Tuff Water Bottle
 L 3.875" x W 3.25" x H 9.75" · 12 pk



AW8
8 Oz



AW16
16 Oz



AW32
32 Oz



OPB8
8 Oz



OPB16
16 Oz



OPB32
32 Oz

Opaque Plastic Water Bottles

These water bottles are constructed from strong, opaque plastic with fun graphics. Features stainless steel ballpoint tube and no-leak seal design which keeps water clean and cage dry.

OPB8 8 Oz Opaque Plastic Water Bottle
 L 3.25" x W 2" x H 8.25" · 12 pk

OPB16 16 Oz Opaque Plastic Water Bottle
 L 3.5" x W 2.5" x H 9.5" · 12 pk

OPB32 32 Oz Opaque Plastic Water Bottle
 L 4.5" x W 3" x H 11.5" · 12 pk



Clear Plastic Water Bottles

Clear plastic makes it easy to view water level. Features stainless steel ballpoint tube and no-leak seal design which keeps water clean and cage dry.

CPB8 8 Oz Clear Plastic Water Bottle
 L 3.25" x W 2" x H 8.25" · 12 pk

CPB16 16 Oz Clear Plastic Water Bottle
 L 3.5" x W 2.5" x H 9.5" · 12 pk

CPB32 32 Oz Clear Plastic Water Bottle
 L 4.25" x W 3" x H 11.5" · 12 pk



CPB8
8 Oz



CPB16
16 Oz



CPB32
32 Oz

Poultry Waterers & Feeders

These poultry products are designed to help you reach your expanding consumer base, including both newcomers to backyard poultry and backyard enthusiasts interested in different sizes, features, and price points.

DT9857 1.5 Quart/1.5 Liter Plastic Poultry Waterer
L 7.37" x W 7.37" x H 7.62" · 6 pk

DT9858 3.5 Quart/3.5 Liter Plastic Poultry Waterer
L 9.25" x W 9.25" x H 9.25" · 6 pk

DT9862 2.5 Gallon/10 Liter Plastic Poultry Waterer
L 14" x W 14" x H 12.75" · 6 pk

DT9854 1.5 Pound Plastic Poultry Feeder
L 7.37" x W 7.37" x H 5.75" · 6 pk

DT9855 5 Pound Plastic Poultry Feeder
L 9.25" x W 9.25" x H 8.25" · 6 pk

DT9856 15 Pound Plastic Poultry Feeder
L 14" x W 14" x H 11" · 6 pk

DT9859 5 Quart/5 Liter Plastic Poultry Waterer
L 10.875" x W 10.875" x H 11.75" · 6 pk

DT9860 7 Pound Plastic Poultry Feeder
L 11" x W 11" x H 12.5" · 6 pk

DT809 Small Plastic Ground Feeder
L 8" x W 3.5" x H 2.5" · 6 pk

The perfect size for a small flock of chicks. Covered top. Individual holes minimize feed waste. 8" long.

DT9864 17 Pound Poultry Feeder - Galvanized
L 14.5" x W 14.5" x H 12" · 6 pk



DT809



! One-piece construction of the jar and built-in Feed Saver Ring



DT9864



DT9851

DT9851 18" Galvanized Trough Feeder

L 17.875" x W 5.875" x H 5.375" · 6 pk

Made from sturdy galvanized steel for durability and features rolled edges for safety. The large 18" trough area holds up to 3 lbs. of feed. Rear hooks allow for easy hanging in the coop or hutch.

Poultry Waterers With Legs

Perfect for starting your small flock of chicks. Start with the removable legs detached and as the birds get larger, add the legs to raise the waterer off the ground. Keeping the waterer off the ground helps prevent the birds from filling the waterer base with dirt and debris during their foraging and scratching. This waterer is molded from durable plastic for years of use. The translucent plastic body makes it quick and easy to check the water level.

DT9870 1.5 Quart/1.5 Liter Poultry Waterer with Legs
L 7.25" x W 7.25" x H 8.75" · 5 pk

DT9872 3 Quart/3 Liter Poultry Waterer with Legs
L 9.25" x W 9.25" x H 10.875" · 5 pk

DT9874 1 Gallon/5 Liter Poultry Waterer with Legs
L 11" x W 11" x H 13.5" · 5 pk

DT9876 2 Gallon/8 Liter Poultry Waterer with Legs
L 12.5" x W 12.5" x H 15" · 5 pk

DT9878 2.5 Gallon/10 Liter Poultry Waterer with Legs
L 13.75" x W 13.75" x H 16.25" · 5 pk

DT9863 2 Gallon Poultry Fount - Galvanized
L 14.5" x W 14.5" x H 11.125" · 6 pk



Farm Tough Products



Poultry Feeders with Legs

This is a great poultry feeder designed exclusively for the hobbyist. Start with the removable legs detached for chicks and as the birds get larger, add the legs to raise the feeder off the ground. The built-in Feed Saver Ring minimizes spillage and prevents wasted food. Durable one-piece construction of the jar and Feed Saver Ring for quick and easy assembly. Made of impact-resistant plastic that won't rust or corrode. The included plastic lid protects the feed from the elements.

DT9871 4 Pound Poultry Feeder with Legs
L 9.5" x W 9.5" x H 11.75" · 5 pk

DT9873 8.5 Pound Poultry Feeder with Legs
L 11.5" x W 11.5" x H 14.75" · 5 pk

DT9875 17.5 Pound Poultry Feeder with Legs
L 15" x W 15" x H 17.75" · 5 pk

DT9877 26 Pound Poultry Feeder with Legs
L 17.5" x W 17.5" x H 20" · 5 pk

DT9879 35 Pound Poultry Feeder with Legs
L 18" x W 18" x H 25" · 5 pk

Beginner Poultry Kit

DTBPKIT Beginner Poultry Kit

L 15" x W 10.25" x H 9.375" · 1 pk

This handy kit contains everything you need to get your chicks started! Includes a 250W red heat lamp bulb and 10.5" reflector lamp to provide safe heat, plus an 8" ground feeder, a 1.5-lb. plastic feeder and a 1.5-qt. plastic chick waterer. You'll also get our Guide to Backyard Poultry, which includes helpful tips, information and fun facts for your new flock. Bulb is 250 Watts/120 Volts, with a 6,000-hour life. 8" ground feeder has 12 feeding holes (6 per side) and a covered top to keep out debris.



Live Trap Combo

ELT42 Live Trap Combo Pack

L 32.5" x W 11" x H 12.5" (Large Trap)

L 24" x W 7" x H 7" (Small Trap) · 1pk

This combo pack features two traps in the most popular sizes. Both are Single-Door Entry Live Traps that catch unwanted animals without injury so they can be humanely disposed of or relocated. Features a spring-loaded door that is easy to bait and set and quick to release. Beneath the convenient carrying handle is a steel plate to protect hands from contact with the animal. Larger size works great for raccoons, porcupines, turtles, foxes, and other smaller-sized animals. Smaller size is best for squirrels, chipmunks, rabbits, muskrats, mink, and other smaller-sized animals.



See Page 58
for additional
Live Traps

NEW!

Double-Tuf® Wire Dog Crates

- The all-new Double-Tuf® Wire Crate easily adapts for home, travel, and training purposes.
- Larger sizes feature a removable divider panel that creates a smaller space for a puppy (this helps with house training), and then allows the crate to expand as the dog grows to adult size.
- Two doors provide flexibility in use and transport.
- Secure latches will not jiggle loose when in the downward locked position.
- E-coated for corrosion resistance, with rounded corners on all panels to help ensure safety for owner and pet.
- Popular suitcase-style crate with removable plastic carrying handle sets up in seconds and folds down for compact storage.
- Includes removable, easy-to-clean ABS plastic tray.
- Comes collapsed but fully assembled. Set up is as easy as 1...2...3...



ITEM	DESCRIPTION	SIZE	CASE PACK
NEW! DTWCXSM	Extra Small Wire Double Door Crate	L 20" x W 13.375" x H 3.75"	1 pk
NEW! DTWCML	Small Wire Double Door Crate	L 25.25" x W 18.625" x H 4"	1 pk
NEW! DTWCMED	Medium Wire Double Door Crate	L 31.25" x W 21.625" x H 3.625"	1 pk
NEW! DTWCLRG	Large Wire Double Door Crate	L 36.75" x W 24.5" x H 3.75"	1 pk
NEW! DTWCXLG	Extra Large Wire Double Door Crate	L 43.5" x W 27.625" x H 3.625"	1 pk
NEW! DTWCGNT	Giant Wire Double Door Crate	L 49.375" x W 30.625" x H 3.75"	1 pk



REPLACEMENT PARTS



1-800-260-0888

Farm & Ranch Products Since 1941

ITEM NUMBER	UPC	PRODUCT DESCRIPTION
Beekeeping Items		
LIDMTLS	084369179874	Metal Lid Small
LIDMTLL	084369179881	Metal Lid Large
LIDPL	084369179867	Plastic Lid Flip Top
MBOARD	084369182874	Moisture Board for HOTBOX 10-Frame Size
HF9BLACK Plastic Hookover Goat Trough		
168755	084369168755	Goat Trough Grate (metal grate that fits on the top of the goat trough)
Plastic Fence Feeder		
FF11KIT	084369154444	Hardware Kit for FF11
FF16KIT	084369154437	Hardware Kit for FF16
FF20KIT	084369002066	2 Brackets, 4 Hex Nuts, 4 - 1" Screws
Float Valves See Figure 1 on page 100		
T804	084369096140	L Bracket Plated
T806	084369806008	1/4 X 20 X 2 Thumb Screw
T805	A 084369805001	Mounting Bracket
T808M	084369808101	Metal Housing
T808ASP	084369809009	Plastic Housing for Anti-Siphon
T809AS	D 084369152051	Anti-Siphon Float For TM825AS & TM830AS
T809KIT	E 084369808125	For TM825 & TM830 - Float, Dart, ðRubber Valve Seat
T811AS	F 084369811002	Anti-Siphon Valve Stem Housing
T810AS	G 084369810005	Anti-Siphon Valve Stem
T812AS	084369812009	Anti-Siphon Orifice
T814ASKIT	084369008143	1 Anti-Siphon Valve Stem Housing, 1 Anti-Siphon Valve Stem, 1 Plastic Orifice, 1 Hose Washer, 1 Valve Seat
T825KIT	084369995252	Trough-O-Matic® Kit
T825TKIT	084369995269	Parts Kit for TM825T & TM830T
T826	084369826006	Valve Seat
T826AS	084369826105	3/8" Neoprene Valve Seat
T828	084369828000	Washer for Trough-O-Matic®
T832P	084369831116	Orifice Insert for Trough-O-Matic
TOMASKIT	084369153249	Anti Siphon Repair Kit: 1 Float Assembly, 1 Anti-Siphon Valve Stem, 1 Plastic Orifice Insert, 1 Valve Seat, 1 Hose Washer, 1 - 2" Cotter Pin, 1 - 1" Cotter Pin
TOMKIT	084369153232	Trough-O-Matic Repair Kit: 4 Valve Seats, 4 Plastic Darts, 4 Washers, 4 Orifice Inserts, 4 - 2" Cotter Pins
77 Push Paddle Waterer See Figure 2 on page 100		
7705PK	A 084369152006	77 Pack: Valve Complete, Bagged & UPC
7706	084369770606	Nylon Retainer Nut
7707	084369770705	Valve Retainer Washer
771PK	B 084369152013	77 Pack: Paddle Assembly, Bagged & UPC
7716PK	C 084369152020	77 Pack: Mounting Bracket, Bagged & UPC
7717	084369771702	Nylon Pipe Plug
7718KIT	D,E 084369152037	77 Kit-Valve Retaining
7719KIT	F,G,H 084369152044	77 Kit-Paddle Mounting
Plastic Auto Stock Waterer with Drain Plug		
ASWDPKIT	084369187541	Auto Stock Waterer Drain Plug Kit
166560	084369166560	Hardware Kit
88SW & 88ESW Stock Waterers See Figure 3 on page 100		
SW8	084369800006	Rubber Grommet
SW9	084369100090	Bracket - Plated
SW10	084369101004	Fiber Washer
SW11	084369110003	90 Duro Neoprene
SW14	084369140003	1/2" Flanged Lock Nut
SW19	084369190008	Plug
SW20	084369121019	Valve
SW23	084369230001	Float Only
SW13KIT	084369154567	Hardware Kit
SW24KIT	084369154574	Valve Assembly Kit
SW25CKIT	084369096133	Float Assembly Complete

ITEM NUMBER	UPC	PRODUCT DESCRIPTION
ST40, 100, 150, 75, ST15 Stock Tanks		
STKIT	084369154321	Stock Tank Drain Plug Kit
Ever Full Dog Waterer		
PW1303	084369105095	Shield for PW13
PW503	084369105033	Shield for PW5
FW16 DuraMate Automatic Waterer		
FW1602BLUE	084369159739	Float Cover
FW1602GREEN	084369159722	Float Cover
FW1602RED	084369001700	Float Cover
FW1603	084369001557	Bracket
FW1604	084369995238	Plastic Plug for Side of Waterer
FW1608	084369001724	Hose Adapter
FW1609	084369001762	Soft Plug for Bottom of Waterer
FW16KIT	084369001687	FW16 Kit: 2 Brackets, 1 Plug, 6 - 5/8" Screws, 4 Hex Nuts, 4 - 1" Screws, 1 Adapter, 1 Grommet Bumper, 1 Hose Washer
FW1630KIT	084369161770	Hose Accessory - FW16
160179	084369160179	Metal Cover for FW16 Automatic Waterer
PF25 Foal Feeder		
PF25KIT	084369110013	Parts Kit For PF25 Foal Feeder
168830 Hay Grazer		
168908	084369168908	Grazer Spring, Latch, Clip
CP8 Calf Pail		
CP8KIT	084369801140	Kit: 2 Brkts, 1 Mounting Plate, 4 - 3/8" Bolts, 1 Nipple, 1 Valve Assembly
CP804	084369008839	Calf Pail Nipple
CP804PK	084369008815	1 Pk CP804 Nipple in Bag w/ UPC
CP805CPK	084369008822	1 Pk Plastic Valve in Bag w/ UPC
CP806	084369096126	Neoprene Gasket
PDF1 DuraForks		
PDF102	084369001021	PDF1 Wood Handle
PDF103BERRYBLUE	084369158992	Replacement Fork Head
PDF103BLACK	084369001038	Replacement Fork Head
PDF103BLUE	084369001045	Replacement Fork Head
PDF103BURGUNDY	084369001052	Replacement Fork Head
PDF103GREEN	084369001069	Replacement Fork Head
PDF103HOTPINK	084369158763	Replacement Fork Head
PDF103LIMEGREEN	084369158985	Replacement Fork Head
PDF103ORANGE	084369178945	Replacement Fork Head
PDF103PURPLE	084369001083	Replacement Fork Head
PDF103RED	084369000079	Replacement Fork Head
PDF103TEAL	084369001076	Replacement Fork Head
PDFIKIT	084369100007	Kit: 1 Screw, 1 Nut
CA500 Muck Cart		
CA500AXLE	084369155038	Muck Cart Axle
CA500HOOP	084369155069	Muck Cart Hoop
CA500KIT	084369155021	Hardware Kit for Muck Cart
CA500KS	084369155045	Muck Cart Kickstand
CA500TIRE	084369155052	Muck Cart Tire Assembly
CA500TUBE	084369155076	Muck Cart Tire Tube
Galvanized Hanging Poultry Feeders		
912301	084369091466	Wire Locks for Hanging Feeders
912302	084369091480	Push On Clips for Hanging Feeders
914001	084369091503	Bail Handles for Hanging Feeders
Galvanized Poultry Waterers		
983207	084369096119	Slit Rubber Gasket
DTPLUG	659276936287	Replacement Plug for DT9863 Waterer

ITEM NUMBER	UPC	PRODUCT DESCRIPTION
Deluxe Hen Hydrators		
DHLLIDL	084369189255	Lid Deluxe Hen Hydrator Little Giant®
PHF11 & PFH22 Plastic Poultry Feeders		
DPHF3KIT	084369189521	Hardware Kit for DPHF3
DPHF1KIT	084369189545	Hardware Kit for DPHF1
DPHF2KIT	084369189569	Hardware Kit for DPHF2
PPF3, PPF5 & PPF7 Plastic Poultry Waterers		
PPF302	084369301121	Poultry Jar Base
PPF305	084369301152	Mold Rite Black Cap
PPF308	084369301176	4" Cap
PPF310KIT	084369096195	3 O-Rings, 1 PPF305
Dome Waterers - See Figure 7 on page 100		
188210	084369188210	O-Ring Black For Dome Waterer Lid
188227	084369188227	Screw Cap For Dome Waterer
188234	084369188234	Plug For Dome Waterer
188937	084369188937	Legs for Dome Feeder/Waterer
Double-Tuf Poultry Feeders and Waterers		
936560	659276936560	Sm. Blue Plastic Legs for DT Feeder/Waterer - 3 pc
936638	659276936638	Med. Blue Plastic Legs for DT Feeder/Waterer - 3 pc
936706	659276936706	Med Blue Plastic Legs for DT Feeder/Waterer - 4 pc
936775	659276936775	Lg. Blue Plastic Legs for DT Feeder/Waterer - 4 pc
2500, 2525 & 2550 Plastic Poultry Waterers See Figure 4 on page 100		
2506	A 084369250603	Water Valve
2507	B 084369250702	Brass Fountain Post
2508	C 084369250801	Regular Bowl
2509	D 084369250900	Stem Assembly Less Post
2509C	084369990110	Stem Assembly With Post
2510	084369251006	Brass Screen 50 X 60 Mesh
2511	084369251105	3/4" Gasket Plain Rubber
2514	084369251402	Control & Lock Nut
2515	E 084369251501	Chick Bowl
2516	084369251600	Control Spring
2518	084369251808	4 In 1 Tool
2532	F 084369253208	King Size Bowl
2538	084369253802	5/16" Internal Lock Washer
Incubators & Egg Turners		
5203	084369520300	4 X 8 Window
5233	084369990219	Red Plug
6305	084369157513	Motor Replacement
7300	084369170987	Force Air Incubator Fan Kit w/ Heater
8300	084369173599	Heating Element for 9300 - No Fan
12350	084369177283	CSA-listed 24V Heater Kit for 12300 w/ Fan
165341	084369165341	Rounded Corners Incubator Bottom
167741	084369167741	Incubator Power Cord
191265	084369191265	Digital Controller Assembly Kit
191289	084369191289	Incubator Sensor Assembly Kit
176750	084369176750	UL-listed Power Cord for 12300 Incubator
191272	084369191272	UL-listed 24 V Controller Kit
Hot-Shot® Parts See Figure 5 on page 100		
HS3	731141502961	Green Case w/O End Cover
HS5	731141503289	Green Case w/End Cover
SS3	731141502978	Red Case w/O End Cover
SS5	731141503296	Red Case w/End Cover
ECBLK2	731141502596	Black Case End Cover (for use on green and red prods)
PL5P1	731141000856	Black Nut w/Blk Insert
PRDKIT2	731141503098	White Safety Clip & Thong
SS7P1	731141000870	Brass Hold Down Nut Bag
SS8P2	731141503074	Protective Boot In Plug

ITEM NUMBER	UPC	PRODUCT DESCRIPTION
Hot-Shot® Parts (Continued)		
PRDKIT1	731141503081	Parts Kit: 1 ECBLK, 2-PRDKIT2 & 2 PL5P1
PRDKIT3	731141503272	Seals & O-Ring
RBP3	731141503302	Rechargeable Battery Pack
Springer Magrath® Parts		
BATTERYDOOR	659276912489	Battery Door
Nesting Boxes		
GNBSKT	084369186773	Replacement Basket
PNBKIT	084369188098	Hardware Kit for PNBI
Wire Crates, Exercise Pen & Barrier		
150897	084369150897	Plastic Handle for Wire Crates/Exercise Pens
EF3, PW5 & PW13 Automatic Waterers		
165600KIT	084369166799	Float Assembly Replacement Kit
AH Rabbit Hutches		
AH242407	084369995214	J Hook for Rabbit Hutch
AH242408	084369157582	Door Guard
AH242409	084369995207	Spring for Rabbit Hutch
ACC2KIT	084369157599	Clips, Spring, Door Latch For Rabbit Hutch
API® Replacement Parts		
75	022102750003	EZ-Tilt Deck Mount for 14B & 650
292428	022102292428	Bowl for 400
294125	022102294125	Bracket for 600
294132	022102294132	Hardware Kit for 600
293494	022102293494	Ring for 970
8WW-B	022102000160	Battery for 8WW
297768	022102297768	77 Thermostat for 77UH
298956	022102298956	Element for 77UH
295177	022102295177	Tankside Thermostat for 71502
298949	022102298949	Element 71502
295641	022102295795	Nut for 15DP De-Icer
295795	022102295795	Nut for 2002DP Drain Plug De-Icer & 99DP Drain Plug De-Icer
296723	022102296723	Rubber Seal for 2002DP De-Icer & 99DP Drain Plug De-icer
300888	022102300888	Water Wiggler Spinner Assembly
305692	022102305692	3 Gallon Jug Assembly for HPW33
BBSTAND	022102304435	Bird Bath Stand for 970
DHLLIDA	022102305814	Lid Deluxe Heated Hen Hydrator API®
Cattle Pumps See Figure 6 on page 100		
BRASSBUSHING	659276912625	CPS Brass Bushing
BTMCAP	659276912694	CPS Bottom Cap
CPSHOSE	659276912830	CPS Finished Hose
CPSREDBAG	659276912908	CPS 17" x 37" 17 oz. Carry Bag
CPSTH	659276912977	CPS T-Handle
CPSWASHER	659276913042	CPS Hose Washer
ERING	659276913110	CPS E Ring
MALEEND	659276913530	CPS Male End
NLCLAMP	659276902473	CPS Nose Lead Clamp
NOSELEAD	659276913608	CPS Nose Lead Finished
ORING	659276913677	CPS O Ring
PLUNGERSEALS	659276913745	CPS Cap Plunger Seal
TOPCAP	659276914162	CPS Top Cap Assembly
Automatic Poultry Waterer		
PCLGLID	084369189583	Lid for 166386 Automatic Poultry Waterer

Farm & Ranch Products Since 1941

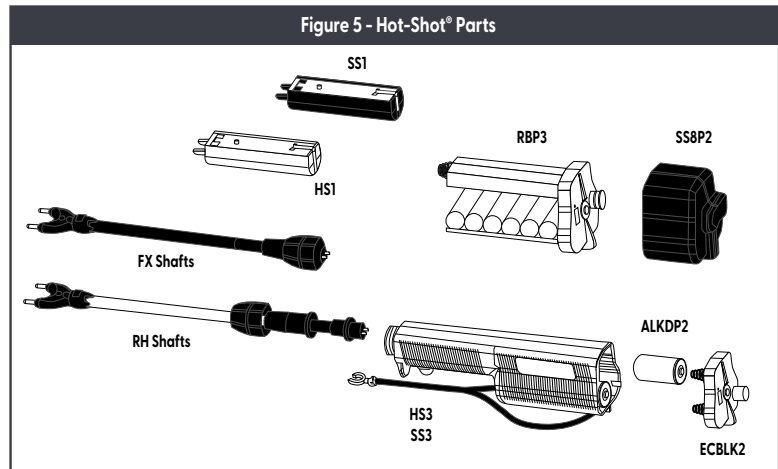
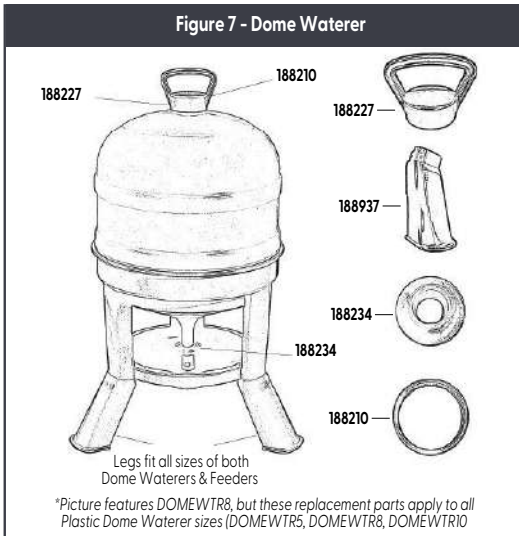
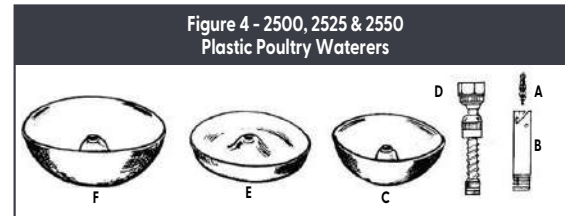
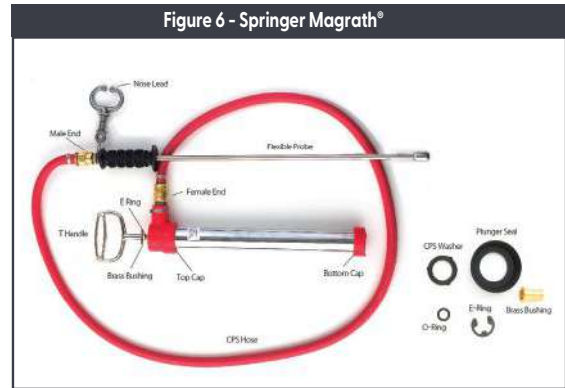
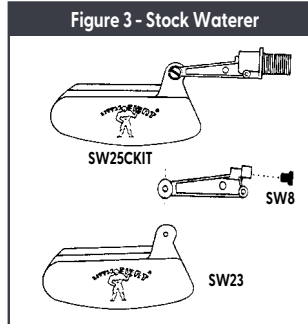
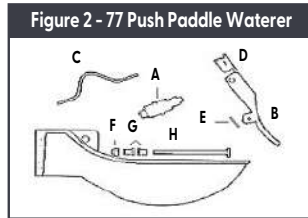
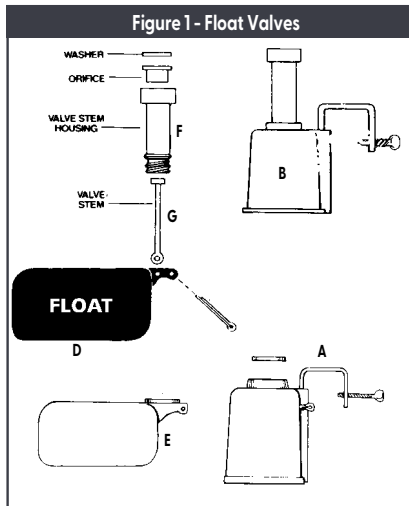

Miller Manufacturing Standard Warranty

For Little Giant®, Double-Tuf®, API®, Pet Lodge® and Springer Magrath® items - we offer a 1 year manufacturing warranty defective, you must have proof of purchase in order to begin the process. This Warranty does not apply to damage caused by misuse or neglect in the field, or failure to follow installation instructions.

Miller Manufacturing Company products are warranted to the original purchaser to be free from defects in material and workmanship under normal use and service. Miller's obligations under this Warranty shall be limited to the repair or exchange of any part of parts which may thus prove defective under normal use and service within 30 days from the date of shipment by Miller to the original purchase, and which Miller's examination shall disclose to its satisfaction to be thus defective. Purchaser must deliver any part or parts to: Miller Manufacturing Company, 1450 West 13th Street, Glencoe, MN 55336 for examination. This Warranty does not apply to damage caused by misuse or neglect in the field, or failure to follow installation instructions.

DISCLAIMER: Due to the numerous factors relating to the hatching of eggs, Miller Manufacturing Company makes no warranty whatsoever in respect to the number of eggs that will be hatched using the Little Giant® brand incubators or egg turners. The warranty is expressly in lieu of all other warranties expressed or implied including the warranties of merchantability and fitness for use and all other obligations or liabilities on our part. We neither assume nor authorize any other person to assume for us, any other liability in connection with the sale of Miller products or any part thereof which has been subject to accident, negligence, alteration, abuse, or misuse. We make no warranty whatsoever in respect to accessories or parts not supplied by us. The above warranty applies to all Miller Manufacturing products unless otherwise specified.

API® Products

All products in the API® line are fully warranted against defects in workmanship for a period of one year from date of purchase, unless otherwise noted.

API® Heated Hoses must be sent back to Miller for final inspection. Please contact your customer service representative directly and they will provide a return material authorization (RMA) number. The item(s) must be shipped back for final inspection to: Miller Returns Department, 1450 West 13th Street, Glencoe, MN 55336. If item is under warranty and is deemed defective a credit or repair will be given.

Livestock Prods

Miller Manufacturing maintains a complete repair service at the factory for both Hot-Shot® and Springer Magrath® prods. If a livestock prod fails due to a defect within the specified warranty period, the unit must be returned to the factory for examination. If the product is found to be defective and is within the warranty period, replacement or repairs will be made. The product will be returned postage paid.

This warranty does not include case breakage or any form of physical damage, or damage due to normal wear and tear or tampering with the handle or motor unit.



miller-mfg.com

UPC/ITEM LISING

Farm & Ranch Products Since 1941

ITEM #	DESCRIPTION	UPC	CASE PK	PG#
77	Push-Paddle Automatic Stock Waterer	084369000772	1	40
89	1 Pint Plastic Feed Scoop	084369000895	36	41
90	1 Qt Stainless Steel Heated Pet Bowl	022102090000	6	70
92	Soda Bottle Lamb Nipple 12 Pack	084369000925	12	29, 44
97	2 Qt Colf Bottle Holder	084369000970	6	44
300	Bird Bath De-Icer	022102030006	6	80
400	Heated Bird Bath w/ Stand	022102040005	6	78
600	Heated Bird Bath w/ Hardware	022102060003	6	78
650	Deck-Mounted Heated Bird Bath	022102650006	6	78
666	1 Gal Plastic Screw-On Poultry Waterer Jar	084369006668	12	15
680	1 Gal Plastic Nesting Poultry Waterer Jar	084369006804	12	15
692	1 Qt Screw-On Poultry Jar w/ Perf Carton	084369190268	12	8, 15
732	1 Qt Quail Waterer Base w/ Perf Carton	843691902705	12	15
742BERRYBLUE	1 Quart Screw-On Poultry Waterer Base	084369191616	12	8, 15
742HOTPINK	1 Quart Screw-On Poultry Waterer Base	084369191609	12	8, 15
742PURPLE	1 Qt Screw-On Poultry Waterer Base w/ Perf Carton	084369190305	12	8, 15
742RED	1 Qt Screw-On Poultry Waterer Base w/ Perf Carton	084369190282	12	8, 15
742YELLOW	1 Qt Screw-On Poultry Waterer Base w/ Perf Carton	084369190312	12	8, 15
750	1 Gal Plastic Screw-On Poultry Waterer Base	084369075008	12	15
750LIMEGREEN	1 Gal Screw-On Poultry Waterer Base	084369162784	12	15
750PURPLE	1 Gal Screw-On Poultry Waterer Base	084369162777	12	15
750YELLOW	1 Gal Screw-On Poultry Waterer Base	084369162791	12	15
780	1 Gal Plastic Nesting Poultry Waterer Base	084369007801	12	15
780LIMEGREEN	1 Gal Nesting-Style Poultry Waterer Base	084369162814	12	15
780PURPLE	1 Gal Nesting-Style Poultry Waterer Base	084369162807	12	15
780YELLOW	1 Gal Nesting-Style Poultry Waterer Base	084369162821	12	15
806APPLEGREEN	1 Qt Plastic Feeder Base	084369153331	12	8, 15
806BERRYBLUE	1 Quart Plastic Feeder Base	084369191630	12	8, 15
806HOTPINK	1 Quart Plastic Feeder Base	084369191623	12	8, 15
806RED	1 Qt Plastic Feeder Base	084369153300	12	8, 15
806YELLOW	1 Qt Plastic Feeder Base	084369153317	12	8, 15
820	20" Plastic Flip-Top Poultry Ground Feeder Red	084369008204	12	12
820LIMEGREEN	20" Plastic Flip-Top Poultry Ground Feeder	084369162913	12	12
820PURPLE	20" Plastic Flip-Top Poultry Ground Feeder	084369162937	12	12
820YELLOW	20" Plastic Flip-Top Poultry Ground Feeder	084369162920	12	12
970	Heated Birdbath w/ Stand	022102097009	6	78
973	3 Qt Nursing Bottle Holder	084369163415	6	44
1018	Poultry Fount Bowl Guard	084369011181	1	17
2500	Game Bird Automatic Poultry Fount	084369025003	6	17
2525	Baby Chick Poultry Fount	084369025256	6	17
2550	King Size Automatic Poultry Fount	084369025508	6	17
6300	Automatic Egg Turner	084369157476	1	23
6302	Quail Rails	084369157490	1	23
6303	Incubator Thermometer Kit	084369157506	1	23
6400	CSA Listed Egg Turner	084369183932	1	23
7300	Force Air Incubator Fan Kit w/ Heater	084369170987	1	23
7506	1 Gal Complete Plastic Poultry Fount	084369075060	6	15
7506LIMEGREEN	1 Gal Complete Plastic Poultry Fount	084369163002	6	15
7506PURPLE	1 Gal Complete Plastic Poultry Fount	084369163019	6	15
7506YELLOW	1 Gal Complete Plastic Poultry Fount	084369163026	6	15
7521	Floating De-Icer, 1500 Watt	022102752106	6	72
7621	Floating De-Icer, 1000 Watt	022102762105	6	72
7906	3 Gal Plastic Poultry Drinker	084369154949	6	12
9112	12 lb Hanging Metal Poultry Feeder	084369091121	6	10
9144	Metal Hanging Poultry Feeder Cover	084369091442	1	10
9203	3 Qt Galvanized Feed Scoop	084369092036	12	41
9204	4 Qt Galvanized Feed Scoop	084369092043	12	41
9206	6 Qt Galvanized Feed Scoop	084369092067	12	41
9312	2 Qt Nursing Bottle w/ Screw-On Nipple	084369093125	12	44
9313	3 Qt Nursing Bottle w/ Screw-On Nipple	084369162630	12	44
9500	Still Air Incubator	084369190398	1	23
9808	Round Metal Chick Feeder	084369098083	12	9
9810	1 Qt Jar Metal Feeder Base	084369098106	12	9
9812	2 Qt Nursing Bottle w/ Snap-On Nipple	084369098120	12	44
9813	3 Qt Nursing Bottle w/ Snap-On Nipple	084369162630	12	44
9814	12" Metal Slide-Top Poultry Ground Feeder	084369098144	12	11
9818	18" Metal Reel Top Poultry Ground Feeder	084369098182	12	11
9822	18" Metal Slide-Top Poultry Ground Feeder	084369098229	12	11
9824	24" Metal Reel Top Poultry Ground Feeder	084369098243	12	11
9826	1 Qt Jar Metal Waterer Base	084369098267	12	9
9830	24" Metal Slide-Top Poultry Ground Feeder	084369098304	12	11

ITEM #	DESCRIPTION	UPC	CASE PK	PG#
9832	2 Gal Double Wall Metal Poultry Fount	084369098328	4	10
9833	3 Gal Double Wall Metal Poultry Fount	084369098335	2	10
9835	5 Gal Double Wall Metal Poultry Fount	084369098359	2	10
9836	36" Reel-Top Poultry Range Feeder	084369098366	6	11
9838	8 Gal Double Wall Metal Poultry Fount	084369098380	2	11
9848	48" Reel-Top Poultry Range Feeder	084369098489	6	11
10500	Circulated Air Incubator	084369190404	1	23
11500	Deluxe Incubator w/ Egg Turner	084369190411	1	23
12500	UL Certified Circulated Air Incubator	084369190428	1	23
71502	Stock Tank Tankside Heater	022102715026	1	73
100021	6 Qt Funnel w/ Screen	084369100021	6	59
100038	2 Qt Funnel w/ Screen	084369100038	6	59
100045	1 Pint Funnel w/ Screen	084369100045	6	59
100069	1 Pint Funnel w/ Extension	084369100069	6	59
100403	24" Metal Pet Exercise Pen	084369100403	1	82
100410	36" Metal Pet Exercise Pen	084369100410	1	82
100427	48" Metal Pet Exercise Pen	084369100427	1	82
100434	Adjustable Wire Auto Barrier	084369100434	1	82
100441	30" Metal Pet Exercise Pen	084369100441	1	82
150552	Small Plastic Tray for Wire Crates	084369150552	1	83
150569	Medium Plastic Tray for Wire Crates	084369150569	1	83
150576	Large Plastic Tray for Wire Crates	084369150576	1	83
150583	XL Plastic Tray for Wire Crates	084369150583	1	83
150590	Giant Plastic Tray for Wire Crates	084369150590	1	83
150903	Small Wire Pop-up Rabbit Cage	084369150903	1	89
150910	Medium Wire Pop-up Rabbit Cage	084369150910	1	89
150927	Large Wire Pop-up Rabbit Cage	084369150927	1	89
150934	Small Plastic Bottom Rabbit Home	084369150934	1	89
150941	Medium Plastic Bottom Rabbit Home	084369150941	1	89
150958	Large Plastic Bottom Rabbit Home	084369150958	1	89
152235	Small Fleece Pet Bed Cream	084369152235	12	84
152242	Medium Fleece Pet Bed Cream	084369152242	12	84
152259	Large Fleece Pet Bed Cream	084369152259	12	84
152266	XL Fleece Dog Bed Cream	084369152266	6	84
152273	Giant Fleece Pet Bed Cream	084369152273	6	84
153171	Wire Rabbit Hay Rack	084369153171	12	91
153218	42" Exercise Pen Pet Lodge	084369153218	1	82
157292	Small Double Door Plastic Crate	084369157292	3	84
157308	Medium Double Door Plastic Crate	084369157308	3	84
157315	Large Double Door Plastic Crate	084369157315	2	84
157322	X Large Double Door Plastic Crate	084369157322	2	84
157339	Giant Double Door Plastic Crate	084369157339	1	84
157759	3 Qt Water Tower Deluxe	084369157759	2	87
157766	3 lb Chow Tower Deluxe	084369157766	2	87
157773	8 Qt Water Tower Deluxe	084369157773	2	87
157780	8 lb Chow Tower Deluxe	084369157780	2	87
157797	16 Qt Water Tower Deluxe	084369157797	2	87
157803	16 lb Chow Tower Deluxe	084369157803	2	87
160742	Small Fleece Pet Bed Chocolate	084369160742	12	84
160759	Medium Fleece Pet Bed Chocolate	084369160759	12	84
160766	Large Fleece Pet Bed Chocolate	084369160766	12	84
160773	XL Fleece Dog Bed Chocolate	084369160773	6	84
160780	Giant Fleece Pet Bed Chocolate	084369160780	6	84
163620	Plastic Nesting Box	084369163620	6	21
165525	Plastic Open Nesting Box	084369165525	6	21
166386	Automatic Poultry Waterer w/ Cover	084369166386	1	17
166713	Bucket Handle Grip, 3 Pack	084369166713	12	26
167451	Galvanized Round Hanging Poultry Waterer	084369167451	6	9
167543	Galvanized Hanging Corner Poultry Feeder	084369167543	6	9
167611	Galvanized Bucket Poultry Waterer	084369167611	4	9
168779	Basic Goat and Sheep Feeder	085765005088	1	29, 35
168793	Classic 2-in-1 Goat and Sheep Feeder	085765005057	1	29, 35
168830	Hay Grazer Hay Feeder	085765002995	1	35
169516	Sprayer Boom	085765052532	1	47
170017	10.5" Brooder Reflector Lamp	084369170017	4	20
170024	250 Watt Red Bulb For Brooder Lamp	084369170024	12	20
170031	250 Watt Clear Heat Lamp Bulb	084369170031	12	20
171267	Galvanized High Capacity Poultry Feeder	084369171267	1	11
171601	Oral Syringe and Medicine Dropper	084369171601	12	93
172035	Poultry Nipple 4 Pack	084369172035	12	16
172196	Chick Brooder Kit	084369172196	1	20

*Red font indicates new item #

UPC/ITEM LISTING



1-800-260-0888

Farm & Ranch Products Since 1941

ITEM #	DESCRIPTION	UPC	CASE PK	PG#
179195	Extra Small Plastic Tray	084369179195	1	83
179225	Extra Small 18" Fleece Bed Cream	084369179225	12	84
188890	Side Mount Poultry Nipple 4 Pack	084369188890	12	16
914043	30-lb Hanging Metal Poultry Feeder	084369040433	6	10
914273	40-lb Hanging Metal Poultry Feeder	084369041737	6	10
101NA	Fluid Feeder Nipple Attachment	659276911642	1	67
10430S	30" Nylon OB Calf Strap	659276911710	1	68
10452CS	52" Nylon and Chain OB Calf Strap	659276911789	1	68
10460S	60" Nylon OB Calf Strap	659276911857	1	68
106ONM	Orphan-No-More Calf Claimer Powder	659276106062	12	68
10FB	10 Qt Heated Flat Back Bucket	022102010114	5	70
10N	Sinking De-Icer, 1000 Watt	022102010107	6	72
14B	14" Heated Bird Bath w/ EZ-Tile Deck and Pole Mount	022102141009	6	78
15A	2-in-1 Sinking De-Icer, 1500 Watt	022102015104	6	73
15DP	Drain Plug De-Icer, 1500 Watt	022102015126	6	73
15N	Sinking De-Icer, 1500 Watt	022102015102	6	72
16HB	16 Gal Heated Bucket	022102016116	4	70
1B	1 Qt Plastic Heated Pet Bowl	022102123456	6	77
200ZDP	Universal Drain Plug De-Icer, 1500 Watt	022102200201	6	73
200PP	ESP Power Pak Only w/ 4 Alkaline Batteries	659276200005	6	66
200PPC	Power Pack In Clamshell	659276932784	6	66
200PPRC	Power Pack Rechargeable In Clamshell	659276934320	6	66
200PPWOB	ESP Power Pak Only	65927691925	6	66
20FB	20 Qt Heated Flat Back Bucket	022102020113	6	70
22SA	Stock Prod 22" Replacement Shaft	659276220003	6	66
22SAC	22" Prod Shaft Assembly In Clamshell	659276934603	6	66
250D	Pail and Bird Bath De-Icer, 200 Watt	022102025019	6	71
28CSG	ClickShield™ Cord Lock	022102281125	12	75
28CSK	ClickShield™ Cord Lock	022102281132	12	75
28CSO	ClickShield™ Cord Lock	022102281118	12	75
300CPS	CPS Complete 300 Cattle Pump System	659276300002	1	68
300CPSPR	36" Replacement Probe for 300CPS Cattle Pump System	659276919194	1	68
320PO	Replacement Pump for Cattle Pump System	659276912069	1	68
34SA	Stock Prod 34" Replacement Shaft	659276340008	6	66
34SAC	Stock Prod 34" Replacement Shaft In Clamshell	659276936423	6	66
44SA	Stock Prod 44" Replacement Shaft	659276440005	6	66
44SAC	Stock Prod 44" Replacement Shaft In Clamshell	659276936492	6	66
480NBG	Bolus Gun	659276912137	1	67
4WW	Standard Water Wiggler®	022102041101	6	79
500CPS	CPS Complete 500 Cattle Pump System	659276912205	1	68
500CPSPR	60" Replacement Probe for 500CPS Cattle Pump	659276912274	1	68
50PLFF	2 Qt Crimp Style Fluid Feeder w/ Plastic Probe	659276500006	6	67
50PLGLFF	1 Gal Crimp Style Fluid Feeder w/ Plastic Probe	659276901209	6	67
50PLNSFF	2 Qt Gravity Style Fluid Feeder w/ Plastic Probe	659276900752	6	67
50SSFF	2 Qt Crimp Style Fluid Feeder w/ Stainless Steel Probe	659276501003	6	67
50SSGLFF	1 Gal Crimp Style Fluid Feeder w/ Stainless Steel Probe	659276901353	6	67
52IG	Floating De-Icer w/ Guard, 1500 Watt	022102052114	6	72
742G	Bucket Heater, 1000 Watt	022102074215	6	71
77UH	Utility Heater, 500 Watt	022102007701	6	71
7WW	Aurora Water Wiggler®	022102071108	6	79
840MTN	Transfer Needle	659276912342	1	68
88ESW	Epoxy-Coated Steel Automatic Stock Waterer	084369001885	1	40
88R	Galvanized De-Icer Guard	022102088106	6	72
88SW	Galvanized Steel Automatic Stock Waterer	084369008888	1	40
89PLWDP	Plastic Automatic Stock Waterer w/ Drain Plug	084369187510	1	40
8WW	Solar Water Wiggler®	022102008111	6	79
90BERRYBLUE	5 Pint Plastic Utility Scoop	084369162869	12	41
90BLUE	5 Pint Plastic Utility Scoop	084369093002	12	41
90GREEN	5 Pint Plastic Utility Scoop	084369094009	12	41
90HOTPINK	5 Pint Plastic Utility Scoop	084369162838	12	41
90LIMEGREEN	5 Pint Plastic Utility Scoop	084369162845	12	41
90PURPLE	5 Pint Plastic Utility Scoop	084369072410	12	41
90RED	5 Pint Plastic Utility Scoop	084369000901	12	41
90TEAL	5 Pint Plastic Utility Scoop	084369097000	12	41
90WHITE	5 Pint Plastic Utility Scoop	084369095006	12	41
90YELLOW	5 Pint Plastic Utility Scoop	084369162852	12	41
92PK	Soda Bottle Lamb Nipple, 3 Pack	084369003926	12	29, 44
93CB	2 Qt Screw-On Nursing Bottle	084369009932	12	44
93PK	Screw-On Calf Nipple In Bag UPC	084369001939	12	44
93SC	Screw-On Nipple Cap	084369002943	1	44
93SCN	Screw-On Calf Nipple for use w/ 93SC Nipple Cap	084369008833	225	44

ITEM #	DESCRIPTION	UPC	CASE PK	PG#
93SCPK	Screw-On Nipple Cap 12 Pack	084369002936	12	44
94LN	Snap-On Lamb Nipple	084369008826	150	44
94PK	Snap-On Lamb Nipple	084369000949	12	44
9803CB	3 Qt Snap-On Nursing Bottle	084369162609	12	44
98CB	2 Qt Snap-On Nursing Bottle	084369000987	12	44
98CN	Snap-On Calf Nipple	084369001984	110	44
98PK	Snap-On Calf Nipple, 2 Pack	084369003988	12	44
98P-L	Large Plastic Heated Pet Mat	022102098136	6	76
98P-M	Medium Plastic Heated Pet Mat	022102098129	6	76
98P-S	Small Plastic Heated Pet Mat	022102098112	6	76
98P-XS	Extra Small Plastic Heated Pet Mat	022102098099	6	76
99DP	Universal Drain Plug De-Icer, 1500 Watt	022102099119	6	73
9HB	9 Qt Plastic Heated Bucket	022102912340	6	70
9SA	9" Replacement Shaft for Stock Prod	659276900004	6	66
9SAC	9" Prod Shaft Assembly In Clamshell	659276934535	6	66
ACCI	Cage Clips, 1-lb bag	084369010450	12	91
ACP2	Wire Clip Pliers	084369010405	12	91
ACUIBLACK	1/2 Pint Plastic Cage Cup	084369150989	12	92
ACUIBLUE	1/2 Pint Plastic Cage Cup	084369151900	12	92
ACUIGREEN	1/2 Pint Plastic Cage Cup	084369151931	12	92
ACUIPURPLE	1/2 Pint Plastic Cage Cup	084369151962	12	92
ACU2BLACK	1 Pint Plastic Cage Cup	084369150996	12	92
ACU2BLUE	1 Pint Plastic Cage Cup	084369151917	12	92
ACU2GREEN	1 Pint Plastic Cage Cup	084369151948	12	92
ACU2PURPLE	1 Pint Plastic Cage Cup	084369151979	12	92
ACU4BLACK	1 Qt Cage Cup	084369151009	12	92
ACU4BLUE	1 Qt Cage Cup	084369151924	12	92
ACU4GREEN	1 Qt Cage Cup	084369151955	12	92
ACU4PURPLE	1 Qt Cage Cup	084369151986	12	92
ACU5	1 Qt Metal Cage Cup	084369010429	12	91
ACU6	1 Pint Metal Cage Cup	084369169592	12	91
ACU7	1/2 Pint Metal Cage Cup	084369169615	12	91
ADP2424	Metal Rabbit Hutch Dropping Pan, 24" by 24"	084369010344	1	90
ADP3030	Metal Rabbit Hutch Dropping Pan, 30" by 30"	084369010368	1	90
ADP3036	Metal Rabbit Hutch Dropping Pan, 30" by 30"	084369010375	1	90
AF3ML	3" Metal Small Animal Feeder w/ Lid	084369010078	12	92
AF3S	3" Metal Small Animal Feeder w/ Sifter Bottom	084369010085	12	92
AF3SL	3" Metal Small Animal Feeder w/ Lid and Sifter Bottom	084369010092	12	92
AF5ML	5" Metal Small Animal Feeder w/ Lid	084369010115	12	92
AF5S	5" Metal Small Animal Feeder w/ Sifter Bottom	084369010122	12	92
AF5SL	5" Metal Small Animal Feeder w/ Lid and Sifter Bottom	084369010139	12	92
AF7ML	7" Metal Small Animal Feeder w/ Lid	084369010153	12	92
AF7S	7" Metal Small Animal Feeder w/ Sifter Bottom	084369010160	12	92
AF7SL	7" Metal Small Animal Feeder w/ Lid and Sifter Bottom	084369010177	12	92
AH2424	24" by 24" Rabbit Hutch	084369010184	1	90
AH3030	30" by 30" Rabbit Hutch	084369010207	1	90
AH3036	30" by 36" Rabbit Hutch	084369010219	1	90
AHFK24	Rabbit Hutch Frame Kit 24"	084369010221	1	90
AHFK30	Rabbit Hutch Frame Kit 30"	084369010238	1	90
ALKDP2	6-Pack of UltraPro Alkaline Batteries - Size C For Hot-Shot®	731141503265	12	63
ANI	Small Animal Nest	084369010320	1	91
AUG2424	Urine Guard Kit For AH2424 Hutch	084369010276	1	90
AUG3030	Urine Guard Kit For AH3030 Hutch	084369010290	1	90
AUG3036	Urine Guard Kit For AH3036 Hutch	084369010306	1	90
AW8	8 Oz Weather-Tuff Water Bottle	084369000284	12	94
AW16	16 Oz Weather-Tuff Water Bottle	084369000161	12	94
AW32	32 Oz Weather-Tuff Water Bottle	084369000321	12	94
BATT6PK	6-Pk UltraPro Alkaline Batteries - Size C For Springer	659276936843	12	66
BBI0BLACK	10 Qt Plastic Better Bucket	085765010228	1	26
BBI0BLUE	10 Qt Plastic Better Bucket	085765010235	1	26
BBI0GREEN	10 Qt Plastic Better Bucket	085765010211	1	26
BBI0RED	10 Qt Plastic Better Bucket	085765010204	1	26
BB20BLACK	20 Qt Plastic Better Bucket	085765010037	1	26
BB20BLUE	20 Qt Plastic Better Bucket	085765010044	1	26
BB20GREEN	20 Qt Plastic Better Bucket	085765010020	1	26
BB20RED	20 Qt Plastic Better Bucket	085765010013	1	26
BB64	64 Oz Bunny Bottle	084369096423	6	93
BBRUSH	Bottle Brush	084369159272	12	93
BDT250	Bird Bath De-Icer w/ Aluminum Base, 250 Watt	022102111262	6	80
BEEFEED	8 Oz Bee Feeding Stimulant	084369179676	6	53
BEGHIVEKIT	10-Frame Beginner Hive Kit	084369179744	1	49



miller-mfg.com

UPC/ITEM LISING

Farm & Ranch Products Since 1941

ITEM #	DESCRIPTION	UPC	CASE PK	PG#
BKBR14	Beekeeping Brush	084369174060	3	52
BKDUM	Beekeeping for Dummies book	084369174978	6	53
BKT5	5 Gal Plastic Bucket	084369177061	3	54
BKTFDR2	2 Gal Bucket Feeder	084369175753	3	53
BPF2	2-Hole Baby Pig Feeder	084369000215	8	43
BPF3	3-Hole Baby Pig Feeder	084369000307	6	43
BPW4	1 Gal Baby Pig Waterer	084369000048	6	43
BROODER	Chick Brooder	084369186810	1	20
CA500	Muck Cart	084369153454	1	47
CANDLER	Egg Candler	084369179898	6	23
CEGGBRN	Ceramic Nest Eggs Brown	084369179904	6	19
CEGGWHT	Ceramic Nest Eggs White	084369179959	6	19
CH12	12 Lb Chow Hound Pet Feeder	084369001120	1	85
CH25	25 Lb Chow Hound Pet Feeder	084369001250	1	85
CH50	50 Lb Chow Hound Pet Feeder	084369001502	1	85
CKDISP	Chick Starter Kit	084369163293	1	15
COLDKNIFE	Uncapping Cold Knife	084369179669	6	55
CP8	8 Qt Plastic Calf Nursing Pail	084369000086	6	29, 43
CP9	8 Qt Plastic Feed Pail	084369009003	5	43
CPB8	8 Oz Clear Plastic Bottle	084369096331	12	94
CPB6	16 Oz Clear Plastic Bottle	084369096348	12	94
CPB32	32 Oz Clear Plastic Bottle	084369096355	12	94
CPHBLUE	8 Qt Hook Over Feed Pail	084369009515	6	29, 31, 43
CPHGREEN	8 Qt Hook Over Feed Pail	084369009522	6	29, 31, 43
CPHRED	8 Qt Hook Over Feed Pail	084369009508	6	29, 31, 43
CR3GRANITE	20 Oz Crock Pet Bowl	084369030595	12	86
CR4GRANITE	Large 48-Oz Crock Pet Bowl	084369030625	12	86
CR5GRANITE	Jumbo 96-Oz Crock Pet Bowl	084369030656	12	86
CUP2	Poultry Drinking Cups 2 Pack	084369186834	6	12
DBSTAND	Metal Stand for Deep Base Poultry Waterer	084369185486	5	13
DBW1	1 Gal Deep Base Poultry Waterer	084369185455	5	13
DBW2	2 Gal Deep Base Poultry Waterer	084369185462	5	13
DBW3	3 Gal Deep Base Poultry Waterer	084369185479	5	13
DDL1	Double-Door Entry Live Animal Trap	084369096515	1	58
DDL2	Double-Door Entry Live Animal Trap	084369096522	1	58
DDL4	Double-Door Entry Live Animal Trap	084369096539	1	58
DEEPBOX10	10-Frame Deep Hive Body	084369174473	1	50
DF10	10 Qt All-Purpose Rubber Pail	084369000109	12	38
DF12	12 Qt Heavyweight Rubber Pail	084369000123	12	38
DF12FB	12 Qt Rubber Flat Back Bucket	084369995177	12	36
DF18FB	18 Qt Rubber Flat Back Bucket	084369000796	12	36
DF18HF	18 Qt Rubber Hook Over Feeder	084369195258	6	28, 36
DF3D	3 Gal Rubber Pan w/ Handles	084369168359	1	37
DF650D	6.5 Gal Rubber Tub w/ Handles	084369168373	1	37
DF8	8 Qt Light-Duty Rubber Pail	084369000802	12	38
DF8FB	8 Qt Flat Back Rubber Bucket	084369995160	12	36
DFC20	5 Gal Rubber Corner Bucket	084369000208	6	36
DFP18	18 Qt Rubber Pail w/ Pouring Lip	084369000819	12	38
DFRBLACK	5-Pack Deep Hive Frame	084369173766	1	51
DFW20	20 Qt Flat Back Rubber Bucket	084369012003	12	36
DH25	Deluxe 25ft Winterflo Heated Hose	022102300895	3	75
DH50	Deluxe 50ft Winterflo Heated Hose	022102300901	3	75
DHH1	Deluxe Hen Hydrator 1 Gal	084369188371	3	16
DHH3	Deluxe Hen Hydrator 3 Gal	084369188388	3	16
DOMEFDR35	35 Lb. Plastic Dome Feeder	084369185394	1	14
DOMEFDR45	45 Lb. Plastic Dome Feeder	084369185417	1	14
DOMEFDR60	60 Lb. Plastic Dome Feeder	084369185431	1	14
DOMEWTR10	10 Gal. Plastic Dome Waterer	084369185448	1	14
DOMEWTR5	5 Gal. Plastic Dome Waterer	084369185400	1	14
DOMEWTR8	8 Gal. Plastic Dome Waterer	084369185424	1	14
DPIRED	DuraPitch I	084369096218	4	45
DP201RED	DuraPitch II Stall Fork Head	084369096492	1	45
DP2RED	DuraPitch II	084369096324	3	45
DPHF11	Deluxe Plastic Hanging Poultry Feeder 11 lb	84369189538	3	13
DPHF22	Deluxe Plastic Hanging Poultry Feeder 22 lb	84369189552	2	13
DPHF3	Deluxe Plastic Hanging Poultry Feeder 3 lb	84369189514	6	13
DT00102	V Auger Hopper	085765001028	1	42
DT00103	Auger Hopper Replacement Strap	085765001035	1	42
DT00104	Large Round Auger Hopper	085765001042	1	42
DT15	3-in-1 De-Icer, 1500 Watt	02210211156	6	72
DT250	Bucket/Utility De-Icer, 250 Watt	02210211255	6	71

ITEM #	DESCRIPTION	UPC	CASE PK	PG#
DT500	Bucket/Utility De-Icer, 500 Watt	022102111552	6	71
DT6BERRYBLUE	Plastic DuraTote	084369195012	6	47
DT6BLACK	Plastic DuraTote	084369006064	6	47
DT6BLUE	Plastic DuraTote	084369006002	6	47
DT6BURGUNDY	Plastic DuraTote	084369006088	6	47
DT6GREEN	Plastic DuraTote	084369006019	6	47
DT6HOTPINK	Plastic DuraTote	084369158633	6	47
DT6LIMEGREEN	Plastic DuraTote	084369195005	6	47
DT6NAVY	Plastic DuraTote	084369006095	6	47
DT6PURPLE	Plastic DuraTote	084369006071	6	47
DT6RED	Plastic DuraTote	084369006026	6	47
DT6TEAL	Plastic DuraTote	084369006057	6	47
DT809	Small Plastic Ground Feeder	084369182218	6	95
DT9851	18' Galv Trough Feeder	084369181174	6	95
DT9854	1.5 Lb Plastic Poultry Feeder	084369181204	6	95
DT9855	5 Lb Plastic Poultry Feeder	084369181211	6	95
DT9856	15 Lb Plastic Poultry Feeder	084369181228	6	95
DT9857	1.5 Qt Plastic Poultry Waterer	084369181235	6	95
DT9858	3.5 Qt Plastic Poultry Waterer	084369181242	6	95
DT9859	5 Qt Plastic Poultry Waterer	084369181239	6	95
DT9860	7 lb. Plastic Poultry Feeder	084369181246	6	95
DT9862	2.5 Gal Plastic Pltry Waterer	084369181215	6	95
DT9863	2 Gal Poultry Fount Berry Blue	659276935518	6	10, 95
DT9864	17 Lb Poultry Feeder Berry Blue	659276935587	6	10, 95
DT9870	1.5 Qt Poultry Waterer w/ Legs	659276929982	5	95
DT9871	4 Lb Poultry Feeder w/ Legs	659276930056	5	96
DT9872	3 Qt Poultry Waterer w/ Legs	659276930124	5	95
DT9873	8.5 Lb Poultry Feeder w/ Legs	659276930193	5	96
DT9874	1 Gal Poultry Waterer w/ Legs	659276930261	5	95
DT9875	17.5 Lb Poultry Feeder w/ Legs	659276930339	5	96
DT9876	2 Gal Poultry Waterer w/ Legs	659276930407	5	95
DT9877	26 Lb Poultry Feeder w/ Legs	659276930476	5	96
DT9878	2.5 Gal Poultry Waterer w/ Legs	659276930544	5	95
DT9879	35 Lb Poultry Feeder w/ Legs	659276930612	5	96
DTBPKIT	Beginner Poultry Kit	659276929630	1	96
DT515	Sinking De-Icer, 1500 Watt	022102150001	6	72
DTSSBLUE	DuraTote Stool and Tote Box	084369195159	2	46
DTSSHOTPINK	DuraTote Stool and Tote Box	084369195197	2	46
DTSSRED	DuraTote Stool and Tote Box	084369195111	2	46
DTWCXSM	Extra Small Double-Tuf® Wire Crate Single Door	659276939080	1	97
DTWCXSL	Small Double-Tuf® Wire Crate Single Door	659276938526	1	97
DTWCMD	Medium Double-Tuf® Wire Crate Double Door	659276938595	1	97
DTWCLRG	Large Double-Tuf® Wire Crate Double Door	659276938663	1	97
DTWCXLG	Extra Large Double-Tuf® Wire Crate Double Door	659276938731	1	97
DTWCGNT	Giant Double-Tuf® Wire Crate Double Door	659276938809	1	97
DUCKFDR11	11 Lb. Plastic Duck Feeder	084369191388	6	8
DUCKWTR3	3 Gal Duck Waterer	084369191395	6	8
DX32	DuraProd® Electric Livestock Prod w/ FX32	731141501025	6	63
DX36	DuraProd® Electric Livestock Prod w/ RH36	731141501056	6	63
DXABP	Alkaline Battery Pack for DuraProd® Electric Livestock Prod	731141501322	1	63
DXDOMEFDR50	Deluxe Dome Feeder 50 Lb	084369190350	4	14
DOMEFDR65	Deluxe Dome Feeder 65 Lb	084369190367	3	14
DOMEFDR80	Deluxe Dome Feeder 65 Lb	084369190374	3	14
DOMEWTR8	Deluxe Dome Waterer 8 Gal	08436919329	4	14
DOMEWTR10	Deluxe Dome Waterer 10 Gal	084369190336	3	14
DOMEWTR13	Deluxe Dome Waterer 13 Gal	084369190343	3	14
DXD1	Limited Duration Prod Replacement Motor	731141501308	1	62
DXD32	Limited Duration DuraProd® Electric Livestock Prod, 32" Flex	731141501148	6	62
DXR32	DuraProd® Rechargeable Livestock Prod, 32" Flexible	731141501087	6	63
DXR36	DuraProd® Rechargeable Livestock Prod, 36" Fiberglass	731141501117	6	63
DXRBP	DuraProd® Rechargeable Battery Pack	731141501315	1	63
DXRC1	DuraProd® 110V Charger Base/Adapter	731141501346	1	63
DXRKIT	DuraProd® 4-Piece Rechargeable Kit	731141501407	1	63
EB13	Large Egg Basket	084369172301	6	19
EB8	Small Egg Basket	084369172295	6	19
EF3	3 Gal Plastic Ever Full Pet Bowl	084369003117	1	86
EFF1	Earth Friendly Fountain	084369096447	36	93
EGGAPRON	Egg Collecting Apron	084369191562	6	18
EGGFLAT30	Egg Flats 30 Count 5 x 6 Package of 12	084369181990	4	19
ELT42	Economy Live Trap	085765926062	1	96
ENSC3BERRYBLUE	3 Qt Plastic Enclosed Scoop Berryblue	084369190633	6	41

*Red font indicates new item #

UPC/ITEM LISTING



1-800-260-0888

Farm & Ranch Products Since 1941

ITEM #	DESCRIPTION	UPC	CASE PK	PG#
ENSC3BLACK	3 Qt Plastic Enclosed Scoop Black	084369190596	6	41
ENSC3BLUE	3 Qt Plastic Enclosed Scoop Blue	084369190589	6	41
ENSC3GREEN	3 Qt Plastic Enclosed Scoop Green	084369190572 0	6	41
ENSC3HOTPINK	3 Qt Plastic Enclosed Scoop Hotpink	084369190602	6	41
ENSC3LIMEGREEN	3 Qt Plastic Enclosed Scoop Limegreen	084369190626	6	41
ENSC3RED	3 Qt Plastic Enclosed Scoop Red	084369190565	6	41
ENSC3YELLOW	3 Qt Plastic Enclosed Scoop Yellow	084369190619	6	41
ENTFDR	Beehive Entrance Feeder	084369174107	3	53
ENTREDCR	Beehive Entrance Reducer	084369179652	3	52
ES1	Easy Scoop Pooper Scooper w/ Wooden Handle	084369096706	6	88
ES2	Easy Scoop II w/ Telescoping Handle	084369096713	6	88
ESCAPE	Bee Escape, Porter Style	084369175593	6	52
EXT2SS	2-Frame Stainless Steel Extractor	084369175777	1	54
FFIIBLACK	11" Fence Feeder w/ Clips	084369154420	6	29, 30
FFIIREAD	11" Fence Feeder w/ Clips	084369154413	6	29, 30
FFI6BLACK	16" Fence Feeder w/ Clips	084369154406	6	29, 30
FFI6RED	16" Fence Feeder w/ Clips	084369154399	6	29, 30
FF20BLACK	20 Qt Fence Feeder	084369002035	6	30
FF20BLUE	20 Qt Fence Feeder	084369003018	6	30
FF20GREEN	20 Qt Fence Feeder	084369004015	6	30
FF20RED	20 Qt Fence Feeder	084369002011	6	30
FOUNDDEEP5	Deep Wax--coated Plastic Foundation 5 pack	084369182614	6	51
FOUNDMED5	Medium Wax--coated Plastic Foundation 5 pack	084369182621	6	51
FPIOBLACK	10 Qt Plastic Feed Pan	084369010023	12	32, 85
FPI8BLACK	18 Qt Plastic Feed Pan	084369008433	6	32
FPI8BLUE	18 Qt Plastic Feed Pan	084369008419	6	32
FPI8GREEN	18 Qt Plastic Feed Pan	084369008426	6	32
FPI8RED	18 Qt Plastic Feed Pan	084369008402	6	32
FPH22BLACK	22 Qt Feed Pan with Handles	084369191401	6	32
FPH22BLUE	22 Qt Feed Pan with Handles	08436919142	6	32
FPH22GREEN	22 Qt Feed Pan with Handles	0843691914322	6	32
FPH22RED	22 Qt Feed Pan with Handles	084369191482	6	32
FRAMEFDR	Frame Feeder	084369175760	3	53
FRAMEREST	Metal Frame Holder	084369179690	3	52
FRGRIP	Frame Grip	084369174145	3	52
FS800	Feed Saver Ring	084369160018	6	27
FTIIBLUE	11 Gal Poly/Rubber FlexTub	085765300077	1	30
FTIIGREEN	11 Gal Poly/Rubber FlexTub	085765300060	1	30
FTIIHOTPINK	11 Gal Poly/Rubber FlexTub	085765300176	1	30
FTIILIMEGREEN	11 Gal Poly/Rubber FlexTub	085765300183	1	30
FTIIPURPLE	11 Gal Poly/Rubber FlexTub	085765300114	1	30
FTIIREAD	11 Gal Poly/Rubber FlexTub	085765300084	1	30
FTB32	32 Oz Flip-Top Easy Fill Water Bottle	084369096676	12	93
FWI6BLUE	DuraMate Automatic Waterer	084369001618	1	40
FWI6GREEN	DuraMate Automatic Waterer	084369001625	1	40
FWI6MTLBLACK	DuraMate Automatic Waterer w/ Metal Cover	084369160117	1	40
FWI6RED	DuraMate Automatic Waterer	084369001601	1	40
FX22	22" Flex Shaft	731141000344	6	64
FX22C	22" Flex Prod Shaft Assembly In Clamshell	731141502855	6	64
FX32	32" Flex Shaft	731141000351	6	64
FX42	42" Flex Shaft	731141000368	6	64
FX52	52" Flex Shaft	731141010015	6	64
GBT8	8 Gal Galvanized Bushel Tub	085765002780	1	33
GGC10CAN	10 Gal Galvanized Garbage Can	084369188418	1	34
GGC10LID	Lid for 10 Gal Galvanized Garbage Can	084369188425	6	34
GGC20CAN	20 Gal Galvanized Garbage Can	084369188432	1	34
GGC20LID	Lid for 20 Gal Galvanized Garbage Can	084369188449	6	34
GGC31CAN	31 Gal Galvanized Garbage Can	084369188456	1	34
GGC31LID	Lid for 31 Gal Galvanized Garbage Can	084369188463	6	34
GGC6CAN	6 Gal Galvanized Storage Bin	084369188395	1	34
GGC6LID	Lid for 6 Gal Galvanized Storage Bin	084369188401	6	34
GLVLG	Goatskin Gloves - Large	084369173902	3	51
GLVMD	Goatskin Gloves - Medium	084369174961	3	51
GOT105	10.5 Gal Galvanized Oval Tub	084369170673	1	33
GOT16	16 Gal Galvanized Oval Tub	084369170680	1	33
GOT2	2 Gal Galvanized Oval Tub	084369170567	1	33
GOT4	4 Gal Galvanized Oval Tub	084369170574	1	33
GOT55	5.5 Gal Galvanized Oval Tub	084369170581	1	33
GOT75	7.5 Gal Galvanized Oval Tub	084369170666	1	33
GPI	1 Gal Galvanized Pan	084369188487	6	33, 42, 59
GPI0	10 Qt Galvanized Dairy Pail	084369173490	1	33

ITEM #	DESCRIPTION	UPC	CASE PK	PG#
GP12	12 Qt Galvanized Dairy Pail	085765002865	1	33
GP13	13 Qt Galvanized Utility Pan	084369096096	12	33, 42, 59
GP14	14 Qt Galvanized Dairy Pail	085765002889	1	33
GP3P	3 Pint Galvanized Pail	085765002759	1	33
GP5	5 Qt Galvanized Dairy Pail	084369173483	1	33
GP8	8 Qt Galvanized Dairy Pail	085765002841	1	33
GST16	16 Gal Galvanized Square Tub	084369173520	1	34
GWCI0	10 Qt Galvanized Watering Can	085765002964	1	35
GWT105	10.5 Gal Galvanized Round Tub	084369173506	1	34
GWT1375	13.75 Gal Galvanized Round Tub	085765002728	1	33
GWT15	15 Gal Galvanized Round Tub	084369173513	1	34
GWT1675	16.75 Gal Galvanized Round Tub	085765002735	1	33
GWT425	4.25 Gal Galvanized Round Tub	085765002704	1	33
HB130	Heater Base 110Watts	084369181723	1	74
HB140	Heater Base 110Watts CSA Certified	084369186933	1	74
HBEAR12	12 Oz Plastic Bear Bottle case of 12 bottles w/ lids	084369173692	1	55
HDHH3	Deluxe Htd Hen Hydrator 3 Gal	022102305678	3	16, 74
HF12BERRYBLUE	12 Qt Plastic Hook Over Feeder	084369162890	6	31
HF12BLACK	12 Qt Plastic Hook Over Feeder	084369001168	6	31
HF12BLUE	12 Qt Plastic Hook Over Feeder	084369001137	6	31
HF12GREEN	12 Qt Plastic Hook Over Feeder	084369001144	6	31
HF12HOTPINK	12 Qt Plastic Hook Over Feeder	084369162876	6	31
HF12LIMEGREEN	12 Qt Plastic Hook Over Feeder	084369162883	6	31
HF12RED	12 Qt Plastic Hook Over Feeder	084369001151	6	31
HF15BLACK	15 Qt Hook Over Feeder - Economy	084369153287	6	31
HF15BLUE	15 Qt Hook Over Feeder - Economy	084369153263	6	31
HF15GREEN	15 Qt Hook Over Feeder - Economy	084369153270	6	31
HF15RED	15 Qt Hook Over Feeder - Economy	084369153256	6	31
HF52BLACK	52 Qt Hook Over Trough	084369168151	1	28, 31
HF9BLACK	9 Qt Hook Over Goat Trough	084369168311	1	28, 31
HFORK	Uncapping Scratcher Fork	084369175678	6	54
HFP24DBLACK	16 Qt Hook Over Portable Feeder w/ Divider	084369152358	3	28, 31
HFP24DBLUE	16 Qt Hook Over Portable Feeder w/ Divider	084369152396	3	28, 31
HFP24DGREEN	16 Qt Hook Over Portable Feeder w/ Divider	084369152433	3	28, 31
HFP24DRED	16 Qt Hook Over Portable Feeder w/ Divider	084369152471	3	28, 31
HGFD	Double Door Hog Feeder	084369150460	1	42
HGFS	Single Door Hog Feeder	084369150453	1	42
HIVE10	10-Frame Complete Hive	084369173704	1	50
HIVE10KIT	10-Frame Deluxe Beginner Hive Kit	084369175746	1	49
HIVEPLUG	Beehive Hole Plug	084369175586	6	52
HJAR16	16 Oz Glass Jar, 1 pound, case of 12 bottles w/ lids	084369175722	1	55
HJAR32	32 Oz Glass Jar, 2 pounds, Case of 12 bottles w/ lids	084369175715	1	55
HKNIFE	Electric Uncapping Knife	084369175661	1	55
HLABEL	Labels for Honey Jars	084369175739	12	55
HNYGATE	Honey Gate	084369177108	6	54
HOTBOX	Hotbox Winterizer w/ Moisture Board	084369178532	1	55
HP1	2 Qt Rubber Feed Pan	084369010009	6	37, 85
HP15	15 Gal Heavy-Duty Rubber Tub	084369000154	3	37
HP2	4 Qt Rubber Feed Pan	084369002004	6	37, 85
HP3	3 Gal Feed Pan	084369000031	6	28, 37
HP650	6.5 Gal Rubber All-Purpose Tub	084369006507	6	37
HP750	6.5 Gal Rubber Feeder Tub w/ Hooks	084369007504	6	37
HP86	8 Qt Rubber Feed Pan	084369190732	6	37, 85
HPB5	5 Qt Heated Pet Bowl	022102304299	6	77
HPM-S	Heated Poultry Mat Small	022102303834	6	74
HPW33	3 Gal Heated Poultry Waterer	022102304305	4	12, 74
HS1	Replacement Motor for HS2000® Electric Livestock Prod.	731141001105	1	62
HS232	Green Prod w/ 32" Flexible Shaft	731141503159	6	62
HS236	Green Prod w/ 36" Fiberglass Shaft	731141503166	6	62
HS242	Green Prod w/ 42" Flexible Shaft	731141503180	6	62
HSR232	Green Prod w/ 32" Flexible Shaft	731141503197	6	62
HSR236	Green Prod w/ 36" Fiberglass Shaft	731141503203	6	62
HSTRAINP	Fabric Honey Filter	084369176637	3	54
HSTRAINSS	Stainless Steel Honey Strainer	084369175685	1	54
HT10	Hive Tool	084369173940	6	52
HU2HS	Green Prod Alkaline Battery Handle	731141503036	6	62
HU2HSC	Green Prod Batt Clamshell	731141502503	6	62
HU2HSR	Green Prod Rechargeable Handle	731141503043	6	62
HU2HSRC	Green Prod Rechg Clamshell	731141502510	6	62
HU2HSRCHG	Green Rechg W Usb Charger	731141502558	6	62
HU2S	Red Prod Alkaline Battery Handle	731141503050	6	62



miller-mfg.com

UPC/ITEM LISING

Farm & Ranch Products Since 1941

ITEM #	DESCRIPTION	UPC	CASE PK	PG#
HU2SC	Red Prod Battery Clamshell	731141502527	6	61
HU2SR	Red Prod Rechargeable Handle	731141503067	6	61
HU2SRC	Red Prod Rechargeable Clamshell	731141502534	6	61
HU2SRCHG	Red Rechargeable W/12V Charger	731141502541	6	61
HUDX	DuraProd® Handle w/ Batteries	731141501254	6	63
HUDXB	DuraProd Handle w/ Batteries Bulk	731141501445	6	63
HUDXD	Limited Duration Prod Replacement Handle w/ Batteries	731141501278	6	62
HUDXR	DuraProd® Rechargeable Handle	731141501261	6	63
HUDXRB	DuraProd Rechargeable Handle Bulk	731141501452	6	63
HVEIL	Beekeeping Veil w/ Built-In Hat	084369173988	3	51
INNERCOVER	Beehive Inner Cover	084369179621	1	50
JKT2XL	XXL Beekeeping Jacket	084369177436	3	51
JKT1G	Large Beekeeping Jacket	084369175548	3	51
JKTM	Medium Beekeeping Jacket	084369175531	3	51
JKTXL	XL Beekeeping Jacket	084369175555	3	51
KC20	20 Oz Kennel Crock	084369096386	12	88
KC40	40 Oz Kennel Crock	084369158053	12	88
LGBPKIT	Little Giant® Beginner Poultry Kit	084369191647	1	20
LT2	Single Door Live Animal Trap	084369011204	1	58
LT3	Single Door Live Animal Trap	084369011303	1	58
LT4	Single Door Live Animal Trap	084369011402	1	58
LT5	Single Door Live Animal Trap	084369096089	1	58
MDF2	Metal DuraFork	084369000024	3	45
MDF201	Metal DuraFork Replacement Fork Head	084369201001	30	45
MEDBOX10	10-Frame Medium Super	084369173728	1	50
MF1GREEN	1 Qt Mineral Feeder	084369167956	1	42
MF35BLACK	3.5 Qt Mineral Feeder	084369158008	12	30
MF6BERRYBLUE	6 Qt Plastic Mini Feeder	084369162968	6	28, 31
MF6BLUE	6 Qt Plastic Mini Feeder	084369060011	6	28, 31
MF6GREEN	6 Qt Plastic Mini Feeder	084369060028	6	28, 31
MF6HOTPINK	6 Qt Plastic Mini Feeder	084369162944	6	28, 31
MF6LIMEGREEN	6 Qt Plastic Mini Feeder	084369162951	6	28, 31
MF6RED	6 Qt Plastic Mini Feeder	084369060035	6	28, 31
MFRLITE	5-Pack Medium Hive Frame	084369173742	1	51
MJ9810	Mason Jar Baby Chick Feeder	084369173629	6	9
MJ9826	Mason Jar Baby Chick Waterer	084369173636	6	9
MPIOBLACK	10 Qt Plastic Salt and Mineral Block Pan	084369010016	12	32
NESTPAD10	Fiber Poultry Nesting Pads	084369191548	6	18
OPB16	16 Oz Opaque Plastic Bottle	084369096478	12	94
OPB32	32 Oz Opaque Plastic Bottle	084369096485	12	94
OUTERCOVER	Beehive Outer Cover	084369179614	1	50
P15N	Sinking Pond De-Icer, 1500 Watt	0221021915006	6	80
P20FBLID	Lid for 20 Qt Flatback Bucket	084369191241	6	13
P20FBBLACK6	20 Qt Plastic Bucket	084369187312	6	25, 28
P20FBBLUE6	20 Qt Plastic Bucket	084369187343	6	25, 28
P20FBGRAY6	20 Qt Plastic Flatback Bucket	084369191777	6	25, 28
P20FBHOTPINK6	20 Qt Plastic Bucket	084369187398	6	25, 28
P20FBLAVENDER6	20 Qt Plastic Flatback Bucket	084369191807	6	25, 28
P20FBLID	Lid for 20 Qt Flatback Bucket	084369191241	6	25
P20FBNNAVY6	20 Qt Plastic Bucket	084369187428	6	25, 28
P20FBORANGE6	20 Qt Plastic Bucket	084369187435	6	25, 28
P20FBPURPLE6	20 Qt Plastic Bucket	084369187442	6	25, 28
P20FBRED6	20 Qt Plastic Bucket	084369187466	6	25, 28
P20FBTEAL6	20 Qt Plastic Bucket	084369187480	6	25, 28
P22FBBLACK	22 Qt Flat Back Plastic Bucket	084369022071	12	25
P22FBBLUE	22 Qt Flat Back Plastic Bucket	084369022019	12	25
P22FBGREEN	22 Qt Flat Back Plastic Bucket	084369022026	12	25
P22FBNNAVY	22 Qt Flat Back Plastic Bucket	084369022125	12	25
P22FBPURPLE	22 Qt Flat Back Plastic Bucket	084369022095	12	25
P22FBRED	22 Qt Flat Back Plastic Bucket	084369022033	12	25
P22FBTEAL	22 Qt Flat Back Plastic Bucket	084369022064	12	25
P24FBBLACK	22 Qt Flat Back Plastic Bucket w/Knob Bail	084369024075	12	25
P24FBBLUE	22 Qt Flat Back Plastic Bucket w/Knob Bail	084369024013	12	25
P24FBGREEN	22 Qt Flat Back Plastic Bucket w/Knob Bail	084369024020	12	25
P24FBRED	22 Qt Flat Back Plastic Bucket w/Knob Bail	084369024037	12	25
P3BLUE	3 Gal Plastic Utility Pan	084369000666	12	32, 59
P3GREEN	3 Gal Plastic Utility Pan	084369000673	12	32, 59
P3RED	3 Gal Plastic Utility Pan	084369000659	12	32, 59
P5BERRYBLUE6	5 Qt Plastic Utility Pan Berryblue	084369190671	6	32, 85
P5BLUE6	5 Qt Plastic Utility Pan Blue	084369190640	6	32, 85
P5HOTPINK6	5 Qt Plastic Utility Pan Hotpink	084369190695	6	32, 85

ITEM #	DESCRIPTION	UPC	CASE PK	PG#
P5LIMEGREEN6	5 Qt Plastic Utility Pan Limegreen	084369190701	6	32, 85
P5PURPLE6	5 Qt Plastic Utility Pan Purple	084369190718	6	32, 85
P5RED	5 Qt Plastic Utility Pan Red	084369190664	6	32, 85
P5TEAL6	5 Qt Plastic Utility Pan Teal	084369190725	6	32, 85
P65BLUE	6.5 Gal Plastic All-Purpose Tub	084369000741	6	27
P65GREEN	6.5 Gal Plastic All-Purpose Tub	084369000758	6	27
P65RED	6.5 Gal Plastic All-Purpose Tub	084369000765	6	27
P7521	Floating Pond De-Icer, 1500 Watt	0221021915217	6	80
P7621	Floating Pond De-Icer, 1000 Watt	0221021916212	6	80
P800BLACK	8 Gal Plastic Round Feeder	084369080064	6	27
P800BLUE	8 Gal Plastic Round Feeder	084369080002	6	27
P800GREEN	8 Gal Plastic Round Feeder	084369080019	6	27
P800HOTPINK	8 Gal Plastic Round Feeder	084369160025	6	27
P800NAVY	8 Gal Plastic Round Feeder	084369080095	6	27
P800PURPLE	8 Gal Plastic Round Feeder	084369080071	6	27
P800RED	8 Gal Plastic Round Feeder	084369080026	6	27
P800TEAL	8 Gal Plastic Round Feeder	084369080057	6	27
P8BERRYBLUE6	8 Qt Plastic Bucket	084369186957	6	25
P8BLACK6	8 Qt Plastic Bucket	084369186971	6	25
P8BLUE6	8 Qt Plastic Bucket	084369187022	6	25
P8FBERRYBLUE6	8 Qt Flatback Plastic Bucket	084369190756	6	25
P8FBBLACK6	8 Qt Flatback Plastic Bucket	084369190763	6	25
P8FBBLUE6	8 Qt Flatback Plastic Bucket	084369190770	6	25
P8FBGRAY6	8 Qt Plastic Flatback Bucket	084369191760	6	25
P8FBHOTPINK6	8 Qt Flatback Plastic Bucket	084369190800	6	25
P8FBLAVENDER6	8 Qt Plastic Flatback Bucket	084369191791	6	25
P8BNAVY6	8 Qt Flatback Plastic Bucket	084369190824	6	25
P8BORANGE6	8 Qt Flatback Plastic Bucket	084369190749	6	25
P8BPURPLE6	8 Qt Flatback Plastic Bucket	084369190831	6	25
P8FBRED6	8 Qt Flatback Plastic Bucket	084369190848	6	25
P8FBTEAL6	8 Qt Flatback Plastic Bucket	084369190855	6	25
P8GRAY6	8 Qt Plastic Bucket	084369191524	6	25
P8HOTPINK6	8 Qt Plastic Bucket	084369187107	6	25
P8LAVENDER6	8 Qt Plastic Bucket	084369191524	6	25
P8NAVY6	8 Qt Plastic Bucket	084369187152	6	25
P8ORANGE6	8 Qt Plastic Bucket	084369187169	6	25
P8PURPLE6	8 Qt Plastic Bucket	084369187176	6	25
P8RED6	8 Qt Plastic Bucket	084369187206	6	25
P8TEAL6	8 Qt Plastic Bucket	084369187251	6	25
P8WHITE6	8 Qt Plastic Bucket	084369187268	6	25
PAD42G	42" Sorting Paddle	731141001587	6	64
PAD42R	42" Sorting Paddle	731141001563	6	64
PAD48B	48" Sorting Paddle	731141001600	6	64
PAD48G	48" Sorting Paddle	731141001617	6	64
PAD48R	48" Sorting Paddle	731141001594	6	64
PBL	Large Heated Pet Bed 7.3 Watts	022102305591	6	76
PBLP3	3 Gal Plastic Pan Feeder	084369000239	12	32
PBM	Medium Heated Pet Bed 7.3 Watts	022102305584	6	76
PBR	Round Heated Pet Bed 7.3 Watts w/ Fleece Cover	022102305807	6	76
PBS	Small Heated Pet Bed 7.3 Watts	022102305577	6	76
PBW	Pet Bed Warmer 7.3 Watts	22102305838	6	76
PCF6BLACK	26 Qt Corner Feeder	084369000642	6	30
PCF6BLUE	26 Qt Corner Feeder	084369000628	6	30
PCF6GREEN	26 Qt Corner Feeder	084369000635	6	30
PCF6RED	26 Qt Corner Feeder	084369000611	6	30
PCLGLID	Lid For 11 and 22 Lb Poultry Hanging Feeder Large	84369189583	1	13
PCSMID	Lid For 3 Lb Poultry Hanging Feeder Small	84369189576	1	13
PDFIA	Plastic DuraFork Assorted Pack	084369000437	1	45
PDFIBERRYBLUE	Plastic DuraFork	084369158978	3	45
PDFIBLACK	Plastic DuraFork	084369000093	3	45
PDFIBLUE	Plastic DuraFork	084369000338	3	45
PDFIBURGUNDY	Plastic DuraFork	084369000390	3	45
PDFIGREEN	Plastic DuraFork	084369000345	3	45
PDFIHOTPINK	Plastic DuraFork	084369158657	3	45
PDFIKIT	Parts Kit for PDFL	084369100007	1	45
PDFILIMEGREEN	Plastic DuraFork	084369158961	3	45
PDFIORANGE	Plastic DuraFork	084369178938	3	45
PDFIPURPLE	Plastic DuraFork	084369000383	3	45
PDFIRED	Plastic DuraFork	084369000017	3	45
PDFITEAL	Plastic DuraFork	084369000062	3	45
PDFI03DISP	Fork Head Display-Lime/Hot Pink	084369186421	1	46

*Red font indicates new item #

UPC/ITEM LISTING



1-800-260-0888

Farm & Ranch Products Since 1941

ITEM #	DESCRIPTION	UPC	CASE PK	PG#
PDF103DISPRED	Fork Head Display-Red only	084369190459	1	46
PDF103DISPGREEN	Fork Head Display-Green only	084369190466	1	46
PDF3RED	Plastic DuraFork w/ Aluminum Handle	084369096157	3	45
PDFFERED	Plastic DuraFork w/ Ergonomic Handle	084369001078	3	45
PDP2424	Plastic Rabbit Hutch Dropping Pan	084369101443	6	90
PF25	9 Qt Foal Feeder	08436900253	1	30
PGB1	1 Gal Painted Galvanized Bucket Waterer for Poultry	084369186698	6	9
PGB2	2 Gal Painted Galvanized Bucket Waterer for Poultry	084369186711	4	9
PLTRYDISP	Poultry Kit	084369163699	1	15
PM	Power-Mite® Pocket-Size Electric Livestock Prod	731141000238	6	63
PMH	Leather Holster For Power-Mite®	731141000429	1	63
PMT	The Better Mouse Trap, 2 Pack	084369096607	6	59
PNBI	Deluxe Plastic Nesting Box	084369188081	5	21
POLLENSUB	Pollen Substitute Powder	084369181686	18	53
PPF3	3 Gal Plastic Poultry Waterer	084369096164	2	13
PPF5	5 Gal Plastic Poultry Waterer	084369096171	2	13
PPF7	7 Gal Plastic Poultry Waterer	084369096188	1	13
PROSWEET1	Pro Sweet Liquid Bee Feed 1 Gal	084369190244	4	53
PRT	Rodent Trap	084369096614	6	59
PS32BLACK	32 Oz Professional Spray Bottle	084369161800	12	47
PS32BLUE	32 Oz Professional Spray Bottle	084369003247	12	47
PS32GREEN	32 Oz Professional Spray Bottle	084369003278	12	47
PS32HOTPINK	32 Oz Professional Spray Bottle	084369161817	12	47
PS32PURPLE	32 Oz Professional Spray Bottle	084369003261	12	47
PS32RED	32 Oz Professional Spray Bottle	084369003216	12	47
PS32TEAL	32 Oz Professional Spray Bottle	084369003223	12	47
PSB40BLACK	40 Qt Muck Tub	084369161640	6	27
PSB40BLUE	40 Qt Muck Tub	084369161626	6	27
PSB40GREEN	40 Qt Muck Tub	084369161633	6	27
PSB40RED	40 Qt Muck Tub	084369161619	6	27
PSB70BERRYBLUE	70 Qt Muck Tub	084369159036	6	27
PSB70BLACK	70 Qt Muck Tub	084369000703	6	27
PSB70BLUE	70 Qt Muck Tub	084369000734	6	27
PSB70GREEN	70 Qt Muck Tub	084369000727	6	27
PSB70HOTPINK	70 Qt Muck Tub	084369158640	6	27
PSB70LIMEGREEN	70 Qt Muck Tub	084369159029	6	27
PSB70ORANGE	70 Qt Muck Tub	084369178921	6	27
PSB70PURPLE	70 Qt Muck Tub	084369162906	6	27
PSB70RED	70 Qt Muck Tub	084369000710	6	27
PSTKR12C	Springer Rechg Batt. Pk w/12V Chrgr	659276932920	6	66
PT20BLACK	20 Gal Utility Tub	085765002285	1	59
PW13	13 Qt Galvanized Ever Full Pet Bowl	084369003100	1	86
PW5	5 Qt Plastic Ever Full Pet Bowl	084369000055	1	86
PWBURSH	Cleaning Brush for Poultry Waterers	084369191586	6	18
QLC10	10 Oz Quick Lock Crock	084369096683	12	93
QLC20	20 Oz Quick Lock Crock	084369096690	12	93
RT10	120 volt charger for RBP3	731141000474	1	61
RI2	12V Charger For RBP3	731141000481	1	61
RBP3	NICAD Rechargeable Battery Pack	731141503302	1	61
RC2	Medium Restraining Cone	084369173377	6	21
RC3	Large Restraining Cone	084369173384	6	21
RH24	24" Rigid Fiberglass Shaft	731141000290	6	64
RH36	36" Rigid Fiberglass Shaft	731141000306	6	64
RH48	48" Rigid Fiberglass Shaft	731141000313	6	64
RH48CL	48" Rigid Fiberglass Shaft In Clamshell	731141503142	6	64
RH60	60" Rigid Fiberglass Shaft	731141000320	6	64
RH72	72" Rigid Fiberglass Shaft	731141000337	6	64
RHCK1	Rabbit Hutch Complete Kit	084369101436	1	89
RNESTPAD6	Reusable Poultry Nesting Pads	084369191555	6	18
RM3DISP	3-Roll Rubber Mat Display	085765140659	1	57
RM4096	Pre-Cut Rubber Utility Mat, 96" by 40"	085765409602	1	56
RM4872	Pre-Cut Rubber Utility Mat, 72" by 48"	085765487204	1	56
RM4896	Pre-Cut Rubber Utility Mat, 96" by 48"	085765489604	1	56
RM60120	Pre-Cut Rubber Utility Mat, 120" by 60"	085765601204	1	56
RM6096	Pre-Cut Rubber Utility Mat, 96" by 60"	085765609606	1	56
RMDIA380	Check Plate Roll Flooring	085765140468	1	57
RMDIA440	40-Foot Checker-Plate Rolled Rubber Mat	085765140482	1	57
RMDOT349	49-Foot Round Dot Rolled Rubber Mat	085765140437	1	57
RML13636	Trak-Safe Interlocking Mat	085765140727	1	56
RMRACK	Pre-Cut Utility Mat Rack Display	085765610008	1	56
RMWR349	49-Foot Wide Rib Rolled Rubber Mat	085765140550	1	57

ITEM #	DESCRIPTION	UPC	CASE PK	PG#
RUSBHSUS	USB Charger Hot-Shot U.S. Plug	731141502572	1	61
RUSBSPUS	USB Charger Springer U.S. Plug	659276934399	1	66
SB1	4 lb Wire Salt Block Holder	084369101313	6	42
SB50	5 Qt Stainless Steel Heated Pet Bowl	022102011500	6	72
SBP3	1 Qt Salt Block Feeder	084369167932	1	42
SBPU	Universal Block Holder and Feeder	084369168335	1	42
SC1	SureCatch Multiple-Catch Mouse Trap	084369096652	6	59
SCREENBOARD	Beehive Screened Bottom Board	084369179638	1	50
SHOB	Adjustable Sho-Stik	731141000405	6	64
SHOR	Adjustable Sho-Stik	731141000382	6	64
SHOS	Adjustable Sho-Stik	731141000399	6	64
SKELTER	Egg Skelter	084369191517	4	18
SKEWER	Chicken Treat Skewer	084369191531	6	18
SMFUEL	Smoker Fuel	08436917827	6	52
SOLIDBOARD	Beehive Solid Bottom Board	084369179645	1	50
SPL42	42" Sorting Pole	731141001549	12	64
SPL48	48" Sorting Pole	731141001815	12	64
SPL54	54" Sorting Pole	731141001556	12	64
SR12	Springer 12V Charger	659276932999	1	58
SR12OU	Charger 120V Wall Unit U.S. Plug	659276933552	1	58
SS1	Replacement Motor for SABRE-SIX® Electric Livestock Prod	731141000504	1	61
SS13P	13 Qt Stainless Steel Dairy Pail	085765003053	1	35
SS16P	16 Qt Stainless Steel Dairy Pail	085765003107	1	35
SS20P	20 Qt Stainless Steel Dairy Pail	085765003152	1	35
SS232	Red Prod w/ 32" Flexible Shaft	731141503210	6	61
SS236	Red Prod w/ 36" Fiberglass Shaft	731141503227	6	61
SS242	Red Prod w/ 42" Flexible Shaft	731141503241	6	61
SS9P	9 Qt Stainless Steel Dairy Pail	085765003008	1	29, 35
SSH1	Salt Spool Hanger	084369101382	1	93
SSH2	Mineral and Salt Spool w/ Hanger	084369101399	12	93
SSW3	Mineral Spool, 24 pc Counter Display	084369003339	24	93
SSWHITE	White Salt Spool, 24 pc Counter Display	084369180931	24	93
ST100	100 Gal Poly Oval Stock Tank	084369153898	1	38
ST15	15 Gal Poly Oval Stock Tank	084369153928	1	38
ST150	150 Gal Poly Oval Stock Tank	084369153881	1	38
ST40	40 Gal Poly Oval Stock Tank	084369153911	1	38
ST75	75 Gal Poly Oval Stock Tank	084369153904	1	38
STKIT	Stock Tank Drain Plug Kit	084369154321	1	38
TAP1	Pet Tap Adaptor	084369096409	12	86
TAP2	Tap Adaptor for Farm Animals	084369096416	12	42
TB4	Chicken Treat Ball 4 Inch	084369191524	12	18
TM825	Plastic Trough-O-Matic® Stock Tank Float Valve	084369008259	6	39
TM825AS	Plastic Trough-O-Matic® w/ Anti-Siphon	084369018258	5	39
TM825T	Plastic Trough-O-Matic® w/ Exp. Brackets	084369082518	6	39
TM830	Metal Trough-O-Matic® Stock Tank Float Valve	084369008303	6	39
TM830AS	Metal Trough-O-Matic® w/ Anti-Siphon	084369018302	5	39
TM830T	Metal Trough-O-Matic® w/ Exp. Brackets	084369083010	6	39
TP3	3 Gal Travel Pal Pet Waterer	084369096201	2	88
TR20GALV	20 in Galvanized Poultry Trough Feeder w/ Grate	084369186803	6	12
TR20PLN	20 in Plastic Poultry Trough Feeder Narrow Spacing	084369186780	12	12
TR20PLW	20 in Plastic Poultry Trough Feeder Wide Spacing	084369186797	12	12
TWB3	Water Boy Travel Tank Pet Waterer	084369158060	6	88
TYSUIT	Large Tyvek Coverall	084369174022	3	51
TYSUITMD	Medium Tyvek Coverall	084369175197	3	51
TYSUITXL	XL Tyvek Coverall	084369175227	3	51
UBI0BLACK	10 Qt Round Plastic Utility Bucket	084369159432	12	25
UBI0BLUE	10 Qt Round Plastic Utility Bucket	084369159449	12	25
UBI0GREEN	10 Qt Round Plastic Utility Bucket	084369159456	12	25
UBI0RED	10 Qt Round Plastic Utility Bucket	084369159463	12	25
UBI0WHITE	10 Qt Round Plastic Utility Bucket	084369160728	12	25
VP2349PK3	VersaPad Flooring 1pc Sold in Eaches Increments of 3	084369188364	3	56
W250	250 Watt Auto Waterer De-Icer	022102111545	6	71
W500	500 Watt Auto Waterer De-Icer	022102111576	6	71
WB10	Plastic Wall Bracket	084369001106	1	26
WB60	Metal Wall Bracket	084369010190	1	26, 36
WCGNT	Giant Wire Double Door Crate	084369182522	1	83
WCLRG	Large Wire Double Door Crate	084369182508	1	83
WCMD	Medium Wire Double Door Crate	084369182492	1	83
WCMSL	Small Wire Single Door Crate	084369182485	1	83
WCXLG	Extra Large Wire Double Door Crate	084369182515	1	83
WCXSM	Extra Small Wire Single Door Crate	084369182553	1	83

Full Service Marketing Support

You won't go it alone...we're here to support you! We have a full-service Marketing and Sales team ready to help you succeed. Our team can assist you with in-store events, marketing, merchandising support, creating value-added content, and offering training and education for customers and staff. We also have planogram kits available for order, containing everything you need to set an eye-catching display in your store! We have a full library of marketing collateral available to help you promote our products, and we have the capability to create custom pieces of content by request. At Miller Manufacturing, we're proud to be your partner.

WHY BEES?
Keeping bees might be simpler than you think! Beekeeping is a simple hobby with sweet rewards! The world has been crying out for bees since the dawn of time. Bees are the most important pollinators on the planet. Without them, we would not have the fruits, vegetables, and flowers that we love to eat. Bees are also a source of honey, a natural sweetener that is healthier than refined sugar. Beekeeping is a rewarding hobby that can help you connect with nature and support local agriculture.

Honey is delicious!
If you're looking for a natural sweetener, honey is the way to go. It's a natural source of energy and contains antioxidants. Honey is also a natural preservative and can be used in a variety of recipes. Try adding honey to your morning coffee or using it as a natural hair conditioner.

Backyard beekeeping is great for the bees!
Backyard beekeeping is a great way to support local agriculture and protect the environment. Bees are essential for pollinating many of the crops that we eat. By keeping bees in your backyard, you can help to increase the local bee population and ensure that your food sources are healthy and abundant.

Our food sources depend on it!
Bees are essential for pollinating many of the crops that we eat. Without bees, we would not have the fruits, vegetables, and flowers that we love to eat. By keeping bees in your backyard, you can help to increase the local bee population and ensure that your food sources are healthy and abundant.

BEE-FRIENDLY PLANTS
Which plants do bees love? You can help the bees by planting these plants in your garden:

- Lavender
- Wild Geranium
- Poppies
- Clover
- Sunflowers
- Beesbalm
- Chrysanthemum
- Purple Coneflower
- Sedum
- Nubia Coneflower
- Agave
- Zinnia
- Marigolds
- Milkweed

MILLER MANUFACTURING • WWW.MILLER.MFG.COM
A simple hobby with sweet rewards!

Sellsheets & in-store informational tear-off pads

Pet Lodge
DOUBLE DOOR DOG CRATE
PERFECT FOR HOME, TRAINING & TRAVEL

What size crate do I need?

EXTRA SMALL	SMALL	MEDIUM	LARGE	EXTRA LARGE	CRATE
Weight: Under 10 lbs	Weight: 10-25 lbs	Weight: 25-50 lbs	Weight: 50-75 lbs	Weight: 75-100 lbs	Weight: 100+ lbs
Wire Crate Model #P15614	Wire Crate Model #P15615	Wire Crate Model #P15616	Wire Crate Model #P15617	Wire Crate Model #P15618	Wire Crate Model #P15619
Plastic Crate Model #P15620	Plastic Crate Model #P15621	Plastic Crate Model #P15622	Plastic Crate Model #P15623	Plastic Crate Model #P15624	Plastic Crate Model #P15625

WHY CRATE TRAIN?
Crate training your dog offers tremendous benefits.

- With the correct crate method, crate training is a positive experience for your dog.
- It's the perfect place for your dog to be when you're not home.
- It's the perfect place for your dog to be when you're away.
- It's a safe, secure, and comfortable place for your dog to rest.
- It's a simple training tool for your dog. It's easy to use and easy to clean.

For more information or to place an order contact your Miller Sales Representative www.miller-mfg.com or 800-260-0888

LIVE TRAP Size Guide

- RATS & WEASELS**
Suggested Trap: LT1
1.125" x W 7.75" x H 6.5"
- CHIPMUNKS & SQUIRRELS**
Suggested Trap: LT2
1.25" x W 7.75" x H 7.5"
- RABBITS, SKUNKS & WOODCHUCKS**
Suggested Trap: LT3
1.25" x W 8.25" x H 10.125"
- RACCOONS, PORCUPINES & TURTLES**
Suggested Trap: LT4
1.32.125" x W 10.125" x H 12.25"
- FOXES, CATS & DOGS**
Suggested Trap: LTS
1.42.25" x W 16.75" x H 16.75"

INCUBATION
Start your flock right!

We have a selection of incubators & accessories to help you grow your flock!

www.miller-mfg.com

In-store display signs

Guide to BACKYARD POULTRY
A guide to BEEKEEPING by Little Giant

Inside you'll find...
• How to choose the best breed for your backyard
• Everything you need to know to get started
• A step-by-step guide to raising your flock

Inside you'll find...
• The best breeds for your backyard
• How to choose the right hive
• A step-by-step guide to raising your bees

A simple hobby with sweet rewards!

In-store informational booklets

api
HEATED PRODUCTS
A trusted name in heated products for over 65 years

HOT-SHOT
HEATED FOR GUARANTEED WARMTH
HELIODIC, DURABLE, SAFE.
75 years

In-Store Headers

Planogram Kits

Everything you need to CARE FOR YOUR FLOCK

Planogram Kits

Planogram Kits



HOT-SHOT



Double-Tuf



Customer Service

(800) 260-0888
Hours: M – F, 7 AM to 5 PM CT
Main Phone: (651) 982-5100
Main Fax: (651) 982-5101
Live Chat: www.miller-mfg.com
customerservice@miller-mfg.com
www.miller-mfg.com

Corporate Office

2915 Commers Drive, Suite 100
Eagan, MN 55121 USA
Fax: (651) 982-5243

Manufacturing

1400 West 13th Street
Glencoe, MN 55336 USA

Distribution Center

1450 West 13th Street
Glencoe, MN 55336 USA

Our Fundamentals

From the very beginning, the success of our business has been the result of the behaviors and exceptional efforts of our employees. And at the foundation of our exceptional employees is an extraordinary culture. Miller's 26 "Fundamentals" define our unique culture. They're what set us apart and drive our continued success.



Scan to learn more about the 26 "Fundamentals"



For more information about Miller Manufacturing and our products scan this QR code.



Check out our YouTube channel for a wide variety of short videos on Miller Manufacturing products.

Stay Connected With Us!



miller-mfg.com



[@MillerMfg](https://twitter.com/MillerMfg)



[Youtube.com/millermfg](https://www.youtube.com/millermfg)



[Linkedin.com/company/miller-manufacturing](https://www.linkedin.com/company/miller-manufacturing)



[@millermanufacturing](https://www.instagram.com/millermanufacturing)



[Miller Manufacturing](https://www.facebook.com/MillerManufacturing)



MIX
From responsible sources

FSC® C022483

12/25