

# DIVERSITECH®

Simplify  
the way  
you Work™

Issue 19



# HVAC

Product Catalog

1

PADS

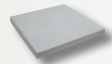

29

AIR  
MOVEMENT



37

GAS



41

CONDENSATE  
MANAGEMENT



63

GENERAL  
INDUSTRIAL



75

DEVCO

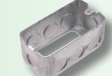

113

ELECTRICAL



151

TOOLS



175

PLUMBING

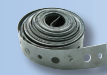

187

DUCTLESS  
SYSTEMS



203

MAINTENANCE  
CHEMICALS



233

INLINE  
COMPONENTS



249

DISTRIBUTOR  
SUPPORT



Welcome to our Issue 19 HVAC Catalog. This catalog is our largest and most comprehensive offering to the HVAC distributor. We've included many products and categories to help you consolidate your purchasing and make it easy to get what you need, all from one source. At DiversiTech our goal is to help you Simplify the Way You Work.

This Issue 19 catalog is full of new products and ideas to improve your business and help you add on sales. From pumps and motors to our new DiversiTech chemical packaging, we've filled this catalog full of great products and support to help you grow and succeed. We've also revamped the design of the catalog to make it easier to find what you need, fast. We hope you enjoy this new catalog and we look forward to your feedback and continued business.

Thank you for trusting your business to DiversiTech.

# How To Use This Catalog

## Literature and Support

DiversiTech provides complete literature and support collateral for many of the items in this catalog. Catalog items that have literature or other support pieces available are marked with an icon similar to the one to the left.

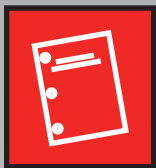

To view the complete listing of merchandising, literature and other collateral please see the Distributor Support section on pages 250-254.

## Images

We've made it easy for you to download any of the images in this catalog in either a JPG or EPS format. To download an image please visit our image library at [ftp://images.diversitech.com](http://images.diversitech.com)

This is the item number to use when ordering.

UOM=Unit of Measure. UOM will either be EA (each) or PK (pack). This tells how the item is priced to you, either by the each or by the pack.

| CATALOG NO. | DESCRIPTION                               | UOM | ORDER MULTIPLE |
|-------------|---|-----|----------------|
| C222        | Closed End Connectors 22-14 W, pack of 18 | PK  | 1              |

Brief listing of information about this item

Order multiple is the increment in which the item must be ordered. In this example, you can order in any increment since the order multiple is one.

| CATALOG NO. | DESCRIPTION                   | UOM | ORDER MULTIPLE |
|-------------|-------------------------------|-----|----------------|
| DDS-30      | 30A Fusible Disconnect Switch | EA  | 10             |

We've updated our listings to include Unit of Measure and Order Multiple for each item

In this example, this item is priced by the each.

This item must be ordered in multiples of 10; i.e. 10, 20, 30, etc.

# Image Downloads

For a specific catalog number please use the following format: For a JPG image go to : [ftp://images.diversitech.com/screen/catalog#.jpg](http://images.diversitech.com/screen/catalog#.jpg)  
 For an EPS image go to : [ftp://images.diversitech.com/print/catalog#.eps](http://images.diversitech.com/print/catalog#.eps)  
 For example, to download a JPG image of our CP-22 Condensate Pump from page 58 you would find the catalog number from the picture and enter [ftp://images.diversitech.com/screen/CP-22.jpg](http://images.diversitech.com/screen/CP-22.jpg)

# PADS

Air Handler Base.....26  
Anti-Vibration Pads..... 27-28  
Cladlite® Lightweight Equipment Pads.....22  
E Lite® Plastic Equipment Pads.....21  
Enviropad™.....25  
Heat Pump Pads .....25  
Heat Pump Risers .....26  
Heater Pads .....25  
Hef-T-Pad™.....24  
Mounting Brackets, Blocks .....27  
The Black Pad® .....24  
The Hurricane Pad™.....23  
Ultralite® Lightweight Equipment Pads.....20-21

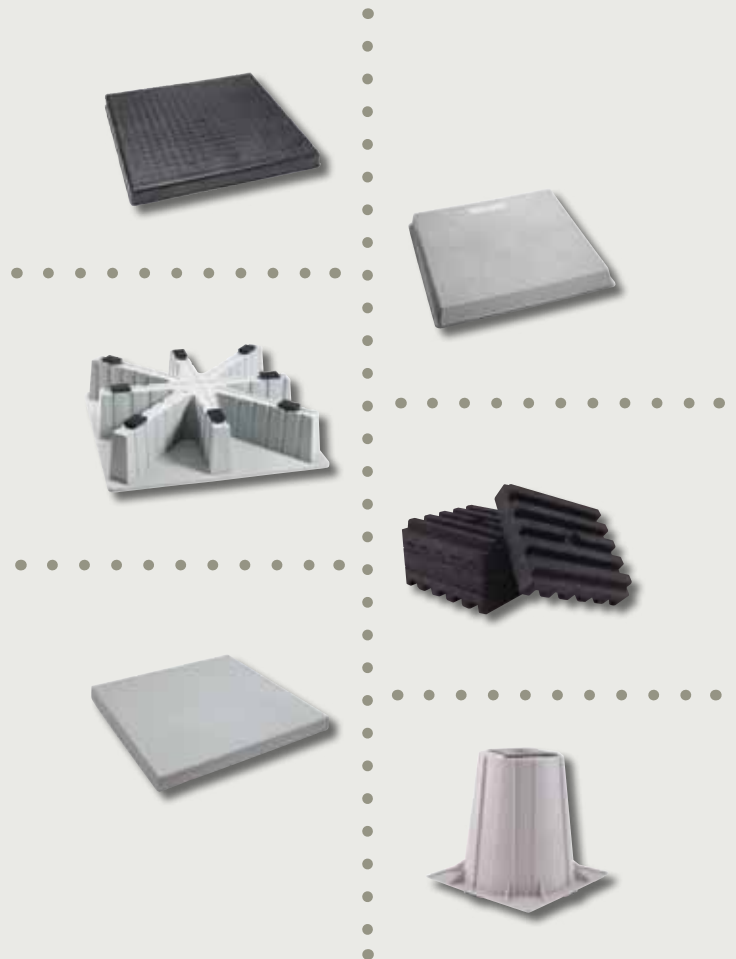

# E Lite® Plastic Equipment Pads

**E** Lite® is a plastic pad designed as a mounting base for air conditioning condensers. The rugged design provides uniform and generous ribbing for optimum, self-leveling ground support without inserts. E Lite® is injection molded from polypropylene, resulting in a pad that is lightweight, but not too light. A subtle texture prevents unit slide and presents a classic appearance, which is enhanced by rounded edges and a concrete gray color. Each pad is molded with its size in raised letters.



This information is available as a contractor handout.  
Order item number LIT-FLY-ELITE.

## TECHNICAL DATA

### MATERIAL

Polypropylene

### FREEZE/THAW

Flawless performance under the 25-cycle regimen specified by ASTM C67

### CHEMICAL RESISTANCE

Does not crack, flake, or warp when tested per ASTM D2299 with the following:

- R-22 and R-134a
- Synthetic canine urine
- Compressor oil
- Salt solution, 20% by volume



*Each pad is molded with its size in raised letters.*

## FEATURES AND BENEFITS

- Lightweight, yet rugged
- Drillable for securing unit
- Uniform ribbing transfers load evenly
- Unaffected by UV or weather
- Subtle texture resists unit slide



*The bottom of a 2" E Lite® pad shows extensive ribbing.*



*The bottom of a 3" E Lite® pad shows ribbing plus additional surface support.*



*E Lite® plastic equipment pads are manufactured at DiversiTech's Conyers, Georgia plant.*

# Hef-T-Pad™ Equipment Pads

*Hef-T-Pad™ is an injection molded equipment pad created from high impact polypropylene with UV inhibitors making it easy to handle, yet durable and strong. It does not require any additional equipment for moving and handling. Hef-T-Pad™ is resistant to impact, ultraviolet degradation and weathering and will not crack, flake, or warp. It is virtually impervious to climatic variations. Hef-T-Pad™ is drillable to permit installation of refrigerant and electrical lines under and through the pad and to allow equipment to be easily secured to the pad.*



This information is available as a contractor handout.  
Order item number LIT-FLY-HEF.

## FEATURES AND BENEFITS OF THE HEF-T-PAD™

Stabilization foot increases the surface area for bearing stabilization on soil; reduces sinking in soft soil under heavy load. Support ribs provide structural support.



Stabilization flange provides a wide perimeter that reduces sinking in soft soil under heavy load. Both the flange and ribbing provide reinforcement for the corners.



The thick walled polymer is suitable for drilling and screw fastening of equipment, line sets, and electrical connections.



Attractive neutral gray color with pad size and branding clearly embossed on pad surface.



Textured surface provides good aesthetics and a non-skid surface.

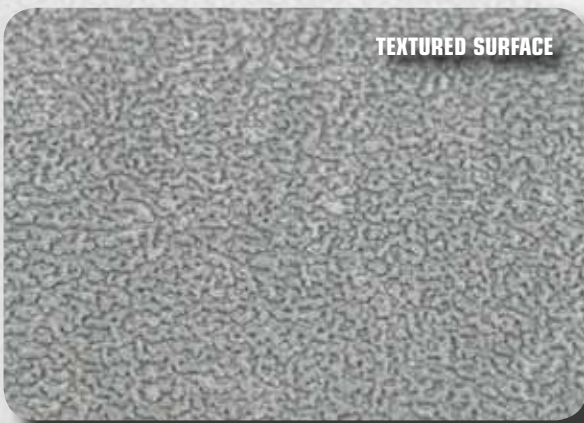

Pad size is molded into the side of the pad as well as the top surface.



# The Black Pad® replaces Concrete Equipment Bases

## Eco-friendly

**A**n innovative equipment base, The Black Pad® uses ground, recycled rubber in a co-injection process. The pad is extremely durable, resistant to ultraviolet light, and heavier than a completely plastic pad. The Black Pad® is ideal for pool and spa pumps, filters and heaters. The Black Pad® is extremely weather resistant and easy to drill and secure pool and spa equipment.



This information is available as a contractor handout.  
Order item number LIT-FLY-BPPPOOL.



- No cracking and less breakage than concrete
- Extremely durable, yet lightweight
- UV resistant; unaffected by weather
- Generous ribbing for optimum, self-leveling ground support
- Outer edges have rounded corners with double-thick walls
- Uniform ribbing transfers load evenly
- Textured surface prevents equipment slippage
- Drillable for securing equipment
- Made of recycled material
- ICC Certified to 1997 Standard Swimming Pool Code sections 305.2 Mounting and section 405 Equipment Foundations and Enclosures.

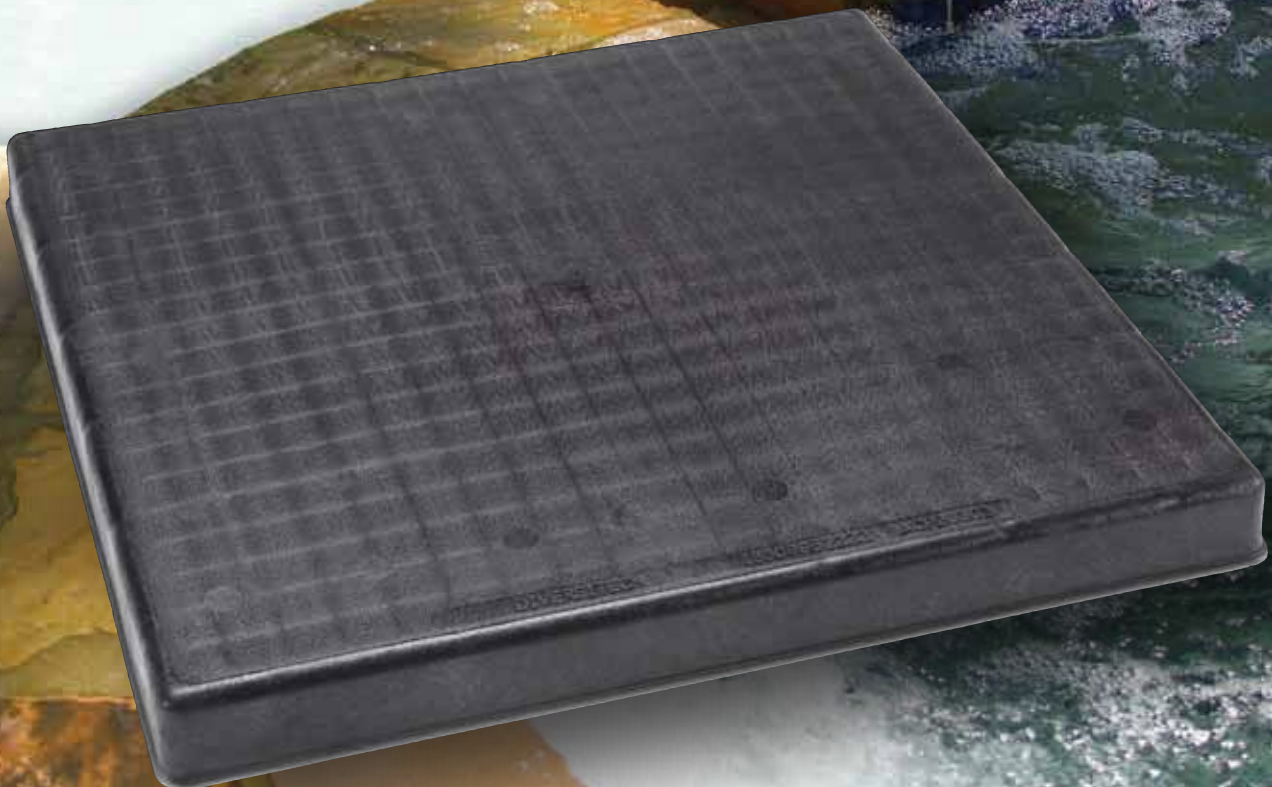
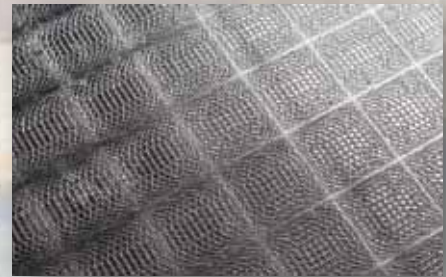

# UltraLite<sup>®</sup> Equipment Pads



UltraLite<sup>®</sup> Pads are made by DiversiTech, North America's largest manufacturer of equipment pads.

## FEATURES AND BENEFITS

**LIGHTWEIGHT** At an average weight of 2-1/2 pounds per square foot (12 kg. per square metre), the UltraLite lightweight concrete pad is one of the lightest equipment mounting products available today. Lightweight products are important for ease of handling on job site.

**DURABLE** The exterior of the UltraLite lightweight concrete pad is specifically engineered for long-term exterior weather resistance.

**DUCTILE** The skin and core of the UltraLite lightweight concrete pad is specifically engineered for flexibility and ductility demanded of job site handling. Additionally, the ductility of the outer skin facilitates conformance to slight ground contours without fracture.

**TIME/LABOR SAVINGS** Time is money, and hence any time savings on site translates into money saved. The UltraLite lightweight concrete pad literally installs in seconds while providing a solid foundation for the condensing unit.

**CONCRETE SURFACE** The concrete external skin of the UltraLite lightweight concrete pad is not subject to ultraviolet degradation or weathering discoloration.

**VIBRATION ABSORBING** The engineered polystyrene core in the UltraLite lightweight concrete pad absorbs and dampens vibration associated with normal operation of a condensing unit.

**FREEZE/THAW RESISTANT** The UltraLite lightweight concrete pad is vapor permeable. Water vapor evaporates through the pad, hence the concrete outer skin is not subject to expansion cracks.

**FLAME RESISTANT** The concrete outer skin of the UltraLite lightweight concrete pad is resistant to heating caused by the compressor. Additionally, the surface is resistant to heat from incidental torch flame during site installation.

**OUTSIDE STORAGE** The UltraLite lightweight concrete pad is intended for life in the outdoors. As such, the pad is suitable for exterior storage prior to site installation.

## TECHNICAL DATA

### LOADING

To achieve the maximum permissible pad load capacity, the earth under the pad must be capable of supporting the transmitted compression load of the UltraLite pad. All values tabulated assume the earth has a bearing capacity of at least 1000 pounds per square foot (48 kPa).

The allowable loads assume a uniformly distributed loading on the pad surface (that is, a relatively flat-bottomed condenser unit in contact with the pad). For condenser units with footpads or other point loads, the maximum concentrated load for any size UltraLite pad is 125 pounds per 2" (56 kg per 50 mm) diameter (or equivalent surface area) footpad.

### CHEMICAL RESISTANCE

In normal usage conditions an equipment pad can be exposed to a variety of chemicals. The UltraLite pad has been fully tested in accordance with ASTM D2299 for resistance against:

- R-22 and R-134a
- Compressor oil
- Salt solution, 20 percent by volume
- Synthetic canine urine

The UltraLite pad performs extraordinarily well under these testing criteria. UltraLite does not craze, soften, delaminate, or spall under exposure in this test.

### FREEZE/THAW TESTING

The UltraLite pad has been independently tested to the rigorous freeze-thaw regimen specified by ASTM C67. This standard dictates a twenty-five cycle freeze-thaw sequence. The freeze portion of the sequence takes place with the top surface of the UltraLite pad under 1/2" (12 mm) of water. Once twenty-five cycles are complete, the pad is examined using visual magnification. No cracks or crazing is permitted. UltraLite has performed flawlessly.



# CladLite® Equipment Pads



***Tough. Durable. Strong.***

CladLite® Equipment Pads provide the strength and durability customers demand in an easy to install pad. CladLite® Pads are up to 80% lighter than solid concrete but still provide rock solid support for equipment. Once it's set, so are you. CladLite® Pads stay in place and can withstand anything mother nature can throw at them. These pads provide superior resistance to sun, moisture, and freeze-thaw conditions. And the vibration dampening EPS foam core is unaffected by water, soil, fungus or bacteria. CladLite® Pads are available in 2" and 3" thickness and more than 70 different sizes so you can get the exact pad you need for the job. Get the concrete pads that homeowners prefer – CladLite®.

**CLADLITE® SPECIFICATIONS**

**Allowable Load:** 125 lbs. per 2" diameter foot

**Freeze/Thaw:** Flawless performance under the 25-cycle regimen specified by ASTM C67

**Chemical Resistance:** Does not craze, soften, delaminate, or spall when tested per ASTM D2299 with the following:

- R-22 and R-134a
- Compressor oil
- Synthetic canine urine
- Salt solution, 20% by volume

**Foam Core:** ASTM Type 1 EPS

**Flame Resistance:** Cladding resists compressor heat and incidental torch contact. Not to be used under heating devices.



# Heat Pump Pad™

*Ideal for snowy climates, the new DiversiTech Heat Pump Pad™ is the perfect solution for protecting equipment and ensuring proper operation year round. The Heat Pump Pad™ provides a full 8" clearance from ground level in a compact 36" square footprint. Included with every Heat Pump Pad™ are 8 anti-vibration pads, specifically molded into slots in the pad to reduce vibration and provide quiet operation of your equipment. The base of the pad is also angled to direct melting snow or condensate away from the unit and pad. Heat Pump Pads are made from recycled polypropylene so they are eco-friendly and are built tough to provide many years of service. These pads also nest together for easier transportation and warehousing.*

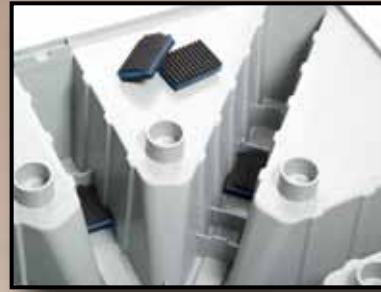

Each Heat Pump Pad™ includes eight Anti-Vibration pads to reduce equipment vibration and noise.

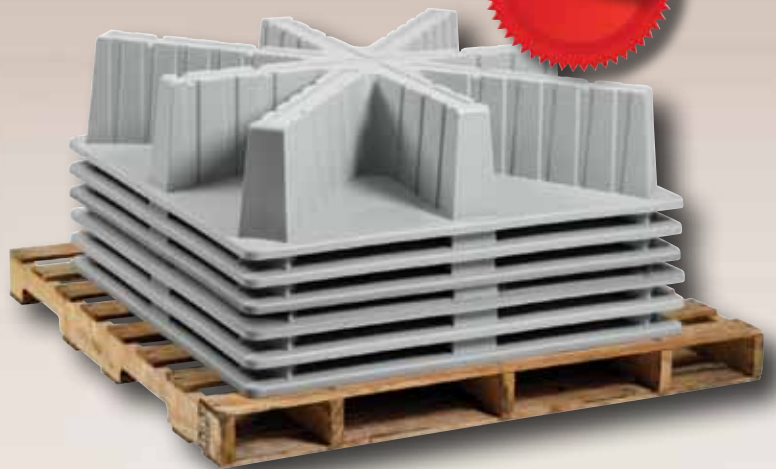

This information is available as a contractor handout.  
Order item number LIT-FLY-HEAT.



# The Hurricane Pad™

## THE HURRICANE & THE HURRICANE T-CLASS PADS

Hurricane Strength Equipment Pads designed to Florida's tough standards.

- Steel reinforced
- 9,000 PSI fiber-concrete
- Much lighter than solid concrete
- The Hurricane Pads keep units from sliding or blowing over in 150 MPH winds when properly attached (see The Hurricane T-Class Pads section at right for exceptions)

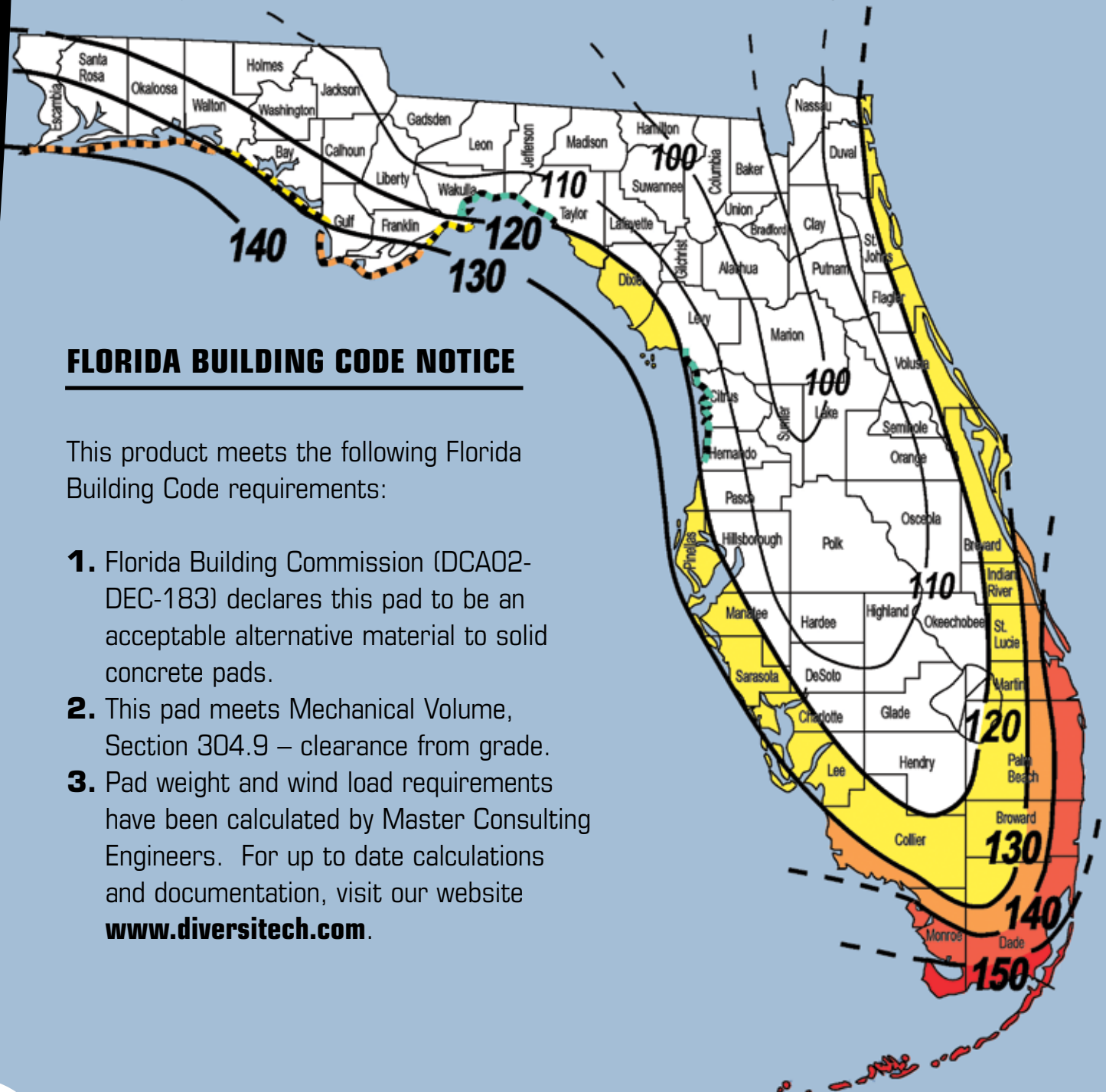

### FLORIDA BUILDING CODE NOTICE

This product meets the following Florida Building Code requirements:

1. Florida Building Commission (DCA02-DEC-183) declares this pad to be an acceptable alternative material to solid concrete pads.
2. This pad meets Mechanical Volume, Section 304.9 – clearance from grade.
3. Pad weight and wind load requirements have been calculated by Master Consulting Engineers. For up to date calculations and documentation, visit our website [www.diversitech.com](http://www.diversitech.com).

This information is available as a contractor handout.  
Order item number LIT-FLY-HPAD.



## THE HURRICANE T-CLASS PADS

For certain taller equipment profiles that are used in high wind zone areas, T-Class pads may be required. For a complete list of pad sizes and information, please go to [www.diversitech.com](http://www.diversitech.com).



*Equipment must be properly attached to The Hurricane Pad™ or The Hurricane T-Class Pad™ in order to prevent sliding and tipping in high winds.*

# Anti-Vibration Pads

## EVA™ PAD: The BEST Performer

EVA™ (Extreme Vibration Attenuation) is the latest generation in vibration dampening technology. In the most severe vibration extremes, testing shows the EVA™ pad outperforms cork and rubber by greater than 3:1 and outperforms our competitor's "waffle" pad by greater than 8:1! The enhanced performance comes from the special composite foam center which is structurally more sound than cork. EVA™ is not affected by oils or chemicals that can break down cork and is much more effective at vibration dampening than solid rubber. Designed to withstand 50 psi. Choose EVA™ to get the best of both worlds!

ANTI-VIBRATION PAD PERFORMANCE

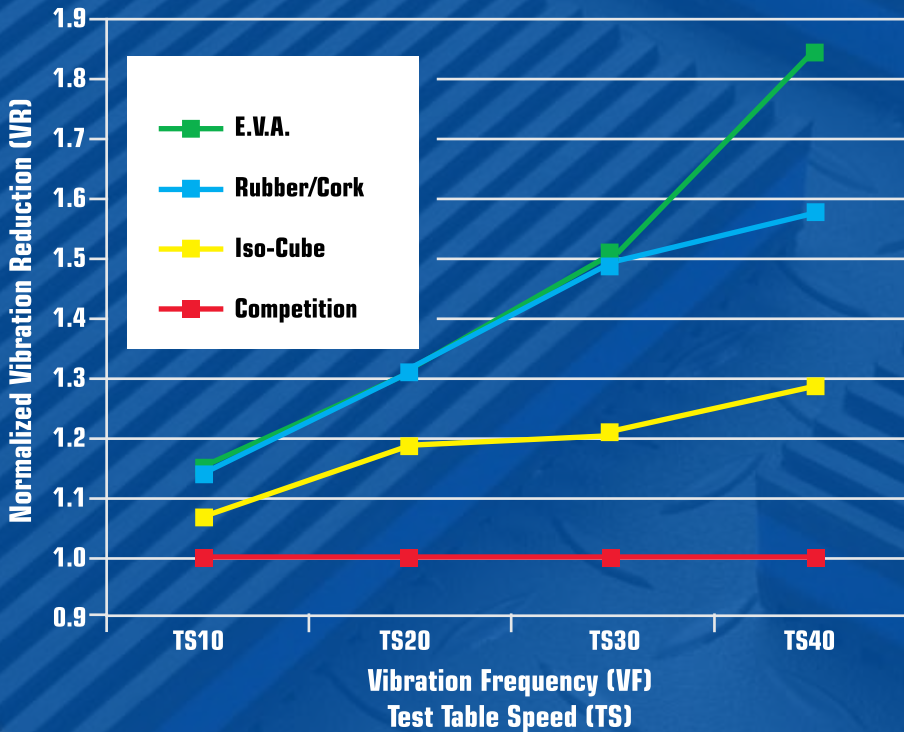

This information is available as a contractor handout.  
Order item number LIT-FLY-AVPAD.

## **RUBBER/CORK PAD: The Industry Standard**

These pads are made with the highest quality elastomeric oil resistant padding. Designed to withstand 50 psi. The rubber pads are corrugated on both sides and laminated to the cork center.

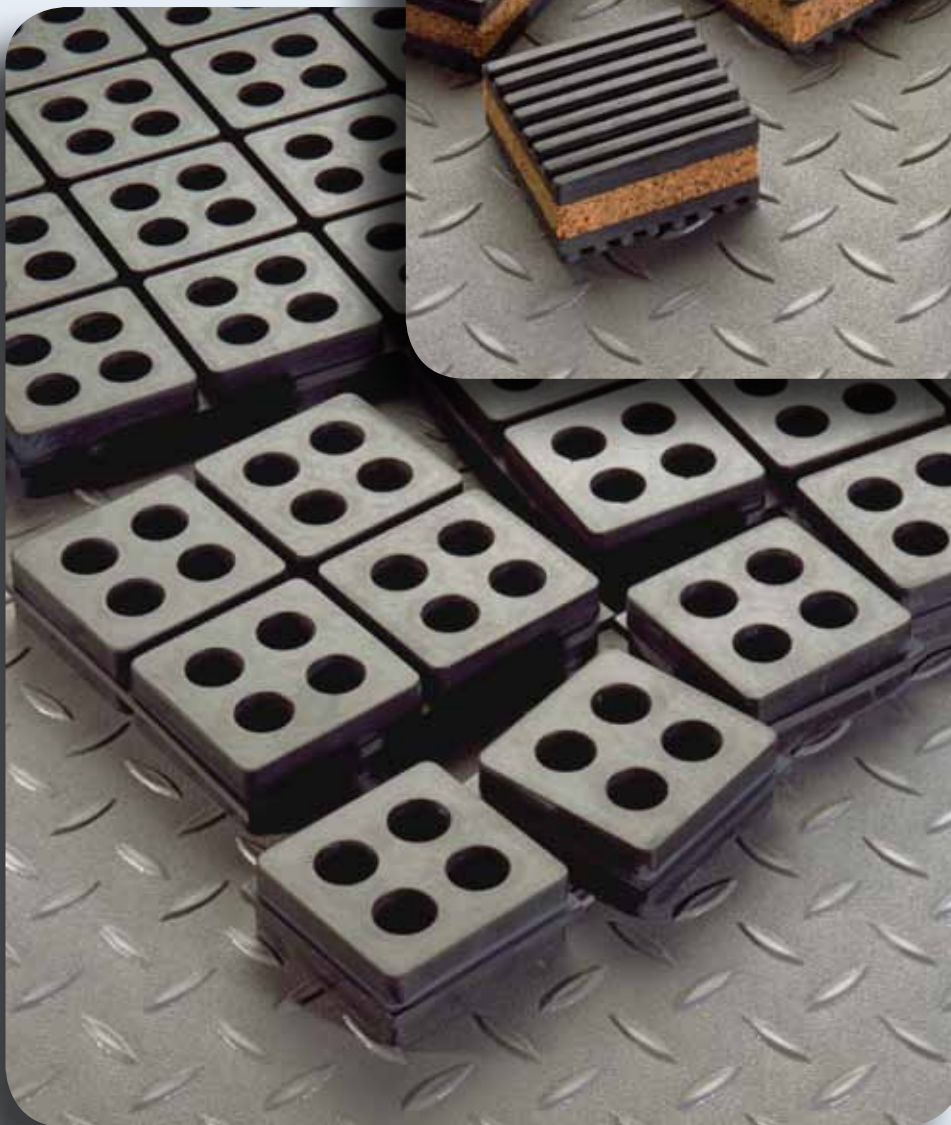
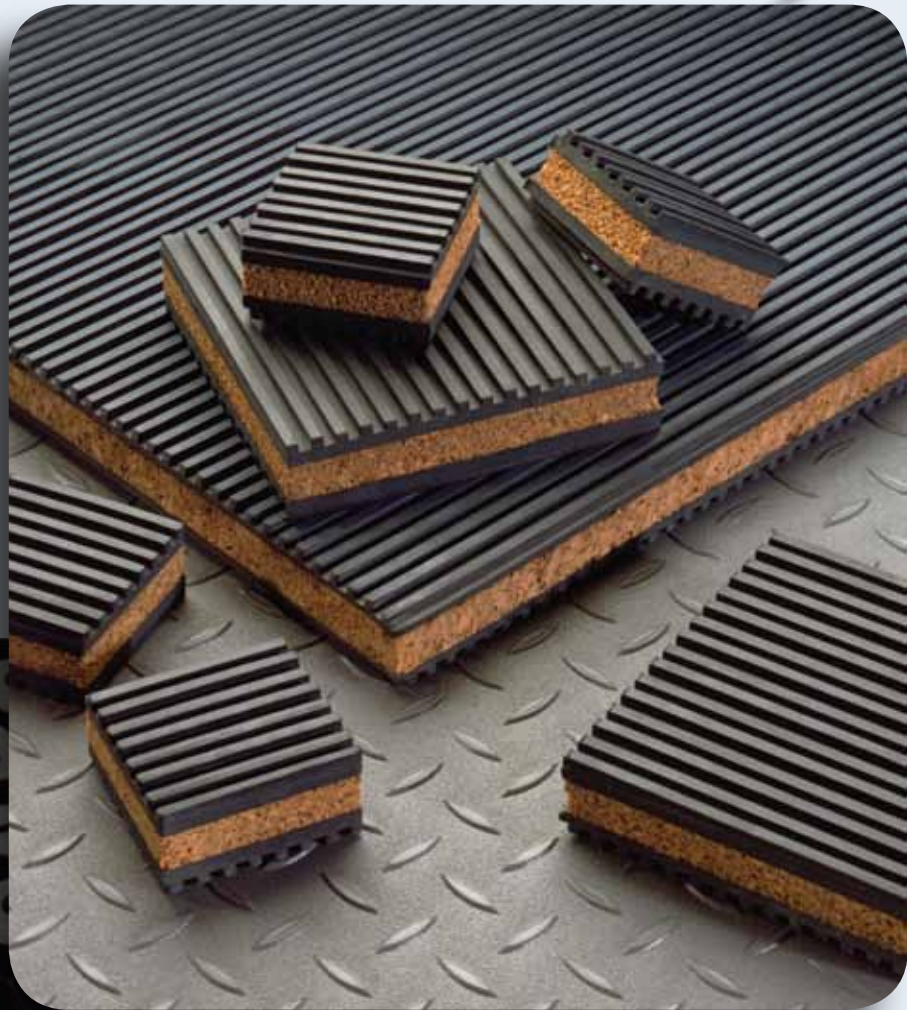

## **ISO-CUBE: Solid Rubber Tough**

Natural rubber pads designed to reduce vibration and noise emanating from refrigeration or AC equipment. Circular design offers a suction cup effect eliminating the need to bolt the pads down. A standard 18" pad divides into eighty-one 2" segments which may be cut or torn into smaller pads. The 50 durometer pads will withstand a load of 180 psi with great resiliency.

# A/C Brackets

*DiversiTech offers a complete selection of quality air conditioning brackets for standard and mini-split condensing units.*



### AIR CONDITIONING BRACKETS

These heavy duty 1/8" thick steel A/C brackets are perfect for hanging A/C condensers and heat pumps outside the home.

## Hef-T-Bracket™



### HEF-T-BRACKET™ TYPE 2

These brackets feature a cross bar that is attached to a wall and two L-shaped brackets that are hooked and bolted into place on the cross bar.



When operating in heat pump mode, the unit will produce condensate which is easily captured and managed using this snap on drain pan.

**Hef-T-Block™**



**HEF-T-BLOCK™**

For use as mounting bases when condensing units must be bolted down. End caps are also available for aesthetics.



**Hef-T-Frame™**

The flexibility of the Hef-T-Frame™ equipment support system means that “designing” is simple. It is a perfect solution for mounting any type of equipment. Simply start with a Hef-T-Frame™ Base and add as many Hef-T-Frame™ Extenders as needed to create your own system.

*See pages 188-189 for more information on the Hef-T-Frame™ equipment support system.*



**ULTRALITE® LIGHTWEIGHT EQUIPMENT PADS**

A true concrete equipment pad at the weight of plastic (about 2.5 lbs. per square foot). UltraLite® is strengthened by miles of fiber in each square foot of fiber-cement coating. This fiber allows the pad to flex instead of cracking or breaking. The textured surface prevents the condensing unit or portable generator from sliding, and allows water drainage, while the engineered encapsulated polystyrene (EPS) core prevents warping and provides a solid bottom to resist settling. Unaffected by soil conditions, ultraviolet (UV) light, temperature extremes, and other weather conditions.

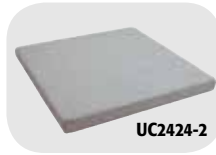

**3" UltraLite® Pads**

Where local codes supersede the International code and require a pad thicker than 2" – 3" UltraLite® is the solution.



**2" UltraLite® Pads**

The 2" thick UltraLite® pad is the industry standard. Used across a wide variety of applications, unless a thicker pad (3") is required by the local building code.

| CATALOG NO. | SIZE    | PAD WT. | PALLET QTY. | PALLET WT. | UOM | ORDER MULTIPLE |
|-------------|---------|---------|-------------|------------|-----|----------------|
| UC1636-2    | 16 X 36 | 11      | 20          | 250        | EA  | 20             |
| UC2424-2    | 24 X 24 | 15      | 20          | 323        | EA  | 20             |
| UC2430-2    | 24 X 30 | 17      | 20          | 361        | EA  | 20             |
| UC2436-2    | 24 X 36 | 22      | 20          | 455        | EA  | 20             |
| UC2448-2    | 24 X 48 | 18      | 20          | 385        | EA  | 20             |
| UC2626-2    | 26 X 26 | 17      | 20          | 365        | EA  | 20             |
| UC2628-2    | 26 X 28 | 19      | 20          | 397        | EA  | 20             |
| UC2636-2    | 26 X 36 | 21      | 20          | 446        | EA  | 20             |
| UC3030-2    | 30 X 30 | 21      | 20          | 441        | EA  | 20             |
| UC3036-2    | 30 X 36 | 27      | 20          | 571        | EA  | 20             |
| UC3040-2    | 30 X 40 | 30      | 20          | 617        | EA  | 20             |
| UC3143-2    | 31 X 43 | 26      | 20          | 551        | EA  | 20             |
| UC3232-2    | 32 X 32 | 24      | 20          | 501        | EA  | 20             |
| UC3234-2    | 32 X 34 | 23      | 20          | 485        | EA  | 20             |
| UC3237-2    | 32 X 37 | 28      | 20          | 579        | EA  | 20             |
| UC3434-2    | 34 X 34 | 23      | 20          | 493        | EA  | 20             |
| UC3445-2    | 34 X 45 | 45      | 20          | 915        | EA  | 20             |
| UC3636-2    | 36 X 36 | 27      | 20          | 555        | EA  | 20             |
| UC3640-2    | 36 X 40 | 29      | 20          | 608        | EA  | 20             |
| UC3648-2    | 36 X 48 | 35      | 20          | 725        | EA  | 20             |
| UC3842-2    | 38 X 42 | 30      | 20          | 625        | EA  | 20             |
| UC4040-2    | 40 X 40 | 32      | 20          | 644        | EA  | 20             |
| UC4147-2    | 41 X 47 | 39      | 20          | 805        | EA  | 20             |

U.S. Patents 7,334,385; 7,232,589; 6,931,822; 6,927,183; 5,728,458; 5,664,394; 5,268,226; 5,209,968, and patents pending. ICBO PFC-5112.

| CATALOG NO. | SIZE    | PAD WT. | PALLET QTY. | PALLET WT. | UOM | ORDER MULTIPLE |
|-------------|---------|---------|-------------|------------|-----|----------------|
| UC1636-3    | 16 X 36 | 18      | 15          | 297        | EA  | 15             |
| UC2424-3    | 24 X 24 | 18      | 15          | 294        | EA  | 15             |
| UC2430-3    | 24 X 30 | 21      | 15          | 339        | EA  | 15             |
| UC2436-3    | 24 X 36 | 26      | 15          | 412        | EA  | 15             |
| UC2442-3    | 24 X 42 | 28      | 15          | 441        | EA  | 15             |
| UC2448-3    | 24 X 48 | 28      | 15          | 443        | EA  | 15             |
| UC2626-3    | 26 X 26 | 17      | 15          | 279        | EA  | 15             |
| UC2636-3    | 26 X 36 | 29      | 15          | 428        | EA  | 15             |
| U2660-3     | 26 X 60 | 55      | 15          | 850        | EA  | 15             |
| UC2838-3    | 28 X 38 | 30      | 15          | 471        | EA  | 15             |
| UC3030-3    | 30 X 30 | 23      | 15          | 370        | EA  | 15             |
| UC3036-3    | 30 X 36 | 30      | 15          | 471        | EA  | 15             |
| UC3040-3    | 30 X 40 | 33      | 15          | 517        | EA  | 15             |
| UC3048-3    | 30 X 48 | 40      | 15          | 625        | EA  | 15             |
| U3060-3     | 30 X 60 | 63      | 15          | 970        | EA  | 15             |
| UC3232-3    | 32 X 32 | 26      | 15          | 411        | EA  | 15             |
| UC3237-3    | 32 X 37 | 27      | 15          | 436        | EA  | 15             |
| U3353-3     | 33 X 53 | 68      | 15          | 1,045      | EA  | 15             |
| UC3434-3    | 34 X 34 | 27      | 15          | 427        | EA  | 15             |
| UC3445-3    | 34 X 45 | 39      | 15          | 612        | EA  | 15             |
| U3465-3     | 34 X 65 | 71      | 15          | 1,090      | EA  | 15             |
| UC3636-3    | 36 X 36 | 34      | 15          | 528        | EA  | 15             |
| UC3642-3    | 36 X 42 | 32      | 15          | 510        | EA  | 15             |
| UC3648-3    | 36 X 48 | 37      | 15          | 579        | EA  | 15             |
| U3650-3     | 36 X 50 | 38      | 15          | 595        | EA  | 15             |
| U3654-3     | 36 X 54 | 71      | 15          | 1,096      | EA  | 15             |
| U3660-3     | 36 X 60 | 49      | 15          | 767        | EA  | 15             |
| U3678-3     | 36 X 78 | 99      | 15          | 1,510      | EA  | 15             |
| UC3842-3    | 38 X 42 | 35      | 15          | 550        | EA  | 15             |
| U3865-3     | 38 X 65 | 85      | 15          | 1,300      | EA  | 15             |
| U3870-3     | 38 X 70 | 113     | 15          | 1,720      | EA  | 15             |
| UC4040-3    | 40 X 40 | 34      | 15          | 510        | EA  | 15             |
| UC4042-3    | 40 X 42 | 36      | 15          | 565        | EA  | 15             |
| U4054-3     | 40 X 54 | 81      | 15          | 1,240      | EA  | 15             |
| UC4347-3    | 43 X 47 | 60      | 15          | 925        | EA  | 15             |
| U4550-3     | 45 X 50 | 81      | 15          | 1,240      | EA  | 15             |
| U4558-3     | 45 X 58 | 93      | 15          | 1,420      | EA  | 15             |
| U4848-3     | 48 X 48 | 85      | 15          | 1,300      | EA  | 15             |
| U4854-3     | 48 X 54 | 91      | 15          | 1,390      | EA  | 15             |
| U4866-3     | 48 X 66 | 108     | 15          | 1,645      | EA  | 15             |
| U5053-3     | 50 X 53 | 92      | 15          | 1,405      | EA  | 15             |
| U5056-3     | 50 X 56 | 97      | 15          | 1,480      | EA  | 15             |
| U5075-3     | 50 X 75 | 130     | 15          | 1,975      | EA  | 15             |
| U5079-3     | 50 X 79 | 145     | 15          | 2,200      | EA  | 15             |
| U5252-3     | 52 X 52 | 94      | 15          | 1,435      | EA  | 15             |
| U5260-3     | 52 X 60 | 109     | 15          | 1,660      | EA  | 15             |
| U5557-3     | 55 X 57 | 109     | 15          | 1,660      | EA  | 15             |
| U6067-3     | 60 X 67 | 134     | 15          | 2,035      | EA  | 15             |

\* California Earthquake Code Compliant.



Literature – Download all literature from the DiversiTech website using the Form ID shown in the icon. The URL is [www.diversitech.com/literature/FORMID.pdf](http://www.diversitech.com/literature/FORMID.pdf)

**ULTRALITE® LIGHTWEIGHT EQUIPMENT PADS cont'd**

**3" UltraLite® Wedge Pads**

The new UltraLite® Wedge Pad is designed for Lennox condensing units.



UC3132-3L



| CATALOG NO. | SIZE    | PAD WT. | PALLET QTY. | PALLET WT. | UOM | ORDER MULTIPLE |
|-------------|---------|---------|-------------|------------|-----|----------------|
| UC3132-3L   | 31 X 32 | 23.33   | 15          | 350        | EA  | 15             |
| UC3539-3L   | 35 X 39 | 33.46   | 15          | 502        | EA  | 15             |
| UC4044-3L   | 40 X 44 | 37.53   | 15          | 563        | EA  | 15             |

**UltraLite® Earthquake Code Compliant Pads**

Required nearly exclusively in Southern California, the UltraLite® pad is available for compliance with strict attachment provisions detailed in earthquake prone local building codes.

UltraLite® earthquake code compliant pads are only available for sale in regions where local codes mandate installation of pads with these particular characteristics. Currently these locales include most of Southern California, portions of Washington, and portions of Oregon.



UC2424-3CA



| CATALOG NO.           | SIZE     | PAD WT. | PALLET QTY. | PALLET WT. | UOM | ORDER MULTIPLE |
|-----------------------|----------|---------|-------------|------------|-----|----------------|
| UC2424-3CA            | 24 X 24  | 14      | 15          | 241        | EA  | 15             |
| UC2436-3CA            | 24 X 36  | 22      | 15          | 349        | EA  | 15             |
| <b>NEW</b> UC2448-3CA | 24 X 48* | 28      | 15          | 443        | EA  | 15             |
| UC2636-3CA            | 26 X 36  | 29      | 15          | 428        | EA  | 15             |
| UC2838-3CA            | 28 X 38  | 26      | 15          | 411        | EA  | 15             |
| UC3030-3CA            | 30 X 30  | 22      | 15          | 351        | EA  | 15             |
| UC3036-3CA            | 30 X 36  | 25      | 15          | 400        | EA  | 15             |
| UC3040-3CA            | 30 X 40  | 34      | 15          | 510        | EA  | 15             |
| UC3232-3CA            | 32 X 32  | 24      | 15          | 381        | EA  | 15             |
| UC3445-3CA            | 34 X 45  | 33      | 15          | 516        | EA  | 15             |
| UC3636-3CA            | 36 X 36  | 28      | 15          | 441        | EA  | 15             |
| UC3642-3CA            | 36 X 42  | 32      | 15          | 510        | EA  | 15             |
| UC3648-3CA            | 36 X 48  | 37      | 15          | 579        | EA  | 15             |
| UC4040-3CA            | 40 X 40  | 34      | 15          | 510        | EA  | 15             |

**E LITE® PLASTIC EQUIPMENT PADS**

E Lite's rugged design provides uniform and generous ribbing for optimum, self-leveling ground support without inserts. The result is a pad that is lightweight, but not too light. A subtle texture prevents unit slide and presents a classic appearance, which is enhanced by rounded edges and a concrete gray color. Each pad is molded with a size label and a symbol representing content of recycled material.



EL2424-2



**3" E Lite® Pads**

Used where local codes supersede the International code and require a pad thicker than 2".



EL5658-3



**2" E Lite® Pads**

The 2" thick E Lite® pad is the choice for plastic pads, unless a thicker pad (3") is required by the local building code.

| CATALOG NO. | SIZE    | PAD WT. | PALLET QTY. | PALLET WT. | UOM | ORDER MULTIPLE |
|-------------|---------|---------|-------------|------------|-----|----------------|
| EL2424-2    | 24 X 24 | 7       | 44          | 333        | EA  | 44             |
| EL2430-2    | 24 X 30 | 9       | 22          | 219        | EA  | 22             |
| EL2436-2    | 24 X 36 | 11      | 22          | 256        | EA  | 22             |
| EL2626-2    | 26 X 26 | 8       | 22          | 205        | EA  | 22             |
| EL3030-2    | 30 X 30 | 11      | 22          | 265        | EA  | 22             |
| EL3036-2    | 30 X 36 | 13      | 22          | 313        | EA  | 22             |
| EL3040-2    | 30 X 40 | 15      | 22          | 346        | EA  | 22             |
| EL3232-2    | 32 X 32 | 13      | 22          | 300        | EA  | 22             |
| EL3238-2    | 32 X 38 | 15      | 22          | 351        | EA  | 22             |
| EL3244-2    | 32 X 44 | 17      | 22          | 401        | EA  | 22             |
| EL3434-2    | 34 X 34 | 14      | 22          | 350        | EA  | 22             |
| EL3636-2    | 36 X 36 | 16      | 22          | 373        | EA  | 22             |
| EL3640-2    | 36 X 40 | 18      | 22          | 410        | EA  | 22             |
| EL3648-2    | 36 X 48 | 29      | 22          | 663        | EA  | 22             |
| EL3842-2    | 38 X 42 | 19      | 22          | 470        | EA  | 22             |

| CATALOG NO. | SIZE    | PAD WT. | PALLET QTY. | PALLET WT. | UOM | ORDER MULTIPLE |
|-------------|---------|---------|-------------|------------|-----|----------------|
| EL1838-3    | 18 X 38 | 16      | 16          | 300        | EA  | 16             |
| EL2424-3    | 24 X 24 | 13      | 16          | 225        | EA  | 16             |
| EL2430-3    | 24 X 30 | 16      | 16          | 277        | EA  | 16             |
| EL2436-3    | 24 X 36 | 19      | 16          | 321        | EA  | 16             |
| EL3030-3    | 30 X 30 | 20      | 16          | 345        | EA  | 16             |
| EL3040-3    | 30 X 40 | 26      | 16          | 448        | EA  | 16             |
| EL3232-3    | 32 X 32 | 21      | 16          | 353        | EA  | 16             |
| EL3238-3    | 32 X 38 | 26      | 16          | 448        | EA  | 16             |
| EL3244-3    | 32 X 44 | 30      | 16          | 499        | EA  | 16             |
| EL3434-3    | 34 X 34 | 22      | 16          | 400        | EA  | 16             |
| EL3636-3    | 36 X 36 | 28      | 16          | 471        | EA  | 16             |
| EL3640-3    | 36 X 40 | 31      | 16          | 521        | EA  | 16             |
| EL3648-3    | 36 X 48 | 36      | 16          | 601        | EA  | 16             |
| EL3842-3    | 38 X 42 | 33      | 16          | 575        | EA  | 16             |
| EL3870-3    | 38 X 70 | 36      | 16          | 604        | EA  | 16             |
| EL4040-3    | 40 X 40 | 31      | 16          | 546        | EA  | 16             |
| EL4558-3    | 45 X 58 | 33      | 16          | 545        | EA  | 16             |
| EL4848-3    | 48 X 48 | 29      | 16          | 481        | EA  | 16             |
| EL4872-3    | 48 X 72 | 72      | 16          | 1,177      | EA  | 16             |
| EL5252-3    | 52 X 52 | 48      | 16          | 793        | EA  | 16             |
| EL5658-3    | 56 X 58 | 43      | 16          | 715        | EA  | 16             |

**CLADLITE® LIGHTWEIGHT EQUIPMENT PADS**

Concrete surface and superior performance at 20% the weight of conventional concrete pads. The cladding provides superior resistance to sun, moisture and freeze-thaw conditions; the engineered encapsulated polystyrene (EPS) core is virtually impervious to water, soil conditions, fungus and bacteria. CladLite® is further strengthened by continuous steel reinforcement throughout the cladding. CladLite® is code approved for installation throughout the U.S.

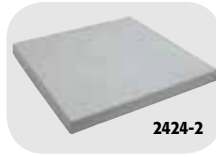

2424-2



**3" CladLite® Pads**

Used where local codes supersede the International code and require a pad thicker than 2".

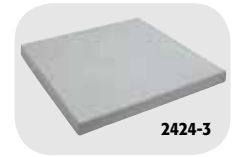

2424-3



**2" CladLite® Pads**

The 2" thick CladLite® pad is the choice for equipment pads, unless a thicker pad (3") is required by the local building code.

| CATALOG NO.       | SIZE     | PAD WT. | PALLET QTY. | PALLET WT. | UOM | ORDER MULTIPLE |
|-------------------|----------|---------|-------------|------------|-----|----------------|
| 1636-2            | 16 X 36  | 33      | 25          | 850        | EA  | 25             |
| 2424-2            | 24 X 24  | 36      | 25          | 913        | EA  | 25             |
| 2430-2            | 24 X 30  | 37      | 25          | 950        | EA  | 25             |
| 2436-2            | 24 X 36  | 50      | 25          | 1,275      | EA  | 25             |
| 2442-2            | 24 X 42  | 57      | 25          | 1,450      | EA  | 25             |
| 2448-2            | 24 X 48  | 72      | 25          | 1,825      | EA  | 25             |
| 2454-2            | 24 X 54  | 84      | 25          | 2,125      | EA  | 25             |
| 26-2              | 26 Round | 31      | 25          | 800        | EA  | 25             |
| 2626-2            | 26 X 26  | 38      | 25          | 975        | EA  | 25             |
| 2636-2            | 26 X 36  | 54      | 25          | 1,375      | EA  | 25             |
| 2660-2            | 26 X 60  | 95      | 25          | 2,400      | EA  | 25             |
| 2838-2            | 28 X 38  | 55      | 25          | 1,400      | EA  | 25             |
| 30-2              | 30 Round | 36      | 25          | 925        | EA  | 25             |
| 3030-2            | 30 X 30  | 48      | 25          | 1,225      | EA  | 25             |
| 3036-2            | 30 X 36  | 60      | 25          | 1,525      | EA  | 25             |
| 3040-2            | 30 X 40  | 70      | 25          | 1,775      | EA  | 25             |
| 3048-2            | 30 X 48  | 72      | 25          | 1,825      | EA  | 25             |
| 3060-2            | 30 X 60  | 112     | 25          | 2,825      | EA  | 25             |
| 3143-2            | 31 X 43  | 83      | 25          | 2,100      | EA  | 25             |
| 32-2              | 32 Round | 44      | 25          | 1,125      | EA  | 25             |
| 3232-2            | 32 X 32  | 54      | 25          | 1,375      | EA  | 25             |
| 3237-2            | 32 X 37  | 66      | 25          | 1,675      | EA  | 25             |
| 3434-2            | 34 X 34  | 63      | 25          | 1,600      | EA  | 25             |
| 36-2              | 36 Round | 51      | 25          | 1,300      | EA  | 25             |
| 3636-2            | 36 X 36  | 76      | 25          | 1,925      | EA  | 25             |
| 3640-2            | 36 X 40  | 81      | 25          | 2,050      | EA  | 25             |
| 3648-2            | 36 X 48  | 115     | 25          | 2,900      | EA  | 25             |
| 3654-2            | 36 X 54  | 93      | 25          | 2,350      | EA  | 25             |
| 3842-2            | 38 X 42  | 81      | 25          | 2,100      | EA  | 25             |
| 4147-2            | 41 X 47  | 115     | 25          | 2,900      | EA  | 25             |
| <b>NEW</b> 4848-2 | 48 X 48  | 100     | 25          | 2,525      | EA  | 25             |
| 5050-2            | 50 X 50  | 120     | 20          | 2,425      | EA  | 20             |

U.S. Patent number 4,505,449, and patents pending. ICBO No. PFC-5112.

| CATALOG NO. | SIZE     | PAD WT. | PALLET QTY. | PALLET WT. | UOM | ORDER MULTIPLE |
|-------------|----------|---------|-------------|------------|-----|----------------|
| 1636-3      | 16 X 36  | 46      | 20          | 945        | EA  | 20             |
| 2424-3      | 24 X 24  | 49      | 20          | 995        | EA  | 20             |
| 2430-3      | 24 X 30  | 57      | 20          | 1,165      | EA  | 20             |
| 2436-3      | 24 X 36  | 63      | 20          | 1,285      | EA  | 20             |
| 2448-3      | 24 X 48  | 71      | 20          | 1,445      | EA  | 20             |
| 2460-3      | 24 X 60  | 105     | 20          | 2,125      | EA  | 20             |
| 2626-3      | 26 X 26  | 53      | 20          | 1,085      | EA  | 20             |
| 2660-3      | 26 X 60  | 109     | 20          | 2,205      | EA  | 20             |
| 2838-3      | 28 X 38  | 84      | 20          | 1,705      | EA  | 20             |
| 3030-3      | 30 X 30  | 62      | 20          | 1,265      | EA  | 20             |
| 3036-3      | 30 X 36  | 71      | 20          | 1,445      | EA  | 20             |
| 3040-3      | 30 X 40  | 94      | 20          | 1,905      | EA  | 20             |
| 3060-3      | 30 X 60  | 130     | 15          | 1,975      | EA  | 15             |
| 3143-3      | 31 X 43  | 74      | 20          | 1,505      | EA  | 20             |
| 32-3        | 32 Round | 67      | 20          | 1,365      | EA  | 20             |
| 3232-3      | 32 X 32  | 68      | 20          | 1,385      | EA  | 20             |
| 3237-3      | 32 X 37  | 87      | 20          | 1,765      | EA  | 20             |
| 3345-3      | 33 X 45  | 117     | 20          | 2,365      | EA  | 20             |
| 3434-3      | 34 X 34  | 86      | 20          | 1,770      | EA  | 20             |
| 3465-3      | 34 X 65  | 160     | 15          | 2,425      | EA  | 15             |
| 36-3        | 36 Round | 80      | 20          | 1,625      | EA  | 20             |
| 3636-3      | 36 X 36  | 100     | 20          | 2,025      | EA  | 20             |
| 3640-3      | 36 X 40  | 120     | 20          | 2,425      | EA  | 20             |
| 3648-3      | 36 X 48  | 132     | 20          | 2,665      | EA  | 20             |
| 3650-3      | 36 X 50  | 137     | 15          | 2,080      | EA  | 15             |
| 3660-3      | 36 X 60  | 163     | 15          | 2,470      | EA  | 15             |
| 3678-3      | 36 X 78  | 196     | 10          | 1,985      | EA  | 10             |
| 3842-3      | 38 X 42  | 132     | 20          | 2,700      | EA  | 20             |
| 3865-3      | 38 X 65  | 179     | 15          | 2,710      | EA  | 15             |
| 3870-3      | 38 X 70  | 179     | 10          | 1,815      | EA  | 10             |
| 4042-3      | 40 X 42  | 170     | 10          | 1,700      | EA  | 10             |
| 4054-3      | 40 X 54  | 167     | 15          | 2,530      | EA  | 15             |
| 4062-3      | 40 X 62  | 179     | 10          | 1,815      | EA  | 10             |
| 4147-3      | 41 X 47  | 140     | 15          | 2,125      | EA  | 15             |
| 4183-3      | 41 X 83  | 231     | 10          | 2,335      | EA  | 10             |
| 4550-3      | 45 X 50  | 158     | 15          | 2,395      | EA  | 15             |
| 4558-3      | 45 X 58  | 177     | 15          | 2,680      | EA  | 15             |
| 4766-3      | 47 X 66  | 219     | 10          | 2,215      | EA  | 10             |
| 4848-3      | 48 X 48  | 150     | 15          | 2,275      | EA  | 15             |
| 5053-3      | 50 X 53  | 194     | 15          | 2,935      | EA  | 15             |
| 5056-3      | 50 X 56  | 212     | 10          | 2,145      | EA  | 10             |
| 5058-3      | 50 X 58  | 212     | 10          | 2,145      | EA  | 10             |
| 5070-3      | 50 X 70  | 257     | 10          | 2,595      | EA  | 10             |
| 5252-3      | 52 X 52  | 197     | 10          | 1,995      | EA  | 10             |
| 5557-3      | 55 X 57  | 237     | 10          | 2,395      | EA  | 10             |
| 6067-3      | 60 X 67  | 284     | 10          | 2,865      | EA  | 10             |



Literature - Download all literature from the DiversiTech website using the Form ID shown in the icon. The URL is [www.diversitech.com/literature/FORMID.pdf](http://www.diversitech.com/literature/FORMID.pdf)

### The Hurricane Pad™

Designed specifically for the hurricane prone regions of Florida and the Gulf Coast, The Hurricane Pad™ meets stringent local code requirements for wind resistance. Heavier than a normal concrete pad, this 4" pad provides sufficient weight to meet code. For certain taller equipment, The Hurricane T-Class Pad™ is needed. Due to their extra weight, standard freight terms only apply for shipments to Florida. All other shipments are shipped FOB Conyers, GA.



H2424-4



### The Hurricane T-Class Pad™

The Hurricane T-Class Pad™ is even heavier than The Hurricane Pad™ and is designed to meet the higher wind loads of taller equipment. The taller the piece of equipment mounted to the pad, the greater the wind load on the pad. These heavier 4" pads provide sufficient weight to meet code for these taller condensing units. Due to their extra weight, standard freight terms for The Hurricane T-Class Pad™ only apply for shipments to Florida. All other shipments are shipped FOB Conyers, GA.



HT2424-4



| CATALOG NO. | SIZE    | PALLET QTY. | UOM | ORDER MULTIPLE |
|-------------|---------|-------------|-----|----------------|
| H1840-4     | 18 X 40 | 16          | EA  | 16             |
| H2424-4     | 24 X 24 | 16          | EA  | 16             |
| H2436-4     | 24 X 36 | 16          | EA  | 16             |
| H3030-4     | 30 X 30 | 16          | EA  | 16             |
| H3060-4     | 30 X 60 | 16          | EA  | 16             |
| H3232-4     | 32 X 32 | 16          | EA  | 16             |
| H3345-4     | 33 X 45 | 16          | EA  | 16             |
| H3434-4     | 34 X 34 | 16          | EA  | 16             |
| H3636-4     | 36 X 36 | 16          | EA  | 16             |
| H3642-4     | 36 X 42 | 16          | EA  | 16             |
| H3648-4     | 36 X 48 | 16          | EA  | 16             |
| H3652-4     | 36 X 52 | 8           | EA  | 8              |
| H3672-4     | 36 X 72 | 8           | EA  | 8              |
| H3842-4     | 38 X 42 | 16          | EA  | 16             |
| H3852-4     | 38 X 52 | 8           | EA  | 8              |
| H3865-4     | 38 X 65 | 8           | EA  | 8              |
| H4040-4     | 40 X 40 | 8           | EA  | 8              |
| H4242-4     | 42 X 42 | 8           | EA  | 8              |
| H4545-4     | 45 X 45 | 8           | EA  | 8              |
| H4558-4     | 45 X 58 | 8           | EA  | 8              |
| H5151-4     | 51 X 51 | 8           | EA  | 8              |
| H5557-4     | 55 X 57 | 8           | EA  | 8              |

| CATALOG NO. | SIZE    | PALLET QTY. | UOM | ORDER MULTIPLE |
|-------------|---------|-------------|-----|----------------|
| HT2424-4    | 24 X 24 | 10          | EA  | 10             |
| HT2436-4    | 24 X 36 | 10          | EA  | 10             |
| HT3030-4    | 30 X 30 | 10          | EA  | 10             |
| HT3060-4    | 30 X 60 | 10          | EA  | 10             |
| HT3232-4    | 32 X 32 | 10          | EA  | 10             |
| HT3345-4    | 33 X 45 | 10          | EA  | 10             |
| HT3434-4    | 34 X 34 | 10          | EA  | 10             |
| HT3636-4    | 36 X 36 | 10          | EA  | 10             |
| HT3642-4    | 36 X 42 | 10          | EA  | 10             |
| HT3648-4    | 36 X 48 | 10          | EA  | 10             |
| HT3652-4    | 36 X 52 | 10          | EA  | 10             |
| HT3672-4    | 36 X 72 | 10          | EA  | 10             |
| HT3842-4    | 38 X 42 | 10          | EA  | 10             |
| HT3852-4    | 38 X 52 | 10          | EA  | 10             |
| HT3865-4    | 38 X 65 | 10          | EA  | 10             |
| HT4040-4    | 40 X 40 | 10          | EA  | 10             |
| HT4242-4    | 42 X 42 | 10          | EA  | 10             |
| HT4545-4    | 45 X 45 | 10          | EA  | 10             |
| HT4558-4    | 45 X 58 | 10          | EA  | 10             |
| HT5151-4    | 51 X 51 | 10          | EA  | 10             |
| HT5557-7    | 55 X 57 | 10          | EA  | 10             |

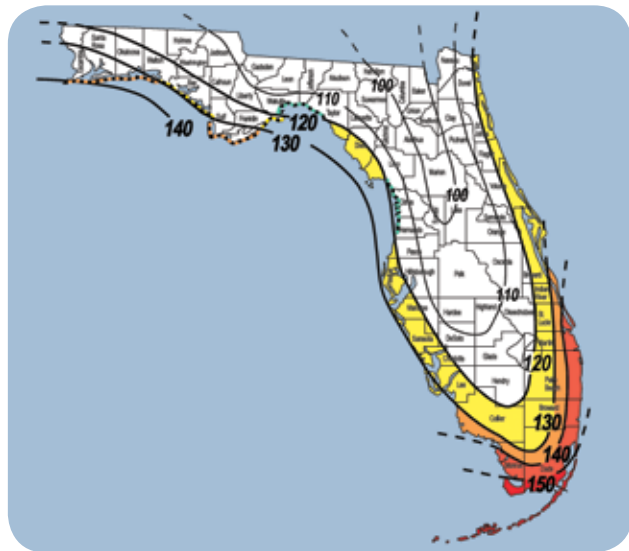

### The Hurricane Pad Attachment Bracket

Bracket secures condenser to The Hurricane Pad. Use #8 self-drilling or self-tapping screws to secure condenser to brackets. Be sure to place brackets according to local building code requirements.



HC-1



| CATALOG NO. | DESCRIPTION                                       | UOM | ORDER MULTIPLE |
|-------------|---|-----|----------------|
| HC-1        | The Hurricane Pad Attachment Bracket, pack of 4   | PK  | 1              |
| HC-1-100    | The Hurricane Pad Attachment Bracket, pack of 100 | PK  | 1              |

**THE BLACK PAD®**

**The Black Pad® – 2"**

The Black Pad® is an innovative equipment pad using ground, recycled rubber in a co-injection process. The pad is extremely durable, resistant to ultraviolet light, and heavier than a completely plastic pad. The Black Pad® is suitable for use with pool pumps, filters, and heaters and complies with the 1997 Standard Swimming Pool Code sections 305.2 Mounting and section 405 Equipment Foundations and Enclosures.

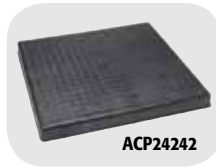

ACP24242



| CATALOG NO. | SIZE    | PAD WT. | PALLET QTY. | PALLET WT. | UOM | ORDER MULTIPLE |
|-------------|---------|---------|-------------|------------|-----|----------------|
| ACP24242    | 24 X 24 | 10      | 24          | 240        | EA  | 24             |
| ACP24362    | 24 X 36 | 15      | 24          | 360        | EA  | 24             |
| ACP30302    | 30 X 30 | 13      | 24          | 312        | EA  | 24             |
| ACP32322    | 32 X 32 | 16      | 24          | 384        | EA  | 24             |
| ACP32442    | 32 X 44 | 23      | 24          | 552        | EA  | 24             |
| ACP36362    | 36 X 36 | 19      | 24          | 456        | EA  | 24             |
| ACP38422    | 38 X 42 | 25      | 24          | 600        | EA  | 24             |

**The Black Pad® – 3"**

Used where local codes supersede the International code and require a pad thicker than 2".

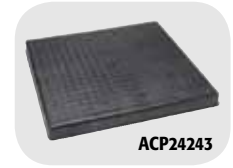

ACP24243



| CATALOG NO. | SIZE    | PAD WT. | PALLET QTY. | PALLET WT. | UOM | ORDER MULTIPLE |
|-------------|---------|---------|-------------|------------|-----|----------------|
| ACP24243    | 24 X 24 | 12      | 16          | 192        | EA  | 16             |
| ACP24363    | 24 X 36 | 25      | 16          | 400        | EA  | 16             |
| ACP28383    | 28 X 38 | 25      | 16          | 400        | EA  | 16             |
| ACP30303    | 30 X 30 | 20      | 16          | 320        | EA  | 16             |
| ACP30363    | 30 X 36 | 29      | 16          | 464        | EA  | 16             |
| ACP32323    | 32 X 32 | 25      | 16          | 400        | EA  | 16             |
| ACP32443    | 32 X 44 | 35      | 16          | 560        | EA  | 16             |
| ACP36363    | 36 X 36 | 23      | 16          | 368        | EA  | 16             |
| ACP36483    | 36 X 48 | 37      | 16          | 592        | EA  | 16             |
| ACP40403    | 40 X 40 | 31      | 16          | 496        | EA  | 16             |
| ACP52523    | 52 X 52 | 75      | 15          | 1,125      | EA  | 15             |

**HEF-T-PAD™**

**Hef-T-Pad™ – 2"**

Hef-T-Pad™ is an injection molded equipment pad created from high impact polypropylene with UV inhibitors making it easy to handle, yet durable and strong. It does not require any additional equipment for moving and handling. It is resistant to impact, ultra violet degradation and weathering and will not crack, flake, or warp. The Hef-T-Pad™ is virtually impervious to climatic variations. It is drillable to permit installation of refrigerant and electrical lines under and through the pad and to allow equipment to be easily secured to the pad.



X3030211



| CATALOG NO. | SIZE        | PAD WT. | PALLET QTY. | PALLET WT. | UOM | ORDER MULTIPLE |
|-------------|-------------|---------|-------------|------------|-----|----------------|
| X2424211    | 24 X 24 X 2 | 6       | 24          | 208        | EA  | 24             |
| X2430211    | 24 X 30 X 2 | 8       | 24          | 251        | EA  | 24             |
| X2436211    | 24 X 36 X 2 | 10      | 24          | 290        | EA  | 24             |
| X3030211    | 30 X 30 X 2 | 10      | 24          | 290        | EA  | 24             |
| X3232211    | 32 X 32 X 2 | 11      | 24          | 312        | EA  | 24             |
| X3244211    | 32 X 44 X 2 | 14      | 24          | 382        | EA  | 24             |
| X3636211    | 36 X 36 X 2 | 13      | 24          | 367        | EA  | 24             |
| X3830211    | 38 X 30 X 2 | 14      | 24          | 378        | EA  | 24             |
| X3836211    | 38 X 36 X 2 | 14      | 24          | 376        | EA  | 24             |
| X3842211    | 38 X 42 X 2 | 17      | 24          | 464        | EA  | 24             |

**Hef-T-Pad™ – 3"**

The 3" Hef-T-Pad™ shares the same great qualities of the 2" pad but works for areas that require a thicker pad to be used.



X3030311



| CATALOG NO. | SIZE         | PAD WT. | PALLET QTY. | PALLET WT. | UOM | ORDER MULTIPLE |
|-------------|--------------|---------|-------------|------------|-----|----------------|
| X2424311    | 24 X 24 X 3  | 9       | 16          | 200        | EA  | 16             |
| X2436311    | 24 X 36 X 3  | 12      | 16          | 242        | EA  | 16             |
| X3030311    | 30 X 30 X 3  | 13      | 16          | 264        | EA  | 16             |
| X3232311    | 32 X 32 X 3  | 16      | EA          | 300        | EA  | 16             |
| X3238311    | 32 X 38 X 3  | 16      | EA          | 296        | EA  | 16             |
| X3244311    | 32 X 44 X 3  | 14      | EA          | 273        | EA  | 16             |
| X3636311    | 36 X 36 X 3  | 17      | EA          | 319        | EA  | 16             |
| X3848311    | 38 X 48 X 3  | 24      | EA          | 428        | EA  | 16             |
| X5055301    | 50 X 55 X 3  | 42      | EA          | 724        | EA  | 16             |
| X2600311    | 26 X 3 Round | 9       | EA          | 194        | EA  | 16             |



Literature – Download all literature from the DiversiTech website using the Form ID shown in the icon. The URL is [www.diversitech.com/literature/FORMID.pdf](http://www.diversitech.com/literature/FORMID.pdf)

**ENVIROPAD™**

**EnviroPad™ – 2"**

An injection molded equipment pad created from 100% recycled materials to minimize environmental impact. It does not require any additional equipment for moving and handling. EnviroPad™ is resistant to impact, ultra-violet degradation and weathering (virtually impervious to climatic variations), and will not crack, flake, or warp. Drillable to permit installation of refrigerant and electrical lines under and through the pad and to allow equipment to easily secure to the pad.



**EnviroPad™ – 3"**

The 3" EnviroPad™ shares the same great qualities of the 2" pad but works for areas that require a thicker pad to be used.



| CATALOG NO.     | SIZE        | PAD WT. | PALLET QTY. | PALLET WT. | UOM | ORDER MULTIPLE |
|-----------------|-------------|---------|-------------|------------|-----|----------------|
| <b>EP2424-2</b> | 24 X 24 X 2 | 6       | 24          | 208        | EA  | 24             |
| <b>EP3030-2</b> | 30 X 30 X 2 | 10      | 24          | 290        | EA  | 24             |
| <b>EP3232-2</b> | 32 X 32 X 2 | 11      | 24          | 312        | EA  | 24             |
| <b>EP3244-2</b> | 32 X 44 X 2 | 14      | 24          | 382        | EA  | 24             |
| <b>EP3636-2</b> | 36 X 36 X 2 | 13      | 24          | 367        | EA  | 24             |
| <b>EP3842-2</b> | 38 X 42 X 2 | 17      | 24          | 450        | EA  | 24             |

| CATALOG NO.     | SIZE        | PAD WT. | PALLET QTY. | PALLET WT. | UOM | ORDER MULTIPLE |
|-----------------|-------------|---------|-------------|------------|-----|----------------|
| <b>EP2424-3</b> | 24 X 24 X 3 | 9       | 16          | 200        | EA  | 16             |
| <b>EP3030-3</b> | 30 X 30 X 3 | 13      | 16          | 264        | EA  | 16             |
| <b>EP3232-3</b> | 32 X 32 X 3 | 16      | 16          | 300        | EA  | 16             |
| <b>EP3244-3</b> | 32 X 44 X 3 | 14      | 16          | 273        | EA  | 16             |
| <b>EP3636-3</b> | 36 X 36 X 3 | 17      | 16          | 319        | EA  | 16             |
| <b>EP3848-3</b> | 36 X 36 X 3 | 24      | 16          | 378        | EA  | 16             |

**HEAT PUMP PADS**

**Heat Pump Pad™**

Provides an effective base for heat pump equipment installed in snowy climates. Rather than a combination of a typical 2" (or 3") equipment pad and 6" heat pump risers, the Heat Pump Pad™ provides a full 8" of elevation in a simple 36" by 36" footprint. The star pattern of the integral risers allows for installation of equipment with different size footprints up to 36" X 36". Also included are eight anti-vibration pads uniquely designed to fit into the guide slots on the top of the integral risers. The base is sloped outward to allow for easy drainage of condensate or defrost cycle condensate when the outdoor coil is operating in heat pump mode. Nestable for efficient shipping, transportation, and warehousing. Injection molded from concrete gray, recycled polypropylene material, the Heat Pump Pad™ is environmentally friendly and designed to last longer than the equipment it supports. Patent(s) pending.



| CATALOG NO.     | SIZE        | PAD WT. | PALLET QTY. | PALLET WT. | UOM | ORDER MULTIPLE |
|-----------------|-------------|---------|-------------|------------|-----|----------------|
| <b>HP3636-8</b> | 36 X 36 X 8 | 16      | 16          | 264        | EA  | 16             |

**HEATER PADS**

**Heater Pad**

A heavy duty version of an all concrete pad designed specifically for pool heater and filter applications. Due to their extra weight, standard freight terms for Heater Pads only apply for shipments to Georgia and Florida. All other shipments are shipped FOB Conyers, Georgia.

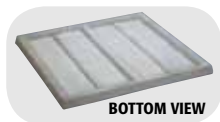
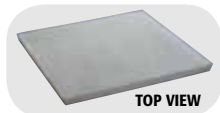

| CATALOG NO.     | SIZE        | PAD WT. | PALLET QTY. | PALLET WT. | UOM | ORDER MULTIPLE |
|-----------------|-------------|---------|-------------|------------|-----|----------------|
| <b>LF2436-2</b> | 24 X 36 X 2 | 66      | 20          | 1,345      | EA  | 20             |
| <b>LF3030-2</b> | 30 X 30 X 2 | 73      | 20          | 1,485      | EA  | 20             |
| <b>LF3036-2</b> | 30 X 36 X 2 | 89      | 20          | 1,805      | EA  | 20             |
| <b>LF3636-2</b> | 36 X 36 X 2 | 120     | 15          | 1,825      | EA  | 15             |
| <b>LF2436-3</b> | 24 X 36 X 3 | 88      | 15          | 1,345      | EA  | 15             |
| <b>LF3030-3</b> | 30 X 30 X 3 | 92      | 15          | 1,430      | EA  | 15             |
| <b>LF3636-3</b> | 36 X 36 X 3 | 170     | 10          | 1,725      | EA  | 10             |

**HEAT PUMP RISERS**

**Heat Pump Risers**

Sturdy and stable, DiversiTech's Heat Pump Riser provides the desired elevation for condensers, heat pumps, and air handlers. The one-piece, heavy-duty plastic unit is manufactured in three heights. Butyl mastic on the top and bottom guarantees no slipping and reduced vibration and noise. Available in 1 or 2 piece risers.

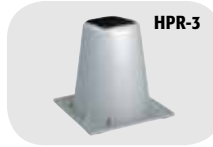

| CATALOG NO.      | DESCRIPTION                    | UOM | ORDER MULTIPLE |
|------------------|--------------------------------|-----|----------------|
| <b>HPR-3</b>     | Riser – 3"                     | EA  | 48             |
| <b>HPR-6</b>     | Riser – 6"                     | EA  | 36             |
| <b>HPR-12</b>    | Riser – 12"                    | EA  | 16             |
| <b>HPR-3-2P</b>  | Two Piece Riser – 3"           | EA  | 32             |
| <b>HPR-6-2P</b>  | Two Piece Riser – 6"           | EA  | 16             |
| <b>HPR-3-2PG</b> | Two Piece Dark Gray Riser – 3" | EA  | 32             |
| <b>HPR-6-2PG</b> | Two Piece Dark Gray Riser – 6" | EA  | 16             |
| <b>HPR-EXT</b>   | 4" Extension                   | EA  | 28             |

**Furnace Mounting Blocks**

Each furnace mounting block can support 40% more weight than competitive products – over 500 pounds! Easy peel and stick installation.

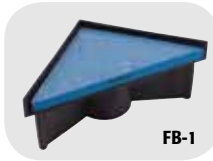

| CATALOG NO. | DESCRIPTION            | UOM | ORDER MULTIPLE |
|-------------|------------------------|-----|----------------|
| <b>FB-1</b> | Furnace Mounting Block | EA  | 72             |

**AIR HANDLER BASE**

**Air Handler Base – Heavy-duty Adjustable**

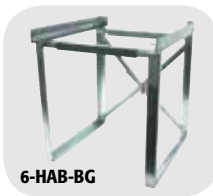

| CATALOG NO.     | DESCRIPTION                  | UOM | ORDER MULTIPLE |
|-----------------|------------------------------|-----|----------------|
| <b>6-HAB-BG</b> | Black Steel Air Handler Base | EA  | 1              |

**Heat Pump Riser – Structural**



HPR-6S is a patent pending structural heat pump riser engineered to deliver sturdy and stable elevation for condensers, heat pumps, and air handlers. The one-piece light weight polymer unit is precision injection molded in a new computer generated geometric design. Butyl mastic included on the top and bottom guarantee no slipping and reduced vibration and noise.

| CATALOG NO.   | DESCRIPTION                  | UOM | ORDER MULTIPLE |
|---------------|------------------------------|-----|----------------|
| <b>HPR-6S</b> | Heat Pump Riser – Structural | EA  | 36             |

**Air Handler Block**

Lightweight styrofoam block (concrete gray) provides A/C air handler support in attic installations.

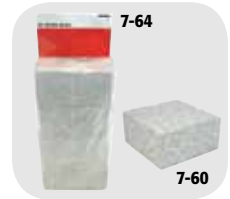

| CATALOG NO. | DESCRIPTION                                | UOM | ORDER MULTIPLE |
|-------------|--|-----|----------------|
| <b>7-60</b> | Air Handler Block 8" x 8" x 4"             | EA  | 144            |
| <b>7-64</b> | Air Handler Block 8" x 8" x 4" – pack of 4 | PK  | 4              |

**MOUNTING BRACKETS, BLOCKS**

**Air Conditioner Brackets**

These heavy duty 1/8" thick steel AC brackets are perfect for hanging A/C condensers and heat pumps outside the home. Mount at any height to allow for easy maintenance under units. No need to wait for finished grade or landscaping prior to installation of AC unit. Pre-punched holes for easy installation. Powder coated gray finish. Load rating 600 lbs. per pair.



| CATALOG NO.   | DESCRIPTION                          | UOM | ORDER MULTIPLE |
|---------------|--------------------------------------|-----|----------------|
| <b>ACB-30</b> | AC Mounting Bracket – 30", pack of 2 | PK  | 1              |
| <b>ACB-36</b> | AC Mounting Bracket – 36", pack of 2 | PK  | 1              |
| <b>ACB-42</b> | AC Mounting Bracket – 42", pack of 2 | PK  | 1              |
| <b>ACB-48</b> | AC Mounting Bracket – 48", pack of 2 | PK  | 1              |

**Hef-T-Bracket™ (Type 2)**

Used for supporting condensing units, Hef-T-Brackets (Type 2) feature a cross bar that is attached to a wall, and two L-shaped brackets that are hooked and bolted into place on the cross bar. The condensing unit is mounted onto the L-shaped brackets, and fastened using the bolts and anti-vibration washers provided.



| CATALOG NO.    | DESCRIPTION                      | ARM LENGTH | LOAD RATING PER ARM | UOM | ORDER MULTIPLE |
|----------------|----------------------------------|------------|---------------------|-----|----------------|
| <b>230-B2M</b> | Hef-T-Bracket™ (Type 2) – Medium | 18"        | 165#                | EA  | 1              |
| <b>230-B2L</b> | Hef-T-Bracket™ (Type 2) – Large  | 21"        | 220#                | EA  | 1              |

**Hef-T-Block™**

Used as mounting bases when condensing units must be bolted down. Available in three lengths. End caps are also available for aesthetics. Furnished complete with mounting bolts. Maximum load capacity is 900 pounds per mounting block. Installation temperature range from -4F (-20C) to 140F (60C). Hef-T-Blocks fit all mini-split condensing units with a unique sliding rail feature.



| CATALOG NO.      | DESCRIPTION                             | UOM | ORDER MULTIPLE |
|------------------|---|-----|----------------|
| <b>230-MB14W</b> | 14" Hef-T-Block™ (White), pack of 2     | PK  | 1              |
| <b>230-MB17W</b> | 17" Hef-T-Block™ (White), pack of 2     | PK  | 1              |
| <b>230-MB36W</b> | 36" Hef-T-Block™ (White), pack of 2     | PK  | 1              |
| <b>230-MBCW</b>  | Hef-T-Block™ End Cap (White), pack of 4 | PK  | 1              |

**Hef-T-Bracket™ (Type 3)**

Used for supporting condensing units, Hef-T-Brackets (Type 3), just like Hef-T-Brackets (Type 2), feature a cross bar that is attached to a wall, and two L-shaped brackets that are hooked and bolted into place on the cross bar. The condensing unit is mounted onto the L-shaped brackets, and fastened using the bolts and anti-vibration washers provided.

The Hef-T-Bracket™ (Type 3) features an innovative locking mechanism called Easy-Fit™. Easy-Fit™ enables the arms to be joined to the uprights in a matter of seconds. A spring-lock automatically secures the joint, preventing the arms from being dislodged accidentally. All brackets are furnished complete with an integral bubble level to make correct installation of the crossbar easier.



| CATALOG NO.    | DESCRIPTION                      | ARM LENGTH | LOAD RATING PER ARM | UOM | ORDER MULTIPLE |
|----------------|----------------------------------|------------|---------------------|-----|----------------|
| <b>230-B3M</b> | Hef-T-Bracket™ (Type 3) – Medium | 19"        | 100#                | EA  | 1              |
| <b>230-B3L</b> | Hef-T-Bracket™ (Type 3) – Large  | 21"        | 150#                | EA  | 1              |

**ANTI-VIBRATION PADS**

**E.V.A. Anti-Vibration Pad**

The latest generation in vibration dampening technology. The most effective vibration dampening pad available on the market. The EVA Pad was tested against other pads at four different vibration settings. In the most severe vibration extremes, the EVA Pad outperforms cork and rubber by a margin of greater than 3:1! This is due to the special composite foam center which is much more structurally sound than cork. It is not affected by oils or chemicals that can break down cork and is much more effective at vibration dampening than solid rubber. All this at a very competitive price. Designed to withstand 50 psi.

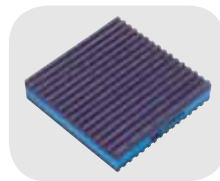

| CATALOG NO.   | DESCRIPTION                 | UOM | ORDER MULTIPLE |
|---------------|-----------------------------|-----|----------------|
| <b>MP-2E</b>  | 2" x 2" x 7/8" E.V.A. Pad   | EA  | 48             |
| <b>MP-3E</b>  | 3" x 3" x 7/8" E.V.A. Pad   | EA  | 36             |
| <b>MP-4E</b>  | 4" x 4" x 7/8" E.V.A. Pad   | EA  | 24             |
| <b>MP-6E</b>  | 6" x 6" x 7/8" E.V.A. Pad   | EA  | 24             |
| <b>MP-12E</b> | 12" x 12" x 7/8" E.V.A. Pad | EA  | 12             |
| <b>MP-18E</b> | 18" x 18" x 7/8" E.V.A. Pad | EA  | 6              |

**Rubber/Cork Anti-Vibration Pad**

Highest quality elastomeric oil resistant padding. Designed to withstand 50 psi. The rubber pads are corrugated on both sides. The cork is laminated between two corrugated pads. Ideal for air conditioners, compressors, cooling towers, presses, machines, etc.

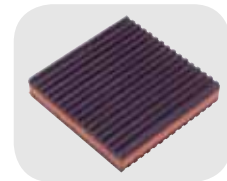

| CATALOG NO.   | DESCRIPTION                  | UOM | ORDER MULTIPLE |
|---------------|------------------------------|-----|----------------|
| <b>MP-2C</b>  | 2" x 2" x 7/8" Rubber/Cork   | EA  | 48             |
| <b>MP-3C</b>  | 3" x 3" x 7/8" Rubber/Cork   | EA  | 36             |
| <b>MP-4C</b>  | 4" x 4" x 7/8" Rubber/Cork   | EA  | 24             |
| <b>MP-6C</b>  | 6" x 6" x 7/8" Rubber/Cork   | EA  | 24             |
| <b>MP-8C</b>  | 8" x 8" x 7/8" Rubber/Cork   | EA  | 12             |
| <b>MP-12C</b> | 12" x 12" x 7/8" Rubber/Cork | EA  | 12             |
| <b>MP-18C</b> | 18" x 18" x 7/8" Rubber/Cork | EA  | 6              |

ANTI-VIBRATION PADS cont'd

**Rubber Anti-Vibration Pad**

Highest quality elastomeric oil resistant padding. Designed to withstand 50 lbs. psi. The rubber pads are corrugated on both sides. Ideal for air conditioners, compressors, cooling towers, presses, machines, etc.

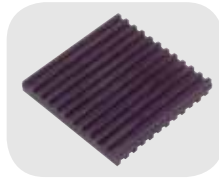

| CATALOG NO.  | DESCRIPTION             | UOM | ORDER MULTIPLE |
|--------------|-------------------------|-----|----------------|
| <b>MP-2</b>  | 2" x 2" x 3/8" Rubber   | EA  | 48             |
| <b>MP-3</b>  | 3" x 3" x 3/8" Rubber   | EA  | 36             |
| <b>MP-4</b>  | 4" x 4" x 3/8" Rubber   | EA  | 24             |
| <b>MP-6</b>  | 6" x 6" x 3/8" Rubber   | EA  | 24             |
| <b>MP-8</b>  | 8" x 8" x 3/8" Rubber   | EA  | 12             |
| <b>MP-12</b> | 12" x 12" x 3/8" Rubber | EA  | 12             |
| <b>MP-18</b> | 18" x 18" x 3/8" Rubber | EA  | 6              |

**Iso-Cube Economy Anti-Vibration Pad**

Natural rubber pads, designed to reduce vibration and noise emanating from refrigeration and air conditioning equipment. The circular design in each pad offers a suction cup effect, which eliminates the need to bolt the pads down. A standard 18" (46cm) pad is divided into eighty-one 2" (5cm) segments, each of which may be cut or torn to provide smaller pads. These 50 durometer pads will withstand a load of 180 psi with greater resiliency.



| CATALOG NO.   | DESCRIPTION               | UOM | ORDER MULTIPLE |
|---------------|---------------------------|-----|----------------|
| <b>ISO-2</b>  | 2" x 2" x 3/4" Iso-Cube   | EA  | 24             |
| <b>ISO-4</b>  | 4" x 4" x 3/4" Iso-Cube   | EA  | 12             |
| <b>ISO-18</b> | 18" x 18" x 3/4" Iso-Cube | EA  | 6              |

**Silent Support Anti-Vibration Pad**

Silent Support is DiversiTech's recycled rubber anti-vibration pad. When placed under highly vibration prone equipment, it will absorb much of the energy and prevent most unwanted noise. If the equipment needs to be slightly raised, the Silent Support can form an interlocking stack.



**MP-6S**

| CATALOG NO.  | DESCRIPTION                                    | UOM | ORDER MULTIPLE |
|--------------|--|-----|----------------|
| <b>MP-6S</b> | 6"W x 6"L x 1-1/2"H Recycled Rubber, pack of 4 | PK  | 4              |



Literature – Download all literature from the DiversiTech website using the Form ID shown in the icon. The URL is [www.diversitech.com/literature/FORMID.pdf](http://www.diversitech.com/literature/FORMID.pdf)

# AIR MOVEMENT

Dryer Duct, Vent Hose, Hose Clamps..... 32-33  
Duct Strap, Ties, Clamps..... 34-35  
Permanent Air Filters .....32  
Tapes..... 35-36  
Pure-Beam™ Ultraviolet Light .....36  
Ventilation Products ..... 33-34



# PURE-BEAM™ Ultraviolet Light

*The Pure-Beam™ ultraviolet light is designed for HVAC air disinfection and surface irradiation. Exposure to Pure-Beam™ significantly reduces air contamination caused by fungus, mold, and viruses and can cleanse surfaces overcome by mold and slime.*

- The Pure-Beam™ ultraviolet light is an excellent way to maintain indoor air quality.
- This UV Light includes a ballast, transformer, and bracket for even more convenience.
- Overall dimensions are small which makes installation easy.
- The included transformer allows operation using 120, 208, and 240/220 VAC power.
- UV lights are unobtrusive and transparent in operation, requiring little maintenance.



## FREQUENTLY ASKED QUESTIONS

**Q: What are the dimensions of the bulb?**

**A:** 14" L x 2" W x 2" H

**Q: What type of UV Light is used?**

**A:** UV-C.

**Q: What data is available to see how effective this product is?**

**A:** Scientific tests show that UV light exposure can significantly reduce air contamination caused by mold, fungus, viruses, and can cleanse surfaces of mold and slime. Ultraviolet light technology has been endorsed or specified by numerous government agencies as well as various industry groups such as:

- GSA
- NIOSH
- ASHRAE
- EPA
- CDC



**Q: What is the kill zone?**

**A:** The kill zone is the area surrounding the UV lamp in which contaminants are destroyed. Shining UV light on a surface even 6 feet away for a length of time can easily disinfect it. However, in air disinfection, the kill zone is typically 2 – 2.5 feet on all sides of the UV lamp due to the fast-moving air current.

**Q: How far from plastic surfaces does the light have to be placed in order to avoid any degradation?**

**A:** Choose a mounting location that prevents ultraviolet light exposure to plastic materials and wiring that has unknown resistance to ultraviolet light.

**Q: If placed near a filter, will any degradation of the filter occur?**

**A:** If installed near an air filter, check with the filter manufacturer for UV properties and safety.

**Q: How long does a bulb last?**

**A:** The lamp is guaranteed to last at least 9000 hours or one year.

**Q: What is the warranty period?**

**A:** The ballast has a 5 year warranty period.

**Q: What voltage does this UV light operate on?**

**A:** The lamp is powered by a 24 VAC ballast. It can be connected directly to the HVAC system's 24 VAC if there is at least 50 VA available. The transformer included also allows the system to operate at 110/120V or 208V/230V.

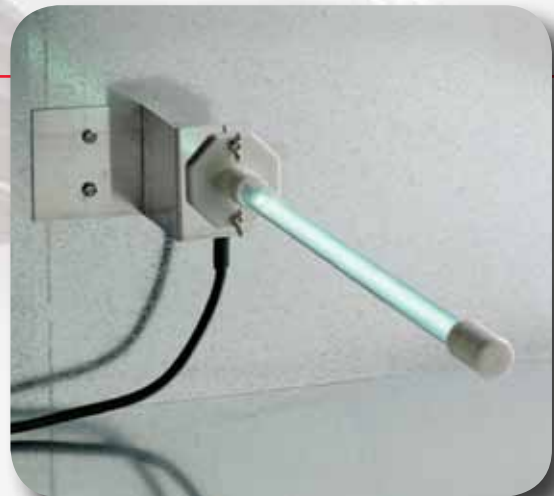

## PERMANENT AIR FILTERS

Every filter makes trade-offs between letting too much air through (good for the unit) and trapping too much “stuff” (good for the homeowner). Where is the right balance? What is best for the homeowner and their unit? DiversiTech offers two permanent air filters. Choose the Red Label Filter for a good balance between ample air flow and ability to trap dust. Choose the Blue Label Filter if you feel greater air flow is needed, perhaps for older units.

### Red Label Permanent Air Filters

- 0.12 Initial Resistance
- 82% Peak Dust Arrestance
- 76% Average Dust Arrestance
- 147 gm. Dust Holding Capacity



| CATALOG NO.  | 1" NOMINAL SIZE | DESCRIPTION                    | UOM | ORDER MULTIPLE |
|--------------|-----------------|--------------------------------|-----|----------------|
| AFR1212-1    | 12" x 12" x 1"  | Red Label Permanent Air Filter | EA  | 1              |
| AFR1220-1    | 12" x 20" x 1"  | Red Label Permanent Air Filter | EA  | 1              |
| AFR1224-1    | 12" x 24" x 1"  | Red Label Permanent Air Filter | EA  | 1              |
| AFR1420-1    | 14" x 20" x 1"  | Red Label Permanent Air Filter | EA  | 1              |
| AFR1424-1    | 14" x 24" x 1"  | Red Label Permanent Air Filter | EA  | 1              |
| AFR1425-1    | 14" x 25" x 1"  | Red Label Permanent Air Filter | EA  | 1              |
| AFR1430-1    | 14" x 30" x 1"  | Red Label Permanent Air Filter | EA  | 1              |
| AFR1520-1    | 15" x 20" x 1"  | Red Label Permanent Air Filter | EA  | 1              |
| AFR1620-1    | 16" x 20" x 1"  | Red Label Permanent Air Filter | EA  | 1              |
| AFR1624-1    | 16" x 24" x 1"  | Red Label Permanent Air Filter | EA  | 1              |
| AFR1625-1    | 16" x 25" x 1"  | Red Label Permanent Air Filter | EA  | 1              |
| AFR1818-1    | 18" x 18" x 1"  | Red Label Permanent Air Filter | EA  | 1              |
| AFR1824-1    | 18" x 24" x 1"  | Red Label Permanent Air Filter | EA  | 1              |
| AFR1825-1    | 18" x 25" x 1"  | Red Label Permanent Air Filter | EA  | 1              |
| AFR2020-1    | 20" x 20" x 1"  | Red Label Permanent Air Filter | EA  | 1              |
| AFR2024-1    | 20" x 24" x 1"  | Red Label Permanent Air Filter | EA  | 1              |
| AFR2025-1    | 20" x 25" x 1"  | Red Label Permanent Air Filter | EA  | 1              |
| AFR2030-1    | 20" x 30" x 1"  | Red Label Permanent Air Filter | EA  | 1              |
| AFR2424-1    | 24" x 24" x 1"  | Red Label Permanent Air Filter | EA  | 1              |
| AFR2525-1    | 25" x 25" x 1"  | Red Label Permanent Air Filter | EA  | 1              |
| AFR-CUSTOM-1 | Custom 1"       | Red Label Permanent Air Filter | EA  | 1              |
| AFR-CUSTOM-2 | Custom 2"       | Red Label Permanent Air Filter | EA  | 1              |

2" Red Label Permanent Air Filters are available in all above sizes. Specify 2" when ordering.

### Blue Label Permanent Air Filters

- 0.08 Initial Resistance
- 73% Peak Dust Arrestance
- 67% Average Dust Arrestance
- 99 gm. Dust Holding Capacity



| CATALOG NO.  | 1" NOMINAL SIZE | DESCRIPTION                     | UOM | ORDER MULTIPLE |
|--------------|-----------------|---------------------------------|-----|----------------|
| AFB1020-1    | 10" x 20" x 1"  | Blue Label Permanent Air Filter | EA  | 1              |
| AFB1212-1    | 12" x 12" x 1"  | Blue Label Permanent Air Filter | EA  | 1              |
| AFB1220-1    | 12" x 20" x 1"  | Blue Label Permanent Air Filter | EA  | 1              |
| AFB1224-1    | 12" x 24" x 1"  | Blue Label Permanent Air Filter | EA  | 1              |
| AFB1420-1    | 14" x 20" x 1"  | Blue Label Permanent Air Filter | EA  | 1              |
| AFB1424-1    | 14" x 24" x 1"  | Blue Label Permanent Air Filter | EA  | 1              |
| AFB1425-1    | 14" x 25" x 1"  | Blue Label Permanent Air Filter | EA  | 1              |
| AFB1430-1    | 14" x 30" x 1"  | Blue Label Permanent Air Filter | EA  | 1              |
| AFB1520-1    | 15" x 20" x 1"  | Blue Label Permanent Air Filter | EA  | 1              |
| AFB1620-1    | 16" x 20" x 1"  | Blue Label Permanent Air Filter | EA  | 1              |
| AFB1624-1    | 16" x 24" x 1"  | Blue Label Permanent Air Filter | EA  | 1              |
| AFB1625-1    | 16" x 25" x 1"  | Blue Label Permanent Air Filter | EA  | 1              |
| AFB1818-1    | 18" x 18" x 1"  | Blue Label Permanent Air Filter | EA  | 1              |
| AFB1824-1    | 18" x 24" x 1"  | Blue Label Permanent Air Filter | EA  | 1              |
| AFB1825-1    | 18" x 25" x 1"  | Blue Label Permanent Air Filter | EA  | 1              |
| AFB2020-1    | 20" x 20" x 1"  | Blue Label Permanent Air Filter | EA  | 1              |
| AFB2024-1    | 20" x 24" x 1"  | Blue Label Permanent Air Filter | EA  | 1              |
| AFB2025-1    | 20" x 25" x 1"  | Blue Label Permanent Air Filter | EA  | 1              |
| AFB2030-1    | 20" x 30" x 1"  | Blue Label Permanent Air Filter | EA  | 1              |
| AFB2424-1    | 24" x 24" x 1"  | Blue Label Permanent Air Filter | EA  | 1              |
| AFB2525-1    | 25" x 25" x 1"  | Blue Label Permanent Air Filter | EA  | 1              |
| AFB-CUSTOM-1 | Custom 1"       | Blue Label Permanent Air Filter | EA  | 1              |
| AFB-CUSTOM-2 | Custom 2"       | Blue Label Permanent Air Filter | EA  | 1              |

2" Blue Label Permanent Air Filters are available in all above sizes. Specify 2" when ordering.

#### LIMITED LIFETIME WARRANTY

DiversiTech hereby guarantees to the original purchaser that this DiversiTech permanent air filter will remain free of defects in materials and workmanship, when used in accordance with the recommended guidelines, for the life of the unit on which it is installed. Should this air filter be found to be defective, the remedies of the original purchaser are expressly limited to having DiversiTech replace the filter free of charge. To obtain the replacement filter, the original purchaser must return the defective filter to DiversiTech, 2175 East Park Drive, Conyers, GA 30013, with postage charges prepaid. The warranty does not include the cost of installing the DiversiTech permanent air filter or any other costs, all of which shall be borne by the original purchaser. This warranty does not cover damage due to abuse, improper installation, installation in other than standard residential air conditioning and/or heating units, cleaning by high pressure hose or sprays or by use of highly caustic or corrosive cleaning agents. DiversiTech makes no other warranty whatsoever and all other warranties of merchantability and fitness whether expressed or implied are limited to the life of the original air conditioning or heating unit on which the DiversiTech permanent air filter is installed.

## DRYER DUCT, VENT HOSE, HOSE CLAMPS

### Louvered Dryer Vent Hood

Louvered vent hoods are available with aluminum pipe and collar or hood only. Ideal for dryer and bathroom fan exhausts.



| CATALOG NO. | DESCRIPTION                                    | UOM | ORDER MULTIPLE |
|-------------|--|-----|----------------|
| 650-014     | 4" Hood Only – White                           | EA  | 12             |
| 650-015     | 4" Hood Only w/Bird Guard – White              | EA  | 12             |
| 650-016     | 4" Hood, Pipe and Collar – White (Assembled)   | EA  | 12             |
| 650-017     | 4" Hood, Pipe and Collar – White (Unassembled) | EA  | 18             |
| 650-036     | 3" Hood, Pipe and Collar – White (Assembled)   | EA  | 12             |

### Plastic Wide Mouth Dryer Vent Hood

Hood, aluminum pipe and collar.



| CATALOG NO. | DESCRIPTION                 | UOM | ORDER MULTIPLE |
|-------------|-----------------------------|-----|----------------|
| 650-031     | 3" White Hood – Assembled   | EA  | 12             |
| 650-012     | 4" White Hood – Assembled   | EA  | 12             |
| 650-013     | 4" White Hood – Unassembled | EA  | 18             |
| 650-023     | 4" Brown Hood – Assembled   | EA  | 12             |

**DRYER DUCT, VENT HOSE, HOSE CLAMPS cont'd**

**Metallic Duct – 5 Ply**

Pure aluminum 5 ply multi-layered flexible metallic duct. U.L. 181 Listed. Will “contain” a fire up to 265°F.



| CATALOG NO. | DESCRIPTION                  | UOM | ORDER MULTIPLE |
|-------------|------------------------------|-----|----------------|
| FUL0425     | 4" x 25' 5 Ply Metallic Duct | EA  | 4              |
| FUL0625     | 6" x 25' 5 Ply Metallic Duct | EA  | 4              |

**Metallic Duct – 2 Ply**

2 ply metallic duct – aluminum outside, polyester inside. Ideal for bath fan ducting and all purpose venting.



| CATALOG NO. | DESCRIPTION                  | UOM | ORDER MULTIPLE |
|-------------|------------------------------|-----|----------------|
| FM0450      | 4" x 50' 2 Ply Metallic Duct | EA  | 1              |

**Semi-Rigid Aluminum Duct**

8' length compressed to 28".



| CATALOG NO. | DESCRIPTION                    | UOM | ORDER MULTIPLE |
|-------------|--------------------------------|-----|----------------|
| 650-011     | 4" x 8' Flexible Aluminum Duct | EA  | 9              |
| 650-021     | 3" x 8' Flexible Aluminum Duct | EA  | 14             |
| 650-074     | 6" x 8' Flexible Aluminum Duct | EA  | 3              |

**Periscope Connection Kit**

For tight space duct venting. Contains one male snap-lock fitting and one draw-band with clamp. Adjustable 17" to 28".



| CATALOG NO. | DESCRIPTION      | UOM | ORDER MULTIPLE |
|-------------|------------------|-----|----------------|
| 650-020     | 4" Periscope Kit | EA  | 9              |

**Dryer Vent Hose**

High quality flexible white vinyl tubing. Available in 3" or 4" diameters. One 50' roll per box.



| CATALOG NO. | DESCRIPTION                | UOM | ORDER MULTIPLE |
|-------------|----------------------------|-----|----------------|
| 650-005     | Dryer Vent Hose – 3" x 50' | EA  | 1              |
| 650-006     | Dryer Vent Hose – 4" x 50' | EA  | 1              |

**Dryer Hose Clamps**

Available for 3" or 4" dryer vent hose. Steel screw design or convenient spring action design.



| CATALOG NO. | DESCRIPTION                   | UOM | ORDER MULTIPLE |
|-------------|-------------------------------|-----|----------------|
| 650-008     | Steel Screw Clamp for 4" Hose | EA  | 50             |
| 650-010     | Spring Clamp for 4" Hose      | EA  | 500            |

**Aluminum Dryer Vent Hoods, Kits, and Fittings**

Aluminum vent hood with flange plate. Kits include flexible vinyl tubing and two clamps.



| CATALOG NO. | DESCRIPTION            | UOM | ORDER MULTIPLE |
|-------------|------------------------|-----|----------------|
| 650-001     | 4" Aluminum Hood       | EA  | 12             |
| 650-002     | 3" Aluminum Hood       | EA  | 12             |
| 650-003     | 4" Hood / 8' Tubing    | EA  | 1              |
| 650-004     | 4" Hood / 5' Tubing    | EA  | 1              |
| 650-018     | 4" 90° Elbow           | EA  | 12             |
| 650-038     | 4" Aluminum Wide Mouth | EA  | 10             |

**VENTILATION PRODUCTS**

**Versa Cap® Flue and Hot Stack Caps**

Non-clogging positive draft design, recommended for flue or hot stack installation. Clamp fitting adjustable for all standard sizes. Aluminum model. U.L. Listed.

| CATALOG NO. | PIPE O.D.       | DOUBLE WALL | SINGLE WALL | J-M TRANS. SITE | HEIGHT/OVERALL DIAMETER | UOM | ORDER MULTIPLE |
|-------------|-----------------|-------------|-------------|-----------------|-------------------------|-----|----------------|
| 6-3050      | 2-7/8"-5"       | 3 and 4     | 3 and 4     | 3 and 4         | 4-1/2" x 6-5/8"         | EA  | 12             |
| 6-5070      | 4-7/8"-7"       | 5 and 6     | 5 and 6     | 5 and 6         | 4-3/4" x 9-1/2"         | EA  | 12             |
| 6-7090      | 6-7/8"-9"       | 7 and 8     | 7 and 8     | 7 and 8         | 5-7/8" x 11-5/8"        | EA  | 12             |
| 6-9011      | 8-7/8"-11"      | 9 and 10    | 9 and 10    | 9 and 10        | 6-1/2" x 12-3/4"        | EA  | 6              |
| 6-1200      | 11-7/8"-14-1/2" | 12          | 12 and 14   | 12              | 8-11/16" x 17-9/16"     | EA  | 2              |



### Flue Caps

PVC Flue Caps are an affordable way to protect today's high efficiency furnaces from dirt, moisture and other debris.

- Protection for high efficiency furnaces
- Universal flue cap fits 1.5", 2" and 3" PVC pipe
- Reduces draft inducer motor rust
- Helps to eliminate pressure switch service calls
- Resistant to UV radiation and oxidative degradation
- CSA approved for use in 90% AFUE heating applications



EC-1

| CATALOG NO. | DESCRIPTION    | UOM | ORDER MULTIPLE |
|-------------|----------------|-----|----------------|
| EC-1        | E cap Flue Cap | EA  | 12             |

### Smokeys

Smoke emitter cartridges provide effective, low cost leak testing of heat exchangers, air ducts, tanks and boilers. Visual air balancing of HVAC systems. Cartridges produce clean, non-toxic, oil-free smoke through chemical reaction. Use also for fire drills as well as the placement and testing of smoke alarms/detectors.



14175

| CATALOG NO. | DESCRIPTION                                      | UOM | ORDER MULTIPLE |
|-------------|--|-----|----------------|
| 14145       | 45 second burn time, 150 cu. ft., pack of 10     | PK  | 1              |
| 14175       | 75 second burn time, 600 cu. ft., pack of 10     | PK  | 1              |
| 14250       | 2-1/2 minute burn time, 1,100 cu. ft., pack of 5 | PK  | 1              |
| 14340       | 4 minute burn time, 2,500 cu. ft., pack of 5     | PK  | 1              |
| 14460       | 8 minute burn time, 18,000 cu. ft.               | EA  | 1              |

### Roof Flashing

Easy to install. The no-caulk flashing slips over vent stack and automatically adjusts to pipe size and roof angle. 24 gauge galvanized steel.



5-11830



| CATALOG NO. | DESCRIPTION                      | UOM | ORDER MULTIPLE |
|-------------|----------------------------------|-----|----------------|
| 5-11830     | Roof Flashing - 1/2" - 3/4" - 1" | EA  | 12             |
| 5-11840     | Roof Flashing - 1-1/4" - 1-1/2"  | EA  | 12             |
| 5-11853     | Roof Flashing - 2"               | EA  | 12             |
| 5-11866     | Roof Flashing - 3"               | EA  | 12             |
| 5-11879     | Roof Flashing - 4"               | EA  | 12             |

## DUCT STRAP, TIES, CLAMPS

### Cable Tie Holder

Finally an easier way to hold 24" to 48" cable ties. Easy to carry across your back or around your waist.



CTH-1

| CATALOG NO. | DESCRIPTION      | UOM | ORDER MULTIPLE |
|-------------|------------------|-----|----------------|
| CTH-1       | Cable Tie Holder | EA  | 1              |

### Duct Fans

- Features electrical junction box for UL and code compliant electrical connection.

An efficient way to increase air circulation, keep room temperatures consistent, and lower heating and cooling costs. Metal construction, powerful no-maintenance motors and a one-use thermal fuse mean these fans will be up to the task for years. Straightforward installation into any 120V system with detailed instructions, templates, and diagrams. Available in many sizes. A great way to give slow vents a boost. Conforms to UL STD 507, Certified to CSA STD C22.2 #113



625-AF6

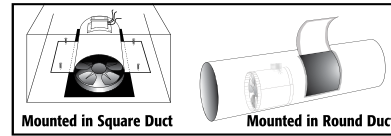

| CATALOG NO. | DESCRIPTION                      | UOM | ORDER MULTIPLE |
|-------------|----------------------------------|-----|----------------|
| 625-AF6     | Duct Fan 6" dia., 240 CFM, 37W   | EA  | 1              |
| 625-AF8     | Duct Fan 8" dia., 420 CFM, 37W   | EA  | 1              |
| 625-AF10    | Duct Fan 10" dia., 650 CFM, 35W  | EA  | 1              |
| 625-AF12    | Duct Fan 12" dia., 975 CFM, 65W  | EA  | 1              |
| 625-AF14    | Duct Fan 14" dia., 1350 CFM, 65W | EA  | 1              |

### Roof Louver

Unique interior louver design, eliminating the need for a screen. The square hood has been designed for maximum air movement. Large nailing flange for easy installation. U.L. Listed.



6-R50A



| CATALOG NO. | DESCRIPTION            | UOM | ORDER MULTIPLE |
|-------------|------------------------|-----|----------------|
| 6-R50A      | Roof Louver - Aluminum | EA  | 10             |

### Egg Crate Louvers - Air Return Diffusers

White polystyrene 1/2" open cell grid.

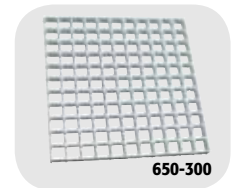

650-300

| CATALOG NO. | DESCRIPTION                        | UOM | ORDER MULTIPLE |
|-------------|------------------------------------|-----|----------------|
| 650-300     | Egg Crate Louvers - 2' x 2' x 1/2" | EA  | 20             |
| 650-200     | Egg Crate Louvers - 2' x 4' x 3/8" | EA  | 15             |
| 650-100     | Egg Crate Louvers - 2' x 4' x 1/2" | EA  | 10             |

### Heavy Duty Cable Ties

6.6 nylon, the heavy duty duct straps feature smooth insertion, and a locking mechanism that gives ductwork a firm hold. Accommodates 7 to 15 inch duct. Tensioning tool for 32"+ allows operator to adjust strap to any desired tension.



| CATALOG NO.   | DESCRIPTION  | UOM | ORDER MULTIPLE |
|---------------|--|-----|----------------|
| <b>7-P24</b>  | 24" Long - Fits up to 6" Duct - 175 lb. Tensile          | EA  | 50             |
| <b>7-P36</b>  | 36" Long - Fits up to 10" Duct - 175 lb. Tensile         | EA  | 50             |
| <b>7-P36B</b> | 36" Long - Black - Fits up to 10" Duct - 175 lb. Tensile | EA  | 50             |
| <b>7-P48</b>  | 48" Long - Fits up to 14" Duct - 175 lb. Tensile         | EA  | 50             |
| <b>7-P48B</b> | 48" Long - Black - Fits up to 14" Duct - 175 lb. Tensile | EA  | 50             |
| <b>7-L300</b> | Tensioning Tool for 120-175 lb. Ties                     | EA  | 1              |

### Strapping Hanger Iron

Galvanized 3/4" vent strapping, hanger iron, plumber's tape, pipe hanger tape and many other uses. 1/4" centers for bolts or nails.



| CATALOG NO.       | DESCRIPTION                                 | UOM | ORDER MULTIPLE |
|-------------------|---|-----|----------------|
| <b>710-A1710</b>  | Hanger Iron (Galv.) - 10' Rolls - 28 Gauge  | EA  | 50             |
| <b>710-A1650</b>  | Hanger Iron (Galv.) - 50' Rolls - 28 Gauge  | EA  | 10             |
| <b>710-A16100</b> | Hanger Iron (Galv.) - 100' Rolls - 28 Gauge | EA  | 6              |

### Hanging Wire

18 gauge galvanized on reel.



| CATALOG NO.     | DESCRIPTION                          | UOM | ORDER MULTIPLE |
|-----------------|--------------------------------------|-----|----------------|
| <b>710-182G</b> | 2# Roll - 330' - 18 Gauge Galvanized | EA  | 16             |
| <b>710-185G</b> | 5# Roll - 830' - 18 Gauge Galvanized | EA  | 16             |

### Duct Strap - Woven Polypropylene

Webbed duct strap possessing high tensile and abrasion resistance. Chemical resistant. Use for flex duct - easy to cut and staple to joists. U.L. Listed to spec 2043.



| CATALOG NO.          | DESCRIPTION   | UOM | ORDER MULTIPLE |
|----------------------|---|-----|----------------|
| <b>710-100</b>       | Duct Strap - 1-3/4" x 100 Yards - Black                         | EA  | 24             |
| <b>NEW 710-100LA</b> | Duct Strap - 1-3/4" x 100 yards - Black - City of L.A. Approved | EA  | 24             |
| <b>710-101</b>       | Duct Strap - 1-3/4" x 100 Yards - Silver                        | EA  | 24             |
| <b>710-102</b>       | Duct Strap - 3" x 100 Yards - Black                             | EA  | 8              |
| <b>710-103</b>       | Duct Strap - 3" x 100 Yards - Silver                            | EA  | 8              |

### Duct Strap - Metallic - Roll

Galvanized duct strap in convenient cardboard dispenser. Solid strapping, easy to drill or nail.



| CATALOG NO.    | DESCRIPTION                                    | UOM | ORDER MULTIPLE |
|----------------|--|-----|----------------|
| <b>710-001</b> | Metallic Duct Strap - 26 Gauge - 1" x 100'     | EA  | 1              |
| <b>710-002</b> | Metallic Duct Strap - 30 Gauge - 1" x 100'     | EA  | 1              |
| <b>710-003</b> | Metallic Duct Strap - 30 Gauge - 1-1/2" x 100' | EA  | 1              |
| <b>710-004</b> | Metallic Duct Strap - 26 Gauge - 1-1/2" x 100' | EA  | 1              |
| <b>710-005</b> | Metallic Duct Strap - 22 Gauge - 1" x 100'     | EA  | 1              |

## TAPES

### Stick-E-Tape

Self-adhesive aluminum tape with temperature range of -40°F to 200°F. Easily painted. Excellent vapor barrier; effective UV and water shield over urethane foam. Preferred duct and pipe wrap.



| CATALOG NO.  | DESCRIPTION                              | UOM | ORDER MULTIPLE |
|--------------|--|-----|----------------|
| <b>50302</b> | Stick-E-Tape - AFT-701-2 - 2" x 50' Roll | EA  | 24             |
| <b>50304</b> | Stick-E-Tape - AFT-701-4 - 4" x 50' Roll | EA  | 12             |
| <b>50306</b> | Stick-E-Tape - AFT-701-6 - 6" x 50' Roll | EA  | 8              |

### Aluminum Foil Tape

Prevents heating and cooling losses. Blocks odors and moisture. Easy to handle. Use for HVAC and refrigeration systems. -35°F to +260°F working temperatures. 3-5 year shelf life. Made in USA.



| CATALOG NO.     | DESCRIPTION                         | UOM | ORDER MULTIPLE |
|-----------------|-------------------------------------|-----|----------------|
| <b>640-AF2</b>  | 2" Aluminum Foil Tape - 50 yds.     | EA  | 24             |
| <b>640-AF25</b> | 2-1/2" Aluminum Foil Tape - 50 yds. | EA  | 20             |
| <b>640-AF3</b>  | 3" Aluminum Foil Tape - 50 yds.     | EA  | 16             |

### Foil Scrim Kraft Tape

Non-tearable, diamond patterned backing with an aggressive rubber based adhesive system for consistently dependable performance. Made in the USA.



640-FSK2

| CATALOG NO. | DESCRIPTION                           | UOM | ORDER MULTIPLE |
|-------------|---------------------------------------|-----|----------------|
| 640-FSK2    | Foil Scrim Kraft Tape – 2” – 50 Yards | EA  | 24             |
| 640-FSK3    | Foil Scrim Kraft Tape – 3” – 50 Yards | EA  | 16             |

### UL Listed Foil Tape

Unique acrylic adhesive for airtight bonds on joints and seams of fiberglass duct systems. Flexible, easy to use. Meets or exceeds performance standard AFLS-100-73 and UL 181 A-P.



640-UL25

| CATALOG NO. | DESCRIPTION                                 | UOM | ORDER MULTIPLE |
|-------------|---|-----|----------------|
| 640-UL25    | UL 181 Listed Foil Tape – 2-1/2” – 60 Yards | EA  | 16             |
| 640-UL3     | UL 181 Listed Foil Tape – 3” – 60 Yards     | EA  | 16             |

### Flex Duct Tape

Specially designed to meet new UL181B-FX code for flex duct. Higher adhesion and tack than traditional cloth duct tapes. Conformable, hand tearable foil; 3 mil thickness. 2” x 120 yds. Code identification printed on the tape. Acrylic adhesive for superior performance in extreme environments. (-35°F to 260°F)



640-FD2S

| CATALOG NO. | DESCRIPTION                  | UOM | ORDER MULTIPLE |
|-------------|------------------------------|-----|----------------|
| 640-FD2S    | Flex Duct Tape – Silver – 2” | EA  | 24             |
| 640-FD2B    | Flex Duct Tape – Black – 2”  | EA  | 24             |
| 640-FD3S    | Flex Duct Tape – Silver – 3” | EA  | 16             |
| 640-FD3B    | Flex Duct Tape – Black – 3”  | EA  | 16             |

### Cloth Duct Tapes

High-tack, excellent strength. Superior performance in sealing air handling systems. Heavy cloth content for easier tearing and additional strength. Made in the USA.



PC-622-S

PC-622-B

| CATALOG NO. | DESCRIPTION   | UOM | ORDER MULTIPLE |
|-------------|---|-----|----------------|
| PC-622-S    | 2” x 60 Yards – Premium Grade Duct Tape – Silver    | EA  | 24             |
| PC-622-B    | 2” x 60 Yards – Premium Grade Duct Tape – Black     | EA  | 24             |
| PC-609-S    | 2” x 60 Yards – Industrial Grade Duct Tape – Silver | EA  | 24             |
| PC-609-B    | 2” x 60 Yards – Industrial Grade Duct Tape – Black  | EA  | 24             |
| PC-600-S    | 2” x 60 Yards – Contractor Grade Duct Tape – Silver | EA  | 24             |
| PC-600-B    | 2” x 60 Yards – Contractor Grade Duct Tape – Black  | EA  | 24             |
| PC-783      | 2” x 60 Yards – Metallized UL181B-FX Flex Duct Tape | EA  | 24             |

## ULTRAVIOLET LIGHT

### Pure-Beam™ Ultraviolet Light

Pure-Beam™ ultraviolet light is designed for HVAC air disinfection and surface irradiation. The 17 watt UV-C lamp is a powerful tool for improved indoor air quality. Installs in the HVAC system or ductwork on either the return or supply air side of the furnace or air handler. DiversiTech's Pure-Beam™ ultraviolet light provides a healthier environment in your home, thanks to the germicidal qualities of the UV light spectrum present in the Pure-Beam™ light. Ultraviolet light deactivates the DNA of dust mites, bacteria, viruses and other pathogens and destroys their ability to multiply and cause disease. Placement of a Pure-Beam™ light in an airstream or near a drain pan can help to decrease the air contamination of any home.

Exposure to Pure-Beam™ significantly reduces air contamination caused by fungus, mold, and viruses and can cleanse surfaces overcome by mold and slime. Overall size is 14” L x 2” W x 2” H for easy placement. Includes the UV lamp, a UL listed ceramic base, and mounting bracket.



UV-1



UV-BULB

| CATALOG NO. | DESCRIPTION                                 | UOM | ORDER MULTIPLE |
|-------------|---|-----|----------------|
| UV-1        | Ultraviolet Light with 24 VAC elec. ballast | EA  | 1              |
| NEW UV-BULB | Replacement Bulb – 24V                      | EA  | 1              |



Literature – Download all literature from the DiversiTech website using the Form ID shown in the icon. The URL is [www.diversitech.com/literature/FORMID.pdf](http://www.diversitech.com/literature/FORMID.pdf)

# GAS

Black Steel Welded Nipples .....40  
Gas Valves and Connectors.....38  
Igniters..... 40  
Malleable Black Iron Pipe Fittings.....38-39



**GAS VALVES AND CONNECTORS**

**Dormont 30 Series**

Corrugated, stainless steel connectors with special Supr-Safe® design to increase flexibility. Maximum service and safety, approved for indoor or outdoor use. Perfect for range and furnace connection. AGA and CGA approved.

3131 Series: 5/8" O.D. x 1/2" I.D. 1/2" MIP x 1/2" FIP Connectors

3132 Series: 7/8" O.D. x 1/2" I.D. 1/2" MIP x 1/2" FIP Connectors



30-3132-18

| CATALOG NO. | DESCRIPTION              | UOM | ORDER MULTIPLE |
|-------------|--------------------------|-----|----------------|
| 30-3131-24  | Gas Connector – 24" Long | EA  | 12             |
| 30-3131-36  | Gas Connector – 36" Long | EA  | 12             |
| 30-3131-48  | Gas Connector – 48" Long | EA  | 12             |
| 30-3132-12  | Gas Connector – 12" Long | EA  | 12             |
| 30-3132-18  | Gas Connector – 18" Long | EA  | 12             |
| 30-3132-24  | Gas Connector – 24" Long | EA  | 12             |
| 30-3132-30  | Gas Connector – 30" Long | EA  | 12             |
| 30-3132-36  | Gas Connector – 36" Long | EA  | 12             |
| 30-3132-48  | Gas Connector – 48" Long | EA  | 12             |
| 30-3132-60  | Gas Connector – 60" Long | EA  | 12             |
| 30-3132-72  | Gas Connector – 72" Long | EA  | 12             |

**Dormont 20 Series**

1/2" O.D. x 3/8" I.D. 1/2" MIP x 1/2" FIP Connectors



20-3132-18

| CATALOG NO. | DESCRIPTION              | UOM | ORDER MULTIPLE |
|-------------|--------------------------|-----|----------------|
| 20-3132-18  | Gas Connector – 18" Long | EA  | 12             |
| 20-3132-24  | Gas Connector – 24" Long | EA  | 12             |
| 20-3132-36  | Gas Connector – 36" Long | EA  | 12             |
| 20-3132-48  | Gas Connector – 48" Long | EA  | 12             |

**Dormont 20 Series with Valve**

1/2" O.D. x 3/8" I.D. 1/2" MIP x 1/2" FIP Ball Valve



20-3135-18

| CATALOG NO. | DESCRIPTION              | UOM | ORDER MULTIPLE |
|-------------|--------------------------|-----|----------------|
| 20-3135-18  | Gas Connector – 18" Long | EA  | 12             |
| 20-3135-24  | Gas Connector – 24" Long | EA  | 12             |
| 20-3135-36  | Gas Connector – 36" Long | EA  | 12             |
| 20-3135-48  | Gas Connector – 48" Long | EA  | 12             |

**Gas Ball Valve**

Gas Ball Valves meet the stringent ISO 9000 quality standard. AGA and CGA certified.



91-3042

| CATALOG NO. | DESCRIPTION  | UOM | ORDER MULTIPLE |
|-------------|--|-----|----------------|
| 91-3042     | 5/8" O.D. Flare x 3/4" FIP for "30 Series" Gas Conn. | EA  | 10             |
| 91-2032     | 1/2" O.D. Flare x 1/2" FIP for "20 Series" Gas Conn. | EA  | 10             |
| 92-3232     | 1/2" FIP x 1/2" FIP                                  | EA  | 10             |
| 92-4242     | 3/4" FIP x 3/4" FIP                                  | EA  | 10             |

**MALLEABLE BLACK IRON PIPE FITTINGS**

- Material: ASTM A 197 Cupola Malleable Iron, 150 lb.
- Dimensions: ANSI B 16.3  
Malleable Iron Threaded Fittings  
ANSI B 16.14  
Ferrous Pipe Plugs, Bushings etc.  
ANSI B 16.39  
Malleable Iron Threaded Pipe Unions
- Threads: ANSI B 2.1 or BS 21
- Tensile Strength: 28.4 kg/mm.min

**45 Degree Ell**



BPF-04

| CATALOG NO. | DESCRIPTION          | UOM | ORDER MULTIPLE |
|-------------|----------------------|-----|----------------|
| BPF-04      | 1/2" 45 Degree Elbow | EA  | 50             |
| BPF-05      | 3/4" 45 Degree Elbow | EA  | 40             |
| BPF-06      | 1" 45 Degree Elbow   | EA  | 20             |

**90 Degree Ell**



BPF-01

| CATALOG NO. | DESCRIPTION          | UOM | ORDER MULTIPLE |
|-------------|----------------------|-----|----------------|
| BPF-01      | 1/2" 90 Degree Elbow | EA  | 50             |
| BPF-02      | 3/4" 90 Degree Elbow | EA  | 35             |
| BPF-03      | 1" 90 Degree Elbow   | EA  | 20             |

### 90 Degree Street Elbow



| CATALOG NO. | DESCRIPTION                 | UOM | ORDER MULTIPLE |
|-------------|-----------------------------|-----|----------------|
| BPF-13      | 1/2" 90 Degree Street Elbow | EA  | 60             |
| BPF-14      | 3/4" 90 Degree Street Elbow | EA  | 35             |
| BPF-15      | 1" 90 Degree Street Elbow   | EA  | 30             |

### Reducing Coupling



| CATALOG NO. | DESCRIPTION                   | UOM | ORDER MULTIPLE |
|-------------|-------------------------------|-----|----------------|
| BPF-10      | 3/4" x 1/2" Reducing Coupling | EA  | 60             |
| BPF-11      | 1" x 1/2" Reducing Coupling   | EA  | 30             |
| BPF-12      | 1" x 3/4" Reducing Coupling   | EA  | 30             |

### Bushing



| CATALOG NO. | DESCRIPTION             | UOM | ORDER MULTIPLE |
|-------------|-------------------------|-----|----------------|
| BPF-22      | 3/4" x 1/2" Hex Bushing | EA  | 50             |
| BPF-23      | 1" x 1/2" Hex Bushing   | EA  | 50             |
| BPF-24      | 1" x 3/4" Hex Bushing   | EA  | 50             |

### Reducing Tee



| CATALOG NO. | DESCRIPTION                     | UOM | ORDER MULTIPLE |
|-------------|---------------------------------|-----|----------------|
| BPF-19      | 1/2" x 1/2" x 3/4" Reducing Tee | EA  | 45             |
| BPF-20      | 3/4" x 1/2" x 1/2" Reducing Tee | EA  | 45             |
| BPF-21      | 3/4" x 1/2" x 3/4" Reducing Tee | EA  | 45             |
| BPF-34      | 1" x 1" x 1/2" Reducing Tee     | EA  | 50             |

### Cap



| CATALOG NO. | DESCRIPTION | UOM | ORDER MULTIPLE |
|-------------|-------------|-----|----------------|
| BPF-25      | 1/2" Cap    | EA  | 75             |
| BPF-26      | 3/4" Cap    | EA  | 40             |
| BPF-27      | 1" Cap      | EA  | 35             |

### Tee



| CATALOG NO. | DESCRIPTION | UOM | ORDER MULTIPLE |
|-------------|-------------|-----|----------------|
| BPF-16      | 1/2" Tee    | EA  | 40             |
| BPF-17      | 3/4" Tee    | EA  | 35             |
| BPF-18      | 1" Tee      | EA  | 20             |

### Coupling



| CATALOG NO. | DESCRIPTION   | UOM | ORDER MULTIPLE |
|-------------|---------------|-----|----------------|
| BPF-07      | 1/2" Coupling | EA  | 60             |
| BPF-08      | 3/4" Coupling | EA  | 50             |
| BPF-09      | 1" Coupling   | EA  | 25             |

### Union



| CATALOG NO. | DESCRIPTION | UOM | ORDER MULTIPLE |
|-------------|-------------|-----|----------------|
| BPF-31      | 1/2" Union  | EA  | 25             |
| BPF-32      | 3/4" Union  | EA  | 20             |
| BPF-33      | 1" Union    | EA  | 15             |

### Plug



| CATALOG NO. | DESCRIPTION | UOM | ORDER MULTIPLE |
|-------------|-------------|-----|----------------|
| BPF-28      | 1/2" Plug   | EA  | 25             |
| BPF-29      | 3/4" Plug   | EA  | 15             |
| BPF-30      | 1" Plug     | EA  | 20             |

**BLACK STEEL WELDED NIPPLES**

**Black Steel Welded Nipples**

- ASTM A-120 (NOM-B-10)
- Sch. 40
- 700 PSI test pressure
- Welded Steel



| CATALOG NO. | DESCRIPTION                       | UOM | ORDER MULTIPLE |
|-------------|-----------------------------------|-----|----------------|
| BPN-1       | 1/2" x CL Black Welded Nipple     | EA  | 25             |
| BPN-2       | 1/2" x 1-1/2" Black Welded Nipple | EA  | 25             |
| BPN-3       | 1/2" x 2" Black Welded Nipple     | EA  | 25             |
| BPN-4       | 1/2" x 2-1/2" Black Welded Nipple | EA  | 25             |
| BPN-5       | 1/2" x 3" Black Welded Nipple     | EA  | 25             |
| BPN-6       | 1/2" x 3-1/2" Black Welded Nipple | EA  | 25             |
| BPN-7       | 1/2" x 4" Black Welded Nipple     | EA  | 25             |
| BPN-8       | 1/2" x 4-1/2" Black Welded Nipple | EA  | 25             |
| BPN-9       | 1/2" x 5" Black Welded Nipple     | EA  | 25             |
| BPN-10      | 1/2" x 5-1/2" Black Welded Nipple | EA  | 25             |
| BPN-11      | 1/2" x 6" Black Welded Nipple     | EA  | 25             |
| BPN-12      | 1/2" x 7" Black Welded Nipple     | EA  | 25             |
| BPN-13      | 1/2" x 8" Black Welded Nipple     | EA  | 25             |
| BPN-14      | 1/2" x 9" Black Welded Nipple     | EA  | 25             |
| BPN-15      | 1/2" x 10" Black Welded Nipple    | EA  | 25             |
| BPN-16      | 1/2" x 11" Black Welded Nipple    | EA  | 25             |
| BPN-17      | 1/2" x 12" Black Welded Nipple    | EA  | 25             |
| BPN-18      | 3/4" x CL Black Welded Nipple     | EA  | 25             |
| BPN-19      | 3/4" x 1-1/2" Black Welded Nipple | EA  | 25             |
| BPN-20      | 3/4" x 2" Black Welded Nipple     | EA  | 25             |
| BPN-21      | 3/4" x 2-1/2" Black Welded Nipple | EA  | 25             |
| BPN-22      | 3/4" x 3" Black Welded Nipple     | EA  | 25             |
| BPN-23      | 3/4" x 3-1/2" Black Welded Nipple | EA  | 25             |
| BPN-24      | 3/4" x 4" Black Welded Nipple     | EA  | 25             |
| BPN-25      | 3/4" x 4-1/2" Black Welded Nipple | EA  | 25             |

**Black Steel Welded Nipples (cont'd)**

| CATALOG NO. | DESCRIPTION  | UOM | ORDER MULTIPLE |
|-------------|--|-----|----------------|
| BPN-26      | 3/4" x 5" Black Welded Nipple                          | EA  | 25             |
| BPN-27      | 3/4" x 5-1/2" Black Welded Nipple                      | EA  | 25             |
| BPN-28      | 3/4" x 6" Black Welded Nipple                          | EA  | 25             |
| BPN-29      | 3/4" x 7" Black Welded Nipple                          | EA  | 25             |
| BPN-30      | 3/4" x 8" Black Welded Nipple                          | EA  | 25             |
| BPN-31      | 3/4" x 9" Black Welded Nipple                          | EA  | 25             |
| BPN-32      | 3/4" x 10" Black Welded Nipple                         | EA  | 25             |
| BPN-33      | 3/4" x 11" Black Welded Nipple                         | EA  | 25             |
| BPN-34      | 3/4" x 12" Black Welded Nipple                         | EA  | 25             |
| BPN-35      | 1" x CL Black Welded Nipple                            | EA  | 25             |
| BPN-37      | 1" x 2" Black Welded Nipple                            | EA  | 25             |
| BPN-38      | 1" x 2-1/2" Black Welded Nipple                        | EA  | 25             |
| BPN-39      | 1" x 3" Black Welded Nipple                            | EA  | 25             |
| BPN-40      | 1" x 3-1/2" Black Welded Nipple                        | EA  | 25             |
| BPN-41      | 1" x 4" Black Welded Nipple                            | EA  | 25             |
| BPN-42      | 1" x 4-1/2" Black Welded Nipple                        | EA  | 25             |
| BPN-43      | 1" x 5" Black Welded Nipple                            | EA  | 25             |
| BPN-44      | 1" x 5-1/2" Black Welded Nipple                        | EA  | 25             |
| BPN-45      | 1" x 6" Black Welded Nipple                            | EA  | 25             |
| BPN-46      | 1" x 7" Black Welded Nipple                            | EA  | 25             |
| BPN-47      | 1" x 8" Black Welded Nipple                            | EA  | 25             |
| BPN-48      | 1" x 9" Black Welded Nipple                            | EA  | 25             |
| BPN-49      | 1" x 10" Black Welded Nipple                           | EA  | 25             |
| BPN-50      | 1" x 11" Black Welded Nipple                           | EA  | 25             |
| BPN-51      | 1" x 12" Black Welded Nipple                           | EA  | 25             |
| BPN-52      | 1/2" x 18" Black Welded Nipple                         | EA  | 5              |
| BPN-53      | 1/2" x 24" Black Welded Nipple                         | EA  | 5              |
| BPN-54      | 1/2" x 36" Black Welded Nipple                         | EA  | 5              |
| BPN-A12     | 1/2" Assortment Pack, 6 each of CL thru 6", pack of 66 | PK  | 1              |
| BPN-A34     | 3/4" Assortment Pack, 6 each of CL thru 6", pack of 66 | PK  | 1              |
| BPN-A1      | 1" Assortment Pack, 6 each of CL thru 6", pack of 66   | PK  | 1              |

**IGNITERS**

**TrueStart™ Universal Igniter Kits**

Igniters are constructed of high grade silicon nitride for an upgraded replacement to hundreds of silicon carbide igniters. Easy installation. Full 3 year warranty.

**IGN-1F** TrueStart™ Universal Flat Hot Surface Igniter Kit includes: 1 flat silicon nitride igniter, 2 mounting adapter brackets, hardware and full installation instructions.

**IGN-1R** TrueStart™ Universal Round Hot Surface Igniter Kit includes: 1 round silicon nitride igniter, 2 mounting adapter brackets, hardware and full installation instructions.



| CATALOG NO. | DESCRIPTION  | UOM | ORDER MULTIPLE |
|-------------|--|-----|----------------|
| IGN-1F      | TrueStart™ Universal Flat Hot Surface Igniter Kit  | EA  | 1              |
| IGN-1R      | TrueStart™ Universal Round Hot Surface Igniter Kit | EA  | 1              |

**Pilot Replacements**

Replacement pilots and accessories for selected Carrier/BDP units. Full 2 year warranty. Made in America.

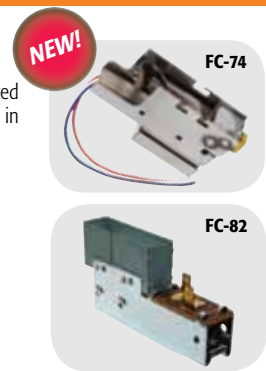

| CATALOG NO. | DESCRIPTION   | UOM | ORDER MULTIPLE |
|-------------|---|-----|----------------|
| FC-73       | 2 Wire Pilot Light – Replacement for the Carrier 732 2 wire pilot light commonly known as Carrier/BDP part number LH33JZ053 | EA  | 1              |
| FC-74       | 3 Wire Pilot Light – Replacement for the Carrier 740A 3 wire pilot light commonly known as Carrier/BDP part number LH680005 | EA  | 1              |
| FC-82       | Blower on Relay – Replacement for the Carrier/BDP 821 Blower on Relay commonly known as a Carrier part number HN680001      | EA  | 1              |
| FC-87       | Spark Electrode – Replacement for the Carrier/BDP 871 Spark Electrode commonly known as Carrier/BDP part number LH680512    | EA  | 1              |

# CONDENSATE MANAGEMENT

|   |       |
|---|-------|
| Condensate Drain Line Cleaners.....         | 61    |
| Condensate Drain Line Switches.....         | 59-60 |
| Condensate Drain Pans, Fittings, Adapters.. | 56-57 |
| Condensate Pumps .....                      | 57-58 |
| Drain Gun and Cartridges .....              | 61    |
| Drain Line, Hose, Hose Clamps.....          | 59    |
| Pan-Patch™ .....                            | 61    |
| Tapes.....                                  | 60    |

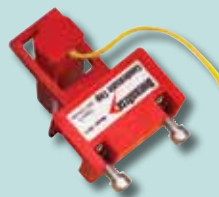
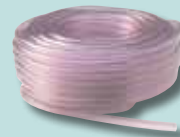
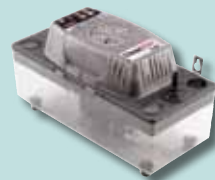

# ClearVue™ Pump

## About ClearVue™

The new ClearVue™ condensate pump from DiversiTech is unlike any other pump available. ClearVue™ features iQ Technology™ which makes ClearVue™ the smartest condensate pump on the market. iQ Technology™ provides ClearVue™ the ability to “think” and adapt to changing conditions. It’s not just off or on like a regular pump. ClearVue™ senses the amount of condensate water in the tank and its rate of inflow and adjusts its speed and lift to match the conditions and keep the tank clear. ClearVue™ starts pumping slowly and only accelerates if needed. And since it pumps slowly, ClearVue™ is super quiet and easy to live with.

With its Floatless Sensor™ technology, ClearVue™ doesn’t have the usual problems associated with float switch pumps. No more stuck floats or misaligned contacts to cause problems and potential damage. ClearVue™ uses Floatless Sensor™ technology to detect the condensate level in the tank and make the right decision about what to do next. ClearVue™ pump also features a see-through tank to give the contractor and homeowner a clear view of water, blockage, and buildup in the tank. This clear tank allows for quick troubleshooting due to normal buildup caused by daily condensate generation. ClearVue™ gives you the most improved, user-inspired features on the market.

## What makes ClearVue™ Better?

- The ClearVue™ pump features iQ Technology™ which allows ClearVue™ to change pump speed and lift based on condensate flow. Other pumps are simply off or on but ClearVue™ starts pumping slowly, then gradually accelerates its lift if needed.
- Floatless Sensor™ technology means more reliable operation and no problems from stuck or fouled mechanical floats. ClearVue’s Floatless Sensor™ detects the condensate level without a float for reliable, accurate operation. **No float, no problems.**
- World’s only self-cleaning condensate pump. ClearVue™ features a unique self-cleaning mode to maintain itself and help keep drain lines clear. Also, if ClearVue™ senses a blockage, it will begin self-cleaning and pulse the condensate water to try to remove the blockage.
- ClearVue™ also offers a clear tank that allows the user to see what’s happening inside. This means faster and more accurate troubleshooting.



[www.clearvuepump.com](http://www.clearvuepump.com)

**iQ**  
TECHNOLOGY™  
**FLOATLESS  
SENSOR™**

This information is available as a contractor handout.  
Order item number LIT-FLY-CLRVUE.

## ClearVue™ PUMP™

## iQ TECHNOLOGY™

0-22'  
Variable Speed  
and Lift  
Self-Cleaning



Stainless Steel  
Mounting Tabs

Reversible  
Deck

Clear Tank



**FLOATLESS  
SENSOR™**

Silicone  
Rubber Feet

# NO FLOAT, NO PROBLEMS



**Floatless Sensor™ Technology**  
ClearVue's sensors tell it how high the water is in the tank and how fast the in-flow is. It then adjusts pump speed and lift to keep the tank clear and the system running properly. *No float, no problems.*



**Molded Silicone Rubber Feet**  
Specially designed rubber feet dampen vibration and noise, making ClearVue™ quiet and easy to live with. And like the feet on all DiversiTech pumps, they are installed at the factory and stay in place.



**Push Button Drain**  
Need to drain the tank quickly? Simply push the DRAIN button and ClearVue™ removes all the water in the tank—fast.



**Stainless Steel Hang Tabs**  
Two stainless steel hanging tabs offer many installation options. The tabs are sturdy and durable and will last longer than standard plastic mounts.



**Clear Tank**  
ClearVue™ also offers a clear tank so you can easily see what's happening inside the tank. The clear tank makes it easy to see the water level and diagnose other issues if needed.



**LED Indicator Lights**  
4 LED indicator lights – Ready, Pumping, Cleaning, and Alarm. LED lights tell you what mode the pump is in at any given time.



**Check Valve**  
Removable duckbill check valve resists corrosion and wear and is self-cleaning.



**Innovative Packaging**  
An innovative packaging design with a clear front shows the pump and highlights its unique features. Several ClearVue™ pumps may also be stacked together to create a powerful visual display.

# DiversiTech Condensate Pumps



**Metal Hang Tabs**

Shatterproof stainless steel hang tabs have hole-and-slot design for easy mounting. Tabs are located on convenient 8" centers.



**Indicator Lights**

Red, yellow, and green indicator lights show the pump status. Green for power applied, yellow for pump running, and red for high level alarm.



**Overflow Safety Switch**

1/4" quick connect terminals provide easy connection to the built-in overflow switch. Three terminals are provided allowing the installer flexibility to connect air handler shut-down and optional alarm as needed. Switch features SPDT isolated contacts ready for connection to building automation systems.



**Four Inlet Holes**

Four inlets versus two or three on other pumps provide the greatest installation versatility. Inlet holes have a reinforced wall for durability.



**Rubber Feet**

Rubber feet dampen vibration which reduces noise.



**Pan Pill Dispenser**

A pan tablet dispenser is included free with every pump. Perfectly compatible with DiversiTech's Pro-Treat® pan tablets.



**Vibration Isolation**

An elastomeric motor mounting gasket dampens vibration.



**Check Valve**

Removable check valve for easy cleaning.

This information is available as a contractor handout.  
Order item number LIT-FLY-PUMP.



C  
O  
N  
D  
E  
N  
S  
A  
T  
E  
  
M  
A  
N  
A  
G  
E  
M  
E  
N  
T



### Overflow Safety Switch

1/4" quick connect terminals provide easy connection to the built-in overflow switch. Three terminals are provided allowing the installer flexibility to connect air handler shut-down and optional alarm as needed. Switch features SPDT isolated contacts ready for connection to building automation systems.



## 22' Lift

22' of lift standard  
versus 20' from  
other pumps.

Suitable for use  
with condensate from  
condensing boilers and  
high efficiency (condensing)  
furnaces.

# High Rise Pan™

The High Rise Pan™ is an innovative new plastic drain pan design which allows placement of an air handler 2-3/4" above the outside lip of the pan without the need for separate, cumbersome mounting blocks. The pan has a molded-in network of risers to give a 5" lift. The risers are positioned to accept a wide variety of air handler sizes. Each riser has a specially shaped area at each end to accommodate a 2" x 2" anti-vibration pad which allows for quiet operation at all times.

Other features include heavy duty reinforcement throughout to give plenty of support as well as rolled edges for durability. One-piece plastic construction ensures no rust, leaks, or seams to split.

Each High Rise Pan™ comes complete with a Condensate Cop™ float switch, six E.V.A. anti-vibration pads, and one 3/4" PVC male adapter. Installation is straightforward and hassle-free.

*Water pushes to the side of the pan preventing stagnant water from building up in inaccessible areas. This helps prevent slime and algae accumulations, eliminating call backs due to foul smells.*

**Now available in a Single Pack box, too!**

**Nestable! High Rise Pans™ take up less space.**

*DiversiTech High Rise Pans™ are nestable, thus creating a tremendous decrease in volume needed to store and transport the pans.*

## FEATURE

## BENEFIT

### Nestable

Because DiversiTech High Rise Pans™ are nestable, there is a tremendous decrease in volume needed to store and transport the pans.



### Eliminates a single line vendor

Eliminating a vendor cuts distributor costs and saves warehouse and transportation costs.

### Water pushes to the side of the pan

This prevents stagnant water in inaccessible areas which helps prevent slime and algae buildup, eliminating call backs because of smell.

### Includes EVA™ pads

EVA™ pads increase the overall height of the unit which increases available drain line pitch. EVA™ pads also create better sound and vibration dampening for a quieter installation, meaning less call backs due to noise.

### Standard anti-vibration pad

Uses a standard, easily available anti-vibration pad, eliminating the need to stock extra SKUs of anti-vibration pads. Competitor products use specialized grommets which are not commonly available.



### Installation kit includes six EVA™ pads and Condensate Cop™ float switch

The universal CC-1 can be placed anywhere on the pan. It can also be used on other secondary drain pans (metal or plastic). You will never forget a part because you have a complete kit!

### 80% thicker than the standard drain pan

Stronger and more durable for job site installations; resists work place installation damage, minimizing the need to replace drain pans damaged at job site.



### ABS construction/flexible material

Time-tested material has been used for 15 years in the market. Flexibility allows for easier fit in tight work places and a faster installation. You'll have peace of mind for long term performance.

### Heat/cold resistance

Meets structural and temperature requirements for attic installations.

### 5" riser

5" riser gives additional height needed to assure proper drain line pitch. Stack EVA™ pads for additional height.

### Heavy-duty reinforced construction

Gives support for a wider range of air handler applications, minimizing the need to replace drain pans damaged at the job site.



# Metal Drain Pan

*DiversiTech introduces the ultimate in drain pan design — the seamless, nestable, metal drain pan with rolled edges.*

C  
O  
N  
D  
E  
N  
S  
A  
T  
E  
  
M  
A  
N  
A  
G  
E  
M  
E  
N  
T

DIVERSITECH

## FEATURES

## BENEFITS

### Seamless

The seamless design of DiversiTech metal drain pans virtually eliminates leaks from seams and folded corners found in conventional metal drain pans.

### Nestable

Because DiversiTech drain pans are nestable, there is a tremendous decrease in volume needed to store and transport metal drain pans. A stack of seventy DiversiTech metal drain pans is only 12" high. Therefore, seventy DiversiTech pans fit in the same space as six conventional 2" deep non-nesting drain pans!

### Single Piece Design

The DiversiTech metal drain pan is stamped from a single sheet of 26 gauge galvanized steel which prevents leaks.

### Rolled Edge

The rolled edge virtually eliminates hand injuries during handling.

### Two Outlets

Easy, flexible installation with an outlet on both the long and short side of the pan — no need to cut an outlet if you have the wrong pan on the job.

### Fittings Included

Get everything you need for the installation of the pan in a single package. Fittings are included with DiversiTech metal drain pans.



*70 DiversiTech drain pans fit in the same space as 6 conventional 2" deep non-nesting drain pans!*

# Safety Overflow Switch (SOS™)

## What is the Safety Overflow Switch (SOS™)?

**D**esigned for use on 3/4" PVC condensate drain line, the SOS snaps easily over existing drain line tubing and can be glued in place using PVC cement.

The SOS electronically senses water near the inside wall of the PVC drain tubing. By locating the SOS with its body away from the normal flow, it can detect a possible overflow condition when the PVC drain line becomes full with water. Like a culvert, a condensate drain line is normally mostly empty with a small amount of water flowing in the lower parts of the horizontal run. Since the SOS's sensor component only covers part of the tubing, a low volume of flowing water does not activate the switch. The pipe must be full or near full to activate the switch. The SOS can be mounted horizontally, vertically, or at any angle.

The SOS works with 24 VAC control circuits and typical contactors. When not detecting water, it is normally closed and allows normal air conditioner operation. When water nears the SOS's sensor, the switch triggers and the control circuit is opened. Then, the LED indicator lights to show that there may be system trouble.

*Furnished complete with switch, 5' (1.5 meter) 18 AWG, 2 wire lead, and a 3/4" PVC male fitting adapter for direct coupling to a primary pan drain line connection.*



This information is available as a contractor handout.  
Order item number LIT-FLY-COND.

- SOS electronically senses water in the PVC drain tubing.
- SOS is designed for use on 3/4" PVC condensate drain line.
- SOS snaps easily over existing drain line tubing.

## ALTERNATE INSTALLATION

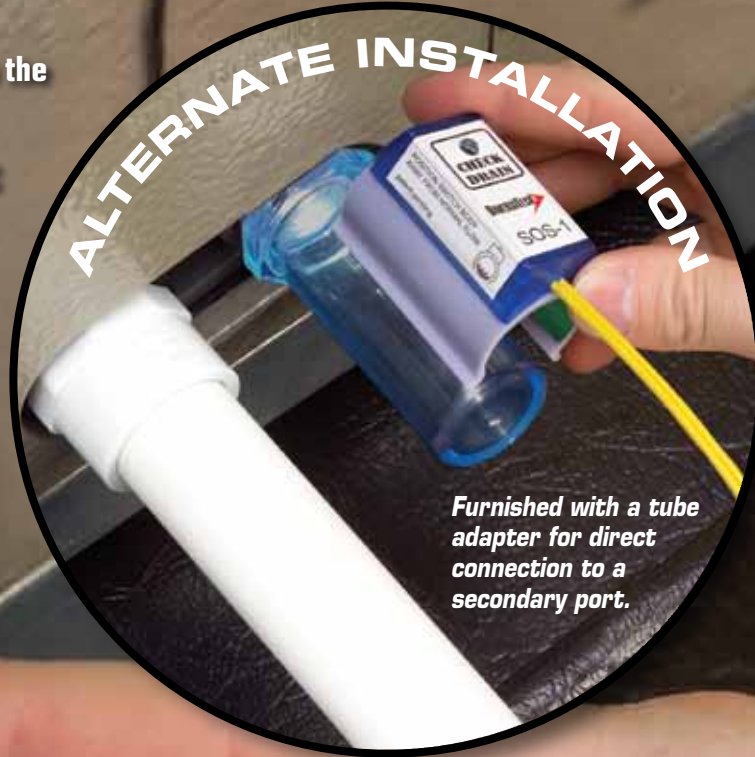

*Furnished with a tube adapter for direct connection to a secondary port.*



# Wet Switch Flood Detector

## WHAT IS THE WET SWITCH?

**T**he Wet Switch is a solid state device designed to detect the presence of condensate water overflow. The Wet Switch is placed into the secondary drain pan — a normally dry pan. If the primary drain pan fails, condensate water will overflow into the secondary drain pan. Upon sensing moisture, the Wet Switch will turn the system off (typically the cause of the condensing water) to help prevent damage to carpets, walls, woodwork, ceilings, and other property.

- Hydrophilic Pad
- Integral Feet
- Stainless Steel Sensor Array
- Solid State Electronics
- Epoxy Encapsulated Electronics
- Double Throw Relay
- Standard 24VAC control
- Multiple Unit Connectivity

The Wet Switch is designed to interrupt the operation of cooling systems. However, it is a water activated switch and can be used in a variety of other applications.

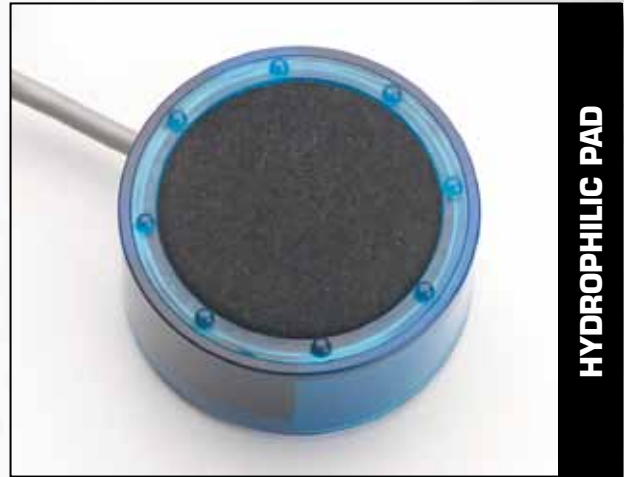

HYDROPHILIC PAD



INTEGRAL FEET



STAINLESS STEEL SENSORS

## HYDROPHILIC PAD

A high tech polymeric fiber quickly draws water into the sensor array using proven capillary technology.

## INTEGRAL FEET

Integral feet raise the hydrophilic pad and sensor array off the drain pan slightly to prevent nuisance tripping and pan corrosion (metal pans only) from interfering with the sensor array.

## STAINLESS STEEL SENSOR ARRAY

A high tech array of multiple stainless steel sensors detects even a minimal amount of water drawn into the hydrophilic pad.

## COMPACT PACKAGE

This technology is packed into a 3-5/8" diameter by 1-1/4" high cylinder. Furnished complete with 5-conductor 22AWG stranded cable, 6' long.

## DOUBLE THROW RELAY

Allows for wiring to interrupt system and to sound an alarm (by others) when moisture is detected.

## SOLID STATE ELECTRONICS

Proven electronics prevent mechanical failure in an aggressive operating environment.

## MULTIPLE UNIT CONNECTIVITY

Multiple unit connectivity allows for multiple Wet Switches to be connected in series to adequately cover large drain pan areas.



# Charles Gallo Drain Gun



**T**he Charles Gallo Drain Gun is a lightweight (3oz.) portable tool designed to blow out condensate drain lines instantly. Simply insert a Swoosh CO<sub>2</sub> cartridge into the Charles Gallo Drain Gun and with a press of the trigger — **SWOOSH** — 800 psi of oil free food grade air clears the line.

## INSTRUCTIONS:

- Unscrew cup and insert cartridge with the narrow end up.
- Without depressing the trigger, screw the cup slowly into the head until the cartridge contacts the puncture pin.
- Quickly and firmly screw the unit together to puncture and seal the cartridge in the same motion.

Note: Not completely screwing the unit together may result in escaping gas.

- Release the red safety catch.
- Depress the lever to discharge the Swoosh CO<sub>2</sub> cartridge. For condensate drains, a quick and full discharge is best.

*The Charles Gallo Drain Gun is for use with condensate drain and oil burner lines only.*

This information is available as a contractor handout.  
Order item number LIT-FLY-GG.

## SMALL AND LIGHTWEIGHT

The Charles Gallo Drain Gun packs cleaning power into a small, lightweight package. This prevents the need for carrying heavy air or nitrogen tanks.

## AIR POWER

The Charles Gallo Drain Gun uses CO<sub>2</sub>, eliminating the mess caused by water back flushing drain lines.

## ENVIRONMENTALLY FRIENDLY

The Charles Gallo Drain Gun uses carbon dioxide (CO<sub>2</sub>), a common component of air, and is totally safe for use in the environment. The Charles Gallo Drain Gun is an excellent alternative to the environmentally unfriendly practice of using refrigerant to clean the drain line.

## FLEXIBLE HOSE ASSEMBLY

The flexible hose assembly enables you to maneuver through cabinets, coils, and hard to reach drains.

## ADAPTER KIT

An adapter kit is available to allow for use on oil burner lines and tighter areas with a 90° fitting.



*Fittings increase the versatility of the innovative Charles Gallo Drain Gun and are available from your distributor.*

### 90° FITTING FOR TIGHT AREAS



### FITTING FOR OIL BURNER LINES



### FITTING FOR LARGER DRAINS



## CONDENSATE DRAIN PANS, FITTINGS, ADAPTERS

### High Rise Pans™

The High Rise Pan™ is an innovative new plastic drain pan design which allows placement of an air handler 2 3/4" above the outside lip of the pan without the need for separate, cumbersome mounting blocks. The pan has a molded-in network of risers to give a 5" lift. The risers are positioned to accept a wide variety of air handler sizes.

Each riser has a specially shaped area at each end to accommodate a 2" x 2" anti-vibration pad which allows for quiet operation at all times. Other features include heavy duty reinforcement throughout to give plenty of support as well as rolled edges for durability. One-piece plastic construction ensures no rust, leaks, or seams to split.

Each High Rise Pan™ comes complete with a Condensate Cop™ float switch, 6 EVA™ anti-vibration pads, and 1 3/4" PVC male adapter. Installation is straightforward and hassle-free.

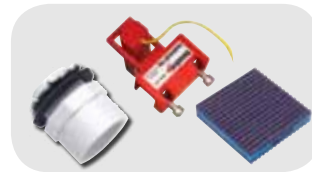

| CATALOG NO.            | DESCRIPTION   | UOM | ORDER MULTIPLE |
|------------------------|---|-----|----------------|
| <b>6-HK2748</b>        | High Rise Pan™ 27" x 48" with Installation Kit including: One CC-1 Condensate Cop, Six MP-2E 2" x 2" EVA™ Pads, One 6-1 3/4" PVC male adapter                   | EA  | 5              |
| <b>NEW! 6-HK2748SP</b> | Single Pack Kit – High Rise Pan™ 27" x 48" with Installation Kit including: One CC-1 Condensate Cop, Six MP-2E 2" x 2" EVA™ Pads, One 6-1 3/4" PVC male adapter | EA  | 1              |
| <b>6-HK2766</b>        | High Rise Pan™ 27" x 66" with Installation Kit including: One CC-1 Condensate Cop, Six MP-2E 2" x 2" EVA™ Pads, One 6-1 3/4" PVC male adapter                   | EA  | 5              |
| <b>NEW! 6-HK2766SP</b> | Single Pack Kit – High Rise Pan™ 27" x 66" with Installation Kit including: One CC-1 Condensate Cop, Six MP-2E 2" x 2" EVA™ Pads, One 6-1 3/4" PVC male adapter | EA  | 1              |
| <b>6-HK3050</b>        | High Rise Pan™ 30" x 50" with Installation Kit including: One CC-1 Condensate Cop, Six MP-2E 2" x 2" EVA™ Pads, One 6-1 3/4" PVC male adapter                   | EA  | 5              |
| <b>NEW! 6-HK3050SP</b> | Single Pack Kit – High Rise Pan™ 30" x 50" with Installation Kit including: One CC-1 Condensate Cop, Six MP-2E 2" x 2" EVA™ Pads, One 6-1 3/4" PVC male adapter | EA  | 1              |
| <b>6-HK3060</b>        | High Rise Pan™ 30" x 60" with Installation Kit including: One CC-1 Condensate Cop, Six MP-2E 2" x 2" EVA™ Pads, One 6-1 3/4" PVC male adapter                   | EA  | 5              |
| <b>NEW! 6-HK3060SP</b> | Single Pack Kit – High Rise Pan™ 30" x 60" with Installation Kit including: One CC-1 Condensate Cop, Six MP-2E 2" x 2" EVA™ Pads, One 6-1 3/4" PVC male adapter | EA  | 1              |

### A/C Secondary Condensate Drain Pans

Rolled edges for durability, ribbed bottoms for rigidity, and reinforced corners for strength. 3/4" PVC fittings are included with each pan. No seams, no rust, and no leakage. ABS materials will not put out toxic smoke. Available in over 20 convenient sizes. Five pans per clip. Complies with Southern Building Code.



| CATALOG NO.             | BOTTOM DIMENSION<br>IN. | BOTTOM DIMENSION<br>CM. | OVERALL DIMENSION<br>IN. | OVERALL DIMENSION<br>CM. | DEPTH<br>IN. | DEPTH<br>CM. | UOM | ORDER MULTIPLE |
|-------------------------|-------------------------|-------------------------|--------------------------|--------------------------|--------------|--------------|-----|----------------|
| <b>6-1838L</b>          | 18" x 38"               | 46 x 97                 | 20" x 40"                | 51 x 102                 | 2"           | 5            | EA  | 5              |
| <b>6-1838S</b>          | 18" x 38"               | 46 x 97                 | 20" x 40"                | 51 x 102                 | 2"           | 5            | EA  | 5              |
| <b>6-1846L</b>          | 18" x 46"               | 46 x 117                | 20" x 48"                | 51 x 122                 | 2"           | 5            | EA  | 5              |
| <b>6-1846S</b>          | 18" x 46"               | 46 x 117                | 20" x 48"                | 51 x 122                 | 2"           | 5            | EA  | 5              |
| <b>6-2424L</b>          | 24" x 24"               | 61 x 61                 | 26" x 26"                | 66 x 66                  | 2"           | 5            | EA  | 5              |
| <b>6-2626L</b>          | 26" x 26"               | 66 x 66                 | 28" x 28"                | 71 x 71                  | 2"           | 5            | EA  | 5              |
| <b>6-2739L</b>          | 27" x 39"               | 69 x 99                 | 29" x 41"                | 74 x 104                 | 2"           | 5            | EA  | 5              |
| <b>6-2748L</b>          | 27" x 48"               | 69 x 122                | 29" x 50"                | 74 x 127                 | 2"           | 5            | EA  | 5              |
| <b>6-2748S</b>          | 27" x 48"               | 69 x 122                | 29" x 50"                | 74 x 127                 | 2"           | 5            | EA  | 5              |
| <b>NEW! 6-2748L-100</b> | 27" x 48"               | 69 x 122                | 29" x 50"                | 74 x 127                 | 2"           | 5            | EA  | 100            |
| <b>6-2763L</b>          | 27" x 63"               | 69 x 160                | 29" x 65"                | 74 x 165                 | 2"           | 5            | EA  | 5              |
| <b>6-2763S</b>          | 27" x 63"               | 69 x 160                | 29" x 65"                | 74 x 165                 | 2"           | 5            | EA  | 5              |
| <b>6-3030L</b>          | 30" x 30"               | 76 x 76                 | 32" x 32"                | 81 x 81                  | 2"           | 5            | EA  | 5              |
| <b>6-3050L</b>          | 30" x 50"               | 76 x 127                | 32" x 52"                | 81 x 132                 | 2"           | 5            | EA  | 5              |
| <b>6-3050S</b>          | 30" x 50"               | 76 x 127                | 32" x 52"                | 81 x 132                 | 2"           | 5            | EA  | 5              |
| <b>6-3060L</b>          | 30" x 60"               | 76 x 152                | 32" x 62"                | 81 x 157                 | 2"           | 5            | EA  | 5              |
| <b>6-3060S</b>          | 30" x 60"               | 76 x 152                | 32" x 62"                | 81 x 157                 | 2"           | 5            | EA  | 5              |
| <b>NEW! 6-3060L-100</b> | 30" x 60"               | 76 x 152                | 32" x 62"                | 81 x 157                 | 2"           | 5            | EA  | 100            |
| <b>6-3263L</b>          | 32" x 63"               | 81 x 160                | 34" x 65"                | 86 x 165                 | 2"           | 5            | EA  | 5              |
| <b>6-3263S</b>          | 32" x 63"               | 81 x 160                | 34" x 65"                | 86 x 165                 | 2"           | 5            | EA  | 5              |
| <b>6-3636L</b>          | 36" x 36"               | 91 x 91                 | 38" x 38"                | 97 x 97                  | 2"           | 5            | EA  | 5              |
| <b>6-3660L</b>          | 36" x 60"               | 91 x 152                | 38" x 62"                | 97 x 157                 | 2"           | 5            | EA  | 5              |
| <b>6-3660S</b>          | 36" x 60"               | 91 x 152                | 38" x 62"                | 97 x 157                 | 2"           | 5            | EA  | 5              |

L = Drain Line Outlets in Long Side

S = Drain Line Outlets in Short Side



Literature – Download all literature from the DiversiTech website using the Form ID shown in the icon. The URL is [www.diversitech.com/literature/FORMID.pdf](http://www.diversitech.com/literature/FORMID.pdf)

### A/C Condensate Drain Pan Fittings



| CATALOG NO. | DESCRIPTION                | UOM | ORDER MULTIPLE |
|-------------|----------------------------|-----|----------------|
| 6-1         | 3/4" Slip                  | EA  | 50             |
| 6-2         | 1" Slip                    | EA  | 50             |
| 6-3         | 3/4" Slip with Plastic Nut | EA  | 50             |
| 6-5         | 3/4" Female Pipe Thread    | EA  | 50             |

### Metal Drain Pan

The ultimate in drain pan design – tailored for easy distribution and installation. Full of features to make life easier on both the distributor and the contractor. Seamless, one piece metal construction with rolled edges on all sides for maximum safety and integrity. Nestable as well – a stack of 70 pans is only a foot high! Once on site, you'll never have to return to the distributor for missing parts. The fittings are packaged with the pan for simple and efficient installation. Choose between two possible drain outlet positions and install with confidence.



| CATALOG NO. | DESCRIPTION                          | UOM | ORDER MULTIPLE |
|-------------|--------------------------------------|-----|----------------|
| 6-M2748     | 26 Gauge Metal Drain Pan – 27" x 48" | EA  | 5              |
| 6-M2763     | 26 Gauge Metal Drain Pan – 27" x 63" | EA  | 5              |
| 6-M3030     | 26 Gauge Metal Drain Pan – 30" x 30" | EA  | 5              |
| 6-M3050     | 26 Gauge Metal Drain Pan – 30" x 50" | EA  | 5              |
| 6-M3060     | 26 Gauge Metal Drain Pan – 30" x 60" | EA  | 5              |
| 6-M3263     | 26 Gauge Metal Drain Pan – 32" x 63" | EA  | 5              |

### Condensate Drain Pans

When a mini-split system operates in heat pump mode, the outdoor coil becomes the evaporator coil. Typically, condensation generates from the evaporator coil. In certain installations, the condenser coil may be mounted overhead on brackets affixed to a wall. In these overhead applications, dripping condensation may be a nuisance. Condensate drain pans bolt onto the condenser mounting brackets, and the drain line can be plumbed to a nearby drain location. Furnished complete with all mounting hardware and drain pan outlet, condensate drain pans are available in either plastic or powder coated steel.



| CATALOG NO. | DESCRIPTION                         | UOM | ORDER MULTIPLE |
|-------------|-------------------------------------|-----|----------------|
| 230-DPPL    | Poly Condensate Drain Pan (Large)   | EA  | 1              |
| 230-DPML    | Metal Condensate Drain Pan (Large)  | EA  | 1              |
| 230-DPPM    | Poly Condensate Drain Pan (Medium)  | EA  | 1              |
| 230-DPMM    | Metal Condensate Drain Pan (Medium) | EA  | 1              |

### Mini-Split Drain Adapters

Mini-Split fan units – either ceiling cassettes or wall cassettes – typically have a unique (metric) drain line fitting. DiversiTech's adapters convert this metric fitting to standard drain line tubing sizes.



| CATALOG NO. | DESCRIPTION                        | UOM | ORDER MULTIPLE |
|-------------|------------------------------------|-----|----------------|
| 230-DLFY    | Mini-Split Drain Line Wye          | EA  | 1              |
| 230-DLF16   | 16mm Mini-Split Drain Line Adapter | EA  | 1              |
| 230-DLF18   | 18mm Mini-Split Drain Line Adapter | EA  | 1              |
| 230-DLF20   | 20mm Mini-Split Drain Line Adapter | EA  | 1              |
| 230-DLF25   | 25mm Mini-Split Drain Line Adapter | EA  | 1              |
| 230-DLF32   | 32mm Mini-Split Drain Line Adapter | EA  | 1              |

## CONDENSATE PUMPS

### ClearVue™ Pump

No Float, No Problems! ClearVue's iQ Technology™ and Floatless Sensor™ make this the most advanced condensate pump ever. This new pump can provide up to 22' of lift if needed. ClearVue™ runs at the minimum speed needed, saving wear on the pump. The pump selects the lowest effective speed, making it quieter than a regular pump. Its unique self-cleaning feature senses problems and automatically enters a self-cleaning mode using condensate water to fix the issue. The ClearVue™ pump features a clear bottom tank to easily check the water level.

Other features include: stainless steel mounting tabs, silicone rubber feet, reversible deck, four inlet holes, and LED indicator lights.



| CATALOG NO. | DESCRIPTION                               | UOM | ORDER MULTIPLE |
|-------------|---|-----|----------------|
| IQP-120     | ClearVue™ Pump – 120V – 0-22' Lift        | EA  | 6              |
| IQP-120T    | ClearVue™ Pump w/Tube – 120V – 0-22' Lift | EA  | 6              |
| IQP-230     | ClearVue™ Pump – 230V – 0-22' Lift        | EA  | 6              |
| IQP-230T    | ClearVue™ Pump w/Tube – 230V – 0-22' Lift | EA  | 6              |

### Low Profile Pumps

The new CP-22LP comes packed with all the same great features found in the CP-22, but now in a low profile package. This pump is only 4 3/8" tall so it's a good fit for those instances where space is at a premium. The shorter reservoir holds 1/3 gallon. Suitable for use with condensate up to 160°F.



| CATALOG NO. | DESCRIPTION                          | UOM | ORDER MULTIPLE |
|-------------|--------------------------------------|-----|----------------|
| CP-22LP     | Condensate Pump – 120V – Low Profile | EA  | 6              |
| CP-22LP-230 | Condensate Pump – 230V – Low Profile | EA  | 6              |

### CP-22 Pumps

Suitable for use with condensate from high efficiency condensing furnaces and boilers which produce acidic condensate. 22' of lift compared to the typical 20'. Features include vibration dampening feet and motor mounts, metal hang tabs, four inlet holes, a clear indicator display, a float switch and check valve, and pan pill dispenser. Integrating the CP-22 into your system is easy. 1/4" quick connect terminals provide easy connection to the built in overflow switch. 3 terminals are provided allowing flexibility to connect air-handler shut-down and optional alarm as needed. The new CP-22LP comes packed with all the same great features found in the CP-22, but now in a low profile package. This pump is only 4 3/8" tall so it's a good fit for those instances where space is at a premium. The shorter reservoir holds 1/3 gallon. Suitable for use with condensate up to 160°F.



CP-22



| CATALOG NO. | DESCRIPTION                            | UOM | ORDER MULTIPLE |
|-------------|--|-----|----------------|
| CP-22       | Condensate Pump - 120V                 | EA  | 6              |
| CP-22T      | Condensate Pump - 120V w/20' 3/8" Tube | EA  | 6              |
| CP-22-230   | Condensate Pump - 230V                 | EA  | 6              |
| CP-22-230T  | Condensate Pump - 230V w/20' 3/8" Tube | EA  | 6              |

### Mini-Split Pump

The DiversiTech CP-35MS Mini-Split Condensate Pump is ideal for installations with limited space or where suction lift is required. The slim profile allows it to fit into a variety of small spaces. The pump can be mounted inside the SpeediChannel or other line set covering systems or alongside the refrigeration pipe insulation.



CP-35MS

| CATALOG NO. | DESCRIPTION                | UOM | ORDER MULTIPLE |
|-------------|----------------------------|-----|----------------|
| CP-35MS     | Mini-Split Condensate Pump | EA  | 6              |

### General Purpose Pumps

The DiversiTech CP-16 condensate pump is an economical alternative that's based off of the proven CP-22 design. More compact than the CP-22, it's designed to lift to a maximum of 16 feet. The CP-16 shares many of the great features of the CP-22, including hang tabs, four inlet holes, float switch, overflow switch, and a check valve.



CP-16

| CATALOG NO. | DESCRIPTION                   | UOM | ORDER MULTIPLE |
|-------------|-------------------------------|-----|----------------|
| CP-16       | Condensate Pump 16' Lift 120V | EA  | 6              |
| CP-16-230   | Condensate Pump 16' Lift 230V | EA  | 6              |

### Replacement Check Valve

Check valve installs easily and prevents water from travelling backwards into the pump and overflowing.



CP-CV

| CATALOG NO. | DESCRIPTION                       | UOM | ORDER MULTIPLE |
|-------------|-----------------------------------|-----|----------------|
| CP-CV       | Replacement Check Valve for CP-22 | EA  | 1              |

### Flow-Plus™ Pump Treatment Tablets for Condensate Pumps

A unique polymer pan treatment in tablet form for use exclusively in DiversiTech's condensate pump. The tablet dispensing drawer in the pump holds 3 tablets. A dosage lasts up to 3 months depending on the volume of condensate generated. Even when fully dissolved, the tablets provide a lasting treatment in the pump and downstream drain line. Provides long-lasting treatment that controls slime growth over time and can extend the life of the pump.



FLOW-PLUS-CP



| CATALOG NO.  | DESCRIPTION   | UOM | ORDER MULTIPLE |
|--------------|---|-----|----------------|
| FLOW-PLUS-CP | Flow-Plus™ for Condensate Pumps - 6 Tablets/Clamshell | EA  | 36             |



Literature - Download all literature from the DiversiTech website using the Form ID shown in the icon. The URL is [www.diversitech.com/literature/FORMID.pdf](http://www.diversitech.com/literature/FORMID.pdf)

## DRAIN LINE, HOSE, HOSE CLAMPS

### Clear Vinyl Tubing

Clear vinyl hose applications include: air conditioning and refrigeration condensate drains, condensate pump discharge lines and humidifier overflows.



| CATALOG NO. | DESCRIPTION                | UOM | ORDER MULTIPLE |
|-------------|----------------------------|-----|----------------|
| 7-14        | 1/4" ID Clear Vinyl Tubing | EA  | 100'           |
| 7-38        | 3/8" ID Clear Vinyl Tubing | EA  | 100'           |
| 7-12        | 1/2" ID Clear Vinyl Tubing | EA  | 100'           |
| 7-58        | 5/8" ID Clear Vinyl Tubing | EA  | 100'           |
| 7-34        | 3/4" ID Clear Vinyl Tubing | EA  | 100'           |
| 7-78        | 7/8" ID Clear Vinyl Tubing | EA  | 50'            |
| 7-10        | 1" ID Clear Vinyl Tubing   | EA  | 50'            |

### Gorilla Tube™ Clear Vinyl Tubing

Applications include: air conditioning and refrigeration condensate drains, condensate pump discharge lines, and humidifier overflows.

Several sizes from 1/4" to 1" diameter. Non-toxic clear vinyl chloride.

Select Gorilla Tube™ over standard clear vinyl tube because:

- Extra rigid design resists crimping and kinking due to durometer value of 80 (Shore A) and thicker wall
- Maximum service temperature 140°F (60°C)
- Better performance in cold weather climates.



| CATALOG NO. | DESCRIPTION  | UOM | ORDER MULTIPLE |
|-------------|--|-----|----------------|
| 7-14P       | 1/4", .250" I.D., .360" O.D., .055 wall thickness  | EA  | 100'           |
| 7-38P       | 3/8", .375" I.D., .495" O.D., .060 wall thickness  | EA  | 100'           |
| 7-12P       | 1/2", .500" I.D., .631" O.D., .066 wall thickness  | EA  | 100'           |
| 7-58P       | 5/8", .625" I.D., .771" O.D., .073 wall thickness  | EA  | 100'           |
| 7-34P       | 3/4", .750" I.D., .913" O.D., .082 wall thickness  | EA  | 100'           |
| 7-78P       | 7/8", .875" I.D., 1.050" O.D., .088 wall thickness | EA  | 50'            |
| 7-10P       | 1", 1.000" I.D., 1.215" O.D., .108 wall thickness  | EA  | 50'            |

### Mini-Split Condensate Drain Line

A unique drain line for mini-split units. This large diameter drain line is typical for mini-split installations. Furnished in 160 feet lengths with cut marks every 3.28 feet.



| CATALOG NO. | DESCRIPTION                   | UOM | ORDER MULTIPLE |
|-------------|-------------------------------|-----|----------------|
| 230-DL16    | 5/8" ID Mini-Split Drain Line | EA  | 160'           |
| 230-DL20    | 3/4" ID Mini-Split Drain Line | EA  | 160'           |

### Hose Clamps

Partial stainless, worm drive, adjustable. 300 series stainless steel 1/2" band with plated 5/16" slotted hex head screw and housing, except the B-4H which has a 5/16" band and 1/4" nut. Recommended for most applications. 100% interlock construction features one-piece housing which directly locks into band. Spot weld free design.



| CATALOG NO. | DESCRIPTION   | UOM | ORDER MULTIPLE |
|-------------|---|-----|----------------|
| B-4H        | No. 4, 7/32" - 5/8" diameter, 3/16" - 5/16" hose I.D.         | EA  | 10             |
| B-6H        | No. 6, 3/8" - 7/8" diameter, 1/4" - 3/8" hose I.D.            | EA  | 10             |
| B-8H        | No. 8, 7/16" - 1" diameter, 5/16" - 1/2" hose I.D.            | EA  | 10             |
| B-10H       | No. 10, 9/16" - 1-1/16" diameter, 3/8" - 5/8" hose I.D.       | EA  | 10             |
| B-12H       | No. 12, 9/16" - 1-1/4" diameter, 5/8" - 3/4" hose I.D.        | EA  | 10             |
| B-16H       | No. 16, 11/16" - 1-1/2" diameter, 3/4" - 1" hose I.D.         | EA  | 10             |
| B-20H       | No. 20, 3/4" - 1-3/4" diameter, 1" - 1-1/4" hose I.D.         | EA  | 10             |
| B-24H       | No. 24, 1-1/16" - 2" diameter, 1-1/4" - 1-1/2" hose I.D.      | EA  | 10             |
| B-28H       | No. 28, 1-5/16" - 2-1/4" diameter, 1-1/4" - 1-3/4" hose I.D.  | EA  | 10             |
| B-32H       | No. 32, 1-9/16" - 2-1/2" diameter, 1-1/2" - 2" hose I.D.      | EA  | 10             |
| B-36H       | No. 36, 1-13/16" - 2-3/4" diameter, 1-3/4" - 2-1/4" hose I.D. | EA  | 10             |

## CONDENSATE DRAIN LINE SWITCHES

### Condensate Cop™

Condensate Cop™ is a unique clamp-on float switch intended for HVAC drain pan installation. The Condensate Cop™ features a large over-clamping area that fits easily over the edge of all types of drain pans; including formed plastic and galvanized sheet metal.

A separate float/probe assembly swivels to accommodate drain pans having sloped sides. The swivel action allows the installer to position the float switch for best operation and then clamp it into place. The probe features an inlet grill which prevents the float from being blocked or damaged by insulation or other debris. Sealed inside the probe is a magnetically actuated normally closed switch. The switch opens when rising water presents a potential flooding condition. Two wire connection for easy hook up to a thermostat "Y" (compressor) circuit. Provided complete with 5' (1.5 meter) leads, wire nuts, and clamping screws. Small size, 24V/1.5 amp NC reed switch.

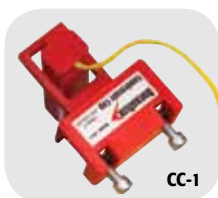

| CATALOG NO. | DESCRIPTION                      | UOM | ORDER MULTIPLE |
|-------------|----------------------------------|-----|----------------|
| CC-1        | Condensate Cop™ Drain Pan Switch | EA  | 12             |

### Universal Alarm

A universal low-voltage alarm that can indicate possible system trouble. Use with the Wet Switch, SOS, Condensate Cop, CP-22 (all types) and all float switches on 24VAC control circuits. If an alarm condition exists, the homeowner can turn the alarm off with a "silence" button until service is obtained, however a red trouble LED will remain lit. Also features: easy 2 wire connection, label to print contractor information, and low current draw. Actuates at greater than 18V to prevent any false alarms due to low voltage.

Includes 2 wire nuts, a sheet metal screw, and double sided tape for convenient installation options. Also includes instructions for wiring normally open switch systems (for the CP-22 or other condensate pumps).



| CATALOG NO. | DESCRIPTION               | UOM | ORDER MULTIPLE |
|-------------|---------------------------|-----|----------------|
| UA-1        | Universal Alarm for 24VAC | EA  | 12             |

### A/C Condensate Float Switch

Designed for use in condensate drain pan overflow. Easily installed on the side of the auxiliary drain pan. Single pole, double throw normally OPEN or normally CLOSED.



| CATALOG NO. | DESCRIPTION             | UOM | ORDER MULTIPLE |
|-------------|-------------------------|-----|----------------|
| 6-JMP       | Condensate Float Switch | EA  | 1              |

### Wet Switch Flood Detector

A solid state control designed to help prevent flooding, damage to carpets, walls, furniture, ceilings, etc. Now has a built-in test and reset button for easier installation. Turns system off when detecting moisture due to condensate or drain leaks. One or two drops will cause Wet Switch to turn off a unit, alerting a serviceman to a moisture problem. A lit LED indicates the Wet Switch is activated and has turned the unit off. Reset simply by drying the absorbent pad with a paper towel and pressing the reset switch. Connects to 24 VAC. More than one unit may be connected to a system. 2 amp contact rating. Simple 5 wire installation. Sales displays available.



| CATALOG NO. | DESCRIPTION               | UOM | ORDER MULTIPLE |
|-------------|---------------------------|-----|----------------|
| WS-1        | Wet Switch Flood Detector | EA  | 1              |

### Safety Overflow Switch (SOS)

Designed for use on 3/4" PVC condensate drain line. Snaps easily over existing drain line tubing and can be glued in place using PVC cement. The SOS electronically senses water near the inside wall of the PVC drain tubing. By locating the SOS with its body away from the normal flow, it can be used to detect a possible overflow condition when the PVC drain line becomes full with water. Like a culvert, the condensate drain line is normally mostly empty with a small amount of water flowing in the lower parts of the horizontal run. Since the sensor component of the SOS only covers part of the tubing, a low volume of flowing water does not activate the switch. The pipe must be full or near full to activate the switch. Mount SOS horizontally, vertically, or at any angle.



Works with 24 VAC control circuits and typical contactors. When not detecting water, the SOS is normally closed and allows normal air conditioner operation. When water approaches the SOS's sensor, the switch triggers, and the control circuit is opened. The LED indicator lights to show that there may be system trouble, and the SOS is doing its job. Includes press to test switch.

Furnished complete with switch, 5' (1.5 meter) 18 AWG, 2 wire lead, and a 3/4" PVC male fitting adapter for direct coupling to a primary pan drain line connection. Now available with Push to Test button.



| CATALOG NO. | DESCRIPTION            | UOM | ORDER MULTIPLE |
|-------------|------------------------|-----|----------------|
| SOS-1       | Safety Overflow Switch | EA  | 1              |

Patents pending.

## TAPES

### Tommy Tape

Self-adhering silicone tape which fuses to itself in 24 hours and creates an air and water-tight bond. Tommy Tape is waterproof and can wrap around anything from extension cords to tool grip wraps. Tommy Tape amazingly does not crack and peel in cold weather.



| CATALOG NO. | DESCRIPTION                            | UOM | ORDER MULTIPLE |
|-------------|--|-----|----------------|
| TTP-1       | Tommy Tape - 20 mil x 1" x 10' - Black | EA  | 10             |

### Cork Insulation Tape

Adheres firmly to all metals. Use on hot or cold pipes to stop condensation and drips.



| CATALOG NO. | DESCRIPTION   | UOM | ORDER MULTIPLE |
|-------------|---|-----|----------------|
| 6-330       | Cork Insulation Tape - 1/8" x 2" x 30' Roll - Black | EA  | 12             |

### Teflon Tape

Made of pure white Teflon. Non-toxic. For use with chemicals, solvents, oxygen, and on food lines. Withstands up to 2000 psi of pressure.



| CATALOG NO. | DESCRIPTION               | UOM | ORDER MULTIPLE |
|-------------|---------------------------|-----|----------------|
| 6-733       | Teflon Tape - 1/2" x 520" | EA  | 100            |
| 6-734       | Teflon Tape - 1/2" x 260" | EA  | 100            |
| 6-735       | Teflon Tape - 3/4" x 520" | EA  | 100            |
| 6-736       | Teflon Tape - 3/4" x 260" | EA  | 100            |

### Foam Insulation Tape

Superior self-adhesive foam tape can be used on hot or cold pipes. Fits well around valves and fittings. Easily cut and molded.



| CATALOG NO. | DESCRIPTION   | UOM | ORDER MULTIPLE |
|-------------|---|-----|----------------|
| 6-9718      | Foam Insulation Tape - 1/8" x 2" x 30' Roll - Black | EA  | 12             |



Literature - Download all literature from the DiversiTech website using the Form ID shown in the icon. The URL is [www.diversitech.com/literature/FORMID.pdf](http://www.diversitech.com/literature/FORMID.pdf)

## CONDENSATE DRAIN LINE CLEANERS

### Flow-Plus™ Inline Cleaner

Flow-Plus™ Inline Cleaner installs in the 3/4" condensate drain line to maintain clean condensate water and pump operation (if applicable). Unique design allows Flow-Plus™ tablets to dissolve slowly, maintaining condensate flow for up to eight months. User replaceable tablet pack.



| CATALOG NO. | DESCRIPTION                      | UOM | ORDER MULTIPLE |
|-------------|----------------------------------|-----|----------------|
| IC-1        | Flow-Plus™ Inline Cleaner        | EA  | 6              |
| IC-1R       | Flow-Plus™ Replacement Cartridge | EA  | 12             |

## PAN-PATCH™

### Pan-Patch™

A two part epoxy coating with anti-microbial additives designed for HVAC applications. A self leveling formula that is ideal in a damp or wet environment. Pan-Patch™ resists corrosion and stops pan leaks without replacing the pan. Light gray in color, one gallon covers about 160 square feet with 10 mil thickness.



| CATALOG NO.  | DESCRIPTION                              | COVERAGE    | UOM | ORDER MULTIPLE |
|--------------|--|-------------|-----|----------------|
| PANPATCH-BAG | Pan-Patch™ Pan Sealant – bag, pack of 10 | 8 sq. ft.   | PK  | 1              |
| PANPATCH-32  | Pan-Patch™ Pan Sealant – 1 quart         | 40 sq. ft.  | EA  | 9              |
| PANPATCH     | Pan-Patch™ Pan Sealant – 1 gallon        | 160 sq. ft. | EA  | 4              |

## DRAIN GUN AND CARTRIDGES

### Charles Gallo brand Drain Gun and SWOOSH CO<sub>2</sub> Cartridges

Clears condensate drains with a SWOOSH! A lightweight (3 oz.) portable tool designed to blow out drain lines instantly. New larger SWOOSH CO<sub>2</sub> cartridges now deliver 1200 PSI of oil free food grade to clear the line. Each unit comes equipped with a tapered fitting to work on 3/8" – 3/4" drain openings. Flexible hose assembly maneuvers through cabinets, coils and hard to reach drains. Cartridges are environmentally safe and recyclable. No need for air or nitrogen tanks. Reduces labor costs and time on service calls.



| CATALOG NO. | DESCRIPTION                                      | UOM | ORDER MULTIPLE |
|-------------|--|-----|----------------|
| GG-1        | Charles Gallo Drain Gun for A/C Condensate Lines | EA  | 6              |
| GGC-12      | SWOOSH CO <sub>2</sub> Cartridges, pack of 12    | PK  | 6              |
| GG-1A       | Charles Gallo Drain Gun Adapter Kit              | EA  | 1*             |
| GG-1H       | Charles Gallo Drain Gun Hose Assembly            | EA  | 1              |

\*See page 55 for details.

# In a class by itself.



**DIVERSITECH**



The new **ClearVue™** condensate pump isn't like all the other pumps. It features Floatless Sensor™ technology for super reliable operation without a mechanical float — No Float, No Problems. And ClearVue even has a brain. Built-in iQ Technology™ adjusts pump speed and lift as needed so ClearVue can adapt to any conditions. ClearVue even cleans itself to ensure worry-free operation. Learn more about how ClearVue stands out from the crowd at [www.clearvuepump.com](http://www.clearvuepump.com)

# GENERAL INDUSTRIAL

|  |       |
|--|-------|
| Abrasive Cloths .....                        | 69    |
| Aerosols .....                               | 74    |
| Batteries By Rayovac® .....                  | 72    |
| Carton Sealing Tape and Dispenser.....       | 67    |
| Contact Cleaners.....                        | 71    |
| Degreasers.....                              | 71-72 |
| Hand Cleaners.....                           | 69    |
| Industrial Towels.....                       | 65    |
| Lubricants .....                             | 69-71 |
| Markers .....                                | 73    |
| Paints and Primers .....                     | 73    |
| Safety Supplies, Devices .....               | 64    |
| Sealant, Epoxy, Glue .....                   | 74    |
| Sealing Compounds, Adhesive.....             | 67-68 |
| Sheet Metal Screws .....                     | 66-67 |
| Wasp, Hornet, and Yellow Jacket Killers..... | 72    |



### Leather Work Gloves

Versatile leather work gloves ideal for many industrial jobs. These leather work gloves offer: wing thumb pattern, continuous pull patch, seamless full leather index finger, leather knuckle strap, leather finger tips, full jersey lined palm and thumb with elastic gather on back. Generously sized for a good working fit.



540-2114

| CATALOG NO. | DESCRIPTION  | UOM | ORDER MULTIPLE |
|-------------|--|-----|----------------|
| 540-2114    | Leather Glove w/Safety Cuff, 1 pair per pack                 | EA  | 1              |
| 540-2214    | Leather Glove w/4-1/2" Waterproof Cuff, 1 pair per pack      | EA  | 1              |
| 540-2144    | Leather Glove w/Full Red Jersey Lining, 1 pair per pack      | EA  | 1              |
| 540-2200    | Renegade® Performance Glove w/Kevlar Thread, 1 pair per pack | EA  | 1              |

### Heavy Duty Work Gloves

Your choice of durable work gloves. Washable, breathable, and durable for everyday use.



| CATALOG NO. | DESCRIPTION                                    | UOM | ORDER MULTIPLE |
|-------------|--|-----|----------------|
| 540-HU1M    | Heavy Utility Gloves - Medium, 1 pair per pack | EA  | 1              |
| 540-HU1L    | Heavy Utility Gloves - Large, 1 pair per pack  | EA  | 1              |
| 540-BH1M    | Box Handler Gloves - Medium, 1 pair per pack   | EA  | 1              |
| 540-BH1L    | Box Handler Gloves - Large, 1 pair per pack    | EA  | 1              |
| 540-LG1M    | Leather Gloves - Medium, 1 pair per pack       | EA  | 1              |
| 540-LG1L    | Leather Gloves - Large, 1 pair per pack        | EA  | 1              |

### Nitrile Gloves

Purple, foam control gloves for industrial use that provide a high level of wet and dry grip. Standard in applications where tactile sensitivity is required.



540-1005M

| CATALOG NO. | DESCRIPTION                              | UOM | ORDER MULTIPLE |
|-------------|--|-----|----------------|
| 540-1005M   | Nitrile Gloves - Medium, 1 pair per pack | EA  | 1              |
| 540-1005L   | Nitrile Gloves - Large, 1 pair per pack  | EA  | 1              |

### Latex Gloves

Disposable natural latex rubber which provide a natural feel and grip.



23010

| CATALOG NO. | DESCRIPTION                    | UOM | ORDER MULTIPLE |
|-------------|--------------------------------|-----|----------------|
| 23010       | Latex Gloves, pack of 50 pairs | PK  | 1              |

### Dust Masks

Extremely lightweight, disposable, nuisance dust mask for non-toxic particles. Metal noseclips to fit individual facial contours.



5-500

| CATALOG NO. | DESCRIPTION            | UOM | ORDER MULTIPLE |
|-------------|------------------------|-----|----------------|
| 5-500       | Dust Masks, pack of 50 | PK  | 1              |

### Shoe Covers

Slip these shoe covers on in seconds to protect carpet, tile, or wood from dirt and scuff marks. Customers will appreciate your professional appearance.



SC-1

| CATALOG NO. | DESCRIPTION                             | UOM | ORDER MULTIPLE |
|-------------|---|-----|----------------|
| SC-1        | Dark Blue Shoe Covers, pack of 50 pairs | PK  | 1              |

### First Aid Kits

10 and 25-unit first aid kits packaged in economy plastic boxes to assist when industrial accidents occur.



FAK-25

| CATALOG NO. | DESCRIPTION           | UOM | ORDER MULTIPLE |
|-------------|-----------------------|-----|----------------|
| FAK-10      | 10-Unit First Aid Kit | EA  | 1              |
| FAK-25      | 25-Unit First Aid Kit | EA  | 1              |

**INDUSTRIAL TOWELS**

**WypAll Plus**

Absorbs grease, oil, water and solvents from floors, hands, parts, tools and machinery. Tough enough for extra heavy jobs. Comes in a convenient pop-up box of 100 towels.



5-05790

| CATALOG NO. | DESCRIPTION                           | UOM | ORDER MULTIPLE |
|-------------|---------------------------------------|-----|----------------|
| 5-05790     | WypAll Plus Towels—White, pack of 100 | PK  | 1              |

**WypAll ShopPro X80 Towels**

Like a rental shop towel, only more consistent. Engineered to feel like cloth and work even better. Absorbs more oil and water faster pound for pound than laundered shop towels. The ShopPro X80 is simply the heaviest duty towel in the Kimberly Clark line. 160 towels/box.



5-41041

| CATALOG NO. | DESCRIPTION                            | UOM | ORDER MULTIPLE |
|-------------|--|-----|----------------|
| 5-41041     | WypAll ShopPro X80 Towels, pack of 160 | PK  | 1              |

**Teri® Towels**

The Teri® reinforced towels feature multi-ply tissue reinforced with nylon webbing for added strength on the job. Made from 100% recycled paper. Towel size is 9-3/4" x 16-3/4". Towel color is white. Comes in a convenient pop up box. 126 towels/box. 10 boxes/case.



5-34790

| CATALOG NO. | DESCRIPTION                         | UOM | ORDER MULTIPLE |
|-------------|-------------------------------------|-----|----------------|
| 5-34790     | Teri Reinforced Towels, pack of 126 | PK  | 1              |

**Shop Towels**

Heavy duty reusable towels. For wipe ups of grease, oil, water, etc. 100% cotton material is pre-shrunk and hemmed. Each towel measures 13" x 16".



ST-10

| CATALOG NO. | DESCRIPTION             | UOM | ORDER MULTIPLE |
|-------------|-------------------------|-----|----------------|
| ST-4        | Shop Towels, pack of 4  | PK  | 1              |
| ST-10       | Shop Towels, pack of 10 | PK  | 1              |
| ST-24       | Shop Towels, pack of 24 | PK  | 1              |

**Workhorse® Manufactured Rags**

The economical alternative to scrap rags. Workhorse® Manufactured Rags is the first product to be made from Kimberly-Clark's advanced new material – Hydroknit®. Durable, rag tough construction stands up to any task. Can be re-used time and time again. Available in white or blue.



5-41455

| CATALOG NO. | DESCRIPTION                         | UOM | ORDER MULTIPLE |
|-------------|-------------------------------------|-----|----------------|
| 5-41455     | 9-3/4" x 16-3/4" White, pack of 100 | PK  | 1              |
| 5-41411     | 9-3/4" x 16-3/4" Blue, pack of 100  | PK  | 1              |

**Terry Towels**

100% cotton. Minimum of 14" x 17". Pre-washed for absorbency, fully-hemmed, all-white, and reusable.

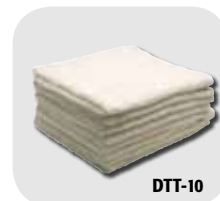

DTT-10

| CATALOG NO. | DESCRIPTION              | UOM | ORDER MULTIPLE |
|-------------|--------------------------|-----|----------------|
| DTT-10      | Terry Towels, pack of 10 | PK  | 1              |
| DTT-24      | Terry Towels, pack of 24 | PK  | 1              |

**Kimtex® Towels**

Long lasting Kimtex® stands up to oils, chemicals and solvents better than ordinary shop towels. Cloth-like feel and performance. Towel size is 9-3/4" x 16-3/4". 100 towels/box. 5 boxes/case.



5-33570

| CATALOG NO. | DESCRIPTION                     | UOM | ORDER MULTIPLE |
|-------------|---------------------------------|-----|----------------|
| 5-33570     | Kimtex Shop Towels, pack of 100 | PK  | 1              |

### Sheet Metal Screws – Taper Point

Hex washer slotted head. Burr-free. Full 1/4" head will not strip out of hex driver opening. Heat treated tapered point will not break or "walk". Packaged in resealable plastic cartons.



### Sheet Metal Screws – Drill Point

Self-drilling, self-tapping. Hex washer head. Produces the optimum hole size, resulting in a tighter fit. Made from special heat treated steel for extra strength. Packaged in resealable plastic cartons.



| CATALOG NO.     | DESCRIPTION  | UOM | ORDER MULTIPLE |
|-----------------|--|-----|----------------|
| 5-SCR63-8       | 6 x 3/8 Taper Point, pack of 1,000                       | PK  | 1              |
| 5-SCR63-8BULK   | 6 x 3/8 Taper Point – Bulk, pack of 20,000               | PK  | 1              |
| 5-SCR71-2       | 7 x 1/2 Taper Point, pack of 1,000                       | PK  | 1              |
| 5-SCR71-2BULK   | 7 x 1/2 Taper Point – Bulk, pack of 15,000               | PK  | 1              |
| 5-SCR81-2       | 8 x 1/2 Taper Point, pack of 1,000                       | PK  | 1              |
| 5-SCR81-25M     | 8 x 1/2 Taper Point, pack of 5,000                       | PK  | 1              |
| 5-SCR81-2BULK   | 8 x 1/2 Taper Point – Bulk, pack of 12,000               | PK  | 1              |
| 5-SCR83-4       | 8 x 3/4 Taper Point, pack of 1,000                       | PK  | 1              |
| 5-SCR83-4BULK   | 8 x 3/4 Taper Point – Bulk, pack of 10,000               | PK  | 1              |
| 5-SCR81         | 8 x 1 Taper Point, pack of 500                           | PK  | 1              |
| 5-SCR81BULK     | 8 x 1 Taper Point – Bulk, pack of 7,500                  | PK  | 1              |
| 5-SCR81-12-100  | 8 x 1-1/2 Taper Point, pack of 100                       | PK  | 1              |
| 5-SCR81-12      | 8 x 1-1/2 Taper Point, pack of 250                       | PK  | 1              |
| 5-SCR81-12W     | 8 x 1-1/2 Taper Point w/White Head, pack of 250          | PK  | 1              |
| 5-SCR81-12WTBUL | 8 x 1-1/2 Taper Point w/White Head – Bulk, pack of 5,000 | PK  | 1              |
| 5-SCR81-12BULK  | 8 x 1-1/2 Taper Point – Bulk, pack of 5,000              | PK  | 1              |
| 5-SCR82-100     | 8 x 2 Taper Point, pack of 100                           | PK  | 1              |
| 5-SCR82         | 8 x 2 Taper Point, pack of 350                           | PK  | 1              |
| 5-SCR82W        | 8 x 2 Taper Point w/White Head, pack of 250              | PK  | 1              |
| 5-SCR82BULK     | 8 x 2 Taper Point – Bulk, pack of 3,000                  | PK  | 1              |
| 5-SCR101-2      | 10 x 1/2 Taper Point, pack of 1,000                      | PK  | 1              |
| 5-SCR101-2BULK  | 10 x 1/2 Taper Point – Bulk, pack of 14,000              | PK  | 1              |
| 5-SCR103-4      | 10 x 3/4 Taper Point, pack of 1,000                      | PK  | 1              |
| 5-SCR103-4BULK  | 10 x 3/4 Taper Point – Bulk, pack of 10,000              | PK  | 1              |
| 5-SCR101        | 10 x 1 Taper Point, pack of 500                          | PK  | 1              |
| 5-SCR101BULK    | 10 x 1 Taper Point – Bulk, pack of 7,000                 | PK  | 1              |

| CATALOG NO.       | DESCRIPTION                                  | HEAD SIZE | UOM | ORDER MULTIPLE |
|-------------------|--|-----------|-----|----------------|
| 5-SCR61-2DP       | 6 x 1/2 Drill Point, pack of 1,000           | 1/4"      | PK  | 1              |
| 5-SCR61-2DPBULK   | 6 x 1/2 Drill Point – Bulk, pack of 15,000   | 1/4"      | PK  | 1              |
| 5-SCR81-2DP       | 8 x 1/2 Drill Point, pack of 1,000           | 1/4"      | PK  | 1              |
| 5-SCR81-2DPBULK   | 8 x 1/2 Drill Point – Bulk, pack of 10,000   | 1/4"      | PK  | 1              |
| 5-SCR83-4DP       | 8 x 3/4 Drill Point, pack of 500             | 1/4"      | PK  | 1              |
| 5-SCR83-4DPBULK   | 8 x 3/4 Drill Point – Bulk, pack of 10,000   | 1/4"      | PK  | 1              |
| 5-SCR81DP         | 8 x 1 Drill Point, pack of 500               | 1/4"      | PK  | 1              |
| 5-SCR81DPBULK     | 8 x 1 Drill Point – Bulk, pack of 7,500      | 1/4"      | PK  | 1              |
| 5-SCR81-12DP      | 8 x 1-1/2 Drill Point, pack of 500           | 1/4"      | PK  | 1              |
| 5-SCR81-12DPBULK  | 8 x 1-1/2 Drill Point – Bulk, pack of 5,000  | 1/4"      | PK  | 1              |
| 5-SCR82DP         | 8 x 2 Drill Point, pack of 350               | 1/4"      | PK  | 1              |
| 5-SCR82DPBULK     | 8 x 2 Drill Point – Bulk, pack of 2,500      | 1/4"      | PK  | 1              |
| 5-SCR101-2DP      | 10 x 1/2 Drill Point, pack of 500            | 5/16"     | PK  | 1              |
| 5-SCR101-2DPBULK  | 10 x 1/2 Drill Point – Bulk, pack of 10,000  | 5/16"     | PK  | 1              |
| 5-SCR103-4DP      | 10 x 3/4 Drill Point, pack of 500            | 5/16"     | PK  | 1              |
| 5-SCR103-4DPBULK  | 10 x 3/4 Drill Point – Bulk, pack of 5,000   | 5/16"     | PK  | 1              |
| 5-SCR101DP        | 10 x 1 Drill Point, pack of 500              | 5/16"     | PK  | 1              |
| 5-SCR101DPBULK    | 10 x 1 Drill Point – Bulk, pack of 5,000     | 5/16"     | PK  | 1              |
| 5-SCR101-12DP     | 10 x 1-1/2 Drill Point, pack of 250          | 5/16"     | PK  | 1              |
| 5-SCR101-12DPBULK | 10 x 1-1/2 Drill Point – Bulk, pack of 3,500 | 5/16"     | PK  | 1              |
| 5-SCR102DP        | 10 x 2 Drill Point, pack of 350              | 5/16"     | PK  | 1              |
| 5-SCR102DPBULK    | 10 x 2 Drill Point – Bulk, pack of 2,500     | 5/16"     | PK  | 1              |

### Masonry Screw



| CATALOG NO. | DESCRIPTION                                | UOM | ORDER MULTIPLE |
|-------------|--|-----|----------------|
| 5-SCRMS     | Masonry Screw – 1/4" x 1-1/4", pack of 250 | PK  | 1              |

### Masonry Bit



| CATALOG NO. | DESCRIPTION              | UOM | ORDER MULTIPLE |
|-------------|--------------------------|-----|----------------|
| 540-DB6     | Masonry Bit – 3/16" x 6" | EA  | 1              |

## SHEET METAL SCREWS cont'd

### Sheet Metal Screw Assortment Kit

The 7 most popular sizes in one multi-compartmented, resealable, plastic container. Perfect for the toolbox. Contains:

- 7 x 1/2 Taper Point – 175 pieces
- 8 x 1/2 Drill Point – 100 pieces
- 8 x 1 Taper Point – 50 pieces
- 8 x 2 Taper Point – 40 pieces
- 8 x 1/2 Taper Point – 175 pieces
- 8 x 3/4 Taper Point – 60 pieces
- 8 x 1-1/2 Taper Point – 50 pieces
- 1/4" Nut Setter – 1 each



| CATALOG NO. | DESCRIPTION                       | UOM | ORDER MULTIPLE |
|-------------|-----------------------------------|-----|----------------|
| 5-SCR-AK    | Sheet Metal Screw Assortment Pack | EA  | 1              |

### Anchor Kit

Plastic anchor kit for sheet rock applications. Kit includes 100 anchors, screws and 1 masonry bit.



| CATALOG NO. | DESCRIPTION   | UOM | ORDER MULTIPLE |
|-------------|---|-----|----------------|
| 540-AK100   | Anchor size 1/4 x 1, Screw Size 10 x 1-1/4 HWH Head Size 5/16 hex | EA  | 1              |

## CARTON SEALING TAPE AND DISPENSER

### Carton Sealing Tape

2" nominal width, 110 yd. length, clear. 2.4 mil.



| CATALOG NO. | DESCRIPTION                                  | UOM | ORDER MULTIPLE |
|-------------|--|-----|----------------|
| 540-2110C   | Carton Sealing Tape – 2" x 110 Yards – Clear | EA  | 36             |

### Carton Tape Dispenser

Heavy duty, boxed.



| CATALOG NO. | DESCRIPTION              | UOM | ORDER MULTIPLE |
|-------------|--------------------------|-----|----------------|
| 540-DISP    | 2" Carton Tape Dispenser | EA  | 1              |

## SEALING COMPOUNDS, ADHESIVE

### DiversiGum Sealing Compound

Non-hardening. For plugging openings through foundations or around refrigeration tube entry.



| CATALOG NO. | DESCRIPTION  | UOM | ORDER MULTIPLE |
|-------------|--|-----|----------------|
| 6-202-1     | DiversiGum Sealing Compound – 1 lb. Slug               | EA  | 24             |
| 6-202-2     | DiversiGum Sealing Compound – 2 lb. Slug               | EA  | 20             |
| AG-25       | DiversiGum Sealing Compound – 3/8" x 25' Caulking Cord | EA  | 12             |

### Silicone Sealant

Food grade 100% RTV Silicone Sealant. Can be used in applications for continuous use to 450°F. UV and water resistant. Long-term flexibility. Non-paintable. Available in 10.3 fl. oz. tube for use in standard caulk gun or in 3 fl. oz. squeeze tube.



| CATALOG NO. | DESCRIPTION                                     | UOM | ORDER MULTIPLE |
|-------------|---|-----|----------------|
| 7-4000      | Clear Silicone Sealant – 10.3 fl. oz. Tube      | EA  | 12             |
| 7-4001      | Clear Silicone Sealant – 3 fl. oz. Squeeze Tube | EA  | 48             |
| 7-4100      | White Silicone Sealant – 10.3 fl. oz. Tube      | EA  | 12             |
| 7-4101      | White Silicone Sealant – 3 fl. oz. Squeeze Tube | EA  | 48             |
| 7-4200      | Aluminum Silicone Sealant – 10.3 fl. oz. Tube   | EA  | 12             |

### Caulk Gun



| CATALOG NO. | DESCRIPTION                    | UOM | ORDER MULTIPLE |
|-------------|--------------------------------|-----|----------------|
| 7-100       | Caulk Gun – Super Ratchet Type | EA  | 12             |
| 7-200       | Caulk Gun – Standard Duty      | EA  | 12             |

### High Temp Red Silicone Sealant

A one part non-slumping paste that cures to a tough, rubbery solid at room temperature. Formulated to perform at temperatures ranging from -85°F to 500°F for continuous operation, and to 600°F for intermittent exposure. Tack free cure time – 15 minutes. Full cure time – 24 hours.



| CATALOG NO. | DESCRIPTION   | UOM | ORDER MULTIPLE |
|-------------|---|-----|----------------|
| 7-4300      | High Temp Red Silicone Sealant – 10.1 oz. Cartridge | EA  | 12             |

### 25 Year Acrylic Latex Painter's Caulk

For both interior and exterior use. DiversiTech's 25 Year Acrylic Latex Painter's Caulk forms a tough, paintable resilient bond to all building material surfaces. Excellent resistance to water, weathering and moisture vapor.



| CATALOG NO. | DESCRIPTION                                    | UOM | ORDER MULTIPLE |
|-------------|--|-----|----------------|
| 7-4500      | White Acrylic Latex Caulk – 10.1 oz. Cartridge | EA  | 12             |
| 7-4400      | Clear Acrylic Latex Caulk – 10.1 oz. Cartridge | EA  | 12             |

### Firestop Products for Class A Buildings

U.L. Classified. Code Approved. Seal penetrations of plumbing, refrigeration and AC lines, ducts, vents and electrical cable through fire-rated floors, walls and ceilings. Easy-to-use, non-shrinking, non-toxic and permanently flexible. Blocks fire, gas, smoke, air and water migration. Use ceramic fiber filler together with putty or caulk for thick penetrations. Technical bulletins available.



| CATALOG NO. | DESCRIPTION                                   | UOM | ORDER MULTIPLE |
|-------------|---|-----|----------------|
| 16491       | Firestop Caulk – Red – 10.3 fl. oz. cartridge | EA  | 12             |

### Geocel Caulking Sealant

Exceptional bonding and sealing caulk for interior and exterior applications involving seams, joints, ductwork, flashing and any similar use. Excellent adhesion to virtually any surface (metals, fiberglass, wood, concrete, brick and most plastics) even if moisture is present. Resealable, paintable, flexible. Will not crack, chip or peel. Specially formulated for the HVACR industry.



| CATALOG NO. | DESCRIPTION                                     | UOM | ORDER MULTIPLE |
|-------------|---|-----|----------------|
| 18001       | Clear Geocel Sealant – 11 oz. Cartridge         | EA  | 24             |
| 18002       | White Geocel Sealant – 11 oz. Cartridge         | EA  | 24             |
| 18003       | Aluminum/Gray Geocel Sealant – 11 oz. Cartridge | EA  | 24             |

### Pro-Air Duct Sealant – UL 181 AM-BM Listed

Water-based fiber-reinforced duct sealant/mastic formulated for indoor/outdoor use. Meets U.L. Class 1 rating and local codes while featuring long term flexibility and strength. Use on metal heating, ventilating, and A/C duct systems; as well as fiberglass duct board systems and flex duct systems. Recommended for use to 10" of water column pressure without the need for fiberglass mesh reinforcement.



| CATALOG NO. | DESCRIPTION  | UOM | ORDER MULTIPLE |
|-------------|--|-----|----------------|
| 800-008     | Pro-Air Duct Sealant – 1/10 Gallon Tube – 10.5 oz. | EA  | 12             |
| 800-009     | Pro-Air Duct Sealant – 1 Gallon Pail               | EA  | 4              |

### Foam Sealant – One Component

One component closed-cell expanding polyurethane foam sealant for lineal caulking applications. Air-moisture cure. Tack free in 20 minutes; fully cured in 12 hours. Paintable. Use for insulating and sealing around windows, doors, pipes, ducts and vents. Non-toxic when cured. Paint to protect from UV exposure. "R" value 4.7 (1" thickness). Foam contains fire retarding chemical and is U.L. Listed but not rated as a firestop product. Environmental concerns have led us to replace CFC's and HCFC's with hydrocarbon material in our one component foam products. See instructions on each product to ensure safe use and quality results.



| CATALOG NO. | DESCRIPTION   | UOM | ORDER MULTIPLE |
|-------------|---|-----|----------------|
| 01714       | Foam Sealant – 12 oz. Can – Yields 275' (3/8" bead) | EA  | 12             |
| 01724       | Foam Sealant – 20 oz. Can – Yields 460' (3/8" bead) | EA  | 12             |

### Foam Sealant – Two Component

Two component closed-cell expanding polyurethane foam sealant for cavity filling, surface coating and insulation applications. Rapid chemical cure (Component A and Component B). Tack free in 2 minutes, fully cured in 20 minutes. Use for insulation repairs in refrigerated enclosures. Spray coat and insulate tanks, pipes, tubs and panels. Non-toxic when cured. Paint to protect from UV exposure. "R" value 5 (1" thickness). Kits include dispensing nozzles, hose and flow control mechanism. Foam contains fire retarding chemicals and is U.L. Listed but is not rated as a firestop product.



| CATALOG NO. | DESCRIPTION  | UOM | ORDER MULTIPLE |
|-------------|--|-----|----------------|
| 10012       | Foam – 2 Kit – 15 bd. ft. Kit – Yields 1 cu. ft.   | EA  | 12             |
| 10180       | Foam – 2 Kit – 200 bd. ft. Kit – Yields 15 cu. ft. | EA  | 1              |
| 10600       | Foam – 2 Kit – 600 bd. ft. Kit – Yields 50 cu. ft. | EA  | 1              |

### Pro-Air Industrial Grade Spray Adhesive

A clear, pressure sensitive aerosol adhesive with exceptional tack and shear strength characteristics. An excellent choice for most permanent adhesive applications: duct liner and wrap, sheet aluminum, fiberglass insulation board, and much more. The aerosol package offers a specially designed web spray pattern for even, controlled distribution. Flammability meets aerosol flame extension test requirements. Coverage is approximately 90-100 square feet per pound.



| CATALOG NO. | DESCRIPTION   | UOM | ORDER MULTIPLE |
|-------------|---|-----|----------------|
| 315-20      | Sure Stick Heavy Duty Spray – 12 oz.                | EA  | 12             |
| GP1-40BL    | Pro-Air Spray Adhesive – 38 lb. Disposable Cylinder | EA  | 1              |
| GN-23H      | Spray Gun   | EA  | 1              |
| SH-06       | 6' Spray Hose                                       | EA  | 1              |
| SH-12       | 12' Spray Hose                                      | EA  | 1              |

**ABRASIVE CLOTHS**

**Abrasive Cloth**

Aluminum oxide, high quality 120 grit, abrasive cloth to thoroughly clean copper and steel tubing. Works wet or dry. Exceeds industry standards for abrasive cloth.



| CATALOG NO. | DESCRIPTION                       | UOM | ORDER MULTIPLE |
|-------------|-----------------------------------|-----|----------------|
| SC-10       | Abrasive Cloth – 1-1/2" x 10 yds. | EA  | 24             |
| SC-25       | Abrasive Cloth – 1-1/2" x 25 yds. | EA  | 12             |

**Grip-Cut™**

Open mesh sand screen cloth. Aluminum oxide grain resin bonded to synthetic nylon cloth. 100% waterproof, but can also be used dry for sanding by hand or with portable tools. Most effective where clogging is a problem, such as soft materials. 180 grit.



| CATALOG NO. | DESCRIPTION                                 | UOM | ORDER MULTIPLE |
|-------------|---|-----|----------------|
| SCM-5       | Grip-Cut™ – 1-1/2" x 5 yds.                 | EA  | 24             |
| SCM-10      | Grip-Cut™ – 1-1/2" x 10 yds.                | EA  | 24             |
| SCM-25      | Grip-Cut™ – 1-1/2" x 25 yds.                | EA  | 12             |
| SCM-10MP    | Grip-Cut™ – 1-1/2" x 12" Strips – 10 strips | EA  | 50             |

**All Purpose Cleaning Pads**

For cleaning copper tubes and fittings. Nylon will not rust. Can be used wet or dry. Leaves no residue and is long lasting.



| CATALOG NO. | DESCRIPTION                            | UOM | ORDER MULTIPLE |
|-------------|--|-----|----------------|
| ACP-10      | All Purpose Cleaning Pads – pack of 10 | PK  | 1              |

**HAND CLEANERS**

**Fast Orange® Hand Cleaner**

Three out of five people prefer Fast Orange® over other hand cleaners. The first biodegradable, waterless hand cleaner with aloe, lanolin, and jojoba. Smooth lotion and extra-fine pumice available. USDA Approved.



| CATALOG NO. | DESCRIPTION  | UOM | ORDER MULTIPLE |
|-------------|--|-----|----------------|
| HCO-7       | Fast Orange® – 7-1/2 fl. oz. Smooth Squeeze Bottle | EA  | 12             |
| HCO-15      | Fast Orange® – 15 oz. Smooth Squeeze Bottle        | EA  | 6              |
| HCO-64      | Fast Orange® – 1/2 Gallon Smooth with Dispenser    | EA  | 6              |
| HCO-128     | Fast Orange® – 1 Gallon Smooth with Dispenser      | EA  | 4              |
| HCP-7       | Fast Orange® – 7-1/2 fl. oz. Pumice Squeeze Bottle | EA  | 12             |
| HCP-15      | Fast Orange® – 15 oz. Pumice Squeeze Bottle        | EA  | 12             |
| HCP-128     | Fast Orange® – 1 Gallon Pumice with Dispenser      | EA  | 4              |

**Kimberly-Clark Waterless Hand Wipes**

These wipes go wherever hands go to get dirty. Full sized 12" x 12" wipes for full sized cleaning. Natural cleaning agent is tough on grease, grime, ink, and paint. Dual textured – smooth for wiping on one side and tough for scrubbing on the other. More wipes with our 75 count bucket.



| CATALOG NO. | DESCRIPTION                                  | UOM | ORDER MULTIPLE |
|-------------|--|-----|----------------|
| 5-42272     | Kimberly-Clark Waterless Hand Wipes – Bucket | EA  | 1              |

**LUBRICANTS**

**Pull-A-Spout Oiler**

All purpose oiler with a 14" telescoping spout. Zooms out for long shots, and in for short shots, even zooms around corners. Squeeze bottle action. Perfect lubricant for general industrial use. Contains four ounces of finest quality carbon free, rust and oxidation inhibited lubricating oil. Plastic container won't short out around electrical connections. No leakage.



| CATALOG NO. | DESCRIPTION                            | UOM | ORDER MULTIPLE |
|-------------|--|-----|----------------|
| CO-1        | Pull-A-Spout Oiler – 4 oz. – (Display) | EA  | 12             |

**Rust Breaker**

Quickly loosens rusted bolts, screws, shafts, piping, and all types of "Frozen" connections and assemblies. The answer for rusty or corroded fastenings on cars, trucks, trailers, tractors, farm machinery, appliances, washing machines, plumbing, water pumps, fishing reels, power tools, gardening equipment, and hundreds of other mechanisms. Packaged in a handy telescoping spout applicator.



| CATALOG NO. | DESCRIPTION                      | UOM | ORDER MULTIPLE |
|-------------|----------------------------------|-----|----------------|
| CR-1        | Rust Breaker – 4 oz. – (Display) | EA  | 12             |

**WD-40**

Loosens rusted parts. Stops squeaks. Removes tar, grease and adhesives. Displaces moisture. Protects metal. New Smart Straw can.



| CATALOG NO. | DESCRIPTION    | UOM | ORDER MULTIPLE |
|-------------|----------------|-----|----------------|
| 741-001     | WD-40 – 8 oz.  | EA  | 12             |
| 741-002     | WD-40 – 11 oz. | EA  | 12             |

**3-36® Multi-Purpose Lubricant & Corrosion Inhibitor**

A multi-purpose petroleum based compound that forms a clear, thin film that lubricates and protects against wear and corrosion. The product also displaces moisture and cleans.



| CATALOG NO. | DESCRIPTION  | UOM | ORDER MULTIPLE |
|-------------|--|-----|----------------|
| CRC-2       | 3-36® Multi-Purpose Lubricant & Corrosion Inhibitor – 11 oz.   | EA  | 12             |
| CRC-2G      | 3-36® Multi-Purpose Lubricant & Corrosion Inhibitor – 1 Gallon | EA  | 4              |

**SP-400™ Corrosion Inhibitor**

Long-term corrosion inhibitor that protects equipment subject to heat, humidity, chemicals or severely corrosive atmospheres. This product is best to use on machined surfaces and assemblies subjected to long periods of storage.



| CATALOG NO. | DESCRIPTION                          | UOM | ORDER MULTIPLE |
|-------------|--------------------------------------|-----|----------------|
| CRC-3       | SP-400™ Corrosion Inhibitor – 10 oz. | EA  | 12             |

**Zinc-It® Instant Cold Galvanize™ Zinc Rich Galvanize Coating**

High-performance zinc coating that electrochemically bonds with ferrous metals to form a galvanic cell. The product also fights rust and corrosion and can be used as a touch-up for damaged galvanized coatings. Zinc-It® Instant Cold Galvanize™ Zinc Rich Galvanize Coating dries quickly.



| CATALOG NO. | DESCRIPTION   | UOM | ORDER MULTIPLE |
|-------------|---|-----|----------------|
| CRC-5       | Zinc-It® Instant Cold Galvanize™ Zinc Rich Galvanize Coating – 13 oz. | EA  | 12             |

**Bright Zinc-It® Light Duty Instant Cold Galvanize™ Zinc Rich Galvanize Coating**

An epoxy-ester based coating that creates a barrier film between the environment and the base metal to prevent rust and corrosion from forming or spreading.



| CATALOG NO. | DESCRIPTION   | UOM | ORDER MULTIPLE |
|-------------|---|-----|----------------|
| CRC-5BC     | Bright Zinc-It® Light Duty Instant Cold Galvanize™ Zinc Rich Galvanize Coating – 13 oz. | EA  | 12             |

**Sta-Plex™ Extreme Pressure Premium Red Grease**

A superior multi-purpose certified lithium complex based grease which contains extreme pressure, anti-wear, and anti-oxidation additives. The product is very useful in high temperature and performance applications. The drop point is 500°F.



| CATALOG NO. | DESCRIPTION  | UOM | ORDER MULTIPLE |
|-------------|--|-----|----------------|
| CRC-13      | Sta-Plex™ Extreme Pressure Premium Red Grease – 14 oz. | EA  | 12             |

**Heavy Duty Silicone Mold Release**

This product provides maximum releases and is useful in difficult to remove parts. The Heavy Duty Silicone Mold Release is colorless, odorless, non-staining and non-corrosive.



| CATALOG NO. | DESCRIPTION                               | UOM | ORDER MULTIPLE |
|-------------|---|-----|----------------|
| CRC-6       | Heavy Duty Silicone Mold Release – 12 oz. | EA  | 12             |

**Ultra Lite 3-36® Ultra Thin Non Staining Lubricant**

Ultra-thin, non-staining lubricant that resists oil, dirt and dust build-up. This lubricant also seals out moisture and protects against corrosion. It is excellent for drying out electrical components.



| CATALOG NO. | DESCRIPTION   | UOM | ORDER MULTIPLE |
|-------------|---|-----|----------------|
| CRC-1       | Ultra Lite 3-36® Ultra Thin Non Staining Lubricant – 11 oz. | EA  | 12             |

**White Lithium Grease**

White Lithium Grease has superior lubrication and durability in any weather or temperature. It is useful as a break-in lubricant for bearings or as a general purpose lubricant and corrosion inhibitor for tools, machinery and equipment.



| CATALOG NO. | DESCRIPTION                   | UOM | ORDER MULTIPLE |
|-------------|-------------------------------|-----|----------------|
| CRC-9       | White Lithium Grease – 10 oz. | EA  | 12             |

**LUBRICANTS cont'd**

**Screwloose® Industrial Penetrating Oil**

A no-compromise penetrant that attacks corrosion to free corroded fasteners and mechanical components. A super-fast, powerful, concentrated penetrating solvent that loosens rust scale and corrosion and instantly penetrates minute and tightly fitted crevices.



CRC-8

| CATALOG NO. | DESCRIPTION                                     | UOM | ORDER MULTIPLE |
|-------------|---|-----|----------------|
| CRC-8       | Screwloose® Industrial Penetrating Oil – 11 oz. | EA  | 12             |

**Knock'er Loose® Penetrating Solvent**

An industrial strength, low viscosity penetrant designed to rapidly loosen and free seized, bound or frozen fasteners. This product also quickly permeates rust, scale, gum, grease and corrosion. Independent tests reveal that it outperforms its competition.



CRC-1KB

| CATALOG NO. | DESCRIPTION                                  | UOM | ORDER MULTIPLE |
|-------------|--|-----|----------------|
| CRC-1KB     | Knock'er Loose® Penetrating Solvent – 13 oz. | EA  | 12             |

**CONTACT CLEANERS**

**HF™ Contact Cleaner**

A petroleum distillate based precision cleaner with a flash point of 205°F. It can be an alternative to CFCs when applications require higher flashpoints.



CRC-4-140

| CATALOG NO. | DESCRIPTION                  | UOM | ORDER MULTIPLE |
|-------------|------------------------------|-----|----------------|
| CRC-4-140   | HF™ Contact Cleaner – 11 oz. | EA  | 12             |

**Electronic Degreaser**

This Advanced Technology Formula is non-chlorinated, non-conductive, non-corrosive and non-staining. It rapidly dissolves grease, oil and sludge for better efficiency of mechanical equipment. The Electronic Degreaser has no flash or fire point.



CRC-4NU

| CATALOG NO. | DESCRIPTION                   | UOM | ORDER MULTIPLE |
|-------------|-------------------------------|-----|----------------|
| CRC-4NU     | Electronic Degreaser – 15 oz. | EA  | 12             |

**QD® Contact Cleaner**

This contact cleaner is suitable for cleaning sensitive electronics and electrical equipment and does not leave any residue. It evaporates quickly and is safe to use on all plastics. This product is more useful where lower flashpoint cleaners are acceptable. The QD® Contact Cleaner is NSF K2 Registered.



CRC-4CF

| CATALOG NO. | DESCRIPTION                  | UOM | ORDER MULTIPLE |
|-------------|------------------------------|-----|----------------|
| CRC-4CF     | QD® Contact Cleaner – 11 oz. | EA  | 12             |

**NT™ Precision Cleaner**

This cleaner is classified as an HFE/HFC-based contact cleaning solvent. There is no flash or fire point. It works fast to remove dirt, light oils and other contaminants.



CRC-4NS

| CATALOG NO. | DESCRIPTION                    | UOM | ORDER MULTIPLE |
|-------------|--------------------------------|-----|----------------|
| CRC-4NS     | NT™ Precision Cleaner – 12 oz. | EA  | 12             |

**DEGREASERS**

**Heavy Duty Degreaser II**

The Heavy Duty Degreaser II is a non-chlorinated, zero VOC formula for cleaning where chlorinated solvents are prohibited. It has a high flashpoint of 180°F. This degreaser effectively removes soils with no residue build-up. Please exercise caution on plastics.



CRC-7-140

| CATALOG NO. | DESCRIPTION                      | UOM | ORDER MULTIPLE |
|-------------|----------------------------------|-----|----------------|
| CRC-7-140   | Heavy Duty Degreaser II – 15 oz. | EA  | 12             |

**Chlor-Free® Degreaser**

Non-chlorinated degreasing solvent which is used to remove oil, grease and other contaminants. It is especially useful for applications requiring a quick turnaround and where a low flashpoint solvent can be used.



CRC-7Z

| CATALOG NO. | DESCRIPTION                    | UOM | ORDER MULTIPLE |
|-------------|--------------------------------|-----|----------------|
| CRC-7Z      | Chlor-Free® Degreaser – 14 oz. | EA  | 12             |

## DEGREASERS cont'd

### Heavy Duty Degreaser

This degreaser rapidly and effectively removes grease, oil, tar, and other residue to increase operating efficiency of equipment. It has no flash or fire point, making it an excellent alternative to 1,1,1-based cleaners. Please use caution on plastics.



| CATALOG NO. | DESCRIPTION                   | UOM | ORDER MULTIPLE |
|-------------|-------------------------------|-----|----------------|
| CRC-7X      | Heavy Duty Degreaser – 19 oz. | EA  | 12             |

### Citrus Degreaser

The Citrus Degreaser has a new Low VOC Formula. The product removes grease, oil and lubricants with no water wash-off. It evaporates quickly and leaves no residue. The product gives off a pleasant citrus scent and is NSF C1 Registered.



| CATALOG NO. | DESCRIPTION               | UOM | ORDER MULTIPLE |
|-------------|---------------------------|-----|----------------|
| CRC-7PS     | Citrus Degreaser – 15 oz. | EA  | 12             |

## BATTERIES BY RAYOVAC®

**Rayovac is the Industrial Product Leader!** Rayovac is the leader in the industrial battery market and has been for years, with an estimated 50% share of the traditional industrial distribution channel. Rayovac introduced the top-selling industrial flashlight to the market, and set the quality standard by which all other industrial flashlights are measured today. Whether your customer is searching for a toolbox-tough flashlight or high-performance batteries, Rayovac offers a broad range of products to meet your needs.

### Rayovac Industrial Maximum Alkaline Batteries – Contractor Packs

- Contractor preferred, clear, re-sealable package
- Greater battery per pack quantities command higher battery sales
- Displays much more readily than other competitive batteries
- In an HVAC test market, the Contractor Packs outsold the standard packs by a greater than 2 to 1 ratio!



| CATALOG NO. | DESCRIPTION  | UOM | ORDER MULTIPLE |
|-------------|--|-----|----------------|
| 7-ALAA-24   | Alkaline AA Battery – Contractor Pack, pack of 24  | PK  | 1              |
| 7-ALAAA-18  | Alkaline AAA Battery – Contractor Pack, pack of 18 | PK  | 1              |
| 7-ALC-12    | Alkaline C Battery – Contractor Pack, pack of 12   | PK  | 1              |
| 7-ALD-12    | Alkaline D Battery – Contractor Pack, pack of 12   | PK  | 1              |
| 7-AL9V-8    | Alkaline 9V Battery – Contractor Pack, pack of 8   | PK  | 1              |

### Rayovac Industrial Maximum Alkaline Batteries – Shrink Packed

- Same battery performance as the Contractor Packs at a lower cost
- Formulated specifically to exceed the everyday demands of industrial applications
- Outstanding dependability for “must work” applications



| CATALOG NO. | DESCRIPTION                                     | UOM | ORDER MULTIPLE |
|-------------|---|-----|----------------|
| 7-ALAA      | Alkaline AA Battery – Shrink Packed, pack of 8  | PK  | 1              |
| 7-ALAAA     | Alkaline AAA Battery – Shrink Packed, pack of 8 | PK  | 1              |
| 7-ALC       | Alkaline C Battery – Shrink Packed, pack of 6   | PK  | 1              |
| 7-ALD       | Alkaline D Battery – Shrink Packed, pack of 6   | PK  | 1              |
| 7-AL9V      | Alkaline 9V Battery – Shrink Packed, pack of 6  | PK  | 1              |

### Rayovac Lantern Batteries

- Dependable performance – for “must work” applications
- Available in General Purpose, Heavy Duty, and Alkaline Maximum



| CATALOG NO. | DESCRIPTION  | UOM | ORDER MULTIPLE |
|-------------|--|-----|----------------|
| 7-6VGP      | 6 Volt General Purpose – Spring Terminals, pack of 12    | PK  | 1              |
| 7-6VHD      | 6 Volt Heavy Duty – Spring Terminals, pack of 12         | PK  | 1              |
| 7-6VHDM     | 6 Volt Heavy Duty Maximum – Spring Terminals, pack of 12 | PK  | 1              |
| 7-806       | 6 Volt Alkaline Maximum – Spring Terminals, pack of 6    | PK  | 1              |
| 7-918       | 6 Volt General Purpose – Screw Terminals, pack of 6      | PK  | 1              |
| 7-944       | 6 Volt Lantern Battery, pack of 6                        | PK  | 1              |

## WASP, HORNET, AND YELLOW JACKET KILLERS

### Sting Less Wasp & Hornet Killer

Kills wasps, hornets and yellow jackets. Very fast-acting when insects are hit directly. Allow approximately 24 hours for those that were not directly hit. This container delivers a 20-foot jet blast to knock down the insects and allow for the user to remain at a safe distance.



| CATALOG NO. | DESCRIPTION                                     | UOM | ORDER MULTIPLE |
|-------------|---|-----|----------------|
| 436-20      | Sting Less Wasp & Hornet Spray – 14 oz. Aerosol | EA  | 12             |

### Wasp & Hornet Killer by ENFORCER

Enforcer's Wasp & Hornet Killer shoots a 20-foot jet blast for instant knockdown of wasps, hornets, and yellow jackets. Enforcer's Wasp & Yellow Jacket Foam is a 20-foot blast of blanketing foam that plugs yellow jacket holes and clings to wasp and hornet nests, preventing their escape.



| CATALOG NO. | DESCRIPTION   | UOM | ORDER MULTIPLE |
|-------------|---|-----|----------------|
| 8-WH16      | Enforcer Wasp & Hornet Killer – 16 oz. Aerosol      | EA  | 12             |
| 8-FWH16     | Enforcer Wasp & Yellow Jacket Foam – 16 oz. Aerosol | EA  | 12             |

## MARKERS

### Valve Action Marker

Large ink supply for increased mileage. Fast drying, smear and water resistant. Utilizes a patented valve-activated ink feed mechanism to supply ink as required, down to the last drop.



| CATALOG NO. | DESCRIPTION                             | UOM | ORDER MULTIPLE |
|-------------|---|-----|----------------|
| 540-799     | Valve Action Marker-Regular Tip - Red   | EA  | 12             |
| 540-800     | Valve Action Marker-Regular Tip - Black | EA  | 12             |

### Valve Action Paint Marker

Bright, crisp, opaque colors. The oil-based paint is quick drying and permanent on most surfaces. These markers also feature the patented valve-operated feed mechanism and a medium point.



| CATALOG NO. | DESCRIPTION                        | UOM | ORDER MULTIPLE |
|-------------|------------------------------------|-----|----------------|
| 540-805     | Valve Action Paint Marker - Black  | EA  | 12             |
| 540-806     | Valve Action Paint Marker - Red    | EA  | 12             |
| 540-807     | Valve Action Paint Marker - White  | EA  | 12             |
| 540-808     | Valve Action Paint Marker - Yellow | EA  | 12             |

### Felt Tip Markers

Permanent markers for metal, glass, paper, and plastic. 20% more ink than competitors. Durable metal body.

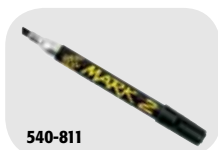

| CATALOG NO. | DESCRIPTION                          | UOM | ORDER MULTIPLE |
|-------------|--------------------------------------|-----|----------------|
| 540-811     | Metal Bodied Felt Tip Marker - Black | EA  | 12             |

## PAINTS AND PRIMERS

### Industrial Enamel

Finally an aerosol paint that sprays in any direction without clogging. We guarantee it! Dries tack free in 10 to 20 minutes; fully dry in just one hour. Excellent corrosion and solvent resistance. Resists heat up to 250°F. Now in 20 oz. cans. Product meets most recent VOC legislation and is currently compliant.



| CATALOG NO. | DESCRIPTION                                       | UOM | ORDER MULTIPLE |
|-------------|---|-----|----------------|
| 799-020     | Industrial Enamel - Gloss Black - 20 oz.          | EA  | 6              |
| 799-021     | Industrial Enamel - Flat Black - 20 oz.           | EA  | 6              |
| 799-022     | Industrial Enamel - Gloss White - 20 oz.          | EA  | 6              |
| 799-023     | Industrial Enamel - Machinery Dark Gray - 20 oz.  | EA  | 6              |
| 799-024     | Industrial Enamel - Machinery Light Gray - 20 oz. | EA  | 6              |
| 799-025     | Industrial Enamel - Aluminum - 20 oz.             | EA  | 6              |
| 799-026     | Industrial Enamel - OSHA Red - 20 oz.             | EA  | 6              |
| 799-031     | All Purpose Enamel - Gray Primer - 20 oz.         | EA  | 6              |

### General Purpose Spray Paint

New, more complete line of professional quality fast drying spray paints. Color code compressors or refrigerant recovery cylinders to match standard refrigerant identifying colors. Touch up equipment housings. Product meets most recent VOC legislation and is currently compliant.



| CATALOG NO. | DESCRIPTION   | UOM | ORDER MULTIPLE |
|-------------|---|-----|----------------|
| 799-001     | Spray Paint - Gloss Black - 16 oz.                  | EA  | 6              |
| 799-002     | Spray Paint - Flat Black - 16 oz.                   | EA  | 6              |
| 799-003     | Spray Paint - Gloss White - 16 oz.                  | EA  | 6              |
| 799-004     | Spray Paint - Flat White - 16 oz.                   | EA  | 6              |
| 799-005     | Spray Paint - Dark Machinery Gray - 16 oz.          | EA  | 6              |
| 799-006     | Spray Paint - Gray Primer - 16 oz.                  | EA  | 6              |
| 799-007     | Spray Paint - Red Primer - 16 oz.                   | EA  | 6              |
| 799-008     | Spray Paint - Bright Yellow - 16 oz.                | EA  | 6              |
| 799-009     | Spray Paint - Astro Blue - 16 oz.                   | EA  | 6              |
| 799-010     | Spray Paint - Orange - 16 oz.                       | EA  | 6              |
| 799-011     | Spray Paint - Aluminum (Silver) - 16 oz.            | EA  | 6              |
| 799-012     | Spray Paint - Brite Zinc Galvanizing Spray - 20 oz. | EA  | 6              |
| 799-013     | Spray Paint - Bright Red - 16 oz.                   | EA  | 6              |

### High Heat Spray Paint

An ultra high temperature coating formulated to resist temperatures up to 1300°F. Great for use on boilers, furnaces, steam pipes, chimney collars, compressors and engine manifolds. Product meets most recent VOC legislation and is currently compliant.



| CATALOG NO. | DESCRIPTION                      | UOM | ORDER MULTIPLE |
|-------------|----------------------------------|-----|----------------|
| 799-040     | High Heat Spray Paint - Aluminum | EA  | 6              |
| 799-041     | High Heat Spray Paint - Black    | EA  | 6              |

## SEALANT, EPOXY, GLUE

### J-B Weld

The world's finest cold-weld compound for use when welding or soldering is out of the question due to cost, down time for repairs, or technical or environmental considerations. A remarkably easy, convenient, and inexpensive alternative to welding, soldering, and brazing. Literally pennies per use.



JB8265

| CATALOG NO. | DESCRIPTION           | UOM | ORDER MULTIPLE |
|-------------|-----------------------|-----|----------------|
| JB8265      | J-B Weld 2 Part Epoxy | EA  | 1              |

### Thread Sealant with Teflon

General purpose sealant with the lubricity of Teflon for metal pipes. Won't shred like Teflon Tape. Allows easy disassembly. Resists common shop fluids. -60° to 400°F temp. resistance. Pressure resistance of 5000 PSI.



7-80632

| CATALOG NO. | DESCRIPTION                                     | UOM | ORDER MULTIPLE |
|-------------|---|-----|----------------|
| 7-80632     | Thread Sealant - 1/4 Pint Brush Can             | EA  | 12             |
| 7-80633     | Thread Sealant - 1 Pint Brush Can., 12 per pack | EA  | 12             |

### Super Glue



DEP052

| CATALOG NO. | DESCRIPTION              | UOM | ORDER MULTIPLE |
|-------------|--------------------------|-----|----------------|
| DEP052      | Super Glue - 2 Gram Tube | EA  | 12             |

### Wagner Adhesive Sealant

For refrigerant sealing. Eliminates fastener loosening, leakage, and corrosion. Cures between thread flanks to seal against leakage and prevents thread corrosion. Offers sealing with maximum solvent resistance to the action of refrigerant (11, 12 and 22), ammonia and sulfur dioxide. Withstands corrosive liquids used in metal finishings and process industries. Ideal sealant for refrigeration, A/C, and process equipment using corrosive chemicals.



CAS-2712

| CATALOG NO. | DESCRIPTION                            | UOM | ORDER MULTIPLE |
|-------------|--|-----|----------------|
| CAS-2712    | Wagner Adhesive Sealant - 0.34 fl. oz. | EA  | 10             |

### Fast Cure Epoxy

DEP056 contains 10 individually-wrapped, pre-measured packages. Each unique sealed package contains the exact A/B portion required for most small jobs. Easy peel-open containers press into shape to form handy mix-and-dispense cup. Re-closable cylinder contains: Ten 0.12 oz. mixer packs and mixing sticks. Epoxy is also available in 1 pound kits (DEP8001 and DEP8002).



DEP8001

DEP056

| CATALOG NO. | DESCRIPTION                      | UOM | ORDER MULTIPLE |
|-------------|----------------------------------|-----|----------------|
| DEP056      | Epoxy Mixer Cups                 | EA  | 10             |
| DEP8001     | Aluminum Epoxy Putty - 1 lb. Kit | EA  | 24             |
| DEP8002     | White Epoxy Putty - 1 lb. Kit    | EA  | 24             |

## AEROSOLS

### Sure-Stick Heavy Duty Adhesive Spray

Wide web spray adhesive ideal for both temporary or permanent bonding. Waterproof, transparent and non-staining. Use for the toughest adhesive applications with leather, cardboard, most plastics, polyethylene sheeting and insulation in HVAC applications. Cleans with mineral spirits. Not for use on vinyl.



315-20

| CATALOG NO. | DESCRIPTION                                | UOM | ORDER MULTIPLE |
|-------------|--|-----|----------------|
| 315-20      | Sure-Stick Adhesive Spray - 12 oz. Aerosol | EA  | 12             |

### CBC II Contact Cleaner

A plastic safe, non-flammable electronic contact and circuit board cleaner. Dries fast, leaves no residue. No harsh fumes or odors.



362-16

| CATALOG NO. | DESCRIPTION                             | UOM | ORDER MULTIPLE |
|-------------|---|-----|----------------|
| 362-16      | CBC II Contact Cleaner - 10 oz. Aerosol | EA  | 12             |

### Sweat-Free Pipe Insulation Spray

An aerosol spray on insulation specifically developed for cold water pipes, refrigeration and air conditioning lines. Stops sweating and dripping problems. Dries to a clean, white, flexible and water-resistant coating. Adheres to galvanized, black iron, steel, brass, copper and PVC piping.



770-15

| CATALOG NO. | DESCRIPTION                                 | UOM | ORDER MULTIPLE |
|-------------|---|-----|----------------|
| 770-15      | Sweat-Free Pipe Insulation - 15 oz. Aerosol | EA  | 12             |



|  |         |
|--|---------|
| Anchors .....                              | 104-105 |
| Bolts and Washers.....                     | 107     |
| Boxes, Rings, and Covers .....             | 93-94   |
| Bulbs.....                                 | 111     |
| Cable Connectors .....                     | 94-95   |
| Cable Ties and Accessories .....           | 107-108 |
| Conduit Fittings.....                      | 95-96   |
| Drill Bits.....                            | 103     |
| General Tools .....                        | 110     |
| High Temperature Solderless Terminals....  | 89-90   |
| Nuts and Bolts.....                        | 106     |
| Plastic Anchor Kits .....                  | 105     |
| Power Cords and Work Lights.....           | 111-112 |
| Safety/Protective Equipment.....           | 112     |
| Screws .....                               | 103-104 |
| Slip-On Solderless Terminals .....         | 84-85   |
| Special Purpose Solderless Terminals ..... | 90-91   |
| Specialty Fasteners.....                   | 108-109 |
| Specialty Fittings .....                   | 110     |
| Specialty Tools.....                       | 111     |
| Standard Solderless Terminals .....        | 86-88   |
| Storage Containers.....                    | 112     |
| Tapes.....                                 | 110     |
| Terminal Kits.....                         | 92      |
| Testers, Leads, Clips, Fuses .....         | 102-103 |
| Waterproof Solderless Terminals .....      | 88-89   |
| Wire .....                                 | 96-97   |
| Wiring Devices .....                       | 97-102  |

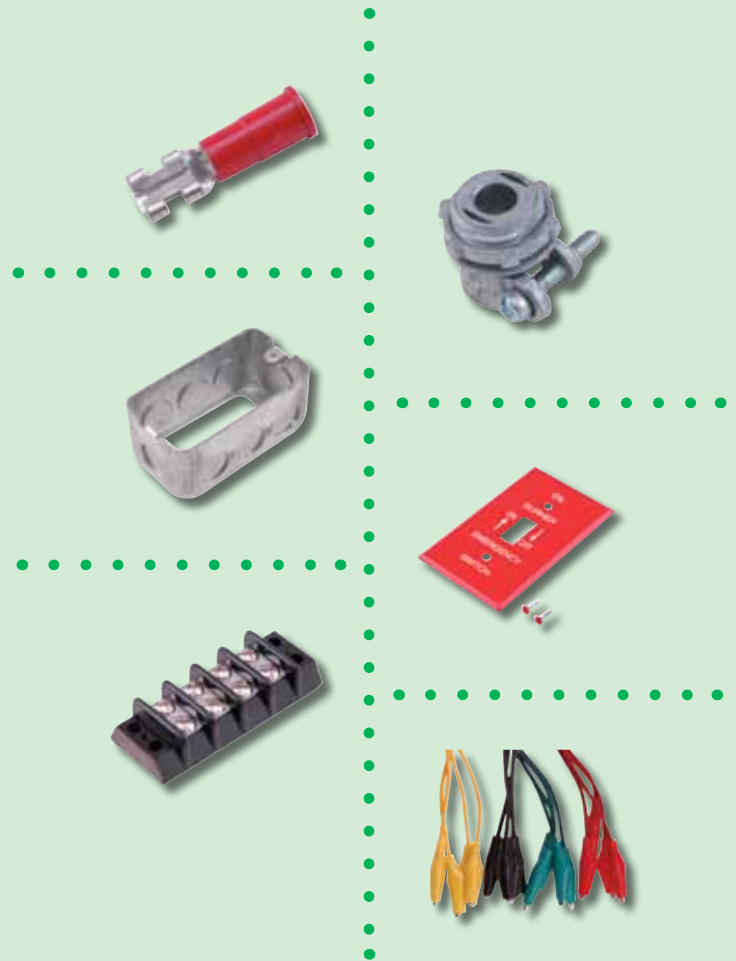

# How to sell DEVCO products

*DEVCO merchandising displays are an easy and attractive way to showcase a variety of DEVCO products in your store. Offered in three different versions, each display rack includes everything you need to create extra sales for your business.*



## Easy to Display

DEVCO provides turnkey merchandising solutions for wholesale distribution. Attractive, easy to set-up merchandising displays provide a great way to highlight DEVCO products and make it easy for customers to find what they need. The point of sale display merchandises the products, enabling the distributor to add additional sales.

The products merchandised on the carousel are impulse buy items. The items are packed so they cost the contractor only a few dollars, and most are less than \$10 each.

## Easy to Profit

DEVCO displays provide a typical distributor branch with easy add-on sales that build profits. Each display can generate significant sales and margins for the store while providing contractors with the parts they need to finish the job. These self-service displays are a great way to increase revenue with minimal effort.

## The Perfect Plan

Each DEVCO Merchandising display comes with a complete plan-o-gram to make merchandising it simple and fast. And there are three different versions available so you can choose the display that's right for your business and customers.

And when you purchase the DEVCO products to fill it up, the merchandising rack is **loaned free of charge**.

| Display Rack      | Featured Products   |
|-------------------|---|
| <b>EZC</b>        | Solderless terminals, ground connectors, fasteners, anchor kits, cable ties, washers, hex nuts, cable clamps, sheet metal screws and hose clamps                                      |
| <b>Electrical</b> | Ground adaptors, outlets, boxes, bushings, cable connectors, extension rings, indicator lights, plugs and connectors, receptacles, reducing washers, toggle switches and hook up wire |
| <b>Combo</b>      | Solderless terminals, insulated rings, ground adaptors, covers, reducing washers, plugs and connectors, hook up wire, fasteners, hex nuts and self drilling screws                    |



# PLAN-O-GRAM FOR DEVCO ELEC RACK (MKT-POP-DEVELEC)

D  
E  
V  
C  
O

### PANEL A

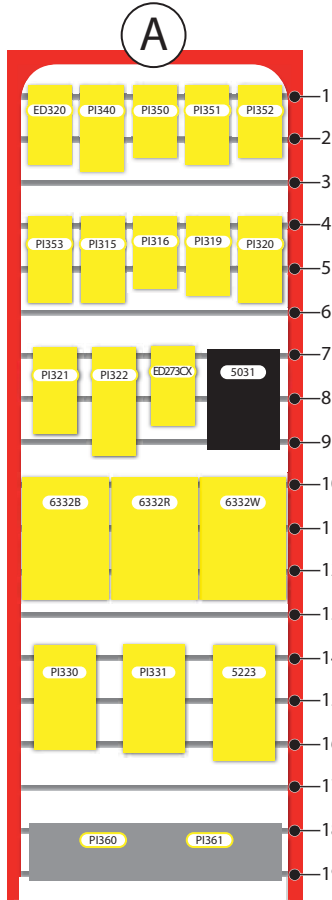

### PANEL B

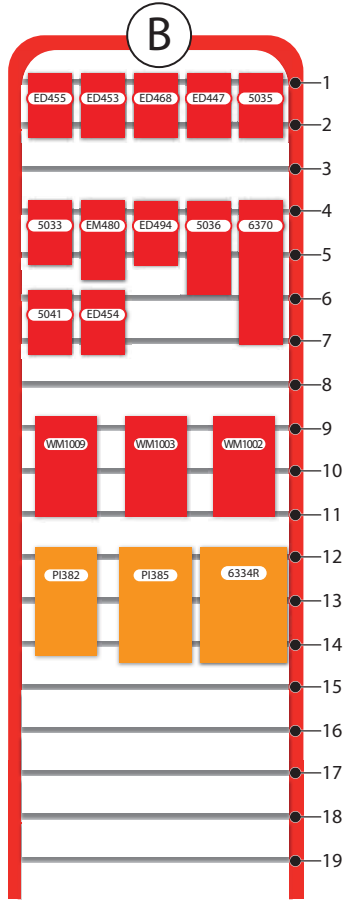

### PANEL C

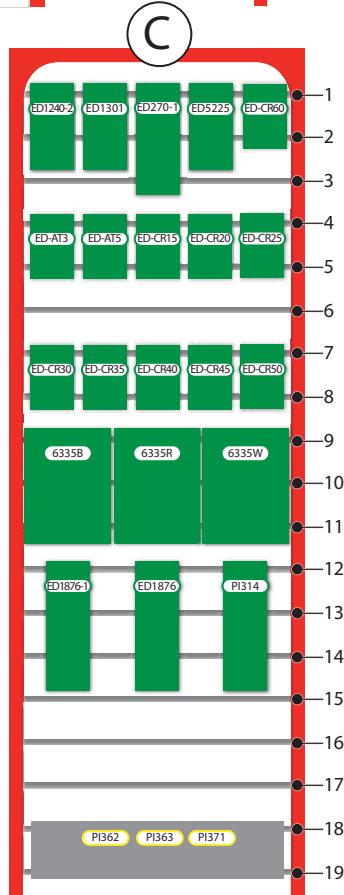

### PANEL D

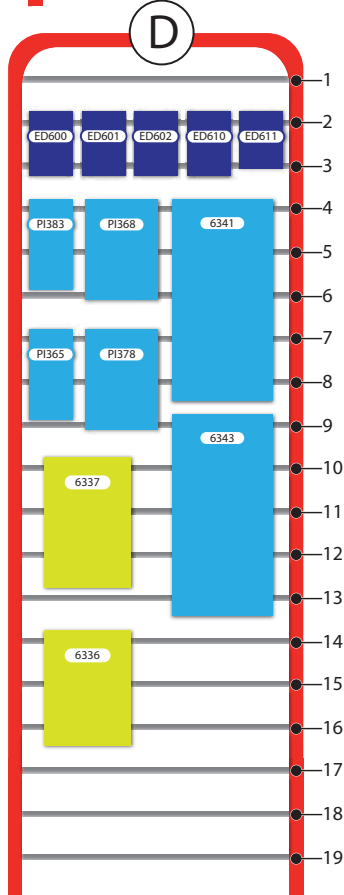

### MKT-POP-DEVELEC

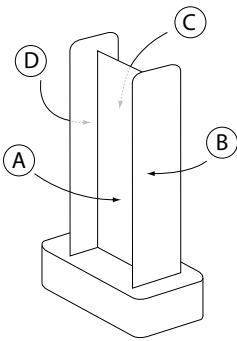

### MKT-POP-DEVELEC Merchandising Rack 72" x 22" x 20.5"



# PLAN-O-GRAM FOR DEVCO EZC RACK (MKT-POP-DEVEZC)

D  
E  
V  
C  
O

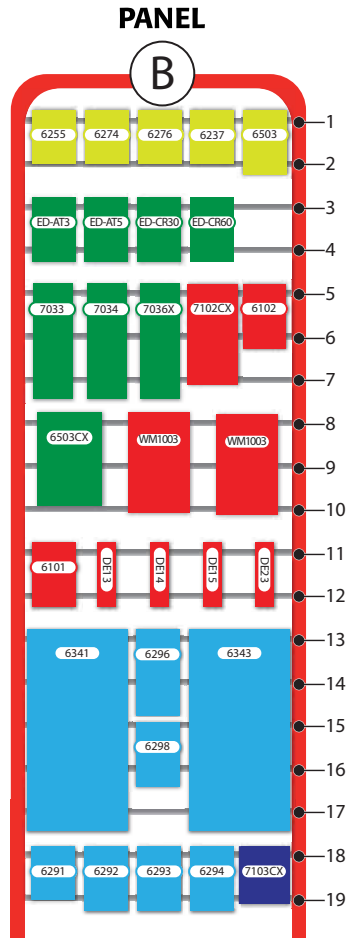
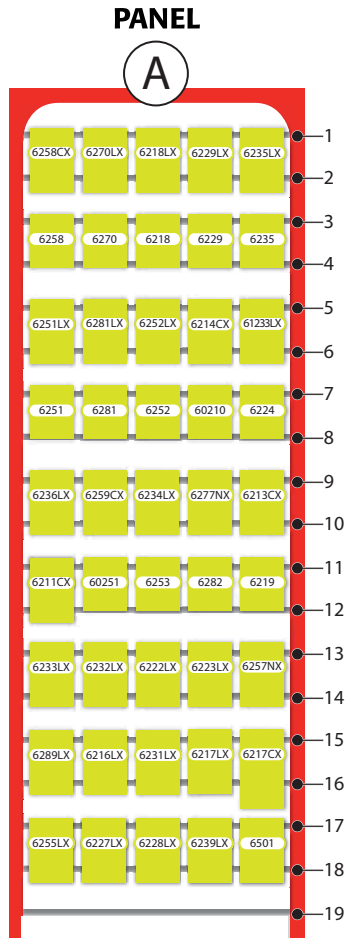

MKT-POP-DEVEZC

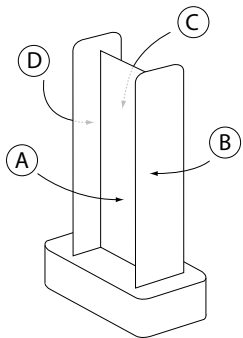
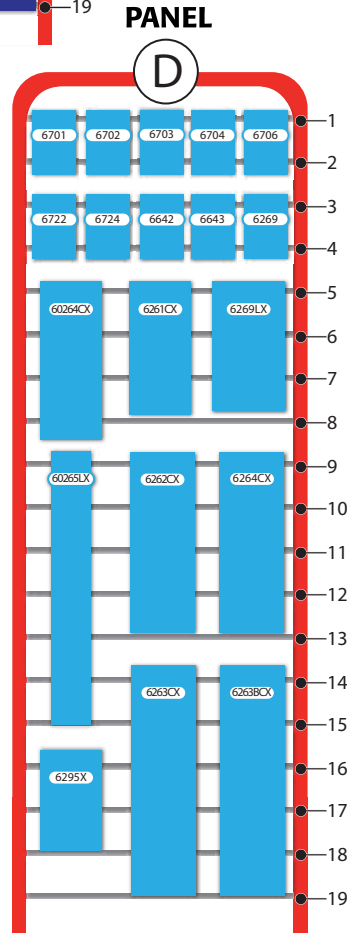
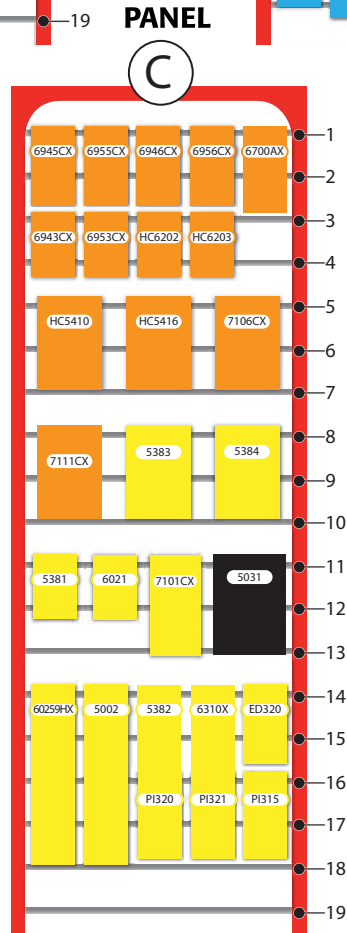

MKT-POP-DEVEZC  
Merchandising Rack  
72" x 22" x 20.5"



# PLAN-O-GRAM FOR DEVCO COMBO RACK (MKT-POP-DEVCOMBO)

## PANEL A

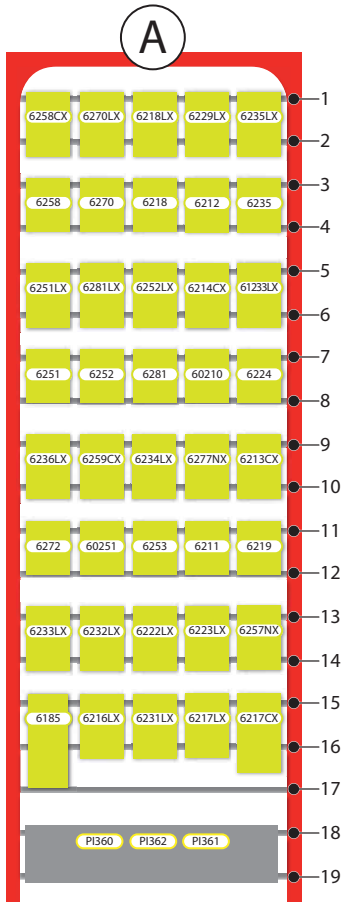

## PANEL B

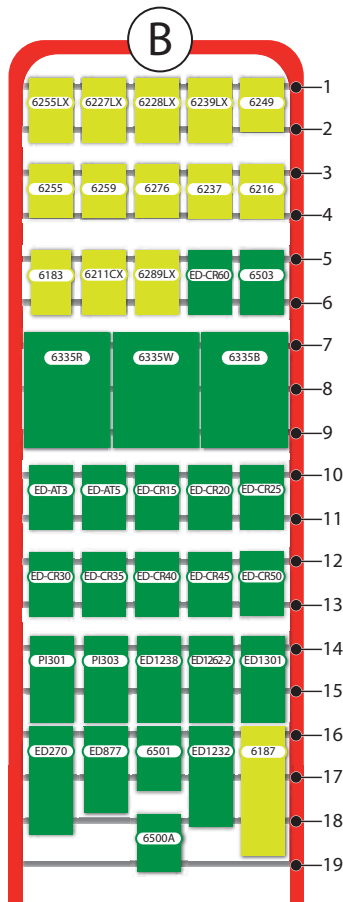

## PANEL C

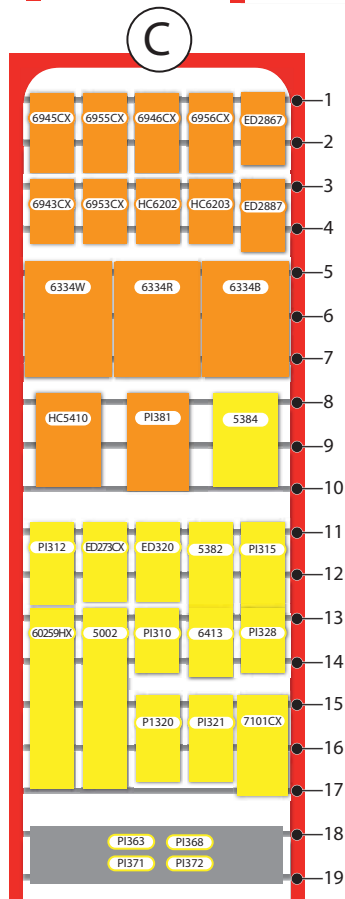

## PANEL D

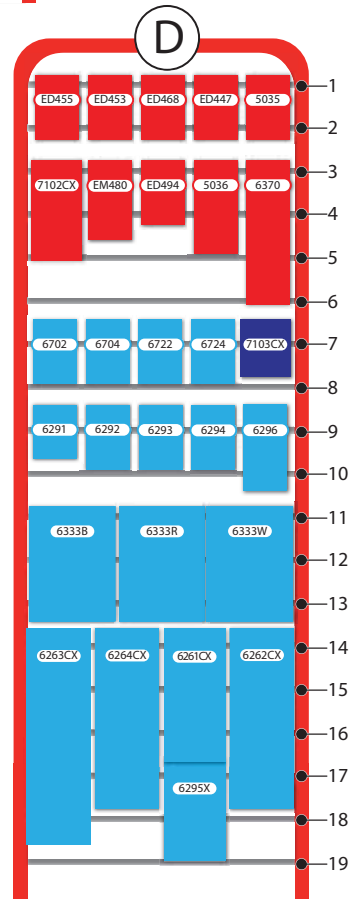

MKT-POP-DEVCOMBO

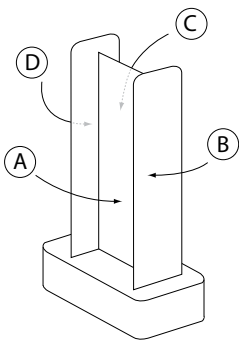

MKT-POP-DEVCOMBO Merchandising Rack 72" x 22" x 20.5"

**PLAN-O-GRAM FOR DEVCO PB-16 RACK (MKT-POP-DEV16)**

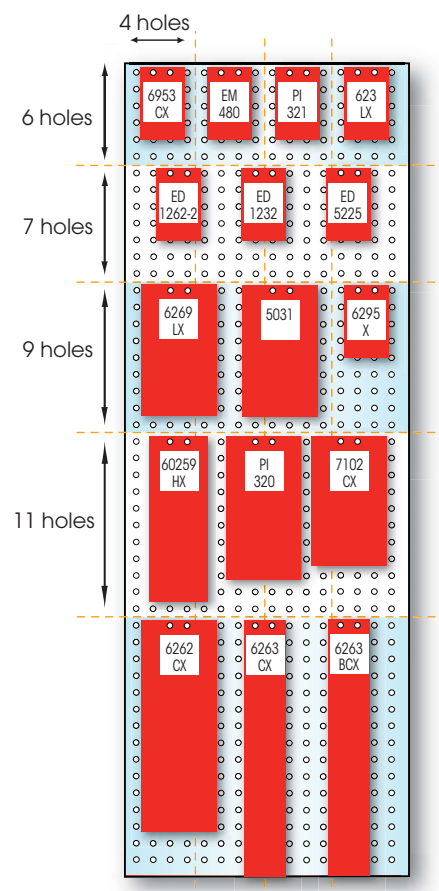
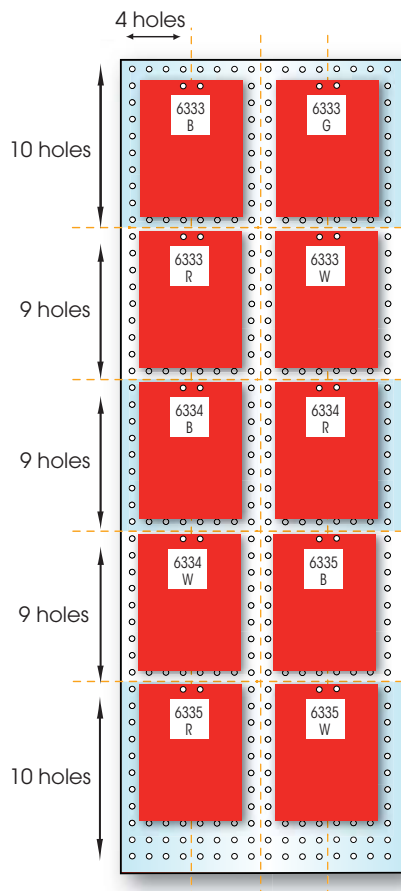
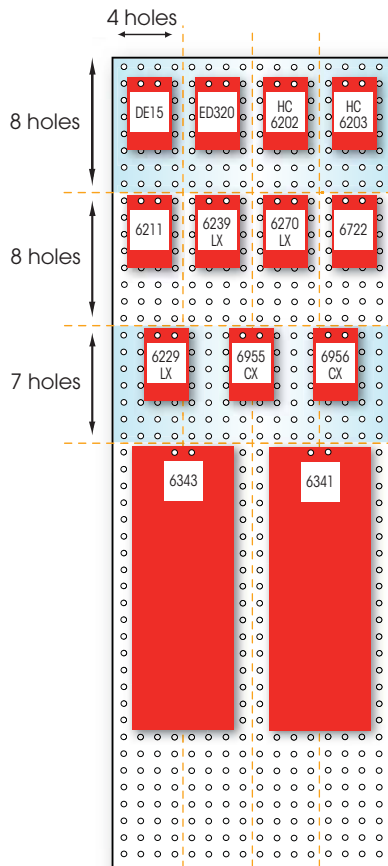
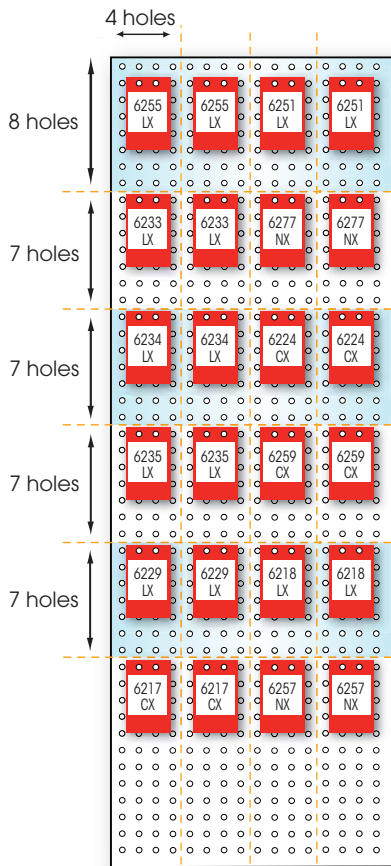



## DEVCO RACKS MASTER ITEM LIST (BY RACK)

This DEVCO product list includes any DEVCO item that is part of the plan-o-gram display for either the EZC, ELEC, COMBO, or PB-16 versions of the DEVCO rack. This cross reference indicates on which display rack each item should be placed.

| ITEM # | ITEM DESCRIPTION  | ELEC | EZC | COMBO | PB-16 | ITEM #  | ITEM DESCRIPTION  | ELEC | EZC | COMBO | PB-16 |
|--------|---|------|-----|-------|-------|---------|---|------|-----|-------|-------|
| 5002   | Crimp Tool w/ Cutter & Stripper Ins.                          |      | X   | X     |       | 6706    | Flat Washer 1/2in Uss zn Pltd.                          |      | X   |       |       |
| 5031   | Test Leads (ins. Alligator clips) Low Voltage 22in 8pcs       | X    | X   | X     | X     | 6722    | Fender Washer 1/4in zn Pltd.                            |      | X   | X     | X     |
| 5033   | Alligator Clips (steel) 2in long for probes .075in-.08in      | X    |     |       |       | 6724    | Fender Washer 3/8in zn Pltd.                            |      | X   | X     |       |
| 5035   | Alligator Clips (copper) B&R Ins 2in long                     | X    |     | X     |       | 7033    | Toggle Bolt w/wing 3/16inx4inzn Pltd.                   |      | X   |       |       |
| 5036   | Test Clip (steel 20A) B&R Insulators 2-7/16in long            | X    |     | X     |       | 7034    | Toggle Bolt w/wing 1/4inx4in zn Pltd.                   |      | X   |       |       |
| 5041   | Test Leads Low Voltage Hook Ty22ga 36in red & black           | X    |     |       |       | 60210   | Tab Ad. Ins. .250 16-14 multi stack male & female       | X    | X   |       |       |
| 5223   | Triple Outlet 2 Pole 3 Wire 15A-125V Polarized plastic        | X    |     |       |       | 60251   | Slip-On F 12-10 Non-Ins. .250                           | X    | X   |       |       |
| 5381   | Nylon Cable Clamp 1/8in I.D.                                  |      | X   |       |       | 60259HX | Comp. Lead Kt 12in 10ga wire                            | X    | X   | X     |       |
| 5382   | Nylon Cable Clamp 1/4in I.D.                                  |      | X   | X     |       | 60264CX | Cable Tie 6in w/ #8 Hole 30# 1-3/8in B. Dia nat 100/PK  | X    |     |       |       |
| 5383   | Nylon Cable Clamp 3/8in I.D.                                  |      | X   |       |       | 60265LX | Cable Tie 14in 50# 4in B. Dia natural 50 pcs            | X    | X   |       |       |
| 5384   | Nylon Cable Clamp 1/2in I.D.                                  |      | X   | X     |       | 61233LX | Slip-on M & F 16-14 .250 Full Ins Nylon 50 pcs          | X    | X   |       |       |
| 6021   | Rnd Head Screw (#6 8 10-32 x 1/2in 1-1/2in) zn Pltd.          |      | X   |       |       | 6211CX  | Tab Ad. S. F Dbl M Non-Ins.100 pcs                      | X    | X   |       |       |
| 6101   | Motor Shaft Keys (1/8in 3/16in 1/4in 3/16in x 1/4in) zn Pltd. |      | X   |       |       | 6213CX  | Flag F QD 16-14 Non-Ins. .250 100 pcs                   | X    | X   |       |       |
| 6102   | Motor Shaft Keys (1/4insq 5/16insq 3/8insq) zn Pltd.          |      | X   |       |       | 6214CX  | Slip-on F 16-14 Non-Ins. .250 100 pcs                   | X    | X   |       |       |
| 6183   | Terminal Block 20A-250V 6 pos                                 | X    |     | X     |       | 6216LX  | Ring 16-14 Ins. #10 Stud 50 pcs                         | X    | X   |       |       |
| 6185   | Terminal Block 20A-250V 10 pos                                | X    |     | X     |       | 6217CX  | Butt Conn. 16-14 Ins. 100 pcs                           | X    | X   | X     |       |
| 6187   | Terminal Block 20A-250V 14 pos                                | X    |     | X     |       | 6217LX  | Butt Conn. 16-14 Ins. 50 pcs                            | X    | X   |       |       |
| 6211   | Tab Ad. S. F Dbl M .250 Non-Ins.                              |      |     | X     | X     | 6218LX  | Slip-on F 16-14 Ins. .250 50 pcs                        | X    | X   | X     |       |
| 6212   | Dbl. M. Tab Ad. .S. F. Non-Ins.                               |      |     | X     |       | 6222LX  | Dead End Conn. 22-14 Fully Ins. 50 pcs                  | X    | X   |       |       |
| 6216   | Ring 16-14 Ins. #10 Stud                                      |      |     | X     |       | 6223LX  | Dead End Conn. 18-10 Fully Ins. 50 pcs                  | X    | X   |       |       |
| 6218   | Slip-on F 16-14 Ins. .250                                     | X    | X   |       |       | 6227LX  | Spade 16-14 Ins. #8 Stud                                | X    | X   |       |       |
| 6219   | Slip-on M 16-14 Ins. .250                                     | X    | X   |       |       | 6228LX  | Spade 16-14 Ins. #10 Stud 50 pcs                        | X    | X   |       |       |
| 6224   | Flag F QD 12-10 Non-Ins. .250                                 | X    | X   | X     |       | 6229LX  | Slip-on F 16-14 Full Ins. .250                          | X    | X   | X     |       |
| 6229   | Slip-on F 16-14 Full Ins. .250                                | X    |     |       |       | 6231LX  | Butt Conn. 12-10 Ins. 50 pcs                            | X    | X   |       |       |
| 6235   | Slip-on F 22-18 Ins. .250                                     | X    | X   |       |       | 6232LX  | Butt Conn. 22-18 Ins. 50 pcs                            | X    | X   |       |       |
| 6237   | Spade 22-18 Ins. #8 Stud                                      | X    | X   |       |       | 6233LX  | Slip-on F 16-14 .250 Full Ins. Nylon 50 pcs             | X    | X   | X     |       |
| 6251   | Slip-on F 12-10 Ins. .250                                     | X    | X   |       |       | 6234LX  | Slip-on M 16-14 .250 Full Ins. Nylon 50 pcs             | X    | X   | X     |       |
| 6252   | Ring 12-10 Ins. #10 Stud                                      | X    | X   |       |       | 6235LX  | Slip-on F 22-18 Ins. .250 50 pcs                        | X    | X   | X     |       |
| 6253   | Ring 12-10 Ins. 1/4in Stud                                    | X    | X   |       |       | 6236LX  | Ring 22-18 Ins. #8 Stud 50 pcs                          | X    | X   | X     |       |
| 6255   | Spade 12-10 Ins. #10 Stud                                     | X    | X   |       |       | 6239LX  | Spr. Spade 16-14 Ins. #8 Stud                           | X    | X   | X     |       |
| 6258   | Comp. Flag F. 16-14 Non-Ins. .250                             | X    | X   |       |       | 6251LX  | Slip-on F 12-10 Ins. .250                               | X    | X   | X     |       |
| 6259   | Comp. Flag F. 12-10 Non-Ins. .250                             |      |     | X     |       | 6252LX  | Ring 12-10 Ins. #10 Stud                                | X    | X   |       |       |
| 6269   | Cable Tie Mount   | X    |     |       |       | 6255LX  | Spade 12-10 Ins. #10 Stud 50 pcs                        | X    | X   | X     |       |
| 6270   | Comp. Flag F. 12-8 Non-Ins. .250                              | X    | X   |       |       | 6257NX  | Ring #8 Ins. 1/4in Stud 25 pc                           | X    | X   | X     |       |
| 6274   | Spade 16-14 Ins. #6 Stud                                      | X    |     |       |       | 6258CX  | Comp. Flag F. 16-14 Non-Ins. .250 100 pcs               | X    | X   |       |       |
| 6276   | Spr. Spade 16-14 Ins. #6 Stud                                 | X    | X   |       |       | 6259CX  | Comp. Flag F. 12-10 Non-Ins. .250 100 pcs               | X    | X   | X     |       |
| 6281   | Slip-on F 16-14 Ins. .187                                     | X    | X   |       |       | 6261CX  | Cable Tie 6in 18# 1-3/8in B. Dia natural 100 pcs        | X    | X   |       |       |
| 6282   | Slip-on F 22-18 Ins. .187                                     | X    |     |       |       | 6262CX  | Cable Tie 7-1/2in 50# 1-3/4in B. Dia natural 100 pcs    | X    | X   | X     |       |
| 6291   | Wire Connector Mini-Gray                                      | X    | X   |       |       | 6263CX  | Cable Tie 11in 50# 3in B. Dia natural 100 pcs           | X    | X   | X     |       |
| 6292   | Wire Connector Tiny-Blue                                      | X    | X   |       |       | 6263BCX | Cable Tie 11in 50# 3in B. Dia black 100 pcs             | X    |     | X     |       |
| 6293   | Wire Connector Small-Orange                                   | X    | X   |       |       | 6264CX  | Cable Tie 7in w/ #10 Hole 50# 1-3/4in B. Dia nat 100/PK | X    | X   |       |       |
| 6294   | Wire Connector Medium-Yellow                                  | X    | X   |       |       | 6269LX  | Cable Tie Mount 50 pcs                                  | X    |     | X     |       |
| 6296   | Wire Connector Large-Red                                      | X    | X   |       |       | 6270LX  | Comp. Flag F. 12-8 Non-Ins. .250 50 pcs                 | X    | X   | X     |       |
| 6298   | Wire Connector XLarge-Gray                                    | X    |     |       |       | 6277NX  | Flag F QD 16-14 .250 Fully Ins. Nylon 25 pcs            | X    | X   | X     |       |
| 6336   | Thermostat Wire 3 Conduct.40 ft.                              | X    |     |       |       | 6281LX  | Slip-on F 16-14 Ins. .187 50 pcs                        | X    | X   |       |       |
| 6337   | Thermostat Wire 5 Conduct.40 ft.                              | X    |     |       |       | 6287XX  | Butt Conn. #8 Ins. 10 pcs                               |      |     | X     |       |
| 6341   | SJTO Service Cord 16 GA 20 ft.                                | X    | X   | X     | X     | 6289LX  | Bullet Plug & Rec. 16-14 Ins. 50 pcs                    | X    | X   |       |       |
| 6343   | SJTO Service Cord 14 GA 20 ft.                                | X    | X   | X     | X     | 6295X   | Assorted Wire Connectors                                | X    | X   | X     |       |
| 6370   | Heat Shrink Tubing Assort. B&W 1/8in & 1/4in supplied 6in     | X    |     | X     |       | 6310X   | Grease Fitting Assortment box                           | X    |     |       |       |
| 6413   | Fin. Hex Nut 1/4in-20 zn Pltd.                                |      |     | X     |       | 6332B   | Hook-up Wire 16ga blk. 48 ft                            | X    |     |       |       |
| 6501   | Fin. Hex Nut 1/4in-20 zn Pltd.                                | X    | X   |       |       | 6332R   | Hook-up Wire 16ga red. 48 ft                            | X    |     |       |       |
| 6503   | Fin. Hex Nut 3/8in-16 zn Pltd.                                | X    | X   |       |       | 6332W   | Hook-up Wire 16ga wht. 48 ft                            | X    |     |       |       |
| 6642   | HH Cap Screw 3/8in-16 x 1in                                   | X    |     |       |       | 6333B   | Hook-up Wire 14ga blk. 48 ft                            | X    | X   | X     |       |
| 6643   | HH Cap Screw 3/8in-16 x 1 1/2in                               | X    |     |       |       | 6333G   | Hook-up Wire 14ga grn. 48 ft                            | X    | X   | X     |       |
| 6701   | Flat Washer 3/16in Uss zn Pltd.                               | X    |     |       |       | 6333R   | Hook-up Wire 14ga red. 48 ft                            | X    | X   | X     |       |
| 6702   | Flat Washer 1/4in Uss zn Pltd.                                | X    | X   |       |       | 6333W   | Hook-up Wire 14ga wht. 48 ft                            | X    | X   | X     |       |
| 6703   | Flat Washer 5/16in Uss zn Pltd.                               | X    |     |       |       | 6334B   | Hook-up Wire 12ga blk. 48 ft                            | X    | X   | X     |       |
| 6704   | Flat Washer 3/8in Uss zn Pltd.                                | X    | X   |       |       | 6334R   | Hook-up Wire 12ga red 48 ft                             | X    | X   | X     |       |

continued

**DEVCO RACKS MASTER ITEM LIST (BY RACK) cont'd**

| ITEM #   | ITEM DESCRIPTION  | ELEC | EZC | COMBO | PB-16 |
|----------|---|------|-----|-------|-------|
| 6334W    | Hook-up Wire 12ga wht. 48 ft                                  | X    |     | X     | X     |
| 6335B    | Hook-up Wire 10ga blk. 48 ft                                  | X    |     | X     | X     |
| 6335R    | Hook-up Wire 10ga red 48 ft                                   | X    |     | X     | X     |
| 6335W    | Hook-up Wire 10ga wht. 48 ft                                  | X    |     | X     | X     |
| 6339XL   | Thermostat Wire 10 Conduct. 40 ft                             | X    |     |       |       |
| 6500A    | Asst Mach. Screw Hex Nuts 6-32 8-32 10-32 zn Pltd.            |      |     | X     |       |
| 6503CX   | Fin. Hex Nut 3/8in-16 zn Pltd. 100 pcs                        |      | X   |       |       |
| 6700AX   | Flat Washer Assortment Pack 3/16 1/4 5/16 3/8 1/2 5/8 inch    |      | X   |       |       |
| 6943CX   | Self Drilling Screw #8x1/2in 1/4in Hex Head zn Pltd. 100/PK   | X    | X   |       |       |
| 6945CX   | Self Drilling Screw #8x3/4in 1/4in Hex Head zn Pltd. 100/PK   | X    | X   |       |       |
| 6946CX   | Self Drilling Screw #8x1in 1/4in Hex Head zn Pltd. 100/PK     | X    | X   |       |       |
| 6953CX   | Drill Tip Screw #10x1/2in 5/16in Hex Head 100/PK              | X    | X   | X     |       |
| 6955CX   | Drill Tip Screw #10x3/4in 5/16in Hex Head 100/PK              | X    | X   | X     |       |
| 6956CX   | Self Drilling Screw #10x1in 5/16in Hex Head zn Pltd. 100/PK   | X    | X   | X     |       |
| 7036X    | Toggle Bolt w/wing 3/8inx4in zn Pltd.                         |      | X   |       |       |
| 7101CX   | Anch Kit Yellow #8x1in w 3/16in bit 100 s + 100 a             | X    | X   |       |       |
| 7102CX   | Anch Kit Red #10x1-1/4in w 1/4in bit 100 s + 100 a            |      | X   | X     | X     |
| 7103CX   | Anch Kit Blue #4x3/4in w 5/32in bit 100 s + 100 a             |      | X   | X     |       |
| 7106CX   | Plug Anchor Kit Green #10x1in 1/4in bit 100 s +100 a bag      |      | X   |       |       |
| 7111CX   | Plug Anchor Kit Blue #14x1in w 5/16in bit 100 s +100 a bag    |      | X   |       |       |
| DE13     | Magnetic Hex Chuck 1/4in x 1-3/4in                            |      | X   |       |       |
| DE14     | Magnetic Hex Chuck 5/16in x 1-3/4in                           |      | X   |       |       |
| DE15     | Magnetic Hex Chuck 3/8in x 1-7/8 in                           |      | X   |       | X     |
| DE23     | Magnetic Hex Chuck 1/4in x 2-9/16 in                          |      | X   |       |       |
| ED1232   | Toggle Switch D.P. 30A-120/277V brown                         | X    |     | X     | X     |
| ED1238   | Toggle Switch S.P. 20A-120/277V brown                         | X    |     | X     |       |
| ED1240-2 | Toggle Switch S.P. 15A-120/277V brown                         | X    |     |       |       |
| ED1262-2 | Toggle Switch D.P. 15A-120/277V brown                         | X    |     | X     | X     |
| ED1301   | Toggle Switch S.P. 15A-120V brown                             | X    |     | X     |       |
| ED1301-1 | Toggle Switch S.P. 15A-120V ivory                             | X    |     |       |       |
| ED1709   | Grounding Plug rubber handle 15A-125V 2pl 3 wire              | X    |     | X     |       |
| ED1876   | Single Receptacle 20A-250V 2 pl. 3 wr. brown                  | X    |     |       |       |
| ED1876-1 | Single Receptacle 20A-250V 2 pl. 3 wr. ivory                  | X    |     |       |       |
| ED270    | Duplex Receptacle 15A-125V 2 pl. 3 wr. brown                  | X    |     | X     |       |
| ED270-1  | Duplex Receptacle 15A-125V 2 pl. 3 wr. ivory                  | X    |     |       |       |
| ED273CX  | Electrical Staple insul size #5 5/8in x 1/4in 100/PK          | X    |     | X     |       |
| ED2867   | Armored Plug 15A-125V 2pl.3 wr. vinyl enclosed                | X    |     | X     |       |
| ED2887   | Armored Connector 15A-125V 2pl. 3 wr. vinyl enclosed          | X    |     | X     |       |
| ED320    | Vinyl Grommet Asst. contains: ED300 thru ED316                | X    | X   | X     | X     |
| ED447    | Bat Handle Switch metal SPST on-off 10A/277V-20A/125V AC      | X    |     | X     |       |
| ED453    | Bat Handle Switch metal DPDT on-on 10A/277V-20A/125V AC       | X    |     | X     |       |
| ED454    | Bat Handle Switch metal SPDT on-on 10A/277V-20A/125V AC       | X    |     |       |       |
| ED455    | Bat Handle Switch metal DPST on-off 10A/277V-20A/125V AC      | X    |     | X     |       |
| ED468    | Bat Handle Switch metal SPDT on-off-on 10A/277V-20A/125V      | X    |     | X     |       |
| ED4867   | Right Angle Plug 15A-125V 2pl. 3 wr.                          | X    |     |       |       |
| ED494    | Bat Handle Switch metal DPDT on-off-on 10A/277V-20A/125V      | X    |     | X     |       |
| ED5225   | Switch & Receptacle 2p 3w (sw:15A-120VAC& rec:15A-125VAC) brn | X    |     |       | X     |
| ED600    | Indicator Light 28V red PC lens incandescent bulb             | X    |     |       |       |
| ED601    | Indicator Light 28V green PC lens incandescent bulb           | X    |     |       |       |
| ED602    | Indicator Light 28V amber PC lens incandescent bulb           | X    |     |       |       |
| ED610    | Indicator Light 105-125V AC red nylon lens neon bulb          | X    |     |       |       |
| ED611    | Indicator Light 105-125V AC gm PC lensneon blb-G2B Imp&resstr | X    |     |       |       |
| ED877    | Duplex Receptacle 20A-125V 2 pl. 3 wr. brown                  | X    |     | X     |       |
| EM480    | In-Line Fuse Holder 1-1/4 x 1/4in fuses to 20A/32V 14ga       | X    |     | X     | X     |
| HC5410   | Hose Clamp 9/16in-1-1/8in SSHousing&band st hex screw         |      | X   | X     |       |
| HC5416   | Hose Clamp 3/4in-1-1/2in SSHousing&band st hex screw          |      | X   |       |       |
| HC6202   | Hose Clamp 1/4in-5/8in SS housing&band st hex screw           | X    | X   | X     |       |
| HC6203   | Hose Clamp 5/16in-7/8in SSHousing&band st hex screw           | X    | X   | X     |       |
| PI301    | Cond Nip 1/2in offset zn w pltd. stl locknuts insul. bushings | X    |     | X     |       |
| PI303    | Cond Nip 1/2in str galv steel w pltd. stl lock insul.         | X    |     | X     |       |

| ITEM #  | ITEM DESCRIPTION  | ELEC | EZC | COMBO | PB-16 |
|---------|---|------|-----|-------|-------|
| PI306   | EMT Strap fits 1/2in conduit one hole zn Pltd. steel        | X    |     | X     |       |
| PI307   | EMT Strap fits 3/4in conduit one hole zn Pltd. steel        | X    |     | X     |       |
| PI309   | Romex Stap 1in x 1/2in non-ins. steel 14/2-10/3             | X    |     | X     |       |
| PI310   | Reduc. Wash 3/4in to 1/2in Rsd Fln Galv St                  | X    |     | X     |       |
| PI312   | BX Conct set screw 3/8in Tr. 1/2in KO. zn die cast          | X    |     | X     |       |
| PI315   | BX Connector 90 3/8inTr. 1/2in KO zn die cast               | X    | X   | X     |       |
| PI316   | Knockout Seal for 1/2in KO zn Pltd. steel                   | X    |     |       |       |
| PI319   | Romex Connector 3/4in Tr. 3/4in KO. zn Pltd. die cast       | X    |     |       |       |
| PI320   | Romex Connector 3/8in Tr. 1/2in KO. zn Pltd. die cast 25/PK | X    | X   | X     | X     |
| PI321   | Romex Connector 3/8in Tr.1/2 in KO. zn Pltd. die cast       | X    | X   | X     | X     |
| PI322   | BX Conct str sqze 3/8in Tr. 1/2in KO. zn die cast           | X    |     |       |       |
| PI328   | Split Bolt Connector Cu use (6 max sol & 7 max strnd)       | X    |     | X     |       |
| PI330   | Romex Stap plastic 3/8inx1/2in for 2 cond. romex 12/2-14/2  | X    |     |       |       |
| PI331   | Plastic in Anti-Shortin Bush 14/2 14/3 & 12/2 BX cable      | X    |     |       |       |
| PI340   | Combo Cable Connector for romex & BX 3/8in Tr. 1/2in KO     | X    |     |       |       |
| PI350   | Metal LT Connc straight 1/2in Tr. 1/2in K.O                 | X    |     |       |       |
| PI351   | Metal LT Connc straight 3/4in Tr. 3/4in K.O.                | X    |     |       |       |
| PI352   | Liquid Tight Connector 90 1/2in Tr. 1/2in K.O. zn die cast  | X    |     |       |       |
| PI353   | Liquid Tight Connector 90 3/4in Tr. 3/4in K.O. zn die cast  | X    |     |       |       |
| PI360   | Box galv. steel 4in x 2-1/8inx 1-7/8in 1/2in KO 13 in3      | X    |     | X     |       |
| PI361   | Box galv. steel 4in x 2-1/8inx 2-1/8in 1/2in KO 14.5 in3    | X    |     | X     |       |
| PI362   | 1900 Box galv. steel 4X4X1-1/2 1/2&3/4 KO 21 in3            | X    |     | X     |       |
| PI363   | 1900 Box galv. steel 4X4X2-1/8in 1/2&3/4 KO 30.3 in3        | X    |     | X     |       |
| PI365   | Utility Cover Toggle Switch 2-11/32in x 4-1/4in Pltd. steel | X    |     | X     |       |
| PI366   | Cover Duplex Receptacle 2-11/32in x 4-1/4in Pltd. steel     | X    |     | X     |       |
| PI367   | Utility Cover Blank 2-11/32in x 4-1/4in Pltd. steel         | X    |     | X     |       |
| PI368   | 1900 Cover Sw/Dup Rec cad fin. steel 4in x 4in raised 1/2in | X    |     | X     |       |
| PI371   | 1900 Cover Blank Flat galv. steel                           | X    |     | X     |       |
| PI378   | 1900 Cover Duplex Recept cadil fin. steel 4X4 raised 1/2in  | X    |     |       |       |
| PI381   | Fuse Outlet & Switch w cover 1/2HP-125V AC galv. steel      | X    |     | X     |       |
| PI382   | Weatherproof Cover Blank Al 1 Gang w gasket anodized        | X    |     |       |       |
| PI385   | Wthrprf Box AL2-3/4inx4-1/2inx23 1/2in holes 2 plugs 19 in3 | X    |     |       |       |
| WM1002  | Cable Marker Book alpha numer                               | X    |     |       |       |
| WM1003  | Cable Marker Book numeric contains 10 each: 1 - 45          | X    | X   | X     |       |
| WM1009  | Cable Marker Book line & term                               | X    |     |       |       |
| WM1014  | Cable Marker Book 180 Blank Write-On 1/2in x 1-1/2in        | X    |     |       |       |
| ED-AT3  | Blade Fuses - 3 Amp - Purple, Pack of 10                    | X    | X   | X     |       |
| ED-AT5  | Blade Fuses - 5 Amp - Tan, Pack of 10                       | X    | X   | X     |       |
| ED-CR15 | Dual Element Fuses - 15 Amp, Pack of 2                      | X    |     | X     |       |
| ED-CR20 | Dual Element Fuses - 20 Amp, Pack of 2                      | X    |     | X     |       |
| ED-CR25 | Dual Element Fuses - 25 Amp, Pack of 2                      | X    |     | X     |       |
| ED-CR30 | Dual Element Fuses - 30 Amp, Pack of 2                      | X    | X   | X     |       |
| ED-CR35 | Dual Element Fuses - 35 Amp, Pack of 2                      | X    |     | X     |       |
| ED-CR40 | Dual Element Fuses - 40 Amp, Pack of 2                      | X    |     | X     |       |
| ED-CR45 | Dual Element Fuses - 45 Amp, Pack of 2                      | X    |     | X     |       |
| ED-CR50 | Dual Element Fuses - 50 Amp, Pack of 2                      | X    |     | X     |       |
| ED-CR60 | Dual Element Fuses - 60 Amp, Pack of 2                      | X    | X   | X     |       |



## SLIP-ON SOLDERLESS TERMINALS

### Insulated Male Slip-Ons

The insulation on fully insulated slip-ons is vinyl or nylon.



| CATALOG NO. | DESCRIPTION                         | WIRE RANGE | TAB SIZE | UOM | ORDER MULTIPLE |
|-------------|-------------------------------------|------------|----------|-----|----------------|
| 60219       | Insulated Male Slip-On, pack of 23  | 22-18      | .250     | PK  | 1              |
| 60219LX     | Insulated Male Slip-On, pack of 50  | 22-18      | .250     | PK  | 1              |
| 60220       | Insulated Male Slip-On, pack of 23  | 16-14      | .187     | PK  | 1              |
| 60220LX     | Insulated Male Slip-On, pack of 50  | 16-14      | .187     | PK  | 1              |
| 6219        | Insulated Male Slip-On, pack of 22  | 16-14      | .250     | PK  | 1              |
| 6219LX      | Insulated Male Slip-On, pack of 50  | 16-14      | .250     | PK  | 1              |
| 61221LX     | Insulated Male Slip-On, pack of 50  | 12-10      | .250     | PK  | 1              |
| 61221CX     | Insulated Male Slip-On, pack of 100 | 12-10      | .250     | PK  | 1              |

### Non-Insulated Male Slip-Ons



| CATALOG NO. | DESCRIPTION                             | WIRE RANGE | TAB SIZE | UOM | ORDER MULTIPLE |
|-------------|---|------------|----------|-----|----------------|
| 61219       | Non-Insulated Male Slip-On, pack of 37  | 22-18      | .250     | PK  | 1              |
| 61220       | Non-Insulated Male Slip-On, pack of 37  | 16-14      | .187     | PK  | 1              |
| 6220        | Non-Insulated Male Slip-On, pack of 38  | 16-14      | .250     | PK  | 1              |
| 6220CX      | Non-Insulated Male Slip-On, pack of 100 | 16-14      | .250     | PK  | 1              |
| 61222       | Non-Insulated Male Slip-On, pack of 27  | 12-10      | .250     | PK  | 1              |
| 61222CX     | Non-Insulated Male Slip-On, pack of 100 | 12-10      | .250     | PK  | 1              |

### Insulated Female Slip-Ons

The insulation on fully insulated slip-ons is vinyl or nylon.



| CATALOG NO. | DESCRIPTION                           | WIRE RANGE | TAB SIZE | UOM | ORDER MULTIPLE |
|-------------|---------------------------------------|------------|----------|-----|----------------|
| 6282        | Insulated Female Slip-On, pack of 22  | 22-18      | .187     | PK  | 1              |
| 6282LX      | Insulated Female Slip-On, pack of 50  | 22-18      | .187     | PK  | 1              |
| 6235        | Insulated Female Slip-On, pack of 22  | 22-18      | .250     | PK  | 1              |
| 6235LX      | Insulated Female Slip-On, pack of 50  | 22-18      | .250     | PK  | 1              |
| 6235CX      | Insulated Female Slip-On, pack of 100 | 22-18      | .250     | PK  | 1              |
| 6281        | Insulated Female Slip-On, pack of 22  | 16-14      | .187     | PK  | 1              |
| 6281LX      | Insulated Female Slip-On, pack of 50  | 16-14      | .187     | PK  | 1              |
| 6218        | Insulated Female Slip-On, pack of 22  | 16-14      | .250     | PK  | 1              |
| 6218LX      | Insulated Female Slip-On, pack of 50  | 16-14      | .250     | PK  | 1              |
| 6218CX      | Insulated Female Slip-On, pack of 100 | 16-14      | .250     | PK  | 1              |
| 6251        | Insulated Female Slip-On, pack of 17  | 12-10      | .250     | PK  | 1              |
| 6251LX      | Insulated Female Slip-On, pack of 50  | 12-10      | .250     | PK  | 1              |
| 6251CX      | Insulated Female Slip-On, pack of 100 | 12-10      | .250     | PK  | 1              |
| 61223LX     | Insulated Female Slip-On, pack of 50  | 12-10      | .340     | PK  | 1              |

### Non-Insulated Female Slip-Ons



| CATALOG NO. | DESCRIPTION                               | WIRE RANGE | TAB SIZE | UOM | ORDER MULTIPLE |
|-------------|---|------------|----------|-----|----------------|
| 60235       | Non-Insulated Female Slip-On, pack of 36  | 22-18      | .110     | PK  | 1              |
| 6221CX      | Non-Insulated Female Slip-On, pack of 100 | 16-14      | .187     | PK  | 1              |
| 6214        | Non-Insulated Female Slip-On, pack of 35  | 16-14      | .250     | PK  | 1              |
| 6214CX      | Non-Insulated Female Slip-On, pack of 100 | 16-14      | .250     | PK  | 1              |
| 60214*      | Non-Insulated Female Slip-On, pack of 28  | 16-14      | .250     | PK  | 1              |
| 60218       | Non-Insulated Female Slip-On, pack of 15  | 16-14      | .300     | PK  | 1              |
| 60218LX     | Non-Insulated Female Slip-On, pack of 50  | 16-14      | .300     | PK  | 1              |
| 60251       | Non-Insulated Female Slip-On, pack of 26  | 12-10      | .250     | PK  | 1              |
| 60251CX     | Non-Insulated Female Slip-On, pack of 100 | 12-10      | .250     | PK  | 1              |
| 61224       | Non-Insulated Female Slip-On, pack of 14  | 12-10      | .340     | PK  | 1              |

\* This terminal features insulation grip.

### Fully Insulated Female Slip-Ons

The insulation on fully insulated slip-ons is vinyl or nylon.



| CATALOG NO. | DESCRIPTION                                 | WIRE RANGE | TAB SIZE | UOM | ORDER MULTIPLE |
|-------------|---|------------|----------|-----|----------------|
| 6229**      | Fully Insulated Female Slip-On, pack of 11  | 22-18      | .250     | PK  | 1              |
| 6229LX**    | Fully Insulated Female Slip-On, pack of 50  | 22-18      | .250     | PK  | 1              |
| 6233        | Fully Insulated Female Slip-On, pack of 14  | 16-14      | .250     | PK  | 1              |
| 6233LX      | Fully Insulated Female Slip-On, pack of 50  | 16-14      | .250     | PK  | 1              |
| 6233CX      | Fully Insulated Female Slip-On, pack of 100 | 16-14      | .250     | PK  | 1              |
| 61227NX*    | Fully Insulated Female Slip-On, pack of 25  | 12-10      | .250     | PK  | 1              |
| 61234LX     | Fully Insulated Female Slip-On, pack of 50  | 12-10      | .250     | PK  | 1              |

\* This terminal features insulation grip.

\*\*This terminal is usually supplied vinyl and has an insulation grip.

### Fully Insulated Male Slip-Ons

The insulation on fully insulated slip-ons is vinyl or nylon.



| CATALOG NO. | DESCRIPTION                              | WIRE RANGE | TAB SIZE | UOM | ORDER MULTIPLE |
|-------------|--|------------|----------|-----|----------------|
| 6234        | Fully Insulated Male Slip-On, pack of 14 | 16-14      | .250     | PK  | 1              |
| 6234LX      | Fully Insulated Male Slip-On, pack of 50 | 16-14      | .250     | PK  | 1              |
| 61235LX     | Fully Insulated Male Slip-On, pack of 50 | 12-10      | .250     | PK  | 1              |

## Non-Insulated Flag Female Slip-Ons

Part 6213 features insulation grip.

**6224**

| CATALOG NO.    | DESCRIPTION                                    | WIRE RANGE | TAB SIZE | UOM | ORDER MULTIPLE |
|----------------|--|------------|----------|-----|----------------|
| <b>60224</b>   | Non-Insulated Flag Female Slip-On, pack of 24  | 22-18      | .187     | PK  | 1              |
| <b>60225</b>   | Non-Insulated Flag Female Slip-On, pack of 24  | 22-18      | .250     | PK  | 1              |
| <b>60225CX</b> | Non-Insulated Flag Female Slip-On, pack of 100 | 22-18      | .250     | PK  | 1              |
| <b>60213</b>   | Non-Insulated Flag Female Slip-On, pack of 26  | 16-14      | .187     | PK  | 1              |
| <b>60213CX</b> | Non-Insulated Flag Female Slip-On, pack of 100 | 16-14      | .187     | PK  | 1              |
| <b>6213</b>    | Non-Insulated Flag Female Slip-On, pack of 34  | 16-14      | .250     | PK  | 1              |
| <b>6213CX</b>  | Non-Insulated Flag Female Slip-On, pack of 100 | 16-14      | .250     | PK  | 1              |
| <b>6224</b>    | Non-Insulated Flag Female Slip-On, pack of 20  | 12-10      | .250     | PK  | 1              |
| <b>6224CX</b>  | Non-Insulated Flag Female Slip-On, pack of 100 | 12-10      | .250     | PK  | 1              |

## Fully Insulated Flag Female Slip-Ons

The insulation is vinyl or nylon.

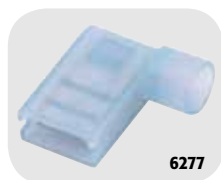
**6277**

| CATALOG NO.   | DESCRIPTION                                     | WIRE RANGE | TAB SIZE | UOM | ORDER MULTIPLE |
|---------------|---|------------|----------|-----|----------------|
| <b>6277</b>   | Fully Insulated Flag Female Slip-On, pack of 9  | 16-14      | .250     | PK  | 1              |
| <b>6277NX</b> | Fully Insulated Flag Female Slip-On, pack of 25 | 16-14      | .250     | PK  | 1              |

## Flag Female Compressor Terminals

Also known as hermetic header terminals, these non-insulated terminals are designed with a larger distance between the "rolls" to allow for the rod in hermetic header applications. The increased distance allows the rod to slip in between them. Parts 6258 and 6259 are notched for bending. The notches are cut between the slip-on portion and the conductor barrel and enable the back of the slip-on portion to be folded against the conductor barrel after the wire connection is made.

**6270**
**6258**

| CATALOG NO.    | DESCRIPTION                                  | WIRE RANGE | FITS     | UOM | ORDER MULTIPLE |
|----------------|--|------------|----------|-----|----------------|
| <b>6271</b>    | Flag Female Compressor Terminal, pack of 12  | 18-16      | .090 pin | PK  | 1              |
| <b>6271CX</b>  | Flag Female Compressor Terminal, pack of 100 | 18-16      | .090 pin | PK  | 1              |
| <b>6273LX</b>  | Flag Female Compressor Terminal, pack of 50  | 18-12      | .250 tab | PK  | 1              |
| <b>6270</b>    | Flag Female Compressor Terminal, pack of 9   | 12-8       | .250 tab | PK  | 1              |
| <b>6270LX</b>  | Flag Female Compressor Terminal, pack of 50  | 12-8       | .250 tab | PK  | 1              |
| <b>6258*</b>   | Flag Female Compressor Terminal, pack of 17  | 16-14      | .250 tab | PK  | 1              |
| <b>6258CX*</b> | Flag Female Compressor Terminal, pack of 100 | 16-14      | .250 tab | PK  | 1              |
| <b>6259</b>    | Flag Female Compressor Terminal, pack of 14  | 12-10      | .250 tab | PK  | 1              |
| <b>6259CX</b>  | Flag Female Compressor Terminal, pack of 100 | 12-10      | .250 tab | PK  | 1              |

\* This terminal features insulation grip.

## Combination Pack: Set of 6233 and 6234

**61233**

| CATALOG NO.    | DESCRIPTION   | WIRE RANGE | TAB SIZE | UOM | ORDER MULTIPLE |
|----------------|---|------------|----------|-----|----------------|
| <b>61233</b>   | Set of Fully Insulated M/F Slip-Ons, pack of 6 pairs  | 16-14      | .250     | PK  | 1              |
| <b>61233LX</b> | Set of Fully Insulated M/F Slip-Ons, pack of 25 pairs | 16-14      | .250     | PK  | 1              |

## Flag Female Compressor Terminal Kit

Parts 6258, 6271, 6259, 6273, 6270 in a four compartment, clear plastic box. Parts 6270 and 6273 are put in the same compartment.

**6200HX**

| CATALOG NO.   | DESCRIPTION                         | UOM | ORDER MULTIPLE |
|---------------|-------------------------------------|-----|----------------|
| <b>6200HX</b> | Flag Female Compressor Terminal Kit | EA  | 1              |

## Compressor Lead Kit

Kit includes three leads:

- flag female compressor terminal (.250 tab; part 6259)
- waterproof butt connector (12-10 wire range; part 62231)
- piece of 10 gauge wire

**60259HX**

| CATALOG NO.    | DESCRIPTION                       | UOM | ORDER MULTIPLE |
|----------------|-----------------------------------|-----|----------------|
| <b>60259HX</b> | Compressor Lead Kit with 12" wire | EA  | 1              |



## STANDARD SOLDERLESS TERMINALS

### Insulated Hooks



| CATALOG NO. | DESCRIPTION                 | WIRE RANGE | STUD | UOM | ORDER MULTIPLE |
|-------------|-----------------------------|------------|------|-----|----------------|
| 6242        | Insulated Hooks, pack of 22 | 22-18      | #8   | PK  | 1              |
| 6242LX      | Insulated Hooks, pack of 50 | 22-18      | #8   | PK  | 1              |
| 6244        | Insulated Hooks, pack of 20 | 16-14      | #8   | PK  | 1              |
| 6244LX      | Insulated Hooks, pack of 50 | 16-14      | #8   | PK  | 1              |

### Non-Insulated Hooks



| CATALOG NO. | DESCRIPTION                     | WIRE RANGE | STUD | UOM | ORDER MULTIPLE |
|-------------|---------------------------------|------------|------|-----|----------------|
| 6243        | Non-Insulated Hooks, pack of 20 | 16-14      | #8   | PK  | 1              |

### Insulated Butt Connectors



| CATALOG NO. | DESCRIPTION                           | WIRE RANGE | UOM | ORDER MULTIPLE |
|-------------|---------------------------------------|------------|-----|----------------|
| 6232        | Insulated Butt Connector, pack of 26  | 22-18      | PK  | 1              |
| 6232LX      | Insulated Butt Connector, pack of 50  | 22-18      | PK  | 1              |
| 6232CX      | Insulated Butt Connector, pack of 100 | 22-18      | PK  | 1              |
| 6217        | Insulated Butt Connector, pack of 27  | 16-14      | PK  | 1              |
| 6217LX      | Insulated Butt Connector, pack of 50  | 16-14      | PK  | 1              |
| 6217CX      | Insulated Butt Connector, pack of 100 | 16-14      | PK  | 1              |
| 6231        | Insulated Butt Connector, pack of 16  | 12-10      | PK  | 1              |
| 6231LX      | Insulated Butt Connector, pack of 50  | 12-10      | PK  | 1              |
| 6231CX      | Insulated Butt Connector, pack of 100 | 12-10      | PK  | 1              |
| 6287        | Insulated Butt Connector, pack of 5   | 22-18      | PK  | 1              |
| 6287XX      | Insulated Butt Connector, pack of 10  | 8          | PK  | 1              |
| 6287NX      | Insulated Butt Connector, pack of 25  | 8          | PK  | 1              |

### Non-Insulated Butt Connectors



| CATALOG NO. | DESCRIPTION                               | WIRE RANGE | UOM | ORDER MULTIPLE |
|-------------|---|------------|-----|----------------|
| 60231       | Non-Insulated Butt Connector, pack of 15  | 12-10      | PK  | 1              |
| 60231CX     | Non-Insulated Butt Connector, pack of 100 | 12-10      | PK  | 1              |

### Nylon Insulated Butt Connectors



| CATALOG NO. | DESCRIPTION                                | WIRE RANGE | UOM | ORDER MULTIPLE |
|-------------|--|------------|-----|----------------|
| 61217       | Nylon Insulated Butt Connector, pack of 17 | 16-14      | PK  | 1              |
| 61231       | Nylon Insulated Butt Connector, pack of 12 | 12-10      | PK  | 1              |

### Butt Connector Assortment Kit

Includes parts 6217, 6231, and 6232.



| CATALOG NO. | DESCRIPTION                   | UOM | ORDER MULTIPLE |
|-------------|-------------------------------|-----|----------------|
| 6200BSX     | Butt Connector Assortment Kit | EA  | 1              |

### Insulated Spades



| CATALOG NO. | DESCRIPTION                   | WIRE RANGE | STUD | UOM | ORDER MULTIPLE |
|-------------|-------------------------------|------------|------|-----|----------------|
| 61214       | Insulated Spades, pack of 23  | 22-18      | #6   | PK  | 1              |
| 6237        | Insulated Spades, pack of 22  | 22-18      | #8   | PK  | 1              |
| 6237LX      | Insulated Spades, pack of 50  | 22-18      | #8   | PK  | 1              |
| 61256       | Insulated Spades, pack of 23  | 22-18      | #10  | PK  | 1              |
| 61256LX     | Insulated Spades, pack of 50  | 22-18      | #10  | PK  | 1              |
| 6274        | Insulated Spades, pack of 22  | 16-14      | #6   | PK  | 1              |
| 6274LX      | Insulated Spades, pack of 50  | 16-14      | #6   | PK  | 1              |
| 6227        | Insulated Spades, pack of 22  | 16-14      | #8   | PK  | 1              |
| 6227LX      | Insulated Spades, pack of 50  | 16-14      | #8   | PK  | 1              |
| 6227CX      | Insulated Spades, pack of 100 | 16-14      | #8   | PK  | 1              |
| 6228        | Insulated Spades, pack of 22  | 16-14      | #10  | PK  | 1              |
| 6228LX      | Insulated Spades, pack of 50  | 16-14      | #10  | PK  | 1              |
| 60274       | Insulated Spades, pack of 18  | 12-10      | #6   | PK  | 1              |
| 60254       | Insulated Spades, pack of 18  | 12-10      | #8   | PK  | 1              |
| 60254LX     | Insulated Spades, pack of 50  | 12-10      | #8   | PK  | 1              |
| 60254CX     | Insulated Spades, pack of 100 | 12-10      | #8   | PK  | 1              |
| 6255        | Insulated Spades, pack of 17  | 12-10      | #10  | PK  | 1              |
| 6255LX      | Insulated Spades, pack of 50  | 12-10      | #10  | PK  | 1              |
| 6255CX      | Insulated Spades, pack of 100 | 12-10      | #10  | PK  | 1              |

## Non-Insulated Spades



| CATALOG NO. | DESCRIPTION                       | WIRE RANGE | STUD | UOM | ORDER MULTIPLE |
|-------------|-----------------------------------|------------|------|-----|----------------|
| 61215       | Non-Insulated Spades, pack of 22  | 22-18      | #6   | PK  | 1              |
| 60237       | Non-Insulated Spades, pack of 23  | 22-18      | #8   | PK  | 1              |
| 60237CX     | Non-Insulated Spades, pack of 100 | 22-18      | #8   | PK  | 1              |
| 61257       | Non-Insulated Spades, pack of 25  | 22-18      | #10  | PK  | 1              |
| 61275CX     | Non-Insulated Spades, pack of 100 | 16-14      | #6   | PK  | 1              |
| 6225        | Non-Insulated Spades, pack of 24  | 16-14      | #8   | PK  | 1              |
| 6225CX      | Non-Insulated Spades, pack of 100 | 16-14      | #8   | PK  | 1              |
| 6226        | Non-Insulated Spades, pack of 23  | 16-14      | #10  | PK  | 1              |
| 6226CX      | Non-Insulated Spades, pack of 100 | 16-14      | #10  | PK  | 1              |
| 61274       | Non-Insulated Spades, pack of 16  | 12-10      | #6   | PK  | 1              |
| 61218       | Non-Insulated Spades, pack of 17  | 12-10      | #8   | PK  | 1              |
| 6254        | Non-Insulated Spades, pack of 22  | 12-10      | #10  | PK  | 1              |
| 6254LX      | Non-Insulated Spades, pack of 50  | 12-10      | #10  | PK  | 1              |
| 6254CX      | Non-Insulated Spades, pack of 100 | 12-10      | #10  | PK  | 1              |

## Insulated Block Spade Terminals



| CATALOG NO. | DESCRIPTION                                | WIRE RANGE | STUD | UOM | ORDER MULTIPLE |
|-------------|--|------------|------|-----|----------------|
| 60275LX     | Insulated Block Spade Terminal, pack of 50 | 16-14      | #8   | PK  | 1              |

## Insulated Spring Spades



| CATALOG NO. | DESCRIPTION                          | WIRE RANGE | STUD | UOM | ORDER MULTIPLE |
|-------------|--------------------------------------|------------|------|-----|----------------|
| 60209       | Insulated Spring Spades, pack of 22  | 22-18      | #6   | PK  | 1              |
| 6238        | Insulated Spring Spades, pack of 22  | 22-18      | #8   | PK  | 1              |
| 6238LX      | Insulated Spring Spades, pack of 50  | 22-18      | #8   | PK  | 1              |
| 6276        | Insulated Spring Spades, pack of 21  | 16-14      | #6   | PK  | 1              |
| 6276LX      | Insulated Spring Spades, pack of 50  | 16-14      | #6   | PK  | 1              |
| 6239        | Insulated Spring Spades, pack of 22  | 16-14      | #8   | PK  | 1              |
| 6239LX      | Insulated Spring Spades, pack of 50  | 16-14      | #8   | PK  | 1              |
| 60228       | Insulated Spring Spades, pack of 22  | 16-14      | #10  | PK  | 1              |
| 60256       | Insulated Spring Spades, pack of 17  | 12-10      | #8   | PK  | 1              |
| 60256CX     | Insulated Spring Spades, pack of 100 | 12-10      | #8   | PK  | 1              |
| 60255       | Insulated Spring Spades, pack of 16  | 12-10      | #10  | PK  | 1              |
| 60255LX     | Insulated Spring Spades, pack of 50  | 12-10      | #10  | PK  | 1              |

## Non-Insulated Spring Spades



| CATALOG NO. | DESCRIPTION                             | WIRE RANGE | STUD | UOM | ORDER MULTIPLE |
|-------------|---|------------|------|-----|----------------|
| 60238       | Non-Insulated Spring Spades, pack of 25 | 22-18      | #8   | PK  | 1              |
| 60201       | Non-Insulated Spring Spades, pack of 27 | 22-18      | #10  | PK  | 1              |
| 60226       | Non-Insulated Spring Spades, pack of 24 | 16-14      | #8   | PK  | 1              |
| 60240       | Non-Insulated Spring Spades, pack of 27 | 16-14      | #10  | PK  | 1              |

## Insulated Flange Spades



| CATALOG NO. | DESCRIPTION                         | WIRE RANGE | STUD | UOM | ORDER MULTIPLE |
|-------------|-------------------------------------|------------|------|-----|----------------|
| 61236       | Insulated Flange Spades, pack of 21 | 22-18      | #6   | PK  | 1              |
| 61237       | Insulated Flange Spades, pack of 21 | 22-18      | #8   | PK  | 1              |
| 61239       | Insulated Flange Spades, pack of 17 | 16-14      | #6   | PK  | 1              |
| 61276       | Insulated Flange Spades, pack of 22 | 16-14      | #8   | PK  | 1              |
| 61276LX     | Insulated Flange Spades, pack of 50 | 16-14      | #8   | PK  | 1              |
| 61255       | Insulated Flange Spades, pack of 16 | 12-10      | #10  | PK  | 1              |
| 61255LX     | Insulated Flange Spades, pack of 50 | 12-10      | #10  | PK  | 1              |

## Non-Insulated Flange Spades



| CATALOG NO. | DESCRIPTION                             | WIRE RANGE | STUD | UOM | ORDER MULTIPLE |
|-------------|---|------------|------|-----|----------------|
| 61238       | Non-Insulated Flange Spades, pack of 24 | 22-18      | #8   | PK  | 1              |
| 61201       | Non-Insulated Flange Spades, pack of 24 | 22-18      | #10  | PK  | 1              |
| 61226       | Non-Insulated Flange Spades, pack of 24 | 16-14      | #8   | PK  | 1              |
| 61240       | Non-Insulated Flange Spades, pack of 24 | 16-14      | #10  | PK  | 1              |



## STANDARD SOLDERLESS TERMINALS cont'd

### Insulated Rings



61202

| CATALOG NO. | DESCRIPTION                  | WIRE RANGE | STUD  | UOM | ORDER MULTIPLE |
|-------------|------------------------------|------------|-------|-----|----------------|
| 61202       | Insulated Rings, pack of 22  | 22-18      | #6    | PK  | 1              |
| 6236LX      | Insulated Rings, pack of 50  | 22-18      | #8    | PK  | 1              |
| 61206       | Insulated Rings, pack of 19  | 22-18      | 1/4"  | PK  | 1              |
| 61208       | Insulated Rings, pack of 17  | 22-18      | 5/16" | PK  | 1              |
| 61210       | Insulated Rings, pack of 15  | 22-18      | 3/8"  | PK  | 1              |
| 61210LX     | Insulated Rings, pack of 50  | 22-18      | 3/8"  | PK  | 1              |
| 6272        | Insulated Rings, pack of 22  | 16-14      | #6    | PK  | 1              |
| 60272LX     | Insulated Rings, pack of 50  | 16-14      | #8    | PK  | 1              |
| 6216        | Insulated Rings, pack of 23  | 16-14      | #10   | PK  | 1              |
| 6216LX      | Insulated Rings, pack of 50  | 16-14      | #10   | PK  | 1              |
| 6216CX      | Insulated Rings, pack of 100 | 16-14      | #10   | PK  | 1              |
| 60216       | Insulated Rings, pack of 20  | 16-14      | 1/4"  | PK  | 1              |
| 61204       | Insulated Rings, pack of 19  | 16-14      | 5/16" | PK  | 1              |
| 60245       | Insulated Rings, pack of 17  | 16-14      | 3/8"  | PK  | 1              |
| 60247       | Insulated Rings, pack of 17  | 12-10      | #6    | PK  | 1              |
| 60252CX     | Insulated Rings, pack of 100 | 12-10      | #8    | PK  | 1              |
| 6252        | Insulated Rings, pack of 17  | 12-10      | #10   | PK  | 1              |
| 6252LX      | Insulated Rings, pack of 50  | 12-10      | #10   | PK  | 1              |
| 6253LX      | Insulated Rings, pack of 50  | 12-10      | 1/4"  | PK  | 1              |
| 6253CX      | Insulated Rings, pack of 100 | 12-10      | 1/4"  | PK  | 1              |
| 61212       | Insulated Rings, pack of 13  | 12-10      | 5/16" | PK  | 1              |
| 60253       | Insulated Rings, pack of 13  | 12-10      | 3/8"  | PK  | 1              |
| 60253LX     | Insulated Rings, pack of 50  | 12-10      | 3/8"  | PK  | 1              |
| 61254       | Insulated Rings, pack of 10  | 12-10      | 1/2"  | PK  | 1              |
| 6257        | Insulated Rings, pack of 6   | 8          | 1/4"  | PK  | 1              |
| 6257NX      | Insulated Rings, pack of 25  | 8          | 1/4"  | PK  | 1              |
| 60257       | Insulated Rings, pack of 6   | 8          | 5/16" | PK  | 1              |
| 60257NX     | Insulated Rings, pack of 25  | 8          | 5/16" | PK  | 1              |
| 60258NX     | Insulated Rings, pack of 25  | 8          | 3/8"  | PK  | 1              |
| 61252       | Insulated Rings, pack of 5   | 6          | 5/16" | PK  | 1              |
| 61252NX     | Insulated Rings, pack of 25  | 6          | 5/16" | PK  | 1              |

### Non-Insulated Rings



61203

| CATALOG NO. | DESCRIPTION                      | WIRE RANGE | STUD  | UOM | ORDER MULTIPLE |
|-------------|----------------------------------|------------|-------|-----|----------------|
| 61203       | Non-Insulated Rings, pack of 23  | 22-18      | #6    | PK  | 1              |
| 60236       | Non-Insulated Rings, pack of 28  | 22-18      | #8    | PK  | 1              |
| 60206       | Non-Insulated Rings, pack of 25  | 22-18      | #10   | PK  | 1              |
| 61207       | Non-Insulated Rings, pack of 24  | 22-18      | 1/4"  | PK  | 1              |
| 61209       | Non-Insulated Rings, pack of 19  | 22-18      | 5/16" | PK  | 1              |
| 61211       | Non-Insulated Rings, pack of 20  | 22-18      | 3/8"  | PK  | 1              |
| 61272       | Non-Insulated Rings, pack of 23  | 16-14      | #6    | PK  | 1              |
| 6215        | Non-Insulated Rings, pack of 27  | 16-14      | #8    | PK  | 1              |
| 6215CX      | Non-Insulated Rings, pack of 100 | 16-14      | #8    | PK  | 1              |
| 60215       | Non-Insulated Rings, pack of 24  | 16-14      | #10   | PK  | 1              |
| 60215CX     | Non-Insulated Rings, pack of 100 | 16-14      | #10   | PK  | 1              |
| 60205       | Non-Insulated Rings, pack of 21  | 16-14      | 1/4"  | PK  | 1              |
| 60205CX     | Non-Insulated Rings, pack of 100 | 16-14      | 1/4"  | PK  | 1              |
| 61205       | Non-Insulated Rings, pack of 23  | 16-14      | 5/16" | PK  | 1              |
| 61205CX     | Non-Insulated Rings, pack of 100 | 16-14      | 5/16" | PK  | 1              |
| 61245       | Non-Insulated Rings, pack of 17  | 16-14      | 3/8"  | PK  | 1              |
| 61247       | Non-Insulated Rings, pack of 16  | 12-10      | #6    | PK  | 1              |
| 60204       | Non-Insulated Rings, pack of 20  | 12-10      | #8    | PK  | 1              |
| 60202       | Non-Insulated Rings, pack of 17  | 12-10      | 1/4"  | PK  | 1              |
| 61213       | Non-Insulated Rings, pack of 12  | 12-10      | 5/16" | PK  | 1              |
| 61253       | Non-Insulated Rings, pack of 15  | 12-10      | 3/8"  | PK  | 1              |

### Flag Rings



6247

| CATALOG NO. | DESCRIPTION             | WIRE RANGE | STUD | UOM | ORDER MULTIPLE |
|-------------|-------------------------|------------|------|-----|----------------|
| 6247        | Flag Rings, pack of 27  | 16-14      | #10  | PK  | 1              |
| 6247CX      | Flag Rings, pack of 100 | 16-14      | #10  | PK  | 1              |
| 6248        | Flag Rings, pack of 20  | 12-10      | #10  | PK  | 1              |

## WATERPROOF SOLDERLESS TERMINALS

Waterproof terminals are assembled with high grade heat shrinkable insulation. When heated, the insulation shrinks around the crimped connection and wire, sealing out moisture and corrosion. Wire insulation grip for severe vibration applications.

### Waterproof Rings



62236

| CATALOG NO. | DESCRIPTION                 | WIRE RANGE | STUD | UOM | ORDER MULTIPLE |
|-------------|-----------------------------|------------|------|-----|----------------|
| 62236       | Waterproof Rings, pack of 5 | 22-18      | #8   | PK  | 1              |
| 62273       | Waterproof Rings, pack of 4 | 16-14      | #8   | PK  | 1              |
| 62216       | Waterproof Rings, pack of 4 | 16-14      | #10  | PK  | 1              |

### Waterproof Butt Connectors



62232

| CATALOG NO. | DESCRIPTION                            | WIRE RANGE | UOM | ORDER MULTIPLE |
|-------------|--|------------|-----|----------------|
| 62232       | Waterproof Butt Connectors, pack of 4  | 22-18      | PK  | 1              |
| 62232XX     | Waterproof Butt Connectors, pack of 10 | 22-18      | PK  | 1              |
| 62231       | Waterproof Butt Connectors, pack of 3  | 12-10      | PK  | 1              |
| 62231XX     | Waterproof Butt Connectors, pack of 10 | 12-10      | PK  | 1              |

## WATERPROOF SOLDERLESS TERMINALS cont'd

### Fully Insulated Waterproof Female Slip-Ons



| CATALOG NO. | DESCRIPTION                                | WIRE RANGE | TAB SIZE | UOM | ORDER MULTIPLE |
|-------------|--|------------|----------|-----|----------------|
| 62235       | Fully Insulated Female Slip-Ons, pack of 3 | 22-18      | .250     | PK  | 1              |
| 62218       | Fully Insulated Female Slip-Ons, pack of 3 | 16-14      | .250     | PK  | 1              |
| 62251       | Fully Insulated Female Slip-Ons, pack of 3 | 12-10      | .250     | PK  | 1              |

### Waterproof Spades



| CATALOG NO. | DESCRIPTION                  | WIRE RANGE | STUD | UOM | ORDER MULTIPLE |
|-------------|------------------------------|------------|------|-----|----------------|
| 62227       | Waterproof Spades, pack of 5 | 16-14      | #8   | PK  | 1              |
| 62228       | Waterproof Spades, pack of 4 | 16-14      | #10  | PK  | 1              |

### Fully Insulated Waterproof Male Slip-Ons



| CATALOG NO. | DESCRIPTION                              | WIRE RANGE | TAB SIZE | UOM | ORDER MULTIPLE |
|-------------|--|------------|----------|-----|----------------|
| 62219       | Fully Insulated Male Slip-Ons, pack of 3 | 16-14      | .250     | PK  | 1              |

## HIGH TEMPERATURE SOLDERLESS TERMINALS

Non-insulated terminals constructed of nickel plated steel; rated at 900°F (482°C).

### High Temperature Male Slip-Ons



| CATALOG NO. | DESCRIPTION                           | WIRE RANGE | TAB SIZE | UOM | ORDER MULTIPLE |
|-------------|---------------------------------------|------------|----------|-----|----------------|
| 4220        | High Temp. Male Slip-Ons, pack of 21  | 16-14      | .250     | PK  | 1              |
| 4220CX      | High Temp. Male Slip-Ons, pack of 100 | 16-14      | .250     | PK  | 1              |
| 4218        | High Temp. Male Slip-Ons, pack of 17  | 18-14      | .187     | PK  | 1              |
| 4219        | High Temp. Male Slip-Ons, pack of 21  | 12-10      | .250     | PK  | 1              |

### High Temperature Flag Female Slip-Ons



| CATALOG NO. | DESCRIPTION                                  | WIRE RANGE | TAB SIZE | UOM | ORDER MULTIPLE |
|-------------|--|------------|----------|-----|----------------|
| 4213        | High Temp. Flag Female Slip-Ons, pack of 16  | 16-14      | .250     | PK  | 1              |
| 4213CX      | High Temp. Flag Female Slip-Ons, pack of 100 | 16-14      | .250     | PK  | 1              |
| 4224        | High Temp. Flag Female Slip-Ons, pack of 11  | 12-10      | .250     | PK  | 1              |
| 4224NX      | High Temp. Flag Female Slip-Ons, pack of 25  | 12-10      | .250     | PK  | 1              |
| 4224CX      | High Temp. Flag Female Slip-Ons, pack of 100 | 12-10      | .250     | PK  | 1              |

### High Temperature Female Slip-Ons



| CATALOG NO. | DESCRIPTION                             | WIRE RANGE | TAB SIZE | UOM | ORDER MULTIPLE |
|-------------|---|------------|----------|-----|----------------|
| 4221        | High Temp. Female Slip-Ons, pack of 20  | 16-14      | .187     | PK  | 1              |
| 4221CX      | High Temp. Female Slip-Ons, pack of 100 | 16-14      | .187     | PK  | 1              |
| 4214        | High Temp. Female Slip-Ons, pack of 21  | 16-14      | .250     | PK  | 1              |
| 4214CX      | High Temp. Female Slip-Ons, pack of 100 | 16-14      | .250     | PK  | 1              |
| 4204        | High Temp. Female Slip-Ons, pack of 17  | 12-10      | .250     | PK  | 1              |
| 4204CX      | High Temp. Female Slip-Ons, pack of 100 | 12-10      | .250     | PK  | 1              |

### High Temperature Spades



| CATALOG NO. | DESCRIPTION                    | WIRE RANGE | STUD | UOM | ORDER MULTIPLE |
|-------------|--------------------------------|------------|------|-----|----------------|
| 4226        | High Temp. Spades, pack of 23  | 16-14      | #10  | PK  | 1              |
| 4226CX      | High Temp. Spades, pack of 100 | 16-14      | #10  | PK  | 1              |
| 4254CX      | High Temp. Spades, pack of 100 | 12-10      | #10  | PK  | 1              |



## HIGH TEMPERATURE SOLDERLESS TERMINALS cont'd

### High Temperature Rings



| CATALOG NO. | DESCRIPTION                   | WIRE RANGE | STUD | UOM | ORDER MULTIPLE |
|-------------|-------------------------------|------------|------|-----|----------------|
| 4206        | High Temp. Rings, pack of 25  | 22-18      | #6   | PK  | 1              |
| 4206CX      | High Temp. Rings, pack of 100 | 22-18      | #6   | PK  | 1              |
| 4236CX      | High Temp. Rings, pack of 100 | 22-18      | #10  | PK  | 1              |
| 4272CX      | High Temp. Rings, pack of 100 | 16-14      | #6   | PK  | 1              |
| 4215        | High Temp. Rings, pack of 21  | 16-14      | #10  | PK  | 1              |
| 4215CX      | High Temp. Rings, pack of 100 | 16-14      | #10  | PK  | 1              |
| 4205CX      | High Temp. Rings, pack of 100 | 16-14      | 1/4" | PK  | 1              |
| 4252        | High Temp. Rings, pack of 14  | 12-10      | #10  | PK  | 1              |
| 4252CX      | High Temp. Rings, pack of 100 | 12-10      | #10  | PK  | 1              |
| 4253        | High Temp. Rings, pack of 14  | 12-10      | 1/4" | PK  | 1              |
| 4253CX      | High Temp. Rings, pack of 100 | 12-10      | 1/4" | PK  | 1              |

### High Temperature Butt Connectors



| CATALOG NO. | DESCRIPTION                             | WIRE RANGE | UOM | ORDER MULTIPLE |
|-------------|---|------------|-----|----------------|
| 4217CX      | High Temp. Butt Connectors, pack of 100 | 16-14      | PK  | 1              |
| 4231        | High Temp. Butt Connectors, pack of 17  | 12-10      | PK  | 1              |

### High Temperature Assortment

Includes parts 4213, 4215, and 4204, and 4254.



| CATALOG NO. | DESCRIPTION           | UOM | ORDER MULTIPLE |
|-------------|-----------------------|-----|----------------|
| 4200AX      | High Temp. Assortment | EA  | 1              |

## SPECIAL PURPOSE SOLDERLESS TERMINALS

### Fully Insulated Receptacles



| CATALOG NO. | DESCRIPTION                             | WIRE RANGE | UOM | ORDER MULTIPLE |
|-------------|---|------------|-----|----------------|
| 6284        | Fully Insulated Receptacles, pack of 12 | 22-18      | PK  | 1              |
| 6284LX      | Fully Insulated Receptacles, pack of 50 | 22-18      | PK  | 1              |
| 6286        | Fully Insulated Receptacles, pack of 12 | 16-14      | PK  | 1              |
| 6286LX      | Fully Insulated Receptacles, pack of 50 | 16-14      | PK  | 1              |

### Tap Connectors

Designed to make tap splices.



| CATALOG NO. | DESCRIPTION                                    | WIRE RANGE | UOM | ORDER MULTIPLE |
|-------------|--|------------|-----|----------------|
| 6241        | Tap Splice – blue, pack of 15                  | 16-14      | PK  | 1              |
| 62402       | Tap Splice – red, pack of 9                    | 22-18      | PK  | 1              |
| 6240        | Tap Splice – yellow, pack of 10                | 12-10      | PK  | 1              |
| 6245        | Tap Splice, mates w/.250 tab – blue, pack of 9 | 18-14      | PK  | 1              |

### Non-Insulated Receptacles



| CATALOG NO. | DESCRIPTION                           | WIRE RANGE | UOM | ORDER MULTIPLE |
|-------------|---------------------------------------|------------|-----|----------------|
| 60284       | Non-Insulated Receptacles, pack of 36 | 22-18      | PK  | 1              |
| 60286       | Non-Insulated Receptacles, pack of 36 | 16-14      | PK  | 1              |

### Fully Insulated Dead End Connectors



| CATALOG NO. | DESCRIPTION                                     | WIRE RANGE | UOM | ORDER MULTIPLE |
|-------------|---|------------|-----|----------------|
| 6222        | Fully Insulated Dead End Connectors, pack of 27 | 22-14      | PK  | 1              |
| 6222LX      | Fully Insulated Dead End Connectors, pack of 50 | 22-14      | PK  | 1              |
| 6223        | Fully Insulated Dead End Connectors, pack of 21 | 18-10      | PK  | 1              |
| 6223LX      | Fully Insulated Dead End Connectors, pack of 50 | 18-10      | PK  | 1              |
| 6250        | Fully Insulated Dead End Connectors, pack of 8  | 18-8       | PK  | 1              |

### Combination Packs



| CATALOG NO. | DESCRIPTION   | UOM | ORDER MULTIPLE |
|-------------|---|-----|----------------|
| 6288        | Combination Pack with parts 6283 and 6284, pack of 7 pairs  | PK  | 1              |
| 6288LX      | Combination Pack with parts 6283 and 6284, pack of 25 pairs | PK  | 1              |
| 6289        | Combination Pack with parts 6285 and 6286, pack of 7 pairs  | PK  | 1              |
| 6289LX      | Combination Pack with parts 6285 and 6286, pack of 25 pairs | PK  | 1              |

## SPECIAL PURPOSE SOLDERLESS TERMINALS cont'd

### Insulated Plugs



| CATALOG NO. | DESCRIPTION                 | WIRE RANGE | UOM | ORDER MULTIPLE |
|-------------|-----------------------------|------------|-----|----------------|
| 6283        | Insulated Plugs, pack of 17 | 22-18      | PK  | 1              |
| 6283LX      | Insulated Plugs, pack of 50 | 22-18      | PK  | 1              |
| 6285        | Insulated Plugs, pack of 17 | 16-14      | PK  | 1              |
| 6285LX      | Insulated Plugs, pack of 50 | 16-14      | PK  | 1              |

### Non-Insulated Plugs



| CATALOG NO. | DESCRIPTION                     | WIRE RANGE | UOM | ORDER MULTIPLE |
|-------------|---------------------------------|------------|-----|----------------|
| 60285       | Non-Insulated Plugs, pack of 37 | 16-14      | PK  | 1              |

### Tab Adapters – Quick Disconnect with Screw



| CATALOG NO. | DESCRIPTION                                   | UOM | ORDER MULTIPLE |
|-------------|---|-----|----------------|
| 6209        | Fits .250 Tab, #6-32 x 1/4" Screw, pack of 5  | PK  | 1              |
| 6209LX      | Fits .250 Tab, #6-32 x 1/4" Screw, pack of 50 | PK  | 1              |

### Tab Adapters – Piggy Back Slip-Ons

Multi-stack, .250 male tab, .250 female slip-on.



| CATALOG NO. | DESCRIPTION                                    | WIRE RANGE | UOM | ORDER MULTIPLE |
|-------------|--|------------|-----|----------------|
| 6210        | Non-Insulated Piggy Back Slip-Ons, pack of 20  | 16-14      | PK  | 1              |
| 6210CX      | Non-Insulated Piggy Back Slip-Ons, pack of 100 | 16-14      | PK  | 1              |
| 60210       | Insulated Piggy Back Slip-Ons, pack of 11      | 16-14      | PK  | 1              |
| 60210LX     | Insulated Piggy Back Slip-Ons, pack of 50      | 16-14      | PK  | 1              |
| 60210CX     | Insulated Piggy Back Slip-Ons, pack of 100     | 16-14      | PK  | 1              |

### Tab Adapters – Single Female Double Male Tabs

.250 male, .250 female.



| CATALOG NO. | DESCRIPTION  | TAB SIZE | UOM | ORDER MULTIPLE |
|-------------|--|----------|-----|----------------|
| 6208        | Tab Adapter; 1 female, 2 male; Bent 90°, pack of 12        | .250     | PK  | 1              |
| 6208LX      | Tab Adapter; 1 female, 2 male; Bent 90°, pack of 50        | .250     | PK  | 1              |
| 6211        | Tab Adapter; 1 female, 2 male; Wye, pack of 27             | .250     | PK  | 1              |
| 6211CX      | Tab Adapter; 1 female, 2 male; Wye, pack of 100            | .250     | PK  | 1              |
| 6212        | Tab Adapter; 1 female, 2 male; Stacked, pack of 16         | .250     | PK  | 1              |
| 6212CX      | Tab Adapter; 1 female, 2 male; Stacked, pack of 100        | .250     | PK  | 1              |
| 60234       | Tab Adapter; 1 female, 2 male; Fully Insulated, pack of 12 | .250     | PK  | 1              |

### Tab Adapters – Male Tabs



| CATALOG NO. | DESCRIPTION                              | TAB SIZE | STUD | UOM | ORDER MULTIPLE |
|-------------|--|----------|------|-----|----------------|
| 61230       | Male Tabs – Straight, pack of 23         | .250     | #6   | PK  | 1              |
| 61230CX     | Male Tabs – Straight, pack of 100        | .250     | #6   | PK  | 1              |
| 6230        | Male Tabs – Straight, pack of 28         | .250     | #8   | PK  | 1              |
| 6230CX      | Male Tabs – Straight, pack of 100        | .250     | #8   | PK  | 1              |
| 60230CX     | Male Tabs – Straight, pack of 100        | .250     | #10  | PK  | 1              |
| 60249       | Male Tabs – 1 pair, bent 90°, pack of 22 | .250     | #10  | PK  | 1              |



## DEVCO TERMINAL KITS

| CATALOG NO.                      | DESCRIPTION  | TERMINALS            |                                      |  |                                       |       |              |      |      |      |      |      |      |                      |      |      |      |
|----------------------------------|--|----------------------|--------------------------------------|--|---------------------------------------|-------|--------------|------|------|------|------|------|------|----------------------|------|------|------|
|                                  | <p><b>NOTE:</b> Some kits have parts not shown in chart. Please refer to the DESCRIPTION for these parts. Except where noted, kits come in clear plastic boxes.</p>  |                      |                                      | <b>HIGH TEMP</b>                             |                                       |       |              |      |      |      |      |      |      |                      |      |      |      |
| <b>6200HX</b>                    | <b>Flag Female Compressor Terminal Kit:</b> 8-18 wire range in a 4-compartment box with parts 6270 and 6273 in the same compartment.   |                      |                                      |  |                                       |       |              |      |      |      |      | 6258 | 6259 | 6270<br>6271<br>6273 |      |      |      |
| <b>6200MX</b><br><b>6200MSX*</b> | .187, .250 tabs; 12-10 wire range; #8, #10 studs in a 13-compartment polypropylene box.  | 6217<br>6231<br>6232 | 6218<br>6235<br>6251<br>6281         |  | 6216<br>6252                          |       |              |      | 6213 |      |      |      | 6259 |                      |      | 6211 |      |
| <b>6201MX</b>                    | .187, .250 tabs; 22-10 wire range; #8, #10 studs in a 21-compartment metal box. (Includes parts 6233, 6234, and 6277, not shown in chart).   | 6217<br>6231<br>6232 | 6218<br>6235<br>6251<br>6281<br>6282 |  | 6216<br>6236<br>6252                  | 6228  | 6238<br>6239 |      |      | 6224 |      | 6258 | 6259 |                      |      | 6211 |      |
| <b>6202MX</b>                    | <b>Insulated Terminal Kit:</b> .187, .250 tabs; 22-10 wire range; #8, #10, #6, 1/4" studs in an 18-compartment box. Parts 6233 & 6234, and parts 6222 & 6223 are pairs (not shown in chart).                                   | 6217<br>6231<br>6232 | 6218<br>6235<br>6251<br>6281<br>6282 |  | 6216<br>6252<br>6253<br>6272<br>60246 | 60254 | 6238<br>6239 |      |      |      |      |      |      |                      |      |      |      |
| <b>6203MX</b>                    | <b>Non-Insulated Terminal Kit:</b> Includes High Temp. Terminals and Flag Female Compressor Terminals. .250 tab; 22-10 wire range; #8, #10 studs in an 18-compartment box. (Includes parts 6209 and 6210, not shown in chart). |                      |                                      | 4204<br>4213<br>4214<br>4215<br>4252<br>4254 |                                       |       |              | 6214 | 6213 | 6224 |      | 6258 | 6259 | 6270<br>6271         | 6230 | 6208 | 6211 |
| <b>4200AX</b>                    | <b>High Temperature Terminal Kit:</b> .250 tab; 16-10 wire; #10 stud in a bag  |                      |                                      | 4204<br>4213<br>4215<br>4254                 |                                       |       |              |      |      |      |      |      |      |                      |      |      |      |
| <b>6200X</b>                     | .250 tab; 16-14 wire; #8 stud in a 6-compartment box.  | 6217                 |                                      |  |                                       |       |              | 6214 | 6213 |      | 6215 |      |      |                      | 6230 |      | 6211 |
| <b>6200AX</b>                    | .250 tab; 16-14 wire range; #8, #10 studs in a 6-compartment box.  | 6217                 | 6218                                 |  | 6216                                  |       |              |      | 6213 |      |      |      |      |                      | 6230 |      | 6211 |
| <b>6200BX</b>                    | .250 tab; 16-14 wire; #8 stud in a 4-compartment box.  |                      |                                      |  |                                       |       |              | 6214 | 6213 |      | 6215 |      |      |                      |      |      | 6211 |
| <b>6200BSX</b>                   | 22-10 wire range in a bag.   | 6217<br>6231<br>6232 |                                      |  |                                       |       |              |      |      |      |      |      |      |                      |      |      |      |
| <b>6200CX</b>                    | .250 tab; 16-14 wire; #10 stud in a 4-compartment box.   |                      | 6218                                 |  | 6216                                  |       |              |      | 6213 |      |      |      |      |                      |      |      | 6211 |
| <b>6200DX</b>                    | .250 tab; 12-10 wire range; #8, #10 studs in a 6-compartment box.  | 6231                 | 6251                                 |  | 6252                                  |       |              |      |      | 6224 |      |      |      |                      | 6230 |      | 6211 |

\*Contains a crimper.

## BOXES, RINGS, AND COVERS

### Steel Utility Boxes\*

Galvanized steel.



PI360

| CATALOG NO. | LENGTH | WIDTH  | DEPTH  | CAPACITY (cubic in.) | KNOCKOUT (in.) | UOM | ORDER MULTIPLE |
|-------------|--------|--------|--------|----------------------|----------------|-----|----------------|
| PI360       | 4"     | 2-1/8" | 1-7/8" | 13.0                 | 1/2            | EA  | 1              |
| PI360-3/4   | 4"     | 2-1/8" | 1-7/8" | 13.0                 | 3/4 & 1/2      | EA  | 1              |
| PI361       | 4"     | 2-1/8" | 2-1/8" | 14.5                 | 1/2            | EA  | 1              |
| PI361-3/4   | 4"     | 2-1/8" | 2-1/8" | 14.5                 | 3/4 & 1/2      | EA  | 1              |

### Steel 1900 Boxes\*

Galvanized steel.



PI362

| CATALOG NO. | LENGTH | WIDTH | DEPTH  | CAPACITY (cubic in.) | KNOCKOUT (in.) | UOM | ORDER MULTIPLE |
|-------------|--------|-------|--------|----------------------|----------------|-----|----------------|
| PI362       | 4"     | 4"    | 1-1/2" | 21.0                 | 3/4 & 1/2      | EA  | 1              |
| PI363       | 4"     | 4"    | 2-1/8" | 30.3                 | 3/4 & 1/2      | EA  | 1              |

### Steel Octagon Box\*

Galvanized steel.



PI364

| CATALOG NO. | LENGTH | WIDTH | DEPTH  | CAPACITY (cubic in.) | KNOCKOUT (in.) | UOM | ORDER MULTIPLE |
|-------------|--------|-------|--------|----------------------|----------------|-----|----------------|
| PI364       | 4"     | 4"    | 1-1/2" | 15.5                 | 3/4 & 1/2      | EA  | 1              |

### Extension Rings\*

Galvanized steel.



PI390

| CATALOG NO. | LENGTH | WIDTH  | DEPTH  | CAPACITY (cubic in.) | KNOCKOUT (in.) | UOM | ORDER MULTIPLE |
|-------------|--------|--------|--------|----------------------|----------------|-----|----------------|
| PI390       | 4"     | 2-1/8" | 1-7/8" | 13.0                 | 1/2            | EA  | 1              |
| PI391       | 4"     | 4"     | 1-1/2" | 21.0                 | 3/4 & 1/2      | EA  | 1              |

### Device Rings\*

Galvanized steel.



PI387

| CATALOG NO. | DESCRIPTION      | NUMBER DEVICES | RAISED | UOM | ORDER MULTIPLE |
|-------------|------------------|----------------|--------|-----|----------------|
| PI387       | 1900 Device Ring | 1              | 1/2"   | EA  | 1              |
| PI388       | 1900 Device Ring | 2              | 1/2"   | EA  | 1              |

### Weatherproof Boxes\*

Heavy-duty die cast aluminum with baked aluminum finish. Boxes have two closure plugs and three holes.



PI385

| CATALOG NO. | LENGTH | WIDTH  | DEPTH | CAPACITY (cubic in.) | HOLE SIZE (in.) | UOM | ORDER MULTIPLE |
|-------------|--------|--------|-------|----------------------|-----------------|-----|----------------|
| PI385       | 4-1/2" | 2-3/4" | 2"    | 19.0                 | 1/2             | EA  | 1              |
| PI385-34    | 4-1/2" | 2-3/4" | 2"    | 19.0                 | 3/4             | EA  | 1              |

### Weatherproof Covers\*

Covers fit part PI385. The covers come with gaskets.

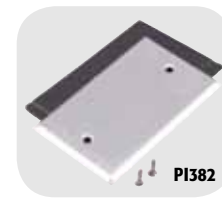

PI382

| CATALOG NO. | DESCRIPTION  | UOM | ORDER MULTIPLE |
|-------------|--|-----|----------------|
| PI382       | Blank Cover  | EA  | 1              |
| PI386       | Lever Switch Cover for standard toggle type switches | EA  | 1              |
| PI389       | Duplex Receptacle Cover                              | EA  | 1              |
| PI389-GFI   | GFI Receptacle Cover                                 | EA  | 1              |

### Weatherproof Box with Lever Switch Cover\*

Includes parts PI385 and PI386.



PI384

| CATALOG NO. | DESCRIPTION                             | UOM | ORDER MULTIPLE |
|-------------|---|-----|----------------|
| PI384       | Weatherproof Box and Lever Switch Cover | EA  | 1              |

\*Items in this section are Underwriter's Laboratories listed or recognized under the prime manufacturer's name.



## BOXES, RINGS, AND COVERS cont'd

### Plated Steel Utility Covers\*



| CATALOG NO. | DESCRIPTION                | WIDTH    | LENGTH | UOM | ORDER MULTIPLE |
|-------------|----------------------------|----------|--------|-----|----------------|
| PI365       | Toggle Switch              | 2-11/32" | 4-1/4" | EA  | 1              |
| PI366       | Duplex Receptacle          | 2-11/32" | 4-1/4" | EA  | 1              |
| PI367       | Blank Cover                | 2-11/32" | 4-1/4" | EA  | 1              |
| PI375       | Standard Single Receptacle | 2-11/32" | 4-1/4" | EA  | 1              |

### Utility Covers\*

Utility covers are 4 1/4" x 2-11/32".



| CATALOG NO. | DESCRIPTION   | UOM | ORDER MULTIPLE |
|-------------|---|-----|----------------|
| PI383       | Appliance Switch, .4687" dia. hole, baked cadilite finish | EA  | 1              |
| PI373       | Red finish, "Emergency Oil Burner" in white letters       | EA  | 1              |
| PI374       | Red finish, "Emergency Gas Burner" in white letters       | EA  | 1              |

### Utility Plates\*

Utility plates are 4 1/2" x 2-3/4".



| CATALOG NO. | DESCRIPTION   | UOM | ORDER MULTIPLE |
|-------------|---|-----|----------------|
| PI393       | Red finish, "Emergency Oil Burner" in white letters | EA  | 1              |
| PI394       | Red finish, "Emergency Gas Burner" in white letters | EA  | 1              |

### Accessory Oval Head Screws for Covers\*

Size: 6-32 x 1/2"



| CATALOG NO. | DESCRIPTION                                      | UOM | ORDER MULTIPLE |
|-------------|--|-----|----------------|
| PI313       | Chrome plated steel Oval Head Screws, pack of 20 | PK  | 1              |

### Steel 1900 Covers\*

Baked Cadilite finish steel covers are raised 1/2" with fully depressed corners. Size: 4" x 4".



| CATALOG NO. | DESCRIPTION   | UOM | ORDER MULTIPLE |
|-------------|---|-----|----------------|
| PI377       | Single Toggle   | EA  | 1              |
| PI378       | Single Duplex Receptacle                              | EA  | 1              |
| PI379       | One Standard Single Receptacle                        | EA  | 1              |
| PI368       | Toggle Switch and Duplex Receptacle                   | EA  | 1              |
| PI369       | Two Duplex Receptacles                                | EA  | 1              |
| PI370       | Toggle Switch and Standard Single Receptacle          | EA  | 1              |
| PI376       | Two Toggle Switches                                   | EA  | 1              |
| PI371       | Flat, Blank, Galvanized steel (not Cadilite finished) | EA  | 1              |

### Safety Plates\*



| CATALOG NO. | DESCRIPTION                     | UOM | ORDER MULTIPLE |
|-------------|---------------------------------|-----|----------------|
| PI232       | Safety Plate – approximately 6" | EA  | 6              |
| PI232CX     | Safety Plate – approximately 6" | EA  | 100            |

## CABLE CONNECTORS

### Zinc Plated Die Cast Steel Romex Connectors\*

Zinc plated die cast connectors are for use with Romex, Service, and U.F. Cable.



| CATALOG NO. | DESCRIPTION                                       | TRADE SIZE | KNOCKOUT | UOM | ORDER MULTIPLE |
|-------------|---|------------|----------|-----|----------------|
| PI321       | Zinc plated die cast Romex Connector, pack of 8   | 3/8"       | 1/2"     | PK  | 1              |
| PI320       | Zinc plated die cast Romex Connector, pack of 25  | 3/8"       | 1/2"     | PK  | 1              |
| PI319       | Zinc plated die cast Romex Connector, pack of 4   | 3/4"       | 3/4"     | PK  | 1              |
| PI319CX     | Zinc plated die cast Romex Connector, pack of 100 | 3/4"       | 3/4"     | PK  | 1              |

### Combination Couplings

For connecting E.M.T. to flexible steel conduit.



| CATALOG NO. | DESCRIPTION                         | UOM | ORDER MULTIPLE |
|-------------|-------------------------------------|-----|----------------|
| PI440*      | 1/2" E.M.T. to 3/8" Flex, pack of 4 | PK  | 1              |

\*Items in this section are Underwriter's Laboratories listed or recognized under the prime manufacturer's name.

## CABLE CONNECTORS cont'd

### BX and Greenfield Connectors\*

Zinc die cast.



### Liquid-Tite Connectors\*

Zinc die cast.



| CATALOG NO. | DESCRIPTION  | TRADE SIZE | KNOCKOUT | UOM | ORDER MULTIPLE |
|-------------|--|------------|----------|-----|----------------|
| PI311       | Set Screw Type Connector, 25 per pack  | 3/8"       | 1/2"     | EA  | 25             |
| PI312       | Set Screw Type Connector, 8 per pack   | 3/8"       | 1/2"     | EA  | 8              |
| PI322       | Straight Connector, squeeze type, for armored cable and flexible conduit, 8 per pack | 3/8"       | 1/2"     | EA  | 8              |
| PI324       | Straight Connector, squeeze type, for armored cable and flexible conduit, 6 per pack | 3/4"       | 3/4"     | EA  | 6              |
| PI315       | 90° Connector, 3 per pack  | 3/8"       | 1/2"     | EA  | 3              |
| PI341       | 90° Connector, 4 per pack  | 1/2"       | 1/2"     | EA  | 4              |
| PI342       | 90° Connector, 4 per pack  | 3/4"       | 3/4"     | EA  | 4              |
| PI325       | Set Screw Connector, 6 per pack  | 1/2"       | 1/2"     | EA  | 6              |
| PI340       | Combination Cable Connector suitable for Romex or BX and Greenfield, 8 per pack      | 3/8"       | 1/2"     | EA  | 8              |
| PI318       | Duplex Connector with single screw, clamp type, 2 per pack                           | 3/8"       | 1/2"     | EA  | 2              |

| CATALOG NO. | DESCRIPTION                                | TRADE SIZE | KNOCKOUT | UOM | ORDER MULTIPLE |
|-------------|--|------------|----------|-----|----------------|
| PI350       | Straight Liquid-Tite Connector, 2 per pack | 1/2"       | 1/2"     | EA  | 2              |
| PI351       | Straight Liquid-Tite Connector, 2 per pack | 3/4"       | 3/4"     | EA  | 2              |
| PI352       | 90° Liquid-Tite Connector                  | 1/2"       | 1/2"     | EA  | 1              |
| PI353       | 90° Liquid-Tite Connector                  | 3/4"       | 3/4"     | EA  | 1              |
| PI355       | 45° Liquid-Tite Connector                  | 3/4"       | 3/4"     | EA  | 1              |

### Rigid Conduit Bodies\*



### Thinwall E.M.T. Connectors\*

Zinc die cast.



| CATALOG NO. | DESCRIPTION                          | TRADE SIZE | BODY TYPE | UOM | ORDER MULTIPLE |
|-------------|--------------------------------------|------------|-----------|-----|----------------|
| PI458       | Includes steel cover, screws, gasket | 1/2"       | Back (LB) | EA  | 1              |
| PI459       | Includes steel cover, screws, gasket | 3/4"       | Back (LB) | EA  | 1              |

| CATALOG NO. | DESCRIPTION  | TRADE SIZE | KNOCKOUT | UOM | ORDER MULTIPLE |
|-------------|--|------------|----------|-----|----------------|
| PI411       | Compression Type Connectors, 8 per pack  | 1/2"       | 1/2"     | EA  | 8              |
| PI412       | Compression Type Connectors, 8 per pack  | 3/4"       | 3/4"     | EA  | 8              |
| PI415       | Compression Type Couplings, 8 per pack   | 1/2"       |          | EA  | 8              |
| PI416       | Compression Type Couplings, 8 per pack   | 3/4"       |          | EA  | 8              |
| PI426       | Compression Type Straight Connectors for connecting E.M.T. to Liquid-Tight, 8 per pack | 3/4"       |          | EA  | 8              |
| PI419       | Set Screw Type Connectors, 8 per pack  | 1/2"       | 1/2"     | EA  | 8              |
| PI431       | Set Screw Type 90° Connectors, 8 per pack  | 1/2"       | 1/2"     | EA  | 8              |
| PI432       | Set Screw Type 90° Connectors, 8 per pack  | 3/4"       | 3/4"     | EA  | 8              |
| PI435       | Set Screw Type Offset Connectors, 8 per pack   | 1/2"       | 1/2"     | EA  | 8              |
| PI436       | Set Screw Type Offset Connectors, 8 per pack   | 3/4"       | 3/4"     | EA  | 8              |

## CONDUIT FITTINGS

### Straps

One-hole straps. Zinc plated steel.



### Reducing Washers

Reducing washers are for reducing knockout holes. These washers have raised flanges for a tight fit and are made of galvanized steel.



| CATALOG NO. | DESCRIPTION                                  | UOM | ORDER MULTIPLE |
|-------------|--|-----|----------------|
| PI306       | Straps fit 1/2" E.M.T. Conduit, pack of 20   | PK  | 1              |
| PI306CX     | Straps fit 1/2" E.M.T. Conduit, pack of 100  | PK  | 1              |
| PI307       | Straps fit 3/4" E.M.T. Conduit, pack of 12   | PK  | 1              |
| PI307CX     | Straps fit 3/4" E.M.T. Conduit, pack of 100  | PK  | 1              |
| PI908       | Straps fit 1" E.M.T. Conduit, pack of 10     | PK  | 1              |
| PI908CX     | Straps fit 1" E.M.T. Conduit, pack of 100    | PK  | 1              |
| PI909LX     | Straps fit 1-1/4" E.M.T. Conduit, pack of 50 | PK  | 1              |
| PI206       | Straps for 14-2 Romex, pack of 20            | PK  | 1              |

| CATALOG NO. | DESCRIPTION  | UOM | ORDER MULTIPLE |
|-------------|--|-----|----------------|
| PI304       | Reducing Washer - reduces hole from 1" to 1/2", pack of 10     | PK  | 1              |
| PI305       | Reducing Washer - reduces hole from 1" to 3/4", pack of 10     | PK  | 1              |
| PI305LX     | Reducing Washer - reduces hole from 1" to 3/4", pack of 50     | PK  | 1              |
| PI308**     | Reducing Washer - reduces hole from 1/2" to 15/32", pack of 10 | PK  | 1              |
| PI310       | Reducing Washer - reduces hole from 3/4" to 1/2", pack of 28   | PK  | 1              |
| PI310LX     | Reducing Washer - reduces hole from 3/4" to 1/2", pack of 50   | PK  | 1              |
| PI911       | Reducing Washer - reduces hole from 2" to 1/2", pack of 5      | PK  | 1              |
| PI912       | Reducing Washer - reduces hole from 2" to 3/4", pack of 5      | PK  | 1              |
| PI912LX     | Reducing Washer - reduces hole from 2" to 3/4", pack of 50     | PK  | 1              |
| PI913       | Reducing Washer - reduces hole from 1-1/2" to 1/2", pack of 4  | PK  | 1              |
| PI913LX     | Reducing Washer - reduces hole from 1-1/2" to 1/2", pack of 50 | PK  | 1              |
| PI914       | Reducing Washer - reduces hole from 1-1/2" to 3/4", pack of 4  | PK  | 1              |

\*Items in this section are Underwriter's Laboratories listed or recognized under the prime manufacturer's name.

\*\*PI308 reduces hole to fit appliance switch.



## CONDUIT FITTINGS cont'd

### Knockout Seals and Hole Plug

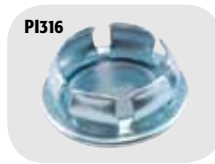

| CATALOG NO. | DESCRIPTION                                       | UOM | ORDER MULTIPLE |
|-------------|---|-----|----------------|
| PI316       | For 1/2" knockouts, zinc plated steel, pack of 10 | PK  | 1              |
| PI317       | For 3/4" knockouts, zinc plated steel, pack of 50 | PK  | 1              |
| ED406       | Nylon Hole Plug for 3/8" hole, pack of 28         | PK  | 1              |

### Conduit Nipples\*

Used to connect two electrical utility boxes where room is limited. Zinc die cast steel. Comes with plated steel locknuts.



| CATALOG NO. | DESCRIPTION               | SIZE | CONNECTION | UOM | ORDER MULTIPLE |
|-------------|---------------------------|------|------------|-----|----------------|
| PI203       | Conduit Nipple, pack of 6 | 1/2" | Straight   | PK  | 1              |

### Conduit Nipples\*

PI301 is zinc die cast steel. PI303 is galvanized steel. All come with plated steel locknuts and plastic insulating bushings.



| CATALOG NO. | DESCRIPTION               | SIZE      | CONNECTION | UOM | ORDER MULTIPLE |
|-------------|---------------------------|-----------|------------|-----|----------------|
| PI301       | Conduit Nipple, pack of 4 | 1/2"      | Offset     | PK  | 1              |
| PI303       | Conduit Nipple, pack of 4 | 1/2" x 2" | Straight   | PK  | 1              |

### Bushings and Locknuts



| CATALOG NO. | DESCRIPTION   | UOM | ORDER MULTIPLE |
|-------------|---|-----|----------------|
| PI331       | Plastic "Anti-Short" Bushings for 14/2, 14/3, 12/2 BX cable, pack of 35 | PK  | 1              |
| PI344       | 3/4" Conduit Locknut, Zinc plated steel, pack of 10                     | PK  | 1              |
| PI345*      | 1/2" Plastic Insulating Bushing, pack of 10                             | PK  | 1              |
| PI346*      | 3/4" Plastic Insulating Bushing, pack of 10                             | PK  | 1              |

### Electrical Staples



| CATALOG NO. | DESCRIPTION  | SIZE        | UOM | ORDER MULTIPLE |
|-------------|--|-------------|-----|----------------|
| PI330       | Plastic; for 2 conductor Romex and other NM cable conductor; 12/2-14/2 range; UV protected, pack of 50 | 3/8" x 1/2" | PK  | 1              |
| PI332       | Plastic; for 3 conductor Romex and other NM cable conductor; 12/3-14/3 range; UV protected, pack of 50 | 3/8" x 3/4" | PK  | 1              |
| PI309       | Steel; non-insulated for Romex and NM cable; 14/2-10/3 range, pack of 154                              | 1" x 1/2"   | PK  | 1              |
| ED273       | Insulated coppered finish; size #5, pack of 50   | 5/8" x 1/4" | PK  | 1              |
| ED273CX     | Insulated coppered finish; size #5, pack of 100  | 5/8" x 1/4" | PK  | 1              |

## WIRE

### TFFN Stranded Hook-Up Wire\*

Packaged in handy dispenser bag. Polyvinyl chloride insulation. Wire rating: 600V, 90°C. Insulation: oil resistant nylon coating.

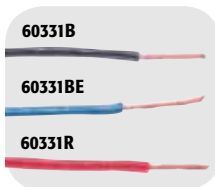

| CATALOG NO. | COLOR              | GAUGE | STRANDS | O.D. | LENGTH | UOM | ORDER MULTIPLE |
|-------------|--------------------|-------|---------|------|--------|-----|----------------|
| 60331B      | Black, pack of 50' | 18    | 16      | .09" | 48'    | PK  | 1              |
| 60331BE     | Blue, pack of 50'  | 18    | 16      | .09" | 48'    | PK  | 1              |
| 60331GY     | Gray, pack of 50'  | 18    | 16      | .09" | 48'    | PK  | 1              |
| 60331P      | Pink, pack of 50'  | 18    | 16      | .09" | 48'    | PK  | 1              |
| 60331R      | Red, pack of 50'   | 18    | 16      | .09" | 48'    | PK  | 1              |
| 60331W      | White, pack of 50' | 18    | 16      | .09" | 48'    | PK  | 1              |
| 6332B       | Black, pack of 50' | 16    | 26      | .10" | 48'    | PK  | 1              |
| 6332G       | Green, pack of 50' | 16    | 26      | .10" | 48'    | PK  | 1              |
| 6332R       | Red, pack of 50'   | 16    | 26      | .10" | 48'    | PK  | 1              |
| 6332W       | White, pack of 50' | 16    | 26      | .10" | 48'    | PK  | 1              |

### THHN Stranded Hook-Up Wire\*

Packaged in handy dispenser bag. Polyvinyl chloride insulation. Wire rating: 600V, 90°C. Insulation: oil resistant nylon coating.

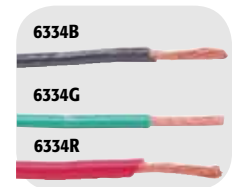

| CATALOG NO. | COLOR              | GAUGE | STRANDS | O.D. | LENGTH | UOM | ORDER MULTIPLE |
|-------------|--------------------|-------|---------|------|--------|-----|----------------|
| 6333B       | Black, pack of 50' | 14    | 19      | .11" | 48'    | PK  | 1              |
| 6333G       | Green, pack of 50' | 14    | 19      | .11" | 48'    | PK  | 1              |
| 6333R       | Red, pack of 50'   | 14    | 19      | .11" | 48'    | PK  | 1              |
| 6333W       | White, pack of 50' | 14    | 19      | .11" | 48'    | PK  | 1              |
| 6334B       | Black, pack of 50' | 12    | 19      | .13" | 48'    | PK  | 1              |
| 6334G       | Green, pack of 50' | 12    | 19      | .13" | 48'    | PK  | 1              |
| 6334R       | Red, pack of 50'   | 12    | 19      | .13" | 48'    | PK  | 1              |
| 6334W       | White, pack of 50' | 12    | 19      | .13" | 48'    | PK  | 1              |
| 6335B       | Black, pack of 50' | 10    | 19      | .17" | 48'    | PK  | 1              |
| 6335G       | Green, pack of 50' | 10    | 19      | .17" | 48'    | PK  | 1              |
| 6335R       | Red, pack of 50'   | 10    | 19      | .17" | 48'    | PK  | 1              |
| 6335W       | White, pack of 50' | 10    | 19      | .17" | 48'    | PK  | 1              |
| 6360B       | Black, pack of 50' | 8     | 19      | .22" | 25'    | PK  | 1              |
| 6360R       | Red, pack of 50'   | 8     | 19      | .22" | 25'    | PK  | 1              |
| 6360W       | White, pack of 50' | 8     | 19      | .22" | 25'    | PK  | 1              |

\*Items in this section are Underwriter's Laboratories listed or recognized under the prime manufacturer's name.

## WIRE cont'd

### Thermostat Wire\*

Thermoplastic insulated, jacketed wire for low voltage applications. Conductors are solid copper, individually insulated and color coded.

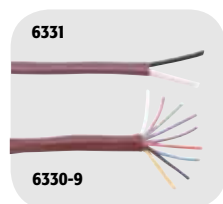

| CATALOG NO. | DESCRIPTION                  | CONDUCTORS | WIRE GAUGE | LENGTH | UOM | ORDER MULTIPLE |
|-------------|------------------------------|------------|------------|--------|-----|----------------|
| 6331        | Thermostat Wire, pack of 40' | 2          | 20         | 40'    | PK  | 1              |
| 6336        | Thermostat Wire, pack of 40' | 3          | 20         | 40'    | PK  | 1              |
| 6330-4      | Thermostat Wire, pack of 40' | 4          | 20         | 40'    | PK  | 1              |
| 6337        | Thermostat Wire, pack of 40' | 5          | 20         | 40'    | PK  | 1              |
| 6330-6      | Thermostat Wire, pack of 40' | 6          | 20         | 40'    | PK  | 1              |
| 6338        | Thermostat Wire, pack of 40' | 8          | 20         | 40'    | PK  | 1              |
| 6330-9      | Thermostat Wire, pack of 40' | 9          | 20         | 40'    | PK  | 1              |
| 6339        | Thermostat Wire, pack of 25' | 10         | 20         | 25'    | PK  | 1              |
| 6339XL      | Thermostat Wire, pack of 40' | 10         | 20         | 40'    | PK  | 1              |

### High Temperature Range Wire\*

200°C glass braided, three conductor twisted wire. 600V; silicone rubber insulated.



| CATALOG NO. | COLOR                              | WIRE GAUGE | LENGTH | UOM | ORDER MULTIPLE |
|-------------|------------------------------------|------------|--------|-----|----------------|
| 6383-35     | Black, Red, and White, pack of 5'  | 14         | 5'     | PK  | 1              |
| 6383-325    | Black, Red, and White, pack of 25' | 14         | 25'    | PK  | 1              |
| 6384-35     | Black, Red, and White, pack of 5'  | 12         | 5'     | PK  | 1              |
| 6384-325    | Black, Red, and White, pack of 25' | 12         | 25'    | PK  | 1              |

### SJTO Service Cord\*

Features stranded bare copper, PVC insulation; PVC jacket. Cord is oil resistant. Cords have 3 individually insulated conductors. Ratings: 300V; 60°C.

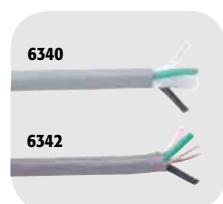

| CATALOG NO. | DESCRIPTION                    | WIRE GAUGE | LENGTH | UOM | ORDER MULTIPLE |
|-------------|--------------------------------|------------|--------|-----|----------------|
| 6340        | SJTO Service Cord, pack of 12' | 16         | 12'    | PK  | 1              |
| 6341        | SJTO Service Cord, pack of 20' | 16         | 20'    | PK  | 1              |
| 6342        | SJTO Service Cord, pack of 12' | 14         | 12'    | PK  | 1              |
| 6343        | SJTO Service Cord, pack of 20' | 14         | 20'    | PK  | 1              |

### Stranded High Temperature Wire\*

Thermoplastic equipment insulated wire. CSA listed at 105°C; 600V. Insulation thickness: .03". MTW/ AWM/TEW

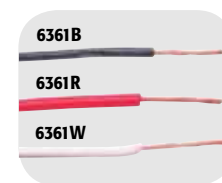

| CATALOG NO. | COLOR              | GAUGE | STRANDS | O.D.  | LENGTH | UOM | ORDER MULTIPLE |
|-------------|--------------------|-------|---------|-------|--------|-----|----------------|
| 6361B       | Black, pack of 48' | 18    | 16      | .113" | 48'    | PK  | 1              |
| 6361R       | Red, pack of 48'   | 18    | 16      | .113" | 48'    | PK  | 1              |
| 6361W       | White, pack of 48' | 18    | 16      | .113" | 48'    | PK  | 1              |
| 6362B       | Black, pack of 48' | 16    | 26      | .125" | 48'    | PK  | 1              |
| 6362R       | Red, pack of 48'   | 16    | 26      | .125" | 48'    | PK  | 1              |
| 6362W       | White, pack of 48' | 16    | 26      | .125" | 48'    | PK  | 1              |
| 6363B       | Black, pack of 48' | 14    | 19      | .139" | 48'    | PK  | 1              |
| 6363R       | Red, pack of 48'   | 14    | 19      | .139" | 48'    | PK  | 1              |
| 6363W       | White, pack of 48' | 14    | 19      | .139" | 48'    | PK  | 1              |
| 6364B       | Black, pack of 48' | 12    | 19      | .158" | 48'    | PK  | 1              |
| 6364R       | Red, pack of 48'   | 12    | 19      | .158" | 48'    | PK  | 1              |
| 6364W       | White, pack of 48' | 12    | 19      | .158" | 48'    | PK  | 1              |
| 6365B       | Black, pack of 48' | 10    | 19      | .182" | 48'    | PK  | 1              |
| 6365R       | Red, pack of 48'   | 10    | 19      | .182" | 48'    | PK  | 1              |
| 6365W       | White, pack of 48' | 10    | 19      | .182" | 48'    | PK  | 1              |

## WIRING DEVICES

### Thermoplastic Handle Plug\*

Standard grade; flexible spring prongs; furnished with face washer. Rating: 15A-125V.



| CATALOG NO. | DESCRIPTION | MAX. CORD DIAMETER | POLES | WIRES | MATERIAL      | UOM | ORDER MULTIPLE |
|-------------|-------------|--------------------|-------|-------|---------------|-----|----------------|
| ED179       | Handle Plug | .406"              | 2     | 2     | Thermoplastic | EA  | 2              |

### Grounding Rubber Handle Plug\*



| CATALOG NO. | DESCRIPTION           | FITS CORD DIAMETER | POLES | WIRES | RATING   | UOM | ORDER MULTIPLE |
|-------------|-----------------------|--------------------|-------|-------|----------|-----|----------------|
| ED1703      | Grounding Handle Plug | .25"-60"           | 2     | 3     | 20A-250V | EA  | 1              |
| ED1709      | Grounding Handle Plug | .25"-60"           | 2     | 3     | 15A-125V | EA  | 1              |

\*Items in this section are Underwriter's Laboratories listed or recognized under the prime manufacturer's name.



## WIRING DEVICES cont'd

### Tandem Grounding Rubber Handle Plug\*



| CATALOG NO. | DESCRIPTION        | FITS CORD DIAMETER | POLES | WIRES | RATING   | UOM | ORDER MULTIPLE |
|-------------|--------------------|--------------------|-------|-------|----------|-----|----------------|
| ED1711      | Tandem Handle Plug | .25"-.60"          | 2     | 3     | 15A-250V | EA  | 1              |

### Armored Plug\*

Vinyl enclosed.



| CATALOG NO. | DESCRIPTION  | FITS CORD DIAMETER | POLES | WIRES | RATING   | UOM | ORDER MULTIPLE |
|-------------|--------------|--------------------|-------|-------|----------|-----|----------------|
| ED2867      | Armored Plug | .25"-.625"         | 2     | 3     | 15A-125V | EA  | 1              |

### Right Angle Plug\*



| CATALOG NO. | DESCRIPTION      | FITS CORD DIAMETER | POLES | WIRES | RATING   | UOM | ORDER MULTIPLE |
|-------------|------------------|--------------------|-------|-------|----------|-----|----------------|
| ED4409      | Right Angle Plug | .25"-.655"         | 2     | 3     | 20A-125V | EA  | 1              |
| ED4509      | Right Angle Plug | .25"-.655"         | 2     | 3     | 20A-250V | EA  | 1              |
| ED4867      | Right Angle Plug | .25"-.655"         | 2     | 3     | 15A-125V | EA  | 1              |

### Rubber Connector\*

Standard grade.



| CATALOG NO. | DESCRIPTION      | FITS CORD DIAMETER | POLES | WIRES | RATING   | UOM | ORDER MULTIPLE |
|-------------|------------------|--------------------|-------|-------|----------|-----|----------------|
| ED252       | Rubber Connector | .25"-.60"          | 2     | 3     | 15A-125V | EA  | 1              |

### Armored Connector\*

Vinyl enclosed.



| CATALOG NO. | DESCRIPTION       | FITS CORD DIAMETER | POLES | WIRES | RATING   | UOM | ORDER MULTIPLE |
|-------------|-------------------|--------------------|-------|-------|----------|-----|----------------|
| ED2887      | Armored Connector | .225"-.60"         | 2     | 3     | 15A-125V | EA  | 1              |

### Ground Adapter\*

Polarized, 2 pole to 3 wire grounding, polypropylene body.



| CATALOG NO. | DESCRIPTION    | RATING   | UOM | ORDER MULTIPLE |
|-------------|----------------|----------|-----|----------------|
| ED419       | Ground Adapter | 15A-125V | EA  | 2              |

### Triple Outlets\*

Polarized, high impact resistant plastic.



| CATALOG NO. | DESCRIPTION                | RATING   | UOM | ORDER MULTIPLE |
|-------------|----------------------------|----------|-----|----------------|
| 5223        | Heavy duty, 2 pole, 3 wire | 15A-125V | EA  | 1              |
| 5223B       | Heavy duty, 2 pole, 3 wire | 15A-125V | EA  | 25             |
| 5224        | 2 pole, 2 wire             | 15A-125V | EA  | 1              |

### Power Supply Replacement Cords\*

For power tools or appliances. Black vinyl cord is flexible in very cold environments. Wire type is SJEW-A.



| CATALOG NO. | DESCRIPTION            | WIRE | RATING   | LENGTH | UOM | ORDER MULTIPLE |
|-------------|------------------------|------|----------|--------|-----|----------------|
| 5240        | Black Replacement Cord | 16/3 | 13A/125V | 10'    | EA  | 1              |
| 5242        | Black Replacement Cord | 14/3 | 15A/125V | 10'    | EA  | 1              |

### Receptacles\*

2 pole, 3 wire (ground included).



| CATALOG NO. | DESCRIPTION       | RATING   | COLOR | UOM | ORDER MULTIPLE |
|-------------|-------------------|----------|-------|-----|----------------|
| ED1876      | Single Receptacle | 20A-250V | Brown | EA  | 1              |
| ED1876-I    | Single Receptacle | 20A-250V | Ivory | EA  | 1              |
| ED1877      | Single Receptacle | 20A-125V | Brown | EA  | 1              |
| ED270**     | Duplex Receptacle | 15A-125V | Brown | EA  | 1              |
| ED270-I**   | Duplex Receptacle | 15A-125V | Ivory | EA  | 1              |
| ED877       | Duplex Receptacle | 20A-125V | Brown | EA  | 1              |
| ED877-I     | Duplex Receptacle | 20A-125V | Ivory | EA  | 1              |

\*\*Standard Grade

\*Items in this section are Underwriter's Laboratories listed or recognized under the prime manufacturer's name.

### Toggle Switch and Receptacle Combination Device\*

Switch (single pole): 15A-120V AC  
 Receptacle: 15A-125V AC; two pole three wire grounding



| CATALOG NO. | DESCRIPTION                               | UOM | ORDER MULTIPLE |
|-------------|---|-----|----------------|
| ED5225      | Toggle Switch and Receptacle – Brown Body | EA  | 1              |

### Porcelain Outlet Box Lampholders\*

Features one-piece pull chain. Two screw terminals, 2 pole, 2 wire. 4-1/2" outer diameter. These lampholders fit 3-1/4" and 4" boxes. Rating: Lampholder: 660W/125V. Outlet: 15A/125V.



| CATALOG NO. | DESCRIPTION                                       | UOM | ORDER MULTIPLE |
|-------------|---|-----|----------------|
| ED9726      | Porcelain Outlet Box Lampholder – U ground outlet | EA  | 1              |

### Toggle Switches\*

Silent switch; ground included.



| CATALOG NO. | DESCRIPTION | RATING          | COLOR | UOM | ORDER MULTIPLE |
|-------------|-------------|-----------------|-------|-----|----------------|
| ED1240-2    | Single Pole | 15A-120/277V AC | Brown | EA  | 1              |
| ED1238      | Single Pole | 20A-120/277V AC | Brown | EA  | 1              |
| ED1301**    | Single Pole | 15A-120V AC     | Brown | EA  | 1              |
| ED1301-I**  | Single Pole | 15A-120V AC     | Ivory | EA  | 1              |
| ED1262-2    | Double Pole | 15A-120/277V AC | Brown | EA  | 1              |
| ED1262-2I   | Double Pole | 15A-120/277V AC | Ivory | EA  | 1              |
| ED1232      | Double Pole | 30A-120/277V AC | Brown | EA  | 1              |

\*\*Standard Grade

### Utility Fuse Outlets\*



| CATALOG NO. | DESCRIPTION  | UOM | ORDER MULTIPLE |
|-------------|--|-----|----------------|
| PI380       | Utility Fuse Outlet with Cover; 3/4HP-125V AC only; galvanized steel construction            | EA  | 1              |
| PI381       | Utility Fuse Outlet and Switch with Cover; 1/2HP-125V AC only; galvanized steel construction | EA  | 1              |

### Fuse Holders



| CATALOG NO. | DESCRIPTION  | UOM | ORDER MULTIPLE |
|-------------|--|-----|----------------|
| EM480       | In-Line Fuse Holder for use with 1-1/4 x 1/4" fuses up to 20 amps, 32 volts, 15" lead; 14 gauge red vinyl insulated wire                             | EA  | 1              |
| EM484       | Self-Stripping Fuse Holder mates with blade-type fuse .205 x .025". 18-14 AWG. Size: 1.37" L x .44" H x .95" W Max. Insulation Outer Diameter: .145" | EA  | 2              |

### Metal Bat Handle Toggle Switches\*

Features black phenolic plastic case; brass terminals; steel and zinc chromate frame and support; all other external parts are brass/bright nickel. These heavy duty toggle switches have screw terminals. Part ED447 has an "ON-OFF" face plate.

Specifications: 10A/277V-20A/125V AC

Single Pole: 3/4HP 125-250V AC

Double Pole: 1-1/2HP 125-250V AC



| CATALOG NO. | DESCRIPTION              | SEQUENCE  | CIRCUIT                   | UOM | ORDER MULTIPLE |
|-------------|--------------------------|-----------|---------------------------|-----|----------------|
| ED447       | Bat Handle Toggle Switch | ON-OFF    | Single Pole, Single Throw | EA  | 1              |
| ED453       | Bat Handle Toggle Switch | ON-ON     | Double Pole, Double Throw | EA  | 1              |
| ED454       | Bat Handle Toggle Switch | ON-ON     | Single Pole, Double Throw | EA  | 1              |
| ED455       | Bat Handle Toggle Switch | ON-OFF    | Double Pole, Single Throw | EA  | 1              |
| ED468       | Bat Handle Toggle Switch | ON-OFF-ON | Single Pole, Double Throw | EA  | 1              |
| ED494       | Bat Handle Toggle Switch | ON-OFF-ON | Double Pole, Double Throw | EA  | 1              |

### Toggle Switch with Neon Pilot Light Combination Device\*

Switch: 15A-120V AC  
 Neon Pilot Light: 1/25W, 120V AC



| CATALOG NO. | DESCRIPTION                                      | UOM | ORDER MULTIPLE |
|-------------|--|-----|----------------|
| ED227       | Toggle Switch with Neon Pilot Light – Brown Body | EA  | 1              |
| ED227-I     | Toggle Switch with Neon Pilot Light – Ivory Body | EA  | 1              |

### Vinyl Grommets

These grommets exhibit high dielectric strength and are oil, ozone, and UV resistant. Durometer hardness 60 shore "A".

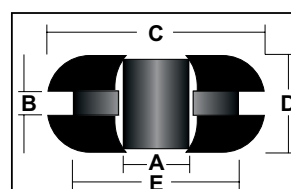

| CATALOG NO. | DESCRIPTION         | A (in.) | B (in.) | C (in.) | D (in.) | E (in.) | UOM | ORDER MULTIPLE |
|-------------|---------------------|---------|---------|---------|---------|---------|-----|----------------|
| ED302       | Grommet, pack of 15 | 3/16    | 1/16    | 7/16    | 7/32    | 5/16    | PK  | 1              |
| ED304       | Grommet, pack of 14 | 1/4     | 1/16    | 9/16    | 1/4     | 3/8     | PK  | 1              |
| ED312       | Grommet, pack of 6  | 25/64   | 1/8     | 27/32   | 3/8     | 21/32   | PK  | 1              |

\*Items in this section are Underwriter's Laboratories listed or recognized under the prime manufacturer's name.



### Vinyl Grommet Assortment Packs



| CATALOG NO. | DESCRIPTION                                     | UOM | ORDER MULTIPLE |
|-------------|---|-----|----------------|
| ED320       | General Assortment – contains all grommet sizes | EA  | 1              |

### 6180 Series Terminal Blocks\*

Constructed of high barrier thermoplastic. Rated 20A-250V.



| CATALOG NO. | DESCRIPTION    | NO. OF POSITIONS | LENGTH (in.) | WIDTH (in.) | SCREW SIZE | MAX. WIRE SIZE | UOM | ORDER MULTIPLE |
|-------------|----------------|------------------|--------------|-------------|------------|----------------|-----|----------------|
| 6182        | Terminal Block | 4                | 2.16         | .88         | 6-32       | 22-14          | EA  | 1              |
| 6183        | Terminal Block | 6                | 2.91         | .88         | 6-32       | 22-14          | EA  | 1              |
| 6184        | Terminal Block | 8                | 3.66         | .88         | 6-32       | 22-14          | EA  | 1              |
| 6185        | Terminal Block | 10               | 4.41         | .88         | 6-32       | 22-14          | EA  | 1              |
| 6186        | Terminal Block | 12               | 5.16         | .88         | 6-32       | 22-14          | EA  | 1              |
| 6187        | Terminal Block | 14               | 5.91         | .88         | 6-32       | 22-14          | EA  | 1              |

### 6190 Series Terminal Blocks\*

6190 Series Terminal Blocks are constructed of phenolic. 9/16" centers. Rated 30A-600V.



| CATALOG NO. | DESCRIPTION    | NO. OF POSITIONS | LENGTH (in.) | WIDTH (in.) | SCREW SIZE | MAX. WIRE SIZE | UOM | ORDER MULTIPLE |
|-------------|----------------|------------------|--------------|-------------|------------|----------------|-----|----------------|
| 6192        | Terminal Block | 4                | 3.22         | 1.31        | 8-32       | 14-12          | EA  | 1              |
| 6193        | Terminal Block | 6                | 4.34         | 1.31        | 8-32       | 14-12          | EA  | 1              |
| 6194        | Terminal Block | 8                | 5.47         | 1.31        | 8-32       | 14-12          | EA  | 1              |
| 6195X       | Terminal Block | 10               | 6.59         | 1.31        | 8-32       | 14-12          | EA  | 1              |
| 6197X       | Terminal Block | 14               | 8.84         | 1.31        | 8-32       | 14-12          | EA  | 1              |

### Terminal Block Jumpers\*

These jumpers connect two positions on a terminal block. Made of nickel plated brass.



| CATALOG NO. | DESCRIPTION   | UOM | ORDER MULTIPLE |
|-------------|---|-----|----------------|
| 6278CX      | Jumpers for Terminal Block 6180 Series, pack of 100 | PK  | 1              |
| 6279        | Jumpers for Terminal Block 6190 Series, pack of 5   | PK  | 1              |
| 6279CX      | Jumpers for Terminal Block 6190 Series, pack of 100 | PK  | 1              |

### Heat Shrink Tubing\*

Heat Shrink Tubing is made of flame-retardant polyolefin. Thin walled, all purpose tubing. Rated 600V, 125°C. 2500 volts/mil. dielectric strength. Inert to fungus. Virtually unaffected by corrosives, common fluids, and solvents. Pieces are 6" in length.



| CATALOG NO. | COLOR                    | INNER DIAMETER MAX SUPPLIED | INNER DIAMETER MIN. RECOVERED | UOM | ORDER MULTIPLE |
|-------------|--------------------------|-----------------------------|-------------------------------|-----|----------------|
| 6373        | Black & White, pack of 7 | 1/8"                        | 1/16"                         | PK  | 1              |
| 63076B      | Black, pack of 10        | 3/8"                        | 3/16"                         | PK  | 1              |
| 63077B      | Black, pack of 10        | 1/2"                        | 1/4"                          | PK  | 1              |
| 63078B      | Black, pack of 10        | 3/4"                        | 3/8"                          | PK  | 1              |
| 63079B      | Black, pack of 10        | 1"                          | 1/2"                          | PK  | 1              |

### Heat Shrink Tubing Assortments\*

Heat Shrink Tubing is made of flame-retardant polyolefin. Thin walled, all purpose tubing. Rated 600V, 125°C. 2500 volts/mil. dielectric strength. Inert to fungus. Virtually unaffected by corrosives, common fluids, and solvents. Pieces are 6" in length.



| CATALOG NO. | COLOR                     | INNER DIAMETER MAX SUPPLIED | INNER DIAMETER MIN. RECOVERED | UOM | ORDER MULTIPLE |
|-------------|---------------------------|-----------------------------|-------------------------------|-----|----------------|
| 6370        | Black & White, pack of 12 | 1/8", 1/4"                  | 1/16", 1/8"                   | PK  | 1              |
| 6371        | Black & White, pack of 7  | 1/8", 1/4", 3/8"            | 1/16", 1/8", 3/16"            | PK  | 1              |
| 63070       | Black, pack of 3          | 3/8" – 1/2"                 | 3/16" – 1/4"                  | PK  | 1              |

### Indicator Lights

Terminals are tin plated brass. Wire leads are 22 AWG, 4.4–4.8" long, 1/2" stripped. Mounting will snap-fit into .500-.505 diameter hole in .020-.100" thick panels.



| CATALOG NO. | LENS COLOR       | LENS MATERIAL | VOLTAGE     | BULB TYPE         | UOM | ORDER MULTIPLE |
|-------------|------------------|---------------|-------------|-------------------|-----|----------------|
| ED600       | Red, pack of 2   | Polycarbonate | 28V         | Incandescent      | PK  | 1              |
| ED601       | Green, pack of 2 | Polycarbonate | 28V         | Incandescent      | PK  | 1              |
| ED602       | Amber, pack of 2 | Polycarbonate | 28V         | Incandescent      | PK  | 1              |
| ED603       | Blue, pack of 2  | Polycarbonate | 28V         | Incandescent      | PK  | 1              |
| ED604       | White, pack of 2 | Polycarbonate | 28V         | Incandescent      | PK  | 1              |
| ED610       | Red, pack of 2   | Nylon         | 105-125V AC | Neon              | PK  | 1              |
| ED611       | Green, pack of 2 | Polycarbonate | 105-125V AC | Neon**            | PK  | 1              |
| ED612       | Amber, pack of 2 | Nylon         | 105-125V AC | Neon              | PK  | 1              |
| ED613       | Blue, pack of 2  | Polycarbonate | 105-125V AC | Neon <sup>1</sup> | PK  | 1              |
| ED620       | Red, pack of 2   | Polycarbonate | 208-250V AC | Neon              | PK  | 1              |
| ED621       | Green, pack of 2 | Polycarbonate | 208-250V AC | Neon**            | PK  | 1              |
| ED622       | Amber, pack of 2 | Polycarbonate | 208-250V AC | Neon              | PK  | 1              |
| ED623       | Blue, pack of 2  | Polycarbonate | 208-250V AC | Neon <sup>1</sup> | PK  | 1              |

\*Items in this section are Underwriter's Laboratories listed or recognized under the prime manufacturer's name. \*\*Neon bulb incorporates C2B lamp and resistor.

**WIRING DEVICES cont'd**
**Indicator Lights\***

Terminals are tin plated brass. Wire leads are 22 AWG, 4.4-4.8" long, 1/2" stripped. .31" minimum diameter mounting.

**ED710**

| CATALOG NO.  | LENS COLOR       | LENS MATERIAL | VOLTAGE     | BULB TYPE         | UOM | ORDER MULTIPLE |
|--------------|------------------|---------------|-------------|-------------------|-----|----------------|
| <b>ED710</b> | Red, pack of 2   | Polycarbonate | 105-125V AC | Neon              | PK  | 1              |
| <b>ED711</b> | Green, pack of 2 | Polycarbonate | 105-125V AC | Neon**            | PK  | 1              |
| <b>ED712</b> | Amber, pack of 2 | Polycarbonate | 105-125V AC | Neon              | PK  | 1              |
| <b>ED713</b> | Blue, pack of 2  | Polycarbonate | 105-125V AC | Neon <sup>†</sup> | PK  | 1              |
| <b>ED714</b> | White, pack of 2 | Polycarbonate | 105-125V AC | Neon              | PK  | 1              |

**Screw-On Grounding Connector\***

Designed to make positive ground connections. The square wire spring adjusts to various wire combinations while twisting the wires together. Thermoplastic shell. Flame retardant. Hole in tip for ground wire.

**8289**

| CATALOG NO. | DESCRIPTION  | UOM | ORDER MULTIPLE |
|-------------|--|-----|----------------|
| <b>8289</b> | #14 - #10 AWG; Min.: 2 #14; Max.: 4 #12, pack of 9 | PK  | 1              |

**Standard Wire Connectors\***

Connectors are color coded with spring inserts. Heat resistant (105°C) thermoplastic. Connectors are for copper to copper connections. Parts 6294 and 6296 can connect aluminum to aluminum and copper to aluminum (dry locations only).

**6292**

| CATALOG NO.   | DESCRIPTION   | UOM | ORDER MULTIPLE |
|---------------|---|-----|----------------|
| <b>6291</b>   | Mini Gray Standard Wire Connectors, pack of 29      | PK  | 1              |
| <b>6291CX</b> | Mini Gray Standard Wire Connectors, pack of 100     | PK  | 1              |
| <b>6292</b>   | Tiny Blue Standard Wire Connectors, pack of 25      | PK  | 1              |
| <b>6292CX</b> | Tiny Blue Standard Wire Connectors, pack of 100     | PK  | 1              |
| <b>6293</b>   | Small Orange Standard Wire Connectors, pack of 20   | PK  | 1              |
| <b>6293CX</b> | Small Orange Standard Wire Connectors, pack of 100  | PK  | 1              |
| <b>6294</b>   | Medium Yellow Standard Wire Connectors, pack of 18  | PK  | 1              |
| <b>6294CX</b> | Medium Yellow Standard Wire Connectors, pack of 100 | PK  | 1              |
| <b>6296</b>   | Large Red Standard Wire Connectors, pack of 12      | PK  | 1              |
| <b>6296CX</b> | Large Red Standard Wire Connectors, pack of 100     | PK  | 1              |
| <b>6298</b>   | X-Large Gray Standard Wire Connectors, pack of 6    | PK  | 1              |
| <b>6298LX</b> | X-Large Gray Standard Wire Connectors, pack of 50   | PK  | 1              |
| <b>6295X</b>  | Assortment: Includes 6291, 6292, 6293, 6294, 6296   | EA  | 1              |

**Winged Wire Connectors\***

Durable thermoplastic material. Flame retardant, abrasion resistant, non-porous, and non-corrosive. Expandable spring grips into the wire and adjusts itself to the wire size and shape so pre-twisting is unnecessary. Even during temperature changes, they resist vibrations and retain holding power. Parts 8284 and 8286 are for use with copper to copper, aluminum to aluminum, and copper to aluminum (dry locations only).

**8286**

| CATALOG NO.     | DESCRIPTION                                      | UOM | ORDER MULTIPLE |
|-----------------|--|-----|----------------|
| <b>8284</b>     | Small Yellow Winged Wire Connectors, pack of 18  | PK  | 1              |
| <b>8284CX-B</b> | Small Yellow Winged Wire Connectors, pack of 100 | PK  | 1              |
| <b>8286</b>     | Medium Red Winged Wire Connectors, pack of 14    | PK  | 1              |
| <b>8286CX</b>   | Medium Red Winged Wire Connectors, pack of 100   | PK  | 1              |
| <b>8286CX-B</b> | Medium Red Winged Wire Connectors, pack of 100   | PK  | 1              |
| <b>8282</b>     | X-Large Blue Winged Wire Connectors, pack of 6   | PK  | 1              |
| <b>8282LX</b>   | X-Large Blue Winged Wire Connectors, pack of 50  | PK  | 1              |

-B indicates boxed product. All other catalog numbers are poly bagged.

**Scotchlok™ Wire Connectors\***

Made of flexible PVC plastic that allows the flared skirt to adjust, providing added insulation protection. Crush-proof housing allows room for the spring to expand and provide maximum wire contact. Conserves space in crowded boxes or enclosures.

**8296**

| CATALOG NO. | DESCRIPTION                                       | UOM | ORDER MULTIPLE |
|-------------|---|-----|----------------|
| <b>8296</b> | Medium Red Scotchlok™ Wire Connectors, pack of 10 | PK  | 1              |
| <b>8298</b> | Large Gray Scotchlok™ Wire Connectors, pack of 5  | PK  | 1              |

**Porcelain Wire Connectors\***

For high temperature applications over 105°C (300 volts maximum). For stranded copper connections only.

**4293**

| CATALOG NO.   | DESCRIPTION   | UOM | ORDER MULTIPLE |
|---------------|---|-----|----------------|
| <b>4293</b>   | Small White Porcelain Wire Connectors, pack of 17   | PK  | 1              |
| <b>4293CX</b> | Small White Porcelain Wire Connectors, pack of 100  | PK  | 1              |
| <b>4294</b>   | Medium White Porcelain Wire Connectors, pack of 15  | PK  | 1              |
| <b>4294CX</b> | Medium White Porcelain Wire Connectors, pack of 100 | PK  | 1              |
| <b>4296</b>   | Large White Porcelain Wire Connectors, pack of 13   | PK  | 1              |
| <b>4296CX</b> | Large White Porcelain Wire Connectors, pack of 100  | PK  | 1              |

**Box Grounding Clip**

Zinc plated.

**PI336**

| CATALOG NO.  | DESCRIPTION   | UOM | ORDER MULTIPLE |
|--------------|---|-----|----------------|
| <b>PI336</b> | For #10, #12, and #14 copper grounding wire, pack of 11 | PK  | 1              |

\*Items in this section are Underwriter's Laboratories listed or recognized under the prime manufacturer's name.  
 \*\*Neon bulb incorporates G2B lamp and resistor.  
 †Neon bulb incorporates T2B lamp and resistor.



## WIRING DEVICES cont'd

### Aluminum Solderless Lugs\*



| CATALOG NO. | DESCRIPTION                                      | WIRE RANGE | AMP RATING | UOM | ORDER MULTIPLE |
|-------------|--|------------|------------|-----|----------------|
| PI221       | Small Lug for aluminum or copper wire, pack of 6 | 6-14       | 2          | PK  | 1              |
| PI222       | Large Lug for aluminum or copper wire, pack of 6 | 2-14       | 2          | PK  | 1              |

### Electrolytic Copper Solderless Lugs\*



| CATALOG NO. | DESCRIPTION                           | WIRE RANGE | AMP RATING | UOM | ORDER MULTIPLE |
|-------------|---------------------------------------|------------|------------|-----|----------------|
| PI226       | Small Lug for copper wire, pack of 6  | 10-14      | 25         | PK  | 1              |
| PI227       | Medium Lug for copper wire, pack of 6 | 6-14       | 35-50      | PK  | 1              |
| PI228       | Large Lug for copper wire, pack of 6  | 4-14       | 70         | PK  | 1              |

### Split Bolt Connectors\*

Made of silicone bronze. For copper use only.



| CATALOG NO. | DESCRIPTION                     | MAX. SOLID WIRE | MAX. STRANDED WIRE | UOM | ORDER MULTIPLE |
|-------------|---------------------------------|-----------------|--------------------|-----|----------------|
| PI326       | Split Bolt Connector, pack of 3 | 10              | 12                 | PK  | 1              |
| PI327       | Split Bolt Connector, pack of 3 | 8               | 8                  | PK  | 1              |
| PI328       | Split Bolt Connector, pack of 3 | 6               | 7                  | PK  | 1              |
| PI929       | Split Bolt Connector, pack of 3 | 4               | 5                  | PK  | 1              |
| PI930       | Split Bolt Connector, pack of 3 | 2               | 3                  | PK  | 1              |

### Pigtails

Wire has #10 spade on one end; 10-32 x 3/8" slotted round head screw on the other.



| CATALOG NO. | DESCRIPTION         | WIRE LENGTH | WIRE GAUGE | WIRE TYPE | UOM | ORDER MULTIPLE |
|-------------|---------------------|-------------|------------|-----------|-----|----------------|
| PI337-3     | Pigtails, pack of 5 | 8"          | 14         | Stranded  | PK  | 1              |
| PI337-4     | Pigtails, pack of 5 | 8"          | 12         | Stranded  | PK  | 1              |

### Ground Fitting Clamp\*



| CATALOG NO. | DESCRIPTION  | UOM | ORDER MULTIPLE |
|-------------|--|-----|----------------|
| PI237       | For 8, 6, 4 bare grounding wire; fits 1/2"-1" pipe | EA  | 1              |

### Cable Markers

Cable markers come in books of 450 markers with matching terminal markers. Markers are mounted on dispenser cards in the book. Cable markers are suitable for above and below ground applications. Books are made of vinyl impregnated cloth that resists moderate amounts of dirt, oil and heat. The blank Write-On Markers (WM1014) are made of durable vinyl film that resists water, oils, and fungus. They can also withstand extremes in temperature.



| CATALOG NO. | DESCRIPTION   | UOM | ORDER MULTIPLE |
|-------------|---|-----|----------------|
| WM1002      | Alpha-Numeric Cable Marker Book; contains 10 each: A-Z, 0-15, +, -, /   | EA  | 1              |
| WM1003      | Numeric Cable Marker Book; contains 10 each: 1-45   | EA  | 1              |
| WM1009      | Line and Terminal Cable Marker Book; contains 45 each: 1, 2, 3, A, B, C; contains 30 each: T1, T2, T3, L1, L2, L3 | EA  | 1              |
| WM1014      | 180 Blank Write-On Markers, 1/2" x 1-1/2"   | EA  | 1              |

## TESTERS, LEADS, CLIPS, FUSES

### Testers



| CATALOG NO. | DESCRIPTION  | UOM | ORDER MULTIPLE |
|-------------|--|-----|----------------|
| EM111*      | Neon Bulb Tester tests 90-500 volts AC or DC live circuits   | EA  | 1              |
| EM217       | Low Voltage Tester tests 5-50 volts AC or DC; attached alligator clips   | EA  | 1              |
| EM469       | Continuity Tester tests cold circuits without external power source; uses 2 AA batteries; 26" test lead with alligator probe | EA  | 1              |

### Clips

All clips have vinyl red and black insulators.



| CATALOG NO. | DESCRIPTION   | UOM | ORDER MULTIPLE |
|-------------|---|-----|----------------|
| 5033        | Steel Alligator Clips for use with test probes (.075"-.080"); 1-31/32" long; jaws open 5/16" max., pack of 2 red, 2 black, 4 clips                          | PK  | 1              |
| 5034        | Small Copper Alligator Clips for 20 gauge wire or smaller; 1-3/32" long; jaws open 3/16" min., solder or crimp connections, pack of 2 red, 2 black, 4 clips | PK  | 1              |
| 5035        | Copper Alligator Clips; 1-31/32" long; jaws open 5/16" max.; crimp slotted screw connection, pack of 2 red, 2 black, 4 clips                                | PK  | 1              |
| 5036        | Steel Test Clips; 20A, 2-7/16" long; jaws open 5/8" max.; crimp slotted screw connection, pack of 1 red, 1 black, 2 clips                                   | PK  | 1              |

\*Items in this section are Underwriter's Laboratories listed or recognized under the prime manufacturer's name.

## Test Leads



| CATALOG NO. | DESCRIPTION   | UOM | ORDER MULTIPLE |
|-------------|---|-----|----------------|
| 5031        | Low Voltage Test Leads; eight 22" long, color-coded leads with fully insulated alligator clips                            | EA  | 1              |
| 5041        | Small Hook Type Low Voltage Test Leads; retractable hooks, 36" thermoplastic 22 gauge wire, nylon body/plunger, red/black | EA  | 1              |
| 5042        | Large Hook Type Low Voltage Test Leads; retractable hooks, 36" PVC insulated 20 gauge wire, nylon body/plunger, red/black | EA  | 1              |
| 5045        | Instrument Test Lead Adapter fits a standard .080" tip jack to an alligator clip; 6" lead                                 | EA  | 1              |
| 5046        | Flexible Test Leads; steel alligator clips with vinyl red and black insulators; 36" 20 gauge wire; extremely flexible     | EA  | 1              |

## Dual Element Fuses – 250V

Provides time delay for temporary over-current conditions and motor running protection for heating and air conditioning equipment. Eliminates unnecessary maintenance from harmless overloads.



| CATALOG NO. | DESCRIPTION                            | UOM | ORDER MULTIPLE |
|-------------|--|-----|----------------|
| ED-CR15     | Dual Element Fuse – 15 Amps, pack of 2 | PK  | 1              |
| ED-CR20     | Dual Element Fuse – 20 Amps, pack of 2 | PK  | 1              |
| ED-CR25     | Dual Element Fuse – 25 Amps, pack of 2 | PK  | 1              |
| ED-CR30     | Dual Element Fuse – 30 Amps, pack of 2 | PK  | 1              |
| ED-CR35     | Dual Element Fuse – 35 Amps, pack of 2 | PK  | 1              |
| ED-CR40     | Dual Element Fuse – 40 Amps, pack of 2 | PK  | 1              |
| ED-CR45     | Dual Element Fuse – 45 Amps, pack of 2 | PK  | 1              |
| ED-CR50     | Dual Element Fuse – 50 Amps, pack of 2 | PK  | 1              |
| ED-CR60     | Dual Element Fuse – 60 Amps, pack of 2 | PK  | 1              |

U.L. Class RK-5, Standard for Safety 198E, Current Limiting Fuses, Interrupting Rating 200,000 Amps. rms. A.C.

## Blade (Auto) Fuses



| CATALOG NO. | DESCRIPTION                             | UOM | ORDER MULTIPLE |
|-------------|---|-----|----------------|
| ED-AT3      | Blade Fuse – 3 Amp – Purple, pack of 10 | PK  | 1              |
| ED-AT5      | Blade Fuse – 5 Amp – Tan, pack of 10    | PK  | 1              |

## SCREWS

### Combo Head Sheet Metal Screws

Zinc plated steel.



| CATALOG NO. | DESCRIPTION                    | LENGTH | SCREW SIZE | UOM | ORDER MULTIPLE |
|-------------|--------------------------------|--------|------------|-----|----------------|
| 6822        | Combo Head Screws, pack of 102 | 3/8"   | #6         | PK  | 1              |
| 6822DX      | Combo Head Screws, pack of 500 | 3/8"   | #6         | PK  | 1              |
| 6823        | Combo Head Screws, pack of 96  | 1/2"   | #6         | PK  | 1              |
| 6826DX      | Combo Head Screws, pack of 500 | 1"     | #6         | PK  | 1              |
| 6843        | Combo Head Screws, pack of 69  | 1/2"   | #8         | PK  | 1              |
| 6843DX      | Combo Head Screws, pack of 500 | 1/2"   | #8         | PK  | 1              |
| 6845        | Combo Head Screws, pack of 56  | 3/4"   | #8         | PK  | 1              |
| 6845DX      | Combo Head Screws, pack of 500 | 3/4"   | #8         | PK  | 1              |
| 6846        | Combo Head Screws, pack of 47  | 1"     | #8         | PK  | 1              |
| 6848        | Combo Head Screws, pack of 36  | 1-1/2" | #8         | PK  | 1              |
| 6849        | Combo Head Screws, pack of 26  | 2"     | #8         | PK  | 1              |
| 6853        | Combo Head Screws, pack of 48  | 1/2"   | #10        | PK  | 1              |
| 6855        | Combo Head Screws, pack of 46  | 3/4"   | #10        | PK  | 1              |
| 6858        | Combo Head Screws, pack of 26  | 1-1/2" | #10        | PK  | 1              |
| 6859        | Combo Head Screws, pack of 19  | 2"     | #10        | PK  | 1              |
| 6863        | Combo Head Screws, pack of 38  | 1/2"   | #12        | PK  | 1              |
| 6865        | Combo Head Screws, pack of 32  | 3/4"   | #12        | PK  | 1              |
| 6866        | Combo Head Screws, pack of 26  | 1"     | #12        | PK  | 1              |
| 6868        | Combo Head Screws, pack of 18  | 1-1/2" | #12        | PK  | 1              |
| 6876        | Combo Head Screws, pack of 20  | 1"     | #14        | PK  | 1              |
| 6877        | Combo Head Screws, pack of 16  | 1-1/4" | #14        | PK  | 1              |
| 6878        | Combo Head Screws, pack of 15  | 1-1/2" | #14        | PK  | 1              |

### Sheet Metal Screw Assortments

6800BX and 6800HX come in a four-compartment, clear plastic box.



| CATALOG NO. | DESCRIPTION   | UOM | ORDER MULTIPLE |
|-------------|---|-----|----------------|
| 6800A       | Combo Head Screws: #8 x 1/2", #8 x 3/4", #10 x 3/4", #10 x 1"                         | EA  | 1              |
| 6800BX      | Combo Head Screws: #6 x 3/8", #8 x 1/2", #8 x 3/4", #10 x 3/4", #10 x 1"              | EA  | 1              |
| 6800HX      | Slotted Hex Washer Head Screws: #6 x 3/8", #8 x 1/2", #8 x 3/4", #10 x 3/4", #10 x 1" | EA  | 1              |

### Slotted Round Head Machine Screws – Assortments

Zinc plated steel.



| CATALOG NO. | DESCRIPTION                                   | SIZES                | LENGTHS      | UOM | ORDER MULTIPLE |
|-------------|---|----------------------|--------------|-----|----------------|
| 6020        | Slotted Round Head Machine Screws, pack of 81 | #6-32                | 1/2", 1", 2" | PK  | 1              |
| 6030        | Slotted Round Head Machine Screws, pack of 61 | #8-32                | 1/2", 1", 2" | PK  | 1              |
| 6040        | Slotted Round Head Machine Screws, pack of 53 | #10-32               | 1/2", 1", 2" | PK  | 1              |
| 6021        | Slotted Round Head Machine Screws, pack of 56 | #6-32, #8-32, #10-32 | 1/2", 1", 2" | PK  | 1              |



## SCREWS cont'd

### Self-Drilling Screw Repair Kit

For use as replacements for screws in stripped holes.



| CATALOG NO. | DESCRIPTION  | UOM | ORDER MULTIPLE |
|-------------|--|-----|----------------|
| 6900AX      | Contains: #12 x 3/4", #12 x 1", #14 x 3/4", #14 x 1" | EA  | 1              |

## ANCHORS

### Metal Drive Anchors



| CATALOG NO. | DESCRIPTION              | SIZE          | EMBEDMENT | PULLOUT LOAD | UOM | ORDER MULTIPLE |
|-------------|--------------------------|---------------|-----------|--------------|-----|----------------|
| 7233RLX     | Drive Anchor, pack of 50 | 1/4" X 3/4"   | 5/8"      | 500 lb.      | PK  | 1              |
| 7234RLX     | Drive Anchor, pack of 50 | 1/4" X 1"     | 7/8"      | 944 lb.      | PK  | 1              |
| 7235RLX     | Drive Anchor, pack of 50 | 1/4" X 1-1/4" | 1-1/8"    | 1,146 lb.    | PK  | 1              |
| 7236R       | Drive Anchor, pack of 10 | 1/4" X 1-1/2" | 1-3/8"    | 854 lb.      | PK  | 1              |
| 7236RLX     | Drive Anchor, pack of 50 | 1/4" X 1-1/2" | 1-3/8"    | 854 lb.      | PK  | 1              |

### Drive Fasteners

These steel fasteners can be driven into dry wall like a nail and are secured by turning the screw down completely to expand the ribs.



| CATALOG NO. | DESCRIPTION               | HOLE SIZE | GRIP RANGE    | UOM | ORDER MULTIPLE |
|-------------|---------------------------|-----------|---------------|-----|----------------|
| 7301        | Drive Fastener, pack of 6 | 1/4"      | 3/16" to 3/8" | PK  | 1              |
| 7302        | Drive Fastener, pack of 6 | 1/4"      | 1/8" to 1/2"  | PK  | 1              |
| 7303        | Drive Fastener, pack of 6 | 1/4"      | 1/8" to 3/16" | PK  | 1              |

### Drop-In Expansion Anchor Setting Tool



| CATALOG NO. | DESCRIPTION                          | UOM | ORDER MULTIPLE |
|-------------|--------------------------------------|-----|----------------|
| 7145        | For use with anchor part number 7141 | EA  | 1              |
| 7146        | For use with anchor part number 7142 | EA  | 1              |
| 7147        | For use with anchor part number 7143 | EA  | 1              |

### Drop-In Expansion Anchors

These heavy-duty anchors are made of carbon steel. They are set by means of an internal plug and setting tool.



| CATALOG NO. | DESCRIPTION         | BOLT SIZE | THREADS PER INCH | HOLE DEPTH | THREAD DEPTH | DRILL BIT SIZE | UOM | ORDER MULTIPLE |
|-------------|---------------------|-----------|------------------|------------|--------------|----------------|-----|----------------|
| 7141        | Anchor, pack of 4   | 1/4"      | 20               | 1"         | 3/8"         | 3/8"           | PK  | 1              |
| 7141CX      | Anchor, pack of 100 | 1/4"      | 20               | 1"         | 3/8"         | 3/8"           | PK  | 1              |
| 7142        | Anchor, pack of 4   | 3/8"      | 18               | 1-5/8"     | 1/2"         | 1/2"           | PK  | 1              |
| 7142LX      | Anchor, pack of 50  | 3/8"      | 18               | 1-5/8"     | 1/2"         | 1/2"           | PK  | 1              |
| 7143        | Anchor, pack of 4   | 1/2"      | 13               | 2"         | 3/4"         | 5/8"           | PK  | 1              |
| 7143LX      | Anchor, pack of 50  | 1/2"      | 13               | 2"         | 3/4"         | 5/8"           | PK  | 1              |

### Self-Drilling Gypsum Wallboard Anchors

- Anchors pre-drill precise hole in gypsum wallboard
- No special tools required; anchors easily install with a #2 or #3 phillips screwdriver, slotted driver, or powerdriver
- These anchors replace plastic plugs and toggles
- Deep thread design provides strong engagement in 3/8", 1/2", and 5/8" gypsum wallboard
- Full range to cover all wall fastening applications
- Available in corrosion-resistant, non-conductive white nylon
- Can easily be backed out
- Low profile head
- Anchors listed are supplied with combo head screws.



| CATALOG NO. | DESCRIPTION   | SCREW SIZE  | MAX. FIXTURE | UOM | ORDER MULTIPLE |
|-------------|---|-------------|--------------|-----|----------------|
| 7316X       | E-Z Ancor <sup>®</sup> ; nylon, pack of 10                      | #8 x 1-1/4" | 3/4"         | PK  | 1              |
| 7316L       | E-Z Ancor <sup>®</sup> ; nylon, pack of 50                      | #8 x 1-1/4" | 3/4"         | PK  | 1              |
| 7311X       | E-Z Ancor <sup>®</sup> ; zinc die cast*, pack of 10             | #6 x 1-1/4" | 3/4"         | PK  | 1              |
| 7311L       | E-Z Ancor <sup>®</sup> ; zinc die cast*, pack of 50             | #6 x 1-1/4" | 3/4"         | PK  | 1              |
| 7317X       | E-Z Ancor Lite <sup>™</sup> ; nylon, pack of 10                 | #6 x 1-1/4" | 3/4"         | PK  | 1              |
| 7317L       | E-Z Ancor Lite <sup>™</sup> ; nylon, pack of 50                 | #6 x 1-1/4" | 3/4"         | PK  | 1              |
| 7321X       | E-Z Toggle <sup>™</sup> ; zinc die cast; heavy-duty, pack of 10 | #8 x 2-1/8" | 5/8"         | PK  | 1              |

\*Smaller version of the E-Z Ancor<sup>®</sup> with a versatile core that can use #6 or #8 sheet metal screws or #6, #7, #8 drywall screws.

**DEVCO PLASTIC ANCHOR KITS**

| CATALOG NO.   |                 | ANCHOR | DRILL SIZE     | DRILL BIT INCLUDED | SCREW       | SCREW SIZE          |                 |
|---------------|-----------------|--------|----------------|--------------------|-------------|---------------------|-----------------|
| SMALL PACK*   | 100 PACK        |        |                |                    |             |                     |                 |
|               | <b>7103CX</b>   |        | $\frac{5}{32}$ |                    |             | <b>#4 x 3/4"</b>    |                 |
|               | <b>7101CX</b>   |        | $\frac{3}{16}$ |                    |             | <b>#8 x 1"</b>      |                 |
|               | <b>7101HCX</b>  |        |                |                    |             | <b>#8 x 1"</b>      |                 |
|               | <b>7103CX-6</b> |        | $\frac{3}{16}$ |                    |             | <b>#6 x 3/4"</b>    |                 |
|               | <b>7102CX</b>   |        | $\frac{1}{4}$  |                    |             | <b>#10 x 1-1/4"</b> |                 |
|               | <b>7102HCX</b>  |        |                |                    |             | <b>#8 x 1"</b>      |                 |
| <b>7106X</b>  | <b>7106CX</b>   |        | $\frac{1}{4}$  |                    |             | <b>#10 x 1"</b>     |                 |
| <b>7124RX</b> |                 |        | $\frac{1}{4}$  |                    |             | <b>#10 x 1"</b>     |                 |
| <b>7124X</b>  |                 |        |                |                    | <b>None</b> | <b>None</b>         | <b>#10 x 1"</b> |
|               | <b>7124CX</b>   |        |                |                    | <b>None</b> | <b>None</b>         | <b>#10 x 1"</b> |
| <b>7104</b>   |                 |        | $\frac{1}{4}$  | <b>None</b>        |             | <b>#8 x 1"</b>      |                 |
| <b>7106</b>   |                 |        | $\frac{1}{4}$  | <b>None</b>        |             | <b>#10 x 1"</b>     |                 |
| <b>7105LX</b> |                 |        | $\frac{5}{16}$ |                    |             | <b>#14 x 1-1/2"</b> |                 |
| <b>7111X</b>  | <b>7111CX</b>   |        | $\frac{5}{16}$ |                    |             | <b>#14 x 1"</b>     |                 |
|               | <b>7111HCX</b>  |        |                |                    |             | <b>#14 x 1"</b>     |                 |
| <b>7111</b>   |                 |        |                |                    | <b>None</b> |                     | <b>#14 x 1"</b> |

| *SMALL PACK | COUNT |
|-------------|-------|
| 7104        | 37    |
| 7106        | 28    |
| 7106X       | 40    |
| 7111        | 16    |
| 7111X       | 40    |
| 7124RX      | 45    |
| 7124X       | 24    |
| 7105LX      | 50    |



## NUTS AND BOLTS

### Finished Hex Nuts

Zinc plated steel.

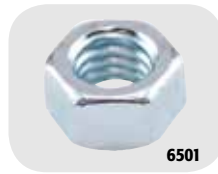

| CATALOG NO. | DESCRIPTION                    | SIZE       | UOM | ORDER MULTIPLE |
|-------------|--------------------------------|------------|-----|----------------|
| 6501        | Finished Hex Nuts, pack of 60  | 1/4" - 20  | PK  | 1              |
| 6501CX      | Finished Hex Nuts, pack of 100 | 1/4" - 20  | PK  | 1              |
| 6502        | Finished Hex Nuts, pack of 38  | 5/16" - 18 | PK  | 1              |
| 6503        | Finished Hex Nuts, pack of 25  | 3/8" - 16  | PK  | 1              |
| 6503CX      | Finished Hex Nuts, pack of 100 | 3/8" - 16  | PK  | 1              |
| 6505        | Finished Hex Nuts, pack of 11  | 1/2" - 13  | PK  | 1              |
| 6505LX      | Finished Hex Nuts, pack of 50  | 1/2" - 13  | PK  | 1              |
| 6507        | Finished Hex Nuts, pack of 6   | 5/8" - 11  | PK  | 1              |
| 6507LX      | Finished Hex Nuts, pack of 50  | 5/8" - 11  | PK  | 1              |

### Machine Screw Hex Nuts

Zinc plated steel.



| CATALOG NO. | DESCRIPTION                        | SIZE                 | UOM | ORDER MULTIPLE |
|-------------|------------------------------------|----------------------|-----|----------------|
| 6526        | Machine Screw Hex Nuts, pack of 49 | #8 - 32              | PK  | 1              |
| 6528        | Machine Screw Hex Nuts, pack of 44 | #10 - 24             | PK  | 1              |
| 6500A       | Assortment, 23 of each             | #6-32, #8-32, #10-32 | EA  | 1              |

### Nylon Insert Lock Nuts

NE Series. Zinc plated steel.



| CATALOG NO. | DESCRIPTION                        | SIZE       | UOM | ORDER MULTIPLE |
|-------------|------------------------------------|------------|-----|----------------|
| 65001       | Nylon Insert Lock Nuts, pack of 34 | 1/4" - 20  | PK  | 1              |
| 65002       | Nylon Insert Lock Nuts, pack of 26 | 5/16" - 18 | PK  | 1              |
| 65028       | Nylon Insert Lock Nuts, pack of 42 | #10 - 24   | PK  | 1              |

### Toggle Bolts

Toggle Bolts are slotted, round head machine screws with spring wings. Zinc plated steel.



| CATALOG NO. | DESCRIPTION              | LENGTH | BOLT SIZE | HOLE SIZE | UOM | ORDER MULTIPLE |
|-------------|--------------------------|--------|-----------|-----------|-----|----------------|
| 7032        | Toggle Bolts, pack of 6  | 4"     | 1/8"      | 3/8"      | PK  | 1              |
| 7033        | Toggle Bolts, pack of 6  | 4"     | 3/16"     | 1/2"      | PK  | 1              |
| 7034        | Toggle Bolts, pack of 5  | 4"     | 1/4"      | 5/8"      | PK  | 1              |
| 7036X       | Toggle Bolts, pack of 4  | 4"     | 3/8"      | 1"        | PK  | 1              |
| 7063        | Toggle Bolts, pack of 5  | 6"     | 3/16"     | 1/2"      | PK  | 1              |
| 7064        | Toggle Bolts, pack of 4  | 6"     | 1/4"      | 5/8"      | PK  | 1              |
| 7066X       | Toggle Bolts, pack of 4  | 6"     | 3/8"      | 1"        | PK  | 1              |
| 7066NX      | Toggle Bolts, pack of 25 | 6"     | 3/8"      | 1"        | PK  | 1              |

### Stove Bolts

Stove Bolts are a combination of slotted round head machine screws and finished hex nuts. Zinc plated steel.



| CATALOG NO. | DESCRIPTION             | SIZE      | LENGTH | UOM | ORDER MULTIPLE |
|-------------|-------------------------|-----------|--------|-----|----------------|
| 6401        | Stove Bolts, pack of 42 | #10 - 24  | 1/2"   | PK  | 1              |
| 6402        | Stove Bolts, pack of 38 | #10 - 24  | 3/4"   | PK  | 1              |
| 6403        | Stove Bolts, pack of 34 | #10 - 24  | 1"     | PK  | 1              |
| 6404        | Stove Bolts, pack of 27 | #10 - 24  | 1-1/2" | PK  | 1              |
| 6405        | Stove Bolts, pack of 22 | #10 - 24  | 2"     | PK  | 1              |
| 6411        | Stove Bolts, pack of 22 | 1/4" - 20 | 1/2"   | PK  | 1              |
| 6412        | Stove Bolts, pack of 20 | 1/4" - 20 | 3/4"   | PK  | 1              |
| 6413        | Stove Bolts, pack of 18 | 1/4" - 20 | 1"     | PK  | 1              |
| 6414        | Stove Bolts, pack of 15 | 1/4" - 20 | 1-1/2" | PK  | 1              |
| 6415        | Stove Bolts, pack of 13 | 1/4" - 20 | 2"     | PK  | 1              |
| 6416        | Stove Bolts, pack of 11 | 1/4" - 20 | 2-1/2" | PK  | 1              |

### Motor Bolts

Motor Bolts are all-thread rods. Four machine screw hex nuts are included with each bolt. Zinc plated steel.



| CATALOG NO. | DESCRIPTION             | SIZE     | LENGTH | UOM | ORDER MULTIPLE |
|-------------|-------------------------|----------|--------|-----|----------------|
| 6108        | Motor Bolts, pack of 16 | #8 - 32  | 1-1/2" | PK  | 1              |
| 6109        | Motor Bolts, pack of 16 | #10 - 32 | 1-1/2" | PK  | 1              |

### Hex Head Cap Screws

Hex Head Cap Screws are made of low carbon, grade 2 steel. USS Classification. Total thread length equals 2 x diameter + 1/4".



| CATALOG NO. | DESCRIPTION                     | SIZE       | LENGTH | UOM | ORDER MULTIPLE |
|-------------|---------------------------------|------------|--------|-----|----------------|
| 6600        | Hex Head Cap Screws, pack of 34 | 1/4" - 20  | 1/2"   | PK  | 1              |
| 6601        | Hex Head Cap Screws, pack of 28 | 1/4" - 20  | 3/4"   | PK  | 1              |
| 6602        | Hex Head Cap Screws, pack of 25 | 1/4" - 20  | 1"     | PK  | 1              |
| 6603        | Hex Head Cap Screws, pack of 18 | 1/4" - 20  | 1-1/2" | PK  | 1              |
| 6604        | Hex Head Cap Screws, pack of 15 | 1/4" - 20  | 2"     | PK  | 1              |
| 6605        | Hex Head Cap Screws, pack of 12 | 1/4" - 20  | 2-1/2" | PK  | 1              |
| 6622        | Hex Head Cap Screws, pack of 15 | 5/16" - 18 | 1"     | PK  | 1              |
| 6623        | Hex Head Cap Screws, pack of 12 | 5/16" - 18 | 1-1/2" | PK  | 1              |
| 6625        | Hex Head Cap Screws, pack of 8  | 5/16" - 18 | 2-1/2" | PK  | 1              |
| 6641        | Hex Head Cap Screws, pack of 14 | 3/8" - 16  | 3/4"   | PK  | 1              |
| 6642        | Hex Head Cap Screws, pack of 12 | 3/8" - 16  | 1"     | PK  | 1              |
| 6643        | Hex Head Cap Screws, pack of 8  | 3/8" - 16  | 1-1/2" | PK  | 1              |
| 6644        | Hex Head Cap Screws, pack of 7  | 3/8" - 16  | 2"     | PK  | 1              |
| 6645        | Hex Head Cap Screws, pack of 5  | 3/8" - 16  | 2-1/2" | PK  | 1              |
| 6682        | Hex Head Cap Screws, pack of 7  | 1/2" - 13  | 1"     | PK  | 1              |
| 6683        | Hex Head Cap Screws, pack of 5  | 1/2" - 13  | 1-1/2" | PK  | 1              |
| 6685        | Hex Head Cap Screws, pack of 3  | 1/2" - 13  | 2-1/2" | PK  | 1              |

## BOLTS AND WASHERS

### Flat Washers

Zinc plated steel. USS Classification. Only 6707S and 6707S-2X are SAE Classification.

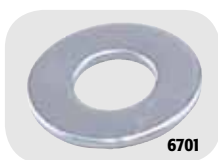

| CATALOG NO. | DESCRIPTION                     | SIZE               | INNER DIAMETER | OUTER DIAMETER | UOM | ORDER MULTIPLE |
|-------------|---------------------------------|--------------------|----------------|----------------|-----|----------------|
| 6701        | Flat Washers (USS), pack of 160 | 3/16"              | 1/4"           | 9/16"          | PK  | 1              |
| 6702        | Flat Washers (USS), pack of 72  | 1/4"               | 5/16"          | 3/4"           | PK  | 1              |
| 6703        | Flat Washers (USS), pack of 33  | 5/16"              | 3/8"           | 7/8"           | PK  | 1              |
| 6704        | Flat Washers (USS), pack of 37  | 3/8"               | 7/16"          | 1"             | PK  | 1              |
| 6704-2X     | Flat Washers (USS), pack of 134 | 3/8"               | 7/16"          | 1"             | PK  | 1              |
| 6706        | Flat Washers (USS), pack of 11  | 1/2"               | 9/16"          | 1-3/8"         | PK  | 1              |
| 6706-2X     | Flat Washers (USS), pack of 52  | 1/2"               | 9/16"          | 1-3/8"         | PK  | 1              |
| 6700AX      | Assortment                      | All sizes included |                |                | EA  | 1              |

### Fender Washers

Zinc plated steel.

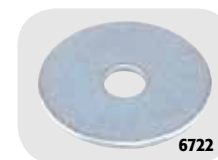

| CATALOG NO. | DESCRIPTION                | SIZE | INNER DIAMETER | OUTER DIAMETER | UOM | ORDER MULTIPLE |
|-------------|----------------------------|------|----------------|----------------|-----|----------------|
| 6722        | Fender Washers, pack of 20 | 1/4" | 9/32"          | 1-1/4"         | PK  | 1              |
| 6722-2X     | Fender Washers, pack of 92 | 1/4" | 9/32"          | 1-1/4"         | PK  | 1              |
| 6724        | Fender Washers, pack of 12 | 3/8" | 13/32"         | 1-1/2"         | PK  | 1              |
| 6724-2X     | Fender Washers, pack of 66 | 3/8" | 13/32"         | 1-1/2"         | PK  | 1              |

### Medium Split Lock Washers

Spring type. Zinc plated steel.



| CATALOG NO. | DESCRIPTION                           | SIZE  | UOM | ORDER MULTIPLE |
|-------------|---------------------------------------|-------|-----|----------------|
| 6730        | Medium Split Lock Washers, pack of 95 | 3/16" | PK  | 1              |
| 6731        | Medium Split Lock Washers, pack of 72 | 1/4"  | PK  | 1              |
| 6732        | Medium Split Lock Washers, pack of 59 | 5/16" | PK  | 1              |
| 6733        | Medium Split Lock Washers, pack of 38 | 3/8"  | PK  | 1              |
| 6735        | Medium Split Lock Washers, pack of 18 | 1/2"  | PK  | 1              |

## CABLE TIES AND ACCESSORIES

### Heavy Duty Nylon Cable Ties

Black ties are weather and UV resistant. Items in this section are Underwriters' Laboratories listed or recognized under the prime manufacturer's name.

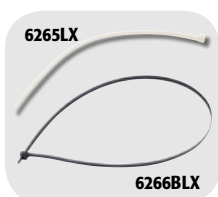

| CATALOG NO. | DESCRIPTION                    | LENGTH | COLOR   | MAX. BUNDLE DIAMETER | TENSILE STRENGTH | UOM | ORDER MULTIPLE |
|-------------|--------------------------------|--------|---------|----------------------|------------------|-----|----------------|
| 6265LX      | Nylon; Heavy-duty, pack of 50  | 14"    | Natural | 4"                   | 175 lb.          | PK  | 1              |
| 6265CX      | Nylon; Heavy-duty, pack of 100 | 14"    | Natural | 4"                   | 175 lb.          | PK  | 1              |
| 6265BLX     | Nylon; Heavy-duty, pack of 50  | 14"    | Black   | 4"                   | 175 lb.          | PK  | 1              |
| 6265BCX     | Nylon; Heavy-duty, pack of 100 | 14"    | Black   | 4"                   | 175 lb.          | PK  | 1              |
| 6266BLX     | Nylon; Heavy-duty, pack of 50  | 36"    | Black   | 11"                  | 175 lb.          | PK  | 1              |
| 6260BLX     | Nylon; Heavy-duty, pack of 50  | 48"    | Black   | 15"                  | 175 lb.          | PK  | 1              |

### Nylon Cable Ties with Mounting Hole

Black ties are weather and UV resistant. Items in this section are Underwriters' Laboratories listed or recognized under the prime manufacturer's name.

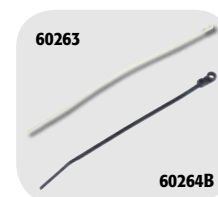

| CATALOG NO. | DESCRIPTION                    | MOUNTING HOLE | LENGTH | COLOR   | MAX. BUNDLE DIAMETER | TENSILE STRENGTH | UOM | ORDER MULTIPLE |
|-------------|--------------------------------|---------------|--------|---------|----------------------|------------------|-----|----------------|
| 60264CX     | Tie w/mtg. hole, pack of 100   | #8            | 6"     | Natural | 1-3/8"               | 30 lb.           | PK  | 1              |
| 60264BLX    | Tie w/mtg. hole, pack of 50    | #8            | 6"     | Black   | 1-3/8"               | 30 lb.           | PK  | 1              |
| 60264BCX    | Tie w/mtg. hole, pack of 100   | #8            | 6"     | Black   | 1-3/8"               | 30 lb.           | PK  | 1              |
| 6264LX      | Tie w/mtg. hole, pack of 50    | #10           | 7"     | Natural | 1-3/4"               | 50 lb.           | PK  | 1              |
| 6264CX      | Tie w/mtg. hole, pack of 100   | #10           | 7"     | Natural | 1-3/4"               | 50 lb.           | PK  | 1              |
| 6264BLX     | Tie w/mtg. hole, pack of 50    | #10           | 7"     | Black   | 1-3/4"               | 50 lb.           | PK  | 1              |
| 6264BCX     | Tie w/mtg. hole, pack of 100   | #10           | 7"     | Black   | 1-3/4"               | 50 lb.           | PK  | 1              |
| 6264BMX     | Tie w/mtg. hole, pack of 1,000 | #10           | 7"     | Black   | 1-3/4"               | 50 lb.           | PK  | 1              |
| 60263CX     | Tie w/mtg. hole, pack of 100   | #10           | 11"    | Natural | 3"                   | 50 lb.           | PK  | 1              |
| 60263BLX    | Tie w/mtg. hole, pack of 50    | #10           | 11"    | Black   | 3"                   | 50 lb.           | PK  | 1              |
| 60263BCX    | Tie w/mtg. hole, pack of 100   | #10           | 11"    | Black   | 3"                   | 50 lb.           | PK  | 1              |
| 61265LX     | Tie w/mtg. hole, pack of 50    | #10           | 14"    | Natural | 4"                   | 50 lb.           | PK  | 1              |
| 61265BCX    | Tie w/mtg. hole, pack of 100   | #10           | 14"    | Black   | 4"                   | 50 lb.           | PK  | 1              |



## CABLE TIES AND ACCESSORIES cont'd

### Nylon Cable Ties

Black ties are weather and UV resistant. Items in this section are Underwriters' Laboratories listed or recognized under the prime manufacturer's name.

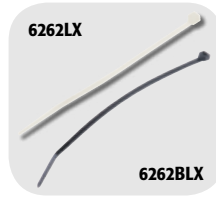

| CATALOG NO. | DESCRIPTION                     | LENGTH | COLOR   | MAX. BUNDLE DIAMETER | TENSILE STRENGTH | UOM | ORDER MULTIPLE |
|-------------|---------------------------------|--------|---------|----------------------|------------------|-----|----------------|
| 6267MX      | Nylon Cable Ties, pack of 1,000 | 4"     | Natural | 13/16"               | 18 lb.           | PK  | 1              |
| 6267BLX     | Nylon Cable Ties, pack of 50    | 4"     | Black   | 13/16"               | 18 lb.           | PK  | 1              |
| 6267BCX     | Nylon Cable Ties, pack of 100   | 4"     | Black   | 13/16"               | 18 lb.           | PK  | 1              |
| 6261BL      | Nylon Cable Ties, pack of 100   | 6"     | Natural | 1-3/8"               | 18 lb.           | PK  | 1              |
| 6261CX      | Nylon Cable Ties, pack of 1,000 | 6"     | Natural | 1-3/8"               | 18 lb.           | PK  | 1              |
| 6261BCX     | Nylon Cable Ties, pack of 50    | 6"     | Black   | 1-3/8"               | 18 lb.           | PK  | 1              |
| 6261MX      | Nylon Cable Ties, pack of 100   | 6"     | Black   | 1-3/8"               | 18 lb.           | PK  | 1              |
| 6268BL      | Nylon Cable Ties, pack of 100   | 6"     | Natural | 1-3/8"               | 30 lb.           | PK  | 1              |
| 6268CX      | Nylon Cable Ties, pack of 1,000 | 6"     | Natural | 1-3/8"               | 30 lb.           | PK  | 1              |
| 6268MX      | Nylon Cable Ties, pack of 100   | 6"     | Black   | 1-3/8"               | 30 lb.           | PK  | 1              |
| 6268BMX     | Nylon Cable Ties, pack of 1,000 | 6"     | Black   | 1-3/8"               | 30 lb.           | PK  | 1              |
| 6262LX      | Nylon Cable Ties, pack of 50    | 7-1/2" | Natural | 1-3/4"               | 50 lb.           | PK  | 1              |
| 6262CX      | Nylon Cable Ties, pack of 100   | 7-1/2" | Natural | 1-3/4"               | 50 lb.           | PK  | 1              |
| 6262MX      | Nylon Cable Ties, pack of 1,000 | 7-1/2" | Natural | 1-3/4"               | 50 lb.           | PK  | 1              |
| 6262BLX     | Nylon Cable Ties, pack of 50    | 7-1/2" | Black   | 1-3/4"               | 50 lb.           | PK  | 1              |
| 6262BCX     | Nylon Cable Ties, pack of 100   | 7-1/2" | Black   | 1-3/4"               | 50 lb.           | PK  | 1              |
| 6262BMX     | Nylon Cable Ties, pack of 1,000 | 7-1/2" | Black   | 1-3/4"               | 50 lb.           | PK  | 1              |
| 6263NX      | Nylon Cable Ties, pack of 25    | 11"    | Natural | 3"                   | 50 lb.           | PK  | 1              |
| 6263LX      | Nylon Cable Ties, pack of 50    | 11"    | Natural | 3"                   | 50 lb.           | PK  | 1              |
| 6263CX      | Nylon Cable Ties, pack of 100   | 11"    | Natural | 3"                   | 50 lb.           | PK  | 1              |
| 6263DX      | Nylon Cable Ties, pack of 500   | 11"    | Natural | 3"                   | 50 lb.           | PK  | 1              |
| 6263BNX     | Nylon Cable Ties, pack of 25    | 11"    | Black   | 3"                   | 50 lb.           | PK  | 1              |
| 6263BLX     | Nylon Cable Ties, pack of 50    | 11"    | Black   | 3"                   | 50 lb.           | PK  | 1              |
| 6263BCX     | Nylon Cable Ties, pack of 100   | 11"    | Black   | 3"                   | 50 lb.           | PK  | 1              |
| 6263BDX     | Nylon Cable Ties, pack of 500   | 11"    | Black   | 3"                   | 50 lb.           | PK  | 1              |
| 60265NX     | Nylon Cable Ties, pack of 25    | 14"    | Natural | 4"                   | 50 lb.           | PK  | 1              |
| 60265LX     | Nylon Cable Ties, pack of 50    | 14"    | Natural | 4"                   | 50 lb.           | PK  | 1              |
| 60265BLX    | Nylon Cable Ties, pack of 50    | 14"    | Black   | 4"                   | 50 lb.           | PK  | 1              |

### Black Nylon Cable Tie Assortment

Black ties are weather and UV resistant. Items in this section are Underwriters' Laboratories listed or recognized under the prime manufacturer's name.



| CATALOG NO. | DESCRIPTION | LENGTH        | COLOR          | MAX. BUNDLE DIAMETER | TENSILE STRENGTH | UOM | ORDER MULTIPLE |
|-------------|-------------|---------------|----------------|----------------------|------------------|-----|----------------|
| 62000AX     | Assortment  | 7-1/2"<br>11" | Black<br>Black | 1-3/4"<br>3"         | 50 lb.<br>50 lb. | EA  | 1              |

### Cable Tie Mounts

Approximately 1" square; adhesive backed. These mounts can be mounted with a screw and will accept up to 75 lb. ties.



| CATALOG NO. | DESCRIPTION   | UOM | ORDER MULTIPLE |
|-------------|---|-----|----------------|
| 6269        | Cable Tie Mounts; 1" square; adhesive backed, pack of 11    | PK  | 1              |
| 6269LX      | Cable Tie Mounts; 1" square; adhesive backed, pack of 50    | PK  | 1              |
| 6269CX      | Cable Tie Mounts; 1" square; adhesive backed, pack of 100   | PK  | 1              |
| 6269MX      | Cable Tie Mounts; 1" square; adhesive backed, pack of 1,000 | PK  | 1              |

## SPECIALTY FASTENERS

### Nylon Cable Clamps



| CATALOG NO. | DESCRIPTION                    | FITS PIPE OUTER DIAMETER | THICKNESS | WIDTH | UOM | ORDER MULTIPLE |
|-------------|--------------------------------|--------------------------|-----------|-------|-----|----------------|
| 5381        | Nylon Cable Clamps, pack of 54 | 1/8"                     | .050"     | 3/8"  | PK  | 1              |
| 5382        | Nylon Cable Clamps, pack of 48 | 1/4"                     | .050"     | 3/8"  | PK  | 1              |
| 5383        | Nylon Cable Clamps, pack of 41 | 3/8"                     | .050"     | 3/8"  | PK  | 1              |
| 5384        | Nylon Cable Clamps, pack of 35 | 1/2"                     | .050"     | 3/8"  | PK  | 1              |
| 5385        | Nylon Cable Clamps, pack of 21 | 5/8"                     | .060"     | 1/2"  | PK  | 1              |
| 5386        | Nylon Cable Clamps, pack of 19 | 3/4"                     | .060"     | 1/2"  | PK  | 1              |
| 5387        | Nylon Cable Clamps, pack of 18 | 7/8"                     | .060"     | 1/2"  | PK  | 1              |
| 5391        | Nylon Cable Clamps, pack of 12 | 1-1/4"                   | .060"     | 1/2"  | PK  | 1              |
| 5392        | Nylon Cable Clamps, pack of 11 | 1-3/8"                   | .060"     | 1/2"  | PK  | 1              |
| 5380AX      | Assortment                     | 1/8" - 1"                |           |       | EA  | 1              |

### Hose Clamps

Hose Clamps have stainless steel housings and bands. The screws are plated steel and have slotted hex heads allowing a socket wrench, nut driver, or screwdriver to be used.



| CATALOG NO. | DESCRIPTION             | SAE NO. | SAE DIAMETER RANGE (in.) | APPROX. RANGE (in.) | UOM | ORDER MULTIPLE |
|-------------|-------------------------|---------|--------------------------|---------------------|-----|----------------|
| HC6202      | Hose Clamps, pack of 6  | *       | N/A                      | 1/4 to 5/8          | PK  | 1              |
| HC6203      | Hose Clamps, pack of 6  | 6       | .44 - .78                | 5/16 to 7/8         | PK  | 1              |
| HC5410      | Hose Clamps, pack of 6  | 10      | .56 - 1.06               | 9/16 to 1-1/8       | PK  | 1              |
| HC5410X     | Hose Clamps, pack of 10 | 10      | .56 - 1.06               | 9/16 to 1-1/8       | PK  | 1              |
| HC5416      | Hose Clamps, pack of 6  | 16      | .81 - 1.50               | 3/4 to 1-1/2        | PK  | 1              |
| HC5416X     | Hose Clamps, pack of 10 | 16      | .81 - 1.50               | 3/4 to 1-1/2        | PK  | 1              |
| HC5420      | Hose Clamps, pack of 6  | 20      | .81 - 1.75               | 13/16 to 1-3/4      | PK  | 1              |
| HC5420X     | Hose Clamps, pack of 10 | 20      | .81 - 1.75               | 13/16 to 1-3/4      | PK  | 1              |
| HC5424      | Hose Clamps, pack of 6  | 24      | 1.06 - 2.00              | 1-1/16 to 2         | PK  | 1              |
| HC5436      | Hose Clamps, pack of 4  | 36      | 1.81 - 2.75              | 1-1/2 to 2-3/4      | PK  | 1              |
| HC5436X     | Hose Clamps, pack of 10 | 36      | 1.81 - 2.75              | 1-1/2 to 2-3/4      | PK  | 1              |

## SPECIALTY FASTENERS cont'd

### Pipe Hanging Strap

Non-plated steel.



| CATALOG NO. | DESCRIPTION                      | SIZE       | UOM | ORDER MULTIPLE |
|-------------|----------------------------------|------------|-----|----------------|
| PI335       | Pipe Hanging Strap; 28 gauge AWG | 3/4" x 10' | EA  | 1              |

### Nylon Rods

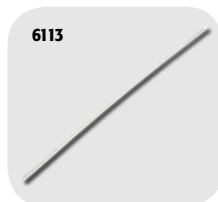

| CATALOG NO. | DESCRIPTION                       | DIAMETER | THREADS (in.) | LENGTH | UOM | ORDER MULTIPLE |
|-------------|-----------------------------------|----------|---------------|--------|-----|----------------|
| 6113        | Nylon Rods; All-Thread, pack of 4 | 3/8"     | 16            | 2'     | PK  | 1              |
| 6115        | Nylon Rods; All-Thread, pack of 2 | 1/2"     | 13            | 2'     | PK  | 1              |

### Nylon Nut and Washer



| CATALOG NO. | DESCRIPTION                     | WASHER DIAMETER INNER | WASHER DIAMETER OUTER | THREAD SIZE | UOM | ORDER MULTIPLE |
|-------------|---------------------------------|-----------------------|-----------------------|-------------|-----|----------------|
| 6513        | Nylon Nut and Washer, pack of 6 | 7/16"                 | 3/4"                  | 3/8"-16     | PK  | 1              |
| 6515        | Nylon Nut and Washer, pack of 4 | 1/2"                  | 3/4"                  | 1/2"-13     | PK  | 1              |

### Cotter Pins

Assortment of regular Cotter Pins with extended prongs.



| CATALOG NO. | DESCRIPTION  | UOM | ORDER MULTIPLE |
|-------------|--|-----|----------------|
| 6011        | Cotter Pins: 1/16" x 1-1/2"; 3/32" x 1-1/2"; 1/8" x 1-1/2", pack of 51 | PK  | 1              |

### Motor Shaft Key Assortments

Made of cold rolled 1018 steel. Zinc plated.



| CATALOG NO. | DESCRIPTION   | UOM | ORDER MULTIPLE |
|-------------|---|-----|----------------|
| 6101        | Small Assortment includes: 1/8" x 1/8" x 1-3/16"; 3/16" x 3/16" x 1-3/16"; 3/16" x 1/4" x 1-3/16"; 1/4" x 1/4" x 1-3/4" | EA  | 1              |
| 6102        | Large Assortment includes: 1/4" x 1/4" x 1-3/4"; 5/16" x 5/16" x 3"; 3/8" x 3/8" x 3                                    | EA  | 1              |

### Fast Nuts

Fast Nuts, type "U", are used on sheet metal where no threaded hole is available for mounting covers or access panels.



| CATALOG NO. | DESCRIPTION                                 | UOM | ORDER MULTIPLE |
|-------------|---|-----|----------------|
| 6351        | Fast Nuts for use with #8 screw, pack of 7  | PK  | 1              |
| 6352        | Fast Nuts for use with #10 screw, pack of 6 | PK  | 1              |
| 6353        | Fast Nuts for use with #14 screw, pack of 5 | PK  | 1              |

### Set Screws

Set Screws have cup points and hex socket heads. Class 3A threads. Made of heat treated alloy steel.



| CATALOG NO. | DESCRIPTION                     | SIZE                       | UOM | ORDER MULTIPLE |
|-------------|---------------------------------|----------------------------|-----|----------------|
| 6002        | Set Screws, pack of 33          | #8-32 x 3/16"              | PK  | 1              |
| 6003        | Set Screws, pack of 25          | #10-32 x 3/16"             | PK  | 1              |
| 6004        | Set Screws, pack of 27          | 1/4"-28 x 1/4"             | PK  | 1              |
| 6005        | Set Screws, pack of 27          | 1/4"-20 x 1/4"             | PK  | 1              |
| 6006        | Set Screws, pack of 19          | 5/16"-18 x 5/16"           | PK  | 1              |
| 6007        | Set Screws, pack of 14          | 3/8"-16 x 3/8"             | PK  | 1              |
| 6000        | Large Assortment; course thread | 1/4"-20; 5/16"-18; 3/8"-16 | EA  | 1              |
| 6001        | Small Assortment; fine thread   | #8-32; #10-32; 1/4"-28     | EA  | 1              |



## SPECIALTY FITTINGS

### Grease Fittings

Case hardened steel fittings plated with yellow dip chromate and built-in ball checks. Assortment available in clear plastic box.



| CATALOG NO. | DESCRIPTION  | UOM | ORDER MULTIPLE |
|-------------|--|-----|----------------|
| 6311        | Grease Fittings: 1/4"-28 Tapered Thread; straight, pack of 8 | PK  | 1              |
| 6312        | Grease Fittings: 1/8" Pipe Thread; straight, pack of 5       | PK  | 1              |
| 6313        | Grease Fittings: 1/4" Pipe Thread; straight, pack of 2       | PK  | 1              |
| 6321        | Grease Fittings: 1/4"-28 Tapered Thread; 90°, pack of 3      | PK  | 1              |
| 6322        | Grease Fittings: 1/8" Pipe Thread; 90°, pack of 3            | PK  | 1              |
| 6310X       | Assortment includes: 6311, 6312, 6321, 6322                  | EA  | 1              |

## TAPES

### Tape

Part 5247 holds up to 7 pounds per square inch when attached to steel surface.



| CATALOG NO. | DESCRIPTION                      | LENGTH     | UOM | ORDER MULTIPLE |
|-------------|----------------------------------|------------|-----|----------------|
| 5247        | Double Backed Foam Mounting Tape | 1" x 48"   | EA  | 1              |
| 5255        | Vinyl Electrical Tape            | 3/4" x 60' | EA  | 1              |

### Teflon® Tape



| CATALOG NO. | DESCRIPTION              | LENGTH      | UOM | ORDER MULTIPLE |
|-------------|--------------------------|-------------|-----|----------------|
| 5246        | Teflon® Thread Seal Tape | 1/2" x 520" | EA  | 1              |

## GENERAL TOOLS

### Devco Crimpers

Crimps insulated and non-insulated terminals 22 to 10 AWG, cuts bolts #4-40 through #10-24, and strips stranded wire 22 to 10 AWG and solid wire 18 to 8 AWG. Features two precision ground wire cutters, one on the nose and the other behind the pivot point. Plastic cushion handle.



| CATALOG NO. | DESCRIPTION                           | UOM | ORDER MULTIPLE |
|-------------|---------------------------------------|-----|----------------|
| 5002        | Devco Crimpers; plastic coated handle | EA  | 1              |

### Blind Rivet Tools



| CATALOG NO. | DESCRIPTION  | UOM | ORDER MULTIPLE |
|-------------|--|-----|----------------|
| 5107        | Heavy-duty tool; 4 interchangeable nose pieces to accommodate 3/32", 1/8", 5/32", 3/16" steel or aluminum rivets | EA  | 1              |

### Magnetic Hex Chucks

Magnetic Hex Chucks may be used with an electric drill to drive hex washer head screws.



| CATALOG NO. | DESCRIPTION        | SIZE  | HEX HEAD DIAMETER | LENGTH  | UOM | ORDER MULTIPLE |
|-------------|--------------------|-------|-------------------|---------|-----|----------------|
| DE13        | Magnetic Hex Chuck | 1/4"  | 7/16"             | 1-3/4"  | EA  | 1              |
| DE14        | Magnetic Hex Chuck | 5/16" | 1/2"              | 1-3/4"  | EA  | 1              |
| DE15        | Magnetic Hex Chuck | 3/8"  | 9/16"             | 1-7/8"  | EA  | 1              |
| DE23        | Magnetic Hex Chuck | 1/4"  | 7/16"             | 2-9/16" | EA  | 1              |
| DE24        | Magnetic Hex Chuck | 5/16" | 1/2"              | 2-9/16" | EA  | 1              |
| DE25        | Magnetic Hex Chuck | 3/8"  | 9/16"             | 2-9/16" | EA  | 1              |
| DE26        | Magnetic Hex Chuck | 7/16" | 5/8"              | 2-9/16" | EA  | 1              |
| DE33*       | Magnetic Hex Chuck | 1/4"  | 7/16"             | 3"      | EA  | 1              |

\*Magnetic insert bit holder with a "C" ring retainer

**SPECIALTY TOOLS**
**Cable Tie Tensioning Tools**

| CATALOG NO. | DESCRIPTION                        | UOM | ORDER MULTIPLE |
|-------------|------------------------------------|-----|----------------|
| 5007        | Plastic tool for ties up to 75 lb. | EA  | 1              |

**Precision Screwdriver Set**

Set of six screwdrivers. Slotted sizes 1.4mm, 2.0mm, 2.4mm, and 3.0mm Phillips sizes #0 and #1.



| CATALOG NO. | DESCRIPTION                     | UOM | ORDER MULTIPLE |
|-------------|---------------------------------|-----|----------------|
| 5022        | Set of 6 Precision Screwdrivers | EA  | 1              |

**Radiator Vent Keys**

| CATALOG NO. | DESCRIPTION                   | UOM | ORDER MULTIPLE |
|-------------|-------------------------------|-----|----------------|
| DE22        | Radiator Vent Keys, pack of 4 | PK  | 1              |

**Valve Stem Repair Tool**

Removes and installs valve core; extracts damaged core; re-threads inside of stem; re-threads outer part of stem and installs new stem.



| CATALOG NO. | DESCRIPTION            | UOM | ORDER MULTIPLE |
|-------------|------------------------|-----|----------------|
| KD2077      | Valve Stem Repair Tool | EA  | 1              |

**BULBS**
**Incandescent Light Bulbs**

Multi-filaments support increased bulb light. Filaments have solid nickel leads. Brass base is rust and freeze resistant. Bulbs are designed for 130 volts. Rough Service bulbs are designed for maximum vibration resistance. Toughcoat helps prevent shattering on impact for superior safety. Comes in standard pack of six.



| CATALOG NO. | DESCRIPTION  | WATTS | UOM | ORDER MULTIPLE |
|-------------|--|-------|-----|----------------|
| 5262        | General Service Bulbs; rated: 5,000 hours, pack of 6 | 60    | PK  | 1              |
| 5263        | General Service Bulbs; rated: 5,000 hours, pack of 6 | 75    | PK  | 1              |
| 5264        | General Service Bulbs; rated: 5,000 hours, pack of 6 | 100   | PK  | 1              |
| 5265        | General Service Bulbs; rated: 5,000 hours, pack of 6 | 150   | PK  | 1              |
| 5231        | Rough Service Bulbs, pack of 6                       | 75    | PK  | 1              |
| 5232        | Rough Service Bulbs, pack of 6                       | 100   | PK  | 1              |
| 5266        | Rough Service Bulbs, pack of 6                       | 150   | PK  | 1              |
| 5250        | Appliance Bulbs, pack of 6                           | 25    | PK  | 1              |

**POWER CORDS AND WORK LIGHTS**
**Power Block Extension Cords\***

Cords feature multiple outlets. They have three grounded outlets – the most allowed for outdoor use. 15A/125V.



| CATALOG NO. | DESCRIPTION                | WIRE | LENGTH | COLOR  | UOM | ORDER MULTIPLE |
|-------------|----------------------------|------|--------|--------|-----|----------------|
| 5220        | Power Block Extension Cord | 12/3 | 2'     | Yellow | EA  | 1              |
| 5222        | Power Block Extension Cord | 14/3 | 25'    | Orange | EA  | 1              |
| 5206        | Power Block Extension Cord | 12/3 | 50'    | Yellow | EA  | 1              |

**Round Extension Cords\***

Comes in bright orange or yellow, depending upon availability.



| CATALOG NO. | DESCRIPTION          | WIRE | LENGTH | RATING   | UOM | ORDER MULTIPLE |
|-------------|----------------------|------|--------|----------|-----|----------------|
| 5225        | Round Extension Cord | 16/3 | 25'    | 13A/125V | EA  | 1              |
| 5226        | Round Extension Cord | 16/3 | 50'    | 13A/125V | EA  | 1              |
| 5228        | Round Extension Cord | 14/3 | 25'    | 15A/125V | EA  | 1              |
| 5229        | Round Extension Cord | 14/3 | 50'    | 15A/125V | EA  | 1              |
| 5230        | Round Extension Cord | 14/3 | 100'   | 13A/125V | EA  | 1              |

\*Items in this section are Underwriter's Laboratories listed or recognized under the prime manufacturer's name.



## POWER CORDS AND WORK LIGHTS *cont'd*

### Work Lights\*

Retractable Work Light features metal guard, switch, grounded outlet, and 20' cord. Magnetic Work Light features swivel lock handle, grounded outlet, and 25' heavy cord; can be hung or can stand alone with magnetic power.



| CATALOG NO. | DESCRIPTION                                    | UOM | ORDER MULTIPLE |
|-------------|--|-----|----------------|
| 5205        | Retractable Work Light; 7A/125V; 18/3 SVT wire | EA  | 1              |
| 5207        | Magnetic Work Light; 115V; 18/3 SJT wire       | EA  | 1              |

### Trouble Lights\*

All-weather; extra flexible with metal guard.



| CATALOG NO. | DESCRIPTION   | WIRE | CORD LENGTH | RATING   | UOM | ORDER MULTIPLE |
|-------------|---------------|------|-------------|----------|-----|----------------|
| 5200        | Trouble Light | 16/3 | 25'         | 13A/125V | EA  | 1              |
| 5201        | Trouble Light | 16/3 | 50'         | 13A/125V | EA  | 1              |

## STORAGE CONTAINERS

### Metal Parts Boxes

Metal Parts Boxes are prime cold rolled steel with baked gray enamel finish. The finish is rust and acid resistant. Each box comes with high impact plastic tray, positive pull down catch, and stick-back parts labels for lid interiors.



| CATALOG NO. | DESCRIPTION     | NO. OF COMPARTMENTS | DIMENSIONS (L x W x D) | UOM | ORDER MULTIPLE |
|-------------|-----------------|---------------------|------------------------|-----|----------------|
| 8200M       | Metal Parts Box | 21                  | 13-3/8" x 9-1/4" x 2"  | EA  | 1              |
| 8220M       | Metal Parts Box | 24                  | 18" x 12" x 3"         | EA  | 1              |

### Satchel Style Case

Parts box made from rugged copolymer material with high impact translucent lid and handle on the side. 15 removable dividers allow up to 24 compartments.



| CATALOG NO. | DESCRIPTION        | NO. OF COMPARTMENTS | DIMENSIONS (L x W x D) | UOM | ORDER MULTIPLE |
|-------------|--------------------|---------------------|------------------------|-----|----------------|
| 8233        | Satchel Style Case | Up to 24            | 15" x 11-3/4" x 2-1/2" | EA  | 1              |

### Styrene Parts Boxes



| CATALOG NO. | DESCRIPTION       | COLOR | NO. OF COMPARTMENTS | DIMENSIONS (L x W x D)   | UOM | ORDER MULTIPLE |
|-------------|-------------------|-------|---------------------|--------------------------|-----|----------------|
| 8206        | Styrene Parts Box | Clear | 1                   | 4-7/8" x 3-1/4" x 1-1/8" | EA  | 1              |
| 8207        | Styrene Parts Box | Clear | 4                   | 4-7/8" x 3-1/4" x 1-1/8" | EA  | 1              |
| 8208        | Styrene Parts Box | Clear | 6                   | 4-7/8" x 3-1/4" x 1-1/8" | EA  | 1              |

### Polypropylene Parts Boxes

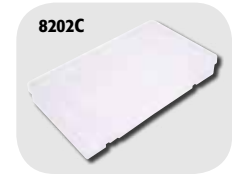

| CATALOG NO. | DESCRIPTION             | COLOR       | NO. OF COMPARTMENTS | DIMENSIONS (L x W x D) | UOM | ORDER MULTIPLE |
|-------------|-------------------------|-------------|---------------------|------------------------|-----|----------------|
| 8201        | Polypropylene Parts Box | Yellow      | 13                  | 11" x 6-3/4" x 1-1/4"  | EA  | 1              |
| 8201C       | Polypropylene Parts Box | Translucent | 13                  | 11" x 6-3/4" x 1-1/4"  | EA  | 1              |
| 8202        | Polypropylene Parts Box | Clear       | 18                  | 11" x 6-3/4" x 1-1/4"  | EA  | 1              |
| 8202C       | Polypropylene Parts Box | Translucent | 18                  | 11" x 6-3/4" x 1-1/4"  | EA  | 1              |
| 8202P       | Polypropylene Parts Box | Translucent | 18                  | 11" x 6-3/8" x 1-3/4"  | EA  | 1              |
| 8203        | Polypropylene Parts Box | Yellow      | 24                  | 11" x 6-3/4" x 1-1/4"  | EA  | 1              |
| 8203C       | Polypropylene Parts Box | Translucent | 24                  | 13-1/8" x 9" x 2-5/8"  | EA  | 1              |

## SAFETY/PROTECTIVE EQUIPMENT

### Dust Mask

Disposable Dust Mask is durable, comfortable, and easy to breathe through. Can be worn with eyeglasses. *Not for use in spray painting or as protection against toxic materials or biohazards.*



| CATALOG NO. | DESCRIPTION                      | UOM | ORDER MULTIPLE |
|-------------|----------------------------------|-----|----------------|
| ER317B      | Disposable Dust Mask – box of 50 | EA  | 1              |

\*Items in this section are Underwriter's Laboratories listed or recognized under the prime manufacturer's name.

# ELECTRICAL

|                                       |         |
|---------------------------------------|---------|
| Bearings .....                        | 144     |
| Capacitors .....                      | 124-126 |
| Compressor Heaters .....              | 146     |
| Conduit, Fittings, Cable .....        | 137-138 |
| Contactors .....                      | 127-128 |
| Disconnect Switches .....             | 132-133 |
| Electrical Supplies .....             | 133-135 |
| Electrical Tapes .....                | 150     |
| Fan Centers .....                     | 129     |
| Fuses .....                           | 136-137 |
| Hard Start Kits .....                 | 126     |
| Monitors .....                        | 141     |
| Motor Brackets .....                  | 144     |
| Motors .....                          | 142-143 |
| Relays .....                          | 128     |
| Stranded Copper THHN Wire .....       | 140     |
| Terminals, Connectors .....           | 149     |
| Thermal Controls .....                | 145     |
| Thermostat Guards .....               | 131     |
| Thermostat Wire .....                 | 132     |
| Thermostats .....                     | 130-131 |
| Time Delays .....                     | 141     |
| Transformers .....                    | 129     |
| Whips .....                           | 139     |
| Wire Connectors .....                 | 146-147 |
| Wire/Cable Ties, Mounts, Clamps ..... | 147-148 |

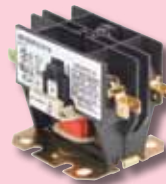

# A/C Disconnect Switches

E  
L  
E  
C  
T  
R  
I  
C  
A  
L

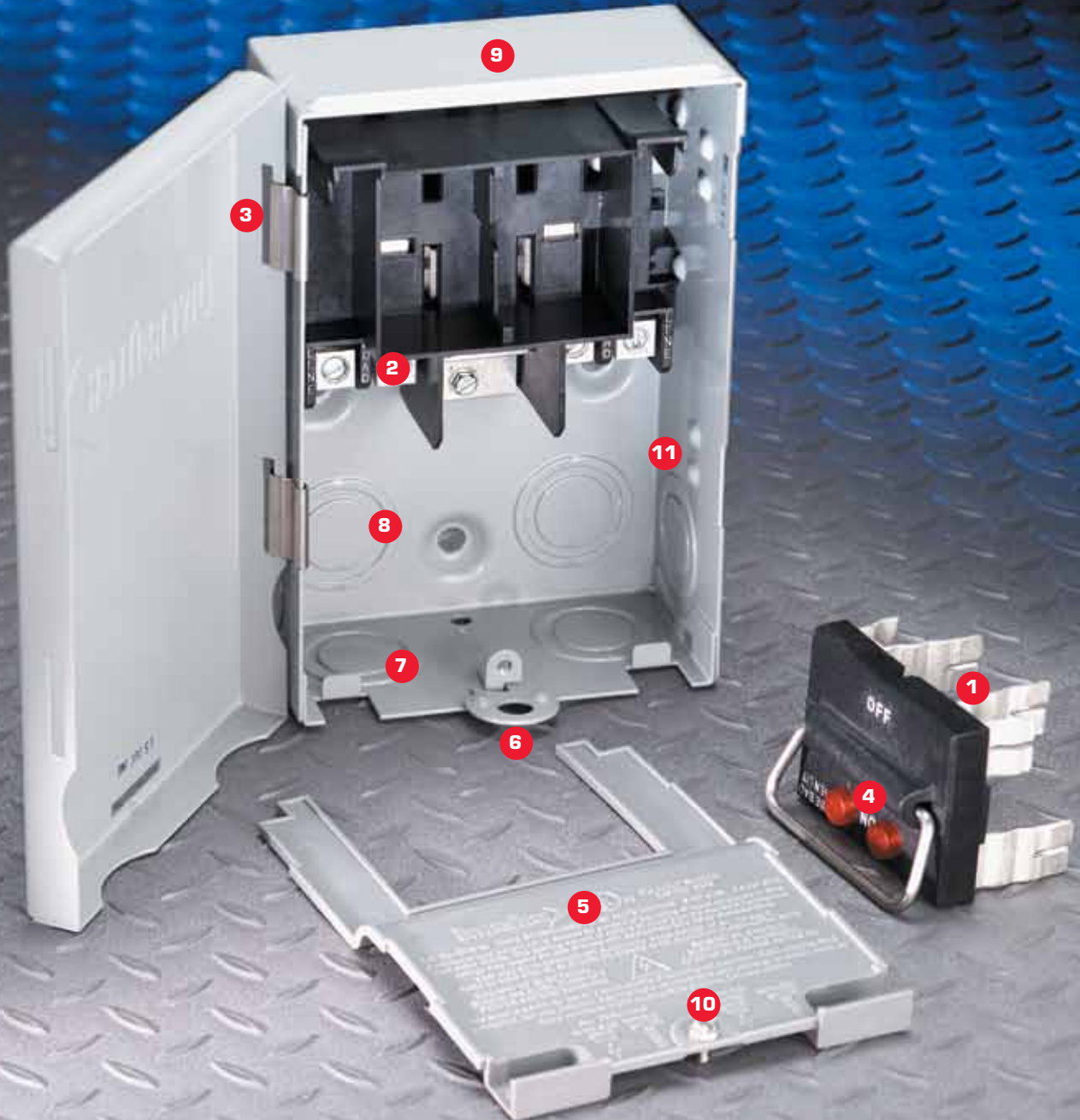

## A/C DISCONNECT FEATURES AND BENEFITS

- 1 Fuses install into pull-out handle
- 2 Line, load, and ground terminals aligned for easy hook up with heavy wires
- 3 Reversible side-opening door
- 4 Indicator lights for blown fuses
- 5 Full dead front
- 6 Folding pivot locking tab
- 7 Knockouts accommodate three sizes (1/2", 3/4", and 1" )
- 8 Rear entry knockouts
- 9 Heavy gauge steel case
- 10 Standard 1/4" head screw on dead front
- 11 Large internal wiring space



### FUSES INSTALL INTO PULL-OUT HANDLE

The DiversiTech disconnect switch is available in two versions – fusible and non-fusible. On the fusible configuration, the pull-out handle also functions as a removable fuse holder. This feature permits easy removal and replacement of fuses. Rather than requiring a fuse puller to reach inside the disconnect switch and remove the blown fuses, one can easily change the fuses with the fuse holder removed from the disconnect switch.

### INDICATOR LIGHT FOR BLOWN FUSE

The fusible disconnect switch has an indicator light for fuse condition. When a fuse is blown, the red indicator light illuminates to show not only that a fuse is bad, but specifically, which fuse needs replacement. This feature provides rapid troubleshooting for the contractor inspecting an installation. One can tell instantly (visually) whether a fuse is bad.



### MOUNTING AND INLINE WIRING

A unique feature to the DiversiTech disconnect switch is the design of wiring terminals inline. This straight-line arrangement provides for quick and easy wire connection — no need to cut the connection wires to different lengths. All wires are easily installed without unnecessary bending or twisting.

### REVERSIBLE SIDE OPENING DOOR

The unique reversible side opening door provides for easy field change from left-hand hinge to right-hand hinge. The standard left-hand hinge is adequate for most all installations except for tight, inside, right-hand corners. In these instances, simply remove the two stainless steel hinge clips and move them to the right-hand side. This permits the door to hinge on the right.



# VARI-TORQUE™ with Precision Relay

## WHY ARE HARD START KITS NEEDED?

### PSC Motors (and Compressors)

A permanent split capacitor – (PSC) motor does not have separate capacitors for starting and running. Rather, a single capacitor, sized somewhere between the appropriate start and run sizes, is used in series with the motor's start winding. This permanently connected capacitor functions as an undersized start capacitor and an oversized run capacitor.

This single capacitor design is energy efficient and works well under low starting torque requirements. When there are higher starting torque needs (as in a hard to start condition), the motor will draw abnormally high current and may not start at all.

When a motor draws higher than normal current in a residential air conditioning installation, lights in the home will dim, and the motor will create excess heat, reducing its usable life.



### Thermostatic Expansion Valves

Use of a thermostatic expansion valve (TEV) can dramatically improve the efficiency of a cooling system. By accurately controlling the system's superheat, the TEV achieves full utilization of evaporator coil surface area.

A drawback to the use of TEVs with PSC motor powered compressors is the need for off-cycle pressure equalization. Specifically, when the system is off, and the compressor is not cycling refrigerant, the TEV is closed. The closed TEV does not allow refrigerant to flow through the system. The non-flowing refrigerant can cause high back pressure on the discharge of the compressor, and hence a hard starting condition. Select TEVs can be sized with a bleed port that allows a small flow of liquid refrigerant to bypass the TEV. Normal industry practice is for bleed holes to equalize systems in 3 to 5 minutes. By definition, TEV bleed ports are very small – normally 0.028" to 0.055". As in any control valve, small holes are prone to corrosion and debris. TEVs with bleed holes are typically available only on original equipment, and are normally not available in the

aftermarket.

The simple solution is to install a hard start kit whenever a TEV is installed on a system.



## TYPES OF HARD START KITS

### PTC Devices

Positive Temperature Coefficient (PTC) equipped hard start kits use a thermally controlled resistor to connect and disconnect the boosting capacitor in the motor circuit.

At ambient temperature, the PTC has low resistance (near short circuit), and hence the boosting capacitor is connected to the motor circuit. As the motor starts, and begins to draw current, the PTC warms up, ultimately reaching a temperature near 180°C, has high resistance (open circuit) and disconnects the boosting capacitor from the motor circuit.

This thermally based capacitor disconnection may or may not be after the motor actually starts. If the boosting capacitor disconnects before the motor starts, the hard start kit has little effect on starting. Once the motor circuit is de-energized, the PTC must cool down to ambient temperature before the boosting capacitor is connected back in the circuit. This cool down process can take 3 to 5 minutes.



### Timing Devices

A hard start kit equipped with a timing device simply uses a several hundred millisecond or several second time delay. This delay leaves the boosting capacitor in the circuit until the timer expires and disconnects it from the motor circuit.

### Voltage Monitoring (Potential Relay) Devices

During starting the voltage present on the auxiliary (starting) winding varies in proportion to the rotor speed and the applied line voltage. When the rotor is stopped or turning at low RPM, the voltage (in electrical terms called potential) is also low. As the motor spins up to speed, the voltage increases to a point where a voltage sensing device (potential relay) opens and disconnects the start boost capacitor.

### Vari-Torque

The best motor starting technology is a combination of voltage monitoring and timing. The Vari-Torque uses a precision relay to monitor voltage, and an adjustable timer to precisely dial in the amount of time the boosting capacitor is connected in the circuit. Vari-Torque allows adjustment of the applied start boost-seconds while maintaining potentiometric protection of the start winding through precision electronic monitoring of the motor's dynamics as the rotor comes up to speed.

This information is available as a contractor handout.  
Order item number LIT-FLY-DST10.

## VARI-TORQUE™ FEATURES AND BENEFITS

### Variable torque adjustment

The variable torque adjustment is unique to the DST-10 from DiversiTech. This feature allows for a single product to be used in a broad range of installations from small appliance compressors to 10 ton refrigeration compressors.



### LED indicating function

The DST-10 incorporates an LED that shows definitively when the hard start kit is working. The LED lights when the DST-10 is assisting with the motor start.



### Simple 2-wire hookup

The DST-10 is furnished complete with two lead wires connected in parallel across the PSC motor's run capacitor. Simply push on terminal connectors to assure a rapid but secure connection.



### Slim consistent cylindrical design

The DST-10 product package does not include any boxy add-on components that make installation difficult.



### Multiple mounting methods

The DST-10 is equipped with a convenient stainless steel clip for simple slide on attachment. Additionally, the DST-10 has a conventional through hole for attachment with a sheet metal screw.



### Piggyback terminals

The DST-10 lead wires have piggyback end terminals in the event the run capacitor does not have a spare terminal available. In this instance, simply disconnect one of the wires attached to the capacitor and re-attach it to the DST-10 piggyback terminal. Then, attach the DST-10 piggyback terminal to the open terminal on the capacitor.



# Fractional Horsepower Motors

## FEATURES AND BENEFITS



**COLOR PACKAGING**

Bright, colorful, easy to read packaging removes confusion about motors. The distributor can easily identify the stock of motors on the shelf. The application, voltage, and horsepower of a motor are visible at a glance.



**CAPACITOR SIZE**

The appropriate size 370 VAC run capacitor is noted on every motor carton.



**INNOVATIVE PACKAGING**

A unique styrofoam cradle inside the motor carton supports and protects the motor, shaft, and mounting bolts during shipment.



**LARGER DIAGRAM**

An extra large wiring diagram is supplied on the motor itself, on the motor carton, and also in the installation and safety instruction sheet. This large wiring diagram makes it very easy to read.

| CROSS REFERENCE GUIDE |          |
|-----------------------|----------|
| WG840728              |          |
| 370V-230 VAC          | 1/4 hp   |
| MARS                  | 03728    |
| PACKARD               | 63128    |
| GEMLINE               | EM3728   |
| MARATHON              | X213     |
| AD SMITH              | FSE10265 |
| FASCO                 | 0909     |

**CROSS REFERENCE**

For your convenience, Wagner provides a complete manufacturer cross-reference on the side of every motor carton.



**LARGE LABEL**

Informative product label contains the motor model number in large type. The UPC code is also printed on every motor label.



**CARTON HANDLE**

The motor carton has been designed with an innovative handle to make the motors much easier to carry.



**EXTENDED BOLTS**

Extended mounting bolts provide for easier installation in cramped spaces. With the longer bolts, the installer is able to more easily start the threaded mounting nut.

This information is available as a contractor handout.  
Order item number LIT-FLY-MOTORS.



**EXTENDED WIRES**

Wagner motor wires are thirty inches long. The added length makes it easier for the contractor to install the new motor.



**WIRE STRIPPING**

Partial stripping leaves the insulation on the motor connection wire. This protects the stranded copper wire and prevents damage to individual strands.



**REVERSING PLUG**

The electrical reversing plug simplifies rotation direction changes.



**INSULATED DISCONNECTS**

Run capacitor connections are insulated for increased safety. Flag disconnects on condenser fan motors and inline disconnects on direct drive furnace blower motors are provided.

## MULTIPLE HORSEPOWER MOTORS

Multiple horsepower motors allow the contractor and distributor to consolidate multiple part codes into a single stocking unit. The multiple horsepower motor allows the contractor to carry one motor that can be used as a replacement for a wide variety of OEM and other replacement motors, saving time and money.



- *All the features and benefits of standard motors*
- *Plus multiple horsepower*
- *Variety of voltages, applications, and speeds are available.*

# Digital 3-Phase Line Voltage Monitor

The DTP-3 is an automatic digital voltage monitor and control system.

By continuously measuring the incoming line voltage, the DTP-3 monitor will detect voltages outside of the tolerance that you set.

If these limits are exceeded, the response timer is started. This timer may be set to a long time value to avoid nuisance tripping, or to a short time value to offer a higher level of load protection.

If the voltage remains outside of the selected tolerance after the time has elapsed, the DTP-3 will turn off its output relay and protect your device. While the load is off, an additional lockout timer is activated to avoid rapid restarts.

- Read Line and Load Side Voltage Instantly
- Simple Three Button Access for Easy Monitoring and Set-Up
- Fault Memory Records Problems for Later Display
- Six Digital Voltmeters Built In
- Sequential Start Timer Built In
- Lock Out Timer Built In
- Response Timer Built In

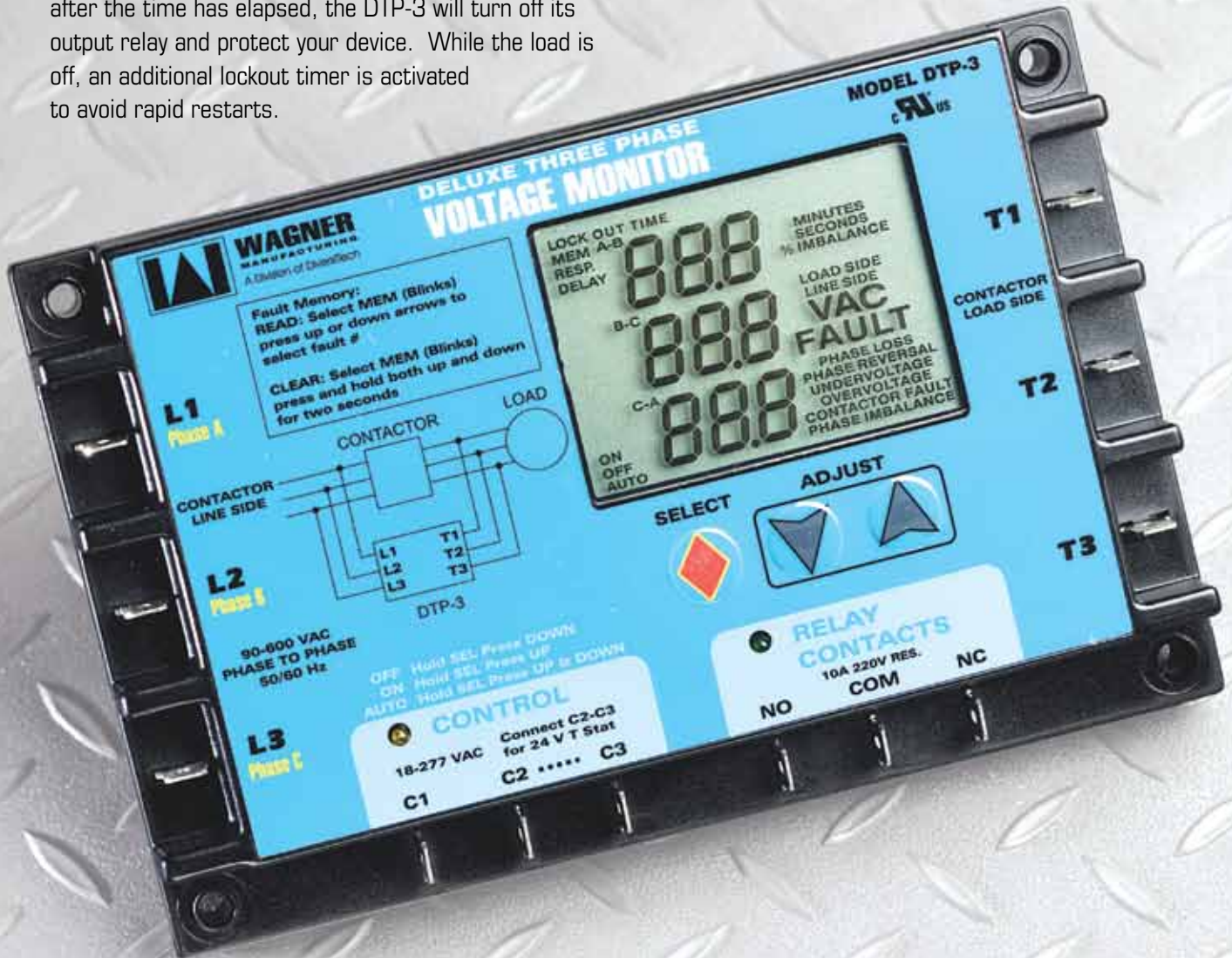

## FEATURES AND BENEFITS

### Large Digital LCD Display

Provides instant display of the system's operating voltage, not just indicator lights. System setup is simplified by using the display to set the exact voltage range you want to monitor. Other controls use dials for system adjustment that can lead to inaccurate settings and motor burnout.

### Super Simple Operation

Just three buttons set up everything. Easy adjustment of voltage tolerance and timers.

### Small Size

Small footprint and low profile fits where other can't.

### 10 Amp Rated Output Relay with Isolated Contacts

Powerful relay can connect to just about any control circuit. Normally-Open and Normally-Closed contacts are provided for connection to any type of system, motor control or alarm.

### 2 LED Indicators

Glowing light-emitting-diodes show applied control voltage and output relay operation at a glance.

### Precision Digital Circuitry

Completely eliminates the ambiguity associated with analog controls and screwdriver adjustments.

### Adjustable Response Time

This timer sets the amount of time between when a voltage outside of the selected tolerance is detected and when the output relay is de-energized. Setting low time values offers faster protection. Setting longer times provides greater resistance to nuisance tripping.

### Adjustable Delay Time

This timer sets the amount of time before the protected system is allowed to restart. Typically this timer is set to a value which allows the protected system to bleed-off high pressures or to cool down to a safe value for restarting.

### Broad Voltage Adjustment Range

User adjustable monitored voltage range from 160 to 650 VAC. This broad adjustment range incorporates voltages for the majority of compressor installation requirements. Therefore, this single unit can be used across a broad range of installations.

## DTP-3 FACTS

### Protection

Loss of Phase, Phase Reversal, Voltage Imbalance, Low Voltage, High Voltage.

### Display

Large custom LCD indicates all operating conditions at a glance. Three large sets of digits provide easy system troubleshooting.

### Voltmeter

Simultaneous display of all three line voltage pairs. One button switches to contactor load side voltage reading.

### Input Voltage Range

90 – 650 VAC at 50 or 60 hertz.

### Voltage Trip Point

Adjustable in 1 percent increments between 6% and 18% of the selected operating voltage. Restart voltage set point fixed at +3%.

### Voltage Symmetry

Adjustable imbalance set point from 2% to 25% of selected operating voltage.

### Lockout Delay Timer

Fully adjustable 0 to 720 seconds (0 to 12 minutes). Digital display shows remaining time and user set points.

### Sequential Start Timer

0 – 30 seconds in 1 second increments.

### Response Timer

0.1 to 20 seconds digital display shows remaining time and user set points.

### Memory

Up to 25 previous fault conditions are recorded for display as desired.

# Monitor Digital Trifasico de Linea de Voltaje

El DTP-3 es un monitor de voltaje y sistema de control automático digital.

Por estar midiendo continuamente la entrada de la línea de voltaje, este monitor detectará voltajes fuera de la tolerancia que se fijó.

Si este limite es excedido arrancará el Regulador de respuesta. Este regulador podrá ser fijado a una mayor escala de tiempo para evitar el ruido molesto del corte y arranque, o a una escala menor de tiempo para ofrecer un mayor nivel de protección de carga.

Si el voltaje permanece fuera de la tolerancia seleccionada después que el tiempo ha transcurrido, el DTP-3 apagará su relevador de rendimiento y protegerá su aparato. Mientras la carga esta apagada un regulador de cierre adicional es activado para evitar arranques inmediatos.

- Lectura de línea y de la carga de voltaje instantáneamente
- Tres simples botones de acceso para fácil monitoreo e instalación
- Registro de problemas en falla de memoria para posterior exhibición
- Seis voltímetros digitales integrados
- Regulador de arranque secuencial integrado
- Regulador de cierre integrado
- Regulador de respuesta integrado



## DTP-3 CARACTERISTICAS Y BENEFICIOS

### La gran pantalla digital LCD

suministra al instante la operación del sistema de voltaje no solo luces indicadoras. El sistema programable es simplificado por usar la pantalla para fijar el rango exacto de voltaje que quiera monitorear. Otros controles usan botones para ajustar el sistema, que pueden dirigir hacia una programación inexacta y falla de motor.

### Operación super simple

solo tres botones operan todo. Fácil ajuste de tolerancia de voltaje y reguladores de tiempo.

### Pequeña medida

y su práctico contorno el cual se ajusta donde otros no pueden.

### Relevador de salida de 10 amps con contactos aislados

Relevador de poder que puede conectarse con cualquier circuito de control. Normalmente-Abierto y Normalmente-Cerrado contactos son suministrados para conectarse a cualquier tipo de sistema, control de motor o alarma.

### 2 indicadores LED

muestran el voltaje de control aplicado y la operación del relevador de salida en un solo vistazo.

### Los circuitos de precisión digital

eliminan completamente la ambigüedad asociada con controles análogos y ajustes de desarmador.

### Regulador de respuesta ajustable

Este regulador fija la cantidad de tiempo cuando un voltaje externo de la tolerancia seleccionada es detectado y cuando el relevador de salida es de-energizado. El fijar valores de tiempo bajos ofrece una más rápida protección. El fijar un tiempo prolongado suministra gran resistencia evitando el ruido molesto del corte y arranque.

### Regulador retardador de tiempo ajustable

Este regulador fija la cantidad de tiempo antes que al sistema de protección se le permita re-iniciar. Típicamente este regulador es fijado a un valor el cual permita al sistema de protección descargar altas presiones o que se enfríe a un valor seguro para re-iniciar.

### Amplio ajuste del rango de voltaje

El usuario monitorea el rango ajustable del voltaje de 160 a 650 VAC. Este amplio rango de ajuste incorpora voltajes para la mayoría de los requerimientos de instalación de compresores. Así mismo, esta unidad puede ser usada a través de un rango amplio de instalaciones.

## DTP-3 HECHOS

### Proteccion

Pérdida de fase, cambio de fase, desequilibrio de voltaje, bajo voltaje, alto voltaje.

### Pantalla

Los LCD hechos a la medida indican todas las condiciones de operación en un vistazo. Tres juegos grandes de dígitos suministran fácilmente los problemas del sistema.

### Voltmetro

Pantalla simultanea de las tres líneas pares de voltaje. Un botón cambia al contactor para la lectura de la carga de voltaje.

### Suministro de voltaje

90-650 VAC a 50 o 60 hertz.

### Margen de error del voltaje

Ajustable en un porcentaje de entre 6% y 18% de la operación del voltaje seleccionado. Re-inicio con un +3% del voltaje establecido.

### Simetria del voltaje

Desequilibrio ajustable establecido de 2% a 25% de la operación del voltaje seleccionado.

### Regulador retardador de cierre

Completamente ajustable de 0 a 720 segundos (0 a 12 minutos) la pantalla digital muestra el tiempo restante y los puntos establecidos por el usuario.

### Arrancador secuencial de tiempo

0 – 30 segundos en incrementos de 1 segundo.

### Regulador de respuesta

0.1 a 20 segundos la pantalla digital muestra el tiempo restante y los puntos establecidos por el usuario.

### Memoria

Hasta 25 condiciones de falla previas son almacenadas para mostrarse según se requiera.

**CAPACITORS**

**Motor Run Capacitors – 370 VAC**

Single capacitance. Oval, metal can.



| CATALOG NO. | uf   | CAN HT. INCHES | UOM | ORDER MULTIPLE |
|-------------|------|----------------|-----|----------------|
| 37020H      | 2    | 2.17           | EA  | 1              |
| 37030H      | 3    | 2.17           | EA  | 1              |
| 37040H      | 4    | 2.17           | EA  | 1              |
| 37050H      | 5    | 2.17           | EA  | 1              |
| 37050HB     | 5    | 2.17           | EA  | 100*           |
| 37060H      | 6    | 1.77           | EA  | 1              |
| 37075H      | 7.5  | 2.17           | EA  | 1              |
| 37075HB     | 7.5  | 2.17           | EA  | 100*           |
| 37100H      | 10   | 2.56           | EA  | 1              |
| 37100HB     | 10   | 2.56           | EA  | 100*           |
| 37125H      | 12.5 | 2.95           | EA  | 1              |
| 37150H      | 15   | 2.95           | EA  | 1              |
| 37175H      | 17.5 | 2.95           | EA  | 1              |
| 37200H      | 20   | 2.56           | EA  | 1              |
| 37250H      | 25   | 2.95           | EA  | 1              |
| 37300H      | 30   | 3.35           | EA  | 1              |
| 37350H      | 35   | 3.35           | EA  | 1              |
| 37400H      | 40   | 3.94           | EA  | 1              |
| 37450H      | 45   | 3.94           | EA  | 1              |
| 37500H      | 50   | 4.53           | EA  | 1              |
| 37600H      | 60   | 4.92           | EA  | 1              |
| 37700H      | 70   | 4.92           | EA  | 1              |
| 37800H      | 80   | 4.53           | EA  | 1              |

\*100 per pack

**Motor Run Capacitors – 370 VAC**

Single capacitance. Round, metal can.



| CATALOG NO. | uf   | CAN HT. INCHES | UOM | ORDER MULTIPLE |
|-------------|------|----------------|-----|----------------|
| 37050R      | 5    | 2.22           | EA  | 1              |
| 37075R      | 7.5  | 2.22           | EA  | 1              |
| 37100R      | 10   | 2.22           | EA  | 1              |
| 37125R      | 12.5 | 2.22           | EA  | 1              |
| 37150R      | 15   | 2.22           | EA  | 1              |
| 37175R      | 17.5 | 2.61           | EA  | 1              |
| 37200R      | 20   | 2.61           | EA  | 1              |
| 37250R      | 25   | 3.00           | EA  | 1              |
| 37300R      | 30   | 2.95           | EA  | 1              |
| 37350R      | 35   | 3.35           | EA  | 1              |
| 37400R      | 40   | 3.54           | EA  | 1              |
| 37450R      | 45   | 3.00           | EA  | 1              |
| 37500R      | 50   | 3.00           | EA  | 1              |
| 37550R      | 55   | 3.00           | EA  | 1              |
| 37600R      | 60   | 4.53           | EA  | 1              |
| 37800R      | 80   | 3.99           | EA  | 1              |

**Motor Run Capacitors – 370 VAC**

Dual capacitance. Oval, metal can.



| CATALOG NO. | uf     | CAN HT. INCHES | UOM | ORDER MULTIPLE |
|-------------|--------|----------------|-----|----------------|
| 3GJ0515     | 15+5   | 2.95           | EA  | 1              |
| 3GJ1015     | 15+10  | 2.95           | EA  | 1              |
| 3GJ0520     | 20+5   | 2.95           | EA  | 1              |
| 3GJ1520     | 20+15  | 3.94           | EA  | 1              |
| 3GJ0525     | 25+5   | 3.35           | EA  | 1              |
| 3GJ1025     | 25+10  | 2.95           | EA  | 1              |
| 3GJ0330     | 30+3   | 3.94           | EA  | 1              |
| 3GJ0530     | 30+5   | 3.94           | EA  | 1              |
| 3GJ7530     | 30+7.5 | 3.94           | EA  | 1              |
| 3GJ0535     | 35+5   | 3.94           | EA  | 1              |
| 3GJ7535     | 35+7.5 | 3.94           | EA  | 1              |
| 3GJ7545     | 45+7.5 | 3.94           | EA  | 1              |
| 3GJ0540     | 40+5   | 3.94           | EA  | 1              |
| 3GJ0545     | 45+5   | 4.53           | EA  | 1              |
| 3GJ0555     | 55+5   | 4.92           | EA  | 1              |
| 3GJ7555     | 55+7.5 | 4.92           | EA  | 1              |
| 3GJ1060     | 60+10  | 4.92           | EA  | 1              |

**Motor Run Capacitors – 370 VAC**

Dual capacitance. Round, metal can.



| CATALOG NO. | uf     | CAN HT. INCHES | UOM | ORDER MULTIPLE |
|-------------|--------|----------------|-----|----------------|
| 3GR0325     | 25+3   | 3.00           | EA  | 1              |
| 3GR0330     | 30+3   | 3.00           | EA  | 1              |
| 3GR0335     | 35+3   | 3.40           | EA  | 1              |
| 3GR0340     | 40+3   | 3.99           | EA  | 1              |
| 3GR0425     | 25+4   | 3.00           | EA  | 1              |
| 3GR0525     | 25+5   | 3.54           | EA  | 1              |
| 3GR0530     | 30+5   | 3.54           | EA  | 1              |
| 3GR7530     | 30+7.5 | 3.40           | EA  | 1              |
| 3GR0435     | 35+4   | 3.40           | EA  | 1              |
| 3GR0515     | 15+5   | 2.61           | EA  | 1              |
| 3GR0520     | 20+5   | 2.61           | EA  | 1              |
| 3GR0535     | 35+5   | 3.74           | EA  | 1              |
| 3GR0540     | 40+5   | 3.94           | EA  | 1              |
| 3GR0545     | 45+5   | 3.74           | EA  | 1              |
| 3GR0550     | 50+5   | 3.54           | EA  | 1              |
| 3GR0555     | 55+5   | 3.40           | EA  | 1              |
| 3GR0560     | 60+5   | 3.54           | EA  | 1              |
| 3GR0570     | 70+5   | 3.99           | EA  | 1              |
| 3GR0580     | 80+5   | 5.96           | EA  | 1              |
| 3GR1080     | 80+10  | 5.16           | EA  | 1              |
| 3GR7540     | 40+7.5 | 3.99           | EA  | 1              |
| 3GR7555     | 55+7.5 | 3.40           | EA  | 1              |
| 3GR7560     | 60+7.5 | 3.40           | EA  | 1              |
| 3GR7580     | 80+7.5 | 3.40           | EA  | 1              |
| 3GR1035     | 35+10  | 3.99           | EA  | 1              |

**Motor Run Capacitors – 440 VAC**

Single capacitance. Oval, metal can.



| CATALOG NO. | uf   | CAN HT. INCHES | UOM | ORDER MULTIPLE |
|-------------|------|----------------|-----|----------------|
| 45020H      | 2    | 1.77           | EA  | 1              |
| 45030H      | 3    | 1.77           | EA  | 1              |
| 45040H      | 4    | 2.17           | EA  | 1              |
| 45050H      | 5    | 2.17           | EA  | 1              |
| 45060H      | 6    | 2.95           | EA  | 1              |
| 45075H      | 7.5  | 2.17           | EA  | 1              |
| 45100H      | 10   | 2.56           | EA  | 1              |
| 45125H      | 12.5 | 2.95           | EA  | 1              |
| 45150H      | 15   | 2.95           | EA  | 1              |
| 45175H      | 17.5 | 3.94           | EA  | 1              |
| 45200H      | 20   | 2.56           | EA  | 1              |
| 45250H      | 25   | 2.95           | EA  | 1              |
| 45300H      | 30   | 3.35           | EA  | 1              |
| 45350H      | 35   | 3.35           | EA  | 1              |
| 45400H      | 40   | 3.94           | EA  | 1              |
| 45450H      | 45   | 3.94           | EA  | 1              |
| 45500H      | 50   | 4.53           | EA  | 1              |
| 45550H      | 55   | 4.53           | EA  | 1              |
| 45600H      | 60   | 5.31           | EA  | 1              |
| 45700H      | 70   | 3.75           | EA  | 1              |
| 45800H      | 80   | 3.75           | EA  | 1              |

**Motor Run Capacitors – 440 VAC**

Dual capacitance. Oval, metal can.



| CATALOG NO. | uf     | CAN HT. INCHES | UOM | ORDER MULTIPLE |
|-------------|--------|----------------|-----|----------------|
| 4JJ0525     | 25+5   | 3.35           | EA  | 1              |
| 4JJ0530     | 30+5   | 3.94           | EA  | 1              |
| 4JJ0535     | 35+5   | 3.94           | EA  | 1              |
| 4JJ0540     | 40+5   | 3.94           | EA  | 1              |
| 4JJ0545     | 45+5   | 4.53           | EA  | 1              |
| 4JJ0555     | 55+5   | 3.75           | EA  | 1              |
| 4JJ7535     | 35+7.5 | 4.92           | EA  | 1              |
| 4JJ7540     | 40+7.5 | 4.92           | EA  | 1              |
| 4JJ7545     | 45+7.5 | 4.92           | EA  | 1              |
| 4JJ1055     | 55+10  | 3.75           | EA  | 1              |
| 4JJ0560     | 60+5   | 4.92           | EA  | 1              |

**Motor Run Capacitors – 440 VAC**

Single capacitance. Round, metal can.



| CATALOG NO. | uf   | CAN HT. INCHES | UOM | ORDER MULTIPLE |
|-------------|------|----------------|-----|----------------|
| 45150R      | 15   | 2.61           | EA  | 1              |
| 45175R      | 17.5 | 2.95           | EA  | 1              |
| 45200R      | 20   | 3.40           | EA  | 1              |
| 45250R      | 25   | 2.95           | EA  | 1              |
| 45300R      | 30   | 3.99           | EA  | 1              |
| 45350R      | 35   | 3.94           | EA  | 1              |
| 45400R      | 40   | 3.94           | EA  | 1              |
| 45450R      | 45   | 4.53           | EA  | 1              |
| 45500R      | 50   | 4.92           | EA  | 1              |
| 45550R      | 55   | 3.99           | EA  | 1              |
| 45600R      | 60   | 4.53           | EA  | 1              |
| 45800R      | 80   | 4.97           | EA  | 1              |

**Motor Run Capacitors – 440 VAC**

Dual capacitance. Round, metal can.



| CATALOG NO. | uf     | CAN HT. INCHES | UOM | ORDER MULTIPLE |
|-------------|--------|----------------|-----|----------------|
| 4JR0525     | 25+5   | 3.54           | EA  | 1              |
| 4JR7525     | 25+7.5 | 3.99           | EA  | 1              |
| 4JR0530     | 30+5   | 3.54           | EA  | 1              |
| 4JR7530     | 30+7.5 | 3.88           | EA  | 1              |
| 4JR0535     | 35+5   | 3.74           | EA  | 1              |
| 4JR7535     | 35+7.5 | 3.54           | EA  | 1              |
| 4JR0440     | 40+4   | 3.40           | EA  | 1              |
| 4JR0540     | 40+5   | 3.54           | EA  | 1              |
| 4JR7540     | 40+7.5 | 4.72           | EA  | 1              |
| 4JR0545     | 45+5   | 3.74           | EA  | 1              |
| 4JR7545     | 45+7.5 | 3.40           | EA  | 1              |
| 4JR0550     | 50+5   | 4.13           | EA  | 1              |
| 4JR7550     | 50+7.5 | 3.40           | EA  | 1              |
| 4JR0555     | 55+5   | 4.92           | EA  | 1              |
| 4JR1055     | 55+10  | 4.57           | EA  | 1              |
| 4JR7555     | 55+7.5 | 3.40           | EA  | 1              |
| 4JR0560     | 60+5   | 4.92           | EA  | 1              |
| 4JR7560     | 60+7.5 | 5.91           | EA  | 1              |
| 4JR1060     | 60+10  | 3.99           | EA  | 1              |

**CAPACITORS cont'd**

**Motor Start Capacitors – 110/125 VAC**

Variable capacitance. Round, plastic can.



| CATALOG NO. | uf        | CASE DIAMETER | CAN HT. INCHES | UOM | ORDER MULTIPLE |
|-------------|-----------|---------------|----------------|-----|----------------|
| 56-72       | 56-72     | 1.437         | 2.75           | EA  | 1              |
| 88-108      | 88-108    | 1.437         | 2.75           | EA  | 1              |
| 108-130     | 108-130   | 1.437         | 2.75           | EA  | 1              |
| 124-156     | 124-156   | 1.437         | 2.75           | EA  | 1              |
| 145-175     | 145-175   | 1.437         | 2.75           | EA  | 1              |
| 161-193     | 161-193   | 1.437         | 2.75           | EA  | 1              |
| 189-227     | 189-227   | 1.437         | 2.75           | EA  | 1              |
| 200-240     | 200-240   | 1.437         | 2.75           | EA  | 1              |
| 216-259     | 216-259   | 1.437         | 2.75           | EA  | 1              |
| 233-292     | 233-292   | 1.437         | 2.75           | EA  | 1              |
| 270-324     | 270-324   | 1.437         | 2.75           | EA  | 1              |
| 324-388     | 324-388   | 1.437         | 2.75           | EA  | 1              |
| 340-408     | 340-408   | 1.437         | 3.37           | EA  | 1              |
| 378-440     | 378-440   | 1.437         | 3.37           | EA  | 1              |
| 400-480     | 400-480   | 1.437         | 3.37           | EA  | 1              |
| 460-552     | 460-552   | 1.437         | 3.37           | EA  | 1              |
| 540-648     | 540-648   | 1.812         | 3.37           | EA  | 1              |
| 590-708     | 590-708   | 1.812         | 3.37           | EA  | 1              |
| 708-850     | 708-850   | 1.812         | 3.37           | EA  | 1              |
| 829-995     | 829-995   | 2.062         | 4.37           | EA  | 1              |
| 1000-1200   | 1000-1200 | 2.062         | 4.37           | EA  | 1              |

**Motor Start Capacitors – 220/250 VAC**

Variable capacitance. Round, plastic can.



| CATALOG NO. | uf      | CASE DIAMETER | CAN HT. INCHES | UOM | ORDER MULTIPLE |
|-------------|---------|---------------|----------------|-----|----------------|
| 43-53220    | 43-53   | 1.437         | 3.365          | EA  | 1              |
| 56-72220    | 56-72   | 1.437         | 2.75           | EA  | 1              |
| 72-88220    | 72-88   | 1.812         | 3.365          | EA  | 1              |
| 88-108220   | 88-108  | 1.812         | 3.37           | EA  | 1              |
| 108-130220  | 108-130 | 1.812         | 3.37           | EA  | 1              |
| 124-156220  | 124-156 | 1.812         | 3.37           | EA  | 1              |
| 145-175220  | 145-175 | 1.812         | 3.37           | EA  | 1              |
| 161-193220  | 161-193 | 1.812         | 4.37           | EA  | 1              |
| 189-227220  | 189-227 | 2.062         | 3.37           | EA  | 1              |
| 216-259220  | 216-259 | 2.062         | 3.37           | EA  | 1              |
| 233-292220  | 233-292 | 2.062         | 3.37           | EA  | 1              |
| 270-324220  | 270-324 | 2.062         | 4.37           | EA  | 1              |

**Motor Start Capacitors – 330 VAC**

Variable capacitance. Round, plastic can.



| CATALOG NO. | uf      | CASE DIAMETER | CAN HT. INCHES | UOM | ORDER MULTIPLE |
|-------------|---------|---------------|----------------|-----|----------------|
| 43-53330    | 45-53   | 1.812         | 3.365          | EA  | 1              |
| 72-88330    | 72-88   | 1.812         | 3.365          | EA  | 1              |
| 88-108330   | 88-108  | 1.812         | 3.37           | EA  | 1              |
| 108-130330  | 108-130 | 2.062         | 4.37           | EA  | 1              |
| 124-156330  | 124-156 | 2.062         | 4.37           | EA  | 1              |
| 145-175330  | 145-175 | 2.062         | 4.37           | EA  | 1              |
| 161-193330  | 161-193 | 2.062         | 4.37           | EA  | 1              |
| 189-227330  | 189-227 | 2.062         | 4.37           | EA  | 1              |
| 216-259330  | 216-259 | 2.062         | 4.37           | EA  | 1              |
| 270-324330  | 270-324 | 2.062         | 4.37           | EA  | 1              |

**HARD START KITS**

**Torque Plus – DST-5 300% Boost, DST-6 500% Boost**

Totally solid state, our DST-5 is just right for all permanent split capacitor (PSC) compressors from 1/2 to 10 H.P. It can be used on units that operate on 120 through 288 Volts. The DST-6 offers a larger capacitor for severely hard-to-start compressors. The DST-6 can be used on all PSC single phase compressors from 1-1/2 to 10 H.P. A unique combination of relay and safety timer. The capacitor is automatically disconnected in 0.5 seconds if the compressor fails to start.



| CATALOG NO. | DESCRIPTION                          | UOM | ORDER MULTIPLE |
|-------------|--------------------------------------|-----|----------------|
| DST-5       | Torque Plus – 300% Torque Multiplier | EA  | 1              |
| DST-6       | Torque Plus – 500% Torque Multiplier | EA  | 1              |

**VariTorque™ 690% Boost, Adjustable & Automatic, Instant Recycling**

The next generation in Compressor Hard Start technology – the Varitorque™ 690% Boost, Instant Recycling Hard Start Kit. Adjustable starting torque allows installer to optimize motor starting and minimize problems normally associated with hard start kits. Adjust to reduce electrical load problems including light flicker on compressor startup. Includes patent pending circuitry which protects capacitor, motor and relay. LED indicator provides easy 2 wire hookup. 1/2 to 10 HP.



| CATALOG NO. | DESCRIPTION               | UOM | ORDER MULTIPLE |
|-------------|---------------------------|-----|----------------|
| DST-10      | VariTorque Hard Start Kit | EA  | 1              |



Literature – Download all literature from the DiversiTech website using the Form ID shown in the icon. The URL is [www.diversitech.com/literature/FORMID.pdf](http://www.diversitech.com/literature/FORMID.pdf)

### DiversiTech Definite Purpose Contactors

Two pole, small frame.



| CATALOG NO. | FL AMPS | COIL VAC | UOM | ORDER MULTIPLE |
|-------------|---------|----------|-----|----------------|
| EC30224     | 30      | 24       | EA  | 1              |
| EC302120    | 30      | 120      | EA  | 1              |
| EC302240    | 30      | 240      | EA  | 1              |
| EC40224     | 40      | 24       | EA  | 1              |
| EC402120    | 40      | 120      | EA  | 1              |
| EC402240    | 40      | 240      | EA  | 1              |

### DiversiTech Three Pole Definite Purpose Contactors

Three pole, large frame.



| CATALOG NO. | FL AMPS | COIL VAC | UOM | ORDER MULTIPLE |
|-------------|---------|----------|-----|----------------|
| EC30324     | 30      | 24       | EA  | 1              |
| EC303120    | 30      | 120      | EA  | 1              |
| EC303240    | 30      | 240      | EA  | 1              |
| EC40324     | 40      | 24       | EA  | 1              |
| EC403120    | 40      | 120      | EA  | 1              |
| EC403240    | 40      | 240      | EA  | 1              |

### Definite Purpose Contactors

Three pole, large frame. 30-40 Amp contactors work with the DD11 auxiliary contacts, and 50-90 Amp contactors work with the D10 and D11 auxiliary contacts.



| CATALOG NO. | FL AMPS | COIL VAC | UOM | ORDER MULTIPLE |
|-------------|---------|----------|-----|----------------|
| DP30324     | 30      | 24       | EA  | 1              |
| DP303120    | 30      | 120      | EA  | 1              |
| DP303240    | 30      | 240      | EA  | 1              |
| DP40324     | 40      | 24       | EA  | 1              |
| DP403120    | 40      | 120      | EA  | 1              |
| DP403240    | 40      | 240      | EA  | 1              |
| DP50324     | 50      | 24       | EA  | 1              |
| DP503120    | 50      | 120      | EA  | 1              |
| DP503240    | 50      | 240      | EA  | 1              |
| DP60324     | 60      | 24       | EA  | 1              |
| DP603120    | 60      | 120      | EA  | 1              |
| DP603240    | 60      | 240      | EA  | 1              |
| DP75324     | 75      | 24       | EA  | 1              |
| DP753120    | 75      | 120      | EA  | 1              |
| DP753240    | 75      | 240      | EA  | 1              |
| DP90324     | 90      | 24       | EA  | 1              |
| DP903120    | 90      | 120      | EA  | 1              |
| DP903240    | 90      | 240      | EA  | 1              |

### Definite Purpose Contactors

Single pole, small frame. These contactors will work with the DD11 auxiliary contacts.



| CATALOG NO. | FL AMPS | COIL VAC | UOM | ORDER MULTIPLE |
|-------------|---------|----------|-----|----------------|
| DP30124     | 30      | 24       | EA  | 1              |
| DP301120    | 30      | 120      | EA  | 1              |
| DP301240    | 30      | 240      | EA  | 1              |

### Definite Purpose Contactors

Two pole, small frame. These contactors will work with the DD11 auxiliary contacts.

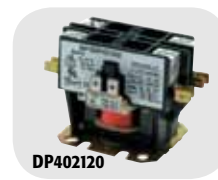

| CATALOG NO. | FL AMPS | COIL VAC | UOM | ORDER MULTIPLE |
|-------------|---------|----------|-----|----------------|
| DP25224     | 25      | 24       | EA  | 1              |
| DP252120    | 25      | 120      | EA  | 1              |
| DP252240    | 25      | 240      | EA  | 1              |
| DP30224     | 30      | 24       | EA  | 1              |
| DP302120    | 30      | 120      | EA  | 1              |
| DP302240    | 30      | 240      | EA  | 1              |
| DP40224     | 40      | 24       | EA  | 1              |
| DP402120    | 40      | 120      | EA  | 1              |
| DP402240    | 40      | 240      | EA  | 1              |

### Definite Purpose Contactors

Four pole, large frame. These contactors will work with the DD11 auxiliary contacts.



| CATALOG NO. | FL AMPS | COIL VAC | UOM | ORDER MULTIPLE |
|-------------|---------|----------|-----|----------------|
| DP304120    | 30      | 120      | EA  | 1              |
| DP30424     | 30      | 24       | EA  | 1              |
| DP304240    | 30      | 240      | EA  | 1              |
| DP304277    | 30      | 277      | EA  | 1              |
| DP404120    | 40      | 120      | EA  | 1              |
| DP40424     | 40      | 24       | EA  | 1              |
| DP404240    | 40      | 240      | EA  | 1              |
| DP404277    | 40      | 277      | EA  | 1              |

**CONTACTORS cont'd**

**Contactor Accessories**

Replacement coils.



| CATALOG NO. | CONTACTOR FRAME SIZE | VOLTAGE | UOM | ORDER MULTIPLE |
|-------------|----------------------|---------|-----|----------------|
| DA2V14      | 50-60 Amp            | 24      | EA  | 1              |
| DA2V02      | 50-60 Amp            | 120     | EA  | 1              |
| DA2V09      | 50-60 Amp            | 240     | EA  | 1              |
| DA2V06      | 50-60 Amp            | 480     | EA  | 1              |
| DA3V14      | 75-90 Amp            | 24      | EA  | 1              |
| DA3V02      | 75-90 Amp            | 120     | EA  | 1              |
| DA3V09      | 75-90 Amp            | 240     | EA  | 1              |
| DA3V06      | 75-90 Amp            | 480     | EA  | 1              |

**Contactor Accessories**

D10 and D11 auxiliary contacts are designed for 50 Amp to 90 Amp 3 pole contactors while the DD11 auxiliary contacts are designed for 20 to 40 Amp 3 pole contactors.



| CATALOG NO. | CONTACTOR FRAME SIZE | VOLTAGE   | UOM | ORDER MULTIPLE |
|-------------|----------------------|-----------|-----|----------------|
| D10         | 1-N.O.               | 50-90 Amp | EA  | 1              |
| D11         | 1-N.O. 1-N.C.        | 50-90 Amp | EA  | 1              |
| DD11        | 1-N.O. 1-N.C.        | 20-40 Amp | EA  | 1              |

**RELAYS**

**General Purpose Relays – 9400 Series**

| CATALOG NO. | DESCRIPTION | AMPS RES | FLA/LRA@125V | FLA/LRA@250V | COIL VOLTAGE | UOM | ORDER MULTIPLE |
|-------------|-------------|----------|--------------|--------------|--------------|-----|----------------|
| D90-360     | SPST-NO     | 18       | 12/60        | 8/48         | 24 VAC       | EA  | 1              |
| D90-362     | SPST-NO     | 18       | 12/60        | 8/48         | 120 VAC      | EA  | 1              |
| D90-364     | SPST-NO     | 18       | 12/60        | 8/48         | 240 VAC      | EA  | 1              |
| D90-370     | SPDT        | 18       | 12/60        | 8/48         | 24 VAC       | EA  | 1              |
| D90-372     | SPDT        | 18       | 12/60        | 8/48         | 120 VAC      | EA  | 1              |
| D90-374     | SPDT        | 18       | 12/60        | 8/48         | 240 VAC      | EA  | 1              |
| D90-380     | SPST NO+NC  | 18       | 12/60        | 8/48         | 24 VAC       | EA  | 1              |
| D90-382     | SPST NO+NC  | 18       | 12/60        | 8/48         | 120 VAC      | EA  | 1              |
| D90-384     | SPST NO+NC  | 18       | 12/60        | 8/48         | 240 VAC      | EA  | 1              |



**General Purpose Relays – 8400 Series**



| CATALOG NO. | DESCRIPTION | AMPS RES/IND | COIL VOLTAGE | UOM | ORDER MULTIPLE |
|-------------|-------------|--------------|--------------|-----|----------------|
| D90-290Q    | SPST-NO     | 16/8         | 24 VAC       | EA  | 1              |
| D90-291Q    | SPST-NO     | 16/8         | 120 VAC      | EA  | 1              |
| D90-292Q    | SPST-NO     | 16/8         | 240 VAC      | EA  | 1              |
| D90-293Q    | SPDT        | 8/8          | 24 VAC       | EA  | 1              |
| D90-294Q    | SPDT        | 8/8          | 120 VAC      | EA  | 1              |
| D90-295Q    | SPDT        | 8/8          | 240 VAC      | EA  | 1              |

**Potential Relays**



| CATALOG NO. | COIL VOLTAGE | PICK-UP MIN | PICK-UP MAX | DROP-OUT MAX | UOM | ORDER MULTIPLE |
|-------------|--------------|-------------|-------------|--------------|-----|----------------|
| DPR063      | 168          | 140         | 153         | 45           | EA  | 1              |
| DPR064      | 395          | 242         | 272         | 140          | EA  | 1              |
| DPR065      | 332          | 171         | 184         | 90           | EA  | 1              |
| DPR066      | 395          | 223         | 252         | 130          | EA  | 1              |
| DPR067      | 420          | 300         | 328         | 121          | EA  | 1              |
| DPR068      | 502          | 314         | 342         | 135          | EA  | 1              |
| DPR069      | 395          | 180         | 195         | 105          | EA  | 1              |
| DPR071      | 420          | 223         | 259         | 121          | EA  | 1              |

**General Purpose Switching Relays**



| CATALOG NO. | COIL VOLTAGE | TERMINALS 1-2-3 | TERMINALS 4-5-6 | UOM | ORDER MULTIPLE |
|-------------|--------------|-----------------|-----------------|-----|----------------|
| D-90340     | 24           | POWER           | POWER           | EA  | 1              |
| D-90341     | 110/120      | POWER           | POWER           | EA  | 1              |
| D-90342     | 208/240      | POWER           | POWER           | EA  | 1              |

## FAN CENTERS

Low voltage for one and two speed fan motors; auxiliary circuits in heating, cooling, or heating/cooling applications.

- DPDT Relay
- UL, CUR file E237660
- Color-coded pre-stripped leads
- 24V coil voltage, power, and duty rated contacts
- Mounts directly to 4" electrical box



| CATALOG NO.    | VOLTAGE | UOM | ORDER MULTIPLE |
|----------------|---------|-----|----------------|
| <b>D-90113</b> | 120     | EA  | 1              |
| <b>D-90118</b> | 208/240 | EA  | 1              |

## TRANSFORMERS

### Transformers – Class 2 1585 UL Recognized



| CATALOG NO.  | VA | PRI         | SEC | UOM | ORDER MULTIPLE |
|--------------|----|-------------|-----|-----|----------------|
| <b>T1401</b> | 40 | 120         | 24  | EA  | 1              |
| <b>T1403</b> | 40 | 208/240     | 24  | EA  | 1              |
| <b>T1404</b> | 40 | 120/208/240 | 24  | EA  | 1              |

### Transformers – Class 2 1585 UL Recognized

Plate-mount with terminal connection.



| CATALOG NO.  | VA | PRI         | SEC | UOM | ORDER MULTIPLE |
|--------------|----|-------------|-----|-----|----------------|
| <b>T4401</b> | 40 | 120         | 24  | EA  | 1              |
| <b>T4403</b> | 40 | 120/208/240 | 24  | EA  | 1              |
| <b>T4501</b> | 50 | 120/208/240 | 24  | EA  | 1              |

### Transformers – Class 2 1585 UL Recognized



| CATALOG NO.  | VA | PRI         | SEC | UOM | ORDER MULTIPLE |
|--------------|----|-------------|-----|-----|----------------|
| <b>T2401</b> | 40 | 120         | 24  | EA  | 1              |
| <b>T2402</b> | 40 | 277         | 24  | EA  | 1              |
| <b>T2403</b> | 40 | 208/240     | 24  | EA  | 1              |
| <b>T2404</b> | 40 | 120/208/240 | 24  | EA  | 1              |

### Transformers – Class 2 1585 UL Recognized

Multi-mount with wire connection secondary.



| CATALOG NO.  | VA | PRI         | SEC       | UOM | ORDER MULTIPLE |
|--------------|----|-------------|-----------|-----|----------------|
| <b>T5401</b> | 40 | 120         | 24        | EA  | 1              |
| <b>T5403</b> | 50 | 120/208/240 | 24        | EA  | 1              |
| <b>T5404</b> | 50 | 120/208/240 | 24/12/2.5 | EA  | 1              |

### Transformers – Class 2 1585 UL Recognized

Multi-mount with terminal connection secondary.



| CATALOG NO.  | VA        | PRI         | SEC | UOM | ORDER MULTIPLE |
|--------------|-----------|-------------|-----|-----|----------------|
| <b>T3401</b> | <b>40</b> | 120         | 24  | EA  | 1              |
| <b>T3402</b> | <b>40</b> | 208/240     | 24  | EA  | 1              |
| <b>T3403</b> | <b>40</b> | 120/208/240 | 24  | EA  | 1              |
| <b>T3501</b> | <b>50</b> | 120/208/240 | 24  | EA  | 1              |

### Transformers – Class 2 1585 UL Recognized

Heavy duty with external fuse (T67XX) or circuit breaker (T77XX).



| CATALOG NO.  | VA | PRI             | SEC | UOM | ORDER MULTIPLE |
|--------------|----|-----------------|-----|-----|----------------|
| <b>T6751</b> | 75 | 480             | 24  | EA  | 1              |
| <b>T6752</b> | 75 | 120/208/240     | 24  | EA  | 1              |
| <b>T6753</b> | 75 | 120/208/240/480 | 24  | EA  | 1              |
| <b>T7751</b> | 75 | 120/208/240     | 24  | EA  | 1              |
| <b>T7752</b> | 75 | 120/208/240/480 | 24  | EA  | 1              |

**THERMOSTATS**

**9400 Series Digital Non-Programmable Thermostat**

- ROBERTSHAW
- 1 Heat/1 Cool
- Large Back-lit Display
- Winter and Summer Setpoint Memory
- 24V Heating & Cooling System Compatibility
- Compressor Short Cycle Protection
- When discontinued, replace with 675-RS4110



675-9400

| CATALOG NO. | DESCRIPTION                         | UOM | ORDER MULTIPLE |
|-------------|-------------------------------------|-----|----------------|
| 675-9400    | Digital Non-Programmable Thermostat | EA  | 1              |

**9420 Series Digital Non-Programmable Thermostat**

- ROBERTSHAW
- 2 Heat/2 Cool
- Large Back-lit Display
- Winter and Summer Setpoint Memory
- 24V Heating & Cooling System Compatibility
- Adjustable 1st and 2nd Stage Differential
- When discontinued, replace with 675-RS4220



675-9420

| CATALOG NO. | DESCRIPTION                        | UOM | ORDER MULTIPLE |
|-------------|------------------------------------|-----|----------------|
| 675-9420    | 2 Heat/2 Cool Heat Pump Thermostat | EA  | 1              |

**9500 Series Digital Non-Programmable Thermostat**

- ROBERTSHAW
- 1 Heat/1 Cool
- Compatible with all standard 24 VAC heating and cooling systems
- O & B Terminals
- Automatic Compressor Short Cycle Protection
- When discontinued, replace with 675-RS4110



675-9500

| CATALOG NO. | DESCRIPTION                      | UOM | ORDER MULTIPLE |
|-------------|----------------------------------|-----|----------------|
| 675-9500    | 1 Heat/1 Cool Digital Thermostat | EA  | 1              |

**9505 Series Digital Non-Programmable Thermostat**

- ROBERTSHAW
- 1 Heat
- Compatible with all standard 24 VAC or millivolt heating systems
- Positive Off Switch
- When discontinued, replace with 675-RS4110



675-9505

| CATALOG NO. | DESCRIPTION               | UOM | ORDER MULTIPLE |
|-------------|---------------------------|-----|----------------|
| 675-9505    | 1 Heat Digital Thermostat | EA  | 1              |

**9515 Series Digital Non-Programmable Thermostat**

- ROBERTSHAW
- 2 Heat/2 Cool
- Compatible with all standard 24 VAC multi-stage heating & cooling systems
- O & B Terminals
- Automatic Compressor Short Cycle Protection
- Worry-Free Memory Storage
- Adjustable 1st and 2nd Stage Differential
- When discontinued, replace with 675-RS4220



675-9515

| CATALOG NO. | DESCRIPTION                      | UOM | ORDER MULTIPLE |
|-------------|----------------------------------|-----|----------------|
| 675-9515    | 2 Heat/2 Cool Digital Thermostat | EA  | 1              |

**9520 Series Digital Non-Programmable Thermostat**

- ROBERTSHAW
- 2 Heat/2 Cool
- Compatible with all Standard 24 VAC Heat Pump Systems
- O & B Terminals
- Automatic Compressor Short Cycle Protection
- Lighted System Status Indicators
- Worry Free Memory Storage
- Adjustable 1st and 2nd stage differential
- When discontinued, replace with 675-RS4220



675-9520

| CATALOG NO. | DESCRIPTION                                | UOM | ORDER MULTIPLE |
|-------------|--|-----|----------------|
| 675-9520    | 2 Heat/2 Cool Digital Heat Pump Thermostat | EA  | 1              |

**9600 Series Digital Programmable Thermostat**

- ROBERTSHAW
- 1 Heat/1 Cool
- Compatible with all standard 24 VAC heating and cooling systems
- Weekly 5-2 Day Programming
- Automatic Compressor Short Cycle Protection
- When discontinued, replace with 675-RS5110



675-9600

| CATALOG NO. | DESCRIPTION                           | UOM | ORDER MULTIPLE |
|-------------|---------------------------------------|-----|----------------|
| 675-9600    | 1 Heat/1 Cool Programmable Thermostat | EA  | 1              |

**9610 Series Digital Programmable Thermostat**

- ROBERTSHAW
- 1 Heat/1 Cool
- Compatible with all standard 24 VAC heating and cooling systems
- 7 Day Programming
- Quickset™
- ENERGY STAR rated for Energy Savings
- O & B Terminals
- When discontinued, replace with 675-RS5110



675-9610

| CATALOG NO. | DESCRIPTION                                 | UOM | ORDER MULTIPLE |
|-------------|---|-----|----------------|
| 675-9610    | 1 Heat/1 Cool 7 Day Programmable Thermostat | EA  | 1              |



Literature – Download all literature from the DiversiTech website using the Form ID shown in the icon. The URL is [www.diversitech.com/literature/FORMID.pdf](http://www.diversitech.com/literature/FORMID.pdf)

### 9615 Series Digital Programmable Thermostat

- ROBERTSHAW
- 2 Heat/2 Cool
- Compatible with all standard 24 VAC heat pump systems
- Quickset™
- ENERGY STAR rated for Energy Savings
- Multi Colored LEDs indicate system status
- 24V Powered with Battery Backup
- Adjustable 1st and 2nd stage differential
- When discontinued, replace with 675-RS5220



675-9615

| CATALOG NO. | DESCRIPTION                           | UOM | ORDER MULTIPLE |
|-------------|---------------------------------------|-----|----------------|
| 675-9615    | 2 Heat/2 Cool Programmable Thermostat | EA  | 1              |

### 9620 Series Digital Programmable Thermostat

- ROBERTSHAW
- 2 Heat/2 Cool
- Compatible with all standard 24 VAC heat pump systems
- Quickset™
- ENERGY STAR rated for Energy Savings
- Multi Colored LEDs indicate system status
- 24V Powered with Battery Backup
- Adjustable 1st and 2nd stage differential
- When discontinued, replace with 675-RS5220



675-9620

| CATALOG NO. | DESCRIPTION   | UOM | ORDER MULTIPLE |
|-------------|---|-----|----------------|
| 675-9620    | 2 Heat/2 Cool Digital Programmable Heat Pump Thermostat | EA  | 1              |

### Touchscreen Thermostat

A US DOE Energy Star rated touchscreen room thermostat built upon easy-to-use, but powerful technology which efficiently heats or cools your home. It's never been so easy to keep your home HVAC operating costs so low! By programmably altering temperature set point based on room occupancy patterns, this thermostat ensures that energy isn't thrown away. Fan modes include On, Automatic, and Intermittent (10 minutes every hour) and are programmable through a 7 day regimen with 4 events per day. Each mode is programmable per event; programs can be copied day to day. And, the thermostat's Energy Watch program makes it easier than ever to track of the total operating cost of the HVAC system.



675-TS21

Superior user interface! The scratch resistant dot matrix screen shows simple or dynamic displays with virtual buttons. Outstanding features such as:

- automatic daylight savings changeover
- negative image and automatic nighttime display
- temperature
- filter monitor
- clock/date
- humidity control (675-TS32H only)

and readouts which include fahrenheit or celcius, as well as indoor and outdoor temperature make this thermostat the ultimate choice. Permanent (non-battery) memory for settings, a variable security lock and custom installer message add peace of mind.

2-wire model easily allows for the retro-fit of a Touchscreen Thermostat into installations where only 2 wires are available from the air handler to the thermostat location.



LIT-FLY-TS

| CATALOG NO. | DESCRIPTION   | UOM | ORDER MULTIPLE |
|-------------|---|-----|----------------|
| 675-TS21    | Touchscreen Thermostat 2 Heat/1 Cool                      | EA  | 1              |
| 675-TS32    | Touchscreen Thermostat 3 Heat/2 Cool                      | EA  | 1              |
| 675-TS32H   | Touchscreen Thermostat 3 Heat/2 Cool and Humidity Control | EA  | 1              |

### THERMOSTAT GUARDS

#### Plastic Thermostat Guards

Use to prevent tampering with thermostats. The covers are clear, allowing complete viewing of the thermostat and current settings. Furnished complete with ring and/or solid base. Includes vent holes for easy airflow across the thermostat. Lockable with universal key. Internal dimensional clearance/sizing for thermostats as noted.



585-TG1

| CATALOG NO. | DESCRIPTION                | T-STAT CLEARANCE         | UOM | ORDER MULTIPLE |
|-------------|----------------------------|--------------------------|-----|----------------|
| 585-TG      | Clear Plastic w/Two Bases  | 8-1/4" x 4-1/2" x 3-1/4" | EA  | 1              |
| 585-TG1     | Clear Plastic w/Two Bases  | 5-3/4" x 3-1/2" x 2-3/4" | EA  | 1              |
| 585-TG2     | Clear Plastic w/Two Bases  | 4-3/4" x 4-1/4" x 2-3/4" | EA  | 1              |
| 585-TG5     | Clear Plastic w/Solid Base | 3-1/2" x 3-1/4" x 2-1/4" | EA  | 1              |
| 585-TG6     | Clear Plastic w/Two Bases  | 6-1/4" x 3-3/4" x 1-3/4" | EA  | 1              |

#### Steel Thermostat Guards

Steel thermostat guards are used to prevent tampering with thermostats. The covers are steel, giving complete tamper protection of the thermostat, and physical impact protection. Great for warehouse and industrial locations. Furnished complete with ring and/or solid base as noted. Includes vent holes for easy airflow across the thermostat. Lockable with universal key. Internal dimensional clearance/sizing for thermostats as noted.



585-TG4

| CATALOG NO. | DESCRIPTION              | T-STAT CLEARANCE         | UOM | ORDER MULTIPLE |
|-------------|--------------------------|--------------------------|-----|----------------|
| 585-TG3     | Beige Steel w/Solid Base | 6" x 4" x 3"             | EA  | 1              |
| 585-TG4     | Beige Steel w/Ring Base  | 6" x 4" x 3"             | EA  | 1              |
| 585-TG7     | Beige Steel w/Solid Base | 5-1/2" x 3-1/2" x 2-3/4" | EA  | 1              |
| 585-TG8     | Beige Steel w/Ring Base  | 5" x 3" x 2-3/4"         | EA  | 1              |
| 585-TG9     | Beige Steel w/Two Bases  | 6" x 4" x 3"             | EA  | 1              |

#### Cross Reference

| DIVERSITECH PART NO. | BEKO PART NO. | BRAMEC PART NO. | MARS PART NO. |
|----------------------|---------------|-----------------|---------------|
| 585-TG               | BTG-UK2       | 13012           | 70220         |
| 585-TG1              | BTG-RK        | 13016           | 70210         |
| 585-TG2              | BTG-K         | 13008           | 70205         |
| 585-TG3              | BTG-UM        | 13010           | 70223         |
| 585-TG4              | BTG-UWM       | 13011           | 70224         |
| 585-TG5              | BTG-EK        | 13004           | 70201         |
| 585-TG6              | BTG-DK        | 13018           | 70217         |
| 585-TG7              | BTG-54VL      | 13002           | 70215         |
| 585-TG8              | BTG-54VLW     | 13001           | 70216         |

**THERMOSTAT WIRE**

**Thermostat Wire**

Class 2 thermostat wire for indoor wiring needs. Soft drawn bare copper wire, semi-rigid PVC insulation and PVC overall jacket. Packaged on aluminum spool.



620-18-5

| CATALOG NO. | DESCRIPTION                          | UOM | ORDER MULTIPLE |
|-------------|--------------------------------------|-----|----------------|
| 620-18-2    | 18 AWG, 2 Conductors – 500 ft. Spool | EA  | 4              |
| 620-18-3    | 18 AWG, 3 Conductors – 500 ft. Spool | EA  | 4              |
| 620-18-4    | 18 AWG, 4 Conductors – 250 ft. Spool | EA  | 4              |
| 620-18-5    | 18 AWG, 5 Conductors – 250 ft. Spool | EA  | 4              |
| 620-18-6    | 18 AWG, 6 Conductors – 250 ft. Spool | EA  | 4              |
| 620-18-7    | 18 AWG, 7 Conductors – 250 ft. Spool | EA  | 4              |
| 620-18-8    | 18 AWG, 8 Conductors – 250 ft. Spool | EA  | 4              |
| 620-18-9    | 18 AWG, 9 Conductors – 250 ft. Spool | EA  | 4              |
| 620-18-10   | 18 AWG,10 Conductors – 250 ft. Spool | EA  | 4              |
| 620-18-12   | 18 AWG,12 Conductors – 250 ft. Spool | EA  | 4              |
| 620-20-2    | 20 AWG, 2 Conductors – 500 ft. Spool | EA  | 4              |
| 620-20-3    | 20 AWG, 3 Conductors – 500 ft. Spool | EA  | 4              |
| 620-20-4    | 20 AWG, 4 Conductors – 250 ft. Spool | EA  | 4              |
| 620-20-5    | 20 AWG, 5 Conductors – 250 ft. Spool | EA  | 4              |
| 620-20-6    | 20 AWG, 6 Conductors – 250 ft. Spool | EA  | 4              |
| 620-20-7    | 20 AWG, 7 Conductors – 250 ft. Spool | EA  | 4              |
| 620-20-8    | 20 AWG, 8 Conductors – 250 ft. Spool | EA  | 4              |
| 620-20-10   | 20 AWG,10 Conductors – 250 ft. Spool | EA  | 4              |

U.L. Listed. Meets Subject 13 per Article 725, 1990 NEC.

**Plenum Thermostat Wire**

UL Listed type CL2P – NEC Article 725.



620-18-5P

| CATALOG NO. | DESCRIPTION                          | UOM | ORDER MULTIPLE |
|-------------|--------------------------------------|-----|----------------|
| 620-18-2P   | 18 AWG, 2 Conductors – 500 ft. Spool | EA  | 4              |
| 620-18-3P   | 18 AWG, 3 Conductors – 500 ft. Spool | EA  | 4              |
| 620-18-4P   | 18 AWG, 4 Conductors – 250 ft. Spool | EA  | 4              |
| 620-18-5P   | 18 AWG, 5 Conductors – 250 ft. Spool | EA  | 4              |
| 620-18-6P   | 18 AWG, 6 Conductors – 250 ft. Spool | EA  | 4              |
| 620-18-8P   | 18 AWG, 8 Conductors – 250 ft. Spool | EA  | 4              |

**Wire for Mini-Split Installation**

Wire and cabling specific for mini-split installation power supply and control circuits.

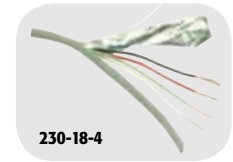

230-18-4

| CATALOG NO. | DESCRIPTION                              | UOM | ORDER MULTIPLE |
|-------------|--|-----|----------------|
| 230-18-4    | Stranded Shielded CL3R, 50' per roll     | EA  | 1              |
| 230-16-2    | Stranded Shielded CL3R, 50' per roll     | EA  | 1              |
| 230-14-3    | Solid Non-Shielded CL3R, 50' per roll    | EA  | 1              |
| 230-14-4    | Stranded Non-Shielded CL3R, 50' per roll | EA  | 1              |
| 230-14-7    | Stranded Non-Shielded CL3R, 50' per roll | EA  | 1              |
| 230-14-4S   | Stranded Shielded CL3R, 50' per roll     | EA  | 1              |

**DISCONNECT SWITCHES**

**DiversiTech Pull-out Disconnect Switches with Side Opening Door**

- Fused models designed with fuses in pull-out handle for easy replacement
- Line, load, and ground terminals aligned for ease of wiring
- Reversible door – opens to the left or to the right
- Side opening door opens more than 180 degrees for maximum access
- Fused models have indicator lights for blown fuses
- Full dead front
- UL Listed IRF9, NEMA TYPE 3R: Raintight, Sleet Resistant – Outdoor
- US Patent Number 6,630,637.



DDS-60



| CATALOG NO. | DESCRIPTION                       | UOM | ORDER MULTIPLE |
|-------------|-----------------------------------|-----|----------------|
| DDS-30      | 30A Fusible Disconnect Switch     | EA  | 10             |
| DDS-60      | 60A Fusible Disconnect Switch     | EA  | 10             |
| DDS-60U     | 60A Non-Fusible Disconnect Switch | EA  | 10             |

**DiversiTech Low-Profile Disconnect Switch**

- Slightly smaller design than standard DiversiTech Disconnects
- Side opening door
- Full dead front
- UL Listed IRF9, NEMA TYPE 3R: Raintight, Sleet Resistant – Outdoor



EDS-60U

| CATALOG NO. | DESCRIPTION                       | UOM | ORDER MULTIPLE |
|-------------|-----------------------------------|-----|----------------|
| EDS-60U     | 60A Non-Fusible Disconnect Switch | EA  | 10             |



Literature – Download all literature from the DiversiTech website using the Form ID shown in the icon. The URL is [www.diversitech.com/literature/FORMID.pdf](http://www.diversitech.com/literature/FORMID.pdf)

**DISCONNECT SWITCHES cont'd**

**QO200TR A/C Disconnect**

- 60 amp switch rated for 10 HP motors at 240 VAC.
- On-Off circuit breaker type switch. No pull-out head that can be lost or stolen.
- Four, one-inch combination knockouts – two in back and two in bottom end wall.
- Removing the cover housing provides open access to lugs for easy wiring.



**QO200TR**  
**SQUARE D**  
GROUPE SCHNEIDER

| CATALOG NO.    | DESCRIPTION           | UOM | ORDER MULTIPLE |
|----------------|-----------------------|-----|----------------|
| <b>QO200TR</b> | 60A Disconnect Switch | EA  | 1              |

**Non-Metallic Disconnects**

NEMA 3R rated non-metallic, pullout type, excellent for coastal environments. Single phase 240 Volts AC.



**750-P30F**  
**SQUARE D**  
GROUPE SCHNEIDER

| CATALOG NO.      | DESCRIPTION        | UOM | ORDER MULTIPLE |
|------------------|--------------------|-----|----------------|
| <b>750-P30F</b>  | Fusible 30 Amp     | EA  | 10             |
| <b>750-P60F</b>  | Fusible 60 Amp     | EA  | 10             |
| <b>750-P60NF</b> | Non-Fusible 60 Amp | EA  | 10             |

**Three Phase Disconnects**

UL listed, File E5239. Meets UL98 for enclosed switches and NEMA Std. KS-1. Suitable as service entrance equipment when applied with neutral or ground lug kit. Rainproof type 3R enclosure.



**750-30F-3PH**  
**SQUARE D**  
GROUPE SCHNEIDER

| CATALOG NO.         | DESCRIPTION        | UOM | ORDER MULTIPLE |
|---------------------|--------------------|-----|----------------|
| <b>750-30F-3PH</b>  | Fusible 30 Amp     | EA  | 1              |
| <b>750-60F-3PH</b>  | Fusible 60 Amp     | EA  | 1              |
| <b>750-60NF-3PH</b> | Non-Fusible 60 Amp | EA  | 1              |

**ELECTRICAL SUPPLIES**

**Electrical Toggle Switches**

Side wire design with automatic grounding and large binding head terminal screws for fast wiring. Lubricated cam provides smooth lever action.



**620-601**

| CATALOG NO.       | DESCRIPTION                         | UOM | ORDER MULTIPLE |
|-------------------|-------------------------------------|-----|----------------|
| <b>620-600</b>    | 20A-1 HP 120V, Single Pole, Brown   | EA  | 10             |
| <b>620-601</b>    | 20A-1 HP 120V, Single Pole, Ivory   | EA  | 10             |
| <b>625-CS120W</b> | 20A-1HP 120V Single Pole, White     | EA  | 10             |
| <b>620-602</b>    | 20A-1 HP 120V, 3-Way, Brown         | EA  | 10             |
| <b>620-603</b>    | 20A-1 HP 120V, 3-Way, Ivory         | EA  | 10             |
| <b>625-1301W</b>  | 15A-1/2HP 120V Single Pole, White   | EA  | 10             |
| <b>620-604</b>    | 15A-1/2 HP 120V, Single Pole, Brown | EA  | 10             |
| <b>620-605</b>    | 15A-1/2 HP 120V, Single Pole, Ivory | EA  | 10             |
| <b>620-606</b>    | 15A-1/2 HP 120V, 3-Way, Brown       | EA  | 10             |
| <b>620-607</b>    | 15A-1/2 HP 120V, 3-Way, Ivory       | EA  | 10             |

U.L. Listed. C.S.A. Certified. Verified to Federal Spec. WS896E.

**Electrical Duplex Receptacles**

Automatic grounding for fast installation. Heavy duty mounting strap for additional assembly strength. Copper alloy power/ground contacts for optimum continuity. Side wire design with large binding head terminal screws for fast wiring.



**620-701**      **620-700**  
**625-CR15W**      **620-704**

| CATALOG NO.      | DESCRIPTION                    | UOM | ORDER MULTIPLE |
|------------------|--------------------------------|-----|----------------|
| <b>620-700</b>   | 15A, 125V, Brown               | EA  | 10             |
| <b>620-701</b>   | 15A, 125V, Ivory               | EA  | 10             |
| <b>625-CR15W</b> | 15A 125V, White                | EA  | 10             |
| <b>620-702</b>   | 20A, 125V, Brown               | EA  | 10             |
| <b>620-703</b>   | 20A, 125V, Ivory               | EA  | 10             |
| <b>625-CR20W</b> | 20A 125V, White                | EA  | 10             |
| <b>620-704</b>   | 15A, 125V, Brown – Residential | EA  | 10             |
| <b>620-705</b>   | 15A, 125V, Ivory – Residential | EA  | 10             |
| <b>625-270W</b>  | 15A 125V, White – Residential  | EA  | 10             |

U.L. Listed. C.S.A. Certified (NEMA 5-15 Type).

**ELECTRICAL SUPPLIES cont'd**

**Switch/Plug Combo**

Use with air handlers and condensate pumps. Touch-A-Matic design, with exclusive spring loaded steel ball mechanism for smooth, positive contact movement. Small neon pilot light ON when switch is ON, is built-in to the switch on switch/receptacle.



| CATALOG NO. | DESCRIPTION                    | UOM | ORDER MULTIPLE |
|-------------|--------------------------------|-----|----------------|
| 620-274W    | White 1P 3W Grounding—15A 120V | EA  | 10             |

U.L. Listed. C.S.A. Approved.

**Plastic Wall Plates**

Non-flammable thermoplastic, phenolic or urea material. Color-matched 1/2" long steel mounting screws furnished. Smooth surface – no recessed areas to collect dirt, discolor. Easy to clean. Full weight and thickness provide high dielectric strength, minimum moisture absorption, impact resistance. Warp resistant, fit flush to wall.



| CATALOG NO. | DESCRIPTION                     | UOM | ORDER MULTIPLE |
|-------------|---------------------------------|-----|----------------|
| 625-2139B   | Double Toggle Cover – Brown     | EA  | 10             |
| 625-2139V   | Double Toggle Cover – Ivory     | EA  | 10             |
| 625-2139W   | Double Toggle Cover – White     | EA  | 10             |
| 625-2132B   | Duplex Receptacle Cover – Brown | EA  | 25             |
| 625-2132V   | Duplex Receptacle Cover – Ivory | EA  | 25             |
| 625-2132W   | Duplex Receptacle Cover – White | EA  | 10             |
| 625-2129B   | Blank Cover – Brown             | EA  | 25             |
| 625-2129V   | Blank Cover – Ivory             | EA  | 25             |
| 625-2129W   | Blank Cover – White             | EA  | 25             |
| 625-2134B   | Single Toggle Cover – Brown     | EA  | 25             |
| 625-2134V   | Single Toggle Cover – Ivory     | EA  | 25             |
| 625-2134W   | Single Toggle Cover – White     | EA  | 25             |

U.L. Listed. C.S.A. Approved.

**Switch Covers**



| CATALOG NO. | SIZE             | TYPE      | DESCRIPTION                                    | UOM | ORDER MULTIPLE |
|-------------|------------------|-----------|--|-----|----------------|
| 625-S17     | 4" X 4"          | Gas       | 4" Square Box                                  | EA  | 1              |
| 625-S16     | 4-1/4" X 2-3/4"  | Gas       | Utility/Handy Box                              | EA  | 1              |
| 625-S15     | 4-1/2" X 2-1/2"  | Gas       | Flush Mount                                    | EA  | 1              |
| 625-S14     | 4" X 4"          | Oil       | 4" Square Box                                  | EA  | 1              |
| 625-S13     | 4-1/4" x 2-3/4"  | Oil       | Utility/Handy Box                              | EA  | 1              |
| 625-S19     | 4-1/2" X 2-1/2"  | Oil       | Flush Mount                                    | EA  | 1              |
| 625-S20     | 4-3/4" X 2-1/2"  | Emergency | Switch Plate                                   | EA  | 1              |
| 625-S21     | 4-1/4" X 2-7/10" | Emergency | Switch Plate                                   | EA  | 1              |
| 625-S18     | 3/4"             |           | Switch Guard (Wall plate/ switch not included) | EA  | 1              |

**Toggle Switches**

Single pole-double pole – A.C. Underwriters' Listed CSA APP. No. 10016. Furnished with screw terminals.

- Rating A: 20A – 125VAC, 20A – 250VAC, 1 H.P. at 120-240V
- Rating B: 15A – 125/250VAC, 3/4 H.P. at 240V.



| CATALOG NO. | DESCRIPTION                          | RATING | UOM | ORDER MULTIPLE |
|-------------|--------------------------------------|--------|-----|----------------|
| TS-1        | Toggle Switch – SP-ST – ON/OFF       | A      | EA  | 1              |
| TS-2        | Toggle Switch – SP-DT – ON/OFF       | A      | EA  | 1              |
| TS-3        | Toggle Switch – SP-DT-CO – ON/OFF/ON | B      | EA  | 1              |
| TS-4        | Toggle Switch – DP-ST – ON/OFF       | A      | EA  | 1              |
| TS-5        | Toggle Switch – DP-DT – ON/OFF       | A      | EA  | 1              |
| TS-6        | Toggle Switch – DP-DT-CO – ON/OFF/ON | B      | EA  | 1              |

**Toggle Switch Cover**

Weatherproof body for toggle switches up to 15/16" long.



| CATALOG NO. | DESCRIPTION         | UOM | ORDER MULTIPLE |
|-------------|---------------------|-----|----------------|
| 625-B1      | Toggle Switch Cover | EA  | 5              |

**Power Supply Cord (Pigtails)**

Stranded bare copper conductors. Grounding conductors. PVC jacket. Right and straight angle male plug. 110 Volt. 16 AWG x 6' long. SPT-2.



| CATALOG NO. | DESCRIPTION                        | UOM | ORDER MULTIPLE |
|-------------|------------------------------------|-----|----------------|
| 625-16-6    | Power Supply Cord – Straight Plug  | EA  | 50             |
| 625-16-690  | Power Supply Cord – 90 Degree Plug | EA  | 50             |

**Dryer Receptacle**



| CATALOG NO. | DESCRIPTION                              | UOM | ORDER MULTIPLE |
|-------------|--|-----|----------------|
| 625-1225    | Dryer Receptacle 30A 125/250V NEMA 14-30 | EA  | 10             |

U.L. Listed. C.S.A. Approved.

**Range Receptacle**



| CATALOG NO. | DESCRIPTION                               | UOM | ORDER MULTIPLE |
|-------------|---|-----|----------------|
| 625-1212    | Range Receptacle 50A 125/250V NEMA 14-50R | EA  | 10             |

U.L. Listed. C.S.A. Approved.

### Electrical Outlet Boxes, Extensions and Covers

4" steel octagon outlet box, extensions and covers.



| CATALOG NO. | DESCRIPTION                      | UOM | ORDER MULTIPLE |
|-------------|----------------------------------|-----|----------------|
| 620-300     | 1-1/2" Deep, 1/2" and 3/4" K.O.s | EA  | 50             |
| 620-301     | 2-1/8" Deep, 1/2" and 3/4" K.O.s | EA  | 25             |
| 620-302     | 1-1/2" Deep, 1/2" K.O. Extension | EA  | 50             |
| 620-303     | Flat Blank Cover                 | EA  | 50             |
| 620-304     | Flat, Duplex Receptacle Cover    | EA  | 50             |
| 620-306     | Flat Cover 1/2" K.O. in Center   | EA  | 50             |

Conforms to Article 370 of NEC. U.L. Listed.

### Electrical Outlet Boxes, Extensions and Covers

4" steel square outlet box, extensions and covers.



| CATALOG NO. | DESCRIPTION                                | UOM | ORDER MULTIPLE |
|-------------|--|-----|----------------|
| 620-400     | 1-1/4" Deep, 1/2" K.O.s                    | EA  | 50             |
| 620-401     | 2-1/8" Deep, 1/2" and 3/4" K.O.s           | EA  | 25             |
| 620-403     | 1-1/2" Deep, 1/2" K.O.s                    | EA  | 50             |
| 620-404     | 1-1/2" Deep, 1/2" and 3/4" K.O.s Extension | EA  | 50             |
| 620-405     | Flat Cover 1/2" K.O. in Center             | EA  | 50             |
| 620-406     | Flat Blank Cover                           | EA  | 50             |
| 620-408     | Flat, One Toggle Switch Cover              | EA  | 50             |
| 620-409     | Flat, One Duplex Receptacle Cover          | EA  | 50             |
| 620-410     | Flat, Two Toggle Switch Cover              | EA  | 50             |
| 620-411     | One Switch and One Duplex Receptacle Cover | EA  | 50             |
| 620-412     | Flat, Two Duplex Receptacle Cover          | EA  | 50             |

Conforms to Article 370 of NEC. U.L. Listed.

### Electrical Outlet Boxes, Extensions and Covers

4-11/16" steel square outlet box covers.



| CATALOG NO. | DESCRIPTION                      | UOM | ORDER MULTIPLE |
|-------------|----------------------------------|-----|----------------|
| 620-500     | 2-1/8" Deep, 1/2" and 3/4" K.O.s | EA  | 25             |
| 620-501     | Flat Blank Cover                 | EA  | 25             |
| 620-502     | Raised Cover for Single Device   | EA  | 25             |
| 620-503     | Flat Cover 1/2" K.O. in Center   | EA  | 25             |

Conforms to Article 370 of NEC. U.L. Listed.

### Electrical Outlet Boxes, Extensions and Covers

Standard steel utility (Handy) boxes and covers.



| CATALOG NO. | DESCRIPTION                       | UOM | ORDER MULTIPLE |
|-------------|-----------------------------------|-----|----------------|
| 620-200     | 1-1/2" Deep, 1/2" K.O.s           | EA  | 50             |
| 620-201     | 1-7/8" Deep, 1/2" K.O.s           | EA  | 50             |
| 620-202     | 2-1/8" Deep, 1/2" K.O.s           | EA  | 50             |
| 620-20134   | 1-7/8" Deep, 3/4" K.O.s           | EA  | 50             |
| 620-252     | Flat, Two Duplex Receptacle Cover | EA  | 100            |
| 620-253     | Flat, Toggle Switch Cover         | EA  | 100            |
| 620-254     | Flat Blank Cover                  | EA  | 100            |
| 620-255     | Flat Cover 1/2" K.O.              | EA  | 100            |

Conforms to Article 370 of NEC. U.L. Listed.

### Homeline Circuit Breakers

Homeline circuit breakers provide the high level of protection you expect from Square D. No other name in circuit protection is more trusted for reliability and performance than Square D. These are the only breakers accepted in genuine Square D Homeline Load Centers.



| CATALOG NO. | DESCRIPTION      | UOM | ORDER MULTIPLE |
|-------------|------------------|-----|----------------|
| 625-GS15H   | Single Pole, 15A | EA  | 10             |
| 625-GS20H   | Single Pole, 20A | EA  | 10             |
| 625-GS30H   | Single Pole, 30A | EA  | 10             |
| 625-GS40H   | Single Pole, 40A | EA  | 10             |
| 625-GS50H   | Single Pole, 50A | EA  | 10             |
| 625-GD15H   | Two Pole, 15A    | EA  | 10             |
| 625-GD20H   | Two Pole, 20A    | EA  | 10             |
| 625-GD30H   | Two Pole, 30A    | EA  | 10             |
| 625-GD40H   | Two Pole, 40A    | EA  | 10             |
| 625-GD50H   | Two Pole, 50A    | EA  | 10             |
| 625-GD60H   | Two Pole, 60A    | EA  | 10             |
| 625-GD100   | Two Pole, 100A   | EA  | 10             |

**FUSES**

**Dual Element Fuses – 250V**

Provides time delay for temporary over-current conditions and motor running protection for heating and air conditioning equipment. Eliminates unnecessary maintenance from harmless overloads.



| CATALOG NO. | DESCRIPTION | UOM | ORDER MULTIPLE |
|-------------|-------------|-----|----------------|
| 7-CRNR15    | 15 Amps     | EA  | 10             |
| 7-CRNR20    | 20 Amps     | EA  | 10             |
| 7-CRNR25    | 25 Amps     | EA  | 10             |
| 7-CRNR30    | 30 Amps     | EA  | 10             |
| 7-CRNR35    | 35 Amps     | EA  | 10             |
| 7-CRNR40    | 40 Amps     | EA  | 10             |
| 7-CRNR45    | 45 Amps     | EA  | 10             |
| 7-CRNR50    | 50 Amps     | EA  | 10             |
| 7-CRNR60    | 60 Amps     | EA  | 10             |

U.L. Class RK-5, Standard for Safety 198E, Current Limiting Fuses, Interrupting Rating 200,000 Amps. rms. A.C.

**One Time Fuses**

Protection to lighting, heating, and other non-transient circuits.



| CATALOG NO. | DESCRIPTION | UOM | ORDER MULTIPLE |
|-------------|-------------|-----|----------------|
| 7-10KOTN30  | 30 Amps     | EA  | 10             |
| 7-10KOTN35  | 35 Amps     | EA  | 10             |
| 7-10KOTN40  | 40 Amps     | EA  | 10             |
| 7-10KOTN45  | 45 Amps     | EA  | 10             |
| 7-10KOTN50  | 50 Amps     | EA  | 10             |
| 7-10KOTN60  | 60 Amps     | EA  | 10             |

U.L. Class H, Standard for Safety 1988, One Time Fuse Interrupting Rating 10,000 Amps. rms. A.C.

**Time Delay Fuses – 600V**



| CATALOG NO. | DESCRIPTION | UOM | ORDER MULTIPLE |
|-------------|-------------|-----|----------------|
| 626-HASR15  | 15 Amp      | EA  | 10             |
| 626-HASR20  | 20 Amp      | EA  | 10             |
| 626-HASR25  | 25 Amp      | EA  | 10             |
| 626-HASR30  | 30 Amp      | EA  | 10             |
| 626-HASR35  | 35 Amp      | EA  | 10             |

U.L. Listed.

**Time Delay Plug Fuses**



| CATALOG NO. | DESCRIPTION                 | UOM | ORDER MULTIPLE |
|-------------|-----------------------------|-----|----------------|
| 626-10T     | Type "T" Plug Fuse – 10 Amp | EA  | 4              |
| 626-15T     | Type "T" Plug Fuse – 15 Amp | EA  | 4              |
| 626-20T     | Type "T" Plug Fuse – 20 Amp | EA  | 4              |
| 626-25T     | Type "T" Plug Fuse – 25 Amp | EA  | 4              |
| 626-30T     | Type "T" Plug Fuse – 30 Amp | EA  | 4              |

U.L. Listed.

**Plug Fuses – Fast Acting**

Expels gases caused by the blowing fuse, but doesn't allow flame to escape. Glass top for safety against shock. Positive visual indication of OK condition or blown condition. Distinguishes between overload and dead short conditions. Magnifying center of face. Shapes of face openings identify ratings. Meets Federal Specification WF-791E/Gen. Type 791/1. Base "W" Fast acting fuses.



| CATALOG NO. | DESCRIPTION        | UOM | ORDER MULTIPLE |
|-------------|--------------------|-----|----------------|
| 626-15      | Plug Fuse – 15 Amp | EA  | 4              |
| 626-20      | Plug Fuse – 20 Amp | EA  | 4              |
| 626-25      | Plug Fuse – 25 Amp | EA  | 4              |
| 626-30      | Plug Fuse – 30 Amp | EA  | 4              |

U.L. Listed.

**Type "S" Non-Tamper Fuses**

Provides specific overcurrent protection. Time-delay element protects against premature blowing from motors in air conditioners or compressors. Visual indication of good or blown condition.



| CATALOG NO. | DESCRIPTION              | UOM | ORDER MULTIPLE |
|-------------|--------------------------|-----|----------------|
| 626-3S      | Type "S" Fuse – 3.2 Amp  | EA  | 4              |
| 626-4S      | Type "S" Fuse – 4 Amp    | EA  | 4              |
| 626-5S      | Type "S" Fuse – 5 Amp    | EA  | 4              |
| 626-6S      | Type "S" Fuse – 6.25 Amp | EA  | 4              |
| 626-10S     | Type "S" Fuse – 10 Amp   | EA  | 4              |
| 626-15S     | Type "S" Fuse – 15 Amp   | EA  | 4              |
| 626-20S     | Type "S" Fuse – 20 Amp   | EA  | 4              |
| 626-25S     | Type "S" Fuse – 25 Amp   | EA  | 4              |
| 626-30S     | Type "S" Fuse – 30 Amp   | EA  | 4              |

U.L. Listed. C.S.A. Approved.

**In-Line Fuse Holder**

For fusing all control circuits up to 30 amp. Features rigid plastic protective covering for each fuse. Used on AC and DC circuits.



| CATALOG NO. | DESCRIPTION         | UOM | ORDER MULTIPLE |
|-------------|---------------------|-----|----------------|
| FH-1        | In-Line Fuse Holder | EA  | 10             |

U.L. Listed.

**FUSES cont'd**

**Blade (Auto) Fuses**



| CATALOG NO. | DESCRIPTION                            | UOM | ORDER MULTIPLE |
|-------------|--|-----|----------------|
| 626-AT0003  | Blade Fuse – 3 Amp – Purple, pack of 5 | PK  | 1              |
| 626-AT0005  | Blade Fuse – 5 Amp – Tan, pack of 5    | PK  | 1              |

**Fuse Pullers**



| CATALOG NO. | DESCRIPTION                               | UOM | ORDER MULTIPLE |
|-------------|---|-----|----------------|
| 626-38071   | Fuse Puller – For Fuse Sizes 1/4" to 1/2" | EA  | 10             |
| 626-38073   | Fuse Puller – For Fuse Sizes 1" to 1-3/4" | EA  | 1              |

**Fuse Adapters**



| CATALOG NO. | DESCRIPTION                                       | UOM | ORDER MULTIPLE |
|-------------|---|-----|----------------|
| 626-38632   | Fuse Adapter – 60 to 30 Reducer for Class H, 250V | EA  | 1              |
| 626-38636   | Fuse Adapter – 60 to 30 Reducer for Class H, 600V | EA  | 1              |

**Fuseblocks**



| CATALOG NO. | DESCRIPTION                              | UOM | ORDER MULTIPLE |
|-------------|--|-----|----------------|
| 626-23133   | Fuseblock – 1 Pole Screw Class H, 250V   | EA  | 1              |
| 626-23233   | Fuseblock – 2 Pole Screw Class H, 250V   | EA  | 1              |
| 626-23333   | Fuseblock – 3 Pole Screw Class H, 250V   | EA  | 1              |
| 626-26311   | Fuseblock – 3 Pole Box Lug Class H, 250V | EA  | 1              |

**Box Cover Units**

Maximum amps: 15. Maximum AC volts: 125. For use with Type "T" Plug Fuses.



| CATALOG NO. | DESCRIPTION                     | UOM | ORDER MULTIPLE |
|-------------|---------------------------------|-----|----------------|
| 620-608     | Switch/Fuse Combo (ESSU)        | EA  | 1              |
| 620-6081    | Plug Fuse Base Only (ESOU)      | EA  | 1              |
| 620-6082    | Receptacle/Fuse Combo (ESRU)    | EA  | 1              |
| 620-6083    | Switch/Fuse Combo Square (ESSY) | EA  | 1              |

U.L. Listed and C.S.A. Certified.

**CONDUIT, FITTINGS, CABLE**

**Liquid Tite Flexible Conduit**

For electrical applications: outside, inside and industrial uses including transformer connections, air conditioning and heating. Joins with metallic or non-metallic connectors, easy to cut. Impact resistant, chemical resistant, and will not kink. U.L. and C.U.L. Listed. For use as indicated in Article 351 of the 1987 NEC.



| CATALOG NO.  | DESCRIPTION  | UOM | ORDER MULTIPLE |
|--------------|--|-----|----------------|
| 750-12100    | 1/2" x 100' Liquid Tite Conduit – Non-Metallic, 100' per roll          | EA  | 1              |
| 750-12100BOX | 1/2" x 100' Liquid Tite Conduit – Non-Metallic (in box), 100' per roll | EA  | 1              |
| 750-121000   | 1/2" x 1000' Liquid Tite Conduit – Non-Metallic, 1000' per roll        | EA  | 1              |
| 750-34100    | 3/4" x 100' Liquid Tite Conduit – Non-Metallic, 100' per roll          | EA  | 1              |
| 750-34700    | 3/4" x 700' Liquid Tite Conduit – Non-Metallic, 700' per roll          | EA  | 1              |
| 750-10100    | 1" x 100' Liquid Tite Conduit – Non-Metallic, 100' per roll            | EA  | 1              |
| 750-10400    | 1" x 400' Liquid Tite Conduit – Non-Metallic, 400' per roll            | EA  | 1              |
| 750-1550     | 1-1/2" x 50' Liquid Tite Conduit – Non-Metallic, 50' per roll          | EA  | 1              |
| 750-15100    | 1-1/2" x 100' Liquid Tite Conduit – Non-Metallic, 100' per roll        | EA  | 1              |
| 750-2050     | 2" x 50' Liquid Tite Conduit – Non-Metallic, 50' per roll              | EA  | 1              |
| 750-500      | 1/2" x 100' Liquid Tite Conduit – Metallic, 100' per roll              | EA  | 1              |
| 750-600      | 3/4" x 100' Liquid Tite Conduit – Metallic, 100' per roll              | EA  | 1              |

**Aluminum Armored MC Cable**

90°, C Rated aluminum metal clad cable system. THHN solid copper with specially compounded heat-resistant U.L. Listed insulation and jacket. Flexible interlocked aluminum armor. Extremely durable – withstands severe handling. U.L. Listed #4. Conforms to NEC article 333.



| CATALOG NO. | DESCRIPTION                                    | UOM | ORDER MULTIPLE |
|-------------|--|-----|----------------|
| 640-122     | 12-2 Aluminum Armored MC Cable – 100' per roll | EA  | 1              |
| 640-123     | 12-3 Aluminum Armored MC Cable – 100' per roll | EA  | 1              |
| 640-142     | 14-2 Aluminum Armored MC Cable – 100' per roll | EA  | 1              |
| 640-143     | 14-3 Aluminum Armored MC Cable – 100' per roll | EA  | 1              |

**CONDUIT, FITTINGS, CABLE cont'd**

**Romex Connectors – Metallic**

Cable connectors for Romex Wire. Zinc die-cast.



| CATALOG NO. | DESCRIPTION                             | UOM | ORDER MULTIPLE |
|-------------|---|-----|----------------|
| 750-RC841   | 3/8" Romex Connector for 1/2" Knockouts | EA  | 100            |
| 750-RC842   | 3/4" Romex Connector for 3/4" Knockouts | EA  | 50             |

U.L. Listed and C.S.A. Approved.

**Liquid Tite Connectors**

For use with metallic and non-metallic liquid tite conduit, Type B. Provides smooth connection, no sharp edges to strip wire. Wiring easily pulled through. U. L. Listed. C.U.L. Listed.



| CATALOG NO.   | DESCRIPTION                                 | UOM | ORDER MULTIPLE |
|---------------|---|-----|----------------|
| 750-NMLT50    | 1/2" Non-Metallic Straight Connector        | EA  | 25             |
| 750-NMLT4550  | 1/2" Non-Metallic 45 Degree Elbow Connector | EA  | 10             |
| 750-NMLT9050  | 1/2" Non-Metallic 90 Degree Elbow Connector | EA  | 10             |
| 750-NMLT75    | 3/4" Non-Metallic Straight Connector        | EA  | 10             |
| 750-NMLT4575  | 3/4" Non-Metallic 45 Degree Elbow Connector | EA  | 10             |
| 750-NMLT9075  | 3/4" Non-Metallic 90 Degree Elbow Connector | EA  | 10             |
| 750-NMLT100   | 1" Non-Metallic Straight Connector          | EA  | 5              |
| 750-NMLT90100 | 1" Non-Metallic 90 Degree Elbow             | EA  | 5              |
| 750-NMLT150   | 1-1/2" Non-Metallic Straight Connector      | EA  | 5              |
| 750-NMLT90150 | 1-1/2" Non-Metallic 90 Degree Elbow         | EA  | 5              |
| 750-NMLT200   | 2" Non-Metallic Straight Connector          | EA  | 5              |
| 750-NMLT90200 | 2" Non-Metallic 90 Degree Elbow             | EA  | 5              |
| 750-MLT50     | 1/2" Metallic Straight Connector            | EA  | 25             |
| 750-MLT9050   | 1/2" Metallic 90 Degree Elbow               | EA  | 10             |
| 750-MLT75     | 3/4" Metallic Straight Connector            | EA  | 10             |
| 750-MLT9075   | 3/4" Metallic 90 Degree Elbow               | EA  | 10             |

**Single Piece Liquid Tite Fittings**

Conduit threads onto ferrule and up inside the outer body. An inside taper squeezes down on the outside of conduit for a superior liquid tight seal. The cut portion of the conduit does not show, giving a more finished appearance. Easy to use at a lower cost than regular liquid tite fittings.



| CATALOG NO.  | DESCRIPTION                    | UOM | ORDER MULTIPLE |
|--------------|--------------------------------|-----|----------------|
| 750-SLTC50   | 1/2" Straight Screw-On Fitting | EA  | 25             |
| 750-SLTC9050 | 1/2" 90° Screw-On Fitting      | EA  | 25             |
| 750-SLTC75   | 3/4" Straight Screw-On Fitting | EA  | 25             |
| 750-SLTC9075 | 3/4" 90° Screw-On Fitting      | EA  | 25             |

**EMT (Thinwall) Fittings**



| CATALOG NO. | DESCRIPTION                         | UOM | ORDER MULTIPLE |
|-------------|-------------------------------------|-----|----------------|
| 625-800     | Set Screw Connector – 1/2"          | EA  | 50             |
| 625-801     | Set Screw Connector – 3/4"          | EA  | 25             |
| 625-304     | Strap – One Hole – 1/2"             | EA  | 100            |
| 625-305     | Strap – One Hole – 3/4"             | EA  | 100            |
| 625-541     | Strap – Two Hole – 1/2", pack of 50 | PK  | 1              |
| 625-542     | Strap – Two Hole – 3/4", pack of 50 | PK  | 1              |
| 625-810     | Set Screw Coupling – 1/2"           | EA  | 50             |
| 625-811     | Set Screw Coupling – 3/4"           | EA  | 25             |

**BX Set Screw Connectors**

BX cable range = .445 to .630 diameter. U.L. Listed. CSA Approved.



| CATALOG NO. | DESCRIPTION       | UOM | ORDER MULTIPLE |
|-------------|-------------------|-----|----------------|
| 640-845     | Trade Size – 3/8" | EA  | 100            |

**Non-Metallic Sheathed Cable (Romex Wire)**

600V building wire. Easy to pull and strip, flame and moisture resistant. Saves time, labor and money. Color coded conductors of copper, PVC insulation and outer jacket with ground.



| CATALOG NO. | DESCRIPTION                                      | UOM | ORDER MULTIPLE |
|-------------|--|-----|----------------|
| 620-6-2     | 6 AWG, 2 Conductors with Ground – 125' per pack  | EA  | 1              |
| 620-8-2     | 8 AWG, 2 Conductors with Ground – 125' per pack  | EA  | 1              |
| 620-10-2    | 10 AWG, 2 Conductors with Ground – 250' per pack | EA  | 1              |
| 620-12-2    | 12 AWG, 2 Conductors with Ground – 250' per pack | EA  | 1              |
| 620-14-2    | 14 AWG, 2 Conductors with Ground – 250' per pack | EA  | 1              |

U.L. Listed 719 Federal Specifications J-C94.

**Cable Staples**

Cable Staples for NMB Cable (Romex) and Copper Insulated Staples for thermostat wire.



| CATALOG NO. | DESCRIPTION                                 | UOM | ORDER MULTIPLE |
|-------------|---|-----|----------------|
| 625-183     | Romex Staples – 1/2"                        | EA  | 100            |
| 625-184     | Romex Staples – 1/2"                        | EA  | 500            |
| 625-155     | Copper Insulated #5 Staples for T-Stat Wire | EA  | 100            |

## DiversiWhips

Liquid-tight flexible conduit system. A labor saving convenience kit for A/C unit hookup. Also use for heat pumps, refrigeration, hot tubs, swimming pools and outdoor lighting. Three distinct wire colors for ease of hook-up. 1 straight and 1 90° metallic or non-metallic connector. 90° connector\* is removable for straight connections. (Second straight connector not included.) U.L. & C.U.L. Listed.



6-12-4

| CATALOG NO. | DESCRIPTION   | UOM | ORDER MULTIPLE |
|-------------|---|-----|----------------|
| 6-12-4      | 1/2 x 4' #10 THHN Wire – Metallic Connectors              | EA  | 6              |
| 6-12-6      | 1/2 x 6' #10 THHN Wire – Metallic Connectors              | EA  | 6              |
| 6-34-4      | 3/4 x 4' #8 THHN Wire – Metallic Connectors               | EA  | 6              |
| 6-34-6      | 3/4 x 6' #8 THHN Wire – Metallic Connectors               | EA  | 6              |
| 6-34-8      | 3/4 x 8' #8 THHN Wire – Metallic Connectors               | EA  | 3              |
| 6-12-4NMM   | 1/2 x 4' #10 THHN Wire – Non-Metallic Connectors          | EA  | 6              |
| 6-12-6NMM   | 1/2 x 6' #10 THHN Wire – Non-Metallic Connectors          | EA  | 6              |
| 6-34-3NMM   | 3/4 x 3' #8 THHN Wire – Non-Metallic Connectors           | EA  | 6              |
| 6-34-4NMM   | 3/4 x 4' #8 THHN Wire – Non-Metallic Connectors           | EA  | 6              |
| 6-34-6NMM   | 3/4 x 6' #8 THHN Wire – Non-Metallic Connectors           | EA  | 6              |
| 6-34-8NMM   | 3/4 x 8' #8 THHN Wire – Non-Metallic Connectors           | EA  | 3              |
| 6-12-6NMSP8 | 1/2 x 6' #8 Wire – Single Piece – Non-Metallic Connectors | EA  | 6              |

\*For DiversiWhips produced with 2 straight connectors, add S to part number (ex: 6-12-4S).

## DiversiWhips Pallet Packs

DiversiWhips are now available in a convenient, bulk-packaged pallet pack at a discounted price. Pallet pack makes an attractive floor-standing display. 1 straight and 1 90° metallic or non-metallic connector.



B6-12-4

| CATALOG NO. | DESCRIPTION                                      | UOM | ORDER MULTIPLE |
|-------------|--|-----|----------------|
| B6-12-4     | 1/2 x 4' #10 THHN Wire – Metallic Connectors     | EA  | 90             |
| B6-12-6     | 1/2 x 6' #10 THHN Wire – Metallic Connectors     | EA  | 60             |
| B6-34-4     | 3/4 x 4' #8 THHN Wire – Metallic Connectors      | EA  | 60             |
| B6-34-6     | 3/4 x 6' #8 THHN Wire – Metallic Connectors      | EA  | 45             |
| B6-12-4NMM  | 1/2 x 4' #10 THHN Wire – Non-Metallic Connectors | EA  | 90             |
| B6-12-6NMM  | 1/2 x 6' #10 THHN Wire – Non-Metallic Connectors | EA  | 60             |
| B6-34-4NMM  | 3/4 x 4' #8 THHN Wire – Non-Metallic Connectors  | EA  | 60             |
| B6-34-6NMM  | 3/4 x 6' #8 THHN Wire – Non-Metallic Connectors  | EA  | 45             |

## DiversiWhips with Extended Length Wires

DiversiWhips are available with extra long lead wires for those difficult to wire applications. These whips offer 10" of lead wire on the straight side and 18" of lead wire on the 90° side.



6-12-4R

| CATALOG NO. | DESCRIPTION                                      | UOM | ORDER MULTIPLE |
|-------------|--|-----|----------------|
| 6-12-4R     | 1/2 x 4' #10 THHN Wire – Metallic Connectors     | EA  | 6              |
| 6-12-6R     | 1/2 x 6' #10 THHN Wire – Metallic Connectors     | EA  | 6              |
| 6-34-4R     | 3/4 x 4' #8 THHN Wire – Metallic Connectors      | EA  | 6              |
| 6-34-6R     | 3/4 x 6' #8 THHN Wire – Metallic Connectors      | EA  | 6              |
| 6-12-4NMR   | 1/2 x 4' #10 THHN Wire – Non-Metallic Connectors | EA  | 6              |
| 6-12-6NMR   | 1/2 x 6' #10 THHN Wire – Non-Metallic Connectors | EA  | 6              |
| 6-34-4NMR   | 3/4 x 4' #8 THHN Wire – Non-Metallic Connectors  | EA  | 6              |
| 6-34-6NMR   | 3/4 x 6' #8 THHN Wire – Non-Metallic Connectors  | EA  | 6              |

## DiversiWhips for the Swimming Pool Industry

A labor saving kit for hookup of swimming pool motors, pumps, filters, and timers. Three distinct wire colors for ease of hookup. 1 straight and 1 90° metallic or non-metallic connector included.



6-12-4P

| CATALOG NO. | DESCRIPTION                                      | UOM | ORDER MULTIPLE |
|-------------|--|-----|----------------|
| 6-12-4P     | 1/2 x 4' #12 THHN Wire – Metallic Connectors     | EA  | 6              |
| 6-12-6P     | 1/2 x 6' #12 THHN Wire – Metallic Connectors     | EA  | 6              |
| 6-12-8P     | 1/2 x 8' #12 THHN Wire – Metallic Connectors     | EA  | 6              |
| 6-12-4NMP   | 1/2 x 4' #12 THHN Wire – Non-Metallic Connectors | EA  | 6              |
| 6-12-6NMP   | 1/2 x 6' #12 THHN Wire – Non-Metallic Connectors | EA  | 6              |
| 6-12-8NMP   | 1/2 x 8' #12 THHN Wire – Non-Metallic Connectors | EA  | 6              |

## Solid Wire Whips

| CATALOG NO.  | DESCRIPTION   | UOM | ORDER MULTIPLE |
|--------------|---|-----|----------------|
| 6-12-4NMSWP  | 1/2 x 4' #12 Solid 3 Wire – Non-Metallic Connectors | EA  | 6              |
| 6-12-6NMSWP  | 1/2 x 6' #12 Solid 3 Wire – Non-Metallic Connectors | EA  | 6              |
| 6-12-8NMSWP  | 1/2 x 8' #12 Solid 3 Wire – Non-Metallic Connectors | EA  | 3              |
| 6-12-4NM4SWP | 1/2 x 4' #12 Solid 4 Wire – Non-Metallic Connectors | EA  | 6              |
| 6-12-6NM4SWP | 1/2 x 6' #12 Solid 4 Wire – Non-Metallic Connectors | EA  | 6              |
| 6-12-8NM4SWP | 1/2 x 8' #12 Solid 4 Wire – Non-Metallic Connectors | EA  | 3              |

**STRANDED COPPER THHN WIRE**

**Stranded Copper Wire in Clear Dispenser Pack, 194°F**

UL, 600 V, 90°C Stranded THHN wire. 19 strand copper.



| CATALOG NO. | DESCRIPTION             | UOM | ORDER MULTIPLE |
|-------------|-------------------------|-----|----------------|
| W801        | 08 Gauge, 10 ft., Black | EA  | 1              |
| W802        | 08 Gauge, 10 ft., Red   | EA  | 1              |
| W803        | 08 Gauge, 10 ft., Green | EA  | 1              |
| W804        | 08 Gauge, 10 ft., Blue  | EA  | 1              |
| W805        | 08 Gauge, 10 ft., White | EA  | 1              |
| W101        | 10 Gauge, 10 ft., Black | EA  | 1              |
| W102        | 10 Gauge, 10 ft., Red   | EA  | 1              |
| W103        | 10 Gauge, 10 ft., Green | EA  | 1              |
| W104        | 10 Gauge, 10 ft., Blue  | EA  | 1              |
| W105        | 10 Gauge, 10 ft., White | EA  | 1              |
| W121        | 12 Gauge, 15 ft., Black | EA  | 1              |
| W122        | 12 Gauge, 15 ft., Red   | EA  | 1              |
| W123        | 12 Gauge, 15 ft., Green | EA  | 1              |
| W124        | 12 Gauge, 15 ft., Blue  | EA  | 1              |
| W125        | 12 Gauge, 15 ft., White | EA  | 1              |
| W141        | 14 Gauge, 20 ft., Black | EA  | 1              |
| W142        | 14 Gauge, 20 ft., Red   | EA  | 1              |
| W143        | 14 Gauge, 20 ft., Green | EA  | 1              |
| W144        | 14 Gauge, 20 ft., Blue  | EA  | 1              |
| W145        | 14 Gauge, 20 ft., White | EA  | 1              |

**Stranded Copper Wire on Spool**

UL, 600 V, 90°C Stranded THHN wire. 19 strand copper. 100 ft. per spool.



| CATALOG NO. | DESCRIPTION                    | UOM | ORDER MULTIPLE |
|-------------|--------------------------------|-----|----------------|
| W801-100    | 08 Gauge, 100 ft. Spool, Black | EA  | 1              |
| W802-100    | 08 Gauge, 100 ft. Spool, Red   | EA  | 1              |
| W803-100    | 08 Gauge, 100 ft. Spool, Green | EA  | 1              |
| W804-100    | 08 Gauge, 100 ft. Spool, Blue  | EA  | 1              |
| W805-100    | 08 Gauge, 100 ft. Spool, White | EA  | 1              |
| W101-100    | 10 Gauge, 100 ft. Spool, Black | EA  | 1              |
| W102-100    | 10 Gauge, 100 ft. Spool, Red   | EA  | 1              |
| W103-100    | 10 Gauge, 100 ft. Spool, Green | EA  | 1              |
| W104-100    | 10 Gauge, 100 ft. Spool, Blue  | EA  | 1              |
| W105-100    | 10 Gauge, 100 ft. Spool, White | EA  | 1              |
| W121-100    | 12 Gauge, 100 ft. Spool, Black | EA  | 1              |
| W122-100    | 12 Gauge, 100 ft. Spool, Red   | EA  | 1              |
| W123-100    | 12 Gauge, 100 ft. Spool, Green | EA  | 1              |
| W124-100    | 12 Gauge, 100 ft. Spool, Blue  | EA  | 1              |
| W125-100    | 12 Gauge, 100 ft. Spool, White | EA  | 1              |
| W141-100    | 14 Gauge, 100 ft. Spool, Black | EA  | 1              |
| W142-100    | 14 Gauge, 100 ft. Spool, Red   | EA  | 1              |
| W143-100    | 14 Gauge, 100 ft. Spool, Green | EA  | 1              |
| W144-100    | 14 Gauge, 100 ft. Spool, Blue  | EA  | 1              |
| W145-100    | 14 Gauge, 100 ft. Spool, White | EA  | 1              |

**Stranded Copper Wire on Spool**

UL, 600 V, 90°C Stranded THHN wire. 19 strand copper. 50 ft. per spool.



| CATALOG NO. | DESCRIPTION                   | UOM | ORDER MULTIPLE |
|-------------|-------------------------------|-----|----------------|
| W801-50     | 08 Gauge, 50 ft. Spool, Black | EA  | 1              |
| W802-50     | 08 Gauge, 50 ft. Spool, Red   | EA  | 1              |
| W803-50     | 08 Gauge, 50 ft. Spool, Green | EA  | 1              |
| W804-50     | 08 Gauge, 50 ft. Spool, Blue  | EA  | 1              |
| W805-50     | 08 Gauge, 50 ft. Spool, White | EA  | 1              |
| W101-50     | 10 Gauge, 50 ft. Spool, Black | EA  | 1              |
| W102-50     | 10 Gauge, 50 ft. Spool, Red   | EA  | 1              |
| W103-50     | 10 Gauge, 50 ft. Spool, Green | EA  | 1              |
| W104-50     | 10 Gauge, 50 ft. Spool, Blue  | EA  | 1              |
| W105-50     | 10 Gauge, 50 ft. Spool, White | EA  | 1              |
| W121-50     | 12 Gauge, 50 ft. Spool, Black | EA  | 1              |
| W122-50     | 12 Gauge, 50 ft. Spool, Red   | EA  | 1              |
| W123-50     | 12 Gauge, 50 ft. Spool, Green | EA  | 1              |
| W124-50     | 12 Gauge, 50 ft. Spool, Blue  | EA  | 1              |
| W125-50     | 12 Gauge, 50 ft. Spool, White | EA  | 1              |
| W141-50     | 14 Gauge, 50 ft. Spool, Black | EA  | 1              |
| W142-50     | 14 Gauge, 50 ft. Spool, Red   | EA  | 1              |
| W143-50     | 14 Gauge, 50 ft. Spool, Green | EA  | 1              |
| W144-50     | 14 Gauge, 50 ft. Spool, Blue  | EA  | 1              |
| W145-50     | 14 Gauge, 50 ft. Spool, White | EA  | 1              |

**High Temperature Wire, 400°F (204°C), 600 V.**

7 strand tin coated copper wire with silicone rubber insulation protected by a braided fiberglass jacket. Use on the front of all gas furnaces with spark ignition because of flame roll-out on start up. Also on all power feeds to electric strip and duct heaters. Also used on all heat producing food preparation equipment.



| CATALOG NO. | DESCRIPTION                          | UOM | ORDER MULTIPLE |
|-------------|--------------------------------------|-----|----------------|
| WHT20       | 14 gauge, 10 ft. black, 10 ft. white | EA  | 1              |
| WHTB14-50   | 14 gauge, black, 50 ft.              | EA  | 1              |
| WHTR14-50   | 14 gauge, red, 50 ft.                | EA  | 1              |
| WHTW14-50   | 14 gauge, white, 50 ft.              | EA  | 1              |
| WHTB12-20   | 12 gauge, black, 20 ft.              | EA  | 1              |
| WHTB12-50   | 12 gauge, black, 50 ft.              | EA  | 1              |
| WHTB10-20   | 10 gauge, black, 20 ft.              | EA  | 1              |
| WHTB10-50   | 10 gauge, black, 50 ft.              | EA  | 1              |



Literature – Download all literature from the DiversiTech website using the Form ID shown in the icon. The URL is [www.diversitech.com/literature/FORMID.pdf](http://www.diversitech.com/literature/FORMID.pdf)

**MONITORS**

**Digital Three Phase Line Voltage Monitor**

Offers continuous protection against voltage anomalies which can damage compressors, motors and other sensitive electrically operated devices.

**PROTECTION:** Loss of Phase, Phase Reversal, Voltage Imbalance, Low Voltage, High Voltage

**DISPLAY:** Large custom LCD display indicates all operating conditions at a glance. Three large sets of digits provide easy system troubleshooting.

**VOLTMETER:** Three independent voltmeters read both line and contactor load (backside) voltages.

**MONITORED VOLTAGE:** 160 to 600 Volts 50-60 Hz.

**POWER SUPPLY:** Power for the WPC-500 is automatically derived from any active phase. System operation is not dependent on the control voltage or a specific phase for power.

**CONTROL VOLTAGE:** 19-277 VAC. Anticipator load is provided for operation with 24 volt electronic and mechanical thermostats.

**OPERATING VOLTAGE SET POINT:** 175 to 650 VAC. Digitally adjustable in one volt increments.

**VOLTAGE TRIP POINT:** Adjustable in 1% increments between 6% and 18% of selected operating voltage. Restart voltage set point (hysteresis) fixed at cutout voltage + 3%.

**VOLTAGE SYMMETRY:** Adjustable imbalance trip point from 2% to 25% of selected operating voltage.

**RESPONSE TIMES:**  
 Phase Loss/Reversal: 100 mS max.  
 Imbalance: Adjustable Response Timer  
 Over or Under Voltage: Adjustable Response Timer

**LOCKOUT DELAY TIMER:** Fully adjustable 0 to 720 Seconds (0 to 12 minutes). Digital display shows remaining time and user set points.

**SEQUENTIAL START TIMER:** 0 to 30 seconds in one second increments.

**RESPONSE TIMER:** 0.1 to 20 Seconds. Digital display shows remaining time and user set points.

**MEMORY:** Up to 25 past fault conditions are stored for later retrieval and analysis. The faults may be displayed or cleared by the front panel buttons.



**DTP-3**



| CATALOG NO.  | DESCRIPTION                     | UOM | ORDER MULTIPLE |
|--------------|---------------------------------|-----|----------------|
| <b>DTP-3</b> | Digital 3-Phase Motor Protector | EA  | 1              |

**Digital Single Phase Line Voltage Monitor**

Automatic voltage monitor and control system. Continuously measures incoming line voltage, allowing detection of any voltage outside the tolerances that you set. If these limits are exceeded, the response timer begins counting. You may also set response time – a short time for a quick response or a long time to avoid nuisance tripping. If the voltage remains outside the tolerance after the time has elapsed, the DSP-1 will turn off its output relay and protect your device. While output is off, an additional delay timer activates to avoid rapid restarts.

**FEATURES:**  
 Digital voltmeter displays instantaneous line voltage;  
 Automatic voltage tester adjusts from 90 to 300 volts;  
 Adjustable response timer (0.1 to 10 sec.) prevents nuisance tripping;  
 Adjustable delay timer (1 to 720 sec.) prevents rapid restarts;  
 Digital display makes for easy viewing and operation

**SPECIFICATIONS:**  
 Voltmeter: 70 to 325 Volts  
 Voltage Set Point: 90 to 300 Volts  
 Tolerance Limits: 6 to 18%  
 Response Timer: 0.1 to 10 seconds  
 Delay Timer: 1 to 720 seconds  
 Output Relay: 10 Amps, 250 VAC resistive, single-pole/double-throw  
 Control Input: 18 to 250 VAC with anticipator load for 24 volt thermostats



**DSP-1**

| CATALOG NO.  | DESCRIPTION                          | UOM | ORDER MULTIPLE |
|--------------|--------------------------------------|-----|----------------|
| <b>DSP-1</b> | Digital Single Phase Motor Protector | EA  | 1              |

**TIME DELAYS**

**Adjustable Delay on Break Timer**

Adjusts from 6 seconds to 8 minutes. Spin-proof knob. Works with 24, 120 or 240 VAC control circuits. Supports up to 1.5 Amps. Two wire hookup for easy installation. Solid state with quick disconnect terminals. Mounts with one self-tapping screw. Conformal coated circuitry protects against moisture and shock. UR recognized for USA and Canada. Works with anticipator type thermostats.

**HOW IT WORKS:** Immediately upon application of power, the Delay on Break timer enables circuit operation. Once power is interrupted, the circuit opens for the time set on the dial. After the time period elapses, the circuit closes, allowing the protected motor or compressor to start. For typical HVAC applications, the operation of the timer is transparent and will go unnoticed.



**ADB-1**

**ADB-2**

| CATALOG NO.  | DESCRIPTION                                | UOM | ORDER MULTIPLE |
|--------------|--|-----|----------------|
| <b>ADB-1</b> | Adjustable Delay on Break                  | EA  | 1              |
| <b>ADB-2</b> | Adjustable Delay on Break w/Terminal Leads | EA  | 1              |

**Adjustable Delay on Make Timer**

Ideal for random starting of multiple units. Adjusts from 6 seconds to 8 minutes. Spin proof knob. Works with 24, 120 or 240 VAC control circuits. Supports up to 1.5 Amps. Two wire hookup for easy installation. Solid state with quick-disconnect terminals. Mounts with one self-tapping screw. Conformal coated circuitry protects against moisture and shock. UR recognized for US and Canada. Works with anticipator type thermostats.

**HOW IT WORKS:** These timers delay circuit closure upon application of power. Only after the set time period elapses and power remains ON will the circuit close, allowing the protected motor or compressor to start. For typical HVAC installations, timers are adjusted to random times to prevent power circuit overloads, thus are often called random start timers.



**ADM-1**

**ADM-2**

| CATALOG NO.  | DESCRIPTION                               | UOM | ORDER MULTIPLE |
|--------------|---|-----|----------------|
| <b>ADM-1</b> | Adjustable Delay on Make                  | EA  | 1              |
| <b>ADM-2</b> | Adjustable Delay on Make w/Terminal Leads | EA  | 1              |

**MOTORS**

**Direct Drive Furnace Blower Motors**

- Installs with all Standard 48 Frame Mounting Brackets
- Standard Shaft Length, Diameter, and Flats
- Uses 370V Capacitors
- Standard 48 Frame Motor Casing Size
- 2.5" Diameter Hub Rings included
- Low Power Consumption
- Automatic Thermal Overload Protector
- Continuous Duty, Air Over
- Electrically Reversible
- Class B Insulation
- Speed: 1075/3
- Quiet Operation
- 60 HZ



| CATALOG NO. | HP  | VOLTAGE | SPEED  | FLA  | UOM | ORDER MULTIPLE |
|-------------|-----|---------|--------|------|-----|----------------|
| WG840583    | 1/4 | 115     | 1075/3 | 4.6  | EA  | 1              |
| WG840584    | 1/4 | 208-230 | 1075/3 | 2.2  | EA  | 1              |
| WG840585    | 1/3 | 115     | 1075/3 | 6.7  | EA  | 1              |
| WG840586    | 1/3 | 208-230 | 1075/3 | 2.9  | EA  | 1              |
| WG840587    | 1/2 | 115     | 1075/3 | 10.2 | EA  | 1              |
| WG840588    | 1/2 | 208-230 | 1075/3 | 5.0  | EA  | 1              |
| WG840589    | 3/4 | 115     | 1075/3 | 11.3 | EA  | 1              |
| WG840590    | 3/4 | 208-230 | 1075/3 | 5.4  | EA  | 1              |
| WG840595    | 1   | 115     | 1075/3 | 12.6 | EA  | 1              |
| WG840596    | 1   | 208-230 | 1075/3 | 5.59 | EA  | 1              |

**Condenser Fan Motors**

- Installs with all Standard 48 Frame Mounting Brackets
- Standard Shaft Length, Diameter, and Flats
- Drain Holes with Plugs in both end plates
- Automatic Thermal Overload Protector
- Standard 48 Frame Motor Casing Size
- Low Power Consumption
- 60 C Ambient Design
- Electrically Reversible
- Continuous Air Over
- Class B Insulation
- Quiet Operation
- Extended Studs
- 30" Leads
- 60 HZ



| CATALOG NO. | HP  | VOLTAGE | SPEED  | FLA | UOM | ORDER MULTIPLE |
|-------------|-----|---------|--------|-----|-----|----------------|
| WG840727    | 1/6 | 208-230 | 1075/1 | 1.3 | EA  | 1              |
| WG840728    | 1/4 | 208-230 | 1075/1 | 2.2 | EA  | 1              |
| WG840729    | 1/3 | 208-230 | 1075/1 | 2.8 | EA  | 1              |
| WG840730    | 1/2 | 208-230 | 1075/1 | 4.2 | EA  | 1              |
| WG840731    | 3/4 | 208-230 | 1075/1 | 4.5 | EA  | 1              |
| WG840204    | 1/4 | 208-230 | 825/1  | 1.5 | EA  | 1              |
| WG840205    | 1/3 | 208-230 | 825/1  | 2.2 | EA  | 1              |

**High Temperature Condenser Fan Motors**



- 70°C Ambient Temperature
- Installs with all Standard 48 Frame Mounting Brackets
- Standard Shaft Length, Diameter, and Flats
- Drain Holes with Plugs in both end plates
- Automatic Thermal Overload Protector
- Standard 48 Frame Motor Casing Size
- Low Power Consumption
- Electrically Reversible
- Continuous Air Over
- Class B Insulation
- Quiet Operation
- Extended Studs
- 30" Leads
- 60 HZ



| CATALOG NO. | HP  | VOLTAGE | SPEED  | FLA  | UOM | ORDER MULTIPLE |
|-------------|-----|---------|--------|------|-----|----------------|
| WG840728HT  | 1/4 | 208-230 | 1075/1 | 2.2  | EA  | 1              |
| WG840729HT  | 1/3 | 208-230 | 1075/1 | 2.8  | EA  | 1              |
| WG840730HT  | 1/2 | 208-230 | 1075/1 | 4.2  | EA  | 1              |
| WG840736HT  | 1/4 | 460     | 1075/1 | 1.65 | EA  | 1              |
| WG840737HT  | 1/3 | 460     | 1075/1 | 2.85 | EA  | 1              |
| WG840738HT  | 1/2 | 460     | 1075/1 | 4.3  | EA  | 1              |
| WG840739HT  | 3/4 | 460     | 1075/1 | 5.3  | EA  | 1              |
| WG840204HT  | 1/4 | 208-230 | 825/1  | 1.5  | EA  | 1              |
| WG840205HT  | 1/3 | 208-230 | 825/1  | 2.2  | EA  | 1              |



Literature - Download all literature from the DiversiTech website using the Form ID shown in the icon. The URL is [www.diversitech.com/literature/FORMID.pdf](http://www.diversitech.com/literature/FORMID.pdf)

**Multiple Horsepower Motors**

The Multi-Horsepower motors are specially designed to cover a range of applications. The condenser fan motors range from 1/2 to 1/5; 1/3 to 1/6 both at 1075 rpm; 1/3 to 1/6 at 825rpm. The direct drive furnace blower motors range from 1/2 to 1/6 in both 115 and 230 volts and 3/4 to 1/5 in both 115 and 230 volts all at 1075rpm. These motors feature reversing plugs, extended thru bolts 36 inch leads and are designed for 370 volt capacitors. Installs with all 48 frame mounting brackets.



| CATALOG NO. | APPLICATION | VOLTAGE | SPEED  | (1) HP-FLA | (2) HP-FLA | (3) HP-FLA | (4) HP-FLA | (5) HP-FLA | UOM | ORDER MULTIPLE |
|-------------|-------------|---------|--------|------------|------------|------------|------------|------------|-----|----------------|
| WG840463    | DDFB        | 115     | 1075/4 | 1/2-7.0    | 1/3-6.7    | 1/4-4.4    | 1/5-3.2    | 1/6-2.4    | EA  | 1              |
| WG840464    | DDFB        | 208-230 | 1075/4 | 1/2-3.9    | 1/3-3.6    | 1/4-2.5    | 1/5-1.8    | 1/6-1.3    | EA  | 1              |
| WG840465    | CF          | 208-230 | 1075/2 | 1/3-2.8    | 1/4-2.0    | 1/5-1.7    | 1/6-1.5    |            | EA  | 1              |
| WG840466    | DDFB        | 115     | 1075/4 | 3/4-8.1    | 1/2-6.6    | 1/3-4.6    | 1/4-3.8    | 1/5-3.1    | EA  | 1              |
| WG840467    | DDFB        | 208-230 | 1075/4 | 3/4-3.8    | 1/2-3.7    | 1/3-2.5    | 1/4-1.8    | 1/5-1.7    | EA  | 1              |
| WG840468    | CF          | 208-230 | 1075/2 | 1/2-3.0    | 1/3-2.5    | 1/4-2.0    | 1/5-1.3    |            | EA  | 1              |
| WG840469    | CF          | 208-230 | 825/2  | 1/3-2.1    | 1/4-1.7    | 1/5-1.5    | 1/6-1.2    |            | EA  | 1              |

**MOTOR CROSS REFERENCE GUIDE**

| Application                       | HP         | Voltage | Speed  | 370V Capacitor | Wagner   | Mars  | Packard | Gemline | Marathon | AO Smith | Fasco | Emerson | Smart  |
|-----------------------------------|------------|---------|--------|----------------|----------|-------|---------|---------|----------|----------|-------|---------|--------|
| Condenser Fan Motor               | 3/4        | 208-230 | 1075/1 | 10             | WG840731 | O3731 |         |         |          | FSE1076S | D929  | 1868    | SE3731 |
|                                   | 1/2        | 208-230 | 1075/1 | 10             | WG840730 | O3730 | 63130   | EM3730  | X221     | FSE1056S | D907  | 1862    | SE3730 |
|                                   | 1/3        | 208-230 | 1075/1 | 7.5            | WG840729 | O3729 | 63129   | EM3729  | X214     | FSE1036S | D908  | 1861    | SE3729 |
|                                   | 1/4        | 208-230 | 1075/1 | 5              | WG840728 | O3728 | 63128   | EM3728  | X213     | FSE1026S | D909  | 1860    | SE3728 |
|                                   | 1/6        | 208-230 | 1075/1 | 5              | WG840727 | O3727 |         |         | X411     | FSE1016S | D905  | 1859    | SE3727 |
|                                   | 1/6 to 1/3 | 208-230 | 1075/2 |                | WG840465 |       |         |         |          | FE6000   | D2827 | 5462    | SE3465 |
|                                   | 1/5 to 1/2 | 208-230 | 1075/2 |                | WG840468 |       |         |         |          | FE6002   |       | 5465    | SE3468 |
|                                   | 1/6 to 1/3 | 208-230 | 825/2  |                | WG840469 |       |         |         |          | FE6001   | D2826 | 5464    | SE3469 |
| Direct Drive Furnace Blower Motor | 1          | 115     | 1075/3 | 20             | WG840595 | O3595 |         |         |          | BDL1106  |       | 8906    |        |
|                                   | 1          | 208-230 | 1075/3 | 15             | WG840596 | O3596 |         |         | X023     | BD1106   |       | 8907    |        |
|                                   | 3/4        | 115     | 1075/3 | 15             | WG840589 | O3589 |         | EM3589  | X009     | DL1076   | D728  | 8904    | SE3589 |
|                                   | 3/4        | 208-230 | 1075/3 | 10             | WG840590 | O3590 | 63990   | EM3590  | X010     | D1076    | D729  | 8905    | SE3590 |
|                                   | 1/2        | 115     | 1075/3 | 5              | WG840587 | O3587 | 63987   | EM3587  | X004     | FDL1056  | D701  | 1865    | SE3587 |
|                                   | 1/2        | 208-230 | 1075/3 | 5              | WG840588 | O3588 | 63988   | EM3588  | X005     | FD1056   | D703  | 1973    | SE3588 |
|                                   | 1/3        | 115     | 1075/3 | 5              | WG840585 | O3585 |         | EM3585  | X002     | FDL1036  | D727  | 1864    | SE3585 |
|                                   | 1/3        | 208-230 | 1075/3 | 5              | WG840586 | O3586 | 63986   | EM3586  | X003     | FD1036   | D923  | 1972    | SE3586 |
|                                   | 1/4        | 115     | 1075/3 | 5              | WG840583 | O3583 | 63983   | EM3583  |          | FDL1026  | D721  | 1863    | SE3583 |
|                                   | 1/4        | 208-230 | 1075/3 | 5              | WG840584 | O3584 | 63984   | EM3584  | X001     | D1026    | D725  | 1971    | SE3584 |
|                                   | 1/6 to 1/2 | 115     | 1075/4 |                | WG840463 |       |         |         |          | FDL6001  | D2835 | 5460    | SE3463 |
|                                   | 1/6 to 1/2 | 208-230 | 1075/4 |                | WG840464 |       |         |         |          | FDL6000  | D833  | 5461    |        |
|                                   | 1/5 to 3/4 | 115     | 1075/4 |                | WG840466 |       |         |         |          | FDL6002  | D2832 | 5470    | SE3466 |
|                                   | 1/5 to 3/4 | 208-230 | 1075/4 |                | WG840467 |       |         |         |          | FD6001   | D2833 | 5471    | SE3467 |

**MOTOR BRACKETS**

**DiversiTech Motors Bracket**



| CATALOG NO.  | DESCRIPTION  | UOM | ORDER MULTIPLE |
|--------------|--|-----|----------------|
| <b>DMB-1</b> | Fixed Lug Assembly for 5-1/2" diameter motors      | EA  | 1              |
| <b>DMB-2</b> | Adjustable Lug Assembly for 5-1/2" diameter motors | EA  | 1              |

**Motor Mount – Flex Bracket**

Torsion Flex Bracket holds motor securely. Fits 5- 1/2" motors. Typically used for Goodman equipment.



| CATALOG NO.  | DESCRIPTION                             | UOM | ORDER MULTIPLE |
|--------------|---|-----|----------------|
| <b>DMB-3</b> | 5-1/2" Motor Mount Torsion Flex Bracket | EA  | 1              |

**Rheem Motor Bracket**



| CATALOG NO.    | DESCRIPTION                               | UOM | ORDER MULTIPLE |
|----------------|---|-----|----------------|
| <b>A60306K</b> | Mounting Plate for Rheem Condensing Units | EA  | 1              |

**BEARINGS**

**Cushioned Pillow Blocks**

| CATALOG NO.    | DESCRIPTION                 | INDUSTRY NO. | LAU NO.    | BEARING SHAFT SIZE | UOM | ORDER MULTIPLE |
|----------------|-----------------------------|--------------|------------|--------------------|-----|----------------|
| <b>535-BB1</b> | Bronze Bearing Pillow Block | NAH8A        |            | 1/2"               | EA  | 1              |
| <b>535-BB2</b> | Bronze Bearing Pillow Block | NAH10A       | 38-2204-01 | 5/8"               | EA  | 1              |
| <b>535-BB3</b> | Bronze Bearing Pillow Block | NAH12A       | 38-2086-01 | 3/4"               | EA  | 1              |
| <b>535-BB4</b> | Bronze Bearing Pillow Block | NAH16A       | 38-2087-01 | 1"                 | EA  | 1              |



**Side Flange Mount Pillow Blocks**

| CATALOG NO.    | DESCRIPTION            | INDUSTRY NO. | BEARING SHAFT SIZE | UOM | ORDER MULTIPLE |
|----------------|------------------------|--------------|--------------------|-----|----------------|
| <b>535-BB5</b> | Cushioned Flange Block | NVH12A       | 3/4"               | EA  | 1              |
| <b>535-BB6</b> | Cushioned Flange Block | NVH10A       | 5/8"               | EA  | 1              |



### Fusible Links

Fusible Links are temperature-sensitive, one time devices. Engineered as safety links, they open the circuit if the designed limit temperature is reached.

| CATALOG NO.     | FUSIBLE TEMP °F | TYPE       | PRONG TYPE  | QTY/PACK  | UOM | ORDER MULTIPLE |
|-----------------|-----------------|------------|-------------|-----------|-----|----------------|
| <b>HFL-4257</b> | 257°            | In-Line    |             | pack of 4 | PK  | 1              |
| <b>HFL-4300</b> | 300°            | In-Line    |             | pack of 4 | PK  | 1              |
| <b>HFL-4333</b> | 333°            | In-Line    |             | pack of 4 | PK  | 1              |
| <b>HFL-5257</b> | 257°            | Face Plate | Straight    | pack of 2 | PK  | 1              |
| <b>HFL-5258</b> | 257°            | Face Plate | Right Angle | pack of 2 | PK  | 1              |
| <b>HFL-5300</b> | 300°            | Face Plate | Straight    | pack of 2 | PK  | 1              |
| <b>HFL-5301</b> | 300°            | Face Plate | Right Angle | pack of 2 | PK  | 1              |
| <b>HFL-5333</b> | 333°            | Face Plate | Straight    | pack of 2 | PK  | 1              |



### Replacement Element Kits

Field repair damaged element sections of electric heaters. Each kit contains a specific KW replacement element, two ceramic terminal insulator sets, plated bolts, nuts and washers.

| CATALOG NO.    | WATTAGE AT |      | IN PLACE LENGTH (INCHES) |         | UOM | ORDER MULTIPLE |
|----------------|------------|------|--------------------------|---------|-----|----------------|
|                | 240V       | 208V | MINIMUM                  | MAXIMUM |     |                |
| <b>HEK-100</b> | 1000       | 750  | 14"                      | 35"     | EA  | 1              |
| <b>HEK-200</b> | 2000       | 1500 | 26"                      | 65"     | EA  | 1              |
| <b>HEK-400</b> | 4000       | 3000 | 45"                      | 135"    | EA  | 1              |
| <b>HEK-500</b> | 5000       | 3750 | 54"                      | 162"    | EA  | 1              |



### Sequencers

Used in electric heat systems to stage blower motors and heating elements. All are for 24V control.

| CATALOG NO.    | NO. CIRCUITS  | KILXON NO.  | SWITCH CONFIGURATION | DELAY ON TIME MIN.-MAX. SECONDS | DELAY OFF TIME MIN.-MAX. SECONDS | UOM | ORDER MULTIPLE |
|----------------|---------------|-------------|----------------------|---------------------------------|----------------------------------|-----|----------------|
| <b>HDR-101</b> | 1 Main        | 60000A0211  | SPST-NO              | 1-24                            | 45-75                            | EA  | 1              |
| <b>HDR-102</b> | 1 Main        | 60000A0147  | SPST-NO              | 30-75                           | 1-40                             | EA  | 1              |
| <b>HDR-201</b> | 2 Main        | 60000E0110  | DPST-NO              | 1-24                            | 45-75                            | EA  | 1              |
| <b>HDR-202</b> | 2 Main        | 60000E0109  | DPST-NO              | 30-70                           | 1-40                             | EA  | 1              |
| <b>HDR-211</b> | 2 Main Staged | 60200A0117  | DPST-NO              | 30-110                          | 1-40                             | EA  | 1              |
| <b>HDR-212</b> | 2 Main Staged | 60200A0127  | DPST-NO              | 1-25                            | 50-110                           | EA  | 1              |
| <b>HDR-221</b> | 3 Main Staged | 51172-131-6 | DPST-NO SPST-NO      | 1-25                            | 50-110                           | EA  | 1              |
| <b>HDR-222</b> | 4 Main Staged | 51172-131-7 | 2 DPST-NO            | 1-40                            | 50-110                           | EA  | 1              |



### Manual Reset Fire Stat

This bi-metal switch is used as a manual reset. When temperature condition is met, the device opens. The manual reset can only be reset after proper cool-down of the switch. The HMR-130 is a popular "fire stat" in ducted air distribution systems. Should temperatures in the duct exceed 130°F, the switch opens, shutting down the whole system so no fire or smoke can be spread by the fan.

| CATALOG NO.    | DESCRIPTION                     | UOM | ORDER MULTIPLE |
|----------------|---------------------------------|-----|----------------|
| <b>HMR-130</b> | Bi-metal Manual Reset Fire Stat | EA  | 1              |



## COMPRESSOR HEATERS

Extends the life of air conditioners and refrigeration compressors. Corrosion resistant exterior. High temperature silicone rubber element and insulated leads. Voltages through 600. Wattage for each model matches compressor requirements. Moisture proof, easy to install. Nominal power consumption. UL listed, CSA certified.



| CATALOG NO.     | RATED VOLTS | RATED WATTS | FITS COMPRESSOR  | GIRTH DIMENSIONS MIN. | GIRTH DIMENSIONS MAX. | SHAPE | UOM | ORDER MULTIPLE |
|-----------------|-------------|-------------|--|-----------------------|-----------------------|-------|-----|----------------|
| <b>CH-100</b>   | 240         | 50          | Bendix/Westinghouse: C, D  | 30-3/16"              | 37"                   | OVL   | EA  | 1              |
| <b>CH-100-3</b> | 480         |             | Copeland: Y<br>Hitachi: 753FH3-H, 1001FH4-H<br>Tecumseh: B, C, CL, AG, AV<br>Carlisle: W (70-88) |                       |                       |       | EA  | 1              |
| <b>CH-101</b>   | 240         | 54          | Aspera: H  | 27-7/16"              | 34-1/4"               | OVL   | EA  | 1              |
| <b>CH-101-1</b> | 208         |             | Bendix/Westinghouse: E   |                       |                       |       | EA  | 1              |
| <b>CH-101-2</b> | 120         |             | Bristol/Sunstrand: H10A, H21A,   |                       |                       |       | EA  | 1              |
| <b>CH-101-3</b> | 480         |             | Carrier: 6A25, 26, 28, 29, 6A35,<br>Copeland: CR   |                       |                       |       | EA  | 1              |
| <b>CH-102</b>   | 240         | 60          | Aspera: J  | 25-3/4"               | 32-9/16"              | OVL   | EA  | 1              |
| <b>CH-102-2</b> | 120         |             | Bristol/ Sunstrand: H10C, H20C,  |                       |                       |       | EA  | 1              |
| <b>CH-102-3</b> | 480         |             | Trane: D4340/7669  |                       |                       |       | EA  | 1              |
| <b>CH-196</b>   | 240         | 40          | Copeland   | 19-7/8"               | 26-5/8"               | RND   | EA  | 1              |
| <b>CH-196-2</b> | 120         |             | 6" Scroll  |                       |                       |       | EA  | 1              |
| <b>CH-196-3</b> | 480         |             |  |                       |                       |       | EA  | 1              |
| <b>CH-196-6</b> | 575         |             |  |                       |                       |       | EA  | 1              |
| <b>CH-230</b>   | 240         | 70          | Copeland   | 21-5/8"               | 28-1/2"               | RND   | EA  | 1              |
| <b>CH-230-3</b> | 480         |             | 7-1/2" Scroll  |                       |                       |       | EA  | 1              |
| <b>CH-230-6</b> | 575         |             |  |                       |                       |       | EA  | 1              |
| <b>CH-103</b>   | 240         | 45          | Bendix/Westinghouse: A   | 24-3/4"               | 31-9/16"              | OVL   | EA  | 1              |
| <b>CH-103-2</b> | 120         |             | Copeland: RR, SR<br>Tecumseh: AB, AW   |                       |                       |       | EA  | 1              |
| <b>CH-104</b>   | 240         | 75          | Bristol/Sunstrand: H10G, H20G,   | 41-1/2"               | 48-5/16"              | RND   | EA  | 1              |
| <b>CH-104-3</b> | 480         |             | Carrier: 6A88  |                       |                       |       | EA  | 1              |
| <b>CH-105</b>   | 240         | 50          | Copeland: VR<br>Trane: D4340/7670<br>Westinghouse: CD072, CD090                                  | 32-1/2"               | 39-5/16"              | RND   | EA  | 1              |
| <b>CH-135</b>   | 240         | 45          | Copeland: JR   | 20-5/16"              | 27-1/8"               | OVL   | EA  | 1              |
| <b>CH-135-2</b> | 120         |             | Tecumseh: AK   |                       |                       |       | EA  | 1              |
| <b>CH-197</b>   | 240         | 25          | Fedders/Chrysler: 2870908<br>Sanyo: CR15F, CR20F, CR33F  | 13-3/4"               | 20-9/16"              | RND   | EA  | 1              |
| <b>CH-202-3</b> | 480         | 70          | Copeland: BR   | 33-3/4"               | 36-3/4"               | RND   | EA  | 1              |
| <b>CH-280</b>   | 240         | 70          | Copeland 7.25 Scroll   | 20-4/5"               | 28"                   | RND   | EA  | 1              |

## WIRE CONNECTORS

### Wire Connectors – Screw-On

Color-coded connectors make quick, secure connections for positive continuity. High-dielectric thermoplastic shell resists chemical action from hydrocarbons, dilute acid or alkaline solutions. Deep skirt design prevents exposure of bare wire.

623-002



| CATALOG NO.    | DESCRIPTION   | UOM | ORDER MULTIPLE |
|----------------|---|-----|----------------|
| <b>623-001</b> | Gray Screw-On – Size 71B, #22 to #16 AWG, 300V Max, pack of 100   | PK  | 1              |
| <b>623-002</b> | Blue Screw-On – Size 72B, #22 to #16 AWG, 300V Max, pack of 100   | PK  | 1              |
| <b>623-003</b> | Orange Screw-On – Size 73B, #22 to #14 AWG, 600V Max, pack of 100 | PK  | 1              |
| <b>623-004</b> | Yellow Screw-On – Size 74B, #18 to #10 AWG, 600V Max, pack of 100 | PK  | 1              |
| <b>623-005</b> | Red Screw-On – Size 76B, #18 to #10 AWG, 600V Max, pack of 100    | PK  | 1              |

U.L. Listed. CSA Approved.

### Wire Connectors – Winged

Wings give surer grip; offset center design provides great twisting leverage. Expandable square-wire spring instantly adjusts to shape and size to create a strong, vibration-resistant connection. Same tough shell as screw-on type.

623-007



| CATALOG NO.    | DESCRIPTION   | UOM | ORDER MULTIPLE |
|----------------|---|-----|----------------|
| <b>623-000</b> | Lg. Gray Winged – Size 78B, #14 to #8 AWG, 600V Max, pack of 50 | PK  | 1              |
| <b>623-006</b> | Yellow Winged – Size 84, #22 to #10 AWG, 600V Max, pack of 100  | PK  | 1              |
| <b>623-007</b> | Red Winged – Size 86, #18 to #10 AWG, 600V Max, pack of 100     | PK  | 1              |
| <b>623-008</b> | Blue Winged – Size 89, #10 to #6, 600V Max, pack of 50          | PK  | 1              |

U.L. Listed. C.S.A. Approved.

### Wire Connectors – Screw-On

Color-coded connectors make quick, secure connections for positive continuity. High-dielectric thermoplastic shell resists chemical action from hydrocarbons, dilute acid or alkaline solutions. Deep skirt design prevents exposure of bare wire. New handy carry handle and grip bottle.



| CATALOG NO. | DESCRIPTION  | UOM | ORDER MULTIPLE |
|-------------|--|-----|----------------|
| 623-011     | Gray Screw-On – Size 71B, #22 to #16 AWG, 300V Max., pack of 900   | PK  | 1              |
| 623-012     | Blue Screw-On – Size 72B, #22 to #16 AWG, 300V Max., pack of 600   | PK  | 1              |
| 623-013     | Orange Screw-On – Size 73B, #22 to #14 AWG, 600V Max., pack of 300 | PK  | 1              |
| 623-014     | Yellow Screw-On – Size 74B, #18 to #10 AWG, 600V Max., pack of 200 | PK  | 1              |
| 623-015     | Red Screw-On – Size 76B, #18 to #10 AWG, 600V Max., pack of 160    | PK  | 1              |

U.L. Listed. C.S.A. Approved.

### Porcelain Wire Connectors



| CATALOG NO. | DESCRIPTION                     | AWG                  | UOM | ORDER MULTIPLE |
|-------------|---------------------------------|----------------------|-----|----------------|
| CPN1        | Porcelain – Small, pack of 15   | 22-16, 2 Strand Wire | PK  | 1              |
| CPN1C       | Porcelain – Small, pack of 100  | 22-16, 2 Strand Wire | PK  | 1              |
| CPN2        | Porcelain – Medium, pack of 10  | 18-14, 2 Strand Wire | PK  | 1              |
| CPN2C       | Porcelain – Medium, pack of 100 | 18-14, 2 Strand Wire | PK  | 1              |
| CPN3        | Porcelain – Large, pack of 10   | 18-14, 3 Strand Wire | PK  | 1              |
| CPN3C       | Porcelain – Large, pack of 100  | 18-14, 3 Strand Wire | PK  | 1              |

### Wire Connectors – Contractor Packs



| CATALOG NO. | DESCRIPTION                                | UOM | ORDER MULTIPLE |
|-------------|--|-----|----------------|
| C222        | Closed End Connectors 22-14 W, pack of 18  | PK  | 1              |
| C222C       | Closed End Connectors 22-14 W, pack of 100 | PK  | 1              |
| C223        | Closed End Connectors 18-10 W, pack of 15  | PK  | 1              |
| C223C       | Closed End Connectors 18-10 W, pack of 100 | PK  | 1              |
| C241        | Blue Wire Connectors 22-16 W, pack of 20   | PK  | 1              |
| C243        | Orange Wire Connectors 22-14 W, pack of 15 | PK  | 1              |
| C245        | Yellow Wire Connectors 18-10 W, pack of 13 | PK  | 1              |
| C247        | Red Wire Connectors 18-10 W, pack of 10    | PK  | 1              |
| C312        | Yellow Winged Wire Connectors, pack of 13  | PK  | 1              |
| C312L       | Yellow Winged Wire Connectors, pack of 50  | PK  | 1              |
| C512        | Red Winged Wire Connectors, pack of 10     | PK  | 1              |
| C512L       | Red Winged Wire Connectors, pack of 50     | PK  | 1              |

U.L. Listed. CSA Approved.

### WIRE/CABLE TIES, MOUNTS, CLAMPS

#### Cable Tie Assortment Pack



| CATALOG NO. | DESCRIPTION   | UOM | ORDER MULTIPLE |
|-------------|---|-----|----------------|
| 7-711       | Natural Cable Tie Assortment – 7" and 11", pack of 150      | PK  | 25             |
| 7-711-B     | Black Cable Tie Assortment – 7" and 11", pack of 150        | PK  | 25             |
| 7-5811      | Natural Cable Tie Assortment – 5", 8", and 11", pack of 450 | PK  | 30             |
| 7-5811-B    | Black Cable Tie Assortment – 5", 8", and 11", pack of 450   | PK  | 30             |

#### Heavy Duty Cable Ties

6.6 nylon, the heavy duty duct straps feature smooth insertion, and a locking mechanism that gives ductwork a firm hold. Accommodates 7 to 15 inch duct. Tensioning tool for 32"+ allows operator to adjust strap to any desired tension.



| CATALOG NO. | DESCRIPTION  | UOM | ORDER MULTIPLE |
|-------------|--|-----|----------------|
| 7-P24       | 24" Long – Fits up to 6" Duct – 175 lb. Tensile          | EA  | 50             |
| 7-P36       | 36" Long – Fits up to 10" Duct – 175 lb. Tensile         | EA  | 50             |
| 7-P36B      | 36" Long – Black – Fits up to 10" Duct – 175 lb. Tensile | EA  | 50             |
| 7-P48       | 48" Long – Fits up to 14" Duct – 175 lb. Tensile         | EA  | 50             |
| 7-P48B      | 48" Long – Black – Fits up to 14" Duct – 175 lb. Tensile | EA  | 50             |
| 7-L300      | Tensioning Tool for 120-175 lb. Ties                     | EA  | 1              |

#### Cable Tie Holder

Finally an easier way to hold 24" to 48" cable ties. Easy to carry across your back or around your waist.



| CATALOG NO. | DESCRIPTION      | UOM | ORDER MULTIPLE |
|-------------|------------------|-----|----------------|
| CTH-1       | Cable Tie Holder | EA  | 1              |

WIRE/CABLE TIES, MOUNTS, CLAMPS cont'd

White Nylon Wire Ties

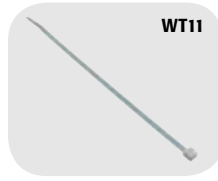

| CATALOG NO. | DESCRIPTION  | TENSILE STRENGTH | UOM | ORDER MULTIPLE |
|-------------|--|------------------|-----|----------------|
| WT04        | White Wire Ties – 4" Nylon, pack of 40                       | 18               | PK  | 1              |
| WT04C       | White Wire Ties – 4" Nylon, pack of 100                      | 18               | PK  | 1              |
| WT05        | White Wire Ties – 5" Nylon, pack of 35                       | 18               | PK  | 1              |
| WT05C       | White Wire Ties – 5" Nylon, pack of 100                      | 18               | PK  | 1              |
| WT07        | White Wire Ties – 7" Nylon, pack of 30                       | 50               | PK  | 1              |
| WT07C       | White Wire Ties – 7" Nylon, pack of 100                      | 50               | PK  | 1              |
| WT11        | White Wire Ties – 11" Nylon, pack of 15                      | 50               | PK  | 1              |
| WT11C       | White Wire Ties – 11" Nylon, pack of 100                     | 50               | PK  | 1              |
| WT15        | White Wire Ties – 15" Nylon, pack of 12                      | 50               | PK  | 1              |
| WT15C       | White Wire Ties – 15" Nylon, pack of 100                     | 50               | PK  | 1              |
| WTA1        | White Wire Ties – Assorted 4", 7", and 11" Nylon, pack of 30 |                  | PK  | 1              |

Black Nylon Wire Ties

Ultraviolet resistant for outdoor use.



| CATALOG NO. | DESCRIPTION  | TENSILE STRENGTH | UOM | ORDER MULTIPLE |
|-------------|--|------------------|-----|----------------|
| WTB05       | Black Wire Ties – 5" Nylon, pack of 35                       | 18               | PK  | 1              |
| WTB05C      | Black Wire Ties – 5" Nylon, pack of 100                      | 18               | PK  | 1              |
| WTB07       | Black Wire Ties – 7" Nylon, pack of 30                       | 50               | PK  | 1              |
| WTB07C      | Black Wire Ties – 7" Nylon, pack of 100                      | 50               | PK  | 1              |
| WTB07M      | Black Wire Ties – 7" Nylon, pack of 1000                     | 50               | PK  | 1              |
| WTB11       | Black Wire Ties – 11" Nylon, pack of 15                      | 50               | PK  | 1              |
| WTB11C      | Black Wire Ties – 11" Nylon, pack of 100                     | 50               | PK  | 1              |
| WTB11CR     | Black Wire Ties, Releasable – 11" Nylon, pack of 100         | 50               | PK  | 1              |
| WTB11D      | Black Wire Ties – 11" Nylon, pack of 500                     | 50               | PK  | 1              |
| WTB11M      | Black Wire Ties – 11" Nylon, pack of 1000                    | 50               | PK  | 1              |
| WTB15       | Black Wire Ties – 15" Nylon, pack of 12                      | 50               | PK  | 1              |
| WTB15C      | Black Wire Ties – 15" Nylon, pack of 100                     | 50               | PK  | 1              |
| WTBA1       | Black Wire Ties – Assorted 4", 7", and 11" Nylon, pack of 28 | 50               | PK  | 1              |

White Nylon Ties with Mounting Hole

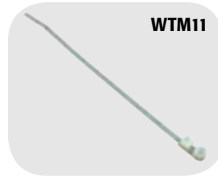

| CATALOG NO. | DESCRIPTION   | TENSILE STRENGTH | UOM | ORDER MULTIPLE |
|-------------|---|------------------|-----|----------------|
| WTM05       | White Wire Ties with Mounting Hole – 5" Nylon, pack of 13   | 18               | PK  | 1              |
| WTM05C      | White Wire Ties with Mounting Hole – 5" Nylon, pack of 100  | 18               | PK  | 1              |
| WTM07       | White Wire Ties with Mounting Hole – 7" Nylon, pack of 11   | 50               | PK  | 1              |
| WTM07C      | White Wire Ties with Mounting Hole – 7" Nylon, pack of 100  | 50               | PK  | 1              |
| WTM11       | White Wire Ties with Mounting Hole – 11" Nylon, pack of 6   | 50               | PK  | 1              |
| WTM11C      | White Wire Ties with Mounting Hole – 11" Nylon, pack of 100 | 50               | PK  | 1              |
| WTM14       | White Wire Ties with Mounting Hole – 14" Nylon, pack of 5   | 50               | PK  | 1              |
| WTM14C      | White Wire Ties with Mounting Hole – 14" Nylon, pack of 100 | 50               | PK  | 1              |

Black Nylon Ties with Mounting Hole



| CATALOG NO. | DESCRIPTION   | TENSILE STRENGTH | UOM | ORDER MULTIPLE |
|-------------|---|------------------|-----|----------------|
| WTMB05      | Black Wire Ties with Mounting Hole – 5" Nylon, pack of 12   | 18               | PK  | 1              |
| WTMB05C     | Black Wire Ties with Mounting Hole – 5" Nylon, pack of 100  | 18               | PK  | 1              |
| WTMB07      | Black Wire Ties with Mounting Hole – 7" Nylon, pack of 10   | 50               | PK  | 1              |
| WTMB07C     | Black Wire Ties with Mounting Hole – 7" Nylon, pack of 100  | 50               | PK  | 1              |
| WTMB11      | Black Wire Ties with Mounting Hole – 11" Nylon, pack of 6   | 50               | PK  | 1              |
| WTMB11C     | Black Wire Ties with Mounting Hole – 11" Nylon, pack of 100 | 50               | PK  | 1              |
| WTMB14      | Black Wire Ties with Mounting Hole – 14" Nylon, pack of 5   | 50               | PK  | 1              |
| WTMB14C     | Black Wire Ties with Mounting Hole – 14" Nylon, pack of 100 | 50               | PK  | 1              |

Wire and Cable Clamps – Nylon



| CATALOG NO. | DESCRIPTION   | UOM | ORDER MULTIPLE |
|-------------|---|-----|----------------|
| WC02        | Wire and Cable Clamps – 1/8" Diameter, pack of 40         | PK  | 1              |
| WC03        | Wire and Cable Clamps – 3/16" Diameter, pack of 40        | PK  | 1              |
| WC04        | Wire and Cable Clamps – 1/4" Diameter, pack of 35         | PK  | 1              |
| WC05        | Wire and Cable Clamps – 5/16" Diameter, pack of 35        | PK  | 1              |
| WC06        | Wire and Cable Clamps – 3/8" Diameter, pack of 30         | PK  | 1              |
| WC07        | Wire and Cable Clamps – 7/16" Diameter, pack of 30        | PK  | 1              |
| WC08        | Wire and Cable Clamps – 1/2" Diameter, pack of 25         | PK  | 1              |
| WC09        | Wire and Cable Clamps – 9/16" Diameter, pack of 20        | PK  | 1              |
| WC10        | Wire and Cable Clamps – 5/8" Diameter, pack of 20         | PK  | 1              |
| WC12        | Wire and Cable Clamps – 3/4" Diameter, pack of 15         | PK  | 1              |
| WC14        | Wire and Cable Clamps – 7/8" Diameter, pack of 15         | PK  | 1              |
| WC16        | Wire and Cable Clamps – 1" Diameter, pack of 14           | PK  | 1              |
| WCA1        | Wire and Cable Clamps Assortment – 1/8" to 1", pack of 26 | PK  | 1              |

Wire Tie Mounts



| CATALOG NO. | DESCRIPTION  | UOM | ORDER MULTIPLE |
|-------------|--|-----|----------------|
| WTM1        | White Wire Tie Mounts – Adhesive Back, pack of 4   | PK  | 1              |
| WTM1C       | White Wire Tie Mounts – Adhesive Back, pack of 100 | PK  | 1              |
| WTM2        | White Wire Tie Mounts – #8 Screw, pack of 7        | PK  | 1              |
| WTM2C       | White Wire Tie Mounts – #8 Screw, pack of 100      | PK  | 1              |

All above sizes are available in 100 packs. Add "C" to the end of the part number.

**TERMINALS, CONNECTORS**

**Term Lok Compressor Repair Kit**

Finally, a product that simplifies the repair of burned or damaged spade terminals when reconnecting or replacing a compressor. Fits both non-burned and burned terminals. Connects to the compressor via precision brass cylinders that fit over the terminals and connect with stainless steel set screws. Wires are permanently attached. Standard factory 600V, 65 strand machine wire. Easy to install and guaranteed for the life of the compressor.



| CATALOG NO. | DESCRIPTION                     | UOM | ORDER MULTIPLE |
|-------------|---------------------------------|-----|----------------|
| TLC-3-8     | 3 Wire, 8 Gauge Connection Kit  | EA  | 1              |
| TLC-3-10    | 3 Wire, 10 Gauge Connection Kit | EA  | 1              |
| TLC-3-12    | 3 Wire, 12 Gauge Connection Kit | EA  | 1              |

**Replacement Compressor Leads**

Extreme heat within compressors typically causes failure of wiring insulation. This can cause corrosion to the inner strands of copper within the wire used for compressor hook-up. This reduces the power flow to the compressor causing the unit to overheat and can prevent the compressor from starting. A MINIMUM of 12" of wire must be removed. The DiversiTech Replacement Compressor Leads are ideal for replacing this corroded wiring. 24" leads also available for replacing wire all the way to the contactor and capacitor.



| CATALOG NO. | DESCRIPTION                                 | UOM | ORDER MULTIPLE |
|-------------|---|-----|----------------|
| CC33        | Compressor Leads – 12" with Butt, pack of 3 | PK  | 1              |
| CC33-18     | Compressor Leads – 18" with Butt, pack of 3 | PK  | 1              |
| CC33-24     | Compressor Leads – 24" with Ring, pack of 3 | PK  | 1              |

**Grommets – Vinyl (By Panel Hole Size)**



| CATALOG NO. | DESCRIPTION   | UOM | ORDER MULTIPLE |
|-------------|---|-----|----------------|
| GV04        | Grommets – 1/4", pack of 18                                   | PK  | 1              |
| GV05        | Grommets – 5/16", pack of 15                                  | PK  | 1              |
| GV06        | Grommets – 3/8", pack of 13                                   | PK  | 1              |
| GV07        | Grommets – 7/16", pack of 12                                  | PK  | 1              |
| GV08        | Grommets – 1/2", pack of 12                                   | PK  | 1              |
| GV10        | Grommets – 5/8", pack of 7                                    | PK  | 1              |
| GV12        | Grommets – 3/4", pack of 5                                    | PK  | 1              |
| GV14        | Grommets – 7/8", pack of 4                                    | PK  | 1              |
| GV16        | Grommets – 1", pack of 4                                      | PK  | 1              |
| GVA1        | Assortment – Small – GV04, GV05, GV06, GV07, GV08, pack of 15 | PK  | 1              |
| GVA2        | Assortment – Large – GV08, GV10, GV12, GV14, GV16, pack of 5  | PK  | 1              |

Sizes shown above also available in 100 packs.

**Alligator Clips**



| CATALOG NO. | DESCRIPTION                              | UOM | ORDER MULTIPLE |
|-------------|--|-----|----------------|
| ACK4        | Two Red and Two Black Boots with 4 Clips | EA  | 1              |

**Transparent Plastic Boxes with Terminal Assortments**

Boxes are made of soft, pliable, durable "K" resin with 18 compartments containing the most popular terminals, including hi-temp and compressor terminals.



| CATALOG NO. | DESCRIPTION  | UOM | ORDER MULTIPLE |
|-------------|--|-----|----------------|
| PA10        | 180 Terminals (10 Each Kind)                           | EA  | 1              |
| PA25        | 450 Terminals (25 Each Kind)                           | EA  | 1              |
| PA25AP      | Appliance Parts Technician Assortment (mostly Hi-Temp) | EA  | 1              |
| PA18        | "K" Resin Plastic Box Only                             | EA  | 1              |

**Compartmented Storage Boxes**



| CATALOG NO. | DESCRIPTION  | UOM | ORDER MULTIPLE |
|-------------|--|-----|----------------|
| MB21        | 21 Compartmented Metal Box   | EA  | 1              |
| MB22        | 21 Compartmented Metal Box w/230 popular items including hi-temp and compressor terminals, nylon ties and clamps | EA  | 1              |

**Heat Shrink Tubing – Polyolefin 50% Shrink Commercial Grade – Black**



| CATALOG NO. | DESCRIPTION                                     | UOM | ORDER MULTIPLE |
|-------------|---|-----|----------------|
| HS03        | 3/16" I.D. Expanded – 4" Long, pack of 8        | PK  | 1*             |
| HS04        | 1/4" I.D. Expanded – 4" Long, pack of 7         | PK  | 1*             |
| HS06        | 3/8" I.D. Expanded – 4" Long, pack of 6         | PK  | 1*             |
| HS08        | 1/2" I.D. Expanded – 4" Long, pack of 5         | PK  | 1*             |
| HS012       | 3/4" I.D. Expanded – 4" Long, pack of 4         | PK  | 1*             |
| HS16        | 1" I.D. Expanded – 4" Long, pack of 3           | PK  | 1*             |
| HS24        | 1.5" I.D. Expanded – Per Foot                   | EA  | 1'             |
| HS32        | 2" I.D. Expanded – Per Foot                     | EA  | 1'             |
| HSA1        | Assorted 3/16", 1/4", 3/8" – 4" Long, pack of 7 | PK  | 1              |
| HSA2        | Assorted 1/2", 3/4", 1" – 4" Long, pack of 4    | PK  | 1              |

Available in lengths up to 250 ft.

\*These items are also available in bulk. To order, enter the catalog number followed by the letter "B". For example, HS03B is the bulk part number for HS03. Bulk items are priced and shipped by the foot.

**ELECTRICAL TAPES**

**Scotch 3M Super 33+ Electrical Tape**

Premium grade, 7 mil thick, all-weather vinyl insulating tape. Performs continuously in a temperature ambient of up to 220°F and as low as 0°F. Resealable plastic case. Made in USA.



| CATALOG NO. | DESCRIPTION                            | UOM | ORDER MULTIPLE |
|-------------|--|-----|----------------|
| <b>ET33</b> | Super 33+ Electrical Tape – 3/4" x 66' | EA  | 10             |

**Scotch 3M Super 88 Electrical Tape**

Premium grade, 8.5 mil thick, all-weather vinyl insulating tape. Performs continuously in a temperature ambient of up to 220°F and as low as 0°F. Excellent resistance to abrasion, moisture, acids and corrosion. Packaged in a resealable plastic case. Made in the USA.



| CATALOG NO. | DESCRIPTION                           | UOM | ORDER MULTIPLE |
|-------------|---------------------------------------|-----|----------------|
| <b>ET44</b> | Super 88 Electrical Tape – 3/4" x 66' | EA  | 10             |

**Scotch 35 Vinyl Electrical Tape**

This 7 mil premium grade electrical vinyl tape stretches to conform to virtually any shape that requires color-coded insulation. Abrasion and weather resistant. Measures 3/4" x 66'.



| CATALOG NO.  | DESCRIPTION                    | UOM | ORDER MULTIPLE |
|--------------|--------------------------------|-----|----------------|
| <b>ET35N</b> | Vinyl Electrical Tape – Orange | EA  | 10             |
| <b>ET35G</b> | Vinyl Electrical Tape – Green  | EA  | 10             |
| <b>ET35R</b> | Vinyl Electrical Tape – Red    | EA  | 10             |
| <b>ET35W</b> | Vinyl Electrical Tape – White  | EA  | 10             |

**Glass Cloth, Moisture Sealing, and Economy Electrical Tapes**



| CATALOG NO.    | DESCRIPTION                                   | UOM | ORDER MULTIPLE |
|----------------|---|-----|----------------|
| <b>GC275</b>   | 1/2" x 66' Glass Cloth Electrical Tape by 3M  | EA  | 10             |
| <b>GC277</b>   | 3/4" x 66' Glass Cloth Electrical Tape by 3M  | EA  | 10             |
| <b>ET130C1</b> | 1" x 30' Moisture Sealing Splicing Tape by 3M | EA  | 10             |
| <b>ET22</b>    | 3/4" x 66' Hiawatha Electrical Tape by 3M     | EA  | 10             |
| <b>AT-1700</b> | 3/4" x 66' TemFlex™ by 3M                     | EA  | 10             |

**Economy Electrical Tape**



| CATALOG NO.   | DESCRIPTION                        | UOM | ORDER MULTIPLE |
|---------------|------------------------------------|-----|----------------|
| <b>6-3460</b> | 3/4" x 60' Economy Electrical Tape | EA  | 10             |

# TOOLS

|  |         |
|--|---------|
| Allen Wrenches.....                        | 159     |
| Brushes.....                               | 163-165 |
| Calipers.....                              | 166     |
| Channellock® Products.....                 | 152     |
| Clipboards.....                            | 157     |
| Electrical Supplies.....                   | 158     |
| Fin Tools.....                             | 160     |
| Flashlights and Lanterns By Rayovac®.....  | 163     |
| Flashlights By Mag-Lite®.....              | 162     |
| Gauges.....                                | 167     |
| Hobby and Cutting Knives.....              | 168     |
| HVAC Airflow Instruments.....              | 173     |
| Manometers, Pressure.....                  | 173     |
| Measuring Tapes, Staples and Staple Guns.. | 156     |
| Meters, Detectors, Alarms.....             | 170-171 |
| Miscellaneous Tools.....                   | 161-162 |
| Monitors.....                              | 159     |
| Nut Setters.....                           | 152     |
| Refractometers.....                        | 172     |
| Retrieving Tool/Mini-Lights.....           | 157     |
| Saws and Saw Blades.....                   | 155     |
| Scales.....                                | 158     |
| Screwdrivers, Driver Sets.....             | 167     |
| Snips, Notchers, Crimpers, Seamers.....    | 153     |
| Straps, Truck Rope.....                    | 160-161 |
| Test Leads.....                            | 156     |
| Testers.....                               | 172     |
| Thermometers/Probes.....                   | 168-170 |
| Tool Bags.....                             | 156     |
| Tube Working Tools.....                    | 154-155 |
| Welding Torches, Supplies.....             | 152     |



**WELDING TORCHES, SUPPLIES**

**Hand Torch**

Combustion tip concentrates heat – reduces brazing time by 40%. This series has been redesigned with a patent pending ceramic igniting 1 piece stainless tip feature as well as a new diaphragm type regulator. Extremely durable with a full 3 year warranty.



| CATALOG NO. | DESCRIPTION | UOM | ORDER MULTIPLE |
|-------------|-------------|-----|----------------|
| 525-TX504   | Hand Torch  | EA  | 1              |

**Portable Hand Torch**

Developed for the professional. This portable torch is built with patented swirl combustion. 360° tip for easy use, rugged brass regulator, easy to clean orifice, and interchangeable tip capability. Designed to operate with a tank of either MAPP or Propane gas.



| CATALOG NO. | DESCRIPTION         | UOM | ORDER MULTIPLE |
|-------------|---------------------|-----|----------------|
| 525-STK9    | Portable Hand Torch | EA  | 1              |

**Heat Resistant Cloth**

This flame barrier drop cloth withstands temperatures to 3,000°F. No asbestos. Protects walls, floors, equipment, components and adjacent surfaces from torch flames when soldering, brazing or welding. All cloths have edges taped and sewn with grommets at each corner. Highly resistant to many chemicals and acids.

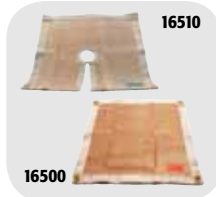

| CATALOG NO. | DESCRIPTION   | UOM | ORDER MULTIPLE |
|-------------|---|-----|----------------|
| 16500       | 18" x 18" Plain   | EA  | 1              |
| 16510       | 18" x 18" Keyhole w/cutout for draping over pipes/tubes | EA  | 1              |
| 16520       | 36" x 36" Plain   | EA  | 1              |

**Map-Pro and Propane Gas**



| CATALOG NO. | DESCRIPTION            | UOM | ORDER MULTIPLE |
|-------------|------------------------|-----|----------------|
| 525-MT1     | Map-Pro Gas – 16 oz.   | EA  | 12             |
| 525-PT1     | Propane Gas – 14.1 oz. | EA  | 12             |

**NUT SETTERS**

**Nut Setter – Power**

Magnetic hex drive nut setter to be used with any 1/4" power bit. Individually packed.



| CATALOG NO. | DESCRIPTION                              | UOM | ORDER MULTIPLE |
|-------------|--|-----|----------------|
| 5-MSH1/4MC  | Hex Drive – 1/4", 1-3/4" long, 1/4" nut  | EA  | 30             |
| 5-MSH5/16MC | Hex Drive – 1/4", 1-3/4" long, 5/16" nut | EA  | 30             |

**Magnetic Nut Setters – Bulk**



| CATALOG NO. | DESCRIPTION                              | UOM | ORDER MULTIPLE |
|-------------|--|-----|----------------|
| 540-400     | Magnetic Nut Setters – 5/16", pack of 30 | PK  | 1              |
| 540-500     | Magnetic Nut Setters – 1/4", pack of 30  | PK  | 1              |

**CHANNELLOCK® PRODUCTS**

**Tongue and Groove Pliers**

Patented design, permalock fasteners and reinforcing edge. Dipped plastic comfort grips.



| CATALOG NO. | DESCRIPTION                                | UOM | ORDER MULTIPLE |
|-------------|--|-----|----------------|
| 545-420     | 9-1/2" Tongue and Groove Pliers            | EA  | 1              |
| 545-422     | 9-1/2" Curved Jaw Tongue and Groove Pliers | EA  | 1              |
| 545-424     | 4-1/2" Tongue and Groove Pliers            | EA  | 1              |
| 545-426     | 6-1/2" Tongue and Groove Pliers            | EA  | 1              |
| 545-430     | 10" Tongue and Groove Pliers               | EA  | 1              |
| 545-440     | 12" Tongue and Groove Pliers               | EA  | 1              |
| 545-442     | 12" Curved Jaw Tongue and Groove Pliers    | EA  | 1              |
| 545-460     | 16" Tongue and Groove Pliers               | EA  | 1              |

**SNIPS, NOTCHERS, CRIMPERS, SEAMERS**

**Aviation Snips**

Moly alloy tool steel blade is hot drop-forged and scientifically heat-treated to provide a strong, longer lasting cutting edge. Durable serrated blades are designed to grip the metal for cutting ease. The patent pending spring on these snips is guaranteed to last for the life of the tool. Will cut 18 gauge cold-rolled steel.



| CATALOG NO. | DESCRIPTION   | UOM | ORDER MULTIPLE |
|-------------|---|-----|----------------|
| 540-6716S   | Aviation Snip – Cuts Straight – Yellow Handle         | EA  | 6              |
| 540-6716L   | Aviation Snip – Cuts Left – Red Handle                | EA  | 6              |
| 540-6716R   | Aviation Snip – Cuts Right – Green Handle             | EA  | 6              |
| 540-6716B   | Aviation Snip – Bulldog Notching Snip – Yellow Handle | EA  | 6              |

**HVAC Tools**

Hot drop-forged carbon steel blades. Compound leverage action handles. Heavy duty plastic grips.



| CATALOG NO. | DESCRIPTION                           | UOM | ORDER MULTIPLE |
|-------------|---------------------------------------|-----|----------------|
| 540-FACTMN1 | 8" Notcher – 31° Cutting Angle        | EA  | 3              |
| 540-FACTMC5 | 8" Crimper – 22 Ga. Crimping Capacity | EA  | 3              |
| 540-FACTMS1 | 3" Straight Seamer – 22 Ga. Capacity  | EA  | 2              |
| 540-FACTMS2 | 3" Offset Seamer – 22 Ga. Capacity    | EA  | 2              |

**Offset Snips**

The same high quality construction as the Aviation Snips with an additional advantage – the Offset Snips allow your hand to stay above metal for cutting ease and comfort.



| CATALOG NO. | DESCRIPTION                             | UOM | ORDER MULTIPLE |
|-------------|---|-----|----------------|
| 540-6510L   | Offset Snip – Cuts Left – Red Handle    | EA  | 6              |
| 540-6510R   | Offset Snip – Cuts Right – Green Handle | EA  | 6              |

**Upright Snips**

This snip significantly improves sheet metal cutting. The ergonomic design allows for easier cutting in tight places, improved safety by elevating hands above metal working surfaces, and increases wrist range motion.



| CATALOG NO. | DESCRIPTION                        | UOM | ORDER MULTIPLE |
|-------------|------------------------------------|-----|----------------|
| 540-6900L   | Upright Snips – Left-handed Model  | EA  | 6              |
| 540-6900R   | Upright Snips – Right-handed Model | EA  | 6              |

**Tinner Snips**

Constructed of the finest quality high carbon tool steel. Hot drop-forged and heat-treated to assure strength and durability. "Kush-N-Cote" vinyl coated handles for added comfort. Available in a Straight Pattern for a powerful straight cutting snip or Duckbill Pattern for cutting scrolls, circles, or straight lines. 12-1/2" long.



| CATALOG NO. | DESCRIPTION                  | UOM | ORDER MULTIPLE |
|-------------|------------------------------|-----|----------------|
| 540-P127S   | Straight Cutting Tinner Snip | EA  | 6              |
| 540-P127D   | Duckbill Tinner Snip         | EA  | 6              |

TUBE WORKING TOOLS

### Kut-All Plastic Tube and Hose Cutter

Tough, durable nylon. Blade closes into its own handle for safe handling. Replaceable high carbon, teflon coated steel blades. Ideal for cutting up to 1-1/8" I.D. plastic tubing, reinforced plastic tubing, rigid plastic pipe, and rubber hose.



| CATALOG NO. | DESCRIPTION                          | UOM | ORDER MULTIPLE |
|-------------|--------------------------------------|-----|----------------|
| PK-2        | Kut-All Plastic Tube and Hose Cutter | EA  | 1              |
| PK-2B       | Replacement Blades                   | EA  | 1              |

### Little Helper™ – All Purpose Cutter

Cuts up to 1-1/4" polyethylene, thinwall PVC, ABS, rubber hose, NM conduit and clear vinyl tubing. Reversible stainless steel blade, like two blades in one. Sturdy all metal construction.



| CATALOG NO. | DESCRIPTION             | UOM | ORDER MULTIPLE |
|-------------|-------------------------|-----|----------------|
| 548-001     | Little Helper™ – Carded | EA  | 1              |
| 548-002     | Replacement Blades      | EA  | 1              |

### Big Helper™ PVC Pipe Cutter

Ratchet style pipe cutters cut up to 2-1/2" Sch. 40 PVC Pipe. Ratchet action requires minimal pressure to easily cut through PVC pipe. Molybdenum stainless steel blade won't rust or break and lasts twice as long as most competitor's. The Mega-Cutter is now available – the strongest pipe cutter on the market today!



| CATALOG NO. | DESCRIPTION                  | UOM | ORDER MULTIPLE |
|-------------|------------------------------|-----|----------------|
| 548-003     | 1" O.D. Cutting Capacity     | EA  | 1              |
| 548-004     | 1" Replacement Blade         | EA  | 1              |
| 548-005     | 1-1/4" O.D. Cutting Capacity | EA  | 1              |
| 548-006     | 1-1/4" Replacement Blade     | EA  | 1              |
| 548-009     | 1-5/8" O.D. Cutting Capacity | EA  | 1              |
| 548-010     | 1-5/8" Replacement Blade     | EA  | 1              |
| 548-007     | 2-1/2" O.D. Mega-Cutter      | EA  | 1              |
| 548-008     | 2-1/2" Mega-Blade            | EA  | 1              |

### PVC Ratchet Cutter

- For repeated heavy-duty cutting.
- Cuts hose, PVC, CPVC, polyethylene, PEX and ABS up to 2".
- Ratchet action for easy cutting.
- High carbon steel blade provides longer sharpness and clean cuts.
- Aluminum body is lighter and corrosion resistant.
- Safety locking clasp.



| CATALOG NO. | DESCRIPTION                                    | UOM | ORDER MULTIPLE |
|-------------|--|-----|----------------|
| 6-T118      | Capacity: up to 2" (50mm); Length: 17" (425mm) | EA  | 1              |
| 6-T118BG    | Replacement Blade                              | EA  | 1              |

### E•Z™ Ratchet Tubing Cutter

- Ratcheting action rotates the cutter around the tube allowing a standard size cutter to be used in close quarter applications.
- Longer handle requires less effort to rotate cutter reducing hand fatigue.
- Wide hardened flared grooved rollers allow true cuts close to flared end tubing to avoid tube replacement in existing installations.
- Cuts copper, aluminum, brass, thin wall tubing and stainless steel.
- Spare cutting wheel supplied in handle.



| CATALOG NO. | DESCRIPTION                            | UOM | ORDER MULTIPLE |
|-------------|--|-----|----------------|
| 6-T133      | Capacity: 5/16" to 1-1/8" (8mm – 30mm) | EA  | 1              |

### E•Z™ Ratchet II Tube and Pipe Cutter

- Cuts without rotating tool completely around tube or pipe.
- Exclusive "One-Hand" operation.
- Ratchets in 5° increments while cutting 360° around tube.
- Large cutting diameter 1/8" to 1-1/8" (3mm-28mm).
- Cuts copper, brass, aluminum, stainless steel, PVC and thin wall conduit.
- Replaceable cutting wheels: 6-TRW1352.



| CATALOG NO. | DESCRIPTION                         | UOM | ORDER MULTIPLE |
|-------------|-------------------------------------|-----|----------------|
| 6-T135      | Capacity: 1/8" to 1-1/8" (3mm-28mm) | EA  | 1              |
| 6-TRW1352   | Replacement Wheels                  | EA  | 2              |

### Trigger Action Plastic Pipe and Hose Cutter

- For cutting PVC, CPVC, Polyethylene, PEX, ABS.
- Easily fits into tight spaces.
- Quick blade replacement.



| CATALOG NO. | DESCRIPTION             | UOM | ORDER MULTIPLE |
|-------------|-------------------------|-----|----------------|
| 6-T117      | Capacity: 1-5/8" (42mm) | EA  | 1              |
| 6-T117BG    | Replacement Blade       | EA  | 1              |

### One-Handed PVC/Hose Cutter

- For cutting PVC, CPVC, Polyethylene, PEX and ABS tubing.
- One-handed Operation.
- Quick-Blade Reset.
- Ratchet system holds blade in place while you adjust your grip to increase pressure.
- High carbon steel blade maintains sharpness and resists chipping.
- Handle locking strap for safe storage.
- Exclusive, easy replaceable blade feature.
- Ergonomically designed handle for comfort.
- Replacement Blade, No. 6-T119BG.



| CATALOG NO. | DESCRIPTION                                      | UOM | ORDER MULTIPLE |
|-------------|--|-----|----------------|
| 6-T1191     | Capacity: 1/8" to 1-5/8"; Length: 8-1/4" (210mm) | EA  | 1              |
| 6-T1191BG   | Replacement Blade                                | EA  | 1              |

**TUBE WORKING TOOLS cont'd**

**Mini Tubing Cutter**

- Comfort grip design for easy turning.
- Full size bearing tool steel cutter wheel.
- Large fluted adjusting knob for greater torque.
- Cuts copper, aluminum, brass, thin wall tubing and stainless steel.
- Wide hardened flared grooved rollers allows true cuts close to flared end tubing to avoid tube replacement in existing installations.



| CATALOG NO. | DESCRIPTION                         | UOM | ORDER MULTIPLE |
|-------------|-------------------------------------|-----|----------------|
| 6-T129X     | Capacity: 1/8" to 7/8" (3mm – 22mm) | EA  | 1              |

**Plier Flaring Tool**

- All-steel construction.
- Freewheeling cone self centers accurately over tubing.
- Quick release allows insertion and removal of tubing easily.
- Quick release plier action handles hold tubing securely while flaring.
- Can be used in confined areas.
- Industrial quality.
- Vinyl handles for greater comfort.



| CATALOG NO. | DESCRIPTION                                    | UOM | ORDER MULTIPLE |
|-------------|--|-----|----------------|
| 6-T152      | Capacity: 3/16", 1/4", 5/16", 3/8", 1/2", 5/8" | EA  | 1              |

**Swivel Head Deburring Tool**

- Professional quality and performance of higher price deburring tools.
- Two interchangeable blades.



| CATALOG NO. | DESCRIPTION                                   | UOM | ORDER MULTIPLE |
|-------------|---|-----|----------------|
| 6-T482V     | Handle length: 5-1/8" (130mm)                 | EA  | 1              |
| 6-T482A     | Blade for steel, copper, aluminum and plastic | EA  | 1              |

**SAWS AND SAW BLADES**

**Deluxe Hi-Tension Hacksaw**

Hackframe featuring handle and end pieces made of die cast aluminum. Lightweight yet rigid and highly tensioned (up to 25,000 psi) for cleaner, surer cut. Permanent blade pins feature versatile angling (up to 55°) for flush cutting. Blade can be inserted in handle to be used as compass saw. Frame will fit most standard tool boxes.



| CATALOG NO.   | DESCRIPTION                                    | UOM | ORDER MULTIPLE |
|---------------|--|-----|----------------|
| 540-278HX0002 | Hacksaw Frame with Blade                       | EA  | 1              |
| 540-278BM0024 | Replacement Blades for Hacksaw Frame 12" x 24T | EA  | 1              |

**Bi-Metal Reciprocating Saw Blades**

Premium high speed steel with a flexible alloy back. Bi-metal blades fit all reciprocating saws with 1/2" shank.



| CATALOG NO.  | DESCRIPTION  | UOM | ORDER MULTIPLE |
|--------------|--|-----|----------------|
| 540-RB636W   | 6" x 6T Wood and Nail Slope 3/4" x 6" x .050       | EA  | 5              |
| 540-RB656WS  | 6" x 6T Wood and Nail Scroll 3/4" x 6" x .050      | EA  | 5              |
| 540-RB956W   | 9" x 6T Wood and Nail 3/4" x 9" x .050             | EA  | 5              |
| 540-RB125W   | 12" x 6T Wood and Nail 3/4" x 12" x .050           | EA  | 5              |
| 540-RB414M   | 4" x 14T Short Metal Cutting 3/4" x 4" x .035      | EA  | 5              |
| 540-RB418M   | 4" x 18T Short Metal Cutting 5/8" x 4" x .035      | EA  | 5              |
| 540-RB424M   | 4" x 24T Thin Short Metal Cutting 5/8" x 4" x .035 | EA  | 5              |
| 540-RB610HDM | 6" x 10T HD Metal Cutting 3/4" x 6" x .035         | EA  | 5              |
| 540-RB614HDM | 6" x 14T HD Metal Cutting 3/4" x 6" x .035         | EA  | 5              |
| 540-RB618HDM | 6" x 18T HD Metal Cutting 3/4" x 6" x .035         | EA  | 5              |
| 540-RB624HDM | 6" x 24T HD Metal Cutting 3/4" x 6" x .035         | EA  | 5              |
| 540-RB810HDM | 8" x 10T HD Metal Cutting 3/4" x 8" x .035         | EA  | 5              |
| 540-RB814HDM | 8" x 14T HD Metal Cutting 3/4" x 8" x .035         | EA  | 5              |
| 540-RB636DW  | Drywall Cutting with V Head 5/8" x 6" x .035       | EA  | 5              |
| 540-R8CCRF   | Cast Iron-Ceramic Tile Carbide Grit 8" Long        | EA  | 1              |

TEST LEADS

Multi Color Test Leads

Easy to use multi-colored test leads. 5 colors (white, red, black, yellow, green) with 2 connections each for easy testing on the job. Wire is 18 gauge, 18" long.



| CATALOG NO. | DESCRIPTION            | UOM | ORDER MULTIPLE |
|-------------|------------------------|-----|----------------|
| CT800       | Multi Color Test Leads | EA  | 1              |

Standard Test Leads

- Handy jumper test leads
- Medium alligator clips
- Insulated boots
- Wire gauge: 16 gauge
- Length: 36"
- Amps: 10
- Volts: 300V
- Weight: 0.12 lb.



| CATALOG NO. | DESCRIPTION                      | UOM | ORDER MULTIPLE |
|-------------|----------------------------------|-----|----------------|
| 6-TL100     | Standard Test Leads – 36" Length | EA  | 1              |

Test Leads

Alligator clips are covered by pure vinyl boots for flexibility at any temperature without cracking.



| CATALOG NO. | DESCRIPTION                                  | UOM | ORDER MULTIPLE |
|-------------|--|-----|----------------|
| FTL3        | Pair, Red and Black – 36"                    | EA  | 1              |
| FTL3D       | Pair, Red and Black – Super Heavy Duty – 36" | EA  | 1              |
| ACK4        | 2 Red and 2 Black Boots w/4 Alligator Clips  | EA  | 1              |

All Weather Test Leads

- Flexible soft leads
- Ideal for cold months
- Medium alligator clips with insulated boots
- Volts: 300V
- Amps: 10
- Wire gauge: 18 gauge
- Length: 36"
- Weight: 0.26 lb.



| CATALOG NO. | DESCRIPTION                         | UOM | ORDER MULTIPLE |
|-------------|-------------------------------------|-----|----------------|
| 6-TL360W    | All Weather Test Leads – 36" Length | EA  | 1              |

MEASURING TAPES, STAPLES AND STAPLE GUNS

Power Measuring Tapes

Rust resistant yellow lacquered blade with easy to read inch/foot markings (English). Both chrome and neon case have belt clips and finger-tip blade lock. Ultralife tape is our highest quality tape measure – lasts up to 10 times longer than typical blades, with patented "blade wiper" that cleans the blade as you measure.



| CATALOG NO. | DESCRIPTION                                      | UOM | ORDER MULTIPLE |
|-------------|--|-----|----------------|
| 540-12      | Power Tape – Chrome 1/2" x 12'                   | EA  | 6              |
| 540-25      | Power Tape – Chrome 1" x 25'                     | EA  | 6              |
| 540-25R     | Power Tape – Neon Orange 1" x 25'                | EA  | 6              |
| 540-25G     | Power Tape – Neon Green 1" x 25'                 | EA  | 6              |
| 540-25UL    | Power Tape – Ultralife 1" x 25' with Yellow Case | EA  | 6              |

T-50 Series Staples and Staple Guns

The #1 selling staple gun in the world! Used extensively by building contractors, home do-it-yourselfers and specialty trade applications for tacking insulation, ceiling tile, window screening, cornerite, and 1001 other jobs ranging from light to heavy duty work. The T-50 Outward Clinch Staple Gun is ideal for fiberglass ductwork.



| CATALOG NO. | DESCRIPTION                                   | UOM | ORDER MULTIPLE |
|-------------|---|-----|----------------|
| 540-T50M    | T50M Heavy Duty Staple Gun Tacker             | EA  | 1              |
| 540-T50MOC  | T50MOC Outward Clinch Staple Gun              | EA  | 1              |
| 540-504     | 1/4" Leg Staples for T50 Staple Guns (1,250)  | EA  | 4              |
| 540-506     | 3/8" Leg Staples for T50 Staple Guns (1,250)  | EA  | 4              |
| 540-508     | 1/2" Leg Staples for T50 Staple Guns (1,250)  | EA  | 4              |
| 540-509     | 9/16" Leg Staples for T50 Staple Guns (1,250) | EA  | 4              |

TOOL BAGS

Double Zipper Rigger's Bag

Rugged, lightweight soft-sided tote/organizer for tools and business accessories. Features double pull top zipper for easy access, reinforced bottom panel to keep bag's wide profile, and padded carrying handle. Total of 50 multi-use pockets!



| CATALOG NO. | DESCRIPTION                | UOM | ORDER MULTIPLE |
|-------------|----------------------------|-----|----------------|
| 5-1115      | Double Zipper Rigger's Bag | EA  | 1              |

BigMouth™ Bag

Internal metal frame holds bag wide open for easy access to tools and supplies. Reinforced interior bottom panel enables the BigMouth bag to keep its wide profile. Padded sides and bottom. Built of super tough, super light fabric.



| CATALOG NO. | DESCRIPTION   | UOM | ORDER MULTIPLE |
|-------------|---------------|-----|----------------|
| 5-1135      | BigMouth™ Bag | EA  | 1              |

**CLIPBOARDS**

**Clipboards and Form Holders**

Rugged aluminum construction to protect your paperwork and forms. Smooth aluminum surfaces provide excellent writing support.

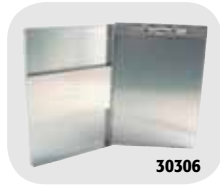

| CATALOG NO. | DESCRIPTION  | UOM | ORDER MULTIPLE |
|-------------|--|-----|----------------|
| 30306       | SNAPAK Clipboard on Box w/Hinged Back – 8-1/2" x 12" | EA  | 1              |
| 30309       | REDI-RITE Clipboard on Box – 8-1/2" x 12"            | EA  | 1              |
| 30310       | CRUISER MATE 2 Compartment Clipboard – 8-1/2" x 12"  | EA  | 1              |

**RETRIEVING TOOL/MINI-LIGHTS**

**Telescoping Mini-Light and Magnetic Pickup**

- A powerful permanent magnetic pick-up tool.
- Ideal for retrieving steel and iron parts from hard-to-reach and see work areas.
- Magnet is fitted in a 5-1/2" (140mm) long ergonomically designed handle.
- 4 Alkaline, "LR41", batteries with a battery life of 48 continuous hours.
- Light Bulb has a life of 100,000 hours of continuous use.
- Mini-Light is fastened to a chrome plated brass wand with a double ball joint.
- Ball and socket feature for simple, positive adjustments.



| CATALOG NO. | DESCRIPTION                                | UOM | ORDER MULTIPLE |
|-------------|--|-----|----------------|
| 6-T582      | Telescoping Mini-Light and Magnetic Pickup | EA  | 1              |

**"Lite-It" Clip-On Mini-Light**

- Clips on to anything, anytime, anywhere for instant, direct light.
- Light is fastened to a rugged high-impact ABS plastic Alligator Clip with a double ball joint that adjusts to any angle.
- 4 Alkaline, "LR41", batteries with a battery life of 48 continuous hours.
- LED bulb has a life of 100,000 hours of continuous use.



| CATALOG NO. | DESCRIPTION                 | UOM | ORDER MULTIPLE |
|-------------|-----------------------------|-----|----------------|
| 6-T580      | Clip-On Mini-Light (Carded) | EA  | 1              |

**Mechanical Pickup**

- Strong four prong steel jaws retrieve small items from hard-to-reach places.
- Smooth actuator for greater control.
- Chrome finish to prevent rust.
- Flexible shaft to avoid obstacles.

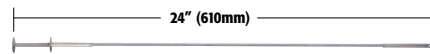
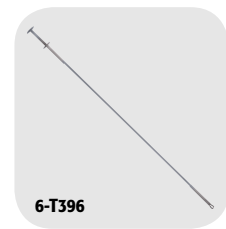

| CATALOG NO. | DESCRIPTION  | UOM | ORDER MULTIPLE |
|-------------|--|-----|----------------|
| 6-T396      | 4-Prong Steel Jaws; Chrome Finished w/Flexible Shaft | EA  | 1              |

**Reach-It**

Retracts to 5" long. Made of durable chrome plated brass. Match can be quickly inserted.



| CATALOG NO. | DESCRIPTION                   | UOM | ORDER MULTIPLE |
|-------------|-------------------------------|-----|----------------|
| R-1         | Reach-It – extends to 26-3/4" | EA  | 12             |

**Magnetic Retrieving Tool**

Extra high flux magnet for greater pickup. Super adjustable telescoping action. Bright chrome plated brass handle. Outperforms the standard Alinco V Magnet 4 to 1. The telescoping handle lets you pick up ferrous objects where your hand cannot reach. Fits in your pocket when closed for easy accessibility.



| CATALOG NO. | DESCRIPTION   | UOM | ORDER MULTIPLE |
|-------------|---|-----|----------------|
| 540-601     | Tool – Pocket Telescopic extends from 5-7/8" (12cm) to 25-9/16" (63cm) – Carded | EA  | 12             |

**ELECTRICAL SUPPLIES**

**Outdoor Extension Cord**

Heavy duty, round, vinyl extension cord designed for industrial use. Orange vinyl jacket protects against oil, grease, ozone, and gives added flexibility at below freezing temperatures. Vinyl plugs and connectors are molded on and won't break or pull off cord.



| CATALOG NO. | DESCRIPTION                              | UOM | ORDER MULTIPLE |
|-------------|--|-----|----------------|
| 7-ECC50725  | 25' 15 AMP Extension Cord SJTW-A 14/3    | EA  | 14             |
| 7-ECC50730  | 50' 15 AMP Extension Cord SJTW-A 14/3    | EA  | 10             |
| 7-ECC50735  | 100' 13 AMP Extension Cord SJTW-A 14/3   | EA  | 5              |
| 7-ECC1625   | 25' 15 Amp Extension Cord SJTW-A 16/3    | EA  | 24             |
| 7-ECC1650   | 50' 15 Amp Extension Cord SJTW-A 16/3    | EA  | 12             |
| 7-ECC16100  | 100' 13 Amp Extension Cord SJTW-A 16/3   | EA  | 6              |
| 7-ECC1225   | 25' Extension Cord, 12/3 SJTW-A, 15 AMP  | EA  | 10             |
| 7-ECC1250   | 50' Extension Cord, 12/3 SJTW-A, 15 AMP  | EA  | 6              |
| 7-ECC12100  | 100' Extension Cord, 12/3 SJTW-A, 15 AMP | EA  | 3              |

Type: SJTW-A U.L. Listed, meets OSHA Requirements.

**Power Blocks**

Professional design gives contractors and industrial personnel maximum flexibility in arranging portable power needs at the job site. Vinyl connectors are solid molded for high resistance to breakage and abuse.



| CATALOG NO. | DESCRIPTION  | UOM | ORDER MULTIPLE |
|-------------|--|-----|----------------|
| 7-AD010000  | Triple tap power block adapter converts single 15 AMP 125V U-ground outlet to 3 15A, 125V U-ground outlets | EA  | 10             |

**Metal Guard Trouble Lights**

Designed for rugged use by contractors and industrial. Tough plastic handles are heat and shock resistant, with switch and 15A, 125V grounding side outlet.



| CATALOG NO. | DESCRIPTION                   | UOM | ORDER MULTIPLE |
|-------------|-------------------------------|-----|----------------|
| 7-TLC10625  | 25' Metal Guard Trouble Light | EA  | 1              |
| 7-TLC10630  | 50' Metal Guard Trouble Light | EA  | 1              |

AWG: 16/3 TYPE: SJTW-A U.L. Listed, meets OSHA Requirements.

**Rough Service Light Bulbs**

Designed to withstand unusual shock and abuse on drop cords, mechanic trouble lights, extension cords and anywhere else severe shocks may be encountered. 4 bulbs per box for 100 watt bulbs. 4 bulbs per box for 75 watt bulbs. 120/case.



| CATALOG NO. | DESCRIPTION                               | UOM | ORDER MULTIPLE |
|-------------|---|-----|----------------|
| 7-75W       | 75 Watt Rough Service Bulb – Bulk Packed  | EA  | 120            |
| 7-100W      | 100 Watt Rough Service Bulb – Bulk Packed | EA  | 120            |

**SCALES**

**Electronic Utility Scales**

Constructed for heavy duty weighing. Perfect for warehouse use, check weighing, large crates and shipping freight. Low profile platform. Control panel can be wall mounted for easy viewing. Large LCD display. Operates with AC adapter (included) or one 9V battery (not included).



| CATALOG NO. | DESCRIPTION                      | UOM | ORDER MULTIPLE |
|-------------|----------------------------------|-----|----------------|
| 660-004     | 150 lb. Capacity (Pelouze #4010) | EA  | 1              |
| 660-005     | 400 lb. Capacity (Pelouze #4040) | EA  | 1              |

**Utility Scales**

Large easy to read dial can be viewed from top or side. Low profile enables you to slide cartons and crates onto scale. Memory Lock holds reading when dial is obscured. Perfect for shipping and receiving parcels or crates in the mailroom or warehouse.



| CATALOG NO. | DESCRIPTION                       | UOM | ORDER MULTIPLE |
|-------------|-----------------------------------|-----|----------------|
| 660-002     | 100 lb. Capacity (Pelouze #P100S) | EA  | 1              |
| 660-003     | 250 lb. Capacity (Pelouze #P250S) | EA  | 1              |

**MONITORS**

**007 Control Checker**

A lifetime tool for monitoring and checking safety controls and operating controls. One unit for all voltages 24-460 VAC or DC without switching dials or meters. Compact, 4 oz, reliable. Saves troubleshooting. For normally closed controls, 007 connects in parallel with safety control. When the safety control opens in response to a problem in the system, 007 red LED turns on and remains on until reset manually. With intermittent problem, the LED remains on indicating the control is open. For operating controls, 007 verifies the status of all types indicating if there is power to the holding coil, the NC contact is open or closed, the thermostat contacts are open or closed, there is power to the contactor or starting holding coil, the overloads are open or closed, or there is a bad connection either on control or power side. NOTE: May use with lockout relays. Features battery check and reset switch. Includes 9-volt battery. 007 may be used over and over.



TC-007

| CATALOG NO. | DESCRIPTION         | UOM | ORDER MULTIPLE |
|-------------|---------------------|-----|----------------|
| TC-007      | 007 Control Checker | EA  | 1              |

U.S. Pat. No. 4,092,625.

**Tattle-Tale Control Monitor**

Identifies open controls in seconds. A single eye monitoring device for determining which, safety control has opened in response to a malfunction. Saves wasted hours tracing a safety control shutdown, even if intermittent. A quick, inexpensive way to visually spot where the problem is. Simply install in parallel with each safety control. When a control opens, the red indicator flag pops up. You will know immediately which area of the system is experiencing problems. Disposable, safe, simple to use, and pocket sized. Monitors safety controls, fuses, overload relays, motor protectors, freeze controls, limit controls, safety switches, fusible links, or steam control. CAUTION: Not to be used with lockout relays, use TC-007.



TT-24

| CATALOG NO. | DESCRIPTION  | UOM | ORDER MULTIPLE |
|-------------|--|-----|----------------|
| TT-24       | Tattle-Tale Control Monitor – 24 Volt AC or DC, pack of 3  | PK  | 1              |
| TT-120      | Tattle-Tale Control Monitor – 120 Volt AC or DC, pack of 3 | PK  | 1              |
| TT-240      | Tattle-Tale Control Monitor – 240 Volt AC or DC, pack of 3 | PK  | 1              |

Tolerance on all voltages shown is ± 20%. U.S. Pat. No. 4,250,480.

**ALLEN WRENCHES**

**Allen Wrenches**

The finest quality wrenches available anywhere.



AW-8

| CATALOG NO. | DESCRIPTION  | UOM | ORDER MULTIPLE |
|-------------|--|-----|----------------|
| AW-8        | 3" Handle, 8 Bits, Standard Fold-Ups .050", 1/16", 5/64", 3/32", 7/64", 1/8", 9/64", 5/32"           | EA  | 1              |
| AW-9        | 4" Handle, 9 Bits, Standard Fold-Ups 5/64", 3/32", 7/64", 1/8", 9/64", 5/32", 3/16", 7/32", 1/4"     | EA  | 1              |
| AWL-5       | 5-1/4" Handle, 5 Bits, Long Arm Fold-Ups 3/16", 7/32", 1/4", 5/16", 3/8"                             | EA  | 1              |
| AWL-9       | 6-1/4" Handle, 9 Bits, Long Arm Fold-Ups 5/64", 3/32", 7/64", 1/8", 9/64", 5/32", 3/16", 7/32", 1/4" | EA  | 1              |

**Allen Duracast™ Fold Ups**

Unique "double foldout" design. This convenient pocket wrench set opens from both the top and bottom for fast, easy access to each and every bit. Instead of unfolding the top wrenches to get at the wrenches underneath, just turn the FOLD UP over. Specially contoured handle, so you'll never cut your hands or snag clothing.



AWZ-2500

| CATALOG NO. | DESCRIPTION  | UOM | ORDER MULTIPLE |
|-------------|--|-----|----------------|
| AWZ-2500    | 3-1/2" Handle, 9 Bits .050", 1/16", 5/64", 3/32", 7/64", 1/8", 9/64", 5/32", 3/16" | EA  | 1              |
| AWZ-3000    | 4-1/4" Handle, 9 Bits 5/64", 3/32", 7/64", 1/8", 9/64", 5/32", 3/16", 7/32", 1/4"  | EA  | 1              |

**Allen Wrenches – Long Arm**

Most needed combination of Allen Wrenches packaged in clearly marked vinyl pouches.



AW-96

| CATALOG NO. | DESCRIPTION  | UOM | ORDER MULTIPLE |
|-------------|--|-----|----------------|
| AW-96       | 9 Keys, 6" long arm series: 5/64", 3/32", 1/8", 5/32", 3/16", 7/32", 1/4", 5/16", 3/8" | EA  | 1              |
| AW-712      | 7 Keys, 12" long arm series: 5/64", 3/32", 1/8", 5/32", 3/16", 7/32", 1/4"             | EA  | 1              |

**Allen Wrenches – Individual Sizes**

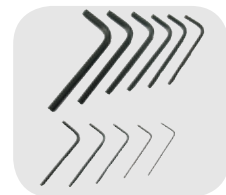

| CATALOG NO. | DESCRIPTION              | UOM | ORDER MULTIPLE |
|-------------|--------------------------|-----|----------------|
| AW-96-8     | Allen Wrench 6" x 1/8"   | EA  | 25             |
| AW-96-10    | Allen Wrench 6" x 5/32"  | EA  | 25             |
| AW-712-8    | Allen Wrench 12" x 1/8"  | EA  | 25             |
| AW-712-10   | Allen Wrench 12" x 5/32" | EA  | 25             |

**FIN TOOLS**

**Multi-Head Fin-Tool**

Conveniently straightens and cleans condenser and evaporator fins. Each nylon head slides into the master handle and tightens in place. Heads are designed to fit units with fin spacing of 4–24 fins per inch. Each head is engraved with its own size and is color coded for fast identification. Heads are angled so that when inserted in the handle, the hand is a safe distance from the sharp fins. Heads may also be reversed in the handle so that combing with an upward stroke (recommended method) may be done easily with proper leverage. The master handle rests comfortably in a man-size grip, is rigid and long lasting.



| CATALOG NO.  | DESCRIPTION  | UOM | ORDER MULTIPLE |
|--------------|--|-----|----------------|
| <b>T-100</b> | Kit – 1 Handle and 6 Heads: 8, 9, 10, 11, 12, 14       | EA  | 12             |
| <b>T-1</b>   | Handle Only – Black                                    | EA  | 1              |
| <b>T-8</b>   | Head 8 FPI – Orange, pack of 3                         | PK  | 1              |
| <b>T-9</b>   | Head 9 FPI – Yellow, pack of 3                         | PK  | 1              |
| <b>T-10</b>  | Head 10 FPI – Natural, pack of 3                       | PK  | 1              |
| <b>T-11</b>  | Head 11 FPI – Blue, pack of 3                          | PK  | 1              |
| <b>T-12</b>  | Head 12 FPI – Green, pack of 3                         | PK  | 1              |
| <b>T-14</b>  | Head 14 FPI – Lt. Green, pack of 3                     | PK  | 1              |
| <b>T-101</b> | Kit – 1 Handle and 6 Heads: 13, 15, 16, 17, 18, 20     | EA  | 12             |
| <b>T-13</b>  | Head 13 FPI – Pink, pack of 3                          | PK  | 1              |
| <b>T-15</b>  | Head 15 FPI – Aqua, pack of 3                          | PK  | 1              |
| <b>T-16</b>  | Head 16 FPI – Brown, pack of 3                         | PK  | 1              |
| <b>T-17</b>  | Head 17 FPI – Blue, pack of 3                          | PK  | 1              |
| <b>T-18</b>  | Head 18 FPI – Red, pack of 3                           | PK  | 1              |
| <b>T-20</b>  | Head 20 FPI – Purple, pack of 3                        | PK  | 1              |
| <b>T-21</b>  | Head 21 & 22 FPI – Rose (for Carrier unit), pack of 3  | PK  | 1              |
| <b>T-23</b>  | Head 23 & 24 FPI – Black (for Carrier unit), pack of 3 | PK  | 1              |

U.S. Patent No. 4,018,076.

**Fin-Tool**

Long lasting metal fin straightener. Straightens and cleans condenser and evaporator fins. One tool for all units. The heavy duty spring wire bristles automatically adjust to ALL fin spacings. An exclusive tension adjustment band is featured to allow maximum rigidity and ease of operation. Straightens most severely damaged fins.



| CATALOG NO.  | DESCRIPTION                             | UOM | ORDER MULTIPLE |
|--------------|---|-----|----------------|
| <b>T-200</b> | Fin-Tool                                | EA  | 1              |
| <b>T-300</b> | Fin-Tool with heavy duty bicycle handle | EA  | 12             |

**SuperComb**

Easier to grip, easier to use tool for straightening condenser and evaporator fins. Straightens 50% more fins in one stroke. Keeps hands a safe distance from fins. Easy to grip, strong, durable, heavy duty nylon. Color coded for easy identification. Sold individually or 6 per set. Sales display available.



| CATALOG NO.  | DESCRIPTION  | UOM | ORDER MULTIPLE |
|--------------|--|-----|----------------|
| <b>T-408</b> | 8 and 10 FPI – Orange                                      | EA  | 6              |
| <b>T-409</b> | 9 and 15 FPI – Yellow                                      | EA  | 6              |
| <b>T-411</b> | 11 and 13 FPI – Blue                                       | EA  | 6              |
| <b>T-412</b> | 12 and 14 FPI – Green                                      | EA  | 6              |
| <b>T-417</b> | 16 and 17 FPI – Lime                                       | EA  | 6              |
| <b>T-418</b> | 18 and 20 FPI – Red  | EA  | 6              |
| <b>T-400</b> | Set of 6 – 1 Ea.: T-408, T-409, T-411, T-410, T-417, T-418 | EA  | 1              |

**STRAPS, TRUCK ROPE**

**Truck Rope**

All-purpose high strength polypropylene truck rope is C.H.P. approved.



| CATALOG NO.  | DESCRIPTION             | UOM | ORDER MULTIPLE |
|--------------|-------------------------|-----|----------------|
| <b>25001</b> | Truck Rope – 3/8" x 50' | EA  | 1              |

**Polypropylene Twisted Rope**

All-purpose utility rope resists rot, mildew, petroleum products and most chemicals.

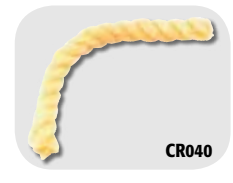

| CATALOG NO.  | DESCRIPTION  | LENGTH     | MIN. BREAKAGE | COLOR  | UOM | ORDER MULTIPLE |
|--------------|--------------|------------|---------------|--------|-----|----------------|
| <b>CR040</b> | Utility Rope | 1/4" x 50' | 1,130 lbs.    | Yellow | EA  | 1              |

**Lashing Strap**

Quickly lashes and secures refrigerators, air conditioners, washers, driers, etc. Strong nylon webbing rated at 3000 lbs. and end hooks at 1200 lbs. tensile strength. Hand loop for easy tightening. Steel cam lever buckle is easy to adjust and releases quickly. Secures a maximum load of 1000 pounds. 12' long.



| CATALOG NO.   | DESCRIPTION          | UOM | ORDER MULTIPLE |
|---------------|----------------------|-----|----------------|
| <b>HS-144</b> | Lashing Strap – 144" | EA  | 6              |

**Ratchet Strap**

Easy ratcheting permits tie-down of appliances securely. An innovative latch and a fast release cam reduces socket wear. Cadmium-plated steel buckle has a positive lock that eliminates release due to vibration. When closed, the handle locks the latch into the sprocket to prevent inadvertent release. 16' nylon webbing rated at 3000 PSI tensile. Vinyl coated end hooks rated at 1200 PSI tensile.



| CATALOG NO.   | DESCRIPTION         | UOM | ORDER MULTIPLE |
|---------------|---------------------|-----|----------------|
| <b>HS-192</b> | Ratchet Strap – 16' | EA  | 3              |

**STRAPS, TRUCK ROPE cont'd**

**Hanging Strap**

Strong, versatile, easy way to secure loose gear safely. Tie down ladders, tubing, cylinders or almost anything in seconds. Cannot snap back. Strong, durable 1" polypropylene webbing. Reinforced grommet lets you hang it up, tie it up, hook it up or attach it permanently. Spring loaded adjustable buckle. Easy to get firm tension with no slipping. Make an endless length by connecting 2 or more together.



| CATALOG NO. | DESCRIPTION  | UOM | ORDER MULTIPLE |
|-------------|--|-----|----------------|
| HS-30       | Hanging Strap – 31"                                | EA  | 24             |
| HS-30-2     | Hanging Strap – 31", 2 Straps per Card, pack of 12 | PK  | 1              |
| HS-60       | Hanging Strap – 60"                                | EA  | 24             |
| HS-60-2     | Hanging Strap – 60", 2 Straps per Card, pack of 12 | PK  | 1              |

**Rubber Tie Down Strap**

Can stretch to double its length. Quickly ties down ladders, tubing, cylinders or almost anything. Extra heavy steel "S" hooks on each end. Resists cracking and deterioration.



| CATALOG NO. | DESCRIPTION                 | UOM | ORDER MULTIPLE |
|-------------|-----------------------------|-----|----------------|
| RS-9        | Rubber Tie Down Strap – 10" | EA  | 10             |
| RS-15       | Rubber Tie Down Strap – 15" | EA  | 10             |
| RS-20       | Rubber Tie Down Strap – 21" | EA  | 10             |
| RS-31       | Rubber Tie Down Strap – 31" | EA  | 10             |
| RS-41       | Rubber Tie Down Strap – 41" | EA  | 10             |

**MISCELLANEOUS TOOLS**

**Expando Adjustable Condenser Tube Cleaner**

Removes mineral scale and sludge from inside water-cooled condenser tubes fast! Saves time-consuming brushing or flushing. Attaches to a threaded rod which fits into an Expando handle or your electric drill. With a reaming action, the stainless steel blades scrape inside the tube, providing an unrestricted flow. Virtually clogproof, it expands or reduces in diameter to fit scale deposits—just the tube. Use EC-810 couplings for connecting additional rods.



| CATALOG NO. | DESCRIPTION                                       | UOM | ORDER MULTIPLE |
|-------------|---|-----|----------------|
| E-5         | Condenser Tube Cleaner – 5/16" to 3/8" I.D. Tubes | EA  | 1              |
| E-6         | Condenser Tube Cleaner – 3/8" to 1/2" I.D. Tubes  | EA  | 1              |
| E-8         | Condenser Tube Cleaner – 1/2" to 5/8" I.D. Tubes  | EA  | 1              |
| E-10        | Condenser Tube Cleaner – 5/8" to 3/4" I.D. Tubes  | EA  | 1              |
| EB-6        | Blades for E-5 and E-6                            | EA  | 1              |
| EB-8        | Blades for E-8                                    | EA  | 1              |
| EB-10       | Blades for E-10                                   | EA  | 1              |
| EC-56       | Couplings for E-5 and E-6                         | EA  | 3              |
| EC-810      | Couplings for E-8 and E-10                        | EA  | 3              |
| EE-30       | Rods – 30" 1/4-28                                 | EA  | 3              |
| EE-48       | Rods – 48" 1/4-28                                 | EA  | 3              |
| EH-1        | Handle  | EA  | 1              |

**Telescopic Inspection Mirror**

Fast, accurate visual inspection of hidden areas with an almost limitless number of positions. Double ball joint links swivel mirrors for viewing to 360°. Precision engineered links are made from tempered spring steel to withstand the stresses of constant repositioning. Moves freely, holds desired position.



| CATALOG NO. | DESCRIPTION   | UOM | ORDER MULTIPLE |
|-------------|---|-----|----------------|
| M-1         | Mirror – 1-1/4" Circular – extends 6-1/4" to 18-1/4"              | EA  | 1              |
| M-2         | Mirror – 2-1/4" Circular – extends 10" to 14"                     | EA  | 1              |
| M-3         | Mirror – 2-1/8" x 3-1/2" Rectangular – extends 11-1/4" to 15-1/4" | EA  | 1              |
| M-4         | Mirror – 7/8" Circular – extends 6-1/2"                           | EA  | 1              |
| M-5         | Mirror – 1" x 2" Oval – extends 8-1/2"                            | EA  | 1              |
| M-3G        | Refill Mirrors Only 2-1/8" x 3-1/2"                               | EA  | 12             |
| M-5G        | Refill Mirrors Only Oval 1" x 2"                                  | EA  | 12             |
| M-1R        | Replacement Head for M-1  | EA  | 1              |
| M-2R        | Replacement Head for M-2  | EA  | 1              |
| M-3R        | Replacement Head for M-3  | EA  | 1              |
| M-4R        | Replacement Head for M-4  | EA  | 1              |
| M-5R        | Replacement Head for M-5  | EA  | 1              |

**Compressor TOTE**

Makes light work of a heavy job. Powder coated, strong steel construction. Recommended for use with all compressors up to 5 tons. Compatible with high efficiency compressors. Pick up a compressor from its box. Carry a compressor up a ladder. Now with black protective finish.



| CATALOG NO. | DESCRIPTION     | UOM | ORDER MULTIPLE |
|-------------|-----------------|-----|----------------|
| ACT-6       | Compressor Tote | EA  | 6              |

**4-Piece Hook and Pick Set**

For separating wires, removing small fuses, "O" rings, retrieving washers and loose parts too small to pick up with your fingers. Bright-dipped, anodized hex-shaped aluminum handles with powerful magnet on end. Handy screw-in hook, pick, point and scribe. High carbon polished needle steel. All in a compact zip-lock vinyl pouch that fits in your shirt pocket! Set includes four screw-in tips plus handle.

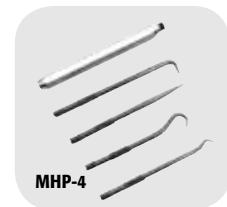

| CATALOG NO. | DESCRIPTION               | UOM | ORDER MULTIPLE |
|-------------|---------------------------|-----|----------------|
| MHP-4       | 4-Piece Hook and Pick Set | EA  | 1              |

MISCELLANEOUS TOOLS cont'd

ScrewGrab®

Helps remove or tighten screws even if they are stripped. One drop on the screwdriver tip or hex wrench grabs the screw so it turns or tightens more easily. Stops tools from slipping off rounded or deformed fasteners. Torque is increased over 400%. Works instantly, wipes clean, non-staining, non-sticky, non-corrosive, non-irritating. Unlimited shelf life.



CSG-1

| CATALOG NO. | DESCRIPTION              | UOM | ORDER MULTIPLE |
|-------------|--------------------------|-----|----------------|
| CSG-1       | ScrewGrab® – 0.5 fl. oz. | EA  | 12             |

Mechanical Screw Starter

A simple, easy way to end fumbling with hard to position screws. Just insert the screw on the prongs of the screw starter, and a simple twist will lock the screw ready for trouble free starting. Tool automatically releases and resets. Use with ferrous or non-ferrous screws. Nylon handle.



S-3

| CATALOG NO. | DESCRIPTION                                | UOM | ORDER MULTIPLE |
|-------------|--|-----|----------------|
| S-3         | One End Slotted, Phillips on Other, 9-1/4" | EA  | 1              |

FLASHLIGHTS BY MAG-LITE®

Each Mag-Lite Flashlight offers these features: 1. Exclusive cam-driven beam that changes from spot to flood with a turn of the head. 2. Patented, self-cleaning switch. 3. High quality White Star Krypton bulb (second bulb included in the tail cap) 4. High grade rubber O-rings at each opening to insure water resistance and enhance ability to withstand shock. 5. Anodized finish both inside and out to offer optimum corrosion resistance. 6. Limited lifetime warranty. 7. Manufactured in the USA.

Mag-Lite® C and D Cell Flashlights

Police, security, emergency, medical and fire professionals have come to rely on Mag-Lite C and D Cell flashlights more than any other brand. They know serious duty demands serious equipment. The finest flashlight in the world!



| CATALOG NO. | DESCRIPTION                          | UOM | ORDER MULTIPLE |
|-------------|--------------------------------------|-----|----------------|
| 7-S2C016    | 2 Cell C Mag-Lite Flashlight – Black | EA  | 1              |
| 7-S3C016    | 3 Cell C Mag-Lite Flashlight – Black | EA  | 1              |
| 7-S4C016    | 4 Cell C Mag-Lite Flashlight – Black | EA  | 1              |
| 7-S2D016    | 2 Cell D Mag-Lite Flashlight – Black | EA  | 1              |
| 7-S3D016    | 3 Cell D Mag-Lite Flashlight – Black | EA  | 1              |
| 7-S4D016    | 4 Cell D Mag-Lite Flashlight – Black | EA  | 1              |
| 7-S5D016    | 5 Cell D Mag-Lite Flashlight – Black | EA  | 1              |
| 7-S6D016    | 6 Cell D Mag-Lite Flashlight – Black | EA  | 1              |

Mini Mag-Lite®

Until the Mini Mag-Lite was introduced, no one had ever dreamed a flashlight could be so small, yet so powerful. Named as one of the “products America makes best” by Fortune and Money magazines.



7-M3A016

| CATALOG NO. | DESCRIPTION                      | UOM | ORDER MULTIPLE |
|-------------|----------------------------------|-----|----------------|
| 7-M3A016    | Mini Mag-Lite AAA – Black        | EA  | 1              |
| 7-M3A036    | Mini Mag-Lite AAA – Red          | EA  | 1              |
| 7-M2A016    | Mini Mag-Lite AA – Black         | EA  | 1              |
| 7-M2A036    | Mini Mag-Lite AA – Red           | EA  | 1              |
| 7-M2A026    | Mini Mag-Lite AA – Camouflage    | EA  | 1              |
| 7-AM2A056   | Mini Mag-Lite AA Holster – Black | EA  | 12             |

Solitaire AAA Single Cell Flashlights

Less than an ounce and about three inches in length. Using only a single AAA battery, its focusing beam is surprisingly bright. A spare bulb, battery, and a key lead are included.



7-K3A016

| CATALOG NO. | DESCRIPTION                      | UOM | ORDER MULTIPLE |
|-------------|----------------------------------|-----|----------------|
| 7-K3A016    | Solitaire AAA Flashlight – Black | EA  | 1              |
| 7-K3A036    | Solitaire AAA Flashlight – Red   | EA  | 1              |
| 7-K3A116    | Solitaire AAA Flashlight – Blue  | EA  | 1              |

Mag-Lite® Replacement Bulbs



7-LK3A001

| CATALOG NO. | DESCRIPTION                                    | UOM | ORDER MULTIPLE |
|-------------|--|-----|----------------|
| 7-LK3A001   | Solitaire Replacement Bulb – 2 per Card        | EA  | 12             |
| 7-LM2A001   | Mini Mag-Lite AA Replacement Bulb – 2 per Card | EA  | 12             |
| 7-LWSA201   | 2 Cell C or D Replacement Bulb – 2 per Card    | EA  | 12             |
| 7-LWSA301   | 3 Cell C or D Replacement Bulb – 2 per Card    | EA  | 12             |
| 7-LWSA401   | 4 Cell C or D Replacement Bulb – 2 per Card    | EA  | 12             |

Mag Charger System

The ultimate, rechargeable lighting tool; the most powerful and durable hand-held flashlight of its size. Battery pack is rechargeable 1000 times. Electroformed reflector emits an incredibly bright, high intensity light. Includes: Mag Charger Flashlight, charging unit, battery pack, two mounting brackets, 12V Cigarette Lighter Adapter, and 110V AC Converter.



7-RX1019

| CATALOG NO. | DESCRIPTION        | UOM | ORDER MULTIPLE |
|-------------|--------------------|-----|----------------|
| 7-RX1019    | Mag Charger System | EA  | 1              |

Magna-Lite

Unbreakable pocket flashlite/magnifier. Ideal for checking small serial numbers and names on compressors or where poor light makes reading difficult. Powerful, optical-quality magnifying lens. Lightweight. Replaceable penlight batteries.



ML-100

| CATALOG NO. | DESCRIPTION            | UOM | ORDER MULTIPLE |
|-------------|------------------------|-----|----------------|
| ML-100      | Magna-Lite – 1-1/2 oz. | EA  | 12             |

**FLASHLIGHTS AND LANTERNS BY RAYOVAC®**

**Rayovac is the Industrial Product Leader!**

Rayovac is the leader in the industrial battery market and has been for years, with an estimated 50% share of the traditional industrial distribution channel. Rayovac introduced the top-selling industrial flashlight to the market, and set the quality standard by which all other industrial flashlights are measured today. Whether your customer is searching for a toolbox-tough flashlight or high-performance batteries, Rayovac offers a broad range of products to meet your needs.

**Rayovac Industrial Flashlights and Lanterns**

- Toolbox tough polypropylene construction
- Scratch resistant, unbreakable lens
- Full lifetime warranty
- Made in USA



| CATALOG NO.     | DESCRIPTION                               | UOM | ORDER MULTIPLE |
|-----------------|---|-----|----------------|
| <b>7-IN2</b>    | 2 Cell D Size                             | EA  | 6              |
| <b>7-IN2K</b>   | 2 Cell D Size with Krypton Bulb           | EA  | 6              |
| <b>7-IN2MS</b>  | 2 Cell D Size Orange MSHA and UL Approved | EA  | 6              |
| <b>7-16V-B2</b> | 6 Volt Industrial Lantern with Battery    | EA  | 2              |
| <b>7-301K</b>   | Krypton Beam Lantern with 918 Battery     | EA  | 1              |

**Rayovac LED Flashlights**



| CATALOG NO.          | DESCRIPTION              | UOM | ORDER MULTIPLE |
|----------------------|--------------------------|-----|----------------|
| <b>7-LUX2AA3W-B</b>  | Highbeam 2AA 80 Lumen    | EA  | 4              |
| <b>7-SE4W3C</b>      | Sportsman Extra 3C Lumen | EA  | 4              |
| <b>7-SPHW3AAA-BX</b> | Sportsman 3AAA 20 Lumen  | EA  | 6              |

**Rayovac Industrial Swivel Lights**

- 90° pivoting head shines light exactly where you're working
- Stand up base, non-roll design, built in hanging ring
- 200% brighter Krypton beam
- Rubber handle and end caps for comfort and durability



| CATALOG NO.       | DESCRIPTION                               | UOM | ORDER MULTIPLE |
|-------------------|---|-----|----------------|
| <b>7-ILJ2AA-B</b> | 2 Cell AA Size Swivel Lite with Batteries | EA  | 6              |
| <b>7-ISL2D-B</b>  | 2 Cell D Size Swivel Lite with Batteries  | EA  | 6              |

**Rayovac Roughneck Flashlights**

- Superior dependability and toughness
- Spot to flood focus
- Krypton bulb
- Chemical and solvent resistant



| CATALOG NO.     | DESCRIPTION                          | UOM | ORDER MULTIPLE |
|-----------------|--------------------------------------|-----|----------------|
| <b>7-R2D</b>    | 2 Cell D Size Roughneck              | EA  | 6              |
| <b>7-R2AA-B</b> | 2 Cell AA Size Roughneck w/Batteries | EA  | 6              |
| <b>7-R3D</b>    | 3 Cell D Size Roughneck              | EA  | 6              |

**BRUSHES**

**Chip Brushes**

100% pure bristle, wood handle. Poly sleeve over bristles. Inexpensive (use once and throw away). Excellent for applying duct adhesive.



| CATALOG NO.  | DESCRIPTION         | UOM | ORDER MULTIPLE |
|--------------|---------------------|-----|----------------|
| <b>B-500</b> | Chip Brush – 1/2"   | EA  | 36             |
| <b>B-501</b> | Chip Brush – 1"     | EA  | 36             |
| <b>B-502</b> | Chip Brush – 1-1/2" | EA  | 36             |
| <b>B-503</b> | Chip Brush – 2"     | EA  | 24             |
| <b>B-504</b> | Chip Brush – 2-1/2" | EA  | 12             |
| <b>B-505</b> | Chip Brush – 3"     | EA  | 12             |

**Tin Handle Acid Brushes**

Manufactured with electrolyte tin plate and filled with 100% pure stiff horsehair, tied with a steel staple. This combination gives lasting qualities when used with heat and acids or other cleaning agents.

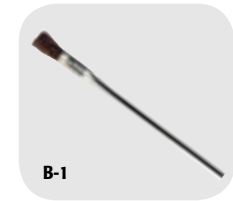

| CATALOG NO. | DESCRIPTION                | UOM | ORDER MULTIPLE |
|-------------|----------------------------|-----|----------------|
| <b>B-1</b>  | Tin Handle Acid Brush 3/8" | EA  | 144            |
| <b>B-2</b>  | Tin Handle Acid Brush 1/2" | EA  | 144            |

**Welder's Brush**

Stainless steel bristles used for cleaning all metals. Great for cleaning aluminum prior to soldering.

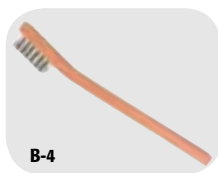

| CATALOG NO. | DESCRIPTION    | UOM | ORDER MULTIPLE |
|-------------|----------------|-----|----------------|
| <b>B-4</b>  | Welder's Brush | EA  | 12             |

**Power Fitting Brushes**

Hex shaft locks into all standard and quick lock type chucks for easy change over. Stainless steel wire.



| CATALOG NO.      | DESCRIPTION                             | UOM | ORDER MULTIPLE |
|------------------|---|-----|----------------|
| <b>542-09746</b> | Power Fitting Brush – 1/2" ID (5/8" OD) | EA  | 12             |
| <b>542-09748</b> | Power Fitting Brush – 3/4" ID (7/8" OD) | EA  | 12             |

**BRUSHES cont'd**

**Refrigerator Coil Brush**

Clean refrigerator coils, fan blades and areas under and behind appliances. 27-1/2" in length with 11-3/4" brush length. Bristles are 3/4" on the end tapering to 1-1/2" toward the handle.



| CATALOG NO. | DESCRIPTION             | UOM | ORDER MULTIPLE |
|-------------|-------------------------|-----|----------------|
| <b>B-27</b> | Refrigerator Coil Brush | EA  | 1              |

**Wood Handle Dope Brush**

Select horsehair bristles secured tightly in metal ferrule.



| CATALOG NO.      | DESCRIPTION                        | UOM | ORDER MULTIPLE |
|------------------|------------------------------------|-----|----------------|
| <b>542-10007</b> | Wood Handle Dope Brush – 3/4" x 7" | EA  | 36             |

**Duct Cleaning Brush**

Black fiber bristles twisted in wire. 2-1/8" dia. x 7" Brush x 48" overall length.



| CATALOG NO.      | DESCRIPTION         | UOM | ORDER MULTIPLE |
|------------------|---------------------|-----|----------------|
| <b>542-76220</b> | Duct Cleaning Brush | EA  | 1              |

**Parts Cleaning Brush**

Heavy duty black polypropylene bristles in strong plastic handle.



| CATALOG NO.      | DESCRIPTION          | UOM | ORDER MULTIPLE |
|------------------|----------------------|-----|----------------|
| <b>542-25015</b> | Parts Cleaning Brush | EA  | 12             |

**Outside Tube Cleaning Brushes**

Tough molded plastic holder with comfortable sure grip design and high carbon steel bristles. 6 per box.

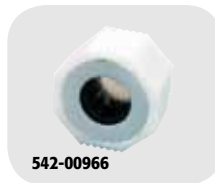

| CATALOG NO.      | DESCRIPTION                                     | UOM | ORDER MULTIPLE |
|------------------|---|-----|----------------|
| <b>542-00966</b> | Outside Tube Cleaning Brush – 1/2" ID (5/8" OD) | EA  | 6              |
| <b>542-00968</b> | Outside Tube Cleaning Brush – 3/4" ID (7/8" OD) | EA  | 6              |

**2-in-1 Copper Tube Cleaning Brush**

Easy to hold combination tool that really works. One end cleans the fitting. The other cleans the tube.



| CATALOG NO.  | DESCRIPTION   | UOM | ORDER MULTIPLE |
|--------------|---|-----|----------------|
| <b>B-996</b> | 2-in-1 Copper Tube Cleaning Brush – 1/2" ID (5/8" OD) | EA  | 1              |
| <b>B-998</b> | 2-in-1 Copper Tube Cleaning Brush – 3/4" ID (7/8" OD) | EA  | 1              |

**Copper Tube Fitting Brushes**

Highest quality brushes to clean fittings faster, easier and more safely. Made with strong, resilient, rustproof stainless steel bristles secured in a 4-ply wire with easy-to-grip plastic handle. Economy models feature same quality stainless steel, but secured in 2-ply wire.



| CATALOG NO.  | DESCRIPTION  | UOM | ORDER MULTIPLE |
|--------------|--|-----|----------------|
| <b>B-924</b> | Copper Tube Fitting Brush – 1/4" O.D., 9/32" Brush Dia.            | EA  | 1              |
| <b>B-925</b> | Copper Tube Fitting Brush – 3/8" O.D., 13/32" Brush Dia.           | EA  | 1              |
| <b>B-926</b> | Copper Tube Fitting Brush – 1/2" O.D., 17/32" Brush Dia.           | EA  | 1              |
| <b>B-927</b> | Copper Tube Fitting Brush – 5/8" O.D., 11/16" Brush Dia.           | EA  | 1              |
| <b>B-928</b> | Copper Tube Fitting Brush – 3/4" O.D., 13/16" Brush Dia.           | EA  | 1              |
| <b>B-929</b> | Copper Tube Fitting Brush – 7/8" O.D., 15/16" Brush Dia.           | EA  | 1              |
| <b>B-930</b> | Copper Tube Fitting Brush – 1" O.D., 1-1/8" Brush Dia.             | EA  | 1              |
| <b>B-931</b> | Copper Tube Fitting Brush – 1-1/8" O.D., 1-1/4" Brush Dia.         | EA  | 1              |
| <b>B-932</b> | Copper Tube Fitting Brush – 1-3/8" O.D., 1-1/2" Brush Dia.         | EA  | 1              |
| <b>B-934</b> | Copper Tube Fitting Brush – 1-5/8" O.D., 1-3/4" Brush Dia.         | EA  | 1              |
| <b>B-935</b> | Copper Tube Fitting Brush – 2-1/8" O.D., 2-1/4" Brush Dia.         | EA  | 1              |
| <b>B-124</b> | Copper Tube Fitting Brush – Economy 1/4" O.D., 9/32" Brush Dia.    | EA  | 6              |
| <b>B-125</b> | Copper Tube Fitting Brush – Economy 3/8" O.D., 13/32" Brush Dia.   | EA  | 6              |
| <b>B-126</b> | Copper Tube Fitting Brush – Economy 1/2" O.D., 17/32" Brush Dia.   | EA  | 6              |
| <b>B-127</b> | Copper Tube Fitting Brush – Economy 5/8" O.D., 11/16" Brush Dia.   | EA  | 6              |
| <b>B-128</b> | Copper Tube Fitting Brush – Economy 3/4" O.D., 13/16" Brush Dia.   | EA  | 6              |
| <b>B-129</b> | Copper Tube Fitting Brush – Economy 7/8" O.D., 15/16" Brush Dia.   | EA  | 6              |
| <b>B-130</b> | Copper Tube Fitting Brush – Economy 1" O.D., 1-1/8" Brush Dia.     | EA  | 6              |
| <b>B-131</b> | Copper Tube Fitting Brush – Economy 1-1/8" O.D., 1-1/4" Brush Dia. | EA  | 6              |
| <b>B-132</b> | Copper Tube Fitting Brush – Economy 1-3/8" O.D., 1-1/2" Brush Dia. | EA  | 6              |

**BRUSHES cont'd**

**Carbon Steel Curved Handle Scratch Brush**

Used for general purpose cleaning.



| CATALOG NO. | DESCRIPTION                              | UOM | ORDER MULTIPLE |
|-------------|--|-----|----------------|
| B-10        | Carbon Steel Curved Handle Scratch Brush | EA  | 1              |

**Fin Whisk**

A plastic handled whisk for cleaning condenser and evaporator fins.



| CATALOG NO. | DESCRIPTION     | UOM | ORDER MULTIPLE |
|-------------|-----------------|-----|----------------|
| B-26        | Fin Whisk Brush | EA  | 12             |

**Condenser/Heat Exchanger Brushes**

Ideal for cleaning mineral deposits from inside metal tubes. Especially recommended for use with power tools, although handle for manual use is available.



| CATALOG NO. | DESCRIPTION  | UOM | ORDER MULTIPLE |
|-------------|--|-----|----------------|
| B-602       | Condenser/Heat Exchanger Brush - 1/4" Brass 8-32 Female        | EA  | 1              |
| B-702       | Condenser/Heat Exchanger Brush - 1/4" Nylon 8-32 Female        | EA  | 1              |
| B-802       | Condenser/Heat Exchanger Brush - 1/4" Stainless 8-32 Female    | EA  | 1              |
| B-604       | Condenser/Heat Exchanger Brush - 3/8" Brass 12-24 Female       | EA  | 1              |
| B-704       | Condenser/Heat Exchanger Brush - 3/8" Nylon 12-24 Female       | EA  | 1              |
| B-804       | Condenser/Heat Exchanger Brush - 3/8" Stainless 12-24 Female   | EA  | 1              |
| B-607       | Condenser/Heat Exchanger Brush - 7/16" Brass 12-24 Female      | EA  | 1              |
| B-707       | Condenser/Heat Exchanger Brush - 7/16" Nylon 12-24 Female      | EA  | 1              |
| B-807       | Condenser/Heat Exchanger Brush - 7/16" Stainless 12-24 Female  | EA  | 1              |
| B-610       | Condenser/Heat Exchanger Brush - 1/2" Brass 12-24 Female       | EA  | 1              |
| B-710       | Condenser/Heat Exchanger Brush - 1/2" Nylon 12-24 Female       | EA  | 1              |
| B-810       | Condenser/Heat Exchanger Brush - 1/2" Stainless 12-24 Female   | EA  | 1              |
| B-613       | Condenser/Heat Exchanger Brush - 9/16" Brass 12-24 Female      | EA  | 1              |
| B-713       | Condenser/Heat Exchanger Brush - 9/16" Nylon 12-24 Female      | EA  | 1              |
| B-813       | Condenser/Heat Exchanger Brush - 9/16" Stainless 12-24 Female  | EA  | 1              |
| B-616       | Condenser/Heat Exchanger Brush - 5/8" Brass 12-24 Female       | EA  | 1              |
| B-716       | Condenser/Heat Exchanger Brush - 5/8" Nylon 12-24 Female       | EA  | 1              |
| B-816       | Condenser/Heat Exchanger Brush - 5/8" Stainless 12-24 Female   | EA  | 1              |
| B-619       | Condenser/Heat Exchanger Brush - 11/16" Brass 12-24 Female     | EA  | 1              |
| B-719       | Condenser/Heat Exchanger Brush - 11/16" Nylon 12-24 Female     | EA  | 1              |
| B-819       | Condenser/Heat Exchanger Brush - 11/16" Stainless 12-24 Female | EA  | 1              |
| B-622       | Condenser/Heat Exchanger Brush - 3/4" Brass 12-24 Female       | EA  | 1              |
| B-722       | Condenser/Heat Exchanger Brush - 3/4" Nylon 12-24 Female       | EA  | 1              |
| B-822       | Condenser/Heat Exchanger Brush - 3/4" Stainless 12-24 Female   | EA  | 1              |
| B-628       | Condenser/Heat Exchanger Brush - 7/8" Brass 12-24 Female       | EA  | 1              |
| B-728       | Condenser/Heat Exchanger Brush - 7/8" Nylon 12-24 Female       | EA  | 1              |
| B-828       | Condenser/Heat Exchanger Brush - 7/8" Stainless 12-24 Female   | EA  | 1              |
| B-633       | Condenser/Heat Exchanger Brush - 1" Brass 12-24 Female         | EA  | 1              |
| B-733       | Condenser/Heat Exchanger Brush - 1" Nylon 12-24 Female         | EA  | 1              |
| B-833       | Condenser/Heat Exchanger Brush - 1" Stainless 12-24 Female     | EA  | 1              |

**Condenser/Heat Exchanger Brushes for Commercial Tube Cleaning**

For all commercial power tube cleaning machines. 1/4" and 3/8" dia. brushes have 8-32 female threads. 7/16"-1" brushes have 1/4-28 male threads. Use 7/16"-1" brushes for both CW and CCW rotation using a 1/4-28 NF jam locknut.



| CATALOG NO. | DESCRIPTION   | UOM | ORDER MULTIPLE |
|-------------|---|-----|----------------|
| B-202       | Condenser/Heat Exchanger Brush - 1/4" Brass 8-32 Female       | EA  | 1              |
| B-302       | Condenser/Heat Exchanger Brush - 1/4" Nylon 8-32 Female       | EA  | 1              |
| B-402       | Condenser/Heat Exchanger Brush - 1/4" Stainless 8-32 Female   | EA  | 1              |
| B-204       | Condenser/Heat Exchanger Brush - 3/8" Brass 8-32 Female       | EA  | 1              |
| B-304       | Condenser/Heat Exchanger Brush - 3/8" Nylon 8-32 Female       | EA  | 1              |
| B-404       | Condenser/Heat Exchanger Brush - 3/8" Stainless 8-32 Female   | EA  | 1              |
| B-207       | Condenser/Heat Exchanger Brush - 7/16" Brass 1/4-28 Male      | EA  | 1              |
| B-307       | Condenser/Heat Exchanger Brush - 7/16" Nylon 1/4-28 Male      | EA  | 1              |
| B-407       | Condenser/Heat Exchanger Brush - 7/16" Stainless 1/4-28 Male  | EA  | 1              |
| B-210       | Condenser/Heat Exchanger Brush - 1/2" Brass 1/4-28 Male       | EA  | 1              |
| B-310       | Condenser/Heat Exchanger Brush - 1/2" Nylon 1/4-28 Male       | EA  | 1              |
| B-410       | Condenser/Heat Exchanger Brush - 1/2" Stainless 1/4-28 Male   | EA  | 1              |
| B-213       | Condenser/Heat Exchanger Brush - 9/16" Brass 1/4-28 Male      | EA  | 1              |
| B-313       | Condenser/Heat Exchanger Brush - 9/16" Nylon 1/4-28 Male      | EA  | 1              |
| B-413       | Condenser/Heat Exchanger Brush - 9/16" Stainless 1/4-28 Male  | EA  | 1              |
| B-216       | Condenser/Heat Exchanger Brush - 5/8" Brass 1/4-28 Male       | EA  | 1              |
| B-316       | Condenser/Heat Exchanger Brush - 5/8" Nylon 1/4-28 Male       | EA  | 1              |
| B-416       | Condenser/Heat Exchanger Brush - 5/8" Stainless 1/4-28 Male   | EA  | 1              |
| B-219       | Condenser/Heat Exchanger Brush - 11/16" Brass 1/4-28 Male     | EA  | 1              |
| B-319       | Condenser/Heat Exchanger Brush - 11/16" Nylon 1/4-28 Male     | EA  | 1              |
| B-419       | Condenser/Heat Exchanger Brush - 11/16" Stainless 1/4-28 Male | EA  | 1              |
| B-222       | Condenser/Heat Exchanger Brush - 3/4" Brass 1/4-28 Male       | EA  | 1              |
| B-322       | Condenser/Heat Exchanger Brush - 3/4" Nylon 1/4-28 Male       | EA  | 1              |
| B-422       | Condenser/Heat Exchanger Brush - 3/4" Stainless 1/4-28 Male   | EA  | 1              |
| B-228       | Condenser/Heat Exchanger Brush - 7/8" Brass 1/4-28 Male       | EA  | 1              |
| B-328       | Condenser/Heat Exchanger Brush - 7/8" Nylon 1/4-28 Male       | EA  | 1              |
| B-428       | Condenser/Heat Exchanger Brush - 7/8" Stainless 1/4-28 Male   | EA  | 1              |
| B-233       | Condenser/Heat Exchanger Brush - 1" Brass 1/4-28 Male         | EA  | 1              |
| B-333       | Condenser/Heat Exchanger Brush - 1" Nylon 1/4-28 Male         | EA  | 1              |
| B-433       | Condenser/Heat Exchanger Brush - 1" Stainless 1/4-28 Male     | EA  | 1              |

**Extension Rods for Condenser Tube Brushes**

Aluminum rods thread into each other to make an endless length.



| CATALOG NO. | DESCRIPTION  | UOM | ORDER MULTIPLE |
|-------------|--|-----|----------------|
| BE-24       | 24" Rods w/male thread one end, female other 12-24 thread size | EA  | 3              |
| BE-36       | 36" Rods w/male thread one end, female other 12-24 thread size | EA  | 3              |
| BE-48       | 48" Rods for 1/4" brushes only 8-32 thread size                | EA  | 3              |
| BH-1        | Handgrip - 4" long threads into rods                           | EA  | 1              |

**THERMOMETERS**

**Digital Thermometer**

Temperature range from -40° F to 230° F. Packaged on attractive display card.



541-300

| CATALOG NO. | DESCRIPTION         | UOM | ORDER MULTIPLE |
|-------------|---------------------|-----|----------------|
| 541-300     | Digital Thermometer | EA  | 1              |

**Jumbo Display – Thermo/Hygrometer**

- Displays Inside Humidity and Temperature
- Jumbo Display (3" x 1.5")
- 2 Key Operation: Min/Max and Reset
- Memory for High and Low Temp. and Humidity
- Wall or Desk Mount
- Low Battery Indicator (Battery Included)
- 14°F to 122°F (-10°C to 50°C)



6-DTH03

| CATALOG NO. | DESCRIPTION             | UOM | ORDER MULTIPLE |
|-------------|-------------------------|-----|----------------|
| 6-DTH03     | Jumbo Thermo/Hygrometer | EA  | 1              |

**Pocket Thermometers**

1" diameter dials with 5" stems (.145 dia.). Adjustable for recalibration. All stainless steel construction. Polycarbonate crystal. 1% accuracy full scale. Plastic pocket sheath included.



TD-1

| CATALOG NO. | DESCRIPTION                         | UOM | ORDER MULTIPLE |
|-------------|-------------------------------------|-----|----------------|
| TD-1        | Pocket Thermometer – 0°F to 220°F   | EA  | 12             |
| TD-2        | Pocket Thermometer – -40°F to 160°F | EA  | 12             |

**Digital Psychrometer – Precision Temperature and Humidity Instrument**

- Electronic Capacitance Type Polymer Film Sensor
- Microprocessor-based Design
- F/C Switch Data Hold
- Low Battery Indicator
- Memory (Min/Max)
- Wet Bulb and Dry Bulb Temperature
- Dew Point Measurement
- Accuracy: Humidity +/-5% @25°C from 10% to 90% RH Temperature +/- 1°C, 1°F (All temp. ranges)
- Ideal for setting up new equipment
- Batteries Included.



6-SAM990DW

| CATALOG NO. | DESCRIPTION          | UOM | ORDER MULTIPLE |
|-------------|----------------------|-----|----------------|
| 6-SAM990DW  | Digital Psychrometer | EA  | 1              |

**Deluxe Digital Pocket Thermometer**

- Water and Drop Resistant, Rugged Construction
- Data Hold
- F/C Switch
- On/Off Switch
- Auto Power Off
- 2.5" Probe
- Protective Cover with Clip
- -40°F to 300°F, -40°C to 150°C
- Same as HDT304K



6-HDT303K

| CATALOG NO. | DESCRIPTION                       | UOM | ORDER MULTIPLE |
|-------------|-----------------------------------|-----|----------------|
| 6-HDT303K   | Deluxe Digital Pocket Thermometer | EA  | 1              |

**CALIPERS**

**Digital Fractional Calipers**

- Heavy Duty Stainless Steel Construction.
- Convenient Auto On/Off Feature.
- Three Mode Digital Display: Decimal Inches, Fractions, Metric.
- Accuracy: +/- 0.001" +/- 0.02mm.
- Resolution: 0.0005", 0.01mm, 1/64".
- Includes: 1 "LR44/357" battery.



6-T147

| CATALOG NO. | DESCRIPTION               | UOM | ORDER MULTIPLE |
|-------------|---------------------------|-----|----------------|
| 6-T147      | Range: 0 - 6" (0 - 153mm) | EA  | 1              |

**GAUGES**

**Wire Gauge**

- American Standard wire gauge 0 to 36 used for gaging non-ferrous wire and metals such as copper, brass and aluminum.
- Satin finished, heavy gauge hardened/tempered steel.
- Decimal equivalents of each size are stamped on reverse side.
- 3-1/4" diameter, 3/32" thick.



| CATALOG NO. | DESCRIPTION                                     | UOM | ORDER MULTIPLE |
|-------------|---|-----|----------------|
| 6-T20       | Steel Wire Gauge – 3-1/4" diameter, 3/32" thick | EA  | 1              |

**Sheet Metal Gauge**

- For gaging uncoated sheet metal, plate iron and steel.
- Gauge numbers are U.S. Standard 0 to 36.
- Decimal equivalents of each size are stamped on reverse side.
- Satin finished, heavy gauge steel is hardened and tempered.
- 3-1/4" diameter, 3/32" thick.



| CATALOG NO. | DESCRIPTION  | UOM | ORDER MULTIPLE |
|-------------|--|-----|----------------|
| 6-T21       | Steel Sheet Metal Gauge – 3-1/4" diameter, 3/32" thick | EA  | 1              |

**Manifold Gauge**

DiversiTech's MG-1 Manifold Gauge provides the technician with a precision diagnostic and monitoring analog gauge set complete with hoses.

The Manifold Gauge and Hose Set includes:

- 2 valve brass manifold
- 5' long high pressure hose set
- For use with the following refrigerants:
  - R-410A
  - R-22
  - R-407C
- Detailed gauge readings in PSI °F

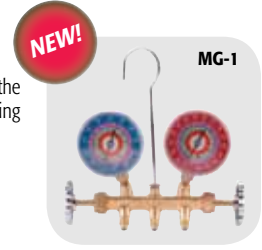

| CATALOG NO. | DESCRIPTION                 | UOM | ORDER MULTIPLE |
|-------------|-----------------------------|-----|----------------|
| MG-1        | Manifold Gauge and Hose Set | EA  | 1              |
| MG-RGR      | Replacement Gauge – red     | EA  | 1              |
| MG-RGB      | Replacement Gauge – blue    | EA  | 1              |

**SCREWDRIVERS, DRIVER SETS**

**Pocket 4-in-1 Mini Screwdriver**

- This screwdriver is ideal for technicians, hobbyists and do-it-yourselfers.
- 2 double-ended chrome vanadium blades.
- 1/16" and 1/8" slotted tip and #1 and #00 cross-point tip.
- Blades are held in carrier handle.
- Change blade sizes instantly.
- Convenient pocket clip and capped ends.



| CATALOG NO. | DESCRIPTION   | UOM | ORDER MULTIPLE |
|-------------|---|-----|----------------|
| 6-T744      | Pocket 4-in-1 Mini Screwdriver – Length: 5-1/8" (130mm) | EA  | 1              |

**6-Piece Precision Screwdriver Set**

- For repairing jewelry, cameras, eyeglasses and instruments.
- Fingertip swivel head for greater control.
- Convenient stand-up case.
- Includes: Phillips #1, #0 and Slotted tip 1/8", 3/32", 6/64", 1/16".
- Handles plated to prevent rust.
- Available individually carded or in a countertop display box.

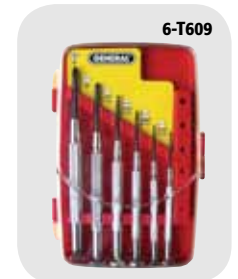

| CATALOG NO. | DESCRIPTION   | UOM | ORDER MULTIPLE |
|-------------|---|-----|----------------|
| 6-T609      | 6-Piece Set includes: Phillips #1, #0 and Slotted tip 1/8", 3/32", 6/64", 1/16" | EA  | 1              |

**6-in-1 Flip Driver**

- High-quality precision screwdriver for mechanics, technicians, hobbyists and do-it-yourselfers.
- 2 double-ended blades, 3/16" x No. 1, 1/4" x No. 2 Phillips are held in a reversible carrier.
- Change blade sizes instantly.
- Carrier doubles as a 1/4" and 5/16" Nut Driver that snugly fits in handle.
- Precision engineered 800 Series Versa-Grip™ handle for maximum performance.

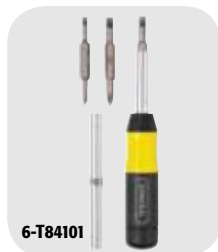

| CATALOG NO. | DESCRIPTION                 | UOM | ORDER MULTIPLE |
|-------------|-----------------------------|-----|----------------|
| 6-T84101    | 6-in-1 Flip Driver (Carded) | EA  | 1              |

**Combination Screwdrivers**

Multiple bits in one handy screwdriver. No need for a toolbox for those quick jobs. Lifetime guarantee.



| CATALOG NO. | DESCRIPTION   | UOM | ORDER MULTIPLE |
|-------------|---|-----|----------------|
| 5-41        | 4-in-1 with #1 and #2 Phillips, 3/16 and 5/16 Slotted                                 | EA  | 12             |
| 5-61        | 6-in-1 with #1 and #2 Phillips, 3/16 and 5/16 Slotted 1/4 Nut Driver, 5/16 Nut Driver | EA  | 12             |

**HOBBY AND CUTTING KNIVES**

**“The Quad™” 14-Piece Saw/Driver Set**

- A 4-in-1 cutting and driving system:
  - 1) Jab Saw with straight handle and special Sheetrock reciprocal blade.
  - 2) Keyhole Saw in the pistol grip handle position.
  - 3) Power Driver in the pistol grip position.
  - 4) Speed Driver, screw or nut driver with straight handle.
- The keyless Quick-Change locking chuck accepts both Quick-Change bits and industry standard reciprocating saw blades.
- 14 piece set includes: 3 Reciprocating saw blades, drywall, Metal/PVC, wood, 4” magnetic speed lock bit holder, 7 most popular insert bits; 1/4” hex to square drive insert bit adaptor for using 1/4” sockets; (bits not included); 2 position quick change locking handle and convenient holster with belt-clip.
- Swivel locking chuck holds all reciprocating blades and speed shank power bits.
- Comfortable handle easily locks in the straight or pistol grip position.



| CATALOG NO. | DESCRIPTION             | UOM | ORDER MULTIPLE |
|-------------|-------------------------|-----|----------------|
| 6-T86014    | 14-Piece Saw/Driver Set | EA  | 1              |

**THERMOMETERS/PROBES**

**30:1 High Performance Ultra Wide-Range Infrared Thermometer**

High precision and high performance unit, can be used in most industrial applications, including furnaces and heat exchangers.

- Switchable ON/OFF Laser sighting
  - °F/°C Switchable
  - High/Low Audible Alarm
  - Backlit LCD Display
  - Min/Max/Avg
  - Auto Measuring
  - Extended, long time measuring reliability
  - 10 point memory
  - Temperature data storage
  - Low Battery indication
  - Ultra-low power consumption in shutdown mode
  - Electronic trigger lock
  - Ergonomic design
  - Distance to spot ratio: 30:1
  - Range: -25.6° to 1400°F (-32° to 760°C)
  - Emissivity: Adjustable 0.1 to 1.0
  - Accuracy (@ ambient temperature of 77°F/25°C):
    - ±5°F (±3°C) within -25.6° to -4°F (-32° to -20°C)
    - ±3°F (±2°C) within -4° to 212°F (-20° to 100°C)
    - ±2% within 212° to 1400°F (100° to 760°C)
  - Thermopile: 8 ~ 14 m
  - Repeatability: ±2°F (±1°C)
  - Resolution: 0.1°F (0.1°C)
  - Response Time: 500 ms.
  - Operating Temperature: 32° to 122°F (0° to 50°C), 10 to 90%RH
  - Auto Power Off: Automatic after approx. 6 seconds
  - Battery Life: 16 hours
  - Dimensions: 7.8” x 6.5” x 2” (200x166x51mm)
  - Weight: 10.6 oz. (300 g) Approx.
- Includes: 1 “9V” battery; instruction manual; carrying case.

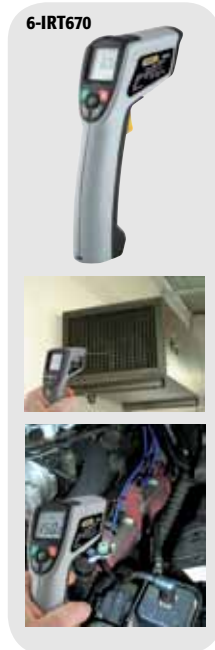

| CATALOG NO. | DESCRIPTION   | UOM | ORDER MULTIPLE |
|-------------|---|-----|----------------|
| 6-IRT670    | 30:1 High-Performance Ultra Wide-Range Infrared Thermometer | EA  | 1              |

**12:1 S/B Refrigeration, A/C and Food Service Infrared Thermometer**

Ideal for subcooling applications, particularly food service, refrigeration and air conditioning.

- Switchable ON/OFF Laser sighting
  - oF/oC Switchable
  - Backlit LCD Display
  - Auto Measuring
  - Extended, long time measuring reliability
  - Temperature data storage
  - Low Battery indication
  - Ultra-low power consumption in shutdown mode
  - Electronic trigger lock
  - Ergonomic design
  - Distance to spot ratio: 12:1
  - Range: -58° to 600°F (-50° to 316°C)
  - Emissivity: Fixed at 0.97
  - Accuracy (@ ambient temperature of 77°F/25°C):
    - ±5°F (±3°C) within -58° to -22°F (-50° to -30°C)
    - ±3°F (±2°C) within -22° to 212°F (-30° to 100°C)
    - ±2% within 212° to 600°F (100° to 316°C)
  - Thermopile: 8 ~ 14 m
  - Repeatability: ±2°F (±1°C)
  - Resolution: 0.1°F (0.1°C)
  - Response Time: 500 ms.
  - Operating Temperature: 32° to 122°F (0° to 50°C), 10 to 90%RH
  - Auto Power Off: Automatic after approx. 6 seconds
  - Battery Life: 16 hours
  - Dimensions: 6.69” x 5.23” x 1.77” (170x133x45mm)
  - Weight: 5.8 oz. (163 g) Approx.
- Includes: 1 “9V” battery; Instruction manual; carrying case.

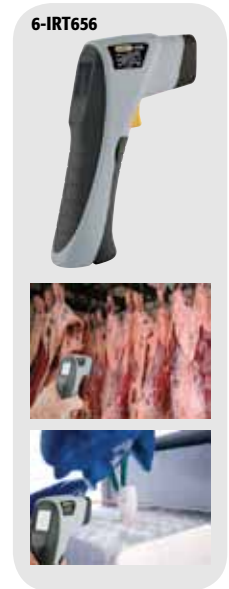

| CATALOG NO. | DESCRIPTION  | UOM | ORDER MULTIPLE |
|-------------|--|-----|----------------|
| 6-IRT656    | 12:1 S/B Refrigeration, A/C, and Food Service Infrared Thermometer | EA  | 1              |

**THERMOMETERS/PROBES cont'd**

**Pocket HVAC General Purpose Infrared Thermometer**

Convenient and accurate measurement in most HVAC/R application and industrial jobs.

- Easy to use
  - Auto power off
  - Lock function
  - Min/Max readings
  - Fits in your pocket
  - Distance to spot ratio: 6:1
  - Range: -67° to 482°F (-55° to 250°C)
  - Emissivity: Fixed at 0.95
  - Accuracy: ±0.6° °F/°C
  - Response time: 1 second
- Includes: 1 "9V" battery; neck strap.



| CATALOG NO. | DESCRIPTION                                       | UOM | ORDER MULTIPLE |
|-------------|---|-----|----------------|
| 6-IRT203    | Pocket HVAC Infrared Thermometer (Blister packed) | EA  | 1              |

**Pocket HVAC General Purpose Infrared Thermometer**

For use in labs, industrial control and audits and measuring differential temperature T1/T2.

- Dual probe input
  - Accepts K-type thermocouple probes
  - T1/T2 temperature differential
  - Data hold
  - Max hold
  - °F/°C switch
  - Auto power off
  - CE approved
  - Range: -58° to 2000°F (-50° to 1093°C)
  - Accuracy: ±1.8°F from -22° to 302°F (±4°F at all other ranges); ±1°C from -30° to 150°C (±2°C at all other ranges)
  - Probe length: 5" with 3 ft. cord
- Includes: 1 "LR44" battery; molded hard case; 2 "K" type beaded tip probes.



| CATALOG NO. | DESCRIPTION                                       | UOM | ORDER MULTIPLE |
|-------------|---|-----|----------------|
| 6-DT8803    | Digital Thermometer with 2 K-Type Probes and Case | EA  | 1              |

**HVAC/R Digital Stem Thermometer**

- On/Off switch
  - °F/°C switch
  - Data hold switch
  - Pocket clip
  - Velcro strip for pipes
  - Magnetic back for grilles and registers
  - Range: -40° to 302°F (-40° to 150°C)
  - Resolution: ±0.1°
  - Accuracy: ±1.8°F (1°C)
  - Sampling Rate: 1 second
- Includes: 1 "LR44" battery.



| CATALOG NO.  | DESCRIPTION                     | UOM | ORDER MULTIPLE |
|--------------|---------------------------------|-----|----------------|
| 6-YHDT303KVM | HVAC/R Digital Stem Thermometer | EA  | 1              |

**Horizontal Refrigerator/Freezer Analog Thermometer**

- Horizontal reading
- Hanging or free standing
- Easy to read display
- °F and °C scales
- Range: -40° to 80°F (-40° to 27°C)
- Dimensions: 1.25" x 4.75" x 0.75"

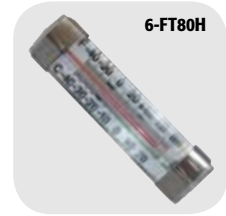

| CATALOG NO. | DESCRIPTION  | UOM | ORDER MULTIPLE |
|-------------|--|-----|----------------|
| 6-FT80H     | Horizontal Refrigerator/Freezer Analog Thermometer | EA  | 1              |

**Refrigerator/Freezer Analog Thermometer**

- Stainless steel
- Hanging or free standing
- Easy-to-read round dial
- °F only
- Temperature Indicators
- Range: -20° to 80°F (-29° to 27°C)
- Dial diameter: 2.5"



| CATALOG NO. | DESCRIPTION                             | UOM | ORDER MULTIPLE |
|-------------|---|-----|----------------|
| 6-FT80R     | Refrigerator/Freezer Analog Thermometer | EA  | 1              |

**Analog Pocket Thermometer with Magnifying Lens**

- Range 6-320: -40° to 160°F
  - Range 6-321: -0° to 220°F
  - Rugged stainless steel probe
- Includes: Protective sheath with pocket clip.

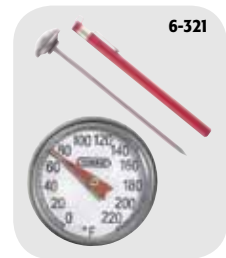

| CATALOG NO. | DESCRIPTION                                    | UOM | ORDER MULTIPLE |
|-------------|--|-----|----------------|
| 6-320       | Analog Pocket Thermometer: Range -40° to 160°F | EA  | 1              |
| 6-321       | Analog Pocket Thermometer: Range -0° to 220°F  | EA  | 1              |

**Jumbo Display Indoor/Outdoor Thermometer**

For measuring and monitoring both indoor and outdoor temperature.

- Measures with water resistant outdoor probe
  - Monitors outdoor temp. -58° to 158°F
  - Monitors indoor temp. 32° to 122°F
  - Large jumbo LCD display
  - Recall of Min/Max
  - 12 foot cable with probe
  - Wall mount or stand for desktop display
  - 12/24 hour clock
  - Range: -58° to 158°F (-50° to 70°C)
  - Unit size: 4 x .75 x 4.5
- Includes: 1 "AAA" battery; mounting accessories.



| CATALOG NO. | DESCRIPTION                              | UOM | ORDER MULTIPLE |
|-------------|--|-----|----------------|
| 6-DT898P    | Jumbo Display Indoor/Outdoor Thermometer | EA  | 1              |

**THERMOMETERS/PROBES cont'd**

**Digital Temperature and Humidity Pen**

Ideal for HVAC, laboratories, hospitals, computer rooms, greenhouses, printing, film processing, and more.

- Simultaneous displays temperature and humidity
  - Data hold freezes measured values
  - °F/°C switch
  - Auto power off after 20 minutes
  - Min/Max memory
  - Fits in your shirt pocket
  - Range: 14° to 122°F (-10° to 50°C)
  - Humidity range: 20 to 90% RH
  - Temp. accuracy: ±1.8°F (±1°C)
  - Humidity accuracy: ±5%
  - Resolution: ±0.1°, 1% RH
  - Dimensions: 5.9" x 0.8" x 0.6"
- Includes: 1 "CR2032" battery; pocket clip on back.



| CATALOG NO. | DESCRIPTION                          | UOM | ORDER MULTIPLE |
|-------------|--------------------------------------|-----|----------------|
| 6-PTH8708   | Digital Temperature and Humidity Pen | EA  | 1              |

**Economy Temperature and Humidity Pen**

Hand-held convenience for accurate measurement of temperature and humidity.

- Simultaneous display of relative humidity and temperature
  - °F/°C switch
  - Pocket size for quick & reliable measurements at any location
  - Min/Max memory (temp & humidity)
  - "Clear" function erases stored readings to record new values
  - Humidity range: 20 to 90% RH
  - Range: 14° to 122°F (-10° to 50°C)
  - Humidity accuracy: ±5%
  - Temp. accuracy: ±1.8°F (±1°C)
  - Resolution: ±0.1°, 1% RH
  - Dimensions: 5.9" x 0.8" x 0.6"
- Includes: 1 "LR44" battery; protective cover with clip.



| CATALOG NO. | DESCRIPTION                          | UOM | ORDER MULTIPLE |
|-------------|--------------------------------------|-----|----------------|
| 6-LAM122    | Economy Temperature and Humidity Pen | EA  | 1              |

**Refrigerator/Oven Thermometer**

- Stainless steel
- Hanging or free standing
- Easy-to-read round dial
- °F/°C
- Temperature Indicators
- Range: 150° to 600°F (50° to 300°C)
- Dial diameter: 2.5"



| CATALOG NO. | DESCRIPTION                   | UOM | ORDER MULTIPLE |
|-------------|-------------------------------|-----|----------------|
| 6-OT550     | Refrigerator/Oven Thermometer | EA  | 1              |

**Digital Jumbo Display Service Thermometer**

For use in labs, industrial control and food service applications.

- Displays ambient temperature and remote temperature via probe
  - Temperature alarm function with high & low limits
  - Audible & visual alarm set points
  - Probe is immersible in water
  - Clock displays hours & minutes
  - Sensor wire compartment
  - Range: -58° to 302°F (-50° to 150°C)
  - Resolution: 0.1°
  - Accuracy: ±1.8°F (±1°C)
  - Response time: 1 second
  - Probe length: 5.125"
- Includes: 1 "AAA" battery; wrist strap.



| CATALOG NO. | DESCRIPTION                               | UOM | ORDER MULTIPLE |
|-------------|---|-----|----------------|
| 6-PT300M    | Digital Jumbo Display Service Thermometer | EA  | 1              |

**METERS, DETECTORS, ALARMS**

**HVACR Refrigerant Leak Detector**

- Industrial and Automotive uses.
- Detects ALL halogenated refrigerants
  - Sensitivity adjustment dial
  - High sensitivity
  - Equipped with quality sensor
  - Flexibility up to 3 gr/yr
  - Microcomputer processor control
- Includes: 2 "C" batteries.



| CATALOG NO. | DESCRIPTION                     | UOM | ORDER MULTIPLE |
|-------------|---------------------------------|-----|----------------|
| 6-RLD202    | HVACR Refrigerant Leak Detector | EA  | 1              |

**Natural Gas Detector Pen**

- Ideal for HVAC, household etc.
- Audible and visible annunciation
  - LEDs: green, on; yellow, 500 ppm; red 200ppm
  - Detects lng, lpg, ch4, methane, butane, flammable gas
  - Catalytic combustion sensor
  - Precalibrated
  - Compact and lightweight
  - Sensitivity: lpg 2000 ppm, lng 4000 ppm
- Includes: 2 "AA" batteries; wrist strap.



| CATALOG NO. | DESCRIPTION              | UOM | ORDER MULTIPLE |
|-------------|--------------------------|-----|----------------|
| 6-PNG2000A  | Natural Gas Detector Pen | EA  | 1              |

### High Performance Refrigerant Leak Detector with Pump

- HVAC, Industrial, Automotive, small leaks.
- Microprocessor Control with advanced digital signal processing
  - Multi color visual display
  - High-median-Low leak sensitivity selector
  - Low battery indication
  - Semiconductor gas sensor
  - Detection of R-134a, R-404A, R-410A, R-407C, R22 Freon gas, etc.
  - Sensitivity (H/M/L): R-22, 134a 3g/year 15g/year 30g/year, R-404A, 407C, 410A 4g/year 20g/year 40g/year
  - 15.5" (40cm) flexible stainless probe
  - Reference Leak source included
  - Ambient concentration reset
  - Long-life, DC brushless fan
  - Automatic zero and background compensation
  - Alarm Method: Buzzer, Tricolor LED bar indicator
  - Snake Tube length: 40cm (15.5")
  - Dimension / Weight: 6.8"H x 2.6"W x 2.2"D (173x66x56mm) approximately 14.1 oz (400g)
  - Battery Life: Approx. 7 hours normal use
  - Auto power OFF: 10 minutes
  - Disable Auto Power Off: Press and Hold "Hi" button then power on the meter
  - Warm-Up Time: Approximately 45 seconds
  - Altitude: < 2000M (6500')
  - Operating Temperature and Humidity: 32° to 104°F (0° to 40°C), < 80% RH
  - Storage Temperature and Humidity: 14° to 140°F (-10° to 60°C), < 70% RH
- Includes: 4 "AA" Alkaline batteries; leak check bottle; molded hard case.



6-RLD382P

| CATALOG NO. | DESCRIPTION                                       | UOM | ORDER MULTIPLE |
|-------------|---|-----|----------------|
| 6-RLD382P   | High Performance Refrigerant Leak Detector w/Pump | EA  | 1              |

### Mini AC AMP Clamp Meter

- HVAC, Industrial uses.
- Data hold
  - Auto ranging
  - Easy-to-use
  - Continuity beeper
  - Low battery indicator
  - Auto power off
  - Jumbo LCD display
  - AC voltage: to 600V
  - AC current: to 600A
  - Resistance: to 200V
  - Sampling rate: 2 times/second
  - Jaw opening: 1"
  - Dimensions: 7.4" x 2" x 1.3"
  - Weight: 7.4 oz.
- Includes: 2 "AAA" batteries; all weather test leads; soft carrying case.



6-DAMP221

| CATALOG NO. | DESCRIPTION             | UOM | ORDER MULTIPLE |
|-------------|-------------------------|-----|----------------|
| 6-DAMP221   | Mini AC AMP Clamp Meter | EA  | 1              |

### Digital UL Listed Multimeter

- Economical Electrical Readings.
- 7 Functions – 20 Ranges
  - High Impact Thermoplastic Case
  - Simple Operation
  - Small Pocket Size
  - Safety Recessed Test Lead Connections
  - Ranges and Accuracy
  - AC Voltage: 0-200/600 Vac, ±2.5%
  - DC Voltage: 0-200mV/2/20/200/600 Vdc, ±2%
  - DC Current: 0-2000uA/20m/200mA/10Adc, ±1%
  - Resistance: 0-200/2k/20k/200k/2M/20MΩ, ±1.5%
- Includes: Battery Test; Diode Test; Continuity Buzzer.

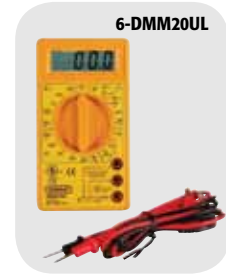

6-DMM20UL

| CATALOG NO. | DESCRIPTION                  | UOM | ORDER MULTIPLE |
|-------------|------------------------------|-----|----------------|
| 6-DMM20UL   | Digital UL Listed Multimeter | EA  | 1              |

### Digital Multimeter with Bright Screen Display

- Autorangeing, Easy-to-Use, Easy-to-See.
- 10 Functions – 37 Ranges
  - Manual and Autorangeing
  - High Impact Thermoplastic Case
  - Simple Operation
  - Safety Recessed Test Lead Connections
  - Overload Protection on all Ranges
  - Audible Continuity
  - 10A AC/DC Range
  - Data Hold
  - Auto Power Off
  - Backlit LCD Display
  - Ranges and Accuracy
  - AC Voltage: 0-200mV/2/20/200/600 Vac, ±1%
  - DC Voltage: 0-200mV/2/20/200/600 Vdc, ±0.5%
  - AC Current: 0-2mA/20m/200mA/10Aac, ±1.5%
  - DC Current: 0-2mA/20m/200mA/10Adc, ±1.2%
  - Resistance: 0-200/2k/20k/200k/2M/20MΩ, ±1%
  - Capacitance: 0-20n/200nF/2u/20u/100uF, ±3%
  - Frequency: 1-20/200/2k/20k/200k/2MHz, ±0.2%
  - Duty Cycle: 0.1 to 99.9%, ±1%
- Includes: Test leads; 1 "9V" battery.



6-DMM45

| CATALOG NO. | DESCRIPTION                                   | UOM | ORDER MULTIPLE |
|-------------|---|-----|----------------|
| 6-DMM45     | Digital Multimeter with Bright Screen Display | EA  | 1              |

**TESTERS**

**Low Voltage Screwdriver Tester**

Tests for continuity, polarity, breaks in lines.

- LED light & buzzer indication
- AC contact & non-contact
- DC volts
- Checks fuses
- Continuity and polarity checks
- Microwave leakage test
- AC voltage: 6 to 30 VAC
- DC voltage / polarity check: 1.5 to 30 VDC
- Continuity test: 0 to 80M<sup>Ω</sup>

Includes: 1 "LR44" battery.



| CATALOG NO. | DESCRIPTION                    | UOM | ORDER MULTIPLE |
|-------------|--------------------------------|-----|----------------|
| 6-CT500AV   | Low Voltage Screwdriver Tester | EA  | 1              |

**Test Cord (Female)**

- Red and black heavy duty boots
- Large clips
- 3 wire
- Get power in remote areas without 110V outlet
- Volts: 3 to 20V
- Amps: 125
- Wire gauge: 16 gauge
- Length: 24"
- Weight: 0.36 lb.



| CATALOG NO. | DESCRIPTION        | UOM | ORDER MULTIPLE |
|-------------|--------------------|-----|----------------|
| 6-CT700F    | Test Cord (Female) | EA  | 1              |

**LED Screwdriver Continuity Tester**

- A Screwdriver/Tester You Can See!
- Self Test
- AC Voltage Test 70 to 250BAC
- Continuity Test
- Polarity Check
- Checks Fuses
- Bright Red LED
- When the tip is in direct contact with the live (HOT) part of the AC Voltage, the red LED lights up.



| CATALOG NO. | DESCRIPTION                           | UOM | ORDER MULTIPLE |
|-------------|---------------------------------------|-----|----------------|
| 6-ST600LED  | Red LED Screwdriver Continuity Tester | EA  | 1              |

**Leak Test Gauge**

- Gas Gauge Testers
- Ideal for pressure testing all new installations for leaks and passing inspection code
- Special sensitive diaphragm gauges for more accurate low pressure reading



| CATALOG NO. | DESCRIPTION                               | UOM | ORDER MULTIPLE |
|-------------|---|-----|----------------|
| TG-05       | Leak Test Gauge – 3/4" FPT., 5 psi        | EA  | 1              |
| TG-30-12    | Leak Test Gauge – 1/2" FPT. Conn., 30 psi | EA  | 1              |
| TG-30       | Leak Test Gauge – 3/4 FPT. Conn., 30 psi  | EA  | 1              |
| TG-30-1     | Leak Test Gauge – 1" FPT. Conn., 30 psi   | EA  | 1              |

**Audible/Visual Circuit Tester**

- Contact and Non Contact Audible and Visual Indication
- Detects Hot Side
- 70 to 250 VAC
- Detects Break in Line
- Checks Fuses
- Detects the Presence of AC Voltage "Non Contact" Through Wires, Dry Wall & Wood
- 3 Position Sensitivity
- Batteries Included



| CATALOG NO. | DESCRIPTION                          | UOM | ORDER MULTIPLE |
|-------------|--------------------------------------|-----|----------------|
| 6-CT500AV   | Deluxe Audible/Visual Circuit Tester | EA  | 1              |

**REFRACTOMETERS**

Glycol and Brake Fluid.

- Ethylene and Propylene Glycol
- -60 to 32°F, 1.15 to 1.3 S/G
- 6.2"L x 1.8"D
- Weight: 7 oz.
- Resolution (%): 10°F, 0.01 S/G



| CATALOG NO. | DESCRIPTION   | UOM | ORDER MULTIPLE |
|-------------|---------------|-----|----------------|
| 6-REF401    | Refractometer | EA  | 1              |

**HVAC AIRFLOW INSTRUMENTS**

**Digital One-Piece Air Flow Meter with CFM Display**

HVAC Environment, Exhausts, Blowers.

- Displays: CFM, FPM, MPH, KPH, MPS, temp and knots
  - Single hand airflow measurement
  - Handy recessed service grip
  - Single and multi-point average
  - RS-232 output
  - Min/Max
  - Data hold
  - °F/°C switch
  - Range: 14° to 122°F (-10° to 50°C)
  - Air flow range: 80 to 5900 FPM (0.4 to 30 m/s)
  - Accuracy: ±3% full scale, ±2°F (±1°C)
  - Resolution: 1 ft/min (0.01 m/sec), 0.1°
  - Display size: 1.25" x 1.625"
  - Dimensions: 7" x 2.5" x 1.75"
- Includes: 1 "9V" battery; molded hard case.

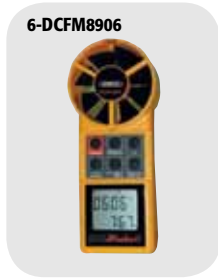

| CATALOG NO. | DESCRIPTION                                       | UOM | ORDER MULTIPLE |
|-------------|---|-----|----------------|
| 6-DCFM8906  | Digital One-Piece Air Flow Meter with CFM Display | EA  | 1              |

**Digital Air Flow Meter with CFM and BTU Display**

Measures Temperature, Dew Point, Relative Humidity, Wet Bulb, Air Velocity, Air Volume, Capacity.

- Displays BTU, CFM, temperature, humidity, dew point, FPM, MPH, KPH, knots and MPS
  - Min/Max function with memory recall
  - Auto power off
  - Range: -40 to 1580F (-200 to 700C)
  - Air flow range: to 6900 FPM (0.3 to 35 m/s)
  - Humidity range: ±5%
  - Air velocity accuracy: ±5%
  - Temperature accuracy: ±10F (±0.60C)
  - Humidity accuracy: ±3% (10-90%)
  - Resolution: 0.1 to 1 m/sec, 0.10, 0.1%RH
  - Display size: 1.25" x 1.625"
  - Dimensions: 7" x 2.5" x 1.75"
- Includes: 4 "AAA" batteries; molded hard case.



| CATALOG NO. | DESCRIPTION                                     | UOM | ORDER MULTIPLE |
|-------------|---|-----|----------------|
| 6-WDCFM8951 | Digital Air Flow Meter with CFM and BTU Display | EA  | 1              |

**MANOMETERS, PRESSURE**

**Hydrogauge Manometer**

Economical Pressure measurements.

- Replaces ordinary U-tube manometers
  - Measures gas pressure easily and efficiently
  - Direct reading, no plus or minus readings to add together as in old fashioned U-tubes
  - Fills like a glass of water, no more air bubbles
  - Strong magnet for mounting
  - Heavy-duty construction
  - Made of industrial grade, flexible PVC plastic
  - Lightweight; Easy to use
  - 6-HG15 water column height: 15"
  - Plastic: 30" to 36" of industrial grade flexible plastic
  - Hose fitting: All brass
- Includes: Mounting magnet.

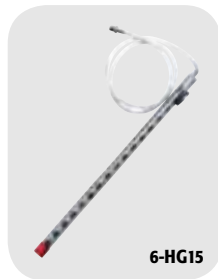

| CATALOG NO. | DESCRIPTION          | UOM | ORDER MULTIPLE |
|-------------|----------------------|-----|----------------|
| 6-HG15      | Hydrogauge Manometer | EA  | 1              |

**Gas Pressure Test Kit**

Rugged, Heavy Duty Field Use.

- Measure Natural gas (methane) or LP gas pressure across appliance manifolds.
  - Test gas stoves, furnaces, dryers and other gas appliances. Can also be used for other non-corrosive gases.
  - Large 2" sensitive diaphragm gauge is calibrated in inches of water column, also shows ounces per square inch
  - Magnified lens
  - Easier to use than a manometer
  - Range: 0 to 35 inches of water column (in. H<sub>2</sub>O) 0 to 20 ounces per square inch (oz./in<sup>2</sup>)
- Includes: 2" sensitive diaphragm gauge; 3' of rubber tubing; brass fitting for quick connection to the appliance manifold 3/8" NPT; molded hard case.



| CATALOG NO. | DESCRIPTION           | UOM | ORDER MULTIPLE |
|-------------|-----------------------|-----|----------------|
| 6-GPK035    | Gas Pressure Test Kit | EA  | 1              |

# The Perfect Pad for Every Project

**E LITE**  
DIVERSITECH

**HEF-T-PAD**  
DIVERSITECH

**THE BLACK PAD**  
DIVERSITECH

**ULTRALITE**  
DIVERSITECH

**CLADLITE**  
DIVERSITECH

**E Lite**<sup>®</sup>

**UltraLite**<sup>®</sup>

**CladLite**<sup>®</sup>

**Hef-T-Pad**<sup>™</sup>

**THE Black Pad**<sup>®</sup>

With DiversiTech's complete lineup of durable equipment pads, you're sure to find the right one for any project. From our lightweight Hef-T-Pads to sturdy concrete CladLites we offer the best selection of materials and sizes so your customers get what they need. Check out the complete pad and product offering at [www.diversitech.com](http://www.diversitech.com)

**DIVERSITECH**

# PLUMBING

|  |         |
|--|---------|
| CPVC-CTS Pipe and Fittings .....       | 181     |
| Nylon Fittings .....                   | 181-182 |
| Oatey® Products .....                  | 184     |
| PVC Condensate Pipe .....              | 176     |
| PVC DWV Fittings.....                  | 180     |
| PVC Primer and Cement.....             | 183     |
| PVC Schedule 40 Pressure Fittings..... | 176-179 |
| Supports.....                          | 180     |
| Tapes and Sealing.....                 | 185     |
| Tubing, Clamps, and Kits.....          | 185     |



**PVC CONDENSATE PIPE**

Polyvinyl Chloride, white PVC 1120

| CATALOG NO.      | DESCRIPTION                                       | UOM | ORDER MULTIPLE |
|------------------|---|-----|----------------|
| 5-2001           | 1/2" PVC – PSI 315 – 10' Straight End             | EA  | 500'           |
| 5-2002           | 3/4" PVC – PSI 200 – 10' Straight End             | EA  | 500'           |
| 5-2005           | 3/4" PVC – PSI 200 – 20' Belled End               | EA  | 500'           |
| 5-401            | 3/4" PVC – Sch. 40 – 10' Straight End             | EA  | 500'           |
| <b>NEW</b> 5-406 | 3/4" PVC – Sch. 40 – 20' Straight End             | EA  | 500'           |
| 5-407            | 3/4" PVC – Sch. 40 – 20' Belled End               | EA  | 500'           |
| 5-404            | 2" PVC – Sch.40/DWV, ASTM 2665 – 10' Straight End | EA  | 100'           |
| 5-405            | 3" PVC – Sch.40/DWV, ASTM 2665 – 10' Straight End | EA  | 50'            |
| <b>NEW</b> 5-402 | 1" PVC – Sch. 40 – 10' Plain End                  | EA  | 100'           |
| 5-416            | 1" PVC – Sch. 40 – 20' Belled End                 | EA  | 200'           |
| 5-417            | 1-1/4" PVC – Sch. 40 – 20' Belled End             | EA  | 200'           |
| 5-418            | 1-1/2" PVC – Sch. 40 – 20' Belled End             | EA  | 200'           |



**PVC SCHEDULE 40 PRESSURE FITTINGS**

**90 Ell (Slip x Slip)**

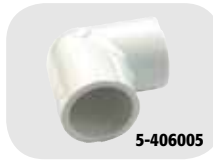

| CATALOG NO. | DESCRIPTION   | UOM | ORDER MULTIPLE |
|-------------|---------------|-----|----------------|
| 5-406005    | 1/2" 90 Ell   | EA  | 50             |
| 5-406007    | 3/4" 90 Ell   | EA  | 50             |
| 5-406010    | 1" 90 Ell     | EA  | 50             |
| 5-406012    | 1-1/4" 90 Ell | EA  | 25             |
| 5-406015    | 1-1/2" 90 Ell | EA  | 25             |
| 5-406020    | 2" 90 Ell     | EA  | 25             |
| 5-406025    | 2-1/2" 90 Ell | EA  | 10             |
| 5-406030    | 3" 90 Ell     | EA  | 10             |

**90 Ell (Slip x FIPT)**



| CATALOG NO. | DESCRIPTION   | UOM | ORDER MULTIPLE |
|-------------|---------------|-----|----------------|
| 5-407005    | 1/2" 90 Ell   | EA  | 50             |
| 5-407007    | 3/4" 90 Ell   | EA  | 50             |
| 5-407010    | 1" 90 Ell     | EA  | 50             |
| 5-407012    | 1-1/4" 90 Ell | EA  | 25             |
| 5-407015    | 1-1/2" 90 Ell | EA  | 25             |
| 5-407020    | 2" 90 Ell     | EA  | 10             |
| 5-407025    | 2-1/2" 90 Ell | EA  | 10             |
| 5-407030    | 3" 90 Ell     | EA  | 10             |

**90 Ell Reducing (Slip x Slip)**



| CATALOG NO. | DESCRIPTION                 | UOM | ORDER MULTIPLE |
|-------------|-----------------------------|-----|----------------|
| 5-406101    | 3/4" x 1/2" 90 Ell Reducing | EA  | 50             |
| 5-406130    | 1" x 1/2" 90 Ell Reducing   | EA  | 50             |
| 5-406131    | 1" x 3/4" 90 Ell Reducing   | EA  | 50             |

**90 Ell Reducing (Slip x FIPT)**



| CATALOG NO. | DESCRIPTION                 | UOM | ORDER MULTIPLE |
|-------------|-----------------------------|-----|----------------|
| 5-407074    | 1/2" x 3/4" 90 Ell Reducing | EA  | 50             |
| 5-407101    | 3/4" x 1/2" 90 Ell Reducing | EA  | 50             |
| 5-407130    | 1" x 1/2" 90 Ell Reducing   | EA  | 50             |
| 5-407131    | 1" x 3/4" 90 Ell Reducing   | EA  | 50             |

**90 Ell (FIPT x FIPT)**



| CATALOG NO.         | DESCRIPTION          | UOM | ORDER MULTIPLE |
|---------------------|----------------------|-----|----------------|
| <b>NEW</b> 5-408007 | 90 Ell (FIPT x FIPT) | EA  | 50             |

90 Street Ell (MIPT x Slip)



| CATALOG NO. | DESCRIPTION          | UOM | ORDER MULTIPLE |
|-------------|----------------------|-----|----------------|
| 5-410005    | 1/2" 90 Street Ell   | EA  | 50             |
| 5-410007    | 3/4" 90 Street Ell   | EA  | 50             |
| 5-410010    | 1" 90 Street Ell     | EA  | 50             |
| 5-410012    | 1-1/4" 90 Street Ell | EA  | 25             |
| 5-410015    | 1-1/2" 90 Street Ell | EA  | 25             |

Female Adapter Reducing (Slip x FIPT)



| CATALOG NO. | DESCRIPTION                         | UOM | ORDER MULTIPLE |
|-------------|-------------------------------------|-----|----------------|
| 5-435074    | 1/2" x 3/4" Female Adapter Reducing | EA  | 50             |
| 5-435075    | 1/2" x 1" Female Adapter Reducing   | EA  | 50             |
| 5-435101    | 3/4" x 1/2" Female Adapter Reducing | EA  | 50             |
| 5-435102    | 3/4" x 1" Female Adapter Reducing   | EA  | 50             |
| 5-435131    | 1" x 3/4" Female Adapter Reducing   | EA  | 50             |

90 Street Ell (SPIG x Slip)



| CATALOG NO. | DESCRIPTION          | UOM | ORDER MULTIPLE |
|-------------|----------------------|-----|----------------|
| 5-409005    | 1/2" 90 Street Ell   | EA  | 50             |
| 5-409007    | 3/4" 90 Street Ell   | EA  | 50             |
| 5-409010    | 1" 90 Street Ell     | EA  | 50             |
| 5-409012    | 1-1/4" 90 Street Ell | EA  | 25             |
| 5-409015    | 1-1/2" 90 Street Ell | EA  | 25             |
| 5-409020    | 2" 90 Street Ell     | EA  | 10             |

Male Adapter Reducing (MIPT x Slip)



| CATALOG NO. | DESCRIPTION                       | UOM | ORDER MULTIPLE |
|-------------|-----------------------------------|-----|----------------|
| 5-436074    | 1/2" x 3/4" Male Adapter Reducing | EA  | 50             |
| 5-436101    | 3/4" x 1/2" Male Adapter Reducing | EA  | 50             |
| 5-436102    | 3/4" x 1" Male Adapter Reducing   | EA  | 50             |
| 5-436131    | 1" x 3/4" Male Adapter Reducing   | EA  | 50             |

45 Ell (Slip x Slip)



| CATALOG NO. | DESCRIPTION   | UOM | ORDER MULTIPLE |
|-------------|---------------|-----|----------------|
| 5-417005    | 1/2" 45 Ell   | EA  | 50             |
| 5-417007    | 3/4" 45 Ell   | EA  | 50             |
| 5-417010    | 1" 45 Ell     | EA  | 50             |
| 5-417012    | 1-1/4" 45 Ell | EA  | 25             |
| 5-417020    | 2" 45 Ell     | EA  | 25             |
| 5-417025    | 2-1/2" 45 Ell | EA  | 10             |
| 5-417030    | 3" 45 Ell     | EA  | 10             |

Male Adapter (MIPT x Slip)



| CATALOG NO. | DESCRIPTION         | UOM | ORDER MULTIPLE |
|-------------|---------------------|-----|----------------|
| 5-436005    | 1/2" Male Adapter   | EA  | 100            |
| 5-436007    | 3/4" Male Adapter   | EA  | 50             |
| 5-436010    | 1" Male Adapter     | EA  | 50             |
| 5-436012    | 1-1/4" Male Adapter | EA  | 25             |
| 5-436015    | 1-1/2" Male Adapter | EA  | 25             |
| 5-436020    | 2" Male Adapter     | EA  | 25             |
| 5-436025    | 2-1/2" Male Adapter | EA  | 10             |
| 5-436030    | 3" Male Adapter     | EA  | 10             |

Female Adapter (Slip x FIPT)



| CATALOG NO. | DESCRIPTION           | UOM | ORDER MULTIPLE |
|-------------|-----------------------|-----|----------------|
| 5-435005    | 1/2" Female Adapter   | EA  | 100            |
| 5-435007    | 3/4" Female Adapter   | EA  | 50             |
| 5-435010    | 1" Female Adapter     | EA  | 50             |
| 5-435012    | 1-1/4" Female Adapter | EA  | 25             |
| 5-435015    | 1-1/2" Female Adapter | EA  | 25             |
| 5-435020    | 2" Female Adapter     | EA  | 25             |
| 5-435025    | 2-1/2" Female Adapter | EA  | 10             |
| 5-435030    | 3" Female Adapter     | EA  | 10             |

Adapter (Insert x Slip)



| CATALOG NO. | DESCRIPTION                  | UOM | ORDER MULTIPLE |
|-------------|------------------------------|-----|----------------|
| 5-474007    | 3/4" Adapter (Insert x Slip) | EA  | 50             |

**PVC SCHEDULE 40 PRESSURE FITTINGS** cont'd

**Coupling (Slip x Slip)**



| CATALOG NO. | DESCRIPTION     | UOM | ORDER MULTIPLE |
|-------------|-----------------|-----|----------------|
| 5-429005    | 1/2" Coupling   | EA  | 100            |
| 5-429007    | 3/4" Coupling   | EA  | 50             |
| 5-429010    | 1" Coupling     | EA  | 50             |
| 5-429012    | 1-1/4" Coupling | EA  | 25             |
| 5-429015    | 1-1/2" Coupling | EA  | 25             |
| 5-429020    | 2" Coupling     | EA  | 25             |
| 5-429025    | 2-1/2" Coupling | EA  | 10             |
| 5-429030    | 3" Coupling     | EA  | 10             |

**Tee (Slip x Slip x Slip)**



| CATALOG NO. | DESCRIPTION | UOM | ORDER MULTIPLE |
|-------------|-------------|-----|----------------|
| 5-401005    | 1/2" Tee    | EA  | 50             |
| 5-401007    | 3/4" Tee    | EA  | 50             |
| 5-401010    | 1" Tee      | EA  | 50             |
| 5-401012    | 1-1/4" Tee  | EA  | 25             |
| 5-401015    | 1-1/2" Tee  | EA  | 25             |
| 5-401020    | 2" Tee      | EA  | 25             |
| 5-401025    | 2-1/2" Tee  | EA  | 10             |
| 5-401030    | 3" Tee      | EA  | 10             |

**Cap (Slip)**



| CATALOG NO. | DESCRIPTION | UOM | ORDER MULTIPLE |
|-------------|-------------|-----|----------------|
| 5-447005    | 1/2" Cap    | EA  | 100            |
| 5-447007    | 3/4" Cap    | EA  | 100            |
| 5-447010    | 1" Cap      | EA  | 50             |
| 5-447012    | 1-1/4" Cap  | EA  | 25             |
| 5-447020    | 2" Cap      | EA  | 25             |
| 5-447030    | 3" Cap      | EA  | 10             |

**Tee (Slip x FIPT x Slip)**



| CATALOG NO. | DESCRIPTION             | UOM | ORDER MULTIPLE |
|-------------|-------------------------|-----|----------------|
| 5-403005    | 1/2" Tee (S x FIPT x S) | EA  | 50             |
| 5-402007    | 3/4" Tee (S x S x FIPT) | EA  | 50             |
| 5-403007    | 3/4" Tee (S x FIPT x S) | EA  | 50             |

**Cap (FIPT)**



| CATALOG NO. | DESCRIPTION | UOM | ORDER MULTIPLE |
|-------------|-------------|-----|----------------|
| 5-448005    | 1/2" Cap    | EA  | 100            |
| 5-448007    | 3/4" Cap    | EA  | 100            |
| 5-448010    | 1" Cap      | EA  | 50             |
| 5-448015    | 1-1/2" Cap  | EA  | 25             |
| 5-448020    | 2" Cap      | EA  | 10             |
| 5-448025    | 2-1/2" Cap  | EA  | 10             |
| 5-448030    | 3" Cap      | EA  | 10             |

**Tee (Slip x Slip x FIPT)**



| CATALOG NO.         | DESCRIPTION             | UOM | ORDER MULTIPLE |
|---------------------|-------------------------|-----|----------------|
| <b>NEW</b> 5-402007 | 3/4" Tee (S x S x FIPT) | EA  | 50             |

**Clean Out Tee**



| CATALOG NO.            | DESCRIPTION        | UOM | ORDER MULTIPLE |
|------------------------|--------------------|-----|----------------|
| <b>NEW</b> 510-3400-10 | 3/4" Clean Out Tee | EA  | 10             |
| 510-3400               | 3/4" Clean Out Tee | EA  | 50             |

**Cross (Slip x Slip x Slip x Slip)**



| CATALOG NO.         | DESCRIPTION                       | UOM | ORDER MULTIPLE |
|---------------------|-----------------------------------|-----|----------------|
| <b>NEW</b> 5-420007 | Cross (Slip x Slip x Slip x Slip) | EA  | 50             |

### Reducing Bushing (MIPT X FIPT)



5-439131

| CATALOG NO.         | DESCRIPTION                     | UOM | ORDER MULTIPLE |
|---------------------|---------------------------------|-----|----------------|
| <b>NEW 5-439131</b> | Reducing Bushing 1" MIPT x 3/4" | EA  | 100            |

### Reducer Bushing (SPIG X FIPT)



5-438101

| CATALOG NO. | DESCRIPTION                 | UOM | ORDER MULTIPLE |
|-------------|-----------------------------|-----|----------------|
| 5-438101    | 3/4" x 1/2" Reducer Bushing | EA  | 100            |
| 5-438130    | 1" x 1/2" Reducer Bushing   | EA  | 100            |
| 5-438131    | 1" x 3/4" Reducer Bushing   | EA  | 100            |

### Reducer Bushing (SPIG x Slip)



5-437101

| CATALOG NO. | DESCRIPTION                   | UOM | ORDER MULTIPLE |
|-------------|-------------------------------|-----|----------------|
| 5-437101    | 3/4" x 1/2" Reducer Bushing   | EA  | 100            |
| 5-437130    | 1" x 1/2" Reducer Bushing     | EA  | 100            |
| 5-437131    | 1" x 3/4" Reducer Bushing     | EA  | 100            |
| 5-437210    | 1-1/2" x 3/4" Reducer Bushing | EA  | 25             |
| 5-437251    | 2" x 1-1/2" Reducer Bushing   | EA  | 10             |
| 5-437339    | 3" x 2-1/2" Reducer Bushing   | EA  | 10             |

### Traps (Slip x Slip)

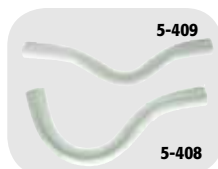

5-409

5-408

| CATALOG NO. | DESCRIPTION                      | UOM | ORDER MULTIPLE |
|-------------|----------------------------------|-----|----------------|
| 5-408       | 3/4" "P" Trap (Slip x Slip)      | EA  | 100            |
| 5-409       | 3/4" Running Trap (Slip x Slip)  | EA  | 100            |
| 5-410       | 3/4" Mini "P" Trap (Slip x Slip) | EA  | 100            |
| 5-411       | 1" "P" Trap (Slip x Slip)        | EA  | 50             |
| 5-412       | 1/2" "P" Trap (Slip x Slip)      | EA  | 100            |
| 5-414       | 3/4" "J" Trap (Slip x Slip)      | EA  | 100            |
| 5-415       | 1" "R" Trap (Slip x Slip)        | EA  | 50             |

### Plug (Slip)



5-449005

| CATALOG NO. | DESCRIPTION | UOM | ORDER MULTIPLE |
|-------------|-------------|-----|----------------|
| 5-449005    | 1/2" Plug   | EA  | 50             |
| 5-449007    | 3/4" Plug   | EA  | 50             |
| 5-449010    | 1" Plug     | EA  | 50             |
| 5-449015    | 1-1/2" Plug | EA  | 25             |
| 5-449020    | 2" Plug     | EA  | 10             |
| 5-449025    | 2-1/2" Plug | EA  | 10             |
| 5-449030    | 3" Plug     | EA  | 10             |

### Plug (MIPT)



5-450005

| CATALOG NO. | DESCRIPTION | UOM | ORDER MULTIPLE |
|-------------|-------------|-----|----------------|
| 5-450005    | 1/2" Plug   | EA  | 50             |
| 5-450007    | 3/4" Plug   | EA  | 50             |
| 5-450010    | 1" Plug     | EA  | 50             |
| 5-450015    | 1-1/2" Plug | EA  | 25             |
| 5-450020    | 2" Plug     | EA  | 10             |
| 5-450025    | 2-1/2" Plug | EA  | 10             |
| 5-450030    | 3" Plug     | EA  | 10             |

### KwikRepair™ Coupler

Helps repair PVC lines quickly and easily. It does the job without using more than one fitting; no O-rings to fail. Significantly helps lower labor costs. It is especially effective when applications require limited space. The sleeves slide and glue onto the pipe, eliminating bending of the pipe for repair or replacement.



5-PRC-34

| CATALOG NO. | DESCRIPTION         | UOM | ORDER MULTIPLE |
|-------------|---------------------|-----|----------------|
| 5-PRC-34    | KwikRepair™ Coupler | EA  | 10             |

### 3/4" Rubber Elbow

Allows for quick disconnect and reconnect of drain lines. Made of 60 DURO EPDM.



5-520

| CATALOG NO. | DESCRIPTION        | UOM | ORDER MULTIPLE |
|-------------|--------------------|-----|----------------|
| 5-520       | 3/4" Rubber Elbows | EA  | 50             |

PVC DWV FITTINGS

45 Elbows



| CATALOG NO. | DESCRIPTION                     | UOM | ORDER MULTIPLE |
|-------------|---------------------------------|-----|----------------|
| 5-321020    | 2" 45 Elbow (Hub x Hub)         | EA  | 50             |
| 5-321030    | 3" 45 Elbow (Hub x Hub)         | EA  | 20             |
| 510-D323020 | 2" 45 Street Elbow (Hub x SPIG) | EA  | 50             |
| 510-D323030 | 3" 45 Street Elbow (Hub x SPIG) | EA  | 20             |

Couplings (Hub x Hub)



| CATALOG NO. | DESCRIPTION                       | UOM | ORDER MULTIPLE |
|-------------|-----------------------------------|-----|----------------|
| 5-100020    | 2" Couplings (Hub x Hub)          | EA  | 100            |
| 5-100030    | 3" Couplings (Hub x Hub)          | EA  | 60             |
| 510-D102251 | 2" x 1-1/2" Couplings (Hub x Hub) | EA  | 25             |
| 510-D102338 | 3" x 2" Couplings (Hub x Hub)     | EA  | 20             |

90 Elbow (Hub x Hub)



| CATALOG NO. | DESCRIPTION                        | UOM | ORDER MULTIPLE |
|-------------|------------------------------------|-----|----------------|
| 5-300020    | 2" 90 Elbow (Hub x Hub)            | EA  | 50             |
| 510-D304020 | 2" Long Sweep 90 Elbow (Hub x Hub) | EA  | 25             |
| 5-300030    | 3" 90 Elbow (Hub x Hub)            | EA  | 25             |
| 510-D304030 | 3" Long Sweep 90 Elbow (Hub x Hub) | EA  | 10             |

DWV Bend Fittings



| CATALOG NO. | DESCRIPTION             | UOM | ORDER MULTIPLE |
|-------------|-------------------------|-----|----------------|
| 5-300050    | 2" H x SPG Long Sweep   | EA  | 25             |
| 5-300060    | 2 1/4" Bend SPG x H STR | EA  | 50             |
| 510-D309020 | 2" Street Ell SPG x H   | EA  | 25             |
| 510-D309030 | 3" Street Elbow SPG x H | EA  | 10             |

DWV Vent Tee



| CATALOG NO. | DESCRIPTION | UOM | ORDER MULTIPLE |
|-------------|-------------|-----|----------------|
| 510-D441020 | 2" Vent Tee | EA  | 25             |
| 510-D441030 | 3" Vent Tee | EA  | 10             |

DWV Bushings



| CATALOG NO. | DESCRIPTION                             | UOM | ORDER MULTIPLE |
|-------------|---|-----|----------------|
| 510-437292  | 2.5" x 2" Reducing Bushing (SPIG x HUB) | EA  | 10             |
| 510-437338  | 3" x 2" Reducing Bushing (SPIG x SLIP)  | EA  | 10             |
| 510-438338  | 3" x 2" Bushing (SPIG x FIPT)           | EA  | 10             |

SUPPORTS

Plastic DWV J-Hooks



| CATALOG NO.    | DESCRIPTION                      | UOM | ORDER MULTIPLE |
|----------------|----------------------------------|-----|----------------|
| 515-J2000      | 2" x 7-1/2" DWV Swiveling J-Hook | EA  | 25             |
| 515-J3000      | 3" x 7-1/2" DWV Swiveling J-Hook | EA  | 25             |
| NEW 515-NS2000 | 2" DWV Non-swiveling J-Hook      | EA  | 50             |
| NEW 515-NS3000 | 3" DWV Non-swiveling J-Hook      | EA  | 25             |

Strapping Hanger Iron

Galvanized 3/4" vent strapping, hanger iron, plumber's tape, pipe hanger tape and many other uses. 1/4" centers for bolts or nails.



| CATALOG NO. | DESCRIPTION                                 | UOM | ORDER MULTIPLE |
|-------------|---|-----|----------------|
| 710-A1710   | Hanger Iron (Galv.) - 10' Rolls - 28 Gauge  | EA  | 50             |
| 710-A1650   | Hanger Iron (Galv.) - 50' Rolls - 28 Gauge  | EA  | 10             |
| 710-A16100  | Hanger Iron (Galv.) - 100' Rolls - 28 Gauge | EA  | 6              |

## CPVC-CTS PIPE AND FITTINGS BY FLOWGUARD® GOLD™

Flowguard Gold is a patented CPVC formulated compound developed by BF Goodrich to improve the impact resistance of CPVC hot and cold water plumbing products.

| CATALOG NO.        | DESCRIPTION                | UOM | ORDER MULTIPLE |
|--------------------|----------------------------|-----|----------------|
| 4700-12            | 1/2" x 10' CPVC Pipe, 500' | EA  | 1              |
| 4701-12            | 1/2" Coupling S x S        | EA  | 20'            |
| 4704-12            | 1/2" Adapter M x S         | EA  | 20'            |
| 4703-12            | 1/2" Adapter F x S         | EA  | 25'            |
| 4707-12            | 1/2" 90° Elbow S x S       | EA  | 20'            |
| 4706-12            | 1/2" 45° Elbow S x S       | EA  | 20'            |
| 4711-12            | 1/2" Tee S x S x S         | EA  | 20'            |
| <b>NEW</b> 4718-12 | 3/4" x 1/2" CPVC Bushing   | EA  | 10'            |
| 47072-12           | 1/2" 90° Street Ell S x S  | EA  | 10'            |
| 4700-34            | 3/4" x 10' CPVC Pipe, 250' | EA  | 1              |
| 4701-34            | 3/4" Coupling S x S        | EA  | 20'            |
| 4704-34            | 3/4" Adapter M x S         | EA  | 10'            |
| 4703-34            | 3/4" Adapter F x S         | EA  | 25'            |
| 4707-34            | 3/4" 90° Elbow S x S       | EA  | 20'            |
| 4706-34            | 3/4" 45° Elbow S x S       | EA  | 20'            |
| 4711-34            | 3/4" Tee S x S x S         | EA  | 20'            |
| 47072-34           | 3/4" 90° Street Ell S x S  | EA  | 10'            |



## NYLON FITTINGS\*

### Elbow (Barb x Barb)



| CATALOG NO.        | DESCRIPTION                 | UOM | ORDER MULTIPLE |
|--------------------|-----------------------------|-----|----------------|
| 701-018            | Elbow - 1/2 Barb, pack of 2 | PK  | 1              |
| 701-023            | Elbow - 3/4 Barb, pack of 2 | PK  | 1              |
| 701-040            | Elbow - 5/8 Barb, pack of 2 | PK  | 1              |
| <b>NEW</b> 701-046 | Elbow - 3/8 Barb, pack of 2 | PK  | 1              |

### Female Adapter (Barb x FIPT)



| CATALOG NO.        | DESCRIPTION                              | UOM | ORDER MULTIPLE |
|--------------------|--|-----|----------------|
| 701-006            | Adapter - 3/4 Barb x 3/4 FIPT, pack of 2 | PK  | 1              |
| 701-041            | Adapter - 1/2 Barb x 1/2 FIPT, pack of 2 | PK  | 1              |
| <b>NEW</b> 701-053 | Adapter - 1/2 Barb x 3/4 FIPT, pack of 2 | PK  | 1              |

### Elbow (FIPT x FIPT)



| CATALOG NO.        | DESCRIPTION                 | UOM | ORDER MULTIPLE |
|--------------------|-----------------------------|-----|----------------|
| <b>NEW</b> 701-047 | Elbow - 3/4 FIPT, pack of 2 | PK  | 1              |

### Female Adapter Elbow (Barb x FIPT)



| CATALOG NO. | DESCRIPTION   | UOM | ORDER MULTIPLE |
|-------------|---|-----|----------------|
| 701-019     | Elbow - 1/2 Barb x 3/4 FIPT, pack of 2              | PK  | 1              |
| 701-024     | Elbow - 3/4 Barb x 3/4 FIPT, pack of 2              | PK  | 1              |
| 701-055     | Elbow - 1/2 Barb x 3/4 FIPT Bottom Drain, pack of 2 | PK  | 1              |

\*All fittings packaged with identification. To order nylon fittings in bulk, enter catalog number followed by the letter "B." For example, 701-001B is the bulk part number for 701-001. Bulk sold in packs of 100.

**NYLON FITTINGS\* cont'd**

**Male Adapter Elbow (Barb x MIPT)**



| CATALOG NO. | DESCRIPTION                            | UOM | ORDER MULTIPLE |
|-------------|--|-----|----------------|
| 701-020     | Elbow – 1/2 Barb x 3/4 MIPT, pack of 2 | PK  | 1              |
| 701-021     | Elbow – 1/4 Barb x 1/4 MIPT, pack of 2 | PK  | 1              |
| 701-022     | Elbow – 1/4 Barb x 3/8 MIPT, pack of 2 | PK  | 1              |
| 701-025     | Elbow – 3/4 Barb x 3/4 MIPT, pack of 2 | PK  | 1              |
| 701-026     | Elbow – 3/8 Barb x 1/2 MIPT, pack of 2 | PK  | 1              |
| 701-027     | Elbow – 3/8 Barb x 3/8 MIPT, pack of 2 | PK  | 1              |
| 701-028     | Elbow – 5/8 Barb x 3/4 MIPT, pack of 2 | PK  | 1              |
| 701-044     | Elbow – 1/2 Barb x 3/4 MIPT, pack of 2 | PK  | 1              |

**Tee (Barb x Barb x Barb)**



| CATALOG NO. | DESCRIPTION                           | UOM | ORDER MULTIPLE |
|-------------|---------------------------------------|-----|----------------|
| 701-034     | Tee – 1/2 Barb, pack of 2             | PK  | 1              |
| 701-035     | Tee – 1/2 x 3/4 x 1/2 Barb, pack of 2 | PK  | 1              |
| 701-036     | Tee – 1/4 Barb, pack of 2             | PK  | 1              |
| 701-037     | Tee – 3/4 Barb, pack of 2             | PK  | 1              |
| 701-038     | Tee – 3/8 Barb, pack of 2             | PK  | 1              |
| 701-039     | Tee – 5/8 Barb, pack of 2             | PK  | 1              |

**Male Adapter (Barb x MIPT)**



| CATALOG NO. | DESCRIPTION                              | UOM | ORDER MULTIPLE |
|-------------|--|-----|----------------|
| 701-001     | Adapter – 1/2 Barb x 1/2 MIPT, pack of 2 | PK  | 1              |
| 701-002     | Adapter – 1/2 Barb x 3/4 MIPT, pack of 2 | PK  | 1              |
| 701-003     | Adapter – 1/2 Barb x 3/8 MIPT, pack of 2 | PK  | 1              |
| 701-004     | Adapter – 1/4 Barb x 1/4 MIPT, pack of 2 | PK  | 1              |
| 701-005     | Adapter – 1/4 Barb x 3/8 MIPT, pack of 2 | PK  | 1              |
| 701-007     | Adapter – 3/4 Barb x 3/4 MIPT, pack of 2 | PK  | 1              |
| 701-012     | Adapter – 3/8 Barb x 1/2 MIPT, pack of 2 | PK  | 1              |
| 701-013     | Adapter – 3/8 Barb x 3/8 MIPT, pack of 2 | PK  | 1              |
| 701-014     | Adapter – 5/8 Barb x 3/4 MIPT, pack of 2 | PK  | 1              |
| 701-042     | Adapter – 3/8 Barb x 1/4 MIPT, pack of 2 | PK  | 1              |
| 701-043     | Adapter – 3/8 Barb x 3/4 MIPT, pack of 2 | PK  | 1              |

**Garden Hose Adapters**



| CATALOG NO. | DESCRIPTION                              | UOM | ORDER MULTIPLE |
|-------------|--|-----|----------------|
| 701-008     | Adapter – 3/4 MGHT x 3/4 FGHT, pack of 2 | PK  | 1              |
| 701-009     | Adapter – 3/4 MGHT x 3/4 FIPT, pack of 2 | PK  | 1              |
| 701-010     | Adapter – 3/4 MGHT x 3/4 MIPT, pack of 2 | PK  | 1              |
| 701-011     | Adapter – 3/4 MIPT x 3/4 FGHT, pack of 2 | PK  | 1              |

**Bushing (MIPT x FIPT)**



| CATALOG NO.        | DESCRIPTION                              | UOM | ORDER MULTIPLE |
|--------------------|--|-----|----------------|
| <b>NEW</b> 701-015 | Bushing – 1 MIPT x 3/4 FIPT, pack of 2   | PK  | 1              |
| <b>NEW</b> 701-016 | Bushing – 1/2 MIPT x 3/8 FIPT, pack of 2 | PK  | 1              |
| <b>NEW</b> 701-017 | Bushing – 3/4 MIPT x 1/2 FIPT, pack of 2 | PK  | 1              |

**Hose Mender (Barb x Barb)**



| CATALOG NO. | DESCRIPTION                       | UOM | ORDER MULTIPLE |
|-------------|-----------------------------------|-----|----------------|
| 701-029     | Hose Mender – 1/2 Barb, pack of 2 | PK  | 1              |
| 701-030     | Hose Mender – 1/4 Barb, pack of 2 | PK  | 1              |
| 701-031     | Hose Mender – 3/4 Barb, pack of 2 | PK  | 1              |
| 701-032     | Hose Mender – 3/8 Barb, pack of 2 | PK  | 1              |
| 701-033     | Hose Mender – 5/8 Barb, pack of 2 | PK  | 1              |

\*All fittings packaged with identification. To order nylon fittings in bulk, enter catalog number followed by the letter "B." For example, 701-001B is the bulk part number for 701-001. Bulk sold in packs of 100.

**PVC PRIMER AND CEMENT**

**Pro-Weld™ PVC Cement (Regular Body)**

Pro-Weld™ PVC Cement is a clear, regular bodied solvent cement designed to be used on Type I and II PVC pipe and fittings up to and including 4 inch diameter. Pro-Weld™ meets ASTM Standard D-2564.



| CATALOG NO.  | DESCRIPTION   | UOM | ORDER MULTIPLE |
|--------------|---|-----|----------------|
| <b>PW-4</b>  | Pro-Weld™ – 4 oz. Brush-Top Container – Regular Body  | EA  | 24             |
| <b>PW-8</b>  | Pro-Weld™ – 8 oz. Brush-Top Container – Regular Body  | EA  | 24             |
| <b>PW-16</b> | Pro-Weld™ – 16 oz. Brush-Top Container – Regular Body | EA  | 24             |
| <b>PW-32</b> | Pro-Weld™ – 32 oz. Brush-Top Container – Regular Body | EA  | 12             |

**Pro-Weld™ PVC Cement (Universal – PVC/ABS/CPVC)**

Pro-Weld™ Universal Cement is a clear, medium bodied, high strength cement for use on PVC to PVC, CPVC to CPVC, and ABS to ABS connections. Pro-Weld Universal sets up fast and works with all rigid schedule 40 and 80 piping up to 6 inches in diameter. Complies with ASTM D2564, D2235, and F493.



| CATALOG NO.   | DESCRIPTION   | UOM | ORDER MULTIPLE |
|---------------|---|-----|----------------|
| <b>PWU-4</b>  | Pro-Weld™ – 4 oz. Brush-Top Container – Universal – PVC/ABS/CPVC  | EA  | 24             |
| <b>PWU-8</b>  | Pro-Weld™ – 8 oz. Brush-Top Container – Universal – PVC/ABS/CPVC  | EA  | 24             |
| <b>PWU-16</b> | Pro-Weld™ – 16 oz. Brush-Top Container – Universal – PVC/ABS/CPVC | EA  | 24             |

**Pro-Weld™ PVC Cement (Heavy Body)**

Pro-Weld™ Heavy Body is a clear, heavy bodied, very high strength industrial grade PVC cement. It has a medium setting time and works with all rigid schedule 40 and 80 pipe diameters up to 12 inches. Complies with ASTM D2564 and NSF.



| CATALOG NO.   | DESCRIPTION   | UOM | ORDER MULTIPLE |
|---------------|---|-----|----------------|
| <b>PWH-4</b>  | Pro-Weld™ – 4 oz. Brush-Top Container – Heavy Body  | EA  | 24             |
| <b>PWH-8</b>  | Pro-Weld™ – 8 oz. Brush-Top Container – Heavy Body  | EA  | 24             |
| <b>PWH-16</b> | Pro-Weld™ – 16 oz. Brush-Top Container – Heavy Body | EA  | 24             |

**Pro-Prime™ PVC Primer (Purple)**

A purple-tinted primer formulated to remove dirt and oil from the surface of Type I and II PVC piping, as well as soften the piping in preparation for solvent welding. Pro-Prime™ contains purple pigment which provides verification that the primer has been applied to the pipe surface. Pro-Prime™ meets ASTM Standard F-656.



| CATALOG NO.  | DESCRIPTION                             | UOM | ORDER MULTIPLE |
|--------------|---|-----|----------------|
| <b>PP-4</b>  | Pro-Prime™ – 4 oz. Brush-Top Container  | EA  | 24             |
| <b>PP-8</b>  | Pro-Prime™ – 8 oz. Brush-Top Container  | EA  | 24             |
| <b>PP-16</b> | Pro-Prime™ – 16 oz. Brush-Top Container | EA  | 24             |
| <b>PP-32</b> | Pro-Prime™ – 32 oz. Can                 | EA  | 12             |

NEW

**Pro-Weld™ PVC Cement (Pool and Turf – Blue)**

Pro-Weld™ Blue Pool and Turf is a blue colored, medium bodied, high strength PVC cement for welding rigid or flexible PVC in wet conditions where the system needs to be pressurized quickly. Pro-Weld Blue Pool and Turf sets up very fast and works with all rigid and flexible schedule 40 and 80 pipe diameters up to 6 inches. Complies with ASTM D2564 and NSF.



| CATALOG NO.   | DESCRIPTION   | UOM | ORDER MULTIPLE |
|---------------|---|-----|----------------|
| <b>PWB-4</b>  | Pro-Weld™ – 4 oz. Brush-Top Container – Pool and Turf – Blue  | EA  | 24             |
| <b>PWB-8</b>  | Pro-Weld™ – 8 oz. Brush-Top Container – Pool and Turf – Blue  | EA  | 24             |
| <b>PWB-16</b> | Pro-Weld™ – 16 oz. Brush-Top Container – Pool and Turf – Blue | EA  | 24             |

**Pro-Prime™ Clear PVC Primer**

Clear primer that removes dirt and oil from the surface of Type I and II PVC piping. Softens the piping to prepare for solvent welding. Pro-Prime Clear primer meets ASTM Standard F-656.



| CATALOG NO.   | DESCRIPTION                                   | UOM | ORDER MULTIPLE |
|---------------|---|-----|----------------|
| <b>PPC-4</b>  | Pro-Prime™ Clear – 4 oz. Brush-Top Container  | EA  | 24             |
| <b>PPC-8</b>  | Pro-Prime™ Clear – 8 oz. Brush-Top Container  | EA  | 24             |
| <b>PPC-16</b> | Pro-Prime™ Clear – 16 oz. Brush-Top Container | EA  | 24             |
| <b>PPC-32</b> | Pro-Prime™ Clear – 32 oz. Can                 | EA  | 12             |

OATEY® PRODUCTS

### All-purpose Clear Cement for ABS, PVC and CPVC Pipe and Fittings

Heavy-bodied clear cement recommended for use on ABS, PVC, and CPVC pipe and fittings up to 12" in diameter. Flows freely and provides a thick layer of cement on the pipe. Apply at temperatures 40° to 90°F.



| CATALOG NO. | DESCRIPTION           | UOM | ORDER MULTIPLE |
|-------------|-----------------------|-----|----------------|
| 530-30818   | Clear Cement – 4 oz.  | EA  | 24             |
| 530-30821   | Clear Cement – 8 oz.  | EA  | 24             |
| 530-30834   | Clear Cement – 16 oz. | EA  | 24             |

### PVC Gray Cement for High Efficiency Furnaces, Vent and Make-Up Air

Medium-bodied gray colored cement for use on Sch. 40 conduit, drain waste, and vent pipe. Flows freely and covers with a thicker layer than regular PVC. Can be applied at temperatures 40° to 100°F.



| CATALOG NO. | DESCRIPTION          | UOM | ORDER MULTIPLE |
|-------------|----------------------|-----|----------------|
| 530-30883   | Gray Cement – 4 oz.  | EA  | 24             |
| 530-30884   | Gray Cement – 8 oz.  | EA  | 24             |
| 530-30885   | Gray Cement – 16 oz. | EA  | 24             |

NSF and UPC listed. Exceeds ASTM D-2564.

### PVC Cement – Clear

PVC Cement is clear. All cans have brushtop applicator.



| CATALOG NO. | DESCRIPTION             | UOM | ORDER MULTIPLE |
|-------------|-------------------------|-----|----------------|
| 5-14        | Oatey #31012 – 1/4 Pint | EA  | 24             |
| 5-12        | Oatey #31013 – 1/2 Pint | EA  | 24             |
| 5-10        | Oatey #31014 – 1 Pint   | EA  | 24             |
| 5-32        | Oatey #31015 – 32 oz.   | EA  | 12             |

### All Weather PVC Cement

Medium bodied cement for PVC pipe and fittings up to 6". Formulated for fast initial set-up from -15°F to 100°F. Exceeds ASTM D-2564.



| CATALOG NO. | DESCRIPTION                 | UOM | ORDER MULTIPLE |
|-------------|-----------------------------|-----|----------------|
| 530-31132   | All Weather Cement – 16 oz. | EA  | 24             |
| 530-31133   | All Weather Cement – 32 oz. | EA  | 12             |

### Heavy Duty PVC Cement

Heavy bodied clear cement recommended for use on PVC pipe and fittings up to 12" in diameter for Sch. 40 and Sch. 80 potable water pressure pipe, gas, conduit, drain waste and vent pipe. Exceeds ASTM D-2564.



| CATALOG NO. | DESCRIPTION                | UOM | ORDER MULTIPLE |
|-------------|----------------------------|-----|----------------|
| 530-30850   | Heavy Duty Cement – 4 oz.  | EA  | 24             |
| 530-30863   | Heavy Duty Cement – 8 oz.  | EA  | 24             |
| 530-30876   | Heavy Duty Cement – 16 oz. | EA  | 24             |

### Rain-R-Shine Blue Cement

Medium bodied blue colored cement for PVC pipe and fittings up to 6 inches in diameter. A very fast setting cement formulated for wet conditions and/or when quick pressurization and fast installation is needed. Exceeds ASTM D-2564.



| CATALOG NO. | DESCRIPTION                  | UOM | ORDER MULTIPLE |
|-------------|------------------------------|-----|----------------|
| 530-30890   | Rain-R-Shine Cement – 4 oz.  | EA  | 24             |
| 530-30891   | Rain-R-Shine Cement – 8 oz.  | EA  | 24             |
| 530-30893   | Rain-R-Shine Cement – 16 oz. | EA  | 24             |

### Purple Primer for PVC Pipe and Fittings (Black Label)

Recommended for all PVC and CPVC installations – all sizes/schedules. Purple tinted primer formulated to remove surface dirt and grease as well as soften the pipe surface to allow for a fast, secure and permanent solvent weld. For use in areas where codes call for primer verification.



| CATALOG NO. | DESCRIPTION            | UOM | ORDER MULTIPLE |
|-------------|------------------------|-----|----------------|
| 530-30755   | Purple Primer – 4 oz.  | EA  | 24             |
| 530-30756   | Purple Primer – 8 oz.  | EA  | 24             |
| 530-30757   | Purple Primer – 16 oz. | EA  | 24             |

NSF and UPC listed. Exceeds ASTM F-656.

### PVC Primer – Clear

Recommended for all PVC and CPVC applications. Can be used on all sizes and schedules. Formulated to remove all surface dirt, grease, and grime as well as soften the pipe in preparation for solvent cement. This primer can be used when you want a cleaner installation. Meets ASTM F-656 and is NSF listed.



| CATALOG NO. | DESCRIPTION                 | UOM | ORDER MULTIPLE |
|-------------|-----------------------------|-----|----------------|
| 530-30752   | PVC Primer – Clear – 16 oz. | EA  | 24             |
| 530-30753   | PVC Primer – Clear – 32 oz. | EA  | 12             |

**TUBING, CLAMPS, AND KITS**

**Polyethylene Tubing**

F.D.A. approved, flexible, non-toxic tubing. Tasteless and odorless, lightweight, low density. Ideal for drinking water lines, evaporative coolers, and radiant heating. I.D.: 11/64", O.D.: 1/4", Wall: 0.040, Max. W/P (in.) 150 PSI @ 70F.



PE-104

| CATALOG NO. | DESCRIPTION               | UOM | ORDER MULTIPLE |
|-------------|---------------------------|-----|----------------|
| PE-104      | Polyethylene Tubing, 100' | EA  | 1              |

**Icemaker Kit**

Supplies water to most refrigerators with automatic icemakers, humidifiers and evaporative coolers. Contains self-tapping valve and all necessary fittings.



750-402

| CATALOG NO. | DESCRIPTION                    | UOM | ORDER MULTIPLE |
|-------------|--------------------------------|-----|----------------|
| 750-401     | Icemaker Kit – Poly Tube – 25' | EA  | 1              |
| 750-402     | Icemaker Kit – Copper – 25'    | EA  | 1              |

**Hose Clamps**

Partial stainless, worm drive, adjustable. 300 series stainless steel 1/2" band with plated 5/16" slotted hex head screw and housing, except the B-4H which has a 5/16" band and 1/4" nut. Recommended for most applications. 100% interlock construction features one-piece housing which directly locks into band. Spot weld free design.



B-4H

| CATALOG NO. | DESCRIPTION   | UOM | ORDER MULTIPLE |
|-------------|---|-----|----------------|
| B-4H        | No. 4, 7/32" – 5/8" dia., 3/16" – 5/16" hose I.D.         | EA  | 10             |
| B-6H        | No. 6, 3/8" – 7/8" dia., 1/4" – 3/8" hose I.D.            | EA  | 10             |
| B-8H        | No. 8, 7/16" – 1" dia., 5/16" – 1/2" hose I.D.            | EA  | 10             |
| B-10H       | No. 10, 9/16" – 1-1/16" dia., 3/8" – 5/8" hose I.D.       | EA  | 10             |
| B-12H       | No. 12, 9/16" – 1-1/4" dia., 5/8" – 3/4" hose I.D.        | EA  | 10             |
| B-16H       | No. 16, 11/16" – 1-1/2" dia., 3/4" – 1" hose I.D.         | EA  | 10             |
| B-20H       | No. 20, 3/4" – 1-3/4" dia., 1" – 1-1/4" hose I.D.         | EA  | 10             |
| B-24H       | No. 24, 1-1/16" – 2" dia., 1-1/4" – 1-1/2" hose I.D.      | EA  | 10             |
| B-28H       | No. 28, 1-5/16" – 2-1/4" dia., 1-1/4" – 1-3/4" hose I.D.  | EA  | 10             |
| B-32H       | No. 32, 1-9/16" – 2-1/2" dia., 1-1/2" – 2" hose I.D.      | EA  | 10             |
| B-36H       | No. 36, 1-13/16" – 2-3/4" dia., 1-3/4" – 2-1/4" hose I.D. | EA  | 10             |

**Self Tapping Water Valve**

Installs on all copper tube lines from 3/8" O.D. to 1-1/8" O.D. without shutting off water. No drilling required. Features 1/4" compression fitting. Stainless steel piercing needle. Special molded gasket seals on both tubing and valve. Will not slip or turn on tubing.



QAV-2

| CATALOG NO. | DESCRIPTION                  | UOM | ORDER MULTIPLE |
|-------------|------------------------------|-----|----------------|
| QAV-2       | Self Tapping Water Tap Valve | EA  | 1              |

**TAPES AND SEALING**

**Teflon Tape**

Made of pure white Teflon. Non-toxic. For use with chemicals, solvents, oxygen, and on food lines. Withstands up to 2000 psi of pressure.



6-733

| CATALOG NO. | DESCRIPTION               | UOM | ORDER MULTIPLE |
|-------------|---------------------------|-----|----------------|
| 6-733       | Teflon Tape – 1/2" x 520" | EA  | 100            |
| 6-734       | Teflon Tape – 1/2" x 260" | EA  | 100            |
| 6-735       | Teflon Tape – 3/4" x 520" | EA  | 100            |
| 6-736       | Teflon Tape – 3/4" x 260" | EA  | 100            |

**DiversiGum™ Sealing Compound**

Non-hardening. For plugging openings through foundations or around refrigeration tube entry.



6-202-1

| CATALOG NO. | DESCRIPTION   | UOM | ORDER MULTIPLE |
|-------------|---|-----|----------------|
| 6-202-1     | DiversiGum™ Sealing Compound – 1 lb. Slug               | EA  | 24             |
| 6-202-2     | DiversiGum™ Sealing Compound – 2 lb. Slug               | EA  | 20             |
| AG-25       | DiversiGum™ Sealing Compound – 3/8" x 25' Caulking Cord | EA  | 12             |

# one purchase order. **multiple advantages.**

Save **TIME, EFFORT** and **MONEY** With Consolidated Purchasing.



- Thousands of SKUs
- Installation and Maintenance Parts & Services
- Equipment Pads, Chemicals and Accessories

**DIVERSITECH** 

800.995.2222  
WWW.DIVERSITECH.COM

# DUCTLESS SYSTEMS

|                                   |         |
|-----------------------------------|---------|
| Channels .....                    | 198     |
| Condensate Drainage .....         | 202     |
| Condenser Equipment Mounting..... | 201     |
| Equipment Support Systems.....    | 202     |
| Fittings .....                    | 198-200 |
| Roof Inlets.....                  | 200     |
| Wire .....                        | 201     |

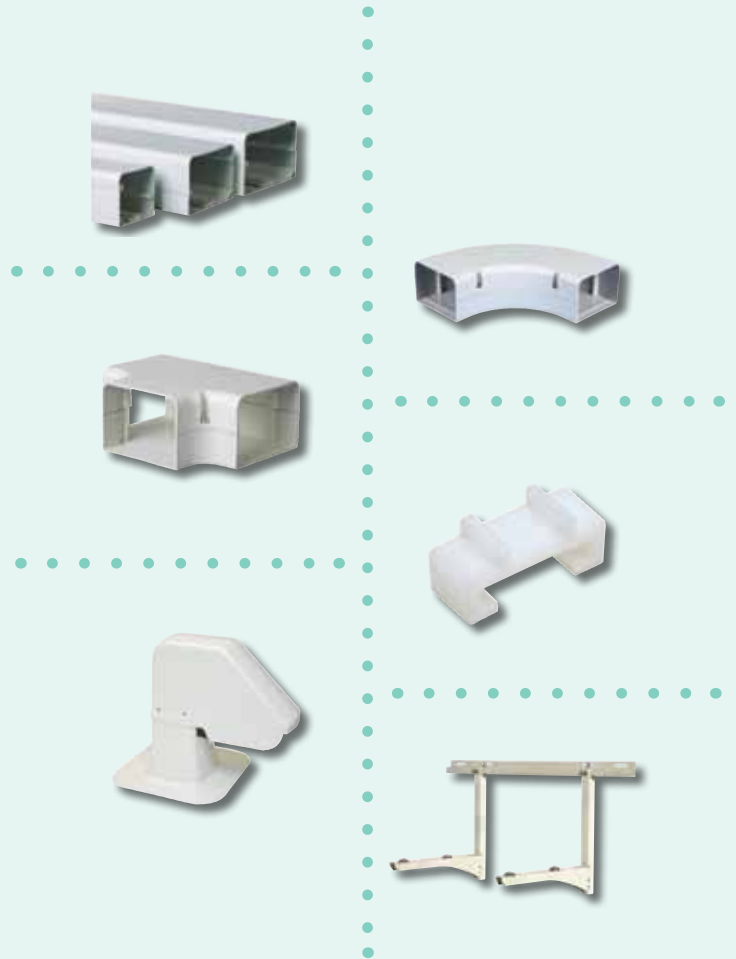

# Hef-T-Frame™

## INSTALLATION



Step 6

D  
U  
C  
T  
L  
E  
S  
S  
  
S  
Y  
S  
T  
E  
M  
S



***Hef-T-Frame™ – Utility Room Installation, Gravity Drain***

*Condensate management is needed for heat pumps.*



***Hef-T-Frame™ – Utility Room Installation, Condensate Pump***

# Hef-T-Foot™

*Recycled rubber condensing unit and accessory mounting blocks.*



## ROOFTOP INSTALLATIONS



***Hef-T-Foot™ –  
Rooftop/Ground Mount  
Installation***

***Hef-T-Foot™ –  
Rooftop/Ground Mount  
Accessory/Pipe Support  
Installation***



## UTILITY ROOM INSTALLATIONS



**Hef-T-Foot™ –  
Utility Room Installation,  
Gravity Drain**

Condensate management is needed for heat pumps.



**Hef-T-Foot™ –  
Utility Room Installation,  
Condensate Pump**

## Hef-T-Bracket™ – Wall Mounted Mini-Split Brackets



**HEF-T-BRACKET™ TYPE 2**

These brackets feature a cross bar that is attached to a wall and two L-shaped brackets that are hooked and bolted into place on the cross bar.

When operating in heat pump mode, the unit will produce condensate which is easily captured and managed using this snap on drain pan.

# SpeediChannel™ Line Set Cover System

DiversiTech SpeediChannel™ is an innovative channel system used to cover air conditioning line sets. The two part system has a base and a cover. The base is fastened to a wall or ceiling, then a clever little plastic clip (SpeediClip™) snaps into a channel already molded into the base. Then, using standard cable ties, the line set, cables, control wires, and/or condensate drain line are fastened in place. The cover then snaps simply on top of the base.



The SpeediChannel™ system is available in three widths – 3", 4", and 6". Each piece of SpeediChannel™ is 6-1/2 feet long. A complete line of couplings, elbows, and tees are available for the SpeediChannel™ system.

Manufactured from rigid PVC, the SpeediChannel™ system is a natural color that is a very close match to the typical mini-split condensing unit case. However, the SpeediChannel™ system can be painted as desired to match any wall color. The PVC used in the SpeediChannel™ system is resistant to UV light and is UL rated.



DiversiTech recommends attaching the base to the wall or ceiling and the line sets to the system every 15" to allow for the system to carry the full weight of the line sets.

*The SpeediChannel™ can also be used inside.*



This information is available as a contractor handout.  
Order item number LIT-FLY-MSPLIT.



*Cut your installation time!  
SpeediClip™ – fastest  
SpeediChannel™  
installation.*

D  
U  
C  
T  
L  
E  
S  
S  
S  
Y  
S  
T  
E  
M  
S



# SpeediChannel™ System Installation

## Step 1

Attach the SpeediChannel™ base to the wall about every 15 inches with screws suitable for the wall construction (siding, stucco, brick, etc.). Screw through the center of the molded rail. Slide the connecting piece (elbow, union, tee, etc.) under the SpeediChannel™ before attaching the end of the channel to the wall. When cutting lengths of SpeediChannel™, allow 1/8" gap between the end of the SpeediChannel™ and the stop inside the fitting to allow for thermal expansion.



## Step 3

Install the line set, drain line, and wires inside the SpeediChannel™. Test the equipment installation prior to tightening the cable ties. Tighten the cable ties snug, but not so tight they damage the tubing insulation or kink the drain line. Trim excess length from the cable tie.



## Step 4

Attach the SpeediChannel™ to the base.

## Step 2

Slide one SpeediClip™ with cable tie about every 20 inches along the inside sliding rail.



### Step 5



Attach the fitting covers with the screws provided.



### Step 6

When complete, paint the Speedi-Channel™ to match surface of installation (if desired).



# DiversiTech SpeediChannel™ System

## SIZING CHART AND SELECTION INFORMATION

### Maximum Line Set, Drain Pipe, and Cable Capacity using 3/8" Insulation

| Model      | 230-D3      | 230-D4      | 230-D6  |
|------------|-------------|-------------|---------|
| Dimensions | 3" x 2-1/2" | 4" x 2-3/4" | 6" x 3" |
| Length     | 78"         | 78"         | 78"     |

### Mini-Split Systems – Liquid and Suction Line with 3/8" Insulation

|                 |               |                    |                     |
|-----------------|---------------|--------------------|---------------------|
| Liquid Line     | 3/8"          | 2 x 1/4"           | 1 x 1/4" + 2 x 3/8" |
| Suction Line    | 5/8"          | 2 x 3/8"           | 1 x 1/2" + 2 x 5/8" |
| Drain Hose      | 3/4" OD       | 2 x 3/4" OD        | 3 x 3/4" OD         |
| Power Cable     | 1 x UF 14-3   | 2 x 1/2" SealTite  | 3 x 1/2" SealTite   |
| Control Cable   | 1 Pair 18 AWG | 2 Pairs 18 AWG     | 3 Pairs 18 AWG      |
| Nominal Tonnage | 1–3 Tons      | 1x3 Ton or 2x1 Ton | 1x3 Ton or 2x2 Ton  |

### Conventional Split Systems – Liquid Line Plain, Suction Line with 3/8" Insulation

|                 |                |                   |                   |
|-----------------|----------------|-------------------|-------------------|
| Liquid Line     | 3/8"           | 3/8"              | 3/8"              |
| Suction Line    | 3/4" or 7/8"   | 1-1/8"            | 1-1/8"            |
| Drain Hose      | 3/4" PVC       | 3/4" PVC          | 3/4" PVC          |
| Power Cable     | 1 x UF 14-2    | 1 x 1/2" SealTite | 1 x 1/2" SealTite |
| Control Cable   | 1 Pair 18 AWG  | 1 Pair 18 AWG     | 1 Pair 18 AWG     |
| Nominal Tonnage | Up to 3.5 Tons | 4–5 Tons          | 7.5 Tons and up   |

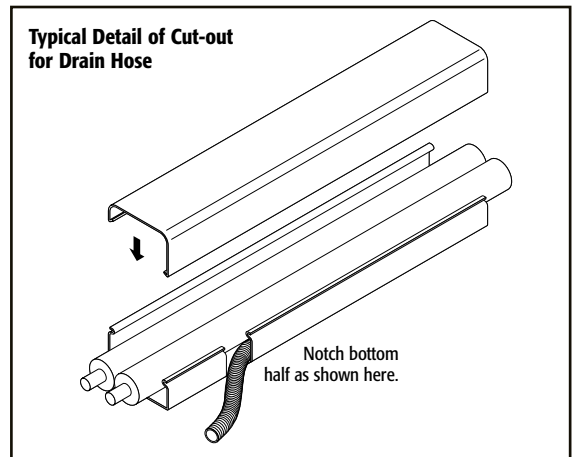
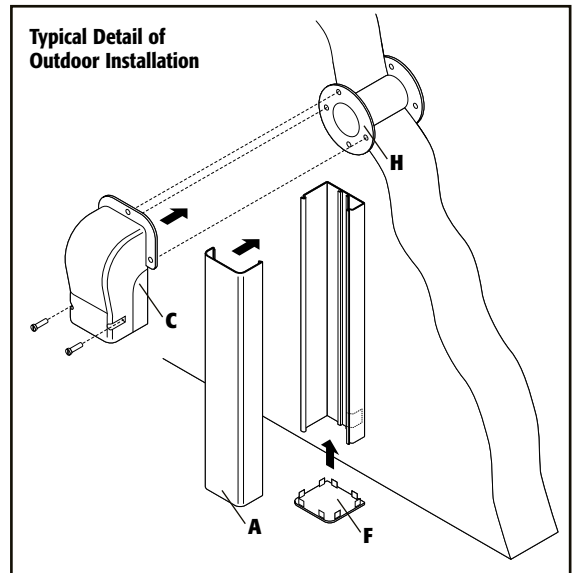
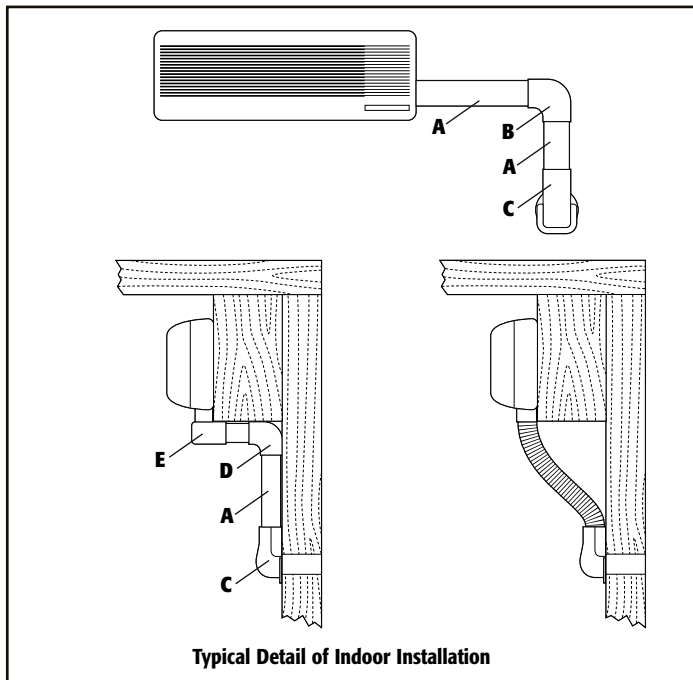

### Typical Detail of Flex Joint Application

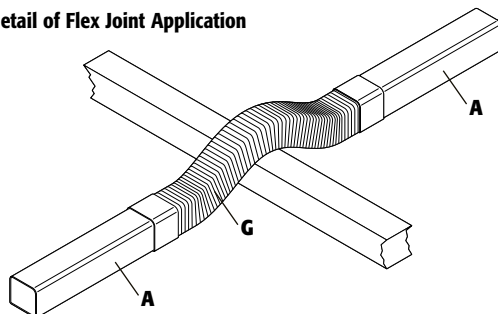

- A - 230-D
- B - 230-FB
- C - 230-WC
- D - 230-EB
- E - 230-EIN
- F - 230-DC
- G - 230-FJ
- H - 230-WS2

NOTE:  
Suffix parts A-G  
with the duct  
size needed  
(5, 4, or 6)

# DiversiTech SpeediChannel™ System

## TECHNICAL SPECIFICATIONS

|                           |   |                               |                               |                             |
|---------------------------|---|-------------------------------|-------------------------------|-----------------------------|
| <b>Color</b>              | Natural   |                               |                               |                             |
| <b>Size</b>               | <b>230-D3:</b> 3" x 2-1/2" OD                           | <b>230-D4:</b> 4" x 2-3/4" OD | <b>230-D6:</b> 6" x 3-1/8" OD | <b>Standard Length:</b> 78" |
| <b>Material</b>           | Weather Resistant PVC, UV Stabilized and Fire Resistant |                               |                               |                             |
| <b>Fire Rating</b>        | Meets UL 94V-0  |                               |                               |                             |
| <b>Temperature Range</b>  | -4°F TO 140°F   |                               |                               |                             |
| <b>Weather Resistance</b> | Tested to over 2,000 hours                              |                               |                               |                             |
| <b>Fixing Screws</b>      | Stainless Steel   |                               |                               |                             |

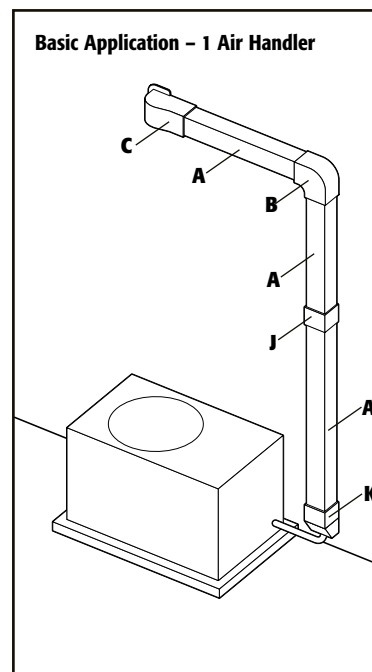
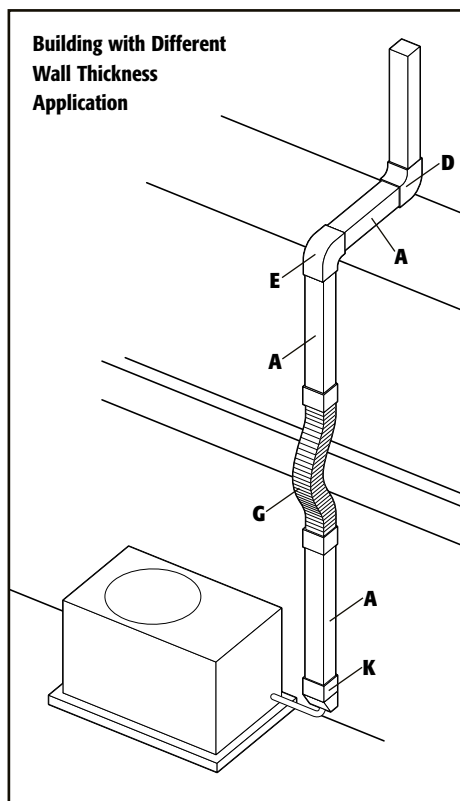
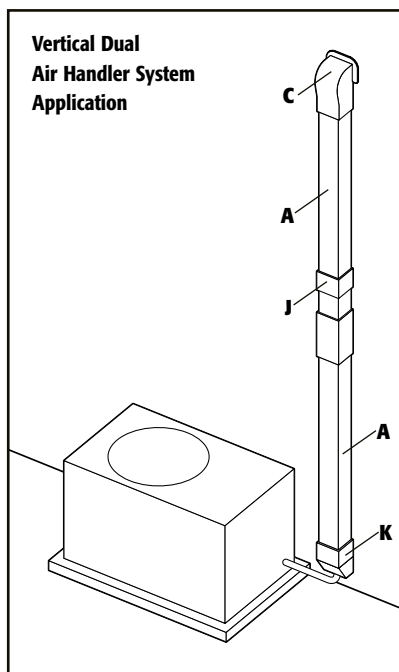
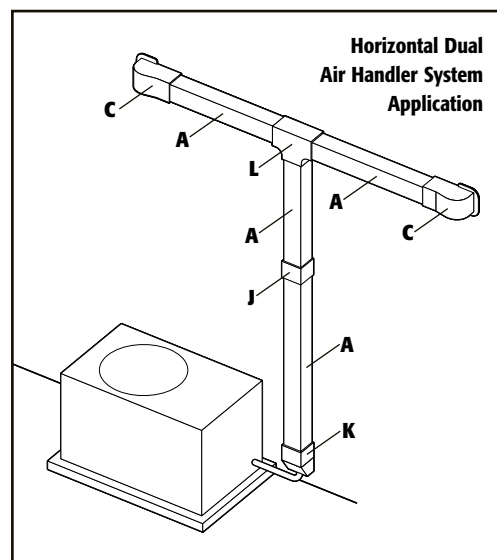
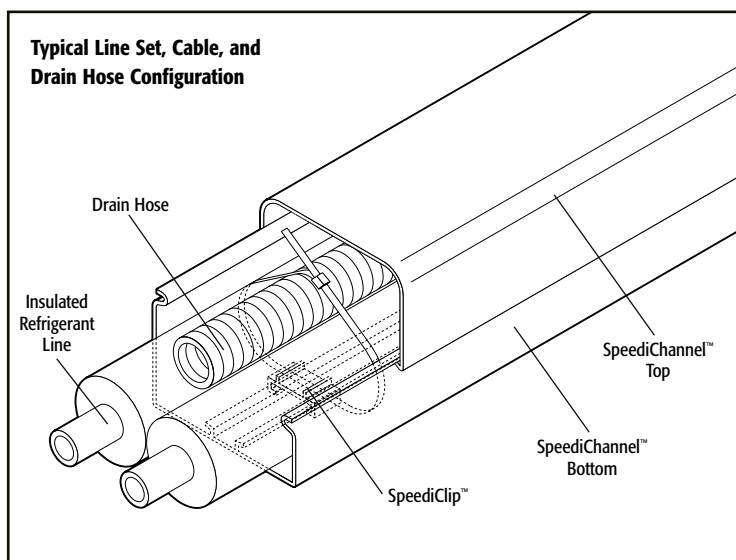

- A** - 230-D
- B** - 230-FB
- C** - 230-WC
- D** - 230-EB
- E** - 230-EIN
- F** - 230-DC
- G** - 230-FJ
- H** - 230-WS2
- J** - 230-CP
- K** - 230-DE
- L** - 230-TC

NOTE:  
Suffix parts A-G  
with the duct  
size needed  
(3, 4, or 6)

## CHANNELS

### SpeediChannel™

The DiversiTech SpeediChannel™ is available in three widths, all in 6-1/2 feet lengths.

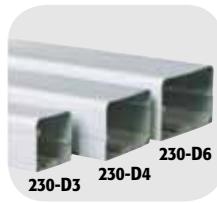

| CATALOG NO.   | DESCRIPTION       | UOM | ORDER MULTIPLE |
|---------------|-------------------|-----|----------------|
| <b>230-D3</b> | 3" SpeediChannel™ | EA  | 6              |
| <b>230-D4</b> | 4" SpeediChannel™ | EA  | 6              |
| <b>230-D6</b> | 6" SpeediChannel™ | EA  | 5              |

## FITTINGS

### Union Coupling

Used for joining two pieces of SpeediChannel™ – each cover being the same size. Each coupling is individually packed, and is furnished complete with stainless steel screws.



| CATALOG NO.    | DESCRIPTION       | UOM | ORDER MULTIPLE |
|----------------|-------------------|-----|----------------|
| <b>230-CP3</b> | 3" Union Coupling | EA  | 10             |
| <b>230-CP4</b> | 4" Union Coupling | EA  | 10             |
| <b>230-CP6</b> | 6" Union Coupling | EA  | 10             |

### 90° Inside Elbow

90° inside elbows are used to route the SpeediChannel™ around an inside corner. Each elbow is individually packed, and is furnished complete with stainless steel screws.



| CATALOG NO.    | DESCRIPTION               | UOM | ORDER MULTIPLE |
|----------------|---------------------------|-----|----------------|
| <b>230-EB3</b> | 3" 90 degree Inside Elbow | EA  | 10             |
| <b>230-EB4</b> | 4" 90 degree Inside Elbow | EA  | 10             |
| <b>230-EB6</b> | 6" 90 degree Inside Elbow | EA  | 10             |

### Wall Penetration

Wall sleeves and penetration covers are used to transition from the SpeediChannel™ system to a through wall penetration. The wall sleeve creates a neat hole through the wall, and the line set is covered by the wall cover. DiversiTech's wall covers are designed to allow for easy installation - even after the line set has been installed. A unique hooking and fastening arrangement allows for quick and easy installation. Each wall cover is individually packed, and is furnished complete with stainless steel screws to attach the wall cover to the base. Three screws (supplied by others) are needed to fasten the wall cover to whatever type of wall construction the system is being installed on.



| CATALOG NO.    | DESCRIPTION               | UOM | ORDER MULTIPLE |
|----------------|---------------------------|-----|----------------|
| <b>230-WC3</b> | 3" Wall Penetration Cover | EA  | 10             |
| <b>230-WC4</b> | 4" Wall Penetration Cover | EA  | 10             |
| <b>230-WC6</b> | 6" Wall Penetration Cover | EA  | 10             |
| <b>230-WS2</b> | 2-1/2" Wall Sleeve        | EA  | 10             |

### 90° Outside Elbow

90° outside elbows are used to route the SpeediChannel™ around an outside corner. Each elbow is individually packed, and is furnished complete with stainless steel screws.



| CATALOG NO.     | DESCRIPTION                | UOM | ORDER MULTIPLE |
|-----------------|----------------------------|-----|----------------|
| <b>230-EIN3</b> | 3" 90 degree Outside Elbow | EA  | 10             |
| <b>230-EIN4</b> | 4" 90 degree Outside Elbow | EA  | 10             |
| <b>230-EIN6</b> | 6" 90 degree Outside Elbow | EA  | 10             |

### 90° Long Radius Bend

90° long radius flat bends are used to route the SpeediChannel™ around an obstacle. The long radius of the elbow allows a gentle bending radius on the copper line set. Each elbow is individually packed, and is furnished complete with stainless steel screws.



| CATALOG NO. | DESCRIPTION                | UOM | ORDER MULTIPLE |
|-------------|----------------------------|-----|----------------|
| 230-LFB3    | 3" 90 deg Long Radius Bend | EA  | 10             |
| 230-LFB4    | 4" 90 deg Long Radius Bend | EA  | 10             |
| 230-LFB6    | 6" 90 deg Long Radius Bend | EA  | 10             |

### 90° Flat Bend

90° flat bends are used to route the SpeediChannel™ around an obstacle. Each bend is individually packed, and is furnished complete with stainless steel screws.



| CATALOG NO. | DESCRIPTION         | UOM | ORDER MULTIPLE |
|-------------|---------------------|-----|----------------|
| 230-FB3     | 3" 90 deg Flat Bend | EA  | 10             |
| 230-FB4     | 4" 90 deg Flat Bend | EA  | 10             |
| 230-FB6     | 6" 90 deg Flat Bend | EA  | 10             |

### 45° Flat Bend

45° flat bends are used to route the SpeediChannel™ around an obstacle. Each bend is individually packed, and is furnished complete with stainless steel screws.



| CATALOG NO. | DESCRIPTION            | UOM | ORDER MULTIPLE |
|-------------|------------------------|-----|----------------|
| 230-FB453   | 3" 45 degree Flat Bend | EA  | 10             |
| 230-FB454   | 4" 45 degree Flat Bend | EA  | 10             |
| 230-FB456   | 6" 45 degree Flat Bend | EA  | 10             |

### T-Joint

Used for creating a tee connection between three pieces of SpeediChannel™ – all covers being the same size. The tee can be combined with the reducing coupling to join SpeediChannel™s of different sizes. Each tee is individually packed, and is furnished complete with stainless steel screws.



| CATALOG NO. | DESCRIPTION | UOM | ORDER MULTIPLE |
|-------------|-------------|-----|----------------|
| 230-TJ4     | 4" T-Joint  | EA  | 10             |
| 230-TJ6     | 6" T-Joint  | EA  | 10             |

### Reducer Coupling

Used for joining two pieces of SpeediChannel™ – each cover being a different size. Each coupling is individually packed, and is furnished complete with stainless steel screws.



| CATALOG NO. | DESCRIPTION              | UOM | ORDER MULTIPLE |
|-------------|--------------------------|-----|----------------|
| 230-TC34    | 3" x 4" Reducer Coupling | EA  | 10             |
| 230-TC46    | 4" x 6" Reducer Coupling | EA  | 10             |

### Flex Joint

An accordion style piece of SpeediChannel™, the flex joint can be extremely flexible routing a SpeediChannel™ system around virtually any type of obstacle. Each joint is 20" long and can be combined together for longer flex runs. Unlike competitor systems, the DiversiTech flex joint does NOT require the use of a union coupling. The DiversiTech flex joint slides tightly inside the SpeediChannel™ system.

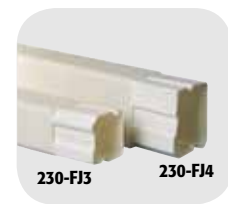

| CATALOG NO. | DESCRIPTION   | UOM | ORDER MULTIPLE |
|-------------|---------------|-----|----------------|
| 230-FJ3     | 3" Flex Joint | EA  | 10             |
| 230-FJ4     | 4" Flex Joint | EA  | 10             |

### Duct End

The duct end is used to terminate a run of SpeediChannel™ to a small opening – just large enough for the line set and condensate drain line to pass through. Gives a neat/clean installation.



| CATALOG NO. | DESCRIPTION | UOM | ORDER MULTIPLE |
|-------------|-------------|-----|----------------|
| 230-DE3     | 3" Duct End | EA  | 10             |
| 230-DE4     | 4" Duct End | EA  | 10             |
| 230-DE6     | 6" Duct End | EA  | 10             |

### Cap

Used to cap the end of a SpeediChannel™ run. Easily snaps into the end of the SpeediChannel™.

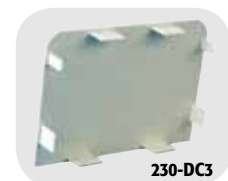

| CATALOG NO. | DESCRIPTION | UOM | ORDER MULTIPLE |
|-------------|-------------|-----|----------------|
| 230-DC3     | 3" Cap      | EA  | 10             |
| 230-DC4     | 4" Cap      | EA  | 10             |
| 230-DC6     | 6" Cap      | EA  | 10             |

**FITTINGS cont'd**

**Flat Wall Escutcheon**

Typically used to cover a rough opening in a soffit, wall, or ceiling penetration. One side of the escutcheon is flat to allow for a SpeediChannel™ run going along a wall, and penetrating through an adjacent wall or ceiling. This is the most common type of wall penetration. Furnished in two parts, the escutcheon easily snaps onto the SpeediChannel™.



| CATALOG NO.    | DESCRIPTION             | UOM | ORDER MULTIPLE |
|----------------|-------------------------|-----|----------------|
| <b>230-FR3</b> | 3" Flat Wall Escutcheon | EA  | 10             |
| <b>230-FR4</b> | 4" Flat Wall Escutcheon | EA  | 10             |
| <b>230-FR6</b> | 6" Flat Wall Escutcheon | EA  | 10             |

**Wall Escutcheon**

Typically used to cover a rough opening in a wall or ceiling penetration. The hole in the escutcheon is centered to allow for a free standing SpeediChannel™ to penetrate through a wall or ceiling. This is the fairly un-common type of wall or ceiling penetration. Check carefully, as you may need the Flat Wall Escutcheon. Furnished in two parts, the escutcheon easily snaps onto the SpeediChannel™.



| CATALOG NO.    | DESCRIPTION        | UOM | ORDER MULTIPLE |
|----------------|--------------------|-----|----------------|
| <b>230-WR3</b> | 3" Wall Escutcheon | EA  | 10             |
| <b>230-WR4</b> | 4" Wall Escutcheon | EA  | 10             |
| <b>230-WR6</b> | 6" Wall Escutcheon | EA  | 10             |

**SpeediChannel™ Fitting Kit**

The SpeediChannel™ Fitting Kit provides a simple mix of the basic fittings used in a typical SpeediChannel™ installation job. Included are one coupling, one wall penetration, one inside elbow, one long radius flat bend, and one pack of ten SpeediClips and 11" cable ties. Two kits are available – one for 3" channel and one for 4" channel.



| CATALOG NO.    | DESCRIPTION                   | UOM | ORDER MULTIPLE |
|----------------|-------------------------------|-----|----------------|
| <b>230-IK3</b> | 3" SpeediChannel™ Fitting Kit | EA  | 1              |
| <b>230-IK4</b> | 4" SpeediChannel™ Fitting Kit | EA  | 1              |

**SpeediChannel™ Accessories**

A variety of accessories that are complementary or required for installing DiversiTech's SpeediChannel™ system.



| CATALOG NO.         | DESCRIPTION                                | UOM | ORDER MULTIPLE |
|---------------------|--|-----|----------------|
| <b>230-DCLIP-10</b> | SpeediClip™ and 11" Cable Ties, pack of 10 | PK  | 1              |
| <b>230-DCLIP</b>    | *SpeediClip™, pack of 50                   | PK  | 1              |
| <b>230-DSCREW</b>   | SpeediChannel™, pack of 100                | PK  | 1              |
| <b>WTB11C</b>       | Black Wire Ties – 11", pack of 100         | PK  | 1              |

\*Sold Separately.

**ROOF INLETS**

**Roof Inlets**

"Roof entrance" adapters for linesets are the ultimate solution for a professional flat roof installation. Manufactured from UV weather resistant plastics, the Roof Inlet combines a series of features:

- the Roof Inlet body part is equipped with a slope avoiding possible damage to the insulation and preventing kinks into the copper tubes.
- the Roof Inlet base holes allow a steady fixation (depending on the roof surface type and composition).
- the Roof Inlet cap is firmly fixed to the body with stainless steel bolts.



| CATALOG NO.       | DESCRIPTION                     | UOM | ORDER MULTIPLE |
|-------------------|---------------------------------|-----|----------------|
| <b>230-INJ465</b> | SpeediChannel™ Roof Inlet – 5"  | EA  | 2              |
| <b>230-INJ462</b> | SpeediChannel™ Roof Inlet – 10" | EA  | 2              |

## CONDENSER EQUIPMENT MOUNTING

### Hef-T-Block™

Used as mounting bases when condensing units must be bolted down. Available in three lengths. End caps are also available for aesthetics. Furnished complete with mounting bolts. Maximum load capacity is 900 pounds per mounting block. Installation temperature range from -4F (-20C) to 140F (60C). Hef-T-Blocks fit all mini-split condensing units with a unique sliding rail feature.



230-MB17W



230-MBCW

| CATALOG NO. | DESCRIPTION                             | UOM | ORDER MULTIPLE |
|-------------|---|-----|----------------|
| 230-MB14W   | 14" Hef-T-Block™ (White), pack of 2     | PK  | 1              |
| 230-MB17W   | 17" Hef-T-Block™ (White), pack of 2     | PK  | 1              |
| 230-MB36W   | 36" Hef-T-Block™ (White), pack of 2     | PK  | 1              |
| 230-MBCW    | Hef-T-Block™ End Cap (White), pack of 4 | PK  | 1              |

### Hef-T-Bracket™ (Type 2)

Used for supporting condensing units, Hef-T-Brackets (Type 2) feature a cross bar that is attached to a wall, and two L-shaped brackets that are hooked and bolted into place on the cross bar. The condensing unit is mounted onto the L-shaped brackets, and fastened using the bolts and anti-vibration washers provided.



230-B2L

| CATALOG NO. | DESCRIPTION                      | ARM LENGTH | LOAD RATING PER ARM | UOM | ORDER MULTIPLE |
|-------------|----------------------------------|------------|---------------------|-----|----------------|
| 230-B2M     | Hef-T-Bracket™ (Type 2) – Medium | 18"        | 165#                | EA  | 1              |
| 230-B2L     | Hef-T-Bracket™ (Type 2) – Large  | 21"        | 220#                | EA  | 1              |

### Hef-T-Bracket™ (Type 3)

Used for supporting condensing units, Hef-T-Brackets (Type 3), just like Hef-T-Brackets (Type 2), feature a cross bar that is attached to a wall, and two L-shaped brackets that are hooked and bolted into place on the cross bar. The condensing unit is mounted onto the L-shaped brackets, and fastened using the bolts and anti-vibration washers provided.

The Hef-T-Bracket™ (Type 3) features an innovative locking mechanism called Easy-Fit™. Easy-Fit™ enables the arms to be joined to the uprights in a matter of seconds. A spring-lock automatically secures the joint, preventing the arms from being dislodged accidentally. All brackets are furnished complete with an integral bubble level to make correct installation of the crossbar easier.



230-B3L



| CATALOG NO. | DESCRIPTION                      | ARM LENGTH | LOAD RATING PER ARM | UOM | ORDER MULTIPLE |
|-------------|----------------------------------|------------|---------------------|-----|----------------|
| 230-B3M     | Hef-T-Bracket™ (Type 3) – Medium | 19"        | 100#                | EA  | 1              |
| 230-B3L     | Hef-T-Bracket™ (Type 3) – Large  | 21"        | 150#                | EA  | 1              |

### Air Conditioner Brackets

These heavy duty 1/8" thick steel A/C brackets are perfect for hanging A/C condensers and heat pumps outside the home. Mount at any height to allow for easy maintenance under units. No need to wait for finished grade or landscaping prior to installation of A/C unit. Pre-punched holes for easy installation. Powder coated gray finish. Load rating 600 lbs. per pair.



ACB-30

| CATALOG NO. | DESCRIPTION                          | UOM | ORDER MULTIPLE |
|-------------|--------------------------------------|-----|----------------|
| ACB-30      | AC Mounting Bracket – 30", pack of 2 | PK  | 1              |
| ACB-36      | AC Mounting Bracket – 36", pack of 2 | PK  | 1              |
| ACB-42      | AC Mounting Bracket – 42", pack of 2 | PK  | 1              |
| ACB-48      | AC Mounting Bracket – 48", pack of 2 | PK  | 1              |

## WIRE

### Wire for Mini-Split Installation

Wire and cabling specific for mini-split installation power supply and control circuits.



230-14-4S

| CATALOG NO. | DESCRIPTION                              | UOM | ORDER MULTIPLE |
|-------------|--|-----|----------------|
| 230-18-4    | Stranded Shielded CL3R, 50' per roll     | EA  | 1              |
| 230-16-2    | Stranded Shielded CL3R, 50' per roll     | EA  | 1              |
| 230-14-3    | Solid Non-Shielded CL3R, 50' per roll    | EA  | 1              |
| 230-14-4    | Stranded Non-Shielded CL3R, 50' per roll | EA  | 1              |
| 230-14-7    | Stranded Non-Shielded CL3R, 50' per roll | EA  | 1              |
| 230-14-4S   | Stranded Shielded CL3R, 50' per roll     | EA  | 1              |

**EQUIPMENT SUPPORT SYSTEMS**

**Hef-T-Frame™**

The flexibility of the Hef-T-Frame™ means that “designing” is simple. The design consists of a Hef-T-Frame™ Base and a Hef-T-Frame™ Extender which combine to provide a solution for mounting any type of equipment.

Simply start with a Hef-T-Frame™ Base and add the required number of Hef-T-Frame™ Extenders to create your own system. Hef-T-Frame™ Extenders can be added in any direction to make a system of any size in multiples of 4’. Each frame has a maximum dimension of 4’.

Each Hef-T-Frame™ Base and Hef-T-Frame™ Extender is capable of supporting 1,100 lbs. safe working load. Be sure the underlying roof structure can support the weight of the equipment and frame system. Each frame weighs 66 lbs. (Hef-T-Frame™ Base) and 53 lbs. (Hef-T-Frame™ Extender).



**PH-BF**



**PH-EF**

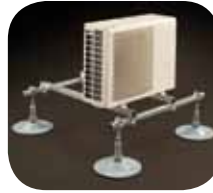

| CATALOG NO.  | DESCRIPTION           | UOM | ORDER MULTIPLE |
|--------------|-----------------------|-----|----------------|
| <b>PH-BF</b> | Hef-T-Frame™ Base     | EA  | 1              |
| <b>PH-EF</b> | Hef-T-Frame™ Extender | EA  | 1              |

**Hef-T-Foot™**

The Hef-T-Foot™ is used to support small pipework, runs of cable tray, or an alternative to supporting condensing units, air source heat pumps or a variety of outdoor equipment.

The Hef-T-Foot™ with strut comes in four lengths – 9.8”, 15.7”, 23.6”, 39.4”. They are manufactured from heavy duty recycled rubber and come complete with .8” x 1.6” galvanized steel strut adhered to the rubber with industrial adhesive. The rubber is strong and durable with drain slots moulded into the underside to allow standing water to flow under the foot.



**FF-250-S**



**FF-250-UNI**

| CATALOG NO.       | DESCRIPTION                               | UOM | ORDER MULTIPLE |
|-------------------|---|-----|----------------|
| <b>FF-250-S</b>   | Hef-T-Foot™ – 9.8” with 1.6” x .8” strut  | EA  | 1              |
| <b>FF-400-S</b>   | Hef-T-Foot™ – 15.7” with 1.6” x .8” strut | EA  | 1              |
| <b>FF-600-S</b>   | Hef-T-Foot™ – 23.6” with 1.6” x .8” strut | EA  | 1              |
| <b>FF-1000-S</b>  | Hef-T-Foot™ – 39.4” with 1.6” x .8” strut | EA  | 1              |
| <b>FF-250-UNI</b> | Hef-T-Foot™ – 9.8” Universal              | EA  | 1              |

**Hef-T-Foot™ Installation Variants**



**CONDENSATE DRAINAGE**

**Condensate Drain Pans**

When a mini-split system is operated in heat pump mode, the outdoor coil becomes the evaporator coil. There is typically condensation generated from the evaporator coil. In certain installations, the condenser coil may be mounted overhead on brackets affixed to a wall. In these overhead mount applications, dripping condensation may be objectionable. Condensate drain pans bolt onto the condenser mounting brackets, and the drain line can be plumbed to a suitable nearby drain location. Furnished complete with all mounting hardware, and drain pan outlet, condensate drain pans are available in either plastic or powder coated steel.



**230-DPPL**

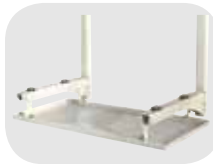

| CATALOG NO.     | DESCRIPTION                         | UOM | ORDER MULTIPLE |
|-----------------|-------------------------------------|-----|----------------|
| <b>230-DPPL</b> | Poly Condensate Drain Pan (Large)   | EA  | 1              |
| <b>230-DPML</b> | Metal Condensate Drain Pan (Large)  | EA  | 1              |
| <b>230-DPPM</b> | Poly Condensate Drain Pan (Medium)  | EA  | 1              |
| <b>230-DPMM</b> | Metal Condensate Drain Pan (Medium) | EA  | 1              |

**Mini-Split Condensate Drain Line**

A unique drain line for mini-split units. This large diameter drain line is typical for mini-split installations. Furnished in 160 feet lengths with cut marks every 3.28 feet.



**230-DL16**

| CATALOG NO.     | DESCRIPTION                   | UOM | ORDER MULTIPLE |
|-----------------|-------------------------------|-----|----------------|
| <b>230-DL16</b> | 5/8” ID Mini-Split Drain Line | EA  | 160’           |
| <b>230-DL20</b> | 3/4” ID Mini-Split Drain Line | EA  | 160’           |

**Mini-Split Drain Adapters**

Mini-Split fan units – either ceiling cassettes or wall cassettes – typically have a unique (metric) drain line fitting. DiversiTech’s adapters convert this metric fitting to standard drain line tubing sizes.



**230-DLFY**

**230-DLF16**

| CATALOG NO.      | DESCRIPTION                        | UOM | ORDER MULTIPLE |
|------------------|------------------------------------|-----|----------------|
| <b>230-DLFY</b>  | Mini-Split Drain Line Wye          | EA  | 1              |
| <b>230-DLF16</b> | 16mm Mini-Split Drain Line Adapter | EA  | 1              |
| <b>230-DLF18</b> | 18mm Mini-Split Drain Line Adapter | EA  | 1              |
| <b>230-DLF20</b> | 20mm Mini-Split Drain Line Adapter | EA  | 1              |
| <b>230-DLF25</b> | 25mm Mini-Split Drain Line Adapter | EA  | 1              |
| <b>230-DLF32</b> | 32mm Mini-Split Drain Line Adapter | EA  | 1              |

# MAINTENANCE CHEMICALS

Accessories .....221  
 Air Filter Products..... 227  
 Coil Cleaners ..... 217-218, 224-225  
 Coil Cleaning Aerosols..... 212, 225  
 Deodorizers and Degreasers ..... 229  
 DiversiTech Aerosol Cleaners .....218  
 DiversiTech Leak Detectors .....218  
 Drain Pan Disinfectant, Sealant..... 226  
 Flushing Products ..... 222  
 Glycols.....219, 230-231  
 Heating Products .....231  
 Hoses, Sprayers ..... 232  
 Ice Machine Products..... 228  
 Leak Detectors ..... 226  
 Odor Neutralizers ..... 229  
 Pan Treatments ..... 227  
 Pan Treatments/Disinfectants ..... 219-220  
 Refrigeration Oils..... 228  
 System Cleaners ..... 226  
 Test Kits, Strips, and Prevention ..... 222  
 Thread Sealants .....221  
 Vacuum Pump Oil..... 229



# Triple "D"<sup>™</sup> Universal Coil Cleaner<sup>™</sup>

Triple "D"<sup>™</sup> is a Universal Coil Cleaner<sup>™</sup> suitable for use on condenser and evaporator coils. It is metal safe and does not attack aluminum or copper coil components, extending equipment life and diminishing potential for refrigerant leaks. Triple "D"<sup>™</sup> is a safer, more versatile product than conventional acid or non-acid coil cleaners. One product does it all — truly a Universal Coil Cleaner<sup>™</sup>.

## FEATURES

## BENEFITS

**Universal Coil Cleaner<sup>™</sup>** One product for multiple applications reduces inventory and eliminates potential product mis-application.

### **Metal Safe**

Conventional foaming acid coil cleaners actually attack and chemically react with the aluminum coil components. This reaction is exhibited by a foaming action. Conventional foaming non-acid coil cleaners are so strong (because they lack the unique inhibitor in Triple "D"<sup>™</sup>) they also attack the aluminum coil components. The attack/reaction dissolves the aluminum, destroying the heat-transfer ability of the coil, and creates the potential for refrigerant leaks. Over time, the reduction in heat transfer ability for the coil increases energy consumption significantly.

### **Super Concentrated**

Lower cost per mixed gallon. Triple "D"<sup>™</sup> is a 6:1 dilution ratio, making 7 gallons of usable product per gallon of concentrate.

### **Multiple Packages/Forms**

Available as a concentrated liquid, pre-diluted liquid, aerosol, or Granular Coil Cleaner<sup>™</sup>. Same product — different packages.

### **NSF Registered**

Assurance that Triple "D"<sup>™</sup> is safe as a cleaner in restaurants, hospitals, government institutions, and any food preparation area. Rinse thoroughly after use.

### **Safe for Rubber Roofs**

Does not damage engineered polymeric or rubber roofing.

### **Corrosion Inhibited**

Conventional foaming acid and non-acid coil cleaners actually attack and chemically react with the aluminum (and sometimes copper) coil components. This reaction is exhibited by a foaming action. The reaction dissolves the aluminum, destroying the heat-transfer ability of the coil, and creates the potential for refrigerant leaks.

### **Biodegradable**

Triple "D"<sup>™</sup> is manufactured from chemicals that break down naturally in the environment. When a coil is cleaned, the rinse water is typically washed into the storm sewer.

### **Non-Foaming**

Foaming of coil cleaners is exhibited when the cleaner chemically reacts with the aluminum (and sometimes the copper) coil components. This reaction is exhibited by a foaming action. The reaction dissolves the aluminum, destroying the heat-transfer ability of the coil, and creates the potential for refrigerant leaks. Additionally, foaming action on foaming coil cleaners is an exothermic (heat generating) chemical reaction. This heat is extreme and can damage coils.

### **Non-Toxic**

Triple "D"<sup>™</sup> is manufactured from chemicals that break down naturally in the environment. When a coil is cleaned, the rinse water is typically washed into the storm sewer. Conventional acid coil cleaners contain dangerous hydrofluoric acid that is extremely toxic to humans and animals. For complete details of how hazardous hydrofluoric acid is to humans and animals, download an independent acid exposure treatment guide at [www.diversitech.com/literature/hfacid.pdf](http://www.diversitech.com/literature/hfacid.pdf)

### **Inhibited Non-Acid Formulation**

Triple "D"<sup>™</sup> contains a unique inhibitor that allows for a very strong alkaline (non-acid) formulation that effectively cleans coils. Other non-acid coil cleaners are either too weak to effectively clean a coil, or are so strong (and hence foaming) that they attack the aluminum coil.

## Aluminum Loss of Foaming Coil Cleaners vs. Triple "D"<sup>TM</sup>

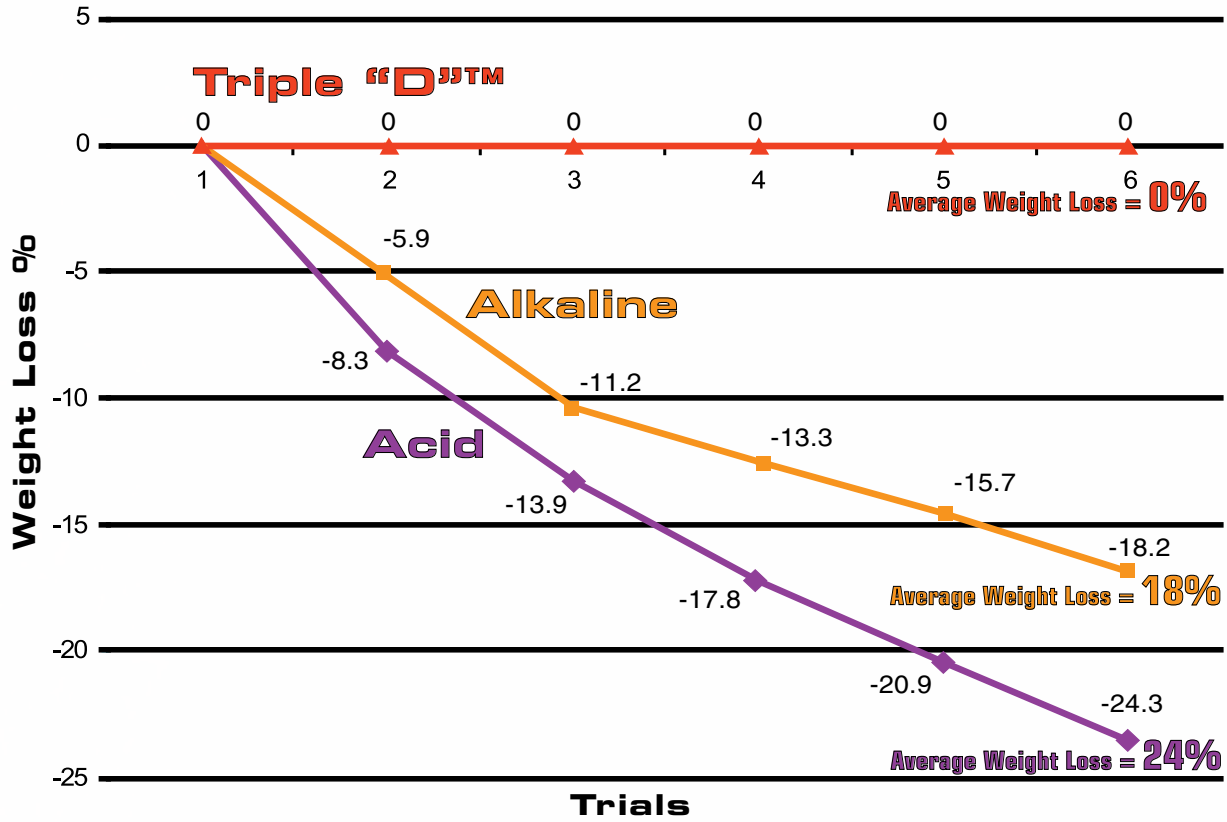

As shown above, conventional foaming acid coil cleaners and foaming non-acid coil cleaners actually attack and chemically react with the aluminum coil components. This reaction is exhibited by a foaming action. The attack/reaction dissolves the aluminum, destroying the heat-transfer ability of the coil and creating the potential for refrigerant leaks.

# Pro-Flush™ HVAC Flushing Solvent

***Pro-Flush™ answers your need for a professional quality flushing solvent with the components to match.***

- Formulated for R-410A retrofits, refrigerant conversions and compressor burnouts
- Lower cost solution than competitive pre-charged kits
- Solvents are non-VOC, conform to EPA SNAP standards, and are non-HAZMAT
- Low toxicity and residue free
- Flash Point: No flash point to boiling (41°C/106°F) - TAG Closed Cup (per ASTM D-56)
- Kit includes reusable tank with a pressure relief valve for added safety, a hose, and an injector trigger nozzle
- Better delivery system



## FREQUENTLY ASKED QUESTIONS

**Q: What refrigerants is Pro-Flush™ compatible with?**

**A:** Pro-Flush™ is compatible with CFC and HFC refrigerants and compressor oils.

**Q: Is Pro-Flush™ safe to use?**

**A:** Pro-Flush™ is safe, nontoxic, and residue free. In addition, Pro-Flush™ conforms to EPA's Significant New Alternatives Program (SNAP) standards.

**Q: Is Pro-Flush™ HAZMAT?**

**A:** Pro-Flush™ is not HAZMAT for storage or ground transportation.

**Q: What is the advantage of the reusable injector tank?**

**A:** 1. The reusable tank lowers cost since you only need to buy the Pro-Flush™ refill cans.  
2. Pre-charged cans include refrigerant propellants which are more expensive to use than nitrogen.  
3. The trigger assembly allows for infinite control of dosage insuring more economical use of the solvent.  
4. Using nitrogen as the propellant is less expensive and more environmentally friendly than using HFC-134A. HFC-134A is a powerful greenhouse gas. One kilogram of HFC-134A has the same global warming impact as 1,430 kilograms of carbon dioxide (<http://www.epa.gov/cpd/mac/service>).

**Q: Can the injector tank be over pressurized during nitrogen pressurization?**

**A:** Over pressurization is highly unlikely but possible. The injector valve has a reseating pressure relief safety valve set at 200 psi. This helps prevent potential bursting and resultant injury.

**Q: What if I don't require the entire can of Pro-Flush™ Solvent to clean a system or line set?**

**A:** The injection nozzle allows you to control the dose rate and any left over solvent can be stored in the injector for future use.

**Q: How does the dose rate for Pro-Flush™ for burnouts and retrofits compare with the competitors?**

**A:** For R22 to 410A conversions, we recommend 3-second bursts of solvent. A 16-ounce can of Pro-Flush™ will treat up to 500 feet of liquid line. For burnouts, we recommend 2-3 oz. per ton. Pro-Flush™ uses less solvent per application than Nu-Calgon. Treatment results will vary depending on the application and conditions of the line set when serviced.

**Q: Why do you recommend only charging the injector tank to 50psi, then injecting in 3 second bursts?**

**A:** Tests are conclusive that injecting the solvent at lower pressure assures longer solvent to oil contact time. In addition, the smaller volume delivered in short bursts assists in completely dissolving contaminants. In this case, less is better.

**Q: Is nitrogen necessary for use with Pro-Flush™?**

**A:** Nitrogen is used as the propellant for Pro-Flush™. Nitrogen is required with all flushing systems to purge any residual solvent and contaminants through the system.

**Q: Do pre-charged canister systems dispense 100% of the flushing solvent?**

**A:** In many cases pre-charged canister systems will not fully dispense the flushing solvent depending on temperature. At lower temperatures, the R-134a propellant provides less pressure and may leave solvent in the canister. The Pro-Flush™ system allows contractors to add additional nitrogen if there is still solvent left, regardless of temperature.



# Power Sprayer

*Stop pumping up your old sprayer  
and enjoy the freedom and speed  
of the new DiversiTech Power Sprayer.*

M  
A  
I  
N  
T  
E  
N  
A  
N  
C  
E  
  
C  
H  
E  
M  
I  
C  
A  
L  
S



This information is available as a contractor handout.  
Order item number LIT-FLY-SPRAYER.





*DiversiTech's new Power Sprayer makes coil cleaning easier and faster than ever before. This new unit is designed as a backpack sprayer and holds up to 4 gallons of coil cleaning solution. The battery powered unit will spray continuously for 10 hours on a single charge. Included are three different nozzles to give you the right spray for any situation. Other features include padded backpack straps for a comfortable fit, plug-in charger for fast recharging, and a convenient center mount handle. The sprayer also comes with an extra long spray wand with curved tip for accurate application of cleaner and a large on/off valve which can lock in position for easier spraying of big jobs. The large tank opening also makes it easy to add coil cleaner and mix to the correct ratio. The Power Sprayer has been tested and is compatible with all DiversiTech coil cleaners.*



# HVAC Maintenance Chemical Comparison Chart



| Product Name      | Product Name              | Product Color  | Product Description   | Nu-Calgon                                 |
|-------------------|---------------------------|--|---|---|
| <b>TRIPLE-D</b>   | <b>TRIPLE-D</b>           | amber   | Universal Coil Cleaner  | NO EQUIVALENT                             |
| <b>PRO-GREEN</b>  | <b>POWER-PLUS</b>         | green  | Alkaline Evaporator Coil and System Cleaner, Degreaser                        | Evap Pow'r-C                              |
| <b>PRO-BLUE</b>   | <b>SUPER-FOAM</b>         | blue   | Maximum Foaming Alkaline Condenser Coil Cleaner, Degreaser and Brightener     | Nu-Brite                                  |
| <b>PRO-BROWN</b>  | <b>SUPER-BRITE</b>        | brown  | Ultra High Foaming Alkaline Condenser Coil Cleaner, Degreaser and Brightener  | Alka-Brite Plus                           |
|                   | <b>COIL-KLEEN</b>         | red  | Foaming Acid Coil Cleaner and Brightener (contains no hydrofluoric [HF] acid) | Cal-Brite                                 |
| <b>PRO-BUBBLE</b> | <b>BUBBLE -N- TROUBLE</b> | pink   | Freeze-Protected Polymer Based Spray Leak Detector                            | Cal-Blue & Fluorescent Gas Leak Detectors |
| <b>SANI C-N-D</b> | <b>SANI C-N-D</b>         | blue  | Air Handler and Drain Pan Disinfectant  | Bio-Fresh                                 |
| <b>FLOW-PLUS</b>  | <b>FLOW-PLUS</b>          | blue   | Long Lasting Polymer Pan Treatment  | Pan Pads                                  |

MAINTENANCE CHEMICALS

This information is available as a contractor handout.  
Order item number LIT-FLY-CHEMX.

| Virginia KMP                         | Stewart Hall             | Rectorseal              | Hydro-Balance | Ace                          | Vapco            |
|--------------------------------------|--------------------------|-------------------------|---------------|------------------------------|------------------|
| THERE IS NO EQUIVALENT TO TRIPLE "D" |                          |                         |               |                              |                  |
| Acti-Kleen                           | Coil-Rite                | Concentrated Evaporator | Hydro-Coil    | Non-Rinse Evaporator Cleaner | H.P. Cleaner     |
| Alki-Foam                            | Renewz                   | Alkaline Extra Strength | Hydro-Kleen   | Alkaline Coil Cleaner        | Foaminator       |
| Foam-Max                             | Foam-A-Coil              | NO EQUIVALENT           | Black Max     | Foam-n-Clean                 | Foamtastic       |
| Acti-Brite                           | Con-Coil                 | Condenser Coil Cleaner  | Hydro-Foam    | Supreme Coil Cleaner         | Brite-Alum       |
| Locator Leak Detector                | NO EQUIVALENT            | Better Bubble           | NO EQUIVALENT | Fast Find Leak Detector LT   | Low Temp Bubbles |
| NO EQUIVALENT                        | Coil & Duct Disinfectant | NO EQUIVALENT           | NO EQUIVALENT | Bacti-Gard                   | NO EQUIVALENT    |
| CDC Anti-Clog                        | Actabs                   | NO EQUIVALENT           | Slime Away    | Pan Protector                | Pan Pills        |



Authorized by USDA for use in Federally inspected meat and poultry plants



EPA Registered

# Condensate Pan Treatments - SIMPLIFIED

## THE NEED

Environmental debris, slime, rust, etc. accumulate in condensate drain pans resulting in:

- Indoor Air Quality problems including musty odors and Dirty Sock Syndrome
- Pan overflows caused by plugged drain lines
- Equipment malfunction

## THE SOLUTION

Use pan treatment products as part of a regular preventive maintenance program to:

- Eliminate one of the causes of Sick Building Syndrome
- Stop costly overflow problems that damage floors, ceilings, and furniture
- Reduce unscheduled service calls

## THE PRODUCTS

### EXTENDED RELEASE TREATMENTS

- Several manufacturers produce various time release products
- Highest value – most active ingredient per dollar
- Easiest maintenance program – dose only once every three months or longer
- Only effective solution for equipment larger than six tons

### RAPID RELEASE TREATMENTS

- Lowest cost per tablet
- Shortest time between dosing



## Flow-Plus™ Condensate Pan Treatment

- A true water activated, time release treatment
- Water soluble polymer leaves no residue or carrier to be removed
- Adheres to drain pans – eliminates product floating and blocking the drain line
- No corrosive vapors – safe for computer rooms
- Recommended dosage – choose size according to equipment tonnage. Each size is designed to last a minimum of three months.

SCM-183-16 – 1/2 to 3 tons

SCM-181-06 – 3-5 tons

SCM-184-MT – 5-20 tons

SCM-182-HT – 20-50 tons

**STACKABLE!**  
*This unique feature increases the time between maintenance visits.*



## Pro-Treat® 151 Premium Condensate Drain Pan Treatment

- EPA Registered
- Kills algae and eliminates odors
- Fast acting
- Residual effect of the clean pan lasts for a month
- No corrosive vapors – safe for computer rooms
- Recommended dosage: 1 tablet for every 3 tons each month

## Pro-Treat® 161 Condensate Drain Pan Treatment

- More active ingredient than the economy version
- Fast acting
- Residual effect of the clean pan lasts for about a month
- No corrosive vapors – safe for computer rooms
- Recommended dosage: 2 tablets for every 3 tons each month

## Pro-Treat® 200 Condensate Drain Pan Treatment

- Lowest cost product per tablet
- Sufficient active ingredient to treat the pan
- No corrosive vapors – safe for computer rooms
- Recommended dosage: 3 tablets for every 3 tons each month

# 3-STEP PROCESS for Solving IAQ Problems

M  
A  
I  
N  
T  
E  
N  
A  
N  
C  
E  
  
C  
H  
E  
M  
I  
C  
A  
L  
S

1



## STEP 2: DISINFECT

### SANI C-N-D™ Coil and Drain Pan Disinfectant

Disinfect and deodorize the evaporator coil and drain pan with SANI C-N-D™, an EPA registered biocide, fungicide, viricide, and mildewstat. The broad spectrum biocide in SANI C-N-D™ assures control of many air-borne pathogens that can be spread via contaminated air handling equipment.

## STEP 1: CLEAN

### TRIPLE-D™ Degreaser • Detergent • Deodorant

Clean the evaporator coil and condensate pan with TRIPLE-D™, a USDA authorized non-foaming alkaline coil cleaner. Cleaning the dirt from the coil and pan not only improves equipment efficiency, but also removes an important source of contamination that can create slime and sludge in the drain pan and cause pan overflow.

2



*The American Lung Association states that most people spend 90% of their time indoors<sup>1</sup>. DiversiTech offers the 3-STEP PROCESS to help control IAQ problems caused by the micro-organisms in the atmosphere in which we live and work.*

<sup>1</sup>www.lungusa.org

## STEP 3: MAINTAIN

### FLOW-PLUS™ Condensate Pan Treatment

Place FLOW-PLUS™ in the condensate pan (choose size according to equipment tonnage below). FLOW-PLUS™ is a totally soluble long term polymer treatment that keeps the drain pan and condensate lines clean for a minimum of three months. This prevents pan overflow problems.

| PRODUCT NO. | EQUIPMENT TONNAGE |
|-------------|-------------------|
| SCM-183     | 1/2 to 3 tons     |
| SCM-181     | 3 to 5 tons       |
| SCM-184     | 5 to 20 tons      |
| SCM-182     | 20 to 50 tons     |
| SCM-185     | Over 50 tons      |



### Why clean coils?

#### CONDENSER COIL

Cleaning the condenser coil does one thing — improves the heat transfer efficiency between the refrigerant inside the coil and the ambient air outside. The more efficient this heat transfer, the more efficiently the cooling system operates.

With efficient heat transfer and an efficiently operating condensing unit, the system consumes less energy because it draws less current. By lowering current consumed in the unit, the life of the equipment is extended.

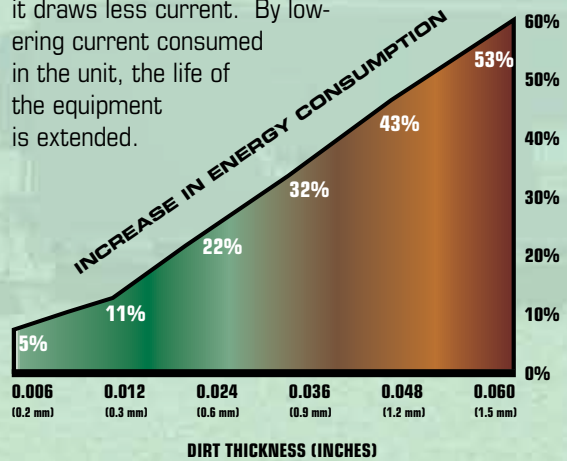

#### EVAPORATOR COIL

Cleaning the evaporator coil improves indoor air quality. It addresses building related illness and sick building syndrome.

### How frequently should coils be cleaned?

We recommend a minimum of twice per year, more frequently if there is dirty ambient air.



# New Look—Same Great Results



The new DiversiTech chemical line is ready for you. This enhanced product line features all new color-coded packaging to make it stand out on shelf and even easier to sell in your store. With bold new graphics and easy to read labels, DiversiTech chemicals provide your customers with the quality solutions they need for their business. Enhance your showroom and your sales with the new look of DiversiTech.



## COIL CLEANERS

### Pro-Red Plus™

Pro-Red Plus™ Non-Acid Coil Cleaner and Brightener is an easy to use, concentrated, fast-acting product that foams and lifts away stubborn deposits from air-cooled condensers and coils. It removes tarnish and corrosion deposits, and leaves a bright clean shine on aluminum and copper coils.

Pro-Red Plus™ Non-Acid Coil Cleaner and Brightener cleans by chemical action. Its brightening properties are as effective as conventional acid coil cleaners, but Pro-Red Plus™ does not contain extremely toxic hydrofluoric acid. The vigorous foaming action eliminates the need for prolonged soaking, steam cleaning or scrubbing coils. Non-acid formula does not emit corrosive fumes, and will not rust ferrous metals.



| CATALOG NO.       | DESCRIPTION  | UOM | ORDER MULTIPLE |
|-------------------|--|-----|----------------|
| <b>PRO-RED+32</b> | Pro-Red Plus™ Cleaner and Brightener (non-acid) – 32 oz. bottle      | EA  | 12             |
| <b>PRO-RED+</b>   | Pro-Red Plus™ Cleaner and Brightener (non-acid) – 1 gallon container | EA  | 4              |
| <b>PRO-RED+5</b>  | Pro-Red Plus™ Cleaner and Brightener (non-acid) – 5 gallon pail      | EA  | 1              |

### Pro-Blue™

The Pro-Blue™ is a heavy-foaming, alkaline-based coil cleaner which will assist in removing the build-up on your air-cooled condenser. Buy the Pro-Blue™ and help your condenser look as good as new.



| CATALOG NO.        | DESCRIPTION   | UOM | ORDER MULTIPLE |
|--------------------|---|-----|----------------|
| <b>PRO-BLUE-32</b> | Pro-Blue™ Foaming Concentrate (non-acid) – 32 oz. bottle      | EA  | 12             |
| <b>PRO-BLUE</b>    | Pro-Blue™ Foaming Concentrate (non-acid) – 1 gallon container | EA  | 4              |
| <b>PRO-BLUE-5</b>  | Pro-Blue™ Foaming Concentrate (non-acid) – 5 gallon pail      | EA  | 1              |

### Pro-Green™

The Pro-Green™ is a non-toxic, self rinsing evaporative coil cleaner which is a safe-to-use product on your evaporator coils. This coil cleaner can also be used on air-cooled condensers, electronic filters and fan blades.



| CATALOG NO.         | DESCRIPTION  | UOM | ORDER MULTIPLE |
|---------------------|--|-----|----------------|
| <b>PRO-GREEN-32</b> | Pro-Green™ No Rinse (non-toxic) – 32 oz. bottle      | EA  | 12             |
| <b>PRO-GREEN</b>    | Pro-Green™ No Rinse (non-toxic) – 1 gallon container | EA  | 4              |
| <b>PRO-GREEN-5</b>  | Pro-Green™ No Rinse (non-toxic) – 5 gallon pail      | EA  | 1              |

### Pro-Yellow™

Pro-Yellow™ is an easy to apply, non-acid coil cleaner and brightener. This effective formula quickly removes dirt and grime from outdoor coils and leaves them clean and bright. It's strong foaming action removes even stubborn deposits easily.



| CATALOG NO.          | DESCRIPTION                                  | UOM | ORDER MULTIPLE |
|----------------------|--|-----|----------------|
| <b>PRO-YELLOW-32</b> | Pro-Yellow™ (non-toxic) – 32 oz. bottle      | EA  | 12             |
| <b>PRO-YELLOW</b>    | Pro-Yellow™ (non-toxic) – 1 gallon container | EA  | 4              |
| <b>PRO-YELLOW-5</b>  | Pro-Yellow™ (non-toxic) – 5 gallon pail      | EA  | 1              |

### Pro-Brown™

An ultra-high foaming formula that pulls out deeply embedded dirt. The fast, dual-action formula cleans and brightens. Pro-Brown™ is biodegradable and safer than foaming hydrofluoric acid cleaners.

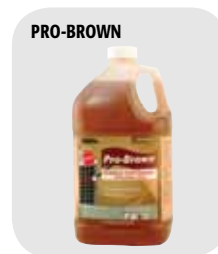

| CATALOG NO.         | DESCRIPTION  | UOM | ORDER MULTIPLE |
|---------------------|--|-----|----------------|
| <b>PRO-BROWN-32</b> | Pro-Brown™ Foaming Coil Cleaner – 32 oz. bottle      | EA  | 12             |
| <b>PRO-BROWN</b>    | Pro-Brown™ Foaming Coil Cleaner – 1 gallon container | EA  | 4              |
| <b>PRO-BROWN-5</b>  | Pro-Brown™ Foaming Coil Cleaner – 5 gallon pail      | EA  | 1              |

### Eco-Coil™ Environmentally Friendly Coil Cleaner

Eco-Coil™ is an effective, environmentally friendly coil cleaner and brightener. Eco-Coil™ uses biodegradable, earth-friendly components to quickly clean away dirt and deposits. This formula is effective on both indoor and outdoor coils and cleans while protecting the environment from harsh chemicals.

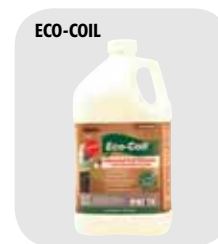

| CATALOG NO.        | DESCRIPTION  | UOM | ORDER MULTIPLE |
|--------------------|--|-----|----------------|
| <b>ECO-COIL-32</b> | Eco-Coil™ Environmentally Friendly Coil Cleaner – 32 oz. bottle      | EA  | 12             |
| <b>ECO-COIL</b>    | Eco-Coil™ Environmentally Friendly Coil Cleaner – 1 gallon container | EA  | 4              |
| <b>ECO-COIL-5</b>  | Eco-Coil™ Environmentally Friendly Coil Cleaner – 5 gallon pail      | EA  | 1              |

### Triple-D™ Universal Coil Cleaner

Triple-D™ is a Universal Coil Cleaner suitable for use on condenser *and* evaporator coils. Metal safe and does not attack aluminum or copper coil components, extending equipment life and diminishing potential for refrigerant leaks. Safe for rooftop units.

Triple-D™ is available in a package to fit any contractor's needs – super concentrated liquid, pre-mixed trigger sprayer, convenient aerosol, and industry leading Granular Coil Cleaner. In liquid form, Triple-D™ is super concentrated. A single gallon of concentrate makes 75% more mixed coil cleaner than conventional concentrations. The liquid concentrate is also NSF Registered, assuring that it is safe as a cleaner in restaurants, hospitals, government institutions, and any food preparation area (rinse thoroughly after use). Triple-D™ is a safer, more versatile product than conventional acid or non-acid coil cleaners. One product does it all – truly a Universal Coil Cleaner.

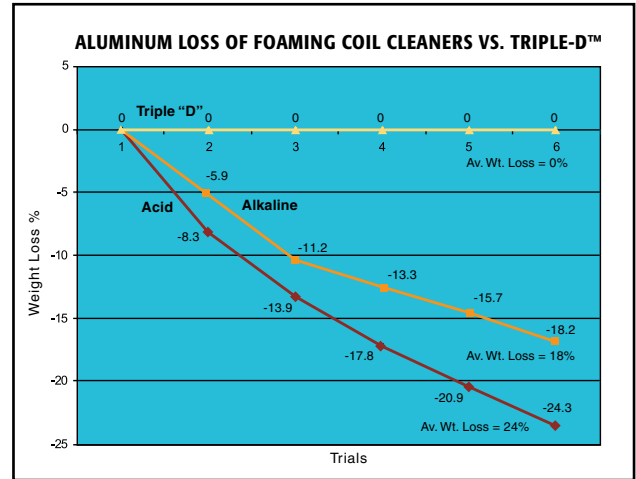
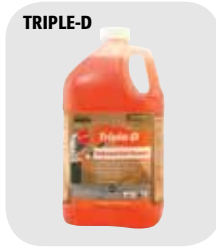

Conventional foaming acid and non-acid coil cleaners attack and chemically react with the aluminum coil components. This reaction is exhibited by a foaming action. The attack/reaction dissolves the aluminum, destroying the heat-transfer ability of the coil and creating the potential for refrigerant leaks.

| CATALOG NO.          | DESCRIPTION                                       | UOM | ORDER MULTIPLE |
|----------------------|---|-----|----------------|
| <b>TRIPLE-D</b>      | Triple-D™ – 1 gallon concentrate                  | EA  | 4              |
| <b>TRIPLE-D-5</b>    | Triple-D™ – 5 gallon concentrate                  | EA  | 1              |
| <b>TRIPLE-D-AER</b>  | Triple-D™ – 19 oz. Aerosol                        | EA  | 12             |
| <b>TRIPLE-D-GRAN</b> | Triple-D™ – 1 lb. Granular                        | EA  | 12             |
| <b>TRIPLE-D-32</b>   | Triple-D™ – 32 oz. bottle – concentrate           | EA  | 12             |
| <b>TRIPLE-D-RTU</b>  | Triple-D™ – 1 quart trigger sprayer – pre-diluted | EA  | 12             |

### DIVERSITECH AEROSOL CLEANERS

#### Case-Care

Case-Care is a hard case and diffuser cleaner that is safe and effective for use on all fan set units. Use Case-Care to remove smudge marks from fingers on cases and cassettes as well as nicotine, grease and other soils.



| CATALOG NO.      | DESCRIPTION                        | UOM | ORDER MULTIPLE |
|------------------|------------------------------------|-----|----------------|
| <b>CASE-CARE</b> | Case and Diffuser Cleaner – 17 oz. | EA  | 12             |

#### Coil-Care

Coil-Care is a safe and effective evaporator cleaner and disinfectant formulated to contain a bactericide and fungicide. Coil-Care removes unpleasant odors. This non-rinse product means you can spray and walk away!



| CATALOG NO.      | DESCRIPTION                                  | UOM | ORDER MULTIPLE |
|------------------|--|-----|----------------|
| <b>COIL-CARE</b> | Evaporator cleaner and disinfectant – 17 oz. | EA  | 12             |

### DIVERSITECH LEAK DETECTORS

#### Leak-Seek

Leak-Seek is a leak detector spray that when applied, creates long lasting bubbles that are ideal for identifying slow low pressure leaks. Leak-Seek produces fast and accurate results by clinging to surfaces – even upside down – and contains fluorescent to aid visibility. Leak-Seek is alcohol and solvent free.



| CATALOG NO.      | DESCRIPTION                    | UOM | ORDER MULTIPLE |
|------------------|--------------------------------|-----|----------------|
| <b>LEAK-SEEK</b> | Leak Detector Spray – 13.5 oz. | EA  | 12             |



Literature – Download all literature from the DiversiTech website using the Form ID shown in the icon. The URL is [www.diversitech.com/literature/FORMID.pdf](http://www.diversitech.com/literature/FORMID.pdf)

**GLYCOLS**

DiversiTech produces the most complete line of industrial coolant and heat transfer products in the HVAC/R Industry. Our product line includes ProTek PG propylene glycol products formulated with food-grade corrosion inhibitors and ProTek EG ethylene glycol products for industrial applications. Both product groups are designed to provide freeze and burst protection and are formulated with inhibitors and antifoam agents to provide long-term stability against system corrosion and fouling.

**ProTek™ Closed Loop Heat Transfer Fluid**

ProTek™ for closed loop water recirculation systems is a blue liquid. Available in three concentrations: original ProTek-100™, ProTek-50™, and ProTek-Plus™. Each concentration may be further diluted to alter freeze and burst temperatures. Refer to the technical data sheet for specific information.



| CATALOG NO.       | DESCRIPTION                   | GLYCOL/<br>WATER RATIO | UOM | ORDER<br>MULTIPLE |
|-------------------|-------------------------------|------------------------|-----|-------------------|
| <b>PG-50</b>      | ProTek-50™ – 1 Gallon Jug     | 35/65                  | EA  | 4                 |
| <b>PG-50-5</b>    | ProTek-50™ – 5 Gallon Pail    | 35/65                  | EA  | 1                 |
| <b>PG-50-55</b>   | ProTek-50™ – 55 Gallon Drum   | 35/65                  | EA  | 1                 |
| <b>PG-100</b>     | ProTek-100™ – 1 Gallon Jug    | 70/30                  | EA  | 4                 |
| <b>PG-100-5</b>   | ProTek-100™ – 5 Gallon Pail   | 70/30                  | EA  | 1                 |
| <b>PG-100-55</b>  | ProTek-100™ – 55 Gallon Drum  | 70/30                  | EA  | 1                 |
| <b>PG-PLUS</b>    | ProTek-Plus™ – 1 Gallon Jug   | 95/5                   | EA  | 4                 |
| <b>PG-PLUS-5</b>  | ProTek-Plus™ – 5 Gallon Pail  | 95/5                   | EA  | 1                 |
| <b>PG-PLUS-55</b> | ProTek-Plus™ – 55 Gallon Drum | 95/5                   | EA  | 1                 |

**ProTek EG™**

An inhibited ethylene glycol based heat transfer fluid designed for use in hydronic, chilled and closed water.



| CATALOG NO.  | DESCRIPTION                 | GLYCOL/<br>WATER RATIO | UOM | ORDER<br>MULTIPLE |
|--------------|-----------------------------|------------------------|-----|-------------------|
| <b>EG</b>    | ProTek EG™ – 1 Gallon Jug   | 95/5                   | EA  | 4                 |
| <b>EG-5</b>  | ProTek EG™ – 5 Gallon Pail  | 95/5                   | EA  | 1                 |
| <b>EG-55</b> | ProTek EG™ – 55 Gallon Drum | 95/5                   | EA  | 1                 |

**ProTek-BG™ for Cast Iron Water Boilers**

A red liquid boiler grade product formulated specifically with corrosion inhibitors necessary for use in water boilers.



| CATALOG NO.     | DESCRIPTION                 | GLYCOL/<br>WATER RATIO | UOM | ORDER<br>MULTIPLE |
|-----------------|-----------------------------|------------------------|-----|-------------------|
| <b>PG-BG</b>    | ProTek-BG™ – 1 Gallon Jug   | 70/30                  | EA  | 4                 |
| <b>PG-BG-5</b>  | ProTek-BG™ – 5 Gallon Pail  | 70/30                  | EA  | 1                 |
| <b>PG-BG-55</b> | ProTek-BG™ – 55 Gallon Drum | 70/30                  | EA  | 1                 |

**ProTek™ PG-AL – Safe for Aluminum Heat Exchangers**

Universal heat transfer fluid. An inhibited heat transfer fluid that is safe for use in boilers and hydronic systems including aluminum heat exchangers. Operating range is -100°F to 190°F. ProTek™ PG-AL is an orange liquid.



| CATALOG NO.     | DESCRIPTION                    | GLYCOL/<br>WATER RATIO | UOM | ORDER<br>MULTIPLE |
|-----------------|--------------------------------|------------------------|-----|-------------------|
| <b>PG-AL</b>    | ProTek™ PG-AL – 1 Gallon Jug   | 70/30                  | EA  | 4                 |
| <b>PG-AL-5</b>  | ProTek™ PG-AL – 5 Gallon Pail  | 70/30                  | EA  | 1                 |
| <b>PG-AL-55</b> | ProTek™ PG-AL – 55 Gallon Drum | 70/30                  | EA  | 1                 |

**PAN TREATMENTS/DISINFECTANTS**
**Sani C-N-D™ Coil and Drain Pan Disinfectant**

Sani C-N-D™ is an EPA registered disinfectant, fungicide, mildewstat and viricide. It is ready-to-use and assures consistent, effective results. Sani C-N-D™ destroys “dirty sock,” mildew and other malodors.



| CATALOG NO.        | DESCRIPTION                                   | UOM | ORDER<br>MULTIPLE |
|--------------------|---|-----|-------------------|
| <b>SANI-CND-32</b> | Sani C-N-D™ Disinfectant – 32 oz. Container   | EA  | 12                |
| <b>SANI-CND</b>    | Sani C-N-D™ Disinfectant – 1 Gallon Container | EA  | 4                 |
| <b>SANI-CND-5</b>  | Sani C-N-D™ Disinfectant – 5 Gallon Pail      | EA  | 1                 |
| <b>SANI-CND-55</b> | Sani C-N-D™ Disinfectant – 55 Gallon Drum     | EA  | 1                 |

**Pro-Treat® 151 Premium Condensate Drain Pan Treatment**

Pro-Treat® 151 premium tablets penetrate and help remove sludge that can plug drain pans and drain lines and foul humidifier pans. Kills odors associated with slime and sludge, minimizing maintenance problems from overflow and water damage caused by fouled pans, plugged traps, or drain lines. Tablets are 100% soluble, easy-to-use, and do not form any deposits in the pan or drain line. Approved for computer rooms. Dosage: 1 tablet per 3 tons each month. PROTREAT-151 is EPA registered.



| CATALOG NO.         | DESCRIPTION  | UOM | ORDER<br>MULTIPLE |
|---------------------|--|-----|-------------------|
| <b>PROTREAT-151</b> | Pro-Treat® 151 Premium Drain Pan Treatment – 100 Tablets/Jar | EA  | 12                |

### Pro-Treat® 200 Economy Condensate Drain Pan Treatment

Economical with 200 tablets per jar. Safe, non-corrosive, odor-free and 100% soluble. Approved for computer rooms. Convenient, easy-to-use tablet form provides prolonged cleaning action. Dosage: 3 tablets per 3 tons per month.

PROTREAT-200



PROTREAT-217



| CATALOG NO.  | DESCRIPTION  | UOM | ORDER MULTIPLE |
|--------------|--|-----|----------------|
| PROTREAT-200 | Pro-Treat® 200 Economy Drain Pan Treatment – 200 Tablets/Jar | EA  | 12             |
| PROTREAT-217 | Pro-Treat® 217 Economy Drain Pan Treatment – 200 Tablets/Jar | EA  | 12             |

### Flow-Plus™ Condensate Pan Treatment

A unique polymer formula that maintains condensate flow and prevents drain pan overflow. 100% active. Flow-Plus™ leaves no residue, no waste, and is nonclogging. Effective, long-term condensate activated release. Environmentally safe, non-toxic, and non-corrosive. Also economical with sizes to meet all tonnage requirements.

| CATALOG NO.   | EQUIPMENT TONNAGE |
|---------------|-------------------|
| FLOW-PLUS-25  | 1/2 to 3 tons     |
| FLOW-PLUS-200 | 1/2 to 3 tons     |
| FLOW-PLUS-6   | 3 to 5 tons       |
| FLOW-PLUS-10  | 5 to 20 tons      |
| FLOW-PLUS-125 | 20 to 50 tons     |

| CATALOG NO.   | DESCRIPTION  | UOM | ORDER MULTIPLE |
|---------------|--|-----|----------------|
| FLOW-PLUS-25  | Flow-Plus™ Condensate Pan Treatment – 25 Tabs/Jar      | EA  | 12             |
| FLOW-PLUS-200 | Flow-Plus™ Condensate Pan Treatment – 200 Tabs/Jar     | EA  | 4              |
| FLOW-PLUS-6   | Flow-Plus™ Condensate Pan Treatment – 6 oz. Clamshells | EA  | 24             |
| FLOW-PLUS-10  | Flow-Plus™ Condensate Pan Treatment – 10 oz. Tubs      | EA  | 18             |
| FLOW-PLUS-125 | Flow-Plus™ Condensate Pan Treatment – 1.25 lb. Tubs    | EA  | 8              |

FLOW-PLUS-25



FLOW-PLUS-200



### Pro-Treat® 152 King-Size Premium Condensate Drain Pan Treatment

Economical, safe, effective king-size tablets last three times longer. Safe, non-corrosive, odor-free and 100% soluble. Computer room approved. Keeps drain pans and condensate lines clean and free flowing. Dosage: 1 tablet per 3 tons per 3 months.

PROTREAT-152



| CATALOG NO.  | DESCRIPTION   | UOM | ORDER MULTIPLE |
|--------------|---|-----|----------------|
| PROTREAT-152 | Pro-Treat® 152 King-Size Premium Drain Pan Treatment – 12 Tablets/Jar | EA  | 6              |

### Pro-Treat® 161 Condensate Drain Pan Treatment

Controls odors and eliminates condensate drain pan overflows and the resulting water damage. 100% soluble, easy-to-use, non-corrosive, and non-toxic. Use regularly to assure season-long, trouble-free condensate drain pan performance. Approved for computer rooms. Dosage: 2 tablets per 3 tons each month.

PROTREAT-161



| CATALOG NO.  | DESCRIPTION  | UOM | ORDER MULTIPLE |
|--------------|--|-----|----------------|
| PROTREAT-161 | Pro-Treat® 161 Drain Pan Treatment – 100 Tablets/Jar | EA  | 12             |

### Pro-Treat® 350 Condensate Drain Pan Treatment

Place a Pro-Treat® 350 tablet in a condensate drain pan and condensed moisture will slowly dissolve the tablet, thinly coating the pan surface to give prolonged cleaning action on sludge. Dosage: one or two tablets are recommended in each pan per month. For industrial use only!

PROTREAT-350



| CATALOG NO.  | DESCRIPTION   | UOM | ORDER MULTIPLE |
|--------------|---|-----|----------------|
| PROTREAT-350 | Pro-Treat® 350 Condensate Pan Treatment – 100 Tablets per Jar | EA  | 24             |

### Flow-Plus™ Pump Treatment Tablets for Condensate Pumps

A unique polymer pan treatment in tablet form for use exclusively in DiversiTech's condensate pump. The tablet dispensing drawer in the pump holds 3 tablets. A dosage lasts up to 3 months depending on the volume of condensate generated. Even when fully dissolved, the tablets provide a lasting treatment in the pump and downstream drain line. Provides long-lasting treatment that controls slime growth over time and can extend the life of the pump.

FLOW-PLUS-CP



| CATALOG NO.  | DESCRIPTION   | UOM | ORDER MULTIPLE |
|--------------|---|-----|----------------|
| FLOW-PLUS-CP | Flow-Plus™ for Condensate Pumps – 6 Tablets/Clamshell | EA  | 36             |

**ACCESSORIES**
**Pro-Bubble™ Leak Detector**

Easy-to-use, high-bubbling, viscoelastic blue leak detector. New improved formula.



| CATALOG NO.          | DESCRIPTION  | UOM | ORDER MULTIPLE |
|----------------------|--|-----|----------------|
| <b>PRO-BUBBLE-32</b> | Pro-Bubble™ Leak Detector – 32 oz. bottle with Spray Top | EA  | 12             |

**Coil Guard™**

Ideally used in coastal areas, where salt air accelerates rust and decay. Highly recommended for use in all geographical areas to prolong the life of a unit. When applied properly, Coil Guard™ dries quickly and immediately resists salt spray, alcohol, acids, and soap solutions. Weather will not blacken it. Coil Guard™ has high dielectric properties and has no effect on heat transfer. Our blue tinted product is used to ensure complete coverage of coating.



| CATALOG NO.    | DESCRIPTION                        | UOM | ORDER MULTIPLE |
|----------------|------------------------------------|-----|----------------|
| <b>CG-AER</b>  | Clear Coil Guard™ – 20 oz. Aerosol | EA  | 12             |
| <b>CGB-AER</b> | Blue Coil Guard™ – 20 oz. Aerosol  | EA  | 12             |

**Radiant Leak Finder™**

Radiant color and viscous clinging formula exposes the smallest leaks. Freeze-protected – remains effective down to 0° F.



| CATALOG NO.  | DESCRIPTION                            | UOM | ORDER MULTIPLE |
|--------------|--|-----|----------------|
| <b>RLF-8</b> | Radiant Leak Finder™ – 8 oz. Container | EA  | 12             |

**Pan-Patch™**

Pan-Patch™ is a two part epoxy coating with anti-microbial additives designed for HVAC applications. It is a self leveling formula that is ideal in a damp or wet environment. Pan-Patch™ resists corrosion and stops pan leaks without replacing the pan. Light gray in color, one gallon covers about 160 square feet with 10 mil thickness.



| CATALOG NO.         | DESCRIPTION                              | COVERAGE    | UOM | ORDER MULTIPLE |
|---------------------|--|-------------|-----|----------------|
| <b>PANPATCH-BAG</b> | Pan-Patch™ Pan Sealant – bag, pack of 10 | 8 sq. ft.   | PK  | 1              |
| <b>PANPATCH-32</b>  | Pan-Patch™ Pan Sealant – 1 quart         | 40 sq. ft.  | EA  | 9              |
| <b>PANPATCH</b>     | Pan-Patch™ Pan Sealant – 1 gallon        | 160 sq. ft. | EA  | 4              |

**Cool-Weld™ Heat Barrier Spray**

Spray on thick gel formula that protects surfaces from heat and damage. Odorless, non-toxic gel coats rubber, plastic, and painted surfaces to shield them during welding or soldering.



| CATALOG NO.        | DESCRIPTION                                      | UOM | ORDER MULTIPLE |
|--------------------|--|-----|----------------|
| <b>COOLWELD-32</b> | Cool-Weld™ Heat Barrier Spray – 32 oz. Container | EA  | 12             |

**THREAD SEALANTS**
**PRO-TITE™ Resin Based Thread Sealant**

Resin based thread sealant that adheres to internal surfaces, fills voids while forming a flexible fluid tight seal. Specifically formulated for use on metals and plastics subject to extreme vibration. Serviceable at temperatures from -100°F (-73°C) to 400°F (204°C) and from full vacuum to 10,000 PSI. Pro-Tite™ is impervious to most chemicals including refrigerants, petroleum products, gases, steam, etc. Alcohol based.



| CATALOG NO.      | DESCRIPTION                                       | UOM | ORDER MULTIPLE |
|------------------|---|-----|----------------|
| <b>CLL-1</b>     | Pro-Tite™ Thread Sealant – 1-1/3 oz. Squeeze Tube | EA  | 12             |
| <b>CLL-4</b>     | Pro-Tite™ Thread Sealant – 4 oz. Brush Top        | EA  | 12             |
| <b>CLL-16</b>    | Pro-Tite™ Thread Sealant – 16 oz. Brush Top       | EA  | 12             |
| <b>NEW 61028</b> | Pro-Tite™ Thread Sealant – 1 Gallon Can           | EA  | 1              |

## Glycol Testing Strips

DiversiTech's glycol test strip is used to measure the flow and/or burst rating of a system with glycol added. Differing types and concentrations of glycol provide different levels of protection for a system. This easy to use test strip shows what temperature your system is protected to.



| CATALOG NO.        | DESCRIPTION                   | UOM | ORDER MULTIPLE |
|--------------------|-------------------------------|-----|----------------|
| <b>SCM-PG-TEST</b> | Glycol Test Strip, pack of 10 | PK  | 1              |

## Acid Test Kit™

Detects acid in refrigeration oil. Convenient, one-step test means no chemicals to mix. Easy to evaluate. Color change indicates acidity; color intensity reveals the amount of acid present in the oil sample.



| CATALOG NO.   | DESCRIPTION                | UOM | ORDER MULTIPLE |
|---------------|----------------------------|-----|----------------|
| <b>ATK-4</b>  | Acid Test Kit™, pack of 4  | PK  | 1              |
| <b>ATK-1</b>  | Acid Test Kit™             | EA  | 1              |
| <b>ATK-1P</b> | Acid Test Kit™ for POE Oil | EA  | 1              |

## Acid Eliminator

Keeps acid away; compatible with all refrigerants and oils. Chemically neutralizes and prevents acids that are formed in air conditioning and refrigeration systems due to refrigerant and refrigeration oil break-down, moisture, and compressor burnout. Easy-to-use, no complicated charts. Works fast, circulates quickly, and leaves no solids or solid residuals. Will not harm system components. Can prevent system breakdown.



| CATALOG NO.  | DESCRIPTION                            | UOM | ORDER MULTIPLE |
|--------------|--|-----|----------------|
| <b>CAN-4</b> | Acid Eliminator – 4 oz. Plastic Bottle | EA  | 12             |

## Pro-Thaw™ Liquid Dryer for Refrigerants

Chemically dries all refrigerants (R-12, R-22, R-134a, etc.), methyl chloride and methylene chloride. Frees up systems frozen due to moisture contamination in 5 minutes and prevents refreezing. Does not contain any dissolved solids, leaves no residue and works with or without solid dryers.



| CATALOG NO.   | DESCRIPTION                    | UOM | ORDER MULTIPLE |
|---------------|--------------------------------|-----|----------------|
| <b>CTZ-1</b>  | Pro-Thaw™ – 1 oz. Plastic Jar  | EA  | 24             |
| <b>CTZ-4</b>  | Pro-Thaw™ – 4 oz. Plastic Jar  | EA  | 12             |
| <b>CTZ-16</b> | Pro-Thaw™ – 16 oz. Plastic Jar | EA  | 6              |

## FLUSHING PRODUCTS

### Pro-Flush™ HVAC Flushing Solvent

A flushing solvent for A/C and refrigeration systems formulated for R-410A retrofits, refrigerant conversions and compressor burnouts. Compatible with all refrigerants and compressor oils. All solvents in Pro-Flush™ are non-VOC and conform to EPA SNAP standards: low toxicity and residue-free.

Available as a kit or in a 16 oz. solvent refill. The kit makes servicing quick, easy, and safe, as well as assuring you get to the job site with all necessary hardware in hand for 1-stop servicing. The kit includes: 16 oz. container of Pro-Flush™ solvent, refillable Pro-Flush™ injector tool pressure tank, pressure relief valve for added safety, large rubber adapter that flushes up to 1-1/4" line sets, service hose.



| CATALOG NO.           | DESCRIPTION   | UOM | ORDER MULTIPLE |
|-----------------------|---|-----|----------------|
| <b>PF-KIT</b>         | Pro-Flush™ Kit – injector, 16 oz. refill, nozzle adapter and hose | EA  | 1              |
| <b>PF-16</b>          | Pro-Flush™ HVAC Flushing Solvent – 16 oz. Refill                  | EA  | 6              |
| <b>NEW PF-ADAPTER</b> | Pro-Flush™ Line Set Adapter                                       | EA  | 1              |
| <b>NEW PF-IGUN</b>    | Replacement Injector Tool   | EA  | 1              |
| <b>NEW PF-IHOSE</b>   | 2' Replacement Hose   | EA  | 1              |



Literature – Download all literature from the DiversiTech website using the Form ID shown in the icon. The URL is [www.diversitech.com/literature/FORMID.pdf](http://www.diversitech.com/literature/FORMID.pdf)

## Quality Manufacturing means Quality Products.

Part of the DiversiTech family since 1998, Specialty Chemical produces a host of quality chemical solutions for HVAC customers. The Specialty Chemical brand has always meant exceptional quality and innovative products to solve the toughest industry problems. From dependable products like Flow-Plus™ to the improved coil cleaner Triple-D™, Specialty Chemical delivers the results customers demand. Trust the brand that combines technology and innovation to help your business succeed even more.

**Specialty  
Chemical**   
A DiversiTech Company

COIL CLEANERS

Triple-D™ Universal Coil Cleaner

Triple-D™ is a Universal Coil Cleaner suitable for use on condenser *and* evaporator coils. Metal safe and does not attack aluminum or copper coil components, extending equipment life and diminishing potential for refrigerant leaks. Safe for rooftop units.

Triple-D™ is available in a package to fit any contractors needs – super concentrated liquid, pre-mixed trigger sprayer, convenient aerosol, and industry leading Granular Coil Cleaner. In liquid form, Triple-D™ is super concentrated. A single gallon of concentrate makes 75% more mixed coil cleaner than conventional concentrations. The liquid concentrate is also NSF Registered, assuring that it is safe as a cleaner in restaurants, hospitals, government institutions, and any food preparation area (rinse thoroughly after use). Triple-D™ is a safer, more versatile product than conventional acid or non-acid coil cleaners. One product does it all – truly a Universal Coil Cleaner.



| CATALOG NO.  | DESCRIPTION                                       | UOM | ORDER MULTIPLE |
|--------------|---|-----|----------------|
| SCM-707-RTU  | Triple-D™ – 1 quart trigger sprayer – pre-diluted | EA  | 12             |
| SCM-707-20   | Triple-D™ – 19 oz. Aerosol                        | EA  | 12             |
| SCM-707-GRAN | Triple-D™ – 1 lb. Granular                        | EA  | 12             |
| SCM-707-32   | Triple-D™ – 32 oz. container                      | EA  | 12             |
| SCM-707-01   | Triple-D™ – 1 gallon concentrate                  | EA  | 4              |
| SCM-707-05   | Triple-D™ – 5 gallon concentrate                  | EA  | 1              |
| SCM-707-30   | Triple-D™ – 30 gallon concentrate                 | EA  | 1              |
| SCM-707-55   | Triple-D™ – 55 gallon concentrate                 | EA  | 1              |

Power-Plus™ Alkaline Evaporator Coil Cleaner

Power-Plus™ is inhibited, thus will not attack aluminum or other soft metals when mixed as directed. It is also self-rinsing, saving cleaning time. Power-Plus is fragrance-free, making it the product of choice in hypoallergenic situations. USDA AUTHORIZED



| CATALOG NO. | DESCRIPTION   | UOM | ORDER MULTIPLE |
|-------------|---|-----|----------------|
| SCM-703-32  | Power-Plus™ Alkaline Evaporator Coil Cleaner – 32 oz. Container   | EA  | 12             |
| SCM-703-01  | Power-Plus™ Alkaline Evaporator Coil Cleaner – 1 Gallon Container | EA  | 4              |
| SCM-703-05  | Power-Plus™ Alkaline Evaporator Coil Cleaner – 5 Gallon Pail      | EA  | 1              |
| SCM-703-30  | Power-Plus™ Alkaline Evaporator Coil Cleaner – 30 Gallon Drum     | EA  | 1              |
| SCM-703-55  | Power-Plus™ Alkaline Evaporator Coil Cleaner – 55 Gallon Drum     | EA  | 1              |

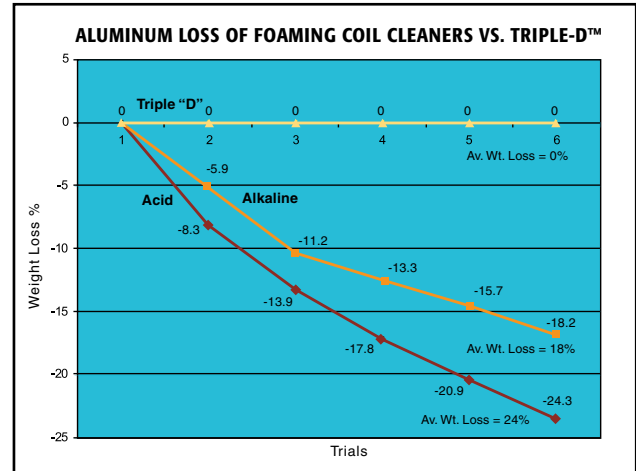

Conventional foaming acid and non-acid coil cleaners attack and chemically react with the aluminum coil components. This reaction is exhibited by a foaming action. The attack/reaction dissolves the aluminum, destroying the heat-transfer ability of the coil and creating the potential for refrigerant leaks.

Super-Brite™ Brown Foaming Coil Cleaner

An ultra-high foaming formula that pulls out deeply embedded dirt. The fast, dual-action formula cleans and brightens. Super-Brite™ is biodegradable and safer than foaming hydrofluoric acid cleaners.



| CATALOG NO. | DESCRIPTION  | UOM | ORDER MULTIPLE |
|-------------|--|-----|----------------|
| SCM-720-32  | Super-Brite™ Brown Foaming Coil Cleaner – 32 oz. Container   | EA  | 12             |
| SCM-720-01  | Super-Brite™ Brown Foaming Coil Cleaner – 1 Gallon Container | EA  | 4              |
| SCM-720-05  | Super-Brite™ Brown Foaming Coil Cleaner – 5 Gallon Pail      | EA  | 1              |
| SCM-720-30  | Super-Brite™ Brown Foaming Coil Cleaner – 30 Gallon Drum     | EA  | 1              |
| SCM-720-55  | Super-Brite™ Brown Foaming Coil Cleaner – 55 Gallon Drum     | EA  | 1              |

Super-Foam™ Maximum Power Foaming Coil Cleaner

Heavy-duty foaming formula penetrates, breaks down, and foams out oil, grease, and dirt. Fortified with LA-544 to quickly suspend and float away soil. Dense, expanding foam efficiently cleans and brightens even the thickest, dirtiest condenser coils.



| CATALOG NO. | DESCRIPTION   | UOM | ORDER MULTIPLE |
|-------------|---|-----|----------------|
| SCM-718-32  | Super-Foam™ Foaming Coil Cleaner – 32 oz. Container   | EA  | 12             |
| SCM-718-01  | Super-Foam™ Foaming Coil Cleaner – 1 Gallon Container | EA  | 4              |
| SCM-718-05  | Super-Foam™ Foaming Coil Cleaner – 5 Gallon Pail      | EA  | 1              |
| SCM-718-30  | Super-Foam™ Foaming Coil Cleaner – 30 Gallon Drum     | EA  | 1              |
| SCM-718-55  | Super-Foam™ Foaming Coil Cleaner – 55 Gallon Drum     | EA  | 1              |

**COIL CLEANERS cont'd**

**Foam-Power™ Alkaline Expanding Foam Coil Cleaner**

Concentrated high foaming formula creates pressure generating foam to force deep soils to coil surfaces. High foaming action removes oxides and soils as it cleans and brightens. Powerful penetrating formula emulsifies grease and oil, allowing fast and easy rinsing. USDA AUTHORIZED



| CATALOG NO.       | DESCRIPTION   | UOM | ORDER MULTIPLE |
|-------------------|---|-----|----------------|
| <b>SCM-712-32</b> | Foam-Power™ Alkaline Foam Coil Cleaner – 32 oz. Container   | EA  | 12             |
| <b>SCM-712-01</b> | Foam-Power™ Alkaline Foam Coil Cleaner – 1 Gallon Container | EA  | 4              |
| <b>SCM-712-05</b> | Foam-Power™ Alkaline Foam Coil Cleaner – 5 Gallon Pail      | EA  | 1              |
| <b>SCM-712-30</b> | Foam-Power™ Alkaline Foam Coil Cleaner – 30 Gallon Drum     | EA  | 1              |
| <b>SCM-712-55</b> | Foam-Power™ Alkaline Foam Coil Cleaner – 55 Gallon Drum     | EA  | 1              |

**Coil-Kleen™ Foaming Acid Condenser Cleaner**

Less hazardous because it contains no dangerous hydrofluoric acid. High-foaming action and easy rinsing minimizes cleaning time. Effectively removes salts and scale as it brightens. USDA AUTHORIZED



| CATALOG NO.       | DESCRIPTION   | UOM | ORDER MULTIPLE |
|-------------------|---|-----|----------------|
| <b>SCM-706-32</b> | Coil-Kleen™ Foaming Acid Condenser Cleaner – 32 oz. Container   | EA  | 12             |
| <b>SCM-706-01</b> | Coil-Kleen™ Foaming Acid Condenser Cleaner – 1 Gallon Container | EA  | 4              |
| <b>SCM-706-05</b> | Coil-Kleen™ Foaming Acid Condenser Cleaner – 5 Gallon Pail      | EA  | 1              |
| <b>SCM-706-30</b> | Coil-Kleen™ Foaming Acid Condenser Cleaner – 30 Gallon Drum     | EA  | 1              |
| <b>SCM-706-55</b> | Coil-Kleen™ Foaming Acid Condenser Cleaner – 55 Gallon Drum     | EA  | 1              |

**Free-Foam™ Alkaline Coil and Filter Cleaner**

Concentrate is especially effective on baked-on grease and oils. Controlled foaming allows safe use on indoor equipment. Deodorizes and neutralizes obnoxious odors found in air handling equipment. USDA AUTHORIZED



| CATALOG NO.       | DESCRIPTION  | UOM | ORDER MULTIPLE |
|-------------------|--|-----|----------------|
| <b>SCM-702-32</b> | Free-Foam™ Alkaline Coil and Filter Cleaner – 32 oz. Container   | EA  | 12             |
| <b>SCM-702-01</b> | Free-Foam™ Alkaline Coil and Filter Cleaner – 1 Gallon Container | EA  | 4              |
| <b>SCM-702-05</b> | Free-Foam™ Alkaline Coil and Filter Cleaner – 5 Gallon Pail      | EA  | 1              |
| <b>SCM-702-30</b> | Free-Foam™ Alkaline Coil and Filter Cleaner – 30 Gallon Drum     | EA  | 1              |
| <b>SCM-702-55</b> | Free-Foam™ Alkaline Coil and Filter Cleaner – 55 Gallon Drum     | EA  | 1              |

**COIL CLEANING AEROSOLS**

**Saf-N-Kleen™ Aerosol Solvent Coil Cleaner**

High-solvency formula quickly and easily dissolves dirt, grease, oil or other residue while the blasting nozzle separates the materials from the surface. Non-flammable, non-conductive formula is safe to use on live equipment.



| CATALOG NO.   | DESCRIPTION  | UOM | ORDER MULTIPLE |
|---------------|--|-----|----------------|
| <b>357-20</b> | Saf-N-Kleen™ Solvent Coil Cleaner – 18 oz. Aerosol | EA  | 12             |

**Foam-Plus™ Aerosol Foaming Coil Cleaner**

Heavy-duty foaming detergent coil cleaner in an aerosol can. Non-flammable and water-based with no chlorinated solvents. Blasting foam stream reaches into tight areas for maximum cleaning. The foaming alkaline detergent quickly liquifies dirt, grease, oil or other residue and is completely self-rinsing on condensate producing coils.



| CATALOG NO.   | DESCRIPTION                                      | UOM | ORDER MULTIPLE |
|---------------|--|-----|----------------|
| <b>358-20</b> | Foam-Plus™ Foaming Coil Cleaner – 19 oz. Aerosol | EA  | 12             |

**DRAIN PAN DISINFECTANT, SEALANT**

**Sani C-N-D™ Coil and Drain Pan Disinfectant**

Sani C-N-D™ is an EPA registered disinfectant, fungicide, mildewstat and viricide. It is ready-to-use and assures consistent, effective results. Sani C-N-D™ destroys "dirty sock," mildew and other malodors.



| CATALOG NO.       | DESCRIPTION                                   | UOM | ORDER MULTIPLE |
|-------------------|---|-----|----------------|
| <b>SCM-810-32</b> | Sani C-N-D™ Disinfectant – 32 oz. Container   | EA  | 12             |
| <b>SCM-810-01</b> | Sani C-N-D™ Disinfectant – 1 Gallon Container | EA  | 4              |
| <b>SCM-810-05</b> | Sani C-N-D™ Disinfectant – 5 Gallon Pail      | EA  | 1              |
| <b>SCM-810-30</b> | Sani C-N-D™ Disinfectant – 30 Gallon Drum     | EA  | 1              |
| <b>SCM-810-55</b> | Sani C-N-D™ Disinfectant – 55 Gallon Drum     | EA  | 1              |

**Pan-Kote Heavy Duty Drain Pan Patch**

A super-durable rubberized coating used to fill-in and patch HVAC drain pans. Seals out rust and corrosion. Stays flexible in variable weather conditions.



| CATALOG NO.   | DESCRIPTION                               | UOM | ORDER MULTIPLE |
|---------------|---|-----|----------------|
| <b>641-14</b> | Pan-Kote Drain Pan Patch – 14 oz. Aerosol | EA  | 12             |

**LEAK DETECTORS**

**Bubble-N-Trouble™ Freeze Protected Spray-On Leak Detector**

Non-corrosive, non-toxic, and biodegradable. Does not attack metal or interfere with brazing or soldering. Spray-on application allows easy access for hard to reach places. Tacking agent holds solution on test surface making Bubble-N-Trouble™ very economical. USDA AUTHORIZED



| CATALOG NO.       | DESCRIPTION   | UOM | ORDER MULTIPLE |
|-------------------|---|-----|----------------|
| <b>SCM-806-32</b> | Bubble-N-Trouble™ Freeze Protected Leak Detector – 32 oz. Spray       | EA  | 12             |
| <b>SCM-806-01</b> | Bubble-N-Trouble™ Freeze Protected Leak Detector – 1 Gallon Container | EA  | 4              |

**Detecto™ Iridescent Leak Detector**

Detecto™ clings to the surface to allow detection of slow leaks. Detecto™ creates highly-visible, easy-to-see iridescent bubbles. Non-toxic, non-corrosive, and safe for use in food service applications.



| CATALOG NO.       | DESCRIPTION  | UOM | ORDER MULTIPLE |
|-------------------|--|-----|----------------|
| <b>SCM-805-08</b> | Detecto™ Iridescent Leak Detector – 8 oz. Container    | EA  | 24             |
| <b>SCM-805-01</b> | Detecto™ Iridescent Leak Detector – 1 Gallon Container | EA  | 4              |

**SYSTEM CLEANERS**

**D'Scale™ Acid Scale Remover for Cooling Towers**

D'Scale™ will not create corrosive acidic foam. D'Scale™ has pH indicating dye. The color changes to yellow when acid has been consumed. Each gallon dissolves 3 pounds of scale.



| CATALOG NO.       | DESCRIPTION                                      | UOM | ORDER MULTIPLE |
|-------------------|--|-----|----------------|
| <b>SCM-709-01</b> | D'Scale™ Acid Scale Remover – 1 Gallon Container | EA  | 4              |
| <b>SCM-709-05</b> | D'Scale™ Acid Scale Remover – 5 Gallon Pail      | EA  | 1              |
| <b>SCM-709-30</b> | D'Scale™ Acid Scale Remover – 30 Gallon Drum     | EA  | 1              |
| <b>SCM-709-55</b> | D'Scale™ Acid Scale Remover – 55 Gallon Drum     | EA  | 1              |

## PAN TREATMENTS

### Flow-Plus™ Condensate Pan Treatment

A unique polymer formula that maintains condensate flow and prevents drain pan overflow. 100% active. Flow-Plus™ leaves no residue, no waste, and is nonclogging. Effective, long-term condensate activated release. Environmentally safe, non-toxic, and non-corrosive. Also economical with sizes to meet all tonnage requirements.



| CATALOG NO. | EQUIPMENT TONNAGE |
|-------------|-------------------|
| SCM-183     | 1/2 to 3 tons     |
| SCM-181     | 3 to 5 tons       |
| SCM-184     | 5 to 20 tons      |
| SCM-182     | 20 to 50 tons     |
| SCM-185     | Over 50 tons      |

| CATALOG NO. | DESCRIPTION  | UOM | ORDER MULTIPLE |
|-------------|--|-----|----------------|
| SCM-183-16  | Flow-Plus™ Condensate Pan Treatment – 25 Tabs/Jar      | EA  | 12             |
| SCM-183-200 | Flow-Plus™ Condensate Pan Treatment – 200 Tabs/Jar     | EA  | 4              |
| SCM-181-06  | Flow-Plus™ Condensate Pan Treatment – 6 oz. Clamshells | EA  | 24             |
| SCM-184-MT  | Flow-Plus™ Condensate Pan Treatment – 10 oz. Tubs      | EA  | 18             |
| SCM-182-HT  | Flow-Plus™ Condensate Pan Treatment – 1.25 lb. Tubs    | EA  | 8              |
| SCM-185-8   | Flow-Plus™ Condensate Pan Treatment – 7.5 lb. Tubs     | EA  | 1              |

### Flow-Plus™ Pump Treatment Tablets for Condensate Pumps

A unique polymer pan treatment in tablet form for use exclusively in DiversiTech's condensate pump. The tablet dispensing drawer in the pump holds 3 tablets. A dosage lasts up to 3 months depending on the volume of condensate generated. Even when fully dissolved, the tablets provide a lasting treatment in the pump and downstream drain line. Provides long-lasting treatment that controls slime growth over time and can extend the life of the pump.



SCM-186-6



| CATALOG NO. | DESCRIPTION   | UOM | ORDER MULTIPLE |
|-------------|---|-----|----------------|
| SCM-186-6   | Flow-Plus™ for Condensate Pumps – 6 Tablets/Clamshell | EA  | 36             |

### Pro-Treat® Pan Strips

Pro-Treat® Pan Strips kill odor causing bacteria and last up to 6 months. Use in the primary drain pan of cooling units such as air conditioners and refrigerators. Pro-Treat® Pan Strips control foul-smelling odors caused by mildew, fungi, bacteria, algae, and slime. For use in hotels, schools, colleges, hospitals, nursing homes, airports, and many other locations.



| CATALOG NO. | DESCRIPTION                               | STRIPS/PACK | UOM | ORDER MULTIPLE |
|-------------|---|-------------|-----|----------------|
| PS-075      | Pro-Treat® Pan Strips – for up to 3/4 Ton | 10          | EA  | 12             |
| PS-01       | Pro-Treat® Pan Strips – for 1 to 2 Ton    | 10          | EA  | 12             |
| PS-03       | Pro-Treat® Pan Strips – for 3 to 5 Ton    | 6           | EA  | 24             |
| PS-07       | Pro-Treat® Pan Strips – for 7 to 12 Ton   | 2           | EA  | 24             |
| PS-20       | Pro-Treat® Pan Strips – for 20 to 25 Ton  | 1           | EA  | 24             |
| PS-40       | Pro-Treat® Pan Strips – for 40 to 50 Ton  | 1           | EA  | 12             |

EPA Registration #6836-254-69966

| DiversiTech Pro-Treat Pan Strips | Pan Guard | Hydrobalance Sta-Clean | Ace Pan Protectors | Trane Time Release | Vapco Sani-Pan Strips |
|----------------------------------|-----------|------------------------|--------------------|--------------------|-----------------------|
| PS-075                           | AG4/.75H  | CS-50 & 50B            | TR14               | CHM00256           | SPS-1T                |
| PS-01                            | AG6/1.50H | CS-100                 | TR28               | CHM00257           | SPS-3T                |
| PS-03                            | AG12/1.5H | CS-250                 | TR65               | CHM00258           | SPS-5T                |
| PS-07                            | AG-N2     | CS-600                 | TR150              | CHM00259           | SPS-10T               |
| PS-20                            | AG-N      | CS-1200                | TR300              | CHM00260           | SPS-20T               |
| PS-40                            | AG-D      |                        | TR300D             | CHM00264           | SPS-50T               |

## AIR FILTER PRODUCTS

### Filter-Aide™ AC and Furnace Filter Enhancer

Polymer-charged formula enhances filter performance by helping filter triggering pollutants. Improves indoor air quality. Will not support bacteria growth. Prolongs equipment life and is compatible with all air filters.



SCM-713-32

| CATALOG NO. | DESCRIPTION  | UOM | ORDER MULTIPLE |
|-------------|--|-----|----------------|
| SCM-713-32  | Filter-Aide™ AC and Furnace Filter Enhancer – 32 oz. Container   | EA  | 12             |
| SCM-713-01  | Filter-Aide™ AC and Furnace Filter Enhancer – 1 Gallon Container | EA  | 4              |



Literature – Download all literature from the DiversiTech website using the Form ID shown in the icon. The URL is [www.diversitech.com/literature/FORMID.pdf](http://www.diversitech.com/literature/FORMID.pdf)

## ICE MACHINE PRODUCTS

### Super-Kool™ Nickel-Safe and Metal-Safe Ice Machine Cleaner

An economical, fast-acting, non-foaming acid sequestrant formula that quickly removes soil and mineral buildup. This safe, highly-concentrated, inhibited formula will not attack nickel or other metal components. USDA AUTHORIZED



| CATALOG NO.           | DESCRIPTION  | UOM | ORDER MULTIPLE |
|-----------------------|--|-----|----------------|
| SCM-705-16            | Super-Kool™ Ice Machine Cleaner – 16 oz. Bottle      | EA  | 12             |
| SCM-705-01            | Super-Kool™ Ice Machine Cleaner – 1 Gallon Container | EA  | 4              |
| SCM-705-05            | Super-Kool™ Ice Machine Cleaner – 5 Gallon Pail      | EA  | 1              |
| <b>NEW</b> SCM-705-30 | Super-Kool™ Ice Machine Cleaner – 30 Gallon Drum     | EA  | 1              |

## REFRIGERATION OILS

### Pro-Lube™ Mineral Oil

Specialty Chemical mineral oil (by Calumet) is a superior mineral naphthenic refrigeration oil designed to meet the operating requirements of modern residential and commercial air conditioning and refrigeration compressors. These oils have a low pour point, low wax floc temperature and are chemically and thermally stable in the presence of refrigerants. OEM approved by Copeland, Carlyle, Trane, and other major compressor manufacturers. Always follow compressor manufacturer's oil viscosity recommendations. Mineral oil is specially recommended for lubrication of compressors containing ammonia, R-11, 12, 13, 22, 113, 114, 123, 500 and 502 refrigerants in residential, industrial and commercial service. DO NOT USE WITH HFC REFRIGERANTS SUCH AS R-134A.



| CATALOG NO. | DESCRIPTION   | UOM | ORDER MULTIPLE |
|-------------|---|-----|----------------|
| 3WF-01      | SUS150 ISO32 Pro-Lube™ Mineral Oil – 1 Gallon Jug   | EA  | 4              |
| 3WF-05      | SUS150 ISO32 Pro-Lube™ Mineral Oil – 5 Gallon Pail  | EA  | 1              |
| 3WF-55      | SUS150 ISO32 Pro-Lube™ Mineral Oil – 55 Gallon Drum | EA  | 1              |
| 4WF-01      | SUS300 ISO68 Pro-Lube™ Mineral Oil – 1 Gallon Jug   | EA  | 4              |
| 4WF-05      | SUS300 ISO68 Pro-Lube™ Mineral Oil – 5 Gallon Pail  | EA  | 1              |
| 4WF-55      | SUS300 ISO68 Pro-Lube™ Mineral Oil – 55 Gallon Drum | EA  | 1              |

### Pro-Lube-ALK™ Alkylbenzene

Specialty Chemical alkylbenzene is recommended for refrigeration, air conditioning, and heat pump applications using HCFC and CFC refrigerants. An excellent choice when retrofitting to the new refrigerants which are HCFC based such as R-401A (MP-39), R-401B (MP-66), R-402A (HP-80), R-402B (HP-81). OEM approved by Copeland and other compressor manufacturers.



| CATALOG NO. | DESCRIPTION   | UOM | ORDER MULTIPLE |
|-------------|---|-----|----------------|
| ALK150-01   | SUS150 ISO32 Pro-Lube™ Alkylbenzene – 1 Gallon Jug  | EA  | 4              |
| ALK150-05   | SUS150 ISO32 Pro-Lube™ Alkylbenzene – 5 Gallon Drum | EA  | 1              |
| ALK200-01   | SUS200 ISO46 Pro-Lube™ Alkylbenzene – 1 Gallon Jug  | EA  | 4              |
| ALK300-01   | SUS300 ISO68 Pro-Lube™ Alkylbenzene – 1 Gallon Jug  | EA  | 4              |
| ALK300-05   | SUS300 ISO68 Pro-Lube™ Alkylbenzene – 5 Gallon Drum | EA  | 1              |

### Pro-Lube-POE™ Polyolester

Specialty Chemical POE is custom formulated for use in refrigeration compressors. This series contains no ozone depleting substances and is compatible with new HFC refrigerants as well as existing CFC and HCFC refrigerants. POE is also compatible with traditional mineral oil lubricants.



| CATALOG NO. | DESCRIPTION  | UOM | ORDER MULTIPLE |
|-------------|--|-----|----------------|
| POE32-32    | SUS150 ISO32 Pro-Lube-POE™ Polyolester – 1 Quart Can   | EA  | 12             |
| POE32-01    | SUS150 ISO32 Pro-Lube-POE™ Polyolester – 1 Gallon Can  | EA  | 6              |
| POE68-32    | SUS300 ISO68 Pro-Lube-POE™ Polyolester – 1 Quart Can   | EA  | 12             |
| POE68-01    | SUS300 ISO68 Pro-Lube-POE™ Polyolester – 1 Gallon Can  | EA  | 6              |
| POE100-32   | SUS500 ISO100 Pro-Lube-POE™ Polyolester – 1 Quart Can  | EA  | 12             |
| POE100-01   | SUS500 ISO100 Pro-Lube-POE™ Polyolester – 1 Gallon Can | EA  | 6              |

## VACUUM PUMP OIL

### Pro-Lube-VAC™ Vacuum Pump Oil

Specialty Chemical VP-68 Premium Vacuum Pump Oil is now based on a highly refined paraffinic based stock. This new improved formulation is lighter in color and provides better viscosity and oxidation stability than the previous formulation. VP-68 provides excellent cold start performance; formulated to meet minimum moisture content specifications.



| CATALOG NO. | DESCRIPTION                                    | UOM | ORDER MULTIPLE |
|-------------|--|-----|----------------|
| VP68-32     | Pro-Lube-VAC™ Vacuum Pump Oil – 1 Quart Jug    | EA  | 12             |
| VP68-01     | Pro-Lube-VAC™ Vacuum Pump Oil – 1 Gallon Jug   | EA  | 4              |
| VP68-05     | Pro-Lube-VAC™ Vacuum Pump Oil – 5 Gallon Pail  | EA  | 1              |
| VP68-55     | Pro-Lube-VAC™ Vacuum Pump Oil – 55 Gallon Drum | EA  | 1              |

## DEODORIZERS AND DEGREASERS

### Blue Blitz™ New Concept Cleaner-Deodorizer-Degreaser

Blue Blitz™ is a unique, fast-acting formula that cuts through tough grime and grease as it cleans and deodorizes. It is easy-to-use and cleans smudges and stains in one step.



| CATALOG NO. | DESCRIPTION   | UOM | ORDER MULTIPLE |
|-------------|---|-----|----------------|
| SCM-815-32  | Blue Blitz™ Cleaner-Deodorizer-Degreaser – 32 oz.   | EA  | 12             |
| SCM-815-01  | Blue Blitz™ Cleaner-Deodorizer-Degreaser – 1 Gallon | EA  | 4              |

### Saf-T-Kleen II™ Safety Solvent Degreaser

Non-conductive Saf-T-Kleen II™ is safe for use on motors and electrical circuitry. The fast-drying formula has powerful dissolving action that leaves no residue. It is a no-flash formula eliminating fire hazards.



| CATALOG NO. | DESCRIPTION                                  | UOM | ORDER MULTIPLE |
|-------------|--|-----|----------------|
| SCM-816-01  | Saf-T-Kleen II™ Solvent Degreaser – 1 Gallon | EA  | 4              |

## ODOR NEUTRALIZERS

### Duct-Fresh Gel

A non-toxic, super-effective odor neutralizer for HVAC ducts, proficient at destroying stubborn odors including pet, smoke, and musty smells in residential, industrial and commercial applications. Effective for up to 6 months.



| CATALOG NO.           | DESCRIPTION               | UOM | ORDER MULTIPLE |
|-----------------------|---------------------------|-----|----------------|
| SCM-832-08            | Duct-Fresh Gel – 8 oz.    | EA  | 12             |
| SCM-832-16            | Duct-Fresh Gel – 16 oz.   | EA  | 8              |
| <b>NEW</b> SCM-831-32 | Duct-Fresh Spray – 32 oz. | EA  | 12             |
| SCM-832-48            | Duct-Fresh Gel – 48 oz.   | EA  | 8              |

### Duct-Fresh Spray

A non-toxic, instantaneous, super-effective odor neutralizer for HVAC ducts. Destroys stubborn pet odors, smoke, and musty smells in residential, industrial and commercial applications. Great for spot-treating malodor problem areas.



| CATALOG NO. | DESCRIPTION                | UOM | ORDER MULTIPLE |
|-------------|----------------------------|-----|----------------|
| SCM-831-32  | Duct-Fresh Spray – 1 Quart | EA  | 12             |

Specialty Chemical produces the most complete line of industrial coolant and heat transfer products in the HVAC/R Industry. Our product line includes ProTek PG propylene glycol products formulated with food-grade corrosion inhibitors and ProTek EG ethylene glycol products for industrial applications. Both product groups are designed to provide freeze and burst protection and are formulated with inhibitors and antifoam agents to provide long-term stability against system corrosion and fouling.

## ProTek™ Closed Loop Heat Transfer Fluid

ProTek™ for closed loop water recirculation systems is a blue liquid. Available in three concentrations: original ProTek-100™, ProTek-50™, and ProTek-Plus™. Each concentration may be further diluted to alter freeze and burst temperatures. Refer to the technical data sheet for specific information.

SCM-129-01



| CATALOG NO.            | DESCRIPTION                       | GLYCOL/<br>WATER RATIO | UOM | ORDER<br>MULTIPLE |
|------------------------|-----------------------------------|------------------------|-----|-------------------|
| SCM-126-01             | ProTek-50™ – 1 Gallon Jug         | 35/65                  | EA  | 4                 |
| SCM-126-05             | ProTek-50™ – 5 Gallon Pail        | 35/65                  | EA  | 1                 |
| <b>NEW</b> SCM-126-30  | ProTek-PG™-50 – 30 Gallon Drum    | 35/65                  | EA  | 1                 |
| SCM-126-55             | ProTek-50™ – 55 Gallon Drum       | 35/65                  | EA  | 1                 |
| SCM-129-01             | ProTek-100™ – 1 Gallon Jug        | 70/30                  | EA  | 4                 |
| SCM-129-05             | ProTek-100™ – 5 Gallon Pail       | 70/30                  | EA  | 1                 |
| <b>NEW</b> SCM-129-30  | ProTek-100™ – 30 Gallon Drum      | 70/30                  | EA  | 1                 |
| SCM-129-55             | ProTek-100™ – 55 Gallon Drum      | 70/30                  | EA  | 1                 |
| SCM-129-275            | ProTek-100™ – 275 Gallon Tote     | 70/30                  | EA  | 1                 |
| SCM-128-01             | ProTek-Plus™ – 1 Gallon Jug       | 95/5                   | EA  | 4                 |
| SCM-128-05             | ProTek-Plus™ – 5 Gallon Pail      | 95/5                   | EA  | 1                 |
| <b>NEW</b> SCM-128-30  | ProTek-PG™-Plus – 30 Gallon Drum  | 95/5                   | EA  | 1                 |
| SCM-128-55             | ProTek-Plus™ – 55 Gallon Drum     | 95/5                   | EA  | 1                 |
| <b>NEW</b> SCM-140-01  | ProTek PG™ 5050 – 1 Gallon Jug    | 50/50                  | EA  | 1                 |
| <b>NEW</b> SCM-140-55  | ProTek PG™ 5050 – 55 Gallon Drum  | 50/50                  | EA  | 1                 |
| <b>NEW</b> SCM-140-275 | ProTek PG™ 5050 – 275 Gallon Tote | 50/50                  | EA  | 1                 |
| <b>NEW</b> SCM-127-55  | ProTek PG™ 6040 – 55 Gallon Drum  | 60/40                  | EA  | 1                 |

## ProTek-RV™ for Recreational Vehicles

An economical, effective solution to prevent freeze and burst of water lines in RV's, boats, and vacation homes.

SCM-132-01



| CATALOG NO.           | DESCRIPTION                    | GLYCOL/<br>WATER RATIO | UOM | ORDER<br>MULTIPLE |
|-----------------------|--------------------------------|------------------------|-----|-------------------|
| SCM-132-01            | ProTek-RV™ – 1 Gallon Jug      | 28/72                  | EA  | 4                 |
| SCM-132-05            | ProTek-RV™ – 5 Gallon Pail     | 28/72                  | EA  | 1                 |
| <b>NEW</b> SCM-132-30 | ProTek-PG™-RV – 30 Gallon Drum | 28/72                  | EA  | 1                 |
| SCM-132-55            | ProTek-RV™ – 55 Gallon Drum    | 28/72                  | EA  | 1                 |

## Glycol Inhibitors

Extend the service life of glycols with Pro-Tek™ Inhibitor. Pro-Tek™ Inhibitor is a glycol corrosion inhibitor additive designed for use in both propylene and ethylene glycol heat transfer/antifreeze solutions. Pro-Tek™ Inhibitor extends the glycol service life by restoring residual alkalinity and neutralization of acids. Pro-Tek™ Inhibitor is both non-toxic and food safe.

SCM-117-16



| CATALOG NO. | DESCRIPTION                                  | UOM | ORDER<br>MULTIPLE |
|-------------|--|-----|-------------------|
| SCM-117-16  | Glycol Corrosion Inhibitor Additive – 16 oz. | EA  | 12                |

## ProTek EG™

An inhibited ethylene glycol based heat transfer fluid designed for use in hydronic, chilled and closed water.

SCM-123-01



| CATALOG NO.           | DESCRIPTION                          | GLYCOL/<br>WATER RATIO | UOM | ORDER<br>MULTIPLE |
|-----------------------|--------------------------------------|------------------------|-----|-------------------|
| SCM-123-01            | ProTek EG™ – 1 Gallon Jug            | 95/5                   | EA  | 4                 |
| SCM-123-05            | ProTek EG™ – 5 Gallon Pail           | 95/5                   | EA  | 1                 |
| SCM-123-30            | ProTek EG™ – 30 Gallon Pail          | 95/5                   | EA  | 1                 |
| SCM-123-55            | ProTek EG™ – 55 Gallon Drum          | 95/5                   | EA  | 1                 |
| <b>NEW</b> SCM-124-01 | ProTek EG™-30 – 1 Gallon Jug         | 30/70                  | EA  | 4                 |
| <b>NEW</b> SCM-124-05 | ProTek EG™-30 – 5 Gallon Pail        | 30/70                  | EA  | 1                 |
| <b>NEW</b> SCM-124-55 | ProTek EG™-30 – 55 Gallon Drum       | 30/70                  | EA  | 1                 |
| <b>NEW</b> SCM-137-01 | ProTek EG™ 4060 Bulk – 1 Gallon Jug  | 40/60                  | EA  | 4                 |
| <b>NEW</b> SCM-138-01 | ProTek EG™ 5050 Bulk – 1 Gallon Jug  | 50/50                  | EA  | 4                 |
| <b>NEW</b> SCM-138-05 | ProTek EG™ 5050 Bulk – 5 Gallon Pail | 50/50                  | EA  | 1                 |

## ProTek™ PG-AL – Safe for Aluminum Heat Exchangers

Universal heat transfer fluid. An inhibited heat transfer fluid that is safe for use in boilers and hydronic systems including aluminum heat exchangers. Operating range is -100°F to 190°F. ProTek™ PG-AL is an orange liquid.

SCM-134-01



| CATALOG NO. | DESCRIPTION                    | GLYCOL/<br>WATER RATIO | UOM | ORDER<br>MULTIPLE |
|-------------|--------------------------------|------------------------|-----|-------------------|
| SCM-134-01  | ProTek™ PG-AL – 1 Gallon Jug   | 70/30                  | EA  | 4                 |
| SCM-134-05  | ProTek™ PG-AL – 5 Gallon Pail  | 70/30                  | EA  | 1                 |
| SCM-134-30  | ProTek™ PG-AL – 30 Gallon Drum | 70/30                  | EA  | 1                 |
| SCM-134-55  | ProTek™ PG-AL – 55 Gallon Drum | 70/30                  | EA  | 1                 |

## ProTek-BG™ for Cast Iron Water Boilers

A red liquid boiler grade product formulated specifically with corrosion inhibitors necessary for use in water boilers.

SCM-130-01



| CATALOG NO.           | DESCRIPTION                    | GLYCOL/<br>WATER RATIO | UOM | ORDER<br>MULTIPLE |
|-----------------------|--------------------------------|------------------------|-----|-------------------|
| SCM-130-01            | ProTek-BG™ – 1 Gallon Jug      | 70/30                  | EA  | 4                 |
| SCM-130-05            | ProTek-BG™ – 5 Gallon Pail     | 70/30                  | EA  | 1                 |
| <b>NEW</b> SCM-130-30 | ProTek-PG™-BG – 30 Gallon Drum | 70/30                  | EA  | 1                 |
| SCM-130-55            | ProTek-BG™ – 55 Gallon Drum    | 70/30                  | EA  | 1                 |

### Specialty Chemical Glycol Cross Reference Chart

| Specialty Chemical         | Product No. | Description      | Color  | Hercules          | Noble          | Interstate      | Houghton     | Utility               | Harvey          | Black Swan             | Whitlam        | Nu-Calgon     | Va. KMP    | Camco                | ComStar     | SOS            |
|----------------------------|-------------|------------------|--------|-------------------|----------------|-----------------|--------------|-----------------------|-----------------|------------------------|----------------|---------------|------------|----------------------|-------------|----------------|
| ProTek-PG-Plus             | SCM-128     | Concentrate 95%  | Blue   | Cryo-tek AG       | Super No Burst | Intercool P-300 | Safe-T-Therm | Super Polar No-Freeze |                 | Freeze-Guard Sub Artic | Freeze-Fighter |               |            |                      | ProFrost    | SOS Antifreeze |
| ProTek-PG-100              | SCM-129     | -100 F Burst 70% | Blue   | Cryo-tek -100     | No Burst -100  |                 |              | No-Freeze             | Harvey Heat 100 | Freeze-Guard AG        |                | Freez Kontr'l | Pipe-Saver | Winter Ban 100       | Freeze-Safe |                |
| ProTek-PG-BG Boiler Grade  | SCM-130     | -100 F Burst 70% | Red    |                   |                |                 |              |                       |                 |                        |                |               |            | Boiler Antifreeze AL |             |                |
| ProTek-PG-AL Aluminum Safe | SCM-134     | -100 F Burst 70% | Orange |                   | No Burst AL    |                 |              |                       |                 | Freeze-Guard           |                |               |            |                      |             |                |
| ProTek-PG-50               | SCM-126     | -50 F Burst 35%  | Blue   | Cryo-tek Original | No Burst LC    |                 |              | Pipe Guard            | Harvey Heat 50  |                        |                |               |            |                      |             |                |
| ProTek-PG-RV               | SCM-132     | RTU 28%          | Blue   |                   | RV             |                 |              | RV Guard              | Harvey Heat RV  |                        |                | Burst Kontr'l |            | RV                   |             |                |
| ProTek-PG-60/40            | SCM-127     | 60% glycol       | Blue   |                   |                | Intercool NFE   | Wintrex      |                       |                 |                        |                | freez-therm   |            |                      |             |                |
| ProTek EG                  | SCM-123     | Concentrate 95%  | Pink   |                   |                |                 |              |                       |                 |                        |                |               |            |                      |             |                |
| ProTek EG 50/50            | SCM-138     | 50% glycol       | Pink   |                   |                |                 |              |                       |                 |                        |                |               |            | Frost Free           |             |                |
| ProTek EG 40/60            | SCM-137     | 40% glycol       | Pink   |                   |                |                 |              |                       |                 |                        |                |               |            |                      |             |                |

### HEATING PRODUCTS

#### Sure Burn™ Concentrated Fuel Oil Treatment

A state-of-the-art fuel oil treatment designed to insure oil burner ignition even in the most extreme weather conditions. Sure Burn™ acts as a water dispersant and promotes cleaner, more efficient combustion. Also inhibits sludge formation and combats fuel tank corrosion.



| CATALOG NO. | DESCRIPTION   | UOM | ORDER MULTIPLE |
|-------------|---|-----|----------------|
| HP-SB-16    | Sure Burn™ Concentrated Heating Fuel Treatment – 16 oz. | EA  | 12             |

#### Spill Kill™ Powder – Fuel Spill Deodorant and Absorbent

A one-step liquid absorbent and deodorant with a convenient shaker top. Multi-functional Spill Kill™ absorbs and deodorizes fuel oil and other liquid spills. The unique granular formula soaks up liquids and entraps odors much faster than dusty powders. The quick-absorbing action minimizes the slip hazards associated with liquid spills.



| CATALOG NO. | DESCRIPTION  | UOM | ORDER MULTIPLE |
|-------------|--|-----|----------------|
| HP-SKDP-20  | Spill Kill™ Granular Fuel Oil Deodorant and Absorbent – 20 oz. | EA  | 12             |

#### Spill Kill™ Liquid – Fuel Spill Deodorant Spray

Neutralizes noxious fuel oil odors while imparting a pleasant residual fragrance. Using the trigger spray applicator, spray directly on the spill and mist into the air as a space deodorant. The safe, non-flammable formula lends itself to other deodorizing applications where noxious odors are a problem.



| CATALOG NO. | DESCRIPTION                                     | UOM | ORDER MULTIPLE |
|-------------|---|-----|----------------|
| HP-SKDS-16  | Spill Kill™ Fuel Spill Deodorant Spray – 16 oz. | EA  | 12             |

#### Soot Kill™ – Catalytic Soot Remover

Ready-to-use, non-flammable, non-corrosive catalytic soot remover cleans the combustion chamber. Catalytic cleaning action reduces time-consuming vacuuming of the burner chamber. Residual action slows soot accumulation.



| CATALOG NO. | DESCRIPTION                                      | UOM | ORDER MULTIPLE |
|-------------|--|-----|----------------|
| HP-SK-16    | Soot Kill™ Catalytic Soot Remover Spray – 16 oz. | EA  | 12             |

## Garden Hose

High quality product priced for high volume sales. Soft-Flex formulation makes the 5 ply Hose easy to handle. Withstands 500 psi water pressure. Heavy duty solid brass couplings and collar. Full Lifetime Guarantee!

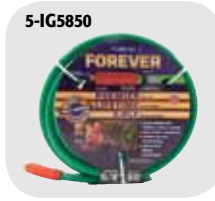

| CATALOG NO. | DESCRIPTION                             | UOM | ORDER MULTIPLE |
|-------------|---|-----|----------------|
| 5-IG5850    | Green Flexion 5-Ply Forever Garden Hose | EA  | 5              |

## Hot Water Hose

High burst strength. 500 PSI. Withstands hot water up to 160°F. EPDM tube. Heavy duty solid brass couplings.



| CATALOG NO. | DESCRIPTION               | UOM | ORDER MULTIPLE |
|-------------|---------------------------|-----|----------------|
| 5-HW5850    | 5/8" x 50' Hot Water Hose | EA  | 5              |

## Power Sprayer

DiversiTech's new Power Sprayer makes coil cleaning easier and faster! Designed as a backpack sprayer, it holds up to 4 gallons of coil cleaning solution. The battery powered unit will spray continuously for 10 hours on a single charge. Included are three different nozzles to give you the right spray for any situation. It also features: padded backpack straps for a comfortable fit, plug-in charger for fast recharging, a convenient center mount handle, an extra long spray wand with curved tip for accurate application, and a large on/off valve which can lock in position for easier spraying of big jobs. The large tank opening also makes it easy to add coil cleaner and mix to the correct ratio. The Power Sprayer is compatible with all DiversiTech coil cleaners.



| CATALOG NO. | DESCRIPTION   | UOM | ORDER MULTIPLE |
|-------------|---|-----|----------------|
| PS-1        | Battery powered/rechargeable backpack sprayer for coil cleaning | EA  | 1              |
| PS-1W       | Replacement Wand for Power Sprayer                              | EA  | 1              |

## Compression Sprayers

Acid impervious poly design with a 36" (91cm) reinforced hose, shut-off with lock-on feature for continuous spraying, a 2-piece nozzle that's detachable for easy clean up and fits directly to the shut-off or extension wand. The Hand-Held Sprayer has a 48 oz. (1.4 l) capacity, perfect for small areas. All sprayers have a full 5 year warranty.



| CATALOG NO. | DESCRIPTION           | UOM | ORDER MULTIPLE |
|-------------|-----------------------|-----|----------------|
| 1002        | Hand Held Sprayer     | EA  | 1              |
| 2601        | 1 Gallon Wand Sprayer | EA  | 1              |
| 2602        | 2 Gallon Wand Sprayer | EA  | 1              |
| 2603        | 3 Gallon Wand Sprayer | EA  | 1              |

## All Purpose Sprayers

Lightweight, versatile gallon size bottle has a 28" flexible hose and easy-to-carry handle. Best for big jobs in hard-to-reach places. Adjustable nozzle will atomize any low viscosity liquid. Adjusts from a mist to a 12' jet stream or anything in between. One pint container has a measured ounce guide. Ideal for water treatment chemicals.



| CATALOG NO. | DESCRIPTION         | UOM | ORDER MULTIPLE |
|-------------|---------------------|-----|----------------|
| BS-64       | Gallon Size Sprayer | EA  | 6              |
| BS-16       | Pint Size Sprayer   | EA  | 12             |
| BS-32       | Quart Size Sprayer  | EA  | 12             |

## Dial-a-Mix Sprayer

Save time and money by dialing in the exact mix ratio to properly clean the coil. This sprayer features 5 mix ratios, a 1/2 gallon capacity bottle and a quick disconnect for fast and easy rinsing.



| CATALOG NO. | DESCRIPTION        | UOM | ORDER MULTIPLE |
|-------------|--------------------|-----|----------------|
| 540-GUN     | Dial-a-Mix Sprayer | EA  | 6              |

## Pistol Grips & Water Nozzle

Pistol Grip – 572 Insulated:  
For spraying hot or cold water. Heavy-duty, self adjusting "duck" packing for lifetime proof seal.  
Water Nozzle – 573 Un-insulated:  
Heavy-duty and holds open clip for continuous spraying. Self-adjusting "duck" for leak proof seal.



| CATALOG NO. | DESCRIPTION              | UOM | ORDER MULTIPLE |
|-------------|--------------------------|-----|----------------|
| 540-572     | Insulated Pistol Grip    | EA  | 12             |
| 540-573     | Uninsulated Water Nozzle | EA  | 12             |



Literature – Download all literature from the DiversiTech website using the Form ID shown in the icon. The URL is [www.diversitech.com/literature/FORMID.pdf](http://www.diversitech.com/literature/FORMID.pdf)

# INLINE COMPONENTS

Access Fittings .....240  
 Brass Fittings .....234-236  
 Control Disconnect.....241  
 Copper Fittings.....236-239  
 Cushion Clamps.....245  
 Driers, Sight Glasses.....241-242  
 Line Piercing Valves and Tools.....242-243  
 Line Sets.....247  
 Refrigerant Charging.....244  
 Refrigerant Labels.....244  
 Refrigerant Recovery Products .....245  
 Tubing Insulation .....246



## BRASS FITTINGS

### Compression Sleeve



D60A-6

| CATALOG NO. | DESCRIPTION             | UOM | ORDER MULTIPLE |
|-------------|-------------------------|-----|----------------|
| D60A-4      | 1/4" Compression Sleeve | EA  | 100            |
| D60A-6      | 3/8" Compression Sleeve | EA  | 100            |
| D60A-8      | 1/2" Compression Sleeve | EA  | 100            |
| D60A-10     | 5/8" Compression Sleeve | EA  | 100            |

### Compression Nut



D61A-8

| CATALOG NO. | DESCRIPTION          | UOM | ORDER MULTIPLE |
|-------------|----------------------|-----|----------------|
| D61A-4      | 1/4" Compression Nut | EA  | 10             |
| D61A-6      | 3/8" Compression Nut | EA  | 10             |
| D61A-8      | 1/2" Compression Nut | EA  | 10             |
| D61A-10     | 5/8" Compression Nut | EA  | 10             |

### Compression Union



D62A-66

| CATALOG NO. | DESCRIPTION            | UOM | ORDER MULTIPLE |
|-------------|------------------------|-----|----------------|
| D62A-44     | 1/4" Compression Union | EA  | 10             |
| D62A-66     | 3/8" Compression Union | EA  | 10             |
| D62A-88     | 1/2" Compression Union | EA  | 10             |
| D62A-1010   | 5/8" Compression Union | EA  | 10             |

### Compression Tee



D64A-88

| CATALOG NO. | DESCRIPTION          | UOM | ORDER MULTIPLE |
|-------------|----------------------|-----|----------------|
| D64A-44     | 1/4" Compression Tee | EA  | 10             |
| D64A-66     | 3/8" Compression Tee | EA  | 10             |
| D64A-88     | 1/2" Compression Tee | EA  | 10             |
| D64A-1010   | 5/8" Compression Tee | EA  | 10             |

### Compression Connector



D68A-6B

| CATALOG NO. | DESCRIPTION                       | UOM | ORDER MULTIPLE |
|-------------|-----------------------------------|-----|----------------|
| D68A-4B     | 1/4" x 1/4" Compression Connector | EA  | 10             |
| D68A-6C     | 3/8" x 3/8" Compression Connector | EA  | 10             |
| D68A-8D     | 1/2" x 1/2" Compression Connector | EA  | 10             |
| D68A-4A     | 1/4" x 1/8" Compression Connector | EA  | 10             |
| D68A-6B     | 3/8" x 1/4" Compression Connector | EA  | 10             |
| D68A-6D     | 3/8" x 1/2" Compression Connector | EA  | 10             |

### Compression Elbow



D69A-6D

| CATALOG NO. | DESCRIPTION                   | UOM | ORDER MULTIPLE |
|-------------|-------------------------------|-----|----------------|
| D69A-4A     | 1/4" x 1/8" Compression Elbow | EA  | 10             |
| D69A-4B     | 1/4" x 1/4" Compression Elbow | EA  | 10             |
| D69A-6B     | 3/8" x 1/4" Compression Elbow | EA  | 10             |
| D69A-6C     | 3/8" x 3/8" Compression Elbow | EA  | 10             |
| D69A-6D     | 3/8" x 1/2" Compression Elbow | EA  | 10             |
| D69A-8D     | 1/2" x 1/2" Compression Elbow | EA  | 10             |

### Flare x MIP Elbow



DE1-6C

| CATALOG NO. | DESCRIPTION                 | UOM | ORDER MULTIPLE |
|-------------|-----------------------------|-----|----------------|
| DE1-4B      | 1/4" Flare x 1/4" MIP Elbow | EA  | 10             |
| DE1-6C      | 3/8" Flare x 3/8" MIP Elbow | EA  | 10             |
| DE1-8D      | 1/2" Flare x 1/2" MIP Elbow | EA  | 10             |
| DE1-12E     | 3/4" Flare x 3/4" MIP Elbow | EA  | 10             |

### Flare x MIP Reducing Elbow



DE1-6B

| CATALOG NO. | DESCRIPTION                          | UOM | ORDER MULTIPLE |
|-------------|--------------------------------------|-----|----------------|
| DE1-6B      | 3/8" Flare x 1/4" MIP Reducing Elbow | EA  | 10             |
| DE1-6D      | 3/8" Flare x 1/2" MIP Reducing Elbow | EA  | 10             |
| DE1-8E      | 1/2" Flare x 3/4" MIP Reducing Elbow | EA  | 10             |
| DE1-8C      | 1/2" Flare x 3/8" MIP Reducing Elbow | EA  | 10             |
| DE1-10D     | 5/8" Flare x 1/2" MIP Reducing Elbow | EA  | 10             |
| DE1-12D     | 3/4" Flare x 1/2" MIP Reducing Elbow | EA  | 10             |

Short Nut



| CATALOG NO. | DESCRIPTION     | UOM | ORDER MULTIPLE |
|-------------|-----------------|-----|----------------|
| DN1-3       | 3/16" Short Nut | EA  | 10             |
| DN1-4       | 1/4" Short Nut  | EA  | 10             |
| DN1-5       | 5/16" Short Nut | EA  | 10             |
| DN1-6       | 3/8" Short Nut  | EA  | 10             |
| DN1-8       | 1/2" Short Nut  | EA  | 10             |
| DN1-10      | 5/8" Short Nut  | EA  | 10             |
| DN1-12      | 3/4" Short Nut  | EA  | 10             |
| DN1-14      | 7/8" Short Nut  | EA  | 5              |

Cap



| CATALOG NO. | DESCRIPTION | UOM | ORDER MULTIPLE |
|-------------|-------------|-----|----------------|
| DN5-4       | 1/4" Cap    | EA  | 10             |
| DN5-6       | 3/8" Cap    | EA  | 10             |
| DN5-8       | 1/2" Cap    | EA  | 10             |
| DN5-10      | 5/8" Cap    | EA  | 10             |

Short Forged Flare Nut



| CATALOG NO. | DESCRIPTION                 | UOM | ORDER MULTIPLE |
|-------------|-----------------------------|-----|----------------|
| DNS4-4      | 1/4" Short Forged Flare Nut | EA  | 10             |
| DNS4-6      | 3/8" Short Forged Flare Nut | EA  | 10             |
| DNS4-8      | 1/2" Short Forged Flare Nut | EA  | 10             |
| DNS4-10     | 5/8" Short Forged Flare Nut | EA  | 10             |
| DNS4-12     | 3/4" Short Forged Flare Nut | EA  | 10             |
| DNS4-14     | 7/8" Short Forged Flare Nut | EA  | 5              |

Plug



| CATALOG NO. | DESCRIPTION | UOM | ORDER MULTIPLE |
|-------------|-------------|-----|----------------|
| DP2-4       | 1/4" Plug   | EA  | 10             |
| DP2-6       | 3/8" Plug   | EA  | 10             |
| DP2-8       | 1/2" Plug   | EA  | 10             |
| DP2-10      | 5/8" Plug   | EA  | 10             |

Flare Tee



| CATALOG NO. | DESCRIPTION    | UOM | ORDER MULTIPLE |
|-------------|----------------|-----|----------------|
| DT2-4       | 1/4" Flare Tee | EA  | 10             |
| DT2-6       | 3/8" Flare Tee | EA  | 10             |
| DT2-8       | 1/2" Flare Tee | EA  | 10             |
| DT2-10      | 5/8" Flare Tee | EA  | 5              |

Flare x MIP Union



| CATALOG NO. | DESCRIPTION                 | UOM | ORDER MULTIPLE |
|-------------|-----------------------------|-----|----------------|
| DU1-4A      | 1/4" Flare x 1/8" MIP Union | EA  | 10             |
| DU1-4B      | 1/4" Flare x 1/4" MIP Union | EA  | 10             |
| DU1-6B      | 3/8" Flare x 1/4" MIP Union | EA  | 10             |
| DU1-6C      | 3/8" Flare x 3/8" MIP Union | EA  | 10             |
| DU1-6D      | 3/8" Flare x 1/2" MIP Union | EA  | 10             |
| DU1-6E      | 3/8" Flare x 3/4" MIP Union | EA  | 10             |
| DU1-8B      | 1/2" Flare x 1/4" MIP Union | EA  | 10             |
| DU1-8C      | 1/2" Flare x 3/8" MIP Union | EA  | 10             |
| DU1-8D      | 1/2" Flare x 1/2" MIP Union | EA  | 10             |
| DU1-8E      | 1/2" Flare x 3/4" MIP Union | EA  | 10             |
| DU1-10D     | 5/8" Flare x 1/2" MIP Union | EA  | 10             |
| DU1-10E     | 5/8" Flare x 3/4" MIP Union | EA  | 10             |
| DU1-12D     | 3/4" Flare x 1/2" MIP Union | EA  | 10             |
| DU1-12E     | 3/4" Flare x 3/4" MIP Union | EA  | 10             |

Flare Union

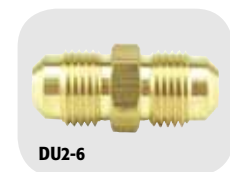

| CATALOG NO. | DESCRIPTION      | UOM | ORDER MULTIPLE |
|-------------|------------------|-----|----------------|
| DU2-4       | 1/4" Flare Union | EA  | 10             |
| DU2-6       | 3/8" Flare Union | EA  | 10             |
| DU2-8       | 1/2" Flare Union | EA  | 10             |
| DU2-10      | 5/8" Flare Union | EA  | 10             |
| DU2-12      | 3/4" Flare Union | EA  | 10             |
| DU2-14      | 7/8" Flare Union | EA  | 5              |

## BRASS FITTINGS cont'd

### Flare x FIP Union



| CATALOG NO.    | DESCRIPTION                   | UOM | ORDER MULTIPLE |
|----------------|-------------------------------|-----|----------------|
| <b>DU3-6C</b>  | 3/8" x 3/8" Flare x FIP Union | EA  | 10             |
| <b>DU3-6D</b>  | 3/8" x 1/2" Flare x FIP Union | EA  | 10             |
| <b>DU3-8C</b>  | 1/2" x 3/8" Flare x FIP Union | EA  | 10             |
| <b>DU3-8D</b>  | 1/2" x 1/2" Flare x FIP Union | EA  | 10             |
| <b>DU3-10D</b> | 5/8" x 1/2" Flare x FIP Union | EA  | 10             |
| <b>DU3-10E</b> | 5/8" x 3/4" Flare x FIP Union | EA  | 10             |

### Flare x Flare Swivel Union



| CATALOG NO.   | DESCRIPTION                          | UOM | ORDER MULTIPLE |
|---------------|--------------------------------------|-----|----------------|
| <b>DUS4-4</b> | 1/4" Flare x 1/4" Flare Swivel Union | EA  | 10             |
| <b>DUS4-6</b> | 3/8" Flare x 3/8" Flare Swivel Union | EA  | 10             |
| <b>DUS4-8</b> | 1/2" Flare x 1/2" Flare Swivel Union | EA  | 10             |

## COPPER FITTINGS

### Male Adapter C x M



| CATALOG NO.      | O.D. SIZE       | I.D. SIZE       | UOM | ORDER MULTIPLE |
|------------------|-----------------|-----------------|-----|----------------|
| <b>C101-0005</b> | 3/8" x 1/2"     | 1/4" x 1/2"     | EA  | 50             |
| <b>C101-0007</b> | 3/8" x 1/8"     | 1/4" x 1/8"     | EA  | 50             |
| <b>C101-0025</b> | 1/2" x 3/8"     | 3/8" x 3/8"     | EA  | 25             |
| <b>C101-0050</b> | 5/8" x 1/2"     | 1/2" x 1/2"     | EA  | 25             |
| <b>C101-0057</b> | 5/8" x 3/4"     | 1/2" x 3/4"     | EA  | 25             |
| <b>C101-0058</b> | 5/8" x 3/8"     | 1/2" x 3/8"     | EA  | 50             |
| <b>C101-0092</b> | 3/4" x 3/4"     | 5/8" x 3/4"     | EA  | 25             |
| <b>C101-0100</b> | 7/8" x 3/4"     | 3/4" x 3/4"     | EA  | 25             |
| <b>C101-0107</b> | 7/8" x 1/2"     | 3/4" x 1/2"     | EA  | 25             |
| <b>C101-0150</b> | 1-1/8" x 1"     | 1" x 1"         | EA  | 10             |
| <b>C101-0159</b> | 1-1/8" x 3/4"   | 1" x 3/4"       | EA  | 10             |
| <b>C101-0215</b> | 1-3/8" x 1-1/4" | 1-1/4" x 1-1/4" | EA  | 10             |
| <b>C101-0222</b> | 1-3/8" x 1"     | 1-1/4" x 1"     | EA  | 10             |
| <b>C101-0295</b> | 1-5/8" x 1-1/2" | 1-1/2" x 1-1/2" | EA  | 10             |
| <b>C101-0390</b> | 2-1/8" x 2"     | 2" x 2"         | EA  | 5              |

### Female Adapter C x F



| CATALOG NO.      | O.D. SIZE       | I.D. SIZE       | UOM | ORDER MULTIPLE |
|------------------|-----------------|-----------------|-----|----------------|
| <b>C105-0025</b> | 1/2" x 3/8"     | 3/8" x 3/8"     | EA  | 25             |
| <b>C105-0050</b> | 5/8" x 1/2"     | 1/2" x 1/2"     | EA  | 25             |
| <b>C105-0057</b> | 5/8" x 3/4"     | 1/2" x 3/4"     | EA  | 25             |
| <b>C105-0058</b> | 5/8" x 3/8"     | 1/2" x 3/8"     | EA  | 25             |
| <b>C105-0059</b> | 5/8" x 1/4"     | 1/2" x 1/4"     | EA  | 25             |
| <b>C105-0100</b> | 7/8" x 3/4"     | 3/4" x 3/4"     | EA  | 25             |
| <b>C105-0107</b> | 7/8" x 1/2"     | 3/4" x 1/2"     | EA  | 25             |
| <b>C105-0150</b> | 1-1/8" x 1"     | 1" x 1"         | EA  | 10             |
| <b>C105-0159</b> | 1-1/8" x 3/4"   | 1" x 3/4"       | EA  | 10             |
| <b>C105-0215</b> | 1-3/8" x 1-1/4" | 1-1/4" x 1-1/4" | EA  | 10             |
| <b>C105-0295</b> | 1-5/8" x 1-1/2" | 1-1/2" x 1-1/2" | EA  | 5              |
| <b>C105-0390</b> | 2-1/8" x 2"     | 2" x 2"         | EA  | 30             |

### Male Adapter Ftg. x M



| CATALOG NO.      | O.D. SIZE       | I.D. SIZE       | UOM | ORDER MULTIPLE |
|------------------|-----------------|-----------------|-----|----------------|
| <b>C114-0050</b> | 5/8" x 1/2"     | 1/2" x 1/2"     | EA  | 25             |
| <b>C114-0100</b> | 7/8" x 3/4"     | 3/4" x 3/4"     | EA  | 25             |
| <b>C114-0150</b> | 1-1/8" x 1"     | 1" x 1"         | EA  | 10             |
| <b>C114-0215</b> | 1-3/8" x 1-1/4" | 1-1/4" x 1-1/4" | EA  | 80             |
| <b>C114-0295</b> | 1-5/8" x 1-1/2" | 1-1/2" x 1-1/2" | EA  | 50             |
| <b>C114-0390</b> | 2-1/8" x 2"     | 2" x 2"         | EA  | 38             |

### Female Adapter Ftg. x F



| CATALOG NO.      | O.D. SIZE       | UOM | ORDER MULTIPLE |
|------------------|-----------------|-----|----------------|
| <b>C115-0050</b> | 5/8" x 1/2"     | EA  | 25             |
| <b>C115-0100</b> | 7/8" x 3/4"     | EA  | 25             |
| <b>C115-0150</b> | 1-1/8" x 1"     | EA  | 10             |
| <b>C115-0215</b> | 1-3/8" x 1-1/4" | EA  | 85             |
| <b>C115-0295</b> | 1-5/8" x 1-1/2" | EA  | 80             |
| <b>C115-0390</b> | 2-1/8" x 2"     | EA  | 40             |

90 Degree Ell C x C



| CATALOG NO. | O.D. SIZE | I.D. SIZE | UOM | ORDER MULTIPLE |
|-------------|-----------|-----------|-----|----------------|
| C235-0002   | 3/8"      | 1/4"      | EA  | 25             |
| C235-0025   | 1/2"      | 3/8"      | EA  | 25             |
| C235-0050   | 5/8"      | 1/2"      | EA  | 25             |
| C235-0090   | 3/4"      | 5/8"      | EA  | 25             |
| C235-0100   | 7/8"      | 3/4"      | EA  | 25             |
| C235-0107   | 7/8"      | 5/8"      | EA  | 25             |
| C235-0150   | 1-1/8"    | 1"        | EA  | 10             |
| C235-0215   | 1-3/8"    | 1-1/4"    | EA  | 50             |
| C235-0295   | 1-5/8"    | 1-1/2"    | EA  | 35             |
| C235-0390   | 2-1/8"    | 2"        | EA  | 17             |

90 Degree Street Ell Ftg. x C



| CATALOG NO. | O.D. SIZE | I.D. SIZE | UOM | ORDER MULTIPLE |
|-------------|-----------|-----------|-----|----------------|
| C254-0002   | 3/8"      | 1/4"      | EA  | 25             |
| C254-0025   | 1/2"      | 3/8"      | EA  | 25             |
| C254-0050   | 5/8"      | 1/2"      | EA  | 25             |
| C254-0090   | 3/4"      | 5/8"      | EA  | 25             |
| C254-0100   | 7/8"      | 3/4"      | EA  | 25             |
| C254-0150   | 1-1/8"    | 1"        | EA  | 10             |
| C254-0215   | 1-3/8"    | 1-1/4"    | EA  | 50             |
| C254-0295   | 1-5/8"    | 1-1/2"    | EA  | 35             |
| C254-0390   | 2-1/8"    | 2"        | EA  | 18             |

90 Degree Long Turn Ell C x C



| CATALOG NO. | O.D. SIZE | I.D. SIZE | UOM | ORDER MULTIPLE |
|-------------|-----------|-----------|-----|----------------|
| C242-0001   | 1/4"      | 1/8"      | EA  | 25             |
| C242-0002   | 3/8"      | 1/4"      | EA  | 25             |
| C242-0015   | 5/16"     | 1/4"      | EA  | 25             |
| C242-0025   | 1/2"      | 3/8"      | EA  | 25             |
| C242-0050   | 5/8"      | 1/2"      | EA  | 25             |
| C242-0090   | 3/4"      | 5/8"      | EA  | 25             |
| C242-0100   | 7/8"      | 3/4"      | EA  | 10             |
| C242-0150   | 1-1/8"    | 1"        | EA  | 10             |
| C242-0215   | 1-3/8"    | 1-1/4"    | EA  | 35             |
| C242-0295   | 1-5/8"    | 1-1/2"    | EA  | 25             |
| C242-0390   | 2-1/8"    | 2"        | EA  | 12             |

90 Degree Long Turn Street Ell Ftg. x C



| CATALOG NO. | O.D. SIZE | I.D. SIZE | UOM | ORDER MULTIPLE |
|-------------|-----------|-----------|-----|----------------|
| C272-0002   | 3/8"      | 1/4"      | EA  | 25             |
| C272-0025   | 1/2"      | 3/8"      | EA  | 25             |
| C272-0050   | 5/8"      | 1/2"      | EA  | 25             |
| C272-0090   | 3/4"      | 5/8"      | EA  | 25             |
| C272-0100   | 7/8"      | 3/4"      | EA  | 10             |
| C272-0150   | 1-1/8"    | 1"        | EA  | 10             |
| C272-0215   | 1-3/8"    | 1-1/4"    | EA  | 35             |
| C272-0295   | 1-5/8"    | 1-1/2"    | EA  | 25             |

45 Degree Ell C x C



| CATALOG NO. | O.D. SIZE | I.D. SIZE | UOM | ORDER MULTIPLE |
|-------------|-----------|-----------|-----|----------------|
| C290-0002   | 3/8"      | 1/4"      | EA  | 25             |
| C290-0025   | 1/2"      | 3/8"      | EA  | 25             |
| C290-0050   | 5/8"      | 1/2"      | EA  | 25             |
| C290-0090   | 3/4"      | 5/8"      | EA  | 25             |
| C290-0100   | 7/8"      | 3/4"      | EA  | 25             |
| C290-0150   | 1-1/8"    | 1"        | EA  | 10             |
| C290-0215   | 1-3/8"    | 1-1/4"    | EA  | 60             |
| C290-0295   | 1-5/8"    | 1-1/2"    | EA  | 40             |
| C290-0390   | 2-1/8"    | 2"        | EA  | 18             |

45 Degree Street Ell Ftg. x C



| CATALOG NO. | O.D. SIZE | I.D. SIZE | UOM | ORDER MULTIPLE |
|-------------|-----------|-----------|-----|----------------|
| C295-0002   | 3/8"      | 1/4"      | EA  | 25             |
| C295-0025   | 1/2"      | 3/8"      | EA  | 25             |
| C295-0050   | 5/8"      | 1/2"      | EA  | 25             |
| C295-0090   | 3/4"      | 5/8"      | EA  | 25             |
| C295-0100   | 7/8"      | 3/4"      | EA  | 25             |
| C295-0150   | 1-1/8"    | 1"        | EA  | 10             |
| C295-0215   | 1-3/8"    | 1-1/4"    | EA  | 60             |
| C295-0295   | 1-5/8"    | 1-1/2"    | EA  | 40             |
| C295-0390   | 2-1/8"    | 2"        | EA  | 18             |

**Coupling (Socket) with Rolled Tube Stop C x C**



| CATALOG NO. | O.D. SIZE | I.D. SIZE | UOM | ORDER MULTIPLE |
|-------------|-----------|-----------|-----|----------------|
| C165-0001   | 1/4"      | 1/8"      | EA  | 25             |
| C165-0002   | 3/8"      | 1/4"      | EA  | 25             |
| C165-0025   | 1/2"      | 3/8"      | EA  | 25             |
| C165-0050   | 5/8"      | 1/2"      | EA  | 25             |
| C165-0090   | 3/4"      | 5/8"      | EA  | 25             |
| C165-0100   | 7/8"      | 3/4"      | EA  | 25             |
| C165-0150   | 1-1/8"    | 1"        | EA  | 10             |
| C165-0215   | 1-3/8"    | 1-1/4"    | EA  | 100            |
| C165-0295   | 1-5/8"    | 1-1/2"    | EA  | 60             |
| C165-0390   | 2-1/8"    | 2"        | EA  | 40             |

**Reducer Coupling w/Stop C x C**



| CATALOG NO. | O.D. SIZE       | I.D. SIZE       | UOM | ORDER MULTIPLE |
|-------------|-----------------|-----------------|-----|----------------|
| C165-0007   | 3/8" x 1/4"     | 1/4" x 1/8"     | EA  | 25             |
| C165-0032   | 1/2" x 3/8"     | 3/8" x 1/4"     | EA  | 25             |
| C165-0058   | 5/8" x 1/2"     | 1/2" x 3/8"     | EA  | 25             |
| C165-0059   | 5/8" x 3/8"     | 1/2" x 1/4"     | EA  | 25             |
| C165-0093   | 3/4" x 5/8"     | 5/8" x 1/2"     | EA  | 25             |
| C165-0094   | 3/4" x 1/2"     | 5/8" x 3/8"     | EA  | 25             |
| C165-0149   | 7/8" x 3/4"     | 3/4" x 5/8"     | EA  | 25             |
| C165-0107   | 7/8" x 5/8"     | 3/4" x 1/2"     | EA  | 25             |
| C165-0159   | 1-1/8" x 7/8"   | 1" x 3/4"       | EA  | 10             |
| C165-1498   | 1-1/8" x 3/4"   | 1" x 5/8"       | EA  | 10             |
| C165-0222   | 1-3/8" x 1-1/8" | 1-1/4" x 1"     | EA  | 100            |
| C165-0223   | 1-3/8" x 7/8"   | 1-1/4" x 3/4"   | EA  | 100            |
| C165-0224   | 1-3/8" x 5/8"   | 1-1/4" x 1/2"   | EA  | 100            |
| C165-0303   | 1-5/8" x 1-3/8" | 1-1/2" x 1-1/4" | EA  | 100            |
| C165-0304   | 1-5/8" x 1-1/8" | 1-1/2" x 1"     | EA  | 100            |
| C165-0305   | 1-5/8" x 7/8"   | 1-1/2" x 3/4"   | EA  | 100            |
| C165-0306   | 1-5/8" x 5/8"   | 1-1/2" x 1/2"   | EA  | 100            |
| C165-0398   | 2-1/8" x 1-5/8" | 2" x 1-1/2"     | EA  | 50             |
| C165-0399   | 2-1/8" x 1-3/8" | 2" x 1-1/4"     | EA  | 50             |
| C165-0400   | 2-1/8" x 1-1/8" | 2" x 1"         | EA  | 50             |
| C165-0401   | 2-1/8" x 7/8"   | 2" x 3/4"       | EA  | 50             |
| C165-0402   | 2-1/8" x 5/8"   | 2" x 1/2"       | EA  | 50             |

**Union C x Brass**



| CATALOG NO. | O.D. SIZE | I.D. SIZE | UOM | ORDER MULTIPLE |
|-------------|-----------|-----------|-----|----------------|
| C657-0025   | 1/2"      | 3/8"      | EA  | 25             |
| C657-0050   | 5/8"      | 1/2"      | EA  | 25             |
| C657-0100   | 7/8"      | 3/4"      | EA  | 100            |
| C657-0150   | 1-1/8"    | 1"        | EA  | 50             |

**Fitting Reducer Coupling Ftg. x C**



| CATALOG NO. | O.D. SIZE       | I.D. SIZE       | UOM | ORDER MULTIPLE |
|-------------|-----------------|-----------------|-----|----------------|
| C410-0007   | 3/8" x 1/4"     | 1/4" x 1/8"     | EA  | 25             |
| C410-0032   | 1/2" x 3/8"     | 3/8" x 1/4"     | EA  | 25             |
| C410-0033   | 1/2" x 1/4"     | 3/8" x 1/8"     | EA  | 25             |
| C410-0058   | 5/8" x 1/2"     | 1/2" x 3/8"     | EA  | 25             |
| C410-0059   | 5/8" x 3/8"     | 1/2" x 1/4"     | EA  | 25             |
| C410-0093   | 3/4" x 5/8"     | 5/8" x 1/2"     | EA  | 25             |
| C410-0107   | 7/8" x 5/8"     | 3/4" x 1/2"     | EA  | 25             |
| C410-0149   | 7/8" x 3/4"     | 3/4" x 5/8"     | EA  | 25             |
| C410-0159   | 1-1/8" x 7/8"   | 1" x 3/4"       | EA  | 10             |
| C410-1498   | 1-1/8" x 3/4"   | 1" x 5/8"       | EA  | 10             |
| C410-0160   | 1-1/8" x 5/8"   | 1" x 1/2"       | EA  | 10             |
| C410-0161   | 1-1/8" x 1/2"   | 1" x 3/8"       | EA  | 10             |
| C410-0222   | 1-3/8" x 1-1/8" | 1-1/4" x 1"     | EA  | 100            |
| C410-0223   | 1-3/8" x 7/8"   | 1-1/4" x 3/4"   | EA  | 100            |
| C410-0224   | 1-3/8" x 5/8"   | 1-1/4" x 1/2"   | EA  | 100            |
| C410-0303   | 1-5/8" x 1-3/8" | 1-1/2" x 1-1/4" | EA  | 100            |
| C410-0304   | 1-5/8" x 1-1/8" | 1-1/2" x 1"     | EA  | 100            |
| C410-0305   | 1-5/8" x 7/8"   | 1-1/2" x 3/4"   | EA  | 100            |
| C410-0306   | 1-5/8" x 5/8"   | 1-1/2" x 1/2"   | EA  | 100            |
| C410-0398   | 2-1/8" x 1-5/8" | 2" x 1-1/2"     | EA  | 50             |
| C410-0399   | 2-1/8" x 1-3/8" | 2" x 1-1/4"     | EA  | 50             |
| C410-0400   | 2-1/8" x 1-1/8" | 2" x 1"         | EA  | 50             |
| C410-0401   | 2-1/8" x 7/8"   | 2" x 3/4"       | EA  | 50             |
| C410-0402   | 2-1/8" x 5/8"   | 2" x 1/2"       | EA  | 50             |

**Cap**



| CATALOG NO. | O.D. SIZE | I.D. SIZE | UOM | ORDER MULTIPLE |
|-------------|-----------|-----------|-----|----------------|
| C154-0002   | 3/8"      | 1/4"      | EA  | 25             |
| C154-0025   | 1/2"      | 3/8"      | EA  | 25             |
| C154-0050   | 5/8"      | 1/2"      | EA  | 25             |
| C154-0090   | 3/4"      | 5/8"      | EA  | 25             |
| C154-0100   | 7/8"      | 3/4"      | EA  | 25             |
| C154-0150   | 1-1/8"    | 1"        | EA  | 10             |
| C154-0215   | 1-3/8"    | 1-1/4"    | EA  | 200            |
| C154-0295   | 1-5/8"    | 1-1/2"    | EA  | 5              |
| C154-0390   | 2-1/8"    | 2"        | EA  | 60             |

**Flush Bushing**



| CATALOG NO. | O.D. SIZE   | I.D. SIZE   | UOM | ORDER MULTIPLE |
|-------------|-------------|-------------|-----|----------------|
| C142-0057   | 5/8" x 1/8" | 1/2" x 1/8" | EA  | 25             |
| C142-0058   | 5/8" x 1/4" | 1/2" x 1/4" | EA  | 25             |

### U-Type Strap



| CATALOG NO. | O.D. SIZE | I.D. SIZE | UOM | ORDER MULTIPLE |
|-------------|-----------|-----------|-----|----------------|
| C947-0025   | 1/2"      | 3/8"      | EA  | 100            |
| C947-0050   | 5/8"      | 1/2"      | EA  | 25             |
| C947-0090   | 3/4"      | 5/8"      | EA  | 25             |
| C947-0100   | 7/8"      | 3/4"      | EA  | 25             |
| C947-0150   | 1-1/8"    | 1"        | EA  | 100            |
| C947-0215   | 1-3/8"    | 1-1/4"    | EA  | 100            |
| C947-0295   | 1-5/8"    | 1-1/2"    | EA  | 100            |
| C947-0390   | 2-1/8"    | 2"        | EA  | 50             |

### Copper Coupling with Dimple Stop



| CATALOG NO. | DESCRIPTION                          | UOM | ORDER MULTIPLE |
|-------------|--------------------------------------|-----|----------------|
| C170-0003   | 5/16" Copper Coupling w/Dimple Stop  | EA  | 25             |
| C170-0100   | 7/8" Copper Coupling w/Dimple Stop   | EA  | 25             |
| C170-0150   | 1-1/8" Copper Coupling w/Dimple Stop | EA  | 10             |

### P-Traps



| CATALOG NO. | DESCRIPTION                      | UOM | ORDER MULTIPLE |
|-------------|----------------------------------|-----|----------------|
| C533-0050   | 5/8" Copper P-Trap, 5 per pack   | EA  | 5              |
| C533-0090   | 3/4" Copper P-Trap, 5 per pack   | EA  | 5              |
| C533-0100   | 7/8" Copper P-Trap, 5 per pack   | EA  | 5              |
| C533-0150   | 1-1/8" Copper P-Trap, 3 per pack | EA  | 3              |
| C533-0215   | 1-3/8" Copper P-Trap, 2 per pack | EA  | 2              |
| C533-0295   | 1-5/8" Copper P-Trap, 2 per pack | EA  | 2              |
| C533-0390   | 2-1/8" Copper P-Trap             | EA  | 1              |

### Tee C x C x C



| CATALOG NO. | O.D. SIZE | I.D. SIZE | UOM | ORDER MULTIPLE |
|-------------|-----------|-----------|-----|----------------|
| C460-0002   | 3/8"      | 1/4"      | EA  | 25             |
| C460-0025   | 1/2"      | 3/8"      | EA  | 25             |
| C460-0050   | 5/8"      | 1/2"      | EA  | 25             |
| C460-0090   | 3/4"      | 5/8"      | EA  | 25             |
| C460-0100   | 7/8"      | 3/4"      | EA  | 10             |
| C460-0150   | 1-1/8"    | 1"        | EA  | 10             |
| C460-0215   | 1-3/8"    | 1-1/4"    | EA  | 35             |
| C460-0295   | 1-5/8"    | 1-1/2"    | EA  | 20             |
| C460-0390   | 2-1/8"    | 2"        | EA  | 10             |

### Reducing Tee C x C x C



| CATALOG NO. | O.D. SIZE                | I.D. SIZE                | UOM | ORDER MULTIPLE |
|-------------|--------------------------|--------------------------|-----|----------------|
| C460-0057   | 5/8" x 5/8" x 7/8"       | 1/2" x 1/2" x 5/8"       | EA  | 10             |
| C460-0058   | 5/8" x 5/8" x 1/2"       | 1/2" x 1/2" x 3/8"       | EA  | 25             |
| C460-0107   | 7/8" x 7/8" x 5/8"       | 3/4" x 3/4" x 1/2"       | EA  | 10             |
| C460-0117   | 7/8" x 5/8" x 7/8"       | 3/4" x 1/2" x 3/4"       | EA  | 10             |
| C460-0118   | 7/8" x 5/8" x 5/8"       | 5/8" x 1/2" x 1/2"       | EA  | 10             |
| C460-0159   | 1-1/8" x 1-1/8" x 7/8"   | 1" x 1" x 3/4"           | EA  | 10             |
| C460-0160   | 1-1/8" x 1-1/8" x 5/8"   | 1" x 1" x 1/2"           | EA  | 10             |
| C460-0180   | 1-1/8" x 5/8" x 1-1/8"   | 1" x 1/2" x 1"           | EA  | 10             |
| C460-0181   | 1-1/8" x 5/8" x 7/8"     | 1" x 1/2" x 3/4"         | EA  | 10             |
| C460-0182   | 1-1/8" x 5/8" x 5/8"     | 1" x 1/2" x 1/2"         | EA  | 10             |
| C460-0222   | 1-3/8" x 1-3/8" x 1-1/8" | 1-1/4" x 1-1/4" x 1"     | EA  | 40             |
| C460-0223   | 1-3/8" x 1-3/8" x 7/8"   | 1-1/4" x 1-1/4" x 3/4"   | EA  | 50             |
| C460-0235   | 1-3/8" x 1-1/8" x 1-1/8" | 1-1/4" x 1" x 1"         | EA  | 50             |
| C460-0236   | 1-3/8" x 1-1/8" x 7/8"   | 1-1/4" x 1" x 3/4"       | EA  | 50             |
| C460-0237   | 1-3/8" x 1-1/8" x 5/8"   | 1-1/4" x 1" x 3/4"       | EA  | 50             |
| C460-0245   | 1-3/8" x 7/8" x 1-3/8"   | 1-1/4" x 5/8" x 1-1/4"   | EA  | 35             |
| C460-0246   | 1-3/8" x 7/8" x 1-1/8"   | 1-1/4" x 5/8" x 1"       | EA  | 50             |
| C460-0247   | 1-3/8" x 7/8" x 7/8"     | 1-1/4" x 5/8" x 5/8"     | EA  | 50             |
| C460-0248   | 1-3/8" x 7/8" x 5/8"     | 1-1/4" x 5/8" x 1/2"     | EA  | 50             |
| C460-0256   | 1-3/8" x 5/8" x 1-3/8"   | 1-1/4" x 1/2" x 1-1/4"   | EA  | 35             |
| C460-0303   | 1-5/8" x 1-5/8" x 1-3/8" | 1-1/2" x 1-1/2" x 1-1/4" | EA  | 25             |
| C460-0304   | 1-5/8" x 1-5/8" x 1-1/8" | 1-1/2" x 1-1/2" x 1"     | EA  | 30             |
| C460-0305   | 1-5/8" x 1-5/8" x 7/8"   | 1-1/2" x 1-1/2" x 3/4"   | EA  | 35             |
| C460-0315   | 1-5/8" x 1-3/8" x 1-5/8" | 1-1/2" x 1-1/4" x 1-1/2" | EA  | 20             |
| C460-0316   | 1-5/8" x 1-3/8" x 1-3/8" | 1-1/2" x 1-1/4" x 1-1/4" | EA  | 20             |
| C460-0317   | 1-5/8" x 1-3/8" x 1-1/8" | 1-1/2" x 1-1/4" x 1"     | EA  | 30             |
| C460-0318   | 1-5/8" x 1-3/8" x 7/8"   | 1-1/2" x 1-1/4" x 3/4"   | EA  | 40             |
| C460-0319   | 1-5/8" x 1-3/8" x 5/8"   | 1-1/2" x 1-1/4" x 1/2"   | EA  | 40             |
| C460-0329   | 1-5/8" x 1-1/8" x 1-3/8" | 1-1/2" x 1" x 1-1/4"     | EA  | 30             |
| C460-0330   | 1-5/8" x 1-1/8" x 1-1/8" | 1-1/2" x 1" x 1"         | EA  | 35             |
| C460-0331   | 1-5/8" x 1-1/8" x 7/8"   | 1-1/2" x 1" x 5/8"       | EA  | 5              |
| C460-0332   | 1-5/8" x 1-1/8" x 5/8"   | 1-1/2" x 1" x 1/2"       | EA  | 40             |
| C460-0339   | 1-5/8" x 7/8" x 1-5/8"   | 1-1/2" x 5/8" x 1-1/2"   | EA  | 20             |
| C460-0340   | 1-5/8" x 7/8" x 1-3/8"   | 1-1/2" x 5/8" x 1-1/4"   | EA  | 30             |
| C460-0341   | 1-5/8" x 7/8" x 1-1/8"   | 1-1/2" x 5/8" x 1"       | EA  | 40             |
| C460-0342   | 1-5/8" x 7/8" x 7/8"     | 1-1/2" x 5/8" x 5/8"     | EA  | 40             |
| C460-0343   | 1-5/8" x 7/8" x 5/8"     | 1-1/2" x 5/8" x 1/2"     | EA  | 40             |
| C460-0350   | 1-5/8" x 5/8" x 1-5/8"   | 1-1/2" x 1/2" x 1-1/2"   | EA  | 20             |
| C460-0398   | 2-1/8" x 2-1/8" x 1-5/8" | 2" x 2" x 1-1/2"         | EA  | 10             |
| C460-0399   | 2-1/8" x 2-1/8" x 1-3/8" | 2" x 2" x 1-1/4"         | EA  | 15             |
| C460-0400   | 2-1/8" x 2-1/8" x 1-1/8" | 2" x 2" x 1"             | EA  | 18             |
| C460-0401   | 2-1/8" x 2-1/8" x 7/8"   | 2" x 2" x 5/8"           | EA  | 20             |
| C460-0402   | 2-1/8" x 2-1/8" x 5/8"   | 2" x 2" x 3/8"           | EA  | 20             |
| C460-0413   | 2-1/8" x 1-5/8" x 2-1/8" | 2" x 1-1/2" x 2"         | EA  | 10             |
| C460-0414   | 2-1/8" x 1-5/8" x 1-5/8" | 2" x 1-1/2" x 1-1/2"     | EA  | 10             |
| C460-0415   | 2-1/8" x 1-5/8" x 1-3/8" | 2" x 1-1/2" x 1-1/4"     | EA  | 10             |
| C460-0416   | 2-1/8" x 1-5/8" x 1-1/8" | 2" x 1-1/2" x 1"         | EA  | 10             |
| C460-0417   | 2-1/8" x 1-5/8" x 7/8"   | 2" x 1-1/2" x 3/4"       | EA  | 20             |
| C460-0418   | 2-1/8" x 1-5/8" x 5/8"   | 2" x 1-1/2" x 1/2"       | EA  | 20             |
| C460-0429   | 2-1/8" x 1-3/8" x 2-1/8" | 2" x 1-1/4" x 2"         | EA  | 10             |
| C460-0430   | 2-1/8" x 1-3/8" x 1-5/8" | 2" x 1-1/4" x 1-1/2"     | EA  | 15             |
| C460-0431   | 2-1/8" x 1-3/8" x 1-3/8" | 2" x 1-1/4" x 1-1/4"     | EA  | 15             |
| C460-0432   | 2-1/8" x 1-3/8" x 1-1/8" | 2" x 1-1/4" x 1"         | EA  | 20             |
| C460-0433   | 2-1/8" x 1-3/8" x 7/8"   | 2" x 1-1/4" x 3/4"       | EA  | 20             |
| C460-0444   | 2-1/8" x 1-1/8" x 2-1/8" | 2" x 1" x 2"             | EA  | 15             |
| C460-0447   | 2-1/8" x 1-1/8" x 1-1/8" | 2" x 1" x 1"             | EA  | 20             |
| C460-0457   | 2-1/8" x 7/8" x 2-1/8"   | 2" x 5/8" x 2"           | EA  | 10             |
| C460-0470   | 2-1/8" x 5/8" x 2-1/8"   | 2" x 1/2" x 2"           | EA  | 15             |

## ACCESS FITTINGS

A convenient low-cost port for refrigeration servicing. May be installed in any position on either high or low side for charging, purging, quick testing or pressure checking. DiversiTech's access fittings have 1/4" SAE male flare access ports and include a quick seal cap and a stainless and brass special refrigerant valve core.

| CATALOG NO. | DESCRIPTION                                 | CONNECTION  | UOM | ORDER MULTIPLE |
|-------------|---|---|-----|----------------|
| VA-3-346    | 3 Way Solder Type, pack of 6                | For 3/16" O.D. tube or 1/4" and 3/8" solder fitting   | PK  | 1              |
| VA-39       | 9 Way Solder Type, pack of 6                | For 3/16", 1/4", 5/16", 3/8" or 1/2" tube. Also fits 3/16", 1/4" and 5/16" solder fitting or 1/8" hole may be drilled in larger size tube | PK  | 1              |
| VA-24       | Straight Solder Type, pack of 6             | 1/8" O.D.S.   | PK  | 1              |
| VA-34       | Straight Solder Type, pack of 6             | 3/16" O.D.S. x 1/4" O.D.F.  | PK  | 1              |
| VA-46       | Straight Solder Type, pack of 6             | 1/4" O.D.S. x 3/8" O.D.F.   | PK  | 1              |
| VA-58       | Straight Solder Type, pack of 6             | 5/16" O.D.S. x 1/2" O.D.F.  | PK  | 1              |
| VA-68       | Straight Solder Type, pack of 6             | 3/8" O.D.S. x 1/2" O.D.F.   | PK  | 1              |
| VAU-24      | Half Union, pack of 6                       | 1/8" MPT  | PK  | 1              |
| VAU-45      | Half Union, pack of 6                       | 1/4" MPT  | PK  | 1              |
| VE-2        | Threaded Elbow, pack of 3                   | 1/8" MPT  | PK  | 1              |
| VS-4        | Swivel Nut w/Depressor, pack of 6           | 1/4" female flare forged swivel nut   | PK  | 1              |
| VST-4       | Swivel Tee w/Permanent Depressor, pack of 3 | 1/4" Access on run x 1/4" female flare w/depressor on female swivel branch end  | PK  | 1              |
| VST-44      | Swivel Tee w/Permanent Depressor, pack of 3 | 1/4" Access on run x 1/4" access on "T" - female swivel on run  | PK  | 1              |
| VT-4        | Forged Brass Tee, pack of 3                 | 1/4" Access all ends with 2 flare nuts, 1 core and cap  | PK  | 1              |
| VT-24       | Threaded Tee, pack of 3                     | 1/8" MPT on branch, 1/4" flare x 1/4" flare access on run   | PK  | 1              |
| VTR-24      | Threaded Tee, pack of 3                     | 1/8" MPT x 1/4" male flare on run x access on branch  | PK  | 1              |
| VTS-10      | Solder Tee Type                             | 5/8" O.D. tube  | EA  | 1              |
| VTS-12      | Solder Tee Type                             | 3/4" O.D. tube  | EA  | 1              |
| VTS-14      | Solder Tee Type                             | 7/8" O.D. tube  | EA  | 1              |
| VTS-18      | Solder Tee Type                             | 1-1/8" O.D. tube  | EA  | 1              |
| VTS-46      | Solder Tee Type, pack of 3                  | 1/4" O.D.S. x 5/16" O.D.F.  | PK  | 1              |
| VTS-56      | Solder Tee Type, pack of 3                  | 5/16" O.D.S. x 3/8" O.D.F.  | PK  | 1              |
| VTS-68      | Solder Tee Type, pack of 3                  | 3/8" O.D.S.   | PK  | 1              |
| VTS-810     | Solder Tee Type, pack of 3                  | 1/2" O.D.S.   | PK  | 1              |
| VTS-3-10    | Solder Tube Elbow                           | 5/8" O.D.S.   | EA  | 1              |
| VTS-3-12    | Solder Tube Elbow                           | 3/4" O.D.S.   | EA  | 1              |
| VTS-3-14    | Solder Tube Elbow                           | 7/8" O.D.S.   | EA  | 1              |
| VTS-3-18    | Solder Tube Elbow                           | 1-1/8" O.D.S.   | EA  | 1              |
| VU-4        | Female Flare Union, pack of 6               | 1/4" female flare w/copper gasket   | PK  | 1              |
| VUR-4       | Full Union, pack of 6                       | 1/4" O.D. flare tube w/forged flare nut   | PK  | 1              |
| VC-4        | Flare Cap, pack of 12                       | 1/4"  | PK  | 1              |
| VC-4R       | Flare Cap w/Core Remover, pack of 12        | 1/4"  | PK  | 1              |
| VVC-1       | Valve Core, pack of 6                       |   | PK  | 1              |



## Brass Adapters

The MSA-45 is used on the new R410 Mini Split systems that have the larger unique fitting on the service valve. The description of that fitting is 1/2" acme Male-20 UN. This adapter will screw onto the 1/2" Acme Male-20 UN fitting and allow you to connect a standard 1/4 service hose to it.



| CATALOG NO. | DESCRIPTION   | UOM | ORDER MULTIPLE |
|-------------|---|-----|----------------|
| MSA-45      | 1/4" Male flare x 1/2" - 20 UNF Female                                  | EA  | 1              |
| MSA-44      | 1/4" Female flare swivel w/depressor tip and seal x 1/4" MPT, pack of 2 | PK  | 1              |

## CONTROL DISCONNECT

For use with controls in centrifugal systems. Quickly disconnects or connects all controls without refrigerant loss or system pumpdown. Installs easily before any high or low pressure control, oil failure control, water regulating valve. Model VD-4A adapts to any access fitting with a 1/4" male flare connection, enabling a service engineer to build up a system in the field. All brass; metal-to-metal seat; will not leak.



| CATALOG NO.  | DESCRIPTION   | UOM | ORDER MULTIPLE |
|--------------|---|-----|----------------|
| <b>VD-4</b>  | Control Disconnect – 1/4" Female Flare, pack of 4         | PK  | 1              |
| <b>VD-4A</b> | Control Disconnect – 1/4" Female Flare Adapter, pack of 4 | PK  | 1              |
| <b>VD-24</b> | Control Disconnect – 1/8" MPT, pack of 4                  | PK  | 1              |
| <b>VD-45</b> | Control Disconnect – 1/4" MPT, pack of 4                  | PK  | 1              |

U.S. Patent No. 4,193,419.

## DRIERS, SIGHT GLASSES

### Liquid Line Driers

High moisture and acid capacity. Maximum filtration capacity. Exceptional compatibility with new polyester oils. Compatible with all existing and new refrigerants and blends including 134a, 401A/B, 402A/B, 404A, 407A/B/C, 410A, 502, 507A. Spring loaded, molecular sieve and activated alumina. Solid copper sweat fittings. Powder paint exterior coating surpasses 500 hour ASTM salt spray test and resists corrosion. Eliminates concern of additive stripping.



| CATALOG NO.    | VIRGINIA KMP  | CONNECTION | CUBIC INCH | UOM | ORDER MULTIPLE |
|----------------|---------------|------------|------------|-----|----------------|
| <b>DAD032</b>  | WLD-032 FLARE | 1/4        | 3          | EA  | 1              |
| <b>DAD032S</b> | WLD-032 SWEAT | 1/4        | 3          | EA  | 1              |
| <b>DAD052</b>  | WLD-052 FLARE | 1/4        | 5          | EA  | 1              |
| <b>DAD052S</b> | WLD-052 SWEAT | 1/4        | 5          | EA  | 1              |
| <b>DAD053</b>  | WLD-053 FLARE | 3/8        | 5          | EA  | 1              |
| <b>DAD053S</b> | WLD-053 SWEAT | 3/8        | 5          | EA  | 1              |
| <b>DAD082</b>  | WLD-082 FLARE | 1/4        | 8          | EA  | 1              |
| <b>DAD083</b>  | WLD-083 FLARE | 3/8        | 8          | EA  | 1              |
| <b>DAD083S</b> | WLD-083 SWEAT | 3/8        | 8          | EA  | 1              |
| <b>DAD084S</b> | WLD-084 SWEAT | 1/2        | 8          | EA  | 1              |
| <b>DAD163</b>  | WLD-163 FLARE | 3/8        | 16         | EA  | 1              |
| <b>DAD163S</b> | WLD-163 SWEAT | 3/8        | 16         | EA  | 1              |
| <b>DAD164</b>  | WLD-164 FLARE | 1/2        | 16         | EA  | 1              |
| <b>DAD164S</b> | WLD-164 SWEAT | 1/2        | 16         | EA  | 1              |
| <b>DAD165</b>  | WLD-165 FLARE | 5/8        | 16         | EA  | 1              |
| <b>DAD303</b>  | WLD303 FLARE  | 3/8        | 30         | EA  | 1              |
| <b>DAD303S</b> | WLD-303 SWEAT | 3/8        | 30         | EA  | 1              |
| <b>DAD304</b>  | WLD-304 FLARE | 1/2        | 30         | EA  | 1              |
| <b>DAD304S</b> | WLD-304 SWEAT | 1/2        | 30         | EA  | 1              |
| <b>DAD305</b>  | WLD-305 FLARE | 5/8        | 30         | EA  | 1              |
| <b>DAD305S</b> | WLD-305 SWEAT | 5/8        | 30         | EA  | 1              |

### Suction Line Driers

The solid-core clean-up dryer was developed for use in a system suction line. The compact design incorporates a large outside diameter shell, which results in a shorter lay-in length, and a larger core, which provides a greater filtration area for maximum operating efficiency. The core material has controlled porosity which effectively removes and holds a maximum amount of contaminants with a minimum of pressure drop. It collects and holds inorganic acids and other harmful contaminants from a motor burnout. This binding process protects the core from acid decomposition. Access valves on both the inlet and outlet sides make it easy to measure pressure accurately. Occasionally, enough contaminant matter may collect in the filter core to cause a slight pressure drop. The access valves on the SLD make it easy to determine if a pressure drop exists and to measure the amount of the drop. The original DSLD, solid core, activated alumina suction line filter dryer. High acid capacity. Low pressure drop – exceptionally high flow rates. Designed for system clean-up. 500 hours salt spray protection. Shortest system cut-out lengths allow installation in tight areas. Two access valves simplify pressure drop measurement. Flare or solid copper sweat fittings.



| CATALOG NO.         | VIRGINIA KMP     | CONNECTION | CUBIC INCH | UOM | ORDER MULTIPLE |
|---------------------|------------------|------------|------------|-----|----------------|
| <b>DSL13-5SVHH</b>  | AL-24-55C Sweat  | 5/8        | 13         | EA  | 1              |
| <b>DSL13-6SVHH</b>  | AL-30-6SC Sweat  | 3/4        | 13         | EA  | 1              |
| <b>DSL27-7SVHH</b>  | AL-30-7SC Sweat  | 7/8        | 27         | EA  | 1              |
| <b>DSL27-9SVHH</b>  | AL-44-9SC Sweat  | 1-1/8      | 27         | EA  | 1              |
| <b>DSL54-11SVHH</b> | AL-75-11SC Sweat | 1-3/8      | 54         | EA  | 1              |
| <b>DSL8-3V-HH</b>   | VSD-3 Flare      | 3/8        | 8          | EA  | 1              |
| <b>DSL8-4V-HH</b>   | VSD-4 Flare      | 1/2        | 8          | EA  | 1              |
| <b>DSL8-4SV-HH</b>  | SSD-4SC Sweat    | 1/2        | 8          | EA  | 1              |
| <b>DSL13-9SV-HH</b> | SSD-9SC Sweat    | 1-1/8      | 13         | EA  | 1              |
| <b>DSS-SLD305SV</b> | VSD-5 & S Sweat  | 5/8        | 30         | EA  | 1              |
| <b>DSS-SLD306SV</b> | VSD-6 & S Sweat  | 3/4        | 30         | EA  | 1              |
| <b>DSS-SLD307SV</b> | VSD-7 & S Sweat  | 7/8        | 30         | EA  | 1              |

## Universal Spun Copper Driers

Manufactured with the latest generation molecular sieves compatible with more than 20 different types of refrigerants, including R-134A. They can be used in all hermetic and open refrigeration systems using CFC, HCFC and HFC gases and mixes such as commercial and domestic refrigerators, freezers and air conditioners ranging from 1/8 to 2.0 HP. Hermetically sealed with extended ends.



| CATALOG NO. | OUTLET   | INLET | DIAMETER | LENGTH GRAMS | DESSICANT R12 | RECOMM. R22 | TONNAGE QUANTITY | UOM | ORDER MULTIPLE |
|-------------|----------|-------|----------|--------------|---------------|-------------|------------------|-----|----------------|
| DX-3        | 1/4"     | 1/4"  | 3/4"     | 7-11/16"     | 10            | 1/3         | 1/2              | EA  | 24             |
| DX-4        | Multiple | 1/4"  | 1"       | 9"           | 18            | 3/4         | 1-1/2            | EA  | 1              |
| DXA-5       | 1/4"     | 1/4"  | 1"       | 9-1/4"       | 20            | 3/4         | 1-1/2            | EA  | 1              |

## Bi Flow Driers

The "DBF" Series is designed specifically for heat pump or reverse cycle application. External check valves are not required since they are incorporated within the filter dryer shell. The core design filters out contaminant particles down to 25 microns. 100% copper sweat or nickel plated flare fittings. Desiccant core provides reliable and effective, removal of solid contaminants, acid and moisture. Provides three times the filtration as the standard bi-flow. Core is cushioned in fiber gaskets to protect core and to insure trouble-free performance. Powder paint exterior coating surpasses 500 hour ASTM salt spray test and resists corrosion.



| CATALOG NO. | VIRGINIA KMP   | CONNECTION | CUBIC INCH | UOM | ORDER MULTIPLE |
|-------------|----------------|------------|------------|-----|----------------|
| DBF083      | V2A-083 Flare  | 3/8        | 8          | EA  | 1              |
| DBF083S     | V2A-083 Sweat  | 3/8        | 8          | EA  | 1              |
| DBF084      | V2A-084 Flare  | 1/2        | 8          | EA  | 1              |
| DBF084S     | V2A-084 Sweat  | 1/2        | 8          | EA  | 1              |
| DBF163      | V2A-163 Flare  | 3/8        | 16         | EA  | 1              |
| DBF163S     | V2A-163 Sweat  | 3/8        | 16         | EA  | 1              |
| DBF164      | V2A-164 Flare  | 1/2        | 16         | EA  | 1              |
| DBF164S     | V2A-164 Sweat  | 1/2        | 16         | EA  | 1              |
| DBF165S     | V2A-165S Sweat | 5/8        | 16         | EA  | 1              |

## Sight Glasses

Sight Glass and Moisture Indicator provides a quick visual diagnosis of refrigerant and moisture levels within a system. The sight glass indicates if the system has the proper refrigerant level, a restricted dryer or excessive pressure-drop. The moisture indicator recognizes moisture within the system. Provides early warning that a potential failure exists resulting in corrosion, chemical damage, restricted flow, or even compressor failure. Etch-resistant glass with a simple color comparison provides easy viewing and quick diagnostics. Flare models feature forged brass body and fittings for corrosion resistance. Sweat models feature copper fittings to permit solder installation without disassembly. Leak-proof design is compact and short in length to easily fit within a unit and provide accuracy in performance.



| CATALOG NO. | VIRGINIA KMP | DESCRIPTION | CONNECTION | UOM | ORDER MULTIPLE |
|-------------|--------------|-------------|------------|-----|----------------|
| DPSG-2      | LDE-2        | FLARE       | 1/4        | EA  | 1              |
| DPSG-3      | LDE-3        | FLARE       | 3/8        | EA  | 1              |
| DPSG-4      | LDE-4        | FLARE       | 1/2        | EA  | 1              |
| DPSG-5      | LDE-5        | FLARE       | 5/8        | EA  | 1              |
| DPSG-2MF    | LDE-2-MF     | MALE/FEMALE | 1/4        | EA  | 1              |
| DPSG-3MF    | LDE-3-MF     | MALE/FEMALE | 3/8        | EA  | 1              |
| DPSG-4MF    | LDE-4-MF     | MALE/FEMALE | 1/2        | EA  | 1              |
| DPSG-5MF    | LDE-5-MF     | MALE/FEMALE | 5/8        | EA  | 1              |
| DPSG-2S     | LDE-2-S      | SWEAT       | 1/4        | EA  | 1              |
| DPSG-3S     | LDE-3-S      | SWEAT       | 3/8        | EA  | 1              |
| DPSG-4S     | LDE-4-S      | SWEAT       | 1/2        | EA  | 1              |
| DPSG-5S     | LDE-5-S      | SWEAT       | 5/8        | EA  | 1              |
| DPSG-7S     | LDE-7-S      | SWEAT       | 7/8        | EA  | 1              |
| DPSG-9S     | LDE-9-S      | SWEAT       | 1-1/8      | EA  | 1              |

## LINE PIERCING VALVES AND TOOLS

### Quick-Tap

Features a valve core in the 1/4" male port. Simply pierce the line and back seat the needle. Flow starts when depressor type charging hose is connected. Flow shuts off automatically when hose is removed. If valve core is not desired, it may be removed. Connect hose, pierce line and back seat needle. This method offers full unrestricted flow. Valve core can be removed or changed at any time without loss of refrigerant if needle is front seated.

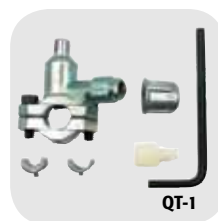

| CATALOG NO. | DESCRIPTION                                  | UOM | ORDER MULTIPLE |
|-------------|--|-----|----------------|
| QT-1        | Quick-Tap - 1/4", 5/16", 3/8" O.D. Tube Size | EA  | 1              |
| QT-2        | Quick-Tap - 1/2", 5/8" O.D. Tube Size        | EA  | 1              |

### Quick-Tap-2

Identical to Quick-Tap except that a nylon handle replaces the hex wrench. Phillips-head screws are used.



| CATALOG NO. | DESCRIPTION                                    | UOM | ORDER MULTIPLE |
|-------------|--|-----|----------------|
| QTH-1       | Quick-Tap-2 - 1/4", 5/16", 3/8" O.D. Tube Size | EA  | 1              |
| QTH-2       | Quick-Tap-2 - 1/2", 5/8" O.D. Tube Size        | EA  | 1              |

## MAC—The Ultimate in Line Piercing Valves

Install valve. Connect charging hose. Service. That's all there is to it! MAC features uniport: 1 connection for piercing and servicing. Sealed with refrigerant resistant "O" rings. Needle automatically back seats after servicing, leaving line free of restriction. Connect to tubing with 2 socket-head screws. (Hex wrench is included with each valve.) Needle depressor is inserted into head of needle. Wing cap is turned down easily by hand until line is pierced. Wing cap is removed and system may be serviced with any charging hose with built-in depressor. When hose is removed, spring loaded needle back-seats forming a leak proof seal. Needle depressor is discarded and wing cap forms extra precautionary seal.



| CATALOG NO. | DESCRIPTION  | UOM | ORDER MULTIPLE |
|-------------|--|-----|----------------|
| QTM-1       | MAC Line Piercing Valve – 1/4", 5/16", 3/8" O.D. Tube Size | EA  | 36             |
| QTM-2       | MAC Line Piercing Valve – 1/2", 5/8" O.D. Tube Size        | EA  | 36             |
| QTM-3       | MAC Line Piercing Valve – 3/16", 1/4" O.D. Tube Size       | EA  | 36             |

## Line Tap and Swivel Valves

The quick, safe and easy option to charge, discharge and test a line. Simply clamp on the DLT valve, attach the DCV-1G control valve, and pierce the line. The control valve features a port for connecting charging lines or gauges. The valve can swivel to any position and also be removed and re-used. These line tap valves are also difficult to tamper with as the line can only be accessed by using the special DCV-1G valve. They feature a specially formulated gasket which can withstand heat up to 302°F. Available in four sizes from 3/16" OD tube size to 3/8". The DCV-1G is designed for use with all four sizes. DLT series line taps are also compatible with existing A-1 Components CV-1G valves and likewise DCV-1G valves are compatible with A-1 Components LT-series line taps.



| CATALOG NO. | DESCRIPTION                    | UOM | ORDER MULTIPLE |
|-------------|--------------------------------|-----|----------------|
| DLT-3G      | Line Tap Valve – 3/16" OD tube | EA  | 1              |
| DLT-4G      | Line Tap Valve – 1/4" OD tube  | EA  | 1              |
| DLT-5G      | Line Tap Valve – 5/16" OD tube | EA  | 1              |
| DLT-6G      | Line Tap Valve – 3/8" OD tube  | EA  | 1              |
| DCV-1G      | Valve for DLT Line Taps        | EA  | 1              |

## Core Storer

All steel valve core remover and storage container. Completely knurled for easier grip, eliminating slippage when using with oily or greasy hands. Core Storer features a compartment for storing extra valve cores. Four replacement cores are included with each tool.



| CATALOG NO. | DESCRIPTION             | UOM | ORDER MULTIPLE |
|-------------|-------------------------|-----|----------------|
| VCR-1       | Core Remover and Storer | EA  | 1              |

## Copper Saddle Valve

For copper-to-copper brazing. Penetrates line in one easy operation with no holes to drill. Steel pin with valve core pierces line and is locked into valve body by tightening cap. Teflon ring assures positive seal. Available in sizes from 1/4" to 1-1/8".



| CATALOG NO. | DESCRIPTION  | UOM | ORDER MULTIPLE |
|-------------|--|-----|----------------|
| VLC-4       | Copper Saddle Valve – 1/4" O.D. Tube Size, pack of 6   | PK  | 1              |
| VLC-5       | Copper Saddle Valve – 5/16" O.D. Tube Size, pack of 6  | PK  | 1              |
| VLC-6       | Copper Saddle Valve – 3/8" O.D. Tube Size, pack of 6   | PK  | 1              |
| VLC-8       | Copper Saddle Valve – 1/2" O.D. Tube Size, pack of 4   | PK  | 1              |
| VLC-10      | Copper Saddle Valve – 5/8" O.D. Tube Size, pack of 3   | PK  | 1              |
| VLC-12      | Copper Saddle Valve – 3/4" O.D. Tube Size, pack of 2   | PK  | 1              |
| VLC-14      | Copper Saddle Valve – 7/8" O.D. Tube Size, pack of 2   | PK  | 1              |
| VLC-18      | Copper Saddle Valve – 1-1/8" O.D. Tube Size, pack of 2 | PK  | 1              |
| VLC-25      | Additional Teflon Rings, pack of 25                    | PK  | 1              |

## Insta-Tap Refrigerant Recovery Tool

The fastest, easiest way to evacuate refrigerant before disposal of a unit. Snaps onto refrigerant line for full and immediate flow. Punctures super large hole for maximum full flow discharge to recovery unit. One tool fits all sizes from 3/16" to 7/8" O.D. hard tubing. Replaceable needle.



| CATALOG NO. | DESCRIPTION                                    | UOM | ORDER MULTIPLE |
|-------------|--|-----|----------------|
| QT-100      | Quick-Tap-2 – 1/4", 5/16", 3/8" O.D. Tube Size | EA  | 1              |
| QT-100N     | Replaceable Hardened Steel Needle and Gasket   | EA  | 1              |
| QT-100G     | Replacement Gasket Only                        | EA  | 3              |

## Core Removal Tool

Designed to remove and replace valve cores without losing the refrigerant charge. Connects to any 1/4" male flare fitting. Saves time, saves refrigerant.



| CATALOG NO. | DESCRIPTION               | UOM | ORDER MULTIPLE |
|-------------|---------------------------|-----|----------------|
| VCRT-1      | Core Removal Tool         | EA  | 1              |
| VCRT-1R     | Replacement Rod Assembly  | EA  | 1              |
| VCRT-1RK    | Replacement O-ring Kit    | EA  | 1              |
| VCRT-1S     | Replacement Shut-off Stem | EA  | 1              |

## REFRIGERANT CHARGING

### Insta-Charge

Faster, safer and more economical method for charging LIQUID refrigerant through the low pressure side of an air conditioning or refrigeration system, without damaging the compressor. Insta-Charge's unique internal restrictor reduces liquid flow to a level below the capacity of the compressor. Converts liquid refrigerant to a saturated vapor for fast entry. Insta-Charge connects directly to the refrigerant can or cylinder valve. Adds liquid tracing dye faster. Eliminates heating of refrigerant cylinder. Made of light weight aluminum. Sold at a fraction of the cost of other fast charging devices.



RC-1

| CATALOG NO. | DESCRIPTION  | UOM | ORDER MULTIPLE |
|-------------|--------------|-----|----------------|
| RC-1        | Insta-Charge | EA  | 1              |

### Oil Transfer System by Gauge-Pro

A quick and easy way to change refrigerant oil with no spillage or mess. Unique hand pump creates a powerful vacuum for the transfer of oil to or from the compressor crankcase at a faster rate. Oil transfers back and forth between the compressor and waste oil tank by creating a vacuum. Oil never touches the pump, thus preventing cross contamination. Pump, durable waste oil container and all hoses are included.



GOTS-1

| CATALOG NO. | DESCRIPTION                        | UOM | ORDER MULTIPLE |
|-------------|------------------------------------|-----|----------------|
| GOTS-1      | Oil Transfer System – 1-1/4 Gallon | EA  | 1              |
| GOTS-2      | Oil Transfer System – 2-1/2 Gallon | EA  | 1              |

## REFRIGERANT LABELS

### DiversiTech Refrigerant ID Labels

These 3" x 4" self-adhesive vinyl labels use a high-tack acrylic adhesive and UV cured screen printing. Color coded to conform to refrigerant labeling convention. Each label indicates the type of refrigerant (eg. R-11), the chemical name (eg. Trichloromonofluoromethane) and the UN No. (eg. UN 1078). Avoid costly mistakes by properly identifying the type of refrigerant contained in recovery cylinders and air conditioning and refrigeration equipment.

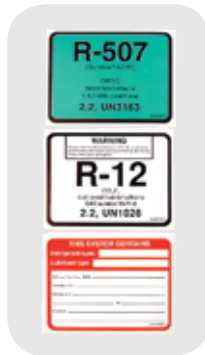

| CATALOG NO.  | DESCRIPTION  | UOM | ORDER MULTIPLE |
|--|--|-----|----------------|
| <b>REFRIGERANT IDENTIFICATION LABELS (3" x 4")</b> |  |     |                |
| 04000  | Assorted Refrigerant ID Labels (R-12, R-22, R-502), pack of 30 | PK  | 1              |
| 04010  | R-408A (FX10) Refrigerant ID Labels, pack of 10                | PK  | 1              |
| 04011  | R-11 Refrigerant ID Labels, pack of 10                         | PK  | 1              |
| 04012  | R-12 Refrigerant ID Labels, pack of 10                         | PK  | 1              |
| 04013  | R-13 Refrigerant ID Labels, pack of 10                         | PK  | 1              |
| 04022  | R-22 Refrigerant ID Labels, pack of 10                         | PK  | 1              |
| 04023  | R-23 Refrigerant ID Labels, pack of 10                         | PK  | 1              |
| 04056  | R-409A (FX56) Refrigerant ID Labels, pack of 10                | PK  | 1              |
| 04113  | R-113 Refrigerant ID Labels, pack of 10                        | PK  | 1              |
| 04114  | R-114 Refrigerant ID Labels, pack of 10                        | PK  | 1              |
| 04123  | R-123 Refrigerant ID Labels, pack of 10                        | PK  | 1              |
| 04134  | R-134a Refrigerant ID Labels, pack of 10                       | PK  | 1              |
| 04401  | R-401A (MP39) Refrigerant ID Labels, pack of 10                | PK  | 1              |
| 04402  | R-402A (HP80) Refrigerant ID Labels, pack of 10                | PK  | 1              |
| 04404  | R-404A (HP62/FX70) Refrigerant ID Labels, pack of 10           | PK  | 1              |
| 04406  | R-406A (GHC) Refrigerant ID Labels, pack of 10                 | PK  | 1              |
| 04407  | R-407C (SUVA 9000/KLEA 66) Refrigerant ID Labels, pack of 10   | PK  | 1              |
| 04410  | R-410A (AZ20) Refrigerant ID Labels, pack of 10                | PK  | 1              |
| 04414  | R-414B Refrigerant ID Labels, pack of 10                       | PK  | 1              |
| 04451  | R-401B (MP66) Refrigerant ID Labels, pack of 10                | PK  | 1              |
| 04452  | R-402B (HP81) Refrigerant ID Labels, pack of 10                | PK  | 1              |
| 04500  | R-500 Refrigerant ID Labels, pack of 10                        | PK  | 1              |
| 04502  | R-502 Refrigerant ID Labels, pack of 10                        | PK  | 1              |
| 04503  | R-503 Refrigerant ID Labels, pack of 10                        | PK  | 1              |
| 04507  | R-507 (AZ50) Refrigerant ID Labels, pack of 10                 | PK  | 1              |
| 04509  | R-416A Refrigerant ID Labels, pack of 10                       | PK  | 1              |

### DiversiTech Refrigerant ID Labels (cont'd)

| CATALOG NO.   | DESCRIPTION                                 | UOM | ORDER MULTIPLE |
|---|---|-----|----------------|
| <b>NON-FLAMMABLE GAS LABELS (4" x 4")</b>               |   |     |                |
| 04700   | Non Flammable Gas Labels, pack of 10        | PK  | 1              |
| <b>SYSTEM REFRIGERANT/OIL LABELS (3" x 4")</b>          |   |     |                |
| 04800   | EPA Warning Labels Labels, pack of 10       | PK  | 1              |
| 04803   | EPA Warning Labels Labels, R22H, pack of 10 | PK  | 1              |
| 04850   | Refrigerant Removed Labels, pack of 10      | PK  | 1              |
| 04852   | System Refrigerant/Oil Labels, pack of 10   | PK  | 1              |
| <b>SYSTEM LUBRICANT IDENTIFICATION LABELS (2" x 3")</b> |   |     |                |
| 04870   | Polyol Ester Oil Labels, pack of 10         | PK  | 1              |
| 04871   | Mineral Oil Labels, pack of 10              | PK  | 1              |
| 04872   | Alkylbenzene Oil Labels, pack of 10         | PK  | 1              |

## REFRIGERANT RECOVERY PRODUCTS

### Refrigerant Recovery Cylinders

DOT Classified for recovery, recycling, service and reclaim. Liquid and vapor valves ("Y" valve or separate valve configurations) are installed in all cylinders. Painted yellow/gray per ARI guidelines. Float switches have 3-pin Brad Harrison connectors.

| CATALOG NO. | DESCRIPTION | DOT CLASS | 3/4" NPT PLUG | FLOAT SWITCH | WATER CAP. | TARE WT. | UOM | ORDER MULTIPLE |
|-------------|-------------|-----------|---------------|--------------|------------|----------|-----|----------------|
| 02033       | 30 lb.      | 4BA400    | YES           | NO           | 26.2 lbs.  | 17 lbs.  | EA  | 1              |
| 02035       | 30 lb.      | 4BA400    | NO            | YES          | 26.2 lbs.  | 17 lbs.  | EA  | 1              |
| 02053       | 50 lb.      | 4BA400    | YES           | NO           | 47.7 lbs.  | 28 lbs.  | EA  | 1              |
| 02055       | 50 lb.      | 4BA400    | NO            | YES          | 47.7 lbs.  | 28 lbs.  | EA  | 1              |
| 02100       | 100 lb.     | 4BW400    | NO            | NO           | 123 lbs.   | 48 lbs.  | EA  | 1              |
| 02255       | 250 lb.     | 4BW260    | YES           | NO           | 239 lbs.   | 85 lbs.  | EA  | 1              |



**Caution:** Never overfill cylinders. Maximum refrigerant capacity is limited to 80% of the water capacity of the cylinder in lbs. (see table above). DOT requires cylinders to be retested every five years. Some recovery equipment uses weight scales to cut off refrigerant fill at 80% of capacity. Be sure cylinder tare weight is correct for this type of equipment.

**DOT Classification Example:** 4BA400: 400 psi working pressure; 800 psi test pressure (double the working pressure); 1,600 psi minimum burst pressure (double the test pressure). Pressure relief/safety valve is set to release at between 75-100% of the test pressure. For example, in the 4BA400 tanks which have a 800 psi test pressure, the relief valve opens at between 600 psi and 800 psi.

## CUSHION CLAMPS

### Cushion Clamps

An industry standard universal clamp that mounts to standard strut. Steel with electro-dichromate finish to resist corrosion. The lock nut has a nylon insert for a positive lock. The polymeric grommet withstands temperatures from -25°C to 125°C and resists the effects of most oils, chemicals, and industrial cleaning compounds.



| CATALOG NO. | DESCRIPTION            | UOM | ORDER MULTIPLE |
|-------------|------------------------|-----|----------------|
| 538-1/4     | Cushion Clamp - 1/4"   | EA  | 25             |
| 538-3/8     | Cushion Clamp - 3/8"   | EA  | 25             |
| 538-1/2     | Cushion Clamp - 1/2"   | EA  | 25             |
| 538-5/8     | Cushion Clamp - 5/8"   | EA  | 25             |
| 538-3/4     | Cushion Clamp - 3/4"   | EA  | 25             |
| 538-7/8     | Cushion Clamp - 7/8"   | EA  | 25             |
| 538-1-1/8   | Cushion Clamp - 1-1/8" | EA  | 10             |
| 538-1-3/8   | Cushion Clamp - 1-3/8" | EA  | 10             |
| 538-1-5/8   | Cushion Clamp - 1-5/8" | EA  | 10             |
| 538-2-1/8   | Cushion Clamp - 2-1/8" | EA  | 10             |
| 538-2-5/8   | Cushion Clamp - 2-5/8" | EA  | 10             |
| 538-3-1/8   | Cushion Clamp - 3-1/8" | EA  | 10             |
| 538-3-5/8   | Cushion Clamp - 3-5/8" | EA  | 10             |
| 538-4-1/8   | Cushion Clamp - 4-1/8" | EA  | 10             |

## TUBING INSULATION

### Tubing Insulation

Highest quality tubing insulation by Armacell. AC Accoflex® tubing insulation is a flexible rubber product from the inventors of elastomeric foam insulation. It is designed exclusively for HVAC, with a tough surface and excellent resistance to ultraviolet damage, condensation and mold.



#### 3/8" WALL

| CATALOG NO. | DESCRIPTION                         | UOM | ORDER MULTIPLE |
|-------------|-------------------------------------|-----|----------------|
| 7-3838      | 3/8" ID x 3/8" Wall, pack of 600'   | PK  | 1              |
| 7-3812      | 1/2" ID x 3/8" Wall, pack of 480'   | PK  | 1              |
| 7-3858      | 5/8" ID x 3/8" Wall, pack of 390'   | PK  | 1              |
| 7-3834      | 3/4" ID x 3/8" Wall, pack of 330'   | PK  | 1              |
| 7-3878      | 7/8" ID x 3/8" Wall, pack of 270'   | PK  | 1              |
| 7-381-18    | 1-1/8" ID x 3/8" Wall, pack of 210' | PK  | 1              |
| 7-381-38    | 1-3/8" ID x 3/8" Wall, pack of 180' | PK  | 1              |
| 7-381-58    | 1-5/8" ID x 3/8" Wall, pack of 120' | PK  | 1              |
| 7-382-18    | 2-1/8" ID x 3/8" Wall, pack of 96'  | PK  | 1              |
| 7-382-58    | 2-5/8" ID x 3/8" Wall, pack of 72'  | PK  | 1              |
| 7-383-18    | 3-1/8" ID x 3/8" Wall, pack of 54'  | PK  | 1              |

#### 1/2" WALL

| CATALOG NO. | DESCRIPTION                         | UOM | ORDER MULTIPLE |
|-------------|-------------------------------------|-----|----------------|
| 7-1238      | 3/8" ID x 1/2" Wall, pack of 450'   | PK  | 1              |
| 7-1212      | 1/2" ID x 1/2" Wall, pack of 396'   | PK  | 1              |
| 7-1258      | 5/8" ID x 1/2" Wall, pack of 300'   | PK  | 1              |
| 7-1234      | 3/4" ID x 1/2" Wall, pack of 240'   | PK  | 1              |
| 7-1278      | 7/8" ID x 1/2" Wall, pack of 210'   | PK  | 1              |
| 7-121-18    | 1-1/8" ID x 1/2" Wall, pack of 150' | PK  | 1              |
| 7-121-38    | 1-3/8" ID x 1/2" Wall, pack of 120' | PK  | 1              |
| 7-121-58    | 1-5/8" ID x 1/2" Wall, pack of 90'  | PK  | 1              |
| 7-122-18    | 2-1/8" ID x 1/2" Wall, pack of 60'  | PK  | 1              |
| 7-122-58    | 2-5/8" ID x 1/2" Wall, pack of 60'  | PK  | 1              |
| 7-123-18    | 3-1/8" ID x 1/2" Wall, pack of 42'  | PK  | 1              |

#### 3/4" WALL

| CATALOG NO. | DESCRIPTION                        | UOM | ORDER MULTIPLE |
|-------------|------------------------------------|-----|----------------|
| 7-3438      | 3/8" ID x 3/4" Wall, pack of 240'  | PK  | 1              |
| 7-3412      | 1/2" ID x 3/4" Wall, pack of 210'  | PK  | 1              |
| 7-3458      | 5/8" ID x 3/4" Wall, pack of 144'  | PK  | 1              |
| 7-3434      | 3/4" ID x 3/4" Wall, pack of 138'  | PK  | 1              |
| 7-3478      | 7/8" ID x 3/4" Wall, pack of 120'  | PK  | 1              |
| 7-341-18    | 1-1/8" ID x 3/4" Wall, pack of 90' | PK  | 1              |
| 7-341-38    | 1-3/8" ID x 3/4" Wall, pack of 72' | PK  | 1              |
| 7-341-58    | 1-5/8" ID x 3/4" Wall, pack of 60' | PK  | 1              |
| 7-342-18    | 2-1/8" ID x 3/4" Wall, pack of 54' | PK  | 1              |
| 7-342-58    | 2-5/8" ID x 3/4" Wall, pack of 48' | PK  | 1              |

### DiversiTech Line Sets

DiversiTech Line Sets are individually packaged in sturdy corrugated cardboard, designed and tested for individual parcel shipment.

Line Sets are designed for air conditioning and refrigeration systems. The copper tube is refrigeration grade tubing to ASTM B280. The suction line is pre-insulated with Armaflex AP pipe insulation. This insulation is a black flexible elastomeric thermal insulation. The expanded closed-cell structure makes it an efficient insulation. It is manufactured without the use of CFC's, HFC's or HCFC's. AP Armaflex contains Microban® antimicrobial product protection for added defense against mold on the insulation.

DiversiTech Min-Split Line Sets are similar to Standard Line Sets but come with additional insulation on the liquid line and flared line ends. Copper tubing complies with ASTM B280 for Seamless Copper Tube for ACR.

AP Armaflex insulation meets ASTM C534, Type I – Tubular Grade 1, ASTM E84, NFPA 255, UL723, CAN/ULC S102, UL94 5V-5A, V-O (E55798), NFPA 90A/90B, UL181, ASTM G21/C1338, ASTM G22, ASTM D1056 2B1, MIL-P-15280J form T, MIL-C-3133C grade SBE3, MEA 96-85-M, and City of LA RR7642.



D40680250B3B6

#### STANDARD LINE SETS

| CATALOG NO.          | LENGTH (FT) | INSULATION WALL | SUCTION LINE | LIQUID LINE | UOM | ORDER MULTIPLE |
|----------------------|-------------|-----------------|--------------|-------------|-----|----------------|
| D61220250            | 25          | 1/2             | 3/4          | 3/8         | EA  | 1              |
| D61220350            | 35          | 1/2             | 3/4          | 3/8         | EA  | 1              |
| D61220500            | 50          | 1/2             | 3/4          | 3/8         | EA  | 1              |
| D61420250            | 25          | 1/2             | 7/8          | 3/8         | EA  | 1              |
| D61420350            | 35          | 1/2             | 7/8          | 3/8         | EA  | 1              |
| D61420500            | 50          | 1/2             | 7/8          | 3/8         | EA  | 1              |
| <b>NEW</b> D61230250 | 25          | 3/8             | 3/4          | 3/4         | EA  | 1              |
| <b>NEW</b> D61230350 | 35          | 3/8             | 3/4          | 3/4         | EA  | 1              |
| <b>NEW</b> D61230500 | 50          | 3/8             | 3/4          | 3/4         | EA  | 1              |
| <b>NEW</b> D61430250 | 25          | 3/4             | 7/8          | 3/8         | EA  | 1              |
| <b>NEW</b> D61430350 | 35          | 3/4             | 7/8          | 3/8         | EA  | 1              |
| <b>NEW</b> D61430500 | 50          | 3/4             | 7/8          | 3/8         | EA  | 1              |
| D61280250            | 25          | 3/8             | 3/4          | 3/8         | EA  | 1              |
| D61280350            | 35          | 3/8             | 3/4          | 3/8         | EA  | 1              |
| D61280500            | 50          | 3/8             | 3/4          | 3/8         | EA  | 1              |
| D61480250            | 25          | 3/8             | 7/8          | 3/8         | EA  | 1              |
| D61480350            | 35          | 3/8             | 7/8          | 3/8         | EA  | 1              |
| D61480500            | 50          | 3/8             | 7/8          | 3/8         | EA  | 1              |

### DiversiTech Line Sets (cont'd)

#### 1-1/8" LINE SETS

| CATALOG NO.          | LENGTH (FT) | INSULATION WALL | SUCTION LINE | LIQUID LINE | UOM | ORDER MULTIPLE |
|----------------------|-------------|-----------------|--------------|-------------|-----|----------------|
| <b>NEW</b> D61880250 | 25          | 3/8             | 1-1/8        | 3/8         | EA  | 1              |
| <b>NEW</b> D61880350 | 35          | 3/8             | 1-1/8        | 3/8         | EA  | 1              |
| <b>NEW</b> D61880500 | 50          | 3/8             | 1-1/8        | 3/8         | EA  | 1              |
| <b>NEW</b> D61820250 | 25          | 1/2             | 1-1/8        | 3/8         | EA  | 1              |
| <b>NEW</b> D61820350 | 35          | 1/2             | 1-1/8        | 3/8         | EA  | 1              |
| <b>NEW</b> D61820500 | 50          | 1/2             | 1-1/8        | 3/8         | EA  | 1              |

#### MINI-SPLIT LINE SETS

| CATALOG NO.              | LENGTH (FT) | INSULATION WALL | SUCTION LINE | LIQUID LINE | UOM | ORDER MULTIPLE |
|--------------------------|-------------|-----------------|--------------|-------------|-----|----------------|
| <b>NEW</b> D40680250B3B6 | 25          | 3/8             | 3/8          | 1/4         | EA  | 1              |
| <b>NEW</b> D40680350B3B6 | 35          | 3/8             | 3/8          | 1/4         | EA  | 1              |
| <b>NEW</b> D40680500B3B6 | 50          | 3/8             | 3/8          | 1/4         | EA  | 1              |
| <b>NEW</b> D40880250B3B6 | 25          | 3/8             | 1/2          | 1/4         | EA  | 1              |
| <b>NEW</b> D40880350B3B6 | 35          | 3/8             | 1/2          | 1/4         | EA  | 1              |
| <b>NEW</b> D40880500B3B6 | 50          | 3/8             | 1/2          | 1/4         | EA  | 1              |
| <b>NEW</b> D41080250B3B6 | 25          | 3/8             | 5/8          | 1/4         | EA  | 1              |
| <b>NEW</b> D41080350B3B6 | 35          | 3/8             | 5/8          | 1/4         | EA  | 1              |
| <b>NEW</b> D41080500B3B6 | 50          | 3/8             | 5/8          | 1/4         | EA  | 1              |
| <b>NEW</b> D61080250B3B6 | 25          | 3/8             | 5/8          | 3/8         | EA  | 1              |
| <b>NEW</b> D61080350B3B6 | 35          | 3/8             | 5/8          | 3/8         | EA  | 1              |
| <b>NEW</b> D61080500B3B6 | 50          | 3/8             | 5/8          | 3/8         | EA  | 1              |

*If ordering by pallet, 15 line sets are packed per pallet.*

# High Rise Pan™



The High Rise Pan™ is an innovative new plastic drain pan design which allows placement of an air handler 2-3/4" above the outside lip of the pan without the need for separate, cumbersome mounting blocks. The pan has a molded-in network of risers to give a 5" lift. The risers are positioned to accept a wide variety of air handler sizes. Each riser has a specially shaped area at each end to accommodate a 2" x 2" anti-vibration pad which allows for quiet operation at all times. Other features include heavy duty reinforcement throughout to give plenty of support as well as rolled edges for durability. One-piece plastic construction ensures no rust, leaks, or seams to split. Each High Rise Pan™ comes complete with a Condensate Cop™ float switch, six EVA™ anti-vibration pads, and one 3/4" PVC male adapter. Installation is straightforward and hassle-free.



- **Nestable**
- **5" Riser**
- **Heat/Cold resistance**
- **Eliminates a single line vendor**
- **Uses standard anti-vibration pad**
- **80% thicker than the standard drain pan**
- **Water pushes to the side of the pan**
- **Heavy-duty reinforced ABS construction/flexible material**
- **Installation kit includes six EVA™ pads and Condensate Cop™ float switch**

# DISTRIBUTOR SUPPORT



## LITERATURE

### Catalogs

DiversiTech's contractor catalog is a handy industry reference for the HVACR contractor, with only a bit of DiversiTech product information. A handy 8-1/2" high by 4-1/4" wide.

| CATALOG NO.         | DESCRIPTION                     | STANDARD PACK |
|---------------------|---------------------------------|---------------|
| <b>LIT-CAT-CD</b>   | HVAC Catalog on CD              | 10            |
| <b>LIT-CAT-CONT</b> | Catalog for Contractors         | 10            |
| <b>LIT-CAT-HVAC</b> | Issue 19 Catalog                | 1             |
| <b>LIT-CAT-NEW</b>  | Issue 18-2 New Products Catalog | 1             |

### Mailers

Each mailer has a specific product focus. Mailers are available to the distributor to promote particular products to their contractor customer base. Sizes vary, but most are 8" X 8".

| CATALOG NO.       | DESCRIPTION              | STANDARD PACK |
|-------------------|--------------------------|---------------|
| <b>3D-MAILER</b>  | Mailer for Triple "D"™   | 1             |
| <b>FVC-MAILER</b> | CleanVent™ Sample Mailer | 40            |

### Tri-Folds

Each DiversiTech tri-fold brochure has a specific product focus. The tri-folds can be used as counter handouts, or mailed to a contractor. Brochure holders are also available. Most tri-folds are 8-1/2" high by 3-5/8" wide.

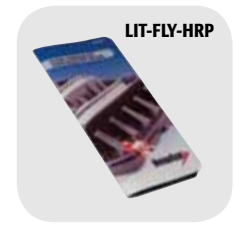

| CATALOG NO.            | DESCRIPTION                                    | STANDARD PACK |
|------------------------|--|---------------|
| <b>LIT-FLY-3D</b>      | Triple "D"™ Brochure                           | 25            |
| <b>LIT-FLY-3STEP</b>   | Three Step Coil Cleaning Brochure              | 25            |
| <b>LIT-FLY-AVPAD</b>   | Anti-vibration Pad Brochure                    | 25            |
| <b>LIT-FLY-BPPOOL</b>  | The Black Pad® Brochure                        | 25            |
| <b>LIT-FLY-CHEMX</b>   | Coil Cleaner Cross Reference Brochure          | 25            |
| <b>LIT-FLY-CLAD</b>    | CladLite® Pad Brochure                         | 25            |
| <b>LIT-FLY-CLRVUE</b>  | ClearVue™ Pump Brochure                        | 25            |
| <b>LIT-FLY-COND</b>    | Condensate Monitoring Switches Brochure        | 25            |
| <b>LIT-FLY-CV</b>      | CleanVent™ Brochure                            | 25            |
| <b>LIT-FLY-DISC</b>    | Fusible Disconnect Brochure                    | 25            |
| <b>LIT-FLY-DS</b>      | Dolly Strap Brochure                           | 25            |
| <b>LIT-FLY-DST10</b>   | Hard Start Kit Brochure                        | 25            |
| <b>LIT-FLY-DTP3</b>    | Three Phase Motor Protector Brochure           | 25            |
| <b>LIT-FLY-DTP3ES</b>  | Three Phase Motor Protector Brochure (Spanish) | 25            |
| <b>LIT-FLY-ELITE</b>   | E Lite® Pad Brochure                           | 25            |
| <b>LIT-FLY-EZMIX</b>   | EZ-Mix™ Granular Coil Cleaner™ Brochure        | 25            |
| <b>LIT-FLY-FLOW</b>    | Flow Plus™ Brochure                            | 25            |
| <b>LIT-FLY-GG</b>      | Charles Gallo Drain Gun Brochure               | 25            |
| <b>LIT-FLY-HEAT</b>    | Heat Pump Pad™ Brochure                        | 25            |
| <b>LIT-FLY-HEF</b>     | Hef-T-Pad™ Brochure                            | 25            |
| <b>LIT-FLY-HPAD</b>    | The Hurricane Pad™ Brochure                    | 25            |
| <b>LIT-FLY-HRP</b>     | High Rise Pan™ Brochure                        | 25            |
| <b>LIT-FLY-INVENT</b>  | Invention Submission Brochure                  | 25            |
| <b>LIT-FLY-MDP</b>     | Metal Drain Pan Brochure                       | 25            |
| <b>LIT-FLY-MOTORS</b>  | Motor Brochure                                 | 25            |
| <b>LIT-FLY-MSPLIT</b>  | SpeediChannel™ Brochure                        | 25            |
| <b>LIT-FLY-PANPILL</b> | Pro-Treat® Pan Tablet Brochure                 | 25            |
| <b>LIT-FLY-PF</b>      | Pro-Flush Brochure                             | 25            |
| <b>LIT-FLY-PUMP</b>    | Condensate Pump Brochure                       | 25            |
| <b>LIT-FLY-SPEC</b>    | Specialty Chemical Brochure                    | 25            |
| <b>LIT-FLY-SPRAYER</b> | Power Sprayer Brochure                         | 25            |
| <b>LIT-FLY-TS</b>      | Touchscreen Thermostat Brochure                | 25            |
| <b>LIT-FLY-UC</b>      | UltraLite® Pad Brochure                        | 25            |
| <b>LIT-FLY-UCSTRAP</b> | UltraLite® Earthquake Pad Brochure             | 25            |
| <b>LIT-FLY-UV</b>      | Pure-Beam™ UV Light Brochure                   | 25            |
| <b>LIT-FLY-WS</b>      | Wet Switch® Brochure                           | 25            |

## MERCHANDISING

### Counter Mats

Each counter mat has a specific product focus. The mats are encapsulated with a tough wearing clear plastic cover, and a non-skid rubber back. Most mats are 20" by 16".



| CATALOG NO.           | DESCRIPTION                                | STANDARD PACK |
|-----------------------|--|---------------|
| <b>MKT-MAT-3D</b>     | Triple "D"™ Counter Mat                    | 1             |
| <b>MKT-MAT-BPOOL</b>  | The Black Pad® Counter Mat                 | 1             |
| <b>MKT-MAT-CHEMX</b>  | Coil Cleaner Cross Reference Counter Mat   | 1             |
| <b>MKT-MAT-CLRVUE</b> | ClearVue™ Pump Counter Mat                 | 1             |
| <b>MKT-MAT-COND</b>   | Condensate Monitoring Switches Counter Mat | 1             |
| <b>MKT-MAT-CV</b>     | CleanVent Counter Mat                      | 1             |
| <b>MKT-MAT-DST10</b>  | Hard Start Kit Counter Mat                 | 1             |
| <b>MKT-MAT-EZMIX</b>  | EZ-Mix™ Granular Coil Cleaner™ Counter Mat | 1             |
| <b>MKT-MAT-GG</b>     | Charles Gallo Drain Gun Counter Mat        | 1             |
| <b>MKT-MAT-MDP</b>    | Metal Drain Pan Counter Mat                | 1             |
| <b>MKT-MAT-MSPLIT</b> | SpeediChannel™ Counter Mat                 | 1             |
| <b>MKT-MAT-PILL</b>   | Pan Pill Counter Mat                       | 1             |
| <b>MKT-MAT-PUMP</b>   | Condensate Pump Counter Mat                | 1             |
| <b>MKT-MAT-UC</b>     | UltraLite® Pad Counter Mat                 | 1             |
| <b>MKT-MAT-WS</b>     | Wet Switch® Counter Mat                    | 1             |

### Literature Holders

| CATALOG NO.           | DESCRIPTION                                  | STANDARD PACK |
|-----------------------|--|---------------|
| <b>MKT-POP-BROCH</b>  | Brochure Holder w/DiversiTech Logo Imprinted | 1             |
| <b>MKT-POP-BROCH4</b> | 4-Pocket Brochure Holder                     | 1             |
| <b>MKT-POP-EASEL</b>  | Acrylic Tri-Fold Brochure Holder             | 1             |

### Posters

| CATALOG NO.              | DESCRIPTION                 | STANDARD PACK |
|--------------------------|-----------------------------|---------------|
| <b>MKT-POSTER-CLRVUE</b> | ClearVue™ Pump Poster       | 1             |
| <b>MKT-POSTER-MSPLIT</b> | SpeediChannel™ Parts Poster | 1             |

### Samples/Demos

| CATALOG NO.         | DESCRIPTION                  | STANDARD PACK |
|---------------------|------------------------------|---------------|
| <b>6-HK2748-SAM</b> | High Rise Pan – 27" x 48"    | 1             |
| <b>6-M3030-SAM</b>  | Metal Drain Pan – 30" x 30"  | 1             |
| <b>MKT-SAM-ELEC</b> | Sample Packet for Electrical | 1             |

### Sales Kits

| CATALOG NO.          | DESCRIPTION              | STANDARD PACK |
|----------------------|--------------------------|---------------|
| <b>MKT-SK-CLRVUE</b> | ClearVue™ Pump Sales Kit | 1             |

### P.O.P. Merchandisers/Displays

MKT-POP-DEVBACKS



MKT-POP-PF



MKT-POP-CP22

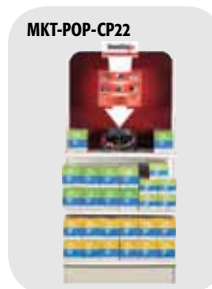

MKT-POP-CHEM



| CATALOG NO.             | DESCRIPTION  | STANDARD PACK |
|-------------------------|--|---------------|
| <b>6-HK2748-SAM</b>     | High Rise Pan – 27" x 48"                            | 1             |
| <b>6-M3030-SAM</b>      | Metal Drain Pan – 30" x 30"                          | 1             |
| <b>MKT-MOTGONDOLA</b>   | Motor Product Display – Gondola                      | 1             |
| <b>MKT-POP-CHEM</b>     | DiversiTech Chemical Display – 24" x 72"             | 1             |
| <b>MKT-POP-CLRGOND</b>  | ClearVue™ Pump Display for Gondola                   | 1             |
| <b>MKT-POP-CLRKIT</b>   | ClearVue™ Pump Distributor POP Kit                   | 1             |
| <b>MKT-POP-CLRSHELF</b> | ClearVue™ Pump Shelf Talker                          | 1             |
| <b>MKT-POP-CLRSTAND</b> | ClearVue™ Pump Banner Stand                          | 1             |
| <b>MKT-POP-CP22</b>     | CP22 Pump Display for Gondola                        | 1             |
| <b>MKT-POP-DEV16</b>    | DEVCO Display Rack – PB16                            | 1             |
| <b>MKT-POP-DEVBACKS</b> | DEVCO Background Graphics – 24" x 32" Pegboard       | Set of 2      |
| <b>MKT-POP-DEVCOMBO</b> | DEVCO Display Rack – Combo                           | 1             |
| <b>MKT-POP-DEVELEC</b>  | DEVCO Display Rack – Electrical                      | 1             |
| <b>MKT-POP-DEVEZC</b>   | DEVCO Display Rack – EZZ                             | 1             |
| <b>MKT-POP-DTBACKS</b>  | DiversiTech Background Graphics – 24" x 32" Pegboard | Set of 2      |
| <b>MKT-POP-DUCT</b>     | SpeediChannel Merchandising Display                  | 1             |
| <b>MKT-POP-GG</b>       | Gallo Gun Counter Display                            | 1             |
| <b>MKT-POP-PF</b>       | Pro-Flush Display                                    | 1             |
| <b>MKT-POP-TS</b>       | Touchscreen Thermostat Display                       | 1             |
| <b>POP-1001</b>         | Merchandiser Display for SOS Switch                  | 1             |
| <b>POP-103</b>          | Merchandiser Display for GG-1 & GGC-12               | 1             |
| <b>POP-106</b>          | Merchandiser Display for GG-1 & GGC-6                | 1             |

## General Policy

**WE ARE COMMITTED TO DO WHAT IT TAKES TO DELIVER WORLD CLASS SERVICE AND PRODUCTS.**

All items not ordered in multiples of standard package quantities will automatically be increased to the next standard package quantity. All purchase orders submitted by our customers are assumed as accepting our general terms and conditions as stated herein, any conflicting terms stated on the purchase order cannot supersede our terms.

## Order Discrepancies:

All order discrepancies must be reported to us within 5 working days from the date of delivery. Any discrepancies reported after this period cannot be honored.

## Terms:

1% 15 days. Net 30 days. Late charges of 1-1/2% per month will be charged following the due date of the invoice. Prices subject to change without notice.

## Minimum Order:

\$100.00 minimum order on all original orders. \$15.00 Broken Pallet Charge will be added for each pad size less than the standard pallet quantities.

## Freight Policy

CONTINENTAL U.S.: All orders in excess of \$2,000 will ship prepaid. This policy applies to any combination of DiversiTech, Wagner, Specialty Chemical, and Devco products.

## Pick Up Allowance

3% of net invoice, 24-hour notice requested. Order must qualify for prepaid freight to receive pick up allowance.

## Lost or Damaged Freight

Although we take special care to insure the safe arrival of your merchandise, our responsibility for damages cease when the customer accepts the shipment. To protect your interest, we suggest that you thoroughly inspect all items before accepting delivery. If your order was damaged in shipment or contains a shortage, report the loss or damage AT ONCE to DiversiTech. Any claims for lost or damaged freight must be noted on the Bill of Lading at the time of delivery. If damage is present, you MUST hold the original carton and merchandise for credit by your Sales Representative – otherwise, no claim can be honored.

## Returns:

No merchandise will be accepted for return without prior authorization. Call our Customer Service Department to request permission to return goods. Instructions on method of return will be given to you at that time. All returns are subject to a 25% restocking charge.

## Warranty Disclaimer

DiversiTech has made a diligent effort to illustrate and describe the products in this catalog accurately; however, such illustrations and descriptions are for the sole purpose of identification, and do not express or imply a warranty that the products are merchantable or fit for a particular purpose, or that the products will necessarily conform to the illustrations or descriptions. DiversiTech assumes no liability for typographical or photographic errors.

DiversiTech reserves the right to make changes in design, material or finish in an effort to improve our products without special notification. If necessary, DiversiTech reserves the right to replace any product shown in catalog with another comparable product without special notification.

## DiversiTech's ULTRALITE®, CLADLITE®, and E LITE® Limited Lifetime Warranty

To the original owner of the ULTRALITE®, CLADLITE®, or E LITE® equipment base, DiversiTech warrants the base to be free of defects in materials and workmanship for the life of the equipment under which it is installed so long as the installing homeowner lives there. All defective merchandise must be returned to the factory, transportation prepaid, and if the same is found to be defective, it will be repaired or replaced free of charge, F.O.B. factory. This warranty does not cover replacement labor cost, or any cost claim incident to the defect, replacement, or reinstallation, nor field repair expenses. This warranty gives you specific legal rights and you may also have other rights which vary from state to state. Some states do not allow the exclusion or limitation of incidental or consequential damages, so the above limitation of exclusion may not apply to you.

## Exclusions and Limitations

DiversiTech's ULTRALITE®, CLADLITE®, and E LITE® equipment pads are designed and manufactured to be used as bases for light, ground supported equipment such as air conditioning condensers, swimming pool filters and heat pumps. Use of ULTRALITE®, CLADLITE®, and E LITE® pads for purposes other than those listed above or improper installation of ULTRALITE®, CLADLITE®, and E LITE® pads may result in pad failure. DiversiTech Corporation disclaims any liability due to such misuse or improper installation. If you have questions concerning the proper installation or use of DiversiTech's ULTRALITE®, CLADLITE®, and E LITE® equipment pads, you should contact our Customer Service Department at (800)995-2222.

**DOMESTIC CREDIT APPLICATION**

For internal use only

**COMPANY NAME:** \_\_\_\_\_

**CUSTOMER #:** \_\_\_\_\_

**SHIP TO** \_\_\_\_\_ **PHONE #** \_\_\_\_\_

**ADDRESS** \_\_\_\_\_ **FAX #** \_\_\_\_\_

**CITY/STATE** \_\_\_\_\_ **ZIP CODE** \_\_\_\_\_

**E-MAIL** \_\_\_\_\_

**BILL TO** \_\_\_\_\_

**NAME** \_\_\_\_\_ **PHONE #** \_\_\_\_\_

**ADDRESS** \_\_\_\_\_ **FAX #** \_\_\_\_\_

**CITY/STATE** \_\_\_\_\_ **ZIP CODE** \_\_\_\_\_

**E-MAIL** \_\_\_\_\_

**PRINCIPALS** \_\_\_\_\_

**BUYING GROUP MEMBER** \_\_\_\_\_

**BUSINESS STRUCTURE\*:** **CORPORATION** \_\_\_\_\_ **PARTNERSHIP** \_\_\_\_\_ **INDIVIDUAL** \_\_\_\_\_ \*Please check one

**CREDIT LIMIT REQUESTED** \_\_\_\_\_ **DUNS #** \_\_\_\_\_

**ESTIMATED SALES VOLUME** \_\_\_\_\_ **FEDERAL TAX ID #** \_\_\_\_\_

**YEARS IN BUSINESS** \_\_\_\_\_

**BANK REFERENCE**

**NAME** \_\_\_\_\_ **PHONE #** \_\_\_\_\_

**ADDRESS** \_\_\_\_\_ **OFFICER** \_\_\_\_\_

**CITY/STATE** \_\_\_\_\_ **ZIP CODE** \_\_\_\_\_

**ACCOUNT #** \_\_\_\_\_

**THREE MAJOR TRADE REFERENCES (U.S. based are preferred)**

**NAME** \_\_\_\_\_ **TITLE** \_\_\_\_\_

**CONTACT** \_\_\_\_\_ **PHONE #** \_\_\_\_\_

**CITY/STATE/ZIP** \_\_\_\_\_ **FAX #** \_\_\_\_\_

**E-MAIL** \_\_\_\_\_ **ACCOUNT NUMBER** \_\_\_\_\_

**NAME** \_\_\_\_\_ **TITLE** \_\_\_\_\_

**CONTACT** \_\_\_\_\_ **PHONE #** \_\_\_\_\_

**CITY/STATE/ZIP** \_\_\_\_\_ **FAX #** \_\_\_\_\_

**E-MAIL** \_\_\_\_\_ **ACCOUNT NUMBER** \_\_\_\_\_

**NAME** \_\_\_\_\_ **TITLE** \_\_\_\_\_

**CONTACT** \_\_\_\_\_ **PHONE #** \_\_\_\_\_

**CITY/STATE/ZIP** \_\_\_\_\_ **FAX #** \_\_\_\_\_

**E-MAIL** \_\_\_\_\_ **ACCOUNT NUMBER** \_\_\_\_\_

Download an electronic version of this form at [www.diversitech.com/literature/creditapp.pdf](http://www.diversitech.com/literature/creditapp.pdf)

**CATEGORY INDEX**

|   |          |  |                   |   |         |
|---|----------|--|-------------------|---|---------|
| 007 Control Checker.....                              | 159      | Blind Rivet Tools.....                                 | 110               | Compression Nut.....                                | 234     |
| 3/4" Rubber Elbow.....                                | 179      | Blue Blitz™ New Concept Cleaner-Deodorizer-Degreaser.. | 229               | Compression Sleeve.....                             | 234     |
| 3-36® Multi-Purpose Lubricant & Corrosion Inhibitor.. | 70       | Blue Label Permanent Air Filters.....                  | 32                | Compression Sprayers.....                           | 232     |
| 45 Degree Ell C x C.....                              | 237      | Bolts and Washers.....                                 | 107               | Compression Tee.....                                | 234     |
| 45 Degree Street Ell Ftg. X C.....                    | 237      | Booster Fans.....                                      | 34                | Compression Union.....                              | 234     |
| 45 Elbows.....  | 180      | Box Cover Units.....                                   | 137               | Compressor Heaters.....                             | 146     |
| 45° Flat Bend.....                                    | 199      | Box Grounding Clip.....                                | 101               | Compressor Lead Kit.....                            | 85      |
| 4-Piece Hook and Pick Set.....                        | 161      | Boxes, Rings, and Covers.....                          | 93-94             | Compressor TOTE.....                                | 161     |
| 6-in-1 Flip Driver.....                               | 167      | Brass Adapters.....                                    | 240               | Condensate Cop™.....                                | 59      |
| 90 Degree Ell C x C.....                              | 237      | Brass Fittings.....                                    | 234-235           | Condensate Drain Line Cleaners.....                 | 61      |
| 90 Degree Long Turn Ell C x C.....                    | 237      | Bright Zinc-It® coating.....                           | 70                | Condensate Drain Line Switches.....                 | 59-60   |
| 90 Degree Long Turn Street Ell Ftg. X C.....          | 237      | Brushes.....   | 163-165           | Condensate Drain Pans.....                          | 57, 202 |
| 90 Degree Street Ell Ftg. X C.....                    | 237      | Bubble-N-Trouble™ Spray-On Leak Detector.....          | 226               | Condensate Drainage.....                            | 202     |
| 90 Elbow (Hub x Hub).....                             | 180      | Bug Spray.....   | 72                | Condensate Pumps.....                               | 57-58   |
| 90° Flat Bend.....                                    | 199      | Bulbs.....   | 111               | Condenser Equipment Mounting.....                   | 201     |
| 90° Inside Elbow.....                                 | 198      | Bushings (MIPT x FIPT).....                            | 182               | Condenser Fan Motors.....                           | 142     |
| 90° Long Radius Bend.....                             | 199      | Bushings and Locknuts.....                             | 96                | Condenser/Heat Exchanger Brushes.....               | 165     |
| 90° Outside Elbow.....                                | 198      | Butt Connector Assortment Kit.....                     | 86                | Conduit Fittings.....                               | 95-96   |
| A/C Brackets.....                                     | 27, 201  | Butt Connectors – Insulated.....                       | 86                | Conduit Nipples.....                                | 96      |
| A/C Condensate Drain Pan Fittings.....                | 57       | BX and Greenfield Connectors.....                      | 95                | Conduit, Fittings, Cable.....                       | 137-138 |
| A/C Condensate Float Switch.....                      | 60       | BX Set Screw Connectors.....                           | 138               | Contact Cleaners.....                               | 71      |
| A/C Pull-out Disconnect Switches.....                 | 132-133  | Cable Connectors.....                                  | 94-95             | Contactors Accessories.....                         | 128     |
| A/C Secondary Condensate Drain Pans.....              | 56       | Cable Markers.....                                     | 102               | Contactors.....                                     | 127-128 |
| Abrasive Cloths.....                                  | 69       | Cable Staples.....                                     | 138               | Control Disconnect.....                             | 241     |
| Access Fittings.....                                  | 240      | Cable Tie Assortment Pack.....                         | 147               | Cool-Weld™ Heat Barrier Spray.....                  | 221     |
| Accessories.....                                      | 221      | Cable Tie Holder.....                                  | 34,147            | Copper Coupling with Dimple Stop.....               | 239     |
| Acid Eliminator.....                                  | 222      | Cable Tie Mounts.....                                  | 108               | Copper Fittings.....                                | 236-239 |
| Acid Test Kit™.....                                   | 222      | Cable Tie Tensioning Tools.....                        | 111               | Copper Saddle Valve.....                            | 243     |
| Acrylic Latex Painter's Caulk.....                    | 68       | Cable Ties and Accessories.....                        | 107-108           | Copper Tube Cleaning Brush.....                     | 164     |
| Adapter (Insert x Slip).....                          | 177      | Calipers.....  | 166               | Copper Tube Fitting Brushes.....                    | 164     |
| Adjustable Delay on Break Timer.....                  | 141      | Cap.....   | 39, 199, 235, 238 | Core Removal Tool.....                              | 243     |
| Adjustable Delay on Make Timer.....                   | 141      | Cap (FIPT).....  | 178               | Core Storer.....                                    | 243     |
| Aerosols.....   | 74       | Cap (Slip).....  | 178               | Cork Insulation Tape.....                           | 60      |
| Air Filter Products.....                              | 227      | Capacitors.....  | 124-126           | Cotter Pins.....                                    | 109     |
| Air Filters.....                                      | 32       | Carbon Steel Curved Handle Scratch Brush.....          | 165               | Counter Mats.....                                   | 251     |
| Air Handler Base.....                                 | 26       | Carton Sealing Tape.....                               | 67                | Coupling.....                                       | 39      |
| Air Handler Block.....                                | 26       | Carton Tape Dispenser.....                             | 67                | Coupling (Slip x Slip).....                         | 178     |
| All Purpose Cleaning Pads.....                        | 69       | Case-Care.....   | 218               | Coupling (Socket) with Rolled Tube Stop C x C.....  | 238     |
| All Purpose Enamel.....                               | 73       | Catalogs.....  | 250               | Couplings (Hub x Hub).....                          | 180     |
| All Purpose Lubricant.....                            | 70       | Caulk Gun.....   | 67                | CP-22 Condensate Pump.....                          | 58      |
| All Purpose Sprayers.....                             | 232      | Caulking Sealant.....                                  | 68                | CPVC-CTS Pipe and Fittings.....                     | 181     |
| All Weather Test Leads.....                           | 156      | CBC II Contact Cleaner.....                            | 74                | Cross (Slip x Slip x Slip).....                     | 178     |
| Allen Wrenches.....                                   | 159      | Channellock® Products.....                             | 152               | Cushion Clamps.....                                 | 245     |
| Alligator Clips.....                                  | 149      | Channels.....  | 198               | Cushioned Pillow Blocks.....                        | 144     |
| All-purpose Clear Cement for ABS, PVC and CPVC        |          | Charles Gallo Brand Drain Gun.....                     | 61                | D'Scale™ Acid Scale Remover for Cooling Towers..    | 226     |
| Pipe and Fittings.....                                | 184      | Chip Brushes.....                                      | 163               | Definite Purpose Contactors.....                    | 127     |
| Aluminum Armored MC Cable.....                        | 137      | Circuit Breakers.....                                  | 135               | Degreasers.....                                     | 71-72   |
| Aluminum Dryer Vent Hoods, Kits, and Fittings.....    | 33       | CladLite® Pads.....                                    | 22                | Deluxe Hi-Tension Hacksaw.....                      | 155     |
| Aluminum Foil Tape.....                               | 35       | Clean Out Tee.....                                     | 178               | Deodorizers and Degreasers.....                     | 229     |
| Aluminum Solderless Lugs.....                         | 102      | Clear Vinyl Tubing.....                                | 59                | Detecto™ Iridescent Leak Detector.....              | 226     |
| Analog Pocket Thermometer with Magnifying Lens..      | 169      | ClearVue™ Pump.....                                    | 57                | DEVCO® Crimpers.....                                | 110     |
| Anchor Kit.....                                       | 67, 105  | Clipboards.....  | 157               | DEVCO® Plastic Anchor Kits.....                     | 105     |
| Anchor.....   | 104-105  | Clips.....   | 102               | DEVCO® Terminal Kits.....                           | 92      |
| Anti-Vibration Pads.....                              | 27-28    | Cloth Duct Tapes.....                                  | 36                | Device Rings.....                                   | 93      |
| Armored Connector.....                                | 98       | Coil Cleaners.....                                     | 217-218, 224-225  | Dial-a-Mix Coil Gun.....                            | 232     |
| Armored Plug.....                                     | 98       | Coil Cleaning Aerosols.....                            | 225               | Digital Air Flow Meter with CFM and BTU Display...  | 173     |
| Audible/Visual Circuit Tester.....                    | 172      | Coil Guard.....  | 221               | Digital Fractional Calipers.....                    | 166     |
| Aviation Snips.....                                   | 153      | Coil Protector.....                                    | 221               | Digital Jumbo Display Service Thermometer.....      | 170     |
| Batteries.....  | 72       | Coil-Care.....   | 218               | Digital One-Piece Air Flow Meter with CFM Display.. | 173     |
| Bearings.....   | 144      | Coil-Kleen™ Foaming Acid Condenser Cleaner.....        | 225               | Digital Pocket Thermometer.....                     | 166     |
| Bi Flow Driers.....                                   | 242      | Cold Galvanize.....                                    | 70                | Digital Psychrometer – Temperature and Humidity     |         |
| Big Helper™ PVC Pipe Cutter.....                      | 154      | Combination Couplings.....                             | 94                | Instrument.....                                     | 166     |
| BigMouth™ Bag.....                                    | 156      | Combination Pack: Set of 6233 and 6234.....            | 85                | Digital Single Phase Line Voltage Monitor.....      | 141     |
| Bi-Metal Reciprocating Saw Blades.....                | 155      | Combination Packs.....                                 | 90                | Digital Thermometer.....                            | 166     |
| Black Nylon Cable Tie Assortment.....                 | 108      | Combination Screwdrivers.....                          | 167               | Digital Three Phase Line Voltage Monitor.....       | 141     |
| Black Nylon Ties with Mounting Hole.....              | 148      | Combo Head Sheet Metal Screws.....                     | 103               | Digital UL Listed Multimeter.....                   | 171     |
| Black Nylon Wire Ties.....                            | 148      | Compartmented Storage Boxes.....                       | 149               | Direct Drive Furnace Blower Motors.....             | 142     |
| Black Steel Welded Nipples.....                       | 40       | Compression Connector.....                             | 234               | Disconnect Switches.....                            | 132-133 |
| Blade (Auto) Fuses.....                               | 103, 137 | Compression Elbow.....                                 | 234               | Disconnects – Insulated.....                        | 91      |

|   |              |  |              |   |              |
|---|--------------|--|--------------|---|--------------|
| Disconnects – Not Insulated.....                    | 91           | Felt Tip Markers.....  | 73           | Garden Hose Adapters.....   | 182          |
| Disinfectants.....                                  | 219, 226     | Female Adapter (Barb x FIPT).....                              | 181          | Gas Ball Valve.....   | 38           |
| DiversiGum™ Sealing Compound.....                   | 67, 185      | Female Adapter (Slip x FIPT).....                              | 177          | Gas Pressure Test Kit.....  | 173          |
| DiversiTech Aerosol Cleaners.....                   | 218          | Female Adapter C x F.....                                      | 236          | Gas Valves and Connectors.....                                      | 38           |
| DiversiTech Leak Detectors.....                     | 218          | Female Adapter Elbow (Barb x FIPT).....                        | 181          | Gauges.....   | 167          |
| DiversiWhips™.....                                  | 139          | Female Adapter Ftg. x F.....                                   | 236          | General Purpose Pumps.....  | 58           |
| Dormont Series.....                                 | 38           | Female Adapter Reducing (Slip x FIPT).....                     | 177          | General Purpose Relays.....   | 128          |
| Double Zipper Rigger's Bag.....                     | 156          | Fender Washers.....  | 107          | General Purpose Spray Paint.....                                    | 73           |
| Drain Gun and Cartridges.....                       | 61           | Filter-Aide™ AC and Furnace Filter Enhancer.....               | 227          | General Tools.....  | 110          |
| Drain Line, Hose, Hose Clamps.....                  | 59           | Fin Tools.....   | 160          | Geocel Caulking Sealant.....  | 68           |
| Drain Pan Disinfectant, Sealant.....                | 226          | Fin Whisk.....   | 165          | Glass Cloth, Moisture Sealing, and Economy<br>Electrical Tapes..... | 150          |
| Drain Pan Sealant.....                              | 226          | Finished Hex Nuts.....   | 106          | Gloves.....   | 64           |
| Drain Pans.....                                     | 56-57        | Fin-Tool.....  | 160          | Glycol Inhibitors.....  | 230          |
| Driers, Sight Glasses.....                          | 241-242      | Firestop Products.....   | 68           | Glycol Testing Strips.....  | 222          |
| Drill Bits.....                                     | 105          | First Aid Kits.....  | 64           | Glycols.....  | 219, 230-231 |
| Drill Point.....                                    | 66           | Fitting Reducer Coupling Ftg. x C.....                         | 238          | Gorilla Tube™ Clear Vinyl Tubing.....                               | 59           |
| Drive Fasteners.....                                | 104          | Fittings.....  | 198-200      | Grease Fittings.....  | 110          |
| Driver Set.....                                     | 167          | Flag Disconnects.....  | 85, 88-89    | Grip-Cut™.....  | 69           |
| Drop-In Expansion Anchor Setting Tool.....          | 104          | Flag Female Compressor Terminal Kit.....                       | 85           | Grommets – Vinyl.....   | 149          |
| Dryer Duct, Vent Hose, Hose Clamps.....             | 32-33        | Flag Female Compressor Terminals.....                          | 85           | Ground Adapter.....   | 98           |
| Dryer Receptacle.....                               | 134          | Flag Rings.....  | 88           | Ground Fitting Clamp.....   | 102          |
| Dryer Vent Hose.....                                | 33           | Flare Tee.....   | 235          | Grounding Rubber Handle Plug.....                                   | 97           |
| Dual Element Fuses – 250V.....                      | 103, 136     | Flare Union.....   | 235          | Hand Cleaners.....  | 69           |
| Duct Cleaning Brush.....                            | 164          | Flare x FIP Union.....   | 236          | Hanging Strap.....  | 161          |
| Duct End.....                                       | 199          | Flare x Flare Swivel Union.....                                | 236          | Hanging Wire.....   | 35           |
| Duct Fans.....                                      | 34           | Flare x MIP Elbow.....   | 234          | Hard Start Kits.....  | 126          |
| Duct Strap, Ties, Clamps.....                       | 34-35        | Flare x MIP Reducing Elbow.....                                | 234          | Heat Pump Pad.....  | 25           |
| Duct Tapes.....                                     | 35-36        | Flare x MIP Union.....   | 235          | Heat Pump Risers.....   | 26           |
| Duct-Fresh Gel, Spray.....                          | 229          | Flashlights and Lanterns By Rayovac®.....                      | 163          | Heat Resistant Cloth.....   | 152          |
| Dust Masks.....                                     | 64, 112      | Flashlights By Mag-Lite®.....                                  | 162          | Heat Shrink Tubing.....   | 100          |
| DWV Bend Fittings.....                              | 180          | Flat Wall Escutcheon.....                                      | 200          | Heat Shrink Tubing – Polyolefin 50% Shrink Commercial<br>Grade..... | 149          |
| DWV Bushings.....                                   | 180          | Flat Washers.....  | 107          | Heater Pads.....  | 25           |
| DWV Vent Tee.....                                   | 180          | Flex Duct Tape.....  | 36           | Heating Products.....   | 231          |
| E Lite® Pads.....                                   | 21           | Flex Joint.....  | 199          | Heavy Duty Cable Ties.....  | 35, 147      |
| E.V.A. Anti-Vibration Pad.....                      | 27           | Flow-Plus Inline Cleaner.....                                  | 61           | Heavy Duty Nylon Cable Ties.....                                    | 107          |
| E•Z™ Ratchet II Tube and Pipe Cutter.....           | 154          | Flow-Plus™ Condensate Pan Treatment.....                       | 220, 227     | Heavy Duty Silicone Lubricant.....                                  | 70           |
| E•Z™ Ratchet Tubing Cutter.....                     | 154          | Flow-Plus™ Pump Treatment Tablets for<br>Condensate Pumps..... | 58, 220, 227 | Heavy Duty Silicone Mold Release.....                               | 70           |
| Eco-Coil™ Coil Cleaner.....                         | 217          | Flue Caps.....   | 34           | Heavy Duty Work Gloves.....   | 64           |
| Economy Electrical Tape.....                        | 150          | Flush Bushing.....   | 238          | Hef-T-Block™.....   | 27, 201      |
| Economy Temperature and Humidity Pen.....           | 170          | Flushing Products.....   | 222          | Hef-T-Bracket™.....   | 27, 201      |
| Egg Crate Louvers – Air Return Diffusers.....       | 34           | Foam Insulation Tape.....                                      | 60           | Hef-T-Foot™.....  | 202          |
| Elbow (Barb x Barb).....                            | 181          | Foam Sealant.....  | 68           | Hef-T-Frame.....  | 202          |
| Elbow (FIPT x FIPT).....                            | 181          | Foam-Plus™ Aerosol Foaming Coil Cleaner.....                   | 225          | Hef-T-Pad™.....   | 24           |
| Electrical Duplex Receptacles.....                  | 133          | Foam-Power™ Alkaline Expanding Foam Coil Cleaner.....          | 225          | Hex Head Cap Screws.....  | 106          |
| Electrical Outlet Boxes, Extensions and Covers..... | 135          | Foil Scrim Kraft Tape.....                                     | 36           | HF™ Contact Cleaner.....  | 71           |
| Electrical Staples.....                             | 96           | Free-Foam™ Alkaline Coil and Filter Cleaner.....               | 225          | High Heat Spray Paint.....  | 73           |
| Electrical Supplies.....                            | 133-135, 158 | Fully Insulated Dead End Connectors.....                       | 90           | High Performance Ultra Wide-Range Infrared<br>Thermometer.....      | 168          |
| Electrical Tapes.....                               | 150          | Fully Insulated Female Slip-Ons.....                           | 84           | High Rise Pans™.....  | 56           |
| Electrical Toggle Switches.....                     | 133          | Fully Insulated Flag Female Slip-Ons.....                      | 85           | High Temp Red Silicone Sealant.....                                 | 67           |
| Electrolytic Copper Solderless Lugs.....            | 102          | Fully Insulated Male Slip-Ons.....                             | 84           | High Temperature Assortment.....                                    | 90           |
| Electronic Degreaser.....                           | 71           | Fully Insulated Receptacles.....                               | 90           | High Temperature Butt Connectors.....                               | 90           |
| Electronic Utility Scales.....                      | 158          | Fully Insulated Waterproof Female Slip-Ons.....                | 89           | High Temperature Condenser Fan Motors.....                          | 142          |
| EMT (Thinwall) Fittings.....                        | 138          | Fully Insulated Waterproof Male Slip-Ons.....                  | 89           | High Temperature Female Slip-Ons.....                               | 89           |
| EnviroPad™.....                                     | 25           | Furnace Mounting Blocks.....                                   | 26           | High Temperature Flag Female Slip-Ons.....                          | 89           |
| Equipment Support Systems.....                      | 202          | Fuse Adapters.....   | 137          | High Temperature Male Slip-Ons.....                                 | 89           |
| Expando Adjustable Condenser Tube Cleaner.....      | 161          | Fuse Holders.....  | 99           | High Temperature Range Wire.....                                    | 97           |
| Extension Cords.....                                | 111          | Fuse Pullers.....  | 137          | High Temperature Rings.....   | 90           |
| Extension Rings.....                                | 93           | Fuseblocks.....  | 137          | High Temperature Solderless Terminals.....                          | 89-90        |
| Extension Rods for Condenser Tube Brushes.....      | 165          | Fuses.....   | 136-137      | High Temperature Spades.....  | 89           |
| Fan Centers.....                                    | 129          | Fusible Links.....   | 145          | High Temperature Wire, 400°F, 600 V.....                            | 140          |
| Fast Cure Epoxy.....                                | 74           | Gallo Gun™, Charles.....                                       | 61           |   |              |
| Fast Nuts.....                                      | 109          | Garden Hose.....   | 232          |   |              |
| Fast Orange® Hand Cleaner.....                      | 69           |  |              |   |              |

**CATEGORY INDEX cont'd**

|   |              |   |          |   |         |
|---|--------------|---|----------|---|---------|
| Hobby and Cutting Knives.....                         | 168          | Louvered Dryer Vent Hood.....                     | 32       | Non-Insulated Female Slip-Ons.....                  | 84      |
| Homeline Circuit Breakers.....                        | 135          | Low Profile Pumps.....                            | 57       | Non-Insulated Flag Female Slip-Ons.....             | 85      |
| Horizontal Refrigerator/Freezer Analog Thermometer .. | 169          | Low Voltage Screwdriver Tester.....               | 172      | Non-Insulated Flange Spades.....                    | 87      |
| Hose Clamps.....                                      | 59, 108, 185 | Lubricants.....                                   | 69-71    | Non-Insulated Hooks.....                            | 86      |
| Hose Mender (Barb x Barb).....                        | 182          | Machine Screw Hex Nuts.....                       | 106      | Non-Insulated Male Slip-Ons.....                    | 84      |
| Hoses, Sprayers.....                                  | 232          | MAC—The Ultimate in Line Piercing Valves.....     | 243      | Non-Insulated Plugs.....                            | 91      |
| Hot Water Hose.....                                   | 232          | Mag Charger System.....                           | 162      | Non-Insulated Receptacles.....                      | 90      |
| Hurricane Pad™.....                                   | 23           | Mag-Lite®.....                                    | 162      | Non-Insulated Rings.....                            | 88      |
| Hurricane Pad™ Attachment Bracket.....                | 23           | Magna-Lite.....                                   | 162      | Non-Insulated Spades.....                           | 87      |
| HVAC Airflow Instruments.....                         | 173          | Magnetic Hex Chucks.....                          | 110      | Non-Insulated Spring Spades.....                    | 87      |
| HVAC Tools.....                                       | 153          | Magnetic Retrieving Tool.....                     | 157      | Non-Metallic Disconnects.....                       | 133     |
| HVAC/R Digital Stem Thermometer.....                  | 169          | Mailers.....                                      | 250      | Non-Metallic Sheathed Cable (Romex Wire).....       | 138     |
| HVACR Refrigerant Leak Detector.....                  | 170          | Male Adapter (Barb x MIPT).....                   | 182      | NT™ Precision Cleaner.....                          | 71      |
| Hydrogauge Manometer.....                             | 173          | Male Adapter (MIPT x Slip).....                   | 177      | Nut Setters.....                                    | 152     |
| Ice Machine Products.....                             | 228          | Male Adapter C x M.....                           | 236      | Nuts and Bolts.....                                 | 106     |
| Icemaker Kit.....                                     | 185          | Male Adapter Elbow (Barb x MIPT).....             | 182      | Nylon Cable Clamps.....                             | 108     |
| Igniters.....   | 40           | Male Adapter Ftg. x M.....                        | 236      | Nylon Cable Ties.....                               | 108     |
| Incandescent Light Bulbs.....                         | 111          | Male Adapter Reducing (MIPT x Slip).....          | 177      | Nylon Cable Ties with Mounting Hole.....            | 107     |
| Indicator Lights.....                                 | 100-101      | Malleable Black Iron and Steel Pipe Fittings..... | 38-39    | Nylon Fittings.....                                 | 181-182 |
| Industrial Enamel.....                                | 73           | Manifold Gauge.....                               | 167      | Nylon Insert Lock Nuts.....                         | 106     |
| Industrial Towels.....                                | 65           | Manometers, Pressure.....                         | 173      | Nylon Insulated Butt Connectors.....                | 86      |
| In-Line Fuse Holder.....                              | 136          | Manual Reset Fire Stat.....                       | 145      | Nylon Nut and Washer.....                           | 109     |
| Insta-Charge.....                                     | 244          | Map-Pro and Propane Gas.....                      | 152      | Nylon Rods.....                                     | 109     |
| Insta-Tap Refrigerant Recovery Tool.....              | 243          | Markers.....                                      | 73       | Oatey® Products.....                                | 184     |
| Insulated Block Spade Terminals.....                  | 87           | Masonry Bit.....                                  | 66       | Odor Neutralizers.....                              | 229     |
| Insulated Butt Connectors.....                        | 86           | Masonry Screw.....                                | 66       | Offset Snips.....                                   | 153     |
| Insulated Female Slip-Ons.....                        | 84           | Measuring Tapes, Staples and Staple Guns.....     | 156      | Oil Transfer System by Gauge-Pro.....               | 244     |
| Insulated Flange Spades.....                          | 87           | Mechanical Pickup.....                            | 157      | One Time Fuses.....                                 | 136     |
| Insulated Hooks.....                                  | 86           | Mechanical Screw Starter.....                     | 162      | One-Handed PVC/Hose Cutter.....                     | 154     |
| Insulated Male Slip-Ons.....                          | 84           | Medium Split Lock Washers.....                    | 107      | Outdoor Extension Cord.....                         | 158     |
| Insulated Plugs.....                                  | 91           | Merchandising.....                                | 251      | Outside Tube Cleaning Brushes.....                  | 164     |
| Insulated Rings.....                                  | 88           | Metal Bat Handle Toggle Switches.....             | 99       | Oval Head Screws for Covers.....                    | 94      |
| Insulated Spades.....                                 | 86           | Metal Drain Pan.....                              | 57       | P.O.P. Merchandisers / Displays.....                | 251     |
| Insulated Spring Spades.....                          | 87           | Metal Drive Anchors.....                          | 104      | Paints and Primers.....                             | 73      |
| Iso-Cube Economy Anti-Vibration Pad.....              | 28           | Metal Guard Trouble Lights.....                   | 158      | Pan Treatments.....                                 | 227     |
| J-B Weld.....   | 74           | Metal Parts Boxes.....                            | 112      | Pan Treatments / Disinfectants.....                 | 219-220 |
| Jumbo Display – Thermo/Hygrometer.....                | 166          | Metallic Duct – 2 Ply.....                        | 33       | Pan-Kote™ Drain Pan Patch.....                      | 226     |
| Jumbo Display Indoor/Outdoor Thermometer.....         | 169          | Metallic Duct – 5 Ply.....                        | 33       | Pan-Patch™.....                                     | 61, 221 |
| Kimberly-Clark Waterless Hand Wipes.....              | 69           | Meters, Detectors, Alarms.....                    | 170-171  | Parts Cleaning Brush.....                           | 164     |
| Kimtex® Towels.....                                   | 65           | Mini AC AMP Clamp Meter.....                      | 171      | Periscope Connection Kit.....                       | 33      |
| Knock'er Loose® Penetrating Solvent.....              | 71           | Mini Tubing Cutter.....                           | 155      | Permanent Air Filters.....                          | 32      |
| Knockout Seals and Hole Plug.....                     | 96           | Mini-Split Condensate Drain Line.....             | 59, 202  | Pigtails.....                                       | 102     |
| Kut-All Plastic Tube and Hose Cutter.....             | 154          | Mini-Split Drain Adapters.....                    | 57, 202  | Pilot Replacements.....                             | 40      |
| KwikRepair™ Coupler.....                              | 179          | Mini-Split Pump.....                              | 58       | Pipe Hanging Strap.....                             | 109     |
| Lashing Strap.....                                    | 160          | Miscellaneous Tools.....                          | 161-162  | Pistol Grips & Water Nozzle.....                    | 232     |
| Latex Gloves.....                                     | 64           | Monitors.....                                     | 141, 159 | Plastic DWV J-Hooks.....                            | 180     |
| Leak Detectors.....                                   | 226          | Motor Bolts.....                                  | 106      | Plastic Hanger Strap.....                           | 34      |
| Leak Test Gauge.....                                  | 172          | Motor Brackets.....                               | 144      | Plastic Thermostat Guards.....                      | 131     |
| Leak-Seek.....  | 218          | Motor Mount – Flex Bracket.....                   | 144      | Plastic Wall Plates.....                            | 134     |
| Leather Work Gloves.....                              | 64           | Motor Run Capacitors – 370 VAC.....               | 124      | Plastic Wide Mouth Dryer Vent Hood.....             | 32      |
| LED Screwdriver Continuity Tester.....                | 172          | Motor Run Capacitors – 440 VAC.....               | 125      | Plated Steel Utility Covers.....                    | 94      |
| Light Bulbs.....                                      | 158          | Motor Shaft Key Assortments.....                  | 109      | Plenum Thermostat Wire.....                         | 132     |
| Line Piercing Valves and Tools.....                   | 242-243      | Motor Start Capacitors – 330 VAC.....             | 126      | Plier Flaring Tool.....                             | 155     |
| Line Sets.....  | 247          | Motor Start Capacitors –110/125VAC.....           | 126      | Plug.....   | 39, 235 |
| Line Tap and Swivel Valves.....                       | 243          | Motor Start Capacitors 220/250 VAC.....           | 126      | Plug (MIPT).....                                    | 179     |
| Liquid Line Driers.....                               | 241          | Motors.....                                       | 142-143  | Plug (Slip).....                                    | 179     |
| Liquid Tite Connectors.....                           | 138          | Mounting Brackets, Blocks.....                    | 27       | Plug Fuses – Fast Acting.....                       | 136     |
| Liquid Tite Flexible Conduit.....                     | 137          | Multi Color Test Leads.....                       | 156      | Pocket 4-in-1 Mini Screwdriver.....                 | 167     |
| Liquid-Tite Connectors.....                           | 95           | Multimeter with Bright Screen Display.....        | 171      | Pocket HVAC General Purpose Infrared Thermometer .. | 169     |
| Lite-It Clip-On Mini-Light.....                       | 157          | Multiple Horsepower Motors.....                   | 143      | Pocket Thermometers.....                            | 166     |
| Literature.....                                       | 250          | Natural Gas Detector Pen.....                     | 170      | Polyethylene Tubing.....                            | 185     |
| Literature Holders.....                               | 251          | Nitrile Gloves.....                               | 64       | Polypropylene Parts Boxes.....                      | 112     |
| Little Helper™ – All Purpose Cutter.....              | 154          | Non-Insulated Butt Connectors.....                | 86       | Polypropylene Twisted Rope.....                     | 160     |

|  |          |   |          |  |                |
|--|----------|---|----------|--|----------------|
| Porcelain Outlet Box Lampholders.....                                | 99       | Range Receptacle.....   | 134      | Scotch® Electrical Tapes.....                                | 150            |
| Porcelain Wire Connectors.....                                       | 101,147  | Ratchet Strap.....  | 160      | Scotchlok™ Wire Connectors.....                              | 101            |
| Posters.....   | 251      | Rayovac Industrial Flashlights and Lanterns.....                  | 163      | Screwdriver Sets.....  | 167            |
| Potential Relays.....  | 128      | Rayovac Industrial Maximum Alkaline Batteries.....                | 72       | ScrewGrab®.....  | 162            |
| Power Block Extension Cords.....                                     | 111      | Rayovac Industrial Swivel Lights.....                             | 163      | ScrewLoose® Penetrating Oil.....                             | 71             |
| Power Blocks.....  | 158      | Rayovac Lantern Batteries.....                                    | 72       | Screw-On Grounding Connector.....                            | 101            |
| Power Cords and Work Lights.....                                     | 111-112  | Rayovac® Batteries.....   | 72       | Screws.....  | 66-67, 103-104 |
| Power Fitting Brushes.....   | 163      | Reach-It.....   | 157      | Sealant, Epoxy, Glue.....                                    | 74             |
| Power Measuring Tapes.....   | 156      | Receptacles.....  | 98       | Sealing Compound.....  | 67-68          |
| Power Sprayer.....   | 232      | Red Label Permanent Air Filters.....                              | 32       | Sealing Compounds, Adhesive.....                             | 67-68          |
| Power Supply Cord (Pigtails).....                                    | 134      | Reducer Bushing (SPIG X FIPT).....                                | 179      | Self Tapping Water Valve.....                                | 185            |
| Power Supply Replacement Cords.....                                  | 98       | Reducer Bushing (SPIG x Slip).....                                | 179      | Self-Drilling Gypsum Wallboard Anchors.....                  | 104            |
| Power-Plus™ Alkaline Evaporator Coil Cleaner.....                    | 224      | Reducer Coupling.....   | 199      | Self-Drilling Screw Repair Kit.....                          | 104            |
| Precision Screwdriver Set.....                                       | 111      | Reducer Coupling w/Stop C x C.....                                | 238      | Semi-Rigid (Flexible) Aluminum Duct.....                     | 33             |
| Pro-Air Duct Sealant – UL 181 AM-BM Listed.....                      | 68       | Reducing Bushing (MIPT x FIPT).....                               | 179      | Sequencers.....  | 145            |
| Pro-Air Industrial Grade Spray Adhesive.....                         | 68       | Reducing Tee.....   | 39       | Set Screws.....  | 109            |
| Pro-Blue™ Coil Cleaner.....  | 217      | Reducing Tee C x C x C.....                                       | 239      | Sheet Metal Gauge.....                                       | 167            |
| Pro-Brown™ Coil Cleaner.....   | 217      | Reducing Washers.....   | 95       | Sheet Metal Screw Assortment Kit.....                        | 67             |
| Pro-Bubble™ Leak Detector.....                                       | 221      | Refractometers.....   | 172      | Sheet Metal Screw Assortments.....                           | 103            |
| Pro-Flush™ HVAC Flushing Solvent.....                                | 222      | Refrigerant Charging.....   | 244      | Sheet Metal Screws.....                                      | 66-67          |
| Pro-Green™ Coil Cleaner.....   | 217      | Refrigerant ID Labels.....  | 244      | Shoe Covers.....   | 64             |
| Pro-Lube-ALK™ Alkylbenzene.....                                      | 228      | Refrigerant Leak Detector with Pump.....                          | 171      | Shop Towels.....   | 65             |
| Pro-Lube-POE™ Polyolester.....                                       | 228      | Refrigerant Recovery Cylinders.....                               | 245      | Short Forged Flare Nut.....                                  | 235            |
| Pro-Lube™ Mineral Oil.....   | 228      | Refrigerant Recovery Products.....                                | 245      | Short Nut.....   | 235            |
| Pro-Lube-VAC™ Vacuum Pump Oil.....                                   | 229      | Refrigeration Oils.....   | 228      | Side Flange Mount Pillow Blocks.....                         | 144            |
| Pro-Prime™ Clear PVC Primer.....                                     | 183      | Refrigerator Coil Brush.....                                      | 164      | Sight Glasses.....   | 242            |
| Pro-Prime™ PVC Primer (Purple).....                                  | 183      | Refrigerator/Freezer Analog Thermometer.....                      | 169      | Silent Support Anti-Vibration Pad.....                       | 28             |
| Pro-Red Plus™ Coil Cleaner.....                                      | 217      | Refrigerator/Oven Thermometer.....                                | 170      | Silicone Sealant.....  | 67             |
| ProTek EG™.....  | 219, 230 | Relays.....   | 128      | Single Piece Liquid Tite Fittings.....                       | 138            |
| ProTek-BG™ for Cast Iron Water Boilers.....                          | 219,230  | Replacement Check Valve.....                                      | 58       | SITO Service Cord.....                                       | 97             |
| ProTek-RV™ for Recreational Vehicles.....                            | 230      | Replacement Compressor Leads.....                                 | 149      | Slip-On Solderless Terminals.....                            | 84-85          |
| ProTek™ Closed Loop Heat Transfer Fluid.....                         | 219, 230 | Replacement Element Kits.....                                     | 145      | Slotted Round Head Machine Screws – Assortments.....         | 103            |
| ProTek™ PG-AL – Safe for Aluminum Heat Exchangers.....               | 219, 230 | Retrieving Tool/Mini-Lights.....                                  | 157      | Smokeys.....   | 34             |
| Pro-Thaw™ Liquid Dryer for Refrigerants.....                         | 222      | Rheem Motor Bracket.....  | 144      | Snips, Notchers, Crimpers, Seamers.....                      | 153            |
| PRO-TITE™ Resin Based Thread Sealant.....                            | 221      | Right Angle Plug.....   | 98       | Solitaire AAA Single Cell Flashlights.....                   | 162            |
| Pro-Treat® 151 Premium Condensate Drain Pan Treatment.....           | 219      | Rigid Conduit Bodies.....   | 95       | Soot Kill™ – Catalytic Soot Remover.....                     | 231            |
| Pro-Treat® 161 Condensate Drain Pan Treatment.....                   | 220      | Robertshaw Thermostats.....                                       | 130-131  | SP-400 Corrosion Inhibitor.....                              | 70             |
| Pro-Treat® 200 Economy Condensate Drain Pan Treatment.....           | 220      | Romex Connectors.....   | 138      | Spade Terminals – Insulated.....                             | 86-89          |
| Pro-Treat® 350 Condensate Drain Pan Treatment.....                   | 220      | Roof Flashing.....  | 34       | Spade Terminals – Not Insulated.....                         | 87             |
| Pro-Treat® Pan Strips.....   | 227      | Roof Inlets - SpeediChannel.....                                  | 200      | Special Purpose Solderless Terminals.....                    | 90-91          |
| Pro-Treat® 152 King-Size Premium Condensate Drain Pan Treatment..... | 220      | Roof Louver.....  | 34       | Specialty Fasteners.....                                     | 108-109        |
| Pro-Weld™ PVC Cement.....  | 183      | Rope.....   | 160      | Specialty Fittings.....                                      | 110            |
| Pro-Yellow™ Coil Cleaner.....  | 217      | Rough Service Light Bulbs.....                                    | 158      | Specialty Tools.....   | 111            |
| P-Traps.....   | 239      | Round Extension Cords.....  | 111      | SpeediChannel™.....  | 198            |
| Pull-A-Spout Oiler.....  | 69       | Rubber Connector.....   | 98       | SpeediChannel™ Accessories.....                              | 200            |
| Pumps.....   | 57-58    | Rubber Tie Down Strap.....  | 161      | SpeediChannel™ Fitting Kit.....                              | 200            |
| Pure-Beam™ UltraViolet Light.....                                    | 36       | Rubber/Cork Anti-Vibration Pad.....                               | 27-28    | Spill Kill™ Liquid – Fuel Spill Deodorant Spray.....         | 231            |
| PVC Cement.....  | 183-184  | Rubber/Cork Anti-Vibration Pad.....                               | 27       | Spill Kill™ Powder – Fuel Spill Deodorant and Absorbent..... | 231            |
| PVC Condensate Pipe.....   | 176      | Rust Breaker.....   | 69       | Split Bolt Connectors.....                                   | 102            |
| PVC DWV Fittings.....  | 180      | S/B Refrigeration, A/C and Food Service Infrared Thermometer..... | 168      | Spray Adhesive.....  | 74             |
| PVC Primer and Cement.....   | 183      | Safety Overflow Switch (SOS).....                                 | 60       | Standard Solderless Terminals.....                           | 86-88          |
| PVC Ratchet Cutter.....  | 154      | Safety Plates.....  | 94       | Standard Test Leads.....                                     | 156            |
| PVC Schedule 40 Pressure Fittings.....                               | 176-179  | Safety Supplies, Devices.....                                     | 64       | Standard Wire Connectors.....                                | 101            |
| QD™ Contact Cleaner.....   | 71       | Safety/Protective Equipment.....                                  | 112      | Sta-Plex™ Grease.....  | 70             |
| QO200TR A/C Disconnect.....  | 133      | Saf-N-Kleen™ Aerosol Solvent Coil Cleaner.....                    | 225      | Steel 1900 Boxes.....  | 93             |
| Quick-Tap.....   | 242      | Saf-T-Kleen II™ Safety Solvent Degreaser.....                     | 229      | Steel 1900 Covers.....                                       | 94             |
| Quick-Tap-2.....   | 242      | Sales Kits.....   | 251      | Steel Octagon Box.....                                       | 93             |
| Radiant Leak Finder™.....  | 221      | Samples/ Demos.....   | 251      | Steel Octagon Box.....                                       | 93             |
| Radiator Vent Keys.....  | 111      | Sani C-N-D™ Coil and Drain Pan Disinfectant ..                    | 219, 226 | Steel Thermostat Guards.....                                 | 131            |
|  |          | Satchel Style Case.....   | 112      | Steel Utility Boxes.....                                     | 93             |
|  |          | Saws and Saw Blades.....  | 155      | Stick-E-Tape.....  | 35             |
|  |          | Scales.....   | 158      | Sting Less Wasp & Hornet Killer.....                         | 72             |

## CATEGORY INDEX cont'd

|  |                    |   |          |  |            |
|--|--------------------|---|----------|--|------------|
| Storage Containers.....  | 112                | Thermal Controls.....                                       | 145      | Valve Action Marker.....                         | 73         |
| Stove Bolts.....   | 106                | Thermometers.....   | 166      | Valve Stem Repair Tool.....                      | 111        |
| Stranded Copper THHN Wire.....                                     | 140                | Thermometers/Probes.....                                    | 168-170  | VariTorque™.....                                 | 126        |
| Stranded Copper Wire in Clear Dispenser Pack.....                  | 140                | Thermoplastic Handle Plug.....                              | 97       | Vent Tee.....                                    | 180        |
| Stranded Copper Wire on Spool.....                                 | 140                | Thermostat Guards.....                                      | 131      | Ventilation Products.....                        | 33-34      |
| Stranded High Temperature Wire.....                                | 97                 | Thermostat Wire.....  | 97, 132  | Versa Cap® Flue and Hot Stack Caps.....          | 33         |
| Strapping Hanger Iron.....   | 35, 180            | Thermostats.....  | 130-131  | Vinyl Grommets.....                              | 99-100     |
| Straps.....  | 34-35, 95, 160-161 | THHN Stranded Hook-Up Wire.....                             | 96       | Wagner Adhesive Sealant.....                     | 74         |
| Straps, Truck Rope.....  | 160-161            | Thinwall EMT Connectors.....                                | 95       | Wall Escutcheon - SpeediChannel.....             | 200        |
| Street 45 Degree Ftg. x C.....                                     | 237                | Thread Sealant with Teflon.....                             | 74       | Wall Penetration - SpeediChannel.....            | 198        |
| Street Ell Ftg. x C.....   | 237                | Thread Sealants.....  | 221      | Wasp & Hornet Killer.....                        | 72         |
| Styrene Parts Boxes.....   | 112                | Three Phase Disconnects.....                                | 133      | Waterless Hand Cleaners.....                     | 69         |
| Suction Line Driers.....   | 241                | Time Delay Fuses.....                                       | 136      | Waterless Hand Wipes.....                        | 69         |
| Super Glue.....  | 74                 | Time Delay Plug Fuses.....                                  | 136      | Waterproof Butt Connectors.....                  | 88         |
| Super-Brite™ Brown Foaming Coil Cleaner.....                       | 224                | Time Delays.....  | 141      | Waterproof Rings.....                            | 88         |
| SuperComb.....   | 160                | Tin Handle Acid Brushes.....                                | 163      | Waterproof Solderless Terminals.....             | 88-89      |
| Super-Foam™ Maximum Power Foaming Coil Cleaner.....                | 224                | Tinner Snips.....   | 153      | Waterproof Spades.....                           | 89         |
| Super-Kool™ Nickel-Safe and Metal-Safe Ice<br>Machine Cleaner..... | 228                | T-Joint.....  | 199      | WD-40®.....                                      | 70         |
| Supports.....  | 180                | Toggle Bolts.....   | 106      | Weatherproof Boxes, Covers.....                  | 93         |
| Sure Burn™ Concentrated Fuel Oil Treatment.....                    | 231                | Toggle Switch and Receptacle Combination Device.....        | 99       | Welder's Brush.....                              | 163        |
| Sure-Stick Heavy Duty Adhesive Spray.....                          | 74                 | Toggle Switch Cover.....                                    | 134      | Welding Torches, Supplies.....                   | 152        |
| Sweat-Free Pipe Insulation Spray.....                              | 74                 | Toggle Switch with Neon Pilot Light Combination Device..... | 99       | Wet Switch Flood Detector.....                   | 60         |
| Switch Covers.....   | 134                | Toggle Switches.....  | 99, 134  | Whips.....                                       | 139        |
| Switch/Plug Combo.....   | 134                | Tommy Tape.....   | 60       | White Lithium Grease.....                        | 70         |
| Swivel Head Deburring Tool.....                                    | 155                | Tongue and Groove Pliers.....                               | 152      | White Nylon Ties with Mounting Hole.....         | 148        |
| System Cleaners.....   | 226                | Tool Bags.....  | 156      | White Nylon Wire Ties.....                       | 148        |
| T-50 Series Staples and Staple Guns.....                           | 156                | Torches.....  | 152      | Winged Wire Connectors.....                      | 101        |
| Tab Adapters - Male Tabs.....                                      | 91                 | Torque Plus.....  | 126      | Wire.....  | 96-97, 201 |
| Tab Adapters - Piggy Back Slip-Ons.....                            | 91                 | Touchscreen Thermostats.....                                | 131      | Wire and Cable Clamps - Nylon.....               | 148        |
| Tab Adapters - Quick Disconnect with Screw.....                    | 91                 | Transformers.....   | 129      | Wire Connectors.....                             | 146-147    |
| Tab Adapters - Single Female Double Male Tabs.....                 | 91                 | Transparent Plastic Boxes with Terminal Assortments.....    | 149      | Wire for Mini-Split Installation.....            | 132, 201   |
| Tandem Grounding Rubber Handle Plug.....                           | 98                 | Traps (Slip x Slip).....                                    | 179      | Wire Gauge.....                                  | 167        |
| Tap Connectors.....  | 90                 | Tri-folds.....  | 250      | Wire Tie Mounts.....                             | 148        |
| Tapes.....   | 35-36, 110, 185    | Trigger Action Plastic Pipe and Hose Cutter.....            | 154      | Wire/Cable Ties, Mounts, Clamps.....             | 147-148    |
| Tapes and Sealing.....   | 185                | Triple Outlets.....   | 98       | Wiring Devices.....                              | 97-102     |
| Tattle-Tale Control Monitor.....                                   | 159                | Triple-D™ Universal Coil Cleaner.....                       | 218, 224 | Wood Handle Dope Brush.....                      | 164        |
| Tee.....   | 178, 182           | Trouble Lights.....   | 112      | Work Lights.....                                 | 112        |
| Tee (Barb x Barb x Barb).....                                      | 182                | TrueStart™ Universal Igniter Kits.....                      | 40       | Workhorse® Manufactured Rags.....                | 65         |
| Tee (Slip x FIPT x Slip).....                                      | 178                | Tube Working Tools.....                                     | 154-155  | WypAll Towels.....                               | 65         |
| Tee (Slip x Slip x FIPT).....                                      | 178                | Tubing Insulation.....                                      | 246      | Zinc Plated Die Cast Steel Romex Connectors..... | 94         |
| Tee (Slip x Slip x Slip).....                                      | 178                | Tubing, Clamps, and Kits.....                               | 185      | Zinc-It® coating.....                            | 70         |
| Tee (C x C x C).....   | 239                | Type "S" Non-Tamper Fuses.....                              | 136      |  |            |
| Teflon Tape.....   | 60, 110, 185       | Type 2 Wall Brackets.....                                   | 27       |  |            |
| Telescopic Inspection Mirror.....                                  | 161                | Type 3 Wall Brackets.....                                   | 27       |  |            |
| Telescoping Mini-Light and Magnetic Pickup.....                    | 157                | UL Listed Foil Tape.....                                    | 36       |  |            |
| Tensioning Tool.....   | 111                | Ultra Lite 3-36® Ultra Thin Non Staining Lubricant.....     | 70       |  |            |
| Teri® Towels.....  | 65                 | Ultra Lite Non-Staining Lubricant.....                      | 70       |  |            |
| Term Lok Compressor Repair Kit.....                                | 149                | UltraLite® Earthquake Code Compliant Pads.....              | 21       |  |            |
| Terminal Block Jumpers.....  | 100                | UltraLite® Lightweight Equipment Pads.....                  | 20-21    |  |            |
| Terminal Blocks.....   | 100                | UltraLite® Wedge Pads.....                                  | 21       |  |            |
| Terminal Kits.....   | 92                 | UltraViolet Light.....                                      | 36       |  |            |
| Terminals, Connectors.....   | 149                | Union C x Brass.....  | 238      |  |            |
| Terry Towels.....  | 65                 | Union Coupling - SpeediChannel.....                         | 198      |  |            |
| Test Cord (Female).....  | 172                | Unions - Gas.....   | 235-238  |  |            |
| Test Kits, Strips, and Prevention.....                             | 222                | Universal Alarm.....  | 59       |  |            |
| Test Leads.....  | 103, 156           | Universal Spun Copper Driers.....                           | 242      |  |            |
| Testers.....   | 102, 172           | Upright Snips.....  | 153      |  |            |
| Testers, Leads, Clips, Fuses.....                                  | 102-103            | Utility Covers.....   | 94       |  |            |
| TFFN Stranded Hook-Up Wire.....                                    | 96                 | Utility Fuse Outlets.....                                   | 99       |  |            |
| The Black Pad®.....  | 24                 | Utility Plates.....   | 94       |  |            |
| The Hurricane Pad™.....  | 23                 | Utility Scales.....   | 158      |  |            |
| The Quad™ 14-Piece Saw/Driver Set.....                             | 168                | U-Type Strap.....   | 239      |  |            |
|  |                    | Vacuum Pump Oil.....  | 229      |  |            |

## PART NUMBER INDEX

|                 |     |                   |     |                 |     |                 |     |              |     |
|-----------------|-----|-------------------|-----|-----------------|-----|-----------------|-----|--------------|-----|
| 01714.....      | 68  | 161-193330.....   | 126 | 230-DL20.....   | 202 | 230-WR6.....    | 200 | 3237-3.....  | 22  |
| 01724.....      | 68  | 1636-2.....       | 22  | 230-DLF16.....  | 57  | 230-WS2.....    | 198 | 324-388..... | 126 |
| 02033.....      | 245 | 1636-3.....       | 22  | 230-DLF16.....  | 202 | 233-292.....    | 126 | 3345-3.....  | 22  |
| 02035.....      | 245 | 16491.....        | 68  | 230-DLF18.....  | 57  | 233-292220..... | 126 | 340-408..... | 126 |
| 02053.....      | 245 | 16500.....        | 152 | 230-DLF18.....  | 202 | 2424-2.....     | 22  | 3434-2.....  | 22  |
| 02055.....      | 245 | 16510.....        | 152 | 230-DLF20.....  | 57  | 2424-3.....     | 22  | 3434-3.....  | 22  |
| 02100.....      | 245 | 16520.....        | 152 | 230-DLF20.....  | 202 | 2430-2.....     | 22  | 3465-3.....  | 22  |
| 02255.....      | 245 | 18001.....        | 68  | 230-DLF25.....  | 57  | 2430-3.....     | 22  | 357-20.....  | 225 |
| 04000.....      | 244 | 18002.....        | 68  | 230-DLF25.....  | 202 | 2436-2.....     | 22  | 358-20.....  | 225 |
| 04010.....      | 244 | 18003.....        | 68  | 230-DLF32.....  | 57  | 2436-3.....     | 22  | 36-2.....    | 22  |
| 04011.....      | 244 | 189-227.....      | 126 | 230-DLF32.....  | 202 | 2442-2.....     | 22  | 362-16.....  | 74  |
| 04012.....      | 244 | 189-227220.....   | 126 | 230-DLFY.....   | 57  | 2448-2.....     | 22  | 36-3.....    | 22  |
| 04013.....      | 244 | 189-227330.....   | 126 | 230-DLFY.....   | 202 | 2448-3.....     | 22  | 3636-2.....  | 22  |
| 04022.....      | 244 | 200-240.....      | 126 | 230-DPML.....   | 57  | 2454-2.....     | 22  | 3636-3.....  | 22  |
| 04023.....      | 244 | 20310.....        | 64  | 230-DPML.....   | 202 | 2460-3.....     | 22  | 3640-2.....  | 22  |
| 04056.....      | 244 | 20-3132-18.....   | 38  | 230-DPMM.....   | 57  | 25001.....      | 160 | 3640-3.....  | 22  |
| 04113.....      | 244 | 20-3132-24.....   | 38  | 230-DPMM.....   | 202 | 2601.....       | 232 | 3648-2.....  | 22  |
| 04114.....      | 244 | 20-3132-36.....   | 38  | 230-DPPL.....   | 57  | 2602.....       | 232 | 3648-3.....  | 22  |
| 04123.....      | 244 | 20-3132-48.....   | 38  | 230-DPPL.....   | 202 | 2603.....       | 232 | 3650-3.....  | 22  |
| 04134.....      | 244 | 20-3135-18.....   | 38  | 230-DPPM.....   | 57  | 26-2.....       | 22  | 3654-2.....  | 22  |
| 04401.....      | 244 | 20-3135-24.....   | 38  | 230-DPPM.....   | 202 | 2626-2.....     | 22  | 3660-3.....  | 22  |
| 04402.....      | 244 | 20-3135-36.....   | 38  | 230-DSCREW..... | 200 | 2626-3.....     | 22  | 3678-3.....  | 22  |
| 04404.....      | 244 | 20-3135-48.....   | 38  | 230-EB3.....    | 198 | 2636-2.....     | 22  | 37020H.....  | 124 |
| 04406.....      | 244 | 216-259.....      | 126 | 230-EB4.....    | 198 | 2660-2.....     | 22  | 37030H.....  | 124 |
| 04407.....      | 244 | 216-259220.....   | 126 | 230-EB6.....    | 198 | 2660-3.....     | 22  | 37040H.....  | 124 |
| 04410.....      | 244 | 216-259330.....   | 126 | 230-EIN3.....   | 198 | 270-324.....    | 126 | 37050H.....  | 124 |
| 04414.....      | 244 | 230-14-3.....     | 132 | 230-EIN4.....   | 198 | 270-324220..... | 126 | 37050HB..... | 124 |
| 04451.....      | 244 | 230-14-3.....     | 201 | 230-EIN6.....   | 198 | 270-324330..... | 126 | 37050R.....  | 124 |
| 04452.....      | 244 | 230-14-4.....     | 132 | 230-FB3.....    | 199 | 2838-2.....     | 22  | 37060H.....  | 124 |
| 04500.....      | 244 | 230-14-4.....     | 201 | 230-FB4.....    | 199 | 2838-3.....     | 22  | 37075H.....  | 124 |
| 04502.....      | 244 | 230-14-4S.....    | 132 | 230-FB453.....  | 199 | 30-2.....       | 22  | 37075HB..... | 124 |
| 04503.....      | 244 | 230-14-4S.....    | 201 | 230-FB454.....  | 199 | 3030-2.....     | 22  | 37075R.....  | 124 |
| 04507.....      | 244 | 230-14-7.....     | 132 | 230-FB456.....  | 199 | 3030-3.....     | 22  | 37100H.....  | 124 |
| 04509.....      | 244 | 230-14-7.....     | 201 | 230-FB6.....    | 199 | 30306.....      | 157 | 37100HB..... | 124 |
| 04700.....      | 244 | 230-16-2.....     | 132 | 230-FJ3.....    | 199 | 30309.....      | 157 | 37100R.....  | 124 |
| 04800.....      | 244 | 230-16-2.....     | 201 | 230-FJ4.....    | 199 | 30310.....      | 157 | 37125H.....  | 124 |
| 04803.....      | 244 | 230-18-4.....     | 132 | 230-FR3.....    | 200 | 30-3131-24..... | 38  | 37125R.....  | 124 |
| 04850.....      | 244 | 230-18-4.....     | 201 | 230-FR4.....    | 200 | 30-3131-36..... | 38  | 37150H.....  | 124 |
| 04852.....      | 244 | 230-B2L.....      | 27  | 230-FR6.....    | 200 | 30-3131-48..... | 38  | 37150R.....  | 124 |
| 04870.....      | 244 | 230-B2L.....      | 201 | 230-IK3.....    | 200 | 30-3132-12..... | 38  | 37175H.....  | 124 |
| 04871.....      | 244 | 230-B2M.....      | 27  | 230-IK4.....    | 200 | 30-3132-18..... | 38  | 37175R.....  | 124 |
| 04872.....      | 244 | 230-B2M.....      | 201 | 230-INJ462..... | 200 | 30-3132-24..... | 38  | 37200H.....  | 124 |
| 1000-1200.....  | 126 | 230-B3L.....      | 27  | 230-INJ465..... | 200 | 30-3132-30..... | 38  | 37200R.....  | 124 |
| 10012.....      | 68  | 230-B3L.....      | 201 | 230-LFB3.....   | 199 | 30-3132-36..... | 38  | 37250H.....  | 124 |
| 1002.....       | 232 | 230-B3M.....      | 27  | 230-LFB4.....   | 199 | 30-3132-48..... | 38  | 37250R.....  | 124 |
| 10180.....      | 68  | 230-B3M.....      | 201 | 230-LFB6.....   | 199 | 30-3132-60..... | 38  | 37300H.....  | 124 |
| 10600.....      | 68  | 230-CP3.....      | 198 | 230-MB14W.....  | 27  | 30-3132-72..... | 38  | 37300R.....  | 124 |
| 108-130.....    | 126 | 230-CP4.....      | 198 | 230-MB14W.....  | 201 | 3036-2.....     | 22  | 37350H.....  | 124 |
| 108-130220..... | 126 | 230-CP6.....      | 198 | 230-MB17W.....  | 27  | 3036-3.....     | 22  | 37350R.....  | 124 |
| 108-130330..... | 126 | 230-D3.....       | 198 | 230-MB17W.....  | 201 | 3040-2.....     | 22  | 37400H.....  | 124 |
| 124-156.....    | 126 | 230-D4.....       | 198 | 230-MB36W.....  | 27  | 3040-3.....     | 22  | 37400R.....  | 124 |
| 124-156220..... | 126 | 230-D6.....       | 198 | 230-MB36W.....  | 201 | 3048-2.....     | 22  | 37450H.....  | 124 |
| 124-156330..... | 126 | 230-DC3.....      | 199 | 230-MBCW.....   | 27  | 3060-2.....     | 22  | 37450R.....  | 124 |
| 14145.....      | 34  | 230-DC4.....      | 199 | 230-MBCW.....   | 201 | 3060-3.....     | 22  | 37500H.....  | 124 |
| 14175.....      | 34  | 230-DC6.....      | 199 | 230-TC34.....   | 199 | 3143-2.....     | 22  | 37500R.....  | 124 |
| 14250.....      | 34  | 230-DCLIP.....    | 200 | 230-TC46.....   | 199 | 3143-3.....     | 22  | 37550R.....  | 124 |
| 14340.....      | 34  | 230-DCLIP-10..... | 200 | 230-TJ4.....    | 199 | 315-20.....     | 68  | 37600H.....  | 124 |
| 14460.....      | 34  | 230-DE3.....      | 199 | 230-TJ6.....    | 199 | 315-20.....     | 74  | 37600R.....  | 124 |
| 145-175.....    | 126 | 230-DE4.....      | 199 | 230-WC3.....    | 198 | 32-2.....       | 22  | 37700H.....  | 124 |
| 145-175220..... | 126 | 230-DE6.....      | 199 | 230-WC4.....    | 198 | 32-3.....       | 22  | 37800H.....  | 124 |
| 145-175330..... | 126 | 230-DL16.....     | 59  | 230-WC6.....    | 198 | 3232-2.....     | 22  | 37800R.....  | 124 |
| 161-193.....    | 126 | 230-DL16.....     | 202 | 230-WR3.....    | 200 | 3232-3.....     | 22  | 378-440..... | 126 |
| 161-193220..... | 126 | 230-DL20.....     | 59  | 230-WR4.....    | 200 | 3237-2.....     | 22  | 3842-2.....  | 22  |

**PART NUMBER INDEX cont'd**

|         |     |          |     |          |     |             |     |           |     |
|---------|-----|----------|-----|----------|-----|-------------|-----|-----------|-----|
| 3842-3  | 22  | 4214     | 89  | 45600H   | 125 | 50304       | 35  | 5226      | 111 |
| 3865-3  | 22  | 4214CX   | 89  | 45600R   | 125 | 50306       | 35  | 5228      | 111 |
| 3870-3  | 22  | 4215     | 90  | 45700H   | 125 | 5031        | 103 | 5229      | 111 |
| 3GJ0330 | 124 | 4215CX   | 90  | 45800H   | 125 | 5033        | 102 | 5230      | 111 |
| 3GJ0515 | 124 | 4217CX   | 90  | 45800R   | 125 | 5034        | 102 | 5231      | 111 |
| 3GJ0520 | 124 | 4218     | 89  | 460-552  | 126 | 5034        | 102 | 5232      | 111 |
| 3GJ0525 | 124 | 4219     | 89  | 4700-12  | 181 | 5035        | 102 | 5240      | 98  |
| 3GJ0530 | 124 | 4220     | 89  | 4700-34  | 181 | 5041        | 103 | 5242      | 98  |
| 3GJ0535 | 124 | 4220CX   | 89  | 4701-12  | 181 | 5042        | 103 | 5246      | 110 |
| 3GJ0540 | 124 | 4221     | 89  | 4701-34  | 181 | 5045        | 103 | 5247      | 110 |
| 3GJ0545 | 124 | 4221CX   | 89  | 4703-12  | 181 | 5046        | 103 | 5250      | 111 |
| 3GJ0555 | 124 | 4224     | 89  | 4703-34  | 181 | 5050-2      | 22  | 5252-3    | 22  |
| 3GJ1015 | 124 | 4224CX   | 89  | 4704-12  | 181 | 5053-3      | 22  | 5255      | 110 |
| 3GJ1025 | 124 | 4224NX   | 89  | 4704-34  | 181 | 5056-3      | 22  | 525-MT1   | 152 |
| 3GJ1060 | 124 | 4226     | 89  | 4706-12  | 181 | 5-05790     | 65  | 525-PT1   | 152 |
| 3GJ1520 | 124 | 4226CX   | 89  | 4706-34  | 181 | 5058-3      | 22  | 525-STK9  | 152 |
| 3GJ7530 | 124 | 4231     | 90  | 4707-12  | 181 | 5070-3      | 22  | 525-TX504 | 152 |
| 3GJ7535 | 124 | 4236CX   | 90  | 47072-12 | 181 | 5-10        | 184 | 5262      | 111 |
| 3GJ7545 | 124 | 4252     | 90  | 47072-34 | 181 | 5-100020    | 180 | 5263      | 111 |
| 3GJ7555 | 124 | 4252CX   | 90  | 4707-34  | 181 | 5-100030    | 180 | 5264      | 111 |
| 3GR0325 | 124 | 4253     | 90  | 4711-12  | 181 | 510-3400    | 178 | 5265      | 111 |
| 3GR0330 | 124 | 4253CX   | 90  | 4711-34  | 181 | 510-3400-10 | 178 | 5266      | 111 |
| 3GR0335 | 124 | 4254CX   | 89  | 4718-12  | 181 | 510-437292  | 180 | 5-300020  | 180 |
| 3GR0340 | 124 | 4272CX   | 90  | 4766-3   | 22  | 510-437338  | 180 | 5-300030  | 180 |
| 3GR0425 | 124 | 4293     | 101 | 4848-2   | 22  | 510-438338  | 180 | 5-300050  | 180 |
| 3GR0435 | 124 | 4293CX   | 101 | 4848-3   | 22  | 5107        | 110 | 5-300060  | 180 |
| 3GR0515 | 124 | 4294     | 101 | 4JJ0525  | 125 | 510-D102251 | 180 | 530-30752 | 184 |
| 3GR0520 | 124 | 4294CX   | 101 | 4JJ0530  | 125 | 510-D102338 | 180 | 530-30753 | 184 |
| 3GR0525 | 124 | 4296     | 101 | 4JJ0535  | 125 | 510-D304020 | 180 | 530-30755 | 184 |
| 3GR0530 | 124 | 4296CX   | 101 | 4JJ0540  | 125 | 510-D304030 | 180 | 530-30756 | 184 |
| 3GR0535 | 124 | 43-53220 | 126 | 4JJ0545  | 125 | 510-D309020 | 180 | 530-30757 | 184 |
| 3GR0540 | 124 | 43-53330 | 126 | 4JJ0555  | 125 | 510-D309030 | 180 | 530-30818 | 184 |
| 3GR0545 | 124 | 436-20   | 72  | 4JJ0560  | 125 | 510-D323020 | 180 | 530-30821 | 184 |
| 3GR0550 | 124 | 45020H   | 125 | 4JJ1055  | 125 | 510-D323030 | 180 | 530-30834 | 184 |
| 3GR0555 | 124 | 45030H   | 125 | 4JJ7535  | 125 | 510-D441020 | 180 | 530-30850 | 184 |
| 3GR0560 | 124 | 45040H   | 125 | 4JJ7540  | 125 | 510-D441030 | 180 | 530-30863 | 184 |
| 3GR0570 | 124 | 45050H   | 125 | 4JJ7545  | 125 | 5-1115      | 156 | 530-30876 | 184 |
| 3GR0580 | 124 | 45060H   | 125 | 4JR0440  | 125 | 5-1135      | 156 | 530-30883 | 184 |
| 3GR1035 | 124 | 45075H   | 125 | 4JR0525  | 125 | 5-11830     | 34  | 530-30884 | 184 |
| 3GR1080 | 124 | 45100H   | 125 | 4JR0530  | 125 | 5-11840     | 34  | 530-30885 | 184 |
| 3GR7530 | 124 | 45125H   | 125 | 4JR0535  | 125 | 5-11853     | 34  | 530-30890 | 184 |
| 3GR7540 | 124 | 45150H   | 125 | 4JR0540  | 125 | 5-11866     | 34  | 530-30891 | 184 |
| 3GR7555 | 124 | 45150R   | 125 | 4JR0545  | 125 | 5-11879     | 34  | 530-30893 | 184 |
| 3GR7560 | 124 | 45175H   | 125 | 4JR0550  | 125 | 5-12        | 184 | 530-31132 | 184 |
| 3GR7580 | 124 | 45175R   | 125 | 4JR0555  | 125 | 5-14        | 184 | 530-31133 | 184 |
| 3WF-01  | 228 | 45200H   | 125 | 4JR0560  | 125 | 515-J2000   | 180 | 5-32      | 184 |
| 3WF-05  | 228 | 45200R   | 125 | 4JR1055  | 125 | 515-J3000   | 180 | 5-321020  | 180 |
| 3WF-55  | 228 | 45250H   | 125 | 4JR1060  | 125 | 515-NS2000  | 180 | 5-321030  | 180 |
| 400-480 | 126 | 45250R   | 125 | 4JR7525  | 125 | 515-NS3000  | 180 | 5-33570   | 65  |
| 4042-3  | 22  | 45300H   | 125 | 4JR7530  | 125 | 5200        | 112 | 5-34790   | 65  |
| 4054-3  | 22  | 45300R   | 125 | 4JR7535  | 125 | 5-2001      | 176 | 535-BB1   | 144 |
| 4062-3  | 22  | 45350H   | 125 | 4JR7540  | 125 | 5-2002      | 176 | 535-BB2   | 144 |
| 4147-2  | 22  | 45350R   | 125 | 4JR7545  | 125 | 5-2005      | 176 | 535-BB3   | 144 |
| 4147-3  | 22  | 45400H   | 125 | 4JR7550  | 125 | 5201        | 112 | 535-BB4   | 144 |
| 4183-3  | 22  | 45400R   | 125 | 4JR7555  | 125 | 5205        | 112 | 535-BB5   | 144 |
| 4200AX  | 90  | 45450H   | 125 | 4JR7560  | 125 | 5206        | 111 | 535-BB6   | 144 |
| 4204    | 89  | 45450R   | 125 | 4WF-01   | 228 | 5207        | 112 | 5380AX    | 108 |
| 4204CX  | 89  | 45500H   | 125 | 4WF-05   | 228 | 5220        | 111 | 5381      | 108 |
| 4205CX  | 90  | 45500R   | 125 | 4WF-55   | 228 | 5222        | 111 | 538-1/2   | 245 |
| 4206    | 90  | 4550-3   | 22  | 5002     | 110 | 5223        | 98  | 538-1/4   | 245 |
| 4206CX  | 90  | 45550H   | 125 | 5007     | 111 | 5223B       | 98  | 538-1-1/8 | 245 |
| 4213    | 89  | 45550R   | 125 | 5022     | 111 | 5224        | 98  | 538-1-3/8 | 245 |
| 4213CX  | 89  | 4558-3   | 22  | 50302    | 35  | 5225        | 111 | 538-1-5/8 | 245 |

**PART NUMBER INDEX cont'd**

|                    |     |                 |     |                   |     |               |     |                        |     |
|--------------------|-----|-----------------|-----|-------------------|-----|---------------|-----|------------------------|-----|
| 5382.....          | 108 | 5-406030.....   | 176 | 540-RB610HDM..... | 155 | 5-435075..... | 177 | 548-002.....           | 154 |
| 538-2-1/8.....     | 245 | 5-406101.....   | 176 | 540-RB614HDM..... | 155 | 5-435101..... | 177 | 548-003.....           | 154 |
| 538-2-5/8.....     | 245 | 5-406130.....   | 176 | 540-RB618HDM..... | 155 | 5-435102..... | 177 | 548-004.....           | 154 |
| 5383.....          | 108 | 5-406131.....   | 176 | 540-RB624HDM..... | 155 | 5-435131..... | 177 | 548-005.....           | 154 |
| 538-3/4.....       | 245 | 540-648.....    | 126 | 540-RB636DW.....  | 155 | 5-436005..... | 177 | 548-006.....           | 154 |
| 538-3/8.....       | 245 | 540-6510L.....  | 153 | 540-RB636W.....   | 155 | 5-436007..... | 177 | 548-007.....           | 154 |
| 538-3-1/8.....     | 245 | 540-6510R.....  | 153 | 540-RB656WS.....  | 155 | 5-436010..... | 177 | 548-008.....           | 154 |
| 538-3-5/8.....     | 245 | 540-6716B.....  | 153 | 540-RB810HDM..... | 155 | 5-436012..... | 177 | 548-009.....           | 154 |
| 5384.....          | 108 | 540-6716L.....  | 153 | 540-RB814HDM..... | 155 | 5-436015..... | 177 | 548-010.....           | 154 |
| 538-4-1/8.....     | 245 | 540-6716R.....  | 153 | 540-RB956W.....   | 155 | 5-436020..... | 177 | 5-500.....             | 64  |
| 5385.....          | 108 | 540-6716S.....  | 153 | 540-T50M.....     | 156 | 5-436025..... | 177 | 5-520.....             | 179 |
| 538-5/8.....       | 245 | 540-6900L.....  | 153 | 540-T50MOC.....   | 156 | 5-436030..... | 177 | 5557-3.....            | 22  |
| 5386.....          | 108 | 540-6900R.....  | 153 | 5-41.....         | 167 | 5-436074..... | 177 | 5-61.....              | 167 |
| 5387.....          | 108 | 5-407.....      | 176 | 5-410.....        | 179 | 5-436101..... | 177 | 56-72.....             | 126 |
| 538-7/8.....       | 245 | 5-407005.....   | 176 | 5-410005.....     | 177 | 5-436102..... | 177 | 56-72220.....          | 126 |
| 5391.....          | 108 | 5-407007.....   | 176 | 5-410007.....     | 177 | 5-436131..... | 177 | 585-TG.....            | 131 |
| 5392.....          | 108 | 5-407010.....   | 176 | 5-410010.....     | 177 | 5-437101..... | 179 | 585-TG1.....           | 131 |
| 5-401.....         | 176 | 5-407012.....   | 176 | 5-410012.....     | 177 | 5-437130..... | 179 | 585-TG2.....           | 131 |
| 5-401005.....      | 178 | 5-407015.....   | 176 | 5-410015.....     | 177 | 5-437131..... | 179 | 585-TG3.....           | 131 |
| 540-1005L.....     | 64  | 5-407020.....   | 176 | 5-41041.....      | 65  | 5-437210..... | 179 | 585-TG4.....           | 131 |
| 540-1005M.....     | 64  | 5-407025.....   | 176 | 5-411.....        | 179 | 5-437251..... | 179 | 585-TG5.....           | 131 |
| 5-401007.....      | 178 | 5-407030.....   | 176 | 5-412.....        | 179 | 5-437339..... | 179 | 585-TG6.....           | 131 |
| 5-401010.....      | 178 | 5-407074.....   | 176 | 541-300.....      | 166 | 5-438101..... | 179 | 585-TG7.....           | 131 |
| 5-401012.....      | 178 | 5-407101.....   | 176 | 5-414.....        | 179 | 5-438130..... | 179 | 585-TG8.....           | 131 |
| 5-401015.....      | 178 | 5-407130.....   | 176 | 5-41411.....      | 65  | 5-438131..... | 179 | 585-TG9.....           | 131 |
| 5-401020.....      | 178 | 5-407131.....   | 176 | 5-41455.....      | 65  | 5-439131..... | 179 | 590-708.....           | 126 |
| 5-401025.....      | 178 | 540-799.....    | 73  | 5-415.....        | 179 | 5-447005..... | 178 | 5-HW5850.....          | 232 |
| 5-401030.....      | 178 | 5-408.....      | 179 | 5-416.....        | 176 | 5-447007..... | 178 | 5-IG5850.....          | 232 |
| 540-12.....        | 156 | 540-800.....    | 73  | 5-417.....        | 176 | 5-447010..... | 178 | 5-MSH1/4MC.....        | 152 |
| 5-402.....         | 176 | 5-408007.....   | 176 | 5-417005.....     | 177 | 5-447012..... | 178 | 5-MSH5/16MC.....       | 152 |
| 5-402007.....      | 178 | 540-805.....    | 73  | 5-417007.....     | 177 | 5-447020..... | 178 | 5-PRC-34.....          | 179 |
| 5-402007.....      | 178 | 540-806.....    | 73  | 5-417010.....     | 177 | 5-447030..... | 178 | 5-SCR101.....          | 66  |
| 540-2110C.....     | 67  | 540-807.....    | 73  | 5-417012.....     | 177 | 5-448005..... | 178 | 5-SCR101-12DP.....     | 66  |
| 540-2114.....      | 64  | 540-808.....    | 73  | 5-417020.....     | 177 | 5-448007..... | 178 | 5-SCR101-12DPBULK..... | 66  |
| 540-2144.....      | 64  | 540-811.....    | 73  | 5-417025.....     | 177 | 5-448010..... | 178 | 5-SCR101-2.....        | 66  |
| 540-2200.....      | 64  | 5-409.....      | 179 | 5-417030.....     | 177 | 5-448015..... | 178 | 5-SCR101-2BULK.....    | 66  |
| 540-2214.....      | 64  | 5-409005.....   | 177 | 5-418.....        | 176 | 5-448020..... | 178 | 5-SCR101-2DP.....      | 66  |
| 540-25.....        | 156 | 5-409007.....   | 177 | 5-420007.....     | 178 | 5-448025..... | 178 | 5-SCR101-2DPBULK.....  | 66  |
| 540-25G.....       | 156 | 5-409010.....   | 177 | 542-00966.....    | 164 | 5-448030..... | 178 | 5-SCR101 BULK.....     | 66  |
| 540-25R.....       | 156 | 5-409012.....   | 177 | 542-00968.....    | 164 | 5-449005..... | 179 | 5-SCR101 DP.....       | 66  |
| 540-278BM0024..... | 155 | 5-409015.....   | 177 | 542-09746.....    | 163 | 5-449007..... | 179 | 5-SCR101 DPBULK.....   | 66  |
| 540-278HX0002..... | 155 | 5-409020.....   | 177 | 542-09748.....    | 163 | 5-449010..... | 179 | 5-SCR102DP.....        | 66  |
| 5-403005.....      | 178 | 540-AK100.....  | 67  | 542-10007.....    | 164 | 5-449015..... | 179 | 5-SCR102DPBULK.....    | 66  |
| 5-403007.....      | 178 | 540-BH1L.....   | 64  | 542-25015.....    | 164 | 5-449020..... | 179 | 5-SCR103-4.....        | 66  |
| 5-404.....         | 176 | 540-BH1M.....   | 64  | 5-42272.....      | 69  | 5-449025..... | 179 | 5-SCR103-4BULK.....    | 66  |
| 540-400.....       | 152 | 540-DB6.....    | 66  | 542-76220.....    | 164 | 5-449030..... | 179 | 5-SCR103-4DP.....      | 66  |
| 5-405.....         | 176 | 540-DISP.....   | 67  | 5-429005.....     | 178 | 5-450005..... | 179 | 5-SCR103-4DPBULK.....  | 66  |
| 540-500.....       | 152 | 540-FCTMC5..... | 153 | 5-429007.....     | 178 | 5-450007..... | 179 | 5-SCR61-2DP.....       | 66  |
| 540-504.....       | 156 | 540-FCTMN1..... | 153 | 5-429010.....     | 178 | 5-450010..... | 179 | 5-SCR61-2DPBULK.....   | 66  |
| 540-506.....       | 156 | 540-FCTMS1..... | 153 | 5-429012.....     | 178 | 5-450015..... | 179 | 5-SCR63-8.....         | 66  |
| 540-508.....       | 156 | 540-FCTMS2..... | 153 | 5-429015.....     | 178 | 5-450020..... | 179 | 5-SCR63-8BULK.....     | 66  |
| 540-509.....       | 156 | 540-GUN.....    | 232 | 5-429020.....     | 178 | 5-450025..... | 179 | 5-SCR71-2.....         | 66  |
| 540-572.....       | 232 | 540-HU1L.....   | 64  | 5-429025.....     | 178 | 5-450030..... | 179 | 5-SCR71-2BULK.....     | 66  |
| 540-573.....       | 232 | 540-HU1M.....   | 64  | 5-429030.....     | 178 | 545-420.....  | 152 | 5-SCR81.....           | 66  |
| 5-406.....         | 176 | 540-LG1L.....   | 64  | 5-435005.....     | 177 | 545-422.....  | 152 | 5-SCR81-12.....        | 66  |
| 5-406005.....      | 176 | 540-LG1M.....   | 64  | 5-435007.....     | 177 | 545-424.....  | 152 | 5-SCR81-12-100.....    | 66  |
| 5-406007.....      | 176 | 540-P127D.....  | 153 | 5-435010.....     | 177 | 545-426.....  | 152 | 5-SCR81-12BULK.....    | 66  |
| 540-601.....       | 157 | 540-P127S.....  | 153 | 5-435012.....     | 177 | 545-430.....  | 152 | 5-SCR81-12DP.....      | 66  |
| 5-406010.....      | 176 | 540-R8CCRF..... | 155 | 5-435015.....     | 177 | 545-440.....  | 152 | 5-SCR81-12DPBULK.....  | 66  |
| 5-406012.....      | 176 | 540-RB125W..... | 155 | 5-435020.....     | 177 | 545-442.....  | 152 | 5-SCR81-12W.....       | 66  |
| 5-406015.....      | 176 | 540-RB414M..... | 155 | 5-435025.....     | 177 | 545-460.....  | 152 | 5-SCR81-12WTBUL.....   | 66  |
| 5-406020.....      | 176 | 540-RB418M..... | 155 | 5-435030.....     | 177 | 5-474007..... | 177 | 5-SCR81-2.....         | 66  |
| 5-406025.....      | 176 | 540-RB424M..... | 155 | 5-435074.....     | 177 | 548-001.....  | 154 | 5-SCR81-25M.....       | 66  |

**PART NUMBER INDEX cont'd**

|                      |     |               |     |                   |     |                   |     |               |     |
|----------------------|-----|---------------|-----|-------------------|-----|-------------------|-----|---------------|-----|
| 5-SCR81-2BULK.....   | 66  | 60237CX.....  | 87  | 61208.....        | 88  | 61272.....        | 88  | 620-252.....  | 135 |
| 5-SCR81-2DP.....     | 66  | 60238.....    | 87  | 61209.....        | 88  | 61274.....        | 87  | 620-253.....  | 135 |
| 5-SCR81-2DPBULK..... | 66  | 60240.....    | 87  | 61210.....        | 88  | 61275CX.....      | 87  | 620-254.....  | 135 |
| 5-SCR81BULK.....     | 66  | 60245.....    | 88  | 61210LX.....      | 88  | 61276.....        | 87  | 620-255.....  | 135 |
| 5-SCR81DP.....       | 66  | 60247.....    | 88  | 61211.....        | 88  | 61276LX.....      | 87  | 620-274W..... | 134 |
| 5-SCR81DPBULK.....   | 66  | 60249.....    | 91  | 61212.....        | 88  | 6-12-8NM4SWP..... | 139 | 620-300.....  | 135 |
| 5-SCR82.....         | 66  | 60251.....    | 84  | 61213.....        | 88  | 6-12-8NMP.....    | 139 | 620-301.....  | 135 |
| 5-SCR82-100.....     | 66  | 60251CX.....  | 84  | 61214.....        | 86  | 6-12-8NMSWP.....  | 139 | 620-302.....  | 135 |
| 5-SCR82BULK.....     | 66  | 60252CX.....  | 88  | 61215.....        | 87  | 6-12-8P.....      | 139 | 620-303.....  | 135 |
| 5-SCR82DP.....       | 66  | 60253.....    | 88  | 61217.....        | 86  | 6182.....         | 100 | 620-304.....  | 135 |
| 5-SCR82DPBULK.....   | 66  | 60253LX.....  | 88  | 61218.....        | 87  | 6183.....         | 100 | 620-306.....  | 135 |
| 5-SCR82W.....        | 66  | 60254.....    | 86  | 61219.....        | 84  | 6-1838L.....      | 56  | 620-400.....  | 135 |
| 5-SCR83-4.....       | 66  | 60254CX.....  | 86  | 61220.....        | 84  | 6-1838S.....      | 56  | 620-401.....  | 135 |
| 5-SCR83-4BULK.....   | 66  | 60254LX.....  | 86  | 61221CX.....      | 84  | 6184.....         | 100 | 620-403.....  | 135 |
| 5-SCR83-4DP.....     | 66  | 60255.....    | 87  | 61221LX.....      | 84  | 6-1846L.....      | 56  | 620-404.....  | 135 |
| 5-SCR83-4DPBULK..... | 66  | 60255LX.....  | 87  | 61222.....        | 84  | 6-1846S.....      | 56  | 620-405.....  | 135 |
| 5-SCR-AK.....        | 67  | 60256.....    | 87  | 61222CX.....      | 84  | 6185.....         | 100 | 620-406.....  | 135 |
| 5-SCRMS.....         | 66  | 60256CX.....  | 87  | 61223LX.....      | 84  | 6186.....         | 100 | 620-408.....  | 135 |
| 6000.....            | 109 | 60257.....    | 88  | 61224.....        | 84  | 6187.....         | 100 | 620-409.....  | 135 |
| 6001.....            | 109 | 60257NX.....  | 88  | 61226.....        | 87  | 6192.....         | 100 | 620-410.....  | 135 |
| 6002.....            | 109 | 60258NX.....  | 88  | 61227NX.....      | 84  | 6193.....         | 100 | 620-411.....  | 135 |
| 6003.....            | 109 | 60259HX.....  | 85  | 61230.....        | 91  | 6194.....         | 100 | 620-412.....  | 135 |
| 6004.....            | 109 | 60263BCX..... | 107 | 61230CX.....      | 91  | 6195X.....        | 100 | 620-500.....  | 135 |
| 6005.....            | 109 | 60263BLX..... | 107 | 61231.....        | 86  | 6197X.....        | 100 | 620-501.....  | 135 |
| 6006.....            | 109 | 60263CX.....  | 107 | 61233.....        | 85  | 6-2.....          | 57  | 620-502.....  | 135 |
| 6007.....            | 109 | 60264BCX..... | 107 | 61233LX.....      | 85  | 62000AX.....      | 108 | 620-503.....  | 135 |
| 6011.....            | 109 | 60264BLX..... | 107 | 61234LX.....      | 84  | 6200BSX.....      | 86  | 620-600.....  | 133 |
| 6020.....            | 103 | 60264CX.....  | 107 | 61235LX.....      | 84  | 6200HX.....       | 85  | 620-601.....  | 133 |
| 60201.....           | 87  | 60265BLX..... | 108 | 61236.....        | 87  | 620-10-2.....     | 138 | 620-602.....  | 133 |
| 60202.....           | 88  | 60265LX.....  | 108 | 61237.....        | 87  | 620-12-2.....     | 138 | 620-603.....  | 133 |
| 60204.....           | 88  | 60265NX.....  | 108 | 61238.....        | 87  | 620-14-2.....     | 138 | 620-604.....  | 133 |
| 60205.....           | 88  | 60272LX.....  | 88  | 61239.....        | 87  | 620-18-10.....    | 132 | 620-605.....  | 133 |
| 60205CX.....         | 88  | 60274.....    | 86  | 6-12-4.....       | 139 | 620-18-12.....    | 132 | 620-606.....  | 133 |
| 60206.....           | 88  | 60275LX.....  | 87  | 61240.....        | 87  | 620-18-2.....     | 132 | 620-607.....  | 133 |
| 60209.....           | 87  | 60284.....    | 90  | 61245.....        | 88  | 620-18-2P.....    | 132 | 620-608.....  | 137 |
| 6021.....            | 103 | 60285.....    | 91  | 61247.....        | 88  | 620-18-3.....     | 132 | 620-6081..... | 137 |
| 60210.....           | 91  | 60286.....    | 90  | 6-12-4NM.....     | 139 | 620-18-3P.....    | 132 | 620-6082..... | 137 |
| 60210CX.....         | 91  | 6030.....     | 103 | 6-12-4NM4SWP..... | 139 | 620-18-4.....     | 132 | 620-6083..... | 137 |
| 60210LX.....         | 91  | 60331B.....   | 96  | 6-12-4NMP.....    | 139 | 620-18-4P.....    | 132 | 620-6-2.....  | 138 |
| 60213.....           | 85  | 60331BE.....  | 96  | 6-12-4NMR.....    | 139 | 620-18-5.....     | 132 | 620-700.....  | 133 |
| 60213CX.....         | 85  | 60331GY.....  | 96  | 6-12-4NMSWP.....  | 139 | 620-18-5P.....    | 132 | 620-701.....  | 133 |
| 60214.....           | 84  | 60331P.....   | 96  | 6-12-4P.....      | 139 | 620-18-6.....     | 132 | 620-702.....  | 133 |
| 60215.....           | 88  | 60331R.....   | 96  | 6-12-4R.....      | 139 | 620-18-6P.....    | 132 | 620-703.....  | 133 |
| 60215CX.....         | 88  | 60331W.....   | 96  | 61252.....        | 88  | 620-18-7.....     | 132 | 620-704.....  | 133 |
| 60216.....           | 88  | 6040.....     | 103 | 61252NX.....      | 88  | 620-18-8.....     | 132 | 620-705.....  | 133 |
| 60218.....           | 84  | 6067-3.....   | 22  | 61253.....        | 88  | 620-18-8P.....    | 132 | 6208.....     | 91  |
| 60218LX.....         | 84  | 6-1.....      | 57  | 61254.....        | 88  | 620-18-9.....     | 132 | 620-8-2.....  | 138 |
| 60219.....           | 84  | 6101.....     | 109 | 61255.....        | 87  | 620-200.....      | 135 | 6208LX.....   | 91  |
| 60219LX.....         | 84  | 6102.....     | 109 | 61255LX.....      | 87  | 620-201.....      | 135 | 6209.....     | 91  |
| 60220.....           | 84  | 61028.....    | 221 | 61256.....        | 86  | 620-20-10.....    | 132 | 6209LX.....   | 91  |
| 60220LX.....         | 84  | 6108.....     | 106 | 61256LX.....      | 86  | 620-20134.....    | 135 | 6210.....     | 91  |
| 60224.....           | 85  | 6109.....     | 106 | 61257.....        | 87  | 620-202.....      | 135 | 6210CX.....   | 91  |
| 60225.....           | 85  | 6113.....     | 109 | 6-12-6.....       | 139 | 620-20-2.....     | 132 | 6211.....     | 91  |
| 60225CX.....         | 85  | 6115.....     | 109 | 61265BCX.....     | 107 | 620-20-3.....     | 132 | 6211CX.....   | 91  |
| 60226.....           | 87  | 6-1200.....   | 33  | 61265LX.....      | 107 | 620-20-4.....     | 132 | 6212.....     | 91  |
| 60228.....           | 87  | 61201.....    | 87  | 6-12-6NM.....     | 139 | 620-20-4.....     | 132 | 6212CX.....   | 91  |
| 60230CX.....         | 91  | 61202.....    | 88  | 6-12-6NM4SWP..... | 139 | 620-20-5.....     | 132 | 6213.....     | 85  |
| 60231.....           | 86  | 61203.....    | 88  | 6-12-6NMP.....    | 139 | 620-20-6.....     | 132 | 6213CX.....   | 85  |
| 60231CX.....         | 86  | 61204.....    | 88  | 6-12-6NMR.....    | 139 | 620-20-7.....     | 132 | 6214.....     | 84  |
| 60234.....           | 91  | 61205.....    | 88  | 6-12-6NMSWP.....  | 139 | 620-20-8.....     | 132 | 6214CX.....   | 84  |
| 60235.....           | 84  | 61205CX.....  | 88  | 6-12-6NMR.....    | 139 | 6-202-1.....      | 67  | 6215.....     | 88  |
| 60236.....           | 88  | 61206.....    | 88  | 6-12-6NMSWP.....  | 139 | 6-202-1.....      | 185 | 6215CX.....   | 88  |
| 60237.....           | 87  | 61207.....    | 88  | 6-12-6P.....      | 139 | 6-202-2.....      | 67  | 6215CX.....   | 88  |
|                      |     |               |     | 6-12-6R.....      | 139 | 6-202-2.....      | 185 | 6216.....     | 88  |

**PART NUMBER INDEX cont'd**

|               |     |                 |     |                 |     |                 |     |                  |     |
|---------------|-----|-----------------|-----|-----------------|-----|-----------------|-----|------------------|-----|
| 6216CX.....   | 88  | 6232.....       | 86  | 6254LX.....     | 87  | 626-25.....     | 136 | 6-2739L.....     | 56  |
| 6216LX.....   | 88  | 6232CX.....     | 86  | 6255.....       | 86  | 626-25S.....    | 136 | 6273LX.....      | 85  |
| 6217.....     | 86  | 6232LX.....     | 86  | 625-541.....    | 138 | 626-25T.....    | 136 | 6274.....        | 86  |
| 6217CX.....   | 86  | 6233.....       | 84  | 625-542.....    | 138 | 626-26311.....  | 137 | 6-2748L.....     | 56  |
| 6217LX.....   | 86  | 6233CX.....     | 84  | 6255CX.....     | 86  | 6-2626L.....    | 56  | 6-2748L-100..... | 56  |
| 6218.....     | 84  | 6233LX.....     | 84  | 6255LX.....     | 86  | 6262BCX.....    | 108 | 6-2748S.....     | 56  |
| 6218CX.....   | 84  | 6234.....       | 84  | 6257.....       | 88  | 6262BLX.....    | 108 | 6274LX.....      | 86  |
| 6218LX.....   | 84  | 6234LX.....     | 84  | 6257NX.....     | 88  | 6262BMX.....    | 108 | 6276.....        | 87  |
| 6219.....     | 84  | 6235.....       | 84  | 6258.....       | 85  | 6262CX.....     | 108 | 6-2763L.....     | 56  |
| 6219LX.....   | 84  | 6235CX.....     | 84  | 625-800.....    | 138 | 6262LX.....     | 108 | 6-2763S.....     | 56  |
| 6220.....     | 84  | 6235LX.....     | 84  | 625-801.....    | 138 | 6262MX.....     | 108 | 6276LX.....      | 87  |
| 6220CX.....   | 84  | 6236LX.....     | 88  | 625-810.....    | 138 | 626-30.....     | 136 | 6277.....        | 85  |
| 62216.....    | 88  | 6237.....       | 86  | 625-811.....    | 138 | 626-30S.....    | 136 | 6277NX.....      | 85  |
| 62219.....    | 89  | 6237LX.....     | 86  | 6258CX.....     | 85  | 626-30T.....    | 136 | 6278CX.....      | 100 |
| 6221CX.....   | 84  | 6238.....       | 87  | 6259.....       | 85  | 626-38071.....  | 137 | 6279.....        | 100 |
| 6222.....     | 90  | 6238LX.....     | 87  | 6259CX.....     | 85  | 626-38073.....  | 137 | 6279CX.....      | 100 |
| 62227.....    | 89  | 6239.....       | 87  | 625-AF10.....   | 34  | 626-38632.....  | 137 | 6281.....        | 84  |
| 62228.....    | 89  | 6239LX.....     | 87  | 625-AF12.....   | 34  | 626-38636.....  | 137 | 6281LX.....      | 84  |
| 6222LX.....   | 90  | 6240.....       | 90  | 625-AF14.....   | 34  | 6263BCX.....    | 108 | 6282.....        | 84  |
| 6223.....     | 90  | 62402.....      | 90  | 625-AF6.....    | 34  | 6263BDX.....    | 108 | 6282LX.....      | 84  |
| 62231.....    | 88  | 6241.....       | 90  | 625-AF8.....    | 34  | 6263BLX.....    | 108 | 6283.....        | 91  |
| 62231.....    | 89  | 6242.....       | 86  | 625-B1.....     | 134 | 6263BNX.....    | 108 | 6283LX.....      | 91  |
| 62231XX.....  | 88  | 6-2424L.....    | 56  | 625-CR15W.....  | 133 | 6263CX.....     | 108 | 6284.....        | 90  |
| 62231XX.....  | 89  | 6242LX.....     | 86  | 625-CR20W.....  | 133 | 6263DX.....     | 108 | 6284LX.....      | 90  |
| 62232.....    | 88  | 6243.....       | 86  | 625-CS120W..... | 133 | 6263LX.....     | 108 | 6285.....        | 91  |
| 62232.....    | 89  | 6244.....       | 86  | 625-GD100.....  | 135 | 6263NX.....     | 108 | 6285LX.....      | 91  |
| 62232XX.....  | 88  | 6244LX.....     | 86  | 625-GD15H.....  | 135 | 626-3S.....     | 136 | 6286.....        | 90  |
| 62232XX.....  | 89  | 6245.....       | 90  | 625-GD20H.....  | 135 | 6264BCX.....    | 107 | 6286LX.....      | 90  |
| 62236.....    | 88  | 6247.....       | 88  | 625-GD30H.....  | 135 | 6264BLX.....    | 107 | 6287.....        | 86  |
| 6223LX.....   | 90  | 6247CX.....     | 88  | 625-GD40H.....  | 135 | 6264BMX.....    | 107 | 6287NX.....      | 86  |
| 6224.....     | 85  | 6248.....       | 88  | 625-GD50H.....  | 135 | 6264CX.....     | 107 | 6287XX.....      | 86  |
| 6224CX.....   | 85  | 6250.....       | 90  | 625-GD60H.....  | 135 | 6264LX.....     | 107 | 6288.....        | 90  |
| 6225.....     | 87  | 6251.....       | 84  | 625-GS15H.....  | 135 | 626-4S.....     | 136 | 6288LX.....      | 90  |
| 6225CX.....   | 87  | 625-1212.....   | 134 | 625-GS20H.....  | 135 | 6265BCX.....    | 107 | 6289.....        | 90  |
| 6226.....     | 87  | 625-1225.....   | 134 | 625-GS30H.....  | 135 | 6265BLX.....    | 107 | 6289LX.....      | 90  |
| 6226CX.....   | 87  | 625-1301W.....  | 133 | 625-GS40H.....  | 135 | 6265CX.....     | 107 | 6291.....        | 101 |
| 6227.....     | 86  | 625-16-6.....   | 134 | 625-GS50H.....  | 135 | 6265LX.....     | 107 | 6291CX.....      | 101 |
| 62273.....    | 88  | 625-16-690..... | 134 | 625-IS5.....    | 138 | 626-5S.....     | 136 | 6292.....        | 101 |
| 6227CX.....   | 86  | 625-183.....    | 138 | 625-S13.....    | 134 | 6266BLX.....    | 107 | 6292CX.....      | 101 |
| 6227LX.....   | 86  | 625-184.....    | 138 | 625-S14.....    | 134 | 626-6S.....     | 136 | 6293.....        | 101 |
| 6228.....     | 86  | 6251CX.....     | 84  | 625-S15.....    | 134 | 6267BCX.....    | 108 | 6293CX.....      | 101 |
| 6228LX.....   | 86  | 6251LX.....     | 84  | 625-S16.....    | 134 | 6267BLX.....    | 108 | 6294.....        | 101 |
| 6229.....     | 84  | 6252.....       | 88  | 625-S17.....    | 134 | 6267MX.....     | 108 | 6294CX.....      | 101 |
| 6229LX.....   | 84  | 625-2129B.....  | 134 | 625-S18.....    | 134 | 6268BL.....     | 108 | 6295X.....       | 101 |
| 6230.....     | 91  | 625-2129V.....  | 134 | 625-S19.....    | 134 | 6268BMX.....    | 108 | 6296.....        | 101 |
| 6230-000..... | 146 | 625-2129W.....  | 134 | 625-S20.....    | 134 | 6268CX.....     | 108 | 6296CX.....      | 101 |
| 6230-001..... | 146 | 625-2132B.....  | 134 | 625-S21.....    | 134 | 6268MX.....     | 108 | 6298.....        | 101 |
| 6230-002..... | 146 | 625-2132V.....  | 134 | 6260BLX.....    | 107 | 6269.....       | 108 | 6298LX.....      | 101 |
| 6230-003..... | 146 | 625-2132W.....  | 134 | 626-10S.....    | 136 | 6269CX.....     | 108 | 6-3.....         | 57  |
| 6230-004..... | 146 | 625-2134B.....  | 134 | 626-10T.....    | 136 | 6269LX.....     | 108 | 6-3030L.....     | 56  |
| 6230-005..... | 146 | 625-2134V.....  | 134 | 626-15.....     | 136 | 6269MX.....     | 108 | 6-3050.....      | 33  |
| 6230-006..... | 146 | 625-2134W.....  | 134 | 626-15S.....    | 136 | 626-AT0003..... | 137 | 6-3050L.....     | 56  |
| 6230-007..... | 146 | 625-2139B.....  | 134 | 626-15T.....    | 136 | 626-AT0005..... | 137 | 6-3050S.....     | 56  |
| 6230-008..... | 146 | 625-2139V.....  | 134 | 6261BCX.....    | 108 | 626-HASR15..... | 136 | 6-3060L.....     | 56  |
| 6230-011..... | 147 | 625-2139W.....  | 134 | 6261BL.....     | 108 | 626-HASR20..... | 136 | 6-3060L-100..... | 56  |
| 6230-012..... | 147 | 625-270W.....   | 133 | 6261CX.....     | 108 | 626-HASR25..... | 136 | 6-3060S.....     | 56  |
| 6230-013..... | 147 | 6252LX.....     | 88  | 6261MX.....     | 108 | 626-HASR30..... | 136 | 63070.....       | 100 |
| 6230-014..... | 147 | 625-304.....    | 138 | 626-20.....     | 136 | 626-HASR35..... | 136 | 63076B.....      | 100 |
| 6230-015..... | 147 | 625-305.....    | 138 | 626-20S.....    | 136 | 6270.....       | 85  | 63077B.....      | 100 |
| 6230CX.....   | 91  | 6253CX.....     | 88  | 626-20T.....    | 136 | 6270LX.....     | 85  | 63078B.....      | 100 |
| 6231.....     | 86  | 6253LX.....     | 88  | 626-23133.....  | 137 | 6271.....       | 85  | 63079B.....      | 100 |
| 6231CX.....   | 86  | 6254.....       | 87  | 626-23233.....  | 137 | 6271CX.....     | 85  | 6310X.....       | 110 |
| 6231LX.....   | 86  | 6254CX.....     | 87  | 626-23333.....  | 137 | 6272.....       | 88  | 6311.....        | 110 |

## PART NUMBER INDEX cont'd

|                |     |               |     |              |     |                 |     |                   |     |
|----------------|-----|---------------|-----|--------------|-----|-----------------|-----|-------------------|-----|
| 6312.....      | 110 | 6363B.....    | 97  | 650-017..... | 32  | 6730.....       | 107 | 6-FT80H.....      | 169 |
| 6313.....      | 110 | 6363R.....    | 97  | 650-018..... | 33  | 6731.....       | 107 | 6-FT80R.....      | 169 |
| 6-320.....     | 169 | 6363W.....    | 97  | 65002.....   | 106 | 6732.....       | 107 | 6-GPK035.....     | 173 |
| 6321.....      | 110 | 6364B.....    | 97  | 650-020..... | 33  | 6733.....       | 107 | 6-HAB-BG.....     | 26  |
| 6-321.....     | 169 | 6364R.....    | 97  | 650-021..... | 33  | 6-733.....      | 60  | 6-HDT303K.....    | 166 |
| 6322.....      | 110 | 6364W.....    | 97  | 650-023..... | 32  | 6-733.....      | 185 | 6-HG15.....       | 173 |
| 6-3263L.....   | 56  | 6365B.....    | 97  | 650-031..... | 32  | 6-734.....      | 60  | 6-HK2748.....     | 56  |
| 6-3263S.....   | 56  | 6365R.....    | 97  | 650-036..... | 32  | 6-734.....      | 185 | 6-HK2748SP.....   | 56  |
| 6-330.....     | 60  | 6365W.....    | 97  | 650-038..... | 33  | 6735.....       | 107 | 6-HK2766.....     | 56  |
| 6330-4.....    | 97  | 6-3660L.....  | 56  | 650-074..... | 33  | 6-735.....      | 60  | 6-HK2766SP.....   | 56  |
| 6330-6.....    | 97  | 6-3660S.....  | 56  | 6500A.....   | 106 | 6-735.....      | 185 | 6-HK3050.....     | 56  |
| 6330-9.....    | 97  | 6370.....     | 100 | 6501.....    | 106 | 6-736.....      | 60  | 6-HK3050SP.....   | 56  |
| 6331.....      | 97  | 6371.....     | 100 | 650-100..... | 34  | 6-736.....      | 185 | 6-HK3060.....     | 56  |
| 6332B.....     | 96  | 6373.....     | 100 | 6501CX.....  | 106 | 675-9400.....   | 130 | 6-HK3060SP.....   | 56  |
| 6332G.....     | 96  | 6383-325..... | 97  | 6502.....    | 106 | 675-9420.....   | 130 | 6-IRT203.....     | 169 |
| 6332R.....     | 96  | 6383-35.....  | 97  | 650-200..... | 34  | 675-9500.....   | 130 | 6-IRT656.....     | 168 |
| 6332W.....     | 96  | 6384-325..... | 97  | 65028.....   | 106 | 675-9505.....   | 130 | 6-IRT670.....     | 168 |
| 6333B.....     | 96  | 6384-35.....  | 97  | 6503.....    | 106 | 675-9515.....   | 130 | 6-JMP.....        | 59  |
| 6333G.....     | 96  | 6401.....     | 106 | 650-300..... | 34  | 675-9520.....   | 130 | 6-LAM122.....     | 170 |
| 6333R.....     | 96  | 640-122.....  | 137 | 6503CX.....  | 106 | 675-9600.....   | 130 | 6-M2748.....      | 57  |
| 6333W.....     | 96  | 640-123.....  | 137 | 6505.....    | 106 | 675-9610.....   | 130 | 6-M2763.....      | 57  |
| 6334B.....     | 96  | 640-142.....  | 137 | 6505LX.....  | 106 | 675-9615.....   | 131 | 6-M3030.....      | 57  |
| 6334G.....     | 96  | 640-143.....  | 137 | 6507.....    | 106 | 675-9620.....   | 131 | 6-M3050.....      | 57  |
| 6334R.....     | 96  | 6402.....     | 106 | 6-5070.....  | 33  | 675-TS21.....   | 131 | 6-M3060.....      | 57  |
| 6334W.....     | 96  | 6403.....     | 106 | 6507LX.....  | 106 | 675-TS32.....   | 131 | 6-M3263.....      | 57  |
| 6335B.....     | 96  | 6404.....     | 106 | 6513.....    | 109 | 675-TS32H.....  | 131 | 6-OT550.....      | 170 |
| 6335G.....     | 96  | 6405.....     | 106 | 6515.....    | 109 | 6800A.....      | 103 | 6-PNG2000A.....   | 170 |
| 6335R.....     | 96  | 640-845.....  | 138 | 6526.....    | 106 | 6800BX.....     | 103 | 6-PT300M.....     | 170 |
| 6335W.....     | 96  | 640-AF2.....  | 35  | 6528.....    | 106 | 6800HX.....     | 103 | 6-PTH8708.....    | 170 |
| 6336.....      | 97  | 640-AF25..... | 35  | 6600.....    | 106 | 6822.....       | 103 | 6-R50A.....       | 34  |
| 6337.....      | 97  | 640-AF3.....  | 35  | 660-002..... | 158 | 6822DX.....     | 103 | 6-REF401.....     | 172 |
| 6338.....      | 97  | 640-FD2B..... | 36  | 660-003..... | 158 | 6823.....       | 103 | 6-RLD202.....     | 170 |
| 6339.....      | 97  | 640-FD2S..... | 36  | 660-004..... | 158 | 6826DX.....     | 103 | 6-RLD382P.....    | 171 |
| 6339XL.....    | 97  | 640-FD3B..... | 36  | 660-005..... | 158 | 6843.....       | 103 | 6-SAM990DW.....   | 166 |
| 6340.....      | 97  | 640-FD3S..... | 36  | 6601.....    | 106 | 6843DX.....     | 103 | 6-ST600LED.....   | 172 |
| 6341.....      | 97  | 640-FSK2..... | 36  | 6602.....    | 106 | 6845.....       | 103 | 6-T117.....       | 154 |
| 6342.....      | 97  | 640-FSK3..... | 36  | 6603.....    | 106 | 6845DX.....     | 103 | 6-T117BG.....     | 154 |
| 6343.....      | 97  | 640-UL25..... | 36  | 6604.....    | 106 | 6846.....       | 103 | 6-T118.....       | 154 |
| 6-34-3nm.....  | 139 | 640-UL3.....  | 36  | 6605.....    | 106 | 6849.....       | 103 | 6-T118BG.....     | 154 |
| 6-34-4.....    | 139 | 6411.....     | 106 | 6622.....    | 106 | 6853.....       | 103 | 6-T1191.....      | 154 |
| 6-34-4NM.....  | 139 | 641-14.....   | 226 | 6623.....    | 106 | 6855.....       | 103 | 6-T1191BG.....    | 154 |
| 6-34-4NMR..... | 139 | 6412.....     | 106 | 6625.....    | 106 | 6858.....       | 103 | 6-T129X.....      | 155 |
| 6-34-4R.....   | 139 | 6413.....     | 106 | 6641.....    | 106 | 6859.....       | 103 | 6-T133.....       | 154 |
| 6-34-6.....    | 139 | 6414.....     | 106 | 6642.....    | 106 | 6863.....       | 103 | 6-T135.....       | 154 |
| 6-3460.....    | 150 | 6415.....     | 106 | 6643.....    | 106 | 6865.....       | 103 | 6-T147.....       | 166 |
| 6-34-6NM.....  | 139 | 6416.....     | 106 | 6644.....    | 106 | 6866.....       | 103 | 6-T152.....       | 155 |
| 6-34-6NMR..... | 139 | 6484.....     | 103 | 6645.....    | 106 | 6868.....       | 103 | 6-T20.....        | 167 |
| 6-34-6R.....   | 139 | 6-5.....      | 57  | 6682.....    | 106 | 6876.....       | 103 | 6-T21.....        | 167 |
| 6-34-8.....    | 139 | 650-001.....  | 33  | 6683.....    | 106 | 6877.....       | 103 | 6-T396.....       | 157 |
| 6-34-8NM.....  | 139 | 650-002.....  | 33  | 6685.....    | 106 | 6878.....       | 103 | 6-T482A.....      | 155 |
| 6351.....      | 109 | 650-003.....  | 33  | 6700AX.....  | 107 | 6900AX.....     | 104 | 6-T482v.....      | 155 |
| 6352.....      | 109 | 650-004.....  | 33  | 6701.....    | 107 | 6-9011.....     | 33  | 6-T580.....       | 157 |
| 6353.....      | 109 | 650-005.....  | 33  | 6702.....    | 107 | 6-9718.....     | 60  | 6-T582.....       | 157 |
| 6360B.....     | 96  | 650-006.....  | 33  | 6703.....    | 107 | 6-CT500AV.....  | 172 | 6-T609.....       | 167 |
| 6360R.....     | 96  | 650-008.....  | 33  | 6704.....    | 107 | 6-CT500AV.....  | 172 | 6-T744.....       | 167 |
| 6360W.....     | 96  | 65001.....    | 106 | 6704-2X..... | 107 | 6-CT700F.....   | 172 | 6-T84101.....     | 167 |
| 6361B.....     | 97  | 650-010.....  | 33  | 6706.....    | 107 | 6-DAMP221.....  | 171 | 6-T86014.....     | 168 |
| 6361R.....     | 97  | 650-011.....  | 33  | 6706-2X..... | 107 | 6-DCFM8906..... | 173 | 6-TL100.....      | 156 |
| 6361W.....     | 97  | 650-012.....  | 32  | 6-7090.....  | 33  | 6-DMM20UL.....  | 171 | 6-TL360W.....     | 156 |
| 6362B.....     | 97  | 650-013.....  | 32  | 6722.....    | 107 | 6-DMM45.....    | 171 | 6-TRW1352.....    | 154 |
| 6362R.....     | 97  | 650-014.....  | 32  | 6722-2X..... | 107 | 6-DT8803.....   | 169 | 6-WDCFM8951.....  | 173 |
| 6362W.....     | 97  | 650-015.....  | 32  | 6724.....    | 107 | 6-DT898P.....   | 169 | 6-YHDT303KVM..... | 169 |
| 6-3636L.....   | 56  | 650-016.....  | 32  | 6724-2X..... | 107 | 6-DTH03.....    | 166 | 701-001.....      | 182 |

## PART NUMBER INDEX cont'd

|              |     |                 |     |                   |     |                    |     |                   |     |
|--------------|-----|-----------------|-----|-------------------|-----|--------------------|-----|-------------------|-----|
| 701-002..... | 182 | 7-100W.....     | 158 | 7317X.....        | 104 | 750-NMLT75.....    | 138 | 7-ALAA.....       | 72  |
| 701-003..... | 182 | 710-100.....    | 35  | 7321X.....        | 104 | 750-NMLT90100..... | 138 | 7-ALAA-24.....    | 72  |
| 701-004..... | 182 | 710-100LA.....  | 35  | 7-34.....         | 59  | 750-NMLT90150..... | 138 | 7-ALAAA.....      | 72  |
| 701-005..... | 182 | 710-101.....    | 35  | 7-341-18.....     | 246 | 750-NMLT90200..... | 138 | 7-ALAAA-18.....   | 72  |
| 701-006..... | 181 | 710-102.....    | 35  | 7-3412.....       | 246 | 750-NMLT9050.....  | 138 | 7-ALC.....        | 72  |
| 701-007..... | 182 | 710-103.....    | 35  | 7-341-38.....     | 246 | 750-NMLT9075.....  | 138 | 7-ALC-12.....     | 72  |
| 701-008..... | 182 | 710-182G.....   | 35  | 7-341-58.....     | 246 | 750-P30F.....      | 133 | 7-ALD.....        | 72  |
| 701-009..... | 182 | 710-185G.....   | 35  | 7-342-18.....     | 246 | 750-P60F.....      | 133 | 7-ALD-12.....     | 72  |
| 701-010..... | 182 | 710-A16100..... | 35  | 7-342-58.....     | 246 | 750-P60NF.....     | 133 | 7-AM2A056.....    | 162 |
| 701-011..... | 182 | 710-A16100..... | 180 | 7-3434.....       | 246 | 750-RC841.....     | 138 | 7-CRNR15.....     | 136 |
| 701-012..... | 182 | 710-A1650.....  | 35  | 7-3438.....       | 246 | 750-RC842.....     | 138 | 7-CRNR20.....     | 136 |
| 701-013..... | 182 | 710-A1650.....  | 180 | 7-3458.....       | 246 | 750-SLTC50.....    | 138 | 7-CRNR25.....     | 136 |
| 701-014..... | 182 | 710-A1710.....  | 35  | 7-3478.....       | 246 | 750-SLTC75.....    | 138 | 7-CRNR30.....     | 136 |
| 701-015..... | 182 | 710-A1710.....  | 180 | 7-34P.....        | 59  | 750-SLTC9050.....  | 138 | 7-CRNR35.....     | 136 |
| 701-016..... | 182 | 7-10KOTN30..... | 136 | 7-38.....         | 59  | 750-SLTC9075.....  | 138 | 7-CRNR40.....     | 136 |
| 701-017..... | 182 | 7-10KOTN35..... | 136 | 7-381-18.....     | 246 | 7-58.....          | 59  | 7-CRNR45.....     | 136 |
| 701-018..... | 181 | 7-10KOTN40..... | 136 | 7-3812.....       | 246 | 7-5811.....        | 147 | 7-CRNR50.....     | 136 |
| 701-019..... | 181 | 7-10KOTN45..... | 136 | 7-381-38.....     | 246 | 7-5811-B.....      | 147 | 7-CRNR60.....     | 136 |
| 701-020..... | 182 | 7-10KOTN50..... | 136 | 7-381-58.....     | 246 | 7-58P.....         | 59  | 7-ECC12100.....   | 158 |
| 701-021..... | 182 | 7-10KOTN60..... | 136 | 7-382-18.....     | 246 | 7-60.....          | 26  | 7-ECC1225.....    | 158 |
| 701-022..... | 182 | 7-10P.....      | 59  | 7-382-58.....     | 246 | 7-64.....          | 26  | 7-ECC1250.....    | 158 |
| 701-023..... | 181 | 710-P100.....   | 34  | 7-383-18.....     | 246 | 7-6VGP.....        | 72  | 7-ECC16100.....   | 158 |
| 701-024..... | 181 | 7-12.....       | 59  | 7-3834.....       | 246 | 7-6VHD.....        | 72  | 7-ECC1625.....    | 158 |
| 701-025..... | 182 | 7-121-18.....   | 246 | 7-3838.....       | 246 | 7-6VHDM.....       | 72  | 7-ECC1650.....    | 158 |
| 701-026..... | 182 | 7-1212.....     | 246 | 7-3858.....       | 246 | 770-15.....        | 74  | 7-ECC50725.....   | 158 |
| 701-027..... | 182 | 7-121-38.....   | 246 | 7-3878.....       | 246 | 7-711.....         | 147 | 7-ECC50730.....   | 158 |
| 701-028..... | 182 | 7-121-58.....   | 246 | 7-38P.....        | 59  | 7-711-B.....       | 147 | 7-ECC50735.....   | 158 |
| 701-029..... | 182 | 7-122-18.....   | 246 | 7-4000.....       | 67  | 7-75W.....         | 158 | 7-16V-B2.....     | 163 |
| 701-030..... | 182 | 7-122-58.....   | 246 | 7-4001.....       | 67  | 7-78.....          | 59  | 7-1LJ2AA-B.....   | 163 |
| 701-031..... | 182 | 7-123-18.....   | 246 | 7-4100.....       | 67  | 7-78P.....         | 59  | 7-IN2.....        | 163 |
| 701-032..... | 182 | 7-1234.....     | 246 | 741-001.....      | 70  | 7-806.....         | 72  | 7-IN2K.....       | 163 |
| 701-033..... | 182 | 7-1238.....     | 246 | 741-002.....      | 70  | 7-80632.....       | 74  | 7-IN2MS.....      | 163 |
| 701-034..... | 182 | 7-1258.....     | 246 | 7-4101.....       | 67  | 7-80633.....       | 74  | 7-ISL2D-B.....    | 163 |
| 701-035..... | 182 | 7-1278.....     | 246 | 7-4300.....       | 67  | 7-918.....         | 72  | 7-K3A016.....     | 162 |
| 701-036..... | 182 | 7-12P.....      | 59  | 7-4400.....       | 68  | 7-944.....         | 72  | 7-K3A036.....     | 162 |
| 701-037..... | 182 | 7-14.....       | 59  | 7-4500.....       | 68  | 799-001.....       | 73  | 7-K3A116.....     | 162 |
| 701-038..... | 182 | 7141.....       | 104 | 750-10100.....    | 137 | 799-002.....       | 73  | 7-L300.....       | 35  |
| 701-039..... | 182 | 7141CX.....     | 104 | 750-10400.....    | 137 | 799-003.....       | 73  | 7-L300.....       | 147 |
| 701-040..... | 181 | 7142.....       | 104 | 750-12100.....    | 137 | 799-004.....       | 73  | 7-LK3A001.....    | 162 |
| 701-041..... | 181 | 7142LX.....     | 104 | 750-121000.....   | 137 | 799-005.....       | 73  | 7-LM2A001.....    | 162 |
| 701-042..... | 182 | 7143.....       | 104 | 750-12100BOX..... | 137 | 799-006.....       | 73  | 7-LUX2AA3W-B..... | 163 |
| 701-043..... | 182 | 7143LX.....     | 104 | 750-15100.....    | 137 | 799-007.....       | 73  | 7-LWSA201.....    | 162 |
| 701-044..... | 182 | 7145.....       | 104 | 750-1550.....     | 137 | 799-008.....       | 73  | 7-LWSA301.....    | 162 |
| 701-046..... | 181 | 7146.....       | 104 | 750-2050.....     | 137 | 799-009.....       | 73  | 7-LWSA401.....    | 162 |
| 701-047..... | 181 | 7147.....       | 104 | 750-30F-3PH.....  | 133 | 799-010.....       | 73  | 7-M2A016.....     | 162 |
| 701-053..... | 181 | 7-14P.....      | 59  | 750-34100.....    | 137 | 799-011.....       | 73  | 7-M2A026.....     | 162 |
| 701-055..... | 181 | 7-200.....      | 67  | 750-34700.....    | 137 | 799-012.....       | 73  | 7-M2A036.....     | 162 |
| 7032.....    | 106 | 7233RLX.....    | 104 | 750-401.....      | 185 | 799-013.....       | 73  | 7-M3A016.....     | 162 |
| 7033.....    | 106 | 7234RLX.....    | 104 | 750-402.....      | 185 | 799-020.....       | 73  | 7-M3A036.....     | 162 |
| 7034.....    | 106 | 7235RLX.....    | 104 | 750-500.....      | 137 | 799-021.....       | 73  | 7-P24.....        | 35  |
| 7036X.....   | 106 | 7236R.....      | 104 | 750-600.....      | 137 | 799-022.....       | 73  | 7-P24.....        | 147 |
| 7063.....    | 106 | 7236RLX.....    | 104 | 750-60F-3PH.....  | 133 | 799-023.....       | 73  | 7-P36.....        | 35  |
| 7064.....    | 106 | 72-88220.....   | 126 | 750-60NF-3PH..... | 133 | 799-024.....       | 73  | 7-P36.....        | 147 |
| 7066NX.....  | 106 | 72-88330.....   | 126 | 750-MLT50.....    | 138 | 799-025.....       | 73  | 7-P36B.....       | 35  |
| 7066X.....   | 106 | 7301.....       | 104 | 750-MLT75.....    | 138 | 799-026.....       | 73  | 7-P36B.....       | 147 |
| 708-850..... | 126 | 7-301K.....     | 163 | 750-MLT9050.....  | 138 | 799-031.....       | 73  | 7-P48.....        | 35  |
| 7-10.....    | 59  | 7302.....       | 104 | 750-MLT9075.....  | 138 | 799-032.....       | 73  | 7-P48.....        | 147 |
| 7-100.....   | 67  | 7303.....       | 104 | 750-NMLT100.....  | 138 | 799-035.....       | 73  | 7-P48B.....       | 35  |
| 710-001..... | 35  | 7311L.....      | 104 | 750-NMLT150.....  | 138 | 799-040.....       | 73  | 7-P48B.....       | 147 |
| 710-002..... | 35  | 7311X.....      | 104 | 750-NMLT200.....  | 138 | 799-041.....       | 73  | 7-R2AA-B.....     | 163 |
| 710-003..... | 35  | 7316L.....      | 104 | 750-NMLT4550..... | 138 | 7-AD010000.....    | 158 | 7-R2D.....        | 163 |
| 710-004..... | 35  | 7316X.....      | 104 | 750-NMLT4575..... | 138 | 7-AL9V.....        | 72  | 7-R3D.....        | 163 |
| 710-005..... | 35  | 7317L.....      | 104 | 750-NMLT50.....   | 138 | 7-AL9V-8.....      | 72  | 7-RX1019.....     | 162 |

**PART NUMBER INDEX cont'd**

|                    |     |                   |     |                   |     |                |     |             |     |
|--------------------|-----|-------------------|-----|-------------------|-----|----------------|-----|-------------|-----|
| 7-S2C016.....      | 162 | ACP28383.....     | 24  | AFR-Custom-2..... | 32  | B-310.....     | 165 | B-810.....  | 165 |
| 7-S2D016.....      | 162 | ACP30302.....     | 24  | AG-25.....        | 67  | B-313.....     | 165 | B-813.....  | 165 |
| 7-S3C016.....      | 162 | ACP30303.....     | 24  | AG-25.....        | 185 | B-316.....     | 165 | B-816.....  | 165 |
| 7-S3D016.....      | 162 | ACP30363.....     | 24  | ALK150-01.....    | 228 | B-319.....     | 165 | B-819.....  | 165 |
| 7-S4C016.....      | 162 | ACP32322.....     | 24  | ALK150-05.....    | 228 | B-322.....     | 165 | B-822.....  | 165 |
| 7-S4D016.....      | 162 | ACP32323.....     | 24  | ALK200-01.....    | 228 | B-328.....     | 165 | B-828.....  | 165 |
| 7-S5D016.....      | 162 | ACP32442.....     | 24  | ALK300-01.....    | 228 | B-32H.....     | 61  | B-833.....  | 165 |
| 7-S6D016.....      | 162 | ACP32443.....     | 24  | ALK300-05.....    | 228 | B-32H.....     | 185 | B-83H.....  | 61  |
| 7-SE4W3C.....      | 163 | ACP36362.....     | 24  | AT-1700.....      | 150 | B-333.....     | 165 | B-8H.....   | 185 |
| 7-SPHW3AAA-BX..... | 163 | ACP36363.....     | 24  | ATK-1.....        | 222 | B-36H.....     | 61  | B-924.....  | 164 |
| 7-TLC10625.....    | 158 | ACP36483.....     | 24  | ATK-1P.....       | 222 | B-36H.....     | 185 | B-925.....  | 164 |
| 7-TLC10630.....    | 158 | ACP38422.....     | 24  | ATK-4.....        | 222 | B-4.....       | 163 | B-926.....  | 164 |
| 800-008.....       | 68  | ACP40403.....     | 24  | AW-712.....       | 159 | B-402.....     | 165 | B-927.....  | 164 |
| 800-009.....       | 68  | ACP52523.....     | 24  | AW-712-10.....    | 159 | B-404.....     | 165 | B-928.....  | 164 |
| 8200M.....         | 112 | ACT-6.....        | 161 | AW-712-8.....     | 159 | B-407.....     | 165 | B-929.....  | 164 |
| 8201.....          | 112 | ADB-1.....        | 141 | AW-8.....         | 159 | B-410.....     | 165 | B-930.....  | 164 |
| 8201C.....         | 112 | ADB-2.....        | 141 | AW-9.....         | 159 | B-413.....     | 165 | B-931.....  | 164 |
| 8202.....          | 112 | ADM-1.....        | 141 | AW-96.....        | 159 | B-416.....     | 165 | B-932.....  | 164 |
| 8202C.....         | 112 | ADM-2.....        | 141 | AW-96-10.....     | 159 | B-419.....     | 165 | B-934.....  | 164 |
| 8202P.....         | 112 | AFB1020-1.....    | 32  | AW-96-8.....      | 159 | B-422.....     | 165 | B-935.....  | 164 |
| 8203.....          | 112 | AFB1212-1.....    | 32  | AWL-5.....        | 159 | B-428.....     | 165 | B-996.....  | 164 |
| 8203C.....         | 112 | AFB1220-1.....    | 32  | AWL-9.....        | 159 | B-433.....     | 165 | B-998.....  | 164 |
| 8206.....          | 112 | AFB1224-1.....    | 32  | AWZ-2500.....     | 159 | B-4H.....      | 61  | BE-24.....  | 165 |
| 8207.....          | 112 | AFB1420-1.....    | 32  | AWZ-3000.....     | 159 | B-4H.....      | 185 | BE-36.....  | 165 |
| 8208.....          | 112 | AFB1424-1.....    | 32  | B-1.....          | 163 | B-500.....     | 163 | BE-48.....  | 165 |
| 8220M.....         | 112 | AFB1425-1.....    | 32  | B-10.....         | 165 | B-501.....     | 163 | BH-1.....   | 165 |
| 8233.....          | 112 | AFB1430-1.....    | 32  | B-10H.....        | 61  | B-502.....     | 163 | BPF-01..... | 38  |
| 8282.....          | 101 | AFB1520-1.....    | 32  | B-10H.....        | 185 | B-503.....     | 163 | BPF-02..... | 38  |
| 8282LX.....        | 101 | AFB1620-1.....    | 32  | B-124.....        | 164 | B-504.....     | 163 | BPF-03..... | 38  |
| 8284.....          | 101 | AFB1624-1.....    | 32  | B-125.....        | 164 | B-505.....     | 163 | BPF-04..... | 38  |
| 8284CX-B.....      | 101 | AFB1625-1.....    | 32  | B-126.....        | 164 | B-602.....     | 165 | BPF-05..... | 38  |
| 8286.....          | 101 | AFB1818-1.....    | 32  | B-127.....        | 164 | B-604.....     | 165 | BPF-06..... | 38  |
| 8286CX.....        | 101 | AFB1824-1.....    | 32  | B-128.....        | 164 | B-607.....     | 165 | BPF-07..... | 39  |
| 8286CX-B.....      | 101 | AFB1825-1.....    | 32  | B-129.....        | 164 | B-610.....     | 165 | BPF-08..... | 39  |
| 8289.....          | 101 | AFB2020-1.....    | 32  | B-12H.....        | 61  | B6-12-4.....   | 139 | BPF-09..... | 39  |
| 8296.....          | 101 | AFB2024-1.....    | 32  | B-12H.....        | 185 | B6-12-4NM..... | 139 | BPF-10..... | 39  |
| 8298.....          | 101 | AFB2025-1.....    | 32  | B-130.....        | 164 | B6-12-6.....   | 139 | BPF-11..... | 39  |
| 829-995.....       | 126 | AFB2030-1.....    | 32  | B-131.....        | 164 | B6-12-6NM..... | 139 | BPF-12..... | 39  |
| 88-108.....        | 126 | AFB2424-1.....    | 32  | B-132.....        | 164 | B-613.....     | 165 | BPF-13..... | 39  |
| 88-108220.....     | 126 | AFB2525-1.....    | 32  | B-16H.....        | 61  | B-616.....     | 165 | BPF-14..... | 39  |
| 88-108330.....     | 126 | AFB-Custom-1..... | 32  | B-16H.....        | 185 | B-619.....     | 165 | BPF-15..... | 39  |
| 8-FWH16.....       | 72  | AFB-Custom-2..... | 32  | B-2.....          | 163 | B-622.....     | 165 | BPF-16..... | 39  |
| 8-WH16.....        | 72  | AFR1212-1.....    | 32  | B-202.....        | 165 | B-628.....     | 165 | BPF-17..... | 39  |
| 91-2032.....       | 38  | AFR1220-1.....    | 32  | B-204.....        | 165 | B-633.....     | 165 | BPF-18..... | 39  |
| 91-3042.....       | 38  | AFR1224-1.....    | 32  | B-207.....        | 165 | B6-34-4.....   | 139 | BPF-19..... | 39  |
| 92-3232.....       | 38  | AFR1420-1.....    | 32  | B-20H.....        | 61  | B6-34-4NM..... | 139 | BPF-20..... | 39  |
| 92-4242.....       | 38  | AFR1424-1.....    | 32  | B-20H.....        | 185 | B6-34-6.....   | 139 | BPF-21..... | 39  |
| A60306K.....       | 144 | AFR1425-1.....    | 32  | B-210.....        | 165 | B6-34-6NM..... | 139 | BPF-22..... | 39  |
| ACB-30.....        | 27  | AFR1430-1.....    | 32  | B-213.....        | 165 | B-6H.....      | 61  | BPF-23..... | 39  |
| ACB-30.....        | 201 | AFR1520-1.....    | 32  | B-216.....        | 165 | B-6H.....      | 185 | BPF-24..... | 39  |
| ACB-36.....        | 27  | AFR1620-1.....    | 32  | B-219.....        | 165 | B-702.....     | 165 | BPF-25..... | 39  |
| ACB-36.....        | 201 | AFR1624-1.....    | 32  | B-222.....        | 165 | B-704.....     | 165 | BPF-26..... | 39  |
| ACB-42.....        | 27  | AFR1625-1.....    | 32  | B-228.....        | 165 | B-707.....     | 165 | BPF-27..... | 39  |
| ACB-42.....        | 201 | AFR1818-1.....    | 32  | B-233.....        | 165 | B-710.....     | 165 | BPF-28..... | 39  |
| ACB-48.....        | 27  | AFR1824-1.....    | 32  | B-24H.....        | 61  | B-713.....     | 165 | BPF-29..... | 39  |
| ACB-48.....        | 201 | AFR1825-1.....    | 32  | B-24H.....        | 185 | B-716.....     | 165 | BPF-30..... | 39  |
| ACK4.....          | 149 | AFR2020-1.....    | 32  | B-26.....         | 165 | B-719.....     | 165 | BPF-31..... | 39  |
| ACK4.....          | 156 | AFR2024-1.....    | 32  | B-27.....         | 164 | B-722.....     | 165 | BPF-32..... | 39  |
| ACP-10.....        | 69  | AFR2025-1.....    | 32  | B-28H.....        | 61  | B-728.....     | 165 | BPF-33..... | 39  |
| ACP24242.....      | 24  | AFR2030-1.....    | 32  | B-28H.....        | 185 | B-733.....     | 165 | BPF-34..... | 39  |
| ACP24243.....      | 24  | AFR2424-1.....    | 32  | B-302.....        | 165 | B-802.....     | 165 | BPN-1.....  | 40  |
| ACP24362.....      | 24  | AFR2525-1.....    | 32  | B-304.....        | 165 | B-804.....     | 165 | BPN-10..... | 40  |
| ACP24363.....      | 24  | AFR-Custom-1..... | 32  | B-307.....        | 165 | B-807.....     | 165 | BPN-11..... | 40  |

**PART NUMBER INDEX cont'd**

|                   |                   |                   |                   |                   |
|-------------------|-------------------|-------------------|-------------------|-------------------|
| BPN-12.....40     | C101-0100.....236 | C165-0295.....238 | C290-0050.....237 | C460-0237.....239 |
| BPN-13.....40     | C101-0107.....236 | C165-0303.....238 | C290-0090.....237 | C460-0245.....239 |
| BPN-14.....40     | C101-0150.....236 | C165-0304.....238 | C290-0100.....237 | C460-0246.....239 |
| BPN-15.....40     | C101-0159.....236 | C165-0305.....238 | C290-0150.....237 | C460-0247.....239 |
| BPN-16.....40     | C101-0215.....236 | C165-0306.....238 | C290-0215.....237 | C460-0248.....239 |
| BPN-17.....40     | C101-0222.....236 | C165-0390.....238 | C290-0295.....237 | C460-0256.....239 |
| BPN-18.....40     | C101-0295.....236 | C165-0398.....238 | C290-0390.....237 | C460-0295.....239 |
| BPN-19.....40     | C101-0390.....236 | C165-0399.....238 | C295-0002.....237 | C460-0303.....239 |
| BPN-2.....40      | C105-0025.....236 | C165-0400.....238 | C295-0025.....237 | C460-0304.....239 |
| BPN-20.....40     | C105-0050.....236 | C165-0401.....238 | C295-0050.....237 | C460-0305.....239 |
| BPN-21.....40     | C105-0057.....236 | C165-0402.....238 | C295-0090.....237 | C460-0315.....239 |
| BPN-22.....40     | C105-0058.....236 | C165-1498.....238 | C295-0100.....237 | C460-0316.....239 |
| BPN-23.....40     | C105-0059.....236 | C170-0003.....239 | C295-0150.....237 | C460-0317.....239 |
| BPN-24.....40     | C105-0100.....236 | C170-0100.....239 | C295-0215.....237 | C460-0318.....239 |
| BPN-25.....40     | C105-0107.....236 | C170-0150.....239 | C295-0295.....237 | C460-0319.....239 |
| BPN-26.....40     | C105-0150.....236 | C222.....147      | C295-0390.....237 | C460-0329.....239 |
| BPN-27.....40     | C105-0159.....236 | C222C.....147     | C312.....147      | C460-0330.....239 |
| BPN-28.....40     | C105-0215.....236 | C223.....147      | C312L.....147     | C460-0331.....239 |
| BPN-29.....40     | C105-0295.....236 | C223C.....147     | C410-0007.....238 | C460-0332.....239 |
| BPN-3.....40      | C105-0390.....236 | C235-0002.....237 | C410-0032.....238 | C460-0339.....239 |
| BPN-30.....40     | C114-0050.....236 | C235-0025.....237 | C410-0033.....238 | C460-0340.....239 |
| BPN-31.....40     | C114-0100.....236 | C235-0050.....237 | C410-0058.....238 | C460-0341.....239 |
| BPN-32.....40     | C114-0150.....236 | C235-0090.....237 | C410-0059.....238 | C460-0342.....239 |
| BPN-33.....40     | C114-0215.....236 | C235-0100.....237 | C410-0093.....238 | C460-0343.....239 |
| BPN-34.....40     | C114-0295.....236 | C235-0107.....237 | C410-0107.....238 | C460-0350.....239 |
| BPN-35.....40     | C114-0390.....236 | C235-0150.....237 | C410-0149.....238 | C460-0390.....239 |
| BPN-37.....40     | C115-0050.....236 | C235-0215.....237 | C410-0159.....238 | C460-0398.....239 |
| BPN-38.....40     | C115-0100.....236 | C235-0295.....237 | C410-0160.....238 | C460-0399.....239 |
| BPN-39.....40     | C115-0150.....236 | C235-0390.....237 | C410-0161.....238 | C460-0400.....239 |
| BPN-4.....40      | C115-0215.....236 | C241.....147      | C410-0222.....238 | C460-0401.....239 |
| BPN-40.....40     | C115-0295.....236 | C242-0001.....237 | C410-0223.....238 | C460-0402.....239 |
| BPN-41.....40     | C115-0390.....236 | C242-0002.....237 | C410-0224.....238 | C460-0413.....239 |
| BPN-42.....40     | C142-0057.....238 | C242-0015.....237 | C410-0303.....238 | C460-0414.....239 |
| BPN-43.....40     | C142-0058.....238 | C242-0025.....237 | C410-0304.....238 | C460-0415.....239 |
| BPN-44.....40     | C154-0002.....238 | C242-0050.....237 | C410-0305.....238 | C460-0416.....239 |
| BPN-45.....40     | C154-0025.....238 | C242-0090.....237 | C410-0306.....238 | C460-0417.....239 |
| BPN-46.....40     | C154-0050.....238 | C242-0100.....237 | C410-0398.....238 | C460-0418.....239 |
| BPN-47.....40     | C154-0090.....238 | C242-0150.....237 | C410-0399.....238 | C460-0429.....239 |
| BPN-48.....40     | C154-0100.....238 | C242-0215.....237 | C410-0400.....238 | C460-0430.....239 |
| BPN-49.....40     | C154-0150.....238 | C242-0295.....237 | C410-0401.....238 | C460-0431.....239 |
| BPN-5.....40      | C154-0215.....238 | C242-0390.....237 | C410-0402.....238 | C460-0432.....239 |
| BPN-50.....40     | C154-0295.....238 | C243.....147      | C410-1498.....238 | C460-0433.....239 |
| BPN-51.....40     | C154-0390.....238 | C245.....147      | C460-0002.....239 | C460-0444.....239 |
| BPN-52.....40     | C165-0001.....238 | C247.....147      | C460-0025.....239 | C460-0447.....239 |
| BPN-53.....40     | C165-0002.....238 | C254-0002.....237 | C460-0050.....239 | C460-0457.....239 |
| BPN-54.....40     | C165-0007.....238 | C254-0025.....237 | C460-0057.....239 | C460-0470.....239 |
| BPN-6.....40      | C165-0025.....238 | C254-0050.....237 | C460-0058.....239 | C512.....147      |
| BPN-7.....40      | C165-0032.....238 | C254-0090.....237 | C460-0090.....239 | C512L.....147     |
| BPN-8.....40      | C165-0050.....238 | C254-0100.....237 | C460-0100.....239 | C533-0050.....239 |
| BPN-9.....40      | C165-0058.....238 | C254-0150.....237 | C460-0107.....239 | C533-0090.....239 |
| BPN-A1.....40     | C165-0059.....238 | C254-0215.....237 | C460-0117.....239 | C533-0100.....239 |
| BPN-A12.....40    | C165-0090.....238 | C254-0295.....237 | C460-0118.....239 | C533-0150.....239 |
| BPN-A34.....40    | C165-0093.....238 | C254-0390.....237 | C460-0150.....239 | C533-0215.....239 |
| BS-16.....232     | C165-0094.....238 | C272-0002.....237 | C460-0159.....239 | C533-0295.....239 |
| BS-32.....232     | C165-0100.....238 | C272-0025.....237 | C460-0160.....239 | C533-0390.....239 |
| BS-64.....232     | C165-0107.....238 | C272-0050.....237 | C460-0180.....239 | C657-0025.....238 |
| C101-0005.....236 | C165-0149.....238 | C272-0090.....237 | C460-0181.....239 | C657-0050.....238 |
| C101-0007.....236 | C165-0150.....238 | C272-0100.....237 | C460-0182.....239 | C657-0100.....238 |
| C101-0025.....236 | C165-0159.....238 | C272-0150.....237 | C460-0215.....239 | C657-0150.....238 |
| C101-0050.....236 | C165-0215.....238 | C272-0215.....237 | C460-0222.....239 | C947-0025.....239 |
| C101-0057.....236 | C165-0222.....238 | C272-0295.....237 | C460-0223.....239 | C947-0050.....239 |
| C101-0058.....236 | C165-0223.....238 | C290-0002.....237 | C460-0235.....239 | C947-0090.....239 |
| C101-0092.....236 | C165-0224.....238 | C290-0025.....237 | C460-0236.....239 | C947-0100.....239 |

**PART NUMBER INDEX cont'd**

|                  |     |                    |     |                |     |               |     |               |     |
|------------------|-----|--------------------|-----|----------------|-----|---------------|-----|---------------|-----|
| C947-0150.....   | 239 | CRC-1.....         | 70  | D61820350..... | 247 | DAD082.....   | 241 | DN1-4.....    | 235 |
| C947-0215.....   | 239 | CRC-13.....        | 70  | D61820500..... | 247 | DAD083.....   | 241 | DN1-5.....    | 235 |
| C947-0295.....   | 239 | CRC-1KB.....       | 71  | D61880250..... | 247 | DAD083S.....  | 241 | DN1-6.....    | 235 |
| C947-0390.....   | 239 | CRC-2.....         | 70  | D61880350..... | 247 | DAD084S.....  | 241 | DN1-8.....    | 235 |
| CAN-4.....       | 222 | CRC-2G.....        | 70  | D61880500..... | 247 | DAD163.....   | 241 | DN5-10.....   | 235 |
| CAS-2712.....    | 74  | CRC-3.....         | 70  | D61A-10.....   | 234 | DAD163S.....  | 241 | DN5-4.....    | 235 |
| CASE-CARE.....   | 218 | CRC-4-140.....     | 71  | D61A-4.....    | 234 | DAD164.....   | 241 | DN5-6.....    | 235 |
| CC-1.....        | 59  | CRC-4CF.....       | 71  | D61A-6.....    | 234 | DAD164S.....  | 241 | DN5-8.....    | 235 |
| CC33.....        | 149 | CRC-4NS.....       | 71  | D61A-8.....    | 234 | DAD165.....   | 241 | DNS4-10.....  | 235 |
| CC33-18.....     | 149 | CRC-4NU.....       | 71  | D62A-1010..... | 234 | DAD303.....   | 241 | DNS4-12.....  | 235 |
| CC33-24.....     | 149 | CRC-5.....         | 70  | D62A-44.....   | 234 | DAD303S.....  | 241 | DNS4-14.....  | 235 |
| CG-AER.....      | 221 | CRC-5BC.....       | 70  | D62A-66.....   | 234 | DAD304.....   | 241 | DNS4-4.....   | 235 |
| CGB-AER.....     | 221 | CRC-6.....         | 70  | D62A-88.....   | 234 | DAD304S.....  | 241 | DNS4-6.....   | 235 |
| CH-100.....      | 146 | CRC-7-140.....     | 71  | D64A-1010..... | 234 | DAD305.....   | 241 | DNS4-8.....   | 235 |
| CH-100-3.....    | 146 | CRC-7PS.....       | 72  | D64A-44.....   | 234 | DAD305S.....  | 241 | DP2-10.....   | 235 |
| CH-101.....      | 146 | CRC-7X.....        | 72  | D64A-66.....   | 234 | DBF083SV..... | 242 | DP2-4.....    | 235 |
| CH-101-1.....    | 146 | CRC-7Z.....        | 71  | D64A-88.....   | 234 | DBF083V.....  | 242 | DP252120..... | 127 |
| CH-101-2.....    | 146 | CRC-8.....         | 71  | D68A-4A.....   | 234 | DBF084SV..... | 242 | DP25224.....  | 127 |
| CH-101-3.....    | 146 | CRC-9.....         | 70  | D68A-4B.....   | 234 | DBF084V.....  | 242 | DP252240..... | 127 |
| CH-102.....      | 146 | CSG-1.....         | 162 | D68A-6B.....   | 234 | DBF163SV..... | 242 | DP2-6.....    | 235 |
| CH-102-2.....    | 146 | CT800.....         | 156 | D68A-6C.....   | 234 | DBF163V.....  | 242 | DP2-8.....    | 235 |
| CH-102-3.....    | 146 | CTH-1.....         | 34  | D68A-6D.....   | 234 | DBF164S.....  | 242 | DP301120..... | 127 |
| CH-103.....      | 146 | CTH-1.....         | 147 | D68A-8D.....   | 234 | DBF164V.....  | 242 | DP30124.....  | 127 |
| CH-103-2.....    | 146 | CTZ-1.....         | 222 | D69A-4A.....   | 234 | DBF165SV..... | 242 | DP301240..... | 127 |
| CH-104.....      | 146 | CTZ-16.....        | 222 | D69A-4B.....   | 234 | DCV-1G.....   | 243 | DP302120..... | 127 |
| CH-104-3.....    | 146 | CTZ-4.....         | 222 | D69A-6B.....   | 234 | DD11.....     | 128 | DP30224.....  | 127 |
| CH-105.....      | 146 | D10.....           | 128 | D69A-6C.....   | 234 | DDS-30.....   | 132 | DP302240..... | 127 |
| CH-135.....      | 146 | D11.....           | 128 | D69A-6D.....   | 234 | DDS-60.....   | 132 | DP303120..... | 127 |
| CH-135-2.....    | 146 | D40680250B3B6..... | 247 | D69A-8D.....   | 234 | DDS-60U.....  | 132 | DP30324.....  | 127 |
| CH-196.....      | 146 | D40680350B3B6..... | 247 | D-90113.....   | 129 | DE1-10D.....  | 234 | DP303240..... | 127 |
| CH-196-2.....    | 146 | D40680500B3B6..... | 247 | D-90118.....   | 129 | DE1-12D.....  | 234 | DP304120..... | 127 |
| CH-196-3.....    | 146 | D40880250B3B6..... | 247 | D90-290Q.....  | 128 | DE1-12E.....  | 234 | DP30424.....  | 127 |
| CH-196-6.....    | 146 | D40880350B3B6..... | 247 | D90-291Q.....  | 128 | DE13.....     | 110 | DP304240..... | 127 |
| CH-197.....      | 146 | D40880500B3B6..... | 247 | D90-292Q.....  | 128 | DE14.....     | 110 | DP304277..... | 127 |
| CH-202-3.....    | 146 | D41080250B3B6..... | 247 | D90-293Q.....  | 128 | DE1-4B.....   | 234 | DP402120..... | 127 |
| CH-230.....      | 146 | D41080350B3B6..... | 247 | D90-294Q.....  | 128 | DE15.....     | 110 | DP40224.....  | 127 |
| CH-230-3.....    | 146 | D41080500B3B6..... | 247 | D90-295Q.....  | 128 | DE1-6B.....   | 234 | DP402240..... | 127 |
| CH-230-6.....    | 146 | D60A-10.....       | 234 | D-90340.....   | 128 | DE1-6C.....   | 234 | DP403120..... | 127 |
| CH-280.....      | 146 | D60A-4.....        | 234 | D-90341.....   | 128 | DE1-6D.....   | 234 | DP40324.....  | 127 |
| CLL-1.....       | 221 | D60A-6.....        | 234 | D-90342.....   | 128 | DE1-8C.....   | 234 | DP403240..... | 127 |
| CLL-16.....      | 221 | D60A-8.....        | 234 | D90-360.....   | 128 | DE1-8D.....   | 234 | DP404120..... | 127 |
| CLL-4.....       | 221 | D61080250B3B6..... | 247 | D90-362.....   | 128 | DE1-8E.....   | 234 | DP40424.....  | 127 |
| CO-1.....        | 69  | D61080350B3B6..... | 247 | D90-364.....   | 128 | DE22.....     | 111 | DP404240..... | 127 |
| COIL-CARE.....   | 218 | D61080500B3B6..... | 247 | D90-370.....   | 128 | DE23.....     | 110 | DP404277..... | 127 |
| COOLWELD-32..... | 221 | D61220250.....     | 247 | D90-372.....   | 128 | DE24.....     | 110 | DP503120..... | 127 |
| CP-16.....       | 58  | D61220350.....     | 247 | D90-374.....   | 128 | DE25.....     | 110 | DP50324.....  | 127 |
| CP-16-230.....   | 58  | D61220500.....     | 247 | D90-380.....   | 128 | DE26.....     | 110 | DP503240..... | 127 |
| CP-22.....       | 58  | D61230250.....     | 247 | D90-382.....   | 128 | DE33.....     | 110 | DP603120..... | 127 |
| CP-22-230.....   | 58  | D61230350.....     | 247 | D90-384.....   | 128 | DEP052.....   | 74  | DP60324.....  | 127 |
| CP-22-230T.....  | 58  | D61230500.....     | 247 | DA2V02.....    | 128 | DEP056.....   | 74  | DP603240..... | 127 |
| CP-22LP.....     | 58  | D61280250.....     | 247 | DA2V06.....    | 128 | DEP8001.....  | 74  | DP753120..... | 127 |
| CP-22LP-230..... | 58  | D61280350.....     | 247 | DA2V09.....    | 128 | DEP8002.....  | 74  | DP75324.....  | 127 |
| CP-22T.....      | 58  | D61280500.....     | 247 | DA2V14.....    | 128 | DLT-3G L..... | 243 | DP753240..... | 127 |
| CP-35MS.....     | 58  | D61420250.....     | 247 | DA3V02.....    | 128 | DLT-4G L..... | 243 | DP903120..... | 127 |
| CP-CV.....       | 58  | D61420350.....     | 247 | DA3V06.....    | 128 | DLT-5G L..... | 243 | DP90324.....  | 127 |
| CPN1.....        | 147 | D61420500.....     | 247 | DA3V09.....    | 128 | DLT-6G L..... | 243 | DP903240..... | 127 |
| CPN1C.....       | 147 | D61430250.....     | 247 | DA3V14.....    | 128 | DMB-1.....    | 144 | DPR063.....   | 128 |
| CPN2.....        | 147 | D61430350.....     | 247 | DAD032.....    | 241 | DMB-2.....    | 144 | DPR064.....   | 128 |
| CPN2C.....       | 147 | D61430500.....     | 247 | DAD032s.....   | 241 | DMB-3.....    | 144 | DPR065.....   | 128 |
| CPN3.....        | 147 | D61480250.....     | 247 | DAD052.....    | 241 | DN1-10.....   | 235 | DPR066.....   | 128 |
| CPN3C.....       | 147 | D61480350.....     | 247 | DAD052S.....   | 241 | DN1-12.....   | 235 | DPR067.....   | 128 |
| CR040.....       | 160 | D61480500.....     | 247 | DAD053.....    | 241 | DN1-14.....   | 235 | DPR068.....   | 128 |
| CR-1.....        | 69  | D61820250.....     | 247 | DAD053S.....   | 241 | DN1-3.....    | 235 | DPR069.....   | 128 |

|                        |     |                  |     |               |     |                    |     |               |     |
|------------------------|-----|------------------|-----|---------------|-----|--------------------|-----|---------------|-----|
| DPR071.....            | 128 | DU3-8D.....      | 236 | ED4509.....   | 98  | EL3238-3.....      | 21  | FM0450.....   | 33  |
| DPSG-2.....            | 242 | DUS4-4.....      | 236 | ED453.....    | 99  | EL3244-2.....      | 21  | FTL3.....     | 156 |
| DPSG-2MF.....          | 242 | DUS4-6.....      | 236 | ED454.....    | 99  | EL3244-3.....      | 21  | FTL3D.....    | 156 |
| DPSG-3.....            | 242 | DUS4-8.....      | 236 | ED455.....    | 99  | EL3434-2.....      | 21  | FUL0425.....  | 33  |
| DPSG-3MF.....          | 242 | DX-3.....        | 242 | ED468.....    | 99  | EL3434-3.....      | 21  | FUL0625.....  | 33  |
| DPSG-4.....            | 242 | DX-4.....        | 242 | ED4867.....   | 98  | EL3636-2.....      | 21  | GC275.....    | 150 |
| DPSG-4MF.....          | 242 | DXA-5.....       | 242 | ED494.....    | 99  | EL3636-3.....      | 21  | GC277.....    | 150 |
| DPSG-5.....            | 242 | E-10.....        | 161 | ED5225.....   | 99  | EL3640-2.....      | 21  | GG-1.....     | 61  |
| DPSG-5MF.....          | 242 | E-5.....         | 161 | ED600.....    | 100 | EL3640-3.....      | 21  | GG-1A.....    | 61  |
| DSL D 13-5SVHH.....    | 241 | E-6.....         | 161 | ED601.....    | 100 | EL3648-2.....      | 21  | GG-1H.....    | 61  |
| DSL D 13-6SVHH.....    | 241 | E-8.....         | 161 | ED602.....    | 100 | EL3648-3.....      | 21  | GGC-12.....   | 61  |
| DSL D 13-9SV-HH.....   | 241 | EB-10.....       | 161 | ED603.....    | 100 | EL3842-2.....      | 21  | GN-23H.....   | 68  |
| DSL D 27-7SVHH.....    | 241 | EB-6.....        | 161 | ED604.....    | 100 | EL3842-3.....      | 21  | GOTS-1.....   | 244 |
| DSL D 27-9SVHH.....    | 241 | EB-8.....        | 161 | ED610.....    | 100 | EL3870-3.....      | 21  | GOTS-2.....   | 244 |
| DSL D 54-11SVHH.....   | 241 | EC-1.....        | 34  | ED611.....    | 100 | EL4040-3.....      | 21  | GPI-40BL..... | 68  |
| DSL D 8-3V-HH VSD..... | 241 | EC302120.....    | 127 | ED612.....    | 100 | EL4558-3.....      | 21  | GV04.....     | 149 |
| DSL D 8-4sV-HHSSD..... | 241 | EC30224.....     | 127 | ED613.....    | 100 | EL4848-3.....      | 21  | GV05.....     | 149 |
| DSL D 8-4V-HH VSD..... | 241 | EC302240.....    | 127 | ED620.....    | 100 | EL4872-3.....      | 21  | GV06.....     | 149 |
| DSP-1.....             | 141 | EC303120.....    | 127 | ED621.....    | 100 | EL5252-3.....      | 21  | GV07.....     | 149 |
| DSPG-2S.....           | 242 | EC30324.....     | 127 | ED622.....    | 100 | EL5658-3.....      | 21  | GV08.....     | 149 |
| DSPG-3S.....           | 242 | EC303240.....    | 127 | ED623.....    | 100 | EM111.....         | 102 | GV10.....     | 149 |
| DSPG-4S.....           | 242 | EC402120.....    | 127 | ED710.....    | 101 | EM217.....         | 102 | GV12.....     | 149 |
| DSPG-5S.....           | 242 | EC40224.....     | 127 | ED711.....    | 101 | EM469.....         | 102 | GV14.....     | 149 |
| DSPG-7S.....           | 242 | EC402240.....    | 127 | ED712.....    | 101 | EM480.....         | 99  | GV16.....     | 149 |
| DSPG-9S.....           | 242 | EC403120.....    | 127 | ED713.....    | 101 | EM484.....         | 99  | GVA1.....     | 149 |
| DSS-SLD305SVVSD.....   | 241 | EC40324.....     | 127 | ED714.....    | 101 | EP2424-2.....      | 25  | GVA2.....     | 149 |
| DSS-SLD306SVVSD.....   | 241 | EC403240.....    | 127 | ED877.....    | 98  | EP2424-3.....      | 25  | H1840-4.....  | 23  |
| DSS-SLD307SVVSD.....   | 241 | EC-56.....       | 161 | ED877-1.....  | 98  | EP3030-2.....      | 25  | H2424-4.....  | 23  |
| DST-10.....            | 126 | EC-810.....      | 161 | ED9726.....   | 99  | EP3030-3.....      | 25  | H2436-4.....  | 23  |
| DST-5.....             | 126 | ECO-COIL.....    | 217 | ED-AT3.....   | 103 | EP3232-2.....      | 25  | H3030-4.....  | 23  |
| DST-6.....             | 126 | ECO-COIL-32..... | 217 | ED-AT5.....   | 103 | EP3232-3.....      | 25  | H3060-4.....  | 23  |
| DT2-10.....            | 235 | ECO-COIL-5.....  | 217 | ED-CR 15..... | 103 | EP3244-2.....      | 25  | H3232-4.....  | 23  |
| DT2-4.....             | 235 | ED1232.....      | 99  | ED-CR 20..... | 103 | EP3244-3.....      | 25  | H3345-4.....  | 23  |
| DT2-6.....             | 235 | ED1238.....      | 99  | ED-CR 25..... | 103 | EP3636-2.....      | 25  | H3434-4.....  | 23  |
| DT2-8.....             | 235 | ED1240-2.....    | 99  | ED-CR 30..... | 103 | EP3636-3.....      | 25  | H3636-4.....  | 23  |
| DTP-3.....             | 141 | ED1262-2.....    | 99  | ED-CR 35..... | 103 | EP3842-2.....      | 25  | H3642-4.....  | 23  |
| DTT-10.....            | 65  | ED1262-2I.....   | 99  | ED-CR 40..... | 103 | EP3848-3.....      | 25  | H3648-4.....  | 23  |
| DTT-24.....            | 65  | ED1301.....      | 99  | ED-CR 45..... | 103 | ER317B.....        | 112 | H3652-4.....  | 23  |
| DU1-10D.....           | 235 | ED1301-I.....    | 99  | ED-CR 50..... | 103 | ET130C1.....       | 150 | H3672-4.....  | 23  |
| DU1-10E.....           | 235 | ED1703.....      | 97  | ED-CR 60..... | 103 | ET22.....          | 150 | H3842-4.....  | 23  |
| DU1-12D.....           | 235 | ED1709.....      | 97  | EDS-60U.....  | 132 | ET33.....          | 150 | H3852-4.....  | 23  |
| DU1-12E.....           | 235 | ED1711.....      | 98  | EE-30.....    | 161 | ET35G.....         | 150 | H3865-4.....  | 23  |
| DU1-4A.....            | 235 | ED179.....       | 97  | EE-48.....    | 161 | ET35N.....         | 150 | H4040-4.....  | 23  |
| DU1-4B.....            | 235 | ED1876.....      | 98  | EG.....       | 219 | ET35R.....         | 150 | H4242-4.....  | 23  |
| DU1-6B.....            | 235 | ED1876-I.....    | 98  | EG-5.....     | 219 | ET35W.....         | 150 | H4545-4.....  | 23  |
| DU1-6C.....            | 235 | ED1877.....      | 98  | EG-55.....    | 219 | ET44.....          | 150 | H4558-4.....  | 23  |
| DU1-6D.....            | 235 | ED227.....       | 99  | EH-1.....     | 161 | FAK-10.....        | 64  | H5151-4.....  | 23  |
| DU1-6E.....            | 235 | ED227-I.....     | 99  | EL1838-3..... | 21  | FAK-25.....        | 64  | H5557-4.....  | 23  |
| DU1-8B.....            | 235 | ED252.....       | 98  | EL2424-2..... | 21  | FB-1.....          | 26  | HC-1.....     | 23  |
| DU1-8C.....            | 235 | ED270.....       | 98  | EL2424-3..... | 21  | FC-73.....         | 40  | HC-1-100..... | 23  |
| DU1-8D.....            | 235 | ED270-I.....     | 98  | EL2430-2..... | 21  | FC-74.....         | 40  | HC5410.....   | 108 |
| DU1-8E.....            | 235 | ED273.....       | 96  | EL2430-3..... | 21  | FC-82.....         | 40  | HC5410X.....  | 108 |
| DU2-10.....            | 235 | ED273CX.....     | 96  | EL2436-2..... | 21  | FC-87.....         | 40  | HC5416.....   | 108 |
| DU2-12.....            | 235 | ED2867.....      | 98  | EL2436-3..... | 21  | FF-250-S.....      | 202 | HC5416X.....  | 108 |
| DU2-14.....            | 235 | ED2887.....      | 98  | EL2626-2..... | 21  | FF-250-UNI.....    | 202 | HC5420.....   | 108 |
| DU2-4.....             | 235 | ED302.....       | 99  | EL3030-2..... | 21  | FH-1.....          | 136 | HC5420X.....  | 108 |
| DU2-6.....             | 235 | ED304.....       | 99  | EL3030-3..... | 21  | FLOW-PLUS-10.....  | 220 | HC5424.....   | 108 |
| DU2-8.....             | 235 | ED312.....       | 99  | EL3036-2..... | 21  | FLOW-PLUS-125..... | 220 | HC5436.....   | 108 |
| DU3-10D.....           | 236 | ED320.....       | 100 | EL3040-2..... | 21  | FLOW-PLUS-200..... | 220 | HC5436X.....  | 108 |
| DU3-10E.....           | 236 | ED406.....       | 96  | EL3040-3..... | 21  | FLOW-PLUS-25.....  | 220 | HC6202.....   | 108 |
| DU3-6C.....            | 236 | ED419.....       | 98  | EL3232-2..... | 21  | FLOW-PLUS-6.....   | 220 | HC6203.....   | 108 |
| DU3-6D.....            | 236 | ED4409.....      | 98  | EL3232-3..... | 21  | FLOW-PLUS-CP.....  | 58  | HCO-128.....  | 69  |
| DU3-8C.....            | 236 | ED447.....       | 99  | EL3238-2..... | 21  | FLOW-PLUS-CP.....  | 220 | HCO-15.....   | 69  |

**PART NUMBER INDEX cont'd**

|                 |     |                |     |                   |     |                |     |                |     |
|-----------------|-----|----------------|-----|-------------------|-----|----------------|-----|----------------|-----|
| HCO-64.....     | 69  | HT3636-4 ..... | 23  | MP-3.....         | 28  | PI232CX.....   | 94  | PI371.....     | 94  |
| HCO-7.....      | 69  | HT3642-4 ..... | 23  | MP-3C.....        | 27  | PI237.....     | 102 | PI373.....     | 94  |
| HCP-128.....    | 69  | HT3648-4 ..... | 23  | MP-3E.....        | 27  | PI301.....     | 96  | PI374.....     | 94  |
| HCP-15.....     | 69  | HT3652-4 ..... | 23  | MP-4.....         | 28  | PI303.....     | 96  | PI375.....     | 94  |
| HCP-7.....      | 69  | HT3672-4 ..... | 23  | MP-4C.....        | 27  | PI304.....     | 95  | PI376.....     | 94  |
| HDR-101.....    | 145 | HT3842-4 ..... | 23  | MP-4E.....        | 27  | PI305.....     | 95  | PI377.....     | 94  |
| HDR-102.....    | 145 | HT3852-4 ..... | 23  | MP-6.....         | 28  | PI305LX.....   | 95  | PI378.....     | 94  |
| HDR-201.....    | 145 | HT3865-4 ..... | 23  | MP-6C.....        | 27  | PI306.....     | 95  | PI379.....     | 94  |
| HDR-202.....    | 145 | HT4040-4 ..... | 23  | MP-6E.....        | 27  | PI306CX.....   | 95  | PI380.....     | 99  |
| HDR-211.....    | 145 | HT4242-4 ..... | 23  | MP-6S.....        | 28  | PI307.....     | 95  | PI381.....     | 99  |
| HDR-212.....    | 145 | HT4545-4 ..... | 23  | MP-8.....         | 28  | PI307CX.....   | 95  | PI382.....     | 93  |
| HDR-221.....    | 145 | HT4558-4 ..... | 23  | MP-8C.....        | 27  | PI308.....     | 95  | PI383.....     | 94  |
| HDR-222.....    | 145 | HT5151-4 ..... | 23  | MSA-44.....       | 240 | PI309.....     | 96  | PI384.....     | 93  |
| HEK-100.....    | 145 | HT5557-7 ..... | 23  | MSA-45.....       | 240 | PI310.....     | 95  | PI385.....     | 93  |
| HEK-200.....    | 145 | IC-1.....      | 62  | P I911.....       | 95  | PI310LX.....   | 95  | PI385-34.....  | 93  |
| HEK-400.....    | 145 | IC-1R.....     | 62  | PA10.....         | 149 | PI311.....     | 95  | PI386.....     | 93  |
| HEK-500.....    | 145 | IGN-1F.....    | 40  | PA18.....         | 149 | PI312.....     | 95  | PI387.....     | 93  |
| HFL-4257.....   | 145 | IGN-1R.....    | 40  | PA25.....         | 149 | PI313.....     | 94  | PI388.....     | 93  |
| HFL-4300.....   | 145 | IQP-120.....   | 57  | PA25AP.....       | 149 | PI315.....     | 95  | PI389.....     | 93  |
| HFL-4333.....   | 145 | IQP-120T.....  | 57  | PANPATCH.....     | 61  | PI316.....     | 96  | PI389-GFI..... | 93  |
| HFL-5257.....   | 145 | IQP-230.....   | 57  | PANPATCH.....     | 221 | PI317.....     | 96  | PI390.....     | 93  |
| HFL-5258.....   | 145 | IQP-230T.....  | 57  | PANPATCH-32.....  | 61  | PI318.....     | 95  | PI391.....     | 93  |
| HFL-5300.....   | 145 | ISO-18.....    | 28  | PANPATCH-32.....  | 221 | PI319.....     | 94  | PI393.....     | 94  |
| HFL-5301.....   | 145 | ISO-2.....     | 28  | PANPATCH-BAG..... | 61  | PI319CX.....   | 94  | PI394.....     | 94  |
| HFL-5333.....   | 145 | ISO-4.....     | 28  | PANPATCH-BAG..... | 221 | PI320.....     | 94  | PI411.....     | 95  |
| HMR-130.....    | 145 | JB8265.....    | 74  | PC-600-B.....     | 36  | PI321.....     | 94  | PI412.....     | 95  |
| HP3636-8.....   | 25  | KD2077.....    | 111 | PC-600-S.....     | 36  | PI322.....     | 95  | PI415.....     | 95  |
| HPR-12.....     | 26  | LEAK-SEEK..... | 218 | PC-609-B.....     | 36  | PI324.....     | 95  | PI416.....     | 95  |
| HPR-3.....      | 26  | LF2436-2.....  | 25  | PC-609-S.....     | 36  | PI325.....     | 95  | PI419.....     | 95  |
| HPR-3-2P.....   | 26  | LF2436-3.....  | 25  | PC-622-B.....     | 36  | PI326.....     | 102 | PI426.....     | 95  |
| HPR-3-2PG.....  | 26  | LF3030-2.....  | 25  | PC-622-S.....     | 36  | PI327.....     | 102 | PI431.....     | 95  |
| HPR-6.....      | 26  | LF3030-3.....  | 25  | PC-783.....       | 36  | PI328.....     | 102 | PI432.....     | 95  |
| HPR-6-2P.....   | 26  | LF3036-2.....  | 25  | PE-104.....       | 185 | PI330.....     | 96  | PI435.....     | 95  |
| HPR-6-2PG.....  | 26  | LF3636-2.....  | 25  | PF-16.....        | 222 | PI331.....     | 96  | PI436.....     | 95  |
| HPR-6S.....     | 26  | LF3636-3.....  | 25  | PF-ADAPTER.....   | 222 | PI332.....     | 96  | PI440.....     | 94  |
| HPR-EXT.....    | 26  | M-1.....       | 161 | PF-IGUN.....      | 222 | PI335.....     | 109 | PI458.....     | 95  |
| HP-SB-16.....   | 231 | M-1R.....      | 161 | PF-IHOSE.....     | 222 | PI336.....     | 101 | PI459.....     | 95  |
| HP-SK-16.....   | 231 | M-2.....       | 161 | PF-KIT.....       | 222 | PI337-3.....   | 102 | PI908.....     | 95  |
| HP-SKDP-20..... | 231 | M-2R.....      | 161 | PG-100.....       | 219 | PI337-4.....   | 102 | PI908CX.....   | 95  |
| HP-SKDS-16..... | 231 | M-3.....       | 161 | PG-100-5.....     | 219 | PI340.....     | 95  | PI909LX.....   | 95  |
| HS012.....      | 149 | M-3G.....      | 161 | PG-100-55.....    | 219 | PI341.....     | 95  | PI912.....     | 95  |
| HS03.....       | 149 | M-3R.....      | 161 | PG-50.....        | 219 | PI342.....     | 95  | PI912LX.....   | 95  |
| HS04.....       | 149 | M-4.....       | 161 | PG-50-5.....      | 219 | PI344.....     | 96  | PI913.....     | 95  |
| HS06.....       | 149 | M-4R.....      | 161 | PG-50-55.....     | 219 | PI345.....     | 96  | PI913LX.....   | 95  |
| HS08.....       | 149 | M-5.....       | 161 | PG-AL.....        | 219 | PI346.....     | 96  | PI914.....     | 95  |
| HS-144.....     | 160 | M-5G.....      | 161 | PG-AL-5.....      | 219 | PI350.....     | 95  | PI929.....     | 102 |
| HS16.....       | 149 | M-5R.....      | 161 | PG-AL-55.....     | 219 | PI351.....     | 95  | PI930.....     | 102 |
| HS-192.....     | 160 | MB21.....      | 149 | PG-BG.....        | 219 | PI352.....     | 95  | PK-2.....      | 154 |
| HS24.....       | 149 | MB22.....      | 149 | PG-BG-5.....      | 219 | PI353.....     | 95  | PK-2B.....     | 154 |
| HS-30.....      | 161 | MG-1.....      | 167 | PG-BG-55.....     | 219 | PI355.....     | 95  | POE100-01..... | 228 |
| HS-30-2.....    | 161 | MG-RGB.....    | 167 | PG-PLUS.....      | 219 | PI360.....     | 93  | POE100-32..... | 228 |
| HS32.....       | 149 | MG-RGR.....    | 167 | PG-PLUS-5.....    | 219 | PI360-3/4..... | 93  | POE32-01.....  | 228 |
| HS-60.....      | 161 | MHP-4.....     | 161 | PG-PLUS-55.....   | 219 | PI361.....     | 93  | POE32-32.....  | 228 |
| HS-60-2.....    | 161 | ML-100.....    | 162 | PH-BF.....        | 202 | PI361-3/4..... | 93  | POE68-01.....  | 228 |
| HSA1.....       | 149 | MP-12.....     | 28  | PH-EF.....        | 202 | PI362.....     | 93  | POE68-32.....  | 228 |
| HSA2.....       | 149 | MP-12C.....    | 27  | PI203.....        | 96  | PI363.....     | 93  | PP-16.....     | 183 |
| HT2424-4.....   | 23  | MP-12E.....    | 27  | PI206.....        | 95  | PI364.....     | 93  | PP-32.....     | 183 |
| HT2436-4.....   | 23  | MP-18.....     | 28  | PI221.....        | 102 | PI365.....     | 94  | PP-4.....      | 183 |
| HT3030-4.....   | 23  | MP-18C.....    | 27  | PI222.....        | 102 | PI366.....     | 94  | PP-8.....      | 183 |
| HT3060-4.....   | 23  | MP-18E.....    | 27  | PI226.....        | 102 | PI367.....     | 94  | PPC-16.....    | 183 |
| HT3232-4.....   | 23  | MP-2.....      | 28  | PI227.....        | 102 | PI368.....     | 94  | PPC-32.....    | 183 |
| HT3345-4.....   | 23  | MP-2C.....     | 27  | PI228.....        | 102 | PI369.....     | 94  | PPC-4.....     | 183 |
| HT3434-4.....   | 23  | MP-2E.....     | 27  | PI232.....        | 94  | PI370.....     | 94  | PPC-8.....     | 183 |

**PART NUMBER INDEX cont'd**

|                       |                     |                      |                  |                       |
|-----------------------|---------------------|----------------------|------------------|-----------------------|
| PRO-BLUE.....217      | S-3.....162         | SCM-702-55.....225   | SH-06.....68     | TLC-3-8.....149       |
| PRO-BLUE-32.....217   | SANI-CND.....219    | SCM-703-01.....224   | SH-12.....68     | TRIPLE-D.....218      |
| PRO-BLUE-5.....217    | SANI-CND-32.....219 | SCM-703-05.....224   | SOS-1.....60     | TRIPLE-D-32.....218   |
| PRO-BROWN.....217     | SANI-CND-5.....219  | SCM-703-30.....224   | ST-10.....65     | TRIPLE-D-5.....218    |
| PRO-BROWN-32.....217  | SANI-CND-55.....219 | SCM-703-32.....224   | ST-24.....65     | TRIPLE-D-AER.....218  |
| PRO-BROWN-5.....217   | SC-1.....64         | SCM-703-55.....224   | ST-4.....65      | TRIPLE-D-GRAN.....218 |
| PRO-BUBBLE-32.....221 | SC-10.....69        | SCM-705-01.....228   | T-1.....160      | TS-1.....134          |
| PRO-GREEN.....217     | SC-25.....69        | SCM-705-05.....228   | T-10.....160     | TS-2.....134          |
| PRO-GREEN-32.....217  | SCM-10.....69       | SCM-705-16.....228   | T-100.....160    | TS-3.....134          |
| PRO-GREEN-5.....217   | SCM-10MP.....69     | SCM-705-30.....228   | T-101.....160    | TS-4.....134          |
| PRO-RED+.....217      | SCM-117-16.....230  | SCM-706-01.....225   | T-11.....160     | TS-5.....134          |
| PRO-RED+32.....217    | SCM-123-01.....230  | SCM-706-05.....225   | T-12.....160     | TS-6.....134          |
| PRO-RED+5.....217     | SCM-123-05.....230  | SCM-706-30.....225   | T-13.....160     | TT-120.....159        |
| PROTREAT-151.....219  | SCM-123-30.....230  | SCM-706-32.....225   | T-14.....160     | TT-24.....159         |
| PROTREAT-152.....220  | SCM-123-55.....230  | SCM-706-55.....225   | T-1401.....129   | TT-240.....159        |
| PROTREAT-161.....220  | SCM-124-01.....230  | SCM-707-01.....224   | T1403.....129    | TTP-1.....60          |
| PROTREAT-200.....220  | SCM-124-05.....230  | SCM-707-05.....224   | T1404.....129    | U V-1.....36          |
| PROTREAT-217.....220  | SCM-124-55.....230  | SCM-707-20.....224   | T-15.....160     | U V-BULB.....36       |
| PROTREAT-350.....220  | SCM-126-01.....230  | SCM-707-30.....224   | T-16.....160     | U2660-3.....20        |
| PRO-YELLOW.....217    | SCM-126-05.....230  | SCM-707-32.....224   | T-17.....160     | U3060-3.....20        |
| PRO-YELLOW-32.....217 | SCM-126-30.....230  | SCM-707-55.....224   | T-18.....160     | U3353-3.....20        |
| PRO-YELLOW-5.....217  | SCM-126-55.....230  | SCM-707-GRAN.....224 | T-20.....160     | U3465-3.....20        |
| PS-01.....227         | SCM-127-55.....230  | SCM-707-RTU.....224  | T-200.....160    | U3650-3.....20        |
| PS-03.....227         | SCM-128-01.....230  | SCM-709-01.....226   | T-21.....160     | U3654-3.....20        |
| PS-07.....227         | SCM-128-05.....230  | SCM-709-05.....226   | T-23.....160     | U3660-3.....20        |
| PS-075.....227        | SCM-128-30.....230  | SCM-709-30.....226   | T2401.....129    | U3678-3.....20        |
| PS-1.....232          | SCM-128-55.....230  | SCM-709-55.....226   | T2402.....129    | U3865-3.....20        |
| PS-1W.....232         | SCM-129-01.....230  | SCM-712-01.....225   | T2403.....129    | U3870-3.....20        |
| PS-20.....227         | SCM-129-05.....230  | SCM-712-05.....225   | T2404.....129    | U4054-3.....20        |
| PS-40.....227         | SCM-129-275.....230 | SCM-712-30.....225   | T-300.....160    | U4550-3.....20        |
| PW-16.....183         | SCM-129-30.....230  | SCM-712-32.....225   | T3401.....129    | U4558-3.....20        |
| PW-32.....183         | SCM-129-55.....230  | SCM-712-55.....225   | T3402.....129    | U4848-3.....20        |
| PW-4.....183          | SCM-130-01.....230  | SCM-713-01.....227   | T3403.....129    | U4854-3.....20        |
| PW-8.....183          | SCM-130-05.....230  | SCM-713-32.....227   | T3501.....129    | U4866-3.....20        |
| PWB-16.....183        | SCM-130-30.....230  | SCM-718-01.....224   | T-400.....160    | U5053-3.....20        |
| PWB-4.....183         | SCM-130-55.....230  | SCM-718-05.....224   | T-408.....160    | U5056-3.....20        |
| PWB-8.....183         | SCM-132-01.....230  | SCM-718-30.....224   | T-409.....160    | U5075-3.....20        |
| PWH-16.....183        | SCM-132-05.....230  | SCM-718-32.....224   | T-411.....160    | U5079-3.....20        |
| PWH-4.....183         | SCM-132-30.....230  | SCM-718-55.....224   | T-412.....160    | U5252-3.....20        |
| PWH-8.....183         | SCM-132-55.....230  | SCM-720-01.....224   | T-417.....160    | U5260-3.....20        |
| PWU-16.....183        | SCM-134-01.....230  | SCM-720-05.....224   | T-418.....160    | U5557-3.....20        |
| PWU-4.....183         | SCM-134-05.....230  | SCM-720-30.....224   | T4401.....129    | U6067-3.....20        |
| PWU-8.....183         | SCM-134-30.....230  | SCM-720-32.....224   | T4403.....129    | UA-1.....59           |
| QO200TR.....133       | SCM-134-55.....230  | SCM-720-55.....224   | T4501.....129    | UC1636-2.....20       |
| QAV-2.....185         | SCM-137-01.....230  | SCM-805-01.....226   | T5401.....129    | UC1636-3.....20       |
| QT-1.....242          | SCM-138-01.....230  | SCM-805-08.....226   | T5403.....129    | UC2424-2.....20       |
| QT-100.....243        | SCM-138-05.....230  | SCM-806-01.....226   | T5404.....129    | UC2424-3.....20       |
| QT-100G.....243       | SCM-140-01.....230  | SCM-806-32.....226   | T6751.....129    | UC2424-3CA.....21     |
| QT-100N.....243       | SCM-140-275.....230 | SCM-810-01.....226   | T6752.....129    | UC2430-2.....20       |
| QT-2.....242          | SCM-140-55.....230  | SCM-810-05.....226   | T6753.....129    | UC2430-3.....20       |
| QTH-1.....242         | SCM-181-06.....227  | SCM-810-30.....226   | T7751.....129    | UC2436-2.....20       |
| QTH-2.....242         | SCM-182-HT.....227  | SCM-810-32.....226   | T7752.....129    | UC2436-3.....20       |
| QTM-1.....243         | SCM-183-16.....227  | SCM-810-55.....226   | T-8.....160      | UC2436-3CA.....21     |
| QTM-2.....243         | SCM-183-200.....227 | SCM-815-01.....229   | T-9.....160      | UC2442-3.....20       |
| QTM-3.....243         | SCM-184-MT.....227  | SCM-815-01.....229   | TC-007.....159   | UC2448-2.....20       |
| R-1.....157           | SCM-185-8.....227   | SCM-815-32.....229   | TD-1.....166     | UC2448-3.....20       |
| RC-1.....244          | SCM-186-6.....227   | SCM-815-32.....229   | TD-2.....166     | UC2448-3CA.....21     |
| RLF-8.....221         | SCM-25.....69       | SCM-831-32.....229   | TG-05.....172    | UC2626-2.....20       |
| RS-15.....161         | SCM-5.....69        | SCM-831-32.....229   | TG-30.....172    | UC2626-3.....20       |
| RS-20.....161         | SCM-702-01.....225  | SCM-832-08.....229   | TG-30-1.....172  | UC2628-2.....20       |
| RS-31.....161         | SCM-702-05.....225  | SCM-832-16.....229   | TG-30-12.....172 | UC2636-2.....20       |
| RS-41.....161         | SCM-702-30.....225  | SCM-832-48.....229   | TLC-3-10.....149 | UC2636-3.....20       |
| RS-9.....161          | SCM-702-32.....225  | SCM-PG-TEST.....222  | TLC-3-12.....149 | UC2636-3CA.....21     |

**PART NUMBER INDEX cont'd**

|                 |     |               |     |                 |     |                 |     |               |     |
|-----------------|-----|---------------|-----|-----------------|-----|-----------------|-----|---------------|-----|
| UC2838-3.....   | 20  | VD-4A.....    | 241 | W125.....       | 140 | WG840589.....   | 142 | WTM1C.....    | 148 |
| UC2838-3CA..... | 21  | VE-2.....     | 240 | W125-100.....   | 140 | WG840590.....   | 142 | WTM2.....     | 148 |
| UC3030-2.....   | 20  | VLC-10.....   | 243 | W125-50.....    | 140 | WG840595.....   | 142 | WTM2C.....    | 148 |
| UC3030-3.....   | 20  | VLC-12.....   | 243 | W141.....       | 140 | WG840596.....   | 142 | WTMB05.....   | 148 |
| UC3030-3CA..... | 21  | VLC-14.....   | 243 | W141-100.....   | 140 | WG840727.....   | 142 | WTMB05C.....  | 148 |
| UC3036-2.....   | 20  | VLC-18.....   | 243 | W141-50.....    | 140 | WG840728.....   | 142 | WTMB07.....   | 148 |
| UC3036-3.....   | 20  | VLC-25.....   | 243 | W142.....       | 140 | WG840728HT..... | 142 | WTMB07C.....  | 148 |
| UC3036-3CA..... | 21  | VLC-4.....    | 243 | W142-100.....   | 140 | WG840729.....   | 142 | WTMB11.....   | 148 |
| UC3040-2.....   | 20  | VLC-5.....    | 243 | W142-50.....    | 140 | WG840729HT..... | 142 | WTMB11C.....  | 148 |
| UC3040-3.....   | 20  | VLC-6.....    | 243 | W143.....       | 140 | WG840730.....   | 142 | WTMB14.....   | 148 |
| UC3040-3CA..... | 21  | VLC-8.....    | 243 | W143-100.....   | 140 | WG840730HT..... | 142 | WTMB14C.....  | 148 |
| UC3048-3.....   | 20  | VP68-01.....  | 229 | W143-50.....    | 140 | WG840731.....   | 142 | X2424211..... | 24  |
| UC3132-3L.....  | 21  | VP68-05.....  | 229 | W144.....       | 140 | WG840736HT..... | 142 | X2424311..... | 24  |
| UC3143-2.....   | 20  | VP68-32.....  | 229 | W144-100.....   | 140 | WG840737HT..... | 142 | X2430211..... | 24  |
| UC3232-2.....   | 20  | VP68-55.....  | 229 | W144-50.....    | 140 | WG840738HT..... | 142 | X2436211..... | 24  |
| UC3232-3.....   | 20  | VS-4.....     | 240 | W145.....       | 140 | WG840739HT..... | 142 | X2436311..... | 24  |
| UC3232-3CA..... | 21  | VST-4.....    | 240 | W145-100.....   | 140 | WHT20.....      | 140 | X2600311..... | 24  |
| UC3234-2.....   | 20  | VST-44.....   | 240 | W145-50.....    | 140 | WHTB10-20.....  | 140 | X3030211..... | 24  |
| UC3237-2.....   | 20  | VT-24.....    | 240 | W801.....       | 140 | WHTB10-50.....  | 140 | X3030311..... | 24  |
| UC3237-3.....   | 20  | VT-4.....     | 240 | W801-100.....   | 140 | WHTB12-20.....  | 140 | X3232211..... | 24  |
| UC3434-2.....   | 20  | VTR-24.....   | 240 | W801-50.....    | 140 | WHTB12-50.....  | 140 | X3232311..... | 24  |
| UC3434-3.....   | 20  | VTS-10.....   | 240 | W802.....       | 140 | WHTB14-50.....  | 140 | X3238311..... | 24  |
| UC3445-2.....   | 20  | VTS-12.....   | 240 | W802-100.....   | 140 | WHTR14-50.....  | 140 | X3244211..... | 24  |
| UC3445-3.....   | 20  | VTS-14.....   | 240 | W802-50.....    | 140 | WHTW14-50.....  | 140 | X3244311..... | 24  |
| UC3445-3CA..... | 21  | VTS-18.....   | 240 | W803.....       | 140 | WM1002.....     | 102 | X3636211..... | 24  |
| UC3539-3L.....  | 21  | VTS-3-10..... | 240 | W803-100.....   | 140 | WM1003.....     | 102 | X3636311..... | 24  |
| UC3636-2.....   | 20  | VTS-3-12..... | 240 | W803-50.....    | 140 | WM1009.....     | 102 | X3830211..... | 24  |
| UC3636-3.....   | 20  | VTS-3-14..... | 240 | W804.....       | 140 | WM1014.....     | 102 | X3836211..... | 24  |
| UC3636-3CA..... | 21  | VTS-3-18..... | 240 | W804-100.....   | 140 | WS-1.....       | 59  | X3842211..... | 24  |
| UC3640-2.....   | 20  | VTS-46.....   | 240 | W804-50.....    | 140 | WT04.....       | 148 | X3848311..... | 24  |
| UC3642-3.....   | 20  | VTS-56.....   | 240 | W805.....       | 140 | WT04C.....      | 148 | X5055301..... | 24  |
| UC3642-3CA..... | 21  | VTS-68.....   | 240 | W805-100.....   | 140 | WT05.....       | 148 |               |     |
| UC3648-2.....   | 20  | VTS-810.....  | 240 | W805-50.....    | 140 | WT05C.....      | 148 |               |     |
| UC3648-3.....   | 20  | VU-4.....     | 240 | WC02.....       | 148 | WT07.....       | 148 |               |     |
| UC3648-3CA..... | 21  | VUR-4.....    | 240 | WC03.....       | 148 | WT07C.....      | 148 |               |     |
| UC3842-2.....   | 20  | WVC-1.....    | 240 | WC04.....       | 148 | WT11.....       | 148 |               |     |
| UC3842-3.....   | 20  | W101.....     | 140 | WC05.....       | 148 | WT11C.....      | 148 |               |     |
| UC4040-2.....   | 20  | W101-100..... | 140 | WC06.....       | 148 | WT15.....       | 148 |               |     |
| UC4040-3.....   | 20  | W101-50.....  | 140 | WC07.....       | 148 | WT15C.....      | 148 |               |     |
| UC4040-3CA..... | 21  | W102.....     | 140 | WC08.....       | 148 | WTA1.....       | 148 |               |     |
| UC4042-3.....   | 20  | W102-100..... | 140 | WC09.....       | 148 | WTB05.....      | 148 |               |     |
| UC4044-3L.....  | 21  | W102-50.....  | 140 | WC10.....       | 148 | WTB05C.....     | 148 |               |     |
| UC4147-2.....   | 20  | W103.....     | 140 | WC12.....       | 148 | WTB07.....      | 148 |               |     |
| UC4347-3.....   | 20  | W103-100..... | 140 | WC14.....       | 148 | WTB07C.....     | 148 |               |     |
| VA-24.....      | 240 | W103-50.....  | 140 | WC16.....       | 148 | WTB07M.....     | 148 |               |     |
| VA-3-346.....   | 240 | W104.....     | 140 | WCA1.....       | 148 | WTB11.....      | 148 |               |     |
| VA-34.....      | 240 | W104-100..... | 140 | WG840204.....   | 142 | WTB11C.....     | 148 |               |     |
| VA-39.....      | 240 | W104-50.....  | 140 | WG840204HT..... | 142 | WTB11C.....     | 200 |               |     |
| VA-46.....      | 240 | W105.....     | 140 | WG840205.....   | 142 | WTB11CR.....    | 148 |               |     |
| VA-58.....      | 240 | W105-100..... | 140 | WG840205HT..... | 142 | WTB11D.....     | 148 |               |     |
| VA-68.....      | 240 | W105-50.....  | 140 | WG840463.....   | 143 | WTB11M.....     | 148 |               |     |
| VAU-24.....     | 240 | W121.....     | 140 | WG840464.....   | 143 | WTB15.....      | 148 |               |     |
| VAU-45.....     | 240 | W121-100..... | 140 | WG840465.....   | 143 | WTB15C.....     | 148 |               |     |
| VC-4.....       | 240 | W121-50.....  | 140 | WG840466.....   | 143 | WTBA1.....      | 148 |               |     |
| VC-4R.....      | 240 | W122.....     | 140 | WG840467.....   | 143 | WTM05.....      | 148 |               |     |
| VCR-1.....      | 243 | W122-100..... | 140 | WG840468.....   | 143 | WTM05C.....     | 148 |               |     |
| VCRT-1.....     | 243 | W122-50.....  | 140 | WG840469.....   | 143 | WTM07.....      | 148 |               |     |
| VCRT-1R.....    | 243 | W123.....     | 140 | WG840583.....   | 142 | WTM07C.....     | 148 |               |     |
| VCRT-1RK.....   | 243 | W123-100..... | 140 | WG840584.....   | 142 | WTM1.....       | 148 |               |     |
| VCRT-1S.....    | 243 | W123-50.....  | 140 | WG840585.....   | 142 | WTM11.....      | 148 |               |     |
| VD-24.....      | 241 | W124.....     | 140 | WG840586.....   | 142 | WTM11C.....     | 148 |               |     |
| VD-4.....       | 241 | W124-100..... | 140 | WG840587.....   | 142 | WTM14.....      | 148 |               |     |
| VD-45.....      | 241 | W124-50.....  | 140 | WG840588.....   | 142 | WTM14C.....     | 148 |               |     |

## CORPORATE HEADQUARTERS

Duluth, GA

### CONYERS MANUFACTURING

Conyers, GA

- Concrete pad products
- Extrusion
- Injection molding
- Transformer pad production

### TEXAS MANUFACTURING

Columbus, TX

- Concrete pad products
- Composite pad products
- Polymer concrete product manufacturing
- Whip assembly
- The Grill Pad® production
- Transformer pad production

### FLORIDA MANUFACTURING

Quincy, FL

- Liquid chemical product manufacturing
- Tablet manufacturing
- Gel fragrance manufacturing

### CONYERS DISTRIBUTION

Conyers, GA

### WEST COAST DISTRIBUTION

Adelanto, CA

### UK DISTRIBUTION

Nottingham, England

### EUROPEAN DISTRIBUTION

Antwerp, Belgium

### CANADIAN DISTRIBUTION

Toronto, Ontario

### EAST WEST CORPORATE HEADQUARTERS

Atlanta, GA

### SHENZHEN DESIGN OFFICE

Shenzhen, China

- Product design and development
- Manufacturing engineering
- Quality control
- Logistics management
- Sub-factory management

### VIETNAM REGIONAL OFFICE

Ho Chi Minh City, Vietnam

- Logistics management
- Quality control
- Sub-factory management

### VIETNAM MANUFACTURING

Binh Duong, Vietnam

- Injection molding
- Compression molding
- Product assembly

Over  
1,000,000  
square feet of  
manufacturing and  
distribution space to  
QUICKLY and COST EFFECTIVELY  
bring TIME SAVING and  
INNOVATIVE products  
to our wholesale  
distribution  
partners.

# DIVERSITECH<sup>®</sup>



Simplify  
the way you  
Work<sup>™</sup>

6650 Sugarloaf Parkway  
Duluth, GA 30097

**678.542.3600**  
**800.995.2222**  
**678.542.3700 Fax**  
**www.diversitech.com**

Download an electronic copy of this catalog at  
[www.diversitech.com/literature/lit-cat-hvac.pdf](http://www.diversitech.com/literature/lit-cat-hvac.pdf)

Send edits/corrections/comments on this catalog to  
[feedback@diversitech.com](mailto:feedback@diversitech.com)

©2010 DiversiTech Corporation  
LIT-CAT-HVAC, 10/10

## About DiversiTech

DiversiTech is North America's largest manufacturer of air conditioning condenser pads and a leading supplier of components and related products for the heating, ventilating, air conditioning, and refrigeration (HVACR) industry.

Headquartered in Atlanta, Georgia, DiversiTech manufactures a suite of products, which includes a wide range of mechanical, electrical, chemical, and structural parts for HVACR and electrical systems, and swimming pool installations. The company maintains manufacturing and distribution facilities in key U.S. locations, Europe, and in the Far East. DiversiTech has enjoyed a continued history of successful growth and has acquired industry-recognized brand names including Devco<sup>®</sup> Enterprises, Wagner<sup>®</sup> Manufacturing, The Black Pad<sup>®</sup>, Hef-T-Pad<sup>™</sup> and Specialty Chemical.