



COMMERCIAL PRICE BOOK 2014 + 2015

EFFECTIVE: 05.04.14

The Delta Commercial Price book provides you with the details you need to choose the right product for your commercial application. From lavatory faucets, flush valves, healthcare specialties, tub/shower, drainage and parts, Delta offers a variety of plumbing products.

For your convenience, our product selections are divided into two sections, **Quick Pick** and **Model Options**.

Quick Pick (starting at page C1) provides you with a list of our most popular models and is set up to simplify your ordering process.

Model Options (starting at page C87) allows you to build a product to meet your unique commercial needs.

SMART SOLUTIONS

Style meets performance with Delta commercial products that not only provide long life, but also enhance their environments. From the beginning, Delta has sought out innovative solutions to help people use water in better ways. These smart features, found across our offerings, are helping to improve the lives of more and more people every day.

Water-Efficient Products

All Delta products that are water-efficient provide a flow rate that's lower than the industry standard. Specific flow rates are noted in the product descriptions.

 **ADA** – some people and some local codes, require fixtures that are compliant with the Americans with Disabilities Act. If someone may visit who has special needs, or if you believe future buyers might appreciate this feature, Delta offers a range of compliant fixtures.

 **Code Compliant** – products compliant with U.S. State and federal drinking water legislation.

 Denotes water-efficient products

H₂Optics® Technology – a hands-free innovation which accurately senses the user's distance, regardless of external factors such as light reflection, clothing color and textures or dryness of one's skin, providing consistent and dependable results.

Proximity® Sensing Technology – the entire faucet body acts as a sensor, activating the faucet when the user's hand comes within 4" of the spout.

Single-handle Diamond™ Valve and 3/8" copper supplies with universal fittings (3/8" compression, 3/8" sweat, or 1/2" I.P.S.).

Battery back-up – provides battery power back-up for HARDWIRE Delta 6 VDC Electronic products. Battery back-up products have a model number suffix of BB.

MODEL/ SERIES #	DESCRIPTION	PAGE NUMBER
--------------------	-------------	----------------

OPTIONAL SPOUTS & SUFFIXES

R2 to R35	Gooseneck and Double Joint Spouts	C89
S2 to S8	Swing Spouts	C90

TUB/SHOWER ROUGH-INS

R10000	MultiChoice® Rough-Ins	C49-C50
R10300-UNWS	MultiChoice® Rough-In for Push Button Diverter	C50
R10700-UNWS	MultiChoice® Rough-In with Diverter Valve for Dual Showers	C50

TRIM-PRESSURE BALANCE

T13090 to T13491	Monitor® 13 Series Tub/Shower Trim	C56-C58
T13391 to T13691	Monitor® 13 Series Tub/Shower Trim with Push Button Diverter	C59
T13H1 & T13H2	Pressure Balance T & S, MultiChoice® Universal	C60-C61, C91
T13H3 & T13H9	Pressure Balance T & S with Diverter for Dual Showers, MultiChoice® Universal	C61, C92
T13H	Add-On Options	C93
T14238-LHD to T14497-SSLHP-LHD	Pressure Balance Trim	C51-C55

TRIMS-THERMOSTATIC

T17TH1 & T17TH2	Thermostatic T & S, MultiChoice® Universal	C62, C94
T17TH3 & T17TH9	Thermostatic T & S with Diverter for Dual Showers, MultiChoice® Universal	C95
T17TH	Add-On Options	C96

PARTS & ACCESSORIES

40000 Series	Shower Rods	C84
40000 Series	Shelving	C82-C83
40000 Series	Recessed Paper and Tissue Holders	C80-C81
40000 Series	Grab Bars	C71-C77
40000 Series	Public Washroom Dispenser	C78-C79
50000 Series	Showerheads/Wall Bars	C65-C70
RPW124HDF to RPW336HDF	HDF Handshower Assemblies	C63-C64

LAVATORY

SINGLE HANDLE

✓ 22C	Single Control Single Hole and 4" Centerset Faucets - Ceramic Cartridge	C13-C14, C98
✓ 23C1	Single Basin Faucets - CER-TECK®	C99
✓ 24T	Single Control Widespread Faucets - S/S Ball	C101
✓ 24T3003	Single Hole Above Deck Mixing Valve for Electronic Faucets	C35
✓ 501LF-HDF to 523LF-TGMHDF	Single Handle 4" Centersets - Diamond Valve	C10-C13
✓ 570LF-WFHDF to 570LF-06ELH	Single Handle Utility Faucet	C20

MODEL/ SERIES #	DESCRIPTION	PAGE NUMBER
--------------------	-------------	----------------

LAVATORY (cont'd)

SINGLE HANDLE (cont'd)

✓ 710LF-HDF to 711LF-HDF	Single Control Widespread Faucets - Diamond Coated Ceramic Cartridge	C20
--------------------------	--	-----

TWO-HANDLE

✓ 21C	Two-Handle Centerset Faucets - CER-TECK®	C16, C97
✓ 23C	Two-Handle 6-12" Widespread Faucets - CER-TECK®	C17-C18, C100
✓ 2529LF-HDF to 2529LF-HDM	Two-Handle 4" Centersets - Brass Cartridge	C15
✓ 3549LF-WFHDF to 3549LF-WFLGHDF	Two-Handle Low Spout Widespreads - Brass Cartridge	C17
✓ 3579LF-WFHDF to 3579LF-WFLGHDF	Two-Handle Gooseneck Widespreads - Brass Cartridge	C19

SINK FAUCETS

SINGLE HANDLE DECK MOUNT KITCHEN

✓ 100LF-HDF, 101LF-HDF & 400LF-HDF	Single Handle Deck Mount Kitchen Faucets - Single Hole, 3-hole and 4-hole	C3
✓ 27C	Single Hole Pantry Faucets - CER-TECK®	C106

TWO-HANDLE DECK MOUNT KITCHEN

✓ 26C3	Two-Handle 8" CAST Deck Mount Faucets - CER-TECK®	C4-C5, C103
✓ 27C1 & 27C2	Two-Handle 8" Below Deck Mount Faucets - CER-TECK®	C5-C6, C104

TWO-HANDLE DECK MOUNT BAR

✓ 25C3 & 25C4	Single Shank Mixing Faucets - CER-TECK®	C7, C102
✓ 27C4 & 27C5	Two-Handle 4" CAST Deck Mount Faucets - CER-TECK®	C6-C7, C105
✓ 2171LF-WBHDF	Two-Handle 4" Deck Mount Faucet - Brass Stems	C6

TWO-HANDLE WALL MOUNT

28C2	Two-Handle 8" CAST Wall Mount Service Sink Faucets - Rigid Spout - CER-TECK®	C8, C107
✓ 28C4 & 28C6	Two-Handle 8" CAST Wall Mount Service Sink Faucets - CER-TECK®	C8, C108
28C8	Two-Handle 8" CAST Wall Mount Rough Chrome Faucets - Rigid Spout - CER-TECK®	C109
*28C9LH	Two-Handle 8" Wall Mount Rough Chrome Mop Sink Faucet	C8, C110
✓ 28P Series	Two-Handle 8" CAST Wall Mount Faucets	C9
28T9	Two-Handle 8" Wall Mount Rough Chrome Mop Sink Faucet	C8, C110
28T910 & 28T911	Mop Sink Accessories	C110

*NEW

DELTA COMMERCIAL TECHNICAL SERVICE 1-877-509-2680
 ONLINE CATALOGS: www.deltacommercialfaucets.com (Core products ONLY)
www.specselect.com (Complete Product Offering & Part Numbering System)

MODEL/ SERIES #	DESCRIPTION	PAGE NUMBER
--------------------	-------------	----------------

MIXING VALVES

✓ R2570-MIXLF,		
✓ R2910-MIXLF &		
✓ R3070-MIXLF	Mixing Valves.....	C38

DRAINAGE

33T2 Series.....	Open Grid Strainers.....	C85, C111
33T2 Series.....	Offset Open Grid Strainers.....	C85, C111
33T3.....	Cast P Traps.....	C86, C111

BEDPAN CLEANSERS

53T5.....	Concealed Wall Mount Bedpan Cleansers.....	C112
54T.....	Volume Control & Foot Pedal Bedpan Cleansers.....	C113
81TBP000 to 81TBP150.....	Bedpan Washer Water Closet Flush Valves.....	C47-C48

SURGEON SCRUB-UP

✓ 54T5.....	Self Close Foot Pedal Valves.....	C114
✓ 54T2401 & 54T2402.....	Third Valve Sink Faucets.....	C114
✓ 3000T3 & 3001T3.....	Electronic Faucets.....	C34-C35, C143-C144

PRE-RINSE FAUCETS

✓ 55C Series.....	Pre-Rinse Faucets - CER-TECK®.....	C9, C115
✓ 55P1513.....	8" Center Wall Mount Pre-Rinse less Wall Bracket.....	C115

FLUSH VALVES MANUAL

81T.....	Exposed - Manual Flush Valves.....	C118
83T.....	Concealed - Manual Flush Valves.....	C119
86T5.....	Urinal Washdown Flush Valves.....	C47, C117
9T400.....	14" Square Stainless Steel Cover and Access Panel.....	C118

ELECTRONIC

81T***BTA.....	Exposed - Electronic Battery Flush Valves.....	C39-C40 C120-C123
81T***HWA.....	Exposed - Electronic Hardwire Flush Valves.....	C40-C41, C121-C123
81T***WMSBT & 81T***WMSHW.....	Exposed - Electronic Battery & Hardwire Flush Valves with Wall Mount Sensor.....	C42, C122
81TWCBRKA to 81TURBTRKA.....	Electronic Exposed Flush Valve Retrofit Kit.....	C123
81T201-DEFM to 81T231-DEFM.....	Exposed - Manual Flush Valves with DEFM-100 Electronic Kit.....	C39
DEFM-100.....	Electronic Side Mount Flush Kit.....	C39
1600T6 & 1601T6.....	H ₂ Optics® Sensing Technology Toilet/Urinal Concealed Flush Valves - Hardwire & Battery.....	C43-C44, C124
1600T9 & 1601T9.....	H ₂ Optics® Sensing Technology Washdown Urinal Concealed Valves - Hardwire & Battery.....	C44-C45, C125
*1600T6 & 1601T6.....	Toilet Concealed Flush Valves less Sensor.....	C43, C126

*NEW

MODEL/ SERIES #	DESCRIPTION	PAGE NUMBER
--------------------	-------------	----------------

FLUSH VALVES (cont'd)

ELECTRONIC (cont'd)

DEMD-86405 to DEMD-86515.....	Electronic Flush Valves for Washdown Urinals.....	C46
----------------------------------	--	-----

METERING

✓ 86T & 87T.....	Metering Handwash Valve.....	C21-C22, C116
✓ 701LF-HDF.....	Metering Handwash Valve.....	C21
✓ 2507LF-HDF to 2517LF-HDF.....	Metering Handwash Valves.....	C21

ELECTRONICS

PROXIMITY® SENSING TECHNOLOGY FAUCETS

✓ 590-PLGHDF to 592-PLGHDFHW.....	Proximity® Sensing Technology Faucets - Battery & Hardwire - Single Hole, 4" and 8" Deck Mount.....	C26
✓ 590TP.....	Proximity® Sensing Technology Faucets - Hardwire & Battery - Single Hole, 4" and 8" Deck Mount.....	C23-C24 C129-C130
✓ 591TP.....	Proximity® Sensing Technology Faucets - Hardwire & Battery - 4" Centerset Deck Mount.....	C25, C133-C134
✓ 600T to 601T.....	Proximity® Sensing Technology Faucets - Hardwire & Battery - Single Hole and 4".....	C23, C135
✓ *620TP to 621TP.....	Proximity® Sensing Technology Faucets - Hardwire & Battery - Gooseneck.....	C136-C137

H₂Optics® FAUCETS

✓ 590LF-HGMHDF to 591LF-LGHGMHDF.....	H ₂ Optics® Sensing Technology Faucets - Battery - Single Hole and 4" Deck Mount.....	C31
✓ ELAVT0001RI.....	Rough-In only for Control Box #1.....	C35
✓ ELAVT0008RI.....	Rough-In only for Control Box #8.....	C35
✓ 590T.....	H ₂ Optics® Sensing Technology Faucets - Hardwire & Battery - Single Hole, 4" and 8" Deck Mount.....	C32, C127-C128
✓ 591T.....	H ₂ Optics® Sensing Technology Faucets - Hardwire & Battery - 4" Centerset.....	C32, C131-C132
✓ 1500T3 & 1501T3.....	H ₂ Optics® Sensing Technology Gooseneck Faucets - Hardwire & Battery - Single Hole, 4" and 8" Deck Mount.....	C33, C140-C141
✓ 1500T4 & 1501T4.....	H ₂ Optics® Sensing Technology Gooseneck Faucets - Hardwire & Battery - Wall Mount.....	C34, C142
✓ 3000T3 & 3001T3.....	H ₂ Optics® Sensing Technology Gooseneck Faucets - Hardwire & Battery - Single Hole, 4" and 8" Deck Mount - Adjustable Program.....	C34-C35 C143-C144
✓ *3000T4 & 3001T4.....	H ₂ Optics® Sensing Technology Low Profile Institutional Hardwire & Battery.....	C36, C145

Complete Table of Contents



MODEL/ SERIES #	DESCRIPTION	PAGE NUMBER
--------------------	-------------	----------------

ELECTRONICS (cont'd)

OTHER SENSOR FAUCETS

✓ DEMD-101LF to DEMD-211LF	Infrared Sensing Single Hole Deck Mount Faucets with/less above Deck Mount Mixing.....	C27
✓ DEMD-301LF to DEMD-311LF	Infrared Sensing Single Hole Deck Mount Faucets with/less above Deck Mount Mixing.....	C28
✓ DEMD-402LF to DEMD-404LF	Infrared Sensing Single Hole Wall Mount Faucets.....	C28

SHOWERS

860T1	Push Button Electronic Shower Hardwire	C32, C138
861T1	Push Button Electronic Shower - Battery	C138
860T	Add-On Options.....	C139

EXPOSED FLUSH VALVES (WC & UR)

81T**BTA.....	Exposed - Electronic Battery Flush Valves.....	C39-C40, C120-C123
81T**HWA.....	Exposed - Electronic Hardwire Flush Valves.....	C40-C41, C121-C123
81T**WMSBT & 81T**WMSHW.....	Exposed - Electronic Battery Flush Valves with Wall Mount Sensor	C42, C122
81T201-DEFM to 81T231-DEFM.....	Exposed- Manual Flush Valves with DEFM-100 Electronic Kit.....	C39
DEFM-100	Electronic Side Mount Flush Kit	C39
DEMD-86405 to DEMD-86515	Electronic Flush Valves for Washdown Urinal	C46

CONCEALED FLUSH VALVES (WC & UR)

1600T6 & 1601T6.....	H ₂ Optics® Sensing Technology Toilet/Urinal Concealed Flush Valves - Hardwire & Battery.....	C43-C44, C124
1600T9 & 1601T9.....	H ₂ Optics® Sensing Technology Washdown Urinal Concealed Valves - Hardwire & Battery.....	C44-C45, C125
*1600T6 & 1601T6.....	Toilet Concealed Flush Valves less Sensor	C43, C126

ACCESSORIES

DESD-250 to DESD-550.....	Infrared Sensing Soap Dispensers	C30
Electronic Accessories	Transformers, Hardwire Converters, Escutcheons, Mixing Valves	C37-C38, C125

LABORATORY

W62.....	Ball Valves.....	C146
W6629 & W6635	Pure Water Faucets.....	C147
W66 Series	Single Water Faucets.....	C148
W67 Series	Two-Handle Mixing Faucets.....	C149-C150

MODEL/ SERIES #	DESCRIPTION	PAGE NUMBER
--------------------	-------------	----------------

COMPONENTS

Spout Outlets and Inserts.....	C151
Spouts.....	C152-C153
Repair Parts.....	C154-C160

Optional Suffixes:

AC = Adjustable Centers
BB = Battery Backup
BT = Battery Operated
BTA = Battery Operated
HGM = 0.5 gpm @ 60 psi flow rate
HW = Hardwire Operated
HWA = Hardwire Operated
KS = Keyed Switch
LS = Limited Swing Gooseneck Spouts
NS = Nickel Stainless
QD = Quick Disconnect
R's = Rigid Swivel Spouts
RI = Rough-In Only
S's = Swing Spouts
SS = Brilliance® Stainless Finish
TGM = 0.35 gpm @ 60 psi flow rate
TI = Temperature Indicators on handles
TR = Trim Only

*NEW

DELTA COMMERCIAL TECHNICAL SERVICE 1-877-509-2680
 ONLINE CATALOGS: www.deltacommercialfaucets.com (Core products ONLY)
www.specselect.com (Complete Product Offering & Part Numbering System)



Numerical Price List

Model Number	Page Number	List Price	Universal Product Code
060115A	C118	54.50	778062096155
060117A	C118	66.00	778062101200
060683A	C37	43.65	055870312005
060704A	C125	53.15	055870304826
060771A	C125	54.10	055870310391
060772A	C125	142.80	055870310407
060917A	C30	33.85	055870313026
060918A	C30	63.50	055870313033
060919A	C30	57.05	055870313002
060958A	C29	41.10	055870331488
060967A	C29	221.70	055870324831
060974A	C29	58.70	055870326446
061047A	C37	101.00	055870342736
061069A	C123	71.10	055870356184
061119A	C135	91.90	055870371316
062021A	C37	18.70	055870359055
068128A	C147	68.55	055870329249
100LF-HDF	C3	136.30	034449643870
101LF-HDF	C3	137.60	034449643887
1500T3320	C33	612.85	055870299979
1500T3420	C140	674.55	055870299962
1500T3428TR	C33	370.40	055870405042
1500T3478TR	C33	370.40	055870406360
1500T4620	C142	664.00	055870325913
1500T4628	C142	962.05	055870325999
1500T4670	C34	664.00	055870325937
1500T4670-BB	C34	708.35	055870363540
1501T3320	C33	612.85	055870295063
1501T3420	C140	674.55	055870300774
1501T3428TR	C33	370.40	055870411913
1501T3478TR	C33	370.40	055870411906
1501T4620	C142	664.00	055870325944
1501T4670	C34	664.00	055870325968
1600T6102RI	C124	488.75	055870296275
1600T6102RI-6IP	C126	488.75	055870406087
1600T6102RI-48IP	C126	488.75	055870406070
1600T6102RI-IP	C43	488.75	055870406094
1600T6102TR	C124	488.75	055870296039
1600T6102TR-LS	C43	488.75	055870406100
1600T6103RI	C43	482.80	055870296312
1600T6103TR	C43	482.80	055870296046
1600T6104RI	C124	369.60	055870296329
1600T6104TR	C124	369.60	055870296053
1600T6202RI	C124	518.50	055870296336
1600T6202TR	C124	518.50	055870296060
1600T6203RI	C124	512.60	055870296343
1600T6203TR	C124	512.60	055870296077
1600T6204RI	C124	399.35	055870296350
1600T6204TR	C124	399.35	055870296084
1600T6302RI	C124	548.30	055870296367
1600T6302TR	C124	548.30	055870296091
1600T6303RI	C124	542.35	055870296374
1600T6303TR	C124	542.35	055870296107
1600T6304RI	C124	429.15	055870296381
1600T6304TR	C124	429.15	055870296114
1600T6402RI	C124	476.80	055870296398
1600T6402TR	C124	476.80	055870296121
1600T6403RI	C124	470.85	055870296404
1600T6403TR	C124	470.85	055870296138
1600T6404RI	C124	357.65	055870296411
1600T6404TR	C124	357.65	055870296145

Model Number	Page Number	List Price	Universal Product Code
1600T9001RI	C44	381.45	055870295919
1600T9001TR	C44	381.45	055870295957
1600T9003RI	C125	369.60	055870295926
1600T9003TR	C125	369.60	055870296008
1600T9006	C125	572.15	055870295896
1601T6102RI	C124	488.75	055870296428
1601T6102TR	C124	488.75	055870296152
1601T6103RI	C44	482.80	055870296435
1601T6103TR	C44	482.80	055870296169
1601T6104RI	C124	369.60	055870296442
1601T6104TR	C124	369.60	055870296176
1601T6202RI	C124	518.50	055870296459
1601T6202TR	C124	518.50	055870296183
1601T6203RI	C124	512.60	055870296466
1601T6203TR	C124	512.60	055870296190
1601T6204RI	C124	399.35	055870296473
1601T6204TR	C124	399.35	055870296206
1601T6302RI	C124	548.30	055870296480
1601T6302TR	C124	548.30	055870296213
1601T6303RI	C124	542.35	055870296497
1601T6303TR	C124	542.35	055870296220
1601T6304RI	C124	429.15	055870296503
1601T6304TR	C124	429.15	055870296237
1601T6402RI	C124	476.80	055870296510
1601T6402TR	C124	476.80	055870296244
1601T6403RI	C124	470.85	055870296527
1601T6403TR	C124	470.85	055870296251
1601T6404RI	C124	357.65	055870296534
1601T6404TR	C124	357.65	055870296268
1601T9001RI	C45	381.45	055870295933
1601T9001TR	C45	381.45	055870296015
1601T9003RI	C125	369.60	055870295940
1601T9003TR	C125	369.60	055870296022
1601T9006	C125	572.15	055870295902
2171LF-WBHDF	C6	172.80	034449648332
21C122	C16	168.10	055870252066
21C132	C16	159.00	055870252707
21C133	C16	157.75	055870267039
21C133-TI	C16	168.10	055870317017
21C134	C16	175.95	055870252721
21C142	C16	155.50	055870251274
21C143	C16	154.25	055870267046
21C144	C16	172.45	055870252745
21C153	C97	166.85	055870269415
21C233	C16	209.90	055870267060
21C542	C97	158.70	055870259232
22C101	C13	164.70	055870267077
22C131	C98	166.55	055870268258
22C151	C98	175.65	055870268289
22C301	C13	194.85	055870267084
22C401	C14	184.70	055870268371
22C601	C14	182.20	055870267091
22C801	C14	215.75	055870267107
23C1041	C99	100.15	055870340930
23C1049	C99	114.75	055870340947
23C332	C17	252.55	055870253735
23C333	C17	251.30	055870267114
23C334	C17	269.50	055870253391
23C342	C17	249.05	055870253742
23C624	C18	261.10	055870253537
23C632	C18	235.05	055870253810

DELTA COMMERCIAL TECHNICAL SERVICE 1-877-509-2680
 ONLINE CATALOGS: www.deltacommercialfaucets.com (Core products ONLY)
www.specselect.com (Complete Product Offering & Part Numbering System)

Numerical Price List



Model Number	Page Number	List Price	Universal Product Code
23C634	C18	252.00	055870253551
23C642	C18	231.55	055870253827
23C643	C18	230.30	055870267121
23C644	C18	248.50	055870253575
24T0001	C101	171.80	055870136588
24T0003	C101	178.60	055870136595
24T2623	C101	291.70	778062075600
24T2633	C101	282.60	778062077307
24T2643	C101	279.10	778062079059
24T3003	C35	207.25	055870285217
2507LF-HDF	C21	219.50	034449708401
2517LF-HDF	C21	249.10	034449708418
2529LF-HDF	C15	181.70	034449662413
2529LF-HDM	C15	193.75	034449662444
2529LF-LGHDF	C15	154.35	034449662420
2529LF-LGHGMHDF	C15	156.80	034449662437
25C3837	C7	232.35	055870267138
25C3847	C7	228.85	055870267145
25C3877	C7	241.45	055870267152
25C3947	C102	228.85	055870258020
25C4837	C7	271.70	055870267169
26C3124	C4	254.65	055870255616
26C3132	C4	228.60	055870255814
26C3133	C4	227.35	055870267176
26C3134	C4	245.55	055870255630
26C3142	C4	225.10	055870255821
26C3143	C4	223.85	055870267183
26C3144	C4	242.05	055870255654
26C3232	C103	207.60	055870255845
26C3233	C103	206.35	055870269781
26C3924	C5	259.25	055870255739
26C3932	C103	233.20	055870255876
26C3933	C4	231.95	055870267190
26C3934	C5	250.15	055870255753
26C3943	C4	228.45	055870267206
26C3944	C5	246.65	055870255777
27C2924	C5	255.55	055870254398
27C2932	C5	229.50	055870254565
27C2933	C5	228.25	055870267213
27C2934	C5	246.45	055870254411
27C2942	C5	226.00	055870254572
27C2943	C5	224.75	055870269866
27C2944	C5	242.95	055870254435
27C2974	C6	255.55	055870254459
27C4822	C6	197.20	055870255159
27C4832	C6	188.10	055870251281
27C4834	C105	205.05	055870254862
27C4842	C6	184.60	055870255166
27C4843	C105	183.35	055870267220
27C4844	C105	201.55	055870254886
27C4924	C7	214.15	055870254947
27C4934	C7	205.05	055870254961
27C4943	C6	183.35	055870267237
27C4944	C7	201.55	055870254985
27C643	C106	167.80	055870340954
28C2283	C107	314.95	055870270121
28C2382	C8	333.20	055870290235
28C2383	C8	331.95	055870267244
28C2384	C107	350.15	055870270404
28C4243	C108	233.60	055870270206
28C4433	C8	241.20	055870267268

Model Number	Page Number	List Price	Universal Product Code
28C4443	C108	237.70	055870270213
28C8063	C109	292.45	055870270312
28C8073	C109	317.45	055870270329
28C8083	C109	300.45	055870270336
28C8183	C109	317.45	055870270343
28C9LH	C8	195.95	055870373549
28C9LH-AC	C110	221.50	055870373556
28P4202LF	C9	198.55	055870373587
28P4402LF	C9	198.55	055870373600
28P4902LF	C9	198.55	055870373624
28T9	C8	155.95	778062593609
28T9-AC	C110	181.50	055870224209
28T910	C110	63.40	778062281605
28T911	C110	35.20	778062281704
3000T3320A	C34	763.50	055870327825
3000T3320A-BB	C34	807.85	055870363502
3000T3370A	C143	763.50	055870328143
3000T3428ATR	C34	499.60	055870346727
3000T3478ATR	C35	499.60	055870411524
3000T4128ATR	C36	1060.00	055870408241
3000T4128ARI	C36	660.00	055870408324
3000T4328ATR	C36	700.00	055870408678
3000T4328ARI	C36	600.00	055870408814
3001T3320A	C34	763.50	055870329706
3001T3428ATR	C34	499.60	055870394087
3001T3478ATR	C35	499.60	055870411890
3001T4328ATR	C145	700.00	055870412293
3001T4328ARI	C145	600.00	055870412286
33T260	C85	21.05	778062401058
33T260-1	C85	24.80	778062627700
33T260-1DC	C85	66.15	055870355828
33T290	C85	39.60	778062407807
33T290-1	C85	43.45	778062616308
33T290-1DC	C86	84.25	055870355811
33T295	C111	43.45	778062408804
33T301	C111	45.90	778062409900
33T311	C86	47.20	778062412054
33T360	C86	58.30	778062421254
3549LF-WFHDF	C17	286.65	034449702942
3549LF-WFLGHDF	C17	262.40	034449702959
3579LF-WFHDF	C19	292.35	034449702966
3579LF-WFLGHDF	C19	273.45	034449702973
400LF-HDF	C3	166.15	034449643894
40118-PS	C71	34.05	034449667579
40118-SS	C71	26.20	034449667067
40124-PS	C71	39.35	034449667586
40124-SS	C71	29.20	034449667074
40124-ST	C71	39.35	034449667128
40130-SS	C71	33.95	034449667081
40136-PS	C71	49.75	034449667593
40136-SS	C71	35.20	034449667098
40142-PS	C71	54.65	034449667609
40142-SS	C71	38.10	034449667104
40148-SS	C72	45.60	034449667111
41124-SS	C72	26.15	034449667135
41124-ST	C72	38.00	034449667142
41130-SS	C72	27.95	034449667159
41136-SS	C72	31.60	034449667166
41142-SS	C72	34.70	034449667173
41218-SN	C73	47.70	034449667197

DELTA COMMERCIAL TECHNICAL SERVICE 1-877-509-2680
 ONLINE CATALOGS: www.deltacommercialfaucets.com (Core products ONLY)
www.specselect.com (Complete Product Offering & Part Numbering System)



Numerical Price List

Model Number	Page Number	List Price	Universal Product Code
41218-ST	C73	47.70	034449667050
41224-SN	C73	53.20	034449667203
41612	C74	93.00	034449714778
41612-CZ	C74	134.85	034449714785
41612-PN	C74	116.25	034449714792
41612-RB	C74	134.85	034449714808
41612-SS	C74	116.25	034449714815
41618	C74	99.00	034449714822
41618-CZ	C74	143.55	034449714839
41618-PN	C74	123.75	034449714846
41618-RB	C74	143.55	034449714853
41618-SS	C74	123.75	034449714860
41624	C74	109.00	034449714877
41624-CZ	C74	158.05	034449714884
41624-PN	C74	136.25	034449714891
41624-RB	C74	158.05	034449714907
41624-SS	C74	136.25	034449714914
41636	C74	125.00	034449714921
41636-CZ	C74	181.25	034449714938
41636-PN	C74	156.25	034449714945
41636-RB	C74	181.25	034449714952
41636-SS	C74	156.25	034449714969
41712	C75	93.00	034449715133
41712-CZ	C75	134.85	034449715140
41712-RB	C75	134.85	034449715157
41712-SS	C75	116.25	034449715164
41718	C75	99.00	034449715171
41718-CZ	C75	143.55	034449715188
41718-RB	C75	143.55	034449715195
41718-SS	C75	123.75	034449715201
41724	C75	109.00	034449715218
41724-CZ	C75	158.05	034449715225
41724-RB	C75	158.05	034449715232
41724-SS	C75	136.25	034449715249
41736	C75	125.00	034449715256
41736-CZ	C75	181.25	034449715263
41736-RB	C75	181.25	034449715270
41736-SS	C75	156.25	034449715287
41812	C76	93.00	034449715416
41812-CZ	C76	134.85	034449715423
41812-RB	C76	134.85	034449715430
41812-SS	C76	116.25	034449715447
41818	C76	99.00	034449715454
41818-CZ	C76	143.55	034449715461
41818-RB	C76	143.55	034449715478
41818-SS	C76	123.75	034449715485
41824	C76	109.00	034449715492
41824-CZ	C76	158.05	034449715508
41824-RB	C76	158.05	034449715515
41824-SS	C76	136.25	034449715522
41836	C76	125.00	034449715539
41836-CZ	C76	181.25	034449715546
41836-RB	C76	181.25	034449715553
41836-SS	C76	156.25	034449715560
41912	C77	93.00	034449715577
41912-CZ	C77	134.85	034449715584
41912-PN	C77	116.25	034449724357
41912-RB	C77	134.85	034449715591
41912-SS	C77	116.25	034449715607
41918	C77	99.00	034449715614
41918-CZ	C77	143.55	034449715621

Model Number	Page Number	List Price	Universal Product Code
41918-PN	C77	123.75	034449724364
41918-RB	C77	143.55	034449715638
41918-SS	C77	123.75	034449715645
41924	C77	109.00	034449715652
41924-CZ	C77	158.05	034449715669
41924-PN	C77	136.25	034449724371
41924-RB	C77	158.05	034449715676
41924-SS	C77	136.25	034449715683
41936	C77	125.00	034449715690
41936-CZ	C77	181.25	034449715706
41936-PN	C77	156.25	034449724388
41936-RB	C77	181.25	034449715713
41936-SS	C77	156.25	034449715720
42006-ST	C84	51.90	034449667647
42205-SS	C84	34.60	034449667289
42205-ST	C84	36.30	034449667265
42206-SS	C84	36.30	034449667296
42206-ST	C84	38.10	034449667272
43018	C82	114.40	034449667418
43024	C82	123.70	034449667234
43224-SN	C82	134.60	034449667425
43424	C82	141.30	034449667401
43618-ST	C82	68.90	034449667388
43624-SN	C83	77.75	034449667357
43624-ST	C83	71.25	034449667227
44000	C79	57.35	034449667654
44080-SS	C79	58.50	034449667531
44081	C79	58.50	034449667548
44970-ST	C80	33.45	034449674584
45070-ST	C80	15.20	034449667364
45072	C80	35.05	034449667456
45270	C80	21.90	034449667463
45272	C81	25.80	034449667487
45362	C81	23.35	034449667517
45371-SS	C79	93.35	034449667630
45470-ST	C81	22.95	034449667302
45568-SS	C79	236.80	034449667623
45569-SS	C78	506.70	034449667494
45700-SS	C78	77.55	034449667500
46090	C81	12.50	034449667616
47000-ST	C83	17.75	034449667241
47100-ST	C83	21.65	034449667258
48000-SS	C78	682.45	034449667524
48100-SS	C79	48.60	034449667562
49000-SS	C78	51.20	034449667470
501LF-HDF	C10	130.50	034449643917
501LF-HGMHDF	C10	132.70	034449643948
501LF-TGMHDF	C10	132.70	034449685405
511LF-HDF	C12	140.90	034449643993
511LF-HGMHDF	C12	143.00	034449643955
515LF-HDF	C12	163.45	034449643979
516LF-HDF	C13	159.05	034449643986
516LF-HGMHDF	C13	161.25	034449643900
520LF-HDF	C10	153.40	034449643924
520LF-HGMHDF	C11	155.70	034449644006
520LF-TGMHDF	C11	155.70	034449685412
52001-DS	C68	187.95	034449669283
52001-UF	C68	170.60	034449669290
52002-DS	C69	192.30	034449669306
52002-UF	C69	181.45	034449669313

DELTA COMMERCIAL TECHNICAL SERVICE 1-877-509-2680
 ONLINE CATALOGS: www.deltacommercialfaucets.com (Core products ONLY)
www.specselect.com (Complete Product Offering & Part Numbering System)

Numerical Price List



Model Number	Page Number	List Price	Universal Product Code
52003-DS	C69	208.60	034449669320
52003-UF	C70	192.30	034449669337
523LF-HDF	C11	149.35	034449643931
523LF-HGMHDF	C11	151.60	034449643962
523LF-TGMHDF	C11	151.60	034449685429
52634-15-BG	C65	35.90	034449674416
52653-BG	C65	22.90	034449674423
52653-PK	C65	22.90	034449669504
52653-SS-PK	C65	30.85	034449715744
52655	C65	45.70	034449668859
52667-15-BG	C65	48.95	034449674430
52672-15-BG	C66	28.30	034449674454
52672-WH15-BG	C66	25.05	034449674461
52692-15-BG	C66	12.00	034449674485
52692-WH15-BG	C66	10.90	034449674478
53T5347	C112	586.00	778062658407
53T5547	C112	539.20	778062658605
54471-15-BG	C67	38.10	034449674492
54471-WH15-BG	C67	34.80	034449674508
54T1104	C113	361.10	778062352954
54T1254	C113	520.40	778062384559
54T2401	C114	261.10	055870175952
54T2402	C114	261.10	055870246126
54T5300A	C114	500.50	055870197046
54T5332A	C114	591.95	055870197114
54T5400A	C114	301.55	055870196445
54T5432A	C114	393.00	055870196513
54T5434A	C114	380.40	055870196544
55030	C67	128.25	034449668927
55511-PK	C67	95.65	034449670104
55531	C67	119.55	034449668958
55C1090	C115	156.95	055870340961
55C1513	C9	608.75	055870340978
55P1000	C115	46.20	055870201033
55P1513	C115	477.30	055870201026
56302	C68	190.15	034449668965
56302-PB	C68	302.20	034449670111
56302-RB	C68	339.30	034449670128
56302-SS	C68	296.85	034449670135
570LF-06ELH	C20	152.55	034449694803
570LF-WFHDF	C20	151.55	034449694780
590LF-HGMHDF	C31	420.70	055870387782
590LF-LGHGMHDF	C31	399.50	055870387799
590T0120	C32	540.50	055870314498
590T0120-BB	C32	584.85	055870363465
590T0121TR	C128	284.80	055870359420
590T0128TR	C128	276.50	055870328914
590T0130	C127	531.40	055870314535
590T0160	C127	540.50	055870314610
590T1120	C32	540.50	055870314672
590TP0120	C23	581.90	055870374904
590TP0128TR	C24	317.90	055870407954
590TP0150	C129	581.90	055870374928
590TP0158TR	C24	317.90	055870407985
590TP0250	C129	648.95	055870374966
590TP0258TR	C24	384.95	055870408029
590TP1120	C23	581.90	055870375024
590TP1150	C129	581.90	055870375048
590-PLGHDF	C26	439.45	055870376533
590-PLGHDFHW	C26	439.45	055870376540
591LF-HGMHDF	C31	440.00	055870387805

Model Number	Page Number	List Price	Universal Product Code
591LF-LGHGMHDF	C31	418.80	055870387812
591T0250	C32	540.50	055870252790
591T1250	C32	540.50	055870251298
591T1258TR	C132	267.80	055870375376
591TP0250	C25	581.90	055870375161
591TP0258TR	C134	309.20	055870405264
591TP0268TR	C25	309.20	055870410541
591TP1250	C25	581.90	055870375208
591-PLGHDF	C26	458.85	055870376557
591-PLGHDFHW	C26	458.85	055870376564
592-PLGHDF	C26	482.65	055870376571
592-PLGHDFHW	C26	482.65	055870376588
59434-15-BG	C66	44.55	034449674515
59434-SS15-BG	C66	64.20	034449674522
59462-B15-BG	C66	35.90	034449674539
59462-WH15-BG	C66	22.90	034449674546
59462-WHB15-BG	C66	26.15	034449674553
600T040	C23	583.30	055870343320
600T040-BB	C23	627.65	055870367005
600T040-BB-SS	C23	684.35	055870412071
600T040-SS	C23	640.00	055870412088
600T050	C23	591.95	055870357457
600T050-SS	C23	648.65	055870412101
600T090	C135	591.95	055870413092
601T040	C23	583.30	055870343344
601T040-SS	C23	640.00	055870412118
601T050	C23	591.95	055870357464
601T050-SS	C23	648.65	055870412125
601T090	C135	591.95	055870413115
620TP3320	C136	581.90	055870411500
701LF-HDF	C21	125.60	034449702928
710LF-HDF	C20	225.65	034449644013
711LF-HDF	C20	238.40	034449644020
81T201	C118	181.45	778062024707
81T201-30	C118	165.80	055870249752
81T201BTA	C39	546.15	055870348141
81T201BTA-DF	C40	546.15	055870361539
81T201BTA-6	C39	546.15	055870349135
81T201BTA-20	C120	520.15	055870349285
81T201BTA-30	C120	520.15	055870349322
81T201-DEFM	C39	500.40	055870362437
81T201HWA	C40	593.60	055870349353
81T201HWA-6	C40	593.60	055870349407
81T201HWA-20	C121	567.55	055870349377
81T201HWA-30	C121	567.55	055870349414
81T201-WMSBT	C42	739.00	055870302129
81T201-WMShw	C42	739.00	055870299856
81T221	C118	198.25	778062027852
81T221BTA	C120	560.05	055870349216
81T221HWA	C121	607.55	055870349247
81T231	C118	181.45	778062029856
81T231-30	C118	165.80	055870249813
81T231BTA	C40	546.15	055870349438
81T231BTA-19	C40	546.15	055870361607
81T231BTA-20	C120	520.15	055870349445
81T231BTA-30	C120	520.15	055870349452
81T231-DEFM	C39	500.40	055870362444
81T231HWA	C41	593.60	055870349469
81T231HWA-19	C41	593.60	055870363816
81T231HWA-20	C121	567.55	055870349476

DELTA COMMERCIAL TECHNICAL SERVICE 1-877-509-2680
 ONLINE CATALOGS: www.deltacommercialfaucets.com (Core products ONLY)
www.specselect.com (Complete Product Offering & Part Numbering System)



Numerical Price List

Model Number	Page Number	List Price	Universal Product Code
81T231HWA-30	C121	567.55	055870349506
81T231-WMSBT	C42	739.00	055870302136
81T231-WMSHW	C42	739.00	055870299863
81T261	C118	286.10	778062037158
81T271	C118	205.40	778062039909
81T291	C118	181.25	778062044057
81TBP000	C47	609.00	055870396388
81TBP100	C48	609.00	055870396395
81TBP150	C48	654.00	055870396401
81TURBTRKA	C123	392.20	055870349513
81TWCBTRKA	C123	392.20	055870349520
83T000	C119	292.55	778062339009
83T140	C119	275.20	778062367057
83T141	C119	290.55	778062367309
83T143	C119	309.30	778062367606
83T240	C119	303.25	778062389707
83T241	C119	312.80	778062389950
83T243	C119	312.80	778062390253
83T340	C119	319.20	778062410456
83T341	C119	337.50	778062410555
83T343	C119	337.50	778062410906
83T430	C119	309.30	778062426358
83T431	C119	303.25	778062426501
860T167	C32	1,247.65	055870323407
860T178	C32	1,247.65	055870407909
861T167	C138	1,247.65	055870323520
86T0104	C116	152.25	055870106079
86T0194	C116	152.25	055870413153
86T1053	C116	254.70	055870140608
86T1093	C116	254.70	055870413160
86T1104	C116	133.15	778062657202
86T1153	C22	239.65	055870137578
86T1193	C116	239.65	055870413177
86T1194	C116	133.15	055870413184
86T151	C116	39.65	778062268255
86T502	C117	126.15	778062341002
86T503	C117	126.15	778062341309
86T505	C47	151.75	778062341507
86T610	C117	63.55	778062362908
87T104	C21	131.85	055870282858
87T105	C22	141.75	055870282872
87T110	C21	161.80	055870282889
87T111	C22	172.45	055870282902
87T151	C22	39.65	055870282919
87T904	C116	131.85	055870413191
87T905	C116	141.75	055870413207
87T910	C116	161.80	055870413214
87T911	C116	172.45	055870413221
9T400	C118	150.40	778062612805
DEFM-100	C39	325.35	055870321069
DEMD-101LF	C27	579.05	055870393585
DEMD-101LF-NS	C27	680.40	055870399242
DEMD-111LF	C27	615.25	055870393592
DEMD-111LF-NS	C27	722.95	055870399259
DEMD-201LF	C27	620.40	055870393608
DEMD-201LF-NS	C27	729.00	055870399266
DEMD-211LF	C27	656.60	055870393615
DEMD-211LF-NS	C27	771.55	055870399280
DEMD-301LF	C28	572.60	055870393622
DEMD-301LF-NS	C28	672.80	055870399297
DEMD-311LF	C28	610.05	055870393639

Model Number	Page Number	List Price	Universal Product Code
DEMD-311LF-NS	C28	716.80	055870399303
DEMD-402LF	C28	758.10	055870393646
DEMD-402LF-NS	C28	890.75	055870399334
DEMD-404LF	C28	724.85	055870393653
DEMD-404LF-NS	C28	851.75	055870399365
DEMD-86405	C46	428.10	055870372634
DEMD-86415	C46	453.95	055870372641
DEMD-86505	C46	453.95	055870372658
DEMD-86515	C46	479.80	055870372665
DESD-250	C30	279.30	055870312982
DESD-550	C30	428.65	055870312999
ELAVT0001RI	C35	395.65	055870388987
ELAVT0008RI	C35	599.80	055870387003
H795	C52	49.10	034449683586
H795SS	C52	64.50	034449683593
H797	C52	41.80	034449683630
H797SS	C52	58.60	034449683647
H798	C52	42.85	034449683531
H798SS	C52	60.05	034449683548
R10000-IP	C49	47.75	034449518000
R10000-IPWS	C49	66.95	034449518017
R10000-MF	C50	47.75	055870347779
R10000-MFWS	C50	66.95	055870347786
R10000-PX	C50	47.75	034449517980
R10000-PXWS	C50	66.95	034449517997
R10000-UN	C49	47.75	034449518024
R10000-UNBX	C49	47.75	034449518048
R10000-UNBXHF	C49	47.75	034449629874
R10000-UNBXT	C49	51.25	034449544191
R10000-UNWS	C49	66.95	034449518031
R10000-UNWSBXT	C49	70.45	034449629294
R10000-UNWSHF	C49	66.95	034449629881
R10300-UNWS	C50	153.70	055870326828
R10700-UNWS	C50	114.50	055870289093
R2910-MIXLF	C38	65.00	034449721783
R2570-MIXLF	C38	166.55	055870401389
R3070-MIXLF	C38	134.95	055870381124
RP30528	C37	79.85	034449417365
RP32508	C37	39.15	034449434539
RP32856	C37	39.15	034449441872
RP34280	C37	107.10	034449447508
RP71072	C81	6.40	034449667449
RPW124HDF	C63	163.65	034449434058
RPW136HDF	C63	180.40	034449434072
RPW324HDF	C63	212.95	034449434096
RPW324HDF-1.5	C64	203.05	055870338241
RPW324HDF-LHD	C64	200.95	055870411357
RPW336HDF	C64	229.90	034449434119
T13090	C56	74.35	034449533515
T13091	C56	74.35	034449533553
T13290	C56	89.70	034449533522
T13291	C56	89.70	034449533560
T13291-LHD	C57	77.35	034449583947
T13291-SSLHD	C57	108.15	034449730525
T13291-SLHD	C57	77.20	034449610407
T13391	C59	74.35	055870327665
T13490	C56	112.00	034449533539
T13491	C58	112.00	034449533577
T13491-BRC	C58	182.10	034449556491
T13491-LHD	C58	100.20	034449572804

DELTA COMMERCIAL TECHNICAL SERVICE 1-877-509-2680
 ONLINE CATALOGS: www.deltacommercialfaucets.com (Core products ONLY)
www.specselect.com (Complete Product Offering & Part Numbering System)

Numerical Price List



Model Number	Page Number	List Price	Universal Product Code
T13491-SLHD	C57	99.30	034449610421
T13491-SSLHD	C58	135.90	034449730679
T13691	C59	112.00	055870327689
T13691-SOS-15	C59	140.00	034449712606
T13H132	C60	104.65	055870345225
T13H133	C91	104.65	055870289451
T13H152	C60	274.00	055870345232
T13H153	C61	274.00	055870285804
T13H163	C60	232.90	055870285811
T13H232	C60	124.55	055870345294
T13H253	C61	293.90	055870285828
T13H332	C92	431.95	055870345355
T13H333	C61	431.95	055870285842
T14238-LHD	C55	105.00	034449730648
T14238-SSLHD	C55	154.00	034449730587
T14251-LHD	C51	151.45	034449730686
T14253-LHD	C51	181.75	034449730686
T14259-LHD	C54	112.50	034449714495
T14259-SSLHD	C54	157.50	034449726818
T14261-LHD	C54	133.35	034449714518
T14261-SSLHD	C54	186.70	034449755320
T14267-LHD	C53	151.50	034449725217
T14267-SSLHD	C53	232.30	034449725224
T14292-LHD	C53	136.60	034449730600
T14294-LHD	C55	102.00	034449730631
T14297-LHP-LHD	C52	135.00	034449730570
T14297-SSLHP-LHD	C52	187.50	034449730532
T14438-LHD	C55	133.60	034449730594
T14438-SSLHD	C55	186.00	034449730617
T14451-LHD	C51	186.00	034449730563
T14453-LHD	C51	240.95	034449730624
T14459-LHD	C54	131.90	034449714501
T14459-SSLHD	C54	184.70	034449726801
T14461-LHD	C54	153.60	034449714525
T14461-SSLHD	C54	215.05	034449726825
T14467-LHD	C53	181.80	034449725194
T14467-SSLHD	C53	274.75	034449725200
T14492-LHD	C53	156.00	034449730655
T14494-LHD	C55	134.50	034449730549
T14497-LHP-LHD	C52	169.00	034449730693
T14497-SSLHP-LHD	C52	234.75	034449730556
T17TH125	C62	385.55	055870346307
T17TH155	C62	516.30	055870346284
T17TH225	C62	405.45	055870346369
T17TH335	C95	674.20	055870346345
U6300	C70	22.90	034449671712
U6300-WH	C70	22.90	034449671729
W6200	C146	44.65	
W6210	C146	99.75	
W6220	C146	151.20	
W6225	C146	151.20	
W6270	C146	83.90	
W6275	C146	155.30	
W6600	C148	139.60	
W6600-9	C148	196.35	
W6600-10	C148	220.20	
W6600-12	C148	267.75	
W6601	C148	137.10	
W6601-9	C148	201.60	
W6601-10	C148	201.60	

Model Number	Page Number	List Price	Universal Product Code
W6601-12	C148	262.80	
W6629	C147	215.15	
W6635	C147	346.95	
W6700	C149	211.90	055870189683
W6700-9	C149	262.85	055870189614
W6700-10	C149	284.20	055870189621
W6700-12	C149	326.10	055870189645
W6720	C149	164.60	055870189492
W6720-9	C149	217.65	055870189447
W6720-10	C149	217.65	055870189454
W6740	C149	228.35	055870189850
W6740-9	C149	279.60	055870189843
W6740-10	C149	279.60	055870190245
W6760	C150	244.00	055870246331
W6760-9	C150	292.60	055870246335
W6760-10	C150	312.80	055870246362

DELTA COMMERCIAL TECHNICAL SERVICE 1-877-509-2680
 ONLINE CATALOGS: www.deltacommercialfaucets.com (Core products ONLY)
www.specselect.com (Complete Product Offering & Part Numbering System)



Quick Pick Products

Delta understands the importance of completing projects in a timely manner and we would like to guide you with selecting the right product in the most user-friendly and efficient way. The Quick Pick section will provide you with a list of some of our most popular and newest models, along with information on pricing, finish options and product features. We believe Quick Pick provides you with a convenient selection process for when you are ready to place your order.

Please always order in full case. Delta Commercial Technical Service 1-877-509-2680.
Online Catalogs: www.deltacommercialfaucets.com (Core products ONLY).
www.specselect.com (Complete Product Offering & Part Numbering System)

Model Case Price Finish Features



Commercial
Single Handle Kitchen Faucet

100LF-HDF 6 136.30 Chrome

- 3-hole 8" installation
- Standard spout swivels 180°
- 8 11/16" long, 9 1/8" high
- 4 3/4" from deck to aerator
- Vandal resistant lever handle(s)
- Red/blue indicator(s)
- Vandal resistant aerator
- 3/8" O.D. inlets with 3/8" fittings
- Includes 1/2" adapters
- 2 1/2" max. deck thickness
- Straight, staggered supply tubes
- 1.5 gpm @ 60 psi, 5.7 L/min @ 414 kPa
- DIAMOND™ Valve



Commercial
Single Handle Kitchen Faucet

101LF-HDF 6 137.60 Chrome

- 1-hole installation
- Standard spout swivels 180°
- 8 11/16" long, 8 1/2" high
- 4 5/16" from deck to aerator
- Vandal resistant lever handle(s)
- Red/blue indicator(s)
- Vandal resistant aerator
- 3/8" O.D. inlets with 3/8" fittings
- Includes 1/2" adapters
- 2 1/2" max. deck thickness
- Straight, staggered supply tubes
- 1.5 gpm @ 60 psi, 5.7 L/min @ 414 kPa
- DIAMOND™ Valve



Commercial
Single Handle Kitchen Faucet with Spray

400LF-HDF 3 166.15 Chrome

- 4-hole 8" installation
- Standard spout swivels 180°
- 8 11/16" long, 9 1/8" high
- 5" from deck to aerator
- Vandal resistant lever handle(s)
- Red/blue indicator(s)
- Vandal resistant aerator
- 3/8" O.D. inlets with 3/8" fittings
- Includes 1/2" adapters
- 2 1/2" max. deck thickness
- Straight, staggered supply tubes
- Matching finish spray
- 1.5 gpm @ 60 psi, 5.7 L/min @ 414 kPa
- DIAMOND™ Valve



Please always order in full case.

= Water Efficient Product - Flow Rate of 1.8 gpm versus Industry Standard ASME.A112.18.1/CSA.B125.1 of 2.2 gpm.



Model Case Price Finish

Commercial
Two Handle Kitchen Faucet

26C3132	1	228.60	Chrome
26C3142	1	225.10	Chrome

For complete 26C series product offering, see page C103

- Features**
- 3-hole 8" installation
 - CAST body
 - 8" long spout swings 360°
 - 5 7/20" from deck to aerator
 - Vandal resistant hooded blade handles
 - Red/blue indicator(s)
 - 26C3132 - Vandal resistant aerator
 - 26C3142 - Standard aerator
 - 1/2" IPS shanks
 - 1 3/4" max. deck thickness
 - 1.5 gpm @ 60 psi, 5.7 L/min @ 414 kPa
 - CER-TECK® cartridges



Commercial
Two Handle Kitchen Faucet

26C3133	1	227.35	Chrome
26C3143	1	223.85	Chrome

- 3-hole 8" installation
- CAST body
- 8" long spout swings 360°
- 5 7/20" from deck to aerator
- Vandal resistant lever handles
- Red/blue indicator(s)
- 26C3133 - Vandal resistant aerator
- 26C3143 - Standard aerator
- 1/2" IPS shanks
- 1 3/4" max. deck thickness
- 1.5 gpm @ 60 psi, 5.7 L/min @ 414 kPa
- CER-TECK® cartridges



Commercial
Two Handle Kitchen Faucet

26C3124	1	254.65	Chrome
26C3134	1	245.55	Chrome
26C3144	1	242.05	Chrome

- 3-hole 8" installation
- CAST body
- 8" long spout swings 360°
- 5 7/20" from deck to aerator
- Vandal resistant sanitary hood blade handles
- Red/blue indicator(s)
- 26C3124 - Vandal resistant laminar outlet w/ Agion® Antimicrobial
- 26C3134 - Vandal resistant aerator
- 26C3144 - Standard aerator
- 1/2" IPS shanks
- 1 3/4" max. deck thickness
- 1.5 gpm @ 60 psi, 5.7 L/min @ 414 kPa
- CER-TECK® cartridges



Commercial
Two Handle Kitchen Faucet

26C3933	1	231.95	Chrome
26C3943	1	228.45	Chrome

- 3-hole 8" installation
- CAST body
- Rigid/swivel gooseneck spout
- 6" long, 12" high spout
- 6 1/10" from deck to aerator
- Vandal resistant lever handles
- Red/blue indicator(s)
- 26C3933 - Vandal resistant aerator
- 26C3943 - Standard aerator
- 1/2" IPS shanks
- 1 3/4" max. deck thickness
- 1.5 gpm @ 60 psi, 5.7 L/min @ 414 kPa
- CER-TECK® cartridges



Please always order in full case.

= Water Efficient Product - Flow Rate of 1.8 gpm versus Industry Standard ASME.A112.18.1/CSA.B125.1 of 2.2 gpm.



Model Case Price Finish

Commercial
Two Handle Kitchen Faucet

26C3924	1	259.25	Chrome
26C3934	4	250.15	Chrome
26C3944	1	246.65	Chrome

For complete 26C series product offering, see page C103

Features

- 3-hole 8" installation
- CAST body
- Rigid/swivel gooseneck spout
- 6" long, 12" high spout
- 6 1/10" from deck to aerator
- Vandal resistant sanitary hood blade handles
- Red/blue indicator(s)
- 26C3924 - Vandal resistant laminar outlet w/ Agion® Antimicrobial
- 26C3934 - Vandal resistant aerator
- 26C3944 - Standard aerator
- 1/2" IPS shanks
- 1 3/4" max. deck thickness
- 1.5 gpm @ 60 psi, 5.7 L/min @ 414 kPa
- CER-TECK® cartridges



Commercial
Two Handle Kitchen Faucet

27C2933	3	228.25	Chrome
27C2943	3	224.75	Chrome

For complete 27C2 series product offering, see page C104

- 3-hole 8" installation
- Below deck mount
- Rigid/swivel gooseneck spout
- 6" long, 12" high spout
- 6 9/31" from deck to aerator
- Vandal resistant lever handles
- Red/blue indicator(s)
- 27C2933 - Vandal resistant aerator
- 27C2943 - Standard aerator
- 1 3/50" max. deck thickness
- 1.5 gpm @ 60 psi, 5.7 L/min @ 414 kPa
- CER-TECK® cartridges



Commercial
Two Handle Kitchen Faucet

27C2932	1	229.50	Chrome
27C2942	6	226.00	Chrome

- 3-hole 8" installation
- Below deck mount
- Rigid/swivel gooseneck spout
- 6" long, 12" high spout
- 6 9/31" from deck to aerator
- Vandal resistant hooded blade handles
- Red/blue indicator(s)
- 27C2932 - Vandal resistant aerator
- 27C2942 - Standard aerator
- 1 3/50" max. deck thickness
- 1.5 gpm @ 60 psi, 5.7 L/min @ 414 kPa
- CER-TECK® cartridges



Commercial
Two Handle Kitchen Faucet

27C2924	1	255.55	Chrome
27C2934	1	246.45	Chrome
27C2944	1	242.95	Chrome

- 3-hole 8" installation
- Below deck mount
- Rigid/swivel gooseneck spout
- 6" long, 12" high spout
- 6 9/31" from deck to aerator
- Vandal resistant sanitary hood blade handles
- Red/blue indicator(s)
- 27C2924 - Vandal resistant laminar outlet w/ Agion® Antimicrobial
- 27C2934 - Vandal resistant aerator
- 27C2944 - Standard aerator
- 1 3/50" max. deck thickness
- 1.5 gpm @ 60 psi, 5.7 L/min @ 414 kPa
- CER-TECK® cartridges



Please always order in full case.

= Water Efficient Product - Flow Rate of 1.8 gpm versus Industry Standard ASME.A112.18.1/CSA.B125.1 of 2.2 gpm.



Model Case Price Finish

Commercial
Two Handle Kitchen Faucet

27C2974 1 255.55 Chrome

For complete 27C2 series product offering, see page C104

Features

- 3-hole 8" installation
- Below deck mount
- Rigid/swivel gooseneck spout
- 6" long, 12" high spout
- 7 1/3" from deck to aerator
- Vandal resistant sanitary hood blade handles
- Red/blue indicator(s)
- Smooth spout end with laminar flow control in spout base
- 1 3/50" max. deck thickness
- 1.0 gpm @ 60 psi, 3.8 L/min @ 414 kPa
- CER-TECK® cartridges



Commercial
Two Handle Bar Faucet

2171LF-WBHDF 6 172.80 Chrome

- 2-hole 4" installation
- Spout swings 360°
- 4 5/32" long, 11" high
- Vandal resistant wrist blade handles
- Red/blue indicator(s)
- Vandal resistant aerator
- 1/2" IPS shanks
- 1" max. deck thickness
- 1/4 turn handle stops
- Brass stems/stainless steel plate
- 1.5 gpm @ 60 psi, 5.7 L/min @ 414 kPa



Commercial
Two Handle Bar Faucet

27C4822 1 197.20 Chrome
27C4832 1 188.10 Chrome
27C4842 1 184.60 Chrome

For complete 27C4 series product offering, see page C105

- 2-hole 4" installation
- CAST body
- Rigid/swivel gooseneck spout
- 4 1/2" long, 12" high spout
- Vandal resistant hooded blade handles
- Red/blue indicator(s)
- 27C4822 - Vandal resistant laminar outlet w/ Agion® Antimicrobial
- 27C4832 - Vandal resistant aerator
- 27C4842 - Standard aerator
- 1/2" IPS shanks
- 1 3/4" max. deck thickness
- 1.5 gpm @ 60 psi, 5.7 L/min @ 414 kPa
- CER-TECK® cartridges



Commercial
Two Handle Bar Faucet

27C4943 3 183.35 Chrome

- 2-hole 4" installation
- CAST body
- Rigid/swivel spout
- 6" long, 12" high spout
- Vandal resistant lever handles
- Red/blue indicator(s)
- Standard aerator
- 1/2" IPS shanks
- 1 3/4" max. deck thickness
- 1.5 gpm @ 60 psi, 5.7 L/min @ 414 kPa
- CER-TECK® cartridges

Please always order in full case.

= Water Efficient Product - Flow Rate of 1.8 gpm versus Industry Standard ASME.A112.18.1/CSA.B125.1 of 2.2 gpm.



Model Case Price Finish

Commercial
Two Handle Bar Faucet

27C4924	1	214.15	Chrome
27C4934	1	205.05	Chrome
27C4944	3	201.55	Chrome

For complete 27C4 series product offering, see page C105

Features

- 2-hole 4" installation
- CAST body
- Rigid/swivel spout
- 6" long, 12" high spout
- Vandal resistant sanitary hood blade handles
- Red/blue indicator(s)
- 27C4924 - Vandal resistant laminar outlet w/ Agion® Antimicrobial
- 27C4934 - Vandal resistant aerator
- 27C4944 - Standard aerator
- 1/2" IPS shanks
- 1 3/4" max. deck thickness
- 1.5 gpm @ 60 psi, 5.7 L/min @ 414 kPa
- CER-TECK® cartridges



Commercial
Two Handle Bar Faucet

25C3837	1	232.35	Chrome
25C3847	1	228.85	Chrome

For complete 25C series product offering, see page C102

- 1-hole installation
- Rigid/swivel gooseneck spout
- 4 1/2" long, 14 1/4" high spout
- Vandal resistant ADA Lever Balanced Handles
- Red/blue indicator(s)
- 25C3837 - Vandal resistant aerator
- 25C3847 - Standard aerator
- 3/8" compression fittings
- 2" max. deck thickness
- 1.5 gpm @ 60 psi, 5.7 L/min @ 414 kPa
- CER-TECK® cartridges



Commercial
Two Handle Bar Faucet

25C3877	1	241.45	Chrome
---------	---	--------	--------

- 1-hole installation
- Rigid/swivel gooseneck spout
- 4 1/2" long, 14 1/4" high spout
- Vandal resistant ADA Lever Balanced Handles
- Red/blue indicator(s)
- Smooth spout end with laminar flow control in spout base
- 3/8" compression fittings
- 2" max. deck thickness
- 1.0 gpm @ 60 psi, 3.8 L/min @ 414kPa
- CER-TECK® cartridges



Commercial
Two Handle Bar Faucet

25C4837	1	271.70	Chrome
---------	---	--------	--------

- 3-hole 4" installation
- 4" coverplate
- Rigid/swivel gooseneck spout
- 4 1/2" long, 14 1/4" high spout
- Vandal resistant ADA lever balanced handles
- Red/blue indicator(s)
- Vandal resistant aerator
- 3/8" compression fittings
- 1 1/2" max. deck thickness
- 1.5 gpm @ 60 psi, 5.7 L/min @ 414 kPa
- CER-TECK® cartridges



Please always order in full case.

= Water Efficient Product - Flow Rate of 1.8 gpm versus Industry Standard ASME.A112.18.1/CSA.B125.1 of 2.2 gpm.

Model Case Price Finish Features



Commercial
Service Sink Faucet

28C2382 1 333.20 Chrome

For complete 28C series product offering, see pages C107-C110

- Wall installation – 8" centers
- Cast body
- Rigid spout with top/bottom brace
- 8" long vacuum breaker spout
- Vandal resistant hooded blade handles
- Red/blue indicator(s)
- Hose thread outlet
- Integral check stops
- CER-TECK® cartridges



Commercial
Service Sink Faucet

28C2383 1 331.95 Chrome

- Wall installation – 8" centers
- Cast body
- Rigid spout with top/bottom brace
- 8" long vacuum breaker spout
- Vandal resistant lever handles
- Red/blue indicator(s)
- Hose thread outlet
- Integral check stops
- CER-TECK® cartridges



Commercial
Service Sink Faucet

28C4433 3 241.20 Chrome



- Wall installation – 8" centers
- Cast body
- 11" long spout – swings 360°
- Vandal resistant lever handles
- Red/blue indicator(s)
- Vandal resistant aerator
- Less integral stops
- 1.5 gpm @ 60 psi, 5.7 L/min @ 414 kPa
- CER-TECK® cartridges



Commercial
Service Sink Faucet

28T9 6 155.95 Rough Chrome

- Wall installation – 8" centers
- Cast body
- Rigid spout with top brace
- 9 1/2" long vacuum breaker spout
- Cross handles
- Red/blue indicator(s)
- Hose thread outlet
- Vacuum breaker
- Integral stops
- Heavy duty cartridges

NEW!



Commercial
Service Sink Faucet

28C9LH 6 195.95 Rough Chrome

- Wall installation – 8" centers
- Cast body
- Rigid spout with top brace
- 9 1/2" long vacuum breaker spout
- 4" metal lever handles
- Red/blue indicator(s)
- Hose thread outlet
- Vacuum breaker
- Integral stops
- Heavy duty cartridges



Please always order in full case.

= Water Efficient Product - Flow Rate of 1.8 gpm versus Industry Standard ASME.A112.18.1/CSA.B125.1 of 2.2 gpm.



Commercial
Service Sink Faucet

28P4902LF 1 198.55 Chrome

- Wall installation - 8" centers
- Cast body
- 8" Gooseneck spout - swings 360°
- Supplied with adjustable centers – 175 mm to 235 mm (6.87" to 9.25")
- Vandal resistant hooded blade handles
- Red/blue indicator(s)
- Vandal resistant aerator
- Less integral stops
- Control mechanism is 1/4 turn cylinder with brass stem, stainless steel plate and non-metallic seats
- 1.5 gpm @ 60 psi, 5.7 L/min @ 414 kPa



Commercial
Service Sink Faucet

28P4402LF 1 198.55 Chrome

- Wall installation - 8" centers
- Cast body
- 8" long spout - swings 360°
- Supplied with adjustable centers – 175 mm to 235 mm (6.87" to 9.25")
- Vandal resistant hooded blade handles
- Red/blue indicator(s)
- Vandal resistant aerator
- Less integral stops
- Control mechanism is 1/4 turn cylinder with brass stem, stainless steel plate and non-metallic seats
- 1.5 gpm @ 60 psi, 5.7 L/min @ 414 kPa



Commercial
Service Sink Faucet

28P4202LF 1 198.55 Chrome

- Wall installation - 8" centers
- Cast body
- 9 1/2" long spout - swings 360°
- Supplied with adjustable centers – 175 mm to 235 mm (6.87" to 9.25")
- Vandal resistant hooded blade handles
- Red/blue indicator(s)
- Vandal resistant aerator
- Less integral stops
- Control mechanism is 1/4 turn cylinder with brass stem, stainless steel plate and non-metallic seats
- 1.5 gpm @ 60 psi, 5.7 L/min @ 414 kPa



Commercial
Pre-Rinse Wall Mount Faucet















55C1513 1 608.75 Chrome

For complete 55C series product offering, see page C115

- Wall installation – 8" centers
- Cast body
- Vandal resistant lever handles
- Red/blue indicator(s)
- High pressure hose
- Stainless steel hose shield
- Integral check stops
- 12" wall bracket – Thin wall kit
- Insulated spray head w/ hook (1.6 gpm @ 60 psi)
- Optional water-saver spray plate (1.2 gpm @ 60 psi)
- CER-TECK® cartridges

Please always order in full case.

= Water Efficient Product - Flow Rate of 1.8 gpm versus Industry Standard ASME.A112.18.1/CSA.B125.1 of 2.2 gpm.

	Model	Case	Price	Finish	Features
	Commercial <i>Single Handle Centerset Lavatory Faucet</i>				<ul style="list-style-type: none"> • 2-hole 4" installation • Solid brass fabricated body • Rigid spout • 5" long, 4 7/8" high • 1 11/16" from deck to aerator • Vandal resistant lever handle(s) • Red/blue indicator(s) • Adjustable handle limit stop • 2" max. deck thickness • Less pop-up • No lift rod hole • Vandal resistant aerator • 1/4" threaded mounting studs • 3/8" OD straight, 4" spaced copper supply tubes with 1/2" IPS fittings • 1.5 gpm @ 60 psi, 5.7 L/min @ 414 kPa • DIAMOND™ Valve
	501LF-HDF	6	130.50	Chrome	
   					
	Commercial <i>Single Handle Centerset Lavatory Faucet</i>				<ul style="list-style-type: none"> • 2-hole 4" installation • Solid brass fabricated body • Rigid spout • 5" long, 4 7/8" high • 1 11/16" from deck to aerator • Vandal resistant lever handle(s) • Red/blue indicator(s) • Adjustable handle limit stop • 2" max. deck thickness • Less pop-up • No lift rod hole • 501LF-HGMHDF - .5 gpm vandal resistant pressure compensating aerator • 501LF-TGMHDF - .35 gpm vandal resistant pressure compensating aerator • 1/4" threaded mounting studs • 3/8" OD straight, 4" spaced copper supply tubes with 1/2" IPS fittings • DIAMOND™ Valve
	501LF-HGMHDF	6	132.70	Chrome	
	501LF-TGMHDF	6	132.70	Chrome	
  					
	Commercial <i>Single Handle Centerset Lavatory Faucet</i>				<ul style="list-style-type: none"> • 3-hole 4" installation • Solid brass fabricated body • Rigid spout • 5" long, 4 7/8" high • 1 11/16" from deck to aerator • Vandal resistant lever handle • Red/blue indicator(s) • Adjustable handle limit stop • 2" max. deck thickness • Metal pop-up • Vandal resistant aerator • 1/4" threaded mounting studs • 3/8" OD straight, 4" spaced copper supply tubes with 1/2" IPS fittings • 1.5 gpm @ 60 psi, 5.7 L/min @ 414 kPa • DIAMOND™ Valve
	520LF-HDF	6	153.40	Chrome	
   					

Please always order in full case.

 = Water Efficient Product - Flow Rate of 1.8 gpm versus Industry Standard ASME.A112.18.1/CSA.B125.1 of 2.2 gpm.

Model	Case	Price	Finish	Features
-------	------	-------	--------	----------



Commercial
Single Handle Centerset Lavatory Faucet

520LF-HGMHDF	6	155.70	Chrome
520LF-TGMHDF	3	155.70	Chrome

- 3-hole 4" installation
- Solid brass fabricated body
- Rigid spout
- 5" long, 4 7/8" high
- 1 11/16" from deck to aerator
- Vandal resistant lever handle(s)
- Red/blue indicator(s)
- Adjustable handle limit stop
- 2" max. deck thickness
- Metal pop-up
- 520LF-HGMHDF - .5 gpm vandal resistant pressure compensating aerator
- 520LF-TGMHDF - .35 gpm vandal resistant pressure compensating aerator
- 1/4" threaded mounting studs
- 3/8" OD straight, 4" spaced copper supply tubes with 1/2" IPS fittings
- DIAMOND™ Valve



Commercial
Single Handle Centerset Lavatory Faucet

523LF-HDF	6	149.35	Chrome
-----------	---	--------	--------

- 2-hole 4" installation
- Solid brass fabricated body
- Rigid spout
- 5" long, 4 7/8" high
- 1 11/16" from deck to aerator
- Vandal resistant lever handle(s)
- Red/blue indicator(s)
- Adjustable handle limit stop
- 2" max. deck thickness
- Metal grid strainer
- No lift rod hole
- Vandal resistant aerator
- 1/4" threaded mounting studs
- 3/8" OD straight, 4" spaced copper supply tubes with 1/2" IPS adapters
- 1.5 gpm @ 60 psi, 5.7 L/min @ 414 kPa
- DIAMOND™ Valve



Commercial
Single Handle Centerset Lavatory Faucet

523LF-HGMHDF	6	151.60	Chrome
523LF-TGMHDF	6	151.60	Chrome

- 2-hole 4" installation
- Solid brass fabricated body
- Rigid spout
- 5" long, 4 7/8" high
- 1 11/16" from deck to aerator
- Vandal resistant lever handle(s)
- Red/blue indicator(s)
- Adjustable handle limit stop
- 2" max. deck thickness
- Metal grid strainer
- No lift rod hole
- 523LF-HGMHDF - .5 gpm vandal resistant pressure compensating aerator
- 523LF-TGMHDF - .35 gpm vandal resistant pressure compensating aerator
- 1/4" threaded mounting studs
- 3/8" OD straight, 4" spaced copper supply tubes with 1/2" IPS adapters
- DIAMOND™ Valve



Please always order in full case.

= WaterSense® Labeled Product - Flow Rate of 1.5 gpm versus Industry Standard ASME.A112.18.1/CSA.B125.1 of 2.2 gpm.

= Water Efficient Product - Flow Rate of 1.5 gpm versus Industry Standard ASME.A112.18.1/CSA.B125.1 of 2.2 gpm.

Model Case Price Finish Features



Commercial
Single Handle Centerset Lavatory Faucet

511LF-HDF 6 140.90 Chrome



- 2-hole 4" installation
- Solid brass fabricated body
- Rigid spout
- 5" long, 7 3/8" high
- 1 11/16" from deck to aerator
- Vandal resistant elbow handle(s)
- Red/blue indicator(s)
- Adjustable handle limit stop
- 2" max. deck thickness
- No lift rod hole
- Vandal resistant aerator
- 1/4" threaded mounting studs
- 3/8" OD straight, 4" spaced copper supply tubes with 1/2" IPS adapters
- 1.5 gpm @ 60 psi, 5.7 L/min @ 414 kPa
- DIAMOND™ Valve



Commercial
Single Handle Centerset Lavatory Faucet

511LF-HGMHDF 6 143.00 Chrome



- 2-hole 4" installation
- Solid brass fabricated body
- Rigid spout
- 5" long, 7 3/8" high
- 1 11/16" from deck to aerator
- Vandal resistant elbow handle(s)
- Red/blue indicator(s)
- Adjustable handle limit stop
- 2" max. deck thickness
- No lift rod hole
- Vandal resistant pressure compensating aerator
- 1/4" threaded mounting studs
- 3/8" OD straight, 4" spaced copper supply tubes with 1/2" IPS adapters
- .5 gpm @ 60 psi, 1.9 L/min @ 414 kPa
- DIAMOND™ Valve



Commercial
Single Handle Centerset Lavatory Faucet

515LF-HDF 6 163.45 Chrome



- 3-hole 4" installation
- Solid brass fabricated body
- Rigid spout
- 5" long, 7 3/8" high
- 1 11/16" from deck to aerator
- Vandal resistant elbow handle
- Red/blue indicator(s)
- Adjustable handle limit stop
- 2" max. deck thickness
- Metal pop-up
- Vandal resistant aerator
- 1/4" threaded mounting studs
- 3/8" OD straight, 4" spaced copper supply tubes with 1/2" IPS adapters
- 1.5 gpm @ 60 psi, 5.7 L/min @ 414 kPa
- DIAMOND™ Valve

Please always order in full case.

= WaterSense® Labeled Product - Flow Rate of 1.5 gpm versus Industry Standard ASME.A112.18.1/CSA.B125.1 of 2.2 gpm.

= Water Efficient Product - Flow Rate of 1.5 gpm versus Industry Standard ASME.A112.18.1/CSA.B125.1 of 2.2 gpm.

Model Case Price Finish Features



Commercial
Single Handle Centerset Lavatory Faucet

516LF-HDF 3 159.05 Chrome

- 2-hole 4" installation
- Solid brass fabricated body
- Rigid spout
- 5" long, 7 3/8" high
- 1 11/16" from deck to aerator
- Vandal resistant elbow handle
- Red/blue indicator(s)
- Adjustable handle limit stop
- 2" max. deck thickness
- Metal grid strainer
- Vandal resistant aerator
- 1/4" threaded mounting studs
- 3/8" OD straight, 4" spaced copper supply tubes with 1/2" IPS adapters
- 1.5 gpm @ 60 psi, 5.7 L/min @ 414 kPa
- DIAMOND™ Valve



Commercial
Single Handle Centerset Lavatory Faucet

516LF-HGMHDF 3 161.25 Chrome

- 2-hole 4" installation
- Solid brass fabricated body
- Rigid spout
- 5" long, 7 3/8" high
- 1 11/16" from deck to aerator
- Vandal resistant elbow handle
- Red/blue indicator(s)
- Adjustable handle limit stop
- 2" max. deck thickness
- Metal grid strainer
- Vandal resistant pressure compensating aerator
- 1/4" threaded mounting studs
- 3/8" OD straight, 4" spaced copper supply tubes with 1/2" IPS adapters
- .5 gpm @ 60 psi, 1.9 L/min @ 414 kPa
- DIAMOND™ Valve



Commercial
Single Handle Centerset Lavatory Faucet

22C101 6 164.70 Chrome

For complete 22C series product offering, see page C98

- 3-hole 4" installation
- Cast brass body
- 5 3/4" long rigid spout
- Vandal resistant lever handle
- Red/blue indicator(s)
- 1/2" IPS shanks
- No lift rod hole
- Vandal resistant aerator with wrench flats
- 1.5 gpm @ 60 psi, 5.7 L/min @ 414 kPa
- Ceramic cartridge with rotational limit stop



Commercial
Single Handle Centerset Lavatory Faucet

22C301 6 194.85 Chrome

- 3-hole 4" installation
- Cast brass body
- 5 3/4" long rigid spout
- Vandal resistant lever handle
- Red/blue indicator(s)
- 1/2" IPS shanks
- Metal pop-up
- Vandal resistant aerator with wrench flats
- 1.5 gpm @ 60 psi, 5.7 L/min @ 414 kPa
- Ceramic cartridge with rotational limit stop



Please always order in full case.

= WaterSense® Labeled Product - Flow Rate of 1.5 gpm versus Industry Standard ASME.A112.18.1/CSA.B125.1 of 2.2 gpm.

= Water Efficient Product - Flow Rate of 1.5 gpm versus Industry Standard ASME.A112.18.1/CSA.B125.1 of 2.2 gpm.

Model Case Price Finish Features



Commercial
Single Handle Centerset Lavatory Faucet

22C401 6 184.70 Chrome

For complete 22C series product offering, see page C98

- 3-hole 4" installation
- Cast brass body
- 5 3/4" long rigid spout
- Vandal resistant lever handle
- Red/blue indicator(s)
- 1/2" IPS shanks
- Metal grid strainer
- Vandal resistant aerator with wrench flats
- 1.5 gpm @ 60 psi, 5.7 L/min @ 414 kPa
- Ceramic cartridge with rotational limit stop



Commercial
Single Handle Single Hole Lavatory Faucet

22C601 6 182.20 Chrome

- 1-hole installation
- Cast brass body
- 5 5/16" long rigid spout
- Vandal resistant lever handle
- Red/blue indicator(s)
- 3/8" compression fittings
- No lift rod hole
- Vandal resistant aerator with wrench flats
- 1.5 gpm @ 60 psi, 5.7 L/min @ 414 kPa
- Ceramic cartridge with rotational limit stop



Commercial
Single Handle Single Hole Lavatory Faucet

22C801 6 215.75 Chrome

- 1-hole installation
- Cast brass body
- 5 5/16" long rigid spout
- Vandal resistant lever handle
- Red/blue indicator(s)
- 3/8" compression fittings
- Metal pop-up
- Vandal resistant aerator with wrench flats
- 1.5 gpm @ 60 psi, 5.7 L/min @ 414 kPa
- Ceramic cartridge with rotational limit stop



Please always order in full case.

= WaterSense® Labeled Product - Flow Rate of 1.5 gpm versus Industry Standard ASME.A112.18.1/CSA.B125.1 of 2.2 gpm.

= Water Efficient Product - Flow Rate of 1.5 gpm versus Industry Standard ASME.A112.18.1/CSA.B125.1 of 2.2 gpm.

Model Case Price Finish Features



Commercial
Two Handle Centerset Lavatory Faucet

2529LF-HDF 6 181.70 Chrome

- 2-hole 4" installation
- Solid brass fabricated body
- 5 1/4" long, 3 1/4" high
- 2" from deck to aerator
- Vandal resistant wrist blade handles
- Red/blue indicator(s)
- 1 3/8" max. deck thickness
- Grid strainer
- No lift rod hole
- Vandal resistant aerator
- 1/2" IPS shanks
- 1.5 gpm @ 60 psi, 5.7 L/min @ 414 kPa



Commercial
Two Handle Centerset Lavatory Faucet

2529LF-HDM 6 193.75 Chrome

- 3-hole 4" installation
- Solid brass fabricated body
- 5 1/4" long, 3 1/4" high
- 2" from deck to aerator
- Vandal resistant wrist blade handles
- Red/blue indicator(s)
- 1 3/8" max. deck thickness
- Metal pop-up
- Vandal resistant aerator
- 1/2" IPS shanks
- 1.5 gpm @ 60 psi, 5.7 L/min @ 414 kPa



Commercial
Two Handle Centerset Lavatory Faucet

2529LF-LGHDF 6 154.35 Chrome

- 2-hole 4" installation
- Solid brass fabricated body
- 5 1/4" long, 3 1/4" high
- 2" from deck to aerator
- Vandal resistant wrist blade handles
- Red/blue indicator(s)
- 1 3/8" max. deck thickness
- Less grid strainer
- No lift rod hole
- Vandal resistant aerator
- 1/2" IPS shanks
- 1.5 gpm @ 60 psi, 5.7 L/min @ 414 kPa



Commercial
Two Handle Centerset Lavatory Faucet

2529LF-LGHGMHDF 6 156.80 Chrome

- 2-hole 4" installation
- Solid brass fabricated body
- 5 1/4" long, 3 1/4" high
- 2" from deck to aerator
- Vandal resistant wrist blade handles
- Red/blue indicator(s)
- 1 3/8" max. deck thickness
- Less grid strainer
- No lift rod hole
- Vandal resistant pressure compensating aerator
- 1/2" IPS shanks
- .5 gpm @ 60 psi, 1.9 L/min @ 414 kPa



Please always order in full case.

= WaterSense® Labeled Product - Flow Rate of 1.5 gpm versus Industry Standard ASME.A112.18.1/CSA.B125.1 of 2.2 gpm.





= Water Efficient Product - Flow Rate of 1.5 gpm versus Industry Standard ASME.A112.18.1/CSA.B125.1 of 2.2 gpm.

	Model	Case	Price	Finish	Features		
	Commercial <i>Two Handle Centerset Lavatory Faucet</i>				<ul style="list-style-type: none"> • 2-hole 4" installation • Cast brass body • Vandal resistant hooded blade handles • Red/blue indicator(s) • 21C122 - Vandal resistant laminar outlet w/ Agion® Antimicrobial • 21C132 - Vandal resistant aerator • 21C142 - Standard aerator • 1 3/4" max. deck thickness • No lift rod hole • 1.5 gpm @ 60 psi, 5.7 L/min @ 414 kPa • CER-TECK® cartridges 		
	21C122	6	168.10	Chrome			
	21C132	6	159.00	Chrome			
	21C142	6	155.50	Chrome			
For complete 21C series product offering, see page C97							
	Commercial <i>Two Handle Centerset Lavatory Faucet</i>				<ul style="list-style-type: none"> • 2-hole 4" installation • Cast brass body • Vandal resistant lever handles • Red/blue indicator(s) • 21C133 - Vandal resistant aerator • 21C143 - Standard aerator • 1 3/4" max. deck thickness • No lift rod hole • 1.5 gpm @ 60 psi, 5.7 L/min @ 414 kPa • CER-TECK® cartridges 		
	21C133	6	157.75	Chrome			
	21C143	6	154.25	Chrome			
	Commercial <i>Two Handle Centerset Lavatory Faucet</i>				<ul style="list-style-type: none"> • 2-hole 4" installation • Cast brass body • Vandal resistant sanitary hood blade handles • Red/blue indicator(s) • 21C134 - Vandal resistant aerator • 21C144 - Standard aerator • 1 3/4" max. deck thickness • No lift rod hole • 1.5 gpm @ 60 psi, 5.7 L/min @ 414 kPa • CER-TECK® cartridges 		
	21C134	6	175.95	Chrome			
	21C144	6	172.45	Chrome			
	Commercial <i>Two Handle Centerset Lavatory Faucet</i>				<ul style="list-style-type: none"> • 3-hole 4" installation • Cast brass body • Vandal resistant lever handles • Red/blue indicator(s) • 1 3/4" max. deck thickness • Metal pop-up • Vandal resistant aerator • 1.5 gpm @ 60 psi, 5.7 L/min @ 414 kPa • CER-TECK® cartridges 		
	21C233	1	209.90	Chrome			
	Commercial <i>Two Handle Centerset Lavatory Faucet</i>				<ul style="list-style-type: none"> • 2-hole 4" installation • Cast brass body • Vandal resistant lever handles • Red/blue 'H', 'C' handle temperature indicators • 1 3/4" max. deck thickness • No lift rod hole • Vandal resistant aerator • 1.5 gpm @ 60 psi, 5.7 L/min @ 414 kPa • CER-TECK® cartridges 		
	21C133-TI	6	168.10	Chrome			

Please always order in full case.

= WaterSense® Labeled Product - Flow Rate of 1.5 gpm versus Industry Standard ASME.A112.18.1/CSA.B125.1 of 2.2 gpm.

= Water Efficient Product - Flow Rate of 1.5 gpm versus Industry Standard ASME.A112.18.1/CSA.B125.1 of 2.2 gpm.

Model	Case	Price	Finish	Features
	Commercial <i>Widespread Lavatory Faucet</i>			<ul style="list-style-type: none"> • 3-hole 6"-16" installation • Solid brass fabricated end valves and spout body • 5 1/4" long rigid spout • 2 3/8" from deck to aerator • Vandal resistant wrist blade handles • Red/blue indicator(s) • 1 1/8" max. deck thickness • Grid strainer • No lift rod hole • Vandal resistant aerator • 1/4 turn handle stops • WF =1/2" IPS adapters • 1.5 gpm @ 60 psi, 5.7 L/min @ 414 kPa • Brass stems/stainless steel plate
3549LF-WFHDF	6	286.65	Chrome	
	Commercial <i>Widespread Lavatory Faucet</i>			<ul style="list-style-type: none"> • 3-hole 6"-16" installation • Solid brass fabricated end valves and spout body • 5 1/4" long rigid spout • 2 3/8" from deck to aerator • Vandal resistant wrist blade handles • Red/blue indicator(s) • 1 1/8" max. deck thickness • No lift rod hole • Vandal resistant aerator • 1/4 turn handle stops • WF =1/2" IPS adapters • 1.5 gpm @ 60 psi, 5.7 L/min @ 414 kPa • Brass stems/stainless steel plate
3549LF-WFLGHDF	6	262.40	Chrome	
	Commercial <i>Widespread Lavatory Faucet</i>			<ul style="list-style-type: none"> • 3-hole 6"-12" installation • 4 1/2" long rigid cast spout • Vandal resistant hooded blade handles • Red/blue indicator(s) • 23C332 - Vandal resistant aerator • 23C342 - Standard aerator • No lift rod hole • 1.5 gpm @ 60 psi, 5.7 L/min @ 414 kPa • CER-TECK® cartridges
23C332	1	252.55	Chrome	
23C342	1	249.05	Chrome	
<p>For complete 23C series product offering, see page C100</p>				
	Commercial <i>Widespread Lavatory Faucet</i>			<ul style="list-style-type: none"> • 3-hole 6"-12" installation • 4 1/2" long rigid cast spout • Vandal resistant lever handles • Red/blue indicator(s) • No lift rod hole • Vandal resistant aerator • 1.5 gpm @ 60 psi, 5.7 L/min @ 414 kPa • CER-TECK® cartridges
23C333	3	251.30	Chrome	
	Commercial <i>Widespread Lavatory Faucet</i>			<ul style="list-style-type: none"> • 3-hole 6"-12" installation • 4 1/2" long rigid cast spout • Vandal resistant sanitary hood blade handles • Red/blue indicator(s) • No lift rod hole • Vandal resistant aerator • 1.5 gpm @ 60 psi, 5.7 L/min @ 414 kPa • CER-TECK® cartridges
23C334	1	269.50	Chrome	

Please always order in full case.

= WaterSense® Labeled Product - Flow Rate of 1.5 gpm versus Industry Standard ASME.A112.18.1/CSA.B125.1 of 2.2 gpm.

= Water Efficient Product - Flow Rate of 1.5 gpm versus Industry Standard ASME.A112.18.1/CSA.B125.1 of 2.2 gpm.



Model Case Price Finish

**Commercial
Widespread Lavatory Faucet**

23C632	1	235.05	Chrome
23C642	1	231.55	Chrome

For complete 23C series product offering, see page C100

Features

- 3-hole 6"-12" installation
- Rigid/swivel gooseneck spout
- 4 1/2" long, 12" high spout
- Vandal resistant hooded blade handles
- Red/blue indicator(s)
- 23C632 - Vandal resistant aerator
- 23C642 - Standard aerator
- 1.5 gpm @ 60 psi, 5.7 L/min @ 414 kPa
- CER-TECK® cartridges



**Commercial
Widespread Lavatory Faucet**

23C624	1	261.10	Chrome
23C634	1	252.00	Chrome
23C644	1	248.50	Chrome

- 3-hole 6"-12" installation
- Rigid/swivel gooseneck spout
- 4 1/2" long, 12" high spout
- Vandal resistant sanitary hood blade handles
- Red/blue indicator(s)
- 23C624 - Vandal resistant laminar outlet w/ Agion® Antimicrobial
- 23C634 - Vandal resistant aerator
- 23C644 - Standard aerator
- 1.5 gpm @ 60 psi, 5.7 L/min @ 414 kPa
- CER-TECK® cartridges



**Commercial
Widespread Lavatory Faucet**

23C643	3	230.30	Chrome
--------	---	--------	--------

- 3-hole 6"-12" installation
- Rigid/swivel gooseneck spout
- 4 1/2" long, 12" high spout
- Vandal resistant lever handles
- Red/blue indicator(s)
- Standard aerator
- 1.5 gpm @ 60 psi, 5.7 L/min @ 414 kPa
- CER-TECK® cartridges



Please always order in full case.

= WaterSense® Labeled Product - Flow Rate of 1.5 gpm versus Industry Standard ASME.A112.18.1/CSA.B125.1 of 2.2 gpm.

= Water Efficient Product - Flow Rate of 1.5 gpm versus Industry Standard ASME.A112.18.1/CSA.B125.1 of 2.2 gpm.

Model Case Price Finish Features



Commercial
Widespread Lavatory Faucet

3579LF-WFHDF 6 292.35 Chrome

- 3-hole 6"-16" installation
- Solid brass fabricated end valves and spout body
- 5 3/4" long, 11" high rigid spout
- 6 1/8" from deck to aerator
- Red/blue indicator(s)
- 1 1/8" max. deck thickness
- Brass stems/stainless steel plate
- Grid strainer
- Laminar flow outlet
- 1/4 turn handle stops
- WF =1/2" IPS adapters
- 1.5 gpm @ 60 psi, 5.7 L/min @ 414 kPa



Commercial
Widespread Lavatory Faucet

3579LF-WFLGHDF 6 273.45 Chrome

- 3-hole 6"-16" installation
- Solid brass fabricated end valves and spout body
- 5 3/4" long, 11" high rigid spout
- 6 1/8" from deck to aerator
- Red/blue indicator(s)
- 1 1/8" max. deck thickness
- Brass stems/stainless steel plate
- Less grid strainer
- Laminar flow outlet
- 1/4 turn handle stops
- WF =1/2" IPS adapters
- 1.5 gpm @ 60 psi, 5.7 L/min @ 414 kPa



Please always order in full case.

= WaterSense® Labeled Product - Flow Rate of 1.5 gpm versus Industry Standard ASME.A112.18.1/CSA.B125.1 of 2.2 gpm.

= Water Efficient Product - Flow Rate of 1.5 gpm versus Industry Standard ASME.A112.18.1/CSA.B125.1 of 2.2 gpm.



Model **Case** **Price** **Finish**

Commercial
Single Handle Bar/Prep Sink Faucet

710LF-HDF 6 225.65 Chrome

Features

- 2-hole installation
- 5 7/32" long, 10 11/64" high rigid spout
- 6 5/32" from deck to aerator
- Vandal resistant elbow handle
- Red/blue indicator(s)
- Adjustable handle limit stop
- 2 1/2" max. deck thickness
- Vandal resistant outlet
- 3/8" OD straight, staggered copper supply tubes with 3/8" fittings
- 1.5 gpm @ 60 psi, 5.7 L/min @ 414 kPa
- DIAMOND™ Valve



Commercial
Single Handle Bar/Prep Sink Faucet

711LF-HDF 6 238.40 Chrome

- 2-hole installation
- Gooseneck spout swings 180°
- 5 7/32" long, 10 11/64" high spout
- 6 5/32" from deck to aerator
- Vandal resistant elbow handle
- Red/blue indicator(s)
- Adjustable handle limit stop
- 2 1/2" max. deck thickness
- Vandal resistant outlet
- 3/8" OD straight, staggered copper supply tubes with 3/8" fittings
- 1.5 gpm @ 60 psi, 5.7 L/min @ 414 kPa
- DIAMOND™ Valve



Commercial
Single Handle Basin Faucet

570LF-WFHDF 6 151.55 Chrome

- 1-hole installation
- 4" long spout swings 360°
- 2 1/4" from deck to aerator
- Vandal resistant lever handle
- Red/blue indicator(s)
- Adjustable handle limit stop
- 1 9/16" max. deck thickness
- Vandal resistant aerator
- Straight, staggered supply tubes with 1/2" IPS adapters
- Order RP9633 for 6" spout
- Order RP63131 for 8" spout
- 1.5 gpm @ 60 psi, 5.7 L/min @ 414 kPa
- Stainless steel ball



Commercial
Single Handle Basin Faucet

570LF-06ELH 6 152.55 Chrome

- 1-hole installation
- 6" long spout swings 360°
- 3 1/2" from deck to aerator
- Vandal resistant elbow handle
- Red/blue indicator(s)
- Adjustable handle limit stop
- 1 9/16" max. deck thickness
- Vandal resistant aerator
- Straight, staggered supply tubes with 1/2" IPS adapters
- Order RP63131 for 8" spout
- 1.5 gpm @ 60 psi, 5.7 L/min @ 414 kPa
- Stainless steel ball



Please always order in full case.

= WaterSense® Labeled Product - Flow Rate of 1.5 gpm versus Industry Standard ASME.A112.18.1/CSA.B125.1 of 2.2 gpm.

= Water Efficient Product - Flow Rate of 1.5 gpm versus Industry Standard ASME.A112.18.1/CSA.B125.1 of 2.2 gpm.

Model Case Price Finish Features



Commercial
Single Handle Metering Faucet

701LF-HDF 6 125.60 Chrome

- 1-hole installation
- 4 1/4" long rigid spout
- 1 1/2" from deck to aerator
- Vandal resistant handle
- Metering, slow-close push style
- 1 1/8" max. deck thickness
- Vandal resistant spray outlet - see (1) below
- 1/2" threaded male inlet shank



Commercial
Two Handle Metering Faucet

2507LF-HDF 6 219.50 Chrome

- 2 or 3-hole 4" installation
- 5" long spout
- 1 7/8" from deck to aerator
- Vandal resistant handles
- Metering, slow-close push style
- 1 3/8" max. deck thickness
- No lift rod hole
- Vandal resistant spray outlet - see (1) below
- 1/2" IPS shanks



Commercial
Two Handle Metering Faucet

2517LF-HDF 6 249.10 Chrome

- 2 or 3-hole 4" installation
- 5" long spout
- Vandal resistant handles
- Metering, slow-close push style
- 1 3/8" max. deck thickness
- Grid strainer
- No lift rod hole
- Vandal resistant spray outlet - see (1) below
- 1/2" IPS shanks



Commercial
Single Handle Metering Faucet

87T104 6 131.85 Chrome
87T110 6 161.80 Chrome

For complete 87T series product offering, see page C116

- 1-hole installation
- Cast brass body
- 5 2/5" long spout
- Vandal resistant push button
- Metering, slow-close push style
- 2 1/2" max. deck thickness
- 87T104 - Single inlet
- 87T110 - Mixing tee and checks
- Vandal resistant spray outlet - see (1) below



(1) All Delta® metering, slow-close faucets have a 0.5 gpm (1.9L/min) flow control vandal resistant spray outlet. It delivers no more than 1/4 gallon per activation when not held open manually.

Please always order in full case.

= Water Efficient Product - Flow Rate of 1.5 gpm versus Industry Standard ASME.A112.18.1/CSA.B125.1 of 2.2 gpm.

Model Case Price Finish Features



Commercial
Single Handle Metering Faucet

87T105	6	141.75	Chrome
87T111	6	172.45	Chrome

For complete 87T series product offering, see page C116

- 1-hole installation
- Cast brass body
- 5 2/5" long spout
- Vandal resistant ADA lever handles
- Metering, slow-close lever style
- 2 1/2" max. deck thickness
- 87T105 - Single inlet
- 87T111 - Mixing tee and checks
- Vandal resistant spray outlet - See (1) below



Commercial
Two Handle Metering Faucet

86T1153	6	239.65	Chrome
---------	---	--------	--------

For complete 86T series product offering, see page C116

- 2-hole 4" installation
- Cast brass body
- 5 1/10" long spout
- Vandal resistant ADA lever handles
- Metering, slow-close lever style
- Red/blue indicator(s)
- 2 3/8" max. deck thickness
- No lift rod hole
- Vandal resistant spray outlet - See (1) below



Commercial
Centerset Coverplate

87T151	12	39.65	Chrome
--------	----	-------	--------

- 4" centerset cover plate
- Cast brass
- Two hold-down shanks
- For 87T series
- Vandal resistant

(1) All Delta® metering, slow-close faucets have a 0.5 gpm (1.9L/min) flow control vandal resistant spray outlet. It delivers no more than 1/4 gallon per activation when not held open manually.

Please always order in full case.

= Water Efficient Product - Flow Rate of 1.5 gpm versus Industry Standard ASME.A112.18.1/CSA.B125.1 of 2.2 gpm.

Model Case Price Finish Features



Commercial Proximity® Deckmount Lavatory Faucet

600T040	3	583.30	Chrome
600T040-SS	3	640.00	Brilliance® Stainless
600T040-BB	3	627.65	Chrome
600T040-BB-SS	3	684.35	Brilliance® Stainless
601T040	3	583.30	Chrome
601T040-SS	3	640.00	Brilliance® Stainless

SS Available Q3 2014

For complete 600T series product offering, see page C135



- 1-hole installation
- Cast brass spout
- 4 11/25" long, 4 9/10" high
- Hands-free activation
- Entire spout is sensor
- Adjustable sensing range
- Surface mounted control box
- Mixing valve required
- 1 1/2" max. deck thickness
- Order 062021A for optional decorative cover plate with 4" centers
- 600T040 - Hardwire, order transformer separately
- 600T040-BB - Hardwire with battery back-up, order transformer separately
- 601T040 - Battery operated, batteries included
- 1.5 gpm @ 60 psi, 5.7 L/min @ 414 kPa



Commercial Proximity® Deckmount Lavatory Faucet

600T050	3	591.95	Chrome
600T050-SS	3	648.65	Brilliance® Stainless
601T050	3	591.95	Chrome
601T050-SS	3	648.65	Brilliance® Stainless

SS Available Q3 2014



- 1-hole installation
- Cast brass spout
- 4 11/25" long, 4 9/10" high
- Hands-free activation
- Entire spout is sensor
- Adjustable sensing range
- Surface mounted control box
- Mixing valve required
- 1 1/2" max. deck thickness
- Order 062021A for optional decorative cover plate with 4" centers
- 600T050 - Hardwire, order transformer separately
- 601T050 - Battery operated, batteries included
- .5 gpm @ 60 psi, 1.9 L/min @ 414 kPa



Commercial Proximity® Deckmount Lavatory Faucet

590TP0120	3	581.90	Chrome
590TP1120	3	581.90	Chrome

For complete 590TP series product offering, see pages C129-C130















- 1-hole installation
- Cast body
- 5" long cast hi-rise spout
- Hands-free activation
- Entire spout is sensor
- Adjustable sensing range
- Surface or recessed mount control box options
- Mixing valve required
- 3" max. deck thickness
- Vandal resistant laminar outlet w/ Agion® Antimicrobial
- Auto shut off feature
- 590TP0120 - Hardwire, order transformer separately
- 590TP1120 - Battery operated, batteries included
- 1.5 gpm @ 60 psi, 5.7 L/min @ 414 kPa

Please always order in full case. Transformers, mixing valves, cover plates and hardwire converters available beginning on page C37.

= WaterSense® Labeled Product - Flow Rate of 1.5 gpm versus Industry Standard ASME.A112.18.1/CSA.B125.1 of 2.2 gpm.

= Water Efficient Product - Flow Rate of 1.5 gpm versus Industry Standard ASME.A112.18.1/CSA.B125.1 of 2.2 gpm.

	Model	Case	Price	Finish	Features
NEW!    	Commercial <i>Proximity® Deckmount Lavatory Faucet Trim</i>				<ul style="list-style-type: none"> • 1-hole installation • Trim only • Requires separate order of ELAVT0008RI for complete product • 5" long cast hi-rise spout • Hands-free activation • Entire spout is sensor • Adjustable sensing range • Surface or recessed mount control box options • 3" max. deck thickness • Vandal resistant laminar outlet w/ Agion® Antimicrobial • Auto shut off feature • Hardwire • Order transformer separately • 1.5 gpm @ 60 psi, 5.7 L/min @ 414 kPa
	590TP0128TR	3	317.90	Chrome	
<p>For complete 590TP series product offering, see pages C129-C130</p>					
NEW!    	Commercial <i>Proximity® Deckmount Lavatory Faucet Trim</i>				<ul style="list-style-type: none"> • 1-hole installation • Trim only • Requires separate order of ELAVT0008RI for complete product • 5" long cast hi-rise spout • Hands-free activation • Entire spout is sensor • Adjustable sensing range • Surface or recessed mount control box options • 3" max. deck thickness • Vandal resistant laminar outlet • Auto shut off feature • Hardwire • Order transformer separately • .5 gpm @ 60 psi, 1.9 L/min @ 414 kPa
	590TP0158TR	3	317.90	Chrome	
NEW!    	Commercial <i>Proximity® Deckmount Lavatory Faucet Trim</i>				<ul style="list-style-type: none"> • 1 or 3-hole installation (4" forged coverplate included) • Trim only • Requires separate order of ELAVT0008RI for complete product • 5" long cast hi-rise spout • Hands-free activation • Entire spout is sensor • Adjustable sensing range • Surface or recessed mount control box options • 2.5" max. deck thickness • Vandal resistant laminar outlet • Auto shut off feature • Hardwire • Order transformer separately • .5 gpm @ 60 psi, 1.9 L/min @ 414 kPa
	590TP0258TR	3	384.95	Chrome	

Please always order in full case. Transformers, mixing valves, cover plates and hardwire converters available beginning on page C37.

 = WaterSense® Labeled Product - Flow Rate of 1.5 gpm versus Industry Standard ASME.A112.18.1/CSA.B125.1 of 2.2 gpm.

 = Water Efficient Product - Flow Rate of 1.5 gpm versus Industry Standard ASME.A112.18.1/CSA.B125.1 of 2.2 gpm.

Model Case Price Finish Features



Commercial
Proximity® Deckmount Lavatory Faucet

591TP0250 6 581.90 Chrome

For complete 591TP series product offering, see pages C133-C134

- 3-hole 4" installation
- Cast body
- 5" long spout
- 4 7/10" from deck to aerator
- Hands-free activation
- Entire spout is sensor
- Adjustable sensing range
- Surface or recessed mount control box options
- 2.5" max. deck thickness
- Mixing valve required
- Vandal resistant laminar outlet
- Auto shut off feature
- Hardwire
- Order transformer separately
- .5 gpm @ 60 psi, 1.9 L/min @ 414 kPa



Commercial
Proximity® Deckmount Lavatory Faucet

591TP1250 6 581.90 Chrome

- 3-hole 4" installation
- Cast body
- 5" long spout
- 4 7/10" from deck to aerator
- Hands-free activation
- Entire spout is sensor
- Adjustable sensing range
- Surface or recessed mount control box options
- 2.5" max. deck thickness
- Mixing valve required
- Vandal resistant laminar outlet
- Auto shut off feature
- Battery operated
- Batteries included
- .5 gpm @ 60 psi, 1.9 L/min @ 414 kPa



NEW!



Commercial
Proximity® Deckmount Lavatory Faucet Trim

591TP0268TR 1 309.20 Chrome

- 3-hole 4" installation
- Trim only
- Requires separate order of ELAVT0008RI for complete product
- Cast body
- 5" long spout
- 4 7/10" from deck to aerator
- Hands-free activation
- Entire spout is sensor
- Adjustable sensing range
- Surface or recessed mount control box options
- 2.5" max. deck thickness
- Vandal resistant laminar outlet
- Auto shut off feature
- Hardwire
- Order transformer separately
- 1.0 gpm @ 60 psi, 3.8 L/min @ 414 kPa



Please always order in full case. Transformers, mixing valves, cover plates and hardwire converters available beginning on page C37.

= WaterSense® Labeled Product - Flow Rate of 1.5 gpm versus Industry Standard ASME.A112.18.1/CSA.B125.1 of 2.2 gpm.



= Water Efficient Product - Flow Rate of 1.5 gpm versus Industry Standard ASME.A112.18.1/CSA.B125.1 of 2.2 gpm.

	Model	Case	Price	Finish	Features
	Commercial <i>Proximity® Deck Mount Lavatory Faucet</i>				<ul style="list-style-type: none"> • 1-hole installation • 5 3/10" long spout • 3 1/5" from deck to aerator • Hands-free activation • Entire spout is sensor • Adjustable sensing range • Surface mounted control box • Mixing valve required • 2" max. deck thickness • Vandal resistant laminar outlet • No lift rod hole • 590-PLGHDF - Battery operated, batteries included • Audible low battery indicator • 590-PLGHDFHW - Hardwire, order transformer separately • .5 gpm @ 60 psi, 1.9 L/min @ 414 kPa
	590-PLGHDF	3	439.45	Chrome	
	590-PLGHDFHW	3	439.45	Chrome	







	Commercial <i>Proximity® Deck Mount Lavatory Faucet</i>				<ul style="list-style-type: none"> • 3-hole 4" installation • 5 3/10" long spout • 3 9/10" from deck to aerator • Hands-free activation • Entire spout is sensor • Adjustable sensing range • Surface mounted control box • Mixing valve required • 2" max. deck thickness • Vandal resistant laminar outlet • No lift rod hole • 4" Anti-rotation forged cover plate • 591-PLGHDF - Battery operated, batteries included • Audible low battery indicator • 591-PLGHDFHW - Hardwire, order transformer separately • .5 gpm @ 60 psi, 1.9 L/min @ 414 kPa
	591-PLGHDF	3	458.85	Chrome	
	591-PLGHDFHW	3	458.85	Chrome	

	Commercial <i>Proximity® Deck Mount Lavatory Faucet</i>				<ul style="list-style-type: none"> • 3-hole 8" installation • 5 3/10" long spout • 3 9/10" from deck to aerator • Hands-free activation • Entire spout is sensor • Adjustable sensing range • Surface mounted control box • Mixing valve required • 2" max. deck thickness • Vandal resistant laminar outlet • No lift rod hole • 8" Anti-rotation forged cover plate • 592-PLGHDF - Battery operated, batteries included • Audible low battery indicator • 592-PLGHDFHW - Hardwire, order transformer separately • .5 gpm @ 60 psi, 1.9 L/min @ 414 kPa
	592-PLGHDF	3	482.65	Chrome	
	592-PLGHDFHW	3	482.65	Chrome	

Please always order in full case. Transformers, mixing valves, cover plates and hardwire converters available beginning on page C37.

 = WaterSense® Labeled Product - Flow Rate of 1.5 gpm versus Industry Standard ASME.A112.18.1/CSA.B125.1 of 2.2 gpm.

 = Water Efficient Product - Flow Rate of 1.5 gpm versus Industry Standard ASME.A112.18.1/CSA.B125.1 of 2.2 gpm.



Model	Case	Price	Finish
Commercial <i>Electronic Lavatory Faucet</i>			
DEMD-101LF	6	579.05	Chrome
DEMD-101LF-NS	6	680.40	Nickel Stainless

- 1-hole installation
- Above deck solenoid and battery
- For cold or premixed water
- Vandal resistant wrench flat spray outlet
- 1 1/2" max. deck thickness
- Battery operated
- Batteries included
- .5 gpm @ 60 psi, 1.9 L/min @ 414 kPa



Model	Case	Price	Finish
Commercial <i>Electronic Lavatory Faucet</i>			
DEMD-111LF	6	615.25	Chrome
DEMD-111LF-NS	6	722.95	Nickel Stainless

- 1-hole installation
- Above deck solenoid and battery
- Side mixer
- Red/blue indicator(s)
- Vandal resistant wrench flat spray outlet
- 1 1/2" max. deck thickness
- Battery operated
- Batteries included
- .5 gpm @ 60 psi, 1.9 L/min @ 414 kPa



Model	Case	Price	Finish
Commercial <i>Electronic Lavatory Faucet</i>			
DEMD-201LF	6	620.40	Chrome
DEMD-201LF-NS	6	729.00	Nickel Stainless

- 1-hole installation
- Above deck electronics
- For cold or premixed water
- Vandal resistant wrench flat spray outlet
- 1 1/4" max. deck thickness
- Battery operated
- Batteries included
- .5 gpm @ 60 psi, 1.9 L/min @ 414 kPa



Model	Case	Price	Finish
Commercial <i>Electronic Lavatory Faucet</i>			
DEMD-211LF	6	656.60	Chrome
DEMD-211LF-NS	6	771.55	Nickel Stainless

- 1-hole installation
- Above deck electronics
- Side mixer
- Red/blue indicator(s)
- Vandal resistant wrench flat spray outlet
- 1 1/4" max. deck thickness
- Battery operated
- Batteries included
- .5 gpm @ 60 psi, 1.9 L/min @ 414 kPa



Please always order in full case.

= Water Efficient Product - Flow Rate of 1.5 gpm versus Industry Standard ASME.A112.18.1/CSA.B125.1 of 2.2 gpm.

Model Case Price Finish Features



Commercial
Electronic Lavatory Faucet

DEMD-301LF	6	572.60	Chrome
DEMD-301LF-NS	6	672.80	Nickel Stainless

- 1-hole installation
- For cold or premixed water
- Vandal resistant wrench flat spray outlet
- 2" max. deck thickness
- Battery operated
- Batteries included
- .5 gpm @ 60 psi, 1.9 L/min @ 414 kPa



Commercial
Electronic Lavatory Faucet

DEMD-311LF	6	610.05	Chrome
DEMD-311LF-NS	6	716.80	Nickel Stainless

- 1-hole installation
- Side mixer
- Red/blue indicator(s)
- Vandal resistant wrench flat spray outlet
- 2" max. deck thickness
- Battery operated
- Batteries included
- .5 gpm @ 60 psi, 1.9 L/min @ 414 kPa



Commercial
Electronic Wall-Mount Lavatory Faucet

DEMD-402LF	6	758.10	Chrome
DEMD-402LF-NS	6	890.75	Nickel Stainless

- 1-hole wall-mount installation
- 8" Spout
- For cold or premixed water
- Hardwire
- Hardwire 24 VAC to 9 VDC converter supplied
- Transformer required (order separately)
- .5 gpm @ 60 psi, 1.9 L/min @ 414 kPa



Commercial
Electronic Wall-Mount Lavatory Faucet

DEMD-404LF	6	724.85	Chrome
DEMD-404LF-NS	6	851.75	Nickel Stainless

- 1-hole wall-mount installation
- 6" Spout
- For cold or premixed water
- Hardwire
- Hardwire 24 VAC to 9 VDC converter supplied
- Transformer required (order separately)
- .5 gpm @ 60 psi, 1.9 L/min @ 414 kPa



Please always order in full case.

= Water Efficient Product - Flow Rate of 1.5 gpm versus Industry Standard ASME.A112.18.1/CSA.B125.1 of 2.2 gpm.

Model	Case	Price	Finish	Features
-------	------	-------	--------	----------



Commercial
DEMDT transformer

060958A	1	41.10	NA
---------	---	-------	----

- Plug in transformer ONLY for DEMD models
- 120 VAC to 9 VDC
- No converter required
- For hardwire conversions, see specification sheets



Commercial
DEMDRe mote

060967A	1	221.70	NA
---------	---	--------	----

- Remote control ONLY for DEMD models



Commercial
DEMDCov ert er

060974A	1	58.70	NA
---------	---	-------	----

- Hardwire converter ONLY for DEMD models
- 24 VAC to 9 VDC
- Transformer required (order separately)
- For hardwire conversions, see specification sheets

Please always order in full case.

= WaterSense® Labeled Product - Flow Rate of 1.5 gpm versus Industry Standard ASME.A112.18.1/CSA.B125.1 of 2.2 gpm.

= Water Efficient Product - Flow Rate of 1.5 gpm versus Industry Standard ASME.A112.18.1/CSA.B125.1 of 2.2 gpm.

Model Case Price Finish Features



Commercial
Electronic Soap Dispenser

DESD-250 1 279.30 Chrome

- 1-hole installation
- Deck mount electronic hand soap dispenser
- Non-metal spout
- 800 ml lotion hand soap with moisturizer included
- Battery operated
- Batteries included
- 2" max. deck thickness
- 3 year warranty



Commercial
Electronic Soap Dispenser

DESD-550 3 428.65 Chrome

- 1-hole installation
- Deck mount electronic hand soap dispenser
- Cast brass spout
- 800 ml lotion hand soap with moisturizer included
- Battery operated
- Batteries included
- 2" max. deck thickness



Commercial
Hand Soap with Moisturizer

060917A 4• 33.85 NA

- 1600 ml antibacterial hand soap
- Hand soap w/moisturizer



Commercial
Soap Dispenser Plug-in Transformer

060918A 1 63.50 NA

- Plug-in transformer to convert DESD-250 or DESD-550 to hardwire
- 120 VAC to 6 VDC
- 060919A not required if this transformer is used



Commercial
Soap Dispenser Converter

060919A 1 57.05 NA

- Hardwire converter to convert DESD-250 or DESD-550 to hardwire
- 24 VAC to 6 VDC
- Transformer required (order separately)

• Full case quantity restriction on this model - priced each. Please always order in full case.



= WaterSense® Labeled Product - Flow Rate of 1.5 gpm versus Industry Standard ASME.A112.18.1/CSA.B125.1 of 2.2 gpm.



= Water Efficient Product - Flow Rate of 1.5 gpm versus Industry Standard ASME.A112.18.1/CSA.B125.1 of 2.2 gpm.

Model	Case	Price	Finish	Features
-------	------	-------	--------	----------



Commercial
H₂Optics® Lavatory Faucet

590LF-LGHGMHDF 6 399.50 Chrome



- 1-hole installation
- All metal faucet construction
- 5 1/4" long, 3 7/8" high rigid spout
- 2 3/8" from deck to aerator
- Hands-free activation
- H₂Optics® Technology
- Self-adaptive technology
- Mixing valve required
- 1" max. deck thickness
- Vandal resistant laminar outlet
- Less grid strainer
- No lift rod hole
- Battery operated
- Batteries included
- .5 gpm @ 60 psi, 1.9 L/min @ 414 kPa



Commercial
H₂Optics® Lavatory Faucet

590LF-HGMHDF 6 420.70 Chrome



- 1-hole installation
- All metal faucet construction
- 5 1/4" long, 3 7/8" high rigid spout
- 2 3/8" from deck to aerator
- Hands-free activation
- H₂Optics® Technology
- Self-adaptive technology
- Mixing valve required
- 1" max. deck thickness
- Vandal resistant laminar outlet
- Grid strainer
- No lift rod hole
- Battery operated
- Batteries included
- .5 gpm @ 60 psi, 1.9 L/min @ 414 kPa



Commercial
H₂Optics® Lavatory Faucet

591LF-LGHGMHDF 6 418.80 Chrome



- 3-hole 4" installation
- All metal faucet construction
- 5 1/4" long, 4 3/8" high rigid spout
- 2 13/16" from deck to aerator
- Hands-free activation
- H₂Optics® Technology
- Self-adaptive technology
- Mixing valve required
- 1 1/2" max. deck thickness
- Vandal resistant laminar outlet
- Less grid strainer
- No lift rod hole
- 4" Anti-rotation forged cover plate
- Battery operated
- Batteries included
- .5 gpm @ 60 psi, 1.9 L/min @ 414 kPa



Commercial
H₂Optics® Lavatory Faucet

591LF-HGMHDF 6 440.00 Chrome



- 3-hole 4" installation
- All metal faucet construction
- 5 1/4" long, 4 3/8" high rigid spout
- 2 13/16" from deck to aerator
- Hands-free activation
- H₂Optics® Technology
- Self-adaptive technology
- Mixing valve required
- 1 1/2" max. deck thickness
- Vandal resistant laminar outlet
- Grid strainer
- No lift rod hole
- 4" Anti-rotation forged cover plate
- Battery operated
- Batteries included
- .5 gpm @ 60 psi, 1.9 L/min @ 414 kPa

Please always order in full case.

Transformers, mixing valves, cover plates and hardwire converters available beginning on page C37.

= Water Efficient Product - Flow Rate of 1.5 gpm versus Industry Standard ASME.A112.18.1/CSA.B125.1 of 2.2 gpm.

Model Case Price Finish Features



Commercial
H₂Optics® Lavatory Faucet

590T0120	3	540.50	Chrome
590T0120-BB	3	584.85	Chrome
590T1120	3	540.50	Chrome

For complete 590T series product offering, see pages C127-C128

- 1-hole installation
- Forged brass solenoid valve
- 5" long cast hi-rise spout
- Hands-free activation
- H₂Optics® Technology
- Field adjustable sensing range and timeout
- Mixing valve required
- 1 1/2" max. deck thickness
- Vandal resistant laminar outlet w/ Agion® Antimicrobial
- 590T0120 - Hardwire, order transformer separately
- Order 061047A to convert 590T0120 to hardwire with battery back-up
- 590T0120-BB - Hardwire with battery backup, order transformer separately
- 590T1120 - Battery operated, batteries included
- 1.5 gpm @ 60 psi, 5.7 L/min @ 414 kPa



Commercial
H₂Optics® Lavatory Faucet

591T0250	6	540.50	Chrome
591T1250	6	540.50	Chrome

For complete 591T series product offering, see pages C131-C132

- 3-hole 4" installation
- Cast body
- 5" long cast spout
- Hands-free activation
- H₂Optics® Technology
- Field adjustable sensing range and timeout
- Mixing valve required
- 2" max. deck thickness
- Vandal resistant laminar outlet
- 591T0250 - Hardwire, order transformer separately
- Order 061047A to convert 591T0250 to hardwire with battery back-up
- 591T1250 - Battery operated, batteries included
- .5 gpm @ 60 psi, 1.9 L/min @ 414 kPa



Commercial
Electronic Shower

860T167	1	1247.65	Chrome
---------	---	---------	--------

For complete 860T series product offering, see page C138

- Recessed metal box mount with pressure-balance mixing valve
- Electronic shower with push button activator
- Vandal resistant handle adjusts temperature
- Red/blue label on cover plate
- 30° vandal resistant cast showerhead
- Hardwire
- Order transformer separately
- 1.5 gpm @ 80 psi, 5.7 L/min @ 550 kPa maximum water usage



NEW!



Commercial
Low Profile Institutional Electronic Shower

860T178	1	1247.65	Chrome
---------	---	---------	--------

- Recessed metal box mount with thermostatic mixing valve
- Electronic shower with push button activator
- Tempered water supplied to solenoid valve
- Field adjustable shower time
- 30° vandal resistant forged showerhead
- Hardwire
- Order transformer separately
- 1.5 gpm @ 80 psi, 5.7 L/min @ 550 kPa maximum water usage



Please always order in full case.

Transformers, mixing valves, cover plates and hardwire converters available beginning on page C37.

 = WaterSense® Labeled Product - Flow Rate of 1.5 gpm versus Industry Standard ASME.A112.18.1/CSA.B125.1 of 2.2 gpm.

 = Water Efficient Product - Flow Rate of 1.5 gpm versus Industry Standard ASME.A112.18.1/CSA.B125.1 of 2.2 gpm.

Model	Case	Price	Finish	Features
-------	------	-------	--------	----------



Commercial
H₂Optics[®] Deck Mount Faucet

1500T3320	1	612.85	Chrome
1501T3320	1	612.85	Chrome

For complete 1500T3 series product offering, see pages C140-C141

- 1-hole installation
- Cast brass body
- 6" long, 14 4/5" high rigid spout
- Hands-free activation
- *H₂Optics*[®] Technology
- Field adjustable sensing range and timeout
- Mixing valve required
- 1.5" max. deck thickness
- Vandal resistant laminar outlet w/ Agion[®] Antimicrobial
- 1500T3320 - Hardwire, order transformer separately
- 1501T3320 - Battery operated, batteries included
- 1.5 gpm @ 60 psi, 5.7 L/min @ 414 kPa



Commercial
H₂Optics[®] Deck Mount Faucet Trim

1500T3428TR	1	370.40	Chrome
1501T3428TR	1	370.40	Chrome

- 3-hole 4" installation
- Trim Only
- Requires separate order of ELAVT0008RI rough for complete product
- Cast brass body
- 6" long, 15 2/5" high rigid spout
- Hands-free activation
- *H₂Optics*[®] Technology
- Field adjustable sensing range and timeout
- Recessed mount 10" x 10" box with thermostatic mixing valve
- 1.5" max. deck thickness
- Vandal resistant laminar outlet w/ Agion[®] Antimicrobial
- 4" forged cover plate
- 1500T3428TR - Hardwire, order transformer separately
- 1501T3428TR - Battery operated, batteries included
- 1.5 gpm @ 60 psi, 5.7 L/min @ 414 kPa



Commercial
H₂Optics[®] Deck Mount Faucet Trim

1500T3478TR	1	370.40	Chrome
1501T3478TR	1	370.40	Chrome

- 3-hole 4" installation
- Trim Only
- Requires separate order of ELAVT0008RI rough for complete product
- Cast brass body
- 6" long, 15 2/5" high rigid spout
- Hands-free activation
- *H₂Optics*[®] Technology
- Field adjustable sensing range and timeout
- Recessed mount 10" x 10" box with thermostatic mixing valve
- 1.5" max. deck thickness
- Smooth end spout with laminar flow control in base
- 4" forged cover plate
- 1500T3478TR - Hardwire, order transformer separately
- 1501T3478TR - Battery operated, batteries included
- 1.5 gpm @ 60 psi, 5.7 L/min @ 414 kPa



Please always order in full case.

Transformers, mixing valves, cover plates and hardwire converters available beginning on page C37.

= WaterSense[®] Labeled Product - Flow Rate of 1.5 gpm versus Industry Standard ASME.A112.18.1/CSA.B125.1 of 2.2 gpm.

= Water Efficient Product - Flow Rate of 1.5 gpm versus Industry Standard ASME.A112.18.1/CSA.B125.1 of 2.2 gpm.

Model Case Price Finish Features



Commercial
H₂Optics[®] Wall Mount Faucet

1500T4670	1	664.00	Chrome
1500T4670-BB	1	708.35	Chrome
1501T4670	1	664.00	Chrome

For complete 1500T4 series product offering, see page C142

- Wall mount installation
- Cast brass body
- 6" long, 16 1/4" high rigid spout
- Hands-free activation
- *H₂Optics*[®] Technology
- Field adjustable sensing range and timeout
- Mixing valve required
- Smooth end spout with laminar flow control in base
- 1500T4670 - Hardwire, order transformer separately
- 1500T4670-BB - Hardwire with battery backup
- 1501T4670 - Battery operated, batteries included
- 1.5 gpm @ 60 psi, 5.7 L/min @ 414 kPa



Commercial
H₂Optics[®] Deck Mount Faucet

3000T3320A	1	763.50	Chrome
3000T3320A-BB	1	807.85	Chrome
3001T3320A	1	763.50	Chrome

For complete 3000T3 series product offering, see pages C143-C144

- 1-hole installation
- Cast brass body
- 6" long, 14 4/5" high rigid spout
- Hands-free activation
- *H₂Optics*[®] Technology
- Water resistant field adjustable program controller with LCD screen
- Mixing valve required
- 1.5" max. deck thickness
- Vandal resistant laminar outlet w/ Agion[®] Antimicrobial
- 3000T3320A - Hardwire, order transformer separately
- 3001T3320A - Battery operated, batteries included
- 1.5 gpm @ 60 psi, 5.7 L/min @ 414 kPa



Commercial
H₂Optics[®] Deck Mount Faucet Trim

3000T3428ATR	1	499.60	Chrome
3001T3428ATR	1	499.60	Chrome

- 3-hole 4" installation
- Trim Only
- Requires separate order of ELAVT0008RI rough-in for complete product
- Cast brass body
- 6" long, 15 2/5" high rigid spout
- Hands-free activation
- *H₂Optics*[®] Technology
- Water resistant field adjustable program controller with LCD screen
- 1.5" max. deck thickness
- Vandal resistant laminar outlet w/ Agion[®] Antimicrobial
- 4" forged cover plate
- 3000T3428ATR - Hardwire order transformer separately
- 3001T3428ATR - Battery operated, batteries included
- 1.5 gpm @ 60 psi, 5.7 L/min @ 414 kPa



Please always order in full case.

Transformers, mixing valves, cover plates and hardwire converters available beginning on page C37.

= WaterSense[®] Labeled Product - Flow Rate of 1.5 gpm versus Industry Standard ASME.A112.18.1/CSA.B125.1 of 2.2 gpm.

= Water Efficient Product - Flow Rate of 1.5 gpm versus Industry Standard ASME.A112.18.1/CSA.B125.1 of 2.2 gpm.

Model	Case	Price	Finish	Features
-------	------	-------	--------	----------



Commercial
H₂Optics[®] Deck Mount Faucet Trim

3000T3478ATR	1	499.60	Chrome
3001T3478ATR	1	499.60	Chrome

For complete 3000T3 series product offering, see pages C143-C144

- 3-hole 4" installation
- Trim Only
- Requires separate order of ELAVT0008RI rough for complete product
- Cast brass body
- 6" long, 15 2/5" high rigid spout
- Hands-free activation
- H₂Optics[®] Technology
- 1.5" max. deck thickness
- Smooth end spout with laminar flow control in base
- 4" forged cover plate
- 3000T3478A - Hardwire, order transformer separately
- 3001T3478A - Battery operated, batteries included
- 1.5 gpm @ 60 psi, 5.7 L/min @ 414 kPa

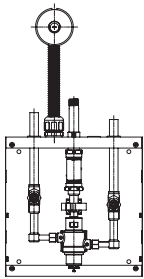

Commercial
Deck Mount Rough Valve

ELAVT0008RI	1	599.80	NA
-------------	---	--------	----

- Rough-in only
- Below deck
- Recessed mount 10" x 10" box with thermostatic mixing valve

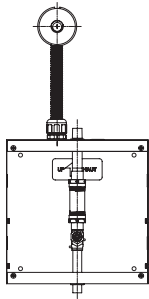

Commercial
Deck Mount Rough Valve

ELAVT0001RI	1	395.65	NA
-------------	---	--------	----

- Rough-in only
- Below deck
- Recessed mount 10" x 10" box with single inlet supply



Commercial
Deck Mount Mixing Valve

24T3003	6	207.25	Chrome
---------	---	--------	--------

- Deck mount mixing valve for 3000T series
- Valve supplies tempered water to below deck solenoid valve for #0 control box
- 3/8" compression connectors
- 1.5" max. deck thickness
- Stainless steel ball valve



Please always order in full case. Transformers, mixing valves, cover plates and hardwire converters available beginning on page C37.

= WaterSense[®] Labeled Product - Flow Rate of 1.5 gpm versus Industry Standard ASME.A112.18.1/CSA.B125.1 of 2.2 gpm.

= Water Efficient Product - Flow Rate of 1.5 gpm versus Industry Standard ASME.A112.18.1/CSA.B125.1 of 2.2 gpm.

Model Case Price Finish Features

NEW!



Commercial
Low Profile Institutional Double Sensor Trim

3000T4128ATR 1 1060.00 Chrome

For complete 3000T4 series product offering, see page C145

- Trim only
- Requires separate order of 3000T4128ARI rough for complete product
- Hands-free activation
- H₂Optics® Technology
- 4.5" x 4.5" stainless steel wall plates with chrome plated rigid stub spout
- Laminar swivel outlet
- Field adjustable sensor range and meter mode retains settings in event of power failure
- Hardwire
- Order transformer separately
- 1.5 gpm @ 60 psi, 5.7 L/min @ 414 kPa



NEW!

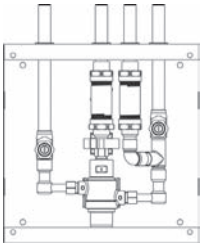

Commercial
Low Profile Institutional Double Sensor Rough

3000T4128ARI 1 660.00 NA

- Rough-in only
- Requires separate order of 3000T4128ATR trim for complete product
- 10" x 10" metal box with thermostatic mixing valve
- 4" square boxes for sensor wall plates
- 4" square box for spout wall plate
- Integral check valves
- Max flow 5.8 gpm @ 45 psi, 22 L/min @ 310 kPa pressure loss
- Min flow .35 gpm, 1.3 L/min @ thermostatic mixing valve



NEW!



Commercial
Low Profile Institutional Single Sensor Trim

3000T4328ATR 1 700.00 Chrome

- Trim only
- Requires separate order of 3000T4328ARI rough for complete product
- Hands-free activation
- H₂Optics® Technology
- 4.5" x 4.5" stainless steel wall plate with chrome plated rigid stub spout
- Laminar swivel outlet
- Field adjustable sensor range and meter mode retains settings in event of power failure
- Hardwire
- Order transformer separately
- 1.5 gpm @ 60 psi, 5.7 L/min @ 414 kPa



NEW!

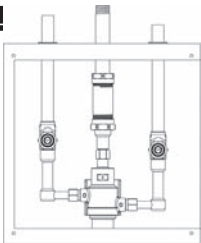

Commercial
Low Profile Institutional Single Sensor Rough

3000T4328ARI 1 600.00 NA

- Rough-in only
- Requires separate order of 3000T4328ATR trim for complete product
- 10" x 10" metal box with thermostatic mixing valve
- 4" square box for sensor wall plate
- 4" square box for spout wall plate
- Integral check valves
- Max flow 5.8 gpm @ 45 psi, 22 L/min @ 310 kPa pressure loss
- Min flow .35 gpm, 1.3 L/min @ thermostatic mixing valve



Please always order in full case.







Transformers, mixing valves, cover plates and hardwire converters available beginning on page C37.



= WaterSense® Labeled Product - Flow Rate of 1.5 gpm versus Industry Standard ASME.A112.18.1/CSA.B125.1 of 2.2 gpm.



= Water Efficient Product - Flow Rate of 1.5 gpm versus Industry Standard ASME.A112.18.1/CSA.B125.1 of 2.2 gpm.

	Model	Case	Price	Finish	Features
	Commercial <i>Optional Hardwire Transformer</i>				<ul style="list-style-type: none"> • Hardwire transformer • Supplies power for up to 10 Delta 590-HDF electronic faucets converted to hardwire or for 10 - 860T or up to 5 - 3000T, 1500T, 590T, 591T, 600T, DEMD, 1600T, 81THWA & 81TWMS series
	RP32508	1	39.15	NA	
	For additional transformers, see page C125				
	Commercial <i>Plug-In Transformer</i>				<ul style="list-style-type: none"> • Plug-in transformer • Supplies power for up to 10 Delta 590-HDF electronic faucets converted to hardwire or for 10 - 860T or up to 5 - 3000T, 1500T, 590T, 591T, 600T, DEMD, 1600T, 81THWA & 81TWMS series
	RP32856	1	39.15	NA	
	Commercial <i>Hardwire Converter with Battery Back-Up</i>				<ul style="list-style-type: none"> • Hardwire converter with battery back-up • For use with series: 590T, 591T, 600T, 860T, 1500T, 1600T, 3000T, 590-HDF, 81THWA, & 81TWMS series
	061047A	1	101.00	NA	
	Commercial <i>Hardwire Converter</i>				<ul style="list-style-type: none"> • Hardwire converter • Converts 24 VAC to 6.4 VDC
	060683A	1	43.65	NA	
	Commercial Accessories <i>4" Cover Plate for 600T Series</i>				<ul style="list-style-type: none"> • 4" centerset cover plate • For Proximity[®] Sensing Technology 600T series lavatory faucet • Reduces max. deck thickness to 1 1/8"
	062021A	1	18.70	Chrome	
	Commercial <i>4" Center Cover Plate</i>				<ul style="list-style-type: none"> • 4" center forged cover plate with locking pin • Anti-rotation (2 1/2" x 7") • For use with 590 HDF series
	RP30528	1	79.85	Chrome	
	Commercial <i>8" Center Cover Plate</i>				<ul style="list-style-type: none"> • 8" center forged cover plate with locking pin • Anti rotation (2 1/2" x 11") • For use with 590 HDF series
	RP34280	1	107.10	Chrome	



Model	Case	Price	Finish	Features
Commercial <i>Mechanical Mixer</i>				

R2910-MIXLF	24	65.00	NA
-------------	----	-------	----

- Mechanical mixer
- 2.0 gpm @ 60psi, 7.6 L/min @ 414 kPa



Commercial <i>Thermostatic Mixing Valve</i>				
---	--	--	--	--

R3070-MIXLF	24	134.95	NA
-------------	----	--------	----

- Thermostatic mixing valve
- IAPMO listed to ASSE 1070
- 3/8" compression inlets/outlets
- Check valves on inlets
- Minimum 0.35 gpm (1.3 L/min) flow rate
- Maximum flow of 5.8 gpm (22 L/min) @ 45 psi pressure loss



Commercial <i>Thermostatic Mixing Valve</i>				
---	--	--	--	--

R2570-MIXLF	1	166.55	NA
-------------	---	--------	----

- Thermostatic mixing valve
- IAPMO listed to ASSE 1069, ASSE 1070
- 1/2" copper sweat inlets/outlets
- Check valves on inlets
- Minimum 0.34 gpm (1.29 L/min) flow rate
- Maximum 11.0 gpm (42 L/min) flow rate



Model Case Price Finish Features



Commercial
Electronic Side Mount Flush Kit

DEFM-100 12 325.35 Chrome

- Electronic side mount flush kit for converting
- manual 81T Teck® flush valves and 86T metering urinals to electronic
- For Sloan®, Crane® and some Zurn® Models
- 3 year warranty
- Battery operated
- Batteries included



Commercial
Manual Water Closet Flush Valve w/ Electronic Flush Kit

81T201-DEFM 1 500.40 Chrome

- 81T201 manual water closet flush valve with DEFM-100 for conversion to electronic operation
- 1 1/2" top spud
- Battery operated
- Batteries included



Commercial
Manual Urinal Flush Valve w/ Electronic Flush Kit

81T231-DEFM 1 500.40 Chrome

- 81T231 manual urinal flush valve with DEFM-100 for conversion to electronic operation
- 3/4" top spud
- Battery operated
- Batteries included



Commercial
H₂Optics® Exposed Flush Valve

81T201BTA 3 546.15 Chrome
81T201BTA-6 3 546.15 Chrome

For complete 81T series product offering, see pages C120-C123

- Electronic exposed flush valve
- Hands-free operation
- H₂Optics® Technology
- For 1 1/2" top inlet water closet fixture
- Body mounted sensor
- Battery operated
- Batteries included
- 81T201BTA - 1.6 gpf, 6 L/f Factory set flush, field adjustable
- 81T201BTA-6 - 1.6 gpf, 6 L/f Factory set flush, NOT field adjustable



Model	Case	Price	Finish	Features
-------	------	-------	--------	----------



Commercial
H₂Optics[®] Exposed Flush Valve

81T201BTA-DF	3	546.15	Chrome
--------------	---	--------	--------

For complete 81T series product offering, see pages C120-C123

- Electronic exposed flush valve
- Hands-free activation
- H₂Optics[®] Technology
- For 1 1/2" top inlet water closet fixture
- Body mounted sensor
- DF models have dual flush settings factory set to ON, providing a 30% water reduced flush based on time and distance
- Battery operated
- Batteries included
- 1.6 gpf, 6 L/f Factory set flush, field adjustable



Commercial
H₂Optics[®] Exposed Flush Valve

81T201HWA	3	593.60	Chrome
81T201HWA-6	3	593.60	Chrome

- Electronic exposed flush valve
- Hands-free operation
- H₂Optics[®] Technology
- For 1 1/2" top inlet water closet fixture
- Body mounted sensor
- Hardwire
- Order transformer separately
- 81T201HWA - 1.6 gpf, 6 L/f Factory set flush, field adjustable
- 81T201HWA-6 - 1.6 gpf, 6 L/f Factory set flush, NOT field adjustable



Commercial
H₂Optics[®] Exposed Flush Valve

81T231BTA	3	546.15	Chrome
-----------	---	--------	--------

- Electronic exposed flush valve
- H₂Optics[®] Technology
- For 3/4" top inlet urinal fixture
- Body mounted sensor
- Battery operated
- Batteries included
- 0.5 gpf, 1.9 L/f Factory set flush, field adjustable



Commercial
H₂Optics[®] Exposed Flush Valve

81T231BTA-19	3	546.15	Chrome
--------------	---	--------	--------

- Electronic exposed flush valve
- H₂Optics[®] Technology
- For 3/4" top inlet urinal fixture
- Body mounted sensor
- Battery operated
- Batteries included
- 0.5 gpf, 1.9 L/f Factory set flush, NOT field adjustable



Please always order in full case.

= WaterSense[®] Labeled Product - Flow Rate of 1.5 gpm versus Industry Standard ASME.A112.18.1/CSA.B125.1 of 2.2 gpm.

= Water Efficient Product - Flow Rate of 1.5 gpm versus Industry Standard ASME.A112.18.1/CSA.B125.1 of 2.2 gpm.



Model Case Price Finish

Commercial
H₂Optics[®] Exposed Flush Valve

81T231HWA 3 593.60 Chrome

For complete 81T series product offering, see pages C120-C123

Features

- Electronic exposed flush valve
- Hands-free activation
- H₂Optics[®] Technology
- For 3/4" top inlet urinal fixture
- Body mounted sensor
- Hardwire
- Order transformer separately
- 0.5 gpf, 1.9 L/f Factory set flush, field adjustable



Commercial
H₂Optics[®] Exposed Flush Valve

81T231HWA-19 3 593.60 Chrome

- Electronic exposed flush valve
- Hands-free activation
- H₂Optics[®] Technology
- For 3/4" top inlet urinal fixture
- Body mounted sensor
- Hardwire
- Order transformer separately
- 0.5 gpf, 1.9 L/f Factory set flush, NOT field adjustable



Please always order in full case.

= WaterSense[®] Labeled Product - Flow Rate of 1.5 gpm versus Industry Standard ASME.A112.18.1/CSA.B125.1 of 2.2 gpm.

= Water Efficient Product - Flow Rate of 1.5 gpm versus Industry Standard ASME.A112.18.1/CSA.B125.1 of 2.2 gpm.

Model Case Price Finish Features



Commercial
H₂Optics[®] Exposed Flush Valve

81T201-WMSBT 1 739.00 Chrome

For complete 81T series product offering, see page C122

- Electronic exposed flush valve
- Hands-free activation
- H₂Optics[®] Technology
- For 1 1/2" top inlet water closet fixture
- Wall mount sensor
- Battery operated
- Batteries included
- 1.6 gpf, 6 L/f Factory set flush, field adjustable



Commercial
H₂Optics[®] Exposed Flush Valve

81T201-WMSHW 1 739.00 Chrome

- Electronic exposed flush valve
- Hands-free activation
- H₂Optics[®] Technology
- For 1 1/2" top inlet water closet fixture
- Wall mount sensor
- Hardwire
- Order transformer separately
- 1.6 gpf, 6 L/f Factory set flush, field adjustable



Commercial
H₂Optics[®] Exposed Flush Valve

81T231-WMSBT 1 739.00 Chrome

- Electronic exposed flush valve
- Hands-free activation
- H₂Optics[®] Technology
- For 3/4" top inlet urinal fixture
- Wall mount sensor
- Battery operated
- Batteries included
- 0.5 gpf, 1.9 L/f Factory set flush, field adjustable



Commercial
H₂Optics[®] Exposed Flush Valve

81T231-WMSHW 1 739.00 Chrome

- Electronic exposed flush valve
- Hands-free activation
- H₂Optics[®] Technology
- For 3/4" top inlet urinal fixture
- Wall mount sensor
- Hardwire
- Order transformer separately
- 0.5 gpf, 1.9 L/f Factory set flush, field adjustable



NEW!



Model Case Price Finish

Commercial
Electronic Concealed Flush Valve Rough

1600T6102RI-IP 1 488.75 NA

For complete 1600T series product offering, see pages C124-C126

Features

- Electronic concealed flush valve rough-in
- Requires separate order of 1600T6102TR-LS trim for complete product
- Supplied as complete flush valve and wall access frame
- For 1 1/2" back inlet wall hung water closet fixture
- 1 1/2" MIP outlet tube supplied
- 1.6 gpf, 6 L/f Factory set flush, field adjustable

NEW!



Commercial
Electronic Concealed Flush Valve Trim

1600T6102TR-LS 1 488.75 Stainless

- Electronic concealed flush valve trim
- Requires separate order of 1600T6102RI-IP rough for complete product
- Supplied as push-button, hardwire converter, solenoid & 14" x 20" stainless steel cover
- Push-button activation
- For 1 1/2" back inlet wall hung water closet fixture
- Hardwire
- Order transformer separately



Commercial
H₂Optics[®] Concealed Flush Valve Rough

1600T6103RI 1 482.80 NA

- Electronic concealed flush valve rough-in
- Requires separate order of 1600T6103TR trim for complete product
- Supplied as complete flush valve and wall access frame
- Hands-free activation
- H₂Optics[®] Technology
- For 1 1/2" back inlet wall hung water closet fixture
- 1.6 gpf, 6 L/f Factory set flush, field adjustable



Commercial
H₂Optics[®] Concealed Flush Valve Trim

1600T6103TR 1 482.80 Stainless

- Electronic concealed flush valve trim
- Requires separate order of 1600T6103RI rough for complete product
- Supplied as sensor, hardwire converter, solenoid & 14" stainless steel cover
- Hands-free activation
- H₂Optics[®] Technology
- For 1 1/2" back inlet wall hung water closet fixture
- Hardwire
- Order transformer separately

Model Case Price Finish Features



Commercial
H₂Optics[®] Concealed Flush Valve Rough

1601T6103RI 1 482.80 NA

For complete 1600T series product offering, see pages C124-C126

- Electronic concealed flush valve rough-in
- Requires separate order of 1601T6103TR trim for complete model
- Supplied as complete flush valve and wall access frame
- Hands-free activation
- H₂Optics[®] Technology
- For 1 1/2" back inlet wall hung water closet fixture
- 1.6 gpf, 6 L/f Factory set flush, field adjustable



Commercial
H₂Optics[®] Concealed Flush Valve Trim

1601T6103TR 1 482.80 Stainless

- Electronic concealed flush valve trim
- Supplied as sensor, solenoid, batteries & 14" stainless steel cover
- Requires separate order of 1601T6103RI rough for complete model
- Hands-free activation
- H₂Optics[®] Technology
- For 1 1/2" back inlet wall hung water closet fixture
- Battery operated
- Batteries included



Commercial
H₂Optics[®] Concealed Valve Rough for Washdown Urinals

1600T9001RI 1 381.45 NA

- Electronic concealed flush valve rough-in for washdown urinals
- Requires separate order of 1600T9001TR trim for complete product
- Supplied as wall box, stop & outlet hose
- Hands-free activation
- H₂Optics[®] Technology
- For 3/4" back inlet
- Field adjustable flow rate
- 0.5 gpf, 1.9 L/f Factory set flush, field adjustable



Commercial
H₂Optics[®] Concealed Valve Trim for Washdown Urinals

1600T9001TR 3 381.45 Stainless

- Electronic concealed flush trim rough-in for washdown urinals
- Requires separate order of 1600T9001RI rough for complete product
- Supplied as sensor, hardwire converter, solenoid & 10" stainless steel cover
- Hands-free activation
- H₂Optics[®] Technology
- For 3/4" back inlet
- Hardwire
- Order transformer separately



Please always order in full case.

Transformers, mixing valves, cover plates and hardwire converters available beginning on page C37.

= Flush valves at 0.5 gpf to 1.27 gpf versus Industry Standard of ASME.A112.2.

Model Case Price Finish Features



Commercial
H₂Optics[®] Concealed Valve Rough for Washdown Urinals

1601T9001RI 1 381.45 NA

For complete 1600T series product offering, see pages C124-C126

- Electronic concealed flush valve rough-in for washdown urinals
- Requires separate order of 1601T9001TR trim for complete product
- Supplied as wall box, step & outlet hose
- Hands-free activation
- H₂Optics[®] Technology
- For 3/4" back inlet
- Field adjustable flow rate
- 0.5 gpf, 1.9 L/f Factory set flush, field adjustable



Commercial
H₂Optics[®] Concealed Valve Trim for Washdown Urinals

1601T9001TR 3 381.45 Stainless

- Electronic concealed flush trim rough-in for washdown urinals
- Requires separate order of 1601T9001RI rough for complete product
- Supplied as sensor, solenoid, batteries & 10" stainless steel cover
- Hands-free activation
- H₂Optics[®] Technology
- For 3/4" back inlet
- Battery operated
- Batteries included



Please always order in full case.

Transformers, mixing valves, cover plates and hardwire converters available beginning on page C37.

= Flush valves at 0.5 gpf to 1.27 gpf versus Industry Standard of ASME.A112.2.



Model Case Price Finish

Commercial
Electronic Washdown Urinal Valve

DEMD-86505 1 453.95 Chrome

Installation Warning: Model shown above must be installed on a fixture providing sufficient air gap protection against backflow

Features

- Electronic washdown urinal valve less vacuum breaker
- Hands-free activation
- Battery operated
- Batteries included
- 0.5 gpf, 1.9 L/f Factory set flush, field adjustable



Commercial
Electronic Washdown Urinal Valve

DEMD-86515 1 479.80 Chrome

- Electronic washdown urinal valve with vacuum breaker
- Hands-free activation
- Battery operated
- Batteries included
- 0.5 gpf, 1.9 L/f Factory set flush, field adjustable



Commercial
Electronic Washdown Urinal Valve

DEMD-86405 1 428.10 Chrome

Installation Warning: Model shown above must be installed on a fixture providing sufficient air gap protection against backflow

- Retrofit electronic washdown urinal valve less vacuum breaker
- Hands-free activation
- Replaces 86T505 manual valve
- Retrofits to stop for 86T505 less vacuum breaker
- Battery operated
- Batteries included
- 0.5 gpf, 1.9 L/f Factory set flush, field adjustable



Commercial
Electronic Washdown Urinal Valve

DEMD-86415 1 453.95 Chrome

- Retrofit electronic washdown urinal valve with vacuum breaker
- Hands-free activation
- Replaces 86T505 manual valve and 86T610 VB outlet
- Retrofits to stop for 86T505 with vacuum breaker
- Battery operated
- Batteries included
- 0.5 gpf, 1.9 L/f Factory set flush, field adjustable



Please always order in full case.

= Flush valves at 0.5 gpf to 1.27 gpf versus Industry Standard of ASME.A112.2.



Model	Case	Price	Finish
-------	------	-------	--------

Commercial
Washdown Urinal Valve

86T505	1	151.75	Chrome
--------	---	--------	--------

Installation Warning: Model shown above must be installed on a fixture providing sufficient air gap protection against backflow
For complete 86T5 series product offering, see page C117

Features

- Cast urinal valve
- For washdown urinal only
- 1/2" back inlet stop
- Vandal resistant handle
- Metering, slow-close lever style
- For 3/4" IP spud
- 0.5 gpf, 1.9 L/f Factory set flush, field adjustable



Commercial
Bedpan Washer Water Closet Flushometer

81TBP000	1	609.00	Chrome
----------	---	--------	--------

For additional bedpan cleanser models, see pages C112-C113

- Bedpan washer water closet flushometer
- With bedpan washer diverter assembly
- 34.38" height from inlet c/l to top of fixture
- For floor mounted or wall mounted top spud bowls
- External water conserving flush volume adjustment
- 1.6 gpm @ 60psi, 6.8 L/min @ 414kPa
Factory set flush, field adjustable

Please always order in full case.

= Flush valves at 0.5 gpf versus Industry Standard of ASME.A112.2.



Commercial
Bedpan Washer Water Closet Flushometer

81TBP100 1 609.00 Chrome

For additional bedpan cleanser models, see pages C112-C113

- Bedpan washer water closet flushometer
- Meets ADA height requirements
- With bedpan washer diverter assembly
- 26.5" height from inlet c/l to top of fixture
- For floor mounted or wall mounted top spud bowls
- External water conserving flush volume adjustment
- 1.6 gpm @ 60psi, 6.8 L/min @ 414kPa
Factory set flush, field adjustable



Commercial
Bedpan Washer Water Closet Flushometer

81TBP150 1 654.00 Chrome

- Bedpan washer water closet flushometer
- Meets ADA height requirements
- With bedpan washer diverter assembly
- 26.5" height from inlet c/l to top of fixture
- For installation where clearance is required around grab bars
- For floor mounted or wall mounted top spud bowls
- External water conserving flush volume adjustment
- 1.6 gpm @ 60psi, 6.8 L/min @ 414kPa
Factory set flush, field adjustable

Please always order in full case.

= Flush valves at 0.5 gpf to 1.27 gpf versus Industry Standard of ASME.A112.2.

How To Order A Complete MultiChoice[®] 13, 14 & 17 Series Tub/Shower Faucet

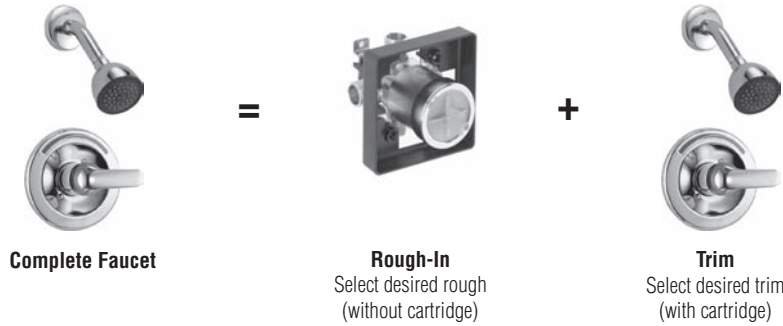

Model	Case	Price	Finish	Features
-------	------	-------	--------	----------



MultiChoice[®] Universal Tub/Shower Rough-In Universal Inlets/Outlets

R10000-UN	12•	47.75	NA
R10000-UNBX	3	47.75	NA
R10000-UNBXT	3	51.25	NA
R10000-UNWS	12	66.95	NA
R10000-UNWSBXT	3	70.45	NA

- Valve body only
- Accepts single-function (13/14), dual-function (17), or dual-function thermostatic (17T) cartridge
- Cartridge ships with trim kit
- 1/2" universal inlets accept 1/2" copper, 1/2" iron pipe, PEX or CPVC adapters
- 1/2" universal outlets, inlets/outlets have male threads
- Back-to-back capability
- BX=single box model
- BXT=single box model, thin wall mounting kit included
- WS=with stops, single box model



MultiChoice[®] Universal High-Flow Shower Rough-In Universal Inlets/Outlets

R10000-UNBXHF	3	47.75	NA
R10000-UNWSHF	12	66.95	NA

- Valve body only
- Shower only
- No tub outlet
- Accepts single-function (13/14), dual-function (17), or dual-function thermostatic (17T) cartridge
- Cartridge ships with trim kit
- 1/2" universal inlets accept 1/2" copper, 1/2" iron pipe, PEX or CPVC adapters
- 1/2" universal outlets, inlets/outlets have male threads
- Back-to-back capability
- BX=single box model
- HF=high flow
- WS=with stops, single box model



MultiChoice[®] Universal Tub/Shower Rough-In IPS Inlets/Outlets

R10000-IP	12•	47.75	NA
R10000-IPWS	12	66.95	NA

- Valve body only
- Accepts single-function (13/14), dual-function (17), or dual-function thermostatic (17T) cartridge
- Cartridge ships with trim kit
- 1/2" female IPS inlets/outlets to accept PEX or CPVC adapters
- Back-to-back capability
- WS=with stops, single box model

• Full case quantity restriction on this model - priced each. Please always order in full case.
Valve rated at minimum 1.25 gpm (4.7 L/min) for 13/14 series pressure balance; 1.5 gpm (5.7 L/min) for 17 series pressure balance; 2.0 gpm (7.6 L/min) for thermostatic at 45 psi (310 kPa). ASSE.1016/ASME.A112.1016/CSA.B125.16

Model Case Price Finish Features



**MultiChoice® Universal Shower Rough
PEX Crimp**

R10000-PX	12	47.75	NA
R10000-PXWS	12	66.95	NA

This valve is designed with an insert fitting that complies with ASTM F1807 and CSA B137.5 and is suitable for use with SDR9 PEX tubing using the crimp ring system of joining. It cannot be used as a cold expansion fitting using a PEX reinforcing ring and PEX tubing.

- Valve body only
- Accepts single-function (13/14), dual-function (17), or dual-function thermostatic (17T) cartridge
- Cartridge ships with trim kit
- 1/2" PEX crimp connections and 1/2" universal outlets with male threads
- Back-to-back capability
- WS=with stops, single box model



**MultiChoice® Universal Shower Rough
PEX Cold Expansion**

R10000-MF	12	47.75	NA
R10000-MFWS	12	66.95	NA

This valve is designed with an insert fitting that complies with ASTM F1960 and is suitable for use with PEX tubing using the cold expansion method of joining. It cannot be used with the crimp ring system of joining.

- Valve body only
- Accepts single-function (13/14), dual-function (17), or dual-function thermostatic (17T) cartridge
- Cartridge ships with trim kit
- 1/2" PEX cold expansion connections and 1/2" universal outlets with male threads
- Back-to-back capability
- MF=PEX cold expansion connections
- WS=with stops, single box model

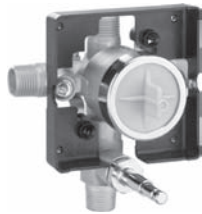

**MultiChoice® Universal Shower Rough
Push-Button Diverter**

R10300-UNWS	1	153.70	NA
-------------	---	--------	----

- Valve body only for push button diverter
- Accepts single function (13/14)
- Cartridge ships with trim kit
- 1/2" universal inlets to accept
- 1/2" copper, 1/2" iron pipe, PEX or CPVC adapters
- 1/2" universal outlets, inlets/outlets have male threads
- Back-to-back capability
- WS = with stops
- Rough-in for push button diverter









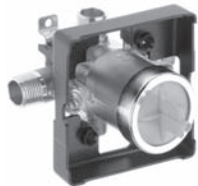











**MultiChoice® Universal Shower Rough
In-Wall Diverter Valve**

R10700-UNWS	6	114.50	NA
-------------	---	--------	----

- For use with MultiChoice® Universal T13H and T17TH Series with diverter valve for dual showers
- Handle and flange ships with trim



• Full case quantity restriction on this model - priced each. Please always order in full case.
Valve rated at minimum 1.25 gpm (4.7 L/min) for 13/14 series pressure balance; 1.5 gpm (5.7 L/min) for 17 series pressure balance; 2.0 gpm (7.6 L/min) for thermostatic at 45 psi (310 kPa). ASSE.1016/ASME.A112.1016/CSA.B125.16

	Model	Case	Price	Finish	Features
NEW!    	Vero™ FP Focus Product <i>Monitor[®] 14 Series Shower Trim - Less Head</i>				<ul style="list-style-type: none"> • Single-function pressure balance cartridge • Order MultiChoice[®] Universal rough separately • LHD = Less showerhead model • Metal lever handle • Handle adjusts temperature • Red/blue pad print escutcheon
	T14253-LHD	6	181.75	Chrome	
NEW!     	Vero™ FP Focus Product <i>Monitor[®] 14 Series Tub & Shower Trim - Less Head</i>				<ul style="list-style-type: none"> • Single-function pressure balance cartridge • Order MultiChoice[®] Universal rough separately • LHD = Less showerhead model • Metal lever handle • Handle adjusts temperature • Red/blue pad print escutcheon • 7 1/8" pull-up tub spout • Sweat onto 1/2" C.W.T. or thread onto 1/2" IPS
	T14453-LHD	6	240.95	Chrome	
NEW!    	Dryden™ FP Focus Product <i>Monitor[®] 14 Series Shower Trim - Less Head</i>				<ul style="list-style-type: none"> • Single-function pressure balance cartridge • Order MultiChoice[®] Universal rough separately • LHD = Less showerhead model • Metal lever handle • Handle adjusts temperature • Red/blue pad print escutcheon
	T14251-LHD	6	151.45	Chrome	
NEW!     	Dryden™ FP Focus Product <i>Monitor[®] 14 Series Tub & Shower Trim - Less Head</i>				<ul style="list-style-type: none"> • Single-function pressure balance cartridge • Order MultiChoice[®] Universal rough separately • LHD = Less showerhead model • Metal lever handle • Handle adjusts temperature • Red/blue pad print escutcheon • 7 1/2" pull-up tub spout • Sweat onto 1/2" C.W.T. or thread onto 1/2" IPS
	T14451-LHD	6	186.00	Chrome	

Please always order in full case.

Valve rated at minimum 1.25 gpm (4.7 L/min) for 14 series pressure balance; 1.5 gpm (5.7 L/min) for 17 series pressure balance; 2.0 gpm (7.6 L/min) for thermostatic at 45 psi (310 kPa). ASSE.1016/ASME.A112.1016/CSA.B125.16

NEW!



Cassidy™ FP Focus Product
Monitor® 14 Series Shower Trim - Less Head

Model	Case	Price	Finish
T14297-LHP-LHD	6	135.00	Chrome
T14297-SSLHP-LHD	6	187.50	Brilliance® Stainless

- Single-function pressure balance cartridge
- Order MultiChoice® Universal rough separately
- LHD = Less showerhead model
- Order handles separately (LHP)
- Handle adjusts temperature
- Red/blue pad print escutcheon

NEW!



Cassidy™ FP Focus Product
Monitor® 14 Series Tub & Shower Trim - Less Head

Model	Case	Price	Finish
T14497-LHP-LHD	6	169.00	Chrome
T14497-SSLHP-LHD	6	234.75	Brilliance® Stainless

- Single-function pressure balance cartridge
- Order MultiChoice® Universal rough separately
- LHD = Less showerhead model
- Order handles separately (LHP)
- Handle adjusts temperature
- Red/blue pad print escutcheon
- 7 2/3" pull-up tub spout
- Sweat onto 1/2" C.W.T. or thread onto 1/2" IPS

Recommended Cassidy™ Bath Collection Handles.



Handle Part #	Case	List Price
H795	6	49.10
H795SS	6	64.50



- Metal cross handle(s)
- Sold as single handle
- For 13/14 Series shower applications



Handle Part #	Case	List Price
H797	6	41.80
H797SS	6	58.60



- Metal lever handle(s)
- Sold as single handle
- For 13/14 Series shower applications



Handle Part #	Case	List Price
H798	6	42.85
H798SS	6	60.05



- Metal lever handle(s)
- Sold as single handle
- For 13/14 Series shower applications

Please always order in full case.

Valve rated at minimum 1.25 gpm (4.7 L/min) for 14 series pressure balance; 1.5 gpm (5.7 L/min) for 17 series pressure balance; 2.0 gpm (7.6 L/min) for thermostatic at 45 psi (310 kPa). ASSE.1016/ASME.A112.1016/CSA.B125.16

NEW!



Model Case Price Finish

Addison[™] FP Focus Product
Monitor[®] 14 Series Shower Trim - Less Head

T14292-LHD 6 136.60 Chrome

Features

- Single-function pressure balance cartridge
- Order MultiChoice[®] Universal rough separately
- LHD = Less showerhead model
- Metal lever handle
- Handle adjusts temperature
- Red/blue pad print escutcheon

NEW!



Addison[™] FP Focus Product
Monitor[®] 14 Series Tub & Shower Trim - Less Head

T14492-LHD 6 156.00 Chrome

- Single-function pressure balance cartridge
- Order MultiChoice[®] Universal rough separately
- LHD = Less showerhead model
- Metal lever handle
- Handle adjusts temperature
- Red/blue pad print escutcheon
- 7 1/2" pull-up tub spout
- Sweat onto 1/2" C.W.T. or thread onto 1/2" IPS



Ara[™] FP Focus Product
Monitor[®] 14 Series Shower Trim

T14267-LHD 6 151.50 Chrome
 T14267-SSLHD 6 232.30 Brilliance[®] Stainless

- Single-function pressure balance cartridge
- Order MultiChoice[®] Universal rough separately
- LHD = Less showerhead model
- Metal lever handle
- Handle adjusts temperature
- Red/blue pad print escutcheon



Ara[™] FP Focus Product
Monitor[®] 14 Series Tub & Shower Trim

T14467-LHD 6 181.80 Chrome
 T14467-SSLHD 6 274.75 Brilliance[®] Stainless

- Single-function pressure balance cartridge
- Order MultiChoice[®] Universal rough separately
- LHD = Less showerhead model
- Metal lever handle
- Handle adjusts temperature
- Red/blue pad print escutcheon
- 9" pull-up tub spout
- Sweat onto 1/2" C.W.T. or thread onto 1/2" IPS

Please always order in full case.

Valve rated at minimum 1.25 gpm (4.7 L/min) for 14 series pressure balance; 1.5 gpm (5.7 L/min) for 17 series pressure balance; 2.0 gpm (7.6 L/min) for thermostatic at 45 psi (310 kPa). ASSE.1016/ASME.A112.1016/CSA.B125.16

= WaterSense[®] Labeled Product - Flow Rate of 1.5 or 2.0 gpm versus Industry Standard ASME.A112.18.1/CSA.B125.1 of 2.5 gpm

= Water Efficient Product - Flow Rate of 1.5 or 2.0 gpm versus Industry Standard of ASME.A112.18.1/CSA.B125.1 of 2.5 gpm

Model	Case	Price	Finish	Features
-------	------	-------	--------	----------



Compel® FP Focus Product
Monitor® 14 Series Shower Trim - Less Head

T14261-LHD	6	133.35	Chrome
T14261-SSLHD	6	186.70	Brilliance® Stainless

- Single-function pressure balance cartridge
- Order MultiChoice® Universal rough separately
- LHD = Less showerhead model
- Metal lever handle
- Handle adjusts temperature
- Red/blue pad print escutcheon



Compel® FP Focus Product
Monitor® 14 Series Tub & Shower Trim - Less Head

T14461-LHD	6	153.60	Chrome
T14461-SSLHD	6	215.05	Brilliance® Stainless

- Single-function pressure balance cartridge
- Order MultiChoice® Universal rough separately
- LHD = Less showerhead model
- Metal lever handle
- Handle adjusts temperature
- Red/blue pad print escutcheon
- 7" pull-up tub spout
- Sweat onto 1/2" C.W.T. or thread onto 1/2" IPS



Trinsic™ FP Focus Product
Monitor® 14 Series Shower Trim - Less Head

T14259-LHD	6	112.50	Chrome
T14259-SSLHD	6	157.50	Brilliance® Stainless

- Single-function pressure balance cartridge
- Order MultiChoice® Universal rough separately
- LHD = Less showerhead model
- Metal lever handle
- Handle adjusts temperature
- Red/blue pad print escutcheon



Trinsic™ FP Focus Product
Monitor® 14 Series Tub & Shower Trim - Less Head

T14459-LHD	6	131.90	Chrome
T14459-SSLHD	6	184.70	Brilliance® Stainless

- Single-function pressure balance cartridge
- Order MultiChoice® Universal rough separately
- LHD = Less showerhead model
- Metal lever handle
- Handle adjusts temperature
- Red/blue pad print escutcheon
- 6 1/8" pull-up tub spout
- Slip-on spout for 1/2" C.W.T.



Please always order in full case.

Valve rated at minimum 1.25 gpm (4.7 L/min) for 14 series pressure balance; 1.5 gpm (5.7 L/min) for 17 series pressure balance; 2.0 gpm (7.6 L/min) for thermostatic at 45 psi (310 kPa). ASSE.1016/ASME.A112.1016/CSA.B125.16

NEW!



Model	Case	Price	Finish	Features
Lahara[®]				
Monitor[®] 14 Series Shower Trim - Less Head				

T14238-LHD	6	105.00	Chrome	
T14238-SSLHD	6	154.00	Brilliance [®] Stainless	

- Single-function pressure balance cartridge
- Order MultiChoice[®] Universal rough separately
- LHD = Less showerhead model
- Metal lever handle
- Handle adjusts temperature
- Red/blue pad print escutcheon

NEW!



Lahara[®]				
Monitor[®] 14 Series Tub & Shower Trim - Less Head				

T14438-LHD	6	133.60	Chrome	
T14438-SSLHD	6	186.00	Brilliance [®] Stainless	

- Single-function pressure balance cartridge
- Order MultiChoice[®] Universal rough separately
- LHD = Less showerhead model
- Metal lever handle
- Handle adjusts temperature
- Red/blue pad print escutcheon
- 6 3/4" pull-up tub spout
- Sweat onto 1/2" C.W.T. or thread onto 1/2" IPS

NEW!



Linden[™]				
Monitor[®] 14 Series Shower Trim - Less Head				

T14294-LHD	6	102.00	Chrome	
------------	---	--------	--------	--

- Single-function pressure balance cartridge
- Order MultiChoice[®] Universal rough separately
- LHD = Less showerhead model
- Metal lever handle
- Handle adjusts temperature
- Red/blue pad print escutcheon

NEW!



Linden[™]				
Monitor[®] 14 Series Tub & Shower Trim - Less Head				

T14494-LHD	6	134.50	Chrome	
------------	---	--------	--------	--

- Single-function pressure balance cartridge
- Order MultiChoice[®] Universal rough separately
- LHD = Less showerhead model
- Metal lever handle
- Handle adjusts temperature
- Red/blue pad print escutcheon
- 6 1/2" pull-up tub spout
- Sweat onto 1/2" C.W.T. or thread onto 1/2" IPS

Please always order in full case.

Valve rated at minimum 1.25 gpm (4.7 L/min) for 14 series pressure balance; 1.5 gpm (5.7 L/min) for 17 series pressure balance; 2.0 gpm (7.6 L/min) for thermostatic at 45 psi (310 kPa). ASSE.1016/ASME.A112.1016/CSA.B125.16

Model Case Price Finish Features



Commercial
Monitor® 13 Series Valve Only Trim

T13090 12 74.35 Chrome

- Single-function pressure balance cartridge
- Order MultiChoice® Universal rough-in separately
- Vandal resistant blade handle
- Handle adjusts temperature
- Red/blue label on escutcheon



Commercial
Monitor® 13 Series Shower Trim

T13290 12 89.70 Chrome

- Single-function pressure balance cartridge
- Order MultiChoice® Universal rough-in separately
- Vandal resistant blade handle
- Handle adjusts temperature
- Red/blue label on escutcheon
- Touch-Clean® full body showerhead
- 2.0 gpm @ 80 psi, 7.6 L/min @ 550 kPa maximum water usage



Commercial
Monitor® 13 Series Tub & Shower Trim

T13490 12 112.00 Chrome

- Single-function pressure balance cartridge
- Order MultiChoice® Universal rough-in separately
- Vandal resistant blade handle
- Handle adjusts temperature
- Red/blue label on escutcheon
- Touch-Clean® full body showerhead
- 5 1/2" long pull-up diverter spout
- Sweat onto 1/2" C.W.T. or thread onto 1/2" IPS
- 2.0 gpm @ 80 psi, 7.6 L/min @ 550 kPa maximum water usage



Commercial
Monitor® 13 Series Valve Only Trim

T13091 12 74.35 Chrome

- Single-function pressure balance cartridge
- Order MultiChoice® Universal rough-in separately
- Metal lever handle(s)
- Handle adjusts temperature
- Red/blue label on escutcheon



Commercial
Monitor® 13 Series Shower Trim

T13291 12 89.70 Chrome

- Single-function pressure balance cartridge
- Order MultiChoice® Universal rough-in separately
- Metal lever handle(s)
- Handle adjusts temperature
- Red/blue label on escutcheon
- Touch-Clean® full body showerhead
- 2.0 gpm @ 80 psi, 7.6 L/min @ 550 kPa maximum water usage



Please always order in full case. Valve rated at minimum 1.25 gpm (4.7 L/min) for 13/14 series pressure balance;

1.5 gpm (5.7 L/min) for 17 series pressure balance; 2.0 gpm (7.6 L/min) for thermostatic at 45 psi (310 kPa). ASSE.1016/ASME.A112.1016/CSA.B125.16

= WaterSense® Labeled Product - Flow Rate of 1.5 or 2.0 gpm versus Industry Standard ASME.A112.18.1/CSA.B125.1 of 2.5 gpm

= Water Efficient Product - Flow Rate of 1.5 or 2.0 gpm versus Industry Standard of ASME.A112.18.1/CSA.B125.1 of 2.5 gpm

Model	Case	Price	Finish	Features
-------	------	-------	--------	----------



Classic
Monitor® 13 Series Shower Trim - Less Head

T13291-LHD	12	77.35	Chrome
T13291-SSLHD	12	108.15	Brilliance® Stainless

- Single-function pressure balance cartridge
- Order MultiChoice® Universal rough separately
- LHD = Less showerhead model
- Metal lever handle
- Handle adjusts temperature
- Red/blue pad print escutcheon



Classic
Monitor® 13 Series Shower Trim - Less Head

T13291-SLHD	12	77.20	Chrome
-------------	----	-------	--------

- Single-function pressure balance cartridge
- Order MultiChoice® Universal rough separately
- LHD = Less showerhead
- Metal lever handle(s)
- Handle adjusts temperature
- Red/blue pad print escutcheon



Classic
Monitor® 13 Series Tub & Shower Trim - Less Head

T13491-SLHD	12	99.30	Chrome
-------------	----	-------	--------

- Single-function pressure balance cartridge
- Order MultiChoice® Universal rough separately
- LHD = Less showerhead
- Metal lever handle(s)
- Handle adjusts temperature
- 5 1/2" pull-up tub spout
- Sweat onto 1/2" C.W.T. or thread onto 1/2" IPS
- Red/blue pad print escutcheon



Please always order in full case.

Valve rated at minimum 1.25 gpm (4.7 L/min) for 13/14 series pressure balance; 1.5 gpm (5.7 L/min) for 17 series pressure balance; 2.0 gpm (7.6 L/min) for thermostatic at 45 psi (310 kPa). ASSE.1016/ASME.A112.1016/CSA.B125.16



= WaterSense® Labeled Product - Flow Rate of 1.5 or 2.0 gpm versus Industry Standard ASME.A112.18.1/CSA.B125.1 of 2.5 gpm



= Water Efficient Product - Flow Rate of 1.5 or 2.0 gpm versus Industry Standard of ASME.A112.18.1/CSA.B125.1 of 2.5 gpm

Model Case Price Finish Features



Commercial
Monitor® 13 Series Tub & Shower Trim

T13491	12	112.00	Chrome
T13491-BRC	12	182.10	Brushed Chrome

- Single-function pressure balance cartridge
- Order MultiChoice® Universal rough-in separately
- Metal lever handle(s)
- Handle adjusts temperature
- Red/blue label on escutcheon
- Touch-Clean® full body showerhead
- 5 1/2" pull-up tub spout
- Sweat onto 1/2" C.W.T. or thread onto 1/2" IPS
- 2.0 gpm @ 80 psi, 7.6 L/min @ 550 kPa maximum water usage



Commercial
Monitor® 13 Series Tub & Shower Trim - Less Head

T13491-LHD	12	100.20	Chrome
T13491-SSLHD	12	135.90	Brilliance® Stainless

- Single-function pressure balance cartridge
- Order MultiChoice® Universal rough-in separately
- LHD = Less showerhead
- Metal lever handle(s)
- Handle adjusts temperature
- 5 1/2" pull-up tub spout
- Sweat onto 1/2" C.W.T. or thread onto 1/2" IPS
- Red/blue pad print escutcheon



Please always order in full case. Valve rated at minimum 1.25 gpm (4.7 L/min) for 13/14 series pressure balance; 1.5 gpm (5.7 L/min) for 17 series pressure balance; 2.0 gpm (7.6 L/min) for thermostatic at 45 psi (310 kPa). ASSE.1016/ASME.A112.1016/CSA.B125.16

= WaterSense® Labeled Product - Flow Rate of 1.5 or 2.0 gpm versus Industry Standard ASME.A112.18.1/CSA.B125.1 of 2.5 gpm

= Water Efficient Product - Flow Rate of 1.5 or 2.0 gpm versus Industry Standard of ASME.A112.18.1/CSA.B125.1 of 2.5 gpm

Model Case Price Finish Features



Commercial
Monitor® 13 Series Valve Only Trim

T13391 12 74.35 Chrome

- Single-function pressure balance cartridge
- Order MultiChoice® Universal push button rough-in separately
- Metal lever handle(s)
- Handle adjusts temperature
- Red/blue pad print escutcheon
- Push-button diverter



Commercial
Monitor® 13 Series Tub & Shower Trim

T13691 12 112.00 Chrome

- Single-function pressure balance cartridge
- Order MultiChoice® Universal push-button rough-in separately
- Metal lever handle(s)
- Handle adjusts temperature
- Red/blue pad print escutcheon
- Push-button diverter
- Touch-Clean® full body showerhead
- Metal tub filler
- Thread onto 1/2" IPS
- 2.0 gpm @ 80 psi, 7.6 L/min @ 550 kPa maximum water usage



Classic
Monitor® 13 Series Tub & Shower Trim

T13691-SOS-15 12 140.00 Chrome

- Single-function pressure balance cartridge
- Order MultiChoice® Universal rough separately
- Metal lever handle(s)
- Handle adjusts temperature
- Red/blue pad print escutcheon
- Push-button diverter
- Touch-Clean® full body showerhead
- Metal tub filler
- Slip onto 1/2" C.W.T
- Removable threaded adapter for 1/2" IPS
- 1.5 gpm @ 80 psi, 5.7 L/min @ 550 kPa maximum water usage



Please always order in full case.

Valve rated at minimum 1.25 gpm (4.7 L/min) for 13/14 series pressure balance; 1.5 gpm (5.7 L/min) for 17 series pressure balance; 2.0 gpm (7.6 L/min) for thermostatic at 45 psi (310 kPa). ASSE.1016/ASME.A112.1016/CSA.B125.16

= WaterSense® Labeled Product - Flow Rate of 1.5 or 2.0 gpm versus Industry Standard ASME.A112.18.1/CSA.B125.1 of 2.5 gpm

= Water Efficient Product - Flow Rate of 1.5 or 2.0 gpm versus Industry Standard of ASME.A112.18.1/CSA.B125.1 of 2.5 gpm

Model	Case	Price	Finish	Features
-------	------	-------	--------	----------



Commercial
13 Series Shower Trim

T13H132 6 104.65 Chrome

For complete T13H series product offering, see pages C91-C92

- Single function pressure balance cartridge
- Order MultiChoice® Universal rough-in separately
- Vandal resistant lever handle
- Red/blue non-removable marking on escutcheon
- Handle adjusts temperature
- Touch-Clean® full body showerhead
- 1.5 gpm @ 80 psi, 5.7 L/min @ 550 kPa maximum water usage



Commercial
13 Series Tub & Shower Trim

T13H232 6 124.55 Chrome

- Single function pressure balance cartridge
- Order MultiChoice® Universal rough-in separately
- Vandal resistant lever handle
- Red/blue non-removable marking on escutcheon
- Handle adjusts temperature
- Pull-up metal diverter spout
- Touch-Clean® full body showerhead
- 1.5 gpm @ 80 psi, 5.7 L/min @ 550 kPa maximum water usage



Commercial
13 Series Shower Trim

T13H152 1 274.00 Chrome

- Single function pressure balance cartridge
- Order MultiChoice® Universal rough-in separately
- Vandal resistant lever handle
- Red/blue non-removable marking on escutcheon
- Handle adjusts temperature
- 24" stainless steel bar
- 70" vinyl hose
- ADA adjustable slide
- Touch-Clean® two-setting handshower
- 1.5 gpm @ 80 psi, 5.7 L/min @ 550 kPa maximum water usage
- Pause, Full Body Spray



Commercial
13 Series Shower Trim

T13H163 6 232.90 Chrome

- Single function pressure balance cartridge
- Order MultiChoice® Universal rough-in separately
- Vandal resistant lever handle
- Red/blue non-removable marking on escutcheon
- Handle adjusts temperature
- 30° Vandal resistant cast showerhead
- 1.5 gpm @ 80 psi, 5.7 L/min @ 550 kPa maximum water usage



Please always order in full case.

Valve rated at minimum 1.25 gpm (4.7 L/min) for 13/14 series pressure balance; 1.5 gpm (5.7 L/min) for 17 series pressure balance; 2.0 gpm (7.6 L/min) for thermostatic at 45 psi (310 kPa). ASSE.1016/ASME.A112.1016/CSA.B125.166

= WaterSense® Labeled Product - Flow Rate of 1.5 or 2.0 gpm versus Industry Standard ASME.A112.18.1/CSA.B125.1 of 2.5 gpm

= Water Efficient Product - Flow Rate of 1.5 or 2.0 gpm versus Industry Standard of ASME.A112.18.1/CSA.B125.1 of 2.5 gpm

Model Case Price Finish Features



**Commercial
13 Series Shower Trim**

T13H153 1 274.00 Chrome

For complete T13H series product offering, see pages C91-C92

- Single function pressure balance cartridge
- Order MultiChoice® Universal rough-in separately
- Vandal resistant blade handle
- Red/blue non-removable marking on escutcheon
- Handle adjusts temperature
- 24" stainless steel bar
- 70" vinyl hose
- ADA adjustable slide
- Touch-Clean® two-setting handshower
- 1.5 gpm @ 80 psi, 5.7 L/min @ 550 kPa maximum water usage
- Pause, Full Body Spray



**Commercial
13 Series Tub & Shower Trim**

T13H253 1 293.90 Chrome

- Single function pressure balance cartridge
- Order MultiChoice® Universal rough-in separately
- Vandal resistant blade handle
- Red/blue non-removable marking on escutcheon
- Handle adjusts temperature
- 24" stainless steel bar
- 70" vinyl hose
- ADA adjustable slide
- Pull-up metal diverter spout
- Touch-Clean® two-setting handshower
- 1.5 gpm @ 80 psi, 5.7 L/min @ 550 kPa maximum water usage
- Pause, Full Body Spray



**Commercial
13 Series Shower Trim**

T13H333 1 431.95 Chrome

- Single function pressure balance cartridge
- Diverter valve
- Order R10700-UNWS MultiChoice® Universal rough-in separately
- Vandal resistant blade handle
- Red/blue non-removable marking on escutcheon
- Handle adjusts temperature
- 24" stainless steel bar
- 70" vinyl hose
- ADA adjustable slide
- Touch-Clean® full body showerhead
- Touch-Clean® two-setting handshower
- 1.5 gpm @ 80 psi, 5.7 L/min @ 550 kPa maximum water usage
- Pause, Full Body Spray



Please always order in full case.

Valve rated at minimum 1.25 gpm (4.7 L/min) for 13/14 series pressure balance; 1.5 gpm (5.7 L/min) for 17 series pressure balance; 2.0 gpm (7.6 L/min) for thermostatic at 45 psi (310 kPa). ASSE.1016/ASME.A112.1016/CSA.B125.16

= WaterSense® Labeled Product - Flow Rate of 1.5 or 2.0 gpm versus Industry Standard ASME.A112.18.1/CSA.B125.1 of 2.5 gpm

= Water Efficient Product - Flow Rate of 1.5 or 2.0 gpm versus Industry Standard of ASME.A112.18.1/CSA.B125.1 of 2.5 gpm

Model Case Price Finish

Features



Commercial
TempAssure® 17T Series Shower Trim

T17TH125 1 385.55 Chrome

For complete T17TH series product offering, see pages C94-C95

- Dual function thermostatic cartridge
- Order MultiChoice® Universal rough-in separately
- Vandal resistant handle
- Red/blue non-removable marking
- Handle adjusts volume
- Dial adjusts temperature
- 3-Setting Touch-Clean® showerhead
- 2.0 gpm @ 80 psi, 7.6 L/min @ 550 kPa maximum water usage
- Full Body Spray, Massage Spray, Soft-Drench Spray



Commercial
TempAssure® 17T Series Shower Trim

T17TH155 1 516.30 Chrome

- Dual function thermostatic cartridge
- Order MultiChoice® Universal rough-in separately
- Vandal resistant handle
- Red/blue non-removable marking
- Handle adjusts volume
- Dial adjusts temperature
- 24" stainless steel bar
- 70" vinyl hose
- ADA adjustable slide
- Touch-Clean® two-setting handshower
- 2.5 gpm @ 80 psi, 9.5 L/min @ 550 kPa
- Pause, Full Body Spray



Commercial
TempAssure® 17T Series Tub & Shower Trim

T17TH225 1 405.45 Chrome

- Dual function thermostatic cartridge
- Order MultiChoice® Universal rough-in separately
- Vandal resistant handle
- Red/blue non-removable marking
- Handle adjusts volume
- Dial adjusts temperature
- Pull-up metal diverter spout
- 3-Setting Touch-Clean® showerhead
- 2.0 gpm @ 80 psi, 7.6 L/min @ 550 kPa maximum water usage
- Full Body Spray, Massage Spray, Soft-Drench Spray



Please always order in full case.

Valve rated at minimum 1.25 gpm (4.7 L/min) for 13/14 series pressure balance; 1.5 gpm (5.7 L/min) for 17 series pressure balance; 2.0 gpm (7.6 L/min) for thermostatic at 45 psi (310 kPa). ASSE.1016/ASME.A112.1016/CSA.B125.16

= WaterSense® Labeled Product - Flow Rate of 1.5 or 2.0 gpm versus Industry Standard ASME.A112.18.1/CSA.B125.1 of 2.5 gpm

= Water Efficient Product - Flow Rate of 1.5 or 2.0 gpm versus Industry Standard of ASME.A112.18.1/CSA.B125.1 of 2.5 gpm

Model Case Price Finish Features



Commercial Adjustable Grab Bar Assembly

RPW124HDF 4 163.65 Stainless/White

- Two-setting white handshower
- Two integral check valves for backflow protection
- Features Touch-Clean® spray holes
- Push button water control
- ADA adjustable slide
- 24" stainless steel bar
- 60"-82" stretchable metal hose
- 2.5 gpm @ 80 psi, 9.5 L/min @ 550 kPa
- Pause, Full Body Spray



Commercial Adjustable Grab Bar Assembly

RPW136HDF 4 180.40 Stainless/White

- Two-setting white handshower
- Two integral check valves for backflow protection
- Features Touch-Clean® spray holes
- Push button water control
- ADA adjustable slide
- 36" stainless steel bar
- 60"-82" stretchable metal hose
- 2.5 gpm @ 80 psi, 9.5 L/min @ 550 kPa
- Pause, Full Body Spray



Commercial Adjustable Grab Bar Assembly

RPW324HDF 4 212.95 Stainless/White

- Two-setting white handshower
- Two integral check valves for backflow protection
- Features Touch-Clean® spray holes
- Push button water control
- ADA adjustable slide
- 24" stainless steel bar
- 60"-82" stretchable metal hose
- 90° chrome wall supply elbow
- 2.5 gpm @ 80 psi, 9.5 L/min @ 550 kPa
- Pause, Full Body Spray



Model Case Price Finish Features



Commercial
Adjustable Grab Bar Assembly

RPW324HDF-1.5 203.05 Stainless/White

- Two-setting white handshower
- Two integral check valves for backflow protection
- Features Touch-Clean® spray holes
- Push button water control
- ADA adjustable slide
- 24" stainless steel bar
- 60"-82" stretchable metal hose
- 90° chrome wall supply elbow
- 1.5 gpm @ 80 psi, 5.7 L/min @ 550 kPa
- Pause, Full Body Spray



NEW!



Commercial
Adjustable Grab Bar Assembly – Less Handshower

RPW324HDF-LHD 4 200.95 Stainless

- ADA adjustable slide
- 24" stainless steel bar
- 60"-82" stretchable metal hose
- 90° chrome wall supply elbow
- LHD = Less handshower model



Commercial
Adjustable Grab Bar Assembly

RPW336HDF 4 229.90 Stainless/White

- Two-setting white handshower
- Two integral check valves for backflow protection
- Features Touch-Clean® spray holes
- Push button water control
- ADA adjustable slide
- 36" stainless steel bar
- 60"-82" stretchable metal hose
- 90° chrome wall supply elbow
- 2.5 gpm @ 80 psi, 9.5 L/min @ 550 kPa
- Pause, Full Body Spray



Please always order in full case. ASME.A112.18.1/CSA.B125.1



= WaterSense® Labeled Product - Flow Rate of 1.5 or 2.0 gpm versus Industry Standard ASME.A112.18.1/CSA.B125.1 of 2.5 gpm



= Water Efficient Product - Flow Rate of 1.5 or 2.0 gpm versus Industry Standard of ASME.A112.18.1/CSA.B125.1 of 2.5 gpm

Model	Case	Price	Finish	Features
-------	------	-------	--------	----------



UniversalShow ering
H₂Okinetic® Single-Setting Contemporary Showerhead

52655	6	45.70	Chrome
-------	---	-------	--------

- Single-setting H₂Okinetic® showerhead
- Self-cleaning H₂Okinetic spray holes
- 4" spray face diameter
- 4 1/2" showerhead length
- 1.5 gpm @ 80 psi, 5.7 L/min @ 550 kPa maximum water usage
- H₂Okinetic Spray



UniversalShow ering
Fundamental Single-Setting Showerhead

52653-PK	6	22.90	Chrome
52653-SS-PK	6	30.85	Brilliance® Stainless

- Single-setting showerhead
- 2 1/4" spray face diameter
- 3 3/4" showerhead length
- 1.5 gpm @ 80 psi, 5.7 L/min @ 550 kPa maximum water usage
- High-Efficiency Spray



UniversalShow ering
Fundamental Single-Setting Showerhead

52653-BG	10	22.90	Chrome
----------	----	-------	--------

- Single-setting showerhead
- 2 1/4" spray face diameter
- 3 3/4" showerhead length
- 1.5 gpm @ 80 psi, 5.7 L/min @ 550 kPa maximum water usage
- High-Efficiency Spray



UniversalShow ering
Premium Touch-Clean® 5-Setting Showerhead

52634-15-BG	10	35.90	Chrome
-------------	----	-------	--------

- Five-setting showerhead
- Features Touch-Clean® spray holes
- 3 3/8" spray face diameter
- 3 3/4" showerhead length
- Bulk packed
- 1.5 gpm @ 80 psi, 5.7 L/min @ 550 kPa maximum water usage
- Pause, Full Body Spray, Full Spray w/Massage, Fast Massage, High-Efficiency Spray



UniversalShow ering
Fundamental Adjustable 6-Jet Showerhead

52667-15-BG	10	48.95	Chrome
-------------	----	-------	--------

- Adjustable spray metal showerhead
- 2 1/2" spray face diameter
- 4 1/4" showerhead length
- Six spray jets
- 1.5 gpm @ 80 psi, 5.7 L/min @ 550 kPa maximum water usage
- Adjustable Full Spray



Please always order in full case.

= WaterSense® Labeled Product - Flow Rate of 1.5 or 2.0 gpm versus Industry Standard of ASME.A112.18.1/CSA.B125.1 of 2.5 gpm

= Water Efficient Product - Flow Rate of 1.5 or 2.0 gpm versus Industry Standard of ASME.A112.18.1/CSA.B125.1 of 2.5 gpm

Model Case Price Finish Features



UniversalShow ering
Fundamental Touch-Clean® Single-Setting Showerhead

52672-15-BG	10	28.30	Chrome
52672-WH15-BG	10	25.05	White

- Single-setting showerhead
- Features Touch-Clean® spray holes
- 2 7/8" spray face diameter
- 3 1/2" showerhead length
- Bulk packed
- 1.5 gpm @ 80 psi, 5.7 L/min @ 550 kPa maximum water usage
- Full Body Spray



UniversalShow ering
Fundamental 3-Setting Showerhead

52692-15-BG	10	12.00	Chrome
52692-WH15-BG	10	10.90	White

- Three-setting showerhead
- 3 5/8" spray face diameter
- Bulk packed
- 1.5 gpm @ 80 psi, 5.7 L/min @ 550 kPa maximum water usage
- Full Body Spray, Full Spray w/Massage, Fast Massage



UniversalShow ering
Premium 5-Setting Handshower

59434-15-BG	10	44.55	Chrome
59434-SS15-BG	10	64.20	Brilliance® Stainless

- Five-setting handshower
- Features Touch-Clean® spray holes
- Handshower only—hose NOT included
- Bulk packed
- 1.5 gpm @ 80 psi, 5.7 L/min @ 550 kPa maximum water usage
- Pause, Full Body Spray, Full Spray w/Massage, Fast Massage, High-Efficiency Spray



UniversalShow ering
Fundamental 2-Setting Handshower

59462-B15-BG	1	35.90	Chrome
59462-WHB15-BG	1	26.15	White

- Two-setting handshower
- Features Touch-Clean® spray holes
- Handshower only—hose NOT included
- Push button trickle
- Bulk packed
- 1.5 gpm @ 80 psi, 5.7 L/min @ 550 kPa maximum water usage
- Pause, Full Body Spray



UniversalShow ering
Fundamental Single-Setting Handshower

59462-WH15-BG	10	22.90	White
---------------	----	-------	-------

- Single-setting handshower
- Features Touch-Clean® spray holes
- Handshower only—hose NOT included
- Bulk packed
- 1.5 gpm @ 80 psi, 5.7 L/min @ 550 kPa maximum water usage
- Full Body Spray



Please always order in full case.

= WaterSense® Labeled Product - Flow Rate of 1.5 or 2.0 gpm versus Industry Standard of ASME.A112.18.1/CSA.B125.1 of 2.5 gpm

= Water Efficient Product - Flow Rate of 1.5 or 2.0 gpm versus Industry Standard of ASME.A112.18.1/CSA.B125.1 of 2.5 gpm

Model	Case	Price	Finish	Features
-------	------	-------	--------	----------



Universal Showering
Fundamental 3-Setting Shower Mount Handshower

54471-15-BG	10	38.10	Chrome
54471-WH15-BG	10	34.80	White

- Three-setting handshower
- 60" stainless steel hose
- Shower arm mount
- Shower arm and flange NOT included
- Bulk packed
- 1.5 gpm @ 80 psi, 5.7 L/min @ 550 kPa maximum water usage
- Full Body Spray, Full Spray w/Massage, Fast Massage



Universal Showering
Adjustable Pin Mount Wall Bar

55030	4	128.25	Chrome
-------	---	--------	--------

- 30" long adjustable wall bar w/pin mount
- Concealed installation screws



Universal Showering
Adjustable Glide Rail Wall Bar

55511-PK	6	95.65	Chrome
----------	---	-------	--------

- 24" long adjustable glide rail w/pin mount
- Adhesive or screw installation



Universal Showering
Adjustable Glide Rail Wall Bar

55531	6	119.55	Chrome
-------	---	--------	--------

- 30" long adjustable glide rail w/pin mount
- Adhesive or screw installation

Please always order in full case.

= WaterSense® Labeled Product - Flow Rate of 1.5 or 2.0 gpm versus Industry Standard of ASME.A112.18.1/CSA.B125.1 of 2.5 gpm

= Water Efficient Product - Flow Rate of 1.5 or 2.0 gpm versus Industry Standard of ASME.A112.18.1/CSA.B125.1 of 2.5 gpm



Model	Case	Price	Finish	Features
-------	------	-------	--------	----------

Universal Showering
Adjustable Grab Bar Assembly

56302	3	190.15	Chrome
56302-PB	3	302.20	Brilliance® Polished Brass
56302-RB	3	339.30	Venetian Bronze®
56302-SS	3	296.85	Brilliance® Stainless

- 60" - 82" stretchable metal hose
- 24" long, 1 1/4" wall grab bar
- ADA slide mechanism



Universal Showering
Adjustable Grab Bar 2-Setting Handshower

52001-DS	4	187.95	Brilliance® Stainless
----------	---	--------	-----------------------

- Two-setting handshower
- 60" - 82" stretchable metal hose
- 24" long, 1 1/2" stainless wall grab bar
- ADA slide mechanism
- White push button handshower
- 2.5 gpm @ 80 psi, 9.5 L/min @ 550 kPa
- Pause, Full Body Spray



Universal Showering
Adjustable Grab Bar 2-Setting Handshower

52001-UF	4	170.60	Brilliance® Stainless
----------	---	--------	-----------------------

- Two-setting handshower
- 70" UltraFlex® hose
- 24" long, 1 1/2" stainless wall grab bar
- ADA slide mechanism
- White push button handshower
- 2.5 gpm @ 80 psi, 9.5 L/min @ 550 kPa
- Pause, Full Body Spray

Model Case Price Finish Features



Universal Showering
Adjustable Grab Bar 2-Setting Handshower

52002-DS 4 192.30 White

- Two-setting handshower
- 60" - 82" stretchable metal hose
- 24" long, 1 1/2" white wall grab bar
- ADA slide mechanism
- White push button handshower
- 2.5 gpm @ 80 psi, 9.5 L/min @ 550 kPa
- Pause, Full Body Spray



Universal Showering
Adjustable Grab Bar 2-Setting Handshower

52002-UF 4 181.45 White

- Two-setting handshower
- 70" UltraFlex[®] hose
- 24" long, 1 1/2" white wall grab bar
- ADA slide mechanism
- White push button handshower
- 2.5 gpm @ 80 psi, 9.5 L/min @ 550 kPa
- Pause, Full Body Spray



Universal Showering
Adjustable Grab Bar 2-Setting Handshower

52003-DS 4 208.60 Brilliance[®] Stainless

- Two-setting handshower
- 60" - 82" stretchable metal hose
- 36" long, 1 1/2" stainless wall grab bar
- ADA slide mechanism
- White push button handshower
- 2.5 gpm @ 80 psi, 9.5 L/min @ 550 kPa
- Pause, Full Body Spray



Model Case Price Finish Features



Universal Show ering
Adjustable Grab Bar 2-Setting Handshower

52003-UF 4 192.30 Brilliance® Stainless

- Two-setting handshower
- 70" UltraFlex® hose
- 36" long, 1 1/2" stainless wall grab bar
- ADA slide mechanism
- White push button handshower
- 2.5 gpm @ 80 psi, 9.5 L/min @ 550 kPa
- Pause, Full Body Spray























Universal Show ering
ADA Grab Bar Handshower Mount

U6300 6 22.90 Black
U6300-WH 6 22.90 White





- Fits 1 1/2" or 1 1/4" round grab bars
- Installs vertically or horizontal
- Rotatable handshower mount



















	Model	Case	Price	Finish	Features
 	Commercial ADA Grab Bar				<ul style="list-style-type: none"> • 18" long • 1 1/2" diameter • 1 1/2" wall clearance • For persons up to 500 pounds • Meets ADA standards • Concealed mounting • Type 304 stainless steel • Grab bar - 18 gauge • 3" diameter flanges - 14 gauge • Snap lock covers - 20 gauge • Mounting hardware included
	40118-PS	3•	34.05	Peened Stainless Steel	
	40118-SS	3•	26.20	Stainless	
 	Commercial ADA Grab Bar				<ul style="list-style-type: none"> • 24" long • 1 1/2" diameter • 1 1/2" wall clearance • For persons up to 500 pounds • Meets ADA standards • Concealed mounting • Type 304 stainless steel • Grab bar - 18 gauge • 3" diameter flanges - 14 gauge • Snap lock covers - 20 gauge • Mounting hardware included
	40124-PS	3•	39.35	Peened Stainless Steel	
	40124-SS	3•	29.20	Brilliance® Stainless	
	40124-ST	3•	39.35	Bright Stainless Steel	
 	Commercial ADA Grab Bar				<ul style="list-style-type: none"> • 30" long • 1 1/2" diameter • 1 1/2" wall clearance • For persons up to 500 pounds • Meets ADA standards • Concealed mounting • Type 304 stainless steel • Grab bar - 18 gauge • 3" diameter flanges - 14 gauge • Snap lock covers - 20 gauge • Mounting hardware included
	40130-SS	3•	33.95	Stainless	
 	Commercial ADA Grab Bar				<ul style="list-style-type: none"> • 36" long • 1 1/2" diameter • 1 1/2" wall clearance • For persons up to 500 pounds • Meets ADA standards • Concealed mounting • Type 304 stainless steel • Grab bar - 18 gauge • 3" diameter flanges - 14 gauge • Snap lock covers - 20 gauge • Mounting hardware included
	40136-PS	3•	49.75	Peened Stainless Steel	
	40136-SS	3•	35.20	Stainless	
 	Commercial ADA Grab Bar				<ul style="list-style-type: none"> • 42" long • 1 1/2" diameter • 1 1/2" wall clearance • For persons up to 500 pounds • Meets ADA standards • Concealed mounting • Type 304 stainless steel • Grab bar - 18 gauge • 3" diameter flanges - 14 gauge • Snap lock covers - 20 gauge • Mounting hardware included
	40142-PS	3•	54.65	Peened Stainless Steel	
	40142-SS	3•	38.10	Stainless	



	Model	Case	Price	Finish	Features
 	Commercial ADA Grab Bar				<ul style="list-style-type: none"> • 48" long • 1 1/2" diameter • 1 1/2" wall clearance • For persons up to 500 pounds • Meets ADA standards • Concealed mounting • Type 304 stainless steel • Grab bar - 18 gauge • 3" diameter flanges - 14 gauge • Snap lock covers - 20 gauge • Mounting hardware included
	40148-SS	3•	45.60	Stainless	
 	Commercial ADA Grab Bar				<ul style="list-style-type: none"> • 24" long • 1 1/4" diameter • 1 1/2" wall clearance • For persons up to 500 pounds • Meets ADA standards • Concealed mounting • Type 304 stainless steel • Grab bar - 18 gauge • 3" diameter flanges - 14 gauge • Snap lock covers - 20 gauge • Mounting hardware included
	41124-SS 41124-ST	3• 3•	26.15 38.00	Stainless Bright Stainless Steel	
 	Commercial ADA Grab Bar				<ul style="list-style-type: none"> • 30" long • 1 1/4" diameter • 1 1/2" wall clearance • For persons up to 500 pounds • Meets ADA standards • Concealed mounting • Type 304 stainless steel • Grab bar - 18 gauge • 3" diameter flanges - 14 gauge • Snap lock covers - 20 gauge • Mounting hardware included
	41130-SS	3•	27.95	Stainless	
 	Commercial ADA Grab Bar				<ul style="list-style-type: none"> • 36" long • 1 1/4" diameter • 1 1/2" wall clearance • For persons up to 500 pounds • Meets ADA standards • Concealed mounting • Type 304 stainless steel • Grab bar - 18 gauge • 3" diameter flanges - 14 gauge • Snap lock covers - 20 gauge • Mounting hardware included
	41136-SS	3•	31.60	Stainless	
 	Commercial ADA Grab Bar				<ul style="list-style-type: none"> • 42" long • 1 1/4" diameter • 1 1/2" wall clearance • For persons up to 500 pounds • Meets ADA standards • Concealed mounting • Type 304 stainless steel • Grab bar - 18 gauge • 3" diameter flanges - 14 gauge • Snap lock covers - 20 gauge • Mounting hardware included
	41142-SS	3•	34.70	Stainless	

• Full case quantity restriction on this model - priced each. Please always order in full case.

	Model	Case	Price	Finish	Features
 	Commercial <i>ADA Grab Bar</i>				<ul style="list-style-type: none"> • 18" long • 1 1/4" diameter • 1 1/2" wall clearance • For persons up to 500 pounds • Meets ADA standards • Concealed mounting • Type 304 stainless steel • Grab bar - 18 gauge • 3 1/16" diameter decorative flanges - 14 gauge • Designer step style snap lock covers - 20 gauge • Mounting hardware included
	41218-SN	3•	47.70	Satin Nickel	
	41218-ST	3•	47.70	Bright Stainless Steel	
 	Commercial <i>ADA Grab Bar</i>				<ul style="list-style-type: none"> • 1 1/4" x 24" Grab Bar with Decorative Flange • 1 1/4" diameter • 1 1/2" wall clearance • For persons up to 500 pounds • Meets ADA standards • Concealed mounting • Type 304 stainless steel • Grab bar - 18 gauge • 3 1/16" diameter decorative flanges - 14 gauge • Designer step style snap lock covers - 20 gauge • Mounting hardware included
	41224-SN	3•	53.20	Satin Nickel	

	Model	Case	Price	Finish	Features
  	Traditional  Focus Product <i>Decorative ADA Grab Bar</i>				<ul style="list-style-type: none"> • 12" decorative grab bar • 1 1/4" diameter • Extends 2 3/4" from wall • Concealed mounting • 3" diameter flanges • 1 1/2" wall clearance • Mounting hardware included • Grab bar wall anchor included • Supports up to 500 lbs when properly installed • Coordinates with Victorian[®], Cassidy[™], Leland[®] and Windemere[®]
	41612	1	93.00	Chrome	
	41612-CZ	1	134.85	Champagne Bronze [™]	
	41612-PN	1	116.25	Polished Nickel	
	41612-RB	1	134.85	Venetian Bronze [®]	
	41612-SS	1	116.25	Brilliance [®] Stainless	
  	Traditional  Focus Product <i>Decorative ADA Grab Bar</i>				<ul style="list-style-type: none"> • 18" decorative grab bar • 1 1/4" diameter • Extends 2 3/4" from wall • Concealed mounting • 3" diameter flanges • 1 1/2" wall clearance • Mounting hardware included • Grab bar wall anchor included • Supports up to 500 lbs when properly installed • Coordinates with Victorian[®], Cassidy[™], Leland[®] and Windemere[®]
	41618	1	99.00	Chrome	
	41618-CZ	1	143.55	Champagne Bronze [™]	
	41618-PN	1	123.75	Polished Nickel	
	41618-RB	1	143.55	Venetian Bronze [®]	
	41618-SS	1	123.75	Brilliance [®] Stainless	
  	Traditional  Focus Product <i>Decorative ADA Grab Bar</i>				<ul style="list-style-type: none"> • 24" decorative grab bar • 1 1/4" diameter • Extends 2 3/4" from wall • Concealed mounting • 3" diameter flanges • 1 1/2" wall clearance • Mounting hardware included • Grab bar wall anchor included • Supports up to 500 lbs when properly installed • Coordinates with Victorian[®], Cassidy[™], Leland[®] and Windemere[®]
	41624	1	109.00	Chrome	
	41624-CZ	1	158.05	Champagne Bronze [™]	
	41624-PN	1	136.25	Polished Nickel	
	41624-RB	1	158.05	Venetian Bronze [®]	
	41624-SS	1	136.25	Brilliance [®] Stainless	
  	Traditional  Focus Product <i>Decorative ADA Grab Bar</i>				<ul style="list-style-type: none"> • 36" decorative grab bar • 1 1/4" diameter • Extends 2 3/4" from wall • Concealed mounting • 3" diameter flanges • 1 1/2" wall clearance • Mounting hardware included • Grab bar wall anchor included • Supports up to 500 lbs when properly installed • Coordinates with Victorian[®], Cassidy[™], Leland[®] and Windemere[®]
	41636	1	125.00	Chrome	
	41636-CZ	1	181.25	Champagne Bronze [™]	
	41636-PN	1	156.25	Polished Nickel	
	41636-RB	1	181.25	Venetian Bronze [®]	
	41636-SS	1	156.25	Brilliance [®] Stainless	









Model	Case	Price	Finish
Transitional  Focus Product <i>Decorative ADA Grab Bar</i>			
41712	1	93.00	Chrome
41712-CZ	1	134.85	Champagne Bronze™
41712-RB	1	134.85	Venetian Bronze®
41712-SS	1	116.25	Brilliance® Stainless

- 12" decorative grab bar
- 1 1/4" diameter
- Extends 2 3/4" from wall
- Concealed mounting
- 3" diameter flanges
- 1 1/2" wall clearance
- Mounting hardware included
- Grab bar wall anchor included
- Supports up to 500 lbs when properly installed
- Coordinates with Addison™, Lahara®, Linden™ and Classic









Model	Case	Price	Finish
Transitional  Focus Product <i>Decorative ADA Grab Bar</i>			
41718	1	99.00	Chrome
41718-CZ	1	143.55	Champagne Bronze™
41718-RB	1	143.55	Venetian Bronze®
41718-SS	1	123.75	Brilliance® Stainless

- 18" decorative grab bar
- 1 1/4" diameter
- Extends 2 3/4" from wall
- Concealed mounting
- 3" diameter flanges
- 1 1/2" wall clearance
- Mounting hardware included
- Grab bar wall anchor included
- Supports up to 500 lbs when properly installed
- Coordinates with Addison™, Lahara®, Linden™ and Classic









Model	Case	Price	Finish
Transitional  Focus Product <i>Decorative ADA Grab Bar</i>			
41724	1	109.00	Chrome
41724-CZ	1	158.05	Champagne Bronze™
41724-RB	1	158.05	Venetian Bronze®
41724-SS	1	136.25	Brilliance® Stainless

- 24" decorative grab bar
- 1 1/4" diameter
- Extends 2 3/4" from wall
- Concealed mounting
- 3" diameter flanges
- 1 1/2" wall clearance
- Mounting hardware included
- Grab bar wall anchor included
- Supports up to 500 lbs when properly installed
- Coordinates with Addison™, Lahara®, Linden™ and Classic



Model	Case	Price	Finish
Transitional  Focus Product <i>Decorative ADA Grab Bar</i>			
41736	1	125.00	Chrome
41736-CZ	1	181.25	Champagne Bronze™
41736-RB	1	181.25	Venetian Bronze®
41736-SS	1	156.25	Brilliance® Stainless

- 36" decorative grab bar
- 1 1/4" diameter
- Extends 2 3/4" from wall
- Concealed mounting
- 3" diameter flanges
- 1 1/2" wall clearance
- Mounting hardware included
- Grab bar wall anchor included
- Supports up to 500 lbs when properly installed
- Coordinates with Addison™, Lahara®, Linden™ and Classic

Model Case Price Finish Features



Contemporary ^{FP} Focus Product
Decorative ADA Grab Bar

41812	1	93.00	Chrome
41812-CZ	1	134.85	Champagne Bronze™
41812-RB	1	134.85	Venetian Bronze®
41812-SS	1	116.25	Brilliance® Stainless

- 12" decorative grab bar
- 1 1/4" diameter
- Extends 2 3/4" from wall
- Concealed mounting
- 3" diameter flanges
- 1 1/2" wall clearance
- Mounting hardware included
- Grab bar wall anchor included
- Supports up to 500 lbs when properly installed
- Coordinates with Compel™ and Trinsic™



Contemporary ^{FP} Focus Product
Decorative ADA Grab Bar

41818	1	99.00	Chrome
41818-CZ	1	143.55	Champagne Bronze™
41818-RB	1	143.55	Venetian Bronze®
41818-SS	1	123.75	Brilliance® Stainless

- 18" decorative grab bar
- 1 1/4" diameter
- Extends 2 3/4" from wall
- Concealed mounting
- 3" diameter flanges
- 1 1/2" wall clearance
- Mounting hardware included
- Grab bar wall anchor included
- Supports up to 500 lbs when properly installed
- Coordinates with Compel™ and Trinsic™



Contemporary ^{FP} Focus Product
Decorative ADA Grab Bar

41824	1	109.00	Chrome
41824-CZ	1	158.05	Champagne Bronze™
41824-RB	1	158.05	Venetian Bronze®
41824-SS	1	136.25	Brilliance® Stainless





- 24" decorative grab bar
- 1 1/4" diameter
- Extends 2 3/4" from wall
- Concealed mounting
- 3" diameter flanges
- 1 1/2" wall clearance
- Mounting hardware included
- Grab bar wall anchor included
- Supports up to 500 lbs when properly installed
- Coordinates with Compel™ and Trinsic™











Contemporary ^{FP} Focus Product
Decorative ADA Grab Bar





41836	1	125.00	Chrome
41836-CZ	1	181.25	Champagne Bronze™
41836-RB	1	181.25	Venetian Bronze®
41836-SS	1	156.25	Brilliance® Stainless

- 36" decorative grab bar
- 1 1/4" diameter
- Extends 2 3/4" from wall
- Concealed mounting
- 3" diameter flanges
- 1 1/2" wall clearance
- Mounting hardware included
- Grab bar wall anchor included
- Supports up to 500 lbs when properly installed
- Coordinates with Compel™ and Trinsic™

Model	Case	Price	Finish	Features
				<ul style="list-style-type: none"> • 12" decorative grab bar • 1 1/4" width • Extends 2 3/4" from wall • Concealed mounting • 3" square flanges • 1 1/2" wall clearance • Mounting hardware included • Grab bar wall anchor included • Supports up to 500 lbs when properly installed • Coordinates with Vero™, Arzo®, Dryden™, Ara™ and Ashlyn™
Angular Modern  Focus Product <i>Decorative ADA Grab Bar</i>				
41912	1	93.00	Chrome	
41912-CZ	1	134.85	Champagne Bronze™	
41912-PN	1	116.25	Polished Nickel	
41912-RB	1	134.85	Venetian Bronze®	
41912-SS	1	116.25	Brilliance® Stainless	
 				PN Available Q2 2014

				<ul style="list-style-type: none"> • 18" decorative grab bar • 1 1/4" width • Extends 2 3/4" from wall • Concealed mounting • 3" square flanges • 1 1/2" wall clearance • Mounting hardware included • Grab bar wall anchor included • Supports up to 500 lbs when properly installed • Coordinates with Vero™, Arzo®, Dryden™, Ara™ and Ashlyn™
AngularModern  Focus Product <i>Decorative ADA Grab Bar</i>				
41918	1	99.00	Chrome	
41918-CZ	1	143.55	Champagne Bronze™	
41918-PN	1	123.75	Polished Nickel	
41918-RB	1	143.55	Venetian Bronze®	
41918-SS	1	123.75	Brilliance® Stainless	
 				PN Available Q2 2014

				<ul style="list-style-type: none"> • 24" decorative grab bar • 1 1/4" width • Extends 2 3/4" from wall • Concealed mounting • 3" square flanges • 1 1/2" wall clearance • Mounting hardware included • Grab bar wall anchor included • Supports up to 500 lbs when properly installed • Coordinates with Vero™, Arzo®, Dryden™, Ara™ and Ashlyn™
Angular Modern  Focus Product <i>Decorative ADA Grab Bar</i>				
41924	1	109.00	Chrome	
41924-CZ	1	158.05	Champagne Bronze™	
41924-PN	1	136.25	Polished Nickel	
41924-RB	1	158.05	Venetian Bronze®	
41924-SS	1	136.25	Brilliance® Stainless	
 				PN Available Q2 2014

				<ul style="list-style-type: none"> • 36" decorative grab bar • 1 1/4" width • Extends 2 3/4" from wall • Concealed mounting • 3" square flanges • 1 1/2" wall clearance • Mounting hardware included • Grab bar wall anchor included • Supports up to 500 lbs when properly installed • Coordinates with Vero™, Arzo®, Dryden™, Ara™ and Ashlyn™
Angular Modern  Focus Product <i>Decorative ADA Grab Bar</i>				
41936	1	125.00	Chrome	
41936-CZ	1	181.25	Champagne Bronze™	
41936-PN	1	156.25	Polished Nickel	
41936-RB	1	181.25	Venetian Bronze®	
41936-SS	1	156.25	Brilliance® Stainless	
 				PN Available Q2 2014

Model Case Price Finish Features



Commercial
Recessed Towel Dispenser and Waste Receptacle

45569-SS 1 506.70 Stainless

- Stainless steel recessed towel dispenser and waste receptacle
- Holds 800 multi-fold, 600 C-fold, or 1,100 single-fold towels
- Unit 304 satin stainless steel
- Seamless door – 18 gauge
- Cabinet – 26 gauge
- Plastic inner container
- 5 1/2" gallon capacity
- Includes tumbler locks and key
- Mounting hardware included
- Overall size 13" x 55 1/8"



Commercial
Towel Dispenser

45700-SS 6 77.55 Stainless

- Stainless steel multi-fold/C-fold towel dispenser
- Holds 525 multi-fold or 400 C-fold towels
- Unit 304 satin stainless steel – 22 gauge
- Refill side indicator slot
- Includes tumbler lock and key
- Mounting hardware included



Commercial
Sanitary Napkin-Tampon Vendor

48000-SS 1 682.45 Stainless

- Stainless steel sanitary napkin-tampon vendor
- Unit 304 satin stainless steel
- Door – 18 gauge
- Cabinet – 26 gauge
- Includes 2 tumbler locks and key
- Mounting hardware included



Commercial
Toilet Seat Cover Cabinet

49000-SS 14 51.20 Stainless

- Stainless steel toilet seat cover cabinet
- 500 seat cover capacity
- Unit 304 satin stainless steel
- Cabinet – 22 gauge
- Mounting hardware included
- Overall size 15 3/4" x 11"

Model Case Price Finish Features



Commercial
Liquid Soap Dispenser

44000 6 57.35 Chrome

- Brass basin mounted liquid soap dispenser
- 32 oz. capacity polyethelene container
- 4" spout
- Adjust up to 3" max. counter thickness
- Mounting hardware included



Commercial
Liquid Soap Dispenser

44081 6 58.50 Chrome

- Stainless steel horizontal liquid soap dispenser
- 40 oz. capacity
- Shut-off soap valve
- View level indicator
- Mounting hardware included



Commercial
Liquid Soap Dispenser

44080-SS 6 58.50 Stainless

- Stainless steel vertical liquid soap dispenser
- 40 oz. capacity
- Shut-off soap valve
- View level indicator
- Mounting hardware included



Commercial
Spare Roll Paper Holder

45371-SS 6 93.35 Stainless

- Stainless steel surface spare roll paper holder
- Dispenses two 1,500 sheet rolls
- Stainless steel
- Includes tumbler lock and key
- Plastic rollers
- Overall size 5 3/4" x 10 3/4"



Commercial
Recessed Towel Dispenser and Waste Receptacle

45568-SS 1 236.80 Stainless



- Stainless steel recessed towel dispenser and waste receptacle
- Holds 475 multi-fold or 350 C-fold towels
- Removable 2 gallon waste receptacle
- Unit 304 Stainless Steel - 22 gauge
- Includes tumbler lock and key
- Overall size 14" x 28"









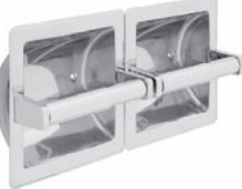



Commercial
Sanitary Napkin Receptacle



48100-SS 6 48.60 Stainless



- Stainless steel sanitary napkin receptacle
- Unit 304 Stainless Steel - 26 gauge
- Flip top lid
- Overall size 8" x 11"

	Model	Case	Price	Finish	Features
	Commercial <i>Recessed Paper Holder</i>				<ul style="list-style-type: none"> • Stainless steel recessed paper holder with plastic roller • Polished stainless steel shell • Plastic spring activated roller • Overall size 6 1/4" x 6 1/4"
	45070-ST	30	15.20	Bright Stainless Steel	
	Commercial <i>Recessed Paper Holder</i>				<ul style="list-style-type: none"> • Brass recessed paper holder with brass roller • Solid brass shell • Brass spring activated roller • Beveled edges • Overall size 6 1/4" x 6 1/4"
	45072	30	35.05	Chrome	
	Commercial <i>Twin Paper Holder</i>				<ul style="list-style-type: none"> • Twin paper holder with 2 plastic rollers • Chrome-plated zamak posts • Plastic spring activated rollers • Horizontal Mounting • Overall size 13 1/2" x 2"
	45270	40	21.90	Chrome	
	Commercial <i>Recessed Twin Paper Holder</i>				<ul style="list-style-type: none"> • Stainless steel recessed twin paper holder, bright stainless • Polished stainless steel frame - 14 gauge • Plastic spring activated rollers • Horizontal mounting • Overall size 12 5/8" x 6 1/4"
	44970-ST	10	33.45	Bright Stainless Steel	

	Model	Case	Price	Finish	Features
	Commercial <i>Twin Paper Holder</i>				<ul style="list-style-type: none"> • Twin paper holder with two brass rollers • Chrome-plated zamak posts • Brass spring activated rollers • Horizontal mounting • Overall size 13 1/2" x 2"
	45272	40	25.80	Chrome	
	Commercial <i>Double Roll Deluxe Paper Holder</i>				<ul style="list-style-type: none"> • Double roll deluxe paper holder • Concealed push button hinge release • Heavy-duty chrome-plated zamak • Spring cabinets - 22 gauge galvanized steel • Overall size 10 7/16" x 2 7/16"
	45362	20	23.35	Chrome	
	Commercial <i>Recessed Extra Roll Paper Holder</i>				<ul style="list-style-type: none"> • Stainless steel recessed extra roll paper holder • Plastic spring activated roller • Spare roll stored in back • Recessed box - 25 gauge galvanized steel • Overall size 6 7/16" x 6 7/16"
	45470-ST	10	22.95	Bright Stainless Steel	
	Commercial <i>Recessed Vanity Tissue Cabinet</i>				<ul style="list-style-type: none"> • Galvanized steel recessed vanity tissue cabinet • For use when no tissue cover is required • Spring loaded for easy tissue box replacement • Recessed box and door - 23 gauge galvanized steel • Overall size 11 3/4" x 5 1/4" x 2 1/8"
	46090	20	12.50	Chrome	
	Commercial <i>Recessed Wall Clamp</i>				<ul style="list-style-type: none"> • Recessed wall clamp • For conventional type installations • Use when backing/framing is not available • Use for chrome and stainless steel recessed items • Steel bracket - 20 gauge • Zinc plated
	RP71072	50	6.40	Chrome	

	Model	Case	Price	Finish	Features
	Commercial TowelShe If 43018	3	114.40	Chrome	<ul style="list-style-type: none"> • 18" towel shelf with one bar • Stainless steel • Concealed mounting • Shelf and towel bar tubing – 3/4" brass • Wall flange – 17 gauge brass • Mounting hardware included
	Commercial TowelShe If 43024	3	123.70	Chrome	<ul style="list-style-type: none"> • 24" brass towel shelf with one bar • Stainless steel • Concealed mounting • Shelf and towel bar tubing – 3/4" stainless steel • Wall flange – 17 gauge stamped stainless steel • Mounting hardware included
	Commercial TowelShe If 43224-SN	3	134.60	Satin Nickel	<ul style="list-style-type: none"> • 24" towel shelf with one bar • Stainless steel • Concealed mounting • Decorative beveled flanges • Shelf and towel bar tubing – 3/4" brass • Seamless drawn tubing • Mounting hardware included
	Commercial TowelShe If 43424	3	141.30	Chrome	<ul style="list-style-type: none"> • 24" towel shelf with two bars • Stainless steel • Concealed mounting • Wall flange – 17 gauge brass • Shelf and towel bar tubing – 3/4" brass • Mounting hardware included
	Commercial TowelShe If 43618-ST	3	68.90	Bright Stainless Steel	<ul style="list-style-type: none"> • 18" stainless steel towel shelf with one bar • Stainless steel • Exposed mounting • Pre-assembled • Shelf and towel bar tubing – 3/4" 304 stainless steel

	Model	Case	Price	Finish	Features
	Commercial Towel Shelf				<ul style="list-style-type: none"> • 24" stainless steel towel shelf with one bar • Stainless steel • Exposed mounting • Pre-assembled • Shelf and towel bar tubing – 3/4" 304 stainless steel
	43624-SN	3	77.75	Satin Nickel	
	43624-ST	3	71.25	Bright Stainless Steel	
	Commercial Small Corner Caddy				<ul style="list-style-type: none"> • Stainless steel small corner caddy • Mounting hardware included • Overall size 6 9/32" x 5 3/32"
	47000-ST	24	17.75	Bright Stainless Steel	
	Commercial Large Corner Caddy				<ul style="list-style-type: none"> • Stainless steel large corner caddy • Mounting hardware included • Overall size 9 9/32" x 6 9/32"
	47100-ST	12	21.65	Bright Stainless Steel	

	Model	Case	Price	Finish	Features
	Commercial ShowerRod				
	42006-ST	3•	51.90	Bright Stainless Steel	<ul style="list-style-type: none"> • Stainless steel rod • 6' long • 1 1/4" diameter • Concealed mounting • 304 polished stainless steel • 3" wall flanges - 14 gauge • Snap lock cover flanges - 20 gauge
	Commercial Curved Shower Rod				
	42205-SS	3•	34.60	Stainless	<ul style="list-style-type: none"> • Adjustable shower rod • 5' long • 1" diameter • Concealed mounting • 5" bow • 304 stainless steel tubing • Oval design prevents rotation and wet floors • Solid brass spring pin design replaces set screw • Eliminates need to tighten product • Mounting hardware included
	42205-ST	3•	36.30	Bright Stainless Steel	
	Commercial Curved Shower Rod				
	42206-SS	3•	36.30	Stainless	<ul style="list-style-type: none"> • Adjustable shower rod • 6' long • 1" diameter • Concealed mounting • 6" bow • 304 stainless steel tubing • Oval design prevents rotation and wet floors • Solid brass spring pin design replaces set screw • Eliminates need to tighten product • Mounting hardware included
	42206-ST	3•	38.10	Bright Stainless Steel	

Model Case Price Finish Features



Commercial
GridStrainer

- 1 1/4" grid strainer
- Cast brass body
- Overflow holes

33T260 1 21.05 Chrome

For complete 33T series product offering, see page C111



Commercial
Grid Strainer - Less Overflow Holes

- 1 1/4" grid strainer
- Cast brass body
- Less overflow holes

33T260-1 1 24.80 Chrome



Commercial
Grid Strainer - Less Overflow Holes

- Hooded open grid strainer
- Cast brass body
- Removable hooded drain cover for splash reduction
- Less overflow holes

33T260-1DC 1 66.15 Chrome



Commercial
GridStrainer

- Offset grid strainer
- Cast brass body
- Overflow holes

33T290 1 39.60 Chrome



Commercial
Grid Strainer - Less Overflow Holes

- Offset grid strainer
- Cast brass body
- Less overflow holes

33T290-1 1 43.45 Chrome





Model	Case	Price	Finish	Features
-------	------	-------	--------	----------

Commercial
Grid Strainer - Less Overflow Holes

33T290-1DC	1	84.25	Chrome	
------------	---	-------	--------	--

For complete 33T series product offering, see page C111

- Hooded open offset grid strainer
- Cast brass body
- Removable hooded drain cover for splash reduction
- Less overflow holes



Commercial
Adjustable P-trap with Cleanout

33T311	1	47.20	Chrome	
--------	---	-------	--------	--

- Adjustable P-trap with cleanout
- Cast brass waste bend
- Slip joint coupling nuts
- Deep, brass wall flange
- 1 1/4" size



Commercial
Adjustable P-trap with Cleanout

33T360	1	58.30	Chrome	
--------	---	-------	--------	--

- Adjustable P-trap with cleanout
- Cast brass waste bend
- Slip joint coupling nuts
- Deep, brass wall flange
- 1 1/2" size



Model Options

Delta is known for its depth of commercial products that meet any project requirement. Part of our solution is having the flexibility to customize products – easily. This section of the price book utilizes our building block process, where you configure the product to your specific needs. It’s all up to you – cartridge, spout, outlet, handle – you select it, we build it. It doesn’t get any better and to top it off we continue to support you by listing some of the most popular selling models within a series, along with a supplemental product list, rough-in, trim and add-on options. Delta has the solutions to meet your current and future needs.

See page C152 for model number and pricing

SPOUT GROUP NO.	SPOUT "ADD-ON" SUFFIX NO.	RIGID/SWIVEL SPOUT DESCRIPTION	"A"		"C"		"L"		PRICE (ADD ON TO REGULAR GOOSENECK FAUCET PRODUCT PRICE)
			MM	IN.	MM	IN.	MM	IN.	
1	R2	Gooseneck Spout	114	4.5	104	4.1	170	6.7	5.05
	R3	Gooseneck Spout	152	6	124	4.9	56	2.2	6.40
	R4	Gooseneck Spout	152	6	124	4.9	146	5.8	5.05
	R5	Gooseneck Spout	152	6	124	4.9	188	7.4	6.40
	R6	Gooseneck Spout	152	6	124	4.9	229	9	9.75
	R7	Gooseneck Spout	229	9	163	6.4	170	6.7	23.00
	R35	Gooseneck Spout	152	6	124	4.9	94	3.7	5.05
2	R2	Gooseneck Spout w/Flow control***	114	4.5	97	3.8	178	7	5.05
	R3	Gooseneck Spout w/Flow control***	152	6	117	4.6	64	2.5	6.40
	R4	Gooseneck Spout w/Flow control***	152	6	117	4.6	152	6	5.05
	R5	Gooseneck Spout w/Flow control***	152	6	117	4.6	196	7.7	6.40
	R6	Gooseneck Spout w/Flow control***	152	6	117	4.6	236	9.3	9.75
	R7	Gooseneck Spout w/Flow control***	229	9	155	6.1	178	7	23.00
	R35	Gooseneck Spout w/Flow control***	152	6	117	4.6	102	4	5.05
3	R17†	Double Joint Spout	359	14.1	38	1.5	218	8.6	62.40

***Must be ordered with Outlet Option #7 or 8.

†Swing spout portion of R17 is brass tubular wall spout. This optional spout is NOT Watersense® applicable.

ALL other gooseneck spouts are made from .09" heavy wall **seamless brass pipe**.

PROCEDURE to PRICE and ORDER a complete faucet with one of the above "OPTIONAL SPOUTS".

- (1) **START** with the **BASE PRODUCT** (which ALWAYS includes the **STANDARD gooseneck spout**)
- (2) **ADD OPTIONAL SUFFIX** if required
- (3) **ADD** the **OPTIONAL SPOUT** selected (from the above list)

PRICING:

E.G.	(1) (2) BASE PRODUCT PRICE	PLUS	(3) OPTIONAL SPOUT ADD-ON PRICE	EQUALS	(4) OPTIONAL SPOUT PRODUCT PRICE
e.g. 1	23C644 - LS 275.00	+	R4 5.05	=	23C644 - LS - R4 280.05

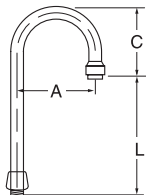

GROUP NO. 1
Regular
Gooseneck

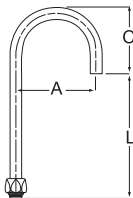

GROUP NO. 2
Smooth End-Flow Control In
Base of Gooseneck Spout
(Available on #7 outlets ONLY)

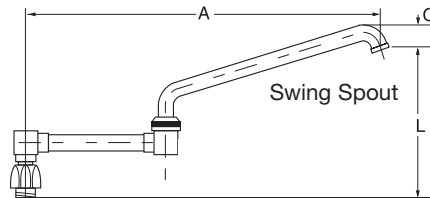

GROUP NO. 3 Double Joint

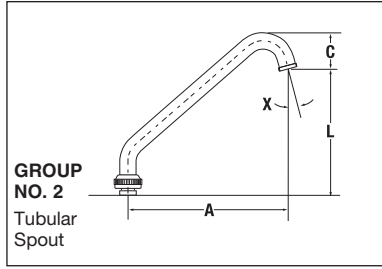
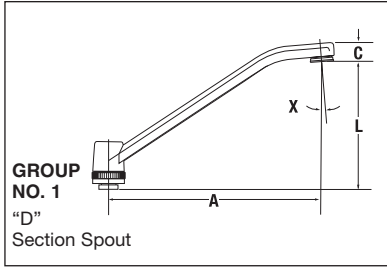

See page C153 for model number and pricing

SPOUT GROUP NO.	SPOUT SUFFIX NUMBER	SWING SPOUT DESCRIPTION	"X" DEGREES	"A"		"C"		"L"		PRICE (ADD-ON TO REGULAR 8" TUBULAR SWING SPOUT FAUCET PRICE)
				MM	IN.	MM	IN.	MM	IN.	
1	S2	8" "D" Section Spout	5	206	8.1	15	0.6	130	5.1	31.20
	S3	6" Tubular Spout	15	140	5.5	38	1.5	107	4.2	4.35
2	S5	8" Tubular Spout	15	185	7.3	41	1.6	147	5.8	4.35
	S7	11" Tubular Spout	16.5	277	10.9	28	1.1	104	4.1	8.05
	S8	14" Tubular Spout	16.5	351	13.8	28	1.1	127	5	12.40

Note: Measurements may vary plus or minus 6 mm (0.25")

E.G.	(1) BASE PRODUCT PRICE	PLUS	(2) OPTIONAL SPOUT ADD-ON PRICE	EQUALS	(3) OPTIONAL SPOUT PRODUCT PRICE
e.g. 1	26C3243 202.85	+	S7 8.05	=	26C3243-S7 210.90
e.g. 2	28C4243 233.60	+	S3 4.35	=	28C4243-S3 237.95

SPECIFYING PROCEDURE FOR OPTIONAL SWING SPOUTS:

1. Select **BASE PRODUCT** with Standard 8" Tubular Swing Spout and with spout outlet and handles required.
2. Select **Optional Swing Spout S** ("ADD-ON" Suffix Number).
3. Attach S (No.) Swing Spout selected to Base Product as a Dash Suffix (-S).

HOW TO SELECT AND SPECIFY ADD-ON OPTIONS:

EG. 1 (1) Base Product Selected:	26C3243	EG. 2 (1) Base Product Selected:	28C4243
(2) Optional Spout selected:	S7 (9" tubular swing spout selected)	(2) Optional Spout selected:	S3 (6" wall form swing spout selected)
(3) End Product Number to Specify:	26C3243-S7	(3) End Product Number to Specify:	28C4243-S3



T13H152



Model

* - Stock Item

- * T13H133
- * T13H152
- * T13H153
- * T13H163
- * T13H253

Price

- 104.65
- 274.00
- 274.00
- 232.90
- 293.90

Rough-in (Order Separately)

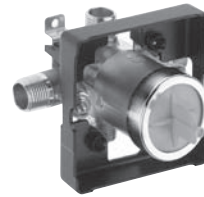

Rough-in for Tub & Shower with Stops

R10000-UNWS * 66.95

Note: Cartridge ships with trim

Trim

Choose trim required. See below. A number from each option column below must be used.

Example: T13H163

Tub/Shower

T13H To order trim, add the prices of chosen variations (listed below). A number from each option column must be used.

Note: Rough-in also required.

VARIATION		SHOWER		HANDLE	
	0	Specify "0" when no shower required		0	0
Shower Valve Only	1				1
Tub and Shower	2	3-Function Touch-Clean® Showerhead, Arm & Set Screw Flange	58.90	2	2
	3	Showerhead, Arm & Set Screw Flange	20.30	3	3
	4			4	4
	5	Handshower with 2 Check Valves, 610 mm (24") S/S Bar with ADA Slide	189.65	5	5
	6	30° Vandal Resistant, Cast Flow Control Wallmount Showerhead	148.55	6	6
	7			7	7
	8	H ₂ Okinetic Technology® Showerhead, Arm & Set Screw Flange	49.60	8	8
	9			9	9

SHOWER FLOW RATES		
SHOWER #	ACTUAL @ 45 PSI (310 kPa)	MAXIMUM @ 80 PSI (552 kPa)
2	1.71 gpm (6.47 L/min)	2.0 gpm (7.6 L/min)
3	1.36 gpm (5.15 L/min)	1.5 gpm (5.7 L/min)
5	1.28 gpm (4.85 L/min)	1.5 gpm (5.7 L/min)
6	1.38 gpm (5.22 L/min)	1.5 gpm (5.7 L/min)
8	1.49 gpm (5.64 L/min)	1.5 gpm (5.7 L/min)

See price page C93 for "Add-On Options" pricing. See page C92 for Shower Valves with Diverter for Dual Showers. Valve rated at minimum 1.25 gpm (4.7 L/min) for 13/14 series pressure balance; 1.5 gpm (5.7 L/min) for 17 series pressure balance; 2.0 gpm (7.6 L/min) for thermostatic at 45 psi (310 kPa). ASSE.1016/ASME.A112.1016/CSA.B125.16

DELTA COMMERCIAL TECHNICAL SERVICE 1-877-509-2680
 ONLINE CATALOGS: www.deltacommercialfaucets.com (Core products ONLY)
 www.specselect.com (Complete Product Offering & Part Numbering System)



T13H332



Model

- * - Stock Item
- * T13H332
- * T13H333

Price

- 431.95
- 431.95

Rough-in (Order Separately)

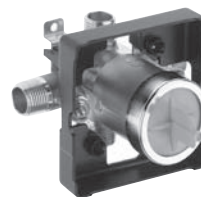

Rough-in for Tub & Shower with In-wall Diverter Valve (not shown) & with Stops

R10700-UNWS * 114.50

Note: Cartridge ships with trim

Trim

Choose trim required. See below. A number from each option column below must be used.

Example: T13H333

T13H To order trim, add the prices of chosen variations (listed below). A number from each option column must be used.

Note: Rough-in also required.

VARIATION		SHOWER		HANDLE		
	0	Specify "0" when no shower outlet required	0		0	
	1		1		1	
	2	3-Function Touch-Clean® Showerhead, Arm & Set Screw Flange 58.90	2	85 mm (3.33") Metal Lever Handle 26.25	2	
Shower, Handshower with 2 Check Valves, Diverter Valve, 610 mm (24") S/S Bar with ADA Slide 385.40	3	Showerhead, Arm & Set Screw Flange 20.30	3	57 mm (2.24") Lever Blade Handle 26.25	3	
	4		4	VARIATION FLOW RATES		
	5		5	VARIATION #	ACTUAL @ 45 PSI (310 kPa)	MAXIMUM @ 80 PSI (552 kPa)
	6	30° Vandal Resistant, Cast Flow Control Wallmount Showerhead 148.55	6	3	1.28 gpm (4.85 L/min)	1.5 gpm (5.7 L/min)
	7		7	9	1.28 gpm (4.85 L/min)	1.5 gpm (5.7 L/min)
	8	H ₂ Okinetic Technology® Showerhead, Arm & Set Screw Flange 49.60	8	SHOWER FLOW RATES		
	9	Tub & Shower (Same as No. 3 above) but with Diverter Spout 427.55	9	SHOWER #	ACTUAL @ 45 PSI (310 kPa)	MAXIMUM @ 80 PSI (552 kPa)
				2	1.71 gpm (6.47 L/min)	2.0 gpm (7.6 L/min)
				3	1.36 gpm (5.15 L/min)	1.5 gpm (5.7 L/min)
				6	1.38 gpm (5.22 L/min)	1.5 gpm (5.7 L/min)
				8	1.49 gpm (5.64 L/min)	1.5 gpm (5.7 L/min)

See price page C93 for "Add-On Options" pricing. See page C91 for Shower Valves **less** Diverter for Dual Showers.



Product Variations 3 & 9 require selection of the second Showerhead from SHOWER Option No. 2, 3, 6 or 8.

Valve rated at minimum 1.25 gpm (4.7 L/min) for 13/14 series pressure balance; 1.5 gpm (5.7 L/min) for 17 series pressure balance; 2.0 gpm (7.6 L/min) for thermostatic at 45 psi (310 kPa). ASSE.1016/ASME.A112.1016/CSA.B125.16

DELTA COMMERCIAL TECHNICAL SERVICE 1-877-509-2680
ONLINE CATALOGS: www.deltacommercialfaucets.com (Core products ONLY)
www.specselect.com (Complete Product Offering & Part Numbering System)

Price additions for Add-On Options:

- To complete an Add-On Option Product Price add the prices of the chosen variations (listed below). A number from the hose and slide bar columns must always be selected, even if it is "0".

HOSE		SLIDE BAR	
Always use "0" if No selection is required from this column	0	Always use "0" if No selection is required from this column	0
	1		1
1753 mm (69") Long CP Stainless Steel Hose (1) -stretches to 92"	2		2
 Add 31.90	3		3
	4		4
		 Add 16.80	5
		<input type="checkbox"/> 914 mm (36") Combination S/S Slide Bar (2)	

Tub/Shower

Notes:

- (1) **Base Product** for the **HOSE, ETC.** options must be from **PRODUCT VARIATION TRIM No.'s 3 or 9** or must include **SHOWER** option **No. 5**
- (2) **Base Product** for **Slide Bar** must be from **PRODUCT VARIATION TRIM No.'s 3 or 9**, or must include **SHOWER** option **No. 5**

HOW TO SELECT AND SPECIFY ADD-ON OPTIONS:

Example No. 1: Base Product selected is R10700-UNWS Rough-in, and a T13H323 finish trim with an Add-On Option of the 36" S/S Slide Bar.
36" S/S Slide Bar Add-On Suffix Number is -05
Model Number to Specify: R10700-UNWS Rough-in and T13H323-05 Finish Trim

PRICING:

EXAMPLE	(1) BASE PRODUCT PRICE	PLUS	(2) ADD-ON OPTION NO. ADD-ON PRICE	EQUALS	(3) END MODEL NUMBER PRICE
No. 1	R10700-UNWS and T13H323 114.50 + 470.55	+	-05 ADD 16.80	=	R10700-UNWS and T13H323-05 601.85



T17TH335



Model

* - Stock Item

* T17TH335

Price

674.20

Rough-in (Order Separately)

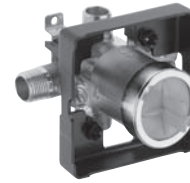

Rough-in for Tub & Shower with In-wall Diverter Valve (not shown) & with Stops

R10700-UNWS * 114.50

Note: Cartridge ships with trim

Trim

Choose trim required. See below. A number from each option column below must be used.

Example: T17TH335

Tub/Shower

T17TH To order trim, add the prices of chosen variations (listed below). A number from each option column must be used.

Note: Rough-in also required.

VARIATION	SHOWER		HANDLE													
	0	Specify "0" when no shower required	0	<table border="1"> <thead> <tr> <th colspan="3">VARIATION FLOW RATES</th> </tr> <tr> <th>VARIATION #</th> <th>ACTUAL @ 45 PSI (310 kPa)</th> <th>MAXIMUM @ 80 PSI (552 kPa)</th> </tr> </thead> <tbody> <tr> <td>3</td> <td>2.42 gpm (9.16 L/min)</td> <td>2.5 gpm (9.5 L/min)</td> </tr> <tr> <td>9</td> <td>2.42 gpm (9.16 L/min)</td> <td>2.5 gpm (9.5 L/min)</td> </tr> </tbody> </table>	VARIATION FLOW RATES			VARIATION #	ACTUAL @ 45 PSI (310 kPa)	MAXIMUM @ 80 PSI (552 kPa)	3	2.42 gpm (9.16 L/min)	2.5 gpm (9.5 L/min)	9	2.42 gpm (9.16 L/min)	2.5 gpm (9.5 L/min)
VARIATION FLOW RATES																
VARIATION #	ACTUAL @ 45 PSI (310 kPa)	MAXIMUM @ 80 PSI (552 kPa)														
3	2.42 gpm (9.16 L/min)	2.5 gpm (9.5 L/min)														
9	2.42 gpm (9.16 L/min)	2.5 gpm (9.5 L/min)														
	1		1													
	2	3-Function Touch-Clean® Showerhead, Arm & Set Screw Flange 58.90	2	<table border="1"> <thead> <tr> <th colspan="3">SHOWER FLOW RATES</th> </tr> <tr> <th>SHOWER #</th> <th>ACTUAL @ 45 PSI (310 kPa)</th> <th>MAXIMUM @ 80 PSI (552 kPa)</th> </tr> </thead> <tbody> <tr> <td>2</td> <td>1.71 gpm (6.47 L/min)</td> <td>2.0 gpm (7.6 L/min)</td> </tr> <tr> <td>3</td> <td>1.82 gpm (6.89 L/min)</td> <td>2.0 gpm (7.6 L/min)</td> </tr> </tbody> </table>	SHOWER FLOW RATES			SHOWER #	ACTUAL @ 45 PSI (310 kPa)	MAXIMUM @ 80 PSI (552 kPa)	2	1.71 gpm (6.47 L/min)	2.0 gpm (7.6 L/min)	3	1.82 gpm (6.89 L/min)	2.0 gpm (7.6 L/min)
SHOWER FLOW RATES																
SHOWER #	ACTUAL @ 45 PSI (310 kPa)	MAXIMUM @ 80 PSI (552 kPa)														
2	1.71 gpm (6.47 L/min)	2.0 gpm (7.6 L/min)														
3	1.82 gpm (6.89 L/min)	2.0 gpm (7.6 L/min)														
Shower, Handshower with 2 Check Valves, Diverter Valve, 610 mm (24") S/S Bar with ADA Slide 627.65	3	Touch-Clean®, Showerhead, Arm & Set Screw Flange 20.30	3													
	4		4													
	5		5	Metal Lever Volume Control Handle w/Temperature Adjustment 26.25												
	6		6													
	7		7													
	8		8													
Tub & Shower (Same as No. 3 above) but with Diverter Spout 669.85	9		9													

See price page C96 for "Add-On Options" pricing. See page C94 for Shower Valves **less** Diverter for Dual Showers.

Product Variations 3 & 9 require selection of the second Showerhead from SHOWER Option No. 2 or 3.



Valve rated at minimum 1.25 gpm (4.7 L/min) for 13/14 series pressure balance; 1.5 gpm (5.7 L/min) for 17 series pressure balance; 2.0 gpm (7.6 L/min) for thermostatic at 45 psi (310 kPa). ASSE.1016/ASME.A112.1016/CSA.B125.16

DELTA COMMERCIAL TECHNICAL SERVICE 1-877-509-2680
 ONLINE CATALOGS: www.deltacommercialfaucets.com (Core products ONLY)
www.specselect.com (Complete Product Offering & Part Numbering System)

Price additions for Add-On Options:

To complete an Add-On Option Product Price add the prices of the chosen variations (listed below). A number from each option column must be used.

Tub/Shower

HOSE		SLIDE BAR	
Always use "0" if No selection is required from this column	0	Always use "0" if No selection is required from this column	0
	1		1
1753 mm (69") Long CP Stainless Steel Hose (1) -stretches to 92"	 Add 31.90		2
	3		3
	4		4
		 Add 16.80	5

Notes:

- (1) **Base Product** for the **HOSE, ETC.** options must be from **PRODUCT VARIATION TRIM No.'s 3 or 9** or must include **SHOWER** option **No. 5**
- (2) **Base Product** for **Slide Bar** must be from **PRODUCT VARIATION TRIM No.'s 3 or 9**, or must include **SHOWER** option **No. 5**

HOW TO SELECT AND SPECIFY ADD-ON OPTIONS:

Example No. 1: Base Product selected is R10700-UNWS Rough-in, and a T17TH325 with 36" S/S Slide Bar. 36" S/S Slide Bar Add-On Suffix Number is -05
Model Number to Specify: R10700-UNWS Rough-in and T17TH325-05 Trim

PRICING:

EXAMPLE	(1) BASE PRODUCT PRICE	PLUS	(2) ADD-ON OPTION NO. ADD-ON PRICE	EQUALS	(3) END MODEL NUMBER PRICE
No. 1	R10700-UNWS and T17TH325 114.50 + 712.80	+	-05 ADD 16.80	=	R10700-UNWS and T17TH325-05 844.10



Model

* - Stock Item

	* 21C132	159.00
	* 21C133	157.75
	* 21C134	175.95
	* 21C142	155.50
	* 21C143	154.25
	* 21C144	172.45
	* 21C153	166.85
	21C542	158.70

Price

ADD-ON "-TI" SUFFIX (ADD THE SUFFIX TO THE END OF THE MODEL NUMBER TO CHOOSE THIS OPTION)		
SUFFIX NUMBER	DESCRIPTION	ADD-ON TO PRICE
-TI	Handle Temperature Indicators "H" (red), "C" (blue) Available on handle options 2, 3 or 4 only	10.35

21C144



Code compliant applies to entire series.

CER-TECK® 21 C



To complete a Product Price add the prices of chosen variations (listed below).
A number from each option column must be used.

BASIC PRODUCT		OUTLET		HANDLES	
	0		0		0
Standard Product Less Pop-up (No Pop-up Hole) 119.90	1		1	5 Fluted 23.00	1
Standard Product With Metal Pop-up 172.05	2	Vandal Resistant 1.5 gpm (5.7 L/min.) Laminar w/Agion® Antimicrobial 23.50	2	102 mm (4") Hooded Blade Handle 24.70	2
Standard Product with Cast Open Grid Strainer (No Pop-up Hole) 143.40	3	Vandal Resistant 1.5 gpm (5.7 L/min.) Flow Control Aerator 14.40	3	76 mm (3") Hooded Lever 23.45	3
Standard Product With Cast Offset Open Grid Strainer (No Pop-up Hole) 163.15	4	Standard 1.5 gpm (5.7 L/min.) Flow Control Aerator 10.90	4	102 mm (4") Blade with Sanitary Hood 41.65	4
Standard Product With Chain Stay (For Plug & Chain) 123.10	5	Vandal Resistant 0.5 gpm (1.9 L/min.) Non-Aerating Spray Outlet 23.50	5	152 mm (6") Wrist with Sanitary Hood 67.15	5
	6		6		6
	7		7		7
	8		8	Self-Closing Hooded Lever Both Sides 50.40	8
	9	NEW (1) Vandal Resistant 0.35 gpm (1.32 L/min.) Non-Aerating Spray Outlet 23.50	9	Self-Closing 5-Fluted Both Sides 50.40	9

Lavatory

(1) Available Q3-2014

Flow rates are at 60 PSI (414 kPa)

DELTA COMMERCIAL TECHNICAL SERVICE 1-877-509-2680
 ONLINE CATALOGS: www.deltacommercialfaucets.com (Core products ONLY)
www.specselect.com (Complete Product Offering & Part Numbering System)



Model

Price

*- Stock Item

*	22C101	164.70
*	22C131	166.55
*	22C151	175.65
*	22C301	194.85
*	22C401	184.70
*	22C601	182.20
*	22C801	215.75

22C101



Code compliant applies to entire series.

22C **1** To complete a Product Price add the prices of chosen variations (listed below).
A number from each option column must be used.

Lavatory

PRODUCT VARIATION		OUTLET		HANDLE	
102 mm (4") Centerset Less Pop-up (With Pop-up Hole)	146.30	0	Vandal Resistant Outlet (Wrench Flats) 1.5 gpm (5.7 L/min.)	12.55	0
102 mm (4") Centerset Less Pop-up (No Pop-up Hole)	134.30	1			89 mm (3 1/2") ADA Compliant Lever Handle
		2	Vandal Resistant 1.5 gpm (5.7 L/min.) Laminar w/Agion® Antimicrobial	23.50	2
102 mm (4") Centerset With Metal Pop-Up	164.45	3	Vandal Resistant 1.5 gpm (5.7 L/min.) Flow Control Aerator	14.40	3
102 mm (4") Centerset With Open Grid Strainer (No Pop-up Hole)	154.30	4	Standard 1.5 gpm (5.7 L/min.) Flow Control Aerator	10.90	4
102 mm (4") Centerset with Offset Open Grid Strainer (No Pop-up Hole)	171.80	5	Vandal Resistant 0.5 gpm (1.9 L/min.) Non-Aerating Spray Outlet	23.50	5
Single Hole Mount Less Pop-up (No Pop-up Hole)	151.80	6			6
		7			7
Single Hole Mount With Metal Pop-Up	185.35	8			8
Single Hole Mount with Open Grid Strainer (No Pop-up Hole)	174.10	9	NEW (1) Vandal Resistant 0.35 gpm (1.32 L/min.) Non-Aerating Spray Outlet	23.50	9

(1) Available Q3-2014

Flow rates are at 60 PSI (414 kPa)

DELTA COMMERCIAL TECHNICAL SERVICE 1-877-509-2680
 ONLINE CATALOGS: www.deltacommercialfaucets.com (Core products ONLY)
www.specselect.com (Complete Product Offering & Part Numbering System)



Model

- * - Stock Item
- * 23C1041
- 23C1049

Price

- 100.15
- 114.75

23C1041

Code compliant applies to entire series.

CER-TECK® 23 C 1 To complete a Product Price add the prices of chosen variations (listed below).
A number from each option column must be used.

BASIC PRODUCT		OUTLET		HANDLE	
Standard Single Basin Faucet Body 76.45	0				0
	1			5 Fluted 12.80	1
	2	Vandal Resistant 1.5 gpm (5.7 L/min.) Laminar w/Agion® Antimicrobial 23.50			2
	3	Vandal Resistant 1.5 gpm (5.7 L/min.) Flow Control Aerator 14.40		70 mm (2 3/4") Lever Blade Handle 12.80	3
	4	Standard 1.5 gpm (5.7 L/min.) Flow Control Aerator 10.90			4
	5	Vandal Resistant 0.5 gpm (1.9 L/min.) Non-Aerating Spray Outlet 23.50			5
	6				6
	7				7
	8			70 mm (2 3/4") Self-closing Lever Blade Handle 27.40	8
	9			Self-Closing 5 Fluted 27.40	9

Lavatory

Flow rates are at 60 PSI (414 kPa)

DELTA COMMERCIAL TECHNICAL SERVICE 1-877-509-2680
ONLINE CATALOGS: www.deltacommercialfaucets.com (Core products ONLY)
www.specselect.com (Complete Product Offering & Part Numbering System)



23C643



Model

* - Stock Item

*	23C332	252.55
*	23C333	251.30
*	23C634	252.00
*	23C642	231.55
*	23C644	248.50

Price

ADD-ON "-LS" SUFFIX		
SUFFIX NUMBER	DESCRIPTION	ADD-ON TO PRICE
-LS	120° Limited Swing Gooseneck (Available on #6 Basic Product ONLY)	26.50

ADD-ON "-TI" SUFFIX		
SUFFIX NUMBER	DESCRIPTION	ADD-ON TO PRICE
-TI	Handle Temperature Indicators "H" (red), "C" (blue) Available on handle options 2, 3 or 4 only	10.35

Code compliant applies to entire series.

CER-TECK® 23 C



To complete a Product Price add the prices of chosen variations (listed below). A number from each option column must be used.

BASIC PRODUCT	OUTLET	HANDLES
0	0	0
1	1	5 Fluted 23.00
2	Vandal Resistant 1.5 gpm (5.7 L/min.) Laminar w/Agion® Antimicrobial 23.50	102 mm (4") Hooded Blade Handle 24.70
Cast Spout Less Pop-up (No Pop-up Hole) 213.45	3	76 mm (3") Hooded Lever 23.45
Cast Spout With Metal Pop-up (With Pop-up Hole) 263.25	4	102 mm (4") Blade with Sanitary Hood 41.65
5	Vandal Resistant 0.5 gpm (1.9 L/min.) Non-Aerating Spray Outlet 23.50	152 mm (6") Wrist with Sanitary Hood 67.15
(Std is R2) Rigid/Swivel Inline Gooseneck Spout Less Pop-up 195.95	6	6
7	Smooth End, Laminar Flow Control in Base of Gooseneck Spout 1.0 gpm (3.8 L/min.) (1) 23.50	7
8	8	Self Closing Hooded Lever Both Sides 50.40
9	9	9

See Page C89 for **Optional Rigid/Swivel Spouts**. These spouts can ONLY be added to **BASIC PRODUCT Option No.6**.

(1) This outlet can ONLY be added to **BASIC PRODUCT Option No.6**.

Flow rates are at 60 PSI (414 kPa)

DELTA COMMERCIAL TECHNICAL SERVICE 1-877-509-2680
 ONLINE CATALOGS: www.deltacommercialfaucets.com (Core products ONLY)
www.specselect.com (Complete Product Offering & Part Numbering System)



24T2643



Model

Model	Price
24T2623	291.70
24T2633	282.60
24T2643	279.10
24T0001 Control Valve Only Less Spout	171.80
24T0003 Control Valve Only Less Spout	178.60

ADD-ON "-LS" SUFFIX		
SUFFIX NUMBER	DESCRIPTION	ADD-ON TO PRICE
-LS	120° Limited Swing Gooseneck	26.50

Code compliant applies to entire series.

24 T 2 6 To complete a Product Price add the prices of chosen variations (listed below).
A number from each option column must be used.

BASIC PRODUCT	OUTLET	HANDLES
0	0	0
1	1	12.35
2	Vandal Resistant 1.5 gpm (5.7 L/min.) Laminar w/Agion® Antimicrobial 23.50	2
3	Vandal Resistant 1.5 gpm (5.7 L/min.) Flow Control Aerator 14.40	19.25
4	Standard 1.5 gpm (5.7 L/min.) Flow Control Aerator 10.90	4
5	Vandal Resistant 0.5 gpm (1.9 L/min.) Non-Aerating Spray Outlet 23.50	5
(Std is R2) Rigid/Swivel Gooseneck Spout Less Pop-up (No Pop-up Hole) 248.95	6	6
7	Smooth End, Laminar Flow Control in Base of Gooseneck Spout 23.50	7
8	8	8
9	9	9

Lavatory

See Page C89 for **Optional Rigid/Swivel Spouts**.

Flow rates are at 60 PSI (414 kPa)



Model

* - Stock Item

- * 25C3837
- * 25C3847
- 25C3947

Price

- 232.35
- 228.85
- 228.85

ADD-ON "-LS" SUFFIX		
SUFFIX NUMBER	DESCRIPTION	ADD-ON TO PRICE
-LS	120° Limited Swing Gooseneck Available on #8 and #9 Spout ONLY	26.50









25C3847



Code compliant applies to entire series.

CER-TECK® 25C3 **127.40 LESS COVER PLATE (BASIC PRODUCT PRICE)**
CER-TECK® 25C4 **166.75 WITH COVER PLATE (BASIC PRODUCT PRICE)**

To complete a Product Price add the prices of chosen variations (listed below) to the **Basic Product Price**.
 A number from each option column must be used.

SPOUT		OUTLET		HANDLES	
	0		0		0
	1		1	5 Fluted  23.00	1
	2	Vandal Resistant 1.5 gpm (5.7 L/min.) Laminar w/Agion® Antimicrobial  23.50	2		2
	3	Vandal Resistant 1.5 gpm (5.7 L/min.) Flow Control Aerator  14.40	3		3
	4	Standard 1.5 gpm (5.7 L/min.) Flow Control Aerator  10.90	4		4
	5	Vandal Resistant 0.5 gpm (1.9 L/min.) Non-Aerating Spray Outlet  23.50	5		5
	6		6		6
	7	Smooth End, Laminar Flow Control in Base of Gooseneck Spout  23.50	7	63.5 mm (2½") Balanced Lever  29.55	7
(Std is R2) 114 mm (4½") Bend Rigid/Swivel Gooseneck Spout  61.00	8		8		8
(Std is R4) 152 mm (6") Bend Rigid/Swivel Gooseneck Spout  61.00	9		9		9

Sink Faucets

See Page C89 for **Optional Rigid/Swivel Spouts**. These spouts can ONLY be added to **SPOUT Option No. 9**.

(1) This outlet can ONLY be added to **SPOUT Option No.'s 8 or 9**.

Flow rates are at 60 PSI (414 kPa)

DELTA COMMERCIAL TECHNICAL SERVICE 1-877-509-2680
 ONLINE CATALOGS: www.deltacommercialfaucets.com (Core products ONLY)
www.specselect.com (Complete Product Offering & Part Numbering System)



26C3933



Model

- * - Stock Item
- 26C3132
- * 26C3133
- * 26C3143
- * 26C3232
- * 26C3233
- * 26C3932
- * 26C3933
- * 26C3934
- * 26C3944

Price

- 228.60
- 227.35
- 223.85
- 207.60
- 206.35
- 233.20
- 231.95
- 250.15
- 246.65

ADD-ON "-LS" SUFFIX		
SUFFIX NUMBER	DESCRIPTION	ADD-ON TO PRICE
-LS	120° Limited Swing Gooseneck Available on #9 Spout ONLY	26.50

ADD-ON "-TI" SUFFIX		
SUFFIX NUMBER	DESCRIPTION	ADD-ON TO PRICE
-TI	Handle Temperature Indicators "H" (red), "C" (blue) Available on handle options 2, 3 or 4 only	10.35

Code compliant applies to entire series.

CER-TECK® 26C3 To complete a Product Price add the prices of chosen variations (listed below). A number from each option column must be used.

SPOUT AND BASIC PRODUCT		OUTLET		HANDLES	
	0		0		0
(Std is S2) 203 mm (8") Wallform Swing Spout	189.50			5 Fluted	23.00
(Std is S5) 203 mm (8") Tubular Swing Spout	168.50	Vandal Resistant 1.5 gpm (5.7 L/min.) Laminar w/Agion® Antimicrobial	23.50	102 mm (4") Hooded Blade Handle	24.70
		Vandal Resistant 1.5 gpm (5.7 L/min.) Flow Control Aerator	14.40	76 mm (3") Hooded Lever	23.45
		Standard 1.5 gpm (5.7 L/min.) Flow Control Aerator	10.90	102 mm (4") Blade with Sanitary Hood	41.65
		Vandal Resistant 0.5 gpm (1.9 L/min.) Non-Aerating Spray Outlet	23.50	152 mm (6") Wrist with Sanitary Hood	67.15
		Smooth End, Laminar Flow Control in Base of Gooseneck Spout 1.0 gpm (3.8 L/min.) (1)	23.50		
(Std is R4) 152 mm (6") Bend Rigid/Swivel Gooseneck Spout	194.10				

See Page C89 for **Optional Rigid/Swivel Spouts**. These spouts can ONLY be added to **SPOUT AND BASIC PRODUCT Option No. 9**.

See Page C90 for **Optional Swing Spouts**. These spouts can ONLY be added to **SPOUT AND BASIC PRODUCT Option No. 2**.

(1) This outlet can ONLY be added to **SPOUT AND BASIC PRODUCT Option No. 9**.

Flow rates are at 60 PSI (414 kPa)

DELTA COMMERCIAL TECHNICAL SERVICE 1-877-509-2680
 ONLINE CATALOGS: www.deltacommercialfaucets.com (Core products ONLY)
www.specselect.com (Complete Product Offering & Part Numbering System)



27C2933



Model

* - Stock Item

27C2933

* 27C2942

* 27C2944

Price

228.25

226.00

242.95

ADD-ON "-LS" SUFFIX		
SUFFIX NUMBER	DESCRIPTION	ADD-ON TO PRICE
-LS	120° Limited Swing Gooseneck (Available on #9 Basic Product ONLY)	26.50

ADD-ON "-TI" SUFFIX		
SUFFIX NUMBER	DESCRIPTION	ADD-ON TO PRICE
-TI	Handle Temperature Indicators "H" (red), "C" (blue) Available on handle options 2, 3 or 4 only	10.35

Code compliant applies to entire series.

CER-TECK® 27C1 **239.30 WITH HOSE AND SPRAY (BASIC PRODUCT PRICE)**
CER-TECK® 27C2 **138.40 LESS HOSE AND SPRAY (BASIC PRODUCT PRICE)**

To complete a Product Price add the prices of chosen variations (listed below) to the **Basic Product Price**.
 A number from each option column must be used.

SPOUT		OUTLET		HANDLES	
	0		0		0
(Std is S2) 203 mm (8") Wallform Swing Spout	59.10 1		1	5 Fluted	23.00 1
(Std is S5) 203 mm (8") Tubular Swing Spout	25.40 2	Vandal Resistant 1.5 gpm (5.7 L/min.) Laminar w/Agion® Antimicrobial	23.50 2	102 mm (4") Hooded Blade Handle	24.70 2
	3	Vandal Resistant 1.5 gpm (5.7 L/min.) Flow Control Aerator	14.40 3	76 mm (3") Hooded Lever	23.45 3
	4	Standard 1.5 gpm (5.7 L/min.) Flow Control Aerator	10.90 4	102 mm (4") Blade with Sanitary Hood	41.65 4
	5	Vandal Resistant 0.5 gpm (1.9 L/min.) Non-Aerating Spray Outlet	23.50 5	152 mm (6") Wrist with Sanitary Hood	67.15 5
	6		6		6
	7	Smooth End, Laminar Flow Control in Base of Gooseneck Spout 1.0 gpm (3.8 L/min.) (1)	23.50 7		7
	8		8		8
(Std is R4) 152 mm (6") Bend Rigid/Swivel Gooseneck Spout	52.00 9		9		9

See Page C89 for **Optional Rigid/Swivel Spouts**. These spouts can ONLY be added to **SPOUT AND BASIC PRODUCT Option No. 9**.

See Page C90 for **Optional Swing Spouts**. These spouts can ONLY be added to **SPOUT AND BASIC PRODUCT Option No. 2**.

(1) This outlet can ONLY be added to **SPOUT AND BASIC PRODUCT Option No. 9**.

Flow rates are at 60 PSI (414 kPa)

DELTA COMMERCIAL TECHNICAL SERVICE 1-877-509-2680
 ONLINE CATALOGS: www.deltacommercialfaucets.com (Core products ONLY)
www.specselect.com (Complete Product Offering & Part Numbering System)



27C4834



Model

* - Stock Item

- * 27C4832
- * 27C4834
- * 27C4842
- * 27C4843
- * 27C4844

Price

- 188.10
- 205.05
- 184.60
- 183.35
- 201.55

Code compliant applies to entire series.

ADD-ON "-LS" SUFFIX		
SUFFIX NUMBER	DESCRIPTION	ADD-ON TO PRICE
-LS	120° Limited Swing Gooseneck (Available on #8 and #9 Spout ONLY)	26.50

ADD-ON "-TI" SUFFIX		
SUFFIX NUMBER	DESCRIPTION	ADD-ON TO PRICE
-TI	Handle Temperature Indicators "H" (red), "C" (blue) Available on handle options 2, 3 or 4 only	10.35

CER-TECK® 27C4 **85.65 LESS POP-UP**
CER-TECK® 27C5 **142.50 WITH METAL POP-UP**

(BASIC PRODUCT PRICE)
(BASIC PRODUCT PRICE)

To complete a Product Price add the prices of chosen variations (listed below) to the **Basic Product Price**.
 A number from each option column must be used.

SPOUT		OUTLET		HANDLES	
	0		0		0
(Std is S2) 203 mm (8") Wallform Swing Spout	60.85		1	5 Fluted	23.00
(Std is S5) 203 mm (8") Tubular Swing Spout	25.85	Vandal Resistant 1.5 gpm (5.7 L/min.) Laminar w/Agion® Antimicrobial	23.50	102 mm (4") Hooded Blade Handle	24.70
(Std is S3) 152 mm (6") Tubular Swing Spout	25.85	Vandal Resistant 1.5 gpm (5.7 L/min.) Flow Control Aerator	14.40	76 mm (3") Hooded Lever	23.45
	4	Standard 1.5 gpm (5.7 L/min.) Flow Control Aerator	10.90	102 mm (4") Blade with Sanitary Hood	41.65
	5	Vandal Resistant 0.5 gpm (1.9 L/min.) Non-Aerating Spray Outlet	23.50	152 mm (6") Wrist with Sanitary Hood	67.15
	6	Hose Thread Outlet	11.00		
	7	Smooth End, Laminar Flow Control in Base of Gooseneck Spout 1.0 gpm (3.8 L/min.) (1)	23.50		
(Std is R2) 114 mm (4 1/2") Bend Rigid/Swivel Gooseneck Spout	63.35		8		8
(Std is R4) 152 mm (6") Bend Rigid/Swivel Gooseneck Spout	63.35		9		9

See Page C89 for **Optional Rigid/Swivel Spouts**. These spouts can ONLY be added to **SPOUT AND BASIC PRODUCT Option No. 9**.

See Page C90 for **Optional Swing Spouts**. These spouts can ONLY be added to **SPOUT AND BASIC PRODUCT Option No. 2**.

(1) This outlet can ONLY be added to **SPOUT AND BASIC PRODUCT Option No. 9**.

Flow rates are at 60 PSI (414 kPa)



Model

* - Stock Item

* 27C643

Price

167.80

27C643



Code compliant applies to entire series.

CER-TECK® 27C To complete a Product Price add the prices of chosen variations (listed below).
A number from each option column must be used.

SPOUT		OUTLET		HANDLE	
	0		0		0
	1		1		1
	2	Vandal Resistant 1.5 gpm (5.7 L/min.) Laminar w/Agion® Antimicrobial 23.50	2		2
(Std is S3) 152 mm (6") Tubular Swing Spout 106.60	3	Vandal Resistant 1.5 gpm (5.7 L/min.) Flow Control Aerator 14.40	3	76 mm (3") Hooded Lever 12.80	3
	4	Standard 1.5 gpm (5.7 L/min.) Flow Control Aerator 10.90	4		4
	5	Vandal Resistant 0.5 gpm (1.9 L/min.) Non-Aerating Spray Outlet 23.50	5		5
(Std is R2) 114 mm (4½") Bend Rigid/Swivel Gooseneck Spout 144.10	6		6		6
	7	Smooth End, Laminar Flow Control in Base of Gooseneck Spout 1.0 gpm (3.8 L/min.) (1) 23.50	7		7
	8		8	Self Closing Hooded Lever 27.40	8
	9		9		9

See Page C89 for **Optional Rigid/Swivel Spouts**. These spouts can ONLY be added to **BASIC PRODUCT Option No. 6**.

See Page C90 for **Optional Swing Spouts**. These spouts can ONLY be added to **SPOUT AND BASIC PRODUCT Option No. 3**.

(1) This outlet can ONLY be added to **BASIC PRODUCT Option No. 6**.

Flow rates are at 60 PSI (414 kPa)

DELTA COMMERCIAL TECHNICAL SERVICE 1-877-509-2680
ONLINE CATALOGS: www.deltacommercialfaucets.com (Core products ONLY)
www.specselect.com (Complete Product Offering & Part Numbering System)



28C2383



Model

* - Stock Item

- 28C2283
- 28C2383
- 28C2384

Price

- 314.95
- 331.95
- 350.15

ADD-ON OPTIONS (ORDER SEPARATELY)		
CATALOGUE NUMBER	DESCRIPTION	PRICE
* 28T910	Mop Holder	63.40
* 28T911	48" Hose and Stainless Steel Hanger	35.20

ADD-ON "-AC" SUFFIX		
SUFFIX NUMBER	DESCRIPTION	ADD-ON TO PRICE
-AC	5½" to 10½" Adjustable Centers (Not available with No. 9 Long Spout)	69.00

CER-TECK® 28C2 **186.50 (BASIC PRODUCT PRICE)**

To complete a Product Price add the prices of chosen variations (listed below) to the **Basic Product Price**.
A number from each option column must be used.

SPOUT		OUTLET		HANDLES	
†140 mm (5½") Spout Plain 57.90	0		0		0
	1	Body Mounted Double Check Vacuum Breaker with Garden Hose End 107.95	1		1
†267 mm (10½") Spout Plain 57.90	2		2	102 mm (4") Hooded Blade Handle 24.70	2
†267 mm (10½") Spout with Adjustable Top/Bottom Brace 74.90	3		3	76 mm (3") Hooded Lever 23.45	3
	4		4	102 mm (4") Blade with Sanitary Hood 41.65	4
	5		5	152 mm (6") Wrist with Sanitary Hood 67.15	5
	6	Spout End Vacuum Breaker with Garden Hose End 39.10	6		6
	7	Spout End Vacuum Breaker, 1219 mm (48") Hose and S/S Hanger 64.10	7		7
	8	Body Mounted Vacuum Breaker with Garden Hose End 47.10	8		8
†406 mm (16") Spout with Bottom Fork Brace 165.20	9	Body Mounted Vacuum Breaker, 1219 mm (48") Hose and S/S Hanger 72.20	9		9

†Distance from wall to spout outlet.



Model

* - Stock Item

* 28C4243

* 28C4433

* 28C4443

Price

233.60

241.20

237.70

ADD-ON "-AC" SUFFIX		
SUFFIX NUMBER	DESCRIPTION	ADD-ON TO PRICE
-AC	5½" to 10½" Adjustable Centers	69.00

28C4443



Code compliant applies to entire series.

CER-TECK® 28C4 **174.10** **LESS INTEGRAL STOPS** **(BASIC PRODUCT PRICE)**
CER-TECK® 28C6 **201.20** **WITH INTEGRAL CHECK STOPS** **(BASIC PRODUCT PRICE)**

To complete a Product Price add the prices of chosen variations (listed below) to the **Basic Product Price**.
 A number from each option column must be used.

SPOUT		OUTLET		HANDLES	
	0		0		0
(Std is S2) 203 mm (8") Wallform Swing Spout	58.45		1		1
(Std is S5) 203 mm (8") Tubular Swing Spout	25.15	Vandal Resistant 1.5 gpm (5.7 L/min.) Laminar w/Agion® Antimicrobial	23.50	102 mm (4") Hooded Blade Handle	24.70
	3	Vandal Resistant 1.5 gpm (5.7 L/min.) Flow Control Aerator	14.40	76 mm (3") Hooded Lever	23.45
(Std is S7) 279 mm (11") Tubular Swing Spout	29.25	Standard 1.5 gpm (5.7 L/min.) Flow Control Aerator	10.90	102 mm (4") Blade with Sanitary Hood	41.65
	5	Vandal Resistant 0.5 gpm (1.9 L/min.) Non-Aerating Spray Outlet	23.50		
	6				
	7				
	8				
(Std is R4) 152 mm (6") Bend Rigid/Swivel Gooseneck Spout	51.35		9		9

See Page C89 for **Optional Rigid/Swivel Spouts**. These spouts can ONLY be added to **SPOUT Option No. 9**.
 See Page C90 for **Optional Swing Spouts**. These spouts can ONLY be added to **SPOUT Option No. 2**.

Flow rates are at 60 PSI (414 kPa)

Sink Faucets

DELTA COMMERCIAL TECHNICAL SERVICE 1-877-509-2680
 ONLINE CATALOGS: www.deltacommercialfaucets.com (Core products ONLY)
www.specselect.com (Complete Product Offering & Part Numbering System)



Model

* - Stock Item

- 28C8063
- * 28C8073
- 28C8083
- 28C8183

Price

- 292.45
- 317.45
- 300.45
- 317.45

ADD-ON OPTIONS (ORDER SEPARATELY)		
CATALOGUE NUMBER	DESCRIPTION	PRICE
* 28T910	Mop Holder	63.40
* 28T911	48" Hose and Stainless Steel Hanger	35.20







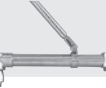

ADD-ON "-AC" SUFFIX (ADD THE SUFFIX TO THE END OF THE MODEL NUMBER TO CHOOSE THIS OPTION)		
SUFFIX NUMBER	DESCRIPTION	ADD-ON TO PRICE
-AC	5½" to 10½" Adjustable Centers	69.00

28C8063



CER-TECK® 28C8 **172.00 (BASIC PRODUCT PRICE)**

To complete a Product Price add the prices of chosen variations (listed below) to the **Basic Product Price**.
A number from each option column must be used.

SPOUT		OUTLET		HANDLES	
†140 mm (5½") Spout Plain  57.90	0				0
†203 mm (8") Spout with Top/Bottom Brace  74.90	1				1
	2			 24.70	2
	3			 23.45	3
	4				4
	5	Garden Hose End  11.00	5		5
	6	Spout End Vacuum Breaker with Garden Hose End  39.10	6		6
	7	Spout End Vacuum Breaker, 1219 mm (48") Hose and S/S Hanger  64.10	7		7
	8	Body Mounted Vacuum Breaker with Garden Hose End  47.10	8		8
	9	Body Mounted Vacuum Breaker, 1219 mm (48") Hose and S/S Hanger  72.20	9		9

†Distance from wall to spout outlet.



COMPRESSION CARTRIDGE		
MODEL	DESCRIPTION	PRICE
28T9	Rough chrome plated with integral stops, pail hook and inline vacuum breaker, metal cross handles	* 155.95
28T9-AC	Same as 28T9 but with 5½" - 10½" (140 mm - 267 mm) adjustable centers	* 181.50

1/4 TURN CERAMIC CARTRIDGE		
MODEL	DESCRIPTION	PRICE
NEW 28C9LH	Rough chrome plated with integral stops, pail hook and inline vacuum breaker, 4" (102 mm) metal lever handles	* 195.95
28C9LH-AC	Same as 28C9LH but with 5½" - 10½" (140 mm - 267 mm) adjustable centers	* 221.50



HOSE AND MOP HOLDER ACCESSORIES		
MODEL	DESCRIPTION	PRICE
28T910	Stainless steel mop hanger, 3" x 26" (76 mm x 660 mm) with 3 rubber grips	* 63.40
28T911	Stainless steel hanger bracket, 3" x 5" (76 mm x 127 mm) with rubber grip and 48" (1219 mm) hose	* 35.20

* - Stock Item

Sink Faucets

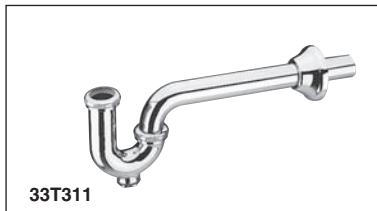

CAST LAVATORY WASTES

MODEL	SIZE	DESCRIPTION	OVERFLOW HOLES		PRICE
			WITH	LESS	
* 33T260	1¼"	P.O. Plug with Open Grid Strainer – Chrome	✓		21.05
* 33T260-1	1¼"	As 33T260 less Overflow Holes – Chrome		✓	24.80
33T260-1DC	1¼"	As 33T260-1 but with Drain Cover		✓	66.15
* 33T290	1¼"	Offset P.O. with Open Grid Strainer – Chrome	✓		39.60
* 33T290-1	1¼"	As 33T290 less Overflow Holes – Chrome		✓	43.45
* 33T290-1DC	1¼"	As 33T290-1 but with Drain Cover (1)		✓	84.25
* 33T295	1¼"	Offset P.O. Plug with Chain & Stopper – Chrome	✓		43.45

CAST P TRAPS

MODEL	SIZE	LENGTH	DESCRIPTION	PRICE
* 33T301	1¼"	14½"	Cast P Traps Less Cleanout	45.90
* 33T311	1¼"	14½"	Cast P Traps With Cleanout	47.20
* 33T360	1½"	11½"	Cast P Traps With Cleanout	58.30

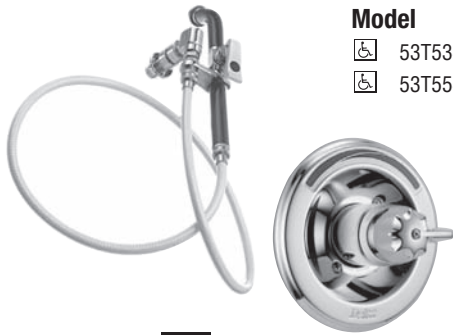
* – Stock Item



Model
 53T5347
 53T5547

Price
 586.00
 539.20

ADD-ON OPTIONS (ADD THE SUFFIX TO THE END OF THE MODEL NUMBER TO CHOOSE THIS OPTION)		
-SUFFIX NUMBER	DESCRIPTION	ADD-ON TO PRICE
-QD	Quick Disconnect Hose	69.00

53T5547



For 81TBP series water closet bedpan cleanser flush valves, see page C48.

Bedpan Cleansers

53T5 **157.30** **(BASIC PRODUCT PRICE)**

To complete a Product Price add the prices of chosen variations (listed below) to the **Basic Product Price**.
 A number from each option column must be used.

SPOUT		OUTLET		HANDLES	
	0		0		0
	1	Spray Outlet 1500 mm (59") Reinforced Vinyl Hose, Hanger and Insulated Handle (1) 137.95	1		1
	2		2		2
Rigid Spout with Wall Mounted Vacuum Breaker 227.95	3		3		3
	4	Spray Outlet with Stop. 1500 mm (59") Reinforced Vinyl Hose, Hanger and Insulated Handle (1) (3) 181.85	4		4
Rigid Spout with Spout End Double Check Vacuum Breaker 181.15	5		5		5
Rigid Spout with Pressure Vacuum Breaker (2) 642.60	6		6		6
	7		7	<input checked="" type="checkbox"/> 57 mm (2.24") Lever Blade Handle 18.90	7
	8		8		8
	9		9		9

- (1) Check with local code authorities for proper cross-flow and hazard protection requirements.
- (2) No. 6 Vacuum Breaker recommended for high hazard cross connections and continuous pressure.
- (3) When using self-close outlet #4, we recommend using #5 or #6 Vacuum Breaker Spouts for continuous pressure.

DELTA COMMERCIAL TECHNICAL SERVICE 1-877-509-2680
 ONLINE CATALOGS: www.deltacommercialfaucets.com (Core products ONLY)
www.specselect.com (Complete Product Offering & Part Numbering System)

Model

- 54T1104
- 54T1254

Price

- 361.10
- 520.40

ADD-ON OPTIONS (ADD THE SUFFIX TO THE END OF THE MODEL NUMBER TO CHOOSE THIS OPTION)		
-SUFFIX NUMBER	DESCRIPTION	ADD-ON TO PRICE
-QD	Quick Disconnect Hose	69.00

54T1104



For 81TBP series water closet bedpan cleanser flush valves, see page C48.

- 54 T 1 Volume Control Valves
- 54 T 1 Volume Control Valves
- 54 T 1 A Foot Pedal Valves Only

To complete a Product Price add the prices of chosen variations (listed below).
A number from each option column must be used.

BASIC PRODUCT		SPOUT		OUTLET	
	0	Use 0 in this column when Basic Product "1" specified	0		0
179.25	1			137.95	1
157.40	2				2
	3	227.95	3		3
578.35	4			181.85	4
	5	181.15	5		5
	6	642.60	6		6
	7		7		7
	8		8		8
	9		9		9

- (1) Check with local code authorities for proper cross-flow and hazard protection requirements.
- (2) No. 6 Vacuum Breaker recommended for high hazard cross connections and continuous pressure.
- (3) When using self-close outlet #4, we recommend using #5 or #6 Vacuum Breaker Spouts for continuous pressure.



54T5432A



Model

- 54T5300A
- 54T5332A
- 54T5400A
- 54T5432A
- 54T5434A
- 54T2401
- 54T2402

Price

- 500.50
- 591.95
- 301.55
- 393.00
- 380.40
- 261.10
- 261.10

54T2401
8" Widespread Faucet with VR 1.5 gpm (5.7 L/min.) Laminar Outlet for 3rd Valve Connection (R2)

54T2402 Same as 54T2401, except with Smooth End Laminar Flow Control in Base of Gooseneck Spout 1.0 gpm (3.8 L/min.)

Code compliant applies to entire series.

54 T 5 **A** To complete a Product Price add the prices of chosen variations (listed below).
A number from each option column must be used.

FOOT PEDAL VALVE		SPOUT		OUTLET	
	0	Select "0" if only pedal valve is required	0	Select "0" if only pedal valve is required	0
	1		1		1
	2	(Std is R2) Wallmount Rigid/Swivel Gooseneck	 94.75	2 Vandal Resistant 1.5 gpm (5.7 L/min.) Laminar w/Agion® Antimicrobial	 23.50
Wall Hung Double Pedal Valve with Inlet and Outlet Stops	3	(Std is R2) Deckmount Rigid/Swivel Gooseneck	 67.95	3 Vandal Resistant 1.5 gpm (5.7 L/min.) Flow Control Aerator	 14.40
Floor Mounted Double Pedal Valve	4		 	4 Standard 1.5 gpm (5.7 L/min.) Flow Control Aerator	 10.90
	5				5
	6				6
	7			7 Smooth End, Laminar Flow Control in Base of Gooseneck Spout 1.0 gpm (3.8 L/min.) (1)	 23.50
	8				8
	9				9

See Page C89 for **Optional Rigid/Swivel Spouts**. These spouts can ONLY be added to **SPOUT Option No.'s 2 or 3**, and **54T2401/54T2402** faucet.

Flow rates are at 60 PSI (414 kPa)

(1) This outlet can ONLY be added to **SPOUT Option No.'s 2 or 3**.

DELTA COMMERCIAL TECHNICAL SERVICE 1-877-509-2680
 ONLINE CATALOGS: www.deltacommercialfaucets.com (Core products ONLY)
www.specselect.com (Complete Product Offering & Part Numbering System)



55C1513



Model

55C1513

Price

608.75

55P1000
0-12" Wall
Bracket Only

46.20

55P1513
8" Wallmount
Pre-Rinse LESS
Wall Bracket and
Thin Wall Kit

477.30



Code compliant applies to entire series.

ADD-ON OPTIONS (ORDER SEPARATELY)		
CATALOGUE NUMBER	DESCRIPTION	PRICE
55C1090	Add-On faucet (S5) (if ordered separately)	156.95

ADD-ON "-AC" SUFFIX		
SUFFIX NUMBER	DESCRIPTION	ADD-ON TO PRICE
-AC	5½" to 10½" Adjustable Centers	69.00

CER-TECK® 55C1

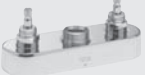
To complete a Product Price add the prices of chosen variations (listed below).
A number from each option column must be used.

BASIC PRODUCT		OUTLET		HANDLES	
	0		0		0
	1	Spray with Spring Loaded S.S. Hose Auto Shut-off	1		1
203 mm (8") Centre Deckmount Faucet, Check Tails  202.80	2		2		2
102 mm (4") Centre Deckmount Faucet, Check Tails  142.65	3		3	76 mm (3") Hooded Lever  23.45	3
	4		4		4
203 mm (8") Centre Wallmount Faucet, Check Stops  234.25	5		5		5
	6		6		6
	7		7		7
	8	Same as No. 1 Above but with Add-On Faucet,(S5) 1.5 gpm @ 60 psi (5.7 L/min. @ 414 kPa)	8		8
	9		9		9

See Page C90 for **Optional Swing Spouts**. These spouts can ONLY be added to **Outlet Option No. 8** and **55C1090**.
Standard spray is 1.6 gpm @ 60 psi (6 L/min. @ 414 kPa).
Optional 1.2 gpm @ 60 psi (4.5 L/min. @ 414 kPa) water and energy saver face plate also provided with 55C series models.

DELTA COMMERCIAL TECHNICAL SERVICE 1-877-509-2680
ONLINE CATALOGS: www.deltacommercialfaucets.com (Core products ONLY)
www.specselect.com (Complete Product Offering & Part Numbering System)

Pre-Rinse Faucets



METERING FAUCETS (with 0.5 gpm (1.9 L/min.) Vandal Resistant Non-Aerating Spray Outlet)

MODEL	DESCRIPTION		PRICE
87T104	Push Button Faucet	*	131.85
87T105	ADA Lever Handle Faucet	♿ *	141.75
87T110	Push Button Faucet with Mixing Tee	*	161.80
87T111	ADA Lever Handle Faucet with Mixing Tee	♿ *	172.45

METERING FAUCETS (with 0.35 gpm (1.32 L/min.) Vandal Resistant Non-Aerating Spray Outlet)

MODEL	DESCRIPTION		PRICE
87T904 (1)	Push Button Faucet		131.85
87T905 (1)	ADA Lever Handle Faucet	♿	141.75
87T910 (1)	Push Button Faucet with Mixing Tee		161.80
87T911 (1)	ADA Lever Handle Faucet with Mixing Tee	♿	172.45

FAUCET COVER PLATE (for above 87T faucets)

MODEL	DESCRIPTION		PRICE
87T151	With Center Faucet Hole for 4" Centers (cast brass)	*	39.65

METERING FAUCETS (with 0.5 gpm (1.9 L/min.) Vandal Resistant Non-Aerating Spray Outlet)

MODEL	DESCRIPTION		PRICE
86T1053	4" Cast Centerset, ADA Lever Handles, Open Grid Strainer	♿ *	254.70
86T1153	4" Cast Centerset, ADA Lever Handle, Less Pop-up Hole	♿ *	239.65

METERING FAUCETS (with 0.35 gpm (1.32 L/min.) Vandal Resistant Non-Aerating Spray Outlet)

MODEL	DESCRIPTION		PRICE
86T1093 (1)	4" Cast Centerset, ADA Lever Handles, Open Grid Strainer	♿	254.70
86T1193 (1)	4" Cast Centerset, ADA Lever Handle, Less Pop-up Hole	♿	239.65

METERING FAUCETS (with 0.5 gpm (1.9 L/min.) Vandal Resistant Non-Aerating Spray Outlet)

MODEL	DESCRIPTION		PRICE
86T0104	Push Button Faucet (86T1104) with Cover Plate (86T151)	*	152.25
86T1104	Push Button Faucet	*	133.15

METERING FAUCETS (with 0.35 gpm (1.32 L/min.) Vandal Resistant Non-Aerating Spray Outlet)

MODEL	DESCRIPTION		PRICE
86T0194 (1)	Push Button Faucet (86T1194) with Cover Plate (86T151)		152.25
86T1194 (1)	Push Button Faucet		133.15

FAUCET COVER PLATE (for above 86T Single hole models)

MODEL	DESCRIPTION		PRICE
86T151	4" Cover Plate for use with 86T1104 & 86T1194		39.65

* – Stock Item

Flow rates are at 60 PSI (414 kPa)

♿ Code compliant products applies to entire series.

(1) Available Q3 - 2014

DELTA COMMERCIAL TECHNICAL SERVICE 1-877-509-2680
 ONLINE CATALOGS: www.deltacommercialfaucets.com (Core products ONLY)
www.specselect.com (Complete Product Offering & Part Numbering System)



FLUSH VALVES FOR WASHDOWN URINAL (No Backflow Protection)			
MODEL	DESCRIPTION		PRICE
86T502	Oscillating Lever Handle Valve, Back Inlet	*	126.15
86T503	Oscillating Lever Handle Valve, Top Inlet	*	126.15
86T505	Oscillating Lever Handle Valve, Back Inlet Stop	*	151.75

INSTALLATION WARNING: Models shown above must be installed on fixtures providing sufficient air gap protection against backflow.

VACUUM BREAKER FOR ABOVE VALVES			
MODEL	DESCRIPTION		PRICE
86T610	3/4" Outlet Tube with Vacuum Breaker	*	63.55

To order Urinal Valves with Vacuum Breaker, order Urinal Valve PLUS Vacuum Breaker (ie 86T505 & 86T610).
 Models supplied LESS Vacuum Breaker must be installed on fixture providing sufficient air gap protection against backflow.
 For DEFM-100 Electronic Sidemount Conversion Kit, see page C39.
 For DEMD-86 Series Electronic Washdown Urinal Valves, see page C46.

* – Stock Item



TECK® FLUSH VALVES, EXPOSED MODELS (Vacuum Breaker Standard)				
MODEL	DESCRIPTION			PRICE
WATER CLOSETS Standard Flush 1.6 gallons (6 liter) Factory Set – Field Adjustable				
81T201	1½" top spud, 11½" height, 1" inlet	♿	*	181.45
81T201-30	1½" top spud, 11½" height (LESS stop, WITH modified tail to fit Sloan®/Zurn® stop)	♿		165.80
81T221	1½" top spud, 24" height, 1" inlet	♿	*	198.25
81T261	1½" top spud (offset), 24" height, 1" inlet	♿		286.10
81T271	1½" back spud, 15" height, 1" inlet	♿		205.40

WATER CLOSET ADDITIONAL OPTIONS & NOTES			
SUFFIX NO.	DESCRIPTION		ADD-ON TO PRICE
WATER CLOSETS			
-1	Trap Seal Primer and for detergent/disinfectant Tee (Add -1 to Flush Valve Model Number) Available on water closet valves only		46.55
-5	Center Bumper on Valve (Add -5 to Flush Valve Model Number) for seat with cover (81T201 & 81T271 ONLY)		13.90
-6	1.6 gallons (6 liter) Factory Set Flush, Not Field Adjustable (Add -6 to Flush Valve Model Number)	Select one only	No Additional Charge
-48	1.27 gallons (4.8 liter) Factory Set Flush, Not Field Adjustable (Add -48 to Flush Valve Model Number)		No Additional Charge

TECK® FLUSH VALVES, EXPOSED MODELS (Vacuum Breaker Standard)				
MODEL	DESCRIPTION			PRICE
URINALS Standard Flush 0.5 gallons (1.9 liter) Factory Set – Field Adjustable				
81T231	¾" top spud, 13" height, ¾" copper sweat inlet	♿	*	181.45
81T231-30	¾" top spud, 13" height (LESS stop, WITH modified tail to fit Sloan®/Zurn® stop)	♿		165.80
81T291	1¼" top spud, 11½" height, 1" inlet	♿		181.25

URINALS ADDITIONAL OPTIONS & NOTES			
SUFFIX NO.	DESCRIPTION		PRICE
-05	0.125 gallons (0.5 liter) Factory Set Flush, Not Field Adjustable (Add -05 to Flush Valve Model Number)	Select one only	No Additional Charge
-19	0.5 gallons (1.9 liter) Factory Set Flush, Not Field Adjustable (Add -19 to Flush Valve Model Number)		No Additional Charge
-38	1.0 gallons (3.8 liter) Factory Set Flush, Not Field Adjustable (Add -38 to Flush Valve Model Number)		No Additional Charge

FLUSH VALVE ACCESSORIES			
MODEL	DESCRIPTION		PRICE
9T400	14" Sq. S/S Cover and Access Panel		150.40
060115A	¾" Dia. C.P. Brass Adjustable Split Ring Hanger		54.50
060117A	1½" Dia. C.P. Brass Adjustable Split Ring Hange		* 66.00

For DEFM-100 Electronic Sidemount Conversion Kit, see page C39.
 Sloan® is a registered trademark of Sloan Valve Company. Zurn® is a registered trademark of Zurn Industries, LLC.

* – Stock Item

DELTA COMMERCIAL TECHNICAL SERVICE 1-877-509-2680
 ONLINE CATALOGS: www.deltacommercialfaucets.com (Core products ONLY)
www.specselect.com (Complete Product Offering & Part Numbering System)



REMOTE CONTROL CONCEALED MODELS (Vacuum Breaker Standard)		
MODEL	DESCRIPTION	PRICE
WATER CLOSETS		
Standard Flush 1.6 gallons (6 liter) Factory Set – Field Adjustable		
83T000	1½" F.I.P. penal back spud, 1" inlet with ⅝" vandal resistant push button	* 292.55
83T140	1½" wall hung back spud, 1" inlet with ⅝" vandal resistant push button	275.20
83T141	1½" wall hung back spud, 1" inlet with oscillating handle	Ⓜ * 290.55
83T143	1½" wall hung back spud, 1" inlet with 1⅝" push button	309.30
83T240	1½" free standing back spud, 1" inlet with ⅝" vandal resistant push button	303.25
83T241	1½" free standing back spud, 1" inlet with oscillating handle	Ⓜ 312.80
83T243	1½" free standing back spud, 1" inlet with 1⅝" push button	312.80
83T340	1½" top spud, 1" inlet with ⅝" vandal resistant push button	319.20
83T341	1½" top spud, 1" inlet with oscillating handle	Ⓜ 337.50
83T343	1½" top spud, 1" inlet with 1⅝" push button	337.50
URINALS		
Standard Flush 0.5 gallons (1.9 liter) Factory Set – Field Adjustable		
83T430	¾" back spud, ¾" inlet with ⅝" vandal resistant push button	* 309.30
83T431	¾" back spud, ¾" inlet with oscillating handle	Ⓜ 303.25

Flush Valves

WATER CLOSET ADDITIONAL OPTIONS & NOTES		
SUFFIX NO.	DESCRIPTION	ADD-ON TO PRICE
WATER CLOSETS		
-1	Trap Seal Primer and for detergent/disinfectant Tee (Add -1 to Flush Valve Model Number) Available on water closet valves only	46.55
-6	1.6 gallons (6 liter) Factory Set Flush, Not Field Adjustable (Add -6 to Flush Valve Model Number)	Select one only No Additional Charge
-48	1.27 gallons (4.8 liter) Factory Set Flush, Not Field Adjustable (Add -48 to Flush Valve Model Number)	

URINAL ADDITIONAL OPTIONS & NOTES		
SUFFIX NO.	DESCRIPTION	ADD-ON TO PRICE
URINALS		
-05	0.125 gallons (0.5 liter) Factory Set Flush, Not Field Adjustable (Add -05 to Flush Valve Model Number)	Select one only No Additional Charge
-19	0.5 gallons (1.9 liter) Factory Set Flush, Not Field Adjustable (Add -19 to Flush Valve Model Number)	
-38	1.0 gallons (3.8 liter) Factory Set Flush, Not Field Adjustable (Add -38 to Flush Valve Model Number)	

* – Stock Item

DELTA COMMERCIAL TECHNICAL SERVICE 1-877-509-2680
 ONLINE CATALOGS: www.deltacommercialfaucets.com (Core products ONLY)
www.specselect.com (Complete Product Offering & Part Numbering System)



Flush Valves

ELECTRONIC BATTERY FLUSHVALVES EXPOSED MODELS

MODEL	DESCRIPTION	PRICE
SINGLE FLUSH WATER CLOSETS		
Standard Flush 1.6 gallons (6 liter) Factory Set – Field Adjustable		
81T201BTA	Battery Operated Electronic, 1½" top spud, 11½" height, 1" inlet	546.15
81T201BTA-20	Battery Operated Electronic Retrofit Kit , 1½" top spud, 11½" height, LESS stop	520.15
81T201BTA-30	Battery Operated Electronic Retrofit Kit , 1½" top spud, 11½" height, LESS stop, WITH modified tail to fit Sloan®/Zurn® stop	520.15
81T221BTA	Battery Operated Electronic, 1½" top spud, 24" height, 1" inlet	560.05
URINALS		
Standard Flush 0.5 gallons (1.9 liter) Factory Set – Field Adjustable		
81T231BTA	Battery Operated Electronic, ¾" top spud, 13" height, ¾" copper sweat inlet	546.15
81T231BTA-20	Battery Operated Electronic Retrofit Kit , ¾" top spud, 13" height, LESS stop	520.15
81T231BTA-30	Battery Operated Electronic Retrofit Kit , ¾" top spud, 13" height, LESS stop, WITH modified tail to fit Sloan®/Zurn® stop	520.15

See pages C124-C126 for Electronic Concealed Models.
Batteries included on all battery version models.

FLUSH VALVE VARIATIONS

SUFFIX NO.	DESCRIPTION	ADD-ON TO PRICE
SINGLE FLUSH WATER CLOSET ADDITIONAL OPTIONS & NOTES		
-1	Trap Seal Primer and for detergent/disinfectant Tee (Add -1 to Flush Valve Model Number) Available on water closet valves only	46.55
-6	1.6 gallons (6 liter) Factory Set Flush, Not Field Adjustable (Add -6 to Flush Valve Model Number)	Select one only No Additional Charge
-13	3.4 gallons (13 liter) Factory Set Flush, Field Adjustable (Add -13 to Flush Valve Model Number) - only available on 81T201BTA-20 and -30	
-48	1.27 gallons (4.8 liter) Factory Set Flush, Not Field Adjustable (Add -48 to Flush Valve Model Number)	
-DF	Dual Flush mode factory set to ON provides full flush or 30% reduced flush based on time and distance from valve. Available only on flush valves with a 1.6 gallons (6 liter) Field Adjustable factory set flush. (Add -DF to Flush Valve Model Number.)	No Additional Charge
URINAL ADDITIONAL OPTIONS & NOTES		
-05	0.125 gallons (0.5 liter) Factory Set Flush, Not Field Adjustable (Add -05 to Flush Valve Model Number)	Select one only No Additional Charge
-19	0.5 gallons (1.9 liter) Factory Set Flush, Not Field Adjustable (Add -19 to Flush Valve Model Number)	
-38	1.0 gallons (3.8 liter) Factory Set Flush, Not Field Adjustable (Add -38 to Flush Valve Model Number)	

Sloan® is a registered trademark of Sloan Valve Company. Zurn® is a registered trademark of Zurn Industries, LLC.

* – Stock Item



ELECTRONIC HARDWIRE FLUSHVALVES EXPOSED MODELS		
MODEL	DESCRIPTION	PRICE
SINGLE FLUSH WATER CLOSETS Standard Flush 1.6 gallons (6 liter) Factory Set – Field Adjustable		
81T201HWA	Hardwire Electronic, 1½” top spud, 11½” height, 1” inlet	593.60
81T201HWA-20	Hardwire Electronic Retrofit Kit , 1½” top spud, 11½” height, LESS stop	567.55
81T201HWA-30	Hardwire Electronic Retrofit Kit , 1½” top spud, 11½” height, LESS stop, WITH modified tail to fit Sloan®/Zurn® stop	567.55
81T221HWA	Hardwire Electronic, 1½” top spud, 24” height, 1” inlet	607.55
URINALS Standard Flush 0.5 gallons (1.9 liter) Factory Set – Field Adjustable		
81T231HWA	Hardwire Electronic, ¾” top spud, 13” height, ¾” copper sweat inlet	593.60
81T231HWA-20	Hardwire Electronic Retrofit Kit , ¾” top spud, 13” height, LESS stop	567.55
81T231HWA-30	Hardwire Electronic Retrofit Kit , ¾” top spud, 13” height, LESS stop, WITH modified tail to fit Sloan®/Zurn® stop	567.55

Flush Valves

See pages C124-C126 for Electronic Concealed Models.
Transformer to be ordered separately for Hardwire Models. See page C125.

FLUSH VALVE VARIATIONS		
SUFFIX NO.	DESCRIPTION	ADD-ON TO PRICE
SINGLE FLUSH WATER CLOSET ADDITIONAL OPTIONS & NOTES		
-1	Trap Seal Primer and for detergent/disinfectant Tee (Add -1 to Flush Valve Model Number) Available on water closet valves only	46.55
-6	1.6 gallons (6 liter) Factory Set Flush, Not Field Adjustable (Add -6 to Flush Valve Model Number)	No Additional Charge
-13	3.4 gallons (13 liter) Factory Set Flush, Field Adjustable (Add -13 to Flush Valve Model Number) - only available on 81T201-20 and -30	No Additional Charge
-48	1.27 gallons (4.8 liter) Factory Set Flush, Not Field Adjustable (Add -48 to Flush Valve Model Number)	No Additional Charge
-BB	Hardwire converter with Battery Back-Up, to keep electronic units running during power failures until power has been fully restored (Add -BB to Flush Valve Model Number)	44.35
-DF	Dual Flush mode factory set to ON provides full flush or 30% reduced flush based on time and distance from valve. Available only on flush valves with a 1.6 gallons (6 liter) Field Adjustable factory set flush. (Add -DF to Flush Valve Model Number.)	No Additional Charge
URINAL ADDITIONAL OPTIONS & NOTES		
-05	0.125 gallons (0.5 liter) Factory Set Flush, Not Field Adjustable (Add -05 to Flush Valve Model Number)	No Additional Charge
-19	0.5 gallons (1.9 liter) Factory Set Flush, Not Field Adjustable (Add -19 to Flush Valve Model Number)	No Additional Charge
-38	1.0 gallons (3.8 liter) Factory Set Flush, Not Field Adjustable (Add -38 to Flush Valve Model Number)	No Additional Charge
-BB	Hardwire converter with Battery Back-Up, to keep electronic units running during power failures until power has been fully restored (Add -BB to Flush Valve Model Number)	44.35

Sloan® is a registered trademark of Sloan Valve Company. Zurn® is a registered trademark of Zurn Industries, LLC.

* – Stock Item



Flush Valves

ELECTRONIC BATTERY FLUSHVALVES EXPOSED MODELS

MODEL	DESCRIPTION	PRICE
WATER CLOSETS		
Standard Flush 1.6 gallons (6 liter) Factory Set – Field Adjustable		
81T201-WMSBT	Battery Operated Electronic, 1½" top spud, 11½" height, 1" inlet, with 4" wall mount sensor	739.00
URINALS		
Standard Flush 0.5 gallons (1.9 liter) Factory Set – Field Adjustable		
81T231-WMSBT	Battery Operated Electronic, ¾" top spud, 13" height, ¾" copper sweat inlet, with 4" wall mount sensor	739.00

ELECTRONIC HARDWIRE FLUSHVALVES EXPOSED MODELS

MODEL	DESCRIPTION	PRICE
WATER CLOSETS		
Standard Flush 1.6 gallons (6 liter) Factory Set – Field Adjustable		
81T201-WMSHW	Hardwire Electronic, 1½" top spud, 11½" height, 1" inlet, with 4" wall mount sensor *	739.00
URINALS		
Standard Flush 0.5 gallons (1.9 liter) Factory Set – Field Adjustable		
81T231-WMSHW	Hardwire Electronic, ¾" top spud, 13" height, ¾" copper sweat inlet, with 4" wall mount sensor *	739.00

See pages C124-C126 for additional Electronic Concealed Models.
Transformer to be ordered separately for Hardwire Models. See page C125.
Batteries included on all battery version models.

FLUSH VALVE VARIATIONS

SUFFIX NO.	DESCRIPTION	ADD-ON TO PRICE
WATER CLOSET ADDITIONAL OPTIONS & NOTES		
-1	Trap Seal Primer and for detergent/disinfectant Tee (Add -1 to Flush Valve Model Number) Available on water closet valves only	46.55
-6	1.6 gallons (6 liter) Factory Set Flush, Not Field Adjustable (Add -6 to Flush Valve Model Number)	Select one only No Additional Charge
-48	1.27 gallons (4.8 liter) Factory Set Flush, Not Field Adjustable (Add -48 to Flush Valve Model Number)	
-BB	Hardwire converter with Battery Back-Up, to keep electronic units running during power failures until power has been fully restored (Add -BB to Flush Valve Model Number. Not available on Battery Operated Units.)	44.35
URINAL ADDITIONAL OPTIONS & NOTES		
-05	0.125 gallons (0.5 liter) Factory Set Flush, Not Field Adjustable (Add -05 to Flush Valve Model Number)	Select one only No Additional Charge
-19	0.5 gallons (1.9 liter) Factory Set Flush, Not Field Adjustable (Add -19 to Flush Valve Model Number)	
-38	1.0 gallons (3.8 liter) Factory Set Flush, Not Field Adjustable (Add -38 to Flush Valve Model Number)	
-BB	Hardwire converter with Battery Back-Up, to keep electronic units running during power failures until power has been fully restored (Add -BB to Flush Valve Model Number. Not available on Battery Operated Units.)	44.35

* – Stock Item

DELTA COMMERCIAL TECHNICAL SERVICE 1-877-509-2680
ONLINE CATALOGS: www.deltacommercialfaucets.com (Core products ONLY)
www.specselect.com (Complete Product Offering & Part Numbering System)



EXPOSED BATTERY OPERATED RETROFIT KIT FOR WATER CLOSET

MODEL	(Standard Flush 1.6 gallon (6 Liter) Factory Set - Field Adjustable) DESCRIPTION	PRICE
81TWCBTRKA	Battery Operated Electronic Water Closet Retrofit Kit LESS Body, Stop, Outlet Tubing	392.20

EXPOSED BATTERY OPERATED RETROFIT KIT FOR URINAL

MODEL	(Standard Flush 0.5 gallon (1.9 Liter) Factory Set - Field Adjustable) DESCRIPTION	PRICE
81TURBTRKA	Battery Operated Electronic Urinal Retrofit Kit LESS Body, Stop, Outlet Tubing	392.20

FLUSH VALVE VARIATIONS

SUFFIX NO.	DESCRIPTION	ADD-ON TO PRICE
SINGLE FLUSH WATER CLOSET ADDITIONAL OPTIONS & NOTES		
-6	1.6 gallons (6 liter) Factory Set Flush, Not Field Adjustable (Add -6 to Flush Valve Model Number)	No Additional Charge
-13	3.4 gallons (13 liter) Factory Set Flush, Field Adjustable (Add -13 to Flush Valve Model Number)	No Additional Charge
-48	1.27 gallons (4.8 liter) Factory Set Flush, Not Field Adjustable (Add -48 to Flush Valve Model Number)	No Additional Charge
-DF	Dual Flush mode factory set to ON provides full flush or 30% reduced flush based on time and distance from valve. Available only on flush valves with a 1.6 gallons (6 liter) Field Adjustable factory set flush. (Add -DF to Flush Valve Model Number.)	No Additional Charge
URINAL ADDITIONAL OPTIONS & NOTES		
-05	0.125 gallons (0.5 liter) Factory Set Flush, Not Field Adjustable (Add -05 to Flush Valve Model Number)	No Additional Charge
-19	0.5 gallons (1.9 liter) Factory Set Flush, Not Field Adjustable (Add -19 to Flush Valve Model Number)	No Additional Charge
-38	1.0 gallons (3.8 liter) Factory Set Flush, Not Field Adjustable (Add -38 to Flush Valve Model Number)	No Additional Charge

HARDWIRE KIT

MODEL	DESCRIPTION	PRICE
061069A	Hardwire Kit for 3RD Gen E-FV (includes 24 VAC to 6 VDC converter, V.R. copper tube conduit and 2 x4" Junction Box) Transformer Ordered Separately	71.10

Transformer to be ordered separately for Hardwire Models, see Page C125.

* – Stock Item

Rough-in and Trim Ordered and Priced Separately.

Flush Valves

HARDWIRE					
WATER CLOSETS		Standard Flush 1.6 gallons (6 liter) Factory Set – Field Adjustable			
MODEL		Fixture Type & SS Cover Size	PRICE		
Rough-in	Trim		Rough-in	Trim	
1600T6102RI	1600T6102TR	Wall Hung, 1½" Back Inlet, 14 x 20" Cover, with 12 x 18" Frame		488.75	488.75
1600T6103RI	1600T6103TR	Wall Hung, 1½" Back Inlet, 14" Cover, with 12" Frame	*	482.80	482.80
1600T6104RI	1600T6104TR	Wall Hung, 1½" Back Inlet, 4" Cover, with Box		369.60	369.60
1600T6202RI	1600T6202TR	Freestanding, 1½" Back Inlet, 14 x 20" Cover, with 12 x 18" Frame		518.50	518.50
1600T6203RI	1600T6203TR	Freestanding, 1½" Back Inlet, 14" Cover, with 12" Frame		512.60	512.60
1600T6204RI	1600T6204TR	Freestanding, 1½" Back Inlet, 4" Cover, with Box		399.35	399.35
1600T6302RI	1600T6302TR	Toilet, 1½" Top Inlet, 14 x 20" Cover, with 12 x 18" Frame		548.30	548.30
1600T6303RI	1600T6303TR	Toilet, 1½" Top Inlet, 14" Cover, with 12" Frame		542.35	542.35
1600T6304RI	1600T6304TR	Toilet, 1½" Top Inlet, 4" Cover, with Box		429.15	429.15
URINALS		Standard Flush 0.5 gallons (1.9 liter) Factory Set – Field Adjustable			
MODEL		Fixture Type & SS Cover Size	PRICE		
Rough-in	Trim		Rough-in	Trim	
1600T6402RI	1600T6402TR	Syphon Jet Urinal, ¾" Back Inlet, 14 x 20" Cover, with 12 x 18" Frame (1)		476.80	476.80
1600T6403RI	1600T6403TR	Syphon Jet Urinal, ¾" Back Inlet, 14" Cover, with 12" Frame (1)	*	470.85	470.85
1600T6404RI	1600T6404TR	Syphon Jet Urinal, ¾" Back Inlet, 4" Cover, with Box (1)		357.65	357.65

Transformer ordered separately. See page C125.

BATTERY					
WATER CLOSETS		Standard Flush 1.6 gallons (6 liter) Factory Set – Field Adjustable			
MODEL		Fixture Type & SS Cover Size	PRICE		
Rough-in	Trim		Rough-in	Trim	
1601T6102RI	1601T6102TR	Wall Hung, 1½" Back Inlet, 14 x 20" Cover, with 12 x 18" Frame		488.75	488.75
1601T6103RI	1601T6103TR	Wall Hung, 1½" Back Inlet, 14" Cover, with 12" Frame		482.80	482.80
1601T6104RI	1601T6104TR	Wall Hung, 1½" Back Inlet, 4" Cover, with Box	*	369.60	369.60
1601T6202RI	1601T6202TR	Freestanding, 1½" Back Inlet, 14 x 20" Cover, with 12 x 18" Frame		518.50	518.50
1601T6203RI	1601T6203TR	Freestanding, 1½" Back Inlet, 14" Cover, with 12" Frame		512.60	512.60
1601T6204RI	1601T6204TR	Freestanding, 1½" Back Inlet, 4" Cover, with Box		399.35	399.35
1601T6302RI	1601T6302TR	Toilet, 1½" Top Inlet, 14 x 20" Cover, with 12 x 18" Frame		548.30	548.30
1601T6303RI	1601T6303TR	Toilet, 1½" Top Inlet, 14" Cover, with 12" Frame		542.35	542.35
1601T6304RI	1601T6304TR	Toilet, 1½" Top Inlet, 4" Cover, with Box		429.15	429.15
URINALS		Standard Flush 0.5 gallons (1.9 liter) Factory Set – Field Adjustable			
MODEL		Fixture Type & SS Cover Size	PRICE		
Rough-in	Trim		Rough-in	Trim	
1601T6402RI	1601T6402TR	Syphon Jet Urinal, ¾" Back Inlet, 14 x 20" Cover, with 12 x 18" Frame (1)		476.80	476.80
1601T6403RI	1601T6403TR	Syphon Jet Urinal, ¾" Back Inlet, 14" Cover, with 12" Frame (1)		470.85	470.85
1601T6404RI	1601T6404TR	Syphon Jet Urinal, ¾" Back Inlet, 4" Cover, with Box (1)		357.65	357.65

(1) When used for top inlet urinal fixture. Exposed tubing, flanges, elbow, etc. supplied by others.

Batteries included in all battery version models.

FLUSH VALVE VARIATIONS			
SUFFIX NO.	DESCRIPTION	ADD-ON TO PRICE	
WATER CLOSET ADDITIONAL OPTIONS & NOTES			
-1	Trap Seal Primer and for detergent/disinfectant Tee (Add -1 to RI Flush Valve Model Number) Available on water closet valves only		46.55
-6	1.6 gallons (6 liter) Factory Set Flush, Not Field Adjustable (Add -6 to RI Flush Valve Model Number)	<input type="checkbox"/>	No Additional Charge
-48	1.27 gallons (4.8 liter) Factory Set Flush, Not Field Adjustable (Add -48 to RI Flush Valve Model Number)	<input type="checkbox"/> Select one only	No Additional Charge
-BB	Battery Back-Up - available on Hardwire operated TR models ONLY.		44.35
URINAL ADDITIONAL OPTIONS & NOTES			
-05	0.125 gallons (0.5 liter) Factory Set Flush, Not Field Adjustable (Add -05 to RI Flush Valve Model Number)	<input type="checkbox"/>	No Additional Charge
-19	0.5 gallons (1.9 liter) Factory Set Flush, Not Field Adjustable (Add -19 to RI Flush Valve Model Number)	<input type="checkbox"/> Select one only	No Additional Charge
-38	1.0 gallons (3.8 liter) Factory Set Flush, Not Field Adjustable (Add -38 to RI Flush Valve Model Number)	<input type="checkbox"/>	No Additional Charge
-BB	Battery Back-Up - available on Hardwire operated TR models ONLY.		44.35

* – Stock Item

DELTA COMMERCIAL TECHNICAL SERVICE 1-877-509-2680
ONLINE CATALOGS: www.deltacommercialfaucets.com (Core products ONLY)
www.specselect.com (Complete Product Offering & Part Numbering System)

Rough-in and Trim Ordered and Priced Separately where noted.

HARDWIRE					
MODEL		(Factory Set 0.5 gallon (1.9 Liter) Flush) Fixture Type & SS Cover Size		PRICE	
Rough-in	Trim			Rough-in	Trim
1600T9001RI	1600T9001TR	¾" Back Inlet, 10" Cover with S/S Outlet Hose		*	381.45 381.45
1600T9003RI	1600T9003TR	¾" Top Inlet, 10" Cover (1)			369.60 369.60
Available as COMPLETE model only				TOTAL PRICE	
1600T9006		Back or Top Inlet, 4" Cover (1)			572.15

Transformer ordered separately for Hardwire models. See below.

BATTERY					
MODEL		(Factory Set 0.5 gallon (1.9 Liter) Flush) Fixture Type & SS Cover Size		PRICE	
Rough-in	Trim			Rough-in	Trim
1601T9001RI	1601T9001TR	¾" Back Inlet, 10" Cover with S/S Outlet Hose			381.45 381.45
1601T9003RI	1601T9003TR	¾" Top Inlet, 10" Cover (1)			369.60 369.60
Available as COMPLETE model only				TOTAL PRICE	
1601T9006		Back or Top Inlet, 4" Cover (1)			572.15

Batteries included in all battery version models.

(1) When used for Top Inlet Urinal Fixture-Exposed Tubing, Flanges, Elbow, etc. SUPPLIED BY OTHERS
Models must be installed on fixtures providing sufficient air gap protection against backflow.

ADD-ON OPTIONS (ADD THE SUFFIX TO THE END OF THE MODEL NUMBER TO CHOOSE THIS OPTION)		
-SUFFIX NUMBER	DESCRIPTION	ADD-ON TO PRICE
-BB	Battery Back-Up - available on Hardwire operated TR or COMPLETE models ONLY.	44.35

OPTIONAL ACCESSORIES (Use Component Parts Discount)		
MODEL	DESCRIPTION	PRICE
060704A	20VA Transformer (For up to 10 – 590 or 860T Series, or up to 5 – 3000T, 1500T, 590T, 590TP, 591T, 591TP, 1600T, 81THW, DEMD, 600T & 620TP Series)	53.15
060771A	40VA Transformer (For up to 10 – 3000T, 1500T, 590T, 590TP, 591T, 591TP, 1600T, 81THW, DEMD, 600T & 620TP Series)	54.10
060772A	100VA Transformer (For up to 25 – 3000T, 1500T, 590T, 590TP, 591T, 591TP, 1600T, 81THW, DEMD, 600T & 620TP Series)	142.80
RP32856	Plug-In Transformer (For up to 10 – 590 or 860T Series, or up to 5 – 3000T, 1500T, 590T, 590TP, 591T, 591TP, 1600T, 81THW, DEMD, 600T & 620TP Series)	39.15

* – Stock Item

Flush Valves



Rough-in and Trim Ordered and Priced Separately.

Flush Valves

HARDWIRE – Water Closet

MODEL		DESCRIPTION	PRICE	
Rough-in	Trim		Rough-in	Trim
1600T6102RI-IP	1600T6102TR-LS	Wall hung, 1½" back inlet, with optional 1½" MIP on outlet tube supplied 14" x 20" cover (less sensor), 12" x 18" frame (1) *	488.75	488.75
1600T6102RI-6IP	1600T6102TR-LS	Wall hung, 1½" back inlet, with optional 1½" MIP on outlet tube supplied 14" x 20" cover (less sensor), 12" x 18" frame (2) *	488.75	488.75
1600T6102RI-48IP	1600T6102TR-LS	Wall hung, 1½" back inlet, with optional 1½" MIP on outlet tube supplied 14" x 20" cover (less sensor), 12" x 18" frame (3) *	488.75	488.75

BATTERY POWERED – Water Closet

MODEL		DESCRIPTION	PRICE	
Rough-in	Trim		Rough-in	Trim
1601T6102RI-IP	1601T6102TR-LS	Wall hung, 1½" back inlet, with optional 1½" MIP on outlet tube supplied 14" x 20" cover (less sensor), 12" x 18" frame (1)	488.75	488.75
1601T6102RI-6IP	1601T6102TR-LS	Wall hung, 1½" back inlet, with optional 1½" MIP on outlet tube supplied 14" x 20" cover (less sensor), 12" x 18" frame (2)	488.75	488.75
1601T6102RI-48IP	1601T6102TR-LS	Wall hung, 1½" back inlet, with optional 1½" MIP on outlet tube supplied 14" x 20" cover (less sensor), 12" x 18" frame (3)	488.75	488.75

- (1) 1.6 gallons (6 litre) Factory Set at 60 PSI – Field Adjustable
- (2) 1.6 gallons (6 litre) Factory Set Flush – Not Field Adjustable
- (3) 1.27 gallons (4.8 litre) Factory Set Flush – Not Field Adjustable

FLUSH VALVE VARIATIONS

SUFFIX NUMBER	DESCRIPTION	PRICE
-BB	Battery back-up – available on hardwire operated TR models ONLY	44.35

Transformer to be ordered separately for hardwire models. See page C125.
 Batteries included in all battery version models.

Flush volumes are at 60 PSI (414 kPa)

* – Stock Item



Model	Price
* - Stock Item	
* 590T0120	540.50
590T0130	531.40
590T0160	540.50

Note : Available as complete models ONLY

Code compliant applies to entire series.

ADD-ON OPTIONS (ADD THE SUFFIX TO THE END OF THE MODEL NUMBER TO CHOOSE THIS OPTION)		
-SUFFIX NUMBER	DESCRIPTION	ADD-ON TO PRICE
-BB	Battery Back-Up - available on Hardwire operated models ONLY	44.35

590T0120 (shown)

590T0 **Hardwire Operated 48.45 (Base Product Price)**
590T1 **Battery Operated 48.45 (Base Product Price)**

To complete a Product Price for the above, add the prices of the chosen variations (listed below) to the **Base Product Price**.
 A number from each option column must be used.

SPOUT AND SENSOR		OUTLET		CONTROL BOX	
	0		0	Base Model with Surface Mount Housing - No Mixing Valve	204.25
Single Hole Deck Mount Hi-Rise Spout with Integral Sensor	1		1	For Recessed Control Box #1, see page C128	1
Deck Mount Hi-Rise Spout with Integral Sensor and 4" Forged Cover Plate	2	Vandal Resistant 1.5 gpm (5.7 L/min.) Laminar w/Agion® Antimicrobial	23.50		2
	3	Vandal Resistant 1.5 gpm (5.7 L/min.) Flow Control Aerator	14.40		3
	4				4
	5	Vandal Resistant 0.5 gpm (1.9 L/min.) Laminar Outlet	23.50		5
	6	Vandal Resistant 1.0 gpm (3.8 L/min.) Laminar Outlet	23.50		6
	7				7
Deck Mount Hi-Rise Spout with Integral Sensor and 8" Forged Cover Plate	8			For Recessed Control Box #8, see page C128	8
	9	NEW (1) Vandal Resistant 0.35 gpm (1.32 L/min.) Non-Aerating Spray Outlet	23.50		9

Transformer to be ordered separately for Hardwire models, see page C125.

Batteries included on all battery version models!

(1) Available Q3 - 2014

Flow rates are at 60 PSI (414 kPa)



Model	Price
* - Stock Item	
590T0121TR	284.80
* 590T0128TR	276.50

Note : Must order Rough-In Number AND Trim Number SEPARATELY

ADD-ON OPTIONS (ADD THE SUFFIX TO THE END OF THE TRIM MODEL NUMBER TO CHOOSE THIS OPTION)		
-SUFFIX NUMBER	DESCRIPTION	ADD-ON TO PRICE
-BB	Battery Back-Up - available on Hardwire operated models ONLY.	44.35

590T0121TR (shown)

Code compliant applies to entire series.

ELAVT0001RI *	Rough-In ONLY with NO Mixing Valve	395.65
ELAVT0008RI *	Rough-In ONLY with Thermostatic Mixing Valve	599.80
590T0 <input type="checkbox"/> <input type="checkbox"/> <input type="checkbox"/> TR	Trim ONLY - Hardwire Operated	48.45 (Base Product Price)
590T1 <input type="checkbox"/> <input type="checkbox"/> <input type="checkbox"/> TR	Trim ONLY - Battery Operated	48.45 (Base Product Price)

To complete a Trim Product Price for the above, add the prices of the chosen variations (listed below) to the **Base Product Price**.
A number from each option column must be used.

SPOUT AND SENSOR		OUTLET		CONTROL BOX	
	0		0	For Surface Mount Control Box #0, see page C127	0
Single Hole Deck Mount Hi-Rise Spout with Integral Sensor	1		1	Recessed Mount with 10" x 10" Box - No Mixing Valve (1) Requires separate purchase of ELAVT0001RI	1
Deck Mount Hi-Rise Spout with Integral Sensor and 4" Forged Cover Plate	2	Vandal Resistant 1.5 gpm (5.7 L/min.) Laminar w/Agion® Antimicrobial	23.50		2
	3	Vandal Resistant 1.5 gpm (5.7 L/min.) Flow Control Aerator	14.40		3
	4				4
	5	Vandal Resistant 0.5 gpm (1.9 L/min.) Laminar Outlet	23.50		5
	6	Vandal Resistant 1.0 gpm (3.8 L/min.) Laminar Outlet	23.50		6
	7				7
Deck Mount Hi-Rise Spout with Integral Sensor and 8" Forged Cover Plate	8			Recessed Mount with 10" x 10" Box with Thermostatic Mixing Valve (1) Requires separate purchase of ELAVT0008RI	8
	9	NEW (2) Vandal Resistant 0.35 gpm (1.32 L/min.) Non-Aerating Spray Outlet	23.50		9

(1) Connection from box to spout not supplied. Batteries included on all battery version models. Transformer to be ordered separately for Hardwire models, see page C125.

(2) Available Q3 - 2014

Flow rates are at 60 PSI (414 kPa)

DELTA COMMERCIAL TECHNICAL SERVICE 1-877-509-2680
ONLINE CATALOGS: www.deltacommercialfaucets.com (Core products ONLY)
www.specselect.com (Complete Product Offering & Part Numbering System)



590TP0150 (shown)

Model

* - Stock Item

- * 590TP0150
- 590TP0250
- 590TP1150

Price

- 581.90
- 648.95
- 581.90

Note : Available as complete models ONLY

Code compliant applies to entire series.

ADD-ON OPTIONS (ADD THE SUFFIX TO THE END OF THE MODEL NUMBER TO CHOOSE THIS OPTION)		
-SUFFIX NUMBER	DESCRIPTION	ADD-ON TO PRICE
-BB	Battery Back-Up - available on Hardwire operated models ONLY	44.35

590TP0 **Hardwire Operated 48.45 (Base Product Price)**

590TP1 **Battery Operated 48.45 (Base Product Price)**

To complete a Product Price add the prices of chosen variations (listed below) to the **Base Product Price**.

A number from each option column must be used.

SPOUT AND SENSOR		OUTLET		CONTROL BOX	
	0		0	Base Model with Surface Mount Housing - No Mixing Valve	0
				204.25	
Single Hole Deck Mount Hi-Rise Spout	305.70	1	1	For Recessed Control Box #1, see page C130	1
Deck Mount Hi-Rise Spout 4" Forged Cover Plate	372.75	2	2		2
		Vandal Resistant 1.5 gpm (5.7 L/min.) Laminar w/Agion® Antimicrobial	23.50		
		3	3		3
		Vandal Resistant 1.5 gpm (5.7 L/min.) Flow Control Aerator	14.40		
		4	4		4
		5	5		5
		Vandal Resistant 0.5 gpm (1.9 L/min.) Laminar Outlet	23.50		
		6	6		6
		Vandal Resistant 1.0 gpm (3.8 L/min.) Laminar Outlet	23.50		
		7	7		7
Deck Mount Hi-Rise Spout 8" Forged Cover Plate	391.85	8	8	For Recessed Control Box #8, see page C130	8
		9	9		9
		NEW (1) Vandal Resistant 0.35 gpm (1.32 L/min.) Non-Aerating Spray Outlet	23.50		

Electronics

Transformer to be ordered separately for Hardwire models, see page C125.

Batteries included on all battery version models.

(1) Available Q3 - 2014

Flow rates are at 60 PSI (414 kPa)

NEW! Proximity® Sensing Technology
Lavatory Faucets Deck Mount – 590TP Series with Recessed Box



Model	Price
* - Stock Item	
* 590TP0128TR	317.90
* 590TP0158TR	317.90

Note : Must order Rough-In Number AND Trim Number SEPARATELY

Code compliant applies to entire series.

590TP0158TR (shown)

ADD-ON OPTIONS (ADD THE SUFFIX TO THE END OF THE MODEL NUMBER TO CHOOSE THIS OPTION)		
-SUFFIX NUMBER	DESCRIPTION	ADD-ON TO PRICE
-BB	Battery Back-Up - available on Hardwire operated models ONLY	44.35

ELAVT0001RI *	Rough-In ONLY with NO Mixing Valve	395.65
ELAVT0008RI *	Rough-In ONLY with Thermostatic Mixing Valve	599.80
590TP0 <input type="checkbox"/> <input type="checkbox"/> <input type="checkbox"/> TR	Trim ONLY - Hardwire Operated	48.45 (Base Product Price)
590TP1 <input type="checkbox"/> <input type="checkbox"/> <input type="checkbox"/> TR	Trim ONLY - Battery Operated	48.45 (Base Product Price)

To complete a Trim Product Price add the prices of chosen variations (listed below) to the **Base Product Price**.
 A number from each option column must be used.

SPOUT AND SENSOR		OUTLET		CONTROL BOX	
	0		0	For Surface Mount Control Box #0, see page C129	0
Single Hole Deck Mount Hi-Rise Spout	1		1	Recessed Mount with 10" x 10" Box - No Mixing Valve (1) Requires separate purchase of ELAVT0001RI	1
Deck Mount Hi-Rise Spout 4" Forged Cover Plate	2	Vandal Resistant 1.5 gpm (5.7 L/min.) Laminar w/Agion® Antimicrobial	2		2
	3	Vandal Resistant 1.5 gpm (5.7 L/min.) Flow Control Aerator	3		3
	4		4		4
	5	Vandal Resistant 0.5 gpm (1.9 L/min.) Laminar Outlet	5		5
	6	Vandal Resistant 1.0 gpm (3.8 L/min.) Laminar Outlet	6		6
	7		7		7
Deck Mount Hi-Rise Spout 8" Forged Cover Plate	8		8	Recessed Mount with 10" x 10" Box with Thermostatic Mixing Valve (1) Requires separate purchase of ELAVT0008RI	8
	9	NEW (2) Vandal Resistant 0.35 gpm (1.32 L/min.) Non-Aerating Spray Outlet	9		9

(1) Connection from box to spout not supplied
 Transformer to be ordered separately for Hardwire models, see page C125.
 Batteries included on all battery version models.
 (2) Available Q3 - 2014

Flow rates are at 60 PSI (414 kPa)

Electronics

DELTA COMMERCIAL TECHNICAL SERVICE 1-877-509-2680
 ONLINE CATALOGS: www.deltacommercialfaucets.com (Core products ONLY)
www.specselect.com (Complete Product Offering & Part Numbering System)



Model	Price
* - Stock Item	
* 591T0250	540.50
* 591T1250	540.50

Note : Available as complete models ONLY

Code compliant applies to entire series.

591T1250 (shown)

ADD-ON OPTIONS (ADD THE SUFFIX TO THE END OF THE MODEL NUMBER TO CHOOSE THIS OPTION)		
-SUFFIX NUMBER	DESCRIPTION	ADD-ON TO PRICE
-BB	Battery Back-Up - available on Hardwire operated models ONLY	44.35

591T0 **Hardwire Operated** **48.45 (Base Product Price)**
591T1 **Battery Operated** **48.45 (Base Product Price)**

To complete a Product Price for the above, add the prices of the chosen variations (listed below) to the **Base Product Price**.
 A number from each option column must be used.

SPOUT AND SENSOR		OUTLET		CONTROL BOX	
	0		0	Base Model Surface Mount - No Mixing Valve 204.25	0
	1		1	For Recessed Control Box #1, see page C132	1
Cast Spout - 102 mm (4") 264.30	2	Vandal Resistant 1.5 gpm (5.7 L/min.) Laminar w/Agion® Antimicrobial 23.50	23.50		2
	3	Vandal Resistant 1.5 gpm (5.7 L/min.) Flow Control Aerator 14.40	14.40		3
	4				4
	5	Vandal Resistant 0.5 gpm (1.9 L/min.) Laminar Outlet 23.50	23.50		5
	6	Vandal Resistant 1.0 gpm (3.8 L/min.) Laminar Outlet 23.50	23.50		6
	7				7
	8			For Recessed Control Box #8, see page C132	8
	9	NEW (1) Vandal Resistant 0.35 gpm (1.32 L/min.) Non-Aerating Spray Outlet 23.50	23.50		9

Transformer to be ordered separately for Hardwire models, see page C125.

Flow rates are at 60 PSI (414 kPa)

Batteries included on all battery version models.

(1) Available Q3 - 2014



Model **Price**
* - Stock Item
☒ * 591T1258TR 267.80

Note : Must order Rough-In Number AND Trim Number SEPARATELY









☑ Code compliant applies to entire series.

591T1258TR (shown)

ADD-ON OPTIONS (ADD THE SUFFIX TO THE END OF THE TRIM MODEL NUMBER TO CHOOSE THIS OPTION)		
-SUFFIX NUMBER	DESCRIPTION	ADD-ON TO PRICE
-BB	Battery Back-Up - available on Hardwire operated models ONLY.	44.35

ELAVT0001RI * Rough-In ONLY with NO Mixing Valve **395.65**
ELAVT0008RI * Rough-In ONLY with Thermostatic Mixing Valve **599.80**
591T0 ☒ ☐ ☐ **TR** Trim ONLY - Hardwire Operated **48.45 (Base Product Price)**
591T1 ☒ ☐ ☐ **TR** Trim ONLY - Battery Operated **48.45 (Base Product Price)**

To complete a Trim Product Price for the above, add the prices of the chosen variations (listed below) to the **Base Product Price**.
A number from each option column must be used.

SPOUT AND SENSOR		OUTLET		CONTROL BOX	
	0		0	For Surface Mount Control Box #0, see page C131	0
	1		1	Recessed Mount with 10" x 10" Box - No Mixing Valve (1) Requires separate purchase of ELAVT0001RI 52.25	1
☒ Cast Spout - 102 mm (4")  151.90	2	Vandal Resistant 1.5 gpm (5.7 L/min.) Laminar w/Agion® Antimicrobial  23.50	2		2
	3	Vandal Resistant 1.5 gpm (5.7 L/min.) Flow Control Aerator  14.40	3		3
	4		4		4
	5	Vandal Resistant 0.5 gpm (1.9 L/min.) Laminar Outlet  23.50	5		5
	6	Vandal Resistant 1.0 gpm (3.8 L/min.) Laminar Outlet  23.50	6		6
	7		7		7
	8		8	Recessed Mount with 10" x 10" Box with Thermostatic Mixing Valve (1) Requires separate purchase of ELAVT0008RI 43.95	8
	9	NEW (2) Vandal Resistant 0.35 gpm (1.32 L/min.) Non-Aerating Spray Outlet  23.50	9		9

(1) Connection from box to spout not supplied.
Transformer to be ordered separately for Hardwire models, see page C125.
Batteries included on all battery version models.
(2) Available Q3 - 2014

Flow rates are at 60 PSI (414 kPa)

DELTA COMMERCIAL TECHNICAL SERVICE 1-877-509-2680
ONLINE CATALOGS: www.deltacommercialfaucets.com (Core products ONLY)
www.specselect.com (Complete Product Offering & Part Numbering System)



Model	Price
591TP0250	581.90
591TP1250	581.90

Note : Available as complete models ONLY

ADD-ON OPTIONS (ADD THE SUFFIX TO THE END OF THE MODEL NUMBER TO CHOOSE THIS OPTION)		
-SUFFIX NUMBER	DESCRIPTION	ADD-ON TO PRICE
-BB	Battery Back-Up - available on Hardwire operated models ONLY.	44.35

Code compliant applies to entire series.

591TP1250 (shown)

591TP0 **Hardwire Operated 48.45 (Base Product Price)**

591TP1 **Battery Operated 48.45 (Base Product Price)**

To complete a Product Price add the prices of chosen variations (listed below) to the **Base Product Price**.

A number from each option column must be used.

SPOUT AND SENSOR		OUTLET		CONTROL BOX	
	0			Base Model Surface Mount - No Mixing Valve 204.25	0
	1			For Recessed Control Box #1, see page C134	1
Cast Spout - 102 mm (4") 305.70	2	Vandal Resistant 1.5 gpm (5.7 L/min.) Laminar w/Agion® Antimicrobial	23.50		2
	3	Vandal Resistant 1.5 gpm (5.7 L/min.) Flow Control Aerator	14.40		3
	4				4
	5	Vandal Resistant 0.5 gpm (1.9 L/min.) Laminar Outlet	23.50		5
	6	Vandal Resistant 1.0 gpm (3.8 L/min.) Laminar Outlet	23.50		6
	7				7
	8			For Recessed Control Box #8, see page C134	8
	9	NEW (1) Vandal Resistant 0.35 gpm (1.32 L/min.) Non-Aerating Spray Outlet	23.50		9

Transformer to be ordered separately for Hardwire models, see page C125.

Batteries included on all battery version models.

(1) Available Q3 - 2014

Flow rates are at 60 PSI (414 kPa)

NEW! Proximity® Sensing Technology
Electronic Faucet – 591TP Series 4" Centerset with Recessed Box



Model	Price
* - Stock Item	
* 591TP0258TR	309.20
* 591TP0268TR	309.20

Note : Must order Rough-In Number AND Trim Number SEPARATELY

ADD-ON OPTIONS (ADD THE SUFFIX TO THE END OF THE TRIM MODEL NUMBER TO CHOOSE THIS OPTION)		
-SUFFIX NUMBER	DESCRIPTION	ADD-ON TO PRICE
-BB	Battery Back-Up - available on Hardwire operated models ONLY.	44.35

Code compliant applies to entire series.

591TP0258TR (shown)

ELAVT0001RI *	Rough-In ONLY with NO Mixing Valve	395.65
ELAVT0008RI *	Rough-In ONLY with Thermostatic Mixing Valve	599.80
591TP0 TR	Trim ONLY - Hardwire Operated	48.45 (Base Product Price)
591TP1 TR	Trim ONLY - Battery Operated	48.45 (Base Product Price)

To complete a Trim Product Price for the above, add the prices of the chosen variations (listed below) to the **Base Product Price**.
 A number from each option column must be used.

SPOUT AND SENSOR		OUTLET		CONTROL BOX	
	0		0	For Surface Mount Control Box #0, see page C133	0
	1		1	Recessed Mount with 10" x 10" Box - No Mixing Valve (1) Requires separate purchase of ELAVT0001RI	52.25
Cast Spout - 102 mm (4")	193.30	Vandal Resistant 1.5 gpm (5.7 L/min.) Laminar w/Agion® Antimicrobial	23.50		2
	2	Vandal Resistant 1.5 gpm (5.7 L/min.) Flow Control Aerator	14.40		3
	3				4
	4				5
	5	Vandal Resistant 0.5 gpm (1.9 L/min.) Laminar Outlet	23.50		6
	6	Vandal Resistant 1.0 gpm (3.8 L/min.) Laminar Outlet	23.50		7
	7				8
	8			Recessed Mount with 10" x 10" Box with Thermostatic Mixing Valve (1) Requires separate purchase of ELAVT0008RI	43.95
	9	NEW (2) Vandal Resistant 0.35 gpm (1.32 L/min.) Non-Aerating Spray Outlet	23.50		9

(1) Connection from box to spout not supplied.
 Transformer to be ordered separately for Hardwire models, see page C125.
 Batteries included on all battery version models.
 (2) Available Q3 - 2014

Flow rates are at 60 PSI (414 kPa)

DELTA COMMERCIAL TECHNICAL SERVICE 1-877-509-2680
 ONLINE CATALOGS: www.deltacommercialfaucets.com (Core products ONLY)
www.specselect.com (Complete Product Offering & Part Numbering System)



✓ Code compliant applies to entire series.

ELECTRONIC BATTERY FAUCETS			
MODEL		DESCRIPTION	PRICE
601T040		Battery Operated Electronic faucet with Proximity® Sensing Technology, Vandal Resistant 1.5 gpm (5.7 L/min) flow rate laminar outlet	* 583.30
601T050		Battery Operated Electronic faucet with Proximity® Sensing Technology, Vandal Resistant 0.5 gpm (1.9 L/min) flow rate laminar outlet	* 591.95
NEW! (1) 601T090		Battery Operated Electronic faucet with Proximity® Sensing Technology, Vandal Resistant 0.35 gpm (1.32 L/min) flow rate non-aerating spray outlet	591.95

ELECTRONIC HARDWIRE FAUCETS			
MODEL		DESCRIPTION	PRICE
600T040		Hardwire Electronic faucet with Proximity® Sensing Technology, Vandal Resistant 1.5 gpm (5.7 L/min) flow rate laminar outlet	* 583.30
600T050		Hardwire Electronic faucet with Proximity® Sensing Technology, Vandal Resistant 0.5 gpm (1.9 L/min) flow rate laminar outlet	* 591.95
NEW! (1) 600T090		Hardwire Electronic faucet with Proximity® Sensing Technology, Vandal Resistant 0.35 gpm (1.32 L/min) flow rate non-aerating spray outlet	591.95

ADD-ON OPTIONS (ADD THE SUFFIX TO THE END OF THE MODEL NUMBER TO CHOOSE THIS OPTION)		
-SUFFIX NUMBER	DESCRIPTION	ADD-ON TO PRICE
-BB	Battery Back-Up - available on Hardwire operated models ONLY	44.35
-SS	Brilliance® Stainless Finish. Available on single hole models and 062021A 4" cover plate ONLY NEW! (Available Q3-2014)	56.70

COVER PLATES		
MODEL	DESCRIPTION	PRICE
062021A	Decorative Cover Plate, 4" (102 mm)	* 18.70
061119A	Decorative Cover Plate, 8" (204 mm)	91.90

Supplied as Complete Model Only, with surface mount control box, no separate rough-in required. Flow rates are at 60 PSI (414 kPa)
 Transformer to be ordered separately for Hardwire Models, see page C125.
 Batteries included on all battery version models.
 Mixing valve to be ordered separately.

* – Stock Item
 (1) Available Q3 - 2014

DELTA COMMERCIAL TECHNICAL SERVICE 1-877-509-2680
 ONLINE CATALOGS: www.deltacommercialfaucets.com (Core products ONLY)
www.specselect.com (Complete Product Offering & Part Numbering System)

**NEW! (Available Q3-2014) Proximity® Sensing Technology Deck Mount
Gooseneck Faucet – 620TP & 621TP Series with Surface Mount Box**



Model

620TP3320

Price

581.90

Note : Available as complete models ONLY

Code compliant applies to entire series.

ADD-ON OPTIONS (ADD THE SUFFIX TO THE END OF THE MODEL NUMBER TO CHOOSE THIS OPTION)		
-SUFFIX NUMBER	DESCRIPTION	ADD-ON TO PRICE
-BB	Battery Back-Up - available on Hardwire operated models ONLY	44.35
-SS	Brilliance® Stainless Finish	60.00

620TP3320 (shown)

620TP3**3****0** **Hardwire Operated 48.45 (Base Product Price)**
621TP3**3****0** **Battery Operated 48.45 (Base Product Price)**

To complete a Product Price add the prices of chosen variations (listed below) to the **Base Product Price**.
 A number from each option column must be used.

SPOUT AND SENSOR		OUTLET		CONTROL BOX	
	0		0	Base Model with Surface Mount Housing - No Mixing Valve 204.25	0
	1		1	For Recessed Control Box #1, see page C137	1
	2	Vandal Resistant 1.5 gpm (5.7 L/min.) Laminar Outlet	23.50		2
Single Hole Deck Mount Gooseneck Spout 305.70	3		3		3
	4		4		4
	5	Vandal Resistant 0.5 gpm (1.9 L/min.) Laminar Outlet	23.50		5
	6	Vandal Resistant 1.0 gpm (3.8 L/min.) Laminar Outlet	23.50		6
	7		7		7
	8		8	For Recessed Control Box #8, see page C137	8
	9		9		9

Electronics

Transformer to be ordered separately for Hardwire models, see page C125.
 Batteries included on all battery version models.

Flow rates are at 60 PSI (414 kPa)

DELTA COMMERCIAL TECHNICAL SERVICE 1-877-509-2680
 ONLINE CATALOGS: www.deltacommercialfaucets.com (Core products ONLY)
www.specselect.com (Complete Product Offering & Part Numbering System)



NEW! (Available Q3-2014) Proximity® Sensing Technology Deck Mount Gooseneck Faucet – 620TP & 621TP Series with Recessed Box



Model
 620TP3328TR **Price**
 317.90

Note : Must order Rough-In Number AND Trim Number SEPARATELY

Code compliant applies to entire series.

ADD-ON OPTIONS (ADD THE SUFFIX TO THE END OF THE MODEL NUMBER TO CHOOSE THIS OPTION)		
-SUFFIX NUMBER	DESCRIPTION	ADD-ON TO PRICE
-BB	Battery Back-Up - available on Hardwire operated models ONLY	44.35
-SS	Brilliance® Stainless Finish	60.00

620TP3328TR (shown)

- ELAVT0001RI *** Rough-In ONLY with NO Mixing Valve **395.65**
- ELAVT0008RI *** Rough-In ONLY with Thermostatic Mixing Valve **599.80**
- 620TP3** **TR** Trim ONLY - Hardwire Operated **48.45 (Base Product Price)**
- 621TP3** **TR** Trim ONLY - Battery Operated **48.45 (Base Product Price)**

To complete a Trim Product Price add the prices of chosen variations (listed below) to the **Base Product Price**.
 A number from each option column must be used.

SPOUT AND SENSOR		OUTLET		CONTROL BOX	
	0		0	For Surface Mount Control Box #0, see page C136	0
	1		1	Recessed Mount with 10" x 10" Box - No Mixing Valve (1) Requires separate purchase of ELAVT0001RI 52.25	1
	2	Vandal Resistant 1.5 gpm (5.7 L/min.) Laminar Outlet	23.50		2
Single Hole Deck Mount Gooseneck Spout 202.00	3		3		3
	4		4		4
	5	Vandal Resistant 0.5 gpm (1.9 L/min.) Laminar Outlet	23.50		5
	6	Vandal Resistant 1.0 gpm (3.8 L/min.) Laminar Outlet	23.50		6
	7		7		7
	8		8	Recessed Mount with 10" x 10" Box with Thermostatic Mixing Valve (1) Requires separate purchase of ELAVT0008RI 43.95	8
	9		9		9

Electronics

(1) Connection from box to spout not supplied.
 Transformer to be ordered separately for Hardwire models, see page C125.
 Batteries included on all battery version models.
 Flow rates are at 60 PSI (414 kPa)



860T167



Model

* - Stock Item

- 860T167
- 861T167

Price

- 1,247.65
- 1,247.65

Note : Available as complete models ONLY



ADD-ON OPTIONS (ADD THE SUFFIX TO THE END OF THE MODEL NUMBER TO CHOOSE THIS OPTION)		
-SUFFIX NUMBER	DESCRIPTION	ADD-ON TO PRICE
-BB	Battery Back-Up - available on Hardwire operated models ONLY	44.35

860T1

Hardwire Operated

861T1

Battery Operated

To complete a Trim Product Price add the prices of chosen variations (listed below).
A number from each option column must be used.

Electronics

			SHOWER	CONTROL SENSOR BOX	
			Specify "0" when no shower required.	0	0
				1	1
				2	2
			Showerhead, Arm & Set Screw Flange 20.30	3	Recessed Mount with 8" Box - No Mixing Valve 698.10 3
				4	4
			Handshower with 2 Check Valves, 610 mm (24") S/S Bar with ADA Slide 247.75	5	5
			30° Vandal Resistant, Cast Flow Control Wallmount Showerhead 189.20	6	Components only UNASSEMBLED 4" Box - No Mixing Valve 431.25 6
			NEW 30° Vandal Resistant, Forged Brass Wallmount Showerhead 189.20	7	Recessed Mount with 10" Box and Pressure Balance Mixing Valve 1,058.45 7
				8	Recessed Mount with 10" Box and Thermostatic Mixing Valve 1,058.45 8
				9	9

SHOWER FLOW RATES		
SHOWER #	ACTUAL @ 45 PSI (310 kPa)	MAXIMUM @ 80 PSI (552 kPa)
3	1.36 gpm (5.15 L/min)	1.5 gpm (5.7 L/min)
5	1.28 gpm (4.85 L/min)	1.5 gpm (5.7 L/min)
6	1.38 gpm (5.22 L/min)	1.5 gpm (5.7 L/min)
7	1.36 gpm (5.15 L/min)	1.5 gpm (5.7 L/min)

Transformer to be ordered separately for Hardwire models, see Page C125.

Batteries included on all battery version models.

See next page for Add-On Options for the 860T Series.

Price additions for Add-On Options:

- To complete an Add-On Option Product Price add the prices of the chosen variations (listed below). A number from the Hose and Slide Bar columns must always be selected, even if it is "0".

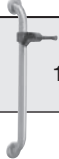
HOSE		SLIDE BAR	
Always use "0" if No selection is required from this column	0	Always use "0" if No selection is required from this column	0
	1		1
1753 mm (69") Long CP stainless steel hose (1) -stretches to 92"	2		2
 Add 31.90	3		3
	4		4
		 Add 16.80	5
		914 mm (36") S/S Slide Bar (2)	

Notes:

- (1) **Base Product** for the **HOSE, ETC.** must include **SHOWER** option **No. 5**
- (2) **Base Product** for S/S Slide Bar must include **SHOWER** option **No. 5**

HOW TO SELECT AND SPECIFY ADD-ON OPTIONS:

Example No. 1: Base Product selected is 860T153, 36" S/S Slide Bar Add-On Suffix Number is -05
Model Number to Specify: 860T153-05

PRICING:

EXAMPLE	(1) BASE PRODUCT PRICE	PLUS	(2) ADD-ON OPTION NO. ADD-ON PRICE	EQUALS	(3) END MODEL NUMBER MODEL PRICE
No. 1	860T153 945.85	+	-05 ADD 16.80	=	860T153-05 962.65



Model	Price
1500T3420	674.55
1501T3420	674.55

Note : Available as complete models ONLY

ADD-ON OPTIONS (ADD THE SUFFIX TO THE END OF THE MODEL NUMBER TO CHOOSE THIS OPTION)		
-SUFFIX NUMBER	DESCRIPTION	ADD-ON TO PRICE
-BB	Battery Back-Up - available on Hardwire operated models ONLY.	44.35

1501T3470 (shown)

Code compliant applies to entire series.

1500T3 **Hardwire Operated 101.10 (Base Product Price)**

1501T3 **Battery Operated 101.10 (Base Product Price)**

To complete a Product Price for the above, add the prices of the chosen variations (listed below) to the **Base Product Price**.

A number from each option column must be used.

SPOUT AND SENSOR		OUTLET		CONTROL BOX	
	0		0	Base Model with Surface Mount Housing - No Mixing Valve 355.05	0
	1		1	For Recessed Control Box #1, see page C141	1
	2	Vandal Resistant 1.5 gpm (5.7 L/min.) Laminar w/Agion® Antimicrobial	23.50		2
133.20	3	Vandal Resistant 1.5 gpm (5.7 L/min.) Flow Control Aerator	14.40		3
194.90	4				4
212.40	5				5
	6				6
	7	Smooth End, Laminar Flow Control in Base of Gooseneck Spout 1.5 gpm (5.7 L/min.)	23.50		7
	8	Smooth End, Laminar Flow Control in Base of Gooseneck Spout 0.5 gpm (1.9 L/min.)	23.50	For Recessed Control Box #8, see page C141	8
	9				9

(1) Optional Spouts R3, R4, R7 and R35 **only** available in this series due to fixed gooseneck supplied.

Flow rates are at 60 PSI (414 kPa)

See page C89 for **Optional Fixed Spouts**.

Transformer to be ordered separately for Hardwire models, see page C125.

Batteries included on all battery version models.

DELTA COMMERCIAL TECHNICAL SERVICE 1-877-509-2680
ONLINE CATALOGS: www.deltacommercialfaucets.com (Core products ONLY)
www.specselect.com (Complete Product Offering & Part Numbering System)



Model	Price
1500T3478TR	370.40
1501T3478TR	370.40

Note : Must order Rough-In Number AND Trim Number SEPARATELY







ADD-ON OPTIONS (ADD THE SUFFIX TO THE END OF THE TRIM MODEL NUMBER TO CHOOSE THIS OPTION)		
-SUFFIX NUMBER	DESCRIPTION	ADD-ON TO PRICE
-BB	Battery Back-Up - available on Hardwire operated models ONLY.	44.35

Code compliant applies to entire series.

1501T3478TR (shown)

ELAVT0001RI *	Rough-In ONLY with NO Mixing Valve	395.65
ELAVT0008RI *	Rough-In ONLY with Thermostatic Mixing Valve	599.80
1500T3 <input type="checkbox"/> <input type="checkbox"/> <input type="checkbox"/> TR	Trim ONLY - Hardwire Operated	101.10 (Base Product Price)
1501T3 <input type="checkbox"/> <input type="checkbox"/> <input type="checkbox"/> TR	Trim ONLY - Battery Operated	101.10 (Base Product Price)

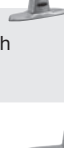
To complete a Trim Product Price for the above, add the prices of the chosen variations (listed below) to the **Base Product Price**.
 A number from each option column must be used.

SPOUT AND SENSOR		OUTLET		CONTROL BOX	
	0			For Surface Mount Control Box #0, see page C140	0
	1			Recessed Mount with 10" x 10" Box - No Mixing Valve (2) Requires separate purchase of ELAVT0001RI	1
	2	Vandal Resistant 1.5 gpm (5.7 L/min.) Laminar w/Agion® Antimicrobial	 23.50		2
 (Std is R5) Single Hole Deck Mount Fixed Gooseneck Spout with Integral Sensor in Base (1)	3	Vandal Resistant 1.5 gpm (5.7 L/min.) Flow Control Aerator	 14.40		3
 (Std is R5) Deck Mount Fixed Gooseneck Spout with Integral Sensor in Base and 4" Forged Cover Plate (1)	4				4
 (Std is R5) Deck Mount Fixed Gooseneck Spout with Integral Sensor in Base and 8" Forged Cover Plate (1)	5				5
	6				6
	7	Smooth End, Laminar Flow Control in Base of Gooseneck Spout 1.5 gpm (5.7 L/min.)	 23.50		7
	8	Smooth End, Laminar Flow Control in Base of Gooseneck Spout 0.5 gpm (1.9 L/min.)	 23.50	Recessed Mount with 10" x 10" Box with Thermostatic Mixing Valve (2) Requires separate purchase of ELAVT0008RI	8
	9				9

(1) Optional Spouts R3, R4, R7 and R35 **only** available in this series due to fixed gooseneck supplied.
 (2) Connection from box to spout not supplied.

See page C89 for **Optional Fixed Spouts**. Flow rates are at 60 PSI (414 kPa)
 Transformer to be ordered separately for Hardwire models, see page C125.
 Batteries included on all battery version models.



1500T4670



Model	Price
1500T4620	664.00
1500T4628	962.05
1501T4620	664.00





Note : Available as complete models ONLY

Code compliant applies to entire series.

ADD-ON OPTIONS (ADD THE SUFFIX TO THE END OF THE MODEL NUMBER TO CHOOSE THIS OPTION)		
-SUFFIX NUMBER	DESCRIPTION	ADD-ON TO PRICE
-BB	Battery Back-Up - available on Hardwire operated models ONLY	44.35

1500T4 **Hardwire Operated 109.85 (Base Product Price)**
1501T4 **Battery Operated 109.85 (Base Product Price)**

To complete a Product Price for the above, add the prices of the chosen variations (listed below) to the **Base Product Price**.
 A number from each option column must be used.

SPOUT AND SENSOR		OUTLET		CONTROL BOX	
	0			Base Model with Surface Mount Housing - No Mixing Valve 385.90	0
	1			Recessed Mount with 10" x 10" Box - No Mixing Valve (1) 503.10	1
	2	Vandal Resistant 1.5 gpm (5.7 L/min.) Laminar w/Agion® Antimicrobial 	23.50		2
	3	Vandal Resistant 1.5 gpm (5.7 L/min.) Flow Control Aerator 	14.40		3
	4				4
	5				5
(Std is R5) Wallmount Gooseneck Spout with Integral Sensor in Base (2) 	6				6
	7	Smooth End, Laminar Flow Control in Base of Gooseneck Spout 1.5 gpm (5.7 L/min.) 	23.50		7
	8			Recessed Mount with 10" x 10" Box with Thermostatic Mixing Valve (1) 683.95	8
	9				9

(1) Connection from box to spout **NOT** supplied. See Page C89 for **Optional Spouts**. Flow rates are at 60 PSI (414 kPa)
 (2) Optional Spouts R3, R4, R7 and R35 **only** available in this series due to fixed gooseneck supplied. Transformer to be ordered separately for Hardwire models, see Page C125.
 Batteries included on all battery version models.

DELTA COMMERCIAL TECHNICAL SERVICE 1-877-509-2680
 ONLINE CATALOGS: www.deltacommercialfaucets.com (Core products ONLY)
www.specselect.com (Complete Product Offering & Part Numbering System)

Electronics



Model	Price
3000T3320A	763.50
3000T3370A	763.50

Supplementary Products

24T3003 Deck Mount Mixing Valve for Control Box #0	207.25
---	--------

Note : Available as complete models ONLY

Code compliant applies to entire series.

ADD-ON OPTIONS (ADD THE SUFFIX TO THE END OF THE MODEL NUMBER TO CHOOSE THIS OPTION)		
-SUFFIX NUMBER	DESCRIPTION	ADD-ON TO PRICE
-BB	Battery Back-Up - available on Hardwire operated models ONLY.	44.35
-KS	3-Position Switch	191.50

3000T3470 (shown)

3000T3 **A Hardwire Operated 251.75 (Base Product Price)**

3001T3 **A Battery Operated 251.75 (Base Product Price)**

To complete a Product Price for the above, add the prices of the chosen variations (listed below) to the **Base Product Price**.

A number from each option column must be used.

SPOUT AND SENSOR		OUTLET		CONTROL BOX	
	0			Base Model with Surface Mount Housing - No Mixing Valve	355.05
	1			For Recessed Control Box #1, see page C144	
	2	Vandal Resistant 1.5 gpm (5.7 L/min.) Laminar w/Agion® Antimicrobial	23.50		
(Std is R5) Single Hole Deck Mount Fixed Gooseneck Spout with Integral Sensor in Base (1)	3	Vandal Resistant 1.5 gpm (5.7 L/min.) Flow Control Aerator	14.40		
(Std is R5) Deck Mount Fixed Gooseneck Spout with Integral Sensor in Base and 4" Forged Cover Plate (1)	4				
(Std is R5) Deck Mount Fixed Gooseneck Spout with Integral Sensor in Base and 8" Forged Cover Plate (1)	5				
	6				
	7	Smooth End, Laminar Flow Control in Base of Gooseneck Spout 1.5 gpm (5.7 L/min.)	23.50		
	8	Smooth End, Laminar Flow Control in Base of Gooseneck Spout 0.5 gpm (1.9 L/min.)	23.50	For Recessed Control Box #8, see page C144	
	9				

(1) Optional Spouts R3, R4, R7 and R35 **only** available in this series due to fixed gooseneck supplied.

See page C89 for **Optional Fixed Spouts**.

Transformer to be ordered separately for Hardwire models, see page C125.

Batteries included on all battery version models.

Flow rates are at 60 PSI (414 kPa)



Model
 3000T3428ATR **Price**
 499.60

Note : Must order Rough-In Number AND Trim Number SEPARATELY

ADD-ON OPTIONS (ADD THE SUFFIX TO THE END OF THE MODEL NUMBER TO CHOOSE THIS OPTION)		
-SUFFIX NUMBER	DESCRIPTION	ADD-ON TO PRICE
-BB	Battery Back-Up - available on Hardwire operated models ONLY.	44.35
-KS	3-Position Switch	191.50

Code compliant applies to entire series.

3000T3478ATR (shown)

ELAVT0001RI * **Rough-In ONLY with NO Mixing Valve** **395.65**
ELAVT0008RI * **Rough-In ONLY with Thermostatic Mixing Valve** **599.80**
3000T3 **ATR Trim ONLY - Hardwire Operated** **251.75 (Base Product Price)**
3001T3 **ATR Trim ONLY - Battery Operated** **251.75 (Base Product Price)**

To complete a Trim Product Price for the above, add the prices of the chosen variations (listed below) to the **Base Product Price**.
 A number from each option column must be used.

SPOUT AND SENSOR		OUTLET		CONTROL BOX	
	0			0	For Surface Mount Control Box #0, see page C143
	1			1	Recessed Mount with 10" x 10" Box - No Mixing Valve (2) Requires separate purchase of ELAVT0001RI 67.70
	2	Vandal Resistant 1.5 gpm (5.7 L/min.) Laminar w/Agion® Antimicrobial	23.50	2	
(Std is R5) Single Hole Deck Mount Fixed Gooseneck Spout with Integral Sensor in Base (1)	3	Vandal Resistant 1.5 gpm (5.7 L/min.) Flow Control Aerator	14.40	3	
(Std is R5) Deck Mount Fixed Gooseneck Spout with Integral Sensor in Base and 4" Forged Cover Plate (1)	4			4	
(Std is R5) Deck Mount Fixed Gooseneck Spout with Integral Sensor in Base and 8" Forged Cover Plate (1)	5			5	
	6			6	
	7	Smooth End, Laminar Flow Control in Base of Gooseneck Spout 1.5 gpm (5.7 L/min.)	23.50	7	
	8	Smooth End, Laminar Flow Control in Base of Gooseneck Spout 0.5 gpm (1.9 L/min.)	23.50	8	Recessed Mount with 10" x 10" Box with Thermostatic Mixing Valve (2) Requires separate purchase of ELAVT0008RI 29.45
	9			9	

(1) Optional Spouts R3, R4, R7 and R35 **only** available in this series due to fixed gooseneck supplied.
 (2) Connection from box to spout not supplied.

See page C89 for **Optional Fixed Spouts**. Flow rates are at 60 PSI (414 kPa) Transformer to be ordered separately for Hardwire models, see page C125.
 Batteries included on all battery version models.



✓ Code compliant applies to entire series.

Rough-in and Trim Ordered and Priced Separately.

HARDWIRE – LAVATORY				
MODEL		DESCRIPTION	PRICE	
Rough-in	Trim		Rough-in	Trim
3000T4128ARI	3000T4128ATR	Double wallmount sensor, wallmount spout, 1.5 gpm (5.7 L/min) *	660.00	1,060.00
3000T4328ARI	3000T4328ATR	Single wallmount sensor, wallmount spout, 1.5 gpm (5.7 L/min) *	600.00	700.00

BATTERY POWERED – LAVATORY				
MODEL		DESCRIPTION	PRICE	
Rough-in	Trim		Rough-in	Trim
3001T4128ARI	3001T4128ATR	Double wallmount sensor, wallmount spout, 1.5 gpm (5.7 L/min)	660.00	1,060.00
3001T4328ARI	3001T4328ATR	Single wallmount sensor, wallmount spout, 1.5 gpm (5.7 L/min)	600.00	700.00



ADD-ON OPTIONS (ADD THE SUFFIX TO THE END OF THE MODEL NUMBER TO CHOOSE THIS OPTION)		
-SUFFIX NUMBER	DESCRIPTION	ADD-ON TO PRICE
-BB	Battery Back-Up - available on Hardwire TR models ONLY.	44.35

Flow rates are at 60 PSI (414 kPa)





RI comes complete with thermostatic mixing valve in 10" x 10" box.
 Transformer to be ordered separately for hardwire models. See page C125.
 Batteries included in all battery version models.

* – Stock Item



Electronics

DELIVERY		Model	Description	No Shank	Standard Handle	Non-Removable Lever	Price
- W6200 GAS (Stock)							
 W6200		W6200 	Ball valve hose cock with 3/8" M.I.P. inlet			✓	44.65

Laboratory Faucets, Deckmount Turrets with Hose Cocks (Ball Valve)

DELIVERY		Model	Description	Standard Shank 4.44" (L)	Standard Handle	Non-Removable Lever	Price	
- W6210 GAS (Stock) - W6220 GAS (Stock) - W6225 GAS (Stock)								
 W6210		SINGLE VALVES						
		W6210 	Single ball valve hose cock, 1/4" I.P. tail			✓	99.75	
		2 VALVES AT 90 DEGREES						
		W6220 	2 ball valve hose cocks @ 90 degrees, 1/4" I.P. tail			✓	151.20	
2 VALVES AT 180 DEGREES								
W6225 	2 ball valve hose cocks @ 180 degrees, 1/4" I.P. tail			✓	151.20			

Laboratory Faucets, Wall Flange with Hose Cocks (Ball Valve)

DELIVERY		Model	Description	Standard Shank 2.38" (N)	Standard Handle	Non-Removable Lever	Price
- W6270 GAS (Stock) - W6275 GAS (Stock)							
 W6270		W6270 	Single ball valve hose cock with 1 1/8" wall flange, 1/4" I.P. tail			✓	83.90
		W6275 	"Y" connector with 2 ball valve hose cocks, flange and 1/4" I.P. tail			✓	155.30

Laboratory

EASY ORDER SYSTEM	
MODEL	SERVICE CODE

SERVICE CODES	
Service	Code
Air	AIR
Argon	A
Carbon Dioxide	CO2
Cold Water	CW
Helium	HE
Hydrogen	H
Natural Gas	GAS
Nitrogen	N
Propane	PRO
Vacuum	VAC

DELIVERY	Model	Description	Price
- W6629 DW (Stock) - W6635 DW (Stock)	068128A	Repair kit for W6629 control valve	68.55
 <p style="text-align: right;">W6635</p>	W6629	Celcon control valve for pure water faucets	215.15
	W6635	Deckmount pure water faucet with combined self-closing and lock-open celcon control valve, C.P. rigid 6" gooseneck with tygon liner	346.95



EASY ORDER SYSTEM	
MODEL	SERVICE CODE



SERVICE CODES	
Service	Code
Distilled Water	DW
De-ionized Water	DI
De-mineralized Water	DM
Reverse Osmosis	RO

Laboratory

DELIVERY		Model	Description	Std. Handle Two Arm Metal	Std. Spout () X = Regular O = Angle VB	Price
- W6600-9 (Stock)	- W6600-10 (Stock)					
	SINGLE WATER FAUCET FOR UP TO 1 1/4" DIA. HOLE					
	W6600	Deckmount compression valve with rigid/swivel gooseneck and nozzle	X (R5)	139.60		
	W6600-9	As W6600 but with in-line vacuum breaker and nozzle	X (R5)	196.35		
	W6600-10	As W6600 but with W6850 rigid/swivel gooseneck with angle vacuum breaker and nozzle	O (R23)	220.20		
	W6600-12	W6600-10 with 77423 aspirator	O (R23)	267.75		
	SINGLE WATER FAUCET FOR UP TO 1 1/2" DIA. HOLE					
	W6601	Deckmount compression valve with rigid/swivel gooseneck and nozzle	X (R5)	137.10		
	W6601-9	As W6601 but with in-line vacuum breaker and nozzle	X (R5)	201.60		
	W6601-10	As W6601 but with W6850 rigid/swivel gooseneck with angle vacuum breaker and nozzle	O (R23)	201.60		
	W6601-12	As W6601-10 but with 77423 aspirator	O (R23)	262.80		

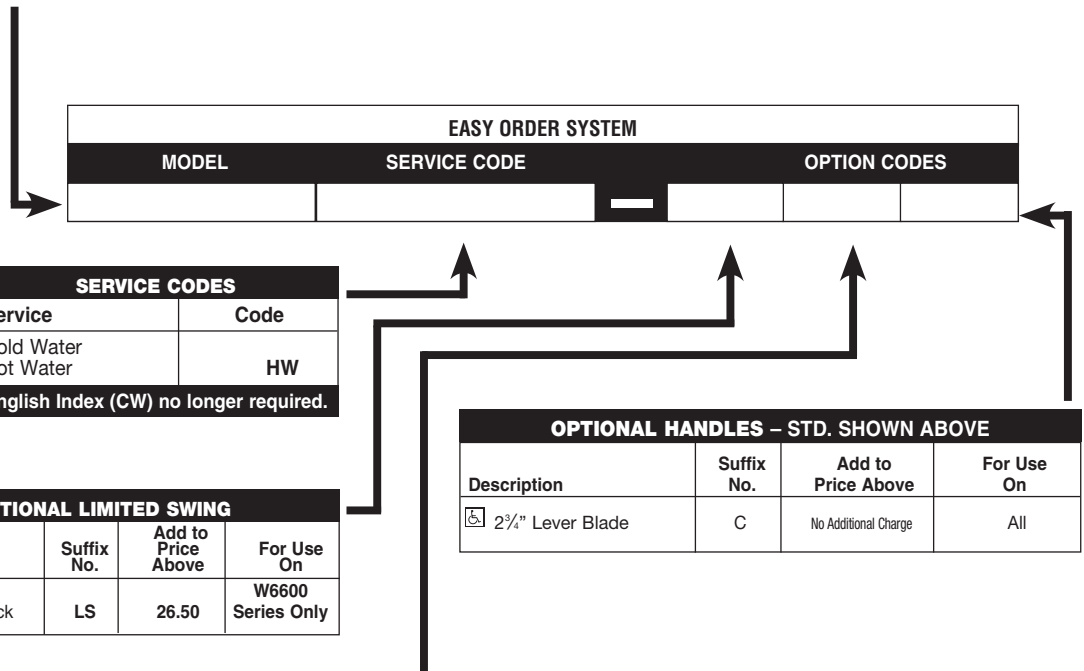

Laboratory

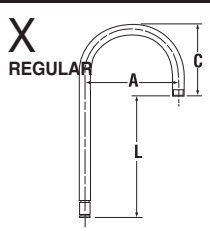
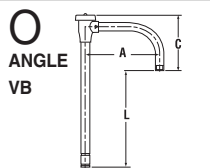
OPTIONAL SPOUTS – OPTIONAL SPOUT <u>MUST</u> BE SAME TYPE AS STD. SPOUT (I.E., REGULAR OR ANGLE VB)								
	Suffix Number	"A"		"C"		"L"		ADD TO PRICE ABOVE
		mm	inches	mm	inches	mm	inches	Chrome Plated
	R2	114	4.5	104	4.1	170	6.7	5.05
	R3	152	6.0	124	4.9	56	2.2	6.40
	R4	152	6.0	124	4.9	146	5.8	5.05
	R5	152	6.0	124	4.9	188	7.4	STD
	R6	152	6.0	124	4.9	229	9	9.75
	R7	229	9.0	163	6.4	170	6.7	23.00
	R23	152	6.0	135	5.3	188	7.4	STD
	R25	229	9.0	135	5.3	188	7.4	5.35

DELTA COMMERCIAL TECHNICAL SERVICE 1-877-509-2680
 ONLINE CATALOGS: www.deltacommercialfaucets.com (Core products ONLY)
www.specselect.com (Complete Product Offering & Part Numbering System)

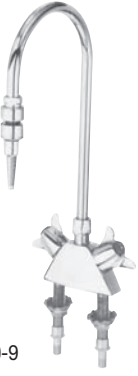
DELIVERY		Model	Description	Std. Handle Two Arm Metal	Std. Spout () X = Regular O = Angle VB	Price
- W6700-9 (Stock)						
 <p>W6700-9</p>	MIXING FAUCET WITH 2 3/4" Centers					
	W6700	With rigid/swivel gooseneck and nozzle outlet, inlets at 2 3/4" centers			X (R5)	211.90
	W6700-9	As W6700 but with in-line vacuum breaker and nozzle outlet			X (R5)	262.85
	W6700-10	As W6700 but with W6850 rigid/swivel gooseneck with angle vacuum breaker and nozzle			O (R23)	284.20
	W6700-12	W6700-10 with 77423 aspirator			O (R23)	326.10
	MIXING FAUCET WITH 4" Centers					
	W6720	With rigid/swivel gooseneck and nozzle outlet, inlets at 4" centers, CAST body			X (R6)	164.60
	W6720-9	As W6720 but with in-line vacuum breaker and nozzle outlet			X (R6)	217.65
	W6720-10	As W6720 but with W6850 rigid/swivel gooseneck with angle vacuum breaker and nozzle			O (R23)	217.65
	MIXING FAUCET WITH 8" Centers					
	W6740	Bar deck faucet w/ rigid/swivel gooseneck and nozzle outlet, inlets at 8" centers, CAST body			X (R6)	228.35
	W6740-9	As W6740 but with in-line vacuum breaker and nozzle outlet			X (R6)	279.60
W6740-10	As W6740 but with W6850 rigid/swivel gooseneck with angle vacuum breaker and nozzle			O (R23)	279.60	

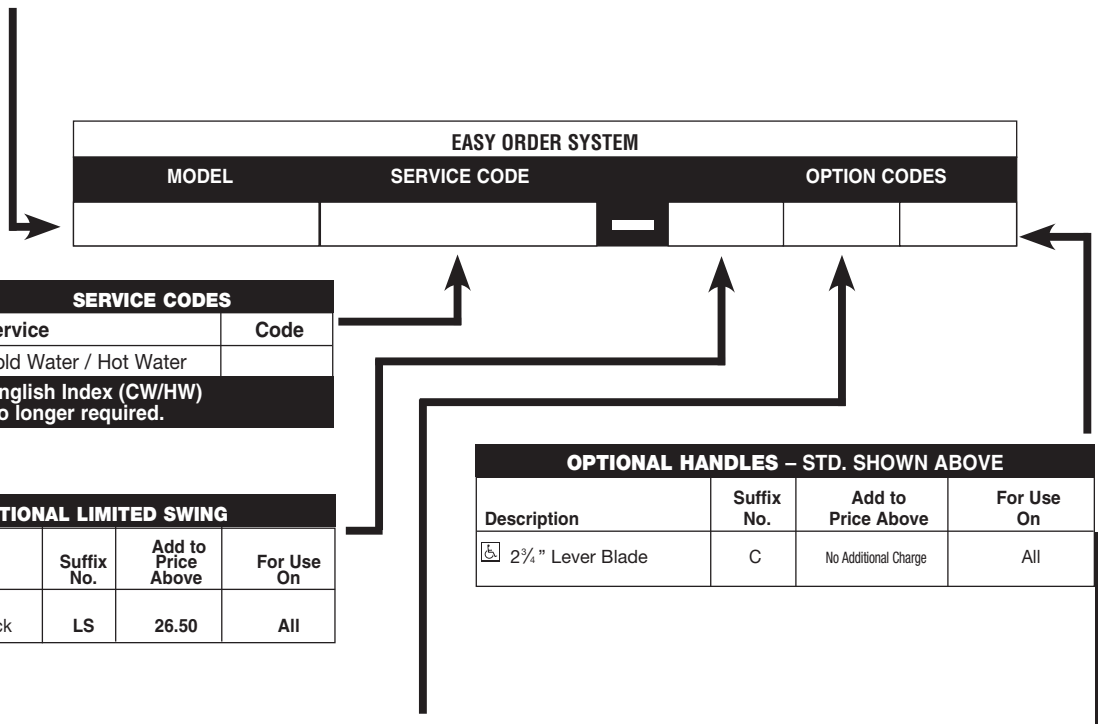

OPTIONAL SPOUTS – OPTIONAL SPOUT MUST BE SAME TYPE AS STD. SPOUT (I.E., REGULAR OR ANGLE VB)

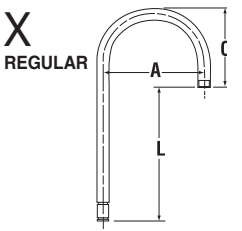
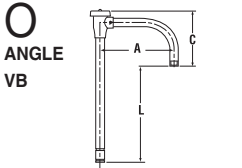
 X REGULAR	Suffix Number	"A"		"C"		"L"		ADD TO PRICE ABOVE
		mm	inches	mm	inches	mm	inches	Chrome Plated
	R2	114	4.5	104	4.1	170	6.7	5.05
	R3	152	6.0	124	4.9	56	2.2	6.40
	R4	152	6.0	124	4.9	146	5.8	5.05
	R5	152	6.0	124	4.9	188	7.4	6.40
	R6	152	6.0	124	4.9	229	9	9.75
	R7	229	9.0	163	6.4	170	6.7	23.00
 O ANGLE VB	R23	152	6.0	135	5.3	188	7.4	STD
	R25	229	9.0	135	5.3	188	7.4	5.35

DELTA COMMERCIAL TECHNICAL SERVICE 1-877-509-2680
 ONLINE CATALOGS: www.deltacommercialfaucets.com (Core products ONLY)
www.specselect.com (Complete Product Offering & Part Numbering System)

 <p>W6760-9</p>	Model	Description	Std. Handle Two Arm Metal	Std. Spout () X = Regular O = Angle VB	Price
	W6760	Single Shank mixing with rigid/swivel gooseneck & nozzle outlet		X (R5)	244.00
	W6760-9	As W6760 but with in-line vacuum breaker and nozzle outlet		X (R5)	292.60
	W6760-10	As W6760 but with W6850 rigid/swivel gooseneck with angle vacuum breaker & nozzle outlet		O (R23)	312.80

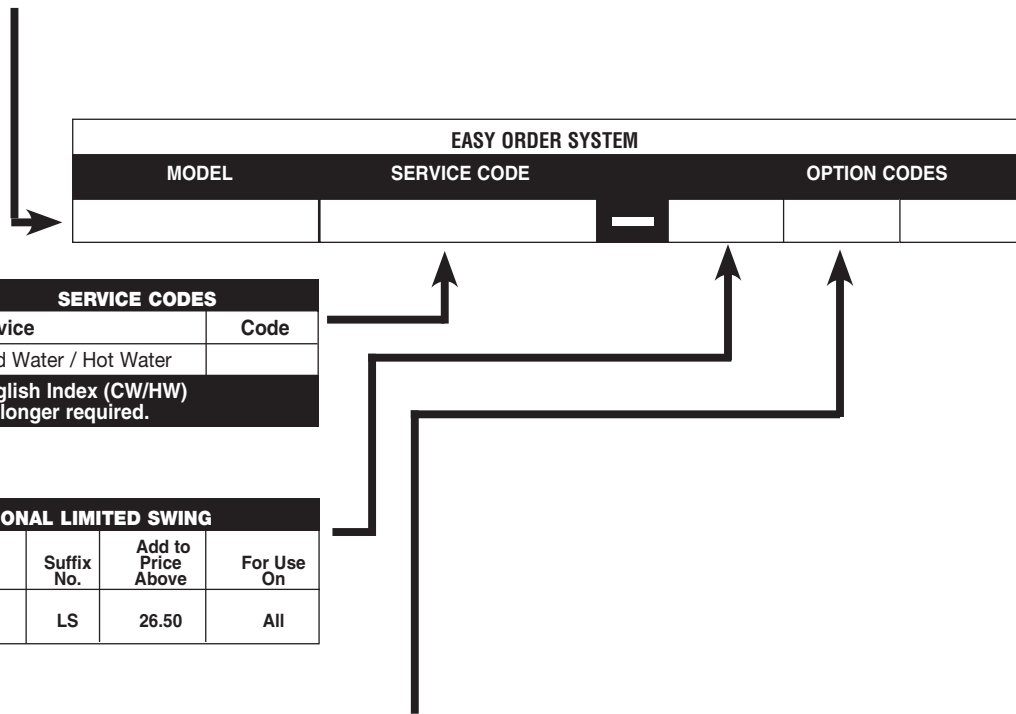

OPTIONAL SPOUTS - OPTIONAL SPOUT MUST BE SAME TYPE AS STD. SPOUT (I.E., REGULAR OR ANGLE VB)

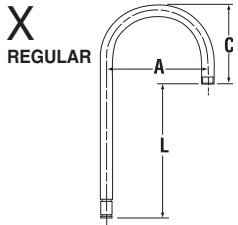
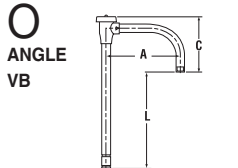
 <p>X REGULAR</p>	Suffix Number	"A"		"C"		"L"		ADD TO PRICE ABOVE
		mm	inches	mm	inches	mm	inches	Chrome Plated
 <p>O ANGLE VB</p>	R2	114	4.5	104	4.1	170	6.7	5.05
	R3	152	6.0	124	4.9	56	2.2	6.40
	R4	152	6.0	124	4.9	146	5.8	5.05
	R5	152	6.0	124	4.9	188	7.4	STD
	R6	152	6.0	124	4.9	229	9	9.75
	R7	229	9.0	163	6.4	170	6.7	23.00
	R23	152	6.0	135	5.3	188	7.4	STD
R25	229	9.0	135	5.3	188	7.4	5.35	

DELTA COMMERCIAL TECHNICAL SERVICE 1-877-509-2680
 ONLINE CATALOGS: www.deltacommercialfaucets.com (Core products ONLY)
www.specselect.com (Complete Product Offering & Part Numbering System)

Inserts for Outlets

MODEL	DESCRIPTION	PRICE
060686A	1.9 L/min. (0.5 gpm) Insert (pkg. of 12) Spray	38.20
060687A	3.8 L/min. (1.0 gpm) Insert (pkg. of 12) Spray	47.05
060688A	5.7 L/min. (1.5 gpm) Antimicrobial Laminar Flow Insert (pkg. of 12) Laminar	94.80
060689A	5.7 L/min. (1.5 gpm) Insert (pkg. of 12) Aerated	26.35

Outlets

FLOW	MODEL	DESCRIPTION	PRICE
1.32 L/min. (0.35 gpm)	061104A	1.32 L/min (0.35 gpm) Vandal Resistant Outlet (Male) Spray	23.60
	061105A	1.32 L/min (0.35 gpm) Vandal Resistant Outlet (Female) Spray	27.75
	061106A	1.32 L/min (0.35 gpm) Outlet (Male) Spray	12.95
	061107A	1.32 L/min (0.35 gpm) Outlet (Female) Spray	12.95
1.9 L/min. (0.5 gpm)	060726A	1.9 L/min. (0.5 gpm) Vandal Resistant Outlet (Female) Spray	27.75
	060666A	1.9 L/min. (0.5 gpm) Outlet (Female) Spray	12.95
	060667A	1.9 L/min. (0.5 gpm) Outlet (Male) Spray	12.95
	061203A	1.9 L/min. (0.5 gpm) Vandal Resistant Outlet (Male) Laminar	24.55
	061204A	1.9 L/min. (0.5 gpm) Vandal Resistant Outlet (Female) Laminar	24.55
	RP31704	1.9 L/min. (0.5 gpm) Vandal Resistant Outlet (Male) Spray	22.05
	RP31704SS	1.9 L/min. (0.5 gpm) Vandal Resistant Stainless Outlet (Male) Spray	70.80
3.8 L/min. (1.0 gpm)	060663A	3.8 L/min. (1.0 gpm) Vandal Resistant Outlet (Female) Spray	25.40
	060566A	3.8 L/min. (1.0 gpm) Vandal Resistant Outlet (Male) Spray	25.40
	060664A	3.8 L/min. (1.0 gpm) Outlet (Female) Spray	12.95
	060665A	3.8 L/min. (1.0 gpm) Outlet (Male) Spray	12.95
	060941A	3.8 L/min. (1.0 gpm) Outlet (Female) Aerated	12.35
	060940A	3.8 L/min. (1.0 gpm) Outlet (Male) Aerated	12.95
	060940SS	3.8 L/min. (1.0 gpm) Stainless Outlet (Male) Aerated	42.75
	061176A	3.8 L/min. (1.0 gpm) Vandal Resistant Outlet (Male) Laminar	26.80
	061177A	3.8 L/min. (1.0 gpm) Vandal Resistant Outlet (Female) Laminar	26.80
5.7 L/min. (1.5 gpm)	060637A	5.7 L/min. (1.5 gpm) Antimicrobial Laminar Flow Vandal Resistant Outlet (Female) Laminar	27.75
	060638A	5.7 L/min. (1.5 gpm) Antimicrobial Laminar Flow Vandal Resistant Outlet (Male) Laminar	27.75
	060639A	5.7 L/min. (1.5 gpm) Vandal Resistant Outlet (Female) Aerated	17.05
	060640A	5.7 L/min. (1.5 gpm) Vandal Resistant Outlet (Male) Aerated	17.05
	060641A	5.7 L/min. (1.5 gpm) Outlet (Female) Aerated	12.95
	060642A	5.7 L/min. (1.5 gpm) Outlet (Male) Aerated	12.95
8.3 L/min. (2.2 gpm)	060719A	8.3 L/min. (2.2 gpm) Outlet (Female) Aerated	12.95
	060720A	8.3 L/min. (2.2 gpm) Outlet (Male) Aerated	12.95
	060721A	8.3 L/min. (2.2 gpm) Vandal Resistant Outlet (Female) Laminar	27.75
	060723A	8.3 L/min. (2.2 gpm) Vandal Resistant Outlet (Female) Aerated	17.05
	060724A	8.3 L/min. (2.2 gpm) Vandal Resistant Outlet (Male) Aerated	17.05

Notes: Female thread 55/64" dia - 27 threads/inch
 Male thread 15/16" dia - 27 threads/inch

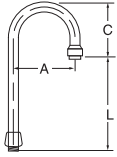

GROUP NO. 1
Regular Gooseneck

Rigid/Swivel Model ONLY	Rigid/Swivel Price	Limited Swing Model ONLY	Limited Swing Price	"A"		"C"		"L"		"ADD-ON" SUFFIX NO.	RIGID/SWIVEL SPOUT DESCRIPTION
				MM	IN.	MM	IN.	MM	IN.		
063092A	67.20	—	—	89	3.5	51	2	173	6.8	R1	Gooseneck Spout
063087A	47.70	063063A	68.80	114	4.5	104	4.1	170	6.7	R2	Gooseneck Spout
063093A	69.10	063064A	106.50	152	6	124	4.9	56	2.2	R3	Gooseneck Spout
063088A	52.05	063065A	74.00	152	6	124	4.9	146	5.8	R4	Gooseneck Spout
063089A	55.85	063066A	80.10	152	6	124	4.9	188	7.4	R5	Gooseneck Spout
063090A	55.85	063067A	80.65	152	6	124	4.9	229	9	R6	Gooseneck Spout
063091A	61.85	063068A	93.35	229	9	163	6.4	170	6.7	R7	Gooseneck Spout
063094A	71.25	063069A	105.80	229	9	163	6.4	348	13.7	R8	Gooseneck Spout
061006A	54.70	061007A	77.70	152	6	124	4.9	94	3.7	R35	Gooseneck Spout

Note: Contact customer service for 1500T and 3000T Series Fixed Spouts.

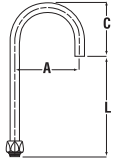

GROUP NO. 2
Smooth End-Flow Control
In Base of Gooseneck
Spout
(Available on #7 outlets ONLY)

060878A	54.20	063070A	74.50	114	4.5	97	3.8	178	7	R2	Gooseneck Spout w/FC
060876A	76.50	063071A	112.25	152	6	117	4.6	64	2.5	R3	Gooseneck Spout w/FC
060872A	58.65	063072A	79.65	152	6	117	4.6	152	6	R4	Gooseneck Spout w/FC
060873A	62.60	063073A	85.85	152	6	117	4.6	196	7.7	R5	Gooseneck Spout w/FC
060874A	62.60	063074A	86.50	152	6	117	4.6	236	9.3	R6	Gooseneck Spout w/FC
060875A	68.95	063075A	98.60	229	9	155	6.1	178	7	R7	Gooseneck Spout w/FC
060877A	75.00	063076A	111.50	229	9	155	6.1	356	14	R8	Gooseneck Spout w/FC
060540A	55.85	063077A	79.65	152	6	117	4.6	102	4	R35	Gooseneck Spout w/FC

Note: Contact customer service for 1500T and 3000T Series Fixed Spouts.

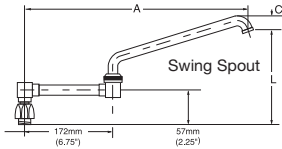

GROUP NO. 4 Double Joint

063015A & 060452A	108.85	—	—	309	12.2	38	1.5	175	6.9	R16	Double Joint Spout
063015A & 060269A	108.85	—	—	359	14.1	38	1.5	218	8.6	R17	Double Joint Spout
063015A & 060455A	108.85	—	—	448	17.6	29	1.1	175	6.9	R18	Double Joint Spout

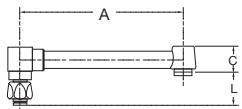

GROUP NO. 5 Plain Spout

060805A	148.35	—	—	81	3.2	33	1.3	38	1.5	R27	Plain Spout
060806A	220.35	—	—	203	8	33	1.3	38	1.5	R19	Plain Spout
060271A	103.25	—	—	89	3.5	33	1.3	43	1.7	R28	Plain VB Spout
060754A	293.80	—	—	203	8	33	1.3	43	1.7	R20	Plain VB Spout

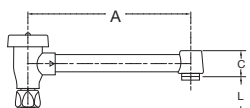

GROUP NO. 5 Plain VB Spout

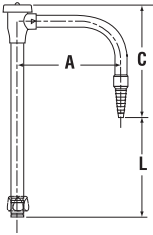
 ANGLE VB	Model	mm "A" inches		mm "C" inches		mm "L" inches		Add-On Suffix #	Price
	W6850	152	6.0	173	6.8	137	5.4	R23	130.65
W6850-1	152	6.0	173	6.8	97	3.8	R22	130.65	
W6850-8	203	8.0	173	6.8	137	5.4	R24	130.80	
W6850-9	229	9.0	173	6.8	137	5.4	R25	135.00	
W6850-12	305	12.0	173	6.8	137	5.4	R26	138.55	

Laboratory Special Replacement Rigid/Swivel Goosenecks (Separate Orders)

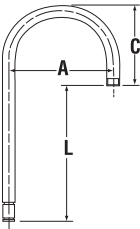
 REGULAR	Model	mm "A" inches		mm "C" inches		mm "L" inches		Add-On Suffix #	Price
	W6890-6	89	3.5	51	2	173	6.8	R1	93.65
W6890-1	114	4.5	104	4.1	170	6.7	R2	59.50	
W6890-7	152	6.0	124	4.9	56	2.2	R3	89.20	
W6890-2	152	6.0	124	4.9	146	5.8	R4	66.55	
W6890	152	6.0	124	4.9	188	7.4	R5	66.55	
W6890-4	152	6.0	124	4.9	229	9	R6	72.55	
W6890-5	229	9.0	163	6.4	170	6.7	R7	89.25	
W6890-8	229	9.0	163	6.4	348	13.7	R8	96.00	

Replacement Swing Spouts (Separate Orders)

SWING SPOUT REPAIR PART			
Model	Description	Add-on Suffix #	Price
063044A	8" "D" Section Spout	S2	52.85
060452A	6" Tubular Spout	S3	27.50
060269A	8" Tubular Spout	S5	47.00
060454A	9" Tubular Spout	S6	27.75
060455A	11" Tubular Spout	S7	58.65
060456A	14" Tubular Spout	S8	71.00
060457A	16" Tubular Spout	S9	40.65

Model	Description	Price
060003A	C.P. Wall flange	10.25
060004A	C.P. 1½" Spud flange	15.05
060022A	Handle screws & index kit includes:	46.85
	12 – short screws	
	12 – long screws	
	12 – red indexes	
	12 – blue indexes	
	1 – driver bit	
060026A	Gooseneck spout repair parts kit includes:	30.65
	1 – rigid collar	
	6 – retaining rings	
	6 – swivel rings	
	12 – "O" rings	
	1 – spout nut	
060027A	Cross handle w/screw, red & blue button	28.85
060028A	Pkg. of 12 – set screws	12.35
	2 – allen keys	
060029A	Check unit kit (2 units)	55.05
060030A	Pkg. of 6 – "O" rings	35.65
	6 – check units	
060032A	Pkg. of 4 – springs	40.65
	for self-close lever handle	
	with L.H. structure (cold water side)	
060033A	Pkg. of 4 – springs	40.65
	for self-close lever handle	
	with R.H. structure (hot water side)	
	and for 5 fluted self-close handles	
060034A	Stem structure complete w/ seat	32.85
060037A	Pkg. of 2 – sani guards	26.10
060042A	Pkg. of 6 – plug buttons	14.40
	6 – "O" rings	
	6 – chain stay posts	
060046A	2¼" lever handle w/ screw red and blue index	22.40
060047A	R.H. structure, regular and long renewable seat	15.85
060048A	L.H. structure, regular and long renewable seat	15.85
060049A	Pkg. of 12 – fiber washers	15.50
	12 – rubber washers	
060051A	Pkg. of 12 – plug buttons	9.75
060052A	Pkg. of 24 – spout "O" rings	11.95
060056A	Pail brace complete	81.75
060057A	14" Cover plate	69.95
060058A	Integral stop structure complete	33.45
060059A	Pkg. of 12 – "O" rings	8.55
060072A	No. 6 x 2" V.P. spanner screws (2) and driver bit	26.15
060073A	No. 10 x 2" V.P. spanner screws (4) and driver bit	30.40
060074A	Pkg. of 5 – springs	13.45
060075A	Pkg. of 5 – plastic handle inserts	6.50
060076A	Pkg. of 12 – C.P. cover screws	20.15
	1 – driver bit	
060077A	Cover and screw (non hold open model)	24.45
060078A	Pkg. of 12 – Cast cap screws	13.35
060079A	Pkg. of 12 – Diaphragms	66.80
060081A	Pkg. of 12 – Plug buttons	11.30
060082A	Pkg. of 20 – "O" rings	14.90
060083A	Pkg. of 12 – Rubber washers	14.90
	12 – Fiber washers	
060094A	Hex coupling ring	9.30

Model	Description	Price
060096A	Renewable seat wrenches for brass and plastic	144.90
	renewable seats	
060115A	¾" Dia. C.P. brass split ring hanger	54.50
060117A	1½" Dia. C.P. brass split ring hanger	66.00
060132A	Handshower, Swivel Wallmount Elbow	218.55
060139A	Pkg. of 24 – seat washers	10.15
060164A	3" Single control lever handle	35.20
060182A	TV Brass renewable seat kit	13.80
060193A	Controller fuse (for 2000T)	12.05
060197A	1⅜" Male thread aerator	8.60
060198A	Single inlet shank parts kit (for 28T9)	31.85
060239A	Wheel handle and screw	4.35
060253A	¾" x 19½" VB Tube	87.50
060254A	59" Bedpan cleanser hose	56.45
060264A	Package of 2 sani-guards	21.35
060269A	8" Tubular swing spout complete	47.00
060270A	Extension shank, tube and flange	77.45
	(for 16" long bottom fork bracket spout) 1 of each	
060271A	3" RCP VB spout complete	103.25
060274A	Wall thermometer kit for shower	324.35
060278A	2.2 gpm (8.3 L/min) VR female laminar flow	26.45
	moderator outlet with wrench (for pre-1998 gooseneck spouts)	
060279A	Vandal Resistant Aerator	16.15
060280A	2.2 gpm (8.3 L/min) Female aerator	12.35
	(for pre-1998 gooseneck spouts)	
060282A	Check structures complete (2 units, pre-1998)	51.15
060302A	Vacuum Breaker Repair Parts Kit	41.80
060303A	Supply Elbow/Flange	26.15
060304A	24" S/S Slide Bar/Hose/Handshower/VB	226.30
060310A	Flow Control, Sprayplate Repair Kit	9.15
060311A	CP Insert	18.65
060316A	1½" TV CP Elbow	57.95
060318A	Flow Control Inserts Only, Pkg. of 6	22.85
060334A	Battery Holder	10.35
060341A	Wrench Kit for Brass Renewable Seat	57.60
060342A	Plug & O'Ring for Handle End	10.35
060344A	Filter Screen for Flush Valve (pkg. of 12)	35.65
060345A	Single Shank Kit with 1.25" Offset	33.00
060346A	12" Flexible Braided Urinal Hose	58.30
060354A	CP Union Tail 1" Longer	42.90
060355A	CP Union Tail 2" Longer	43.85
060365A	O' Ring Kit (6 each per pkg.) for Conn. Lav.	22.35
060397A	6" Long Cover Tube (for optional rough-in problems)	16.75
060400A	1½" x 10" Long CP VB Tube	24.45
060401A	1½" x 22¾" Long CP VB Tube	48.60
060402A	¾" x 11.5" Long VB Tube	42.55
060409A	1¼"x19.6" Long Trap Seal Tube	103.25
060412A	Body Gland	7.95
060424A	Wall Spout w/ Top Brace Bracket Less VB	131.95
060428A	Deck Mount Assembly for R/S Spouts	25.10
060434A	Metal Mounting Hardware	8.20
060436A	Holddown Pkg	10.80
060437A	Holddown package (2 each locknuts, cplg nuts, lockwashers)	7.85
060441A	#3 Scrulox 8 drive bit	6.55
060444A	Locknut	5.40
060445A	CP Deck Flange	10.70
060446A	Fiber Washer (pkg of 12)	7.35

Model	Description	Price
060452A	6" Tubular Swing Spout	27.50
060454A	9" Tubular Swing Spout	27.75
060455A	11" Tubular Swing Spout	58.65
060456A	14" Tubular Swing Spout	71.00
060457A	16" Tubular Swing Spout	40.65
060462A	½" U.A.S. Stop	61.70
060463A	¾" Spud Nut, Washers and Flange Pkg.	26.20
060464A	Deck Flange	8.55
060465A	Rubber Washer (pkg of 12)	4.70
060466A	Wall Flange and Set Screw (pkg of 2)	49.15
060467A	Diverter	13.55
060469A	Fiber Gasket Kit (pkg of 12)	18.10
060473A	Optional Thin Wall Trim Kit	25.35
060479A	Handle & Screw Kit	2.45
060480A	1½" x ¾" Threaded Adapter	15.90
060481A	¾" x 16" Long Rough Tube - Threaded one end	72.25
060482A	1½" x 16" Long Rough Tube - Threaded one end	48.95
060485A	Wall Flange and CP Brass Hub (2 per pkg)	31.25
060486A	1.69" Long Union Tail	23.95
060487A	2.19" Long Union Tail	21.25
060488A	¾" IP Coupling Nut - Chrome	19.90
060489A	1.75" Long Cover Tube	8.55
060493A	O'Ring Kit (6 per pkg)	16.15
060494A	Spray Head Hook & Screw	34.00
060496A	Pre-Rinse Spring Only	63.35
060504A	Cover Tube & S/S Wall Flange	17.55
060505A	CP Cover with Bumper Seat Lid	32.30
060506A	Standard Adjustable Tail CP	30.15
060507A	CP Poppet Pin for Watercloset (3 per pkg)	7.80
060508A	CP Poppet Pin for Urinal (3 per pkg)	9.20
060513A	Adapter	25.20
060514A	Optional Outlet Tube-16" Long	37.50
060523A	FP Repair Kit (1999 on)	68.55
060524A	FP Repair Kit (1999 on)	115.85
060540A	Gooseneck Spout with Flow Control	55.85
060543A	4" Hooded Lever Handle Pkg. (1 Handle, 1 Screw, 1 Alignment Insert, Red and Blue Indexes)	29.10
060544A	Alignment Insert (12/Pkg)	16.65
060546A	4" Plate and Holddown Package (3000TGN Series)	87.70
060547A	8" Plate and Holddown Package (3000TGN Series)	117.50
060552A	8" CP Forged Deck Plate	113.65
060553A	CER-TECK® Structure "O-Ring" Kit (24/Pkg)	13.35
060554A	CER-TECK® bottom seal (24/Pkg)	9.00
060564A	Single Hole Deck gasket	32.00
060566A	VR 1 gpm Flow Control Non-Aerating Spray Outlet	25.40
060570A	¾" Coupling Nut & Washers	13.60
060577A	12" S/S Cover	127.55
060583A	Balanced Lever Handle w/ 1 screw, 1 red and 1 blue index	39.60
060584A	Mounting Hardware (1 gasket, 1 locknut)	25.30
060585A	Cover plate and Mounting Hardware	76.25
060586A	Flexible S/S Supply Tubes (2/pkg) ¾" compression connectors	71.35
060590A	Spout w/ Adj Bracket - No VB 8"	245.95
060591A	Spout w/ Adj Bracket - Inline VB 8"	329.65
060592A	Spout w/ Adj Bracket - Ang VB 8"	346.15
060593A	Spout w/ Adj Bracket - no VB 5.5"	147.40
060594A	Spout w/ Adj Bracket - Ang VB 5½"	147.40

Model	Description	Price
060595A	Straight Wall Brace Assembly	96.95
060596A	Fork Wall Brace Assembly	178.95
060599A	3" Hooded Lever Handle & Screw	25.45
060602A	4" Blade handle w/ screw, 1 red & 1 blue index, alignment insert	55.60
060605A	Toe Test Spout	98.60
060635A	8" Deck Plate	32.00
060636A	Gasket (pkg of 3)	5.25
060637A	Female V.R. 1.5 gpm (5.7 L/min) Laminar w/Antimicrobial	27.75
060638A	Male V.R. 1.5 gpm (5.7 L/min) Laminar w/Antimicrobial	27.75
060639A	Female V.R. 1.5 gpm (5.7 L/min) Flow Control Aerator	17.05
060640A	Male V.R. 1.5 gpm (5.7 L/min) Flow Control Aerator	17.05
060641A	Female 1.5 gpm (5.7 L/min) Std Flow Control Aerator	12.95
060642A	Male 1.5 gpm (5.7 L/min) Std Flow Control Aerator	12.95
060646A	24T3 Series Cam Package	15.40
060647A	24T3 Series Braided hose with ¾" compression connection	29.55
060648A	24T3 Series Inlet Screen (12/Pkg)	59.60
060651A	3 Position Switch Add-on Package Keyed Switch	214.00
060652A	Slow Close Foot Pedal Cartridge (1999 on)	258.15
060654A	ADA Metering Handle (Plain)	44.45
060655A	ADA Metering Handle (Red)	46.90
060656A	ADA Metering Handle (Blue)	46.90
060657A	4" Deck Gasket for 86T ADA Metering (Pkg of 3)	16.75
060658A	4" Deck Gasket for 87T151 (Pkg of 3)	21.10
060660A	Checks for 060659A (Pkg of 6)	22.90
060661A	Holddown Pkg for 87T Single Hole	4.75
060663A	Female V.R. 1.0 gpm (3.8 L/min) Outlet	25.40
060664A	Female Std 1.0 gpm (3.8 L/min) Outlet	12.95
060665A	Male Std 1.0 gpm (3.8 L/min) Outlet	12.95
060666A	Female Std 0.5 gpm (1.9 L/min) Outlet	12.95
060667A	Male Std 0.5 gpm (1.9 L/min) Outlet	12.95
060671A	¾" NPS Solenoid Valve	62.20
060673A	10" x 10" Stainless Cover w/ Override	136.10
060674A	14" x 14" Stainless Cover w/ Override	162.65
060675A	14" x 20" Stainless Cover w/ Override	182.40
060676A	Sensor Module-Washdown Urinal	269.15
060677A	Sensor Module-Urinal FV	269.15
060678A	Sensor Module-Watercloset FV	269.15
060679A	Override Button	67.45
060680A	Solenoid Extension Cable 48" (1600T)	20.80
060681A	Battery Holder (1600T) 4 C Cells Fla	10.50
060683A	24 VAC to 6 VDC Converter	43.65
060684A	Battery Holder (1600T) 4 C Cells Sq	14.90
060685A	Ferrite Bead for Electronic Series	29.65
060686A	0.5 gpm (1.9 L/min) Insert Only	38.20
060687A	1.0 gpm (3.8 L/min) Insert Only	47.05
060688A	1.5 gpm (5.7 L/min) Antimicrobial	94.80
060689A	1.5 gpm (5.7 L/min) Insert Only	26.35
060690A	36" Cable Extension	32.30
060691A	Tube, Urinal	19.20
060692A	Adj TV Ret Ring	3.00
060693A	CP Oscillating Handle	13.20
060694A	¾" C Adaptor	12.85
060695A	TV Guide Screw Gasket	2.30
060696A	½" C X MIP Adaptor	3.80
060697A	1" Copper Inlet Adaptor	15.40
060698A	¾" IP X M Aerator Thd Adaptor	15.25

Model	Description	Price
060701A	CP Outlet Adaptor	30.15
060702A	CP 1/2" NPS Adaptor	33.50
060703A	CP 1/2" x 3/8" IP Bushing	4.00
060704A	20VA Transformer	53.15
060705A	CP Diverter Spout	43.05
060707A	1 1/2" CP Cplg Nut S/A	13.60
060708A	CP 3/8" FIP x 3/8" FIP VB	101.60
060709A	1/2" Angle Vac Breaker	84.85
060710A	Shower Arm Trim S/A	32.85
060711A	3/8 IPS Set Screw Flange	24.15
060712A	Remotrol Parts Pkg	31.60
060715A	Straight VB	55.60
060716A	Wall Mounted Vac Breaker	159.80
060718A	Bracket Holder S/A	37.70
060719A	Aerator, Female, .859 THD, 2.2 gpm	12.95
060720A	Aerator, Male, .937 THD, 2.2 gpm	12.95
060721A	Moderator, Female, 2.2 gpm	27.75
060723A	VP Aerator (Female) & Key S/A, 2.2 gpm	17.05
060724A	VP Aerator (Male) & Key S/A, 2.2 gpm	17.05
060726A	VP Aerator (0.5 gpm), Female, S/A	27.75
060728A	Bedpan Cleanser WITH Stop	196.85
060729A	Bedpan Cleanser LESS Stop	123.10
060730A	CP TECK Line Vacuum Breaker	47.15
060734A	CP VB Coupling Nut	37.35
060735A	CP Union Nut	10.15
060736A	14" Plate w/Studs for Bauer Sensor	111.10
060745A	1 1/4" TV Lockring S/A	16.95
060754A	Plain VB Spout S/A	293.80
060755A	Cage and Push Button	46.85
060756A	Flange & Pin	41.75
060757A	CP 3/8" IP Angle VB	55.30
060759A	CP 3/8" IP Nipple 1.5 IN L	12.20
060761A	RCP 3/8" IP Nipple 3.5 IN L	17.05
060762A	RCP 3/8" IP Nipple 5 IN L	20.10
060764A	1 x 3/4" MIP X FIP Flush Bushing (MO)	12.80
060765A	VP Aerator Key	4.80
060767A	Aqua Controller	679.10
060768A	Short Range WP Sensor 39" L	632.90
060769A	Long Range WP Sensor 39" L	632.90
060771A	40VA Transformer	54.10
060772A	100VA Transformer	142.80
060773A	1 1/4" SJ Nut S/A	10.25
060777A	1 1/2" TV Offset VB & Cplg Ring	204.65
060778A	1 1/2" RGH Cplgs Nut S/A	6.75
060779A	Diaphragm & Guide S/A	28.55
060781A	1 1/2" TV Outlet Tube & Tee S/A	81.45
060782A	TECK 2 1/2" x 10" CP VB S/A	54.85
060783A	TECK 2 1/2" x 22 3/4" CP VB S/A	106.55
060784A	TECK 2 3/4" x 11 1/2" CP VB S/A	80.50
060785A	VB Sleeve M.O.	13.00
060789A	Aerator x 3/8" MIP Adaptor	45.90
060790A	Aerator x 1/2" MIP Adaptor	42.60
060791A	Hose End VB S/A	47.15
060792A	Spout & Flange S/A	112.10
060793A	30 Deg. Inst. Showerhead S/A	178.20
060794A	TECK Fluted Handle & Screw S/A	28.85
060796A	VB for 81T281 AM-Gray S/A	98.70

Model	Description	Price
060797A	Plastic Bumper & Screw S/A	5.70
060798A	Vacuum Breaker S/A w/Gasket	39.15
060799A	Universal TV Washer Repair Kit	17.60
060801A	Universal TV Handle Kit	71.80
060803A	Spout w/ VB Outlet S/A	190.45
060805A	Short Spout S/A	148.35
060806A	Plain Rigid Spout S/A	220.35
060809A	Lever Handle & Screw S/A	17.95
060810A	Handle Cage S/A	21.30
060815A	Osc Handle & Flange S/A	54.95
060816A	1 1/4" PB & Flange S/A	104.75
060819A	Stream Straightener & VP Key	31.75
060820A	Set Screw Flange S/A	21.40
060822A	PB Control Unit Complete	186.65
060824A	Bonnet & Sleeve S/A	28.55
060825A	Hdle Gland & Sleeve S/A	14.20
060826A	M.O. Bedpan Structure	67.70
060841A	Push Button & Set Screw Kit	19.75
060843A	Retrofit Kit-TECK II Exposed	32.10
060844A	Repair Kit-Check/Stop	4.75
060845A	Retrofit Kit-TECK II Concealed	33.70
060848A	SC Cartridge Kit	38.65
060852A	Diverter Valve	214.40
060855A	Modular Junction Box	40.40
060858A	Vacuum Breaker Insert	4.30
060859A	1" CP UAS Stop Assy	121.35
060860A	CP UAS L/Nut & Tail S/A	95.45
060861A	Outlet Tube Washer Set	6.90
060862A	1" Conc UAS Complete	129.65
060863A	1 1/4" x 10" CP TECK II VB Compl	82.00
060864A	4" Blade Handle & Screw Sub-Assembly	34.05
060865A	6" Wrist Hdle & Screw S/A	41.15
060872A	Flow Control Gooseneck Spout	58.65
060873A	Flow Control Gooseneck Spout	62.60
060874A	Flow Control Gooseneck Spout	62.60
060875A	Flow Control Gooseneck Spout	68.95
060876A	Flow Control Gooseneck Spout	76.50
060877A	Flow Control Gooseneck Spout	75.00
060878A	Flow Control Gooseneck Spout	54.20
060880A	Handle Control Unit & Bracket	134.05
060890A	Showerhead S/A, Flo-Trol	33.35
060894A	RGH BR Drain Plug & Gskt	3.25
060895A	CP 1 1/2" x 16" Tube	86.95
060896A	CP 1 1/2" x 6.62 L Tube	61.60
060897A	Anchor Plate & Cap S/A	30.40
060898A	Cover Screws & Driver Bit for 81T-W	8.50
060899A	CP Metal Cover, Screws & Bit for 81T	96.75
060901A	12" Solenoid Extension Cord for 81T	12.00
060902A	36" Solenoid Extension Cord for 81T	17.85
060905A	Cover Gasket	6.15
060906A	Surface Mount Housing	21.30
060907A	Driver Board	157.70
060908A	Solenoid Holder	2.40
060909A	Screen Assembly	1.30
060917A	Lotion with Moisturizers Soap Refill	33.85
060918A	Soap Dispenser Plug-In Transformer	63.50
060919A	Soap Dispenser 24 VAC to 6 VDC Conver	57.05

DELTA COMMERCIAL TECHNICAL SERVICE 1-877-509-2680
ONLINE CATALOGS: www.deltacommercialfaucets.com (Core products ONLY)
www.specselect.com (Complete Product Offering & Part Numbering System)

Model	Description	Price
060920A	Complete Brass Flow Housing & Contr	6.85
060922A	Replacement Faceplates - 1.2, 1.6 & 3.3 gpm (4.5, 6 & 12.5 L/min) One of each	17.65
060923A	Nuts for 1600T Recessed (Pkg. of 12)	36.70
060924A	Retrofit Kit for 1000T6 WC w/ 12" FR	544.45
060925A	Retrofit Kit for 1000T6 WC w/ 4" Box	523.55
060926A	Retrofit Kit for 1000T6 UR w/ 12" FR	544.45
060927A	Retrofit Kit for 1000T6 UR w/ 4" Box	523.55
060928A	Retrofit Kit for 1000T9 Washdown w/	383.15
060931A	E-Soap Spout Assembly Metal	375.15
060932A	Spacer & Adhesive Washer Package	20.50
060933A	Lock Washer & Mounting Nut	5.15
060934A	Bottle Clip (3/Pkg)	7.35
060935A	C-Clip (3/Pkg)	7.35
060936A	Motor Housing Assembly	188.55
060940A	1.0 gpm (3.8 L/min) Male Aerator	12.95
060940SS	SS Male Std. 1.0 gpm (3.8 L/min)	42.75
060941A	Female Std. 1.0 gpm (3.8 L/min) A	12.35
060947A	3" Hooded Lever Handle PR. H/C-TI w/Scr	39.35
060948A	4" Blade Handle PR. H/C-TI w/Screws	48.90
060949A	4" Hooded Lever Handle PR. H/C-TI w/Scr	41.50
060950A	1.75 gpm Flow Regulator (Pkg of 10)	14.70
060951A	Allen wrench for DEFM-100	12.90
060952A	Adaptor Kit for DEFM-100	38.85
060955A	2nd Gen Driver Board	160.25
060958A	Plug-In Transformer for DEMD	41.10
060959A	Battery Box (6 x 1.5AA) for DEMD	77.70
060960A	Aerator Pkg 0.5 gpm for DEMD	34.15
060960ANS	Outlet Pkg. 0.5 gpm Spray Nickel Stainless Finish	36.75
060961A	Aerator Pkg 1 gpm for DEMD	34.15
060961ANS	Outlet Pkg. 1 gpm Spray Nickel Stainless Finish	36.75
060962A	Escutcheon Kit for DEMD	39.15
060963A	Hold Down Pkg for DEMD	31.00
060965A	Sensor Kit for DEMD	312.05
060966A	Solenoid Valve Kit for DEMD	119.30
060967A	Remote Control for DEMD	221.70
060968A	Extension Cable for DEMD	40.45
060971A	1.75 gpm Insert Kit for Cast Showerhead	20.70
060972A	Filter Screen (pkg of 6) for Sloan/Zurn tails	35.65
060973A	1.5 gpm Outlet for 22C w/ wrench flats	17.20
060974A	Hardwire Converter (DEMD Series) 24VAC to 9DC	58.70
060975A	Escutcheon for PB Diverter Shower	43.50
060983A	Driver Board for 860T Series	176.55
060984A	Push Button Extension Cord for 860T Series	26.20
060985A	10" S/S Cover & Screws for 860T #3 Control Box	148.25
060986A	4" S/S Cover & Screws for 860T #6 Control Box	85.05
060987A	12" S/S Cover & Screws for 860T #7 Control Box	198.25
060988A	12" S/S Cover & Screws for 860T #8 Control Box	198.25
060989A	3000T 3rd Gen Controller	512.50
060991A	30 DEG Inst Showerhead 1.75 gpm	169.75
061001A	Wall Mount gasket for 1500T4 (6/pkg)	32.00
061006A	Rigid Swivel Gooseneck - with aerator adaptor	54.70
061007A	Limited Swing Gooseneck - with aerator adaptor	77.70
061010A	1.5 gpm insert kit for cast showerhead	20.70
061011A	30 deg inst showerhead - 1.5 gpm	178.20
061012A	Solenoid assembly (DEMD-800)	119.30
061013A	Holddown package (DEMD-800)	53.90

Model	Description	Price
061014A	Adapter kit (DEMD-800)	8.30
061018A	TECK 1 parts kit	27.60
061019A	Cast cap assembly	61.05
061022A	Electronic flush vlv cap assy.	165.65
061023A	TECK 1 & 2 cover cap & reg.screw	73.80
061024A	TECK 2 reg screw & O ring assy	13.85
061025A	Univ tv parts repair kit	51.40
061028A	Concealed fv cap assy - 4.8 L	58.20
061030A	Sensor for 2nd Gen. 591T Series	123.50
061031A	Gasket for 591T (pkg of 3)	32.50
061032A	860T upgrade kit for old 1000T10 x 3 (8 x 8)	585.65
061033A	860T upgrade kit for old 1000T10x6 (4 x 4)	562.65
061034A	860T upgrade kit for old 1000T10x7 (12 x 12)	612.90
061035A	Set screw for HDF elbow handle	2.95
061036A	Gasket for 500-HDF Series	4.15
061037A	0.5 gpm outlet - 500-HDF Series	12.60
061038A	Aerator key for 500-HDF Series	1.85
061039A	Solenoid valve kit for DEMD wall mount	125.30
061041A	Sensor kit for DEMD wall mount	267.00
061042A	Holddown package for DEMD wall mount	63.40
061043A	Escutcheon kit for DEMD wall mount	8.10
061044A	Adapter pkg for DEMD wall mount	14.15
061045A	Conduit for DEMD wall mount	7.90
061046A	Battery Box for DEMD wall mount	74.00
061047A	Hardwire converter w/ battery-backup	101.00
061050A	Escutcheon	44.55
061051A	T13H handle kit for shower valve	33.45
061052A	Set screw & button	6.55
061053A	Thermostatic escutcheon	47.70
061054A	Temperature knob, cover & screw	46.60
061055A	Diverter handle, screw & button	47.95
061057A	Volume control hdlc assy for T17TH	76.35
061058A	Diverter valve	204.10
061063A	Replaceable lens	11.50
061069A	Hardwire converter & rigid-connection assembly	71.10
061069A-BB	Hardwire Converter w/Rigid Connection for -BB	124.85
061104A	0.35 gpm (1.32 L/min.) V.R. outlet M	23.60
061105A	0.35 gpm (1.32 L/min.) V.R. outlet F	27.75
061106A	0.35 gpm (1.32 L/min.) standard outlet M	12.95
061107A	0.35 gpm (1.32 L/min.) standard outlet F	12.95
061110A	0.5 outlet	22.00
061118A	Careguard 1.5 gpm Laminar Male	26.80
061118ANS	Outlet Pkg. 1.5 gpm Laminar Nickel Stainless Finish	30.00
061119A	8" Proximity Plate	91.90
061124A	Washer Package (Pkg. of 6)	4.75
061125A	30 Deg Institutional Showerhead	166.65
061127A	2 Lever Handles with Screws	25.75
061128A	2 Ceramic Cartridges	42.30
061131A	Extension Kit for Diverter Valve	15.25
061132A	WC E-FV Kit (includes e-board & button)	221.95
061133A	UR E-FV Kit (includes e-board & button)	221.95
061135A	Gasket retrofit kit for 061134A (Pkg of 3)	6.30
061137A	Wrench for 061134A & R2570-MIX	4.15
061138A	Cover Screws for 3rd Gen E-FV (2011)	5.20
061139A	CP Metal Cover for 3rd Gen E-FV (2011)	46.75
061140A	Case Top for 3rd Gen E-FV (2011)	7.90
061141A	Cover Gasket (3/pkg) for 3rd Gen E-FV (2011)	16.75

Model	Description	Price
061142A	W.C. Repair Kit for 3rd Gen E-FV (2011)	379.35
061143A	UR Repair Kit for 3rd Gen E-FV (2011)	379.35
061144A	WC w/Dual Flush Repair Kit for 3rd Gen E-FV (2011)	379.35
061149A	DEMD-86000 Sensor Kit	298.70
061150A	DEMD-86000 Seals and Screw Kit	17.40
061151A	DEMD-86000 Diaphragm	10.50
061152A	DEMD-86000 Outlet Tube	22.25
061156A	4" E-Lav Spout Gasket	48.40
061157A	Spacer Pkg for High Rise Prox	18.30
061158A	Spacer Pkg for 4" CS Prox	42.45
061159A	4" Deck Plate and Holddown Pkg (additional deck thick)	87.70
061160A	8" Deck Plate and Holddown Pkg (additional deck thick)	117.50
061161A	WC E-FV Kit (includes E-board & Button) w/hard connector	221.95
061162A	UR E-FV Kit (includes E-board & Button) w/hard connector	221.95
061163A	Lock Down Kit DEMD-201/211	29.40
061164A	Sensor DEMD-201/211	298.65
061165A	Sensor DEMD-101/111	298.65
061166A	Solenoid Valve Kit DEMD-101/111/201/211	127.00
061167A	Adapter for Vacuum Breaker Tube DEMD-86000	71.75
061168A	DEMD 101/111 Hardwire Converter	22.85
061169A	Cast Cap/Solenoid and Regulating Screw Assy	291.90
061170A	Plastic Case for 3rd Gen E-FV (2011)	9.90
061171A	Tubular Spout for 28P44	25.15
061172A	Gooseneck Spout for 28P49	30.95
061173A	Angular Spout for 28P42	34.50
061175A	HDF Proximity Spacer Package	17.85
061176A	VR Male 1.0 gpm Laminar Outlet	26.80
061177A	VR Female 1.0 gpm Laminar Outlet	26.80
061178A	1.5 gpm Laminar Swivel Outlet	24.55
061185A	VR Male Stream Straightener Outlet (590T/591T)	12.10
061186A	VR Female Stream Straightener Outlet (1500T/3000T)	12.10
061187A	Male Stream Straightener Outlet (600T)	12.10
061189A	Male Laminar Outlet for HP	14.65
061190A	Female Laminar Outlet for HP	14.65
061191A	Elbow & Tee for R3070-MIXTLF	44.10
061196A	Volume Control Handle Assembly for T17TH	73.85
061198A	590TP Spout Gasket	14.30
061199A	Spout and Outlet Pkg. 0.5 gpm	102.90
061199ANS	Spout and Outlet Pkg. 0.5 gpm	113.40
061200A	Spout and Outlet Pkg. 1.0 gpm	102.90
061200ANS	Spout and Outlet Pkg. 1.0 gpm	113.40
061201A	4 x 4 x 4 Box with Bushing & Guard	101.10
061202A	Spout and Outlet Pkg. 1.5 gpm	106.45
061202ANS	Spout and Outlet Pkg. 1.5 gpm	113.40
061203A	Vandal Resistant Male 0.5 Laminar Outlet	24.55
061204A	Vandal Resistant Female 0.5 Laminar Outlet	24.55
061205A	Handshower 2.5 gpm White	31.20
061206A	Proximity Clip on Sensor Pkg	109.00
061209A	Wallmount Sensor Trim Kit (red)	616.85
061210A	Wallmount Sensor Trim Kit (blue)	616.85
061213A	WC Retrofit Complete	162.85
061214A	UR Retrofit Complete	162.85
061215A	Non Hold Open Retrofit Kit	83.50
061216A	WC Diaphragm / Guide	27.10
061217A	UR Diaphragm / Guide	27.10
061221A	2.2 gpm Laminar Outlet for DEMD-400 Series	25.90
061222A	Non Hold Open Concealed Retrofit Kit	74.00

Model	Description	Price
061223A	Non Hold Open Concealed Retrofit Kit	74.00
061226A	Handshower w/Push Button, White 2.5 gpm	32.25
061227A	4 x 4 SS Cover for 81T-WMS	132.00
061228A	RETROFIT KIT BT E-FV WC - 2nd gen to 3rd gen	366.85
061229A	RETROFIT KIT BT E-FV UR - 2nd gen to 3rd gen	366.85
061230A	RETROFIT KIT HW E-FV WC - 2nd gen to 3rd gen	546.60
061231A	RETROFIT KIT HW E-FV UR - 2nd gen to 3rd gen	546.60
061232A	E-Board for 0.5 L 1600T & WMS models	260.25
061233A	Metering Urinal Cartridge	42.80
061234A	Bedpan Spray Face Assembly	11.20
061235A	Bedpan Glide Ring	21.35
061236A	Bedpan Spindle Nut Assembly	31.40
061237A	Bedpan Diverter Assembly	456.05
061238A	83T Cap Assembly	87.50
061239A	Oscillating Handle	18.50
061240A	Urinal Metering Cartridge Kit	60.90
061241A	Urinal Push Button Metering Retrofit	94.50
061242A	Urinal Push Button and Set Screw	26.05
061243A	Tube and Adaptor	148.20
061244A	4 x 4 SS Cover for 1600T6	131.20
061245A	Oscillating Handle Metering Retrofit Kit	99.90
061246A	Oscillating Handle and Bonnet	28.15
061247A	Outlet Tube w/Dual Checks	69.60
061248A	Dual Check Adaptor (1600T9)	95.90
061249A	VB Adaptor Assembly	72.80
061251A	Mounting Box Cover for DEMD Wallmount (2013 on)	61.30
061252A	Dual Driver Board H ₂ Optics® and Proximity	152.00
061253A	M4X5 Set Screw (12/pkg)	7.00
061254A	Outlet Nipple Assembly w ³ / ₈ " Compression	90.30
061255A	Battery Holder - Square 4-AA	12.70
061256A	36" Extension Cable (H ₂ Optics)	43.75
061258A	Holddown Package	32.70
061259A	Proximity Dual Board Ground Wire	34.00
061260A	Push Button Cage Assembly	67.20
061263A	Anchor Plate Truss Screw (12/pkg)	4.20
061264A	Spout Plate 4 x 4"	119.70
061265A	14 x 20" Plate w/Push Button	286.65
062001A	Proximity thin tab	10.20
062002A	Proximity driver board	150.10
062004A	Spacer for 600T Proximity	6.30
062007A	Brass seat	13.05
062021A	4" plate 600T Proximity	18.70
062023A	Recessed Box Connection Kit w/hose and flange	27.00
062025A	Washer for 3rd gen WC (pkg of 3)	13.50
062027A	Cage Repair Kit	5.25
062029A	Prox. Ground Wire Kit	8.00
062031A	Proximity HP Adapter	3.70
062032A	3/8" x 3/8" compression polymer hose	15.65
063000A	RH CER-TECK® cartridge	19.90
063001A	LH CER-TECK® cartridge	19.90
063002A	Structure Repair Kit	32.75
063005A	RH Teck Structure Kit	23.95
063006A	LH Teck Structure Kit	23.95
063007A	Wallmount Gooseneck Spout	169.85
063008A	DM cast spout	114.25
063013A	Renewable Seats (12/pkg)	18.90
063014A	CP cast DM spout	159.55

DELTA COMMERCIAL TECHNICAL SERVICE 1-877-509-2680
ONLINE CATALOGS: www.deltacommercialfaucets.com (Core products ONLY)
www.specselect.com (Complete Product Offering & Part Numbering System)

Model	Description	Price
063015A	Spout base only for DJ spout	108.85
063016A	Two handle inline swing kit	96.55
063017A	Two handle inline gooseneck kit	138.60
063019A	Pre-Rinse Retrofit Kit	462.25
063024A	Tee assembly	19.45
063027A	Cast spout w/ hole	120.15
063028A	Cast spout l/ hole	119.35
063029A	Center body – 10½" long	64.35
063031A	Center diverter body	85.60
063032A	Center body – 6½" long	31.45
063033A	Spout adapter & fiber gasket	27.75
063034A	Shank & washer kit	27.85
063035A	Swing spout adapter & fiber gasket	24.40
063036A	Centre Body for Third Valve Connection	95.50
063041A	Long Renewable Seat	3.65
063044A	8" wallform swing spout	52.85
063046A	Hose end adapter	12.35
063049A	Escutcheon & fiber washer	30.65
063050A	Rigid/swivel adaptor & O-ring	28.55
063054A	CER-TECK® retrofit pkg	33.45
063055A	Gooseneck spout adapter and gasket	23.05
063056A	Swing spout adapter and gasket	23.05
063057A	C Series widespread renewable seat	15.65
063063A	Limited swing gooseneck	68.80
063064A	Limited swing gooseneck	106.50
063065A	Limited swing gooseneck	74.00
063066A	Limited swing gooseneck	80.10
063067A	Limited swing gooseneck	80.65
063068A	Limited swing gooseneck	93.35
063069A	Limited swing gooseneck	105.80
063070A	Limited swing gooseneck	74.50
063071A	Limited swing gooseneck	112.25
063072A	Limited swing gooseneck	79.65
063073A	Limited swing gooseneck	85.85
063074A	Limited swing gooseneck	86.50
063075A	Limited swing gooseneck	98.60
063076A	Limited swing gooseneck	111.50
063077A	Limited swing gooseneck	79.65
063083A	Limited swing gooseneck	44.45
063084A	Gooseneck spout adapter pkg	21.25
063085A	Gooseneck spout adapter pkg	25.45
063086A	CP swing spout adapter	43.00
063087A	Gooseneck spout	47.70
063088A	Gooseneck spout	52.05
063089A	Gooseneck spout	55.85
063090A	Gooseneck spout	55.85
063091A	Gooseneck spout	61.85
063092A	Gooseneck spout	67.20
063093A	Gooseneck Spout	69.10
063094A	Gooseneck Spout	71.25
063101A	RH CP Brass Tuf-Teck Structure	21.35
063102A	LH CP Brass Tuf-Teck Structure	21.35
063103A	Deckmount Gooseneck Spout	101.80
063104A	Nipple	9.75
063105A	Offset Shank & Rubber Washer	116.05
063106A	Check Structure, Gasket & Cap	155.00
063107A	3" Hooded lever handle, CER-TECK®	58.15

Model	Description	Price
063108A	4" Blade Handle W/ Sani Guards, CER-TECK®	81.35
063116A	CP adapter	6.85
063120A	Escutcheon & fiber washer swing spout inline	58.80
063121A	Retrofit pkg 4" hooded lever CER-TECK®	62.35
063124A	Aerator Adapter S/A	7.75
063125A	Single Post Cast Prox.	302.75
063126A	4" Cast Proximity CS	381.75
063127A	Brass Solenoid	115.80
063128A	Box Assembly with Solenoid (Less Driver Board & Battery Holder)	133.95
063129A	590 HDF Proximity Series Spout Assembly	218.30
063130A	Mixing Tee & Checks for 87T Series	71.60
063131A	¾" Female Iron Pipe x ¾" Compression Connector, Nut and Ferrule	4.90
063132A	590T Spout Assembly	315.00
063133A	591T Spout Assembly	420.00
063135A	Screwdriver Stop Repair Kit	9.45
063136A	Thermostatic Mixing Valve ¾"	137.05
063137A	Single Hole Turret GN Spout R5 aerator thread	289.80
063138A	Single Hole Turret GN Spout R5 smooth end	282.80
063139A	Adapter with Flow Control (0.5 gpm)	6.60
063140A	Adapter with Flow Control (1.5 gpm)	6.60
063141A	590 HDF H ₂ OPTICS® Lead Free Spout Assembly	218.30
063142A	Single Hole Mount Turret Assembly - R3 smooth end	296.85
063143A	Single Hole Mount Turret Assembly - R4 smooth end	296.85
063144A	Single Hole Mount Turret Assembly - R7 smooth end	296.85
063145A	Single Hole Mount Turret Assembly - R35 smooth end	296.85
063146A	Single Hole Mount Turret Assembly - R3 thread end	289.80
063147A	Single Hole Mount Turret Assembly - R4 thread end	289.80
063148A	Single Hole Mount Turret Assembly - R7 thread end	289.80
063149A	Single Hole Mount Turret Assembly - R35 thread end	275.95
063150A	Single Hole Wallmount Turret Assembly - R3 smooth end	282.80
063151A	Single Hole Wallmount Turret Assembly - R4 smooth end	282.80
063152A	Single Hole Wallmount Turret Assembly - R5 smooth end	282.80
063153A	Single Hole Wallmount Turret Assembly - R7 smooth end	282.80
063154A	Single Hole Wallmount Turret Assembly - R35 smooth end	282.80
063155A	Single Hole Wallmount Turret Assembly R3 thread end	275.95
063156A	Single Hole Wallmount Turret Assembly R4 thread end	275.95
063157A	Single Hole Wallmount Turret Assembly R5 thread end	275.95
063158A	Single Hole Wallmount Turret Assembly R7 thread end	275.95
063159A	Single Hole Wallmount Turret Assembly R35 thread end	275.95
063160A	Thin Mount Kit	8.15
063161A	Thick Mount Kit	22.30
063162A	1.5 gpm Adapter with Flow Control	41.05
063163A	1.5 gpm Bushing w/Flow Control	14.10
063165A	Single Hole Mount Turret Assembly	335.00
063166A	Single Hole Mount Turret Assembly	335.00
063167A	Single Hole Mount Turret Assembly	335.00
063168A	Single Hole Mount Turret Assembly	335.00
063169A	Single Hole Mount Turret Assembly	335.00
063170A	600T Spout	214.20
063171A	Check Tail Assembly	38.65
063172A	Spring Retainer	55.80
063173A	Hose Assembly & Insulated Grip	120.40
063174A	Spray Head & Hold Open Ring	38.65
063175A	Spray Valve Repair Kit	54.80
063176A	1/2" Angle Stop	165.00

Model	Description	Price
063177A	Lockshield Structure Assembly	31.85
063178A	Foot Pedal Cartridge	75.50
063179A	Thermo Mixing Valve w/Gaskets	248.50
063180A	10 mm to 3/8" Compression Kit	47.00
063193A	Single Hole Turret GN Spout Assembly	315.00
063196A	1.5 gpm Wallmount Showerhead	178.20
063199A	Escutcheon	33.85
063213A	1.75 gpm Wallmount Showerhead	178.20
063214A	2.0 gpm Wallmount Showerhead	178.20
063215A	Anchor Plate & Screw	31.50
063216A	Hold down screw w/"O" ring	58.80
063217A	Anchor Plate "O" ring 12/pkg	25.20
063218A	Slip on Spout Inner "O" ring	6.30
063219A	Slip on Spout Complete 1.5 gpm	189.00
063220A	Slip on Spout Rough-in Box	52.50
063221A	2.2 gpm Male Laminar Outlet w/Wrench	36.85
068030A	Pol DW Valve Handle (16559)	5.25
068031A	3/8" N.P.S.L.*3/8"-18 N.P.T. Shank (17117)	9.40
068032A	Tail (17131)	8.50
068040A	CP Filter Pump S/A (77423)	65.00
068041A	CP (Ball Valve) Nozzle (17260-1)	12.80
068042A	Bagged Locknut & Washer (180002A)	5.75
068046A	Adapter, Tube Inlet (180051A)	13.10
068047A	Tail & Locknut Pkg (180064A)	4.55
068048A	Insert (3/pkg) (180077A)	35.20
068049A	T3733 CP FE Nozzle (180079A)	9.10
068050A	Seat (180099B)	9.70
068051A	Helium Index Button (180140A)	4.30
068052A	Propane Index Button (180142A)	4.30
068053A	Carbon Dioxide Index Button (180145A)	4.30
068056A	Repair DW Stem & Dphgm (77139-1)	15.85
068057A	(CW) Cold Water Index Button (3/pkg) (T1278-1)	12.35
068058A	(NIT) Nitrogen Index Button (3/pkg) (T1278-10)	12.35
068059A	(OXY) Oxygen Index Button (3/pkg) (T1278-11)	12.35
068060A	(ST) Steam Index Button (3/pkg) (T1278-12)	12.35
068061A	(VAC) Vacuum Index Button (3/pkg) (T1278-13)	12.35
068062A	(HW) Hot Water Index Button (3/pkg) (T1278-2)	12.35
068063A	(DW) Distilled Water Index Button (3/pkg) (T1278-3)	12.35
068068A	(DI) De-ionized Water Index Button (3/pkg) (T1278-4)	12.35
068072A	(AIR) Air Index Button (3/pkg) (T1278-6)	12.35
068073A	(A) Argon Index Button (3/pkg) (T1278-7)	12.35
068074A	(GAS) Gas Index Button (3/pkg) (T1278-8)	12.35
068075A	(H) Hydrogen Index Button (3/pkg) (T1278-9)	12.35
068077A	3/8" IP Shank 4.44 L Tail (T2714A-1)	10.65
068078A	3/8" IP Shank 3.25 L (T2714A-2)	9.40
068079A	3/8" IP Shank 2.38 L Tail (T2714A-3)	8.60
068083A	Coupling Nut (T2760-3)	8.85
068086A	CP Plain Button (T3899)	16.40
068087A	1/2" FIP x 3/4" MIP Adaptor (T4399)	8.20
068089A	Str FE Nozzle S/A (77340)	13.60
068090A	CP Filter Pump & Diff S/A (77422)	97.75
068092A	3/8" Cplg. Nut & 1/4" Tail Conn. Pkg. (180003A)	7.20
068093A	1/2" Cplg. Nut & 1/4" Tail Conn. Pkg. (180004A)	3.80
068099A	S/S Needle Structure & Seat (NON-GAS) (180199A)	40.60
068105A	Holddown Nut Kit (310379A)	1.90
068106A	Repair DW Stem Kit (77139-2)	41.90
068128A	W6629 Repair Kit	68.55

Model	Description	Price
RP11768HDF	Brass Lever Handles w/ Screws - (2)	55.15
RP12491	Handles - (2) - Wrist Blade - w/ Screws	64.45
RP21630	D-ESCUt-HDF-SH PBAL T&S -Chrome	31.05
RP21874	Delta Lever Handle w/Set Screw - Chrome	21.30
RP30396	Handle Limit Stop	4.65
RP30522	Model 591 Gasket	5.20
RP30523	Braided Hose	16.55
RP30528	Cast Cover Plate	79.85
RP30532	Battery Holder w/ Label	12.25
RP31704	0.5 gpm V.R. Spray Outlet	22.05
RP31704SS	SS 0.5 gpm Spray Outlet	70.80
RP31705	1.5 gpm V.R. Spray Outlet	21.05
RP32508	Hardwire Transformer	39.15
RP32856	Plug-In Transformer	39.15
RP34280	8" Cover Plate	107.10
RP34322	Single Hole Ceramic Cartridge (for 22T)	26.35
RP34324	4" Ceramic Cartridge (for 22T)	26.35
RP34403	Handle with Button and Set Screw (for 22T)	23.65
RP34403SS	SS Handle w/ Button & Set Screw	19.25
RP34404	Cap (for 22T)	5.00
RP34404SS	SS Cap	9.30
RP34405	Single Hole Mounting Hardware (for 22T)	8.75
RP36203	Extension Nut/Washer for Electronic	11.15
RP42112	Gasket for 22C (4")	11.65
RP44398	Gray Cam, w/ Stops	4.80
RP5212	Delta Handle	15.90
RP52834	HDF handle & set screw	28.20
RP54687	HDF elbow handle & set screw	30.40
RP5645	Delta Elbow Handle w/ Set Screw	25.85
RP6346	Grid Strainer	48.45
RP64449	Hot & Cold Lever Handles with Indicators	25.75
RP7133	Handle w/Set Screw, Cold Slow Close	16.40
W6870	Base with locknut	19.75
W6873	Retort rod with base	91.70
W6878	Flow control aerator and spout end adapter, 3/8" F.I.P. inlet	15.10
W6916	Adapter and flange, 3/8" N.P.T. female	24.50
W6968	Black plastic handle and handle screw	14.20
W69710XY	CP Handle	19.75
W6971ST	CP Handle	19.75
W6973ACE	Acetylene Index Button	17.80
W6973CLW	Index Button	17.80
W6973MG	Index Button	17.80
W6973N2O	Index Button	17.80
W6973RO	Index Button	17.80
W6973WVC	Wetvac Index Button	17.80
W6980	Compression Structure (to 1977) less Seat	19.75

DELTA COMMERCIAL TECHNICAL SERVICE 1-877-509-2680
ONLINE CATALOGS: www.deltacommercialfaucets.com (Core products ONLY)
www.specselect.com (Complete Product Offering & Part Numbering System)

TERMS OF SALE

WARRANTY

These Delta® products are warranted to the original consumer purchaser or commercial user. Please refer to the "Limited Warranty" enclosed with each Delta product for specific details. Additional copies are available upon request.

RETURNED GOODS

Merchandise MAY NOT be returned for credit or replacement without prior inspection and written authorization from Delta Faucet Company (DFC). Any unauthorized return of products is expressly prohibited. A handling charge of 50% will be assessed against anyone attempting to return merchandise without prior authorization. Only product purchased directly from Delta Faucet Company by a wholesaler will be authorized for return. NO EXCEPTIONS.

WARRANTY RETURNS

A full wholesale price credit will be issued to authorized Delta Faucet wholesaler customers for returned merchandise that is defective as described in the warranty. The defective merchandise must be shipped freight prepaid by the least costly method of shipment and the freight cost of such shipment will be added to the price credit. If a replacement is made rather than a credit issued, Delta Faucet Company will ship the replacement freight prepaid. Product returned as defective that is found to be misused, abused, modified or otherwise NOT DEFECTIVE will receive credit at scrap value only.

OTHER RETURNS

All other returns will be handled in accordance with the then-current DFC Return Policy for Non-Defective Faucets, copies of which are available upon request.

PRICES

All prices and specifications of models are subject to change without notice. Orders will be invoiced at the prices prevailing at time of shipment.

NOTE

All orders are subject to all applicable DFC policies in effect at the time of order.

These Terms of Sale are subject to change without notice.

RETURN ADDRESS

All returns are to be sent to the following address:

Delta Faucet Company
3441 Ridgecrest Road Extended, Suite 12
Jackson, Tennessee 38305
Attn: Returned Goods Department

Allora, Arctic, Arzo, Brilliance, CER-TECK, Delta, DURAMOUNT, EZ Anchor, Foundations, Grail, HDF, H2Okinetic, H2Optics, InnoFlex, Innovations, In2ition, Jetted Shower XO, Lahara, Leland, MagnaTite, Monitor, MultiChoice, Orleans, Palo, Pilar, Proximity, Quick-Snap, Scald-Guard, Signature, SpecSelect, Teck, TempAssure, Touch2O, Touch-Clean, Trinsic, Tuf-Teck, Venetian Bronze, Victorian, Waterfall, and Windemere are registered trademarks of Masco Corporation of Indiana.

Addison, Ara, Ashlyn, Cassidy, Champagne Bronze, Collins, Compel, Décor Assist, DIAMOND, Dryden, Fuse, Linden, Multi-Flow, Talbott, Temp2O, Touch2O.xt, Tract-Pack, Vero, and XO Jet Module are trademarks of Masco Corporation of Indiana.

