



\*AC model pictured above

**Standard Efficiency AC  
Packaged Rooftop Unit  
DBC Commercial  
15-25 Nominal Tons  
UP TO 12.8 IEER / 11 EER**



\* Complete warranty details available from your local distributor or manufacturer's representative or at [www.daikincomfort.com](http://www.daikincomfort.com) or [www.daikinac.com](http://www.daikinac.com)



## Our Perfect Package:

Harnessing energy-efficient performance, proven technology, and enhanced comfort for life.

Since becoming the first company in Japan to manufacture packaged air conditioning systems, in 1951, Daikin has supported comfortable indoor living based on the strengths and technologies that have led to the growth of the company becoming one of the world's largest manufacturers of HVAC products, systems and refrigerants.

Today, as a comprehensive global manufacturer of HVAC products and systems, the Daikin brand is committed to being recognized as a truly global and excellent company capable of continually creating new value for its customers. The company plans to pursue sustainable growth and foster business operations that consistently harmonize with the goals of improving indoor comfort.

The group philosophy of the company includes:

- » Creating new value continuously for customers
- » Developing world leading energy-saving technology
- » Being a flexible and dynamic organization
- » Allowing employees to be the driving force for the success of the company
- » Fostering an atmosphere of best practices, boldness, and innovation
- » Thinking and acting globally



# Contents

<b>2</b>	<b>Introduction</b>	2
<b>4</b>	<b>Nomenclature</b>	4
<b>5</b>	<b>Features and Benefits</b>	5
	Applications	8
	Serviceability	8
<b>9</b>	<b>Product Specifications</b>	
	Expanded Cooling Data	12
	Air Flow Data	18
	Electrical Data	20
	Electric Heat	23
	Wiring Diagrams	24
<b>27</b>	<b>Dimensional Data</b>	27
<b>29</b>	<b>Unit Clearances</b>	29
<b>30</b>	<b>Installation</b>	30
	Weights	30
<b>31</b>	<b>Accessories</b>	31
<b>33</b>	<b>Factory and Field Installed Options</b>	33

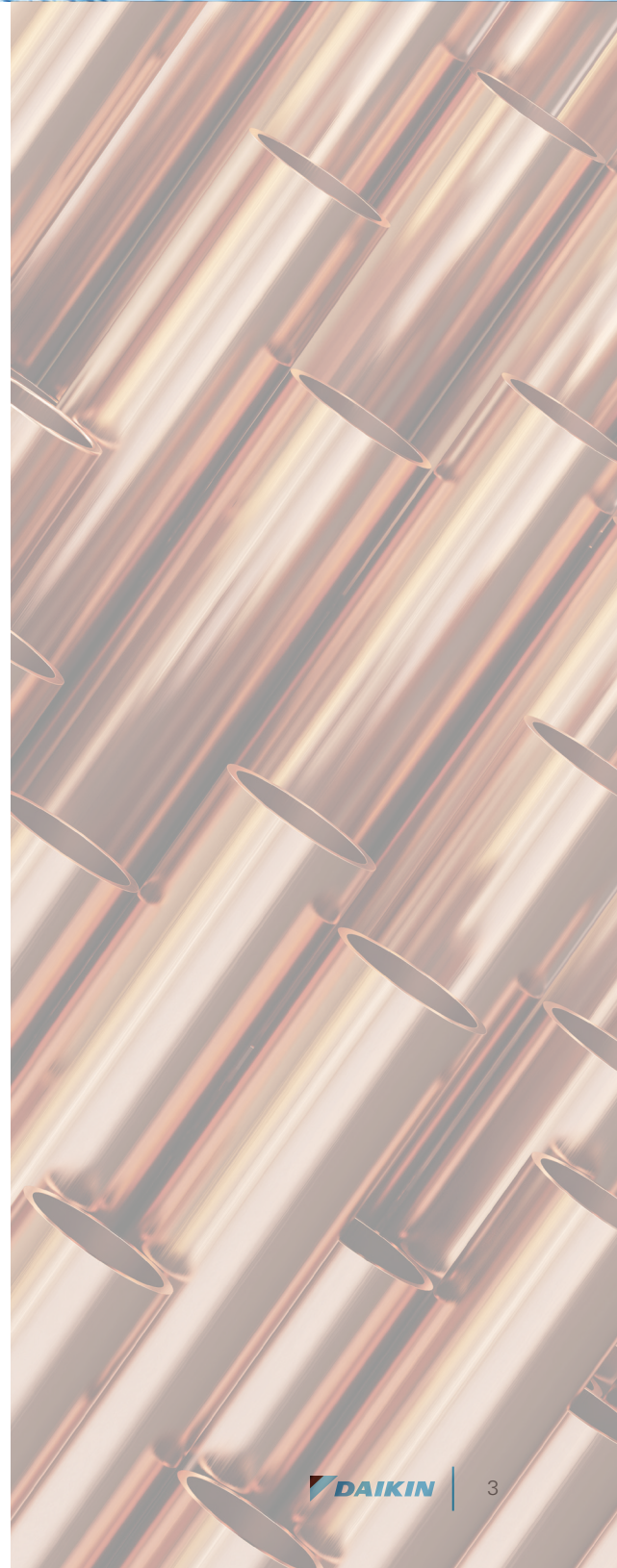

# Nomenclature

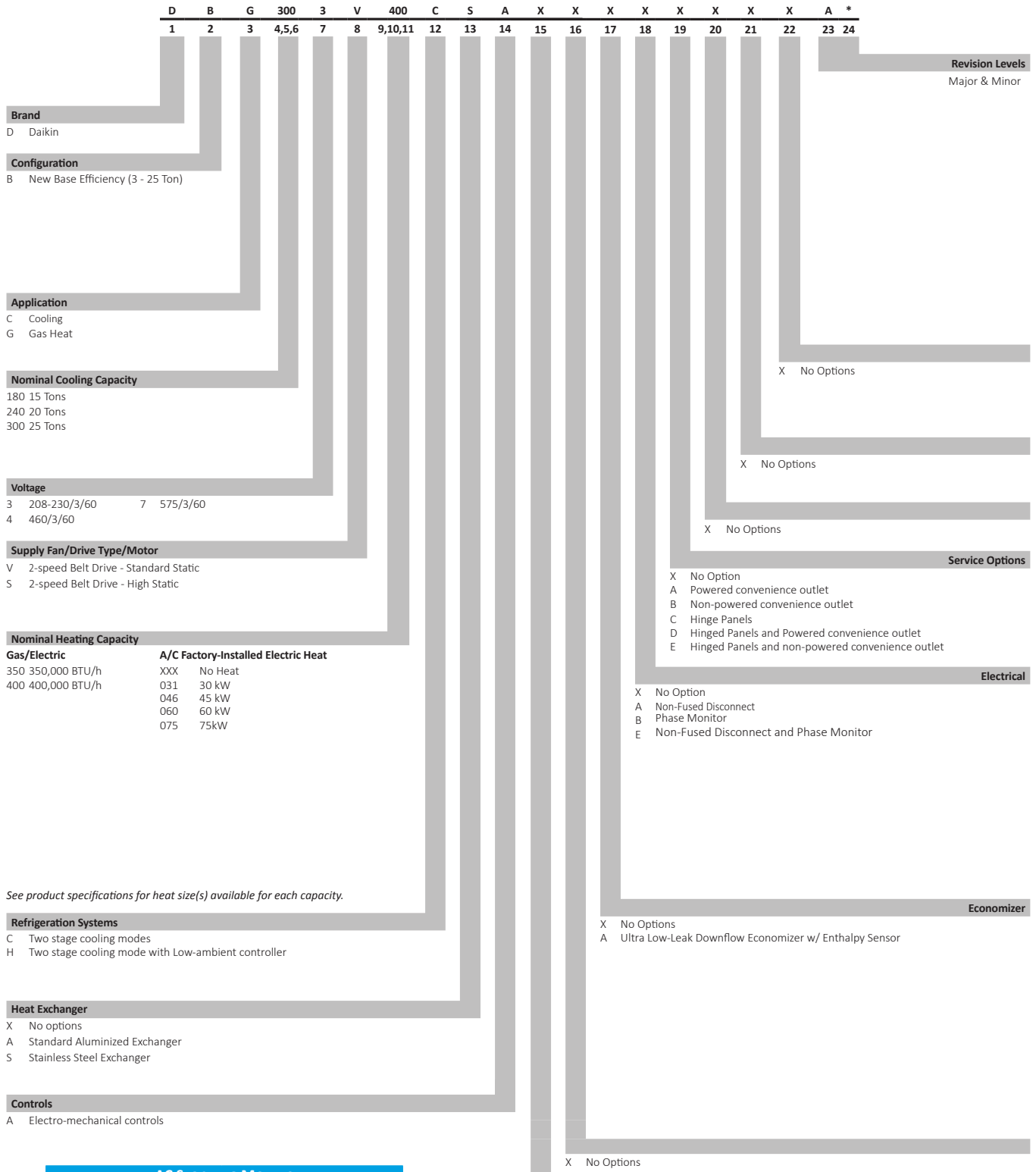

**Brand**  
D Daikin

**Configuration**  
B New Base Efficiency (3 - 25 Ton)

**Application**  
C Cooling  
G Gas Heat

**Nominal Cooling Capacity**  
180 15 Tons  
240 20 Tons  
300 25 Tons

**Voltage**  
3 208-230/3/60 7 575/3/60  
4 460/3/60

**Supply Fan/Drive Type/Motor**  
V 2-speed Belt Drive - Standard Static  
S 2-speed Belt Drive - High Static

**Nominal Heating Capacity**

Gas/Electric	A/C Factory-installed Electric Heat
350 350,000 BTU/h	XXX No Heat
400 400,000 BTU/h	031 30 kW
	046 45 kW
	060 60 kW
	075 75kW

See product specifications for heat size(s) available for each capacity.

**Refrigeration Systems**  
C Two stage cooling modes  
H Two stage cooling mode with Low-ambient controller

**Heat Exchanger**  
X No options  
A Standard Aluminized Exchanger  
S Stainless Steel Exchanger

**Controls**  
A Electro-mechanical controls

AC STOCKING MODELS	
New Daikin 15 – 25 Ton	
MODEL NUMBER	CODE STRING
DBC1803V000001S	DBC1803VXXXXCAXXXXXXXXXX
DBC1804V000001S	DBC1804VXXXXCAXXXXXXXXXX
DBC1807V000001S	DBC1807VXXXXCAXXXXXXXXXX
DBC2403V000001S	DBC2403VXXXXCAXXXXXXXXXX
DBC2404V000001S	DBC2404VXXXXCAXXXXXXXXXX
DBC2407V000001S	DBC2407VXXXXCAXXXXXXXXXX
DBC3003V000001S	DBC3003VXXXXCAXXXXXXXXXX
DBC3004V000001S	DBC3004VXXXXCAXXXXXXXXXX
DBC3007V000001S	DBC3007VXXXXCAXXXXXXXXXX

- Revision Levels**  
Major & Minor
- Service Options**  
X No Option  
A Powered convenience outlet  
B Non-powered convenience outlet  
C Hinge Panels  
D Hinged Panels and Powered convenience outlet  
E Hinged Panels and non-powered convenience outlet
- Electrical**  
X No Option  
A Non-Fused Disconnect  
B Phase Monitor  
E Non-Fused Disconnect and Phase Monitor
- Economizer**  
X No Options  
A Ultra Low-Leak Downflow Economizer w/ Enthalpy Sensor
- Sensors**  
X No Options  
A RA Smoke Detector  
B SA Smoke Detector  
C RA & SA Smoke Detector

Daikin Packaged Rooftop Units are built to perform, with features and options that help provide lower installation and operating costs, superior indoor air quality, quiet operation, and longevity.

### Installation

Daikin Packaged Rooftop units (RTUs) are designed with fast and easy installation in mind for both new construction and retrofit. Installers can benefit from our field installed options such as roof curbs for new constructions.

### Cabinet Construction

Daikin packaged rooftop units are made with high quality galvanized steel with a powder-paint finish to provide higher corrosion resistance.

- » The interior surface in the indoor air section is fully insulated to prevent sweating and thermal losses, using our foil face fiberglass insulation which also omits exposed filter fibers into the airstream.
- » The full perimeter base rail is built using heavy gauge galvanized steel for a stronger structural installation. The base rails are a minimum of 3 ½" tall and include holes to allow for overhead rigging and lifting with forklifts.
- » Condenser hail guards are factory installed as a standard.

### Compressor

High performance, low noise scroll compressors with stage control to match the required total load for efficient part load control.

- » Resiliently factory-mounted on rubber grommets for vibration isolation.
- » Refrigeration circuit includes both a low and high pressure transducer, high pressure safety switch and temperature sensors for the suction and discharge lines.
- » Unit is factory charged with environmental friendly and sustainable R-410A refrigerant.
- » Dual single-stage scroll compressors.
- » Compressor location outside the condenser section to avoid air bypass.
- » Internal overload protection included with compressor.
- » Crankcase heaters and external thermal overload protection are also provided for compressor durability.

### Supply Fan

Indoor fan motors are belt drive as standard to provide easy in the field belt and pulley adjustment for airflow control.

- » Slide out forward curb fan for easier maintenance and replacement.
- » High static drive options for applications with high airflow/static requirements.
- » Each fan assembly is dynamically trim balanced at the factory before shipment for quick start up and efficient operation.
- » Motor with thermal overload and phase failure protection is provided for long lasting operation.

### Coils

All units use large face area outdoor coils. These coils are constructed with seamless copper tubes, mechanically bonded into aluminum plate-type fins with full drawn collars to completely cover the tubes for high operating efficiencies.

The indoor coil section is installed in a draw through configuration to provide better dehumidification.

- » Coils are factory pressure tested to ensure pressure and leak integrity.
- » Coils include a Thermal Expansion Valve per circuit, high and low pressure switches, service ports and high capacity filter drier.
- » High and low pressure switches to be factory installed as fittings instead of brazed for easy removal and replacement.



## Features and Benefits

---

- » Aluminum micro-channel indoor coil on 25-ton units
- » Low Ambient cooling operation down to 35°F outside air temp as standard, with option to perform down to 0°F when selected with low ambient kit.
- » 5mm Smart Coil Technology on all condenser coils for improved performance and reduced refrigerant load.

### Controls and Wiring

Packaged rooftop units come equipped with a well-organized, large, easy to use, weather proof internal control box with easy access, for a better user experience.

- » Units are factory-wired with labeled color-coded wires and complete 24-volt electro-mechanical controls package.
- » Units include single-point power entry as standard and also available with electric heat kits if selected.
- » Terminal blocks are provided as standard for easier installation and field power wiring.

### Filtration

Unit provides a draw-through filter section as standard for better air quality and longer lasting component maintenance.

- » Filters installed on the units are standard off the shelf sizes for easy replacement.
- » One size filter per unit for lower maintenance cost and easy replacement.
- » 2" deep filters standard on all units with option for up to 4" on large chassis (15 tons and over).
- » Easy and fast filter service access.

### Heating Section

Wide range of electric heat selections effectively handle most comfort heating demand from morning warm-up control to full heat.

### Electric Heat

ETL approved electric heat is factory assembled, installed and tested.

- » Heating control is fully integrated into the unit's control system for quick startup and reliable control.

- » Multi-stage capability for application flexibility.
- » Durable low watt density, nickel chromium elements provide longer life.
- » Fuses are provided in each branch circuit to a maximum of 48 Amps per NEC requirements.
- » Single point power connection reduces installation cost.
- » For operational safeties electric heat includes automatic reset, and high temperature limit safety protection and an airflow safety switch to prevent electric heat operation in the event of no airflow.

### Electrical

Units are completely wired and tested at the factory to provide faster commissioning and start-up.

- » Wiring complies with NEC requirements and all applicable UL standards.
- » For ease of use, wiring and electrical components are number coded and labeled according to the electrical diagram.
- » A 115 V GFI convenience outlet requiring independent power supply for the receptacle is optional.
- » An optional unit powered 20 amp 115 V convenience outlet, complete with factory mounted transformer, disconnect switch, and primary and secondary overload protection, eliminates the need to pull a separate 115 V power source.
- » Supply air fan, compressor, and condenser fan motor branch circuits have individual short circuit protection. Unit includes knockouts in the bottom of the main control panels for field wiring entrance.
- » A single point power connection with power block is standard and a terminal board is provided for connecting low voltage control wiring.
- » For better serviceability an optional non-fused disconnect switch is mounted inside the control panel and operated by an externally mounted handle to disconnect the electrical power at the unit.
- » For operational safety, electric heat includes automatic reset, high temperature limit safety protection, and an airflow safety switch to prevent electric heat operation in the event of no airflow.



\*AC model pictured above

### Applications

Daikin Rooftop units are intended for comfort cooling applications in normal heating, ventilating, and air conditioning. Consult your local Daikin sales representative for applications involving operations at high ambient temperatures, high altitudes, non-cataloged voltages, or for job specific unit selections that fall outside of the range of the catalog tables.

For proper operation, units should be rigged in accordance with instructions stated on the installation manual. Fire dampers, if required, must be installed in the ductwork according to local and/or state codes. No space is allowed for these dampers in the unit.

Follow factory check, test and start procedures explicitly to achieve satisfactory start-up and operation.

Most rooftop applications take advantage of the significant energy savings provided with economizer operation. When an economizer system is used, mechanical refrigeration is typically not required below an ambient temperature of 50°F on most cases.

### Serviceability

Daikin packaged rooftop units are built with serviceability in mind, designed to make future maintenance and service on the unit easier and more accessible.

- » Our packaged rooftop units offer a slide out blower to facilitate the access and removal of the fan.
- » Independent compressor outside of the air bypass to eliminate component blockage and provide easy access.
- » Color coded and continuously marked wire to identify point-to-point component connections.
- » Condenser clean out from inside-out.
- » Easy access to control panel.



PHYSICAL DATA COOLING			
Model	DBC1803V000001S	DBC1804V000001S	DBC1807V000001S
<b>REFRIGERATION SYSTEM</b>			
Total, BTU/h	180,000	180,000	180,000
Sensible BTU/h	134,600	134,600	134,600
EER / IEER	11 / 12.8	11 / 12.8	11 / 12.8
Decibels	88	88	88
AHRI Reference #s	6502018	6502018	6502018
<b>EVAPORATOR MOTOR COIL</b>			
Motor Type (Belt Drive)	2-Speed Belt	2-Speed Belt	2-Speed Belt
Indoor Nominal CFM	6,000	6,000	6,000
Indoor Motor FLA (Cooling)	9.1	4.3	3.5
Horsepower - RPM (Speed: Full / Low)	3.0 - 1,760/1,165	3.0 - 1,760/1,165	3.0 - 1,760/1,165
Metering Device	TXV	TXV	TXV
Filter Size (#)	20 x 25 x 2 (6)	20 x 25 x 2 (6)	20 x 25 x 2 (6)
Drain Size (NPT)	1"	1"	1"
R-410A Refrigerant Charge Cir #1 (oz)	186.2	186.2	186.2
R-410A Refrigerant Charge Cir #2 (oz)	170.8	170.8	170.8
Evaporator Coil Face Area (ft <sup>2</sup> )	20	20	20
Rows Deep / Fins per Inch	4 / 16	4 / 16	4 / 16
<b>BELT DRIVE EVAP FAN DATA</b>			
# of Wheels (D x W)	2 (15" x 12")	2 (15" x 12")	2 (15" x 12")
Motor Sheave	1VP50 x 1½"	1VP50 x 1½"	1VP50 x 1½"
Blower Sheave	BK100 x 1¾"	BK100 x 1¾"	BK100 x 1¾"
Belt	BX44	BX44	BX44
<b>CONDENSER FAN/COIL</b>			
Quantity of Condenser Fan Motors	3	3	3
Horsepower - RPM	½ - 1,075	½ - 1,075	½ - 1,075
Fan Diameter / # Fan Blades	22 / 3	22 / 3	22 / 3
Outdoor Nominal CFM	9,000	9,000	9,000
Face Area (ft <sup>2</sup> )	53.3	53.3	53.3
Rows Deep / Fins per Inch	2 / 27	2 / 27	2 / 27
<b>COMPRESSOR</b>			
Quantity / Type	2 / Scroll	2 / Scroll	2 / Scroll
Compressor RLA / LRA CIR. #1	25 / 164	12.2 / 100	9.0 / 78
Compressor RLA / LRA CIR. #2	25 / 164	12.2 / 100	9.0 / 78
<b>ELECTRICAL DATA</b>			
Voltage / Phase / Frequency	208/230-3-60	460-3-60	575-3-60
Standard Max Static	1.2	1.2	1.2
Outdoor Fan FLA / LRA	2.0/4.4	0.85 / 2.2	0.67/1.8
Total Unit Amps	65.1	31.3	23.5
Min. Circuit Ampacity <sup>1</sup>	71.4 / 71.4	34.3	25.7
Max. Overcurrent Protection (amps) <sup>2</sup>	90 / 90	45	30
Entrance Power Supply	2½"	2½"	2½"
Entrance Control Voltage	¾"	¾"	¾"
<b>OPERATING WEIGHT (LBS.)</b>			
	1965	1965	1965
<b>SHIPPING WEIGHT (LBS.)</b>			
Ship Weight (lbs)	2080	2080	2080

<sup>1</sup> Wire size should be determined in accordance with National Electrical Codes. Extensive wire runs will require larger wire sizes.

<sup>2</sup> May use fuses or HACR-type circuit breakers of the same size as noted.

Note: Always check the S&R plate for electrical data on the unit being installed.

PHYSICAL DATA COOLING			
Model	DBC2403V000001S	DBC2404V000001S	DBC2407V000001S
<b>REFRIGERATION SYSTEM</b>			
Total, BTU/h	240,000	240,000	240,000
Sensible BTU/h	181,000	181,000	181,000
EER / IEER	10.0 / 11.6	10.0 / 11.6	10.0 / 11.6
Decibels	88	88	88
AHRI Reference #s	8813880	8813880	8813880
<b>EVAPORATOR MOTOR COIL</b>			
Motor Type (Belt Drive)	2-Speed Belt	2-Speed Belt	2-Speed Belt
Indoor Nominal CFM	7,000	7,000	7,000
Indoor Motor FLA (Cooling)	14	6.6	5.2
Horsepower - RPM (Speed: Full / Low)	5.0 - 1,775/1,185	5.0 - 1,775/1,185	5.0 - 1,775/1,185
Metering Device	TXV	TXV	TXV
Filter Size (#)	20 x 25 x 2 (6)	20 x 25 x 2 (6)	20 x 25 x 2 (6)
Drain Size (NPT)	1"	1"	1"
R-410A Refrigerant Charge Cir #s 1 & 2 (oz)	177 & 195 ozs.	177 & 195 ozs.	177 & 195 ozs.
Face Area (ft <sup>2</sup> )	20	20	20
Rows Deep / Fins per Inch	4 / 16	4 / 16	4 / 16
<b>BELT DRIVE EVAP FAN DATA</b>			
# of Wheels (D x W)	2 (15" x 15")	2 (15" x 15")	2 (15" x 15")
Motor Sheave	1VP60 x 1 $\frac{3}{8}$ "	1VP60 x 1 $\frac{3}{8}$ "	1VP60 x 1 $\frac{3}{8}$ "
Blower Sheave	BK100 x 1 $\frac{7}{16}$ "	BK100 x 1 $\frac{7}{16}$ "	BK100 x 1 $\frac{7}{16}$ "
Belt	BX45	BX45	BX45
<b>CONDENSER FAN/COIL</b>			
Quantity of Condenser Fan Motors	3	3	3
Horsepower - RPM	$\frac{1}{2}$ - 1,075	$\frac{1}{2}$ - 1,075	$\frac{1}{2}$ - 1,075
Fan Diameter / # Fan Blades	22 / 3	22 / 3	22 / 3
Outdoor Nominal CFM	9,000	9,000	9,000
Face Area (ft <sup>2</sup> )	53.3	53.3	53.3
Rows Deep / Fins per Inch	2 / 27	2 / 27	2 / 27
<b>COMPRESSOR</b>			
Quantity / Type	2 / Scroll	2 / Scroll	2 / Scroll
Compressor RLA / LRA CIR. #1	34.0 / 240.0	16.0 / 140.0	12.9 / 107.6
Compressor RLA / LRA CIR. #2	34.0 / 240.0	16.0 / 140.0	12.9 / 107.6
<b>ELECTRICAL DATA</b>			
Voltage / Phase / Frequency	208/230-3-60	460-3-60	575-3-60
Standard Max Static	2.0 / 4.4	0.85 / 2.2	0.67 / 1.8
Outdoor Fan FLA / LRA	88	41.2	33.0
Total Unit Amps	96.4 / 96.4	43.5	35.0
Min. Circuit Ampacity <sup>1</sup>	125 / 125	50	45
Max. Overcurrent Protection (amps) <sup>2</sup>	2 $\frac{1}{2}$ "	2 $\frac{1}{8}$ "	2 $\frac{1}{8}$ "
Entrance Power Supply	$\frac{7}{8}$ "	$\frac{7}{8}$ "	$\frac{7}{8}$ "
Entrance Control Voltage	$\frac{7}{8}$ "	$\frac{7}{8}$ "	$\frac{7}{8}$ "
<b>OPERATING WEIGHT (LBS.)</b>			
	2085	2085	2085
<b>SHIPPING WEIGHT (LBS.)</b>			
Ship Weight (lbs)	2202	2202	2202

<sup>1</sup> Wire size should be determined in accordance with National Electrical Codes. Extensive wire runs will require larger wire sizes.

<sup>2</sup> May use fuses or HACR-type circuit breakers of the same size as noted.

Note: Always check the S&R plate for electrical data on the unit being installed.

PHYSICAL DATA COOLING			
Model	DBC3003V000001S	DBC3004V000001S	DBC3007V000001S
<b>REFRIGERATION SYSTEM</b>			
Total, BTU/h	290,000	290,000	290,000
Sensible BTU/h	196,000	196,000	196,000
EER / IEER	10.2 / 11.8	10.2 / 11.8	10.2 / 11.8
Decibels	92	92	92
AHRI Reference #s	8582013	8582013	8582013
<b>EVAPORATOR MOTOR COIL</b>			
Motor Type (Belt Drive)	2-speed Belt Drive	2-speed Belt Drive	2-speed Belt Drive
Indoor Nominal CFM	8,200	8,200	8,200
Indoor Motor FLA (Cooling)	21	10.1	8.2
Horsepower - RPM (Speed: Full / Low)	7.5 - 1770/1175	7.5 - 1770/1175	7.5 - 1770/1175
Metering Device	TXV	TXV	TXV
Filter Size (#)	20 x 20 x 2 (8)	20 x 20 x 2 (8)	20 x 20 x 2 (8)
Drain Size (NPT)	1"	1"	1"
R-410A Refrigerant Charge Cir #s 1 & 2 (oz)	215 & 198 ozs.	215 & 198 ozs.	215 & 198 ozs.
Face Area (ft <sup>2</sup> )	17.2	17.2	17.2
Rows Deep / Fins per Inch	2 / 15	2 / 15	2 / 15
<b>BELT DRIVE EVAP FAN DATA</b>			
# of Wheels (D x W)	2 (15" x 15")	2 (15" x 15")	2 (15" x 15")
Motor Sheave	1VP60 x 1 $\frac{3}{8}$ "	1VP60 x 1 $\frac{3}{8}$ "	1VP60 x 1 $\frac{3}{8}$ "
Blower Sheave	BK110 x 1 $\frac{7}{16}$ "	BK110 x 1 $\frac{7}{16}$ "	BK110 x 1 $\frac{7}{16}$ "
Belt	BX46	BX46	BX46
<b>CONDENSER FAN/COIL</b>			
Quantity of Condenser Fan Motors	2	2	2
Horsepower - RPM	1 - 1145	1 - 1145	1 - 1145
Fan Diameter / # Fan Blades	30 / 2	30 / 2	30 / 2
Outdoor Nominal CFM	15,000	15,000	15,000
Face Area (ft <sup>2</sup> )	53.3	53.3	53.3
Rows Deep / Fins per Inch	2 / 27	2 / 27	2 / 27
<b>COMPRESSOR</b>			
Quantity / Type	2 / Scroll	2 / Scroll	2 / Scroll
Compressor RLA / LRA CIR. #1	48.1 / 245	18.6 / 125	14.7 / 100
Compressor RLA / LRA CIR. #2	48.1 / 245	18.6 / 125	14.7 / 100
<b>ELECTRICAL DATA</b>			
Voltage / Phase / Frequency	208/230-3-60	460-3-60	575-3-60
Standard Max Static	3.7 / 16.9	1.85 / 8.5	1.5 / 6.82
Outdoor Fan FLA / LRA	125	51.0	40.6
Total Unit Amps	133 / 133	53.8	42.9
Min. Circuit Ampacity <sup>1</sup>	175 / 175	70	50
Max. Overcurrent Protection (amps) <sup>2</sup>	2 $\frac{1}{8}$ "	2 $\frac{1}{8}$ "	2 $\frac{1}{8}$ "
Entrance Power Supply	$\frac{7}{8}$ "	$\frac{7}{8}$ "	$\frac{7}{8}$ "
Entrance Control Voltage	$\frac{7}{8}$ "	$\frac{7}{8}$ "	$\frac{7}{8}$ "
<b>OPERATING WEIGHT (LBS.)</b>			
	2119	2119	2119
<b>SHIPPING WEIGHT (LBS.)</b>			
Ship Weight (lbs)	2387	2387	2387

<sup>1</sup> Wire size should be determined in accordance with National Electrical Codes. Extensive wire runs will require larger wire sizes.

<sup>2</sup> May use fuses or HACR-type circuit breakers of the same size as noted.

Note: Always check the S&R plate for electrical data on the unit being installed.

IDB		Outdoor Ambient Temperature																																			
		65						75						85						95						105						115					
		59	63	67	71	59	63	67	71	59	63	67	71	59	63	67	71	59	63	67	71	59	63	67	71	59	63	67	71								
70	Airflow	Entering Indoor Wet Bulb Temperature																																			
	MBh	176.4	182.8	200.3	-	172.3	178.6	195.6	-	168.2	174.3	191.0	-	164.1	170.1	186.3	-	155.9	161.6	177.0	-	144.4	149.7	164.0	-	144.4	149.7	164.0	-								
	S/T	0.75	0.63	0.43	-	0.78	0.65	0.45	-	0.80	0.67	0.46	-	0.82	0.69	0.48	-	0.86	0.71	0.49	-	0.86	0.72	0.50	-	0.86	0.72	0.50	-								
	ΔT	18	16	12	-	18	16	12	-	18	16	12	-	18	16	12	-	18	16	12	-	17	15	11	-	17	15	11	-								
	HI PR	236	253	268	-	264	284	300	-	301	323	342	-	342	368	389	-	385	414	438	-	425	458	484	-	425	458	484	-								
	LO PR	103	110	120	-	109	116	127	-	114	121	132	-	119	127	139	-	125	133	145	-	129	138	150	-	129	138	150	-								
	MBh	171.2	177.5	194.5	-	167.3	173.4	189.9	-	163.3	169.2	185.4	-	159.3	165.1	180.9	-	151.3	156.9	171.9	-	140.2	145.3	159.2	-	140.2	145.3	159.2	-								
	S/T	0.72	0.60	0.41	-	0.74	0.62	0.43	-	0.76	0.64	0.44	-	0.79	0.66	0.45	-	0.82	0.68	0.47	-	0.82	0.69	0.48	-	0.82	0.69	0.48	-								
	ΔT	19	16	12	-	19	16	13	-	19	16	13	-	19	17	13	-	19	16	12	-	18	15	12	-	18	15	12	-								
	HI PR	233	251	265	-	262	282	297	-	298	320	338	-	339	365	385	-	381	410	433	-	421	453	479	-	421	453	479	-								
	LO PR	102	109	119	-	108	115	126	-	112	120	131	-	118	126	137	-	124	132	144	-	128	136	149	-	128	136	149	-								
	MBh	158.1	163.8	179.5	-	154.4	160.0	175.3	-	150.7	156.2	171.1	-	147.0	152.4	167.0	-	139.7	144.8	158.6	-	129.4	134.1	146.9	-	129.4	134.1	146.9	-								
S/T	0.69	0.58	0.40	-	0.72	0.60	0.41	-	0.73	0.61	0.42	-	0.76	0.63	0.44	-	0.79	0.66	0.46	-	0.79	0.66	0.46	-	0.79	0.66	0.46	-									
ΔT	21	18	14	-	21	18	14	-	21	18	14	-	21	18	14	-	21	18	14	-	20	17	13	-	20	17	13	-									
HI PR	226	243	257	-	254	273	288	-	289	311	328	-	329	354	374	-	370	398	420	-	409	440	464	-	409	440	464	-									
LO PR	99	106	115	-	105	112	122	-	109	116	127	-	115	122	133	-	120	128	139	-	124	132	144	-	124	132	144	-									
75	Airflow	Entering Indoor Dry Bulb Temperature																																			
	MBh	179.4	184.7	199.9	214.5	175.2	180.4	195.3	209.6	171.0	176.1	190.6	204.6	166.9	171.8	186.0	199.6	162.0	166.8	180.5	193.8	153.9	158.5	171.5	184.1	142.6	146.8	158.9	170.5								
	S/T	0.85	0.76	0.58	0.37	0.89	0.79	0.60	0.39	0.91	0.81	0.61	0.40	0.94	0.84	0.63	0.41	0.89	0.80	0.60	0.39	0.93	0.83	0.63	0.40	0.94	0.84	0.63	0.41								
	ΔT	21	19	16	11	21	19	16	11	21	19	16	11	21	20	16	11	22	20	17	11	22	20	16	11	20	19	15	11								
	HI PR	238	256	270	282	267	287	303	316	304	327	345	360	346	372	393	410	389	419	442	461	385	415	438	457	426	458	484	504								
	LO PR	104	111	121	129	110	117	128	137	115	122	133	142	121	128	140	149	126	134	147	156	125	133	145	155	129	138	150	160								
	MBh	174.2	179.3	194.1	208.3	170.1	175.1	189.6	203.5	166.1	171.0	185.1	198.6	162.0	166.8	180.5	193.8	149.5	154.0	166.6	178.8	142.0	146.3	158.3	169.9	131.6	135.5	146.6	157.4								
	S/T	0.81	0.73	0.55	0.35	0.84	0.76	0.57	0.37	0.87	0.77	0.59	0.38	0.89	0.80	0.60	0.39	0.89	0.80	0.60	0.39	0.93	0.83	0.63	0.40	0.94	0.84	0.63	0.41								
	ΔT	22	20	16	11	22	20	17	11	22	20	17	11	22	20	17	11	22	20	17	11	22	20	16	11	20	19	15	11								
	HI PR	236	253	268	279	264	284	300	313	301	323	342	356	342	368	389	406	385	415	438	457	385	415	438	457	426	458	484	504								
	LO PR	103	110	120	128	109	116	127	135	114	121	132	141	119	127	139	148	125	133	145	155	125	133	145	155	129	138	150	160								
	MBh	160.7	165.5	179.1	192.3	157.0	161.6	175.0	187.8	153.3	157.8	170.8	183.3	149.5	154.0	166.6	178.8	142.0	146.3	158.3	169.9	131.6	135.5	146.6	157.4	131.6	135.5	146.6	157.4								
S/T	0.79	0.70	0.53	0.34	0.81	0.73	0.55	0.35	0.83	0.75	0.56	0.36	0.86	0.77	0.58	0.38	0.89	0.80	0.61	0.39	0.89	0.80	0.61	0.39	0.90	0.81	0.61	0.39									
ΔT	24	22	18	13	24	23	18	13	25	23	18	13	25	23	19	13	24	22	18	13	24	22	18	13	23	21	17	12									
HI PR	228	246	260	271	256	276	291	304	292	314	331	346	332	357	377	394	374	402	425	443	413	444	469	489	413	444	469	489									
LO PR	100	107	117	124	106	113	123	131	110	117	128	136	116	123	134	143	121	129	141	150	125	133	146	155	125	133	146	155									

IDB: Entering Indoor Dry Bulb Temperature      Shaded area reflects ACCA (TVA) conditions      High and low pressures are measured at the liquid and suction access fittings.

IDB		Outdoor Ambient Temperature																																			
		65						75						85						95						105						115					
		Airflow				Entering Indoor Wet Bulb Temperature				Airflow				Entering Indoor Wet Bulb Temperature				Airflow				Entering Indoor Wet Bulb Temperature				Airflow				Entering Indoor Wet Bulb Temperature							
80	MBh	182.6	186.5	199.3	213.1	178.3	182.2	194.7	208.1	174.1	177.9	190.0	203.1	169.8	173.5	185.4	198.2	161.3	164.9	176.1	188.3	149.4	152.7	163.2	174.4												
	S/T	0.94	0.88	0.71	0.53	0.97	0.91	0.74	0.55	1.00	0.93	0.76	0.57	1.00	0.96	0.78	0.59	1.00	1.00	0.81	0.61	1.00	1.00	0.82	0.61												
	ΔT	23	22	19	16	24	23	20	16	24	23	20	16	23	23	20	16	22	22	20	16	20	21	18	15												
	HI PR	240	259	273	285	270	290	306	320	307	330	349	363	349	376	397	414	393	423	447	466	434	467	493	515												
	LO PR	106	112	123	131	112	119	130	138	116	123	135	143	122	130	141	151	128	136	148	158	132	140	153	163												
6000	MBh	177.2	180.1	193.5	206.9	173.1	176.9	189.0	202.0	169.0	172.7	184.5	197.2	164.9	168.5	180.0	192.4	156.6	160.1	171.0	182.8	145.1	148.3	158.4	169.3												
	S/T	0.89	0.84	0.68	0.51	0.93	0.87	0.71	0.53	0.95	0.89	0.72	0.54	0.98	0.92	0.75	0.56	1.00	0.95	0.78	0.58	1.00	0.96	0.78	0.59												
	ΔT	24	23	20	16	25	24	20	16	25	24	20	16	25	24	21	16	24	23	20	16	22	22	19	15												
	HI PR	238	256	270	282	267	287	303	316	304	327	345	360	346	372	393	410	389	419	442	461	430	463	488	510												
	LO PR	105	111	121	129	110	117	128	137	115	122	133	142	121	128	140	149	126	134	147	156	131	139	152	162												
4800	MBh	163.6	167.2	178.6	190.9	159.8	163.3	174.4	186.5	156.0	159.4	170.3	182.0	152.2	155.5	166.1	177.6	144.6	147.7	157.8	168.7	133.9	136.8	146.2	156.3												
	S/T	0.86	0.81	0.66	0.49	0.89	0.84	0.68	0.51	0.92	0.86	0.70	0.52	0.94	0.89	0.72	0.54	0.98	0.92	0.75	0.56	0.99	0.93	0.75	0.56												
	ΔT	27	26	22	18	27	26	23	18	27	26	23	18	28	26	23	18	27	26	23	18	25	24	21	17												
	HI PR	231	248	262	274	259	279	294	307	295	317	335	349	335	361	381	398	377	406	429	447	417	449	474	494												
	LO PR	101	108	118	125	107	114	124	132	111	118	129	138	117	124	136	145	123	130	142	152	127	135	147	157												

6750	MBh	185.8	189.3	198.3	211.6	180.4	184.9	193.7	206.6	177.1	180.5	189.1	201.7	172.8	176.1	184.5	196.8	164.2	167.3	175.2	187.0	152.1	155.0	162.3	173.2
	S/T	0.98	0.95	0.86	0.69	1.00	0.98	0.89	0.72	1.00	1.00	0.91	0.74	1.00	1.00	0.94	0.76	1.00	1.00	0.97	0.79	1.00	1.00	0.98	0.80
	ΔT	25	24	23	20	25	25	23	20	24	24	23	20	24	24	24	20	24	23	23	20	21	21	22	19
	HI PR	243	261	276	288	272	293	309	323	310	333	352	367	353	380	401	418	397	427	451	470	439	472	498	520
	LO PR	107	113	124	132	113	120	131	139	117	125	136	145	123	131	143	152	129	137	150	159	133	142	155	165
85	MBh	180.3	183.8	192.5	205.4	176.1	179.6	188.1	200.6	172.0	175.3	183.6	195.8	167.8	171.0	179.1	191.1	159.4	162.5	170.1	180.5	147.6	150.5	157.6	168.1
	S/T	0.94	0.90	0.82	0.66	0.97	0.94	0.85	0.69	1.00	0.96	0.87	0.70	1.00	0.99	0.89	0.73	1.00	1.00	0.93	0.75	1.00	1.00	0.94	0.76
	ΔT	26	25	24	21	26	26	24	21	26	26	24	21	26	26	25	21	24	25	24	21	23	23	23	20
	HI PR	240	259	273	285	270	290	306	320	307	330	349	363	349	376	397	414	393	423	447	466	434	467	493	515
	LO PR	106	112	123	131	112	119	130	138	116	123	135	143	122	130	141	151	128	136	148	158	132	140	153	163
4800	MBh	166.5	169.7	177.7	189.6	162.6	165.7	173.6	185.2	158.7	161.8	169.4	180.8	154.8	157.8	165.3	176.4	147.1	149.9	157.0	167.5	136.3	138.9	145.5	155.2
	S/T	0.90	0.87	0.79	0.64	0.94	0.90	0.81	0.66	0.96	0.93	0.84	0.68	0.99	0.96	0.86	0.70	1.00	0.99	0.90	0.73	1.00	1.00	0.90	0.73
	ΔT	29	28	27	23	29	29	27	23	29	29	27	23	29	29	27	24	28	28	27	23	26	27	25	22
	HI PR	233	251	265	276	262	281	297	310	297	320	338	353	339	365	385	402	381	410	433	452	421	453	479	499
	LO PR	102	109	119	127	108	115	126	134	112	120	131	139	118	126	137	146	124	132	144	153	128	136	149	158

High and low pressures are measured at the liquid and suction access fittings.

Shaded area reflects AHRI (TVA) conditions

IDB: Entering Indoor Dry Bulb Temperature

IDB		Outdoor Ambient Temperature																																			
		65						75						85						95						105						115					
		Airflow				Entering Indoor Wet Bulb Temperature				Airflow				Entering Indoor Wet Bulb Temperature				Airflow				Entering Indoor Wet Bulb Temperature				Airflow				Entering Indoor Wet Bulb Temperature							
70	7875	MBh	235.2	243.8	267.1	-	229.7	238.1	260.9	-	224.2	232.4	254.6	-	218.8	226.8	248.4	-	207.8	215.4	236.0	-	192.5	199.5	218.6	-											
		S/T	0.76	0.63	0.44	-	0.78	0.66	0.45	-	0.80	0.67	0.47	-	0.83	0.69	0.48	-	0.86	0.72	0.50	-	0.87	0.73	0.50	-											
		ΔT	21	18	14	-	21	18	14	-	21	18	14	-	21	18	14	-	21	18	14	-	20	17	13	-											
		HI PR	259	279	294	-	290	313	330	-	330	356	375	-	376	405	428	-	423	456	481	-	468	503	531	-											
	LO PR	100	106	116	-	105	112	122	-	110	117	127	-	115	122	134	-	121	128	140	-	125	133	145	-												
	MBh	228.3	236.7	259.3	-	223.0	231.2	253.3	-	217.7	225.7	247.2	-	212.4	220.1	241.2	-	201.8	209.1	229.1	-	186.9	193.7	212.3	-												
	S/T	0.72	0.60	0.42	-	0.75	0.63	0.43	-	0.77	0.64	0.44	-	0.79	0.66	0.46	-	0.82	0.69	0.48	-	0.83	0.69	0.48	-												
	ΔT	22	19	14	-	22	19	14	-	22	19	14	-	22	19	15	-	22	19	14	-	20	18	13	-												
	HI PR	256	276	291	-	288	310	327	-	327	352	372	-	373	401	423	-	419	451	476	-	463	498	526	-												
	LO PR	99	105	115	-	104	111	121	-	108	115	126	-	114	121	132	-	119	127	139	-	123	131	143	-												
	MBh	210.7	218.4	239.3	-	205.8	213.4	233.8	-	200.9	208.3	228.2	-	196.0	203.2	222.6	-	186.2	193.0	211.5	-	172.5	178.8	195.9	-												
	S/T	0.70	0.58	0.40	-	0.72	0.60	0.42	-	0.74	0.62	0.43	-	0.76	0.64	0.44	-	0.79	0.66	0.46	-	0.80	0.67	0.46	-												
ΔT	24	21	16	-	24	21	16	-	24	21	16	-	25	21	16	-	24	21	16	-	23	20	15	-													
HI PR	249	268	283	-	279	300	317	-	317	341	361	-	361	389	411	-	407	438	462	-	449	483	510	-													
LO PR	96	102	111	-	101	108	118	-	105	112	122	-	110	118	128	-	116	123	134	-	120	127	139	-													
75	7875	MBh	239.2	246.2	266.5	286.1	233.6	240.5	260.3	279.4	228.0	234.8	254.1	272.8	222.5	229.1	247.9	266.1	211.4	217.6	235.5	252.8	195.8	201.6	218.2	234.2											
		S/T	0.86	0.77	0.58	0.37	0.89	0.80	0.60	0.39	0.91	0.82	0.62	0.40	0.94	0.84	0.64	0.41	0.98	0.88	0.66	0.43	0.99	0.88	0.67	0.43											
		ΔT	24	22	18	13	24	22	18	13	24	22	18	13	25	23	19	13	24	22	18	13	23	21	17	12											
		HI PR	262	281	297	310	293	316	333	348	334	359	379	396	380	409	432	451	428	460	486	507	472	508	537	560											
	LO PR	101	107	117	125	106	113	124	132	111	118	129	137	116	124	135	144	122	130	141	151	126	134	146	156												
	MBh	232.2	239.1	258.8	277.7	226.8	233.5	252.8	271.3	221.4	228.0	246.7	264.8	216.0	222.4	240.7	258.4	205.2	211.3	228.7	245.4	190.1	195.7	211.8	227.4												
	S/T	0.82	0.73	0.56	0.36	0.85	0.76	0.58	0.37	0.87	0.78	0.59	0.38	0.90	0.81	0.61	0.39	0.93	0.84	0.63	0.41	0.94	0.84	0.64	0.41												
	ΔT	25	23	19	13	25	23	19	13	25	23	19	13	26	24	19	13	25	23	19	13	24	22	18	12												
	HI PR	259	279	294	307	291	313	330	344	330	356	376	392	376	405	428	446	423	456	481	502	468	503	532	554												
	LO PR	100	106	116	123	105	112	122	130	110	117	127	136	115	122	134	142	121	128	140	149	125	133	145	154												
	MBh	214.3	220.7	238.8	256.3	209.3	215.5	233.3	250.4	204.4	210.4	227.7	244.4	199.4	205.3	222.2	238.5	189.4	195.0	211.1	226.5	175.4	180.6	195.5	209.8												
	S/T	0.79	0.71	0.54	0.34	0.82	0.73	0.56	0.36	0.84	0.75	0.57	0.37	0.87	0.78	0.59	0.38	0.90	0.81	0.61	0.39	0.91	0.81	0.62	0.40												
ΔT	28	26	21	15	28	26	21	15	28	26	21	15	28	26	21	15	28	26	21	15	26	24	20	14													
HI PR	251	270	285	298	282	303	320	334	321	345	364	380	365	393	415	433	411	442	467	487	454	488	516	538													
LO PR	97	103	112	120	102	109	119	126	106	113	123	131	112	119	130	138	117	124	136	145	121	129	141	150													

IDB: Entering Indoor Dry Bulb Temperature      Shaded area reflects ACCA (TVA) conditions      High and low pressures are measured at the liquid and suction access fittings.

IDB		Outdoor Ambient Temperature																																			
		65						75						85						95						105						115					
		59	63	67	71	71	71	59	63	67	71	71	71	59	63	67	71	71	71	59	63	67	71	71	71	59	63	67	71	71	71						
Airflow		Entering Indoor Wet Bulb Temperature																																			
80	MBh	243.4	248.7	265.7	284.1	237.8	242.9	259.6	277.5	232.1	237.2	253.4	270.9	226.4	231.4	247.2	264.3	215.1	219.8	234.8	251.0	199.3	203.6	217.5	232.5												
	S/T	0.94	0.89	0.72	0.54	1.00	0.92	0.75	0.56	1.00	0.94	0.77	0.57	1.00	1.00	0.79	0.59	1.00	1.00	0.82	0.61	1.00	1.00	0.83	0.62												
	ΔT	27	26	22	18	28	26	23	18	27	26	23	18	26	27	23	18	25	26	22	18	23	24	21	17												
	HI PR	264	284	300	313	296	319	337	351	337	363	383	400	384	413	436	455	432	465	491	512	477	514	542	566												
	LO PR	102	108	118	126	108	114	125	133	112	119	130	138	117	125	136	145	123	131	143	152	127	135	148	157												
	MBh	236.3	241.5	258.0	275.8	230.8	235.9	252.0	269.4	225.3	230.3	246.0	263.0	219.8	224.6	240.0	256.6	208.8	213.4	228.0	243.7	193.5	197.7	211.2	225.8												
	S/T	0.90	0.84	0.69	0.51	0.93	0.88	0.71	0.53	0.96	0.90	0.73	0.55	0.99	0.93	0.75	0.56	1.00	0.96	0.78	0.58	1.00	0.97	0.79	0.59												
	ΔT	28	27	23	19	28	27	24	19	28	27	24	19	29	27	24	19	27	27	23	19	25	25	22	17												
	HI PR	262	281	297	310	293	316	334	348	334	359	379	396	380	409	432	451	428	460	486	507	473	509	537	560												
	LO PR	101	107	117	125	106	113	124	132	111	118	129	137	116	124	135	144	122	130	141	151	126	134	146	156												
MBh	218.1	222.9	238.1	254.6	213.1	217.7	232.6	248.6	208.0	212.5	227.1	242.7	202.9	207.3	221.5	236.8	192.8	197.0	210.4	225.0	178.6	182.5	194.9	208.4													
S/T	0.87	0.81	0.66	0.50	0.90	0.84	0.69	0.51	0.92	0.87	0.70	0.53	0.95	0.89	0.73	0.54	0.99	0.93	0.75	0.56	1.00	0.93	0.76	0.57													
ΔT	31	30	26	21	31	30	26	21	32	30	26	21	32	30	26	21	31	30	26	21	29	28	24	19													
HI PR	254	273	288	301	285	306	323	337	324	348	368	384	369	397	419	437	415	446	471	492	458	493	521	543													
LO PR	98	104	114	121	103	110	120	128	107	114	125	133	113	120	131	139	118	126	137	146	122	130	142	151													

IDB		Outdoor Ambient Temperature																																			
		65						75						85						95						105						115					
		59	63	67	71	71	71	59	63	67	71	71	71	59	63	67	71	71	71	59	63	67	71	71	71	59	63	67	71	71	71						
Airflow		Entering Indoor Wet Bulb Temperature																																			
85	MBh	247.7	252.5	264.4	282.1	241.9	246.6	258.3	275.5	236.2	240.7	252.1	269.0	230.4	234.8	246.0	262.4	218.9	223.1	233.7	249.3	202.7	206.7	216.4	230.9												
	S/T	0.99	0.96	0.86	0.70	1.00	0.99	0.89	0.72	1.00	1.00	0.92	0.74	1.00	1.00	0.95	0.77	1.00	1.00	0.98	0.80	1.00	1.00	0.99	0.80												
	ΔT	29	28	27	23	28	28	27	23	28	28	27	23	27	27	27	24	26	26	27	23	24	24	25	22												
	HI PR	267	287	303	316	299	322	340	355	340	366	387	404	388	417	441	460	436	469	496	517	482	519	548	571												
	LO PR	103	109	119	127	109	116	126	134	113	120	131	140	119	126	138	147	124	132	144	154	129	137	149	159												
	MBh	240.5	245.1	256.7	273.9	234.9	239.4	250.7	267.5	229.3	233.7	244.8	261.1	223.7	228.0	238.8	254.8	212.5	216.6	226.9	242.0	196.8	200.6	210.1	224.2												
	S/T	0.94	0.91	0.82	0.67	0.98	0.94	0.85	0.69	1.00	0.97	0.87	0.71	1.00	1.00	0.90	0.73	1.00	1.00	0.94	0.76	1.00	1.00	0.94	0.77												
	ΔT	30	29	28	24	30	30	28	24	30	30	28	24	29	30	28	24	28	28	28	24	26	26	26	23												
	HI PR	264	284	300	313	296	319	337	351	337	363	383	400	384	413	436	455	432	465	491	512	477	514	542	566												
	LO PR	102	108	118	126	108	114	125	133	112	119	130	138	117	125	136	145	123	131	143	152	127	135	148	157												
MBh	221.9	226.2	236.9	252.8	216.8	221.0	231.4	246.9	211.6	215.7	225.9	241.0	206.5	210.5	220.4	235.1	196.1	199.9	209.4	223.4	180.7	185.2	194.0	206.9													
S/T	0.91	0.88	0.79	0.64	0.94	0.91	0.82	0.67	0.97	0.93	0.84	0.68	1.00	0.96	0.87	0.71	1.00	1.00	0.90	0.73	1.00	1.00	0.91	0.74													
ΔT	33	33	31	27	34	33	31	27	34	33	31	27	34	33	31	27	32	33	31	27	30	30	29	25													
HI PR	256	276	291	304	288	309	327	341	327	352	372	388	372	401	423	441	419	451	476	497	463	498	526	549													
LO PR	99	105	115	122	104	111	121	129	108	115	126	134	114	121	132	141	119	127	139	148	123	131	143	153													

IDB: Entering Indoor Dry Bulb Temperature  
 Shaded area reflects AHRI (TVA) conditions  
 High and low pressures are measured at the liquid and suction access fittings.

IDB		Outdoor Ambient Temperature																								
		65				75				85				95				105				115				
		59	63	67	71	59	63	67	71	59	63	67	71	59	63	67	71	59	63	67	71	59	63	67	71	
		Entering Indoor Wet Bulb Temperature																								
		Entering Indoor Dry Bulb Temperature																								
		Entering Indoor Wet Bulb Temperature																								
		Entering Indoor Dry Bulb Temperature																								
70	9202	MBh	284.2	294.5	322.7	-	277.6	287.7	315.2	-	271.0	280.8	307.7	-	264.3	274.0	300.2	-	251.1	260.3	285.2	-	232.6	241.1	264.2	-
		S/T	0.67	0.56	0.39	-	0.70	0.58	0.40	-	0.72	0.60	0.41	-	0.74	0.62	0.43	-	0.77	0.64	0.44	-	0.77	0.65	0.45	-
		ΔT	19	17	13	-	19	17	13	-	19	17	13	-	19	17	13	-	19	17	13	-	18	16	12	-
		kW	22.18	22.65	23.36	-	23.88	24.39	25.17	-	25.38	25.93	26.77	-	26.70	27.29	28.19	-	27.83	28.45	29.39	-	28.80	29.44	30.43	-
		HI PR	270	290	306	-	303	326	344	-	344	370	391	-	392	422	445	-	441	475	501	-	487	524	554	-
	LO PR	102	108	118	-	108	115	125	-	112	119	130	-	118	125	137	-	123	131	143	-	127	136	148	-	
	MBh	275.9	286.0	313.3	-	269.5	279.3	306.0	-	263.1	272.7	298.7	-	256.7	266.0	291.5	-	243.8	252.7	276.9	-	225.9	234.1	256.5	-	
	S/T	0.64	0.54	0.37	-	0.67	0.56	0.38	-	0.68	0.57	0.39	-	0.70	0.59	0.41	-	0.73	0.61	0.42	-	0.74	0.62	0.43	-	
	ΔT	20	17	13	-	20	17	13	-	20	17	13	-	20	18	13	-	20	17	13	-	19	16	12	-	
	kW	22.00	22.47	23.17	-	23.69	24.20	24.97	-	25.17	25.72	26.55	-	26.48	27.07	27.95	-	27.60	28.21	29.14	-	28.56	29.20	30.17	-	
HI PR	267	287	303	-	300	322	340	-	341	367	387	-	388	418	441	-	437	470	496	-	482	519	548	-		
LO PR	101	107	117	-	107	113	124	-	111	118	129	-	116	124	135	-	122	130	142	-	126	134	147	-		
75	9202	MBh	262.1	271.7	297.6	-	256.0	265.3	290.7	-	249.9	259.0	283.8	-	243.8	252.7	276.9	-	231.6	240.1	263.0	-	214.6	222.4	243.7	-
		S/T	0.61	0.51	0.36	-	0.64	0.53	0.37	-	0.65	0.55	0.38	-	0.67	0.56	0.39	-	0.70	0.58	0.40	-	0.71	0.59	0.41	-
		ΔT	20	18	13	-	21	18	14	-	21	18	14	-	21	18	14	-	21	18	13	-	19	17	13	-
		kW	21.66	22.11	22.80	-	23.31	23.80	24.56	-	24.76	25.30	26.12	-	26.05	26.62	27.49	-	27.14	27.74	28.65	-	28.08	28.71	29.66	-
		HI PR	262	282	297	-	294	316	334	-	334	359	379	-	380	409	432	-	428	460	486	-	473	509	537	-
	LO PR	99	105	115	-	105	111	121	-	109	116	126	-	114	121	133	-	120	127	139	-	124	132	144	-	
	MBh	289.0	297.5	322.1	345.7	282.3	290.6	314.6	337.6	275.6	283.7	307.1	329.6	268.8	276.8	299.6	321.5	255.4	262.9	284.6	305.5	236.6	243.6	263.6	283.0	
	S/T	0.76	0.68	0.52	0.3	0.79	0.71	0.54	0.3	0.81	0.73	0.55	0.4	0.84	0.75	0.57	0.4	0.87	0.78	0.59	0.4	0.88	0.79	0.59	0.4	
	ΔT	22	20	17	12	22	21	17	12	22	21	17	12	23	21	17	12	22	20	17	12	21	19	16	10.8	
	kW	22.36	22.83	23.55	24.3	24.07	24.59	25.38	26.2	25.59	26.15	27.00	27.9	26.93	27.52	28.43	29.4	28.07	28.69	29.64	30.6	29.05	29.70	30.69	31.7	
HI PR	272	293	310	322.9	306	329	347	362.3	348	374	395	412.0	396	426	450	469.3	445	479	506	528.0	492	530	559	583.3		
LO PR	103	110	120	127.4	109	116	126	134.6	113	120	131	139.9	119	126	138	147.0	125	132	145	154.0	129	137	150	159.3		
75	8200	MBh	280.6	288.9	312.7	335.6	274.1	282.2	305.4	327.8	267.5	275.4	298.1	320.0	261.0	268.7	290.9	312.2	248.0	255.3	276.3	296.6	229.7	236.5	256.0	274.7
		S/T	0.73	0.65	0.49	0.3	0.76	0.68	0.51	0.3	0.78	0.69	0.52	0.3	0.80	0.72	0.54	0.3	0.83	0.74	0.56	0.4	0.84	0.75	0.57	0.4
		ΔT	23	21	17	12	23	21	18	12	23	21	18	12	23	22	18	12	23	21	17	12	22	20	16	11.2
		kW	22.18	22.65	23.36	24.1	23.88	24.40	25.18	26.0	25.38	25.94	26.78	27.7	26.71	27.30	28.19	29.1	27.83	28.45	29.39	30.4	28.80	29.45	30.43	31.5
		HI PR	270	290	307	319.7	303	326	344	358.7	344	370	391	408.0	392	422	446	464.7	441	475	501	522.7	487	524	554	577.6
	LO PR	102	108	118	126.1	108	115	125	133.3	112	119	130	138.5	118	125	137	145.5	123	131	143	152.5	128	136	148	157.7	
	MBh	266.5	274.4	297.1	318.8	260.3	268.1	290.1	311.4	254.1	261.7	283.2	304.0	248.0	255.3	276.3	296.6	235.6	242.5	262.5	281.7	218.2	224.7	243.2	261.0	
	S/T	0.70	0.63	0.47	0.3	0.72	0.65	0.49	0.3	0.74	0.66	0.50	0.3	0.77	0.69	0.52	0.3	0.80	0.71	0.54	0.3	0.80	0.72	0.54	0.3	
	ΔT	24	22	18	12	24	22	18	12	24	22	18	12	24	22	18	13	24	22	18	12	22	20	17	11.6	
	kW	21.83	22.29	22.99	23.7	23.50	24.00	24.77	25.6	24.97	25.51	26.34	27.2	26.27	26.84	27.72	28.6	27.37	27.98	28.90	29.9	28.32	28.95	29.91	30.9	
HI PR	264	284	300	313.3	297	319	337	351.5	337	363	383	399.8	384	413	437	455.4	432	465	491	512.3	478	514	543	566.0		
LO PR	100	106	116	123.6	106	112	123	130.6	110	117	127	135.7	115	123	134	142.6	121	129	140	149.4	125	133	145	154.6		

IDB: Entering Indoor Dry Bulb Temperature  
 High and low pressures are measured at the liquid and suction access fittings.  
 Design Subcooling, 16 - 19 °F @ the liquid access fitting connection ARI 95 test conditions. Design Superheat 8 - 12 °F @ the compressor suction access fitting connection.

Shaded area reflects ACCA (TVA) Rating Conditions.  
 kW = Total system power  
 Amps: Unit amps (comp.+ evaporator + condenser fan motors)

IDB	Airflow	Outdoor Ambient Temperature																								
		65				75				85				95				105				115				
		59	63	67	71	59	63	67	71	59	63	67	71	59	63	67	71	59	63	67	71	59	63	67	71	
80	9202	MBh	294.1	300.6	321.1	343.3	287.3	293.6	313.6	335.3	280.4	286.6	306.2	327.3	273.6	279.6	298.7	319.3	259.9	265.6	283.8	303.3	240.8	246.0	262.9	281.0
		S/T	0.84	0.79	0.64	0.5	0.87	0.82	0.66	0.5	0.89	0.84	0.68	0.5	0.92	0.86	0.70	0.5	0.96	0.90	0.73	0.5	0.96	0.90	0.74	0.5
	ΔT	25	24	21	16	25	24	21	17	25	24	21	17	25	24	21	17	25	24	21	17	23	22	19	15.4	
	kW	22.54	23.01	23.74	24.5	24.27	24.79	25.59	26.4	25.80	26.37	27.23	28.1	27.15	27.75	28.67	29.6	28.30	28.93	29.89	30.9	29.29	29.95	30.95	32.0	
	HI PR	275	296	313	326.1	309	332	351	366.0	351	378	399	416.2	400	430	455	474.0	450	484	511	533.3	497	535	565	589.2	
	LO PR	104	111	121	128.7	110	117	128	136.0	114	122	133	141.3	120	128	139	148.4	126	134	146	155.6	130	138	151	160.9	
80	8200	MBh	285.6	291.8	311.8	333.3	278.9	285.0	304.5	325.5	272.3	278.2	297.3	317.8	265.6	271.4	290.0	310.0	252.4	257.9	275.5	294.5	233.8	238.9	255.2	272.8
		S/T	0.80	0.75	0.61	0.5	0.83	0.78	0.63	0.5	0.85	0.80	0.65	0.5	0.88	0.82	0.67	0.5	0.91	0.85	0.70	0.5	0.92	0.86	0.70	0.5
	ΔT	26	25	21	17	26	25	22	17	26	25	22	17	26	25	22	17	26	25	21	17	24	23	20	16.0	
	kW	22.36	22.83	23.55	24.3	24.08	24.59	25.38	26.2	25.59	26.15	27.00	27.9	26.93	27.53	28.43	29.4	28.07	28.69	29.64	30.6	29.05	29.70	30.69	31.7	
	HI PR	272	293	310	322.9	306	329	347	362.3	348	374	395	412.1	396	426	450	469.4	446	479	506	528.0	492	530	559	583.4	
	LO PR	103	110	120	127.4	109	116	126	134.6	113	120	131	139.9	119	126	138	147.0	125	132	145	154.0	129	137	150	159.3	
7257	7257	MBh	271.3	277.2	296.2	316.6	265.0	270.8	289.3	309.2	258.7	264.3	282.4	301.9	252.4	257.9	275.5	294.5	239.7	245.0	261.7	279.8	222.1	226.9	242.4	259.2
		S/T	0.77	0.72	0.59	0.4	0.79	0.74	0.61	0.5	0.81	0.76	0.62	0.5	0.84	0.79	0.64	0.5	0.87	0.82	0.67	0.5	0.88	0.83	0.67	0.5
	ΔT	26	25	22	18	27	26	22	18	27	26	22	18	27	26	22	18	27	25	22	18	25	24	21	16.5	
	kW	22.00	22.47	23.17	23.9	23.69	24.20	24.97	25.8	25.17	25.72	26.55	27.4	26.48	27.07	27.95	28.9	27.60	28.21	29.14	30.1	28.56	29.20	30.17	31.2	
	HI PR	267	287	303	316.5	300	322	340	355.1	341	367	387	403.8	388	418	441	460.0	437	470	496	517.5	482	519	548	571.7	
	LO PR	101	107	117	124.9	107	113	124	131.9	111	118	129	137.1	116	124	135	144.0	122	130	142	150.9	126	134	147	156.1	

85	9202	MBh	299.3	305.1	319.5	340.9	292.3	298.0	312.1	332.9	285.3	290.9	304.6	325.0	278.4	283.8	297.2	317.1	264.5	269.6	282.3	301.2	245.0	249.7	261.5	279.0
		S/T	0.88	0.85	0.77	0.6	0.91	0.88	0.79	0.6	0.93	0.90	0.81	0.7	0.96	0.93	0.84	0.7	1.00	0.97	0.87	0.7	1.00	0.97	0.88	0.7
	ΔT	26	26	24	21	27	26	25	21	27	26	25	21	27	26	25	22	26	26	25	21	24	24	23	19.9	
	kW	22.72	23.20	23.93	24.7	24.47	25.00	25.80	26.6	26.01	26.58	27.45	28.4	27.38	27.99	28.91	29.9	28.54	29.18	30.15	31.2	29.54	30.20	31.21	32.3	
	HI PR	278	299	316	329.4	312	336	354	369.6	355	382	403	420.4	404	435	459	478.8	454	489	516	538.6	502	540	571	595.1	
	LO PR	105	112	122	130.0	111	118	129	137.3	115	123	134	142.7	121	129	141	149.9	127	135	148	157.1	131	140	153	162.5	
85	8200	MBh	290.6	296.2	310.2	330.9	283.8	289.3	303.0	323.2	277.0	282.4	295.8	315.5	270.3	275.5	288.6	307.8	256.8	261.7	274.1	292.4	237.8	242.5	253.9	270.9
		S/T	0.84	0.81	0.73	0.6	0.87	0.84	0.76	0.6	0.89	0.86	0.78	0.6	0.92	0.89	0.80	0.7	0.96	0.92	0.83	0.7	0.96	0.93	0.84	0.7
	ΔT	27	27	25	22	28	27	26	22	28	27	26	22	28	27	26	22	27	27	26	22	26	25	24	20.7	
	kW	22.54	23.01	23.74	24.5	24.27	24.79	25.59	26.4	25.80	26.37	27.23	28.1	27.15	27.75	28.67	29.6	28.30	28.93	29.89	30.9	29.29	29.95	30.95	32.0	
	HI PR	275	296	313	326.1	309	332	351	366.0	351	378	399	416.2	400	430	455	474.0	450	484	511	533.3	497	535	565	589.2	
	LO PR	104	111	121	128.7	110	117	128	136.0	114	122	133	141.3	120	128	139	148.4	126	134	146	155.6	130	138	151	160.9	
7257	7257	MBh	276.0	281.4	294.7	314.4	269.6	274.8	287.8	307.1	263.2	268.3	281.0	299.8	256.8	261.7	274.1	292.4	243.9	248.6	260.4	277.8	226.0	230.3	241.2	257.4
		S/T	0.80	0.78	0.70	0.6	0.83	0.80	0.73	0.6	0.85	0.82	0.74	0.6	0.88	0.85	0.77	0.6	0.91	0.88	0.80	0.6	0.92	0.89	0.80	0.7
	ΔT	28	28	26	23	28	28	26	23	28	28	26	23	29	28	27	23	28	28	26	23	26	26	25	21.3	
	kW	22.18	22.65	23.36	24.1	23.88	24.39	25.17	26.0	25.38	25.93	26.77	27.7	26.70	27.29	28.19	29.1	27.83	28.45	29.39	30.4	28.80	29.44	30.43	31.5	
	HI PR	270	290	306	319.6	303	326	344	358.6	344	370	391	407.9	392	422	445	464.6	441	475	501	522.6	487	524	554	577.5	
	LO PR	102	108	118	126.1	108	115	125	133.3	112	119	130	138.5	118	125	137	145.5	123	131	143	152.5	127	136	148	157.7	

IDB: Entering Indoor Dry Bulb Temperature  
 High and low pressures are measured at the liquid and suction access fittings.  
 Design Subcooling, 16 - 19 °F @ the liquid access fitting connection ARI 95 test conditions. Design Superheat 8 - 12°F @ the compressor suction access fitting connection.

Shaded area reflects AHRJ Rating Conditions.  
 kW = Total system power  
 Amps: Unit amps (comp.+ evaporator + condenser fan motors)

## Airflow Data 15

Standard Two-Speed Belt Drive at High Speed — Down Shot

ESP (" H <sub>2</sub> O)	TURNS OPEN													
	0		1		2		3		4		5		6	
	CFM	BHP	CFM	BHP	CFM	BHP	CFM	BHP	CFM	BHP	CFM	BHP	CFM	BHP
0.2	---	---	---	---	---	---	---	---	---	---	7203	2.18	6718	1.84
0.4	---	---	---	---	---	---	7306	2.54	6777	2.14	6257	1.80	5711	1.48
0.6	---	---	7477	2.97	6899	2.51	6323	2.10	5716	1.72	5103	1.39	---	---
0.8	7112	2.96	6467	2.46	5795	2.01	5101	1.61	---	---	---	---	---	---
1.0	5983	2.38	5190	1.89	---	---	---	---	---	---	---	---	---	---
1.2	4426	1.71	---	---	---	---	---	---	---	---	---	---	---	---

Two-Speed High-Static Belt Drive at High Speed — Down Shot

ESP (" H <sub>2</sub> O)	TURNS OPEN											
	0		1		2		3		4		5	
	CFM	BHP	CFM	BHP	CFM	BHP	CFM	BHP	CFM	BHP	CFM	BHP
0.8	---	---	---	---	---	---	---	---	---	---	6580	4.30
1.0	---	---	---	---	---	---	6930	5.14	6432	4.53	5908	3.98
1.2	---	---	---	---	6866	5.52	6382	4.80	5916	4.24	5370	3.68
1.4	---	---	6779	5.80	6417	5.22	5914	4.52	5307	3.89	---	---
1.6	6685	6.06	6391	5.52	5954	4.90	5288	4.18	---	---	---	---
1.8	6248	5.75	5782	5.09	5261	4.50	---	---	---	---	---	---
2.0	5664	5.31	5111	4.71	---	---	---	---	---	---	---	---
2.2	5053	4.81	---	---	---	---	---	---	---	---	---	---

## Airflow Data — 20 Tons

Standard Two-Speed Belt Drive at High Speed — Down Shot

ESP (" H <sub>2</sub> O)	TURNS OPEN													
	0		1		2		3		4		5		6	
	CFM	BHP	CFM	BHP	CFM	BHP	CFM	BHP	CFM	BHP	CFM	BHP	CFM	BHP
0.2	---	---	---	---	---	---	---	---	---	---	---	---	9664	4.05
0.4	---	---	---	---	---	---	---	---	9570	4.08	9197	3.82	8702	3.51
0.6	---	---	---	---	---	---	9038	3.82	8460	3.46	7949	3.14	---	---
0.8	---	---	8171	2.93	7630	3.70	7068	2.79	---	---	---	---	---	---
1.0	---	---	7901	2.85	7203	3.42	---	---	---	---	---	---	---	---
1.2	7344	4.35	---	---	---	---	---	---	---	---	---	---	---	---

Two-Speed High-Static Belt Drive at High Speed — Down Shot

ESP (" H <sub>2</sub> O)	TURNS OPEN											
	0		1		2		3		4		5	
	CFM	BHP	CFM	BHP	CFM	BHP	CFM	BHP	CFM	BHP	CFM	BHP
0.8	---	---	---	---	---	---	---	---	8765	6.05	8225	5.38
1.0	---	---	---	---	---	---	8663	6.43	8040	5.67	7385	4.97
1.2	---	---	8978	7.61	8583	6.90	7978	6.00	7395	5.30	6713	4.60
1.4	8845	7.87	8474	7.26	8021	6.52	7393	5.65	6634	4.86	---	---
1.6	8356	7.58	7989	6.89	7442	6.13	6610	5.22	---	---	---	---
1.8	7810	7.18	7227	6.37	6576	5.62	---	---	---	---	---	---
2.0	7080	6.64	6389	5.89	---	---	---	---	---	---	---	---
2.2	6316	6.02	---	---	---	---	---	---	---	---	---	---

### NOTES

- Airflow table represent dry coil with filters installed; SCFM correction factor for wet coil is 4%.
- Any adjustment made to the blower should not cause the motor to draw more than the motor rated RLA. Minimum rated SCFM is 350 per ton.
- Unit factory shipped with the sheave set at 2.5 turns open.

# Airflow Data 25

Standard Two-Speed Belt Drive at High Speed - Down Shot

TURNS OPEN	0		1		2		3		4		5		6	
	972		941		910		877		845		813		781	
ESP	SCFM	BHP	SCFM	BHP	SCFM	BHP	SCFM	BHP	SCFM	BHP	SCFM	BHP	SCFM	BHP
0.2	---	---	---	---	---	---	10,369	5.07	9,748	4.41	9,191	3.82	8,683	3.28
0.4	---	---	10,802	6.00	10,125	5.30	9,484	4.62	8,905	4.01	8,386	3.46	7,913	2.95
0.6	10,519	6.20	9,821	5.47	9,193	4.81	8,599	4.18	8,062	3.61	7,582	3.10	7,143	2.63
0.8	9,482	5.60	8,839	4.93	8,261	4.32	7,714	3.74	7,220	3.21	6,777	2.74	---	---
1	8,446	5.01	7,857	4.39	7,329	3.83	6,829	3.30	---	---	---	---	---	---
1.2	7,409	4.41	6,876	3.85	---	---	---	---	---	---	---	---	---	---

Two-Speed High Static Belt Drive at High Speed - Down Shot

TURNS OPEN	0		1		2		3		4		5		6	
	1254		1208		1163		1124		1085		1046		1007	
ESP	SCFM	BHP	SCFM	BHP	SCFM	BHP	SCFM	BHP	SCFM	BHP	SCFM	BHP	SCFM	BHP
0.6	---	---	---	---	---	---	---	---	---	---	---	---	11,409	7.12
0.8	---	---	---	---	---	---	---	---	---	---	---	---	10,302	6.46
1	---	---	---	---	---	---	---	---	---	---	10,159	6.79	9,195	5.79
1.2	---	---	---	---	---	---	---	---	9,990	7.11	8,961	6.04	8,087	5.13
1.4	---	---	---	---	---	---	9,789	7.39	8,686	6.25	7,763	5.29	6,980	4.46
1.6	---	---	---	---	9,543	7.63	8,357	6.40	7,382	5.39	6,566	4.53	---	---
1.8	---	---	---	---	7,957	6.48	6,925	5.41	6,077	4.53	---	---	---	---
2	---	---	7,667	6.68	6,370	5.34	---	---	---	---	---	---	---	---
2.2	7,280	6.78	---	---	---	---	---	---	---	---	---	---	---	---

- Airflow table represent dry coil with filters installed; SCFM correction factor for wet coil is 4%.
- Any adjustment made to the blower should not cause the motor to draw more than the motor rated RLA. Minimum rated SCFM is 350 per ton.
- Unit factory shipped with the sheave set at 2.5 turns open.

AIRFLOW PRESSURE DROP OF DOWNFLOW ECONOMIZER FOR 15- TO 25-TON ROOFTOP UNITS (100% RETURN AIR)

CFM	4,500	5,000	5,500	6,000	6,500	7,000	7,500	8,000	8,500	9,000	9,500	10,000
(IN. WG)	0.15	0.18	0.22	0.27	0.32	0.37	0.42	0.48	0.55	0.61	0.69	0.76

## High Efficiency MERV 13 Air Filter Option

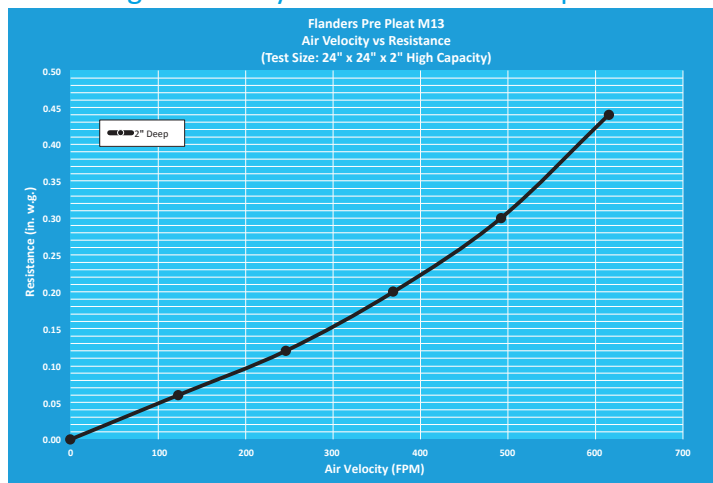

TONNAGE:	FILTER NOMINAL SIZE:	PART NUMBER:	ORDER QTY:
15, 20	20 x 25 x 2	0160L00202	6
25	20 X 20 X 2	0160L00201	8

## Crankcase Heater Selection Table

ZP/ZPS...	COMPRESSOR DIAMETER	COMPRESSOR VOLTAGE			CRANKCASE HEATER WATTS
		230V	460V	575V	
16-31	5.5"	0163R00002S	0163R00031S	0163R00032S	40
39-83	6.58/7.3"	0130L00017S	0130L00018S	0130L00019S	70
103-137	9.14"	0130L00020S	0130L00021S	0130L00022S	90

DB* TONNAGE	COMPRESSOR VOLTAGE			CRANKCASE HEATER WATTS
	230V	460V	575V	
15-20 Ton**	0130L00017S	0130L00018S	0130L00019S	70
25 Ton	0130L00020S	0130L00021S	0130L00022S	90

\*Includes C,G&H models.

\*\*If Compressor Diameter is 9.14" then use 25 Ton Crankcase heaters.

# Electrical Data – 15 Ton

MODEL NUMBER	ELECTRICAL RATING	COMPRESSOR CIRCUIT 1		COMPRESSOR CIRCUIT 2		OUTDOOR FAN MOTOR			INDOOR FAN MOTOR			OPTIONAL ELECTRIC HEAT			OPTIONAL POWERED CONVENIENCE OUTLET	UNIT POWER SUPPLY	
		RLA	LRA	RLA	LRA	QTY	HP	FLA	TYPE	HP	FLA	MODEL	KW*	FLA	FLA	MCA	MOP
DBC1803S	208/230-3-60	25.0	164.0	25.0	164.0	3	0.33	2.0	2-speed High Static Belt Drive	7.50	20.3	-	-	-	-	82.6 / 82.6	100 / 100
												EHK3-31	21.6 / 28.8	60.0 / 69.3	-	100 / 112	100 / 125
												EHK3-46	32.4 / 43.2	90.1 / 104	-	138 / 155	150 / 175
												EHK3-60	43.3 / 57.6	120 / 139	-	175 / 164	175 / 175
												-	-	-	7.2 / 6.5	89.8 / 89.1	110 / 110
												EHK3-31	21.6 / 28.8	60.0 / 69.3	7.2 / 6.5	109 / 120	110 / 125
EHK3-46	32.4 / 43.2	90.1 / 104	7.2 / 6.5	147 / 163	150 / 175												
EHK3-60	43.3 / 57.6	120 / 139	7.2 / 6.5	184 / 172	200 / 175												
DBC1803V	208/230-3-60	25.0	164.0	25.0	164.0	3	0.33	2.0	2-speed Belt Drive	3.00	9.1	-	-	-	-	71.4 / 71.4	90 / 90
												EHK3-31	21.6 / 28.8	60.0 / 69.3	-	86.4 / 98.0	90 / 100
												EHK3-46	32.4 / 43.2	90.1 / 104	-	124 / 141	125 / 150
												EHK3-60	43.3 / 57.6	120 / 139	-	161 / 150	175 / 175
												-	-	-	7.2 / 6.5	78.6 / 77.9	100 / 100
												EHK3-31	21.6 / 28.8	60.0 / 69.3	7.2 / 6.5	95.4 / 106	100 / 110
EHK3-46	32.4 / 43.2	90.1 / 104	7.2 / 6.5	133 / 149	150 / 150												
EHK3-60	43.3 / 57.6	120 / 139	7.2 / 6.5	170 / 158	175 / 175												
DBC1804S	460-3-60	12.2	100.0	12.2	100.0	3	0.33	0.9	2-speed High Static Belt Drive	7.50	9.5	-	-	-	-	39.5	50
												EHK4-31	28.8	34.6	-	55.2	60
												EHK4-46	43.2	52.0	-	76.8	80
												EHK4-60	57.6	69.3	-	81.2	90
												-	-	-	3.3	42.8	50
												EHK4-31	28.8	34.6	3.3	59.3	60
EHK4-46	43.2	52.0	3.3	81.0	90												
EHK4-60	57.6	69.3	3.3	85.3	90												
DBC1804V	460-3-60	12.2	100.0	12.2	100.0	3	0.33	0.9	2-speed Belt Drive	3.00	4.3	-	-	-	-	34.3	45
												EHK4-31	28.8	34.6	-	48.7	50
												EHK4-46	43.2	52.0	-	70.3	80
												EHK4-60	57.6	69.3	-	74.7	80
												-	-	-	3.3	37.6	45
												EHK4-31	28.8	34.6	3.3	52.8	60
EHK4-46	43.2	52.0	3.3	74.5	80												
EHK4-60	57.6	69.3	3.3	78.8	90												
DBC1807S	575-3-60	9.0	78.0	9.0	78.0	3	0.33	0.7	2-speed High Static Belt Drive	7.50	7.5	-	-	-	-	29.8	35
												EHK7-31	28.8	28.9	-	45.5	50
												EHK7-46	43.2	43.4	-	63.6	70
												EHK7-60	57.6	57.8	-	67.2	80
												-	-	-	2.6	32.4	40
												EHK7-31	28.8	28.9	2.6	48.8	50
EHK7-46	43.2	43.4	2.6	66.8	70												
EHK7-60	57.6	57.8	2.6	70.5	80												
DBC1807V	575-3-60	9.0	78.0	9.0	78.0	3	0.33	0.7	2-speed Belt Drive	3.00	3.5	-	-	-	-	25.8	30
												EHK7-31	28.8	28.9	-	40.5	45
												EHK7-46	43.2	43.4	-	58.6	60
												EHK7-60	57.6	57.8	-	62.2	70
												-	-	-	2.6	28.4	35
												EHK7-31	28.8	28.9	2.6	43.8	45
EHK7-46	43.2	43.4	2.6	61.8	70												
EHK7-60	57.6	57.8	2.6	65.5	70												

# Electrical Data – 20 Ton

MODEL NUMBER	ELECTRICAL RATING	COMPRESSOR CIRCUIT 1		COMPRESSOR CIRCUIT 2		OUTDOOR FAN MOTOR			INDOOR FAN MOTOR			OPTIONAL ELECTRIC HEAT			OPTIONAL POWERED CONVENIENCE OUTLET	UNIT POWER SUPPLY	
		RLA	LRA	RLA	LRA	QTY	HP	FLA	TYPE	HP	FLA	MODEL	KW*	FLA	FLA	MCA	MOP
DBC2403S	208/230-3-60	34.0	240.0	34.0	240.0	3	0.33	2.0	2-speed High Static Belt Drive	7.50	20.3	-	-	-	-	103 / 103	125 / 125
												EHK3-31	21.6 / 28.8	60.0 / 69.3	-	103 / 112	125 / 125
												EHK3-46	32.4 / 43.2	90.1 / 104	-	138 / 155	150 / 175
												EHK3-60	43.3 / 57.6	120 / 139	-	175 / 164	175 / 175
												EHK3-75	54.1 / 72.0	150 / 173	-	175 / 199	200 / 225
												-	-	-	7.2 / 6.5	110 / 109	125 / 125
												EHK3-31	21.6 / 28.8	60.0 / 69.3	7.2 / 6.5	110 / 120	125 / 125
												EHK3-46	32.4 / 43.2	90.1 / 104	7.2 / 6.5	147 / 163	150 / 175
												EHK3-60	43.3 / 57.6	120 / 139	7.2 / 6.5	184 / 172	200 / 175
EHK3-75	54.1 / 72.0	150 / 173	7.2 / 6.5	184 / 207	200 / 225												
DBC2403V	208/230-3-60	34.0	240.0	34.0	240.0	3	0.33	2.0	2-speed Belt Drive	5.00	14.0	-	-	-	-	96.4 / 96.4	125 / 125
												EHK3-31	21.6 / 28.8	60.0 / 69.3	-	96.4 / 104	125 / 125
												EHK3-46	32.4 / 43.2	90.1 / 104	-	130 / 147	150 / 150
												EHK3-60	43.3 / 57.6	120 / 139	-	168 / 156	175 / 175
												EHK3-75	54.1 / 72.0	150 / 173	-	168 / 191	200 / 225
												-	-	-	7.2 / 6.5	104 / 103	125 / 125
												EHK3-31	21.6 / 28.8	60.0 / 69.3	7.2 / 6.5	104 / 112	125 / 125
												EHK3-46	32.4 / 43.2	90.1 / 104	7.2 / 6.5	139 / 156	150 / 175
												EHK3-60	43.3 / 57.6	120 / 139	7.2 / 6.5	177 / 164	200 / 175
EHK3-75	54.1 / 72.0	150 / 173	7.2 / 6.5	177 / 199	200 / 225												
DBC2404S	460-3-60	16.0	140.0	16.0	140.0	3	0.33	0.9	2-speed High Static Belt Drive	7.50	9.5	-	-	-	-	48.1	60
												EHK4-31	28.8	34.6	-	55.2	60
												EHK4-46	43.2	52.0	-	76.8	80
												EHK4-60	57.6	69.3	-	81.2	90
												EHK4-75	72.0	86.6	-	98.5	110
												-	-	-	3.3	51.4	60
												EHK4-31	28.8	34.6	3.3	59.3	60
												EHK4-46	43.2	52.0	3.3	81.0	90
												EHK4-60	57.6	69.3	3.3	85.3	90
EHK4-75	72.0	86.6	3.3	103	110												
DBC2404V	460-3-60	16.0	140.0	16.0	140.0	3	0.33	0.9	2-speed Belt Drive	5.00	6.6	-	-	-	-	45.2	60
												EHK4-31	28.8	34.6	-	51.6	60
												EHK4-46	43.2	52.0	-	73.2	80
												EHK4-60	57.6	69.3	-	77.5	90
												EHK4-75	72.0	86.6	-	94.9	110
												-	-	-	3.3	48.5	60
												EHK4-31	28.8	34.6	3.3	55.7	60
												EHK4-46	43.2	52.0	3.3	77.3	80
												EHK4-60	57.6	69.3	3.3	81.7	90
EHK4-75	72.0	86.6	3.3	99.0	110												
DBC2407S	575-3-60	12.9	107.6	12.9	107.6	3	0.33	0.7	2-speed High Static Belt Drive	7.50	7.5	-	-	-	-	38.7	50
												EHK7-31	28.8	28.9	-	45.5	50
												EHK7-46	43.2	43.4	-	63.6	70
												EHK7-60	57.6	57.8	-	67.2	80
												EHK7-75	72.0	72.3	-	81.7	90
												-	-	-	2.6	41.3	50
												EHK7-31	28.8	28.9	2.6	48.8	50
												EHK7-46	43.2	43.4	2.6	66.8	70
												EHK7-60	57.6	57.8	2.6	70.5	80
EHK7-75	72.0	72.3	2.6	84.9	100												
DBC2407V	575-3-60	12.9	107.6	12.9	107.6	3	0.33	0.7	2-speed Belt Drive	5.00	5.2	-	-	-	-	36.4	45
												EHK7-31	28.8	28.9	-	42.6	45
												EHK7-46	43.2	43.4	-	60.7	70
												EHK7-60	57.6	57.8	-	64.3	70
												EHK7-75	72.0	72.3	-	78.8	90
												-	-	-	2.6	39.0	50
												EHK7-31	28.8	28.9	2.6	45.9	50
												EHK7-46	43.2	43.4	2.6	64.0	70
												EHK7-60	57.6	57.8	2.6	67.6	80
EHK7-75	72.0	72.3	2.6	82.0	90												

# Electrical Data – 25 Ton

MODEL NUMBER	ELECTRICAL RATING	COMPRESSOR CIRCUIT 1		COMPRESSOR CIRCUIT 2		OUTDOOR FAN MOTOR			INDOOR FAN MOTOR			OPTIONAL ELECTRIC HEAT			OPTIONAL POWERED CONVENIENCE OUTLET	UNIT POWER SUPPLY	
		RLA	LRA	RLA	LRA	QTY	HP	FLA	TYPE	HP	FLA	MODEL	KW*	FLA	FLA	MCA	MOP
DBC3003S	208/230-3-60	48.1	245.0	48.1	245.0	2	1.00	4.2	2-speed High Static Belt Drive	7.50	21.0	-	-	-	-	138 / 138	175 / 175
												EHK3-31	21.6 / 28.8	60.0 / 69.3	-	138 / 138	175 / 175
												EHK3-46	32.4 / 43.2	90.1 / 104	-	139 / 156	175 / 175
												EHK3-60	43.3 / 57.6	120 / 139	-	176 / 165	200 / 175
												EHK3-75	54.1 / 72.0	150 / 173	-	176 / 199	200 / 225
												-	-	-	7.2 / 6.5	145 / 144	175 / 175
												EHK3-31	21.6 / 28.8	60.0 / 69.3	7.2 / 6.5	145 / 144	175 / 175
												EHK3-46	32.4 / 43.2	90.1 / 104	7.2 / 6.5	148 / 164	175 / 175
												EHK3-60	43.3 / 57.6	120 / 139	7.2 / 6.5	185 / 173	200 / 175
												EHK3-75	54.1 / 72.0	150 / 173	7.2 / 6.5	185 / 208	200 / 225
DBC3003V	208/230-3-60	48.1	245.0	48.1	245.0	2	1.00	4.2	2-speed Belt Drive	7.50	21.0	-	-	-	-	138 / 138	175 / 175
												EHK3-31	21.6 / 28.8	60.0 / 69.3	-	138 / 138	175 / 175
												EHK3-46	32.4 / 43.2	90.1 / 104	-	139 / 156	175 / 175
												EHK3-60	43.3 / 57.6	120 / 139	-	176 / 165	200 / 175
												EHK3-75	54.1 / 72.0	150 / 173	-	176 / 199	200 / 225
												-	-	-	7.2 / 6.5	145 / 144	175 / 175
												EHK3-31	21.6 / 28.8	60.0 / 69.3	7.2 / 6.5	145 / 144	175 / 175
												EHK3-46	32.4 / 43.2	90.1 / 104	7.2 / 6.5	148 / 164	175 / 175
												EHK3-60	43.3 / 57.6	120 / 139	7.2 / 6.5	185 / 173	200 / 175
												EHK3-75	54.1 / 72.0	150 / 173	7.2 / 6.5	185 / 208	200 / 225
DBC3004S	460-3-60	18.6	125.0	18.6	125.0	2	1.00	2.1	2-speed High Static Belt Drive	7.50	10.1	-	-	-	-	56.1	70
												EHK4-31	28.8	34.6	-	56.1	70
												EHK4-46	43.2	52.0	-	77.6	80
												EHK4-60	57.6	69.3	-	81.9	90
												EHK4-75	72.0	86.6	-	99.2	110
												-	-	-	3.3	59.4	70
												EHK4-31	28.8	34.6	3.3	60.1	70
												EHK4-46	43.2	52.0	3.3	81.7	90
												EHK4-60	57.6	69.3	3.3	86.0	90
												EHK4-75	72.0	86.6	3.3	103	110
DBC3004V	460-3-60	18.6	125.0	18.6	125.0	2	1.00	2.1	2-speed Belt Drive	7.50	10.1	-	-	-	-	56.1	70
												EHK4-31	28.8	34.6	-	56.1	70
												EHK4-46	43.2	52.0	-	77.6	80
												EHK4-60	57.6	69.3	-	81.9	90
												EHK4-75	72.0	86.6	-	99.2	110
												-	-	-	3.3	59.4	70
												EHK4-31	28.8	34.6	3.3	60.1	70
												EHK4-46	43.2	52.0	3.3	81.7	90
												EHK4-60	57.6	69.3	3.3	86.0	90
												EHK4-75	72.0	86.6	3.3	103	110
DBC3007S	575-3-60	14.7	100.0	14.7	100.0	2	1.00	1.6	2-speed High Static Belt Drive	7.50	8.2	-	-	-	-	44.6	50
												EHK7-31	28.8	28.9	-	46.4	50
												EHK7-46	43.2	43.4	-	64.5	70
												EHK7-60	57.6	57.8	-	68.1	80
												EHK7-75	72.0	72.3	-	82.5	100
												-	-	-	2.6	47.2	60
												EHK7-31	28.8	28.9	2.6	49.6	60
												EHK7-46	43.2	43.4	2.6	67.7	70
												EHK7-60	57.6	57.8	2.6	71.3	80
												EHK7-75	72.0	72.3	2.6	85.8	100
DBC3007V	575-3-60	14.7	100.0	14.7	100.0	2	1.00	1.6	2-speed Belt Drive	7.50	8.2	-	-	-	-	44.6	50
												EHK7-31	28.8	28.9	-	46.4	50
												EHK7-46	43.2	43.4	-	64.5	70
												EHK7-60	57.6	57.8	-	68.1	80
												EHK7-75	72.0	72.3	-	82.5	100
												-	-	-	2.6	47.2	60
												EHK7-31	28.8	28.9	2.6	49.6	60
												EHK7-46	43.2	43.4	2.6	67.7	70
												EHK7-60	57.6	57.8	2.6	71.3	80
												EHK7-75	72.0	72.3	2.6	85.8	100

## Heat Kit Electrical Data (Blower Only, Heat Mode)

### DBC1803 @ 208 / 240V – 15 TONS

MODEL	RECOMMENDED AIRFLOW RANGE
EHK3-31	5250 - 6750 CFM
EHK3-46	5250 - 6750 CFM
EHK3-60	5250 - 6750 CFM

### DBC1804 @ 480V – 15 TONS

MODEL	RECOMMENDED AIRFLOW RANGE
EHK4-31	5250 - 6750 CFM
EHK4-46	5250 - 6750 CFM
EHK4-60	5250 - 6750 CFM

### DBC1807 @575V – 15 TONS

MODEL	RECOMMENDED AIRFLOW RANGE
EHK7-31	5250 - 6750 CFM
EHK7-46	5250 - 6750 CFM
EHK7-60	5250 - 6750 CFM

### DBC3003 @ 240 / 240V – 25 TONS

MODEL	AIRFLOW RANGE
EHK3-31	7200 - 8500 CFM
EHK3-46	7200 - 8500 CFM
EHK3-60	7200 - 8500 CFM
EHK3-75	7200 - 8500 CFM

### DBC3004@ 480V – 25 TONS

MODEL	AIRFLOW RANGE
EHK4-31	7200 - 8500 CFM
EHK4-46	7200 - 8500 CFM
EHK4-60	7200 - 8500 CFM
EHK4-75	7200 - 8500 CFM

### DBC3007@ 575V – 25 TONS

MODEL	AIRFLOW RANGE
EHK7-31	7200 - 8500 CFM
EHK7-46	7200 - 8500 CFM
EHK7-60	7200 - 8500 CFM
EHK7-75	7200 - 8500 CFM

### DBC2403 @ 208 / 240V – 20 TONS

MODEL	RECOMMENDED AIRFLOW RANGE
EHK3-31	7200 - 8500 CFM
EHK3-46	7200 - 8500 CFM
EHK3-60	7200 - 8500 CFM
EHK3-75	7200 - 8500 CFM

### DBC2404 @ 480V – 20 TONS

MODEL	RECOMMENDED AIRFLOW RANGE
EHK4-31	7200 - 8500 CFM
EHK4-46	7200 - 8500 CFM
EHK4-60	7200 - 8500 CFM
EHK4-75	7200 - 8500 CFM

### DBC2407 @575V – 20 TONS

MODEL	RECOMMENDED AIRFLOW RANGE
EHK7-31	7200 - 8500 CFM
EHK7-46	7200 - 8500 CFM
EHK7-60	7200 - 8500 CFM
EHK7-75	7200 - 8500 CFM

Note: When using electric heat kit, the single-point kit installed in the unit is needed to meet UL requirements.

## kW Correction Factors

kW CORRECTION FACTOR (FOR 208/230V UNITS)					
SUPPLY VOLTAGE	240	230	220	210	208
CORRECTION FACTOR	1	0.92	0.84	0.77	0.75

kW CORRECTION FACTOR (FOR 460V UNITS)			
SUPPLY VOLTAGE	460	440	430
CORRECTION FACTOR	0.92	0.84	0.8

kW CORRECTION FACTOR (FOR 575V UNITS)			
SUPPLY VOLTAGE	560	550	540
CORRECTION FACTOR	0.95	0.91	0.88

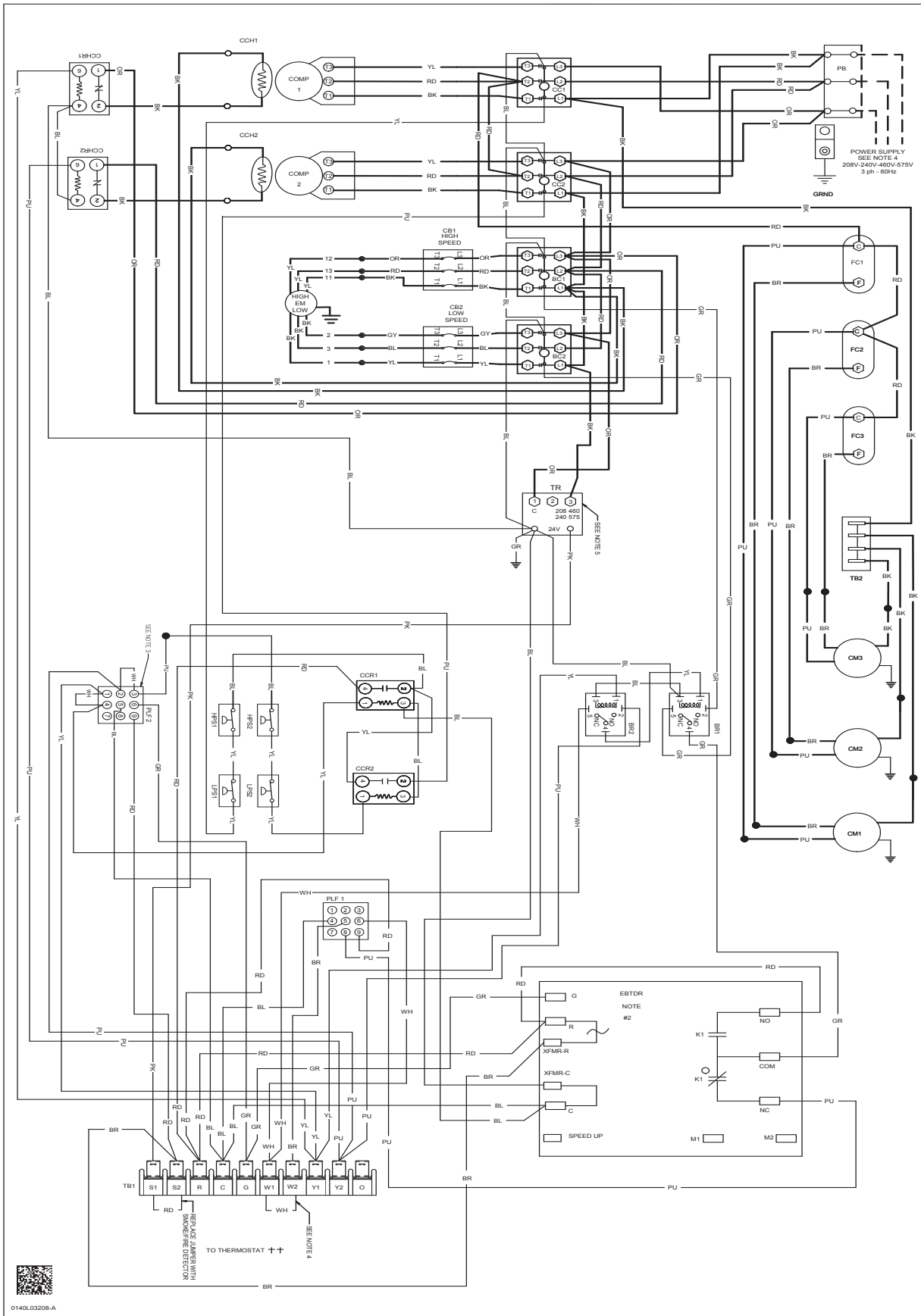

**WARNING**

High Voltage: Disconnect all power before servicing or installing this unit. Multiple power sources may be present. Failure to do so may cause property damage, personal injury, or death.

Wiring is subject to change. Always refer to the wiring diagram on the unit for the most up-to-date wiring.

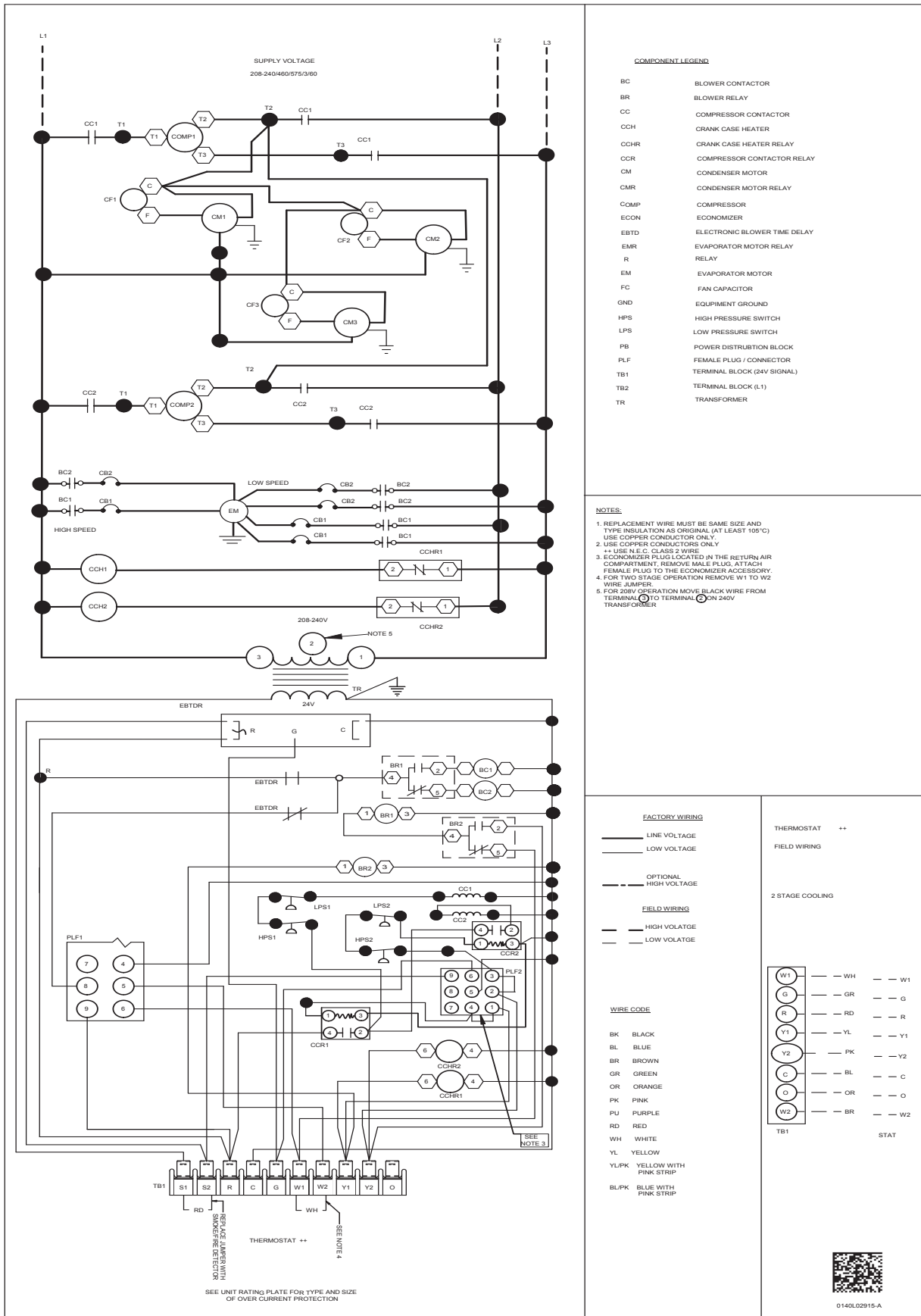

**High Voltage:** Disconnect all power before servicing or installing this unit. Multiple power sources may be present. Failure to do so may cause property damage, personal injury, or death.

**WARNING**

Wiring is subject to change. Always refer to the wiring diagram on the unit for the most up-to-date wiring.

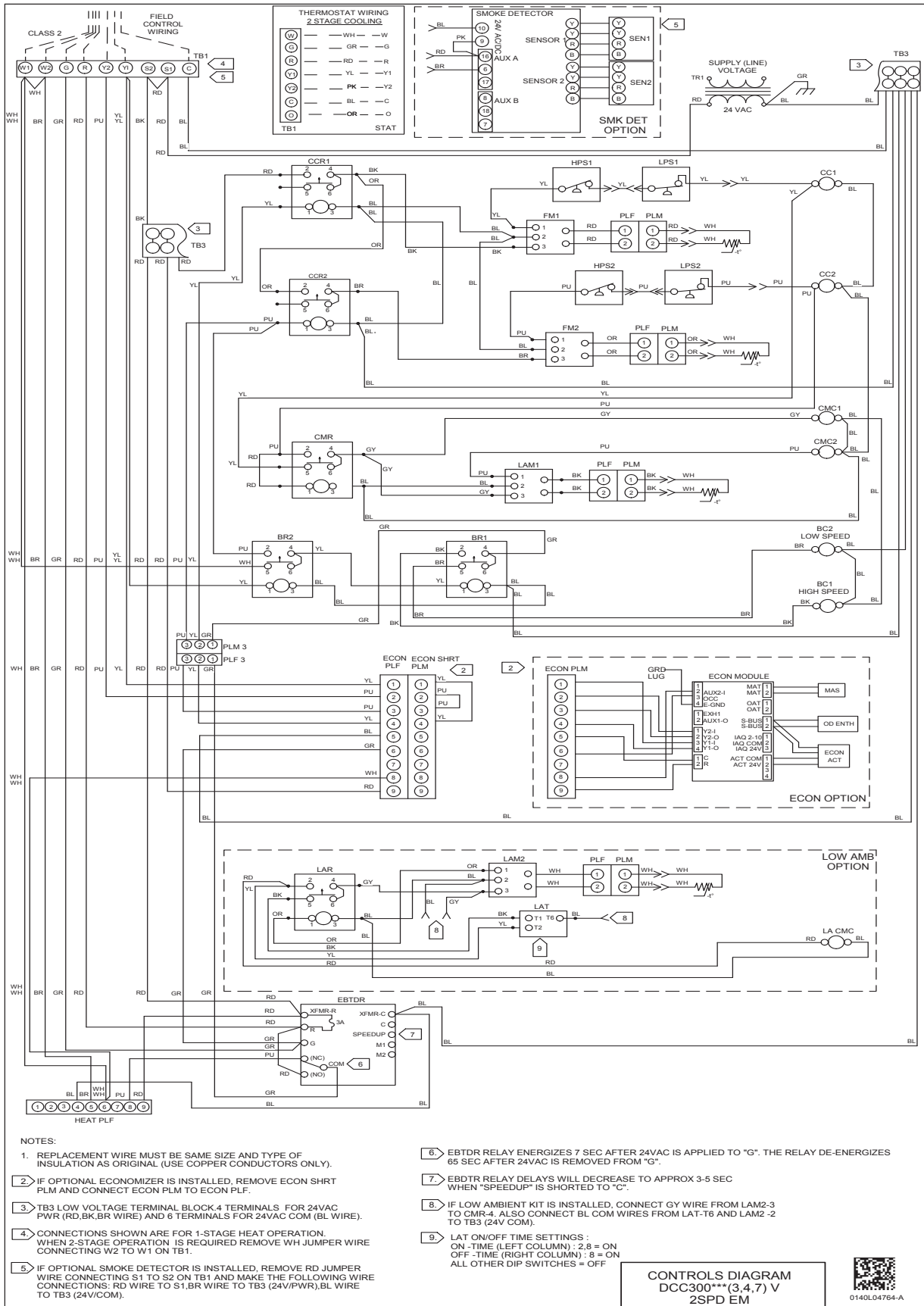

**High Voltage:** Disconnect all power before servicing or installing this unit. Multiple power sources may be present. Failure to do so may cause property damage, personal injury, or death.

**WARNING**

Wiring is subject to change. Always refer to the wiring diagram on the unit for the most up-to-date wiring.

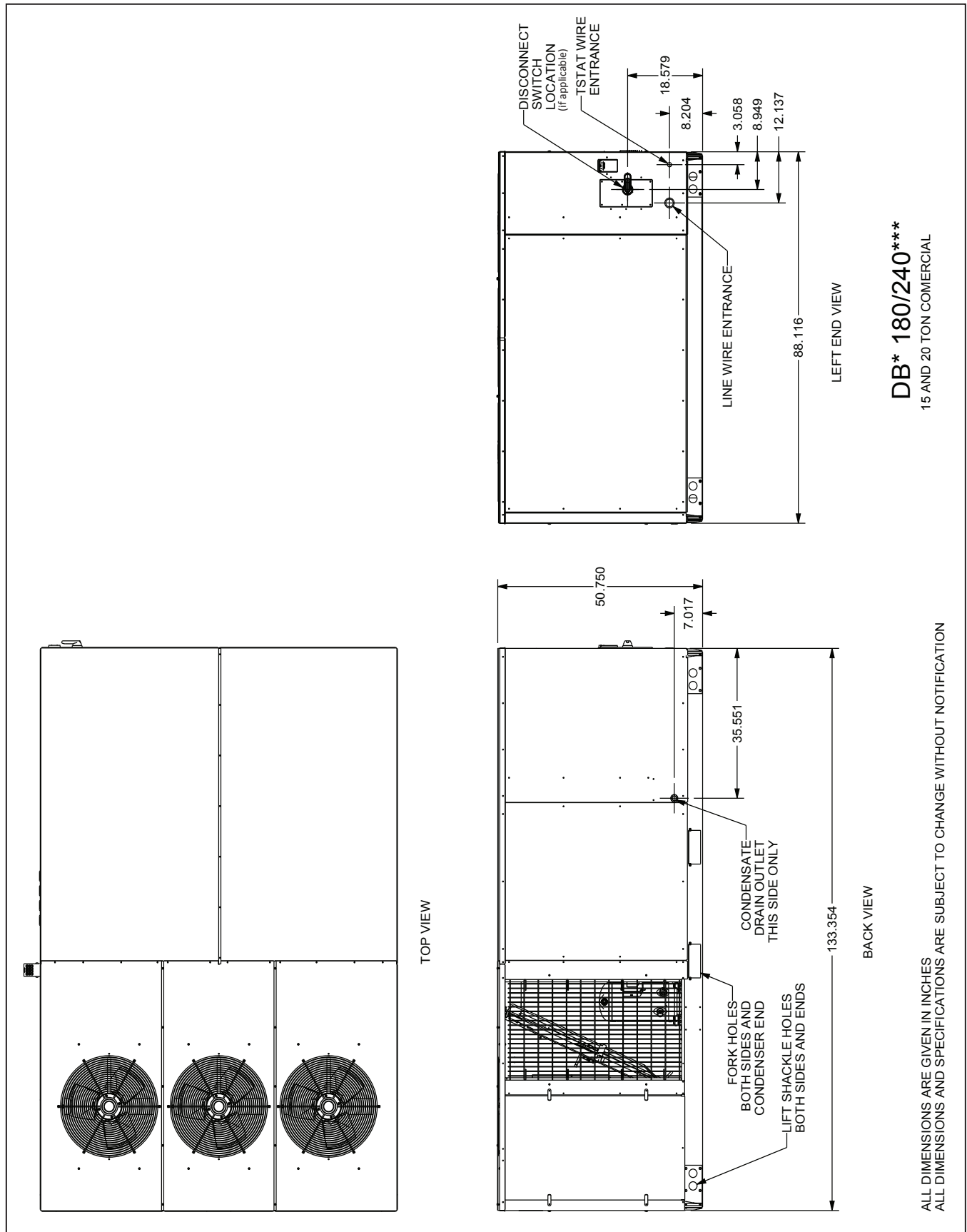

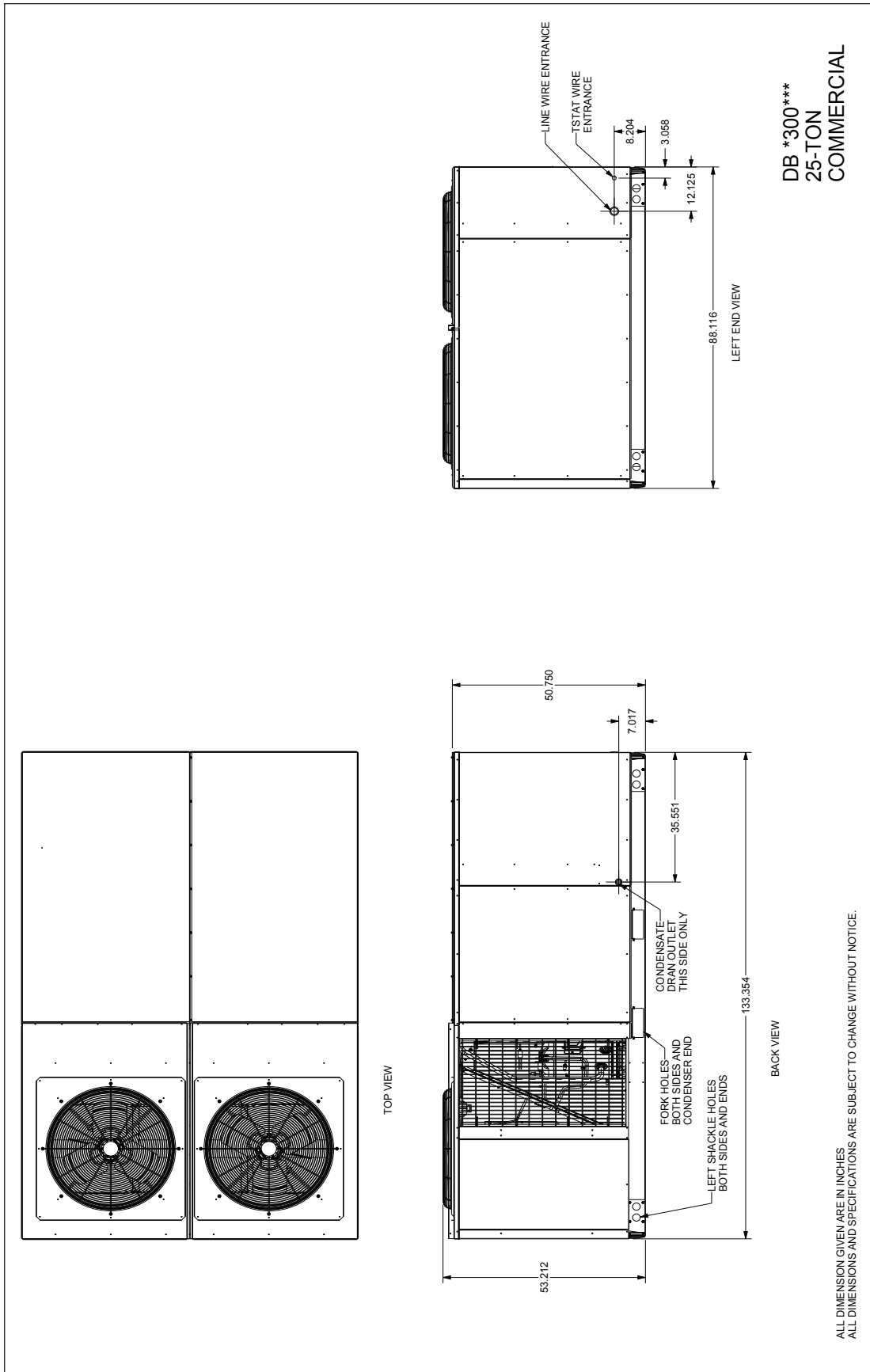

# Unit Clearances

## Electrical Entrance Locations

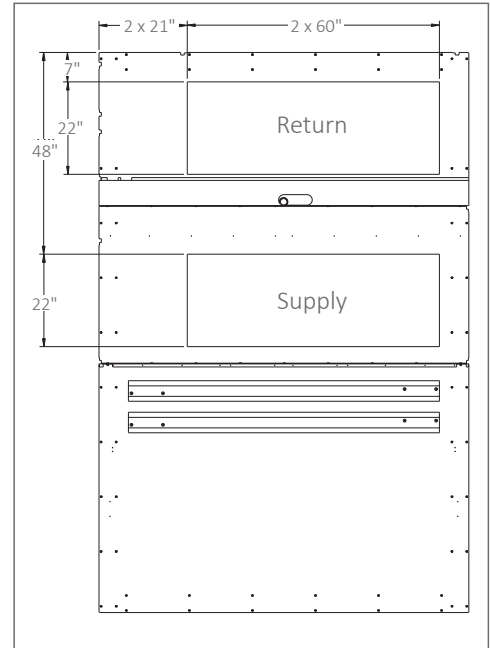
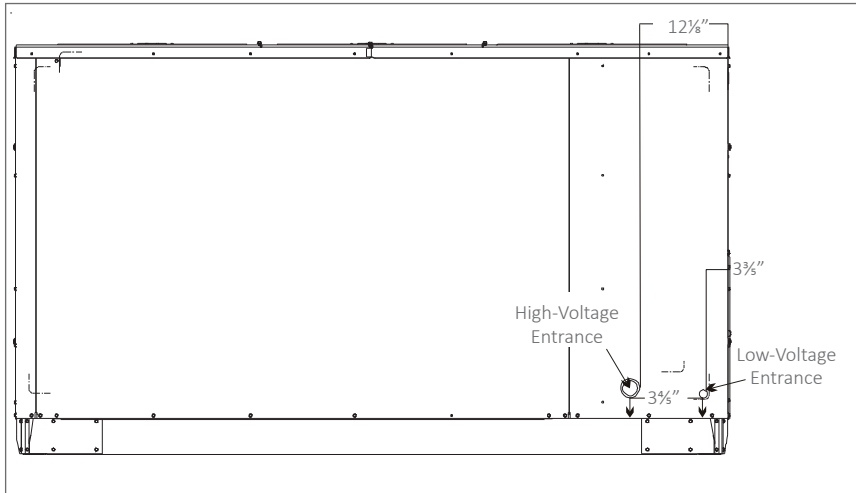

## Service Clearance

Allow for recommended service clearances as shown in the image below. In situations that have multiple units, a 36" minimum clearance is required between the condenser coils. A clearance of 48" is recommended on all sides of the unit to allow service access and to insure proper ventilation and condenser airflow. The top of the unit should be unobstructed. Provide a roof walkway along the sides of the unit for service and access to controls and components. Contact your Daikin sales representative for service requirements less than those recommended.

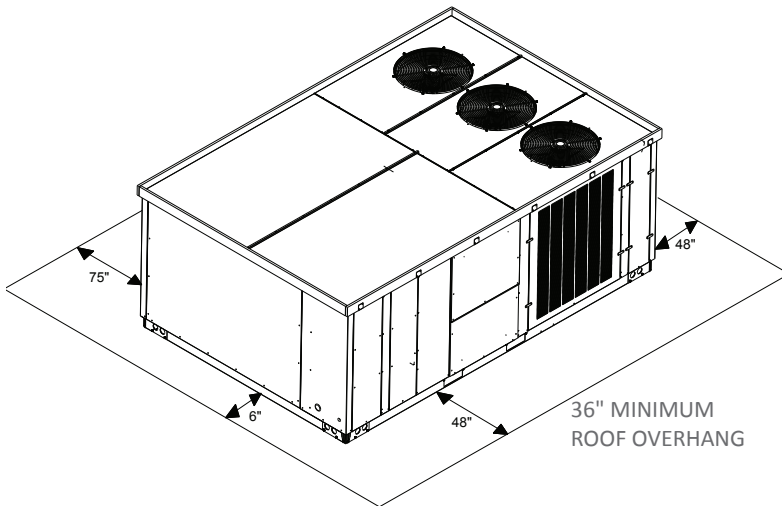

# Installation

## Unit Location

The structural engineer must verify that the roof has adequate support and ability to minimize deflection. Take extreme caution when using on a wooden roof structure. Unit condenser coils should be in a location that avoids any heated exhaust air.

Allow sufficient space around the unit for maintenance/service clearance. Consult your Daikin sales representative if available clearances do not meet minimum recommendations.

Where code considerations, such as the NEC, require extended clearances, these take precedence.

Provisions for forks have been included in the unit base frame. No other fork locations are approved.

- » Unit must be lifted by the four lifting holes located at the base frame corners.
- » Lifting cables should be attached to the unit with shackles.
- » The distance between the crane hook and the top of the unit must not be less than 60".
- » Two spreader bars must span over the unit to prevent damage to the cabinet by the lift cables. Spreader bars must be of sufficient length so that cables do not come in contact with the unit during transport. Remove wood struts mounted beneath unit base frame before setting unit on roof curb. These struts are intended to protect unit base frame from fork lift damage. To remove the struts, extract the sheet metal retainers and pull the struts through the base of the unit. Refer to rigging label on the unit.

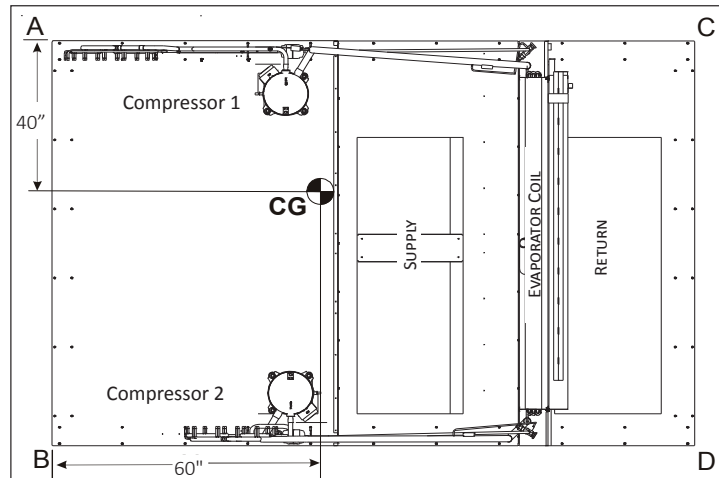
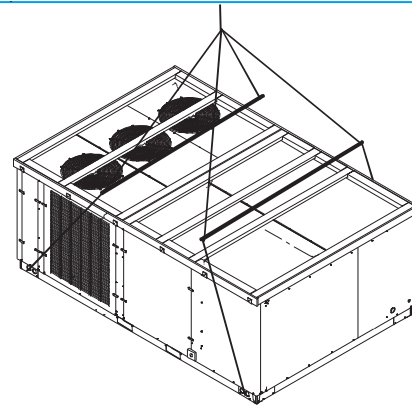

CORNER & CENTER-OF-GRAVITY LOCATIONS

**Important:** If using bottom discharge with roof curb, duct-work should be attached to the curb prior to installing the unit. Refer to the Roof Curb Installation Instructions for proper curb installation. Curbing must be installed in compliance with the National Roofing Contractors Association Manual. Lower unit carefully onto roof mounting curb. While rigging the unit, the center of gravity will cause the condenser end to be lower than the supply air end. Bring condenser end of unit into alignment with the curb. With condenser end of the unit resting on curb member and using curb as a fulcrum, lower opposite end of the unit until entire unit is seated on the curb. When a rectangular cantilever curb is used, take care to center the unit. Check for proper alignment and orientation of supply and return openings with duct. For further and more detailed information please refer to our Daikin Light Commercial Packaged unit IOD.

## Roof Curb Installation

The roof curb is field-assembled and must be installed level (within 1/16" per foot side to side). A sub-base must be constructed by the contractor in applications involving pitched roofs. Gaskets are furnished and must be installed between the unit and curb. For proper installation, follow NRCA guidelines. In applications requiring post and rail installation, an I-beam securely mounted on multiple posts should support the unit on each side. In addition, the insulation on the underside of the unit should be protected from the elements. Applications in geographic areas subjected to seismic or hurricane conditions must meet code requirements for fastening the unit to the curb and the curb to the building structure.

## Weights

15-TON UNITS	WEIGHTS (BLS.)
Weight A	590
Weight B	482
Weight C	492
Weight D	401
Shipping Weight	2080
Operating Weight	1965

20-TON UNITS	WEIGHTS (LBS.)
Weight A	644
Weight B	525
Weight C	504
Weight D	412
Shipping Weight	2202
Operating Weight	2085

25-TON UNITS	WEIGHTS (LBS.)
Weight A	626
Weight B	464
Weight C	501
Weight D	518
Shipping Weight	2377
Operating Weight	2109

Note: These weights are calculated without installed accessories.

## Accessories

Daikin Master Item #	Description	Fits Model Sizes	Field-Installed	Factory-Installed	Operating Weight (lbs)
<b>Curb</b>					
14CURB180300	14" Roof Curb	15-25 tons	√		285
18CURB180300	18" Roof Curb	15-25 tons	√		315
24CURB180300	24" Roof Curb	15-25 tons	√		360
GHRC-180300	Hurricane Restraint Clips	15-25 tons	√		2
<b>Ultra Low-Leak Downflow Economizer &amp; Power Exhaust<sup>1</sup></b>					
SDNECNJ180300B	Ultra Low-Leak Downflow Economizer w/ Enthalpy	15-25 tons	√	√	281
SPE1803002	Downflow Power Exhaust 208/230v	15-25 tons	√		98
SPE1803004	Downflow Power Exhaust 460v	15-25 tons	√		98
SPE1803007	Downflow Power Exhaust 575v	15-25 tons	√		98
<b>Ultra Low-Leak Horizontal Economizer &amp; Power Exhaust<sup>1</sup></b>					
SHZECNJ180300B	Ultra Low-Leak Horizontal Economizer w/ Enthalpy	15-25 tons	√		416
SHPE1803002	Horizontal Power Exhaust 208/230v	15-25 tons	√		200
SHPE1803004	Horizontal Power Exhaust 460v	15-25 tons	√		200
SHPE1803007	Horizontal Power Exhaust 575v	15-25 tons	√		200
<b>Downflow Accessories</b>					
S25FD180300	25% Manual Fresh Air Damper	15-25 tons	√		34
S25MFD180300	25% Motorized Fresh Air Damper	15-25 tons	√		42
S50MFD180300	50% Motorized Fresh Air Damper	15-25 tons	√		42
DNBBS180300	Burglar Bar Sleeves with Supply and Return	15-25 tons	√		60
<b>Horizontal Accessories</b>					
SBRD180300	Barometric Relief	15-25 tons	√		30
HZCURB180300EDR	Horizontal Curb End Discharge Roofed In	15-25 tons	√		950
HZCURB180300NSR	Horizontal Curb Non-Service Side Discharge Roofed In	15-25 tons	√		950
HZCURB180300SSR	Horizontal Curb Service Side Discharge Roofed In	15-25 tons	√		950
HZCURB180300EDS	Horizontal Curb End Discharge Slab Mount	15-25 tons	√		850
HZCURB180300NSS	Horizontal Curb Non-Service Side Discharge Slab Mount	15-25 tons	√		850
HZCURB180300SSS	Horizontal Curb Service Side Discharge Slab Mount	15-25 tons	√		850
SHZE25FD180300	Horizontal Fresh Air Damper 25%	15-25 tons	√		75
SHZRETPNL180300	Horizontal Return Panel	15-25 tons	√		50
<b>Concentrics</b>					
CDK300-530	Concentric Duct Kit Step-Down Diffuser	25 tons	√		244
CDK180	Concentric Duct Kit	15 tons	√		158
CDK240	Concentric Duct Kit	20 tons	√		197
CDK300	Concentric Duct Kit Flush Mount Diffuser	25 tons	√		244
<b>High-Static Kits</b>					
	High static, factory-installed, 230V	15 ton		√	50
	High static, factory-installed, 460V	15 ton		√	50
	High static, factory-installed, 575V	15 ton		√	50
	High static, factory-installed, 230V	20 ton		√	50
	High static, factory-installed, 460V	20 ton		√	50
	High static, factory-installed, 575V	20 ton		√	50
	High static, factory-installed, 25 ton, all voltages	25 ton		√	8
<b>3 phase 208-230V Electric Heat Kits</b>					
EHK3-31	30kw 208-230v 3ph Electric Heat Kit	15-25 tons	√	√	21
EHK3-46	40kw 208-230v 3ph Electric Heat Kit	15-25 tons	√	√	21
EHK3-60	60kw 208-230v 3ph Electric Heat Kit	15-25 tons	√	√	21
EHK3-75	75kw 208-230v 3ph Electric Heat Kit	20 - 25 tons	√	√	21

## Accessories

Daikin Master Item #	Description	Fits Model Sizes	Field-Installed	Factory-Installed	Operating Weight (lbs)
<b>3 phase 460V Electric Heat Kits</b>					
EHK4-31	30kw 460v 3ph Electric Heat Kit	15-25 tons	√	√	21
EHK4-46	40kw 460v 3ph Electric Heat Kit	15-25 tons	√	√	21
EHK4-60	60kw 460v 3ph Electric Heat Kit	15-25 tons	√	√	21
EHK4-75	75kw 460v 3ph Electric Heat Kit	20 - 25 tons	√	√	21
<b>3 phase 575V Electric Heat Kits</b>					
EHK7-31	30kw 575v 3ph Electric Heat Kit	15-25 tons	√	√	21
EHK7-46	40kw 575v 3ph Electric Heat Kit	15-25 tons	√	√	21
EHK7-60	60kw 575v 3ph Electric Heat Kit	15-25 tons	√	√	21
EHK7-75	75kw 575v 3ph Electric Heat Kit	20 - 25 tons	√	√	21
<b>High-Static Kits</b>					
	High static, factory-installed, 230V	15 ton		√	80
	High static, factory-installed, 460V	15 ton		√	80
	High static, factory-installed, 575V	15 ton		√	80
	High static, factory-installed, 230V	20 ton		√	50
	High static, factory-installed, 460V	20 ton		√	50
	High static, factory-installed, 575V	20 ton		√	50
	High static, factory-installed, 25 ton, all voltages	25 ton		√	8
<b>High Efficiency Filters</b>					
0160L00202	High Efficiency MERV 13 Air Filter Nom. Size: 20x25x2; (Order Qty 6)	15, 20 tons	√		9
0160L00201	High Efficiency MERV 13 Air Filter Nom. Size: 20x20x2; (Order Qty 8)	25 tons	√		11
<b>Thermostats</b>					
250803400	AppStat RTU 2H/2C Econ	15-25 tons	√		1
DT4272C	Comm Touch Digital Stat w/ WiFi 4h/2c	15-25 tons	√		1
DT4273C	Comm Touch Digital Stat w/ WiFi and Humidity Control 4h/2c	15-25 tons	√		1
<b>Sensors</b>					
C7232B1022	CO <sub>2</sub> Sensor (Duct Mtd)	15-25 tons	√		1
C7400S1000	Differential Enthalpy Sensor	15-25 tons	√		1
D4120	Smoke Detector- Duct Mounted	15-25 tons	√		1
D4120W	Smoke Detector- Watertight	15-25 tons	√		1
TSTATGAC-WS	Remote indoor sensor	15-25 tons	√		1
<b>Misc Accessories</b>					
	Convenience Outlet: Powered 208/230v, 460v	15-25 tons		√	42
	Convenience Outlet: Powered 575v	15-25 tons		√	42
	Convenience Outlet: Non Powered	15-25 tons		√	2
	Disconnect Switch (non-fused)	15-25 tons		√	5
LAKT23	Low-Ambient Kit, 208-230V - non-DDC	15-20 tons	√	√	32
LAKT24	Low-Ambient Kit, 460V - non-DDC	15-20 tons	√	√	32
LAKT25	Low-Ambient Kit, 575V - non-DDC	15-20 tons	√	√	32
LAKT05	Low-Ambient Kit (all voltages) - non-DDC	25 tons	√	√	2
3PMNDK01	Phase Monitor - Non DDC	15-25 tons	√	√	2
	Smoke Detector (supply and/or return air)	15-25 tons		√	11
	Hinged Panels	15-25 tons		√	34
FSKT02A	Freeze Stat Kit <sup>2</sup>	25 tons	√		1

<sup>1</sup> Use Economizer & Power Exhaust listed within Ultra Low-Leak section

<sup>2</sup> FSK02A is standard on 2 speed, V, models.

**Note:** Where multiple variations are available, the heaviest combination is listed.

### Factory Installed Options

- » **High-Static Kit:** Allows for operation in higher static applications.
- » **Non-Powered Convenience Outlet:** A 120V, 15A, GFCI outlet can be installed in the unit making it easier for technicians to service other units once an electrician runs power to the outlet. Outlet shall be factory-installed and internally mounted with easily accessible 115-v female receptacle. Transformer not included for this option. Outlet shall include a field-installed “While-in-use” cover.
- » **Powered Convenience Outlet:** A 120V, 15A, GFCI outlet can be powered with a step-transformer built into the unit. For use when the unit is not running. When a factory-installed powered convenience outlet is installed in the equipment, the unit MCA (Min. Circuit Ampacity) will increase by 7.5A for 208/230V units; increase by 3.75A for 460V units; and by 3A for 575V units. The MOP (Max. Overcurrent Protection) device must be sized accordingly. Outlet shall be powered from main line power to the rooftop unit. Outlet shall include a field-installed “While-in-use” cover.
- » **Return Air and/or Supply Air Smoke Detectors:** Return air and/or supply air smoke detectors can be installed in the unit. To safely identify the presence of smoke inside the air conditioning system and shutdown the blower to prevent the smoke to disperse into different zones.
- » **Disconnect Switch (non-fused):** A disconnect switch can be installed in the unit with factory wiring complete from the switch to the unit. Please note that for air conditioner and heat pump units, the appropriate electric heat kit must be ordered along with the disconnect switch (non-fused) to be factory-installed. For models with a powered convenience outlet option and a disconnect switch (non-fused) option, the power to the powered convenience outlet will be shut off when the disconnect switch (non-fused) is in the off position. National Electric Code (NEC) and UL approved non-fused switch shall provide unit power shutoff. The switch shall be accessible from outside of the unit and provide local shutdown and lockout capability.
- » **Hinged Access Panels:** Allows access to unit’s major components. Combined with latches for easy access to control box, compressor, filters and blower motor.
- » **Electromechanical Controls:** Basic controls that include terminal block for unit connectivity to T-Stat.
- energized when dampers open past the 0-100% adjustable setpoint on the economizer control. (Damper to be field installed, all wiring and accessory set up is factory installed)
- » **Manual Fresh Air Damper:** Manual damper package shall consist of damper, air inlet screen, and rain hood which can be preset to admit up to 30% outdoor air for year round ventilation.
- » **Motorized Fresh Air Damper:** A two-position damper with rain hood and screen provides 30% outside air when the indoor fan starts and closes when the indoor fan shuts down. Consist of actuator, damper, air inlet screen, and rain hood. Damper shall close upon indoor (evaporator) fan shutoff and/or loss of power. The damper actuator shall plug into the rooftop unit’s wiring harness plug. No hard wiring shall be required.
- » **Horizontal Economizer:** Fully modulating between 0 and 100%, contain seals that meet ASHRAE 90.1 requirements. Includes motor and dampers, minimum position settings, preset linkage, wiring harness with plug, mixed air temperature sensor, and enthalpy control. An optional duct-mounted barometric relief damper is available. An optional return enthalpy sensor is available to provide comparative or differential enthalpy control. Damper blades shall be galvanized steel with composite gears. Plastic or composite blades on intake or return shall not be acceptable. Standard leak rate shall be equipped with dampers not to exceed 2% leakage at 1 in. wg pressure differential. Ultra Low Leak design meets California Title 24 section 140.4 and ASHRAE90.1 requirements for 4 cfm per sq. ft. on the outside air dampers and 10 cfm per sq. ft. on the return dampers. Shall be designed to close damper(s) during loss-of-power situations with spring return built into motor. Economizer controller shall accept a 2-10 Vdc CO<sub>2</sub> sensor input for IAQ/DCV control. In this mode, dampers shall modulate the outdoor air damper to provide ventilation based on the sensor input.
- » Economizer controller shall be Honeywell JADE™ W7220 that provides:
  - 2-line LCD interface screen for setup, configuration and troubleshooting.
  - On-board Fault Detection and Diagnostics (FDD) that senses and alerts when the economizer is not operating properly, per California Title 24.
  - Sensor failure loss of communication identification
  - Automatic sensor detection
  - Capabilities for use with multiple-speed indoor fan systems
  - Utilize digital sensors: Dry bulb and Enthalpy
  - Economizer controller shall provide indications when in free cooling mode, in the DCV mode, or the exhaust fan contact is closed.

### Field Installed Options

- » **Power Exhaust:** Power exhaust shall be used in conjunction with an integrated economizer. This accessory exhausts return air and may be used in either downflow or horizontal (duct-mounted) applications. Horizontal power exhaust is mounted in return ductwork. Power exhaust shall be controlled by economizer controller operation. Exhaust fans shall be

## Field Installed Options

- » **Barometric relief (only when economizer is installed):** Allows air pressure relief inside the building to maintain a constant interior pressure.
  - » **Roof curbs:** Full perimeter roof curb with exhaust capability providing separate air streams for energy recovery from the exhaust air without supply air contamination. Two different heights 14" and 24", allows proper installation and structure stability. Formed galvanized steel with wood nailer strip and shall be capable of supporting entire unit weight.
  - » **Concentric duct kits:** designed to provide a single point air distribution system with the added benefit of having directional air control.
  - » **Restraint mounting clips:** Allows for installation reinforcement for Hurricane and/or seismic events.
  - » **Burglar Bar Sleeves:** Designed to prevent the access thru the return or supply ducting inside the unit.
  - » **Downflow square to round adapter 18":** Installed into a recessed portion of the roof curb, the concentric duct adaptor changes the orientation of the ductwork from square to round for applications utilizing that type of ducting system.
  - » **Side discharge concentric diffuser system:** The Concentric diffuser system is an all in one supply and return duct free arrangement for RTU systems. This system comes with two separate duct connections, one for a supply and another for a return.
  - » **Remote indoor sensor:** Remote sensor to monitor the temperature on zones away from the main thermostat.
  - » **Drain pan overflow switch:** Allows the controls to detect and send an alarm when there is an overflow on the drain pan.
  - » **Filtration:** MERV13 filters available for high air filtration requirements.
  - » **Freeze stat:** Temperature sensing device that monitors the heat exchange to prevent the coil from freezing.
- acceptable. Standard leak rate shall be equipped with dampers not to exceed 2% leakage at 1 in. wg pressure differential. Ultra Low Leak design meets California Title 24 section 140.4 and ASHRAE90.1 requirements for 4 cfm per sq. ft. on the outside air dampers and 10 cfm per sq. ft. on the return dampers. Shall be designed to close damper(s) during loss-of-power situations with spring return built into motor. Economizer controller shall accept a 2-10 Vdc CO2 sensor input for IAQ/DCV control. In this mode, dampers shall modulate the outdoor air damper to provide ventilation based on the sensor input.
- » Economizer controller shall be Honeywell W7220 that provides:
    - 2-line LCD interface screen for setup, configuration and troubleshooting.
    - On-board Fault Detection and Diagnostics (FDD) that senses and alerts when the economizer is not operating properly, per California Title 24.
    - Sensor failure loss of communication identification
    - Automatic sensor detection
    - Capabilities for use with multiple-speed indoor fan systems
    - Utilize digital sensors: Dry bulb and Enthalpy
    - Economizer controller shall provide indications when in free cooling mode, in the DCV mode, or the exhaust fan contact is closed.
  - » **Low Ambient Control:** Allows cooling operation to 0°F outdoor ambient temperature for 7½ - 20 ton units and to 35°F outdoor ambient temperature for 3 - 6 ton units. For 25 ton units, cooling operation is extended from 24°F ambient temperature to 0°F outside air temperature.
  - » **Electric Heat Kits (AC units):** Heater elements are constructed of rust-resistant nickel chromium and are available in 240V-1-phase-60Hz, 240V-3-phase-60Hz, 480V-3-phase-60Hz and 575V-3-phase-60Hz. All heaters have overcurrent protection and high-temperature limit control. A single point wiring connection is provided through a terminal block. Electric heaters are provided with staged heating as standard.
  - » **Phase Monitor:** Phase monitor shall provide protection for motors and compressors against problems caused by phase loss, phase reversal and phase unbalance. Phase monitor is equipped with an LED that provides an ON or FAULT indicator.

## Factory and Field Installed Options

- » **Downflow Economizer:** Fully modulating between 0 and 100%, contain seals that meet ASHRAE 90.1 requirements. Includes motor and dampers, minimum position settings, a preset linkage, a wiring harness with plug, a mixed air temperature sensor, enthalpy control, and a barometric relief damper. An optional return enthalpy sensor is available to provide comparative or differential enthalpy control. Damper blades shall be galvanized steel with composite gears. Plastic or composite blades on intake or return shall not be



