



SiUS071735EA

**R-410A**

# Service Manual

## Inverter Pair Duct Connected Type FDMQ-R Series

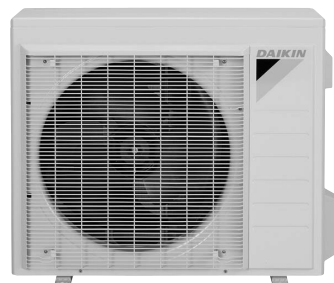
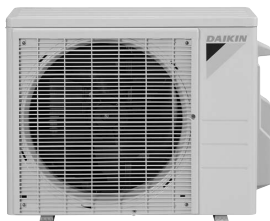

[Applied Models]

- Inverter Pair : Heat Pump

---

# **Inverter Pair Duct Connected Type FDMQ-R Series**

## **●Heat Pump**

### **Indoor Unit**

**FDMQ09RVJU  
FDMQ12RVJU  
FDMQ15RVJU  
FDMQ18RVJU  
FDMQ24RVJU**

### **Outdoor Unit**

**RX09RMVJU  
RX09RMVJU9  
RX12RMVJU  
RX12RMVJU9  
RX15RMVJU  
RX15RMVJUA  
RX18RMVJU  
RX18RMVJU9  
RX18RMVJU9A  
RX24RMVJU  
RX24RMVJUA**

1. Safety Cautions.....	v
1.1 Warnings and Cautions Regarding Safety of Workers.....	v
1.2 Warnings and Cautions Regarding Safety of Users.....	vii
2. Icons Used .....	x
<b>Part 1 List of Functions .....</b>	<b>1</b>
1. Functions.....	2
<b>Part 2 Specifications .....</b>	<b>3</b>
1. Specifications .....	4
<b>Part 3 Printed Circuit Board Connector Wiring Diagram .....</b>	<b>8</b>
1. Indoor Unit.....	9
1.1 FDMQ09/12/15/18/24RVJU .....	9
2. Wired Remote Controller.....	11
2.1 BRC1E73 .....	11
3. Wireless Remote Controller Receiver .....	12
3.1 BRC082A43 .....	12
4. Outdoor Unit.....	13
4.1 RX09/12RMVJU(9).....	13
4.2 RX15/24RMVJU(A), RX18RMVJU(9)(A).....	14
<b>Part 4 Functions and Control.....</b>	<b>15</b>
1. Main Functions.....	16
1.1 Temperature Control .....	16
1.2 Frequency Principle.....	16
1.3 Fan Speed Control for Indoor Unit .....	18
1.4 Program Dry Operation .....	19
1.5 Clock and Calendar Setting (With Wired Remote Controller BRC1E73) ...	20
1.6 Schedule TIMER Operation (With Wired Remote Controller BRC1E73) ...	22
1.7 Drain Pump Control.....	25
1.8 Hot Start Control (In Heating Operation Only).....	27
1.9 Other Functions.....	28
2. Control Specification .....	29
2.1 Mode Hierarchy .....	29
2.2 Frequency Control.....	30
2.3 Controls at Mode Changing/Start-up.....	32
2.4 Discharge Pipe Temperature Control.....	34
2.5 Input Current Control.....	35
2.6 Freeze-up Protection Control .....	36
2.7 Heating Peak-cut Control .....	37
2.8 Outdoor Fan Control.....	38
2.9 Liquid Compression Protection Function.....	38
2.10 Defrost Control .....	39

2.11 Electronic Expansion Valve Control .....	40
2.12 Malfunctions .....	43

## **Part 5 Remote Controller ..... 44**

1. Wired Remote Controller (BRC1E73) .....	45
2. Wireless Remote Controller (BRC082A43) .....	51

## **Part 6 Service Diagnosis..... 53**

1. General Problem Symptoms and Check Items .....	55
2. Troubleshooting with LED .....	56
2.1 Indoor Unit.....	56
2.2 Outdoor Unit.....	56
3. Service Diagnosis .....	57
3.1 Wired Remote Controller (BRC1E73) .....	57
3.2 Wireless Remote Controller (BRC082A43) .....	59
4. Troubleshooting .....	63
4.1 Error Codes and Description .....	63
4.2 Indoor Unit PCB Abnormality .....	64
4.3 Drain Level Control System Abnormality.....	65
4.4 Indoor Fan Motor (DC Motor) or Related Abnormality .....	66
4.5 Indoor Fan PCB Abnormality.....	68
4.6 Humidifier or Related Abnormality.....	69
4.7 Thermistor or Related Abnormality.....	70
4.8 Remote Controller Thermistor Abnormality .....	71
4.9 Signal Transmission Error (Between Indoor Unit and Remote Controller) .....	72
4.10 Signal Transmission Error (Between MAIN Remote Controller and SUB Remote Controller) .....	73
4.11 Low-voltage Detection or Over-voltage Detection.....	74
4.12 Signal Transmission Error (Between Indoor Unit and Outdoor Unit).....	76
4.13 Mismatching of Indoor Unit and Outdoor Unit .....	78
4.14 Outdoor Unit PCB Abnormality.....	79
4.15 OL Activation (Compressor Overload) .....	80
4.16 Compressor Lock .....	82
4.17 DC Fan Lock (Outdoor Fan Motor).....	83
4.18 Input Overcurrent Detection .....	84
4.19 Four Way Valve Abnormality .....	85
4.20 Discharge Pipe Temperature Control.....	87
4.21 High Pressure Control in Cooling .....	88
4.22 System Shutdown due to Compressor Internal Temperature Abnormality .....	90
4.23 Compressor System Sensor Abnormality .....	91
4.24 Position Sensor Abnormality .....	92
4.25 Thermistor or Related Abnormality (Outdoor Unit).....	94
4.26 Electrical Box Temperature Rise .....	96
4.27 Radiation Fin Temperature Rise .....	97





4.28 Output Overcurrent Detection .....	98
5. Check .....	100
5.1 Thermistor Resistance Check .....	100
5.2 Indoor Fan Motor Connector Check .....	101
5.3 Power Supply Waveforms Check .....	101
5.4 Electronic Expansion Valve Check.....	102
5.5 Four Way Valve Performance Check .....	103
5.6 Inverter Unit Refrigerant System Check.....	103
5.7 Inverter Analyzer Check.....	104
5.8 Rotation Pulse Check on the Outdoor Unit PCB.....	106
5.9 Installation Condition Check.....	107
5.10 Discharge Pressure Check.....	107
5.11 Outdoor Fan System Check .....	108
5.12 Main Circuit Short Check.....	108
5.13 Power Module Check .....	110
<b>Part 7 Trial Operation and Field Settings.....</b>	<b>112</b>
1. Pump Down Operation.....	113
2. Forced Cooling Operation .....	114
3. Trial Operation .....	115
4. Field Settings .....	118
4.1 How to Change the Field Settings.....	118
4.2 Overview of the Field Settings.....	121
4.3 MAIN/SUB and Address Setting for Wireless Remote Controller .....	122
4.4 Facility Setting (cooling at low outdoor temperature) .....	124
5. Silicone Grease on Power Transistor/Diode Bridge.....	125
<b>Part 8 Appendix.....</b>	<b>126</b>
1. Piping Diagrams.....	127
1.1 Indoor Unit.....	127
1.2 Outdoor Unit.....	128
2. Wiring Diagrams.....	130
2.1 Indoor Unit.....	130
2.2 Outdoor Unit.....	131
3. Operation Limit.....	133

# 1. Safety Cautions



Be sure to read the following safety cautions before conducting repair work. After the repair work is complete, be sure to conduct a test operation to ensure that the equipment operates normally, and explain the cautions for operating the product to the customer.

	This manual is for the person in charge of maintenance and inspection.
---	--







## Caution Items







The caution items are classified into  **Warning** and  **Caution**. The  **Warning** items are especially important since death or serious injury can result if they are not followed closely. The  **Caution** items can also lead to serious accidents under some conditions if they are not followed. Therefore, be sure to observe all the safety caution items described below.





## Pictograms





-  This symbol indicates an item for which caution must be exercised. The pictogram shows the item to which attention must be paid.
-  This symbol indicates a prohibited action. The prohibited item or action is shown in the illustration or near the symbol.
-  This symbol indicates an action that must be taken, or an instruction. The instruction is shown in the illustration or near the symbol.

## 1.1 Warnings and Cautions Regarding Safety of Workers







 <b>Warning</b>	
<p><b>Do not store equipment in a room with fire sources (e.g., naked flames, gas appliances, electric heaters).</b></p>	
<p><b>Be sure to disconnect the power cable from the socket before disassembling equipment for repair.</b>                      Working on equipment that is connected to the power supply may cause an electrical shock.                      If it is necessary to supply power to the equipment to conduct the repair or inspect the circuits, do not touch any electrically charged sections of the equipment.</p>	
<p><b>If refrigerant gas is discharged during repair work, do not touch the discharged refrigerant gas.</b>                      Refrigerant gas may cause frostbite.</p>	
<p><b>When disconnecting the suction or discharge pipe of the compressor at the welded section, evacuate the refrigerant gas completely at a well-ventilated place first.</b>                      If there is gas remaining inside the compressor, the refrigerant gas or refrigerating machine oil discharges when the pipe is disconnected, and it may cause injury.</p>	
<p><b>If refrigerant gas leaks during repair work, ventilate the area.</b>                      Refrigerant gas may generate toxic gases when it contacts flames.</p>	









 <b>Warning</b>	
<p><b>Be sure to discharge the capacitor completely before conducting repair work.</b> The step-up capacitor supplies high-voltage electricity to the electrical components of the outdoor unit. A charged capacitor may cause an electrical shock.</p>	
<p><b>Do not turn the air conditioner on or off by plugging in or unplugging the power cable.</b> Plugging in or unplugging the power cable to operate the equipment may cause an electrical shock or fire.</p>	
<p><b>Be sure to wear a safety helmet, gloves, and a safety belt when working in a high place (more than 2 m (6.5 ft)).</b> Insufficient safety measures may cause a fall.</p>	
<p><b>In case of R-32 / R-410A refrigerant models, be sure to use pipes, flare nuts and tools intended for the exclusive use with the R-32 / R-410A refrigerant.</b> The use of materials for R-22 refrigerant models may cause a serious accident, such as a damage of refrigerant cycle or equipment failure.</p>	
<p><b>Do not mix air or gas other than the specified refrigerant (R-32 / R-410A / R-22) in the refrigerant system.</b> If air enters the refrigerant system, an excessively high pressure results, causing equipment damage and injury.</p>	









 <b>Caution</b>	
<p><b>Do not repair electrical components with wet hands.</b> Working on the equipment with wet hands may cause an electrical shock.</p>	
<p><b>Do not clean the air conditioner with water.</b> Washing the unit with water may cause an electrical shock.</p>	
<p><b>Be sure to provide an earth / grounding when repairing the equipment in a humid or wet place, to avoid electrical shocks.</b></p>	
<p><b>Be sure to turn off the power switch and unplug the power cable when cleaning the equipment.</b> The internal fan rotates at a high speed, and may cause injury.</p>	

 <b>Caution</b>	
<b>Be sure to conduct repair work with appropriate tools.</b> The use of inappropriate tools may cause injury.	
<b>Be sure to check that the refrigerating cycle section has cooled down enough before conducting repair work.</b> Working on the unit when the refrigerating cycle section is hot may cause burns.	
<b>Conduct welding work in a well-ventilated place.</b> Using a welder in an enclosed room may cause oxygen deficiency.	

## 1.2 Warnings and Cautions Regarding Safety of Users





 <b>Warning</b>	
<b>Do not store the equipment in a room with fire sources (e.g., naked flames, gas appliances, electric heaters).</b>	
<b>Be sure to use parts listed in the service parts list of the applicable model and appropriate tools to conduct repair work. Never attempt to modify the equipment.</b> The use of inappropriate parts or tools may cause an electrical shock, excessive heat generation or fire.	
<b>If the power cable and lead wires are scratched or have deteriorated, be sure to replace them.</b> Damaged cable and wires may cause an electrical shock, excessive heat generation or fire.	
<b>Do not use a joined power cable or extension cable, or share the same power outlet with other electrical appliances, since it may cause an electrical shock, excessive heat generation or fire.</b>	
<b>Be sure to use an exclusive power circuit for the equipment, and follow the local technical standards related to the electrical equipment, the internal wiring regulations, and the instruction manual for installation when conducting electrical work.</b> Insufficient power circuit capacity and improper electrical work may cause an electrical shock or fire.	

 <b>Warning</b>	
<p><b>Be sure to use the specified cable for wiring between the indoor and outdoor units.</b> Make the connections securely and route the cable properly so that there is no force pulling the cable at the connection terminals. Improper connections may cause excessive heat generation or fire.</p>	
<p><b>When wiring between the indoor and outdoor units, make sure that the terminal cover does not lift off or dismount because of the cable.</b> If the cover is not mounted properly, the terminal connection section may cause an electrical shock, excessive heat generation or fire.</p>	
<p><b>Do not damage or modify the power cable.</b> Damaged or modified power cables may cause an electrical shock or fire. Placing heavy items on the power cable, or heating or pulling the power cable may damage it.</p>	
<p><b>Do not mix air or gas other than the specified refrigerant (R-32 / R-410A / R-22) in the refrigerant system.</b> If air enters the refrigerant system, an excessively high pressure results, causing equipment damage and injury.</p>	
<p><b>If the refrigerant gas leaks, be sure to locate the leaking point and repair it before charging the refrigerant. After charging the refrigerant, make sure that there is no leak.</b> If the leaking point cannot be located and the repair work must be stopped, be sure to pump-down, and close the service valve, to prevent refrigerant gas from leaking into the room. Refrigerant gas itself is harmless, but it may generate toxic gases when it contacts flames, such as those from fan type and other heaters, stoves and ranges.</p>	
<p><b>When relocating the equipment, make sure that the new installation site has sufficient strength to withstand the weight of the equipment.</b> If the installation site does not have sufficient strength or the installation work is not conducted securely, the equipment may fall and cause injury.</p>	
<p><b>Check to make sure that the power cable plug is not dirty or loose, then insert the plug into a power outlet securely.</b> If the plug is dusty or has a loose connection, it may cause an electrical shock or fire.</p>	
<p><b>When replacing the coin battery in the remote controller, be sure to dispose of the old battery to prevent children from swallowing it.</b> If a child swallows the coin battery, see a doctor immediately.</p>	

 <b>Caution</b>	
<p><b>Installation of a leakage breaker is necessary in some cases depending on the conditions of the installation site, to prevent electrical shocks.</b></p>	
<p><b>Do not install the equipment in a place where there is a possibility of combustible gas leaks.</b> If combustible gas leaks and remains around the unit, it may cause a fire.</p>	
<p><b>Check to see if parts and wires are mounted and connected properly, and if connections at the soldered or crimped terminals are secure.</b> Improper installation and connections may cause excessive heat generation, fire or an electrical shock.</p>	
<p><b>If the installation platform or frame has corroded, replace it.</b> A corroded installation platform or frame may cause the unit to fall, resulting in injury.</p>	
<p><b>Check the earth / grounding, and repair it if the equipment is not properly earthed / grounded.</b> Improper earth / grounding may cause an electrical shock.</p>	
<p><b>Be sure to measure insulation resistance after the repair, and make sure that the resistance is 1 MΩ or higher.</b> Faulty insulation may cause an electrical shock.</p>	
<p><b>Be sure to check the drainage of the indoor unit after the repair.</b> Faulty drainage may cause water to enter the room and wet the furniture and floor.</p>	
<p><b>Do not tilt the unit when removing it.</b> The water inside the unit may spill and wet the furniture and floor.</p>	

## 2. Icons Used

The following icons are used to attract the attention of the reader to specific information.

Icon	Type of Information	Description
 Warning	Warning	A <b>Warning</b> is used when there is danger of personal injury.
 Caution	Caution	A <b>Caution</b> is used when there is danger that the reader, through incorrect manipulation, may damage equipment, lose data, get an unexpected result or have to restart (part of) a procedure.
 Note:	Note	A <b>Note</b> provides information that is not indispensable, but may nevertheless be valuable to the reader, such as tips and tricks.
	Reference	A <b>Reference</b> guides the reader to other places in this binder or in this manual, where he/she will find additional information on a specific topic.

# Part 1

# List of Functions

1. Functions.....2

# 1. Functions

Category	Functions	FDMQ09/12/15/18/24RVJU RX09/12/15/18/24RMVJU(9)(A) with BRC1E73	FDMQ09/12/15/18/24RVJU RX09/12/15/18/24RMVJU(9)(A) with BRC082A43	Category	Functions	FDMQ09/12/15/18/24RVJU RX09/12/15/18/24RMVJU(9)(A) with BRC1E73	FDMQ09/12/15/18/24RVJU RX09/12/15/18/24RMVJU(9)(A) with BRC082A43
Basic Functions	Inverter (with inverter power control)	●	●	Health & Cleanliness	Auto cleaning filter	—	—
	Operation limit for cooling	Refer to P. 133			Air-purifying filter	—	—
	Operation limit for heating				Titanium apatite deodorizing filter	—	—
	PAM control	●	●		Silver ion anti-bacterial drain pan	●	●
	Standby electricity saving	—	—		Longlife filter (option)	●	●
Compressor	Oval scroll compressor	—	—	Air filter	—	—	
	Swing compressor	●	●	Filter cleaning indicator	●	●	
	Rotary compressor	—	—	Wipe-clean flat panel	—	—	
	Reluctance DC motor	●	●	Washable grille	—	—	
Comfortable Airflow	Power-airflow flap (horizontal blade)	—	—	MOLD PROOF operation	—	—	
	Power-airflow dual flaps (horizontal blade)	—	—	Good-sleep cooling operation	—	—	
	Power-airflow diffuser	—	—	Timer	Setpoint auto reset	●	—
	Wide-angle louvers (vertical blades)	—	—		Setpoint range restriction	●	—
	Auto-swing (up and down)	—	—		WEEKLY TIMER operation	—	—
	Auto-swing (right and left)	—	—		Schedule TIMER operation	●	—
	Individual flap control	—	—		24-hour ON/OFF TIMER	●	—
	3-D airflow	—	—		Count up/down ON/OFF timer	—	●
	COMFORT AIRFLOW operation	—	—		NIGHT SET mode	—	—
	Switchable fan speed (3 steps)	●	●		Off Timer (turns unit off after set time)	●	—
Auto fan speed	●	—	Worry Free (Reliability & Durability)		Auto-restart (after power failure)	●	●
Indoor unit quiet operation	—	—			Self-diagnosis (R/C, LED)	●	●
NIGHT QUIET mode (automatic)	—	—		Wiring error check function	—	—	
Comfort Control	OUTDOOR UNIT QUIET operation (manual)	—	—	Flexibility	Anti-corrosion treatment of outdoor heat exchanger	●	●
	2 selectable temperature sensors	●	—		Multi-split/split type compatible indoor unit	●	●
	Auto-cooling/heating changeover	●	●		H/P, C/O compatible indoor unit	—	—
	Quick warming function	●	●		Flexible power supply correspondence	—	—
	Hot-start function	●	●		Chargeless	32.8 ft (10 m)	32.8 ft (10 m)
	Automatic defrosting	●	●		Either side drain (right or left)	—	—
	Program dry function	●	●		Drain pump	●	●
	Fan only	●	●		Power selection	—	—
	Lifestyle Convenience	POWERFUL operation (non-inverter)	—		—	Remote Control	Low outdoor temperature cooling operation (–20°C) (–4°F)
POWERFUL operation (inverter)		—	—	°F/°C changeover R/C temperature display (factory setting: °F)	●		—
Priority-room setting		—	—	Remote control adaptor (normal open pulse contact) (option)	—		—
COOL/HEAT mode lock		—	—	Remote control adaptor (normal open contact) (option)	—		—
HOME LEAVE operation		—	—	DIII-NET compatible (adaptor) (option)	●		●
ECONO operation		—	—	Wireless LAN connection	—		—
Emergency operation switch		—	●	Wireless (option)	●		●
Signal receiving sign		—	●★1	Wired (option)	●		●
R/C with back light	●	—	Remote Controller				

**Note:** ● : Available  
— : Not available

★1: Receiving sound only

# Part 2 Specifications

1. Specifications .....4

# 1. Specifications

60 Hz, 208 - 230 V

Model	Indoor Unit		FDMQ09RVJU				FDMQ09RVJU			
	Outdoor Unit		Cooling		Heating		Cooling		Heating	
Power Supply			1 phase, 208-230 V, 60 Hz				1 phase, 208-230 V, 60 Hz			
Cooling Capacity ★1 ★4	kW		2.64		—		2.64		—	
	Btu/h		9,000		—		9,000		—	
	kcal/h		2,270		—		2,270		—	
Heating Capacity ★2 ★4	kW		—		3.18		—		3.18	
	Btu/h		—		10,900		—		10,900	
	kcal/h		—		2,750		—		2,750	
Heating Capacity ★3 ★4	kW		—		1.98		—		1.98	
	Btu/h		—		6,800		—		6,800	
	kcal/h		—		1,710		—		1,710	
SEER/HSPF			17.8		10.3		17.8		10.3	
COP (Rated)			—		4.1		—		4.1	
EER (Rated)			11.1		—		11.1		—	
Indoor Unit			FDMQ09RVJU				FDMQ09RVJU			
Casing Color			—				—			
Dimensions (H x W x D)			9-5/8 x 27-9/16 x 31-1/2 (245 x 700 x 800)				9-5/8 x 27-9/16 x 31-1/2 (245 x 700 x 800)			
Coil	Type		Cross Fin Coil				Cross Fin Coil			
	Rows x Stages x Fin per Inch		3 x 26 x 18				3 x 26 x 18			
	Face Area		ft <sup>2</sup> (m <sup>2</sup> )		1-15/16 (0.178)		1-15/16 (0.178)			
Fan	Type		Sirocco Fan				Sirocco Fan			
	Motor Output		W		130		130			
	Airflow Rate	H / M / L	cfm (m <sup>3</sup> /min)		343 / 290 / 240 (9.7 / 8.2 / 6.8)		343 / 290 / 240 (9.7 / 8.2 / 6.8)		343 / 290 / 240 (9.7 / 8.2 / 6.8)	
	External Static Pressure ★5		inH <sub>2</sub> O		0.20 (0.60 - 0.12)		0.20 (0.60 - 0.12)			
			Pa		50 (150 - 30)		50 (150 - 30)			
Sound Pressure Level			dB(A)		32		32		32	
Sound Power Level			dB(A)		46		46		46	
Air Filter ★6			—				—			
Weight (Mass)			Lbs (kg)		64 (29)		64 (29)			
Piping Connections	Liquid		in. (mm)		φ 1/4 (6.4) (Flare)		φ 1/4 (6.4) (Flare)			
	Gas		in. (mm)		φ 3/8 (9.5) (Flare)		φ 3/8 (9.5) (Flare)			
	Drain		in. (mm)		I.D. φ 1 (25) / O.D. φ 1-1/4 (32)		I.D. φ 1 (25) / O.D. φ 1-1/4 (32)			
Remote Controller (Option)	Wired		BRC1E73				BRC1E73			
	Wireless		BRC082A43				BRC082A43			
Outdoor Unit			RX09RMVJU				RX09RMVJU9			
Casing Color			Ivory White				Ivory White			
Dimensions (H x W x D)			21-5/8 x 26-9/16 x 11-3/16 (550 x 675 x 284)				21-5/8 x 26-9/16 x 11-3/16 (550 x 675 x 284)			
Coil	Type		Cross Fin Coil				Cross Fin Coil			
	Rows x Stages x Fin per Inch		2 x 24 x 17				2 x 24 x 17			
	Face Area		ft <sup>2</sup> (m <sup>2</sup> )		3-11/16 (0.342)		3-11/16 (0.342)			
Compressor	Model		1YC23AUXD				1YC23AUXD			
	Type		Hermetically Sealed Swing Type				Hermetically Sealed Swing Type			
	Motor Output		W		790		790			
Fan	Type		Propeller				Propeller			
	Motor Output		W		39		39			
	Airflow Rate		cfm (m <sup>3</sup> /min)		985 (27.9)		985 (27.9)		1,130 (32.0)	
Sound Pressure Level			dB(A)		46		46		50	
Sound Power Level			dB(A)		58		58		62	
Weight (Mass)			Lbs (kg)		60 (27)		60 (27)			
Piping Connections	Liquid		in. (mm)		φ 1/4 (6.4) (Flare)		φ 1/4 (6.4) (Flare)			
	Gas		in. (mm)		φ 3/8 (9.5) (Flare)		φ 3/8 (9.5) (Flare)			
	Drain		in. (mm)		I.D. φ 5/8 (16)		I.D. φ 5/8 (16)			
Safety Devices			Fuse				Fuse			
Capacity Step			%				Compressor Revolution Speed Control (Inverter System)			
Refrigerant Control			Electronic Expansion Valve				Electronic Expansion Valve			
Max. Interunit Piping Length			ft (m)		65-5/8 (20)		65-5/8 (20)			
Max. Interunit Height Difference			ft (m)		49-1/4 (15)		49-1/4 (15)			
Refrigerant	Type		R-410A				R-410A			
	Charge	Lbs (kg)	2.09 (0.95)		2.09 (0.95)		2.09 (0.95)			
Refrigerant Oil	Type		FVC50K				FVC50K			
	Charge	fl oz (L)	12.68 (0.375)		12.68 (0.375)		12.68 (0.375)			
Drawing No.			C: 3D112997D				C: 3D120555A			

- Notes:**
- ★1 Indoor temp. : 80.0°FDB (26.7°CDB), 67.0°FWB (19.4°CWB) / Outdoor temp. : 95.0°FDB (35.0°CDB) / Equivalent piping length : 25 ft (7.6 m) / Level difference : 0
  - ★2 Indoor temp. : 70.0°FDB (21.1°CDB) / Outdoor temp. : 47.0°FDB (8.3°CDB), 43.0°FWB (6.1°CWB) / Equivalent piping length : 25 ft (7.6 m) / Level difference : 0
  - ★3 Indoor temp. : 70.0°FDB (21.1°CDB) / Outdoor temp. : 17.0°FDB (-8.3°CDB), 15.0°FWB (-9.4°CWB) / Equivalent piping length : 25 ft (7.6 m) / Level difference : 0
  - ★4 Capacities are net, including a deduction for cooling (an addition for heating) for indoor fan motor heat.
  - ★5 External static pressure is changeable in 13 (FDMQ09/12RVJU), 11 (FDMQ15/18/24RVJU) stages by remote controller.
  - ★6 Air filter is not standard accessory, but please mount it in the duct system of the suction side. Select its dust collection efficiency (gravity method) 50% or more.

Conversion Formulae	
kcal/h = kW × 860	
Btu/h = kW × 3412	
cfm = m <sup>3</sup> /min × 35.3	

60 Hz, 208 - 230 V

Model	Indoor Unit		FDMQ12RVJU				FDMQ12RVJU			
	Outdoor Unit		RX12RMVJU		RX12RMVJU9		RX12RMVJU9		RX12RMVJU9	
			Cooling	Heating	Cooling	Heating	Cooling	Heating		
Power Supply			1 phase, 208-230 V, 60 Hz				1 phase, 208-230 V, 60 Hz			
Cooling Capacity ★1 ★4	kW		3.18		—		3.18		—	
	Btu/h		10,800		—		10,800		—	
	kcal/h		2,720		—		2,720		—	
Heating Capacity ★2 ★4	kW		—		3.99		—		3.99	
	Btu/h		—		13,600		—		13,600	
	kcal/h		—		3,430		—		3,430	
Heating Capacity ★3 ★4	kW		—		2.49		—		2.49	
	Btu/h		—		8,500		—		8,500	
	kcal/h		—		2,140		—		2,140	
SEER/HSPF			19.4		10.6		19.4		10.6	
COP (Rated)			W/W		—		—		3.7	
EER (Rated)			Btu/W-h		11.6		—		—	
<b>Indoor Unit</b>			<b>FDMQ12RVJU</b>				<b>FDMQ12RVJU</b>			
Casing Color			—				—			
Dimensions (H x W x D)			in. (mm)		9-5/8 x 27-9/16 x 31-1/2 (245 x 700 x 800)		9-5/8 x 27-9/16 x 31-1/2 (245 x 700 x 800)		9-5/8 x 27-9/16 x 31-1/2 (245 x 700 x 800)	
Coil	Type		Cross Fin Coil				Cross Fin Coil			
	Rows x Stages x Fin per Inch		3 x 26 x 18				3 x 26 x 18			
	Face Area		ft <sup>2</sup> (m <sup>2</sup> )		1-15/16 (0.178)		1-15/16 (0.178)		1-15/16 (0.178)	
Fan	Type		Sirocco Fan				Sirocco Fan			
	Motor Output		W		130		130		130	
	Airflow Rate		H / M / L		cfm (m <sup>3</sup> /min)		392 / 332 / 275 (11.1 / 9.4 / 7.8)		392 / 332 / 275 (11.1 / 9.4 / 7.8)	
	External Static Pressure ★5		inH <sub>2</sub> O		0.20 (0.60 - 0.12)		0.20 (0.60 - 0.12)		0.20 (0.60 - 0.12)	
			Pa		50 (150 - 30)		50 (150 - 30)		50 (150 - 30)	
Sound Pressure Level			dB(A)		33		33		33	
Sound Power Level			dB(A)		47		47		47	
Air Filter ★6			—				—			
Weight (Mass)			Lbs (kg)		64 (29)		64 (29)		64 (29)	
Piping Connections	Liquid		in. (mm)		φ 1/4 (6.4) (Flare)		φ 1/4 (6.4) (Flare)		φ 1/4 (6.4) (Flare)	
	Gas		in. (mm)		φ 3/8 (9.5) (Flare)		φ 3/8 (9.5) (Flare)		φ 3/8 (9.5) (Flare)	
	Drain		in. (mm)		I.D. φ 1 (25) / O.D. φ 1-1/4 (32)		I.D. φ 1 (25) / O.D. φ 1-1/4 (32)		I.D. φ 1 (25) / O.D. φ 1-1/4 (32)	
Remote Controller (Option)	Wired		BRC1E73				BRC1E73			
	Wireless		BRC082A43				BRC082A43			
<b>Outdoor Unit</b>			<b>RX12RMVJU</b>				<b>RX12RMVJU9</b>			
Casing Color			Ivory White				Ivory White			
Dimensions (H x W x D)			in. (mm)		21-5/8 x 26-9/16 x 11-3/16 (550 x 675 x 284)		21-5/8 x 26-9/16 x 11-3/16 (550 x 675 x 284)		21-5/8 x 26-9/16 x 11-3/16 (550 x 675 x 284)	
Coil	Type		Cross Fin Coil				Cross Fin Coil			
	Rows x Stages x Fin per Inch		2 x 24 x 17				2 x 24 x 17			
	Face Area		ft <sup>2</sup> (m <sup>2</sup> )		3-11/16 (0.342)		3-11/16 (0.342)		3-11/16 (0.342)	
Compressor	Model		1YC23AUXD				1YC23AUXD			
	Type		Hermetically Sealed Swing Type				Hermetically Sealed Swing Type			
	Motor Output		W		790		790		790	
Fan	Type		Propeller				Propeller			
	Motor Output		W		39		39		39	
	Airflow Rate		cfm (m <sup>3</sup> /min)		1,105 (31.3)		1,105 (31.3)		1,130 (32.0)	
Sound Pressure Level			dB(A)		49		51		51	
Sound Power Level			dB(A)		61		63		63	
Weight (Mass)			Lbs (kg)		60 (27)		60 (27)		60 (27)	
Piping Connections	Liquid		in. (mm)		φ 1/4 (6.4) (Flare)		φ 1/4 (6.4) (Flare)		φ 1/4 (6.4) (Flare)	
	Gas		in. (mm)		φ 3/8 (9.5) (Flare)		φ 3/8 (9.5) (Flare)		φ 3/8 (9.5) (Flare)	
	Drain		in. (mm)		I.D. φ 5/8 (16)		I.D. φ 5/8 (16)		I.D. φ 5/8 (16)	
Safety Devices			Fuse				Fuse			
Capacity Step			%		Compressor Revolution Speed Control (Inverter System)		Compressor Revolution Speed Control (Inverter System)		Compressor Revolution Speed Control (Inverter System)	
Refrigerant Control			Electronic Expansion Valve				Electronic Expansion Valve			
Max. Interunit Piping Length			ft (m)		65-5/8 (20)		65-5/8 (20)		65-5/8 (20)	
Max. Interunit Height Difference			ft (m)		49-1/4 (15)		49-1/4 (15)		49-1/4 (15)	
Refrigerant	Type		R-410A				R-410A			
	Charge		Lbs (kg)		2.09 (0.95)		2.09 (0.95)		2.09 (0.95)	
Refrigerant Oil	Type		FVC50K				FVC50K			
	Charge		fl oz (L)		12.68 (0.375)		12.68 (0.375)		12.68 (0.375)	
Drawing No.			C: 3D112997D				C: 3D120555A			

- Notes:**
- ★1 Indoor temp. : 80.0°FDB (26.7°CDB), 67.0°FWB (19.4°CWB) / Outdoor temp. : 95.0°FDB (35.0°CDB) / Equivalent piping length : 25 ft (7.6 m) / Level difference : 0
  - ★2 Indoor temp. : 70.0°FDB (21.1°CDB) / Outdoor temp. : 47.0°FDB (8.3°CDB), 43.0°FWB (6.1°CWB) / Equivalent piping length : 25 ft (7.6 m) / Level difference : 0
  - ★3 Indoor temp. : 70.0°FDB (21.1°CDB) / Outdoor temp. : 17.0°FDB (-8.3°CDB), 15.0°FWB (-9.4°CWB) / Equivalent piping length : 25 ft (7.6 m) / Level difference : 0
  - ★4 Capacities are net, including a deduction for cooling (an addition for heating) for indoor fan motor heat.
  - ★5 External static pressure is changeable in 13 (FDMQ09/12RVJU), 11 (FDMQ15/18/24RVJU) stages by remote controller.
  - ★6 Air filter is not standard accessory, but please mount it in the duct system of the suction side. Select its dust collection efficiency (gravity method) 50% or more.

Conversion Formulae
kcal/h = kW x 860
Btu/h = kW x 3412
cfm = m <sup>3</sup> /min x 35.3

60 Hz, 208 - 230V

Model	Indoor Unit		FDMQ15RVJU		FDMQ18RVJU	
	Outdoor Unit		RX15RMVJU(A)		RX18RMVJU	
			Cooling	Heating	Cooling	Heating
Power Supply			1 phase, 208-230 V, 60 Hz		1 phase, 208-230 V, 60 Hz	
Cooling Capacity ★1 ★4	kW		4.23	—	5.16	—
	Btu/h		14,400	—	17,600	—
	kcal/h		3,630	—	4,440	—
Heating Capacity ★2 ★4	kW		—	5.28	—	6.33
	Btu/h		—	18,000	—	21,600
	kcal/h		—	4,540	—	5,440
Heating Capacity ★3 ★4	kW		—	3.36	—	3.99
	Btu/h		—	11,500	—	13,600
	kcal/h		—	2,900	—	3,430
SEER/HSPF			20.2	10.3	18.5	10.3
COP (Rated)		W/W	—	3.8	—	3.8
EER (Rated)		Btu/W-h	12.7	—	12.50	—
<b>Indoor Unit</b>			<b>FDMQ15RVJU</b>		<b>FDMQ18RVJU</b>	
Casing Color			—		—	
Dimensions (H x W x D)			in. (mm) 9-5/8 x 39-3/8 x 31-1/2 (245 x 1,000 x 800)		in. (mm) 9-5/8 x 39-3/8 x 31-1/2 (245 x 1,000 x 800)	
Coil	Type		Cross Fin Coil		Cross Fin Coil	
	Rows x Stages x Fin per Inch		2 x 26 x 18		3 x 26 x 18	
	Face Area		ft <sup>2</sup> (m <sup>2</sup> ) 3-1/8 (0.288)		ft <sup>2</sup> (m <sup>2</sup> ) 3-1/8 (0.288)	
Fan	Type		Sirocco Fan		Sirocco Fan	
	Motor Output		W 230		W 230	
	Airflow Rate	H / M / L	cfm (m <sup>3</sup> /min) 516 / 438 / 360 (14.6 / 12.4 / 10.2)	cfm (m <sup>3</sup> /min) 516 / 438 / 360 (14.6 / 12.4 / 10.2)	cfm (m <sup>3</sup> /min) 675 / 572 / 473 (19.1 / 16.2 / 13.4)	cfm (m <sup>3</sup> /min) 675 / 572 / 473 (19.1 / 16.2 / 13.4)
	External Static Pressure ★5		inH <sub>2</sub> O 0.20 (0.60 - 0.20)		inH <sub>2</sub> O 0.20 (0.60 - 0.20)	
		Pa 50 (150 - 50)		Pa 50 (150 - 50)		
Sound Pressure Level		dB(A) 34		dB(A) 35		
Sound Power Level		dB(A) 48		dB(A) 49		
Air Filter ★6			—		—	
Weight (Mass)			Lbs (kg) 77 (35)		Lbs (kg) 82 (37)	
Piping Connections	Liquid	in. (mm)	φ 1/4 (6.4) (Flare)		φ 1/4 (6.4) (Flare)	
	Gas	in. (mm)	φ 1/2 (12.7) (Flare)		φ 1/2 (12.7) (Flare)	
	Drain	in. (mm)	I.D. φ 1 (25) / O.D. φ 1-1/4 (32)		I.D. φ 1 (25) / O.D. φ 1-1/4 (32)	
Remote Controller (Option)	Wired		BRC1E73		BRC1E73	
	Wireless		BRC082A43		BRC082A43	
<b>Outdoor Unit</b>			<b>RX15RMVJU(A)</b>		<b>RX18RMVJU</b>	
Casing Color			Ivory White		Ivory White	
Dimensions (H x W x D)			in. (mm) 28-15/16 x 34-1/4 x 12-5/8 (735 x 870 x 320)		in. (mm) 28-15/16 x 34-1/4 x 12-5/8 (735 x 870 x 320)	
Coil	Type		Cross Fin Coil		Cross Fin Coil	
	Rows x Stages x Fin per Inch		1 x 32 x 18		1 x 32 x 18	
	Face Area		ft <sup>2</sup> (m <sup>2</sup> ) 7-1/8 (0.664)		ft <sup>2</sup> (m <sup>2</sup> ) 7-1/8 (0.664)	
Compressor	Model		2YC36PXD		2YC36PXD	
	Type		Hermetically Sealed Swing Type		Hermetically Sealed Swing Type	
	Motor Output		W 1,100		W 1,100	
Fan	Type		Propeller		Propeller	
	Motor Output		W 91		W 110	
	Airflow Rate		cfm (m <sup>3</sup> /min) 2,313 (65.5)	cfm (m <sup>3</sup> /min) 2,108 (59.7)	cfm (m <sup>3</sup> /min) 2,461 (69.7)	cfm (m <sup>3</sup> /min) 2,553 (72.3)
Sound Pressure Level		dB(A) 50		dB(A) 51		
Sound Power Level		dB(A) 62		dB(A) 63		
Weight (Mass)			Lbs (kg) 97 (44)		Lbs (kg) 97 (44)	
Piping Connections	Liquid	in. (mm)	φ 1/4 (6.4) (Flare)		φ 1/4 (6.4) (Flare)	
	Gas	in. (mm)	φ 1/2 (12.7) (Flare)		φ 1/2 (12.7) (Flare)	
	Drain	in. (mm)	I.D. φ 5/8 (16)		I.D. φ 5/8 (16)	
Safety Devices			Fuse		Fuse	
Capacity Step			%		%	
Refrigerant Control			Compressor Revolution Speed Control (Inverter System)		Compressor Revolution Speed Control (Inverter System)	
Refrigerant Control			Electronic Expansion Valve		Electronic Expansion Valve	
Max. Interunit Piping Length			ft (m) 98-1/2 (30)		ft (m) 98-1/2 (30)	
Max. Interunit Height Difference			ft (m) 65-5/8 (20)		ft (m) 65-5/8 (20)	
Refrigerant	Type		R-410A		R-410A	
	Charge		Lbs (kg) 2.49 (1.13)		Lbs (kg) 2.49 (1.13)	
Refrigerant Oil	Type		FVC50K		FVC50K	
	Charge		fl oz (L) 21.98 (0.650)		fl oz (L) 21.98 (0.650)	
Drawing No.			C: 3D112997D		C: 3D112997D	

- Notes:**
- ★1 Indoor temp. : 80.0°FDB (26.7°CDB), 67.0°FWB (19.4°CWB) / Outdoor temp. : 95.0°FDB (35.0°CDB) / Equivalent piping length : 25 ft (7.6 m) / Level difference : 0
  - ★2 Indoor temp. : 70.0°FDB (21.1°CDB) / Outdoor temp. : 47.0°FDB (8.3°CDB), 43.0°FWB (6.1°CWB) / Equivalent piping length : 25 ft (7.6 m) / Level difference : 0
  - ★3 Indoor temp. : 70.0°FDB (21.1°CDB) / Outdoor temp. : 17.0°FDB (-8.3°CDB), 15.0°FWB (-9.4°CWB) / Equivalent piping length : 25 ft (7.6 m) / Level difference : 0
  - ★4 Capacities are net, including a deduction for cooling (an addition for heating) for indoor fan motor heat.
  - ★5 External static pressure is changeable in 13 (FDMQ09/12RVJU), 11 (FDMQ15/18/24RVJU) stages by remote controller.
  - ★6 Air filter is not standard accessory, but please mount it in the duct system of the suction side. Select its dust collection efficiency (gravity method) 50% or more.

Conversion Formulae
kcal/h = kW × 860
Btu/h = kW × 3412
cfm = m <sup>3</sup> /min × 35.3

Model	Indoor Unit		FDMQ18RVJU		FDMQ24RVJU	
	Outdoor Unit		RX18RMVJU9(A)		RX24RMVJU(A)	
			Cooling	Heating	Cooling	Heating
Power Supply			1 phase, 208-230 V, 60 Hz		1 phase, 208-230 V, 60 Hz	
Cooling Capacity ★1 ★4	kW		5.16	—	6.39	—
	Btu/h		17,600	—	21,800	—
	kcal/h		4,440	—	5,500	—
Heating Capacity ★2 ★4	kW		—	6.33	—	7.02
	Btu/h		—	21,600	—	24,000
	kcal/h		—	5,440	—	6,050
Heating Capacity ★3 ★4	kW		—	3.99	—	4.41
	Btu/h		—	13,600	—	15,000
	kcal/h		—	3,430	—	3,780
SEER/HSPF			18.5	10.3	18.6	10.0
COP (Rated)	W/W		—	3.8	—	3.8
EER (Rated)	Btu/W-h		12.50	—	12.5	—
<b>Indoor Unit</b>			<b>FDMQ18RVJU</b>		<b>FDMQ24RVJU</b>	
Casing Color			—		—	
Dimensions (H x W x D)			in. (mm) 9-5/8 x 39-3/8 x 31-1/2 (245 x 1,000 x 800)		in. (mm) 9-5/8 x 39-3/8 x 31-1/2 (245 x 1,000 x 800)	
Coil	Type		Cross Fin Coil		Cross Fin Coil	
	Rows x Stages x Fin per Inch		3 x 26 x 18		3 x 26 x 18	
	Face Area		ft <sup>2</sup> (m <sup>2</sup> ) 3-1/8 (0.288)		ft <sup>2</sup> (m <sup>2</sup> ) 3-1/8 (0.288)	
Fan	Type		Sirocco Fan		Sirocco Fan	
	Motor Output		W 230		W 230	
	Airflow Rate	H / M / L	cfm (m <sup>3</sup> /min) 675 / 572 / 473 (19.1 / 16.2 / 13.4)	cfm (m <sup>3</sup> /min) 675 / 572 / 473 (19.1 / 16.2 / 13.4)	cfm (m <sup>3</sup> /min) 798 / 678 / 558 (22.6 / 19.2 / 15.8)	cfm (m <sup>3</sup> /min) 798 / 678 / 558 (22.6 / 19.2 / 15.8)
	External Static Pressure ★5		inH <sub>2</sub> O 0.20 (0.60 - 0.20)		inH <sub>2</sub> O 0.20 (0.60 - 0.20)	
		Pa 50 (150 - 50)		Pa 50 (150 - 50)		
Sound Pressure Level		dB(A) 35		dB(A) 35		
Sound Power Level		dB(A) 49		dB(A) 49		
Air Filter ★6			—		—	
Weight (Mass)			Lbs (kg) 82 (37)		Lbs (kg) 82 (37)	
Piping Connections	Liquid	in. (mm)	φ 1/4 (6.4) (Flare)		φ 1/4 (6.4) (Flare)	
	Gas	in. (mm)	φ 1/2 (12.7) (Flare)		φ 5/8 (15.9) (Flare)	
	Drain	in. (mm)	I.D. φ 1 (25) / O.D. φ 1-1/4 (32)		I.D. φ 1 (25) / O.D. φ 1-1/4 (32)	
Remote Controller (Option)	Wired		BRC1E73		BRC1E73	
	Wireless		BRC082A43		BRC082A43	
<b>Outdoor Unit</b>			<b>RX18RMVJU9(A)</b>		<b>RX24RMVJU(A)</b>	
Casing Color			Ivory White		Ivory White	
Dimensions (H x W x D)			in. (mm) 28-15/16 x 34-1/4 x 12-5/8 (735 x 870 x 320)		in. (mm) 28-15/16 x 34-1/4 x 12-5/8 (735 x 870 x 320)	
Coil	Type		Cross Fin Coil		Cross Fin Coil	
	Rows x Stages x Fin per Inch		1 x 32 x 18		2 x 32 x 18	
	Face Area		ft <sup>2</sup> (m <sup>2</sup> ) 7-1/8 (0.664)		ft <sup>2</sup> (m <sup>2</sup> ) 7-1/16 (0.658)	
Compressor	Model		2YC36PXD		2YC36PXD	
	Type		Hermetically Sealed Swing Type		Hermetically Sealed Swing Type	
	Motor Output		W 1,100		W 1,100	
Fan	Type		Propeller		Propeller	
	Motor Output		W 110		W 125	
	Airflow Rate	cfm (m <sup>3</sup> /min)	2,461 (69.7)	2,553 (72.3)	2,642 (74.8)	2,642 (74.8)
Sound Pressure Level		dB(A) 54		dB(A) 55		
Sound Power Level		dB(A) 66		dB(A) 67		
Weight (Mass)			Lbs (kg) 97 (44)		Lbs (kg) 108 (49)	
Piping Connections	Liquid	in. (mm)	φ 1/4 (6.4) (Flare)		φ 1/4 (6.4) (Flare)	
	Gas	in. (mm)	φ 1/2 (12.7) (Flare)		φ 5/8 (15.9) (Flare)	
	Drain	in. (mm)	I.D. φ 5/8 (16)		I.D. φ 5/8 (16)	
Safety Devices			Fuse		Fuse	
Capacity Step			Compressor Revolution Speed Control (Inverter System)		Compressor Revolution Speed Control (Inverter System)	
Refrigerant Control			Electronic Expansion Valve		Electronic Expansion Valve	
Max. Interunit Piping Length			ft (m) 98-1/2 (30)		ft (m) 98-1/2 (30)	
Max. Interunit Height Difference			ft (m) 65-5/8 (20)		ft (m) 65-5/8 (20)	
Refrigerant	Type		R-410A		R-410A	
	Charge	Lbs (kg)	2.49 (1.13)		3.20 (1.45)	
Refrigerant Oil	Type		FVC50K		FVC50K	
	Charge	fl oz (L)	21.98 (0.650)		21.98 (0.650)	
Drawing No.			C: 3D120555A		C: 3D112997D	

- Notes:**
- ★1 Indoor temp. : 80.0°FDB (26.7°CDB), 67.0°FWB (19.4°CWB) / Outdoor temp. : 95.0°FDB (35.0°CDB) / Equivalent piping length : 25 ft (7.6 m) / Level difference : 0
  - ★2 Indoor temp. : 70.0°FDB (21.1°CDB) / Outdoor temp. : 47.0°FDB (8.3°CDB), 43.0°FWB (6.1°CWB) / Equivalent piping length : 25 ft (7.6 m) / Level difference : 0
  - ★3 Indoor temp. : 70.0°FDB (21.1°CDB) / Outdoor temp. : 17.0°FDB (-8.3°CDB), 15.0°FWB (-9.4°CWB) / Equivalent piping length : 25 ft (7.6 m) / Level difference : 0
  - ★4 Capacities are net, including a deduction for cooling (an addition for heating) for indoor fan motor heat.
  - ★5 External static pressure is changeable in 13 (FDMQ09/12RVJU), 11 (FDMQ15/18/24RVJU) stages by remote controller.
  - ★6 Air filter is not standard accessory, but please mount it in the duct system of the suction side. Select its dust collection efficiency (gravity method) 50% or more.

Conversion Formulae
kcal/h = kW x 860
Btu/h = kW x 3412
cfm = m <sup>3</sup> /min x 35.3

# Part 3

# Printed Circuit Board

# Connector Wiring Diagram

1. Indoor Unit.....	9
1.1 FDMQ09/12/15/18/24RVJU .....	9
2. Wired Remote Controller.....	11
2.1 BRC1E73 .....	11
3. Wireless Remote Controller Receiver .....	12
3.1 BRC082A43 .....	12
4. Outdoor Unit.....	13
4.1 RX09/12RMVJU(9).....	13
4.2 RX15/24RMVJU(A), RX18RMVJU(9)(A).....	14

# 1. Indoor Unit

## 1.1 FDMQ09/12/15/18/24RVJU

### Control PCB (A1P)

1) X15A	Connector for float switch
2) X16A	Connector for room temperature thermistor (suction air thermistor)
3) X17A, X18A	Connector for indoor heat exchanger thermistor
4) X25A	Connector for drain pump motor
5) X27A	Connector for terminal block (for power supply)
6) X28A	Connector for power supply wiring (option)
7) X30A	Connector for terminal block (for wired remote controller)
8) X33A	Connector for wiring (option)
9) X35A	Connector for wiring adaptor (option)
10) X70A	Connector for indoor fan PCB (A2P)
11) F1U	Fuse (3.15 A, 250 V)
12) HAP	LED for service monitor (green)
13) DS1	DIP switch for emergency

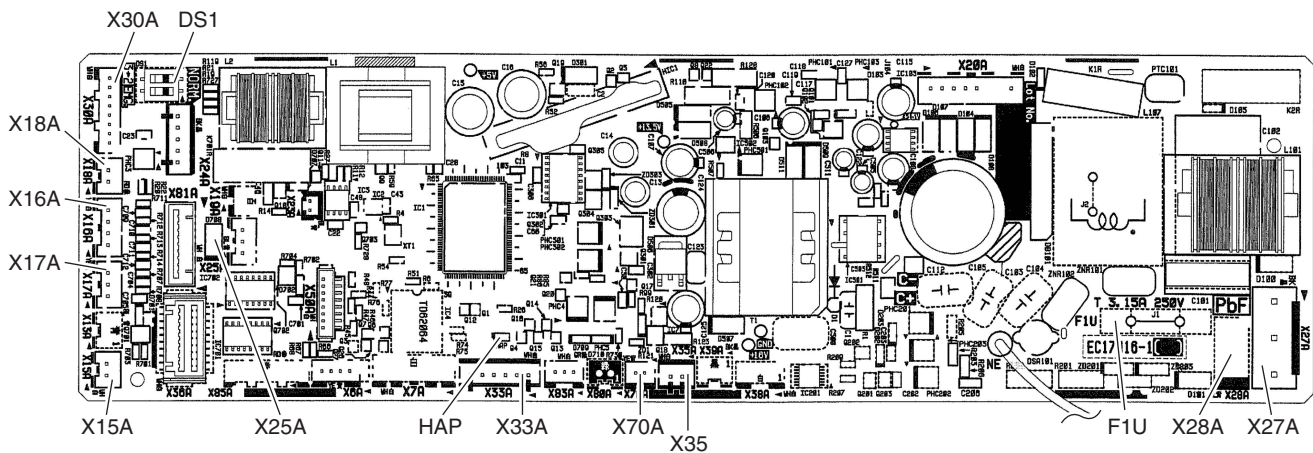

2P486802-2



## 2. Wired Remote Controller

### 2.1 BRC1E73

**Wired Remote  
Controller PCB**

- 1) P1, P2 Terminal for indoor unit
- 2) R4T Room temperature thermistor

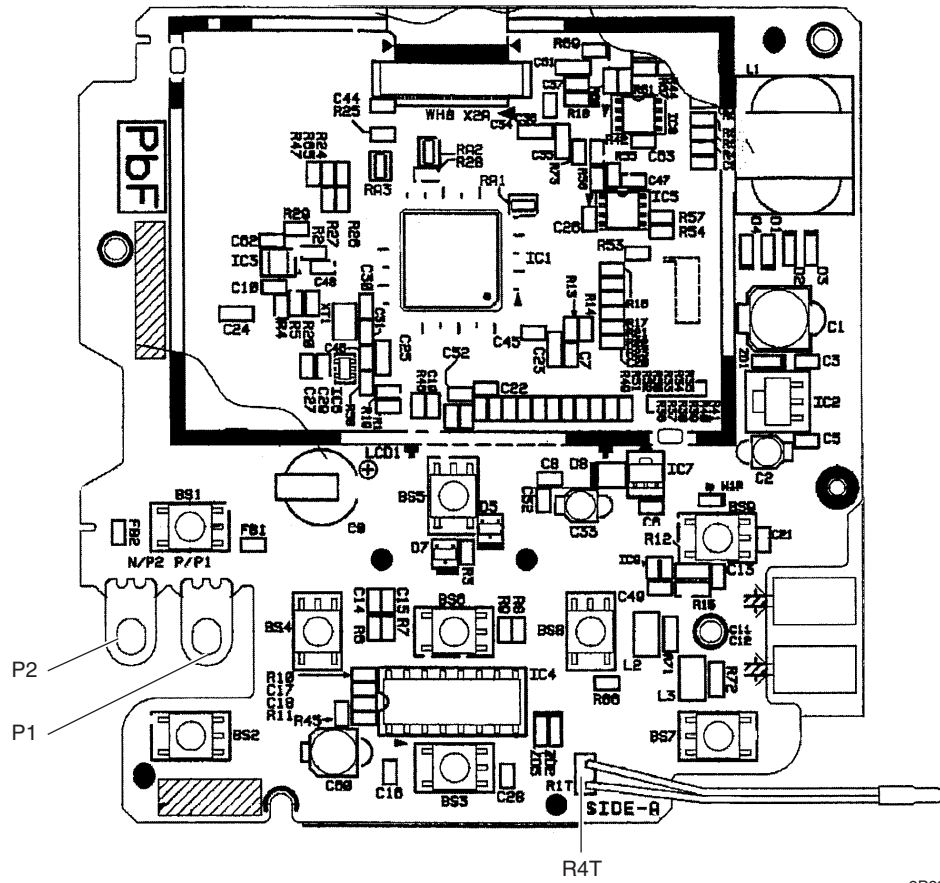

2P298037-7

# 3. Wireless Remote Controller Receiver

## 3.1 BRC082A43

**Wireless Remote Controller PCB**

- 1) SS1 MAIN/SUB setting switch  
\* Refer to page 122 for details.
- 2) SS2 Address setting switch  
\* Refer to page 122 for details.
- 3) P1, P2 Terminal for indoor unit control PCB (A1P)

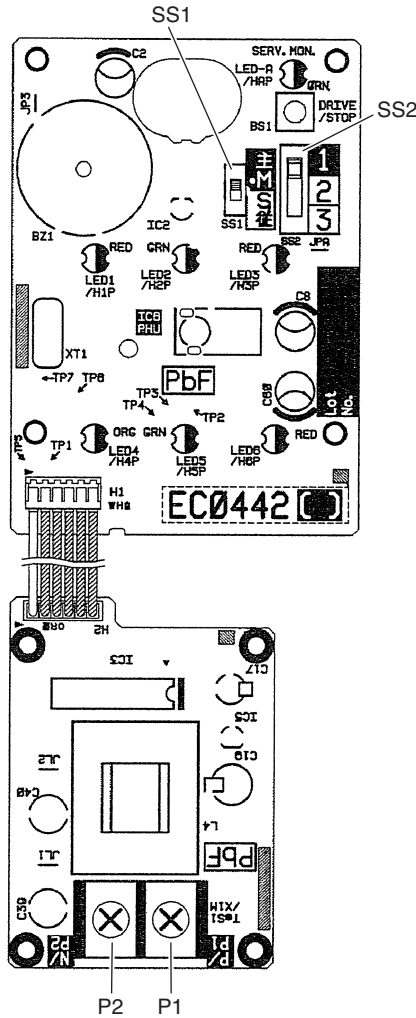

3P156152-1

## 4. Outdoor Unit

### 4.1 RX09/12RMVJU(9)

#### Main PCB (PCB1)

- |                 |  |
|-----------------|--|
| 1) S20          | Connector for electronic expansion valve coil  |
| 2) S30          | Connector for compressor   |
| 3) S40          | Connector for overload protector   |
| 4) S71          | Connector for DC fan motor   |
| 5) S80          | Connector for four way valve coil  |
| 6) S90          | Connector for thermistors<br>(outdoor temperature, outdoor heat exchanger, discharge pipe) |
| 7) HL1, HN1, S  | Connector for terminal block   |
| 8) E1, E2       | Terminal for ground wire   |
| 9) HR1, HR2     | Connector for reactor  |
| 10)FU1, FU2     | Fuse (3.15 A, 250 V)   |
| 11)FU3          | Fuse (20 A, 250 V)   |
| 12)J6           | Jumper for facility setting<br>* Refer to page 124 for details.                            |
| 12)LED A        | LED for service monitor (green)  |
| 13)V2, V3, V150 | Varistor   |

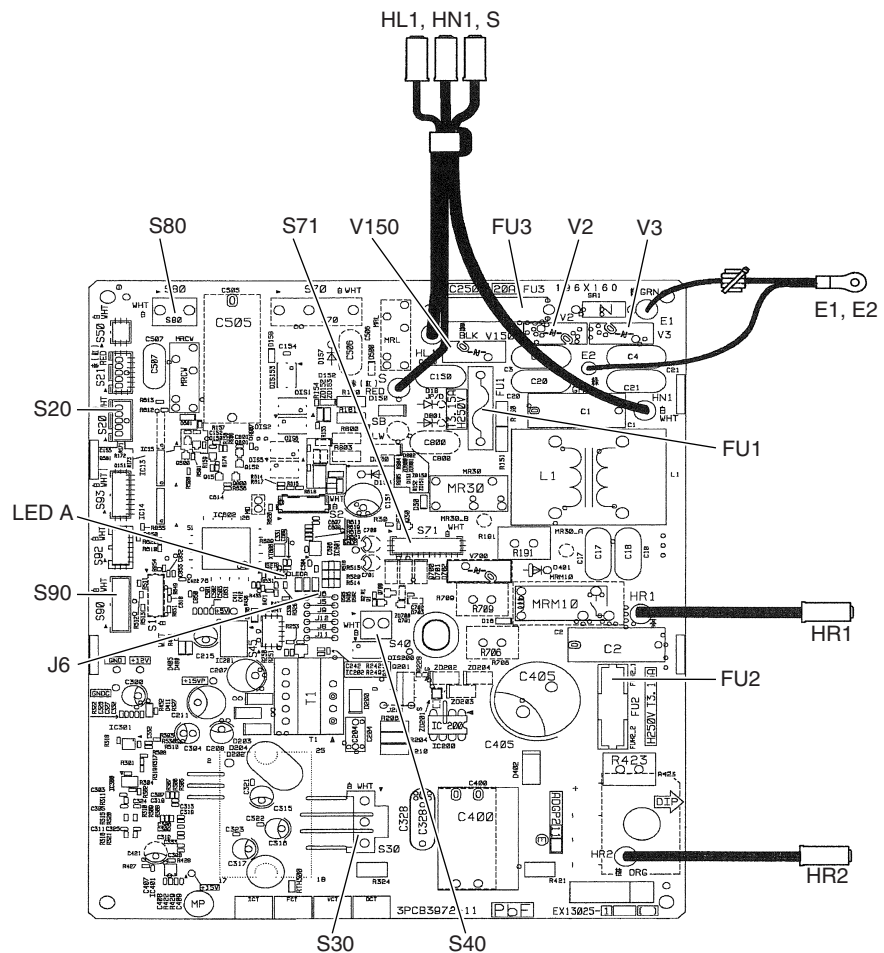

2P504947-57

**Caution**

**Replace the PCB if you accidentally cut a wrong jumper.**

Jumpers are necessary for electronic circuit. Improper operation may occur if you cut any of them.

## 4.2 RX15/24RMVJU(A), RX18RMVJU(9)(A)

### Main PCB

- 1) S20 Connector for electronic expansion valve coil
- 2) S40 Connector for overload protector
- 3) S70 Connector for DC fan motor
- 4) S80 Connector for four way valve coil
- 5) S90 Connector for thermistors  
(outdoor temperature, outdoor heat exchanger, discharge pipe)
- 6) HL1, HN1, S Connector for terminal block
- 7) E1, E2 Terminal for ground
- 8) U, V, W Connector for compressor
- 9) FU1, FU2 Fuse (3.15 A, 250 V)
- 10)FU3 Fuse (30 A, 250 V)
- 11)J6 Jumper for facility setting  
\* Refer to page 124 for details.
- 12)LED A LED for service monitor (green)
- 13)V1, V2, V3 Varistor

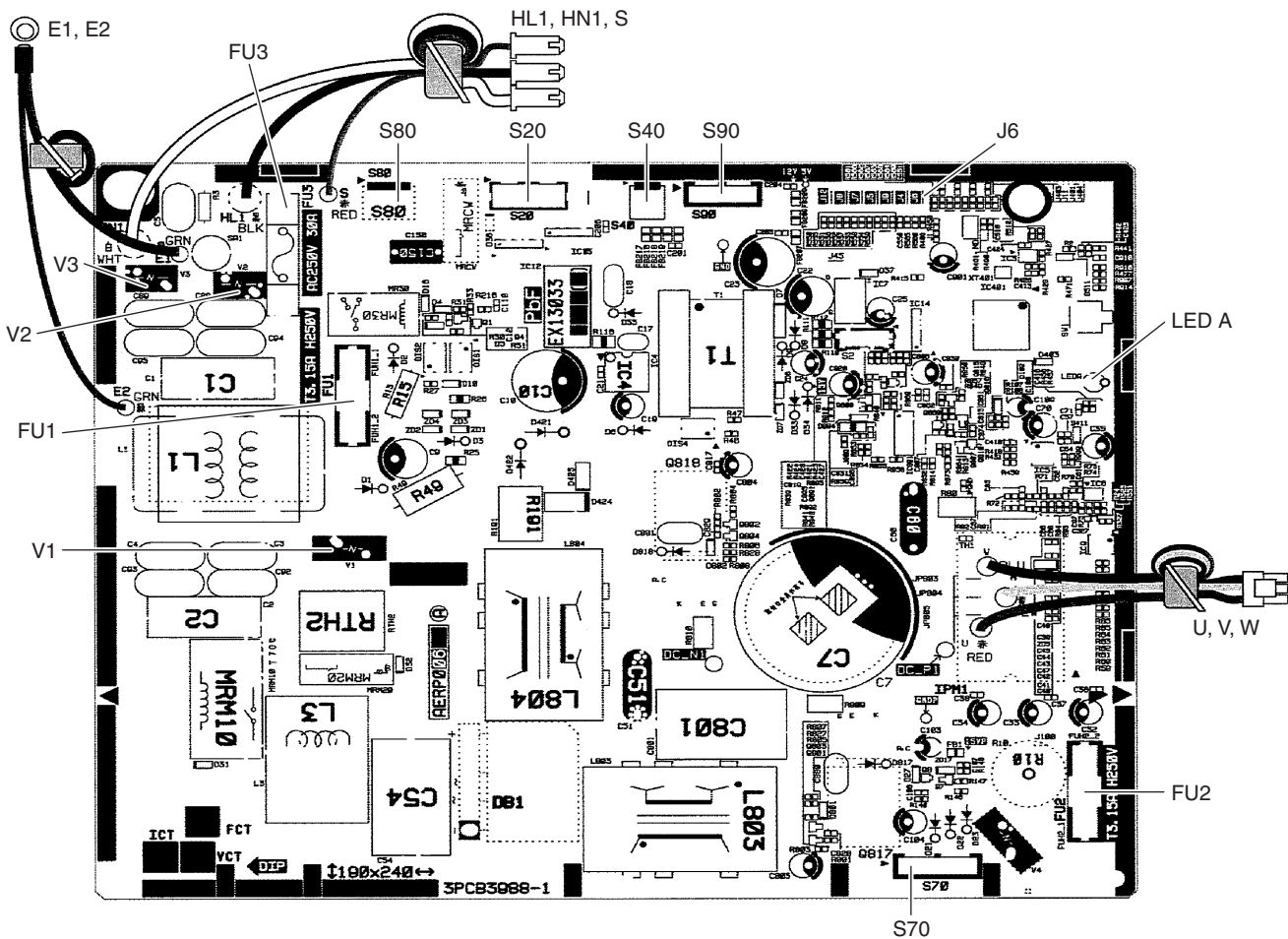

**Caution** Replace the PCB if you accidentally cut a wrong jumper.

Jumpers are necessary for electronic circuit. Improper operation may occur if you cut any of them.

# Part 4

## Functions and Control

1. Main Functions .....	16
1.1 Temperature Control .....	16
1.2 Frequency Principle.....	16
1.3 Fan Speed Control for Indoor Unit .....	18
1.4 Program Dry Operation .....	19
1.5 Clock and Calendar Setting (With Wired Remote Controller BRC1E73) ...	20
1.6 Schedule TIMER Operation (With Wired Remote Controller BRC1E73) ...	22
1.7 Drain Pump Control.....	25
1.8 Hot Start Control (In Heating Operation Only).....	27
1.9 Other Functions.....	28
2. Control Specification .....	29
2.1 Mode Hierarchy .....	29
2.2 Frequency Control.....	30
2.3 Controls at Mode Changing/Start-up.....	32
2.4 Discharge Pipe Temperature Control.....	34
2.5 Input Current Control.....	35
2.6 Freeze-up Protection Control .....	36
2.7 Heating Peak-cut Control .....	37
2.8 Outdoor Fan Control.....	38
2.9 Liquid Compression Protection Function.....	38
2.10 Defrost Control .....	39
2.11 Electronic Expansion Valve Control .....	40
2.12 Malfunctions .....	43

# 1. Main Functions

## 1.1 Temperature Control

### Definitions of Temperatures

The definitions of temperatures are classified as following.

- ◆ Room temperature: temperature of lower part of the room
- ◆ Set temperature: temperature set by remote controller
- ◆ Room thermistor temperature: temperature detected by room temperature thermistor
- ◆ Target temperature: temperature determined by microcomputer

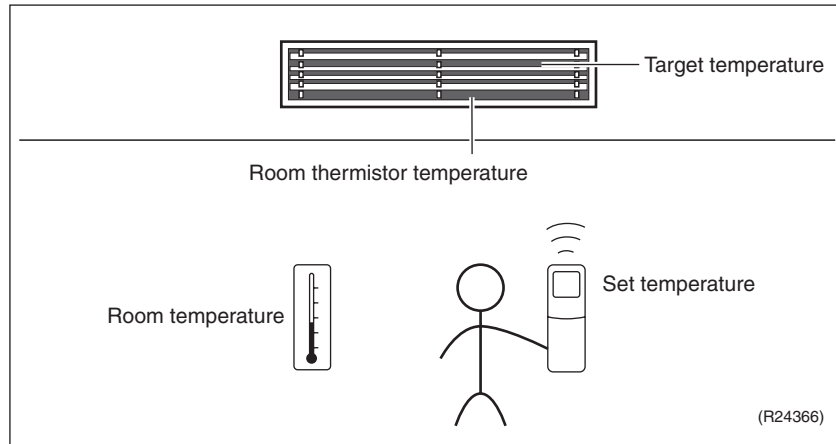

### Temperature Control

The temperature of the room is detected by the room temperature thermistor. However, there is a difference between the temperature detected by room temperature thermistor and the temperature of lower part of the room, depending on the installation condition. Practically, the temperature control is done by the target temperature appropriately adjusted for the indoor unit and the temperature detected by room temperature thermistor.

## 1.2 Frequency Principle

### Control Parameters

The frequency of the compressor is controlled by the following 2 parameters:

- The load condition of the operating indoor unit
- The difference between the room thermistor temperature and the target temperature

The target frequency is adapted by additional parameters in the following cases:

- Frequency restrictions
- Initial settings
- Forced cooling operation

### Inverter Principle

To regulate the capacity, a frequency control is needed. The inverter makes it possible to control the rotation speed of the compressor. The following table explains the inverter principle:

Phase	Description
1	The supplied AC power source is converted into the DC power source for the present.
2	The DC power source is reconverted into the three phase AC power source with variable frequency. <ul style="list-style-type: none"> <li>■ When the frequency increases, the rotation speed of the compressor increases resulting in an increase of refrigerant circulation. This leads to a larger amount of heat exchange per unit.</li> <li>■ When the frequency decreases, the rotation speed of the compressor decreases resulting in a decrease of refrigerant circulation. This leads to a smaller amount of heat exchange per unit.</li> </ul>

The following drawing shows a schematic view of the inverter principle:

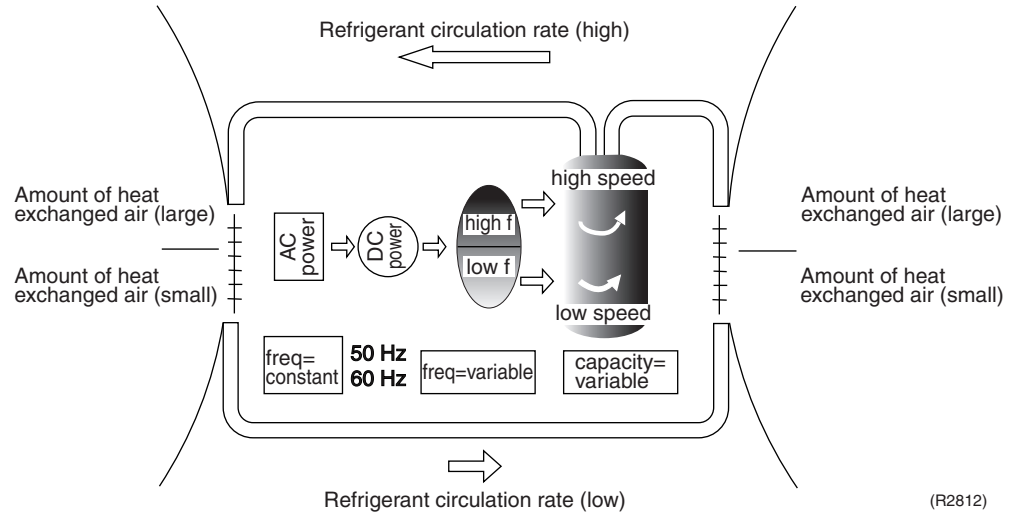

**Inverter Features**

The inverter provides the following features:

- The regulating capacity can be changed according to the changes in the outdoor temperature and cooling/heating load.
- Quick heating and quick cooling  
The rotation speed of the compressor is increased when starting the heating (or cooling). This enables to reach the set temperature quickly.
- Even during extreme cold weather, high capacity is achieved. It is maintained even when the outdoor temperature is 2°C (35.6 °F).
- Comfortable air conditioning  
A fine adjustment is integrated to keep the room temperature constant.
- Energy saving heating and cooling  
Once the set temperature is reached, the energy saving operation enables to maintain the room temperature at low power.

**Frequency Limits**

The following functions regulate the minimum and maximum frequency:

Frequency	Functions
Low	<ul style="list-style-type: none"> <li>■ Four way valve operation compensation. Refer to page 33.</li> </ul>
High	<ul style="list-style-type: none"> <li>■ Compressor protection function. Refer to page 33.</li> <li>■ Discharge pipe temperature control. Refer to page 34.</li> <li>■ Input current control. Refer to page 35.</li> <li>■ Freeze-up protection control. Refer to page 36.</li> <li>■ Heating peak-cut control. Refer to page 37.</li> <li>■ Defrost control. Refer to page 39.</li> </ul>

**Forced Cooling Operation**

Refer to page 114 for details.

## 1.3 Fan Speed Control for Indoor Unit

### ■ With Wired Remote Controller (BRC1E73)

To change the fan speed, press **Fan Speed** button and select the fan speed from Low/Medium/High/Auto.

- ◆ Auto cannot be selected if the indoor unit does not have Auto Fan speed function.
- ◆ The system may change the fan speed automatically for equipment protection purposes.
- ◆ The system may turn off the fan when the room temperature is satisfied.
- ◆ It is normal for a delay to occur when changing the fan speed.
- ◆ If the Auto is selected for the fan speed, the fan speed varies automatically based on the difference between set temperature and room temperature.

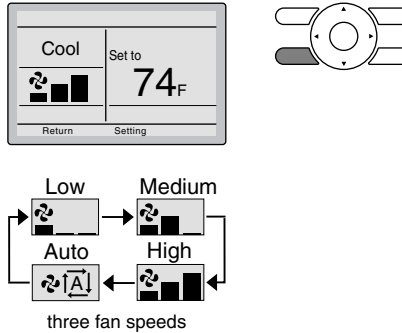

### ■ With Wireless Remote Controller (BRC082A43)

Press **FAN SPEED CONTROL** button.

High, Medium or Low fan speed can be selected.

The microchip may sometimes control the fan speed in order to protect the unit.

## 1.4 Program Dry Operation

### Outline

Program dry operation removes humidity while preventing the room temperature from lowering. Since the microcomputer controls both the temperature and airflow rate, the temperature adjustment and **FAN** setting buttons are inoperable.

### Details

The microcomputer automatically sets the temperature and airflow rate. The difference between the room thermistor temperature at start-up and the target temperature is divided into two zones. Then, the unit operates in an appropriate capacity for each zone to maintain the temperature and humidity at a comfortable level.

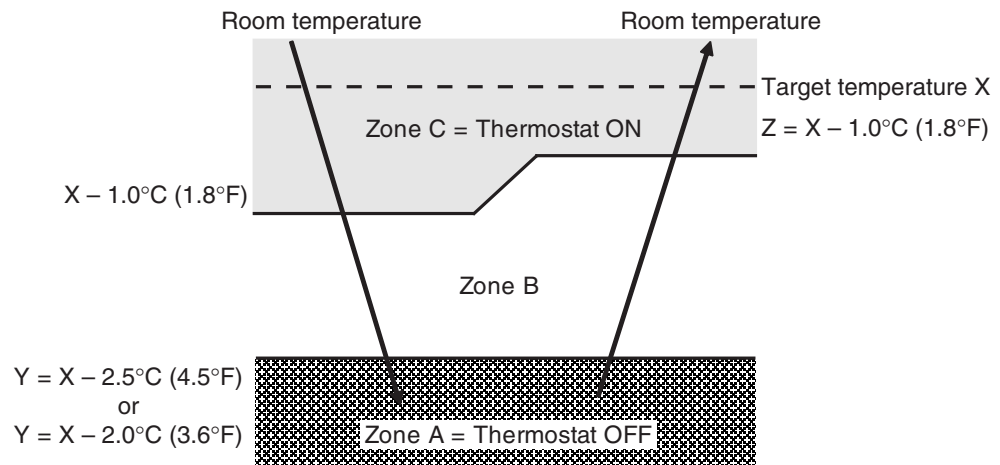

(R24367)

Room thermistor temperature at start-up	Target temperature X	Thermostat OFF point Y	Thermostat ON point Z
24.5°C or more (76.1°F or more)	Room thermistor temperature at start-up	X - 2.5°C (X - 4.5°F)	X - 1.0°C (X - 1.8°F)
16.5 ~ 24°C (61.7 ~ 75.2°F)		X - 2.0°C (X - 3.6°F)	X - 1.0°C (X - 1.8°F)
16°C or less (60.8°F or less)	16°C (60.8°F)	X - 2.0°C (X - 3.6°F)	X - 1.0°C = 15°C (X - 1.8°F = 59°F)

## 1.5 Clock and Calendar Setting (With Wired Remote Controller BRC1E73)

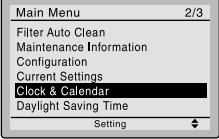
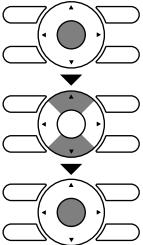
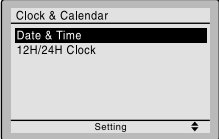
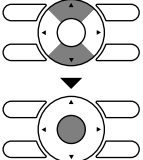
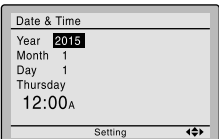
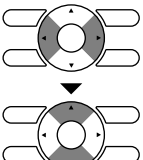
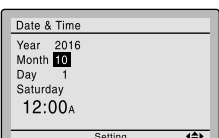
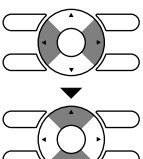
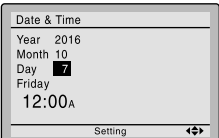
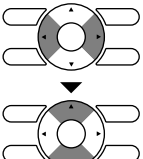
- 
- 1**
- 
- Press **Menu/OK** button to display the main menu screen.
  - Press **▼▲** buttons to select **Clock & Calendar** on the main menu screen. Press **Menu/OK** button to display the clock & calendar screen.
- 
- 
- 2**
- 
- Press **▼▲** buttons to select **Date & Time** on the clock & calendar screen. Press **Menu/OK** button to display the date & time screen.
- 
- 
- 3**
- 
- Select **Year** with **◀▶** buttons. Change the year with **▼▲** buttons. Holding down the button causes the number to change continuously.
- 
- 
- 4**
- 
- Select **Month** with **◀▶** buttons. Change the month with **▼▲** buttons. Holding down the button causes the number to change continuously.
- 
- 
- 5**
- 
- Select **Day** with **◀▶** buttons. Change the day with **▼▲** buttons. Holding down the button causes the number to change continuously. Days of the week change automatically.
- 
- 

(R24368)

6

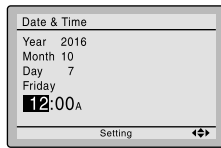

- Select **Hour** with ◀▶ buttons.  
Change the hour with ▼▲ buttons.  
Holding down the button causes the number to change continuously.

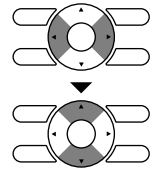

7

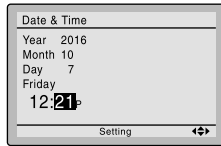

- Select **Minute** with ◀▶ buttons.  
Change the minute with ▼▲ buttons.  
Holding down the button causes the number to change continuously.
- Press **Menu/OK** button.  
The confirmation screen will appear.

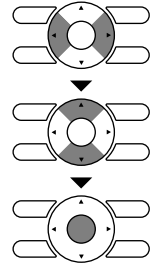

Note:

The date can be set between January 1, 2015 and December 31, 2099.

8

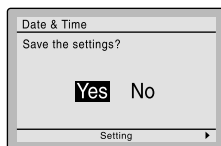

- Press ◀▶ button to select **Yes** on the confirmation screen.  
Press **Menu/OK** button to confirm the clock and return to the basic screen.

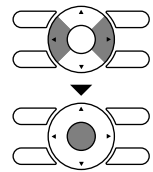

\* When setting the schedule, the display returns to the settings screen.

(R24072)

## 1.6 Schedule TIMER Operation (With Wired Remote Controller BRC1E73)

### Outline

Day settings are selected from 4 patterns:

- ◆ 7 Days
- ◆ Weekday/Sat/Sun
- ◆ Weekday/Weekend
- ◆ Everyday

Up to 5 actions can be set for each day.

### Details

Set the startup time and operation stop time.

ON: Startup time, cooling and heating temperature setpoints can be configured.

OFF: Operation stop time, cooling and heating setback temperature setpoints can be configured.

( --: Indicates that the setback function is disabled for this time period. )

\_\_\_: Indicates that the temperature setpoint and setback temperature setpoint for this time period is not specified. The last active setpoint will be utilized.

### ■ Setting the schedule

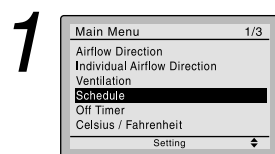

- Press **Menu/OK** button to display the main menu screen.
- Press **▼▲** buttons to select **Schedule**. Press **Menu/OK** button to display the schedule screen.

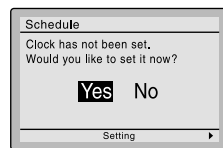

- Before setting the schedule, the clock must be set.
- If the clock has not been set, a screen like the one on the left will appear. Press **◀▶** buttons to select **Yes** and press **Menu/OK** button.

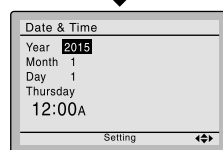

- The date & time screen will appear.
- Set the current year, month, day, and time.

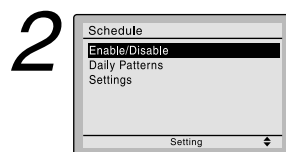
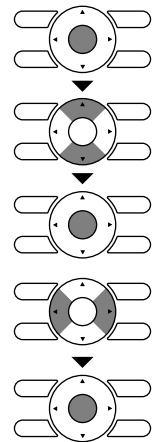

- Press **▼▲** buttons to select the desired function on the schedule screen and press **Menu/OK** button.

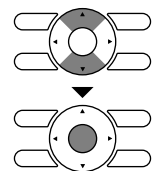

(R24369)

## ■ Daily Patterns

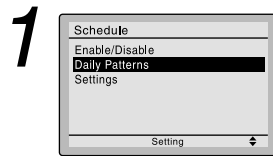

- The schedule screen will appear.
- Press ▼▲ buttons to select **Daily Patterns** on the schedule screen. The daily patterns screen will appear when **Menu/OK** button is pressed.

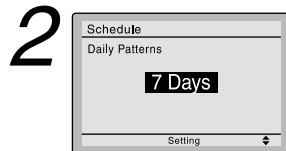
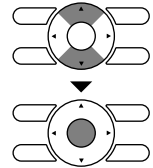

- Press ▼▲ buttons to select **7 Days**, **Weekday/Sat/Sun**, **Weekday/Weekend** or **Everyday** on the daily patterns screen. The confirmation screen will appear when **Menu/OK** button is pressed.

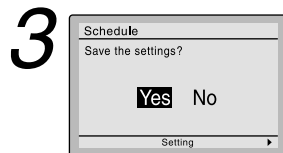
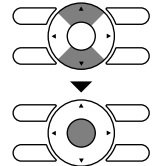

- Press ◀▶ buttons to select **Yes** on the confirmation screen. Pressing **Menu/OK** button enters the daily patterns in the schedule and takes you back to the main menu screen.

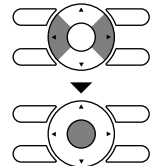

(R24074)

## ■ Settings

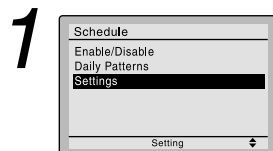

- The schedule screen will appear.
- Press ▼▲ buttons to select **Settings** on the schedule screen. The settings screen will appear when **Menu/OK** button is pressed.

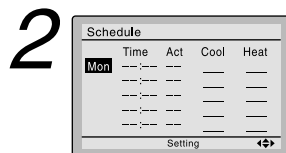
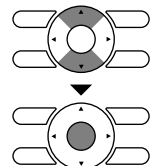

- Press ▼▲ buttons to select the day to be set.
- \* It cannot be selected in the case of **EVDY**.

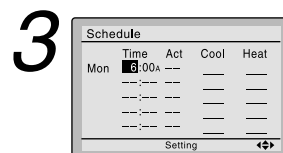
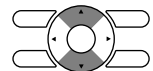

- Input the time for the selected day.
- Press ◀▶ buttons to move the highlighted item and press ▼▲ buttons to input the desired operation start time. Each press of ▼▲ buttons moves the numbers by 1 hour or 1 minute.

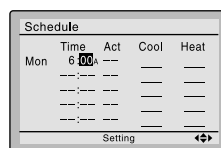
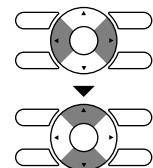

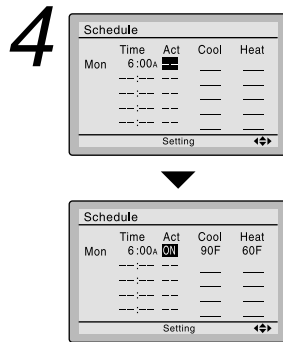

● Press ◀▶ buttons to move the highlighted item and press ▼▲ buttons to configure ON/OFF/-- settings. --, ON, or OFF changes in sequence when ▼▲ buttons are pressed.

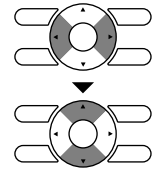

ON: The temperature setpoints can be configured.  
 OFF: The setback temperature setpoints can be configured.  
 --: The temperature setpoints and setback temperature setpoints become disabled.

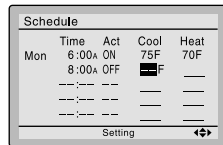

● The cooling and heating temperature setpoints for both ON and OFF (Setback) are configured.

\_: Indicates that the temperature setpoint and setback temperature setpoint for this time period is not specified. The last active setpoint will be utilized.

--: Indicates that the setback function is disabled for this time period.

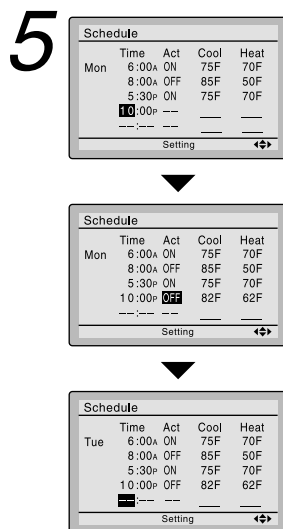

A maximum of five actions per day can be set.

● Press **Menu/OK** button when settings for each day are completed. The confirmation screen will appear.

To copy the settings for the previous day, press **Mode** button so that the existing settings will be copied.

Example: The contents for Monday are copied by pressing **Mode** button after selecting Tuesday.

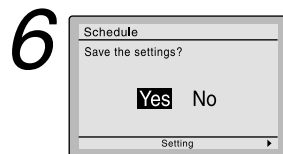
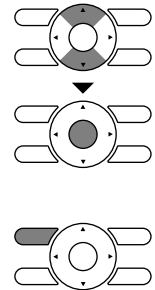

● Press ◀▶ buttons to select **Yes** on the confirmation screen. Pressing **Menu/OK** button confirms the settings for each day and takes you back to the basic screen.

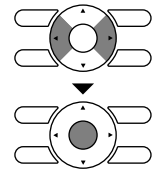

(R24075)

## ■ Enabling or disabling the schedule

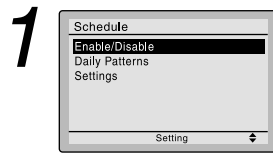

- Display the schedule screen.
- Press ▼▲ buttons to select **Enable / Disable** on the schedule screen.  
Press **Menu/OK** button to display the enable/disable screen.

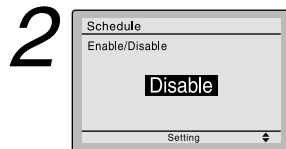
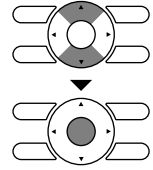

- Press ▼▲ buttons to select **Enable** or **Disable** on the enable/disable screen.  
Press **Menu/OK** button after selecting the item. The confirmation screen is displayed.

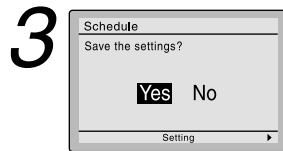
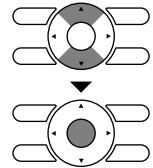

- Press ◀▶ buttons to select **Yes** on the confirmation screen.  
Pressing **Menu/OK** button confirms the enable/disable setting for the schedule and takes you back to the basic screen.

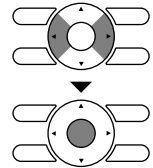

(R24076)

## 1.7 Drain Pump Control

### 1.7.1 Normal Operation

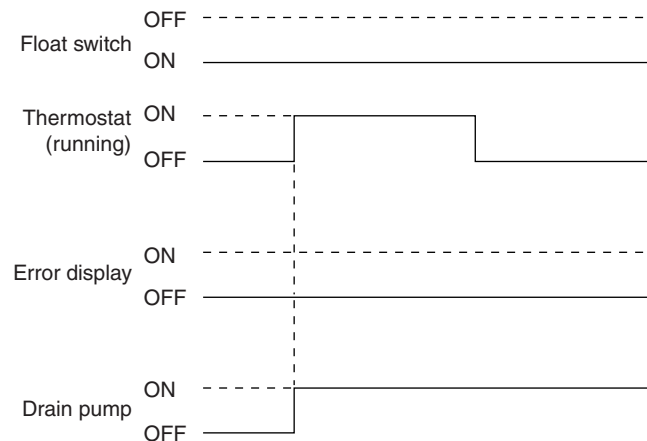

(R24037)

- ◆ The float switch is ON in normal operation.
- ◆ When cooling operation starts (thermostat ON), the drain pump turns ON simultaneously.
- ◆ After the thermostat turns OFF, the drain pump continues to operate.

## 1.7.2 If the Float Switch is OFF with the Thermostat ON in Cooling Operation

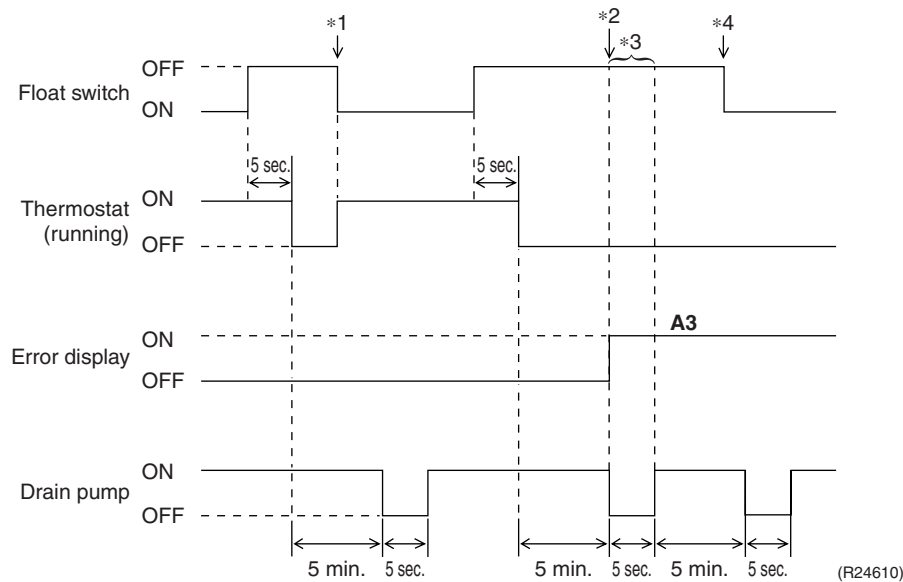

- ◆ When the float switch stays OFF for 5 sec., the thermostat turns OFF.
- ◆ After the thermostat turns OFF, the drain pump continues to operate for another 5 minutes.
- \*1: If the float switch turns ON again during the residual operation of the drain pump, cooling operation also turns on again (thermostat ON).
- \*2: If the float switch remains OFF even after the residual operation of the drain pump has ended, the error code **A3** is determined.
- \*3: The drain pump turns OFF once residual operation has ended, then turns ON again after 5 seconds.
- \*4: After **A3** is determined and the unit comes to an abnormal stop, the thermostat will remain OFF even if the float switch turns ON again.

## 1.7.3 If the Float Switch is OFF with the Thermostat OFF in Cooling Operation

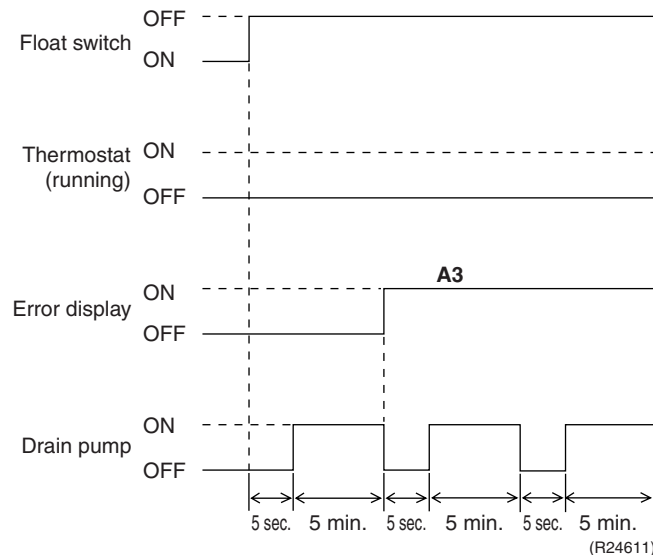

- ◆ When the float switch stays OFF for 5 sec., the drain pump turns ON.
- ◆ If the float switch remains OFF even after the residual operation of the drain pump has ended, the error code **A3** is determined.
- ◆ The drain pump turns OFF once residual operation has ended, then turns ON again after 5 seconds.

### 1.7.4 If the Float Switch Turns OFF and ON Continuously, or the Float Switch Turns OFF While AF Displayed

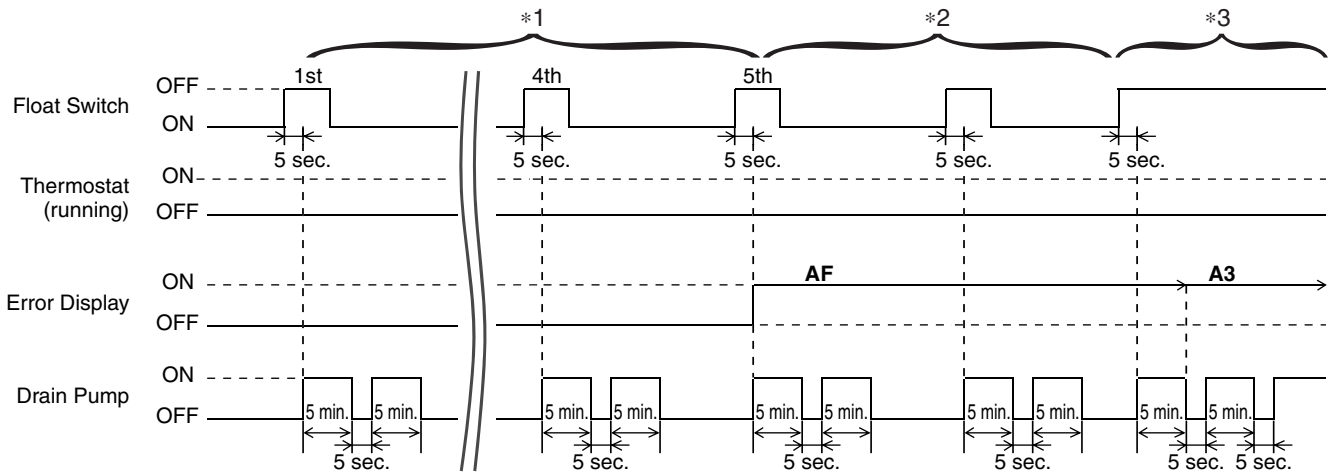

(R24370)

- ◆ When the float switch stays OFF for 5 sec., the drain pump turns ON.
- \*1: If the float switch continues to turn OFF and ON 5 times consecutively, it is judged as a drain system error and the error code **AF** is determined.
- \*2: The drain pump continues to turn ON/OFF in accordance with the float switch OFF/ON even after **AF** is determined.
- \*3: While the error code **AF** is active, if the float switch remains OFF even after the residual operation of the drain pump has ended, the error code **A3** will be determined.

## 1.8 Hot Start Control (In Heating Operation Only)

### Outline

At startup with thermostat ON or after the completion of defrosting in heating operation, the indoor unit fan is controlled to prevent cold air from blasting out and ensure startup capacity.

### Details

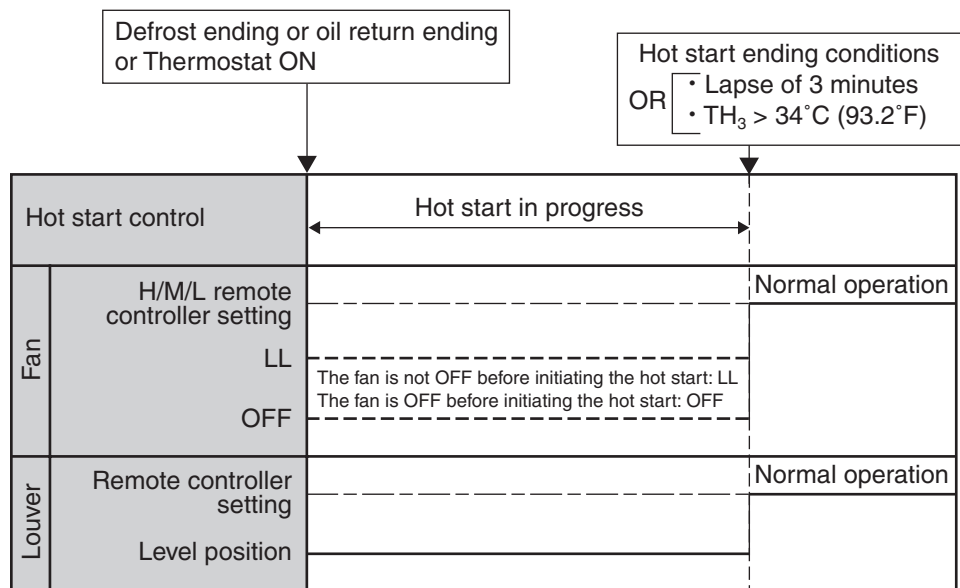

(R24041)

TH<sub>3</sub>: Temperature detected by the indoor heat exchanger thermistor (R3T)

## 1.9 Other Functions

### 1.9.1 Signal Receiving Sign

When the indoor unit receives a signal from the remote controller, the unit emits a signal receiving sound.

### 1.9.2 Auto-restart Function

If a power failure (even a momentary one) occurs during the operation, the system restarts automatically in the same conditions as before when the power supply is restored to the conditions prior to the power failure.



**Note:** It takes 3 minutes to restart the operation because the 3-minute standby function is activated.

### 1.9.3 Emergency Operation Switch (With Wireless Remote Controller BRC082A43)

When the remote controller does not work due to battery failure or the absence thereof, use the emergency operation switch.

#### Start

Press emergency operation switch.

- ◆ The unit runs in the previous mode.
- ◆ The system operates with the previously set airflow direction.

#### Stop

Press emergency operation switch again.

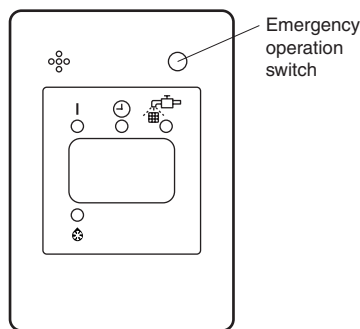

(R24925)

## 2. Control Specification

### 2.1 Mode Hierarchy

#### Outline

The air conditioner control has normal operation mode, forced operation mode, and power transistor test mode for installation and servicing.

#### Details

##### Heat Pump Model

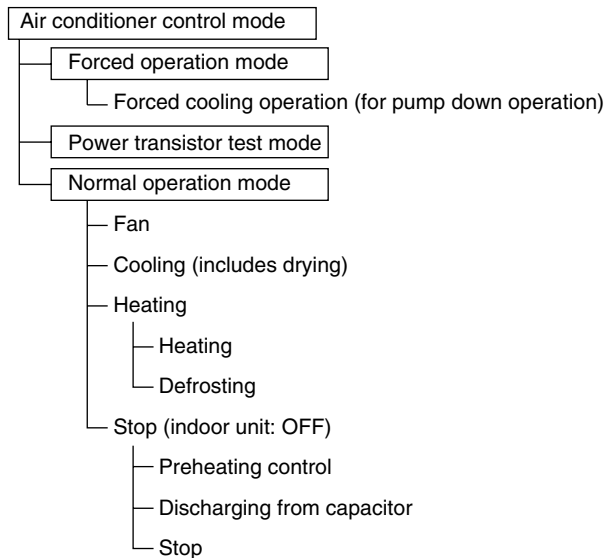

(R22375)



**Note:** Unless specified otherwise, dry operation command is regarded as cooling operation.

## 2.2 Frequency Control

### Outline

The compressor frequency is determined according to the difference between the room thermistor temperature and the target temperature.

When the shift of the frequency is less than zero ( $\Delta F < 0$ ) by PI control, the target frequency is used as the command frequency.

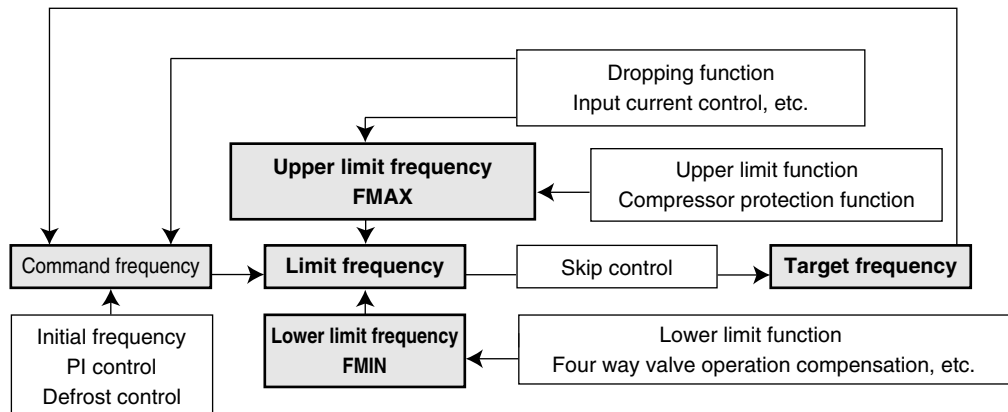

(R18023)

### Details

#### 1. Determine command frequency

Command frequency is determined in the following order of priority.

1. Limiting defrost control time
2. Forced cooling
3. Indoor frequency command

#### 2. Determine upper limit frequency

The minimum value is set as an upper limit frequency among the frequency upper limits of the following functions:

Compressor protection, input current, discharge pipe temperature, heating peak-cut, freeze-up protection, defrost control.

#### 3. Determine lower limit frequency

The maximum value is set as a lower limit frequency among the frequency lower limits of the following functions:

Four way valve operation compensation, draft prevention, pressure difference upkeep.

#### 4. Determine prohibited frequency

There is a certain prohibited frequency such as a power supply frequency.

**Initial Frequency**

When starting the compressor, the frequency is initialized according to the  $\Delta D$  value of the indoor unit.

 **$\Delta D$  signal: Indoor frequency command**

The difference between the room thermistor temperature and the target temperature is taken as the  $\Delta D$  value and is used for  $\Delta D$  signal of frequency command.

 **$\Delta D$  signal for cooling**

Temperature difference	$\Delta D$ signal	Temperature difference	$\Delta D$ signal	Temperature difference	$\Delta D$ signal	Temperature difference	$\Delta D$ signal
-2.0°C (-3.6°F)	*OFF	0°C (0°F)	4	2.0°C (3.6°F)	8	4.0°C (7.2°F)	12
-1.5°C (-2.7°F)	1	0.5°C (0.9°F)	5	2.5°C (4.5°F)	9	4.5°C (8.1°F)	13
-1.0°C (-1.8°F)	2	1.0°C (1.8°F)	6	3.0°C (5.4°F)	10	5.0°C (9.0°F)	14
-0.5°C (-0.9°F)	3	1.5°C (2.7°F)	7	3.5°C (6.3°F)	11	5.5°C (9.9°F)	15

\*OFF = Thermostat OFF

 **$\Delta D$  signal for heating**

Temperature difference	$\Delta D$ signal	Temperature difference	$\Delta D$ signal	Temperature difference	$\Delta D$ signal	Temperature difference	$\Delta D$ signal
-1.5°C (-2.7°F)	*OFF	0.5°C (0.9°F)	4	2.5°C (4.5°F)	8	4.5°C (8.1°F)	12
-1.0°C (-1.8°F)	1	1.0°C (1.8°F)	5	3.0°C (5.4°F)	9	5.0°C (9.0°F)	13
-0.5°C (-0.9°F)	2	1.5°C (2.7°F)	6	3.5°C (6.3°F)	10	5.5°C (9.9°F)	14
0°C (0°F)	3	2.0°C (3.6°F)	7	4.0°C (7.2°F)	11	6.0°C (10.8°F)	15

\*OFF = Thermostat OFF

**PI Control****1. P control**

The  $\Delta D$  value is calculated in each sampling time (20 seconds), and the frequency is adjusted according to its difference from the frequency previously calculated.

**2. I control**

If the operating frequency does not change for more than a certain fixed time, the frequency is adjusted according to the  $\Delta D$  value.

When  $\Delta D$  value is low, the frequency is lowered.

When  $\Delta D$  value is high, the frequency is increased.

**3. Frequency control when other controls are functioning**

- ◆ When frequency is dropping:  
Frequency control is carried out only when the frequency drops.
- ◆ For limiting lower limit:  
Frequency control is carried out only when the frequency rises.

**4. Upper and lower limit of frequency by PI control**

The frequency upper and lower limits are set according to the command of the indoor unit.

When the indoor or outdoor unit quiet operation command comes from the indoor unit, the upper limit frequency is lower than the usual setting.

## 2.3 Controls at Mode Changing/Start-up

### 2.3.1 Preheating Control

---

**Outline** The inverter operation in open phase starts with the conditions of the outdoor temperature, the discharge pipe temperature, the radiation fin temperature and the preheating command from the indoor unit.

---

**Details** Outdoor temperature  $\geq -2.5^{\circ}\text{C}$  ( $27.5^{\circ}\text{F}$ )  $\rightarrow$  Control A (preheating for normal state)  
 Outdoor temperature  $< -2.5^{\circ}\text{C}$  ( $27.5^{\circ}\text{F}$ )  $\rightarrow$  Control B (preheating of increased capacity)

#### Control A

- ◆ ON condition
  - Discharge pipe temperature  $< 0^{\circ}\text{C}$  ( $32.0^{\circ}\text{F}$ )
  - Radiation fin temperature  $< 85^{\circ}\text{C}$  ( $185^{\circ}\text{F}$ )
- ◆ OFF condition
  - Discharge pipe temperature  $> 2^{\circ}\text{C}$  ( $35.6^{\circ}\text{F}$ )
  - Radiation fin temperature  $\geq 90^{\circ}\text{C}$  ( $194^{\circ}\text{F}$ )

#### Control B

- ◆ ON condition
  - Discharge pipe temperature  $< 10^{\circ}\text{C}$  ( $50.0^{\circ}\text{F}$ )
  - Radiation fin temperature  $< 85^{\circ}\text{C}$  ( $185^{\circ}\text{F}$ )
- ◆ OFF condition
  - Discharge pipe temperature  $> 12^{\circ}\text{C}$  ( $53.6^{\circ}\text{F}$ )
  - Radiation fin temperature  $\geq 90^{\circ}\text{C}$  ( $194^{\circ}\text{F}$ )

### 2.3.2 Four Way Valve Switching

---

**Outline** The four way valve coil is energized/not energized depending on the operation mode. (Heating: ON, Cooling/Dry/Defrost: OFF)  
 In order to eliminate the switching sound as the four way valve coil switches from ON to OFF when the heating is stopped, the OFF delay switch of the four way valve is carried out.

---

**Details** **OFF delay switch of four way valve**  
 The four way valve coil is energized for 160 seconds after the operation is stopped.

### 2.3.3 Four Way Valve Operation Compensation

#### Outline

At the beginning of operation as the four way valve is switched, the pressure difference to activate the four way valve is acquired when the output frequency is higher than a certain fixed frequency, for a certain fixed time.

#### Details

##### Starting Conditions

1. When the compressor starts and the four way valve switches from OFF to ON
2. When the four way valve switches from ON to OFF during operation
3. When the compressor starts after resetting
4. When the compressor starts after the fault of four way valve switching

The lower limit of frequency keeps **A** Hz for **B** seconds for any of the conditions above.

When the outdoor temperature is above **C** in heating, the frequency decreases depending on the outdoor temperature.

	09/12 class		15/18/24 class	
	Cooling	Heating	Cooling	Heating
<b>A</b> (Hz)	40	54	48	
<b>B</b> (seconds)	60		70	
<b>C</b>	(°C)	10	15	
	(°F)	50	59	

### 2.3.4 3-Minute Standby

Turning on the compressor is prohibited for 3 minutes after turning it off.  
(The function is not activated when defrosting.)

### 2.3.5 Compressor Protection Function

When turning the compressor from OFF to ON, the upper limit of frequency is set as follows.  
(The function is not activated when defrosting.)

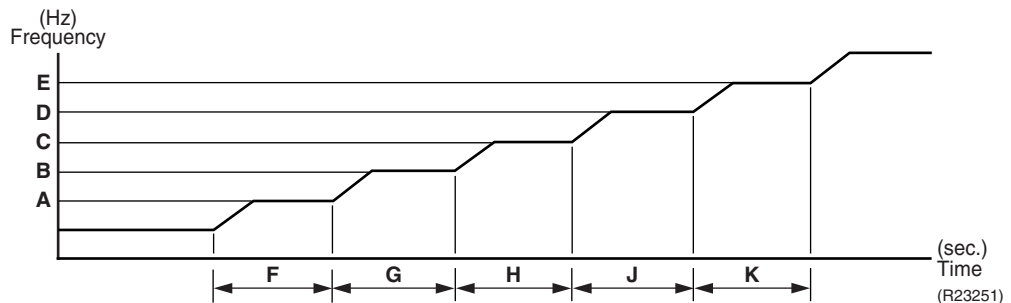

	09/12 class	15/18/24 class
<b>A</b> (Hz)	40	52
<b>B</b> (Hz)	54	68
<b>C</b> (Hz)	72	80
<b>D</b> (Hz)	90	—
<b>E</b> (Hz)	—	—
<b>F</b> (seconds)	180	300
<b>G</b> (seconds)	420	200
<b>H</b> (seconds)	180	460
<b>J</b> (seconds)	120	—
<b>K</b> (seconds)	—	—

## 2.4 Discharge Pipe Temperature Control

**Outline**

The discharge pipe temperature is used as the internal temperature of the compressor. If the discharge pipe temperature rises above a certain level, the upper limit of frequency is set to keep the discharge pipe temperature from rising further.

**Details**

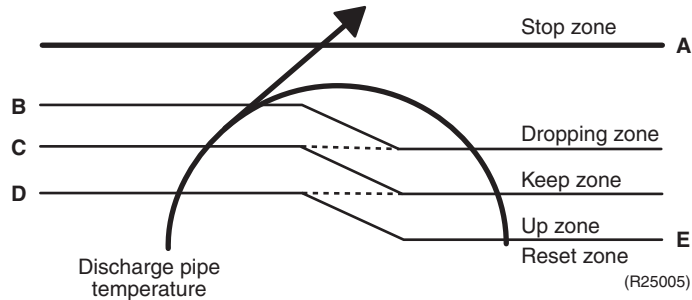

	09/12 class		15/18/24 class	
	(°C)	(°F)	(°C)	(°F)
<b>A</b>	110	230.0	110	230.0
<b>B</b>	103	217.4	103	217.4
<b>C</b>	98	208.4	101.5	214.7
<b>D</b>	93	199.4	100	212.0
<b>E</b>	88	190.4	95	203.0

Zone	Control
Stop zone	When the temperature reaches the stop zone, the compressor stops.
Dropping zone	The upper limit of frequency decreases.
Keep zone	The upper limit of frequency is kept.
Up zone	The upper limit of frequency increases.
Reset zone	The upper limit of frequency is canceled.

## 2.5 Input Current Control

### Outline

The microcomputer calculates the input current while the compressor is running, and sets the frequency upper limit based on the input current.

In case of heat pump models, this control is the upper limit control of frequency and takes priority over the lower limit control of four way valve operation compensation.

### Details

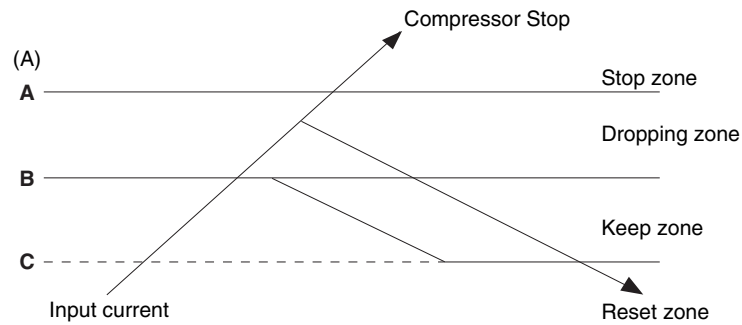

(R23249)

#### Frequency control in each zone

##### Stop zone

- After the input current remains in the stop zone for 2.5 seconds, the compressor is stopped.

##### Dropping zone

- The upper limit of the compressor frequency is defined as operation frequency – 2 Hz.
- After this, the output frequency is lowered by 2 Hz every second until it reaches the keep zone.

##### Keep zone

- The present maximum frequency goes on.

##### Reset zone

- Limit of the frequency is canceled.

	09/12 class		15 class		18 class		24 class	
	Cooling	Heating	Cooling	Heating	Cooling	Heating	Cooling	Heating
<b>A (A)</b>	12		12		12	12.5	18	
<b>B (A)</b>	7	7.5	8		10	10.75	12	11.5
<b>C (A)</b>	6	6.5	7		9	9.75	11	10.5

#### Limitation of current dropping and stop value according to the outdoor temperature

- The current drops when outdoor temperature becomes higher than a certain level (depending on the model).

## 2.6 Freeze-up Protection Control

### Outline

During cooling operation, the signal sent from the indoor unit determines the frequency upper limit and prevents the indoor heat exchanger from freezing.

### Details

When the freeze-up protection control starts, the compressor stops, the airflow rate is fixed to L tap, and the drain pump turns ON. Conditions for starting and ending are as below.

#### Starting conditions

The freeze-up protection control starts when any of the following conditions is satisfied.

- The indoor heat exchanger temperature remains at **A** or lower for 1 minute.
- The accumulated time that the indoor heat exchanger temperature remains at **B** or lower reaches 40 minutes.

#### Accumulated timer clearing condition

- The indoor heat exchanger temperature remains at **C** or higher for 20 minutes.

#### Ending condition

- The indoor heat exchanger temperature remains at **D** or higher for 10 minutes.

	(°C)	(°F)
<b>A</b>	-5	23.0
<b>B</b>	-1	30.2
<b>C</b>	4	39.2
<b>D</b>	7	44.6

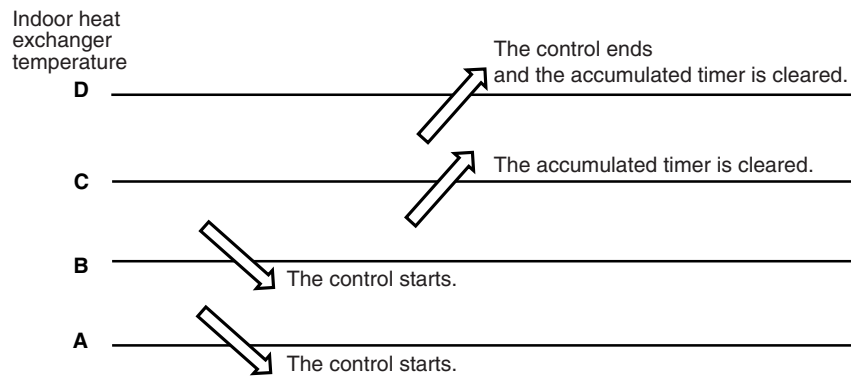

## 2.7 Heating Peak-cut Control

During heating operation, the indoor heat exchanger temperature determines the frequency upper limit to prevent abnormal high pressure.

The operating frequency limitation is judged with the indoor heat exchanger temperature.

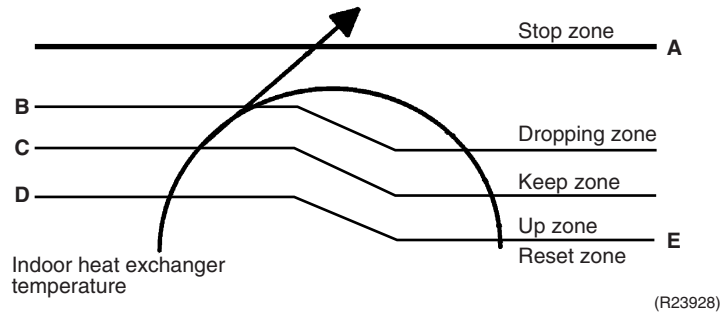

	09/12 class		15 class		18 class		24 class	
	(°C)	(°F)	(°C)	(°F)	(°C)	(°F)	(°C)	(°F)
<b>A</b>	57.5	135.5	60	140.0	60	140.0	60	140.0
<b>B</b>	55	131.0	54	129.2	55	131.0	54	129.2
<b>C</b>	52	125.6	51	123.8	52	125.6	51	123.8
<b>D</b>	50	122.0	49	120.2	50	122.0	49	120.2
<b>E</b>	45	113.0	44	111.2	45	113.0	44	111.2

Zone	Control
Stop zone	When the temperature reaches the stop zone, the compressor stops.
Dropping zone	The upper limit of frequency decreases.
Keep zone	The upper limit of frequency is kept.
Up zone	The upper limit of frequency increases.
Reset zone	The upper limit of frequency is canceled.

## 2.8 Outdoor Fan Control

### 1. Fan ON control to cool down the electrical box

The outdoor fan is turned ON when the electrical box temperature is high while the compressor is OFF.

### 2. Fan OFF control during defrosting

The outdoor fan is turned OFF during defrosting.

### 3. Fan OFF delay when stopped

The outdoor fan is turned OFF 60 ~ 70 seconds after the compressor stops.

### 4. Fan speed control for pressure difference upkeep

The rotation speed of the outdoor fan is controlled for keeping the pressure difference during cooling operation with low outdoor temperature.

- ◆ When the pressure difference is low, the rotation speed of the outdoor fan is reduced.
- ◆ When the pressure difference is high, the rotation speed of the outdoor fan is controlled as well as normal operation.

### 5. Fan speed control during forced cooling operation

The outdoor fan is controlled as well as normal operation during forced cooling operation.

### 6. Fan ON/OFF control when operation (cooling, heating, dry) starts/stops

The outdoor fan is turned ON when the operation starts. The outdoor fan is turned OFF when the operation stops.

## 2.9 Liquid Compression Protection Function

---

### Outline

In order to increase the dependability of the compressor, the compressor is stopped according to the outdoor temperature.

---

### Details

Operation stops depending on the outdoor temperature  
Compressor turns off under the conditions that the system is in cooling operation and outdoor temperature is below 0°C (32°F).

## 2.10 Defrost Control

### Outline

Defrosting is carried out by the cooling cycle (reverse cycle). The defrosting time or outdoor heat exchanger temperature must be more than a certain value to finish defrosting.

### Details

#### Conditions for Starting Defrost

- The starting conditions are determined with the outdoor temperature and the outdoor heat exchanger temperature.
- The system is in heating operation.
- The compressor operates for 6 minutes.
- More than **A** minutes (depending on the duration of the previous defrost control) of accumulated time have passed since the start of the operation, or ending the previous defrosting.

#### Conditions for Canceling Defrost

The judgment is made with the outdoor heat exchanger temperature (**B**).

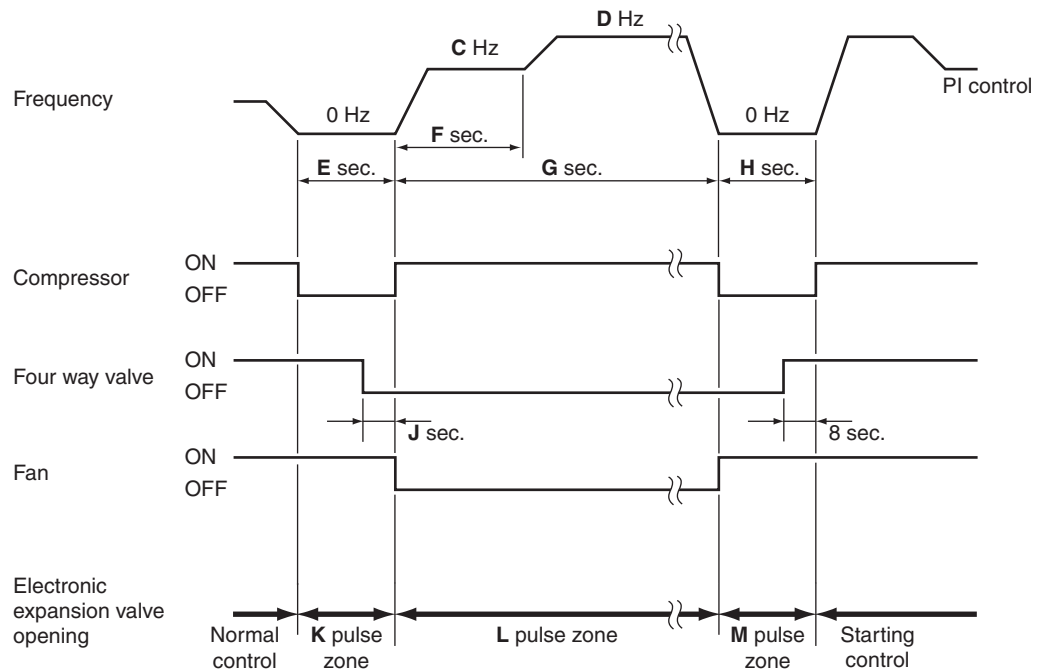

(R21661)

	09/12 class	15/18 class	24 class
<b>A</b> (minute)	20 ~ 25	44	44
<b>B</b>	(°C)	2 ~ 20	6 ~ 12
	(°F)	35.6 ~ 68.0	42.8 ~ 53.6
<b>C</b> (Hz)	64	48	48
<b>D</b> (Hz)	64	70	70
<b>E</b> (seconds)	40	60	60
<b>F</b> (seconds)	60	60	60
<b>G</b> (seconds)	120 ~ 630	120 ~ 460	120 ~ 460
<b>H</b> (seconds)	50	60	90
<b>J</b> (seconds)	8	5	5
<b>K</b> (pulse)	400	450	450
<b>L</b> (pulse)	300	300 ~ 450	300 ~ 450
<b>M</b> (pulse)	350	300	200

## 2.11 Electronic Expansion Valve Control

### Outline

The following items are included in the electronic expansion valve control.

#### Electronic expansion valve is fully closed

1. Electronic expansion valve is fully closed when turning on the power.
2. Pressure equalizing control

#### Open Control

1. Electronic expansion valve control when starting operation
2. Electronic expansion valve control when the frequency changes
3. Electronic expansion valve control for defrosting
4. Electronic expansion valve control when the discharge pipe temperature is abnormally high
5. Electronic expansion valve control when the discharge pipe thermistor is disconnected

#### Feedback Control

Target discharge pipe temperature control

### Details

The following are the examples of electronic expansion valve control which function in each operation mode.

Control	Status							
	Power on : Compressor stop	Operation start	Frequency change under starting control	During target discharge pipe temperature control	Frequency change under target discharge pipe temperature control	Discharge pipe thermistor disconnection	Frequency change under discharge pipe thermistor disconnection control	During defrost control
Starting operation control	—	●	—	—	—	—	—	—
Control when the frequency changes	—	—	●	—	●	—	—	—
Target discharge pipe temperature control	—	—	—	●	—	—	—	—
Discharge pipe thermistor disconnection control	—	—	—	—	—	●	●	—
High discharge pipe temperature control	—	●	●	●	●	—	—	—
Defrost control (heating only)	—	—	—	—	—	—	—	●
Pressure equalizing control	●	—	—	—	—	—	—	—
Opening limit control	—	●	●	●	●	●	●	—

- : Available
- : Not available

### 2.11.1 Initialization as Power Supply On

The electronic expansion valve is initialized (fully closed) when the power is turned on. Then, the valve opening is set and the pressure is equalized.

### 2.11.2 Pressure Equalizing Control

When the compressor is stopped, the pressure equalizing control is activated. The electronic expansion valve opens and the pressure is equalized.

### 2.11.3 Opening Limit Control

The maximum and minimum opening of the electronic expansion valve are limited.

	09/12 class	15/18/24 class
Maximum opening (pulse)	470	480
Minimum opening (pulse)	32	52

The electronic expansion valve is fully closed when cooling operation stops, and is opened at a fixed degree during defrosting.

### 2.11.4 Starting Operation Control

The electronic expansion valve opening is controlled when the operation starts, thus preventing the superheating or liquid compression.

### 2.11.5 Control when the frequency changes

When the target discharge pipe temperature control is active, if the target frequency changes to a specified value in a certain time period, the target discharge pipe temperature control is canceled and the target opening of the electronic expansion valve is changed according to the frequency shift.

### 2.11.6 High Discharge Pipe Temperature Control

When the compressor is operating, if the discharge pipe temperature exceeds a certain value, the electronic expansion valve opens and the refrigerant runs to the low pressure side. This procedure lowers the discharge pipe temperature.

### 2.11.7 Discharge Pipe Thermistor Disconnection Control

#### Outline

The disconnection of the discharge pipe thermistor is detected by comparing the discharge pipe temperature with the condensation temperature. If the discharge pipe thermistor is disconnected, the electronic expansion valve opens according to the outdoor temperature and the operation frequency, operates for a specified time, and then stops.

After 3 minutes, the operation restarts and checks if the discharge pipe thermistor is disconnected. If the discharge pipe thermistor is disconnected, the system stops after operating for a specified time.

If the disconnection is detected repeatedly, the system is shut down. When the compressor runs for 60 minutes without any error, the error counter is reset.

#### Details

##### Determining thermistor disconnection

When the starting control finishes, the detection timer for disconnection of the discharge pipe thermistor (**A** seconds) starts. When the timer is over, the following adjustment is made.

1. When the operation mode is cooling

When the following condition is fulfilled, the discharge pipe thermistor disconnection is ascertained.

Discharge pipe temperature +6°C (+10.8°F) < outdoor heat exchanger temperature

## 2. When the operation mode is heating

When the following condition is fulfilled, the discharge pipe thermistor disconnection is ascertained.

Discharge pipe temperature  $+6^{\circ}\text{C}$  ( $+10.8^{\circ}\text{F}$ )  $<$  indoor heat exchanger temperature

	09/12 class	15/18/24 class
<b>A</b> (seconds)	720	540

### When the thermistor is disconnected

When the disconnection is ascertained, the compressor continues operation for 9 minutes and then stops.

If the compressor stops repeatedly, the system is shut down.

## 2.11.8 Target Discharge Pipe Temperature Control

The target discharge pipe temperature is obtained from the indoor and outdoor heat exchanger temperature, and the electronic expansion valve opening is adjusted so that the actual discharge pipe temperature becomes close to the target discharge pipe temperature. (Indirect SH (superheating) control using the discharge pipe temperature)

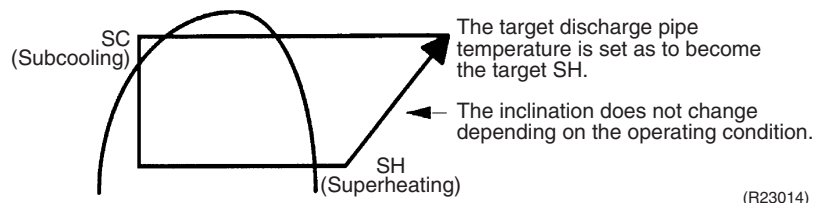

The electronic expansion valve opening and the target discharge pipe temperature are adjusted every **A** seconds. The opening degree of the electronic expansion valve is adjusted by the following.

- ◆ Target discharge pipe temperature
- ◆ Actual discharge pipe temperature
- ◆ Previous discharge pipe temperature

	All outdoor units
<b>A</b> (seconds)	10 ~ 30 ★

★ The time depends on the opening of the electronic expansion valve.

## 2.12 Malfunctions

### 2.12.1 Sensor Malfunction Detection

Sensor malfunction can be detected in the following thermistor:

1. Outdoor heat exchanger thermistor
2. Discharge pipe thermistor
3. Radiation fin thermistor
4. Outdoor temperature thermistor

### 2.12.2 Detection of Overcurrent and Overload

---

**Outline**

An excessive output current is detected and the OL temperature is observed to protect the compressor.

---

**Details**

- If the OL (compressor head) temperature exceeds 130°C (266°F), the system shuts down the compressor.
- If the inverter current exceeds 12.0 ~ 18.0 A (depending on the model), the system shuts down the compressor.  
The upper limit of the current decreases when the outdoor temperature exceeds a certain level.

# Part 5

# Remote Controller

1. Wired Remote Controller (BRC1E73) .....	45
2. Wireless Remote Controller (BRC082A43) .....	51

# 1. Wired Remote Controller (BRC1E73)

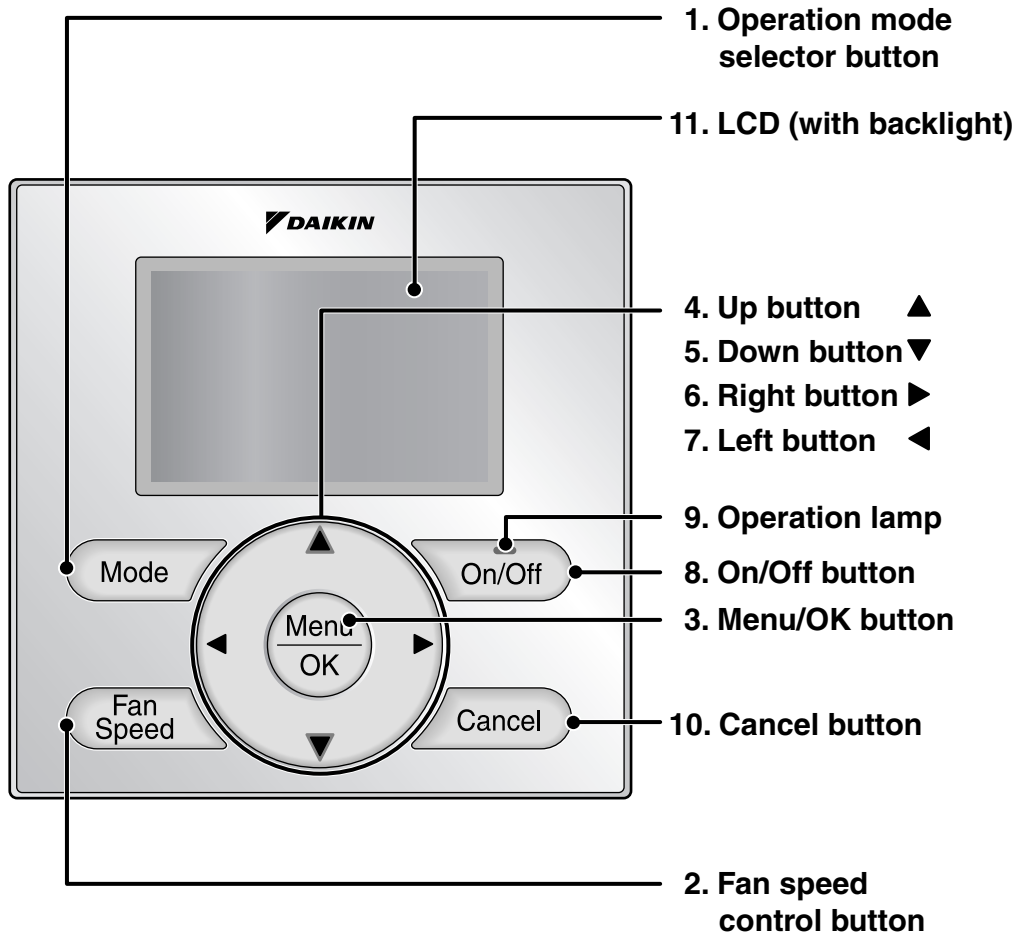

## 1. Operation mode selector button

---

- Press this button to select the operation mode of your preference.
  - \* Available modes vary with the indoor unit model.

## 2. Fan speed control button

---

- Press this button to select the fan speed of your preference.
  - \* Available fan speeds vary with the indoor unit model.

## 3. Menu/OK button

---

- Used to enter the main menu.
- Used to enter the selected item.

## 4. Up button ▲

---

- Used to raise the setpoint.
- The item above the current selection will be highlighted.  
(The highlighted items will be scrolled continuously when the button is continuously pressed.)
- Used to change the selected item.

## 5. Down button ▼

---

- Used to lower the setpoint.
- The item below the current selection will be highlighted.  
(The highlighted items will be scrolled continuously when the button is continuously pressed.)
- Used to change the selected item.

## 6. Right button ►

---

- Used to highlight the next items on the right-hand side.
- Each screen is scrolled in the right-hand direction.

## 7. Left button ◀

---

- Used to highlight the next items on the left-hand side.
- Each screen is scrolled in the left-hand direction.

## 8. On/Off button

---

- Press this button and system will start.
- Press this button again to stop the system.

## 9. Operation lamp

---

- This lamp illuminates solid green during normal operation.
- This lamp flashes if an error occurs.

## 10. Cancel button

---

- Used to return to the previous screen.

## 11. LCD (with backlight)

---

- The backlight will be illuminated for approximately 30 seconds by pressing any button.
- If two remote controllers are used to control a single indoor unit, only the controller accessed first will have backlight functionality.

# Liquid Crystal Display

- Three types of display mode (Standard, Detailed and Simple) are available.
- Standard display is set by default.
- Detailed and Simple displays can be selected in the main menu.

## Standard display

- 10. Changeover controlled by the master indoor unit
- 9. Under centralized control

- 1. Operation mode
- 2. Fan Speed
- 6. Ventilation

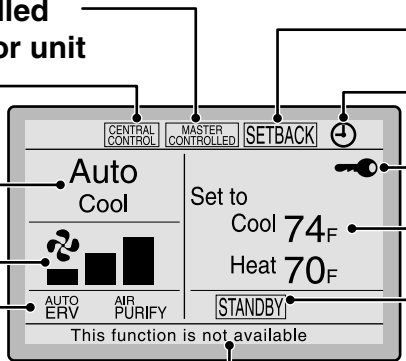

- 11. Setback
- 8. (⊕) Scheduled
- 7. (🔒) Key Lock
- 3. Setpoint
- 4. Stand by for Defrost/ Hot start
- 5. Message

<Standard display example>

## Detailed display

- The airflow direction, clock, and selectable item appear on Detailed display screen in addition to the items appearing on Standard display.

- 12. Airflow Direction (Displayed only when the indoor unit is turned on.)

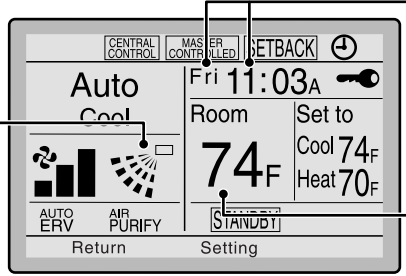

- 13. Current Day/Time (12/24 hour time display)
- 14. Selectable Display Item

<Detailed display example 1>

- No Fan speed display (with no fan speed control function)

- No Airflow Direction display (with no airflow direction settings)

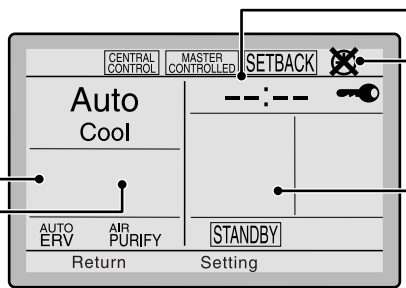

- No Clock display (when the clock has not been set yet)
- 15. (🔒) Unable to schedule
- No Selectable Display Item (with no selectable display item selected)

<Detailed display example 2>

**Simple display**

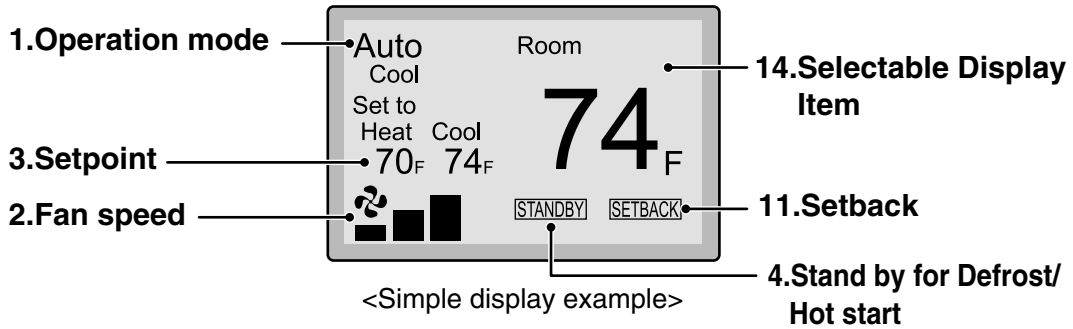

**Note for all display modes**

- Depending on the field settings, while the indoor unit is stopped, OFF may be displayed instead of the operation mode and/or the setpoint may not be displayed.

## 1. Operation mode

- Used to display the current operation mode: Cool, Heat, Vent, Fan, Dry or Auto.
- In Auto mode, the actual operation mode (Cool or Heat) will be also displayed.
- Operation mode cannot be changed when OFF is displayed.  
Operation mode can be changed after starting operation.

## 2. Fan Speed

- Used to display the fan speed that is set for the indoor unit.
- The fan speed will not be displayed if the connected model does not have fan speed control functionality.

## 3. Setpoint

- Used to display the setpoint for the indoor unit.
- Use the Celsius/Fahrenheit item in the main menu to select the temperature unit (Celsius or Fahrenheit).

## 4. Stand by for Defrost/Hot start

“”

**If ventilation icon is displayed in this field:**

- Indicates that an energy recovery ventilator (ERV) is connected.  
For details, refer to the Operation Manual of the ERV.

## 5. Message

**The following messages may be displayed.**

“**This function is not available**”

- Displayed for a few seconds when an Operation button is pressed and the indoor unit does not provide the corresponding function.
- In a remote control group, the message will not appear if at least one of the indoor units provides the corresponding function.

“**Error: Push Menu button**”

“**Warning: Push Menu button**”

- Displayed if an error or warning is detected.



“**Time to clean filter**”

“**Time to clean element**”

“**Time to clean filter & element**”

- Displayed as a reminder when it is time to clean the filter and/or element.

## 6. Ventilation

- Displayed when an energy recovery ventilator is connected.
- **Ventilation Mode icon.** “ AUTO ERV BYPASS”  
These icons indicate the current ventilation mode (ERV only) (AUTO, ERV, BYPASS).
- **Air Purify ICON** “ AIR PURIFY”  
This icon indicates that the air purifying unit (Optional) is in operation.

## 7. Key Lock

- Displayed when the key lock is set.

## 8. Scheduled

- Displayed if the Schedule or Off timer is enabled.

## 9. Under Centralized control “”

- Displayed if the system is under the management of a multi-zone controller (Optional) and the operation of the system through the remote controller is limited.

## 10. Changeover controlled by the master indoor unit “” (VRV only)

- Displayed when another indoor unit on the system has the authority to change the operation mode between cool and heat.

### 11. Setback “”

---

- The setback icon flashes when the unit is turned on by the setback control.

### 12. Airflow Direction “”

---

- Displayed when the airflow direction and swing are set.
- If the connected indoor unit model does not include oscillating louvers this item will not be displayed.

### 13. Current Day/Time (12/24 hour time display)

---

- Displayed if the clock is set.
- If the clock is not set, “-- : --” will be displayed.
- 12 hour time format is displayed by default.
- Select 12/24 hour time display option in the main menu under “Clock & Calendar”.

### 14. Selectable Display Item

---

- Room temperature is selected by default.
- For other choices see the operation manual.

### 15. ~~X~~Unable to schedule

---

- Displayed when the clock needs to be set.
- The schedule function will not work unless the clock is set.

## 2. Wireless Remote Controller (BRC082A43)

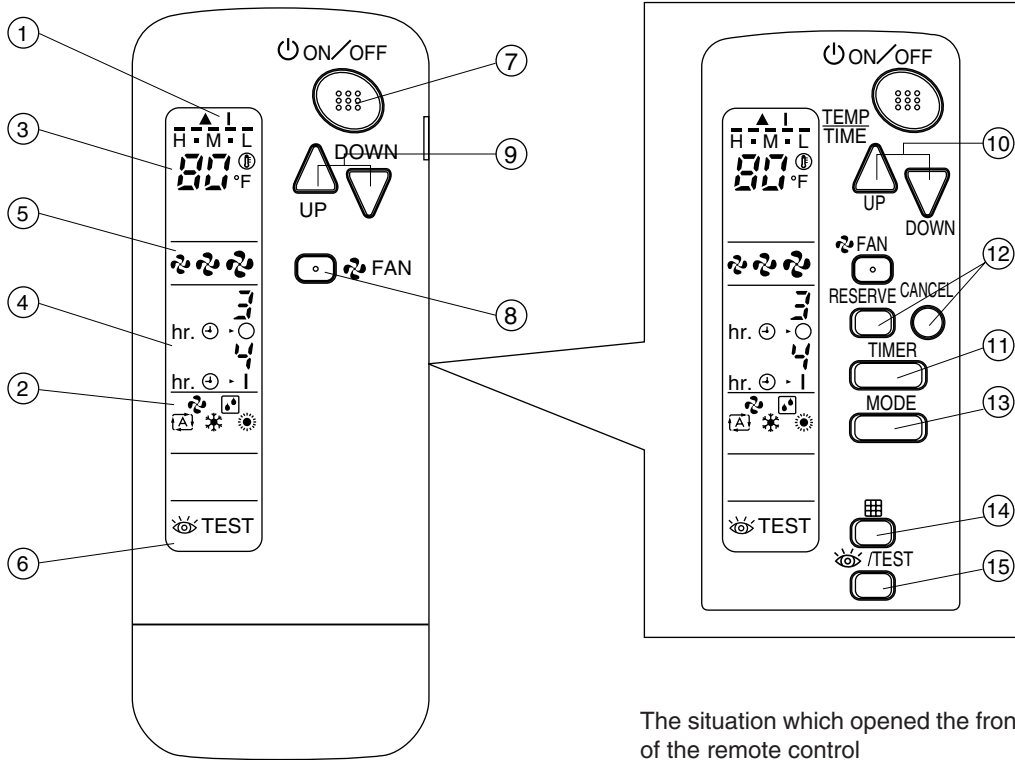





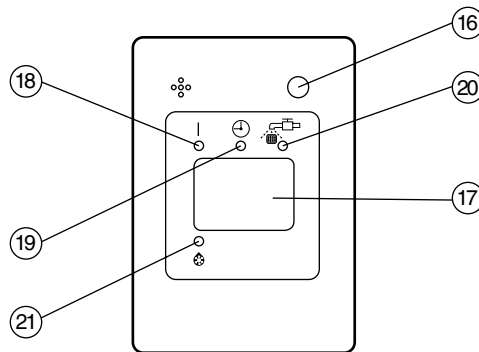









The situation which opened the front cover of the remote control

(R25006)



(R25007)

1	<b>DISPLAY “▲” “I” (SIGNAL TRANSMISSION)</b>	11	<b>TIMER MODE START/STOP BUTTON</b>
	This lights up when a signal is being transmitted.		Use this button for TIMER MODE setting.
2	<b>DISPLAY “” “” “” “” “” (OPERATION MODE)</b>	12	<b>TIMER RESERVE/CANCEL BUTTON</b>
	This display shows the current OPERATION MODE.		Use this button to end timer setting procedure.
3	<b>DISPLAY “” (SET TEMPERATURE)</b>	13	<b>OPERATION MODE SELECTOR BUTTON</b>
	This display shows the set temperature.		Press this button to select OPERATION MODE.
4	<b>DISPLAY “ hr.   hr.   ” (PROGRAMMED TIME)</b>	14	<b>FILTER SIGN RESET BUTTON</b>
	This display shows PROGRAMMED TIME of the system start or stop.		Refer to the section of MAINTENANCE in the operation manual attached to the indoor unit.
5	<b>DISPLAY “” “” “” (FAN SPEED)</b>	15	<b>INSPECTION/TEST OPERATION BUTTON</b>
	This display shows the set fan speed.		This button is pressed for inspection or test operation. Do not use for normal operation.
6	<b>DISPLAY “ TEST” (INSPECTION/ TEST OPERATION)</b>	16	<b>EMERGENCY OPERATION SWITCH</b>
	When the INSPECTION/TEST OPERATION BUTTON is pressed, the display shows the system mode is in.		This switch is readily used if the remote controller does not work.
7	<b>ON/OFF BUTTON</b>	17	<b>RECEIVER</b>
	Press the button and the system will start. Press the button again and the system will stop.		This receives the signals from the remote controller.
8	<b>FAN SPEED CONTROL BUTTON</b>	18	<b>OPERATING INDICATOR LAMP (Red)</b>
	Press this button to select the fan speed (HIGH, MEDIUM or LOW) of your choice.		This lamp stays lit while the air conditioner runs. It flashes when the unit is in trouble.
9	<b>TEMPERATURE SETTING BUTTON</b>	19	<b>TIMER INDICATOR LAMP (Green)</b>
	Use this button for SETTING TEMPERATURE. (Operates with the front cover of the remote controller closed.)		This lamp stays lit while the timer is set.
10	<b>PROGRAMMING TIMER BUTTON</b>	20	<b>AIR FILTER CLEANING TIME INDICATOR LAMP (Red)</b>
	Use this button for programming “START and/or STOP” time. (Operates with the front cover of the remote controller opened.)		Lights up when it is time to clean the air filter.
		21	<b>DEFROST LAMP (Orange)</b>
			Lights up when the defrosting operation has started. (For cooling only type this lamp does not turn on.)

# Part 6

## Service Diagnosis

1. General Problem Symptoms and Check Items .....	55
2. Troubleshooting with LED .....	56
2.1 Indoor Unit.....	56
2.2 Outdoor Unit.....	56
3. Service Diagnosis .....	57
3.1 Wired Remote Controller (BRC1E73) .....	57
3.2 Wireless Remote Controller (BRC082A43) .....	59
4. Troubleshooting .....	63
4.1 Error Codes and Description .....	63
4.2 Indoor Unit PCB Abnormality .....	64
4.3 Drain Level Control System Abnormality.....	65
4.4 Indoor Fan Motor (DC Motor) or Related Abnormality .....	66
4.5 Indoor Fan PCB Abnormality.....	68
4.6 Humidifier or Related Abnormality.....	69
4.7 Thermistor or Related Abnormality.....	70
4.8 Remote Controller Thermistor Abnormality .....	71
4.9 Signal Transmission Error (Between Indoor Unit and Remote Controller) .....	72
4.10 Signal Transmission Error (Between MAIN Remote Controller and SUB Remote Controller) .....	73
4.11 Low-voltage Detection or Over-voltage Detection.....	74
4.12 Signal Transmission Error (Between Indoor Unit and Outdoor Unit).....	76
4.13 Mismatching of Indoor Unit and Outdoor Unit .....	78
4.14 Outdoor Unit PCB Abnormality.....	79
4.15 OL Activation (Compressor Overload) .....	80
4.16 Compressor Lock .....	82
4.17 DC Fan Lock (Outdoor Fan Motor).....	83
4.18 Input Overcurrent Detection .....	84
4.19 Four Way Valve Abnormality .....	85
4.20 Discharge Pipe Temperature Control.....	87
4.21 High Pressure Control in Cooling .....	88
4.22 System Shutdown due to Compressor Internal Temperature Abnormality .....	90
4.23 Compressor System Sensor Abnormality .....	91
4.24 Position Sensor Abnormality .....	92
4.25 Thermistor or Related Abnormality (Outdoor Unit).....	94
4.26 Electrical Box Temperature Rise .....	96
4.27 Radiation Fin Temperature Rise .....	97
4.28 Output Overcurrent Detection .....	98

5. Check .....	100
5.1 Thermistor Resistance Check .....	100
5.2 Indoor Fan Motor Connector Check .....	101
5.3 Power Supply Waveforms Check .....	101
5.4 Electronic Expansion Valve Check.....	102
5.5 Four Way Valve Performance Check .....	103
5.6 Inverter Unit Refrigerant System Check.....	103
5.7 Inverter Analyzer Check .....	104
5.8 Rotation Pulse Check on the Outdoor Unit PCB .....	106
5.9 Installation Condition Check.....	107
5.10 Discharge Pressure Check.....	107
5.11 Outdoor Fan System Check .....	108
5.12 Main Circuit Short Check.....	108
5.13 Power Module Check .....	110

# 1. General Problem Symptoms and Check Items

Symptom	Check Item	Details	Reference Page
The unit does not operate.	Check the power supply.	Check if the rated voltage is supplied.	—
	Check the type of the indoor unit.	Check if the indoor unit type is compatible with the outdoor unit.	—
	Check the outdoor temperature.	Heating/cooling operations are not available when the outdoor temperature is out of the operation limit. Check the reference page for the operation limit.	133
	Diagnose with remote controller indication.	—	63
	Check the wireless remote controller address. If using 2 remote controllers for 1 indoor unit, check MAIN/SUB setting.	Check if address settings for the wireless remote controller and indoor unit are correct. Check if the MAIN/SUB setting is correct.	72, 73
Operation sometimes stops.	Check the power supply.	A power failure of 2 to 10 cycles stops air conditioner operation. (Operation lamp OFF)	—
	Check the outdoor temperature.	Heating/cooling operations are not available when the outdoor temperature is out of the operation limit. Check the reference page for the operation limit.	133
	Diagnose with remote controller indication.	—	63
The unit operates but does not cool, or does not heat.	Check for wiring and piping errors in the connection between the indoor unit and outdoor unit.	—	—
	Check for thermistor detection errors.	Check if the thermistor is mounted securely.	—
	Check for faulty operation of the electronic expansion valve.	Set the unit to cooling operation, and check the temperature of the liquid pipe to see if the electronic expansion valve works.	—
	Diagnose with remote controller indication.	—	63
	Diagnose by service port pressure and operating current.	Check for refrigerant shortage.	—
Large operating noise and vibrations	Check the output voltage of the power module.	—	110
	Check the power module.	—	—
	Check the installation condition.	Check if the required spaces for installation (specified in the installation manual) are provided.	—

## 2. Troubleshooting with LED

### 2.1 Indoor Unit

#### Operation Lamp

The operation lamp blinks when any of the following errors is detected.

1. When a protection device of the indoor or outdoor unit is activated, or when the thermistor malfunctions.
  2. When a signal transmission error occurs between the indoor and outdoor units.
- In either case, conduct the diagnostic procedure described in the following pages.

#### With wired remote controller (BRC1E73)

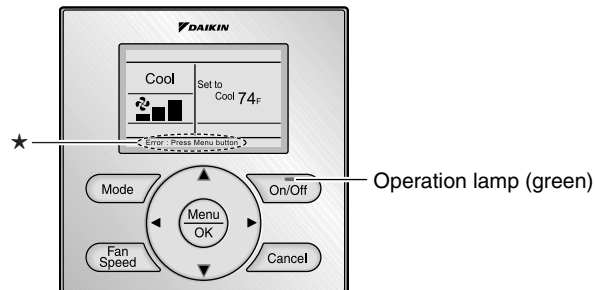

★The error or warning message also blinks on the basic screen. (R23942)

#### With wireless remote controller (BRC082A43)

In case of wireless remote controller, a receiver is installed. When the error occurs, the operation lamp on the receiver blinks.

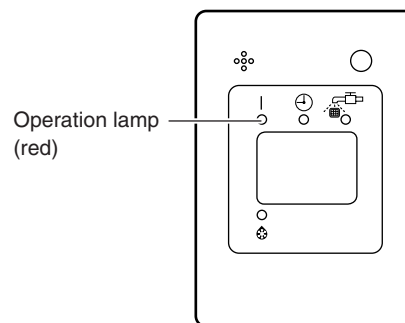

(R25009)

### 2.2 Outdoor Unit

The outdoor unit has one green LED (LED A) on the PCB. When the microcomputer works in order, the LED A blinks. (Refer to pages 13, 14 for the location of LED A.)

# 3. Service Diagnosis

## 3.1 Wired Remote Controller (BRC1E73)

### Relations Between Modes

On power-up, the message “**Checking the connection. Please standby.**” will be displayed on the remote controller screen temporarily and then the basic screen will be displayed. To access a mode from the basic screen, refer to the figure below.  
 When any of the operation buttons is pressed, the backlight will come on and remain lit for about 30 seconds. Be sure to press a button while the backlight is on.

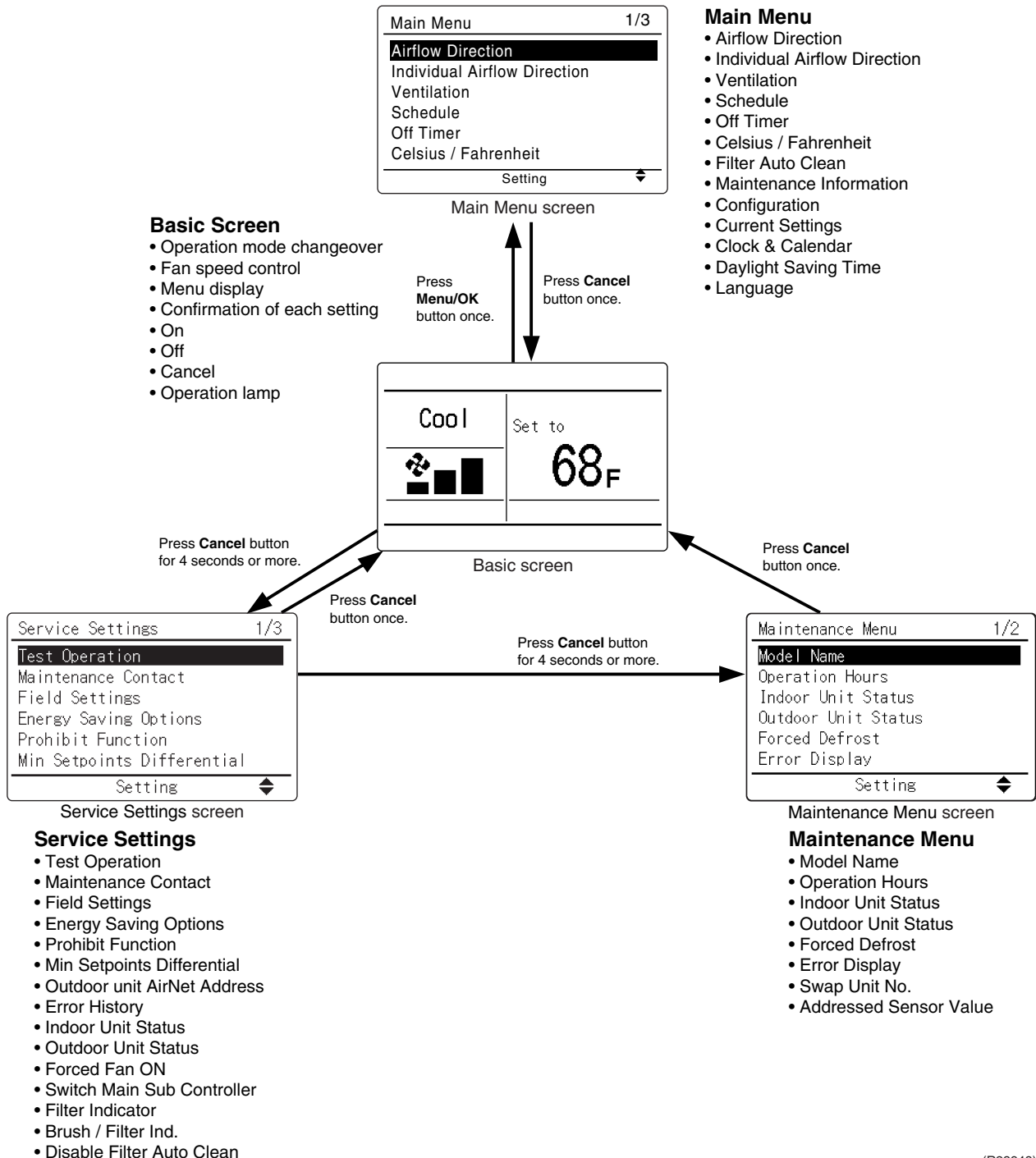

★ The items shown on the remote controller menu are different depending on the connected indoor unit model.

(R23948)

## Service Diagnosis

The following message is displayed on the screen when an error (or a warning) occurs during operation.

Check the error code and take the corrective action specified for the particular model.

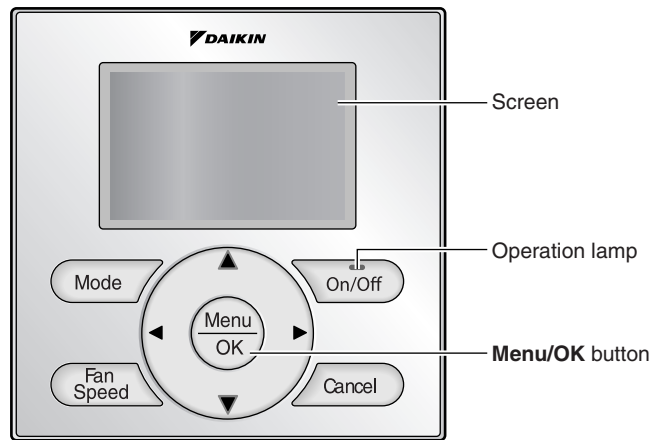

(R18817)

### Operation

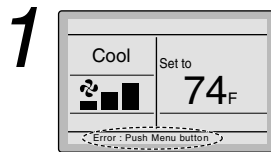

- If an error occurs, either one of the following items will flash in the basic screen.

#### Error: Push Menu button

- \* The Operation lamp will flash.
- \* For Simple display, the message is not displayed, and only the Operation lamp flashes.

#### Warning: Push Menu button

- \* The Operation lamp will not flash.
- \* For Simple display, the message is not displayed, and the Operation lamp does not flash, either.

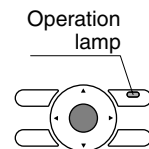

- Press **Menu/OK** button.

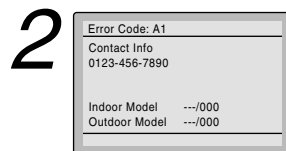

- The error code will flash and the service contact and model name or code may be displayed.
- Notify your Daikin dealer of the Error code and model name or code.

## 3.2 Wireless Remote Controller (BRC082A43)

### Relations Between Modes

The following modes can be selected by using **INSPECTION/TEST OPERATION** button on the remote controller.

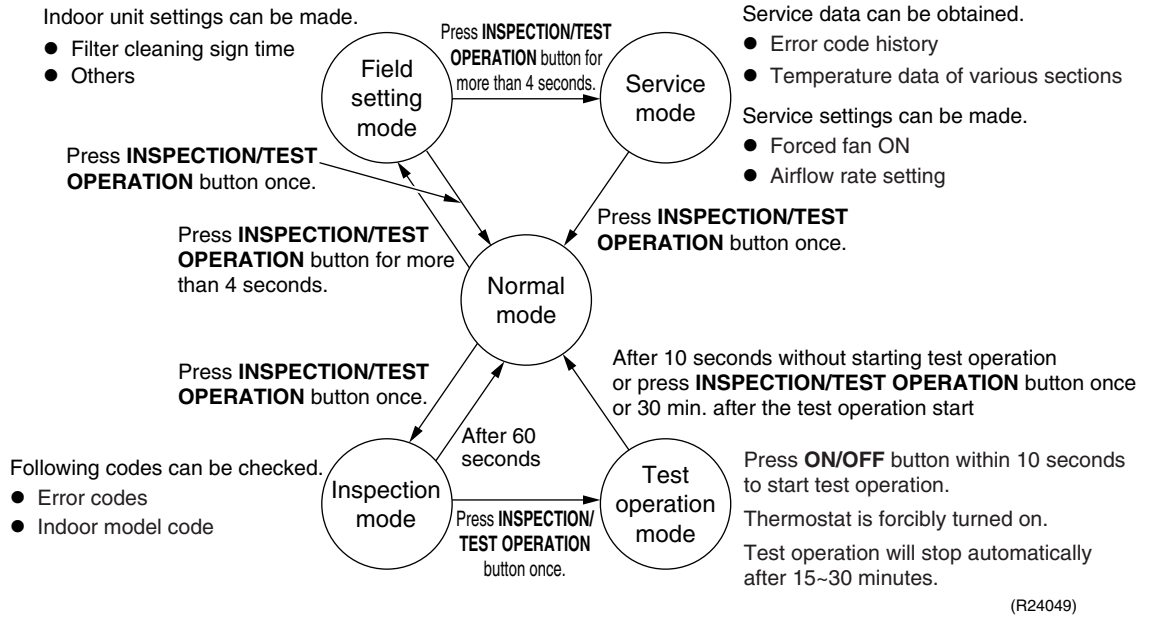

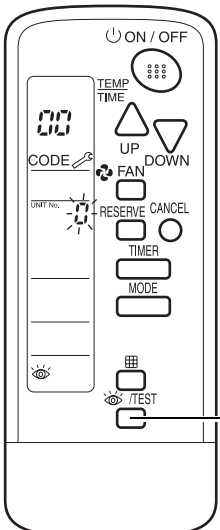

### Service Diagnosis

To find the error code, proceed as follows:

Step	Action
1	<p>Press <b>INSPECTION/TEST OPERATION</b> button to enter the inspection mode. Then the figure  blinks on the UNIT No. display.</p>  <p><b>INSPECTION/TEST OPERATION</b> button</p>

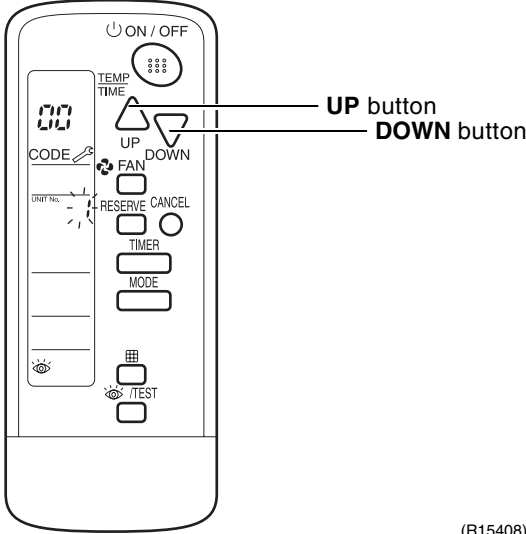
(R24050)

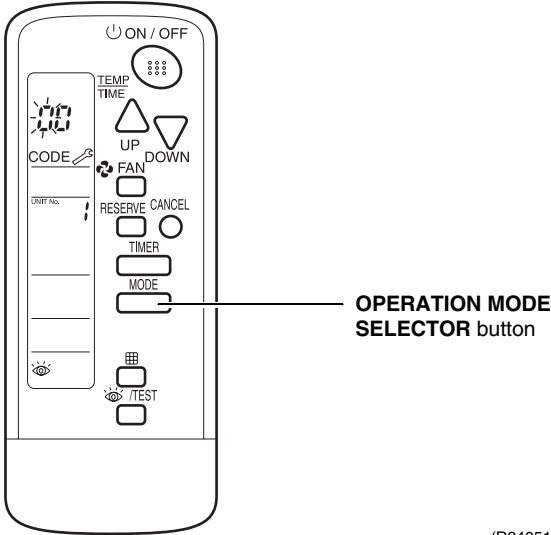
Step	Action								
<p data-bbox="451 240 472 263"><b>2</b></p>	<p data-bbox="540 240 1484 263">Press <b>UP</b> or <b>DOWN</b> button and change the UNIT No. until the indoor unit starts to beep.</p> <div data-bbox="743 289 1269 825">  </div> <p data-bbox="1198 810 1269 832">(R15408)</p> <table border="1" data-bbox="631 900 1388 1144"> <thead> <tr> <th data-bbox="631 900 1010 938">If you hear...</th> <th data-bbox="1010 900 1388 938">Then...</th> </tr> </thead> <tbody> <tr> <td data-bbox="631 938 1010 974">3 short beeps</td> <td data-bbox="1010 938 1388 974">Follow all steps below.</td> </tr> <tr> <td data-bbox="631 974 1010 1108">1 short beep</td> <td data-bbox="1010 974 1388 1108">Follow steps 3 and 4. Continue the operation in step 4 until you hear a long beep. This long beep indicates that the error code is confirmed.</td> </tr> <tr> <td data-bbox="631 1108 1010 1144">1 long beep</td> <td data-bbox="1010 1108 1388 1144">There is no abnormality.</td> </tr> </tbody> </table>	If you hear...	Then...	3 short beeps	Follow all steps below.	1 short beep	Follow steps 3 and 4. Continue the operation in step 4 until you hear a long beep. This long beep indicates that the error code is confirmed.	1 long beep	There is no abnormality.
If you hear...	Then...								
3 short beeps	Follow all steps below.								
1 short beep	Follow steps 3 and 4. Continue the operation in step 4 until you hear a long beep. This long beep indicates that the error code is confirmed.								
1 long beep	There is no abnormality.								
<p data-bbox="451 1176 472 1200"><b>3</b></p>	<p data-bbox="540 1176 1484 1225">Press <b>OPERATION MODE SELECTOR</b> button. The left  (upper digit) indication of the error code blinks.</p> <div data-bbox="735 1247 1286 1783">  </div> <p data-bbox="1222 1774 1294 1796">(R24051)</p>								

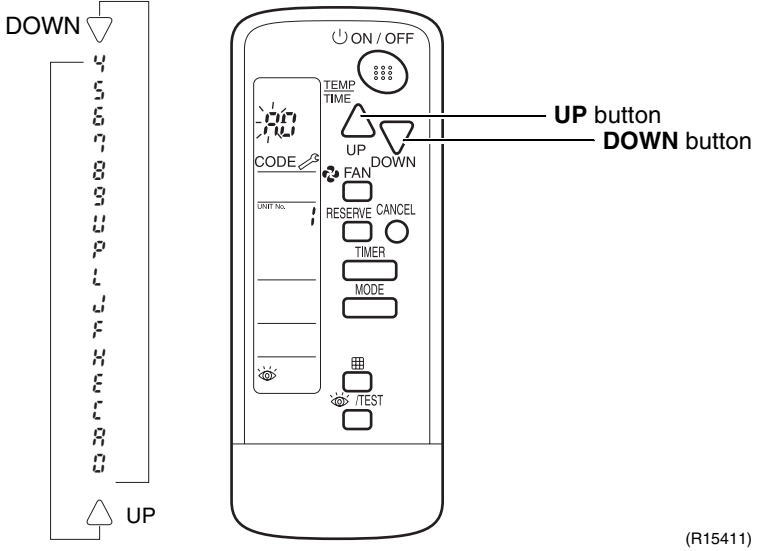
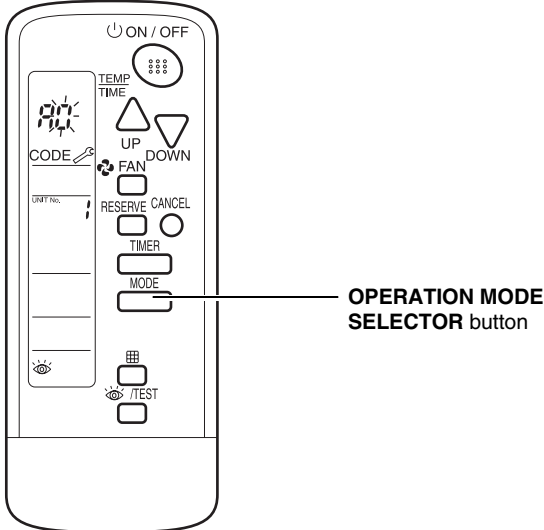
Step	Action								
<p>4</p>	<p>Press <b>UP</b> or <b>DOWN</b> button to change the error code upper digit until the indoor unit beeps.</p>  <p>(R15411)</p> <table border="1" data-bbox="630 904 1388 1053"> <thead> <tr> <th>If you hear...</th> <th>Then...</th> </tr> </thead> <tbody> <tr> <td>2 short beeps</td> <td>The upper digit matches.</td> </tr> <tr> <td>1 short beep</td> <td>No digits match.</td> </tr> <tr> <td>1 long beep</td> <td>Both upper and lower digits match.</td> </tr> </tbody> </table>	If you hear...	Then...	2 short beeps	The upper digit matches.	1 short beep	No digits match.	1 long beep	Both upper and lower digits match.
If you hear...	Then...								
2 short beeps	The upper digit matches.								
1 short beep	No digits match.								
1 long beep	Both upper and lower digits match.								
<p>5</p>	<p>Press <b>OPERATION MODE SELECTOR</b> button. The right 3 (lower digit) indication of the error code blinks.</p>  <p>(R24052)</p>								

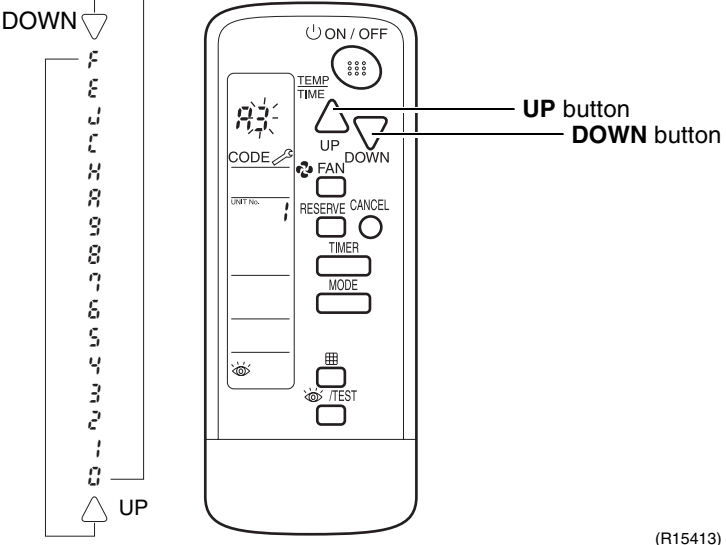
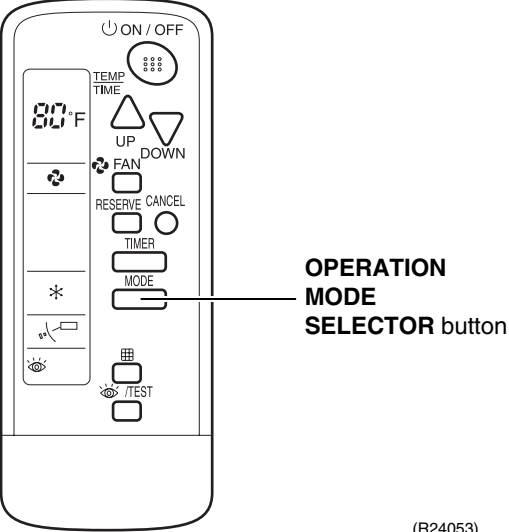
Step	Action						
<p><b>6</b></p>	<p>Press <b>UP</b> or <b>DOWN</b> button and change the error code lower digit until the indoor unit generates long beep.</p>  <p>(R15413)</p> <table border="1" data-bbox="631 910 1390 1017"> <thead> <tr> <th>If you hear...</th> <th>Then...</th> </tr> </thead> <tbody> <tr> <td>2 short beeps</td> <td>No digits match.</td> </tr> <tr> <td>1 long beep</td> <td>Both upper and lower digits match.</td> </tr> </tbody> </table>	If you hear...	Then...	2 short beeps	No digits match.	1 long beep	Both upper and lower digits match.
If you hear...	Then...						
2 short beeps	No digits match.						
1 long beep	Both upper and lower digits match.						
<p><b>7</b></p>	<p>Press <b>OPERATION MODE SELECTOR</b> button to return to the normal mode. If you do not press any button for 1 minute, the remote controller automatically returns to the normal mode.</p>  <p>(R24053)</p>						

# 4. Troubleshooting

## 4.1 Error Codes and Description

	Error Codes	Description	Reference Page
System	<b>00</b>	Normal	—
	<b>U2</b>	Low-voltage detection or over-voltage detection	74
	<b>U4</b>	Signal transmission error (between indoor unit and outdoor unit)	76
	<b>UA</b>	Mismatching of indoor unit and outdoor unit	78
Indoor Unit	<b>A1</b>	Indoor unit PCB abnormality	64
	<b>A3</b>	Drain level control system abnormality	65
	<b>A6</b>	Indoor fan motor (DC motor) or related abnormality	66
	<b>A8</b>	Indoor fan PCB abnormality	68
	<b>AF</b>	Humidifier or related abnormality	69
	<b>C4</b>	Indoor heat exchanger thermistor 1 or related abnormality	70
	<b>C5</b>	Indoor heat exchanger thermistor 2 or related abnormality	70
	<b>C9</b>	Room temperature thermistor or related abnormality	70
	<b>CJ</b>	Remote controller thermistor abnormality	71
	<b>U5</b>	Signal transmission error (between indoor unit and remote controller)	72
	<b>U8</b>	Signal transmission error (between MAIN remote controller and SUB remote controller)	73
Outdoor Unit	<b>E1</b>	Outdoor unit PCB abnormality	79
	<b>E5★</b>	OL activation (compressor overload)	80
	<b>E6★</b>	Compressor lock	82
	<b>E7★</b>	DC fan lock (outdoor fan motor)	83
	<b>E8</b>	Input overcurrent detection	84
	<b>EA</b>	Four way valve abnormality	85
	<b>F3</b>	Discharge pipe temperature control	87
	<b>F6</b>	High pressure control in cooling	88
	<b>F8</b>	System shutdown due to compressor internal temperature abnormality	90
	<b>H0</b>	Compressor system sensor abnormality	91
	<b>H6</b>	Position sensor abnormality	92
	<b>H9</b>	Outdoor temperature thermistor or related abnormality	94
	<b>J3★</b>	Discharge pipe thermistor or related abnormality	94
	<b>J6</b>	Outdoor heat exchanger thermistor or related abnormality	94
	<b>L3</b>	Electrical box temperature rise	96
	<b>L4</b>	Radiation fin temperature rise	97
	<b>L5★</b>	Output overcurrent detection	98
	<b>P4</b>	Radiation fin thermistor or related abnormality	94

★: Displayed only when system-down occurs.

## 4.2 Indoor Unit PCB Abnormality

### Error Code

# A1

### Method of Error Detection

The system checks the data from EEPROM.

### Error Decision Conditions

The data from the EEPROM is not received correctly.

EEPROM (Electrically Erasable Programmable Read Only Memory): A memory chip that holds its content without power. It can be erased, either within the computer or externally and usually requires more voltage for erasure than the common +5 volts used in logic circuits. It functions like non-volatile RAM, but writing to EEPROM is slower than writing to RAM.

### Supposed Causes

- Defective indoor unit PCB
- External factor (noise etc.)

### Troubleshooting



#### Caution

Be sure to turn off the power switch before connecting or disconnecting connectors, or parts may be damaged.

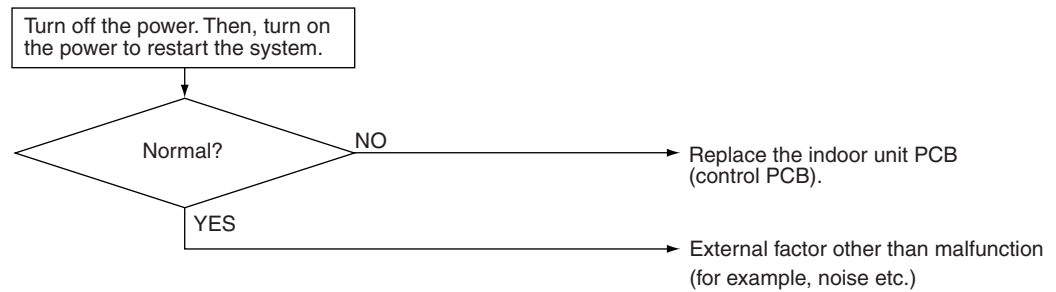

(R22247)

## 4.3 Drain Level Control System Abnormality

Error Code

**A3**

Method of Error Detection

The float switch detects error.

Error Decision Conditions

The water level reaches its upper limit and the float switch turns OFF.

Supposed Causes

- Defective drain pump
- Improper drain piping work
- Clogged drain piping
- Defective float switch
- Defective indoor unit PCB
- Defective connector X15A, X25A on indoor unit PCB

### Troubleshooting

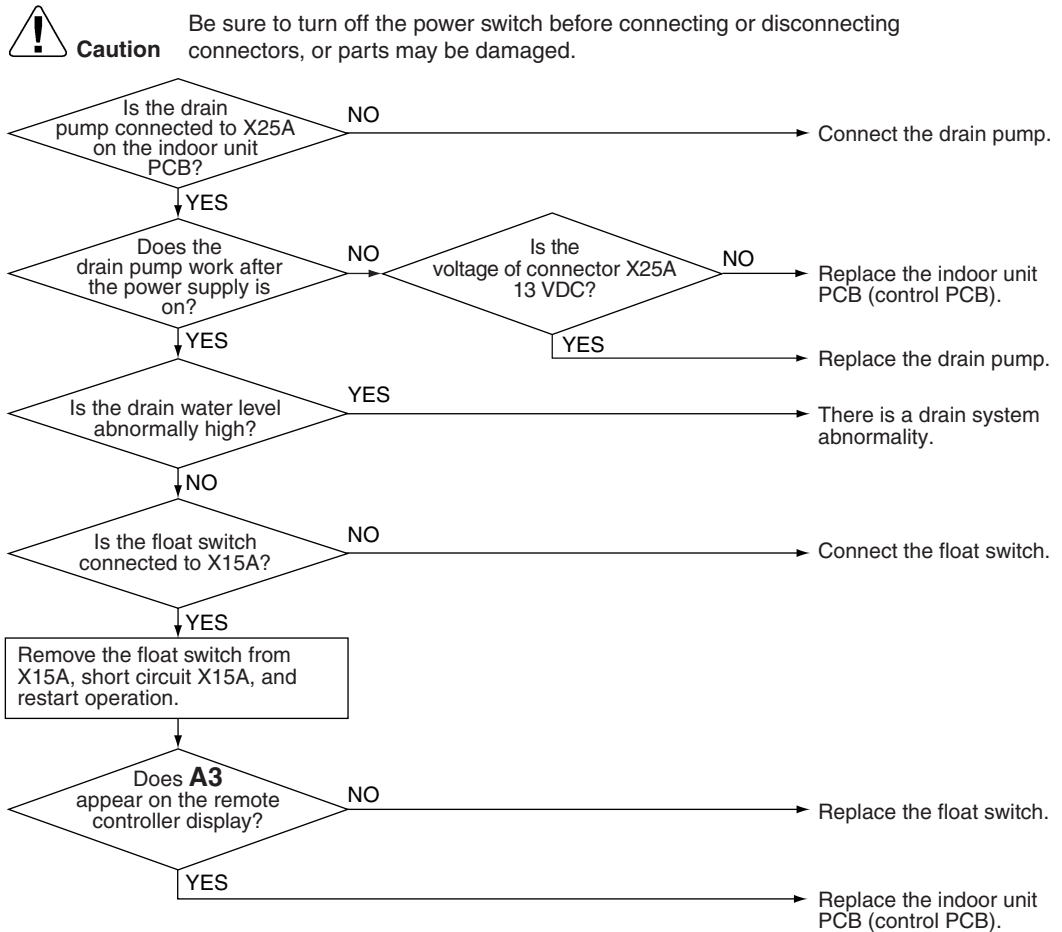

(R25079)

## 4.4 Indoor Fan Motor (DC Motor) or Related Abnormality

Error Code

**A6**

Method of Error  
Detection

- Detection from the current flow on the fan PCB
- Detection from the rotation speed of the fan motor in operation

Error Decision  
Conditions

The rotation speed is less than a certain level for 6 seconds.

Supposed  
Causes

- Clogged foreign matter
- Disconnection of fan motor connectors
- Disconnection of the connector between the indoor unit PCB and the fan PCB
- Defective fan PCB
- Defective fan motor
- No fuse continuity

Troubleshooting



Check No.02  
Refer to P.101



**Caution**

Be sure to turn off the power switch before connecting or disconnecting connectors, or parts may be damaged.

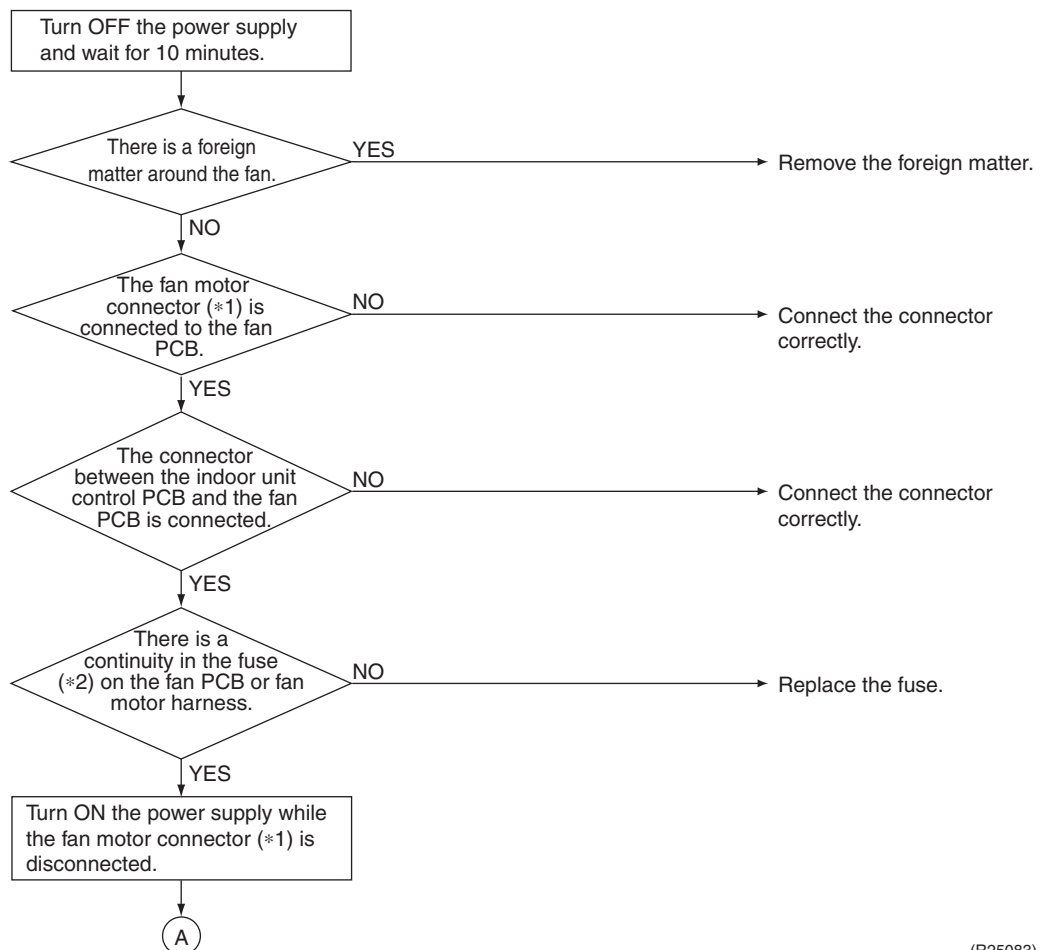

(R25083)

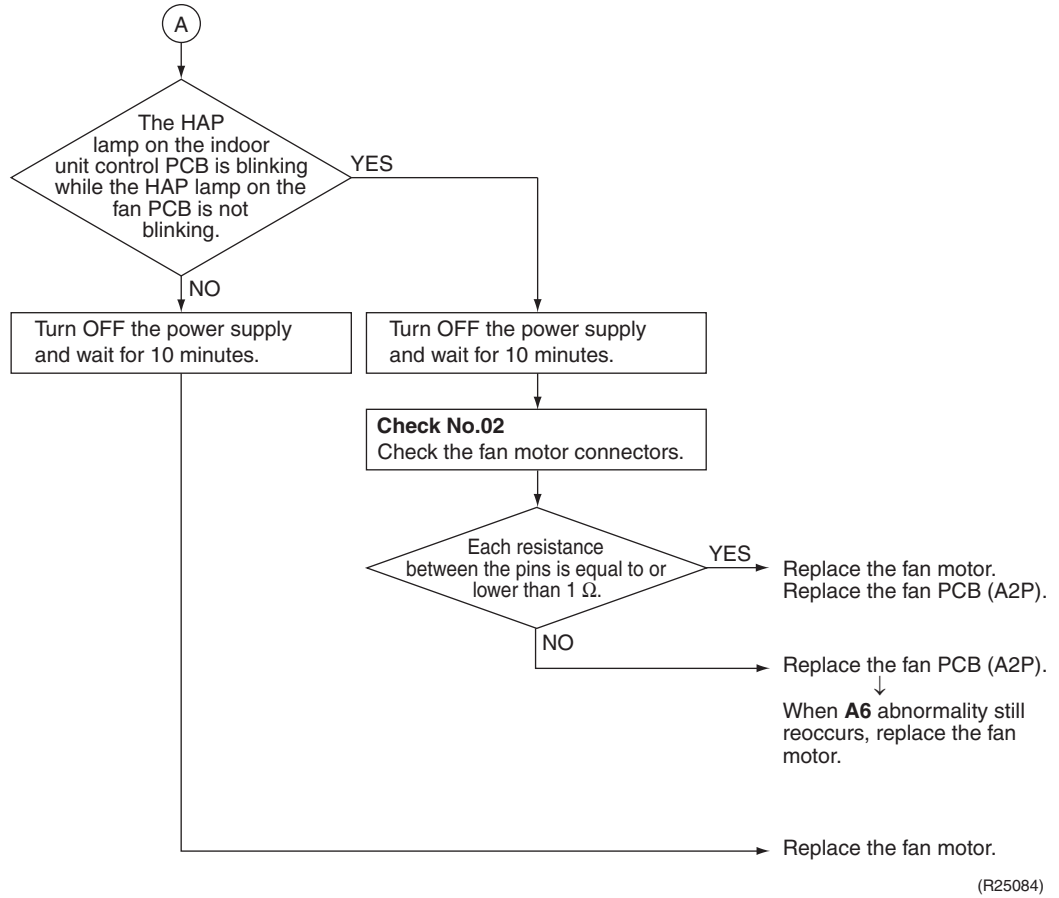

**i** Note Connector

Model	*1 Fan motor connector	*2 Fuse
FDMQ Series	X8A	F2U

## 4.5 Indoor Fan PCB Abnormality

Error Code

**A8**

Method of Error Detection

Microcomputer checks the voltage state of the fan PCB.

Error Decision Conditions

Overvoltage or voltage drop is detected on the fan PCB.

Supposed Causes

- Defective fan PCB
- External factor such as noise

Troubleshooting



**Caution** Be sure to turn off the power switch before connecting or disconnecting connectors, or parts may be damaged.

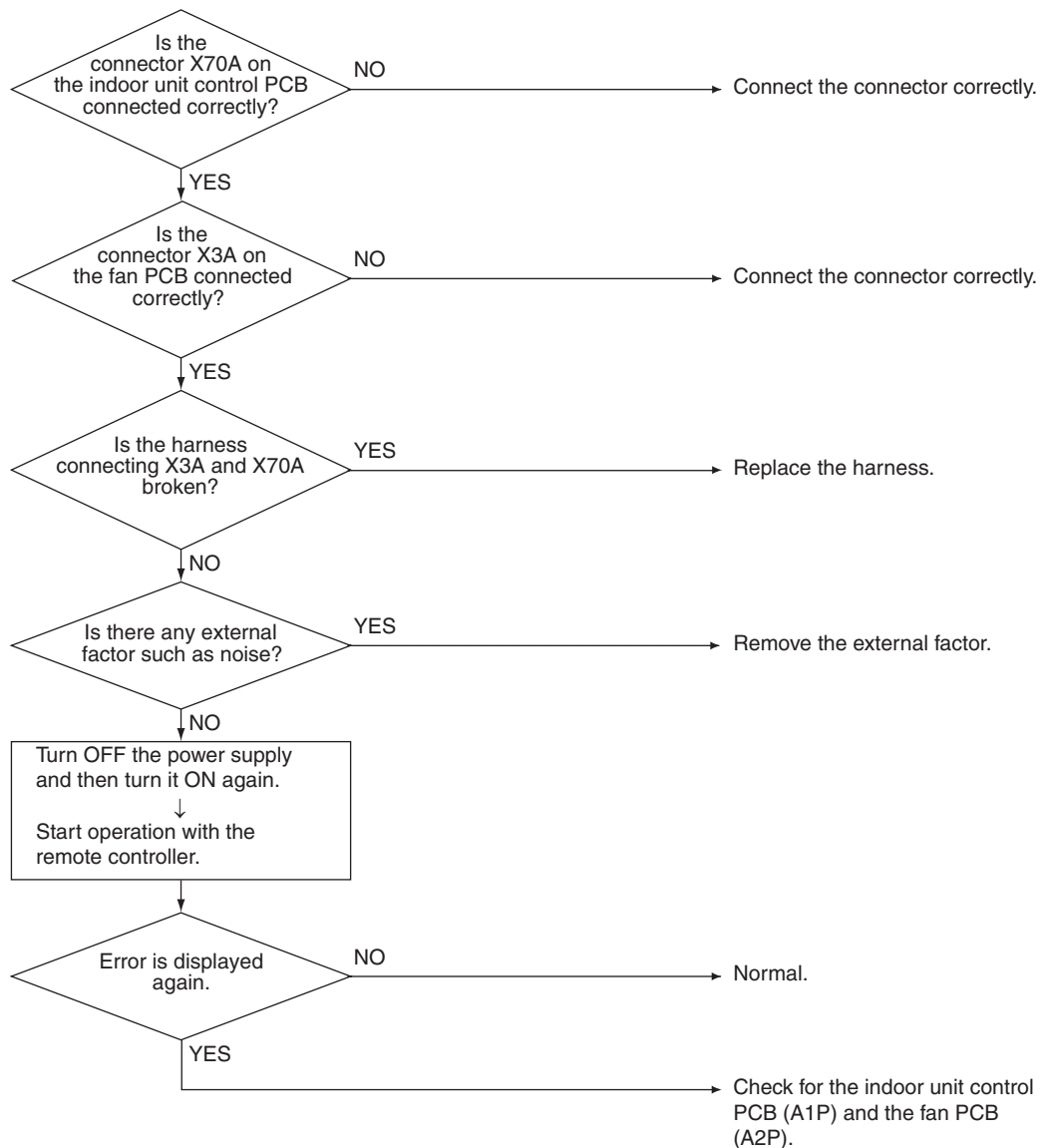

(R25085)

## 4.6 Humidifier or Related Abnormality

<b>Error Code</b>	<b>AF</b>
<b>Method of Error Detection</b>	Water leakage from humidifier(s) is detected based on the float switch ON/OFF changeover while the system is not operating.
<b>Error Decision Conditions</b>	The float switch changes from ON to OFF while the system is OFF.
<b>Supposed Causes</b>	<ul style="list-style-type: none"> <li>■ Defective float switch</li> <li>■ Error in water drain system of humidifier(s)</li> <li>■ Clogged electric expansion valve in humidifier(s)</li> <li>■ Defective indoor unit PCB</li> </ul>

### Troubleshooting

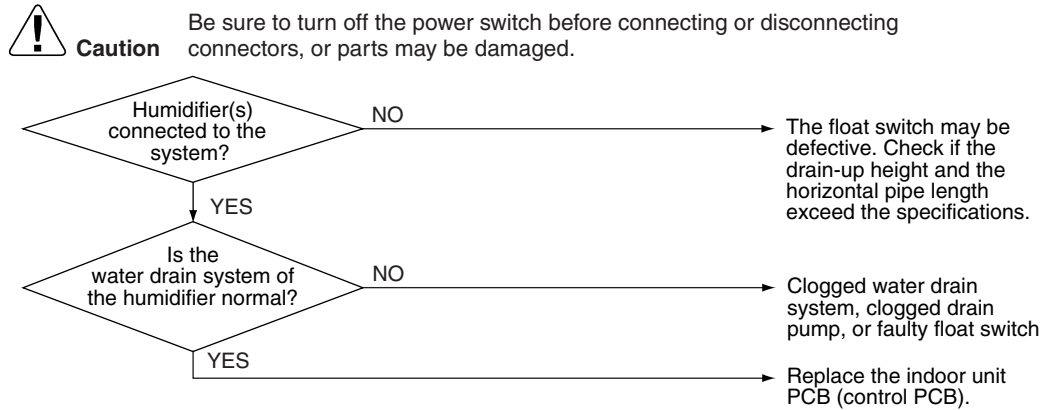

(R24055)

 **Note:** The system continues to operate with the thermostat OFF even while the error code is displayed.

## 4.7 Thermistor or Related Abnormality

Error Code

**C4, C5, C9**

Method of Error Detection

The temperatures detected by the thermistors determine thermistor errors.

Error Decision Conditions

The thermistor is disconnected or shorted while the unit is running.

Supposed Causes

- Disconnection of connector
- Defective thermistor(s)
- Breaking of wires
- Defective indoor unit PCB

Troubleshooting



Check No.01  
Refer to P.100

If the cause of the problem is related to the thermistors, the thermistors should be checked prior to changing the indoor unit PCB.

To check the thermistors, proceed as follows:

Step	Action
1	Disconnect the thermistor from the indoor unit PCB.
2	Read the temperature and the resistance value.
3	Check if the measured values correspond with the values in the table of thermistor resistance check.



**Caution**

Be sure to turn off the power switch before connecting or disconnecting connectors, or parts may be damaged.

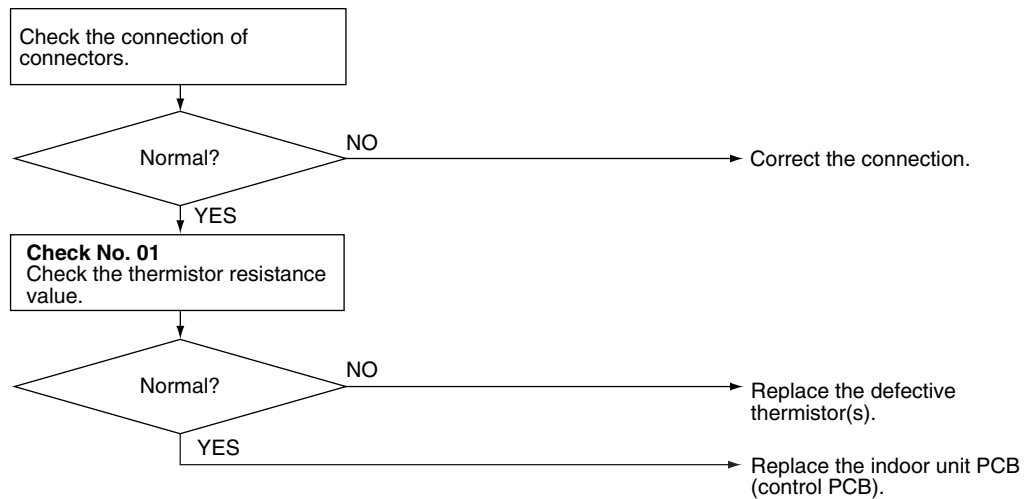

(R24056)

**C4** : Indoor heat exchanger thermistor 1 (liquid pipe) (R2T)

**C5** : Indoor heat exchanger thermistor 2 (R3T)

**C9** : Room temperature thermistor (R1T)



**Note:**

When replacing the defective thermistor(s), replace the thermistors as ASSY.

## 4.8 Remote Controller Thermistor Abnormality

<b>Error Code</b>	<b>CJ</b>
<b>Method of Error Detection</b>	Even if remote controller thermistor is faulty, system is possible to operate by system thermistor. Malfunction detection is carried out by the temperature detected by the remote controller thermistor.
<b>Error Decision Conditions</b>	The remote controller thermistor is disconnected or shorted while the unit is running.
<b>Supposed Causes</b>	<ul style="list-style-type: none"> <li>■ Defective room temperature thermistor in the wired remote controller</li> <li>■ Defective wired remote controller PCB</li> <li>■ External factor such as noise</li> </ul>

### Troubleshooting

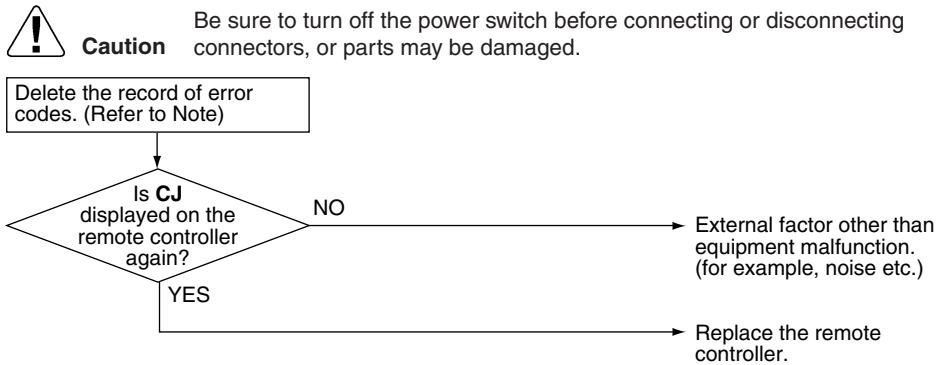

(R23951)

 **Note:** To delete the record of error codes, press **ON/OFF** button for 4 seconds or more while the error code is displayed in the inspection mode.

## 4.9 Signal Transmission Error (Between Indoor Unit and Remote Controller)

Error Code

**U5**

Method of Error Detection

In case of controlling 1 indoor unit with 2 remote controllers, check the system using microcomputer if signal transmission between indoor unit and remote controller (main and sub) is normal.

Error Decision Conditions

Normal transmission does not continue for specified period.

Supposed Causes

- Connection of 2 main remote controllers (when using 2 remote controllers)
- Defective indoor unit PCB
- Defective remote controller
- Transmission error caused by noise

Troubleshooting

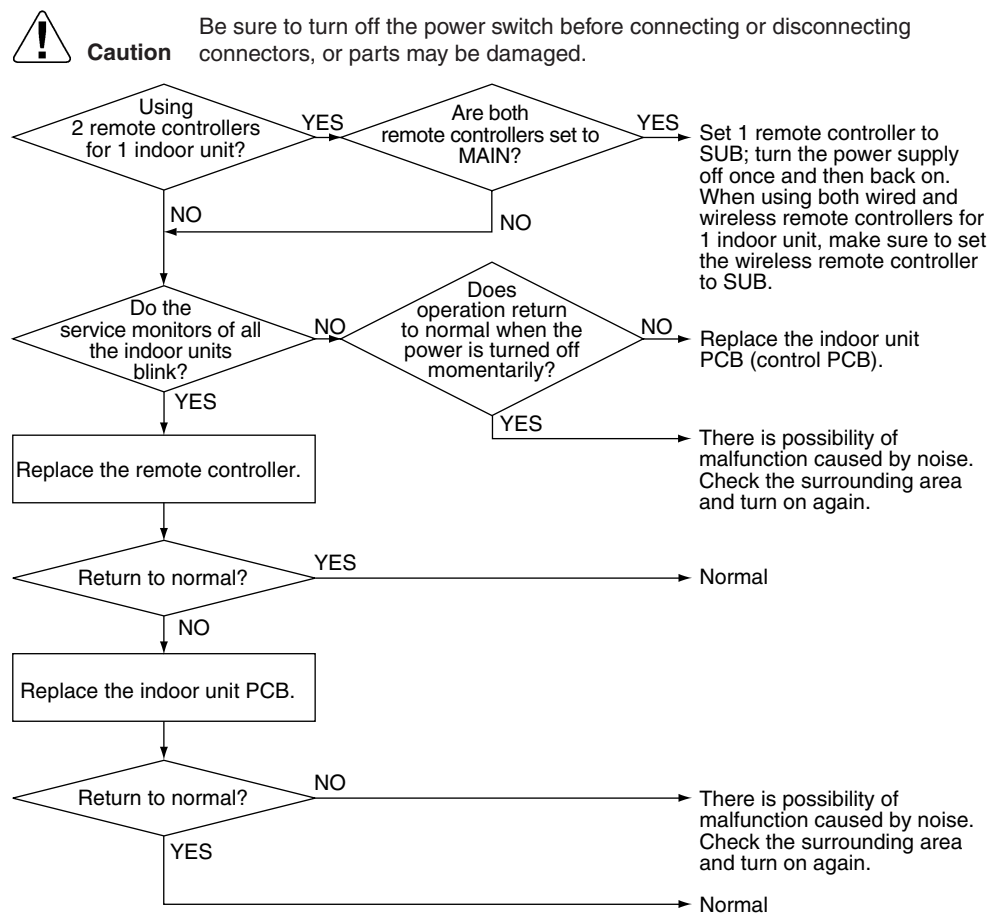

(R24057)



**Note:** For the way to change MAIN/SUB setting of remote controllers, refer to pages 120 and 122.

## 4.10 Signal Transmission Error (Between MAIN Remote Controller and SUB Remote Controller)

**Error Code**

**U8**

**Method of Error Detection**

In case of controlling 1 indoor unit with 2 remote controllers, check the system using microcomputer if signal transmission between MAIN remote controller and SUB remote controller is normal.

**Error Decision Conditions**

Normal transmission does not continue for specified period.

**Supposed Causes**

- Remote controller is set to SUB when using 1 remote controller
- Connection of 2 sub remote controllers (when using 2 remote controllers)
- Defective remote controller PCB

**Troubleshooting**

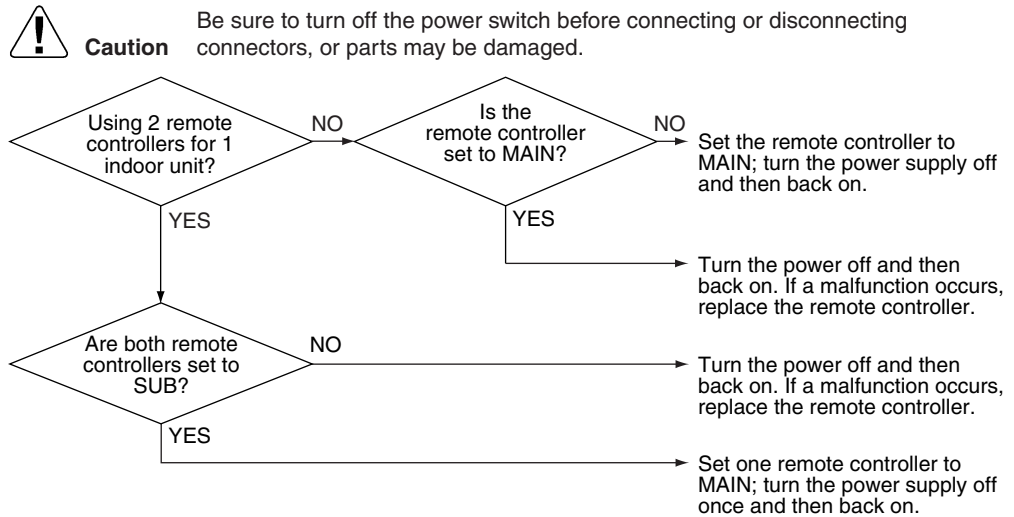

(R24058)



**Note:** For the way to change MAIN/SUB setting of remote controllers, refer to pages 120 and 122.

## 4.11 Low-voltage Detection or Over-voltage Detection

<b>Error Code</b>	<b>U2</b>
<b>Method of Error Detection</b>	<p><b>Low-voltage detection:</b> An abnormal voltage drop is detected by the DC voltage detection circuit.</p> <p><b>Over-voltage detection:</b> An abnormal voltage rise is detected by the over-voltage detection circuit.</p>
<b>Error Decision Conditions</b>	<p><b>Low-voltage detection:</b></p> <ul style="list-style-type: none"> <li>■ The voltage detected by the DC voltage detection circuit is below 180 ~ 196 V (depending on the model).</li> <li>■ The compressor stops if the error occurs, and restarts automatically after 3-minute standby.</li> </ul> <p><b>Over-voltage detection:</b></p> <ul style="list-style-type: none"> <li>■ An over-voltage signal is fed from the over-voltage detection circuit to the microcomputer (over 458 ~ 500 V, depending on the model).</li> <li>■ The compressor stops if the error occurs, and restarts automatically after 3-minute standby.</li> </ul>
<b>Supposed Causes</b>	<ul style="list-style-type: none"> <li>■ Power supply voltage out of specification</li> <li>■ Defective DC voltage detection circuit</li> <li>■ Defective over-voltage detection circuit</li> <li>■ Defective PAM control part</li> <li>■ Disconnection of compressor harness</li> <li>■ Short circuit inside the fan motor winding</li> <li>■ Noise</li> <li>■ Momentary drop of voltage</li> <li>■ Momentary power failure</li> <li>■ Defective outdoor unit PCB</li> </ul>

Troubleshooting



**Caution**

Be sure to turn off the power switch before connecting or disconnecting connectors, or parts may be damaged.

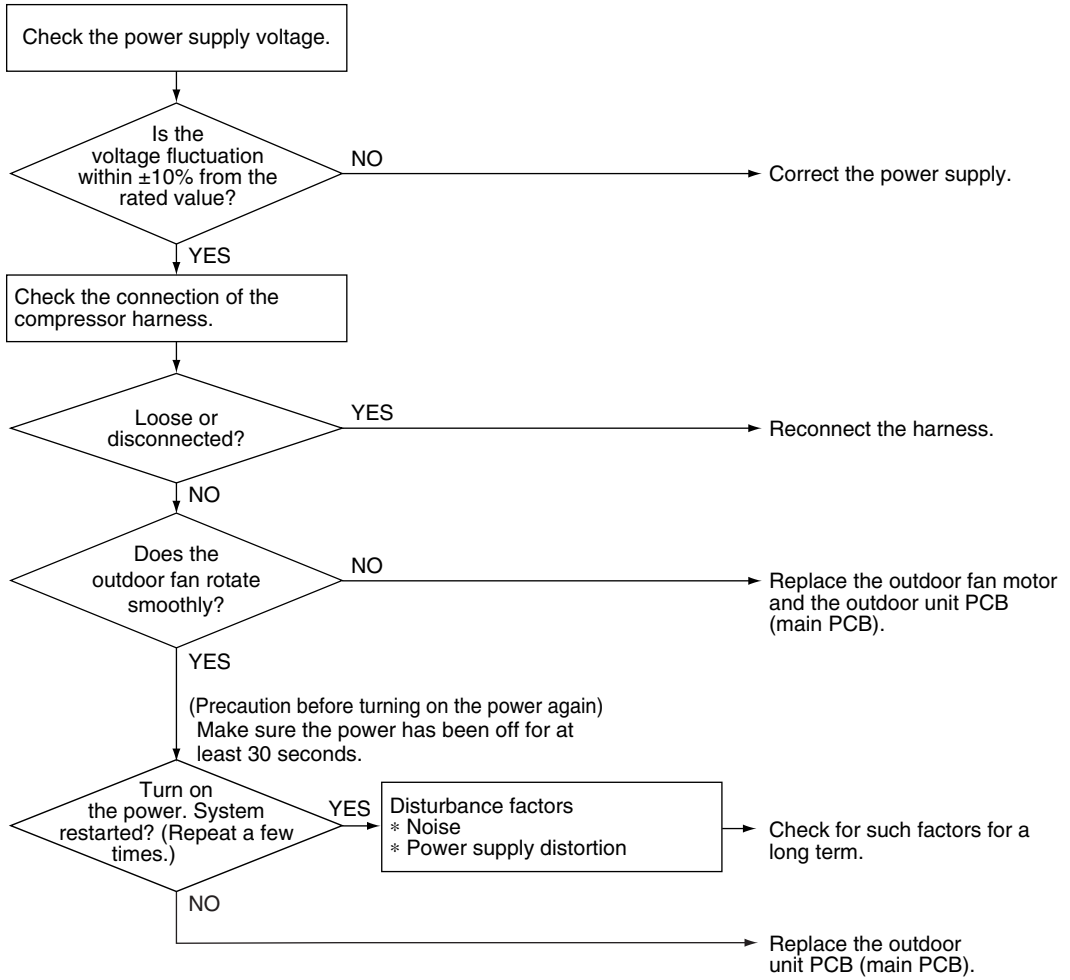

(R22445)

## 4.12 Signal Transmission Error (Between Indoor Unit and Outdoor Unit)

---

<b>Error Code</b>	<b>U4</b>
<b>Method of Error Detection</b>	The signal transmission data from the outdoor unit is checked whether it is normal.
<b>Error Decision Conditions</b>	The data sent from the outdoor unit cannot be received normally, or the content of the data is abnormal.
<b>Supposed Causes</b>	<ul style="list-style-type: none"><li>■ Power supply voltage out of specification</li><li>■ Reduction of power supply voltage</li><li>■ Wiring error</li><li>■ Breaking of the connecting wires between the indoor and outdoor units (wire No. 3)</li><li>■ Defective outdoor unit PCB</li><li>■ Short circuit inside the fan motor winding</li><li>■ Defective indoor unit PCB</li><li>■ Disturbed power supply waveform</li></ul>

---

Troubleshooting



**Check No.11**  
Refer to P.101



**Caution** Be sure to turn off the power switch before connecting or disconnecting connectors, or parts may be damaged.

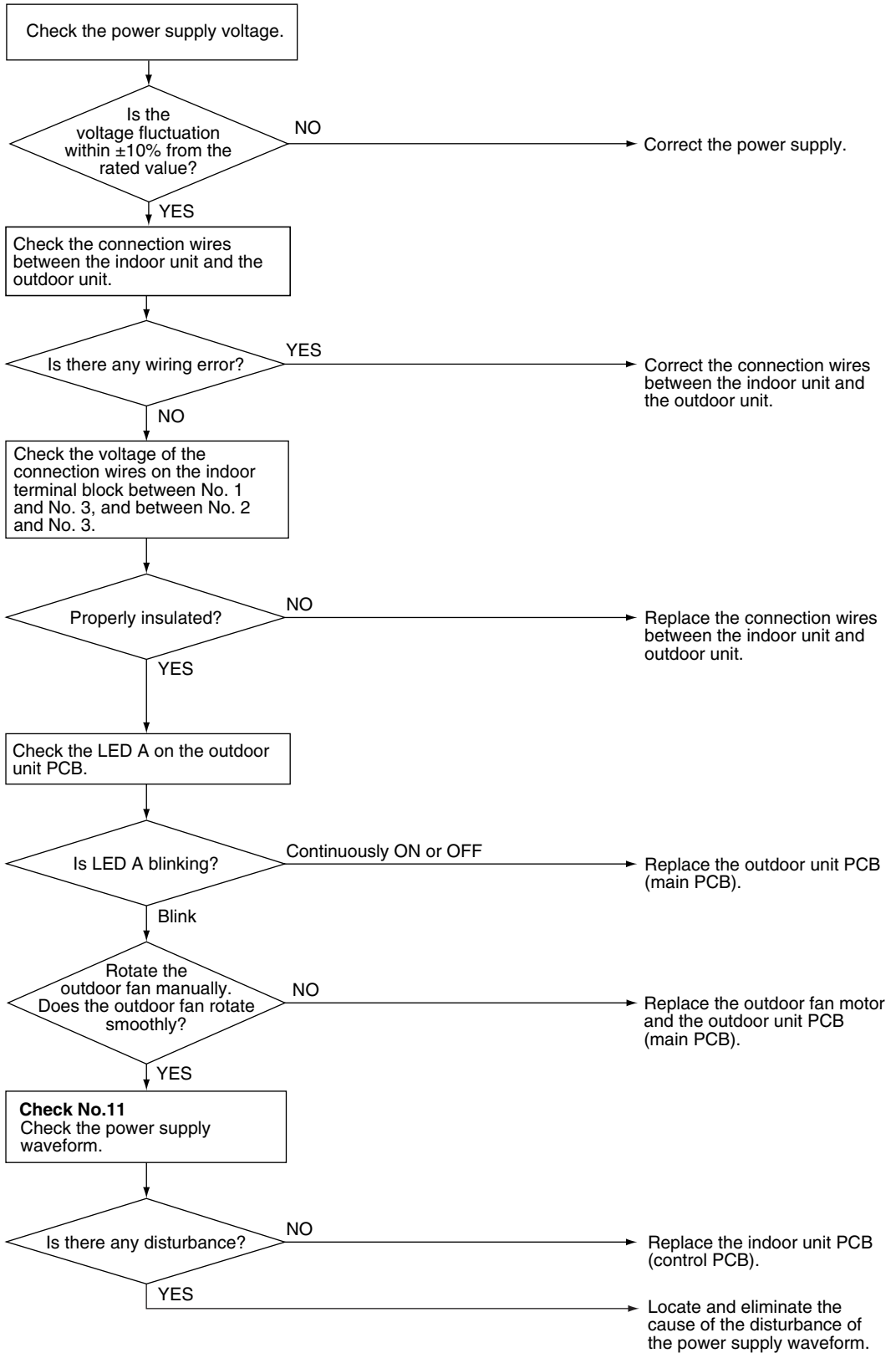

(R24612)

## 4.13 Mismatching of Indoor Unit and Outdoor Unit

Error Code

**UA**

Error Decision Conditions

- Improper combination of indoor and outdoor units

Supposed Causes

- Defective indoor unit PCB
- Indoor-outdoor unit transmission wiring error
- Defective optional unit(s) wirings
- Improper power supply wiring of indoor unit
- Improper wiring of connecting wires between indoor/outdoor units

Troubleshooting



**Caution**

Be sure to turn off the power switch before connecting or disconnecting connectors, or parts may be damaged.

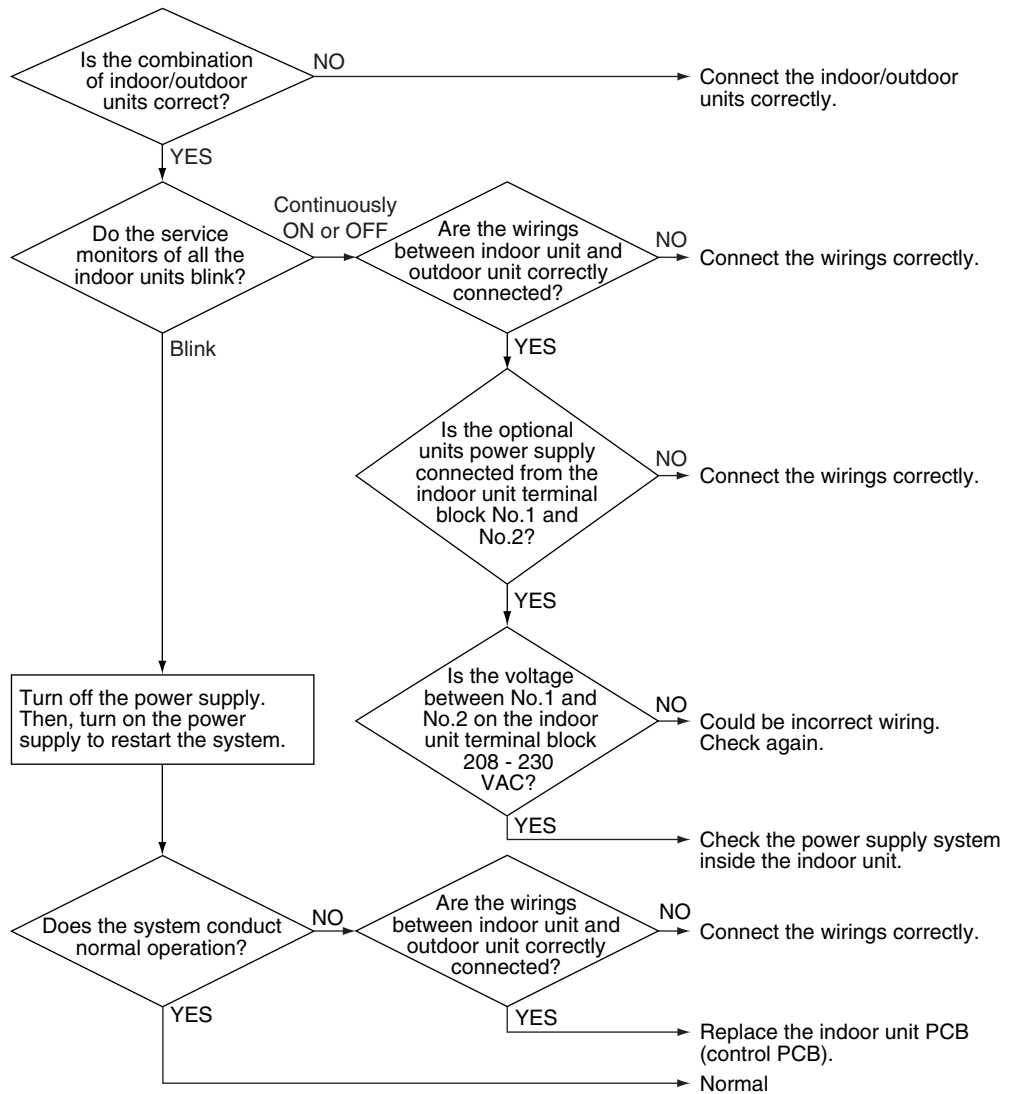

(R24372)

## 4.14 Outdoor Unit PCB Abnormality

<b>Error Code</b>	<b>E1</b>
<b>Method of Error Detection</b>	<ul style="list-style-type: none"> <li>■ The system checks if the microprocessor is working in order.</li> <li>■ The system checks if the zero-cross signal comes in properly.</li> </ul>
<b>Error Decision Conditions</b>	<ul style="list-style-type: none"> <li>■ The microprocessor program runs out of control.</li> <li>■ The zero-cross signal is not detected.</li> </ul>
<b>Supposed Causes</b>	<ul style="list-style-type: none"> <li>■ Defective outdoor unit PCB</li> <li>■ Noise</li> <li>■ Momentary drop of voltage</li> <li>■ Momentary power failure</li> </ul>

### Troubleshooting

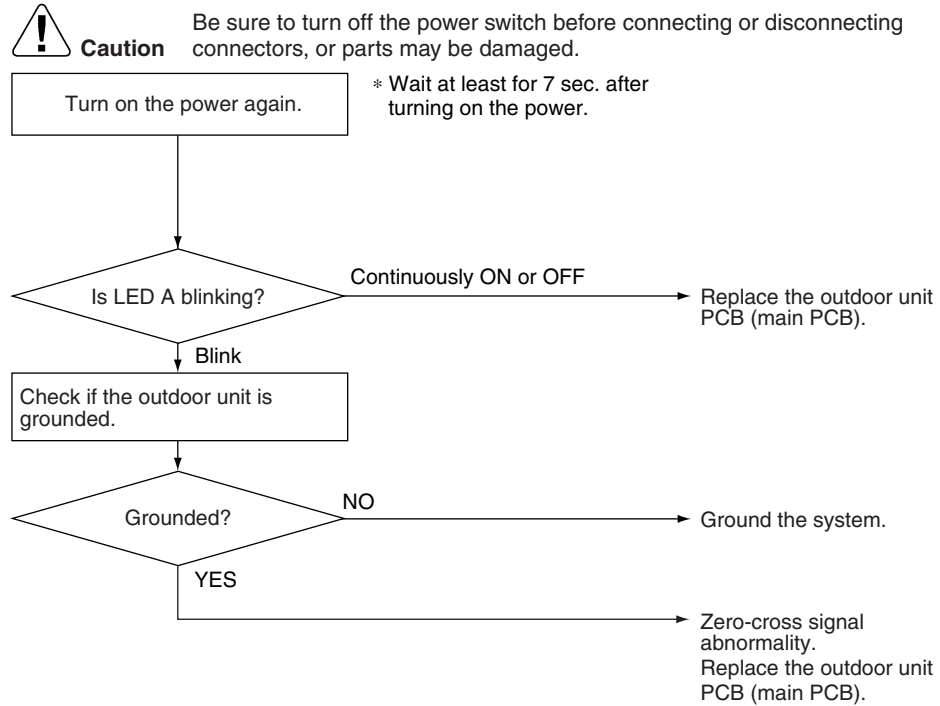

(R21201)

## 4.15 OL Activation (Compressor Overload)

---

<b>Error Code</b>	<b>E5</b>
<b>Method of Error Detection</b>	A compressor overload is detected through compressor OL.
<b>Error Decision Conditions</b>	<ul style="list-style-type: none"><li>■ If the error repeats, the system is shut down.</li><li>■ Reset condition: Continuous run for about 60 minutes without any other error</li></ul>
<b>Supposed Causes</b>	<ul style="list-style-type: none"><li>■ Disconnection of discharge pipe thermistor</li><li>■ Defective discharge pipe thermistor</li><li>■ Disconnection of connector S40</li><li>■ Disconnection of 2 terminals of OL (Q1L)</li><li>■ Defective OL (Q1L)</li><li>■ Broken OL harness</li><li>■ Defective electronic expansion valve or coil</li><li>■ Defective four way valve or coil</li><li>■ Defective outdoor unit PCB</li><li>■ Refrigerant shortage</li><li>■ Water mixed in refrigerant</li><li>■ Defective stop valve</li></ul>

Troubleshooting



Check No.01  
Refer to P.100



Check No.12  
Refer to P.102



Check No.13  
Refer to P.103



Check No.14  
Refer to P.103



**Caution** Be sure to turn off the power switch before connecting or disconnecting connectors, or parts may be damaged.

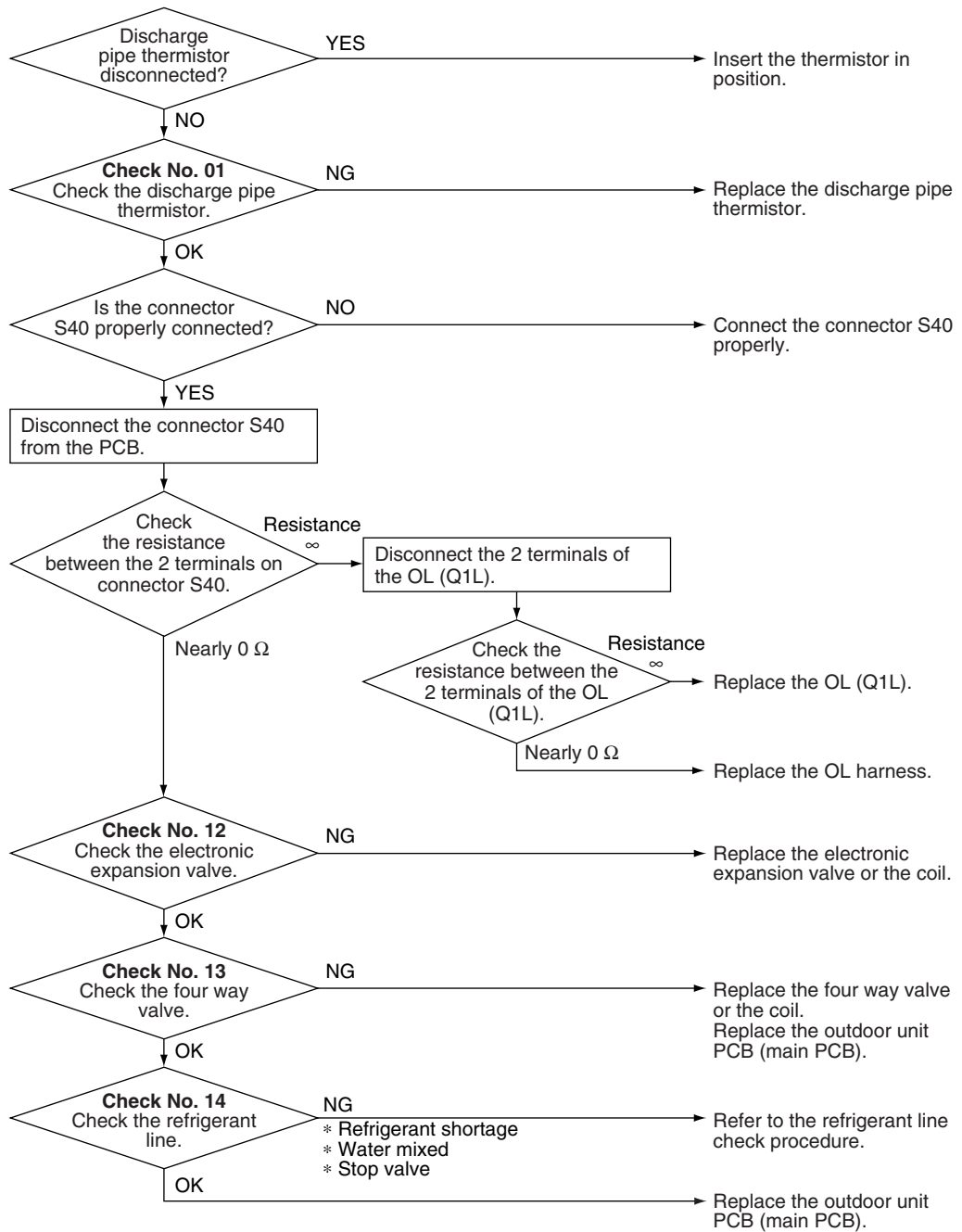

(R22997)



**Note:** OL (Q1L) activating temperature: 130°C (266°F)  
OL (Q1L) recovery temperature: 95°C (203°F)

## 4.16 Compressor Lock

### Error Code

# E6

### Method of Error Detection

A compressor lock is detected by the current waveform generated when applying high-frequency voltage to the motor.

### Error Decision Conditions

- If the error repeats, the system is shut down.
- Reset condition: Continuous run for about 11 minutes without any other error

### Supposed Causes

- Closed stop valve
- Compressor locked
- Disconnection of compressor harness

### Troubleshooting



**Check No.12**  
Refer to P.102



**Check No.15**  
Refer to P.104



#### Caution

Be sure to turn off the power switch before connecting or disconnecting connectors, or parts may be damaged.

(Precaution before turning on the power again)

Make sure the power has been off for at least 30 seconds.

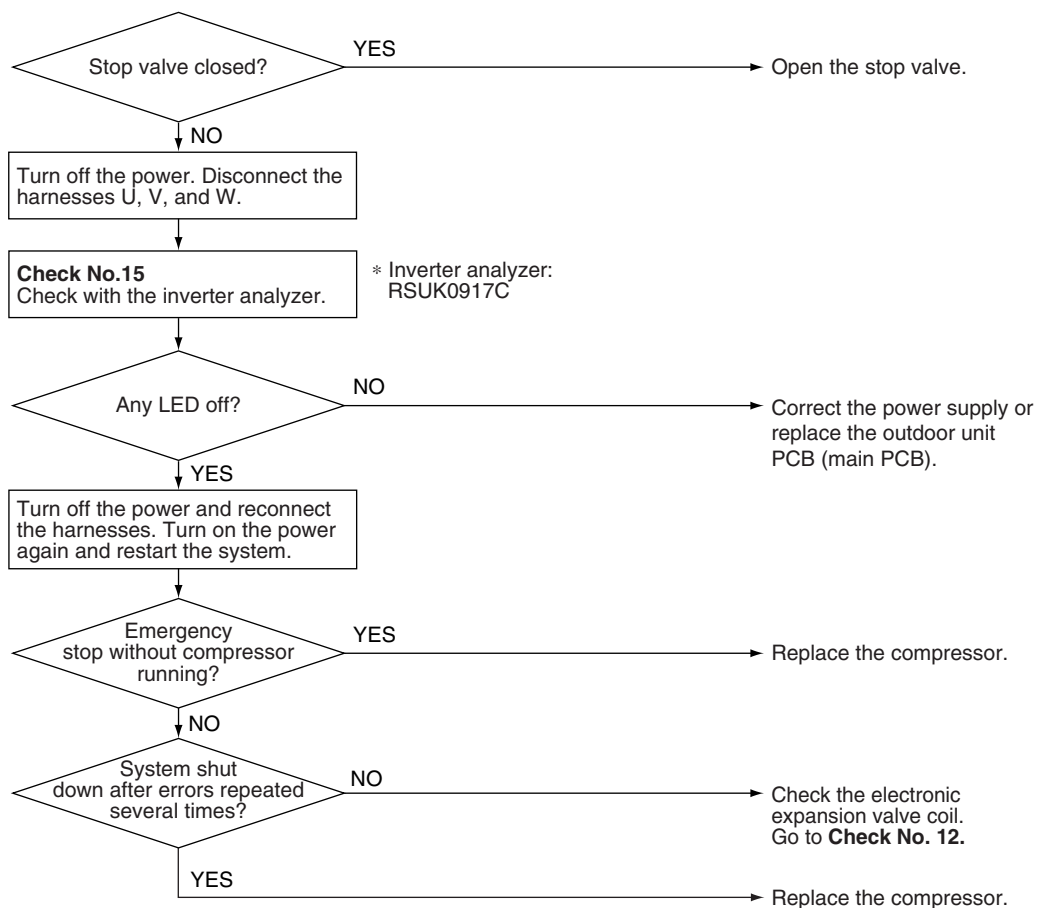

(R21067)

## 4.17 DC Fan Lock (Outdoor Fan Motor)

<b>Error Code</b>	<b>E7</b>
<b>Method of Error Detection</b>	An error is determined with the high-voltage fan motor rotation speed detected by the Hall IC.
<b>Error Decision Conditions</b>	<ul style="list-style-type: none"> <li>■ The fan does not start in 15 ~ 30 seconds even when the fan motor is running.</li> <li>■ If the error repeats, the system is shut down.</li> <li>■ Reset condition: Continuous run for about 11 minutes without any other error</li> </ul>
<b>Supposed Causes</b>	<ul style="list-style-type: none"> <li>■ Disconnection of the fan motor</li> <li>■ Foreign matter stuck in the fan</li> <li>■ Defective fan motor</li> <li>■ Defective outdoor unit PCB</li> </ul>

### Troubleshooting

  
**Check No.16**  
**Refer to P.106**

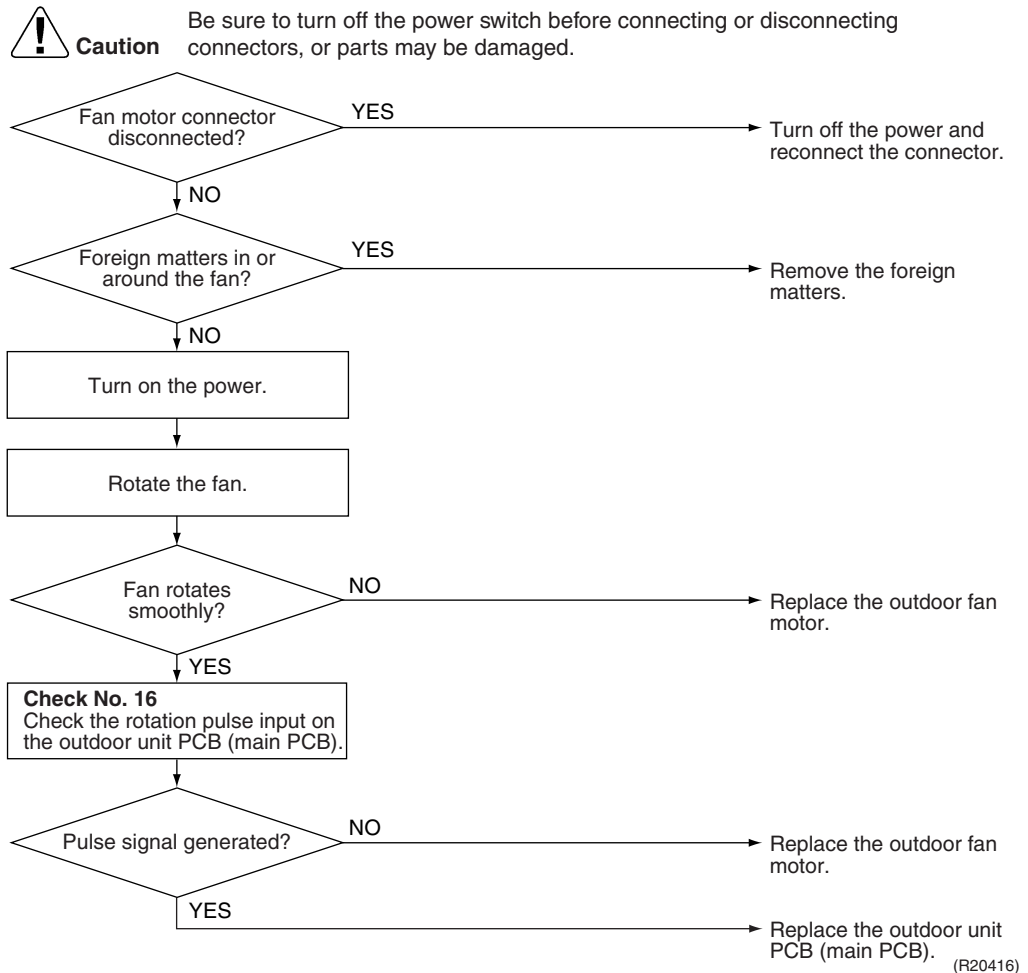

## 4.18 Input Overcurrent Detection

Error Code

**E8**

Method of Error Detection

An input overcurrent is detected by checking the input current value with the compressor running.

Error Decision Conditions

The current exceeds about 12.0 ~ 18.0 A (depending on the model) for 2.5 seconds with the compressor running.  
(The upper limit of the current decreases when the outdoor temperature exceeds a certain level.)

Supposed Causes

- Outdoor temperature is out of operation range.
- Defective compressor
- Defective power module
- Defective outdoor unit PCB
- Short circuit

Troubleshooting



**Check No.15**  
Refer to P.104



**Check No.17**  
Refer to P.107



**Check No.18**  
Refer to P.107



**Caution**

Be sure to turn off the power switch before connecting or disconnecting connectors, or parts may be damaged.

\* An input overcurrent may result from wrong internal wiring. If the system is interrupted by an input overcurrent after the wires have been disconnected and reconnected for part replacement, check the wiring again.

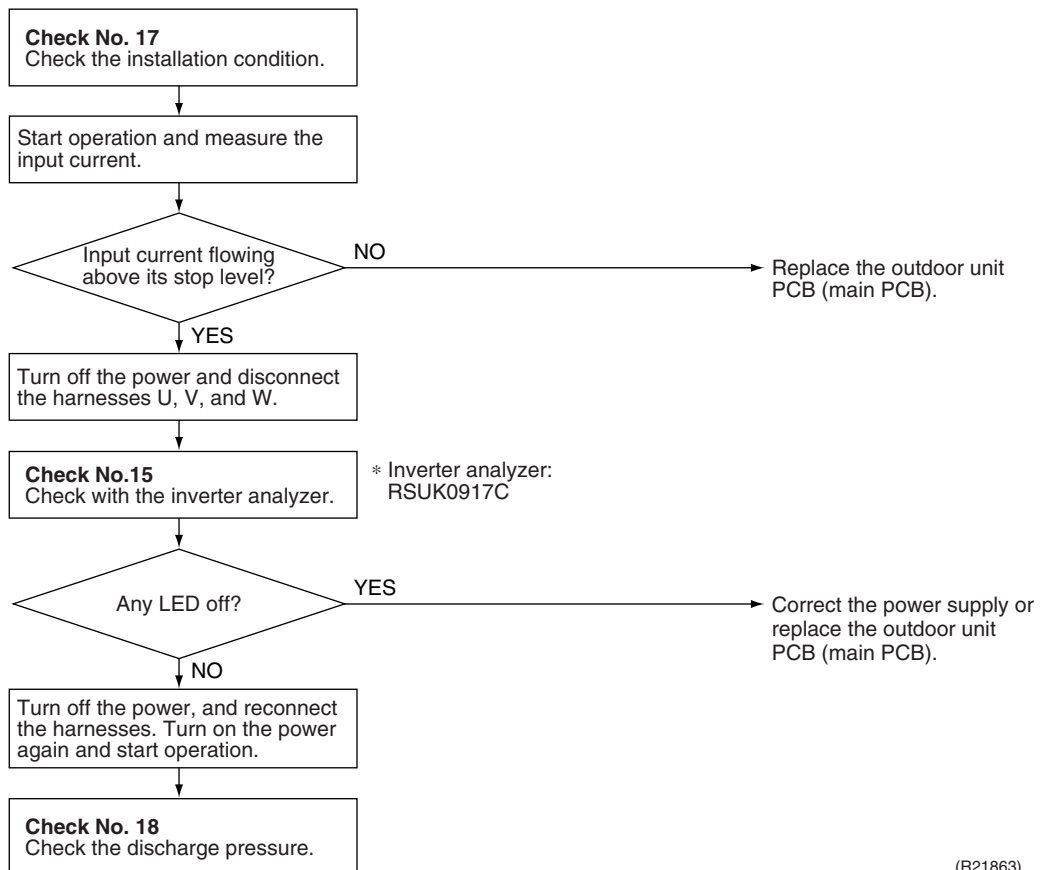

(R21863)

## 4.19 Four Way Valve Abnormality

<b>Error Code</b>	<b>EA</b>
<b>Method of Error Detection</b>	The room temperature thermistor and the indoor heat exchanger thermistor are checked if they function within their normal ranges in each operation mode.
<b>Error Decision Conditions</b>	<p>The following condition continues over 10 minutes after operating for 5 minutes.</p> <ul style="list-style-type: none"> <li>■ Cooling/Dry  <math>A - B &lt; -5^{\circ}\text{C}</math> (<math>A - B &lt; -9^{\circ}\text{F}</math>)</li> <li>■ Heating  <math>B - A &lt; -5^{\circ}\text{C}</math> (<math>B - A &lt; -9^{\circ}\text{F}</math>)</li> </ul> <p style="margin-left: 40px;"> <b>A:</b> Room thermistor temperature  <b>B:</b> Indoor heat exchanger temperature                 </p> <ul style="list-style-type: none"> <li>■ If the error repeats, the system is shut down.</li> <li>■ Reset condition: Continuous run for about 60 minutes without any other error</li> </ul>
<b>Supposed Causes</b>	<ul style="list-style-type: none"> <li>■ Disconnection of four way valve coil</li> <li>■ Defective four way valve, coil, or harness</li> <li>■ Defective outdoor unit PCB</li> <li>■ Defective thermistor</li> <li>■ Refrigerant shortage</li> <li>■ Water mixed in refrigerant</li> <li>■ Defective stop valve</li> </ul>

Troubleshooting



**Check No.01**  
Refer to P.100



**Check No.13**  
Refer to P.103



**Check No.14**  
Refer to P.103



**Caution** Be sure to turn off the power switch before connecting or disconnecting connectors, or parts may be damaged.

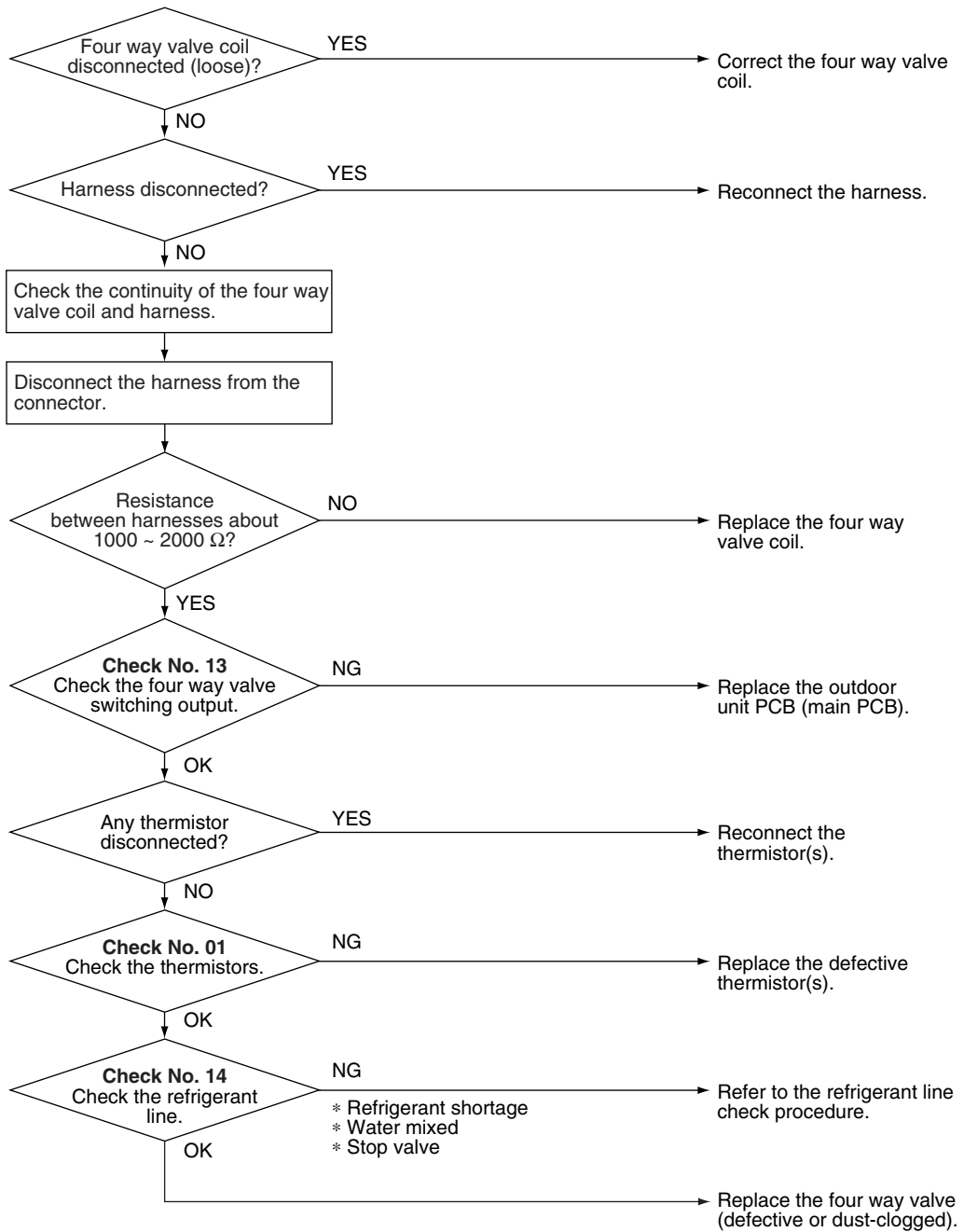

(R20405)

## 4.20 Discharge Pipe Temperature Control

**Error Code** **F3**

**Method of Error Detection** An error is determined with the temperature detected by the discharge pipe thermistor.

**Error Decision Conditions**

- If the temperature detected by the discharge pipe thermistor rises above **A**, the compressor stops.
- The error is cleared when the discharge pipe temperature has dropped below **B**.

	A		B	
	°C	°F	°C	°F
09/12 class	110	230	88	190.4
15/18/24 class	110	230	95	203



★ If the frequency drops, the temperature is lowered in compensation.

- If the error repeats, the system is shut down.
- Reset condition: Continuous run for about 60 minutes without any other error

**Supposed Causes**

- Defective discharge pipe thermistor  
(Defective outdoor heat exchanger thermistor or outdoor temperature thermistor)
- Defective electronic expansion valve or coil
- Refrigerant shortage
- Defective four way valve
- Water mixed in refrigerant
- Defective stop valve
- Defective outdoor unit PCB

**Troubleshooting**

-  **Check No.01**  
Refer to P.100
-  **Check No.12**  
Refer to P.102
-  **Check No.14**  
Refer to P.103

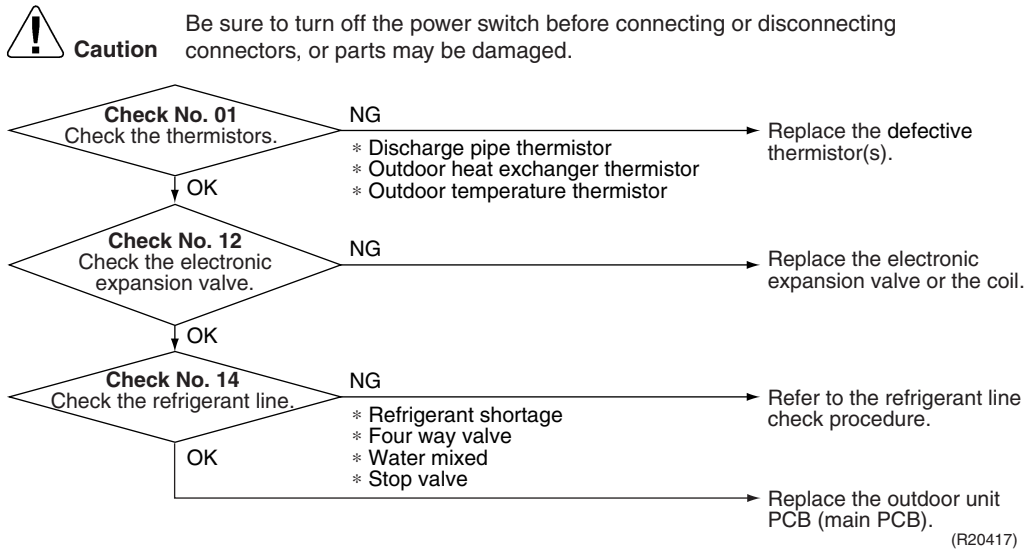

## 4.21 High Pressure Control in Cooling

---

<b>Error Code</b>	<b>F6</b>
<b>Method of Error Detection</b>	High-pressure control (operation halt, frequency drop, etc.) is activated in cooling operation if the temperature sensed by the outdoor heat exchanger thermistor exceeds the limit.
<b>Error Decision Conditions</b>	The temperature sensed by the outdoor heat exchanger thermistor rise above 57.5 ~ 61°C (135.5 ~ 141.8°F) (depending on the model).
<b>Supposed Causes</b>	<ul style="list-style-type: none"><li>■ Installation space not large enough</li><li>■ Dirty outdoor heat exchanger</li><li>■ Defective outdoor fan motor</li><li>■ Defective stop valve</li><li>■ Defective electronic expansion valve or coil</li><li>■ Defective outdoor heat exchanger thermistor</li><li>■ Defective outdoor unit PCB</li></ul>

Troubleshooting



**Check No.01**  
Refer to P.100



**Check No.12**  
Refer to P.102



**Check No.17**  
Refer to P.107



**Check No.18**  
Refer to P.107



**Check No.19**  
Refer to P.108



**Caution** Be sure to turn off the power switch before connecting or disconnecting connectors, or parts may be damaged.

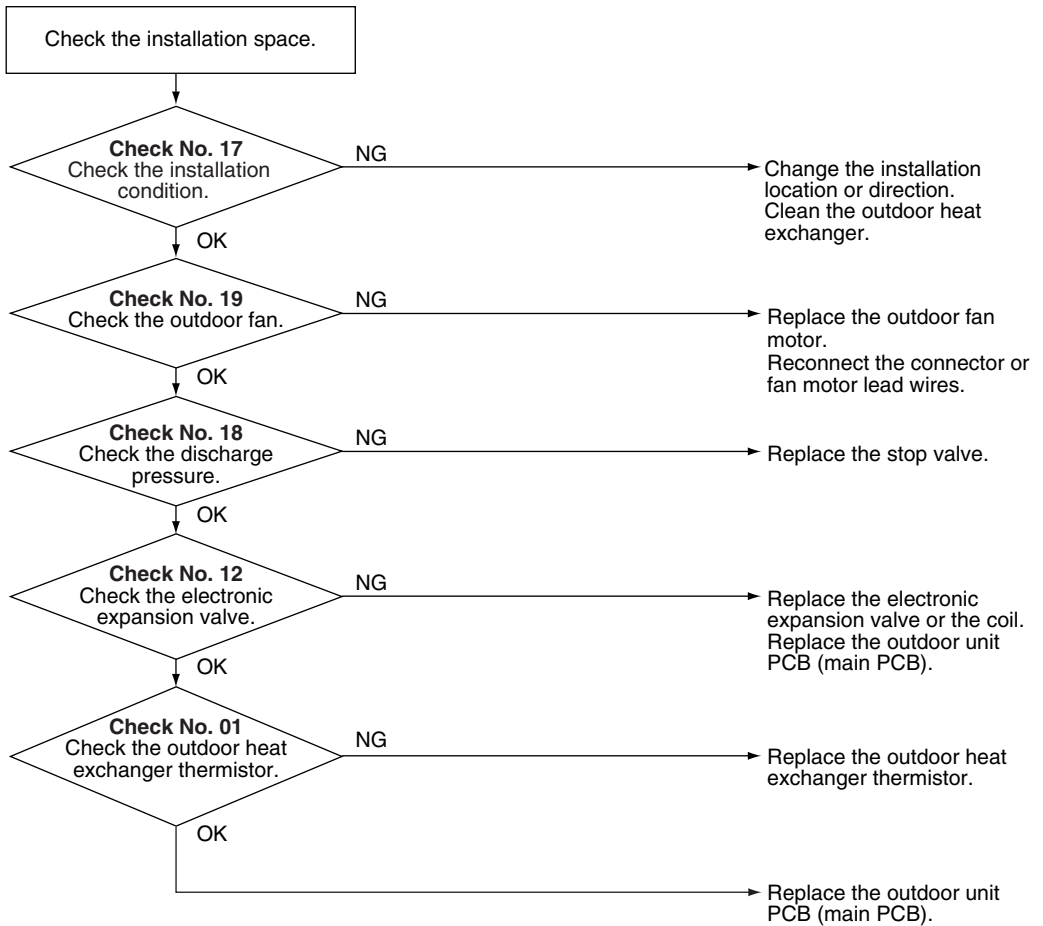

(R20418)

## 4.22 System Shutdown due to Compressor Internal Temperature Abnormality

<b>Error Code</b>	<b>F8</b>
<b>Method of Error Detection</b>	Operation is halted when the temperature detected by the discharge pipe thermistor exceeds the determined limit.
<b>Error Decision Conditions</b>	Temperature exceeds the detection threshold of 127.5°C (261.5°F) during forced cooling operation.
<b>Supposed Causes</b>	<ul style="list-style-type: none"> <li>■ Abnormal operation due to air intrusion</li> <li>■ Defective discharge pipe thermistor</li> </ul>

### Troubleshooting



**Check No.01**  
Refer to P.100



**Caution**

Be sure to turn off the power switch before connecting or disconnecting connectors, or parts may be damaged.

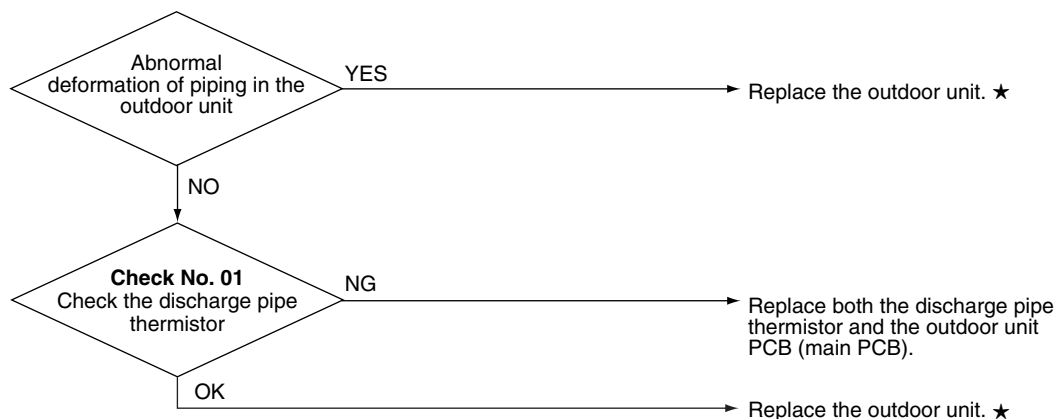

★ Replace the unit as directed in the installation manual, making sure that air does not intrude into the refrigerant pipings.

(R23655)

## 4.23 Compressor System Sensor Abnormality

<b>Error Code</b>	<b>H0</b>
<b>Method of Error Detection</b>	The system checks the DC current before the compressor starts.
<b>Error Decision Conditions</b>	<ul style="list-style-type: none"> <li>■ The voltage converted from the DC current before compressor start-up is out of the range 0.5 ~ 4.5 V.</li> <li>■ The DC voltage before compressor start-up is below 50 V.</li> </ul>
<b>Supposed Causes</b>	<ul style="list-style-type: none"> <li>■ Broken or disconnected harness</li> <li>■ Defective outdoor unit PCB</li> </ul>

### Troubleshooting

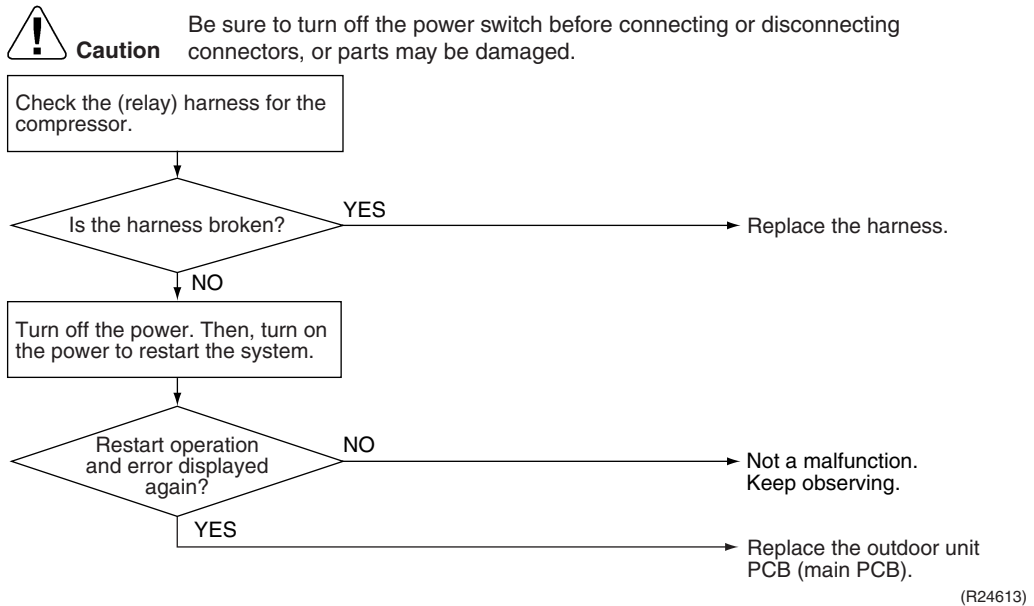

## 4.24 Position Sensor Abnormality

---

<b>Error Code</b>	<b>H6</b>
<b>Method of Error Detection</b>	A compressor start-up failure is detected by checking the compressor running condition through the position detection circuit.
<b>Error Decision Conditions</b>	<ul style="list-style-type: none"><li>■ If the error repeats, the system is shut down.</li><li>■ Reset condition: Continuous run for about 11 minutes without any other error</li></ul>
<b>Supposed Causes</b>	<ul style="list-style-type: none"><li>■ Power supply voltage out of specification</li><li>■ Disconnection of the compressor harness</li><li>■ Defective compressor</li><li>■ Defective outdoor unit PCB</li><li>■ Start-up failure caused by the closed stop valve</li><li>■ Input voltage outside the specified range</li></ul>

Troubleshooting



**Check No.15**  
Refer to P.104



**Check No.18**  
Refer to P.107



**Check No.20**  
Refer to P.108



**Caution** Be sure to turn off the power switch before connecting or disconnecting connectors, or parts may be damaged.

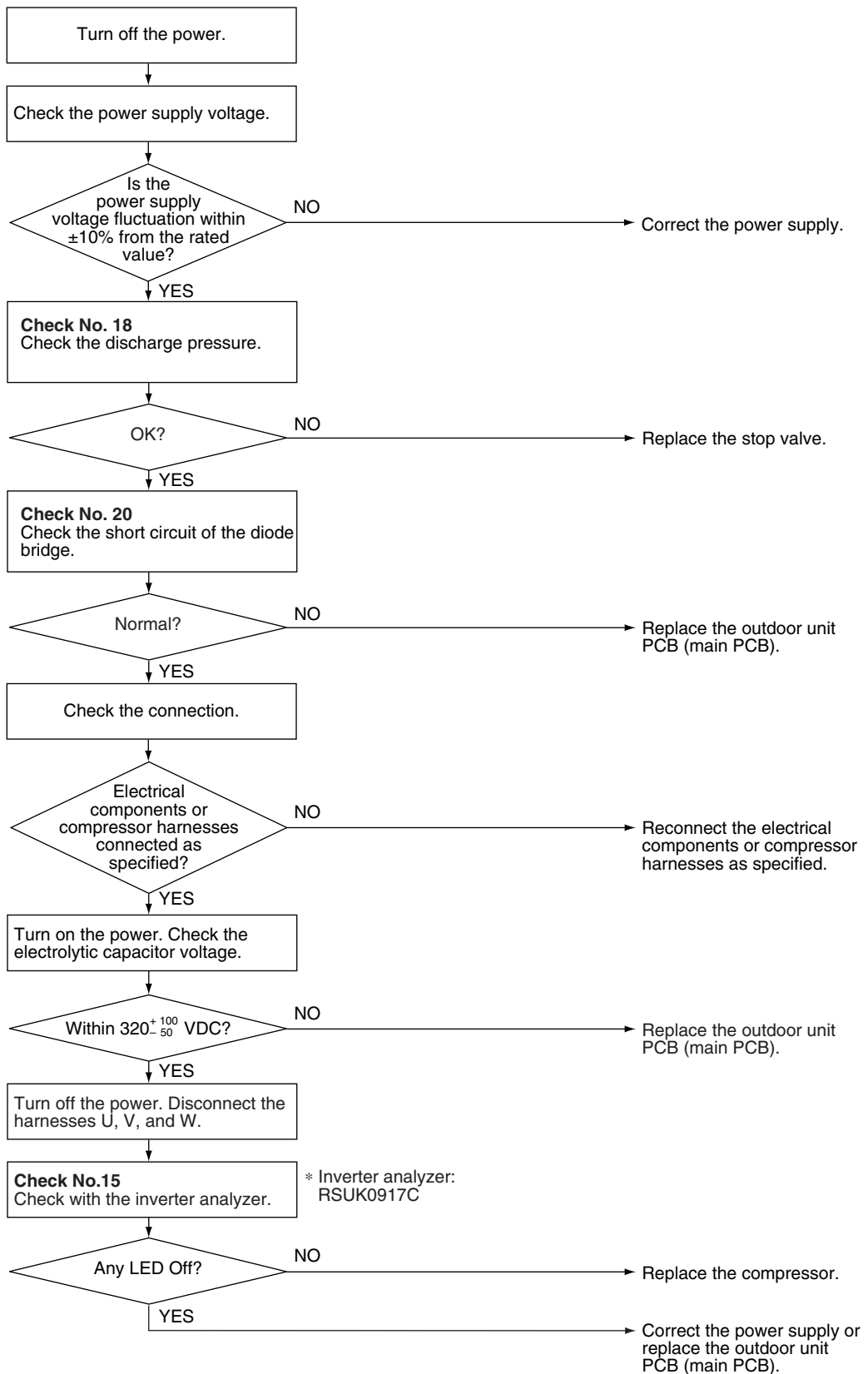

(R22764)

## 4.25 Thermistor or Related Abnormality (Outdoor Unit)

<b>Error Code</b>	<b>H9, J3, J6, P4</b>
<b>Method of Error Detection</b>	This fault is identified based on the thermistor input voltage to the microcomputer. A thermistor fault is identified based on the temperature sensed by each thermistor.
<b>Error Decision Conditions</b>	<ul style="list-style-type: none"> <li>■ The voltage between the both ends of the thermistor is either 4.96 V or more, or 0.04 V or less with the power on.</li> <li>■ <b>J3</b> error is judged if the discharge pipe temperature is lower than the heat exchanger temperature.</li> </ul>
<b>Supposed Causes</b>	<ul style="list-style-type: none"> <li>■ Disconnection of the connector for the thermistor</li> <li>■ Defective thermistor(s)</li> <li>■ Defective heat exchanger thermistor in the case of <b>J3</b> error (outdoor heat exchanger thermistor in cooling operation, or indoor heat exchanger thermistor in heating operation)</li> <li>■ Defective outdoor unit PCB</li> </ul>
<b>Troubleshooting</b>	<p><b>In case of P4</b></p> <p> <b>Caution</b> Be sure to turn off the power switch before connecting or disconnecting connectors, or parts may be damaged.</p> <p><b>Replace the outdoor unit PCB (main PCB).</b></p> <p><b>P4</b> : Radiation fin thermistor</p>

Troubleshooting



**Check No.01**  
Refer to P.100

**In case of H9, J3, J6**



**Caution**

Be sure to turn off the power switch before connecting or disconnecting connectors, or parts may be damaged.

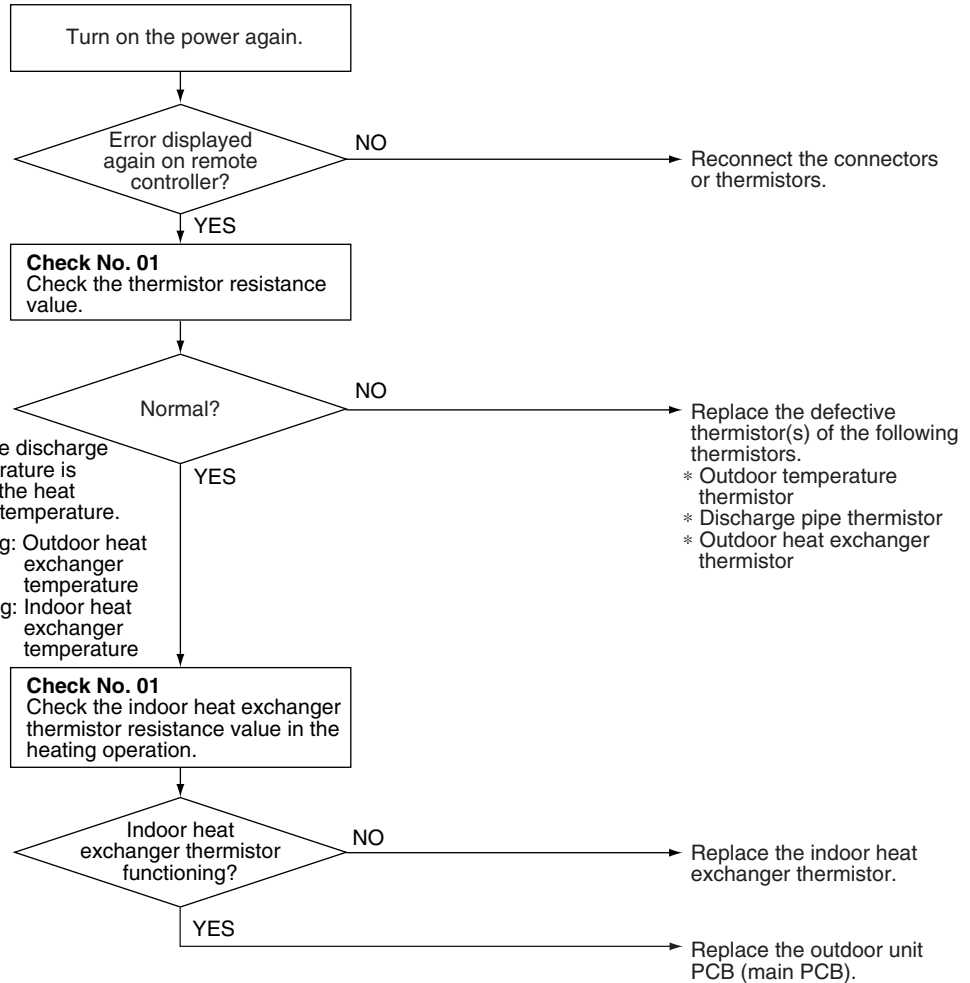

**J3 error:** the discharge pipe temperature is lower than the heat exchanger temperature.

- Cooling: Outdoor heat exchanger temperature
- Heating: Indoor heat exchanger temperature

(R20406)

- H9 :** Outdoor temperature thermistor
- J3 :** Discharge pipe thermistor
- J6 :** Outdoor heat exchanger thermistor



**Note:** When replacing the defective thermistor(s), replace the thermistors as ASSY.

## 4.26 Electrical Box Temperature Rise

**Error Code** **L3**

**Method of Error Detection** An electrical box temperature rise is detected by checking the radiation fin thermistor with the compressor off.

**Error Decision Conditions**



- With the compressor off, the radiation fin temperature is above **A**.
- The error is cleared when the radiation fin temperature drops below **B**.
- To cool the electrical components, the outdoor fan starts when the radiation fin temperature rises above **C** and stops when the radiation fin temperature drops below **B**.

	<b>A</b>		<b>B</b>		<b>C</b>	
	°C	°F	°C	°F	°C	°F
09/12 class	82	179.6	65	149	70	158
15/18/24 class	90	194	64	147.2	81	177.8

**Supposed Causes**

- Defective outdoor fan motor
- Short circuit
- Defective radiation fin thermistor
- Disconnection of connector
- Defective outdoor unit PCB

**Troubleshooting**

-  **Check No.17**  
Refer to P.107
-  **Check No.19**  
Refer to P.108

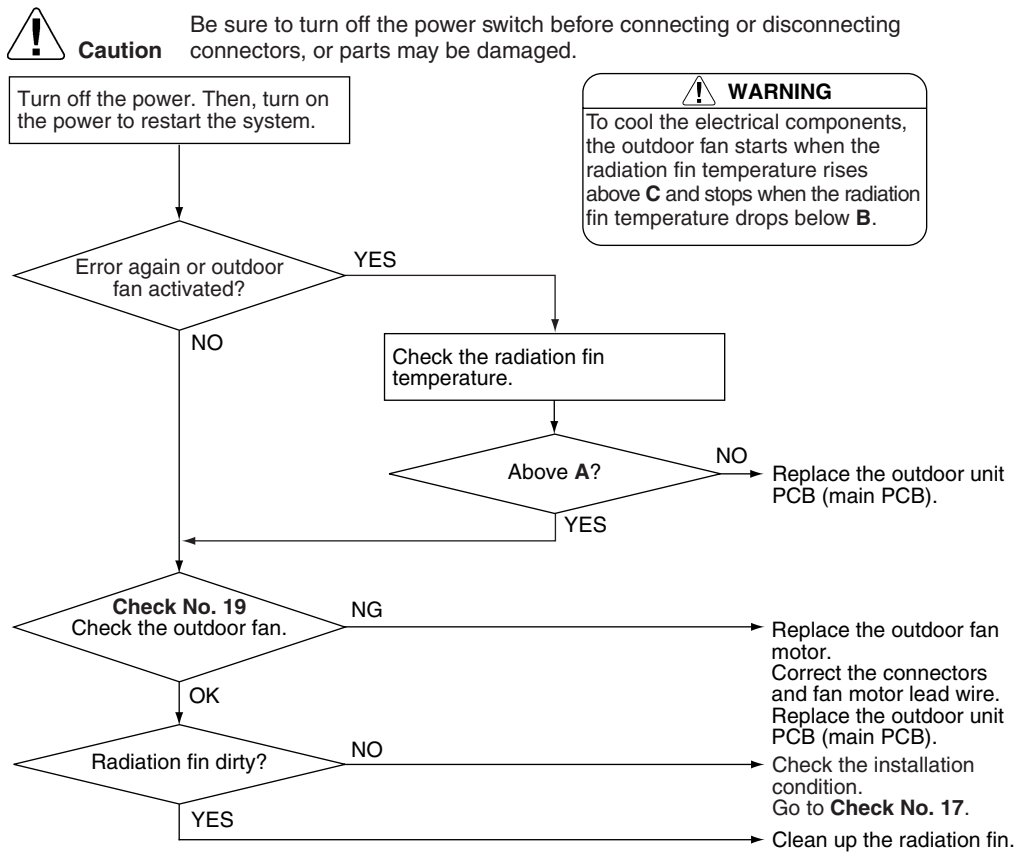

(R22998)

## 4.27 Radiation Fin Temperature Rise

**Error Code** **L4**

**Method of Error Detection** A radiation fin temperature rise is detected by checking the radiation fin thermistor with the compressor on.

- Error Decision Conditions**
- If the radiation fin temperature with the compressor on is above **A**.
  - The error is cleared when the radiation fin temperature drops below **B**.
  - If the error repeats, the system is shut down.
  - Reset condition: Continuous run for about 60 minutes without any other error

	A		B	
	°C	°F	°C	°F
09/12 class	99	210.2	70	158
15/18/24 class	100	212	57	134.6

- Supposed Causes**
- Defective outdoor fan motor
  - Short circuit
  - Defective radiation fin thermistor
  - Disconnection of connector
  - Defective outdoor unit PCB
  - Silicone grease not applied properly on the radiation fin after replacing the outdoor unit PCB

**Troubleshooting**

 **Check No.17**  
Refer to P.107

 **Check No.19**  
Refer to P.108

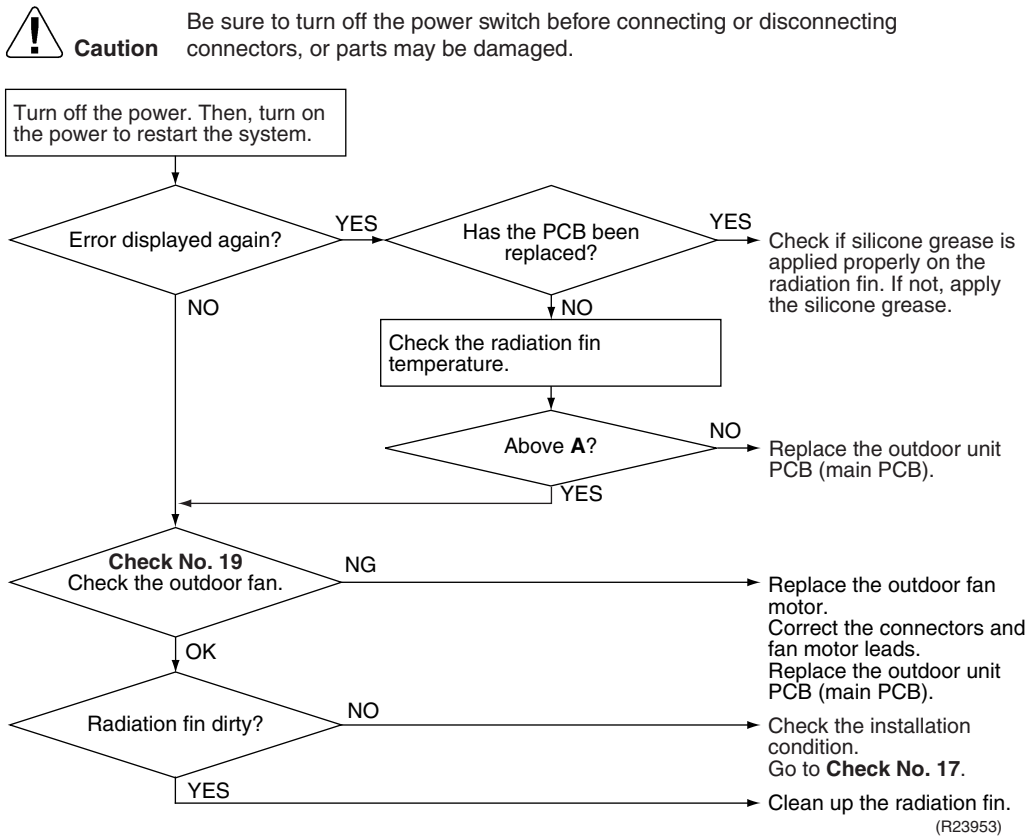

 **Note:** Refer to Silicone Grease on Power Transistor/Diode Bridge on page 125 for details.

## 4.28 Output Overcurrent Detection

---

<b>Error Code</b>	<b>L5</b>
<b>Method of Error Detection</b>	An output overcurrent is detected by checking the current that flows in the inverter DC section.
<b>Error Decision Conditions</b>	<ul style="list-style-type: none"><li>■ A position signal error occurs while the compressor is running.</li><li>■ A rotation speed error occurs while the compressor is running.</li><li>■ An output overcurrent signal is fed from the output overcurrent detection circuit to the microcomputer.</li><li>■ If the error repeats, the system is shut down.</li><li>■ Reset condition: Continuous run for about 11 minutes without any other error</li></ul>
<b>Supposed Causes</b>	<ul style="list-style-type: none"><li>■ Poor installation condition</li><li>■ Closed stop valve</li><li>■ Defective power module</li><li>■ Wrong internal wiring</li><li>■ Abnormal power supply voltage</li><li>■ Defective outdoor unit PCB</li><li>■ Power supply voltage out of specification</li><li>■ Defective compressor</li></ul>

Troubleshooting



**Check No.15**  
Refer to P.104



**Check No.17**  
Refer to P.107



**Check No.18**  
Refer to P.107



**Check No.22**  
Refer to P.110



**Caution** Be sure to turn off the power switch before connecting or disconnecting connectors, or parts may be damaged.

\* An output overcurrent may result from wrong internal wiring. If the system is interrupted by an output overcurrent after the wires have been disconnected and reconnected for part replacement, check the wiring again.

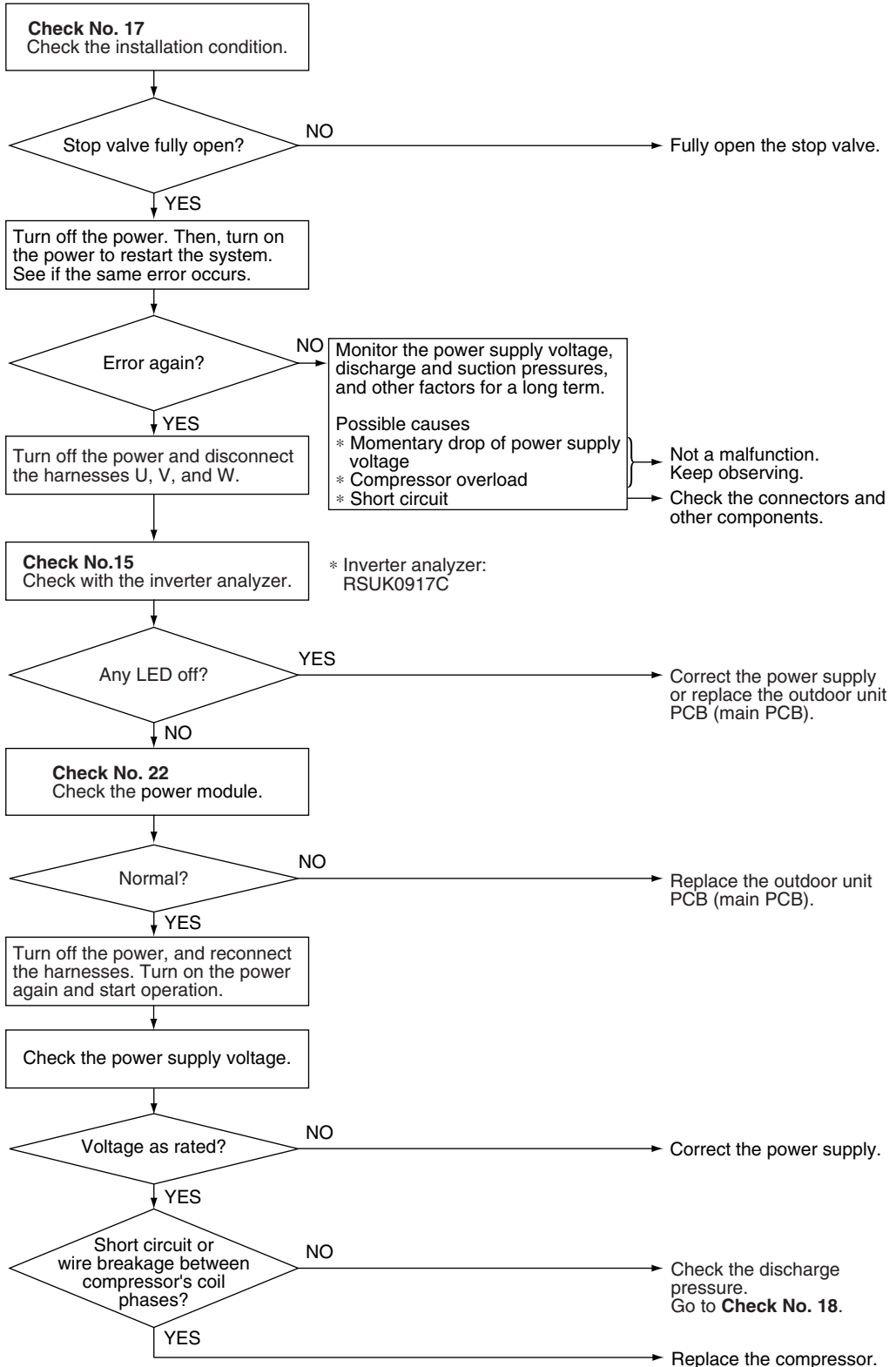

(R21438)

# 5. Check

## 5.1 Thermistor Resistance Check

**Check No.01**

Disconnect the connectors of the thermistors from the PCB, and measure the resistance of each thermistor using a multimeter.

The data is for reference purpose only.

Thermistor temperature		Resistance (kΩ)
°C	°F	
-20	-4	197.8
-15	5	148.2
-10	14	112.1
-5	23	85.60
0	32	65.93
5	41	51.14
10	50	39.99
15	59	31.52
20	68	25.02
25	77	20.00
30	86	16.10
35	95	13.04
40	104	10.62
45	113	8.707
50	122	7.176

(R25°C (77°F) = 20 kΩ, B = 3950 K)

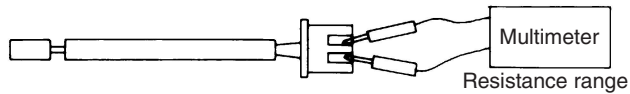
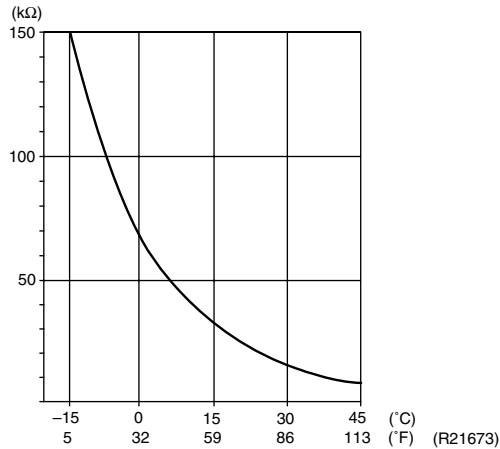

(R19751)

- When the room temperature thermistor is soldered on a PCB, remove the PCB from the control PCB to measure the resistance.
- When the connector of indoor heat exchanger thermistor is soldered on a PCB, remove the thermistor and measure the resistance.

## 5.2 Indoor Fan Motor Connector Check

**Check No.02**

1. Turn the power supply OFF.
2. With the fan motor connector disconnected, measure the resistance between each pin, then make sure that the resistance is more than the value mentioned in the following table.

Measuring points	Judgement
White - Blue	1 MΩ or more
Orange - Blue	100 kΩ or more
Brown - Blue	100 Ω or more
Red - Blue	100 kΩ or more

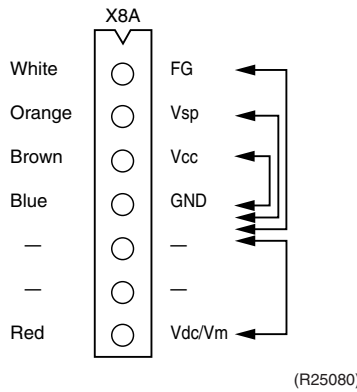

## 5.3 Power Supply Waveforms Check

**Check No.11**

Measure the power supply waveform between No. 1 and No. 2 on the terminal block, and check the waveform disturbance.

- Check if the power supply waveform is a sine wave (Fig.1).
- Check if there is waveform disturbance near the zero-cross (sections circled in Fig.2).

**Fig.1**

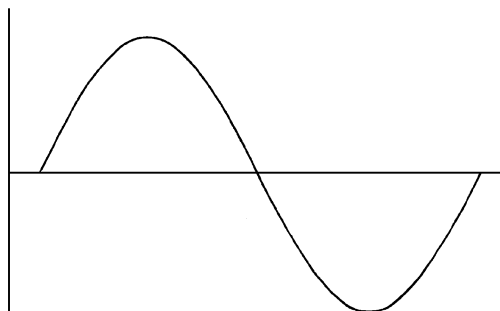

**Fig.2**

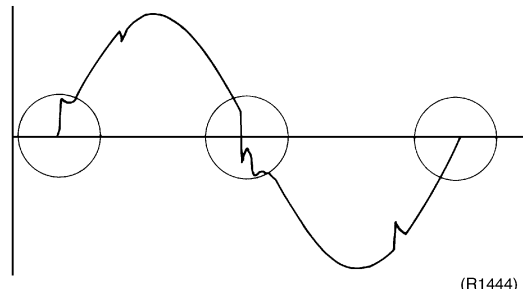

## 5.4 Electronic Expansion Valve Check

### Check No.12

Conduct the following to check the electronic expansion valve (EV).

1. Check if the EV connector is correctly connected to the PCB.
2. Turn the power off and on again, and check if the EV generates a latching sound.
3. If the EV does not generate a latching sound in step 2, disconnect the connector and check the continuity using a multimeter.
4. Check the continuity between the pins 5 - 1, 5 - 2, 5 - 3, 5 - 4 (between the pins 6 - 1, 6 - 2, 6 - 3, and 6 - 4 for the 6P connector models). If there is no continuity between the pins, the EV coil is faulty.
5. If the continuity is confirmed in step 3, the outdoor unit PCB (main PCB) is faulty.

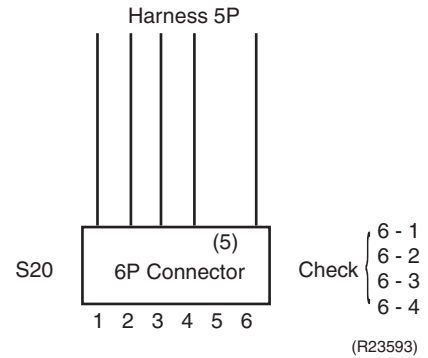
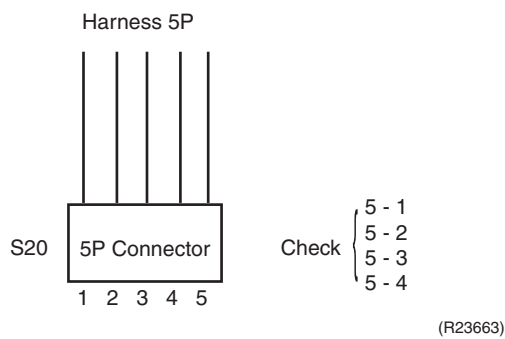

## 5.5 Four Way Valve Performance Check

### Check No.13

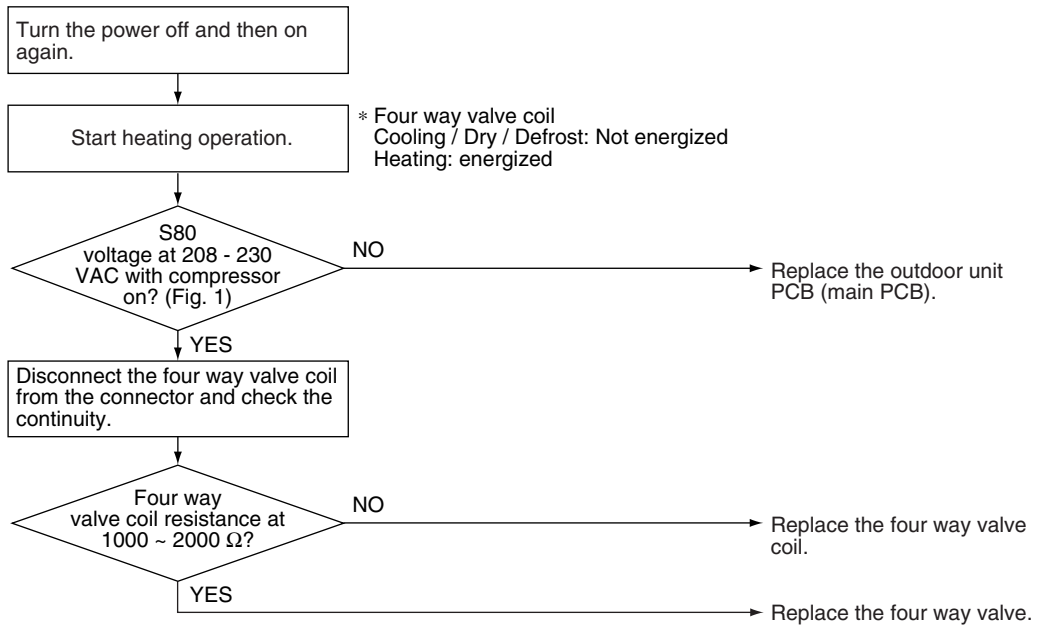

(R21674)

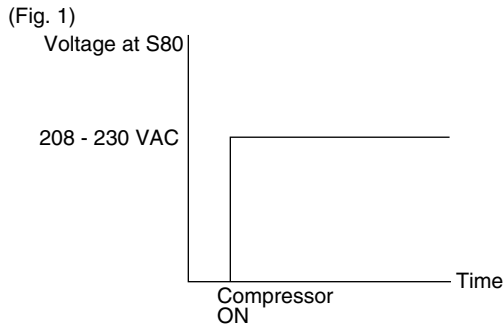

(R14674)

## 5.6 Inverter Unit Refrigerant System Check

### Check No.14

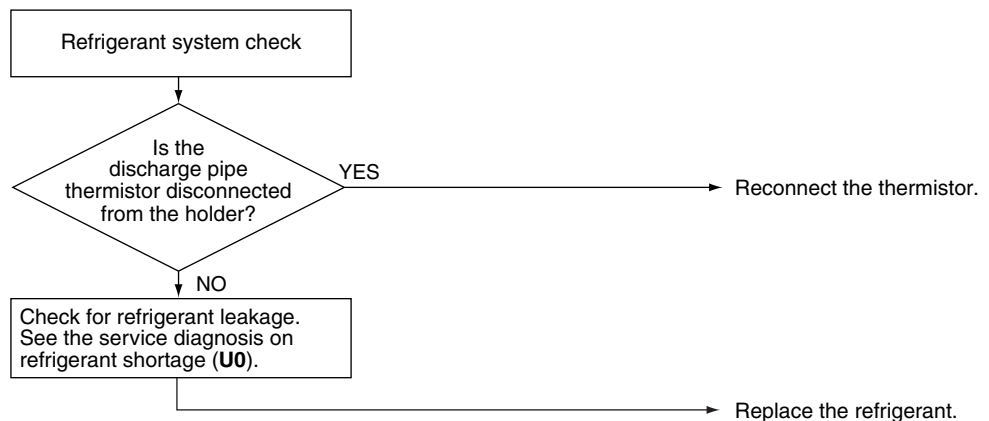

(R15833)

## 5.7 Inverter Analyzer Check

### Check No.15

#### ■ Characteristics

Inverter analyzer: RSUK0917C

If an abnormal stop occurs due to compressor startup failure or overcurrent output when using an inverter unit, it is difficult to judge whether the stop is caused by the compressor failure or some other failure (main PCB, power module, etc.). The inverter analyzer makes it possible to judge the cause of trouble easily and securely. (Connect an inverter analyzer as a quasi-compressor instead of compressor and check the output of the inverter.)

#### ■ Operation Method

##### Step 1

Be sure to turn off the power.

##### Step 2

Install an inverter analyzer instead of a compressor.

##### Note:

Make sure the charged voltage of the built-in smoothing electrolytic capacitor drops to 10 VDC or below before carrying out the service work.

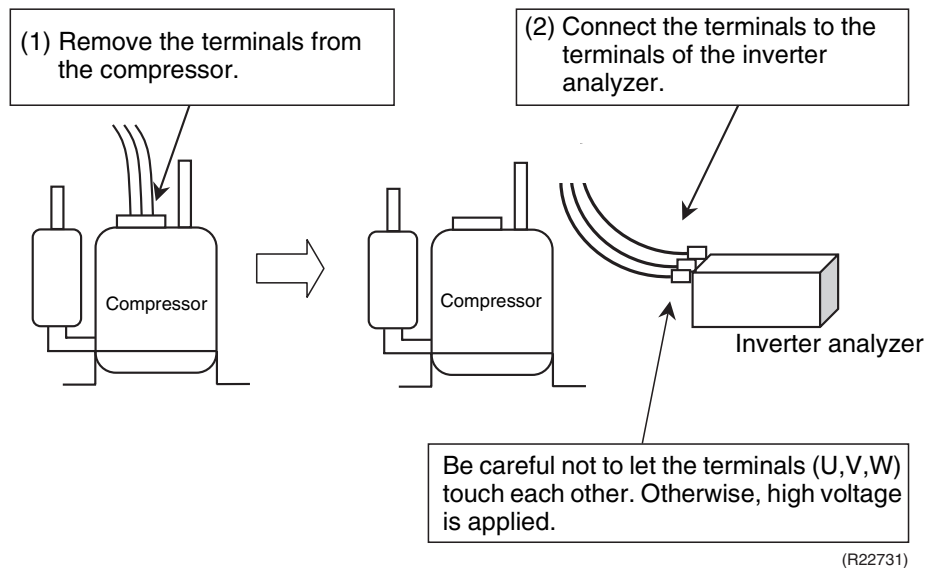

##### Reference:

If the terminals of the compressor are not FASTON terminals (difficult to remove the wire on the terminals), it is possible to connect wires available on site to the outdoor unit from output side of PCB. (Do not connect them to the compressor at the same time, otherwise it may result in incorrect detection.)

**Step 3**

Activate power transistor test operation from the outdoor unit.

■ **Start method of power transistor test operation**



**Note:** Power transistor test operation can be activated only once after turning on the power supply. If reactivation of the power supply transistor operation is needed, turn the power supply off and then on again.

**With Wired Remote Controller (BRC1E73)**

1. Turn the power on.
2. Set FAN operation using the remote controller.
3. Press and hold **Cancel** button for 4 seconds or longer.
4. Select **Test Operation** in the service settings menu, then press **Menu/OK** button.  
→ Basic screen returns and “Test Operation” is displayed at the bottom.
5. Press **On/Off** button within 10 seconds.  
→ 3 minutes after pressing **On/Off** button, power transistor test operation will start.
  - Test operation will stop automatically after about 30 minutes.  
To stop the operation, press **On/Off** button.

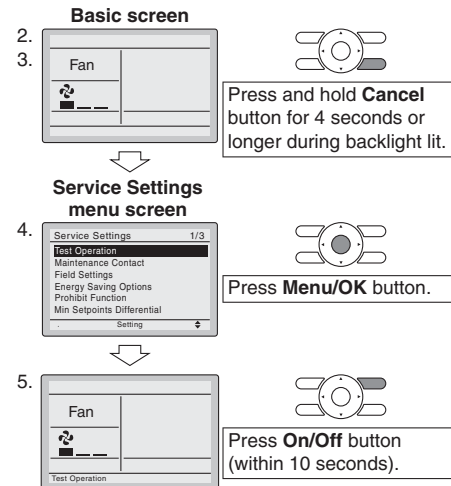

**With Wireless Remote Controller (BRC082A43)**

1. Turn the power on.
2. Press and select FAN operation.
3. Press twice. “TEST” is displayed.
4. Press within 10 seconds.  
→ 3 minutes after pressing , power transistor test operation will start.
  - Test operation will stop automatically after about 30 minutes.  
To stop the operation, press .

■ **Diagnose method (Diagnose according to 6 LEDs lighting status of the inverter analyzer.)**

1. If all the LEDs are lit uniformly, the compressor is defective.  
→ Replace the compressor.
2. If the LEDs are not lit uniformly, check the power module.  
→ Refer to **Check No.22**.
3. If NG in **Check No.22**, replace the power module.  
(Replace the main PCB. The power module is united with the main PCB.)  
If OK in **Check No.22**, check if there is any solder cracking on the PCB.
4. If any solder cracking is found, replace the PCB or repair the soldered section.  
If there is no solder cracking, replace the PCB.

**Caution**

1. When the output frequency is low, the LEDs blink slowly. As the output frequency increases, the LEDs blink quicker. (The LEDs look like they are lit.)
2. On completion of the inverter analyzer diagnosis, be sure to re-crimp the FASTON terminals. Otherwise, the terminals may be burned due to loosening.

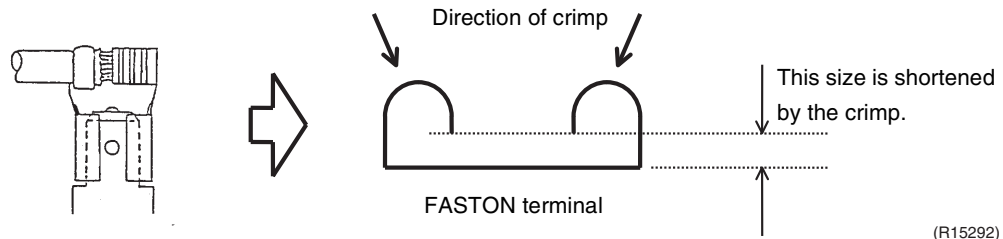

(R15292)

## 5.8 Rotation Pulse Check on the Outdoor Unit PCB

**Check No.16**

Make sure that the voltage is within  $320 \pm_{50}^{100}$  VDC.

1. Set operation off and power off. Disconnect the connector S70 or S71.
2. Check that the voltage between the pins 4 - 7 is 320 VDC.
3. Check that the control voltage between the pins 4 - 3 is 15 VDC.
4. Check that the rotation command voltage between the pins 4 - 2 is 0 ~ 6.5 VDC.
5. Keep operation off and power off. Connect the connector S70 or S71.
6. Check whether 4 rotation pulses (0 ~ 15 VDC) are input at the pins 4 - 1 when the fan motor is rotated 1 turn by hand.

When the fuse is melted, check the outdoor fan motor for proper function.

If NG in step 2 → Defective PCB → Replace the outdoor unit PCB (main PCB).

If NG in step 4 → Defective Hall IC → Replace the outdoor fan motor.

If OK in both steps 2 and 4 → Replace the outdoor unit PCB (main PCB).

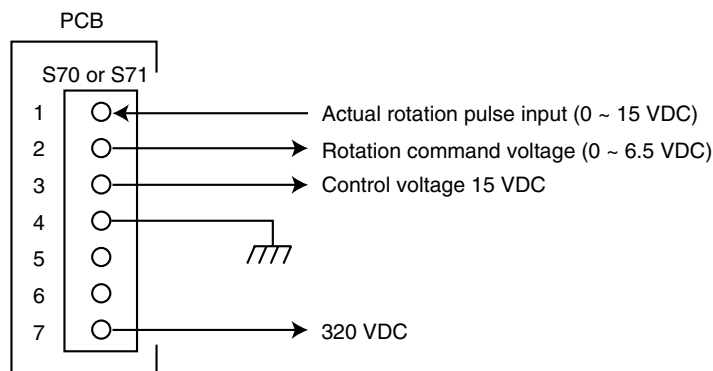

(R20507)

## 5.9 Installation Condition Check

### Check No.17

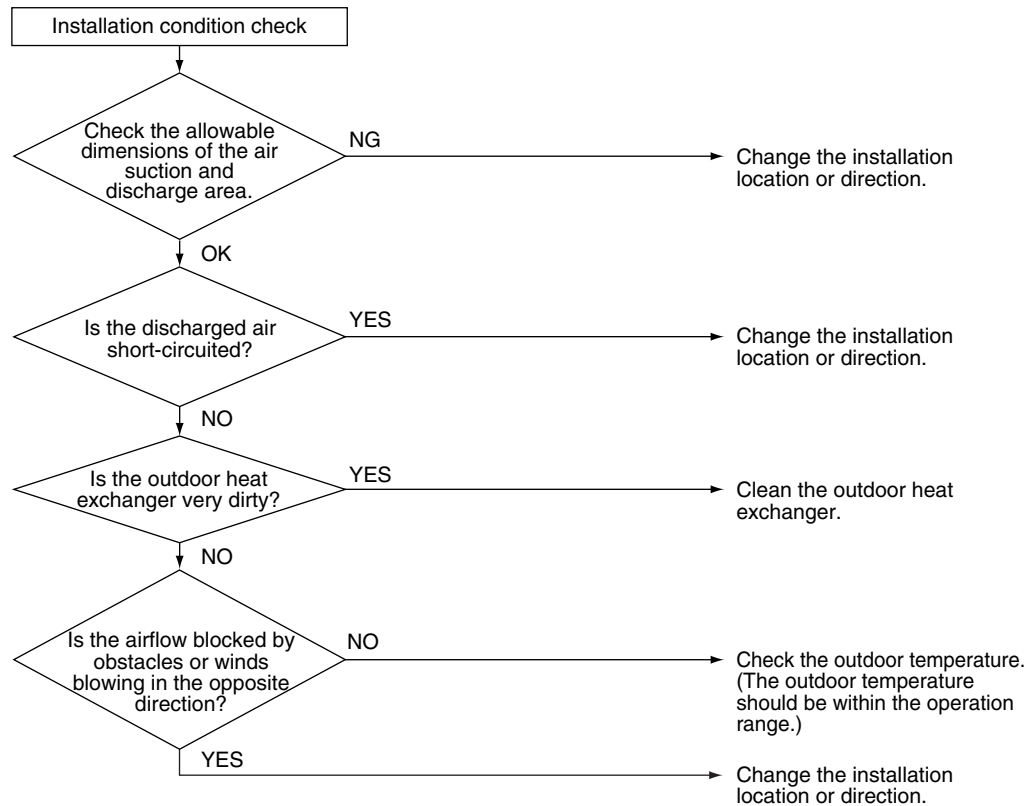

(R19394)

## 5.10 Discharge Pressure Check

### Check No.18

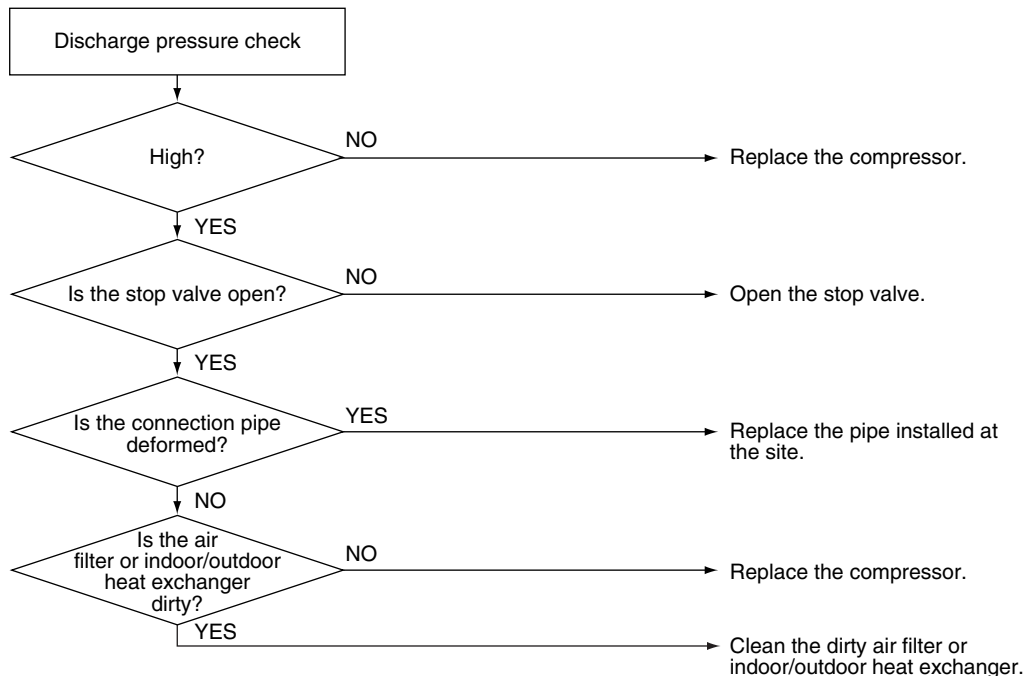

(R19385)

## 5.11 Outdoor Fan System Check

Check No.19

DC motor

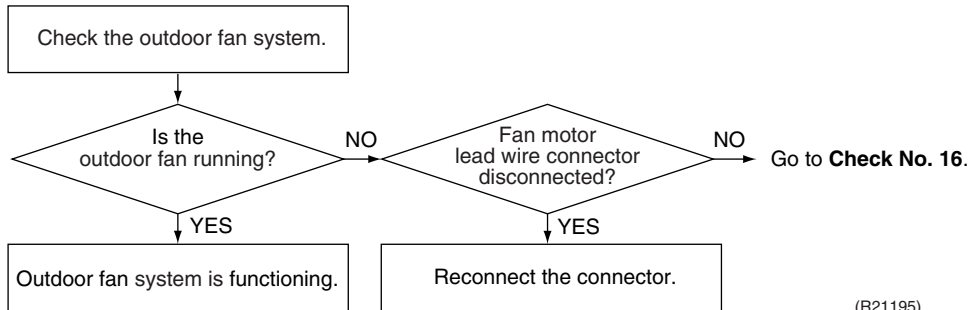

(R21195)

## 5.12 Main Circuit Short Check

Check No.20

Check to make sure that the voltage between (+) and (-) of the diode bridge (DB1) is approximately 0 V before checking.

- Measure the resistance between the pins of the DB1 referring to the table below.
- If the resistance is  $\infty$  or less than 1 k $\Omega$ , short circuit occurs on the main circuit.

Positive terminal (+) of digital multimeter	~ (2, 3)	+ (4)	~ (2, 3)	- (1)
Negative terminal (-) of digital multimeter	+ (4)	~ (2, 3)	- (1)	~ (2, 3)
Resistance is OK.	several k $\Omega$ ~ several M $\Omega$			
Resistance is NG.	0 $\Omega$ or $\infty$			

09/12 class

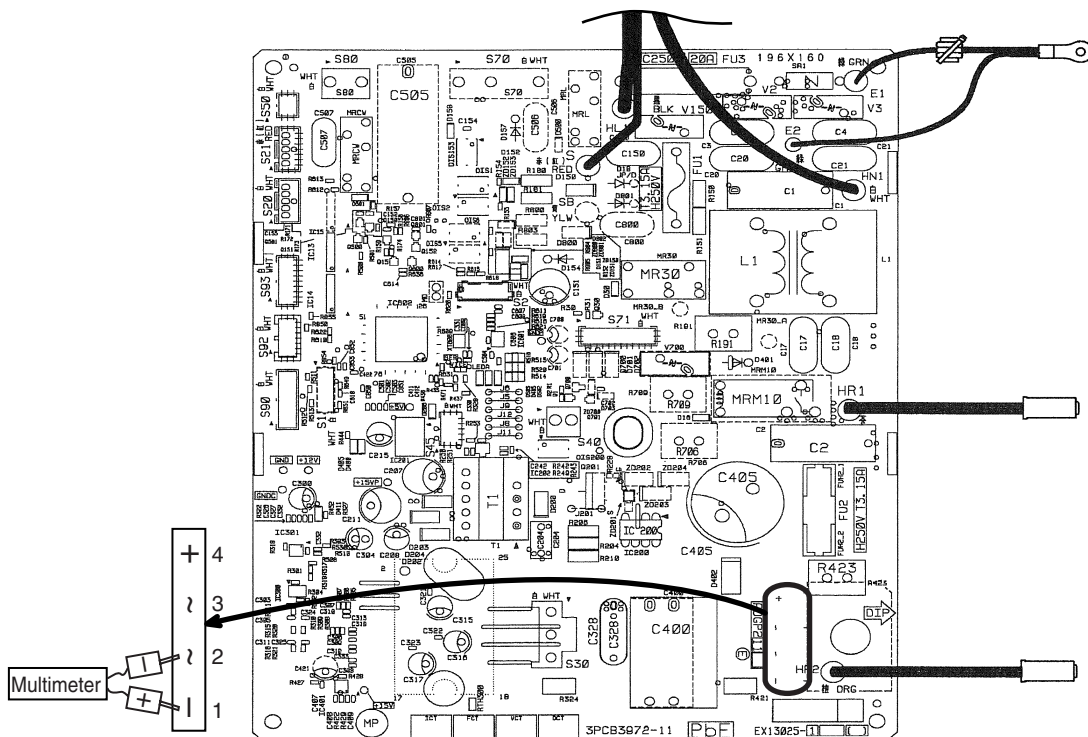

(R20698)

15/18/24 class

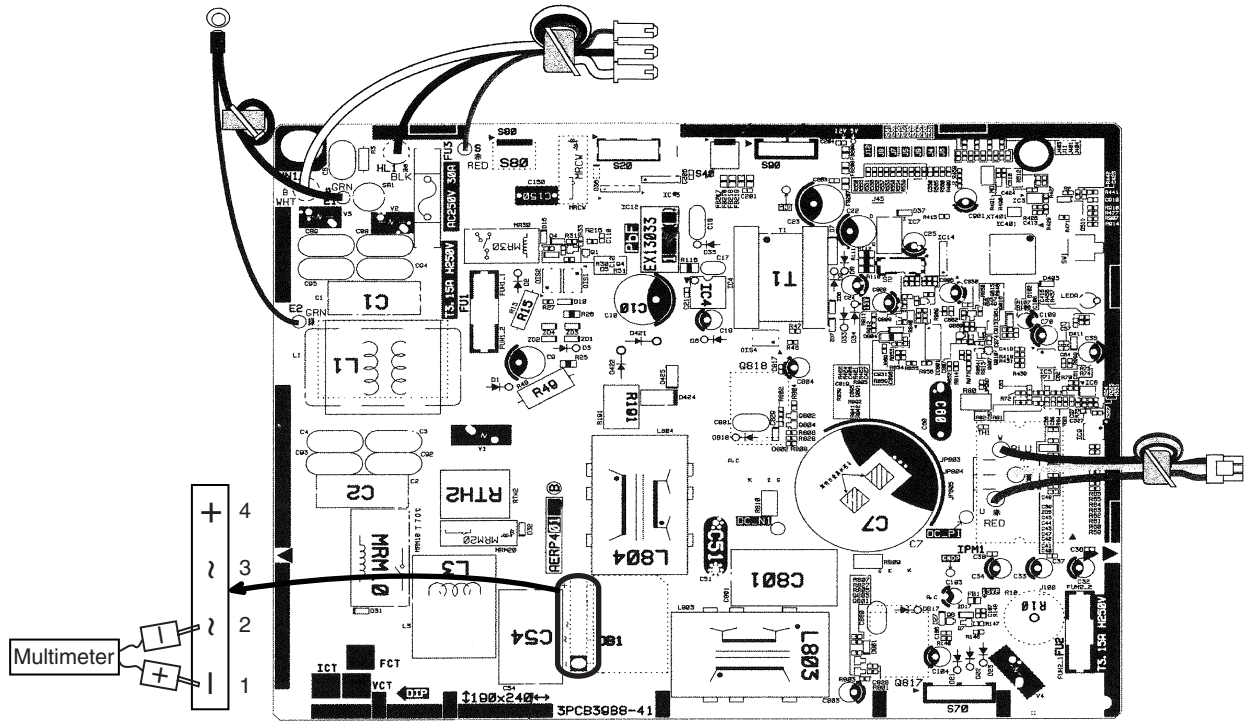

(R25105)

# 5.13 Power Module Check

## Check No.22

Check to make sure that the voltage between (+) and (-) of the power module is approximately 0 V before checking.

- Disconnect the compressor harness connector from the outdoor unit PCB. To disengage the connector, press the protrusion on the connector.
- Follow the procedure below to measure resistance between the terminals of the power module and the terminals of the compressor with a multimeter. Evaluate the measurement results referring to the following table.

Positive terminal (+) of digital multimeter	Power module (+)	UVW	Power module (-)	UVW
Negative terminal (-) of digital multimeter	UVW	Power module (+)	UVW	Power module (-)
Resistance is OK.	several kΩ ~ several MΩ			
Resistance is NG.	0 Ω or ∞			

09/12 class

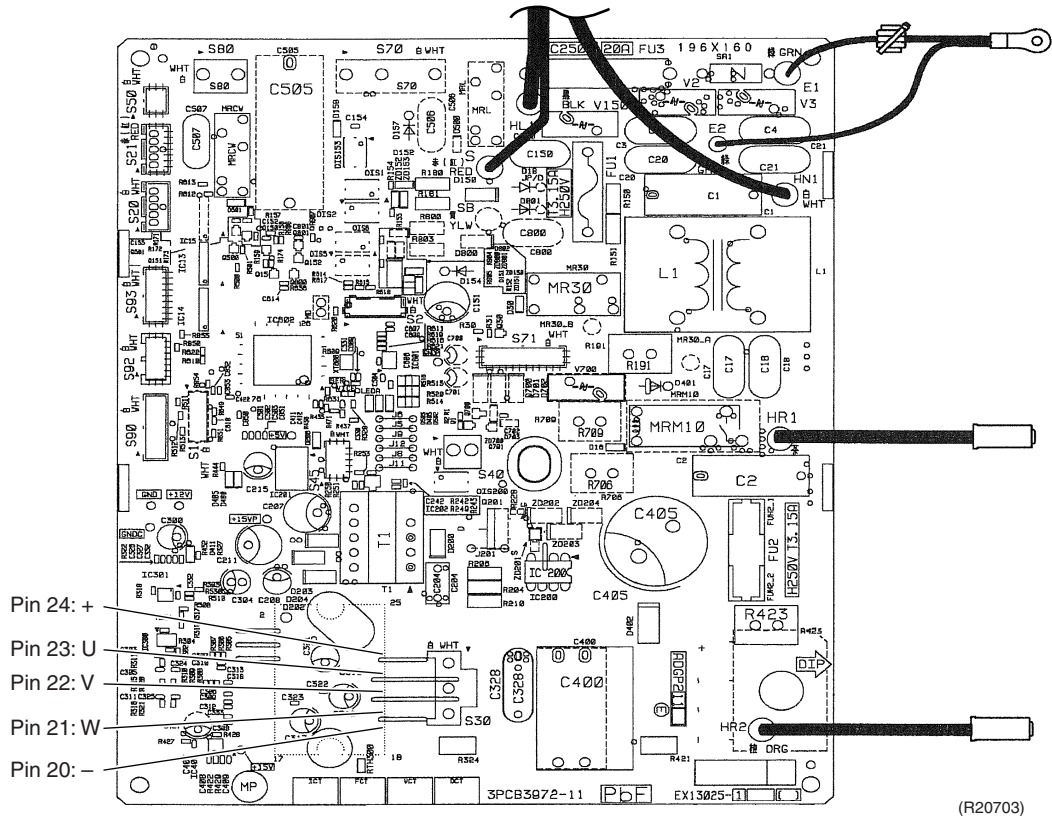

15/18/24 class

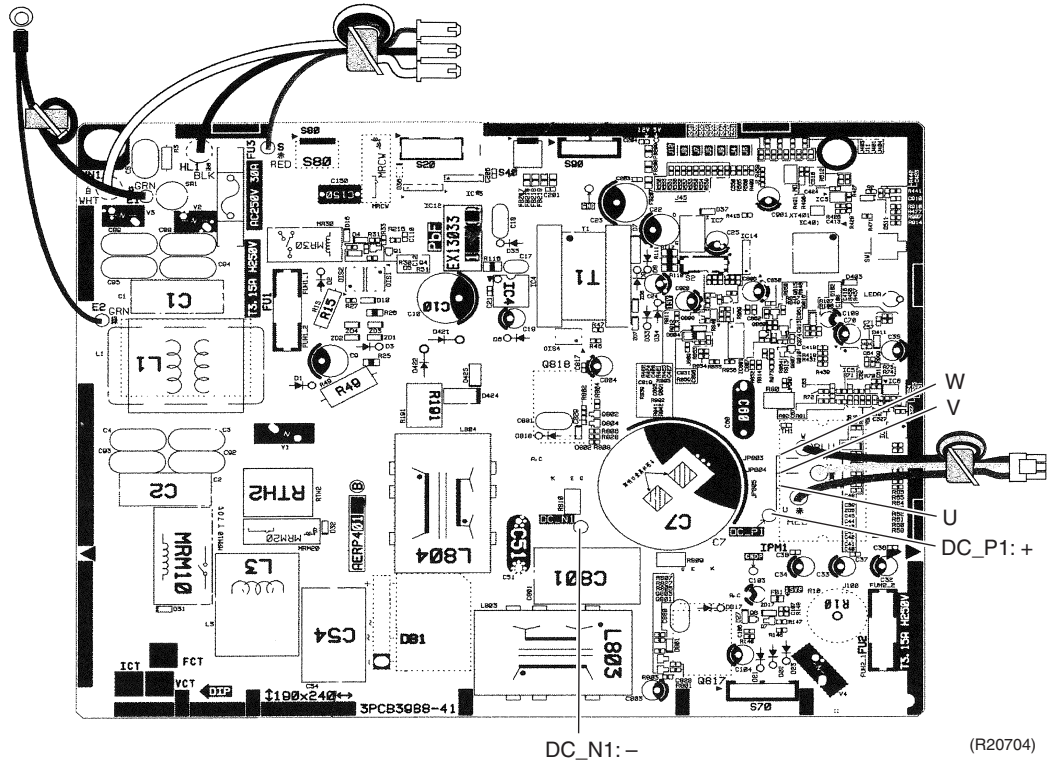

# Part 7

## Trial Operation and Field Settings

1. Pump Down Operation.....	113
2. Forced Cooling Operation .....	114
3. Trial Operation .....	115
4. Field Settings .....	118
4.1 How to Change the Field Settings.....	118
4.2 Overview of the Field Settings.....	121
4.3 MAIN/SUB and Address Setting for Wireless Remote Controller .....	122
4.4 Facility Setting (cooling at low outdoor temperature) .....	124
5. Silicone Grease on Power Transistor/Diode Bridge.....	125

# 1. Pump Down Operation

## Outline

In order to protect the environment, be sure to pump down when relocating or disposing of the unit.

## Details

1. Remove the valve cap from the liquid stop valve and the gas stop valve.
2. Carry out forced cooling operation.
3. After 5 to 10 minutes, close the liquid stop valve with a hexagonal wrench.
4. After 2 to 3 minutes, close the gas stop valve and stop forced cooling operation.
5. Attach the valve cap once procedures are complete.

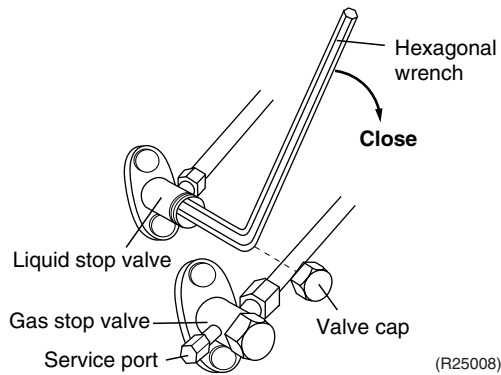

Refer to Forced Cooling Operation on page 114 for details.

## 2. Forced Cooling Operation

### Outline

The forced cooling operation is allowed when both the following conditions are met.

1. The outdoor unit is not abnormal and not in the 3-minute standby mode.
2. The outdoor unit is not operating.

Protection functions have priority over all other functions during forced cooling operation.

### Details

#### ■ With Wired Remote Controller (BRC1E73)

1. Set to COOL operation using the remote controller.
2. Press and hold **Cancel** button for 4 seconds or longer. Service settings menu is displayed.
3. Select **Test Operation** in the service settings menu, and press **Menu/OK** button. Basic screen returns and “Test Operation” is displayed at the bottom.
4. Press **On/Off** button within 10 seconds, and the forced cooling operation starts.
  - ◆ Forced cooling operation will stop automatically after about 15 minutes. To stop the operation, press **On/Off** button.

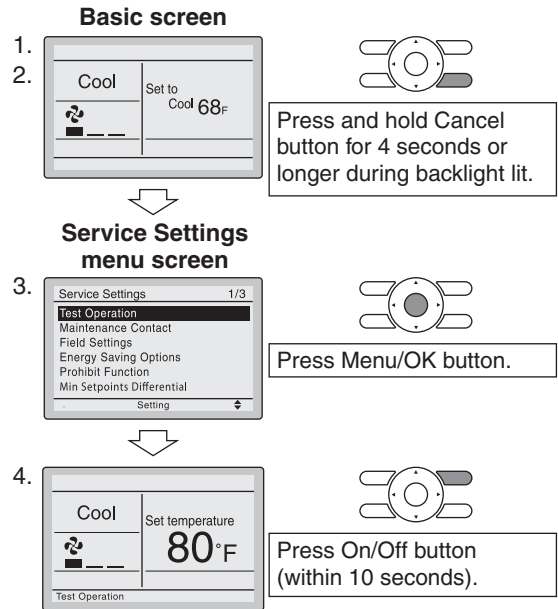

#### ■ With Wireless Remote Controller (BRC082A43)

1. Press button and select the COOL operation.
2. Press button twice. “TEST” is displayed.
3. Press button within 10 seconds, and the forced cooling operation starts.
  - ◆ Forced cooling operation will stop automatically after about 15 minutes. To stop the operation, press button.

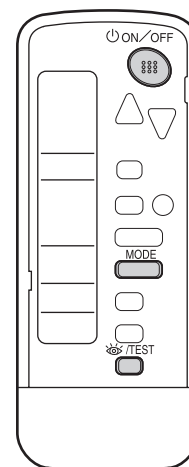

## 3. Trial Operation

---

### Outline

- Make sure to install the decoration panel before carrying out trial operation if the wireless remote controller is used.
- Trial operation should be carried out in either COOL or HEAT operation.
  1. Measure the supply voltage and make sure that it is within the specified range.
  2. In COOL operation, select the lowest programmable temperature; in HEAT operation, select the highest programmable temperature.
  3. Carry out the trial operation following the instructions in the operation manual to ensure that all functions and parts, are working properly.
    - ◆ To protect the air conditioner, restart operation is disabled for 3 minutes after the system has been turned off.
  4. After trial operation is complete, set the temperature to a normal level (78°F to 82°F (26°C to 28°C) in COOL operation, 68°F to 75°F (20°C to 24°C) in HEAT operation).



### Caution

When performing field settings or trial operation without attaching the decoration panel, do not touch the drain pump. This may cause electric shock.  
After finishing the construction of refrigerant piping, drain piping, and electric wiring, conduct trial operation accordingly to protect the unit.

---

### Procedure



When operating the air conditioner in cooling operation in winter, or heating operation in summer, set it to the trial operation mode using the following method.

### ■ With Wired Remote Controller (BRC1E73)

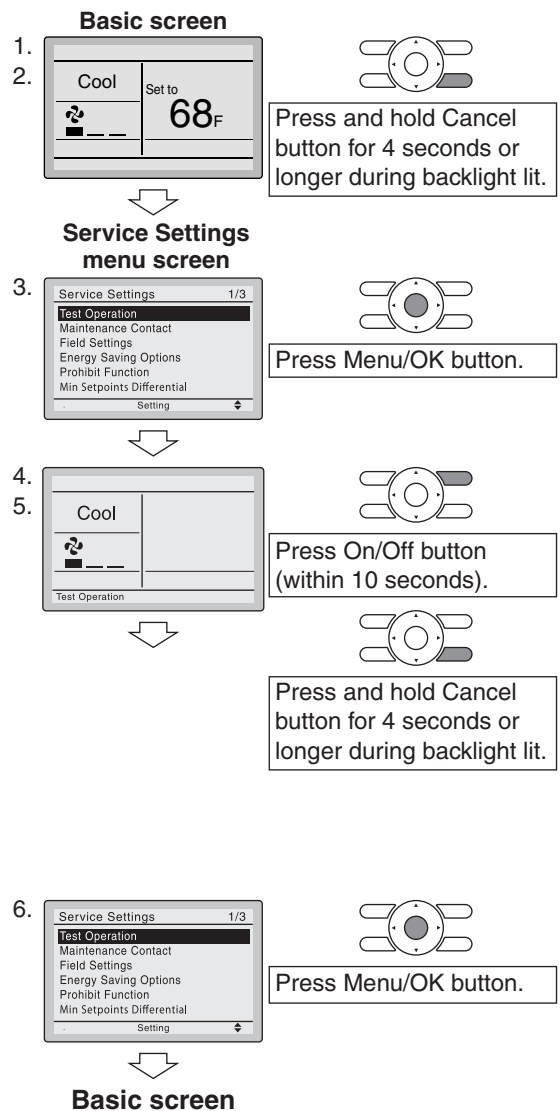
1. Set to COOL or HEAT operation using the remote controller.
2. Press and hold **Cancel** button for 4 seconds or longer. Service settings menu is displayed.
3. Select **Test Operation** in the service settings menu, and press **Menu/OK** button. Basic screen returns and “Test Operation” is displayed at the bottom.
4. Press **On/Off** button within 10 seconds, and the test operation starts.  
Monitor the operation of the indoor unit for a minimum of 10 minutes. During test operation, the indoor unit will continue to cool/heat regardless of the temperature setpoint and room temperature.
  - ◆ In the case of above-mentioned procedures 3 and 4 in reverse order, test operation can start as well.
5. Press and hold **Cancel** button for 4 seconds or longer in the basic screen. Service settings menu is displayed.
6. Select **Test Operation** in the service settings menu, and press **Menu/OK** button. Basic screen returns and normal operation is conducted.
  - ◆ Test operation will stop automatically after 15 ~ 30 minutes. To stop the operation, press **On/Off** button.



■ **With Wireless Remote Controller (BRC082A43)**

1. Press  button and select the COOL or HEAT operation.
2. Press  button twice. "TEST" is displayed.
3. Press  button within 10 seconds, and the test operation starts.

Monitor the operation of the indoor unit for a minimum of 10 minutes. During test operation, the indoor unit will continue to cool/heat regardless of the temperature setpoint and room temperature.

- ◆ In the case of above-mentioned procedures (1) and (2) in reverse order, test operation can start as well.
- ◆ Test operation will stop automatically after 15 ~ 30 minutes. To stop the operation, press  button.
- ◆ Some of the functions cannot be used in the test operation mode.

**Test Items**

Test items	Symptom
Indoor and outdoor units are installed securely.	Fall, vibration, noise
Is the outdoor unit fully installed?	No operation or burn damage
No refrigerant gas leaks.	Incomplete cooling/heating function
Refrigerant gas and liquid pipes and indoor drain hose extension are thermally insulated.	Water leakage
Draining line is properly installed.	Water leakage
Does the power supply voltage correspond to that shown on the name plate?	No operation or burn damage
Only specified wires are used for all wiring, and all wires are connected correctly.	No operation or burn damage
System is properly grounded.	Electrical leakage
Is wiring size according to specifications?	No operation or burn damage
Is something blocking the air outlet or inlet of either the indoor or outdoor units?	Incomplete cooling/heating function
Are refrigerant piping length and additional refrigerant charge noted down?	The refrigerant charge in the system is not clear
Pipes and wires are connected to the corresponding connection ports/terminal blocks for the connected unit.	No cooling/heating
Stop valves are opened.	Incomplete cooling/heating function
Check that the connector of the lead wires of the decoration panel is connected securely.	Louvers do not move
Indoor unit properly receives wireless remote control commands.	No operation

## 4. Field Settings

### 4.1 How to Change the Field Settings

#### Outline

If optional accessories are mounted on the indoor unit, the indoor unit setting may have to be changed. Refer to the instruction manual for each optional accessory.



**Note:** When using 2 remote controllers for 1 indoor unit, change the field settings from MAIN remote controller. Note that the field settings can not be set from SUB remote controller.

#### Wired Remote Controller (BRC1E73)

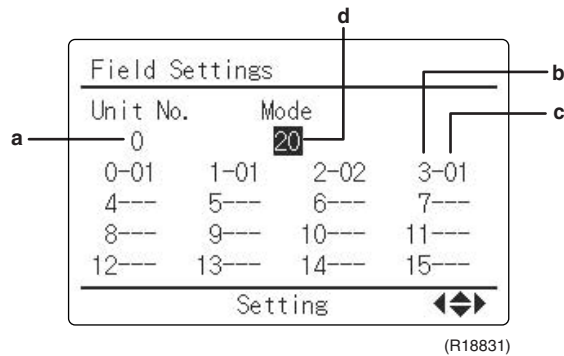

- a Unit No.
- b First code No.
- c Second code No.
- d Mode

1. Press and hold **Cancel** button for 4 seconds or longer. Service settings menu is displayed.

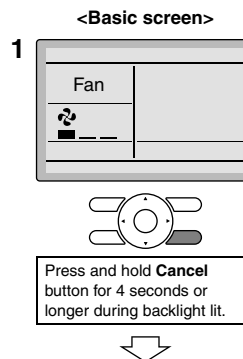

2. Select **Field Settings** in the Service Settings menu, and press **Menu/OK** button. Field settings screen is displayed.

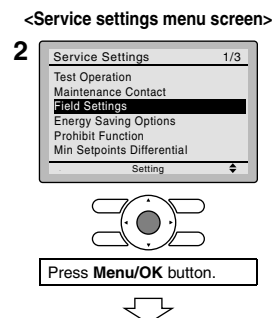

3. Highlight the mode, and select desired "Mode No." by using ▲ ▼ (Up/Down) button.
4. In the case of setting per indoor unit during group control (When Mode No. such as **20**, **22**, **23**, **25** are selected), highlight the unit No. and select "Indoor unit No." to be set by using ▲ ▼ (Up/Down) button. (In the case of group setting, this operation is not needed.)

[ In the case of individual setting per indoor unit, current settings are displayed. And, SECOND CODE NO. " - " means no function. ]

5. Highlight SECOND CODE NO. of the FIRST CODE NO. to be changed, and select desired "SECOND CODE NO." by using ▲ ▼ (Up/Down) button. Multiple identical mode number settings are available.

[ In the case of setting for all indoor units in the remote control group, available SECOND CODE NO. is displayed as " \* " which means it can be changed. When SECOND CODE NO. is displayed as " - ", there is no function. ]

<Service settings screen>

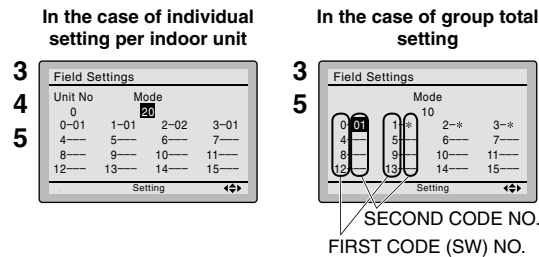

Press **Menu/OK** button.

6. Press **Menu/OK** button. Setting confirmation screen is displayed.
7. Select **Yes** and press **Menu/OK** button. Setting details are determined and field settings screen returns.
8. In the case of multiple setting changes, repeat 3 to 7.
9. After all setting changes are completed, press **Cancel** button twice.
10. Backlight goes out, and **[Checking the connection. Please stand by.]** is displayed for initialization. After the initialization, the basic screen returns.



<Setting confirmation screen>

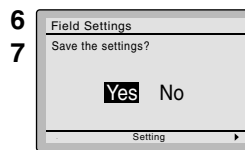

Press **Menu/OK** button.



Setting confirmation



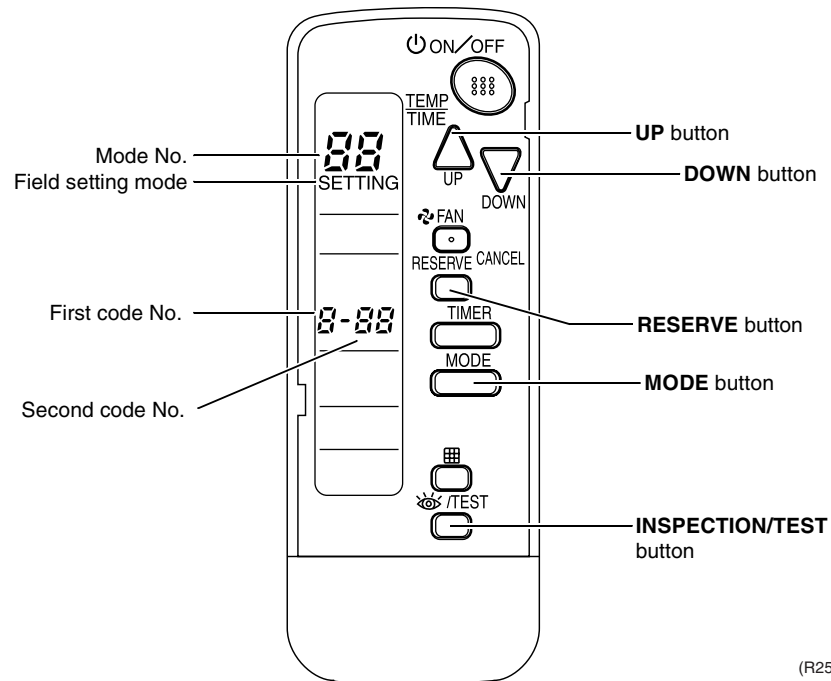

## Wireless Remote Controller (BRC082A43)



(R25096)

To set the field settings, you have to change:

- Mode No.
- First code No.
- Second code No.

1. When in normal mode, hold down /TEST button for at least 4 seconds to enter the Field Set mode.
2. Select the desired Mode No. with **MODE** button.
3. Press  button and select the First code No.
4. Press  button and select the Second code No.
5. Press **RESERVE** button to confirm the settings.
6. Press /TEST button to quit the Field Set mode and to return to normal display again.

## 4.2 Overview of the Field Settings

■ : Factory setting

Mode No.	First Code No.	Description of setting		Second Code No.							
				01	02	03	04	05	06		
10 (20)	0	Filter cleaning sign interval (used to change filter cleaning display interval according to filter contamination)	Longlife filter	Light	Approx. 2,500 hrs.	Heavy	Approx. 1,250 hrs.	—	—	—	—
			Standard filter		Approx. 200 hrs.		Approx. 100 hrs.	—	—	—	—
	3	Filter cleaning sign (used to set filter cleaning display ON/OFF)	Display	No display	—	—	—	—	—		
11 (21)	7	Air volume adjustment	OFF	Air volume adjustment completion	Air volume adjustment start	—	—	—	—		
13 (23)	6	External static pressure	Refer to the table below.								



**Note:** The SECOND CODE NO. is factory set to "01".  
Do not use any settings not listed in the table. For group control with a wireless remote controller, initial settings for all the indoor units of the group are equal. (For group control, refer to the installation manual attached to the indoor unit for group control.)

### External Static Pressure Settings

#### 09/12 class

■ : Factory setting

Mode No.	First Code No.	Second Code No.	Contents
13(23)	6	03	30 Pa
		04	40 Pa
		05	50 Pa
		06	60 Pa
		07	70 Pa
		08	80 Pa
		09	90 Pa
		10	100 Pa
		11	110 Pa
		12	120 Pa
		13	130 Pa
		14	140 Pa
		15	150 Pa

#### 15/18/24 class

Mode No.	First Code No.	Second Code No.	Contents
13(23)	6	05	50 Pa
		06	60 Pa
		07	70 Pa
		08	80 Pa
		09	90 Pa
		10	100 Pa
		11	110 Pa
		12	120 Pa
		13	130 Pa
		14	140 Pa
15	150 Pa		

## 4.3 MAIN/SUB and Address Setting for Wireless Remote Controller

### Outline

- If setting multiple wireless remote controllers to operate in one room, perform address setting for the receiver and the wireless remote controller.
- If using both a wired remote controller and a wireless remote controller with 1 indoor unit, change the MAIN/SUB switch of the signal receiver PCB.

### Signal Receiver PCB Setting

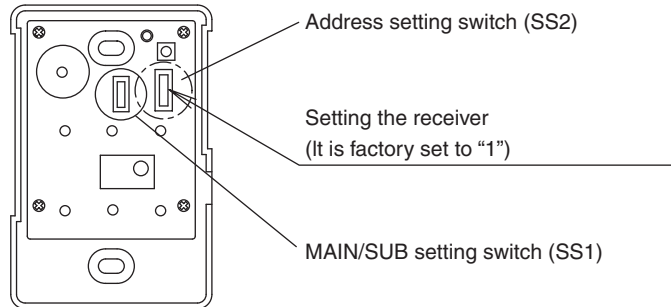

(R24951)

#### MAIN/SUB switch

Set the MAIN/SUB setting switch (SS1) on the signal receiver PCB to SUB.

	MAIN	SUB
MAIN/SUB setting switch (SS1)		

#### Wireless address switch

Set the address setting switch (SS2) on the signal receiver PCB according to the table below.

Unit No.	No.1	No.2	No.3
Address setting switch (SS2)			

**Wireless Remote Controller Address**

Factory set is 1. Change the wireless remote controller address setting by the following steps, if necessary.

1. Hold down button and /TEST button at the same time for at least 4 seconds to enter the field setting mode. (SETTING is indicated on the display).
2. Press FAN button and select display setting (A or B). Each time the button is pressed, the display switches between A and B.
3. Press UP button and DOWN button to set the address.

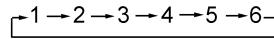

Address can be set from 1 ~ 6, but set it to 1 ~ 3 and to same address as the receiver. (The receiver does not work with address 4 ~ 6.)

4. Press **RESERVE** button to confirm the setting.
5. Hold down /TEST button to quit the field setting mode and return to the normal display.

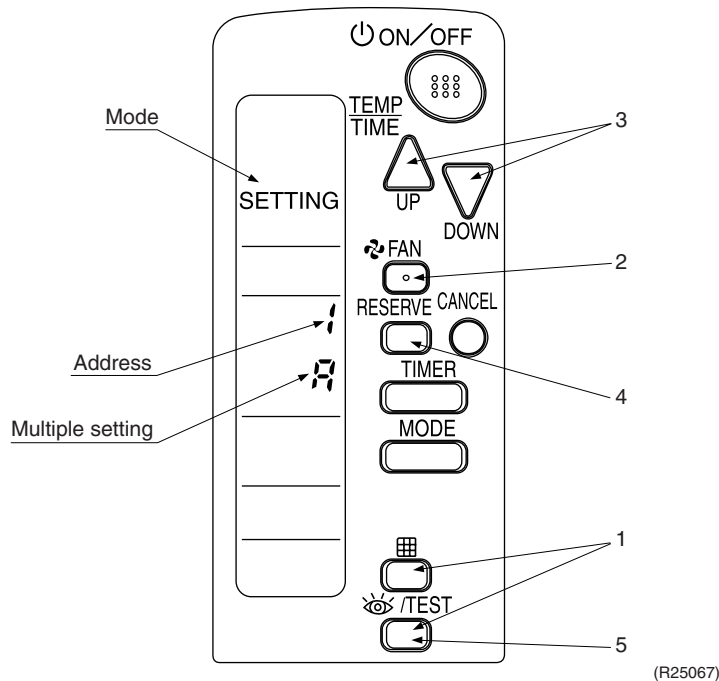

**Multiple Settings**  
A or B

When the indoor unit is controlled by an outside controller (central remote controller, etc.), the indoor unit sometimes does not respond to ON/OFF command or temperature setting command from the wireless remote controller. Check what setting the customer needs and make the multiple setting as shown below.

Remote controller		Indoor unit	
Multiple settings	Remote controller display	To control other air conditions and units	For other than on left
A: Standard	All items displayed.	Commands other than ON/OFF and temperature setting accepted. (1 LONG BEEP or 3 SHORT BEEPS emitted)	All commands accepted. (2 SHORT BEEPS)
B: Multi System	Operations remain displayed shortly after execution	All commands accepted. (2 SHORT BEEPS)	

**After Setting**

Stick the Unit No. label on the receiver and the back of the wireless remote controller.

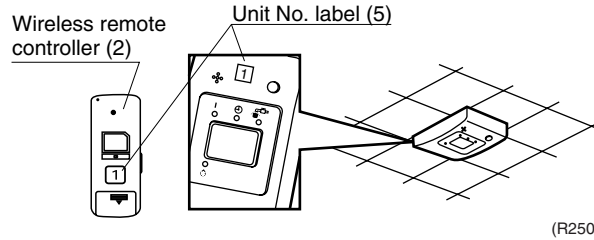

**Note:** Set the Unit No. of the receiver and the wireless remote controller to be the equal. If the settings differ, the signal from the remote controller cannot be transmitted.

## 4.4 Facility Setting (cooling at low outdoor temperature)

**Outline**

This function is limited only for facilities (the target of air conditioning is equipment such as computers). Never use it in a residence or office (the space where there is a human).

**Details**

- Cutting jumper 6 (J6) on the circuit board will extend the operation range to  $-10^{\circ}\text{C}$  ( $14^{\circ}\text{F}$ ). Installing an air direction adjustment grille (sold separately) will further extend the operation range to  $-20^{\circ}\text{C}$  ( $-4^{\circ}\text{F}$ ). In these cases, the unit will stop operating if the outdoor temperature falls below  $-20^{\circ}\text{C}$  ( $-4^{\circ}\text{F}$ ), restarting once the temperature rises above this level.
1. Remove the top plate of the outdoor unit. (09/12 class: 3 screws, 15/18/24 class: 6 screws)
  2. Remove the front plate. (09/12 class: 4 screws, 15/18/24 class: 8 screws)
  3. Cut the jumper (J6) of the PCB inside.



For the location of the jumper, refer to pages 13, 14.

**Caution**

**Replace the PCB if you accidentally cut a wrong jumper.**

Jumpers are necessary for electronic circuit. Improper operation may occur if you cut any of them.

**Caution**

- ◆ If the outdoor unit is installed where the heat exchanger of the unit is exposed to direct wind, provide a windbreak wall.
- ◆ Intermittent noises may be produced by the indoor unit due to the outdoor fan turning on and off when using facility settings.
- ◆ Do not place humidifiers or other items which might raise the humidity in rooms where facility settings are being used.  
A humidifier might cause dew jumping from the indoor unit outlet vent.
- ◆ Cutting jumper 6 (J6) sets the indoor fan tap to the highest position. Notify the user about this.

## 5. Silicone Grease on Power Transistor/Diode Bridge

### Outline

Apply the specified silicone grease to the heat radiation part of a power transistor/diode bridge when you replace an outdoor unit PCB. The silicone grease encourages the heat radiation of a power transistor/diode bridge.

### Details

1. Wipe off the old silicone grease completely.
2. Apply the silicone grease evenly. See the illustrations below for examples of application.
3. Tighten the screws of the power transistor/diode bridge.
4. Make sure that the heat radiation parts are firmly contacted to the radiation fin.

Note: Smoke emission may be caused by bad heat radiation when the silicone grease is not appropriately applied.

- OK: Evenly applied

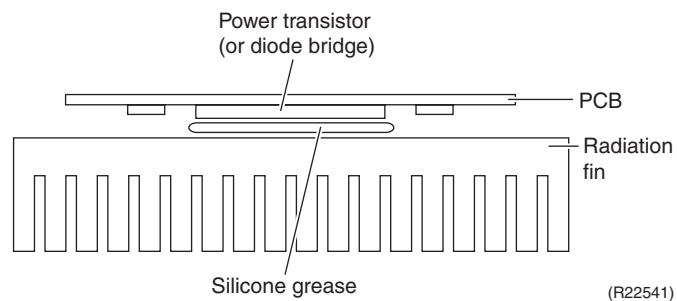

- NG: Not evenly applied

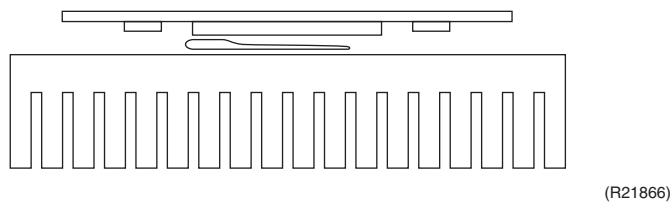

- NG: Foreign matter is stuck.

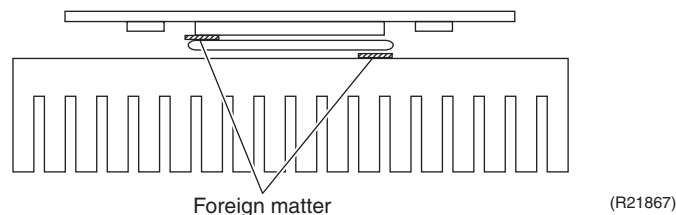

# Part 8 Appendix

1. Piping Diagrams.....	127
1.1 Indoor Unit.....	127
1.2 Outdoor Unit.....	128
2. Wiring Diagrams.....	130
2.1 Indoor Unit.....	130
2.2 Outdoor Unit.....	131
3. Operation Limit.....	133

# 1. Piping Diagrams

## 1.1 Indoor Unit

FDMQ09/12/15/18/24RVJU

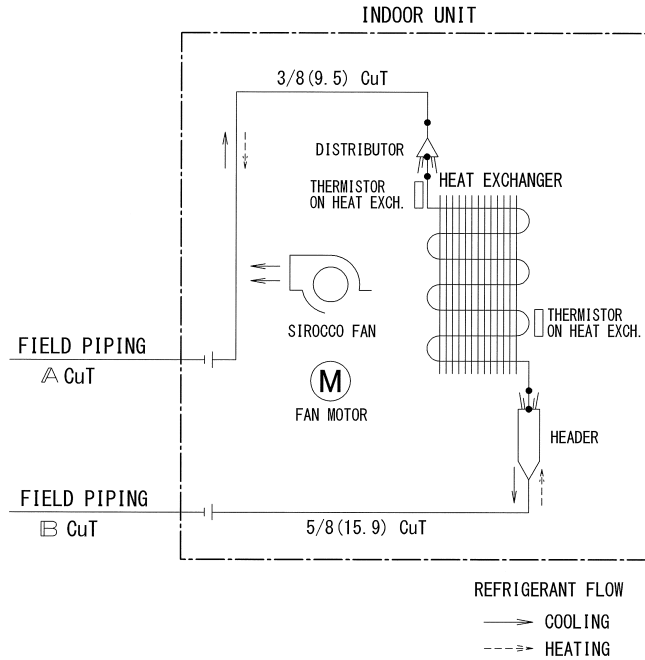

MODEL	A	B
FDMQ09 - 12RVJU	1/4 (6.4)	3/8 (9.5)
FDMQ15 - 18RVJU	1/4 (6.4)	1/2 (12.7)
FDMQ24RVJU	1/4 (6.4)	5/8 (15.9)

C: 4D112974A

# 1.2 Outdoor Unit

## RX09/12RMVJU(9)

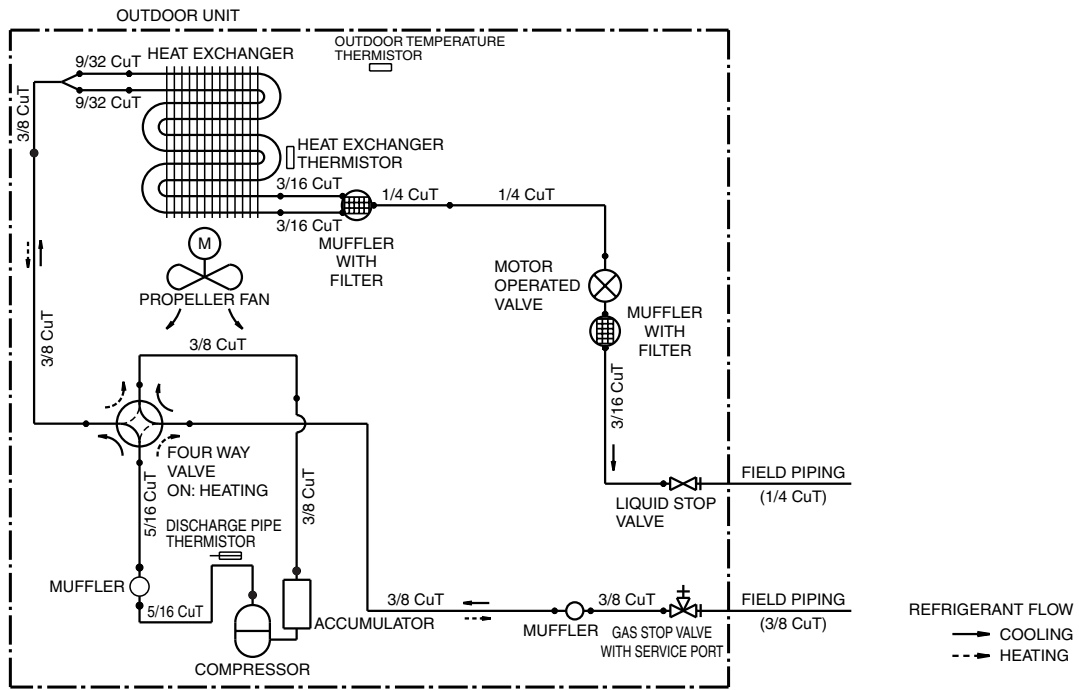

3D092207C

## RX15RMVJU(A), RX18RMVJU(9)(A)

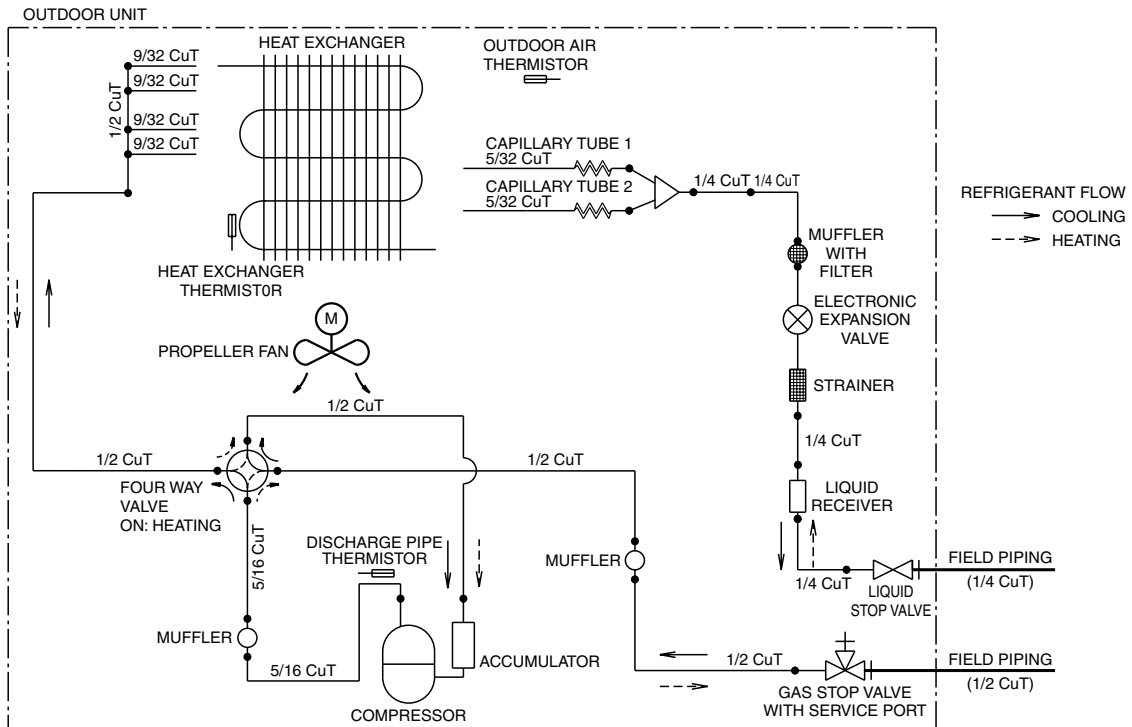

3D092220C

RX24RMVJU(A)

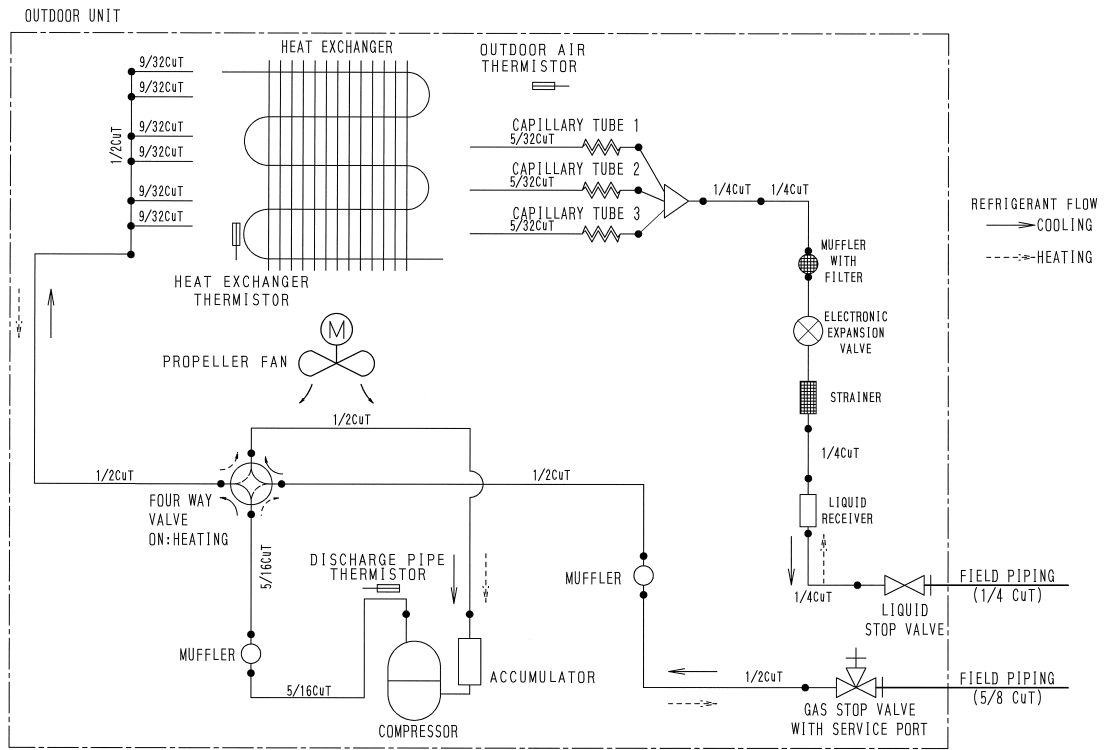

3D092249A

# 2. Wiring Diagrams

## 2.1 Indoor Unit

FDMQ09/12/15/18/24RVJU

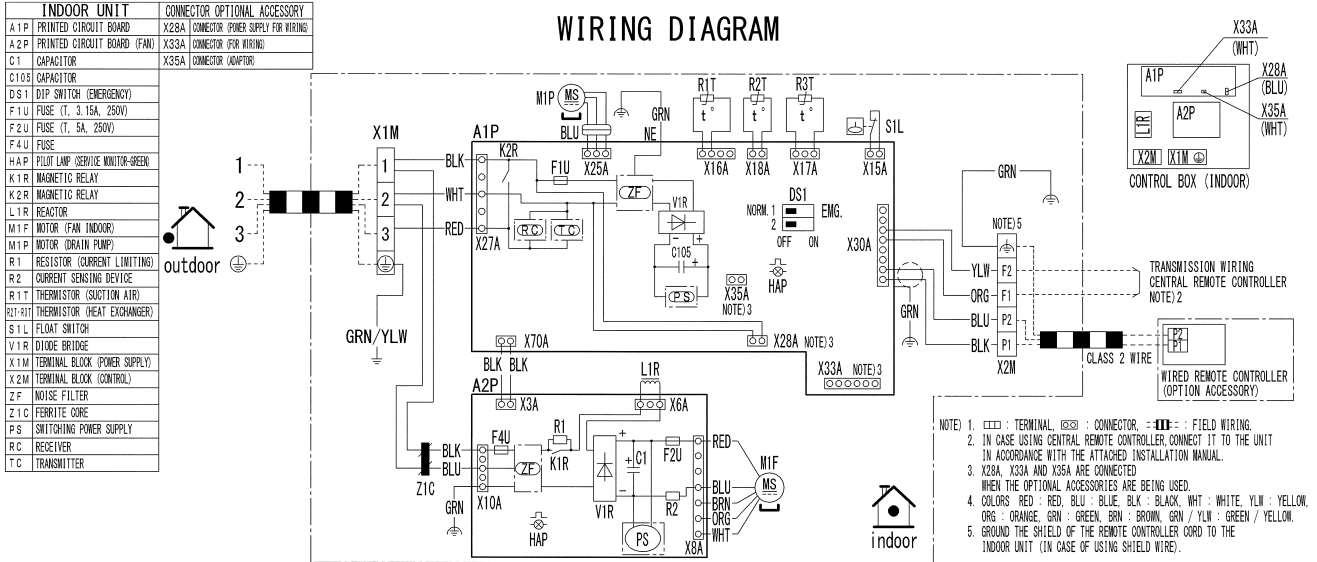

3D112629A



**Note:**

A1P: Control PCB

A2P: Indoor fan PCB

Refer to Part 3 for Printed Circuit Board Connector Wiring Diagram.

## 2.2 Outdoor Unit

### RX09/12RMVJU(9)

#### WIRING DIAGRAM

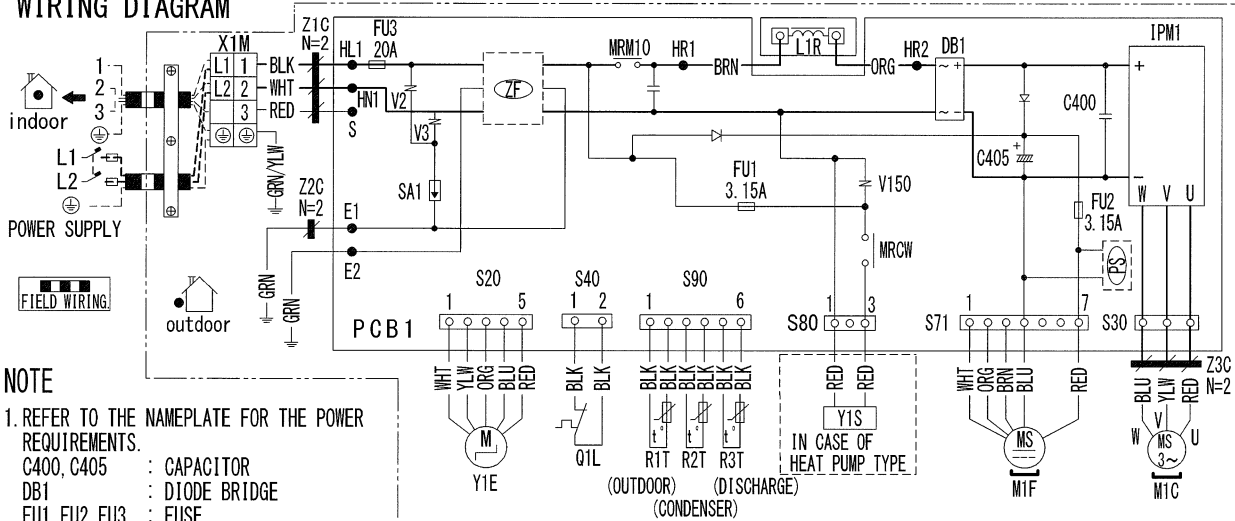

#### NOTE

1. REFER TO THE NAMEPLATE FOR THE POWER REQUIREMENTS.

- C400, C405 : CAPACITOR
- DB1 : DIODE BRIDGE
- FU1, FU2, FU3 : FUSE
- IPM1 : INTELLIGENT POWER MODULE
- L1, L2 : LIVE
- L1R : REACTOR
- M1C : COMPRESSOR MOTOR
- M1F : FAN MOTOR
- MRM10, MRCW : MAGNETIC RELAY
- PCB1 : PRINTED CIRCUIT BOARD

- PS : SWITCHING POWER SUPPLY
- Q1L : OVERLOAD PROTECTOR
- R1T, R2T, R3T : THERMISTOR
- S20, S30, S40, S71, S80, S90 : CONNECTOR
- SA1 : SURGE ARRESTER
- V2, V3, V150 : VARISTOR

- X1M : TERMINAL BLOCK
- Y1E : ELECTRONIC EXPANSION VALVE COIL
- Y1S : REVERSING SOLENOID VALVE COIL
- Z1C ~ Z3C : FERRITE CORE
- ZF : NOISE FILTER
- ⊕ : GROUND

3D112531A



**Note:** PCB1: Main PCB  
Refer to Part 3 for Printed Circuit Board Connector Wiring Diagram.

RX15/24RMVJU(A), RX18RMVJU(9)(A)

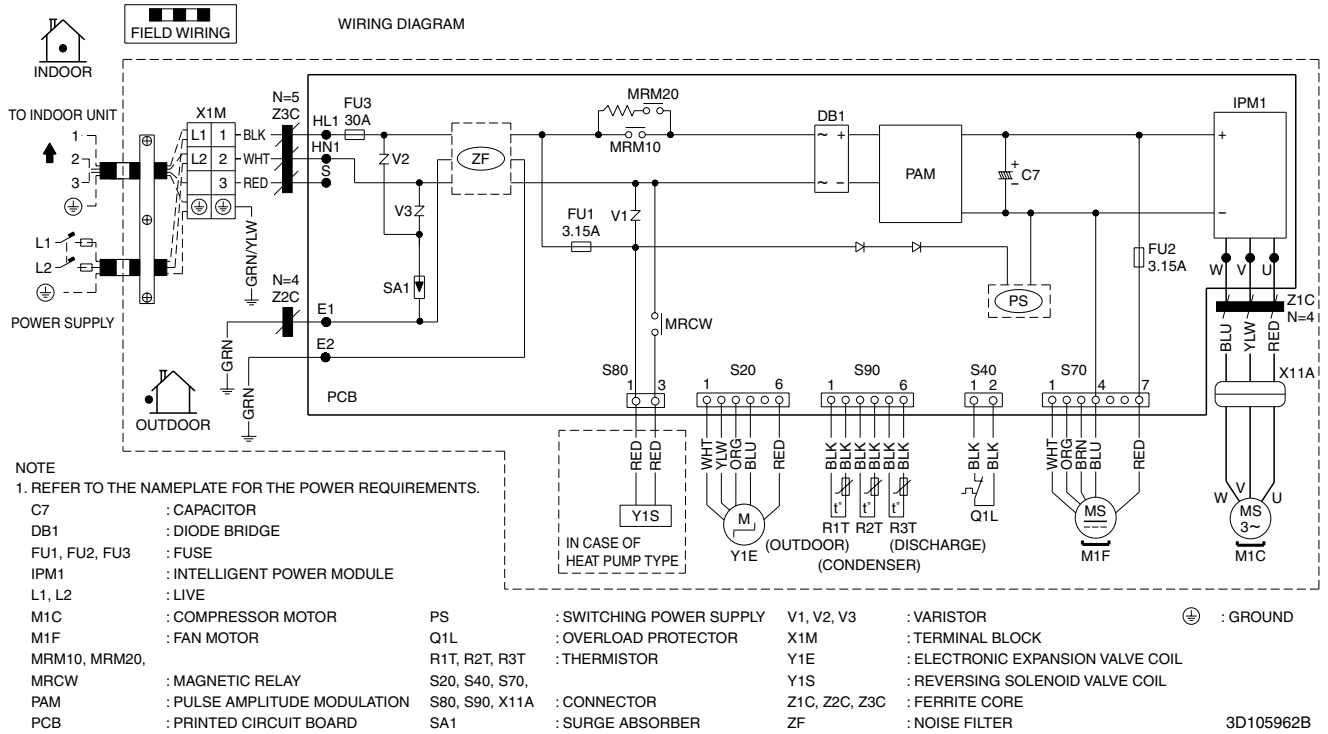

**Note:** PCB: Main PCB  
 Refer to Part 3 for Printed Circuit Board Connector Wiring Diagram.

# 3. Operation Limit

RX09/12RMVJU(9), RX15/24RMVJU(A), RX18RMVJU(9)(A)

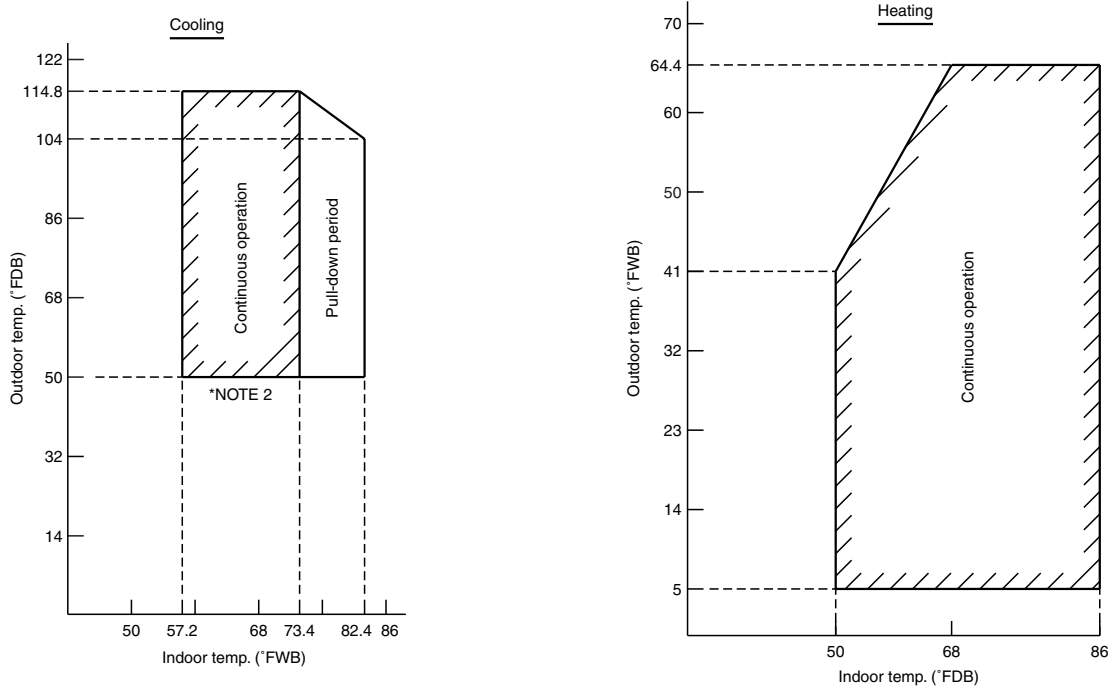

Notes:

1. The graphs are based on the following conditions.

- Equivalent piping length 25ft
- Level difference 0ft

2. Facility Setting (cooling at low outdoor temperature: only for RX model)

This function is limited only for facilities (the target of air conditioning is equipment such as computers).

Never use it in a residence or office (the space where there is a human).

Indoor fan tap should be fixed to high.

- Cutting jumper 6 (J6) on the circuit board

: extend the operation range to 14°F (-10°C).

- Installing an air direction adjustment grille (wind baffle) (sold separately) : extend the operation range to -4°F (-20°C).

3D092209E

# Revision History

Month / Year	Version	Revised contents
01 / 2018	SiUS071735E	First edition
06 / 2020	SiUS071735EA	Model addition: RX09/12RMVJU9, RX15/24RMVJUA, RX18RMVJU9(A)

**Warning**



- Daikin products are manufactured for export to numerous countries throughout the world. Prior to purchase, please confirm with your local authorized importer, distributor and/or retailer whether this product conforms to the applicable standards, and is suitable for use, in the region where the product will be used. This statement does not purport to exclude, restrict or modify the application of any local legislation.
- Ask a qualified installer or contractor to install this product. Do not try to install the product yourself. Improper installation can result in water or refrigerant leakage, electrical shock, fire or explosion.
- Use only those parts and accessories supplied or specified by Daikin. Ask a qualified installer or contractor to install those parts and accessories. Use of unauthorized parts and accessories or improper installation of parts and accessories can result in water or refrigerant leakage, electrical shock, fire or explosion.
- Read the user's manual carefully before using this product. The user's manual provides important safety instructions and warnings. Be sure to follow these instructions and warnings.

If you have any inquiries, please contact your local importer, distributor and/or retailer.

### **Cautions on product corrosion**

1. Air conditioners should not be installed in areas where corrosive gases, such as acid gas or alkaline gas, are produced.
2. If the outdoor unit is to be installed close to the sea shore, direct exposure to the sea breeze should be avoided. If you need to install the outdoor unit close to the sea shore, contact your local distributor.

© All rights reserved

● Specifications, designs and other content appearing in this brochure are current as of June 2020 but subject to change without notice.

SiUS071735EA  
06/2020 AK.B