

BrassCraft®

Retail Catalog

Water & Gas Products



THIS IS OUR CRAFT.®

WATER SUPPLIES

GAS PRODUCTS

WATER HEATER CONNECTORS

FITTINGS

REPAIR PARTS



BrassCraft®, the brand of plumbing products you rely on because it offers the highest quality plumbing products manufactured today. We stand behind our products because we understand reputation and reliability are the only things that matter when the job is finished. Our products are designed for the pro and DIYers alike, never losing sight of what they really need to get the job done right the first time.

American Ingenuity, World-Class Performance.

Brasscraft Manufacturing Company, renowned for innovative products, continually goes beyond the performance of our world-class products with an equally high standard for customer service. We're committed to providing industry-leading merchandising and a variety of packaging options, all delivered through the latest electronic commerce, on-time delivery and world-class distribution.

Water

1/4 Turn Supply Stops.....	6-8
Multi-Turn Supply Stops.....	9-10
Dual Outlet Supply Stops	11-12
Needle & Icemaker/Humidifier Valves.....	13
Water Supply Connectors.....	14-20
Water Supply One-Piece	21
Water Supply Kit	22
Water Supply Fittings	23-28
Components and Accessories	29-30
Water Heater Connectors	31-35

Gas

Gas Connectors	36-43
Installation Kits	44-45
Gas Ball Valves	46-47
Gas Fittings.....	48-49
Gas Components and Accessories.....	50
Point of Purchase.....	51-53
Specifications	54-68
Index	69-71



BrassCraft®

Designed, Machined and Assembled in the USA

Founded in 1946 by Robert Zell in Detroit, Michigan, Brasscraft Manufacturing Company pioneered the one-piece water supply valve and the flexible water supply tube. Today these products have become the industry standard for residential and commercial plumbing projects. Brasscraft Mfg. Co. has headquarters and manufacturing facilities across the U.S. We continue to remain competitive through major investments in our manufacturing facilities and by employing American workers. (Products are annotated where DMA is applicable)

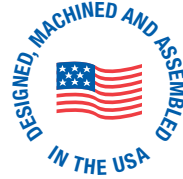

Products

Brasscraft Mfg. Co. makes many of the products we offer in our own North American manufacturing facilities. Many of these products are the same as those used by professional plumbers. In addition to being a prime manufacturer of plumbing supplies, Brasscraft Mfg. Co. also has its own Research & Development and Testing facilities, so you can be assured of top quality when you see the BrassCraft® logo. Our product offering continues to grow, as we continuously add new, innovative products to serve new customers and changing market needs.

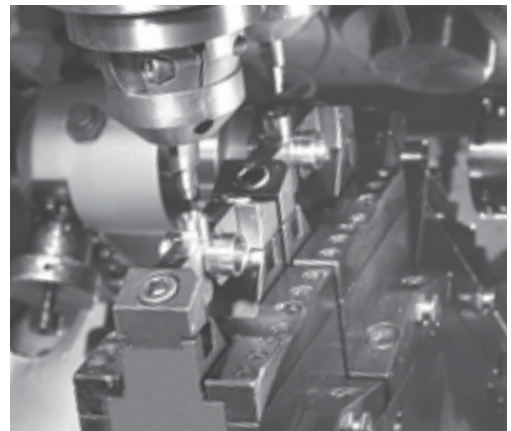

Packaging

BrassCraft® packaging is designed to be appealing and user friendly. Our bright blue and yellow packaging catches the customer's attention, and each package contains complete, detailed installation instructions to make installing the products quick and easy. Our products are available in different packages such as cards, bags, boxes and bulk to serve a variety of customer needs. Our packaging is space efficient, allowing retailers to place more product in less space. This space savings results in more sales and profit dollars per square foot of valuable space. Reorder cards, the same size as the package, are available for each product, which makes display sets and restocking quick, easy and convenient.



Merchandising

BrassCraft® merchandising materials are designed to educate and sell more products. Our merchandising is appealing and informative, acting as a "silent sales person" to provide retailers and consumers with the information they need to locate and select the right products. We offer dynamic and informative department headers, aisle dividers, sizing guides, product displays and consumer take with brochures that make the plumbing department an easy to shop, self-sell aisle.

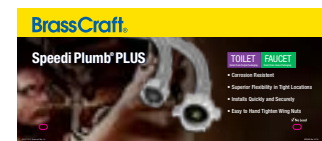

BrassCraft®

Product Assortments

Brasscraft Manufacturing Company offers 15 pre-made product assortments, available in various sizes for each product category. These assortments allow retailers to customize their plumbing department, according to their specific needs. The assortments are developed based on market research and analysis, so they contain the right products that consumers need. Each assortment comes complete with product, merchandising materials, reorder cards and planograms for easy display setup. BrassCraft® product assortments are an easy way to start a profitable plumbing department today!

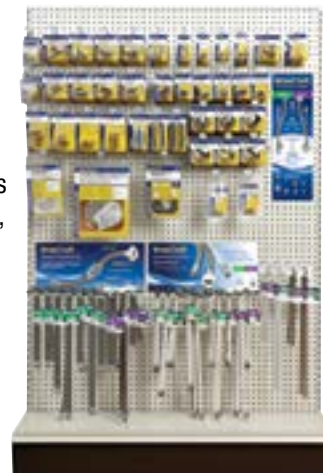

The Latest Technology

When it comes to technology, Brasscraft Mfg. Co. has consistently led the industry. We understand the benefits of electronic commerce, and are constantly striving to implement the latest technologies to serve you better.



EDI System

Saves time and helps ensure order accuracy by electronic order submission through our EDI (Electronic Data Interchange) system.

SureCount™ Verification

Our SureCount™ shipping verification system improves efficiency in the distribution stream and helps reduce your receiving costs. Using state-of-the-art bar code technology, we verify outbound shipments to help eliminate the need to double-check the shipment, saving you time and money.

ROA Interface

Brasscraft Mfg. Co.'s Remote Order Access system helps enable you to:

- Perform order entry and confirmation
- Check order status and ship dates
- Access invoices and packing slips
- Print packing lists
- Track shipments
- View online proof of delivery

Interactive Web

The streamlined, user-friendly site provides detailed information on the growing range of BrassCraft® plumbing supplies. Our website can be used with most handheld devices from smart phones and feature phones to tablet computers.

Compliant Solutions for the 2014 Low Lead Law

As of January 4, 2014, Federal Public Law 111-380 prohibits the sale of plumbing fixtures with a wetted surface area containing more than a weighted average of 0.25% lead. This law virtually eliminates the lead content of pipes, pipe fittings, plumbing fittings and fixtures intended to convey or dispense water for drinking or cooking.

BrassCraft products meet the low-lead law with a comprehensive range of compliant products including brass stops, braided water connectors, brass fittings, and hot water heater connectors.

Look for the checkmark  on packaging to verify that the product meets the no-lead legislation requirements.

Terms and Abbreviations

The following list of terms and abbreviations are used throughout this catalog. For your convenience, we have included a brief definition or explanation for each of these terms. Thank you for choosing the best. Thank you for choosing BrassCraft®!



Fig. 1
Bell Escutcheon



Fig. 2
Faucet Riser



Fig. 3
Braided Flexible
One-Piece Supplies

Comp: Compression

CPVC: Chlorinated Polyvinyl Chloride, a plastic used in plumbing systems

CSA: Canadian Standards Association

Escutcheon: Wall flange, or trim (*Fig. 1*)

FIP: Female Iron Pipe

IAPMO: International Association of Plumbing & Mechanical Officials

ID: Inside Diameter

IPS: Iron Pipe Size

MIP: Male Iron Pipe

Nom: Nominal measurement is 1/8" less than OD of the tube

NSF: National Sanitation Foundation

OD: Outside Diameter

PEX: Cross-linked Polyethylene, a plastic used in plumbing systems

Riser: A water supply tube to a faucet or a toilet (*Fig. 2*)

Braided Flexible One-Piece Supplies: One-piece water supply featuring BrassCraft polymer braid connector and BrassCraft G2 tops. Connector and stop assembled at factory. (*Fig. 3*)

Stop: Turns water supply on/off

UPC: Uniform Plumbing Code

Quality That Runs in the Family

BrassCraft® stops, machined from solid brass, offer the highest quality and most reliable connections. The finished stops are offered for a variety of connections including Compression, Sweat, CPVC and Push Connect. Options include metal stems, lock shields, dual outlets, dual shut-offs, stuffing boxes and handles.

BrassCraft® stops are designed, machined and assembled in the USA for reliability, consistently exceeding industry standards while offering superior performance, and are delivered with exceptional customer service. As the leading manufacturer of water stops for more than 70 years, Brasscraft Mfg. Co. has the stop to meet your needs.

Multi-Turn Stops

Multi-turn stops are the industry standard with proven performance. Available in a wide variety of configurations.



G2™ Series 1/4 Turn Stops

1/4 turn stops offer durable construction and innovation. Available with a full range of options, including push connect technology.



Dual Outlet, Dual Shut off
excluded from Designed, Machined
and Assembled in the U.S.A.



1/4 Turn Water Supply Stops

G2™ Series

1/4 turn technology offers durable construction and proven performance. Additional features and benefits include:

- Positive 1/4 turn shut off
- One-piece shut off mechanism provides smooth operation
- Machined one-piece brass body provides strength, durability, and long lasting performance
- Easy-to-remove handle protects against accidental stop operation during rough-ins
- 100% leak tested

Push Connect Technology

Connect with Confidence. Fast. Reliable. Durable.
Additional features and benefits include:

- Installation ready with pre-assembled tube insert
- No special installation tools required
- Smooth 1/4 turn operation
- Compatible with copper, PEX and CPVC
- 100% leak tested



Dual Outlet, Dual Shut off
excluded from Designed, Machined
and Assembled in the U.S.A.



Part No. UPC	Description Package Size	Finish	Shelf Qty	Case Qty
-----------------	-----------------------------	--------	--------------	-------------

Compression x Compression - Angle (cont.)

G2CR09X CD 026613138046	1/2" Nom Comp x 1/4" OD Comp 1 Per Card. 3.875"L x 3.875"W x 1.175"D	Chrome	5	25
G2CR19X CD 026613138091	1/2" Nom Comp x 3/8" OD Comp 1 Per Card. 3.875"L x 3.875"W x 1.175"D	Chrome	5	25
G2CR39X CD 026613139777	1/2" Nom Comp x 1/2" OD Comp 1 Per Card. 3.875"L x 3.875"W x 1.175"D	Chrome	5	25



Compression x Compression - Straight

G2CR11X CD 026613139753	1/4" Nom Comp x 3/8" OD Comp 1 Per Card. 3.875"L x 3.875"W x 1.175"D	Chrome	5	25
G2CR14X CD 026613137902	1/2" Nom Comp x 3/8" OD Comp 1 Per Card. 3.875"L x 3.875"W x 1.18"D	Chrome	5	25
G2CR34X CD 026613139760	1/2" Nom Comp x 1/2" OD Comp 1 Per Card. 3.875"L x 3.875"W x 1.175"D	Chrome	5	25



Compression x Slip-Joint - Angle

G23341X CD 026613139739	1/2" Nom Comp x 7/16" & 1/2" OD Slip-Joint 1 Per Card. 3.875"L x 3.875"W x 1.175"D	Chrome	5	25
----------------------------	---	--------	---	----



Compression x Slip-Joint - Straight

G23345X CD 026613139746	1/2" Nom Comp x 7/16" & 1/2" OD Slip-Joint 1 Per Card. 3.875"L x 3.875"W x 1.175"D	Chrome	5	25
----------------------------	---	--------	---	----



FIP x Compression - Angle

G2R07X CD 026613138107	1/2" FIP x 1/4" OD Comp 1 Per Card. 3.875"L x 3.875"W x 1.175"D	Chrome	5	25
G2R15X CD 026613139791	3/8" FIP x 1/4" OD Comp 1 Per Card. 3.875"L x 3.875"W x 1.175"D	Chrome	5	25
G2R17X CD 026613137933	1/2" FIP x 1/4" OD Comp 1 Per Card. 3.875"L x 3.875"W x 1.175"D	Chrome	5	25
G2R37X CD 026613139807	1/2" FIP x 1/2" OD Comp 1 Per Card. 3.875"L x 3.875"W x 1.175"D	Chrome	5	25



FIP x Compression - Straight

G2R10X CD 026613139784	3/8" FIP x 3/8" OD Comp 1 Per Card. 3.875"L x 3.875"W x 1.175"D	Chrome	5	25
G2R12X CD 026613138114	1/2" FIP x 3/8" OD Comp 1 Per Card. 3.875"L x 3.875"W x 1.175"D	Chrome	5	25



FIP x Slip-Joint - Angle

G23301X CD 026613138022	1/2" FIP x 7/16" & 1/2" OD Slip-Joint 1 Per Card. 3.875"L x 3.875"W x 1.175"D	Chrome	5	25
----------------------------	--	--------	---	----





Part No. UPC	Description Package Size	Finish	Shelf Qty	Case Qty
FIP x Slip-Joint - Straight				
G23305X CD 026613138039	1/2" FIP x 7/16" & 1/2" OD Slip-Joint 1 Per Card. 3.875"L x 3.875"W x 1.175"D	Chrome	5	25



△CPVC Solvent Weld x Compression - Angle				
G2PR19X CD 026613149639	1/2" Nom CPVC x 3/8" OD Comp 1 Per Card. 3.875"L x 3.875"W x 1.175"D	Chrome	5	25



△CPVC Solvent Weld x Compression - Straight				
G2PR14X CD 026613149622	1/2" Nom CPVC x 3/8" OD Comp 1 Per Card. 3.875"L x 3.875"W x 1.175"D	Chrome	5	25



Push Connect x Compression - Angle				
G2PS19X CD 026613159966	1/2" Nom Push Connect x 3/8" OD Comp 1 Per Clamshell. 4.8125"L x 2.6875"W x 1.25"D	Chrome	5	25



Push Connect x Compression - Straight				
G2PS14X CD 026613159973	1/2" Nom Push Connect x 3/8" OD Comp 1 Per Clamshell. 4.8125"L x 2.6875"W x 1.25"D	Chrome	5	25



Push Connect Combination Removal Tool				
PCT-10-6 026613142197	1/2" Nom and 1/4" Nom Combination Removal Tool 1 Per Bag. 5"L x 3"W x 0.31"D		-	10

△ CPVC pre-torqued fittings eliminate the need for tightening on the job.

Multi-Turn Water Supply Stops

The Industry Standard for
Quality and Reliability.

Features and benefits include:

- Machined one-piece brass body provides strength, durability and long-lasting performance
- Easy-to-remove handle protects against accidental stop operation during rough-ins
- Oval knurled handle provides a secure grip and smooth on/off operation
- Dual outlet configurations available

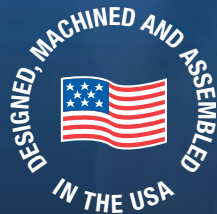
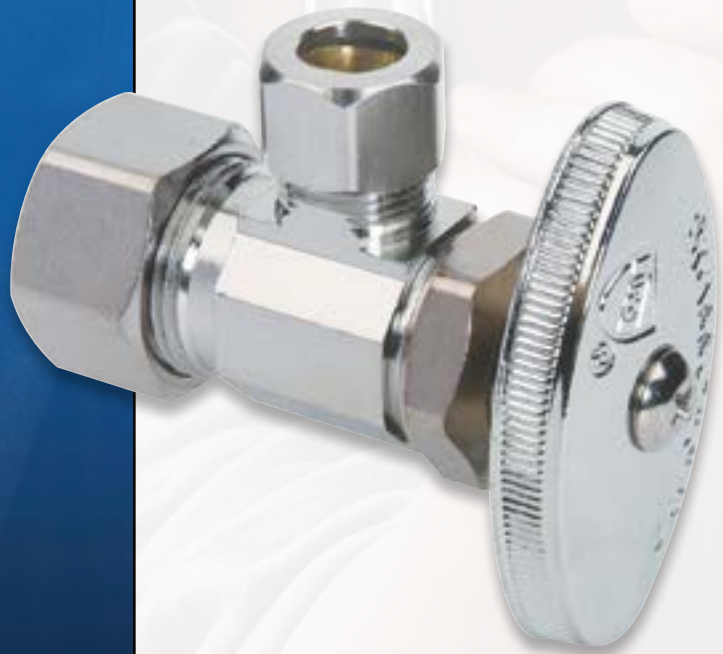

Dual Outlet, Dual Shut off
excluded from Designed, Machined
and Assembled in the U.S.A.





Part No. UPC	Description Package Size	Finish	Shelf Qty	Case Qty
-----------------	-----------------------------	--------	--------------	-------------

Compression x Compression - Angle

OCR19X C1 026613135786	1/2" Nom Comp x 3/8" OD Comp 1 Per Tray. 2.75"L x 2.25"W x 1.1875"D	Chrome	-	20
---------------------------	--	--------	---	----



Compression x Compression - Straight

OCR14X C1 026613135977	1/2" Nom Comp x 3/8" OD Comp 1 Per Tray. 2.75"L x 2.25"W x 1.1875"D	Chrome	-	20
---------------------------	--	--------	---	----



FIP x Compression - Straight

OR32X CD 026613157818	1/2" FIP x 1/2" OD Comp 1 Per Card. 3.875"L x 3.875"W x 1.175"D	Chrome	5	25
--------------------------	--	--------	---	----



FIP x Flare - Angle

OFR17X CD 026613150512	1/2" FIP x 3/8" OD Flare 1 Per Card. 3.875"L x 3.875"W x 1.175"D	Chrome	5	25
---------------------------	---	--------	---	----



Sweat x Compression - Angle

R19X CD 026613151489	1/2" Nom Sweat x 3/8" OD Comp 1 Per Card. 3.875"L x 3.875"W x 1.175"D	Chrome	5	25
-------------------------	--	--------	---	----



Sweat x Compression - Straight

R14X CD 026613151410	1/2" Nom Sweat x 1/4" OD Comp 1 Per Card. 3.875"L x 3.875"W x 1.175"D	Chrome	5	25
-------------------------	--	--------	---	----



Sweat x Compression - Angle With 5" Sweat Extension Tube

CS40BX CD 026613149349	1/2" Nom Sweat x 3/8" OD Comp With Bell Escutcheon 1 Per Clamshell. 7.4375"L x 5.0625"W x 1.25"D	Chrome	-	5
---------------------------	---	--------	---	---



Sweat x Compression - Straight With 5" Sweat Extension Tube

CS41BX CD 026613149400	1/2" Nom Sweat x 3/8" OD Comp With Bell Escutcheon 1 Per Clamshell. 7.4375"L x 5.0625"W x 1.25"D	Chrome	-	5
---------------------------	---	--------	---	---

Part No. UPC	Description Package Size	Finish	Shelf Qty	Case Qty
-----------------	-----------------------------	--------	--------------	-------------

Compression x Compression x Compression - Angle

CR1900DVX C 026613137384	1/2" Nom Comp x 3/8" OD Comp x 1/4" OD Comp 1 Per Bag. 6"L x 6"W	Chrome	-	30
-----------------------------	---	--------	---	----



CR1901DVX CD 026613160375	1/2" Nom Comp x 3/8" OD Comp x 3/8" OD Comp 1 Per Card. 5.875"L x 3.875"W x 2.375"D	Chrome	-	5
------------------------------	--	--------	---	---



FIP x Compression x Compression - Angle

R1700DVX RD 026613160399	1/2" FIP x 3/8" OD Comp x 1/4" OD Comp 1 Per Card. 5.875"L x 3.875"W x 2.375"D	Rough	-	5
-----------------------------	---	-------	---	---



R1701DVX RD 026613160405	1/2" FIP x 3/8" OD Comp x 3/8" OD Comp 1 Per Card. 5.875"L x 3.875"W x 2.375"D	Rough	-	5
-----------------------------	---	-------	---	---





Part No. UPC	Description Package Size	Finish	Shelf Qty	Case Qty
-----------------	-----------------------------	--------	--------------	-------------

Compression x Compression x Compression

CR1901LRX RD 026613137889	1/2" Nom Comp x 3/8" OD Comp x 3/8" OD Comp 1 Per Card. 5.875"L x 3.875"W x 2.375"D	Rough	5	25
------------------------------	--	-------	---	----



FIP x Compression x Compression

R1700RX RD 026613138633	1/2" FIP x 3/8" OD Comp x 1/4" OD Comp 1 Per Card. 5.875"L x 3.875"W x 2.375"D	Rough	5	25
----------------------------	---	-------	---	----

R1701LRX RD 026613138138	1/2" FIP x 3/8" OD Comp x 3/8" OD Comp 1 Per Card. 5.875"L x 3.875"W x 2.375"D	Rough	5	25
-----------------------------	---	-------	---	----

R3701RX RD 026613138121	1/2" FIP x 1/2" OD Comp x 3/8" OD Comp 1 Per Card. 5.875"L x 3.875"W x 2.375"D	Rough	5	25
----------------------------	---	-------	---	----

R3703LRX RD 026613151687	1/2" FIP x 1/2" OD Comp x 1/2" OD Comp 1 Per Card. 5.875"L x 3.875"W x 2.375"D	Rough	5	25
-----------------------------	---	-------	---	----

Brass Needle & Icemaker/Humidifier Valves

Product Applications

- Icemaker
- Humidifiers

Product Advantages

- BrassCraft® Needle Valves have metal-to-metal seats with fine thread adjustment.
- Provide positive sealing and flow adjustment up to the capacity of the valve.
- Backed by Brasscraft Mfg. Co.'s 70 plus year history and reputation for quality and service.

Part No. UPC	Description Package Size	Finish	Shelf Qty	Case Qty
-----------------	-----------------------------	--------	--------------	-------------

Compression Needle Valves

NV105-4X D 026613158341	1/4" OD Comp x 1/4" OD Comp 1 Per Card. 3.875"L x 2.875"W x 1.175"D	Rough	5	25
----------------------------	--	-------	---	----

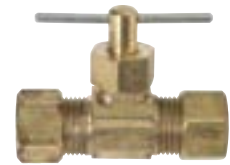

Self-Piercing Needle Valve Kits

PNEV-NCVX D 026613158969	For 3/8" to 1" OD Tube w/1/4" OD Comp , Inc. Saddle Clamp With Self-Locking Nuts, Brass Sleeve & Insert, & Delrin Sleeve 1 Per Card. 3.875"L x 3.875"W x 1.175"D	Rough	5	25
-----------------------------	---	-------	---	----



BC96X 026613148977	For 3/8" to 1" OD Tube w/1/4" OD Comp Incl. Saddle Clamp With Self-Locking Nuts, 1/4" OD x 25' Polyethylene Tube, Brass Sleeve & Inserts & Delrin Sleeve, & 1/4" OD Union 1 Per Clamshell. 9.5"L x 6"W x 1.75"D	Rough	-	5
-----------------------	--	-------	---	---



BC97X 026613148984	For 3/8" to 1" OD Tube w/1/4" OD Comp Incl. Saddle Clamp With Self-Locking Nuts, 1/4" OD x 25' Copper Tube, Brass Sleeve & 1/4" OD Union 1 Per Clamshell. 11.1875"L x 8.625"W x 1.125"D	Rough	-	5
-----------------------	--	-------	---	---



Part No. UPC	Description Package Size	Length	Shelf Qty	Case Qty
-----------------	-----------------------------	--------	--------------	-------------

Faucet - PEX

P1-12A H 026613160030	3/8" OD 1 Per Hang Tag. 1.9375"L x 1.875"W x 0.75"D	12"	5	50
P1-12A 026613044859	3/8" OD Bulk Box. 6.62"L x 4.12"W x 12.88"D	12"	-	100
P1-20A 026613044910	3/8" OD Bulk Box. 6.62"L x 4.12"W x 20.88"D	20"	-	100
P1-30A 026613044958	3/8" OD Bulk Box. 4.12"L x 3.12"W x 30.38"D	30"	-	50
P1-36A H 026613160054	3/8" OD 1 Per Hang Tag. 1.9375"L x 1.875"W x 0.75"D	36"	5	25
P1-36A 026613044965	3/8" OD Bulk Box. 4.12"L x 3.12"W x 36.38"D	36"	-	50

**Toilet - PEX**

P1-12DL H 026613160061	3/8" OD 1 Per Hang Tag. 1.9375"L x 1.875"W x 0.875"D	12"	5	50
P1-12DL F 026613046471	3/8" OD Bulk w/ Flag Label in Box. 15.375"L x 5.75"W x 4"D	12"	-	25
P1-12DL 026613044873	3/8" OD Bulk Box. 6.62"L x 4.12"W x 12.88"D	12"	-	100
P1-20DL F 026613046488	3/8" OD Bulk w/ Flag Label in Box. 21.125"L x 6.5"W x 3.5625"D	20"	-	25
P1-20DL 026613044934	3/8" OD Bulk Box. 6.62"L x 4.12"W x 20.88"D	20"	-	100

**Faucet - Copper**

1-12A CH 026613159980	3/8" OD 1 Per Hang Tag. 1.9375"L x 1.875"W x 0.63"D	12"	5	50
1-20A CH 026613159997	3/8" OD 1 Per Hang Tag. 1.9375"L x 1.875"W x 0.63"D	20"	5	50
1-20A CF 026613046396	3/8" OD Bulk w/ Flag Label in Box. 21.125"L x 6.5"W x 3.5625"D	20"	-	25
1-36A CH 026613160009	3/8" OD 1 Per Hang Tag. 1.9375"L x 1.875"W x 0.63"D	36"	5	25

**Toilet - Copper**

1-12DL CH 026613160016	3/8" OD 1 Per Hang Tag. 1.9375"L x 1.875"W x 0.875"D	12"	5	50
1-12DL CF 026613046426	3/8" OD Bulk w/ Flag Label in Box. 13"L x 4.125"W x 4.25"D	12"	-	25
1-20DL CH 026613160023	3/8" OD 1 Per Hang Tag.	20"	5	50
1-20DL CF 026613046433	3/8" OD Bulk w/ Flag Label in Box. 20.375"L x 5.75"W x 3.75"D	20"	-	25



NOTE: Actual riser length to connect less 1/2"

The Speedi Plumb® PLUS Connector is the Among the Most Corrosion Resistant Water Connector.

- Corrosion Resistant
- No Kinking or Crimping



Part No. UPC	Description Package Size	Length	Shelf Qty	Case Qty
-----------------	-----------------------------	--------	--------------	-------------

Faucet - Compression



PSB830 039166029716	3/8" Comp x 1/2" FIP Bulk w/ Flag Label in Box. 14"L x 4.75"W x 3"D	12"	-	10
PSB832 039166029723	3/8" Comp x 1/2" FIP Bulk w/ Flag Label in Box. 21"L x 4"W x 3.5"D	16"	-	10
PSB836 039166029730	3/8" Comp x 1/2" FIP Bulk w/ Flag Label in Box. 21"L x 4"W x 3.5"D	20"	-	10
PS838 039166030194	3/8" Comp x 1/2" FIP 1 Per Clamshell. 9.5"L x 6"W x 1.75"D	36"	-	5
PSB838 039166032822	3/8" Comp x 1/2" FIP Bulk w/ Flag Label in Box. 38"L x 4.75"W x 3.75"D	36"	-	10
PSB866 039166029938	1/2" Comp x 1/2" FIP Bulk w/ Flag Label in Box. 21"L x 4"W x 3.5"D	20"	-	10

Faucet - FIP



PSB840 039166029891	1/2" FIP x 1/2" FIP Bulk w/ Flag Label in Box. 14"L x 4.75"W x 3"D	12"	-	10
PSB846 039166029914	1/2" FIP x 1/2" FIP Bulk w/ Flag Label in Box. 21"L x 4"W x 3.5"D	20"	-	10

Universal Faucet - FIP



B1-20AU D 026613106762	3/8" Comp x 1/2" FIP With 1/2" IP and 1/2" Comp Valve Adaptor 1 Per Clamshell. 9.5"L x 6"W x 1.75"D	20"	-	5
---------------------------	--	-----	---	---

Faucet - Compression x KC Nosepiece



PSB873 039166029747	3/8" Comp x 3/8" Comp Bulk w/ Flag Label in Box. 14"L x 4.75"W x 3"D	12"	-	10
PSB877 039166029853	3/8" Comp x 3/8" Comp Bulk w/ Flag Label in Box. 21"L x 4"W x 3.5"D	20"	-	10

Toilet - Compression



PSB855 039166029952	3/8" Comp x 7/8" Ballcock Bulk w/ Flag Label in Box. 14"L x 4.75"W x 3"D	9"	-	10
PSB856 039166029969	3/8" Comp x 7/8" Ballcock Bulk w/ Flag Label in Box. 14"L x 4.75"W x 3"D	12"	-	10
PSB857 039166029976	3/8" Comp x 7/8" Ballcock Bulk w/ Flag Label in Box. 21"L x 4"W x 3.5"D	20"	-	10

Toilet - FIP



PSB858 039166030033	1/2" FIP x 7/8" Ballcock Bulk w/ Flag Label in Box. 14"L x 4.75"W x 3"D	12"	-	10
------------------------	--	-----	---	----

Universal Toilet - Compression



B1-12DLU D 026613106731	3/8" Comp x 7/8" Ballcock With 1/2" IP and 1/2" Comp Valve Adaptor 1 Per Clamshell. 9.5"L x 6"W x 1.75"D	12"	-	5
----------------------------	---	-----	---	---

Part No. UPC	Description Package Size	Length	Shelf Qty	Case Qty
-----------------	-----------------------------	--------	--------------	-------------

Washing Machine - Female Hose Thread

BL12-48WA P 026613142043	3/4" Female Hose Thread x 3/4" Female Hose Thread 1 Per Bag. 12"L x 10.5"W x 1.5"D	48"	-	10
BL12-60WA P 026613142050	3/4" Female Hose Thread x 3/4" Female Hose Thread 1 Per Bag. 12"L x 10.5"W x 1.5"D	60"	-	10
BL12-60WA P2 026613160429	3/4" Female Hose Thread x 3/4" Female Hose Thread 2 Per Bag. ?	60"	-	5
BL12-72WA P 026613142067	3/4" Female Hose Thread x 3/4" Female Hose Thread 1 Per Bag. 12"L x 10.5"W x 1.5"D	72"	-	10
BL12-72WA B 026613966113	3/4" Female Hose Thread x 3/4" Female Hose Thread Bulk Box. 20.375"L x 15.75"W x 13.375"D	72"	-	25



Dishwasher - Compression

B1-48DW6 P 026613141787	3/8" Comp x 3/8" Comp With 3/8" MIP Elbow 1 Per Bag. 12"L x 10.5"W x 1.375"D	48"	-	10
----------------------------	---	-----	---	----



Dishwasher - Garden Hose Elbow

B1-48DW12 P 026613141756	3/8" Comp x 3/8" Comp With 3/4" Garden Hose Elbow 1 Per Bag. 12"L x 10.5"W x 1.75"D	48"	-	10
-----------------------------	--	-----	---	----



Dishwasher - Compression

B1-60DW6 P 026613141794	3/8" Comp x 3/8" Comp With 3/8" MIP Elbow 1 Per Bag. 12"L x 10.5"W x 1.5"D	60"	-	10
B1-72DW6 P 026613141800	3/8" Comp x 3/8" Comp With 3/8" MIP Elbow 1 Per Bag. 12"L x 10.5"W x 1.5"D	72"	-	10



B1-72DW F 026613104430	3/8" Comp x 3/8" Comp Bulk w/ Flag Label in Box. 15.8125"L x 12.75"W x 8.375"D	72"	-	10
---------------------------	---	-----	---	----



Universal Dishwasher - Compression

B1U-48DW612 D 026613140797	3/8" Comp x 3/8" Comp With 1/2" IP and 1/2" Comp Stop Adaptors, 3/8" MIP and 3/4" Garden Hose Elbows 1 Per Card. 9.5"L x 7.75"W x 1.75"D	48"	-	10
B1U-72DW612 D 026613160528	3/8" Comp x 3/8" Comp With 1/2" IP and 1/2" Comp Stop Adaptors, 3/8" MIP and 3/4" Garden Hose Elbows	72"	-	5



Dishwasher - Compression

BL3-48DW F 026613104461	1/2" Comp x 1/2" Comp Bulk w/ Flag Label in Box. 8.875"L x 8.875"W x 5.25"D	48"	-	10
BL3-60DW F 026613104478	1/2" Comp x 1/2" Comp Bulk w/ Flag Label in Box. 8.875"L x 8.875"W x 5.25"D	60"	-	10
BL3-72DW F 026613104485	1/2" Comp x 1/2" Comp Bulk w/ Flag Label in Box. 8.875"L x 8.875"W x 5.25"D	72"	-	10



Part No. UPC	Description Package Size	Length	Shelf Qty	Case Qty
-----------------	-----------------------------	--------	--------------	-------------

Dishwasher - Garden Hose Elbow



B1-60DW1 P 026613141169	3/8" Comp x 3/4" Garden Hose Elbow (Crimped) 1 Per Bag. 12"L x 10.5"W x 1.5"D	60"	-	10
----------------------------	--	-----	---	----

Dishwasher - FIP



B8-60DW6 P 026613141824	1/2" FIP x 3/8" Comp With 3/8" MIP Elbow 1 Per Bag. 12"L x 10.5"W x 0.875"D	60"	-	10
----------------------------	--	-----	---	----

Ice Maker/Humidifier/Water Filter



B0-12IM F 026613104836	1/4" Comp x 1/4" Comp Bulk w/ Flag Label in Box. 15.375"L x 5.75"W x 4"D	12"	-	25
B0-60IM P 026613142005	1/4" Comp x 1/4" Comp 1 Per Bag. 12"L x 10.5"W x 1.5"D	60"	-	10
B0-72IM P 026613142012	1/4" Comp x 1/4" Comp 1 Per Bag. 12"L x 10.5"W x 1.5"D	72"	-	10
B0-96IM P 026613142036	1/4" Comp x 1/4" Comp 1 Per Bag. 12"L x 10.5"W x 1.5"D	96"	-	10
B0-120IM P 026613141992	1/4" Comp x 1/4" Comp 1 Per Bag. 12"L x 10.5"W x 1.5"D	120"	-	10

Part No. UPC	Description Package Size	Length	Shelf Qty	Case Qty
Faucet - Compression				
PSB130 039166601301	3/8" Comp x 1/2" FIP Bulk w/ Flag Label in Box. 14"L x 4.75"W x 3"D	12"	-	10
PSB132 039166601325	3/8" Comp x 1/2" FIP Bulk w/ Flag Label in Box. 21"L x 4"W x 3.5"D	16"	-	10
PSB136 039166601363	3/8" Comp x 1/2" FIP Bulk w/ Flag Label in Box. 21"L x 4"W x 3.5"D	20"	-	10
PS138 0391666001385	3/8" Comp x 1/2" FIP 1 Per Clamshell. 9.5"L x 6"W x 1.75"D	36"	-	5
PSB138 0391666010554	3/8" Comp x 1/2" FIP Bulk w/ Flag Label in Box. 38"L x 4.75"W x 3.75"D	36"	-	10



Faucet - FIP				
PSB141 039166601417	1/2" FIP x 1/2" FIP Bulk w/ Flag Label in Box. 14"L x 4.75"W x 3"D	12"	-	10
PSB145 039166601455	1/2" FIP x 1/2" FIP Bulk w/ Flag Label in Box. 21"L x 4"W x 3.5"D	20"	-	10



Faucet - Compression x KC Nosepiece				
PSB173 039166601738	3/8" Comp x 3/8" OD Comp Bulk w/ Flag Label in Box. 14"L x 4.75"W x 3"D	12"	-	10
PSB175 039166601752	3/8" Comp x 3/8" OD Comp Bulk w/ Flag Label in Box. 21"L x 4"W x 3.5"D	16"	-	10
PSB177 039166601776	3/8" Comp x 3/8" OD Comp Bulk w/ Flag Label in Box. 21"L x 4"W x 3.5"D	20"	-	10



Toilet - Compression				
PSB156 039166601561	3/8" Comp x 7/8" Ballcock Bulk w/ Flag Label in Box. 14"L x 4.75"W x 3"D	12"	-	10
PSB157 039166601578	3/8" Comp x 7/8" Ballcock Bulk w/ Flag Label in Box. 21"L x 4"W x 3.5"D	16"	-	10
PSB168 039166601684	1/2" Comp x 7/8" Ballcock Bulk w/ Flag Label in Box. 14"L x 4.75"W x 3"D	12"	-	10



Part No. UPC	Description Package Size	Length	Shelf Qty	Case Qty
-----------------	-----------------------------	--------	--------------	-------------

Washing Machine - Female Hose Thread



BC2456	3/4" Female Hose Thread x 3/4" Female Hose Thread, Red/Blue Fill Hose	60"	-	10
026613160504	2 Per Bag. 11" x 13.5" x 1.5"			

Part No. UPC	Description Package Size	Length	Shelf Qty	Case Qty
-----------------	-----------------------------	--------	--------------	-------------

Faucet - 1/4 Turn One-Piece Supply - Angle Valve Braided Connector

G2PS19B200AX F 026613158525	1/2" Nom Push Connect x 1/2" FIP Bulk w/ Flag Label in Box. 21.5"L x 6.5"W x 5.3125"D	20"	-	25
G2PS19B200HX D 026613160467	1/2" Nom Push Connect x 1/2" FIP 1 Per Card.	20"	-	5



Faucet - 1/4 Turn One-Piece Supply - Straight Valve Braided Connector

G2PS14B200HX F 026613170473	1/2" Nom Push Connect x 1/2" FIP Bulk w/ Flag Label in Box. 21.5"L x 6.5"W x 5.3125"D	20"	-	25
--------------------------------	--	-----	---	----



Toilet - 1/4 Turn One-Piece Supply - Angle Valve Braided Connector

G2PS19B120DLX F 026613158532	1/2" Nom Push Connect x 7/8" Ballcock Bulk w/ Flag Label in Box. 15.375"L x 6.5"W x 5.3125"D	12"	-	25
G2PS19B120DLX D 026613160450	1/2" Nom Push Connect x 7/8" Ballcock 1 Per Card.	12"	-	5



Toilet - 1/4 Turn One-Piece Supply - Straight Valve Braided Connector

G2PS14B120DLX F 026613170480	1/2" Nom Push Connect x 7/8" Ballcock Bulk w/ Flag Label in Box. 15.375"L x 6.5"W x 5.3125"D	12"	-	25
---------------------------------	---	-----	---	----



FLEXIBLE POLYMER BRAIDED ONE-PIECE WATER SUPPLY



Part No. UPC	Description Package Size	Length	Shelf Qty	Case Qty
Low Boy Toilet - Multi-Turn FIP x Compression Angle Valve Braided Connector Compression x Ballcock				
PS8754	1/2" FIP x 3/8" OD Comp	12"	-	5
039166030903	3/8" Comp x 7/8" Ballcock With 1/2" Nom x 1/2" MIP Adaptor 1 Per Clamshell. 9.5"L x 6"W x 1.75"D			

Iron Pipe Fittings

Product Applications

- For use with brass, copper or iron pipe.
- Designed for up to 1,200 PSI.
- Typically used in water and refrigeration systems.



Product Advantages

- All pipe fitting threads meet the standards developed by the Society of Automotive Engineers (SAE).
- Backed by Brasscraft Manufacturing's 70 plus year history and reputation for quality and service.

*Compliant offering available

Part No. UPC	Description Package Size	Finish	Shelf Qty	Case Qty
Pipe Nipples				
113-06-4-CX D 026613158310	3/8" MIP x 4" 2 Per Card. 5.625"L x 3"W x 0.875"D	Chrome	5	25
113-06-6-CX D 026613158242	3/8" MIP x 6" 2 Per Card. 7.75"L x 3"W x 0.875"D	Chrome	5	25
113-08-3-CX D 026613158211	1/2" MIP x 3" 2 Per Card. 5.625"L x 3"W x 0.875"D	Chrome	5	25
113-08-4-CX D 026613158457	1/2" MIP x 4" 2 Per Card. 5.625"L x 3"W x 0.875"D	Chrome	5	25



Brass Compression Fittings

Product Applications

- For use with potable water, instrumentation, hydraulic and pneumatic systems.
- Designed to be used with aluminum, copper and plastic tubing. Not recommended for steel tubing. Plastic tubing requires 63PT insert and 60PT sleeve.

*Compliant offering available

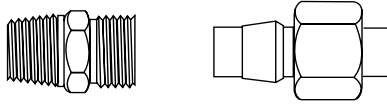

WARNING: Do not use compression fittings for gas connections of any kind.

Product Advantages

- BrassCraft® compression fittings do not require any flaring, soldering or other type of tubing preparation.
- Available in a broad range of sizes and styles.
- Manufactured from brass rod.
- Backed by Brasscraft Manufacturing's 70 plus year history and reputation for quality and service.

Working Pressure Ranges

- Operating temperatures and tubing type are important factors. The following table (73° F temperature with copper tubing) is a good guide to use for proper selection.

PSI	Tube OD (IN)	Tube Wall (IN)
400	1/8	.030
400	3/16	.030
300	1/4	.030
300	5/16	.032
200	3/8	.032
200	1/2	.032
150	5/8	.035
100	3/4	.035
75	7/8	.035

How to Order

- Ordered as complete assemblies (body, nut, sleeve). Nuts and sleeves can also be ordered separately by part number.

Special Orders

- Special fitting configurations and sizes may be ordered. Please furnish a print or sketch of your needs with your inquiry.
- Fittings are available in bulk quantities on request. Contact your sales representative for details.







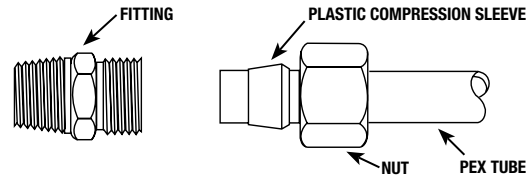



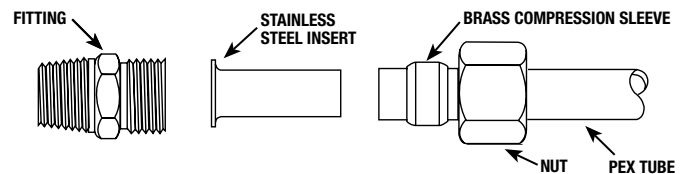

PEX Tube Compression Connection

For PEX Tube 3/8" OD and smaller, use plastic compression sleeve.



For PEX Tube larger than 3/8" OD, use brass compression sleeve with stainless steel tube insert.



Part No. UPC	Description Package Size	Finish	Shelf Qty	Case Qty	
Compression Nuts & Sleeves					
P81 039166021222	For 3/8" OD Tube 2 Each Per Card. 3.875"L x 1.875"W x 1.1"D	Chrome	5	25	
Compression Female Adaptors					
10X CD 026613158297	3/8" OD Tube, Drill Through (No Tube Stop) x 3/8" FIP 2 Per Card. 3.875"L x 2.875"W x 1.22"D	Chrome	5	25	
12X CD 026613158198	3/8" OD Tube, Drill Through (No Tube Stop) x 1/2" FIP 2 Per Card. 3.875"L x 2.875"W x 1.22"D	Chrome	5	25	
Compression Male Adaptors					
11X CD 026613158259	3/8" OD Tube, Drill Through (No Tube Stop) x 3/8" MIP 2 Per Card. 3.875"L x 2.875"W x 1.22"D	Chrome	5	25	
13X CD 026613158266	3/8" OD Tube, Drill Through (No Tube Stop) x 1/2" MIP 2 Per Card. 3.875"L x 2.875"W x 1.22"D	Chrome	5	25	
Compression Sweat Adaptor					
14X CD 026613158167	1/2" Nom Sweat x 3/8" OD Tube, Drill Through (No Tube Stop) 2 Per Card. 3.875"L x 2.875"W x 1.22"D	Chrome	5	25	
Compression Speedi Adaptors					
462-6-6-1X CD 026613158334	3/8" Female Flare x 3/8" OD Tube, Washer Included 1 Per Card. 3.875"L x 1.875"W x 1.1"D	Chrome	5	50	
462-8-6-1X CD 026613158327	1/2" Female Flare x 3/8" OD Tube, Washer Included 1 Per Card. 3.875"L x 1.875"W x 1.1"D	Chrome	5	50	
63-6-8WX CD 026613158273	1/2" Female Comp x 3/8" OD Tube, Rib Washer Included 1 Per Card. 3.875"L x 1.875"W x 1.1"D	Chrome	5	50	
66-6-8WX CD 026613158129	1/2" FIP x 3/8" OD Tube, Rib Washer Included 1 Per Card. 3.875"L x 1.875"W x 1.1"D	Chrome	5	50	
Compression Male Elbow					
69-6-6X CD 026613158136	3/8" OD Tube x 3/8" MIP 2 Per Card. 3.875"L x 2.875"W x 1.22"D	Chrome	5	25	
Compression Reducing Union					
C14X CD 026613158303	5/8" OD Tube x 3/8" OD Tube, Drill Through (No Tube Stop) 2 Per Card. 3.875"L x 2.875"W x 1.22"D	Chrome	5	25	
Valve Adaptors					
CT2-664X P 026613140933	3/8" OD Tube x 3/8" OD Tube x 1/4" Female Comp Nut 1 Per Bag 6"L x 3.5"W x 0.625"D	Rough	-	10	
CT2-664X D 026613140308	3/8" OD Tube x 3/8" OD Tube x 1/4" Female Comp Nut 1 Per Card.	Rough	5	25	
CT2-666X P 026613140926	3/8" OD Tube x 3/8" OD Tube x 3/8" Female Comp Nut 1 Per Bag 6"L x 3.5"W x 0.625"D	Rough	-	10	
CT2-666X D 026613140292	3/8" OD Tube x 3/8" OD Tube x 3/8" Female Comp Nut 1 Per Card.	Rough	5	25	

Part No. UPC	Description Package Size	Finish	Shelf Qty	Case Qty
-----------------	-----------------------------	--------	--------------	-------------

Valve Adaptors (cont.)



ST1-SS4X D 026613140322	1/2" FIP & 7/16" OD Slip Joint x 1/2" MIP x 1/4" OD Tube 1 Per Card.	Rough	5	50
----------------------------	---	-------	---	----



ST1-SS6X D 026613140315	1/2" FIP & 7/16" OD Slip Joint x 1/2" MIP x 3/8" OD Tube 1 Per Card.	Rough	5	50
----------------------------	---	-------	---	----

Part No. UPC	Description Package Size	Finish	Shelf Qty	Case Qty
ΔCPVC Compression Reducing Adaptors				
P14CX CD 026613158280	1/2" Nom CPVC x 3/8" OD Tube 1 Per Card. 3.875"L x 1.875"W x 1.1"D	Chrome	5	25
P44CX RD 026613158143	1/2" Nom CPVC x 5/8" OD Tube 1 Per Card. 5.875"L x 3.875"W x 2.375"D	Rough	5	25
P77CX RD 026613158150	1/2" Nom CPVC x 7/8" OD Tube 1 Per Card. 5.875"L x 3.875"W x 2.375"D	Rough	-	5



ΔCPVC Compression Reducing Elbows				
P19CX CD 026613158228	1/2" Nom CPVC x 3/8" OD Tube 1 Per Card. 3.875"L x 2.875"W x 1.22"D	Chrome	5	25



ΔCPVC Female 90° Drop-Ear Elbows				
P48WX RD 026613158235	1/2" Nom CPVC x 1/2" FIP 1 Per Card. 5.875"L x 3.875"W x 2.375"D	Rough	5	25



Δ CPVC pre-torqued fittings eliminate the need for tightening on the job.

Brass Garden Hose Fittings

Product Applications

- For use with residential and commercial-grade garden hose.

Product Advantages

- Connectors, unions, nuts, elbows and tees machined from brass rod.
- Backed by Brasscraft Manufacturing's 70 plus year history and reputation for quality and service.

*Low Lead offering available



Assembly Instructions

- All female hose connections require a rubber washer inserted prior to installation.



Part No. UPC	Description Package Size	Finish	Shelf Qty	Case Qty
Garden Hose Dishwasher Elbows				
HES-6-12X 026613160184	3/4" Female Hose Thread x 3/8" OD Comp, Hose Washer Included 1 Per Bag 5.81"L x 3"W x 1.625"D	Rough	-	50
HES-6-12X D 026613160207	3/4" Female Hose Thread x 3/8" OD Comp, Hose Washer Included 1 Per Card. 5.625"L x 3"W x 1.625"D	Rough	-	10
HES-6-12X B 026613160191	3/4" Female Hose Thread x 3/8" OD Comp, Hose Washer Included Bulk Packed. 1.875"L x 1.125"W x 1.625"D	Rough	-	200
HES-6-12WNMX D 026613160443	3/8" OD Comp x 3/4" Garden Hose, Comp Nut & Sleeve, Hose Washer Included 1 Per Card.	Rough	-	10
HES-8-12X 026613160221	3/4" Female Hose Thread x 1/2" OD Comp, Hose Washer Included Bulk Bag. 8.66"L x 6.69"W x 0.00"D	Rough	25	200
Vacuum Breaker				
PS612X 039166121038	1"-20 Fine Thread IP To Garden Hose Backflow Preventer 1 Per Card. 3.875"L x 3.875"W x 1.552"D	Rough	5	25



Part No. UPC	Description Package Size	Finish	Shelf Qty	Case Qty
-----------------	-----------------------------	--------	--------------	-------------

Multi-Turn Supply Stop Components

S15-10 CD 026613172477	Loose Key 1 Per Card.	Chrome	-	10
---------------------------	--------------------------	--------	---	----



X15-10 CD 026613160337	Cross Handle 1 Per Card.	Chrome	5	25
---------------------------	-----------------------------	--------	---	----



Multi-Turn Repair Kit

BCSR01 026613141527	Stem/Bib Washer R15S-2P+5 and Two Washers R15-78F & R15-6P included		-	5
------------------------	---	--	---	---



Water Supply Connector Washer Assortment

BCRP01 D 026613160085	Cone Washer Assortment 1 Set Per Card. 3.875"L x 2.875"W x 1.22"D		10	100
--------------------------	--	--	----	-----



Shallow Escutcheons

PS30 039166000302	3/8" IP Shallow (.680 ID) 2 Per Card. 3.875"L x 3.875"W x 0.804"D	Chrome	5	25
----------------------	--	--------	---	----



PS31 039166000319	1/2" IP Shallow (.840 ID) 2 Per Card 3.875"L x 3.875"W x 0.804"D	Chrome	5	25
----------------------	---	--------	---	----

PS32 039166000326	3/4" IP Shallow (1.050 ID) 2 Per Card 3.875"L x 3.875"W x 0.804"D	Chrome	5	25
----------------------	--	--------	---	----



Bell Escutcheons

PS33 039166000333	3/8" IP (11/16" OD) Bell (.687 ID) 2 Per Card 3.875"L x 3.875"W x 1.508"D	Chrome	5	25
----------------------	--	--------	---	----

PS34 039166000340	1/2" IP Bell (.844 ID) 1 Per Card 3.875"L x 3.875"W x 1.508"D	Chrome	5	25
----------------------	--	--------	---	----

PS40 039166000401	1/2" Nom (5/8" OD) Bell (.630 ID) 1 Per Card. 3.875"L x 3.875"W x 1.508"D	Chrome	5	25
----------------------	--	--------	---	----



Chrome Plated Brass Cover Tubes

8489 CD 026613160320	3-1/2" Length for 1/2" Nom Copper Tube Use 650 C Bell Escutcheon 1 Per Card.		5	25
-------------------------	---	--	---	----



Multi-Turn Supply Valve Components

R15-9 CD 026613160344	Screw for Stop Handles 1 Per Card.		5	25
--------------------------	---------------------------------------	--	---	----



Part No. UPC	Description Package Size	Finish	Shelf Qty	Case Qty
-----------------	-----------------------------	--------	--------------	-------------

Multi-Turn Supply Valve Components (cont.)



R15-10T CD 026613144696	Oval Handle 1 Per Card. 3.875"L x 1.875"W x 1.1"D	Chrome	-	5
----------------------------	--	--------	---	---



R15-5 026613041643	Bib Washer Bulk Bag. 5.00"L x 5.00"W x 0.50"D	Rubber	25	1,000
-----------------------	--	--------	----	-------

Faucet Supply Components



P89 039166021826	1/2" Brass Faucet Nuts With 3/8" and 1/2" Friction Rings & Cone Washers 2 Sets Per Card. 3.875"L x 1.875"W x 1.1"D	Rough	10	100
---------------------	---	-------	----	-----

Water Heater Connector Washers



BCRP02 D 026613160092	Fits Most Water Heater Connectors. Nitrile Rubber 2 Per Card. 3.875"L x 1.875"W x 1.1"D	Rubber	5	25
--------------------------	--	--------	---	----



WWCD 026613051970	Washer .940" OD x .675" ID x .218" Thick. For Copper Connectors with an External Dielectric Sleeve Bulk Bag. 6.00"L x 6.00"W x 0.22"D	Rubber	25	1,000
----------------------	--	--------	----	-------

Water Heater Nipples



PS43 039166000432	3/4" MIP x 3/4" MIP x 3" Length. Plastic Lined 2 Per Card. 5.625"L x 3"W x 1.625"D	Steel	-	5
----------------------	---	-------	---	---

Speedi Plumb® PLUS Polymer Braided Water Heater Connectors

Superior Flexibility, Superior Corrosion Resistance



No Kinking, No Crimping

The patented polymer braided jacket is specially engineered to allow the connector to bend freely without kinking or crimping. Easy to install, the connector won't work harden with repeated bending.

Advanced Corrosion Resistance

The polymer braid is specially engineered to resist corrosion from most harsh household cleaning and repair products.

No Dielectric Union Needed*

The engineered polymer braid and rubber core are non-conductive materials and therefore eliminate the need for a dielectric union.

Less Torque to Seal

Rubber washer is easier to install on rough nipple surfaces.

Longer Connector Nuts

A greater number of thread-to-thread contact provides a better seal to lined nipples.



Part No. UPC	Description Package Size	Length	Shelf Qty	Case Qty
.57" ID Tube - FIP X FIP				
BWB0-12 026613965321	3/4" FIP x 3/4" FIP Bulk w/Flag Label. 14"L x 4.75"W x 3"D	12"	-	10
BWB0-15 026613965406	3/4" FIP x 3/4" FIP Bulk w/Flag Label. 20"L x 4.75"W x 2.875"D	15"	-	10
BWB0-18 026613965413	3/4" FIP x 3/4" FIP Bulk w/Flag Label. 20"L x 4.75"W x 2.875"D	18"	-	10
BWB0-24 026613965420	3/4" FIP x 3/4" FIP Bulk w/Flag Label. 26"L x 4.75"W x 2.875"D	24"	-	10
.57" ID Tube - FIP X PEX				
BWB0-18PX 026613107141	3/4" FIP x 3/4" Nom PEX Barb Bulk w/Flag Label. 20"L x 4.75"W x 2.875"D	18"	-	10
.57" ID Tube - FIP X Compression				
BWB05-18 026613120836	3/4" FIP x 5/8" OD Comp Bulk w/Flag Label. 21"L x 5"W x 4.5"D	18"	-	10
BWB08-18 026613965383	3/4" FIP x 7/8" OD Comp Bulk w/Flag Label. 20"L x 4.75"W x 2.875"D	18"	-	10
BWB08-24 026613965390	3/4" FIP x 7/8" OD Comp Bulk w/Flag Label. 26"L x 4.75"W x 2.875"D	24"	-	10



*Check your local inspection office for applicable code requirements.

Part No. UPC	Description Package Size	Length	Shelf Qty	Case Qty
-----------------	-----------------------------	--------	--------------	-------------

.57" ID Tube - MIP X FIP

BWB20-12 026613965437	3/4" MIP x 3/4" FIP Bulk w/Flag Label. 14"L x 4.75"W x 3"D	12"	-	10
BWB20-15 026613965444	3/4" MIP x 3/4" FIP Bulk w/Flag Label. 20"L x 4.75"W x 2.875"D	15"	-	10
BWB20-18 026613965451	3/4" MIP x 3/4" FIP Bulk w/Flag Label. 21"L x 5"W x 4.5"D	18"	-	10
BWB20-24 026613965468	3/4" MIP x 3/4" FIP Bulk w/Flag Label. 26"L x 4.75"W x 2.875"D	24"	-	10

**.57" ID Tube - MIP x Compression**

BWB25-18 026613100333	3/4" MIP X 5/8" OD Comp Bulk w/Flag Label. 20"L x 4.75"W x 2.875"D	18"	-	10
BWB28-18 026613965345	3/4" MIP x 7/8" OD Comp Bulk w/Flag Label. 20"L x 4.75"W x 2.875"D	18"	-	10
BWB28-24 026613965352	3/4" MIP x 7/8" OD Comp Bulk w/Flag Label. 26"L x 4.75"W x 2.875"D	24"	-	10



Copper-Flex™ Water Heater Connectors

Resists Galvanic Corrosion

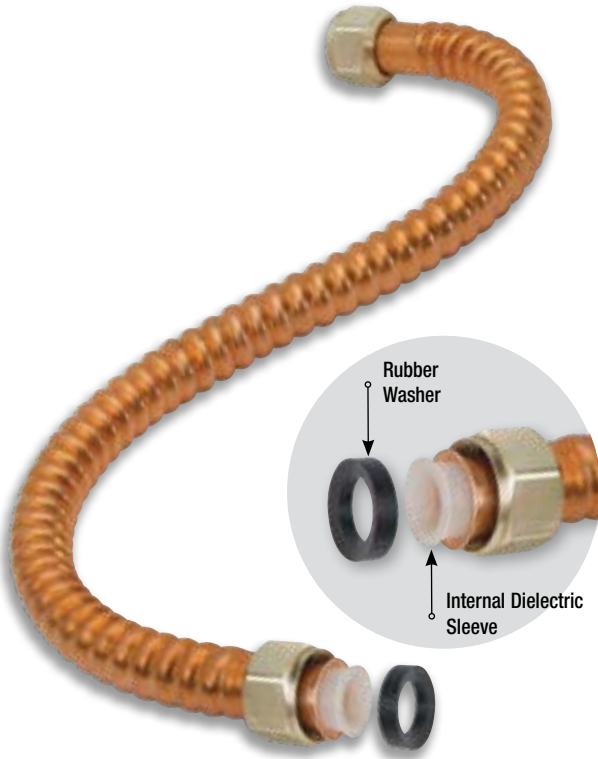

Internal Dielectric Sleeve

Effectively separates dissimilar metals within the waterway to help prevent galvanic corrosion.

No Dielectric Union Needed*

Dielectric sleeve eliminates the need for a dielectric union (plastic lined nipple).

Less Torque to Seal

Rubber washer is more resilient than PEX and easier to install on rough nipple surfaces.

Longer Connector Nuts

A greater number of thread-to-thread contact provides a better seal to lined nipples.

Available for PEX connections



Part No. UPC	Description Package Size	Length	Shelf Qty	Case Qty
7/8" OD Tube - FIP X FIP				
PSC00-12 039166080007	3/4" FIP x 3/4" FIP 1 Per Bag w/Cut-Case Display Box. 18.25"L x 5.8125"W x 7.6875"D	12"	-	25
WB00-12N 026613089287	3/4" FIP x 3/4" FIP Bulk w/Wrap Around Label. 13.5"L x 6"W x 5.38"D	12"	-	25
PSC00-15 039166080014	3/4" FIP x 3/4" FIP 1 Per Bag w/Cut-Case Display Box. 18.25"L x 5.8125"W x 7.6875"D	15"	-	25
WB00-15N 026613089300	3/4" FIP x 3/4" FIP Bulk w/Wrap Around Label. 16.5"L x 6"W x 5.375"D	15"	-	25
PSC00-18 039166080021	3/4" FIP x 3/4" FIP 1 Per Bag w/Cut-Case Display Box. 24.125"L x 5.8125"W x 7.6875"D	18"	-	20
WB00-18N 026613089331	3/4" FIP x 3/4" FIP Bulk w/Wrap Around Label. 18.75"L x 6"W x 6.25"D	18"	-	25
PSC00-24 039166080038	3/4" FIP x 3/4" FIP 1 Per Bag w/Cut-Case Display Box. 24.125"L x 5.8125"W x 7.6875"D	24"	-	15
WB00-24N 026613089348	3/4" FIP x 3/4" FIP Bulk w/Wrap Around Label. 25.5"L x 6"W x 5.375"D	24"	-	25
7/8" OD Tube - FIP x Male/Female Sweat				
PSC034-18 039166080045	3/4" FIP x 3/4" Nom Male/Female Sweat (7/8" ID) 1 Per Bag w/Cut-Case Display Box 18.25"L x 5.8125"W x 7.6875"D	18"	-	20
WB034-18N 026613089423	3/4" FIP x 3/4" Nom Male/Female Sweat (7/8" ID) Bulk w/Wrap Around Label 18.75"L x 6"W x 6.25"D	18"	-	25



⚠ WARNING: For use with water in accessible locations only. DO NOT use with gas – gas will cause corrosion and leakage.

*Check your local inspection office for applicable code requirements.

Part No. UPC	Description Package Size	Length	Shelf Qty	Case Qty
-----------------	-----------------------------	--------	--------------	-------------

7/8" OD Tube - FIP x Male/Female Sweat (cont.)



PSC034-24 039166080052	3/4" FIP x 3/4" Nom Male/Female Sweat (7/8" ID) 1 Per Bag w/Cut-Case Display Box 24.125"L x 5.8125"W x 7.6875"D	24"	-	15
WB034-24N 026613093710	3/4" FIP x 3/4" Nom Male/Female Sweat (7/8" ID) Bulk w/Wrap Around Label. 25.5"L x 6"W x 5.375"D	24"	-	25
WB034-12N 026613089409	3/4" FIP x 3/4" Nom Male/Female Sweat (7/8" ID) Bulk w/Wrap Around Label. 13.5"L x 6"W x 5.38"D	12"	-	25
WB034-15N 026613089416	3/4" FIP x 3/4" Nom Male/Female Sweat (7/8" ID) Bulk w/Wrap Around Label. 16.5"L x 6"W x 5.375"D	15"	-	25

7/8" OD Tube - FIP x PEX Barb



WB07-18 026613048871	3/4" FIP x 3/4" PEX Barb (brass, pre-torqued) Bulk w/Wrap Around Label. 21.5"L x 6"W x 6.25"D	18"	-	25
-------------------------	--	-----	---	----

7/8" OD Tube - FIP/MIP x PEX Barb

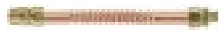

WB27-18 026613107950	3/4" FIP/MIP x 3/4" PEX Barb (brass, pre-torqued) Bulk w/Wrap Around Label. 22"L x 6"W x 6.5"D	18"	-	25
-------------------------	---	-----	---	----

ProCoat® Coated Stainless Steel Water Heater Connectors

Greater Flexibility, Superior Corrosion Resistance

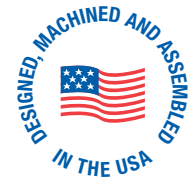

Exclusive ProCoat® Clear Coat

Provides superior corrosion resistance to deterioration from most harsh chemicals that can cause pinhole leaks.

Full Flow, Maximum Performance

With 3/4" full flow internal diameter, our connectors provide greater water flow without obstruction.

Integrated Dielectric Sleeve

Isolates dissimilar metals within the waterway, where galvanic and electrolytic corrosion have their greatest potential.

No Dielectric Union Needed*

Integrated dielectric sleeve eliminates the need to install an additional dielectric union, reducing time and installation costs.

100% Leak Tested

Each connector is leak tested to help ensure connector performance and reliability.



Part No. UPC	Description Package Size	Length	Shelf Qty	Case Qty
3/4" ID Tube - FIP x FIP				
SWB00-12N 026613142562	(3/4" ID) 3/4" FIP x 3/4" FIP Bulk w/Wrap Around Label. 13.5"L x 6"W x 5.38"D	12"	-	25
SWB00-15N 026613142579	(3/4" ID) 3/4" FIP x 3/4" FIP Bulk w/Wrap Around Label. 16.5"L x 6"W x 5.375"D	15"	-	25
SWB00-18N 026613142586	(3/4" ID) 3/4" FIP x 3/4" FIP Bulk w/Wrap Around Label. 18.75"L x 6"W x 6.25"D	18"	-	25
SWB00-24N 026613142593	(3/4" ID) 3/4" FIP x 3/4" FIP Bulk w/Wrap Around Label. 25.5"L x 6"W x 5.375"D	24"	-	25



▲ WARNING: For use with water in accessible locations only. DO NOT use with gas – gas will cause corrosion and leakage.

*Check your local inspection office for applicable code requirements.

Dimensional Data

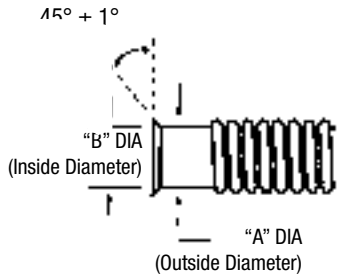
	Connector Series	Size				
		CSST	CSSL	CSSD	CSSC	CSSB
	"A" Diameter Nom OD Tube	3/8"	3/8"	1/2"	5/8"	7/8"
"B" Diameter Nom ID Tube	1/4"	1/4"	3/8"	1/2"	3/4"	
Flare Nut Thread	3/8" OD Tube 9/16-24 Thread	3/8" OD Tube 5/8-18 Thread	1/2" OD Tube 3/4-16 Thread	5/8" OD Tube 15/16-16 Thread	7/8" OD Tube 1-1/16-16 Thread	

Gas connectors may not be permitted for all uses in all locations. Consult with a certified professional installation expert to ensure compliance with all applicable codes.

Connector Flow Capacity – Per ANSI Z21.24 • CSA 6.10*

Connectors should be sized based upon the appliance gas consumption rate. Select a connector with a capacity equal to or greater than appliance input rate.

Connector Series	Nominal Connector (Inch)		STRAIGHT LENGTH CAPACITY - NATURAL GAS BTU PER HOUR							
	ID	OD	12"	18"	24"	30"	36"	48"	60"	72"
CSSL/CSST/BCSSL	1/4	3/8	48,000	43,800	40,000	36,400	33,400	28,300	24,900	23,100
CSSD/BCSSD	3/8	1/2	102,000	93,100	85,000	77,100	71,100	60,500	53,200	49,100
CSSC	1/2	5/8	180,000	164,200	150,000	136,000	125,000	106,000	93,200	86,000
CSSB	3/4	7/8	290,900	290,900	290,900	270,500	255,900	215,000	197,400	173,900

Connector Series	Nominal Connector (Inch)		STRAIGHT LENGTH CAPACITY - LPG (PROPANE) BTU PER HOUR							
	ID	OD	12"	18"	24"	30"	36"	48"	60"	72"
CSSL/CSST/BCSSL	1/4	3/8	76,800	70,080	64,000	58,240	53,440	45,280	39,840	36,960
CSSD/BCSSD	3/8	1/2	163,200	148,960	136,000	123,360	113,760	96,800	85,120	78,560
CSSC	1/2	5/8	288,000	262,720	240,000	217,600	200,000	169,600	149,120	137,600
CSSB	3/4	7/8	465,440	465,440	465,440	432,800	409,440	344,000	315,840	278,240

Connector Series	Nominal Connector (Inch)		STRAIGHT LENGTH CAPACITY - WATTS							
	ID	OD	0.31m	0.46m	0.61m	0.76m	0.92m	1.22m	1.53m	1.83m
CSSL/CSST/BCSSL	1/4	3/8	14,067	12,837	11,723	10,668	9,789	8,294	7,297	6,770
CSSD/BCSSD	3/8	1/2	29,893	27,285	24,911	22,596	20,837	17,731	15,591	14,390
CSSC	1/2	5/8	52,752	48,122	43,961	39,858	36,634	31,066	27,314	25,380
CSSB	3/4	7/8	85,254	85,254	85,254	79,276	74,997	63,010	57,852	50,965

0.64 Sp Gr, 1000 Btu per cu. ft. (37.2 MJ/m³) gas at 0.5 inch water column (124Pa) pressure drop. Per ANSI Z21.24 • CSA 6.10 for use with pressures not to exceed 1/2 PSI.

*The flow capacities in the above charts are the minimum performance criterion established in ANSI Z21.24 • CSA 6.10 & ANSI Z21.75 • CSA 6.27.

Steel Fitting Torque Values – Per ANSI Z21.24 • CSA 6.10

Tube	Torque (inch pounds)**	
	Minimum	Maximum
CSSL	150	250
CSSD	200	390
CSSC	250	520
CSSB	400	780

**Torque range recommended to tighten gas connector

Part No. UPC	Description Package Size	Length	Shelf Qty	Case Qty
1/2" ID (5/8" OD) - MIP x FIP				
CSSC12R-24 P 026613167114	3/4" MIP (1/2" FIP Tap) x 3/4" FIP 1 Per Bag. 14.375"L x 9.25"W x 1.25"D	24"	-	5
CSSC12R-36 P 026613167121	3/4" MIP (1/2" FIP Tap) x 3/4" FIP 1 Per Bag. 12"L x 9.25"W x 1.25"D	36"	-	5
CSSC12R-48 P 026613167138	3/4" MIP (1/2" FIP Tap) x 3/4" FIP 1 Per Bag. 12"L x 10.25"W x 1.25"D	48"	-	5
CSSC12R-60 P 026613167145	3/4" MIP (1/2" FIP Tap) x 3/4" FIP 1 Per Bag. 15.125"L x 10.25"W x 1.25"D	60"	-	5
CSSC12R-72 P 026613167152	3/4" MIP (1/2" FIP Tap) x 3/4" FIP 1 Per Bag. 15.125"L x 10.25"W x 1.25"D	72"	-	5
CSSC45R-24 P 026613167336	1/2" MIP EFV x 1/2" FIP 1 Per Bag. 14.375"L x 9.25"W x 1.25"D	24"	-	5
CSSC45R-36 P 026613167343	1/2" MIP EFV x 1/2" FIP 1 Per Bag. 14.375"L x 9.25"W x 1.25"D	36"	-	5
CSSC45R-48 P 026613167367	1/2" MIP EFV x 1/2" FIP 1 Per Bag. 15.125"L x 10.25"W x 1.25"D	48"	-	5
CSSC45R-60 P 026613167381	1/2" MIP EFV x 1/2" FIP 1 Per Bag. 15.125"L x 10.25"W x 1.25"D	60"	-	5



1/2" ID (5/8" OD) - FIP x FIP				
CSSC22R-24 P 026613167183	3/4" FIP EFV x 3/4" FIP 1 Per Bag. 13.5"L x 9.25"W x 1.2"D	24"	-	5
CSSC22R-36 P 026613167190	3/4" FIP EFV x 3/4" FIP 1 Per Bag. 13.5"L x 9.25"W x 1.2"D	36"	-	5
CSSC22R-48 P 026613167213	3/4" FIP EFV x 3/4" FIP 1 Per Bag. 12"L x 10.25"W x 1.2"D	48"	-	5
CSSC22R-60 P 026613167220	3/4" FIP EFV x 3/4" FIP 1 Per Bag. 12"L x 10.25"W x 1.2"D	60"	-	5



1/2" ID (5/8" OD) - MIP x MIP				
CSSC44R-24 P 026613167237	1/2" MIP EFV x 1/2" MIP (3/8" FIP Tap) 1 Per Bag. 13.5"L x 9.25"W x 1.125"D	24"	-	5
CSSC44R-36 P 026613167251	1/2" MIP EFV x 1/2" MIP (3/8" FIP Tap) 1 Per Bag. 12"L x 9.25"W x 1.125"D	36"	-	5
CSSC44R-48 P 026613167275	1/2" MIP EFV x 1/2" MIP (3/8" FIP Tap) 1 Per Bag. 12"L x 10.25"W x 1.125"D	48"	-	5
CSSC44R-60 P 026613167305	1/2" MIP EFV x 1/2" MIP (3/8" FIP Tap) 1 Per Bag. 12"L x 10.25"W x 1.125"D	60"	-	5



1/2" ID (5/8" OD) - Female Flare x MIP				
CSSC91R-36 P 026613167435	5/8" OD Female Flare EFV x 3/4" MIP (1/2" FIP Tap) 1 Per Bag. 14.375"L x 9.25"W x 1.25"D	36"	-	5
CSSC91R-48 P 026613167442	5/8" OD Female Flare EFV x 3/4" MIP (1/2" FIP Tap) 1 Per Bag. 15.125"L x 10.25"W x 1.25"D	48"	-	5



3/8" ID (1/2" OD) - MIP x MIP				
CSSD44R-12 P 026613167534	1/2" MIP EFV x 1/2" MIP (3/8" FIP Tap) 1 Per Bag. 19.125"L x 3.1875"W x 1.25"D	12"	-	5
CSSD44R-18 P 026613167558	1/2" MIP EFV x 1/2" MIP (3/8" FIP Tap) 1 Per Bag. 12"L x 9.25"W x 1.25"D	18"	-	5
CSSD44R-24 P 026613167565	1/2" MIP EFV x 1/2" MIP (3/8" FIP Tap) 1 Per Bag. 12"L x 9.25"W x 1.25"D	24"	-	5



COATED GAS CONNECTORS WITH EXCESS FLOW VALVE

Part No. UPC	Description Package Size	Length	Shelf Qty	Case Qty
-----------------	-----------------------------	--------	--------------	-------------

3/8" ID (1/2" OD) - MIP x MIP (cont.)



CSSD44R-36 P 026613167602	1/2" MIP EFV x 1/2" MIP (3/8" FIP Tap) 1 Per Bag. 12"L x 9.25"W x 1.25"D	36"	-	5
CSSD44R-48 P 026613167633	1/2" MIP EFV x 1/2" MIP (3/8" FIP Tap) 1 Per Bag. 12"L x 9.25"W x 1.25"D	48"	-	5
CSSD44R-60 P 026613167640	1/2" MIP EFV x 1/2" MIP (3/8" FIP Tap) 1 Per Bag. 12"L x 10.25"W x 1.25"D	60"	-	5
CSSD44R-72 P 026613167657	1/2" MIP EFV x 1/2" MIP (3/8" FIP Tap) 1 Per Bag. 12.875"L x 10.25"W x 1.25"D	72"	-	5

3/8" ID (1/2" OD) - MIP x FIP



CSSD45R-12 P 026613167664	1/2" MIP EFV x 1/2" FIP 1 Per Bag. 19.125"L x 3.1875"W x 1.25"D	12"	-	5
CSSD45R-18 P 026613167671	1/2" MIP EFV x 1/2" FIP 1 Per Bag. 12.875"L x 9.25"W x 1.25"D	18"	-	5
CSSD45R-24 P 026613167688	1/2" MIP EFV x 1/2" FIP 1 Per Bag. 12.875"L x 9.25"W x 1.25"D	24"	-	5
CSSD45R-36 P 026613167695	1/2" MIP EFV x 1/2" FIP 1 Per Bag. 12.875"L x 9.25"W x 1.25"D	36"	-	5
CSSD45R-48 P 026613167701	1/2" MIP EFV x 1/2" FIP 1 Per Bag. 12.875"L x 9.25"W x 1.25"D	48"	-	5
CSSD45R-60 P 026613167718	1/2" MIP EFV x 1/2" FIP 1 Per Bag. 12"L x 10.25"W x 1.25"D	60"	-	5
CSSD45R-72 P 026613167725	1/2" MIP EFV x 1/2" FIP 1 Per Bag. 15.125"L x 10.25"W x 1.25"D	72"	-	5

3/8" ID (1/2" OD) - Female Flare x FIP



CSSD105R-36 P 026613167497	3/4" MIP (1/2" Female Flare) EFV x 1/2" FIP 1 Per Bag. 12.875"L x 9.25"W x 1.25"D	36"	-	5
CSSD105R-48 P 026613167503	3/4" MIP (1/2" Female Flare) EFV x 1/2" FIP 1 Per Bag. 12.875"L x 9.25"W x 1.25"D	48"	-	5

1/4" ID (3/8" OD) - Female Flare x FIP



CSSL115R-24 P 026613167770	1/2" MIP (3/8" Female Flare) EFV X 1/2" FIP 1 Per Bag. 12.875"L x 9.25"W x 1.25"D	24"	-	5
CSSL115R-36 P 026613167787	1/2" MIP (3/8" Female Flare) EFV X 1/2" FIP 1 Per Bag. 12.875"L x 9.25"W x 1.25"D	36"	-	5

1/4" ID (3/8" OD) - MIP x MIP



CSSL44R-24 P 026613167817	1/2" MIP (3/8" FIP) EFV x 1/2" MIP (3/8" FIP) 1 Per Bag. 12"L x 9.25"W x 1.25"D	24"	-	5
CSSL44R-36 P 026613167824	1/2" MIP (3/8" FIP) EFV x 1/2" MIP (3/8" FIP) 1 Per Bag. 12"L x 9.25"W x 1.25"D	36"	-	5
CSSL44R-48 P 026613167831	1/2" MIP (3/8" FIP) EFV x 1/2" MIP (3/8" FIP) 1 Per Bag. 12"L x 9.25"W x 1.25"D	48"	-	5
CSSL44R-60 P 026613167848	1/2" MIP (3/8" FIP) EFV x 1/2" MIP (3/8" FIP) 1 Per Bag. 12.875"L x 9.25"W x 1.25"D	60"	-	5
CSSL47R-24 P 026613167916	1/2" MIP (3/8" FIP) EFV x 3/8" MIP (1/8" FIP) 1 Per Bag. 12"L x 9.25"W x 1.25"D	24"	-	5
CSSL47R-36 P 026613167923	1/2" MIP (3/8" FIP) EFV x 3/8" MIP (1/8" FIP) 1 Per Bag. 12"L x 9.25"W x 1.25"D	36"	-	5
CSSL47R-48 P 026613167930	1/2" MIP (3/8" FIP) EFV x 3/8" MIP (1/8" FIP) 1 Per Bag. 12.875"L x 9.25"W x 1.25"D	48"	-	5

Part No. UPC	Description Package Size	Length	Shelf Qty	Case Qty
-----------------	-----------------------------	--------	--------------	-------------

1/4" ID (3/8" OD) - MIP x MIP (cont.)

CSSL47R-60 P 026613167947	1/2" MIP (3/8" FIP) EFV x 3/8" MIP (1/8" FIP) 1 Per Bag. 12"L x 9.25"W x 1.35"D	60"	-	5
------------------------------	--	-----	---	---



1/4" ID (3/8" OD) - MIP x FIP

CSSL45R-12 P 026613167855	1/2" MIP EFV x 1/2" FIP 1 Per Bag. 19.125"L x 3.1875"W x 1.25"D	12"	-	5
CSSL45R-18 P 026613167862	1/2" MIP EFV x 1/2" FIP 1 Per Bag. 12.875"L x 9.25"W x 1.25"D	18"	-	5
CSSL45R-24 P 026613167879	1/2" MIP EFV x 1/2" FIP 1 Per Bag. 12"L x 9.25"W x 1.35"D	24"	-	5
CSSL45R-36 P 026613167091	1/2" MIP EFV x 1/2" FIP 1 Per Bag. 12"L x 9.25"W x 1.35"D	36"	-	5
CSSL45R-48 P 026613167886	1/2" MIP EFV x 1/2" FIP 1 Per Bag. 12.875"L x 9.25"W x 1.25"D	48"	-	5
CSSL45R-60 P 026613167893	1/2" MIP EFV x 1/2" FIP 1 Per Bag. 12.875"L x 9.25"W x 1.25"D	60"	-	5
CSSL45R-72 P 026613167909	1/2" MIP EFV x 1/2" FIP 1 Per Bag. 12.875"L x 9.25"W x 1.25"D	72"	-	5



COATED GAS CONNECTORS WITH EXCESS FLOW VALVE

ProCoat® Coated Stainless Steel Gas Connectors



The ProCoat® coating helps protect the stainless steel connector from corrosion due to prolonged exposure to harsh chemicals found in common household cleaning, plumbing repair and building products (ammonia, chlorine, solder flux and muriatic acid). Designed for indoor and outdoor use, the ProCoat® coating

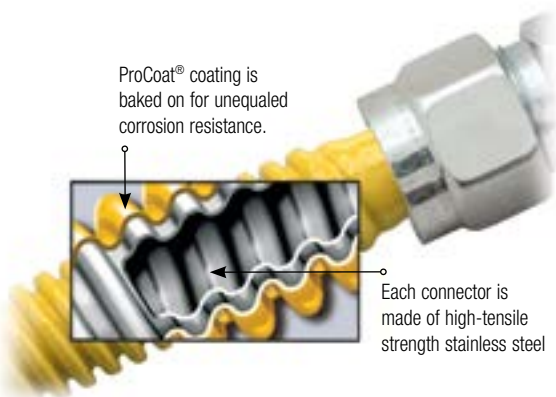

- Superior Corrosion Resistance
- Greater Strength & Flexibility
- Approved for Indoor & Outdoor Use
- 100% Leak Tested
- CSA Certified

**Available
in Black**



Part No. UPC	Description Package Size	Length	Shelf Qty	Case Qty
3/4" ID (7/8" OD) - FIP x MIP				
CSSB21-24 P 026613131511	3/4" FIP x 3/4" MIP (1/2" FIP Tap) 1 Per Bag. 14.25"L x 10.25"W x 1.5"D	24"	-	5
3/4" ID (7/8" OD) - FIP x FIP				
S126624 669771037884	3/4" FIP x 3/4" FIP Bulk w/Flag Label. Includes Mobile Home Instructions 24"L x 1.06"W x 1.06"D	24"	-	10
S126636 669771037891	3/4" FIP x 3/4" FIP Bulk w/Flag Label. Includes Mobile Home Instructions 36"L x 1.25"W x 1.25"D	36"	-	10
S126648 669771037907	3/4" FIP x 3/4" FIP Bulk w/Flag Label. Includes Mobile Home Instructions 48"L x 1.25"W x 1.25"D	48"	-	5
1/2" ID (5/8" OD) - FIP x FIP				
CSSC22-24 P 026613114194	3/4" FIP x 3/4" FIP 1 Per Bag. 13.5"L x 9.25"W x 1.2"D	24"	-	5
CSSC22-36 P 026613114422	3/4" FIP x 3/4" FIP 1 Per Bag. 12"L x 9.25"W x 1.2"D	36"	-	5
CSSC22-48 P 026613114200	3/4" FIP x 3/4" FIP 1 Per Bag. 12"L x 10.25"W x 1.2"D	48"	-	5
CSSC22-60 P 026613114217	3/4" FIP x 3/4" FIP 1 Per Bag. 12"L x 10.25"W x 1.2"D	60"	-	5
CSSC22-72 P 026613121024	3/4" FIP x 3/4" FIP 1 Per Bag. 14.25"L x 10.25"W x 1.2"D	72"	-	5

Part No. UPC	Description Package Size	Length	Shelf Qty	Case Qty
1/2" ID (5/8" OD) - FIP x FIP (cont.)				
CSSC25-36 P 026613116099	3/4" FIP x 1/2" FIP 1 Per Bag. 13.5"L x 9.25"W x 1.2"D	36"	-	5
CSSC25-48 P 026613116105	3/4" FIP x 1/2" FIP 1 Per Bag. 14.25"L x 10.25"W x 1.2"D	48"	-	5
CSSC55-24 P 026613121772	1/2" FIP x 1/2" FIP 1 Per Bag. 13.5"L x 9.25"W x 1.12"D	24"	-	5
CSSC55-36 P 026613115832	1/2" FIP x 1/2" FIP 1 Per Bag. 12"L x 9.25"W x 1.125"D	36"	-	5
CSSC23-48 P 026613116075	3/4" FIP x 3/4" FIP Elbow 1 Per Bag. 14.25"L x 10.25"W x 1.38"D	48"	-	5



1/2" ID (5/8" OD) - MIP x MIP				
CSSC14-24 P 026613121499	3/4" MIP (1/2" FIP Tap) x 1/2" MIP (3/8" FIP Tap) 1 Per Bag. 13.5"L x 9.25"W x 1.125"D	24"	-	5
CSSC14-36 P 026613121505	3/4" MIP (1/2" FIP Tap) x 1/2" MIP (3/8" FIP Tap) 1 Per Bag. 13.5"L x 9.25"W x 1.125"D	36"	-	5
CSSC14-48 P 026613121475	3/4" MIP (1/2" FIP Tap) x 1/2" MIP (3/8" FIP Tap) 1 Per Bag. 14.25"L x 10.25"W x 1.125"D	48"	-	5
CSSC14-60 P 026613121512	3/4" MIP (1/2" FIP Tap) x 1/2" MIP (3/8" FIP Tap) 1 Per Bag. 14.25"L x 10.25"W x 1.125"D	60"	-	5
CSSC14-72 P 026613121017	3/4" MIP (1/2" FIP Tap) x 1/2" MIP (3/8" FIP Tap) 1 Per Bag. 14.25"L x 10.25"W x 1.125"D	72"	-	5
CSSC44-24 P 026613121765	1/2" MIP (3/8" FIP Tap) x 1/2" MIP (3/8" FIP Tap) 1 Per Bag. 13.5"L x 9.25"W x 1.125"D	24"	-	5
CSSC44-36 P 026613114224	1/2" MIP (3/8" FIP Tap) x 1/2" MIP (3/8" FIP Tap) 1 Per Bag. 12"L x 9.25"W x 1.125"D	36"	-	5
CSSC44-48 P 026613114231	1/2" MIP (3/8" FIP Tap) x 1/2" MIP (3/8" FIP Tap) 1 Per Bag. 12"L x 10.25"W x 1.125"D	48"	-	5
CSSC44-60 P 026613121062	1/2" MIP (3/8" FIP Tap) x 1/2" MIP (3/8" FIP Tap) 1 Per Bag. 14.25"L x 10.25"W x 1.125"D	60"	-	5
CSSC44-72 P 026613127583	1/2" MIP (3/8" FIP Tap) x 1/2" MIP (3/8" FIP Tap) 1 Per Bag. 14.25"L x 10.25"W x 1.125"D	72"	-	5



1/2" ID (5/8" OD) - FIP x MIP				
CSSC21-24 P 026613115740	3/4" FIP x 3/4" MIP (1/2" FIP Tap) 1 Per Bag. 13.5"L x 9.25"W x 1.2"D	24"	-	5
CSSC21-36 P 026613114163	3/4" FIP x 3/4" MIP (1/2" FIP Tap) 1 Per Bag. 12"L x 9.25"W x 1.2"D	36"	-	5
CSSC21-48 P 026613114170	3/4" FIP x 3/4" MIP (1/2" FIP Tap) 1 Per Bag. 12"L x 10.25"W x 1.2"D	48"	-	5
CSSC21-60 P 026613114187	3/4" FIP x 3/4" MIP (1/2" FIP Tap) 1 Per Bag. 14.25"L x 10.25"W x 1.25"D	60"	-	5
CSSC21-72 P 026613120911	3/4" FIP x 3/4" MIP (1/2" FIP Tap) 1 Per Bag. 14.25"L x 10.25"W x 1.2"D	72"	-	5
CSSC54-24 P 026613115900	1/2" FIP x 1/2" MIP (3/8" FIP Tap) 1 Per Bag. 13.5"L x 9.25"W x 1.125"D	24"	-	5
CSSC54-36 P 026613114248	1/2" FIP x 1/2" MIP (3/8" FIP Tap) 1 Per Bag. 12"L x 9.25"W x 1.125"D	36"	-	5
CSSC54-48 P 026613114255	1/2" FIP x 1/2" MIP (3/8" FIP Tap) 1 Per Bag. 12"L x 10.25"W x 1.125"D	48"	-	5





Part No. UPC	Description Package Size	Length	Shelf Qty	Case Qty
1/2" ID (5/8" OD) - FIP x MIP (cont.)				
CSSC54-60 P 026613115566	1/2" FIP x 1/2" MIP (3/8" FIP Tap) 1 Per Bag. 14.25"L x 10.25"W x 1.125"D	60"	-	5
CSSC54-72 P 026613125374	1/2" FIP x 1/2" MIP (3/8" FIP Tap) 1 Per Bag. 14.25"L x 10.25"W x 1.125"D	72"	-	5



3/8" ID (1/2" OD) FIP x MIP

CSSD54-12 P 026613114279	1/2" FIP x 1/2" MIP (3/8" FIP Tap) 1 Per Bag. 18.25"L x 3.1875"W x 1.125"D	12"	-	5
CSSD54-18 P 026613114286	1/2" FIP x 1/2" MIP (3/8" FIP Tap) 1 Per Bag. 13.5"L x 9.25"W x 1.125"D	18"	-	5
CSSD54-24 P 026613114293	1/2" FIP x 1/2" MIP (3/8" FIP Tap) 1 Per Bag. 12"L x 9.25"W x 1.25"D	24"	-	5
CSSD54-36 P 026613114309	1/2" FIP x 1/2" MIP (3/8" FIP Tap) 1 Per Bag. 12"L x 9.25"W x 1.25"D	36"	-	5
CSSD54-48 P 026613114316	1/2" FIP x 1/2" MIP (3/8" FIP Tap) 1 Per Bag. 12"L x 9.25"W x 1.25"D	48"	-	5
CSSD54-60 P 026613114323	1/2" FIP x 1/2" MIP (3/8" FIP Tap) 1 Per Bag. 12"L x 9.25"W x 1.125"D	60"	-	5
CSSD54-72 P 026613121482	1/2" FIP x 1/2" MIP (3/8" FIP Tap) 1 Per Bag. 14.25"L x 10.25"W x 1.125"D	72"	-	5



1/4" ID (3/8" OD) - FIP x MIP

CSSL54-12 P 026613115924	1/2" FIP x 1/2" MIP (3/8" FIP Tap) 1 Per Bag. 18.25"L x 3.1875"W x 1"D	12"	-	5
CSSL54-18 P 026613114330	1/2" FIP x 1/2" MIP (3/8" FIP Tap) 1 Per Bag. 12"L x 9.25"W x 1"D	18"	-	5
CSSL54-24 P 026613114347	1/2" FIP x 1/2" MIP (3/8" FIP Tap) 1 Per Bag. 12"L x 9.25"W x 1"D	24"	-	5
CSSL54-30 P 026613118970	1/2" FIP x 1/2" MIP (3/8" FIP Tap) 1 Per Bag. 13.5"L x 9.25"W x 1"D	30"	-	5
CSSL54-36 P 026613114354	1/2" FIP x 1/2" MIP (3/8" FIP Tap) 1 Per Bag. 12"L x 9.25"W x 1"D	36"	-	5
CSSL54-48 P 026613114361	1/2" FIP x 1/2" MIP (3/8" FIP Tap) 1 Per Bag. 12"L x 9.25"W x 1"D	48"	-	5
CSSL54-60 P 026613114378	1/2" FIP x 1/2" MIP (3/8" FIP Tap) 1 Per Bag. 14.25"L x 10.25"W x 1"D	60"	-	5
CSSL54-72 P 026613120546	1/2" FIP x 1/2" MIP (3/8" FIP Tap) 1 Per Bag. 14.25"L x 10.25"W x 1"D	72"	-	5
CSSL87-24 P 026613114392	3/8" FIP x 3/8" MIP (1/8" FIP Tap) 1 Per Bag. 12"L x 9.25"W x 0.93"D	24"	-	5
CSSL87-36 P 026613114408	3/8" FIP x 3/8" MIP (1/8" FIP Tap) 1 Per Bag. 12"L x 9.25"W x 0.85"D	36"	-	5
CSSL87-48 P 026613114415	3/8" FIP x 3/8" MIP (1/8" FIP Tap) 1 Per Bag. 13.5"L x 9.25"W x 0.85"D	48"	-	5
CSSL87-60 P 026613119274	3/8" FIP x 3/8" MIP (1/8" FIP Tap) 1 Per Bag. 14.25"L x 10.25"W x 0.85"D	60"	-	5

Part No. UPC	Description Package Size	Length	Shelf Qty	Case Qty
1/4" ID (3/8" OD) 1/2 FIP x 3/8 FIP with 9/16 24 Fine Thread Female Flare Adapter				
CSST58-18 P 026613180984	1/2" FIP x 3/8" FIP FF FT 1 Per Bag. 9.25"L x 12.88"W x 1.135D	18"	-	5
CSST58-24 P 026613180991	1/2" FIP x 3/8" FIP FF FT 1 Per Bag. 9.25"L x 12.88"W x 1.135D	24"	-	5
CSST58-36 P 026613181004	1/2" FIP x 3/8" FIP FF FT 1 Per Bag. 9.25"L x 12.88"W x 1.135D	36"	-	5
CSST58-60 P 026613181011	1/2" FIP x 3/8" FIP FF FT 1 Per Bag. 10.25"L x 12.88"W x 1.135"D	60"	-	5
CSST58-72 P 026613181028	1/2" FIP x 3/8" FIP FF FT 1 Per Bag. 10.25"L x 12.88"W x 1.135"D	72"	-	5



Gas Installation Kits

Designed to Fit Most New and Older Appliances



Kits contain everything needed to make a quick and EZ gas connection.



- ProCoat® Coated Stainless Steel Gas Connector
- Safety+PLUS® Excess Flow Valve*
- Multiple Steel Gas Fittings to Fit Most Appliances
- Pipe Thread Sealant
- Leak Detection Solution

*Included with PSC1106 K5, PSC1107 K5 and PSC1108X L kits only.



Part No. UPC	Description Package Size	Length	Shelf Qty	Case Qty
-----------------	-----------------------------	--------	--------------	-------------

Black ProCoat® Gas Installation Kit for Gas Log & Space Heater



PSC1079 026613114439	(1) BCSSD54-24 1/2" OD x 24" black coated gas connector (1) AU2-8S 1/2" MIP (3/8" FIP) steel fitting (1) AU1-8S 1/2" FIP steel fitting (1) AU2-8-6S 3/8" MIP steel fitting (1) 3mil tube of pipe thread sealant (1) 3mil tube of leak detection solution 1 Kit Per Box. 9"L x 6.6875"W x 1.25"D	24"	-	5
-------------------------	---	-----	---	---

Safety+PLUS® Gas Installation Kit for Range & Dryer



PSC1106 K5 039166123889	(1) CSSD44R-48 1/2" OD x 48" yellow coated gas connector (1) RU2-8L Safety+PLUS EFV (1/2" MIP) (1) AU2-8S 1/2" MIP (3/8" FIP) steel fitting (1) AU1-8S 1/2" FIP steel fitting (1) AU2-8-6S 3/8" MIP steel fitting (1) 3mil tube of pipe thread sealant (1) 3mil tube of leak detection solution 1 Kit Per Box. 9" L x 9.25" W x 2.25" D	48"	-	5
----------------------------	--	-----	---	---

Part No. UPC	Description Package Size	Length	Shelf Qty	Case Qty
-----------------	-----------------------------	--------	--------------	-------------

Safety+PLUS® Gas Installation Kit for Pro-Grade Range & Furnace (cont.)

PSC1107 K5 039166123896	(1) CSSC54R-48 5/8" OD (15/16-16 Thread) x 48" yellow coated gas connector (1) MRU2-10-12 Safety+PLUS EFV 3/4" MIP (1/2" FIP) (1) MAU2-10-12S 3/4" MIP (1/2" FIP) steel fitting (1) MAU2-10-8S 1/2" MIP steel fitting (1) 3mil tube of pipe thread sealant (1) 3mil tube of leak detection solution 1 Kit Per Box. 9" L x 9.25" W x 2.25" D	48"	-	5
----------------------------	---	-----	---	---



Electric Water Heater Installation Kit

PSC1085X L 039166111619	(2) BWB20-15 3/4" MIP x 3/4" FIP x 15" flexible polymer braided water heater connector (2) 68-14-12X B compression x male adaptor (1) 3mil tube of pipe thread sealant 1 Kit Per Box. 9.0"L x 9.25"W x 2.25"D	15"	-	5
----------------------------	--	-----	---	---



Safety+PLUS® Gas Water Heater Installation Kit

PSC1108X L 039166123902	(2) BWB20-15 3/4" MIP x 3/4" FIP x 15" flexible polymer braided water heater connector (2) 68-14-12X B compression x male adaptor (1) CSSD44R-18 1/2" OD x 18" yellow coated gas connector (1) RU2-8 Safety+PLUS EFV (1/2" MIP) (1) AU2-8-6S 3/8" MIP steel fitting (1) AU1-8S 1/2" FIP steel fitting (1) 3mil tube of pipe thread sealant (1) 3mil tube of leak detection solution 1 Kit Per Box. 9.0"L x 9.25"W x 2.25"D		-	5
----------------------------	--	--	---	---

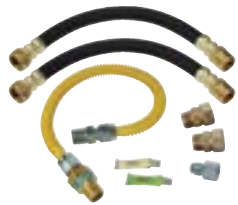

ProCoat® Gas Water Heater Installation Kit

PSC1098 L 039166108558	(1) CSSD44-18 1/2" OD x 18" yellow coated gas connector (2) AU2-8S 1/2" MIP (3/8" FIP) steel fitting (1) AU1-8S 1/2" FIP steel fitting (2) BWB020-15 x 15" braided water heater connector (2) 68-14-12X B compression x male adaptor (1) 3mil tube of pipe thread sealant (1) 3mil tube of leak detection solution 1 Kit Per Box. 10.25"L x 9.25"W x 2.25"D		-	5
---------------------------	--	--	---	---



ProCoat® Tankless Water Heater Installation Kit

PSB1096 L 039166108497	(1) CSSB21-24 7/8" OD x 24" yellow coated gas connector (1) AU2-14-12 1/2" FIP steel fitting (1) AU2-14-16 1" MIP steel fitting (1) AU1-14-12 3/4" FIP steel fitting (1) AU1-14-16 1" FIP steel fitting (1) 3mil tube of pipe thread sealant (2) 3mil tube of leak detection solution 1 Kit Per Bag. 15.125"L x 10.25"W x 1.275"D	24"	-	5
---------------------------	--	-----	---	---



Gas Ball Valves

Superior Performance and Reliability



Forged Brass Body

Eliminates pinhole leaks commonly associated with cast products.

Specially Designed Seat Rings

PTFE seats assure longer life.

Quarter-Turn Design

For easy on/off operation.

Blow-Out Proof Stem

Assembled from the inside with double o-rings to help ensure safe, reliable performance.

100% Leak Tested

Each valve is leak tested to help ensure reliability.

Handle Design

Integrates "T" and lever handles into one, saving inventory SKUs and dollars.

Made in Italy*



Part No. UPC	Description Package Size	Finish	Shelf Qty	Case Qty
-----------------	-----------------------------	--------	--------------	-------------

FIP x FIP



TBV8 026613099415	1/2" FIP x 1/2" FIP Bulk Packed. 2.25"L x 2"W x 1"D		10	50
TBV12 026613099422	3/4" FIP x 3/4" FIP Bulk Packed. 2.69"L x 2.25"W x 1.31"D		10	50
TBV16 026613099439	1" FIP x 1" FIP Bulk Packed. 2.56"L x 2.5"W x 1.62"D		6	36

FIP x FIP - (China)



PSBV503-8 039166081783	1/2" FIP x 1/2" FIP 1 Per Bag. 6"L x 5"W x 1.035"D		-	5
LBV8 026613122052	1/2" FIP x 1/2" FIP Bulk Packed. 2.12"L x 1.985"W x 1.035"D		10	50
PSBV503-12 039166081790	3/4" FIP x 3/4" FIP 1 Per Bag. 8.1875"L x 5"W x 1.375"D		-	5
LBV12 026613122069	3/4" FIP x 3/4" FIP Bulk Packed. 2.38"L x 2.25"W x 1.31"D		10	50

Flare x FIP



PSSC-60 039166055272	5/8" OD Flare (15/16-16 Thread) x 3/4" FIP 1 Per Bag. 6"L x 5"W x 0.75"D		-	5
TBV10-12 026613099385	5/8" OD Flare (15/16-16 Thread) x 3/4" FIP Bulk Packed. 2.5"L x 2.12"W x 1.25"D		10	60
PSSC-68 039166011070	5/8" OD Flare (15/16-16 Thread) x 1/2" FIP 1 Per Bag. 8.1875"L x 5"W x 1.125"D		-	5

*Except where noted

Part No. UPC	Description Package Size	Finish	Shelf Qty	Case Qty
-----------------	-----------------------------	--------	--------------	-------------

Flare x FIP (cont.)

TBV10-8 026613099378	5/8" OD Flare (15/16-16 Thread) x 1/2" FIP Bulk Packed. 2.5"L x 2"W x 1"D		10	60
PSSD-41 039166055210	1/2" OD Flare x 1/2" FIP 1 Per Bag. 6"L x 5"W x 1.25"D		-	5
TBV8-8 026613099361	1/2" OD Flare x 1/2" FIP Bulk Packed. 1.96"L x 1.8"W x 1.25"D		10	50
PSSL-12 039166055203	3/8" OD Flare x 1/2" FIP 1 Per Bag. 6"L x 5"W x 0.9375"D		-	5
TBV6-8 026613099347	3/8" OD Flare x 1/2" FIP Bulk Packed. 2.5"L x 1"W x 2"D		10	50
TBV6F-8 026613099354	3/8" OD Flare (9/16-24 Fine Thread) x 1/2" FIP Bulk Packed. 2.38"L x 2"W x 1"D		10	50



Flare x FIP - Angle

PSSC-61 039166055142	5/8" OD Flare (15/16-16 Thread) x 3/4" FIP 1 Per Bag. 6"L x 5"W x 1.875"D		-	5
TBVA10-12 026613099392	5/8" OD Flare (15/16-16 Thread) x 3/4" FIP Bulk Packed. 2"L x 2.5"W x 2.25"D		10	60



Flare x Flare

TBVF6 026613099316	3/8" OD Flare x 3/8" OD Flare Bulk Packed. 2.63"L x 2"W x 1"D		10	50
-----------------------	--	--	----	----





Part No. UPC	Description Package Size	Finish	Shelf Qty	Case Qty
-----------------	-----------------------------	--------	--------------	-------------

Flare Caps

M40-10 P 026613155715	5/8" OD Flare (15/16-16 Thread) 1 Per Bag. 5"L x 5"W x 0.82"D		-	50
--------------------------	--	--	---	----



Flare x FIP

MAU1-10-12 K5 026613084251	5/8" OD Flare (15/16-16 Thread) x 3/4" FIP Bulk Bag. 8.00"L x 6.00"W x 1.10"D		5	100
-------------------------------	--	--	---	-----

MAU1-10-12S 026613082660	5/8" OD Flare (15/16-16 Thread) x 3/4" FIP Bulk Bag. 12.50"L x 9.00"W x 1.25"D	Rough	25	150
-----------------------------	---	-------	----	-----



MAU1-10-8 K5 026613084275	5/8" OD Flare (15/16-16 Thread) x 1/2" FIP Bulk Bag. 8.00"L x 6.00"W x 1.10"D		5	200
------------------------------	--	--	---	-----



MAU1-10-8S 026613088570	5/8" OD Flare (15/16-16 Thread) x 1/2" FIP Bulk Bag. 12.50"L x 9.00"W x 2.50"D	Rough	25	150
----------------------------	---	-------	----	-----



Flare x MIP

MAU2-10-12 K5 026613084282	5/8" OD Flare (15/16-16 Thread) x 3/4" MIP (1/2" FIP) Bulk Bag. 8.00"L x 6.00"W x 1.10"D		5	120
-------------------------------	---	--	---	-----

MAU2-10-12S 026613082677	5/8" OD Flare (15/16-16 Thread) x 3/4" MIP (1/2" FIP) Bulk Bag. 12.50"L x 9.00"W x 1.19"D	Rough	25	125
-----------------------------	--	-------	----	-----

MAU2-10-8 K5 026613084299	5/8" OD Flare (15/16-16 Thread) x 1/2" MIP (3/8" FIP) Bulk Bag. 6.00"L x 6.00"W x 1.10"D		5	100
------------------------------	---	--	---	-----

MAU2-10-8S 026613082684	5/8" OD Flare (15/16-16 Thread) x 1/2" MIP (3/8" FIP) Bulk Bag. 12.50"L x 9.00"W x 1.13"D	Rough	25	150
----------------------------	--	-------	----	-----



Fine Thread Female Flare Adaptors

PSFT-12 039166105311	3/8" OD Flare (9/16-24 Fine Thread) x 1/2" MIP (3/8" FIP) w/Yellow Chromate Coating 1 Per Bag. 7.4375"L x 3.1875"W x 1.22"D		5	50
-------------------------	--	--	---	----

PSCFT-10 039166082964	3/8" OD Flare (9/16-24 Fine Thread) x 3/8" MIP w/Yellow Chromate Coating 1 Per Card. 2.82"L x 2.75"W x 1.375"D		-	10
--------------------------	---	--	---	----



PSCFT-11 039166082971	3/8" OD Flare (9/16-24 Fine Thread) x 1/2" FIP w/Yellow Chromate Coating 1 Per Card. 2.82"L x 2.75"W x 1.375"D		-	10
--------------------------	---	--	---	----



Flare x FIP

PSSL-13 039166081769	3/8" OD Flare x 3/8" FIP 1 Per Bag. 6.8"L x 3.188"W x 1.22"D		5	50
-------------------------	---	--	---	----

PSSL-15 039166081813	3/8" OD Flare x 1/2" FIP 1 Per Bag. 6.8"L x 3.188"W x 1.22"D		5	50
-------------------------	---	--	---	----

PSSD-42 039166081745	1/2" OD Flare x 1/2" FIP 1 Per Bag. 6.8"L x 3.188"W x 1.22"D		5	50
-------------------------	---	--	---	----

PSSC-62 039166081707	5/8" OD Flare (15/16-16 Thread) x 1/2" FIP 1 Per Bag. 6.8"L x 3.188"W x 1.22"D		5	50
-------------------------	---	--	---	----

PSSC-66 039166081806	5/8" OD Flare (15/16-16 Thread) x 3/4" FIP 1 Per Bag. 6.8"L x 3.188"W x 1.22"D		5	50
-------------------------	---	--	---	----

Part No. UPC	Description Package Size	Finish	Shelf Qty	Case Qty
Flare x FIP Elbow				
PSSC-65 039166081752	5/8" OD Flare (15/16-16 Thread) x 3/4" FIP 1 Per Bag. 7.4375"L x 3.1875"W x 1.22"D		5	50



Flare x MIP				
PSSC-63 039166081714	5/8" OD Flare (15/16-16 Thread) x 1/2" MIP (3/8" FIP) 1 Per Bag. 6.8"L x 3.188"W x 1.22"D		5	50
PSSC-64 039166081721	5/8" OD Flare (15/16-16 Thread) x 3/4" MIP (1/2" FIP) 1 Per Bag. 6.8"L x 3.188"W x 1.22"D		5	50
PSSD-43 039166081738	1/2" OD Flare x 1/2" MIP (3/8" FIP) 1 Per Bag. 6.8"L x 3.188"W x 1.375"D		5	50
PSSD-44 039166105304	1/2" OD Flare x 3/4" MIP 1 Per Bag. 6.8"L x 3.188"W x 1.22"D		5	50
PSSL-14 039166081776	3/8" OD Flare x 3/8" MIP (1/8" FIP) 1 Per Bag. 6.8"L x 3.188"W x 1.22"D		5	50
PSSL-16 039166081820	3/8" OD Flare x 1/2" MIP (3/8" FIP) 1 Per Bag. 6.8"L x 3.188"W x 1.22"D		5	50



Female Flare x MIP				
AU6-8-6 P 026613159348	1/2" Female Flare x 3/8" MIP 1 Per Bag. 7.4375"L x 3.1875"W x 0.875"D		-	5



Female Flare x FIP				
AU7-10-8 P 026613159355	5/8" Female Flare x 1/2" FIP 1 Per Bag.		-	5



Part No. UPC	Description Package Size	Finish	Shelf Qty	Case Qty
-----------------	-----------------------------	--------	--------------	-------------

Seal'n Check Kit



PS1087 039166094714	Includes (3mil) Pipe Thread Sealant & (3mil) Leak Test Solution 1 Kit Per Clamshell. 3.625"L x 0.25"W x 0.75"D		10	50
------------------------	---	--	----	----



PS1087 XL 026613172620	Includes (1 oz) Pipe Thread Sealant & (2 oz) Leak Test Solution 1 Kit Per Slide Pack 5.875"L x 2.5"W x 1.375"D		-	5
---------------------------	---	--	---	---



PSC1094 L 039166105298	(2 oz) Leak Test Solution 1 Bottle per Bag. 6"L x 4"W x 1.25"D		-	5
---------------------------	---	--	---	---

Part No. UPC	Description Package Size
-----------------	-----------------------------

Brochures

BC8470 How to Select & Install Water Supply Stops and Connectors Brochure - 8.5" High x 3.5" Wide



BC8472 How to Select & Install Gas Appliance Connectors Brochure - 8.5" High x 3.5" Wide



BC8473 Procoat Gas Connector Take-With Brochure - 9" High x 10.75" Wide



BC8471 Safety+PLUS Gas Connector Take-With Brochure - 9" High x 11" Wide



Signage

BC8500 Flexible Water Supply Connectors Faucet and Toilet Double Sided Header With Rack - Horizontal - 8" High x 18" Wide



BC8480 Flexible Water Supply Connectors Faucet Divider - Vertical - 24" High x 6" Wide



BC8483 Flexible Water Supply Connectors Toilet Divider - Vertical - 24" High x 6" Wide



Part No. UPC	Description Package Size
-----------------	-----------------------------

Signage (cont.)



BC8491	Polymer Braided Water Heater Connector Header for Rack - 6.5" High x 5.5" Wide
--------	--



BC203	Water Heater Connector Rack w/ProCoat and Copper-Flex Header - 6.5" High x 5.5" Wide
-------	--



BC8501	Gas Connector Rack with ProCoat Header - 11" High x 18" Wide
--------	--



BC8502	Gas Connector Rack with Safety+PLUS Header - 11" High x 18" Wide
--------	--



BC8492	Procoat Aisle Header - Horizontal - 8" High x 24" Wide
--------	--



BC8493	Procoat Aisle Header - Vertical - 24" High x 6" Wide
--------	--



BC8481	Safety+PLUS Aisle Header - Horizontal - 8" High x 24" Wide
--------	--



BC8482	Safety+PLUS Advantage Divider - Vertical - 24" High x 6" Wide
--------	---



BC8503	ProCoat Large Diameter Gas Connector Rack - 6.5" High x 5.5" Wide
--------	---

Part No. UPC	Description Package Size
-----------------	-----------------------------

Sizing Guide

BC8510 Flexible Water Supply Connectors and Faucet and Toilet Sizing Guide - Vertical - 19.5" High x 6.25" Wide



BC8511 Gas Appliance Connector Sizing Guide - 19.5" High x 6.25" Wide



Merchandising Aides

DIH824 Aisle Header Plastic Mounting Frame - 8.5" High x 24.25" Wide
1 Per Each.



PS8024 Metal Vertical Divider Holder - 24" High x 6" Wide
1 Per Each.



DD6000 Wire Brochure Holder - 5" High x 4.25" Wide x 2.75" Deep
1 Per Each.



1/4 TURN SUPPLY VALVES – G2™ SERIES

Use: For use in potable water distribution systems. Not intended for recirculating water systems that produce continuous use temperatures above 115° F.

Design Features:

- **One-piece shut-off mechanism** provides smooth on-off operation
- **Machined one-piece brass body** provides strength, durability, and long-lasting performance
- **Positive 1/4 turn shut off**
- **Easy-to-remove handle** protects accidental valve operation during rough-ins
- **100% leak tested**
- 

Operating Specifications:

Temperature: 40°- 160° F
Pressure: 125 PSI maximum

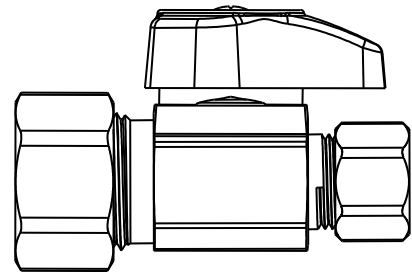
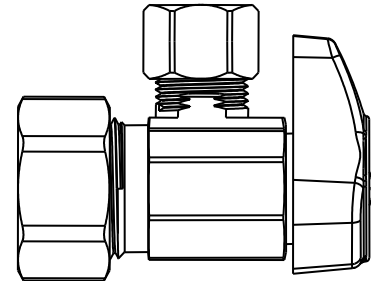

VALVE MATERIAL SPECIFICATIONS

Body	<i>Brass or brass, plated</i>
Handle	<i>Zinc die cast or plated ABS</i>
Handle Screw	<i>Steel, plated</i>
O-ring	<i>Rubber</i>
Stem Shaft	<i>Polypropylene</i>
Stem Barrel	<i>TPE</i>
Compression Sleeve	<i>Brass</i>
Compression Nut	<i>Brass or brass, plated</i>

Listings & Certifications:

- IAPMO listed to ASME A112.18.1 / CSA B125.1



1/4 TURN SUPPLY VALVES – PUSH CONNECT

Use: For use only in potable water distribution systems. Not intended for recirculating water systems that produce continuous use temperatures above 115° F.

Design Features:

- **One-piece shut-off mechanism** provides smooth on-off operation
- **Compatible** with PEX, copper, and CPVC tubing
- **Pre-assembled tube insert** is “installation ready” for a faster connection
- **Fast**, reliable, and secure connection
- **Positive** 1/4 turn shut off
- **Easy-to-remove handle** helps protect against accidental valve operation during rough-ins
- **Compact, machined** one-piece body design
- **100% leak tested**
- 

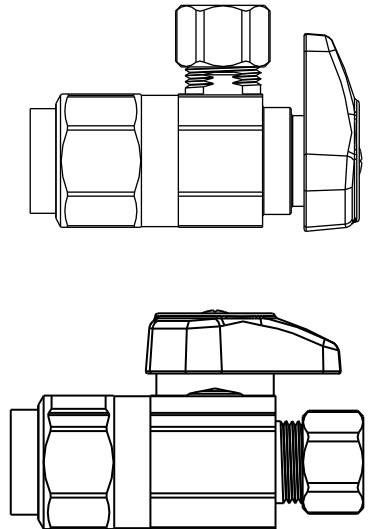

Operating Specifications:

Temperature: 40° - 160° F
Pressure: 125 PSI maximum

VALVE MATERIAL SPECIFICATIONS	
Body	<i>Brass or brass, plated</i>
Handle	<i>Zinc die cast or plated ABS</i>
Handle Screw	<i>Steel, plated</i>
O-ring	<i>Rubber</i>
Stem Shaft	<i>Polypropylene</i>
Stem Barrel	<i>TPE</i>
Removal Flange	<i>Polypropylene</i>
Tube Insert	<i>POM</i>
Gripper Ring	<i>Stainless steel</i>
Push Connect Retainer	<i>Nylon</i>
Compression Sleeve	<i>Brass</i>
Compression Nut	<i>Brass or brass, plated</i>

Listings & Certifications:

- IAPMO listed to ASME A112.18.1 / CSA B125.1 and ASSE 1061



MULTI-TURN SUPPLY VALVES

Use: For use in potable water distribution systems. Not intended for recirculating water systems that produce continuous use temperatures above 115° F.

Design Features:

- **Machined one-piece brass body** provides strength, durability, and long-lasting performance
- **Easy-to-remove handle** protects accidental valve operation during rough-ins
- **Oval knurled handle** provides a secure grip and smooth on/off operation
- **Handle variations** available for specific configurations – see variations page
- **Dual outlet and dual outlet/dual shut-off** configurations available
- 

Operating Specifications:

Temperature: 40° - 140° F

Pressure: 125 PSI maximum

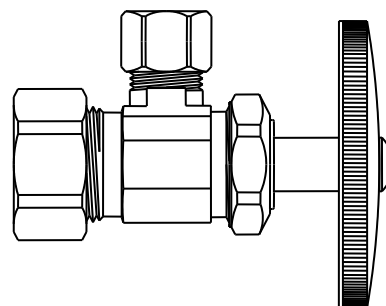
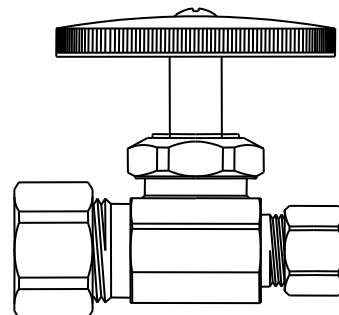
**VALVE MATERIAL SPECIFICATIONS**

Body	<i>Brass or brass, plated</i>
Stem	<i>POM or brass, plated</i>
Handle	<i>Zinc die cast; ABS, plated; or Polycarbonate</i>
Handle Screw	<i>Plated steel</i>
Bib & Packing Washer	<i>Rubber</i>
Packing Nut	<i>Brass or brass, plated</i>
Compression Sleeve	<i>Brass</i>
Compression Nut	<i>Brass or brass, plated</i>

Listings & Certifications:

- IAPMO listed to ASME A112.18.1 / CSA B125.1



WATER SUPPLY CONNECTORS – SUPPLY RISERS, COPPER OR PEX

Use: For use in potable water distribution systems in accessible locations only.

Design Features:

- **One-piece** construction
- **Cut-to-length** for clean, professional installation
- 

Operating Specifications:

Temperature 40° - 180° F
Pressure: 125 PSI maximum

Tubing Diameter: 3/8" OD or 1/2" OD

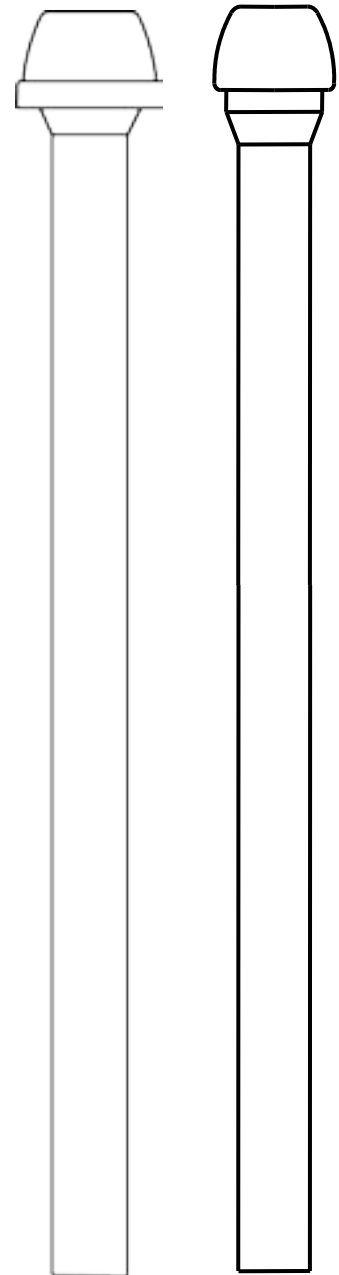

CONNECTOR MATERIAL SPECIFICATIONS	
Tube	<i>Cross-linked Polyethylene (PEX) or copper</i>
Compression Sleeve (3/8"OD)	<i>POM (PEX only)</i>
Insert	<i>POM (copper only)</i>
Optional Brass Nosepiece	<i>Low-Lead brass</i>
Optional Cone Washer	<i>Rubber</i>
Optional Brass Ring	<i>Brass</i>

Listings & Certifications:

- IAPMO listed to ASME A112.18.1 / CSA B125.1



WATER SUPPLY CONNECTORS – SPEEDI PLUMB® PLUS – FLEXIBLE POLYMER BRAIDED

Use: For use only in potable water distribution systems in accessible locations.

Design Features:

- **Corrosion resistance** to harsh chemicals found in most common household cleaning and plumbing repair products
- **Braided polymer-coated fibers** bend freely without kinking or crimping
- **Tough inner core** is reinforced to resist chlorine and chloramine leaching and deterioration
- **Rubber washers** provide a large pliable sealing surface and ensure a long lasting water-tight connection
- **Deep threaded wing nut** for quick and secure connections
- 

Operating Specifications:

Temperature: 40°- 160° F, intermittent to 180° F

Pressure: 125 PSI maximum

CONNECTOR MATERIAL SPECIFICATIONS	
Inner Hose	Reinforced PVC
Braiding	PVC coated polyester yarn
Barb	Brass
Ferrule	Zinc-plated steel
Nut	Brass or polypropylene
Washer	Rubber

Listings & Certifications:

- IAPMO listed to ASME A112.18.6 / CSA B125.6

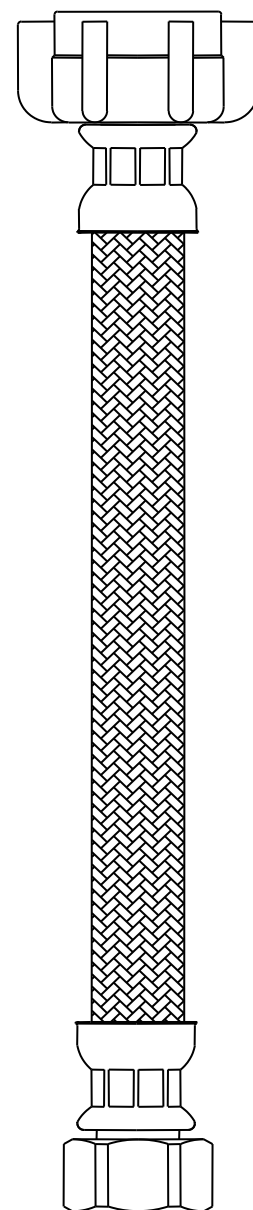

WATER SUPPLY CONNECTORS – SPEEDI PLUMB® – VINYL

Use: For use only in potable water distribution systems in accessible locations.

Design Features:

- **No kink hose.** The specially engineered reinforced PVC hose provides unique flexibility to prevent kinking and crimping
- **Greater strength and durability** with a tighter weave and two-layer bonded construction, outperforms conventional vinyl connectors
- **Rubber washers** provide a large pliable sealing surface and ensure a long lasting water-tight connection
- **Deep threaded wing nut** for quick and secure connections
- **Tough inner core** is reinforced to resist chlorine and chloramine leaching and deterioration
- 

Operating Specifications:

Temperature: 40°- 160° F, intermittent to 180° F
Pressure: 125 PSI maximum

CONNECTOR MATERIAL SPECIFICATIONS	
Hose	<i>PVC with polyester braid reinforcement</i>
Barb	<i>Brass</i>
Ferrule	<i>Zinc-plated steel</i>
Nut	<i>Brass or polypropylene</i>
Washer	<i>Rubber</i>

Listings & Certifications:

- IAPMO listed to ASME A112.18.6 / CSA B125.6

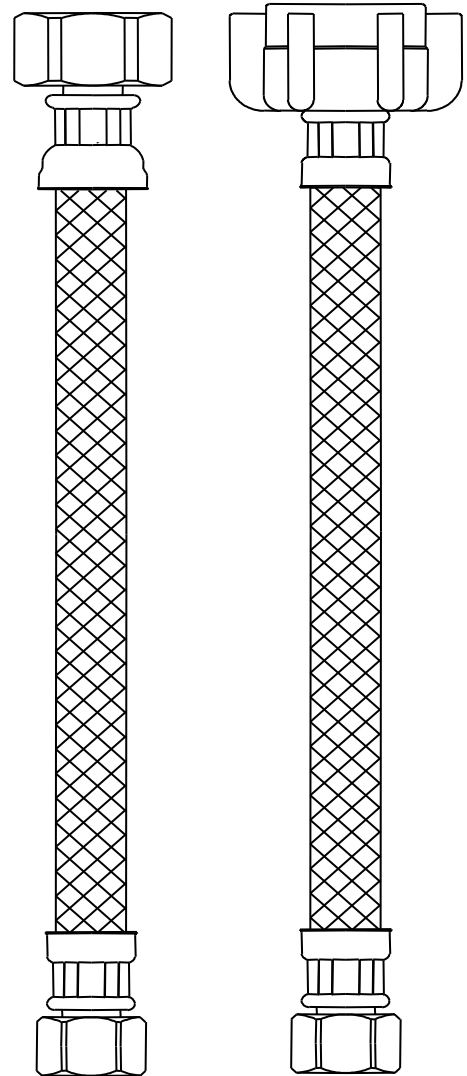

SPEEDI PLUMB® PLUS POLYMER BRAIDED WATER HEATER CONNECTORS

Use: For use only in exposed locations to connect water heaters and other water connected devices to the water supply. Not intended for use with recirculating water systems that produce continuous use temperatures above 115° F. For those applications use the BrassCraft® CopperFlex™ or ProCoat® series connectors.

Design Features:

- **Corrosion resistance** to harsh chemicals found in most common household cleaning, plumbing repair and masonry products when compared to stainless steel braided connectors.
- **Greater strength & flexibility.** The polymer braid exhibits superior elasticity, significantly increasing the flexibility of the connector when compared to stainless steel braiding.
- **No kinking, no crimping.** The polymer braided jacket is specially engineered to bend freely without kinking or crimping the connector
- **Won't work harden** even with repeated bending
- **No dielectric union needed** with installation as the braiding and rubber are constructed of non-conductive materials*
- **Longer connector nuts** allow a greater number of thread-to-thread contact and a better seal.
- 

Operating Specifications:

Temperature: 40° - 160° F, intermittent to 180° F

Pressure: 125 PSI maximum

OPERATING SPECIFICATION				
	12"	15"	18"	24"
Flow Coefficient (Cv)	5.9	5.8	5.6	5.4

ΔP (Pressure Drop) = GPM^2 / Cv^2 for Example: 24" length connector @ 10 GPM

$$\Delta P = 10^2 / 5.4^2 = 100 / 29.16 = 3.43 \text{ psi}$$

MATERIAL SPECIFICATIONS	
Inner Hose	Rubber
Braiding	Coated polyester yarn
Barb	Brass
Ferrule	Brass
Nut	Brass
End Fitting	Brass
Washer	Rubber

Listings & Certifications:

- IAPMO listed to ASME A112.18.6 / CSA B125.6

*Check with your local inspection office for applicable code requirements

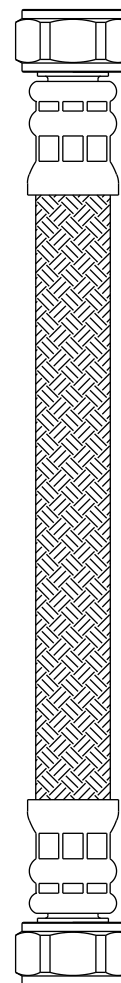

COPPER WATER HEATER CONNECTORS

Use: For use only in exposed locations to connect water heaters and other water connected devices to the water supply.

Design Features:

- **Built-in galvanic corrosion resistance.** Internal dielectric sleeve effectively isolates dissimilar metals within the waterway to prevent galvanic corrosion
- **No dielectric union needed** with installation. Dielectric is built into the design of the connector*
- **Nut provides** full thread engagement resulting in secure connection
- 

Operating Specifications:

Temperature: 40° - 180° F
Pressure: 125 PSI maximum

MATERIAL SPECIFICATIONS	
Tubing	<i>Copper</i>
Dielectric Sleeve	<i>Polypropylene</i>
Nut	<i>Brass</i>
End Fitting	<i>Brass</i>
Washer	<i>Rubber</i>

Listings & Certifications:

- IAPMO listed to ASME A112.18.6 / CSA B125.6



*Check with your local inspection office for applicable code requirements

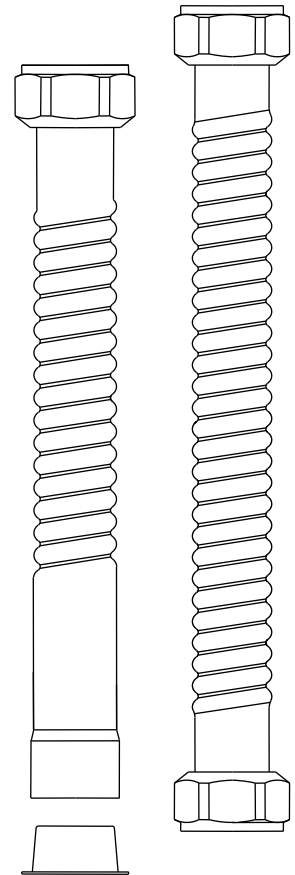

PROCOAT® STAINLESS STEEL WATER HEATER CONNECTORS

Use: For use only in exposed locations to connect water heaters, water softeners, and other water connected devices to the water supply.

Design Features:

- **Corrosion resistant** coating to protect against harsh chemicals found in most common household cleaning, plumbing repair, and masonry products
- **Maximum performance.** ¾" internal diameter provides greater water flow without obstruction
- **Integrated dielectric sleeve** effectively isolates dissimilar metals within the waterway to help prevent galvanic and electrolytic corrosion
- **No dielectric union needed** with installation. Dielectric is built into the design of the connector*
- **Nut provides** full thread engagement resulting in a secure connection
- **100% leak tested** prior to coating application to help ensure connector performance and reliability
- 

Operating Specifications:

Temperature: 40° - 180° F

Pressure: 125 PSI maximum

MATERIAL SPECIFICATIONS

Tubing	<i>Stainless steel</i>
Dielectric Sleeve	<i>Polypropylene</i>
Nut	<i>Brass, chrome plated</i>
Washer	<i>Rubber</i>

Listings & Certifications:

- IAPMO listed to ASME A112.18.6 / CSA B125.6 (File # 0452)

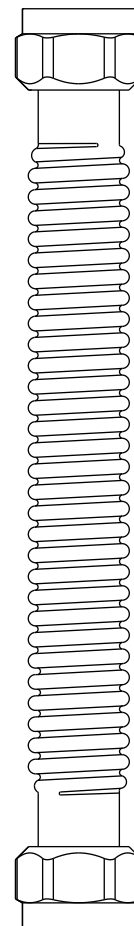

*Check with your local inspection office for applicable code requirements

PROCOAT® GAS APPLIANCE CONNECTORS

Use: For use with indoor and outdoor connections of gas appliances to gas piping system. May be used with natural, manufactured, mixed and liquefied petroleum (LP or propane) gases, and LP gas-air mixtures. Gas connectors may not be permitted for all uses in all locations. Consult with a certified professional installation expert to ensure compliance with all applicable codes.

Design Features:

- **Corrosion resistant** coating to protect against harsh chemicals found in most common household cleaning, plumbing repair, and masonry products
- **UV rays and salt resistant**, ProCoat® gas connectors are certified for indoor and outdoor use
- **100% leak tested**

Operating Specifications:

Temperature: -40° - 150° F
Pressure: 1/2 PSI maximum

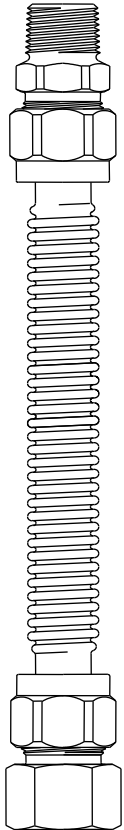

MATERIAL SPECIFICATIONS	
Tubing	<i>Stainless steel</i>
Coating	<i>Polymer blend</i>
Nut	<i>Steel</i>
Fitting	<i>Steel</i>

CONNECTOR FLOW CAPACITY – NATURAL GAS (Straight Length)									
MODEL	ID	12"	18"	24"	30"	36"	48"	60"	72"
CSSB	3/4"	290,900	290,900	290,900	270,500	255,900	215,000	197,400	173,900
CSSC	1/2"	180,000	164,200	150,000	136,000	125,000	106,000	93,200	86,000
CSSD	3/8"	102,000	93,100	85,000	77,100	71,100	60,500	53,200	49,100
CSSL	1/4"	48,000	43,800	40,000	36,400	33,400	28,300	24,900	23,100

CONNECTOR FLOW CAPACITY - LPG (PROPANE) (Straight Length)									
MODEL	ID	12"	18"	24"	30"	36"	48"	60"	72"
CSSB	3/4"	465,440	465,440	465,440	432,800	409,440	344,000	315,840	278,240
CSSC	1/2"	288,000	262,720	240,000	217,600	200,000	169,600	149,120	137,600
CSSD	3/8"	163,200	148,960	136,000	123,360	113,760	96,800	85,120	78,560
CSSL	1/4"	76,800	70,080	64,000	58,240	53,440	45,280	39,840	36,960

Listings & Certifications:

- CSA listed to ANSI Z21.24 / CSA 6.10 standard "Connectors for Gas Appliances"
- CSA listed to ANSI Z21.75 / CSA 6.27 standard "Connectors for Outdoor Gas Appliances & Manufactured Homes" (file #204593)
- The Commonwealth of Massachusetts



GAS BALL VALVES

Use: For use with natural, manufactured, mixed, liquefied petroleum (LP) gas, and LP gas-air mixtures.

The National Fuel Gas Code requires a gas shut-off valve installed upstream, within "easy reach" or 6 feet of the gas appliance

Design Features:

- **Heavy duty forged brass body** helps reduce pinhole leaks commonly associated with cast products
- **Blow-out resistant stem** is assembled from the inside with double o-rings for reliable performance
- **Right-sized handle** helps ensure easy on/off operation even in tight installations
- **Quarter turn operation** for easy on/off flow control
- **PTFE seat** for longer life and consistent performance
- **Approved for indoor/outdoor use**
- **100% leak tested**

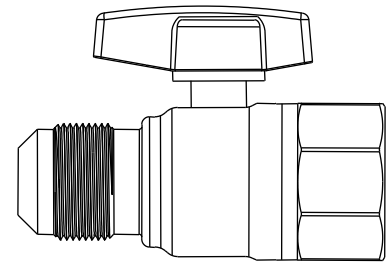
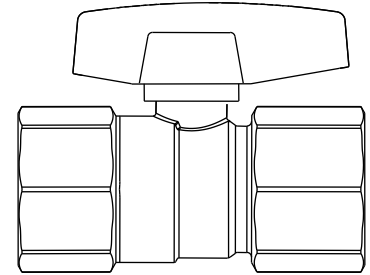
**Operating Specifications:**

Temperature: -40° - 125° F*

Pressure: 5 PSI maximum

* TBV6F-8, TBV10-12, and TBVA10-12 are rated for 32°-125° F

MATERIAL SPECIFICATIONS

Valve Body	Forged brass
Retainer	Forged brass
Ball	Brass, plated
Seat	PTFE
Stem	Brass
O-ring	High-temperature rubber
Handle	Aluminum, coated
Screw	Steel, plated

Listings and Certifications:

- CSA listed to ANSI Z21.15 / CSA 9.1, ANSI / ASME B16.44 and CGA CR91-002



NIPPLES – BRASS PIPE

Use: For use with water, grease, fuels, LP and natural gas, refrigeration, instrumentation, and hydraulic systems in low and medium pressure pipe line connections. Use in combination with brass, copper, and iron pipe.

Design Features:

- **Designed and manufactured** to SAE (Society of Automotive Engineers) thread standards
- **Available** in a broad range of sizes
- **Low-lead** product available

Operating Specifications:

Temperature: -65° - 250° F
Working Pressure: Up to 1200 PSI
Vibration: Fair resistance to vibration and pipe movement depending on conditions

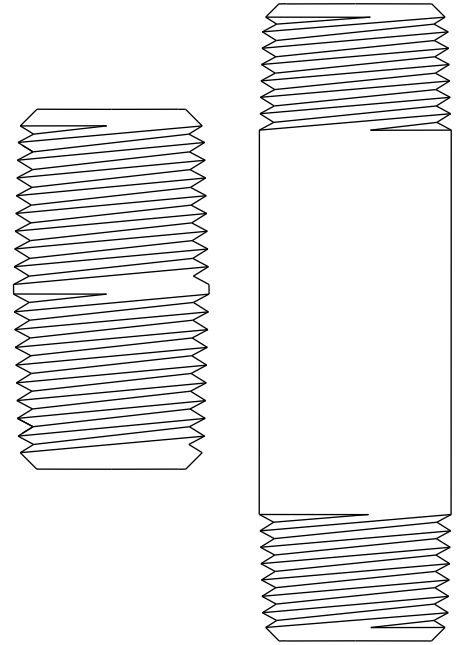

NIPPLE MATERIAL SPECIFICATIONS	
Nipple	<i>Yellow or Low-lead brass</i>

COMPRESSION FITTINGS

Use: For use with potable water, instrumentation, hydraulic, and pneumatic systems. Designed for use with aluminum, copper, and plastic tubing. Not intended for use with steel tubing.

* Plastic tubing requires a plastic insert and sleeve (see 60PT & 63PT).

Design Features:

- **Little to no tube preparation.** Compression fittings do not require flaring, soldering, or other types of tube preparation
- **Available in** a broad range of sizes
- **Low-lead** product available

Operating Specifications:

Temperature: -65° - 250° F at maximum operating pressures

Working Pressure: See chart below

Vibration: Fair vibration resistance

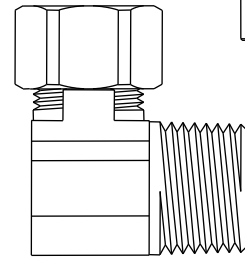
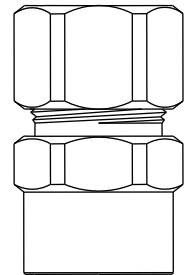
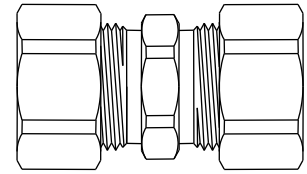

WORKING PRESSURE		
PSI	Tube OD	Tube Wall (Inches)
400	1/8	0.030
400	3/16	0.030
300	1/4	0.030
300	5/16	0.032
200	3/8	0.032
200	1/2	0.032
150	5/8	0.035
100	3/4	0.035
75	7/8	0.035

Standard Product

FITTING MATERIAL SPECIFICATIONS	
Fitting Body	Brass
Compression Sleeve	Brass
Compression Nut	Brass
Option	Chrome plating

Low-lead Product

FITTING MATERIAL SPECIFICATIONS	
Fitting Body	Low-lead brass
Compression Sleeve	Brass
Compression Nut	Brass

FITTINGS – BRASS CPVC TRANSITION

Use: For use with water, grease, fuels, LP and natural gas, refrigeration, instrumentation, and hydraulic systems in low and medium pressure pipe line connections. Use in combination with brass, copper, and iron pipe.

Design Features:

- **Designed and manufactured** to SAE (Society of Automotive Engineers) thread standards
- **Available in** a broad range of sizes
- **Low-lead** product available

Operating Specifications:

Temperature: See Catalog
Working Pressure: Up to 400 PSI – See Catalog
Vibration: Fair resistance to vibration and pipe movement depending on conditions

Standard Product

FITTING MATERIAL SPECIFICATIONS	
Fitting Body	<i>Brass</i>
CPVC Insert	<i>CPVC</i>
CPVC Washer	<i>Rubber</i>
CPVC Nut	<i>Brass</i>
Compression Sleeve	<i>Brass</i>
Compression Nut	<i>Brass</i>

Low-lead Product

FITTING MATERIAL SPECIFICATIONS	
Fitting Body	<i>Low-lead brass</i>
CPVC Insert	<i>CPVC</i>
CPVC Washer	<i>Rubber</i>
CPVC Nut	<i>Brass</i>
Compression Sleeve	<i>Brass</i>
Compression Nut	<i>Brass</i>

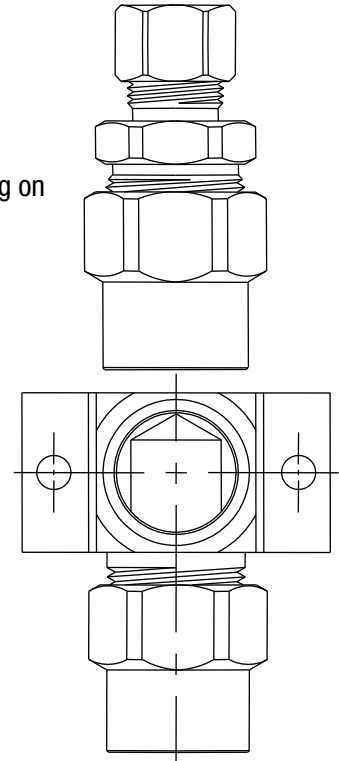

GARDEN HOSE FITTINGS

Use: For use with residential and commercial grade garden hose. All female hose thread connections require a rubber washer inserted prior to installation.

Design Features:

- Available in a broad range of configurations
- Low-lead product available

Operating Specifications:

Temperature: -35° - 100°F at maximum operating pressures

Working Pressure: 75 PSI maximum, intermittent to 150 PSI

Standard Product**FITTING MATERIAL SPECIFICATIONS**

Fitting Body	Brass
Hose Washer	Rubber

Low-lead Product**FITTING MATERIAL SPECIFICATIONS**

Fitting Body	Low-lead brass
Hose Washer	Rubber

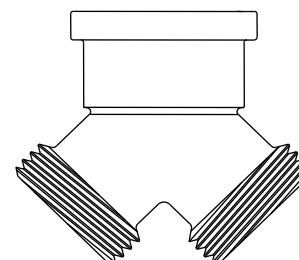
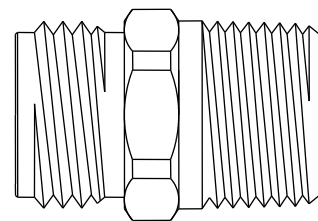
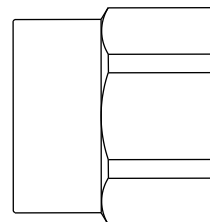

PART NO.	PAGE	PART NO.	PAGE	PART NO.	PAGE
10X CD	25	BC8473	51	CS40BX CD	10
1-12A CH	14	BC8480	51	CS41BX CD	10
1-12DL CF	14	BC8481	52	CSSB21-24 P	40
1-12DL CH	14	BC8482	52	CSSC12R-24 P	37
113-06-4-CX D	23	BC8483	51	CSSC12R-36 P	37
113-06-6-CX D	23	BC8491	52	CSSC12R-48 P	37
113-08-3-CX D	23	BC8492	52	CSSC12R-60 P	37
113-08-4-CX D	23	BC8493	52	CSSC12R-72 P	37
11X CD	25	BC8500	51	CSSC14-24 P	41
1-20A CF	14	BC8501	52	CSSC14-36 P	41
1-20A CH	14	BC8502	52	CSSC14-48 P	41
1-20DL CF	14	BC8503	52	CSSC14-60 P	41
1-20DL CH	14	BC8510	53	CSSC14-72 P	41
12X CD	25	BC8511	53	CSSC21-24 P	41
1-36A CH	14	BC96X	13	CSSC21-36 P	41
13X CD	25	BC97X	13	CSSC21-48 P	41
14X CD	25	BCRP01 D	29	CSSC21-60 P	41
462-6-6-1X CD	25	BCRP02 D	30	CSSC21-72 P	41
462-8-6-1X CD	25	BCSR01	29	CSSC22-24 P	40
63-6-8WX CD	25	BL12-48WA P	17	CSSC22-36 P	40
66-6-8WX CD	25	BL12-60WA P	17	CSSC22-48 P	40
69-6-6X CD	25	BL12-60WA P2	17	CSSC22-60 P	40
8489 CD	29	BL12-72WA B	17	CSSC22-72 P	40
AUG-8-6 P	49	BL12-72WA P	17	CSSC22R-24 P	37
AU7-10-8 P	49	BL3-48DW F	17	CSSC22R-36 P	37
B0-120IM P	18	BL3-60DW F	17	CSSC22R-48 P	37
B0-12IM F	18	BL3-72DW F	17	CSSC22R-60 P	37
B0-60IM P	18	BWB0-12	31	CSSC23-48 P	41
B0-72IM P	18	BWB0-15	31	CSSC25-36 P	41
B0-96IM P	18	BWB0-18	31	CSSC25-48 P	41
B1-12DLU D	16	BWB0-18PX	31	CSSC44-24 P	41
B1-20AU D	16	BWB0-24	31	CSSC44-36 P	41
B1-48DW12 P	17	BWB05-18	31	CSSC44-48 P	41
B1-48DW6 P	17	BWB08-18	31	CSSC44-60 P	41
B1-60DW1 P	18	BWB08-24	31	CSSC44-72 P	41
B1-60DW6 P	17	BWB20-12	32	CSSC44R-24 P	37
B1-72DW F	17	BWB20-15	32	CSSC44R-36 P	37
B1-72DW6 P	17	BWB20-18	32	CSSC44R-48 P	37
B1U-48DW612 D	17	BWB20-24	32	CSSC44R-60 P	37
B1U-72DW612 D	17	BWB25-18	32	CSSC45R-24 P	37
B8-60DW6 P	18	BWB28-18	32	CSSC45R-36 P	37
BC203	52	BWB28-24	32	CSSC45R-48 P	37
BC2456	20	C14X CD	25	CSSC45R-60 P	37
BC8470	51	CR1900DVX C	11	CSSC54-24 P	41
BC8471	51	CR1901DVX CD	11	CSSC54-36 P	41
BC8472	51	CR1901LRX RD	12	CSSC54-48 P	41

PART NO.	PAGE	PART NO.	PAGE	PART NO.	PAGE
CSSC54-60 P.....	42	CSSL54-12 P.....	42	G2R15X CD.....	7
CSSC54-72 P.....	42	CSSL54-18 P.....	42	G2R17X CD.....	7
CSSC55-24 P.....	41	CSSL54-24 P.....	42	G2R37X CD.....	7
CSSC55-36 P.....	41	CSSL54-30 P.....	42	HES-6-12WNMX D.....	28
CSSC91R-36 P.....	37	CSSL54-36 P.....	42	HES-6-12X.....	28
CSSC91R-48 P.....	37	CSSL54-48 P.....	42	HES-6-12X B.....	28
CSSD105R-36 P.....	38	CSSL54-60 P.....	42	HES-6-12X D.....	28
CSSD105R-48 P.....	38	CSSL54-72 P.....	42	HES-8-12X.....	28
CSSD44R-12 P.....	37	CSSL87-24 P.....	42	LBV12.....	46
CSSD44R-18 P.....	37	CSSL87-36 P.....	42	LBV8.....	46
CSSD44R-24 P.....	37	CSSL87-48 P.....	42	M40-10 P.....	48
CSSD44R-36 P.....	38	CSSL87-60 P.....	42	MAU1-10-12 K5.....	48
CSSD44R-48 P.....	38	CSST58-18 P.....	43	MAU1-10-12S.....	48
CSSD44R-60 P.....	38	CSST58-24 P.....	43	MAU1-10-8 K5.....	48
CSSD44R-72 P.....	38	CSST58-36 P.....	43	MAU1-10-8S.....	48
CSSD45R-12 P.....	38	CSST58-60 P.....	43	MAU2-10-12 K5.....	48
CSSD45R-18 P.....	38	CSST58-72 P.....	43	MAU2-10-12S.....	48
CSSD45R-24 P.....	38	CT2-664X D.....	25	MAU2-10-8 K5.....	48
CSSD45R-36 P.....	38	CT2-664X P.....	25	MAU2-10-8S.....	48
CSSD45R-48 P.....	38	CT2-666X D.....	25	NV105-4X D.....	13
CSSD45R-60 P.....	38	CT2-666X P.....	25	OCR14X C1.....	10
CSSD45R-72 P.....	38	DD6000.....	53	OCR19X C1.....	10
CSSD54-12 P.....	42	DIH824.....	53	OFR17X CD.....	10
CSSD54-18 P.....	42	G23301X CD.....	7	OR32X CD.....	10
CSSD54-24 P.....	42	G23305X CD.....	8	P1-12A.....	14
CSSD54-36 P.....	42	G23341X CD.....	7	P1-12A H.....	14
CSSD54-48 P.....	42	G23345X CD.....	7	P1-12DL.....	14
CSSD54-60 P.....	42	G2CR09X CD.....	7	P1-12DL F.....	14
CSSD54-72 P.....	42	G2CR11X CD.....	7	P1-12DL H.....	14
CSSL115R-24 P.....	38	G2CR14X CD.....	7	P1-20A.....	14
CSSL115R-36 P.....	38	G2CR19X CD.....	7	P1-20DL.....	14
CSSL44R-24 P.....	38	G2CR34X CD.....	7	P1-20DL F.....	14
CSSL44R-36 P.....	38	G2CR39X CD.....	7	P1-30A.....	14
CSSL44R-48 P.....	38	G2PR14X CD.....	8	P1-36A.....	14
CSSL44R-60 P.....	38	G2PR19X CD.....	8	P1-36A H.....	14
CSSL45R-12 P.....	39	G2PS14B120DLX F.....	21	P14CX CD.....	27
CSSL45R-18 P.....	39	G2PS14B200HX F.....	21	P19CX CD.....	27
CSSL45R-24 P.....	39	G2PS14X CD.....	8	P44CX RD.....	27
CSSL45R-36 P.....	39	G2PS19B120DLX D.....	21	P48WX RD.....	27
CSSL45R-48 P.....	39	G2PS19B120DLX F.....	21	P77CX RD.....	27
CSSL45R-60 P.....	39	G2PS19B200AX F.....	21	P81.....	25
CSSL45R-72 P.....	39	G2PS19B200HX D.....	21	P89.....	30
CSSL47R-24 P.....	38	G2PS19X CD.....	8	PCT-10-6.....	8
CSSL47R-36 P.....	38	G2R07X CD.....	7	PNEV-NCVX D.....	13
CSSL47R-48 P.....	38	G2R10X CD.....	7	PS1087.....	50
CSSL47R-60 P.....	39	G2R12X CD.....	7	PS1087 XL.....	50

PART NO.	PAGE	PART NO.	PAGE	PART NO.	PAGE
PS138	19	PSC1079	44	SWB00-18N	35
PS30	29	PSC1085X L	45	SWB00-24N	35
PS31	29	PSC1094 L	50	TBV10-12	46
PS32	29	PSC1098 L	45	TBV10-8	47
PS33	29	PSC1106 K5	44	TBV12	46
PS34	29	PSC1107 K5	45	TBV16	46
PS40	29	PSC1108X L	45	TBV6-8	47
PS43	30	PSCFT-10	48	TBV6F-8	47
PS612X	28	PSCFT-11	48	TBV8	46
PS8024	53	PSFT-12	48	TBV8-8	47
PS838	16	PSSC-60	46	TBVA10-12	47
PS8754	22	PSSC-61	47	TBVF6	47
PSB1096 L	45	PSSC-62	48	WB00-12N	33
PSB130	19	PSSC-63	49	WB00-15N	33
PSB132	19	PSSC-64	49	WB00-18N	33
PSB136	19	PSSC-65	49	WB00-24N	33
PSB138	19	PSSC-66	48	WB034-12N	34
PSB141	19	PSSC-68	46	WB034-15N	34
PSB145	19	PSSD-41	47	WB034-18N	33
PSB156	19	PSSD-42	48	WB034-24N	34
PSB157	19	PSSD-43	49	WB07-18	34
PSB168	19	PSSD-44	49	WB27-18	34
PSB173	19	PSSL-12	47	WWCD	30
PSB175	19	PSSL-13	48	X15-10 CD	29
PSB177	19	PSSL-14	49		
PSB830	16	PSSL-15	48		
PSB832	16	PSSL-16	49		
PSB836	16	R14X CD	10		
PSB838	16	R15-10T CD	30		
PSB840	16	R15-5	30		
PSB846	16	R15-9 CD	29		
PSB855	16	R1700DVX RD	11		
PSB856	16	R1700RX RD	12		
PSB857	16	R1701DVX RD	11		
PSB858	16	R1701LRX RD	12		
PSB866	16	R19X CD	10		
PSB873	16	R3701RX RD	12		
PSB877	16	R3703LRX RD	12		
PSBV503-12	46	S126624	40		
PSBV503-8	46	S126636	40		
PSC00-12	33	S126648	40		
PSC00-15	33	S15-10 CD	29		
PSC00-18	33	ST1-SS4X D	26		
PSC00-24	33	ST1-SS6X D	26		
PSC034-18	33	SWB00-12N	35		
PSC034-24	34	SWB00-15N	35		



BrassCraft[®]



Brasscraft Manufacturing Co.
39600 Orchard Hill Place
Novi, Michigan 48375-5331
TOLL-FREE: (877) 272-7755
FAX: (248) 305-6011