

WARNING LABEL
PART NO. V56871
INSTALLED IN THIS
LOCATION. IF MISSING
IT MUST BE REPLACED.

Lead Free*

Reducing Valves

Installation, Operation & Service Instructions

* Contains less than .25% of lead by weight on wetted surfaces.

INSTALLER: PLEASE LEAVE THIS MANUAL FOR THE OWNER'S USE.



SAFETY INSTRUCTIONS

This safety alert symbol will be used in this manual to draw attention to safety related instructions. When used, the safety alert symbol means ATTENTION! BECOME ALERT! YOUR SAFETY IS INVOLVED! FAILURE TO FOLLOW THESE INSTRUCTIONS MAY RESULT IN A SAFETY HAZARD.

DESCRIPTION

The Bell & Gossett Pressure Reducing Valve is designed for filling hot water boilers and associated piping systems to a properly controlled pressure after boiler installation or system servicing. **It is not a safety device and is not intended to be used as a water feed valve to control boiler water at a safe operating level.** They are factory set at specified limits although adjustment is easily made. They are equipped with a built-in strainer and low inlet pressure check valve.

SIZES & PERFORMANCE

MODEL NUMBER	PART NUMBER	BODY MATERIAL	SIZE INCHES	FACTORY SETTING PSIG	ADJUSTABLE RANGE PSIG	
B-38	110190LF	Lead Free Brass*	1/2	12	10-25	
B 7-12	110196LF		3/4			NPT
B-38TU	110191LF		1/2			UNION NPT/SWEAT
FB-38†	110192LF		1/2			NPT
FB-38TU†	110193LF		1/2	UNION NPT/SWEAT		
6	110194LF		1/2	45	25-60	
7	110195LF		3/4			NPT

Maximum Flow 5 1/2-6 GPM at 125 PSIG inlet Pressure.

† **NOTE:** Fast-Fill models must be installed in upright position (i.e. flow arrow along horizontal axis).

NOTE: Bell & Gossett does not recommend using Solder containing Lead for potable water applications.

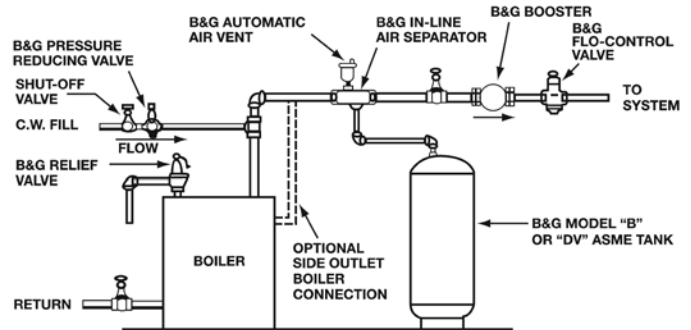

TYPICAL INSTALLATION

INSTALLATION INSTRUCTIONS

The Pressure Reducing Valve must be installed with the flow arrow on the body pointing in the direction of flow. A shut-off valve must be installed on the city water side of the Pressure Reducing Valve. If the Pressure Reducing Valve is not equipped with a fast fill feature, a by-pass may be used for rapid filling, but it must remain closed during normal system operation.

For safe boiler operation, installation of a low water cut off, adequate burner safety control and a properly installed float operated water feed control is recommended. Examples of these types of control devices include the McDonnell & Miller No. RB-24 and RB-120 low water cut offs and the No. 47-2 combination feeder and low water cut off.

Uncontrolled firing and overheating of boiler and boiler components may occur in a hot water heating system that is installed without adequate safety controls. The installation of a functioning air control system and thermal expansion compensation system is required for the proper operation of a hot water heating system.

TEMPERATURE AND PRESSURE LIMITS

Maximum Operating Temperature: 225°F.
Maximum Working Pressure: 125 PSIG

WARNING: Injecting cold water into a boiler that has overheated due to uncontrolled firing and/or improper water level control, can cause excessive stresses in boiler components and possible rupture of the boiler. This will be prevented by proper selection and installation of a water level control and burner safety controls. The shut-off valve at the pressure reducing valve inlet must be closed except when filling the system, after installation, or after service. Failure to follow these instructions could result in serious personal injury or death and property damage.

1. Pipe Reducing Valve into system as shown on typical installation drawing on page 1.

CAUTION: The generous use of pipe joint compound when installing Pressure Reducing Valve will foul the valve operating mechanism, preventing it from functioning properly. Pipe joint compound must be conservatively applied to male threads only. Failure to follow this instruction can result in moderate personal injury or property damage.

CAUTION: The use of PTFE impregnated pipe compound and PTFE tape on pipe threads provides lubricity which can lead to overtightening and breakage. Do not overtighten. Failure to follow this instruction can result in moderate personal injury from hot water and/or property damage.

2. When installing Reducing Valve models that include a sweat union connection feature, first sweat the tailpiece in place, then assemble union nut to Reducing Valve.

WARNING: Use of improper procedures to sweat Reducing Valve models with union connection into a system can damage the Reducing Valve. Before installing sweat union connection to Reducing Valve, the union connection must be first sweated (soldered) into place. Failure to follow these instructions could result in serious personal injury or death and property damage.

OPERATING INSTRUCTIONS

Model No's. B-38, B-38TU and B7-12 are preset at 12 PSI, and No's. 6 and 7 are preset at 45 PSI. Open the cold water fill valve to allow the system to fill until the preset pressure of the valve has been obtained.

Model No's. FB-38 and FB-38TU are preset at 12 PSI, and are equipped with a fast fill lever. When filling the system, the fast fill lever should be manually placed in the top vertical position. **This overrides the pressure regulating function of the reducing valve.** The system should be filled until the boiler pressure gauge indicates the preset pressure of the valve. The fast fill lever should then be placed in the horizontal position for the normal automatic operation.

WARNING: Improper use of fast fill feature can result in over pressurization of the boiler system. The fast fill lever must never be left in the upright position after the system has been filled. The handle must be placed in the horizontal position to avoid over pressurization and unnecessary relief valve discharge. Damage to the Reducing Valve and other system components can result. Failure to follow these instructions could result in serious personal injury or death and property damage.

WARNING: Low pressure conditions may occur during uncontrolled overfiring of the boiler. This could result in cold water being added to an extremely overheated boiler, causing excessive stress on boiler components, and possible rupture of the boiler. The shut-off valve, installed on the Reducing Valve inlet, must be kept closed except during initial system fill, or when manually adding water to the system because of a loss of pressure. This will prevent water from being added to an overheated boiler. **NEVER ADD WATER TO AN OVERHEATED BOILER.** Failure to follow these instructions could result in serious personal injury or death and property damage.

CAUTION: Corrosion and eventual failure of system components can result from the constant addition of fresh water. After the system has been filled, the cold water shut-off valve must be closed. This will prevent system leaks from being undetected by the constant replacement of lost system water. Failure to follow these instructions could result in property damage and/or moderate personal injury.

PRESSURE SETTING

The pressure setting can be changed by the following steps:

1. Allow water in heating system to cool to ambient temperatures.
2. Reducing Valve pressure setting can be adjusted by loosening the jam nut on top of the Reducing Valve and turning the slotted adjusting screw. Turn the screw clockwise to increase the set pressure, or counterclockwise to lower the set pressure. This should be done slowly until the boiler pressure gauge indicates the desired fill pressure.
NOTE: Do not adjust pressure to less than 10 psig.
3. Hold the adjusting screw stationary with a screwdriver and tighten the jam nut.
4. Return the system to operation.
5. Close the cold water shut-off valve.

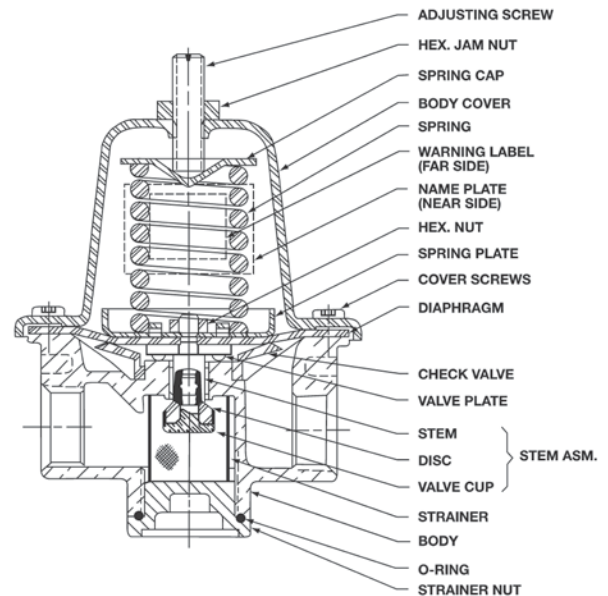

SERVICE INSTRUCTIONS

1. One way to determine if the Pressure Reducing Valve is working is to carefully place your hand on the Reducing Valve body. If the system is up to temperature but the valve body feels cold to the touch, then it is passing water. The problem may be an improper setting (see action on Pressure Setting), a leak downstream, or a faulty valve (which would need to be replaced).
2. If the relief valve discharges periodically, it is an indication that the system may have lost its air cushion in the compression or expansion tank. To determine if this is the case, initiate the following test:
 - a. *Bladder or diaphragm style pre-charged tanks:* Shut off boiler and allow system to cool to ambient temperature. Isolate the tank from the system, then bleed the water from the tank. Place a tire-type pressure gauge on the air valve on the tank. If the pressure is zero, the cushion is lost. The absence of the cushion may be from a leaking air valve. To check if this is the case, add some air to the tank and place some liquid on the valve stem area. If the liquid bubbles, the valve is leaking and must be replaced (see Instruction Manual A01500 for valve replacement). If the absence of the air cushion was not caused by a leaking valve, then the bladder or diaphragm is leaking, and the bladder must either be replaced (for the "B" Series) or the tank must be replaced (for the "D" Series). See Instruction Manual A01500 for bladder replacement.
 - b. *Conventional compression tanks:* Shut off the boiler for approximately 30 minutes. Record the pressure. Turn the boiler on. If, within 8-9 minutes, the pressure gauge at the boiler indicates a value within 10% of the relief valve setting, then the tank is waterlogged and needs to be drained and re-charged (see Instruction Manual S10300 for drain and air-charge procedures).
3. If the Pressure Reducing Valve fails to fill to the set COLD fill pressure, the strainer may be clogged. To service the strainer, follow the following steps:
 - a. Verify that the city water or cold water shut-off valve is closed.
 - b. Turn the boiler on-off switch to the "OFF" position.

 **WARNING:** System fluid under pressure and/or at high temperatures can be very hazardous. Before servicing, reduce system pressure to zero or isolate the pressure reducing valve from the system. Leave drain valve open. Allow system to cool below 100°F. Failure to follow these instructions could result in serious personal injury or death and property damage.

- c. Remove strainer nut located on bottom of reducing valve.
 - d. Remove and clean or replace the strainer.
 - e. Reinstall the strainer nut with O-ring into the reducing valve and tighten to a torque of 10 in-lbs. Min. – 100 in-lbs. Max. Replace the strainer nut with O-ring if it is damaged.
-  **WARNING:** Do not use PTFE when installing the strainer nut with O-ring. The PTFE provides lubricity which can lead to overtightening and breakage. **Do not overtighten.** Failure to follow these instructions can result in moderate personal injury from hot water and/or property damage.
- f. Close the boiler drain and open cold water shut-off valve to refill system.

- g. After system has been filled and vented, turn the boiler on-off switch to the "ON" position and resume normal boiler operation. Close the cold water shut-off valve.

 **WARNING:** Corrosion or leakage are indications that the Pressure Reducing Valve may be about to cause serious damage from leakage or rupture. It must be periodically inspected and if corrosion or leakage is noted, the pressure reducing valve must be serviced or replaced. Failure to follow these instructions could result in serious personal injury or death and property damage.

Valve Repair

To service the valve using the repair kit, follow steps 1, 2 and 3 from above and these additional steps:

- d. Remove the strainer.
- e. Using a size 25 Torx screwdriver, unfasten the six cover screws and remove the body cover. (A 1/8" Allen wrench will work in an emergency, but stripping may occur).
- f. Remove the spring cap and spring.
- g. Remove the hex nut by holding the stem assembly stationary while turning the nut counterclockwise. The stem assembly may drop once the nut has been removed.
- h. Lift off the spring plate, diaphragm and valve plate.
 - i. Pull the rubber check valve from the valve body and replace.
 - j. Insert new stem assembly into valve body through the strainer opening in the housing. Hold in place.
 - k. Place the new valve plate, knob side down, on the stem assembly.
 - l. Set new diaphragm on top of the stem, aligning holes with those in the body.
 - m. Place spring plate over the diaphragm on top of the stem assembly.
 - n. Thread the hex nut on the stem assembly. A dab of Loctite must be added to the hex nut before threading on the stem.

 **CAUTION:** Any more than a dab will seize the valve.

- o. Place spring, spring cap and body cover on top.
- p. Align body cover holes with those in the body and fasten body cover screws.
- q. Reinstall the strainer nut with O-ring into the reducing valve and tighten to a torque of 10 in-lbs. Min. – 100 in-lbs. Max. Replace the strainer nut with O-ring if it is damaged.

 **WARNING:** Do not use PTFE when installing the strainer nut with O-ring. The PTFE provides lubricity which can lead to overtightening and breakage. **Do not overtighten.** Failure to follow these instructions can result in moderate personal injury from hot water and/or property damage.

- r. Close the boiler drain and open cold water shut-off valve to refill system.
- s. After system has been filled and vented, turn the boiler on/off switch to the "ON" position and resume normal boiler operation. If pressure setting differs from previous setting, refer to section on pressure setting. Close cold water shut-off valve.

Xylem |'zīləm|

- 1) The tissue in plants that brings water upward from the roots;
- 2) a leading global water technology company.

We're 12,500 people unified in a common purpose: creating innovative solutions to meet our world's water needs. Developing new technologies that will improve the way water is used, conserved, and re-used in the future is central to our work. We move, treat, analyze, and return water to the environment, and we help people use water efficiently, in their homes, buildings, factories and farms. In more than 150 countries, we have strong, long-standing relationships with customers who know us for our powerful combination of leading product brands and applications expertise, backed by a legacy of innovation.

For more information on how Xylem can help you, go to www.xyleminc.com



Xylem Inc.
8200 N. Austin Avenue
Morton Grove, Illinois 60053
Phone: (847) 966-3700
Fax: (847) 965-8379
www.xyleminc.com/brands/bellgossett