

JOB:	REPRESENTATIVE:	
UNIT TAG:	ORDER NO.	DATE:
ENGINEER:	SUBMITTED BY:	DATE:
CONTRACTOR:	APPROVED BY:	DATE:



ecocirc[®] XL



High Efficiency Large Wet Rotor Circulator with Electronically Commutated Motor (ECM)

DESCRIPTION

The ecocirc[®] XL circulator is designed with a highly efficient electronically commutated permanent magnet motor (ECM/PM Technology). Cast Iron Body designed for closed loop hydronic heating and cooling systems pumping water or water/glycol mix.
 Lead Free Bronze† body designed for plumbing systems or open loop heating and cooling systems.

CONSTRUCTION MATERIALS

Pump Body: Cast Iron or Lead-Free† Bronze
 Impeller: Poly-phenylene Sulfide or Stainless Steel
 Shaft: AISI 420 Stainless Steel
 Rotor: Permanent Magnet
 Bearing: Carbon Sleeve
 Gasket/O-Ring: EPDM
 All Other Wetted Parts: AISI 304 Stainless Steel
 Motor Type: Electronically Commutated Motor /Permanent Magnet
 Motor Insulation Class: F

SPECIFICATIONS

MODEL NO. _____

FLOW _____ HEAD _____

HP _____ RPM _____

VOLTAGE _____ CYCLE _____ PHASE _____

SPECIALS _____

OPERATING DATA

Maximum Working Pressure: 175 psi (12 Bar)
 Minimum Working Temperature: 14°F (-10°C)
 Maximum Working Temperature: 230°F (110°C)
 Ambient Temperature Range: 32°F - 104°F (0°C - 40°C)

SCHEDULE

CAST IRON BODY		LEAD-FREE BRONZE BODY†		RATED MOTOR CHARACTERISTICS						
MODEL NUMBER	PART NUMBER	MODEL NUMBER	PART NUMBER	HP*	VOLTAGE	PHASE	Hz	WATTS RANGE	AMP RANGE	SPEED RANGE
ecocirc XL 20-35	104300	ecocirc XL B 20-35	104400LF	1/12	115	1	50/60	6 - 85	0.1 – 1.3	1500-3500
ecocirc XL 36-45	104301	ecocirc XL B 36-45	104401LF	1/6	115	1	50/60	20 - 200	0.1 – 3.0	1500-4450
ecocirc XL 36-45	104302	ecocirc XL B 36-45	104402LF	1/6	208-230	1	50/60	20 - 200	0.1 – 1.5	1500-4450
ecocirc XL 15-75	104303	ecocirc XL B 15-75	104403LF	1/6	115	1	50/60	30 - 150	0.1 – 2.3	1500-3000
ecocirc XL 15-75	104304	ecocirc XL B 15-75	104404LF	1/6	208-230	1	50/60	30 - 150	0.1 – 1.1	1500-3000
ecocirc XL 55-45	104306	ecocirc XL B 55-45	104406LF	1/2	208-230	1	50/60	30 - 500	0.2 – 2.0	1500-4500
ecocirc XL 20-140	104308	ecocirc XL B 20-140	104408LF	1/2	208-230	1	50/60	35 - 470	0.2 – 2.0	1500-3550
ecocirc XL 65-130	104309	ecocirc XL B 65-130	104409LF	1	208-230	1	50/60	45 - 825	0.5 – 3.5	1100-3550
ecocirc XL 40-200	104312	ecocirc XL B 40-200	104412LF	1	208-230	1	50/60	50 - 825	0.5 – 3.5	1100-3500
ecocirc XL 70-145	104315	ecocirc XL B 70-145	104415LF	2	208-230	1	50/60	55 - 1400	0.6 – 6.0	900-3300
ecocirc XL 40-275	104318	ecocirc XL B 40-275	104418LF	2	208-230	1	50/60	50 - 1400	0.5 – 6.0	900-2900

Note: Where potable water is pumped, use a lead-free† bronze booster. ecocirc XL pumps are recommended for indoor use only.

† = Lead-Free as described in the Reduction of Lead in Drinking Water Act (RLDWA) - certified to NSF 372.

* = Nominal HP

DIMENSIONS AND WEIGHTS

MODEL NO	Nominal Motor HP	DIMENSIONS - INCHES (mm)						APPROX. SHIPPING WEIGHT LBS. (KG)	
		A	B	C	D	E	F	Cast Iron	Bronze
ecocirc XL 20-35	1/12	9.94 (252)	6.38 (162)	8.20 (208)	4.19 (106)	7.20 (183)	4.72 (120)	19.8 (9)	22 (10)
ecocirc XL 36-45	1/6	9.94 (252)	6.38 (162)	8.20 (208)	4.19 (106)	7.20 (183)	4.72 (120)	19.8 (9)	22 (10)
ecocirc XL 15-75	1/6	11.04 (280)	8.5 (216)	8.39 (213)	5.19 (132)	7.57 (192)	4.72 (120)	26.4 (12)	28.6 (13)
ecocirc XL 55-45	1/2	11.89 (302)	6.38 (162)	10.18 (258)	4.19 (106)	8.12 (206)	5.02 (127)	26.4 (12)	28.6 (13)
ecocirc XL 20-140	1/2	13.39 (340)	11.5 (292)	10.41 (264)	5.19 (132)	8.20 (208)	5.02 (127)	35.2 (16)	39.6 (18)
ecocirc XL 65-130	1	14.84 (377)	11.5 (292)	11.80 (299)	4.62 (117)	9.53 (242)	5.77 (146)	39.6 (18)	44 (20)
ecocirc XL 40-200	1	15.17 (385)	11.5 (292)	11.80 (299)	5.19 (132)	9.53 (242)	5.77 (146)	41.8 (19)	46.2 (21)
ecocirc XL 70-145	2	14.84 (377)	11.5 (292)	11.80 (299)	4.62 (117)	9.53 (242)	5.77 (146)	38.4 (17.4)	44 (20)
ecocirc XL 40-275	2	16.04 (407)	12.0 (305)	12.57 (319)	6.00 (152)	10.07 (256)	5.77 (146)	49.6 (22.5)	55 (25)

MODEL NO	FLANGE SIZE INCHES - NPT	# of Bolts	DIMENSIONS - INCHES (mm)				B&G COMPANION FLANGE (Set of 2)	
			G	H	J	K	CAST IRON PN	BRONZE PN
ecocirc XL 20-35	3/4, 1, 1-1/4, 1-1/2	2	4.19 (106)	3.16 (80)	2.62 (66)	0.47 (12)	101001 - 101004 ⁺	101011LF - 101014LF ⁺
ecocirc XL 36-45	3/4, 1, 1-1/4, 1-1/2	2	4.19 (106)	3.16 (80)	2.62 (66)	0.47 (12)	101001 - 101004 ⁺	101011LF - 101014LF ⁺
ecocirc XL 15-75	2	4	5.18 (132)	4.06 (103)	-	0.56 (14)	101215	10216LF
ecocirc XL 55-45	3/4, 1, 1-1/4, 1-1/2	2	4.19 (106)	3.16 (80)	2.62 (66)	0.47 (12)	101001 - 101004 ⁺	101011LF - 101014LF ⁺
ecocirc XL 20-140	2	4	5.19 (132)	4.06 (103)	-	0.56 (14)	101215	10216LF
ecocirc XL 65-130	1, 1-1/4, 1-1/2	2	4.62 (117)	3.44 (87)	2.86 (73)	0.47 (12)	101005 - 101007 ⁺	101015LF - 101017LF ⁺
ecocirc XL 40-200	2	4	5.19 (132)	4.06 (103)	-	0.56 (14)	101215	10216LF
ecocirc XL 70-145	1, 1-1/4, 1-1/2	2	4.62 (117)	3.44 (87)	2.86 (73)	0.47 (12)	101005-101007 ⁺	101015LF-101017LF ⁺
ecocirc XL 40-275	3	4	6.00 (152)	5.06 (129)	-	0.53 (13)	101217	10218LF

*Part numbers represent a Master Carton of 12 flanges with fasteners pack.
1-1/2" is the diameter of the suction and discharge for the 2-bolt models.

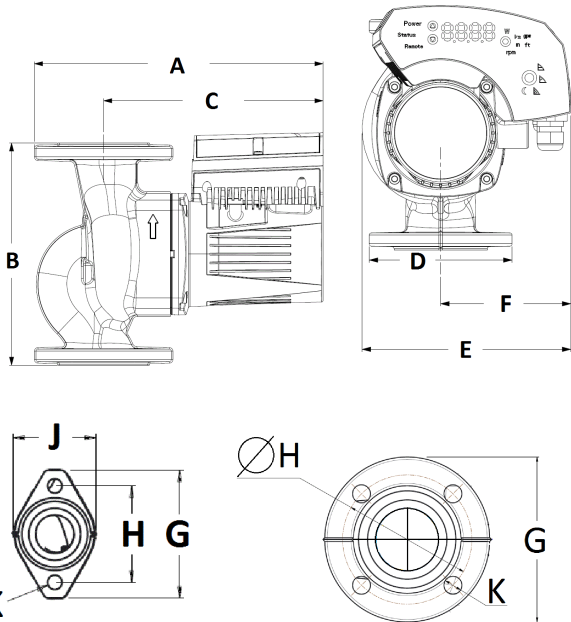

ecocirc XL High Flow Performance Range

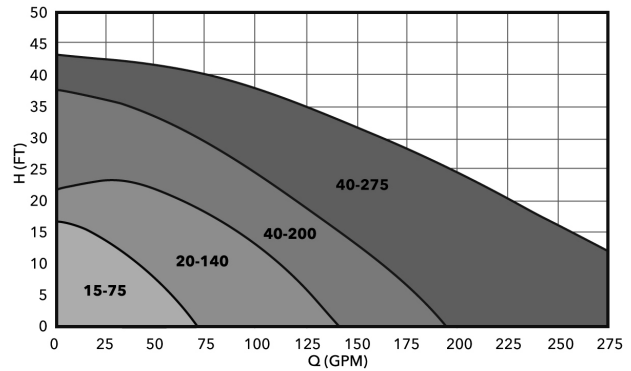

ecocirc XL High Head Performance Range

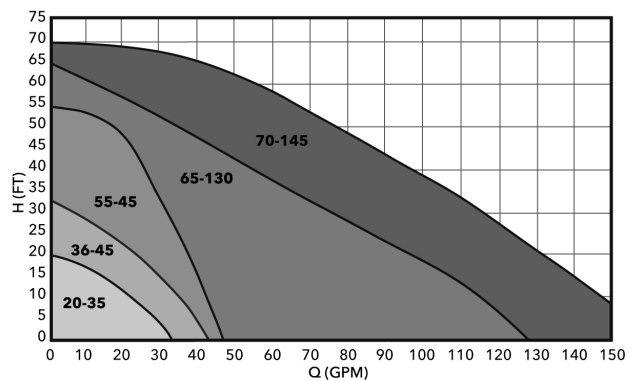

SAFETY STANDARDS AND PROTECTION

- I Enclosure: Class 2, IP44 (equivalent to NEMA Type 2)
- I UL Listed to UL 778; UL 1004-1, 1004-7; and UL 60730-1
- I cUL Listed to C22.2 #108
- I Electronically Thermally Protected (Integrated Motor Protection)
- I Motor Insulation Class: F
- I NSF 372 - ≤ 0.25% lead content by weight on wetted surfaces for Bronze pump models

STANDARD OPERATING MODES

CONSTANT SPEED

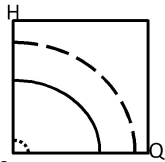

The pump maintains a constant speed at any flow rate. The desired speed is set on the interface panel of the pump.

CONSTANT PRESSURE ($\Delta p-c$)

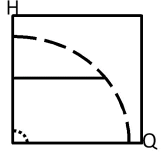

The pump maintains a constant differential pressure at any flow demand until the maximum speed is reached. The desired head of the pump can be set via user interface. Recommended for use in systems with small or constant pressure losses.

PROPORTIONAL PRESSURE ($\Delta p-v$)

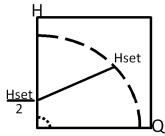

The differential pressure continuously increases or decreases based on the flow demand. The set point head can be set on the pump user interface. Use for systems with large pressure losses.

NIGHT MODE

The pump will automatically reduce speed when there is an abrupt change in fluid temperature. The change in fluid temperature is from a boiler operating in night time setback mode. The built-in temperature sensor is used. (Fixed Speed, Constant Pressure, Proportional Pressure)

TEMPERATURE INFLUENCED OPERATING MODES

SET POINT TEMPERATURE ($\Delta p-T$)

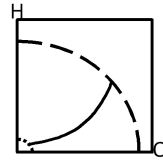

The nominal differential pressure set point is modified based on the fluid temperature. Uses the built-in temperature sensor.

SET POINT TEMPERATURE (T)

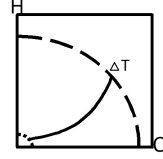

The pump maintains a constant temperature in a system, such as domestic hot water system or a single temperature heating system. Uses the built-in temperature sensor.

DIFFERENTIAL TEMPERATURE (ΔT)

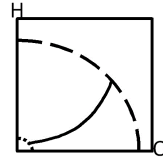

The pump maintains a constant differential temperature between the built-in and external temperature sensors.

INPUT SIGNALS

- I One 0-10V (Analog): Speed Control by external controller
- I One 4-20mA (Analog): Connection with an external pressure sensor for the pressure control mode (two different pressure sensor ranges: 0-15 PSI and 0-30 PSI)
- I One external temperature sensor input for DifferentialTemp operating mode. Sensor Type KTY38 PN:104502
- I One built-in temperature sensor for Set Point Temp and Differential-Temp operating mode.

REMOTE BUILDING MANAGEMENT SYSTEM CAPABILITIES

- I The pump can be monitored or controlled by a signal from BMS (Building Management System). Built-in protocols are BACnet and Modbus. Direct connection to a PC is available.
- I An optional Wi-Fi module can be added to create a short range Wi-Fi field for remote connection to the pump. An internet browser or an App can be used to program the advanced settings. Module PN: 104500

INPUT RELAY: Normally Open Contact Relay for Pump Start/Stop function which can be used with any thermostat.

OUTPUT RELAY: Normally Open Dry Contact Relay for Fault Mode indication.

ONBOARD USER INTERFACE

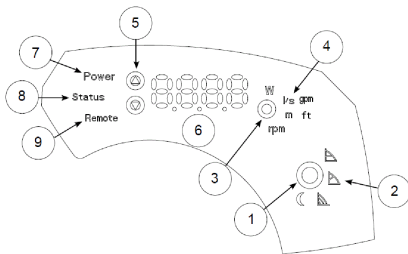

1. Control mode button
2. Control mode indicators
3. Parameter button
4. Parameter indicators
5. Setting buttons
6. Numeric display
7. Power indicator
8. Status / Fault indicator
9. Remote control indicator

CONTROL MODE	ONBOARD USER INTERFACE	EXTERNAL USER INTERFACE	SETPOINT UNITS
CONSTANT SPEED	•	•	RPM
($\Delta p-c$)	•	•	SETPOINT HEAD (ft/m)
($\Delta p-v$)	•	•	SETPOINT HEAD (ft/m)
NIGHT MODE	•	•	-
($\Delta p-T$)		•	SETPOINT HEAD and T
T		•	SETPOINT T
(ΔT)		•	SETPOINT ΔT

The numeric display will show the parameter indicated when running and will display any error and alarm codes.

Xylem Inc.
8200 N. Austin Avenue
Morton Grove, IL 60053
Phone: (847)966-3700
Fax: (847)965-8379
www.bellgossett.com

Bell & Gossett is a trademark of Xylem Inc. or one of its subsidiaries.
© 2015 Xylem Inc.

xylem
Let's Solve Water