

ELECTRICAL

Conduit, Elbows, Couplings and Nipples
Steel (EMT, IMC, GRC) • Aluminum • PVC

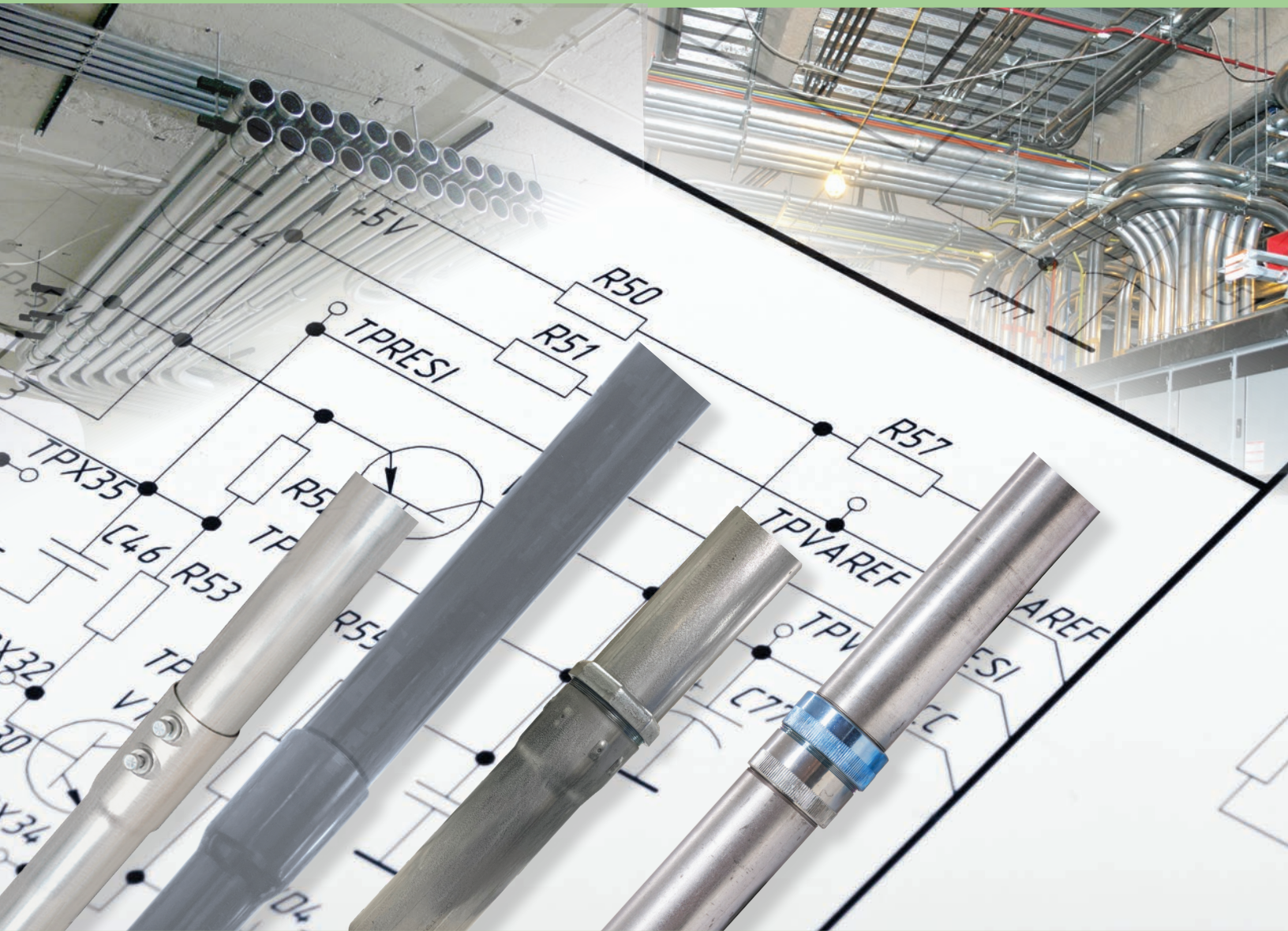

Atkore[™]
Allied Tube
& Conduit

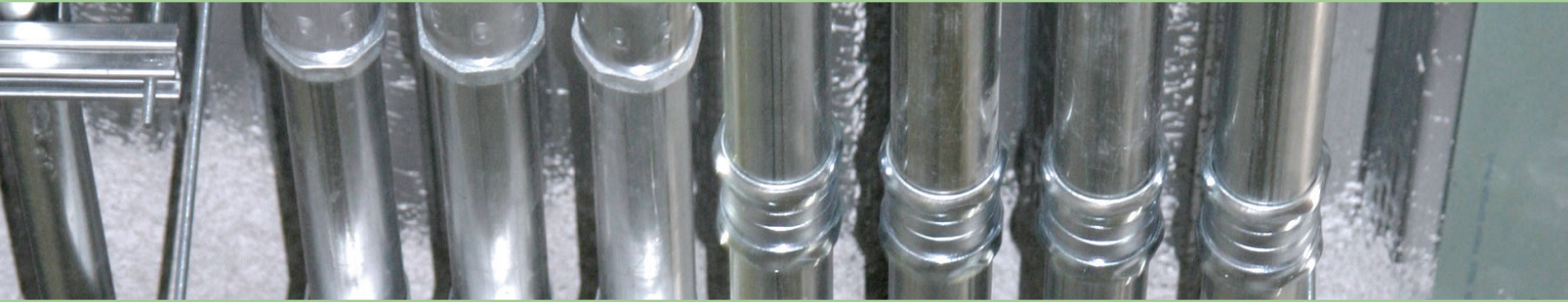

Allied Tube & Conduit®

Since 1959, Allied Tube & Conduit® has been reshaping the pipe and tube industry. The company began with a small 24,000 square foot facility, an innovative idea to galvanize EMT conduit while still “in line”, one tube mill, and 10 employees. Since then, the process of in-line galvanizing EMT and IMC has become the standard in the United States.

Today, the Allied Tube & Conduit® brand is stronger than ever under the leadership of Atkore™. Atkore™ has a global manufacturing footprint with service to customers all over the globe. From construction to manufacturing, our products are hard at work in the center of it all. Atkore™ strives to be core to each customer’s business as well, understanding what they value and need, and providing essential solutions that improve their day-to-day operations.

Allied Tube & Conduit® embodies the same entrepreneurial spirit and innovation that shaped the company back in 1959. We are positioned for continued growth, expansion, and innovation, which means our best days – and products – are yet to come.

Product Innovation & Excellence

Allied Tube & Conduit® is a leading brand for EMT, IMC, and rigid conduits made of steel, PVC, and aluminum. We have products and engineered solutions to meet every application challenge and are continually evolving to serve you better.

Allied Tube & Conduit® carries a large number of products able to be specified, which include steel EMT, IMC, & GRC Elbows, Couplings, & Nipples (ECN); steel fittings; aluminum conduit & fittings, and PVC conduit & fittings. In addition, many made-to-order items are manufactured to suit individual job requirements.

Allied Tube & Conduit® True Color™ EMT provides instant identification of individual power, datacom, and emergency electrical systems. The eight (8) bright colors eliminate the need to spray, powder coat, or tape in the field so installation is quicker, easier, and safer. Allied Tube & Conduit® has a proud history of innovation beginning with our in-line Flo-Coat® process. Over the years, Allied Tube & Conduit® has focused on innovation leading to breakthrough products such as E-Z Pull® IMC, True Color™ Conduit, and Kwik Conduit products.

Allied Tube & Conduit® Kwik-Fit® EMT has an integral steel set screw coupling and the Kwik-Fit® Compression EMT features a built-in steel compression coupling. These innovative built-in couplings significantly reduce installation time up to 50% and eliminate the need to purchase, store, and install separate couplings.

Allied Tube & Conduit® rigid conduit offerings include GRC, aluminum, PVC, and IMC. As for IMC, don’t let the name fool you. It’s true the acronym came from Intermediate Metal Conduit, but the intermediate is specific to the weight and NOT the performance of the conduit. The National Electrical Code® (NEC)® recognizes IMC “for the same use as rigid, including all hazardous location (classified) applications.” When compared with rigid, Allied Tube & Conduit® IMC is up to 30% lighter in weight and saves up to 30% on costs.

Allied Tube & Conduit® factory-installed Super Kwik-Couple™ couplings are available on both IMC and GRC conduit and GRC elbows. These patented couplings eliminate the need to buy expensive unions and 3-piece couplings. Just insert the conduit and tighten the compression nut.

Aluminum rigid conduit combines light weight and corrosion resistance to provide a full-line of easy to install, low maintenance conduit. When specifications call for aluminum, Allied Tube & Conduit® offers a broad line of rigid aluminum conduit, couplings, nipples, and elbows in standard 45°, 90°, and custom radii.

Allied Tube & Conduit® PVC conduit is proven durable and effective for years of maintenance-free performance in underground, encased and exposed applications. Rigid PVC conduit fittings are available and can be used with all brands of rigid PVC conduit.

Our agents, sales and customer service teams are available to assist with questions on application, installation, and availability of our products. Thank you for considering Allied Tube & Conduit® for your conduit and fitting requirements.

Table of Contents

EMT • Electrical Metallic Tubing	
E-Z Pull® EMT	3-4
True Color™ EMT	3-4
Kwik-Fit® EMT	5-6
Kwik-Fit® Compression EMT	5-6
IMC • Intermediate Metal Conduit	
Intermediate Metal Conduit	9-11
Super Kwik-Couple™ IMC	9-11
GRC • Galvanized Rigid Conduit	
Galvanized Rigid Conduit	14-15
Super Kwik-Couple™ GRC	14-15
ECN • Elbows, Couplings & Nipples	
Electrical Metallic Tubing (EMT) Elbows	18-22
90° Elbows	20
45° Elbows	20
Large Radius 90° Elbows	21
Large Radius 45° Elbows	22
Galvanized Rigid Conduit (GRC) Couplings & Elbows	23-31
Couplings	23
Super Kwik Coupling™	23-24
90° Elbows	24
90° Super Kwik-Couple™ Elbow	25
45° Elbows	25
Large Radius 90° Elbows	26-27
Large Radius 45° Elbows	28
Galvanized Rigid Conduit Nipples	29-30
Galvanized Rigid Conduit Yard Elbows	31
Galvanized Running Thread	31
ARC • Aluminum Rigid Conduit	
Aluminum Rigid Conduit	34
Couplings	35
90° Elbows	35
45° Elbows	35
PVC Conduit & Fittings	
Schedule 40	39
Schedule 80	39
Utility Duct	40-41
Standard Radius Elbows	42-47
Schedule 40 - Standard Radius Elbows	42-44
Schedule 80 - Standard Radius Elbows	45-47
Special Radius Elbows	48-50
Schedule 40 - Special Radius Elbows	48-49
Schedule 80 - Special Radius Elbows	50
Special Radius Sweeps	51
Duct - Special Radius Sweeps	51
C-Duct - Special Radius Sweeps	51
Couplings and Adapters	52-53
Expansion Couplings and Meter Risers	54-58
Access Fittings	59
Accessories	60-61
Junction Boxes	62
Cover Plates & Weatherproof Box Covers	63
Cement, Cleaner, Primer	64
Miscellaneous	
Notes	65-66
More Information	67



EMT • Electrical Metallic Tubing

E-Z Pull® EMT	3-4
True Color™ EMT	3-4
Kwik-Fit® EMT	5-6
Kwik-Fit® Compression EMT	5-6



Electrical Metallic Tubing (EMT) & True Color™ EMT



Quality Electrical Metal Tubing



Identify Important Circuits Instantly

E-Z Pull® EMT

- Hot galvanized steel using patented in-line Flo-Coat® process for long lasting exterior protection
- E-Z Pull® interior coating provides a smooth raceway for fast, easier wire-pulling
- Excellent mechanical protection for conductors
- Ductility for faster and easier bending
- Optimal EMI shielding characteristics
- Listed to Safety Standard UL 797
- Manufactured in accordance with ANSI C80.3
- Available in trade sizes ½" (16 mm) - 4" (103 mm)

True Color™ EMT

- All the benefits of E-Z Pull® EMT
- Instant identification of multiple circuits
- Available in 8 colors
- Available in trade sizes ½" (16 mm) - 1½" (41 mm)
- Sizes 2½" - 4" available by special order
- EMT Elbows (Available by special order)



True Color™ Applications

Black EMT

- Blends in dark colored areas

Fire Alarm® EMT

- Emergency circuits
- Fire alarm and security systems

Orange EMT

- Construction/research areas
- Fiber optic systems
- Auto repair/maintenance

Yellow EMT

- High voltage wiring
- Caution areas
- Special equipment

Green EMT

- Hospital and healthcare areas
- Nurse call stations
- Critical circuits

Blue EMT

- Low voltage wiring
- Data com/video
- Network security

Purple EMT

- Specialty wiring systems
- Security systems

White EMT

- Blends in light colored areas

Silver EMT

- Standard Use
- Contemporary architecture

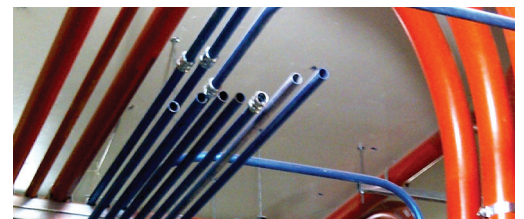
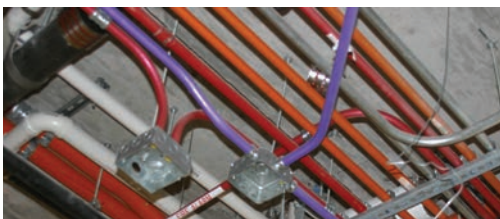

Electrical Metallic Tubing (EMT) & True Color™ EMT

FEATURES & SPECIFICATIONS

Manufactured for Long Life

Allied Tube & Conduit® EMT is precision manufactured from high grade mild strip steel for exceptional durability and long-lasting life. Allied Tube & Conduit® EMT is hot galvanized using a patented in-line Flo-Coat® process. This process combines zinc, a conversion coating, and a clear organic polymer topcoat to form a triple layer of protection against corrosion and abrasion.

E-Z Pull® EMT combines strength with ductility, providing easy bending, cutting and joining while resisting flattening, kinking and splitting. Available in trade sizes ½" (16 mm) - 4" (103 mm).

Coatings

Allied Tube & Conduit® EMT has a special low friction ID coating called E-Z Pull® that greatly improves the slip properties between conduit and wire. With E-Z Pull® EMT, wire pulls through the EMT smoothly and easily, making installation easier and faster.

EMI Shielding

Allied Tube & Conduit® EMT is effective in reducing electromagnetic field levels for encased power distribution circuits, shielding computers and other sensitive electronic equipment from the effects of electromagnetic interference.

Codes & Standards Compliance

Allied Tube & Conduit® EMT is listed to Safety Standard UL 797 and is manufactured in accordance with ANSI C80.3. These standards have been adopted as federal specifications in lieu of WWC 563. EMT is recognized as an equipment grounding conductor by NEC® Section 250-118. Installation of EMT shall be in accordance with the National Electrical Code® (NEC)® and the UL listing information. Allied Tube & Conduit® EMT is listed in category FJMX. Master bundles conform to NEMA Standard RN 2.

Specification Data

To specify Allied Tube & Conduit® EMT, include the following: Electrical Metallic Tubing shall be equal to that manufactured by Allied Tube & Conduit®. EMT shall be hot galvanized steel OD with an organic corrosion resistant ID coating, and shall be listed to UL Safety Standard 797 and manufactured in accordance with ANSI C80.3.

Electrical Metallic Tubing (EMT) and True Color™ EMT

Listed to Safety Standard UL 797

Manufactured in accordance with ANSI C80.3



Trade Size	Metric Designator	Outside Diameter ¹		Nominal Wall Thickness		Approximate Weight 100 ft (30.5 m)		Red and Galvanized Master Bundle Quantity		True Color™ Bundle Quantity	
		(in)	(mm)	(in)	(mm)	(lb)	(kg)	(ft)	(m)	(ft)	(m)
½	16	0.706	17.93	0.042	1.07	30	13.6	7000	2135	3500	1066.8
¾	21	0.922	23.42	0.049	1.24	46	20.9	5000	1525	2500	762.0
1	27	1.163	29.54	0.057	1.45	67	30.4	3000	915	1500*	457.2
1¼	35	1.510	38.35	0.065	1.65	101	45.8	2000	610	2000	609.6
1½	41	1.740	44.20	0.065	1.65	116	52.6	1500	457.5	1500	457.2
2	53	2.197	55.80	0.065	1.65	148	67.1	1200	366.0	1200	365.7
2½	63	2.875	73.03	0.072	1.83	216	98.0	610	186.1	610	185.9
3	78	3.500	88.90	0.072	1.83	263	119.3	510	155.6	510	155.4
3½	91	4.000	101.60	0.083	2.11	349	158.3	370	112.9	370	112.7
4	103	4.500	114.30	0.083	2.11	393	178.3	300	91.5	300	91.5

¹Outside diameter tolerances:

+/- .005 (in) (.13mm) for trade sizes ½" (16mm) through 2" (53mm)

+/- .010 (in) (.25mm) for trade sizes 2½" (63mm)

+/- .015 (in) (.38mm) for trade size 3" (78mm)

+/- .020 (in) (.51mm) for trade sizes 3½" (91mm) and 4" (103mm)

*Blue trade size 1 master bundle size: 3000 ft / 915 m

NOTE: Length = 10 (ft) (3.05m) with a tolerance of +/- .25 (in) (6.35 mm)

Kwik-Fit® & Kwik-Fit® Compression EMT



Faster EMT Installations

- Kwik-Fit® EMT
- Integral steel set screw coupling formed on one end of each length of EMT
- Fast two step installation
- Material and labor savings up to 50%*
- No couplings to purchase, inventory, or install
- Hot galvanized steel using patented in-line Flo-Coat® process for long lasting exterior protection
- E-Z Pull® interior coating provides a smooth raceway for faster, easier wire pulling
- Excellent mechanical protection for conductors
- Ductility for faster and easier bending
- Optimal EMI shielding characteristics
- Listed to UL Safety Standards 797 and to 514B
- Manufactured in accordance with ANSI C80.3
- Available in trade sizes 1¼" (35 mm) - 4" (103 mm)
- True Color™ available by special order

See our Kwik Challenge Videos at
youtube.com/AtkoreInternational



Labor & Material Savings

Kwik-Fit® Compression EMT

- Integral steel compression coupling on one end of each length of EMT
- Fast two step installation
- Material and labor savings of up to 50%*
- No couplings to purchase, inventory, or install
- Couplings seal tight eliminating hours of taping seams
- Hot galvanized steel using patented in-line Flo-Coat® process for long lasting exterior protection
- E-Z Pull® interior coating provides a smooth raceway for faster, easier wire pulling
- Excellent mechanical protection for conductors
- Ductility for faster and easier bending
- Optimal EMI shielding characteristics
- Listed to UL Safety Standards 797 and to 514B
- Manufactured in accordance with ANSI C80.3
- Available in trade sizes 1¼" (35 mm) - 4" (103 mm)
- True Color™ available by special order

Visit www.kwikcalculator.com to estimate your
Material and Labor Savings by using Kwik-Fit® products

* Installation time will vary with job site conditions.

U.S. Patent Number 8,695,218



Kwik-Fit® & Kwik-Fit® Compression EMT

FEATURES & SPECIFICATIONS

Kwik-Fit® and Kwik-Fit® Compression EMT

Kwik-Fit® and Kwik-Fit® Compression EMT have all the benefits of E-Z Pull® EMT with integrated couplings. These built-in couplings significantly reduce installation time, and eliminate the need to purchase, inventory, and install separate couplings.

With Kwik-Fit® EMT, simply insert the plain end of the Kwik-Fit® into the coupling end and tighten the set screws. Unlike traditional set screw couplings, only two screws need to be tightened.

On the Kwik-Fit® Compression EMT, simply insert the plain end of the EMT into the compression coupling end and tighten the gland nut. Unlike traditional compression couplings, only one gland nut needs to be tightened.

Kwik-Fit® and Kwik-Fit® Compression EMT can reduce the installation time up to 50%. Installation time will vary with job site conditions.

Coatings

Both Kwik-Fit® EMT and Kwik-Fit® Compression EMT are made from our E-Z Pull® EMT. See the EMT section for more information about the EMT coatings.

Codes & Standards Compliance

Kwik-Fit® EMT and Kwik-Fit® Compression EMT are allowed for PLENUM USE and meet the requirements of section 300.22 of the National Electrical Code® (NEC)®. Kwik-Fit® Compression EMT meets the requirements of sections 18-27-300.22(b)(1) and 18-27-300.22(c)(1)(a) of the Chicago Electrical Code.

Allied Tube & Conduit® Kwik-Fit® EMT is listed to UL Safety Standards 797 and to 514B Kwik-Fit® Compression EMT is listed to UL Safety Standards 797 and 514B and is UL listed as CONCRETE-TIGHT. Kwik-Fit® Compression EMT also meets ANSI Standard C80.3.

Kwik-Fit® EMT

Listed to Safety Standard UL 797

Manufactured in accordance with ANSI C80.3



Trade Size	Metric Designator	Outside Diameter ¹		Nominal Wall Thickness		Approximate Weight Per 100 ft (30.5 m)		Master Bundle Quantity	
		(in)	(mm)	(in)	(mm)	(lb)	(kg)	(ft)	(m)
1¼	35	1.510	38.35	0.065	1.65	101	45.8	840	256.0
1½	41	1.740	44.20	0.065	1.65	116	52.6	720	219.5
2	53	2.197	55.80	0.065	1.65	148	67.1	500	152.4
2½	63	2.875	73.03	0.072	1.83	216	98.0	350	106.7
3	78	3.500	88.90	0.072	1.83	263	119.3	300	91.4
3½	91	4.000	101.60	0.083	2.11	349	158.3	250	76.2
4	103	4.500	114.30	0.083	2.11	393	178.3	250	76.2

Kwik-Fit® Compression EMT

Listed to Safety Standard UL 797

Manufactured in accordance with ANSI C80.3



Trade Size	Metric Designator	Outside Diameter ¹		Nominal Wall Thickness		Approximate Weight Per 100 ft (30.5 m)		Master Bundle Quantity	
		(in)	(mm)	(in)	(mm)	(lb)	(kg)	(ft)	(m)
1¼	35	1.510	38.35	0.065	1.65	107	48.5	840	256.0
1½	41	1.740	44.20	0.065	1.65	125	56.7	720	219.5
2	53	2.197	55.80	0.065	1.65	162	73.5	500	152.4
2½	63	2.875	73.03	0.072	1.83	239	108.4	350	106.7
3	78	3.500	88.90	0.072	1.83	291	132.0	300	91.4
3½	91	4.000	101.60	0.083	2.11	383	173.7	250	76.2
4	103	4.500	114.30	0.083	2.11	431	195.5	250	76.2

¹Outside diameter tolerances:

+/- .005 (in) (.13mm) for size 1¼" (35mm) through 2" (53 mm)

+/- .010 (in) (.25mm) for size 2½" (63 mm)

+/- .015 (in) (.38mm) for size 3" (78 mm)

+/- .020 (in) (.50mm) for sizes 3½" (91 mm) and 4" (103 mm)

NOTE: Length = 10 (ft) (3.05m) with a tolerance of +/- .25 (in) (6mm)



IMC • Intermediate Metal Conduit

Intermediate Metal Conduit.....	9-11
Super Kwik-Couple™ IMC.....	9-11



Intermediate Metal Conduit (IMC) & Super Kwik-Couple[™] IMC

NEC[®] recognizes Allied Tube & Conduit[®] IMC for same uses as RIGID



Kwik-Release End Cap - No Tools Needed



Quality, Long Lasting, Heavy Duty Steel Conduit



IMC to RIGID Conduit



IMC to EMT

For Faster Installations, Use the Super Kwik-Couple[™] IMC Connection



* U.S. Patent Number: 8,586,881

IMC Conduit

- Light-weight ductile steel conduit for long life and easy bending
- Weighs one-third less than rigid conduit
- Saves up to 30% in cost over GRC
- Hot galvanized exterior to increase corrosion resistance and protect against white rust
- Interior coating creates a smooth, continuous raceway for fast wire-pulling
- Listed to UL Safety Standard 1242 and manufactured in accordance with ANSI C80.6
- True Color[™] IMC available by special order
- Available in trade sizes ½" (16 mm) - 4" (103 mm)

Super Kwik-Couple[™] IMC Conduit Raintight

- Similar benefits of IMC conduit
- High grade durable and ductile steel for long life
- Corrosion resistant exterior and interior finishes
- Super Kwik-Couple[™] IMC is listed to UL Safety Standards 1242 and to 514B and manufactured in accordance with ANSI C80.6
- Eliminates field threading - factory installed patented Super Kwik-Couple[™] connects to both threaded and unthreaded material
- Connect IMC to IMC, GRC, EMT, or PVC
- Reduces material cost - no separate couplings to purchase, store, carry or install
- Reduces labor cost - quick and easy installations
- Compact design allows for easier installation in tight spaces
- Super Kwik-Couple[™] coupling can be easily removed from the conduit and reinstalled in seconds using standard tongue and groove pliers or a strap wrench
- Listed for wet locations
- Permitted for use in Class 1 Division 2 locations per Section 501-10(B)(1) of the NEC[®]
- Available in trade sizes ½" (16 mm) - 4" (103 mm)
- Super Kwik-Couple[™] IMC also available in a dry version

Super Kwik-Couple[™] IMC is not approved for Class 1 Division 1 locations



Intermediate Metal Conduit (IMC) & Super Kwik-Couple™ IMC

FEATURES & SPECIFICATIONS

Allied Tube & Conduit® patented Super Kwik-Couple™ Intermediate Metal Conduit conduit reduces threaded conduit installation time and cost. Super Kwik-Couple™ has an integrated coupling on the conduit exactly where you need it. Allied Tube & Conduit® Super Kwik-Couple™ IMC is precision manufactured for economical protection and long lasting value for the electrical raceway system. Super Kwik-Couple™ conduit is manufactured from premium, work hardened steel partnering electrical and mechanical performance with ductility. Super Kwik-Couple™ IMC is resistant to impact and is easy to cut, bend and join for smooth, continuous raceways. Allied Tube & Conduit® Super Kwik-Couple™ IMC is as strong, lighter in weight, and less expensive than RIGID. In fact, it can save you as much as 30% in overall costs. IMC, covered by Article 342 in the National Electrical Code® (NEC)®, is recognized as an equipment grounding conductor in Article 250 of the NEC® and also provides excellent shielding from electromagnetic fields.

The Allied Tube & Conduit® Advantage™

Allied Tube & Conduit® Super Kwik-Couple™ IMC has a larger internal diameter than rigid conduit, allowing for easier fishing and wire-pulling. Super Kwik-Couple™ IMC is also more “rigid” than RIGID to provide exceptional wiring protection in many applications.

Allied Tube & Conduit® IMC uses the same threaded couplings and fittings as RIGID conduit, and the ¾” NPT threads (ANSI B1.20.1) are also full cut and galvanized after cutting. Color-coded end cap thread protectors keep the threads clean, sharp, and also help to provide instant trade size recognition. Even sizes are color-coded orange, ½” trade sizes are yellow, and ¼” trade sizes are green.

Coatings

Allied Tube & Conduit® IMC is hot galvanized using Allied’s patented in-line Flo-Coat® process. This process combines zinc, a conversion coating, and a clear organic polymer topcoat to form a triple layer of protection against corrosion and abrasion. The interior of Allied Tube & Conduit® IMC is coated with a highly corrosion-resistant lubricating finish for easier wire-pulling. No need to worry about damage to the conduit system, even when pulling through multiple 90° bends.

EMI Shielding

Super Kwik-Couple™ IMC is effective in reducing the effects of electromagnetic fields on encased power distribution circuits, shielding computers and other sensitive electronic equipment from the effects of electromagnetic interference.

Codes & Standards Compliance

IMC is covered by Article 342 of the National Electrical Code® (NEC)®. Allied Tube & Conduit® IMC is listed to Safety Standard UL 1242 and is manufactured in accordance with ANSI C80.6. These standards have been adopted as Federal Specifications in lieu of WWC-581-Type 2. IMC is recognized as an equipment grounding conductor by NEC® Section 250-118.

Super Kwik-Couple™ IMC is listed to UL Safety Standards 1242 and to 514B.

Super Kwik-Couple™ IMC (dry version) does not contain a wet locations listing.

Installation of Super Kwik-Couple™ IMC conduit and elbows shall be in accordance with the National Electrical Code® (NEC)® and the UL listing information. Allied Tube & Conduit® IMC is listed in UL category DYBY. Master bundles conform to NEMA standard RN 2.

Specification Data

To specify Super Kwik-Couple™ IMC, include the following: Intermediate Metal Conduit (IMC) conduit and elbows shall be equal to that manufactured by Allied Tube & Conduit®. IMC shall be hot galvanized steel OD with an organic corrosion resistant ID coating and shall be listed to UL Safety Standard 1242 and manufactured in accordance with ANSI C80.6. It shall be listed by a nationally recognized testing laboratory with follow-up service. Threads shall be hot galvanized after cutting.

Intermediate Metal Conduit (IMC) & Super Kwik-Couple™ IMC

NEC® recognizes Allied Tube & Conduit® IMC for same uses as RIGID

IMC (Intermediate Metal Conduit) Weights and Dimensions

Listed to Safety Standard UL 1242 and UL 514B
Manufactured in accordance with ANSI C80.6



Trade Size	Metric Designator	Average Outside Diameter ¹		Average Wall Thickness ²		Approximate Weight Per 100 ft (30.5 m)		Master Bundle Quantity	
		(in)	(mm)	(in)	(mm)	(lb)	(kg)	(ft)	(m)
½	16	0.815	20.70	0.070	1.79	62	28.1	3500	1067.5
¾	21	1.029	26.13	0.075	1.90	84	38.1	2500	762.5
1	27	1.290	32.76	0.085	2.16	119	54.0	1700	518.5
1¼	35	1.638	41.60	0.085	2.16	158	71.7	1350	411.8
1½	41	1.883	47.82	0.090	2.29	194	88.0	1100	335.5
2	53	2.360	59.94	0.095	2.41	256	116.1	800	244.0
2½	63	2.857	72.56	0.140	3.56	441	200.0	370	112.9
3	78	3.476	88.29	0.140	3.56	543	246.3	300	91.5
3½	91	3.971	100.86	0.140	3.56	629	285.3	240	73.2
4	103	4.466	113.43	0.140	3.56	700	317.5	240	73.2

¹Outside diameter tolerances:

+/- .005 (in) (.13mm) for trade sizes ½" (16mm) through 1" (25mm)
+/- .0075 (in) (.19mm) for trade sizes 1¼" (36mm) through 2" (53mm)
+/- 0.10 (in) (.25mm) for trade sizes 2½" (63mm) through 4" (103mm)

²Wall thickness tolerances:

+ 0.15 (in) (.38mm) and - .000 for trade sizes ½" (13mm) through 2" (53mm)
+ 0.20 (in) (.51mm) and - .000 for trade sizes 2½" (63mm) through 4" (103mm)
NOTE: Length = 10 (ft) (3.05m) with a tolerance of +/- .25 (in) (6.35mm)

Super Kwik-Couple™ IMC Raintight

Listed to Safety Standards UL 1242 and UL 514B
Manufactured in accordance with ANSI C80.6



Trade Size	Metric Designator	Average Outside Diameter ¹		Average Wall Thickness ²		Approximate Weight Per 100 ft (30.5 m)		Master Bundle Quantity	
		(in)	(mm)	(in)	(mm)	(lb)	(kg)	(ft)	(m)
½	16	0.815	20.70	0.070	1.79	63	28.6	1600	487.8
¾	21	1.029	26.13	0.075	1.90	85	38.6	1260	384.1
1	27	1.290	32.76	0.085	2.16	120	54.4	840	256.1
1¼	35	1.638	41.60	0.085	2.16	160	72.6	700	213.4
1½	41	1.883	47.82	0.090	2.29	196	88.9	600	182.9
2	53	2.360	59.94	0.095	2.41	257	116.6	450	137.2
2½	63	2.857	72.56	0.140	3.56	441	200.0	400	122.0
3	78	3.476	88.29	0.140	3.56	542	245.8	300	91.5
3½	91	3.971	100.86	0.140	3.56	621	281.7	250	76.3
4	103	4.466	113.43	0.140	3.56	706	320.2	200	61.0

¹Outside diameter tolerances:

+/- .005 (in) (.13mm) for trade sizes ½" (16mm) through 1" (25mm)
+/- .0075 (in) (.19mm) for trade sizes 1¼" (36mm) through 2" (53mm)
+/- 0.10 (in) (.25mm) for trade sizes 2½" (63mm) through 4" (103mm)
Also available in dry location

²Wall thickness tolerances:

+ 0.15 (in) (.38mm) and - .000 for trade sizes ½" (13mm) through 2" (53mm)
+ 0.20 (in) (.51mm) and - .000 for trade sizes 2½" (63mm) through 4" (103mm)
NOTE: Length = 10 (ft) (3.05m) with a tolerance of +/- .25 (in) (6.35mm)





Galvanized Rigid Conduit	14-15
Super Kwik-Couple™ GRC	14-15



Galvanized Rigid Conduit (GRC) & Super Kwik-Couple™ GRC

Galvanized Rigid Conduit (GRC)

- Hot-dip galvanized for excellent corrosion resistance
- High strength ductile steel for long life and easy bending
- Smooth, continuous raceways for fast wire pulling
- Kwik-Release End Cap to protect threads
- True Color™ GRC available by special order
- Listed to Safety Standard UL 6
- Manufactured in accordance with ANSI C80.1
- Available in trade sizes ½" (16 mm) - 6" (155 mm)



Quality, Long Lasting, Heavy Duty Steel Conduit

Super Kwik-Couple™ GRC Conduit (SKC) Raintight

- Similar benefits of GRC conduit
- High grade durable and ductile steel for long life
- Corrosion resistant exterior and interior finishes
- Super Kwik-Couple™ GRC is listed to UL Safety Standards 6 and to 514B and manufactured in accordance with ANSI C80.1
- Eliminates field threading - factory installed patented Super Kwik-Couple™ connects to both threaded and unthreaded material
- Connect GRC to GRC, IMC, EMT, or PVC
- Reduces material cost - no separate couplings to purchase, store, carry, or install
- Reduces labor cost - quick and easy installations
- Compact design allows for easier installation in tight spaces
- Super Kwik-Couple™ coupling can be easily removed from the conduit and reinstalled in seconds using standard tongue and groove pliers or a strap wrench
- Listed for wet locations
- Permitted for use in Class 1 Division 2 locations per Section 501-10(B)(1) of the NEC®
- Available in trade sizes ½" (16 mm) - 5" (129 mm)
- Super Kwik-Couple™ GRC also available in a dry version

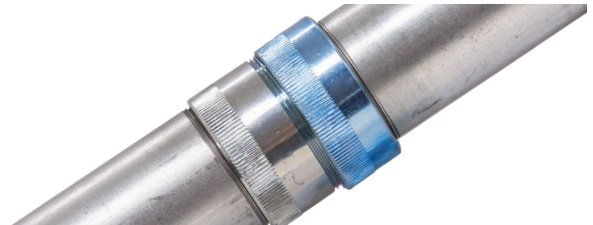

Super Kwik-Couple™ GRC Conduit (SKC) Raintight



GRC to IMC Conduit



GRC to EMT

For Faster Installations, Use the Super Kwik-Couple™ GRC Connection

* U.S. Patent Number: 8,586,881

Super Kwik-Couple™ IMC is not approved for Class 1 Division 1 locations

Galvanized Rigid Conduit (GRC)

Listed to UL 6, manufactured in accordance with ANSI C80.1



Trade Size	Metric Designator	Outside Diameter ¹		Nominal Wall Thickness ²		Approximate Weight Per 100 ft (30.5 m)		Master Bundle Quantity	
		(in)	(mm)	(in)	(mm)	(lb)	(kg)	(ft)	(m)
½	16	0.840	21.34	0.104	2.64	82	37.2	2500	762.5
¾	21	1.050	26.67	0.107	2.72	109	49.4	2000	610.0
1	27	1.315	33.40	0.126	3.20	161	73.0	1250	381.3
1¼	35	1.660	42.16	0.133	3.38	218	98.9	900	274.5
1½	41	1.900	48.26	0.138	3.51	263	119.3	800	244.0
2	53	2.375	60.33	0.146	3.71	350	158.8	600	183.0
2½	63	2.875	73.03	0.193	4.90	559	253.6	370	112.9
3	78	3.500	88.90	0.205	5.21	727	329.8	300	91.5
3½	91	4.000	101.60	0.215	5.46	880	399.2	250	76.3
4	103	4.500	114.30	0.225	5.72	1030	467.2	200	61.0
5	129	5.563	141.30	0.245	6.22	1400	634.5	150	45.8
6	155	6.625	168.28	0.266	6.76	1840	833.9	100	30.5

¹Tolerances: Trade Size ½" to 1½" ±0.015" (0.38mm); Trade Size 2"-6": ±1% Length equals 10 (ft) (3.05m) with a tolerance of +/- .25 (in) (6.35mm)

²For information only. Not a requirement of the UL standard.

* NEMA RN 3 Standard

Galvanized Rigid Conduit (GRC) & Super Kwik-Couple[™] GRC

FEATURES & SPECIFICATIONS

Full Electrical System Protection

Allied Tube & Conduit[®] Super Kwik-Couple[™] GRC conduit is manufactured from mild steel and is highly resistant to damage from impact yet ductile to facilitate bending.

Color-coded end cap thread protectors keep the threads clean, sharp and also provide instant trade size recognition. Even sizes are color-coded blue, ½" sizes are black, and ¾" sizes are red.

Coatings

Conduit: Hot-dip galvanized inside and out providing galvanic corrosion protection. In addition, top coated with a compatible organic layer to protect against white rust. The inside surface is evenly coated for wire-pulling ease, even through multiple 90° bends.

Coupling: Electro-galvanized inside and out to provide galvanic corrosion protection.

EMI Shielding

Allied Tube & Conduit[®] GRC Conduit is effective in reducing the effects of electromagnetic field levels for encased power distribution circuits, shielding computers and other sensitive electronic equipment from the effects of electromagnetic interference.

Codes & Standards Compliance

Allied Tube & Conduit[®] Super Kwik-Couple[™] GRC Conduit is precision manufactured for dependable, long-lasting value

and ultimate protection for electrical conductors. Covered by Article 344 of the National Electrical Code[®] (NEC)[®], GRC conduit is highly resistant to damage from impact. GRC conduit is recognized as an equipment grounding conductor in Section 250.118 of the NEC[®]. Super Kwik-Couple[™] GRC is listed to UL Safety Standards 6 and to UL 514B. Super Kwik-Couple[™] GRC is listed for wet location applications.

Super Kwik-Couple[™] GRC is manufactured to ANSI C80.1, which has been adopted as Federal Specifications in lieu of WWC 581. Installation of Rigid Metal Conduit shall be in accordance with the National Electrical Code[®] (NEC)[®] and UL General Information card #DYIX. Master bundles conform to NEMA standard RN 2.

Specification Data

To specify Super Kwik-Couple[™] GRC Conduit, include the following: GRC Conduit shall be hot-dip galvanized and manufactured by Allied Tube & Conduit[®]. Threads shall be hot galvanized after cutting. GRC conduit shall be listed to UL Safety Standard 6 by a nationally-recognized testing laboratory with follow-up service. It shall be manufactured in accordance with ANSI C80.1.

Super Kwik-Couple[™] GRC conduit shall be listed to UL 6 and UL 514B and manufactured in accordance with ANSI C80.1. Note: Federal specification WW-C-581, Class 1, Type A has been superseded by UL Standard 6, which has been adopted by the Federal Government.

Super Kwik-Couple[™] (GRC) Raintight

Listed to Safety Standards UL 6 and UL 514B
Manufactured in accordance with ANSI C80.1



Trade Size	Metric Designator	Average Outside Diameter ¹		Average Wall Thickness ²		Approximate Weight Per 100 ft (30.5 m)		Bundle Quantity	
		(in)	(mm)	(in)	(mm)	(lb)	(kg)	(ft)	(m)
½	16	0.840	21.34	0.104	2.64	83	37.6	1600	487.8
¾	21	1.050	26.67	0.107	2.72	110	49.9	1260	384.1
1	27	1.315	33.40	0.126	3.20	162	73.5	840	256.1
1¼	35	1.660	42.16	0.133	3.38	220	99.8	700	213.4
1½	41	1.900	48.26	0.138	3.51	265	120.2	600	182.9
2	53	2.375	60.33	0.146	3.71	351	159.2	450	137.2
2½	63	2.875	73.03	0.193	4.90	559	253.6	400	122.0
3	78	3.500	88.90	0.205	5.21	726	329.3	300	91.5
3½	91	4.000	101.60	0.215	5.46	872	395.5	250	76.3
4	103	4.500	114.30	0.225	5.72	1036	469.9	200	61.0
5	129	5.563	141.30	0.245	6.22	1414	641.4	150	45.7

¹Tolerances: Trade Size ½" to 1½" ±0.015" (0.38mm); Trade Size 2"-6": ±1%

²For information only. Not a requirement of the UL standard.





ECN • Elbows, Couplings & Nipples

Electrical Metallic Tubing (EMT) Elbows	18-22
90° Elbows	20
45° Elbows	20
Large Radius 90° Elbows	21
Large Radius 45° Elbows.....	22
Galvanized Rigid Conduit (GRC) Couplings & Elbows	23-31
Couplings	23
Super Kwik Coupling™	23-24
90° Elbows	24
90° Super Kwik-Couple™ Elbow	25
45° Elbows.....	25
Large Radius 90° Elbows	26-27
Large Radius 45° Elbows.....	28
Galvanized Rigid Conduit Nipples	29-30
Galvanized Rigid Conduit Yard Elbows.....	31
Galvanized Running Thread.....	31



Elbows, Couplings & Nipples (ECN)

Electrical Metallic Tubing (EMT) Elbows

- Hot galvanized steel using patented in-line Flo-Coat® process for long lasting exterior protection
- E-Z Pull® interior coating provides a smooth raceway for fast, easier wire-pulling
- Excellent mechanical protection for conductors
- Optimal EMI shielding characteristics
- True Color™ EMT Elbow available by special order
- Listed to Safety Standard UL 797
- Manufactured in accordance with ANSI C80.3
- Available in trade sizes ½" (16 mm) - 4" (103 mm)



Electrical Metallic Tubing (EMT) Elbows



Galvanized Rigid Conduit (GRC) Elbows

Galvanized Rigid Conduit (GRC) Elbows

- Hot-dip galvanized for excellent corrosion resistance
- High strength ductile steel for long life
- Smooth, continuous raceways for fast wire-pulling
- Kwik-Release End Cap to protect threads
- True Color™ GRC Elbow available by special order
- Listed to Safety Standard UL 6
- Manufactured in accordance with ANSI C80.1
- Available in trade sizes ½" (16 mm) - 6" (155 mm)



Super Kwik-Couple™ Rigid Elbows

Super Kwik-Couple™ Rigid Elbows

- Also available with pre-installed Super Kwik-Couple™ Raintight Couplings
- Made to order, contact us for lead times
- UL Listed for wet locations

Galvanized Rigid Conduit (GRC) Couplings

- Electro-galvanized for excellent corrosion resistance
- Listed to Safety Standard UL 6
- Manufactured in accordance with ANSI C80.1
- Available in trade sizes ½" (16 mm) - 6" (155 mm)



Galvanized Rigid Conduit (GRC) Couplings

Super Kwik-Couple™ Rigid Couplings Raintight

- Electro-galvanized for excellent corrosion resistance
- Listed to Safety Standard UL 514B
- UL Listed for wet locations
- Manufactured in accordance with ANSI C80.1
- Available in trade sizes ½" (16 mm) - 5" (103 mm)



Super Kwik-Couple™ Rigid Couplings

Galvanized Rigid Conduit (GRC) Nipples

- Hot-dip galvanized for excellent corrosion resistance
- High strength ductile steel for long life
- Smooth, continuous raceways for fast wire-pulling
- Listed to Safety Standard UL 6



Galvanized Rigid Conduit (GRC) Nipples

Elbows, Couplings & Nipples (ECN)

FEATURES & SPECIFICATIONS

Full Electrical System Protection

Allied Tube & Conduit® EMT and GRC conduit is manufactured from mild steel and offers exceptional durability and long-lasting life.

Color-coded end cap thread protectors keep the threads clean, sharp and also provide instant trade size recognition. Even sizes are color-coded blue, ½" sizes are black, and ¼" sizes are red.

Coatings

EMT: Special low friction ID coating called E-Z Pull® that greatly improves the slip properties between conduit and wire. With E-Z Pull® EMT, wire pulls through the EMT smoothly and easily, making installation easier and faster.

GRC: Hot-dip galvanized inside and out providing galvanic corrosion protection. In addition, top coated with a compatible organic layer to protect against white rust. The inside surface is evenly coated for wire-pulling ease, even through multiple 90° bends.

Couplings: Electro-galvanized inside and out to provide galvanic corrosion protection.

EMI Shielding

Allied Tube & Conduit® GRC Conduit is extremely effective in reducing the effects of electromagnetic field levels for encased power distribution circuits, shielding computers and other sensitive electronic equipment from the effects of electromagnetic interference.

Codes & Standards Compliance

Allied Tube & Conduit® EMT is listed to Safety Standard UL 797 and is manufactured in accordance with ANSI C80.3. These standards have been adopted as federal specifications in lieu of WWC 563. EMT is recognized as an equipment grounding conductor by NEC® Section 250-118.

Allied Tube & Conduit® GRC Conduit is precision manufactured for dependable, long-lasting value and ultimate protection for electrical conductors. Covered by Article 344 of the National Electrical Code® (NEC)®, GRC conduit is highly resistant to damage from impact. GRC conduit is recognized as an equipment grounding conductor in Section 250.118 of the NEC®. GRC is listed to UL Safety Standard 6.

Specification Data

To specify Allied Tube & Conduit® EMT Elbows, include the following: Electrical Metallic Tubing shall be equal to that manufactured by Allied Tube & Conduit®. EMT shall be hot galvanized steel OD with an organic corrosion resistant ID coating, and shall be listed to UL Safety Standard 797 and manufactured in accordance with ANSI C80.3.

To specify GRC Elbows, include the following: GRC Conduit shall be hot-dip galvanized and manufactured by Allied Tube & Conduit®. GRC conduit shall be listed to UL Safety Standard 6 by a nationally-recognized testing laboratory with follow-up service. It shall be manufactured in accordance with ANSI C80.1.



Electrical Metallic Tubing (EMT) Elbows

EMT 90° Elbows

Listed to Safety Standard UL 797

Manufactured in accordance with ANSI C80.3



Trade Size	Metric Designator	Radius (A) ¹		Offset (B) ²		Straight (D) ¹		Approximate Weight Per 100 Pieces		Standard Package
		(in)	(mm)	(in)	(mm)	(in)	(mm)	(lb)	(kg)	
1/2	16	4	102	5/8	149	1 1/2	38	25	11.3	25
3/4	21	4 1/2	114	7	178	1 1/2	38	46	20.9	50
1	27	5 3/4	146	8 3/4	222	1 7/8	48	84	38.1	25
1 1/4	35	7 1/4	184	10 1/8	257	2	51	144	65.3	20
1 1/2	41	8 1/4	210	11 3/4	298	2	51	193	87.5	15
2	53	9 1/2	241	14	356	2	51	296	134.3	10
2 1/2	63	10 1/2	267	16 1/4	413	3	76	504	228.6	1
3	78	13	330	18 3/4	476	3 3/8	79	701	318.0	1
3 1/2	91	15	381	21 1/4	540	3 1/4	83	1047	474.9	1
4	103	16	406	23 3/8	594	3 3/8	86	1310	594.2	1

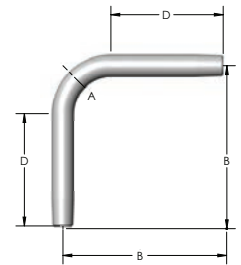

¹Minimum requirement as per UL Standard

²Dimensions and weights are approximate

Sizes 2 1/2" (63 mm) and larger shipped in palletized cartons or bulk

Also available in the following Degrees (60°, 45°, 30°, 22 1/2°, 15° & 11 1/4°)

EMT 45° Elbows

Listed to Safety Standard UL 797

Manufactured in accordance with ANSI C80.3



Trade Size	Metric Designator	Radius (A) ¹		Offset (B) ²		Offset (C) ²		Straight (D) ¹		Approximate Weight Per 100 Pieces		Standard Package
		(in)	(mm)	(in)	(mm)	(in)	(mm)	(in)	(mm)	(lb)	(kg)	
1/2	16	4	102	6 1/8	156	2 1/2	64	1 1/2	38	18	8.2	25
3/4	21	4 1/2	114	7 7/8	187	3 1/8	79	1 1/2	38	33	15.0	50
1	27	5 3/4	146	8 3/4	222	3 5/8	92	1 7/8	48	56	25.4	25
1 1/4	35	7 1/4	184	10 1/8	257	4 1/8	105	2	51	97	44.0	20
1 1/2	41	8 1/4	210	13 1/8	333	5 3/8	137	2	51	145	65.8	15
2	53	9 1/2	241	13 1/8	333	5 1/2	140	2	51	185	83.9	10
2 1/2	63	10 1/2	267	17 1/2	445	7 1/4	184	3	76	360	163.3	1
3	78	13	330	17 1/2	445	7 1/4	184	3 3/8	79	438	198.7	1
3 1/2	91	15	381	26 1/8	664	10 7/8	276	3 1/4	83	873	396.0	1
4	103	16	406	26 1/4	667	10 7/8	276	3 3/8	86	983	445.9	1

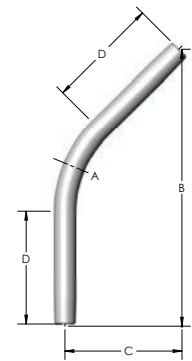

¹Minimum requirement as per UL Standard

²Dimensions and weights are approximate

Sizes 2 1/2" (63 mm) and larger shipped in palletized cartons or bulk

Also available in the following Degrees (90°, 60°, 30°, 22 1/2°, 15° & 11 1/4°)

Electrical Metallic Tubing (EMT) Elbows

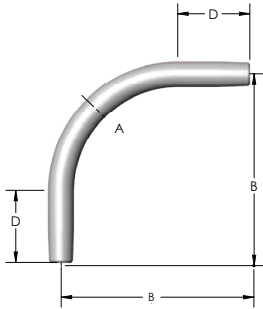

EMT Large Radius 90° Elbows

Listed to Safety Standard UL 797

Manufactured in accordance with ANSI C80.3



Trade Size	Metric Designator	Radius (A) ¹		Offset (B) ²		Straight (D) ¹		Approximate Weight Per 100 Pieces	
		(in)	(mm)	(in)	(mm)	(in)	(mm)	(lb)	(kg)
1¼	35	36	914	46¾	1187	10¾	273	657	298.0
1½	41	24	610	34⅝	879	10⅝	270	570	258.6
1½	41	36	914	46¾	1187	10¾	273	754	342.0
1½	41	48	1219	60¼	1530	12¼	311	967	438.6
2	53	24	610	34⅝	879	10⅝	270	728	330.2
2	53	36	914	46¾	1187	10¾	273	962	436.4
2	53	48	1219	60¼	1530	12¼	311	1233	559.3
2½	63	24	610	34⅝	879	10⅝	270	1062	481.7
2½	63	36	914	46¾	1187	10¾	273	1404	636.9
2½	63	48	1219	60¼	1530	12¼	311	1800	816.5
3	78	24	610	34⅝	879	10⅝	270	1293	586.5
3	78	36	914	46¾	1187	10¾	273	1710	775.7
3	78	48	1219	60¼	1530	12¼	311	2192	994.3
3½	91	24	610	34⅝	879	10⅝	270	1716	778.4
3½	91	30	762	41	1041	11	279	2007	910.4
3½	91	36	914	46¾	1187	10¾	273	2269	1029.2
3½	91	48	1219	60¼	1530	12¼	311	2908	1319.1
4	103	24	610	34⅝	879	10⅝	270	1932	876.4
4	103	30	762	41	1041	11	279	2260	1025.1
4	103	36	914	46¾	1187	10¾	273	2555	1158.9
4	103	48	1219	60¼	1530	12¼	311	3275	1485.5

¹Minimum requirement as per UL Standard

²For information only, not a requirement as per UL Standard

Sizes 2½" (63 mm) and larger shipped in palletized cartons or bulk

Also available in the following Degrees (60°, 45°, 30°, 22½°, 15° & 11¼°)



Electrical Metallic Tubing (EMT) Elbows

EMT Large Radius 45° Elbows

Listed to Safety Standard UL 797

Manufactured in accordance with ANSI C80.3

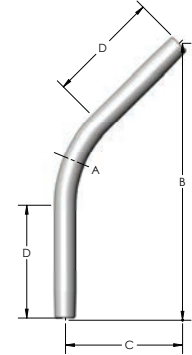

Trade Size	Metric Designator	Radius (A) ¹		Offset (B) ²		Offset (C) ²		Straight (D) ¹		Approximate Weight Per 100 Pieces	
		(in)	(mm)	(in)	(mm)	(in)	(mm)	(in)	(mm)	(lb)	(kg)
1¼	35	36	914	44	1118	18½	470	11	279	410	185
1½	41	24	610	36	914	15	381	11	279	410	185
1½	41	36	914	44	1118	18½	470	11	279	510	230
1½	41	48	1219	54½	1384	22½	572	12	305	600	270
2	53	24	610	36	914	15	381	11	279	510	230
2	53	36	914	44	1118	18½	470	11	279	590	266
2	53	48	1219	54½	1384	22½	572	12	305	760	342
2½	63	24	610	36	914	15	381	11	279	580	261
2½	63	36	914	44	1118	18½	470	11	279	850	383
2½	63	48	1219	54½	1384	22½	572	12	305	1110	500
3	78	24	610	36	914	15	381	11	279	880	396
3	78	36	914	44	1118	18½	470	11	279	1020	459
3	78	48	1219	54½	1384	22½	572	12	305	1360	612
3½	91	24	610	36	914	15	381	11	279	1130	509
3½	91	30	762	40	1016	17	432	11	279	1160	522
3½	91	36	914	44	1118	18½	470	11	279	1390	626
3½	91	48	1219	54½	1384	22½	572	12	305	1800	810
4	103	24	610	36	914	15	381	11	279	1300	585
4	103	30	762	40	1016	17	432	11	279	1560	702
4	103	36	914	44	1118	18½	470	11	279	1600	720
4	103	48	1219	54½	1384	22½	572	12	305	2030	914

¹Minimum requirement as per UL Standard

²For information only, not a requirement as per UL Standard

Sizes 2½" (63 mm) and larger shipped in palletized cartons or bulk

Also available in the following Degrees (60°, 45°, 30°, 22½°, 15° & 11¼°)

Galvanized Rigid Conduit (GRC) Couplings

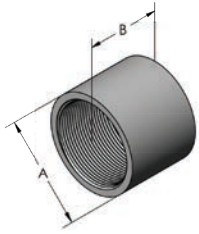

Galvanized Rigid Conduit (GRC) Couplings

Listed to Safety Standard UL 6
Manufactured in accordance with ANSI C80.1



Trade Size	Metric Designator	Nominal OD (A) ¹		Length (B) ¹		Threads Per Inch ¹	Approximate Weight Per 100 Pieces		Standard Package
		(in)	(mm)	(in)	(mm)		(lb)	(kg)	
1/2	16	1.01	25.7	1 5/8	41.3	14	12	5.4	100
3/4	21	1.25	31.8	1 1/64	41.7	14	18	8.2	50
1	27	1.53	38.7	1 31/32	50.0	11 1/2	30	13.6	30
1 1/4	35	1.87	47.5	2 1/32	51.6	11 1/2	37	16.8	25
1 1/2	41	2.16	54.7	2 1/8	52.4	11 1/2	52	23.6	25
2	53	2.65	67.3	2 1/8	54.0	11 1/2	72	32.7	20
2 1/2	63	3.25	82.6	3 3/16	81.0	8	170	77.1	1
3	78	3.87	98.3	3 5/16	84.1	8	210	95.3	1
3 1/2	91	4.50	114.3	3 3/32	86.5	8	340	154.2	1
4	103	4.88	123.8	3 3/64	89.3	8	300	136.1	1
5	129	6.00	152.4	3 61/64	100.4	8	475	215.5	1
6	155	7.20	182.9	4 1/4	108.0	8	765	347.0	1

¹Minimum requirement as per UL Standard

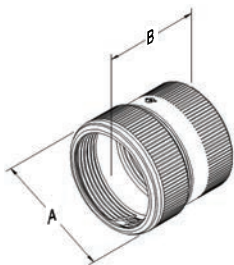

Super Kwik-Coupling[™]

Listed to Safety Standard UL 514B
Manufactured in accordance with ANSI C22.2 No. 18.3-12



Trade Size	Metric Designator	Nominal OD (A)		Length (B)		Threads Per Inch ¹	Approximate Weight Per 100 Pieces		Standard Package
		(in)	(mm)	(in)	(mm)		(lb)	(kg)	
1/2	16	1.25	31.8	1.56	39.6	14	20.0	9.1	25
3/4	21	1.45	36.8	1.62	41.1	14	23.0	10.4	25
1	27	1.71	43.4	1.96	49.8	11 1/2	36.0	16.3	10
1 1/4	35	2.07	52.6	2.08	52.8	12 1/2	46.0	20.9	5
1 1/2	41	2.32	58.9	2.12	53.8	13 1/2	55.0	24.9	5
2	53	2.80	71.1	2.19	55.6	14 1/2	70.0	31.8	2
2 1/2	63	3.45	87.6	3.19	81.0	8	170	76.5	2
3	78	4.08	103.6	3.31	84.1	8	210	94.5	1
3 1/2	91	4.59	116.6	4.15	105.4	8	270	121.5	1
4	103	5.24	133.1	4	101.6	8	370	166.5	1
5	129	6.25	158.8	5.38	136.7	12	538.0	244.0	1

¹Minimum requirement as per UL Standard

Super Kwik-Couple[™] Elbows Available

Trade Size 1/2" (16 mm) to 5" (129 mm) by special order
Single & Double Sided



Galvanized Rigid Conduit (GRC) Couplings & Elbows

Super Kwik-Coupling™ Raintight

Listed to Safety Standard UL 514B

Manufactured in accordance with ANSI C22.2 No. 18.3-12

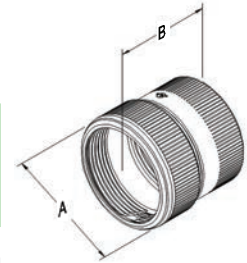

Trade Size	Metric Designator	Nominal OD (A)		Length (B)		Threads Per Inch ¹	Approximate Weight Per 100 Pieces		Standard Package
		(in)	(mm)	(in)	(mm)		(lb)	(kg)	
1/2	16	1.24	31.5	2.11	53.6	14	24.5	11.1	25
3/4	21	1.44	36.6	2.09	53.1	14	28.5	12.9	25
1	27	1.72	43.7	2.46	62.5	11½	43.2	19.6	10
1¼	35	2.07	52.6	2.61	66.3	12½	58.6	26.6	5
1½	41	2.32	58.9	2.65	67.3	13½	67.0	30.4	5
2	53	2.80	71.1	2.71	68.8	14½	84.0	38.1	2
2½	63	3.43	87.1	3.90	99.1	8	175.0	79.4	2
3	78	4.06	103.1	4.02	102.1	9	211.0	95.7	1
3½	91	4.58	116.3	4.33	110.0	10	271.5	123.2	1
4	103	5.08	129.0	4.44	112.8	11	371.5	168.5	1
5	129	6.25	158.8	5.63	143.0	12	610.0	276.7	1

¹Minimum requirement as per UL Standard

Super Kwik-Couple™ Elbows Available

Trade Size 1/2" (16 mm) to 5" (129 mm) by special order
Single & Double Sided

Galvanized Rigid Conduit (GRC) 90° Elbows

Listed to Safety Standard UL 6

Manufactured in accordance with ANSI C80.1

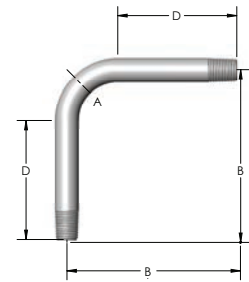

Trade Size	Metric Designator	Radius (A) ¹		Offset (B) ²		Straight (D) ¹		Approximate Weight Per 100 Pieces		Standard Package
		(in)	(mm)	(in)	(mm)	(in)	(mm)	(lb)	(kg)	
1/2	16	4	102	57/8	149	1½	38	68	30.8	50
3/4	21	4½	114	7	178	1½	38	109	49.4	50
1	27	5¾	146	8¾	222	17/8	48	201	91.2	25
1¼	35	7¼	184	10¾	273	2	51	336	152.4	20
1½	41	8¼	210	12¼	311	2	51	460	208.7	15
2	53	9½	241	14½	368	2	51	729	330.7	10
2½	63	10½	267	17	432	3	76	1374	623.2	1
3	78	13	330	195/8	498	37/8	79	2045	927.6	1
3½	91	15	381	22¾	578	3¼	83	2860	1297.3	1
4	103	16	406	237/8	606	35/8	86	3519	1596.2	1
5	129	24	610	347/8	886	35/8	92	6942	3148.9	1
6	155	30	762	45½	1156	3¾	95	11960	5425.1	1

¹Minimum requirement as per UL Standard

²For information only, not a requirement as per UL Standard

Sizes 2½" (63 mm) and larger shipped in palletized cartons or bulk

Also available in the following Degrees (60°, 45°, 30°, 22½°, 15° & 11¼°)

Galvanized Rigid Conduit (GRC) Couplings & Elbows

Galvanized Rigid Conduit (GRC) 90° Super Kwik-Couple™ Elbow

Listed to Safety Standards UL 6 and 514B

Manufactured in accordance with ANSI C80.1 and C22.2 No. 18.3-12

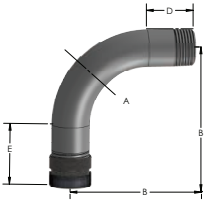

Trade Size	Metric Designator	Radius (A) ¹		Offset (B) ²		Straight (D) ²		Straight (E) ²		Approximate Weight Per 100 Pieces	
		(in)	(mm)	(in)	(mm)	(in)	(mm)	(in)	(mm)	(lb)	(kg)
1/2	16	4	102	5 7/8	149	1 1/2	38	2 7/8	73	93	42.0
3/4	21	4 1/2	114	7	178	1 1/2	38	2 1/2	64	138	62.4
1	27	5 3/4	146	8 3/4	222	1 7/8	48	3 1/2	89	244	110.8
1 1/4	35	7 1/4	184	10 3/4	273	2	51	3 5/8	92	395	179.0
1 1/2	41	8 1/4	210	12 1/4	311	2	51	3 5/8	92	527	239.0
2	53	9 1/2	241	14 1/2	368	2	51	3 5/8	92	813	368.8
2 1/2	63	10 1/2	267	17	432	3	76	4 1/2	114	1549	702.6
3	78	13	330	19 5/8	498	3 1/8	79	4 3/4	121	2256	1023.3
3 1/2	91	15	381	22 3/4	578	3 1/4	83	5 5/8	137	3132	1420.4
4	103	16	406	23 7/8	606	3 3/8	86	5 5/8	137	3891	1764.7
5	129	24	610	34 7/8	886	3 5/8	92	6	152	7552	3425.5

¹Minimum requirement as per UL Standard

²For information only, not a requirement as per UL Standard

Shipped in palletized cartons or bulk

Also available in the following Degrees (60°, 45°, 30°, 22 1/2°, 15° & 11 1/4°)

Also available in dry location

Super Kwik-Couple™ Elbows Available

Trade Size 1/2" (16 mm) to 5" (129 mm) by special order

Single & Double Sided

Galvanized Rigid Conduit (GRC) 45° Elbows

Listed to Safety Standard UL 6

Manufactured in accordance with ANSI C80.1

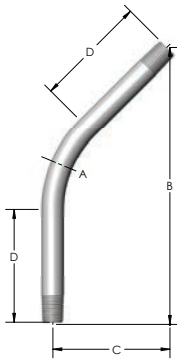

Trade Size	Metric Designator	Radius (A) ¹		Offset (B) ²		Offset (C) ²		Straight (D) ¹		Approximate Weight Per 100 Pieces		Standard Package
		(in)	(mm)	(in)	(mm)	(in)	(mm)	(in)	(mm)	(lb)	(kg)	
1/2	16	4	102	7	178	2 7/8	73	1 1/2	38	55	24.9	50
3/4	21	4 1/2	114	7 7/8	200	3 1/4	83	1 1/2	38	82	37.2	50
1	27	5 3/4	146	9 5/8	244	4	102	1 7/8	48	148	67.1	25
1 1/4	35	7 1/4	184	11 1/8	283	4 5/8	117	2	51	232	105.2	20
1 1/2	41	8 1/4	210	13 3/8	333	5 5/8	137	2	51	329	149.2	15
2	53	9 1/2	241	15 3/4	400	6 1/2	165	2	51	525	238.1	10
2 1/2	63	10 1/2	267	17 1/2	445	7 1/4	184	3	76	932	422.8	1
3	78	13	330	21 7/8	556	9	229	3 1/8	79	1515	687.2	1
3 1/2	91	15	381	26 7/8	664	10 7/8	276	3 1/4	83	2200	997.9	1
4	103	16	406	26 1/4	667	10 7/8	276	3 3/8	86	2575	1168.0	1
5	129	24	610	35 7/8	911	14 7/8	378	3 5/8	92	4783	2169.6	1
6	155	30	762	43 3/8	1102	18	457	3 3/4	95	7590	3442.8	1

¹Minimum requirement as per UL Standard

²For information only, not a requirement as per UL Standard

Sizes 2 1/2" (63 mm) and larger shipped in palletized cartons or bulk

Also available in the following Degrees (90°, 60°, 30°, 22 1/2°, 15° & 11 1/4°)



Galvanized Rigid Conduit (GRC) Elbows

Galvanized Rigid Conduit (GRC) Large Radius 90° Elbows

Listed to Safety Standard UL 6

Manufactured in accordance with ANSI C80.1

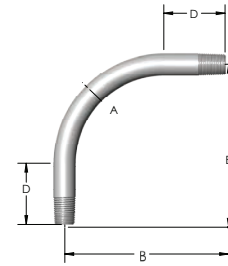

Trade Size	Metric Designator	Radius (A) ¹		Offset (B) ²		Straight (D) ¹		Approximate Weight Per 100 Pieces	
		(in)	(mm)	(in)	(mm)	(in)	(mm)	(lb)	(kg)
1	27	18	457	27 ⁷ / ₈	708	9 ⁷ / ₈	251	644	292.1
1	27	24	610	34 ⁵ / ₈	879	10 ⁵ / ₈	270	792	359.3
1	27	36	914	46 ³ / ₄	1187	10 ³ / ₄	273	1047	474.9
1 ¹ / ₄	35	18	457	27 ⁷ / ₈	708	9 ⁷ / ₈	251	872	395.5
1 ¹ / ₄	35	24	610	34 ⁵ / ₈	879	10 ⁵ / ₈	270	1072	486.3
1 ¹ / ₄	35	30	762	41	1041	11	279	1254	568.8
1 ¹ / ₄	35	36	914	46 ³ / ₄	1187	10 ³ / ₄	273	1417	642.8
1 ¹ / ₄	35	48	1219	61 ¹ / ₄	1556	13 ¹ / ₄	337	1853	840.5
1 ¹ / ₂	41	18	457	27 ⁷ / ₈	708	9 ⁷ / ₈	251	1052	477.2
1 ¹ / ₂	41	24	610	34 ⁵ / ₈	879	10 ⁵ / ₈	270	1293	586.5
1 ¹ / ₂	41	30	762	41	1041	11	279	1512	685.8
1 ¹ / ₂	41	36	914	46 ³ / ₄	1187	10 ³ / ₄	273	1710	775.7
1 ¹ / ₂	41	48	1219	61 ¹ / ₄	1556	13 ¹ / ₄	337	2236	1014.2
2	53	18	457	27 ⁷ / ₈	708	9 ⁷ / ₈	251	1400	635.0
2	53	24	610	30 ³ / ₈	772	6 ³ / ₈	162	1473	668.2
2	53	30	762	41	1041	11	279	2013	913.1
2	53	36	914	46 ³ / ₄	1187	10 ³ / ₄	273	2275	1031.9
2	53	48	1219	61 ¹ / ₄	1556	13 ¹ / ₄	337	2975	1349.5
2 ¹ / ₂	63	18	457	24 ³ / ₈	619	6 ³ / ₈	162	1910	866.4
2 ¹ / ₂	63	24	610	31 ¹ / ₈	791	7 ¹ / ₈	181	2422	1098.6
2 ¹ / ₂	63	30	762	37 ¹ / ₂	953	7 ¹ / ₂	191	2888	1310.0
2 ¹ / ₂	63	36	914	44 ³ / ₄	1137	8 ³ / ₄	222	3447	1563.6
2 ¹ / ₂	63	48	1219	61 ¹ / ₄	1556	13 ¹ / ₄	337	4752	2155.5
3	78	18	457	24 ³ / ₈	619	6 ³ / ₈	162	2484	1126.7
3	78	24	610	33 ¹ / ₈	841	9 ¹ / ₈	232	3393	1539.1
3	78	30	762	38 ⁵ / ₈	981	8 ⁵ / ₈	219	3892	1765.4
3	78	36	914	46 ⁷ / ₈	1191	10 ⁷ / ₈	276	4741	2150.5
3	78	48	1219	60 ¹ / ₄	1530	12 ¹ / ₄	311	6058	2747.9
3 ¹ / ₂	91	24	610	35 ⁵ / ₈	892	11 ⁵ / ₈	283	4400	1995.8
3 ¹ / ₂	91	30	762	38 ¹ / ₂	978	8 ¹ / ₂	216	4693	2128.7
3 ¹ / ₂	91	36	914	47	1194	11	279	5757	2611.4
3 ¹ / ₂	91	48	1219	60 ¹ / ₄	1530	12 ¹ / ₄	311	7333	3326.2
4	103	24	610	35 ⁵ / ₈	892	11 ⁵ / ₈	283	5150	2336.0
4	103	30	762	39 ³ / ₈	1000	9 ³ / ₈	238	5644	2560.1
4	103	36	914	47	1194	11	279	6738	3056.4
4	103	48	1219	60 ¹ / ₄	1530	12 ¹ / ₄	311	8583	3893.2
4	103	60	1524	75 ⁵ / ₈	1927	15 ⁵ / ₈	403	10815	4905.7

¹Minimum requirement as per UL Standard

²For information only, not a requirement as per UL Standard

Shipped in palletized cartons or bulk

Also available in the following Degrees (60°, 30°, 22¹/₂°, 15° & 11¹/₄°)

Chart continued on next page

Galvanized Rigid Conduit (GRC) w/Elbows

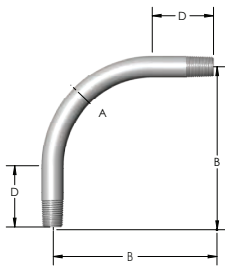

Galvanized Rigid Conduit (GRC) Large Radius 90° Elbows

Listed to Safety Standard UL 6
Manufactured in accordance with ANSI C80.1



Trade Size	Metric Designator	Radius (A) ¹		Offset (B) ²		Straight (D) ¹		Approximate Weight Per 100 Pieces	
		(in)	(mm)	(in)	(mm)	(in)	(mm)	(lb)	(kg)
5	129	36	914	50¾	1289	14¾	375	10033	4551.0
5	129	48	1219	65¼	1657	17¼	438	12833	5821.0
5	129	60	1524	75⅞	1927	15⅞	403	14700	6667.9
6	155	36	914	50¾	1289	14¾	375	13187	5981.6
6	155	48	1219	65¼	1657	17¼	438	16867	7650.9
6	155	60	1524	75⅞	1927	15⅞	403	19320	8763.6

¹Minimum requirement as per UL Standard

²For information only, not a requirement as per UL Standard

Shipped in palletized cartons or bulk

Also available in the following Degrees (60°, 45°, 30°, 22½°, 15° & 11¼°)

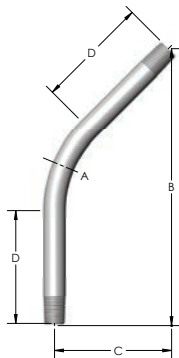

Galvanized Rigid Conduit (GRC) Large Radius 45° Elbows

Listed to Safety Standard UL 6
Manufactured in accordance with ANSI C80.1



Trade Size	Metric Designator	Radius (A) ¹		Offset (B) ²		Offset (C) ²		Straight (D) ¹		Approximate Weight Per 100 Pieces	
		(in)	(mm)	(in)	(mm)	(in)	(mm)	(in)	(mm)	(lb)	(kg)
1	27	18	457	30	762	12½	318	11	279	420	189
1	27	24	610	36	914	15	381	11	279	640	288
1	27	36	914	44	1118	18½	470	11	279	620	279
1¼	35	18	457	30	762	12½	318	11	279	610	275
1¼	35	24	610	36	914	15	381	11	279	800	360
1¼	35	30	762	40	1016	17	432	11	279	900	405
1¼	35	36	914	44	1118	18½	470	11	279	900	405
1¼	35	48	1219	54½	1384	22½	572	12	305	1130	509
1½	41	18	457	30	762	12½	318	11	279	800	360
1½	41	24	610	36	914	15	381	11	279	920	414
1½	41	30	762	40	1016	17	432	11	279	960	432
1½	41	36	914	44	1118	18½	470	11	279	1100	495
1½	41	48	1219	54½	1384	22½	572	12	305	1360	612
2	53	18	457	30	762	12½	318	11	279	1000	450
2	53	24	610	36	914	15	381	11	279	1200	540
2	53	30	762	40	1016	17	432	11	279	1400	630
2	53	36	914	44	1118	18½	470	11	279	1400	630
2	53	48	1219	54½	1384	22½	572	12	305	1810	815
2½	63	18	457	30	762	12½	318	11	279	1500	675
2½	63	24	610	36	914	15	381	11	279	1500	675
2½	63	30	762	40	1016	17	432	11	279	2200	990
2½	63	36	914	44	1118	18½	470	11	279	2200	990
2½	63	48	1219	54½	1384	22½	572	12	305	2890	1301

¹Minimum requirement as per UL Standard

²For information only, not a requirement as per UL Standard

Sizes 2½" (63 mm) and larger shipped in palletized cartons or bulk

Also available in the following Degrees (90°, 60°, 30°, 22½°, 15° & 11¼°)

Chart continued on next page



Galvanized Rigid Conduit (GRC) Elbows & Nipples

Galvanized Rigid Conduit (GRC) Large Radius 45° Elbows

Listed to Safety Standard UL 6

Manufactured in accordance with ANSI C80.1

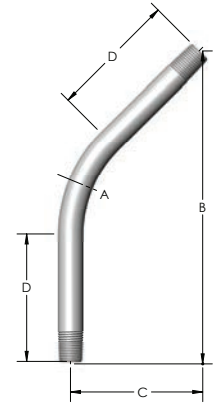

Trade Size	Metric Designator	Radius (A) ¹		Offset (B) ²		Offset (C) ²		Straight (D) ¹		Approximate Weight Per 100 Pieces	
		(in)	(mm)	(in)	(mm)	(in)	(mm)	(in)	(mm)	(lb)	(kg)
3	78	18	457	30	762	12½	318	11	279	2000	900
3	78	24	610	36	914	15	381	11	279	2500	1125
3	78	30	762	40	1016	17	432	11	279	2700	1215
3	78	36	914	44	1118	18½	470	11	279	2900	1305
3	78	48	1219	54½	1384	22½	572	12	305	3880	1746
3½	91	24	610	36	914	15	381	11	279	2860	1287
3½	91	30	762	40	1016	17	432	11	279	2930	1319
3½	91	36	914	44	1118	18½	470	11	279	3500	1575
3½	91	48	1219	54½	1384	22½	572	12	305	4550	2048
4	103	24	610	36	914	15	381	11	279	3400	1530
4	103	30	762	40	1016	17	432	11	279	4100	1845
4	103	36	914	44	1118	18½	470	11	279	4200	1890
4	103	48	1219	54½	1384	22½	572	12	305	5320	2394
4	103	60	1524	62	1575	26	660	12	305	6090	2741
5	129	36	914	44	1118	18½	470	11	279	6000	2700
5	129	48	1219	54½	1384	22½	572	12	305	7230	3254
5	129	60	1524	62	1575	26	660	12	305	8280	3726
6	155	36	914	44	1118	18½	470	12	305	8100	3645
6	155	48	1219	54½	1384	22½	572	12	305	9300	4185
6	155	60	1524	62	1575	26	660	12	305	10650	4793

¹Minimum requirement as per UL Standard

²For information only, not a requirement as per UL Standard

Sizes 2½" (63 mm) and larger shipped in palletized cartons or bulk

Also available in the following Degrees (90°, 60°, 30°, 22½°, 15° & 11¼°)

Galvanized Rigid Conduit (GRC) Nipples

Listed to UL Safety Standard 6

Manufactured in accordance with ANSI C80.1

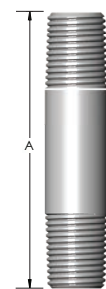

Trade Size	Metric Designator	Length (A)		Total Thread Length ¹		Threads Per Inch ¹	Approximate Weight Per 100 Pieces		Standard Package
		(in)	(mm)	(in)	(mm)		(lb)	(kg)	
½	16	(Close) 1⅛	29	0.78	19.8	14	6	2.7	25
½	16	1½	38	0.78	19.8	14	8	3.6	25
½	16	2	51	0.78	19.8	14	12	5.4	25
½	16	2½	64	0.78	19.8	14	15	6.8	25
½	16	3	76	0.78	19.8	14	19	8.6	25
½	16	3½	89	0.78	19.8	14	22	10.0	25
½	16	4	102	0.78	19.8	14	26	11.8	25
½	16	5	127	0.78	19.8	14	33	15.0	25
½	16	6	152	0.78	19.8	14	40	18.1	25
½	16	8	203	0.78	19.8	14	54	24.5	25
½	16	10	254	0.78	19.8	14	68	30.8	25
½	16	12	305	0.78	19.8	14	82	37.2	25

¹Minimum requirement as per UL Standard

Chart continued on next page

Galvanized Rigid Conduit (GRC) Nipples

Galvanized Rigid Conduit (GRC) Nipples

Listed to UL Safety Standard 6

Manufactured in accordance with ANSI C80.1

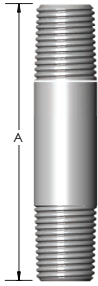

Trade Size	Metric Designator	Length (A)		Total Thread Length ¹		Threads Per Inch ¹	Approximate Weight Per 100 Pieces		Standard Package
		(in)	(mm)	(in)	(mm)		(lb)	(kg)	
3/4	21	(Close) 1 3/8	35	0.79	20.1	14	9	4.1	25
3/4	21	1/2	38	0.79	20.1	14	10	4.5	25
3/4	21	2	51	0.79	20.1	14	14	6.4	25
3/4	21	2 1/2	64	0.79	20.1	14	19	8.6	25
3/4	21	3	76	0.79	20.1	14	24	10.9	25
3/4	21	3 1/2	89	0.79	20.1	14	28	12.7	25
3/4	21	4	102	0.79	20.1	14	34	15.4	25
3/4	21	5	127	0.79	20.1	14	43	19.5	25
3/4	21	6	152	0.79	20.1	14	52	23.6	25
3/4	21	8	203	0.79	20.1	14	73	33.1	25
3/4	21	10	254	0.79	20.1	14	89	40.4	25
3/4	21	12	305	0.79	20.1	14	109	49.4	25
1	27	(Close) 1 1/2	38	0.98	24.9	11 1/2	16	7.3	25
1	27	2	51	0.98	24.9	11 1/2	22	10.0	25
1	27	2 1/2	64	0.98	24.9	11 1/2	28	12.7	25
1	27	3	76	0.98	24.9	11 1/2	36	16.3	25
1	27	3 1/2	89	0.98	24.9	11 1/2	43	19.5	25
1	27	4	102	0.98	24.9	11 1/2	49	22.2	25
1	27	5	127	0.98	24.9	11 1/2	64	29.0	25
1	27	6	152	0.98	24.9	11 1/2	78	35.4	25
1	27	8	203	0.98	24.9	11 1/2	109	49.4	25
1	27	10	254	0.98	24.9	11 1/2	138	62.6	25
1	27	12	305	0.98	24.9	11 1/2	166	75.3	25
1 1/4	35	(Close) 1 3/8	41	1.01	25.7	11 1/2	22	10.0	25
1 1/4	35	2	51	1.01	25.7	11 1/2	28	12.7	25
1 1/4	35	2 1/2	64	1.01	25.7	11 1/2	37	16.8	25
1 1/4	35	3	76	1.01	25.7	11 1/2	47	21.3	25
1 1/4	35	3 1/2	89	1.01	25.7	11 1/2	55	24.9	25
1 1/4	35	4	102	1.01	25.7	11 1/2	66	29.9	25
1 1/4	35	5	127	1.01	25.7	11 1/2	84	38.1	25
1 1/4	35	6	152	1.01	25.7	11 1/2	100	45.4	25
1 1/4	35	8	203	1.01	25.7	11 1/2	136	61.7	25
1 1/4	35	10	254	1.01	25.7	11 1/2	176	79.8	40
1 1/4	35	12	305	1.01	25.7	11 1/2	216	98.0	30
1 1/2	41	(Close) 1 3/4	44	1.03	26.2	11 1/2	28	12.7	25
1 1/2	41	2	51	1.03	26.2	11 1/2	34	15.4	25
1 1/2	41	2 1/2	64	1.03	26.2	11 1/2	44	20.0	25
1 1/2	41	3	76	1.03	26.2	11 1/2	56	25.4	25
1 1/2	41	3 1/2	89	1.03	26.2	11 1/2	68	30.8	25
1 1/2	41	4	102	1.03	26.2	11 1/2	80	36.3	25
1 1/2	41	5	127	1.03	26.2	11 1/2	103	46.7	25
1 1/2	41	6	152	1.03	26.2	11 1/2	122	55.3	50
1 1/2	41	8	203	1.03	26.2	11 1/2	170	77.1	40
1 1/2	41	10	254	1.03	26.2	11 1/2	216	98.0	30
1 1/2	41	12	305	1.03	26.2	11 1/2	260	117.9	20

¹Minimum requirement as per UL Standard

Chart continued on next page



Galvanized Rigid Conduit (GRC) Nipples

Galvanized Rigid Conduit (GRC) Nipples

Listed to UL Safety Standard 6

Manufactured in accordance with ANSI C80.1

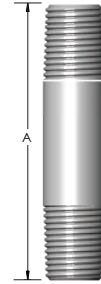

Trade Size	Metric Designator	Length (A)		Total Thread Length ¹		Threads Per Inch ¹	Approximate Weight Per 100 Pieces		Standard Package
		(in)	(mm)	(in)	(mm)		(lb)	(kg)	
2	53	(Close) 2	51	1.06	26.9	11½	44	20.0	25
2	53	2½	64	1.06	26.9	11½	59	26.8	25
2	53	3	76	1.06	26.9	11½	72	32.7	25
2	53	3½	89	1.06	26.9	11½	88	39.9	40
2	53	4	102	1.06	26.9	11½	103	46.7	40
2	53	5	127	1.06	26.9	11½	132	59.9	40
2	53	6	152	1.06	26.9	11½	160	72.6	30
2	53	8	203	1.06	26.9	11½	220	99.8	20
2	53	10	254	1.06	26.9	11½	285	129.3	20
2	53	12	305	1.06	26.9	11½	335	152.0	15
2½	63	(Close) 2¾	70	1.57	39.9	8	84	38.1	1
2½	63	3	76	1.57	39.9	8	100	45.4	1
2½	63	3½	89	1.57	39.9	8	120	54.4	1
2½	63	4	102	1.57	39.9	8	150	68.0	1
2½	63	5	127	1.57	39.9	8	197	89.4	1
2½	63	6	152	1.57	39.9	8	240	108.9	1
2½	63	8	203	1.57	39.9	8	329	149.2	1
2½	63	10	254	1.57	39.9	8	422	191.4	1
2½	63	12	305	1.57	39.9	8	505	229.1	1
3	78	(Close) 2⅝	67	1.63	41.4	8	118	53.5	1
3	78	3	76	1.63	41.4	8	130	59.0	1
3	78	¾	89	1.63	41.4	8	157	71.2	1
3	78	4	102	1.63	41.4	8	200	90.7	1
3	78	5	127	1.63	41.4	8	260	117.9	1
3	78	6	152	1.63	41.4	8	300	136.1	1
3	78	8	203	1.63	41.4	8	411	186.4	1
3	78	10	254	1.63	41.4	8	528	239.5	1
3	78	12	305	1.63	41.4	8	630	285.8	1
4	103	(Close) 2⅞	73	1.73	43.9	8	180	81.6	1
4	103	4	102	1.73	43.9	8	285	129.3	1
4	103	5	127	1.73	43.9	8	380	172.4	1
4	103	6	152	1.73	43.9	8	440	199.6	1
4	103	8	203	1.73	43.9	8	600	272.2	1
4	103	10	254	1.73	43.9	8	775	351.5	1
4	103	12	305	1.73	43.9	8	925	419.6	1
5	129	(Close) 3	76	1.84	46.7	8	240	108.9	1
5	129	5	127	1.84	46.7	8	480	217.7	1
5	129	6	152	1.84	46.7	8	600	272.2	1
5	129	8	203	1.84	46.7	8	825	374.2	1
5	129	10	254	1.84	46.7	8	1055	478.5	1
5	129	12	305	1.84	46.7	8	1260	571.5	1
6	155	(Close) 3⅝	79	1.95	49.5	8	350	158.8	1
6	155	5	127	1.95	49.5	8	660	299.4	1
6	155	6	152	1.95	49.5	8	820	372.0	1
6	155	8	203	1.95	49.5	8	1125	510.3	1
6	155	10	254	1.95	49.5	8	1440	653.2	1
6	155	12	305	1.95	49.5	8	1720	780.2	1

¹Minimum requirement as per UL Standard

Galvanized Rigid Conduit (GRC) Yard 90° Elbows & Running Thread

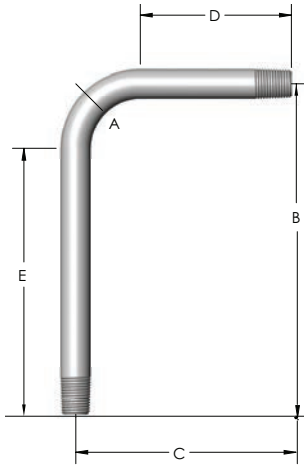

Galvanized Rigid Conduit (GRC) Yard 90° Elbows

Listed to UL Safety Standard 6

Manufactured in accordance with ANSI C80.1



Trade Size	Metric Designator	Radius (A) ¹		Offset (B) ²		Offset (C) ²		Straight (D) ²		Straight (E) ²		Approximate Weight Per 100 Pieces	
		(in)	(mm)	(in)	(mm)	(in)	(mm)	(in)	(mm)	(in)	(mm)	(lb)	(kg)
1/2	16	4	102	18	457	6 7/8	56	2 7/8	56	14	356	140	64
3/4	21	4 1/2	114	18	457	6 3/4	57	2 1/4	57	13 1/2	343	190	86
1	27	5 3/4	146	18	457	8 5/8	22	2 7/8	22	12 1/4	311	300	136
1 1/4	35	7 1/4	184	19 1/4	489	10 1/4	76	3	76	12	305	480	218
1 1/2	41	8 1/4	210	20 1/2	520	11 5/8	86	3 3/8	86	12 1/4	311	630	286
2	53	9 1/2	241	21 1/2	546	14 1/2	127	5	127	12	305	900	408
2 1/2	63	10 1/2	267	22 1/2	572	16	140	5 1/2	140	12	305	1450	658
3	78	13	330	25	635	19 1/4	159	6 1/4	159	12	305	2120	962
3 1/2	91	15	381	27	686	22 3/4	197	7 3/8	197	12	305	2830	1284
4	103	16	406	28	711	24	203	8	203	12	305	3500	1588

¹Minimum requirement as per UL Standard

²For information only, not a requirement as per UL Standard

Sizes 2 1/2" (63 mm) and larger shipped in palletized cartons or bulk

Also available in the following Degrees (60°, 45°, 30°, 22 1/2°, 15° & 11 1/4°)

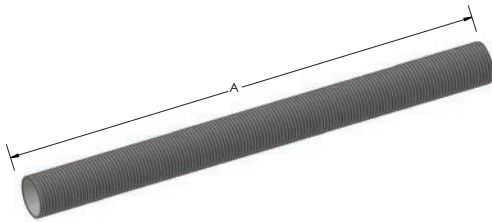

Galvanized Running Thread

Listed to Safety Standard UL6

Manufactured in accordance with ANSI C80.1

Trade Size	Metric Designator	Length (A)		Approximate Weight Per 100 Pieces		Standard Package
		(in)	(mm)	(lb)	(kg)	
1/2	16	36	914.4	185.0	84	1
3/4	21	36	914.4	256.0	116	1
1	27	36	914.4	310.0	141	1
1 1/4	35	36	914.4	425.0	193	1
1 1/2	41	36	914.4	540.0	245	1
2	53	36	914.4	750.0	340	1
2 1/2	63	36	914.4	1150.0	522	1
3	78	36	914.4	1500.0	680	1
3 1/2	91	36	914.4	1900.0	862	1
4	103	36	914.4	2150.0	975	1





Aluminum Rigid Conduit	34
Couplings	35
90° Elbows	35
45° Elbows.....	35



Aluminum Rigid Conduit (ARC)

Aluminum Rigid Conduit (ARC)

- Aluminum Rigid Conduit is light weight and is approximately one-third the weight of steel
- Corrosion resistant aluminum resists most corrosive atmospheres in industrial environments
- Easy to install, no special tools needed to cut, bend or thread
- Low maintenance, doesn't leave discoloring streaks or stains
- Listed to UL Safety Standard 6A
- Manufactured in accordance with ANSI C80.5
- Complete line of elbows and couplings
- Available in trade sizes ½" (16 mm) - 6" (155 mm)



FEATURES & SPECIFICATIONS

Codes & Standards Compliance

Alloy

Allied Tube & Conduit® Rigid Aluminum Conduits and Fittings are all manufactured of 6063 alloy in temper designation T-1 to ensure maximum performance in electrical installations.

Standards

Allied Tube & Conduit® Rigid Aluminum Conduit is listed to Safety Standard UL 6A (Standard for Electrical Rigid Metal Conduit – Aluminum, Red Brass and Stainless Steel) and is manufactured in accordance with ANSI C80.5 (replaces Federal Specification WWC- 540C).

Thread Protectors

Color-coded end caps keep threads clean, sharp and help provide trade size recognition. Even sizes are blue, ½" trade sizes are black, and ¼" trade sizes are red.

Aluminum Rigid Conduit (ARC)

Listed to Safety Standard UL 6A

Manufactured in accordance with ANSI C80.5



Trade Size	Metric Designator	Outside Diameter ¹		Nominal Wall Thickness		Approximate Weight 100 ft (30.5 m)		Quantity in Master Bundle	
		(in)	(mm)	(in)	(mm)	(lb)	(kg)	(ft)	(m)
½	16	0.840	21.34	1.104	2.64	28	12.7	2500	762.5
¾	21	1.050	26.67	0.107	2.72	37	17.0	2500	762.5
1	27	1.315	33.40	0.126	3.20	55	24.7	2000	610.0
1¼	35	1.660	42.16	0.133	3.38	72	32.5	1000	304.8
1½	41	1.900	48.26	0.138	3.51	89	40.2	1000	304.8
2	53	2.375	60.33	0.146	3.71	119	53.8	450	137.2
2½	63	2.875	73.03	0.193	4.90	188	85.0	300	91.5
3	78	3.500	88.90	0.205	5.21	246	111.7	200	61.0
3½	91	4.000	101.60	0.215	5.46	296	134.1	200	61.0
4	103	4.500	114.30	0.225	5.72	350	158.9	200	61.0
5	129	5.563	141.30	0.245	6.22	479	217.2	80	23.4
6	155	6.625	168.28	0.266	6.76	635	287.8	60	18.3

¹Tolerances: ½" to 1½" trade sizes +/- 0.015 (in) 2" to 6" trade sizes +/- 1%

*Each length of conduit with coupling attached will be nominally 10 feet

Aluminum Rigid Conduit (ARC) Couplings & Elbows

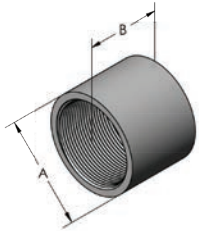

Aluminum Rigid Conduit (ARC) Couplings

Listed to UL Safety Standard 6A. Manufactured in accordance with ANSI C80.1



Trade Size	Metric Designator	Nominal Outside Dimensions (A)		Minimal Acceptable Length (B)		Threads Per Inch	Approximate Weight Per 100 Pieces		Standard Package
		(in)	(mm)	(in)	(mm)		(lb)	(kg)	
1/2	16	1.078	27.38	1 5/8	41.3	14	6	2.7	100
3/4	21	1.328	33.73	1 4/64	41.7	14	9	4.1	50
1	27	1.562	39.67	1 3/32	50.0	11 1/2	13	5.9	30
1 1/4	35	1.953	49.61	2 1/32	51.6	11 1/2	19	8.6	25
1 1/2	41	2.219	56.36	2 1/8	52.4	11 1/2	23	10.4	25
2	53	2.750	69.85	2 1/8	54.4	11 1/2	35	15.9	15
2 1/2	63	3.281	83.34	3 7/8	81.0	8	68	30.8	20
3	78	3.812	96.84	3 7/8	84.1	8	91	41.3	15
3 1/2	91	4.438	112.71	3 13/32	86.5	8	108	49.0	12
4	103	5.000	127.00	3 33/64	89.3	8	142	64.4	12
5	129	6.219	157.96	3 9/64	100.4	8	242	109.8	8
6	155	7.312	185.74	4 1/4	108.0	8	320	145.2	6

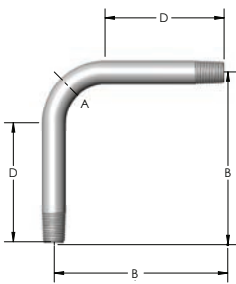

Aluminum Rigid Conduit (ARC) 90° Elbows

Listed to UL Safety Standard 6A. Manufactured in accordance with ANSI C80.1



Trade Size	Metric Designator	Radius (A) ¹		Offset (B)		Straight (D)		Approximate Weight Per 100 Pieces		Standard Package
		(in)	(mm)	(in)	(mm)	(in)	(mm)	(lb)	(kg)	
1/2	16	4	102	5 7/8	149	1/2	38	22	10.0	25
3/4	21	4 1/2	114	7	178	1/2	38	32	14.5	40
1	27	5 3/4	146	8 3/4	222	1 1/8	48	62	28.1	25
1 1/4	35	7 1/4	184	10 1/2	267	2	51	99	44.9	10
1 1/2	41	8 1/4	210	11 3/4	298	2	51	137	62.1	10
2	53	9 1/2	241	14 1/2	268	2	51	228	103.4	5
2 1/2	63	10 1/2	267	17 1/4	438	3	76	427	193.7	80
3	78	13	330	22 3/4	578	3 1/8	79	752	341.1	50
3 1/2	91	15	381	23 3/4	591	3 1/4	83	889	403.3	50
4	103	16	406	23 3/8	594	3 3/8	86	1049	475.8	36
5	129	24	610	34 7/8	886	3 3/8	92	2125	963.9	1
6	155	30	762	45 1/2	1156	3 3/4	95	3738	1695.6	1

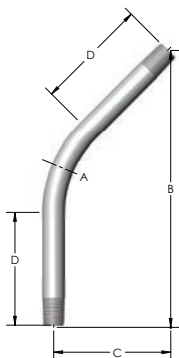

Aluminum Rigid Conduit (ARC) 45° Elbows

Listed to UL Safety Standard 6A. Manufactured in accordance with ANSI C80.1



Trade Size	Metric Designator	Radius (A) ¹		Offset (B)		Offset (C)		Straight (D)		Approximate Weight Per 100 Pieces		Standard Package
		(in)	(mm)	(in)	(mm)	(in)	(mm)	(in)	(mm)	(lb)	(kg)	
1/2	16	4	102	7	178	2 7/8	73	1 1/2	38	18	8.2	25
3/4	21	4 1/2	114	7 7/8	200	3 1/4	83	1 1/2	38	23	10.4	40
1	27	5 3/4	146	8 3/4	222	3 5/8	92	1 7/8	48	40	18.1	25
1 1/4	35	7 1/4	184	10 1/2	267	4 3/8	111	2	51	65	29.5	10
1 1/2	41	8 1/4	210	13 3/8	333	5 3/8	137	2	51	102	46.3	10
2	53	9 1/2	241	14 1/2	368	6	152	2	51	150	68.0	5
2 1/2	63	10 1/2	267	17 1/2	445	7 1/4	184	3	76	278	126.1	80
3	78	13	330	21	533	8 5/8	219	3 1/8	79	442	200.5	50
3 1/2	91	15	381	26 1/8	664	10 7/8	276	3 1/4	83	659	298.9	50
4	103	16	406	26 1/4	667	10 7/8	276	3 3/8	86	777	352.4	36
5	129	24	610	35 7/8	911	14 7/8	378	3 3/8	92	1446	655.9	1
6	155	30	762	43 3/8	1102	18	457	3 3/4	95	2347	1064.6	1





PVC Conduit & Fittings

Schedule 40.....	39
Schedule 80.....	39
Utility Duct.....	40-41
Standard Radius Elbows	42-47
Schedule 40 - Standard Radius Elbows	42-44
Schedule 80 - Standard Radius Elbows	45-47
Special Radius Elbows	48-50
Schedule 40 - Special Radius Elbows	48-49
Schedule 80 - Special Radius Elbows	50
Special Radius Sweeps	51
Duct - Special Radius Sweeps.....	51
C-Duct - Special Radius Sweeps.....	51
Couplings and Adapters	52-53
Expansion Couplings and Meter Risers	54-58
Access Fittings.....	59
Accessories.....	60-61
Junction Boxes	62
Cover Plates & Weatherproof Box Covers.....	63
Cement, Cleaner, Primer	64



Schedule 40 and 80 Rigid PVC Conduit

Trade Size	Part Number		Dimensions (in)		Crate Quantity (ft)	
	10 Foot	20 Foot	Average Outside Diameter	Minimum Wall Thickness	10 Foot	20 Foot
Schedule 40						
½	4005010	4005020	0.840	0.109	6,000	12,000
¾	4007510	4007520	1.050	0.113	4,400	8,800
1	4010010	4010020	1.315	0.133	3,600	7,200
1¼	4012510	4012520	1.660	0.140	3,300	6,600
1½	4015010	4015020	1.900	0.145	2,250	4,500
2	4020010	4020020	2.375	0.154	1,400	2,800
2½	4025010	4025020	2.875	0.203	930	1,860
3	4030010	4030020	3.500	0.216	880	1,760
3½	4035010	4035020	4.000	0.226	630	1,260
4	4040010	4040020	4.500	0.237	570	1,140
5	4050010	4050020	5.563	0.258	380	760
6	4060010	4060020	6.625	0.280	260	520
8*	4080010	4080020	8.625	0.322	140	280
Schedule 80						
½	8005010	8005020	0.840	0.147	6,000	12,000
¾	8007510	8007520	1.050	0.154	4,400	8,800
1	8010010	8010020	1.315	0.179	3,600	7,200
1¼	8012510	8012520	1.660	0.191	3,300	6,600
1½	8015010	8015020	1.900	0.200	2,250	4,500
2	8020010	8020020	2.375	0.218	1,400	2,800
2½	8025010	8025020	2.875	0.276	930	1,860
3	8030010	8030020	3.500	0.300	880	1,760
3½	8035010	8035020	4.000	0.318	630	1,260
4	8040010	8040020	4.500	0.377	570	1,140
5	8050010	8050020	5.563	0.375	380	760
6	8060010	8060020	6.625	0.432	260	520
8*	8080010	8080020	8.625	0.500	140	280

*8 inch products are not included in UL 651 and are therefore not certified by ETL
Product availability varies by region and minimum run quantities may apply



Rated for use with 90 degree C wiring
Sunlight resistant per UL 651
Conforms to UL 651 and NEMA TC 2



Utility Duct Rigid PVC Conduit

Trade Size	Part Number 20 Foot	Dimensions (in)		Crate Quantity (ft)
		Average Outside Diameter	Minimum Wall Thickness	
DB-60				
2	6020020	2.375	0.060	2,800
3	6030020	3.500	0.092	1,760
4	6040020	4.500	0.121	1,140
5	6050020	5.563	0.152	760
6	6060020	6.625	0.182	520
DB-100				
3	1030020	3.500	0.112	1,760
4	1040020	4.500	0.145	1,140
5	1050020	5.563	0.179	760
6	1060020	6.625	0.213	520
DB-120				
1	1210020	1.315	0.060	7,200
1½	1215020	1.900	0.060	4,500
2	1220020	2.375	0.077	2,800
3	1230020	3.500	0.118	1,760
4	1240020	4.500	0.154	1,140
5	1250020	5.563	0.191	760
6	1260020	6.625	0.227	520

If you don't see the product you require, please call for availability
Product availability varies by region and minimum run quantities may apply
Conforms to NEMA TC 6 & 8 and ASTM F 512



Utility/C-Duct Rigid PVC Conduit

Trade Size	Part Number 20 Foot	Dimensions (in)		Crate Quantity (ft)
		Average Outside Diameter	Minimum Wall Thickness	
EB-20				
3	2030020	3.500	0.061	1,760
4	2040020	4.500	0.082	1,140
5	2050020	5.563	0.103	760
6	2060020	6.625	0.125	520
EB-35				
3	3530020	3.500	0.076	1,760
4	3540020	4.500	0.100	1,140
5	3550020	5.563	0.126	760
6	3560020	6.625	0.152	520

Product availability varies by region and minimum run quantities may apply
EB products conform to NEMA TC 6 & 8 and ASTM F 512

Trade Size	Part Number 20 Foot	Dimensions (in)		Crate Quantity (ft)
		Average Outside Diameter	Minimum Wall Thickness	
C-Duct				
4 (white)	9040020WHT	4.350	0.140	1,260
4 (gray)	9040020	4.350	0.140	1,260

C-Duct compliance with CAO-8546 varies by region



Schedule 40 Standard Radius Elbows

Trade Size	Part Number		Dimensions (in)		Package Quantity
	Plain End	Bell End	Average Outside Diameter, D	Radius R	
90°					
½	F4005090P	F4005090	0.840	4.00	50
¾	F4007590P	F4007590	1.050	4.50	25
1	F4010090P	F4010090	1.315	5.75	25
1¼	F4012590P	F4012590	1.660	7.25	25
1½	F4015090P	F4015090	1.900	8.25	25
2	F4020090P	F4020090	2.375	9.50	25
2½	F4025090P	F4025090	2.875	10.50	50
3	F4030090P	F4030090	3.500	13.00	50
3½	F4035090P	F4035090	4.000	15.00	25
4	F4040090P	F4040090	4.500	16.00	25
5	F4050090P	F4050090	5.563	24.00	20
6	F4060090P	F4060090	6.625	30.00	16
45°					
½	F4005045P	F4005045	0.840	4.00	50
¾	F4007545P	F4007545	1.050	4.50	25
1	F4010045P	F4010045	1.315	5.75	25
1¼	F4012545P	F4012545	1.660	7.25	25
1½	F4015045P	F4015045	1.900	8.25	25
2	F4020045P	F4020045	2.375	9.50	25
2½	F4025045P	F4025045	2.875	10.50	50
3	F4030045P	F4030045	3.500	13.00	50
3½	F4035045P	F4035045	4.000	15.00	25
4	F4040045P	F4040045	4.500	16.00	25
5	F4050045P	F4050045	5.563	24.00	20
6	F4060045P	F4060045	6.625	30.00	16

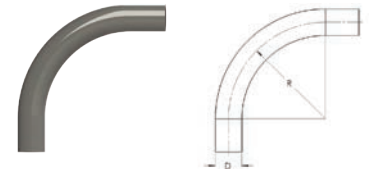

90° Plain End

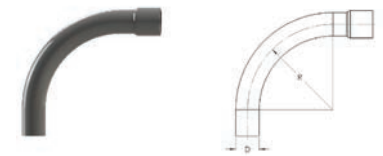

90° Bell End

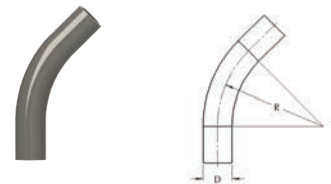

45° Plain End

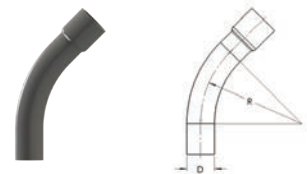

45° Bell End

Product availability varies by region and minimum run quantities may apply
Listed to UL 651



Schedule 40 Standard Radius Elbows

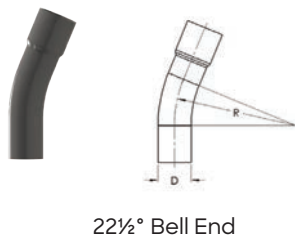
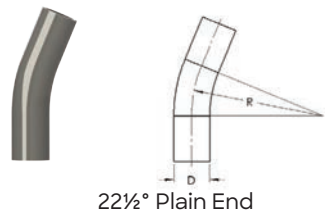
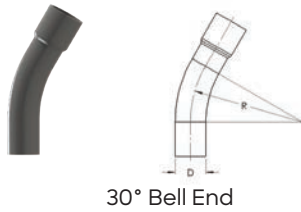
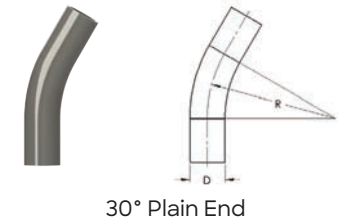

Trade Size	Part Number		Dimensions (in)		Package Quantity
	Plain End	Bell End	Average Outside Diameter, D	Radius R	
30°					
¾	F4007530P	F4007530	1.050	4.50	25
1	F4010030P	F4010030	1.315	5.75	25
1¼	F4012530P	F4012530	1.660	7.25	25
1½	F4015030P	F4015030	1.900	8.25	25
2	F4020030P	F4020030	2.375	9.50	25
2½	F4025030P	F4025030	2.875	10.50	20
3	F4030030P	F4030030	3.500	13.00	50
3½	F4035030P	F4035030	4.000	15.00	25
4	F4040030P	F4040030	4.500	16.00	25
5	F4050030P	F4050030	5.563	24.00	20
6	F4060030P	F4060030	6.625	30.00	16
22½°					
¾	F4007522P	F4007522	1.050	4.50	25
1	F4010022P	F4010022	1.315	5.75	25
1¼	F4012522P	F4012522	1.660	7.25	25
1½	F4015022P	F4015022	1.900	8.25	25
2	F4020022P	F4020022	2.375	9.50	25
2½	F4025022P	F4025022	2.875	10.50	20
3	F4030022P	F4030022	3.500	13.00	50
3½	F4035022P	F4035022	4.000	15.00	25
4	F4040022P	F4040022	4.500	16.00	25
5	F4050022P	F4050022	5.563	24.00	20
6	F4060022P	F4060022	6.625	30.00	16

Product availability varies by region and minimum run quantities may apply
Listed to UL 651



Schedule 40 Standard Radius Elbows

Trade Size	Part Number		Dimensions (in)		Package Quantity
	Plain End	Bell End	Average Outside Diameter, D	Radius R	
11¼°					
¾	F4007511P	F4007511	1.050	4.50	25
1	F4010011P	F4010011	1.315	5.75	25
1¼	F4012511P	F4012511	1.660	7.25	25
1½	F4015011P	F4015011	1.900	8.25	25
2	F4020011P	F4020011	2.375	9.50	25
2½	F4025011P	F4025011	2.875	10.50	20
3	F4030011P	F4030011	3.500	13.00	50
3½	F4035011P	F4035011	4.000	15.00	25
4	F4040011P	F4040011	4.500	16.00	25
5	F4050011P	F4050011	5.563	24.00	20
6	F4060011P	F4060011	6.625	30.00	16

Product availability varies by region and minimum run quantities may apply
Listed to UL 651

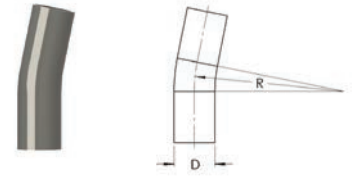

11¼° Plain End

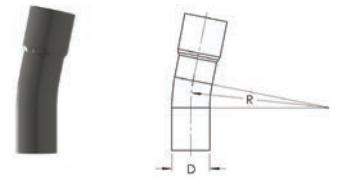

11¼° Bell End

Schedule 80 Standard Radius Elbows

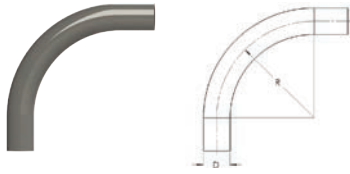

90° Plain End

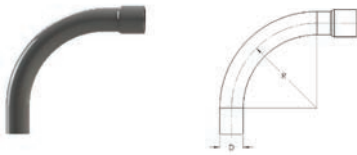

90° Bell End

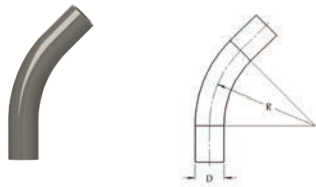

45° Plain End

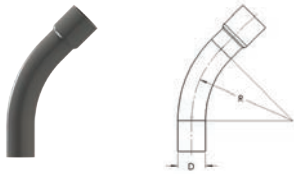

45° Bell End

Trade Size	Part Number		Dimensions (in)		Package Quantity
	Plain End	Bell End	Average Outside Diameter, D	Radius R	
90°					
½	F8005090P	F8005090	0.840	4.00	50
¾	F8007590P	F8007590	1.050	4.50	25
1	F8010090P	F8010090	1.315	5.75	25
1¼	F8012590P	F8012590	1.660	7.25	25
1½	F8015090P	F8015090	1.900	8.25	25
2	F8020090P	F8020090	2.375	9.50	25
2½	F8025090P	F8025090	2.875	10.50	50
3	F8030090P	F8030090	3.500	13.00	50
3½	F8035090P	F8035090	4.000	15.00	25
4	F8040090P	F8040090	4.500	16.00	25
5	F8050090P	F8050090	5.563	24.00	20
6	F8060090P	F8060090	6.625	30.00	16
45°					
½	F8005045P	F8005045	0.840	4.00	50
¾	F8007545P	F8007545	1.050	4.50	25
1	F8010045P	F8010045	1.315	5.75	25
1¼	F8012545P	F8012545	1.660	7.25	25
1½	F8015045P	F8015045	1.900	8.25	25
2	F8020045P	F8020045	2.375	9.50	25
2½	F8025045P	F8025045	2.875	10.50	50
3	F8030045P	F8030045	3.500	13.00	50
3½	F8035045P	F8035045	4.000	15.00	25
4	F8040045P	F8040045	4.500	16.00	25
5	F8050045P	F8050045	5.563	24.00	20
6	F8060045P	F8060045	6.625	30.00	16

Product availability varies by region and minimum run quantities may apply
Listed to UL 651



Schedule 80 Standard Radius Elbows

Trade Size	Part Number		Dimensions (in)		Package Quantity
	Plain End	Bell End	Average Outside Diameter, D	Radius R	
30°					
¾	F8007530P	F8007530	1.050	4.50	25
1	F8010030P	F8010030	1.315	5.75	25
1¼	F8012530P	F8012530	1.660	7.25	25
1½	F8015030P	F8015030	1.900	8.25	25
2	F8020030P	F8020030	2.375	9.50	25
2½	F8025030P	F8025030	2.875	10.50	20
3	F8030030P	F8030030	3.500	13.00	50
3½	F8035030P	F8035030	4.000	15.00	25
4	F8040030P	F8040030	4.500	16.00	25
5	F8050030P	F8050030	5.563	24.00	20
6	F8060030P	F8060030	6.625	30.00	16
22½°					
¾	F8007522P	F8007522	1.050	4.50	25
1	F8010022P	F8010022	1.315	5.75	25
1¼	F8012522P	F8012522	1.660	7.25	25
1½	F8015022P	F8015022	1.900	8.25	25
2	F8020022P	F8020022	2.375	9.50	25
2½	F8025022P	F8025022	2.875	10.50	20
3	F8030022P	F8030022	3.500	13.00	50
3½	F8035022P	F8035022	4.000	15.00	25
4	F8040022P	F8040022	4.500	16.00	25
5	F8050022P	F8050022	5.563	24.00	20
6	F8060022P	F8060022	6.625	30.00	16

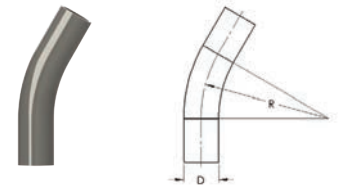

30° Plain End

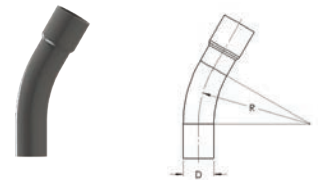

30° Bell End

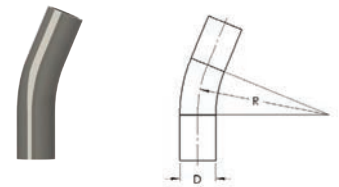

22½° Plain End

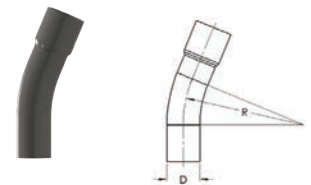

22½° Bell End

Product availability varies by region and minimum run quantities may apply
Listed to UL 651



Schedule 80 Standard Radius Elbows

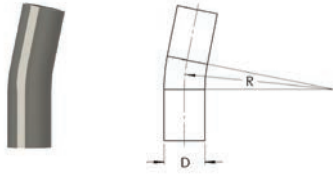

1 1/4° Plain End

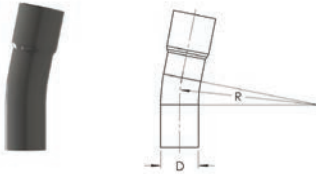

1 1/4° Bell End

Trade Size	Part Number		Dimensions (in)		Package Quantity
	Plain End	Bell End	Average Outside Diameter, D	Radius R	
1 1/4°					
3/4	F8007511P	F8007511	1.050	4.50	25
1	F8010011P	F8010011	1.315	5.75	25
1 1/4	F8012511P	F8012511	1.660	7.25	25
1 1/2	F8015011P	F8015011	1.900	8.25	25
2	F8020011P	F8020011	2.375	9.50	25
2 1/2	F8025011P	F8025011	2.875	10.50	20
3	F8030011P	F8030011	3.500	13.00	50
3 1/2	F8035011P	F8035011	4.000	15.00	25
4	F8040011P	F8040011	4.500	16.00	25
5	F8050011P	F8050011	5.563	24.00	20
6	F8060011P	F8060011	6.625	30.00	16

Product availability varies by region and minimum run quantities may apply
Listed to UL 651



Schedule 40

Plain End Special Radius Elbows

Trade Size	Part Number						Package Quantity
	18" Radius	24" Radius	30" Radius	36" Radius	48" Radius	60" Radius	
90°							
1	F401009018P	F401009024P	F401009030P	F401009036P	F401009048P	F401009060P	25
1¼	F401259018P	F401259024P	F401259030P	F401259036P	F401259048P	F401259060P	25
1½	F401509018P	F401509024P	F401509030P	F401509036P	F401509048P	F401509060P	25
2	F402009018P	F402009024P	F402009030P	F402009036P	F402009048P	F402009060P	50
2½	F402509018P	F402509024P	F402509030P	F402509036P	F402509048P	F402509060P	50
3	F403009018P	F403009024P	F403009030P	F403009036P	F403009048P	F403009060P	50
3½	F403509018P	F403509024P	F403509030P	F403509036P	F403509048P	F403509060P	25
4	F404009018P	F404009024P	F404009030P	F404009036P	F404009048P	F404009060P	25
5	-	F4050090P	F405009030P	F405009036P	F405009048P	F405009060P	20
6	-	-	F4060090P	F406009036P	F406009048P	F406009060P	16
45°							
1	F401004518P	F401004524P	F401004530P	F401004536P	F401004548P	F401004560P	25
1¼	F401254518P	F401254524P	F401254530P	F401254536P	F401254548P	F401254560P	25
1½	F401504518P	F401504524P	F401504530P	F401504536P	F401504548P	F401504560P	25
2	F402004518P	F402004524P	F402004530P	F402004536P	F402004548P	F402004560P	50
2½	F402504518P	F402504524P	F402504530P	F402504536P	F402504548P	F402504560P	50
3	F403004518P	F403004524P	F403004530P	F403004536P	F403004548P	F403004560P	50
3½	F403504518P	F403504524P	F403504530P	F403504536P	F403504548P	F403504560P	25
4	F404004518P	F404004524P	F404004530P	F404004536P	F404004548P	F404004560P	25
5	-	F4050045P	F405004530P	F405004536P	F405004548P	F405004560P	20
6	-	-	F4060045P	F406004536P	F406004548P	F406004560P	16

Call for availability on 30°, 22½° and 11¼° special radius elbows
 Product availability varies by region and minimum run quantities may apply
 Listed to UL 651



Schedule 40 Bell End Special Radius Elbows

Trade Size	Part Number						Package Quantity
	18" Radius	24" Radius	30" Radius	36" Radius	48" Radius	60" Radius	
90°							
1	F401009018	F401009024	F401009030	F401009036	F401009048	F401009060	25
1¼	F401259018	F401259024	F401259030	F401259036	F401259048	F401259060	25
1½	F401509018	F401509024	F401509030	F401509036	F401509048	F401509060	25
2	F402009018	F402009024	F402009030	F402009036	F402009048	F402009060	50
2½	F402509018	F402509024	F402509030	F402509036	F402509048	F402509060	50
3	F403009018	F403009024	F403009030	F403009036	F403009048	F403009060	50
3½	F403509018	F403509024	F403509030	F403509036	F403509048	F403509060	25
4	F404009018	F404009024	F404009030	F404009036	F404009048	F404009060	25
5	-	F4050090	F405009030	F405009036	F405009048	F405009060	20
6	-	-	F4060090	F406009036	F406009048	F406009060	16
45°							
1	F401004518	F401004524	F401004530	F401004536	F401004548	F401004560	25
1¼	F401254518	F401254524	F401254530	F401254536	F401254548	F401254560	25
1½	F401504518	F401504524	F401504530	F401504536	F401504548	F401504560	25
2	F402004518	F402004524	F402004530	F402004536	F402004548	F402004560	50
2½	F402504518	F402504524	F402504530	F402504536	F402504548	F402504560	50
3	F403004518	F403004524	F403004530	F403004536	F403004548	F403004560	50
3½	F403504518	F403504524	F403504530	F403504536	F403504548	F403504560	25
4	F404004518	F404004524	F404004530	F404004536	F404004548	F404004560	25
5	-	F4050045	F405004530	F405004536	F405004548	F405004560	20
6	-	-	F4060045	F406004536	F406004548	F406004560	16

Call for availability on 30°, 22½° and 11¼° special radius elbows
Product availability varies by region and minimum run quantities may apply
Listed to UL 651



Schedule 80 Special Radius Elbows

Trade Size	Part Number			Package Quantity
	24" Radius	36" Radius	48" Radius	
Plain End 90°				
2	F802009024P	F802009036P	F802009048P	50
2½	F802509024P	F802509036P	F802509048P	50
3	F803009024P	F803009036P	F803009048P	50
4	F804009024P	F804009036P	F804009048P	25
5	F8050090P	F805009036P	F805009048P	20
6	-	F806009036P	F806009048P	16
Plain End 45°				
2	F802004524P	F802004536P	F802004548P	50
2½	F802504524P	F802504536P	F802504548P	50
3	F803004524P	F803004536P	F803004548P	50
4	F804004524P	F804004536P	F804004548P	25
5	F8050045P	F805004536P	F805004548P	20
6	-	F806004536P	F806004548P	16
Bell End 90°				
2	F802009024	F802009036	F802009048	50
2½	F802509024	F802509036	F802509048	50
3	F803009024	F803009036	F803009048	50
4	F804009024	F804009036	F804009048	25
5	F8050090	F805009036	F805009048	20
6	-	F806009036	F806009048	16
Bell End 45°				
2	F802004524	F802004536	F802004548	50
2½	F802504524	F802504536	F802504548	50
3	F803004524	F803004536	F803004548	50
4	F804004524	F804004536	F804004548	25
5	F8050045	F805004536	F805004548	20
6	-	F806004536	F806004548	16

Call for availability on 30°, 22½° and 11¼° special radius elbows
Product availability varies by region and minimum run quantities may apply
Listed to UL 651



Utility/C-Duct Special Radius Sweeps

Utility Duct

Trade Size	Part Number				Package Quantity
	24" Radius	36" Radius	48" Radius	60" Radius	
90°					
1	F121009024	F121009036	F121009048	F121009060	25
2	F122009024	F122009036	F122009048	F122009060	50
3	F123009024	F123009036	F123009048	F123009060	50
4	F124009024	F124009036	F124009048	F124009060	25
5	F125009024	F125009036	F125009048	F125009060	20
6	-	F126009036	F126009048	F126009060	16
45°					
1	F121004524	F121004536	F121004548	F121004560	25
2	F122004524	F122004536	F122004548	F122004560	50
3	F123004524	F123004536	F123004548	F123004560	50
4	F124004524	F124004536	F124004548	F124004560	25
5	F125004524	F125004536	F125004548	F125004560	20
6	-	F126004536	F126004548	F126004560	16
22½°					
1	F121002224	F121002236	F121002248	F121002260	25
2	F122002224	F122002236	F122002248	F122002260	50
3	F123002224	F123002236	F123002248	F123002260	50
4	F124002224	F124002236	F124002248	F124002260	25
5	F125002224	F125002236	F125002248	F125002260	20
6	-	F126002236	F126002248	F126002260	16

Sweeps made from DB120, but can be used with any EB or DB duct

4" C-Duct

Degree	Part Number				Package Quantity
	24" Radius	36" Radius	48" Radius	60" Radius	
11¼°	F904001124	F904001136	F904001148	F904001160	25
22½°	F904002224	F904002236	F904002248	F904002260	25
45°	F904004524	F904004536	F904004548	F904004560	25
90°	F904009024	F904009036	F904009048	F904009060	25

If you don't see the product you require, please call for availability
Product availability varies by region and minimum run quantities may apply



Couplings

Trade Size	Part Number	Package Quantity
Couplings		
½	CP05	200
¾	CP07	125
1	CP10	70
1¼	CP12	40
1½	CP15	30
2	CP20	40
2½	CP25	20
3	CP30	40
3½	CP35	30
4	CP40	20
5	CP50	10
6	CP60	8
8*	CP80	1
Long Line Couplings		
1½	LLC15	25
2	LLC20	20
2½	LLC25	25
3	LLC30	25
4	LLC40	15
5	LLC50	8
6	LLC60	4

*8 inch products are not included in UL 651
Conforms to NEMA TC-3

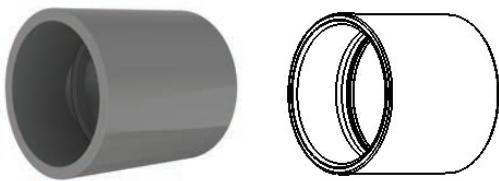

Coupling
Listed to UL 651

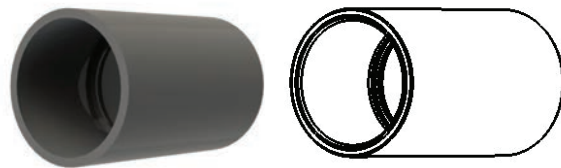

Long Line Coupling
Product appearance may vary by region

Adapters



Terminal Adapters

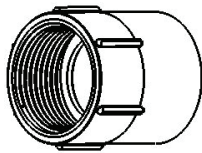

Female Adapters

Trade Size	Part Number	Package Quantity
Terminal Adapters		
½	TA05	200
¾	TA07	125
1	TA10	70
1¼	TA12	40
1½	TA15	30
2	TA20	40
2½	TA25	20
3	TA30	40
3½	TA35	30
4	TA40	20
5	TA50	10
6	TA60	8
8*	TA80	2
Female Adapters		
½	FA05	200
¾	FA07	125
1	FA10	70
1¼	FA12	40
1½	FA15	30
2	FA20	40
2½	FA25	20
3	FA30	40
3½	FA35	30
4	FA40	20
5	FA50	10
6	FA60	8
8*	FA80	2

*8 inch products are not included in UL 651



Expansion Couplings and Repair Sleeve Couplings

Trade Size	Part Number	Package Quantity
One Piece Expansion Couplings		
½	EJ-105	80
¾	EJ-107	50
1	EJ-110	50
1¼	EJ-112	25
1½	EJ-115	25
2	EJ-120	10
Two Piece Expansion Couplings		
½	EJ05	25
¾	EJ07	25
1	EJ10	40
1¼	EJ12	20
1½	EJ15	20
2	EJ20	10
2½	EJ25	9
3	EJ30	9
3½	EJ35	5
4	EJ40	5
5	EJ50	1
6	EJ60	1
Repair Sleeve Couplings		
1	40REC10	50
1¼	40REC12	50
1½	40REC15	50
2	40REC20	50
2½	40REC25	30
3	40REC30	30
4	40REC40	30
5	40REC50	15
6	40REC60	10



Expansion Coupling
One Piece



Expansion Coupling
Two Piece

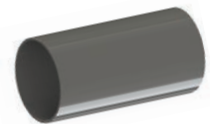

Repair Sleeve Coupling

Product availability may vary by region

Swedge Couplings and Swedge Reducers

Swedge Couplings

Trade Size	Part Number	Package Quantity
DB		
1½	60SWC15	50
2	60SWC20	50
3	60SWC30	30
4	60SWC40	30
5	60SWC50	15
6	60SWC60	10
Schedule 40		
1	40SWC10	50
1¼	40SWC12	50
1½	40SWC15	50
2	40SWC20	50
2½	40SWC25	30
3	40SWC30	30
4	40SWC40	30
5	40SWC50	15
6	40SWC60	10
8	40SWC80	6
Schedule 80		
2	80SWC20	50
3	80SWC30	30
C-Duct		
4 C-Duct to 4 Duct	C60SWC40	30
4	CSWC40	30

Product availability may vary by region



Swedge Coupling

Swedge Reducers Spigot x Spigot

Trade Size	Part Number	Package Quantity
DB		
2½ x 2	60SW2520SS	100
3 x 2	60SW3020SS	80
3 x 2½	60SW3025SS	80
4 x 3	60SW4030SS	60
5 x 4	60SW5040SS	36
6 x 5	60SW6050SS	36
Schedule 40		
1 ½ x 1	40SW1510SS	25
2 x 1½	40SW2015SS	25
2½ x 2	40SW2520SS	80
3 x 2	40SW3020SS	80
3 x 2½	40SW3025SS	80
4 x 3	40SW4030SS	60
5 x 4	40SW5040SS	36
6 x 5	40SW6050SS	36
Schedule 80		
3 x 2	80SW3020SS	80
4 x 3	80SW4030SS	60
5 x 4	80SW5040SS	36

Product availability may vary by region



Swedge Reducer Spigot x Spigot

5° Couplings and Meter Risers

5° Couplings

Trade Size	Part Number		Package Quantity
	Bell x Bell	Bell x Spigot	
DB			
3	605EC30BB	605EC30BS	30
4	605EC40BB	605EC40BS	30
5	605EC50BB	605EC50BS	15
6	605EC60BB	605EC60BS	10
Schedule 40			
2	405EC20BB	405EC20BS	50
3	405EC30BB	405EC30BS	30
4	405EC40BB	405EC40BS	30
5	405EC50BB	405EC50BS	15
6	405EC60BB	405EC60BS	10
C-Duct			
4	C5EC40BB	C5EC40BS	30

Product availability may vary by region



Bell x Bell



Bell x Spigot

Slip Meter Risers

Trade Size	Part Number	Package Quantity
Schedule 40		
2	MTR40200	10
2½	MTR40250	8
3	MTR40300	5
4	MTR40400	3

Product availability may vary by region

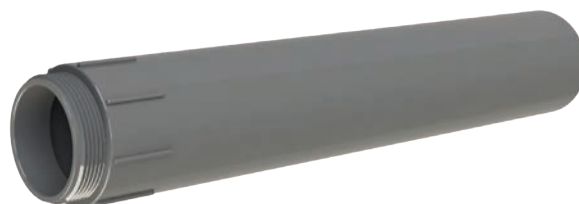

Meter Riser

End Bells and Reducer Bushings

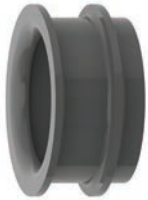

End Bell

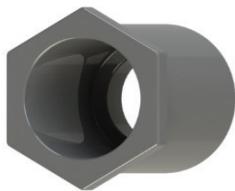

Reducer Bushing

Trade Size	Part Number	Package Quantity
End Bells		
½	MEB05	100
¾	MEB07	100
1	MEB10	50
1¼	MEB12	50
1½	MEB15	50
2	MEB20	40
2½	MEB25	30
3	MEB30	50
3½	MEB35	50
4	MEB40	50
5	MEB50	25
6	MEB60	15
8	MEB80	1
Reducer Bushings		
¾ x ½	MR0705	100
1 x ½	MR1005	100
1 x ¾	MR1007	100
1¼ x ¾	MR1207	50
1¼ x 1	MR1210	50
1½ x 1	MR1510	50
1½ x 1 ¼	MR1512	50
2 x 1	MR2010	50
2 x 1 ¼	MR2012	25
2 x 1 ½	MR2015	25
2½ x 2	MR2520	15
3 x 2	MR3020	25
3 x 2 ½	MR3025	15
4 x 2	MR4020	10
4 x 3	MR4030	10
4 x 3 ½	MR4035	15

Product availability may vary by region



Duct Spacers and Junction Boxes

Trade Size	Part Number	Package Quantity	Part Number	Package Quantity
	Intermediate Spacers		Base Spacers	
2 x 1½	IV2015	350	BV2015	250
2 x 2	IV2020	300	BV2020	225
2 x 3	IV2030	200	BV2030	225
3 x 1½	IV3015	225	BV3015	175
3 x 2	IV3020	200	BV3020	155
3 x 3	IV3030	125	BV3030	150
4 x 1	IV4010	200	BV4010	175
4 x 1½	IV4015	150	BV4015	140
4 x 2	IV4020	125	BV4020	140
4 x 3	IV4030	90	BV4030	120
5 x 1½	IV5015	100	BV5015	120
5 x 2	IV5020	100	BV5020	120
5 x 3	IV5030	80	BV5030	100
6 x 1½	IV6015	100	BV6015	100
6 x 2	IV6020	90	BV6020	100
6 x 3	IV6030	70	BV6030	95
8 x 2	IV8020	60	BV8020	50



Intermediate Spacers



Intermediate and Base Spacers together

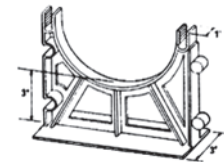

Base Spacers

Trade Size	Self Tapping Screws	Package Quantity	Brass Screw Inserts	Package Quantity
	4x4x2	JB442S	10	JB442
4x4x4	JB444S	10	JB444	10
4x4x6	JB446S	10	JB446	8
5x5x2	JB552S	10	JB552	12
6x6x4	JB664S	10	JB664	15
6x6x6	JB666S	5	JB666	4
8x8x4	JB884S	5	JB884	4
8x8x7	JB887S	4	JB887	4
12x12x4	JB12124S	2	JB12124	2
12x12x6	JB12126S	2	JB12126	4
12x12x8	JB12128S	3	JB12128	3

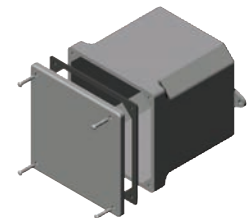

Junction Box

Product appearance may vary by region
Product availability may vary by region

Trade Size	Part Number						Package Quantity	
	LB	T	LR	LL	E	C		T Only
½	LB05	T05	LR05	LL05	E05	C05	25	25
¾	LB07	T07	LR07	LL07	E07	C07	15	15
1	LB10	T10	LR10	LL10	E10	C10	10	10
1¼	LB12	T12	LR12	LL12	E12	C12	10	10
1½	LB15	T15	LR15	LL15	E15	C15	10	10
2	LB20	T20	LR20	LL20	E20	C20	5	5
2½	LB25	T25	LR25	LL25	E25	C25	5	2
3	LB30	T30	LR30	LL30	E30	C30	5	2
3½	LB35	T35	LR35	LL35	E35	C35	4	1
4	LB40	T40	LR40	LL40	E40	C40	4	1

Product availability may vary by region



Type LB

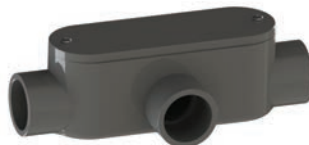

Type T



Type LR



Type LL



Type E



Type C

Accessories

Trade Size	Part Number	Package Quantity
Meter Offsets		
1¼	MO12	50
2	MO20	25
Two Hole Pipe Straps		
½	PS05	400
¾	PS07	200
1	PS10	200
1¼	PS12	200
1½	PS15	200
2	PS20	200
2½	PS25	100
3	PS30	100
4	PS40	100
Pull Elbows		
½ & ¾	PULEL0705	50
Expandable Plugs		
2	KW20L	50
2½	KW25L	30
3	KW30L	30
4	KW40L	30
5	KW50L	20
Temporary Plugs		
1	UTP10	100
1¼	UTP12	100
1½	UTP15	100
2	UTP20	100
2½	UTP25	100
3	UTP30	80
3½	UTP35	80
4	UTP40	50
5	UTP50	40
6	UTP60	30
8	UTP80	12

Product availability may vary by region



Meter Offset



Two Hole Pipe Strap



Pull Elbow



Expandable Plug



Temporary Plug



Junction Box Adapter



Service Entrance Head



End Cap

Trade Size	Part Number	Package Quantity
Junction Box Adapters		
½	JBA05	100
¾	JBA07	100
1	JBA10	100
1¼	JBA12	50
1½	JBA15	50
2	JBA20	25
2½	JBA25	10
3	JBA30	10
3½	JBA35	10
4	JBA40	10
Service Entrance Heads		
½	MH05	25
¾	MH07	25
1	MH10	15
1¼	MH12	20
1½	MH15	5
2	MH20	5
2½	MH25	2
3	MH30	2
3½	MH35	2
4	MH40	2
End Caps		
½	EC05	200
¾	EC07	150
1	EC10	100
1¼	EC12	40
1½	EC15	40
2	EC20	20
2½	EC25	15
3	EC30	10
3½	EC35	25
4	EC40	12
5	EC50	5
6	EC60	10
8	EC80	1

Product availability may vary by region

F-Series Boxes

Type	Trade Size	Part Number	Package Quantity
FSE			
Single Gang	1/2	FSE05	10
Single Gang	3/4	FSE07	10
Single Gang	1	FSE10	10
Single Gang	1/2 - 3/4 - 1 Deep	FSED050710	10
Double Gang	1/2 - 3/4 - 1	FSE-2-050710	5
FSS			
Single Gang	1/2	FSS05	10
Single Gang	3/4	FSS07	10
Single Gang	1	FSS10	10
Double Gang	1/2 - 3/4 - 1	FSS-2-050710	5
FSC			
Single Gang	1/2	FSC05	10
Single Gang	3/4	FSC07	10
Single Gang	1	FSC10	10
Single Gang	1/2 - 3/4 - 1 Deep	FSCD050710	10
Double Gang	1/2 - 3/4 - 1	FSC-2-050710	5
FSCC			
Single Gang	1/2	FSCC05	10
Single Gang	3/4	FSCC07	10
Single Gang	1	FSCC10	10
Double Gang	1/2 - 3/4 - 1	FSCC-2-050710	5
FD Blank			
Single Gang	Deep	FD	20
Double Gang	Deep	FD-2	100

Product availability may vary by region

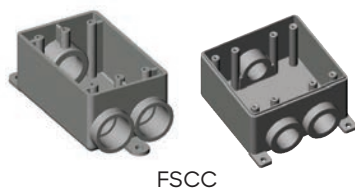
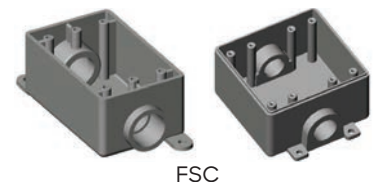
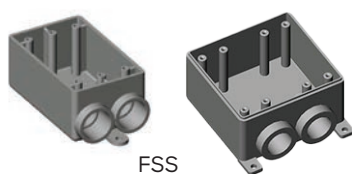
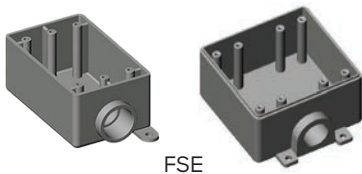

Type	Description	Part Number	Package Quantity
Weatherproof Covers			
Single Gang	Toggle Switch	WTG 15/10	20
Single Gang	Toggle Switch with Lock	VSC 15/10	20
Single Gang	Duplex Receptacle	WDR 15/10	20
Single Gang	GFI Receptacle	WGF 15/10	20
Single Gang	Single Receptacle - 15 amps	WTL 15	10
Double Gang	Double Toggle Switch with Lock	VSC20-2	10
Double Gang	Double GFI Receptacle	VSGG20-2	15
Double Gang	Double Duplex Receptacle	VSDD20-2	15
Covers			
Single Gang	Toggle Switch	TSC 15/10	100
Single Gang	Duplex Receptacle	DRC 15/10	100
Single Gang	Single Blank with Gasket	FSKIT	50
Double Gang	Double Switch	TSC20-2	50
Double Gang	Double Duplex	DRC20-2	50
Double Gang	Double Blank with Gasket	BRC20-2	50

Product availability may vary by region

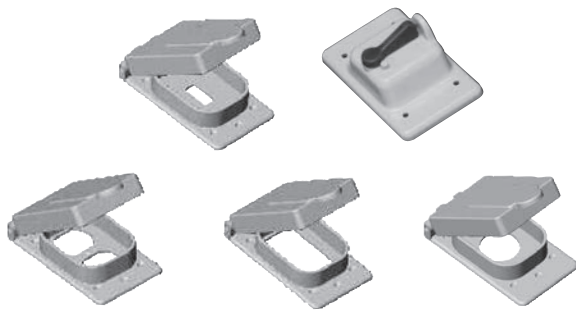

Single Gang Weatherproof Covers



Double Gang Weatherproof Covers



Single Gang Covers



Double Gang Covers

Cement, Cleaner, Primer

Type	Size	Part Number	Package Quantity
Cement			
Regular Body - Clear	Pint	CEMCR10	12
Regular Body - Clear	Quart	CEMCR20	12
Medium Body - Clear	Half Pint	CEMC05	24
Medium Body - Clear	Pint	CEMC10	12
Medium Body - Clear	Quart	CEMC20	12
Medium Body - Clear	Gallon	CEMC80	6
Medium Body - Gray	Quart	CEMG20	12
Heavy Body - Clear	Quart	CEMCH20	12
All Weather - Clear	Pint	CWC10	12
All Weather - Clear	Quart	CWC20	12
All Weather - Blue	Quart	CWB20	12
Cleaner			
Clear	Quart	CLN20	12
Primer			
Clear	Quart	PRMC20	12
Purple	Pint	PRMP10	12
Purple	Quart	PRMP20	12

Product availability may vary by region

Terms and Conditions/ Warranty

All purchases of Allied Tube & Conduit® products are subject to the terms and conditions available at:
www.Atkore.com/terms.

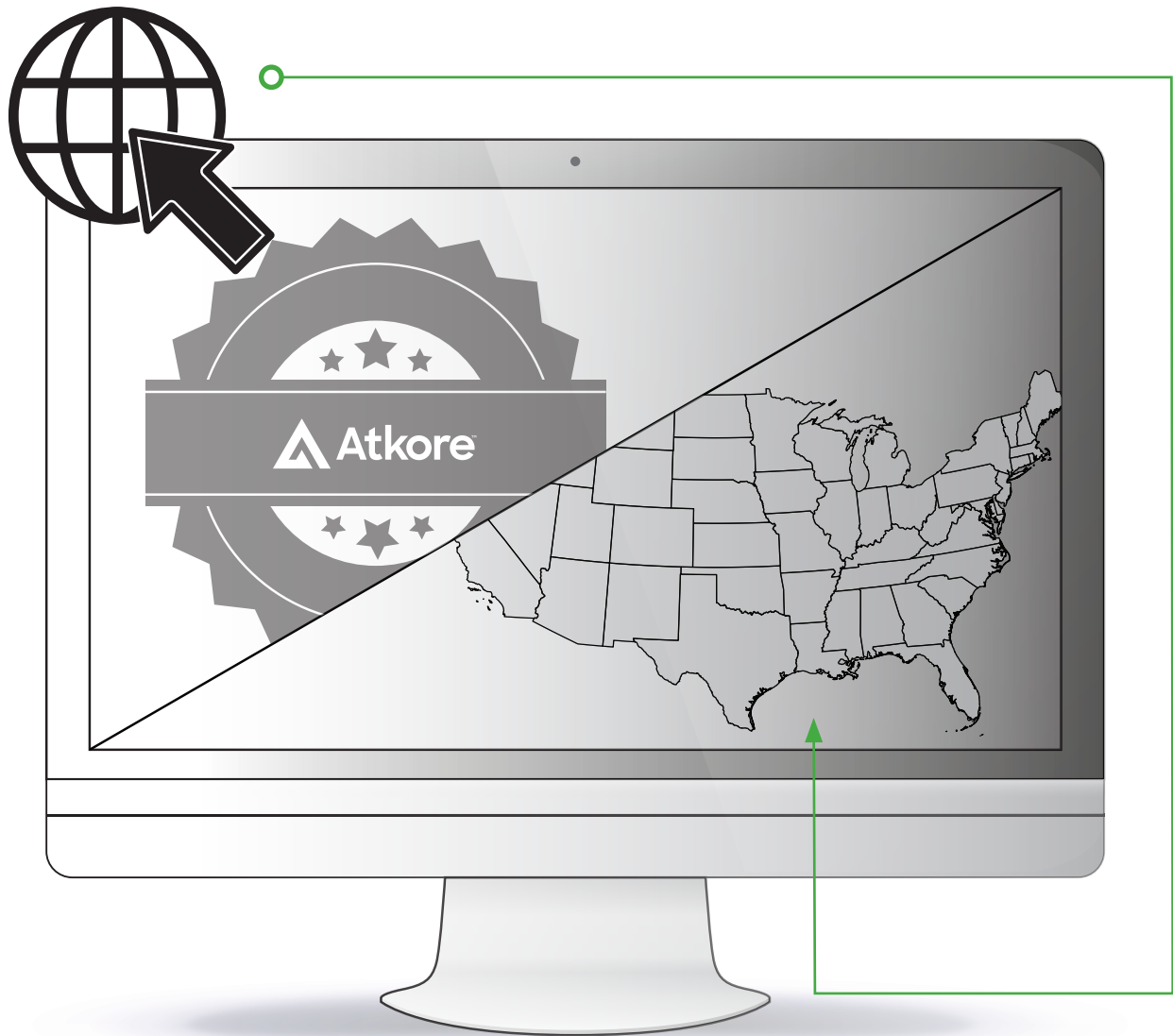

Allied Tube & Conduit® Rep Locator

To find an Allied Tube & Conduit® sales agent in your area visit our rep locator at: www.alliedeg.us/rep-locator

American-made steel conduit.
Reinforcing American workers.



Atkore™
**Allied Tube
& Conduit**

'Made in America.' World-class.

There's a sense of pride that comes from manufacturing products on American soil.* For over 60 years, we've been honored to supply the nation's workforce with quality made steel conduit. And when our unbreakable supply chain joins forces with the American worker, we're building better together.

Learn more at alliedeg.us

*Excludes Kwik products





Allied Tube & Conduit ▲ AFC Cable Systems ▲ Heritage Plastics ▲ Unistrut
Unistrut Construction ▲ Cope ▲ US Tray ▲ Calbrite ▲ Calbond ▲ Kaf-Tech
Columbia-MBF ▲ Eastern Wire + Conduit ▲ ACS/Uni-Fab ▲ Cii
Power-Strut ▲ Calconduit ▲ Razor Ribbon ▲ Calpipe Security
FRE Composites ▲ Vergokan ▲ Flexicon ▲ Marco

Atkore

16100 South Lathrop Avenue
Harvey, IL 60426

TOLL FREE / 800-882-5543

FAX / 708-339-7814

atkore.com/atce

Want to join a company that helps you build
the mindset, skill set and tool set for success?
Visit us at atkore.com/careers