

AMERIMAX™

PRODUCT CATALOG

ROOF DRAINAGE SYSTEMS



MOISTURE PROTECTION



VENTILATION PRODUCTS



OUTDOOR LIVING PRODUCTS

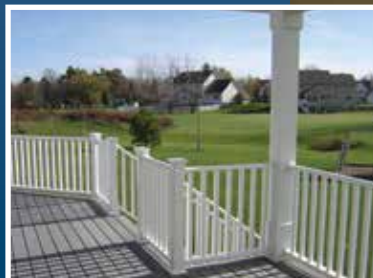

SNOW RETENTION SYSTEMS



StealthFlow®



Diverts damaging rainwater away from your foundation



Fits all standard residential downspouts



No digging required! Simply cover with mulch or straw and it disappears into the landscape

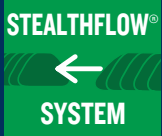

Compatible with other components of the StealthFlow® System



Roof Drainage Systems

page 5

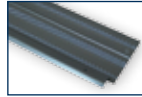

- 5 Special Order Gutter Colors
- 6 Gutter Systems
- 6 K Style Aluminum
- 8 Half Round Aluminum
- 9 K Style Galvanized
- 10 Half Round Galvanized
- 12 Freedom Gray Copper
- 14 K Style Copper
- 15 Half Round Copper
- 16 Vinyl Traditional
- 17 Vinyl Contemporary

- 19 Hangers K Style
- 21 Hangers Half Round
- 22 Shanks K Style & Half Round
- 22 Strainers
- 23 Outlets K Style & Half Round
- 23 Eave Boxes
- 24 Funnels
- 24 Downspout Tubes & Extensions

- 24 Downspout Fasteners
- 26 Gutter Protection
- 27 Gutter Guards
- 27 Gutter Shingle
- 27 Diamond Gutter Shield
- 27 Gutter Cover
- 27 Snap-In Filter
- 28 Snap-In Guard
- 28 Lock-On Gutter Guard
- 28 Hinged Gutter Guard
- 29 Hinged Half Round Gutter Guard

- 29 Co-Polymer Gutter Guard
- 29 Leaf Guard Plus
- 29 Leaf Guard
- 29 Gusher Guard
- 30 Accessories
- 32 Flex-A-Spout®
- 32 Extend-A- Spout™
- 32 Rodent Guard
- 32 Rodent Guard
- 33 Splash Blocks
- 33 SuperScoop™
- 33 Gutter Wedge

- 36 Flex Elbow™
- 36 Clip-Up Diverter Kit
- 36 Vinyl Dripper Flipper FLEX-Drain®

Lawn Drainage System

page 35



35 FLEX-Drain®

Moisture Protection

page 37

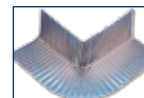

- 37 Roof Edge & Trim
- 37 A, B & C Style
- 40 D & E Style
- 41 Overhanging Roof Edge
- 41 F Style Vinyl
- 42 Vinyl Drip Edge
- 47 ODE Style
- 47 FHA
- 47 Miscellaneous Roof Edge
- 47 H Style
- 48 Vented Roof Edge
- 48 Roof Apron
- 48 Brick Molding

- 49 Window & Door Caps
- 51 West Coast Roof Edges
- 51 Grip Edge
- 51 Drip Edge
- 52 Flashing Angle
- 53 Area Walls, Covers & Grates
- 53 Galvanized Area Walls
- 53 Galvanized Mini Area Walls
- 54 Plastic Cover
- 54 Translucent Cover
- 54 Modular Egress Window Well System
- 54 Galvanized Egress Area Wall
- 54 Escape Ladder
- 57 Trim Coil Painted Aluminum

- 57 Deck Ledger Flashing
- 57 Roll Valley Flashing
- 57 Copper Flashing
- 58 Step Flashing
- 58 Termite Shield
- 59 Corner Flex Flashing
- 59 W Valley
- 59 Z Bar
- 60 Miscellaneous Flashing
- 60 Galvanized Ridge Roll Cap
- 60 Aluminum Flashing Angle
- 60 Aluminum Rain Diverter
- 60 Galvanized Kick Out Diverter

Ventilation Products

page 61



- 61 Pro-Master Ridge Vent™
- 61 AccuVent®
- 61 Soffit & Fascia
- 61 T4 Aluminum Soffit
- 62 D6 Aluminum Soffit
- 62 12"x12' Aluminum Soffit
- 62 16"x12' Center Vent
- 4 Panel Aluminum Soffit
- 62 10"x12' QLok Alum. Soffit
- 62 15"x12' QLok Alum. Soffit
- 62 12"x12' TrapLok Alum. Soffit

- 63 Soffit Hanger
- 63 J Channel
- 63 F Channel
- 63 Crown Moulding
- 63 Double Channel
- 63 Fascia Aluminum 12'

Outdoor Living Products

page 65



- 65 Vinyl Railing Systems
- 65 Railing Kits
- 65 Posts, Caps & Trim
- 67 Optional Accessories
- 68 Continuous Handrail Systems
- 68 Continuous Handrail Components

Snow Retention Systems

page 70



- 70 Snow Guards for Shingle, Slate, Synthetic Slate, Tile & Shake Roofing
- 71 Snow Guards for Metal Roofs
- 74 Aluminum Snow Panels

Miscellaneous

page 75



- 75 Corner Bead
- 76 Caulks & Sealants
- 76 Touch-Up Paint
- 77 Rivets, Nails & Screws
- 78 Metal Bender & Blades, Wall Ties & Utility Sheet, Utility Trim & Starter Strip, Siding Corners, Wind T Bracing & Joist Bridging

Appendix

page A1

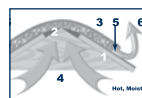

- A1 Gutter Assembly
- A3 Rainfall Intensity Map
- A3 Popular Hanger Choices
- A4 Ventilation
- A5 Snow Guard Technical
- A7 Gutter FAQ's
- A8 Gutter Glossary
- A9 Roof Edge & Trim Styles
- A10 Terms & Conditions
- A11 Aluminum Color Program



Amerimax Home Products, Lancaster, PA

Lancaster, Pennsylvania

450 Richardson Drive, Lancaster, PA 17603
Phone (800) 347-2586 (717) 299-3711
Fax (717) 299-2194

Duluth, Georgia

4455 River Green Parkway, Duluth, GA 30096
Phone (800) 735-6493
Fax (678) 377-0825

Grand Prairie, Texas

3125 N. Great Southwest Parkway, Suite 300
Grand Prairie, TX 75050
Phone (800) 726-4578 (972) 522-0148
Fax (888) 258-3298

Nappanee, Indiana

2341 E. Market Street, Nappanee, IN 46550
Phone (800) 729-5369
Fax (888) 396-2689

Sacramento, California

1835 Diesel Drive, Sacramento, CA 95838
Phone (800) 733-5684
Fax (877) 268-9328

Barrie, Ontario, Canada

26 Lorena Street, Barrie, Ontario, Canada L4N 4P4
Phone (800) 461-5706
Fax (800) 731-0385

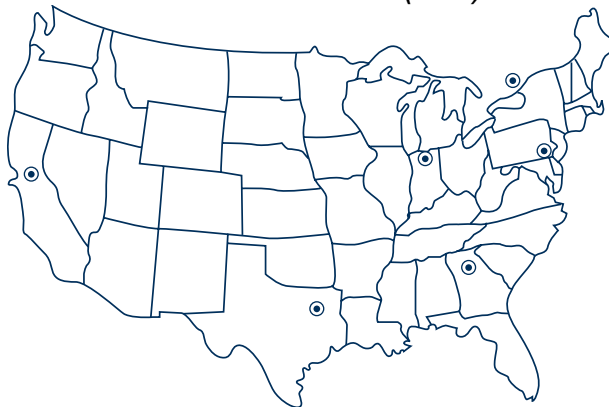

© Shipping Locations

Roof Drainage Systems

Full Range of Special Order Gutter Colors Available!

**Call Amerimax for Details*



5" Gutter System	
Gutter: Sold 10' sections (5")	24002 ___*
Downspout: 10' (2"x3")	24019 ___*
Inside Miter: (5")	5INM ___*
Outside Miter: (5")	5OTM ___*
Right End: (5")	5ENR ___*
Left End: (5")	5ENL ___*
Seamer: 2 per pack with 1 oz. SeamerMate® (Available in 5" only)	25008 ___*
Hidden Hanger with Hex Head Screw: (5")	210121
Hidden Hanger with Roof Strap: 4 pack, nails included. Use when no Fascia Board available (5" only)	21030PK
Unpainted Outlet: (2"x3")***	21051
"A" Style Elbow: (2"x3")	3AE ___*
"B" Style Elbow: (2"x3")	3BE ___*
Downspout Bands	DPB ___*
SeamerMate® 10 oz. Cartridge	85148 or 85150**
Sheet Metal Screws: 8 Per Pack	85354 ___*
Touch-Up Paint: 12 oz. can, 12 Per Carton	13TUP ___*

6" Gutter System	
Gutter: Sold 10' sections (6")	44002 ___*
Downspout: 10' (3"x4")	44011 ___*
Inside Strip Miter: (6")	6ISM ___*
Outside Strip Miter: (6")	6OSM ___*
Right End: (6")	6ENR ___*
Left End: (6")	6ENL ___*
Hidden Hanger with Hex Head Screw: (6")	47814
Unpainted Outlet: (3"x4")	47251
"A" Style Elbow: (3"x4")	4AE ___*
"B" Style Elbow: (3"x4")	4BE ___*
Downspout Bands	DPB ___*
SeamerMate® 10 oz. Cartridge	85148
Sheet Metal Screws: 8 Per Pack	85354 ___*
Touch-Up Paint: 12 oz. can, 12 Per Carton	13TUP ___*

Important Notes:

Allow two week lead time

10' Gutter Sections available only

See page A1 in the Appendix for "Gutter Facts You Should Know Before Purchasing Your Roof Drainage Systems"

End with Drop not available in this program

***21051 Unpainted Outlets are not visible after installation

6" Seamer not available. Installation requires overlap of gutter, screw, and seal with SeamerMate®

Color Fandecks Available



Use the Color Designation below to indicate preferred color:

30° White	010 or 30W
80° White	020 or 80W
Alcoa Musket Brown	AMB
Almond	069 or AL
AMP Dark Bronze	ADB
Black	025 or BL
Bone Linen	230 or LI
Dark Bronze	051 or DBZ
Grecian Green	217 or GG
Herringbone	220 or HE
Heritage Cream	027 or HC

Light Maple	028 or LM
Musket Brown	059 or MB
Natural Clay	790 or NC
Pearl Gray	053 or PG
Pebblestone Clay	PB
Red	221 or RE
Royal Brown	015 or RB
Savannah Wicker	460 or SW
Terra Bronze	200 or BZ
Tuxedo Gray	056 or TG

K Style Aluminum Gutter













See page A1 in the Appendix for "Gutter Facts You Should Know Before Purchasing Your Roof Drainage Systems"

	Description	Carton Qty	White 30°	Brown	Natural Clay	High Gloss White 80°	Royal Brown
	Straight Back Gutter **10'						
	5" .0185"	10	26006	2400619	2400679	-	-
	5" .0255"	10	26002	2400219	-	-	-
	5" .0305"	10	26003	-	-	-	-
	6" .0255"	5	46002	-	-	-	-
	Hem Back Gutter **10'						
	5" .0255"	8	26004	-	-	-	-
	5" .027"	5	-	-	-	K10HG5	K10BR5
	5" .032"	10	-	-	-	K10325	K10B35
	6" .032"	5	-	-	-	K10326	K10BR6
	Miter, Inside						
	5"	20	-	-	-	5INM80W	5INMRB
	5"	10	27201	2520119	25001079	-	-
	6"	10	47001	-	-	6INM80W	6INMRB
	Miter, Outside						
	5"	20	-	-	-	5OTM80W	5OTMRB
	5"	10	27202	2520219	25002079	-	-
	6"	10	47002	-	-	-	-
	6"	20	-	-	-	6OTM80W	6OTMRB
	Strip Miter, Inside						
	5"	20	-	-	-	5ISM80W	5ISMRB
	6"	20	-	-	-	6ISM80W	6ISMRB
	Bay Strip Miter, Inside						
	5"	20	-	-	-	5ISMBG80W	-
	6"	20	-	-	-	6ISMBG80W	-
	Strip Miter, Outside						
	5"	20	-	-	-	5OSM80W	5OSMRB
	6"	20	-	-	-	6OSM80W	6OSMRB
	Bay Strip Miter, Outside						
	5"	20	-	-	-	5OSMBGS80W	-
	6"	20	-	-	-	6OSMB80W	-
	End w/Drop 5"						
	2" x 3" Drop	12	27010	2501019	2501079	-	-
	2" x 3" Drop	20	-	-	-	KEPHG5	KEPBR5
	3" x 4" Drop*	12	27080*	2508019*	-	-	-
	End w/Drop 6"						
	3" x 4" Drop*	10	47080*	-	-	-	-
	*Includes two pieces. Assembly required.						
	Left End						
	5"	50	27005	-	-	5ENL80W	5ENLRB
	5"	15	27205	2520519	25005079	-	-
	6"	50	47005	-	-	6ENL80W	6ENLRB
	Right End						
	5"	50	27006	-	-	5ENR80W	5ENRRB
	5"	15	27206	2520619	25006079	-	-
	6"	50	47006	-	-	6ENR80W	6ENRRB
	Connector						
	5"	50	-	-	-	KSJHG5	KSJBR5
	5"	30	27209	2520919	2500979	-	-
	Seamer with 1 oz. SeamerMate®						
	5", 2/bag	25	27008	2500819	25008079PK	-	-
	6", 2/bag	25	4700825	-	-	-	-

Colors shown are for reference only. All thicknesses are inches unless otherwise noted. Tolerance is ± .002 inches. **Available in longer lengths.

K Style Aluminum Gutter

See page A1 in the Appendix for "Gutter Facts You Should Know Before Purchasing Your Roof Drainage Systems"

	Description	Carton Qty	Unpainted	White 30°	Brown	Natural Clay	High Gloss White 80°	Royal Brown
	Hidden Hanger w/Screw							
	5" - Aluminum	100	210121	-	-	-	-	-
	5" - Aluminum	250	21812	-	-	-	-	-
	See pages 19-22 for more hanger choices.							
	Gutter Screws and Ferrules 10/Pack							
	7" - Galvanized	12 pks	-	33047PK	3304719PK	-	-	-
	Gutter Screws only Bulk							
	7" - Galvanized	250	-	33246	-	-	-	-
	See pages 19-22 for more hanger choices.							
	Downspout 10' Square Corrugated							
	2" x 3" .0145"	10	DSSCPMF3	26010	2401019	2401079	-	-
	2" x 3" .0175"	10	-	26011	2401119	-	-	-
	2" x 3" .019"	10	-	-	-	-	24019020	24019015
	2" x 3" .024"	10	-	DSSC24H3	DSSC24B3	-	-	-
	3" x 3" .024"	10	-	L4061	L4161	-	-	-
	3" x 4" .0175"	10	-	46011	4401119	-	-	-
3" x 4" .024"	10	DSSCPMF4	-	-	-	DS4102480W	DS41024RB	
	Downspout Extension 15"							
	2" x 3"	24	-	27075	2507519	25075079	-	-
	3" x 4"	14	-	47075	4507519	-	-	-
	Downspout Band • Fits 2" x 3" and 3" x 4" downspouts							
		200	-	27229	2522919	-	-	-
		100	-	-	-	25029079	DPB80W	DPBRB
	Front Elbow "A" (75 degree) Square Corrugated							
	2" x 3"	30	-	27064	-	-	3AE80W	3AERB
	2" x 3"	15	-	27264	2526419	25064079	-	-
	3" x 3"	10	-	L4066	L4166	-	-	-
	3" x 4"	10	-	47264	4526419	-	-	-
	3" x 4"	15	-	-	-	-	4AE80W	-
3" x 4"	15	-	-	-	-	-	4AERB	
	Front Elbow "A" (90 degree) Square Corrugated							
	2" x 3"	30	-	-	-	-	3AES80W90	3AESRB90
	3" x 4"	15	-	-	-	-	4AES80W90	4AESRB90
	Front Elbow "A" (60 degree) Square Corrugated							
	2" x 3"	30	-	-	-	-	3AES80W60	3AESRB60
	3" x 4"	30	-	-	-	-	4AES80W60	4AESRB60
	Side Elbow "B" (75 degree) Square Corrugated							
	2" x 3"	30	-	27065	-	-	3BE80W	3BERB
	2" x 3"	15	-	27265	2526519	25065079	-	-
	3" x 4"	15	-	-	-	-	4BE80W	4BERB
3" x 4"	10	-	47265	4526519	-	-	-	
	Side Elbow "B" (90 degree) Square Corrugated							
	2" x 3"	30	-	-	-	-	3BES80W90	3BESRB90
	3" x 4"	30	-	-	-	-	4BES80W90	4BESRB90
	Side Elbow "B" (60 degree) Square Corrugated							
	2" x 3"	30	-	-	-	-	3BES80W60	3BESRB60
	3" x 4"	30	-	-	-	-	4BES80W60	4BESRB60
	Vinyl Transition Elbow • Transitions from "A" style to "B" style • Can be used with metal and vinyl gutter systems.							
	2" x 3"	30	-	37064	-	-	-	-
	3" x 4"	12	-	37065	-	-	-	-

Refer to page 23 for Outlets

Colors shown are for reference only. All thicknesses are inches unless otherwise noted. Tolerance is ± .002 inches.

Half Round Aluminum Gutter

See page A1 in the Appendix for "Gutter Facts You Should Know Before Purchasing Your Roof Drainage Systems"

	Description	Carton Qty	Unpainted	White 30°	High Gloss White 80°	Royal Brown
	Single Bead **10'					
	5" .027"	10	-	-	L10HG5	L10BR5
	5" .032"	10	-	-	L10325	L10B35
	6" .032"	10	-	-	L10HG6	L10BR6
	Miter, Inside					
	5"	20	-	-	LISHG5	LISBA5
	6"	20	-	-	LISHG6	LISBA6
	Miter, Outside					
	5"	20	-	-	LOSHG5	LOSBA5
	6"	20	-	-	LOSHG6	LOSBA6
	End w/Outlet					
	5"	20	-	-	DEPHG5	DEPBA5
	"B" Wide Flange Outlet					
	3" - Aluminum	50	-	-	WBOHG3	WBOBA3
	4" - Aluminum	50	-	-	WBOHG4	WBOBA4
	"B" Outlet					
	3" - Aluminum	50	-	-	RBOHG3	RBOBA3
	4" - Aluminum	50	-	-	RBOHG4	RBOBA4
	End					
	5"	50	-	-	CENHG5	CENBA5
	6"	50	-	-	CENHG6	CENBA6
	Connector					
	5"	50	-	-	SCNHG5	SCNBA5
	6"	50	-	-	SCNHG6	SCNBA6
	#10 Combination Circle & Shank w/Spring Clip					
	5" - Aluminum	50	-	-	CBCHG5	CBCBA5
	6" - Aluminum	50	-	-	CBCHG6	CBCBA6
	Spring Clip for #10 Combination Hanger					
	One Size - Aluminum	50	-	-	SPCLWA	SPCLBA
	See pages 19-22 for more hanger choices.					
	Shank for Adjustable Pitch Rafters					
	#30 - Aluminum	50	-	-	SHHG30	SHBA30
	See pages 19-22 for more hanger choices.					
	Downspout 10' Plain Round					
	3" .019"	10	-	DSPRPSW3	DSPRPHG3	DSPRPBR3
	3" .024"	10	DSPRPMF3	-	-	-
	4" .019"	10	DSPRPMF4	DSPRPSW4	DSPRPHG4	DSPRPBR4
	4" .024"	10	DSPRPMF4	-	DSPRPHG4	DSPRPBR4
	Downspout 10' Round Corrugated					
	3" .019" Individually UPC'd	10	-	-	46026	-
	3" .019"	10	-	-	DSRCPHG3	DSRCPBR3
	4" .024" Individually UPC'd	10	-	-	46018	-
	4" .024"	10	-	-	DSRCPHG4	DSRCPBR4

Colors shown are for reference only. All thicknesses are inches unless otherwise noted. Tolerance is ± .002 inches. **Available in longer lengths.

Half Round Aluminum Gutter

See page A1 in the Appendix for "Gutter Facts You Should Know Before Purchasing Your Roof Drainage Systems"

	Description	Carton Qty	White 30°	High Gloss White 80°	Royal Brown
	Elbow (75 degree) Plain Round (Also available in 90, 60, 45 & 30 degrees)				
	3" .019"	30	-	PR3HG3	PR3BR3
	4" .024"	30	-	PR3HG4	PR3BR4
	Elbow (75 degree) Round Corrugated (Also available in 90, 60, 45 & 30 degrees)				
	3" .019"	30	-	RC3HG3	RC3BR3
	3" .019"	15	-	473741	-
	4" .024"	8	-	470781	-
	4" .024"	30	-	RC3HG4	RC3BR4







K Style Galvanized Gutter

	Description	Carton Qty	White 30°	Brown	Unpainted
	Gutter **10'				
	4" 32 ga.	10	18007	1800719	14007
	5" 32 ga.	10	32007	3200719	28008
	5" 30 ga.	10	-	-	28007
	Miter, Inside				
	4"	10	19201	1920119	15201
	5"	10	33201	3320119	29201
	Miter, Outside				
	4"	10	19202	1920219	15202
	5"	10	33202	3320219	29202
	End w/Drop				
	4"	12	19010	1901019	15010
	5"	12	33010	3301019	29010
	Left End				
	4" 28 ga.	50	19005	-	-
	4" 28 ga.	15	-	1920519	15205
	5" 28 ga.	50	33005	-	-
	5" 28 ga.		-	3320519	29205
	Right End				
	4" 28 ga.	50	19006	-	-
	4" 28 ga.	15	-	1920619	15206
	5" 28 ga.	50	33006	-	-
	5" 28 ga.	15	-	3320619	29206
	Connector				
	4"	30	19209	1920919	15209
	5"	30	33209	3320919	29209
	Seamer with 1 oz. SeamerMate®				
	4"	25	19008	1900819	15008
	5"	25	33008	3300819	29008

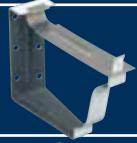
Colors shown are for reference only. All thicknesses are inches unless otherwise noted. Tolerance is ± .002 inches.

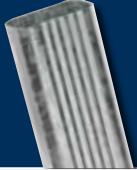
K Style Galvanized Gutter

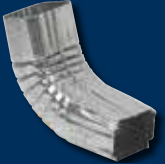
See page A1 in the Appendix for "Gutter Facts You Should Know Before Purchasing Your Roof Drainage Systems"

	Description	Carton Qty	White 30°	Brown	Unpainted
	Snap Lok Bracket (Call for information on top bars, snap straps, and cross bars) 5" Bulk - Galvanized	50	33022	3302219	29022
	See pages 19-22 for more hanger choices.				
	Fascia Bracket, 4/pack 5" - Galvanized 4" - Galvanized	12 pks 12 pks	33020PK 19020	3302019PK 1902019	29020PK 15020
	See pages 19-22 for more hanger choices.				
	Downspout 10' Square Corrugated 2" x 2" 26 ga. 2" x 3" 32 ga. 2" x 3" 30 ga. 3" x 4" 30 ga.	10 10 10 10	- 32014 -	- 3201419 -	DSSCP262 28014 28017 48014
	Downspout Extension 15" 2"x3" 32 ga.	24	33075	3307519	-
	Downspout Band • Fits 2" x 3" and 3" x 4" downspouts	200 100	33229 -	3322919 -	- 29029
	Front "A" Elbow (75 degree) Square Corrugated (Also available in 90, 60, 45 & 30 degrees) 2" x 3" 2" x 3" 2" x 3" 3" x 4" 3" x 4"	30 30 15 30 20	33064 - - - 51064	- - 3326419 - -	- SA63P3 29264 SA63P4 49064
	Side "B" Elbow (75 degree) Square Corrugated (Also available in 90, 60, 45 & 30 degrees) 2" x 3" 2" x 3" 2" x 3" 3" x 4" 3" x 4"	30 30 15 20 30	33065 - - 51065 -	- - 3326519 - -	- SB63P3 29265 49065 SB63P4
	Vinyl Transition Elbow • Transitions from "A" style to "B" style • Can be used with metal and vinyl gutter systems. 2" x 3" 3" x 4"	30 12	37064 37065	- -	- -



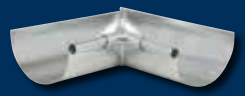
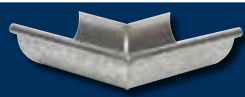









Half Round Galvanized Gutter

	Description	Carton Qty	Unpainted
	5" Single Bead **10' 26 ga. 28 ga.	5 10	L10265 L10285
	6" Single Bead **10' 26 ga.	10	L10266BX
	Miter, Inside 5" 6"	20 20	LIS265 LIS266
	Miter, Outside 5" 6"	20 20	LOS265 LOS266

Colors shown are for reference only. All thicknesses are inches unless otherwise noted. Tolerance is ± .002 inches. **Available in longer lengths.

Half Round Galvanized Gutter

See page A1 in the Appendix for "Gutter Facts You Should Know Before Purchasing Your Roof Drainage Systems"

	Description	Pack Qty.	Unpainted
	End w/Outlet		
	5"	20	DE2653
	6"	20	DE2664
	"B" Outlet, Wide Flange		
	3"	50	RBOMF3
	WB Pop Rivet Style Outlet		
	3"	50	WBP263
	"B" Style Outlet		
	3"	50	RBO263
	4"	50	RBO264
	5"	25	RBO265
	6"	25	RBO266
	End		
	5" 28 ga.	50	CEN265
	6" 28 ga.	50	CEN266
	Connector		
	5"	50	SCN265
	6"	50	SCN266
	#10 Combination Circle & Shank w/Spring Clip		
	5" - Galvanized	50	CCS105
	6" - Galvanized	50	CCS106
	Spring Clip for #10 Combination Hanger		
	One Size - Galvanized	50	SPCLGL
	See pages 19-22 for more hanger choices.		
	Rival Strap Hanger		
	5" - Galvanized	50	RIVGL5
	6" - Galvanized	50	RIVGL6
	See pages 19-22 for more hanger choices.		
	Downspout Plain Round		
	2" 26 ga.	10	42016
	2" 26 ga.	5	DSPRP262
	3" 26 ga.	5	DSPRP263BX
	3" 28 ga.	5	DSPRP283BX
	4" 28 ga.	5	DSPRP284BX
	Downspout 10' Round Corrugated		
	2" 26 ga.	5	DSRCP262
	3" 26 ga.	6	40016
	3" 28 ga.	6	DSRCP283
	4" 26 ga.	5	DSRCP264BX
	4" 28 ga.	5	DSRCP284
	Elbow (75 degree) Plain Round (Also available in 90, 60, 45 & 30 degrees)		
	2" 26 ga.	20	PR63P2
	3" 26 ga.	20	PR63P3
	4" 26 ga.	20	PR63P4
	Elbow (75 degree) Round Corrugated (Also available in 90, 60, 45 & 30 degrees)		
	2" 26 ga.	20	RC63P2
	3" 26 ga.	15	410651
	3" 26 ga.	20	RC63P3
	4" 26 ga.	20	RC63P4
	Downspout Band		
	Round 2"	100	43029

Colors shown are for reference only. All thicknesses are inches unless otherwise noted. Tolerance is ± .002 inches.

FreedomGray® Copper

ROOF DRAINAGE SYSTEMS

Durable, Attractive and Environmentally Friendly FreedomGray® Copper Half Round Gutter Systems Complement any Architectural Style!

- ◆ *Environmentally friendly alternative to lead-coated copper*
- ◆ *Attractive earth-tone gray finish*
- ◆ *Durable & corrosion resistant*
- ◆ *Revere copper substrate per ASTM B370*
- ◆ *Easily cut, bent, formed and installed with same tools as used for copper*
- ◆ *Solders using readily available materials*
- ◆ *25 year warranty*

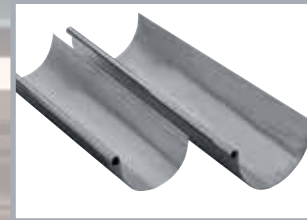

FreedomGray® Copper

ROOF DRAINAGE SYSTEMS

*For More Information,
Call Amerimax 800-347-2586*



Divert damaging rainwater away from your foundation

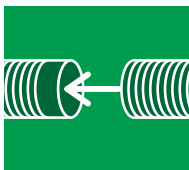

Connect multiple units together to add more length



Fits all standard residential downspouts

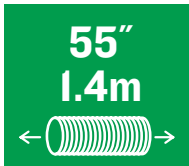

Easily expands from 25" to 55"

More information at Amerimax.com

K Style Copper Gutter

See page A1 in the Appendix for "Gutter Facts You Should Know Before Purchasing Your Roof Drainage Systems"

Roof Drainage Systems



	Description	Carton Qty	Copper 16 oz			
	Straight Back Gutter **10'					
	5"	5	K10CP5			
	6"	5	K10CP6			
	Bay Mitre, Inside					
	5"	20	KISCP5			
	6"	20	KISCP6			
	Bay Strip Mitre, Inside					
	5"	20	5ISMBC			
	6"	20	6ISMBC			
	Bay Mitre, Outside					
	5"	20	KOSCP5			
	6"	20	KOSCP6			
	Bay Strip Mitre, Outside					
	5"	20	5OSMBC			
	6"	20	6OSMBC			
	K Oval Outlet with Lock-in					
	2"	50	OKOCP3			
	3"	50	OKOCP4			
	Left End					
	5"	50	ENLCP5			
	6"	50	ENLCP6			
	Right End					
	5"	50	ENRCP5			
	6"	50	ENRCP6			
	Connector					
	5"	50	KSJCP5			
	K Hidden Hanger w/Screw (Straight Back)					
	5"	100	HIDC5S			
	6"	75	HIDC6S			
See pages 19-22 for more hanger choices.						
	Premium K Fascia Hanger w/Crossbar					
	5"	50	5PFCCP			
	6"	50	6PFCCP			
See pages 19-22 for more hanger choices.						
	Downspout Square Corrugated					
	2" x 3"	5	DSSCPCP3			
	3" x 4"	5	DSSCPCP4			
	Downspout Plain Square					
	2" x 3"	5	PSCP23EA			
	3" x 4"	5	PSCP34EA			
			75 degree	90 degree	60 degree	45 degree
	Front "A" Elbow Square Corrugated					
	2" x 3"	10	SA3CP3	SA4CP3	SA2CP3	SA1CP3
	3" x 4"	10	SA3CP4	SA4CP4	SA2CP4	SA1CP4
	Side "B" Elbow Square Corrugated					
	2" x 3"	10	SB3CP3	SB4CP3	SB2CP3	SB1CP3
	3" x 4"	10	SB3CP4	SB4CP4	SB2CP4	SB1CP4



Colors shown are for reference only. All thicknesses are inches unless otherwise noted. Tolerance is ± .002 inches. **Available in longer lengths.

Half Round Copper Gutter



See page A1 in the Appendix for "Gutter Facts You Should Know Before Purchasing Your Roof Drainage Systems"

	Description	Carton Qty	Copper 16 oz			
	Single Bead **10'					
	5"	5	L10CP5EA			
	Double Bead **10'					
	5"	5	L10DC5			
	Mitre, Inside					
	5"	20	LISCP5			
	Mitre, Outside					
	5"	20	LOSCP5			
	End w/Drop					
	5"	20	DECP53			
	"B" Outlet					
	3"	50	RBOCP3			
	End					
	5"	50	CENCP5			
	Connector					
	5"	50	SCNCP5			
	#10 Combination Circle & Shank w/Spring Clip					
	5"	50	CCC105			
	Rival Strap Hanger					
	5"	50	RIVCP5			
	Downspout Plain Round					
	2"	5	DSPRPCP2			
	Downspout Round Corrugated					
	3"	5	DSRCPCP3			
	Elbow Plain Round					
	2"	20	PR3CP2	PR4CP2	-	PR1CP2
	Elbow Round Corrugated					
	3"	10	RC3CP3	RC4CP3	RC2CP3	RC1CP3
						
	3"	10	PR3CP3	PR4CP3	PR2CP3	PR1CP3
						
	4"	10	PR3CP4	-	-	PR1CP4
						
	4"	10	RC3CP4	-	-	-
			75 degree	90 degree	60 degree	45 degree

Colors shown are for reference only. All thicknesses are inches unless otherwise noted. Tolerance is ± .002 inches.

5" Traditional Style Vinyl Gutter

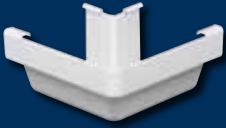





See page A1 in the Appendix for "Gutter Facts You Should Know Before Purchasing Your Roof Drainage Systems"

	Description	Carton Qty	White	Brown	
	Gutter 10' 5"	8	M0573	M1573	
	Inside Corner 5"	4	M0504	M1504	
	Outside Corner 5"	4	M0503	M1503	
	End w/ Outlet 2" x 3" Outlet 3" x 4" Outlet	6 6	M0506-6 M0706	M1506 -	
	End (Pair) 5"	14	M0611	M1611	
	Connector 2 pc 5"	50	M0608	M1608	
	Hidden Hook 1 pc 5"	200	M0622B	M1622B	
	Hidden Hook 2 pc 5"	50	M0521	M1521	
	Downspout 10' 2" x 3" 3" x 4"	6 6	M0593 M0793	M1593 -	
	Downspout Extension 15" 2" x 3" 3" x 4"	9 5	M0594 M0794	- -	





Colors shown are for reference only. All thicknesses are inches unless otherwise noted. Tolerance is ± .002 inches. **Available in longer lengths.

Traditional Style Vinyl Gutter

See page A1 in the Appendix for "Gutter Facts You Should Know Before Purchasing Your Roof Drainage Systems"

	Description	Carton Qty	White	Brown
	Connector			
	2" x 3"	20	M0623	M1623
	3" x 4"	16	M0723	-
	Diverter	20	M0642	M1642
	Downspout Band • Plastic bands for use with metal or vinyl downspouts			
	2" x 3" - Plastic	60	M0634	M1634
	3" x 4" - Plastic	24	39029	3902919
	"A" Elbow			
	2" x 3"	20	M0627	M1627
	3" x 4"	24	M0727	-
	"B" Elbow			
	2" x 3"	20	M0628	M1628
	3" x 4"	10	M0728	-
	Transition Elbow • Transitions from "A" style to "B" style • Can be used with metal and vinyl gutter systems.			
	2" x 3"	30	37064	-
	3" x 4"	12	37065	-

Contemporary Style Vinyl Gutter

	Description	Carton Qty	White	Brown
	Gutter 10"			
	4"	8	T0473	T1473
	5"	8	T0573	T1573
	Vinyl Corner Contemporary			
	4"	10	T0403	T1403
	5"	10	T0503	T1503
	End w/Outlet			
	4"	10	T0409	T1409
	5"	10	T0509	T1509
	Center Outlet			
	4"	10	T0406	T1406
	5"	10	T0506	T1506

Colors shown are for reference only. All thicknesses are inches unless otherwise noted. Tolerance is ± .002 inches.

Contemporary Style Vinyl Gutter









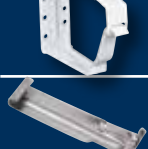

See page A1 in the Appendix for "Gutter Facts You Should Know Before Purchasing Your Roof Drainage Systems"

	Description	Carton Qty	White	Brown	
	End 4" 5"	20 20	T0411 T0511	T1411 T1511	
	Connector 4" 5"	25 25	T0405 T0505	T1405 T1505	
	Hidden Hook 5"	50	T0520	T1520	
	Hidden Hook 2 pc. 4"	50	T0421	T1421	
	Exterior Hook 4" 5"	50 50	T0419 T0519	T1419 T1519	
	Gutter Hanger Steel Roof Rafter (for houses with no fascia board) Unpainted	50	L3250		
	2" Square Downspout 10'	6	T0583	T1583	
	2" Square Downspout Connector	10	T0523	T1523	
	2" Square Diverter	20	T0642	T1642	
	2" Square Downspout Clip	30	T0534	T1534	
	Square Elbow	20	T0525	T1525	

Colors shown are for reference only. All thicknesses are inches unless otherwise noted. Tolerance is ± .002 inches. **Available in longer lengths.

Hangers - K Style

See page A3 in the Appendix for information on popular hanger choices.

	Description	Carton Qty	White 30°	Brown	High Gloss White 80°	Royal Brown	Unpainted	Copper
	#40 K Hanger w/Strap							
	5" - Aluminum	50	-	-	40KWA5	40BRA5	-	-
	6" - Aluminum	50	-	-	40KWA6	40BRA6	-	-
	5" - Galvanized	50	40KGL5	-	-	-	-	-
	6" - Galvanized	50	40KGL6	-	-	-	-	-
	5" - Copper	50	-	-	-	-	-	40KCP5
	#41 K Hanger w/Strap							
	5" - Aluminum	50	-	-	41KWA5	41BRA5	-	-
	6" - Aluminum	50	-	-	41KWA6	41BRA6	-	-
	5" - Copper	50	-	-	-	-	-	41KCP5
	6" - Copper	50	-	-	-	-	-	41KCP6
	Premium K Fascia Hanger w/Crossbar							
	5" - Aluminum	50	-	-	5PFHGC	5PFBRC	-	-
	6" - Aluminum	50	-	-	6PFHGC	6PFBRC	-	-
	5" - Copper	50	-	-	-	-	-	5PFCCP
	Fascia Strap Hanger							
	5" - Aluminum	100	-	-	-	-	21028	-
	Fascia Bracket							
	5", 4/pack - Aluminum	12 pks	25020PK	2502019	-	-	-	-
	5" - Galvanized	12 pks	33020PK	2202019PK	-	-	29029PK	-
	4" - Galvanized	12 pks	19020	1901019	-	-	15020	-
	Snap Lok Bracket (Call for information on top bars, snap straps, and cross bars)							
	5" Bulk - Aluminum	50	25022	2502219	-	-	-	-
	5" Bulk - Galvanized	50	33022	3302219	-	-	29022	-
	Snap Lok Bracket (Call for information on top bars, snap straps, and cross bars)							
	5" Bulk - Aluminum	50	25022	2502219	-	-	-	-
	5", 4/PK - Aluminum	12 pks	25024	2502419	-	-	-	-
	Hidden Hanger w/Screw							
	5" - Aluminum	100	-	-	-	-	210121	-
	5" - Aluminum	250	-	-	-	-	21812	-
	4" - Galvanized	125	-	-	-	-	150121	-
	K Hidden Hanger w/Screw (Hem Back)							
	5" - Aluminum	100	-	-	-	-	HID5SH	-
	6" - Aluminum	75	-	-	-	-	HID6SH	-
	K Hidden Hanger w/Screw (Straight Back)							
	5" - Aluminum	100	-	-	-	-	HID5S	-
	6" - Aluminum	75	-	-	-	-	HID6S	-
	6" - Aluminum	50	-	-	-	-	47814	-
	5" - Copper	100	-	-	-	-	-	HIDC5S
	6" - Copper	75	-	-	-	-	-	HIDC6S
	Hidden Hanger							
	5", 10/PK - Aluminum	25 pks	-	-	-	-	21016PK	-
	5", 50/PK - Aluminum	5 pks	-	-	-	-	21018	-

Colors shown are for reference only. All thicknesses are inches unless otherwise noted. Tolerance is ± .002 inches.

Hangers - K Style





See page A3 in the Appendix for information on popular hanger choices.

	Description	Carton Qty	White 30°	Brown	Natural Clay	High Gloss White 80°	Royal Brown	Unpainted	Copper
	K Hidden Hanger Straight or Hem Back								
	5" - Aluminum	100	-	-	-	-	-	HHMF-5-U	-
	6" - Aluminum	100	-	-	-	-	-	HHMF-6	-
	Hidden Hanger w/Roof Strap								
	5", 4/pack - Aluminum	15 pks	-	-	-	-	-	21030PK	-
	4", 4/pack - Galvanized	15 pks	-	-	-	-	-	15030	-
	<i>*Pack includes the hanger, 9 inch roof strap and a pack of screws for installation.</i>								
	FF Combo Hanger								
	5" - Aluminum	100	-	-	-	-	-	21027	-
	Strap Hanger								
	5" - Galvanized	100	-	-	-	-	-	29023	-
	K Wrap Around Hanger								
	5" - Aluminum	50	-	-	-	KWHWA5	KWHBR5	-	-
	6" - Aluminum	50	-	-	-	KWHWA6	KWHBR6	-	-
	5" - Copper	50	-	-	-	-	-	-	KWHCP5
	6" - Copper	50	-	-	-	-	-	-	KWHCP6
	Spikes & Ferrules 10/packs Aluminum								
	7" Spikes & 5" Ferrules	25 pks	25043	2504319	2504344	-	-	-	-
	8" Spikes & 6" Ferrules	16 pks	4504416	-	-	-	-	-	-
	Spikes & Ferrules 10/packs Galvanized								
	7" Spikes & 5" Ferrules	25 pks	33044	3304419	-	-	-	29044	-
	7" Spikes & 4" Ferrules	25 pks	19044	1904419	-	-	-	15044	-
	Gutter Screws and Ferrules 10/Pack								
	7" - Galvanized	12 pks	33047PK	3304719PK	-	-	-	-	-
	Gutter Screws only Bulk								
	7" - Galvanized	250	33246	-	-	-	-	-	-
	Spikes only								
	7" Bulk - Aluminum	250	25040	2504019	-	-	-	-	-
	7" Bulk - Aluminum	500	-	-	-	SPKWA7	SPKBR7	-	-
	8" Bulk - Aluminum	250	25046	-	-	-	-	-	-
	8" Bulk - Aluminum	500	-	-	-	SPKWA8	SPKBR8	-	-
	7" Bulk - Galvanized	250	33040	3304019	-	-	-	29040	-
	7" 50# Box - Galvanized	1	-	-	-	-	-	29041BX	-
7" 25# Box - Copper	1	-	-	-	-	-	-	SPKCP7	
	8" 25# Box - Copper	1	-	-	-	-	-	SPKCP8	
	Ferrule								
	5" - Aluminum	100	-	-	-	-	-	FERMF5	-
	6" - Aluminum	100	-	-	-	-	-	FERMF6	-
	4" - Plastic	250	-	-	-	-	-	15060	-
	5" - Plastic	250	-	-	-	-	-	21060	-
	6" - Plastic	500	-	-	-	-	-	47042	-
	5" - Galvanized	100	-	-	-	-	-	FERGL5	-
	6" - Galvanized	100	-	-	-	-	-	FERGL6	-
	5" - Copper	100	-	-	-	-	-	-	FERCP5
	6" - Copper	100	-	-	-	-	-	FERCP6	

Colors shown are for reference only.

Hangers - Half Round

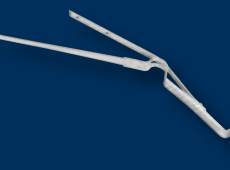
See page A3 in the Appendix for information on popular hanger choices.









	Description	Carton Qty	High Gloss White 80°	Royal Brown	Unpainted	Copper
	#10 Combination Circle & Shank w/Spring Clip					
	5" - Aluminum	50	CBCHG5	CBCBA5	-	-
	6" - Aluminum	50	CBCHG6	CBCBA6	-	-
	5" - Galvanized	50	-	-	CCS105	-
	6" - Galvanized	50	-	-	CCS106	-
	5" - Copper	50	-	-	-	CCC105
6" - Copper	50	-	-	-	CCC106	
	#10 Circle w/Spring Clip, Nut, & Bolt					
	5" - Aluminum	50	CIRHG5	CIRBA5	-	-
	6" - Aluminum	50	CIRHG6	CIRBA6	-	-
	5" - Galvanized	50	-	-	CIRCS5	-
	6" - Galvanized	50	-	-	CIRCS6	-
	5" - Copper	50	-	-	-	CIRCP5
6" - Copper	50	-	-	-	CIRCP6	
	Spring Clip for #10 Combination Hanger					
	One Size - Aluminum	50	SPCLWA	SPCLBA	-	-
	One Size - Galvanized	50	-	-	SPCLGL	-
	Rival Strap Hanger					
	5" - Aluminum	50	RIVHG5	RIVBA5	-	-
	6" - Aluminum	50	RIVHG6	RIVBA6	-	-
	5" - Galvanized	50	-	-	RIVGL5	-
	6" - Galvanized	50	-	-	RIVGL6	-
	5" - Copper	50	-	-	-	RIVCP5
6" - Copper	50	-	-	-	RIVCP6	
	Regal Bar Hanger					
	5" - Mill Finished Aluminum	50	-	-	REGMF5	-
	6" - Mill Finished Aluminum	50	-	-	REGMF6	-
	5" - Galvanized	50	-	-	REGGL5	-
	6" - Galvanized	50	-	-	REGGL6	-
	5" - Copper	50	-	-	-	REGCP5
6" - Copper	50	-	-	-	REGCP6	

Roof Drainage Systems



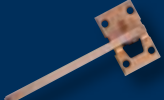

Colors shown are for reference only.

Shanks - K Style & Half Round













	Description	Carton Qty	High Gloss White 80°	Royal Brown	Unpainted	Copper
	Nut & Bolt for Shanks #10, 24 thread x 3/4" long					
	Galvanized	50	-	-	BN-S	-
	Brass	50	-	-	BN-CP	-
	Shank Plate for Fascia					
	#1 - Aluminum	50	SHHG-1	SHBA-1	SHMF-1	-
	#1 - Galvanized	50	-	-	SHCS-1	SHCP-1
	#1 - Copper	50	-	-	-	SHCP-1
	Shank for Ogee or Crown Moulding					
	#6 - Aluminum	50	SHHG-6	SHBA-6	-	-
	#6 - Galvanized	50	SHWS-6	SHBS-6	-	-
	#6 - Copper	50	-	-	-	SHCP-6
	Shank for Cornice					
	#8 - Mill Finish Aluminum	50	-	-	SH-CM8	-
	Shank for Fascia					
	#10 - Galvanized	50	SHWS10	SHBS10	SHCS10	-
	#10 - Copper	50	-	-	-	SHCP10
	Shank for Nailing to Exposed Rafter					
	#11 - Aluminum	50	SHHG11	SHBA11	SHCS11	-
	#11 - Copper	50	-	-	-	SHCP11
	Shank for Nailing to Sheeting					
	#12 - Aluminum	50	SHHG12	SHBA12	SHMF12	-
	#12 - Galvanized	50	SHWS12	SHBS12	SHCS12	-
	#12 - Copper	50	-	-	-	SHCP12
	#25 - Copper	50	-	-	-	SHCP25
	Shank for Adjustable Pitch Rafters					
	#30 - Aluminum	50	SHHG30	SHBA30	-	-
	#30 - Galvanized	50	-	-	SHCS30	-
	#30 - Copper	50	-	-	-	SHCP30
	Shank Extension					
	Aluminum	50	SHHGEX	SHBAEX	-	-
	Copper	50	-	-	-	SHCPEX

Strainers

	Description	Carton Qty	Unpainted	Copper
	Wire Strainers, Round			
	2" - Galvanized	50	RWSGL2	-
	3" - Galvanized	50	RWSGL3	-
	4" - Galvanized	50	RWSGL4	-
	2" - Aluminum	50	RWSMF2	-
	3" - Aluminum	50	RWSMF3	-
	4" - Aluminum	50	RWSMF4	-
	2" - Copper	50	-	RWSCP2
	3" - Copper	50	-	RWSCP3
	4" - Copper	50	-	RWSCP4
	6" - Copper	50	-	RWSCP6
	Leaf Strainer- Expandable			
	3" - Aluminum	48	21048	-
	3" - Aluminum	18	21059	-
	4" - Aluminum	24	21248	-
	3" - Galvanized	18	29059	-
	3" - Galvanized	48	29348	-
	4" - Galvanized	48	29448	-
	Strainer Plastic	24	85059	-

Colors shown are for reference only.

Outlets - K Style & Half Round

	Description	Carton Qty	White 30°	High Gloss White 80°	Royal Brown	Unpainted	Copper
	"C" Wide Flange 2" x 3" for 5" gutter - Galvanized	30	33051	-	-	29051	-
	2" x 3" for 4" gutter - Galvanized	30	-	-	-	15051	-
	"C" Wide Flange 2" x 3" - Aluminum	30	25051	-	-	21051	-
	"K" Oval 3" - Aluminum	50	-	-	-	WKOMF3	-
	Flange Outlet 3" x 3" Aluminum	10	L4063	-	-	-	-
	3" x 4" Aluminum	20	-	-	-	47251	-
	3" x 4" Galvanized	50	-	-	-	49051	-
	"C" Vinyl Outlet 2" x 3" Plastic	30	-	-	-	85051	-
	"B" Narrow Flange 2" x 3" - Galvanized	30	-	-	-	29050	-
	Round Outlet 2" - Galvanized	50	-	-	-	43051	-
	K Oval Outlet with Lock-in 2" - Copper	50	-	-	-	-	OKOCP3
	3" - Copper	50	-	-	-	-	OKOCP4
	WB Pop Rivet Style Outlet 3" - Galvanized	50	-	-	-	WBP263	-
	"B" Style Outlet 3" - Galvanized	50	-	-	-	RBO263	-
	4" - Galvanized	50	-	-	-	RBO264	-
	5" - Galvanized	25	-	-	-	RBO265	-
	6" - Galvanized	25	-	-	-	RBO266	-
	"B" Half Round Outlet 3" - Aluminum	50	-	RBOHG3	RBOBA3	-	-
	4" - Aluminum	50	-	RBOHG4	RBOBA4	-	-
	"B" Outlet 3" - Copper	50	-	-	-	-	RBOCP3
	4" - Copper	50	-	-	-	-	RBOCP4
	"B" Wide Flange Half Round Outlet 3" - Galvanized	50	-	-	-	RBOMF3	-
	3" - Aluminum	50	-	WBOHG3	WBOBA3	-	-
	4" - Aluminum	50	-	WBOHG4	WBOBA4	-	-

Eave Boxes

	Description	Carton Qty	White 80° Aluminum	Copper
	Regular (Open) 3" x 12"	12	EBWA32	EBCP32
	3" x 16"	12	EBWA36	EBCP36
	4" x 12"	12	EBWA42	EBCP42
	4" x 16"	12	EBWA46	EBCP46
	Closed 3" x 16"	12	CBWA36	CBCP36
	4" x 16"	12	CBWA46	CBCP46
	Sloped 3" x 16"	12	SBWA36	SBCP36
	4" x 16"	12	SBWA46	SBCP46

Colors shown are for reference only.

Funnels

	Description	Carton Qty	White 30°	High Gloss White 80°	Brown	Unpainted	Copper
	Vinyl • Connects two downspouts into one 2" x 3"	4	85208	-	85209	-	-
	Oval • Connects two downspouts into one						
	3" - Aluminum	12	-	FUNWA3	FUNBR3	-	-
	4" - Aluminum	12	-	FUNWA4	FUNBR4	-	-
	3" - Galvanized	12	-	-	-	FUNGL3	-
	4" - Galvanized	12	-	-	-	FUNGL4	-
	3" - Copper	12	-	-	-	-	FUNCP3
	Square "Y"						
	2" x 3" - Aluminum	10	SCYLG3	SCYHG3	-	-	-
	3" x 4" - Aluminum	10	SCYLG4	SCYHG4	SCYBR4	-	-
Square Cutoff with Diverter							
2" x 3" - Aluminum	10	SACLG3	SACWA3	SACBA3	-	-	
3" x 4" - Aluminum	10	SACLG4	SACWA4	SACBA4	-	-	

Downspout Tubes & Extensions

	Description	Carton Qty	White 30°	Brown	Natural Clay	High Gloss White 80°	Unpainted	Copper
	Downspout Tube w/Flange							
	2" x 10" - Aluminum	12	-	-	-	DSTWA2	-	-
	3" x 10" - Aluminum	12	-	-	-	DSTWA3	-	-
	4" x 10" - Aluminum	12	-	-	-	DSTWA4	-	-
	2" x 10" - Galvanized	12	-	-	-	-	DSTGL2	-
	3" x 10" - Galvanized	12	-	-	-	-	DSTGL3	-
	4" x 10" - Galvanized	12	-	-	-	-	DSTGL4	-
	2" - Copper	12	-	-	-	-	-	DSTCP2
	3" - Copper	12	-	-	-	-	-	DSTCP3
	4" - Copper	12	-	-	-	-	-	DSTCP4
	Downspout Extension 15"							
	2" x 3" - Aluminum	24	27075	2507519	25075079	-	-	-
	3" x 4" - Aluminum	14	47075	4507519	-	-	-	-
	2" x 3" - Galvanized	24	33075	3307519	-	-	-	-
	2" x 3" - Vinyl	9	M0594	-	-	-	-	-
	3" x 4" - Vinyl	5	M0794	-	-	-	-	-

Downspout Fasteners

	Description	Carton Qty	White	Brown	Natural Clay	Royal Brown	Unpainted	Copper
	#0 Mortar Drive							
	Bronze	50	-	-	-	-	DR-BR0	-
	Galvanized	50	-	-	-	-	DRCS-0	-
	#4 Wood Drive							
	Copper	50	-	-	-	-	-	DRCP-4
	Galvanized	50	-	-	-	-	DRCS-4	-
	# 5 Wood Drive							
	Malleable Iron	50	-	-	-	-	DR-CM5	-
	#6 Drive							
	Aluminum	50	DRWA-6	-	-	DRBRA6	-	-
	Copper	50	-	-	-	-	-	DRCP-6
	Galvanized	50	-	-	-	-	DRCS-6	-
	Rack and Key							
	Aluminum	50	RAK-WA	-	-	RAKBRA	-	-
	(2/Pack) Aluminum	25	85117	-	-	-	-	-
	Copper	50	-	-	-	-	-	RAK-CP
	Galvanized	50	-	-	-	-	-	RAK-CS
	Key							
	Aluminum (use with Alum. and Steel)	50	-	-	-	-	KEY-MF	-
	Bronze (used with Copper)	50	-	-	-	-	-	KEY-BR

Colors shown are for reference only.

Downspout Fasteners

	Description	Carton Qty	White	Brown	Natural Clay	Royal Brown	Unpainted	Copper
	Universal Conductor Band							
	Aluminum	50	WA12CB	-	-	BA12CB	-	-
	Copper	50	-	-	-	-	-	CP12CB
	4" Metco Ornamental Band							
	Aluminum	50	METHG4	-	-	METBR4	-	-
	Copper	50	-	-	-	-	-	METCP4
	3" Metco Ornamental Band							
	Aluminum	50	METHG3	-	-	METBR3	-	-
	Copper	50	-	-	-	-	-	METCP3
	Downspout Band • Fits 2" x 3" and 3" x 4" downspouts							
	Aluminum	200	27229	2522919	-	-	-	-
		100	-	-	25029079	-	-	-
	Downspout Band • Fits 2" x 3" and 3" x 4" downspouts							
	Galvanized	200	33229	3322919	-	-	-	-
		100	-	-	-	-	29029	-
	#31 Pipe Cleat							
	Aluminum	50	PCHG31	-	-	PCBR31	-	-
	Copper	50	-	-	-	-	-	PCCP31
	Conductor Bracket							
	Aluminum 3"	45	3PC30W50U	-	-	3PCRB	-	-
	Aluminum 4"	36	4PC30WU	-	-	-	-	-
	Copper	50	-	-	-	-	-	3PCC
	Round 2" Downspout Band							
	Galvanized	100	-	-	-	-	43029	-
	Downspout Clip • Plastic bands for use with metal or vinyl downspouts							
	2" x 3" - Plastic	60	M0634	M1634	-	-	-	-
	3" x 4" - Plastic	24	39029	3902919	-	-	-	-
	2" Square Downspout Clip							
	Vinyl	30	T0534	T1534	-	-	-	-
	Round Brick Hook							
	3" - Galvanized	50	BPRWS3	-	-	-	BPRGL3	-
	4" - Galvanized	50	BPRWS4	-	-	-	BPRGL4	-
	Square Brick Hook							
	2" x 3" - Galvanized	50	BPSWS3	-	-	-	BPSGL3	-
	3" x 4" - Galvanized	50	BPSWS4	-	-	-	BPSGL4	-
	Round Wood Hook							
	3" - Galvanized	50	PWHWS3	-	-	PBRSH3	PWHGL3	-
	3" (2/Pack) - Galvanized	12 pks	-	-	-	-	85108	-
	4" - Galvanized	50	PWHWS4	-	-	PBRSH4	PWHGL4	-
	4" (2/Pack) - Galvanized	12 pks	85104	-	-	-	-	-
	Square Wood Hook							
	2" x 3" - Galvanized	50	SSWWS3	-	-	-	SSWGL3	-
	2" x 3" (2/Pack) - Galvanized	12 pks	85121	-	-	-	-	-
	3" x 4" - Galvanized	50	SSWWS4	-	-	-	SSWGL4	-
	Plain Round Hinged Downspout Hook							
	3" - Copper Plated Zinc Alloy	50	-	-	-	-	-	HHPRC3
	4" - Copper Plated Zinc Alloy	50	-	-	-	-	-	HHPRC4
	Round Corrugated Hinged Downspout Hook							
	3" - Copper Plated Zinc Alloy	50	-	-	-	-	-	HHRCC3
	4" - Copper Plated Zinc Alloy	50	-	-	-	-	-	HHRCC4
	Square Wired Wood/Brick Hook							
	2" X 3" - Copper	50	-	-	-	-	-	WFHC23
	3" X 4" - Copper	50	-	-	-	-	-	WFHC34
	Downspout Anchors • Anchors for 2" x 3" downspouts							
	2/Pack - Plastic	6 pks	-	-	-	-	85210	-

Colors shown are for reference only.

Gutter Protection

The widest range of products available!

Plastic

Snap-in Filter



- Fine Mesh Screen
- Fits all Residential Gutters

Snap-in Guard



- High Water flow
- Fits all Residential Gutters

Gutter Guard Roll



- Durable Co-Polymer
- Use with Gutter Girders

Gutter Cover



- Solid Heavy Duty PVC
- Fits 4" - 7" systems

*High Debris Filtration
New & Existing Roofs*

*Excellent water flow
New & Existing Roofs*

*Great Value
Easy to Install*

Professional

*Commercial quality
Ideal for New Roofs*

Metal

Diamond Gutter Shield



- Solid Expanded Aluminum
- Locks securely into place

Lock-On Gutter Guard



- Heavy Duty Steel Screen
- Easily snaps into position

Hinged Gutter Guard



- Metal Screen with clips
- Affordable, Classic design

Gutter Shingle



- Powder Coated Steel
- Fits 4" - 7" systems

Gutter Guards

Gutter Shingle	Description	Carton Qty	Weatherwood	Copper
 <p>THE Gutter Shingle GUTTER COVER</p>	3' x 7 1/8", Steel	20	85246	-
	3' x 7 1/8", Copper	20	-	GGSKCP
<ul style="list-style-type: none"> • Fine mesh screen helps block small debris • Textured paint blends with the shingles • Contractor quality with simple installation • Can be installed on any pitch roof • Powder Coated Steel Weatherwood can be used with steel or aluminum systems • Can be used with 4", 5" or 6" K gutter 				

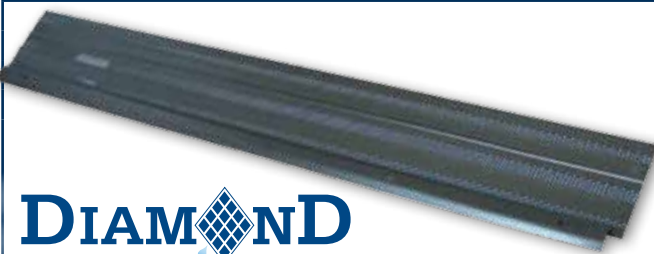
Diamond Gutter Shield	Description	Carton Qty	White	Brown	Black
 <p>DIAMOND Gutter Shield™</p>	3' section, 5"	50	85200BX	85219BX	85235BX
	3' section, 6"	50	86200BX	86219BX	86235BX
	4' section, 5" - 25 pcs	(1) CP	85400BX	85419BX	-
	4' section, 6" - 25 pcs	(1) CP	86400BX	86419BX	-
<ul style="list-style-type: none"> • Pressure Fit Design Makes Installation Easy - No Fasteners Needed • Compatible with Asphalt, Tile or Metal Roof System • Drip Lip Reduces Tiger Striping • Tested to Handle the Heaviest of Rainfall - Up to 40" per Hour • Aluminum with High Impact Powder Coat Finish Reduces Scratching and Cracking 					

Gutter Cover	Description	Carton Qty	White	Clay
	4' Plastic	50	85320	85322
	4' Plastic - 25 pcs	(1) CP	85304BX	85314BX
<ul style="list-style-type: none"> • Flex design made of rigid PVC accommodates many different pitched roofs • Solid Bull Nose Design allows water to roll into the gutter through the process of surface adhesion • Easy to install 4 foot sections fit standard 4", 5" and 6" metal gutters 				



Snap-In Filter	Description	Carton Qty	White	Brown
	3' Plastic	75	86370	86379
	3' Plastic- 25 pcs	(1) CP	86670	86679
<ul style="list-style-type: none"> • Fits 4", 5" & 6" Gutters • Made of high quality, rigid PVC • Snap-In design will not collapse under debris • Install with screen facing the sky 				

Gutter Guards

Roof Drainage Systems

Snap-In Guard	Description	Carton Qty	White	Brown	Black
	3' Plastic	75	85370	85379	85375
	3' Plastic	50	85470	85479	85475
	3' Plastic - 25 pcs	(1) CP	85670	85679	85675
	<ul style="list-style-type: none"> • Fits 4", 5" & 6" Gutters • Made of high quality, rigid PVC • Snap-in design for easy installation 				

Lock-On Gutter Guard	Description	Carton Qty	Black
	3' Galvanized, 5" K Style, 5/pack	5 packs	441-253
	3' Galvanized, 5" K Style, Black	75	441-503
	3' Galvanized, 5" K Style, Brown	75	441-503BR
	4' Galvanized, 5" K Style, Standard	25	GG5KKDI
	4' Galvanized, 6" K Style, Standard	25	GG6KKDI
	4' Galvanized, 5" K Style, Fine Mesh	25	GG5KKDIFM
	4' Galvanized, 6" K Style, Fine Mesh	25	GG6KKDIFM
<ul style="list-style-type: none"> • Fits 5" & 6" Gutters • Made of wire mesh (Standard and Fine) 			

Hinged Gutter Guard	Description	Carton Qty	White	Brown	Black	Unpainted	
	6"x3' Galvanized	75	-	-	-	85280BX	
	6"x3' Galvanized	25	-	-	-	852802	
	5/pk	10 pks	-	-	-	852805	
	5/pk	45 pks	-	-	-	852806	
	6"x3' Galv. Premium Powder Coated						
		50	85416BX	85389BX	85295	-	
		25	854162	853892	-	-	
	5"x3' Galvanized	75	-	-	-	GGGLK5	
	5/pk	30 pks	-	-	-	854054	
	6"x3' Aluminum No UPC	75	-	-	-	GGAK-6	
Hinged Guard Clips Stainless Steel, 8/pack	8/pk	25 pks	-	-	-	85341	
	<ul style="list-style-type: none"> • Convex hinged design provides strength and allows access to gutters • Three foot sections come in sizes that fit any standard style "K" gutters • Made of long lasting galvanized steel, aluminum or copper. Powder coated steel also available • Hinged Guard Clips for standard style "K" gutters only <p>8/pack</p>						

Gutter Guards

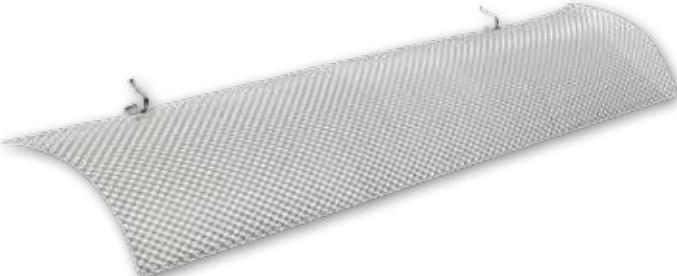
Hinged Half Round Gutter Guard	Description	Carton Qty	Part No.
	Hinged Aluminum		
	5" x 3'	50	GGAR-5
	6" x 3'	50	GGAR-6
	Hinged Copper		
	5" x 3'	25	GGCR-5BX
	6" x 3'	25	GGCR-6BX
<ul style="list-style-type: none"> • Convex hinged design provides strength and allows access to gutters • Three foot sections come in sizes that fit any standard style Half Round gutters • Made of long lasting aluminum or copper 			

Leaf Guard Plus	Description	Carton Qty	White	Brown
	6' sections	20	TA010	TA110
	<ul style="list-style-type: none"> • Leaf guard with added drip protection • Installs easily onto vinyl gutter system hooks • No tools required • For vinyl gutter systems only 			

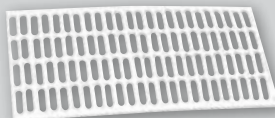
Leaf Guard	Description	Carton Qty	White	Brown
	5' sections	20	T0402	-
	<ul style="list-style-type: none"> • Economical leaf guard • Installs easily onto vinyl gutter system hooks • No tools required • For vinyl gutter systems only 			

Gusher Guard	Description	Carton Qty	White	Brown
	Aluminum 3/Pack	10 pks	25074	2507419
	<ul style="list-style-type: none"> • Attach to front top lip of gutter where overflows occur • Requires screw or rivet attachment • Use on inside miters 			

Note:

The purpose of our Gutter Guard product line is to stop leaves or reduce debris from entering the gutter/eavestrough. Product performance can vary depending on proper installation, product selection, gutter orientation, roof material and slope. Winter weather may cause snow and ice to accumulate at roof eaves. Ice damming can result from improper roof ventilation and inadequate insulation. Heat radiating from below the roof and sun radiation melt snow and it freezes again when temperatures drop below freezing. Icicles can be formed on roof edges due to these conditions whether or not gutters or guards are installed. This is a natural process beyond the manufacturers control and we accept no responsibility for ice and snow accumulation or related consequences.

Leaf Guards are sold as debris protection devices. The manufacturer assumes no responsibility for any other result of this product use.

FLEX A SPOUT™ SYSTEM







KEEPS DESTRUCTIVE RAINWATER AWAY FROM FOUNDATIONS

Downspout Extension

Quickly connect to any size downspout
Easily divert through your landscape
Easily add length
Cover it up
Choose colors that match

Connect Downspout Adapter or Downspout Extension **Choose** Extension Covered Splash Block + Low Profile Extender Splash Block

FLEX-A-SPOUT™ System allows connection of 2 or more components creating unique drainage solutions! Quick and easy to install, no special tools required - Extend, Bend & Connect

 <small>Available in white, green, brown and tan</small>	<h3>DOWNSPOUT EXTENSION</h3>	<ul style="list-style-type: none"> Fits all standard residential downspouts Easy Installation! Extend, Bend, Connect & Bury 	<ul style="list-style-type: none"> Connects to other FLEX-A-SPOUT™ accessories
 <small>Available in white</small>	<h3>DOWNSPOUT ADAPTER</h3>	<ul style="list-style-type: none"> Connects 2x3 and 3x4 inch downspouts to 3 or 4 inch drainpipes Extends up to 16 inches 	<ul style="list-style-type: none"> Easy Installation! Extend, Bend & Connect Connects to other FLEX-A-SPOUT™ accessories
 <small>Available in white, green, brown and tan</small>	<h3>EXTENSION</h3>	<ul style="list-style-type: none"> Adds up to 80 inches to Downspout Extension Redirects water for lawn and garden 	<ul style="list-style-type: none"> Easy Installation! Extend, Bend, Connect & Bury Connects to other FLEX-A-SPOUT™ accessories
 <small>Available in brown</small>	<h3>COVERED SPLASH BLOCK</h3>	<ul style="list-style-type: none"> Easy to hide under light ground cover 	<ul style="list-style-type: none"> Connects to other FLEX-A-SPOUT™ accessories
 <small>Available in brown</small>	<h3>LOW PROFILE EXTENDER</h3>	<ul style="list-style-type: none"> Connects to Covered Splash Block Telescoping Extender adds 9 to 28 inches 	<ul style="list-style-type: none"> Easy to hide under light ground cover
 <small>Available in brown, green and tan</small>	<h3>SPLASH BLOCK</h3>	<ul style="list-style-type: none"> Integrated design stays in place Prevents erosion from runoff water 	<ul style="list-style-type: none"> Connects to other FLEX-A-SPOUT™ accessories

Colors shown are for reference only.

fax 717.299.2194

phone 800.347.2586

Item Number	Description	Color	Carton Qty
85010	Downspout Extension	White	12
85011	Downspout Extension	Green	12
85014	Downspout Extension	Tan	12
85019	Downspout Extension	Brown	12
ADP53229	Downspout Adapter 2" x 3"	White	15
ADP53129	Downspout Adapter 3" x 4"	White	15
86011A	Extension	Green	10
86019A	Extension	Brown	10
86014A	Extension	Tan	10
86010A	Extension	White	10
88219A	Covered Splash Block	Brown	4
88119A	Low Profile Extender	Brown	6
89014	Splash Block	Tan	6
89019	Splash Block	Brown	6
89011	Splash Block	Green	6





Colors shown are for reference only.

Accessories

Roof Drainage Systems



Extend-A-Spout™		Description	Carton Qty	Black
		Low Profile Drainage System	12	81035
		Extender	6	88100
				
 <p>Assembled Low Profile Drainage System</p> <p>Optional Extender</p>		<ul style="list-style-type: none"> • Works with A or B elbow, 2" x 3" or 3" x 4" • Snap-fit technology for easy installation • Unobstructed interior flow to prevent clogging • Beaded seal to avoid leakage • ½" Dam to eliminate backflow • Optional Extender increases overall length capacity an additional 30 inches • Snap-fit design secures the extender in place for long term positioning • Telescoping feature allows owner to adjust the length that best suits their application 		

Catch-A-Raindrop™		Description	Carton Qty	White
		2" x 3"	6	37042
		3" x 4"	4	37043
	<ul style="list-style-type: none"> • Fits most standard residential downspouts • Small, discrete, and worry-free • Affordable way to conserve water • Plants love the pH neutral, fluoride- and chlorine-free water • Diverts water away from your home's foundation • Attach to regular garden hose or use cap 			

Rodent Guard		Description	Carton Qty	White
		2" x 3"	12	37552
		3" x 4"	12	37553
	<ul style="list-style-type: none"> • Rodent Guard attaches to the downspout to prevent rodents and other pests from climbing up the downspout and into gutters and entering the attic • Made of ultra-tough molded Polycarbonate, won't rust • Won't discolor from sun or chemicals • Easy to install • Easy to clean 			

Colors shown are for reference only.

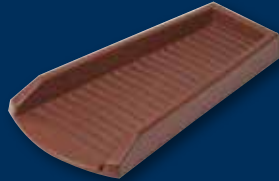
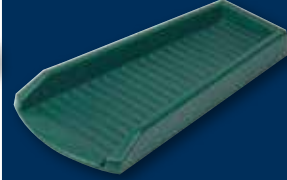
Accessories

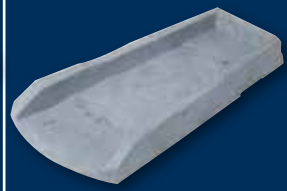
 <p>Splash Blocks</p> <p>12/bundle</p>				
	Brown	Green	Stone	Slate
	3001-12	3002-12	3003-12	3004-12



- 11.5" Wide x 24" Long
- Colors will blend in with any landscape scheme

Roof Drainage Systems



SuperScoop™	Description	Carton Qty	BLACK
 <p>SUPERSCOOP™</p>	Multi Purpose Scoop	12	LY306
	<ul style="list-style-type: none"> • Made of durable plastic resin for long life • Multi-use around the home • Rock salt spreading in winter • Potting soil in summer • Removes debris from gutters 		<ul style="list-style-type: none"> • Use with any style gutter (metal or vinyl) • Measurement units inside scoop and handle for use in various residential tasks
			

Gutter Wedge	Description	Carton Qty	White	Brown
	Fascia Fixer	50	T0539	T1539
	<ul style="list-style-type: none"> • Do away with sagging gutters • Use with 5" or 6" gutters • Use when fascia board or roof truss is slanted or sloped 			



Colors shown are for reference only. All thicknesses are inches unless otherwise noted. Tolerance is ± .002 inches.

Accessories

Roof Drainage Systems

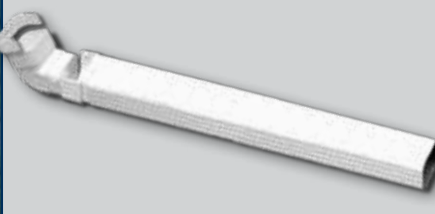
Flex-Elbow™		<i>Description</i>	<i>Carton Qty</i>	<i>White</i>	<i>Brown</i>
		2" x 3" Plastic	24	37084	3708419
<ul style="list-style-type: none"> • Expands 8" to 18" • Use with Aluminum, Steel, or Vinyl • Fits 2" x 3" downspout and 4" and 5" gutters • Easily bends and holds its shape 					

Clip-Up Diverter Kit		<i>Description</i>	<i>Carton Qty</i>	<i>White</i>	<i>Brown</i>
		-	9	KM9030-9	-
<ul style="list-style-type: none"> • For vinyl or metal 2" x 3" downspouts • 30 inches long 					

Vinyl Dripper Flipper		<i>Description</i>	<i>Carton Qty</i>	<i>White</i>	<i>Brown</i>
		-	12	37030	3703019
<ul style="list-style-type: none"> • For vinyl or metal 2" x 3" downspouts • 30 inches long 					

FLEX-Drain System

Versatility. Flexibility. Durability. FLEX-Drain® is simply a better solution from every angle. Our innovative yard drainage system features expandable pipes that outperforms every other brand. FLEX-Drain fittings easily connect systems and make installation a snap. Widely compatible with 3" and 4" corrugated pipe and 4" PVC, FLEX-Drain is designed to work hard and bend easy.

Using no-break copolymers and 100% "virgin" grade material, FLEX-Drain is made with seamless extrusion technology for enhanced performance and durability. With a simple snap, our integrated, soil-tight fittings lock securely and stay connected during backfilling. FLEX-Drain exceeds ASTM standards, delivering greater strength and joint integrity than standard corrugated pipe. For more information, visit Flex-Drain.com.

	Solid Pipe	<ul style="list-style-type: none"> • Available in 8', 12', 25' and 50' lengths • Great for diverting water from one place to another • Water will not seep out until it reaches the end of the pipe
	Perforated Pipe	<ul style="list-style-type: none"> • Available in 8', 12', 25' and 50' lengths • Ideal for ground water drainage like french drains • Use this pipe where surrounding soil is coarse and debris is minimal
	Perforated Pipe with Sock	<ul style="list-style-type: none"> • Available in 25' and 50' lengths • Pipe has spaced slits, covered by a removable polyester sock • Use this pipe where surrounding soil or sand is fine and requires filtration or where debris is present
	Flexible Downspout Adapter	<ul style="list-style-type: none"> • Available in sizes 2' x 3' and 3' x 4' • Adapter fits 3' or 4' corrugated pipe and 4' PVC • Its flexibility allows an easier connection with more versatility than rigid adapters
	Coupler	<ul style="list-style-type: none"> • Female coupler for joining two cut pieces of FLEX-Drain® together • Used to adapt FLEX-Drain® to some wyes and tees to improve the fit and function of the overall system
	Flexible Elbow/Connector™	<ul style="list-style-type: none"> • Expands up to 21', connects 3' or 4' corrugated pipe and 4' PVC • Creates any angle or turn, expands to reach pipes that have been cut short and is an excellent repair piece for damaged sections of pipe
	Flexible T/Y™	<ul style="list-style-type: none"> • Eliminates the need to use rigid wyes and tees, because it flexes to become either • Works with 3' or 4' corrugated pipe and 4' PVC. • Flexes and bends to fit most any angle
	Universal Pipe Connector	<ul style="list-style-type: none"> • Features an inner dimension that connects to 3' pipe and an outer dimension that connects to 4' pipe • The most economical solution for connecting FLEX-Drain, 3' and 4' corrugated pipe and 4' PVC
	End Cap	
	Drain Cap	



FLEX-Drain Pipe

Description	Carton Qty	Black
Solid		
4"x 8'	16	54021
4"x12'	12	51710
4"x 25'	6	51110
4" 25'	3	52110D
4"x 50'	1	52001
4"x 50'	4	52011
Perforated		
4"x 8'	16	54022
4"x 12'	12	51910
4"x 25'	6	51310
4" 25'	3	52310D
4"x 50'	1	52002
4"x 50'	4	52012
Perforated w/ sock		
4"x 25'	6	51510
4"x 25'	3	52510D
4"x 50'	1	52003
4"x 50'	4	52013

FLEX-Drain Fittings

Description	Carton Qty	Black
Downspout Adapter		
2" x 3" x 4"	10	ADP53202
2" x 3" x 3"	8	ADP53602
3" x 4" x 4"	10	ADP53102
Coupler		
4"	20	55020
Flexible Elbow/Connector™		
4"	10	57010
Flexible T/Y™		
4"	4	ADP53702
Universal Pipe Connector		
4"	16	ADP53302
End Caps		
4" End Cap	16	ADP53304
4" Drain Cap	16	ADP53305

Features & Benefits

- Universal Fit —————> Compatible with Other Brands of Pipe and Fittings
- Compact Size —————> Easy Transport
- Less Parts and Tools Required —————> Faster Installation
- Versatility and Variety —————> Adapts to Any Install Situation



Flex-Drain.com

Roof Edge & Trim

See page A4 in the Appendix for product information

A Style - 10'

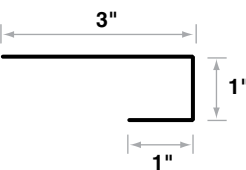
A5	Aluminum		
	Mill Finish	White	Royal Brown
	A-5MF2	A-5WA2	A-5BA2
	(50)	(50)	(50)
	.0125"	.0125"	.0125"

B Style - 10'

B4 1/2	Aluminum	
	White	
	55002	
	(50)	
	.0175"	
B5 1/2	Aluminum	
	White	Brown
	55003	5500319
	(50)	(50)
	.0175"	.0175"
B5 1/2	Aluminum	
	White	Brown
	55013	5501319
	(50)	(50)
	.0145"	.0145"

C Style - 10'

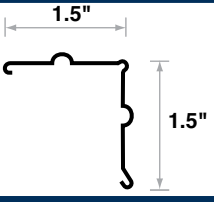
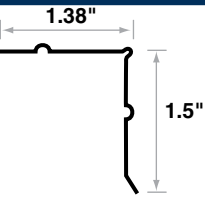
Hemmed C	Galvanized				Galvanized (Embossed)			
	Unpainted	White	Brown	Gray/Bronze	White	Brown		
	56003	57103	5710319	5710333	57203	5720319		
	(40)	(25)	(25)	(25)	(25)	(25)		
	32 ga.	32 ga.	32 ga.	32 ga.	32 ga.	32 ga.		
C3	Aluminum					Galvanized		
	Mill Finish		White		Royal Brown	Unpainted		
	54004	C-3MFB	C-3WAB	C-3WA2	55004	C-3BAB	56004	56704
	(50)	(50)	(50)	(50)	(50)	(50)	(50)	(25)
	.014"	.0175"	.0175"	.0125"	.019"	.0175"	32 ga.	28 ga.

Moisture Protection

Colors shown are for reference only. All thicknesses are inches unless otherwise noted. Tolerance is ± .002 inches. () Carton Quantity

Roof Edge & Trim

See page A4 in the Appendix for product information

C Style - 10' (cont.)								
	Galvanized							
	White	White	Brown					
	57004	57704	5770419					
	(50)	(25)	(25)					
	32 ga.	28 ga.	28 ga.					
	Aluminum	Galvanized						
	White	Unpainted						
	55104	56104	56705					
	(50)	(50)	(25)					
	.019"	32 ga.	28 ga.					
	Galvanized				Galvanized (Embossed)			
	Unpainted	White	Brown	Gray/ Bronze	White			
	56071	57171	5717119	5717133	5761233	57271		
	(25)	(25)	(25)	(25)	(25)	(25)		
	32 ga.	32 ga.	32 ga.	32 ga.	26 ga.	32 ga.		
	Aluminum							
	White				Brown	Royal Brown	Musket Brown	
	C35WA6	C35WAB	C35WA2	55005	5500519	C35BA6	C35BAB	C35MBB
	(50)	(50)	(50)	(50)	(50)	(50)	(50)	(50)
	.016"	.0175"	.0125"	.0175"	.0175"	.016"	.0175"	.0175"
	Aluminum							
	Bright White	Light Maple	Natural Clay	Musket Brown	Pearl Gray	Savannah Wicker	Black	Dark Bronze
	C35BWB	C35LMB	C35NCB	C35AMB	C35PGB	C35SWB	C35BKB	C35DBB
	(50)	(50)	(50)	(50)	(50)	(50)	(50)	(50)
	.0175"	.0175"	.0175"	.0175"	.0175"	.0175"	.0175"	.0175"
	Galvanized							
	Unpainted	Copper						
	56005	C35CPB						
(50)	(20)							
32 ga.	16 oz.							
	Aluminum							
	White		Brown					
	55125	55225	5512519					
	(50)	(50)	(50)					
	.0145"	.019"	.0145"					

Moisture Protection

Roof Edge & Trim

See page A4 in the Appendix for product information

C Style - 10' (cont.)

C4		Galvanized							
		Unpainted	White	Brown	Copper				
		56622	57622	5762219	C-4CPBD				
		(25)	(25)	(25)	(20)				
		28 ga.	29 ga.	29 ga.	16 oz.				
CS4		Aluminum							
		Mill Finish	White	Royal Brown	Copper				
		CS4MF2	CS4WAB	CS4WA2	CS4BAB	CS4BA2	CS4CPB		
		(50)	(50)	(50)	(50)	(50)	(20)		
		.0125"	.019"	.0125"	.019"	.0125"	16 oz.		
C4 Hemmed		Galvanized							
		Unpainted	White	Brown	Gray/Bronze				
		56002	57002	5700219	5700233				
		(25)	(25)	(25)	(25)				
		32 ga.	32 ga.	32 ga.	32 ga.				
C4 1/2		Aluminum							
		White				Royal Brown	Black	Musket Brown	
		C45WAB	C45W24	C45WA6	C45WA2	C45BAB	C45BA6	C45BKB	C45MBB
		(50)	(25)	(50)	(50)	(50)	(50)	(50)	(50)
		.019"	.024"	.016"	.0125"	.019"	.016"	.019"	.019"
			Aluminum		Galvanized				
			White		Unpainted	Copper			
			55006		56006	C45CPB			
			(50)		(25)	(20)			
			.0175"		32 ga.	16 oz.			
	C5 1/2		Aluminum						
		White					Brown	Royal Brown	
		C55W3B	C55W24	C55WAB	C55WA6	55007	C-5WA2	5500719	C-5BA2
		(25)	(25)	(50)	(50)	(50)	(50)	(50)	(50)
		.032"	.024"	.019"	.016"	.0175"	.0125"	.0175"	.0125"
			Aluminum			Galvanized			
			Royal Brown		Musket Brown	Unpainted	White	Royal Brown	Copper
		C55B3B	C55BAB	C55BA6	C55MBB	C55GLB	C55WSB	C55BSB	C55CPB
		(25)	(50)	(50)	(50)	(20)	(50)	(50)	(20)
		.032"	.019"	.016"	.019"	27 ga.	28 ga.	28 ga.	16 oz.

Moisture Protection

Colors shown are for reference only. All thicknesses are inches unless otherwise noted. Tolerance is ± .002 inches. () Carton Quantity

Roof Edge & Trim

See page A4 in the Appendix for product information

C Style - 10' (cont.)

C6	Aluminum				Galvanized			Copper
	Mill Finish	White	Dark Bronze	Royal Brown	Unpainted	White	White	
	54733	55733	C-63DZ	C-63BA	C-6GLB	57733	C-6WSB	C-6CPB
	(25)	(25)	(25)	(25)	(10)	(10)	(10)	(10)
	.032"	.032"	.032"	.032"	28 ga.	27 ga.	27 ga.	16 oz.
	Galvanized							
C7	Unpainted							
	56640							
	(20)							
	32 ga.							
C8	Galvanized							
	White							
	57644							
	(10)							
29 ga.								

D & E Style - 10'

D3	Aluminum		Galvanized
	White	Royal Brown	Unpainted
	D-3WAB	D-3BAB	56008
	(50)	(50)	(50)
	.019"	.019"	32 ga.
	Aluminum		
D4	White		
	D-4WAB		
	(50)		
	.019"		
D5	Galvanized		
	Unpainted		
	56625		
	(25)		
29 ga.			
	Galvanized		
	Unpainted		
	56253		
	(15)		
31 ga.			



Colors shown are for reference only. All thicknesses are inches unless otherwise noted. Tolerance is ± .002 inches. () Carton Quantity

Moisture Protection

Roof Edge & Trim

See page A4 in the Appendix for product information

D & E Style - 10' (cont.)								
Aluminum								
	White		Royal Brown					
	E-3WA6	E-3WAB	E-3BAB					
	(50)	(50)	(50)					
	.016"	.019"	.019"					
Aluminum								
	Mill Finish		White		Royal Brown		Galvanized	
							Unpainted	
	E-4MFB	E-4WA6	E-4WAB	E-4BA6	E-4BAB	56012	56624	
	(50)	(50)	(50)	(50)	(50)	(25)	(25)	
		.019"	.016"	.019"	.016"	.019"	32 ga.	29 ga.
Galvanized								
	Unpainted							
	56626							
	(20)							
	29 ga.							
Copper								
	E-9CPBD							
	(10)							
	16 oz.							

Moisture Protection

Overhanging Roof Edge

F Style Vinyl - 10'			
Vinyl			
	White	Brown	
	37154	3715419	
	(25)	(25)	
	.035"	.035"	
Vinyl Drip Edge - 10'			
Vinyl			
	White		
	T0401		
	(25)		
	-		

Overhanging Roof Edge

See page A11 in the Appendix for product information

F Style - 10'									
	Aluminum								
	Mill Finish	White			Brown		Natural Clay	Bronze	
	54014	55099	55054	5509919	5505419	5505479	5505433		
	(50)	(50)	(50)	(50)	(50)	(50)	(50)		
	.014"	.011"	.0145"	.011"	.0145"	.0145"	.0145"		
	Aluminum				Galvanized				
	Black	Red	Green	Unpainted		White	Brown	Black	
	5505435	55054180	55054181	56014	56214	57014	5701419	5701435	
	(50)	(50)	(50)	(25)	(25)	(25)	(25)	(25)	
	.0145"	.0145"	.0145"	32 ga.	30 ga.	32 ga.	32 ga.	32 ga.	
Galvanized									
	Bronze						Copper		
	5701433						F45CPB		
	(25)						(20)		
	32 ga.						16 oz.		
	Aluminum								
	White				Brown	Royal Brown			
	F45WA2	F45WA6	F45WAB	55199	5519919	F45BA2	F45BA6	F45BAB	
	(50)	(50)	(50)	(50)	(50)	(50)	(50)	(50)	
	.0125"	.016"	.019"	.0125"	.0125"	.0125"	.016"	.019"	
	Aluminum								
	Musket Brown	Mill Finish	Black						
	F45MBB	F45MFB	F45BKB						
	(50)	(50)	(50)						
	.0175"	.019"	.019"						
	Galvanized								
	Unpainted	White	Brown	Bronze	Black				
	56114	57224	5722419	5722433	5722435				
	(25)	(25)	(25)	(25)	(25)				
	32 ga.	31 ga.	31 ga.	31 ga.	31 oz.				
	Aluminum								
	White								
	55024								
	(50)								
.019"									

Moisture Protection



Overhanging Roof Edge

See page A4 in the Appendix for product information

F Style - 10' (cont.)

F5		Aluminum						
	Mill Finish	White					Brown	
	54015	F-5MFB	55055	55015	F-5WAB	F-5W24	F-5WA6	5505519
	(50)	(50)	(50)	(50)	(50)	(25)	(50)	(50)
	.014"	.019"	.0145"	.019"	.019"	.024"	.016"	.0145"
	Aluminum						Galvanized	
	Brown	Royal Brown			Black	Musket Brown	Unpainted	
	5501519	F-5BAB	F-5B24	F-5BA6	F-5BKB	F-5MBB	56015	
	(50)	(50)	(25)	(50)	(50)	(50)	(25)	
	.019"	.019"	.024"	.016"	.019"	.019"	32 ga.	
	Galvanized							
Unpainted		White				Brown		
56215	F-5GLB	57015	57215	57615	F-5WSB	5701519	5721519	
(25)	(20)	(25)	(25)	(25)	(20)	(25)	(25)	
30 ga.	28 ga.	32 ga.	30 ga.	29 ga.	29 ga.	32 ga.	31 ga.	
Galvanized								
Brown	Copper							
5761519	F-5CPB							
(25)	(15)							
29 ga.	16 oz.							
F5 Open Faced		Aluminum			Galvanized			
	Mill Finish	White	Brown	Unpainted	Copper			
	54017	55057	5505719	56217	F50CPB			
	(50)	(50)	(50)	(15)	(10)			
	.014"	.0145"	.0145"	32 ga.	16 oz.			
F5 Open Hemmed		Aluminum						
	Mill Finish		White			Royal Brown		
	F5OMF2	F5OMFB	F50WA2	F50WA6	F50WAB	F50BA2	F50BA6	F50BAB
	(50)	(50)	(50)	(50)	(50)	(50)	(50)	(50)
	.0125"	.019"	.0125"	.016"	.019"	.0125"	.016"	.019"
F5 1/2 Open Faced		Aluminum						
	White							
	55058							
	(50)							
	.0145"							

Moisture Protection

Colors shown are for reference only. All thicknesses are inches unless otherwise noted. Tolerance is ± .002 inches. () Carton Quantity

Overhanging Roof Edge

See page A4 in the Appendix for product information

F Style - 10' (cont.)								
	Aluminum							
	Mill Finish	White			Royal Brown			
	F55OMF	F55OW2	F55OW6	F55OWB	F55OB2	F55OB6	F55OBB	
	(50)	(50)	(50)	(50)	(50)	(50)	(50)	
	.019"	.0125"	.016"	.019"	.0125"	.016"	.019"	
	Aluminum							
	Light Maple	Natural Clay	A Musket Brown	Pearl Gray	Savannah Wicker	Black		
	F55OLM	F55ONC	F55OAMB	F55OPG	F55OSW	F55OBK		
	(50)	(50)	(50)	(50)	(50)	(50)		
	.019"	.019"	.019"	.019"	.019"	.019"		
	Aluminum							
	White	Brown						
	55085	5508519						
	(50)	(50)						
.019"	.019"							
	Aluminum							
	White			Brown		Royal Brown		
	55045	F5MWA6	F5MWAB	55046	5504519	5504619	F5MBA6	F5MBAB
	(50)	(50)	(50)	(35)	(50)	(35)	(50)	(50)
	.0145"	.016"	.019"	.022"	.0145"	.022"	.016"	.019"
	Aluminum							
	Natural Clay		Bronze	Musket Brown	Bright White	White	Bright White	Black
	5504579		5564533	F5MMBB	55045182	55645	5564514	5504535
	(50)		(50)	(50)	(50)	(50)	(50)	(50)
	.0145"		.019"	.019"	.0145"	.019"	.019"	.0145"
	Aluminum							Galvanized
	Light Maple	Natural Clay	Musket Brown	Pearl Gray	Savannah Wicker	Black	Sterling Gray	Unpainted
	5564528	5564579	5564559	5564553	5564546	5564535	5564531	F5MGLB
	(50)	(50)	(50)	(50)	(50)	(50)	(50)	(25)
	.019"	.019"	.019"	.019"	.019"	.019"	.019"	28 ga.
	Galvanized							
White			Brown		Royal Brown	Bronze	Black	
5734500	57245	57045	5724519	5704519	57345015	5734533	5734535	
(25)	(25)	(25)	(25)	(25)	(25)	(25)	(25)	
26 ga.	30 ga.	32 ga.	30 ga.	32 ga.	26 ga.	26 ga.	26 ga.	

Moisture Protection

Overhanging Roof Edge

See page A4 in the Appendix for product information

F Style - 10' (cont.)								
	Galvanized		Aluminum					
	Green	Copper	Royal Brown	Grecian Green	Cert Cypress	Heritage Cream	Granite Gray	
	57345181	F5MCPB	55645015	5564518	5564526	5564527	5564547	
	(25)	(15)	(50)	(50)	(50)	(50)	(50)	
	28 ga.	16 oz.	.019"	.019"	.019"	.019"	.019"	
	Aluminum							
	White	Brown						
	55041	5504119						
	(40)	(40)						
	.0175"	.0175"						
	Aluminum		Aluminum					
	White	Brown	Bright White	Light Maple	Natural Clay	Musket Brown	Pearl Gray	Savannah Wicker
	55155	5515519	55155182	5515528	5515579	5515559	5515553	5515546
	(50)	(50)	(50)	(50)	(50)	(50)	(50)	(50)
	.0145"	.0145"	.0145"	.0145"	.0145"	.0145"	.0145"	.0145"
	Aluminum		Galvanized					
	Royal Brown	Black	White	Brown	Bronze	Black		
	5515515	5515535	57155	5715519	5715533	5715535		
	(50)	(50)	(25)	(25)	(25)	(25)		
	.0145"	.0145"	32 ga.	32 ga.	32 ga.	32 ga.		
	Galvanized							
	White	Brown						
	57157	5715719						
	(25)	(25)						
	32 ga.	32 ga.						
	Aluminum		Aluminum					
	White		Brown	Green	Brown	Black	Bronze	Royal Brown
	55056	55116	5505619	55056181	5511719	5511735	5511733	5511715
	(50)	(50)	(50)	(50)	(50)	(50)	(50)	(50)
	.0145"	.0175"	.0145"	.0145"	.0175"	.0175"	.0175"	.0175"
	Aluminum							Galvanized
	Bright White	Light Maple	Savannah Wicker	Pearl Gray	Musket Brown	Natural Clay	Pebble-stone Clay	White
	5511714	5511728	5511746	5511753	5511759	5511779	5511785	57656
	(50)	(50)	(50)	(50)	(50)	(50)	(50)	(25)
	.0175"	.0175"	.0175"	.0175"	.0175"	.0175"	.0175"	29 ga.

Moisture Protection

Colors shown are for reference only. All thicknesses are inches unless otherwise noted. Tolerance is ± .002 inches. () Carton Quantity

Overhanging Roof Edge

See page A4 in the Appendix for product information

F Style - 10' (cont.)

F5 ½ S Hemmed (Cont.)		Galvanized						
	Brown							
	5765619							
	(25)							
	29 ga.							
F6M Hemmed		Galvanized						
	Unpainted	White	Brown					
	56242	57042	5704219					
	(20)	(20)	(20)					
	32 ga.	32 ga.	32 ga.					
F8 Open Faced		Aluminum			Galvanized			
	Mill Finish	White	Brown	Unpainted	White			
	54018	55017	5501719	56220	57219			
	(50)	(25)	(25)	(15)	(15)			
	.014"	.0145"	.0145"	32 ga.	32 ga.			
F8		Aluminum			Galvanized			
	Mill Finish	White	Brown	Unpainted				
	54219	55219	5521919	56019	56219			
	(25)	(25)	(25)	(15)	(15)			
	.0167"	.0175"	.0175"	32 ga.	32 ga.			
F8 Open Hemmed		Aluminum						
	Mill Finish			White				
	F-8MF2	F-8MFB	54217	F-8WA2	F-8WAB	F-8W24	55217	
	(25)	(25)	(25)	(25)	(25)	(25)	(25)	
	.0125"	.019"	.0167"	.0125"	.019"	.024"	.0175"	
Aluminum								
Brown	Royal Brown			Black	Bright White	Natural Clay		
5521719	F-8BA2	F-8BAB	5521715	F-8BKB	5521714	5521779		
(25)	(25)	(25)	(25)	(25)	(25)	(25)		
.0175"	.0125"	.019"	.0175"	.019"	.0175"	.0175"		
Aluminum					Galvanized			
Musket Brown	Pearl Gray	Savannah Wicker		Black	Unpainted	Copper		
5521759	5521753	5521746		5521735	F-83GL	F-8CPB		
(25)	(25)	(25)		(25)	(20)	(10)		
.0175"	.0175"	.0175"		.0175"	32 ga.	16 oz.		

Moisture Protection

Overhanging Roof Edge

See page A4 in the Appendix for product information

ODE Style - 10'								
	Aluminum							
	LG 30 White	Bright White	Light Maple	Natural Clay	A Musket Brown	Pearl Gray	Savannah Wicker	Royal Brown
	ODE-WA	ODE-BW	ODE-LM	ODE-NC	ODE-AMB	ODE-PG	ODE-SW	ODE-BA
	(50)	(50)	(50)	(50)	(50)	(50)	(50)	(50)
	.019"	.019"	.019"	.019"	.019"	.019"	.019"	.019"
	Aluminum							
	Black	LG 30 White	Royal Brown	Cooper	Dark Bronze			
	ODE-BK	ODEWA6	ODE-BA6	ODE-CP	ODE-DB			
	(50)	(50)	(50)	(10)	(50)			
	.019"	.0145"	.0145"	16 oz.	.019"			

F.H.A. - 10'	
	Galvanized
	Unpainted
	56645
	(20)
	29 ga.

Miscellaneous

H Style - 10'									
	Aluminum							Galvanized	
	Mill Finish	White				Royal Brown		Musket Brown	Unpainted
	H55MFB	H55WA6	55021	H55WAB30W	H55BA6	H55BAB	H55MBB	56021	
	(50)	(50)	(50)	(50)	(50)	(50)	(50)	(25)	
	.019"	.016"	.0175"	.019"	.016"	.019"	.019"	32 ga.	
	Aluminum								
	White	Cooper							
	H55WSB	H55CPB							
	(20)	(10)							
	27 ga.	16 oz.							
H6 1/2		Aluminum	Galvanized						
	White	Unpainted							
	55224	56324							
	(50)	(20)							
	.019"	28 ga.							



Moisture Protection

Colors shown are for reference only. All thicknesses are inches unless otherwise noted. Tolerance is ± .002 inches. () Carton Quantity

Miscellaneous

See page A4 in the Appendix for product information

H Style - 10' (cont.)

H6F Slag Stop	Aluminum							
	Mill Finish		White			Royal Brown		
	H6FMFB	H6FM3B	H6FWA6	H6FW24	H6FW3B	H6FBA6	H6FBAB	H6FB3B
	(50)	(25)	(50)	(25)	(25)	(50)	(50)	(25)
	.019"	.032"	.016"	.024"	.032"	.016"	.019"	.032"
	Aluminum							
	Musket Brown	Copper						
	H6FMBB	H6FCPB						
(50)	(15)							
.019"	16 oz.							

Vented Roof Edge - 10'

Vented D.E.	Aluminum			
	Mill Finish	White	Royal Brown	Copper
	VDE-MF	VDEHGU	VDE-BR	VDE-CP
	(20)	(20)	(20)	(10)
	.027"	.027"	.027"	16 oz.

Roof Apron - 10'

Roof Apron	Aluminum					Galvanized		
	Mill Finish	White	Musket Brown	Pebble-stone Clay	Bronze	Unpainted	White	Brown
	54075	55075	5507559	5507585	5507533	56075	57075	5707519
	(50)	(40)	(40)	(40)	(40)	(25)	(25)	(25)
	.011"	.019"	.019"	.019"	.019"	32 ga.	32 ga.	32 ga.

Brick Molding

	Aluminum
	White
BMCWA9	
(25)	
.019"	

Moisture Protection

Window & Door Cap

See page A4 in the Appendix for product information

Window & Door Cap - 10'

5/8"		Aluminum			
	Mill Finish 54221 (100) .011"	HiGloss White 5522120 (50) .011"			
3/4"		Aluminum			
	Mill Finish				
	54520	54520	54520		
	(50) 42"	(50) 4'	(100) 8'		
	.011"	.011"	.011"		
3/4" x 10'		Aluminum			
	Mill Finish 54231 (100) .011"	White 55231 (100) .011"	HiGloss White 5523120 (50) .011"	Brown 5523119 (100) .011"	
1" x 10'		Aluminum			
	White 55321 (100) .011"	HiGloss White 5532120 (50) .011"			
1 5/16"		Aluminum			
	Mill Finish 54521 (50) 42" .011"	HiGloss White 5525120 (50) .011"	White 55251 (100) .011"	Copper XDCC56 (20) 16 oz.	
1 1/8"		Aluminum			
	Mill Finish 54241 (100) .011"	White 54241 (50) 42" .011"	HiGloss White 55241 (100) .011"	Brown 5524119 (100) .011"	Copper XDCC18 (20) 16 oz.
1 1/4"		Aluminum			
	Mill Finish 54049 (100) .011"	White 54049 (50) 42" .011"	HiGloss White 55049 (50) .0175"		

Moisture Protection

Colors shown are for reference only. All thicknesses are inches unless otherwise noted. Tolerance is ± .002 inches. () Carton Quantity

Window & Door Cap

See page A4 in the Appendix for product information

Window & Door Cap - 10' (cont.)

1 1/2"		Aluminum			
	Mill Finish		White	HiGloss White	
	54261	54261	54261	55261	5526120
	(100)	(50) 42"	(50) 8'	(100)	(50)
	.011"	.011"	.011"	.011"	.011"
1 5/8" x 10'		Galvanized	Aluminum		
	Unpainted	White			
	56060	55060			
	(50)	(50)			
	32 ga.	.0175"			
DC1 - 10'		Aluminum			
	White		Royal Brown		
	DC1WA2	DC1WA6	DC1BA2	DC1BA6	
	(50)	(50)	(50)	(100)	
	.0125"	.0145"	.0145"	.0125"	
DC3 - 10'		Aluminum			
	White				
	DC3WA2	DC3WA6			
	(50)	(50)			
	.0125"	.0145"			
DC3 - 8'		Aluminum			
	White				
	55034				
	(63)				
	.0175"				



Moisture Protection

West Coast Roof Edges

Grip Edge - 10'

		Galvanized		
	Unpainted	White	Brown	
	56787	57787	5778719	
	(20)	(20)	(20)	
	28 ga.	28 ga.	28 ga.	

West Coast Roof Edges

See page A4 in the Appendix for product information

Grip Edge - 10' (cont.)

		Galvanized			
	Unpainted				
	56788				
	(20)				
	28 ga.				
		Galvanized			
	Unpainted				
	56782				
	(20)				
	28 ga.				

Drip Edge - 10'

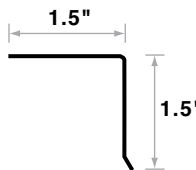
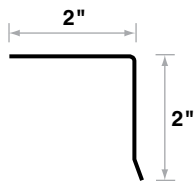
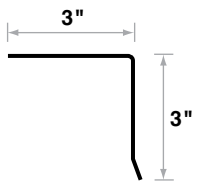
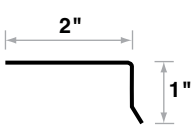
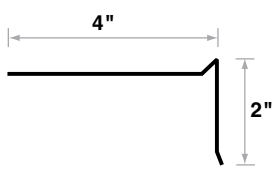
		Galvanized			
	Unpainted	White	Brown	Weatherwood	
	56616	57616	5761619	5761634	
	(20)	(20)	(20)	(20)	
	28 ga.	28 ga.	28 ga.	28 ga.	
		Galvanized			
	Unpainted	White	Brown		
	56602	57602	5760219		
	(20)	(20)	(20)		
	28 ga.	28 ga.	28 ga.		
		Galvanized			
	Unpainted				
	56673				
	(10)				
	28 ga.				
		Galvanized			
	Unpainted				
	56671				
	(20)				
	28 ga.				
		Galvanized			
	Unpainted				
	56742				
	(10)				
	28 ga.				

Colors shown are for reference only. All thicknesses are inches unless otherwise noted. Tolerance is ± .002 inches. () Carton Quantity

Flashing Angle



See page A4 in the Appendix for product information

Flashing Angle - 10'

	Galvanized		
	Unpainted		
	56633		
	(10)		
	28 ga.		
	Galvanized		
	Unpainted		
	56644		
	(10)		
	28 ga.		
	Galvanized		
	Unpainted		
	56664		
	(10)		
	28 ga.		
	Galvanized		
	Unpainted		
	56620		
	(10)		
	28 ga.		
	Galvanized		
	Unpainted		
	56646		
	(10)		
	28 ga.		
	Aluminum		
	Mill Finish	<ul style="list-style-type: none"> • Rust-free aluminum 120 degree angle, used where roof and walls meet. Angle helps weatherproof this area 	
	54450		
	(10)		
	.0167"		

Moisture Protection

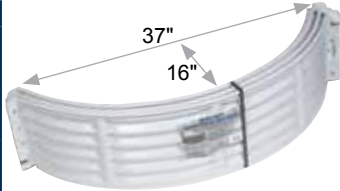
Area Walls, Covers & Grates

Plastic Area Walls	Size	Pack Qty.	Part No.
	12"	3/bundle	75204
	18"	3/bundle	75208
	24"	3/bundle	75210
	<ul style="list-style-type: none"> • Combine units for added heights • Units are pre-drilled and can be bolted together 		

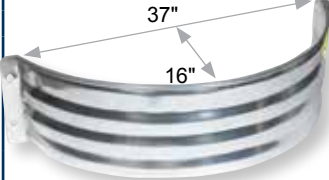
Galvanized Area Walls	Size	Pack Qty.	Part No.
	12"	5/bundle	75004
	18"	5/bundle	75008
	24"	5/bundle	75010
22 ga. Non-stackable			

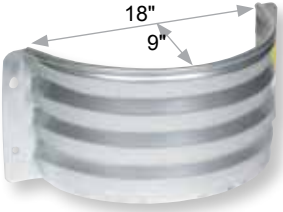
Galvanized Mini Area Wall	Pack Qty.	Part No.
	5/bundle	75016
12" height Mini - (for Foundation Vents)		

Plastic Grate	Pack Qty.	Part No.
	3/bundle	75250
<ul style="list-style-type: none"> • Load Bearing - holds over 500 lbs. • Fits plastic and galvanized area walls • Easy to install 		



Translucent Cover	Pack Qty.	Part No.
	3/bundle	75260
<ul style="list-style-type: none"> • Can be used on metal and plastic area walls with a width of 37" and projection of 16" 		

Moisture Protection

Area Walls, Covers & Grates

Plastic Modular Egress Window Well System and Hinged Window Well Cover

Window Well	Height	Pack Qty.	Part No.	Hinged Cover	Pack Qty.	Part No.
stacked sections shown	20 7/8"	1	75447		1	75449
					clear plastic	
					size: 59" Wide 44 1/2" Depth 6" High	
					weight: 11 lbs.	
<ul style="list-style-type: none"> Accommodates all egress windows from 32" to 48" wide 43" projection from the wall Complies with IRC 2012 Egress Code Multiple well heights available 				<ul style="list-style-type: none"> Individual sections are 20 7/8" in height; when stacked, each additional section adds 14" to the overall height; continue stacking until desired height is reached Hinged cover is clear to allow light in 		

Escape Ladder (for Egress Area Wall)	Size	Pack Qty.	Part No.	Galvanized Egress Area Wall	Size	Pack Qty.	Part No.
	48 1/2" height	1	75450		48" height	1	75448
					60" height	1	75460
14" Wide					16 ga. inside clearance shown here		
<ul style="list-style-type: none"> For use with egress area walls with a height of 48" - 60" IRC 310.2.1 compliant for egress Welded steel construction 				<ul style="list-style-type: none"> 36" projection from the wall Coated with hot-dipped galvanized Mounting holes for attachment to area wall 			

- Bring Safety to Your Basement
- Protect Below Grade Openings in Foundation Walls
- Provides an Emergency Exit from Basement (when used with Egress Window)

- Permit Daylight and Air Flow in Basement
- Covers Help Prevent Children and Pets from Falling into Opening



Dig



Mount



Back Fill



Cover

Colors shown are for reference only. All thicknesses are inches unless otherwise noted. Tolerance is ± .002 inches.

Moisture Protection

Trim Coil - Painted Aluminum

	Smooth Finish (.018") 24" x 50' 1 roll per carton - 24 cartons per skid	PVC Finish (.021") 24" x 50' 1 roll per carton
Color	Part No.	Part No.
Brown	69124	6912497
Royal Brown	6912415	6912468
ALC Musket Brown	6912459	6912425
Cert Musket Brown	6912430	6912452
AMP Dark Bronze	6912451	6912423
AMP Dark Bronze/ Sable Brown	ADBSAB-24	-
Autumn Yellow	6912434	6912443
Black/Black	204-24	-
Black	6912435	6912441
Black/Royal Brown	6912436	-
Buckskin	6912421	-
Glacier Blend	6912437	6912456
Cypress	69124239	6912454
Desert Tan	6912477	6912478
Granite Gray	6912447	6912413
Grecian Green	69124217	6912460
Heritage Cream	69124027	6912462
Herringbone	69124220	6912463
Ivy Green	6912461	6912464
Light Maple	69124028	6912465
Natural Clay	69124079	6912439
Pacific Blue	6912438	6912466
Oxford Blue	6912493	6912494
Pearl Gray	6912453	-
Pebble Stone Clay	6912485	6912486
Sable Brown	69124033	6912470
Sandstone Beige	6912474	6912471
Savannah Wicker	69124046	6912472
Silver Ash	6912432	6912475
Colonial White	6912491	6912492
Snow White	6912484	6912480
Sterling Gray	6912431	6912481
Tuxedo Gray	6912488	6912489
Lomar White	6912455	6912457
Bright White	69124182	6912458
Bronze	6912433	-
Lighthouse Red	69124180	-

	Smooth Finish (.018") 24" x 50' 1 roll per carton - 24 cartons per skid	PVC Finish (.021") 24" x 50' 1 roll per carton
Color	Part No.	Part No.
Almond	6912469	-
Autumn Red	69124101	-
Ber Dark Bronze	69124051	-
Berger Musket Brown	69124059	-
Bermuda Blue	69124102	-
Bone Linen	69124230	-
Charcoal Gray	69124103	-
Flagstone	69124107	-
Forest	69124105	-
Green Tea	69124104	-
Harbor Blue Crane	69124238	-
Hearthstone	69124108	-
Linen	69124106	-
Mountain Cedar	69124109	-
Pearl Crane	69124237	-
Regatta Blue Crane	69124240	-
Rye Crane	69124242	-
Saddle	69124244	-
Sandpiper	69124110	-
Seagrass	69124111	-
Spruce	69124112	-
Storm Crane (Greystone)	6912440	-
Suede	69124113	-
Terra Cotta	69124114	-
Wheat Crane	69124243	-

Moisture Protection

Flame Spread: self-extinguishing - A.S.T.M. D568



Note: All inside rolls are painted white unless specified

For trim nails to color coordinate with painted trim coil, see page 77

Trim Coil - Painted Aluminum

Aluminum (.018") 1 roll/ctn							
Color	Part No.						
	10" x 50'	12" x 50'	14" x 50'	16" x 50'	18" x 50'	20" x 50'	24" x 10' 1 rolls/ctn
Brown/White	69110	69112	69114	69116	69118	69120	69424
Black/White	6911035	-	6911435	-	-	-	-
White/White	-	-	6911455	-	-	-	-
Royal Brown/Lomar White	-	-	6911415	-	-	-	-
Lomar White/Lomar White	-	69112551	-	-	-	-	-
Black/Royal Brown	-	-	6911436	-	-	-	-
Bright White/Bright White	-	-	69114182	-	-	-	-
Black/Royal Brown	-	6911236	-	-	-	-	-

Aluminum (.0112")		
Color	Part No.	
	10" x 10' 12 rolls/ctn	14" x 10' 12 rolls/ctn
Brown/White	69410	69414

Note: All inside rolls are painted white unless specified

Deck Ledger Flashing

8' Deck Ledger Flashing Cap	Pack Qty.	Painted Steel White	Painted Steel Brown	Plastic Gray
 <p>Plastic Deck Ledger</p>	20	57028	5702819	-
	40	-	-	37028

- Fits over ledger board and behind siding to protect from water damage
- Use asphalt paper between metal and pressure-treated lumber
- Plastic Deck Ledger recommended for use with pressure-treated lumber
- Plastic Deck Ledger has slots for nailing

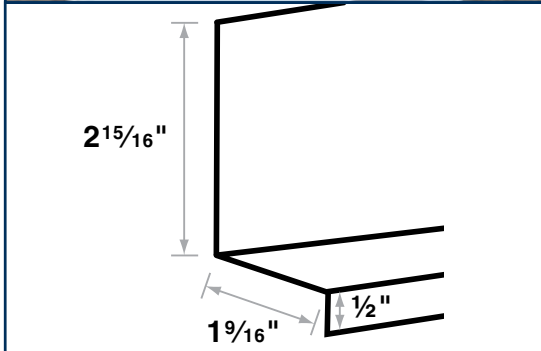
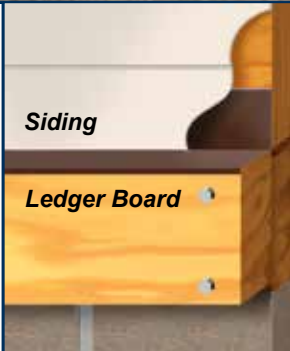
Siding

Ledger Board

Roll Valley Flashing

Size	Aluminum				Galvanized
	Versa (.0078")	Economy (.0092")	Standard (.014")	Commercial (.0167")	Standard (32 ga)
4" x 50'	66004	-	68104	-	70004
6" x 50'	66006	68006	68106	-	70006
8" x 50'	66008	68008	68108	-	70008
10" x 50'	66010	68010	68110	-	70010
12" x 50'	66012	68012	68112	-	70012
14" x 50'	66014	68014	68114	68214	70014
16" x 50'	66016	68016	68116	-	70016
18" x 50'	66018	68018	-	-	70018
20" x 50'	66020	68020	68120	68220	70020
24" x 50'	66024	-	68124	-	70024
28" x 50'	-	-	68128	-	70028
30" x 50'	-	-	-	-	70030
36" x 50'	-	-	-	-	70036
4" x 10'	66304	-	-	-	70404
6" x 10'	66306	68306	-	-	70406
8" x 10'	66308	68308	-	-	70408
10" x 10'	66310	68310	-	-	70410
12" x 10'	66312	68312	-	-	70412
14" x 10'	66314	68314	68414	-	70414
16" x 10'	-	-	-	-	70416
18" x 10'	-	-	-	-	70418
20" x 10'	66320	68320	68420	-	70420
24" x 10'	66324	-	-	-	70424
6" x 25'	66506	-	-	-	-
8" x 25'	-	-	-	-	70508
10" x 25'	66510	68510	-	-	70510
12" x 25'	-	-	-	-	70512
14" x 25'	66514	68514	-	-	70514
16" x 25'	-	-	-	-	70516
20" x 25'	66520	68520	-	-	70520
24" x 25'	-	-	-	-	70524

Color Coded Labels to easily identify gauges!



DuraFlash™ Vinyl Flashing

Color	Part No.	Size	Pack Qty	Skid
White	143018W	14" x 30'	8	240

Copper Nails 1 1/4"

Pack Qty.	Part No.
12/ctn	67003PK

3/8" diameter head approximately 50 nails/pack 1/4 lb./pack

Copper Flashing

16 oz. - 1 roll/ctn .021"		Laminated 3 oz. - 4 roll/ctn .0144"	
Part No.	Size	Part No.	Size
67514	14" x 25'	850678	8" x 20'
67520	20" x 25'	85067	10" x 20'
67314	14" x 10'	8506712	12" x 20'
67320	20" x 10'	850698	8" x 60'
		85069	10" x 60'
		8506912	12" x 60'

Recommended for use with pressure-treated lumber.

Copper Valley Flashing Rolls
16 oz. 100 lb. Rolls

Lengths are approximate depending on the actual weight of the roll.

Part No.	Size	Length
CPEV08	8"	149 ft
CPEV10	10"	119 ft
CPEV12	12"	100 ft
CPEV14	14"	85 ft
CPEV16	16"	75 ft
CPEV18	18"	66 ft
CPEV20	20"	60 ft
CPEV24	24"	50 ft

Colors shown are for reference only. All thicknesses are inches unless otherwise noted. Tolerance is ± .002 inches.

Step Flashing

Unpainted unless otherwise noted

Pack qty.	Part no.	Description
5" x 7" Bulk Packed		
500	68800BX	Aluminum .011
100	70800	Galvanized 32 ga.
500	STFLBB "No UPC"	Black/Brown Alum. .011
100	69857	Brown one side Aluminum .011
100	STFLCP	Copper 16 oz.
5" x 7" Contractor Packed 100/bundle		
5 Bundles	68899	Aluminum .011
5" x 7" 10 Pack		
20/packs	85068	Aluminum .011
20/packs	85070	Galvanized 32 ga.
5" x 8"		
100	70658	Galvanized 30 ga.
75	7095819	Brown Galvanized 28 ga.
6" x 8"		
500	STMF68	Aluminum .011
500	6986836	Brown/Black Aluminum .011
8" x 8"		
100	68888	Aluminum .011
100	70688	Galvanized 32 ga.
100	7068833	Bronze 32 ga.
100	6988833	Terra Bronze flat
100	69888	Brown/White Alum. .011
100	7068819	Brown Galvanized 32 ga.
100	7068835	Black Galvanized 32 ga.
100	69889	Black/Storm .011
100	6988837	Black/Brown flat
8" x 10"		
500	SFM810	Aluminum .011
8" x 12"		
50	70981	Galvanized 28 ga.
50	7098119	Brown Galvanized 32 ga.

Prebent Step Flashing



Unpainted unless otherwise noted

Pack qty.	Part no.	Description
2" x 3" x 7"		
500	SFM237	Aluminum .011
500	SFB237	Royal Brown Aluminum .011
100	SFC237	Copper 16 oz.
2.5" x 2.5" x 7"		
100	68707	Aluminum .011
100	70707BX	Galvanized 32 ga.
100	69707	Brown Aluminum .011
500	SFK227 "No UPC"	Black Aluminum .011
100	SFC227	Copper 16 oz.
4" x 4" x 7"		
100	SFG447	Galvanized 32 ga.
5" x 5" x 7"		
100	SFM557B	Aluminum .011
100	SFG557	Galvanized 32 ga.
4" x 4" x 8"		
(1) CP	68768	Aluminum .011. - 100 pcs
100	68708BX	Aluminum .011
(1) CP	70718	Galvanized 32 ga. - 50 pcs
100	70708	Galvanized 32 ga.
100	70608	Galvanized 28 ga.
100	7070819	Brown Galvanized 32 ga.
75	7090819	Brown Galvanized 28 ga.
(1) CP	7071835	Black Galvanized 32 ga. - 50 pcs
100	7070835	Black Galvanized 32 ga.
100	6876835	Black Aluminum .011
(1) CP	6878835	Black Aluminum .011 - 50 pcs
100	6876833	Bronze Aluminum .011
(1) CP	6878833	Bronze Aluminum .011 - 50 pcs
(1) CP	7071833	Bronze Galvanized 32 ga. - 50 pcs
100	7070833	Bronze Galvanized 32 ga.
(1) CP	7071819BX50	Brown Galvanized 32 ga. - 50 pcs
3" x 4" x 7"		
250	68743BX	Aluminum .011
100	70607	Galvanized 28 ga.
500	SFM347	Aluminum .011
250	6974311	White Aluminum .011
250	6974335BX	Black Aluminum .011
250	6974319BX	Brown Aluminum .011
500	SFB347	Brown Aluminum .011
4" x 4" x 12"		
50	70612	Galvanized 28 ga.
50	7091219	Brown Galvanized 32 ga.

Moisture Protection

Termite Shield

Unpainted Galvanized (30 ga.)



Size	Pack Qty.	Part No.
8" x 8"	25/bundle	85488
9" x 17"	25/bundle	85497

- Termite shields protect home built on block supports.
- These shields cap the blocks that raise the structure off of the ground.
- Good for the Gulf States and other places where termites are prevalent.

Corner Flex® Flashing

Description	Pack Qty.	Part No.
Unpainted Aluminum .012	20	68720

Corner Flex®
Flashing



W-Valley & Z-Bar

W-Valley

Z-Bar

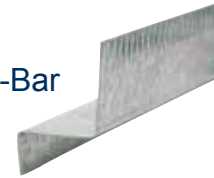

Unpainted unless
otherwise noted

Unpainted Commercial Galvanized (28 ga.)		10/skid
Size	Part no.	
18" x 10'	56718	
20" x 10'	56720	
24" x 10'	56724	

Galvanized Economy Profile (32 ga.)		50/pk
Size	Part no.	
1/2" x 10'	56512	
3/8" x 10'	56514	
5/8" x 10'	56515	
7/16" x 10'	56516	

Unpainted Standard Galvanized (30 ga.)		10/skid
Size	Part no.	
18" x 10'	56124	
20" x 10'	56120	
24" x 10'	56240	

Galvanized Standard Profile (30 ga.)		50/pk
Size	Part no.	
1/2" x 10'	56502	
3/8" x 10'	56510	
3/8" x 8'	566100096	
5/8" x 10'	56511	

Painted Galvanized (30 ga.)		10/skid
Size	Part no.	Color
20" x 10'	5712019	Brown
24" x 10'	5712419	Brown
20" x 10'	5712033	Bronze
18" x 10'	5711833	Bronze
24" x 10'	5712433	Bronze
20" x 10'	5712035	Black
18" x 10'	5711835	Black
24" x 10'	5712435	Black

Aluminum Economy Profile (.0145")		50/pk
Pack qty.	Part no.	Color
7/16" x 10'	54516	-
1/2" x 10'	55512	White
5/8" x 10'	55515	White
1/2" x 10'	5551219	Brown
5/8" x 10'	5551519	Brown

Painted Aluminum (.018")		10/skid
Size	Part no.	Color
18" x 10'	5511835	Black
18" x 10'	55118015	Royal Brown

Aluminum Standard Profile (.0145")		100/pk
Pack qty.	Part no.	Color
5/8" x 10'	54511	-
5/8" x 10'	55511	White
5/8" x 10'	5551119	Brown

Copper (16 oz.)		10/skid
Size	Part no.	
18" x 10'	67118	
24" x 10'	67124	

Z-Bar Profiles					
Economy				Standard	
3/8"	7/16"	1/2"	5/8"	3/8"	5/8"

Colors shown are for reference only. All thicknesses are inches unless otherwise noted. Tolerance is ± .002 inches.

Miscellaneous Flashing

Unpainted Galvanized Ridge Roll Cap (29 ga.)		<i>Description</i>	<i>Pack Qty.</i>	<i>Part No.</i>
	10' x 9"	10	56070	
	<ul style="list-style-type: none"> • Use over doorways where no gutter is in place • Prevents roof runoff from waterfaling • Rust-free aluminum with hemmed edges for strength and safety 			

Unpainted Aluminum Rain Diverter (.020")		<i>Description</i>	<i>Pack Qty.</i>	<i>Part No.</i>
 	60" x 7½" x 2½"	10	54020	
	<ul style="list-style-type: none"> • Use over doorways where no gutter is in place • Prevents roof runoff from waterfaling • Rust-free aluminum with hemmed edges for strength and safety 			

Kick-Out Diverter (29 ga.)		<i>Description</i>	<i>Pack Qty.</i>	<i>Part No.</i>
	White Steel	12	KOWH	
	Black Steel	12	KOBL	
	<ul style="list-style-type: none"> • Meets the IRC 2009 code R905.2.8.3 that requires a 4" vertical Kickout Diverter Sidewall Flashing • Diverts roof drainage away from wall into gutter. Avoids a source of mold problems and foundation damage • Eliminates wall stains at roof line due to uncontrolled rainwater • Electro galvanized steel or powder coated finish to suit your application • Symmetrical construction can be used as Left or Right Diverter • Easy step instructions attached to every KOD flashing bottom face 			

Pro-Master Ridge Vent™

See page A5 in the Appendix for more product information.



Description	Pack Qty.	Part No.
10½" x ¾" x 20'	1 roll/ctn, 36 ctn/skid	PMRV20
10½" x ¾" x 50'	1 roll/ctn, 16 ctn/skid	PMRV50

- An economic and efficient way to ventilate your attic
- Easy to install and nail
- Nails included - both hand and power

AccuVent®

For proper airflow, an attic requires soffit vents at the eaves and a ridge vent at the roof peak. If soffits are blocked with insulation, airflow is blocked. Accuvents help ensure proper attic ventilation by keeping soffits clear of insulation.



Description	Pack Qty.	Part No.
Soffit Insulation Baffle	50 pcs/bundle, 56 bundles/skid	ACCUVENT

- AccuVent is 22.5" x 41" and is designed for all attic applications
- Installs with just 6 staples
- Perforated to adapt for varied roof truss spacing
- Provides efficient airflow
- Quick & easy installation, reduces costs of labor
- Prevents insulation drifting
- Prevents callbacks
- 100% Recycled PVC
- Meets new state building code requirements in MA, NH & RI specifying exterior wind wash barrier

Soffit & Fascia MAINTENANCE FREE OVERHANG

T4 Aluminum Soffit (.019") 16/ctn

Color	Solid Part No.	Vented Part No.
	T4SSGP _____ (add 2-5 digits for color)	T4VSGP _____ (add 2-5 digits for color)
LG 30 White	WTHP	WTHP
Bright White	BWHHP	BWHHP
AHP Brown	BRHP	BRHP
Light Maple	LM	LM
Natural Clay	NC	NC
A Musket Brown	AMB	AMB
Pearl Gray	PG	PG
Savannah Wicker	SW	SW
Royal Brown	RB	RB
Black	BL	BL
Sable Brown	SAB	SAB
Grecian Green	GG	GG
Dark Bronze	ADB	ADB
Heritage Cream	HC	HC
Sandstone Beige	SB	SB
Herringbone	HEHP	HEHP
Almond	AL	AL
Cert Cypress	CYP	CYP
Granite Gray	GGR	GGR
Terra Bronze	BZ	BZ
Dark Bronze	DBZ	DBZ
Tuxedo Gray	TG	TG
Sterling Gray	SGR	SGR

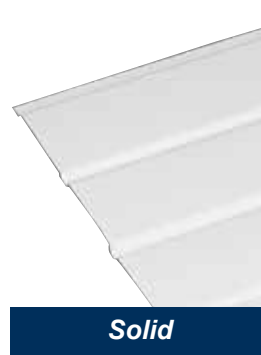
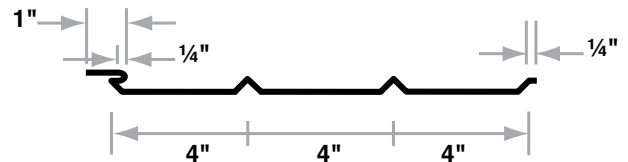

Solid

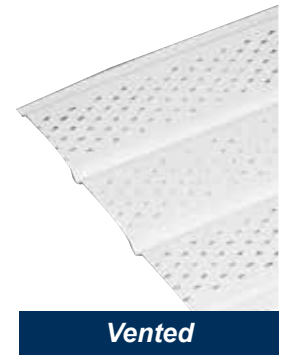

Vented

Colors shown are for reference only. All thicknesses are inches unless otherwise noted. Tolerance is ± .002 inches.

Soffit & Fascia

MAINTENANCE FREE OVERHANG

~Air Flow for Vented Soffit is 6 square inches per 1 square foot.

D6 Aluminum Soffit (.0185") 16/ctn			D6 12"X12' Aluminum Soffit (0.188") 20/ctn		12" x 12' Aluminum Soffit (.0185") 20/ctn		
Color	Solid Part No. SSGP (add 2-3 digits for color)	Vented Part No. VSGP (add 2-3 digits for color)	Part No. Perforated (full round ventilation)		Color	Solid Part No.	Vented Part No.
LG 30 White	WH	WH	White 77202		LG 30 White	77101	77102
Bright White	BW	BW	Pebblestone Clay 7720285		Bright White	77101182	77102182
AHP Brown	BR	BR	Musket Brown 7720259		Green	77101181	77102181
Light Maple	LM	LM	AHP Brown 7720219		Pebblestone Clay	7710185	7710285
Natural Clay	NC	NC			AHP Brown	7710119	7710219
A Musket Brown	AMB	AMB			Bronze	7710133	7710233
Pearl Gray	PG	PG			Natural Clay	7710179	7710279
Savannah Wicker	SW	SW			A Musket Brown	7710159	7710259
Royal Brown	RB	RB					
Black	BL	BL					
Sable Brown	SAB	SAB					
Grecian Green	GG	GG					
Dark Bronze	ADB	ADB					
Heritage Cream	HC	HC					
Sandstone Beige	SB	SB					
Almond	AL	AL					
Terra Bronze	BZ	BZ					
Dark Bronze	DBZ	DBZ					
Herringbone	HE	HE					
Bone Linen	LI	LI					
Tuxedo Gray	TG	TG					

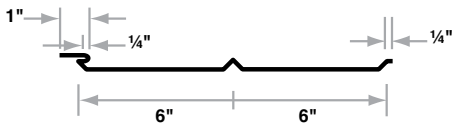

Note - When product is installed in Florida see Approval # FL 5896 for installation instructions.
https://www.floridabuilding.org/pr/pr_app_srch.aspx
Search for FL 5896

16" x 12' Aluminum Center Vent 4 Panel Soffit (.0185") 12/ctn (actual product shown below at right)

Color	Solid Part No.	Vented Part No.
White	-	77117
Brown	-	7711719

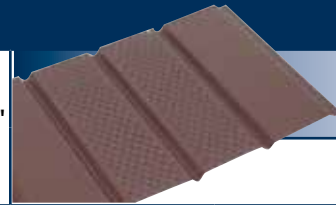
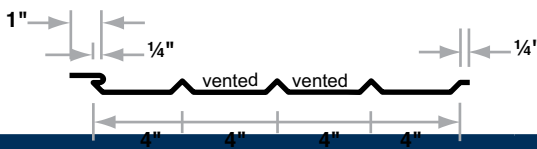

10" x 12' QLOK Aluminum Soffit (.019") 10/ctn (profile below, actual product not shown)

Color	Solid Part No.	Vented Part No.
White	QS10WA	QV10WA
Royal Brown	QS10BA	QV10BA
Natural Clay	QS10NC	QV10NC
Dark Bronze	QS10DB	QV10DB

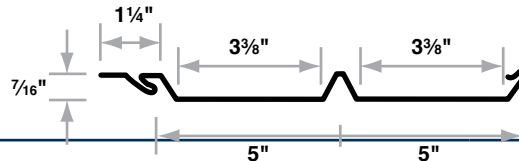

15" x 12' QLOK Aluminum Soffit (.019") 12/ctn (profile below, actual product not shown)

Color	Solid Part No.	Vented Part No.
White	QS15WA	QV15WA
Royal Brown	QS15BA	QV15BA

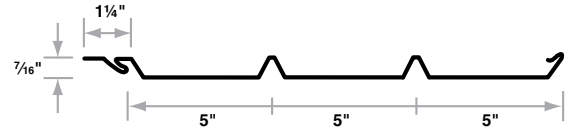

12" x 12' TRAPLOK Aluminum Soffit (.019") 10/ctn (profile below, actual product not shown)

Color	Solid Part No.	Vented Part No.
White	SV12WA	LV12WA
Royal Brown	SV12BA	LV12BA
Dark Bronze	SV12DB	LV12DB

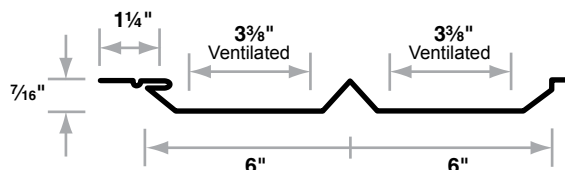

Colors shown are for reference only. All thicknesses are inches unless otherwise noted. Tolerance is ± .002 inches.

Soffit & Fascia

HANGER CHOICES FOR ALUMINUM SOFFIT - ALUMINUM CHANNEL 12'

Color	½" J Channel 50/ctn	¾" J Channel 50/ctn	½" F Channel 25/ctn	Crown Moulding 25/ctn
	(.019")	(.019")	(.0175")	
White	JA50EW	J-34WA	77014	77010
Royal Brown	JA50BA	-	FA50-B*	-
Dark Bronze	JA50DB	-	FA50DB*	-
Brown	-	-	7701419	7701019
Musket Brown	-	-	FA50MB*	-
Natural Clay	JA50NC	-	-	-
A Musket Brown	-	-	7701459	-
Pebblestone Clay	-	-	7701485	-

* 7/8" F Channel Soffit			<p>more colors below</p>	

Color	½" J Channel 50/ctn	½" F Channel 25/ctn
	(.0175")	(.0175")
LG 30 White	77012	77814
Bright White	77012182	77814182
AHP Brown	7701219	7781419
Light Maple	7701228	7781428
Natural Clay	7701279	7781479
Cert Cypress	7701226	7781426
Pearl Gray	7701253	7781453
Savannah Wicker	7701246	7781446
Royal Brown	7701215	7781415
Black	7701235	7781435
Sable Brown	77012033	77814033
Grecian Green	7701218	7781418
Dark Bronze	7701251	7781451
Sterling Gray	7701231	7781431
Granite Gray	7701247	7781447
Heritage Cream	7701227	7781427
Herringbone	77012220	77814220
Pebblestone Clay	7701285	-

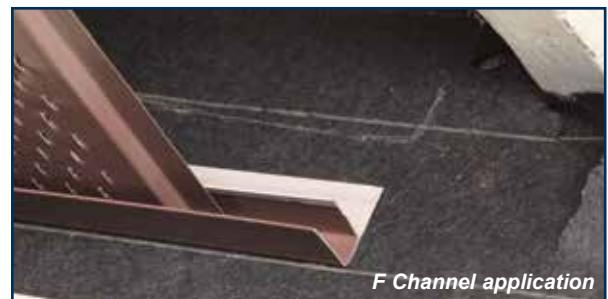
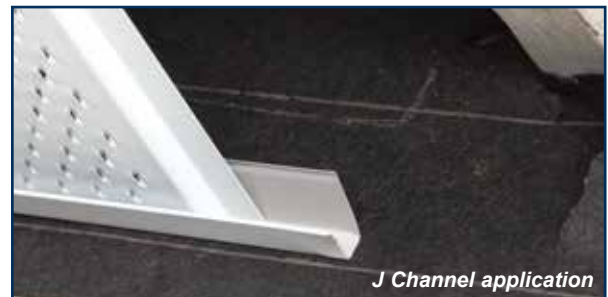

Colors shown are for reference only. All thicknesses are inches unless otherwise noted. Tolerance is ± .002 inches.

Soffit & Fascia

FASCIA - ALUMINUM 12'

Color	Size	(.024") 12/ctn Hemmed
LG 30 White	6"	77223
	8"	77224
Bright White	6"	77223182
	8"	77224182
AHP Brown	6"	7722319
	8"	7722419
Light Maple	6"	7722328
	8"	7722428
Natural Clay	6"	7722379
	8"	7722479
A Musket Brown	6"	7722359
	8"	7722459
Pearl Gray	6"	7722353
	8"	7722453
Savannah Wicker	6"	7722346
	8"	7722446
Royal Brown	6"	7722315
	8"	7722415
Black	6"	7722335
	8"	7722435
Sable Brown	6"	77223033
	8"	77224033
Grecian Green	6"	7722318
	8"	7722418
Dark Bronze	6"	7722351
	8"	7722451
Desert Tan	6"	77223077
	8"	77224077
Cert Cypress	6"	7722326
	8"	7722426
Heritage Cream	6"	7722327
	8"	7722427
Sandstone Beige	6"	7722374
	8"	7722474
Bronze 33	6"	7722333
	8"	7722433
Sterling Gray	6"	7722331
	8"	7722431
Granite Gray	6"	7722347
	8"	7722447

Color	Size	(.0175") 12/ctn	(.024") 25/ctn	(.019") 25/ctn
White	4"	77106	FAS4WA	-
	6"	77103	FAS6WA	FA96WA
	8"	77104	FAS8WA	-
	10"	77105	FAS1WA	-
Royal Brown	4"	-	FAS4BA	-
	6"	-	FAS6BA	-
	8"	-	FAS8BA	-
	10"	-	FAS1BA	-
Brown	4"	7710619	-	-
	6"	7710319	-	-
	8"	7710419	-	-
Bronze	6"	7710333	-	-

Hemmed Wood Grain Fascia- Aluminum 12'

Color	Size	(.018") 12/ctn
White 30 deg	4"	77114WG
	6"	77223WG
	8"	77224WG

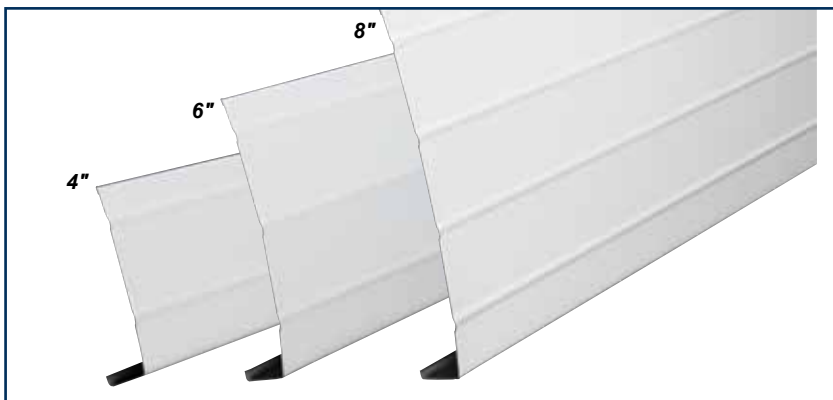
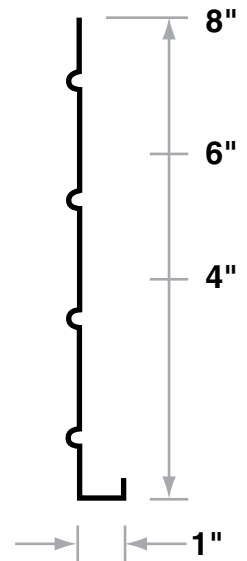

Colors shown are for reference only. All thicknesses are inches unless otherwise noted. Tolerance is ± .002 inches.

Vinyl Railing



VINYL RAILING SYSTEM BY YARDCRAFTERS™



RAILING KITS

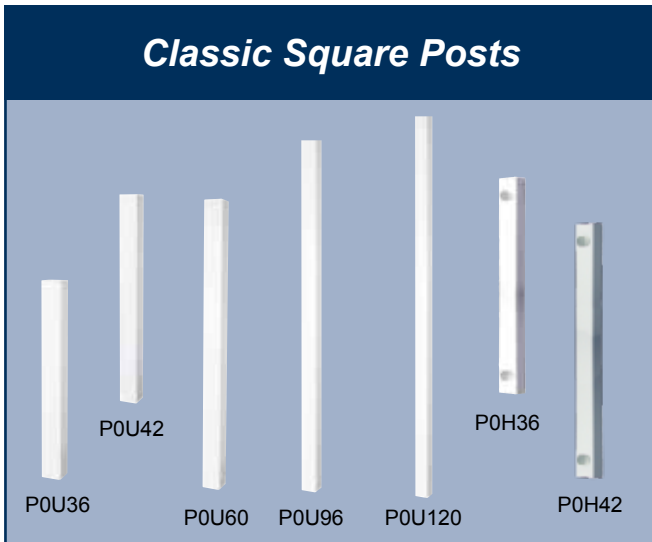

	Description	White	Clay	Sand
COLONIAL TURNED SPINDLE	6' x 36" Line Rail	KS0L6-36	KS3L6-36	-
	8' x 36" Line Rail	KS0L8-36	KS3L8-36	-
	10' x 36" Line Rail	KS0L10-36	KS3L10-36	-
	6' x 42" Line Rail	KS0L6-42	KS3L6-42	-
	8' x 42" Line Rail	KS0L8-42	KS3L8-42	-
	10' x 42" Line Rail	KS0L10-42	KS3L10-42	-
	6' x 36" Stair Rail	KS0S6-36	KS3S6-36	-
	8' x 36" Stair Rail	KS0S8-36	KS3S8-36	-
CLASSIC SQUARE BALUSTER	6' x 36" Line Rail	KB0L6-36	KB3L6-36	KB5L6-36
	8' x 36" Line Rail	KB0L8-36	KB3L8-36	KB5L8-36
	10' x 36" Line Rail	KB0L10-36	KB3L10-36	KB5L10-36
	6' x 42" Line Rail	KB0L6-42	KB3L6-42	KB5L6-42
	8' x 42" Line Rail	KB0L8-42	KB3L8-42	KB5L8-42
	10' x 42" Line Rail	KB0L10-42	KB3L10-42	KB5L10-42
	6' x 36" Stair Rail	KB0S6-36	KB3S6-36	KB5S6-36
	8' x 36" Stair Rail	KB0S8-36	KB3S8-36	KB5S8-36

POSTS, CAPS & TRIM

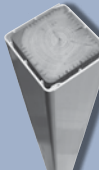
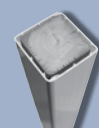

	Description	White	Clay	Sand
 P0W16R	• 4" x 4" Classic posts, sleeve over 4x4 lumber, available in 5 heights			
	• Post Wraps - easy retrofit with 2-piece design, includes trim and fasteners			
 P0W14R	39" Classic Post	P0U36	P3U36	P5U36
	45" Classic Post	P0U42	P3U42	P5U42
	60" Classic Post	P0U60	-	-
	96" Classic Post	P0U96	-	-
	120" Classic Post	P0U120	P3U120	P5U120
	39" Classic Half Post	P0H36	P3H36	P5H36
	45" Classic Half Post	P0H42	P3H42	P5H42
	4" x 4" x 108" Post Wrap	P0W14R	P3W14R	P5W14R
	6" x 6" x 108" Post Wrap	P0W16R	P3W16R	P5W16R

Vinyl Railing



VINYL RAILING SYSTEM BY YARDCRAFTERS™

POSTS, CAPS & TRIM

Colonial Turned Posts

- 4x4 Colonial posts available in 2 heights
- Heavy duty premium vinyl
- Only mounts on KP0SP4 Anchors, not over 4x4 wood post

Description	White	Clay	Sand
39" Colonial Post	P0C36	-	-
45" Colonial Post	P0C42	-	-

Structural Porch Posts

- 5" x 5" x 108" Structural Porch Posts
- Includes painted mounting plates and all fasteners
- Meets building code requirements for load bearing and uplift resistance

Description	White	Clay	Sand
Classic	P0PP22	P3PP22	P5PP22
Colonial	P0PP21	P3PP21	P5PP21

Post Caps and Trim

- Universal Post Trim and Solar Lighted Cap fit 4" x 4" and 5" x 5" posts
- Solar Lighted Cap backed by 2-year warranty!
- Four LEDs, over-sized solar panel - up to 12 hours of night lighting!

Description	White	Clay	Sand
Universal Post Trim	P0F1U	P3F1U	P5F1U
4" x 4" One Piece Trim	R0PTF2	R3PTF2	R5PTF2
5" x 5" Porch Post Trim	R0PPF1	-	-
4" x 4" Square Cap	P0C14	P3C14	P5C14
4" x 4" New England Cap	P0C24	P3C24	P5C24
4" x 4" Ball Cap	P0C34	P3C34	P5C34
Premium Solar Lighted Cap	P0C44	-	-







Vinyl Railing



VINYL RAILING SYSTEM BY YARDCRAFTERS™

OPTIONAL ACCESSORIES

Connectors and Adapters				• 1 Connector set included with each Railing Kit	• Order extra Connector sets when cutting rails into multiple sections		
				Description	White	Clay	Sand
				Line Connectors (Set of 4)	R0WB2	R3WB2	R5WB2
				22½° Line Adapters (Set of 4)	A0AL1	A3AL1	A5AL1
				45° Line Adapters (Set of 2)	A0AL2	A3AL2	A5AL2
				Round Line Adapters (Set of 2)	A0AL3	A3AL3	A5AL3
				Stair Connectors (Set of 4)	A0CS2	A3CS2	A5CS2
				3° Stair Adapters (Set of 4)	A0AS1	A3AS1	A5AS1
				Round Stair Adapters (Set of 2)	A0AS2	A3AS2	A5AS2

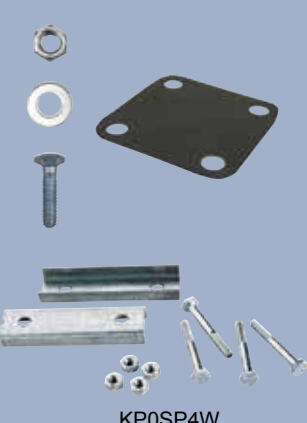
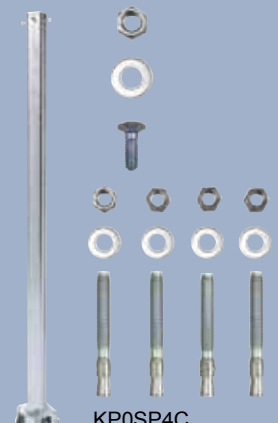
Anchors and Hardware		• Anchoring systems for wood and concrete surfaces	• Heavy duty galvanized steel anchors for 4" x 4" vinyl posts						
 <p>KP0SP4W</p>	<p>Fastening to Wood</p> <ul style="list-style-type: none"> • Includes all hardware for surface mount on wood • Corrosion resistant galvanized hardware • Includes ACQ protective gaskets • Easy to plumb, no shimming required! 		<p>Fastening to Concrete</p> <ul style="list-style-type: none"> • Includes all hardware for surface mount on concrete • Corrosion resistant galvanized hardware • Easy to plumb, no shimming required! 						
	<table border="1"> <thead> <tr> <th>Description</th> <th>Light Duty</th> </tr> </thead> <tbody> <tr> <td>Post Anchor Kit</td> <td>KP0SP4W</td> </tr> </tbody> </table>		Description	Light Duty	Post Anchor Kit	KP0SP4W	<table border="1"> <thead> <tr> <th>Description</th> <th>Heavy Duty</th> </tr> </thead> <tbody> <tr> <td>Post Anchor Kit</td> <td>KP0SP4C</td> </tr> </tbody> </table>	Description	Heavy Duty
Description	Light Duty								
Post Anchor Kit	KP0SP4W								
Description	Heavy Duty								
Post Anchor Kit	KP0SP4C								

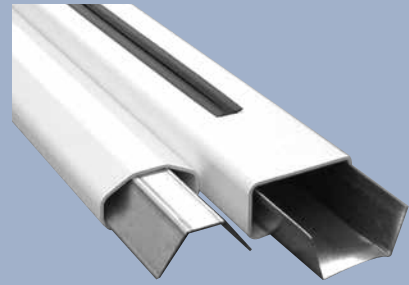
Line Rail for Glass Panel System			
			
<p>Actual length 67-13/16" - Installs on 6' post centers</p>			
Description	White	Clay	Sand
6' Line Rail (for Glass Panel)	R0LP16	R3LP16	R5LP16

Outdoor Living Products

Vinyl Railing



"YARDCRAFTERS"

CONTINUOUS HANDRAIL SYSTEM



- Meets all ADA and building code requirements
- Provides accessibility to ramps, stairwells, and staircases

- For use in residential and commercial applications
- Maintenance free
- Guaranteed for life

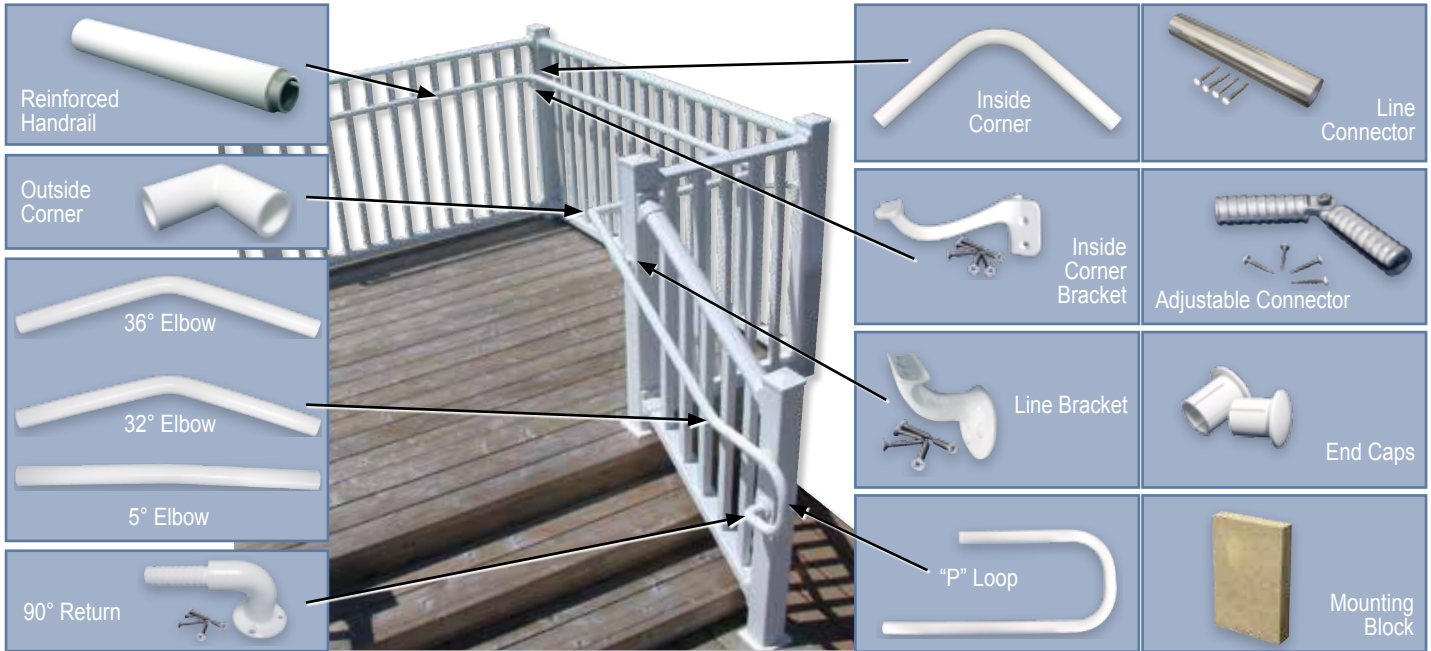

CONTINUOUS HANDRAIL COMPONENTS

		Description	White
	R0H15	1-1/2" x 104" Reinforced Handrail	R0H15
	R0HOC	Outside Corner	R0HOC
	R0HIB	Inside Corner Bracket	R0HIB
	R0HLB	Line Bracket	R0HLB
	R0HR90	90° Return	R0HR90
	R0HIC	Inside Corner	R0HIC
	R0HPL	"P" Loop	R0HPL
	R0HE36	36° Elbow	R0HE36
	R0HE32	32° Elbow	R0HE32
	R0HE5	5° Elbow	R0HE5
	RDHLC	Line Connector	RDHLC
	RDHAC	Adjustable Connector	RDHAC
	R0HC-PR	End Caps (pair)	R0HC-PR
	RCHMB	Mounting Block	RCHMB

Berger Snow Rail for Standing Seam Metal Roofing

SNOW RAIL FOR STANDING SEAM METAL ROOFS

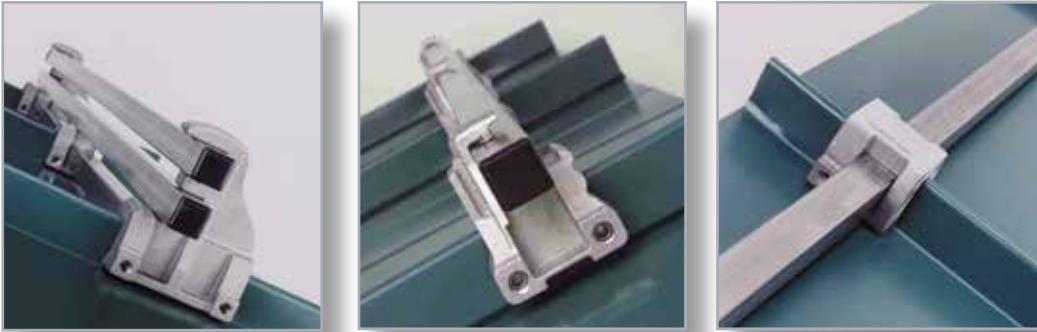

Mullane Snow Guards - Specialty Snow Retention for Traditional Slate Roofing

SNOW GUARDS FOR SLATE, TILE, SHINGLE & SHAKE ROOFS

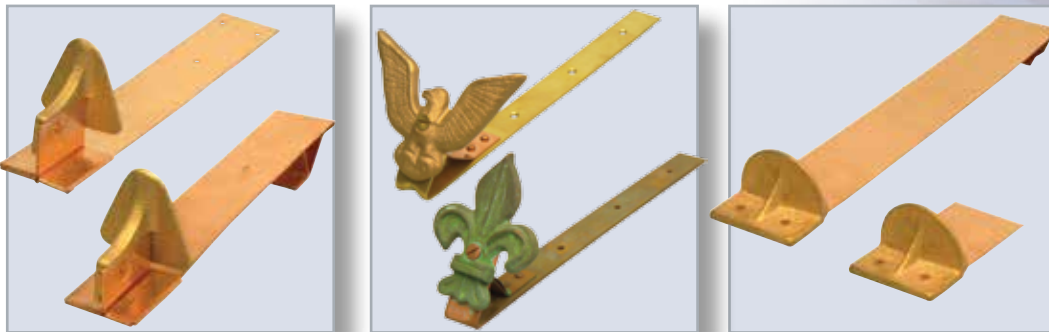

TWO & THREE RAIL PRODUCTS FOR SHINGLE, SLATE & SPECIALTY TILE ROOFS





For More Information on Our Complete Line of Snow Retention Products, Call Amerimax 800-347-2586

Snow Guards for Shingle, Slate, Synthetic Slate, Tile and Shake Roofing

See page A7 in the Appendix for information on snow guard installation and warranty.

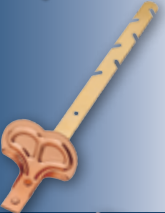
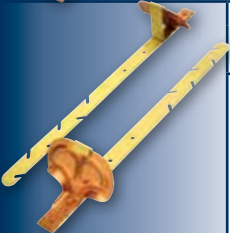
Snow Guards are intended to prevent snow movement and provide for the controlled melt and breakdown of the snow mass into smaller sections, reducing the potential for snow and ice damage to gutters, foundation plantings, parked vehicles, adjacent roofs and equipment, and injury to pedestrians.

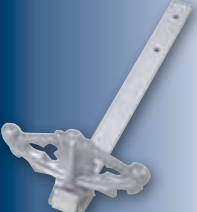
Description	Pack Qty.	Available Colors and Part Numbers	
		Part Number	Available Colors/Materials
 <p>#100 HP</p>	12	85072009	Stainless Steel
	12	SGC100HP	Copper
<p>#100HP - This economical guard is attached to a shorter, solid bar/strap, and is designed for easy installation on shingle roofs</p>			
 <p>#100 Snow Guard Assembly</p>	50	SGC100	Copper
	50	SGS100	Stainless Steel
	50	SGG100	Galvanized
<p>#100 Assembly - This guard has eliminated the necessity of removing slate, avoiding the possibility of breakage. Simply insert the slotted bar under the slate or shingle, engage a nail with one of the conveniently placed slots and pull down to fully secure bar. This style snow guard provides fast installation and is ideal for existing or new construction applications with asphalt shingled roofs.</p>			
 <p>Pro 100 Snow Guard Assembly for Slate & Asphalt Roofs</p>	50	SGCP100	Copper
	50	SGSP100	Stainless Steel
<p>Pro#100 - This heavy-duty snow guard is available in copper and stainless steel for corrugated, flat, slate and asphalt shingled roofs. The superior design of the Pro 100 includes a 1-inch gusset that reinforces the shoe, which makes this snow guard 5 times stronger than traditional residential snow guards. Simply insert the slotted bar under the slate or shingle, engage a nail with one of the conveniently placed slots and pull to fully secure the bar. This style guard provides fast installation and is ideal for existing or new construction application with asphalt shingled roofs.</p>			
 <p>#2 Snow Guard Assembly for Slate Roofs (Heavy Duty)</p>	50	SGML-2	Galvanized Malleable Iron
	50	SGBR-2	Bronze
<p>#2 - This heavy-duty snow guard is available galvanized malleable iron and bronze. It is normally installed during the slate roof application, but is fit for use with wood shake, tile and mineral surfaced shingles. This is not a retrofit product.</p>			
 <p>#95 Snow Guard Assembly for Slate Roofs (Heavy Duty Ornamental)</p>	30	SGML95	Galvanized Malleable Iron
	30	SGBR95	Bronze
	30	SGAL95	Aluminum
<p>#95 - This heavy-duty guard with Gothic styling designed to transfer snow and ice loads more effectively to reduce cracking of the slate. It is normally installed during the slate roof application, but is fit for use with wood shake, tile and mineral surfaced shingles. Excellent in areas that receive heavy snows! This is not a retrofit product.</p>			



Snow Guards for Shingle, Slate, Synthetic Slate, Tile and Shake Roofing

See page A7 in the Appendix for information on snow guard installation and warranty.

Typical spacing for shingle, slate, synthetic slate, tile and shake roofing

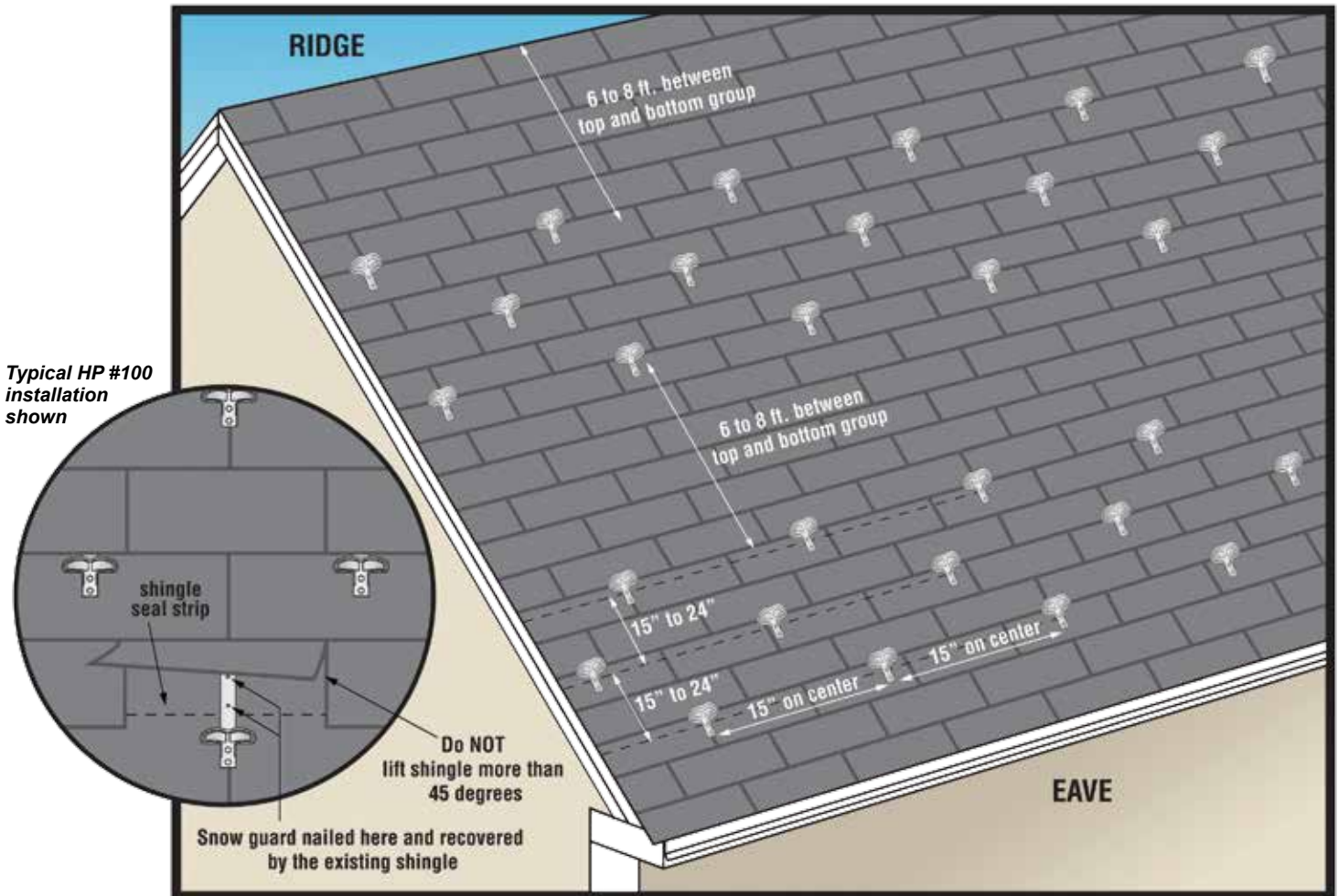



Do not place Snow Guards beyond the bearing wall on an extended roof section. Appendix page A7 for general installation information.

Snow Guards for Metal Roofs

Description	Pack Qty.	Available Colors and Part Numbers		
		Part Number	Available Colors/Materials	
 <p>RT Snow Guard (For Standing Seam Metal Roofs- Seam Mounted) RT-200 - 0.188" (3/16") wide and 1.125" tall</p>	100	RT200M	Mill Finish Aluminum	
	100	RT200E	E-Coat Black Primer	
	100	RT200B	Bronze	
	100	RT200C	Custom Colors	
	100	RT300M	Mill Finish Aluminum	
	100	RT300E	E-Coat Black Primer	
	100	RT300B	Bronze	
	100	RT300C	Custom Colors	
	<i>Custom Color Orders have a three week lead time</i>			
	<p>RT Snow Guards are non-penetrating devices which are secured to the standing seams of metal roofs utilizing stainless steel set screws to clamp them in place and will not restrict thermal movement. Available in mill finish, primer finish and cast bronze (for copper roofs), they are particularly suited to double-lock and mechanically seamed metal roofing.</p> <p>RT-200: will accommodate seams up to 0.188" (3/16") wide and 1.125" tall. RT-300: will accommodate seams up to 0.28" (9/32") wide and 1.125" tall</p>			



Snow Guards for Metal Roofs

See page A5 in the Appendix for information on snow guard installation and warranty.

Description	Pack Qty.	Available Colors and Part Numbers	
		Part Number	Available Colors/Materials
 <p>AP Snow Guard AP-400 0.40" (3/8") wide and 1.75" tall</p> <p>AP-516 0.516 (1/2") wide and 1.75" tall</p> <p><i>Custom Color Orders have a three week lead time</i></p> <p>AP Snow Guards are non-penetrating devices which are secured to the standing seams of metal roofs utilizing stainless steel set screws to clamp them in place and will not restrict thermal movement. The wide, deep blade design makes it particularly effective in retaining snow with the higher seams and wider panel widths common in preformed architectural roofing. AP-400M will accommodate seams up to 0.40" (3/8") wide and 1.75" tall AP-516M will accommodate seams up to 0.516" (1/2") wide and 1.75" tall</p>	50	AP400M	Mill Finish Aluminum
	50	AP400E	E-Coat Black Primer
	50	AP400C	Custom Colors
	50	AP516M	Mill Finish Aluminum
	50	AP516E	E-Coat Black Primer
	50	AP516C	Custom Colors
 <p>SL-1 Snow Guard</p> <p><i>Custom Color Orders have a three week lead time</i></p> <p>SL-1- This popular snow retention product is designed to fit 1" Snap Lock Panel. The throat width has been increased to 4 1/64" (0.64") and a leg lip has been added to allow the guard to "snap" over the seam for a smooth and quick installation.</p>	50	SL-1MF	Mill Finish Aluminum
	50	SL-1EBK	E-Coat Black Primer
	50	SL-1C	Custom Colors
	<p><i>Custom Color Orders have a three week lead time</i></p>		
 <p>SM Snow Guard Surface Mount (Surface Mounted)</p> <p><i>Custom Color Orders have a three week lead time</i></p> <p>SM- Surface Mount Snow Guards are manufactured of cast aluminum and are designed to be adhered to the pan surface of prefinished metal roofs using either a high strength construction adhesive or a combination of mechanical fasteners and an adhesive/sealant. They are particularly effective in retaining snow and ice on metal roofs where there are no suitable seams to which a seam mounted device can be fastened, including batten and cap seam panels.</p>	50	SMMFSG	Mill Finish Aluminum
	50	SMEASG	E-Coat Primer
	50	SMCASG	Custom Colors
	<p><i>Custom Color Orders have a three week lead time</i></p>		
 <p>640 Snow Guard</p> <p><i>Custom Color Orders have a three week lead time</i></p> <p>640 - These are designed to fit between the stiffening ribs of residential metal roof panels. They have a low visibility and can be custom painted to blend with roof materials. They can be attached with adhesives, screws or a combination of both. Not for use with panels with seams or ribs more than 12 inches apart.</p>		640M	Mill Finish Aluminum
		640E	E-Coat Black Primer
		640C	Custom Colors
	<p><i>Custom Color Orders have a three week lead time</i></p>		
<p>Structural Rib</p>  <p>Surface Mount</p>  <p>Clear Snow Guards are manufactured in a high clarity polycarbonate plastic with U.V. stabilizers which provide strength and longevity. The Structural Rib guard is designed to fit over stiffening rib on residential panels. The Surface Mount are particularly effective in retaining snow and ice on metal roofs where there are no suitable seams to which a seam mounted device can be fastened, including batten and cap seam panels. Both have a low visibility and blend with roof materials and can be attached with adhesives, screws or a combination of both.</p>	50	8505022	Clear Plastic
	50	8505011	Clear Plastic
 <p>#100 Snow Guard for Flat Metal Roofs (Surface Mounted)</p> <p>#100 Shoe- Ideal for mounting to ribbed or flat roof panels. Available in stainless steel and copper (for copper roofs) they can be mechanically fastened or soldered. Do not use adhesives to secure, only to keep water out. Not for use with panels with seams or ribs more than 12 inches apart.</p>	50	SG-CPS	Copper
	50	SG-SSS	Stainless Steel
	<p><i>Custom Color Orders have a three week lead time</i></p>		
 <p>#20 Snow Guards for Metal Corrugated Roofs (Surface Mounted)</p> <p>#20- Designed to fit the on the crown (top) of 1-1/4" or 2-1/2" rounded corrugated roofing. Use neoprene washer screws to fasten. This is also available in bronze for use on copper roofs. Do not use adhesives to secure, only to keep water out.</p>	100	SGBR20	Bronze
	100	SGML20	Galvanized Malleable Iron
	<p><i>Custom Color Orders have a three week lead time</i></p>		

Snow Guards for Metal Roofs

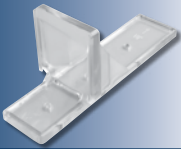
See page A5 in the Appendix for information on snow guard installation and warranty.

Description	Pack Qty.	Available Colors and Part Numbers	
		Part Number	Available Colors/Materials
 <p>Mini Snow Guard Plastic</p>	50	85040	Clear Plastic
<p>Mini Clear Snow Guards are manufactured in a high clarity polycarbonate plastic with U.V. stabilizers which provide strength and longevity. These are designed to fit between the stiffening ribs of residential metal roof panels. They have a low visibility and blend with roof materials. They can be attached with adhesives, screws or a combination of both. Not for use with panels with seams or ribs more than 12 inches apart.</p>			
 <p>SB-190 Surebond Everseal</p>	12	SB-190	-
<p>SB-190 is a field proven sealant adhesive. This unique formula possesses up to 2000 lbs. of tensile strength, but requires 28 consecutive days (672 consecutive hours) with temperatures of 50 degrees Fahrenheit or greater to fully cure. Under certain conditions, temporary measures may need to be employed to hold the snow guard in place until initial set of adhesive has taken place. One tube will adhere 8-10 CL Snow Guards and 14-16 RTMINI Guards.</p> <p>The adhesives are offered for the convenience of the user who assumes full responsibility for its use. These adhesives are used throughout the industry for adhering snow guards with successful results utilizing the directions of the adhesive manufacturer. Adhesive failure does not constitute Amerimax products defect and is not the responsibility of Amerimax.</p>			

Typical spacing for shingle, slate, synthetic slate, tile and shake roofing

Typical Spacing for Metal Roofing

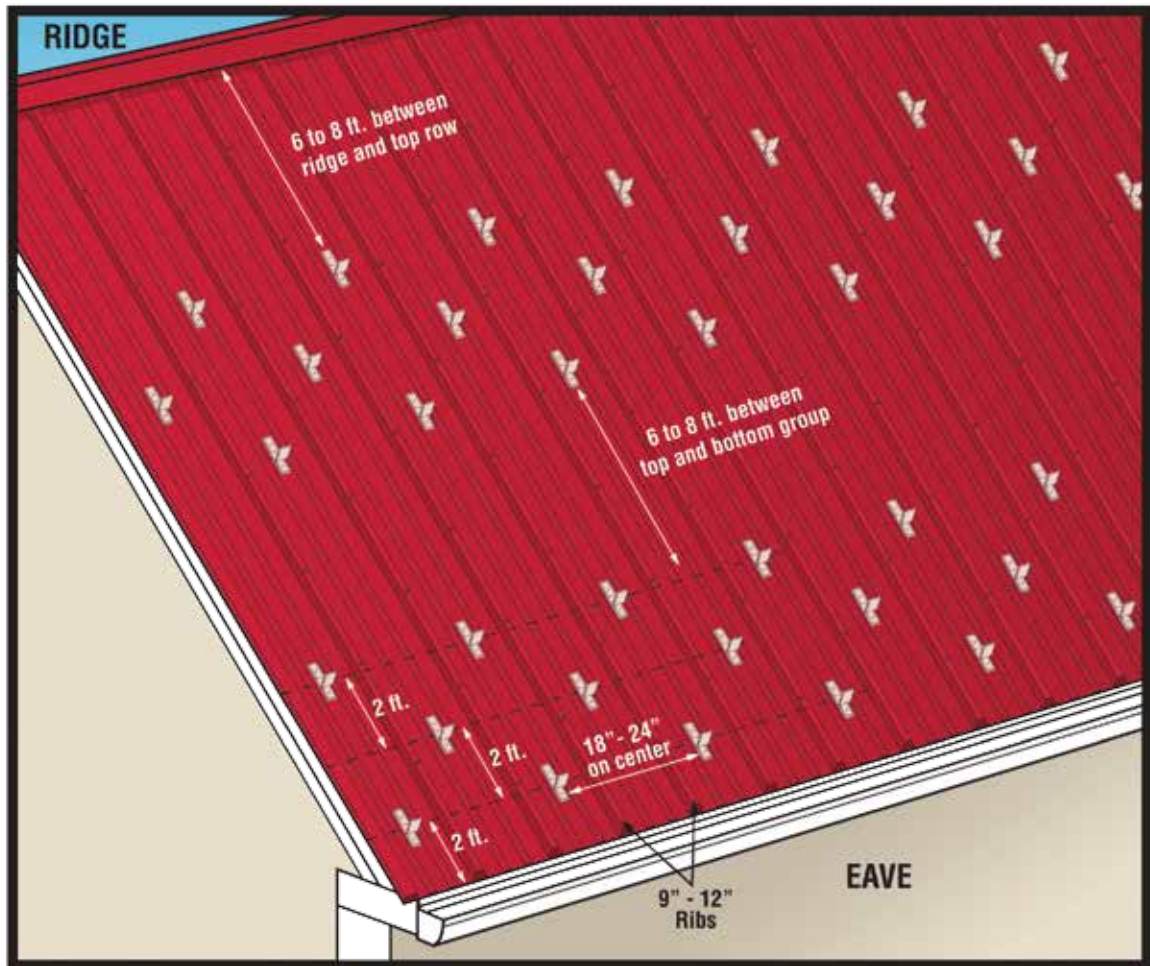

Horizontal spacing will be dictated but how far apart the metal seams or ribs. Shown is a typical RTMINI application on a 9" or 12" center rib panel. Do not place Snow Guards beyond the bearing wall on an extended roof section. Please see Appendix page A5 for general installation information.

Aluminum Snow Panels

	Snow Panel - 30" x 34 ³ / ₄ " (.018)	12	53025
	Rake Cap 36"	12	53027
	Hardware Pack*	12	53029PK
	SeamerMate® Sealant	12	85148

Aluminum Snow Panels are used to reduce ice damming at the roof's edge. Not for use in valley sections of shingle roofs.

*Includes hardware for 6 snow panels: includes 24 1½" nails, 6 snow panel clips

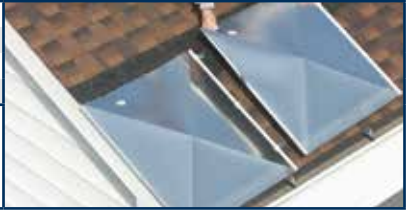

Completed Snow Panel Installation



• Helps Prevent Snow and Ice Dams along Roof Line • Helps Extend Roof Life



Use SeamerMate® sealant (page 76 for more information)



Wide Flange Pliers Metal Bender (page 78 for more information) being used to crimp panels together.



Corner Bead

PVC (.035")



Bull Nose Archway

Description	Pack Qty.	Part No.
3/4" x 8' (slotted)	50	37138
3/4" x 10' (slotted)	50	37140



Bull Nose

Description	Pack Qty.	Part No.
3/4" x 8'	50	37188
3/4" x 10'	50	37190



J Bead

Description	Pack Qty.	Part No.
1/2" x 8'	60	37110
1/2" x 10'	60	37120
5/8" x 8'	50	37128
5/8" x 10'	50	37130



Corner Bead

Description	Pack Qty.	Part No.
1 1/4" x 8'	50	37102
1 1/4" x 10'	50	37100



L Bead

Description	Pack Qty.	Part No.
1/2" 10' (Peel-Away)	50	37150
5/8" x 10'	80	37170



Archway Bead

Description	Pack Qty.	Part No.
1 1/4" x 8' (slotted)	50	37178

Galvanized (30 ga)



Corner Bead Galvanized

Description	Pack Qty.	Part No.
1 1/4" x 1 1/4" x 8'	63	58102
1 1/4" x 1 1/4" x 9'	50	58090
1 1/4" x 1 1/4" x 10'	50	58100



J Bead Galvanized

Description	Pack Qty.	Part No.
1/2" x 8'	63	58110





Bull Nose Galvanized

Description	Pack Qty.	Part No.
8'	30	58188
10'	25	58190

Miscellaneous

Colors shown are for reference only.

Caulks & Sealants

FlashMate®		Color	Pack Qty.	Part No.
 <ul style="list-style-type: none"> • Professional grade brushable sealant for flashing applications now available in a convenient quart size can! • All weather application, will not freeze • Withstands water contact immediately to stop leaks • Stays flexible, will not crack • Mildew resistant and paintable • Prevents rust on any metal surface • VOC compliant 	Clear	12 - 10 oz. cartridges/ctn	85228	
	Clear	6 - 1 quart cans/ctn	85229	
	 <p>cartridge</p>			

SeamerMate®	Pack Qty.	Description	Part No.
	12	10 oz. Cartridge, 4% VOC CONTENT	85148
	24	1 oz. Tubes *CARB VOC compliant	85127
	24	5 oz. Resealable Tubes Gray	85152A
	<ul style="list-style-type: none"> • Permanent Bond Guaranteed • Semi-self leveling • Paintable • Works on wet surfaces • UV Resistant * Meets California VOC requirements 		

Touch-Up Paint

Spray Paint	Pack Qty.	Description	Part No.
	12	White	85241
	12	Brown	85242
	12	80° Hi Gloss White	8524020
	12	Musket Brown A	8524059
	12	Pebblestone Clay	8524085
<ul style="list-style-type: none"> • Great for touching up scratches • Protects metal from weather • Dries quickly • 4.5 ounce spray can 			

15 other colors in 12 oz. cans to match any decor available through special order
Add 2 or 3 digit color code to 13TUP _ _ _

80W	○ 80° Hi Gloss White	*MB	● Musket Brown
30W	○ 30° Low Gloss White	*NC	● Natural Clay
*BL	● Black	*PG	● Pearl Gray
BRN	● Brown	*RB	● Royal Brown
*DB	● Dark Bronze	HE	○ Herringbone
*GG	● Grecian Green	LI	○ Bone Linen
*HC	○ Heritage Cream	*SW	○ Savannah Wicker
*LM	○ Light Maple	PB	○ Pebblestone Clay
DB	● AMP Dark Bronze	RE	● Red
MB	● A Musket Brown	TG	● Tuxedo Gray
AL	○ Almond	BZ	● Terra Bronze

Rivets, Nails & Screws

Rivets	Description	Pack Qty.	White	Brown	Natural Clay	High Gloss White	Royal Brown	Pebble-stone Clay	Musket Brown	Copper
	Aluminum 1½" Long #42									
	1,000 per carton	1	-	-	-	A42ABW	PRRBBX	-	-	-
	Aluminum 1½" Long #42									
	100/pack	10 pks	84025	84034	84079PK	84020	-	84085	84059	-
	Copper #42									
	500 per carton	1	-	-	-	-	-	-	-	A42CPB



1 1/4" Trim Nails To match Trim Coil or Soffit. 1/4 # Pack (approx. 320 nails)

Color	Part No.	Pack Qty.	Color	Part No.	Pack Qty.	Color	Part No.	Pack Qty.
Brown	7769019	6/ctn	Sandstone Beige	7709074s	2/ctn	Flagstone	77090107S	2/ctn
Royal Brown	7709015s	2/ctn	Silver Ash	7709032s	2/ctn	Hearthstone	77090108S	2/ctn
ALC Musket Brown	7769059	6/ctn	Sterling Gray	7709031s	2/ctn	Mountain Cedar	77090109S	2/ctn
AMP Dark Bronze	7709059s	2/ctn	Savannah Wicker	77090046s	2/ctn	Sandpiper	77090110S	2/ctn
	7709059s	2/ctn		77690046	6/ctn	Seagrass	77090111S	2/ctn
Black	7709051s	2/ctn	Lomar White	77090PK	24/ctn	Spruce	77090112S	2/ctn
	7709035s	2/ctn	Bright White	77090182	2/ctn	Suede	77090113S	2/ctn
	7769035	6/ctn		7769020	6/ctn	Terra Cotta	77090114S	2/ctn
Glacier Blend	7709037s	2/ctn	Pacific Blue	7709038s	2/ctn	Lighth-ouse Red	77090180S	2/ctn
	7769037	6/ctn	Granite Gray	7709047s	2/ctn	Buckskin	7709021S	2/ctn
Musket Brown	7709030s	2/ctn	Cypress	7709054s	2/ctn	Bone Linen	77090230S	2/ctn
			Ivy Green	7709061s	2/ctn	Pearl	77090237S	2/ctn
Grecian Green	7709018S	2/ctn	Desert Tan	7709077s	2/ctn	Harbor Blue	77090238S	2/ctn
			Tuxedo Gray	7709088s	2/ctn	Regatta Blue	77090240S	2/ctn
Heritage Cream	77090027s	2/ctn	Autumn Yellow	7709034s	2/ctn	Rye	77090242S	2/ctn
	77690027	6/ctn	Berger DK Bronze	77090051S	2/ctn	Wheat	77090243S	2/ctn
Herringbone	77090022s	2/ctn	Musket Brown	77090059S	2/ctn	Saddle	77090244S	2/ctn
Light Maple	77090028s	2/ctn	Autumn Red	77090101S	2/ctn	Storm	7709040S	2/ctn
Natural Clay	7709079s	2/ctn	Bermuda Blue	77090102S	2/ctn	Almond	7709069S	2/ctn
Pearl Gray	7709053s	2/ctn	Charcoal Gray	77090103S	2/ctn	Oxford Blue	7709093S	2/ctn
Pebble Stone Clay	7709085s	2/ctn	Green Tea	77090104S	2/ctn			
	7769085	6/ctn	Forest	77090105S	2/ctn			
Sable Brown	77090033s	2/ctn	Linen	77090106S	2/ctn			
	77690033	6/ctn						

Miscellaneous

Copper Nails 1 1/4"	Pack Qty.	Part No.
	12/ctn	67003PK
	3/8" diameter head approximately 50 nails/pack 1/4 lb/pack	

Sheet Metal Screws	Description	Pack Qty.	White	Brown	Natural Clay
	8/card	25	85354	85355	85364
	100/pack	24	85361	85369	-
Screws	Description	Pack Qty.	White		
	1 1/2"	25	L0615		
	<ul style="list-style-type: none"> For vinyl gutter hooks Self tapping wood screw 				

Colors shown are for reference only. All thicknesses are inches unless otherwise noted. Tolerance is ± .002 inches.

Metal Bender & Blades

Metal Bender	Description	Pack Qty.	Part No.
	Pliers 3 1/2" Wide Jaw	12/ctn	85028

Bender Accessory Blades	Description	Pack Qty.	Part No.
	7" & 10" • Replacement/accessory blades • Includes one 7" and one 10" blade • Compatible with Metal Bender Pliers (85028)	12/ctn	85030

Wall Ties & Utility Sheet

Galvanized Wall Ties	Description	Pack Qty.	Part No.
	7/8" x 7" (28 ga)	500/ctn	85131

Roof Rafter Brackets	Pack Qty.	White
	50	L3250
<ul style="list-style-type: none"> • Allow gutter hanger installation where no fascia exists • Screws to rafters • Bends to desired angle 		

Utility Trim & Starter Strip

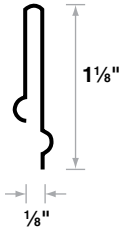

Aluminum Utility Trim	Description	Pack Qty.	High Gloss White
	(.017")	50/ctn	UT19WA

Siding Starter Strip	Description	Pack Qty.	Part No.
	118" Galvanized (No UPC)	20/ctn	56280
	118" Aluminum	40/ctn	54280
	10' Galvanized	20/ctn	56280

Siding Corners

Aluminum Siding Corners	Description	Pack Qty.	Part No.
	8" Embossed	100/ctn	61008
	9" Smooth	100/ctn	61025
	12" Embossed	100/ctn	61012
	12" Smooth	100/ctn	61026

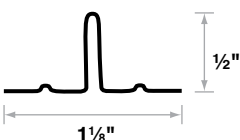
Wind T Bracing & Joist Bridging

Wind T Bracing	Description	Pack Qty.	Part No.
	11' x 3/4" Galvanized (20 ga)	12/ctn	56617
			

Joist Bridging	Description	Pack Qty.	Part No.
	20" Galvanized (24 ga)	200/ctn	85225

Colors shown are for reference only.

Miscellaneous

Point of Purchase

Amerimax offers extensive support with informative POP signage, literature, displays and samples to support selling products at retail.

We can help you customize a planogram to suit your needs.



Gutter & Accessories Store Sets

- Includes Gutter, downspouts and all system components
- Signage providing installation images

- Tear Pads show installation steps and all system and accessory parts for a complete gutter installation

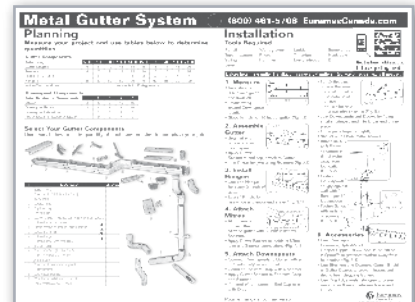

Point of Purchase

Point of Purchase



Flashing & Trim Coil Store Sets

- Extensive color choices and gauges
- Tools and adhesives for installation also available
- Color match for popular vinyl siding and window manufacturers



Gutter Guard Store Sets

- Gutter Guards for every type of gutter and price point
- Attractive signage
- Great 3 or 4 foot end-cap opportunity



Gutter Accessories Store Sets

- Gutter Accessories for effective drainage and foundation protection
- Attractive signage
- Great 3 or 4 foot end-cap opportunity

Gutter Assembly

See pages 5-32 for product ordering information.

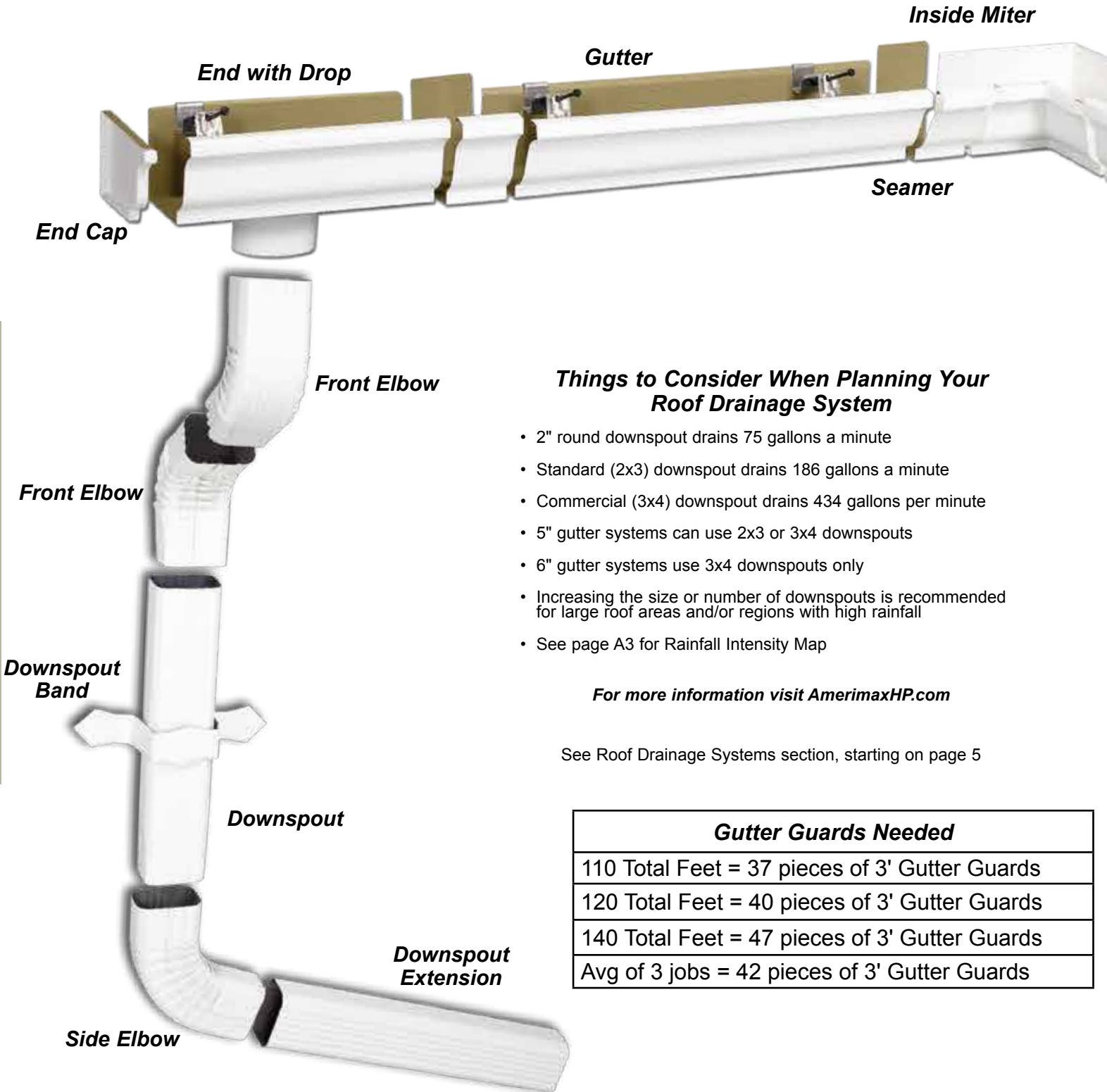

Things to Consider When Planning Your Roof Drainage System

- 2" round downspout drains 75 gallons a minute
- Standard (2x3) downspout drains 186 gallons a minute
- Commercial (3x4) downspout drains 434 gallons per minute
- 5" gutter systems can use 2x3 or 3x4 downspouts
- 6" gutter systems use 3x4 downspouts only
- Increasing the size or number of downspouts is recommended for large roof areas and/or regions with high rainfall
- See page A3 for Rainfall Intensity Map

For more information visit AmerimaxHP.com

See Roof Drainage Systems section, starting on page 5

Gutter Guards Needed
110 Total Feet = 37 pieces of 3' Gutter Guards
120 Total Feet = 40 pieces of 3' Gutter Guards
140 Total Feet = 47 pieces of 3' Gutter Guards
Avg of 3 jobs = 42 pieces of 3' Gutter Guards

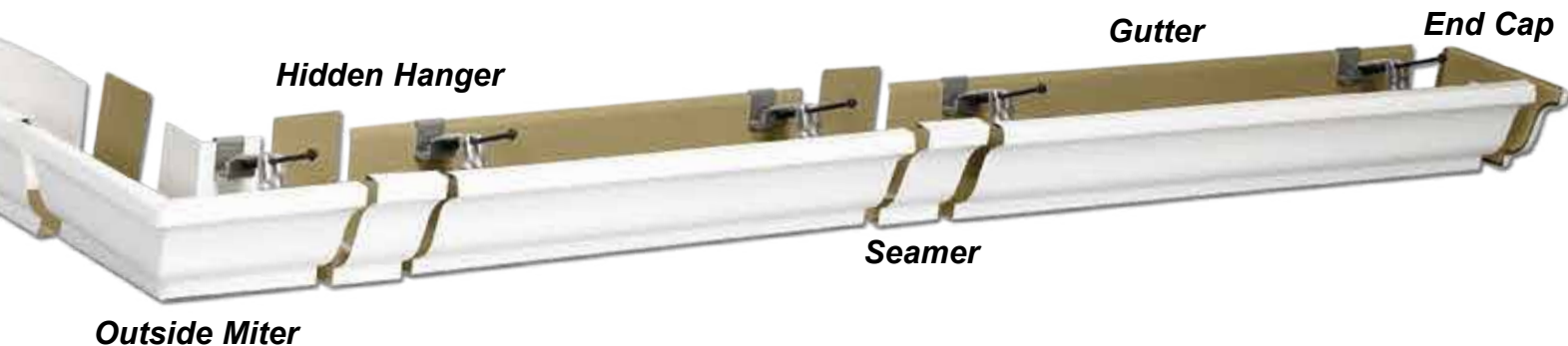

Average House Rancher

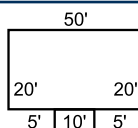

110 total feet of gutter

Average House w/Garage

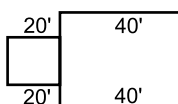

120 total feet of gutter

Average House Hip Roof

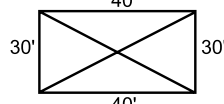

140 total feet of gutter

	Number of Pieces Needed	Number of Pieces Needed	Number of Pieces Needed	Average of three jobs	15 houses	10 houses	5 houses
1. Gutter 10'	11	12	14	13	195	130	65
2. Downspout 10'	4	4	4	4	60	40	20
3. Inside Miter	2	0	0	2	30	20	10
4. Outside Miter	2	0	4	4	60	40	20
5. Left End Cap	2	4	0	4	60	40	20
6. Right End Cap	2	4	0	4	60	40	20
7. Downspout Bands	8	8	8	8	120	80	40
8. Connectors/Seamers™	19	12	18	17	255	170	85
9. End with Drops	4	4	4	4	60	40	20
10. Downspout Extension	4	4	4	4	60	40	20
11. Front Elbow	12	12	12	12	180	120	60
12. Side Elbow	2	2	2	2	30	20	10
Spikes & Ferrules							
Screws & Ferrules							
Fascia Brackets	Every 24"	Every 24"	Every 24"	60	900 Brackets	600 Brackets	300 Brackets
Hidden Hangers	50	60	70				
Roof Hanger w/Strap							
Snap Lok Brackets							
Outlets	4	4	4	4	60	40	20
Rivets	60	60	60	60	900	600	300
Screws							
SeamerMate®	3	3	3	3	45	30	15
Splashblocks	4	4	4	4	60	40	20

Popular Hanger Choices

See pages 19-21 for product ordering information.

Hidden Hanger w/ Screw



*1/4" hex
head screw,
power drive in
fascia board.*

Hidden Hanger



*Requires
nail or screw.*

Hidden Hanger w/Roof Strap



*Only use when
no fascia board
exists. Follow
directions printed
on hanger bag.*

Fascia Bracket



*4 per pack
includes
hanging nails.*

Snap Lok Bracket



*Nails or screws
required. Fasten to
fascia board along
sloped string guide line.
Place gutter into bracket,
snap top bar into slot
and front bracket.*

Spike and Ferrule



*Insert ferrule
into gutter and
hammer spike
through gutter,
ferrule and
fascia board.*

Screw and Ferrule



*Insert ferrule into
gutter and using the
bit provided, drill the
screw through the gutter,
ferrule and fascia board.*

Roof Edge & Trim Styles

See pages 33-48 for product ordering information.

A & B Style

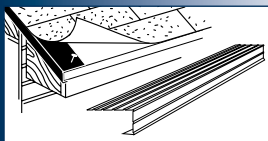

- Used on the rakes of gable roof ends
- Affords neat even finish
- For replacement and new roofs
- Covers and protects exposed wood sheeting edges from moisture deterioration

F Style

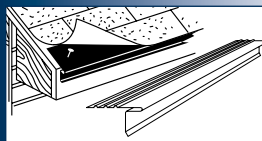

- Overhang gives maximum protection from roof run-off
- Directs run-off into gutters
- Used along gutter line of roof edge
- Protects and covers roof edge
- For new construction and reroofs
- Acts as a starter strip for a true edge to align shingles

C Style

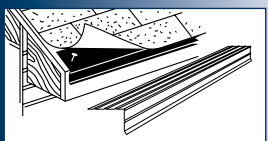

- Used along gutter line of roof's edge
- Drip leg extends run-off away from fascia
- Helps direct run-off into gutters
- Covers and protects wood sheeting edges
- Affords neat even finish

Vinyl

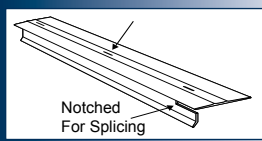

- Slotted every 30" for nailing
- Notched for splicing

D & E Style

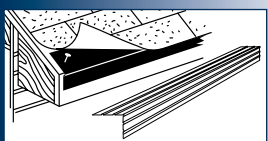

- Metal edges with a 1" to 3" drop
- Protect exposed wood sheeting edges
- For new construction or reroofs

H Style

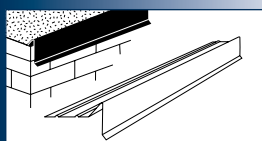

- For flat roofs
- Keep gravel from washing off
- Protect wall roof connections
- Gives neat finished appearance

Roof Apron

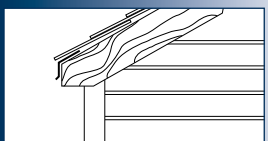

- Used with or without gutter
- Slips under shingles
- Extended drop with a drip lip for fascia board protection

Window & Door Caps



Capping of Window Capping of Door

- Metal edges cap over door and window frames
- Protect against moisture damage

Gutter FAQ's

- 1. WHY DO I NEED GUTTERS?**
 - Gutters control roof runoff, protecting your home's foundation from erosion damage
 - Gutters prevent water damage to exterior walls and basements
 - Gutters add value to your home
- 2. HOW OFTEN SHOULD I CHECK MY GUTTERS?**
 - You should check your gutters every Spring and Fall for clogs, leaks and gutter pulling away from the house
- 3. HOW DO I KNOW WHAT I NEED?**
 - Start with the "Gutter Installation Sheet," available at your local store. It explains:
 1. Gutter System components
 2. How to measure
 3. How to install
- 4. WHAT ARE EAVESTROUGHS AND LEADERS?**
 - Other names for gutters and downspout
- 5. WHAT ARE SEAMLESS GUTTERS?**
 - Gutters formed at the jobsite from a continuous piece of metal, cut to the required length
 - Seamless gutter is the same profile as stick gutter
- 6. WHAT ARE STICK GUTTERS?**
 - Pre-formed gutter sections; typically sold in 10' lengths
 - May also be available in 16', 21' and longer lengths
- 7. WHAT IS "K" STYLE?**
 - Most-common gutter profile; also called "Ogee."
 - Half-round profile is also available
- 8. CAN I MIX METALS (ALUMINUM, STEEL, COPPER) IN MY GUTTER SYSTEM?**
 - Not recommended. Mixing metals can cause a "galvanic reaction" between the metals, leading to corrosion and premature component failure
- 9. HOW MUCH PITCH IS REQUIRED FOR GUTTER RUNS?**
 - Minimum slope of 1/4" for every 10' of gutter
- 10. HOW MANY DOWNSPOUTS DO I NEED?**
 - Recommend one downspout per 20' of gutter. Larger roof areas and/or heavy-rainfall areas may require more downspout
- 11. HOW MANY DOWNSPOUT BANDS/BRACKETS DO I NEED?**
 - Two for every 10' of downspout
- 12. HOW DO I CUT ALUMINUM GUTTERS AND DOWNSPOUTS?**
 - A hacksaw or tin snips will work very well
- 13. WHAT'S THE BEST WAY TO HANG GUTTER?**
 - There are many options. The best one for you depends on where you live and the construction style of your home. Consult an installation professional to determine the best option for you
 - The easiest option is to use a hidden hanger with screw. This is an all-in-one hanger that is easily installed, resists loosening over time, provides a hanging solution that is invisible from ground level and is easily maintained
- 14. DO I NEED CAULK AND HOW MUCH?**
 - Aluminum gutters require SeamerMate® sealant on all seams. Typical usage is 1/2 oz. per seam
 - Vinyl gutter connections are self sealing; they don't require any additional sealant
- 15. WHAT'S THE DIFFERENCE BETWEEN A & B ELBOWS?**
 - A (front) elbows direct water forward or back from the gutter outlet
 - B (side) elbows direct water left or right from the gutter outlet
- 16. HOW DO I KEEP MY GUTTERS CLEAN?**
 - There are lots of easy-to-install options to keep leaves and debris out
 - Popular choices include strainers and plastic or metal gutter guards and covers
- 17. HOW DO I REPAIR LEAKING GUTTERS?**
 - Start by watching the tutorial video in the "How-To" section of our website AmerimaxHP.com
- 18. CAN I PAINT MY GUTTERS?**
 - Both aluminum and steel gutters can be painted. The most important step is to be sure the gutter surface is properly prepared. Use a surface prep solution like Wil-Bond™ to assure proper paint adhesion
 - Consult your local painting professional for the right type of paint for your gutter system
 - Vinyl gutters should not be painted
- 19. WHAT'S WARRANTY ON AMERIMAX® GUTTERS?**
 - See page A12 in the Appendix section of this literature.
- 20. WHERE CAN I BUY AMERIMAX PRODUCTS?**
 - Amerimax products are carried in many leading home centers and hardware retailers throughout the United States and Canada

Gutter Glossary

Apron Gutter Gutter with an additional mounting flange angled behind the top back edge of the gutter.

"B" Style Outlet Type of outlet with a narrow-flange top edge. Flat edge for K gutter and radius or curved top to fit the diameter of Half Round Gutter.

Box Gutter In residential applications, same as Yankee-built gutter. In commercial applications, a large gutter with plain vertical angled profile and a box bead front edge.

Clean Out A section of downspout with a door flap and internal strainer that provides access to clean debris from downspout.

Combo Hanger Semi-circle hanger with a riveted mounting plate. Used to hang Half Round Gutter.

Conductor Head Fabricated metal casting or molded box, funnel, or ornate shape with a wide top opening. Used to improve the water flow of gutter systems. Sometimes called a scupper.

Cutoff A downspout diverter where an external lever controls an internal diverter flap. Directs the water equally to both sides or closes one side off.

Diverter Metal or plastic device that changes the flow direction of rain water.

Downspout Vertical tube connected to the gutter or drain outlet. Removes water in a downward flow.

Drop Another term for a gutter outlet tube.

Eavestrough Another term for gutter.

Elbow A short section of downspout that has been bent across the midpoint to form an angle that changes the direction of water flow.

End Cap Component contoured to match gutter shape and close the open end of a gutter.

End Drop A short section of gutter with a preassembled outlet. Typically used to terminate a gutter section. Can also be used to connect long sections of gutter where a midpoint outlet is required.

Extension A short length of downspout that is used to extend the downspout either horizontally or vertically.

Free Floating Term applied to gutter systems designed to support the gutter without limiting the gutter's ability to expand or contract.

Funnel Tapered component that funnels rainwater from two or more higher downspouts into a single lower downspout.

Gutter Formed channel or trough that collects rainwater from a roof section and directs it to a drain.

Hook Back Open hem on the top back edge of a gutter that accepts a hanger support, allowing gutter to float.

Half Round Gutter Gutter style that is formed in a semi-circle. Can be Single Bead (SB), Double Bead (DB) or Reversed Bead (RB).

K Style Gutter Gutter style with an Ogee curved face, a box top bead and a stepped face bottom.

Miter Gutter component that forms the corner at wall intersections.

Offset Formed section of downspout with two angles. Used to get around obstacles such as wall ledges.

Ogee A reverse curve shape. Another term for "K" style gutter.

Outlet Shaped round, oval or rectangular gutter component that protrudes from the gutter bottom and connects to the downspout or elbow.

Plug-in Outlet European style hopper outlet used with Half Round Gutter.

Connector Component used to connect two pieces of gutter.

Straight Back A gutter with a straight back vertical form and no open hook edge. It can be plain or have a flat hem.

Tile Adaptor Used to connect downspout into PVC, cast or tile ground drain pipes.

Tube Shaped connector that drains the gutter into an elbow or pipe. See outlet.

Yankee Gutter A gutter that is built into the roof below the roof plane or a gutter that is built on top of a cornice at the eave.

Ventilation

See page 61 for product ordering information.

HOW IMPORTANT IS THE AIR WE BREATHE?

Facts

In the US, about 17 million people have asthma and up to 30% of them are sensitive to molds and fungal allergens. (Western Roofing 2001)

It is estimated that 25% of airways disease and 60% of interstitial lung disease may be associated with moisture in the home or work environment, (HUD 2001) and where there is moisture, there is most definitely mold.

Symptoms

A poorly ventilated attic means...

- Increased moisture → Prime condition for the growth of molds and fungal allergens
- Less effective insulation → Higher heating bills due to moisture
- Excessive heat build-up → Higher cooling bills
- Shorter lifespan for the roof → Long-term structural degradation of the attic structure

Pro-Master Ridge Vent™

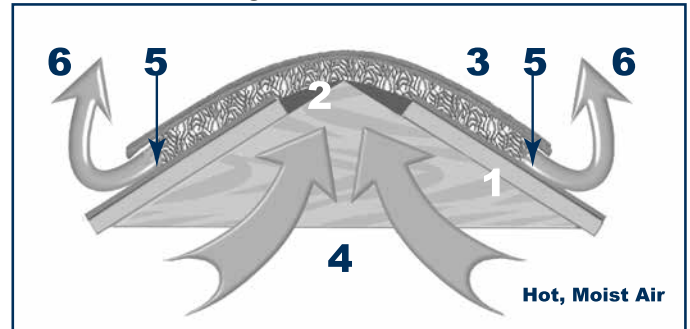

- 1. Roof Sheathing
- 2. Roof Saver Ridge Vent
- 3. Cap Shingle
- 4. Hot, Moist Attic Air
- 5. Negative Pressure
- 6. Exhaust Air

Air flow across the exterior roof ridge draws hot, moist attic air out through the Ridge Vent and pulls fresh air into the attic through the soffit vents. Removal of hot, moist air from the attic reduces cooling costs and eliminates potential damage to your roof.

In today's market homeowners need to know the air they breathe is safe. Clean Air Begins in the Attic. Pro-Master Ridge Vent™

Pro-Master Ridge Vent™ Benefits

- Deters the growth of mold and mildew
- Keeps attic dry deterring rot and structural degradation
- Green Product- made with RECYCLED post industrial fiber.
- No maintenance or operating cost
- UL Class A Fire Rating
- Eliminates unsightly fans and vents.
- Protects roof and shingles from damage due to excessive heat or condensation.

- Installs quickly - grips the roof!
- Passes 110 mph independent wind driven rain test.
- Non Clogging AC132 dust exposure test
- Most economic and efficient way to ventilate your attic.
- Nails included- both hand and power
- Net free area 15.2 sq. in./lineal foot
- Won't deteriorate or corrode from wind, snow, rain or ice.
- Meets attic ventilation requirements for all nationally recognized building codes
- 40-year warranty

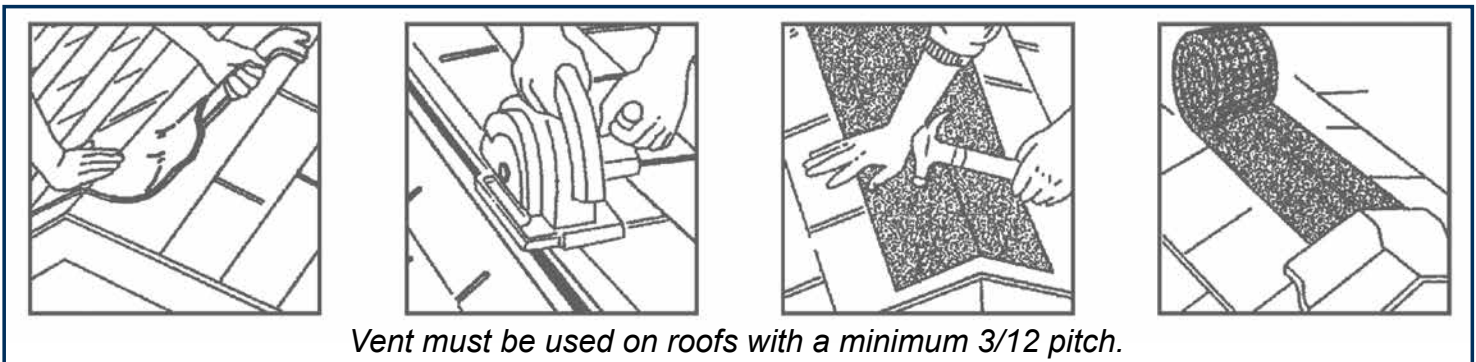

Vent must be used on roofs with a minimum 3/12 pitch.

Snow Guard Technical

See pages 69-74 for product ordering information.

THIS DOCUMENT CONTAINS IMPORTANT SAFETY, WARRANTY AND PRODUCT INFORMATION – READ IT CAREFULLY!

RETAIL SNOW GUARD INSTALLATION GUIDELINES

The purpose of a Snow Guard is to help reduce a slide, not stop it. Snow Guards are intended to reduce the potential for snow and ice damage to gutters, foundation plantings, parked vehicles, adjacent roofs and equipment, and injury to pedestrians. Snow Guards are attached to the roof structure in order to uniformly retain and hold snow in place on the roof area. The Snow Guards need to be applied in sufficient quantity and according to a prescribed pattern in order to be effective. Snow Guards are intended to prevent snow movement and provide for the controlled melt and breakdown of the snow mass into smaller sections.

Snow Guard placement will vary from region to region and will be influenced by roof pitch, the lengths of roof runs and roof features. Placement should be determined by a qualified professional. Placement recommendations can be found in Sheet Metal and Air Conditioning Contractor's National Association (SMACNA) Architectural Sheet Metal Manual and other industry standards. The best practice with any installation is to develop a layout aimed at retaining the snow in place rather than trying to stop it at the eaves after it has begun to slide. This principal is particularly important where adhesive mounted devices are to be used. Always consult building codes, architects and/or engineers when roof pitch exceeds 12:12.

A qualified roofing contractor should be employed to install these products. Roofing professionals have the proper equipment, knowledge and ability to complete the task in a safe and satisfactory manner. The installer is responsible for compliance with all governing building and safety regulations. Prior to application, the installer should evaluate all products in order to determine fitness for use.

Positioning of Berger snow guards required for effective use:

The best positioning will vary depending on the particular roof. In general, snow guards should be placed 1 every 40 inches over entire roof or in 2 groups of 3 staggered rows on 30 inch centers with 1 group at the eave and 1 group midway on roof slope. On long slopes, multiple groups with 6 ft. space separation maximum.

- Do not place Snow Guards beyond the bearing wall on an extended roof section. This can result in ice damming and structural damage to the roof.
- Do not use Snow Guards on low-slope roofs (those with pitches less than 3:12). Snow guards help reduce the momentum of a potential snow slide. On low-slope roofs, snow does not typically slide off in the same manner. Under these circumstances, it is often better to allow the snow to naturally clear itself from the roof as quickly as possible or to manually remove it. Therefore, snow guards are not recommended for low-slope roof applications. Check with the roof manufacturer for specific product application limits and, as always, observe all roof safety guidelines.

- Always check metal roofing warranty before mechanically fastening snow guards. Use of mechanically through fastened snow guards on metal roofing may void metal roofing manufacturer's watertight warranty.
- Do not use competing, or dissimilar metals. Galvanic corrosion will occur when dissimilar metals are in contact in the presence of an electrolyte. Water in the form of condensation, rain or snow is an electrolyte. Water that flows over copper becomes electronegative and will cause corrosion of aluminum or steel. Copper, brass or stainless steel fasteners or nails must be used with copper or brass applications. Make sure rivets are solid copper; do not use copper plated steel rivets in copper or brass assembly. Do not use aluminum or galvanized nails to secure any copper products.

Corrosion will be more rapid in the presence of salts such as ocean coastal areas or chlorinated water, acid rain, and polluted industrial atmospheres. Accelerated corrosion will occur when a larger area of an electronegative (cathode/protected) element contacts a small electropositive (anodic/corroded) element.

SAFETY WARNINGS

- Roofing can be hazardous! Professional installation is recommended. Observe and comply with all OSHA and other safety standards and codes that apply to roof safety.
- Always use personal safety equipment and work shoes designed for roof traction when roofing to reduce the likelihood of falling.
- In order to reduce the likelihood of falling, always use roof jacks, work supports or platforms to assure safe footing while working on steep pitched roofs.

To prevent roofing materials from slipping or falling off the roof, always ensure roof material staging devices such as roof jacks, storage platforms and toe boards are securely fastened to the deck substructure.

When working with ladders, always follow the ladder safety standards and regulations, observe the locations of all power lines and take precaution to avoid any contact with the workers or equipment

To avoid exposure to hazardous conditions, do not work on the roof during inclement weather (including but not limited to lightning storms, high winds, rain, ice and snow conditions). To avoid heat injuries, ensure adequate rest breaks and drink plenty of water when working in high temperatures.

Snow Guard Technical
AMERIMAX HOME PRODUCTS, INC.

SNOW GUARD LIMITED ONE YEAR
WARRANTY AND LIMITATION OF LIABILITY

Amerimax Home Products (hereinafter "AHP" or "Seller") warrants that this product (excluding the adhesives) shall be free from defects in material and workmanship for one (1) year from the date of purchase. Should any of the products prove defective, the obligation of AHP under this warranty shall be limited to replacement of the defective product, or at its option, the cost of the product originally shipped. Replacement of defective product shall not extend the duration of this limited warranty.

CONDITIONS OF THE WARRANTY

NO WARRANTIES, EXPRESS OR IMPLIED, SHALL APPLY IF THIS PRODUCT IS INSTALLED ONTO COMPETING OR DISSIMILAR METALS. Galvanic corrosion will occur when dissimilar metals are in contact in the presence of an electrolyte. Water in the form of condensation, rain or snow is an electrolyte. Water that flows over copper becomes electronegative and will cause corrosion of aluminum or steel.

- Copper, brass or stainless steel fasteners or nails must be used with copper or brass applications. Make sure rivets are solid copper;
- Do not use copper plated steel rivets in copper or brass assembly. Do not use aluminum or galvanized nails to secure any copper products.

Corrosion will be more rapid in the presence of salts such as ocean coastal areas or chlorinated water, acid rain, and polluted industrial atmospheres. Accelerated corrosion will occur when a larger area of an electronegative (cathode/protected) element contacts a small electropositive (anodic/corroded) element.

BUYER'S OBLIGATION

Buyer shall inspect all materials prior to installation so as to mitigate unnecessary expense involved in repairing or replacing defective Snow Guards.

EXCLUSIVE REMEDY

If, upon inspection by the Seller, it is determined to Seller's reasonable satisfaction that the product is defective, Seller shall have the right to either repair or replace the defective product utilizing such normal materials, methods and workmanship as are needed to fulfill the original performance guarantee but without extending the duration thereof. Seller's liability and Buyer's exclusive remedy under this warranty shall be limited to repair or replacement at the Seller's election. **IN FULFILLMENT OF ITS GUARANTEE, SELLER SHALL IN NO EVENT BE LIABLE TO INCUR COSTS WHICH EXCEED SELLER'S COST OF THE DEFECTIVE PRODUCT.**

BUYER HEREBY WAIVES ALL REMEDIES NOT EXPRESSLY PROVIDED HEREIN INCLUDING, BUT NOT LIMITED TO, DAMAGES FOR INJURY TO PERSON OR PROPERTY AND INCIDENTAL AND CONSEQUENTIAL DAMAGES.

NO WARRANTY OF FITNESS FOR PARTICULAR PURPOSE

Due to differences in roof geometry, structural strength, climatic conditions and snow melt rate, the manufacturer does not warrant the suitability of this product for use on a particular structure.

EXCLUSION OF WARRANTIES

THE LIMITED WARRANTY DESCRIBED HEREIN SHALL BE EXCLUSIVE AND IN LIEU OF ANY AND ALL OTHER WARRANTIES, EXPRESS OR IMPLIED, INCLUDING THE WARRANTY OF MERCHANTABILITY OR FITNESS FOR A PARTICULAR PURPOSE. THE SELLER ALSO DISCLAIMS AND BUYER WAIVES ANY LIABILITY OF SELLER IN TORT, STRICT OR OTHERWISE, OR OTHERWISE IN LAW, FOR DAMAGES, DIRECT, INCIDENTAL OR CONSEQUENTIAL, RESULTING FROM A DEFECT IN DESIGN, MATERIAL, WORKMANSHIP, OR MANUFACTURE, WHETHER OR NOT OCCASIONED BY SELLER'S NEGLIGENCE. BBPI IS IN NO EVENT LIABLE FOR INCIDENTAL OR CONSEQUENTIAL DAMAGES, WHETHER THE CLAIM IS BASED ON WARRANTIES, CONTRACT, NEGLIGENCE OR OTHERWISE.

Seller is also not liable for misapplication or modification of this product or incorrect material or defects that were open and obvious at time of installation. AHP is not liable for any consequential damage, schedule delays, additional labor, and or equipment rental costs as a result of open and obvious defects during installation. All warranty claims are limited to AHP's cost of material of the product determined to have a manufacturing defect.

AHP DOES NOT WARRANT THE ADHESIVE INCLUDED WITH THIS PRODUCT. WITH RESPECT TO THE ADHESIVE, AHP DISCLAIMS ALL WARRANTIES, EXPRESS OR IMPLIED, INCLUDING ANY WARRANTY OF MERCHANTABILITY OR FITNESS FOR A PARTICULAR PURPOSE. The adhesives are solely for the convenience of the user. BBPI DISCLAIMS ANY RESPONSIBILITY FOR DEFECTS OR FAILURE IN THE ADHESIVES AND THE BUYER HEREBY ASSUMES FULL RESPONSIBILITY FOR ITS USE. The adhesive provided is used throughout the industry for adhering snow guards with successful results when utilized in accordance with the adhesive manufacturer's instructions. Use of the adhesive is recommended only when weather conditions permit, and proper curing is possible per the manufacturer's instructions.

Terms and Conditions

Prices

1. Prices quoted for materials covered hereby are subject to adjustment by Amerimax Home Products, Inc. (hereinafter referred to as "Seller"), at its shipping points, and will be accepted only upon the conditions as shown in the paragraphs hereafter.
2. Price quoted, unless otherwise indicated, do not include sales, excise or other taxes payable on account of this transaction (except income tax) and such taxes now or hereafter levied applicable to this transaction shall be paid by Buyer.
3. All prices will be P.I.E., price in effect at time of shipment.

Product Availability

Certain products listed in this catalog are not offered at all of the Seller's locations. The product offering is subject to discretion of the Seller.

Freight Terms

1. Buyer's orders will be shipped freight collect from Seller's plant location unless orders are in excess of dollar values stipulated by Seller.
2. No freight costs will be paid by Seller for any Buyer's pickups.

Delivery And Shipment

1. Unless otherwise specified upon delivery of materials f.o.b. Seller's plant, all risk of loss, damage and other incidents of ownership shall immediately pass to Buyer. Bill of Lading or carrier delivery receipt must be signed if shipment is damaged or short.
2. Any routing specified by Buyer will be observed, but Seller shall not be liable for freight allowances, if any, other than that of most economical route. Freight allowances will be made in accordance with Seller's current published price list. Seller reserves the right at all times to control routing.

Payment

1. Standard payment terms of sale are Net 30 Days from date of invoice.
2. All invoices will be dated the day of shipment.
3. Remittance Address: Amerimax Home Products Inc., Dept. #3479, PO Box 2153, Birmingham, AL 35287-3479
4. Payment terms begin aging on the invoice date, not the day the invoice is received.

Delays

1. Seller shall not be liable for delay or failure in performance hereof arising from any cause not within Seller's control, including, but not limited to, accidents, breakdowns or mechanical failure of plant machinery or equipment arising from any cause whatsoever, strikes or other labor troubles; labor shortage, fire, flood, war acts of the public enemy, acts of God, priorities, allocations, limitations or other acts required or requested by Federal or local Governments; or failure of usual sources of supply of materials.

Standard Tolerances

Seller will produce and ship this order within Seller's limitations as to size, gauge, temper and quality, in accordance with the Seller's current pricing.

Limited Warranty

1. Seller warrants [to the original consumer purchaser] all materials sold hereunder to be free from defects in materials and workmanship at time of purchase. THIS WARRANTY IS IN LIEU OF AND EXCLUDES ALL OTHER WARRANTIES, EXPRESS OR IMPLIED, BY OPERATION OF LAW OR OTHERWISE, INCLUDING ANY WARRANTY THAT MATERIALS ARE SUITABLE FOR BUYER'S REQUIREMENTS OR SPECIAL USE AND THE IMPLIED WARRANTIES OF MERCHANTABILITY AND FITNESS OF PURPOSE. SOME STATES DO NOT ALLOW THE ABOVE LIMITATIONS ON THE APPLICABILITY OF AN IMPLIED WARRANTY, SO THE ABOVE LIMITATIONS MAY NOT APPLY TO YOU. IN CONSIDERATION OF THIS WARRANTY, IT IS AGREED THAT SELLER SHALL NOT BE LIABLE FOR ANY INCIDENTAL, SPECIAL OR CONSEQUENTIAL DAMAGES. SOME STATES DO NOT ALLOW THE EXCLUSION OR LIMITATION OF INCIDENTAL, SPECIAL OR CONSEQUENTIAL DAMAGES, SO THE ABOVE EXCLUSION OR LIMITATION MAY NOT APPLY TO YOU. This warranty also does not cover, and Seller hereby disclaims all liability for, any product which has been subject to abuse, alteration, modification, neglect, misuse, abnormal use, or to which parts, not supplied by Seller, have been added, or to defects caused by depreciation or normal wear. [This warranty applies only if Seller's materials are installed and maintained according to Seller's recommended practices and installation instructions.] The suitability of a product for an intended use shall be the sole responsibility of the user. Seller's liability shall in no event exceed the purchase price paid for product only. No person has the authority to change these terms and there are no warranties except as stated herein. Any claim on account of defective materials or for any other cause shall be deemed waived by Buyer unless written notice of such claims is received by Seller within sixty (60) days after date of receipt of materials by Buyer. Seller shall be given a reasonable opportunity to investigate all claims and no materials shall be returned to Seller until after inspection and approval by Seller and receipt by Buyer or written shipping instructions. Seller shall have the option of replacing or repairing any defective materials, refunding the purchase price, or granting a reasonable allowance on account of such defects, and Seller's liability and Buyer's remedies for defective materials shall be limited solely and exclusively as above. This warranty gives you specific legal rights and you may also have other legal rights which vary from state to state.
2. A 20% handling charge plus incurred freight will be made on all material returned without written authorization by Seller.
3. Some returns may be subject to a 20% restocking fee at the discretion of the Seller.

Aluminum Color Program

Color*	Matches	Trim Coil	Gutter & Components	Soffit & Accessories	Fascia	Drip Edge
30 White	Berger		●	●	●	●
80 White	Berger		●			●
Almond	Berger	●	●	●	●	●
AMP Dark Bronze	Berger	●	●			
Autumn Red NEW	CertainTeed	●				
Autumn Yellow	CertainTeed	●				
Bermuda Blue NEW	CertainTeed	●				
* Black/Black or Black/Royal Brown	Berger	●	●	●	●	●
Bone Linen	Berger	●	●	●	●	●
* Bright White/Bright White	Crane/Berger	●		●	●	●
Brown	Crane/Berger	●	●		●	
Buckskin	CertainTeed	●				
Charcoal Gray NEW	CertainTeed	●				
* Colonial White/Colonial White	CertainTeed	●				
Cypress	CertainTeed/Crane	●				
* Dark Bronze/Sable Brown	Berger	●	●	●	●	●
Desert Tan	CertainTeed	●		●	●	●
Flagstone NEW	CertainTeed	●				
Forest NEW	CertainTeed	●				
Glacier Blend	CertainTeed	●				
Granite Gray	CertainTeed	●		●	●	●
Grecian Green	Crane/Berger	●	●	●	●	●
Green Tea NEW	CertainTeed	●				
Greystone	Crane	●			●	
Harbor Blue	Crane	●			●	
Hearthstone NEW	CertainTeed	●				
Heritage Cream	CertainTeed/Crane	●	●	●	●	●
Herringbone	Crane/Berger	●	●		●	
Ivy Green	CertainTeed	●				
Light Maple	CertainTeed	●	●	●	●	●
Lighthouse Red	Crane/Berger	●	●		●	●
Linen NEW	CertainTeed	●				
Lomar White	Berger	●				
Mountain Cedar NEW	CertainTeed	●				
Musket Brown	Berger	●	●	●	●	●
Musket Brown A	Alcoa	●	●	●	●	●
Musket Brown C	CertainTeed	●				
Natural Clay	CertainTeed/Crane	●	●	●	●	●
Oxford Blue	CertainTeed	●				
Pacific Blue	CertainTeed	●				
Pearl	Crane	●			●	
Pearl Gray	Berger	●	●	●	●	●
Pebblestone Clay	Alcoa	●	●	●	●	●
Regatta	Crane	●			●	
Royal Brown	Berger	●	●	●	●	●
Rye	Crane	●			●	
Sable Brown	CertainTeed	●				
Saddle	Crane	●			●	
Sandpiper NEW	CertainTeed	●				
Sandstone Beige	CertainTeed	●		●	●	●
Savannah Wicker	CertainTeed/Crane	●	●	●	●	●
Seagrass NEW	CertainTeed	●				
Silver Ash	CertainTeed/Crane	●				
Snow White	CertainTeed	●				
Spruce NEW	CertainTeed	●				
Sterling Gray	CertainTeed/Crane	●		●	●	●
Suede NEW	CertainTeed	●				
Terra Bronze	Berger	●	●	●	●	●
Terra Cotta NEW	CertainTeed	●				
Tuxedo Gray	Berger	●	●	●	●	●
Wheat	Crane	●			●	

Fascia & Soffit

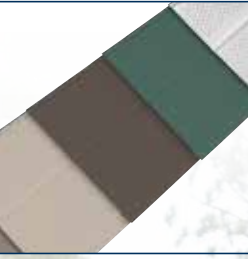

Trim Coil



Drip Edge

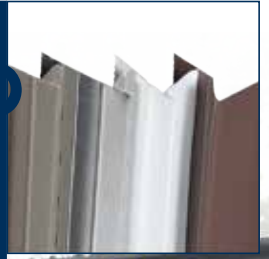

COLOR ACCENTS BY AMERIMAX™

OVER 60 COLOR CHOICES TO MATCH POPULAR SIDING AND WINDOW MANUFACTURERS

- *Fascia is available in 6" and 8" profiles. Soffit is available in D6 and T4 profiles (12" width)*
- *Drip Edge is available in popular C, F, and ODE profiles*
- *Trim Coil colors include matching Finishing Nails*

■ *ROOF DRAINAGE SYSTEMS*



■ *MOISTURE PROTECTION*

■ *VENTILATION PRODUCTS*



■ *OUTDOOR LIVING PRODUCTS*



■ *SNOW RETENTION SYSTEMS*



Amerimax
450 Richardson Drive • Lancaster, PA 17603

800.347.2586

717.299.3711 phone
717.299.2194 fax

Amerimax.com
Email: info@amerimax.com

An OmniMax Company

