

Application

Ideal for use where Lead-Free* valves are required. Designed for installation on potable water lines to protect against both backsiphonage and backpressure of contaminated water into the potable water supply. Assembly shall provide protection where a potential health hazard exists.

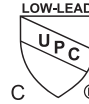

Certified to NSF/ANSI 61 & 372

Standards Compliance

- ASSE® Listed 1013
- IAPMO® Listed
- CSA® Certified B64.4
- AWWA compliant C511
- Approved by the Foundation for Cross Connection Control and Hydraulic Research at the University of Southern California
- UL® Classified (less shut-off valves only, 3/4"-2")
- C-UL® Classified (less shut-off valves only, 3/4"-2")
- NSF® Listed - Standard 61 & 372*
- Certified to NSF/ANSI 372* by IAPMO R&T
*(0.25% MAX. WEIGHTED AVERAGE LEAD CONTENT)

Materials

Housing	Reinforced Nylon, FDA approved
Fasteners	Stainless Steel, 300 Series
Elastomers	Silicone (FDA Approved) Buna Nitrile (FDA Approved)
Internals	Delrin, Nylon, NSF Listed
Springs	Stainless Steel, 300 series
Ball Valves	Cast Bronze, ASTM B 584
Struts	Stainless Steel, 300 Series

Features

Sizes:	1/2", 3/4", 1", 1-1/4", 1-1/2", 2"
Maximum working water pressure	175 PSI
Maximum working water temperature	180°F
Hydrostatic test pressure	350 PSI
End connections	Threaded FNPT ANSI B1.20.1

Options

(Suffixes can be combined)

- with full port QT ball valves (standard)
- L - less ball valves, male pipe thread
- S - with Model SXL lead-free bronze "Y" type strainer
- FT - with integral male 45° flare SAE test fitting
- AG - with air gap
- SAG - with Model SXL lead-free bronze "Y" strainer and air gap
- BOF - with Blow out/Flush fitting
- B - with black fusion epoxy coated ball valves & struts for theft protection
- PF - with Z-Bite™ push fit connections* (1/2" -1" only)
- PR - with Z-Press™ press fit connections*

*Fittings ship in box with valve and must be threaded into valve by hand on site.

Accessories

- Repair kits
- Thermal expansion tank (Mdl. XT)
- Soft seated check valve (Mdl. 40XL2)
- Shock arrester (Model 1250XL)
- QT-SET Quick Test Fitting Set
- Blow out / Flush fitting (RK34-375BOF (1/2" or 3/4"), RK1-375BOF or RK114-350-375BOF)

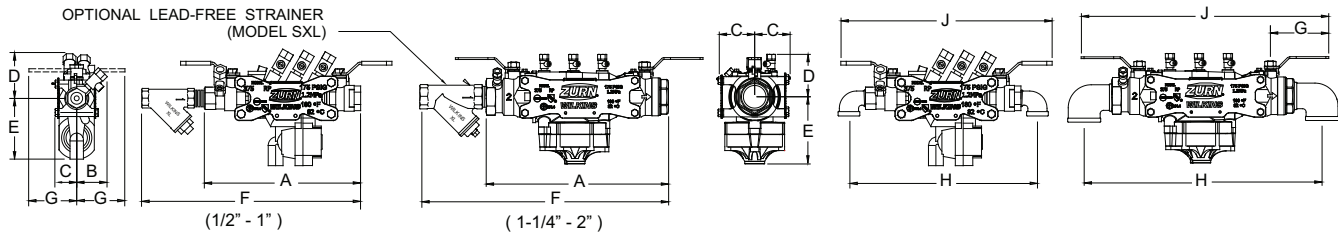

Dimensions & Weights (do not include pkg.)

MODEL 375XL SIZE	DIMENSIONS (approximate)																			WEIGHT					
	A		A LESS BALL VALVES		B		C		D		E		F		G		H		J		LESS BALL VALVES	WITH BALL VALVES			
	in.	mm	in.	mm	in.	mm	in.	mm	in.	mm	in.	mm	in.	mm	in.	mm	in.	mm	in.	mm			lbs.	kg	lbs.
1/2	20	8 7/8	225	n/a	n/a	1 15/16	49	1 3/8	35	2 15/16	75	3 7/8	98	12 1/4	311	3	76	10 7/8	276	12 1/4	311	4.7	2.1	5.7	2.6
3/4	20	8 7/8	225	7 1/8	181	1 15/16	49	1 3/8	35	2 15/16	75	3 7/8	98	12 5/8	321	3	76	11	279	12 1/4	311	4.7	2.1	5.7	2.6
1	25	11 3/16	284	8 7/8	225	2 1/4	57	1 13/16	46	3 7/16	87	4	102	14 9/16	370	4	102	13 3/4	349	15 1/4	387	8.2	3.7	9.7	4.4
1-1/4	32	14 7/8	378	14 3/8	367	3 3/8	86	3 1/8	80	3 3/4	95	5 3/4	146	20 1/2	521	3 3/4	95	18	457	18 1/2	470	18.7	8.5	20.5	9.3
1-1/2	40	15 1/4	387	14 3/8	367	3 3/8	86	3 1/8	80	3 3/4	95	5 3/4	146	22	559	4 1/2	114	18 3/4	476	20 1/4	514	18.3	8.0	21.5	9.8
2	50	16	406	14 3/8	367	3 3/8	86	3 1/8	80	3 3/4	95	5 3/4	146	24	610	4 3/4	120.7	20 3/4	527	20 3/4	527	19.4	8.8	23.5	10.7

MODEL 375XL 1/2" - 1" (STANDARD & METRIC)

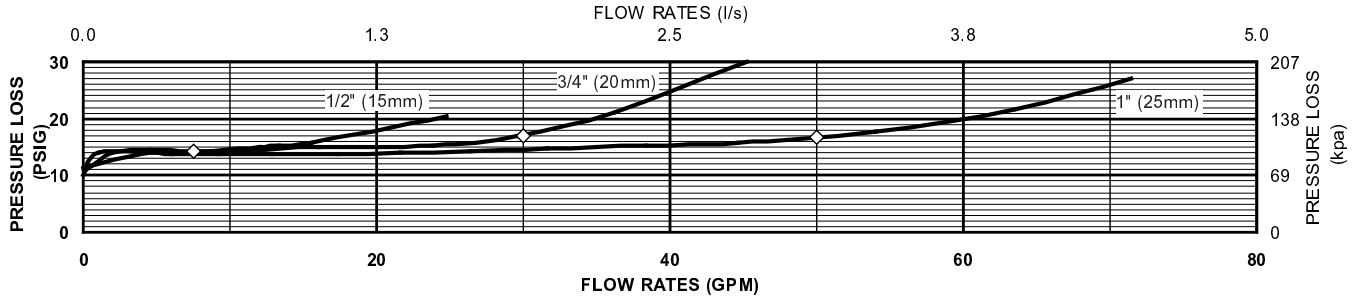

MODEL 375XL 1-1/4" - 2" (STANDARD & METRIC)

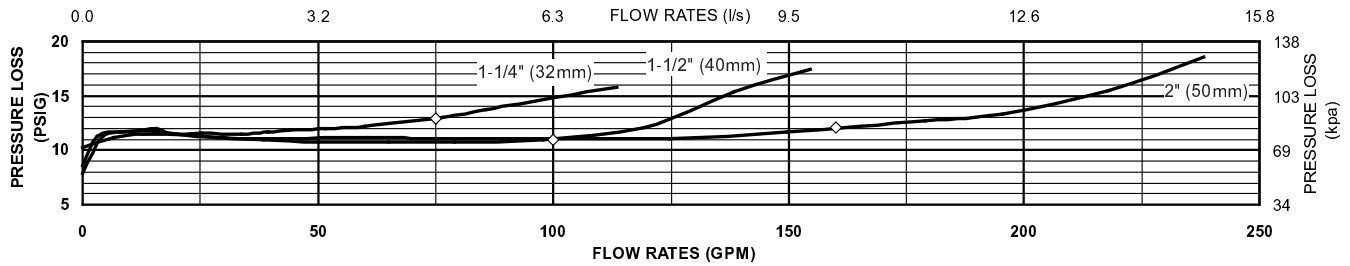

Typical Installation

Local codes shall govern installation requirements. To be installed in accordance with the manufacturers' instructions and the latest edition of the Uniform Plumbing Code. Unless otherwise specified, the assembly shall be mounted at a minimum of 12" (305mm) and a maximum of 30" (762mm) above adequate drains with sufficient side clearance for testing and maintenance. The installation shall be made so that no part of the unit can be submerged.

Relief Valve Discharge Rates

(Worst case condition - If 1st check or relief valve is lodged wide open)

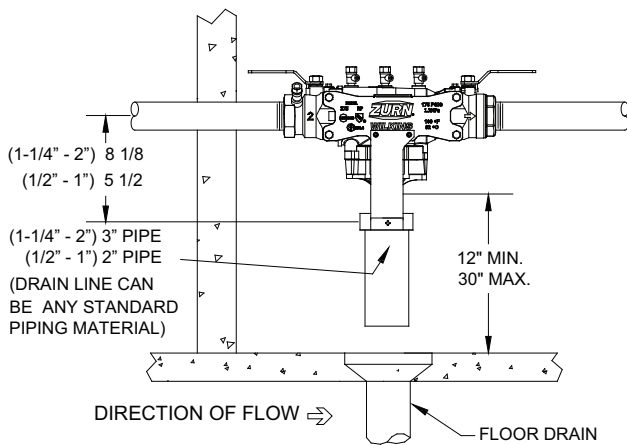
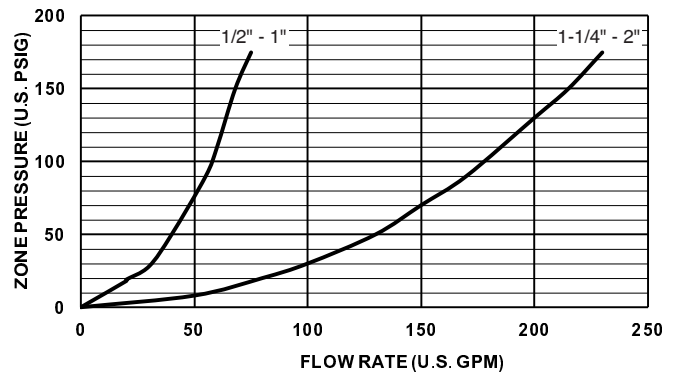

INDOOR INSTALLATION

MODEL 375XLSAG (SHOWN)

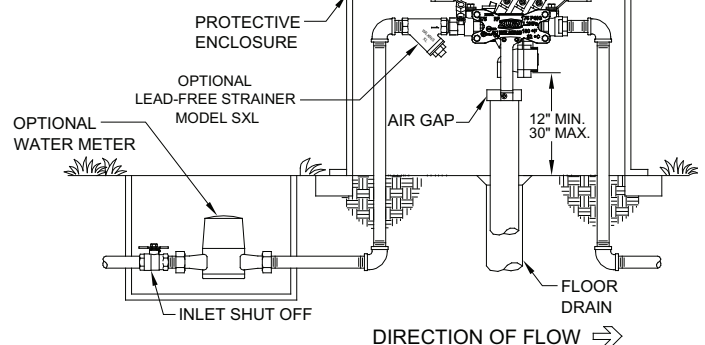

OUTDOOR INSTALLATION

Specifications

The Reduced Pressure Principle Backflow Preventer shall be certified to NSF/ANSI 372, ASSE® Listed 1013, rated to 180°F, and supplied with full port ball valves. The main body shall be Nylon and the seat disc elastomers shall be silicone. If installed indoors, the installation shall be supplied with an air gap adapter. The Reduced Pressure Principle Backflow Preventer shall be a ZURN WILKINS Model 375XL.