

# Metal Raceway HBL500, HBL700 and HBL750 Series

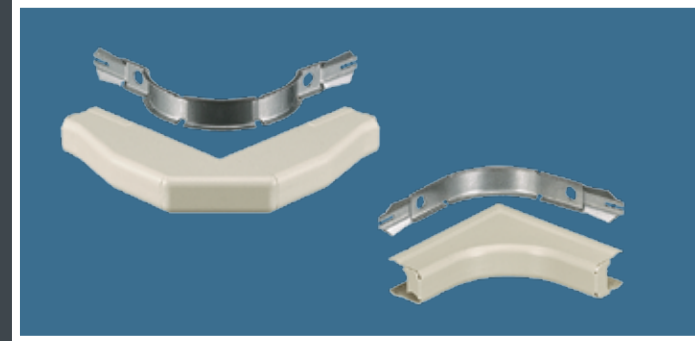

**HUBBELL**<sup>®</sup>  
Wiring Device-Kellems

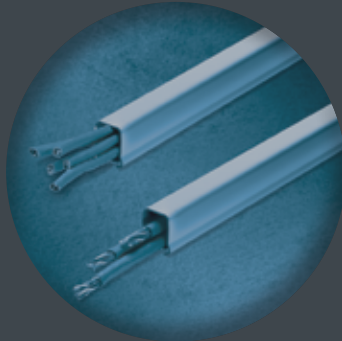
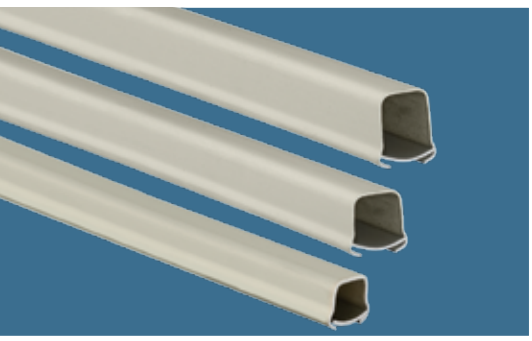

# Metal Raceway HBL500, HBL700 and HBL750 Series

Metal Raceway and Switch/Receptacle Boxes



| HBL500, HBL700 & HBL750 Series | Description  | Color   | Length                  | HBL500 Series             | HBL700 Series  | HBL750 Series  |
|--------------------------------|--|---|-------------------------|---------------------------|--|--|
|                                | <b>Base and Cover</b><br>Available in 5 ft. (1.5m) lengths, packed 50 ft. (15m) per carton and 10 ft. (3m) lengths, packed 100 ft. (30m) per carton. HBL5701C coupling furnished with each length. |   | Ivory<br>Ivory<br>White | 5 ft.<br>10 ft.<br>10 ft. | —<br><b>HBL50010IV</b><br><b>HBL50010W</b><br>A: .53" (13.46)<br>B: .76" (19.30) | —<br><b>HBL700IV</b><br><b>HBL700W</b><br>A: .67" (16.90)<br>B: .76" (19.30) |

| Metal Raceway<br>Wire Fill Capacities |                           | Power<br>(THHN/T90 Nylon) |           |           | Voice  |         | Data<br>(Copper Cables) |            |           |            |               | Data (Multimode<br>Fiber Optic Cables) |                        |                         |
|---------------------------------------|---------------------------|---------------------------|-----------|-----------|--------|---------|-------------------------|------------|-----------|------------|---------------|--|------------------------|-------------------------|
|                                       |                           | 14<br>AWG                 | 12<br>AWG | 10<br>AWG | 4-Pair | 25-Pair | Type<br>RG59U           | Cat.<br>5e | Cat.<br>6 | Cat.<br>6A | Cat. 6<br>STP | (2) or (4) Fiber<br>Round Cable        | Fiber Optic<br>Jumpers | Fiber Optic<br>Zip Cord |
|                                       |                           | Wire O.D. (in.):          | 0.111     | 0.13      | 0.164  | 0.19    | 0.41                    | 0.242      | 0.21      | 0.25       | 0.35          | 0.29                                   | 0.19                   | 0.118                   |
|                                       | Wire Area<br>(sq. in.):   | 0.0097                    | 0.0133    | 0.0211    | 0.0283 | 0.1320  | 0.0460                  | 0.0346     | 0.0491    | 0.0962     | 0.0660        | 0.0283                                 | 0.0109                 | 0.0288                  |
| Series                                | Channel Area<br>(sq. in.) | Wire Fill Capacity        |           |           | 40%    | 40%     | 40%                     | 40%        | 40%       | 40%        | 40%           | 40%                                    | 40%                    | 40%                     |
| HBL500                                | 0.22                      | 7                         | 5         | 3         | 2      | 0       | 1                       | 2          | 1         | 1          | 1             | 2                                      | 8                      | 2                       |
| HBL700                                | 0.26                      | 10                        | 7         | 4         | 3      | 0       | 2                       | 3          | 2         | 1          | 1             | 3                                      | 8                      | 3                       |
| HBL750                                | 0.40                      | 12                        | 9         | 5         | 6      | 1       | 3                       | 5          | 3         | 2          | 2             | 6                                      | 15                     | 6                       |

Note: Pathway (Raceway) fill shall be 40% maximum. Raceway fittings and outlets/receptacles reduce the cross section of the raceway system, thus reducing overall cable fill capacity.



| Standard   | Color          | 1-Gang   | 2-Gang  | 3-Gang  | 4-Gang  | 5-Gang   | 6-Gang   |
|------------|----------------|--|---|---|---|--|--|
|            | Ivory<br>White | <b>HBL5748IVA</b><br><b>HBL5748WA</b><br>A: 4.54" (115.32)<br>B: 2.82" (71.63)<br>C: 1.75" (44.45)   | <b>HBL57482IVA</b><br><b>HBL57482WA</b><br>A: 4.54" (115.32)<br>B: 4.64" (117.86)<br>C: 1.75" (44.45)   | <b>HBL57483IVA</b><br><b>HBL57483WA</b><br>A: 4.54" (115.32)<br>B: 6.45" (163.88)<br>C: 1.75" (44.45) | <b>HBL57484IVA</b><br>—<br>A: 4.54" (115.32)<br>B: 8.26" (209.91)<br>C: 1.75" (44.45) | <b>HBL57485IVA</b><br>—<br>A: 4.54" (115.32)<br>B: 10.01" (255.93)<br>C: 1.75" (44.45) | <b>HBL57486IVA</b><br>—<br>A: 4.54" (115.32)<br>B: 11.89" (301.96)<br>C: 1.75" (44.45) |
| Shallow    | Ivory<br>White | <b>HBL5747IVA</b><br><b>HBL5747WA</b><br>A: 4.54" (115.32)<br>B: 2.82" (71.63)<br>C: 1.38" (35.05)   | <b>HBL57472IVA</b><br><b>HBL57472WA</b><br>A: 4.54" (115.32)<br>B: 4.64" (117.86)<br>C: 1.38" (35.05)   | <b>HBL57473IVA</b><br>—<br>A: 4.54" (115.32)<br>B: 6.45" (163.88)<br>C: 1.38" (35.05)                 | —   | —  | —  |
| Deep       | Ivory<br>White | <b>HBL5744SIVA</b><br><b>HBL5744SWA</b><br>A: 4.54" (115.32)<br>B: 2.82" (71.63)<br>C: 2.25" (57.00) | <b>HBL5744S2IVA</b><br><b>HBL5744S2WA</b><br>A: 4.54" (115.32)<br>B: 4.64" (117.86)<br>C: 2.25" (57.00) | <b>HBL5744S3IVA</b><br>—<br>A: 4.54" (115.32)<br>B: 6.45" (163.88)<br>C: 2.25" (57.00)                | —   | —  | —  |
| Extra Deep | Ivory<br>White | <b>HBL5744IVA</b><br><b>HBL5744WA</b><br>A: 4.54" (115.32)<br>B: 2.82" (71.63)<br>C: 2.75" (69.85)   | <b>HBL57442IVA</b><br><b>HBL57442WA</b><br>A: 4.54" (115.32)<br>B: 4.64" (117.86)<br>C: 2.75" (69.85)   | <b>HBL57443IVA</b><br>—<br>A: 4.54" (115.32)<br>B: 6.45" (163.88)<br>C: 2.75" (69.85)                 | —   | —  | —  |

Base Trade Size KOs: 2- 1/2" | 1- 1/2", 3/4" Concentric | 3- 1/2" | 4- 1/2" | 5- 1/2" | 6- 1/2"  
 1 - Rectangular

Note: For datacom applications, box selection is dependent on depth of connectors (jacks). See our Full Line Catalog at [www.hubbell-wiring.com](http://www.hubbell-wiring.com) for additional information.



| Extension<br>Boxes | Description   | Color          | 1-Gang   | 1-Gang Deep  | 1-Gang Blank  | 2-Gang  | 3-Gang  |
|--------------------|---|----------------|--|--|---|---|---|
|                    | <b>Extension Boxes</b><br>To extend existing flush switch and receptacle boxes. Blank is used where it is desired to blank original outlet. | Ivory<br>White | <b>HBL5751IVA</b><br><b>HBL5751WA</b><br>A: 4.54" (115.32)<br>B: 2.82" (71.63)<br>C: 1.38" (35.05) | <b>HBL5751AIVA</b><br><b>HBL5751AWA</b><br>A: 4.54" (115.32)<br>B: 2.82" (71.63)<br>C: 1.75" (44.45) | <b>HBL5760IVA</b><br>—<br>A: 4.54" (115.32)<br>B: 2.82" (71.63)<br>C: 1.13" (28.70) | <b>HBL57512IVA</b><br>—<br>A: 4.54" (115.32)<br>B: 4.64" (117.86)<br>C: 1.38" (35.05) | <b>HBL57513IVA</b><br>—<br>A: 4.54" (115.32)<br>B: 6.45" (163.88)<br>C: 1.38" (35.05) |

Dimensions in Inches (mm)

Metal Raceway  
**HBL500, HBL700 and HBL750 Series**  
 Specialty Boxes, Round Boxes and Covers



| 1-Gang Specialty Boxes  |                |  | 2-Gang Specialty Boxes  |                       |  |
|---|----------------|--|---|-----------------------|--|
| Description   | Color          | 1-Gang   | Description   | Color                 | 2-Gang   |
| <b>Low Profile Switch/Receptacle</b><br>Base has 1/2" trade size KOs.   | Ivory<br>White | <b>HBL5748SIVA</b><br><b>HBL5748SWA</b><br>A: 4.54" (115.32)<br>B: 2.82" (71.63)<br>C: 1.13" (28.70) | <b>Alarm Device Box</b><br>Surface mounting of alarm devices and safety signals.  | Ivory<br>White<br>Red | <b>HBL5752IVA</b><br>—<br><b>HBL5752RA</b><br>A: 4.54" (115.32)<br>B: 4.64" (117.86)<br>C: 1.38" (35.05) |
| <b>Combination Switch/Recept.</b><br>Connects surface runs of 1/2" trade size conduit, one raceway twistout each side and three raceway twistouts top and bottom. | Ivory<br>White | <b>HBL5745IVA</b><br><b>HBL5745WA</b><br>A: 4.54" (115.32)<br>B: 2.82" (71.63)<br>C: 1.75" (44.45)   | <b>Extra Deep Alarm Device Box</b><br>For surface mounting of alarm devices and safety signals. Cover is 2.75" (69.85) deep.  | Ivory<br>White<br>Red | <b>HBL5753IVA</b><br>—<br><b>HBL5753RA</b><br>A: 4.54" (115.32)<br>B: 4.64" (117.86)<br>C: 2.75" (69.85) |
| <b>Utility Box*</b><br>For use as a tee, cross, pull box, junction box or blank box. Base has 1/2" trade size KOs.  | Ivory<br>White | <b>HBL57242IVA</b><br><b>HBL57242WA</b><br>A: 4.12" (104.78)<br>B: 2.00" (50.80)<br>C: 1.39" (35.31) | <b>Distribution Box</b><br>Twistouts permit three parallel raceway runs on each side. Cover takes devices with mounting screw centers of 2.75" (69.85), 3.5" (89.00), 4.0625" (103.00) and canopy fixture not larger than 4.625" (117.00). Can be used with HBL5736IV (blank cover) to create junction box. | Ivory<br>White        | <b>HBL5735IVA</b><br>—<br>A: 4.54" (115.32)<br>B: 4.64" (117.86)<br>C: 1.38" (35.05)                     |











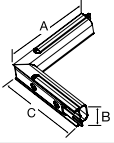

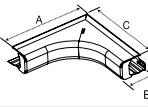

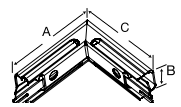
Note: \*Use catalog number HBL5791 for connecting 1/2 in. EMT to HBL5745 and HBL57242 boxes.

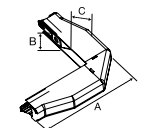

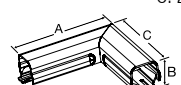

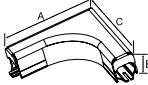

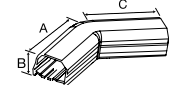

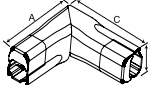
| Round Boxes   | Description   | Color  | 4.75 inches O.D.   | 5.50 inches O.D.   | 6.38 inches O.D.   |
|---|---|--|--|--|--|
|   | <b>Extension Box (Open Base)</b><br>For mounting on 3.25" (83.00) or 4" (102.00) round or square conduit boxes or other recessed outlets. Cover takes any device with mounting screw centers of 2.75" (69.85), 3.5" (89.00) and 4.06" (103.00). | Ivory<br>White   | <b>HBL5737IVA</b><br><b>HBL5737WA</b><br>A: 1.02" (26.00)<br>B: 4.75" (120.65)   | <b>HBL5737AIVA</b><br><b>HBL5737AWA</b><br>A: 1.02" (26.00)<br>B: 5.50" (140.00) | <b>HBL5739AIVA</b><br>—<br>A: 1.02" (26.00)<br>B: 6.38" (162.01) |
| <b>Fixture Box (Solid Base)</b><br>To hang fixtures. Cover takes any device with mounting screw centers of 2.75" (69.85), 3.5" (89.00) and 4.06" (103.00). Both boxes can be used as a pull or junction box when used with HBL5736IV/W (blank cover). | Ivory<br>White  | <b>HBL5738IVA</b><br><b>HBL5738WA</b><br>A: 1.02" (26.00)<br>B: 4.75" (120.65) | <b>HBL5738AIVA</b><br><b>HBL5738AWA</b><br>A: 1.02" (26.00)<br>B: 5.50" (140.00) | <b>HBL5739IVA</b><br><b>HBL5739WA</b><br>A: 1.02" (26.00)<br>B: 6.38" (162.01)   |  |

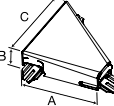
| Specialty Round Boxes   | Description   | Color  | Catalog Number   | Round Covers | Description   | Color          | Catalog Number   |
|---|---|--|--|--------------|---|----------------|--|
|   | <b>Outlet Box</b><br>For devices with mounting screw centers of 1.47" (37.00), 1.63" (41.00), 1.69" (44.00) or 1.84" (46.00).               | Ivory<br>White   | <b>HBL5733IVA</b><br>—<br>A: 1.02" (26.00)<br>B: 3.00" (76.00)                   |              | <b>Blank Cover</b><br>For use with HBL5733IVA. Has 1/2" trade size KO in center.  | Ivory<br>White | <b>HBL5731IV</b><br>—<br>A: .24" (6.10)<br>B: 2.40" (60.96)                |
|   | <b>Fanbox with Solid Base</b><br>Cover accepts fan bracket with mounting centers of 3.2" (81.00). Rated for fans and fixtures up to 50 lbs. | Ivory<br>White   | <b>HBL5738AFIVA</b><br><b>HBL5738AFWA</b><br>A: .38" (9.75)<br>B: 4.19" (106.30) |              | <b>Blank Cover</b><br>For use with HBL5735IVA, HBL5737IVA/WA, HBL5737AIVA/WA, HBL5739AIVA, HBL5738IVA/WA, HBL5738AIVA/WA and HBL5739IVA/WA. Has 1/2" trade size KO in center. | Ivory<br>White | <b>HBL5736IV</b><br><b>HBL5736W</b><br>A: .38" (9.75)<br>B: 4.19" (106.30) |
| <b>Retrofit Box for Fire Alarm Detectors</b><br>For installing round alarm sensors. | Ivory<br>White  | <b>HBL5739AABIVA</b><br><b>HBL5739AABWA</b><br>A: 1.62" (41.15)<br>B: 6.50" (165.10) |  |              |   |                |  |

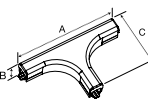

Dimensions in Inches (mm)

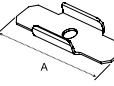

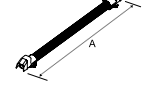
| Elbows  | Description   | Color   | HBL500 Series  | HBL700 and HBL750 Series  | Description  | Color  | HBL500, HBL700 & HBL750 Series   |
|---|---|---|--|---|--|--|--|
|   | <b>Internal Elbow</b><br>For inside surfaces at right angles.   | Ivory<br>White  | <b>HBL517IV</b><br><b>HBL517W</b><br>A: 3.33" (84.51)<br>B: .58" (14.73)<br>C: 3.33" (84.51) | <b>HBL717IVA</b><br><b>HBL717WA</b><br>A: 3.33" (84.51)<br>B: .90" (22.86)<br>C: 3.33" (84.51)  | <b>Internal Elbow Bend Radius</b><br>For inside surface at right angles requiring a 1.5" (38.10) bend radius. Suitable for Category 5, 5e, 6 and 6A applications.      | Ivory<br>White   | <b>HBL5717BRIVA</b><br>—<br>A: 3.33" (84.51)<br>B: .91" (23.11)<br>C: 3.33" (84.51)  |
|   |   |   |  |   |   |  |  |
|   | <b>External Elbow</b><br>For outside surfaces at right angles.  | Ivory<br>White  | <b>HBL518IV</b><br><b>HBL518W</b><br>A: 2.59" (65.71)<br>B: .58" (14.73)<br>C: 2.59" (65.71) | <b>HBL718IVA</b><br><b>HBL718WA</b><br>A: 2.59" (65.71)<br>B: .90" (22.86)<br>C: 2.59" (65.71)  | <b>External Elbow Bend Radius</b><br>For outside surfaces at right angles requiring a 1.5 in. (38.10) bend radius. Suitable for Category 5, 5e, 6 and 6A applications. | Ivory<br>White   | <b>HBL5718BRIVA</b><br>—<br>A: 4.86" (123.43)<br>B: .78" (19.80)<br>C: 1.35" (34.28) |
|   |   |   |  |   |   |  |  |
|   | <b>90° Flat Elbow</b><br>For right angle turns on same surface.   | Ivory<br>White  | <b>HBL511IV</b><br><b>HBL511W</b><br>A: 2.68" (68.13)<br>B: .61" (15.50)<br>C: 2.68" (68.13) | <b>HBL711IVA</b><br><b>HBL711WA</b><br>A: 2.68" (68.13)<br>B: .90" (22.86)<br>C: 2.68" (68.13)  | <b>Flat Elbow Bend Radius</b><br>For right angle turns requiring a 1.5 in. (38.10) bend radius. Suitable for Category 5, 5e, 6 and 6A applications.                    | Ivory<br>White   | <b>HBL5711BRIVA</b><br>—<br>A: 3.16" (80.34)<br>B: .91" (23.11)<br>C: 3.16" (80.34)  |
|       |   |   |  |                                        |  |  |  |
| <b>45° Flat Elbow</b><br>For diagonal 45° turns on same surface.  | Ivory<br>White  | <b>HBL512IV</b><br>—<br>A: 2.46" (62.61)<br>B: .58" (14.73)<br>C: 2.46" (62.61) | <b>HBL712IVA</b><br>—<br>A: 2.70" (68.49)<br>B: .91" (23.06)<br>C: 2.70" (68.49)             | <b>Internal Twisted Elbows</b><br>For 90° twist with 90° turn. For double turn at right angles from one to another. From a flat run on a side wall to a flat run on a ceiling, edge of door or window trim. | Ivory<br>White<br><br>Ivory<br>White   | Right Elbow<br><b>HBL5711RHIVA</b><br><b>HBL5711RHWA</b><br><br>Left Elbow<br><b>HBL5711LHIVA</b><br><b>HBL5711LHWA</b><br>A: 2.98" (75.72)<br>B: .94" (23.75)<br>C: 3.00" (76.20) |  |
|   |   |   |  |                                    |  |  |  |

| Tees  | Description   | Color          | HBL500, HBL700 & HBL750 Series  | Description  | Color   | HBL500, HBL700 & HBL750 Series |
|---|---|----------------|---|--|---|--------------------------------|
|   | <b>Tee Fitting</b><br>For branches at right angles. | Ivory<br>White | <b>HBL5715IVA</b><br><b>HBL5715WA</b><br>A: 3.06" (77.67)<br>B: 1.14" (28.86)<br>C: 3.03" (76.96) | <b>HBL5715BRIVA</b><br>—<br>A: 5.55" (140.88)<br>B: .90" (22.86)<br>C: 3.16" (80.34)   | <b>Tee Fitting Bend Radius</b><br>For branches at right angles requiring a 1.5 in. (38.10) bend radius. Suitable for Category 5, 5e, 6 and 6A applications. | Ivory<br>White                 |
|   |   |                |   |   |   |                                |

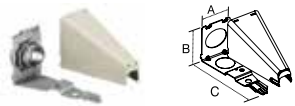
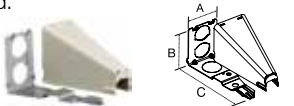
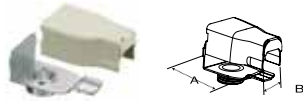
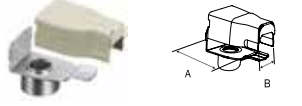
| Fittings  | Description  | Color          | HBL500, HBL700 & HBL750 Series                          | Description  | Color  | HBL500, HBL700 & HBL750 Series |
|---|--|----------------|---|--|--|--------------------------------|
|   | <b>Support Clip</b><br>For supporting lengths of HBL500, HBL700 or HBL750 Raceway. | Ivory<br>White | <b>HBL5703IV</b><br><b>HBL5703W</b><br>A: 2.51" (63.75) | <b>HBL5700FIVA</b><br>—<br>A: 18.00" (457.20)  | <b>Flexible Section</b><br>For getting around offsets, side bends, twisted turns or curved surfaces. | Ivory<br>White                 |
|   |  |                |   |   |  |                                |

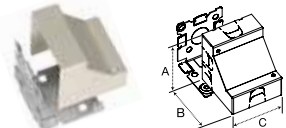
Dimensions in Inches (mm)

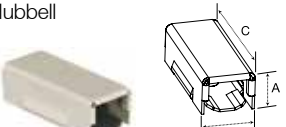

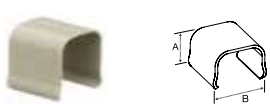
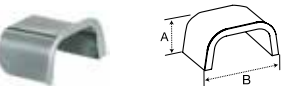

| End Fittings   | Description  | Color                                   | HBL500, HBL700 & HBL750 Series                           | Description  | Color   | HBL500, HBL700 & HBL750 Series        |  |  |
|--|--|---|--|--|---|---------------------------------------|--|--|
|  | <b>Entrance Connector</b><br>One ¾ in. KO for panel or conduit connection. One ¾ in. chase nipple and locknut furnished.                             | Ivory<br>White                          | <b>HBL5786AIVA</b><br><b>HBL5786AWA</b>                  | A: 1.50" (38.10)<br>B: 1.84" (46.74)<br>C: 3.89" (98.87)   | <b>Adjustable Offset Connector</b><br>Two ½ in. KOs for panel or conduit connection. Eliminates offsetting raceway when connecting to surface type panel boxes. One ½ in. chase nipple and locknut furnished. | Ivory<br>White                        | <b>HBL5786IVA</b><br><b>HBL5786WA</b>                    | A: 1.50" (38.10)<br>B: 1.84" (46.74)<br>C: 3.89" (98.87) |
|  |   |   |  |  |    |                                       |  |  |
|  | <b>Elbow Box Connector</b><br>For connecting raceway at right angles to conduit boxes, panel boxes, etc. having ½ in. nipple for trade size conduit. | Ivory<br>White                          | <b>HBL5783IVA</b>  | —<br>A: 2.13" (54.05)<br>B: 1.24" (31.50)  | <b>Elbow Conduit Connector</b><br>For connecting raceway at right angles to ½ in. trade size conduit or armored cable connectors.   | Ivory<br>White                        | <b>HBL5784IVA</b>  | —<br>A: 2.13" (54.05)<br>B: 1.24" (31.50)                |
|   |  |   |  |   |   |                                       |  |  |
| <b>Combination Connector</b><br>For connecting raceway without offsetting to any 3.25 in. (83.00) or 4 in. (102.00) outlet box mounted on the surface with a KO for ½ in. trade size conduit. Spring steel bushing eliminates need for conduit nipple and locknut. | Ivory<br>White   | <b>HBL5785AIVA</b><br><b>HBL5785AWA</b> | A: 1.50" (38.10)<br>B: 1.84" (46.74)<br>C: 3.89" (98.87) | <b>Corner Box</b><br>For connecting HBL500, HBL700 or HBL750 Raceway from ceiling or corner. Each leg of base has ½ in. trade size KO. | Ivory<br>White  | <b>HBL5719IVA</b><br><b>HBL5719WA</b> | A: 2.50" (63.50)<br>B: 2.50" (63.50)<br>C: 2.40" (60.96) |  |
|   |  |   |  |   |   |                                       |  |  |

| Fittings  | Description  | Color                             | HBL500 Series                      | HBL700 Series   | HBL750 Series                       |   |
|---|--|-----------------------------------|------------------------------------|---|-------------------------------------|---|
|   | <b>Transition Fitting</b><br>For transitioning from either Wiremold® V500 to Hubbell HBL500 Raceway or Wiremold® V700 to Hubbell HBL700 Raceway or Wiremold® V700 to Hubbell HBL750 Raceway. | Ivory<br>White                    | <b>HBL500TFIV</b>                  | —<br>A: .65" (16.51)<br>B: .89" (22.61)<br>C: 2.15" (54.61) | <b>HBL700TFIV</b>                   | —<br>A: .78" (19.80)<br>B: .89" (22.61)<br>C: 2.15" (54.61) |
|   |   |                                   |                                    |   |                                     |   |
|   | <b>Mounting Strap (one- or two-hole)</b><br>For mounting HBL500, HBL700 or HBL750 Raceway to surface. Convert to one-hole by breaking off at score.  | Ivory<br>White                    | <b>HBL504IV</b><br><b>HBL504W</b>  | A: .58" (14.73)<br>B: .50" (12.70)                          | <b>HBL7004IV</b><br><b>HBL7004W</b> | A: .70" (17.68)<br>B: .50" (12.70)                          |
|   |   |                                   |                                    |   |                                     |   |
| <b>Connection Cover</b><br>To cover potential openings where two lengths of HBL500, HBL700 or HBL750 Raceway come together. | Ivory<br>White   | <b>HBL506IV</b><br><b>HBL506W</b> | A: .60" (15.24)<br>B: .80" (20.31) | <b>HBL7006IV</b><br><b>HBL7006W</b>                         | A: .69" (17.40)<br>B: .80" (20.31)  |   |
|    |  |                                   |                                    |   |                                     |   |
| <b>Bushing</b><br>Protect wires from potential abrasion. Fits into end of HBL500, HBL700 or HBL750 Raceway.                 | Steel*   | <b>HBL502B</b>                    | A: .35" (8.83)<br>B: .70" (17.68)  | <b>HBL7002B</b>   | A: .49" (12.50)<br>B: .78" (19.80)  |   |
|    |  |                                   |                                    |   |                                     |   |

Note: \*Zinc Plated Steel.

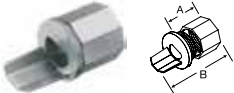
Wiremold® is a registered trademark of the Wiremold Company.

Dimensions in Inches (mm)

| Fittings  | Description   | Material  | HBL500, HBL700 & HBL750 Series |                  | Description  | Material   | HBL500, HBL700 & HBL750 Series  |  |  |
|---|---|---|--------------------------------|------------------|--|--|---|--|--|
|   | <b>Box Connector</b><br>For connecting raceway to conduit boxes or panel boxes having KO for conduit. May also be used for conduit type fittings. | Steel*  | <b>HBL5781</b>                 | <b>HBL5781A</b>  | ½" NPT (13) Male<br>A: .75" (19.1)<br>B: 1.24" (31.62) | ¼" NPT (19) Male<br>A: .75" (19.1)<br>B: 1.24" (31.62) | Steel*  | <b>HBL5791</b><br>A: 1.20" (30.48)<br>B: 1.09" (27.70) |  |
|   |    | <b>Conduit Connector</b><br>For connecting raceway to conduit.  | Steel*                         | <b>HBL5782C</b>  | <b>HBL5782A</b>  | ½" NPT (13) Male<br>A: .75" (19.1)<br>B: 1.75" (44)    | ¾" (19.1) Female<br>A: .75" (19.1)<br>B: 1.75" (44)   | Steel**  | <b>HBL5701C</b><br>A: 2.00" (50.80)                    |
|   |    | <b>Grounding Clamp</b><br>Provides grounding means for ½ in. trade size conduit using locknut.  | Steel**                        | <b>HBL5709GC</b> | A: 1.04" (26.03)<br>B: 1.18" (29.84)                   |  | <b>Ground Clamp</b><br>Used to provide additional grounding of raceway or to ground remotely located devices. Attach ground wire to screw as required by National Electrical Code.  | Steel**  | <b>HBL5709</b><br>A: 2.00" (50.80)                     |
|   |    | <b>Special Nipple</b><br>For hanging or connecting either .375 in. (9.5) or .5 in. (12.7) fixtures to Hubbell fittings with ½ in. trade size KOs. | Steel*                         | <b>HBL5780</b>   | A: .63" (16.00)  |  | <b>Armored Cable Connector</b><br>For connecting 14/2, 14/3, 12/2 and 12/3 "MC" and armored cable to Hubbell fittings. A short piece of HBL500, HBL700 or HBL750 Series Raceway must be used between this connector and the Hubbell fitting. Not for connection to ½ in. (12.7) flex conduit. | Steel**  | <b>HBL5790B</b><br>A: 2.00" (50.80)<br>B: .99" (25.25) |
|  |    |   |                                |                  |  |  |   |  |  |

Note: \*Zinc Plated Steel.  
 \*\*Galvanized Steel.

| Tools | Description   | HBL500 Series  | HBL700 Series    | HBL750 Series    | Description  | Color  | HBL500, HBL700 & HBL750 Series |                                  |
|-------|---|--|------------------|------------------|--|--|--------------------------------|----------------------------------|
|       | <b>Cutter</b><br>Portable cutter for HBL500, HBL700 or HBL750 Series Raceways.      | <b>HBL605CUT</b>   | <b>HBL700CUT</b> | <b>HBL607CUT</b> | <b>Raceway Bender</b><br>Portable bender for HBL500, HBL700 or HBL750 Series Raceways. |  |                                | <b>HBL600B</b>                   |
|       |  | <b>Cutter Replacement Blade</b><br> | <b>HBL605K</b>   | <b>HBL700K</b>   | <b>HBL607K</b>   | <b>Touch-Up Paint Pen</b><br> | Ivory White                    | <b>HBLIWEP</b><br><b>HBLWWEP</b> |

Dimensions in Inches (mm)



## Innovative Box Design

- Hubbell Handi-Screw® eliminates difficult to install long screws for easier installation
- Rounded corners eliminate sharp edges
- One seam construction provides “clean” look
- Box design allows standard wallplates to be mounted flush with virtually no perimeter profile exposed
- Full line of metal wallplates available



## Metallic Raceway

- Single Channel
  - HBL500, HBL700, HBL750, HBL2000, HBL2400 and HBL3000 Series products
- Multi-channel
  - HBL2400D, HBL4750, HBL6750 Series products
- PlugTrak® and Portable PlugTrak®
  - Standard and Tamper-Resistant



## Non-Metallic Raceway

- Single Channel
  - PT1, PP1, PL1, and PW1 Series products
- Multi-channel
  - PW2, PB2, PB3 and PS3 Series products
- Non-metallic PlugTrak® and Portable PlugTrak®
  - Standard and Tamper-Resistant



## Aluminum Raceway

- Single Channel
  - HBLALU2000, HBLALU3800
- Multi-channel
  - HBLALU4800, HBLALU5000, HBLALU7620
- PlugTrak®
  - Standard and Tamper-Resistant

# Metal Raceway

## HBL500, HBL700 and HBL750 Series

**HUBBELL**<sup>®</sup>  
Wiring Device-Kellems

### Hubbell Guides

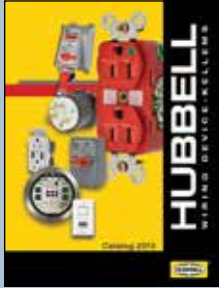

#### 2013 Full Line Catalog

The new Hubbell Wiring Device-Kellems catalog showcases our enhanced product offering to provide a breadth of solutions for the industrial, commercial and residential markets.



#### Hubbell Safety Brochure

Hubbell has always been focused on safety. That's why Hubbell products are designed and developed to first provide maximum safety against injury and the potential dangers of electricity.



#### Hubbell Education Application Guide

Education Application Guide to assist education facility managers and engineers in identifying and deploying wiring devices for power, data, voice and multimedia in a variety of education spaces and applications.



#### Hubbell Healthcare Application Guide

Healthcare Brochure featuring Hospital Grade Plugs, Connectors, Receptacles and more.

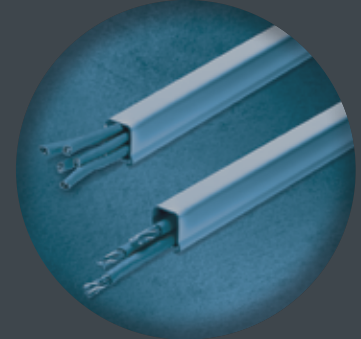
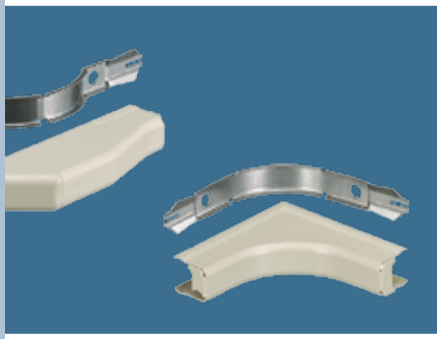

### Literature Support

Hubbell offers an extensive literature library for product support. Downloadable PDFs are available online at [www.hubbell-wiring.com](http://www.hubbell-wiring.com) under the Resources tab.

**HUBBELL**<sup>®</sup>  
Wiring Device-Kellems

[www.hubbell-wiring.com](http://www.hubbell-wiring.com)





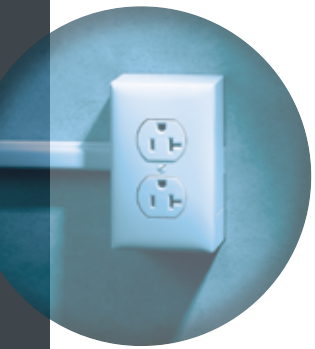
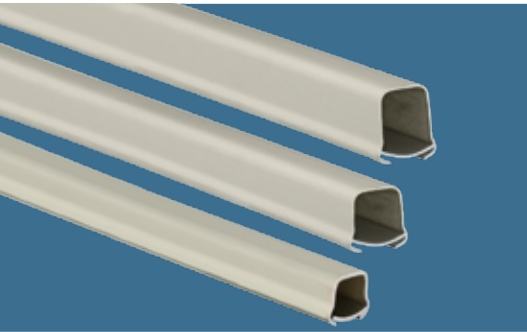

# Metal Raceway HBL500, HBL700 and HBL750 Series

**HUBBELL**<sup>®</sup>  
Wiring Device-Kellems

## Hubbell Guides

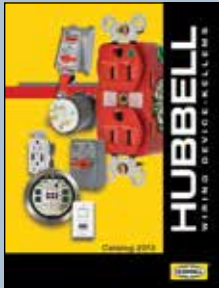

### 2013 Full Line Catalog

The new Hubbell Wiring Device-Kellems catalog showcases our enhanced product offering to provide a breadth of solutions for the industrial, commercial and residential markets.



### Hubbell Safety Brochure

Hubbell has always been focused on safety. That's why Hubbell products are designed and developed to first provide maximum safety against injury and the potential dangers of electricity.



### Hubbell Education Application Guide

Education Application Guide to assist education facility managers and engineers in identifying and deploying wiring devices for power, data, voice and multimedia in a variety of education spaces and applications.



### Hubbell Healthcare Application Guide

Healthcare Brochure featuring Hospital Grade Plugs, Connectors, Receptacles and more.

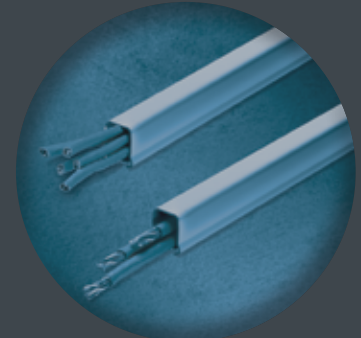
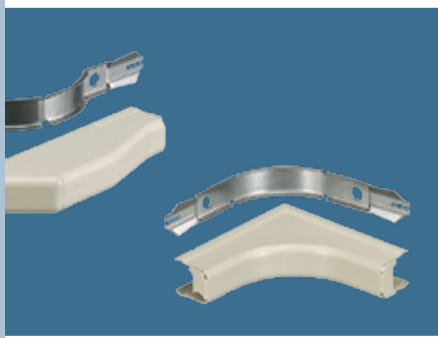

## Literature Support

Hubbell offers an extensive literature library for product support. Downloadable PDFs are available online at [www.hubbell-wiring.com](http://www.hubbell-wiring.com) under the Resources tab.

**HUBBELL**<sup>®</sup>  
Wiring Device-Kellems

[www.hubbellonline.com](http://www.hubbellonline.com)

