

**DETAIL A
(LIFT EYE DETAIL)
(TYP.)**

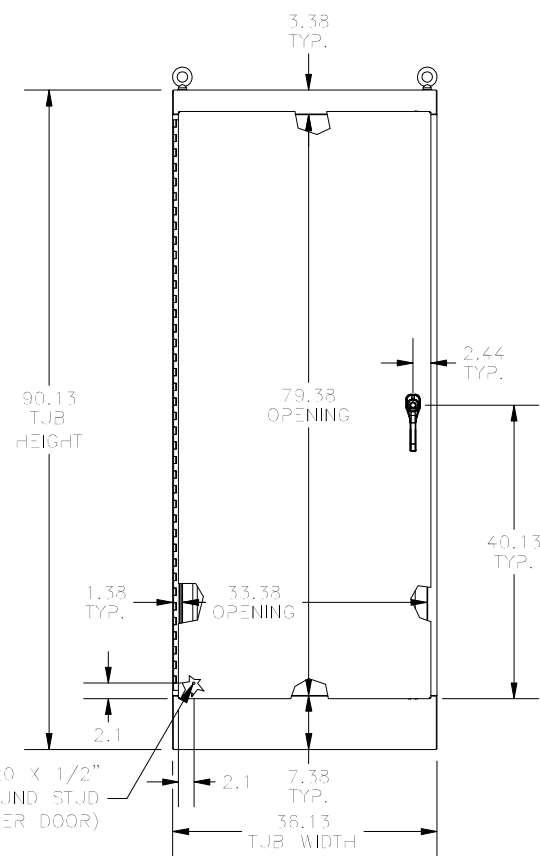

FRONT VIEW

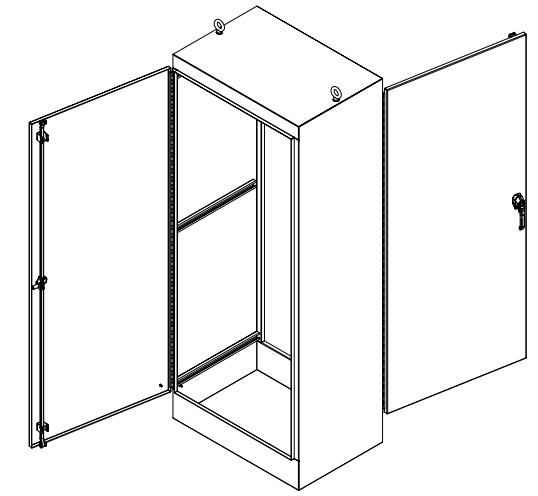
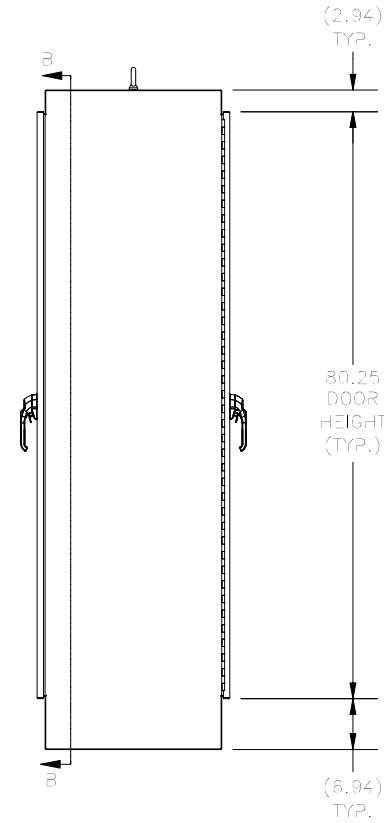

SIDE VIEW

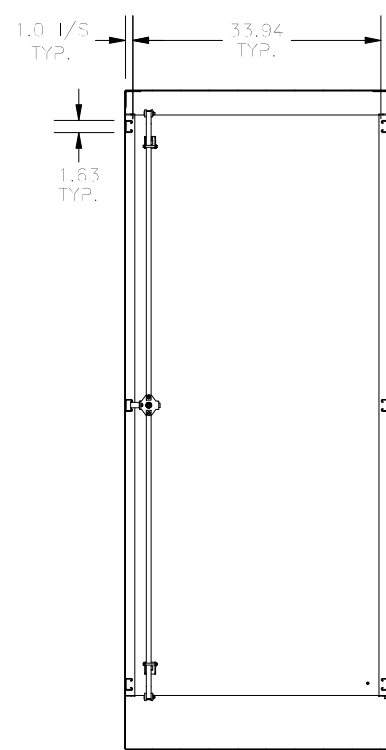

**SECTION B-B
(INSIDE FRONT/BACK OF ENCL)
(TYP. FOR BOTH SIDES)**

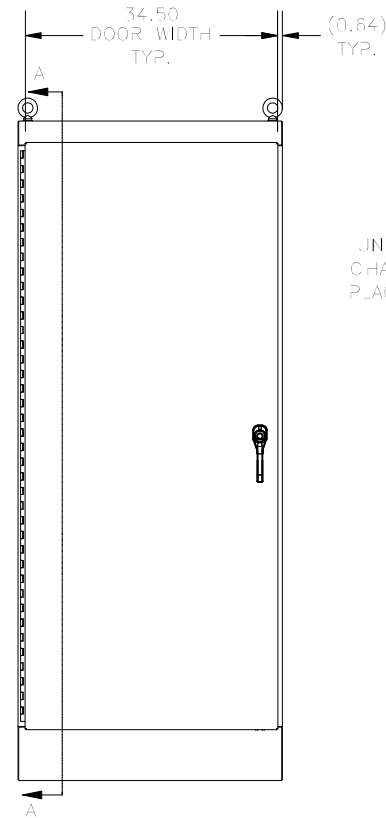

REAR VIEW

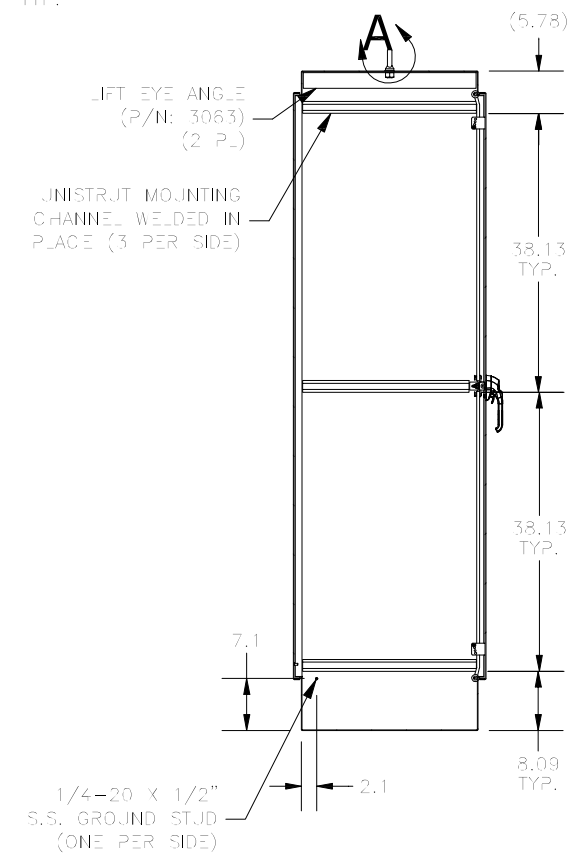

**SECTION A-A
(INSIDE SIDE OF ENCL.)
(TYP.)**

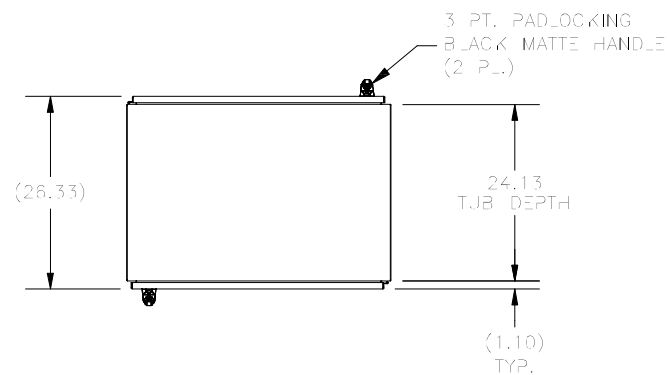
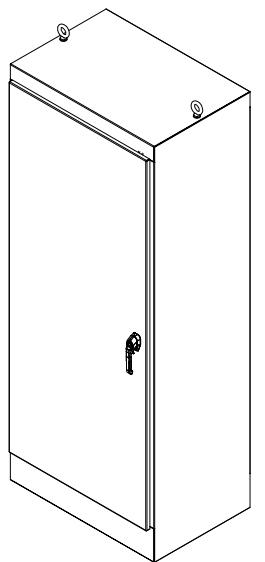

BOTTOM VIEW

PART#: WA903624FSDA
(DATA SUBJECT TO CHANGE WITHOUT NOTICE)

THIS DRAWING IS PROPERTY OF HUBBELL INC. WIEGMANN
ALL INFORMATION IS PROPRIETARY AND NOT TO BE DUPLICATED